

# ELECTRONIC DESIGN

Completely Molded and Flush Rotary Switchplates Permit Wide Variety of Configurations...p 66

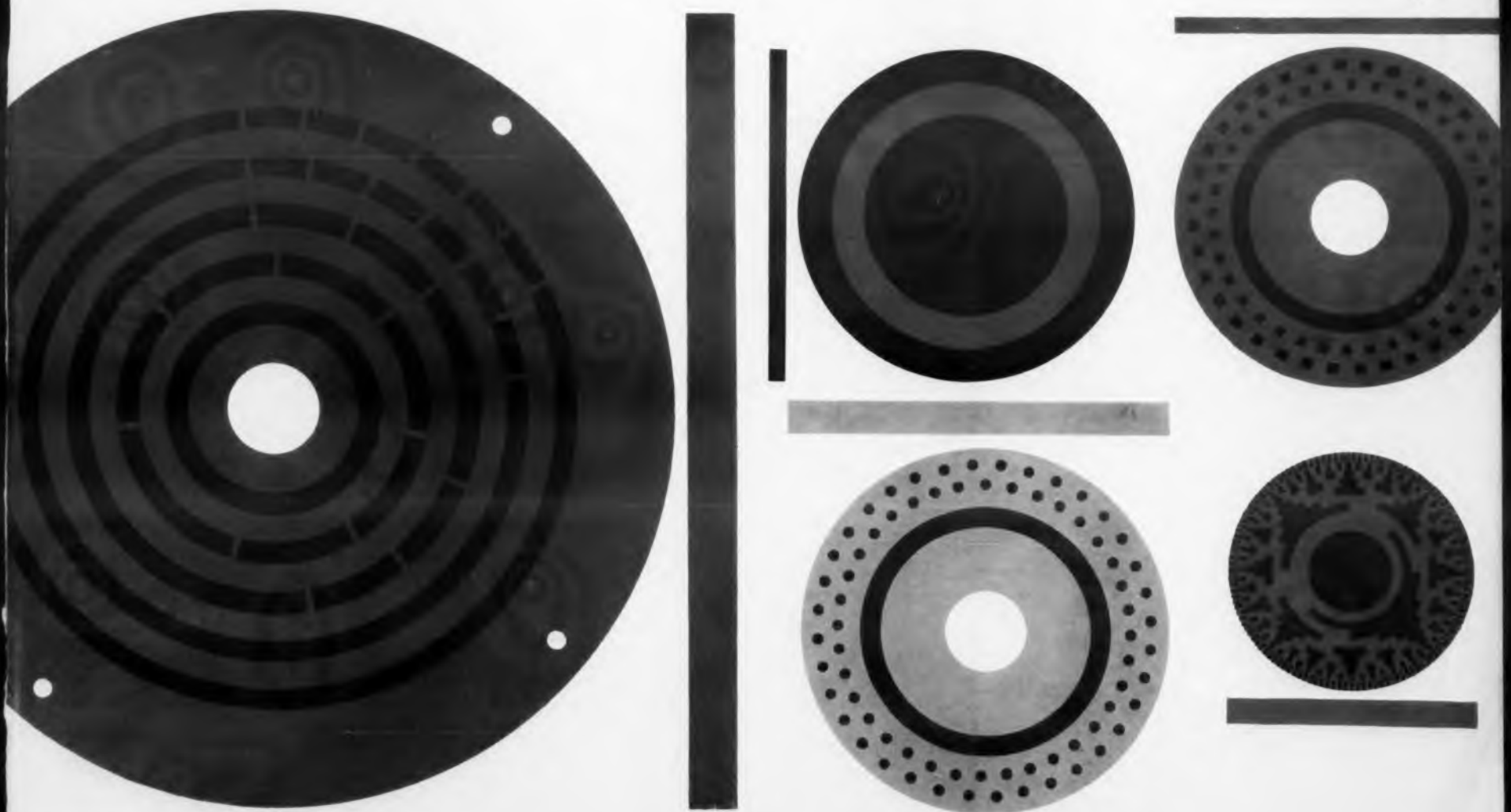



**PIONEERS IN  
MINIATURIZATION**

# NEW PIP SERIES

## ULTRAMINIATURE TRANSISTOR PULSE TRANSFORMERS



**UNITS SHOWN ACTUAL SIZE—IMMEDIATE DELIVERY FROM STOCK**

TRANSISTOR TEST CIRCUIT

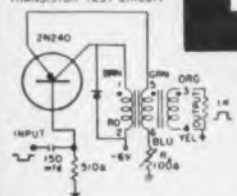

All units individually checked and adjusted, in transistor circuit illustrated, to parameters in table.

#### DEFINITIONS

**Amplitude:** Intersection of leading pulse edge with smooth curve approximating top of pulse.  
**Pulse width:** Microseconds between 50% amplitude points on leading and trailing pulse edges.  
**Rise Time:** Microseconds required to increase from 10% to 90% amplitude.

**Overshoot:** Percentage by which first excursion of pulse exceeds 100% amplitude.

**Drop:** Percentage reduction from 100% amplitude a specified time after 100% amplitude point.

**Backswing:** Negative swing after trailing edge as percentage of 100% amplitude.

- MIL type TP6RX4410CZ — METAL CASED
- Manufactured & Guaranteed to MIL-T-21038
- 5/16" Dia. x 3/16" Ht.; Wt. 1/20 oz.
- Ratio 4:4:1
- Anchored leads, withstands 10 lb. pull test
- Printed circuit use, plastic insulated leads
- Can be suspended by leads or clip mounted

Type No.	APPROX. DCR, OHMS			BLOCKING OSCILLATOR PULSE					COUPLING CIRCUIT CHARACTERISTICS						
	1-Brn 2-Rd	3-Org 4-Yel	5-Grn 6-Blu	Width $\mu$ Sec.	Rise Time	% Over Shoot	Drop %	% Back Swing	P Width $\mu$ Sec.	Volt Out	Rise Time	% Over Shoot	Drop %	Back Swing	Imp. in, out.
PIP-1	.18	.20	.07	.05	.02	0	0	37	.05	9	.018	0	0	12	50
PIP-2	.47	.56	.17	.1	.025	0	0	25	.1	8	.02	0	0	5	50
PIP-3	1.01	1.25	.37	.2	.030	2	0	15	.2	7	.035	0	0	5	100
PIP-4	1.5	1.85	.54	.5	.05	0	0	15	.5	7	.06	0	0	0	100
PIP-5	2.45	3.1	.9	1	.08	0	0	14	1	6.8	.15	0	0	5	100
PIP-6	3.0	3.7	1.1	2	.10	0	0	15	2	6.6	.18	0	2	10	100
PIP-7	4.9	6.05	1.8	3	.20	0	0	14	3	6.8	.20	0	2	10	100
PIP-8	8.0	9.7	2.9	5	.30	0	0	3	5	7.9	.22	0	13	25	200
PIP-9	13.1	15.9	4.7	10	.35	0	5	12	10	6.5	.4	0	15	20	200

PIP-100 Transistor pulse transformer kit, consisting of PIP-1 thru PIP-9 in plastic case.

**AND CUSTOM BUILT  
UNITS TO YOUR SPECS.**

Write for catalog for full details on these and 000 other stock items



## UNITED TRANSFORMER CORP.

150 VARICK STREET, NEW YORK 13, N. Y.

PACIFIC MFG. DIVISION: 4008 W. JEFFERSON BLVD., LOS ANGELES 16, CALIF.  
EXPORT DIVISION: 13 EAST 40th STREET, NEW YORK 16, N. Y. CABLES: "ARLAB"



**COVER:** It was no design problem to come up with this issue's cover. The almost infinite combinations of conductive plastic segments available in these new switchplates produce a natural design. How do you show that the conductive portion is integrally molded with the switchplate body and that the conductive and insulation surface is flush? The "clean" side views depict flushness—achieved by using ingredients with matched coefficients of friction and thermal expansion.

#### Coming Next Issue

In some respects electronic reliability is like the weather—a good many people talk about it but few do anything about it.

ELECTRONIC DESIGN's first major report on reliability was published in 1958. Since then we have spent many patient hours listening to professional views on the subject without hearing anything that was practical enough or significant enough to boil into an informative article. In general, aside from such major programs as Minuteman and Polaris, there has been more talk than concrete action in the realm of reliability in the last three years.

Yet, in view of increasing demands for reliability, is there not some progress afoot? To find out what is being done and what can be done, ED assigned Technical Editor Howard Bierman to explore the field. For months he talked and worked with authorities on reliability. What he has come up with is not the last word on an expanding subject, but it is the best available at present.

Don't miss "Meeting the Reliability Challenge," a six-part article, in the next issue.

◀ CIRCLE 1 ON READER-SERVICE CARD



VIA  
AIR  
MAIL

FIRST CLASS  
Permit No. 725  
New York, N. Y.

B U S I N E S S R E P L Y M A I L

No Postage Stamp Necessary If Mailed in U. S.

POSTAGE WILL BE PAID BY

**ELECTRONIC DESIGN**

ONE DAY READERS INQUIRY SERVICE

850 Third Avenue  
New York 22, New York

VIA  
AIR  
MAIL

FIRST CLASS  
Permit No. 725  
New York, N. Y.

B U S I N E S S R E P L Y M A I L

No Postage Stamp Necessary If Mailed in U. S.

POSTAGE WILL BE PAID BY

**ELECTRONIC DESIGN**

ONE DAY READERS INQUIRY SERVICE

850 Third Avenue  
New York 22, New York

Lift

this page  
for new, new  
convenience  
in measuring  
extremely short  
time intervals  
automatically  
with 10 nsec  
accuracy!



**Versatile programming**

plug-in programming for each individual column, code options with plug-in column cards

**Fast data transfer**

takes just 2 msec;  
prints up to 5 lines per second

**Flexible BCD input**

1-2-2-4 BCD input is standard; dual input available



all yours with this  
new **hp** 562A  
**SOLID STATE  
DIGITAL  
RECORDER**

#### SPECIFICATIONS

**Printing Rate:** 5 lines/sec. maximum

**Column Capacity:** To 11 columns (12 available on special order)

**Print Wheels:** 12-position, 0 through 9, a minus and a blank (Many special character wheels available from stock)

**Driving Source:** Parallel-entry 4-line BCD, 1-2-2-4. Other codes available on plug-in cards. Source reference voltages establish "0" and "1" states, which may be as much as 100 v above or below ground. "1" state 4 to 75 v above "0" reference. Driving power approx. 30  $\mu$ a into 270,000 ohms.

**Print Command:**  $\pm$  pulse, 20  $\mu$ sec or greater in width, 6 to 20 v.

**Hold Signal:** (Available for each data source) -7 v to + 15 v and + 15 v to -7 v.

**Transfer Time:** 2 msec

**Paper Required:** Standard 3" roll or folded

**Line Spacing:** Single or double, adjustable

**Size:** Cabinet, 20 $\frac{3}{4}$ " x 12 $\frac{1}{2}$ " x 18 $\frac{1}{2}$ "; Rack, 19" x 10 $\frac{1}{2}$ " x 16 $\frac{1}{8}$ " deep behind panel.

**Price:**  $\phi$  562A (cabinet) or  $\phi$  562AR (rack mount) \$1,600.00 to \$2,200.00 depending on options.  $\phi$  580A Digital-Analog Converter, price on request.

New, solid state  $\phi$  562A Digital Recorder prints digital data on 3" paper as fast as 5 lines per second, each line containing up to 12 digits. The instrument incorporates a unique data storage unit for each digit column that allows the data source to transfer data to the recorder in just 2 milliseconds, after which the source is free to collect new data.

Besides the standard parallel-entry 4-line BCD code (1-2-2-4), you can easily use other 4-line codes just by substituting plug-in column cards. Ten-line code operation (without data storage feature) is also available with plug-in cards.

Further,  $\phi$  562A accepts dual input (optional) and prints data simultaneously from two unsynchronized sources. A "patch panel" permits programming these two separate, unsynchronous inputs (even if coded differently) in any manner. Combinations of plug-in column code cards and "patch panel" column programming give complete flexibility in both dual-source data acquisition and data print positioning.

Analog output for high-resolution strip chart and X-Y recording is available as an extra-cost built-in feature of the 562A or through the new  $\phi$  580A Digital-Analog Converter, a separate solid state, high-precision instrument.

Designed for use with solid state and vacuum tube counters, Model 562A is ideal for a wide variety of individual and system applications. Call your  $\phi$  representative today.

#### HEWLETT-PACKARD COMPANY

1082K Page Mill Road  
Cable "HEWPACK"

Palo Alto, California, U.S.A.  
DAvenport 6-7000

*Sales representatives in all principal areas*

#### HEWLETT-PACKARD S. A.

Rue du Vieux Billard No. 1  
Cable "HEWPACKSA"

Geneva, Switzerland  
Tel. No. (022) 26. 43. 36



CIRCLE 2 ON READER-SERVICE CARD

100 MC solid state counter

## Measure Time Interval, 10 Nanoseconds to 0.1 Second— with 10 Nanosecond Accuracy!

Now you can get 10 nanosecond resolution in wide-range, automatic digital measurement of extremely short time intervals.

Electronic counter accuracy is yours for such measurements as explosive burning rates, speed and acceleration timing of test vehicles in free-flight wind tunnels, and measurements of a broad range of nuclear phenomena.

The new  $\Phi$  5275A Time Interval Counter, incorporating solid state components, is packaged in the convenient new space-saving  $\Phi$  universal module. It counts 100 megacycles, obtained from an external 1 MC standard by a 100-to-1 multiplying circuit in the counter.

Standard features on the  $\Phi$  5275A Time Interval

Counter include manual front-panel reset, plus automatic and remote reset. A 4-line BCD output permits easy connection for automatic processing and analyzing of data and also may be used to drive the  $\Phi$  562A Digital Recorder. The unique  $\Phi$  data storage technique provides a non-blinking display which reduces eye fatigue thus reducing reading errors.

Significant to many special measurement problems, as many as 20  $\Phi$  5275A Counters may be operated from a single external oscillator (new  $\Phi$  101A described below). In addition to saving valuable rack space, this multiple counter operation from a single stable precision oscillator provides improved performance over multiple-time-base systems, saves operator time and offers real economy.

.....

**New versatility in a stable, accurate, rugged modular 1 megacycle oscillator! Use as a counter time base or moderately priced secondary standard!**

$\Phi$  101A 1 MC OSCILLATOR Designed specifically as the time base for  $\Phi$  5275A Time Interval Counter, the new  $\Phi$  101A provides five parts in  $10^6$  per week stability. It also permits increased measurement accuracy as a time base for other electronic counters.

The  $\Phi$  101A is a solid state version of the time-proved oscillator used in  $\Phi$  524C/D Counters and in the  $\Phi$  100E Secondary Frequency Standard. Long-term stability of

$5/10^6$  per week is achieved by the use of a high quality quartz crystal and by housing critical components in a well regulated oven. Short-term stability, including effects of line, load and ambient temperature variation, is better than  $3/10^6$ . Its rated output of 1 v rms into a 50 ohm load makes it useful for improving the accuracy of counters limited by their own internal time bases.  $\Phi$  523C/D Counters will operate directly from the 1 MC output of the 101A, and an optional 100 KC output is available for use with counters requiring it.

The 101A also is housed in the new  $\Phi$  modular package, equally suitable for benchtop or rack mount applications.



for time interval measurement



hp 5275A TIME INTERVAL COUNTER

## SPECIFICATIONS

### hp 5275A TIME INTERVAL COUNTER

<b>Range:</b>	10 nanoseconds to 0.1 seconds
<b>Resolution:</b>	10 nanoseconds
<b>Accuracy:</b>	$\pm 10$ nanoseconds, $\pm$ time base accuracy
<b>Time Base:</b>	External 1 MC required. hp 101A recommended
<b>Registration:</b>	7 places, direct digital presentation in neon columns
<b>Reads In:</b>	Microseconds, with decimal point
<b>Input Requirements:</b>	Start and stop trigger pulses through separate channels
<b>Input Impedance:</b>	Approx. 50 ohms
<b>Output:</b>	4-line 1-2-2-4 BCD
<b>Minimum Trigger Pulse Requirement:</b>	3.0 volts peak, 1.0 volt per nanosecond rise time, 5 nanoseconds width at 50% point
<b>Trigger Polarity:</b>	Selectable, positive or negative, for each channel independently
<b>Reset:</b>	Automatic, manual (from front panel), or remote through rear-mounted terminal

<b>Standard Frequency Counted:</b>	100 MC
<b>Operating Temperature Range:</b>	$-20^{\circ}$ to $+65^{\circ}$ C
<b>Dimensions:</b>	16 $\frac{3}{4}$ " x 3 $\frac{1}{2}$ " x 11 $\frac{1}{2}$ " deep, 15 lbs.
<b>Price:</b>	\$3,250.00.

### hp 101A 1 MC OSCILLATOR

<b>Stability:</b>	Short-term: 3 parts in 10 <sup>8</sup> ; long-term, 5 parts in 10 <sup>8</sup> /week
<b>Output Frequency:</b>	1 MC sinusoidal, 100 KC optional. Rear BNC connectors
<b>Output Voltage:</b>	1 v rms minimum into 50 ohm load
<b>Source Impedance:</b>	Approx. 15 ohms
<b>Distortion:</b>	Less than 4% with rated load
<b>Oven Temperature Indicator:</b>	Front panel dial thermometer
<b>Frequency Adjustment:</b>	Front panel screwdriver adjustment with range of approximately 1 part in 10 <sup>6</sup> for calibration from primary standard
<b>Dimensions:</b>	16 $\frac{3}{4}$ " x 3 $\frac{1}{2}$ " x 11 $\frac{1}{2}$ " deep, 10 lbs.
<b>Price:</b>	\$500.00.

Data subject to change without notice. Prices f.o.b. factory



## HEWLETT-PACKARD COMPANY

1087K Page Mill Road  
Cable "HEWPACK"

Palo Alto, California, U.S.A.  
DAvenport 6-7000

*Sales representatives in all principal areas*

### HEWLETT-PACKARD S. A.

Rue du Vieux Billard No. 1  
Cable "HEWPACKSA"

Geneva, Switzerland  
Tel. No. (022) 26. 43. 36



DCA-1000A DIVERSITY COMBINER. COMBINING ACTION IS OBTAINED BY SAMPLING NOISE OUTPUT OF EACH RECEIVER BY MEANS OF HIGH-PASS FILTERS.



## POSITIVE DATA RETRIEVAL

**... telemetry data from up to four sources combined into one improved output.** The DCA-1000A Diversity Combiner is designed to handle FM/FM and PDM/FM signals in ground support installations in which up to four receivers with 500 kc and 100 kc bandwidths receive the same RF transmission simultaneously. Signals of the receivers are mixed by combiner into one improved output. The s/n ratio is better than that of any one of equal input, or as good as the best single input. Unit responds instantly to rapid changes in s/n ratio.

Fail-safe circuits assure signal reception at all times. One circuit per input prevents loss of any one of the input signals from causing additional degradation of the output signal. Another circuit guards against complete loss of data should the combiner fail. Each channel has its own plug-in unit, and any one module may be removed for servicing while the others continue to operate. Unit is designed for standard 19-inch relay rack mounting.

Diversity Combiners for non-standard signal reception are available on special order. Where the utmost in exacting communications equipment performance is demanded — Vitro is at work.

**Vitro ELECTRONICS** A DIVISION OF VITRO CORPORATION OF AMERICA  
PRODUCERS OF **NEMS-CLARKE** EQUIPMENT

919 JESUP-BLAIR DRIVE, SILVER SPRING, MARYLAND / 2301 PONTIUS AVENUE, LOS ANGELES 64, CALIFORNIA

CIRCLE 4 ON READER-SERVICE CARD



# CONTENTS

September 13, 1961  
Vol. 9 Number 19

<b>ELECTRONIC DESIGN News</b> .....	4
Bionic System Uses Liquid-State Element .....	4
Significant Bits .....	6
Backlog of Searches Besets Patent Office .....	9
System Identifies Radar-TV Blips .....	12
Sweep Camera Snaps Light Beam in Motion .....	14
Pneumatic Computing Units Built for Process Control .....	16
Message Sorter Feeds 105 Teletype Circuits .....	18
<b>Washington Report</b> .....	20
Industry, Military Use Teaching Devices .....	22
Audio Visual System Aids in Training, Production .....	26
<b>Incidence of Invention Greater If There Is Coincidence of Trial Answers</b> .....	29
Editorial Comment .....	
<b>Bionics Efforts Center on Learning Machines— An ELECTRONIC DESIGN Staff Report</b> .....	30
By following in the steps of nature, designers are finding it possible to build machines that can learn, see, hear and adapt their operations to changing environmental conditions. The early hardware models now being built throughout the industry promise to introduce an era of machine sophistication of an unprecedented level	
<b>Melpar Learner Uses Statistical Switch</b> .....	31
<b>Raytheon's Cybertron Doing Useful Work</b> .....	34
<b>Variable Network Perceptron Almost Completed at GD/E</b> .....	38
<b>RCA Neuron Analog to Do Speech Work</b> .....	40
<b>GE/WADD Analog Includes EL-PC Cells</b> .....	41
<b>Moth's Sync Pulses Aid Neural-Net Study</b> .....	42
<b>GE's Visilog Sensor Operates Like Eye</b> .....	46
<b>Design Considerations for Low-Noise Transistor Input Stages</b> .....	48
Definition and description of the measurements an engineer must often make on transistor circuits input stages—W. A. Rheinfelder	
<b>How to Specify Crystal Filters</b> .....	58
Tells what is available and how to integrate it into your system—Al Strauss	
<b>The Design of Large Servos</b> .....	54
Example is used to explain how eddy-current clutch, magnetic amplifier solutions to integral horsepower servomechanisms can be tackled—L. C. Mackey, J. K. Wetherbee	
<b>Cyclic Memories—A Comparative Evaluation</b> .....	62
An evaluation of nonvolatile cyclic memories—Y. J. Lubkin	
<b>Product Features</b> .....	66
Newly available products of exceptional interest to design engineers	
<b>Rotary Switches Have Completely Molded Switchplates</b> .....	66
Completely molded and flush switchplates virtually eliminate the "slip-stick" phenomena in this rotary switch	
<b>Rundown of Recent Photoelectric Cells</b> .....	68
Presented are several light-sensitive devices recently made available to industry	
<b>New Products</b> .....	70
Introducing this issue's new products are a fiber-optic computer readout tube, a plug-in modular package, a combined ac dc converter-vtvm, and a transistor chopper with a self-contained drive transformer	
<b>New Products Directory</b> .....	72
All the new products presented in this issue are indexed with reference to page and Reader-Service number	

# Electronic Design

Hayden Publishing Company, Inc.  
850 Third Ave., New York 22, N. Y.

<b>Russian Translations</b> .....	<b>168</b>
A Sine and Cosine Memory Store .....	168
<b>German Abstracts</b> .....	<b>172</b>
A Simple Analog Multiplier .....	172
Formulas for Characteristic Impedance .....	173
<b>Ideas for Design</b> .....	<b>164</b>
RC "Blocking Oscillator" Produces Complementary Pulses .....	164
Steering Diodes Prevent Spurious Multi Triggering .....	164
Clock Pulses Generated by Magnetic Core Timer .....	166
Starter Circuit Prevents Stall of Free-Running Multi .....	167
Ideas-for-Design Entry Blank .....	165
<b>Verbal and Visual Aids Spur Engineer Sales Victories</b> .....	<b>178</b>
Further steps to ensure that you will be helping your company if you are called upon to make a sales presentation—R. S. Azarnoff	
<b>Production Products</b> .....	<b>152</b>
<b>New Literature</b> .....	<b>154</b>
<b>Patents</b> .....	<b>160</b>
<b>Books</b> .....	<b>162</b>
<b>Letters</b> .....	<b>176</b>
<b>Careers</b> .....	<b>178</b>
<b>Advertisers' Index</b> .....	<b>184</b>

## More On Computer Memories

Last issue contained three excellent articles on computer design: Logic, timing and memories. In this issue we continue the article on *Cyclic Memories—A Comparative Evaluation* by Y. J. Lubkin. If you haven't yet read the series in the Aug. 30 issue, be sure to look them up.



ELECTRONIC DESIGN is published biweekly by Hayden Publishing Company, Inc., 850 Third Avenue, New York 22, N. Y. T. Richard Gascoigne, Chairman of the Board; James S. Mulholland, Jr., President; Edmund C. Grainger, Jr., Secretary. Printed at Poole Bros., Inc., Chicago, Ill. Accepted as controlled circulation at Chicago, Ill., and at New York, N. Y. Copyright © 1961, Hayden Publishing Company, Inc., 38,820 copies this issue.

# NEW

## High Repetition Rate PULSE GENERATOR at same LOW COST



### Rutherford MODEL B-7B

#### HIGH PERFORMANCE and WIDE VERSATILITY

50 volts into 50 ohms at 30% duty factor... rep. rate to 2 mc... widths  
.05  $\mu$ s to 10,000  $\mu$ s... delays to 10,000  $\mu$ s...

New features for:

#### LONGER LIFE • EASE OF MAINTENANCE and OPERATION

- Printed Circuit Boards with all components clearly identified by schematic symbol numbers
- A new stabilized noise-free repetition rate section
- Variable rise time control
- Rack mountable—new single unit construction
- High volume fan for more efficient cooling

#### OTHER SPECIFICATIONS:

Rise Time: 15  $\mu$ s • Fall Time: 15  $\mu$ s • Attenuation: 50 db in 10 db steps, 20 db continuous control • External Trigger:  $\pm$  10 volts min. • Syn. Out (Synchronizing pulse): .05  $\mu$ s wide, 25 volts amplitude, lags trigger in by .2  $\mu$ s • Size: 19" wide x 8 $\frac{3}{4}$ " high x 12" deep • Weight: 35 lbs. • Power: 105-125 volts, 50-60 cycles, 350 watts, 5 amps. • Low Budget Price: \$720.00 F.O.B. Culver City, California.

Investigate Rutherford's complete line of Pulse accessories designed to fit all requirements. Write for our catalog sheet.

**ENGINEERS:** If your field is Pulse Circuitry Design, a bright future awaits you at Rutherford Electronics Company. Send resume to Glen Stout, Personnel Director.

# Rutherford

## ELECTRONICS CO.

Dept. ED 913 8944 Lindblade Street • Culver City, California

*pulse generators / pulse systems / accurate time delay generators*

CIRCLE 5 ON READER-SERVICE CARD

# Bionic System Uses Liquid-State Element

*Symposium Told of Pattern Recognizer that Uses  
An Electro-Plate-Varied Neuron-Analog Resistor*

**Alan Corneretto**  
News Editor

**A** NEURAL-NET pattern recognizer, called Madaline, that uses liquid-state resistive elements, was among significant developments described at the second annual Bionics Symposium at Cornell University. Sessions were held in Ithaca, N. Y., Aug. 28-29 and Sept. 1.

Also described at the symposium were:

- The first quantitative analysis of electronic neural-net behavior.
- Design of a relatively simple conditional-probability computer.
- Models for pulse-interval modulation systems.

The liquid-state resistive elements were developed at Stanford University by M. E. Hoff and Dr. Bernard Widrow, who delivered a symposium paper on the work. Called mem-

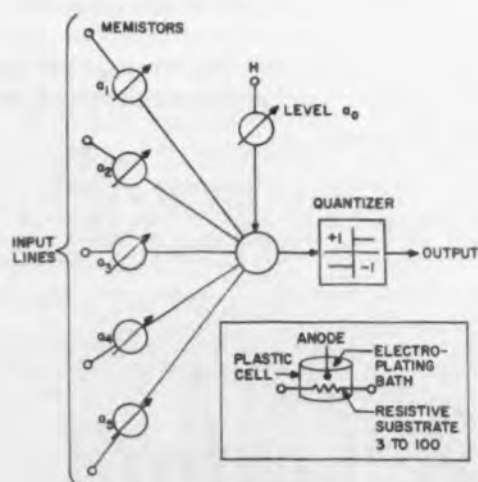

**Neural element** of six memistors is adjusted to provide desired output by adjusting weights or resistances of memistors. The memistor, shown in inset, provides memory for the neuron and is repeated six times in this analog.

istors, the devices are three-terminal cylindrical plastic cells, less than 1/64 of 1 cu in. in volume. They contain a tin-oxide resistive substrate, electro-plating anode, and a bath of copper sulphate and sulphuric acid, which is injected by a hypo-dermic needle. These tiny elements make possible very compact neuron-net machines. When a small dc signal is applied to the anode or the resistive substrate, it increases or decreases the deposit on the substrate. Thus resistance of the unit varies from about 3 to 100 ohms. Though the electroplate in present modules dissolves in two or three weeks, Dr. Widrow says he expects future units to remain stable for years.

## Net of Memistors Composes Variable Element in Analog

The memistors, which are resistors with memories, are used as the variable elements in a neuron analog (called Adaline, for adaptive linear neuron). Seventeen memistors are netted in the basic neural element developed at Stanford. Their resistance-varying capability is used in assigning weights to the neural element. The weights represent experience learned by the neurons during training. The neural elements in turn are connected in networks to form a system for doing work adaptively.

Though somewhat resembling a perceptron, the complete Stanford system differs in two important respects: its associations are not random, and stimuli are only paired to responses rather than being linked more strongly through reward and punish signals.

In the largest system built at the university, six neurons comprising 17 memistors each are interconnected to form a powerful classifier. Outputs of the system's neurons are connected to majority, or "OR", elements to provide the actual machine output.

Each neural element of the system is

adapted to the pattern characteristic so that logic circuitry can provide a desired response.

## Two-Layer Adaptive System Being Constructed at Stanford

The Stanford neurons, basically Kirchoff adders, have been interconnected to show that in logic-tree form they can control signal flow on the basis of characteristics of the signal. Under construction at Stanford is a two-layer adaptive system in which the output of one set of adaptive neurons is the input, in basically parallel operation to the other set. The first layer derives a set of arbitrary signals, which are characteristic of the pattern and are not sensitive to size, position, rotation, or noise. The second layer would indicate recognition of the input pattern.

The key to all the systems being studied by Dr. Widrow's group is the memistor element, which stores positive and negative-gain values. A different type variable element under development at Stanford—the optimistor—depends on detection by a photo cell of the density of electro-plate film formed by a weighting signal.

A different type of semi-linear network system—a conditional probability computer—also was described at the symposium. The computer is under development at the University of Saskatchewan, Saskatoon, for use in industrial process control. The unit is said to be simpler and requires less storage space than the original CPC proposed by Dr. A. M. Uttley.

## Several-Hundred-Input Computers Contemplated

K. H. Reid of the University of Saskatchewan, who delivered a paper on the computer, said it was feasible to build a several-hundred-input machine with a conventional magnetic-tape storage unit. A five-input CPC has been built at the university and is operat-

# HIGH PERFORMANCE!

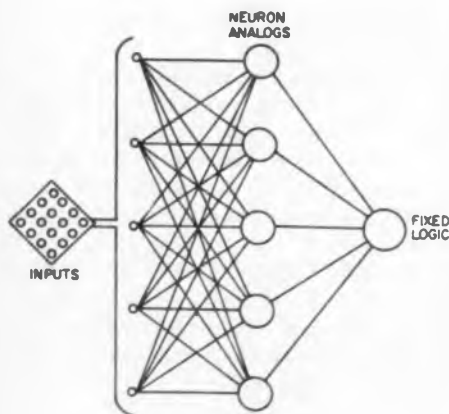

**Six-neural-element** pattern recognizer built at Stanford takes patterns from toggle-switch inputs and after training by feedback from operator gives a desired response in accordance with logic circuitry. Only six of 16 interconnections between inputs and neuron analogs are shown. Fixed logic provides output.

ing in an experimental chemical process. It gives dynamic response to changing conditions by filling in missing bits from signals transmitted by process monitors.

At the University of Wisconsin, researchers are quantitatively analyzing behavior of simulated neural nets to provide a basis for intelligent design of neural-net systems. Prof. C. H. Davidson reports that his group would like this information to develop a temporary memory system for storage of time-varying signals. Hopefully, he says oscillation, which can be induced in neural networks, could be used for this temporary storage.

Several systems of pulse-interval modulation (PIM) have been modeled in hardware at the Polytechnic Institute in Brooklyn, according to another symposium speaker, H. J. Hunt, Jr. PIM is believed to be used in many biological systems. The Brooklyn Poly models simulate the encoding characteristics of sensory receptors. They are reported to exhibit refractory periods, varying thresholds, and adaptation. ■ ■

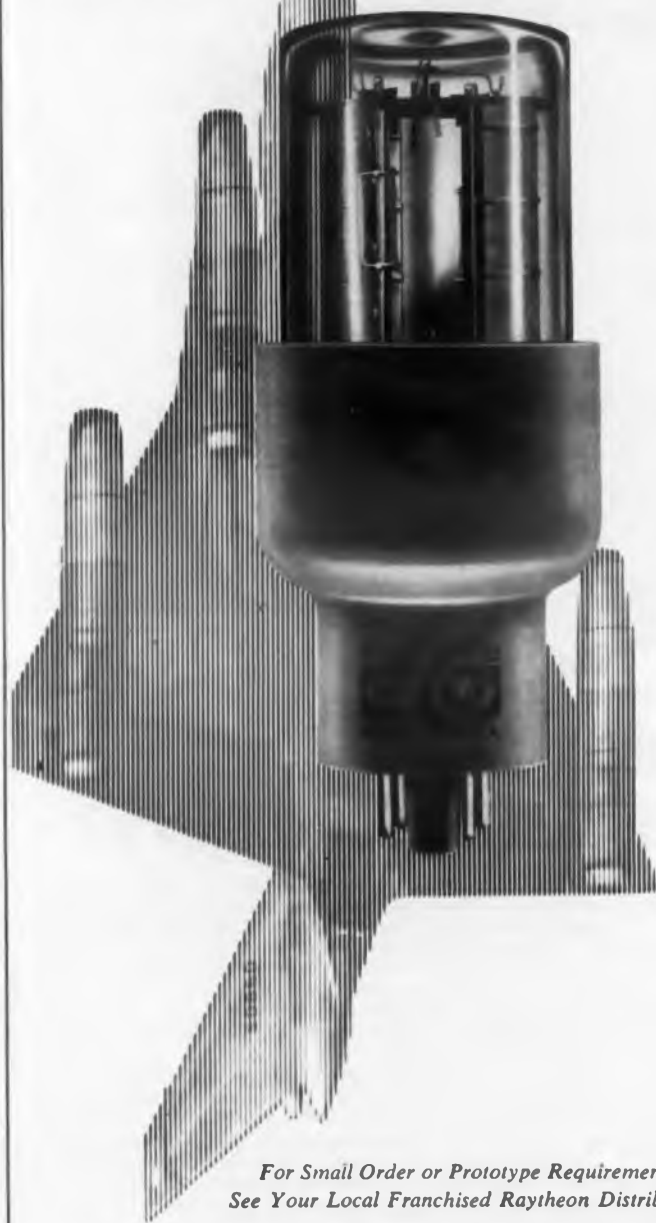

*For Small Order or Prototype Requirements  
See Your Local Franchised Raytheon Distributor.*

Raytheon now offers  
**the 5R4WGB full-wave rectifier —  
ideal for high-current,  
high-PIV power supply requirements  
in rugged environments.**

The reliability of Raytheon 5R4WGB rectifiers is the result of exceptional care in their design and manufacture . . . with no compromise in quality control. Rubber lined bases and hard glass T-14 bulbs protect against severe shock and vibration. Raytheon 5R4WGB rectifiers are specifically designed for rugged industrial and military applications and fully conform to all applicable military specifications.

If you design power supplies or communications equipment, you will be interested in receiving full technical data on the 5R4WGB . . . and other types in Raytheon's expanding line of diode rectifiers.

Please write to: Raytheon, Industrial Components Division, 55 Chapel Street, Newton 58, Massachusetts.

RAYTHEON DIODE RECTIFIERS						
TYPE	SERVICE	HEATER		MAX. PLATE RATINGS		
		VOLTS	AMPS.	PEAK INVERSE (VOLTS)	PEAK CURRENT (AMPERES)	AVERAGE CURRENT (AMPERES)
5R4WGB*	FULL WAVE RECTIFIER	5.0	2.075	2.800	.7	0.185
				2.900		0.190
				2.300		0.275
				2.150		0.275
5B3*	H.W. RECT. (to 36,000 ft.) CLIPPER DIODE (to 36,000 ft.)	2.5	4.9	17,000	0.250	0.065
		2.5	4.9	15,000	8.0	0.240
3B24W 3B24WA*	H.W. RECT. (HALF FIL.) (FULL FIL.)	2.5	3.0	20,000	0.150	0.030
		5.0	3.0	20,000	0.300	0.060
3B20	CLIPPER DIODE	2.5	4.75	15,000	8.0	0.020
3B20	H.W. RECT. (OP. 1) (OP. 2) (OP. 3) CLIPPER DIODE	2.5	4.9	16,000	0.250	0.065
				7,700	0.300	0.080
				5,000	0.300	0.095
4B31*	H.W. RECT. CLIPPER DIODE	5.0	5.0	16,000	0.470	0.150
		5.0	5.0	16,000	12.0	0.060

\*MIL-Std-200E Preferred Type

**RAYTHEON COMPANY**

INDUSTRIAL COMPONENTS DIVISION





## What's different about the NEW 906C VISICORDER OSCILLOGRAPH?

At first glance you may see no difference at all. Just the same functional lines and compact size that you have come to recognize in the Visicorder.

They have not changed since 1956, when the Visicorder principle of oscillography made immediate readout of high frequency data possible for the first time.

Until now, all the improvements that have maintained the Visicorder's record of leadership have been internal:

- increased capacity to 14 channels
- higher frequency response (0-5000 cps)
- simultaneously recorded grid lines
- self-starting lamp for remote operation

But the 906C has a new feature you can see, (look carefully at the back of the case) and one that represents still another breakthrough; a built-in flash tube timing system which not only generates its own time base, but which can also be triggered externally. You can, in other words, use the 906C's

timing system to record time lines simultaneously with data. Or you can trigger the timing circuit externally—either by supplying a pulsing voltage of only +10v into 20K ohms impedance, or simply by causing impedance to drop to 100 ohms or less through shorting-out or other means.

Thus your "time" signal may actually be an event marker related to shaft rotation, belt movement, or any other effect which might be more conveniently fed to the timing circuit than to a galvanometer.

(Owners of Visicorders 906, 906A, and 906B will be glad to know that only a field-change is necessary to economically and easily add this timing system to their instruments).

Write today for full information on the brand-new 906C Visicorder. Ask for Catalog HC-906C. Or call us at SKYline 6-3681, Direct Distance Dialing Code 303.

Minneapolis-Honeywell, Heiland Division  
5200 East Evans Avenue, Denver 22, Colorado

### HONEYWELL INTERNATIONAL

Sales and Service offices in all principal cities of the world, Manufacturing in United States, United Kingdom, Canada, Netherlands, Germany, France, Japan.

## Honeywell

**H** First in Control  
SINCE 1885

CIRCLE 7 ON READER-SERVICE CARD

## NEWS

### SIGNIFICANT BITS

Important news items for electronic designers written for fast scanning.

**High temperature strain gages** are being sprayed on at Boeing Co. of Seattle, Wash. A flame spraying gun employs metal in powdered or wire form. A burning mixture of oxygen acetylene melts it and the molten metal is shot out of the gun by air pressure, in an atomized spray, and adheres at contact. Sprayed-on sensors have withstood temperatures to 1,200 F, the company reports. The expected limit is past 2,000 F. According to Boeing researchers, it would be possible to make heat sensors, erosion and ablative gages and other high-temperature measurement devices by the same method.

0001

**Chances of false targets** being picked up on air defense radars as a result of solar radiation will increase with more widespread utilization of extremely sensitive receivers using parametric amplifiers and masers. Anticipating the problem is a project at the Air Force Cambridge Research Laboratories for analysis of amplitude-modulated solar signals. Basic objectives of the research effort are: (a) To catalog the modulation structure of solar noise bursts to find ways to distinguish solar signals from true radar targets; and (b) To understand better the mechanism of the solar burst and its associated radio signals.

0010

**Semiconductor rectifiers** saved an estimated \$1-million in electrical equipment, according to a report made at the recent Pacific General Meeting of American Institute of Electrical Engineers. Remotely controlled germanium and silicon semiconductor rectifiers were used in place of motor generators in the Baltimore, Md. refinery of the Kennecott Copper Corp. Each rectifier was located adjacent to the electrolytic cell it served, rather than being centrally located. According to the report,

the savings were made without compromising either reliability or production capability.

0011

**Advanced laser components**, for use in optical surveillance systems, will be developed by the Quantum Physics Div. of Electro Optical Systems, Inc., Pasadena, Calif., under a \$94,728 Air Force contract. Program goals include investigation of new techniques and materials used in laser amplifiers, oscillators, and coherent detectors. Emphasis will be placed on cw lasers and high-power pulsed lasers where a high degree of spectral purity and high repetition rates are required.

0100

**An ocean seismograph**, developed for the Vela-Uniform program for improving detection of underground nuclear tests, recently made its first earthquake recording about three miles below the Atlantic Ocean 180 miles off Bermuda. Seismometer, amplifier, fm transmitter and batteries were enclosed in a 14-ft-long underwater device, with a nose cone and spike at one end and tail fins at the other. Signals were transmitted to the surface by acoustic telemetering. An almost complete absence of background noise deep on the ocean floor greatly enhances sensitivity to earth tremors, according to the Air Force Cambridge Research Laboratories, one of many Government agencies participating in the Vela program.

0101

**Experimentation with Echo 1** has led to the following discoveries: a radio bandwidth of at least 1.5 mc and probably greater can be transmitted and received via the balloon-bounce method; atmospheric interference has no effect on the transmission quality of signals bounced from the satellite reflector; transmitting teletypewriter messages, wire-photo facsimile photographs, music and voice over this type of balloon-bounce circuit is feasible; and, in addition, certain theories of radio propagation have been confirmed. These particular experiments, made with the still orbiting satellite, were conducted by Collins Radio Co. of Cedar Rapids, Iowa and its systems division, the Alpha Corp., Dallas, Tex.

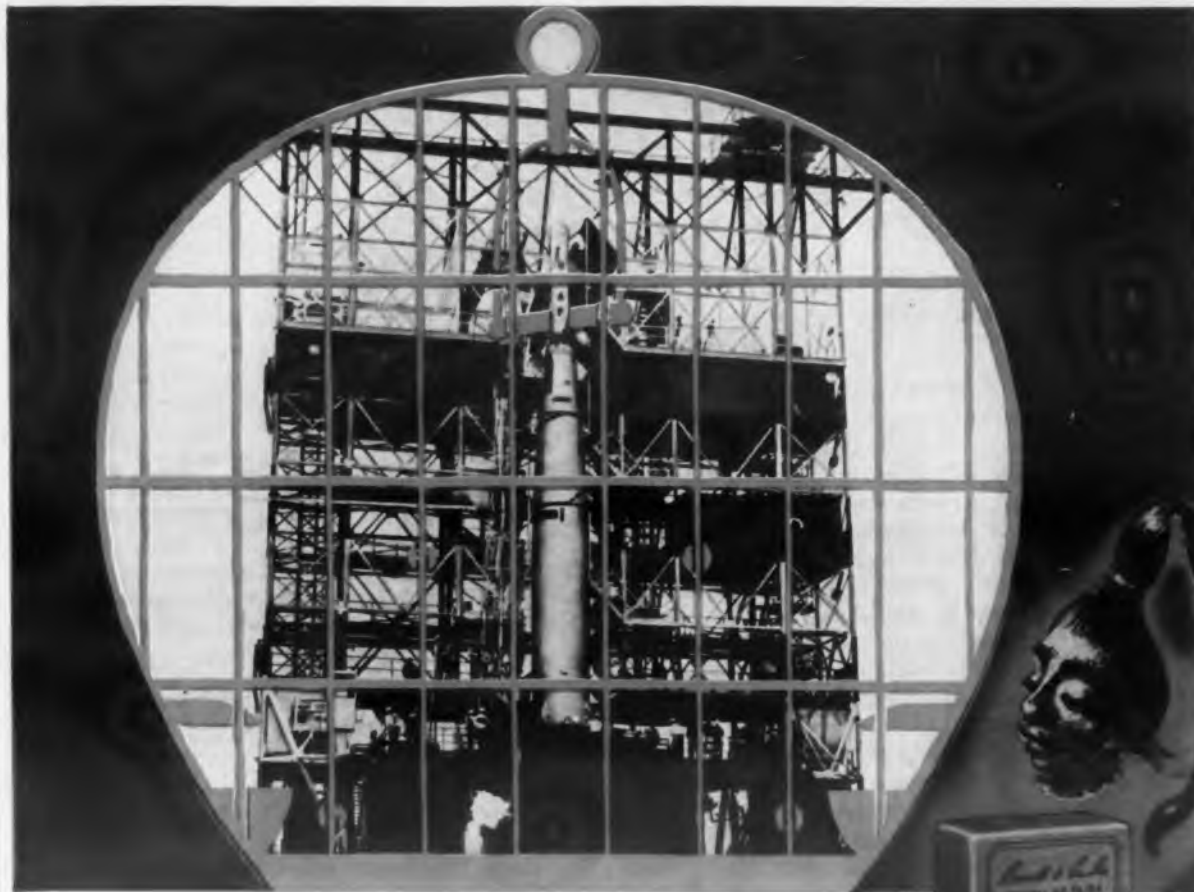

## Only a Bird in a Gilded Cage

As succeeding generations of missiles penetrate the curtain of space that separates Earth from other planets, the importance of electronic guidance, control and airborne telemetry systems becomes obvious. For, without new engineering design techniques to provide reliable communication and control, the most advanced missile is but a bird in a gilded and very expensive cage.

As typical examples of what can be accomplished to insure maximum performance in missile telemetering, communication, data processing and other applications, Burnell & Co. has developed two new filters—a miniature 3 kc crystal filter and, employing modern synthesis techniques, a miniature 500 kc LC toroidal filter possessing low transient distortion characteristics.

### TECHNICAL DATA 3 kc Crystal Filter

Attenuation—3 db B/W—2 cps  
Shape Factor—30/3—5:1  
Impedance—500K in and out  
Temp. Coeff.—.021 cps °C  
Size— $3\frac{1}{2}$  x  $2\frac{3}{16}$  x  $1\frac{1}{16}$   
Insertion Loss— $3\frac{1}{2}$  db  
Also available in any impedance from 500 ohms to 500K

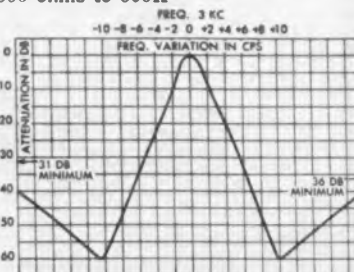

### TECHNICAL DATA 500 kc LC Toroidal Filter

Attenuation—B/W 40 kc at 3 db  
—200 kc at 50 db  
Impedance—50 ohms in and out  
Insertion Loss—4.5 db  
Over and undershoot—  
(for a step modulated  
500 kc carrier)—less than 1%  
Size— $\frac{7}{8}$  x  $3$  x  $1\frac{1}{2}$

Other Burnell filters are available in frequencies up to 30 mcs over a wide range of impedances.

Write for new catalog.

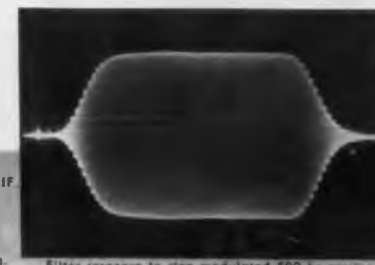

Filter response to step modulated 500 kc carrier

COPYRIGHT BURNELL & CO., INC. 1961

**Burnell & Co., Inc.**

PIONEERS IN microminiaturization OF  
TOROIDS, FILTERS AND RELATED NETWORKS

DIVISIONS: Gray & Kuhs, Inc., Westbury, L. I., New York • Guillemin Research Laboratory, Cambridge, Mass.

EXECUTIVE OFFICE  
AND PLANT  
DEPT. TD34  
PELHAM, NEW YORK  
PELHAM 8-5000  
TELETYPE PELHAM 3433



PACIFIC DIVISION  
SOUTH PASADENA, CALIF.  
MFD. IN CANADA  
BY EDO (CANADA) LTD.  
CORNWALL, ONT.  
WELLINGTON 2-6774

CIRCLE 8 ON READER-SERVICE CARD

# Backlog of Searches Besets Patent Office

*Agency, Fearing Breakdown, Seeks Funds to Develop Generalized Information-Retrieval System by '71*

**John J. Christie**  
News Editor

**T**HE U.S. PATENT Office is the logical proving ground for sophisticated information-retrieval systems, Patent Commissioner David L. Ladd emphasized in an interview with *ELECTRONIC DESIGN* last week.

Reiterating what he has told Congress, the American Bar Association and the National Association of Manufacturers since taking office in April, the 35-year-old commissioner warned that the patent-examining system is heading for a breakdown unless generalized mechanical searching becomes feasible within a decade.

Commissioner Ladd does not believe the necessary hardware can be made available in less than 10 years because of the problems of reducing patent text and drawings to machine language.

The commissioner hopes that up to \$3,000,000 annually will be appropriated over the next few years for basic and applied research on indexing and coding "the most sophisticated classification of technical material available." The \$3,000,000 figure was recommended in a recent report by Dr. Allen Astin, director of the Bureau of Standards, and John C. Green, director of the Commerce Department's Office of Technical Services. If voted by Congress, this fiscal '63 sum will be about five times the amount provided for research in the current budget.

## Ladd Questions Proposed Allocations of Research

The Astin-Green report represents an endorsement of an earlier study by a group headed by Dr. Gilbert King, director of research for International Business Machines Corp. The report will serve as a policy guide

for the information-retrieval research program—with one possible exception.

Commissioner Ladd questions proposals that would put the National Bureau of Standards in charge of a sizable share of the research, all of which would be in the Patent Office budget. He feels that his Office of Research and Planning, for which a director with the rank of assistant commissioner is being sought, should carry the ball, with NBS in an advisory role.

The basic question that this research effort ultimately must answer is whether a universal information-retrieval system, covering all the arts, is economically feasible or whether a series of encapsulated systems, each covering a segregated area of patent search, offers the best solution.

The Patent Office, the commissioner explained, probably will deal with both approaches simultaneously in its program.

A universal system, the commissioner noted, could well prove too costly, in view of the tremendous effort that would be required to convert all data now existing in printed form to whatever form the retrieval machines could accept. A universal system would be out of the question. Mr. Ladd said, without scanning systems capable of extracting and coding automatically all elements in text and drawings.

## Transistor-Cir-File Mechanized On Trial Basis

The segmented approach already is underway on a limited scale, Commissioner Ladd said. He called attention to one project that involves preparation of a mechanical file on transistor circuitry. Patent examiners assigned to this project, on a part-time basis, are analyzing and coding these patents in terms of some 1,000 so-called descriptors or features. The coding is done on regular IBM cards, which are fed into a RAMAC 305 computer to check the logic of the coding. The computer punches out "peek-a-boo" cards. A single patent yields several cards, each bearing about 25 coded terms.

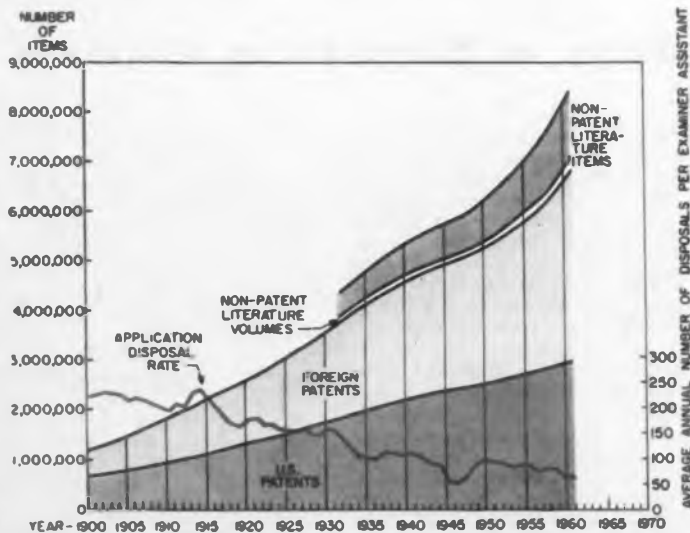

**The Patent Backlog**, as this chart shows, steadily worsens as the number of applications increases year after year while the output per examiner declines as a result of the growing complexity of examining requirements. Manual searching, as portrayed in the photo of a typical Patent Office file room, clearly cannot stem the tide. Unless mechanized searching can take over, the U.S. patent examining system may have to be abandoned.



Thus far, 300 out of 705 patents issued in transistor circuitry have been processed and microfilmed. In addition, this category numbers 940 cross references. By the end of July, there were 1,087 patents pending in transistor circuitry.

The commissioner feels, as do his technical advisors, that such projects will be valuable in testing approaches to file preparation and assist in training personnel in machine methods of handling information. They note that there are several limited areas of technology under consideration for mechanical search.

However, the Astin-Green report notes that such projects "probably cannot be expected to provide more than an interim solution to the search problem in an extremely limited segment of the total active patent art." The report cautions:

"Consequently, plans to introduce mechanized techniques for 'encapsulated' areas into the work of the examining divisions of the Patent Office should be based on sound estimates of expected savings or increased accuracy."

#### File-Preparation Costs Could Torpedo Program

The report urges that more attention be given to research in "mechanization of the preparation of the file." Noting that cost of file preparation rises in direct relationship to the care and detail employed in analysis and coding, the report warns that unless such costs are controlled, the entire program will be economically unfeasible.

"Therefore," Astin and Green conclude, "we believe that a vigorous research program should be undertaken, aimed at new techniques to permit mechanizing the preparation of the patent files. In addition, it would seem useful to develop cooperative relationships with private industry in order that special patent files set up by companies for their own needs can serve a wider purpose."

The new commissioner has no illusions about the job ahead. He is prepared for several years of effort to formulate the searching and retrieval theory on which the effectiveness of high-speed, mechanized procedures will depend. "None of the information-retrieval programs now under way in industry and the universities," Mr. Ladd pointed out, "approaches the depth of document analysis required in patent examining. Minute bits of data are often vital in establishing patentability."

Commissioner Ladd sees the Patent Office as an ideal laboratory for costing out

(continued on p 10)

CIRCLE 9 ON READER-SERVICE CARD ►

1 to 5 mc  
COMPUTERS

3 to 20 mc  
COMPUTERS

10 to 100 mc  
COMPUTERS

## For a 1mc or 100mc-clock Computer

# THERE'S A PHILCO 150 mw MADT\*



Seven important circuit advantages, inherent in every Philco MADT, are:

1. **Tight Parameter Control;**
2. **Charge-Control Specification;**
3. **Exceedingly Low V (SAT);**
4. **Very Low Collector Capacitance;**
5. **Freedom from Latching;**
6. **Excellent Temperature Stability;**
7. **Industry's Best-Documented Reliability.**

Four new Philco 150 mw \*Micro-Alloy Diffused-base Transistors bring even more versatility to industry's most reliable transistor line. Now, you can benefit from MADT proven product advantages in a broader-than-ever range of applications, including those that require high power dissipation. In addition to an expanding line of 150 mw types, there's the new ultra-high-speed 100 mw MADT type 2N976—the world's fastest switch. There's an MADT that gives you optimum cost efficiency for your specific requirements.

For complete information on these high power dissipation MADT's, and application assistance on any transistor circuit, write Dept. ED-91361.

Philco 150 mw  
MADT's are  
immediately available  
in quantities 1-999  
from your Philco  
Industrial Semi-  
conductor Distributor

# PHILCO



Famous for Quality the World Over

LANSDALE DIVISION, LANSDALE, PENNSYLVANIA



# Shallcross

precision  
circuit  
news

# 50:1

**Delay-to-Rise-Time Ratio in Only 6 in<sup>3</sup>**

Total Delay 1.5  $\mu$ sec  
Rise Time 0.03  $\mu$ sec  
Impedance 500 ohms  
PRF 2.5 mc  
Attenuation 1 db  
Distortion 5%  
TC  $\pm 150$  ppm,  $\pm 15$  ppm ( $-10^{\circ}\text{C}$  to  $+50^{\circ}\text{C}$ )

Some of the toughest performance specs we've seen in 12 years of delay line engineering are crammed into the  $\frac{1}{2}$ " x 2" x 6" case of this lumped constant line. Used by a data processing equipment manufacturer, the unit requires uncommon care in component selection and in circuit layout to achieve the desired 50 to 1 delay-to-rise-time ratio in the space allowed.

Special cores and toroidal winding techniques promote maximum Q, and, when coupled with custom miniature capacitors, desired LC characteristics are obtained within the specified space. An ingenious termination further reduces distortion at tapped outputs and appreciably enhances the pulse time characteristic.

Even if your delay line requirements are not so critical, this same Shallcross ingenuity may pay big dividends in reducing size, cost, or circuit complexity for you. Why not outline your needs to us?

## DELAY LINES



**VARIABLE DELAY**

Continuously adjustable delays from 0 to 0.5  $\mu$ sec with 0.005  $\mu$ sec resolution are attainable in this typical Shallcross unit. Maximum rise time is 0.06  $\mu$ sec at maximum delay.



**DISTRIBUTED CONSTANT**

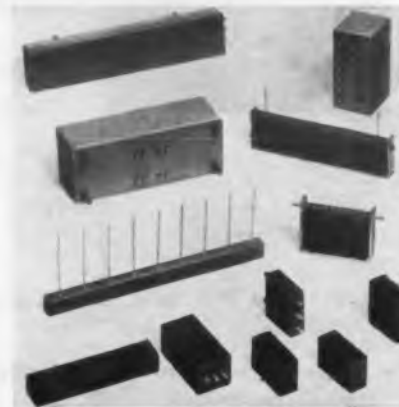

**LUMPED CONSTANT**

Shallcross' family of distributed constant and lumped constant lines utilize the latest refinements in inductors, capacitors, winding, trimming and packaging techniques.

## STEPPING ACCURATELY



Typical of longer Shallcross delay lines, this variable lumped constant unit provides a total delay of 24.65  $\mu$ sec in 15 steps calibrated to 0.05  $\mu$ sec accuracy. Delay-to-rise-time is 100:1—and in a hermetically-sealed package measuring only 2" x 4" x  $7\frac{1}{4}$ ".

Of course variations can be made for your requirements—in impedance, taps, rise time, attenuation and so forth. These are regular occurrences with the many hundred designs produced by Shallcross delay line specialists.

**Shallcross Manufacturing Co.** Selma, North Carolina

Precision wirewound resistors, Switches, Instruments, Delay lines, Resistance networks, Audio attenuators.

CIRCLE 10 ON READER-SERVICE CARD

## NEWS

### Patent Office...

(continued from p 9)

machine-searching systems, in comparison with the exhaustive manual searching.

Statistics support the sense of urgency with which the commissioner has taken up the cause of mechanized searching.

A growing search load, together with the increasing complexity of disclosures in applications, has made the Patent Office's notorious backlog clearly unmanageable under current procedures. Moreover, it is becoming increasingly difficult to assure accuracy of search by present methods.

Beyond the solution to these immediate problems, Commissioner Ladd and his technical advisors hope that information-retrieval systems might ultimately revive the Patent Office's historic but long-dormant function as a technical-information clearing house. ■ ■

### Grooved Plastic Sheets Eliminate TV Image Lines

A grooved plastic sheet that is laminated to the glass panel of a TV picture tube eliminates the line structure in the picture, according to its German manufacturer.

The sheet, described as a cellulose ester, has been introduced by Saba GmbH, a West German concern, and will become standard equipment on all Saba TV sets. It sells for the equivalent of about \$12.50 under the trade name of Sabavision.

Saba says the sheet eliminates picture lines down to a viewing distance of about 30 in. for a 23-in. picture tube. The sheet's many grooves distribute the TV screen's light vertically so that black picture portions between the image's lines are lifted to the light level prevailing above and below them.

Perfection of Sabavision gave rise to a related accessory. The device, called Telelupe, produces electronic magnification of the picture tube image. Telelupe is push-button operated and produces magnification with a factor of about three.

The maximum picture magnification depends on the deflection voltage available. A special circuit protects the picture geometry when the magnifier is turned on. Other special circuits provide for continuous contrast and brightness levels.

## One-Head TV-Tape Unit Offered in W. Germany

A one-head video-tape recorder, reportedly the first manufactured in quantity in West Germany, stirred considerable interest at the recent Berlin Radio Show.

Loewe-Opta A.G. says its recorder—the Optacord 500—uses one ferrite head, which rotates within a cylindrical tape guide at 3,000 rpm. The video track is recorded diagonally, rather than vertically.

The Optacord 500 wraps the tape around a cylindrical guide drum forming one turn of a helix. If the tape's speed is zero, the rotating head writes one slanted track from one edge of the tape to the other. A single track contains an entire frame.

The manufacturer notes that this system makes a single recorded frame visible without movement of the tape. The frame is reproduced because of the relative speed between rotating head and tape.

The machine uses 2-in. magnetic tape and one reel gives a recording-reproduction time of 105 min.

The Optacord 500 is relatively compact, measuring about 28 x 28 x 40 in.



Optacord 500 video-tape recorder is said by its West German manufacturer to be as easy to handle as an audio-tape recorder. Size compares favorably with that of professional audio-tape recorders.

## CERAMICS FOR TRANSISTOR CIRCUITS

*And now...  
Available in  
Ratings to 25V!*

### HYPERCON® CAPACITORS

- Ultra-high capacitance
- Low voltage
- Miniature size
- Low Cost

Designed for use in semi-conductor and other low-voltage circuits, these new Hypercon Disc Ceramic Capacitors offer capacitance values formerly associated only with electrolytic capacitors. Yet they are only a fraction of the size of comparable aluminum electrolytics!

Hypercons have excellent stability, exhibiting no loss in capacitance when operating above room temperature. Their triple-purpose resin coating serves as insulation as well as protection against moisture and mechanical damage.

*Hypercons are in mass production now, available for prompt delivery. For detailed specifications, write for Engineering Data Sheet 6141A to Technical Literature Section, Sprague Electric Company, 347 Marshall Street, North Adams, Massachusetts.*

#### SPRAGUE COMPONENTS

CAPACITORS  
TRANSISTORS  
MAGNETIC COMPONENTS  
RESISTORS

INTERFERENCE FILTERS  
PULSE TRANSFORMERS  
PIEZOELECTRIC CERAMICS  
PULSE-FORMING NETWORKS

HIGH TEMPERATURE MAGNET WIRE  
CERAMIC-BASE PRINTED NETWORKS  
PACKAGED COMPONENT ASSEMBLIES  
FUNCTIONAL DIGITAL CIRCUITS

.1 $\mu$ F  
actual size

3 VOLTS D-C		12 VOLTS D-C		25 VOLTS D-C	
$\mu$ F	Diameter in inches	$\mu$ F	Diameter in inches	$\mu$ F	Diameter in inches
.1	.225	.047	.275	.01	.275
.22	.275	.1	.400	.022	.350
.47	.400	.22	.550	.033	.400
1.0	.595	.33	.660	.047	.490
2.2	.840	.47	.840	.1	.660

# SPRAGUE®

THE MARK OF RELIABILITY

\*Sprague and "S" are registered trademarks of the Sprague Electric Co.

CIRCLE 11 ON READER-SERVICE CARD

1931...Birth of  
AGASTAT®  
reliability



1961...traditional quality  
in the new solid state **AGASTAT**

The AGASTAT time/delay/relay principle dates back to 1931, when the first night airmail flight from New York to Chicago was preparing for take-off. When runway lights failed due to old-style time delay relays, necessity fostered a new design. Thus, through a need for *reliability*, the electro-pneumatic AGASTAT was born—first in a distinguished series of time/delay/relays. **Solid state** AGASTATs meet today's needs for *reliability*. Countless hours of engineering, research and development have produced a static timing relay with the *reliability* essential for critical missile and computer use. Modular construction using selected semiconductor components permits flexibility and uniformity. Rigid quality control and component matching assure dependability.

**Solid state** AGASTAT time/delay/relays are supplied in six basic types for delay on pull-in or drop-out, with fixed or adjustable timing ranges from 0.01 sec. to 10 hours. Special circuitry protects against polarity reversal, provides immunity to voltage variations and transients. Operation—18-32 vdc; .55c to 125c; load capacity up to 5 amps. Write Dept. S2-49 for technical data or immediate engineering assistance on your special requirements.

**AGASTAT TIMING INSTRUMENTS**  
ELASTIC STOP NUT CORPORATION OF AMERICA  
ELIZABETH DIVISION • ELIZABETH, NEW JERSEY

IN CANADA: ESNA CANADA, LTD., 12 GOWER ST., TORONTO 16, ONTARIO, CANADA

CIRCLE 12 ON READER-SERVICE CARD

## NEWS

### System Identifies Radar-TV Blips

*Passive Identification Device, Designed  
For Harbor Control, Proposed for Navy Use*

**A** PASSIVE system for identifying blips on televised displays of radar information has been proposed to the Navy for use by attack landing craft during poor visibility.

The system, called Plan, (Positive Locator Aid to Navigation), is being developed by General Precision, Inc., Tarrytown, N. Y., primarily for harbor control. However, the company hopes the Navy will find it suitable for landing-craft use and harbor defense.

The original use proposed was in a Coast Guard harbor-surveillance system that will shortly be tested in New York Harbor. In this system, data from a harbor-surveillance radar will be relayed to an antenna for transmission to harbor craft equipped with almost-standard uhf television receivers. The picture seen on these screens will be the same as that appearing on the Coast Guard's ppi display. Blips representing ships, buoys and other harbor features will be unidentified on the display.

**Rotating Beam Added to TV Picture  
Permits Ships to Identify Themselves**

General Precision says its system could transmit a rotating beam in synchronism with the television transmissions of the radar data, so that a line would appear on the TV screen of each ship in range as the beam reached the blip representing each ship. As the line swept past the blip, it would drop out of the display on that ship until it touched the next blip, when it would appear



**How-Plan display** would appear on screen of adapted uhf set carried by ship receiving televised radar data and rotating identification beam. Line appears over blip of each ship in turn as beam rotates at about 10 rpm. As soon as it passes through one blip, it drops out of display on that ship's screen.

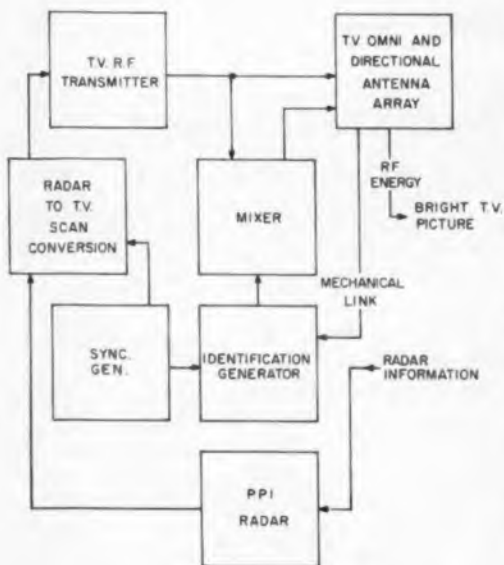

**Plan** system works by generating a rotating beam synchronized with scan-converted and televised radar data.

as a line moving through that spot. Though theoretical range would be line-of-sight, a range of about 10 miles would provide best resolution in a practical system.

The identifying line could originate from a mechanical image viewed by a vidicon or could be electronically generated. In either case its image would be used by an identification generator to provide a voltage-time series of video pulses in synchronism with the radar-to-TV scan-conversion system. A sync-pulse generator would drive the scan converter for generation of the identity display. A series of video pulses generated for the identity-generator display would control rf fed to a directional rotating TV antenna used in conjunction with an omnidirectional TV antenna.

Albert Roberts, a General Precision engineer credited with development of Plan, believes that passive identification could be added to a system like the Coast Guard's at relatively small additional cost. Another application he foresees is in lighthouses, where the system would aid in transmitting identifiable converted-radar TV data.

In harbor-surveillance applications, Mr. Roberts says, the system could be modified to include provision for stopping the identification beam on a particular ship to call attention to a dangerous situation or to give advice. It could also be used for tracking.

Although patents on several versions of Plan have been applied for, no equipment has been built. ■ ■

# SILICON PLANAR 2N709

# 6 NSEC $T_s$ MAX.

## MADE POSSIBLE BY FAIRCHILD PLANAR PROCESS

### 2N709 VERY HIGH SPEED NPN SILICON PLANAR TRANSISTOR ULTRA-FAST SWITCHING APPLICATIONS

JEDEC TO-18 PACKAGE  
300 mW POWER DISSIPATION AT 25°C. FREE AIR TEMPERATURE

#### 2N709 CHARACTERISTICS

	Min.	Typ.	Max.	Condition
$C_{ob}$	.....	.....	3.0 pf	$V_{CB} = 5.0 V; I_C = 0 mA$
$C_{TE}$	.....	.....	2.0 pf	$V_B = 0.5 V; I_C = 0 mA$
$f_T$	.....	800 mc	.....	$V_C = 4.0 V; I_C = 5.0 mA$
$\tau_s$	.....	3.0 ns	6.0 ns	$I_B = I_C = 5.0 mA$
$h_{FE}$	20	.....	120	$I_C = 10 mA; V_{CE} = 0.5 V$
$BV_{CBO}$	12 V	.....	.....	$I_C = 10 \mu A; I_B = 0$
$I_{CBO}$	.....	.....	100 $\mu A$	$V_{CB} = 5.0 V; I_B = 0$

Contact your Fairchild Distributor or Field Office. Or write for complete specifications and pricing information.

### ULTRA-FAST SPEED

100-200 mc saturated switching circuits are now made possible and practical because of: typical  $f_T$  of 800 mc, average DC propagation delay time of 3 nsec. (6 nsec. max.), 3 pf  $C_{ob}$  (max.) and 2 pf  $C_{TE}$  (max.).

### LOW LEAKAGE

With the 2N709 you can design micropower high speed satellite circuits with minimum allowances for leakage. Provides the parameter stability and uniformity characteristic of Fairchild's silicon Planar devices.

### LOW COST

2N709 is on distributor shelves, ready for immediate delivery. You can have this ultra-fast, guaranteed, high-performance device at prices practical for the "breadboard" budget as well as quantity production.

## FAIRCHILD

## SEMICONDUCTOR

545 WHISMAN ROAD, MOUNTAIN VIEW, CALIF. - YORKSHIRE 8-0161 - TWX: BN YW CAL 053  
A DIVISION OF FAIRCHILD CAMERA AND INSTRUMENT CORPORATION

CIRCLE 13 ON READER-SERVICE CARD

now!  
 supply DC from  
 0 to over 1100 volts in steps as small as  $1 \mu\text{v}$ !



The seven 11-position readout-type dials on KIN TEL's new Model 303 DC Voltage Standard let you control the output from 0.000000 to over  $\pm 1100.0000$  volts in three ranges with a resolution of 0.1 part per million of full scale.

The voltage is held stable within 0.0025% of the dialed output for over eight hours, within 0.005% for over 30 days. Absolute accuracy is better than 0.01% of the setting.

The 303 has a four-terminal output—two to furnish current for the load, and two to sample the voltage across the load. By sampling at the load, no error is caused by current flowing through external leads, and the effective source impedance at the load is 0.001 ohm. Full accuracy is maintained with lead lengths on the order of 10 feet.

The output circuit is completely floating, shielded, and guarded—isolated from both chassis and power-line ground. Common-mode intermodulation products are rejected by 120 db at 60 cps.

Output current may be limited by a panel control to 5, 10, 15, or 25 milliamperes. An overload relay disconnects the output terminals if the selected current is exceeded or if the output voltage deviates from the setting.

These features make the 303 an ideal standard. Its wide range and high accuracy make it useful in many laboratory and industrial applications. And its exceptional resolution makes it especially valuable when small increments of voltage are needed. Price \$2800.

Write today for detailed technical literature or demonstration.  
 Representatives in all major cities.

5725 Kearny Villa Road, San Diego 11, California. Phone: BRowning 7-6700

CIRCLE 14 ON READER-SERVICE CARD

**KIN TEL**  
 A DIVISION OF  
**COHU**  
 ELECTRONICS INC.

## NEWS

### Sweep Camera Snaps Light Beam In Motion

Pictures of the flight of light have been achieved by scientists at STL Products Div. of Space Technology Laboratories, Inc.

An electronic STL image converter camera took the pictures by sweeping the image from top to bottom at 168,000 mph.

When adjusted to take individual frame exposures, the image converter camera can record subjects in exposures as brief as 2-1/2 billionths of 1 sec, and can take three frames in succession at a speed equivalent to 20,000,000 exposures per second.

The camera converts optical images to electron images, allowing electronic shuttering, light amplification, and image deflection.

#### Image Amplified on Screen Before It Is Photographed

Optical images are focused on an image-converter tube. The focused light strikes the photo cathode of the tube. The resulting electrons carrying the picture information move toward the anode, where they cross over and are accelerated to a focus on a fluorescent screen at the end of the tube.

The optical image is thus re-created at an amplified intensity on the screen. The amplified image is then focused on the film through a lens system and photographed by conventional means.

A gating grid, placed in the path of the electrons flowing toward the anode, serves as the electronic shutter. Advanced circuit design provides a fast-rising voltage pulse to the gating grid; thus the shutter speed is limited only by the parameters of the pulse forming the circuitry.

#### Plug-In Units Permit Variety Of Framing and Writing Speeds

Interchangeable plug-in units provide a choice of high-speed or standard-speed framing pictures and high-speed or extended time-writing rates.

David G. Fladlien, assistant director of STL Products, believes the camera will be useful in astrophysics, atomic spectroscopy, arc discharges, combustion, high-temperature physics, jet velocity and stability, time-resolved spectroscopy, wave propagation, and velocity, shock waves, and propulsion.

STL is a subsidiary of Thompson Ramo Wooldridge, Inc.

## Aluminum Space 'Flower' Blooms

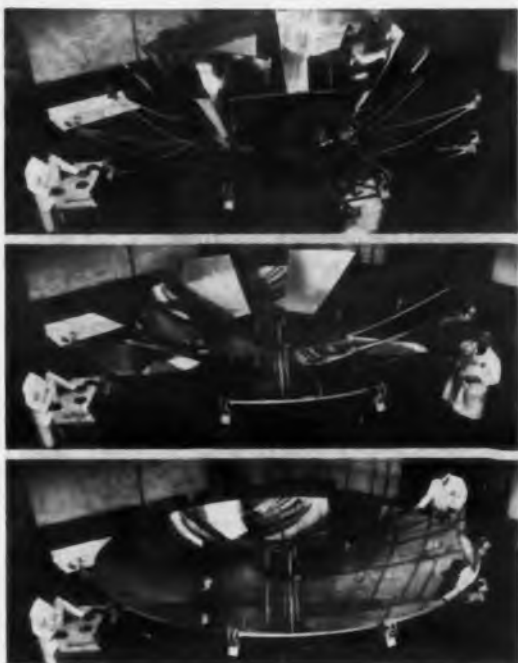

When unfolded in space, this flower-like aluminum-coated unit becomes a 16-ft parabolic mirror. The model shown is part of an experimental solar thermionic electrical-power system and is used only in ground tests. The device was developed by General Electric Co., Philadelphia, for the Air Force's Aeronautical Systems Div. It is designed for possible use in space craft to convert concentrated solar energy or heat into electricity. The mirror is folded for compactness during its space flight.

## Ultrasonic Doppler Unit Measures Landing Speed

An airborne ultrasonic Doppler system to measure an aircraft's rate of descent at touchdown has been developed by Gulon Industries, Inc., of Metuchen, N. J.

The Gulon system, under test at the Wright Air Development Division in Dayton, Ohio, measures an aircraft's velocity during the last 18 in. of vertical descent. Velocity is recorded on an airborne recorder.

Gulon considered electromagnetic and optical approaches to the instrument's design, but found ultrasonics the most economical.

More powerful versions of the doppler system, says Gulon, may someday be applied as automatic flare-out devices for aircraft and soft-landing systems for space vehicles.



HIGH MU

LOW MU

MEDIUM MU

(Now: Eimac 10 and 20 kw ceramic triodes for every application!)

There's an Eimac 10 and 20 kw ceramic triode for class AB<sub>1</sub> audio, for class C RF, for class B linear service ... for every application. These rugged tubes provide dependable power through 110 mc—plus large reserves of grid dissipation! For data write: Power Grid Tube Marketing, Eitel-McCollough, Inc., San Carlos, Calif.



CIRCLE 15 ON READER-SERVICE CARD

# Pneumatic Computing Units Built for Process Control

*Small, Rugged Modules Considered Competitive  
With Electronic Systems In Automation Uses*

**A**N AIR-OPERATED analog-computing module, which like electronic units can be packaged into small, rugged industrial analog computers, has been developed for industrial process control.

The pneumatic unit is the work of the AiResearch Manufacturing Div., Garrett Corp., Phoenix, Ariz. It is priced at \$500.

AiResearch engineers developed the unit as a pneumatic, rather than electronic, system because they felt there was a great need for a mechanical device that would be easier for industrial operators to understand and maintain. The pneumatic unit, has provisions for electrical input and output signals.

AiResearch engineers say their unit could achieve an order-of-magnitude better reliability than even solid-state electronic systems. The unit's designers said their model should be competitive with existing pneumatic systems because it has slightly better accuracy and more installation flexibility. The flexibil-



AiResearch engineer holds one of the new air-operated analog computing modules. The 1-ft-long, 4-lb units will sell for \$500. Computing will be done by balancing forces from pneumatic inputs acting on pivoted rods. Cylinder extending away from box houses piston which is used for moving the input force along the rod during multiplication.

## Russians Like It, Too

According to visitors to Russian technical institutes, the USSR believes that rugged, easily understood and maintained pneumatic-analog controls may be the most practical initial form of industrial automation, particularly for underdeveloped areas.

ity comes from the way in which AiResearch has adapted modular concepts, familiar in electronic-analog computers, to their pneumatic "building blocks."

### Similar Computing Principle Used In Pneumatic-Process Controllers

Actually, the computing principle used in the new units does not differ markedly from that which has been widely used since the 1930's in standard pneumatic-process controllers. The basic computing element in each module is a "see-saw" lever. Force inputs to this lever are via "carts" containing bellows. The carts attempt to rotate the lever around the center pivot, but any rotation is sensed by a nozzle at one end of the lever. Movement of the lever changes the back-pressure in this nozzle and this pressure in turn acts on a rebalance cart. The amount of pressure which must be fed to the rebalance cart also is the output.

Additions and subtractions are performed by the arrangement shown inside the solid lines in the accompanying diagram. The additional circuitry needed for integration is indicated by the dashed lines. A pneumatic re-

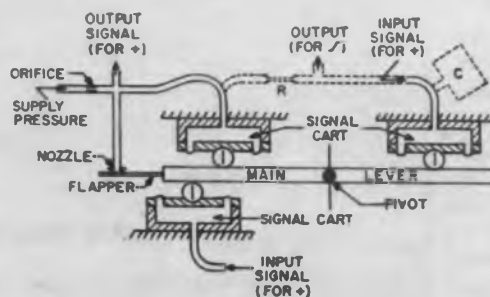

**Computing principle:** Signal carts convert signal pressures into forces acting to rotate lever around its central pivot. Nozzle and flapper sense lever rotation and alter pressure on upper left signal cart to keep lever in balance. Dashed lines show additions to enable unit to integrate.



sistance in the form of a length of capillary tubing would be introduced at *R* and a pneumatic capacitance in the form of a volume would be added at *C*. Then, just as in an electronic analog computer, integration is performed by charging a capacitance in the feedback path around an operational amplifier; pneumatic integration is performed by filling the volume.

#### Piston Servo Used to Move Cart Along Lever In Multiplication

For multiplication, a piston servo is used to move one of the carts along the lever. The cylinder containing this piston can be seen sticking out one side of the unit in the photograph.

The most obvious drawback of the pneumatic units to an electronic engineer is their very limited bandwidth. However, since the time constants of industrial processes are often a matter of hours, or even days, the 1-cps bandwidth of these units probably will not be a disadvantage.

AiResearch has provided means for introducing electrical inputs and outputs through other pivot-nozzle transducers that are voice-coil actuated. Thus these units can be used with increasing numbers of special-purpose electronic instruments, such as gas stream analyzers.

Transducing to electrical signals also may be desirable because pneumatic signals cannot be transmitted over long distances. ■ ■

#### Delta Airlines Will Install Electronic Reservation System

A computer-based electronic system will make flight and passenger information available to reservation agents of Delta Airlines in 66 cities.

The IBM 9074 Sabre system was tailored to the airline's requirements after a two-year study. Installation of the network will begin in April, 1963.

The system, developed by International Business Machines, White Plains, N. Y., will provide high-speed, two-way transmission of data via leased communications lines. A computer center, planned for Atlanta, will be linked to nearly 300 electronic agent sets throughout the country.

Two solid-state IBM 7074 computers, modified to meet the system's requirements, will be used. Each computer is capable of making 250,000 logical decisions a second, and each can retrieve a character from core storage in 4  $\mu$ sec.

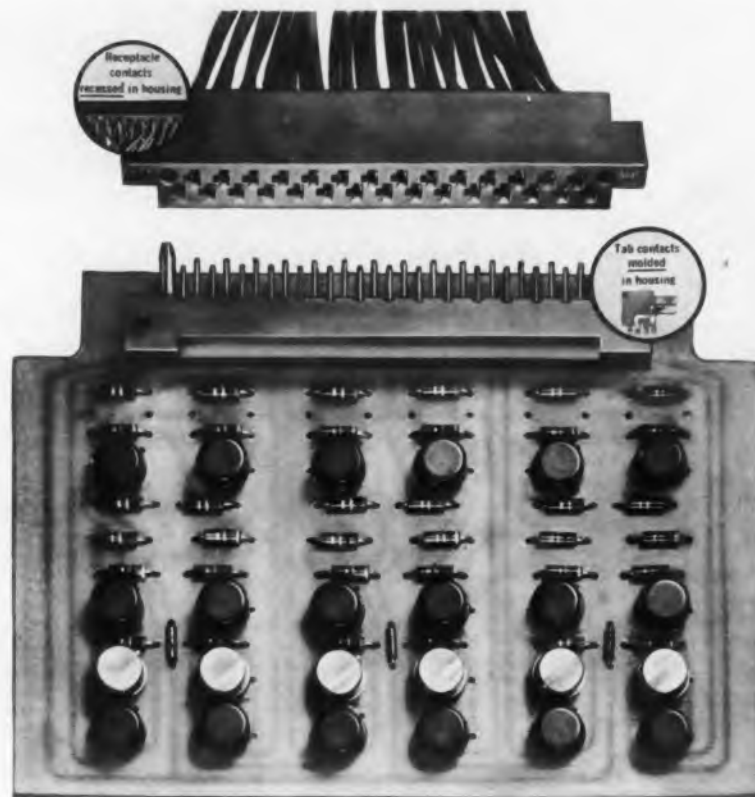

## NO TWIST, TURN OR OFF-CENTER SEATING OF CONTACTS IN THIS CONNECTOR

The AMPPin-cert® Blade Connector is staked down for stand pat positioning on the board . . . gives you positive alignment and perfect contact at all times! No board warpage either! The tab housing acts as a rigidizing member . . . keeps the board straight, level and true regardless of environmental conditions and repeated insertions and extractions. These are just two of the answers that AMPPin-cert Blade Connectors have for maximum reliability, lowest installed costs and trouble free performance. There are many more, for instance:

- no paid-for but unused contacts with AMP's crimp type, snap-in design
- guaranteed individual contact forces
- large contact areas reduce connector pressures, avoid hard wear on plating and increase contact life
- raised barrier sections and large contact cavities prevent moisture entrapment
- recessed cavity construction eliminates need for sleeving
- rigid metal guide pins assure perfect connector mating during insertion

Complete details will be sent on request.

®Trademark of AMP Incorporated

# AMP INCORPORATED

GENERAL OFFICES: HARRISBURG, PENNSYLVANIA

AMP products and engineering assistance are available through subsidiary companies in: Australia • Canada • England • France • Holland • Italy • Japan • Mexico • West Germany

CIRCLE 16 ON READER-SERVICE CARD



## Ripple Current in D.C. Filter Capacitor Applications

A.C. ripple current rating of an electrolytic capacitor is one of the important factors in filter applications. Excessive ripple current can cause excessive temperature rise and can shorten life. This is why it is desirable to understand the facts concerning the effect of ripple currents before specifying electrolytic capacitors for filters.

A typical filter-capacitor application is shown in Figure 1 (a), where a singlephase, full wave bridge rectifier is supplied from a 60 cycle, sinusoidal input. If the switch to the resistive load is open, the capacitor will be charged to peak voltage during the first 1/240 second and will hold its charge, maintaining a constant D.C. voltage across its terminals. There will be no significant A.C. voltage ripple under these conditions, as shown in Figure 1 (b).



Figure 1 (a)

Figure 1 (b)

Figure 1—Typical full wave, singlephase bridge rectifier circuit operating on 60 cycle input is shown in 1 (a). Rectified voltage wave shown in 1 (b) is a constant D.C. voltage so long as load switch remains open.

However, conditions change when the load switch of Figure 1 is closed. The capacitor will be charged to peak voltage during the first 1/240 second as before, but after rectifier voltage reaches peak and begins to decrease, capacitor voltage remains higher than rectifier voltage. The capacitor must now supply load voltage and current until rectifier voltage is again equal to or greater than capacitor voltage. How rapidly capacitor voltage drops during intervals when it is supplying the load is governed by size of load and, hence, rate of discharge of the capacitor. Total drop  $\Delta E$ , shown in Figure 2, is proportional to load current. These drops are what produce the ripple voltage. Ripple voltage is decreased when the filter capacitor is increased in capacity.

$\Delta E$  is the total peak-to-peak ripple voltage and is a complex wave containing harmonics of the fundamental ripple frequency. Exact heating effect calculations on the capacitor would involve determining the effective voltage for each harmonic, determining the rms current from known total impedance of the capacitor at this frequency, and calculating the watts loss from the known resistive component of the capacitor at this frequency. Total loss would be the sum of these individual harmonic contributions. This is a most complicated procedure since harmonic contents vary with application and complete impedance and resistance data versus frequency is not readily available for each capacitor design.

It is well to keep in mind that suppliers' ripple ratings are most usually based on tests conducted using 120 cps sinusoidal currents. Even though the true rms current in a practical situation is equal to the suppliers' rating, it does

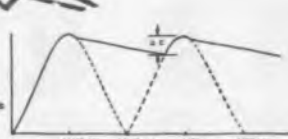

Figure 2

Figure 2—When load switch of Figure 1 is closed, capacitor supplies load voltage and current between successive rectifier input peaks. As capacitor discharges, its terminal voltage drops by amount  $\Delta E$ , creating ripple voltage.

not mean that the heating effect will be the same as that obtained on the suppliers' test. This is due to the different wave forms involved and the harmonic current components mentioned above. However, an accurate rms current measurement is a very close approximation and is a practical first approach.

One method of making this measurement is to insert a low impedance thermal ammeter in series with the negative lead of the capacitor. The impedance of this meter must be small compared to the capacitor impedance or the ripple current will be altered. Large errors can be produced by this method, especially if a large low impedance capacitor is being tested. A thermal type ammeter is recommended for this test since a true rms reading can be obtained from a complex wave and the impedance of this type of meter is very low.

Another approximate measurement can be obtained by inserting a low value resistor or shunt in series with the capacitor and reading the voltage drop with a vacuum tube voltmeter. An additional error is encountered in this method unless the voltmeter used is a special type which reads true rms voltage.

A third method is to estimate, calculate, or measure the ripple voltage and divide by the capacitor impedance. The same errors exist here as mentioned above.

The above methods have been used very satisfactorily; however, when there is doubt or if complicated duty cycles are involved, the most satisfactory answer is obtained by measuring the capacitor case temperature rise by inserting a thermocouple between the insulating sleeve and aluminum can midway between top and bottom. If the ambient temperature is also measured at the same time, temperature rise of the capacitor above ambient can be determined.

Equipment should be operated in this test at maximum load for approximately 2 hours or until two successive measurements, taken 15 minutes apart, show no change in capacitor or ambient temperature. A Sangamo DCM capacitor is safely loaded if temperature rise is not more than 8°C. for 65°C. ambient or 12°C. for 40°C. ambient.

EC61-5

**SANGAMO ELECTRIC COMPANY, Springfield, Illinois**  
— designing toward the promise of tomorrow

## NEWS

# Message Sorter Feeds 105 Teletype Circuits

*Army System Processes Data  
And Transmits on Priority Basis*

**A**N ELECTRONIC message-distribution system will allow the Army to process and route incoming messages to as many as 105 receiving teletypes.

The system, resembling a large digital computer, rapidly and automatically sorts incoming messages according to priority. The equipment was developed by Minneapolis-Honeywell Regulator Co.

Priority messages automatically interrupt communications of lesser importance. The system "recalls" the interrupted messages and re-sends them later.

The unit is known as a Semi-Automatic Teletypewriter Message Distribution System. It consists of 40 cabinets of electronic circuitry and storage elements, a control console, five record page printers, and 105 terminal teletypewriters.

**System's Digital-Logic Controls  
Housed in 4,000 Circuit Cards**

The system's memory consists of a magnetic drum and magnetic-tape units. Four thousand solid-state circuit cards house the digital logic for control of the unit.

This is how the system works:

Messages arriving on several 100-word-per-minute teletype lines are recorded on a magnetic drum and automatically assigned serial numbers. Simultaneously, the message is printed on a monitor teletype.

The magnetic drum provides 1-1/2 min of storage for initial processing. During this time messages are assigned to any of 25 addresses and designated either for action or information by the push of a button for each address.

Priority messages are singled out immediately upon receipt by circuitry, which decodes and recognizes the precedence identifier. An alarm sounds and the operator pushes a button for immediate transmission.

Messages are transferred from the magnetic drum to storage on transmission tape, a continuous loop of magnetic tape. From there they are routed to their addresses as outgoing lines become available.

Messages in transmission storage pass

readout heads five times at intervals of four minutes. If a message completes the transmission-storage cycle without being delivered, it is transferred to intercept storage. From there it can be re-introduced into transmission storage by the operator when volume permits.

Annotation buttons permit addition of notes to messages when they are being addressed. Extended notes can be added, or a message can be edited, by use of a standard teletypewriter keyboard. ■ ■

### Developmental Fuel Cells Use Radioisotope Catalysts

A fuel cell with a radioisotope-coated electrode has been operating continuously for more than two months at the laboratories of Yardney Electric Corp.

Oxygen under pressure is diffused through sintered porous silver electrodes into a low-temperature alkaline electrolyte. Radioisotopes on the silver surface serve as catalysts for the oxygen-electrolyte reaction.

The cells under development have current densities of 150 ma per sq cm, or about 150 amp per sq ft, with polarizations of 0.2 to 0.3 v. Current research is to determine how the radioisotopes aid the oxidation and to find the best isotope for the reaction. Alpha and beta emitters like  $Cu^{114}$  and  $Ni^{63}$  are currently being used.

### COMLOGNET Takes Shape



Electronic-communications equipment for the Air Force's Combat Logistics Network (COMLOGNET) is viewed by Air Force Lieut. Col. F. W. Schultz and the project control manager, George Weilenman, of Radio Corp. of America. The RCA equipment, recently delivered to Norton Air Force Base, San Bernardino, Calif., will be used in the first of five control and switching centers for the communications network linking 350 bases, depots, and installations. The system will be able to transmit 100,000,000 words daily. Western Union Telegraph Co. is the prime contractor for the project, to be completed in 1962.

**6 NEW MOTOROLA GERMANIUM EPITAXIAL MESA SWITCHES  
REPLACE MICRO-ALLOY, DRIFT AND OTHER MESA TYPES**

*with improved performance over a broader range...at lower cost!*

Six new germanium epitaxial switching transistors from Motorola — the 2N960-62, 2N964-66 series — will replace several hundred similar old type devices in 90% of all applications.

With their faster switching time ( $\tau_{RE} = 0.6$  nsec), this new epitaxial mesa switching series will supplant virtually all other germanium micro-alloy, drift, mesa, and other types for high-speed switching applications... in many cases at considerably lower prices.

Designed with improved geometry, the new switch series is intended for applications at both high and low current. Current gain and saturation characteristics are specified at three points (10 mA, 50 mA, & 100 mA), thus clearly characterizing device performance over a broad current range.

For applications where the advantages offered by this new epitaxial series are not essential, Motorola also offers eight new non-epitaxial germanium mesa transistors — the 2N968-75 series — at even lower prices.



FOR MORE INFORMATION on either of these important new mesa series, contact your Motorola District Office, or call or write: Motorola Semiconductor Products Inc., Technical Information Department, 5005 East McDowell Road, Phoenix 8, Arizona.

**MOTOROLA DISTRICT OFFICES:**  
Belmont, Mass. / Burlingame, Calif. / Chicago / Clifton, N. J. / Dallas / Dayton  
Detroit / Glenside, Pa. / Hollywood / Minneapolis / Orlando, Fla. / Phoenix  
Silver Spring, Md. / Syracuse / Toronto, Canada.

REPLACEMENT CHART*						
Process Group	MOTOROLA EPITAXIAL MESA TYPES					
	2N960	2N961	2N962	2N964	2N965	2N966
Micro-alloy Diffused	2N501 2N846 2N588 2N1510	2N769 2N768	2N1499A 2N1500	2N779	—	—
Mesa	2N781 2N705 2N710	2N711	2N782	2N1301 2N795 2N1183 2N934	—	2N1300 2N794
Micro-alloy	2N1122A	2N1122	2N393 2N1427 2N1411	—	—	2N393
Surface Barrier	—	2N128	2N210 2N344 2N345 2N346	—	—	—
Alloy	2N583	—	—	2N582 2N584	—	—
Drift	—	2N643 2N644 2N645	2N1450 2N602	—	2N609	2N603

\*Interchangeability of types shown is on the basis of performance in switching circuit applications. (All Motorola types have 150 mW dissipation in free air, 300 mW at 25°C case temperature.)



**MOTOROLA**  
Semiconductor Products Inc.

A SUBSIDIARY OF MOTOROLA INC.

5005 EAST McDOWELL ROAD • PHOENIX 8, ARIZONA

CIRCLE 18 ON READER-SERVICE CARD

# OVERNIGHT OVERNIGHT DELAY LINES

TO FIT YOUR ELECTRICAL SPECIFICATIONS

# OVERNIGHT

the  
**WEE LINE**

## A NEW MARKETING CONCEPT IN DELAY LINES

Here's the supermarket approach to your delay line problems. It's fast . . . versatile . . . accurate; really something new under the sun! Wee Lines are sectionalized delay lines, mounted on printed circuit boards that conform to MIL-P-13949B. Each section is a discreet value of delay time. The number of sections determines the overall delay time and the delay-to-rise time ratio. A quick computation tells the engineer how many sections are required; the problem is reduced to a simple ordering process; and the Wee Lines are shipped within 24 hours. An innovation designed and manufactured exclusively by Nytronics, Inc.

### FEATURES

- Cut motion, time and costs
- Delay lines made from standard sections shipped in 24 hours
- Will fit 80% of requirements
- Uniform performance characteristics
- Sizes from 6 to over 200 sections
- Encapsulated to conform to MIL-C-15305B, Grade 1, Class B
- Solder lugs for connections; screw or rivet mounting
- Available in standard metal shields

WRITE TODAY FOR DESIGNERS DATA SHEET

## **NYTRONICS, INC.**

850 SPRINGFIELD AVE., BERKELEY HEIGHTS, N. J., • Phone 484-8300 • TWX Summit, N. J. 533

ESSEX ELECTRONICS DIVISION, BERKELEY HEIGHTS, N. J.  
AUTOMATION PRODUCTS DIVISION, LEXINGTON, KY  
ESSEX ELECTRONICS OF CANADA LTD., TRENTON, ONT.

CIRCLE 19 ON READER-SERVICE CARD

# WASHINGTON REPORT



## ***SPACE SHOTS FEATURE NEW SENSORS, DETECTORS***

Two imminent satellite launchings by the National Aeronautics and Space Administration, will expose a variety of sensing and detecting devices to space phenomena.

One 83-lb spacecraft, to be orbited from Cape Canaveral, Fla., will study the behavior of energetic particles. This shot has been dubbed S-3. The other satellite, to be launched from Wallops Station, Va., will be a Scout (S-55) whose mission will be to observe micrometeoroids.

***The S-55 will carry*** five micrometeoroid detectors: pressurized cells, foil gages, wire grids, cadmium-sulfide cells, and impact sensors. Each of the sensors can produce a measurable electrical signal that can be stored and subsequently telemetered from orbit.

The pressurized cells are the primary sensors of the experiment. They are beryllium copper detectors composed of 160 half-cylinders from 0.1000 in. to 0.5000 in. thick.

Each of the 60 foil-gage detectors consists of a circuit developed from an electrochemical deposition process. The circuit, about 90  $\mu$ in. thick, is attached to 1-mil Mylar and mounted on the underside of 304 stainless-steel samples of rocket skin.

There are 46 wire grids, each consisting of a winding of fine copper wire mounted on 1.45 x 7 in. rectangular melamine cards.

The cadmium-sulfide cells are mounted in aluminum flasks. Their exposed surfaces are covered with a sheet of 1/4-mil Mylar, coated with evaporated aluminum on both sides.

The impact detectors—piezoelectric crystal impact-detecting transducers—are acoustically decoupled from the satellite structure and have three levels of impact-detecting sensitivity.

The electronic components in the satellite payload will have two functions. They will be used as a radio beacon during orbital tracking and as experimental telemeters during the approximately one-year lifetime of the scientific package. Two telemeters, working independently to enhance reliability, will be turned on by ground command, and after a minute of data transmission will be turned off by an electronic internal timer.

***High-density packaging*** has been achieved in the energetic-particles satellite. Ten detecting systems and associated electronics have been packed into 1.578 cu in. An octagon-walled platform, of nylon honeycomb and fiber glass, and having an aluminum cover 0.020-in. thick, houses most of the electronics and instruments. A transmitter in the base of the payload allows heat to dissipate through the structure and aluminum cover.

A magnetometer package, containing three orthogonally mounted saturable core magnetometers and calibration coils, reduces the field effects from the electronics and instruments. The vehicle will

carry 5,600 solar cells, weighing 11 lb, in paddles that will be spring-extended in flight. The craft also will contain an optical aspect sensor to determine the orientation in space of the satellite as a function of time.

The system has two basic parts: a digital solar aspect sensor, consisting of a light mask and a number of photo-diodes, and a digital computer to determine the time at which a photo-diode sees the sun and to remember which photo-diode had the input.

### **U.S. TESTS UPPER-ATMOSPHERE BLAST EFFECTS**

The Defense Atomic Support Agency is sponsoring several experiments on nuclear and conventional blast effects in the rarified atmosphere.

A contract has gone to Geophysics Corp. of America for a theoretical study of debris motion after high-altitude nuclear explosions. The company will develop an "idealized" problem in hydrodynamics capable of solution either in analytic form or by programming through computers.

The intense ionizing radiation from debris of high-altitude nuclear blasts increases the electron density in the upper atmosphere over wide regions. This may have widespread effects on radio and radar communications.

***In a Continuing Study*** of missile-warhead performances at high altitudes, the General Mills Electronics Group has lofted 500-lb explosive charges into the atmosphere aboard huge balloons. The program has been dubbed Project Banshee. Three of more than a dozen balloon flights have been completed.

The 200-ft instrumentation chain carried by the balloon includes a command-control and recording package, four pressure-sensing transducer stations, and the explosive charge. The instrument package is recovered from altitudes ranging from 38,000 to 115,000 ft.

The experiments collect data on blast over-pressure vs distance and time; shock-wave velocity, and the duration of the positive phase of the shock wave.

The Atomic Support Agency has for years been sampling radioactive isotopes through high-altitude U-2 flights. Tests over the Western Hemisphere have led the agency to conclude that 95 per cent of the strontium-90 generated by nuclear testing has filtered out of the atmosphere to the earth.

### **PIECEMEAL ATTRITION BY IMPORTS DISTURBS INDUSTRY**

A sector-by-sector invasion of the domestic electronics market by Japan threatens American electronics growth, a Congressional committee has been warned.

Robert C. Sprague, chairman of the imports committee of the Electronic Industries Association, favored trade restrictions, in testimony before the House Subcommittee on the Impact of Imports and Exports on American Employment.

Mr. Sprague, board chairman of Sprague Electric Co., also urged Congress to demand true reciprocity in international trade when it considers renewal of the Trade Act next year.

While the bulk of Japanese electronics shipments to the U.S. has been in transistor radios, competition is spreading to several components and other home-entertainment equipment, Mr. Sprague said.



# semiconductor products news

## Give 'Em the Axe, the Axe, the Axial

It's usually safer to give 'em the axe when the other school has graduated its entire first team, lost its quarterback due to a leg injury, and comes into the game with a line that averages 50 lbs. less than yours. If you want that kind of an edge when you put your tunnel diodes into play, give 'em the axial. G-E's new "back" diodes for ultra high speed computer switching circuits are extremely small, unusually fast and consume very little power in the new axial package shown below. The regular line of general purpose-computer tunnel diodes is also available in this package, in addition to the TO-18 package which has always been popular. We can also supply them in racoon coats, but the cost is rather high.

AXIAL DIODE OUTLINE

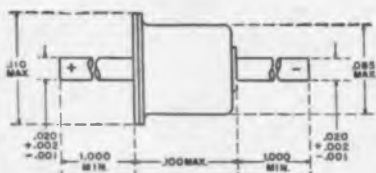

ALL DIMENSIONS IN INCHES.  
DIMENSIONS ARE REFERENCE UNLESS TOLERANCED.

Put PEP in your designs!

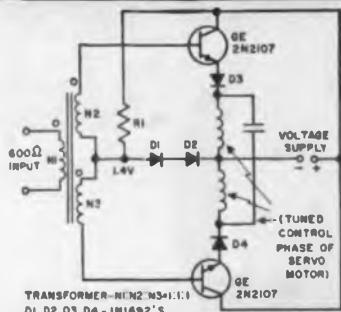

TRANSFORMER-N1N2 N3:1:1:1  
D1, D2, D3, D4 - 1N1692'S

SERVO MOTOR DRIVE CIRCUIT (1 TO 4 WATTS)

Put PEP in your designs!

## If high speed is your problem

... give the car keys to your wife, lock the kid's bicycle in the garage, sink the outboard motor, break the skis, sell the horse and lock yourself in the lab. Frustrated? No need to be. You can satiate that high speed mania by designing a real hot rod switching circuit for industrial and military applications with the G-E 2N705 germanium PNP triode mesa transistor. Gain bandwidth product is 600 mcs, and that's without shaving the head or turning the cam shafts.

For low cost computer applications, and other lower voltage and lower cost circuits, the 2N710, 2N711, 2N725 and 2N1646 types offer all the speed you'll need. For complete details, write to Section 23I106. You'll get your answer by return mail in nanoseconds (if the Post Office will cooperate).

## You May Suh, with a Mesa

... put industrial silicon transistors into your feedback and servo amplifier circuits (or any number of other medium power applications you might have in mind) at germanium prices. New low cost industrial silicon Mesas 2N2106, 07, 08 are like a refreshing hint of mint julep on a humid day if you want top performance at prices that will qualify you as an honorary Kentucky Colonel when the purchasing agent looks at the blueprint (not to mention the boss).

The servo motor drive circuit shown is just one example. Chapter 16 of the G-E Transistor Manual (5th edition) gives you many more feedback and servo amplifier circuit suggestions, and complete details. Don't be like Scarlett O'Hara and "think about it tomorrow." Read that chapter today ... the circuit you save may be your own!



If you have any questions, write us at Section 23I106. General Electric Company, Semiconductor Products Department, Electronics Park, Syracuse, New York. In Canada: Canadian General Electric, 189 Dufferin Street, Toronto, Ont. Export: International General Electric, 150 East 42nd Street, New York 17, New York.



**GENERAL ELECTRIC**

CIRCLE 20 ON READER-SERVICE CARD

# Today's most versatile 11" x 17" XY-(T) Recorder



Moseley Autograf Model 2DR Recorder, today's most compact 11" x 17" rack mount instrument!

## COMPACT RACK MOUNT

\*Built-in time base

Moseley Autograf Model 2DR Recorder mounts flush with rack, takes only 17½" of rack space, is only 5⅛" deep behind control panel, ideal for systems use.

Accepts ac or dc input on each axis, includes calibrated X-axis time base, scale factor vernier, 16 dc ranges, 8 ac ranges, 7 calibrated sweeps on X-axis time base. DC accuracy greater than 0.2% full scale. \$2450.

The Moseley 2D, a benchtop recorder, features the same size and flexibility advantages as the 2DR. This is today's most versatile bench instrument, has all the electronic features of the 2DR and is readily convertible to roll chart use. \$2350 roll chart accessory. \$450 additional.

Write today for full details



**AUTOGRAF** recorders

**F. L. MOSELEY CO.**

Dept. K-9, N. Fair Oaks Avenue, Pasadena, California  
Murray 1-0208 TWX PASA CAL 7687, Cable Mocopas

Field representatives in all principal areas • Data subject to change without notice • Prices f.o.b. Pasadena • Pioneer and leader in X-Y and Strip-Chart Recorders  
CIRCLE 21 ON READER-SERVICE CARD

## NEWS

### Industry, Military Use Teaching Devices

*Some Designs Sophisticated—  
Others Simple and Low-Cost*

**I**MMEDIATE markets for well-designed teaching machines for the military or industry are attracting many companies into this young but fast-moving field.

Equipment design in the many machines shown at a conference and exhibit on teaching machines and programmed learning in New York, Aug. 28-29, seemed to be taking two directions. Some designers are concentrating on simplicity and low cost. Others are directing efforts toward sophisticated machines capable of dealing with students of widely varying background and learning ability. Several exhibitors commented that military and industrial users had been much quicker than educators to see the advantages of both types of equipment.

The Mentor machine introduced at the show by Thompson Ramo Wooldridge, Inc., is one example of the sophisticated approach. The logic circuitry in the experimental model was said to be capable of controlling some 40 teaching machines. Time-sharing of the logic, by use of circuit branching, would allow each student to proceed at his own pace following individual programs based on questions posed by the machine.

#### Full-Logic Machines May Run to \$25,000

The final configuration of Mentor, and price, are not yet definite, according to a company spokesman. He indicated, however, that an individual machine with full logic probably would be priced in the \$25,000 range, and sets of centrally controlled machines in quantities of 200 to 300 might cost about \$6,000 to \$8,000 each.

Visual presentations are possible up to a maximum of 17,000 color frames or 25,000 in black-and-white. A magnetic tape synchronized with the visual material gives verbal information or instructions. Responses are made by pushing buttons at the side of the view screen.

Another sophisticated machine is the AutoTutor Mark II shown by Western Design & Electronics Div. of U. S. Industries, Inc. This machine, a scaled-down version of



*packaging flexibility...*

# **BURNDY MODULAR HYFEN**

*for single conductor, miniature and standard coax cables*

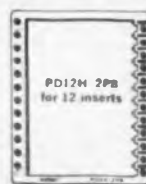
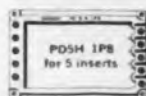
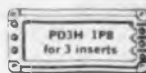
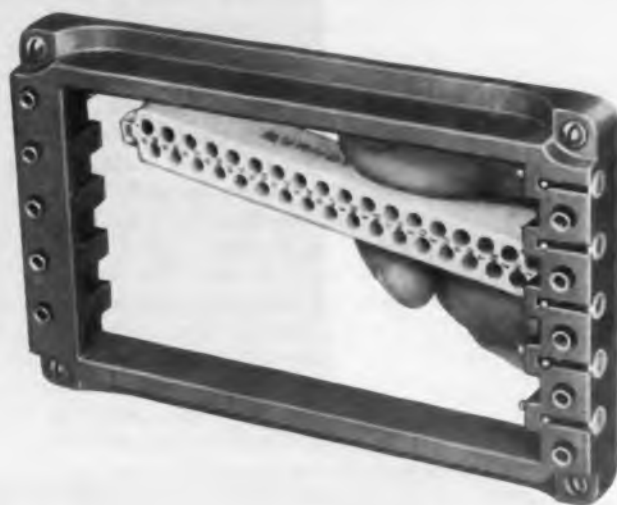

All Contacts Crimp-Type and Removable

## **1 SELECT FRAME AND ADD INSERTS**

Choice of 3, 5, 8, and 12 insert high strength metal frames. Inserts are high dielectric glass-filled molded material with excellent insulation characteristics. Metal ferrules molded in permit frequent insertion and removal of contacts without loss of contact retention force. Inserts may be mounted from front or rear of mounting panel. Jack screws fasten plug to frame, providing necessary engaging forces.

## **2 COMPLETE ASSEMBLY**

Pins and sockets, interchangeable in plug and receptacle, may be inserted before or after inserts are in place. Inserts accommodate 35 single conductor contacts, 21 miniature coax contacts, or 10 standard coax contacts. All contacts are completely crimp-type assuring high reliability of tool-controlled installations. Contacts are individually removable, providing versatility of gang or individual connect and disconnect.

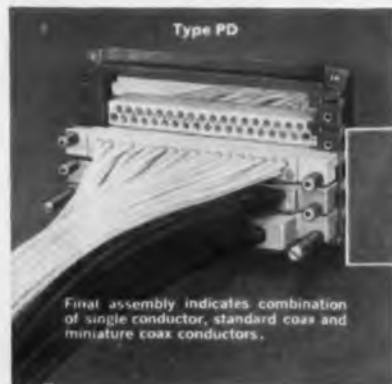

Type PD

Final assembly indicates combination of single conductor, standard coax and miniature coax conductors.

For complete engineering and specification details on the MODULAR HYFEN and other Burndy connectors for electronic use contact OMATON DIVISION

# **BURNDY**

NORWALK, CONNECT.

BICC—BURNDY Ltd. Prescot, Lancs., England

In Continental Europe: Antwerp, Belgium

TORONTO, CANADA

CIRCLE 22 ON READER-SERVICE CARD

**This Completely Reliable  
10 MC Counter/Timer  
Is Fully Programmable**



This is unquestionably the most versatile standard digital counter/timer available today. Every knob you see corresponds to an internal relay matrix that implements remote digital programming of its function. Driven from a tape or card programmer, with its output feeding a high-speed printer, it becomes a fully-automated timing and counting device of remarkable sophistication.

Consider this combination of capabilities:

- An operating range from DC to 10 megacycles.
- Three independent, identical amplifiers, employing the exclusive TSI level-sampling circuit.
- Nine functional modes, embracing every required counting and timing measurement.
- Nine time bases, from 0.1 microsecond to 10 seconds.
- Nine crystal-clock reference frequencies from 0.1 cycle to 10 megacycles.

In themselves, these capabilities constitute a counter/timer/frequency meter of unusual scope and flexibility. With remote programming, they are not equalled in any other commercial instrument.

All of this is done in 5¼" of panel height, through the inherent simplicity of NOR-logic and the thermal and physical efficiency of solid-state circuitry — without hot spots or crowding, and without compromising our admittedly hardheaded ideas about derating.

No plug-ins, no adaptors, no accessories — it's all built in. (Our Model 420 Frequency Extender can be used to increase the frequency measurement range to 220MC.)

The Model 365RP is one of 17 modern precision instruments in the TSI digital equipment line — fully transistorized, thoroughly proven, and completely reliable.

It will pay you to consult TSI when you need digital instrumentation in the real-time domain.

**10MC Remote Programmable Counter/Timer/Frequency Meter, Model 365RP 7-Nixie In-line readout.** Functions: Freq. 0.1 cps-10MC, Freq. Ratio, Period, Period x 10, Period Ratio A/B/C, Self-Test, Straight Count, Count/Internal, Freq. Std (0.1 cps-10MC). Accuracy,  $\pm 1$  count  $\pm$  stability. Stability,  $\pm 5$  parts/10<sup>6</sup>/week.

**TRANSISTOR SPECIALTIES  
INCORPORATED**

Sophisticated Digital Instrumentation



TERMINAL DRIVE, PLAINVIEW, NEW YORK • WELLS 5-8700

CIRCLE 23 ON READER-SERVICE CARD

## NEWS

### Industry, Military . . .

the company's original Mark I, is priced at \$1,250. Written material is presented on a view screen, and students punch buttons to indicate answers to questions. If incorrect answers are chosen, additional material is presented to clear up the student's misunderstanding; a return button is pushed to get back the original material. If a student's answer indicates a lack of understanding of a concept, a series of additional-information slides can be produced. If correct answers are given each time, however, the student progresses rapidly through the material and skips all supplementary data.

A demonstration of girls learning to make pig-tail connections with the aid of a new teaching machine made by Litton Industries, Inc., Los Angeles, and Prentice Hall, Inc., New York, showed the value of these devices for industrial applications. Color slides showing steps in the process were displayed on a view screen in front of the worker. Verbal instructions over earphones were used to describe each operation. The frames can be pretimed or can be switched by the operator with a foot pedal.

This machine, with 36 color-frame capacity and a magnetic tape that can be started over again by flipping a tape cartridge, is priced at \$545.

A similar machine, called Instructron, was shown at the exhibit by American Systems, Inc. Specifications for a Videosonic teaching machine, allowing a variety of slide material and verbal instruction techniques, as well as student responses through pushing buttons, were presented by Hughes Aircraft Co. This machine still is in the research stage, according to Hughes.

A new Management Information Control System was shown by Teleprompter Corp. It permits TV-screen presentations to be received by an executive at the side of his desk, allowing two-way visual, as well as voice, communication between executives in different locations. Data can be stored in a central control area and called for by an executive when necessary.

Transmission of the TV images in this system can be by coaxial cable or microwave link. This is currently expensive, but with the development of more microwave links throughout the country Teleprompter expects these costs to go down.

Price of the Management Information

Control System itself can vary from about \$50,000 to about \$400,000, depending on complexity. An initial installation has been made at Redstone Arsenal, Huntsville, Ala.

An automatic multiple-choice test called the Teletest Communications System, was shown by Corrigan Communications, Inc., Palo Alto, Calif. An instructor has a master console with five choice buttons. When a question is presented, he pushes the button for the correct answer. Each student then pushes a button at his desk to indicate his answers. If the student's answer is correct a green light goes on. If incorrect, a red light flashes and a new choice is made.

This technique is said to let the student know immediately when he has made a mistake, and allows him to determine the correct answer. His score on the test can be determined before he leaves the testing room. An added feature is a percentage meter on the instructor's console which indicates how many students were able to answer each question correctly.

The two-day conference was sponsored by the American Management Association. ■ ■

## Portable Feed Array Built



Feed array for antenna of AN/TPS-27 three-dimensional radar and data-gathering system is designed to be dismantled for convenient transportation. Array is being produced by Gorham Corp., Providence, R. I., for Westinghouse Electric Co.

# An 8-Fold Improvement In Stereo Controls



Here's the kind of variable resistor performance that pays off in greater circuit design freedom . . . in continued customer satisfaction. Thanks to their new high stability SURETRAK® elements, these new Stackpole single-shaft dual controls stay within initially close tolerances throughout years of use or disuse — and with minimum derating.

To learn more about this basic advance in variable resistors for stereo, ask your local Stackpole sales engineer about Type LST (bushing mount) or Type LST-T (twist-tab mount), or write: Electronic Components Div., Stackpole Carbon Co., St. Marys, Pa.

**1. High Stability SURETRAK® Elements** — the first inherently stable carbon composition elements. Less than 3% resistance change from 20°C to 105°C . . . less than 7% change under 95% RH for 240 hours at 40°C . . . negligible change with age and mechanical wear. Excellent load life at 70°C.

**2. Controlled Characteristics** assure that whatever resistance changes do occur will be of similar magnitude and direction in both front and rear SURETRAK elements.

**3. Automatic Element Matching** for maximum uniformity between front and rear elements.

**4. Zero Backlash** between shaft and both sections.

**5. Precise Mechanical Assembly** assures uniform electrical and mechanical performance.

**6. Velvety Smooth "Feel"** available if desired for professional quality stereo equipment.

**7. Tailored Attenuation** — Linear over all or only a portion of the attenuation curve as needed.

**8. Precision to Fit Any Budget** — Degree of tracking limited only by price considerations . . . as close as 1/2 db tracking now possible.

\*Trademark

## STACKPOLE VARIABLE composition RESISTORS

COLDITE 70+® FIXED COMPOSITION RESISTORS • SLIDE AND SNAP SWITCHES • CERAMAG® FERRITE CORES • FIXED COMPOSITION CAPACITORS • CERAMAGNET® CERAMIC MAGNETS • BRUSHES FOR ALL ROTATING ELECTRICAL EQUIPMENT ELECTRICAL CONTACTS • GRAPHITE BEARINGS, SEAL RINGS, ANODES • HUNDREDS OF RELATED CARBON AND GRAPHITE PRODUCTS

CIRCLE 24 ON READER-SERVICE CARD

## Now Pack More Data Into Every Cubic Inch with RCA HIGH DENSITY MEMORY STACKS...



### TEMPERATURE CONTROLLED WITHIN $\pm 2^{\circ}\text{C}$ ... DESIGNED TO MEET MIL SPECIFICATIONS

Occupying only 4.75 x 4.75 x 2 inches of space, this 4,096-word (8 bits per word) temperature-controlled magnetic-memory stack is available for a broad range of military, industrial and commercial computer applications.

RCA introduces new high density temperature-controlled memory stacks to meet the environmental extremes under which many of today's computers must operate. These new stacks incorporating RCA ferrite memory cores with specified wide operating margins are designed to cope with broad variations in power levels. In addition, they are built and tested to meet and exceed the environmental requirements of stringent military specifications.

**MILITARY RELIABILITY:** New RCA miniaturized high density memory stacks undergo and pass the MIL requirements pertaining to: Temperature Cycling, Vibration, Shock, Humidity, High Temperature, Barometric Pressure, Fungus Resistance, Salt Resistance. In addition, all stacks are 100 percent dynamically tested to assure the highest possible degree of dependability under actual computer operating conditions.

**WIDE VARIETY:** New RCA miniaturized memory stacks can be ordered in sizes to suit your requirements. Even the small-

est temperature-controlled versions will maintain a temperature of  $+85^{\circ}\text{C} \pm 2^{\circ}\text{C}$  over free air temperatures ranging from  $-55^{\circ}\text{C}$  to  $\pm 85^{\circ}\text{C}$ . RCA temperature-controlled stacks reach their  $85^{\circ}\text{C}$  operating temperature in only 15 minutes.

With these new miniaturized memory stacks RCA now offers one of the industry's most comprehensive lines of memory components. RCA magnetic memory specialists are ready to custom design virtually any stack you specify.

**SERVICE:** Your local RCA Semiconductor and Materials Division Field Representative is prepared to provide a completely coordinated applications service covering transistors, tunnel diodes and other semiconductor diodes, ferrite components and memory systems. Call him today. For further technical information, write RCA Semiconductor and Materials Division, Commercial Engineering, Section I-18-NN-2, Somerville, N. J.



The Most Trusted Name in Electronics  
RADIO CORPORATION OF AMERICA

**RCA SEMICONDUCTOR & MATERIALS DIVISION** - EAST: Newark, N. J., 744 Broad St., HUmboldt 5-3900 - (Camden, N. J. area), Erlon, N. J., 605 Marlton Pike, HAZel 8-4802 - Syracuse, N. Y., 731 James St., Room 402, GRanite 4-3591 - Baltimore, Md., ENterprise 9-1850 - **NORTHEAST:** Needham Heights 94, Mass., 64 "A" St., HILlcroft 4-7200 - **SOUTHEAST:** Orlando, Fla., 1520 Edgewater Drive, Suite 221, GARDen 4-4768 - **EAST CENTRAL:** Detroit 2, Mich., 714 New Center Bldg., TRinity 5-5600 - **CENTRAL:** Chicago, Ill., Suite 1154, Merchandise Mart Plaza, WHitehall 4-2900 - Minneapolis, Minn., 5805 Excelsior Blvd., WEst 9-0676 - **WEST:** Los Angeles 54, Calif., Box 54074, RAYmond 3-8361 - (San Francisco area), Burlingame, Calif., 1838 El Camino Real, OXFord 7-1620 - **SOUTHWEST:** Dallas 7, Texas, 7905 Carpenter Freeway, FLEetwood 7-8167 - **GOVT:** Dayton, Ohio, 224 N. Wilkinson St., BA 6-2364 - Washington, D.C., 1725 "K" St., N.W., FEderal 7-8500

## NEWS

### Audio-Visual System Aids In Training, Production

An audio-visual system that serves both as a training aid and as a continuous guide in production-line operations has been introduced by Graflex, Inc., a subsidiary of General Precision Equipment Corp.

Graflex's Audio Graphic System provides a synchronized sound and slide presentation. It features a simplified programing method and a relatively easy means of modifying a tape program to accommodate any change orders.

The playback unit weighs 35 lb and measures 17 in. x 15 in. x 13 in. It contains a 35-mm rear-projection 8 in. x 10 in. screen, amplifier, tape deck, speaker, earphones, volume control, and operator-controlled footswitches.

Recording on the instructor unit is done by means of a programing accessory, which contains microphone, controls for recording levels, stop signals and time-delay pulses. The programing unit plugs into the instructor.

Slides of each step in a job operation are shot with a 35-mm camera. The instructor holds 36 slides. Previously prepared commentary is read onto magnetic tape.

The instructor unit can be programed for continuous operation, demand operation, or timed operation. In demand operation, the tape mechanism stops automatically at the end of each block commentary, leaving the accompanying picture on the screen until the operator re-starts the tape by a footswitch.

An accessory enables the instructor to re-start itself in timed operations.

The instructor unit sells for \$695, the programing accessory for \$195, and the timer for \$95.



A worker at the Graflex plant follows an assembly operation on the Audio Graphic System projector. She hears commentary on earphone.



HEIGHT 20 IN. — WEIGHT 45 LBS.

## NEW LITTON INJECTRON\* HOLDS OFF 150 KV, SWITCHES 20 AMPS

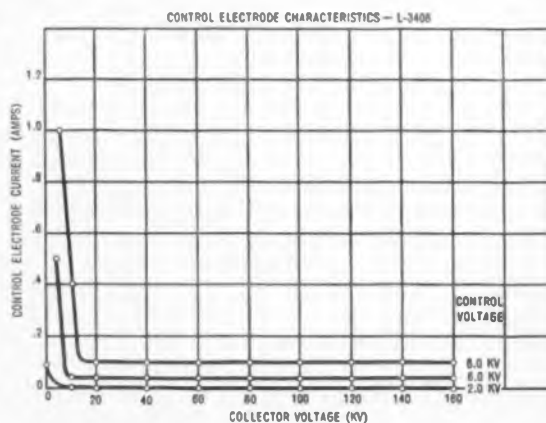
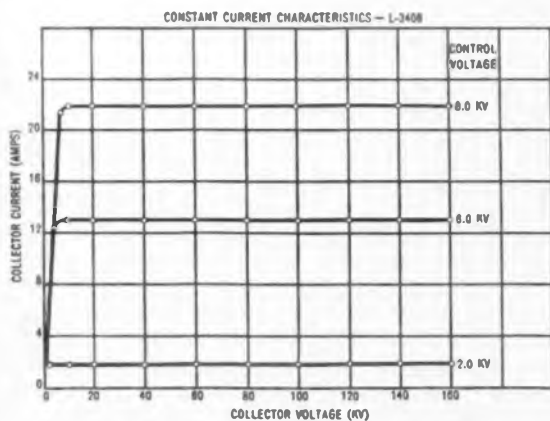

\*An advanced concept by Litton for high power beam switching with high efficiency and fast rise time. Requires only low control voltages. Collector current is largely independent of collector voltage, resulting in pentode-like current characteristics. Ideal for floating deck modulators for switching modulating anode klystrons. L-3408 is in field operation now. Other models for cathode switching to 750 amps, 350 KV coming soon. Contact us at San Carlos, California, for more information.

 **LITTON INDUSTRIES**  
**Electron Tube Division**  
 MICROWAVE TUBES AND DISPLAY DEVICES  
 CIRCLE 26 ON READER-SERVICE CARD

CIRCLE 27 ON READER-SERVICE CARD FOR AMPHENOL-BORG ➤

# Help stamp out close-quarter soldering

Miniaturization can be a mixed blessing. It's good when it conserves precious space and weight. It's bad when it creates a new gamut of how-do-you-put-it-together problems.

Take miniaturized rack and panel connectors, for example. They must be small, lightweight and reliable. But many of them are tough to put together. Consider the plight of the worker whose job requires soldering 50 molded-in contacts in a space not much larger than an air-mail stamp. The job gets done, but when?

One way to unmix the blessings of miniaturization is, obviously, to stamp out this close-quarter soldering.

The same thought occurred to Amphenol designers. In fact, they asked themselves, "Why solder to contacts after the connector is assembled; why not terminate, then assemble?"

So, they designed the Min-Rac 17... the first miniature rack and panel connector with Poke-Home\* contacts.

(To those who are not familiar with Poke-Home contacts—a brief exposition. Poke-Home contacts are so named because they are soldered or crimped to wires before the contacts are assembled to the connector. Contacts are then placed in the connector and pushed into the contact hole where they are firmly retained.)

► Although Poke-Home contacts were not new when Amphenol designers began work on the Min-Rac 17, the contacts were new to miniaturized applications. This spawned a few problems for Amphenol design engineers.

For instance: Working at contact spacings of .115 inch meant that extremely rigid molding tolerances had

to be established. (Tolerances are held to  $\pm .003$ " throughout the insert—some go down to  $+.001$ "  $-.000$ ".)

Materials selection played an important part, too. A long and exhaustive study of over 100 phenolic resins and thermo-plastics conducted by the Amphenol Materials Laboratory convinced Amphenol designers that Zytel 101 offered the optimum combination of strength, insulation-properties, resilience, and weight savings. More testing, more evaluation followed. Strength tests. Insertion and withdrawal tests. Salt spray tests. Finally, the Min-Rac 17 was ready to go.

► How successful was all this effort? We can only judge by what our customers tell us. An equipment manufacturer on Long Island tells us that the Min-Rac 17 made a significant difference in his direct production costs—not to mention the fact that his reject rate took a nose-dive when he switched to the Amphenol Min-Rac 17. Another was most grateful that we had at last provided him with a

way to get high-density crimped terminations into his equipment. (Imagine trying to crimp contacts by hand in a connector as small as the Min-Rac 17. Virtually impossible!) Still another customer in the San Francisco area is highly pleased with our float bushings, which allow him the leeway to correct for slight misalignment errors.

And so it goes.

► To those in our audience who may wish additional information on miniature rack and panel connectors, we make this no-obligation offer. Get in touch with an Amphenol Sales Engineer or Industrial Distributor (if you're in electronics, you're not far from one). He will be most pleased to share his knowledge of the Min-Rac 17, and all Amphenol connectors for that matter, in the hope that a solution to your connection problem may be found. Or, if you prefer, write directly to Dick Hall, Vice President, Marketing, Amphenol Connector Division, 1830 South 54th Avenue, Chicago 5, Illinois.

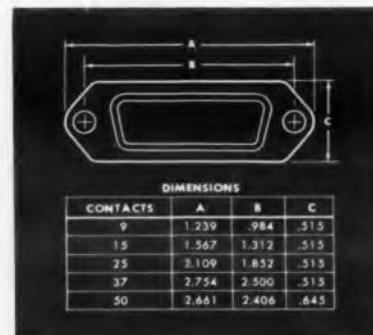

The Min-Rac 17 is designed to mate with other popular miniature rack and panel connectors. Therefore you can immediately apply the advantages of Poke-Home contacts to your present equipment without tooling expense.

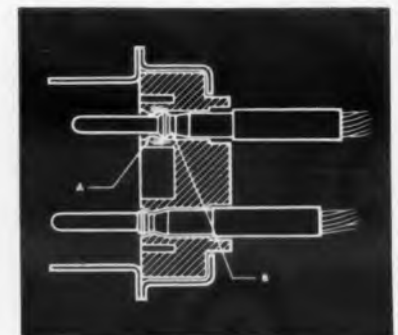

Poke-Home contacts "stay home" because of the precision-molded shoulder (A) and the groove (B) around the contact barrel. Although Poke-Home contacts are held firmly in place, they can also be easily removed if necessary.

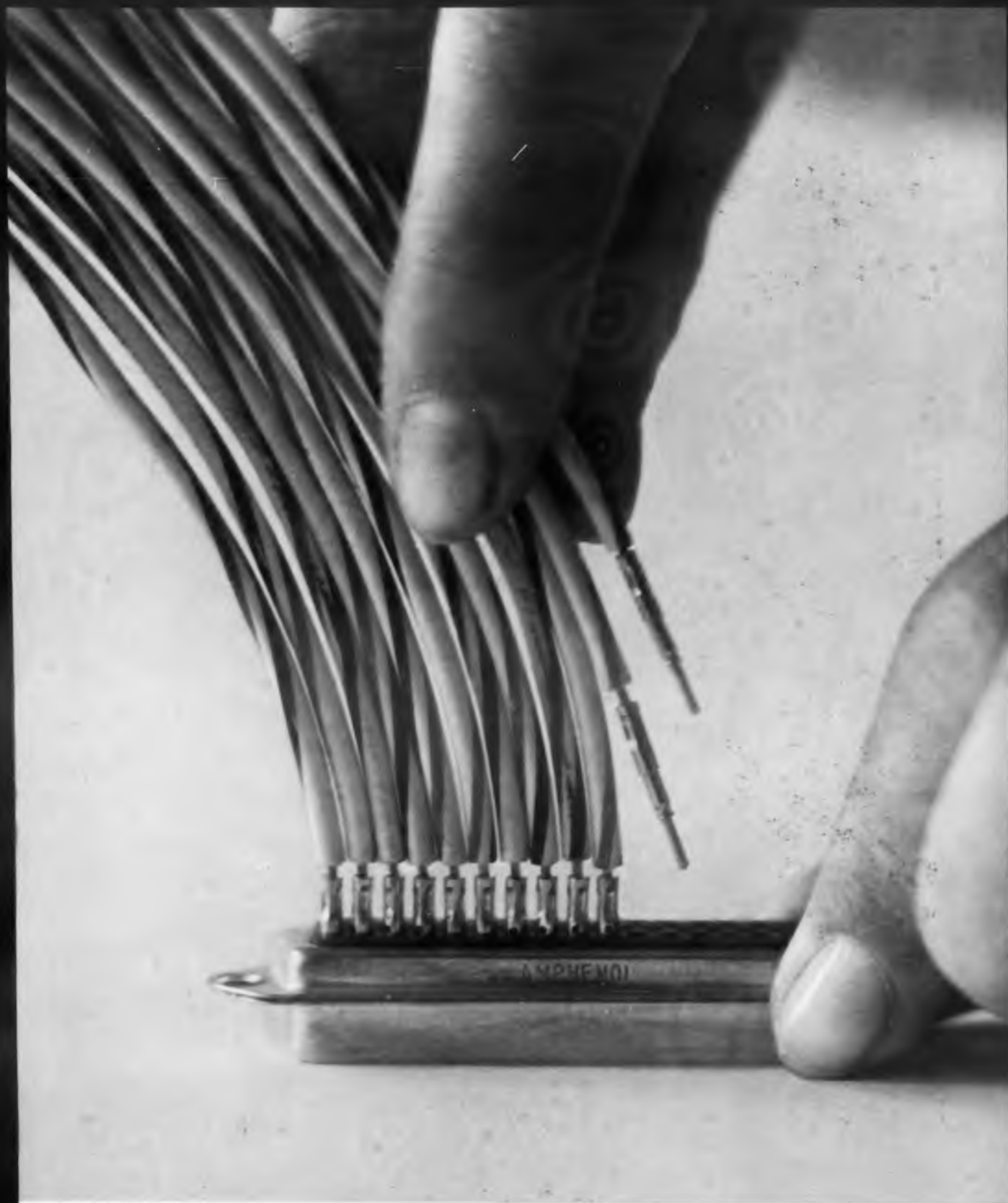

# Look to **FAFNIR**

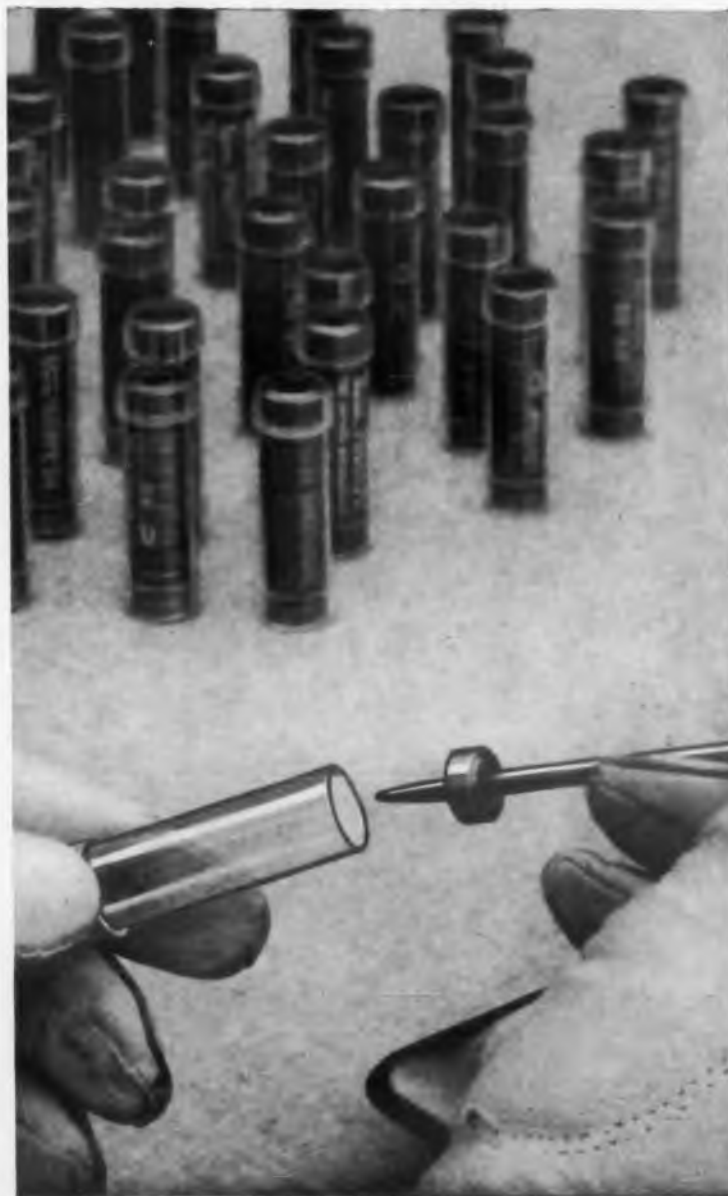

for these six important high performance features in miniature ball bearings

**1. Centerless Honed Raceways**

— The only miniature ball bearings with honed inner and outer races. Noise and vibration reduced to new, low levels.

**2. Vacuum-melt Extra-Clean 440C Stainless Steel**

— No pits or imperfections in balls, raceways. Provides better finish, super-sensitive performance, low torque values.

**3. Balanced Design** — Each size bearing has its own size retainer. No "make-do's". Fafnir "tailor-made" retainers assure optimum pitch circle of balls and bearing balance.

**4. Hardened Retainers** — Hardened 410 stainless steel retainers maintain proper and accurate form when assembled. No distortion. Retainer prongs remain springy, prevent permanent bend.

**5. Heat Stabilization** — Stabilized to 600° F. Standard Fafnir Miniature Ball Bearings take high temperatures.

**6. Precise Tolerances** — Bore, O.D., and internal geometry held to precise tolerances to meet the most exacting customer requirements.

Write for further information. The Fafnir Bearing Company, New Britain, Connecticut.



**MADE IN U. S. A.**

This stamp on a Fafnir Ball Bearing means finest quality and workmanship . . . dependable supply . . . competent engineering help . . . and responsibility in meeting your bearing needs. It's worth bearing in mind.

# FAFNIR

## BALL BEARINGS

CIRCLE 28 ON READER-SERVICE CARD



## Automatic Unit Titles Film At 170 Characters Per Sec

An automatic unit designed for the ground-support data-handling system of the B-58 bomber xerographically prints titling data taken from the aircraft's instruments onto the edges of coded aerial photographs. The system operates at a rate of 15 to 25 ft per min and 170 characters per second.

Designed by Photomechanisms, Inc., Huntington, N. Y., the unit handles film in widths of 9.5 in., 35 mm and 70 mm.

After the film is developed and placed in the titler, data magnetically taped during a reconnaissance flight are searched out, stored briefly, read out on a cathode-ray tube, imaged as letters and numbers onto a xerographic drum, transferred to the film surface, and fixed by chemical vapor.



Automatic film titler for B-58 ground-support system combines data taken during reconnaissance flights with appropriate photographs.

## Developmental Fuels Cells Use Porous Metallic Electrode

Several types of fuel cells under development at Electric Storage Battery Co., Philadelphia, use a porous metallic electrode, said to have the following advantages:

- It is unaffected by saturation with electrolyte if oxygen is low or cut off.
- It will operate efficiently at high current loads.
- It is resistant to corrosion caused by high temperatures or pressures.
- It has high electrical conductivity.
- It can be mass-produced in a variety of shapes.

In one fuel cell under development at the company zinc is oxidized in a potassium hydroxide electrolyte as oxygen is admitted under low pressure.

Another uses a gaseous fuel oxidized by oxygen from the air. This cell reportedly operates at room temperature and normal atmospheric pressure.

SPECIAL DELIVERY

### MINNEAPOLIS-HONEYWELL REGULATOR CO.

*Precision Meter Division*

**GRENIER FIELD, MANCHESTER, NEW HAMPSHIRE**

**TELEPHONE: NATIONAL 5-6971**

SHIPPED TODAY THRU

**CALIFORNIA:** Atlas Electronics Inc., 4618 Santa Fe St., San Diego 9, BR 4-3131; Bell Electronic Corp., 306 E. Alondra Blvd., Gardena, FL 1-5802; Bell Electronic Corp., 1070 O'Brien Drive, Menlo Park, DA 3-9431; Fisher Switches, Inc., 3199 Park Blvd., Palo Alto, DA 1-4080; Ley Co., Elwyn W., 16514 So. Garfield Ave., Paramount, NE 6-8339; Newark Electronics Corp., 4747 W. Century Blvd., Inglewood, OR 8-0441;

**CONNECTICUT:** Radio Shack Corp., 230 Crown St., New Haven, ST 7-7121; Radio Shack Corp., 29 High Ridge St., Stamford, DA 5-4371; **D.C.:** Electronic Wholesalers Inc., 2345 Sherman Ave., N. W., Washington 1, HU 3-5200; **GEORGIA:** Electro-Tech, Inc., 690 Murphy Ave., S. W., Atlanta 10, PL 3-4128; **ILLINOIS:** Newark Electronics Corp., 223 W. Madison St., Chicago 6, ST 2-2944; **MASSACHUSETTS:** Electronic Supply Corp., 205 Alewife Brook Pkwy., Cambridge, UN 4-6300; Radio Shack Corp., 730 Commonwealth Ave., Boston 17, RE 4-1000; **MICHIGAN:** Electronic Supply Corp., 94 Hamblin Ave., Battle Creek, WO 5-1241; **MINNESOTA:** Stark Electronics Supply Co., 112 Third Ave., No. Minneapolis, FE 6-9220; Stark Electronics Supply Co., 154 University Ave., St. Paul 3, CA 2-5292; **MISSOURI:** Van Sickle Radio Electronics Inc., 1113 Pine St., St. Louis 1, CH 1-2700; Walters Radio Supply Inc., 3635 Main St., Kansas City 11, VA 1-8058; **NEW YORK:** A & M Instrument Service Inc., 48-01 31st Ave., Long Island City 3, RA 6-4343; Peerless Radio Distributors, 85 Tenth Ave., N. Y. 11, OR 5-2400; **NEW JERSEY:** Bell Electronic Corp., 399 Rt. #10, land Cross Rd., Rutherford, WE 3-1460; State Electronic Parts Corp., 112 East Liberty Whippany, TU 7-2550; **OHIO:** Herringer Distributing Co., 112 East Liberty St., Cincinnati 10, GA 1-5282; **OREGON:** Branom & Leeland Instrument Co., 6019 N. E. Union, Portland, BU 5-5205; **PEENNSYLVANIA:** Powell Co., Harold H., 2102 Market St., Philadelphia 3, LO 7-5285; **RHODE ISLAND:** Wm. Dandreta & Co., 28 Wolcott St., Providence 8, UN 1-2800; **TEXAS:** Geophysical Supply Co., 1500 Crawford St., P. O. Box #2214, Houston 1, CA 4-0621; Wilkinson Brothers Co., 2406-2408 Ross Ave., P. O. Box #1169, Dallas 21, RI 7-1571; **WASHINGTON:** Branom & Leeland Instrument Co., 2137 2nd Ave., Seattle 1, MA 2-7320.

*Honeywell International Sales and Service offices in all principal cities of the world.*

HANDLE WITH CARE DELICATE INSTRUMENTS DO NOT DROP

**SAME-DAY SHIPMENT** of standard panel meters. DISTRIBUTORS, 26 in key cities throughout the country, insure you same-day shipment on all standard Honeywell Meters and prompt handling of all orders for our top-quality instruments. Just get in touch with our stocking distributor nearest you, (You'll find him listed above), our Sales Representatives, or contact us directly: **PRECISION METER DIVISION, Minneapolis-Honeywell Regulator Company, Manchester, N. H., U. S. A.** In Canada, Honeywell Controls Limited **Honeywell** Toronto 17, Ontario, Honeywell International Sales and Service Offices in all principal cities of the world."

CIRCLE 29 ON READER-SERVICE CARD

#### MISSILES

Sparrow  
Hawk  
Talos  
Sergeant  
LaCrosse  
Nike Hercules  
Nike Ajax  
Bomarc  
Snark  
Polaris  
Mace  
Matador  
Pershing  
Titan  
Atlas  
Minuteman  
SubRoc  
Mauler  
Skybolt



#### AIRCRAFT

F-102  
F-105  
F-104  
B-52  
B-47  
B-56  
B-70  
A3J  
F4H  
S2F-1  
F11F



*the world's most accurate and reliable*

*precision potentiometer*

The mirror-smooth conductive film resistance element, produced by advanced solid-state techniques, mated with precious metal multi-fingered wipers and all-welded precision construction results in:

- INFINITE RESOLUTION
- LINEAR AND NON-LINEAR OUTPUTS TO 0.01%
- MICROVOLT OPERATIONAL NOISE
- LIFE GREATER THAN 30 MILLION REVOLUTIONS

LINEAR AND POTENTIOMETER IN ALL SIZES AND SHAPES - WRITE FOR FREE CATALOG

**COMPUTER INSTRUMENTS CORPORATION**  
92 MADISON AVENUE • HEMPSTEAD, L. I., NEW YORK



# AVAILABLE FROM STOCK!

## C. I. C. PRECISION FILM POTS

You can have any of these precision film pots on their way to you within hours. No need to wait for "custom" pots.

### LINEAR SINGLE TURN FILM POTENTIOMETERS

Diameter	Resistance	Linearity
1/2"	1K	±.5%
	10K	±.5%
	50K	±.5%
7/8"	1K	±.5%
	10K	±.5%
	50K	±.5%
1-3/32"	1K	±.25%
	10K	±.25%
	50K	±.25%
1-3/32"	1K	±.5%
	10K	±.5%
	50K	±.5%
2"	1K	±.25%
	10K	±.25%
	50K	±.25%
2"	5K	±.25%
	20K	±.25%
	50K	±.25%
2"	5K	±.1%
	20K	±.1%
	50K	±.1%
3"	5K	±.1%
	20K	±.1%
	50K	±.1%
3"	5K	±.05%
	20K	±.05%
	50K	±.05%

### SINE-COSINE SINGLE TURN FILM POTENTIOMETERS

Diameter	Resistance	Conformity
1-3/32"	10K	±.75%
	20K	±.75%
2"	10K	±.25%
	20K	±.25%
3"	10K	±.15%
	20K	±.15%

### LINEAR MOTION FILM POTENTIOMETERS

Size	Resistance	Stroke	Linearity
1" Sq.	10K	1" Stroke	±.5%
		2" Stroke	±.5%
	10K	2" Stroke	±.25%
		2" Stroke	±.25%
	10K	3" Stroke	±.1%
		20K	3" Stroke

**WRITE OR CALL IN YOUR ORDER! POTENTIOMETERS WILL BE IN YOUR PLANT WITHIN 24 HOURS!**

FIRST IN FILM POTS



**COMPUTER INSTRUMENTS CORPORATION**  
92 MADISON AVE., HEMPSTEAD, L. I., N. Y.

CIRCLE 30 ON READER-SERVICE CARD

◀ CIRCLE 31 ON READER-SERVICE CARD



# EDITORIAL

---

## Incidence of Invention Greater If There Is Coincidence of Trial Answers

The demand for large, complex systems brought on the attendant need for team work and cooperation. Much was said a few years back about the need for group or committee engineering.

Then there followed rebuttal disagreeing with the hope of miracles from committees. Individualists pointed out that the final inspiration, insight, or understanding occurred to only one man. They thoroughly debunked engineering by committee and the later frequent necessity to debug the project team's effort, upheld the critique charge.

Nevertheless patents continue to be issued to co-inventors and sometimes tri-inventors.

In some cases, one inventor makes one contribution, the other a different contribution. But there are joint efforts in which the contributions are inseparable. The final invention unfolds in the minds of all concerned.

That more than one person should truly have the identical idea is not necessarily surprising. Prolific inventor, Jacob Rabinow, (the proximity fuse, the magnetic clutch, and many others) holds many patents, yet his "re-inventions" are even more numerous. Sometimes his flashes of insight were filed in the patent office 30 years earlier.

If we grant that they can be "invented" jointly, are two heads necessarily better than one? Do better inventions, better solutions result?

This is probably difficult to determine. But ignoring separate contributions and the acceleration of the investigation stages when more than one person is on the problem, it can be said that a joint effort will invent more. When the climate is such that inventions are needed and wanted badly, inventions come forth at greater rates. Similarly, when two or three people look at problems together they stimulate each other. And occasionally both see the answer in the same split-second. The day of the sole inventor is not over, but the joint probing of the uncharted yields many return signals in coincidence. Meaningful synthesis is then more likely. Do not overlook this process.

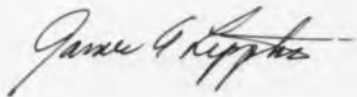

# MODEL 242 Resistance Measuring System



Accuracy  
**± 0.0001%**  
with  
KELVIN KLIP SIMPLICITY

**IN THE ESI SYSTEM CONCEPT OF PRECISION MEASUREMENTS—** the integration of design, instrumentation and "state-of-the-art" metrology technique to achieve the accuracy and precision of measurement demanded by modern science and technology. The matched assembly of Kelvin Ratio Bridge, DC generator-detector and Decade Resistance Standard provides the high accuracy and resolution essential for standards laboratory calibration measurements and is an ideal system for use as a production test unit.

- Compares the percentage difference between the unknown resistance and the product of the standard resistance times the multiplier. Bridge multiplier accurate to better than  $\pm 0.005\%$ .
- Makes comparisons to an accuracy of 1 ppm through the use of substitution techniques.
- Makes direct resistance measurements of  $\pm 0.01\%$  accuracy with clip lead simplicity without calibration or need for zero resistance or lead resistance corrections.
- With Model SR-1010 Resistance Transfer Standards, makes measurements over a wide resistance range traceable to an NBS certified standard with an accuracy of a few ppm.

Complete system in metal cabinet, \$3400, f.o.b. factory.  
Availability 45 to 60 days.

## KELVIN KLIPS

precision 242 accessories for rapid, high-accuracy, 4-terminal measurements. Send for Catalog C-31, ESI technical bulletins on techniques and advantages of the time and labor-saving 4-terminal method.



formerly

**Electro Scientific Industries**

7524 S.W. MACADAM • PORTLAND 19, OREGON  
**ELECTRO-MEASUREMENTS, INC.**

CIRCLE 32 ON READER-SERVICE CARD

visit our display  
**1961 ISA SHOW**  
Booth 83





An ELECTRONIC DESIGN Staff Report

# Bionics Efforts Center on Learning Machines

*Adaptive Systems Predominant as Learn-From-Nature Concept Spreads to Spur Novel Research Designs*

**Alan Corneretto**  
News Editor

**T**HE BIONICS concept—the application of biological knowledge to electronics—is spreading. Not only are there more organizations than a year ago supporting work in the specialty, but researchers are developing new types of equipment, such as sensors and variable-network systems. Further evidence of the concept's growth are new learning machines, pattern recognizers and other devices that have appeared beside the first neuron analogs and rudimentary self-organizing systems.

Bearing such names as Cybertron, Auditrans and Visilog, the new systems indicate that electronic designers are serious about achieving performance beyond the range of conventional equipment by adapting nature's techniques.

In addition to these systems, bionics investigators are working on reliability schemes, memories and research analogs of biological subsystems. Some electronic companies are conducting basic research in bi-

ology, aware that in many areas there is not enough information on living systems to support intelligent exploitation.

Some researchers hold that a detailed knowledge of biological systems is necessary before analogous electronics can be designed. Others believe that the barest inspiration from nature could lead to equipment and that experimental hardware should be built as soon as possible. They reason that nothing is really accomplished until hardware is working. Between these extremes lies the view that equipment design can begin relatively early but that it should be based on complete analysis of its expected operation.

The Autonetics Div. of North American Aviation, Inc., Downey, Calif., for instance, is developing a learning machine that will use a new component, a circulating combiner. This device, essentially a dynamic memory unit that holds large units of digital data in temporary storage while it automatically searches and combines pulses in various patterns, has been proved successful in simulations on a computer, Autonetics reports, but an additional program for more simulation

is being written to provide an even firmer basis for eventual hardware models.

At General Dynamics/Electronics, Rochester, N. Y., however, researchers would rush to exploit, if it were possible at this time, an admittedly "far-out" idea for a molecular memory for a learning system, based on doping macromolecules of one material with atomic quantities of bistable elements, like yttrium, whose state may be changed by photoconductivity.

Most bionic development, though, is done on a middle-ground by researchers who have been struck by an idea that appears useful and who do a reasonable amount of analysis before building research models of equipment on a practical scale to test their concepts.

## **Primary Design Goal Appears To Be Learning Machines**

Learning machines, mainly for pattern-recognition, are the current center of attention for bionics investigators. Designers are looking to nature for help with this equipment because the learning function has proved unattainable so far by convention-

ally organized electronics of practical size. Efficient pattern-recognition machines, especially for visual patterns, have a huge and immediate market awaiting in all sectors of the economy. Hence the great attraction of these systems for designers. The widespread activity in speech recognition is partly explained by the relationship of this specialty to the speech-bandwidth-compression problem, whose solution or even alleviation would also bring great rewards.

Most of the learning machines and adaptive pattern recognizers under development are of the neural-net type, including systems at Aeronutronic, Burroughs, Cornell Aeronautical Laboratories, General Electric-LMED, General Dynamics/Electronics, Philco, Stanford Research Institute and the University of Illinois.

Among the non-neural-net types are systems at Autonetics, Brooks Research, International Telephone and Telegraph Laboratories, Litton Industries, Melpar, Rabinow, Raytheon, and System Development Corp.

Several bionics programs are devoted to developing reliable systems, generally through redundancy of some sort, emulating nature's favorite type of construction. Redundant networks of neural-type logic are under study at Bell Telephone Laboratories, Radio Corp. of America, General Dynamics/Electronics, Wright Air Development Div., Massachusetts Institute of Technology and Air Force Cambridge Research Center.

Other redundancy projects include two programs at General Electric. One involves redundant basic logical function blocks, the other redundant components in power supplies. There is also a program at Magnavox in which redundant-component Quad circuits have been developed for most logical functions. And in the Signal Corps Advent communication satellite program, the satellite payload is being designed to use redundant components for reliability. ■ ■

## Melpar Learner Uses Statistical Switch

**A**MONG the non-neural-net learning machines under development is a system of Melpar, Inc., Falls Church, Va., that uses a "statistical switch" technique to achieve self-organization. A simple system that can be trained to provide a "0" or "1" output for any combination of binary inputs has been breadboarded. Melpar reports that under test this decision element achieved its maximum level of learning in about eight attempts for initial learning and 16 tries for complete relearning. The company hopes to apply the "self-organizing binary logical network" to pattern-recognition and adap-

tive-filter circuits. In other applications, the network's digital output would be converted to analog signals to give solutions to analog control problems.

According to Melpar, the statistical switch is the key to the self-organizing characteristics of the network. The average state—or fraction of the total open or closed period—of the switch over any period is modified and controlled by the learning process. In its initial state the switch averages approximately equal time in the open and closed positions. Learning becomes the adjustment of the average state of the switch toward a

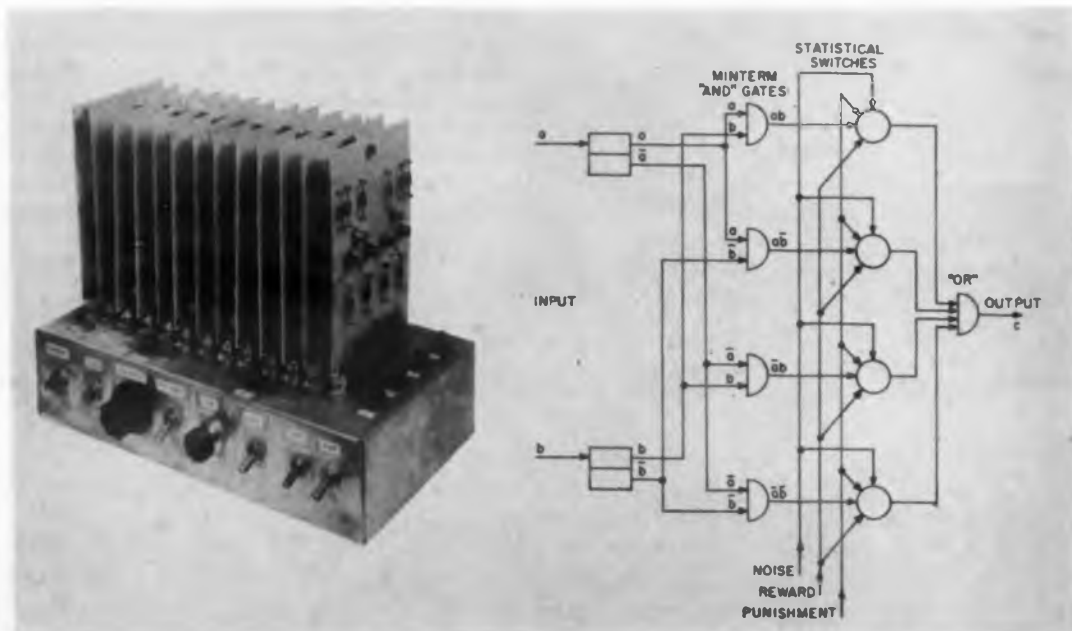

**Self-organizing** binary logical network breadboarded at Melpar can be taught to decide, on the basis of "reward" and "punishment" signals whether a "0" or "1" output is desired for any of the combinations of binary inputs. Key elements in the network are the statistical switches, which change value in accordance with what is learned, until each is completely open or closed for implementation of a logic function.

## BIONICS

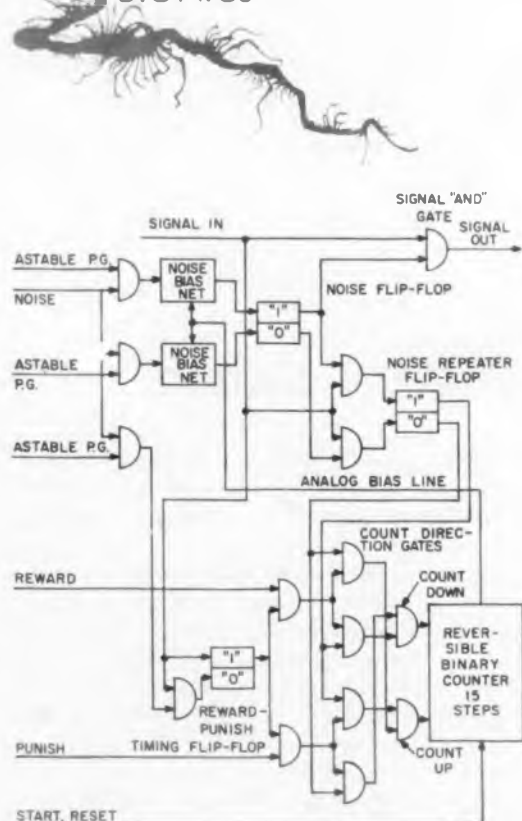

Typical statistical switch can be connected with other elements to solve all Boolean functions of any number of input variables. PG units are pulse generators.

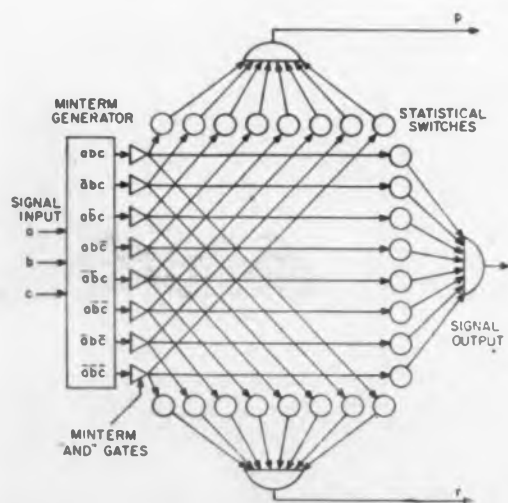

Self-organizing logical system for three inputs and two outputs is a more general version of the two-input-one-output unit. Because only those switches that connect input to output gates are contributing usefully for any one input, elements can be time-shared, thereby reducing their number and the system's complexity.

completely closed position, depending on the function to be implemented.

An input signal to the switch passes to the output through the Signal AND Gate, (see diagram), if the noise flip-flop is set to the "1" state. The average time this circuit spends in the "0" or "1" state is controlled by the number of trigger pulses passed by each noise-bias net. These pulses are generated by sampling a relatively low-frequency noise source with astable pulse generators having different pulse-repetition intervals, so that the AND-gate outputs are sharp spikes with a random and essentially independent time of occurrence. The noise-bias nets are resistor-capacitor-diode networks driven in push-pull by an analog bias voltage developed from the setting of the binary counter.

### Statistical Switch Uses Counter As Its Memory Element

A 15-step counter constitutes the memory element of the statistical switch. The analog voltage, corresponding to the count used to bias the noise-bias networks, is developed by summing currents in weighted resistors. The noise-repeater and count-direction gates accomplish the conversion to count-up and count-down instructions for the counter. When a signal pulse is received, it is fed through the noise-repeater gates to the noise-repeater flip-flop, setting it to the same condition as the noise flip-flop. This repeater function is said to be necessary because "reward" or "punishment" may occur after the input signal arrives, and during this interval the noise flip-flop may change its state.

If the function to be performed requires the closing of the statistical switch, reward

will cause the count to decrease, permitting more trigger pulses to pass through the upper bias network and fewer through the lower bias network, thereby increasing the average time for which the Signal AND Gate is operative. Punishment causes the counter to count up, which, in turn, reverses the process described. If the function to be performed had required the statistical switch to be open, the count direction for reward and punishment would be reversed. The reward and punishment pulses are applied to the count-direction gates for a finite time following the signal, as determined by the reward-punish timing flip-flop and gates. These gates ensure that only those switches that received signal inputs are rewarded or punished. The flip-flop is reset after a statistically variable period by sampling the noise generator with an astable pulse generator, as previously described. An AND gate and an inverter are included to inhibit the reset so long as the signal is present. (The signal may remain present for some time; it is not constrained to be a pulse.)

### Time-Sharing of Elements Could Hold Down Complexity

Melpar's studies indicate that any  $n$ -input-to- $k$ -output function requires  $2^n$  AND gates,  $k \times 2^n$  statistical switches, and  $k$  OR gates. Fortunately, because size of a learner increases rapidly with the number of input variables, a great number of problems can be specially simplified for solution in the network. In general, says the company, the more *a priori* information at hand, the less complicated the circuit will be.

In addition much of the hardware in a practical system could be used on a time-shared basis, it is believed. In the diagram of the three-input-three-output network, only those statistical switches that connect the input AND gate to the output OR gates are contributing to the performance of the network for a specific input. The other switches are kept idle until a suitable input is received.

Melpar plans to store the statistical state of each of these switches as a four-bit binary number to be read out to the output generator on command. In such a practical system, the output generator would comprise as many statistical switches as there would be required outputs. On generation of the output function, reward or punishment signals would be applied to the statistical switches

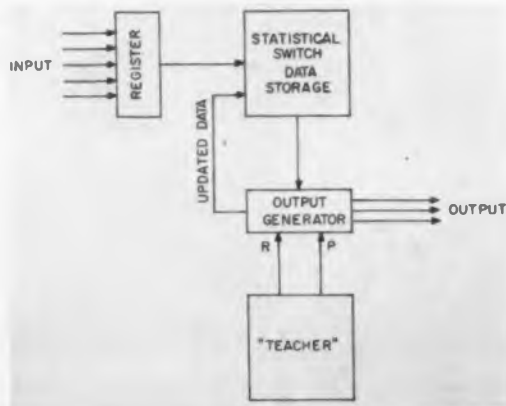

Practical learning system would have memory to permit time-sharing of basic elements.



## Waveform Recognizer Is Analog

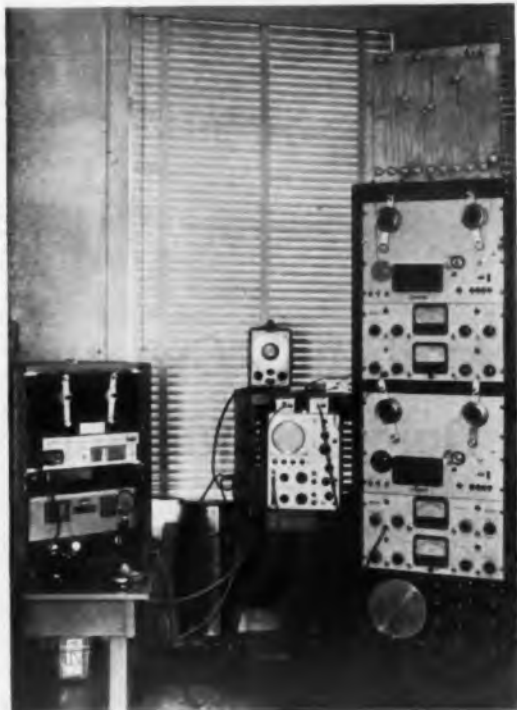

**Auditrans speech recognizer** under development at Bulova Research and Development Laboratories (ED, Aug. 2, 1961, p 16) uses tape-loop memory of spoken words against which input words are matched by correlation techniques. Actual comparison is of internally generated waveform envelopes based on amplitude or other characteristics. This research model is all-analog and has a 10-word memory. A practical system under development will probably have an optical storage system using a flying-spot scanner and cathode-ray tubes. Auditrans concept is said to be suitable for recognition of any patterns or waveforms.

in the output generator. The updated statistical states would then be returned to central storage.

If time were available and the outputs were independent of one another, a further reduction would be possible by implementing only one switch. This could be shared between the output generator stations.

Melpar believes that using time-sharing, a 10-input-four-output learning element, could be built in a standard relay rack. Such a unit would be the equivalent of  $1,024 \times 10$ -input AND gates, 4,096 statistical switches, and  $4 \times 1,024$ -input OR gates with a capability of organizing to any one of about  $10^{1,200}$  connectives. ■ ■

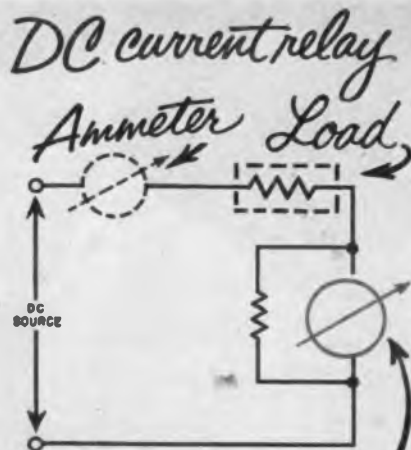

*Weston Sensitrol*

*AC voltage relay*

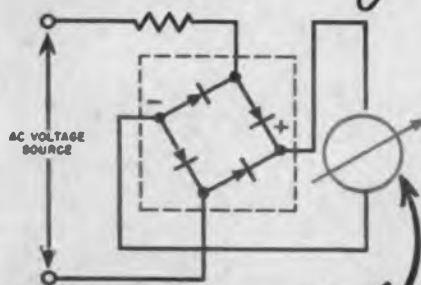

*Weston Sensitrol*

## WESTON SENSITROL FOR MORE RELIABLE CONTROL

*Model 1092—the most versatile, all-purpose relay... especially useful in prototype circuitry.*

A truly all-purpose relay, the Weston Model 1092 Sensitrol® is serving diverse applications from commercial display to production line control. This meter-type relay with magnetic contacts is also used for continuous pulsing control and in circuits for holding variables such as temperature, voltage and light levels within critically narrow limits.

**Simplicity of operation** is an important factor in the growing popularity of Model 1092. A single adjustment screw controls a wide range of accurately repeatable DC values . . . from 0-50 microamperes, or comparable span of 0-100 millivolts. This instrument can be mounted on magnetic or non-magnetic panels, thanks to special Weston Cormag® self-shielded movement.

It can handle up to 100 milliamperes at 120 volts AC or DC without chatter.

**Many economies** are possible with low-cost Model 1092 — another factor contributing to its wide application. Because it can be adjusted for an almost infinite number of settings, it eliminates the need for stocking a variety of relays in production work.

Call your Weston representative for full information about "Sensitrol" Relays, or write: Daystrom, Incorporated, Weston Instruments Division, Newark 12, New Jersey. International Sales Division: 100 Empire St., Newark 12, N. J. In Canada: 840 Caledonia Rd., Toronto 19, Ontario.



Model 1092 Sensitrol® Relay has built-in reset mechanism operated with 120 volts AC, continuous. Reset time 0.25 sec. Response time approximately 0.3 sec. Size: 3.5" diameter flush case for panel mounting.

**DAYSTROM, INCORPORATED**  
WESTON INSTRUMENTS DIVISION  
*Reliability by Design*



## How to shrink a filter!

Magnetics Inc. "120" solves the problem of core size vs. inductance in miniaturized circuits

Trying to squeeze high core inductance into a small space for use in miniaturized resonance, filter, audio, or carrier frequency circuits usually ends in a compromise. You either force more out of a smaller core, or you use a larger one. Not so, however, if you're familiar with the Magnetics Inc. "120."

This molybdenum permalloy core has a .655 inch outer diameter—is just between the .500 and the .800 inch core you may be using. What makes this little fellow unique is its inductance per 1,000 turns . . . higher than either of its neighbors, whether 60, 125 or 160 permeabilities.

Note, too, that like all Magnetics Inc. powder cores, the "120" is performance-proved and rated within realistic

inductance limits. All permeabilities are available from stock now. What's more, the 125 permeability core is inductance stabilized within  $\pm 0.1\%$  from  $0^\circ$  to  $55^\circ\text{C}$ .

More information on this and other cores in the Magnetics Inc. line is contained in design bulletin PC-203 R. It's yours by writing Magnetics Inc., Department ED-91, Butler, Pennsylvania.

**MAGNETICS Inc.**

CIRCLE 34 ON READER-SERVICE CARD

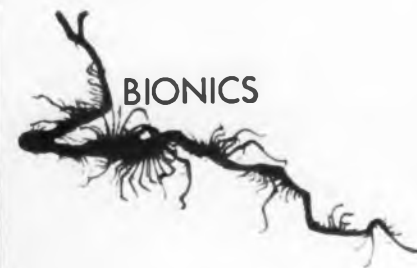

BIONICS

## Raytheon's Cybertron Doing Useful Work

**A** DIFFERENT learning technique, based on a special and reportedly powerful type of correlation, is used in Raytheon's Cybertron, a concept implemented in two different hardware systems. Both are digital, single-level, distributed-memory data processors designed to recognize time-varying signal waveforms. In operation they compare input with stored waveforms.

An operator, by pressing a punish-signal button, trains the Cybertron as it compares input signals with previously learned and stored memory functions. These are distributed throughout the elements of the system. The organization is such that if the input



Cybertron learning machine, Raytheon's K200, is designed to recognize speech through the use of special correlation techniques and stored vocabulary. A Flexowriter output will type phonetic symbols of sounds spoken into a vocoder type of input. Magnetic-drum memory, at far left, for stored sounds is used as an analog store.



**Distributed memory** in Cybertron is not critically dependent on linearity of system elements.

signal is incorrectly identified, it will be either added to or subtracted from the total of the system's stored experience. Correct recognition indicates that the system is a filter that is equivalent to the difference between the desired and all known interfering signals. Recognition initiates no modifying action.

The input signal is added to the memory when it is of a class whose output response is a signal that should be recognized; it is subtracted when its response should be rejected. As a result of this converging technique, the initial untrained memory is modified so it recognizes, becoming, in effect, a series of complex filters.

In the existing Cybertrons, actual association of new with stored information is made through use of the processing equivalent of a correlation integral. Other association techniques are planned for different situations, where signal-to-noise conditions or other factors would reduce the effectiveness of the correlation-integral method.

Raytheon reports that the basic association procedure and the technique by which the memory is modified are the key features of the system. Identification is said to be not critically dependent on memory errors, local memory failures, or linearity of the multipliers in the association and memory units.

#### **One Cybertron Already Working On Practical Problems**

A K100 Cybertron, constructed to test feasibility of the concept, is reported to be

THOMAS A.

# EDISON

sealed thermostats

feature close control,

lasting stability



Edison Sealed Thermostats are widely used in crystal ovens, electronic ovens and oscillator compartments—and many other electronic components adversely affected by temperature variations. Capable of maintaining temperatures within  $0.2^{\circ}\text{C}$ , Edison sealed thermostats offer these special features:

- Slow-make, slow-break principle, insures small temperature differential.
- Protective gas atmosphere minimizes effects of contact arcing under heavy loads, resulting in high stability.
- Radiant energy, and conducted or convected heat is rapidly transmitted to the bimetal by the highly conductive gas fill.
- Long bimetal arm is highly sensitive to temperature changes and assures accurate control, predictable performance.

For complete data on Edison Sealed Thermostats, write for Bulletin No. 3009B.

**Thomas A. Edison Industries**  
**INSTRUMENT DIVISION**

55 LAKESIDE AVENUE, WEST ORANGE, N. J.  
CIRCLE 35 ON READER-SERVICE CARD



# 600 MCS GAIN-BANDWIDTH PRODUCT... with General Electric's High Speed Germanium Mesa

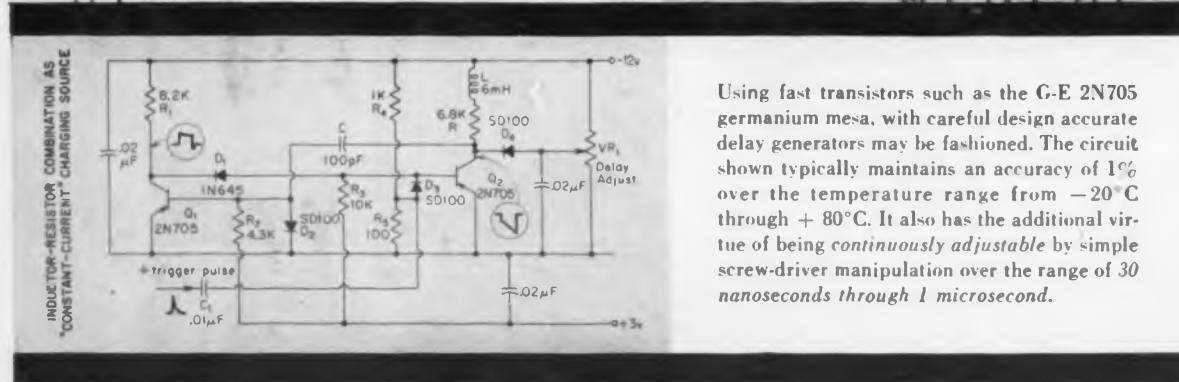
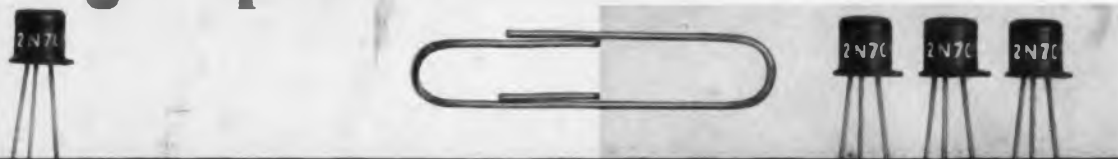
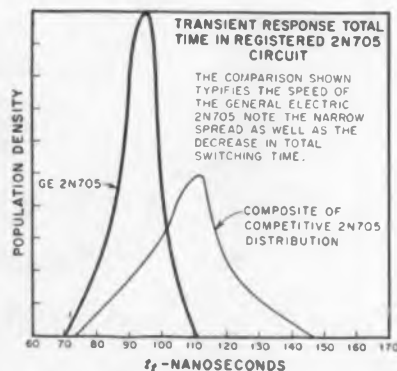

If high speed is your problem in industrial and military switching applications, G-E type 2N705 germanium PNP triode mesa transistor offers you the performance and reliability you have been looking for. Extended life tests to 7,000 hours document the reliability story. And gain-bandwidth product of 600 mcs answers the question of speed. It is also designed to meet the mechanical and environmental requirements of MIL-S-19500/B.

For low cost computer applications, specify General Electric 2N711. For other lower voltage, lower cost applications, types 2N710, 2N725, and 2N1646 are also available. Your Semiconductor Products District Sales Manager can give you all the technical details. Or write to Semiconductor Products Department, Section 231105, General Electric Company, Electronics Park, Syracuse, New York.



## GENERAL ELECTRIC

CIRCLE 36 ON READER-SERVICE CARD

### RATINGS AND CHARACTERISTICS (25°C)

Dissipation	2N705		2N711		mw
	150	150	150	150	
Total Dissipation (25°C Ambient)*					
Static Characteristics	Collector Cutoff Current (V <sub>CE</sub> = -5V)		Collector Cutoff Current (V <sub>CE</sub> = -5V)		μa
		-3		-3	
Voltage Characteristics	Collector to Emitter Breakdown (I <sub>C</sub> = -100 μa)		Collector to Emitter Breakdown (I <sub>C</sub> = -100 μa)		volts
		-15		-12	
	Collector to Emitter Saturation 2N705 (I <sub>B</sub> = -0.4 ma., I <sub>C</sub> = -10 ma)		Collector to Emitter Saturation 2N711 (I <sub>B</sub> = -0.5 ma., I <sub>C</sub> = -10 ma)		volts
		-0.3		-0.5	
High Frequency Characteristics	Gain-Bandwidth Product (I <sub>C</sub> = 10 ma, V <sub>CE</sub> = -5V)		Gain-Bandwidth Product (I <sub>C</sub> = 10 ma, V <sub>CE</sub> = -5V)		mcs
		600**		600**	

\*Derate 2 mw/°C increase in case temperature above 25°C.  
\*\*Typical

FOR FAST DELIVERY OF HIGH SPEED GERMANIUM MESA TRANSISTORS AT FACTORY-LOW PRICES, CALL YOUR G-E SEMICONDUCTOR DISTRIBUTOR

## BIONICS

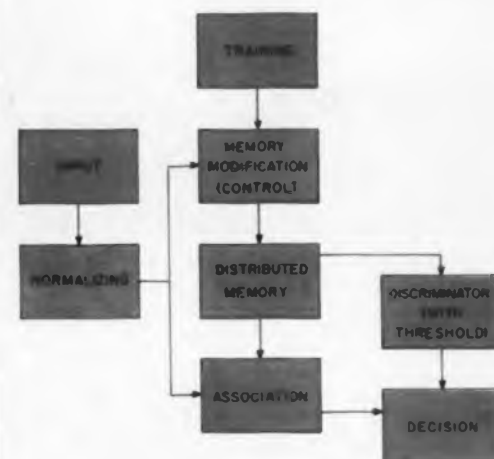
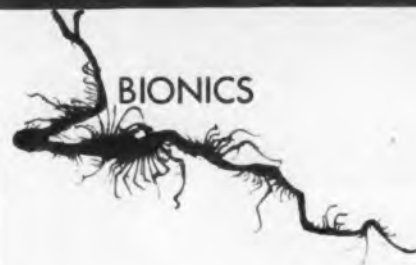

First Cybertron built has paper-tape input and output, can be trained to recognize patterns like this cardiogram curve, or sonar, radar or other waveforms. The system is now working on actual adaptive-recognition problems for a military agency.

working on spectral signature problems for a military agency. It has also been used for the design of a radar correlation filter. This system has a paper-tape input and memory and is not on-line. A much larger, K200 Cybertron is nearing completion. Designed to recognize speech in real time, it is being developed as part of a company-sponsored speech-bandwidth-compression program.

This system has a microphone and vocoder type of input, a Flexowriter output to type phonetic symbols of recognized speech, and a magnetic drum memory used as an analog store. The K200 has 192 learning elements consisting of storage, association and discriminator or control circuitry. It is designed to process 40 phonemes, enough to solve all speech recognition problems in the English language, according to Raytheon.

A visual-pattern-recognizing version is also under study, as are multi-level Cybertrons. Future systems may be analog; digital implementation was chosen for the existing units because of the availability of digital building blocks. The company says an analog

## Why Study Nature?

In his book, "Echoes of Bats and Men," D. R. Griffin shows that a case can be made for the bat in a comparison with airborne radar for target and obstacle detection by pulse echolocation. Here is how three echolocation systems compare:

	Airplane	Big brown bat	Little brown bat
Target detected		Insect	wire
Target diameter, d (cm)	300	1	$1.8 \times 10^{-2}$
Range of detection, R (cm)	$8 \times 10^6$	200	90
Weight of apparatus, W (grams)	$9 \times 10^4$	0.1	0.05
Emitted power, P (watts)	$10^4$	$10^{-5}$	$10^{-6}$
R/PWd	$2.9 \times 10^{-5}$	$2 \times 10^8$	$10^{11}$
$R^4/PWd^2$	$5 \times 10^{13}$	$1.6 \times 10^{15}$	$3.8 \times 10^{17}$
$R^4/PWd^4$	$5.5 \times 10^3$	$1.6 \times 10^{15}$	$1.2 \times 10^{22}$

In this table an allowance of 10 per cent of the bats' weight is made for those portions of a bat used for "radar" purposes. The first "efficiency" index,  $R/PWd$ , makes the AN/APS-10 look very bad. But this simple index assumes that range will increase in direct proportion to power; it does not allow for signal attenuation on both the outgoing and return legs. The second index,  $R^4/PWd^2$ , makes allowance for this fact and for the reasonable assumption that echo power varies as the square of the target diameter. The final efficiency index is adjusted for Rayleigh scattering, which becomes a factor in the domain of tiny target size.

implementation of the concept would be more natural.

A complementary system, Aide (Adapted Identification Decision Equipment), is also under study at the company's Norwood, Mass., laboratories. Aide would use the results of what a Cybertron learned to solve special recognition or other problems non-adaptively. Being a copy of the trained memory of a Cybertron, it would be much less expensive and complex than a system having a complete learning ability. This concept is being explored at several organizations where learning machines are under development. ■ ■

# HEAT EXCHANGERS BY STRATOS

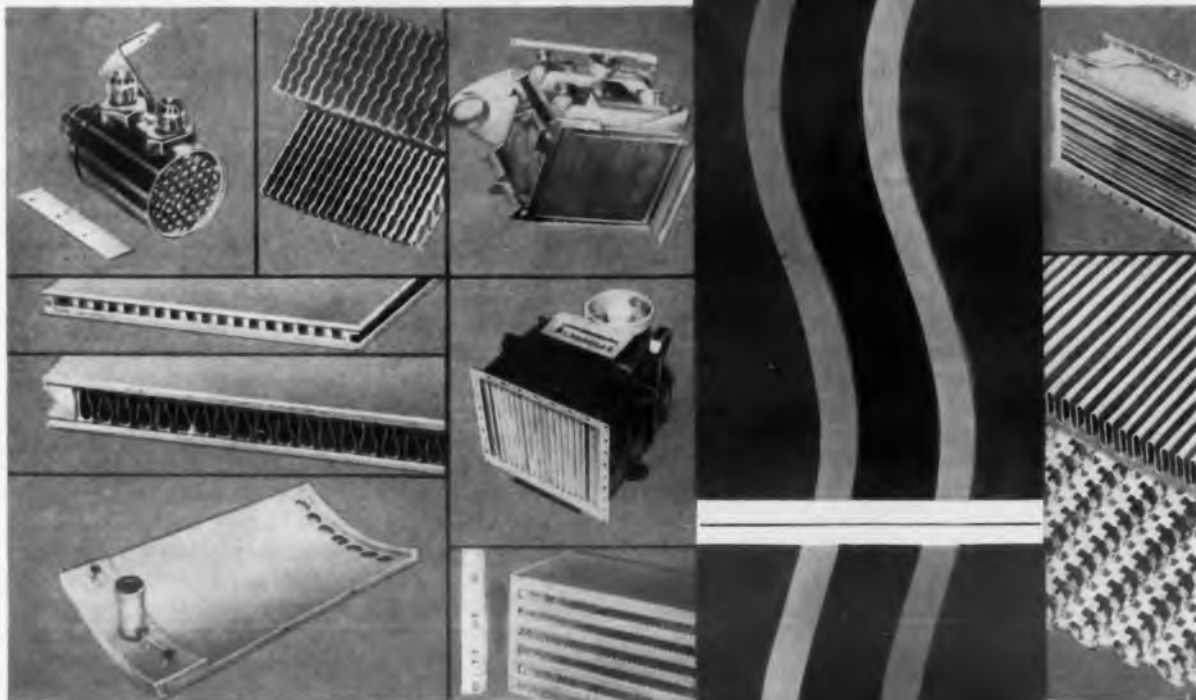

## Maximum heat transfer — Minimum pressure drop Plate and Fin — Tubular — Complex shapes

Light, compact, efficient! These service proven characteristics are finding more and more users for STRATOS heat exchangers. Why? . . . Commercial, military, marine and electronic cooling applications alike, benefit from STRATOS design advances.

"Custom" applications at reasonable prototype costs and in short lead times result from STRATOS design and fabrication techniques.

STRATOS combines the most effective heat transfer surfaces with given minimum pressure drop characteristics and proven structural design with fabricated materials compatible with the given application.

Air-to-air, liquid-to-gas or liquid-to-liquid, from cryogenic to extreme high temperature applications, STRATOS experience and capability in electronic cooling, refrigeration systems, cooling of oil and other liquids, can serve you. For additional information write—

# STRATOS<sup>®</sup>

A DIVISION OF THE FAIRCHILD STRATOS CORPORATION  
(FORMERLY FAIRCHILD ENGINE & AIRPLANE CORPORATION)  
DAY SHORE, L. I., N. Y.

CIRCLE 37 ON READER-SERVICE CARD

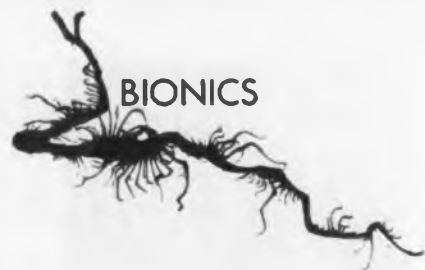

## BIONICS

# Variable-Network Perceptron Almost Completed at GD/E

**A** LEARNING machine specifically based on processes believed to occur in the human brain is being built at General Dynamics/Electronics. This system, called a variable-network distributed-state response model (DSR), is essentially a special-purpose digital computer with unique logic. It will be programmed to recognize visual patterns.

Like the perceptron developed by Cornell Aeronautical Laboratories, it consists of a set of multilevel association elements connected to a set of receptor cells and a set of response units. In both systems excitation of the sensory elements by a stimulus pattern causes a distribution of activity in the association elements. This distribution is marked by a change in some characteristic or value of the association elements. If following this

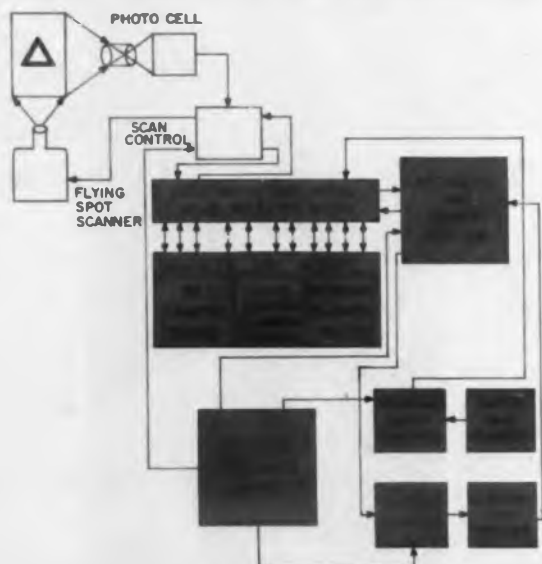

**Adaptive pattern recognizer**, distributed-state-response model, nearing completion at General Dynamics/Electronics is a special-purpose variable-network digital computer resembling a perceptron. Stimulating inputs from a scanner distribute values through synapse and association elements on track of disk memory and evoke a response, which changes the distribution of values. System can be trained by reinforcement of responses, so that input of a previously learned stimulus will correlate the distribution to evoke desired response.

change of value, a response element operates—either spontaneously or by being forced—a new permanent distribution of value is created. The new value is such that whenever the original stimulus pattern is again presented, it will correlate with the distribution, so as to favor the spontaneous operation of the previously associated response.

The digital DRS model is a variable network system, unlike the perceptron of the Cornell Aeronautical Laboratories, which has a fixed analog network through which voltage values are distributed to form memory and which is organized so that sensory units drive association elements directly. Variations in the DSR system's network are developed by synapse units that correspond to the connecting elements between living neurons. The synapse units lie between the sensory and association units of the DSR system. They are the source of signals for the association elements and receive feedback from the system's response elements.

By placing these variable synapses or impedances on the lead of every association unit, General Dynamics researchers believe they have solved the problem of impossible associations. This problem arises when the response of the system to one stimulus is completely incompatible with another association, that may later be desirable.

### Hardware Model of DSR System Designed to Recognize Patterns

A hardware version of the digital DSR system is nearing completion at General Dynamics. It has a flying-spot scanner input (equivalent to a  $32 \times 32$  photocell retina), 4,096 synapses, 256 association elements, 32 response units and a magnetic disk memory.

Programming the model consists of writing into each of the synapse words the address of the association element with which that word is associated, and into each of the response words the 16 different association elements with which each response is connected.

During reading, the spot of the flying-spot scanner scans the pattern to be recognized

in synchronism with the revolution of the memory and stores a "1" in the activity-bit position of all synapses that are connected to active portions of the pattern. The ambient values of the appropriate active synapses are then summed for each association element, and the resultant association-element values are summed for each response element. The responses may be of either the single (largest value) or multiple (coded) type. Reinforcement is achieved by depressing an appropriate typewriter key.

A smaller variable-network DSR model simulated on a computer performed very well, according to the company. The research system being built is expected to recognize patterns in a maximum of about 4 sec each. The company says a system built for practical use would recognize in microseconds. The characteristics of the variable-network DSR system have been summarized by General Dynamics as follows:

- Random organization of the association cells may be used but is not required.
- Memory traces are distributed throughout the system.
- Any cell may simultaneously participate as a member of many different memory traces.
- Increasing failure of elements causes a gradual decrease in performance rather than catastrophic failure.
- Memory is a process of response reinforcement rather than coded or classified lists of experience.
- Recognition is automatic and rapid, without any search and comparison.

The company is also considering multi-layer systems in which the responses of one model would be the inputs to another. Learning in such a system would be more spontaneous than the conditioned-reflex type predominant in single-layer models.

### Much Bionics Work Based On Organization of Human Brain

The General Dynamics work and that of many other organizations in bionics is based

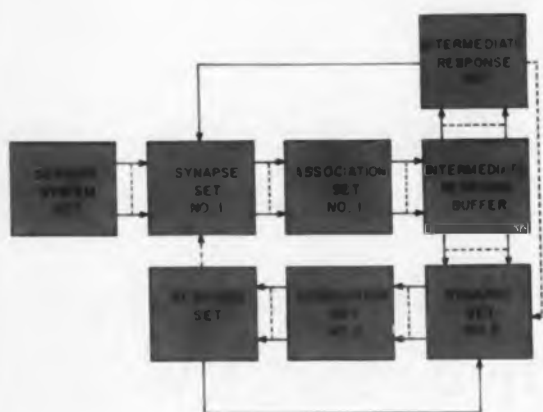

Multilayer distributed-state-response systems are also under study at General Dynamics. In this two-layer system, the responses of the first are inputs to the second. Independent feedback loops connect each response set to its synapse set. Third feedback loop (dotted line) is in effect a forward reinforcement mechanism by which reinforcement of events in the first layer could directly reinforce synapses in the second level. Learning in such a system would be more naturalistic than in any conditioned-reflex-type perceptron systems.

on the belief that much of the human brain is a randomly organized network of neurons with inputs from receptor cells, such as retinal elements.

In one hypothesis, stimulation of particular receptors is said to lead to the formation of closed systems of reverberating association area cells whose activity persists after the stimulation ceases. This activity in turn induces permanent changes in the active cells—changes that increase in depth every time activity occurs. The seat of memory in this model is composed of the synaptic junctions, and the model implies that the memory function is performed by changes in the transfer functions of these junctions. In effect, the brain could be conceived as a variable network in which the variation is achieved through modification of randomly distributed impedances.

Variable-network distributed-state-response models, perceptrons and other systems under development lean heavily on hypotheses such as these. The hope is that the power of neural-net logic can be combined with the advantages of microminiature electronics to achieve some of the performance of living systems—especially such functions as learning, low-power operation, reliability, self-repairability and large memory capacity. These are the incentives for much neuron and neuron analog research. ■ ■

# MEET THE WORLD'S FINEST DISTRIBUTOR TEAM



Francis R. Mine  
Airwork Corporation, Miami, Fla.



Lester Avnet  
Avnet Electronics Corporation,  
Westbury, L.I., N.Y.



John W. Busacker  
Contact Electronics, Inc.,  
Dallas, Texas



Harold M. Powell  
Harold M. Powell Co., Philadelphia, Pa.



Robert Avnet  
Avnet Corporation, Los Angeles, Calif.

... *... serving industry with quality*

## BENDIX ELECTRICAL CONNECTORS

Each member of this world's finest team heads an organization having experience, ability and facilities unmatched elsewhere in the field of connector distribution. The entire team works toward the same goal—fast, efficient supply of the Bendix® Electrical Connectors best suited to your exact needs.

They supply to industry a nearly incredible number of connectors—running into literally tens of thousands of models—through a system pioneered by Scintilla

Division in 1953. This is the *component assembly* technique, which anticipates connector needs and even permits overnight deliveries when required.

Their strategically located stocks are both broad and deep—with factory assembly and quality control standards that are extensions of those we maintain in our own manufacturing operations. Remember when you need high-quality connectors—your Bendix distributor can be an indispensable member of your team!

Scintilla Division

SIDNEY, N. Y.



Canadian Affiliate: Aviation Electric, Ltd., 200 Laurentien Blvd., Montreal 9, Quebec.  
Export Sales & Service: Bendix International, 205 E. 42nd St., New York 17, N. Y.

CIRCLE 38 ON READER-SERVICE CARD





Photo: Stelma, Inc., Stamford, Conn.  
Electronic Communications Systems

## Becco Ammonium Persulfate etches cleanly!

For etching printed circuits, Becco's ammonium persulfate process offers important advantages. As one large producer of printed circuits puts it: "Ammonium persulfate is better all around. We have experienced little trouble and far fewer rejects. It is more easily dissolved than ferric chloride, and can be safely

handled in large volumes, with resultant cost savings.

"Moreover, the persulfate solution etches cleanly with a minimum of undercut and can be used with all conventional resists, and on all laminates. A 'natural' for solder-plated resist."

Switch to Becco ammonium persulfate and get these advantages:

1. Various types of circuits can be etched in one system.
2. Etchant is relatively non-corrosive.
3. Etchant remains clear and transparent in use.
4. After-treatment is simplified.
5. Sludge formation is avoided during etching.
6. Waste solution can be easily disposed of.
7. Copper can be recovered from spent etching solution.
8. Venting of the etching area is unnecessary.
9. Equipment corrosion is minimized.
10. Cost of etching solution is low.
11. Conversion from other etching processes is simple and inexpensive.

Want more information? We'll be glad to send full details.  
Just write us at Department ED-61-18.

## BECCO Ammonium Persulfate

Putting Ideas to Work



FOOD MACHINERY AND CHEMICAL CORPORATION  
Becco Chemical Division

General Sales Offices:  
161 EAST 42nd STREET, NEW YORK 17, N. Y.

CIRCLE 39 ON READER-SERVICE CARD



BIONICS

## RCA Neuron Analog To Do Speech Work

AT Radio Corp. of America, Camden, N. J., speech investigators have developed a neuron analog said to have a firing rate that can be varied over a 30:1 ratio above threshold. The device is said to be basically a four-transistor, one-shot multi-vibrator with low-impedance input and output. Its time constants are reportedly about the same as those of human neurons.

A definitely ordered net of 100 of the neurons is being built for inclusion in a speech-research system that will be used to study the invariants of speech, RCA reports. Data acquired through use of the equipment, which will resemble the auditory pre-processing of humans, will be used to design a speech-recognition system that will use a net of neuron analogs and appropriate logic. The company hopes that the networks of its recognizer will have self-healing and self-optimizing capabilities. A visual-pattern recognition system is also under study at RCA.

Among features cited for the neuron analog are these:

- Low input and output impedances to minimize paths through the logic nets.
- Integration and refractory time constants that are independent of the input connections, because of the wide variance in the number and weight of the input connections to different neurons.
- Equal-strength excitation and inhibition connections, independent of transistor gain factors—for repeatability.
- Stable thresholds with a minimum of variation among circuits.

Computer simulations of networks of the neuron analogs combined with a model of the cochlea portion of the ear have duplicated many psycho-acoustic phenomena, such as masking, equal loudness, sensation, amplitude-independent frequency discrimination, and others, RCA reports. ■ ■

## GE/WADD Analog Includes EL-PC Cells

**G**ENERAL Electric, Syracuse, N. Y., has built and is testing a very elaborate neuron analog for the Wright Air Development Div. of the Air Force. This analog is designed to simulate an actual neuron closely and is believed to be the first hardware model that takes into account the action of the chemical environment surrounding an actual neuron. Electroluminescent-photoconductive cells are the basic elements of the simulation. Magnetic aperture cores are also used.

The complete neuron, it is hoped, will exhibit some of the properties of a biological neuron, including excitation, inhibition, threshold, summing and others. The el-pc cells and memory units in the transmission-line portion of the analog are organized in groups, called g-sets, that route signals coming from sensors or other neurons to other components. One 20-cell g-set receives signals from the same logic level; another 20-cell set receives signals from other logic levels. Added to these are automatic bias adjustments, which have a fix-or-forget memory, feedback loops to provide a weight factor, an output expander, and an output comparator. The comparator, actually a difference amplifier, combines the output of the units mentioned with a similar set that corresponds to a chemical environment. In biological systems this environment can affect the action of an individual neuron. ■ ■

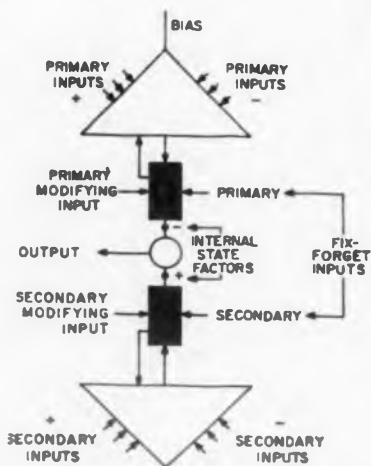

**Organization of WADD neuron analog** requires one group of components that represent line portion of neuron (below of center circle) and another to represent chemical environment surrounding a biological neuron (at right of circle).

**Twenty-input array** of cells for the neuron analog being built by General Electric for WADD is made up of transfluxor elements mounted on electroluminescent-photoconductive cells.

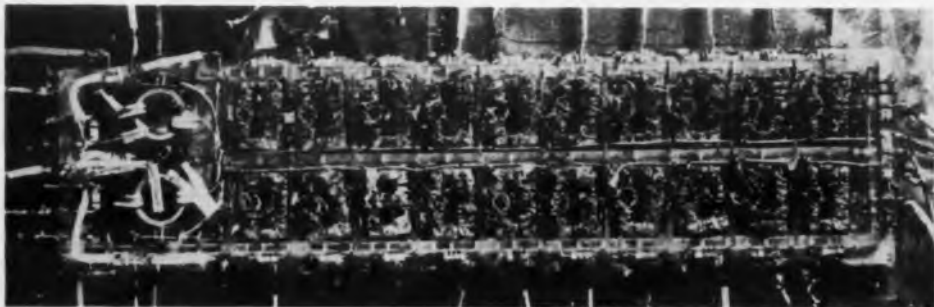

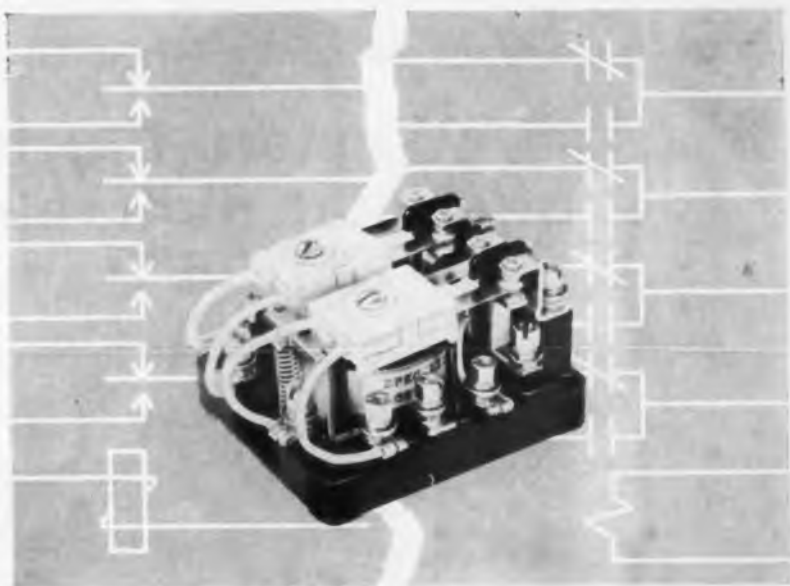

## NEW WARD LEONARD, 4-POLE RELAY

*more compact, more economical than ever  
...for relay circuits up to 10 amps*

Here's a new 4-pole, double-throw, power-handling relay that measures only 2-5/8" W x 3-1/8" H x 1-29/32" D and weighs only 11 ounces . . . only slightly larger than previous 3-pole relays, yet its contacts are rated up to 10 amps, non-inductive.

It's the new W/L NYLINE Bulletin 110 relay—another Ward Leonard relay you can stake your reputation on.

Look at these outstanding design features for long trouble-free life: Simplified nylon contact finger support to insure full electrical spacing and simplified contact placement . . . self-cleaning, self-aligning, silver contacts—for positive make and break with superior wiping action and follow . . . flexible silicone insulated leads connecting leaf-spring contact fingers and terminals . . . and many other big features.

You'll find complete information on the new 4-pole NYLINE relay (plus 2- and 3-pole models) in Ward Leonard Bulletin 110. Write for your copy and a list of stocking distributors today. Ward Leonard Electric Co., 77 South Street, Mount Vernon, New York. (In Canada: Ward Leonard of Canada, Ltd., Toronto.)

### ENGINEERING DATA—4-POLE DT RELAY

#### CONTACT RATINGS

Volts	D.C. Amps.*		A.C. Amps.*	
	N.O.	N.C.	N.O.	N.C.
0-24	10	10	10	10
25-125	1	1	10	10
126-250	..	..	10	10

COIL VOLTAGES: 6, 8, 10, 12, 24, 32, 48, 115, 230

AVG. COIL WATTS: 3.5 D.C.; 5.0 A.C.

PICK-UP: 85% or less of rated coil voltage.

WEIGHT: 11 ounces.

DIMENSIONS: 2-5/8" W x 3-1/8" H x 1-29/32" D.

\*Ratings are non-inductive.

RESULT-ENGINEERED CONTROLS

# WARD LEONARD

## ELECTRIC CO.

MOUNT VERNON  
NEW YORK

RESISTORS • RHEOSTATS • RELAYS • CONTROLS • DIMMERS  
CIRCLE 40 ON READER-SERVICE CARD

To Contractors and Subcontractors on U. S. Government Projects

## Western Electric offers the high reliability JAN 2N1195 Transistor

The JAN 2N1195 is a diffused base germanium mesa transistor for video, radio frequency, and switching applications. This transistor is not selected from a broad distribution of electrical values. Laureldale's controlled manufacturing conditions assure the circuit designer of uniform lot-to-lot transistor characteristics.

### MAXIMUM RATINGS AT 25°C

Power dissipation in free air	225 MW*
Collector breakdown voltage	30 Volts
Emitter breakdown voltage	1 Volt
Maximum junction temperature	100°C

\*Conservative - 300 MW capability has been established

### TYPICAL ELECTRICAL CHARACTERISTICS

$f_{ab}$	750 MC
$R_{ehie}$ (250 MC)	55 Ohms
C (dep)	1.2 $\mu$ f
$h_{fb}$ (1000 cps)	.98

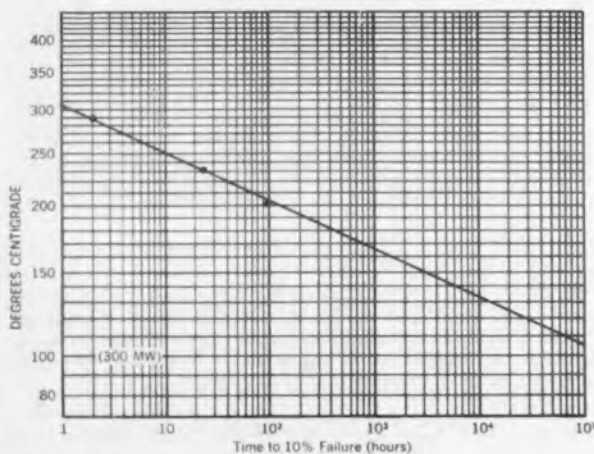

#### RELIABILITY

Lot by lot life tests have established a failure rate of less than 0.1% for 1000 hours at 100° C. This chart illustrates results obtained at high storage temperatures and demonstrates the inherent reliability of the JAN 2N1195 transistor.

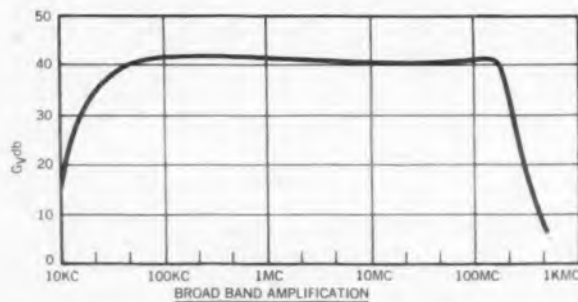

Insertion voltage gain of 8 stage amplifier using two JAN 2N1195's as output transistors.

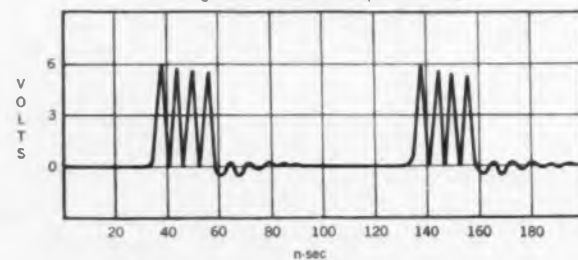

Output of 160 MC multiplexer using JAN 2N1195 transistors.

The JAN 2N1195 transistor can be purchased in quantity from Western Electric's Laureldale Plant. For technical information, price, and delivery, please address your request to Sales Department, Room 103, Western Electric Company, Incorporated, Laureldale Plant, Laureldale, Pa. Telephone - Area Code 215 - Walker 9-9411.



CIRCLE 41 ON READER-SERVICE CARD



## Moth's Sync Pulses Aid Neural-Net Study

**A**N APPLICATION of neurophysiology to communications is being investigated at the Air Force Cambridge Research Center, Bedford, Mass. The studies which are related to research on moths, established a relationship between synchronizing signals and the operation of the moth's sensory system.

Two of the three fibers that connect a moth's ear with its brain terminate in acoustic sense cells—those affected by acoustic stimulation. One of these cells is much more sensitive than the other. It responds to signals about 20 to 25 db weaker than those required to produce a response in the other. The third fiber comes from a large cell that apparently is not acoustic.

On the basis of two assumptions:

1. the large cells generate synchronizing signals that help the moth's brain decode acoustic signals such as "radar" pulses emitted by a moth-hunting bat; and
2. these sounds are first picked up by the sensitive cells; the Air Force researchers hypothesize that additional pulses from the less sensitive cells could confuse decoding and encoding by interfering with the sync pulses. This apparently happens when loud signals from bats are picked up by the less sensitive cells. The moth flies irregularly, as though taking evasive action, which could be explained as "faulty" operation of its desynchronized control system.

#### Neural-Net Logic Could Convert Parallel to Serial Data

The Air Force researchers believe that electronic neural-net logic may be able to

CIRCLE 234 ON READER-SERVICE CARD ➤



for quality  
**RELAYS, CRYSTALS,  
SEMICONDUCTORS**

NICKEL-SILVER • BRASS • COPPER  
MU-METAL • COLD ROLLED STEEL  
CUPRO-NICKEL • STAINLESS STEEL

## QUALITY CANS



**HUDSON**

has prototype  
quantities in stock



FOR DETAILS SEE OTHER SIDE.....

RETAIN THIS CATALOG SHEET FOR YOUR FILES

DETACH AND

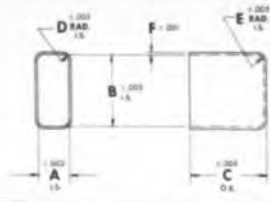

TC NO.	A	B	C	D	E	F
29-1	.359	.759	.852	.080	.020	.012
29-2	.359	.759	.870	.080	.020	.012
29-3	.359	.759	.977	.080	.020	.012
29-4	.359	.759	1.000	.080	.020	.012
29-5	.359	.759	.687	.080	.020	.012
29-6	.359	.759	.360	.080	.020	.012
29-7	.359	.759	1.375	.080	.020	.012
40-1	.359	.759	.877	.030	.020	.012
40-2	.359	.759	1.035	.030	.020	.012
40-3	.359	.759	.885	.030	.020	.012
41-1	.356	.756	.485	.080	.032	.005
42-1	.450	.700	.843	.047	.015	.016
42-2	.450	.700	.781	.047	.015	.016
43-1	.387	.787	.865	.093	.032	.010
44-1	.365	.765	.870	.077	.015	.012
44-2	.365	.765	1.141	.077	.015	.012
46-1	.354	.766	.326	.015	.015	.006
47-1	.363	.767	.870	.030	.030	.010
47-2	.363	.767	.977	.030	.030	.010
47-3	.363	.767	1.276	.030	.030	.010
47-4	.363	.767	.880	.030	.030	.010
47-5	.363	.767	1.312	.030	.030	.010
47-6	.363	.767	1.250	.030	.030	.010
48-1	.370	.782	.835	.026	.025	.008
49-1	.366	.770	.867	.035	.015	.012
49-2	.366	.770	1.437	.035	.015	.012
50-1	.344	.534	.383	.088	.025	.005
51-1	.179	.379	.595	.040	.040	.010
51-2	.179	.379	.775	.040	.040	.010
52-1	.550	.983	1.252	.061	.015	.012
53-1	.358	.768	.833	.015	.025	.014
54-1	.362	.767	.875	.032	.015	.012

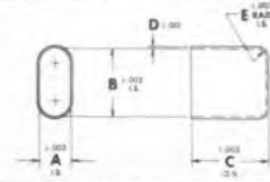

TC NO.	A	B	C	D	E
25-1	.318	.755	.850	.012	1/64
25-2	.318	.755	.870	.012	1/64
25-3	.318	.755	1.162	.012	1/64
25-4	.318	.755	1.175	.012	1/64
25-5	.318	.755	.881	.012	1/64
25-6	.318	.755	1.375	.012	1/64
25-7	.318	.755	1.152	.012	1/64
25-8	.318	.755	.988	.012	1/64
25-9	.318	.755	1.437	.012	1/64
25-10	.318	.755	.865	.012	1/64
26-1	.378	.881	1.175	.012	1/64
26-2	.378	.881	1.230	.012	1/64
30-1	.293	.698	.750	.010	1/64
30-2	.293	.698	1.640	.010	1/64
30-3	.293	.698	2.500	.010	1/64
30-4	.293	.698	3.000	.010	1/64
30-5	.293	.698	1.375	.010	1/64
30-6	.293	.698	1.500	.010	1/64
30-7	.293	.698	.572	.010	1/64
30-8	.293	.698	.969	.010	1/64
30-9	.293	.698	1.984	.010	1/64
30-10	.293	.698	1.750	.010	1/64
30-11	.293	.698	.322	.010	1/64
34-1	.298	.732	.483	.008	1/64
39-1	.350	.842	.785	.010	1/64

**Hudson Tool & Die Com**

18-38 Malvern Street, Newark

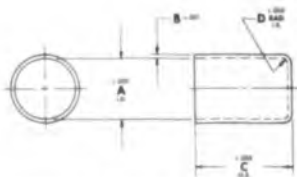

TC NO.	A	B	C	D
TC-3-1	196	.010	.300	.015
TC-3-2	196	.010	.340	.015
TC-4-1	222	.010	1.000	.015
TC-7-1	217	.008	.375	.015
TC-8-1	.290	.010	.562	.015
TC-9-1	347	.008	.875	.015
TC-10-1	.109	.012	.235	.015
TC-11-1	.2065	.010	.400	.015
TC-13-1	.229	.006	.375	.005

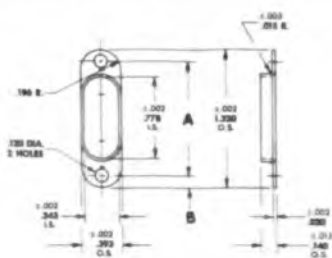

TCB NO.	A	B
TCB-1	1.078	.121
TCB-7	1.062	.129

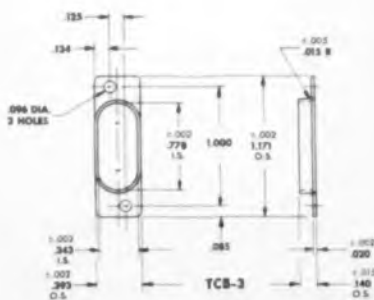
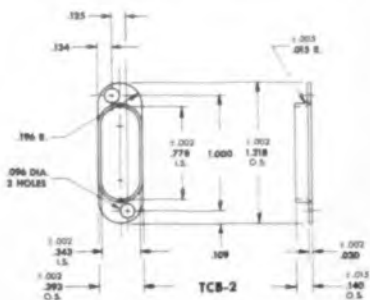

# Some Ideas



for your file of practical information on  
drafting and reproduction

— KEUFFEL & ESSER CO. —

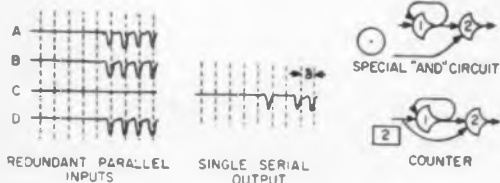

**AND and counter neuron-logic circuits** could transform four parallel inputs to a serial output. Numbers are threshold levels, and delta is spacing equal to synaptic delay of neurons. The delay could be used to synchronize signals.

perform the parallel-input-to-serial-output functions necessary to enable synchronizing signals to aid extraction of information from pulsed data. W. B. Bishop of the Cambridge Research Center has shown how a message carried by four parallel channels can be transformed to a single serial binary message on one channel by neural-net logic.

If the message 1101, shown is repeated four times on channels A, B, C, D, in the drawing, is processed by a suitable network of neurons that uses the AND and counter circuits shown, the output will be a single serial message. The two typical neuron circuits appear several times in the array. The AND circuit is the same as an electronic AND circuit except that exact coincidence of the two inputs is not required. Instead a pulse appearing on one fiber will keep the

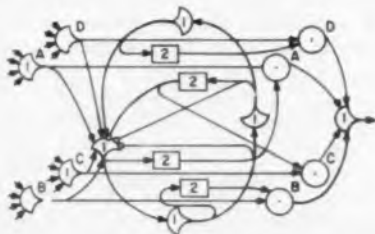

**Decoder arrangement of AND and counter circuits** in previous drawing (shown here as circles and rectangles) could transform A, B, C, D parallel inputs to serial, one-channel output. First signal to arrive starts pulse around heavy-line loop of self-exciting neurons. Inhibitor connections prevent succeeding impulses from generating more pulses in the loop. After circulating pulse makes its second trip around loop, it causes an output, provided that appropriate AND circuit has been facilitated by a pulse from another of the input channels.

The stone tablet and chisel were pretty widely used writing and drawing instruments in their day.

But they don't command much of a following any longer. Like so many tools of the past, they gave way to better methods of portraying information. Some of these methods occurred by accident, some were developed by experts to serve specialized needs. Three good examples of the latter are described here.

## A Couple of "Better" Pencils

When polyester drafting film first came into use, it was found that standard graphite pencils with clay binders, while fine for paper, smudged too readily on film.

So a new kind of pencil was needed—and developed. It was called the Duralar. With both binder and color agent made entirely of plastic. Duralar deposited a black, dense line on film, which could neither be smudged nor washed away.

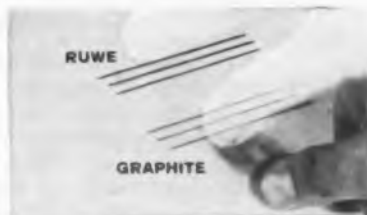

But since washability is not the touchstone of every drafting operation, K&E went a step further. Result—the Ruwe pencil. Having all the "fine feel" and erasibility of graphite, on both film and cloth, the Ruwe deposits a blacker, denser line than graphite, with the smudge resistance the old graphite pencil could not provide.

Here's why: the Ruwe pencil is graphite, but with a plastic binder instead of clay. Color coded in five degrees of hardness from 2S to 6S. Ruwe is available in wood pencils and leads. More good news is that Ruwe is now available in 2S and 3S hardnesses for fine-line automatic pencils as well. The lead is just .036" in thickness—ideal for free-hand lettering.

It's interesting to note, that since the introduction of Ruwe, other plastic-graphitic pencils have been placed on the market. If you're interested in testing the original we'll send free Ruwe pencils to you—just send the coupon.

## Now You See 'em... Now You Don't

For engineering drawings, or freehand sketches, K&E GUIDE LINE™ tracing papers, cloths and films make light work for you—by making light work for you. The light blue cross-section lines are visible to the eye, but will not reproduce on your diaz or blueprints. Other companies make similar products but here's the important K&E contribution: GUIDE LINE is now available in the widest variety of

drafting media ever. Specifically: ALBANENE® and CRYSTALENE® 100% rag stock tracing papers, PHOENIX® water-resistant tracing cloth and HERCULENE® polyester base drafting film. So whichever sheet you use, odds are it's available in GUIDE LINE first.

We especially recommend GUIDE LINE products for accurately guiding freehand work such as plant layouts, organization charts, electrical diagrams, etc. Your freehand work actually will look more like a finished detail than a sketch. And confidential notes will drop out too, if written or typed in special colors.

Available in a wide variety of grid sizes, GUIDE LINE comes in rolls or pads on ALBANENE and CRYSTALENE, in rolls on PHOENIX and HERCULENE, and can be supplied with your own title block or special heading.

Send for some free samples and the GUIDE LINE brochure.

## Through The Looking Glass

No more "Alice in Wonderland" wandering about when you want to locate the graph sheet you need for a specific job. Reason—K&E graph sheets now are packaged with a new "looking glass"—A time-saving visual package. This unique pack-

age has a window in the front so you can see the sheet inside. This is a boon, especially if you use a wide variety of graph sheets. Apart from the packaging, we've done a few other things to make graph-sheet selection easy and infallible.

Every user of graph paper puts it to a different task. So we have put together a complete line of graph papers, one or more of which will almost certainly meet your particular requirements. As a matter of fact, odds are 1000 to 1 that we already make and sell the sheet you require. In the event that we don't, we'll work with you to create it.

And we bend over backwards to make sure every sheet with the K&E symbol more than does its job. To insure accuracy of performance, every K&E graph sheet ever made was printed from precision-engraved plates by the letterpress process. The paper used—translucent or opaque—has at least 50% rag content—100% in some cases. And before any of it ever gets to the printer, it undergoes extensive examination in our quality control labs.

There is a lot more we could tell you about K&E graph sheets. We have prepared a selection guide for your use. If you'd like to have one, it's free, along with some sample sheets in the new visual package.

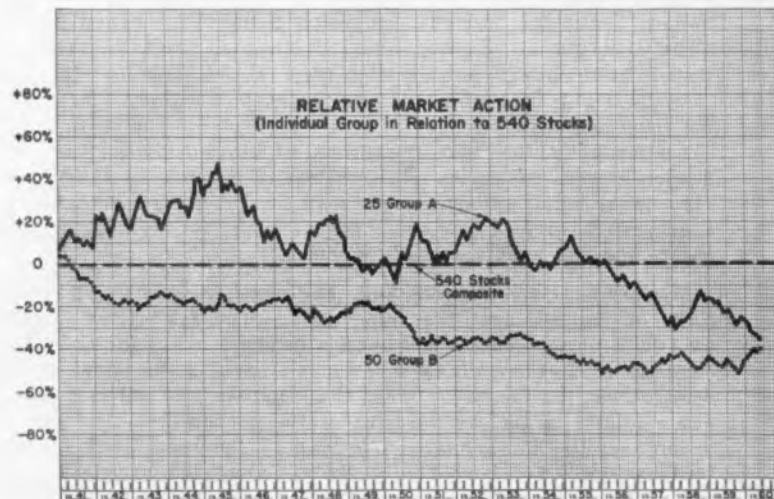

12,300 variables at a glance. Here's a typical stock market chart used to study relative market action. Center line is market behavior of 540 stocks over 20-year period. Two basic stock groups of 25 and 50 individual stocks, averaged, are plotted against market (figured at zero per cent). Resultant chart shows all-important slope of curve which—far more than gross increases—tells the story of the stocks' vitality. No list of statistics, no matter how exhaustive, could give the relative interactions shown here. This picture is possible only with a graph.

KEUFFEL & ESSER CO., Dept. 5D-9, Hoboken, N. J.

Please send me free:

- Ruwe Pencils  GUIDE LINE™ Brochure and Samples  
 Graph-paper Selection Guide and Samples

Name & Title \_\_\_\_\_

Company & Address \_\_\_\_\_

4234



## BIONICS

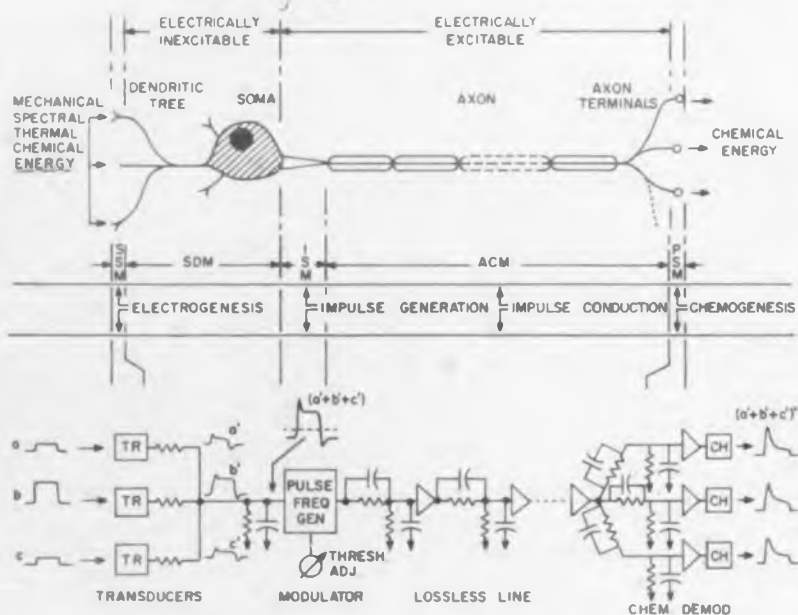

### A Neuron and Its Electronic Analog

Much bionic research is devoted to exploiting nature's neuron technology. To do this various models of neurons have been postulated as basic elements of proposed and implemented neural-net systems. The model shown here is a suggestion of J. F. Davis, Allen Memorial Institute, Montreal. It is intended as a clarification rather than as a proposal for implementation.

Anatomically the neuron consists of several distinct portions: the dendritic tree, consisting of a system of branching dendrites leading from many input synapses; the body of the neuron or soma; and the axon system, divided into three parts, the initial segment, the axon cylinder, and the axon terminal branches.

**Membranes Cover Neuron Cell.** The membranes covering various portions of the cell are: the sub-synaptic membrane (SSM) immediately subjacent to any input synapse on a dendrite or on the body, the soma-dendrite membrane (SDM) covering all parts of the dendritic tree and some except for the parts under the synapses, the initial segment membrane (ISM) in the general area of the axon hillock, the axon cylinder membrane (ACM) including a portion of the main axon and the axon terminal branches, and finally the pre-synaptic membrane (PSM) at the endings of axon branches where synapses are formed with other neurons.

**How Neurons Work.** This model assumes that nerve impulses, as electrical signals, do not cross the synaptic gap. Whatever electrical effect remains at the input synapses from the arrival of a volley of nerve impulses from the previous neurons is ineffective in causing this neuron to fire because of the electrical inexcitability of the sub-synaptic and soma-dendritic membrane. Energy (or information), usually chemical (but of mechanical, thermal or spectral type in the case of specialized sensory neurons) arrives at one or more dendritic inputs. This energy or signal passes through the dendritic structures and the body of the cell to the initial segment of the axon, and it is not until the signal arrives at this

point that the decision is made as to whether or not this neuron will fire. All of the neuron's capability for combining information (including some data reduction, summation, integration and other transfer functions), therefore, is built into these parts of the neuron.

**Several Electric Potentials Involved.** The energy input is converted into electrical potential signals by the process known as electrogenesis, various types of potentials are involved: generator potentials, excitatory post-synaptic potentials and inhibitory post-synaptic potentials. These may correspond perfectly in waveform to the waveform of the input energy or they may be somewhat distorted by partial differentiation. By electrical conduction through the cell and surrounding electrolyte these potentials reach the initial segment of axon where they are summated. At this point the effective summated potential may be altered by a biasing or threshold effect in which local dc or slowly changing or rhythmic electrical fields in the vicinity of the cell body may play a part.

Impulse generation, then, occurs at the initial segment and the impulses (representing a pulse-frequency-coded version of the summated and modified input information) are conducted along the axon cylinder and out to the end of the axon terminal branches without any further change in amplitude or waveform. At the ends of the output branches the electrical impulses each release a small amount of chemical transmitter substance into the synaptic gap (a process that can be called chemogenesis) so that the output energy or information appears in the form of a release of chemicals, the changing concentration of which represents decoded or demodulated signals resulting from the volley of impulses coming down the axon.

**How Electrical Analog Works.** In the electrical analog, chemical or other forms of information ( $a$ ,  $b$ ,  $c$ ) are shown entering transducers that convert the chemical information into electrical information of approximately equivalent waveforms, but sometimes slightly modified (as shown in  $a'$ ,  $b'$ , and  $c'$ ). These generator potentials are added together in a resistive network, but there is a time constant or capacitive factor in this network, which allows some integration to spread out over the time axis. The initial segment of axon is shown in the analog as a pulse frequency generator into which is fed the summated potentials ( $a' + b' + c'$ ) and upon which operates a bias effect or threshold effect (shown as a horizontal broken line in the waveform).

**Transmission Line Is Lossless.** The analog of the axon cylinder and branching is shown as a lossless transmission line with virtually perfect phase characteristics such that the impulses from the pulse-frequency generator arrive at the outputs in the same form in which they were generated except for a delay in time. The output electrical impulses pass through another set of transducers that convert them to chemical signals. The time constant of the chemical demodulation process is such that the output chemical signal represents the envelope or integrated version of the arriving volley of impulses. The branching at the axon terminal has a multiplication effect in which each terminal ending releases the same chemical signal. These output signals are, therefore, chemical analogs of the modified and combined chemical inputs to the neuron. They may be used by one or more succeeding neurons in passing the data onto other parts of the central nervous system.

**This Neuron Is Analog.** The neuron in this model is an essentially analog device, in which several analog signals are combined and modified in some way meaningful to the position in which the neuron functions relative to the central nervous system as a whole, and giving out a somewhat delayed signal, also in analog form, which represents the combined information. The discontinuous signals observed when an electrode is placed on or near the neuron or its axon should not be seen as representing digital or binary nerve-cell activity but as a pulse-frequency-coded version of the analog signal in the course of transmission to nearby or distant parts of the nervous system.

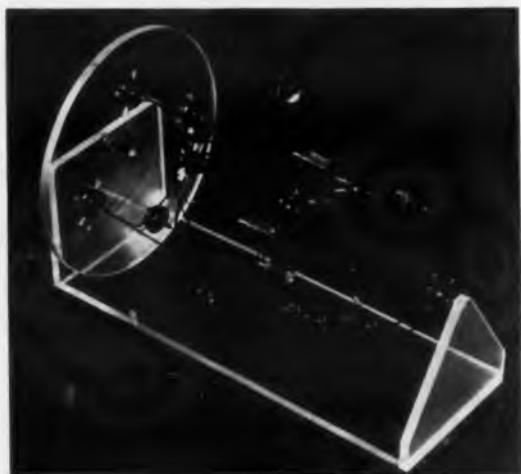

**Model of neural net** for parallel-to-serial conversion shows vertical loop with self-exciting neurons on it, complete spheres representing AND circuits of other neurons, cylinders representing counter circuits, and input and output neurons.

"2" neuron facilitated, or receptive, long enough to allow a pulse on the other fiber to trigger the neuron and produce an output. The counter circuit performs the same function as an electronic counter. Although the circuit shown counts only to two before producing an output, a cascade of similar circuits could count to any number.

A complete network to produce a serially coded output from repeated parallel inputs is shown below. The chain of self-exciting neurons appears in heavy lines. Circles are AND gates, rectangles are counters with numbers showing how far the circuit counts before giving a single-pulse output. Numbers in fan-shaped neurons show threshold. The first impulse to arrive on A, B, C or D fibers will start a pulse on its way around the loop. Inhibitor connections prevent succeeding pulses from starting more pulses in the chain. Outputs will occur as this circulating pulse makes its second trip around the loop, provided that the appropriate AND circuit has been facilitated by a pulse from one of the parallel channels. Inhibiting connections cancel the circulating pulse after two trips around the loop. A three-dimensional, nonworking model of this system has been built.

Studies are underway at the Cambridge Research Center to adapt neural-net probabilistic logic to computational and communication problems, including possible secure communications links. ■ ■

# 15 SECOND CURE

\*\*\*\*\*

## ONE YEAR SHELF LIFE

\*\*\*\*\*

## NONBURNING

*Parts rigid on  
ejection from  
the mold!*

WITH TOTALLY NEW

# EMC

90 SERIES

**EPOXY MOLDING COMPOUNDS**  
FOR TRANSFER and COMPRESSION MOLDING

For Molding—  
Resistors  
Capacitors  
Coils  
Coil Bobbins  
Semi-Conductors  
Transformers  
Potting Cans  
Terminal Blocks  
Component Cases  
and similar devices

MAIL TODAY FOR FULL DETAILS

AMERICAN-MARIETTA COMPANY  
3400 13th Ave. S.W., Seattle, Wn.

Rush complete information on new EMC 90 Series compounds to:

Name \_\_\_\_\_

Title \_\_\_\_\_

Firm \_\_\_\_\_

Address \_\_\_\_\_

City \_\_\_\_\_

Zone \_\_\_\_\_ State \_\_\_\_\_



THESE  
SPICES  
HAVE  
THEIR  
SPACE  
SUITS  
ON

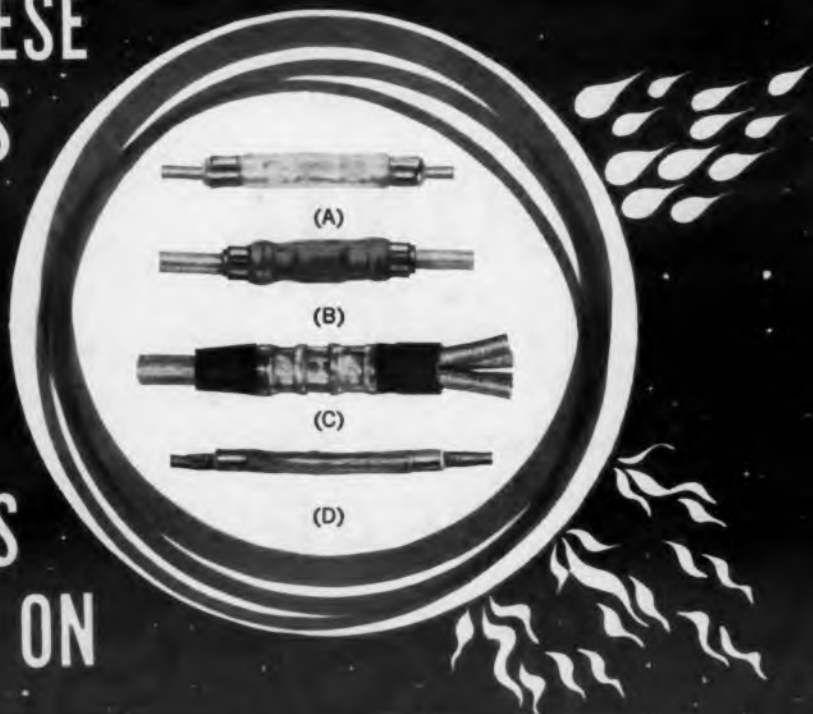

Splices in aircraft and missile circuitry must be dressed to weather the most withering kinds of high-altitude temperatures, moisture, vibration, shock, corona. AMP INCORPORATED splices are dressed for it, no matter what the environmental threat. High-altitude heat? AMP's STRATO-THERM (A) line of splices are designed to keep circuits intact at continuous temperatures to 1200°F. The post-insulated Strato-Therm splice (illustrated) has a Teflon® outer sleeve and silver-plated electrolytic copper inner sleeve, plus metal crimping rings, for full circumferential protection to solid, stranded or combination conductors. Splices available in materials to resist effects of high energy fuels compounded with Hydrazine and for connecting Chromaloy and Alumel cables. AMP's positive compression crimp insures electrical soundness. The insulated Strato-Therm splice is ideal for temperatures up to 550°F.

What about moisture breathing? The CERTI-SEAL (B) splice molds an all-nylon sleeve over the conductors, then compression-crimps tin-plated copper rings over the nylon, for positive moisture-proofing of more than 100 different insulation diameters. Protection for large wire sizes? The AMPLI-NYL (C) splice gives total nylon insulation to spliced wire in sizes #8-1/0 AWG; it will accommodate single-to-single, single-to-multiple, and multiple-to-multiple wire combinations. An airworthy splice for shielded wire? The TERMA-SHIELD (D) splice, for single or multiple connectors, is post-insulated with either nylon or Teflon. Conductors and shield braids are each crimped permanently and positively together, with insulation separating each conducting member. AMP is splice-conscious. It will pay you to consult with AMP where reliable space-age circuitry is the goal. Send for specific information on these AMP splices.

# AMP INCORPORATED

GENERAL OFFICES: HARRISBURG, PENNSYLVANIA

AMP products and engineering assistance are available through subsidiary companies in: Australia • Canada • England • France • Holland • Italy • Japan • Mexico • West Germany

® by Patent Trademark

CIRCLE 44 ON READER-SERVICE CARD

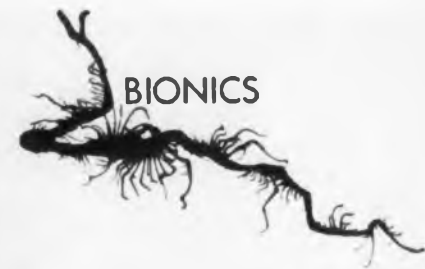

## GE's Visilog Sensor Operates Like Eye

THE Visilog, a bionic sensor, is under development at General Electric Co.'s Advanced Electronics Center, Ithaca, N. Y. It is being designed to sense its own orientation, with respect to surfaces in its environment, in the same way believed used by humans—by abstracting information from the presence of texture on surfaces.

In a stationary Visilog this could be done by measuring the slant angle between the two lines: the line of sight from the device to the surface, and the projected image of the line on the surface. The first step in doing this would be to scan the surface from nadir to horizon. In humans such a scan gives an impression of depth, because the size or spacing of the texture elements decreases with distance.

In a Visilog, if this scanning were done across the retina of the device at a uniform rate and an exact computation were made of the relative change in texture element density per unit retinal distance, the result would be a function of the slant angle that could be used to measure the angle, reports GE. The company says it has established that this is indeed what happens with humans—experimental subjects have extracted slant information from just such stimuli.

According to the company, a stationary machine that extracted this information from the input image would be able to describe partially the environment that surrounded it.

A moving Visilog could give distance—and time—information and would be much more practical. The company is designing a moving-toy-type Visilog to demonstrate some of the concept's capabilities.

By analyzing vectors generated by several lines of sight, the moving Visilog could provide all the information given by a sta-

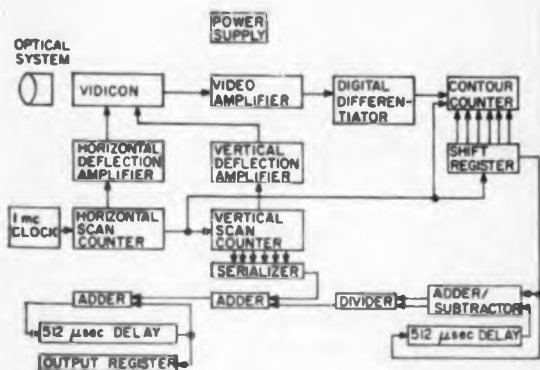

**Rudimentary stationary Visilog.** in hypothetical configuration, would be able to determine its orientation with respect to a plane surface. Scanning system and computing circuitry would enable it to measure changes in textural elements of a surface to calculate slant angle to the surface. This implementation is more complex and expensive than others under study at General Electric.

tionary unit and more, the company says. GE researchers have described a Visilog system that would develop time-to-contact information from scans of a surface.

In this example, an optical system moves in a linear path, with no roll angle, above and toward a textured surface. The point where the path of motion intersects the surface appears to remain stationary, while the image of any other fixed point on the surface moves away from the origin on a straight line until it goes off the retina. This can be described as a set of radiating vectors, each of which describes the motion over a short interval of time of any image point at the base of the vector.

Rates of change of the vector lengths change with time. Properly normalized, these derivatives yield the reciprocal of time-to-contact, according to the company.

Because the analysis that a Visilog performs is a geometric one of patterns of radiation reflected from objects to a point in space, and because it depends only on the presence of stable local inhomogeneities (texture), the Visilog need not operate in the visible spectrum, GE researchers speculate. They suggest that such texture differences as reflectance and color might be used and that data could be extracted from a sensor that measured heat in the infrared portion of the spectrum. Texture in this case would be equivalent to local stable inhomogeneities in temperature. Even the stationary Visilog is said to have broader possibilities than that of calculating slant angle. ■ ■



## Only 1-1/2 ounces (including the switch plate)

Heinemann's new Series VP may well be the lightest circuit breaker made. For sure, it's one of the smallest and most compact you'll find around. Yet, remarkably, it's capable of handling all the functions of much larger Heinemann breakers.

It is temperature-stable. Current rating and calibrated trip-points are completely unaffected by ambient

temperature. No derating . . . ever.

It is available with a choice of time relays. You can have either a "fast" or "slow" delay. Or instantaneous response.

It can be furnished with any of Heinemann's special-function internal circuits. With a little ingenuity and a special circuit, you can make the breaker do such out-of-the-

ordinary chores as remote switching, circuit "slaving," alarm signaling.

The matchbox-size Series VP is available in any integral or fractional rating you might need, from 0.050 to 15 amps (at 110V, 60 or 400 cycles AC, or 50V DC).

Bulletin VP will give you detailed specifications and dimensions. A copy is yours for the asking.

**HEINEMANN ELECTRIC COMPANY**  **156 BRUNSWICK PIKE, TRENTON 2, N. J.**

CIRCLE 45 ON READER-SERVICE CARD

EA 2460

# Design Considerations For Low Noise Transistor Input Stages

*When designing low-noise transistor input stages, the engineer must make practical compromises among the various parameters of interest. In this article, author Rheinfelder discusses the general design objectives for these circuits. He begins by presenting basic definitions, and specific circuit requirements.*

*Subsequent articles will deal with low-noise circuit measurements and with design recommendations for practical circuitry.*

**William A. Rheinfelder**  
Applications Engineer  
Motorola Semiconductor Products Inc.  
Phoenix, Ariz.

THE random motion of free electrons in a conductor, caused by thermal agitation, generates very small currents. Although the sum of all these currents over a long period of time is zero, at a given instant a net current in one direction may result. These transient currents produce a voltage across a resistor of so-called "white" noise, a voltage which has a constant spectral density independent of frequency.

According to Nyquist the mean square noise voltage is:

$$E_n^2 = 4 kTRB \quad (1)$$

where  $k$  = Boltzmann's constant

=  $1.372 \times 10^{-23}$  joules per deg K (absolute)

$T$  = temperature of conductor in deg K

$R$  = resistance of conductor in ohms

$B$  = bandwidth of circuits following the resistance in cps

For 75 F (or 24 C) we obtain:

$$E_n^2 = 1.63 \times 10^{-20} RB \quad (2)$$

Eq. 2 is plotted in Fig. 1 for easy reference. The random motion of electrons in a conductor is unaffected by superimposed voltages as long as they do not generate heat.

Practical resistors generally follow Eq. 1 only over a limited operating range. Their

spectral distribution is uneven at very low or at high frequencies. Both dc and signal currents increase the noise in practical resistors. This is due to the nonlinear relation between resistance and applied voltage, internal arcing, and other defects which introduce noise modulation, etc.

In noise figure or signal to noise calculations the bandwidth can be considered constant and Eq. 2 can be simplified to

$$E_n^2 = a^2 R \quad (3)$$

where  $a^2 = 1.63 \times 10^{-20} B = 4 kTB$

This equation is used to calculate equivalent input noise at the base of a transistor.

We assume for the moment an ideal transistor, not generating any noise except for

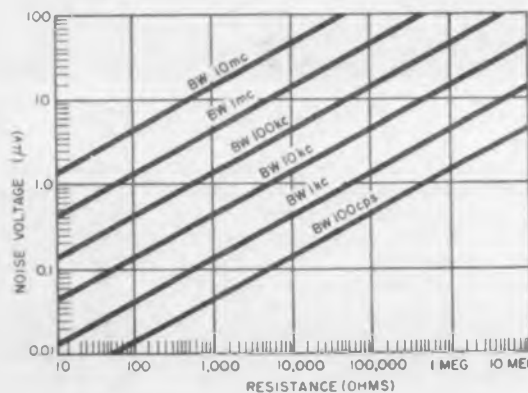

Fig. 1. Noise voltage is plotted for various values of bandwidth and resistance.

thermal noise in the input resistance. Fig. 2 show an actual circuit and Fig. 3 its equivalent. Since only the resistive part of an impedance produces noise, the tuned circuit has been replaced by its equivalent parallel resistance at resonance.

$$R_D = Q\omega L \quad (4)$$

where  $R_D$  = equivalent parallel resistance of tuned circuit in ohms

$Q$  = magnification factor of coil

$L$  = inductance of coil in henries

$R_i$  = the input resistance of the transistor.

A noise-free transistor is assumed. A noise generator, according to Eq. 3, is connected in series with each resistance. The various signals at the base must be added by the sum of the squares method because independent ac voltages are involved.

The mean square noise voltage appearing across the input to the assumed noise-free amplifier is

$$E_n^2 = \frac{a^2 R_s R_D R_i}{R_s R_D + R_D R_i + R_s R_i} \quad (5)$$

This can be obtained from Fig. 3 or from the equivalent circuit of Fig. 4.

## Receiver Performance Given by Signal-to-Noise Ratio, Noise Figure

In a receiver the signal-to-noise ratio is simply defined by the ratio of signal power to noise power at a specified point in the

circuit. While it is important to have as high a signal-to-noise ratio as possible in the output, a low ratio does not imply that the receiver performs poorly. It is possible the signal is arriving from the antenna with poor signal to noise. And, if the noise is at the same frequency as the signal, the best receiver will not improve on the ratio.

As a figure of performance for a receiver, a term called noise figure,  $F$ , has been defined as the ratio of input signal to noise ratio to output signal to noise ratio. Various other definitions may be used, for instance, noise figure  $F$  is noise power output to noise power input divided by the power gain of the amplifier.

$$F = \frac{P_{si} P_{no}}{P_{so} P_{ni}} = \frac{P_{no}}{P_{ni}} \cdot \frac{1}{G} \quad (6)$$

where  $P_{si}$  = signal input power  
 $P_{so}$  = signal output power  
 $P_{ni}$  = noise input power  
 $P_{no}$  = noise output power  
 $G$  = power gain

The input noise power has been standardized as the thermal noise which is available from the resistance component of the signal source. The maximum available noise power of a generator with source resistance  $R$  occurs under matched conditions:

$$P_{ni} (max) = \frac{E_n^2}{4R} \quad (7)$$

Substituting from Eq. 3 we obtain:

$$P_{ni} (max) = kTB = \frac{a^2}{4} \quad (8)$$

With this definition of  $P_{ni}$ , the noise figure  $F$  is also equal to the ratio of noise power output of a practical amplifier to noise power output of an ideal noiseless amplifier. It is, therefore, a true indication of amplifier performance, and 0 db noise figure represents the best possible value. Pure thermal noise of the source is the limiting factor.

Noise figure can also be expressed simply by the square of the voltage ratios, since the resistances cancel. This yields a form more convenient for calculation.

$$F = \frac{E_{si}^2 E_{no}^2}{E_{ni}^2 E_{so}^2} \quad (9)$$

where  $E_{si}$  = signal input voltage  
 $E_{ni}$  = noise input voltage  
 $E_{so}$  = signal output voltage  
 $E_{no}$  = noise output voltage

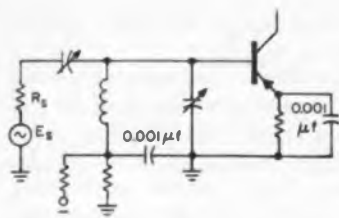

Fig. 2. Typical circuit for which the expression for the equivalent input noise,  $E_n^2$ , is calculated in the text.

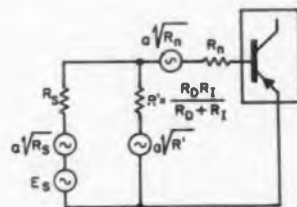

Fig. 5. Noise generated in transistor amplifier of Fig. 3 is represented by the equivalent noise generator  $a\sqrt{R_n}$  and the equivalent noise resistance  $R_n$ .

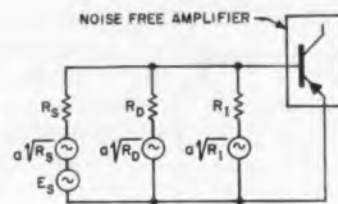

Fig. 3. Circuit equivalent of Fig. 2 has noise generators, given by Eq. 3, connected in series with each equivalent resistance, feeding a noise free amplifier with infinite input impedance.

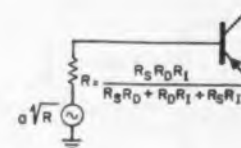

Fig. 4. Equivalent circuit of Fig. 3 is further reduced to a noise voltage source and single resistor feeding an ideal amplifier.

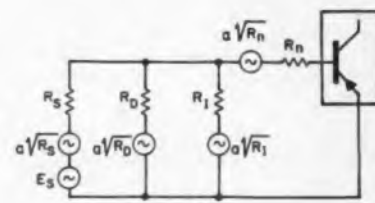

Fig. 6. Simplified circuit for calculating noise figure is derived from the circuit of Fig. 5.

The standard input noise is, from Eq. 8:

$$E_{ni}^2 = 4kTBR_s = a^2 R_s \quad (10)$$

If we now calculate the noise figure of the simplified circuit of Fig. 3, we have to evaluate  $E_{no}$  and  $E_{so}$  at the output of the network into the noise-free amplifier.  $E_{no}^2$  has already been evaluated in Eq. 5:

$$E_{no}^2 = \frac{a^2 R_s R_D R_I}{R_s R_D + R_D R_I + R_I R_s} \quad (11)$$

To calculate the signal output voltage all the noise generators of Fig. 3 are replaced by short circuits. Thus we obtain:

$$E_{so}^2 = E_{si}^2 \frac{R_D R_I}{R_s R_D + R_D R_I + R_I R_s} \quad (12)$$

Substituting Eqs. 10, 11 and 12 into Eq. 9 we obtain:

$$F = 1 + \frac{R_s}{R_D} + \frac{R_s}{R_I} = 1 + \frac{R_s}{R'} \quad (13)$$

where  $R'$  = equivalent parallel resistance of  $R_D$  and  $R_I$ .

For matched conditions where  $R_s = R'$ , the noise figure equals 2, corresponding to 3 db. Thus, with matching and with an ideal noiseless amplifier following, a noise figure

of 3 db is the best which can be obtained. By decreasing the ratio of  $R_s$  to  $R'$  the noise figure can be made to approach unity, corresponding to 0 db.

#### Equivalent Noise Resistance Lumps All Noise Sources

In a transistor amplifier, noise is generated in various ways. However, noise in an active element is most commonly considered by introducing the equivalent noise resistance,  $R_n$ . All noise is assumed to be generated in this resistance, with a noiseless transistor following it. The equivalent noise generator  $a\sqrt{R_n}$  is shown in Fig. 5.

Using the equivalent noise resistances, noise figure and signal-to-noise calculations may be made easily because only resistances are involved. Also an easy comparison may be made between different devices.

A simplified circuit for calculating noise figure is shown in Fig. 6. Here,  $R_D$  and  $R_I$  are replaced by  $R'$ . Evaluating the mean square voltage at output and input of the network both for signal and noise, and using Eq. 9 leads to the following expression for noise figure:

$$F = 1 + \frac{R_s}{R'} + \frac{R_n}{R_s} \left(1 + \frac{R_s}{R'}\right)^2 \quad (14)$$

(continued on p 50)

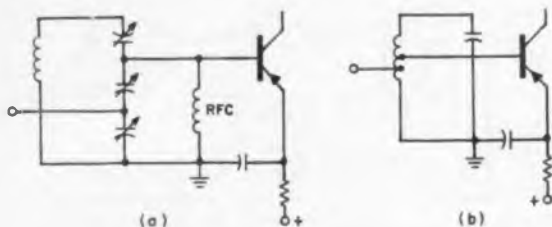

Fig. 7. Calculating the Q and the signal loss of either of these circuits shows that with higher selectivity in front of the first transistor, both the signal input power and signal to noise decrease.

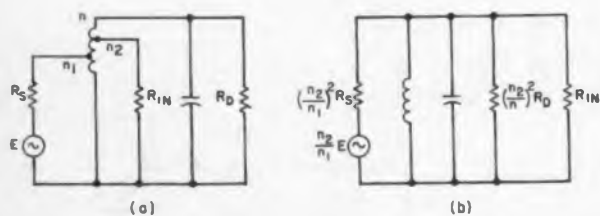

Fig. 8. The circuit of Fig. 7b can be simplified as in (a) and then further reduced as in (b).

Differentiating  $F$  with respect to  $R_s$  leads to the expression for  $R_s'$ , giving minimum noise figure  $F'$ :

$$R_s' = R' \sqrt{\frac{R_n}{R_n + R'}} \quad (15)$$

$$F' = 1 + \frac{2R_n}{R'} + 2 \sqrt{\frac{R_n(1 + R_n)}{R'}} \quad (16)$$

The optimum source resistance is obtained at a certain mismatch ratio and hence some sacrifice in gain. Under matched conditions the noise figure is, from Eq. 14, with  $R_s = R'$ ,

$$F_{(matched)} = 2 + 4 \frac{R_n}{R_s} \quad (17)$$

with the minimum being 3 db as before, if  $R_n = 0$ .

#### Cross Modulation and Intermodulation Add Important Distortions

Cross modulation is a form of interference occurring in a nonlinear device having third order curvature if two or more modulated signals are present simultaneously. The modulation of an interfering carrier appears as modulation of the carrier to which the receiver is tuned. The frequency of the interfering carrier is important only because the amplitude at the base of the transistor changes with frequency due to the selectivity of the input tuned circuit. For cross modulation

to take place, third or higher order nonlinearities must exist.

Intermodulation distortion is interference caused by two or more modulated or unmodulated signals beating together to form a sum or difference frequency to which the receiver is tuned. It is caused by mixing action. Usually, it is considered together with the family of spurious responses inherent in mixer operation. For this interference to take place, the following frequency relationship must exist:

$$nf_1 \pm mf_2 = f_0 \quad (18)$$

where  $n, m =$  integral numbers

$f_1, f_2 =$  carrier frequencies

$f_0 =$  frequency receiver is tuned to.

The frequency  $f_0$  will be produced by second order curvature. Intermodulation interference is caused by modulated and unmodulated carriers as well. For clarity, cross modulation and intermodulation are compared in Table I.

Generally, intermodulation is of a smaller order of magnitude because the receiver is tuned to neither  $f_1$  nor  $f_2$ . Therefore these frequencies are attenuated considerably by the selectivity of the input tuned circuit.

Cross modulation, however, is a major form of interference because the receiver is tuned to one of the required carriers (which is the desired signal). Further, the undesired carrier frequency and sidebands can be anywhere since no frequency relationship exists between desired and interfering signal.

After cross modulation has taken place there is no way of removing the interference. Not even the sharpest crystal filter will remove it because it appears in the if channel as true modulation of the desired carrier. A narrow if bandwidth removes both the desired modulation sidebands and the interference modulation in the same amount. Thus, signal to noise remains unchanged.

In general, the signal to noise of the majority of present receivers (including expensive communication units) is determined by cross modulation rather than by if bandwidth. This is because far too little emphasis is put on designing for low cross modulation. Instead, crystal filters are added in the if strip in the mistaken belief that a narrower bandwidth will improve the signal to noise.

The bandwidth of the receiver must be wide enough to accommodate the sidebands of the desired signal. Once cross modulation has taken place, decreasing the bandwidth

beyond this point will not improve the signal to noise. The only way to minimize cross modulation is to avoid it. This means that the receiver front end must be designed for low noise and interference. The stages most susceptible to cross modulation are the rf stages, the first and second mixer and the last if stage.

#### Proper Design Minimizes Effects Of Cross Modulation

Several means can be taken to minimize cross modulation. The gain of the rf stages, that is the stages with low selectivity, must be kept as small as possible. The lower limit is, of course, reached at the point where the over-all noise figure deteriorates due to noise in the second stage. A compromise between noise figure and cross modulation must be made. Generally, a gain of about 10 db is a good value to be used for the rf stages. A tapped tuned circuit for the collector load may be used to reduce the gain and also improve the selectivity.

The selectivity of the early receiver stages should be made as high as possible. This calls for double tuned circuits after the rf stage and high-Q circuits in the whole front end. A double tuned circuit may also be used ahead of the first stage to decrease cross modulation at the expense of noise figure. At frequencies below 50-mc antenna noise is usually much larger than receiver noise. Therefore it is more important to design for low cross modulation in this frequency range rather than for low noise figure. A double-tuned input circuit may be used.

A third way to minimize cross modulation is to properly choose the dc-operating point. Since cross modulation is caused only by third and higher power terms of the transfer characteristic, it is possible to minimize these terms by adjusting the dc conditions. In critical cases, no agc should be applied to the rf stage until a sufficient signal strength is reached. In this way cross modulation becomes unimportant.

A fourth method for decreasing cross modulation is to introduce high frequency negative feedback. Cross modulation is reduced in proportion to the feedback factor as long as the feedback is resistive. An unbypassed emitter resistance may be used.

#### Low Frequency Noise Can Also Modulate Carrier

Similar interfering conditions exist if, instead of an interfering signal, a noise source is present in the circuit. All transistors

**Table 1. Comparison Between Cross and Intermodulation Distortions**

	Cross Modulation	Inter-modulation
Receiver tuned to frequency	$f_0$	$f_0$
Carrier frequencies necessary for interference to be produced	$f_0$ (with or without modulation)	$f_1$ (with or without modulation)
	$f_2$ with modulation	$f_2$ (with or without modulation)
Frequency relationship required	no	$nf_1 \pm mf_2 = f_0$ $n, m$ integer numbers
Caused by	Third (or higher) order curvature	Second (or higher) order curvature

have considerable low frequency noise. This noise can act as the interfering signal to modulate the desired carrier (or even the existing high-frequency noise) to produce a poor signal-to-noise ratio or increased high-frequency noise.

This noise modulation effect is by no means small and can be readily measured. In a typical portable receiver the signal to noise (ratio of modulated to unmodulated carrier) increased by only 6 db when the carrier increased 45 db. Without noise modulation the signal to noise should have also increased 45 db.

Noise modulation can be reduced by the same methods used for cross modulation. In addition, it is possible to remove parts of the interfering low frequency noise by bypassing and shorting the proper circuits for audio frequencies. It is therefore very important to design the first stages in a transistorized receiver to produce the least audio noise possible.

#### 'Best' Low Noise Design Must Be a Compromise

After the previous discussions it is obvious that the design for low noise must be a compromise between lowest noise figure and lowest cross modulation, both of which affect the signal to noise. Cross modulation effects are decreased when higher selectivity is used in front of the first transistor,

## New Bourns Precision Potentiometer Resolves the Quality-Price Dilemma!

Here is military reliability in a competitively-priced industrial potentiometer. Bourns wirewound 10 turn Model 3500 measures just  $\frac{7}{8}$ " in diameter by 1" long—shorter by  $\frac{1}{2}$ " than units available elsewhere—yet has a resistance element 20% longer than that of comparable potentiometers.

Fully meeting military requirements for steady-state humidity, Model 3500 can also be provided at a 10% premium to meet the cycling humidity specs of MIL-STD 202, Method 106. It's the only  $\frac{7}{8}$ " 10-turn potentiometer guaranteed to meet this spec. Its published characteristics incorporate wide safety margins.

Reliability insurance is provided by the exclusive Bourns Silver-weld<sup>®</sup> bond between terminal and resistance wire. Virtually indestructible under thermal or mechanical stress, this termination

eliminates a chief cause of potentiometer failure. In addition, a special close-tolerance rotor almost completely does away with backlash.

Model 3500 is also subjected to the rigorous double-check of Bourns' exclusive Reliability Assurance Program. In short, every possible step is taken to ensure that the performance you specify is the performance you get. Write for complete data.

Resistances	500 $\Omega$ to 125K, $\pm 3\%$ , std. (to 250K spl.)
Linearity	$\pm 0.25\%$ std.
Power rating	2w at 70°C
Operating temp.	-65° to +125°C
Mech. life	2,000,000 shaft revolutions

**INTER-OFFICE MEMORANDUM**

To John Miller-Design Engineer

From Paul Hammond-Reliability Engineer

*John - you'll like this one - reliable + inexpensive! Paul*

**BOURNS**

BOURNS, INC., TRIMPOT DIVISION  
6135 MAGNOLIA AVE., RIVERSIDE, CALIF.  
PHONE: OVERLAND 4-1700 • TWA: R 2922  
CABLE: BOURNSINC

Manufacturer: Trimpot<sup>®</sup> potentiometers; transducers for position, pressure, acceleration. Plants: Riverside, California; Ames, Iowa; and Toronto, Canada

CIRCLE 46 ON READER-SERVICE CARD



# FROM ELECTRONIC MEASUREMENTS

## 0-1500 V DC POWER SUPPLIES



Model 238A  
With Rear Terminals

### CONSTANT-VOLTAGE

In addition to covering a complete voltage range—0 to 1500 V—this programmable, regulated power supply can deliver rated current of 100 ma at any output voltage . . . even at less than a volt.

But an even more useful feature is its continuously variable current-limiting control. Here's a feature that's finding more application with every passing day.

When it comes to regulation, the Model 238A is truly flexible. Standard regulation is 0.1% line or load. However, 0.01% regulation is available by means of an optional plug-in chopper unit.

The chart below lists just a few of the many Electronic Measurements off-the-shelf, constant-voltage power supplies. For complete information request Catalog BR1961.

MODEL	VOLTS DC	RANGE	CURRENT
238A	0-1500 V DC		0-100 MA
237A	0-600 V DC		0-1 AMP
235A	0-600 V DC		0-500 MA
234A	0-300 V DC		0-500 MA
230A	0-200 V DC		0-1 AMP
228A	0-150 V DC		0-1 AMP
229A	0-150 V DC		0-300 MA
218A	0-100 V DC		0-3 AMP
221A	0-100 V DC		0-500 MA
225A	0-75 V DC		0-2 AMP
215A	0-50 V DC		0-3 AMP



Model C638A  
With Rear Terminals

### CONSTANT-CURRENT

Here's the newest in Electronic Measurements' line of Constant Current Power Supplies . . . a full 1500 V compliance at constant current outputs from less than a ma to 100 ma. Like all Electronic Measurements Power Supplies, the Model C638A has a lot of built-in extras too. For example, there's a modulation input . . . there are also provisions for remote programming . . . and an adjustable voltage compliance control that in effect provides for voltage-limiting.

Specifications include a high output impedance of  $10^4$  megohms at 0.5  $\mu$ a to 0.5 megohm at 100 ma. Above 2.2  $\mu$ a, regulation is better than 0.15%, line or load. Ripple is less than 0.01%  $\pm 1 \mu$ a.

The following listing shows some of the constant current models available. For complete information, request Specification Sheet 3072B.

MODEL	RANGE	VOLTAGE COMPLIANCE (MINIMUM)
	MIN. MAX.	
C614A	10 $\mu$ a	100 V
C613A	10 $\mu$ a	50 V
C621A	5 $\mu$ a	100 V
C620A	5 $\mu$ a	50 V
C633A	2.2 $\mu$ a	300 V
C629A	2.2 $\mu$ a	50 V
C632A	2.2 $\mu$ a	300 V
C624A	2.2 $\mu$ a	100 V
C638A	1 $\mu$ a	1500 V
C631A	1 $\mu$ a	300 V
C612A	1 $\mu$ a	100 V

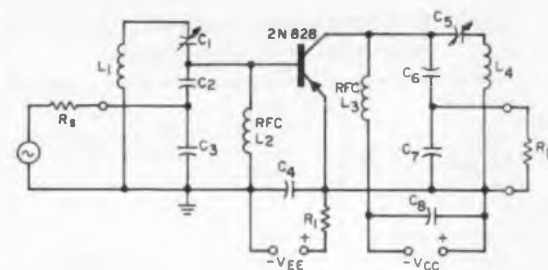

Fig. 9. Recommended low noise circuit. (This circuit will be discussed more fully in a subsequent article.)

Unfortunately this also decreases the signal input power and with it the signal to noise. Therefore, according to Eq. 6, the noise figure deteriorates. This is seen by calculating the Q and the signal loss of the circuits of Fig. 7. Equivalent of Fig. 7b are shown in Fig. 8.

From Figs. 7b and 8b we obtain the expression for the maximum available power:

$$P_{AV} = \frac{\left(\frac{n_2}{n_1}\right)^2 E^2}{4 \left(\frac{n_2}{n_1}\right)^2 R_s} = \frac{E^2}{4R_s} \quad (19)$$

This power is applied to both the reflected losses of the coil  $(n_2/n)^2 R_D$  and  $R_{in}$ . Under matched conditions the power into  $R_{in}$  is

$$P_{in} = P_{AV} - P_D = \frac{E^2}{4R_s} - \frac{E^2}{4R_D} \left(\frac{n}{n_2}\right)^2 \quad (20)$$

To make the second term small,  $n_2$  and  $R_D$  must be as large as possible. A large  $R_D$  means a high-Q coil and practical limits do exist. The largest  $n_2$  is equal to  $n$ . Under this condition we get the lowest circuit Q because the coil is loaded directly by  $R_{in}$ . Therefore the maximum signal input power is reached at the widest bandwidth. At smaller values of  $n_2$ , the circuit Q can be raised at a loss in signal input power. The limiting case is the Q of the coil itself.

#### Factors To Remember In Low Noise Design Are Summarized

It is evident that to decrease the interference, any circuit requires a high quality transistor with a very low noise figure. However, in a practical circuit, some sacrifice in noise figure may be necessary to achieve the required signal to noise.

For a low noise figure we need maximum signal input power (widest bandwidth). For low cross modulation we need smallest band-



**ELECTRONIC**  
**MEASUREMENTS**  
COMPANY, INCORPORATED  
EATONTOWN • NEW JERSEY

CIRCLE 47 ON READER-SERVICE CARD

width (small signal input power). The proper compromise must be made with regard to frequency, mode of operation, adjacent channel allocations, atmospheric interference, etc.

In general, below 50 mc, the equivalent noise resistance of antennas is high and noise figure should be sacrificed for lower bandwidth. Above 50 mc, noise figure may be more important but even here a few decibels in noise figure can be sacrificed. For instance, in a typical case with 3.2-db noise figure a bandwidth of 50 mc resulted, which was too great for low cross modulation. However, at a noise figure of 4 db the bandwidth was reduced to 4 mc; at 5 db to 2.5 mc.

Another aspect of the ideal input circuit deals with mismatching and noise figure. As will be explained in a subsequent article, mismatching does not give any improvement if the noise figure under matched conditions is 10 db or more.

However, with a noise-free transistor, the noise figure is 3 db matched and can be asymptotically reduced by mismatching to 0 db (the case of zero source resistance or infinite input resistance). The maximum improvement possible by mismatching is therefore less than 3 db if noise is generated in the transistor.

It is found that in the common emitter configuration a source resistance below the input resistance is optimum. For common base the opposite is true. Therefore, some intermediate configuration could be found where matching and lowest noise figure coincide. A circuit having these properties has been developed in Europe. It is an intermediate between the common base and common emitter circuit.

A mutual inductance-coupled input circuit or a lattice filter must be used. Preliminary measurements indicate that the signal losses in this input network at high frequencies are higher than the improvement possible by mismatching if the mutual inductance coupling is used. This circuit has been called "tap-circuit" by us, because the common base — common emitter configuration is established by a tap across the input coil. Slight detuning of the input circuit also decreases the noise figure. It can be shown that in the tap circuit the minimum noise figure occurs at exact resonance.

Without going into this circuit or feedback, and other more complicated schemes, the recommended low noise circuit is as shown in Fig. 9. It will be discussed fully in a subsequent article. ■ ■

## 3 WATTS at 1120 Mc from 7 WATTS at 140 Mc

## A VARACTOR FOR EVERY PURPOSE

220 new epitaxial silicon high power varactors in four package styles — subminiature glass case • double-ended cartridge • "pill" case • new "coaxial pill" case — all hermetically sealed, make *this* kind of harmonic generation possible now.

A WIDE VARIETY of PIV ratings and capacitance values allows selection of the optimum diode in each case style for your circuit application.

The data reported below was obtained by the Waveguide Systems Division of Microwave Associates\* in a tandem chain of three doubler stages, each using a selected single Microwave Associates' epitaxial silicon high power varactor.

This high power output and remarkable harmonic efficiency was achieved without boosters, without power supply, in passive circuits.

Since the initial introduction of varactors on a commercial basis by Microwave Associates, we have continued to lead the way in varactor technology.

Microwave Associates' unsurpassed varactor circuit capabilities are your assurance of varactors tested to meet specific harmonic generation requirements.

The Waveguide Systems Division of Microwave Associates offers capabilities for the design and delivery of complete harmonic generator circuits.

Write for a copy of "SELECTION OF VARACTORS FOR POWER HARMONIC GENERATION" and for the 1961 Semiconductor Division Short Form Catalog.

\* Support received by (USAF) ETL Aeronautical Systems Division Contract #AF33 (616) — 7232.

with MICROWAVE ASSOCIATES  
— EPITAXIAL SILICON  
HIGH-POWERED VARACTORS

ONE VARACTOR  
ONE VARACTOR  
ONE VARACTOR

140 Mc  
7 Watts

1120 Mc  
3 Watts

MICROWAVE ASSOCIATES, INC.  
SEMICONDUCTOR DIVISION

Burlington, Massachusetts — Building 3-3000  
Western Union Bldg — TWA Building, Mass. 01412

© 1961 by MICROWAVE ASSOCIATES, INC., 27 W. 44th Street, N.Y.C. N.Y. U.S.A. 10018

CIRCLE 48 ON READER-SERVICE CARD

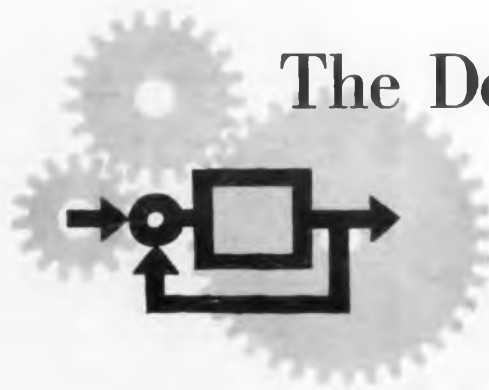

## The Design of Large Servos

*Servos larger than the familiar instrument types present practical problems to the designer because of the lack of specially tailored components. After briefly describing the components which they have found useful in solving integral-hp servo problems, the authors detail design steps for reducing these components to reasonably high-performance servomechanisms.*

**Larry C. Mackey, John K. Wetherbee**  
Battelle Memorial Institute  
Columbus, Ohio.

**T**HE STATE of the art in the design and development of low-power (a few watts to fractional-horsepower) servomechanisms has been highly developed. However, there has developed an increasing need for control systems in which the torque is orders of magnitude larger than the torque which can be produced by these precise, relatively low-power "instrument" servos; and, yet, the accuracy, transient response, and stability of the smaller units must be achieved in the larger.

In the development of a servomechanism to position accurately a large steerable radio telescope (see box p 57), it was necessary to

develop a torque unit which would produce torques that were orders of magnitude larger than those developed in smaller units. Since the design procedures used in this unit are of general interest to those who have integral horsepower servo design problems, they will be used as the basis of this article. To present these design procedures logically, the hardware solutions for the units comprising the system will be discussed first. Then the complete system design and test will be described.

### Torque Units For Large Servos Are First Hurdle

The torque unit for the example had to be reliable and maintenance-free. In addition, it had to have extremely low-level radio-fre-

quency noise characteristics. A torque unit with these characteristics and yet capable of developing the required torque is shown as part of Fig. 1a. This unit employs two induction motors, two eddy-current clutches and a gear train. (Two 7-1/2-hp, 1,800-rpm induction motors were used in the example to develop the required torque). The torque is transmitted to the load by two eddy-current clutches (1-1/2 hp in the example) and a gear train.

The amount of torque transmitted through the clutches is controlled by the current in the clutch field coil which produces a magnetic coupling between the input and output members. The output members of the clutches drive two pinions meshed to a common gear. The pinions develop opposing torques so that if each clutch is developing the same torque, the torque delivered to the load is zero.

### Power Amplifier Must Be Able To Work Into Inductive Load

The power amplifier used to excite the control field of the eddy-current clutch must also be reliable and relatively maintenance-free and have low-level radio-frequency noise characteristics. The amplifier in addition must be capable of working into the highly inductive clutch field-coil load.

The two single-phase, full-wave-bridge, magnetic-amplifier circuits with dc outputs



Authors Larry Mackey and John Wetherbee before the breadboard of the large Servo used as the "example." The two 7-1/2-hp, 1,800-rpm induction motors drive the two 1-1/2-hp eddy-current clutches bolted to their inner faces. The output members of the clutches in turn drive the short shaft in the middle. The shaft represents the servo's output and is sized to be the inertial equivalent of the actual load that would be reflected back through the step-down gearing. The motors run in opposition; at null the clutches each transmit enough torque to cancel each other and the shaft doesn't move.

The tachometer and potentiometer for velocity and position feedback are shown belt-driven off the interconnecting shaft. Magnetic power amplifiers and other system electronics are in racks behind the authors.

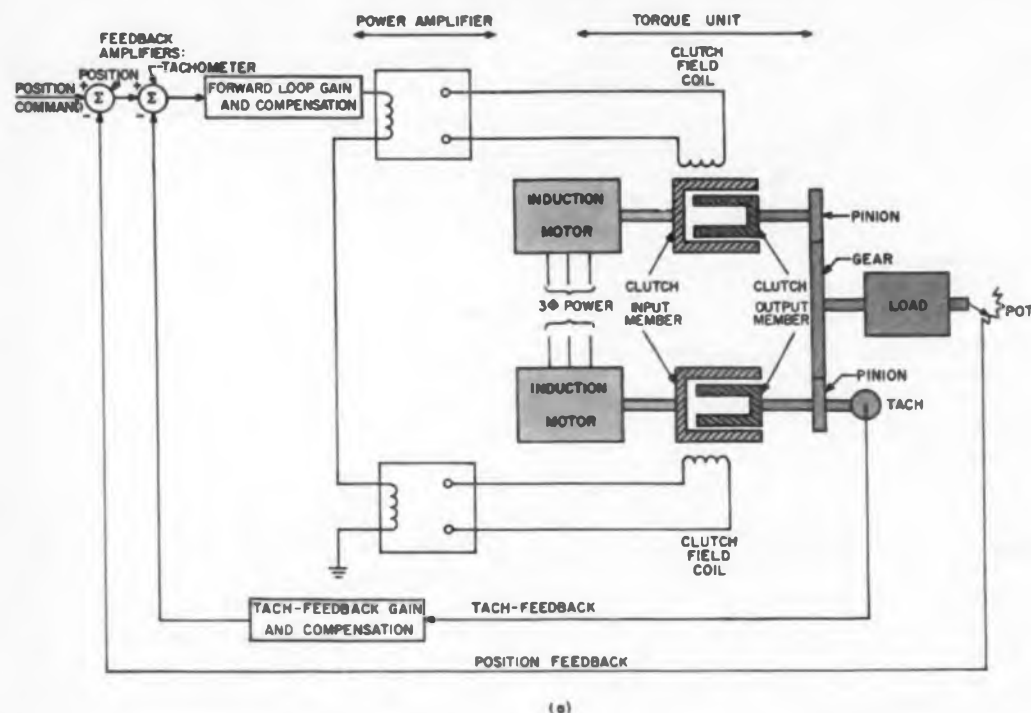

Fig. 1. (a) Schematic of large servo (left) with performance and reliability approaching that of a smaller instrument servo. Magnetic amplifiers replace transistors in the power amplifier and two eddy-current clutches driven by constant-speed induction motors replace the two-phase servo motor. Backlash is eliminated by driving the load gear in opposition with the two clutches. (b) Block diagram of large servo (below) indicates the form of typical time constants found in this type of servo's loop. The numerical values are for the example described in the text.

shown schematically in Fig. 2 satisfy these requirements. The core and coils of this amplifier have very good reliability and, by derating the solid-state diodes in the circuit, sufficient over-all reliability can be achieved. The only maintenance required of this amplifier is corrective (replacing failed components). The radio-frequency noise generated by this amplifier consists of harmonics of the power-supply frequency; the rf spectrum harmonics are relatively low amplitude.

The two free-wheeling diodes shunted by the 2-K resistors provide a low-impedance path for the inductive currents of the clutch coil while the flux in the core of the magnetic amplifier is being reset. It is this low-impedance path that makes the operation of the magnetic amplifier satisfactory when working into an inductive load.

The control coils of the magnetic amplifier are connected so that the control signal increases the current in the field coil of one clutch while simultaneously decreasing it in the other. In this manner push-pull action is established that will give full continuous control of torque through a positive and negative range of operation.

The clutches should be biased to approximately one-half their rated output torque by exciting the bias coils of the magnetic amplifiers with a dc voltage. Biasing the clutches makes it possible to operate the clutches in the linear portion of their torque-vs-field-

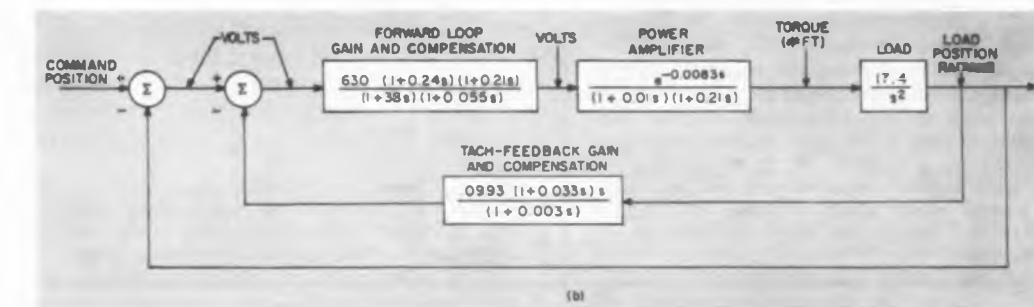

coil-current characteristics. This results in linear load-torque-vs-control-signal characteristics over a positive and negative range of torques. The bias torque which cancels at the output shaft also keeps the gears under constant load, thereby eliminating backlash.

### Two Time Constants and a Time Lag In Power Section Transfer Function

The dynamic performance of the power amplifier and its load is described by a transfer function having two time constants and a transport lag. One of the time constants is associated with the input circuit to the magnetic amplifier, and the other is associated with the inductive load. The transport lag is inherent in the magnetic-amplifier circuit and is related to the power-supply frequency.

The clutch field coil can be represented by an  $L$ - $R$  circuit where the  $L$  is the equivalent

inductance and the  $R$  is the resistance of the clutch field coil. The time constant associated with the load is then given, in seconds, by the ratio of  $L/R$ . For the clutch used, the time constant was 0.154 sec.

The time constant associated with the input to the magnetic amplifier is dependent upon the number of turns of the control windings, the resistance in series with the windings, and  $K$  factor of the magnetic amplifier. The  $K$  factor is usually given in the manufacturer's magnetic amplifier data. The time constant for the circuit of Fig. 2 (the example) is given by the equation:

$$\tau_m = K \left[ \frac{N_c^2}{R_c} + \frac{N_b^2}{R_b} \right] \text{ sec}$$

where:

$$N_c = \text{number of turns on control winding.}$$

(continued on p 56)

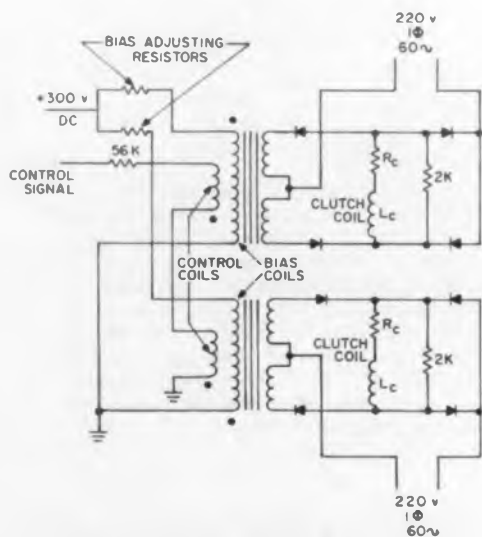

**Fig. 2.** Power amplifier for large servo: two magnetic amplifiers in series provide the push-pull signals for the eddy-current clutches. The control winding in the upper magnetic amplifier opposes the bias while the control winding in the lower magnetic amplifier aids the bias. Thus a control signal which increases the torque transmitted through one clutch will decrease it in the other.

$N_B$  = number of turns on bias winding.

$R_c$  = resistance in series with control winding.

$R_B$  = resistance in series with bias winding.

$K$  = factor for particular magnetic amplifier.

For the magnetic amplifier and circuit used, the time constant  $\tau_m$  was 0.01 sec.

The transport delay for the circuit of Fig. 2 is approximately one half cycle of the power supply voltage. For a 60-cps supply frequency, this is 0.0083 sec.

The transfer function for the power amplifier and its load can be checked experimentally by the usual frequency response techniques of applying sinusoidal voltages of various frequencies to the control windings of the magnetic amplifier. This voltage and the resulting steady-state sinusoidal current in the load circuit are recorded for each frequency. The ratio, in decibels, of peak load

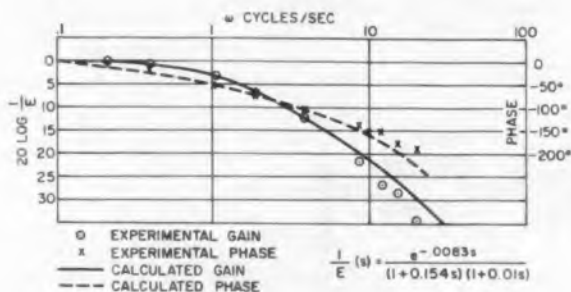

**Fig. 3.** Bode diagram comparing experimental and calculated results. The differences between the two plots are due to higher order coupling effects within the magnetic amplifier.

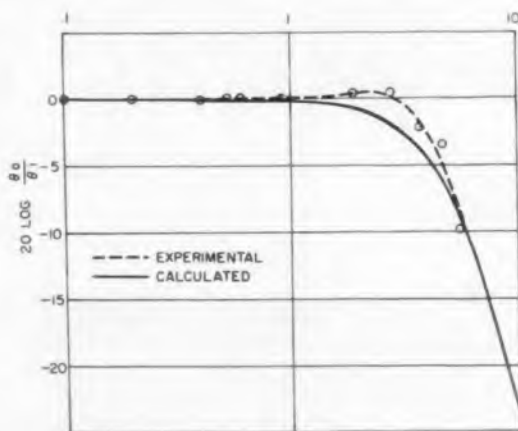

**Fig. 4.** Closed loop frequency response plot for large servo. The peaking in the experimental response is due to higher order coupling terms in both the magnetic amplifier (see also Fig. 3) and the clutch.

current to peak excitation voltage and phase in degrees between the voltage and current are plotted as a function of frequency. From this "Bode" plot and a similar plot for the transfer function, the accuracy of the transfer function can be graphically judged.

Fig. 3 is the Bode diagram from the experimental data of the example after being normalized to 0 db at zero frequency. An  $L-R$  circuit was used to simulate the load for this test. Plotted with the experimental data is the Bode diagram of the transfer function. The two are in good agreement in the frequency range of interest.

#### Loads for Large Servos Can Usually Be Scaled for Laboratory Simulation

The block diagram of the over-all servo system is shown in Fig. 1a. The input to the servo is the desired position for the load. The position feedback amplifier compares the command position with the actual load position, and the resulting error signal in

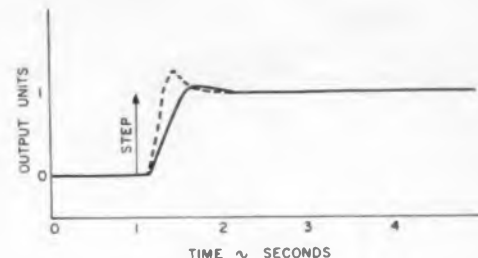

**Fig. 5.** Response of servo to step input: solid line is response when gains are adjusted for static stiffness of 630 lb-ft per radian and a velocity constant of 10 per sec. Dashed line is for gains adjusted for static stiffness of 1,260 lb-ft per radian and a velocity constant of 15 per sec.

turn is compared with the tachometer feedback signal in the tachometer feedback amplifier. The output of the tachometer amplifier, after being further amplified and compensated, is used to excite the control windings of the magnetic amplifiers which produce the control currents in the clutch field coils. The actual load in the case of the example was a large inertia (in the form of a 600-ft diam antenna) driven by the clutches through a step-down gear box. In the breadboarding of larger servos the actual load can usually be simulated in the laboratory by less cumbersome inertias attached directly to the torque units. To the extent that the step-down gearing is eliminated, progressively smaller physical inertias can represent the actual load.

#### Adjustment of Compensation To Meet Specifications

The desired performance of the example servomechanism was specified by two parameters, the velocity constant and the static stiffness, along with a well-damped transient response. The velocity constant is a measure of how well the load will follow a constant velocity command, and the static stiffness a measure of how well the load will remain in a fixed position when it is acted upon by a disturbance torque (a wind load on an antenna, for example).

The velocity constant of a servo is defined as the ratio of the command velocity to the constant position error which results from the velocity input. When a constant velocity is commanded at the input, the load, after transients have subsided, will have the same velocity as the command input. Since the tachometer generates a voltage proportional to this velocity, a position error voltage must exist which cancels this amplified tachometer voltage at the tachometer feedback am-

plier. The larger the tachometer feedback gain, the larger the position error must be to cancel this voltage.

The gain of the tachometer feedback is directly related to the damping of the servo: the larger the gain, the greater the damping. It is seen that there are two conflicting requirements on the tachometer gain: high gain for good damping, and low gain for a large velocity constant.

The static stiffness is defined as the ratio of disturbance torque to the steady-state position error. When a constant disturbance torque acts on the load, the load position is different from the command position. This produces a position error which is amplified by the forward-loop gain and causes a torque equal to the disturbance torque to be transmitted to the load. The larger the forward-loop gain, the smaller the position error required to produce a torque equal to the disturbance torque.

The effect of increasing the forward-loop gain is to decrease the damping. Again there are two conflicting requirements on the forward loop gain: high gain to produce good static stiffness, and low gain to have good damping.

The compensation, as the name implies, is added to alter the system in a way that the high forward-loop gain and the low tachometer feedback gain can be achieved in a system that has the desired damping.

The values for the transfer functions of the compensation networks used for the example are given in Fig. 1b, along with the other system transfer functions. Experimental work with the breadboard was used to arrive at the compensation values.

#### Calculated and Experimental Transfer Functions Used in Performance Evaluation

The laboratory performance of the servo's breadboard should be measured and compared with the performance predicted using a block diagram such as Fig. 1b. Several different types of inputs can be used to measure the closed-loop system performance. Sinusoidal command inputs were used for the example in the same manner that they were used to measure the performance of the power amplifier, and a constant disturbance torque was applied at the load end to measure the static stiffness of the system. Step command inputs (nearly instantaneous changes of the command position to another position) were used to measure the settling time and damping.

To obtain the frequency response of the

servo, sinusoidal command inputs of various frequencies were used to excite the system. These inputs and the resulting sinusoidal load positions were recorded for each frequency. Fig. 4 is a plot of the ratio, in db, of peak load position to peak command position as a function of frequency. The bandwidth of the servo, as defined by the frequency at which the response is down 3 db, is about 4 cps. The calculated frequency response obtained by using the block diagram of Fig. 1b, is plotted with the experimental data for comparison. The agreement between the experimental data and the predicted frequency response is considered good for a servomechanism as large as the example.

To measure the static stiffness, a constant disturbance torque was applied to the load. The torque was generated by applying a known force to a lever arm of known length attached to the load. The rotation of the load from its command position could then be measured when the disturbance torque was applied. The static stiffness measured for the example in this manner was 630 lb-ft per radian. To calculate the static stiffness from the block diagram, Fig. 1b, assume a disturbance torque acting on the load is of such a magnitude as to cause a position error of one radian. A position error of one radian is equivalent to 1 v in Fig. 1b, and will cause a steady-state torque of 630 lb-ft to be transmitted to the load by the clutches. The torque transmitted to the load by the clutches must equal the disturbance torque for the system to be in a steady-state condition. The static stiffness of the example was 630 lb-ft disturbance torque divided by the one-radian position error or 630 lb-ft per radian, which was the same as the measured static stiffness.

Because of the limited travel available in the potentiometer used to measure the load position in the example's breadboard, it was impractical to measure the velocity constant. In such a case, however, the velocity constant can be calculated with a high degree of confidence, if other calculations have been in good agreement with the experimental data. To calculate the velocity constant from the block diagram of Fig. 1b, assume a command velocity of one radian per second has been applied to the input. The load will then have a velocity of one radian per second. When the load velocity is one radian per second, the tachometer will generate a voltage of such a magnitude that the output of the tachometer feedback gain and compensation network will be 0.0993 v. A position error voltage of 0.0993 must exist to cancel

#### Where a Large Servo is Needed:



Drives for this 600-ft diam radio telescope (shown here in artist's conception) were the project which produced the large-servo "example" used in this article. The 600-ft antenna is being installed by the Office of Naval Research (USN) at Sugar Grove, W. Va. "Hundreds" of the units of the type described (but with 15- to 25-hp motors) will be used in unison to move what is claimed will be "the world's largest movable structure."

While hydraulic or other types of electrical servos are often used for large servo applications, only the all-electric eddy-current clutch system was felt to have the combination of reliability, low-maintenance requirements and performance needed.

The General Electric Co., Erie, Pa., is manufacturing the motors, clutches as well as the magnetic and other amplifiers for the Sugar Grove servos.

out the tachometer feedback voltage at the tachometer feedback amplifier. The position error which corresponds to this voltage is 0.0993 radian. The velocity constant is then one radian per sec divided by 0.0993 radian or approximately 10 (1/sec).

The transient response of the example to a step input is given by Fig. 5. The transient with the system gains adjusted as in Fig. 1b was well damped, and the settling time (time to settle at the command position) is about 0.4 sec. Fig. 5 also shows the response of the example to a step input with the gains adjusted so that the static stiffness of the system is 1,260 lb-ft per radian and the velocity constant is about 15 (1/sec). With these gains, the transient is no longer over-damped, having about 50 per cent overshoot; however, the transient stabilizes at the new command position in about 0.2 sec. ■ ■

# How To Specify Crystal Filters

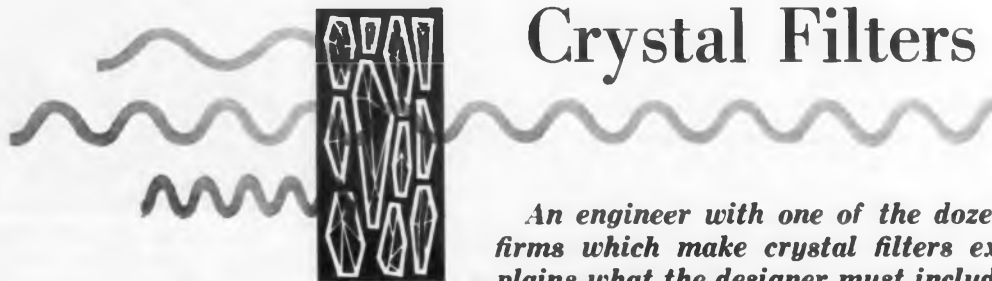

*An engineer with one of the dozen firms which make crystal filters explains what the designer must include in his specifications to obtain the right crystal filter for his application.*

**Al Strauss**  
Bulova Electronics  
Woodside, N. Y.

**T**HE attraction of crystal filters for the designer is that they provide high selectivity with excellent stability. From the total circuit standpoint, by using crystal filters, the designer finds that he can simplify his circuit. In the process reliability is increased, not only because of the simplification, but because many of the eliminated components have reliabilities much less than that of quartz.

As an indication of the performance of crystal filters, a quartz element may have a Q in the hundreds of thousands, an inductance in the thousands of henries, and a stability of one part in  $10^7$  per day. At the same time, there is no electromagnetic coupling to any other coil in the system.

Fortunately, as this piece will attempt to show, crystal filters can be obtained in a fairly wide variety of frequency combinations. To the basic frequency ranges permitted by the quartz elements can be added the additional ranges allowed by the com-

bination of quartz elements with coils.

Fig. 1 shows these ranges in terms of center frequencies and bandwidths for pass-band filters. Bandwidths of 12.0 per cent and operating frequencies of 110 mc are the present limits for crystal filters. Bandwidths less than 0.01 per cent can be obtained with crystal Q's in excess of 200,000 at an additional expense.

Actually the 12 per cent limitation is rather artificial for, by wedding a crystal filter with an LC filter, bandwidths up to 30 per cent are possible. The stabilities for these

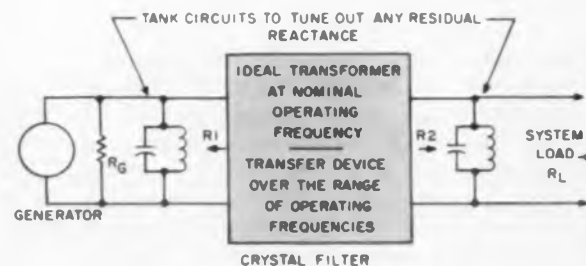
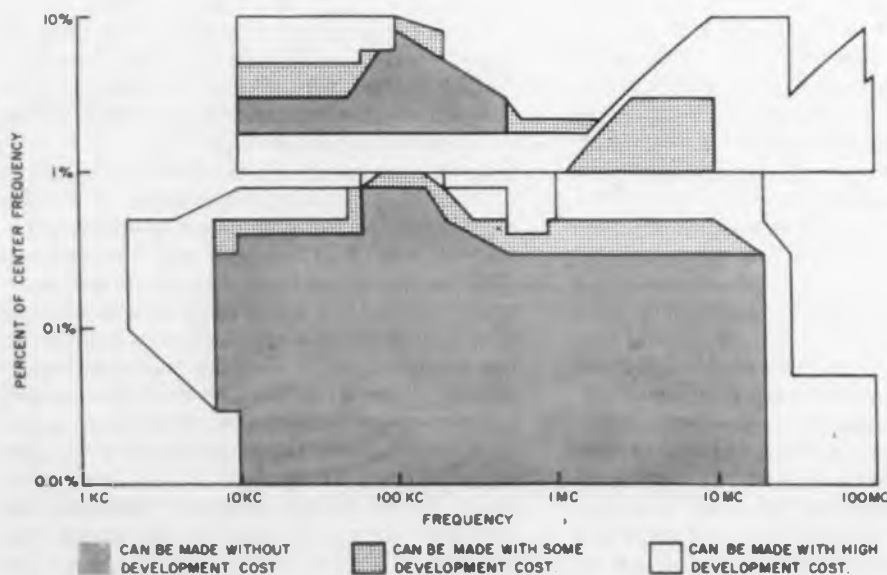

**Fig. 2.** It is important that the filter, when in the circuit, see pure resistances which match the filter's input and output resistances. Circuit capacitances which alter this matching by more than  $\pm 5$  per cent must be tuned out by tank circuits.

**Fig. 1.** Bandwidth vs frequency for crystal filters. Though based on the filters produced by the author's company, the chart is believed to be fairly representative of industry practice. Note the "grey" area between the lower narrow-band areas and the upper "wide-band" areas. The author believes most of the future development efforts in crystal filters will go towards extending the upper frequency limits.

## How to Order Crystal Filters

The following is a guide to the type of information that the firms which produce crystal filters like to have from engineers. Note that the electrical and mechanical requirements are listed separately.

### A. Electrical Requirements:

1. *Specific Frequency.* In the case of symmetrical band pass, this will be the center frequency, while for a single side band this will be the carrier frequency.
2. *Bandwidth of Filter.* This is usually described at the 3-db level, although it may be at the 1- or 6-db levels.
3. *Shape Factor.* This determines the number of sections of the filter (see Table 2.).
4. *Input, Output Impedance.* See Table 1.
5. *Other Requirements.* As required, such as ripple and variation due to temperature.

### B. Mechanical Requirements:

1. *Size of Can.*
2. *Location of Mounting Studs or Inserts.*
3. *Location of Terminals.*
4. *Type of Terminals.*
5. *Other Mechanical Requirements.* Unusual environments such as humidity, excessive humidity, shock, vibration or pressure.

modified crystal filters are still greater than for straight LC filters, though not as great as the stabilities of the all-quartz filters.

### Start the Design Right

It is strongly recommended that the systems engineer introduce the crystal filter into his design during the initial phases. Often a complete system is designed and then during the development a crystal filter is introduced almost as an afterthought. By this time much of the advantage of using a crystal filter can be lost.

Because a compromise will probably have to be made between the characteristics of the established system and the crystal filter, full utilization of the crystal filter's ability to control frequency-voltage characteristics will not be achieved in such a system.

### How the Filter Fits in the System

To design the filter into his system, the engineer need only regard the filter as an ideal transformer at the nominal operating frequency. If, in Fig. 2, the terminations

## CIRCUIT IDEA FILE

## New Transistor Applications

# Looking for simplicity in a servo amplifier?

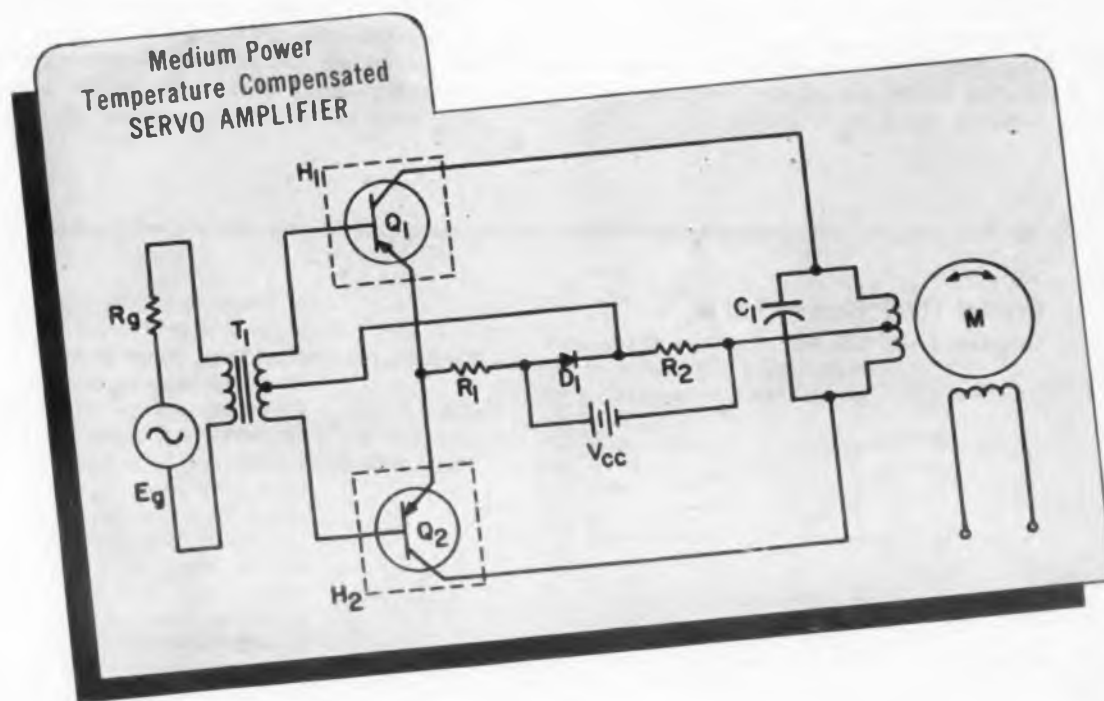

This Class B push-pull servo amplifier using Honeywell's medium power transistors features:

- Temperature compensation—the germanium diode compensates for the transistor emitter diode temperature characteristic.
- Negligible crossover distortion—the same diode applies a slight forward bias so that the transistors are operating Class AB.

- Medium power—rated at 6 watts output into a size 15 servo motor.
- Simplicity—permits a package size limited only by the heat dissipators.

Honeywell's medium power transistors are packaged in a compact case for ease of mounting and versatility of wiring. For specifications and additional information, send the coupon below to: Honeywell, Dept. ED-9-134, Minneapolis 8, Minnesota.

### COMPONENTS

Q<sub>1</sub> Q<sub>2</sub>—Honeywell 2N 1658  
 R<sub>1</sub>—5 ohms—R<sub>2</sub>—1000 ohms  
 C<sub>1</sub>—5μf—D<sub>1</sub>—1N 91 or equivalent  
 V<sub>cc</sub>—28 VDC—M—Size 15 servo motor  
 T<sub>1</sub>—UTC SSO-14 or equivalent  
 E<sub>g</sub>—400 cycle generator with R<sub>g</sub>≈1500 ohms  
 H<sub>1</sub> H<sub>2</sub>—5" x 5" x 1/16" aluminum plates

# Honeywell

**First in Control**  
 SINCE 1885

Sales and Service offices in all principal cities of the world.

KINDLY CHECK ONE OR BOTH OF THE FOLLOWING:

Please send me your 2N 1658 and 2N 1659 specification sheets which include notes on the above servo amplifier.

Please have a Honeywell field engineer call on me at my convenience.

NAME \_\_\_\_\_

ADDRESS \_\_\_\_\_

COMPANY \_\_\_\_\_

CITY \_\_\_\_\_ STATE \_\_\_\_\_

CIRCLE 49 ON READER-SERVICE CARD



change the magnitude of the impedances seen by the filter by more than  $\pm 5$  per cent from pure resistances, then the corrective tank circuits will have to be added. The filter must "see" the system as the two resistors  $R_1$  and  $R_2$ . In many applications, this  $\pm 5$  per cent tolerance is such that a tank circuit need not be included and  $R_1 = R_g$  and  $R_2 = R_L$ .

For band rejection filters, the ideal transformer concept is still applicable so long as the nominal operating frequency is taken as any passed frequency two or more bandwidths from the center frequency of the rejected band.

### Crystal Filter Nomenclature

**Insertion Loss:** The loss of a filter at the minimum loss of frequency of the filter, usually measured in db.

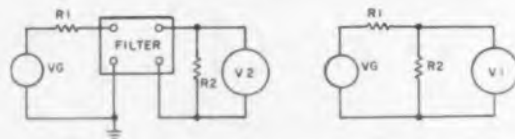

$$\text{Insertion Loss} = 20 \log \frac{V_1}{V_2} \text{ db}$$

**Attenuation:** The loss at any frequency relative to the minimum loss of the filter.

**Bandwidth:** Width measured in frequency between two points at the same db level, typically the 3-db bandwidth. In a symmetrical filter a bandwidth is usually specified for the 3-db level.

**Shape Factor:** The ratio (usually maximum) between a high attenuation level bandwidth and a low attenuation level bandwidth. For example, the interpretation of "60 db to 3-db shape factor is 3.3 to 1," is that the bandwidth at 60 db is 3.3 times the bandwidth at 3 db.

**Pass-Band Ripple:** This is the difference of the minimum loss point to the maximum loss point in a specified pass-band bandwidth and is measured in db.

**Pass Band Filter:** A filter which passes a band

of frequency while attenuating above and below this band.

$$\text{Insertion Gain} = 20 \log \frac{R_1 + R_2}{2\sqrt{R_1 R_2}} \text{ (db)}$$

As an ideal transformer, and at the nominal operating frequency, the filter will provide a voltage gain of:

This is the gain at the load that occurs with the insertion of the filter between  $R_g$  and  $R_L$ . The system engineer need do little more for by using these nominal conditions as references he can specify the desired voltage or phase characteristics over the full frequency range within the values obtainable with the filter. From these, the engi-

**Band Suppression or Band Reject Filter:** A filter which suppresses a band of frequency and passes frequencies above and below this band.

**Single Side-Band Filter:** A term applied to a band pass filter in which the shape factor of the slope one side of the filter is greater than on the other side. The name single side band is derived from the system use of filters to suppress a carrier frequency and transmit one or both side bands. Bandwidths that are available in single side-band filters are the same as for the symmetrical filters.

**Comb. Set of Band Pass Filters:** A grouping of filters of the same bandwidth and impedance equally spaced where the similarity in shape and insertion loss level are stressed.

**Input and Output Impedance:** This is the resistive load which the filter must see at its input and output terminals in order that the characteristics called for are met. This impedance must be strictly resistive. Any reactance load which the filter may see must be tuned out, if possible, and if not it must be controlled to a given value in order that it may be incorporated into the filter design.

neers of the firm supplying the filter can take over and provide the proper filter.

No matter how ideal a crystal may appear there is always some resistance loss. For crystals alone, this rarely amounts to more than 0.2 db. However, one or more transformers are normally included in a filter. Coil losses in these transformers are inevitable. For most applications these coil losses may be held to less than 3 db and for almost all applications to less than 8 db. Since the coil losses are "flat" losses and constant over the operating range, the system engineer can easily provide for them.

Whenever the system engineer can, he should choose the impedances  $R_g$  and  $R_L$  alike. Also, he should try to make their level as nearly equal to the values shown in Table 1 as possible. The overlap in Table 1 is due to the variety of crystal cuts used.

If the impedances cannot be kept to these values, an upper limit of

$$\frac{3 \times 10^3}{f}$$

should be used. The "f" in this equation is in kilocycles per second and represents the state of the art.

Temperature stability is normally held to  $-0.01$  per cent over a range of 100 C. At frequencies greater than 1 mc, this figure can be improved to 0.004 per cent. To obtain better than this, the filter can be put in an oven and the frequency stability improved to one part in  $10^7$  per day.

The selectivity as measured by the shape factor may be as high as 1.1 to 1 bandwidth ratio of that at 1 db to the bandwidth at 80 db.

Temperature characteristics of narrow band filters are almost completely dependent on the variation of the crystal parameters with temperature. Coils do not play an important part in shaping narrow-band filters. Therefore, variations in inductance with temperature can usually be compensated for by use of temperature-compensated capacitors. Insertion loss and ripple vary only slightly, usually within the specified requirements imposed on room temperature.

Though coils are not needed for shaping in narrow-band filters, they are sometimes needed to balance out the stray capacitance and provide a required impedance.

### "Wide-Band" a Relative Term for Crystal Filters

"Wide-band crystal filters" cover bandwidths from about 1.2 to 12 per cent. They are considered wide-band because they get

**Table 1. Preferred Impedances for Frequency Ranges**

Nominal Operating Frequency, f	Preferred Impedance, Z
2-50 kc	$3 \times 10^2 \times (\% \text{ bandwidth})$
4-500 "	$5 \times 10^3 \times (\% \text{ bandwidth})$
50-500 "	$2 \times 10^4 \times (\% \text{ bandwidth})$
55-550 "	$3 \times 10^4 \times (\% \text{ bandwidth})$
80-700 "	$2 \times 10^5 \times (\% \text{ bandwidth})$
$0.5 \times 10^1$ - $30 \times 10^1$ kc	$0.2 \times (\% \text{ bandwidth})/f^2$
$15 \times 10^1$ - $90 \times 10^1$ "	$80 \times (\% \text{ bandwidth})/f^2$
$25 \times 10^1$ - $110 \times 10^1$ "	$475 \times (\% \text{ bandwidth})/f^2$

**Table 2. Typical Shape Factors for Wide-Band Symmetrical Crystal Filters**

Type	Db Ratio	Shape Factor
3WS	40/3	3/1
	60/3	4/1
5WS	60/6	2.5/1
	40/3	1.7/1
6WS	60/6	1.7/1
10WS	60/6	1.5/1

their effective width due to coils which act in the circuit to widen the bandwidth beyond that obtainable with the crystals.

These wide-band crystal filters do not attain the widths obtainable with LC filters and would therefore be considered "narrow-band" in comparison. Therefore, it must be understood that "wide-band" as applied to crystal filters is a relative term. Here again, as Fig. 1 shows, the feasible ranges of crystal filter bandwidths vary across the spectrum.

Coils are an integral part of the design of wide-band filters. The effective resistance of the coil is part of the termination of the filter and is in this sense essential. Variations in coils, however, do not effect the attenuation characteristics of filters as critically as they do in regular LC filters because of the lattice and half-lattice construction which permits these coils to be resonant outside the balance portion of the filter. A typical narrow-band, two-crystal filter has a shape factor at a 40/3 db ratio of approximately 8:1, whereas a two-crystal, wide-band filter has a shape factor of about 3:1.

Table 2 gives typical shape factors for various wide-band symmetrical filters. ■ ■

# TUNG-SOL 6977

*subminiature  
indicator triode  
saves display space*

Here's an indicator triode for computer and business machine applications that will replace neon lamps in computer circuits. It has the advantage of low voltage drain with great economy of display area.

The Tung-Sol 6977 is a filamentary, high vacuum, subminiature triode with a fluorescent anode. Especially advantageous in transistorized circuits, its high input impedance and small signal requirements do not load these circuits.

Tung-Sol design and manufacturing skills are being applied constantly to the problems of improving componentry in all fields where industrial and special purpose tubes find their specialized uses.

If you have questions regarding the application of type 6977, or any tube type, you are invited to bring them to Tung-Sol. You will be pleased with the results. Tung-Sol Electric Inc., Newark 4, N. J. TWX: NK193

#### TYPICAL OPERATION

Heater Voltage <sup>®</sup> AC	1.0 Volts
Anode Voltage DC	80 Volts
Grid Resistance	100,000 Ohms
Grid Supply Voltage for max. light output	0 Volt
Grid Supply Voltage at zero light output	- 3 Volts

TECHNICAL ASSISTANCE IS AVAILABLE THROUGH: Atlanta, Ga.; Columbus, Ohio; Culver City, Calif.; Dallas, Tex.; Denver, Colo.; Detroit, Mich.; Irvington, N.J.; Meirose Park, Ill.; Newark, N.J.; Philadelphia, Pa.; Seattle, Wash. In Canada: Abbey Electronics, Toronto, Ont.

 **TUNG-SOL<sup>®</sup>**



# Cyclic Memories—A Comparative Evaluation



## ●Part 2 ● (Nonvolatile Memories)

*Here is the concluding part of Y. J. Lubkin's critical evaluation of cyclic memories. The first part (ED, Aug. 30, pp 56-63) dealt with volatile memories. Here, Mr. Lubkin treats nonvolatile memories.*

**Yale Jay Lubkin**  
Loral Electronics  
Bronx, N. Y.

**T**HE ONLY forms of nonvolatile cyclic memory in wide use are devices in which a magnetic surface moves past a magnetic read-write head. These devices take the form of drums, disks, and endless tape loops. They are used when a moderate to large amount of storage is required with a low cost per bit and with moderate access time. The capacity range is quite wide, varying from 5,000 to 16,000,000 bits on drums, and from 5,000 to 30,000,000 bits on single disks. There is no essential limit on the capacity of tape loops.

Cyclic rotation rates for drums, disks, and tape loops vary from about 1 rpm to about 200,000 rpm. Most popular rates are 1,800, 3,600, 12,000, and 24,000 rpm, corresponding to speeds available from four- and two-pole motors for 60 and 400 cps, respectively. Cost per bit varies from a maximum of \$100, in one case known to the author, to a minimum of about a mill. Costs exceeding a dollar a bit are rare, the usual price being a few cents.

### **Magnetic Drums Store Data on Cylinder Surfaces**

A magnetic drum is a cylinder upon which a magnetic coating is deposited. The coating is usually either a dispersion of iron oxide or

a plating of a nickel alloy like Permalloy. Nearly all modern drums use direct motor drive. Most drums are supported on ball bearings, but high-speed drums use fluid (air or liquid) bearings. Some drums have been built with magnetic bearings.

Data are normally stored on a drum in sequence on each of a number of tracks. The data are stored as a sequence of permanently magnetized spots, impressed on the drum surface by a magnetic head. The same head is generally used for reading as well as writing.

The storage capacity of a drum is the

product of the number of tracks and the number of bits per track. The number of tracks per inch of linear drum dimension varies from about 10 to 32, with the total number of tracks varying between five and 500. When an extremely large number of tracks is required, it is frequently better to use several drums or to change the design approach.

The number of bits per circumferential inch of track varies over a wide range. A survey by the author several years ago revealed that about a dozen manufacturers were designing drums with a packing density of 60 bits per in.; two used a packing density of about 150 bits per in.; two had a density of about 300 per in.; and one had same drum design at 150 bits per in.

### **Manufacturer's "Know-How" May Determine Drum Capacity**

While drum eccentricity, coating, head spacing, and head design are important, the major factor determining the bit-packing density appears to be the manufacturer's understanding of the nature of the recording process. As example, with one manufacturer's drum, the author has recorded at 300 bits per in. with better safety margins and reliability, and with lower drive power, than the manufacturer had obtained from the same drum design at 150 bits per in.

One large-capacity drum, shown in Fig. 5, stores 15,000,000 bits with a density of 1,040 bits per in. With electronics, this drum sells for about \$30,000, or about 2 miles per bit. The drum uses a surface of ground Cunife, while most drums use a dispersion of iron oxide. It is completely immersed in kerosene, while most drums run in air. The heads float on a thin film of kerosene to maintain an ef-



**Fig. 5.** Magnetic file drum by Laboratory for Electronics, Inc., is only 14 in. high, 15 in. in diameter. It can store 15 million bits with an average access time of 180 msec.

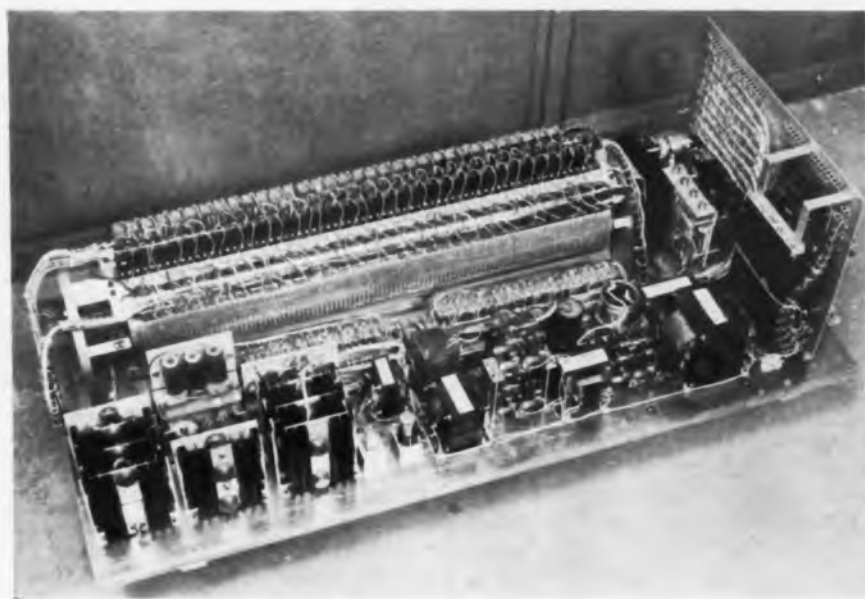

**Fig. 6.** Flux-sensitive drum can store up to about 15,000 bits. The heads, individual bistable magnetic amplifiers, can write at up to about 200 bits per minute and can read at about 7,500 bits per minute. Made by Consolidated Controls Corp., such drums are intended for program control rather than computer memory.

fective drum-to-head air gap of about 0.1 mil, while usual air gaps vary from 0.5 to 3.0 mil with 1.0 mil being most common.

When a drum serves as the main storage of a computer, a clock track on the drum sets the computer timing. Speed variations of the drum will normally have little effect on system performance, since the entire computer is synchronized to the drum. When a drum is used with random-access devices like magnetic cores, little difficulty is encountered, because the random-access circuitry will tolerate small variations in clock rate. If the drum is used with another synchronous device, like another drum or a delay-line register, then one of four conditions must be satisfied:

1. The two synchronous media must be synchronized (as in the Edvac, with its drum and delay line).

2. The computer must operate separately with the two media (as in Elecom 125, which used a drum and quartz delay lines. Signals from one medium were not used by the same portion of the computer at the same time as signals from the other).

3. An asynchronous buffer must be used (as with the multiple drums on many commercial machines).

4. The computer must use one medium to

sample another (as with many drum machines where the drum samples punched-card input).

#### Flux-Sensitive Drum Heads Give Asynchronous Operation

A novel variant of the drum that permits asynchronous operation uses flux-sensitive read heads rather than the common, flux-derivative read heads. Early models used a separate magnet for each bit and recorded at 10 bits per in., two tracks per in. One unit, shown in Fig. 6, stores 15,000 bits in a drum size normally used for several million bits.

Such drums are driven by stepping motors rather than the usual induction or hysteresis motors, and they are intended for industrial control rather than computer memory. Bits can be written or read while the drum is stationary.

#### Disk Memories Cut Bulk for Large Storage

The volume-to-surface ratio of a drum is quite high, so the physical bulk of large-capacity drums makes their design, use, and transportation difficult. Disks have a much lower ratio of volume to surface, so they allow for comparatively light structures with



**Fig. 7.** The BD-500 Bernoulli Disk memory of Laboratory for Electronics, Inc. can store 500,000 bits. In the drawing, the black section (A) represents the flexible Mylar disk. (B) is the stabilizing backplate, (C) is one of the read/write heads, (D) is the backplate bearing cartridge, (E) is a connector ring, and (F) is the drive motor.

large storage capacity.

Two approaches to disk memories are current, one using disks of a rigid material such as aluminum or quartz, and one using a flexible material supported by gas pressure. Each type has advantages and disadvantages offsetting those of the other.

In a drum, all tracks have the same peripheral speed, so the packing density in all tracks is the same if the number of bits per track is the same. This is not true in a disk because the track speed is proportional to the distance from the disk track to the center of the disk.

Hence, for a given number of bits per track, the packing density is highest for the inner tracks and lowest for the outer tracks. A disk operated this way, with a fixed number of bits per track (for uniform bit rate), will yield maximum storage when the outer half radius is used for storage and the inner half is left blank.

But the capacity can be increased if more bits are recorded in the outer tracks than in the inner tracks. A favored technique is to record at a given density from the one-third radius point to the two-thirds radius point, and to double the density thereafter. This enables a capacity increase of 33 per cent compared with the uniform-bit-per-track

technique. The tracks recorded at higher density are considered to be two interleaved tracks of normal density, separated by computer logic.

A thin, flexible sheet of Mylar, coated with a magnetic dispersion, and rotated at high speed, makes for another type of disk memory called a Bernoulli disk. A typical Bernoulli-disk memory is shown in Fig 7. When the disk is not turning, it hangs limply, but at rotational speeds, the disk flattens out under centrifugal force and assumes a nearly planar form.

Head-to-disk spacing is maintained by mounting the heads in a plate and allowing the disk to move axially. An air film, produced by disk pumping, controls the actual spacing. The disk has holes and slots in the edge to control the pumping action and to regulate the head-to-disk spacing.

Since the head-to-disk spacing of the Bernoulli disk is not constant (near the disk center the spacing is smaller than near the edge), the maximum recording density is approximately constant, in bits per track, over the entire usable portion of the disk. Typical values of bit-packing density lie in the range of 200 to 300 bits per in. Bernoulli disks are available with storage up to two megabits.

#### **Bernoulli Disks Are Rugged, But Can Not Take High Heat**

Bernoulli disks have the advantage of an inexpensive recording medium (Mylar film is much cheaper than an aluminum drum, for instance), and the advantage of great ruggedness. Since the forces exerted on the disk by its pumping action and by centrifu-

gal force are much greater than those exerted by acceleration of the disk during shock and vibration, operation of the disk is little affected by shock and vibration. Indeed, a standard demonstration is to pound a running Bernoulli disk with a hammer without any momentary loss of data.

The Bernoulli disk has a number of serious defects which limit its military applications. The power requirements of the disk are appreciably higher than that of a rigid disk or drum of the same capacity, and much of the delivered motor power goes into heating the Mylar film. Because of this, the upper temperature limit of the Bernoulli disk is less than that of other media we have considered.

Lifetime to failure is undoubtedly shorter than that of other media because of the heating effect, though a great many years of life can be expected if temperatures are kept moderate. Lastly, the disk is not suitable for low or very high rotational speeds—the first because the film will not maintain its shape at low speeds (below about 1,800 rpm), and the last because of excessive power consumption, film heating, and centrifugal force.

#### **Rigid Disks Give Fast Access For Bulk Storage**

Rigid disks have found use in two widely divergent applications: small disks for airborne and other small computers and large disks for bulk storage. The favored material for large disks is aluminum, while aluminum and quartz are both popular for small military disks.

The small rigid disks frequently run in helium or Freon rather than air to mini-

mize windage power. They can operate at very high rotation rates with little motor power. Multiple-disk assemblies on a common shaft are quite common. They tend to reduce the cost per bit stored, which is higher, in general, for the small rigid disks than for the other forms of disk and drum memory (primarily because of the military environmental specifications).

One approach to small-disk design uses a deposited nickel coating on a quartz disk, with the coating etched so each bit space is magnetically separated from all other bit spaces. This isolates the flux of each bit from that of adjacent bits; it prevents flux fringing; and it produces clean signals with a high signal-to-noise ratio. Packing densities with this technique are limited to about 300 per in. by the state of the art in etching.

The large disks, up to 4 ft in diameter, are generally used in multiple for storing large amounts of data. Smaller media use one or more heads per track, while the large disks frequently use one or more heads per disk face.

One large disk assembly (Telex II), uses 64 disks to store more than 600,000,000 bits. It is almost superfluous to note that the large disk arrays are not intended for mobile or airborne applications. The 600,000,000-bit Telex II weighs 3,000 lb. and requires 7 kw.

A variant of the disk memory, the juke-box memory, has movable disks. The juke-box memories are more flexible than the disk files which use disks fixed in position, but they have a higher mean access time. A juke-box memory is shown in Fig 8.

The large disk memories use a number of interesting techniques to maximize data. The

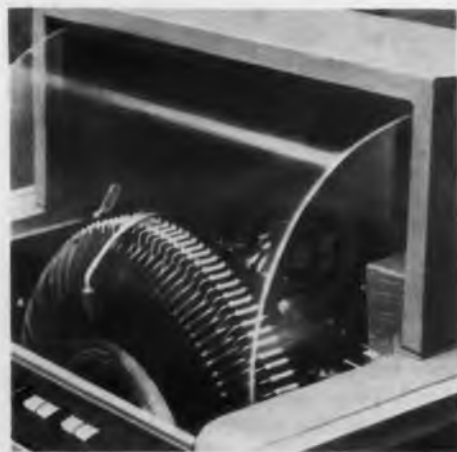

**Fig. 8.** Disks can be removed and exchanged quickly in RCA's model 361 file.



**Fig. 9.** Multiple disk file made by Bryant Computer Products can have as many as 20 disks.

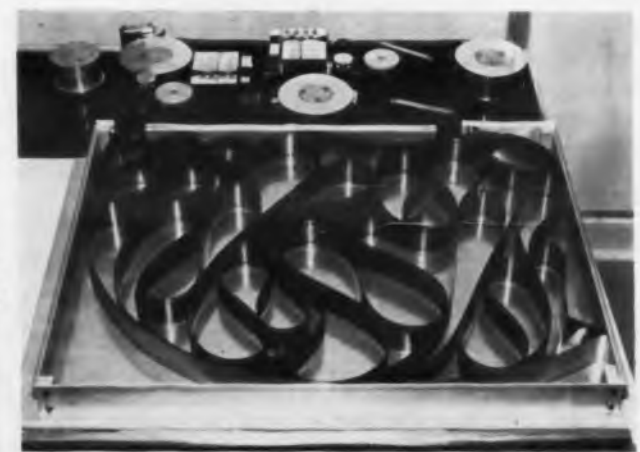

**Fig. 10.** Royal McBee's RPC-9100 magnetic tape storage unit has an endless loop of tape in a stationary cartridge.

Bryant 4000, (Fig. 9), which stores 30,000,000 bits per disk on a maximum of 20 disks, divides each disk surface into six zones, with a different clock track in each zone. The zones are recorded at an average packing density of 240 bits per in. and at clock rates varying from 165 kc to 420 kc.

Extremely tight track spacing is used to minimize size, and 64 tracks per in. of radius are provided. Disk diameter is 39 in. and disk rotation rate is about 1,000 rpm. Maximum access time is 150 msec. Power requirements are about 3 kw. Air-floating heads maintain a head-to-disk spacing of 0.5 mil.

#### Endless Tape Loops Have Low Bit Cost, Slow Access

One form of large-capacity memory is the endless tape loop. Early designs, built by the National Bureau of Standards and others, packaged a tape loop in a basket made of parallel glass plates separated by slightly more than the tape width. The tape drapes at random in the basket. Tape is pulled out of the basket, it travels past the read-write heads, and then it is pushed back into the basket. More recent units store the tape in a removable cartridge.

In the Royal McBee device shown in Fig. 10, each cartridge can store 960,000 alphanumeric characters in 10,000 blocks of 96 characters, for a total storage of nearly 6,000,000 bits.

Tape loops of this form are useful when an entire file of data must be referred to in blocks which are arranged in an ordered manner. They appear unsuitable for the pseudo-random access for which a large disk file may be used because of their high access time. But their low cost per bit, indefinitely expandable size (by adding extra cartridges), and light weight make them attractive for many applications where moderately long access time is bearable.

One unsuccessful variant of the tape loop was a tape-drum combination, which used a very wide (18 in.) magnetic tape on which information was recorded in pages. The read-write heads were arrayed on a drum, and a page of the tape was curved to fit around the drum.

In any page position, the memory had the characteristics of a magnetic drum, but pages could be changed by moving the tape. Storage capacity was high and access time to read any bit on the page was low, but construction difficulties and the competition of other media led to the effective abandonment of the idea. ■ ■

# Go Ahead Pour on the juice

Exclusive Handi-Vider\* finger tip control lets you dial voltages with unmatched ease.



with new **SF**  
precision dc sources, 20 ma output  
across the board 0 to 6000 vdc. accurate to 0.25%.

Introducing three precision dc sources by Smith-Florence, combining more most wanted features at a remarkably low cost. Check them out. Model 120 covers the range of 500 to 2210 vdc. Only 3½" high, it features in-line controls, regulated filament power, modular construction and removable rubber feet for rack or bench use. Price, \$450. Model 122 provides 0 to 3000 vdc. Model 123, 0 to 6000 vdc. Mounted on 5¼" panels, these models feature Handi-Vider\* in-line controls, voltage and current metering, and reversible polarity. They are the only supplies offering maximum output down to zero voltage. Price of Model 122 is \$595, Model 123, \$695.



Use of modular construction and standardized components simplifies maintenance.

#### All Models Feature:

STABILITY—.005% per hour \* REGULATION—.01% for ±10% line change and/or 20 ma load change \* RIPPLE—less than 5 mv rms at any output voltage and current of either polarity \* RESOLUTION—10 mv at output voltage.

For Complete Details ask for our new data folder which also includes information on the Model 170 regulated precision 20 KV 5 ma hi-voltage source and our complete line of general purpose supplies. Please write, or for immediate service, call your nearby Smith-Florence sales representative.

\*Registered trade mark



**SMITH-FLORENCE, INC.**  
OVERLAKE INDUSTRIAL PARK  
BOX 717 • REDMOND, WASHINGTON  
PHONE: TUCKER 5-4385

*tiny but mighty!*  
**PROPIMAX<sup>®</sup> 2**



(ACTUAL SIZE)

**6½ OZ.**

A featherweight with heavyweight power! The Rotron PROPIMAX 2 produces more air flow for its size than any other unit commercially available. At 400 cps., under free delivery, this mighty ~~mini~~ moves 120 CFM. Ideally suited for ground or airborne applications. For airborne or missile applications, the PROPIMAX 2 is equipped with the exclusive ALTIVAR motor which automatically compensates for varying air densities at increased altitudes. Also available in 60 cps model for a compact and lightweight cooling device. Physically and aerodynamically symmetrical, permitting reversible air flow by merely turning end for end. Mounting is by servo rings.

*Write for complete details*

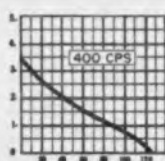
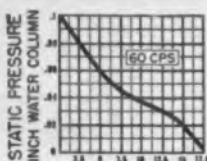
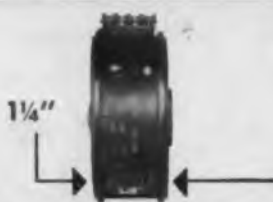

AIR VOLUME -CFM



**ROTRON** mfg. co., inc.

WOODSTOCK, NEW YORK • ORiCLE 9-2401  
 In Canada: The Hoover Co., Ltd., Hamilton, Ont.

CIRCLE 52 ON READER-SERVICE CARD



# Rotary Switches Have Completely Molded Switchplates

**T**HE VIRTUAL elimination of "slip-stick" phenomena is made possible by the use of completely molded switch plates in the construction of precision rotary switches. Long wear-life capabilities, with good signal-to-noise ratios are possible under conditions of light load.

The new line of conductive plastic precision rotary switches, manufactured by the Markite Corp., 155 Waverly Place, New York, N. Y., is extremely resistant to vibration, shock and acceleration . . . at least 50 g at

5 to 2,000 cps, as well as shock loading and acceleration in excess of 100 g without malfunction.

Each switchplate embodies highly conducting sections of conductive plastic integrally co-molded, together with terminals, to the insulator plastic sections. Conducting and insulator sections are of matched coefficients of friction and thermal expansion which virtually eliminate "slip-stick."

The switch plate yields conducting and nonconducting sections that present a hard, smooth surface to the





Load conditions are 100 v at 50  $\mu$ a; signal duration is: ON, 12 deg of rotation; OFF, 57 deg of rotation.

precious metal wiper, obviating life limiting galling and wear problems. The ultra-flush switch surface of 2 to 4  $\mu$ in. eliminates wiper bounce and affords low wiper friction. This permits wiper pressure of 60 to 80 g with low torque.

Development of moisture traps and moisture short circuit paths are precluded by the use of dense-molded materials throughout the switchplate. The wear in the conductive and nonconductive areas is essentially equal, therefore extended use does not develop a nonflush surface with consequent wiper bounce.

Conductive plastics possessing resistivities in the range of  $10^2$  to  $10^2$  ohms per cm can be utilized in these switchplates.

Spot checks indicate that at light loads a minimum of  $3 \times 10^7$  revolutions can be expected. Speed can be at least 180 ft per min, surface speed. Signals checked at 18-, 180- and 1,000 ft per min were essentially identical.

Switches have been designed for sampling, telemetering, programing, square wave generators and as mechanical choppers. Prices are expected to run in the range of \$30 to \$1,500, depending on the complexity of the switch and allied components, with deliveries from 4 to 12 weeks.

For more information on this line of conductive plastic precision rotary switches, turn to the Reader-Service Card and circle 251.



## NEW FLEXIBLE PRINTED CIRCUITRY

from Garlock

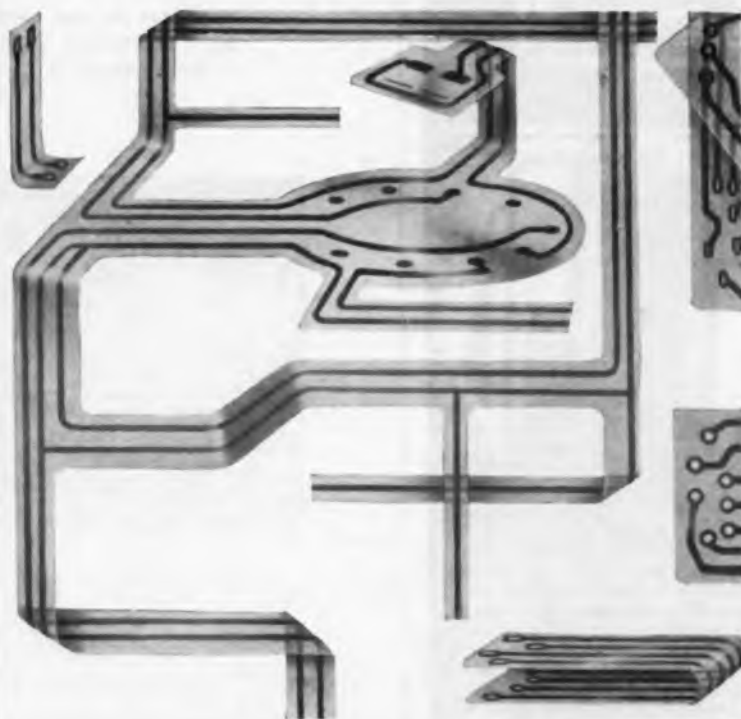

Garlock flexible printed circuitry can be economically Induction soldered due to high temperature resistance of Teflon FEP.

Teflon FEP<sup>®</sup>—and its outstanding electrical, physical and thermal properties—has been incorporated by Garlock into an advanced circuit design that offers many distinct advantages over conventional wiring or rigid printed wiring boards.

**Greater design freedom.** Garlock Flexible Printed Circuitry can be bent or twisted into any desired shape to allow design freedom without compromise to overall reliability. It can be designed to conform exactly to package contours and component parts. Garlock offers terminations adaptable to common industry standards.

**Maximum reliability.** Garlock Flexible Printed Circuitry is made of etched copper completely encapsulated between two layers of Teflon FEP. Permanently bonded under pressure, this encapsulation affords both line-to-line and line-to-ground protection, and will resist penetration of harmful moisture and gases. No adhesive is used to effect the bond, eliminating any possibility of breakdown through aging.

**Reduced size and weight.** Garlock Flexible Printed Circuitry can often cut overall package dimensions by as much as 50%. Being extremely flexible, it will hug curves, go around corners, conform to the most eccentric layout. And, because of excellent electrical properties a thinner gauge of Teflon FEP can handle the same job that requires thick gauges of other insulating materials. This, combined with the use of less copper, greatly reduces package weight.

**For more information,** call your nearest Garlock Electronic Products representative for more data, or write Garlock Electronic Products, Garlock Inc., Camden 1, New Jersey.

# G A R L O C K

Canadian Div.: Garlock of Canada Ltd.  
Plastics Div.: United States Gasket Company.

Order from the Garlock 2,000 . . . two thousand different styles of Packings, Gaskets, Seals, Molded and Extruded Rubber, Plastic Products.

<sup>®</sup>DuPont Trademark

CIRCLE 53 ON READER-SERVICE CARD

# THE *light* TOUCH

## IN AUTOMATION AND CONTROL



Our sales are in the old view of a 52-0000

Clairex Photoconductive Cells, like the human eye, are "windows to the world" of control system design. Our continually expanding line now includes the 5-1 series of hermetically sealed Cadmium Sulphide cells, employing a sensitive material formulation that matches the spectral sensitivity of the human eye! These are the first real "electronic eyes" and thus are particularly useful in applications involving human vision — such as Daylight Switches, Photography, and Automatic Brightness Control in Television Receivers.

 **CLAIREX**  
CORPORATION

and New Facilities      for more Drawing Needs  
First 50 Street, New York 1, N. Y. • MU 8-0948

CIRCLE 54 ON READER-SERVICE CARD

## PRODUCT FEATURES

# Rundown of Recent Photoelectric Cells

*The need for sturdy, uniform photoelectric devices has been made apparent by the numbers and types of requests recently received by ELECTRONIC DESIGN. Presented here are the latest products to be announced.*



### Cadmium Sulfide Cells For Industrial Controls 252

Rugged and reliable cadmium sulfide photoconductor cells are designed for use as controlling devices in commercial and industrial applications. All units are vacuum sealed to provide complete protection from moisture, dust and dirt. Units are cylindrical, approximately 1/2 in. in height and 1/2 in. in diam. Present types are designed for automatic contrast control in cathode ray tubes and as on-off switches in furnace control.

Sylvania Electric Products Inc., Dept. ED, 1100 Main St., Buffalo 9, N. Y.

*P&A: price depends upon specifications; immediate.*

---

### Silicon Photosensors Are Designed As Readout Devices 253



Up to 20 v of reverse breakdown voltage with under 10  $\mu$ a of leakage current can be handled by this line of silicon photosensors. Designed as readout devices for use in conjunction with circuitry to convert light information into usable electrical signals such as pulses and sinusoidal waves, the voltage capabilities of these diodes permit the use of direct coupled circuitry. The units are hermetically sealed in glass envelopes of 0.080 in. in diameter. They have side reading capabilities. Spectral response covers the range from 5,000 to 11,000 Å.

Philco Corp., Dept. ED, Tioga and C Sts., Philadelphia 34, Pa.

*P&A: from \$5 to \$12; immediate.*



### Photoelectric Modulators Offer SPST or DPST Switching 258

Designed to match circuit impedances of 1.5 K, photoelectric modulators M10L and M20L offer either spst or dpst switching action. Being nonmechanical in design they have no contact wear or nonohmic conduction effects and create no vibration in other circuit elements. The devices employ a light-modulated photoconductor as the switching element and are life-rated in excess of 5,000 hr. Specifications are: modulation frequency, dc to 1 kc; dynamic range, 1  $\mu$ v to 10 v; carrier phase shift, 0 or 180 deg; ambient temperature, -20 to +100 C; weight, 1 oz; dimensions, 2-1/2 in. long x 3/4 in. in diameter.

Cambridge Electronics Corp., Dept. ED, 294 Centre St., Newton 58, Mass.

**P&A:** \$21 to \$50, depending on quantity; from 3 to 10 days.



### Photoconductive Cell Approximates Spectral Perception Of The Human Eye 259

This cadmium sulfide cell is capable of measuring either tungsten or daylight over a wide range of color temperatures through variation in its conductance. The I series as it is called will contain six distinct types designed for normal and low impedance transistor type applications in both side and end view hermetically sealed configurations. The response curves of the I series share a common peak and axis of symmetry with the spectral response of the human eye. Typical applications are: reliable light switches, crt brightness and contrast control and exposure meters without correction filters.

Clairex Corp., Dept. ED, 8 W. 30th St., New York, N. Y.

**P&A:** \$4 ea; from stock in small quantities.

# more than the name is new

Fairchild Stratos Corporation\* is a new name-but the new doesn't stop there. There is dynamic new leadership-new energy and enthusiasm-new programs and projects...and the creative technical skills to implement them.

Perhaps most significant are the exciting new career opportunities ahead for creative professionals in such fields as guided missiles, drone systems, space satellite equipment, precision mechanical equipment and sophisticated electronic systems. This is the new look of Fairchild Stratos. This is the plan for sound and vigorous growth for the immediate future and for the long term. Fairchild Stratos is on the go.



\* FORMERLY FAIRCHILD ENGINE AND AIRPLANE CORPORATION

- AIRCRAFT - MISSILES DIVISION  
HAGERSTOWN, MARYLAND
- AIRCRAFT SERVICE DIVISION  
ST. AUGUSTINE, FLORIDA
- ELECTRONIC SYSTEMS DIVISION  
WYANDANCH, NEW YORK
- STRATOS DIVISION  
BAY SHORE, L.I., NEW YORK AND  
MANHATTAN BEACH, CALIFORNIA

CIRCLE 55 ON READER-SERVICE CARD

# NEW PRODUCTS

Covering all new products generally specified by engineers designing electronic original equipment. Use the Reader-Service Card for more information on any product. Merely circle number corresponding to that appearing at the top of each description.



## Fiber-Optic Tube Prints Computer Readout Data

257

Text a full page wide is reproduced by the fiber-optic Charactron shaped-beam tube. The device permits direct contact-printing of computer readout data on a line-at-a-time basis without conventional lens systems. With 100 to 150 characters per line, typical printing rates of 5,000 characters per sec have been achieved. The fiber-optic faceplate is 8-1/2 in. long and 1/2 in. wide, and uses light-pipes 0.008 in. in diameter and 1/2 in. long.

General Dynamics-Electronics, Dept. ED, 1895 Hancock St., San Diego 12, Calif.  
**P&A:** About \$5,000; 60 to 90 days.

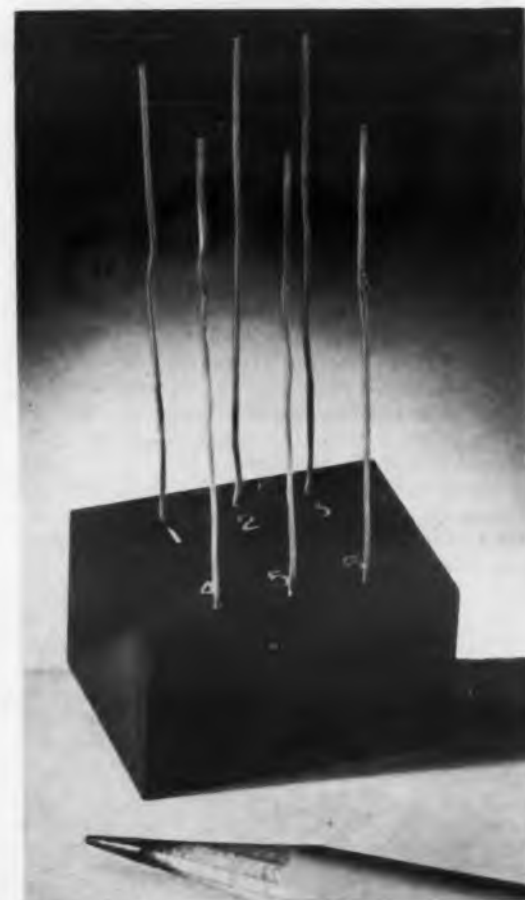

## Miniature Transistor Chopper Contains Own Drive Transformer

254

The drive transformer is self-contained in this miniature transistorized chopper. Noise level is 1 mv or less. Designated type 6022-3, the chopper is encapsulated for severe environmental operation, and is made for printed-circuit mounting. Input signal level for the single-package device is 30 v, 3 ma max. Sinusoidal or square-wave drive voltage can be 5.7 to 14 v rms, 50 to 5,000 cps. At a drive rating of 6.3 v rms, dwell time is 180 deg, and phase angle is within  $\pm 5$  deg. Temperature range is  $-55$  to  $+125$  C. Chopper is said to have unlimited life when operated within rated characteristics.

Airpax Electronics, Inc., Dept. ED, Cambridge, Md.

**P&A:** \$82.50 each in quantity; 2 to 6 weeks.

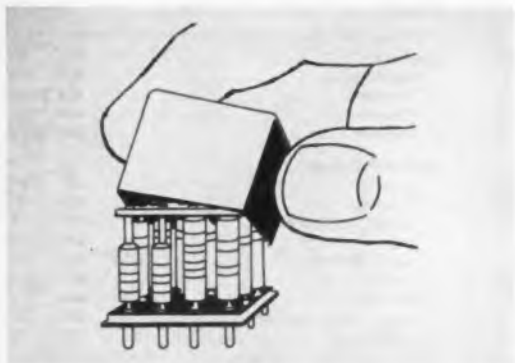

### Plug-In Modular Package Provides Automatic Circuit Encapsulation 256

Encapsulate your own circuits with Circu-paks. The devices consist of a header with gold-plated pins staked in place and a snap-on case with a hole in the top for epoxy filling. A circuit can be wired onto the header, which is available with pins arranged in either standard tube socket or printed-circuit grid configurations. Circuit is tested, and any adjustments made. When operation is as desired, the case is snapped on, and the unit is filled with epoxy. A solid, environmentally sealed unit results. The operation can be easily automated. Cases in various cubical and cylindrical shapes from 1/2 x 1/2 x 3/8 in. to 1-1/2 x 3/4 x 3/4 in. are available.

U. S. Dielectric Inc., Dept. ED, 181 Greenwood St., Worcester, Mass.

P&A: \$0.50 each, \$5 for sample kit; from stock.



### Combined AC/DC Converter-VTVM Operates at 5-Cps Frequencies 255

Resolution of 25  $\mu$ v with 0.5% ripple is provided by the model HVC-30, which serves as either an ac/dc converter or as an ac vtm. Operation extends down to 5 cps. Inputs to the vtm section range from 10 mv to 300 v full scale at 10-meg impedance, accurate to 1%. Calibration voltages of 0.01, 0.1, and 1 v, 0.1% accurate, are provided. On the 20-cps filter setting, output reaches 99% of full value in 1/2 sec, with less than 0.7% ripple at 20 cps and 0.1% ripple at 60 cps. The converter-voltmeter can be mounted in either rack or case.

Houston Instrument Corp., Dept. ED, P. O. Box 22234, Houston 27, Tex.

P&A: \$775; 30 days.



the  
Slant  
on this  
Power  
Supply  
is

0-325 vdc  
@800 ma,  
Stabilized to  
0.01%

(even at the angle shown)

#### HB GROUP Optional 0.1% or 0.01% regulation:

PRICE	0.1% MODELS	DC OUTPUT RANGE		0.01% MODELS	PRICE
		VOLTS	MA		
\$295.00	HB 2M	0-325	0-200	HB 20M	\$495.00
\$350.00	HB 4M	0-325	0-400	HB 40M	\$550.00
\$395.00	HB 6M	0-325	0-600	HB 60M	\$595.00
\$415.00	HB 8M	0-325	0-800	HB 80M	\$615.00

FOR COMPLETE SPECIFICATIONS, WRITE FOR CATALOG B-611

**kepc**  
Inc.

131-36 SANFORD AVENUE • FLUSHING 52, N. Y. • IN 1-7000 • TWX # NY 4-5196

#### PACKAGED: 3 1/2" HIGH x 19" W x 14 3/8" D: EQUIPPED FOR REMOTE PROGRAMMING AND CURRENT REGULATED OPERATION.

This remarkably compact capability derives from a unique hybrid design which employs semi-conductor components in the reference amplifier for optimum regulation characteristics, and vacuum tubes in the power stage of the series regulator for high voltage reliability.

Visit us at NEC Show—Booths 218-220

CIRCLE 56 ON READER-SERVICE CARD

*Choose the exact motor you need from the Barber-Colman family of enclosed, permanent magnet, reversible types for industrial and airborne applications*



HYLM-1" dia



FYLM-1-1/4" dia

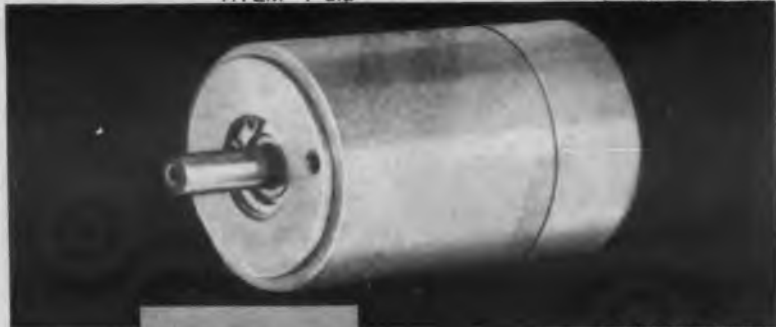

CYLM-1-1/2" dia



- TOTALLY CLOSED ALL-METAL HOUSING FOR EXTRA STRENGTH AND COMPACT, CLEAN DESIGN
- IMPROVED CONSTANT TENSION BRUSH RIGGINGS
- ALNICO VI RING MAGNETS CAST IN PLACE FOR MAXIMUM MAGNET AND PHYSICAL STRENGTH
- STRAIGHT-THROUGH SHAFTS MEET MILITARY SPECIFICATIONS

## d-c small motors

TYPE HYLM, top left, typical specifications (27 V): Horsepower, intermittent duty—.017. Torque—1.0 oz-in. Speed—17,000 rpm. Power input—23 watts. Length—1.59". Diameter—1.00".

TYPE FYLM, top right, typical specifications: Horsepower, intermittent duty—up to .055. Speed—5,000 to 20,000 rpm. Power input—2 to 70 watts. Length—1.77" to 2.40". Diameter—1.25".

TYPE CYLM, lower photo, typical specifications: Horsepower, intermittent duty, up to 0.1. Speed—5,000 to 20,000 rpm. Power input—7 to 155 watts. Length—2.125" to 3.125". Diameter—1.50".

Radio noise filters, gearheads, governors, blowers, other special features also available on above motors.

WRITE FOR LATEST QUICK REFERENCE FILE on the complete line of Barber-Colman d-c and a-c motors, tach generators, blowers, gearheads, ultra-sensitive relays.

## BARBER-COLMAN COMPANY

Dept. U, 1883 Rock Street, Rockford, Illinois

CIRCLE 57 ON READER-SERVICE CARD



# New Products Directory

A complete index of all new products contained in this issue of ELECTRONIC DESIGN, including page and reader-service numbers.

Category	p	no.
<b>Amplifiers</b>		
audio	365	116
dc	379	132
power	504	76
pulse	692	96
servo	359	133
servo	680	138
servo	650	103
synchro	425	118
vhf	438	113
vhf	439	95
vhf preamp	366	116
wideband	651	97
<b>Antennas</b>		
communications	526	88
<b>Capacitors</b>		
condenser box	405	141
decade	406	138
feed-through	387	104
film-dielectric	384	118
general purpose	404	137
mylar	611	91
mylar	688	100
paper	511	80
tantalum	399	109
tantalum slug	496	78
<b>Circuits</b>		
channel-regulator	495	76
circuit modules	376	128
crystal oscillator	367	126
digital breadboard	528	74
converter	386	119
dynamic analyzer	520	84
fm demodulator	429	119
ferrite core memory	478	83
frequency detector	467	122
frequency sensor	623	127
logic card	463	146
logic module	468	137
ratio bridge	380	132
signal conditioner	479	82
voltage converter	507	86
<b>Controls</b>		
inductance	625	140
miniature	505	77
motor	506	86
motor	652	97
temperature	472	116
<b>Cooling Equipment</b>		
axial blower	644	102
axial fan	445	115
cooler kit	502	84
forced-air heat dissipator	388	131
heat sink	696	101
high-volume fan	454	139
thermoelectric cooler	352	149
transistor heat dissipator	383	131
transistor radiators	503	76
tube axial blower	615	134

Category	p	no.
<b>Counters</b>		
angle	356	150
decade	499	84
frequency	444	115
impulse	521	89
<b>Data Equipment</b>		
counter	645	106
flip-flop	600	107
gathering system	637	110
logic inverter	647	104
logic module	634	105
pulsar	642	104
recorder	681	113
strain-gage plotter	403	112
transducer	595	111
<b>Delay Lines</b>		
general purpose	589	98
general purpose	593	82
general purpose	464	147
magnetostrictive	440	91
magnetostrictive	599	110
<b>Devices</b>		
damping kit	169	130
ferrite cores	421	115
gating	368	114
laser crystals	493	77
linear transducers	437	128
magnetic sensing	442	137
rf attenuators	484	87
reference compensator	648	120
telemetry filters	693	95
<b>Generators</b>		
pulse	531	90
solid-state	474	127
synchronous	649	141
<b>Gyros</b>		
rate	492	78
rate	686	92
<b>Hardware</b>		
cable clamp	377	102
card racks	360	116
ceramic-metal housings	629	120
chassis-slide	391	138
coil form	459	139
concealed latch	392	136
fluorescent lampholders	433	124
precision dials	436	135
printed-circuit chassis	513	90
racks and cabinets	486	74
seal	501	78
slip-ring assemblies	423	114
transistor sockets	373	121
vinyl handle assemblies	510	76
Xenon lamps	594	107
<b>Materials</b>		
aluminum powder	370	116
copper-clad laminate	471	124
crystals	422	112
diode sealer	266	153
high-purity cesium	535	74
insulation	385	106
molding compounds	603	99
polyurethane resin	475	129
<b>Meters</b>		
ac-dc multimeter	485	76
ampere-hour	689	95
amplifier-ohmmeter	432	118
digital voltmeter	462	151
digital voltmeter	691	92
digital voltmeter	677	95
digital voltmeter	604	98
heading indicator	355	126
ohmmeter	363	147
phase angle	579	142
rate	591	187
ratio	687	94
transfer voltmeter	632	121
volt-ohmmeter	515	76
<b>Ovens</b>		
batch	262	152

Category	p	no.
<b>Photoconductors</b>		
device	678	94
photosensor	580	117
solar cell	530	74
<b>Potentiometers</b>		
ac	389	125
multi-turn	533	75
servo	592	127
temperature	578	145
trimmer	695	96
wirewound	523	89
<b>Power Supplies</b>		
ac converter	461	140
battery eliminator-charger	381	134
circuit breaker	527	88
current-regulated	402	112
dc	586	111
dc	487	90
dc-ac inverters	508	80
dc-to-dc converter	476	149
general purpose	354	126
general purpose	430	133
general purpose	630	148
general purpose	517	76
laboratory	498	77
semiconductor test	396	106
static converter	639	103
voltage regulators	414	146
<b>Production Equipment</b>		
electron-beam evaporator	477	83
header machine	408	144
parts handler	265	153
process monitor	447	131
sonic gun	512	74
tubing marker	261	152
welder	395	109
welder	470	125
winding head	263	152
<b>Recorders</b>		
chart	627	117
general purpose	458	151
telemeter	457	142
two-channel	393	132
<b>Rectifiers</b>		
selenium	448	82
silicon	679	94
silicon	420	112
<b>Relays</b>		
general purpose	455	140
solid-state	410	147
solid-state control	518	76
static	631	145
voltage sensing	426	119
<b>Resistors</b>		
high-temperature	435	128
light-dependent	456	150
power	413	146
power	509	90
resistor element	626	135
resistor network	465	149
temperature-sensitive	610	104
<b>Semiconductor Devices</b>		
diodes	466	145
epitaxial transistors	361	129
germanium mesa transistors	490	88
germanium transistors	362	129
multiple diode	628	103
power transistor	372	85
silicon transistor	418	82
silicon transistor	419	151
<b>Servo Devices</b>		
clutch-brake	537	74
miniature gearmotors	427	133
servo actuator	494	75
servo gearboxes	497	74
<b>Switches</b>		
general purpose	415	142
lighted	682	115
rf	488	74
rotary	534	81
solid-state	643	102
static	608	136

Category	p	no.
<b>Systems</b>		
carrier failure alarm	606	101
data acquisition	525	80
data conversion	431	122
disk file	500	86
encoder readout	371	128
information logger	683	101
ionization equipment	522	114
multiplexing	417	149
payload instrumentation	532	81
protective network	644	102
stabilization network	411	144
<b>Tape Equipment</b>		
certifier	460	151
computer tape	635	111
perforator	529	80
<b>Temperature Chambers</b>		
environmental	576	99
general purpose	482	85
high-low	633	126
test stand	483	82
<b>Terminals and Connectors</b>		
insulated terminals	598	120
printed-circuit	684	92
printed circuit	524	77
printed-circuit	481	87
rf connectors	685	91
reverse-feedthrough	451	83
teflon feedthrough	616	100
threaded terminals	450	143
two-pin connectors	353	121
<b>Test Equipment</b>		
antenna standard	400	108
dc corona	434	124
cable	409	143
decade resistor	397	113
gas detector	638	105
hipot tester	577	143
load cell	636	105
multivolt discriminator	424	125
power recorder	575	110
pulse power calibrator	489	75
ratio analyzer	694	96
recording wave analyzer	390	130
resistance box	397	113
signal conditioner	394	108
signal generator	378	108
signal tracer	407	144
test instruments	364	148
transient detector	453	148
transient detector	452	141
transistor tester	536	74
two-trace scope	624	139
<b>Thermometers and Thermocouples</b>		
cryogenic thermometer	622	85
vacuum thermocouples	443	136
<b>Timers</b>		
compact	491	89
elapsed-time meter	640	117
electronic	428	122
nuclear delay	382	130
<b>Tools</b>		
crimping	357	126
soldering iron	516	78
tap setting device	519	81
wire stripper	264	153
<b>Transformers</b>		
general purpose	449	150
isolation	446	134
miniature	698	97
<b>Tubes</b>		
cathode-ray	401	109
discharge	514	76
image orthicon	641	105
printing	441	91
pulse	351	116
vidicon	473	38
voltage regulator	690	94
<b>Wire and Cable</b>		
cable assemblies	480	82
coaxial cable	416	87
cable coating	374	135
insulated wire	375	128
resistance wire	369	114

*High-torque, fast-reversing  
Barber-Colman quality motors  
for low-cost servo systems  
utilizing either transistor  
or vacuum tube control*

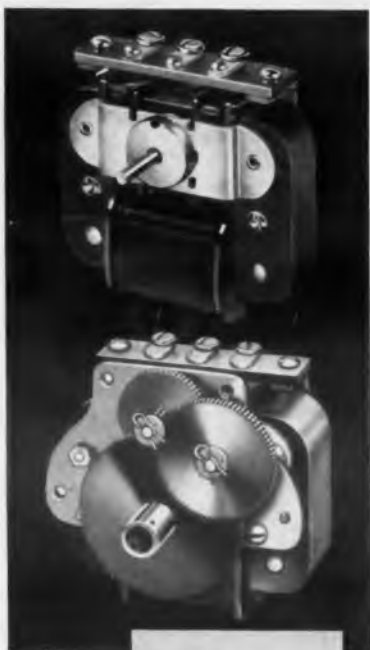

THE MARK OF QUALITY



FAST-REVERSING  
LOW-INERTIA ROTORS  
HIGH STARTING TORQUE  
ELECTRODYNAMIC BRAKING  
ADAPTABLE TO SPLIT-PHASE  
CAPACITOR OPERATION  
AVAILABLE WITH 2-PHASE OR  
ELECTRONIC CONTROL WINDINGS  
AVAILABLE WITH OPEN OR  
CLOSED GEAR REDUCTIONS

## **a-c small motors**

Barber-Colman shaded pole reversible motors are adaptable to a variety of electronic control circuits to meet the many different requirements of applications demanding a compact, powerful, fast-reversing motor. In many servo systems they satisfactorily replace motors costing twice as much. Ratings are from .00015 to .04 hp. For further information write for literature on use of these motors in servo systems with transistor or vacuum tube amplifiers.

THE WIDE LINE OF BARBER-COLMAN A-C MOTORS includes unidirectional, synchronous, and reversible types . . . with or without reduction gearing . . . open or enclosed. Stator and rotor sets also available. Write for quick reference file.

**BARBER-COLMAN COMPANY**

Dept. U, 1283 Rock Street, Rockford, Illinois

CIRCLE 58 ON READER-SERVICE CARD

## NEW PRODUCTS

### Transistor Tester

536



For all npn and pnp types. With small-signal transistors and circuit impedance above 500 ohms, model 990 in-circuit transistor tester has a maximum error of about 5%. Power transistors can be tested with peak collector currents of 700 ma. Five  $I_{cbo}$  and three Beta ranges are provided.

Precision Apparatus Co., Inc., Dept. ED, 70-31 84th St., Glendale 27, N. Y.

### Clutch-Brake Combination

537

Have in-line construction. Size 100 clutch-brake combination has a torque output of 30 oz-in. at 2-w power input; size 130 is rated at 110 oz-in. at 3.5 w. A special attachment for conversion to continuous-slip operation at infinitely variable torque is used. Standard voltages are from 6 to 100 v dc; various combinations may be specified.

Dial Products Co., Dept. ED, 19 Cottage St., Bayonne, N. J.

Price: from \$58.20.

### Digital Breadboard

528



Self-contained digital breadboard and training console, called the Digilab, includes from 30 to 40 digital elements. It also contains a manual pulser, a manual reset, an external pulse input, a clock-frequency switch, computer-type indicator lights, a power supply and other equipment needed to construct a wide variety of digital networks.

Tech Serv Inc., Dept. ED, 4911 College Ave., College Park, Md.

P&A: \$755 to \$895; 2 to 4 weeks.

### High-Purity Cesium

535



Purity is 99.9%. Cesium metal, which must be packaged in a vacuum or under argon gas, is available in steel and glass containers and in a multi-ampuled package designed to facilitate the use of small quantities. Its melting point is 83 F; boiling point is 1,238 F. Possible applications include thermionic converters.

Dow Chemical Co., Dept. ED, Midland, Mich.

Price: \$1.00 per g; \$375 per lb for 5 to 8 lb.

### Sonic Gun

512

Generates to 150 db. The sonic gun provides for instantaneous ultrasonic defoaming, degassing, mixing and dispersing in pipe lines or tanks, and can also be used as a noise source for signaling or environmental testing. It can be made to meet specifications for any work requiring 10 to 100 kc.

Ultrasonic Industries Inc., Dept. ED, Ames Court, Engineers Hill, Plainview, L. I., N. Y.

Price: \$300.

### Racks and Cabinets

486



Sloped-front vertical racks are among the new designs offered in this line of modular racks and cabinets. This cabinet shape provides for easy surveillance of instrumentation in large installations of meters, regulators, scopes and other equipment.

Equipto Electronics Corp., Dept. ED, 319 N Webster St., Naperville, Ill.

### RF Switches

488



Relay-type rf switches are designed to meet the requirements of missile applications. Model 2BN18DSR, for example, is a spdt relay for applications to 1,000 mc, with crosstalk of 40 db or more and 0.25-db maximum insertion loss. Vswr is 1.25 with a 50-ohm termination. Operating voltage is 26 to 30 v dc. Life is 1 million cycles, continuous duty.

General Communication Co., Dept. ED, 677 Beacon St., Boston 15, Mass.

### Silicon Solar Cell

530

For space-power applications. Solar cells for space vehicles and satellites have conversion efficiencies of 13% and 14%. A photolithography process provides a grid network with extremely uniform positioning and dimensions on the surface of the cell.

Solar Systems, Inc., Dept. ED, 8241 N. Kimball Ave., Skokie, Ill.

Availability: some types, stock.

### Servo Gear Boxes

497



Precision servo gear boxes are offered in over 720 variable units, providing even and exact binary ratios from 2:1 to 625:1. Backlash is held to 30 in all models. Maximum rated output torque is 250 oz-in. in the 1/8-in. shaft series to 500 oz-in. in the 1/4-in. shaft series. Designed for all servo, computer and research applications, the units can have slip clutch, anti-backlash gears or both.

PIC Design Corp., Dept. ED, 477 Atlantic Ave., East Rockaway, L. I., N. Y.

Availability: \$45 to \$75; stock.

### Servo Actuator

494



Clutch-type servo actuator series 3170 is designed for computer and missile applications with high precision and low power requirements. Torque range is 1 to 70 lb-in. Speed range is 285 to 4.6 rpm. Frequency response is high. An ac or dc motor and actuator connectors can be supplied as required.

Lear, Inc., Electro-Mechanical Div., Dept. ED, 110 Ionia Ave., N. W., Grand Rapids 2, Mich.

### Pulse-Power Calibrator

489



Uses interchangeable rf heads. Series 5000 pulse-power calibrator has a power-level resolution of 0.1 db or better. A precision attenuator provides power-measurement accuracy to  $\pm 0.5$  db over the frequency range of each rf head for direct power input levels from  $-5$  to  $+63$  dbm.

General Communication Co., Dept. ED, 677 Beacon St., Boston 15, Mass.

### Multi-Turn Potentiometers

533



Rated at 0.5 to 30,000 ohms. Potentiometers with up to 40 turns have a temperature coefficient of 20 ppm for most resistances, infinite resolution and linearities to 0.01%. Ratios may be achieved to allow the input shaft to rotate any number of turns from 1/2 to 1,000 for the full resistance range.

Vogue Instrument Corp., Dept. ED, Brooklyn, N. Y.



Because photomechanical reproduction has been developed to micron accuracy, masks in subminiature sizes are standard production at Buckbee Mears Company. Evaporation masks for mesa transistors, germanium and silicon are no longer a challenge. Anything that can be drawn can be reproduced. Drawings up to 1,000 times size are reduced exactly by special cameras to produce a perfect matrix for *exact* reproduction of the component demanded.

For straight line rulings, cross line rulings, calibrated dials, and concentric circles an especially designed ruling engine produces master rulings up to 2,000 lines per inch with linear accuracies up to 14 inches of  $\pm .000039$ . Also concentric circles of 10 inch diameter to the same tolerances.

Anything that can be drawn can be reproduced—*exactly*. Before you decide it can't be done, send us your problem.

*Our answer could surprise and please you, as it did the designers of a space antenna when a conductor 20 feet long was etched to an accuracy of .015 inches over an area of 17.45 feet; or as it did the Bell Laboratories when they asked for thousands of apertures spaced to .00005 in 1 square inch of nickel.*

**buckbee mears**



245 EAST SIXTH STREET • ST. PAUL 1, MINNESOTA

CIRCLE 60 ON READER-SERVICE CARD

## NEW PRODUCTS

### Channel Regulator

495



For multiplexing system type 33A. Type 331A channel regulator is for automatic frequency synchronization and signal-level regulation on channel 1 of the firm's three-stack multiplexing system. Regulation circuitry effects a 5:1 ratio of output improvement over received line signals. Absolute synchronization is produced.

Lenkurt Electric Co., Inc., Dept. ED, San Carlos, Calif.

### Discharge Tubes

514



Hollow-cathode discharge tubes for use in atomic absorption spectroscopy are available for analysis of materials containing iron, copper, nickel, zinc, manganese and other elements. They have low starting voltages, low operating voltage and stable current.

Westinghouse Electronic Tube Div., Dept. ED, Box 284, Elmira, N. Y.

Availability: samples, stock; quantities, 30 days.

### AC-DC Multimeter

485



Four-digit multimeter type 850 measures dc volts, dc ratios and ac volts over ranges of  $\pm 0.0001$  to  $\pm 999.9$ . Accuracy is  $\pm 1$  digit on dc voltages and ratios,  $\pm 0.1\%$  or 2 digits on ac voltages. Average dc balance time is 50 msec; average ac balance time is 2 sec below 400 cps and 500 msec above 400 cps.

Electro Instruments, Inc., Dept. ED, 8611 Balboa Ave., San Diego 11, Calif.

### Power Amplifier

504



Linear power amplifier model SC-907, rated at 1 kw, is designed for operation with the SC-901 and SC-910 single-sideband radio sets. It consists of two units: power amplifier and power supply. It provides amplification over the range of 2 to 30 mc for SSB, compatible am, cw, FSK and ISB. Course tuning is automatic; fine tuning requires adjusting two controls.

General Dynamics/Electronics, Military Products Div., Dept. ED, 1400 N. Goodman St., Rochester 3, N. Y.

### Transistor Radiator-Retainers

503



Double-ended radiators and retainers are available for mounting TO-5, 8, 9, 11, 12, 29, 33, 37, 38, 39, 42, 43 and other transistors. They have a tapped base for quick mounting in flip-flop or push-pull circuits. Material is aluminum alloy as per QQ-A-268, finish is black anodize as per MIL-A-8625, type II.

The Birtcher Corp., Industrial Div., Dept. ED, 745 S. Monterey Pass Road, Monterey Park, Calif.

Availability: 2 to 3 weeks.

### Vinyl Handle Assemblies

510



Hardware is steel or brass, in any of 12 finishes. The handle assemblies have a Mylar protected insert laminated to the vinyl handle. They can be attached to fans, corrugated boxes, tool chests, small instruments and other devices. They can be supplied in any length, according to customer specifications.

Philadelphia Handle Co., Dept. ED, 1643 Haddon Ave., Camden 3, N. J.

### Power Supplies

517



High-voltage, low-current power supplies are for applications that usually require a cathode-ray tube such as oscilloscopes, spectrum analyzers and TV systems. Called H D & K Kilopaks, they are compact, use solid-state circuitry and are hermetically sealed.

Atlee Corp., Wesco Div., Dept. ED, 27 Olive St., Greenfield, Mass.

### Volt-Ohmmeter

515



Semi-digital, solid-state volt-ohmmeter type 21A combines analog and digital circuitry. It has four voltage ranges covering from 3.2 to 3,200 v and six resistance ranges covering 320 ohms to 32 meg. Accuracy is  $\pm 15\%$  of full scale; input impedance is 10 meg; response time is 1 sec on most ranges.

J-Omega Co., Dept. ED, Los Altos, Calif.  
P&A: \$650; stock.

### Solid-State Control Relay

518



Ultra-sensitive solid-state control relay, designated the Magsense A-82, has a signal output of 0 to 100  $\mu$ a. Continuously controlling 30 w in the output with 1- $\mu$ a signal changes, it is capable of operating at 260,000 cycles per day. The output is the solid-state equivalent of spdt, 1 amp. Operation is dc.

Daystrom, Inc., Control Systems Div., Dept. ED, 4455 Miramar Road, La Jolla, Calif.

## Printed-Circuit Connector

524



Breakdown voltage is 2,200 v ac at sea level; current rating is 3 amp. This printed-circuit connector has 140 terminations divided into sets of 38 and 32 contacts. Insulator material is diallyl phthalate as per MIL-M-19833, type GDI-30. Over-all length is 8.63 in. with 0.100-in. contact spacing.

Viking Industries Inc., Dept. ED, 21343 Roscoe Blvd., Canoga Park, Calif.

Availability: stock.

## Laser Crystals

493

In boules or rods with ends polished optically flat and parallel. Stock crystals include ruby and  $\text{CaF}_2$  doped with divalent samarium or trivalent uranium. Reflective surfaces are evaporated metallic coatings or multiple dielectric layers. Custom-grown crystals such as  $\text{CaF}_2$ ,  $\text{CdF}_2$ ,  $\text{BaF}_2$  and  $\text{MgF}_2$  can be obtained with activators.

Isomet Corp., Dept. ED, 433 Commercial Ave., Palisades Park, N. J.

## Laboratory Power Supply

498

Rated at 50 amp dc. Model MTR28-50 power supply is designed to provide the dynamic regulation required by load transistors. Static regulation is  $\pm 0.1\%$  for line and load; dynamic regulation is  $\pm 0.5\%$  for line and  $\pm 2.0$  v for load. Voltage output is 24 to 32 v. No tubes or moving parts are used. Special protective circuitry ensures against overload.

Perkin Electronics Corp., Dept. ED, 345 Kansas St., El Segundo, Calif.

## Miniature Controls

505



Composition controls style RV1, are rated at 1/5 w at 70 C, derated to zero at 120 C. They are available in values of 500 ohms to 1 meg. linear taper. Tolerance is  $\pm 10\%$  and breakdown point is 900 v ac rms to ground at atmospheric pressure. Model JMP has a standard bushing; model JML, a locking type bushing. Requirements of MIL-R-94B are met.

Centralab Div., Globe-Union Inc., Dept. ED, 900 E. Keefe Ave., Milwaukee 1, Wis.

Price: \$2.27 to \$4.50.

# DUAL-BEAM OSCILLOSCOPE

DC-TO-25 MC, 14-NANOSECOND RISETIME WITH FAST-RISE PLUG-IN UNITS

TYPE 551



You can compare waveforms simply, conveniently, reliably with a Tektronix Type 551 Dual-Beam Oscilloscope.

You can display up to four traces at once—with Tektronix dual-trace units in both channels.

Or, you can interchange any combination of 16 other "letter-series" plug-in units for such applications as dual-beam pulse sampling . . . transistor-risetime testing . . . semiconductor-diode-recovery-time studies . . . strain gage and other transducer measurements . . . as well as multiple-trace work in other specialized displays or general-purpose laboratory experiments.

If you need a fast-rise, dual-beam oscilloscope—offering signal-handling ease and dependability in dc-to-25 mc waveform-comparison analyses—consider a Tektronix Type 551.



## CHARACTERISTICS

Common X-Independent Y Deflection. Adaptable Vertical System—Accepts interchangeable plug-in preamplifiers. Versatile Sweep Features—Wide range from 0.1  $\mu\text{sec}/\text{cm}$  to 5  $\text{sec}/\text{cm}$  in 24 calibrated sweep rates, continuously variable uncalibrated to 12  $\text{sec}/\text{cm}$ . 5x magnifier increases calibrated sweep time to 20  $\text{nsec}/\text{cm}$ . Single sweep facilitates recording one-shot phenomena. Complete Triggering Facilities—Amplitude-level (manual) selection or fully automatic control. High Writing Rate—10-KV accelerating potential provides bright traces at low repetition rates. 4 by 10 centimeter display for each beam, with 2 centimeter overlap. Precise Amplitude Calibrator—With 18 square-wave voltages (from 0.2 mv to 100 v peak-to-peak) available at the front panel.

Type 551 (without preamplifiers) . . . . . \$1800

Includes Indicator Unit, Power Unit, 4 Probes, 7 other accessories.  
price f.o.b. factory

For a demonstration of the capabilities of a Type 551 in your own waveform-comparison analyses, call your Tektronix Field Engineer.

**Tektronix, Inc.** P. O. BOX 500 • BEAVERTON, OREGON / Mitchell 4-0161 • TWX-BEAV 311 • Cable: TEKTRONIX

TEKTRONIX FIELD OFFICES: Albuquerque, N. Mex. • Atlanta, Ga. • Baltimore (Towson) Md. • Boston (Lexington) Mass. • Buffalo, N.Y. • Chicago (Park Ridge) Ill. • Cleveland, Ohio • Dallas, Texas • Dayton, Ohio • Denver, Colo. • Detroit (Lathrup Village) Mich. • Endicott (Endwell) N.Y. • Greensboro, N.C. • Houston, Texas • Indianapolis, Ind. • Kansas City (Mission) Kan. • Los Angeles, Calif. Area (East Los Angeles, Encino • West Los Angeles) • Minneapolis, Minn. • Montreal, Quebec, Canada • New York City Area (Albany • L.I., N.Y. • Stamford, Conn. • Union, N.J.) • Orlando, Fla. • Philadelphia, Pa. • Phoenix (Scottsdale) Ariz. • Poughkeepsie, N.Y. • San Diego, Calif. • San Francisco, Calif. Area (Lafayette, Palo Alto) • St. Petersburg, Fla. • Syracuse, N.Y. • Toronto (Willowdale) Ont., Canada • Washington, D.C. (Annandale, Va.).

TEKTRONIX ENGINEERING REPRESENTATIVES: Hawthorne Electronics: Portland, Oregon; Seattle, Washington • Kentron Hawaii Ltd., Honolulu, Hawaii; Tektronix is represented in twenty overseas countries by qualified engineering organizations.

In Europe please contact Tektronix International A.G., Terasseweg 1A, Zug, Switzerland, Phone (042) 4-91-92, for the address of the Tektronix Representative in your country.

CIRCLE 62 ON READER-SERVICE CARD

FOR MICROWAVE  
RELAY SERVICE:

NOW 3  
TUBES  
DO THE JOB  
OF 23!

Varian Associates' VA-244 series of reflex klystrons is designed for versatility in microwave relay applications. Three high-performance tubes can do jobs which formerly required 23 different types. They're engineered for flexibility, ideal for equipment in the common carrier bands. Series covers the microwave spectrum from 5.8 to 7.9 kMc. Use VA-244 series klystrons as transmitter tubes with average power output of 1 watt. As local oscillators, they operate at reduced voltages, with average power output of 60 milliwatts. Reliable, exceptionally stable, fully conduction-cooled. Low FM distortion, improved single-screw tuning.



SHOWN ACTUAL SIZE

#### FREQUENCY RANGE

**TUBE #1:** VA-244A 5.8-6.6 kMc  
**TUBE #2:** VA-244B 6.5-7.3 kMc  
**TUBE #3:** VA-244C 7.1-7.9 kMc

The versatility of the VA-244 series minimizes manufacturers' and customers' stocking problems. Order in quantity to take advantage of price reductions. For technical data, write Tube Division.



**VARIAN associates**  
PALO ALTO 21, CALIFORNIA

BOMAC LABORATORIES, INC.  
VARIAN ASSOCIATES OF CANADA, LTD.  
S-F-D LABORATORIES, INC.  
SEMICON ASSOCIATES, INC.  
SEMICON OF CALIFORNIA, INC.  
VARIAN A.G. (SWITZERLAND)

## NEW PRODUCTS

### Tantalum Slug Capacitors

496



Meet MIL-C-3965B. Hat-shaped tantalum slug capacitors series TS are available in all three sizes called for by MIL-C-3965B. They can also be furnished in the 125 C rating as commercial units with a K tolerance of  $\pm 10\%$  as well as an S tolerance of  $-15\%$  and  $+20\%$ .

Ohmite Manufacturing Co., Dept. ED, 3634 Howard St., Skokie, Ill.

*Availability: stock.*

### Seal

501

No solders, fluxes, heat or sparking results. The SAC-seal type 110 is designed for sealing by the Koldweld process. Special tools required can be furnished.

Scully-Anthony Corp., Dept. ED, 4707 Willow Springs Road, La Grange, Ill.

### Soldering Iron

516

For microminiature applications. The B-2000 soldering iron weighs 2-3/4 oz and has a tip temperature of 850 F. Soldering iron tips with shank diameters of 1/8 to 3/8 in. in various shapes and working surfaces can also be furnished.

American Electrical Heater Co., Dept. ED, 6110 Cass Ave., Detroit 2, Mich.

### Rate Gyro

492

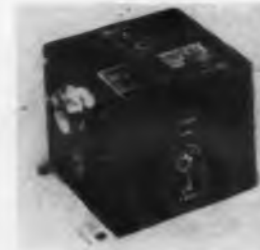

Pitch, yaw and roll rates are monitored by the RGO2-0902-1 rate gyro. Gyro and filter are individually hermetically sealed and mounted on an aluminum base. Rf noise is filtered to meet MIL-1-16910A. Axis alignment can be made within 6 min. Weight is 2.5 lb.

Humphrey, Inc., Dept. ED, 2805 Canon St., San Diego 6, Calif.



# NEW

2N1015  
2N1015A  
2N1015B  
2N1016  
2N1016A  
2N1016B



150 Watt

2N1212  
2N1208  
2N1616  
2N1617  
2N1618  
2N1616A  
2N1617A  
2N1618A  
2N1724



85 Watt

## SILICON TRANSISTOR CORP. ADDS 2 NEW SERIES. THE COMPLETE LINE OF HIGH POWER SILICON TRANSISTORS

The series ...

2N1015      2N1016  
2N1015A    2N1016A  
2N1015B    2N1016B

are 150 watt single-end stud types. With collector-emitter voltages of 100 volts. Saturation resistance of 0.5 ohms. Minimum beta of 10 at 5 amps.

The series

2N1212      2N1616  
2N1208      2N1617  
                  2N1618

are double-ended 11/16" 85 watt hex stud types.

And ...

2N1616A  
2N1724    2N1617A  
                  2N1618A

are the most popular series in this package, with dramatic improvements from STC.

BYCEO of 80 volts. Saturation resistance of 0.5 ohms. Minimum beta of 10 at 5 amps.

Both STC series have the lowest leakage currents in the industry...high temperature stability...low thermal resistance and reliability at full power ratings. Write for Catalog listing complete line of STC's high and intermediate power silicon transistors and silicon diodes.

### SILICON TRANSISTOR CORP.

CARLE PLACE, LONG ISLAND, NEW YORK Pioneer 2-4100

CIRCLE 64 ON READER-SERVICE CARD



### FOR IMMEDIATE DELIVERY CONTACT THESE STC DISTRIBUTORS

***In Alabama:***

MG Electronics & Equipment Co.  
Birmingham — FA 2-0449

***In Arizona:***

Southwest Industrial Electronics  
Phoenix — AL 2-1741

***In California:***

Finn Electronics Corp.  
San Carlos—LY 1-4423  
Hollywood Radio & Electronics, Inc.  
Hollywood—HO 4-8321  
Kierulff Electronics, Inc.  
Los Angeles—RI 8-2444  
San Diego — BR 6-3334  
Shanks & Wright, Inc.  
San Diego — BE 9-0176

***In Connecticut:***

N.E.E.D., Inc.  
Danbury—PI 3-9844  
Sun Radio & Electronics Co., Inc.  
Stamford — WH 9-7715

***In Florida:***

Gulf Semiconductors, Inc.  
Miami — MO 5-3574  
Hammond Electronics, Inc.  
Orlando — GA 5-0511

***In Indiana:***

Graham Electronics Supply, Inc.  
Indianapolis — ME 4-8486

***In Maryland:***

Valley Electronics, Inc.  
Towson — VA 5-7820

***In Massachusetts:***

Durrell Electronics, Inc.  
Waltham — TW 3-7020  
N.E.E.D., Inc.  
Watertown—WA 6-1130

***In New Jersey:***

Sun Radio & Electronics Co., Inc.  
Princeton — WA 1-2150

***In New York:***

Arrow Electronics, Inc.  
Mineola, L.I. — PI 6-8686  
Progress Electronics  
New York — CA 6-5611  
Stack Industrial Electronics, Inc.  
Binghamton — RA 3-6326  
Standard Electronics, Inc.  
Buffalo — TT 3-5000  
Sun Radio & Electronics Co., Inc.  
New York — OR 5-8600  
Valley Industrial Electronics, Inc.  
Utica — RA 4-5168

***In Pennsylvania:***

Philadelphia Electronics, Inc.  
Philadelphia — LO 8-7444

***In Tennessee:***

Electra Distributing Co.  
Nashville — AL 5-8444

***In Texas:***

All State Electronics, Inc.  
Dallas — RI 1-1295  
Lenert Company  
Houston—CA 4-2663

CIRCLE 65 ON READER-SERVICE CARD

## NEW PRODUCTS

### Paper Capacitors

511



Miniature, metal-clad, hermetically sealed paper capacitors type 231P are offered in ranges from 0.001 to 6  $\mu$ f at 50 v dc. The dielectric system consists of plastic coated Kraft paper and Vitamin-Q inert oil impregnant. A wide variety of mounting arrangements, including integral side studs, end studs and screw-neck mountings can be furnished.

Sprague Electric Co., Dept. ED, 347 Marshall St., North Adams, Mass.

### DC-AC Inverters

508

Provide 50 to 2,000 cps. These solid-state dc-ac inverters have a  $\pm 1\%$  regulation for input variations or no-load to full-load variations. Distortion is 5% max. Input is 24 to 30 v dc. The inverters are designed for long life and maintenance-free operation.

NJE Corp., Dept. ED, 20 Boright Ave., Kenilworth, N. J.

### Tape Perforator

529

Low-speed model SP-2 tape perforator, with a punching rate of up to 120 codes per sec, is similar to the firm's model GP-2. The print station provides 64 symbols. The tape passes horizontally over the punch head directly into the punch and die assembly.

Soroban Engineering, Inc., Dept. ED, Box 1717, Melbourne, Fla.

### Data Acquisition System

525



Real-time, fm-fm, multi-channel data acquisition system, called the Midas, is suitable for laboratory or industrial use. Applications include sensing and transmitting pressure, strain and acceleration; measurement of gas-turbine strains and temperatures, forces acting upon rotating helicopter blades and dynamic pressure in steam turbines.

Unilectron Inc., Dept. ED, 129 Binney St., Cambridge 42, Mass.

Now up to 500 PRV... the

# HIGH CURRENT SILICON

#### Cathode terminal

... tin dipped to provide low resistance connection.

#### Gate

... reinforced welded connection provides maximum protection against rough handling and leakage.

#### Hermetic seals

... Kovar metal to matched oxide-bonded ceramic seals protect against thermal shock, cycling; enhance electrical stability, low leakage current.

#### Welded main seal

... maximum protection against housing leaks.

#### Steel hex

... maximum protection against damage from wrench.

#### Silicon pellet

... large area diffused junction provides conservative current densities, high surge current ratings.

#### Insulated lead

... Silicone rubber lead prevents shorting.

#### Ceramic insulation

... shock resistant, provides long creepage path which is ideal for severe industrial and military environments.

#### Hard soldered joints

... maximum protection against failures caused by thermal fatigue, cyclical loading; rugged tungsten back-up plates isolate junction from thermal stresses.

### RATINGS AND CHARACTERISTICS

	C50 (2N1909-16)	C55**	C60 (2N2023-30)	C61	
Transient Peak Reverse Voltage (Non-recurrent < 5 millisecond)*	Up to 600	Up to 600	Up to 400	Up to 400	volts
Repetitive Peak Reverse Voltage (PRV)*	Up to 500	Up to 500	Up to 300	Up to 300	volts
Max. Allowable Repetitive Peak Forward Blocking Voltage (PFV)	600	600	400	400	volts
Minimum Forward Breakover Voltage (V <sub>BO</sub> )	500	500	300	300	volts
Peak One Cycle Surge Current (I <sub>surge</sub> )	1000	1000	1000	1000	Amps
Max. Gate Current to Fire at 25°C	70	70	70	70	ma
Max. Thermal Resistance	0.4	0.4	0.4	0.4	°C/watt
Storage Temperature	-40 to +125	-40 to +125	-65 to +150	-40 to +150	°C
Stud Torque	150	150	150	150	In-Lbs.

\* Rating assumes rectifier cell heat sink of less than 3.5°C/watt.

\*\* C55 ratings identical to C50, except guaranteed turn-off time is 20 usec or less.

*inside story of General Electric*

# CONTROLLED RECTIFIERS

**G-E HIGH CURRENT SCR's** are three junction semiconductor devices for use in power control and power switching applications requiring blocking voltages up to 600 volts and load currents up to 110 amperes D.C. Series and parallel circuits may be used for higher power applications. Outstanding features of the most completely specified high current SCR's on the market today include:

- Well defined, sensitive firing characteristics over the complete temperature range
- Up to 500 PRV for 2N1909-16 (C50) series
- Transient PRV ratings
- 100% testing of all specified electrical and thermal characteristics
- 1<sup>2</sup>t ratings permit easy fuse selection
- Operating temperature range available from -65°C to +150°C
- Available as inverter types with specified turn-off times

For complete technical data and applications information for your specific circuit requirements, call your G-E Semiconductor Products District Sales Manager. Or write Rectifier Components Department, Section 23I34, General Electric Company, Auburn, New York. In Canada: Canadian General Electric, 189 Dufferin Street, Toronto, Ont. Export: International General Electric, 150 East 42nd Street, New York 17, N. Y.

For fast delivery of High Current SCR's at factory-low prices, see your authorized G-E distributor

**GENERAL  ELECTRIC**

CIRCLE 66 ON READER-SERVICE CARD

ELECTRONIC DESIGN • September 13, 1961

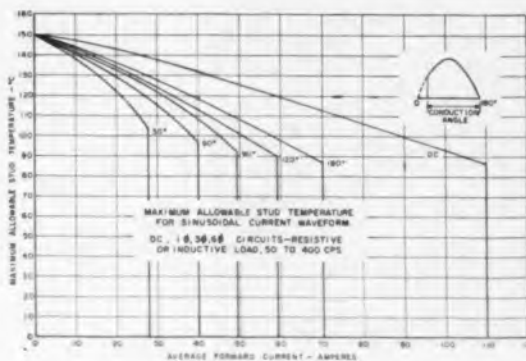

2N2023-30 (C60) and C61 Series

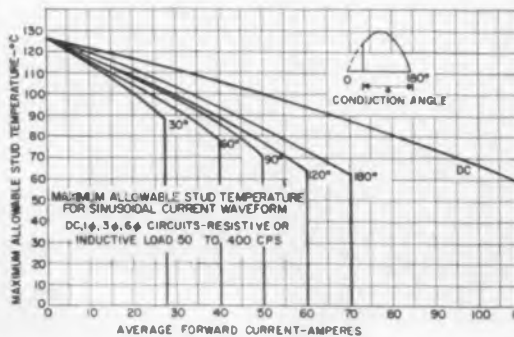

2N1909-16 (C50) Series

## Rotary Switch

534



Exceeds MIL-S-6807A. Series 3-1900 miniature rotary selector switch with 22.5-deg indexing, is designed for ground and airborne electrical systems where execution of tap, transfer and sequence functions is required. Power handling capacity is up to 5 amp at 115 v ac and 3 amp at 28 v dc, resistive, and 2 amp at 28 v dc, inductive.

Janco Corp., Dept. ED, 3111 Winona Ave., Burbank, Calif.

## Tap Setting Device

519



For push-in taps in the firm's models C-200 and BC-200 potentiometers. Designed to simplify field setting of potentiometer taps, the tap setting device is furnished complete with tweezers, bonding agent and styrene carrying case.

DeJur-Amsco Corp., Dept. ED, 45-01 Northern Blvd., Long Island City 1, N. Y.

## Payload Instrumentation Package

532



Rocket payload instrumentation package type TM 18-01a incorporates most of the instruments needed for rocket probes including telemetry, commutators, magnetometers, accelerometers, accelerometer pre-amplifiers, calibration and control circuitry. The package measures 5 in. in diameter and 13 in. high; it withstands high shock and vibration.

Washington Technological Associates, Inc., Dept. ED, 979 Rollins Ave., Rockville, Md.

New Development  
by ERIE



# Tan'ta-con

The Tantacon makes possible high capacitance per unit volume, while maintaining low, linear temperature characteristics for capacitance and low dissipation factor over a wide operating temperature range.

Solid electrolyte eliminates leakage problems, and quality Erie construction assures long shelf and operating life.

## TANTACON SPECIFICATIONS

Supplied in metal MIL cases sizes A and B (insulated and non-insulated)

Capacitance range: 1.0 mf to 56 mf

Capacitance tolerances:  $\pm 5\%$  (on request),  $\pm 10\%$ ,  $\pm 20\%$

Voltage ratings: 6, 10, 15, 20 and 35 VDCW

Operating temperature range:  $-80^{\circ}\text{C}$  to  $+85^{\circ}\text{C}$  at full rated voltage

Specify the polar tantalum capacitor with the ultimate in reliability, stability and compactness—specify TANTACONS by Erie.

Write for Bulletin 511 for complete specifications.



**ELECTRONICS DIVISION**  
**ERIE RESISTOR CORPORATION**

644 West 12th Street \* Erie 6, Pennsylvania

*Sales Offices in principal cities of U. S. A., Canada, Europe*

**CIRCLE 67 ON READER-SERVICE CARD**

## NEW PRODUCTS

### Signal Conditioner 479



Strain-gage signal conditioner type SSC-1 offers any configuration of bridge circuitry, up to four calibration points, single and double shunt, plus-or-minus and plus-and-minus calibration. Long-term stability is 0.1%; short-term stability is 0.01%. Each of the eight channels is contained on three printed-circuit, plug-in cards.

Astra Technical Instrument Corp., Dept. ED, 12930 Panama St., Los Angeles 66, Calif.

### Silicon Transistor 418

Switching transistor type 2N-957 is for use in vhf and if amplifiers. Voltage rating is 40 v, power rating 800 mw. Minimum dc beta is 45. Minimum ac beta is 40 at 1 mc, and 2 at 100 mc. It is packaged in a TO-18 configuration.

Fairchild Semiconductor, Dept. ED, 545 Whisman Road, Mountain View, Calif.

Price: \$6.50 for 1 to 99, \$4.50 for 100 to 999.

### Temperature Test Stands 483



Movable temperature test stands with a working surface of 24 x 30 in. centralize tests made with the firm's portable temperature chambers. Storage space is provided on a shelf beneath the unit.

Delta Design, Inc., Dept. ED, 3163 Adams Ave., San Diego 16, Calif.

### Delay Line 593



Fixed magnetostrictive delay line L30 provides delays from 250 to 850  $\mu$ sec. Adjustment range is 8  $\mu$ sec. Pulse width is 0.5 to 5  $\mu$ sec, center frequency range 100 kc to 1 mc, bandwidth 1 mc max. Signal-to-noise ratio is at least 20:1. Temperature coefficient is 5 to 10 ppm per degree C, or 0  $\pm$  1 ppm if required.

Ferranti Electric Inc., Electronics Div., Dept. ED, Industrial Park No. 1, Plainview, N. Y.

### Cables and Cable Assemblies 480

Miniature coaxial and triaxial cables and cable assemblies are furnished with connectors in 50, 75 and 95-ohm sizes. Standard line includes braided or solid conductor, Teflon insulation, silver-plated shield, and Teflon, nylon or composition jackets.

Boston Insulated Wire & Cable Co., Dept. ED, Bay St., Boston 25, Mass.

### Selenium Rectifier 488

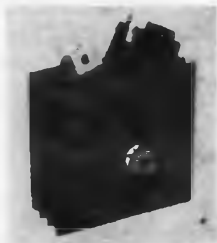

Ratings from 0.46 to 379.2 amp at an ambient temperature of 40 C and up to 948 amp in force-cooled applications are available. Selenium rectifier Mark 5 ranges from 1 x 1 in. to 12 x 16 in. in size, in both 26 v and 33 v rms types.

Syntron Co., Semiconductor Div., Dept. ED, Homer City, Pa.  
Availability: from stock.

## Electron-Beam Evaporator

477



A complete system, the Mark V evaporator includes electron gun, vacuum chamber, mechanical roughing and diffusion pumps, power supply and console. It is designed for the evaporation of ultra-high-purity metallic and ceramic films. Spot diameter can be controlled from 0.01 to over 0.5 in. and focal length, from 4 to 12 in.

Alloyd Electronics Corp., Dept. ED, 37 Cambridge Parkway, Cambridge, Mass.

## Ferrite Core Memory 478

Has a 5- $\mu$ sec memory cycle. Access time is 2  $\mu$ sec and buffer cycle is 2.5  $\mu$ sec. The type RQA ferrite core memory has word capacities of 1,024 up to 32,768, available in lengths of 8 to 60 bits. A wide range of reference levels and signal amplitudes can be furnished for compatibility with tube and transistor circuits. Temperature range is 0 to 50 C at humidity conditions to 95%.

Ampex Computer Products Co., Dept. ED, P. O. Box 329, Culver City, Calif.

## Reverse Feedthrough 451



Provides 90-deg turn. Subminiature reverse feedthrough Type RFT-SM-18 TUR-L2 has a Teflon body and brass studs. Height is 0.378 in. and body diameter is 0.148 in. Studs are terminated in turrets at both ends, measuring 0.040 in. in diameter, may be finished in solder or gold plated.

Sealectro Corp., Dept. ED, 610 Fayette Ave., Mamaroneck, N. Y.

# A CLOSE LOOK AT RCA'S "DARK HEATER"

*and how  
it benefits  
you*

You are looking at a major advance in tube technology. The filament at the right in this special demonstration envelope is a new RCA "Dark Heater". The "Dark Heater" operates at a temperature about 350°K below that of the 1500 to 1700°K of a conventional heater (left). Yet at this much lower temperature, the "Dark Heater" can produce the same cathode temperature as the conventional heater. Reason: the superior thermal emissivity of the dark coating.

For additional information on the "Dark Heater" call your RCA Field Representative or write Commercial Engineering Section I-18-DE-1, RCA Electron Tube Division, Harrison, N. J.

EAST: 744 Broad Street, Newark 2, New Jersey, Humboldt 5-3900 - MIDWEST: Suite 1154, Merchandise Mart Plaza, Chicago 54, Illinois, Whitehall 4-2900 - WEST: 6801 E. Washington Blvd., Los Angeles 22, Calif., Raymond 3-8361.

The cooler operating "Dark Heater" offers many receiving tube advantages to equipment manufacturers, including:

- **Longer heater life**—because of the inherently greater tensile strength of heater wire at lower temperatures.

- **Reduced chance of heater failure**—because the smaller thermal change during heater cycling and the greatly reduced operating temperatures minimize tendency toward recrystallization and burnout.

- **Heater-current stability on life**—especially desirable in maintaining a constant cathode temperature.

- **Reduced AC heater-cathode leakage and hum**—due to elimination of "spike" or pulse leakage currents.

- **Greater safety factor in established heater-cathode voltage ratings**

- **Improved mechanical stability**—cooler operation of the "Dark Heater" minimizes changes in heater shape during life, reducing the possibility of heater damage and heater shorts.

The revolutionary "Dark Heater" is the key to improved performance and longer life for receiving tubes. Now available in an increasing number of RCA receiving tubes, the "Dark Heater" will be incorporated in those RCA receiving types where potential benefits of increased life and reliability can be realized.



The Most Trusted Name in Electronics

*Why Varian's  
G-10 Potentiometer Recorder  
is the*



## **PRACTICAL RECORDING CHOICE**

This recorder has gained an enviable reputation over the years for performing reliably in every recording chore within its capabilities. It owes nothing to styling but the dictates of practicality and delivers performance to match — 10 to 100 mv d.c. full scale; sixteen chart speeds from 1"/hr. to 16"/min.; 1% accuracy and 1/2%-of-span sensitivity; 1 or 2 1/2 second full scale balance time; economical 5" charts with a flat platen for easy note-making. Prices — from \$385.00. Fast delivery; parts and service — world-wide.

Consider the rightness of the G-10 — a potentiometer recorder that has stood the test of time, use and acceptance.

For details, write Instrument Division:



**VARIAN associates**  
PALO ALTO 21, CALIFORNIA

NMR & EPR SPECTROMETERS, MAGNETS, FLUXMETERS, GRAPHIC RECORDERS, MAGNETOMETERS, MICROWAVE TUBES,  
MICROWAVE SYSTEM COMPONENTS, HIGH VACUUM EQUIPMENT, LINEAR ACCELERATORS, RESEARCH AND DEVELOPMENT SERVICES

CIRCLE 69 ON READER-SERVICE CARD

## NEW PRODUCTS

### Decade Counter

499



Frequency response is 200 kc, with less than 5- $\mu$ sec pulse resolution, electrical reset to zero and an output to drive similar decades. Model F1601 miniature decade counter operates on 12 v at 100 ma and has a flexible cable with printed-circuit or amphenol connector. Dimensions are 1-7/8 x 2-1/8 x 4-1/4 in. Weight is 6 oz.

Robotomics Enterprises, Inc., Dept. ED, 4624 E. Garfield, Phoenix 8, Ariz.

P&A: \$98; 3 to 4 weeks.

### Dynamic Analyzer

520

Frequency range is 5 to 2,500 cps; response is flat within 1 db. The dynamic analyzer is a frequency-tuned band-pass filter for such uses as vibration analysis in rotating devices, harmonic and random wave analysis, bearing analysis and transmissibility studies. A recorder output is provided.

General Dynamics/Electronics, Information Technology Div., Dept. ED, P. O. Box 2449, San Diego 12, Calif.

### Cooler Kit

502



Semiconductor cooler kit contains representative types of semiconductor coolers including natural-convection units and forced-convection modular packages. Included is a handbook which outlines the theory as well as practical techniques for temperature, power and air-flow measurement.

Wakefield Engineering, Inc., Dept. ED, Wakefield, Mass.

Price: \$38.50.

## HOW RED IS A BLUSH?



## CETRON

### PHOTO CELLS DO HUNDREDS OF JOBS

How red is red! How bright is a light! These answers, and hundreds of others are all possible—instantly with the use of Cetron Photo Cells.

For counting, color sorting, color registration, light intensity, Cetron Photo Cells do the job fast and accurately. Wherever circuitry for automation requires energy from changing light or color . . . you can be certain with Cetron.

#### Cetron Photo Cells are used in:

- Sound Reproduction
- Facsimile
- Counting and Sorting
- Burglar Alarms
- High Speed Color Registration
- Spectroscopy Reproduction

Cetron Photo Tubes are available to meet requirements of JAN Specifications.

*Cetron Engineers are always available to help in your tube requirements—just write, wire or phone.*

YOUR DEPENDABLE SOURCE FOR  
RECTIFIER, THYRATRON AND PHOTO TUBES



# CETRON

ELECTRONIC CORPORATION  
715 HAMILTON ST. • GENEVA, ILL.

CBS INTERNATIONAL | ATLAS RADIO CORP., LTD.  
New York 22, New York | Toronto 19, Ontario  
European Representatives | Canadian Representatives

CIRCLE 70 ON READER-SERVICE CARD

ELECTRONIC DESIGN • September 13, 1961



## Temperature Chamber 482



Range is -100 to 500 F. Model 1060B temperature chamber is for testing of large assemblies where gradient, control variation and drift cannot exceed  $\pm 1$  C. Volume is about 6 cu ft. Fixtures are available for testing large quantities of small components for quality-control test runs. Mil specs are met.

Delta Design, Inc., Dept. ED, 3163 Adams Ave., San Diego 16, Calif.

## Power Transistors 372

Germanium power transistors with junction temperature ratings of 110 C and maximum power dissipation ratings of 170 w are made in eight types. Housed in TO-36 packages, types 2N2075-2N2082 are capable of 30 w dissipation at 95-C case temperature. Range of  $BV_{CE0}$  is 40 to 80;  $h_{FE}$  at  $I_C=5$  amp is 20 to 70.

Motorola Semiconductor Products Inc., Technical Information Center, Dept. ED, 5005 E. McDowell Road, Phoenix 8, Ariz.  
Price: \$1.95 to \$8.75 ea, 100 up.

## Cryogenic Thermometer 622



Operates at 1.5 K. Miniature cryogenic thermometer CG-1 measures from 1.5 to 5.0 K with accuracy and repeatability better than  $\pm 0.050$  K. Length is 0.350 in., diameter 0.130 in. Weight is less than 0.5 g.

Radiation Research Corp., Dept. ED, Westbury, N. Y.

CIRCLE 71 ON READER-SERVICE CARD ➤



## WHEN THE HEAT'S ON DEPEND ON THESE CTS CERMET RESISTORS

with Space Age 500° C High Stability Metal-Ceramic Element

CTS cermet resistors have exceptionally high stability and reliability... tested extensively and proven under extreme environmental conditions... achieved by a unique, rugged, hard-surfaced metal-ceramic element processed at over 600°C. Specially adaptable to miniaturization because of high load and heat capabilities in small areas. Wide resistance range.



### CERADOT

#### Solid Cermet Fixed Resistors

- 50 ohms thru 100K ohms.
- .050" dia. x .030" L. Other sizes available with or without leads.
- Power rating: 1/10 watt at 125°C.

Kit of 8 different resistance values available at nominal cost.  
Request Data Sheet 185 for technical specs.



### CeraTrols® Series 400

- 3 Watt 1 1/4" dia. Semi-Precision Military Variable Resistor
- Interchangeable with Style RV4 MIL-R-94 but far exceeds temperature and stability requirements.
- Available with 1%, 2% or 3% linearity.
- Power ratings: 3 watts at 85°C, 2 watts at 125°C, derated linearly to zero load at 175°C.

Request Data Sheet 179 for technical specs.



### CERAFER

#### Modular Fixed Resistors

- 5 to 300,000 ohms resistance per square. Resistance of 10 ohms to 1 megohm available in short straight paths without resorting to lattice or grid patterns.
- Unaffected by solvents, potting compounds or corrosive atmosphere.
- Resistant to nuclear radiation and high vacuum conditions.

Kit of 10 different resistance values—10 wafers with 2 identical resistors per wafer—available at nominal cost.  
Request Data Sheet 181 for technical specs.



### CeraTrols Series 500

- 1 1/4 Watt 1/2" dia. Semi-Precision Military Variable Resistor
- Interchangeable with Style RV5 MIL-R-94 but far exceeds temperature and stability requirements.
- Available with 1%, 2% or 3% linearity.
- Power ratings: 1 1/4 watts at 85°C, 1 watt at 125°C, derated linearly to zero load at 175°C.

Request Data Sheet 180 for technical specs.



### CERATRIM Series 170

#### 42-Turn 150°C Square Trimmer Resistor

- Available with wire leads or p.c. pins out bottom or side.
- Power Rating: 1 watt at 50°C derated linearly to zero load at 150°C.

Request Data Sheet 178 for technical specs.



### CeraTrols Series 600

#### 1/2 Watt 1/8" dia. Military Variable Resistor

- Interchangeable with Style RV6 MIL-R-94B but far exceeds temperature and stability requirements.
- Power ratings: 1/2 watt at 85°C, 1/4 watt at 125°C, derated linearly to zero load at 175°C.

Request Data Sheet 175 for technical specs.



### CERATRIM Series 180

#### 25-Turn 200°C Rectangular Trimmer Resistor

- Available with p.c. pins or wire leads.
- Power Rating: 1 watt at 125°C derated linearly to zero load at 200°C.

Request Data Sheet 177 for technical specs.



Founded 1896

## CTS Corporation

Elkhart, Indiana

Factories in Elkhart & Berne, Indiana; South Pasadena, California; Asheville, North Carolina and Streetsville, Ontario, Canada.

Sales Offices and Representatives conveniently located throughout the world. CTS specialists are willing to help solve your cermet resistor problems.

## NEW PRODUCTS

### Motor Speed Control

506



Provides 2% regulation with input voltage variations of  $\pm 10\%$  over the temperature range of  $-55$  to  $+100$  C. Designed for controlling a 28-v dc input, the speed control can be furnished as a separate module measuring 2-1/4 x 2-1/4 x 3/4 in. or it may be attached to any dc-driven commutator with a 1/2-in. extension of the case.

Instrument Development Laboratories, Inc., Dept. ED, 67 Mechanic St., Attleboro, Mass.

### Disk File

500

With 22 to 88 million characters. The 301 disk file system is offered in four standard models. Two files can be connected to provide a total capacity of 176 million characters. Average accessibility time is 100 msec. Each file holds 1 to 24 magnetic disks, 39 in. in diameter, in a vertical position. Data is recorded on both sides.

Radio Corp. of America, Dept. ED, 30 Rockefeller Plaza, New York 20, N. Y.

P&A: \$3,000 up, monthly lease rate.

### Voltage-to-Frequency Converter

507



Linearity is 0.1% or better. The Volcon voltage-to-frequency converter can be used in control and instrumentation applications, including fm signal generators, frequency-control systems and digital voltmeters. Nominal center frequency is 600 kc. Stability approaches that of a good crystal oscillator.

Neshaminy Electronic Corp., Dept. ED, Neshaminy, Pa.

Price: \$75.

## BE THE FIRST IN YOUR BLOCK TO DRIVE A 1937 PACKARD

# WIN this fine Classic Car

A 1937 Packard—12 cylinder Coupe in mint condition and, to pick it up, a weekend flight for 2 to Southern California on a new first class, non-classic airplane.

If you miss narrowly you get **\$1,000**  
Third place is worth **\$300**

Settle this bet for us— **WHICH PSI AD IS BEST?**

Three different PSI ads appear on the pages following this spread. Our switchboard operator has money riding on one. The Assistant Quality Assurance Control Chief likes another. Our Advertising Manager thinks they're all nice. It's a problem—for you to decide. And easy. All you have to do is—

- 1** Read the 3 ads (carefully, please, the ad manager is sensitive) and rate them 1-2-3. Use ESP, Ouiji Board, or just guess.
- 2** Then guess how many first place votes each ad in your 1-2-3 order will get.
- 3** Write your answers on one of the entry cards bound into this magazine following the last

PSI ad and mail it *fast*. The closing date of the contest is October 15, 1961.

Now wasn't that easy? And that's all you have to do. We'll do the rest... counting and judging... which is certainly no reference to your honesty. It's just that we'll have all the cards. Which seems fair.

First prize will go to the entry which comes closest to picking the number of votes for the top-rated ad, and, naturally, the correct order. Second and third prizes will go to folks who get next nearest and next, next nearest.

Here are some more rules and hints. It might help you win if you'll read them.

### HELPFUL OFFICIAL CONTEST RULES

#### HINTS FOR CONTESTANTS

It is not necessary for you to be an expert. Our own preliminary investigation reveals some pretty hairy sounding guesses. You are welcome to use psychology, a digital computer, even zoology if you think it'll help.

However, here are a couple of small hints that might get you started. The 2 magazines in which the contest appears have a combined paid and controlled circulation of 96,000. Some people read both magazines, which is one reason why we chose them in the first place. But nobody knows how many.

And then there's "pass-along", which is not a cowboy show, but is the result of some generous fellows letting others read their magazines, which we think is nice. Multiply by 3.4 for this factor.

Then you have to figure that some people won't enter, which is the only thing about it that seems unfair to us.

The total number of first place votes for any of the 3 ads could range anywhere from 2,000 to 75,000. Now, doesn't that offer plenty of room for your guesses?

1. Read 3 ads (A, B and C) on following pages. Indicate on one of the official entry blanks (bound in following ad C) your opinion of how contest entrants will rate each ad in order of advertising effectiveness. Then estimate number of contestants who will select each of the ads as being the most effective. There is nothing to buy.

2. Winners will be chosen on basis of accuracy in guessing:

a. Order in which most entrants in contest will rate 3 ads.

b. Total number who will vote for top-rated ad.

In event of ties, entries most closely guessing number of votes for second-rated ad (or, if necessary, third-rated) will win.

If further ties exist, entrants will be required to write a statement in 25 words or less telling why they selected top ad. In case of ties after statements have been submitted, duplicate prizes will be awarded.

3. First prize winner will get 1937 Packard 12-cylinder coupe (see picture)—Engine #906495-B; California License VJU 966. Winner, if living over 100 mi. from Los Angeles, will also get a one-way first-class air line flight for 2 persons from his home town to Los Angeles. They will be week-end guests of PSI for car presentation and title transfer at PSI plant. Winner will also receive fuel and oil for return trip to winner's home together

with \$100.00 deductible collision insurance and comprehensive. (PI and PD to be supplied by winner through own insurance broker.) In event winner elects to ship car by public carrier, PSI will reimburse expense to extent of distance covered, based on 8 mi.-per-gal. of fuel and an engine oil change every 1,000 mi. Second prize, a check for \$1,000.00 (one thousand dollars) will be mailed to second prize winner's business address. Third prize winner will receive a check for \$300.00 (three hundred dollars) mailed to his business address.

4. Contest is open only to persons actively engaged in electronic field in the 50 U.S. states, D.C. and in Canada. Employees of Thompson Ramo Wooldridge Inc., its divisions, affiliates, subsidiaries, distributors, advertising agencies and The Reuben H. Donnelly Corporation (judging firm) are not eligible.

5. All entries must be on official entry post-cards (in present issue, this magazine) or obtained from Pacific Semiconductors, Inc. by writing: Advertising Dept., 12955 Chadron Ave., Hawthorne, Calif.

6. All entries must be postmarked no later than Oct. 15, 1961, and received in Los Angeles by Oct. 25, 1961. Only one entry per person and one prize per family. All entries will be mailed to: PO Box 16, Los Angeles 51, Calif.

7. Winners will be notified by mail about 30 days after contest's close. No entries returned; all become property of sponsor.

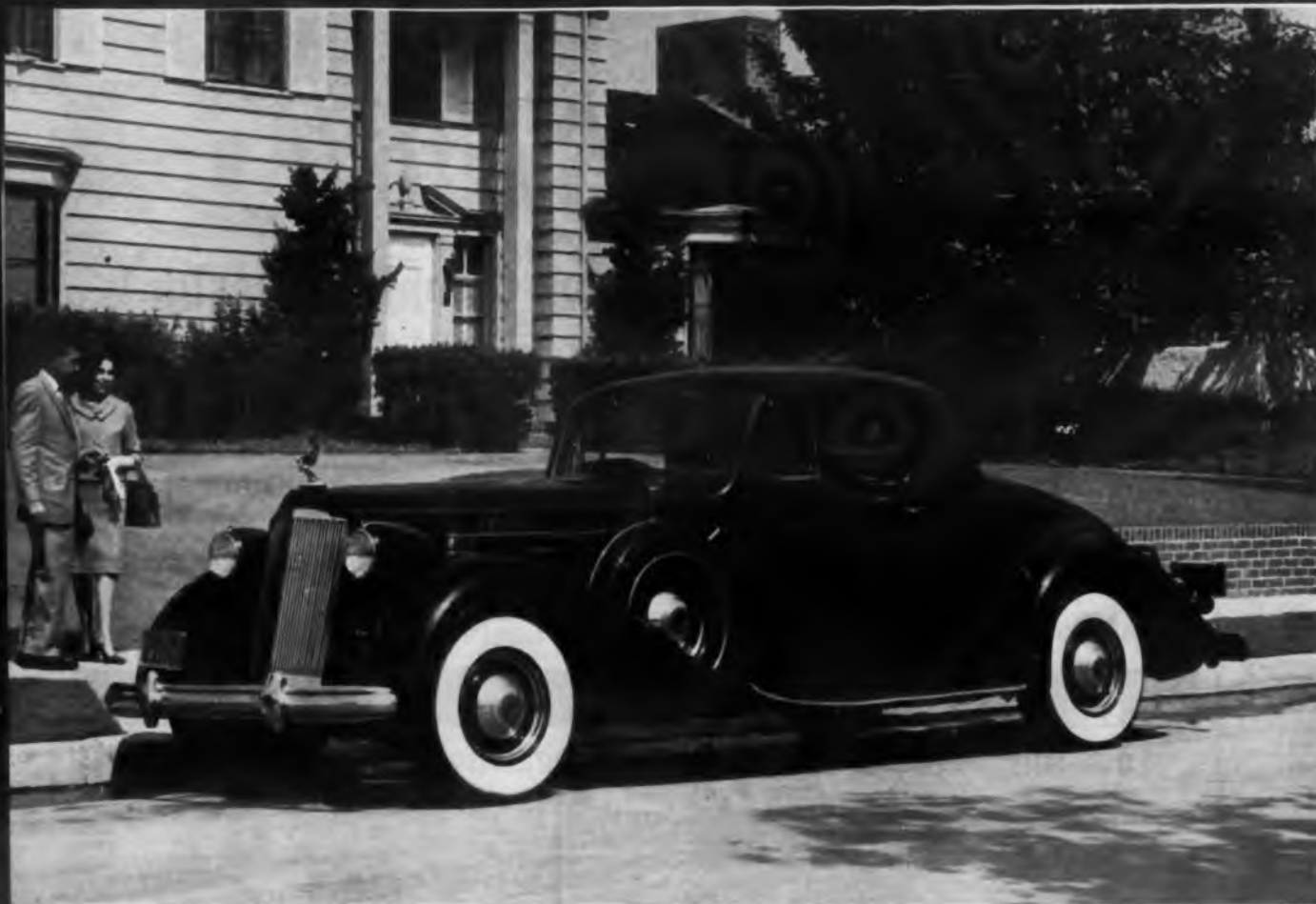

## MOVE SEVEN STALLS UP IN THE COMPANY PARKING LOT

If you have ever suffered the indignity of a second class parking space—had to stand by while protocol usurped your rightful place—then you know frustration. If you have ever sneaked past a Vice President in the company cafeteria line, you know the meaning of one-upmanship, and the fiendish glee which accompanies it.

Now, with a victory in this PSI contest, you can accomplish both. End that deep frustration, because your Classic 1937 Packard-12 rightfully belongs next to the President's common carriage. And just think of all the competitors you'll be one up on—for this automobile wasn't even ordinary in 1937.

You'll have great fun dropping your wallet in strategic meetings, careful that it falls open to your membership card in a Classic Car Club. Idly, you can mention the Concourse d'Elegance at Pebble Beach, the Polo Club in Darien, Connecticut, or the joys of Boca Raton in winter.

Not to mention the sheer pleasure of driving this marvelous machine, waving casually, or grandly, as the mood assails you, to folks who knew you when. Think of the opportunities to smile quietly, cast your eyes down with some modesty, as friends exclaim in admiration over the virginal appearance of the upholstery, its discreet use of chrome, its obvious good taste. To them, you are a man among men, a master of the art of gracious living.

And there will be your own feelings to consider. The sense of belonging with the uncommon, those who under-

stand the elegance of the past. The feeling of command as you wheel through traffic, all eyes on you. The knowledge of smooth, quiet power, accompanied by size and weight adhering to the philosophy that these are the factors to provide comfort and safety in motoring.

There will be those who will be awestruck by the gleaming black finish of your automobile. And times when you can quietly mention your Packard-12 engine has a displacement of 473 cubic inches, a bore of 3-7/16 inches, a stroke of 4 1/4 inches, a wheel base of 134 inches, 5,255 pounds of massive strength and comfort. Such information may be all you'll need to bring tears to your sports car aficionado friends. You can even squash the miles-per-gallon type with the quiet disclaimer that your classic car runs beautifully on regular gasoline.

And think of the joy of inviting a golfing companion to place his bag in one of the locked hatches on either side. Or perhaps insisting you drive to a meeting with two vice presidents in the rumble seat.

Lest you believe our generosity ends with this magnificent automobile, let us hasten to add right here, the trip for 2 to pick it up in Lawndale, California. Right there is something to talk about. How many people do you know who have had a free flight to Lawndale?

Do enter the contest right now. It may be a way to alter your life, your hopes, your dreams considerably—to gain prestige—to shake empire builders at their very cores.

 **Pacific Semiconductors, Inc.**

A SUBSIDIARY OF THOMPSON RAMO WOOLDRIDGE INC.



12955 CHADRON AVE., HAWTHORNE, CALIFORNIA

TURN  
PAGE

### Printed-Circuit Connector

481



Designed for space applications, the Digi-Klip printed-circuit board connector withstands temperatures of over 200 C without fatigue or contact failure. It has a beryllium-copper, heat-treated wire mounting in two 0.21-in. holes spaced at 0.25 in.

Components Corp., Dept. ED, Denville, N. J.

Price: \$25 per 1,000.

### Coaxial Cables

416

For high temperatures. New versions of miniature high-temperature coaxial cables included in MIL-C-17C have made possible seven new constructions. Types RG-178B/U to RG-180B/U are available with Teflon FEP jackets, usable to 200 C. Types RG-187A/U, RG-188A/U, RG-195A/U and RG-196A/U are available with annealed center conductors and TFE jackets, usable to 250 C.

Times Wire and Cable Co., Inc., Dept. ED, Wallingford, Conn.

### RF Attenuators

484



High-power rf attenuators models AX-100 and AX-500 are rated at 100 and 500 w, respectively. Accuracy is  $\pm 0.3$  db. Frequency ranges are dc to 700 mc and dc to 1,000 mc with reduced accuracy. Standard attenuation values are 10, 20 and 30 db; others can be furnished.

Electro Impulse Laboratory, Inc., Dept. ED, 208 River St., Red Bank, N. J.

## NEW PRODUCTS

### Germanium Mesa Transistors

490



High-speed germanium mesa transistors are available in four types, designated 2N705, 2N710, 2N711 and 2N725. Typical switching speed is 96 nsec. Gain-bandwidth product is about 600 mc. Housing is standard JEDEC TO-18. Units have high mechanical strength and low failure rates on operating and storage-life tests.

General Electric Co., Dept. ED, Kelley Bldg., Liverpool, N. Y.

Price: \$1.60 to \$2.80 to OEM.

### Communications Antennas

526

Range is 150 to 170 mc. These communications antennas, known as Gibson antennas, include single element dipole and stacked colinear dipole types. They have solid dipole elements, gamma match to 50-ohm coaxial line, element length and tuning to exact operating frequency and better than 1.2 vswr. They withstand severe icing and winds up to 100 mph.

Brad Thompson Industries, Inc., Dept. ED, 83-810 Tamarisk St., Indio, Calif.

### Circuit Breaker

527



For aircraft use. The Klixon 6752-12 circuit breaker meets MS24571 aircraft requirements and exceeds MIL-C-5809C. It has a rupture capacity of 6,000 amp, 120 v ac, 400 cps; 4,200 amp, 205 v ac, 400 cps; 6,000 amp, 30 v dc. Vibration limit is 10 g at 1,500 cps; ambient temperature range is -65 to +250 F.

Texas Instruments, Inc., Metals & Controls Inc., Dept. ED, 34 Forest St., Attleboro, Mass.

AD  
A

# The Logical Logic Switch

for your Computer Design!

# PSI 2N920 - 2N919

(high  $h_{FE}$ )

(medium  $h_{FE}$ )

**FAST SWITCHING • LOW  $V_{CE}$  (Sat) • LINEAR  $h_{FE}$  versus  $I_C$  and  $V_{CE}$**

**TRIPLE DIFFUSED SILICON PLANAR TRANSISTORS**

Look what happens in fast switching circuitry...

TRANSISTOR TYPE	$t_{ON}$	$t_{OFF}$	$t_{TOTAL}$
PSI Laminar (Triple diffused planar)	5	5	10 NSec
Micro-Alloy Diffused	5	7	12
Epitaxial	6	8	14
Mesa (double diffused)	10	11	21
Planar (double diffused)	12	13	25

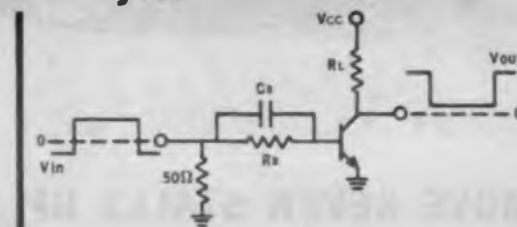

(SCHEMATIC - CIRCUIT B)

## It's logical to specify PSI Logic Transistors

- \* **ADDED ADVANTAGES** of low leakage, better stability under varying environmental conditions and inherent greater reliability - as well as switching performance competitive in all aspects with germanium logic transistors!
- \* **PRICE PARITY** with germanium switches of competitive speeds is rapidly being reached. Volume in 1962 will wipe away any remaining differential.
- \* When epitaxial transistors have come of age and are *proved* reliable they will provide a ready second source to the *production-proved* PSI Triple Diffused Planar transistors.

**EXPERT FIELD ENGINEERING SERVICE** is immediately available. There are PSI field offices from coast to coast. Call one of them now!



*Pacific Semiconductors, Inc.*



A SUBSIDIARY OF THOMPSON RAMO WOOLDRIDGE INC. • 12955 CHADRON AVE., HAWTHORNE, CALIFORNIA

# Why PSI is ONE of America's TOP TWO IN SILICON TRANSISTORS

it's simple as

**A**dvanced R & D

Pacific Semiconductors, Inc. was first to make silicon computer diodes commercially available, and is the industry's number one diode source.

Until early 1960, PSI's transistor development was largely concentrated on providing certain vital transistors for satellite communication programs and developing broad technology in basic transistor techniques. Since that time this work has led to explosive growth in silicon switching transistor capability. Why?

**B**usinesslike engineering

Original PSI research led to the first Triple Diffused Silicon Mesa Transistors nearly four years ago. Its objective was to attain large volume production of devices with extraordinary electrical characteristics—very fast switching, extremely low saturation, superior high current and small signal beta and broad VHF versatility. Products of that research are the now-famous 2N1505-2N1506 VHF communication transistors, the 2N1899 high frequency power transistors, the 2N1837 premium switch, the 2N920 logic switch and the PT601 core driver transistors—along with scores of less glamorous but equally important “work horse” transistors for every application in today's and tomorrow's design.

**C**oordinated marketing

including product services, quality control and applications engineering in its framework—is a completely self-sufficient and dynamically-growing PSI operation. PSI triple diffused, isolated base (planar) production technology is turning out medium and low power core drivers and switches which are equal to or better than any specifications available in the industry. These devices are available in TO-5, TO-8, TO-18 and the new TO-46 and TO-51 packages.

The PSI transistor operation happily teams the theoretical and the practical—all the way from R&D to the field engineers. The ultimate selling price of a new device is considered just as realistically as the exciting electrical characteristics of the device itself—in the PSI Coordinated Marketing philosophy.

When your problem requires Advanced R&D—Businesslike Engineering—Coordinated Marketing—we'd like to have the privilege of talking it over with you. Phone, wire or write a PSI field engineering office near you!



*Pacific Semiconductors, Inc.*

A SUBSIDIARY OF THOMPSON RAMO WOOLDRIDGE INC.

12955 CHADRON AVENUE • HAWTHORNE, CALIFORNIA

## Wirewound Potentiometers

523



Linearity is 0.01%. Model 20-A infinite-resolution wirewound potentiometers can be supplied for continuous rotation applications or with solid-end stops, rated at 800 oz-in. Resistances are from 0.5 to 1,000 ohms.

Vogue Instrument Corp., Dept. ED, 2350 Linden Blvd., Brooklyn 8, N. Y.

P&A: \$35; 2 to 3 weeks.

## Impulse Counter

521



Life is 500 million counts. Driven by an electromagnetic stepping motor, the impulse counter can count 100 per sec. It can be used to measure time and distance directly in decimals and is particularly suitable for data processing and automation equipment. It can be furnished with five or six-figure drums.

Ringsdorf Carbon Corp., Dept. ED, East McKeesport, Pa.

## Compact Timer

491



For complex programming. The timer combines a 115-v ac, 400-cps, synchronous motor with a 28-v dc magnetic clutch to provide two or more fixed or adjustable timing sequences with automatic reset. It is designed to withstand 15-g shock and is sealed for environmental protection. Weight is 2.75 lb; dimensions are 3-21/32 x 3-13/32 x 3-1/2 in.

Glove Industries, Inc., Dept. ED, 1784 Stanley Ave., Dayton 4, Ohio.

## NEW PRODUCTS

### Power Resistors

509

With  $\pm 10$  ppm per deg C temperature coefficient from  $-55$  to  $+350$  C. Code C-10 power resistors have inductive or non-inductive windings, power ratings of 1/2 to 10 w, resistances of 25 ohms to 275 K and tolerances to  $\pm 0.05\%$ .

Omtronics Manufacturing, Inc., Dept. ED, P. O. Box 1419, Peony Park Station, Omaha 14, Nebr.

P&A: \$0.70 to \$3; 1 to 3 weeks.

### Printed-Circuit Chassis

513



Holds up to 30 cards. Rack mounting combination printed-circuit card file and chassis consists of one to three files with chassis plate for power supply or up to four files without chassis plate. It can be furnished in steel or aluminum, 9 to 24 in. deep in 1-in. increments. Panel height is 5-1/4 to 19-1/4 in. in 1-3/4 in. increments.

Western Devices, Inc., Dept. ED, 600 W. Florence Ave., Inglewood 1, Calif.

P&A: \$50 to \$250; 14 days.

### Clock Pulse Generator

531

For 5-mc operation, type 2011 CL Logix Block clock pulse generator is a variable frequency oscillator. Repetition rate is 0.2 to 250  $\mu$ sec with frequency variations of 5 mc to 4 kc. Continuous frequency variation is by means of three capacitors located on the module and an external potentiometer.

Rese Engineering, Inc., Dept. ED, A and Courtland Streets, Philadelphia 20, Pa.

### DC Power Supplies

487

Rated at 10 and 200 amp. Designed for electrolytic plating, these power supplies have 2% voltage accuracy and Powerstat voltage control. Voltage outputs are from 6 to 15 v. Components are rated for long life.

Gates Electronics Co., Dept. ED, 2243 White Plains Road, New York, N. Y.

P&A: \$75 to \$210; stock.

AD C

# 72 reasons why YOU SHOULD SPECIFY PSI TRIPLE DIFFUSED SILICON PLANAR TRANSISTORS

## HIGH SPEED SWITCHING TRANSISTORS

TYPE	Total Power @25°C Case Watts	V <sub>CS0</sub> Min.	V <sub>CSR</sub> Min.	V <sub>ES0</sub> Min.	f <sub>c</sub> mc Typ.	hrs* 20 min	V <sub>CS sat</sub> * Max.	Pkg.
2N708	1.0	25	20	5	250	20 min	.80	TO-18
2N708A	1.0	25	20	5	350	20-60	.80	TO-18
2N708B	1.0	25	20	5	350	20-60	.40	TO-18
2N793	1.0	25	20	5	350	40-120	.60	TO-18
2N834	1.0	40	30	5	350	25 min	.35	TO-18
2N8919	1.2	25	20	5	400	20-60	.30	TO-18
2N939	1.2	25	20	5	400	40-150	.35	TO-18
2N991	1.2	50	30	5	400	20-60	.30	TO-18
2N992	1.2	50	30	5	400	40-120	.30	TO-18
2N1252	2.0	30	20	5	210	15-45	1.5	TO-5
2N1253	2.0	30	20	5	210	30-90	1.5	TO-5

## STANDARD SWITCHING TRANSISTORS

TYPE	Total Power @25°C Case Watts	V <sub>CS0</sub> Min.	V <sub>CSR</sub> Min.	V <sub>ES0</sub> Min.	f <sub>c</sub> mc Typ.	hrs*	V <sub>CS sat</sub> * Max.	Pkg.
2N487	4.0	60	60	8	190	12-28	5.0V	TO-5
2N490	4.0	100	100	8	190	12-28	5.0V	TO-5
2N698	4.0	60	60	8	190	20-90	5.0V	TO-5
2N697	4.0	100	100	8	190	20-90	5.0V	TO-5
TYPE	Total Power @25°C Case Watts	V <sub>CS0</sub> Min.	V <sub>CSR</sub> Min.	V <sub>ES0</sub> Min.	f <sub>c</sub> mc Typ.	hrs*	V <sub>CS sat</sub> * Max.	Pkg.
2N696	2.0	60	40	5	200	20-60	1.5	TO-5
2N697*	2.0	60	40	5	200	40-120	1.5	TO-5
2N698	2.0	120	80	5	190	20 min	5.0	TO-5
2N699	2.0	120	80	5	190	40-120	5.0	TO-5
2N700	1.2	40	20	5	—	30-120	.4	TO-18
2N717	1.5	60	40	5	200	20 min	1.5	TO-18
2N718	1.5	60	40	5	200	40-120	1.5	TO-18
2N719	1.5	120	80	5	190	20 min	5.0	TO-18
2N720	1.5	120	80	5	190	40-120	5.0	TO-18
2N717A	1.5	75	50	7	200	20-60	1.5	TO-18
2N718A	1.5	75	50	7	200	40-120	1.5	TO-18
2N719A	1.5	120	80	7	190	20-60	5.0	TO-18
2N720A	1.5	120	80	7	190	40-120	5.0	TO-18
2N1428	2.0	60	30	5	170	100-300	1.5	TO-5
2N1613	3.0	75	50	7	200	40-120	1.5	TO-5
2N1711	3.0	75	50	7	170	100-300	1.5	TO-5
2N1823	3.0	120	80	7	190	40-120	5.0	TO-5

\* MIL-S-19500/MA (Sig C)

## GENERAL PURPOSE SWITCHING TRANSISTORS

2N1200	2.0	40	25	3	190	—	—	TO-5
2N1200	2.0	45	30	4.5	190	40-120	1.4	TO-5
2N1200	2.0	45	30	4.5	170	12-50	1.4	TO-5
2N1200	2.0	25	20	5	190	10 min	1.4	TO-5

\*SEE DATA SHEETS FOR CONDITIONS

## PREMIUM SWITCHING TRANSISTORS

2N1637	2.0	80	50	5	210	40-120	.30	TO-5
2N1637A	2.0	80	50	5	210	40-120	.30	TO-5
2N1490	2.0	30	25	4	235	15-45	.80	TO-5
2N1490A	2.0	30	25	4	235	15-45	.80	TO-5
2N1410	2.0	45	30	4	235	20-60	.80	TO-5
2N1410A	2.0	45	30	4	235	20-60	.80	TO-5
PT350	2.0	180	80	5	200	40-150	2.0	TO-5
PT350A	2.0	120	80	5	200	40-150	2.0	TO-5

## SPECIAL PURPOSE SWITCHING TRANSISTORS

2N1240	2.0	120	150	5	220	5 min	0.7	TO-5
PT501	13.0	80	45	4	210	30-90	1.0	TO-5
PT500	13.0	80	45	4	210	15-45	1.0	TO-5
2N1000	125.0	140	100	5	50 min	10-20	2.0	Single End
2N1001	125.0	140	100	5	50 min	15-40	2.0	Single End

\*SEE DATA SHEETS FOR CONDITIONS

## VERY HIGH FREQUENCY TRANSISTORS

TYPE	Total Power @25°C Case Watts	V <sub>CS0</sub> Min.	V <sub>CSR</sub> Min.	V <sub>ES0</sub> Min.	Power Gain @ 1-20mc Typ.	Power Gain @ 1-70mc Typ.	Power Gain @ 1-100mc Typ.	Pkg.
PT720	1.2	25	15	5	—	—	15db P <sub>0</sub> -2W	TO-18
2N797	1.0	50	50	4	—	—	8db P <sub>0</sub> -2W	TO-18
2N1220	2.0	80	50	3	18db P <sub>0</sub> -0.35W	10.5db P <sub>0</sub> -0.35W	7db P <sub>0</sub> -0.35W	TO-5
2N1242	2.0	150	125	5	—	—	12db P <sub>0</sub> -0.4W	TO-5
2N1505	3.0	50	40	3	10db P <sub>0</sub> -1.2W	8db P <sub>0</sub> -1.2W	6db P <sub>0</sub> -1W	TO-5
2N1506	3.0	60	40	4	12db P <sub>0</sub> -1.2W	10db P <sub>0</sub> -1.2W	8.5db P <sub>0</sub> -1W	TO-5
2N1710	13.0	60	40	3	18db P <sub>0</sub> -5W	8db P <sub>0</sub> -5W	8db P <sub>0</sub> -5W	TO-5
2N1700	13.0	75	60	4	12db P <sub>0</sub> -5W	8db P <sub>0</sub> -7W	8db P <sub>0</sub> -7W	TO-5
PT351	12.0	—	80	4	—	—	10db P <sub>0</sub> -3W	TO-5

HF HIGH POWER TRANSISTORS										
TYPE	V <sub>CS0</sub> Min.	V <sub>CSR</sub> Min.	V <sub>ES0</sub> Min.	hrs	10mc hrs	f <sub>c</sub> mc	5 mc Class C Amplifier	Power Out	Power Gain	Pkg.
2N1000	140	100	5	10 min	3	30 min	125W	10db	Single End	
2N1000	140	100	5	10-20	3	30 min	125W	10db	Single End	
2N1001	140	100	5	10-40	3	30 min	125W	10db	Single End	
2N1000	140	100	5	10 min	3	30 min	125W	10db	Double End	
2N1000	140	100	5	10-30	3	30 min	125W	10db	Double End	
2N1004	140	100	5	10-40	3	30 min	125W	10db	Double End	
PT500	80	80	5	10 min	3	30 min	125W	10db	Single End	



# Pacific Semiconductors, Inc.



A SUBSIDIARY OF THOMPSON RAMO WOOLDRIDGE INC.

12955 CHADRON AVENUE, HAWTHORNE, CALIFORNIA

Official  
Entry Cards

# "WHICH PSI AD IS TOPS?" CONTEST

WIN THAT PACKARD

## YOUR CARD

Take a card...  
Fill it out...  
mail it in.  
It's addressed...  
and postage paid.  
(Back up 5 pages for  
the rules.)

## YOUR FRIENDS

"Pass along" readers are  
welcome, too.  
Anybody connected with the  
electronics industry qualifies  
for this.

**ENTER NOW!  
CONTEST CLOSES  
OCTOBER 15.**

## FOR MORE ENTRY CARDS

Write: Advertising Dept.  
12955 Chadron Ave.  
Hawthorne, Calif.  
Or, phone nearest  
PSI Sales Office (below).  
They may still have a supply  
on hand.

OFFICIAL  
ENTRY CARD

### "WHICH PSI AD IS TOPS?" Pacific Semiconductors, Inc.

Ad # \_\_\_\_\_ is TOPS. And it will be voted FIRST by \_\_\_\_\_  
(INDICATE A, B, OR C) (NUMBER OF ENTRANTS) \*

Ad # \_\_\_\_\_ is 2nd. BUT it will be voted FIRST by \_\_\_\_\_  
(NUMBER OF ENTRANTS) \*

Ad # \_\_\_\_\_ is 3rd. BUT it will be voted FIRST by \_\_\_\_\_  
(NUMBER OF ENTRANTS) \*

\*For ball park figures, see "Helpful Hints" - 5 pages back.

NAME: \_\_\_\_\_

TITLE OR JOB: \_\_\_\_\_

FIRM: \_\_\_\_\_

ADDRESS: \_\_\_\_\_

CITY: \_\_\_\_\_ ZONE: \_\_\_\_\_ STATE: \_\_\_\_\_

### "WHICH PSI AD IS TOPS?" Pacific Semiconductors, Inc.

Ad # \_\_\_\_\_ is TOPS. And it will be voted FIRST by \_\_\_\_\_  
(INDICATE A, B, OR C) (NUMBER OF ENTRANTS) \*

Ad # \_\_\_\_\_ is 2nd. BUT it will be voted FIRST by \_\_\_\_\_  
(NUMBER OF ENTRANTS) \*

Ad # \_\_\_\_\_ is 3rd. BUT it will be voted FIRST by \_\_\_\_\_  
(NUMBER OF ENTRANTS) \*

\*For ball park figures, see "Helpful Hints" - 5 pages back.

NAME: \_\_\_\_\_

TITLE OR JOB: \_\_\_\_\_

FIRM: \_\_\_\_\_

ADDRESS: \_\_\_\_\_

CITY: \_\_\_\_\_ ZONE: \_\_\_\_\_ STATE: \_\_\_\_\_

OFFICIAL  
ENTRY CARD



# Pacific Semiconductors, Inc.



A SUBSIDIARY OF THOMPSON RAMO WOOLDRIDGE INC.

12955 CHADRON AVE., HAWTHORNE, CALIFORNIA

## SALES OFFICES

NEW YORK—870 Broadway, Newark 4, New Jersey •  
HUMboldt 4-5616 • TWX: NK 1010  
Boston—471 Washington Street, Wellesley 81, Mass. •  
CEdar 5-0171  
Syracuse—4455 E. Genesee Street, Syracuse, New York •  
Gibson 6-4800  
PENNSYLVANIA—No. 4 Township Line Road, Philadel-  
phia 17, Pa. • RAAndolph 5-1626 • TWX: JNKTN 1064  
Baltimore—1811 North Rolling Road, Baltimore 7, Md. •  
WINDox 4-3622 • TWX: WDLN MD 232  
ILLINOIS—6957 West North Avenue, Oak Park, Illinois •  
Village 8-9750 • TWX: OKP 1547

Dallas—P.O. Box 6067, Dallas, Texas • Riverside 7-1258  
Detroit—1204 No. Woodward Ave., Royal Oak, Michigan •  
Lincoln 8-4722  
St. Paul—1602 Selby Ave., St. Paul 4, Minn. • Midway 6-9361  
Missouri—3100 Kingsley Dr., Florissant, Mo. • MA 1-4353  
CALIFORNIA—8271 Melrose Ave., Los Angeles 46, Calif.  
OLive 3-7850  
San Diego—2223 El Cajon Blvd.—Room 211 •  
CYpress 7-3961  
Palo Alto—701 Welch Road—Suite 205, Palo Alto, Calif. •  
DAvenport 1-2240

DISTRIBUTORS IN MAJOR ELECTRONIC CENTERS COAST-TO-COAST

Postage  
Will Be Paid  
by  
Addressee

No  
Postage Stamp  
Necessary  
If Mailed in the  
United States

**BUSINESS REPLY MAIL**

First Class Permit No. 41411, Los Angeles, California

**Pacific Semiconductors, Inc.**  
P.O. Box 16, L.A. 51, Calif.  
Los Angeles, California

Postage  
Will Be Paid  
by  
Addressee

No  
Postage Stamp  
Necessary  
If Mailed in the  
United States

**BUSINESS REPLY MAIL**

First Class Permit No. 41411, Los Angeles, California

**Pacific Semiconductors, Inc.**  
P.O. Box 16, L.A. 51, Calif.  
Los Angeles, California

**WIN**

**1937 PACKARD-12 COUPE**

and weekend for 2 in Southern California

**1<sup>ST</sup> PRIZE**

**\$1,000 CASH**

**2<sup>ND</sup> PRIZE**

**\$300 CASH**

**3<sup>RD</sup> PRIZE**

see six preceding pages

**PSI DISTRIBUTORS**

**Western**

**ASTRONICS, INC.**  
9310 North Central, Phoenix 20, Ariz.  
944-1551 (602)  
**CASHIN TIPTON, INC.**  
3270 Rosacrans St., San Diego 10, Calif.  
AC 2-0408 (714) TWXSD-8456 (U)  
**ELECTRONIC PARTS CO., INC.**  
222 Truman St., N.E., Albuquerque, N.M.  
AL 8-0946  
**ELECTRONIC SUPPLY CORP.**  
2085 E. Foothill Blvd., Pasadena, Calif.  
MU 1-5291  
**ELMAR ELECTRONICS, INC.**  
140 - 11th St., Oakland, Calif.  
TE 4-3311 (415)  
**INLAND ELECTRONIC SUPPLY CO., INC.**  
715 E. Broadway, Tucson, Arizona  
MA 4-8404  
**KIERULFF ELECTRONICS, INC.**  
1106 Morena Blvd., San Diego 10, Calif.  
BR 6-3349 RI 7-0271  
**K-TRONICS**  
1030 Byram St., Los Angeles 15, Calif.  
RI 8-5231 TWX LA 2803  
**Mechanical ELECTRONICS, INC.**  
1275 Sherman Street, Denver 3, Colo  
AM 6-3421  
**SANTA MONICA RADIO PARTS CORP.**  
1517 Second St., Santa Monica, Calif.  
EX 3-8231 UP 0-7676  
**SEATTLE RADIO SUPPLY, INC.**  
2117 Second Ave., Seattle 1, Wash.  
MA 4-2345 (206)  
**STANBARD SUPPLY CO.**  
225 E. 8th South St., Salt Lake City 10, Utah  
EL 5-2971

**Midwestern**

**BLENDALE ELECTRONICS SUPPLY CO.**  
12530 Hamilton Ave., Detroit, Mich.  
TU 3-1500  
**GRAMAM ELECTRONICS SUPPLY, INC.**  
122 S. Senate Ave., Indianapolis 25, Ind.  
ME 4-8486 TWX IP-363-X  
**HARDMAN ELECTRONICS, INC.**  
615 So. First St., St. Louis 2, Missouri  
MA 1-0231  
**LEW BORN CO.**  
1211 La Salle, Minneapolis 3, Minn.  
FE 9-6351  
**OIL CAPITAL ELECTRONICS CORP.**  
708 S. Sheridan, Tulsa 16, Oklahoma  
TE 6-2541 TWX TU-1818 (U)  
**PACE ELECTRONIC SUPPLIES, INC.**  
6141 Touhy Ave., Chicago 48, Illinois  
RD 3-6300  
**PIONEER ELECTRONIC SUPPLY CO.**  
5403 Prospect Ave., Cleveland 15, Ohio  
SU 1-9410 CV-970  
**RADIO & TV SUPPLY CO.**  
716 Pratt Ave., Huntsville, Ala.  
JE 6-8553  
**STERLING ELECTRONICS, INC.**  
1616 McKinney Avenue (P.O. Box 1229)  
TWX HO-878  
Houston 1, Texas CA 5-1321  
Beaumont, Texas TE 3-7503  
**WHOLESALE ELECTRONIC SUPPLY**  
2809 Ross Ave., Dallas 1, Texas  
TA 4-3001 DL-1149  
Fort Worth, Texas ED 6-0461

**Eastern**

**ALMO RADIO CO.**  
913 Arch St., Philadelphia 7, Pa.  
WA 2-5818  
**Morristown, Pa. BR 2-7580**  
Wilmington, Del. CL 6-9487  
**CRAMER ELECTRONICS, INC.**  
811 Boylston St., Boston 18, Mass  
CO 7-4700 - Enterprise 6425  
**B & H DISTRIBUTING CO., INC.**  
2525 North 7th St., Harrisburg, Pa.  
CE 6-8001  
**EAST COAST ELECTRONICS, INC.**  
1012 Sligh Blvd. S.W., Orlando, Fla.  
CH 1-3353  
**ELECTRONIC WHOLESALEERS, INC.**  
1301 Hibiscus Blvd.  
Melbourne, Fla. FA 3-1441  
Miami, Fla. FR 7-2911  
St Petersburg OR 1-5171  
Orlando GA 3-6411  
Ft Lauderdale WA 3-2204  
**ELECTRONIC WHOLESALEERS, INC.**  
2345 Sherman Ave., N.W., Wash. 1, D.C.  
HU 3-5200  
**E. S. LOMAS, DISTRIBUTORS**  
227 Laurier Ave., W., Ottawa 4, Canada  
CE 2-8504  
**PEERLESS RADIO DISTRIBUTORS, INC.**  
19 Wilbur St., Lynbrook, Long Island, N.Y.  
LY 3-2121 WD 4-4334  
**STACH INDUSTRIAL ELECTRONICS, INC.**  
45 Washington St., Binghamton, N.Y.  
RA 3-8328  
Elmira, New York RE 3-6513  
Ithaca, New York Phone 2-3221  
Kempore 23, N.Y. TR 3-1643  
**TERMINAL-HUBBARD ELECTRONICS, INC.**  
234 W. 17th St., New York 11, N.Y.  
CH 3-5200  
**WHOLESALE RADIO PARTS CO.**  
308 W. Redwood St., Baltimore 1, Md.  
MU 3-2134  
York, Pa. YOrk 47-1007

**Export**

**M.C.P. ELECTRONICS, LTD.**  
88 Strand, London, W.C. 2  
Wembley 1191  
Cable Address: MINCPEPRO, London  
Representing United Kingdom  
**MACHINE & PRODUCTS COMPANY**  
52 Wall St., New York 3, New York  
WHITANI 4-4370  
Cable Address: MACHPROCOM, New York  
Representing Europe  
**HARWIT INTERNATIONAL, INC.**  
1108 Venice Blvd., Los Angeles 15, Calif.  
Richmond 9-1815  
Cable Address: HARINTER, Los Angeles  
Representing Asia,  
South America, Japan



## Mylar Capacitors

611



Rated from 1 to 50 kv, these dc mylar capacitors exceed MIL-C-25A-E specifications. Designed for 10,000-hr life at 65 C, they operate between -60 and +105 C. Units are said to be small and lightweight, and have footed brackets. Three-layer dielectric is employed.

Corson Electric Manufacturing Co., Dept. ED, 540 39th St., Union City, N. J.

## Electrostatic Printing Tube

441

A 250,000 element per sq. in. mosaic is provided on the face of the type B3C2 Printapix electrostatic printing tube. The direct-writing cathode-ray tube prints alpha-numeric characters on nonsensitized paper at rates of 100,000 per sec. Precharged pigment powder adheres to electrostatic charges on paper.

Litton Industries, Electron Tube Div., Dept. ED, 960 Industrial Road, San Carlos, Calif.

## Magnetostrictive Delay Lines

440

A 5-msec delay with a bit rate of 500 kc is offered by the type FM 200-5000 Magline series magnetostrictive delay lines. Unit includes transistorized circuitry providing zero insertion loss and output pulse identical to input. Limiting action in amplifier removes noise from the signal. Device measures 10-1/2 x 11-1/2 x 1 in.

Control Electronics, Inc., Dept. ED, 10 Stepar Place, Huntington Station, L.I., N.Y.

## RF Connectors

685



Subminiature 50-ohm coaxial rf connectors of the 1000 series have no flashover at 70,000 ft at 1 kv, and operate at 200 C for long periods. Cable pull-out resistance of the small, lightweight devices is 30 lb min.

Micon, Inc., Dept. ED, Roosevelt Field, Garden City, N. Y.

Availability: stock to 30 days.

fast-growing demand for Synkote® wire



More and more engineers find it extremely useful to have a specialist like PLASTOID equipped to jump into the job. Our know-how stems from years of service to the U.S. government — to such major industries as aircraft, missiles, electronics, communications and ship building. Our service extends from the straight filling of your exact specifications to the designing, engineering and producing of wire and cable. Whether you order a few conductors, or hundreds — in stock or specially developed, Synkote® wire and cable is engineered to do the job. Performance is peak, thru constant testing and research. For samples, technical assistance, prices, true wire economy, call your Plastoid representative.

**PLASTOID**  
CORPORATION  
42-61 24TH STREET / LONG ISLAND CITY 1, N. Y. / ST 6-8200

CIRCLE 77 ON READER-SERVICE CARD

**NEW!**  
**SYLVANIA**  
**2N781**  
**2N782**

# epitaxial GERMANIUM mesas



**• SYLVANIA 2N781**  
... world's fastest PNP germanium switch!

CONDITIONS	MAX.
$V_{BE(sat)} = 0.5 \text{ V}; I_{B1} = -1 \text{ mA}$	$t_d + t_f, 60 \text{ nsec}$
$V_{CC} = -3.5 \text{ V}; R_C = 300 \text{ Ohms}$	$t_r, 20 \text{ nsec}$
$I_{B1} = 0.25 \text{ mA}$	$t_f, 50 \text{ nsec}$

... features unusually low  $V_{CE(sat)}$

CONDITIONS	MAX.
$I_C = -10 \text{ mA}, I_B = -1 \text{ mA}$	-0.16 V
$I_C = -100 \text{ mA}, I_B = -10 \text{ mA}$	-0.25 V

**SYLVANIA 2N781**—a remarkable advance in epitaxial mesa techniques — is a superior switching device featuring speeds previously unattainable with a germanium transistor. Too, it provides exceptionally low saturation voltage at all current levels.

**SYLVANIA 2N782**, electrically similar to the **2N781**, is specifically designed for service where high speed switching, low saturation voltage and economy are prime design requirements.

**SYLVANIA 2N781, 2N782**, utilize the TO-18 package with the collector internally tied to the case. Both are products of highly automated Sylvania manufacturing techniques and possess exceedingly uniform electrical characteristics.

**IN STOCK NOW!** For immediate delivery call your Sylvania Franchised Semiconductor Distributor or contact your Sylvania Sales Engineer. Technical data available from Semiconductor Division, Sylvania Electric Products Inc., Dept. 189, Woburn, Mass.

# SYLVANIA

SUBSIDIARY OF

## GENERAL TELEPHONE & ELECTRONICS



CIRCLE 78 ON READER-SERVICE CARD

## NEW PRODUCTS

### Printed-Circuit Connectors

684



Bifurcated, bellows-type printed circuit connectors provide constant contact under extremes of shock and vibration. Single- and double-row connectors in various multiples up to 130 contacts are standard.

Masterite Industries, Dept. ED, 851 W. Olive St., Inglewood, Calif.

Availability: stock.

### Digital Voltmeter

691



Solid-state switching logic in voltmeter/ratiometer 848 eliminates contact maintenance problems. Three-position tilting readout shows four decimal digits, polarity sign, and decimal point. Average balance time is 50 msec.

Electro Instruments, Inc., Dept. ED, 8611 Balboa Ave., San Diego 11, Calif.

### Rate Gyro

686



Self-checking rate gyro JRS incorporates a spin motor running detector which indicates wheel speed, and a gimbal torquer which checks gimbal operation and pick-off sensitivity. Checking circuits are completely isolated from operational circuits. The 2.2-lb gyro measures 2.1 in. OD, 4.6 in. long. Linearity is 0.25% of full-scale max. Gyro withstands 100-g shock and 40-g vibration.

Minneapolis-Honeywell, Boston Div., Dept. ED, 1400 Soldiers Field Road, Boston, Mass.  
Availability: 120 days.

3 names  
with but a  
single\* thought!

**TIME**  
ELECTRONIC SALES

**CARS**

**CANNON  
PLUGS**



CANNON  
AUTHORIZED  
ASSEMBLY LINE  
producing  
Cannon plugs  
with Cannon  
Designed tools

24 HOUR  
DELIVERY  
even on your  
special  
requirements



WIDEST RANGE  
OF PLUGS  
in depth always  
in stock at  
OEM prices even  
in production  
quantities

SOURCE  
INSPECTION  
available where  
required



\*service!

Now more than ever before, you can  
save time by calling TIME - your  
Cannon Authorized Plug Specialist

**TIME**

ELECTRONIC SALES

Community Drive and Pond Hill Road  
Great Neck, New York

HUnter 7-0100 TWX: GT NK 5674

CIRCLE 79 ON READER-SERVICE CARD

ELECTRONIC DESIGN • September 13, 1961

# LET CANNON HELP SOLVE YOUR COAXIAL CONNECTOR PROBLEMS

as we did in this example

## PROBLEM

Design a lightweight connector assembled to RG-90/U cable capable of  
(1) continuous operation at 1000 watts CW over the range of 0.00—5.0 kilomegacycles  
from sea level to 70,000 feet altitude (2) remaining sealed while unmated  
(3) withstanding 150-pound pull on the center contact (4) withstanding 170 hours  
of standard salt spray (5) thermocycling 6 cycles of  $-55^{\circ}\text{C}$  to  $+95^{\circ}\text{C}$ ;  
18 cycles (240 hours) of humidity and elevated temperature (6) 12 hours of sand  
and dust; (7) 8 hours of vibration-altitude with RF power applied at  
temperatures from  $-55^{\circ}\text{C}$  to  $+95^{\circ}\text{C}$  and altitudes from sea level to 70,000 feet—  
every cable assembly (consisting of two straight plugs on 50 inches of  
cable) shall exhibit no greater VSWR than 1.2:1, and a similar assembly (consisting  
of two right angle plugs and cable) shall exhibit no greater VSWR than 1.25:1

## EVALUATION

Considering that the total VSWR of the measurement system is principally  
composed of: (1) A Slotted Line and its connector (up to 1.05:1), (2) the  
internal and mating characteristics of the input connector, (3) the  
input connector-cable junction, (4) the output connector-cable junction, (5) the  
internal and mating characteristics of the output connector, and (6) the  
load and its characteristics (up to 1.05:1). Further considering the high degree of  
probability of many of the discontinuities being in phase several times  
over the pass band of more than seven octaves; and that the product of all these  
possible discontinuities must not exceed 1.2:1, it is then readily apparent that  
the individual connector and its cable junction must exhibit extremely  
low reflections.

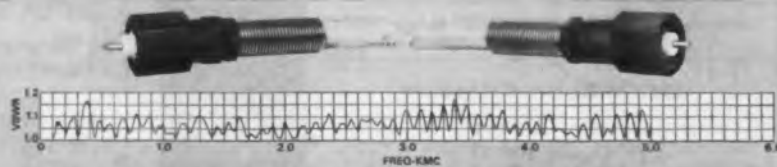

## SOLUTION

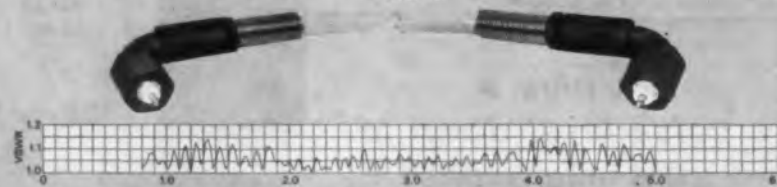

THE Cannon ALLT-PR3-M-34 Assembly and the ALLT-RPR3-M-34 Assembly.  
The single slotted line measuring technique was chosen for the best compromise  
between speed and accuracy. Measurements were made at 20 mc intervals,  
before and after environmental tests. Actual VSWR curves are shown.

This problem is only one of many for which Cannon has found a solution. If you need help with  
your coaxial problems, or any connector problems, consult the world's most experienced  
manufacturer of electrical connectors. Write to:

**CANNON ELECTRIC COMPANY**, 3208 Humboldt Street, Los Angeles 31, California

CIRCLE 80 ON READER-SERVICE CARD

**CANNON  
PLUGS**

**NOW**



## **MICRO-MIDGET CHOPPERS FROM STOCK!**

### **RATINGS**

**Drive: 6.3 volts at 60 CPS or 400 CPS**

**Signal Level: 10 VDC at 2 MA max.**

**Size: World's Smallest**

**Contact Action: SPDT BBM**

**Temperature Range: - 65°C to + 100°C**

**Life: 2,000 hours minimum**

**Shock: 100 G**

***. . . plus a  
noise level down to  
0.6 microvolts!***



CAMBRIDGE DIVISION • CAMBRIDGE, MARYLAND

CIRCLE 81 ON READER-SERVICE CARD

## NEW PRODUCTS

### Ratiometer

687



Complex voltage ratiometer model 551 makes ac measurements of magnitude and phase angle, as well as in-phase and quadrature components. Ratio reference for in-phase measurements is provided by an inductive divider having an accuracy of one ppm. An attenuating network of dual scale mechanism allows direct reading of phase angles of all input voltages and ratios.

North Atlantic Industries, Inc., Dept. ED, Plainview, N. Y.

### Photoconductors

678

Cadmium sulfide photoconductors are made for commercial and industrial applications. Units are vacuum-sealed for protection against environmental contamination. Applications include automatic TV contrast control, and on-off control of oil burners.

Sylvania Electric Products Inc., Dept. ED, 1100 Main St., Buffalo 9, N. Y.

### Silicon Rectifiers

679

Compact line of silicon rectifiers provides cabinet size reduction of 45%. Units are available in capacities of 1,000, 1,500, 2,000, 2,500 and 3,000 amp with a wide choice of control regulation.

Allied Research Products, Inc., Dept. ED, 4004-06 E. Monument St., Baltimore 5, Md.

### Voltage Reference

690



Diffused-junction silicon voltage regulator DEC 5651 directly replaces the 5651 voltage reference vacuum tube. Housed in a molded epoxy package, the device provides an output of  $87\text{ v} \pm 2\%$ . Operating current is 1.5 to 3.5 ma.

Dickson Electronics Corp., Dept. ED, 248 Wells Fargo Ave., Scottsdale, Ariz.

## POMONA PATCH CORDS

- DESIGNED TO MEET RIGID INDUSTRIAL AND MILITARY APPLICATIONS
- MOLDED PLUG BODY
- BERYLLIUM COPPER SPRING HEAT TREATED
- RELIABLE SOLDER BONDED CONNECTIONS



DOUBLE PLUG



ALLIGATOR CLIPS

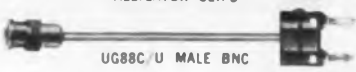

UG88C/U MALE BNC



PHONE TIPS



PL259

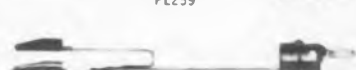

MINIGATOR CLIPS



ALLIGATOR TO PL259



PL259 MALE



UG88C/U MALE BNC



ALLIGATOR TO UG88C/U MALE BNC

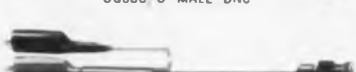

MODEL P .080 PHONE TIPS



MODEL B BANANA PLUG

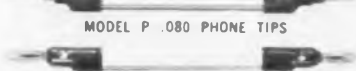

MODEL HB EXTENSION STACKING

SEND FOR FREE GENERAL CAT. 6-61

REFER TO 1961-62 EEM

**POMONA**  
*Electronics* CO. INC.

1500 East Ninth Street, Pomona, California  
CIRCLE 82 ON READER-SERVICE CARD

## Ampere-Hour Meter

689



Mercury microcoulombmeter provides direct reading of ampere hours on dc or pulsed dc with any waveform. Model 150E is housed in a plastic case with a 10-division scale; model 150, element alone, measures 1-1/2 in. long by 0.050 in. OD.

Curtis Instruments, Inc., Dept. ED, 45 Kisco Ave., Mount Kisco, N. Y.

P&A: model 150, \$5; 150E, \$8; stock.

## Remote Terminating Amplifier 439

Low and high vhf remote terminating amplifier has adjustable tilt. With a gain of 15 db in the 54- to 88-mc band, and 22 db in the 174- to 216-mc band, the model LHT-6204 amplifier has input and output impedances of 75 ohms. Gain can be controlled over 10 db. Unit has a regulated power supply which operates from 40 to 60 v ac.

Entron, Inc., Dept. ED, P. O. Box 287, Bladensburg, Md.

## AC/DC Digital Voltmeter 677

Accurate within 0.1%. Digital voltmeter model 502B measures dc from  $\pm 100 \mu\text{v}$  to  $\pm 1 \text{ kv}$ , ac from 30 cps to 10 kc between 1 mv and 1 kv. Measurements are accurate within 0.01% of reading  $\pm 1$  digit on dc, 0.1% of reading or  $\pm 3$  digits on ac. Voltmeter is controllable by remote contact closures.

Kin Tel Div., Cohu Electronics, Inc., Dept. ED, 5725 Kearny Villa Road, San Diego 11, Calif.

P&A: \$4,245; delivery from stock.

## Telemetry Filters 693



Low-distortion telemetry filters are available for all standard frequencies from 400 cps to 70 kc. The Perma-D series uses standard mechanical packages. Delay distortion is less than 6%. Filters are made for vacuum-tube and transistor equipment.

Hisonic, Inc., Dept. ED, P. O. Box 534, Shawnee, Kan.

The only  
true measure of  
**eyelet  
price**

**Installed Cost**



\*IC Installed Cost... not the initial cost of eyelets, but the total cost when the eyelets have been installed in your product.

and here's **JUST ONE**  
of the ways **UNITED**  
helps you cut **IC:**

**REDUCED  
ENGINEERING COSTS!**

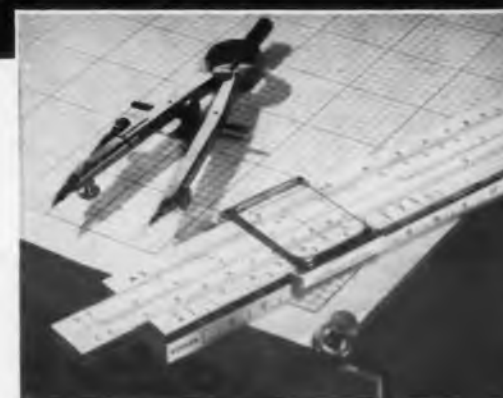

With United's system of standardized eyelet sizes, you no longer have to hunt through literally thousands of cataloged items to find the right eyelet. 60 years of experience prove that United's 65 standard sizes will handle a vast majority of all eyeletting applications. As a result, your engineering specification time is cut to a bare minimum! Of course, there are always occasions when unusual application needs or exceptional production requirements call for special eyelet types or sizes... or special eyelet tooling. But here again, United helps cut your engineering costs, because you can call on our complete application engineering service for the specialized assistance you need.

for all the dollar-saving facts . . .



. . . that show how United can help you cut Installed Costs through lower engineering costs (and through lower tooling, down-time and acquisition costs), ask for your free copy of the new bulletin "Eyelets and Price Buying." Simply phone the United office in your area or write direct to Fastener Division, United Shoe Machinery Corporation, 1952 River Road, Shelton, Connecticut.



**United Eyelets**



Fastener Division

UNITED SHOE MACHINERY CORPORATION Shelton, Connecticut

BRANCHES: ATLANTA, GA. • CHICAGO, ILL. • CINCINNATI, CLEVELAND AND COLUMBUS, OHIO • DALLAS, TEXAS • HARRISBURG, PA. • JOHNSON CITY, N.Y. • LOS ANGELES, CALIF. • LYNCHBURG, VA. • MILWAUKEE, WISC. • NASHVILLE, TENN. • NEW YORK, N.Y. • PHILADELPHIA, PA. • ROCHESTER, N.Y. • ST. LOUIS, MO.

CIRCLE 83 ON READER-SERVICE CARD



**Gamewell made a sector pot with .0006" wire.** This subminiature sector pot is wound with .0006" wire at over 1000 turns per inch. Required winding length tolerance is only .005". ■ Here's one example of the hundreds of "special" pot design requests that Gamewell is answering with an unqualified YES. ■ Find out what Gamewell YES service — Your Engineered Specials service — can do for you. Write to Gamewell today for the complete facts. \***your Engineered Specials service**



THE GAMEWELL COMPANY, POTENTIOMETER DIVISION, 1424 CHESTNUT STREET, NEWTON UPPER FALLS 64, MASSACHUSETTS. A SUBSIDIARY OF E. W. BLISS COMPANY.  
CIRCLE 84 ON READER-SERVICE CARD

## NEW PRODUCTS

### Film Trimmer

695



Operates to 150 C. Trimmer potentiometers use element of fused oxide deposited on a glass substrate. Temperature coefficient is 50 ppm per deg C. The stepless devices operate from -65 to +150 C, and withstand 30-g shock and 20-g vibration from 20 to 2,000 cps.

Intellux, Inc., Dept. ED, 30 Salsipuedes St., Santa Barbara, Calif.

### Pulse Amplifier

692



Capacity driver T-165, a 250-kc pulse amplifier, will drive up to 75 shift register elements or up to 150 flip-flops at temperatures below +45 C. Container measures 7/8 in. OD by 2-3/16 in. seated height and plugs into a standard 9-pin miniature tube socket.

Engineered Electronics Co., Dept. ED, 1441 E. Chestnut Ave., Santa Ana, Calif.

P&A: \$45.85; stock.

### Ratio Analyzer

694



Output-to-input ratio analyzer RA01-0101-1 is useful in checking calibration of accelerometers, rate gyros, and other devices with potentiometer pickoff. With two operating ranges of 1 K to 10 K and 5 K up, the device has an overall accuracy of 0.10%.

Humphrey, Inc., Dept. ED, 2805 Canon St., San Diego, Calif.

## Wideband Amplifier

651



Flat from 1 to 100 mc within 1 db, the model WB-100 wideband amplifier is completely transistorized. Gain is 20 db min. Input and output impedances are 50 ohms at 30 mc. Output voltage is 70.5 mv peak. Noise figure is 8 db. The device, said to be lightweight and rugged, measures 6 x 2 x 1-5/8 in. Power requirements are +3 and -15 v dc.

Teltronics, Inc., Dept. ED, 23-27 Main St., Nashua, N. H.

**P&A:** \$200.00; two weeks.

## Miniature Transformers

698



Military and industrial specifications are met by this line of transformers for pulse and other applications. Included are balanced, four-winding designs for differential input parallel circuit isolation. Custom types are also made.

James Electronics, Inc., Dept. ED, 4050 N. Rockwell St., Chicago 18, Ill.

## Motor Control

652



For driving a 1/20 hp motor directly from a 60-cps line, the model 309-A motor control is a solid-state device. Shaft speed range is from 100 to 5,000 rpm, with a maximum load torque of 10 oz at any speed. Speed remains constant within 2% over load range. Power drain is 150 w max.

Industrial Control Co., Dept. ED, Central Ave. at Pinelawn, Farmingdale, L. I., N. Y.

# SUBMIN TRANSISTORS

## Patterns of Reliability

Key to the ability of Raytheon subminiature transistors to meet the shock and vibration of stringent military and industrial applications is their reliable welded hermetic seal. Made possible by Raytheon's thirty-five years of achievement in welding and glass seal technology they fully meet the variable frequency vibration, centrifuge, and mechanical shock requirements of MIL-S-19500B. To further assure reliable operation and stability of electrical parameters all units are sealed in a carefully controlled atmosphere. Vacuum baked and aged at elevated temperatures.

More than 95% smaller and 87% lighter than their TO-5 equivalents, Raytheon subminiature transistors provide excellent power dissipation and extreme dependability for high density circuit packages. Raytheon's complete line offers a wide selection of silicon and germanium types in low-cost, single and double-ended versions, immediately available in quantity.

For complete technical data and application engineering assistance, as well as price information, please write or call the Raytheon office nearest you. For immediate local delivery, call on your Raytheon distributor.

## RAYTHEON COMPANY

### SEMICONDUCTOR DIVISION

SILICON AND GERMANIUM DIODES AND TRANSISTORS • SILICON RECTIFIERS • CIRCUIT-PAKS

BALTIMORE, MD., Southfield 1-0450 • BOSTON, MASS., DEcatur 2-7177 • CHICAGO, ILL., NAtional 5-4000 • DALLAS, TEXAS, LAKeside 6-7921 • DAYTON, OHIO, BALdwin 3-8128  
DETROIT, MICH., TRInity 3-5330 • ENGLEWOOD CLIFFS, N. J., LOWell 7-4911 (Manhattan, Wisconsin 7-6400) • LOS ANGELES, CAL., PLymouth 7-3151 • ORLANDO, FLA., GARDen 3-0518  
PHILADELPHIA, PA. (Haddonfield, N.J.), HAZel 8-1272 • SAN FRANCISCO, CAL. (Redwood City), EMerson 9-5566 • SYRACUSE, N. Y., HOWard 3-9141 • CANADA: WaterloO, Ont., SHerwood 5-6811  
GOVERNMENT RELATIONS: Washington, D. C., METropolitan 8-5205

CIRCLE 85 ON READER-SERVICE CARD





# The EITRONIC Series

## SIX NEW DIGITAL INSTRUMENTS for measuring voltage, ratios, and resistance with all-electronic speed and reliability

...including the world's first full-5-digit solid state digital voltmeter / ratiometer

**They're all-electronic!** No moving parts. No contacts to clatter or wear. All the inherent advantages of solid state circuitry: speed, ruggedness, reliability and coolness.

**They're fast!** 20 readings per second, average. High speed eliminates reading delays due to cycling caused by decreasing voltages.

**They're reliable!** Carefully selected components, rigorous testing programs and accelerated aging—equivalent to 100 hours of actual operation—combine to give EITRONIC instruments an unequalled mean-time-to-failure figure.

**They're accurate!** Production EITRONIC instruments provide a

true, absolute DC accuracy of 0.01%; AC 0.1%.

**They're automatic!** Virtually eliminates operator error. Even decimal point placement and polarity indication are automatic.

**They're human engineered!** Unique readout tilts to 3 positions, is easy to read whether instrument is used on a bench, at eye level or high in a rack. Modular construction permits exhaustive testing during assembly, facilitates trouble shooting and field servicing.

**They're available now!** Your EI field engineer has a new 8-page folder which gives complete specifications on the EITRONIC Series. Ask him for a copy today.

Another significant breakthrough in digital instrumentation from

**E I Electro Instruments, Inc.**  
8611 BALBOA AVENUE, SAN DIEGO 11, CALIFORNIA



Engineers: Challenging opportunities now available. Contact Mr. Harvey Fleming.

## NEW PRODUCTS

### Delay Line

589

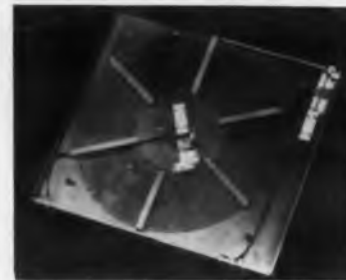

**Suitable for commercial and less severe military environments,** fixed magnetostrictive delay line L40 provides delays from 2,500 to 3,500 or 5,000  $\mu$ sec. Delay adjustment range is  $\pm 4 \mu$ sec from specified delay. Measuring 7-7/8 x 11-5/8 x 13/32 in., package weighs 1-3/4 lb. Digit rate in nrz recording can reach 2 mc.

Ferranti Electric Inc., Electronics Div., Dept. ED, Industrial Park No. 1, Plainview, N. Y.

### Digital Voltmeter

604

**Automatic ranging and polarity, 500-msec balance time, and silent reed relays** have been combined in digital voltmeter model V-71. Range is 1 mv to 999.9 v; accuracy 0.01%,  $\pm 1$  digit. Weight is 28 lb, panel height 5-1/4 in.

Cubic Corp., Dept. ED, 5575 Kearny Villa Road, San Diego 11, Calif.

### AC Standby Supply

581



**Static standby ac power supply** provides 60-cps power when the line supply fails. Response is instantaneous. Input is 115/220/440 v, 3-phase, 60 cps; battery voltage is 43 to 56 v dc. Output is 2.5 kva, 1 phase, 115  $\pm 0.5$  v, 60 cps  $\pm 1\%$ . Efficiency is 80% at full load.

Tapco Div., Thompson Ramo Wooldridge Inc., Dept. ED, 23555 Euclid Ave., Cleveland 17, Ohio.

◀ CIRCLE 86 ON READER-SERVICE CARD



Mechanical interlock relay SIL holds an armature operated indefinitely after the coil is de-energized. The shock- and vibration-resistant relay is available with coils for a number of dc voltages up to 110 v plus diode-rectified 110 v ac. Electrical interlock relay SEL is wired so that both coils are controlled by pulsing over a single lead. Free of mechanical wear, life expectancy is 30 million operations. The SEL is available with coil ratings up to 60 v dc.

Automatic Electric Sales Corp., Dept. ED, Northlake, Ill.

### Molding Compound 603

Polyurethane-based molding and encapsulating compound 783 operates from -65 to +300 F. The material has Shore hardness of 65  $\pm$  5, tensile strength of 2,500 to 3,500 psi, and 600% elongation.

Coast Pro-Seal & Manufacturing Co., Dept. ED, 2235 Beverly Blvd., Los Angeles 57, Calif.

### Temperature Chamber 576



Vacuum-pressure temperature chamber model ASU-40-3-HC provides a pressure range of 20 to 32 in. mercury, absolute, over temperatures from -40 to +200 F. It is designed for testing and calibrating pressure-indicating instruments. The stainless-steel chamber contains a working area of 3 cu ft.

Cincinnati Sub Zero Products, Dept. ED, 3932 Reading Road, Cincinnati 29, Ohio.

CIRCLE 241, 242 ON READER-SERVICE CARD

ACTUAL SIZE



# NEW PRODUCT ADVANCES FROM Transitron

ACTUAL SIZE

## TMD-914 and TMD-916 DIFFUSED SILICON MICRODIODES MICRO-EQUIVALENTS of the 1N914 and 1N916

Duplicating the specifications of the popular 1N914 and 1N916, these microminiature very fast switching silicon diodes offer low capacitance and are designed for use in extremely high speed transistorized computer circuitry. Their durable construction in an all-glass package features TRUE hermetic sealing and a unit capable of providing long-term reliability under extreme environmental conditions.

Recovery time: 0.004 micro-second.

SPECIFICATIONS AT 25°C

	TMD-914	TMD-916
Maximum Forward Voltage at 10mA	1 Volt	1 Volt
Maximum Inverse Current at 20V	.025 $\mu$ A	.025 $\mu$ A
Minimum Inverse Voltage at 100 $\mu$ A	100 Volts	100 Volts
Maximum Capacitance at 0 Volts	4 $\mu$ F	2 $\mu$ F

For further information, write for Bulletin PB-71C. Circle 241 on Reader-Service Card

## 6.3 VOLT CERTIFIED SILICON VOLTAGE REFERENCES

Now, for the first time in the industry, silicon voltage references that have exhibited voltage stabilities as low as  $\pm$ .002% for 1000 hours are being CERTIFIED and offered by Transitron. These significant features are associated with each unit:

- Actual readings recorded periodically over 1000 hours included with each certification document.
- Serialization of units for convenient reference to their production and life test histories at Transitron.

Manufacturers of missiles and precision instruments who require a stable voltage reference of small size and weight may look to Transitron for these references which are certified at point of purchase.

Type	Certified* Voltage Stability (%)	Voltage Range at $I_z = 7.5$ mA at 25°C (Volts)		Temperature Stability Maximum Voltage Change (+25°C to +100°C) at $I_z = 7.5$ mA (Volts)	Maximum Dynamic Resistance at $I_z = 7.5$ mA at 25°C (Ohms)
		Min.	Max.		
1N3501	$\pm$ 0.01	6.2	6.5	$\approx$ 0.006	12
1N3502	$\pm$ 0.01	6.2	6.5	$\approx$ 0.003	12
1N3503	$\pm$ 0.005	6.2	6.5	$\approx$ 0.006	12
1N3504	$\pm$ 0.002	6.2	6.5	$\approx$ 0.006	12

\*Voltage References certified for voltage stability observed during 1000 hours operation.

For further information, write for Bulletin TE-1352F-1.

Circle 242 on Reader-Service Card

# Transitron



electronic corporation  
wakefield, melrose, boston, mass.

SALES OFFICES IN PRINCIPAL CITIES THROUGHOUT THE U.S.A. AND EUROPE • CABLE ADDRESS: TRELCO

For quantities 1-999 call your nearest Transitron Industrial Distributor.

## NEW PRODUCTS

### Feedthrough Terminals

616



Teflon-insulated feedthrough terminals, type FT-SM-75L2, are made for equipment encountering vibration and high temperature. Units are of press-fit design. Height is 0.343 in.; over-all diameter is 0.172 in., and mounting bushing is 0.15 in. in diameter. Stud is of hole-through type with a turret. Temperatures from -65 to +200 C are withstood.

Sealectro Corp., Dept. ED, 610 Fayette Ave., Mamaroneck, N. Y.

### Coaxial Relay

697



High-power vacuum enclosed relays RC30 (spst) and RC31 (spdt) will handle 300 kw cw at 30 mc. Designed for remote switching of 6-in. coaxial lines, the T-configuration relays operate on 24 v dc and have a characteristic impedance of 50 ohms at 2 to 30 mc. Crosstalk is below 60 db at 30 mc.

Jennings Radio Manufacturing Corp., Dept. ED, P. O. Box 1278, San Jose, Calif.

### Mylar Capacitors

688



High-voltage dc capacitors use mylar, kraft paper, and polybutene oil dielectrics. Fifteen ranges are made from 1 to 50 kv. Usable from -60 to +105 C, units surpass requirements of MIL-C-25A.

Corson Electric Manufacturing Corp., Dept. ED, 540 39th St., Union City, N. J.

Standardize with this multi-purpose film wire success!

Phelps  
Dodge

# POLY- Therm



Has replaced as many  
as six standard wires  
in these important  
applications!

Motors

Poly-Thermalze®—Patents applied for.

Licenses: Rex Magnet Wire Co., Inc., Division of Aluminum Company of America, and Essex Wire Corporation.

# Phelps Dodge

**Coils**

**Dry-type  
Transformers**

- Best balance of overall properties without sacrifice of any one property!
- High dielectric for thermal protection at operating temperatures (Class F 155C)!
- Cost reduction benefits through standardizing inventory to one wire for most applications!

Any time your problem is magnet wire, consult Phelps Dodge for the quickest, surest answer!



**PHELPS DODGE COPPER PRODUCTS**  
CORPORATION  
**INCA MANUFACTURING DIVISION**  
FORT WAYNE, INDIANA

CIRCLE 88 ON READER-SERVICE CARD

ELECTRONIC DESIGN • September 13, 1961

## Heat Sinks

696



Transistor heat dissipators stock-mount on insulators and allow direct heat-contact with the transistor. Three-inch lengths with four of the common hole patterns are available from stock. Model HS 201 will accommodate 85% of power transistors in use.

Invar Electronics Corp., Dept. ED, 1723 Cloverfield Blvd., Santa Monica, Calif.

Price: \$0.70 to \$1.60.

## Information Logger

683



Multi-channel information logger model 1043 accepts bipolar analog signal inputs, which are converted to digital words. Data from 30 channels are sampled sequentially with an over-all multiplexing and conversion accuracy of 0.1%. Output is recorded on paper or magnetic tape.

Lockheed Electronics Co., Dept. ED, Plainfield, N. J.

## Carrier Failure Alarm

606



For frequency-shift communications equipment, the type 256 carrier failure alarm lights a panel lamp and actuates a relay upon any signal failure. Gradual deterioration is also detected; threshold level can be preset to desired level. Unit transistorized, measures 7/8 x 5-1/4 x 11-3/4 in.

Northern Radio Co., Dept. ED, 147 W. 22 St., New York, N. Y.

# ANNOUNCING Spir-O-foam!



- NEW, Non-returnable, No charge, Reel
- Matched Spir-O-lok Connectors
- Marked for Easy Identification and Measuring
- Perfect RF Shielding
- Eliminates Pressurizing

## NEW Aluminum Sheathed, Semi-Flexible Coaxial Cable

**Low-loss Broadband Performance Quality Assured by Prodelin . . .  
Designers and Manufacturers of "Job-Packaged" Antenna Systems**

Spir-O-foam, a cellular polyethylene insulated coaxial cable, with its companion Spir-O-lok connector, now answers industry's demand for truly matched performance. Spir-O-lok connectors are backed by years of service-proved features, including simple field assembly without special tools, to provide improved reliability for economical maintenance-free service. The development of Spir-O-foam with Spir-O-lok connectors demonstrates the single source capability of Prodelin, offering complete product line versatility without equal.

Spir-O-foam is supplied on non-returnable reels, at no extra charge, to eliminate two-way freight costs and laborious record keeping. Immediate delivery — Stocked from Coast to Coast.

Send for Catalog 598

■ TELEVISION ■ TELEMETRY ■ MOBILE ■ MICROWAVE ■ MARINE ■



Main Office: 307 Bergen Ave., Kearny, N. J. • WY 1-8600 • California Engineering Offices & Warehouse  
Stock: 427 W. 5th St., Los Angeles 13 • MA 8-3451 • 870 Tennessee St., San Francisco 7 • AT 2-8472

CIRCLE 89 ON READER-SERVICE CARD

## NEW PRODUCTS

### Protective Network

644



Rated at 125-v, 2-amp dc, this solid-state protective network protects against inductive spikes and transients up to 1,500 v peak. Temperature range is  $-65$  to  $+150$  C. Device is a miniature single-phase, full-wave bridge using diffused silicon rectifiers.

Solitron Devices, Inc., Dept. ED, 500 Livingston St., Norwood, N. J.

**Availability:** from stock.

### Cable Clamps

377



For cord, cables and tubing. Type NE clamp is made of aluminum with a flame- and oil-resistant neoprene cushion to prevent cutting and scraping of cable insulation. Clamps are available in sizes for 1/8-in. to 2-in. cable in 1/16-in. increments.

Richco Plastic Co., Dept. ED, 3722 W. North Ave., Chicago 47, Ill.

### Solid-State Switch

643



Handling 20 amp at 125 v ac, the model LJ-1105-AC solid-state switch measures 1 x 2-1/4 x 3/4 in. and weighs 2.5 oz. Unit requires no external power, does not arc or spark, and is said to have noise-free operation.

L J Products, Dept. ED, 7464 Girard Ave., La Jolla, Calif.

**Availability:** stock to two weeks.

## AUGAT

HEAT DISSIPATORS  
FOR  
POWER TRANSISTORS



for TO-3  
Transistors  
or Diodes



for TO-36  
Transistors



for 2N-1015  
Transistors

Augat's new Heat Dissipators utilize a minimum of space and still offer the large radiating surfaces needed for maximum transfer of heat. All Augat dissipators feature a parallel, open-fin construction assuring low thermal resistance. They are readily adaptable to forced air cooling for even lower resistance.

Augat Heat Dissipators are manufactured in three styles to accommodate the TO-3, TO-36 and 2N-1015 transistors or their equivalent.

Write for Bulletin No. HD-261 which describes this new line in full detail.

### AUGAT BROS., INC.

31 Perry Avenue, Attleboro, Mass.

CIRCLE 90 ON READER-SERVICE CARD

## Servo Amplifier

650



Less than  $0.1 \mu\text{a}$  input is required per volt output with the model 1160-4 servo amplifier. The device, transistorized, is made for use with size 11 servo motors, and has a low input impedance. The amplifier, with power output stage and gain control, is mounted on a printed circuit card measuring  $4\text{-}5/8 \times 3\text{-}7/8$  in.

Magnetic Instruments Co., Inc., Dept. ED, Thornwood, N. Y.  
**P&A:** \$75.00; from stock in small quantities.

## Static Converter

639

Provides up to 10 kv. Small, efficient static converter model MC provides outputs from 0.5 to 10 kv dc in 12 standard models. Input is 24 to 30 v dc, 250 ma. Output power is 3 w, ripple 0.3% rms. Efficiency is 50% at 3 w, 30% at 1.5 w. The 12-oz unit measures  $1\text{-}1/2 \times 3\text{-}1/4 \times 2\text{-}1/4$  in.

Arnold Magnetics Corp., Dept. ED, 6050 W. Jefferson Blvd., Los Angeles 16, Calif.

## Multiple Diode

628



Twin and triple diodes, housed in TO-33 packages, simplify logic network construction. Types 2DG-001 and 3DG001 combine germanium diodes having these characteristics: forward voltage drop at 5 ma, 0.4 v max; reverse breakdown voltage of 20 v; reverse current of  $15 \mu\text{a}$  max at  $-2$  v, junction temperature; recovery time,  $0.25 \mu\text{sec}$ ; temperature range,  $-65$  to  $+85$  C.

Radio Corp. of America, Semiconductor & Materials Div., Dept. ED, Somerville, N. J.

## RAYTHEON TRANSFORMER TALK

Facts about transformers that have solved equipment design problems • No. 4 in a series.

# Look at what epoxy encapsulation has done for high-voltage plate transformers

## has done for high-voltage plate transformers



Raytheon encapsulation techniques are successfully applied to 3.25 KVA units for startling reductions in size and weight.

The transformer illustrated at left measures just  $9\text{-}9/16 \times 15\text{-}1/16 \times 9\text{-}11/16$  in. Yet, it will deliver 11,750 dc volts at 0.275 dc amperes in a full-wave bridge rectifier circuit.

Reliability? Raytheon produced over 500 units of this design for military applications without a single reported failure.

Epoxy encapsulation, now commonly used in small transformers, had never before been successfully applied to large high-voltage power transformers. Now, with newly developed techniques in casting and curing epoxy, Raytheon has solved one of the toughest encapsulation problems known.

This same kind of engineering experience and skill is being applied to a wide range of transformer design and production problems from small silicone rubber impregnated units for high-temperature application to high-voltage designs like the one described here.

Write today for descriptive folder and technical article describing Raytheon encapsulated transformers. Address Magnetic Operation, Microwave and Power Tube Division, Raytheon Company, Foundry Avenue, Waltham 54, Massachusetts.

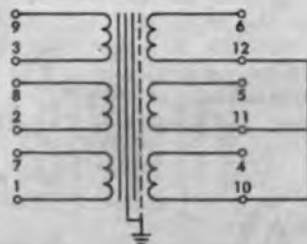

50% SMALLER, 30% LIGHTER than its predecessors, this 3.25 KVA plate transformer has proven itself in continued performance under actual environmental conditions.

RAYTHEON

RAYTHEON COMPANY

MICROWAVE AND POWER TUBE DIVISION

# PAKTRON MASTERPIECE MINIATURE CAPACITOR!

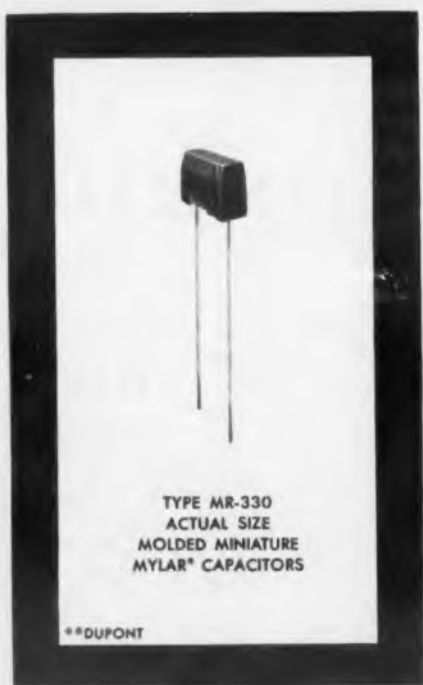

- 1—TEMPERATURE RANGE:**  $-55^{\circ}\text{C}$  to  $125^{\circ}\text{C}$  derating above  $85^{\circ}\text{C}$  to 50% at  $125^{\circ}\text{C}$ .
- 2—TEMPERATURE STABILITY:** Capacitance change less than 2.5%,  $25^{\circ}\text{C}$ – $85^{\circ}\text{C}$ .
- 3—INSULATION RESISTANCE:** Exceeds  $5 \times 10^{10}$  at  $25^{\circ}\text{C}$ .
- 4—DISSIPATION FACTOR:** Less than .003 at 1000 cycles,  $25^{\circ}\text{C}$ .
- 5—DIELECTRIC STRENGTH:** Pretested at 250% of rated voltage.
- 6—MOISTURE RESISTANCE:** I.R. exceeds  $10^{10}$  ohms after 24 hours exposure to 15 PSI steam pressure.
- 7—LIFE TEST:** 150% rated voltage at  $125^{\circ}\text{C}$  for 250 hours.

# PAKTRON

PACKAGED ELECTRONICS



DIVISION OF ILLINOIS TOOL WORKS  
1321 LESLIE AVENUE ALEXANDRIA, VA.

CIRCLE 92 ON READER-SERVICE CARD



## NEW PRODUCTS

### Pulser

642

**Balance-wheel regulated transistorized pulser, model E-59, has a 2.5-sec accuracy per 24 hr. Pulse rate is from 4 to 10 pps, with typical output square wave form, +6 v, 5 msec on, 95 msec off. Unit requires 1.5 to 12 v, 0.3 ma power. Device measures 2-1/16 x 1-21/32 x 1-1/32 in. Other models with flip-flop circuits have longer pulse rates.**

Presin Co., Inc., Dept. ED, 2014 Broadway, Santa Monica, Calif.

**P&A:** \$10 to \$12; stock to four weeks.



### Temperature-Sensitive Resistor

610

**Temperature coefficient is adjustable on the model 7610 Temp-A-Just resistor. Standard resistance values from 100 ohms to 5 K have temperature coefficient variable between 10 and 4,500 ppm per C. Units, hermetically sealed, measure 1 x 1 x 0.3 in. and weigh 11 g. Temperature range is -55 to +150 C. Units compensate for temperature-sensitive components.**

Conrad-Carson Electronics, Inc., Dept. ED, 1347 Broadway, El Cajon, Calif.

**Price:** \$8.75.

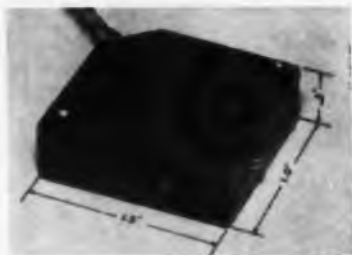

### Logic Inverter Package

647

**Transistorized logic inverter package contains eight inverters in a volume less than 5 x 4 x 1 in. Designated model I-141-DC, the device has a frequency range to 1 mc. Logic levels are 0 to -5 v.**

Digital Design Corp., Dept. ED, P. O. Box 21, Clay, N. Y.

**P&A:** \$94.00; stock to six weeks.

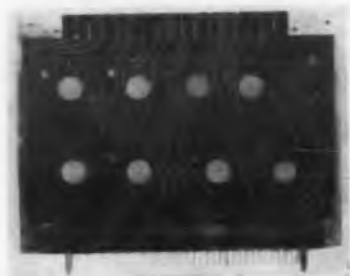

### Feedthrough Capacitor

387

**Shielding from uhf and vhf radiation is provided by the type 1107 ceramic disk feedthrough capacitor. Resonant frequency is higher than 1 Gc. Capacities from 5 to 1,000 pf at 500 wvdc are available.**

Hi-Q Div., Aerovox Corp., Dept. ED, Myrtle Beach, S. C.



### Axial Blower

646

**Measuring 3.44 in. sq, this axial blower delivers 15 cu ft per min against 0.2 in. water pressure. Device operates at 3,600 rpm from 117-v, 60-cps, single-phase power. Unit meets MIL specs, and has a continuous-operation life of over 2,500 hr. Housing is cast aluminum. Device is 3.25 in. long and weighs 12 oz.**

Globe Industries, Inc., Dept. ED, 1784 Stanley Ave., Dayton 4, Ohio.



## Ruggedized Image Orthicon Tubes 641

A 600-line resolution is achieved by this line of ruggedized image orthicon tubes, despite 1,000-cycle vibration and 44-g acceleration. Construction unites target and mesh, eliminating microphonic bars and related interference. Electron gun and multiplier unit are ruggedized. Type ZL-7805 tube has infrared sensitivity; type ZL-7806 tube has sensitivity down to  $10^{-6}$  ft-c; type ZL-7807 tube has high sensitivity and ultraviolet response. Military specs are met or exceeded.

General Electric Co., Cathode Ray Tube Dept., Dept. ED, Syracuse, N. Y.

*Availability: In sample quantity.*

## Load Cells 636

Up to 500,000-lb loads are measured by these load cells. Devices have resistance-wire strain gages which can be 50% overloaded without damage. Bridge impedance is 120 ohms. Typical input voltage is 10 v; output is 25 mv full scale. Linearity and hysteresis are within 0.2%. Temperatures from -300 to +750 F are withstood.

Microdot Inc., Dept. ED, 220 Calif.

## Logic Modules 634

Transistorized logic modules are mounted on 4-1/2 x 6-1/2 in. plug-in cards. The series includes a basic active element, a clock oscillator and pulse amplifier, gates, flip-flops, delay lines, Nixie drivers, and blocking oscillators. Gates operate at 200-kc standard, 1-mc high speed. Power requirements are 1.5,  $\pm 15$ , and 45 v dc.

General Applied Science Laboratories, Inc., Dept. ED, Merrick and Stewart Ave., Westbury, N. Y.

## Gas Detector 638

Sulfur hexafluoride in concentrations of one part per 10 million are detected and measured by this electronegative gas detector. Air samples are pumped to the instrument from a probe. Unit is transistorized.

Westinghouse Electric Co., Dept. ED, P. O. Box 2278, Pittsburgh 30, Pa.



# THE MOST

## SILICON CHOPPERS

From 1 mV "on"  
to 80 V "off"

# SPERRY

SPERRY SEMICONDUCTOR  
DIVISION

OF  
SPERRY RAND CORPORATION  
NORWALK, CONNECTICUT



## NEARLY PERFECT SWITCH

(And we don't mean a shell game)

### HERE ARE THE FACTS IN A NUTSHELL . . .

- High breakdown ratings — 50 to 80 volts
- Two point control of current/voltage offset parameters
- Matched pairs to standard tolerance of 100  $\mu\text{v}$
- 10 million -to -1 minimum "off" to "on" resistance ratio
- Typically 30,000 megohms reverse resistance
- Typically 50 ohms forward resistance
- High temperature stability
- Unlimited quantities available
- Available from local Sperry Authorized Distributors

Don't gamble — you put your experience on the line when specifying for analog computers, D.C. amplifiers, electronic commutators and multiplex equipment.

Sperry now offers you a complete series of silicon transistors for single use or matched pairs that have the best combination of chopper characteristics — plus an extra margin of safety which provides true design flexibility.

Type Number	$BV_{C10}$ (Volts)	$BV_{C15}$ (Volts)	$BV_{E50}$ (Volts)	$V_{r1}$ (max) Offset Voltage (mV)	$I_{r1}$ (max) Offset Current ( $\text{m}\mu\text{A}$ )	Price 1 — 99	PRICE 100 — 999
2N1917	-8	-25	-25	1.0	1.0	\$ 9.75	\$7.50
2N1918	-8	-25	-25	3.0	3.0	7.80	6.00
2N1919	-18	-40	-40	2.0	1.0	12.35	9.50
2N1920	-18	-40	-40	3.0	1.5	8.77	6.75
2N1921	-50	-50	-50	4.0	2.0	5.20	4.00
2N1922	-80	-80	-80	4.0	2.0	6.50	5.00

Write for 16 page Technical Application Bulletin #2107 and new Chopper transistor data sheets on types 2N1917 through 2N1922.

**SEMICONDUCTOR IS OUR MIDDLE NAME**. . . SEMICONDUCTOR INTEGRATED NETWORKS (SEMI-NETS®). TUNNEL DIODES. MESA AND ALLOY SILICON TRANSISTORS AND DIODES. SALES OFFICES: CHICAGO, ILLINOIS; EL SEGUNDO, CALIFORNIA; WESTWOOD, NEW JERSEY; TEWKSBURY, MASSACHUSETTS; STAMFORD, CONNECTICUT; TOWSON, MARYLAND; MASSAPEQUA PARK, NEW YORK. SEMICONDUCTOR OPPORTUNITIES AVAILABLE TO QUALIFIED ENGINEERS

\*Trade Mark, Sperry Rand Corporation



NEW  
FROM  
WELDMATIC

# *ELECTRONIC* BUTT WELDER



**DELIVERS ACCURATE, REPEATABLE END TO END WELDS OF WIRE RANGING FROM .008" TO .040"**

Built to handle continuous production line runs, this unit is equally at home on any number of special butt weld situations. For example, use the 1040 to lengthen leads for circuit convenience; salvage short lead components; switch component lead materials; weld different materials for circuit design and convenience. Force setting of up to 10 lbs. and power range of up to 80 watt-seconds allows wide latitude in materials. Easy to operate. Full compliance raceways assure consistent in-line abutment of the workpieces while automatic wire length stops facilitate rapid loading and positioning of parts. Immediate delivery. Ask your local Weldmatic representative for details, or write to us for Bulletin 1040 at 950 Royal Oaks Drive, Monrovia, California.

W61-6

**WELDMATIC DIVISION / UNITEK**

CIRCLE 94 ON READER-SERVICE CARD

## NEW PRODUCTS

### Counters

645

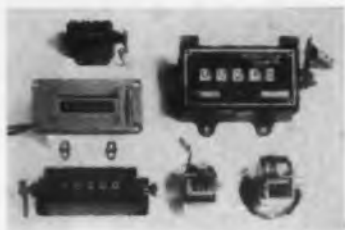

Rated at 700 strokes per min, these counters are for light and medium duty. Model HL-5 is for light applications. Model HE-6 is an electric counter for either base or panel mounting. Model HM-5 is a medium-duty counter for machine use. Model HT-4 is a hand tally, and model HD-4 is a desk tally. Model 5A is a heavy-duty industrial counter for machine applications.

Hart Manufacturing Co., Dept. ED, Ann Arbor, Mich.

### Color-Striped Insulation

385



Silicone-rubber insulation is color striped for single and multiconductor hook-up wire and cable. Many color combinations are available. Ink will not rub off; insulation will not fray. Insulated wire in AWG sizes 24 through 10 are available.

Boston Insulated Wire and Cable Co., Dept. ED, 65 Bay St., Boston 25, Mass.

### Power Supply

396



For semiconductor testing. Power supply model 511 supplies 0 to 50 v at up to 100 ma. Programming time is less than 50 msec. Drift is 0.015% per day at 50 v; load and line regulation are about 1 mv at 50 v. There are no voltage transients.

Walden Electronics Co., Dept. ED, 1 Park Ave., Arlington 74, Mass.

P&A: \$400; 6 weeks.



## new Keithley megohm bridge

**MODEL 515** measures  $10^5$  to  $10^{15}$  ohms with accuracy of .05 to 1%

The new line-operated 515 Megohm Bridge answers the need for a highly accurate, guarded Wheatstone Bridge for standardization and calibration of resistors in the ranges of  $10^5$  to  $10^{15}$  ohms. It is also ideal for measurement of resistor voltage coefficient, leakage and insulation resistances. Speed of calibration is greatly increased over previously available bridges by a semi-automatic calibration feature. Subsequent direct reading speeds operation. Other features include shielded measuring compartment, self-contained bridge potential, a remote test chamber, bench or rack operation. \$1,500.00



Shielded measuring compartment, easily accessible in front panel, permits critical measurements without stray pickup.



for details write

**KEITHLEY  
INSTRUMENTS**

12415 EUCLID AVENUE  
CLEVELAND 6, OHIO

CIRCLE 95 ON READER-SERVICE CARD

ELECTRONIC DESIGN • September 13, 1961

## Miniature Flip-Flop 600



Passivated components, mounted on a ceramic substrate measuring 0.310 x 0.310 in., form a flip-flop operating at speeds in the nanosecond range. The components are unaffected by environmental extremes and have low failure rates. Circuits are produced on custom order.

General Instrument Semiconductor Div., Dept. ED, 65 Gouverneur St., Newark 4, N. J.

## Xenon Lamp 594



Point-source xenon lamp X-75 has an arc size of 0.015 x 0.015 in. White light has an average brightness of 80,000 candles per cm<sup>2</sup>, color temperature of 6,200 K. Spectral output is 2,200 to beyond 14,000 angstroms. The 75-w lamp is 3 in. long, 1/2 in. in diameter.

PEK Labs, Inc., Dept. ED, 4024 Transport St., Palo Alto, Calif.

## Rate Meter 591



Transistorized count rate meter CRM-593 operates with any detector. Aural and visual displays are presented. Meter has 1-mv input sensitivity and provides 3-kv supply. There are five count rate ranges to 100,000 cpm, and four probable error settings of 2, 5, 10 and 15% for each range. Recorder drive output is provided.

Technical Services Dept., Instrument and Control Div., Nuclear Corp. of America, Danville, Ill.

CIRCLE 96 ON READER-SERVICE CARD ►

# INSTANT ENGINEERING DRAWINGS



**FASTER PRINTS MEAN FASTER PRODUCT DEVELOPMENT, FASTER PRODUCTION.** Imagine locating a drawing or record in seconds. Imagine having a work-size print in just 8 seconds. All this, and more, can happen when your drawings and records are on microfilm . . . with FILMSORT<sup>®</sup> Aperture Cards and THERMO-FAX "Filmac" Reader-Printers. This is the way many companies are saving valuable engineering and drafting time, saving the cost of full-size print preparation, saving space, and saving print distribution costs. The cost? Far less than you would expect for such amazing efficiency. Find out now how you, too, can put microfilm to work—get Instant Engineering Drawings when you need them, where you need them—with 3M Microfilm Products.

**3M MICROFILM**  
BRAND PRODUCTS

3M Company Dept. FCD-9131, St. Paul 6, Minn.

Please send me information about Instant Engineering Drawings.

NAME \_\_\_\_\_  
TITLE \_\_\_\_\_  
COMPANY \_\_\_\_\_  
ADDRESS \_\_\_\_\_  
CITY \_\_\_\_\_ ZONE \_\_\_\_\_ STATE \_\_\_\_\_

THE TERMS "FILMSORT" AND "THERMO-FAX" ARE REGISTERED TRADEMARKS OF  
**MINNESOTA MINING AND  
MANUFACTURING COMPANY**   
... WHERE RESEARCH IS THE KEY TO TOMORROW

## NEW PRODUCTS

### Multiplex Generator

378



Self-calibrating multiplex stereo signal generator, model SG-292, has control switches, output level control and meter, inputs for A and B signals, and SCA on the front panel.

Crosby-Teletronics, Inc., Dept. ED, Westbury, N. Y.

P&A: \$1,000; six to eight weeks.

### Signal Conditioner

394



Analog sensor module SAM-1 takes low-level signal inputs from strain-gage transducers and produces a proportional output voltage. Over-all stability is 0.02%, noise less than 5  $\mu$ v, output up to 100 ma. Units are 4-1/4 in. wide, 7 in. high.

Allegany Instrument Co. Div. of Textron Electronics, Inc., 1091 Wills Mountain, Cumberland, Md.

P&A: \$1,750; 60 days.

### Antenna Standards

400



Operating from 10 kc to 300 mc, standard antenna set Model SA-301 permits laboratory standardization of field strength meters. Components furnished include all necessary loop and dipole antennas, baluns, tripods, precision meters, cables and other accessory items. When used with an rf signal source the set is complete with all items needed to perform calibration.

Empire Devices, Inc., Dept. ED, Amsterdam, N.Y.

## SILICONE NEWS from Dow Corning

# When Going Is Rough

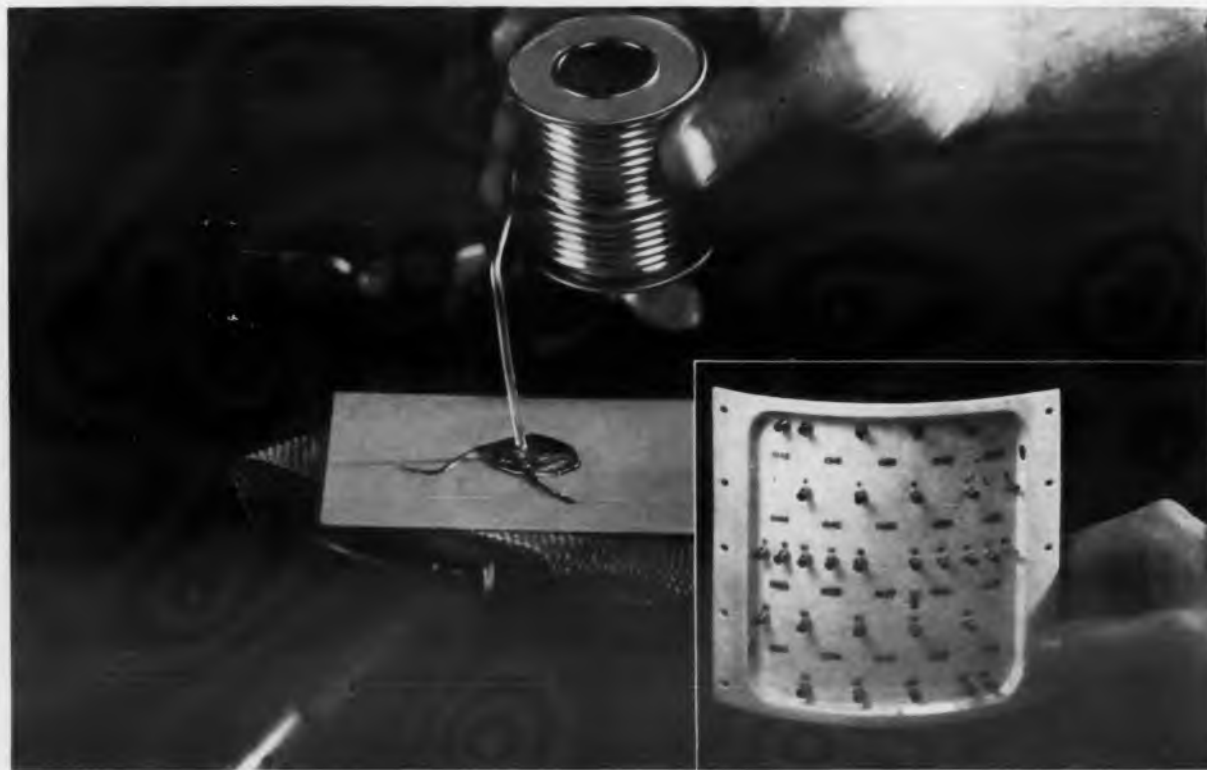

## For Environmental Engineering... Select Silicone-Glass Laminates

LOX cold . . . high Mach heat . . . corona . . . ozone . . . launching and sonic shock — more and more environmental challenges are being met by Dow Corning Silicones.

Take glass laminates bonded with Dow Corning silicone resins, as examples. Silicone glass laminates have good mechanical strength, low loss factor, low moisture absorption, excellent resistance to arcing, corona, corrosive atmospheres, fungus and contaminants. What's even more important, they retain these properties despite elevated temperatures, storage, environmental aging, rapidly changing ambients, vibration and shock. Heat resistance of silicone-glass laminates is exceptional . . . up to 250 C continuous for years . . . much higher for short time periods. Lastly, silicone-glass laminates, even in thin sections, have fine machinability and resist creep under pressure of terminal fasteners.

Lear, Inc., Grand Rapids, Michigan mounts the mica capacitors of their Model 2013J Stable Platform on this formed silicone-glass laminate terminal board. Lear engineers chose glass laminates after an intermediate material had been tried. Tolerance requirements, plus assembler variations, dictated a material that could be formed . . . would withstand soldering temperatures . . . would hold its form despite environmental extremes. Environmental conditions are: —40 to 160 F; shocks of 30 G's for about 11 milliseconds each; complex wave vibration for 20 minutes in each plane as follows — 30-100 cps: 0.46 g<sup>2</sup>/cps and 100-2000 cps: 0.015 g<sup>2</sup>/cps.

Silicone-glass laminates made with Dow Corning resins are available from leading laminators. Write for a list.

For 12-page manual  
"Silicones for the Electronic Engineer"  
Write Dept. 4021a



## Dow Corning

CIRCLE 770 ON READER SERVICE CARD

ELECTRONIC DESIGN • September 13, 1961

# ...Specify Silicones

## Flexible from -100 to 300F

Silastic®, the Dow Corning silicone rubber, is specified by Airtron, a division of Litton Industries, for the jacket of their silver-plated brass, and all-aluminum flexible waveguide designed to resist operating temperatures from -100 to 300 F. With its Silastic jacket, Airtron's Flexaguide is particularly suited for applications in the missile field where environmental operating conditions are severe. In addition, the jacket supports the waveguide during flexure, insures airtightness for pressurized applications. Silastic resists a long list of environments including: cold, heat, ozone, oxygen, voltage stress, thermal cycling, corona, corrosive atmospheres, and weathering.



CIRCLE 773 ON READER SERVICE CARD

## Rigid, Void-Free Protection

This induction heating coil is used to keep metal molten. Metal splatter caused frequent insulation and coil failure until the decision was made to encapsulate the unit in Dow Corning solventless silicone resin. The resin — with zirconium orthosilicate filler — forms a tough, rigid armor that withstands temperatures as high as 300 C indefinitely . . . much higher for short time periods. With no solvents to evaporate, the resin cures without voids. Note the excellent fill between plates of an encapsulated test capacitor.



CIRCLE 772 ON READER SERVICE CARD

## For Rapid Heat Dissipation

Dow Corning silicone fluids are used as dielectric coolants for rapid heat dissipation because of their thermal stability and relatively flat viscosity-temperature curves. They can be pumped at high speeds without breakdown due to shear; maintain consistency from -65 to 250 C; and they will not oxidize or act as corrosives to metals even at high temperature. For these reasons and because of low vapor pressure, Sierra Electronics, Menlo Park, California specifies Dow Corning 200 Fluid as the heat transfer medium in their 100 and 500 watt, 60 ohm coaxial RF loads.

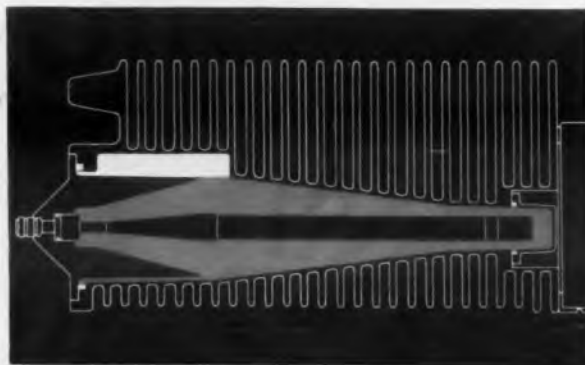

CIRCLE 771 ON READER SERVICE CARD

**CORPORATION** MIDLAND, MICHIGAN

branches: ATLANTA BOSTON CHICAGO CLEVELAND DALLAS LOS ANGELES NEW YORK WASHINGTON, D.C.

CIRCLE 770, 771, 772, 773 ON READER SERVICE CARD

ELECTRONIC DESIGN • September 13, 1961

## Dual-Range Welder

395



Resistance welding power supply has two capacity ranges. Discharge time is about 1 msec. Repetition rate is 100 to 160 welds per min. Standard model 1039 and voltage-regulated model 1049 are bench-mounted. Watt-second meter, stepless heat selector, and watt-second range selector are provided.

Unitek Corp., Weldmatic Div., Dept. ED, 950 Royal Oaks Drive, Monrovia, Calif.

## Cathode-Ray Tube

401



Has reduced spot size. Model M-1014P16 tube uses a bundle of 0.001 in. fibers set into a 5-in. aluminized screen in a panel measuring 5/8 x 3-1/2 in., providing 625 vertical light dots by 3,500 horizontal light dots or lines. It uses electrostatic focus and magnetic deflection with a 40-deg deflection angle to minimize deflection defocusing and provide high corner resolution.

Electronic Tube Corp., Dept. ED, 1200 E. Mermaid Lane, Philadelphia 18, Pa.

## Tantalum Capacitor

399



Wet-anode capacitor exceeds the requirements of MIL-C-3965-B. Type-Q units are available in standard capacitance tolerances of  $\pm 10$ ,  $\pm 20$ , and  $+50, -15\%$ . Devices are supplied in three case sizes with capacitance values ranging from 1.7 to 330  $\mu\text{f}$ . Standard life expectancy is 3,000 hr. Special types offer 10,000-hr service.

ITT Components Div. of International Telephone and Telegraph Corp., Dept. ED, Palo Alto, Calif.



All  
**LAMBDA**  
 Power Supplies  
 guaranteed  
 for  
**5**  
 years

Every Lambda power supply carries a written guarantee that it will perform to specifications for five full years. You can install power supplies now with complete assurance that they will still perform to design standards in 1966. *Lambda's guarantee, which covers workmanship and materials (except for tubes and fuses), has been in effect on all power supplies sold since 1953. It is your strongest assurance of power supply performance in installations where dependability is an absolute necessity for round-the-clock, heavy-duty service.*

SEND FOR NEW LAMBDA CATALOG 61



Nine Models Available  
 Voltages up to 330 VDC—Currents up to 20 Amp  
 Convection Cooled—Short Circuit Proof



**LAMBDA ELECTRONICS CORP.**

515 BROAD HOLLOW ROAD • HUNTINGTON, L. I., NEW YORK • 516 MYRTLE 4-4200

Western Regional Office: 230 North Lake Avenue, Pasadena, California • Phone: Code 213, MUrray 1-2544  
 New England Regional Office: 275 Boston Post Road, Marlboro, Massachusetts • Phone: Code 617, HUntley 5-7122  
 Middle Atlantic District Office: 515 Broad Hollow Road, Huntington, L. I., New York • Phone: Code 516, MYrtle 4-4200

## NEW PRODUCTS

AC Power Recorder

575



For aircraft applications. Dual-channel, ac power recorder has a standard rating of 120 v at 60 cps; other ratings can be furnished. Channel 1 has a scale of 0 to 5 amp; channel 2, 100 to 140 v, 200 to 280 v or 400 to 560 v. Frequency response is 25 to 500 cps.

Rustrak Instrument Co., Dept. ED, 130 Silver St., Manchester, N. H.

Price: \$149.50.

Data Gathering System 637

Portable data gathering system, model S-3100, weighs 130 lb. Instrument is packaged in two aluminum carrying cases. Up to 100 analog voltage inputs are accepted and recorded in digital format without intermediate transcription. Unit, transistorized, is available with a variety of sampling rates and digital outputs.

Epsco, Inc., Dept. ED, 275 Massachusetts Ave., Cambridge, Mass.

Delay Line

599



Magnetostriuctive delay line 6106 is made for space applications. A storage capacity of up to 10,000 bits at a 2-mc digit rate is provided in a volume of 62 cu in., weight of 14 oz. Up to 5,000  $\mu$ sec delay is possible. Signal-to-noise ratio is 20:1.

Ferranti Electric Inc., Electronics Div., Dept. ED, Industrial Park No. 1, Plainview, N. Y.

◀ CIRCLE 97 ON READER-SERVICE CARD

## Power Supply

586



**For solid-state computers.** Operating from ac line, 100 to 125 v, solid-state power supply provides four channels of dc power: +15 v dc, -15 v dc, +6 v dc, and -6 v dc. Regulation on all outputs is held to  $\pm 2\%$  under maximum line, load, and temperature change. Ripple is 5 mv peak-to-peak; efficiency is 50% min.

Magnetic Research Corp., Dept. ED, 3160 W. El Segundo Blvd., Hawthorne, Calif.

## Computer Tape

635

**For photoelectric and electro-mechanical readers,** this opaque computer tape is mylar-reinforced. Thickness from 0.002 to 0.0045 in. provides up to 2,700 ft on a 10-in. reel. Made for high-speed readers, tape is able to withstand thousands of readings without elongation of holes.

Arvey Corp., Dept. ED, 3500 N. Kimball Ave., Chicago 18, Ill.

**Price:** \$9.00 to \$15.00 per 500-ft reel.

## Temperature Transducers

595



**One-piece stainless steel temperature transducers** are made for use in almost any environment in ranges covering from -452 to +1,750 F. Accuracy is 0.1% of range, 0.01% on special order. Response is fast, linearity high, hysteresis low. Units withstand shock of 100 g for 11 msec, pressure from 0 to 5,000 psi, vibration of 20 g to 2 kc.

Temtro, Inc., Dept. ED, 3016-C S. Halladay, Santa Ana, Calif.

nearly everybody  
in electronic  
laboratories reads  
Video Instrument catalogs...  
get yours!

When your mind gets back to amplifiers, remember that Video Instruments now provides four types of laboratory and field tested solid state amplifiers—chopper stabilized, sub-miniature airborne, galvanometer driver, and “pure” direct coupled. Complete specifications are available in Vi's latest catalog—and, as a reward for promptness, we will also send you a technical discussion of common mode rejection. Write Video Instruments—then get back to work.

**VIDEO INSTRUMENTS COMPANY, INC.** 3002 Pennsylvania Avenue, Santa Monica, California **Vi**



## NEW PRODUCTS

### Power Supply

402



Current-regulated power supply model 254 provides 65 to 105 v dc from 1.5 to 7.5 amp, or 65 to 110 v dc from 1.5 to 6.0 amp. Ripple is 0.5% peak-to-peak, current regulation  $\pm 1\%$  line or load. Space is provided for internal mounting of a traveling-wave tube and its focusing solenoid.

Alfred Electronics, Dept. ED, 897 Commercial St., Palo Alto, Calif.

**P&A:** \$490; from stock.

### Silicon Rectifiers

420

High-voltage rectifiers CR-101 through CR-110 have piv ratings from 1,200 to 10,000 v, average current ratings from 550 to 825 ma at 60 C. Ambient temperature range is  $-65$  to  $+125$  C. Maximum forward voltage drop is 1.2 to 9.6 v.

Radio Corp. of America, Semiconductor and Materials Div., Dept. ED, Somerville, N. J.

### Nickel Sulphate Hexadrate

422

Single crystals of nickel sulphate hexadrate are suitable for application as windows in the infrared region. The solution-grown crystals range in size from 25 to 200 g and up.

Semi-Elements, Inc., Dept. ED, Saxonburg Blvd., Saxonburg, Pa.

**P&A:** \$0.50 to \$1.25 per g; immediate.

### Strain-Gage Plotter

403



With computer entry capability. Strain-gage recording and plotting system, with digital output, uses 10 input conditioning modules of 10 channels each. Fixed data may be entered via a parameter board. Output is both a typewritten log sheet and punched paper tape for computer entry.

B & F Instruments, Inc., Dept. ED, 3644 N. Lawrence St., Philadelphia 40, Pa.

## TANTALUM CAPACITORS

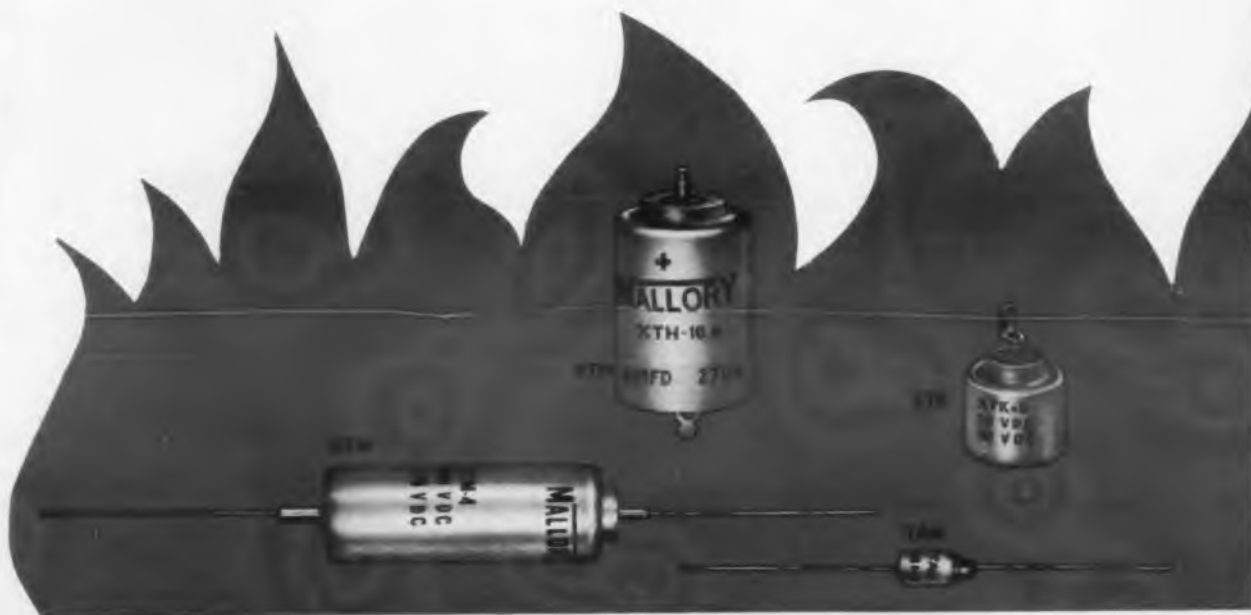

from the industry's widest selection...

the highest temperatures—up to 200°C . . . the highest capacitances—up to 2250 microfarads . . . the smallest sizes—new 125°C miniature TAH . . . many terminal arrangements are available in the XT series.

seven different high temperature types . . . with the

sintered pellet anode pioneered by Mallory for extreme environments.

. . . plus seven other tantalum capacitor types—including foil, solid electrolyte, encapsulated, miniature, microminiature. Write for catalog and consultation. Mallory Capacitor Company, Indianapolis 6, Indiana.

## FOR THE HOTTEST JOBS



P. R. MALLORY & CO. Inc.  
**MALLORY**

**Mallory Tantalum Capacitors**  
Stocked by these distributors

- Arlington, Va.  
Rucker Electronic Products
- Baltimore, Md.  
Radio Electric Service
- Binghamton, N.Y.  
Federal Electronics
- Boston, Mass.  
Cramer Electronics, Inc.  
DeMambro Radio Supply Co.  
Lafayette Radio
- Bridgeport, Conn.  
Westconn Electronics
- Buffalo, N.Y.  
Wehle Electronics
- Chicago, Ill.  
Allied Radio Corp.  
Newark Electronics Corp.
- Cincinnati, Ohio  
United Radio
- Cleveland, Ohio  
Pioneer Electronics
- Dallas, Texas  
Engineering Supply Co.
- Dayton, Ohio  
Allied Supply Co.
- Denver, Colo.  
Denver Electronics
- Houston, Texas  
Harrison Equipment Co., Inc.  
Lenert Company
- Indianapolis, Ind.  
Graham Electronics
- Los Angeles, Calif.  
California Electronics  
Kieruff Electronics, Inc.  
Electronic Supply Corp.  
Radio Product Sales
- Minneapolis, Minn.  
Northwest Radio
- Montreal, Que.  
Canadian Electrical Supply Co.
- Mountainside, N.J.  
Federated Purchaser, Inc.
- Nashville, Tenn.  
Electra Dist. Co.
- Newark, N.J.  
Lafayette Radio
- New York, N.Y.  
Harrison Radio Corp.  
Harvey Radio Co., Inc.  
Lafayette Radio  
Milo Electronics  
Terminal Hudson Electronics
- Oakland, Calif.  
Elmar Electronics, Inc.
- Orlando, Fla.  
East Coast Radio
- Ottawa, Ont.  
Wackid Radio-TV Lab.
- Pale Alto, Calif.  
Zack Electronics
- Perth Amboy, N.J.  
Atlas Electronics
- Philadelphia, Pa.  
Herbach & Rademan  
Philadelphia Electronics
- Pittsburgh, Pa.  
Radio Parts Co.
- St. Louis, Mo.  
Olive Electronics
- Seattle, Wash.  
F. B. Connelly Co.
- Tampa, Florida  
Thurrow Distributors, Inc.
- Toronto, Ont.  
Alpha Aracon Radio Co.  
Electro Sonic Supply  
Wholesale Radio & Electronics
- Tucson, Ariz.  
Standard Radio Parts
- Tulsa, Okla.  
Engineering Supply Co.
- Washington, D.C.  
Capitol Radio Wholesalers  
Electronic Industrial Sales
- White Plains, N.Y.  
Westchester Electronic Supply Co., Inc.
- Winston-Salem, N.C.  
Dalton-Hege Radio



A complete line of aluminum and tantalum electrolytics, motor start and run capacitors.

**Resistance Box**

397



Substitution box model 1702 permits rapid direct substitution of 36 different resistance values from 15 ohms to 10 meg. The power dissipation of all resistors is 1 w.

Precision Apparatus Co., Inc., Dept. ED, Glendale 27, N.Y.

Price: \$15.95.

**Line Extender Amplifier**

438

For both low and high band vhf operation the model ABX-40R line extender has a gain of 38 db. Operating from 54 to 88 mc, and from 174 to 216 mc, the instrument is flat within 0.75 db and has an 8.5-db noise figure. Bands have separate gain controls. Device has a regulated power supply, and is stable within 0.2 db for 20% line variation.

Entron, Inc., Dept. ED, P. O. Box 287, Bladensburg, Md.

**Two-Pen Recorder**

681

Accurate to  $\pm 0.20\%$ . Two-pen strip chart recorder model 83 provides six chart speeds from 2 to 60 in. per min. 15 voltage ranges from 0.5 mv to 20 v per in. with vernier control, chart roll actuator and pen lowering switch. Over-all accuracy is  $\pm 0.20\%$  of full scale, and reset-tability is better than 0.1% of full scale. Paper transport takes 9-1/2-in. by 120-ft chart rolls.

F. L. Moseley Co., Dept. ED, 409 N. Fair Oaks Ave., Pasadena, Calif.

**Decade Resistor/Divider**

398

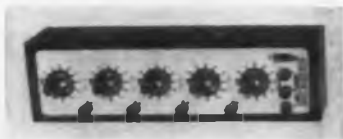

For use with bridges and in the determination of resistance values, model 1601 resistor/divider has five decades providing 0 to 111,110 ohms in steps of 1 ohm. Tolerance is  $\pm 5\%$ . Four voltage divider posts permit use as a general purpose wide-range voltage divider and permit practical voltage ratios between 0.0001 and 1.0 (10,000 to 1).

Precision Apparatus Co., Inc., Dept. ED, Glendale 27, N.Y.

Price: \$29.95.



**vacuum gauges** for low pressure measurement. The Westinghouse line of pressure measuring devices is broad and standardized for typical applications in industrial vacuum processing systems, laboratory and research work, environmental testing and space exploration. Their sensitivity and rugged construction is proven by successful performance in NASA'S Aerobee Hi Rocket at altitudes from 70 to 125 miles. Specialized devices are offered in envelopes and tubulation made of Pyrex and Nonex glass and Kovar. Standard tubulation is from  $\frac{3}{8}$ " to 1" and special larger sizes can be supplied. For direct mounting into the vacuum system, flange-mounted gauges are available. Most of these gauges are available from stock to 30 days delivery. Developmental work is progressing on extending the Bayard-Alpert type range and in the cold cathode gauge principle. Whether your application is standard or special, write on your Company letterhead to: Westinghouse Electric Corporation, Elmira, N. Y. *You can be sure ... if it's Westinghouse.*



**Westinghouse**

Pressure sensitive ranges of Westinghouse Vacuum Gauges in mm of Hg.

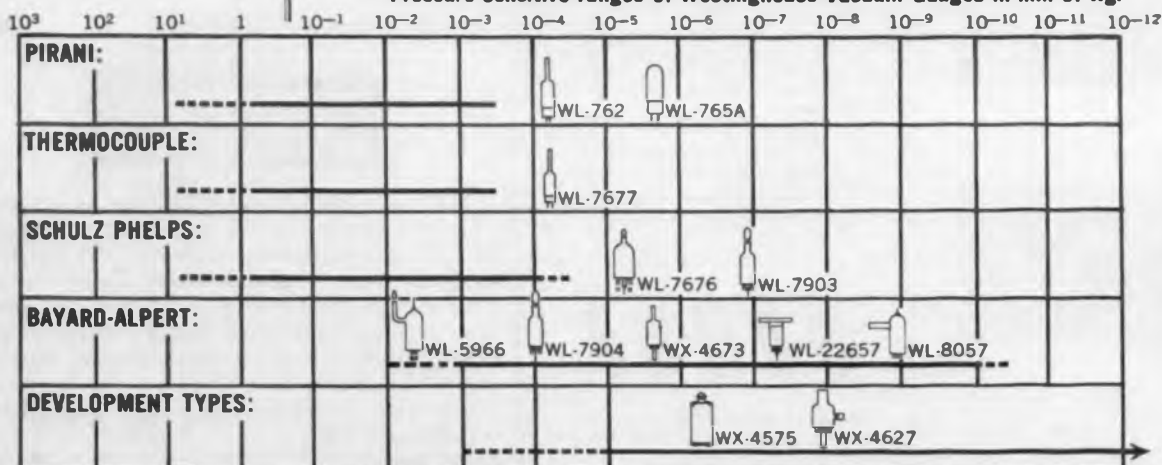

CIRCLE 100 ON READER-SERVICE CARD

## NEW PRODUCTS

### Gating Device

368



**For silicon controlled rectifiers.** The Siligate functions effectively with a single scr, two in full-wave, or two back-to-back for ac. It may be controlled by dc current, variable resistance, or directly by transistors. Capacity is 3 amp to 100 amp.

Dresser Electronics, HST Div., Dept. ED, 555 N. Fifth St., Garland, Tex.

Price: \$85 to \$110.

### Ionization Equipment

522

**Research ionizer** model RG-3, with continuously variable output of either positive or negative ions, will provide up to one million ions per cc. Research ion counter model ICF-6 is a companion instrument for measuring positive or negative air ion concentrations. Recorder permits a continuous record of ion count.

Philco Corp., Industrial Products, Dept. ED, 4700 Wissahickon Ave., Philadelphia 44, Pa

### Slip Rings

423

**Low-noise slip rings** are made for space environments. The rings have low torque; light materials are used for minimum weight. Assemblies are available with up to several hundred circuits.

Slip Ring Co. of America, Dept. ED, 3612 W. Jefferson Blvd., Los Angeles 16, Calif.

### Resistance Wire

369



**Improved Neuroloy** resistance wire, composed of 55/45 Cu/Ni, offers high resistivity in fine wire with a low temperature coefficient. It is suitable for precision wound and vitreous enamelled resistors. Wire withstands corrosion at operating temperatures under 1,000 F.

Molecu Wire Corp., Dept. ED, Eatontown-Freehold Pike, Scobeyville, N. J.

CIRCLE 101 ON READER-SERVICE CARD ➤



MICRO SWITCH Precision Switches



Start your panel design with the

**Reliability, Styling and Flexibility of**

**MICRO SWITCH lighted push-button switches**

The flexibility of MICRO SWITCH "Series 2" lighted push-button switches enables you to precisely tailor your control panel to your requirements. Hundreds of switch and indicator combinations can be assembled by simply snapping together the correct modular parts. Their clean, modern styling complements your panel design without dominating it. Most important, any of the 18 switch units you select has MICRO SWITCH reliability. That's why these "Series 2" switches serve on some of the most crucially important control panels in the world. Write for the colorful Catalog 67, or see the Yellow Pages for the nearby MICRO SWITCH Branch Office.

Save 50% on space. Indicator and switching unit are combined in one device to save panel space.



It's a snap! Modular parts snap together and then snap into panel slots without tools.

MICRO SWITCH . . . FREEPORT, ILLINOIS  
A division of Honeywell

*In Canada: Honeywell Controls, Limited, Toronto 17, Ontario*



**Honeywell**  
MICRO SWITCH Precision Switches

**HONEYWELL INTERNATIONAL**

Sales and service offices in all principal cities of the world. Manufacturing in United States, United Kingdom, Canada, Netherlands, Germany, France, Japan.



## MICRO SWITCH Precision Switches



Eighteen different switching units are available to match virtually all circuitry requirements.

### Hundreds of switch and indicator combinations ...with MICRO SWITCH reliability

The functional color combinations on "Series 2" switches can be split laterally or longitudinally. Up to four colors can be used behind each display screen. Projected color makes it possible for the display screen to change color to indicate a change in the circuit.

Available switching units include hermetically sealed units, small but rugged long-life types and space-saving subminiature assemblies. Momentary-contact or alternate-action units are available in a choice of circuitry to exactly match requirements. Insist on MICRO SWITCH reliability by specifying "Series 2" push-button switches for your panel. You may obtain prompt engineering help by simply checking the Yellow Pages for the MICRO SWITCH Branch Office. Send for Catalog 67.

MICRO SWITCH . . . FREEPORT, ILLINOIS  
A division of Honeywell

*In Canada: Honeywell Controls, Limited, Toronto 17, Ontario*



# Honeywell

MICRO SWITCH Precision Switches

**HONEYWELL INTERNATIONAL**  
Sales and service offices in all principal cities of the world. Manufacturing in United States, United Kingdom, Canada, Netherlands, Germany, France, Japan.



## Axial Fan

445



For spot cooling or chassis cooling in missile avionics and ground-support equipment, model F234-1 provides 100 cfm at 0.25 in. static pressure at 55,000 ft altitude; or 58 cfm at 1.0 in. static pressure at sea level. Weight is 0.72 lb. Size is 2-1/4 in. long by 3 in. in diameter at mounting rings.

Western Gear Corp., Dept. ED, 132 W. Colorado St., Pasadena, Calif.

## Lighted Switch

682

Rated at 10 amp. Illuminated pushbutton switch provides momentary- or alternate-action control of two circuits. Rating is 10 amp at 125 or 250 v ac, 30 v dc; bulbs operate on 6, 12, or 28 v. Colored buttons are made in four sizes and shapes.

Micro Switch Div., Minneapolis-Honeywell Regulator Co., Dept. ED, Freeport, Ill.

## Ferrite Cores

421

Toroidal ferrite cores 229M1 and 230M1 are made for use in coincident-current magnetic memory devices. Size is 0.050 x 0.030 x 0.015 in. The 229M1 has a switching time of 0.55  $\mu$ sec at a driving current of 800 ma; the 230M1 switches in 1  $\mu$ sec at a driving current of 440 ma.

Radio Corp. of America, Semiconductor and Materials Div., Dept. ED, Somerville, N. J.

## Frequency Counter

444



Range is 0 to 220,000 pps, 1 to 220,000 cps. Frequency counter and preset translator model 740 offers direct conversion from frequency to physical units. Nixie readout is provided in 4, 5 or 6 decades. Accuracy is  $\pm 0.001\%$   $\pm 1$  count. It is especially useful in flow rate measurement, linear velocity measurement, production monitoring and engine-turbine test and calibration.

Erie-Pacific, Div. of Erie Resistor Corp., Dept. ED, 12932 S. Weber Way, Hawthorne, Calif.



**TRANSISTORS**—Shown here in magnification is a Mesa transistor with fine gold wire. Handy & Harman manufactures this whisker wire to exact tolerances and highest purity standards. The cap is gold plated from Handy & Harman fine gold anodes. Photo courtesy of Western Electric.



**CAPACITOR CANS**—These tantalum electrolytic capacitors are completely leaktight and highly resistant to corrosion. The containers that are also used to seal the liquid and internals are drawn from Handy & Harman fine silver sheet. Photo courtesy of Fan-steel Metallurgical Corporation, North Chicago, Ill.



**CAPACITORS**—Electrodes in these solid-state porcelain capacitors are formed from silver paste derived from Handy & Harman silver flake. Other types of capacitors for high-temperature applications have lead wires of Handy & Harman Consil 998, a nickel-bearing alloy. Photo courtesy of Vitramon, Incorporated, Bridgeport, Conn.

# TRANSISTORS, CAPACITORS AND COME WHAT MAY

*... just a few of the jobs involving  
HANDY & HARMAN precious metals*

Handy & Harman's effectiveness in supplying the semiconductor and related fields is based on long experience with precious metals, coupled with our interest and ability in working closely with designers, engineers and manufacturers in the electrical and electronics industries.

These few examples are indicative of our continuing and expanding activities in furnishing precious metals: gold and silver and their alloys in wire, strip and foil; silver powders, flake and paint; silver bimetals; silver sintered metals; anodes, etc. The "etc." is our invitation to you to send us any questions you may have regarding the applicability of precious metals in your products or processes.

Would you like further information on these and others of our precious-metals products? Our Technical Bulletins contain a wealth of information and are yours for the asking:

A-1 .....	Fine Silver	A-4 ...	Silver Conductive Coatings
A-2 .....	Silver-Copper Alloys	A-5 .....	Silver Powder and Flake
A-3 .....	Silver-Magnesium-Nickel	25 ..	Vacuum Tube Grade Brazing Alloys

Your No. 1 Source of Supply and Authority on Precious Metals

# HH HANDY & HARMAN

General Offices: 850 Third Avenue, New York 22, N.Y.

Offices and Plants: Bridgeport, Conn. • Chicago, Ill. • Cleveland, Ohio  
Dallas, Texas • Detroit, Mich. • Los Angeles, Calif. • Providence, R. I.  
Toronto, Ontario • Montreal, Quebec



# UP TO 16



## RUGGED ITT HIGH-VOLTAGE SILICON CARTRIDGE RECTIFIERS

This ITT high-voltage line represents the latest advances of the state of the art. Constructed from selected p-n junction diodes assembled in series within an insulated cartridge, each silicon rectifier is completely vibration-safe and moisture resistant. Available with axial leads, or with ferrule terminals which permit mounting into standard 30-ampere fuse clips. In high-voltage, high-current, high-temperature applications, these ITT rectifiers satisfy the most stringent military and industrial requirements.

*Write for information on the complete line of ITT high-voltage silicon cartridge rectifiers. Application assistance is available for your specific requirements.*



**SEMICONDUCTOR DEPARTMENT ■ COMPONENTS DIVISION**  
INTERNATIONAL TELEPHONE AND TELEGRAPH CORPORATION, CLIFTON, NEW JERSEY  
CIRCLE 103 ON READER-SERVICE CARD

CARTRIDGE TYPE		
Absolute Max. Rtg. Res. Ind. Load at 75°C Ambient		
EIA TYPE	PEAK INVERSE VOLTAGE (PIV) (V)	MAX. RECTIFIED DC OUTPUT CURRENT (ma)
1N1134	1500	100
1N1136	1800	85
1N1138	2400	60
1N1140	3600	65
1N1142	4800	50
1N1143A	6000	65
1N1145	7200	60
1N1147	12000	48
1N1149	16000	45

Operating Temp. Range: -55°C to +150°C Ambient

NOTE: Permissible current at 25°C is 115% of the value at 75°C. Derate linearly from 75°C to zero current at 150°C.

AXIAL LEAD TYPE		
MAXIMUM RATINGS		
EIA TYPE NUMBER	PEAK INVERSE VOLTAGE (PIV) (V)	MAX. AVERAGE RECT. CURRENT * (ma) @ 25°C
1N1730	1000	200
1N1731	1500	200
1N1732	2000	200
1N1733	3000	150
1N1734	5000	100
1N2382	4000	150
1N2383	6000	100
1N2384	8000	70
1N2385	10000	70

\*Resistive or Inductive Load  
Continuous DC Voltage Same as PIV  
Max. Surge Current (10msec) at 100°C: 2.5 Amperes  
Operating Temp. Range: -55°C to +150°C Ambient

## NEW PRODUCTS

### Card Racks

360



Printed circuit card files, mounted in relay racks, hold 38, 30 or 23 cards. All hardware is provided. Height is 3-1/2 to 10-1/2 in., depth 4-5/8 to 14-7/8 in., in 1-3/4-in. increments. Material is 0.062-in. cadmium-plated steel.

Western Devices, Inc., Dept. ED, 600 W. Florence Ave., Inglewood 1, Calif.

**P&A:** \$31 to \$35; 10 to 14 days.

### Alumina Powder

370

Semiconductor-grade alumina powder is made for production polishing of Si and Ge wafers. Particle sizes of 1.0, 0.3, and 0.05 microns are made. Hardness is 8 or 9 mh.

Crystal Products Dept., Linde Co., Dept. ED, 4120 Kennedy Ave., East Chicago, Ind.

### Audio Amplifier

365



Rated at 70 w. Power amplifier model 9 provides over 70 w at less than 0.1% distortion in most of the audio range, less than 0.5% at 20 kc. Intermodulation distortion is less than 0.5%, hum and noise 90 db down. A switch selects 40-w triode operation. Damping factor is 17, output impedance 1, 4, 8 and 16 ohms. Balance and bias adjustment is provided. Panel height is 8 3/4 in.

Marantz Co., Inc., Industrial Dept., Dept. ED, 25-14 Broadway, Long Island City 6, N. Y.

**Price:** \$324 to \$354.

### Pulse Tube

351



Warranted for 2,500 hr, pulse tube 7899 is a forced-air cooled triode designed for use as a hard tube modulator or pulsed rf amplifier. Plate dissipation is 7.5 kw, duty factor 0.025. Peak plate current is 85 amp max, dc plate voltage 20 kv max.

Amperex Electronic Corp., Power Tube Div., Dept. ED, 230 Duffy Ave., Hicksville, N. Y.

### Temperature Control

472

Thermistor/thermocouple system A+540 combines continuous multipoint process temperature control with indication at a central point. Probes contain a thermistor and a thermocouple; thermistor connects to a transistorized controller, thermocouple to a potentiometric indicator.

Atkins Technical Inc., Dept. ED, 1276 W. Third St., Cleveland 13, Ohio.

### VHF Preamplifier

366



Low-noise, broad-band vhf preamplifier VHA-2 has a pass band from 55 to 260 mc, a noise figure of 6 db max, and average gain of 16 db with  $\pm 1.5$  db maximum ripple. Impedance is 50 ohms, input and output. Ambient temperature range is -25 F to +140 F. Unit is suitable for remote operation.

Applied Technology, Inc., Dept. ED, 930 Industrial Ave., Palo Alto, Calif.

**P&A:** \$875; 60 days.

## Chart Recorder

627



Operates 50 days. Inkless event recorder 620, made with 10 and 20 channels, can operate more than 50 days without a change in charts. Available chart speeds range from 3/4 in. per hr to 6 in. per sec. Heated styli record on waxless chart paper.

Esterline Angus Instrument Co., Inc., Dept. ED, P. O. Box 596, Indianapolis 6, Ind.

P&A: \$500 to \$600; immediate.

## Elapsed Time Meter 640

Up to 10,000 hr in steps of 0.1 hr can be registered on the model H21M elapsed time meter. Power input is 110, 225, or 420 v, 50 or 60 cps. Meter is available either flushmounting with internally mounted motor, or panelmounting with external motor.

English Electric Co., Ltd., Dept. ED, English Electric House, Strand, London WC 2, England.

## Miniature Photosensor 580



For displacement measurement. Photosensor MPS100 is useful in applications prohibiting mechanical loading and where a controlled-intensity spot may be used. It consists of a pair of silicon photodiodes; output is a differential voltage. With a tungsten source, light sensitivity is 250 mv at 50 mw per sq cm; light displacement sensitivity is 35 mv per mw per 0.001 in. with a 0.020-in. diam light spot.

Micro Systems, Inc., Dept. ED, 319 Agostino Road, San Gabriel, Calif.

P&A: \$75 to \$20; immediate.

CIRCLE 104 ON READER-SERVICE CARD ➔

**DAVEN/GENERAL MILLS**  
Blazing new trails in component reliability!

5

*extra features*

*at no extra cost!*

### Daven metal film resistors

- True glass-to-metal seal plus epoxy encapsulation
- 25 PPM/°C. temperature coefficient over normal operating temperatures at no surcharge
- Weldable leads, which are readily solderable, are standard on all units at no surcharge
- Exceeds MIL-R-10509D, Characteristic C specs
- Off-the-shelf delivery from your Daven distributor

Write for full details on Types DA 2 and DA 4



**THE DAVEN COMPANY, Livingston, New Jersey**

General  
Mills

RESISTORS

TODAY, MORE THAN EVER, THE DAVEN © STANDS FOR DEPENDABILITY

## NEW PRODUCTS

### Synchro Amplifier

425



Buffer amplifier 802-A will allow a small synchro transmitter to drive many synchro control transformers without loss of accuracy or excessive loading. Unit is transistorized and sealed. Three units are necessary for each buffer system. Unit is for synchro stators rated at 90 v per line.

Industrial Control Co., Dept. ED, Central Ave. at Pinelawn, Farmingdale, Long Island, N. Y.

### Amplifier-Ohmmeter

432



For industrial applications, this device has pre-amplifier capabilities and can convert a voltmeter to an ohmmeter. The instrument, designated Ampli-Ohm AO-45, can give a 1-mv instrument a sensitivity of 10 or 100  $\mu$ v with a gain stability of 0.01% and a gain accuracy of  $\pm$ 0.01% of full scale. It permits reading resistances with the Cubic V-45 voltmeter from 0.1 ohm to 10.999 meg.

Cubic Corp., Dept. ED, San Diego, Calif.  
Price: \$980.

### Film Dielectric Capacitors

384



For commercial applications, the series 64F Lectrofilm capacitors are said to be smaller, lighter, and more reliable than similar metal-clad units. Capacitances from 0.001  $\mu$ f, 100 v, to 0.68  $\mu$ f, 600 v, are available in 20% decades. Units operate at 85 C and are derated to 125 C.

General Electric Co., Capacitor Dept., Dept. ED, Hudson Falls, N. Y.  
Price: \$0.11 to \$0.46 each.

## TAKE A SECOND LOOK

IT'S THE 2N174—PART OF DELCO RADIO'S POWER TRANSISTOR FAMILY WHICH HAS PROVED ITS STUFF FOR YEARS IN HUNDREDS OF MILITARY AND INDUSTRIAL APPLICATIONS: MISSILES, COMMUNICATIONS, DATA PROCESSING, AND ULTRASONICS, TO NAME A FEW. THIS MULTI-PURPOSE PNP GERMANIUM POWER TRANSISTOR HAS THE HIGH PERFORMANCE AND VERSATILITY TO MEET OR EXCEED THE MOST RIGID ELECTRICAL AND ENVIRONMENTAL REQUIREMENTS. ( DESIGNED FOR GENERAL USE WITH 28-VOLT POWER SUPPLIES, THE 2N174 MAY ALSO BE USED WITH 12 VOLTS WHERE HIGHER RELIABILITY IS DESIRED. MAXIMUM EMITTER CURRENT—15 AMPERES, MAXIMUM COLLECTOR DIODE RATING—80 VOLTS, THERMAL RESISTANCE—BELOW .6°C/W AND MAXIMUM POWER DISSIPATION—50 WATTS AT 71°C, MOUNTING BASE TEMPERATURE. THE 2N174'S LOW SATURATION RESISTANCE PROVIDES HIGH EFFICIENCY IN SWITCHING OPERATIONS. ( LIKE ALL DELCO TRANSISTORS, EVERY 2N174 MUST PASS AT LEAST A DOZEN ELECTRICAL AND ENVIRONMENTAL TESTS—BEFORE AND AFTER AGING—BEFORE IT LEAVES DELCO RADIO'S LABORATORIES. THIS 200 PERCENT TESTING, COMBINED WITH FIVE YEARS OF REFINEMENTS IN MASS PRODUCTION, MEANS CONSISTENT UNIFORMITY IN THE PRODUCT . . . AT A LOW PRICE. ( THE 2N174 IS JUST ONE OF MANY DEPENDABLE TRANSISTORS PRODUCED BY DELCO RADIO TO SUPPLY ALL YOUR TRANSISTOR NEEDS. FOR MORE DETAILS OR APPLICATIONS ASSISTANCE ON THE 2N174 OR OTHER DELCO TRANSISTORS, CONTACT YOUR NEAREST DELCO RADIO SALES OFFICE.

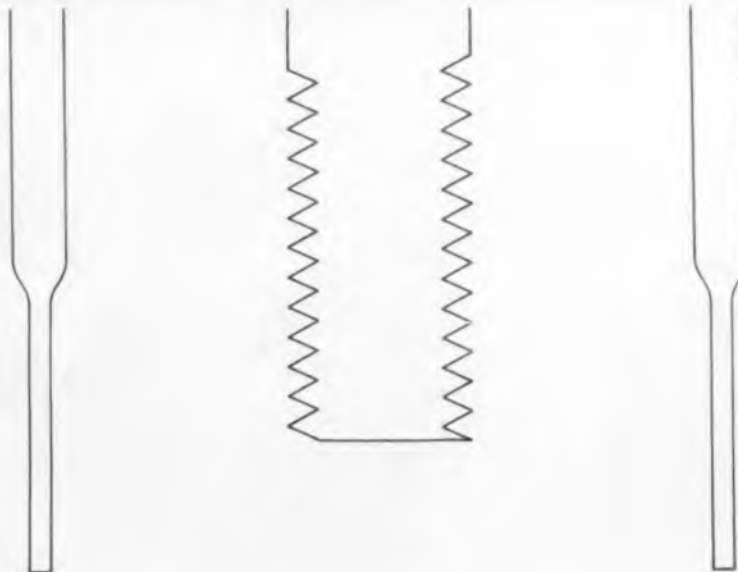

Union, New Jersey  
324 Chestnut Street  
MURdock 7-3770

Santa Monica, California  
726 Santa Monica Blvd.  
UPton 0-8807

Chicago, Illinois  
5750 West 51st Street  
PORTsmouth 7-3500

Detroit, Michigan  
57 Harper Avenue  
TRinity 3-8560

**DELCO**  
DEPENDABILITY  
**RADIO**  
RELIABILITY

DIVISION OF GENERAL MOTORS • KOKOMO, INDIANA  
CIRCLE 105 ON READER-SERVICE CARD

ELECTRONIC DESIGN • September 13, 1961



**DELCO  
SEMICONDUCTORS  
NOW AVAILABLE AT  
THESE DISTRIBUTORS:**

New York:

**HARVEY RADIO CO., INC.**  
103 West 43rd St., New York 36, N. Y.  
JU 2-1500

San Francisco:

**SCHAD ELECTRONIC SUPPLY, INC.**  
499 South Market St., San Jose 13, Calif.  
CY 8-0511

Detroit:

**GLENDALE ELECTRONIC  
SUPPLY COMPANY**  
12530 Hamilton Ave., Detroit 3, Michigan  
TU 3-1500

Boston:

**GREENE-SHAW DISTRIBUTING CO.**  
341 Watertown St., Newton 58, Mass.  
WO 9-8900

Philadelphia:

**ALMO RADIO COMPANY**  
913 Arch St., Philadelphia, Pennsylvania  
WA 2-5918

Baltimore:

**RADIO ELECTRIC SERVICE**  
5 North Howard St., Baltimore, Maryland  
LE 9-3835

Seattle:

**C&G ELECTRONICS COMPANY**  
2221 Third Avenue, Seattle 1, Washington  
MA 4-4354

Chicago:

**MERQUIP ELECTRONICS, INC.**  
5904 West Roosevelt, Chicago, Illinois  
AU 7-6274

Los Angeles:

**RADIO PRODUCTS SALES, INC.**  
1501 South Hill St., Los Angeles 15, Calif.  
RI 8-1271

Minneapolis:

**GEORGE SPENCER, INC.**  
5305 Cedar Lake Rd., Minneapolis 16, Minn.  
LI 5-8811

Birmingham:

**FORBES DISTRIBUTING CO., INC.**  
2610 Third Ave. S., Birmingham 5, Ala.  
AL 1-4104

West Palm Beach:

**GODDARD, INC.**  
1309-11 N. Dixie, West Palm Beach, Florida  
TE 3-5701 or WX-9000

Phoenix:

**ASTRONICS, INC.**  
9310 North Central, Phoenix 20, Arizona  
944-1551

Richmond:

**MERIDIAN ELECTRONICS, INC.**  
1001 W. Broad St., Richmond 20, Virginia  
EL 5-2834

Cincinnati:

**UNITED RADIO, INC.**  
1314 Vine Street, Cincinnati 10, Ohio  
CH 1-6530

Ask for a complete catalog

**DELCO  
RADIO**

CIRCLE 106 ON READER-SERVICE CARD

ELECTRONIC DESIGN • September 13, 1961

**Voltage Sensing Relay**

**426**



Accuracy is within 2% on both high-and low-voltage limits for this solid state relay. It monitors high and low voltage on a go-no-go basis. Temperature range is 55 to 100 C. Size is 1-3/8 x 1 x 2 in. The meter relay will perform a safety function in the ground checkout of a ground-to-air missile system.

Guide Manufacturing Co., Dept. ED, 7602 San Fernando Road, Sun Valley, Calif.

**Digital-to-Angle Converters**

**386**



Relay-programed synchro standards, series A-203S-RC, serve as digital-to-angle converters and can be controlled from tape. Handling 50 signals per sec, devices have a response time of 10 msec. Settings are at increments of 5, 10 or 15 deg, accurate within 2 sec. Applications include radar, guidance and servo testing and checkout.

Astrosystems, Inc., Dept. ED, 220 E. 23rd St., New York 10, N. Y.

P&A: \$850 to \$3,600; 3 to 8 weeks.

**FM Demodulator**

**429**



Dual co-channel reception with improved signal-to-noise ratio is possible with fm Demodulator type 310. This fm receiver modification unit can separate and demodulate interfering co-channel signals even if they have the same average frequency and peak deviation. Levels may differ by as much as 20 db.

General Electronic Laboratories, Inc., Dept. ED, 18 Ames St., Cambridge 39, Mass.

P&A: \$3,500; six weeks.



# mark of reliability

*These two fingerprints may look alike  
but an expert can prove them to be as  
different as night and day.*

Silicon rectifiers and regulators look alike on the surface, too, but their internal structure often differs. Those who know choose "nae" because this symbol on a semiconductor assures the utmost in performance and reliability.

**ZENER 1-WATT REGULATORS AVAILABLE IN EXTREMELY LOW VOLTAGES — 200°C STORAGE TESTED.** The "nae" mark on these constant voltage elements in the new compact flangeless case means reliability in control and similar circuits. These quality semiconductors give excellent stability and regulation over a wide operating range, and can carry up to 500 ma. Hermetically sealed encapsulation, axial lead design and small size gives them long-term reliability under extreme environmental conditions. Try them and let us prove it.

#### SPECIFICATIONS

At 25°C and Test Current Listed

NAE & JEDEC TYPE NO.	ZENER VOLTAGE Volts	TEST CURRENT Milliamperes	DYNAMIC IMPEDANCE OHMS
PRS3011	2.8	150	25
PRS3012	3.1	150	20
PRS3013	3.4	150	20
PRS3014	3.8	150	15
PRS3015	4.2	150	10
PRS3016	4.6	100	10
PRS3017	5.0	100	4
1N1765 thru 1N1802	5.6 to 200	100 to 5	1.2 to 1100

Write on your letterhead for specific information and sample of Zener type desired.

*NAE makes Industry's most complete range of 1-watt Zener regulators.*

**nae** *"first in reliability"*



**NORTH AMERICAN ELECTRONICS, INC.**

71 Linden Street, West Lynn, Mass.

TWA Lynn, Mass 805U LYnn 8-4800 AFFILIATE OF 

CIRCLE 107 ON READER-SERVICE CARD



## Metalized Bond Now Over 15,000 PSI

Advanced metalizing and brazing techniques at Coors now produce bond strengths better than 15,000 psi. Test parts, as shown above, are being considered for standard ceramic-to-metal test specimens by ASTM. These Coors test parts are run with each group of customer parts to guarantee specifications. Coors is presently metalizing and brazing parts of large mass and complex design, using these high strength techniques. For the newest techniques in high temperature, high strength ceramic-to-metal assemblies, write for Technical Data Sheet No. 0500, "How Ceramic-To-Metal Seals Are Made"—or call your nearest Coors Regional Sales Manager: WEST COAST, William S. Smith, Jr., EM 6-R129, Redwood City, Calif.; MIDWEST, John E. Marozek, FR 2-7100, Chicago, Ill.; CENTRAL, Donald Dobbins, GL 4-9618, Canton, Ohio; EAST COAST, John J. McManus, MA 7-3996, Manhasset, N.Y.; NEW ENGLAND, Warren G. McDonald, FR 4-0663, Schenectady, N.Y.; SOUTHWEST, Kenneth R. Lundy, DA 7-5716, Dallas, Texas; SOUTHWEST, William H. Ramsey, UN 4-6369, Houston, Texas.

# Coors

## ALUMINA CERAMICS

Coors Porcelain Co., Golden, Colo.



DETAIL OF  
METALIZED AREAS  
ON TERMINAL

## NEW PRODUCTS

### Reference Junction Compensator 648



Having all-welded components, the model CJ-1A reference junction compensator meets MIL-E-5272 environmental specifications. Long-term stability is  $\pm 5 \mu V$ . Individual channels can be stacked for multiple-channel operation. Power consumption is  $50 \mu W$  per channel. Units, epoxy-encapsulated, measure  $1/2 \times 1/4 \times 3/4$  in. and weigh less than 5 g. Standard units compensate for the chromel-alumel thermocouple curve.

G. B. S. Labs., Inc., Dept. ED, 18-06 126th St., College Point 56, N. Y.

### Insulated Terminals 598



Teflon terminal types include miniature and subminiature stand-offs and feed-throughs, receptacles, plugs, jacks, and probes. Terminals withstand temperatures from  $-100$  to  $+250$  C, and are made in a variety of colors.

Microdot Inc., Dept. ED, 200 Pasadena Ave., South Pasadena, Calif.

### Ceramic-Metal Housings 629



Withstand 1,700 F. Made for packaging power and controlled rectifiers, ceramic-to-metal housings are capable of withstanding

◀ **CIRCLE 108 ON READER-SERVICE CARD**



temperatures to 1,700 F. Shear strength is around 15,000 psi. Made of metallized alumina ceramic brazed to metal hardware, the devices offer a true hermetic seal.

Advanced Vacuum Products, Inc., Dept. ED, 430 Fairfield Ave., Stamford, Conn.

## Transfer Voltmeter 632



Operates to 30 mc. Transfer voltmeter model 393 measures ac voltages up to 50 v, from 25 cps to 30 mc, in terms of a dc voltage. Accuracy of transfer is 0.1% from 25 cps to 10 mc, and 0.5% to 30 mc.

Ballantine Laboratories, Inc., Dept. ED, Boonton, N. J.  
P&A: \$950; August, 1961.

## Transistor Sockets 373

Teflon socket No. 69012-0623 accepts TO-8 rf power transistors. The three tubular contacts are beryllium copper, silver-plated and gold-flashed. Socket 69012-0528 is made for Fairchild micrologic elements. Material is Teflon TFE; there are eight tubular contacts. Sockets are mounted by compression. Other types are available.

Garlock Electronic Products, Dept. ED, Camden, N. J.

## Two-Pin Connectors 353



Miniature connectors of series TM are made for cables with a common shield over a twisted pair, or for dual power leads. Saddle clamps are used for nonshielded wires; for shielded plugs, a collet clamp prevents rotation and increases retention by about 30 lb.

Cannon Electric Co., Dept. ED, 1943 Placenta Ave., Costa Mesa, Calif.

CIRCLE 109 ON READER-SERVICE CARD ►

# ENGINEERING NEWS-#8

## SIX PUSHBUTTON SWITCHES

CHECKED

*[Signature]*

ENGR.

*[Signature]*

CONTROL SWITCH DIVISION

### SUB-SUBMINIATURE

B7000 is only  $\frac{1}{2}$ " diameter,  $1\frac{1}{4}$ " total length. Available with a bushing or flange mounting. Flange can be engraved. Anodized aluminum case, plastic plunger cap and solder lugs. Rated 1 amp at 28 VDC. The perfect pushbutton for subminiaturized instruments and control panels.

### MOISTURE-PROOF, 6 CIRCUIT TYPES

W100 is available at S.P.S.T. (N.O. or N.C.), S.P.D.T., 2-circuit, and 3-terminal (N.O. or N.C.). Designed to MIL-S-6743, MS-25089. Completely moisture-proof and enclosed in anodized aluminum case with silicon rubber boot. Available with any of 8 mounting adapters (Adapter P shown) to meet any mounting or panel requirement. Rated 10 amps at 28 VDC resistive.

### LOW COST, U.L. LISTED

B2000 series switches are considerably smaller than standard  $\frac{1}{2}$  amp momentary pushbuttons, yet cost much less and actually are U.L. rated at 8 amps, 120 VAC. Select S.P.S.T. circuit either N.O. or N.C., with solder lugs or pigtail leads. Mounts in  $\frac{1}{2}$ " dia. hole.

### WITH OR WITHOUT LIGHT

WC1500 is a very small moisture-proof switch (designed to MIL-S-6743) with a minimum life of 25,000 operations at rated load. Available with or without indicator light in pushbutton, and rated at 2 amp ind. or 4 amp res., 28 VDC. D.P.D.T. or 4-circuit. Mounts in  $\frac{3}{8}$ " diameter panel hole.

### MOISTURE-PROOF, ALTERNATE ACTION

J3136 is a new moisture-proof switch originally designed for military ground support and aircraft equipment. Two-circuits, rated at 5 amp ind. or 10 amps res. at 28 VDC; 5 amp (.75 P.F.) ind. or 10 amp res. at 120 VAC. Life is 25,000 operations min. at rated load. Anodized aluminum case with solder lug terminals, and 8 styles of mounting adapters available. Mounts in  $\frac{3}{8}$ " dia. hole.

### 20 AMPS., PUSH-PUSH

J100 is a S.P.S.T. switch rated 20 amps res. at 28 VDC; 10 amps res. at 115 VAC. Ruggedly built to give compactness and durability under critical operating conditions. Weighs only 1 oz. Total plunger travel is only  $\frac{1}{4}$ ". Overall size: 1" diameter,  $2\frac{1}{2}$ " long.



The switches shown above are merely samples from the full line of CONTROL SWITCH pushbuttons. Perhaps one of these is a solution to a switching problem you face. If not, write for your free copy of CATALOG 100 for details on the wide range of switches available, including basic switches, toggles, lighted pushbuttons, indicator lights and many other types.



**CONTROLS COMPANY OF AMERICA**

**CONTROL SWITCH DIVISION**

Manufacturers of a full line of switches, controls and indicators for all military and commercial applications. All standard units stocked for immediate delivery by leading parts Distributors.

4216 W. Lake St. - Chicago 24, Ill. - Telephone Van Buren 6-3100 - TWX CG 1400

# Electronic Products **NEWS**

by **CARBORUNDUM**®



## New Dummy Antenna Load offered to ham operators

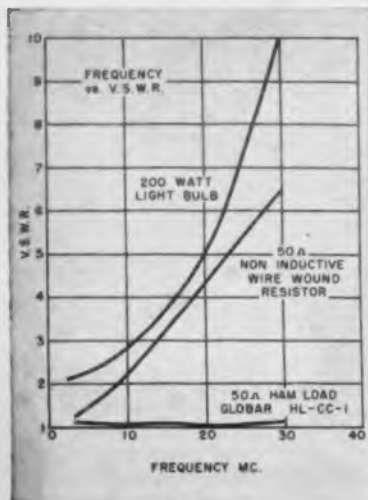

This new coaxial antenna impedance simulator HL-CC-1 was developed by Carborundum for use with ham radio equipment.

Specifications are: Short time power rating 250 watts (up to 5 min.); continuous rating 150 watts; V.S.W.R. 0-30 megacycles, 1.5 maximum.

With design changes, similar loads can be supplied for operation anywhere in the frequency range up to 1 kilo megacycle and for dissipating up to 1 Kw continuously.

Resistive component of the load is one of Carborundum's high temperature non-inductive resistors. It is furnished with coaxial terminations.

Available from electronic distributors, these ham antenna loads prevent radiation and interference while tuning, testing and making measurements.

For more information on Carborundum's dummy loads for other applications, write to Dept. EDL-91, Globar Plant, Refractories Div., Carborundum Co., Niagara Falls, N. Y.

Circle 774 on Reader-Service Card

## High Purity Crushable Ceramic Preforms meet Govt. Specs.



Crushable ceramic preforms for precision swaged thermocouples for atomic energy and turbine engine applications are available from Carborundum.

The following materials exceed the requirements of A.E.C. Specification SPC-SR-101-(ORO), Oak Ridge National Laboratories Specification ORNL Spec. 7444-1 and Knolls Atomic Power Laboratories ORPM 7-1.

1. High Purity Magnesium Oxide—Type 0333, certified purity 99.4% min. MgO and less than 25 ppm boron.
2. High Purity Fused Aluminum Oxide—Type 1513, certified purity 99.6% min. Al<sub>2</sub>O<sub>3</sub> and less than 2 ppm boron.
3. Stabilized Zirconium Oxide—Type 0956, certified purity 91.9% min. and less than 10 ppm boron.

Standard sizes are from .022 O.D. with holes from .005. Standard preforms are offered for 1, 2 and 4 hole applications. Others are available on request.

For Technical Data Sheet and other information contact Dept. EDP-91, Latrobe Plant, Refractories Div., Carborundum Co., Latrobe, Pa.

Circle 775 on Reader-Service Card

## Carborundum insulators make possible 5-yr. guarantee for Electronic Air Cleaner

Key to the operation of an electronic air cleaner made by The Electro-Air Cleaner Co., McKees Rocks, Pa., is the ionizing collecting cell shown here.

Insulators supporting the electrically charged plates are exposed to extreme conditions of dirt and moisture, yet must prevent high voltage leakage. The search for a suitable material ended with Carborundum's steatite insulators. Operation

is so successful that The Electro-Air Cleaner Co. is able to guarantee its product for a full five years.

Ceramic insulating materials and parts, including metallized ceramics and ceramic-to-metal assemblies, are specialties of Carborundum's Latrobe Plant. For more information, write Dept. EDC-91, Refractories Division, Carborundum Company, Latrobe, Pa.

Circle 776 on Reader-Service Card



For ceramic parts and metallized assemblies, Kovar alloy, ceramic resistors, varistors and thermistors . . . count on **CARBORUNDUM**

CIRCLE 774, 775, 776 ON READER-SERVICE CARD

## NEW PRODUCTS

### Electronic Timer

428



General purpose electronic timer is transistorized. Full-scale time ranges are 0.1, 1, 10 and 100 sec, with three models for choice of use as an interval timer, time delay relay or cycling timer. Repeat accuracy is 1% of full scale on all units. Load contacts are double-make double-break, rated at 25 amp, 120 v ac resistive or inductive. Designation is type 940.

Giannini Controls Corp., Cramer Div., Dept. ED, Centerbrook, Conn.

### Frequency Detectors

467

Expanded scale and linear versions are available in the Statitak line of frequency detectors. Units provide frequency or speed indication with an accuracy of  $\pm 0.25\%$  and a linearity of  $\pm 0.10\%$ . Filtered outputs of 0 to 5 v correspond to frequency ranges of 0 to 600, 0 to 2,000 and 0 to 6,000 cps in the linear version, and  $\pm 1$  v corresponds to  $\pm 20\%$  deviation in the 60- and 400-cps expanded-scale version.

Crydom Laboratories, Inc., Dept. ED, 12850 Western Ave., Garden Grove, Calif.

P&A: \$60 to \$108 for prototypes; 14 days.

### Data Conversion System

431



10,000 conversions per sec can be achieved with the 7320 system which is for digitizing analog information for direct entry into computers. It can also be used to prepare digital magnetic tape in computer format. Conversion accuracy is  $\pm 0.05\%$  or 1 mv, whichever is greater ( $\pm 1/2$  the least significant digit).

Monitor Systems Inc., Dept. ED, Fort Washington Industrial Park, Fort Washington, Pa.

**T**HE unique direct-carbon-transfer writing method produces a trace from 2 to 3 times finer than any other direct-writing technique. This allows twice as many lines per millimeter . . . **twice the definition!** Resolution is unsurpassed . . . each line is uniform in width and contrast, revealing the most minute variations in the phenomena measured with utmost fidelity. This writing technique combined with the advanced pen-motor design produces a wider frequency response at **larger amplitudes.** Continuous recording of data can be displayed simultaneously on 8 channels . . . up to 8 independent event markers can be added. Ten chart speeds — 0.1 to 500 mm/sec. — provide a 5000:1 chart speed ratio.

The AO Tracemaster has become the new standard of performance for these and many other reasons . . . write now for the full story!

see the **AO**  
**Trace-master**  
. . . plus other  
advance direct  
writing recorder  
instrumentation  
. . . at I. S. A.

**Booth 323**

CIRCLE 111 ON READER-SERVICE CARD



**AO Trace-master provides**  
**twice the definition**  
**of any other direct**  
**writing technique**

American  Optical  
COMPANY

INSTRUMENT DIVISION, LIMEFORD 13, NEW YORK

## NEW PRODUCTS

### Fluorescent Lampholders

433



Rated at 75 w, 250 v, the bi-pin lampholder is made for T-5 fluorescent lamps. Designed for 4-, 6-, 8-, and 13-w lamps, it measures 23/32 x 19/32 x 3/8 in. in depth. Lampholders are furnished with 6-in. No. 18 AWG 105 C AWM plastic wire leads. Other lengths and wire types are available on request.

Circle F Manufacturing Co., Dept. ED, 720 Monmouth St., Trenton, N. J.

### Copper Clad Laminate

471

Punching grade laminate has good flame retardancy and low water absorption. Identified as CuClad N-6009, this laminate combines the high electrical properties of regular XXXP copper-clad laminates with excellent punching and machining qualities. Designed for use in 105C Class applications.

Minnesota Mining & Manufacturing Co., Mica Insulator Div., Dept. ED, Schenectady 1, N. Y.

Price: \$0.84 per sq ft, for 500 sq ft or more; 1/16 in. thick with 1 oz copper on one side.

### DC Corona Tester

434



Voltage supply is 20 kv dc, corona-free. Model 5435 has a corona pickup filter network and detector. Voltage pattern of corona discharge is displayed on a built-in oscilloscope. A vacuum bell jar allows simulated high altitude testing of insulating materials, cables, components and assemblies. Output is metered in ranges of 0 to 5,000 and 0 to 20,000 v, and 0 to 50 to 500 and 0 to 5,000 ma leakage current.

Associated Research, Inc., Dept. ED, 3777 W. Belmont Ave., Chicago 18, Ill.

Extra quality at no extra cost with Bendix Semiconductors

# Bendix Bulletin

## HOW TO GET IMPROVED PERFORMANCE IN SWITCHING CIRCUITS

*Bendix 2N1008 medium-power, medium-speed series solving design problems on wide front*

Called the "workhorse of the transistor industry," the new Bendix\* Driver Transistor series is winning the nod from more and more engineers daily. These men find it the answer to audio frequency and switching applications requiring extra performance.

The Bendix units combine higher voltage rating and high current gain with more linear current gain characteristics for low distortion and more efficient switching.

It is this kind of extra quality—combined with exceptional dependability and versatility—that's making these special Bendix devices the choice of more and more design engineers every day in answering audio frequency and switching application needs. Further advantages: Cost is low, and delivery in JEDEC TO-5 packages is fast.

For full details, write BENDIX SEMICONDUCTOR PRODUCTS, HOLMDEL, NEW JERSEY. \*TRADEMARK

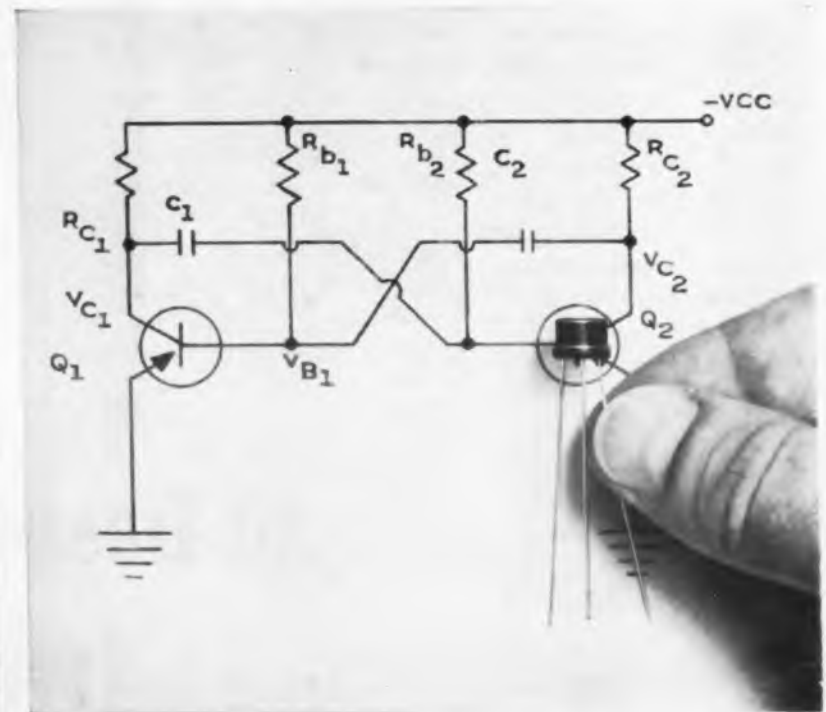

Typical Bendix 2N1008-equipped multivibrator circuit used in digital computers as a frequency divider, and in other medium-speed triggering applications.

### APPLICATION, PERFORMANCE DATA INDICATE BROAD USAGE

TYPE NUMBERS	MAXIMUM RATINGS					TYPICAL OPERATION		
	Vce	Ic	Pc	Tj	T storage	hfe	fcb	Vce (Sat)
	Vdc	mAdc	mW	°C	°C	Ic=10 mAdc	Ic=100 mAdc Ib=10 mAdc	
2N1008	-20	300	400	85	-65 to +85	90	1.2 mc	0.15 Vdc
2N1008A	-40	300	400	85	-65 to +85	90	1.2 mc	0.15 Vdc
2N1008B	-60	300	400	85	-65 to +85	90	1.2 mc	0.15 Vdc
2N1176	-15	300	300	85	-65 to +85	65	1.2 mc	0.15 Vdc
2N1176A	-40	300	300	85	-65 to +85	65	1.2 mc	0.15 Vdc
2N1176B	-60	300	300	85	-65 to +85	65	1.2 mc	0.15 Vdc

Ideal for such applications as:

**TRANSISTOR DRIVER • AUDIO AMPLIFIER (CLASS A OR B)  
POWER SUPPLY • SERVO CONTROL • AUDIO OSCILLATOR  
MOTOR CONTROL • RELAY DRIVER • POWER SWITCH**

### BENDIX SEMICONDUCTOR DIVISION

HOLMDEL, NEW JERSEY



Main Office: South Street, Holmdel, N. J.—Ph: SM 7-5400  
• New England Office: 114 Waltham, Lexington, Mass.—Ph: VO 2-7650 • Detroit Office: 12950 West 8 Mile Road, Detroit 37, Mich.—Ph: JO 6-1420 • Midwest Office: 2N565 York Rd., Elmhurst, Ill.—Ph: BR 9-5050 • West Coast Office: 117 E. Providence Ave., Burbank, Calif.—Ph: VI 9-3961 • Canadian Affiliate: Computing Devices of Canada, P.O. Box 508, Ottawa 4, Ont. • Export Office: Bendix International, 205 E. 42nd Street, New York 17, N.Y.

CIRCLE 112 ON READER-SERVICE CARD

ELECTRONIC DESIGN • September 13, 1961

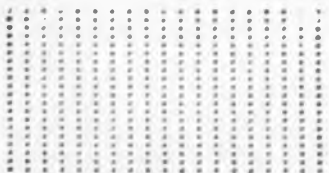

**SEMICONDUCTORS NOW  
AVAILABLE FROM  
DISTRIBUTOR STOCK IN  
QUANTITIES UP TO**

**999**

**FACTORY PRICES APPLY!**

**ATLANTA, GA.**  
Ack Radio Supply Co.  
331 Luckie St., N.W.—JACKSON 4-8477

**BALTIMORE, MD.**  
Electronic Wholesalers  
3004 Wilkens Ave.—WILKENS 5-3400

**BIRMINGHAM, ALA.**  
Ack Semiconductors, Inc.  
3101 Fourth Ave.—FAIRLAX 2-0588

**BOSTON, MASS.**  
Cramer Electronics  
811 Boylston St.—COPLY 7-4700

**BUFFALO, N. Y.**  
Summit Distributors  
916 Main St.—TT 4-3450

**CHICAGO, ILL.**  
Newark Electronics  
223 W. Madison St.—STATE 2 2944

**DETROIT, MICH.**  
Rissi Electronic Supply  
14405 Wyoming Ave.—TEXAS 4-8420

**GLENDALE, CALIF.**  
R. V. Weatherford Co.  
6921 San Fernando Rd.  
VICTORIA 9-2741

**LOS ANGELES, CALIF.**  
Radio Product Sales  
1501 S. Hill St.—RICHMOND 8-1271

**MELBOURNE, FLA.**  
Electronic Wholesalers  
1301 Hibiscus—PARKWAY 3-1441

**MIAMI, FLA.**  
Electronic Wholesalers  
61 Northeast Ninth St.  
FRANKLIN 7-2511

**NEW YORK, N. Y.**  
Milgray—New York  
136 Liberty St.—RECTOR 2-4400

Milo Electronics  
530 Canal St.—BEEKMAN 3-2980  
Terminal—Hudson  
236 W. 17th St.—HELSEA 3-5200

**OAKLAND, CALIF.**  
Elmar Electronics  
140 11th St.—HIGATE 4-7011

**PHILADELPHIA, PA.**  
Radio Electric Serv. Co.  
701 Arch St.—WALNUT 5-5840

**SEATTLE, WASH.**  
Seattle Radio Supply, Inc.  
2117 Second Ave.—MAIN 4-2341

**WASHINGTON, D. C.**  
Electronic Wholesalers  
2345 Sherman Way, N.W.  
HUDSON 3-5200

Bendix Semiconductor Division



HOLMDEL, N. J.

CIRCLE 113 ON READER-SERVICE CARD

ELECTRONIC DESIGN • September 13, 1961

## AC Potentiometer

389



Ten-turn ac potentiometer, called size-9 Ver-nistat, has a 30,000-ohm input impedance, a 160-ohm output impedance, and a 0.2-mv per v quadrature at 400 cps. A tapped autotransformer is said to provide precise voltage ratios, linear to 0.05%. A precision potentiometer permits interpolation between tapped voltages. Unit is made for servo, computer, guidance, and fire-control systems.

Perkin-Elmer Corp., Dept. ED, Norwalk, Conn.

## Electron Beam Welder

470

Operating with 15,000 w, a wide range of spot sizes is available, from 0.020 to 2 in. Unit welds wafer-thin materials such as tungsten and molybdenum and their alloys, as well as ingots or compactions. Gun pressure of 0.05 microns can be sustained with chamber pressures as high as 10 to 25 microns. Chamber system can be evacuated to a pressure of  $10^{-4}$  mm Hg for continuous welding.

Electro-Glass Laboratories, Inc., Dept. ED, Beaverton, Ore.

## Millivolt Discriminators

424



For automatic testing, process control and other applications, models 710 and 711 are stable, light-modulator dc amplifiers operating a thyratron tube and relay. They are identical except for the means of adjusting the trip level from 0.2 to 10 mv. Uses also include go, no-go automatic control applications.

Keithley Instruments, Dept. ED, 12415 Euclid Ave., Cleveland 6, Ohio.

P&A: model 710 \$450, model 711 \$470; 60 days.



here — at last  
is real stability!

## 0.01% total — from this new transistorized power supply

Add up *all* the factors: line and load regulation of 0.0005%; short-term drift of 0.001%; and, hum and noise of 50uv rms. Result: total stability of 0.01%!

Krohn-Hite's new Model UHR-T361 transistorized power supply is an important new bench supply for development, measurement and research. Its phenomenal stability also makes it ideal for component tests, and powering computer circuits.

Voltage range: 0-36 volts. Current: 0-1 ampere. AC output impedance: 250 microhms. Transient response: 25 usec. Line voltage: 115/230; 50-400 cps.

The extremely tight line and load regulation of the Model UHR-T361, plus its remote sensing feature, permit remote operation with better regulation at 100 feet, 0.001%, than most other supplies at their terminals. The supply also features remote voltage control for automatic programming.

Constant voltage or constant current can be obtained from this supply. The voltage is constant under pulsed or steady-state resistive or reactive loads. The current is constant to within 0.01%.

Krohn-Hite's new UHR-T361 is convection-cooled, and fully protected against short-circuit, overvoltage, overtemperature, and on/off voltage surges.

Get full information on the UHR-T361, and the 3, 5, and 10 amp Krohn-Hite transistorized power supplies.



### KROHN-HITE CORPORATION

580 Massachusetts Avenue • Cambridge 39, Mass.

Pioneering in Quality Electronic Instruments

CIRCLE 114 ON READER-SERVICE CARD

# WRAP-AROUND MAGNETIC SHIELDS

APPLIED IN SECONDS

*Economical*  
**CO-NETIC & NETIC**

*Magnetic Shielding Foils*

For Any Size or Shape Components



Netic and Co-Netic foils are universally used as an evaluation tool; ultimately, as a production solution. Available in continuous lengths on rolls up to 15" wide . . . for human production line or to fit automated existing reels of your tape serving machinery. Furnished in final annealed state ready for your operation.

## HOW YOU SAVE SPACE, WEIGHT, TIME, MONEY

Minimum weight and displacement shielding designs are possible due to the magnetic shielding effectiveness of Co-Netic and Netic foils . . . foils can be supplied FROM .002", even thinner if you desire. Ordinary scissors cut foil easily to exact contour and size required. Foil can be wrapped quickly around hard-to-get-at components, saving valuable time, minimizing tooling costs.

## HOW TO INCREASE RELIABILITY

Guard against performance degradation from unpredictable magnetic field conditions to which your equipment may be exposed. Eliminate such failure or erratic performance possibilities with dependable Co-Netic and Netic protection . . . assuring *performance repeatability* for your device over a *wider range* of magnetic field conditions.

Co-Netic and Netic alloys are not affected significantly by dropping, vibration or shock. They are characterized by low magnetic retention and do not require periodic annealing. When grounded, they effectively shield electrostatic as well as magnetic fields over a wide range of intensities.

Every satellite and virtually all guidance devices increase reliability with Netic and Co-Netic magnetic shielding alloys. Use these highly adaptable foils for saving valuable space, weight, time and money . . . in solving your magnetic shielding problems for military, commercial and laboratory applications.

## PHONE YOUR NEAREST SALES OFFICE TODAY:

BALTIMORE, MARYLAND, HOplins 7-3766  
UNION CITY, NEW JERSEY, UNion 4-9577  
MERIDEN, CONNECTICUT, BEverly 7-9232  
MIAMI, FLORIDA, Highland 4-1118  
DALLAS, TEXAS, Fleetwood 1-1615  
ALBUQUERQUE, NEW MEXICO, AMherst 8-6797  
LOS ANGELES, CALIFORNIA, WEbster 1-1041

PALO ALTO, CALIFORNIA, DAVenport 1-5064  
SAN DIEGO, CALIFORNIA, ACADEmy 4-1717  
SEATTLE, WASHINGTON, EAst 3-8545  
PHOENIX, ARIZONA, AMhurst 4-4934  
HOUSTON, TEXAS, HOmestead 5-7780  
WESTMOUNT, MONTREAL, QUEBEC  
WELLington 7-1167

# MAGNETIC SHIELD DIVISION

Perfection Mica Company

1322 N. ELSTON AVENUE, CHICAGO 22, ILLINOIS

*DIVISION OF PERMANENTLY EFFECTIVE NETIC CO-NETIC MAGNETIC SHIELDING*

CIRCLE 115 ON READER-SERVICE CARD

## NEW PRODUCTS

### Power Supplies 354



Automatic overvoltage protection feature of 7500 series power supplies operates within 50  $\mu$ sec. for internal or external malfunctions. Regulation is 0.01%, ripple 1 mv. Standard transistor models provide 0 to 36 v dc at up to 50 amp.

Systems Research Corp., Dept. ED, 7635 Tobias Ave., Van Nuys, Calif.

*P&A: \$400 up; 4 to 6 weeks.*

### Crimping Tool 357



Portable pneumatic crimping tool handles No. 20 through No. 12 contacts, producing a crimp equivalent to Class I, MIL-T-22520. The four-indent crimp assures positive mechanical and electrical connections. Magazine holds up to 102 contacts. Weight is 5 lb.

Corp., Dept. ED, Hillside, N.J.  
Buchanan Electrical Products

### Heading Indicator 355



Variation control indicator C-3335/AJN is a navigation aid made for military aircraft. Calibrated in degrees, the indicator converts magnetic heading to true heading. Size is 3-1/2 x 3-1/2 x 7-1/2 in. long. Unit conforms to MIL-T-5422C.

Temec, Inc., Dept. ED, 7833 Haskell Ave., Van Nuys, Calif.

### High-Low Chamber 633



Cascade refrigeration system and resistance heating units provide temperature ranges from -100 to +350 and +500 F. Freon coolant is used. Test space sizes are 2, 3, 8, 27 and 64 cu ft. Interior sleeves and walls are of welded stainless steel.

Bemco Inc., Dept. ED, 9908 San Fernando Road, Pacoima, Calif.

*P&A: \$1,925; 4 to 6 weeks.*

### Encoder Readout Systems 371

Used with comparators, encoder readout systems have resolution of 1 part in 3 million. Encoder package measures 3-1/2 in. OD by 5-3/4 in. long. Storage and translation unit is rack-mounted. Outputs can be provided to operate an in-line readout, tape punch, data-logging typewriter, or other device.

Wang Laboratories Inc., Dept. ED, Natick, Mass.

### Crystal Oscillator 367



Transistorized, packaged crystal oscillator provides 1 v (into 1.5 K) at 1 mc for reference and time-base applications. Stability over 0 to 60 C is 1 in 10 million. Unit requires 27 v dc; ac or dc heater voltage is 115 v, model CCO-72SA, or 27 v, model CCO-72SD.

Bliley Electric Co., Dept. ED, Union Station Bldg., Erie, Pa.

*Availability: Immediate.*



## Frequency Sensor

623

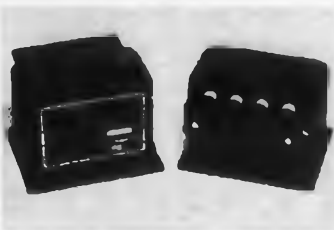

Static frequency sensing controller PA 2143 provides relay actuation at  $310 \pm 10$  cps on increasing frequency, drop-out at  $305 \pm 5$  cps on decreasing frequency. Input is 102 to 124 v rms line-to-neutral, three phase, four wire, 0 to 550 cps. Qualification testing includes operation to 125 C.

Power Instruments Corp., Dept. ED, 235 Oregon St., El Segundo, Calif.

P&A: \$225; 3 weeks.

## Solid-State Generator 474

Weighing 1 g in size 2 (type 201) and 7 g in size 5 (type 501), solid-state generator produces a sine wave output as a function of shaft angle. Supply current is 10 to 200 ma continuous, ac or dc; output is 0.01 mv per ma. Operating temperature range is  $-55$  to  $+200$  C. Maximum speed is over 10,000 rpm.

The Omnite Co., Dept. ED, P. O. Box 491, Westminster, Calif.

## Servo Potentiometers 592



Rated at 1 to 4.5 w, precision servo potentiometers can be ganged to at least five sections. All have anodized aluminum cases and servo mountings or standard bushings. Model 9, with ranges to 50 K, has linearity of  $\pm 0.25\%$ , rating of 1 w. The 2-w model 15 provides linearity of  $\pm 0.1\%$  in ranges to 250 K. Model 20, rated at 4.5 w, has ranges to 400 K, linearity tolerance of  $\pm 0.1\%$ .

Hoffman Electronics Corp., Dept. ED, 3761 S. Hill St., Los Angeles, Calif.

CIRCLE 116 ON READER-SERVICE CARD ►

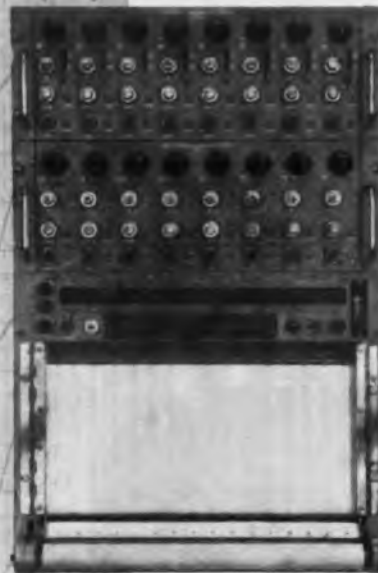

... with Sanborn® High, Medium or Low Gain 8-Channel Amplifiers and Flush-Front Recorder in only 32" of panel space

In the 32" panel space version, Sanborn 16-channel direct writing systems use a flush-front 358-16 Recorder and any two "950" series 8-channel amplifiers — available in transistorized high and medium gain types with floating and guarded inputs, low gain with high resistance balanced to ground inputs. Max. sensitivities are 20 uv/mm, 1 mv/mm and 20 mv/mm for high, medium and low gain systems. Frequency response ranges for the three are 100, 125 and 125 cps. Recorder has 9 chart speeds, 8" of visible record, inkless recording in true rectangular coordinates on Sanborn Permapaper® charts.

# RECORD 16 VARIABLES

on a single 16" chart

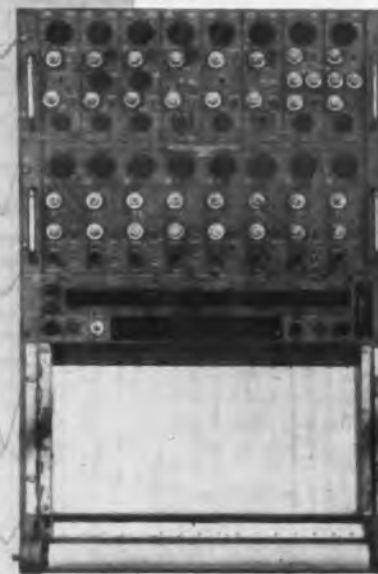

... with 8 channels identical, 8 more with miniature plug-in preamplifiers for greater flexibility

Eight interchangeable, plug-in "850" preamplifiers, each with 7" x 2" panel, plug into chassis with common power supply. Available types are Phase-Sensitive Demodulator, DC Coupling, Carrier and Low Level; MOPA available for Carrier and Low Level excitation. Frequency response is DC to 125 cps, 3 db down at 10 mm peak-to-peak depending on type of preamplifier. Linearity is better than 0.5%. Inputs are single-ended, floating and guarded, or push-pull, depending on type of "850" preamplifier used. Remaining eight channels can comprise any 8-channel "950" amplifier.

With each of these systems, you have a choice of vertical or horizontal chart plane recorders. Flush-front vertical recorder ("350" style) has electrical speed shift, requires only  $17\frac{1}{4}$ " vertical panel space. Horizontal recorder facilitates viewing and making notations on record, occupies  $21\frac{1}{2}$ " of panel space, has mechanical speed shift. Both recorders have velocity feedback-damped galvanometers . . . automatic stylus heat control . . . separate timer/marker stylus . . . inkless direct writing on quick loading, rectangular coordinate charts with 20 mm wide channels.

For complete specifications and application engineering assistance, contact your nearest Sanborn Sales-Engineering Representative. Offices throughout the U. S., Canada and foreign countries.

 INDUSTRIAL DIVISION

**SANBORN  
COMPANY**

175 Wyman St., Waltham 54, Mass.

SEE THIS EQUIPMENT AND OTHER SANBORN OSCILLOGRAPHIC RECORDING SYSTEMS AT BOOTHS 2014 AND 2016, WESCON SHOW, AUG. 22-25.

At Macarr Inc....

# where dependability comes first



## **RED/LINE** timing relays "Pay Off"!

After trying several other time delay devices in their automatic control equipment for carbon arc lamps, design engineers at Macarr Inc. turned to G-V Red/Line Timing Relays. By holding in a current limiting resistor in the circuit until the arc had struck, the Red/Line Relay provides complete continuity of operation and lengthens the life of the DC power supply feeding the carbon arc. As an added advantage, it also facilitates smooth, soft starting of the carbon arc. So, at Macarr, the high quality of G-V Red/Line Timing Relays is "paying off".



More and more companies are finding the reliable performance of G-V Red/Line Timing Relays makes them best for their products. G-V Red/Line Relays will "pay off" in your product, too. Your customers appreciate the importance of high quality, reliable components. G-V Red/Line Timing Relays are specially designed for industrial applications. They have the precision, reliability and long life needed to "pay off" in industrial use.

Your G-V distributor has them in stock now. Call him or write for Bulletin 131 today.



**G-V CONTROLS INC.**  
Livingston, New Jersey

## NEW PRODUCTS

### Linear Transducers

437



Designed for 400-cps operation, this line of universal linear displacement transducers can be used from 60 to 6,000 cps. Six models offer input voltages from 12 to 115 v with input impedances from 150 to 5,500 ohms. Outputs range from 10 to 35 v. Weight is 2-1/4 oz.

Dynamic Measurements Co., Dept. ED, Terwood Road, Willow Grove, Pa.

### Circuit Modules

376

Solid-state encapsulated circuits include flip-flops, gates, inverters, amplifiers, emitter followers and pulse generators. Switching speed is 500 kc. The nine-pin plug-in package measures 0.75 in. high.

Peninsular Electronics Corp., Dept. ED, 3510 S. Orange Ave., Orlando, Fla.

### Insulated Wire

375

Teflon insulated wire is available in long lengths, in all standard colors, with or without stripes, solid and stranded conductors, in gages 20 through 26. Temperature rating is 200 C.

Philadelphia Insulated Wire Co., Dept. ED, Moorestown, N. J.

### High-Temperature Resistors

435

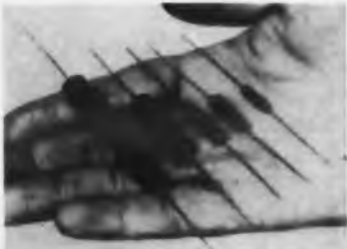

Coefficients of 25, 50 or 100 ppm/C are available. Resistors are encapsulated in a high temperature, nonflammable black epoxy shell. Line meets MIL-R-10519C RN60 to RN80. Designation is Noble-Met.

American Components, Inc., Dept. ED, 8th Ave. and Harry St., Conshohocken, Pa.

P&A: \$1.55 to \$0.55; two weeks.

8001

Noble-Met resistors are available in a wide range of values and tolerances. They are available in a variety of packages for use in a wide range of applications. For more information, contact Noble-Met at 10000 Conshohocken Ave., Conshohocken, Pa. 19348.

Noble-Met Commercial and Industrial Division

CIRCLE 118 ON READER-SERVICE CARD

CIRCLE 117 ON READER-SERVICE CARD

## Germanium Transistors 362



Diffused-junction mesa switching transistors 2N968-2N975 permit simplified logic circuit design through a wide selection of parameters. Turn-off time (in transistor-resistor logic) is 150 to 275 nsec;  $BV_{CBO}$ , 7, 12 and 15 v;  $h_{FE}$ , 20 and 40.

Motorola Semiconductor Products Inc., Technical Information Center, Dept. ED, 5005 E. McDowell Road, Phoenix 8, Ariz.

Price: \$0.80 to \$3.05 ea, 100 to 999.

## Polyurethane Resin 475

High-dielectric polyurethane resin Poly U is suitable for potting and encapsulation. Cure time at room temperature is 4 hr; material cures without excessive voids or shrinkage, and may be used in foam formulations.

Isochem Resins Corp., Dept. ED, 221 Oak St., Providence 9, R. I.

Price: \$7.50, sample kit.

## Epitaxial Transistors 361

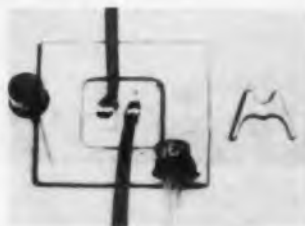

Germanium epitaxial mesa transistors 2N960-2N962 and 2N964-2N966 are suitable for virtually all high-speed switching applications. Maximum turn-off time is 85 to 100 nsec;  $BV_{CBO}$  is 15 and 12 v;  $h_{FE}$  at 10, 50, and 100 ma is 20 or 40. Housed in TO-18 packages, the devices operate in both high- and low-current circuits.

Motorola Semiconductor Products Inc., Technical Information Center, Dept. ED, 5005 E. McDowell Road, Phoenix 8, Ariz.

Price: \$2.95 to \$4.25 ea, 100 up.

CIRCLE 119 ON READER-SERVICE CARD ➤

Another CMC First...

# 100 mc SOLID STATE Universal Counter-Timer



WEIGHT 25 LBS.

### KEY SPECIFICATIONS

#### FREQUENCY

0 cps to 100 mc

#### TIME INTERVAL

0.02  $\mu$ sec to  $10^3$  sec

#### PERIOD

0 cps to 10 mc

#### INPUT SENSITIVITY

1.0v rms

#### GATE TIMES (FREQUENCY)

1  $\mu$ sec to 10 sec in 8 decade steps or external. Reads in cps, kc, mc.

#### FREQUENCY OUTPUTS

0.1 cps to 1 mc output in decade steps

#### ACCURACY

$\pm 1$  count  $\pm$  stability  
 $\pm 10$  nanosecond  $\pm$  stability

#### STABILITY

Short term:  $\pm 1$  part in  $10^4$   
Long term: within 5 parts in  $10^4$

#### PRICE, F.O.B. FACTORY

\$3,950; inline readout \$200 extra

\* SEVEN BASIC FUNCTIONS, including dc to 100 mc frequency measurements without heterodyning techniques \* Time interval measurements with 10 nanosecond resolution \* Straight or totalizing counting \* Frequency ratio measurement \* Period measurement \* Sensitivity better than 1.0v rms \* Power consumption 50 watts \* Decade count-down time base (no adjustments necessary) \* Two year free service warranty \* No vacuum tubes \* Connector on rear providing standard 1-2-4-8 BCD output for operating printer, punch, etc.

Model 728B is a production unit, not a showpiece prototype. Demonstrators are now in the hands of CMC engineering reps. Call, wire or write to arrange a demonstration. Complete technical data plus a copy of our new 20 page short form catalog is yours for the asking.

CMC

Computer  
Measurements  
Company

12970 BRADLEY AVENUE • SAN FERNANDO, CALIFORNIA  
EMPIRE 7-2161

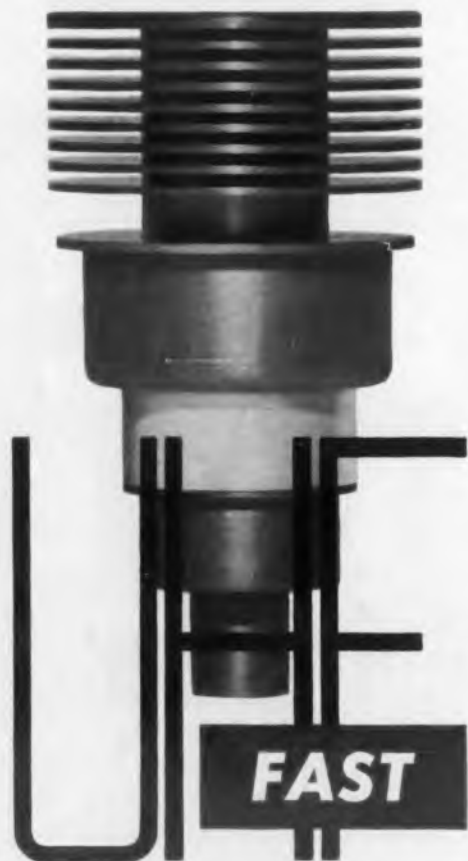

## Frequency Stabilization ML-7855

Special anode design of ML-7855 permits frequency stable operation within 10-15 seconds after application of high voltage. (Frequency change during this initial period is less than 1 mc).

ML-7855 provides frequency stable operation with unregulated supply — change in plate dissipation has no effect upon frequency.

**CW operation** to 2500 mc, with 1000 V Ebb, 100 ma Ia.

**Plate-pulsed** to 3000 mc, with 3500 v eb, 3.0 a Ib, with a tp of 3 usec at 0.0025 Du.

Send for UHF brochure



CIRCLE 120 ON READER-SERVICE CARD

## NEW PRODUCTS

### Nuclear Delay Timer

382



Uniaxial acceleration of 2 to 2.8 g applied over a specified time period from 15 to 35 sec will actuate the model D5307 nuclear delay timer. Should the acceleration fall below the specified level before the time period expires, the timer resets itself. Unit is small, light weight, and sealed. Shelf life is 10 years.

Leesona Corp., Dept. ED, 90-28 Van Wyck Expressway, Jamaica 18, N. Y.

### Damping Device Kit

469

Over 15 damping effects can be set up and observed with this kit. Designated Airpot, the kit offers two-way, one-way pull and one-way push damping modes. Each Airpot is constructed of a low-expansion glass cylinder fitted with a carbon piston to tolerances closer than 0.0002 in. A choice of five different coupling springs to link damping action to a device is offered.

Electric Regulator Corp., Dept. ED, Pearl St., Norwalk, Conn.

Price: \$19.95.

### Recording Wave Analyzer

390



Waveforms from 20 to 20,000 cps are analyzed in three decades by the model 800 recording wave analyzer. The amplitude of all frequency components in any waveform is measured and recorded. Full-scale sensitivity ranges from 15 mv to 6 v. Frequency accuracy is within 3%; amplitude accuracy, 5%. Chart is pre-calibrated for electrical, acoustic, and displacement inputs.

Optron Corp., Dept. ED, 335 S. Salinas St., Santa Barbara, Calif.



## FLOWS AT IDEAL RATE, LEAVES NO SOLDERING RESIDUES

Non-corrosive HYDRAZINE FLUX,\* used industry-wide in liquid form, has now been incorporated into core solder. This fast, efficient flux vaporizes completely at soldering temperatures. It leaves no residue which would support fungus growth. Will not corrode.

In H-32 core solder for the first time, HYDRAZINE FLUX offers more advantages than ever. When flux is normally applied, far more than is actually needed is used. Now, the exact ratio of flux to solder provides for proper wetting. Thereafter the flux decomposes and is eliminated. Cleaning and production time are saved.

TEST HYDRAZINE FLUX AND CORE SOLDER in your own plant. Write for samples of either H-Series Fluxes or H-32 core-solder form and technical literature.

\*U.S. Patent No. 2,612,459

Available only from Fairmount and its sales agents:

**Fairmount**  
CHEMICAL CO., INC.  
136 Liberty St., N. Y. 6, N. Y.

CIRCLE 121 ON READER-SERVICE CARD

**Now!**  
new  
economies in **NYLON GEARS**  
means savings in gear costs up to 90%

Our many years of successful production of Nylon Gears can now make even greater economies for you. With the great variety in molds now possible, Nylon should not only be considered as an economy measure but the answer to many problems where compact design is necessary. Nylon Gears are quiet, durable, efficient and need less lubrication — they mate perfectly with metal gears. Let our engineers with more than a decade in gear experience consider your gear problems **DURING** the design process — send blueprints or specs for prompt estimates. Gears made only to your specifications. None carried in stock.

106  
**PROCESS GEAR CO., INC.**  
3305 W. Newport Ave. • Chicago 18, Illinois

CIRCLE 122 ON READER-SERVICE CARD

ELECTRONIC DESIGN • September 13, 1961



# TOROIDS

**We specialize in heavy wire TOROIDAL COMPONENTS—magamps, transformers, etc.**

Equipped with the largest selection of winding machines, **UNIVERSAL** offers coils from 1/16" Fin. I.D. up to 30" O.D.

**WIRE RANGE FROM #2—#50.**

We also offer "Pot" Windings and Encapsulated Construction to MIL T-27A.



**UNIVERSAL TOROID COIL WINDING, INC.**

171ED Colv Street  
Irvington 11, N. J.  
ESsex 4-9804

The most COMPLETE line of TOROIDAL equipment in the world.

CIRCLE 123 ON READER-SERVICE CARD



**HAMLIN**  
electrical and  
electronic  
components

ACTUAL SIZE

ACTUAL SIZE

**MAGNETIC REED SWITCHES**

Operate in any position — hermetically sealed — use in wet, dry, or "explosive" atmosphere. Not affected by high or low temps. Compact, rapid cycling, long life.

**GRAVITY SENSING ELECTROLYTIC POTENTIOMETER**

Excellent for gyroscope correction mechanisms. Not materially affected by vibrations. Keeps "hunting" to minimum. Compact — extremely accurate.

**MERCURY SWITCHES**

Many design ideas. Super-sensitive — sealed against trouble. Select from huge variety of electrical and operating characteristics, contacts, lead and terminal arrangements. Custom designs upon request.

**Specify HAMLIN**

for systems to indicate or integrate functions of: RPM's thru circuits • TIME • MOTION • MEASUREMENT • TEMPERATURE • POSITION • SEQUENCE • FLOW • PRESSURE • LIQUID LEVEL

**Specify HAMLIN**

if you manufacture: TEMP. or FLOW CONTROLS • IND. PROCESS CONTROLS • ALARM DEVICES • GYROSCOPIC INSTRUMENTS • AUTOMATION • ATOMIC POWER REACTORS • RELAYS

SEND FOR BULLETIN  
**HAMLIN** INC.

DEPT. ED • LAKE and GROVE STREETS • LAKE MILLS, WISCONSIN

CIRCLE 124 ON READER-SERVICE CARD

ELECTRONIC DESIGN • September 13, 1961

## Forced-Air Heat Dissipator

388



Ten semiconductors are handled by the model FA-71 forced-air heat dissipator. The unit, 12 in. long, dissipates 780 w. Blower and thermostat-controlled air switches are built in. Made of aluminum, dissipators have a thermal resistance of about 0.25 C per w. Lengths of 6 to 24 in. are available.

Vemaline Products Co., Dept. ED, Franklin Lakes, N. J.

P&A: \$75.00; two to four weeks.

## Transistor Heat Dissipator

383



Press-fit transistor heat dissipator, type TXBP-050-037, fits on TO-8 transistor cases from 0.48 to 0.51 in. in diameter. Unit is suitable for printed-circuit board, chassis, or heat-sink mounting. Made of beryllium copper, the device has an insulube or black cadmium finish.

International Electronic Research Corp., Dept. ED, 135 W. Magnolia Blvd., Burbank, Calif.

P&A: \$0.80 to \$1.65; from stock.

## Process Monitor

447



Ten points of any process variable measurable by transducers generating dc millivolt outputs or changes in resistance are monitored. Scanning speeds available are from 1 to 10 sec per point. Ten red lights indicate scanning position. Calibration accuracy is 0.25% of full scale span. Sensitivity is 1  $\mu$ v, independent of scale span.

Thermo Electric Co., Inc., Dept. ED, Saddle Brook, N. J.

# TELONIC HD-1A Sweeps RF, IF, and Video



With the Telonic HD-1A Sweep Generator you can now cover frequencies from 1 to 900 megacycles with a single instrument for both the laboratory and the production line. The HD-1A provides continuously variable center frequency selection, a built-in 0 to 50 db attenuator, external marker input, and provisions for up to eight plug-in fixed markers.

The military type sweep unit used in the HD-1A assures a service life of 5 years, plus, and features excellent stability even at minimum sweep width. Flatness is  $\pm 5\%$  and display linearity better than 1.2:1.

Priced at only \$995.00, the HD-1A is widely used in design and manufacturing of IF and RF amplifiers, broad-band video equipment, and other devices requiring broad center frequency testing. Function-wise, it will normally replace a number of ordinary signal or sweep generators. Full details on Bulletin T-209A.

*Telonic* INDUSTRIES, INC.

BEECH GROVE, INDIANA — PHONE STATE 7-7241

NEED ONE NOW? 24 HOUR DELIVERY VIA  
TELONIC JET ORDER SERVICE

CIRCLE 125 ON READER-SERVICE CARD

*when reliability is  
designed into a component,  
it costs no more!*



## Aladdin DURA-CLAD and other standard Aladdin TRANSFORMERS

for applications in

- Data Processing Equipment
- Missile Guidance
- Automatic Controls
- Multiplex Telephone Systems
- Telemetry Interstage Coupling

Aladdin DURA-CLADS are designed for reliability and made on automatic machinery.

The DURA-CLADS and other Aladdin transformers are used at frequencies from 20 CYCLES to 30 MEGACYCLES.

*For a free sample to try on for size, (infinite impedance—ie., no windings), check No. 249 on the Reader-Service card in this issue.*

**NOW AVAILABLE:** The Aladdin Transformer Encyclopedia. Write for your copy on company letterhead to:

 **Aladdin ELECTRONICS**  
A Division of Aladdin Industries, Inc.  
Nashville 10, Tenn.  
PULSE AND WIDE-BAND TRANSFORMERS AND INDUCTORS  
CIRCLE 249 ON READER-SERVICE CARD

## NEW PRODUCTS

### Plug-In DC Amplifier

379



Drift is limited to 3 mv for temperature variations up to 120 F by the model 205 plug-in solid-state dc amplifier. At constant ambient temperature, drift is  $\pm 0.25$  mv. Amplifier has a gain of  $10 \pm 2\%$ , a frequency response from dc to 100 kc, 5% down. Distortion is less than 1% at rated output; peak-to-peak output voltage is 5 v. Unit has an octal base with mounting holes, and measures 2 x 2-7/8 x 1-3/8 in.

Quan-Tech Laboratories, Inc., Dept. ED, Boonton, N. J.

P&A: \$105.00; in production quantities.

### Two-Channel Recorder

393

Chart speeds of 3/4 in. per hr to 3 in. per sec are available on the model 602 two-channel recorder. Full-scale sensitivities of 50  $\mu$ a to 10 amp are provided. The upper 25% of the range can be expanded over 80% of the scale. Center-zero operation is available. Accuracy is 1% to 2%. An electromagnet-operated event pen is mounted in the margin.

Estertine Angus Instrument Co., Inc., Dept. ED, P. O. Box 596, Indianapolis 6, Ind.

### RC Ratio Bridge

380



For testing resistors, capacitors, and transformers, the model CB-26 resistance-capacitance-ratio bridge measures capacitance over four ranges from 10 pf to 2,000  $\mu$ f, resistance from 0.5 ohm to 200 meg, capacitor leakage at 3 to 500 v dc, and ratio of turns, reactance, or resistance of transformers from 0.5:1 to 20:1. A low-voltage bridge analyzes small electrolytic capacitors.

Precision Apparatus Co., Inc., Dept. ED, 70-31 84th St., Glendale 27, N. Y.

Price: \$79.95.

## INTRODUCING THE NEW

# Flowtronic

55 SERIES

## AIR VELOCITY METERS

MODEL 55 A1

MODEL 55 B1



Rugged, reliable instrument for making accurate direct readings of:

Air Velocity      Air Temperature  
Surface Temperature

- Eight transistor electronic circuit
- Rapid or damped meter response
- Model 55A1 powered by rechargeable batteries
- Model 55B1 operates on 115v a.c. line
- Electrical output with response from d.c. to 1kc
- Only \$475.

Write for Bulletin 64



**FLOW CORPORATION**

11 Carleton Street • Cambridge 42, Mass. • TR 6-9843

CIRCLE 127 ON READER-SERVICE CARD



## PRECISION is ready to ship...

Fast delivery from an arbor list of over 2000 different sizes and shapes, plus modern high speed equipment and special fabricating service assure you coil forms to your exact dimensional and material specifications...when you want them and in the quantity desired.

**Mechanical specifications**—any shape, I.D., O.D. or length... Di-Formed or bowed sidewall construction... rolled, spun, notched, punched or formed.

**Materials**—any dielectrical material or combination, including kraft, fish paper, acetate, DuPont Mylar, Johns-Manville Quinterra, Resinite (phenolic impregnated), etc.

Ask about our special mandril service. Request Arbor List and Bulletin 235-355.



**PRECISION PAPER TUBE CO.**

2055 WEST CHARLESTON STREET • CHICAGO 47, ILL.  
Eastern Plant: 1 Flower Street, Marlford, Conn.  
Representatives Throughout United States and Canada

CIRCLE 128 ON READER-SERVICE CARD

ELECTRONIC DESIGN • September 13, 1961

*this is a*  
\***RENBRANDT**  
*original*



\*the precision-made,  
miniature-size  
flexible coupling  
with ZERO BACKLASH

You save space and weight with Renbrandt Miniature Flexible Couplings. They have torsional rigidity, angular and linear flexibility, low inertia . . . and yet are ENTIRELY FREE OF BACKLASH. The unique disc-type design assures long life at a moderate price. A complete line is available for 1/16" through 1/2" shafts in all combinations. Many hub styles, including clamp and set screw.

For exacting requirements specify Renbrandt Couplings. Prompt delivery on prototype or production orders. Send for catalog or send your requirements for quotes.

This is a TINYMITE Flexible Coupling



Low cost. No backlash. Nylon insulating center piece. For manual controls, tuners, plug-in units, sub-miniaturization, etc. 1/8" dia. by 1/8" long. Std. sizes for 1/16, 1/8, 1/4" shafts. Special sizes available.

**RENBRANDT**

Renbrandt, Inc.  
6-B Parmelee St.  
Boston 18, Mass.  
tel: Highlands 5-8910

CIRCLE 129 ON READER-SERVICE CARD

**MINIATURE  
PRE-  
AMPLIFIERS**

type {  
A102  
A102S  
A102H



**Features:**

Miniature in size, 1 1/4"x1 1/2"x2 1/2". Non-microphonic, no hum. Extremely low distortion. Self powered, completely transistorized.

**Specifications:**

FREQUENCY RESPONSE, 3 DB BANDWIDTH:  
A102 - 2 cps to 100 kc; A102S - 0.5 cps to 15 kc; A102H - 4 cps to 750 kc.  
NOISE LEVEL: Less than 3 microvolts.



**AD-YU**

**ELECTRONICS LAB., INC.**

249 Torhune Avenue, Passaic, New Jersey

**SUB-AUDIO  
TUNED  
AMPLIFIER**

type 301

Frequency Range:  
0.3 cycle to 3 kc, continuously adjustable.



**Specifications:**

**AMPLIFICATION:** Approximately 38 db at center frequency.

**FREQUENCY RESPONSE:** 35 db down for second harmonic, 45 db down for third harmonic and 50 db down for higher harmonics.

**INPUT IMPEDANCE:** Over 6 megohms shunted with 25 uuf.

**OUTPUT IMPEDANCE:** Approx. 280 ohms.

CIRCLE 130 ON READER-SERVICE CARD

ELECTRONIC DESIGN • September 13, 1961

**Power Supply**

430



Regulated high-voltage power supply model 15-W-004 can be used as a multiplier phototube bleeder supply and in other applications. Input is 18 to 30 v dc. Units are available in seven output voltages ranging from 800 v (-10 v) to 2,000 v (-50 v). Output current is 100  $\mu$ a and output ripple is less than 250 mv. Drift is less than 2% over the temperature range of -10 to +130 F.

Franklin Systems, Inc., Dept. ED, 2734 Hillsboro Road, West Palm Beach, Fla.

**Servo Amplifier**

359



Two-phase servo motors from size 11 up to 1/4 hp can be driven by servo amplifier model A439. Amplifier controls power to both phases of the motor so that at null the power to the motor is zero. Several wattage ranges are made for industrial and military use.

Westamp, Inc., Dept. ED, 11277 Massachusetts Ave., Los Angeles 25, Calif.

**Miniature Gearmotors**

427



Up to 35 oz-in. torque continuous duty is provided by dc gearmotors type VS. End-mounted reducer provides 62 ratios from 7.88:1 to 25,573.65:1, and the side-mounted reducer provides a choice of 27 ratios from 26.93:1 to 2,511.84:1. End-mounted reducer and VS motor is 7/16 x 7/8 x 3-3/4 in. long maximum. Side-mounted reducer and VS motor is 7/8 x 7/8 x 2-1/4 in. long.

Globe Industries, Inc., Dept. ED, 1784 Stanley Ave., Dayton 4, Ohio.

**High Power  
Sweep  
To 1250 MC  
From  
TELONIC**



With a maximum output of 14 volts — 4 watts. Telonic PD Sweep Generators provide a new era in sweep techniques. They operate in 4 different modes — swept RF, modulated swept RF, CW, and modulated CW—selected by a function switch. Their display linearity is better than 1.2:1, and output is flat within  $\pm 7.5\%$  over the maximum sweep width.

The instrument's built-in turret attenuators provide a range of 0 to 59 db in 1 db steps with direct dial readout of attenuation value. Provisions for an external marker and fixed plug-in markers are also included.

Available in 7 models covering various frequency ranges up to 1250 mc, the PD units are ideal for high power applications. Since their output level is 100 times greater than that of other sweep generators, the usefulness of swept techniques is greatly expanded. In fact, the response of a device having as much as 60 or 70 db loss can be easily displayed on a high-gain oscilloscope with a PD unit.

Specifications on all PD models may be obtained from Technical Bulletin T-217B.

*Telonic*

INDUSTRIES, INC.

BEECH GROVE, INDIANA—PHONE STATE 7-7241

NEED ONE NOW? 24 HOUR DELIVERY VIA  
TELONIC JET ORDER SERVICE

CIRCLE 131 ON READER-SERVICE CARD



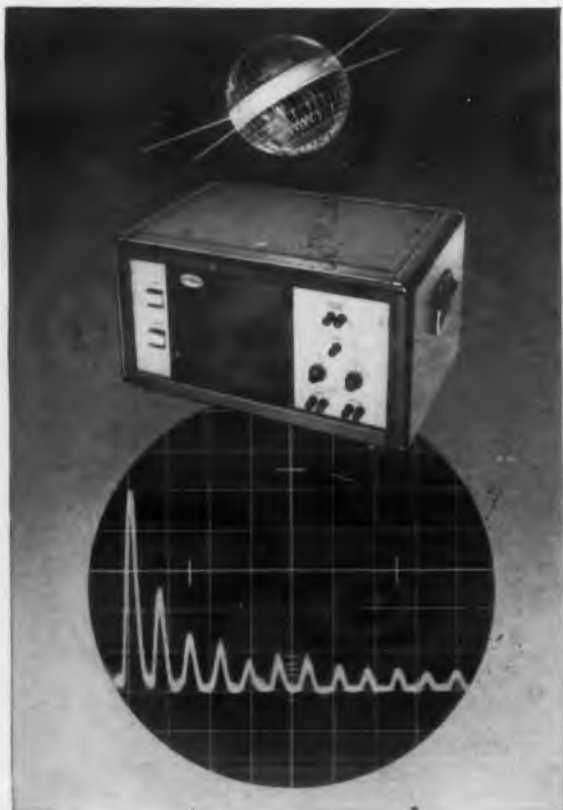

High Speed • High Resolution  
High Sensitivity Spectrum Analysis  
with *Rayspan*  
**SPECTRUM ANALYZER**

Raytheon Rayspan Spectrum Analyzers, through a unique application of multiple filters, can analyze entire spectrums as wide as 33 kc at scanning rates as high as 200 times per second with excellent resolution and a dynamic range of 40 db. Frequencies as low as 8 cps can be identified. Resolution for two equal-amplitude signals is approximately 0.7% or 3% of the analysis band depending on the Rayspan model employed.

Any model can be adapted for use with high speed, helix recorders to provide permanent records of frequency versus real time. A built-in timing pulse generator allows scan-by-scan synchronization of Rayspan with an oscilloscope.

For complete technical data please write to: Raytheon, Industrial Components Division, 55 Chapel Street, Newton 58, Massachusetts.



**RAYTHEON COMPANY**  
INDUSTRIAL COMPONENTS DIVISION  
CIRCLE 132 ON READER-SERVICE CARD

## NEW PRODUCTS

### Isolation Transformer

446



Designed for critical circuits requiring good isolation for power line equipment, isolation transformer HIT-15 is rated at 150 w. Input is 115 v 50/60 cps. Effective capacity coupling between primary and secondary windings is less than 0.1 pf.

United Transformer Corp., Dept. ED, 150 Varick St., New York 13, N. Y.

### Tube-Axial Blower

615



Air-conditioned service in missile-ground support equipment is provided by the model STA-1000-11278 tube-axial blower. The unit has a cast aluminum housing, a 10-in. tapered-blade fan, and a 416-v, 400-cps aircraft-type motor. Motors for other voltages can be furnished. The blower delivers about 1,800 cu ft per min at a static pressure of 1 in. of water. MIL specs are met.

Torrington Manufacturing Co., Dept. ED, Torrington, Conn.

### Battery Eliminator-Charger

381



Built-in LC filter is provided with the model P-28 battery eliminator-charger. Output is con-

## revolutionizes soldering!



Sample, left, shows ordinary solder. Sample, right, shows ALPHA Cen-Tri-Core Solder's 33 1/3% greater flow.

You get 33 1/3% greater flow with ALPHA Cen-Tri-Core Energized® Rosin-filled Solder because only ALPHA Cen-Tri-Core is made this way . . .

ALPHA Cen-Tri-Core is specially processed from virgin tin and lead plus highly mobile energized rosin. Result? A 33 1/3% increase in flow and wetting. More reliable solder connections. Increased joints per pound.

Made of a rosin-coated center wire which is visually inspected before an extruded outer sleeve is added, every inch of this "core within a core" solder is filled with fast-acting, non-conductive flux. Meets Fed. Spec. QQS-571C. Write for details!

When dependability counts!

**alpha metals, inc.** 

58C Water St., Jersey City 4, N. J.

In Los Angeles, Calif.: 2343 Saybrook Ave.

In Chicago, Ill.: ALPHALOY Corp., 2250 S. Lumber St.

Other ALPHA products: Fluxes • Solder Preforms • High Purity Metals

CIRCLE 133 ON READER-SERVICE CARD



New, improved paper electrical tapes. Use them uncured, for excellent pressure sensitive characteristics, or cured, for high adhesion and solvent resistance. Class A insulation. Easy roll release.

**PERMACEL** NEW BRUNSWICK  
NEW JERSEY

Tapes • Electrical Insulating Materials • Adhesives

CIRCLE 134 ON READER-SERVICE CARD

ELECTRONIC DESIGN • September 13, 1961

## standard knobs



## widest choice



## fastest delivery



Variety and versatility in a complete standard line of thermosetting plastic knobs. Combinations, variations in types, sizes and colors delivered promptly. Send for catalog.

## kurz-kasch

Kurz-Kasch, Inc., 1415 S. Broadway, Dayton 1, Ohio

CIRCLE 135 ON READER-SERVICE CARD

## for fan applications

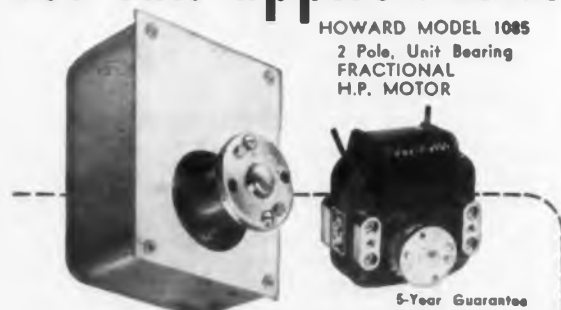

HOWARD MODEL 1085  
2 Pole, Unit Bearing  
FRACTIONAL  
H.P. MOTOR

5-Year Guarantee

### Available with Open or Closed Construction

**MOUNTING:** From rear or by special pads on front.

**BEARING:** Single, long-life, permanently lubricated.

**STATOR:** Vacuum varnish impregnated coil on molded nylon bobbin.

**ROTOR:** Dynamically balanced for ultra-quiet operation.

**ROTATION:** Unidirectional (CW or CCW as specified).

**SHAFT-HUB:** Assures positive and accurate location of connecting part (fan) which must run concentric. Can also be furnished with shaft extension from hub.

Send us your specifications or write for complete catalog.

HP: 1/750 to 1/105

NO LOAD RPM: 3400

FULL LOAD RPM:\*

2000-3200

INPUT WATTS: 0-30

VOLTS:

115 V. 60 cy. AC std.

\*Lower full load speeds also available.

POWERED BY

### HOWARD INDUSTRIES, INC.

1725 State Street, Racine, Wisconsin  
Divisions: Electric Motor Corp., Cyclish Motor Corp., Loyd Geraghty Co.,  
Racine Electric Products

**HOWARD**

CIRCLE 136 ON READER-SERVICE CARD

ELECTRONIC DESIGN • September 13, 1961

tinuously variable from 0 to 6 or 12 v, 6 and 10 amp max respectively for continuous current on standard output. Intermittent currents of 12 and 20 amp respectively are handled. Filtered output provides 5 amp max. Voltage and current are monitored.

Precision Apparatus Co., Inc., Dept. ED, 70-31 84th St., Glendale 27, N. Y.

Price: \$64.95.

### Precision Dials

436



Tolerance is 6 min for the range of 0 to 360 deg. Precision dials and verniers have engraved divisions and numbers. Standard diameters range from 2 to 6 in. in 1/2 in. increments. Other diameters are available. Dials are available in clear aluminum and in white or black military paint. Graduations and numbers are filled with a contrasting color paint.

Ackerman Engravers, Inc., Dept. ED, 43-22 36th St., Long Island City 1, N. Y.

### Cable Coating

374

Polyethylene resin Alathon 3530 gives wire and cable smooth insulation coatings at production speeds up to 4,000 ft per min. Physical and electrical properties are good. Melt index is 0.3. Ten standard colors are available; resin may be colored with concentrates to meet government requirements.

E. I. Du Pont De Nemours & Co., Dept. ED, Wilmington, Del.

### Resistor Element

626

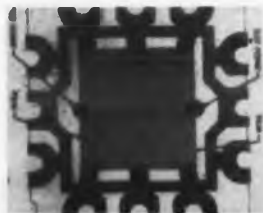

Micromodule film-resistor elements are mounted on a ceramic wafer measuring 0.310 in. sq by 0.010 in. thick. Resistance between terminals can be tailored by scoring or cutting. Basic films have values of 100, 500, or 1,000 ohms; films on each side can differ in value.

Ohmite Manufacturing Co., Dept. ED, 3677 Howard St., Skokie, Ill.,

## Precision RF Attenuators From TELONIC



The wide selection of Telonic RF Attenuators presents the electronic design engineer with an off-the-shelf unit for a variety of applications. Available in turret, dual turrets, gangs, and toggle switch styles, each Telonic attenuator carries the same characteristics of high quality and accuracy at a low, low cost.

Turret attenuators, such as the TA-50 shown above, are used individually or collectively to cover ranges as wide as 110 db in 1 db steps, frequencies up to 1250 mc, with accuracies approaching high-priced microwave units. Multiple turret attenuators are capable of operating two separate RF circuits, or may be used in series. Rotary switching action is positive and without the inconvenience of push-pull mechanisms.

Toggle switch attenuators cover a range up to 102 db in 9 db steps over 0 to 300 megacycles. Featuring ruggedness and high reliability, these attenuators are available in both standard and custom versions.

Full details on all types are available in Data File T-400.

*Telonic* INDUSTRIES, INC.  
BEECH GROVE, INDIANA - PHONE STATE 7-7241

NEED ONE NOW? 24 HOUR DELIVERY VIA  
TELONIC JET ORDER SERVICE

CIRCLE 137 ON READER-SERVICE CARD

135

# RELAX...



with American Aluminum  
Quality ... Dependability ... Service!

Yes, you can really relax when you place your aluminum fabricating problems in the competent hands of American Aluminum. Backed by 50 years of progressive engineering know-how, AA can serve you from design to finished product . . . all under one roof. Immediate attention, with emphasis on quality and dependability, is given to your specific needs when using American Aluminum's "Peace of Mind" service. All you have to do is sit back and relax . . . let us do the worrying!

**SPECIALISTS IN CONTRACT MANUFACTURING  
OF ALUMINUM FOR THE ELECTRONICS INDUSTRY**

Complete fabricating facilities for Deep Drawing, Heat Treating, Spinnings, Assembly, Brake Work, Stampings, Anodizing, Welding, Finishing.

Complete die making facilities  
Stock dies on hand for many shapes  
Complete inspection facilities



Send for brochure "ALUMINUM  
FABRICATING FOR INDUSTRY"

**AMERICAN ALUMINUM COMPANY**

Manufacturers of Aluminum Products  
for industry since 1910

Sheffield Street, Mountainside, New Jersey

CIRCLE 138 ON READER-SERVICE CARD

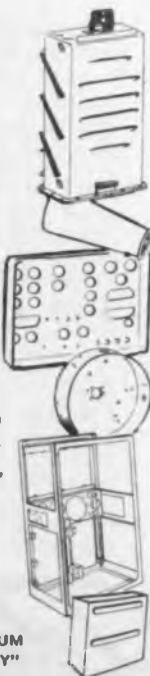

## NEW PRODUCTS

### Concealed Latch

392



Slight pressure at any point on an access panel will release this concealed latch, called the Touch Latch. Similar pressure closes and locks the latch and panel. Single-hold mounting with a common nut does not require riveting, welding, or special tooling. Unit may also be mounted in castings with tapped holes.

Camloc Fastener Corp., Dept. ED, 1 Spring Valley Road, Paramus, N. J.

### Vacuum Thermocouples

443



Low-frequency af and uhf vacuum thermocouples are available. Heater ratings are from 1.25 ma for the low and audio frequency types to 5 ma for the uhf type. Unmounted, open-wire thermocouples are available for meter manufacturers. Custom made types are also available.

Barker Sales Co., Dept. ED, 339 Broad Ave., Ridgefield, N. J.

Availability: 3 to 4 weeks, from stock.

### Static Switch

608



For vibration, shock, and acceleration environments, this solid-state static switch re-

## IS YOUR JOB COSTING YOU \$84,000.00?

It could be costing you this much—and even more.

The average increase in salary of the Electronics Men placed through Cadillac this year is \$2,800. If these men merely maintain their present increase through 30 additional work-years, then their earning power has increased \$84,000.00.

What about you? Are you earning less these days than your capability dictates? If so, we suggest that you contact Cadillac.

Cadillac is employed by 520 top electronics firms—coast to coast. Our service is completely confidential and absolutely free of charge. The companies pay our costs.

### FREE — Opportunities Bulletin

Find out the top positions in electronics every month. Send us your name and home address direct or circle Reader Service Card Number 885



**LON D. BARTON**  
President

**CADILLAC  
ASSOCIATES, INC.**

29 East Madison Bldg.  
Chicago 2, Illinois  
Financial 6-9400

"Where More Electronic Executives Find Their Positions Than Anywhere Else In The World."

CIRCLE 885 ON READER-SERVICE CARD



**FOR CONTINUOUS  
OPERATION AT TEMPERATURES  
UP TO 155° C.**

Natvar Isoglas and Isolastane afford heavy duty equipment extra protection against frequent overloads beyond Class B rating. Isoglas consists of a glass fabric coated with an isocyanate reacted resin. Isolastane is similar except that an elastomeric resin is used. These products are outstanding in their

- thermal stability
- resistance to crazing and cracking
- resistance to solvents, Askarel, and other non-flammable synthetic insulating liquids
- toughness and scuff resistance
- wet dielectric strength
- flexibility at low temperatures
- fungistatic qualities

Also available laminated with other insulating materials for slot lining, coil supports, and phase insulation. Ask for Data Sheet and Samples.

**NATVAR CORPORATION**

FORMERLY THE NATIONAL YARNISHED PRODUCTS CORPORATION  
Telephone TWX Cable Address  
FULTON 8-8800 SAWAY, N.J. RAN 1134 NATVAR SAWAY, N.J.  
241 RANDOLPH AVENUE • WOODBRIDGE, NEW JERSEY  
CIRCLE 140 ON READER-SERVICE CARD

ELECTRONIC DESIGN • September 13, 1961

## NOW Standard MINIATURE MODULE CASES

Cut Costs  
Speed Production

Grayhill/MOLDTRONICS is now making available a wide assortment of stock-mold Module Cases for miniature transformers, transistors, crystals and, potting of other miniature components,—all uniform, highest quality, fully inspected and ready for your assembly lines. They will save you tooling costs and get you into production faster. Molded of electrical grade phenolic, diallyls or epoxys.

Full details in Bulletin 1200.  
Write for your copy.

ALSO CUSTOM MOLDED CASES  
TO YOUR SPECIFICATIONS

 **MOLDTRONICS, INC.**  
215 Burlington Clarendon Hills, Illinois

MOLDTRONICS, INC. . . . miniature thermosetting plastic custom molding  
CIRCLE 141 ON READER-SERVICE CARD

right off the shelf®

## STAR STAINLESS MACHINE SCREWS

18/8 430

Sizes: 0/80  
to 1/2" dia.

pan head  
binding  
flat (up to 1/4")  
round  
oval  
fillister  
truss

Specials  
to order

phillips &  
slotted

Immediate delivery on ALL SIZES •  
COARSE & FINE • ANY QUANTITY.  
Made to AN & MS SPECS. 100° FLAT  
HEADS available.

Send for your Star catalog today, on  
letterhead please.

 **STAR STAINLESS SCREW CO.**  
663 Union Blvd., Paterson 2, N.J., Cliford 6-2308  
Direct New York Telephone: Wisconsin 7-6310  
Direct Philadelphia Telephone WALnut 5-3660

CIRCLE 142 ON READER-SERVICE CARD

ELECTRONIC DESIGN • September 13, 1961

places multipole relays. Unit switches 10 v max through 50 ohms on, 5 meg off. Power requirement is 10 ma at 28 v. Temperatures from -55 to +100 C, shock of 1,500 g, acceleration of 10,000 g, and vibration of 30 g peak from 20 to 2,000 cps are withstood.

Applied Electronics Corp. of N. J., Dept. ED,  
P. O. Box 43, Metuchen, N. J.

### Logic Modules 468

Flip flops, multivibrators, amplifiers, gates and other units are included in the 1200 series of digital logic modules. Applications include shift registers, accumulators and counters. Modules are applicable to airborne and space use.

Computer Techniques, Inc., Dept. ED, 3300 Northern Boulevard, Long Island City 1, N. Y.  
P&A: \$3.74 to \$13.76 in production quantities; from stock.

### Capacitors 404



Capacitors from 10 to 1,000 pf. Special 1/4-in. long Cerafil capacitors are made in lacquer coated, durez-coated or epoxy-molded cases. Units can be made with ratings up to 100 v dc. Capacity tolerance as low as +7-1/2% can be supplied.

Aerovox Corp., Hi-Q Div., Dept. ED, Olean, N. Y.

### Magnetic Sensing Devices 442



Transverse and axial field types operate from -40 to +100 C, with continuous operation at 85 C. The transverse Hall-effect magnetic sensing device measures 0.500 x 0.130 x 0.19 in. thick. Designation is model BH200. The axial field type, model BH203, is 0.195 in. in diameter and 3/16 in. long. Both units are non-inductive.

F. W. Bell, Inc., Semi-Conductor Div., Dept. ED, 1356 Norton Ave., Columbus 12, Ohio.  
Price: \$32.00 each.

## D.P.D.T. Co-Axial Switch By TELONIC



Low VSWR and minimum cross-talk are just two of the many advantages you'll get with Telonic's TS-1 co-axial switch. A double pole, double throw unit, the TS-1 is compact, light in weight, and precision made to give the ultimate in service. Useful to 1500 mc, it has a VSWR less than 1.1:1, insertion loss below .1 db, and cross-talk rejection of over 70 db, all at 1000 mc.

Ideal for circuit switching applications where constant impedance is required, the TS-1 is made for lab, production, and field use. Point contact design and positive detent action assures precise repeatability. Silver-plated, self cleaning contacts guarantee long, trouble-free operation.

Normally furnished with indicator knob and BNC connectors, the TS-1 is also available in custom versions. Two or more may be stacked in tandem, and wafer switch sections may be added if desired.

Complete specifications are available in Technical Bulletin T-226.

 **INDUSTRIES, INC.**  
BEECH GROVE, INDIANA - PHONE STATE 7-7241

NEED ONE NOW? 24 HOUR DELIVERY VIA  
TELONIC JET ORDER SERVICE

CIRCLE 143 ON READER-SERVICE CARD



## keep your signals clean with engineered magnetic shielding

Keep stray magnetic fields out of your high gain input transformers and cathode ray tubes. Keep your signals free of noise, hum, cross-talk and distortion. You can do it only with *engineered* magnetic shielding.

These high-permeability shields are made from existing tools in a broad variety of single and multiple structures—cylinders, spheres, truncated cones—for applications ranging from dc into the audio range and higher. They can be used with almost all conventional transformer core and coil assemblies to provide any degree of magnetic, electrostatic or RF shielding against undesired signals of

all classes. Reduction of field strengths to 100 db and beyond is common.

With Magnetic Metals shielding, both the electrical and mechanical engineering is already done for you. Simply let us know your requirements . . . We'll engineer the exact type of shielding you need. In selection of raw material, design, fabrication, annealing, testing and gaging, Magnetic Metals has amassed a great backlog of shielding experience. For a better understanding of shielding and help in specifying it, write for our informative booklet, "Magnetic Shielding of Transformers and Tubes."

**MAGNETIC  
METALS**

### MAGNETIC METALS COMPANY

Hayes Avenue at 21st Street, Camden 1, N.J.

853 Production Place, Newport Beach, California

transformer laminations • motor laminations • tape-wound cores  
powdered molybdenum permalloy cores • electromagnet shields



CIRCLE 144 ON READER-SERVICE CARD

## NEW PRODUCTS

### Chassis Slide

391



Available in eight sizes from 10 to 24 in., the Universal Chassis Slide is arranged for detent, tilt, or nontilt assembly, and front, back, or side mounting. Slide is permanently lubricated. Detent locks in any of seven positions. Chassis can be easily removed from cabinet, but cannot be removed accidentally.

Metal-Craft, Inc., Dept. ED, 34 Burgess Place, Wayne, N. J.

### Servo Amplifier

680

Stable and uniform response is provided by 5-w servo amplifier SA 5601. Gain is  $54 \pm 1$  db from  $-55$  to  $+125$  C with all signal levels below saturation, and supply voltage of  $56 \pm 3$  v. Size is 1.390 x 1.035 x 1.005 in. Amplifier will drive any size 8, 10 or 11 servo motor with a 26-v control-phase rating.

Clifton Precision Products Co., Inc., Dept. ED, 5050 State Road, Drexel Hill, Pa.

Availability: stock.

### Vidicon Tube

473

With resolution of 1,200 lines, vidicon type RCA-8051 is made for use with 35-mm film camera optics. Nonmagnetic materials are used in the front end. Flat face-plate is free of distortion.

Radio Corp. of America, Electron Tube Div., Industrial Tube Products Dept. Dept. ED, Harrison, N. J.

### Decade Condenser

406



For design and experimental work. Model 1904 has a capacitance range of 0.0001 to 0.111  $\mu$ f in steps of 0.0001  $\mu$ f. Accuracy is  $\pm 1\%$ . Ratings are 350 wvdc, 500 v intermittent, 1,000 v test. Power factor is 0.001% or better.

Precision Apparatus Co., Inc., Dept. ED, Glendale 27, N. Y.

Price: \$29.95.



**Mil Spec  
Hook-Up Wire  
by Belden**

Regularly exceeds the rigid requirements of Military Specifications for electronic or electrical applications. All colors, types, sizes, insulations, and temperature ranges in stock — for immediate shipment. Ask for Catalog 861.

**Belden**

WIREMAKER FOR INDUSTRY  
SINCE 1902 — CHICAGO

magnet wire • power supply cords •  
cord sets • portable cordage •  
control cables • electronic wire



*looking for a special potentiometer?*

*...reach for*



Your copy of EDC lists 157 different types of potentiometers in its PRODUCT LOCATOR. 27 categories from "AC" to "Wire-wound" are included. Each sub-listing such as "Clutch," "Linear Motion," "Microminiature," "Precision," or "Self-trimming" gives manufacturers' name and thumbnail specs to aid in rapid selection. 52 items are further described by special literature bound in sections 2 or 3 of EDC.

This is only one example of the more than 7,000 products from 2,212 companies which are displayed.

Handy Inquiry Cards or Application Data Forms are bound in to make it easier for you to obtain additional data — and manufacturers' reps are also listed if you wish to phone for quick price and delivery information.

*Electronic Designers' Catalog* is one more service provided by the publishers of *Electronic Design*.





## Two-Trace Scope

624



Operating to 5 mc, this dual-gun oscilloscope is designed for easy maintenance and repair. Identical vertical amplifiers give identical traces over the full screen face with no phase shift. Vertical sensitivity is 1 mv per cm; sweep range is 1  $\mu$ sec to 1 sec per cm.

Packard Bell Electronics, Dept. ED, 12333 W. Olympic Blvd., Los Angeles 64, Calif.

Price: \$495.

## Coil Form

459

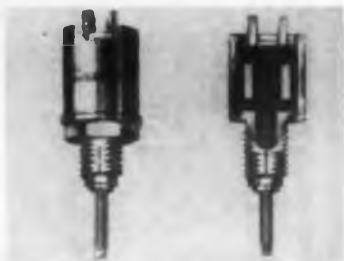

Shielded coil form PLS-9 measures 7/16 in. in diameter and 1/2 in. high, has high shock resistance and enclosed windings. Locking device permits tuning while core is locked. Forms are made for ranges from 0.2 mc up, with two to six terminals.

Cambridge Thermionic Corp., Dept. ED, Cambridge, Mass.

P&A: \$0.65 ea, 250 to 499; stock.

## High Volume Fan

454



Delivering 550 cfm at a low decibel rating, propeller fan model 1PB95W is powered by a continuous-duty 115-v, 60-cps, single-phase shaded pole motor that is totally enclosed. All hardware is stainless steel or cadmium plated. Lubrication temperature range is -68 to +93 C.

McLean Engineering Laboratories, Dept. ED, Princeton, N. J.



## LOOK HERE FOR ANSWERS TO YOUR RELAY PROBLEMS

### IT'S WHAT'S INSIDE THAT COUNTS IN TIME DELAY RELAYS



Especially when milliseconds count! Note the printed circuit construction of Leach's optional output time delay relays. This economical line of off-the-shelf electronic units includes time delays on release and time delays on operate—in a timing range of 100 milliseconds to 60 seconds. These standard components are available with fixed or adjustable timing to meet your most critical requirements. And they're all 100% inspected during manufacture for highest reliability!

Bulletin TD-200.

### WE'RE LOADED WITH LITERATURE...

Write for bulletins, write for information, write for details and specifications. Or mail your request on the Reader-Service Card!

### BLOCK THAT SHOCK!

Leach balanced-armature relays provide high resistance to shock (50 G's) and vibration (15 G's to 2000 cps). They meet or exceed MIL-R-25018, MIL-R-5757C and MIL-R-6106C. Choose from 4,000 variations of 20 basic types!

Bulletin BA-859.

### NOT A SQUARE IN THE WHOLE FAMILY!



When only a round can relay will fit your need, Leach offers this family group in contact configurations of 2, 4 and 6 PDT and in contact ratings ranging from dry circuit to 10 amps.

Bulletin RC-300.

### SUBMINIATURE CRYSTAL CANS, TOO!

Want big performance, compact size? Get both in a wide range of standard relay configurations. Dual coils... balanced rotary armature for 2 amp, 2 PDT switching in aerospace and electronic control applications. Bulletin CC-M200 and M101.

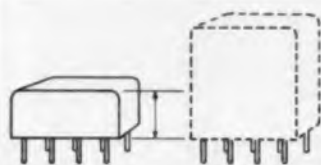

### WHAT'S HALF OF A SUBMINIATURE?

Answer: The new Leach Half-Size Crystal Can Relay. Half the height of a subminiature but boasting the same base dimensions, the same performance! Amazing.

Bulletin CC-M250.

LEACH CORPORATION, 18435 Susana Road, Compton, California • District offices and field representatives in principal cities of U.S. • Export: Leach International, S.A. Forty-one years of serving the control needs of the aircraft, missile and electronic industries



## LOOK TO LEACH

## NEED RELAYS FAST?

When you need immediate delivery on prototype or small quantities of relays, look to Leach for standard stocks—available to you locally at factory prices. Each of these relays is backed by 41 years of Leach experience in meeting the high performance requirements of the aerospace and electronic industries.

### DISTRIBUTORS:

Inglewood, California  
Flight Electronics Supply Corp.  
423 South Hindry  
ORegon 8-5122

San Jose, California  
Weatherbie Industrial Electronics, Inc.  
333 Prevost Street  
CYpress 7-9550

San Diego, California  
Atlas Electronic  
4618 Santa Fe  
BRowing 4-3131

### LEACH DISTRICT SALES OFFICES:

Seattle 8, Washington  
South Annex Bldg., Room 201  
King County Airport  
Boeing Field  
PArkway 5-6978

Palo Alto, California  
814 San Antonio Road  
YORkshire 8-4408

Los Angeles 17, California  
1101 Wilshire Blvd.  
HUNtley 2-0790

Dayton 2, Ohio  
333 West First Street, Room 250  
BAIdwin 2-8652

New York, New York  
405 Lexington Avenue, Suite 3204  
YUkon 6-2520

Washington, D.C.  
Suite 307  
1700 K Street, N.W.  
STERling 3-1147

## LOOK TO LEACH

LEACH CORPORATION,  
18435 SUSANA ROAD,  
COMPTON, CALIFORNIA

EXPORT: LEACH INTERNATIONAL, S.A.

**NEW**

# twin contact miniature DC-AC choppers



Eleven types, both single  
and double pole.  
Long life.  
Low noise level.  
Extreme reliability.

DPDT  
LOW COST  
FULL ISOLATION

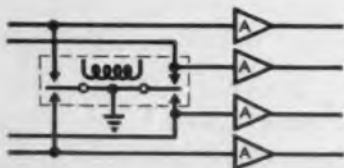

Write for Catalog 515 B

## STEVENS INCORPORATED ARNOLD

QUALITY SINCE 1943

7 ELKINS ST., SOUTH BOSTON 27, MASS.

S/A 14 1/2

CIRCLE 148 ON READER-SERVICE CARD

## NEW PRODUCTS

### Relay

455



Sensitive relay type 3000 has pull-in power rating of 20 to 350 mw, and operating time of 3 to 5 msec. A remanent magnetic core can be fitted to hold contact after power is removed. Relay can be supplied with up to 10 sets of double-throw contacts, will operate at 650 v, and interrupt 10-amp loads.

Ellis & Freed, Dept. R, Dept. ED, P. O. Box 549, Times Square Station, New York 36, N. Y.  
Price: typical 6pdt, \$5.20 ea, 100 units.

### Inductance-Controlled

625



Solid-state oscillator model LSE can be used with all types of variable inductor transducers. Device tunes to any IRIG channel. Output voltage is 3 v rms, impedance 100 ohms, harmonic distortion 3%. Unit operates on 24 to 32 v dc with less than  $\pm 1\%$  bandwidth change. Built to meet military specifications, the oscillator withstands shock, vibration and acceleration of 100 g; temperature range is  $-65$  to  $+165$  F.

Pace Engineering Co., Dept. ED, 13035 Saticoy St., North Hollywood, Calif.

### AC Converter

461



Accurate within  $\pm 0.1\%$ . Used with a five-digit voltmeter, solid-state converter 882 provides ac measurement from 0.00001 to 999.9 v. Frequency range is 30 cps to 10 kc. Average ac balance time is 1 sec; accuracy is  $\pm 0.1\%$  of reading, or two digits.

Electro Instruments, Inc., Dept. ED, 8611 Balboa Ave., San Diego 11, Calif.

**$-100^{\circ}\text{F}$   
to  
 $+350^{\circ}\text{F}$   
test chamber  
for  
only \$285**



Model ELH-0.5-LC

Here it is — a quality temperature chamber at a previously unheard of budget price! The Econ-O-Line Mark II is designed specifically for components and small assemblies — gives you complete temperature test capability for production line, research or development lab. Ruggedly constructed for long, accurate service, its features include:

- Temperature control to  $\pm 2^{\circ}\text{F}$ .
- Liquid CO<sub>2</sub> refrigeration
- United Electric indicating controller
- 11" x 12" x 5" work area
- Rugged aluminum liner
- Fan circulation with external motor
- 1" port and plug for external connections

Delivery from stock. For complete data, write today for Bulletin C-19.



ASSOCIATED TESTING LABORATORIES, INC.  
(Manufacturing Division)  
150 ROUTE 46 • WAYNE, NEW JERSEY • Clifford 6-2800  
TEST LABORATORIES  
Wayne, N.J. • Winter Park, Fla. • Burlington, Mass.

**-100° to +350°F  
and  
20% to 95% RH  
-and never  
a mechanical  
problem**



Model  
ELHH 4 LC

A major advance in environmental test chamber design, Associated's Econ-O-Line Low-High Temperature-Humidity Chamber eliminates mechanical problems by eliminating the mechanical refrigeration system entirely. Breakdown, leaks, other mechanical failures can't happen, because Liquid CO<sub>2</sub> is used for both temperature pull-down and humidity control. Other advanced design and performance features include:

- Pull down to -100° from ambient in 15 minutes
- Heat up to +350° within 60 minutes
- Temperature control  $\pm 2^\circ\text{F}$
- Humidity control  $\pm 5\%$  RH
- 2 pen, 2 cam programming and recording controller
- Fan circulation with external motor
- 18" x 18" x 18" stainless steel, welded interior
- Integral demineralizer with replaceable cartridge

**Price \$2675**

Write today for Bulletin C-20.



**Associated**

ASSOCIATED TESTING LABORATORIES, INC.  
(Manufacturing Division)  
190 ROUTE 46 • WAYNE, NEW JERSEY • CLifford 6-2800  
TEST LABORATORIES  
Wayne, N.J. • Winter Park, Fla. • Burlington, Mass.

CIRCLE 150 ON READER-SERVICE CARD

ELECTRONIC DESIGN • September 13, 1961

## Condenser Box

405



Substitution box model 1803 provides 18 values to EIA specifications. Capacity range is 0.0001 to 0.22  $\mu\text{f}$ . Capacitors in the 100- to 470- $\mu\text{f}$  range are silvered mica,  $\pm 5\%$  accuracy, rated at 500 vdc. Capacitors in the 0.001- to 0.22- $\mu\text{f}$  range are molded, have a  $\pm 10\%$  accuracy, and are rated at 600 vdc.

Precision Apparatus Co., Inc., Dept. ED, Glendale 27, N. Y.

Price: \$12.95.

## Transient Detector

452



Battery-operated transient detector model TD 661 is useful in semiconductor applications. It uses a dial to establish the set point and an indicating lamp for readout. Range is 0 to 2,000 v, accuracy is  $\pm 2\%$  of reading. Transient duration time is a minimum of 1  $\mu\text{sec}$ .

Regent Controls, Inc., Dept. ED, Harvard Ave., Stamford, Conn.

P&A: \$195; from stock.

## Synchronous Generator

649



This 16-mc synchronous generator, model SG-46, is a plug-in digital module. The device converts a randomly timed, arbitrarily shaped input pulse into a standard pulse for use in the firm's H-PAC series modules. The assertion and negation outputs can drive six unit loads at 16 mc. One de-coupled and two ac-coupled inputs are provided. Unit measures 3-3/8 x 5 in.

Computer Control Co., Dept. ED, 983 Concord St., Framingham, Mass.

Availability: from stock.

# IN STOCK FOR IMMEDIATE QUANTITY DELIVERY...

## 11 High performance servomotors

### ~ precision built by Helipot!

For immediate delivery - write, wire, or phone Mr. Ray Forbes at Helipot, Fullerton, California. Phone: TRojan 1-4848. Teletype: FULLERTON CAL 5210. Or contact your local Helipot rep.



**Beckman**

INSTRUMENTS, INC.

**HELIPOT DIVISION**

Fullerton, California  
Mountainside, New Jersey

Excitation	Fixed Phase	26v	26v	26v	26v	26v	26v	26v	26v	26v	26v	115v	115v	115v	115v	115v	115v	115v	115v
400 cycles	Control Phase	33v	33v	33/16.5v	33/16.5v	33/16.5v	33/16.5v	33/16.5v	33/16.5v	33/16.5v	33/16.5v	33/16.5v	40/20v	40/20v	40/20v	40/20v	40/20v	40/20v	40/20v
Length, inches		0.865	1.565	0.840	1.165	1.332	1.350	1.850	1.340	1.915	2.049	2.552	5,900	6,000	6,000	6,000	6,000	6,000	6,000
No-load speed, RPM		10,000	10,000	6,000	6,000	5,000	6,000	6,000	6,000	5,300	6,000	5,900	34,200	38,500	26,500	41,500	70,700	67,800	67,800
Torque at stall oz. in. (nominal)		0.1	0.1	0.22	0.33	0.22	0.22	0.33	0.22	0.22	0.33	0.6	0.6	0.6	0.6	0.6	0.6	0.6	0.6
Acceleration at stall, rad/sec <sup>2</sup>		50,000	37,000	86,500	86,500	33,800	67,800	70,700	41,500	26,500	38,500	34,200	\$135.00	\$130.00	\$125.00	\$75.00	\$130.00	\$125.00	\$125.00
Price, single unit		\$200.00	\$300.00	\$75.00	\$80.00	\$120.00	\$125.00	\$130.00	\$75.00	\$125.00	\$130.00	\$135.00	\$130.00	\$125.00	\$75.00	\$130.00	\$125.00	\$125.00	\$125.00

CIRCLE 151 ON READER-SERVICE CARD

Gertsch announces:



## the CRB line of complex ratio bridges



Ideal for voltage and phase comparison.  
Measures complex voltage ratios—both in-phase and quadrature—with high accuracy.

Available in small, transistorized units to completely automatic, self-nulling types.

These Gertsch CRB instruments are designed for testing 3- or 4-terminal networks, including transformers, synchros, resolvers, gyros, and transducers. The Gertsch line includes:



**SOLID STATE BRIDGE**—Model CRB-4. Instrument is fully transistorized . . . highly accurate. A self-contained, phase-sensitive null indicator permits rapid measurements.  $R_1 + R_2$  voltage ratios are read from concentric switch dials. *Battery or line* operation . . . case or rack mounting. Operating frequency range: 380-420 cps. Weight 20 pounds.



**COMPLEX RATIO BRIDGE**—Models CRB-1B and CRB-2B. In these units, quadrature component reading is indicated either as rectangular coordinate,  $\tan \theta$ , or  $\theta$  directly in degrees. Useful for measuring angles as small as  $.001^\circ$ . Six-place resolution, with high accuracy. Cabinet or rack mounting.

CRB-1B 30-1,000 cps

2.5 f or 200 V max.

CRB-2B 50-3,000 cps

.35 f or 200 V max.



**AUTOMATIC COMPLEX RATIO BRIDGE**—Model CRB-3. A self-nulling AC bridge with digital readout of both in-phase and quadrature voltage ratios. Excellent for production testing.

Accuracy of bridge is  $.002\%$  max. Five-place resolution, with automatic quadrant indication. Unit is self-contained, requiring no external calibration sources, and is equipped for external printer readout.

*Complete literature on all units sent on request. Bulletin CRB.*

**Gertsch**

**GERTSCH PRODUCTS, INC.**

3211 S. La Cienega Blvd., Los Angeles 16, Calif. • UPTON 0-2761 • VERMONT 9-2201

CIRCLE 152 ON READER-SERVICE CARD

## NEW PRODUCTS

### Phase Angle Meter

579



Direct reading of phase angle in tenths of degrees is provided by phase unit model 526D for frequencies from 396 to 404 cps. At other frequencies readings are presented in time units; range is 1 cps to 20 kc. The plug-in unit equips an electronic counter to measure any lead or lag phase angle, with accuracy approaching  $\pm 0.1\%$ .

Hewlett-Packard Co., Dept. ED, 1501 Page Mill Road, Palo Alto, Calif.

P&A: \$750; 12 weeks.

### Switches

415



Speed-sensitive switches are available with 4, 5 and 6 elements. Each switch has independent, adjustable, normally open and normally closed contacts rated for 10 amp at 115 v ac. Normal speed of the governor shaft can be as high as 7,000 rpm. Low speed setting can be as low as 200 rpm if the top speed does not exceed 2,500 rpm.

Synchro-Start Products, Inc., Dept. ED, 8151 N. Ridgeway Ave., Skokie, Ill.

### Telemeter Recorder

457



With 4-in. chart. Used with Metameter telemetry systems, recorder 670 has one or two pens. Each pen may have one or two retransmitting slidewires, and a maximum of four adjustable alarm contacts. Chart width is 4 in.

The Bristol Co., Dept. ED, Waterbury 20, Conn.

*- the ultra  
new YOKE!*



**Deflectron\***  
By **Celco**

**MAJOR ADVANCE IN  
THE SCIENCE OF  
ELECTRON BEAM DEFLECTION!**

**SPOT RECOVERY**

**Fastest! to 1  $\mu$ S**

**SPOT SIZE**

**Smallest - by 25%**

**SPOT SWEEP**

**Straightest.....**

**\* DEFLECTRONS for DISPLAYS**

Where ordinary precision  
yokes **FAIL** to meet your  
requirements.

Write for NEW "DEFLECTRON"  
Data and Standard Yoke  
Catalog. 

**Celco**

*Constantine Engineering  
Laboratories Co.*

Main Plant: MAHWAN, N. J. DAVis 7-1123  
PACIFIC DIV.-UPLAND, CALIF. YUkon 2-0215  
CENTRAL DIV.-LANESBORO, PA. ULYsses 3-3500

CIRCLE 153 ON READER-SERVICE CARD

ELECTRONIC DESIGN • September 13, 1961

# KOH-I-NOOR

PRECISION MATCHED  
INSTRUMENTS

Koh-I-Noor offers draftsmen an important new dimension in a comprehensive line of instruments and accessories meticulously matched to provide new high levels of professional performance, efficiency and convenience.

No. 3065

## NOW... TWO KOH-I-NOOR RAPIDOGRAPH TECHNICAL FOUNTAIN PENS

In 7 "color-coded" precision line widths: 00, 0, 1, 2, 2½, 3, 4. Uses India (or regular) ink for ruling, lettering, tracing or writing with equal facility.

**MODEL NO. 3065:** A new model with 7 interchangeable drawing point sections, each color-coded to indicate a different line width. Best buy for the professional who requires frequent change of line widths. Each drawing point section complete with airtight refillable ink cartridge. Interchange is accomplished quickly, cleanly. Comes in handy desk top container.

**MODEL NO. 3060:** The regular Koh-I-Noor Rapidograph "Technical" Fountain Pen with self-contained automatic filling system, and pocket clip is a standard drafting room tool.

No. 3060

## KOH-I-NOOR RAPIDOGUIDE AND TEMPLATES

for use with corresponding  
Rapidograph Fountain Pen

**Rapidoguide:** High quality lettering guides with elevating metal rails, developed to fit the seven different point sizes of Rapidograph Technical Fountain Pens. Each has upper and lower case letters, numerals, and characters all on one guide.

**Templates:** Precision engineered for use with Rapidograph Pen, Koh-I-Noor Drawing Pen, Leads and Holders.

Write for Descriptive Literature

# KOH-I-NOOR

INCORPORATED  
Bloomsbury 24, New Jersey

CIRCLE 154 ON READER-SERVICE CARD

## Hipot Testers

577



**Nondestructive hipot testers** are offered in 22 models with outputs of 0 to 1,500 v to 0 to 10 kv ac, all suitable for testing to ASTM, NEMA and UL spec. They have a 5-ft input cord, 5-ft high-voltage output leads, continuously variable voltage control and breakdown indicator.

Duncan Electric Co., Davenport Manufacturing Div., Dept. ED, 2530 N. Elston Ave., Chicago 47, Ill.

## Cable and Harness Tester

409



**Tests 17 conductors.** Series 701 cable and harness tester provides rapid simultaneous continuity and breakdown testing. Continuity tests are made at a maximum current of 500 ma. Acceptance limit is adjustable between 1 and 5 ohms. Breakdown test voltages of 500 to 2,500 are available in 5 steps.

Slaughter Co., Dept. ED, Piqua, Ohio.

## Threaded Terminal

450



**Made of Teflon,** threaded feed-through Type FT-500 TI permits high torque installation techniques. Unit has a screw-driver slot milled across the threaded stud to facilitate holding the mounted terminal while high torque may be applied to the terminal nut. Length is 0.743 in. Threaded stud is 4-40 2A x 0.234 in.

Sealectro Corp., Dept. ED, 610 Fayette Ave., Mamaroneck, N. Y.





*Helitrim® 1/2" square trimming pots give you...*

**• UNIQUE SLIP CLUTCH STOP • SEALED ALL-METAL HOUSING**  
*as standard features!*

Where small size and high operating temperature are important considerations, choose between two 1/2" square Helitrim trimming potentiometers. The Model 70 has Teflon leads. The Model 71 has gold-plated pins. Both are precision-built by Helipot to give you *special features as standard!*

These Helitrim extras include a slip-clutch stop that prevents open circuits – positively keeps the wiper from going off the end of the coil and into dead space. And rugged all-metal housings that provide humidity-resistant operation under the most severe environmental conditions.

Just as important is ease and accuracy of adjustment. There's no guesswork with Helitrim potentiometers – the adjustment screw makes 42 complete turns. This gives extra meaning to the pot's outstanding resolution – as fine as 0.083% in the upper resistance values.

Performance? Take a look at these specs. You'll see why top performance, too, is standard with Helipot.

**STANDARD SPECIFICATIONS**

Resistance range, ohms .....	10 to 50,000
Resistance tolerance .....	±5%
Resolution in percent .....	1.01 to 0.083
	(depending upon total resistance)
Adjustment screw rotation .....	42 turns, ±1 turn
Power rating, watts .....	1 at 50°C
Torque, max. oz. in. ....	10
Life expectancy, adjusting screw revolutions .....	10,000
Temperature range .....	-55°C to +150°C

Price? These pots are competitively priced at \$5.35 for the Model 70 and \$5.95 for the Model 71. Considerably less in quantity!

Availability? Your nearest Helipot representative has both models in stock – ready for immediate delivery. Call him today.

**Beckman**

INSTRUMENTS, INC.

**HELIPOT DIVISION**

Fullerton, California

POTS : MOTORS : METERS

SHOWN ACTUAL SIZE



## SIZE 5 COMPONENTS

### FOR SERVO SYSTEM MINIATURIZATION

A complete family of Size 5 components for every servo system function is now available from Kearfott. Stainless steel housings, shafts and bearings protect the units against environmental extremes and contribute to stability under shock, vibration, and temperature fluctuations. • Standard 26-v, 400-cps excitation. • Operating temperature range -55° to +125°C.

### CHARACTERISTICS

#### SYNCHROS

	VOLTAGE (400 cps)	T.R.	NULL (mv)	ERROR (min)
Transmitter CJO 0565 100	26	.454	34	10
Control Transformer Low Z-CJO 0555 100	11.8	1.765	34	10
High Z-CJO 0552 900	11.8	1.765	34	10
Differential CJO 0595 100	11.8	1.154	34	10
Resolver Low Z-CJO 0585 100	26	1.0	34	10
High Z-CJO 0589 100	26	1.0	34	10

#### SERVO MOTORS

	J126-06	J126-02	SYNCHRONOUS MOTOR CJO 0172 200
No-Load Speed	9800 rpm	9800 rpm	Pull-In Torque 0.06 in. oz
Stall Torque	0.10 in. oz	0.10 in. oz	Pull-Out Torque 0.10 in. oz
Rotor Moment of Inertia	0.175 gm cm <sup>2</sup>	0.175 gm cm <sup>2</sup>	Pull-Out Power 4 w
Voltage $\phi 1 / \phi 2$ (400 cps)	26/36-CT	26/26	
Power Input /Phase	1.7 w	1.7 w	

#### MOTOR GENERATORS

MOTOR	CJ40812001	CJO0812650	CJO0813200
Voltage $\phi 1 / \phi 2$ (400 cps)	26/36-CT	26/36-CT	26/26
Power / $\phi$	1.5 w	1.5 w	1.5 w
No-Load Speed	8000 rpm	8000 rpm	8000 rpm
Stall Torque	0.10 in. oz	0.10 in. oz	0.10 in. oz
GENERATOR			
Voltage (400 cps)	26 v	26 v	26 v
Volts/1000 RPM	0.1 v	0.1 v	0.5 v
Null	1.3 mv	10 mv	6.7 mv

Size 5 gearheads range in reduction ratios from 20:1 to 1019:1 for servomotors and motor tachometers above. In addition to Size 5 clutches, brakes, and brake-clutches, Size 6 are available.

Write for complete data



**KEARFOTT DIVISION  
GENERAL PRECISION, INC.**

Little Falls, New Jersey

## NEW PRODUCTS

### Signal Tracer

407



For rf and af signals. Model ST-22 is capable of handling all receiver or amplifier signal levels, including the high gain needed for direct tracing of signal at receiver antenna input terminals. It provides a wattmeter circuit for checking power drain of equipment under test over the range of 36 to 500 w.

Precision Apparatus Co., Inc., Dept. ED, Glendale 27, N. Y.

Price: \$59.95.

### Stabilization Networks

411



Line stabilization networks are used in radio-frequency interference measurement. Type JN17-852 meets the requirements of MIL-1-6181. Type JN17-586 meets MIL-1-16910 and type JN17-853 meets MIL-1-26600.

Sprague Electric Co., Dept. ED, 347 Marshall St., North Adams, Mass.

### Header Machine

408



Produces 6,000 units per hour. Completely automatic transistor header machine may be adapted to many different precision operations including welding, punching and threading. It can assemble as many as 40 different kinds of parts at the same time.

Rhebo Corp., Dept. ED, 1108 W. Evelyn Ave., Sunnydale, Calif.

Let us show  
you how to  
**KEEP  
COMPONENT  
COSTS  
DOWN!**

## PRECISION WIRE FORMS



Send a sample or blue print  
for estimates.

Art Wire specializes in wire forms designed for today's automatic production lines . . . manufactured with the precision and uniformity that assure the economy of an uninterrupted work flow. Reduced down-time, and the lower costs made possible by Art Wire's modern production methods mean greater savings to you, and greater profit in your operations.

**ART WIRE AND STAMPING CO.**  
17 Boyden Place, Newark 2, N. J.

CIRCLE 157 ON READER-SERVICE CARD

CIRCLE 156 ON READER-SERVICE CARD

ELECTRONIC DESIGN • September 13, 1961



Space-age achievements, from missiles to computers, owe a major part of their success to tiny but tremendously reliable REED INSTRUMENT BEARINGS. Specifically, REED bearings contribute to the dependability of miniaturized control, communications and navigation systems — through their ability to perform smoothly under exacting conditions over long periods of service. This reliability, in bearings of no more than  $\frac{1}{16}$ " OD, is a major reason why REED should rank high among your approved sources for instrument bearings.

6108

# REED

REED INSTRUMENT BEARING COMPANY  
Los Angeles, California  
Div. of GSP Industries, Inc.

CIRCLE 158 ON READER-SERVICE CARD  
ELECTRONIC DESIGN • September 13, 1961

## Static Relay

631



With no moving parts, static relay model 514 latches in either position, and holds on position when contact load is lost. Switching time can be as low as 22  $\mu$ sec. Both ac and dc types are available in spst and dpdt arrangements. Operating temperature range is  $-65$  to  $+160$  F, operating life one million cycles at full load.

Autronics Corp., Dept. ED, 180 N. Vinado Ave., Pasadena, Calif.  
P&A: \$78.50; 3 weeks.

## Temperature Potentiometers

578



Accuracy is  $\pm 0.3\%$  of range. Type 8694 single-range and type 8695 double-range temperature potentiometers indicate temperature in deg F on 15 ranges. Type 8696 double-range millivolt potentiometer is calibrated for emf measurements from 0 to 22 and 20 to 64.

Leeds & Northrup Co., Dept. ED, 4934 Stenton Ave., Philadelphia 44, Pa.

## Diode Dice

466



Silicon mesa diode dice meet or exceed MIL-S-19500B without additional sealing. Ultra-fast computer diode type MSC-1 has less than 2 nsec recovery, less than 2 pf capacitance, more than 75 v piv. General purpose type MSC-2 has piv greater than 300 v, less than 10 na leakage. Size is about 0.020 x 0.020 x 0.007 in. thick.

Microsemiconductor Corp., Dept. ED, 11250 Playa Court, Culver City, Calif.  
P&A: \$2.50 ea, 100 units; stock.



# NEW DUAL-FUNCTION DELTA COUPLER

Kearfott's new broad band, precision calibrated variable directional coupler may also be used as a precision variable attenuator. Adjustable from 5 to 70 DB, it covers these ranges in either function. Accuracy is within  $\pm 1$  DB of absolute attenuation over the specified range, and is displayed on a direct reading dial. Low USWR, low insertion loss and high directivity are inherent in the instrument.

## AVAILABLE IN FOUR FREQUENCY RANGES

C99 1270001	500—1000 MC
C99 1270002	1000—2000 MC
C99 2270001	2000—4000 MC
C99 3270001	4000—8000 MC

Maximum average power handling capability: 200 watts

Write for complete data



KEARFOTT DIVISION  
GENERAL PRECISION, INC.

Little Falls, New Jersey

CIRCLE 159 ON READER-SERVICE CARD

A BASIC GUIDE TO  
PRECISION POTENTIOMETERS



The Raytron Catalog of Precision Potentiometers describes, illustrates and provides electrical, mechanical and general specifications on most of our standard units. Drawings, temperature rating curves and general engineering data are also included to enable rapid, accurate selection of potentiometers which will meet all requirements, normal or special.

Whatever your specifications in single-turn, linear and non-linear units, the name Raytron guarantees high-precision, exact performance and environmental compliance...at minimum cost.

WRITE FOR YOUR PERSONAL CATALOG OF RAYTRON  
PRECISION POTENTIOMETERS.



GEORGE RATTRAY & COMPANY  
a subsidiary of

**INSTRUMENTS FOR INDUSTRY, INC.**

301 NEW SOUTH ROAD, HICKSVILLE, L. I., N. Y.

CIRCLE 160 ON READER-SERVICE CARD



## NEW PRODUCTS

### Power Resistors

413



Rated at 10 and 20. Types 260E and 261E have integral mounting brackets that make them particularly useful for printed wiring boards and in applications where severe vibration is present. Suitable for stack mounting, these units are smaller in physical size than cylindrical-core power resistors.

Sprague Electric Co., Dept. ED, 347 Marshall St., North Adams, Mass.

### Voltage Regulators

414



Heavy-duty automatic regulators are for 50/60 cycles, 3-phase applications that require a constant output voltage with zero waveform distortion. Output is adjustable from 440 to 480 v; input range is 380 to 520 v. Both 240 and 480 kva types are available. Units with higher capacities and other input ranges are also made.

The Superior Electric Co., Dept. EMHC, Dept. ED, Bristol, Conn.

### Logic Cards

463



Digital logic cards operate from dc to 1 mc; flip-flops can be used as counters to 2 mc. Circuits include Schmitt trigger, a four-flip-flop card, and a two-input NOR gate card.

General Applied Science Laboratories, Inc., Dept. ED, Merrick & Stewart Aves., Westbury, N. Y.

Availability: stock to 30 days.

**PRECISION  
RESISTANCE  
WELDING  
EQUIPMENT**

# TWEezer WELD

SMALL PARTS BY  
THE MILLIONS

**Special Purpose  
Welding Machines**

- SEMI-CONDUCTOR EQUIPMENT
- BUTT WELDERS
- CONTACT WELDERS
- ASSEMBLY MACHINES



**SEMI-AUTOMATIC  
CONTACT  
WELDING MACHINE**

... which feeds, welds and cuts off contact material automatically — all in one operation. Tweezer Weld has complete design facilities for special purpose welding equipment, and facilities available for producing parts for your special needs on a production basis at our plant.

**BENCH MOUNTED STORED  
ENERGY WELDER**



- TW5 low friction welding head
- Stored energy panel of 80 Watt second capacity
- Discharge time of 0.0008 to 0.0012 second
- Permits welding of difficult materials . . . copper, silver, tungsten, etc.
- Reliable welds without discoloration, deformation, metallurgical change
- Welding head interchangeable for increased pressure (TW3 head), or for hard-to-get-to assemblies (Plier type electrode)

Complete line of bench heads and controls available for varied purposes

**FEDERAL TOOL ENGINEERING CO.**  
1400 Pompton Ave.  
Cedar Grove, New Jersey

**1/4  
second!**



**WITH L&N's HIGH SPEED SPEEDOMAX® RECORDER**

Need to follow extremely fast-changing d-c millivolt signals... get detailed records for test analysis? Then you'll want this Speedomax instrument, widely-used for rocket testing, radiation monitoring of nuclear reactors, and other data-gathering applications.

The pen speeds across the 9½" chart and balances in 0.25 second or less without overshoot. Even when loaded with an alarm contact, a retransmitting slidewire and a digital encoder, it balances in 0.4 sec. or less.

**LIST NO. — 69801-C4-E2-F7-N3-P28-742 SPEEDOMAX G RECORDER**, normally available for delivery from stock.

**Record** — Single-point continuous line.

**Measuring Circuit** — D-c potentiometer.

**Electrical Range** — 0 to 10 mv.

**Accuracy Rating** — ±0.3% of range.

**Dead Band** — 0.15% of range.

**Span Step Response Time Rating** — With unloaded slidewire shaft, 0.25 sec.; with loaded shaft, 0.4 sec. or less.

**Chart Speed** — ½" per second, exact. Chart and balancing motor switching provided.

**Chart Number** — 742, 100 uniform div. in 9½" with ¼" overtravel at each end.

**Standardization** — Semi-automatic.

**Power Supply** — Operates on 12v, 60~.

**Price** — \$1186.00 f.o.b. Phila. or North Wales, Pa. (subject to change without notice). Use List No. 69801-C4-E2-F7-N3-P28-742 when ordering from L&N, 4908 Stenton Ave., Phila. 44, Pa.



CIRCLE 162 ON READER-SERVICE CARD  
ELECTRONIC DESIGN • September 13, 1961

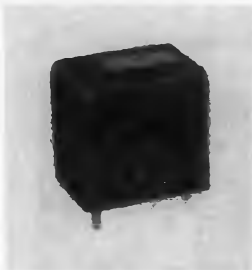

Has no moving parts. Model SSR-2828-3504 is an ac switching relay rated at over 100 million operations. Actuation time is 2 μsec, drop-out time 5 μsec. Actuation or drive frequency can be as high as 5 kc. Operating temperature range is from -55 to +100 C. Maximum contact rating is 150 v, 4 amp rms, resistive or inductive.

Solid State Electronics Co., Dept. ED, 15321 Rayen St., Sepulveda, Calif.



Direct-reading ohmmeter MV-279B provides measurement accurate within 0.25% of full scale. Total range is 0.1 ohm to 2.5 meg, in 14 overlapping ranges. Constant-current energy source allows use of a linear scale. Meter operates from 117 v, 50 to 60 cps, and an internal 1.4-v mercury battery.

Millivac Instruments, Inc., Dept. ED, Box 997, Schenectady, N. Y.



Accurate to 0.01%, time delay relay 31800 has a delay range of 50 msec to infinity. Contact arrangements range from spst to 4pdt, with ratings at 28 v dc or 115 v ac of up to 10 amp resistive, 5 amp inductive.

A. W. Haydon Co., Dept. ED, 4060 Ince Blvd., Culver City, Calif.



***THE LEADER***  
*in R.F. Voltage Measurements*  
*at Low Level*

**from 10 KC to 600 MC**

MODEL 91-CA  
 300 microvolts to 3 volts  
 Price: \$495

MODEL 91-C  
 1000 microvolts to 3 volts  
 Price: \$395

ALSO MANUFACTURERS OF THE FOLLOWING INSTRUMENTS:



DC Millivoltmeter



Inductance Bridge



Capacitance Bridge



UHF Grid Dip Meter

**Boonton *ELECTRONICS* Corp.**

Morris Plains, N. J. • Jefferson 9-4210

CIRCLE 163 ON READER-SERVICE CARD

There is a difference  
in crystal quality

Specify **McCoy** ALL-GLASS Units

and see for yourself!

Regardless of their size, type or frequency — crystals bearing the name McCOY have an enviable reputation for delivering the ultimate in dependable performance.

Their fabulous quality — which, heretofore could only be enjoyed — can now be seen in the new McCOY G-1, G-20 and Micro-Module ALL-GLASS Crystals.

Because they are sealed in vacuum,

their performance CANNOT be affected by atmospheric pressure changes or exposure to another vacuum.

Lower resistance (higher Q) results from the true "hard glass" vacuum seal as well as greatly increased long term stability and ability to withstand extremes of shock and vibration; also better control of crystal parameters.

## ALL GLASS STANDARD SIZE AND MINIATURE CRYSTAL UNITS



shown  
actual  
size

### G-1 (Military HC-27/U)

This vacuum sealed, hard glass crystal unit possesses all of the quality features for which the McCoy M-1 is so famous. It has long term frequency stability approximately five times better than the conventional metal types. Available in frequencies from 2000 kc to 200 mc.

### G-20 (Military HC-26/U)

### G-21 (Military HC-29/U)

This vacuum sealed, hard glass crystal unit meets the new CR-73/U and CR-74/U specifications. It has long term frequency stability approximately five times better than the conventional metal type. Available in frequencies from 5000 kc to 200 mc.

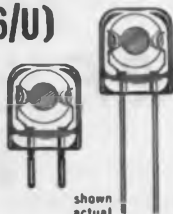

shown  
actual  
size



shown  
actual  
size

### MICRO MODULE CRYSTALS-GLASS

.28" square x .110" thick; frequency range 100 mc to 200 mc. Now available in limited quantities.

Write today for our free illustrated catalogs which include complete listing of military specifications. For specific needs, write, wire or phone us. Our research section is anxious to assist you.

**McCoy**

SUBSIDIARY OF OAK MANUFACTURING CO

**ELECTRONICS  
COMPANY**

Dept. ED-9  
MT. HOLLY SPRINGS, PA.  
Phone: HUnter 6-3411



CIRCLE 164 ON READER-SERVICE CARD



## NEW PRODUCTS

### Test Instruments

364



Ultra-sensitive dc picoammeter MV-111A-L provides full-scale ranges from 100 pa to 250 ma, with 1% accuracy. Model MV-127-A-L is a dc microvoltmeter with ranges from 100  $\mu$ v through 1 kv. Basic accuracy is 1%. The dc microvoltammeter MV-07B has ranges from 10  $\mu$ v through 1 kv, and 10 pa through 1 ma. Accuracy is 1% voltage, 2% amperes. All instruments have individual calibration controls.

Millivac Instruments, Inc., Dept. ED, Box 997, Schenectady, N. Y.

### Transient Detector

453



Transistorized and battery operated, transient detector model TD 761M is useful in semiconductor applications. Range is 0 to 2,000 v. Transient duration is a minimum of 1  $\mu$ sec. Measurement from 0 to 1,000 v is in increments of 50 v; 1,000 to 2,000 v, increments of 100 v. Readout device is a 3-1/2 in. dc meter.

Regent Controls, Inc., Dept. ED, Harvard Ave., Stamford, Conn.

P&A: \$325; from stock.

### Power Supply

630



Relay-type switching power supply model 293B is made for diode life testing. Unit supplies a maximum of 50 amp average forward current at 12 v and piv up to 1,400 v. Forward and reverse outputs are metered and may be adjusted by powerstats.

Aerotronic Associates, Inc., Dept. ED, Contocock, N. H.

P&A: \$650.

## NOW FROM KIDDE ELECTRONICS!



Envelope dimension directly above: 23" x 12" x 15".

Static inverters, converters, frequency changers, power supplies: Lighter, more reliable, lower in cost!

Now, with new engineering techniques, Kidde Electronics Laboratories can offer static inverters, converters, frequency changers and power supplies which are more reliable, lighter in weight, and lower in cost. For example, static inverters can employ symmetry modulation, pulse width control or stepped wave techniques; static frequency changers can employ intermediate DC or straight-through method consisting of switch or phase modulation techniques. Kidde working units employing these techniques cover the following ranges:

**Static Frequency Changers** - 10 VA to 10 KVA, 50 cps to 3200 cps upward and downward.

**Static Inverters** - 10 VA to 10 KVA, frequencies to 5,000 cycles, sinusoidal and square wave.

**Static Converters (DC to DC)** - Voltage step up and down. Input less than 1V. Output greater than 16KV. 10 microamps to 1000 amps, dissipative and non-dissipative regulation.

**Static Power Supplies** - Special purpose type static power supplies, 10W to 5KW, 1V to 16KV, dissipative and non-dissipative, regulated.

**Kidde**  
**EL**ectronics  
Laboratories



WALTER KIDDE & COMPANY, INC.  
974 Brighton Road, Clifton, N. J.

POWER,  
CONTROL,  
SIGNAL  
CIRCUITS...



... all in one  
**ROYAL  
CABLE!**

**ROYAL MULTI-CONDUCTOR CABLES** are designed, manufactured and quality-controlled to your exact specifications... for a myriad of uses... for simple or complex applications. Cable elements and materials may be combined to include signal, control and power circuits into one construction and within

one jacket. Royal is equipped and experienced to provide a finished cable that will assure predictable, dependable on-the-job performance. And remember, Royal is ready... to quote... to supply... to satisfy.

Write for new Catalog No. 4C-61... (includes charts on Royal RG and special application cables, physical characteristics, test procedures, engineering tables, etc.)

**ROYAL ELECTRIC CORPORATION**  
301 Saratoga Ave., Pawtucket, R. I.  
In Canada: Royal Electric Company  
(Quebec) Ltd., Pointe Claire, Quebec

**ROYAL**  
ELECTRIC  
...an associate of

CIRCLE 166 ON READER-SERVICE CARD  
ELECTRONIC DESIGN • September 13, 1961

## Thermoelectric Coolers

352



**Reach -90 C.** Designed for infrared detector cooling, thermoelectric elements are capable of achieving -78 to -90 C. The elements are also useful for cooling electronic devices which may be widely separated in physical location.

Pesco Products Div., Borg-Warner Corp., Dept. ED, Bedford, Ohio.

## Multiplexing System

417

**Up to 18 channels** from a single 3-kc voice channel are provided by the C-8102 FSK voice band modem. Maximum transmission rate is 75 bits per sec, equivalent to 100 words per min in teletype operation, on each channel. The data channels consist of tone signals separated by 170 cycles in a frequency range of 425 to 3,315 cps.

Collins Radio Co., Dept. ED, P. O. Box 1891, Dallas 21, Tex.

## DC-to-DC Converter

476

**Handles 80 w.** Separate outputs of converter model 46-129-0 are +200 v dc, +28 v dc, -28 v dc and 6.3 v ac. Regulation is  $\pm 1\%$  on 28 v and  $\pm 5\%$  on the 200 v dc and 6.3 v ac outputs. Power input is 28 v dc. Temperature range is 0 to 65 C. Weight is 4.5 lb. Converter is for satellite applications.

Magnetic Research Corp., Dept. ED, 3160 W. El Segundo Blvd., Hawthorne, Calif.

## Resistor Networks

465



**Thin film tin oxide resistor networks** are made to military specifications. Range of resistance values is 50 ohms to 4 meg. Temperature coefficient of  $\pm 50$  ppm per degree C is standard; tolerances to  $\pm 1\%$  are available.

Intellux, Inc., Dept. ED, 30 S. Salsipuedes St., Santa Barbara, Calif.

**Price: \$10, four-resistor network sample.**

# Reduce static circuit costs... install Westinghouse Voltrap\* surge suppressors

## PROBLEM

411B Bridge; #302 cell, 3X3 Fins  
2-C RMS Input-115 volts; d-c output-98 volts  
2-C switching surges

## SOLUTION

### Without Voltrap

411B Bridge  
#302K 500PRV @ \$7.80

### With Voltrap

302g 350PRV @ \$56.60

Add Voltrap @ 5.27  
\$61.87

Actual savings with  
Westinghouse Voltrap - \$25.93 or 29.5%

Substantial savings in static circuits are now possible with VOLTRAP surge suppressors, because they provide reliable, guaranteed surge clamping permitting use of less expensive lower PRV rated silicon devices.

**How does it work?** — A static device with Zener characteristics, VOLTRAP surge suppressor provides a shunt discharge path for surge currents and clamps dangerous surge voltages to safe levels. VOLTRAP devices clamp the surge voltage peak to 250% or 280% of its rms voltage rating permitting use of silicon devices with PRV ratings only 10% above VOLTRAP clamping voltage.

Westinghouse VOLTRAP units have these additional exclusive advantages:

- Open construction allows free air circulation resulting in cooler and more reliable operation.
- VOLTRAP bridge designs permit simplified installation and wiring.

- Clamping voltage ratings guaranteed because each individual unit is oscilloscope tested.

### Ratings available:

- Eight discharge currents: 2, 3, 5, 10, 20, 40, 65, 80 amps.
- Sixteen a-c rms voltages in 30 volt steps: 30 to 480 volts.
- Clamping voltage range: 250% or 280% nominal rms voltage rating.
- Units either polarized or non-polarized.
- Finishes available for various environmental conditions.

Call your local Westinghouse sales engineer now for complete information on the savings you can make by installing VOLTRAP surge suppressors in your static circuits. Or, if you prefer, send in the coupon below.

*You can be sure . . . if it's Westinghouse.*

J-28007



**Westinghouse**

To: Westinghouse Electric Corporation  
General Purpose Control Dept.  
P.O. Box 2025, Buffalo, N.Y.

- Please send me your Technical Data 19-163 on Voltrap Surge Suppressors.
- Please have a Westinghouse electronics engineer call for an appointment.

Name \_\_\_\_\_

Address \_\_\_\_\_

Company \_\_\_\_\_

City \_\_\_\_\_ State \_\_\_\_\_

CIRCLE 167 ON READER-SERVICE CARD



## CRT OF THE MONTH

**New! Fiber Optics Faceplate, High Resolution Electron Guns**—minimize spot size . . . increase light output 40-80 times over conventional CRTs designed for data display, radar, or other exacting uses.

Faceplates using fiber optics eliminate halation, refraction and light transmission problems common to conventional CR tubes. ETC model M-1014 illustrated, uses 0.001" dia fibers in a  $\frac{6}{8}$ " x  $3\frac{1}{2}$ " panel insert gaining 625 vertical dots by 3,500 horizontal dots or lines.

Electro-static focus, 40° magnetic deflection for minimum defocusing, maximum corner resolution.



Larger ETC fiber optics CRTs available from 1" to 6" dia, resolutions of 2,000 by 2,000 dots/inch.

# pacing trends

## IN CATHODE RAY TUBE DESIGN

### ...since 1937

Over 100 standard types . . . many specials . . . produced for oscilloscopes and critical display instrumentation. 1 to 10 guns; square, round, or rectangular faces; high resolution; spiral band for radar, fire control, counter-measures, guidance—where quality control counts most. Submit your application details for an engineering review.

*electronic tube corporation*

1200 E. MERMAID LANE, PHILADELPHIA 18, PENNA

CIRCLE 168 ON READER-SERVICE CARD

## NEW PRODUCTS

### Angle Counter

356



Remote angle counter RAC-1 provides an in-line digital display of angle from 0 to 360 deg at a remote location. Housing is size 25, length is 3 in. Accuracy and resolution are 0.1 deg. Power requirement is 28 v, ac or dc.

Theta Instrument Corp., Dept. ED, 520 Victor St., Saddle Brook, N. J.

P&A: \$500; 8 weeks.

### Transformer

449



Delivers 60 mw at 400 cps. Used for three-phase to two-phase or four-phase transformation, the unit has an output of 11.6 v rms, two-phase, with an input of 11.6 v rms, three phase. It is encased in a hermetically sealed metal container. Lead termination is a 7-pin hermetically sealed glass header.

Supreme Transformer Co., Dept. ED, Chicago, Ill.

### Light-Dependent Resistor

456



Compact light-dependent resistor type B8.731-.04 has a resistance ratio in excess of 25,000:1 for light intensity change from darkness to 1,400 foot candles. Operating temperature range is -40 to +85 C. Size is 0.42 x 0.06 in.

Ferroxcube Corp. of America, Dept. ED, Saugerties, N. Y.

Price: \$10, kit of four.

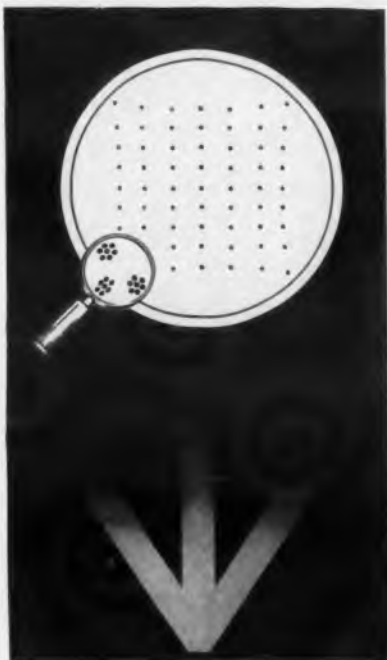

# WHY

## MAJOR C. R. TUBE MFGRS. RECOMMEND SYNTRONIC YOKES

Exceptional manufacturing uniformity. Achieved by unique pepperpot tube testing—the most comprehensive method known for precise measurement for spot uniformity . . . to attain extremely accurate focusing. For technical details, request ELECTRONIC INDUSTRIES reprint #6-57 from Syntronic Instruments, Inc.

Call your nearest SYNTRONIC REP today

Boston-New Eng.:	NORwood 7-3164
New York Area:	OXford 5-0255
Phila. Area:	MOhawk 4-4200
Wash.-Balt. Area:	APpleton 7-1023
Indianapolis:	Victor 8-0359
Los Angeles:	CUmberland 3-1201

# syntronic

## INSTRUMENTS, INC.

100 Industrial Road, Addison, Illinois  
Phone: Kingswood 3-6444

The industry's broadest yoke line . . . already tested for quantity production. Or, yokes can be custom designed to your precise requirement.



CIRCLE 169 ON READER-SERVICE CARD

ELECTRONIC DESIGN • September 13, 1961

# NEW Stromberg- Carlson lightweight telephone handsets



... for a wide range of applications such as dictating systems, mobile radio, carrier and microwave.

These new lightweight Stromberg-Carlson handsets, No. 33 and No. 35, incorporate push-to-talk switches, broadening the range of their applications. Both feature high gain, high-efficiency transmitter and receiver.

The No. 33 model is furnished with a bar type switch, located on the underside of the handle.

The No. 35 handset is furnished with a button switch on the side of the handle near the receiver end. Also available with both button and bar switches.

For technical details and ordering information, contact any of these sales offices: Atlanta—750 Ponce de Leon Place, N.E.; Chicago—564 W. Adams Street; Kansas City (Mo.)—2017 Grand Avenue; Rochester—1040 University Ave.; San Francisco—1805 Rollins Rd.

**GENERAL DYNAMICS  
/ELECTRONICS**

CIRCLE 170 ON READER-SERVICE CARD  
ELECTRONIC DESIGN • September 13, 1961

## Magnetic-Tape Certifier

460



Automatic magnetic-tape certifier model C can be used with any transport at normal speed and packing density. All channels are inspected simultaneously; tape stops when a drop-out occurs.

Cybetronics, Inc., Dept. ED, 235 High St., Waltham 54, Mass.

## Digital Voltmeter

462



Solid-state digital voltmeter uses a floating input circuit, providing constant high input impedance. Range and polarity selection are automatic on four ranges, up to  $\pm 1,199.9$  v. In-line, in-plane projection readout is visible up to 50 ft. Panel height is 6-1/4 in.

Electronic Associates, Inc., Dept. ED, Long Branch, N. J.

## Silicon Transistors

419

For switching applications. Silicon npn switching transistors have collector current rating of 500 ma, typical  $h_{FE}$  of 40, type 2N696, and 75, type 2N697. Collector-to-base breakdown voltage is 75 v, collector cut-off current  $1 \mu\text{a}$  at 25 C,  $100 \mu\text{a}$  at 150 C. Housed in a TO-5 package, devices meet MIL-S-19500B.

Radio Corp. of America, Semiconductor and Materials Div., Dept. ED, Somerville, N. J.  
*Availability: Stock.*

## Recorder

458



Four-pen chart recorder will handle any set of variables that can be transduced into an electrical quantity. Ample torque is available for auxiliary functions such as slidewires and alarm contacts.

The Bristol Co., Dept. ED, Waterbury 20, Conn.

# Actions → STOP → for Review

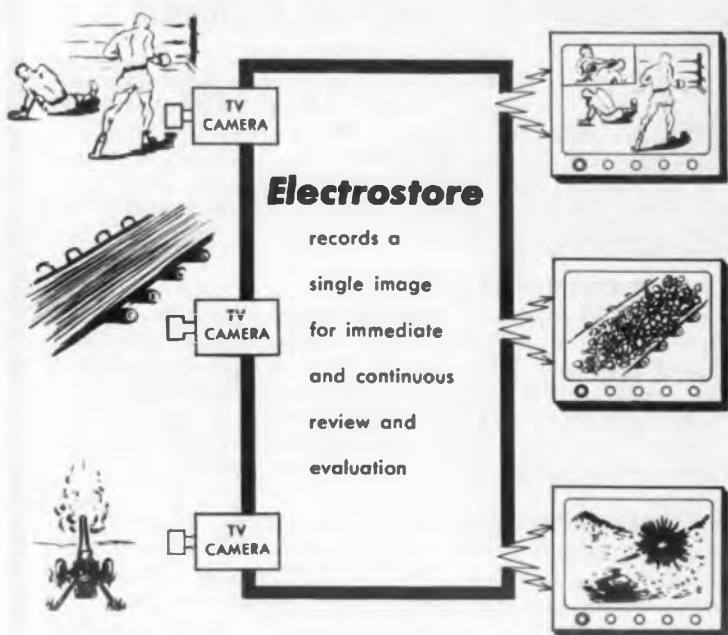

## WHEN IN DOUBT — CAPTURE FUGITIVE EVENTS

Make the *right* decision. Let the Electrostore provide you with an accurate review of the facts.

## AN ELECTROSTATIC RECORDING TUBE SYSTEM

Electronic in operation, the "Electrostore" gives: immediate recall and display, prolonged or repeated viewing, high quality reproduction. In addition, the system needs no tape or film, no rewinding or processing. It has no moving parts.

## ASK US ABOUT ELECTROSTORE

When you have to make the *right* decision, take a *second* look, a *longer* look, a *better* look — get in touch with us for prompt engineering help in resolving your particular image-recall problem. Ask for Charles Phaneuf.



2300 WASHINGTON ST.

INSTRUMENTS, Inc. NEWTON LOWER FALLS 62, MASS.

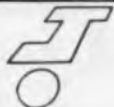

Telephone (Boston) Woodward 9-8440

CIRCLE 171 ON READER-SERVICE CARD

## Outstanding Missile and Space Openings for Electronic/Electrical Engineers

The Boeing Company, system contractor on the Dyna-Soar manned space glider and weapon system integrator on the solid-fuel Minuteman ICBM, has a number of immediate openings for graduate Electronic/Electrical engineers. These positions, available in areas described below, offer challenge and scope, and exceptional opportunities to advance to higher levels of responsibility and income.

### RADIO FREQUENCY INTERFERENCE

Assignments in this area include performing electro-interference tests on military equipment; developing familiarization with RFI specification and compliance requirements; evaluating the physics of generation of electro-magnetic interference and methods of reducing susceptibility to both radiated and conducted interference. Requirements: BSEE degree plus minimum of two years of applicable experience.

### ELECTRONICS PACKAGING DESIGN

Duties in this area include evaluation, selection, development and documentation of packaging techniques and systems; evaluation, selection, test and qualification of electronic parts and documenting pertinent engineering information; evaluation, development and application of hardware designs for all types of electronic circuits; design, evaluation and qualification of electronic packaging; selection, design and test of production processes; evaluation, selection, test and qualification of special materials.

Salaries are competitively commensurate with education and experience. Boeing provides travel and moving allowances. In Seattle you'll enjoy the advantages of the uncongested, evergreen Pacific Northwest area, famous for mild year-round climate, unexcelled recreational facilities, modern housing, fine schools and outdoor Western living for the whole family.

*Send your resume, today, to: Mr. William B. Evans, The Boeing Company, P. O. Box 3707 - ESH, Seattle 24, Washington. All qualified applicants will receive consideration for employment without regard to race, creed, color or national origin.*



CIRCLE 901 ON CAREER INQUIRY FORM, page 181



## PRODUCTION PRODUCTS

### Tubing Marker

261



Coding and identification tubing of flexible plastic is fed, cut, and marked by the model ETMA automatic tube marking machine. Tubing from 1/8 to 1 in. in diameter is processed and cut into 3/8 to 2 in. lengths. Production rate is 60 to 190 pieces per min. Dry heat bond process is used, with temperatures adjustable from 200 to 600 F.

The Acromark Co., Dept. ED, 410 Morrell St., Elizabeth 4, N. J.

### Batch Ovens

262

Provide to 400 and 600 F. The Power-O-Matic 60 batch ovens provide straight-line control of temperature without cycling. Four sizes providing 16 to 36 cu ft are available. Construction is of heavy steel with Fiberglas wool insulated triple side walls.

Blue M Electric Co., Dept. ED, 138th and Chatham St., Blue Island, Ill.

### Toroid Winding Head

263



Rapid, easy insertion and removal of cores is provided by the type 601 toroidal coil winding head assembly. Head replaced 6-in. shuttle head equipment in the firm's line of winders. Coils ranging from 5/8 in. ID to over 5 in. OD can be wound.

Boesch Manufacturing Div., Waltham Precision Instrument Co., Inc., Dept. ED, 45 River St., Danbury, Conn.

## WHITSO STANDOFF TERMINALS

...Largest Line Available

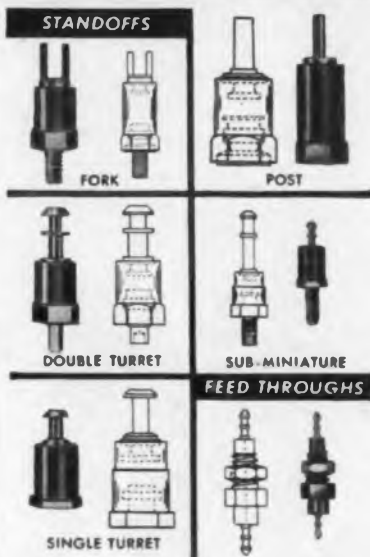

### DIALYL PHTHALATE AND MELAMINE BODY MATERIALS TO MEET MILITARY STANDARDS

Get the exact standoff or feed through terminal you want from a full range of types, sizes, body materials and plating combinations. Specials can be supplied to specification. The Whitso line is complete to the fullest extent of every industrial, military and commercial requirement.

Standoff terminals include fork, single and double turret, post, standard, miniature and sub-miniature body types—male, female or rivet mountings—molded or metal base. Feed through terminals are furnished standard or to specification.

**Plating Combinations:** Many terminal and mounting combinations furnished as standard.

**Specials:** Body materials and plating combinations, also dimensions, can be supplied to specifications.

### PROMPT DELIVERY IN ECONOMICAL QUANTITY RUNS

Get facts on the most complete, most dependable source for terminals and custom molded parts. Request catalog.



**WHITSO, INC.**  
9326 Byron Street, Schiller Park, Illinois  
(Chicago Suburb)

CIRCLE 172 ON READER-SERVICE CARD  
ELECTRONIC DESIGN • September 13, 1961

## POLARIS PROVEN CONNECTORS



# LIONEL

## Series WM-20

Extra Reliability With—

- Rugged Die-Cast Housings
- Diallyl Phthalate Moldings
- Beryllium Copper Contacts For Extended Insertion/Withdrawal Life



Five sizes, 34 to 104 contact range • Also available for #16 wire terminations • Meet applicable MIL specs • Materials & specifications modified to meet your special needs—

- Write Dept. 19-PW for Series WM-20 Dimensional Data Sheets



## Lionel Electronic Laboratories

(Formerly Anton Electronic Laboratories)

1226 Flushing Ave.  
Brooklyn 37, N. Y.

CIRCLE 173 ON READER-SERVICE CARD  
ELECTRONIC DESIGN • September 13, 1961

## Wire Stripper

264



Thermal wire stripper combines the type WS30 stripper and model H101CD power supply. Oxidation and heat build-up are resisted. Operation is by straight-pull action; it can be used on any insulation, including Teflon. Power supply is also suitable to power a soldering iron.

Contact, Inc., Dept. ED, P. O. Box 6, Hudson, N. H.

## Parts Handling System

265



Small, delicate parts and components are handled with this system called a Vacuum Tweezer. An aluminum pencil connected to a vacuum generator by rubber tubing is used with various sizes of pick-up needles. Finger operation controls vacuum.

Anco Products, Dept. 118, Dept. ED, 276 Park Ave., Collingswood, N. J.

Price: \$39.95 fob Collingswood.

## Diode Sealer

266



Ohmic contact glass diodes receive final sealing in an inert atmosphere. Unit seals seven diodes per cycle, with 50 cycles per hour. Ohmic contact pressure is predetermined.

Research Instrument Co., Inc., Dept. ED, 558 Main St., Westbury, N. Y.

P&A: \$4,200; 2 months.

NEW FROM T/I

# CLOCK PULSE GENERATORS

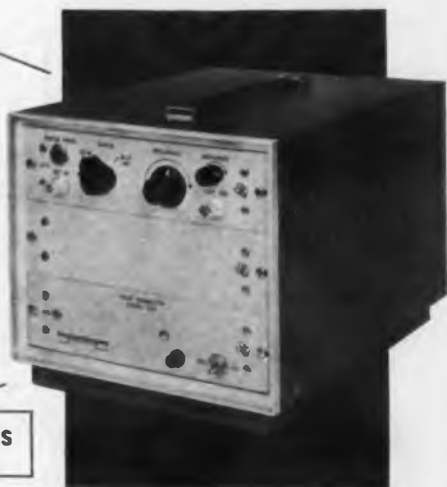

Very Fast Repetition Rates  
(UP TO 100 MEGACYCLES)

Texas Instruments 6100 Series Clock Pulse Generators include models offering repetition rates from 100 cps to 100 MC. Provision is made for external drive input for single pulse and to permit operation of several generators from master source. All models have pulse width of less than 8 nanosec at one-half pulse height and rise times of 4 nanosec; 0-4 V continuously variable amplitude; 93-ohm output impedance.

Write for complete information.

APPARATUS DIVISION  
PLANTS IN HOUSTON  
AND DALLAS, TEXAS



TEXAS INSTRUMENTS  
INCORPORATED  
3609 BUFFALO SPEEDWAY  
P. O. BOX 66027 HOUSTON 8, TEXAS

461

CIRCLE 174 ON READER-SERVICE CARD

## WHERE QUALITY COUNTS

### PRECISION BUILT CHASSIS SLIDES



These quality ball bearing slides provide the highest service ability under any conditions. Two types—16 styles and sizes available. Some for industrial and military applications, others for commercial use.

### CUSTOM DESIGNED HANDLES



29 styles and sizes available. Some are steel, others are brass and many are cast aluminum. Beautifully made with durable attractive finish. Designed for rugged applications.

For complete information see your Bud Distributor or write for Bulletin S-6060.



**BUD RADIO, INC.**

Cleveland 3, Ohio

CIRCLE 175 ON READER-SERVICE CARD



**do you tremble  
at the sign of a sine?**

Does a sine-cosine pot in your pet project mean special prices and annoying delay? No need to pay more . . . no need to wait. Ace has a full line of sine-cosine function pots — in sizes, conformities and driving resistances to meet all your requirements — and delivery is prompt. Our standard line — which meets 95% of your needs — we can ship promptly . . . AND a special one goes off to you with minimum delay! Ace offers, as standards, conformities in a  $\frac{7}{8}$ " or  $1-1/16$ " size that you'd pay for as a special in a 2" size elsewhere! Consider the space, weight and money you save!

Ace's standard sine-cosine line includes sizes from  $\frac{3}{4}$ " to 3", driving resistances from 1K to 1 megohm, in comparable conformities from 0.5% peak to peak. So if you think you have a special requirement — talk to us! Chances are it's an Ace standard sine-cosine pot!

*This  $\frac{3}{4}$ " sine-cosine ACEPOT® features conformity of 1.0%, peak to peak, in a resistance range of 1K to 30K. Other driving resistance ranges and conformities available.*

See us at IRE Booth 1912-1914

**ACE** ELECTRONICS ASSOCIATES, INC.  
99 Dover Street, Somerville 44, Mass.

SOMerset 6-5130 TmX SMVL 181 West. Union WUX

Acepot® Acotrim® Acoset® Aceahm® \*Reg. Appl. for

CIRCLE 176 ON READER-SERVICE CARD

# NEW LITERATURE

## Servo Units

267

Servo system components available in kit form are listed in 12-page catalog No. 2. Physical specifications and dimensional drawings are included for components, which can be assembled into prototype systems. Gap Instrument Co., 116 E. Merrick Road, Freeport, L. I., N. Y.

## Tape Recorders

A bibliography of articles on tape recorders is collected in this eight-page bulletin. Over 400 articles from journals and conferences from 1954 to 1960 are listed. *Send \$1.00 to Kinelogic Corp., Dept. ED, 1256 N. Fair Oaks Ave., Pasadena, Calif.*

## Coaxial Transmission Lines

268

Straight sections, connectors, elbows, and hardware and accessories associated with rigid coaxial transmission lines are cataloged in this 12-page brochure. Electrical and physical characteristics are given, with tables, graphs, nomograms, and dimensional drawings. Technical Appliance Corp., Sherburne, N. Y.

## Metallic Standoffs

269

Metallic spacers and posts are described in four-page data-sheet No. SPPM-1. Physical specifications and prices are given for over 100 items. Angler Industries, Inc., 75 Winthrop St., Newark, N. J.

## Components and Equipment

270

The firm's line of electronic components and equipment is described in this 400-page illustrated catalog. Chemicals, tools, hardware, plugs and jacks, resistors, test equipment, communications, sound, and high-fidelity apparatus, antennas, and related components are included. GC Electronics Co., Dept. FR-62, 400 S. Wyman St., Rockford, Ill.

## Ceramic Capacitors

271

Plastic-molded and dip-plastic-coated ceramic capacitors are described in this 16-page booklet. General specifications are given, with curves of temperature characteristics. Dimensional drawings of the cases are included. Gulton Industries, Inc., 212 Durham Ave., Metuchen, N. J.

## Beam Switching Tube

272

Switching tubes, the firm's Beam-X line, are covered by this 24-page brochure. Theory of operation, circuit design, and applications are discussed; illustrations and characteristics curves are included. Burroughs Corp., Electronic Components Div., P. O. Box 1226, Plainfield, N. J.

## Tape Heads

273

Tape heads which record seven tracks in line or thirteen tracks interlaced are described in this illustrated brochure. Physical and electrical specifications are given in chart and tabular form. Test data on each unit is included. Norton Associates, Inc., 240 Old Country Road, Hicksville, L. I., N. Y.

## Waveguide Flanges

274

Mechanical specifications for waveguide flanges, including single and dual choke and cover for both pressure and nonpressure applications, are listed in 14-page catalog No. FA61-1. Microwave Development Laboratories, Inc., Natick, Mass.

## Sidewall Hybrids

275

Over 100 sidewall short-slot hybrids are described in this 12-page catalog, No. HS61. Various styles and terminations are illustrated. Electrical and mechanical data are tabulated with waveguide sizes. Microwave Development Laboratories, Inc., Natick, Mass.

**Traveling-Wave Tubes 276**

Low-noise traveling-wave tubes are described in this 16-page bulletin. It includes a basic description of low-noise traveling-wave tube design, application information and technical specifications on 7 tube types now available in production or sample quantities. For copies of PT-53 write to General Electric Co., Schenectady 5, N. Y.

**Waveguide Filters 277**

Electrical data on waveguide filters, including band-pass and insertion loss ratings, are given in 12-page catalog No. FP61. An engineering section permits approximation of filter lengths and number of cavities required for desired slope of filter envelope. Microwave Development Laboratories, Inc., Natick, Mass.

**Tungsten Alloy 278**

A heavy tungsten alloy, Kennerium W-10, is described in eight-page bulletin No. B-500. Physical properties, machining recommendations, joining and engineering suggestions are included. Applications, particularly for radioactive shielding and rotational balancing, are considered. Kennametal, Inc., Latrobe, Pa.

**Telemetry Antennas 279**

Over 30 antennas for missile guidance, tracking, and telemetry operations are described in eight-page catalog T. Illustrations and specifications are included. Rotators, patch panels, and other accessories are listed. Andrew Corp., P. O. Box 807, Chicago 42, Ill.

**Silicone Fluids 280**

Use of silicone fluids as hydraulic and damping fluids, dielectrics and lubricants, antifoam agents, coatings for ceramics and glass, and as additives in urethane foams is outlined in bulletin S-9. Tables and graphs indicate properties of various grades of the fluids. General Electric Co., Silicon Products Dept., Waterford, N. Y.

**Magnetic Contactors 281**

A line of NEMA size 3 and 4 magnetic contactors and starters is covered by eight-page bulletin GEA-7326. Illustrations and diagrams outline installation of the units. Characteristics are tabulated. Modification kits are listed and discussed. General Electric Co., Schenectady 5, N. Y.

**Vibratory Equipment and Power Tools 282**

Vibratory materials and parts handling equipment, mechanical shaft seals, paper joggers, portable power tools and power rectification equipment are described in catalog No. 616. Specifications and over 200 illustrations are included. Syntron Co., 283 Lexington Ave., Homer City, Pa.

**Printed Circuits 283**

Flexible, flush, and multi-layer printed circuits are described in this technical bulletin entitled "Depth in Circuitry". Applications, specifications, and electrical data are outlined. U. S. Engineering Co., 13536 Saticoy St., Van Nuys, Calif.

**Circuit Breakers 284**

This selector wheel is made to simplify selection of the most suitable circuit-breaker from among the firm's line. Wheel can be rotated until the most favorable electrical and physical parameters are found, at which point the model number can be read off. Westinghouse Electric Co., Standard Control Div., Beaver, Pa.

**Antenna Instrumentation 285**

Antenna pattern recording equipment, receivers, transmitters, control devices, antenna positioners, microwave components, recorder supplies, and auxiliary equipment are described and illustrated in this 16-page catalog. Specifications and prices are included. Scientific-Atlanta, Inc., 2162 Piedmont Road, N. E., Atlanta, Ga.

NEW FROM T/I

# VARIABLE WIDTH PULSE GENERATOR

Continuously Variable  
Pulse Width and Delay



The 6500 Series includes the features of Texas Instruments 6100 Series plus additional outputs with continuously variable delay from 0-1000 nanosec. All outputs provide controls for continuously variable pulse width from 20-1000 nanosec up to 90% duty cycle. Output amplitude is 0-5 V; rise times of 5 nanosec; repetition rates up to 25 MC.

WRITE FOR COMPLETE INFORMATION.

APPARATUS DIVISION  
PLANTS IN HOUSTON  
AND DALLAS, TEXAS



TEXAS INSTRUMENTS  
INCORPORATED  
3609 BUFFALO SPEEDWAY  
P. O. BOX 66027 HOUSTON 6 TEXAS

462

CIRCLE 177 ON READER-SERVICE CARD

## HALF-X, HALF-X<sub>L</sub> and HALF-K<sub>U</sub>

These miniaturized waveguides—and many others—have been Turbo developed and built for scores of systems applications. Proved in performance for a decade.

Many components, and test equipment items are available from stock. If your system needs miniaturization, send us your specifications for evaluation and recommendations.

TURBO MACHINE COMPANY, LANSDALE, PA.

Telephone: Ulysses 5-5131

# TURBO



CIRCLE 178 ON READER-SERVICE CARD

Ambient Temperature  
Changes Can't  
Affect This  
New AO  
**TRACE-MASTER**



This AO TRACE-MASTER is the world's finest 8-channel direct writing recorder. The cooling equipment is also the world's finest . . . because it's made by McLEAN.

thanks to **McLEAN**  
**Cooling Equipment!**

When American Optical Co. designed the new TRACE-MASTER, it had to detect the tiniest variables with the greatest fidelity. To do this it was necessary to eliminate excessive temperature gradients by using highly reliable cooling equipment. McLEAN and only McLEAN was selected for this critical task. McLEAN's cooling units contribute importantly to the high-quality trace and superior performance of the AO TRACE-MASTER.

McLEAN blowers are smart, compact, and easy to install. Over 100 models in various panel heights and CFM's are available.

*Also a complete line of fractional horsepower motors*



**MODEL 2E408,**  
Over 15,000 in use  
all over the world.



**WRITE TODAY**  
44 Page Packaged  
Cooling Catalog



**McLEAN** ENGINEERING  
LABORATORIES

*World Leader in Packaged Cooling*

Princeton, N. J. • WALnut 4-4440

TWX Princeton, New Jersey 636

CIRCLE 179 ON READER-SERVICE CARD



## NEW LITERATURE

### Test Instruments 297

A direct-reading LC meter, an indicator unit, a waveform generator, two pulse generators, and two power supplies are described in this 12-page booklet. Specifications, performance characteristics, and illustrations are included. Tektronix, Inc., P. O. Box 500, Beaverton, Ore.

### Ovens 298

Laboratory heating equipment and apparatus are described in 24-page Catalog 92. Included are high-temperature box and tube furnaces and combustion tubes. Burrell Corp., 2223 Fifth Ave., Pittsburgh 19, Pa.

### Silicone Molds 299

Silicone release and parting agents are described in this 12-page brochure, S-13. Reliability of release, stability at high temperatures, spreading, and chemical inertness are discussed. Silicone Products Dept., General Electric, Waterford, N. Y.

### Industrial Tubes

"Industrial Tubes by National" is a 23-page booklet giving hints for equipment using ignitrons, thyratrons, and gas-filled rectifiers. Maintenance problems are discussed. Send twenty-five cents to National Electronics, Inc., Dept. ED, Geneva, Ill.

### Magnetic Preamplifiers 300

Six-page technical bulletin, No. 10-C, describes the use of magnetic amplifiers for thermocouples, strain gages, photocells and other low-level dc signals. Design of low-level and common-mode isolation instrumentation and controls with magnetic amplifiers is outlined. Acromag, Inc., 22515 Telegraph Road, Southfield, Mich.

### Zener Diodes

This 185-page manual covers silicon Zener diodes and rectifiers. Use of Zeners in regulated power supplies is discussed, with reference to schematic drawings, tables and curves. Properties of silicon rectifiers are also considered. Send \$2.00 to Motorola Semiconductor Products, Inc., Dept. ED, 5005 E. McDowell Road, Phoenix, Ariz.

# NOW

## Check Out Critical Temperatures on

Microminiature  
circuitry  
Transistors  
Diodes  
Breadboards  
Motors  
Generators  
Bearings  
Transformers  
Packaged equipment



with

## Easy-To-See COLOR CHANGING Thermochrom DetectoTemp CRAYONS PAINTS

Simple to apply, these indicating materials show the temperature by changing to a distinct, totally different color. They provide a most convenient means for determining whether equipment or components are operating within specified temperature ranges.



**Thermochrom**  
18 crayons cover temperatures  
from 45° C to 670° C.  
**DETECTOTEMP**  
Available in 4 oz. and 1 lb. metal cans.  
36 types cover temperatures  
from 40° C to 1350° C.  
Multichange paints available  
with as many as 4 color changes.

Write for colorful folder.

## CURTISS WRIGHT

Princeton Division • Princeton, New Jersey  
Also available through your AIRCO distributor  
In CANADA: Canadian Curtis-Wright Ltd. Industrial  
Process Controls, Davis Road, Oakville, Ontario  
CIRCLE 180 ON READER-SERVICE CARD

## TUCOR BWO'S ATTAIN EXTREME STATE OF ART IN SPECTRAL PURITY



T15C1C

A special hollow-beam gun in a solenoid-focussed tube provides Tucor backward wave oscillators with a unique degree of spectral purity and non-microphonic response. Tucor BWO's, of which models are available for the handling of frequencies from 3 through 14 Kmc, retain this purity through conditions of extreme shock, vibration, temperature and humidity.

Designed expressly for systems requiring Doppler information, these tubes are completely encapsulated with an integral heat sink. This design provides an extremely stable frequency output, as well as one of the narrowest spectra of any generators over a wide tuning range.

Low noise output is another feature of Tucor BWO's, which, like all Tucor tubes, are highly processed to provide extra dependability under adverse conditions. Further details on them are continued in the current Tucor Catalogue.



**TUCOR  
INC.**

59 Danbury Road (Route 7), Wilton, Connecticut

CIRCLE 181 ON READER-SERVICE CARD

ELECTRONIC DESIGN • September 13, 1961

## Assembly Tools

301

Equipment for staking, swaging, riveting, punching, marking, and terminal setting, including automatic and semi-automatic instruments, is described in the 16-page catalog, "Electric Assembly Tools." Operation and application of the various tools is discussed. Black and Webster, Inc., 570 Pleasant St., Watertown 72, Mass.

## Potentiometers

Information on precision potentiometers is given in this 42-page catalog. The construction and operation of different types of potentiometers are explained. The firm's line of potentiometers is cataloged, with electrical and mechanical specifications. Write on company letterhead to: The Gamewell Co., Dept. ED, Newton Upper Falls 64, Mass.

## Silicones

Booklet No. CDS-288, eight pages describes silicones for electrical and electronic applications. Included are sections on silicone varnishes, potting and encapsulating materials, adhesives, dielectric fluids and greases, and insulation. Write to: General Electric Co., Silicone Products Dept., Dept. ED, Waterford, N. Y.

## Copper-Clad Laminates

302

Physical and electrical properties of Micarta copper-clad laminates for printed circuits are given in this eight-page brochure, B8215. Recommended applications are included for each laminate. Westinghouse Electric Corp., Micarta Div., Hampton, S. C.

## V-Band Coupling

303

"How, When and Why to Use a V-Band Coupling", an eight-page booklet, No. WB-1, explains the advantages of V-band coupling in design and product appearance, and in consideration of assembly time and manufacturing costs. Available coupling and flange configurations are illustrated. Marman Div., Aeroquip Corp., 11214 Exposition Blvd., Los Angeles, Calif.

## Power Supplies

A line of dc power supplies and test instruments is described in this 16-page catalog. Specifications furnished include ratings, dimensions and weights of the equipment. Write on company letterhead to Opad Electric Co., Dept. ED, 43 Walker St., New York 13, N. Y.

NEW FROM T/I

# PROGRAMMED PULSE GENERATOR

Highest Repetition Rates  
(UP TO 25 MEGACYCLES)



Texas Instruments 6200 Series provides signals at higher repetition rates than previously available, for applications in high speed logic circuit and memory system development. Ten pulse times are selectable in any combination for each of the two outputs by front panel controls. Other performance specifications similar to the 6500 Series. All TI Pulse Generators use solid state circuitry and modular construction for reliability and versatility.

WRITE FOR COMPLETE INFORMATION.

APPARATUS DIVISION  
PLANTS IN HOUSTON  
AND DALLAS, TEXAS



TEXAS INSTRUMENTS  
INCORPORATED  
3609 BUFFALO SPEEDWAY  
P. O. BOX 66027 HOUSTON 6, TEXAS

485

CIRCLE 182 ON READER-SERVICE CARD



## NO CEILING ON LINE SUPPORT IDEAS

33,000 TYPES AND SIZES OF  
LINE SUPPORT CLAMPS, BLOCKS  
AND HARNESS STRAPS

For Aircraft, Missiles and Original Equipment of all kinds. Designs available for application in extreme environments... withstand jet engine heat or stratospheric cold... silicone impregnated, fiberglass cushioned, thermoflex, stainless steel. You name it... ADEL has it!

Build LINE SUPPORT reliability into your system.

Specify ADEL for quality in volume

COMPLETE CATALOG AVAILABLE UPON REQUEST

Reliability  
**ADEL**

PRODUCTS  
DIVISION

A DIVISION OF GENERAL METALS CORPORATION

1444 Washington Avenue,  
Huntington 4, W. Virginia  
DISTRICT OFFICES:  
Burbank, California  
Mineola, Long Island, New York  
Dayton, Ohio - Wichita, Kansas



CIRCLE 103 ON READER-SERVICE CARD

KEEP AHEAD WITH HAVEG

# HAVELEX™

Haveg's Precision Molded Rigid Inorganic  
INSULATING MATERIAL

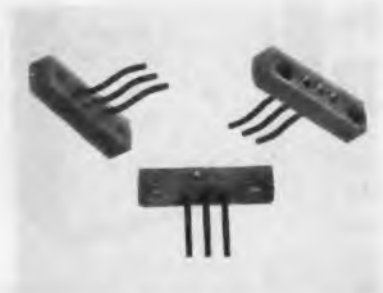

Havelex offers all of these unique features—

- Dimensional Stability
- 1000°F. Continuous Temperature Resistance
- Dielectric Strength
- Mechanical Strength
- Low Loss, Low Power Factor
- Arc Resistance
- No Moisture Absorption
- Integrally Moulded Metal Inserts
- Hermetically Sealed Inserts

Havelex's unusual combination of properties coupled with Haveg's broad experience in custom molding intricate shapes offers unlimited design possibilities. Pictured above is a recent example of how Haveg solved an important problem with Havelex.

A major transistor manufacturer wanted thin-walled metal tubes precision molded into an inorganic material for high temperature testing of his product. The tubes were contoured to facilitate lead insertion and removal—yet insure electrical contact during the testing period.

Haveg engineers will be happy to work with you on your particular project—to help you "Keep ahead with Haveg."

Havelex offers all of these unique features—

- Dimensional Stability
- 1000°F. Continuous Temperature Resistance
- Dielectric Strength
- Mechanical Strength
- Low Loss, Low Power Factor
- Arc Resistance
- No Moisture Absorption
- Integrally Moulded Metal Inserts
- Hermetically Sealed Inserts



CIRCLE 184 ON READER-SERVICE CARD

## Wassco GLO-MELT RESISTANCE SOLDERING



... for Perfect  
lead-to-pin joints  
on All sizes of A/N  
and similar connections

Wassco GLO-MELT  
... for Fast-Efficient  
Accurate-Permanent  
connections.

238-B  
POWER UNITS • HANDPIECES • ACCESSORIES  
for all jobs from Micro-Miniature to Heavy-Current connectors

WRITE FOR DESCRIPTIVE LITERATURE, PRICES AND NEAREST DISTRIBUTOR

Wassco GLO-MELT DIVISION  
AMERICAN ELECTRICAL HEATER COMPANY  
DETROIT 2, MICHIGAN

CIRCLE 185 ON READER-SERVICE CARD

## NEW LITERATURE

### Resistors 286

Physical and electrical characteristics for a line of wire-wound and carbon-film resistors are given in this 24-page catalog. Precision power resistors, epoxy-encased carbon-film resistors, printed-circuit resistors for military and commercial applications are described. Mepco, Inc., Morristown, N. J.

### Capacitor Reliability 287

Reliability tests which were conducted over a period of thirty years are described in this manual, No. 60121. Information useful in the design of high-reliability circuits, such as the effects of voltage, temperature, frequency, insulating materials, and area of windings, is included. Life, capacitance and leakage current as affected by extended temperatures are discussed. John E. Fast & Co., 3598 N. Elston Ave., Chicago 18, Ill.

### Mechanical Filters 288

This four-piece package on mechanical filters contains a general catalog with filter specifications and performance curves, a short-form catalog, a specification sheet on ferrite filters for mobile and missile applications, and a sheet on filter installation. Collins Radio Co., Western Div., 2700 W. Olive Ave., Burbank, Calif.

### Potentiometers 289

A line of precision potentiometers is described in this 28-page technical catalog. Detailed specifications, outline drawings, and general information on miniature and full size units are included. DeJur-Amsco Corp., Electronic Sales Div., 45-01 Northern Blvd., Long Island City 1, N. Y.

### DC Power Supplies 290

Semiconductor dc power supplies rated to 100 amp are listed in this 12-page catalog. Performance characteristics are given for more than 80 models. Electronic Measurements Co., Red Bank, Eatontown, N. J.

### Accelerometers 291

Operation and application of the firm's line of accelerometers is outlined in this eight-page brochure, "Donner 4310." Circuit diagrams, operating curves, and specifications are included. Donner Scientific Co., Concord, Calif.

RELIABILITY  
DELIVERED

## NEW SUBMINIATURE COAXIAL R F CONNECTORS

SMALLEST, LIGHTEST, MATCHED  
IMPEDANCE SUBMINIATURE  
CONNECTOR AVAILABLE

MICON, new as a company, old in experience, makes available the industry's most extensive line of uniquely designed bulkhead, chassis, line and printed wiring board connectors of the 50 ohm screw-on type.

The following are Micon 1000 Series exclusive features:

- 25% smaller than other matched connectors
- 1000 volt minimum flashover up to 70,000 feet
- Cable pullout resistance — 30 pounds minimum
- No rubber or plastic boots — the only all metal-to-metal contact available
- Field inspection requires no tools or spare parts
- Coupling nut pullout resistance — 100 pounds minimum
- Extended temperature range of  $-100^{\circ}\text{C}$  to  $+200^{\circ}\text{C}$
- 25% lighter than any other matched line cable connector



We, at MICON,  
have prepared  
an evaluation kit  
which is available  
on request.

BOOTH 216

MICON ELECTRONICS, INC.  
ROOSEVELT FIELD,  
GARDEN CITY, L. I., NEW YORK  
a wholly owned subsidiary of Metalcraft, Inc.

CIRCLE 186 ON READER-SERVICE CARD

## The Philbrick USA-3 amplifier:

Performance,  
Reliability  
and Low Cost



This printed circuit device — a universal stabilized operational amplifier — has more performance and reliability per dollar than any other amplifier available today. This is why it is one of the most popular items in Philbrick's complete line of operational amplifiers.

### LOOK AT ITS PERFORMANCE —

A guaranteed minimum open-loop DC gain of 10 million, dropping off, 6 db per octave, to unity-gain at one megacycle. That is why we call it "universal". Drift, noise, and offset, together, are under 100 microvolts, and its input current is less than  $10^{-10}$  amps. The output will develop 8 milliamps within the useful range of  $\pm 100$  volts.

### LOOK AT ITS RELIABILITY —

No need for statistical analysis, we will just boast that hardly a whisper has ever been heard from the users of over 10,000 units sold in the past four years. The USA-3 is designed to prevent self-destruction even when its output is shorted, and it has no components which may give trouble — such as electrolytic capacitors or glow lamps.

**LOOK AT ITS COST,** then look around you. You will not find an amplifier on the market with such performance for \$95 (1 to 9 for the low price of \$9.50 units)

Write for complete information to:

GEORGE A.  
**PHILBRICK**  
RESEARCHES, INC.

127 CLARENDON ST. BOSTON 16, MASS.  
COMMONWEALTH 6-5378, TWX: 88 1052, FAX: 08M  
REPRESENTATIVES IN PRINCIPAL CITIES  
EXPORT OFFICE: 248 W. 17TH ST., N. Y. 11, N. Y.  
TEL. CHELSEA 3-5208, CABLE: TRILRUSH

CIRCLE 187 ON READER-SERVICE CARD

ELECTRONIC DESIGN • September 13, 1961

## Transistor Specifications

Specifications for preferred transistors, including those on the Military Preferred List, are given in this reference book. Both U. S. and United Kingdom military specifications are reproduced. The manual, entitled "Transistor Specification Manual," contains 609 pages bound, loose-leaf, in a hard cover. Supplements will be issued periodically. Send \$10.00 to ARINC Research Corp., Dept. ED, 1700 K St., N.W., Washington 6, D. C.

## Industrial Capacitors 292

Solid electrolyte tantalum capacitors, molded plastic tubulars, subminiature tubulars, paper, mylar, electrolytic, and ceramic capacitors for industrial applications are listed in this 20-page catalog. Astron Sales Corp., 255 Grant Ave., East Newark, N. J.

## Radio Telescope Antennas 293

Data on radio telescopes and their antennas is given in report No. WDL-TR-1500 entitled "Reflector Antennas for Radio and Radar Astronomy." Telescopes throughout the world are listed by country. All known antennas of area greater than 10 sq m are included. Philco Corp., Government and Industrial Div., Western Development Laboratories, 3875 Fabian Way, Palo Alto, Calif.

## Relays 294

Power, general and special purpose, plate circuit, sensitive, and telephone type relays are listed in this eight-page catalog. Over 40 models are included. Descriptions, dimensions, technical specifications and prices are given for more than 450 variations of the basic relays. Potter and Brumfield, Technical Information Section, Princeton, Ind.

## Component Holders 295

Over 400 component holders said to be shock-resistant and vibration-free are described in this 64-page catalog. Masterite Industries, 851 W. Olive St., Inglewood, Calif.

## Data System 296

A 3,600-point high-speed automatic monitor system for military or industrial applications is described in this four-page bulletin, No. 101. Bulletin gives standard design specifications and discusses use of the system for control of nuclear reactors. Monitor Systems, Inc., Dept. 17, Ft. Washington Industrial Park, Ft. Washington, Pa.

NEW FROM TI

# HIGH SPEED A-D-A CONVERTER



1.5  $\mu$ sec per bit

All solid state circuitry

Texas Instruments Model 430 Analog-Digital-Analog Converter, a high speed, all solid state instrument, combines an exceptionally fast conversion time with high accuracy and wide dynamic range. The basic speed (analog-to-digital) is 1.5 microseconds per bit plus 4.5 microseconds per conversion; accuracy is  $\pm 0.1\%$  of the input voltage or  $\pm 2$  mv, whichever is greater. Dynamic range of the instrument is above 80 db if the full complement of 14 bits (including sign) is specified.

Write for complete information.

APPARATUS DIVISION  
PLANTS IN HOUSTON  
AND DALLAS, TEXAS



**TEXAS INSTRUMENTS  
INCORPORATED**  
3809 BUFFALO SPEEDWAY  
P O BOX 66027 HOUSTON 6 TEXAS

CIRCLE 188 ON READER-SERVICE CARD

## ABOARD A RADAR PICKET PLANE

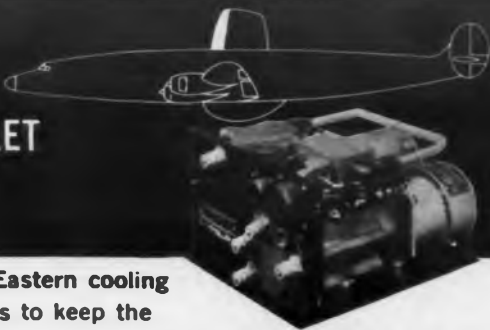

... a new Eastern cooling system helps to keep the Philco APS-103 search radar on the lookout for bogies and bandits. The liquid cooling unit has a capacity of 1600 watts, but weighs only 15 lbs., and fits into a compact 5-9/32" x 9-7/8" x 7-7/8" volume. Designed for operation to 50,000 feet, it features an ingenious internal manifold which makes for simplicity, reliability, and which eliminates most internal connections. If you need efficient, miniaturized light weight cooling units for airborne electronics cooling, call on Eastern. Eastern is your perfect source for liquid tube cooling units for capacities from 50 to 20,000 watts.



**EASTERN INDUSTRIES**  
100 Skiff Street, Hamden 14, Conn.

West Coast Office:  
4203 Spencer St.,  
Torrance, Calif.

CIRCLE 189 ON READER-SERVICE CARD

**NEW**  
**12½**  
**watt**

## Mallory wire-wound control

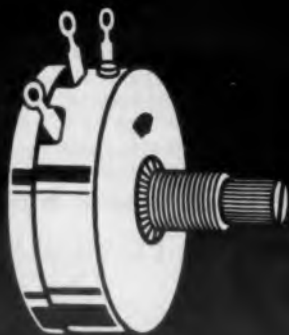

• economical • compact • long life •

Special construction permits 12½ watt capacity in a 4 watt size control. Dependable, long life. Built to stand severe shock and vibration, still maintain positive contact. Economy replacement for power rheostats in many applications. Wide assortment of resistance values, tapers, shafts, multi-ganged arrangements.

Other Mallory wire-wound controls at 2 watts, 4 watts, 7 watts . . . plus specials built to your specs. Mallory Controls Company, Frankfort, Indiana . . . a division of

P. R. MALLORY & CO. Inc.  
**MALLORY**



carbon  
controls



vitreous  
resistors



rotary  
switches



plugs  
& jacks

CIRCLE 190 ON READER-SERVICE CARD

# PATENTS

Benjamin Bernstein

## Bootstrap Circuits

Patent No. 2,983,831. J. F. Walton  
(Assigned to Elcor, Inc.)

Two cascaded, emitter-follower circuits, having feedback through a very low capacitance power supply, comprise a very high-input-impedance linear amplifier. To drive a capacitive load, a third transistor may be placed in parallel with the load and operated near cut-off during capacitor charging. When the control signal reverses, the transistor short-circuits to rapidly discharge the load.

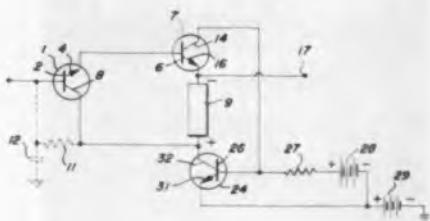

In Fig. 1, the bootstrap connection of transistors 1 and 7 couples a linear waveform, generated across capacitor 12, to a load at terminal 17. When the capacitor charges, the voltage on emitter 16 follows to raise supply 9 and increase the voltage of collector 8. This increases the capacitor voltage linearly, especially when transistor 7 is operated as a constant-current device controlled by transistor 19.

Fig. 2 presents a circuit for driving a capacitive load. A positive pulse applied to terminal 2 raises the voltage at terminal 17 and increases the current of collector 14. The volt drop coupled to base 26 decreases the current through transistor 24. This in-

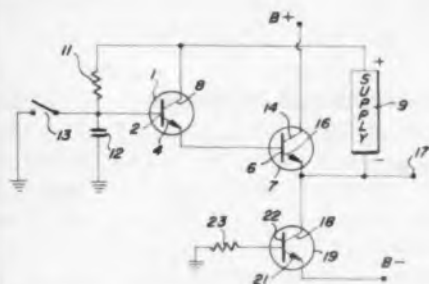

## REMOTE DATA RETRIEVERS, EVENT AND DATA RECORDERS

117.50

121.00

122.99

127.99

## PRINT AND PLOT SIMULTANEOUSLY

HOGAN FAXimile recorders are available with up to 2000 individual styli for simultaneous recording. A wide range of stylus spacings is offered—up to 100 to the inch for high-speed facsimile, television and radar recorders and high resolution printers and plotters. Chart widths to 30" and feed rates to 50" per second.

Hogan specializes in electrolytic techniques for event, spectrum analysis, oscillograph and facsimile recording, frequency time analysis and special purpose binary and gray scale record applications. Hogan electrolytic recording papers provide a permanent high contrast black on white record which is reproducible on most conventional office duplicators.

Whatever your recording problem may be—contact HOGAN FAXimile, a subsidiary of TELautograph Corporation, 635 Greenwich Street, New York 14, N. Y.

HOGAN FAXimile Corporation • 635 Greenwich St., New York 14, N. Y.  
A SUBSIDIARY OF TELAUTOGRAPH CORPORATION

CIRCLE 191 ON READER-SERVICE CARD

ELECTRONIC DESIGN • September 13, 1961



creases the output voltage further. In a similar manner, when the applied voltage is negative, transistor 24 conducts hard and discharges the load.

### Transistor Inverter and Half-Wave Rectifier Circuit

Patent No. 2,958,032. K. S. Vogt

A transistor oscillator converts battery voltage to high dc voltage. The transistor is protected against high voltage surges by a diode which conducts during the off time of the amplifier.

Transistor 18 is connected as a feedback oscillator through coupling windings 32 and 42, while the high-voltage load connects across the sec-

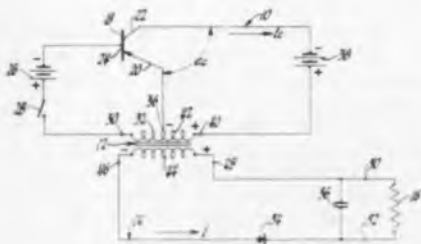

ondary winding 44. Diode 54 conducts when the transistor is nonconducting so that the high inverse voltage does not appear across the transistor.

### Electron Multiplier, Spurious Noise Baffle

Patent No. 2,983,845. D. C. Damoth (Assigned to North American Aviation, Inc.)

Spurious noise in electron multipliers due to stray electrons, gas molecules and photons is reduced by an apertured baffle placed normal to the path of the electron beam.

In the presence of crossed electric and magnetic fields, the beam path is cycloidal from cathode 10 to anode 30. The density of electrons increases after each impact against the tin oxide secondary emissive plate 20. Baffle 29 contacts envelope 9 to block the stray particles.

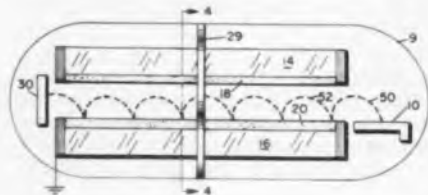

# Electroplated

# WIRES



Special equipment, built in our own plant, permits us to plate wire continuously... Our electroplates are consistently uniform and well bonded to the base wire... Wires for electrical contacts — in a range of diameters — may be plated with Rhodium, Gold or Platinum... Electrical contacts for handling currents at very low voltages, can be made from our wire, with the greatest reliability.

Write for Brochure

**SIGMUND COHN MFG. CO., INC.**  
 121 SO. COLUMBUS AVE., MOUNT VERNON, N. Y.

SIGMUND COHN CORP. OF CALIFORNIA • 151C N. Maple St., Burbank, Cal.



CIRCLE 192 ON READER-SERVICE CARD

ELECTRONIC DESIGN • September 13, 1961

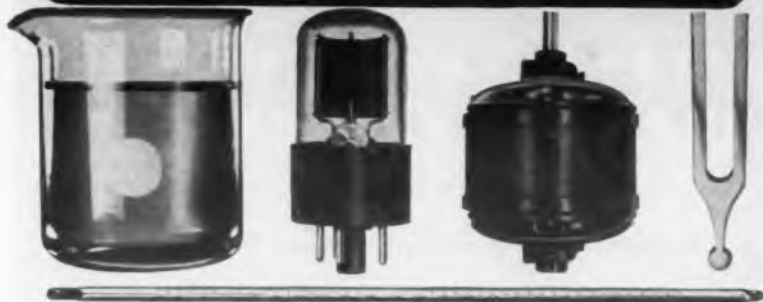

## WITH A. P. I. METER-RELAYS YOU CAN MONITOR AND CONTROL JUST ABOUT ANYTHING!

Handy gadget, the A.P.I. meter-relay. You can use it to indicate, monitor, and control practically any electrically transduceable variable. Things like moisture content, pH, motor load, radiation level, temperature, speed, light, sound. And, because it's so highly sensitive (0-5 microamps or millivolts is the minimum range), you can pipe-in thermocouple, strain gauge and other low-level signals directly, without amplification.

It's a highly reliable device, too. You can reasonably expect to get at least 10,000,000 perfect make-break operations. You'll probably get twice that many. We have.

You can spec A.P.I. meter-relays in any range you want, from the minimums mentioned up to 0-50 amps or 0-500 volts, AC or DC. We can calibrate scales in any units you require. Control set-points can be either single (high or low) or double (both high and low). Catalog 4J will give you much useful and interesting information about meter-relays. It will also give you detailed, explicit specs and prices. Yours for the asking, of course.



**ASSEMBLY PRODUCTS INC.**

CHESTERLAND 17 OHIO

CIRCLE 193 ON READER-SERVICE CARD

SA 2398

161

Electron Products

BW and BWE  
High Voltage Capacitors

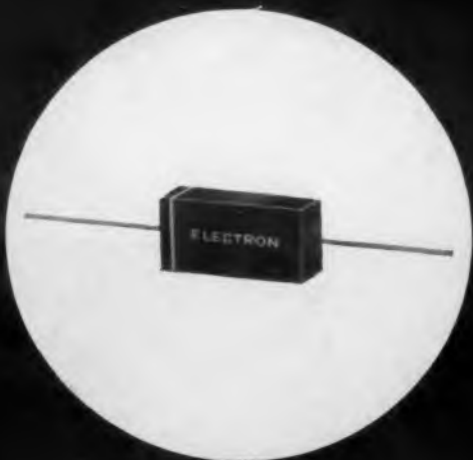

### Newest-Smallest High Voltage Capacitors!

Compact configuration, lighter weight and extremely low noise are features deserved by design engineers seeking smaller, more reliable high voltage capacitors.

BWE Series epoxy tube capacitors are designed for applications as AC and DC power supply ripple filter capacitors, voltage doubler circuits and blocking capacitors. Basic construction is similar to the Mil-C-14157 Hi-Rel Spec and meets environmental test conditions of Mil-C-25. Rectangular shaped, non-metallic case eliminates need for large stand-off terminals. The BW wrap and fill version is available for similar applications in less stringent environments.

Up to 30,000V operation with standard capacity from .001 to .2 mfd. Standard capacity tolerance  $\pm 20\%$  (also available to  $\pm 1\%$ ). Competitively priced against other less sophisticated versions. Technical information and test data available upon request.

#### Specifications:

- Operating Temperature:  $-55^{\circ}\text{C}$  to  $+125^{\circ}\text{C}$
- Insulation Resistance: 30,000 M $\Omega$  min. @  $25^{\circ}\text{C}$
- Dissipation Factor: 1.0% max. @  $25^{\circ}\text{C}$
- Test Voltage: 200% of rated voltage

## ELECTRON PRODUCTS

430 North Halstead Street, Pasadena, California

 division of Marshall Industries

CIRCLE 194 ON READER-SERVICE CARD



## BOOKS

### Dictionary of Mechanical Engineering

*Alfred Del Vecchio, Philosophical Library, Inc., 150 E. 40 St., New York 16, N. Y., 346 pp, \$6.00*

Lists definitions of terms in fields which include architecture, automatic controls, engineering mechanics, power plants, basic electricity and mathematics, and welding.

### Introduction To The Theory Of Linear Differential Equations

*E. G. Poole, Dover Publications, Inc., 180 Varick St., New York 14, N. Y., 217 pp, \$1.65*

Advanced treatment of ordinary linear differential equations including conformal representation, Lamé's equation, Mathieu's equation, regular singularities and the hypergeometric equation.

### A Treatise On the Calculus of Finite Differences

*George Poole, Dover Publications, Inc., 180 Varick St., New York 14, N. Y., 350 pp, \$1.85*

### Field Theory For Engineers

*Parry Moon and Domina Eberle Spencer, D. Van Nostrand Co., Inc., 120 Alexander St., Princeton, N. J., 530 pp, \$12.75*

The separation of variables method is applied to unify the branches of field theory—including electromagnetic, acoustical, thermal, and gravitational. Presents the eleven coordinate systems of Eisenhart as well as bicylindrical, bispherical, and toroidal systems. A background in differential equations, vector analysis and elementary physics is assumed.

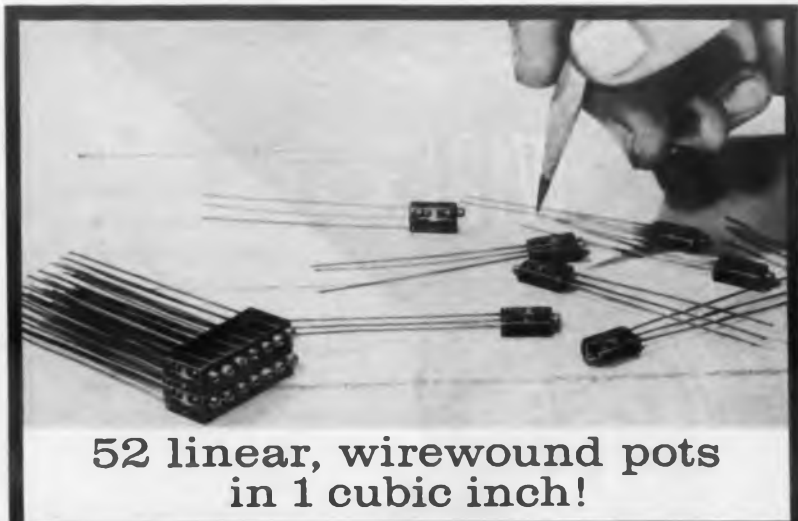

## 52 linear, wirewound pots in 1 cubic inch!

You may never use 52 pots in such a small space, but you could with the new Atohm Series 320. It's a precision, trimmer pot measuring only .250" x .435" x .150", but providing resistances from 5 ohms to 50K ohms. Its simple, linear mechanism provides a more uniform winding, more ohms per linear length, and better mechanical distribution of the resistant material. Unique, clip-type mounting. *Write for complete data.*

**ATOHM ELECTRONICS**

7648 San Fernando Road, Sun Valley, California



CIRCLE 195 ON READER-SERVICE CARD

ELECTRONIC DESIGN • September 13, 1961

### Applied Optics and Optical Design, Part 2

A. E. Conrady, Dover Publications, Inc., 180 Varick St., New York 14, N. Y., 842 pp, \$2.95 (paperbound).

Sets forth the concepts of geometrical and physical optics and applies them to the design of the simpler optical instruments.

### Electronics

Paul M. Chirlian and Armen H. Zemanian, McGraw-Hill Book Co., Inc., 330 W. 42 St., New York 36, N. Y., 335 pp, \$8.75

Intended for a first course in electronics, this text emphasizes physical electronics, rather than circuitry.

### An Engineering Approach to Gyroscopic Instruments

Elliott J. Siff and Claude L. Emmerich, Robert Speller & Sons, Publishers Inc., 33 W. 42 St., New York 36, N. Y., 120 pp, \$7.50

Quantitative relations are derived which can be applied to the solution of gyroscopic problems. Special designs are also presented, including air bearings, electrostatic and electromagnetically supported gyros, vibrating and particle gyros.

### Sequential Decoding

John M. Wozencraft and Barney Reiffen, The Technology Press of MIT and John Wiley & Sons, Inc., 440 Fourth Ave., New York 16, N. Y., 75 pp.

Considers the problem of coding and decoding from a probabilistic point of view. Sequential decoding is applied to the binary symmetric channel, with some extension to more general channels. Convolutional encoding is also discussed.

### An Introduction To Electrotechnology

S. J. Kowalski, John F. Rider Publisher Inc., 116 W. 14 St., New York 11, N. Y., 316 pp, \$7.00

Undergraduate text dealing with ac and dc circuits.

### Basics of Analog Computers

Thos. D. Truitt and A. E. Rogers, John F. Rider Publishers, Inc., 116 W. 14 St., New York 11, N. Y., 394 pp, \$12.50

Simplified presentation of the design concepts, devices and applications of the analog computer. Written as an introduction to the subject for maintenance technicians and programmers.





## PRECISION - Square, Flat and Rectangular Wire with Controlled Edges

For **WELDED** electronic circuitry,  
for **WIRE-WRAP** and **PLUG** or **PIN**  
type **CONNECTORS** for computers,  
control systems, missiles, etc., Also  
for springs, terminals, forms, fittings,  
prongs, contacts and clips.

**Silvercoat® Beryllium Copper — Brass — Bronze — ni-clad-ti  
Titanium — Aluminum — Hot Solder Dipped — Tinned — etc.**

Square and rectangular shaped wires are frequently used in modern "wrapped" terminal and pin or plug type connectors. For this application the edges must be finished quite sharp (usually .003 radius corners or less) but without a burr or flashing. Also required are closely controlled dimensional tolerances and smooth finish. Uniformity of temper is essential. Therefore close control of all facets of wire manufacturing is of paramount importance.

**LITTLE FALLS ALLOYS, INC.** 189 CALDWELL AVENUE,  
PATERSON 1, NEW JERSEY

CIRCLE 196 ON READER-SERVICE CARD

ELECTRONIC DESIGN • September 13, 1961

THE LEADER  IN ACCURACY



## 0.0001% RATIO ACCURACY NOW GUARANTEED FOR 5 YEARS

The JRL Model VDR-106 is the only Primary Standard DC Voltage Divider of its kind to have a written performance Guarantee of 0.0001% ratio accuracy for a 5 year period. The reliability history established by standard laboratories, production facilities and discriminating instrument users since July 16, 1956, indicates the unique accuracy and long range stability of this precise instrument.

Of over 100 VDR Dividers in production and laboratory use since 1956, only one has been returned to the factory out of accuracy specification. Other units checked, including Serial Nos. 2 and 16 maintained here at Julie Research Laboratories, are still within one part per million as specified in our literature. This complete absence of drift prevailed despite instances of years of service under extreme environmental conditions in production testing. It should be noted that these units have no facilities for adjustments or recalibration. As with all JRL Dividers, no adjustments are required to maintain the stated accuracy of 0.0001%.

The stability of resistance ratios with temperature, voltage, humidity and time is largely a function of the stability of the basic resistors used and of the design of associated interconnections, insulation and switching components. Primary Standard Dividers manufactured by Julie Research Laboratories achieve unique accuracy and stability through the use of the type NB-1\* resistor and consistently meticulous design of all associated components.

This company has followed a policy of conservative rating (a safety factor of 2 times, Minimum) of these standards and instruments and has gone so far as to develop new techniques for verification of the unusually high accuracies specified for its equipment.†

†It is possible to determine the accuracy of the VDR-106 to a certainty of 1 part in ten million using the Primary Standard ratio technique described in Precision Vol. IV No. 1.

Copies are available upon request.

\*Patent Applied For



**JULIE RESEARCH  
LABORATORIES INC.**

603 West 130th St., New York 27, N. Y.

CIRCLE 197 ON READER-SERVICE CARD

# IDEAS FOR DESIGN

## Vote for Ideas Valuable to You

Vote for the Ideas which are valuable to you. Other engineers will vote for the Ideas which are most valuable to them. The Idea which receives the most "Valuable" votes will be judged "Most Valuable of Issue." Its author will receive a \$50 award.

Choose the Ideas which suggest a solution to a problem of your own or stimulate your thinking or which you think are clever.

The Ideas chosen as the most valuable in each issue will be eligible for the \$1,000 Idea of the Year award.

So vote for the Ideas you find most valuable. And, after you've voted, why not send in an Idea of your own?

## RC-"Blocking Oscillator" 737 Produces Complementary Pulses

In designing a pulse circuit for one of our systems we developed an interesting configuration which, for want of a better name, we call an RC-coupled blocking oscillator. The circuit, shown in the figure, produces two sharp, opposite-polarity pulses. Their periods can range from the low frequencies to the frequency limit of the transistors.

Transistor  $T_1$  and  $T_2$  are a complementary pair connected in a symmetrical circuit where  $R_2 = R_4$ ,  $R_1 = R_3$  and  $C_1 = C_2$ . The interval  $t_2$  is determined primarily by the parallel combination of resistors  $R_5$  and  $R_1$  and capacitor  $C_1$ . Thus:

$$t_2 \cong 1/2 R_5 // R_1 \cdot C_1$$

Interval  $t_1$  is determined by the input impedance of either transistor and  $C_1$  (or  $C_2$ ). That is:

$$t_1 \cong \beta R_2 \cdot C_1 \approx \beta R_4 \cdot C_2$$

If the interval  $t_1$  is not critical, both  $R_2$  and  $R_4$  can be removed. With resistance  $R_5$  set by potentiometer,  $t_2$  can be easily varied.

Note that another of the reasons that we refer to the circuit as a "blocking oscillator" is that both transistors are on during  $t_1$  and off during  $t_2$ . However, any further

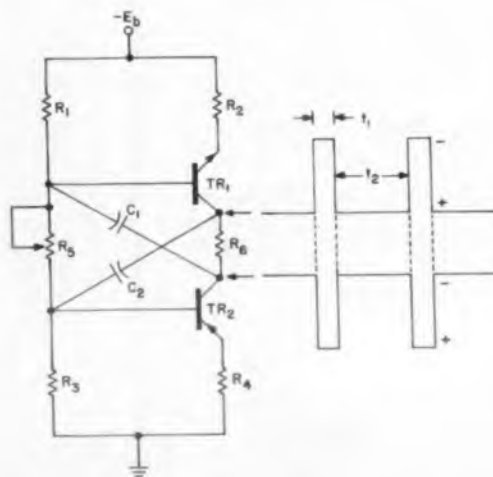

Opposite polarity pulses are produced by this variable-frequency, complementary-transistor-pair circuit.

analysis of this circuit by the readers of ELECTRONIC DESIGN would be appreciated.

*J. André Bourget, Design Specialist, The Martin Co., Baltimore, Md.*

If this idea is valuable to you, give it a vote by circling Reader-Service number 737.

## Steering Diodes Prevent Spurious Multi Triggering 743

Spurious triggering of multivibrators by stray noise pulses can be prevented by connecting a common steering-diode net as shown in the figure. With this addition the multi can only be triggered when input pulses exceed a minimum threshold level.

Referring to the circuit, if transistor  $Q_1$  is conducting,  $Q_2$  is off and resistor  $R_2$  reverse-biases diode  $D_2$ , hence a positive pulse cannot pass to the base of  $Q_2$ .

However,  $Q_1$ , has a very low collector voltage and because of this,  $R_1$  does not reverse-

## \$50 "Most Valuable of Issue" Award for Reduced Capacitor Idea

W. E. Zrubek, design engineer with Westinghouse Electric Corp., Baltimore, Md., has won ELECTRONIC DESIGN's eighth \$50 Most Valuable of Issue Award.

Mr. Zrubek receives the award for his Idea for Design, "Long Period Multivibrator Reduces Timing Capacitor Size," which appeared in the July 5 issue. The idea described a method for building a transistorized monostable multivibrator with a small capacitor.

bias  $D_1$ . A positive-going trigger pulse of any amplitude can pass through  $D_1$  to turn  $Q_1$  off.

By including resistor  $R_3$  between the steering diodes, a minimum reverse-bias is established which inhibits the passage of

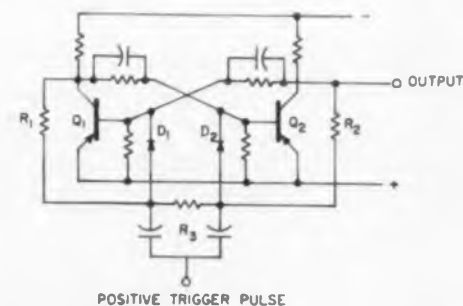

Steering-diode net and resistor  $R_3$  establish threshold trigger level to safeguard against spurious triggering by stray noise pulses.

signals below the bias level. Thus, the signal threshold level, below which noise cannot trigger the circuit, is set.

*J. Eugene Harrison, Manager Communications Laboratory, General Dynamics Electronics, Rochester, N. Y.*

If this idea is valuable to you, give it a vote by circling Reader-Service number 743.

## SEVENTH ANNIVERSARY AWARDS

# IDEAS-FOR-DESIGN

*Entry Blank*

### How You Can Participate

#### Rules For Awards

Here's how you can participate in Ideas for Design's Seventh Anniversary Awards: All engineer readers of **ELECTRONIC DESIGN** are eligible.

Entries must be accompanied by filled-out Official Entry Blank or facsimile. Ideas submitted must be original with the author, and must not have been previously published (publication in internal company magazines and literature excepted).

Ideas suitable for publication should deal with:

1. new circuits or circuit modifications
2. new design techniques
3. designs for new production methods
4. clever use of new materials or new components in design
5. design or drafting aids
6. new methods of packaging
7. design short cuts
8. cost saving tips

#### Awards:

1. Each Idea published will receive an honorarium of \$20.
2. The Idea selected as the most valuable in the issue in which it appears will receive \$50.
3. The Idea selected as the Idea of the Year will receive a Grand Prize of \$1,000 in cash.

The Idea of the Year will be selected from those entries chosen Most Valuable of the Issue.

Most Valuable of the Issue and Idea of the Year selections will be made by the readers of **ELECTRONIC DESIGN**. The readers will select the outstanding Ideas by circling keyed numbers on the Reader-Service cards. Payment will be made eight weeks after Ideas are published.

Exclusive publishing rights for all Ideas will remain with the Hayden Publishing Co.

Ideas-for-Design Editor  
**ELECTRONIC DESIGN**  
850 Third Ave.  
New York 22, N. Y.

**Idea** (State the problem and then give your solution. Include sketches or photos that will help get the idea across.)

*(Use separate sheet if necessary)*

I submit my Idea for Design for publication in **ELECTRONIC DESIGN**. I understand it will be eligible for the Seventh Anniversary Awards—\$20 if published, \$50 if chosen Most Valuable of Issue, \$1,000 if chosen Idea of the Year.

I have not submitted my Idea for Design for publication elsewhere. It is entirely original with me and does not violate or infringe any copyrights, patents or trademarks or the property rights of any other person, firm or corporation.  
Hayden Publishing Company, Inc. shall have the exclusive publication rights to these Ideas for Design selected for publication in **ELECTRONIC DESIGN**. This right extends to the subsequent use of the Idea for Design by Hayden in any of its other publications. Honorariums, if any, for subsequent publication shall be solely in the discretion of Hayden Publishing Company, Inc.

Name \_\_\_\_\_ Title \_\_\_\_\_

Company Name \_\_\_\_\_

Address \_\_\_\_\_

For Additional Entry Blanks, circle **750** on Reader-Service Card.

With Eastman 910 Adhesive...

## Ultra-miniature components bonded in seconds

There are over 150 components in Sonotone's new Model "66" hearing aid—yet the housing is no larger than a lump of sugar. In this example of miniaturization at its finest, Sonotone uses Eastman 910 Adhesive in more than a dozen fastening operations, joining parts made of plastic, rubber and metal. Many of the bonds are made by flowing the thin, clear adhesive into tiny spaces, and this is accom-



plished without stringing or balling. Eastman 910 Adhesive will form bonds with almost any kind of material.

*Skeptical?* Then send \$5 for a trial kit and try it on your toughest job. Kits and further information are available from Armstrong Cork Company, Industrial Adhesives Division, 9103 Ithaca St., Lancaster, Pa., or from Eastman Chemical Products, Inc., Dept. ED-5, Kingsport, Tenn.



There is no adhesive like Eastman 910 Adhesive

**SETS FAST**—Makes firm bonds in seconds to minutes.  
**VERSATILE**—Joins virtually any combination of materials.  
**HIGH STRENGTH**—Up to 5,000 lb./in.<sup>2</sup> depending on the materials being bonded.  
**READY TO USE**—No catalyst or mixing necessary.  
**CURES AT ROOM TEMPERATURE**—No heat required to initiate or accelerate setting.  
**CONTACT PRESSURE SUFFICIENT.**  
**LOW SHRINKAGE**—Virtually no shrinkage on setting as neither solvent nor heat is used.  
**GOES FAR**—One-pound package contains about 14,000 one-drop applications.  
 The use of Eastman 910 Adhesive is not suggested at temperatures above 175°F., or in the presence of extreme moisture for prolonged periods.

See Sweets' 1961 Product Design File 10d Ea

### Here are the types of bonds that can be made with Eastman 910 Adhesive

Among the stronger: Natural rubber, SBR, Buna N, most types of neoprene, steel, aluminum, brass, copper, most woods, vinyls, phenolics, cellulose, polyesters, polyurethanes, and nylon.

Among the weaker: polystyrene, polyethylene and fluoro-hydrocarbon plastics (shear strengths up to 150 lbs./in.<sup>2</sup>).

CIRCLE 199 ON READER-SERVICE CARD

## IDEAS FOR DESIGN

### Clock Pulses Generated By Magnetic Core Timer

744

Clock pulses at frequencies as high as one megacycle can be generated with the magnetic core circuit shown in the figure. Two pulses are obtained from each core and the circuit can be designed for a variety of pulse shapes and time bases.

The circuit is "started" by a momentary closing of the START switch. Transistor  $T_1$  then drives core  $C_1$  into positive saturation. This flux change is sensed by the winding in series with the base of  $T_2$ . Transistor  $T_2$  now conducts and drives  $C_1$  back into negative saturation.

This second flux change is sensed by the winding in series with the base of  $T_3$  and the progression continues. The result is that as each transistor conducts, it supplies a voltage pulse at its timing point.

Waveform shape and frequency may be varied through the design of the delay and wave shape ( $D$  and  $W$ ) circuits, and through selecting the cores to be used.

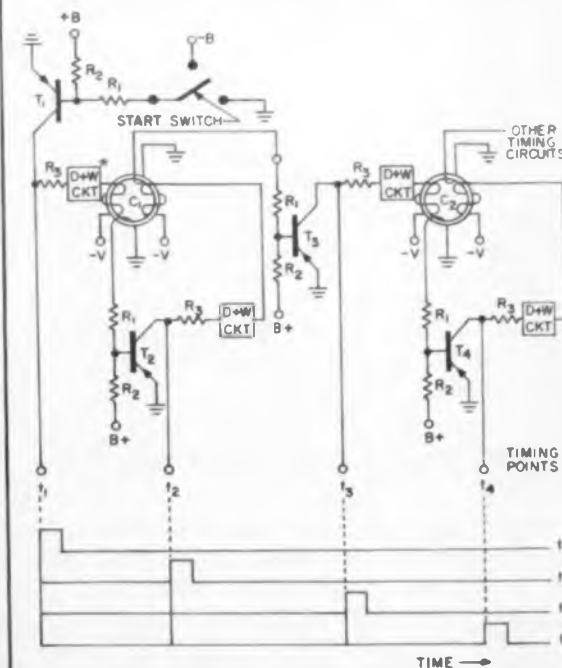

\*D+W = DELAY AND WAVEFORM

Magnetic-core clock pulse generator provides two pulses per core. Stages can be added as desired.

Philip I. Hershberg, Project Engineer, Air Force Cambridge Research Laboratories, Waltham, Mass.

If this Idea is valuable to you, give it a vote by circling Reader-Service number 744.

## Admiral TRANSISTOR MOUNTS

INCREASES FUNCTIONAL RELIABILITY—PREVENTS SHORT CIRCUITS  
 REDUCES INSULATION AND VIBRATION PROBLEMS

RECOMMENDED for rigid, insulated, vibrationless mounting of transistors having a lead base-diameter of .100" and .200". Admiral's universal 5-hole pattern accommodates parts with 3 or 4 leads and of various

sizes and configurations. The standoff type allows air space for thermal insulation and corrects alignment with holes in printed circuit boards. All are precision molded of Zytel 101.

### ADAPTER SHIELD A-18

Use with TO-18 to convert .100" to .200" dia. hole pattern. 3-holes on a 45° angle.

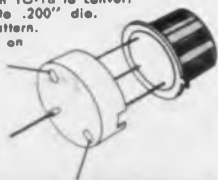

### STANDARD SHIELD S-18

3-holes, .100" dia. hole pattern. Use with TO-18.

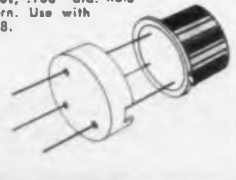

### UNIVERSAL TRANSISTOR MOUNT UM-5 UM-9 UM-12

5-holes, 4 standoff legs, .200" dia. hole pattern.

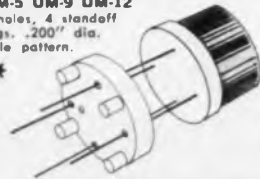

### UNIVERSAL TRANSISTOR SHIELD US-5 US-9 US-12

5-holes, .200" dia. hole pattern.



Use with TO-5, TO-9, TO-12 Triads Solder Seal and oval Welded Silicon Transistors

Write today for free descriptive catalog sheet.

532 West Windsor Road.

Admiral PLASTICS CORP.

Glendale 4, Calif.

CIRCLE 200 ON READER-SERVICE CARD



## Starter Circuit Prevents Stall of Free-Running Multi 734

A symmetrical, free-running multivibrator can be protected from stalling at turn-on by adding the AND-gate starter shown. The gate prevents stalling, while in no way interfering with normal, balanced operation after the unit starts oscillating.

In an ordinary multi, stalling can occur when there is insufficient unbalance in the initial rate of change of current in the two halves of the circuit. Purposely introducing an unbalance may be undesirable because of side effects.

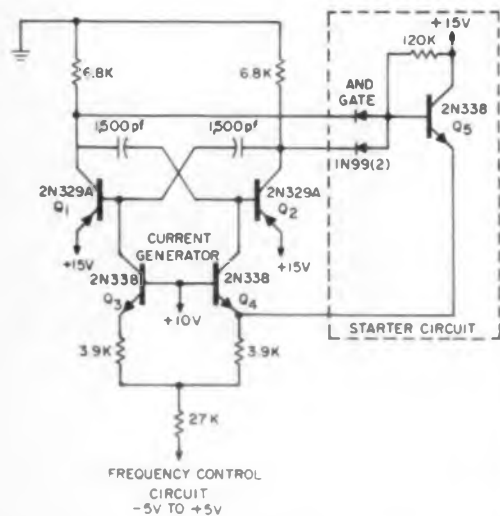

**AND gate** added to symmetrical, free-running multivibrator guards against turn-on stall without interfering with normal, balanced operation.

When power is supplied, the two-input AND-gate connected to the collectors of transistors  $Q_1$  and  $Q_2$  provides a source of signal which turns off, or begins turn-off, in  $Q_1$  and in  $Q_2$ . This causes the multi to start oscillating. Since during normal operation, the signals at the collectors of  $Q_1$  and  $Q_2$  are a complementary pair, the output of the AND gate is false and  $Q_5$  is nonconducting.

If the multivibrator stalls, it does so with both  $Q_1$  and  $Q_2$  in a saturated condition, because both sides are driven with voltage-controlled current generators. In a stalled condition, the output of the AND circuit is approximately 15 v and  $Q_5$  is conducting. It draws current from current generator  $Q_3$ , which in turn reduces current in  $Q_2$ , promoting the start of oscillations.

*Martin T. Pett, Space Technology Laboratories, Canoga Park, Calif.*

If this Idea is valuable to you, give it a vote by circling Reader-Service number 734.

## BEST SHORT WAVE LENGTH RESPONSE

*SCOTCH<sup>®</sup> BRAND High Resolution Tapes offer superior high frequency results*

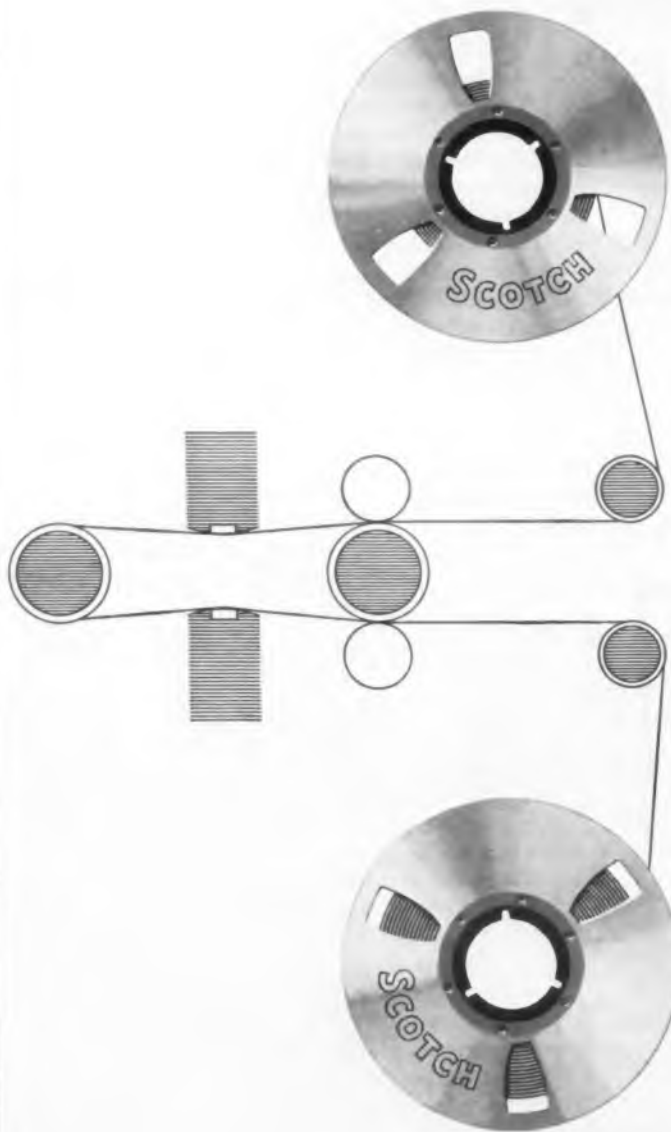

IN INSTRUMENTATION Tapes, a good *bit* may well depend on the character of the magnetic coating—and the uniformity with which it is applied. At short wave lengths, the head responds only to the flux nearest it—thus, the thinner the coating, the more it concentrates flux in that narrow region next to the gap where the head can use it best.

"SCOTCH" BRAND High Resolution Tapes 457, 458 and 459 testify to the great skill "SCOTCH" BRAND experts have in laying down a thin uniform coating that results in intimate head-to-tape contact, as shown in the diagram. This famous trio of tapes reproduces the critical short wave lengths, offers the superior response and resolution that lets you pack more information to the inch.

Much of their fine performance at high frequencies rests with the famed "SCOTCH" BRAND high potency oxides and their higher magnetic retentivity. At optimum bias settings, the coating is about 50% more sensitive to short wave lengths than ordinary coatings.

These tapes give you three great bases on which to build toward miniaturization. No. 458, with a 1.5 mil polyester base, offers standard recording time and maximum strength. No. 459, with a 1.0 mil polyester base, gives 50% extra recording time. No. 457, with a .65 mil base of tensilized polyester, delivers twice the standard recording time. One of the key factors in the consistent performance of the "SCOTCH" BRAND High Resolution Tapes is their uniformity—from reel to reel and within the reel. All three tapes offer a uniformity in magnetic coating and base that goes far to eliminate errors in performance.

In producing uniform tapes for all applications, nothing replaces the years of experience offered by the "SCOTCH" BRAND research and manufacturing team—the same team responsible for most tape advances. So check the entire "SCOTCH" BRAND line: Heavy Duty Tapes 497, 498 and 499 outwear ordinary tapes 15 times, even under adverse operating conditions. High Output Tape 428 offers top output at low frequencies. Sandwich Tapes 488 and 489 wear 30 times as long as ordinary tapes, cut head wear and oxide rub-off. And more reels of Standard Tapes 408 and 403 have been sold than any other kind.

Your nearby 3M Representative serves as a convenient source of information in all major cities. Contact him or write Magnetic Products Div., 3M Company, Dept. MBQ-91, St. Paul 6, Minn.

© 1961 3M Co.

"SCOTCH" is a registered trademark of 3M Company, St. Paul 6, Minnesota. Export: 99 Park Avenue, New York, N. Y. In Canada: London, Ontario.

**SCOTCH BRAND MAGNETIC TAPE**  
FOR INSTRUMENTATION

MINNESOTA MINING AND MANUFACTURING COMPANY  
... WHERE RESEARCH IS THE KEY TO TOMORROW



CIRCLE 201 ON READER-SERVICE CARD



## Allison Transistorized Noise Sources with Uniform Spectral Density — 5 cps to 30 kcps

Here's the ideal noise source for shaker tables, high-level environmental acoustic testing, and other applications requiring a uniform output of a random (white) noise. Allison Noise Sources are all solid state devices. They are non-microphonic and can be used in areas of high ambient noise and vibration. The Allison 650 is a small, lightweight portable instrument, battery or AC powered, from \$265.00 up; the Allison 655 is a miniature, welded and incapsulated unit, 1" x 1 1/4" x 1 1/8", \$36.00 in 100 lots. Write today for spectrum curves, complete specifications, and prices.

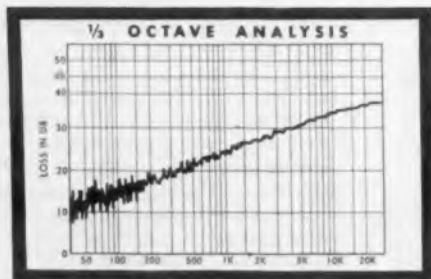

**FREE LITERATURE!** Clip coupon, attach to company letterhead, and mail today for literature on noise sources.

NAME \_\_\_\_\_

**ALLISON LABS.**

**Allison Laboratories, Inc.**

11301 OCEAN AVENUE, LA HABRA, CALIFORNIA

*proved dependable in years of service*

CIRCLE 202 ON READER-SERVICE CARD

## RUSSIAN TRANSLATIONS

J. George Adashko

# A Sine and Cosine Memory Store

**S**INE and cosine functions for use in computers are usually either stored in tabular form or are generated by successive approximations. This article describes a tabular storing device designed for analog and digital harmonic analyzers and synthesizers. It is used in the relay-type "Sintez" computer at the Leningrad Electrotechnical Institute of Communications. However, the mathematical principles are applicable to other types of computers, including electronic ones.

Harmonic analyzers and synthesizers have to calculate the polynomials

$$(A_n \cos nx + B_n \sin nx)$$

for a series of nodal values of  $x$ , namely  $x_0$ ,  $x_0 + \Delta x$ ,  $x_0 + 2\Delta x$ , etc. Any device for the generation of sines and cosines should, therefore, be able to deliver the values of  $\sin nx$  and  $\cos nx$  for the running values of  $x$  and the harmonic number,  $n$ .

### Argument $Nx$ Is Reduced To Acute Angle

A special scheme is used in the Sintez computer which reduces  $nx$  to an acute angle. The running values of  $x$  are given in "grads" (the 90° quadrant is divided into 100 parts; 1 grad = 0.9°) with a spacing  $\Delta x$  equal to 1 grad. The number of harmonics is also 100. Thus, the sine table consists of 101 values of  $\sin x$  in the first quadrant. These values are stored in the computer in a diode matrix table.

The table has 101 address buses and an output bus for each stored significant figure (6 decimal places in the Sintez computer). Information is delivered when the address buses of the table receive the address—the value of  $nx$  reduced to an acute angle and expressed either in direct code (for the sine function) or in complementary code (to determine the cosine,  $\cos x = \sin(100 - x)$ ).

The access unit yields the values of the

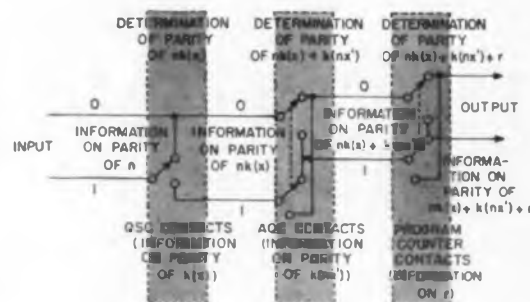

Relay-contact version of code-forming network.

argument  $nx$ , reduced to an acute angle, to determine the code in which the reduced argument is to be sent to the address buses of the table. It also determines the sign of the products:

$$A_n \cos nx, B_n \sin nx \quad (1)$$

We denote by  $k(z)$  the quotient of the division of some angle  $z$  by 100 (that is, the integral part of the quotient), and by  $z'$ , the remainder. Then  $k(z) + 1$  denotes the quadrant in which  $z$  is located and

$$z = z' + 100k(z) \quad (2)$$

We have in mind here the value of  $z$  measured from the start of the period. It is sufficient to count  $k(z)$  to the nearest multiple of 4.

### Decimal Step Adder Generates the Argument $x$

To generate the argument  $x$ , the access unit has a two-column, decimal step adder, SA. On proceeding to the next node, the SA performs the operation of addition,  $x + \Delta x$ . The overflow of the SA is counted in the

## Announcing 30-Day Delivery on U Band, Two-Cavity Oscillators For Parametric Amplifier Pumping

Sperry Electronic Tube Division, Gainesville, Florida, announces an *immediate* solution to the drive source problems which have plagued developers of parametric amplifiers for some time. Now Sperry can deliver a U band, two-cavity klystron oscillator in just 30 days.

Fast delivery is possible because development work is completed on all tubes within the frequency and power output parameters described below. Soundness of the development work is already proved, since tubes of this type have been operating in several systems for some time.

Sperry has developed a whole family of these oscillators. They cover the entire U band, and deliver output powers from 200 mW to 1.5 W.



quadrant-step counter, QSC. Therefore, if we write:

$$x = x' + 100 k(x) \quad (3)$$

then  $x'$  is stored in the SA and  $k(x)$  is stored in the QSC.

The device also contains an arc adder, AA, which generates the values of  $nx'$ . On proceeding to a new value of  $n$ , this adder receives the value of  $x'$  from the SA and performs the operation  $nx' + x'$ . This adder also has two decimal columns. Its overflow is stored in the arc quadrant counter, AQC. Analogous to Eq. 3,

$$nx' = (nx')' + 100 k(nx') \quad (4)$$

with  $(nx')'$  stored in the AA, and  $k(nx')$  in the AQC. From Eqs. 3 and 4:

$$nx = (nx')' + 100[k(nx') + nk(x)] \quad (5)$$

Thus,  $(nx')'$  is the value of  $nx$ , reduced to an acute angle, and is the address sent to the table. The contacts of the QSC and the AQC help the circuitry determine the code of the address  $(nx')'$ , Fig. 1, and sign of the products, (1).

From Eq. 5 we have:

$$\left. \begin{array}{l} \sin nx \\ \cos nx \end{array} \right\} = \sin [(nx')' + 100m_1], \quad (6)$$

where

$$m_1 = nk(x) + k(nx') + r$$

and

$$r = \begin{cases} 0 & \text{if } \sin nx \text{ is computed} \\ 1 & \text{if } \cos nx \text{ is computed} \end{cases}$$

Thus, the code in which  $(nx')'$  is sent to the table depends on whether  $m_1$  is even (direct code) or odd (complementary code).

Actually, if  $m_1$  is even, the argument of Eq. 6 falls in the first and third quadrants, and the table should yield the values of  $\sin$

### APPLICATIONS

All tubes in the new Sperry family operate with a characteristic flat-top mode. This constant relationship between beam voltage and output power makes tubes in the series particularly suited for driving parametric amplifiers, and for use in doppler radars and FM communication systems.

One important benefit of the flat-top mode characteristic is the availability of frequency modulation with very low incidental amplitude modulation. This inherent amplitude stability, together with high power output levels, makes the new oscillator family particularly useful for parametric amplifier applications. The same characteristics contribute to the desirability of these tubes for use in doppler radars and FM communication systems.

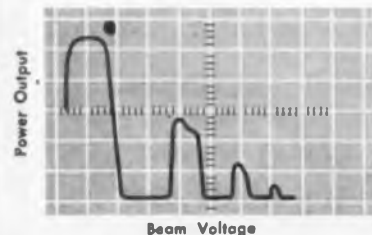

Typical mode shapes of two-cavity oscillator.

### RATINGS

Two-cavity oscillators in the Sperry series completely blanket the 12.5 to 18 kMc frequency range covered by the U band. The "family" of

tubes is divided into two branches, one ranging from 12.5 to 15.5 kMc, and the other covering the 15.5 to 18 kMc area.

Output power ranges from 200 mW to 1.5 W in the lower frequency group, and from 200 mW to 1 W at the higher frequencies.

If optimum tuned, rather than flat-top mode operation is desired, power output may be increased 25%.

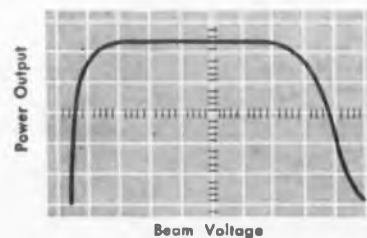

A typical main mode, adjusted for optimum flat-top operation.

### INHERENT BENEFITS

Tubes in the new Sperry family enjoy all the inherent benefits of two-cavity klystron design. These

include precision tuning, high stability, amazing ruggedness and unusual stability at high output levels.

The series incorporates two design features which result in significant size and weight savings.

1. Electrostatic focusing, eliminating the heavy focusing magnets required in many designs.

2. A unique fixed-tuned design, in which the cavities are pressed into a configuration which delivers the customer's specified frequency.

All the tubes in this series show efficiencies in the area of 3.4% with the flat-top mode, and all have low levels of vibration-induced AM and FM noise.

### PRICE AND AVAILABILITY

At power output levels from 0.2 to 0.5 watts, tubes in the new Sperry family are priced at \$2,295 each. With output from .5 to 1.5 watts, the price is \$2,795 each. Tubes will be tuned to your specified center frequency, and they will deliver your specified power output level. All oscillators in this U band series will be shipped within thirty days of receipt of order.



WRITE FOR SPERRY'S NEW BROCHURE which describes the new U band oscillator family in greater detail. For the brochure, or for application assistance and quotation, contact:

R. F. Forlaw, Section 501  
Sperry Electronic Tube Division  
Sperry Rand Corporation, Gainesville, Fla.

SPERRY ELECTRONIC TUBE DIVISION  
GAINESVILLE, FLORIDA • GREAT NECK, N. Y.

SPERRY

ELECTRONIC  
TUBE  
DIVISION

# NEW! WYLE Miniature Temperature Chamber

For Small Parts and  
Black Boxes



Wyle Model C-106 Miniature Chamber

Offering You...

- CLOSER TEMPERATURE CONTROL
- COOLER OUTSIDE SKIN
- BETTER OPERATING ECONOMY
- GREATER FLEXIBILITY
- FASTER HEATING & COOLING RATES

**Revolutionary NEW "Sensor"** The new Wyle liquid CO<sub>2</sub>-cooled Model C-106 Miniature Temperature Chamber is the first to use a revolutionary new type electronic resistance bulb controller that "anticipates" temperature changes and thus effects minimum variation over the full range.

Extra thick layers of new, improved insulation retard flow of heat to outside skin... skin stays cooler. Interchangeable plug-in doors, with various provisions for specimen mounting, instrumentation, specimen operation, and observation, assure minimum downtime. All features lead to greater economy of operation.

## RACK...STACK...OR SIDE-BY-SIDE MOUNTING



Fits standard 19" racks... Flush top & bottom... Flush sides

640 Cu. In. Capacity ● -100°F to +500°F  
Range ● 8" x 8" x 10" Test Volume Dimensions ● Weight... Approx. 55 Lbs. ● Heating & Cooling Rates... Up to 100°F per Minute

**Write TODAY for Full Information!**

DEPARTMENT MIN

# WYLE

LABORATORIES  
MANUFACTURING DIVISION

128 MARYLAND STREET, EL SEGUNDO, CALIFORNIA  
OTHER FACILITIES AT WESTBURY, NEW YORK...NEW  
HYDE PARK, NEW YORK...AND AT NORCO, CALIF.  
CIRCLE 204 ON READER-SERVICE CARD

## RUSSIAN TRANSLATIONS

$(nx)'$ . If  $m_1$  is odd, the argument falls in the second and fourth quadrants, and the table should deliver  $\cos (nx)'$ .

Whether  $m_1$  is even or odd is determined by a step-by-step logic network. This network determines successively the parities of  $nk(x)$ ,  $nk(x) + nk(nx')$ , and  $nk(x) + k(nx') + r$  from the parities of  $n$ ,  $k(x)$ ,  $k(nx')$ , and  $r$ . The buses over which these quantities are transmitted consists of two wires, "0" and "1". If the corresponding quantity is even, a pulse is produced in the 0 wire; if odd, in the 1 wire.

### Russian Logic Network Uses Relays

Because all the input and intermediate quantities assume only two values (0 and 1) in this logic network, the network is very easy to construct. Fig. 1 shows the relay-contact representation of the network used in the Sintez computer. The positions of the contacts in the figure correspond to even values of  $k(x)$ ,  $k(nx')$ , and  $r$ .

Let us consider the formation of the signs of the products, (1). Taking these products into account:

$$\left. \begin{aligned} \text{sign}(B_n \sin nx) \\ \text{sign}(A_n \cos nx) \end{aligned} \right\} = \left\{ \begin{aligned} \text{sign } B_n \\ \text{sign } A_n \end{aligned} \right\} \text{sign} \left\{ (nx)' \right. \\ \left. + 100 [nk(x') + k(nx') + r] \right\}$$

Introducing:

$$s = \begin{cases} 0, & \text{if the coefficient is positive} \\ 1, & \text{if the coefficient is negative} \end{cases}$$

(we shall show presently that this choice is not accidental), we have:

$$\left. \begin{aligned} \text{sign}(B_n \sin nx) \\ \text{sign}(A_n \cos nx) \end{aligned} \right\} = \text{sign} \sin \left\{ (nx)' \right. \\ \left. + 100 [nk(x) + k(nx) + r + s] \right\}.$$

From this we see that the sign of interest to us is determined by the value of

$$m_2 = nk(x) + k(nx) + r + s.$$

Namely, if  $m_2 = 0, 1; 4, 5; \dots$ , then the sign of the product is plus; if  $m_2 = 2, 3; 6, 7; \dots$ , then the sign is minus. It is assumed that the values of  $m_2$  and  $nk(x)$  are reduced to the modulus 4 (this is true for  $k(nx)$ ,  $r$ , and  $s$ ).

It is possible to construct a logical network for  $m_2$  made up of a series of successive

free

send for the

## ALLIED 1962 ELECTRONICS SUPPLY CATALOG

592 PAGES  
MOST COMPLETE

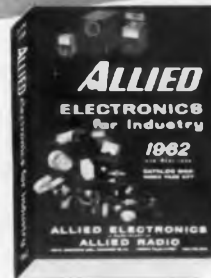

### BUY AT FACTORY PRICES

- WORLD'S LARGEST STOCKS... SPECIALIZING IN:
- Semiconductors
  - Connectors
  - Relays, Switches
  - Transformers
  - Knight-Kit® Instruments in Low-Cost Kit Form
  - Electronic Parts for Every Industrial Need
  - Special-Purpose Tubes
  - Test Equipment, Meters
  - Resistors, Controls
  - Capacitors

### ANYTHING IN ELECTRONICS IN A HURRY

One order to Allied fills the whole bill—from the world's largest stocks of electronic equipment. You get same-day shipment. You buy at factory prices. Write today for the FREE 1962 ALLIED catalog.

ONE ORDER  
TO ALLIED  
FILLS THE  
WHOLE BILL

## ALLIED ELECTRONICS

a subsidiary of

## ALLIED RADIO

100 N. Western Ave., Dept. 905-11, Chicago 80, Ill.

send for  
FREE  
CATALOG

CIRCLE 205 ON READER-SERVICE CARD

## FOR MISSILE AGE LACING TAPES AND CORDS

SPECIFY

HEMINWAY  
& BARTLETT

## NYLON · DACRON · FIBERGLAS

These extra strong, fungus-proof flat braided lacing tapes and cords are specially processed to meet every lacing requirement in missiles and airplanes. Tying is faster, easier, tighter. Nylon and Dacron come wax-coated, wax-free or with G. E. Finish. For high-temperature work (up to 600) choose Teflon coated Fiberglass Tapes.

All Heminway & Bartlett flat braided lacing tapes and cords meet government specifications. Write today for free samples.

## THE HEMINWAY & BARTLETT MFG. CO.

Electronics Division, 500 Fifth Avenue, New York 36, N.Y.  
Distributor—Alpha Wire, New York

CIRCLE 206 ON READER-SERVICE CARD

ELECTRONIC DESIGN • September 13, 1961



### NEW instrument bearings let you beef up the shaft without increasing bearing O. D.

Here are four new opportunities to design shaft-to-housing relationships not possible with other bearings. Thinner cross sections permit extra large bore-to-O. D. ratios.

This new series is manufactured to ABEC-5 precision standards or better, of 440C stainless steel, with plastic crown retainers which act as lubricant reservoirs.

Write for complete information.

BORE + .0000 - .0002	OUTSIDE DIAMETER + .0000 - .0002	WIDTH + .000 - .001	BEARING NUMBER	RADIUS	LAND DIAMETERS		BALLS		C RATING
					INNER	OUTER	NO.	SIZE	
.3750	.6750	.1562	SR620T	.010	.457	.542	12	1 16	81
.5000	.7500	.1562	SR824T	.010	.587	.672	16	1 16	95
.6250	.8750	.1562	SR1028T	.010	.712	.797	18	1 16	98
.7500	1.0000	.1562	SR1232T	.010	.837	.922	22	1 16	108

**NEW HAMPSHIRE BALL BEARINGS, INC.**  
PETERBOROUGH, N. H.

CIRCLE 207 ON READER-SERVICE CARD

**PULSE and RF**

# AMPLIFIERS

WITH  
**NANOSECOND RISETIMES**

Representing a significant contribution to broad-band high-gain amplifier design, the RHG Electronics Laboratory series of pulse and rf amplifiers provide risetimes from <2 to <10 nanoseconds, negligible ringing or overshoot, and self-contained power supplies. Systems are available with characteristics other than those shown below. Higher pulse voltages, impedance levels, special configurations can be custom engineered to your specifications.

Model No.	Max. Pulse Width, 10% Drop $\mu$ Sec.	Rise-time (Nanosecs)	Peak Output Voltage (Volts)	RF Bandpass	Gain db
G50	100	<10	2.5	100 cps- 50 mcs	60
G50C	10	<10	2.5	1000 cps- 50 mcs	100
G70	100	<7	2.5	100 cps- 70 mcs	50
G70C	10	<7	2.5	1000 cps- 70 mcs	90
G100	100	<5	1.5	100 cps-100 mcs	30
G100C	10	<5	1.5	1000 cps-100 mcs	70
G1150	10	<3	0.25	1000 cps-150 mcs	40
G300	10	<2	5.0	1000 cps-300 mcs	20

Input and output impedances: Model G300—150 $\Omega$ , all other models—50 $\Omega$ .



**RHG ELECTRONICS LABORATORY, INC.**  
94 Milbar Blvd., Farmingdale, N. Y.

CIRCLE 208 ON READER-SERVICE CARD

ELECTRONIC DESIGN • September 13, 1961

### How Does the Russian Approach Compare with Ours?

The sine-cosine memory the Russians have described in this article certainly has its equivalent in American equipment. But how does their technique compare with ours?

We'd like to know what you, the reader, thinks. From your own professional experience, would you say that the Russians' memory store is equal to what we have? Is their technique better, or not as good? Is it "old-hat", or an interesting new approach?

We'd appreciate hearing your opinions. Send them to J. George Adashko, ELECTRONIC DESIGN, 850 Third Ave., New York 22, N. Y.

steps. In this network, the quantities  $n$ ,  $nk(x)$ ,  $k(nx')$ , as well as the quantities generated in the individual steps,  $nk(x)$  and  $nk(x) + k(nx')$ , assume the four values 0, 1, 2, and 3. Here, the wires 0, 1 and 2, 3 are paired.

Since  $s = 0$  and 1, the outputs, 0, 1, of the stage where  $nk(x) + k(nx') + r$  is generated are also connected with the outputs 2 and 3, thus simplifying the network.

This procedure can also be used in analog computers. The diode matrix is replaced by voltage dividers (potentiometers) from which the sine and cosine functions are picked off and multiplied by  $A_n$  and  $B_n$ . The products  $A_n \cos nx$  and  $B_n \cos nx$  (for one value of  $x$ ) are obtained successively for different values of  $n$ . They can be stored and summed by means of capacitors, as proposed in reference 4.

Translated from "Design of Memory for the Storage of Sines and Cosines," G. G. Men'shikov and L. M. Rakhovich, Leningrad Electrotechnical Institute of Communications, (News of the Higher Institutions of Learning—Instrument Building), No. 2, 1961, March-April 1961, pp 67-71.

#### References

1. High-Speed Computers. Coll. of translations, edited by D. Yu. Panov. IL, 1952, p 38.
2. Vil'davskii, G. I. Sine-cosine Digital Devices. Problems of Radio and Electronics. General-Engineering, series, 1959, No. 2, pp 64-76.
3. Zaednyi, A. M. and Rakhovich, L. M. Specialized Computer for Harmonic Synthesis and Analysis. Trudy, Leningrad Electrotech. Commun. Inst. 1959, No. 1 (38).
4. Men'shikov, G. G. Desk Model Instrument for Harmonic Synthesis. Science Note, Leningrad State Univ., Math. Series, 1958, No. 33, pp 48-53.

## VALPEY

crystal controlled

### PACKAGED OSCILLATORS

a stable solid state source for systems

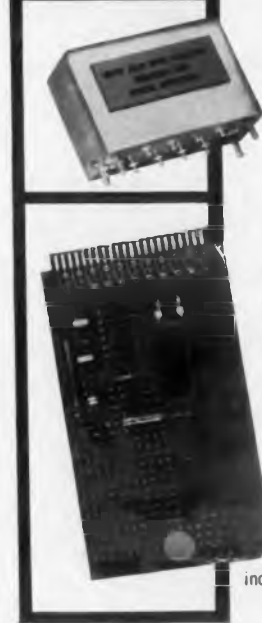

Temperature controlled packaged oscillators, either sealed units or plug-in printed circuit modules, offer the reliability and stability of quartz crystal control over a frequency spectrum of 60 cps to 20 MC. Stabilities from: 0.1% to 0.001% are standard, custom designed units stable to 5 parts in 10<sup>6</sup> are available as complete packages. Features include: small size, temperature range from -65°C to 125°C, ruggedized units to meet severe environmental conditions. Outputs available include: standardized pulse, square wave or stable sine-wave — working into load impedances from 50 ohms and up

depending on frequency range. The Valpey engineering staff will be pleased to submit quotations according to your specifications for packaged oscillator applications including pulsed or gated circuits, frequency sources and standards, time bases or other advanced circuitry needs. Specification sheets on request.

## VALPEY QUARTZ CRYSTALS

Crystals in all frequency ranges can be manufactured or developed to meet long term stability and other special requirements. Miniature and sub-miniature frequency control crystals for commercial or military applications are available to 125 MC. High frequency crystals for lattice type and single signal filters are available in frequency range from 1500 KC to 23,000 MC.

Ruggedized Low Frequency Oscillator and Filter Crystals compactly designed for applications where space is important and environmental conditions severe. Frequency range 5 KC to 350 KC.

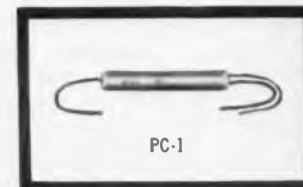

For complete information on Valpey Crystals request catalog



*Craftsmanship in crystals since 1931*

Quartz Crystals • Ovens • Precision Optics • Crystals for Ultrasonics and Delay Lines • Packaged Oscillators  
Fabrication of Rods for LASER

### VALPEY CRYSTAL CORP.

HIGHLAND ST., HOLLISTON, MASS.  
Tel. GArden 9-4851, 9-4854

CIRCLE 209 ON READER-SERVICE CARD

**ALLIED'S**  
**NEW**  
**6 POLE**  
**Sub-Miniature Relay**  
 with  
**0.2 Inch Grid Spaced**  
**Terminals\***



**OPERATING CONDITIONS**

**CONTACT RATING:**

2 amperes non-inductive or 1 ampere inductive  
 at 29 volts d-c or 115 volts a-c  
 Low level contacts are available on request

**AMBIENT TEMPERATURE:**

- 65°C to + 125°C

**VIBRATION:**

5-28 cps at 0.5 inch double amplitude  
 28-2000 cps at a constant 20g

**SHOCK:**

50g operational

**WEIGHT:**

1.8 ounces maximum

\*Also available with straight pins for printed  
 circuit application

Write for Bulletin JH-18D #25

**ALLIED CONTROL**  
 ALLIED CONTROL COMPANY, INC.  
 2 EAST END AVENUE, NEW YORK 21, N. Y.  
 CIRCLE 210 ON READER-SERVICE CARD

**GERMAN ABSTRACTS**

E. Brenner

**A Simple Analog Multiplier**

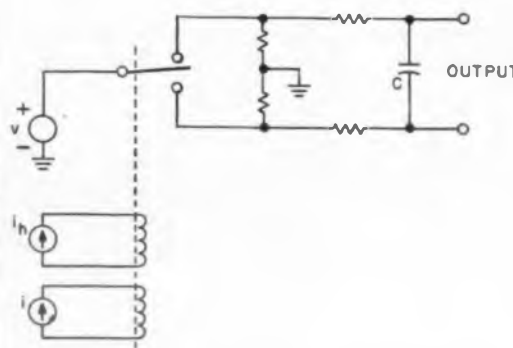

Fig. 1. Analog multiplier uses polarized relay for the multiplication of  $v \times i$ .

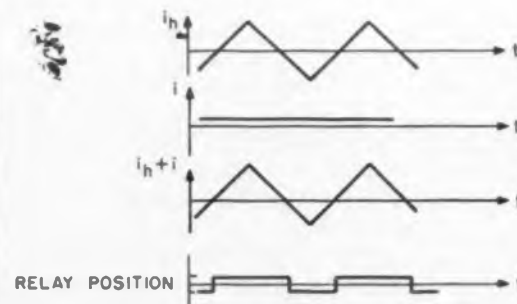

Fig. 2. Waveforms of analog multiplier assuming  $i = \text{const.}$

**A**NALOG multipliers generally fall into one of three classes, depending on their application. For slowly varying signals, servomultipliers are suitable; for faster operation, time-division multipliers are used. Other systems depend on square law devices, together with the relationship

$$4xy = (x + y)^2 - (x - y)^2$$

A simple time-division multiplier which uses so few components that it can be used as a wattmeter is shown in Fig. 1. Its principle of operation can be described with the aid of the waveforms shown in Fig. 2.

The two functions to be multiplied are represented by the voltage  $v$  and the current  $i$ . For purposes of explanation these are assumed to be constants. However, the circuit works quite well as long as both  $v$  and  $i$  have no significant spectral components at frequencies near or above the switching frequency.

The function  $i$ , supplied by a current source, is applied, together with the switching current  $i_h$ , to the control winding of a relay. (It is necessary that the peak value of  $i_h$  exceed the peak value of  $i$ ). The switching current is most conveniently made triangular as shown.

When the current  $i$  is zero, the switching occurs symmetrically and the average value of the output voltage is zero. As  $i$  increases, the switching occurs unsymmetrically and the average value of the output voltage is proportional to the quotient of  $vi$  and  $i_{hmax}$ :

$$v_{out} = K vi/i_{hmax}$$

In principle the circuit can also be used as a divider.

Abstracted from an article by A. Schief, *Elektronische Rundschau*, Vol. 15, No. 4, April 1961, pp 153-154.

## Formulas For Characteristic Impedance

**F**ORMULAS for conductor arrangements of cylindrical conductor and plane shielding are not generally available. Moreover, many of the formulas apply only to conductors far from the plane boundaries. The formulas below are deduced, by conformal mapping methods from inductance and capacitance values, for a cylinder over an infinite plane.

**Cylindrical Conductor in a Right Angle Corner, Fig. 1.** Various approximations for the characteristic impedance for this arrangement as a function of the ratio of spacing to wire radius are given in Fig. 1. Defining:

$$A = \frac{4x^2 - 2 - 1/(4x^2)}{[8x^2 - 2 - 1/(8x^2)]^{1/2}} \quad (1)$$

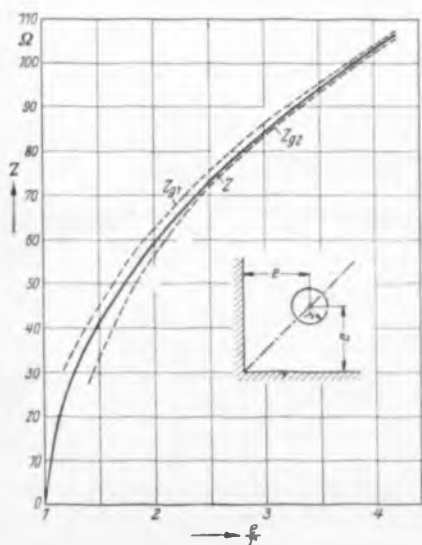
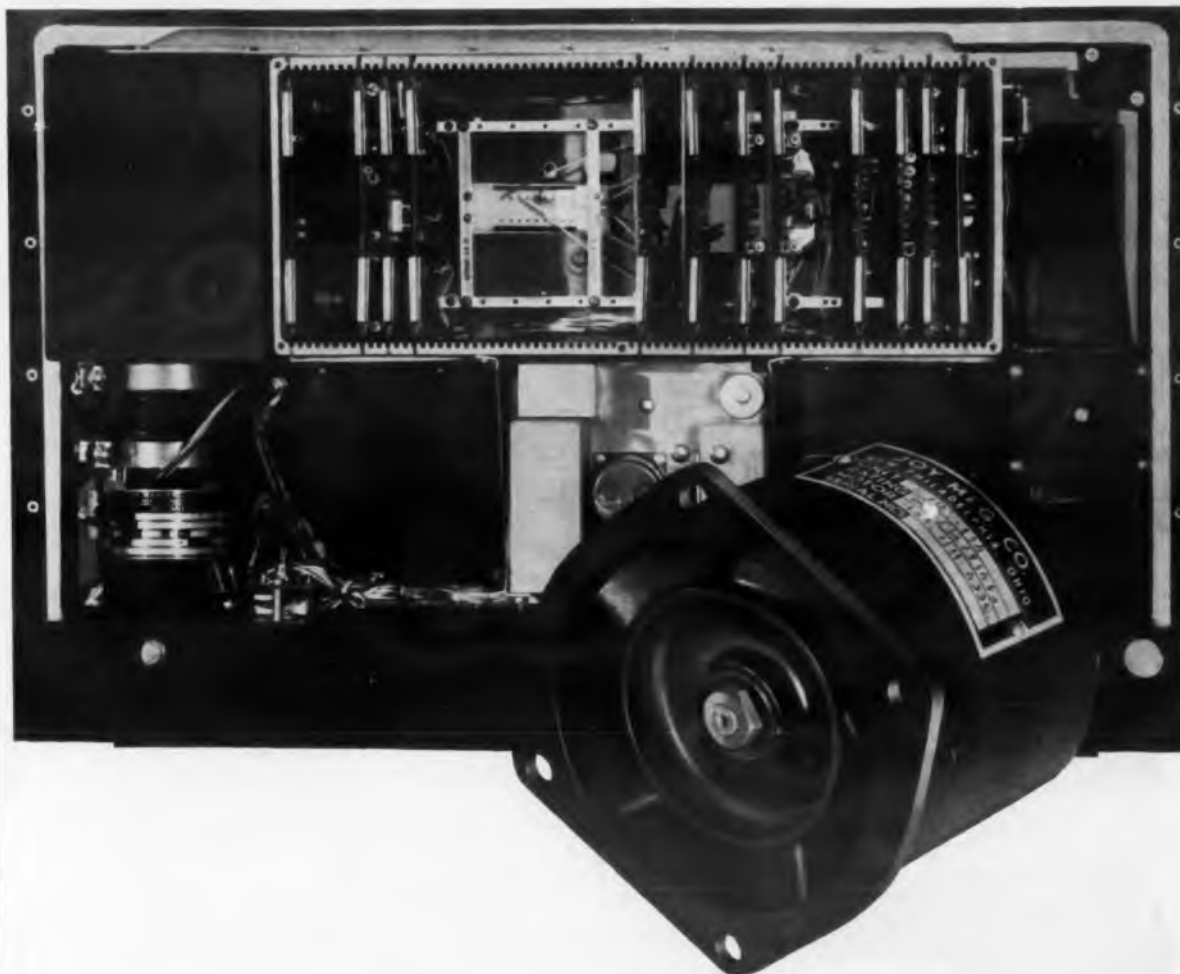

Fig. 1. Characteristic impedance of cylindrical conductor in square corner.



## JOY FAN COOLS AMPEX WIDEBAND TAPE RECORDER ...new unit records 4 channels—occupies just 3.5 cu. ft.

The Ampex Wideband Tape Recorder, with frequency range of 10 cps to 4 mc, displaces only 3.5 cubic feet. With this size limit and rigid internal temperature specs of 104° to 140° F, Ampex designers specified Joy Axivane fans for cooling.

Operating at 23,000 rpm on 400 cycle AC, the Joy blower circulates 60 cfm at 10" static pressure through a built-in heat exchanger system. The straight-through vaneaxial design permits integral mounting directly on

the heat exchanger. The system maintains the internal temperature specified regardless of wide variations in ambient temperature.

With long experience in design problems of this kind, Joy can design small blowers of high pressures or high volumes to suit your exact electronic cooling need. And literally thousands of designs are available off-the-shelf. Let our cooling experts work with you. For more information write for Bulletin 2565-57.

### AIR MOVING EQUIPMENT FOR ALL INDUSTRY



# JOY

Joy Manufacturing Company  
Oliver Building, Pittsburgh 22, Pa.

In Canada: Joy Manufacturing Company  
(Canada) Limited, Galt, Ontario

CIRCLE 211 ON READER-SERVICE CARD



# Strip

EMBEDDED  
Components!

To replace or repair defective parts or to salvage valuable parts in embedded circuits, just remove encapsulating resin (epoxies and polyesters) with newly developed and improved

## MONASTRIP EP STRIPPER SOLVENT

Also used as a cleaner on potting tools and equipment. Helps speed up your operation and prolongs the life of these tools indefinitely. Will not corrode, discolor or damage metals, conductors or enamels. To learn how to make components look like new, write Chemical Division of

**MONA INDUSTRIES, Inc.**  
PATERSON, 17 NEW JERSEY

CIRCLE 212 ON READER-SERVICE CARD

I believe they do have a point!

**Introducing an alligator clip with a "microscopic tip"!**

*the Mueller* **MICRO-GATOR**

Here is the alligator clip you can now use where no other clip will do! On printed circuits, in tight spots and on tiny terminals too crowded for anything but its "microscopic" tip. Fully insulated right down to the nose. It offers all the speed, free handed ease and convenience associated with other Mueller alligator clips.

Strong new type, keyed-in hinge. Traditionally snappy Mueller spring. Clinch-in easy for gripping wire.

Tough Vinyl skin tight insulator. Lip action tip slot. A ringer for the popular Mini-gator insulator.

**INSULATORS SOLD SEPARATELY.** (Standard Red and Black colors. White, Blue, Yellow and Green also available.)

**FREE SAMPLE** of clip and insulator, on request to factory

**Mueller Electric Co.**

1580H East 31st St., Cleveland 14, Ohio

CIRCLE 213 ON READER-SERVICE CARD

## GERMAN ABSTRACTS

represents the formula:

$$Z = 30 \ln(\sqrt{2} xA) \quad x \geq 1.5$$

The upper dotted line is given by:

$$Z_{01} = 60 \ln(\sqrt{2} x) \quad x \geq 4$$

and the lower line is given by:

$$Z_{02} = 60 \ln(A) \quad x \geq 2.5$$

**Cylindrical Conductor in a Square Pipe.** Fig. 2. The characteristic impedance as a function of  $s/d$  is shown by the solid line. Letting  $x = s/d$  and with  $A$  defined as in Eq. 1, two relevant approximations are:

$$Z_{01} = 23.8 \ln(\sqrt{2} xA) \quad 1.5 < x < 2.6$$

and:

$$Z_{02} = 60 \ln x \quad x > 4.5$$

**Additional Geometries, Fig. 3.** Results for cylindrical conductor in a deep rectangular slot, between two parallel planes and within a slit are shown in Fig. 3. The relevant formulas follow.

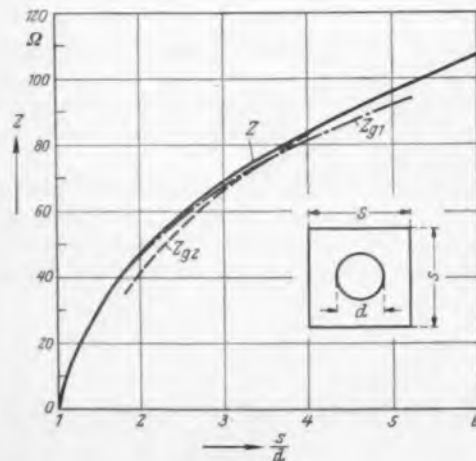

Fig. 2. Characteristic impedance of cylindrical conductor in square pipe.

## NEW . . TYMETER GRADINETIC®

# SECOND BY SECOND 5 DIGIT 12 OR 24 HOUR READOUT DIGITAL CLOCK

Pat. No. 2587777  
Other Pat. Pending



#110

• Split Second Timing • Second by Second 00-59 Kinetic Gradient Readout • Time is registered on 5 Polygonal Drums • One Hour Drum, One 10 Minute Drum, One Minute Drum, Two Seconds Drums • Large  $\frac{3}{16}$ " easy to read digits, 12 hour clock •  $\frac{5}{16}$ " easy to read digits, 24 hour clock • Full vision in line readout digital display • Independent front panel time reset controls reset digits individually • Completely enclosed in anodized metal dustproof case • Height  $4\frac{1}{2}$ ", Width 12", Depth  $3\frac{1}{2}$ " • Weight 6 lbs. • Front panel mount... desk or bench use • UL approved motor and cord. Guaranteed one year.



**SECOND BY SECOND  
GRADIENT READOUT**

Write for Catalog on Complete Line Showing Specifications

**PENNWOOD NUMECHRON CO.**

ELECTRONIC TIMING DIVISION  
7249 FRANKSTOWN AVE. PITTSBURGH 8, PA. FRemont 1-4200

CIRCLE 214 ON READER-SERVICE CARD

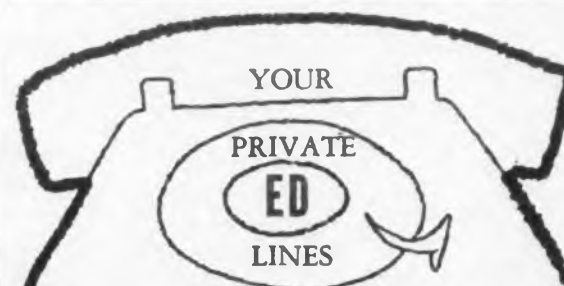

When employment information is obtained through **ELECTRONIC DESIGN**, it's sent direct to your home, so that only you and one prospective employer at a time know about it. You can conduct your employment campaign privately—as it should be conducted.

This is why every Reader Service Card reserves a line for your home address, and why circled numbers are detached from Career Inquiry Service Forms sent to companies.

You can apply for many jobs simultaneously . . . only *you* will know how many.

Use the Career Inquiry Service Form, and the Reader Service Card when job hunting. They're your *private lines* to employment opportunities . . . another service for you from **ELECTRONIC DESIGN**.





## PRECISION PLASTIC BALLS

ACE is one of America's leading mass producers of seamless plastic balls for almost every commercial and industrial use. Most plastics including nylon and teflon. Complete range of sizes, colors and tolerances. Small runs or large runs. Huge stocks for immediate delivery. Quick, low-cost service on specials. Write, wire or call for samples, price lists and handy new selection chart.

EXTRUDERS  
SINCE 1931  
FABRICATORS

ACE PLASTIC COMPANY 91-58 VAN WYCK EXPWY. JAMAICA 35, N. Y.

CIRCLE 216 ON READER-SERVICE CARD

Suppress  
lead wire  
errors with  
REC's new



## TRIPLE BRIDGE UNIT

Check these advantages in resistance temperature measurement applications:

- Suppresses large lead resistance changes (up to 5 ohms)
- Suppresses variable lead resistances at null and when unbalanced
- Suppresses unequal lead resistances
- Trims out calibration differences
- Multiple temperature ranges
- Standardized 10 mv. DC output
- Full line of auxiliary equipment

This precision-made, plug-in unit permits convenient change of full-scale temperature and corrects known calibration errors of sensor. Basic 10-channel unit provides 10 temperature ranges for each of 10 sensors.

For more information write for Bulletin 86012



**ROSEMOUNT  
ENGINEERING  
COMPANY**

4900 West 78th Street, Minneapolis 24, Minn

SPECIALISTS IN TEMPERATURE AND PRESSURE MEASUREMENTS

CIRCLE 217 ON READER-SERVICE CARD

ELECTRONIC DESIGN • September 13, 1961

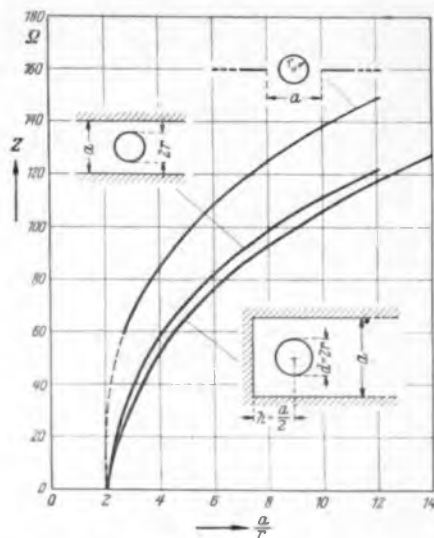

Fig. 3. Characteristic impedance for the three structures shown.

For the slit arrangement:

$$Z = 60 \ln (a/r) \quad a/r > 2.5$$

For the conductor between parallel planes, let:

$$B = \left[ \frac{2}{\tan (\pi r/a)} \right]^2$$

then:

$$Z = 30 \ln (B - 2 - 1/B) \quad a/r > 5$$

or:

$$Z = 60 \ln (2a/\pi r) \quad a/r > 8$$

For the slot geometry, let

$$D = \left[ \frac{2 \tan (\pi h/a)}{\tan (\pi r/a)} \right]^2$$

and

$$Z = 30 \ln (D - 2 - 1/D) \quad a/r > 4; h/r > 2$$

In the special case shown,  $a = 2h$  and

$$D = \left[ \frac{1.834}{\tan (\pi r/a)} \right]^2$$

and for  $a/r > 6$ ,

$$Z = 60 \ln (0.584 a/r)$$

Abstracted from an article by W. Buschbeck, *Telefunken Zeitung*, Vol. 34, No. 131, March 1961, pp 69-76.

# POSITIVE CONTROL NEGATIVE VARIATION in power line voltage

The TIC 600 Series of automatic voltage regulators absorb high overload surges while delivering undistorted 1/4% true RMS voltage regulation over a 50-70 c.p.s. range... are designed for unrestricted industrial and laboratory use.



MODEL 607



MODEL 605



MODEL 601



ECONOMY MODEL 650  
(Has most features of 600 Series. Send for complete information)

### The Features:

- Continuously adjustable output voltage
- Rapid voltage correction
- Independent of power load factor
- Quickly replaceable plug-in control circuit
- Combined circuit breaker and line switch
- No relays to stick
- Suitable for three-phase operation, delta or wye connection



### SPECIFICATIONS

MODEL	650	601	605	607
FREQ. RANGE	50-70 c.p.s.			
KVA RATING	1	3.6-1.8	12 6	30 15
OUTPUT AMPS	10	30 15	100 50	250 125
OUTPUT VOLTS ADJ. 10%	105/125	115	115	
CORRECTABLE INPUT VARIATION	±17%	±10% ±20%	±10% ±20%	±10% ±20%
RESPONSE SPEED V/SEC	30	10 20	5 10	2.5 5
WEIGHT (LBS.)	30	45	110	170

Send for complete information.

**TIC Tel-Instrument**  
ELECTRONICS CORP.

INDUSTRIAL DIVISION

728 GARDEN STREET, CARLSTADT, N. J. • Tel: WEbster 3-1600

CIRCLE 218 ON READER-SERVICE CARD

# BREAKTHROUGH!



**T** = **MILLISECONDS  
TO MONTHS**

A small, rugged, reliable solid state magnetic time base accurate to 0.05%

Here's a revolutionary new timing device from Honeywell. The basic module is a single pulse rate magnetic oscillator with periods of 1/100 second up to five seconds. Countdown circuitry provides any time extension.

Specifications include accuracies of better than 0.05% over a temperature range of -65° to +125° F. with supply voltage variations  $\pm 10\%$ . Oscillator power requirements are 8 ma at 6 vdc, and the timer is available with fixed or variable time periods and single or multiple outputs, depending upon requirements.

*The timer's use of a magnetic core oscillator instead of other devices insures exceptional long term stability.*

Rugged enough for gun-fired projectiles, the new Honeywell timer is excellent for military applications like safing, arming, fuzing and programming mines, torpedoes, missiles, satellites and other mechanisms.

Size of the timer depends upon the time interval desired and packaging requirements. The five-second module occupies only one cubic inch. Each additional decade counter stage requires another cubic inch.

Highly reliable, with a long shelf life, this new timer represents a remarkable design breakthrough. For further information write Honeywell Military Products Group, 600 Second St. No., Hopkins, Minn.

## Honeywell



*Military Products Group*

CIRCLE 219 ON READER-SERVICE CARD

# LETTERS

## Kudos to ED's Transistor Data Chart

Dear Sir:

Just a note of "thanks" and appreciation for the July 1961 issue of *ELECTRONIC DESIGN*. In particular, the Transistor Data Chart is the handiest and most valuable thing of its kind I have ever seen. I think the outstanding feature of this chart is its division into specific areas of application. We will use this chart frequently in the months to come.

I also appreciate the new binding as *DESIGN* gets hard usage in this office.

John H. Garley  
Chief, Research and Development  
Datatronic Systems, Inc.  
San Diego, Calif.

► *Many readers apparently agree with Mr. Garley. During the first fifteen days after the Transistor Data Chart appeared, individual requests for reprints poured in at the rate of over 260 a day rapidly using up our supply.*

## More on Molecular Computers

Your June 21 edition of *ELECTRONIC DESIGN*, p 14, carried a story of our Mol-E-Com molecular computer.

You might be interested in knowing that a good number of inquiries have been received on this article which indicate a pretty thorough readership of these news "briefs".

Apparently through a typographical error, a few technical aspects of our efforts on this machine have been reduced in significance. In discussing the memory, the article states that it is "planned to have an expandable random-access memory of 1,600 bits." This figure should actually read 16,000 bits.

In discussing its planned potential of about 50,000 operations per sec, you concluded with the term "hopefully". I mention this only to point out that our design data indicate that we will achieve this capability and that such results will be based on engineering design rather than fond hope.

Finally, in the fourth paragraph, a mention is made of our planned use of functional blocks of etched germanium, about 3/4 in. square and 1/64 in. thick. In this respect, our current plans do not call for the use of germanium but rather silicon for functional

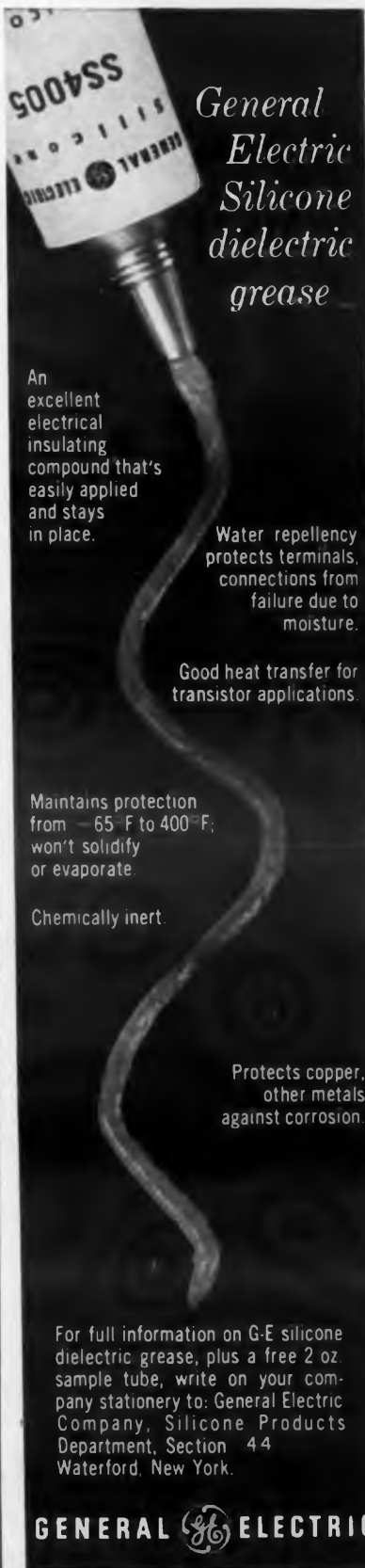

*General Electric Silicone dielectric grease*

An excellent electrical insulating compound that's easily applied and stays in place.

Water repellency protects terminals, connections from failure due to moisture.

Good heat transfer for transistor applications.

Maintains protection from -65°F to 400°F; won't solidify or evaporate.

Chemically inert.

Protects copper, other metals against corrosion.

For full information on G-E silicone dielectric grease, plus a free 2 oz. sample tube, write on your company stationery to: General Electric Company, Silicone Products Department, Section 44, Waterford, New York.

**GENERAL ELECTRIC**



dial  
**BARCLAY**

**7-7777**

for immediate delivery of



from our IBM controlled inventory.

[ Do your prints show the NEW Garlock part numbers? Ask for our conversion chart, now, to save valuable time. ]



LONG ISLAND: IVanhoe 6-7660  
NEW JERSEY: Delaware 3-8780  
CALL COLLECT ORDER DEPT. - BA 7-7785  
TWX-NY1-177 / CABLE: "HARRISORAD"

CIRCLE 221 ON READER-SERVICE CARD

ELECTRONIC DESIGN • September 13, 1961

blocks. These blocks, each providing separate electronic functions, would be mounted and interconnected in standard units about 3/4 in. square and 1/64 in. thick but each containing four or more functional blocks.

L. M. Dowling, Manager  
Computer Development  
Westinghouse Electric Corp.  
Baltimore, Md.

► *We're pleased to learn that news of the molecular computer, the information about which came from Westinghouse sources, drew many inquiries, even though marred by one typographical error—the memory capacity.*

### Diallyl Phthalates As Good as Epoxies

In line with your "Accuracy Policy," allow us to clear up two points contained in the boxed insert appearing on p 55 of your Aug. 2, 1961 issue pertaining to the article "How to Choose Modifiers for Epoxy." You quoted Mr. Paul S. Byrd, "in some cases epoxy molding powders can compete with diallyl phthalate. (He said) that epoxies have shorter molding cycles than DAP and that they can be machined without destroying their surface properties."

Please be advised that the molding cycles of diallyl phthalate compounds under equal conditions are as short as the molding cycles of epoxy compounds. As far as maintenance of surface properties is concerned, daily tests show that both materials suffer to the same extent if the surface of a molded part is disturbed or altered by machining, grinding, drilling, or other similar operations.

We feel qualified to make the above statements because we are compounding both types of compounds, i.e., epoxy molding compounds and diallyl phthalate molding compounds.

Felix C. Karas  
Vice President  
Mesa Plastics Co.  
Los Angeles, Calif.

► *One molder, John L. Hull, vice president, Hull Corp., Hatboro, Pa., told ELECTRONIC DESIGN that what may have caused confusion here is that Mr. Byrd's company, American-Marietta, Newark, Ohio, happens to have an epoxy molding powder which is (for the present at least) faster than other epoxy molding powders.*



## Micatemp Aerospace Wire Resists Nose Cone Heat in Minuteman

Rockbestos Micatemp wire is an ultra-high temperature lead wire that will withstand temperatures up to 2000°F. Because of its ability to carry current at such extreme temperatures, it is used for wiring sub-assemblies in the Minuteman nose cone. Micatemp is also highly resistant to vibration fatigue and radiation.

Developed specifically for missile and satellite wiring, Rockbestos Micatemp wire offers interesting design capabilities for many other military and industrial applications. If you are looking for an ultra-high temperature or radiation resistant wire for your project, be sure to consider Micatemp.

*The new Rockbestos Aerospace & Electronic Catalog can help solve your wire and cable problems. Send for your copy today.*



**ROCKBESTOS WIRE & CABLE CO.**

DIVISION OF **CERRO CORPORATION**

MAIN OFFICE AND FACTORY: Nicoll and Canner Streets, New Haven, Conn.

CIRCLE 222 ON READER-SERVICE CARD

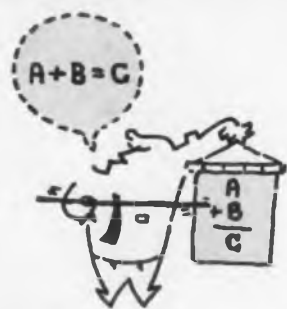

## Verbal and Visual Aids Spur Engineer Sales Victories

**Roy S. Azarnoff**  
Consultant to Raytheon Co.  
Boston University  
Boston, Mass.

*This is the second part of a two-part series on how engineers can make effective sales presentations. The first article (ED, Aug. 16, p 144) gave hints on how to analyze the customer and organize the basic sales message.*

**Y**OU ARE an engineer, and your company has asked you to lead a team in making a sales presentation to a customer. You have analyzed the customer's wants and have formulated your basic message to meet these wants. Don't rest there. What you have is not yet enough to "sell" the customer. You must have words and pictures that will bridge the gap between your basic message (which probably only makes sense to you) and the customer's mind.

Verbal aids are the primary tool for transplanting your basic message from your mind to the customer's. To get yourself started on the task of finding words that will aid your message, consider that they can be broken down into *definitions, comparisons, statistics and examples*. Thinking up a few in each category will start you toward rounding out your complete verbal presentation.

**Definitions** come in many forms. Describe a transistor as part of a family of semiconductor devices, in terms of its mechanical and thermal properties. Define it in terms of its function and end use. Explain its component parts.

To define a high-frequency transistor as a "device used above 1 or 2 mc" makes little sense when the listeners do not yet know what a transistor is. (In a mixed technical-and-nontechnical audience the technique is to work in definitions in such a way as to educate the nontechnical people but not offend the technical people.)

**Comparisons** provide one of the most useful tools the engineer has in translating technical information into layman's terms. Here is a statement that needs a comparison:

"The Palomar Observatory is equipped with a 48-in. telescope."

This is not impressive as such. However, this comment makes it so:

"The 48-in. telescope could photograph a candle flame 10,000 miles away."

Here is another illustration:

"The reliability required by a million-hour test is roughly equivalent to printing the *Encyclopaedia Britannica* without a typographical error."

Reliability is a good example of a subject that calls for easily grasped comparisons. Use them side by side with the point to be illustrated when possible:

"The National Bureau of Standards has developed a high-resolution camera capable of projecting a parallel line pattern with a spacing of 50,000 lines per in. This can be compared to writing out the Bible four times on a postage stamp."

But don't overuse comparisons. Comparisons and analogies will be accepted favorably by your audience only to the extent that they appear naturally. If you "strain" an analogy by endeavoring to use it as "proof" of an idea your audience will lose respect for you.

**Statistics** are used to support statements or to generalize from specific examples. Use them to demonstrate the importance of an idea. For example:

"Our company produces 83 per cent of the electronic components in this field. Most people consider us the leader in the field."

Unless exactness is required, use round numbers. "About 200,000" can be understood and retained more easily than "198,673." Use statistics sparingly.

**Examples** add clarity and concreteness to ideas. People prefer the specific to the general. Use examples as a basis for drawing the conclusions:

Example A + Example B + Example C = Conclusion. Or, working deductively: Conclusion = Example A + Example B + Example C.

Three rules govern use of examples.

- (1) Select those that your analysis of the audience indicates will be understood.
- (2) Keep them reasonably short.
- (3) Identify them as real or hypothetical.

### Visual Aids Supplement Your Verbal Presentation

Use such visual aids as graphs, tables and diagrams to present concepts that cannot be transmitted solely by verbal means. One picture is worth a thousand words only when the picture is relevant to the audience and to the subject.

And if the presentation is being held in your own plant, don't overlook the possibility of a short, interesting tour of the very facilities or equipment you are talking about.

Determine the type and size of visual aids you will use by the number of listeners and the size of the room, as well as by what you want to show in the aids. For up to about 75 people, 30-by-40-in. charts are effective. For more than 100 persons, a projector and screen will probably be necessary. But films should not be overdone, because when the lights are out, the speaker is no longer the focus of attention.

Prepare visual aids in advance rather than trust that you will be able to draw something on a blackboard while you talk. Make them neat, large enough to see, simple and dramatic. Show them only when needed and remove them as soon as you are finished using them.



Position them so that everyone can see them easily. If you pass around handouts, wait until all eyes are again centered on you. Visual aids should supplement, not supplant, verbal aids.

And while on the subject of mechanical aids, don't overlook audio aids, such as tape recorders, if they will tell part of your story (e.g. to illustrate the difference between noise levels in various kinds of equipment).

#### Plan the Staging to Eliminate Awkward Moments

The presentation itself will consist of four elements: the audience, the team leader, the speakers and the stage arrangements. The audience is not under the control of the team, but the other elements are, and the part that they play should be rehearsed in advance.

As team leader, you coordinate the entire presentation. You may give a portion of the presentation, but your primary function is to serve as the chairman. You introduce the speakers, indicating their qualifications. After each speaker, you summarize the talk and relate it to the basic message.

After all the speakers have given their talks, you start off the general question-and-answer period by summarizing the entire presentation to renew interest in each speaker's talk. This usually elicits questions for each speaker. The skilled leader receives each question and calls upon the person he thinks best suited to answer it. He may also choose to answer all or part of any question himself.

If no leader has been designated, the unfortunate tendency is for the last speaker to linger at the lectern and to attempt to reply to all of the questions. Most of the questions are for the last speaker anyway, as the audience tends to forget items it wanted to ask previous speakers. But this situation is poor, because the last speaker may not be the best qualified to answer each question.

As a speaker, you must remember that you are in view of the audience even when you are seated. You can help to focus attention on the speaker by looking at him and showing interest in his remarks.

Wear a name plate (or place a card before

## ELECTRONIC ENGINEERS & PHYSICISTS

# REPUBLIC AVIATION NEWS

## NEW RECONNAISSANCE ROLE FOR "ELECTRONIC PLANE"

### NEW PRIME CONTRACT AWARDED REPUBLIC CREATES DEMANDING ASSIGNMENTS FOR EE'S & PHYSICISTS

The development of a reconnaissance capability for Republic's F-105D marks the first "marriage" of an all-weather reconnaissance system with an all-weather airborne weapon system. The one-man F-105D has already earned the title of the "world's first electronic plane," because its integrated complex of electronic systems permits it to be almost fully automatic. Flight control, navigation, target seeking, identification and tracking, fire control for diverse weapons are all automatically controlled.

With the addition of a sophisticated reconnaissance system the F-105D becomes a flying electronic platform. System design and analysis of the new reconnaissance package and its aerospace ground support present stimulating new challenges to electronic engineers and physicists. Optimum integration of the whole electronic complex offers unique problems.

#### SENIOR & INTERMEDIATE POSITIONS NOW OPEN TO ENGINEERS (EE) AND PHYSICISTS, TO PERFORM SYSTEMS DESIGN, ANALYSIS, TEST AND RELIABILITY ENGINEERING ON:

Radars (front & side looking)  
Infrared Systems  
Antennas, Radomes  
Data Links

Digital Computers  
Flight & Fire Control Systems  
High Speed Tape Recorders  
Optical Systems

Aerospace Ground Support Equipment

These opportunities are at 2 Republic locations: Mineola and Farmingdale, Long Island. For further information, write in confidence to:

▶ Mr. George R. Hickman  
Technical Employment Manager,  
Dept. 12J-2  
Republic Aviation Corporation  
Farmingdale, Long Island, New York

▶ Mr. Paul Hartman  
Technical Employment, Dept. 12J-2A  
Missile Systems Division  
Republic Aviation Corporation  
223 Jericho Turnpike  
Mineola, Long Island, N. Y.



All Republic programs are backed up by the new Paul Moore Research & Development Center, an integrated complex of eight laboratories dedicated to the advancement of all aspects of aerospace technology.



**REPUBLIC**  
AVIATION CORPORATION

All qualified applicants will receive consideration for employment without regard to race, creed, color or national origin.

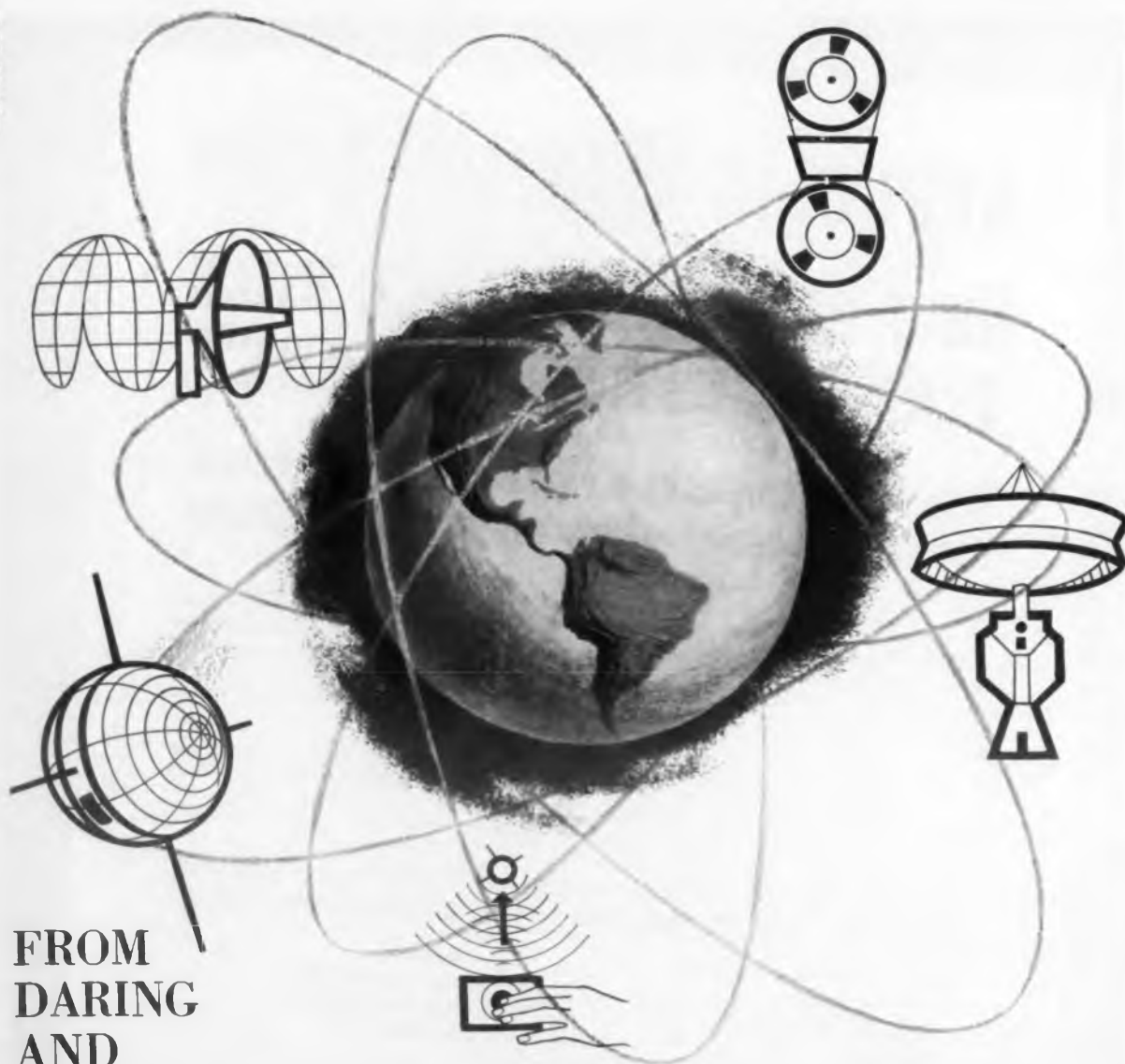

## FROM DARING AND DOING — *New space communications concepts*

Consider a career at PHILCO Western Development Laboratories, on the San Francisco Peninsula. New concepts of communications with lunar reaches and beyond can be your projects. Here you devise and "do", unencumbered by dogma or dialectics. Constantly expanding programs and new research assignments assure you personal recognition and advancement.

PHILCO Western Development Laboratories pioneers in all phases of space communications, with important and growing projects that

include satellite instrumentation, range design and operation, missile tracking, data handling and control equipment.

Your family will enjoy Northern California. You ski, swim and sail in season, or just bask, with both the opportunity and wherewithal to enjoy your favorite diversions. PHILCO Western Development Laboratories is indeed a fortunate conjuncture of challenging work and affluent living. For information on opportunities in electronic engineering, for men with degrees from B.S. to Ph.D., please write Mr. W. E. Daly, Dept. D-9.

All qualified applicants will receive consideration for employment without regard to race, creed, color or national origin: U. S. citizenship or current transferable Department of Defense clearance required.

**PHILCO**  
Famous for Quality the World Over

**WESTERN DEVELOPMENT LABORATORIES**  
3875 Fabian Way, Palo Alto, California

CIRCLE 902 ON CAREER INQUIRY FORM

## DESIGNING YOUR FUTURE

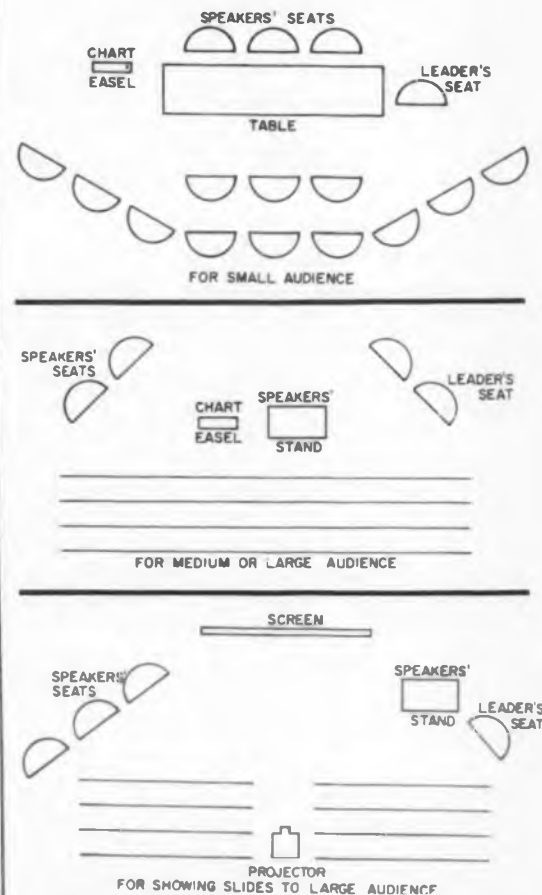

Room arrangements for presentations to small, medium and large audiences should be planned. Visual aids (and audio, including a public-address system, if needed) should suit the size of the audience.

you with your name printed large enough for the audience to see) to help the audience when it wants to address you during the question-and-answer period. Courtesy requires that you stand to answer questions or to deliver a talk. To add to the "team-ness" of the presentation, you can hold one another's visual aids, run projectors, etc. Audiences are influenced by a speaker's appearance; make the most favorable impression possible in this respect.

As for staging arrangements, the primary requisites are easy access from the speaker's chair to the lectern, seating that permits the audience to view each participant and the team leader, and a prominent position for displaying the visual aids. A little forethought in planning the stage arrangements



ELECTRONIC DESIGN **CAREER INQUIRY SERVICE** USE BEFORE OCT. 25, 1961

After completing, mail career form to ELECTRONIC DESIGN, 850 Third Avenue, New York, N. Y. Our Reader Service Department will forward copies to the companies you select below.

19

(Please print with a soft pencil or type.)

Name \_\_\_\_\_ Telephone \_\_\_\_\_

Home Address \_\_\_\_\_ City \_\_\_\_\_ Zone \_\_\_\_\_ State \_\_\_\_\_

Date of Birth \_\_\_\_\_ Place of Birth \_\_\_\_\_ Citizenship \_\_\_\_\_

Position Desired \_\_\_\_\_

Educational History				
College	Dates	Degree	Major	Honors

Recent Special Training \_\_\_\_\_

\_\_\_\_\_

Employment History				
Company	City and State	Dates	Title	Engineering Specialty

Outstanding Engineering and Administrative Experience \_\_\_\_\_

\_\_\_\_\_

\_\_\_\_\_

Professional Societies \_\_\_\_\_

Published Articles \_\_\_\_\_

Minimum Salary Requirements (Optional) \_\_\_\_\_

Use section below instead of Reader Service Card. Do not write personal data below this line. This section will be detached before processing.

Circle Career Inquiry numbers of companies that interest you

900 901 902 903 904 905 906 907 908 909 910 911 912 913 914 915 916 917 918 919 920 921 922 923 924  
925 926 927 928 929 930 931 932 933 934 935 936 937 938 939 940 941 942 943 944 945 946 947 948 949

## Advancement Your Goal? Use CONFIDENTIAL Action Form

ELECTRONIC DESIGN's Confidential Career Inquiry Service helps engineers "sell" themselves to employers—as confidentially and discreetly as they would do in person. The service is fast. It is the first of its kind in the electronics field and is receiving high praise from personnel managers.

To present your job qualifications immediately to companies, simply fill in the attached resume.

Study the employment opportunity ads in this section. Then circle the numbers at the bottom of the form that correspond to the numbers of the ads that interest you.

ELECTRONIC DESIGN will act as your secretary, type neat duplicates of your application and send them to all companies you select—the same day the resume is received.

The standardized form permits personnel managers to inspect your qualifications rapidly. If they are interested, they will get in touch with you.

Painstaking procedures have been set up to ensure that your application receives complete, confidential protection. We take the following precautions:

- All forms are delivered unopened to one reliable specialist at ELECTRONIC DESIGN.
- Your form is kept confidential and is processed only by this specialist.
- The "circle number" portion of the form is detached before the application is sent to an employer, so that no company will know how many numbers you have circled.
- All original applications are placed in confidential files at ELECTRONIC DESIGN, and after a reasonable lapse of time, they are destroyed.

If you are seeking a new job, act now!



Perhaps you've been doing as well as you'd expected—*up to now*. But, if you're apprehensive about the future—if you've wished your assignments were more stimulating—your work more rewarding—you owe it to yourself to investigate the opportunities at Motorola.

Here you will be encouraged to use *all* of your creative talents. You'll work on projects that spark vision, that inspire imagination. Because Motorola is an "engineer's company" you'll be working with respected men who can contribute to your growth—men who are quick to recognize and advance skill. You'll be working for a *secure*, diversified company not wholly dependent on one single market.

There are dozens of fine opportunities covering a wide range of fields of interest—just a few of which are listed below.

Write today. We'll send you a complete description of "Your Life at Motorola"—in Chicago; Phoenix; Riverside, California; Culver City, California; Minneapolis, Minnesota. Naturally your request will be kept in complete confidence.

- Radar transmitters and receivers
- Radar circuit design
- Electronic countermeasure systems
- Military communications equipment design
- Pulse circuit design
- IF strip design
- Device using klystron, traveling wave tube and backward wave oscillator
- Display and storage devices

#### 2-WAY RADIO COMMUNICATIONS

- VHF & UHF receiver
- Transmitter design and development
- Power supply
- Systems engineering
- Antenna design
- Selective signaling

- Transistor applications
- Crystal engineering
- Sales engineering

- Design of VHF & UHF FM communications in portable or subminiature development
- Microwave field engineers
- Transistor switching circuit design
- Logic circuit design
- T.V. circuit design engineering
- Home radio design
- New product design
- Auto radio design
- Mechanical engineering
- Semi-conductor device development
- Semi-conductor application work

#### MR. W. H. HAUSMANN

Engineering Personnel Mgr. Dept. C  
4545 Augusta Blvd., Chicago 51, Ill.

All qualified applicants will receive consideration for employment without regard for race, creed, color, or national origin.



# MOTOROLA inc.

CIRCLE 903 ON CAREER INQUIRY FORM

## DESIGNING YOUR FUTURE

will make the rest of the presentation go more smoothly.

### Plan Question-Answer Period With Several Categories in Mind

Because the question-and-answer period can't be prepared for as specifically as a talk can be, it is often a cause for concern. You will not be overwhelmed by questions if you remember that replies generally fall in just a few categories:

**Report**—The most common form of reply is a straightforward factual account of what was done, who did it, how it was done, when, where, and why.

**Remind**—If your questioner asks for information previously given during the presentation, tactfully remind him that the topic was already covered and summarize the content briefly.

**Recommend**—Often specific information is called for that you may not have. If this is the case, do not make up answers that might later discredit you and your company. Tell the person you do not know *the* answer but will give him *an* answer. Recommend several possible approaches.

**Redirect**—If you can't answer a question in any way, there are two suitable options. First, you can pass the question on to someone who might be better able to answer it. Second, you can write it down and promise to send the answer by mail. Of course, this promise must be kept promptly.

**Rehearsed**—If you can anticipate what some questions will be, you can rehearse answers in advance to ensure a ready, accurate, thought-out reply. (A side benefit from this is that if the audience is slow in starting to ask questions, the team leader can ask one of these previously prepared questions to start the question-and-answer session off.)

**Restate**—When questions are asked that don't make sense as worded or that you are not immediately prepared to answer, you can gain time by restating the question in your own words and asking the questioner to verify the meaning and intent.

Your success in making effective sales presentations may very well have a bearing on your advancement in the concern. Even if your main interest is not in selling electronic products, sooner or later, as an engineer, you will have to present and "sell" your own ideas. The techniques you learn in making "enforced" sales presentations will stand you in good stead then. ■ ■

ENGINEERS • SCIENTISTS

**e**nvironment FOR  
**m**aximum  
**r**esponsibility

Broad technical objectives at Electro-Mechanical Research, Inc. (e.m.r.), including the development of the test instrumentation subsystem for the Dyna-Soar manned space glider, provide an environment for maximum responsibility for senior engineers and scientists.

e.m.r. is engaged in the conception, design and construction of airborne and ground telemetry and data processing equipments. Fundamental investigations are also being made into advanced electronic systems.

At e.m.r., growth is planned and diversified, research is company-sponsored, bringing exceptional opportunity to engineers and scientists with broad capabilities and a sincere desire to advance the state of the art.

### Immediate career incentives for SYSTEM DESIGN SPECIALISTS

Must have at least five years' hardware design experience, in such areas as magnetics and solid state circuitry, RF transmitters, and semiconductor applications, DC through UHF.

Please direct inquiries in confidence to  
ROLAND E. HOOD, JR.,  
Personnel Manager, Systems Division



**e**lectro-  
**m**echanical  
**r**esearch, inc.

P. O. Box 3041-E, Sarasota 1, Florida

**e**xploration . . .  
**m**anufacture / **r**eliability

Qualified applicants considered without regard to race, creed, color or national origin.

CIRCLE 904 ON CAREER INQUIRY FORM  
ELECTRONIC DESIGN • September 13, 1961

## ADVERTISERS' INDEX

September 13, 1961

Advertiser	Page
AMP, Incorporated	17, 46
Ace Electronics Associates, Inc.	154
Ace Plastic Company	175
Adel Products Division	157
Ad-Yu Electronics, Lab., Inc.	133
Admiral Plastics Corp.	166
Airpax Electronics, Inc.	94
Aladdin Electronics	132
*Allied Control Company, Inc.	172
Allied Radio	170
Allison Laboratories, Inc.	168
Alpha Metals, Inc.	134
American Aluminum Company	136
American Electrical Heater Company	158
American-Marietta Company	45
American Optical Company	123
Amphenol-Borg Electronics Corporation	26 B-C
Art Wire and Stamping Co.	144
*Assembly Products Inc.	161
Associated Testing Laboratories, Inc.	140-141
Atohm Electronics	162
Augat Bros., Inc.	102
Barber-Colman Company	72, 73
Beckman Instruments, Inc.	141, 143
Belden	138A
Bendix Corporation, The Red Bank Div.	124, 125
Bendix Corporation, The Scintilla Div.	39
Boeing Company, The	152
*Boonton Electronics Corp.	147
Borg Warner Controls	Cover III
*Bourns, Inc.	51
Buckbee Mears Co.	75
*Bud Radio, Inc.	153
*Burndy Corporation	23
Burnell & Co., Inc.	7
*CTS Corporation	85
Cadillac Associates, Inc.	136
Cannon Electric Company	93
Carborundum Co., The	122
*Celco Constantine Engineering Labs, Inc.	142
Cetron Electronic Corp.	84
*Clairex Corporation	68
*Cohn Mfg Co., Inc., Sigmond	161
*Computer Instruments Corporation	28
Computer-Measurements Company	129
Controls Company of America	121
Coors Porcelain Co.	120
*Curtiss-Wright Corporation	156
*Daven Co., The	117
*Daystrom, Inc., Weston Instrument Div.	33
Delco Radio, Div. of General Motors Corp.	118, 119
*Dow Corning Corporation	108, 109
ESI Electro Scientific Industries	29
*Eastern Industries, Inc.	159
Eastman Chemical Products, Inc.	166
Edison Industries, Thomas A.	35
Eitel-McCullough, Inc.	15
Elastic Stop Nut Corp. of America	12
Electro Instruments, Inc.	98
Electro Mechanical Research, Inc.	182
Electronic Design	184
Electronic Designers' Catalog	138-B
Electronic Measurements Co., Inc.	52
Electronic Tube Corp.	150
Erie Resistor Corporation	82

\*Manufacturers' catalog appears in 1960-1961 ELECTRONIC DESIGNERS' CATALOG

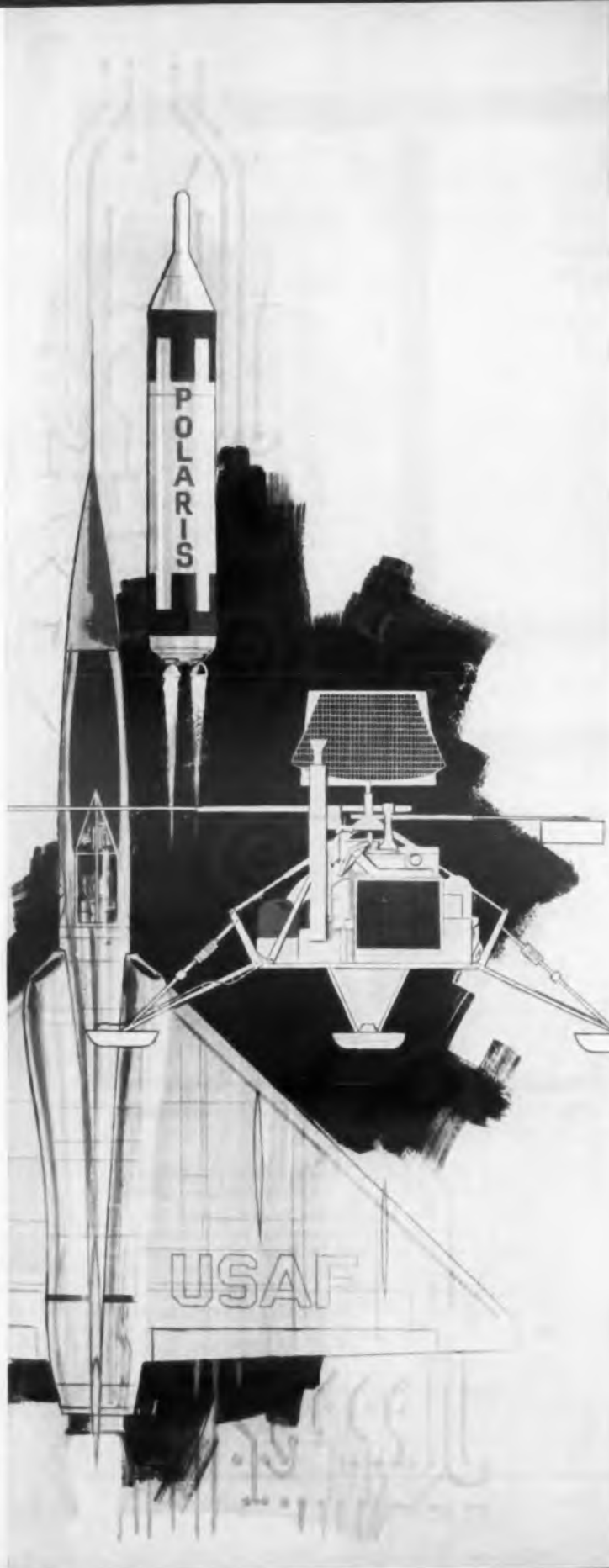

Opportunities for

# circuit designers

Requirements of new and continuing projects, such as Surveyor and supersonic interceptor fire control systems have created new openings for circuit designers. The engineers selected for these positions will be assigned to the following design tasks:

- 1 the development of high power airborne radar transmitters, the design of which involves use of the most advanced components,
- 2 the design of low noise radar receivers using parametric amplifiers, solid state masers and other advanced microwave components,
- 3 radar data processing circuit design, including range and speed trackers, crystal filter circuitry and a variety of display circuits,
- 4 high efficiency power supplies for airborne and space electronic systems,
- 5 telemetering and command circuits for space vehicles such as Surveyor and the Hughes Communication Satellite,
- 6 timing, control and display circuits for the Hughes COLIDAR\* (Coherent Light Detection and Ranging).

In addition, openings exist for several experienced systems engineers capable of analysis and synthesis of systems involving the type of circuits and components described above.

If you are interested and believe that you can contribute, please airmail your resume to:

**Mr. Robert A. Martin**, Supervisor, Scientific Employment, Hughes Aerospace Engineering Division, Culver City 82, California.

\*Trademark H. A. C.

**We promise you a reply within one week.**

*Creating a new world with electronics*

**HUGHES**

HUGHES AIRCRAFT COMPANY  
AEROSPACE DIVISIONS

AT HUGHES, ALL QUALIFIED APPLICANTS WILL BE CONSIDERED FOR EMPLOYMENT WITHOUT REGARD TO RACE, CREED, COLOR OR NATIONAL ORIGIN.



## CIRCUIT DESIGN

If this is your career interest, we have projects involving digital computers of extremely small size. Let us tell you more about this — confidentially. Write to Mr. Harry Laur — Research and Engineering Staff.

Qualified applicants will be considered regardless of race, creed, color or national origin.



LITTON SYSTEMS, INC. Data Systems Division  
Canoga Park, California

If you live in the  
EAST or MIDWEST  
write or phone  
the LITTON  
Research & Engineering  
Staff Representative

nearest you:  
Mr. Harry Laur,  
221 Crescent Street,  
Waltham, Mass.  
TWinbrook 9-2200.

Mr. Garrett Sanderson,  
375 Park Ave.,  
New York City, New York.  
PLaza 3-6060.

Mr. Robert L. Baker,  
360 No. Michigan Ave.,  
Chicago, Ill. ANdover 3-3131

CIRCLE 906 ON CAREER INQUIRY FORM

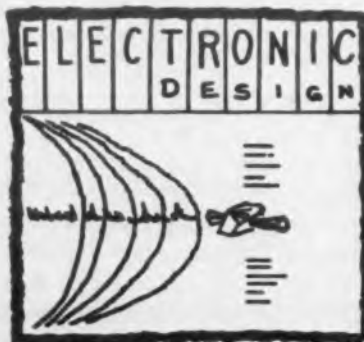

most  
effective  
on  
the  
job



A recent circulation estimate revealed that 95% of *ELECTRONIC DESIGN*'s readers receive the magazine at their plants—on the job where it is most effective as a design workbook.

By receiving *ELECTRONIC DESIGN* at work, you're getting extra values from it. These extra values—known to marketing people as time and place utilities—add to the usefulness of any item. Only in-plant distribution gives you: Time Value—because *ELECTRONIC DESIGN* arrives precisely when you can use it best . . . while you're working; Place Value—because it arrives where it can really be put to work . . . on the job, at the point of design.

If you don't receive your copies where you work, write to our Circulation Department and request that your subscription be addressed to you at your plant. By putting *ELECTRONIC DESIGN* on the job you'll be getting the most value from it.

Arriving at the plant, *ELECTRONIC DESIGN* brings new ideas to be applied to your current projects. You and your fellow designers can discuss timely topics together—expressing your views and comments while the news is fresh in your minds. And, when searching for sources, for products, for new techniques, you need look no further than the copies of *ELECTRONIC DESIGN* right on your desk.

Advertiser Page

Fairair Bearing Company, The . . . . . 26D  
Fairchild Stratos Corporation . . . . . 37, 69  
Fairchild Semiconductor Corporation . . . . . 13  
Fairmount Chemical Co., Inc. . . . . 130  
Federal Tool Engineering Co. . . . . 146  
Flow Corporation . . . . . 132  
Food Machinery and  
Chemical Corporation . . . . . 40

G-V Controls, Inc. . . . . 128  
Gamewell Co., The . . . . . 96  
Garlock, Inc. . . . . 67  
General Dynamics/Electronics . . . . . 151  
General Electric Company, Rectifier  
Components Div. . . . . 80, 81  
General Electric Company,  
Silicone Products Dept. . . . . 176  
General Electric Company,  
Semiconductor Products Dept. . . . . 21, 36  
Gertsch Products, Inc. . . . . 142  
Grayhill, Inc. . . . . 137

Hamlin, Inc. . . . . 131  
Handy & Harmon . . . . . 115  
Harrison Electronics Corp. . . . . 177  
Haveg Industries, Inc. . . . . 158  
Holland Div. of Minneapolis Honeywell . . . . . 6  
Heinemann Electric Company . . . . . 47  
Hemingway & Bartlett Mfg. Co. . . . . 170  
Hewlett-Packard Company . . . . . 1, 1A, 1B  
Hitemp Wires Co. . . . . 186  
Hogan Faximile Corp. . . . . 160  
Honeywell Military Products Group . . . . . 176  
Howard Industries, Inc. . . . . 135  
Hudson Tool & Die Co., Inc. . . . . 42A-B  
Hughes Aircraft Company . . . . . 183

ITT Semiconductor Dept. . . . . 116  
Illinois Tool Works . . . . . 104  
Image Instruments, Inc. . . . . 151  
Instruments for Industry, Inc. . . . . 146

Joy Manufacturing Company . . . . . 173  
Julie Research Laboratories, Inc. . . . . 163

Kearfott Division,  
General Precision, Inc. . . . . 144, 145  
Keithley Instruments . . . . . 106  
Keppo, Inc. . . . . 71  
Keuffel & Esser Co. . . . . 43  
Kidd & Company, Inc., Walter . . . . . 148  
Kintel, Div. of Cohu Electronics, Inc. . . . . 14  
Koh-i-noor, Incorporated . . . . . 143  
Krohn-Hite Corporation . . . . . 125  
Kurz-Kasch . . . . . 135

Lambda Electronics Corp. . . . . 110  
Leach Corporation . . . . . 139  
Leeds & Northrup . . . . . 147  
Lionel Electronic Laboratories . . . . . 153  
Little Falls Alloys, Inc. . . . . 163  
Litton Industries . . . . . 26A, 184

McCoy Electronics Co. . . . . 148  
McLean Engineering Laboratories . . . . . 156  
Machlett Laboratories, Inc., The . . . . . 130  
Magnetic Metals Company . . . . . 138  
Magnetics, Inc. . . . . 34

\*Manufacturers' catalog appears in 1960-1961  
*ELECTRONIC DESIGNER'S CATALOG*

Mallory & Co., Inc. P. R.	112, 113, 160
Marshall Industries	162
Micon Electronics, Inc.	158
Micro Switch, A Division of Honeywell	114A-B
Microwave Associates, Inc.	53
Minneapolis Honeywell Regulator Co., Semiconductor Div.	59
Minneapolis Honeywell Regulator Co., Precision Meters	27
Minnesota Mining & Mfg. Co., Microfilm Products	107
Minnesota Mining & Mfg. Co., Magnetic Products Div.	167
Mona Industries, Inc.	174
Moseley Co., F. L.	22
*Motorola Semiconductor Products, Inc.	19, 182, 185
Mueller Electric Co.	174

Natvar Corp.	136
New Hampshire Ball Bearings, Inc.	171
North American Electronics, Inc.	119
Nytronics, Inc.	20

Pacific Semiconductors, Inc.	86, 87, 88, 89, 90, 90A-B
Paktron Packaged Electronics	104
Pennwood Numechron Co.	174
Perfection Mica Company	126
Permacel	134
Phelps Dodge Copper Products Corp.	100, 101
*Philbrick Researches, Inc., George A.	159
*Philco, Lansdale Division	9
Philco Western Development Labs.	180
Plastoid Corporation	91
Pomona Electronics Co., Inc.	94
Precision Paper Tube Co.	132
Process Gear Co., Inc.	139
Prodelin, Inc.	102

RHG Electronics Laboratory, Inc.	171
Radio Corporation of America, Electron Tube Div.	83, Cover IV
Radio Corporation of America, Semiconductor & Materials Div.	26
*Raytheon Co., Industrial Components Div.	5, 134
Raytheon Co., Microwave and Power Tube Div.	103
Raytheon Co. Semiconductor Div.	97
Republic Aviation Corporation	179
Reed Instrument Bearing Company	145
Renbrandt, Inc.	133
Rockbestos Wire & Cable Co.	177
Rosemount Engineering Co.	175
Rotron Mfg. Co., Inc.	66
Royal Electric Corporation	149
Rutherford Electronics, Inc.	3

SKF Industries	145
Sanborn Company	127
Sangamo Electric Company	18
Shallcross Manufacturing Co.	10
Silicon Transistor Corporation	79
Smith-Florence, Inc.	65
Sperry Electronic Tube Div., Sperry Rand Corp.	169
Sperry Semiconductor Div. of Sperry Rand Corporation	105
Sprague Electric Company	11
Stackpole Carbon Co.	25
Star Stainless Screw Co.	137
Stevens Arnold, Incorporated	140
Stratos, a Div. of Fairchild Stratos Corp.	37
*Sylvania Electric Products, Inc., Semiconductor Products Div.	92
Syntronic Instruments, Inc.	150

\*Manufacturers' catalog appears in 1960-1961  
ELECTRONIC DESIGNERS' CATALOG

FOR MILITARY EQUIPMENT MANUFACTURERS...

## New MIL-STD-701B List Simplifies Zener Diode Selection For Design Engineers

Expansion of the Diode List Gives You Choice of  
Wide Range of "Guidance" and "Preferred" Types  
... Solves Non-Standard Parts Approval Problem

FOR YEARS, the designer of military equipment circuits has been faced with the problem of his having to select from a bewildering hodgepodge of thousands of zener diode part numbers ... and then going to the costly, time-consuming trouble in most cases of having to justify non-standard parts.

But no more. The apparent move by the Military to force zener standardization by means of the expanded Diode List in MIL-STD-701B has given design engineers an opportunity to solve this zener selection problem almost completely.

Now, as indicated in the Diode List reproduced here, a specific "Preferred" or "Guidance" MIL part number is shown for EVERY common voltage for the 400 mw thru 50 w types.

So save time and trouble by selecting your zener diodes from the list at the left.

For your convenience, MOTOROLA IS NOW SUPPLYING COMMERCIAL-INDUSTRIAL ZENERS TO THE SPECIFICATIONS OF EVERY "GUIDANCE" DEVICE ... plus, as recently announced, Motorola is also the first to be able to offer you 10 w zeners to the requirements of MIL-S-19500/124 (Sig. C).

MIL-STD-701B VOLTAGE REGULATOR DIODES "PREFERRED" AND "GUIDANCE" TYPES				
Ez Nom. V dc	400 mw	1 w	10 w	50 w
3.3	1N746A	—	—	—
3.6	1N747A	—	—	—
3.9	1N748A	—	—	—
4.3	1N749A	—	—	—
4.7	1N750A	—	—	—
5.1	1N751A	—	—	—
5.6	1N752A	—	—	—
6.2	1N753A	—	—	—
6.8	1N754A	1N3016B	1N2970B	1N2804B
7.5	1N755A	1N3017B	1N2971B	1N2805B
8.2	1N756A	1N3018B	1N2972B	1N2806B
9.1	1N757A	1N3019B	1N2973B	1N2807B
10	1N758A	1N3020B	1N2974B	1N2808B
11	1N962B	1N3021B	1N2975B	1N2809B
12	1N963B	1N3022B	1N2976B	1N2810B
13	1N964B	1N3023B	1N2977B	1N2811B
15	1N965B	1N3024B	1N2979B	1N2813B
16	1N966B	1N3025B	1N2980B	1N2814B
18	1N967B	1N3026B	1N2982B	1N2816B
20	1N968B	1N3027B	1N2984B	1N2818B
22	1N969B	1N3028B	1N2985B	1N2819B
24	1N970B	1N3029B	1N2986B	1N2820B
27	1N971B	1N3030B	1N2988B	1N2822B
30	1N972B	1N3031B	1N2989B	1N2823B
33	1N973B	1N3032B	1N2990B	1N2824B
36	1N974B	1N3033B	1N2991B	1N2825B
39	1N975B	1N3034B	1N2992B	1N2826B
43	1N976B	1N3035B	1N2993B	1N2827B
47	1N977B	1N3036B	1N2995B	1N2829B
51	1N978B	1N3037B	1N2997B	1N2831B
56	1N979B	1N3038B	1N2999B	1N2832B
62	1N980B	1N3039B	1N3000B	1N2833B
68	1N981B	1N3040B	1N3001B	1N2834B
75	1N982B	1N3041B	1N3002B	1N2835B
82	1N983B	1N3042B	1N3003B	1N2836B
91	1N984B	1N3043B	1N3004B	1N2837B
100	1N985B	1N3044B	1N3005B	1N2838B
110	1N986B	1N3045B	1N3007B	1N2840B
120	1N987B	1N3046B	1N3008B	1N2841B
130	1N988B	1N3047B	1N3009B	1N2842B
150	1N989B	1N3048B	1N3011B	1N2843B
160	1N990B	1N3049B	1N3012B	1N2844B
180	1N991B	1N3050B	1N3014B	1N2845B
200	1N992B	1N3051B	1N3015B	1N2846B

### FOR INDUSTRIAL-COMMERCIAL USERS

A special note to non-military equipment manufacturers ... if you're not concerned with meeting military specifications — and economy is your prime concern — Motorola's widest-in-the-industry selection of EIA and non-standard number zeners (more than 2,100 devices) offers you the exact type of unit for your non-military requirements at considerable cost savings.

For further information on Motorola "Preferred" and commercial "Guidance" zener diodes — or any Motorola semiconductors — contact your Motorola Semiconductor District Sales Office or call or write: Technical Information Center at the address below.

#### MOTOROLA SEMICONDUCTOR DISTRICT SALES OFFICES:

Belmont, Mass., Ivanhoe 4-5070  
Burlingame, Cal., Diamond 2-3228  
Chicago, Ill., Avenue 2-4300  
Clifton, N. J., Gregory 2-5300  
Dallas, Tex., Lakeside 6-8931  
Dayton, Ohio, AXminster 3-4164  
Detroit, Mich., Broadway 3-7171  
Glenside, Pa., Turner 7-7020  
Hollywood, Cal., Hollywood 2-0821  
Minneapolis, Minn., Liberty 5-2198  
New York, N. Y., Wisconsin 7-2980  
Philadelphia, Pa., Waverly 7-6144  
Phoenix, Ariz., 273-6364  
Silver Springs, Md., Juniper 5-4485  
Syracuse, N. Y., Granite 4-3321  
Winter Park, Fla., Midway 7-2507  
Toronto, Ont., Plymouth 9-2222



**MOTOROLA**  
Semiconductor Products Inc.

A SUBSIDIARY OF MOTOROLA INC.

5005 EAST McDOWELL ROAD • PHOENIX 8, ARIZONA

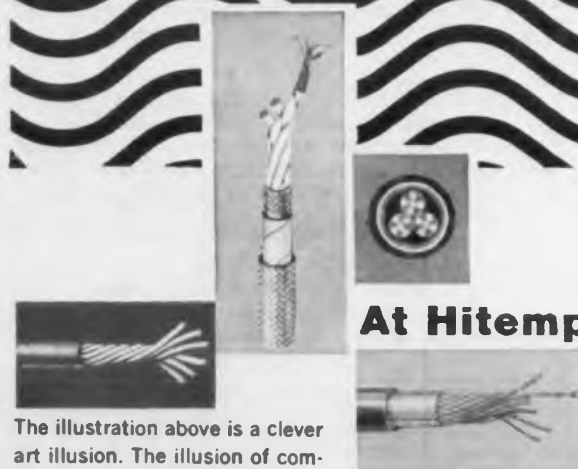
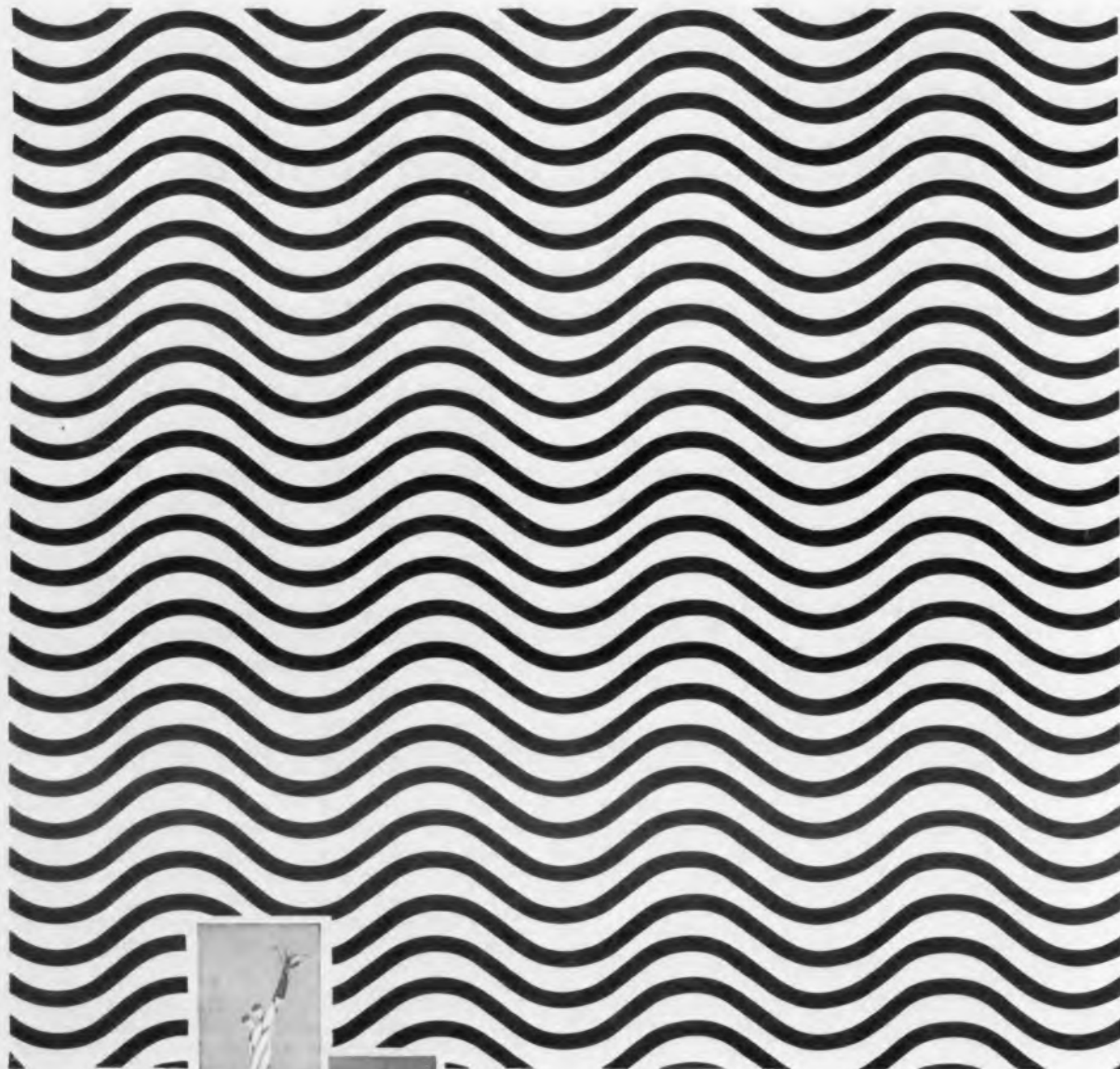

## At Hitemp—Quality is not an illusion

The illustration above is a clever art illusion. The illusion of comparable quality that different brands of wire and cable give is also clever. To the naked eye, they seem identical.

Most brands of wire and cable may be produced with similar materials and equipment. One brand, however, will outlast, outperform the others — Hitemp.

The reason? Because Hitemp has the greatest store of experience in the industry—two modern production facilities that are second to none—and more than one-fourth

of its entire work force devoted solely to inspection and quality control.

Hitemp products are for you, the wire and cable user who requires quality and reliability that is fact, not illusion.

Hitemp is a Division of Simplex Wire & Cable Co.

### HITEMP WIRES CO.

1200 SHAMES DRIVE, WESTBURY, NEW YORK  
1532 S. CALIFORNIA AVE., MONROVIA, CALIF.

CIRCLE 225 ON READER-SERVICE CARD



Advertiser	Page
Tektronix, Inc. ....	77
Tel-Instrument Electronics Corp. ....	175
Telonic Industries, Inc. ....	131, 133, 135, 137
Texas Instruments Incorporated ....	153, 155, 157, 159
Time Electronic Sales ....	93
Transistor Specialties, Incorporated ....	24
Transitron Electronic Corporation ....	99
Tucor, Inc. ....	157
*Tung-Sol Electric, Inc. ....	61
*Turbo Machine Company ....	155

United Shoe Machinery Corporation ..	95
United Transformer Corp. ....	Cover II
Universal Toroid Coil Winding Inc. ....	131

Valpey Crystal Corp. ....	171
Varian Associates ....	78, 84
Vector Manufacturing Co., Inc. ....	128
Video Instruments Co., Inc. ....	111
Vitro Electronics ....	2

Ward Leonard Electric Co. ....	41
Weldmatic Div./Unitek ....	106
Western Electric Company, Inc. ....	42
*Westinghouse Electric Corporation ....	114, 149
Wyle Laboratories ....	170
Whitso, Inc. ....	152

\*Manufacturers' catalog appears in 1960-1961  
ELECTRONIC DESIGNERS' CATALOG.

### Advertising Representatives

**Sales Service Suppr.:** Alvin D. Ross  
**New York:** Berry Conner, Jr., James P. Quinn, Charles J. Stillman, Jr., John M. Weber, Thomas P. Barth, 850 Third Avenue, Plaza 1-5530

**Boston:** Richard Parker, Copley 7-0288

**Philadelphia:** Blair McClenachan, Muhawk 7-0625

**Chicago:** Thomas P. Kavooras, Fred T. Bruce, 864 N. Michigan Avenue, Superior 7-8054

**Cleveland:** Douglas H. Boynton, 442-5055

**Los Angeles:** John V. Quillman, Kenneth M. George, Pierre J. Braudé, 3275 Wilshire Blvd., Dunkirk 2-7337

**San Francisco:** James W. Claar, Daventport 1-7646, (Palo Alto)

**Southeastern:** Pirnie & Brown, Morgan Pirnie, Harold V. Brown, G. H. Krimmier, 1722 Rhodes-Haverty Bldg., Atlanta, Ga., Jackson 2-8113

**London, W1:** Brayton Nichols, 7 Blenheim Street

**Tokyo:** Karl H. Bachmeyer Associates, 27 Morimoto-cho, 1-chome, Azabu, Minato-ku



# ELECTRONIC DESIGN - ONE DAY SERVICE

USE BEFORE OCTOBER 25th, 1961

C

Name \_\_\_\_\_

Title \_\_\_\_\_

Company \_\_\_\_\_

Company Address \_\_\_\_\_

City \_\_\_\_\_

Zone \_\_\_\_\_

State \_\_\_\_\_

10 20 30 40	50 60 70 80 90	100 110 120 130 140	150 160 170 180 190	200 210 220 230 240	250 260 270 280 290
1 11 21 31 41	51 61 71 81 91	101 111 121 131 141	151 161 171 181 191	201 211 221 231 241	251 261 271 281 291
2 12 22 32 42	52 62 72 82 92	102 112 122 132 142	152 162 172 182 192	202 212 222 232 242	252 262 272 282 292
3 13 23 33 43	53 63 73 83 93	103 113 123 133 143	153 163 173 183 193	203 213 223 233 243	253 263 273 283 293
4 14 24 34 44	54 64 74 84 94	104 114 124 134 144	154 164 174 184 194	204 214 224 234 244	254 264 274 284 294
5 15 25 35 45	55 65 75 85 95	105 115 125 135 145	155 165 175 185 195	205 215 225 235 245	255 265 275 285 295
6 16 26 36 46	56 66 76 86 96	106 116 126 136 146	156 166 176 186 196	206 216 226 236 246	256 266 276 286 296
7 17 27 37 47	57 67 77 87 97	107 117 127 137 147	157 167 177 187 197	207 217 227 237 247	257 267 277 287 297
8 18 28 38 48	58 68 78 88 98	108 118 128 138 148	158 168 178 188 198	208 218 228 238 248	258 268 278 288 298
9 19 29 39 49	59 69 79 89 99	109 119 129 139 149	159 169 179 189 199	209 219 229 239 249	259 269 279 289 299
300 310 320 330 340	350 360 370 380 390	400 410 420 430 440	450 460 470 480 490	500 510 520 530 540	550 560 570 580 590
301 311 321 331 341	351 361 371 381 391	401 411 421 431 441	451 461 471 481 491	501 511 521 531 541	551 561 571 581 591
302 312 322 332 342	352 362 372 382 392	402 412 422 432 442	452 462 472 482 492	502 512 522 532 542	552 562 572 582 592
303 313 323 333 343	353 363 373 383 393	403 413 423 433 443	453 463 473 483 493	503 513 523 533 543	553 563 573 583 593
304 314 324 334 344	354 364 374 384 394	404 414 424 434 444	454 464 474 484 494	504 514 524 534 544	554 564 574 584 594
305 315 325 335 345	355 365 375 385 395	405 415 425 435 445	455 465 475 485 495	505 515 525 535 545	555 565 575 585 595
306 316 326 336 346	356 366 376 386 396	406 416 426 436 446	456 466 476 486 496	506 516 526 536 546	556 566 576 586 596
307 317 327 337 347	357 367 377 387 397	407 417 427 437 447	457 467 477 487 497	507 517 527 537 547	557 567 577 587 597
308 318 328 338 348	358 368 378 388 398	408 418 428 438 448	458 468 478 488 498	508 518 528 538 548	558 568 578 588 598
309 319 329 339 349	359 369 379 389 399	409 419 429 439 449	459 469 479 489 499	509 519 529 539 549	559 569 579 589 599
600 610 620 630 640	650 660 670 680 690	700 710 720 730 740	750 760 770 780 790	For employment brochures give home address	870 880 890
601 611 621 631 641	651 661 671 681 691	701 711 721 731 741	751 761 771 781 791	_____	871 881 891
602 612 622 632 642	652 662 672 682 692	702 712 722 732 742	752 762 772 782 792	_____	872 882 892
603 613 623 633 643	653 663 673 683 693	703 713 723 733 743	753 763 773 783 793	_____	873 883 893
604 614 624 634 644	654 664 674 684 694	704 714 724 734 744	754 764 774 784 794	_____	874 884 894
605 615 625 635 645	655 665 675 685 695	705 715 725 735 745	755 765 775 785 795	_____	875 885 895
606 616 626 636 646	656 666 676 686 696	706 716 726 736 746	756 766 776 786 796	_____	876 886 896
607 617 627 637 647	657 667 677 687 697	707 717 727 737 747	757 767 777 787 797	_____	877 887 897
608 618 628 638 648	658 668 678 688 698	708 718 728 738 748	758 768 778 788 798	_____	878 888 898
609 619 629 639 649	659 669 679 689 699	709 719 729 739 749	759 769 779 789 799	_____	879 889 899

If 25 or more items circled  
please describe reasons:

For Change of Address:

Old Company Name \_\_\_\_\_

- I Do Design Work  
 I Supervise Design Work  
 I Do No Design Work

Old Company Address \_\_\_\_\_

City \_\_\_\_\_

Zone \_\_\_\_\_

State \_\_\_\_\_



# ELECTRONIC DESIGN - ONE DAY SERVICE

USE BEFORE OCTOBER 25th, 1961

D

Name \_\_\_\_\_

Title \_\_\_\_\_

Company \_\_\_\_\_

Company Address \_\_\_\_\_

City \_\_\_\_\_

Zone \_\_\_\_\_

State \_\_\_\_\_

10 20 30 40	50 60 70 80 90	100 110 120 130 140	150 160 170 180 190	200 210 220 230 240	250 260 270 280 290
1 11 21 31 41	51 61 71 81 91	101 111 121 131 141	151 161 171 181 191	201 211 221 231 241	251 261 271 281 291
2 12 22 32 42	52 62 72 82 92	102 112 122 132 142	152 162 172 182 192	202 212 222 232 242	252 262 272 282 292
3 13 23 33 43	53 63 73 83 93	103 113 123 133 143	153 163 173 183 193	203 213 223 233 243	253 263 273 283 293
4 14 24 34 44	54 64 74 84 94	104 114 124 134 144	154 164 174 184 194	204 214 224 234 244	254 264 274 284 294
5 15 25 35 45	55 65 75 85 95	105 115 125 135 145	155 165 175 185 195	205 215 225 235 245	255 265 275 285 295
6 16 26 36 46	56 66 76 86 96	106 116 126 136 146	156 166 176 186 196	206 216 226 236 246	256 266 276 286 296
7 17 27 37 47	57 67 77 87 97	107 117 127 137 147	157 167 177 187 197	207 217 227 237 247	257 267 277 287 297
8 18 28 38 48	58 68 78 88 98	108 118 128 138 148	158 168 178 188 198	208 218 228 238 248	258 268 278 288 298
9 19 29 39 49	59 69 79 89 99	109 119 129 139 149	159 169 179 189 199	209 219 229 239 249	259 269 279 289 299
300 310 320 330 340	350 360 370 380 390	400 410 420 430 440	450 460 470 480 490	500 510 520 530 540	550 560 570 580 590
301 311 321 331 341	351 361 371 381 391	401 411 421 431 441	451 461 471 481 491	501 511 521 531 541	551 561 571 581 591
302 312 322 332 342	352 362 372 382 392	402 412 422 432 442	452 462 472 482 492	502 512 522 532 542	552 562 572 582 592
303 313 323 333 343	353 363 373 383 393	403 413 423 433 443	453 463 473 483 493	503 513 523 533 543	553 563 573 583 593
304 314 324 334 344	354 364 374 384 394	404 414 424 434 444	454 464 474 484 494	504 514 524 534 544	554 564 574 584 594
305 315 325 335 345	355 365 375 385 395	405 415 425 435 445	455 465 475 485 495	505 515 525 535 545	555 565 575 585 595
306 316 326 336 346	356 366 376 386 396	406 416 426 436 446	456 466 476 486 496	506 516 526 536 546	556 566 576 586 596
307 317 327 337 347	357 367 377 387 397	407 417 427 437 447	457 467 477 487 497	507 517 527 537 547	557 567 577 587 597
308 318 328 338 348	358 368 378 388 398	408 418 428 438 448	458 468 478 488 498	508 518 528 538 548	558 568 578 588 598
309 319 329 339 349	359 369 379 389 399	409 419 429 439 449	459 469 479 489 499	509 519 529 539 549	559 569 579 589 599
600 610 620 630 640	650 660 670 680 690	700 710 720 730 740	750 760 770 780 790	For employment brochures give home address	870 880 890
601 611 621 631 641	651 661 671 681 691	701 711 721 731 741	751 761 771 781 791	_____	871 881 891
602 612 622 632 642	652 662 672 682 692	702 712 722 732 742	752 762 772 782 792	_____	872 882 892
603 613 623 633 643	653 663 673 683 693	703 713 723 733 743	753 763 773 783 793	_____	873 883 893
604 614 624 634 644	654 664 674 684 694	704 714 724 734 744	754 764 774 784 794	_____	874 884 894
605 615 625 635 645	655 665 675 685 695	705 715 725 735 745	755 765 775 785 795	_____	875 885 895
606 616 626 636 646	656 666 676 686 696	706 716 726 736 746	756 766 776 786 796	_____	876 886 896
607 617 627 637 647	657 667 677 687 697	707 717 727 737 747	757 767 777 787 797	_____	877 887 897
608 618 628 638 648	658 668 678 688 698	708 718 728 738 748	758 768 778 788 798	_____	878 888 898
609 619 629 639 649	659 669 679 689 699	709 719 729 739 749	759 769 779 789 799	_____	879 889 899

If 25 or more items circled  
please describe reasons:

For Change of Address:

Old Company Name \_\_\_\_\_

- I Do Design Work  
 I Supervise Design Work  
 I Do No Design Work

Old Company Address \_\_\_\_\_

City \_\_\_\_\_

Zone \_\_\_\_\_

State \_\_\_\_\_



VIA  
AIR  
MAIL

FIRST CLASS  
Permit No. 725  
New York, N. Y.

BUSINESS REPLY MAIL

No Postage Stamp Necessary if Mailed in U. S.

POSTAGE WILL BE PAID BY

**ELECTRONIC DESIGN**

ONE DAY READERS INQUIRY SERVICE

850 Third Avenue  
New York 22, New York

VIA  
AIR  
MAIL

FIRST CLASS  
Permit No. 725  
New York, N. Y.

BUSINESS REPLY MAIL

No Postage Stamp Necessary if Mailed in U. S.

POSTAGE WILL BE PAID BY

**ELECTRONIC DESIGN**

ONE DAY READERS INQUIRY SERVICE

850 Third Avenue  
New York 22, New York



**Publisher:** Robert E. Ahrendorf  
**Editor:** Edward E. Grazda  
**Managing Editor:** James A. Lippke  
**Technical Editors:** G. H. Rostky,  
H. Bierman, R. H. Cushman,  
M. W. Meisels, A. Rosenblatt  
**News Editors:** R. Haavind, *Chief*;  
A. Corneretto, J. J. Christie,  
R. N. Ross  
**New Products Editors:** A. W. Solda,  
*Chief*; C. H. Farley, E. G. Farrell  
**Washington Editor:** A. Warren  
**West Coast Editor:** T. E. Mount  
**Consulting Editor:** R. N. DeFloria  
**Contributing Editors:** J. G. Adashko,  
E. Brenner, B. Bernstein  
**Editorial Production:** D. S. Viebig,  
A. Abramoff  
**Art Director:** R. A. Schulze  
**Art Assistants:** J. Aruego, R. Podhirny  
**Technical Illustrator:** C. Westphal  
**Production Manager:** T. V. Sedita  
**Asst. Prod. Mgr.:** H. De Polo  
**Production Assistants:** P. Bergang,  
M. Spector  
**Circulation Manager:** N. M. Elston  
**Asst. Circ. Mgr.:** H. A. Hunter  
**Reader-Service:** L. Blair

*Hayden Publishing Company, Inc.*  
**Chairman of the Board:**  
T. Richard Gascoigne  
**President:** James S. Mulholland, Jr.

### Accuracy Policy

Recognizing the power of the printed word to influence, it is ELECTRONIC DESIGN's policy:

- To make all reasonable efforts to insure accuracy of editorial matter.
- To publish promptly corrections brought to our attention.
- To not knowingly publish misleading advertisements.
- To reserve the right to refuse any advertisement.

Readers noting errors or misstatements of facts are encouraged to write the editor.

### Subscription Policy

ELECTRONIC DESIGN is circulated only to qualified design engineers of U. S. manufacturing companies, industrial consultants and government agencies. If design for manufacturing is your responsibility, you qualify for subscription without charge provided you send us the following information on your company's letterhead: Your name and engineering title, your company's main products and description of your design duties. The letter must be signed by you personally. ANY ADDRESS CHANGES FOR OLD SUBSCRIBERS NECESSITATE A RESTATEMENT OF THESE QUALIFICATIONS. Please include a copy of your old address stencil with your request. Allow six weeks for change to become effective. Subscription rate for nonqualified subscribers—\$25.00 per year U.S.A., \$35.00 per year all other countries. Single copy \$1.50.



*NEW additions to a proven line of R-F equipment...*

## BORG-WARNER CONTROLS' TEST INSTRUMENTS

**New styling...new convenience...  
new versatility...new accuracy!**

Now, a fresh new approach to precision laboratory test instruments...designed and engineered by Borg-Warner Controls to meet the most demanding needs of industry. The result of 15 years of leadership in high-power radio-frequency equipment, these new instruments are superior in styling...in convenience and versatility...in accuracy and performance.

Clean, functional design. Handsome two-tone brown and beige color schemes. Simplified controls—no crowding or confusion of knobs. Finest quality meters for quick, clear, accurate readings. Most important of all, better resolution due to improved design. Don't buy any laboratory quality test equipment until you've examined these advanced new models!



FOLD-AWAY  
CARRYING HANDLES



WIND-UP  
POWER CORD



VERSATILE! All instruments  
can be used on bench,  
or rack-mounted



Write or call for technical bulletins on  
Vacuum Tube Voltmeter (10 CPS/4 MC)...  
Volt-Ohm Meter (20 CPS 700 MC)...VSWR Indicator  
...R-F Power Meter...R-F Signal Generators  
covering HF, VHF, UHF and SHF. For your  
convenience, local sales representatives are available  
for demonstration and consultation in your area.



®

## BORG-WARNER CONTROLS

DIVISION OF BORG-WARNER CORPORATION

P. O. Box 1679 • Santa Ana, California  
Phone KImberly 5-5581 • Teletype S AnA 5291

CIRCLE 226 ON READER-SERVICE CARD

RCA-7448 5 DST  
with 3.8" display



RCA-4412 10 DST  
combines B display  
with extreme  
environmental resistance

## Write your own specifications for Display Storage Tubes

Fill in your requirements in a Display Storage Tube—then leave the rest to RCA. With RCA DST's, you have widest possible latitude in your choice of

Characteristic	Your requirement
Writing speed	_____
Size of display	_____
Degree of environmental resistance	_____
Degree of resolution	_____
Number of writing guns	_____
Type of deflection	_____
Collimation simplicity	_____
Selective erasure	_____
Other special features you require	_____

Each DST in our broad line was designed to particular customer specifications. If no existing RCA DST quite fills your bill, our long experience in pioneering DST's—plus our extensive facilities for research, manufacturing, and testing—are at your disposal to produce the tube you need at low cost, and in the shortest possible time.

Specify RCA display storage tubes to update present radar indicators. *For: airborne weather avoidance radar—terrain clearance radar—fire control radar—airborne electronic counter-measures systems—laboratory analysis of transient electronic phenomena.*

### A FEW OF THE MANY RCA DISPLAY STORAGE TUBES —AND THE FEATURES THEY PROVIDE

Type Number	Description	Maximum Diameter (Inches)	Minimum Useful Viewing Diameter (Inches)	Writing Speed (Inches per Second)	Maximum Brightness (Foot-lamberts)	Typical Resolution (Lines per Inch)
2053	High-writing speed catches microsecond phenomena. Integral magnetic shield. Electrostatic Deflection.	5.56	3.8	300,000	2500	50
4412	Large Screen. Designed to withstand severe environmental conditions of shock, vibration, temperature, humidity, altitude. Integral magnetic shield. Electrostatic deflection.	10.88	8	30,000	200	44
7183	Magnetic Deflection.	5.19	4	—	12000	50
7315	Slow writing speed. Excellent integrating and half-tone capabilities. Electrostatic Deflection.	5.31	3.8	3,000	2500	50
7448	High writing speed to "freeze" microsecond transients. Electrostatic Deflection.	5.31	3.8	300,000	2500	50
C73904	Two writing guns for simultaneous writing of two independent signals. Electrostatic Deflection.	5.31	3.8	75,000	2500	50
C73922	Increased display area. Selective erasing gun erases specific parts of stored signal without affecting other parts. Electrostatic Deflection.	7	5.2	8,000	750	45
C73959	High-resolution capability with slow writing speed. Electrostatic Deflection.	5.31	3.8	3,000	200	110

For information that will solve your display storage problem, call your RCA Field Representative, or write to Marketing Manager, RCA Industrial Tube Products, Lancaster, Pa.



The Most Trusted Name  
in Electronics

RCA ELECTRON TUBE DIVISION FIELD OFFICES... NEWARK 2, N. J., 744 Broad St., HUmboldt 5-3900 • CHICAGO 54, ILLINOIS, Suite 1154, Merchandise Mart Plaza, WHitehall 4-2900 • LOS ANGELES 22, CALIF., 6801 E. Washington Blvd., RAymond 3-8361 • BURLINGAME, CALIF., 1838 El Camino Real, ORford 7-1620 • GOVERNMENT SALES... BRISON, N. J., 415 South Fifth St., HUmboldt 5-3900 • DAYTON 2, OHIO, 224 N. Wilkinson St., BALdwin 6-2366 • WASHINGTON 7, D. C., 1725 "K" St., N.W., FEderal 7-8500.

HAYDEN PUBLISHING COMPANY, INC.  
850 Third Avenue, New York 22, N. Y.

D E S I G N