

ELECTRONIC DESIGN

FEBRUARY 17, 1960

THE LIBRARY OF
CONGRESS
SERIAL RECORD
MAY 5 - 1960
COPY

Controllable Solid-State Timing Modules Can Implement Logic Functions

...p. 74

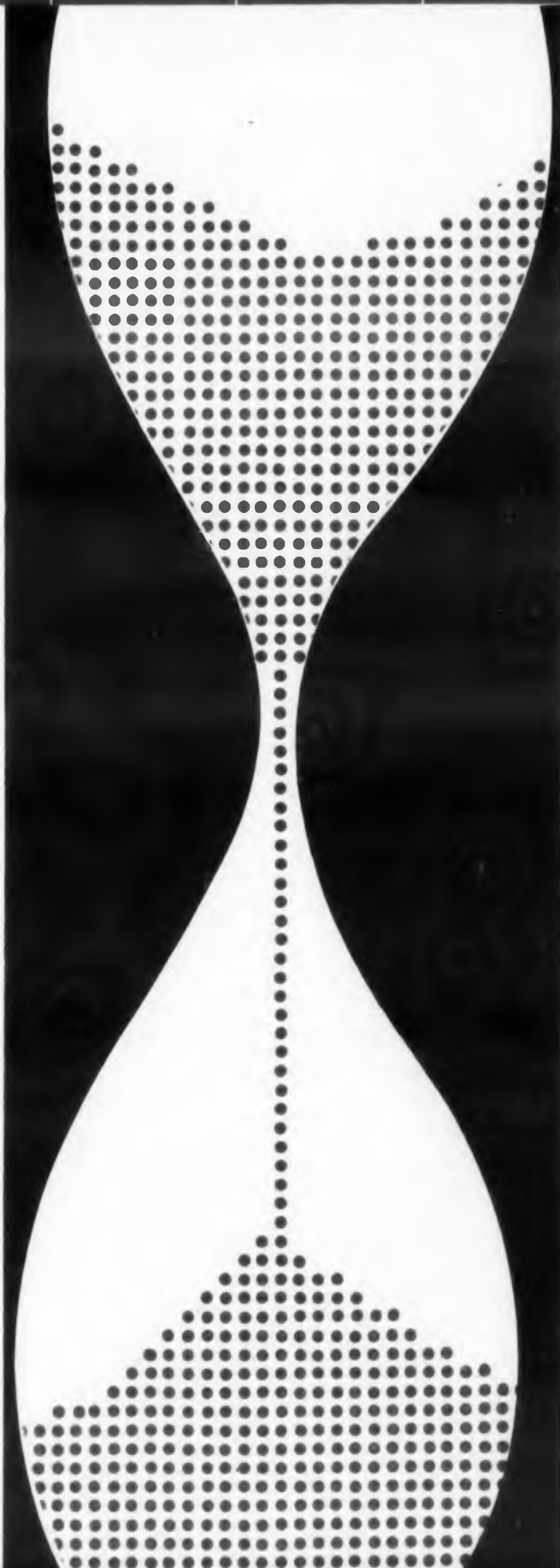
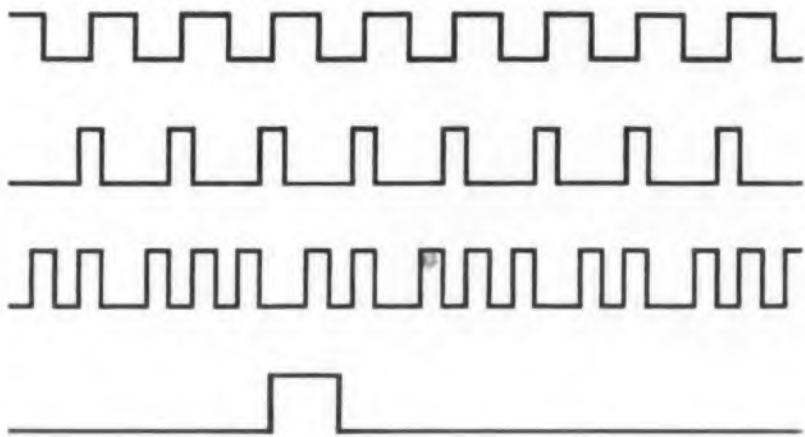

SYNCHROS *for* GYRO PLATFORMS

by *CPPPC*

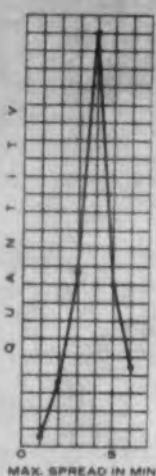

6' max. error spread Synchro for Gyro Pick-Off

The SG-17- and ST-17- type pancake synchros (SG-18- and ST-18- with housings) are our most standard line for gyro pick-off applications.

These units have been manufactured in large quantity and are readily available for prototype breadboarding. The high accuracies shown on the left are obtainable in standard 26v or 115v units.

Pancake Resolver for Gimbal Mounting

Clifton Precision produces special pancake resolvers for direct gimbal mounting. They were developed for use in cascaded amplifier-less resolver systems and have been trimmed for 10K input impedance, 0° phase shift and a constant transformation ratio, with temperature, at 900cy. Accuracies of 4', perpendicularities of 3' and nulls of 1mv/v of output or less can be held.

Special techniques maintain concentricity between rotor and stator — thus reducing difficulties commonly encountered in gimbal mountings.



Custom Designed Pancakes

CPPC has developed a number of special pancakes (drawings below) with relatively large bores and narrow stack heights.

Means have been devised to minimize error due to clamping pressures on these thin units.

Special accuracies have been maintained where required. Let us know your needs.

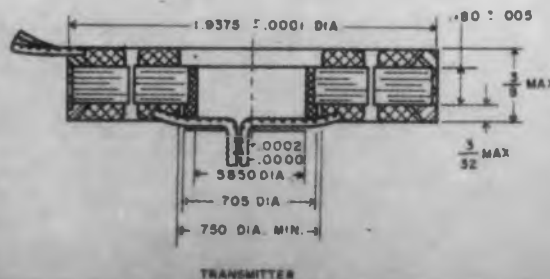
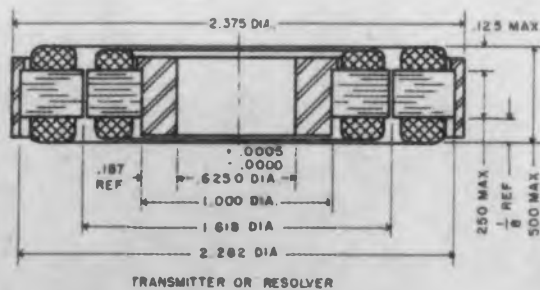
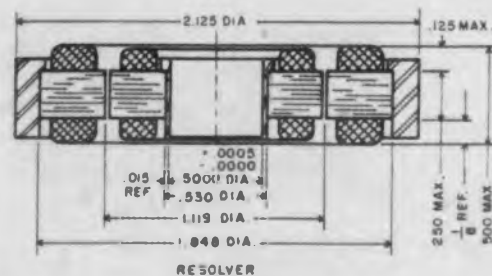

ENGINEERS — Join the leader in the rotating components field. Write David D. Brown, Director of Personnel, Dept. J7

CPPPC CLIFTON PRECISION PRODUCTS Co., INC.
CLIFTON HEIGHTS, PENNSYLVANIA

Sales Office: 9014 W. Chester Pike, Upper Darby, Pa., HIlltop 9-1200 • TWX Flanders, Pa. 1122—or our Representatives

CIRCLE 1 ON READER-SERVICE CARD

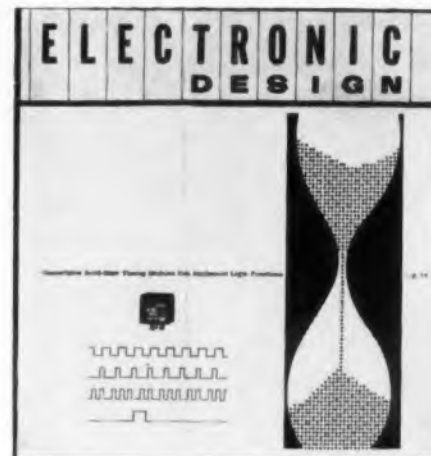

COVER: A wide variety of precise timing and logic functions is available in new solid-state timing modules. On the cover, our artist has used an hourglass to symbolize time and a variety of pulses to symbolize the flexibility of these timing modules.

Selected Topics In This Issue

Military

- Experts Discuss Reliability p 8
- Moletronics in the Future p 18
- NASA Launches Satellite p 26

Materials

- Thermoplastic Recording p 4
- Selecting RFI Gaskets p 46

Semiconductors, Circuits, Components

- Microdiode Reliability p 28
- Dissipative Filters p 50
- LC Matching Pads p 58
- Tunnel Diodes p 66
- Solid-State Timing Modules .. p 74
- Rise, Storage, Fall-Time Meter p 76

Design

- Good Design is Good Business p 56
- Direct A-D Converter p 62
- RC-RL Nomographs p 167

Communications, Radar

- AM Stereo with One Transmitter p 16
- Tubeless Radars Predicted p 30
- VORTACS Installed p 33
- Line-Type Modulator p 42

Computers

- Magnet-Twistor Memory p 13
- Cores Arrays p 27
- Computer Tape to Words p 54

Nuclear Science

- Radiation Detector p 10

Highlights of this issue

Exclusive series of radio frequency interference (RFI) developments and tunnel-diode circuits continue in this issue.

"Don't accept a new job until you evaluate . . . the concern you intend to join," says Eugene B. Shea, employment counselor for Cadillac Associates, Inc. He answers seven important questions that may help you determine the career potential of an electronics company. Read his methods of job measurement on page 236.

Human factor engineering in industry is becoming more and more of a challenge to industrial designers such as Paul Wrablica. No longer concerned with product appearance alone, industrial designers are now focusing on the need to modify equipment to more functional styling. At the same time, serious consideration must be given to the human operator who will work with the product. Meet Paul Wrablica in this issue and begin his series of articles in which he describes this fresh approach to knobs, panels, housings, and other electronic components.

Renewed interest in reliable radar modulator circuits has prompted *ELECTRONIC DESIGN* to present a step-by-step designer's guide to line-type modulators. This three-part series contains all the practical data needed to solve design problems. Part 1 appears in this issue and gives a detailed description of the discharge circuit.

Catastrophe will result unless makers of components start working on molecular electronics, says Col. W. S. Heavner, chief of the Wright Air Development Division. Read what he has to say to manufacturers on page 18.

Reliability is everybody's problem, but exactly who is at fault for the lack of reliability? Bureaucracy, lack of foresight, red tape, lack of time and money, too many people, lack of coordination—all have been blamed at one time or another. Read what military and industrial specialists concerned with the problem had to say to *ELECTRONIC DESIGN* at the recent Reliability Symposium.

NEW

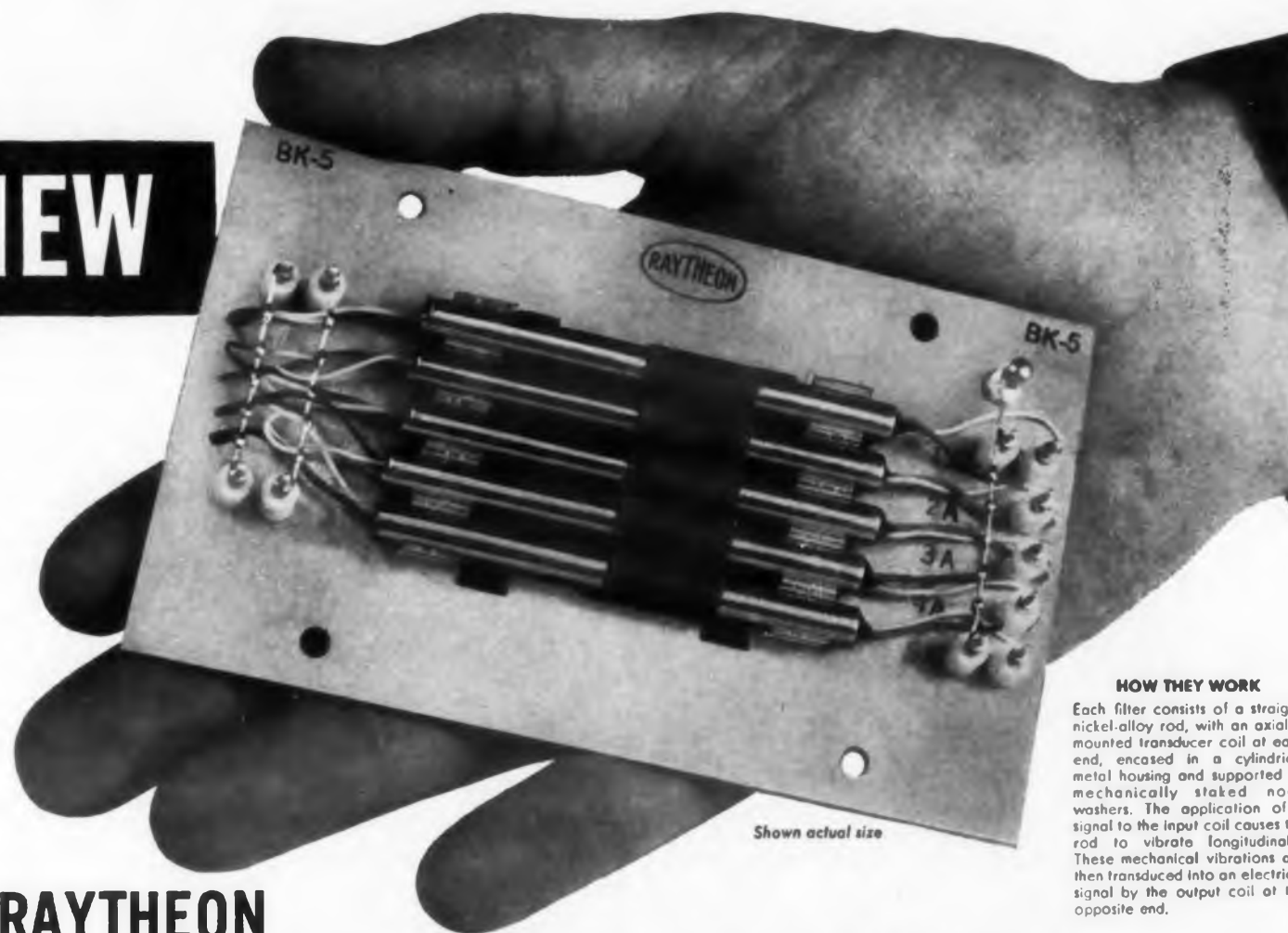

HOW THEY WORK

Each filter consists of a straight, nickel-alloy rod, with an axially-mounted transducer coil at each end, enclosed in a cylindrical metal housing and supported by mechanically staked node washers. The application of a signal to the input coil causes the rod to vibrate longitudinally. These mechanical vibrations are then transduced into an electrical signal by the output coil at the opposite end.

RAYTHEON MAGNETOSTRICTION BANDPASS FILTER ARRAYS

cost less...weigh less...take less space

In addition to advantages in economy, size and weight, new Raytheon Magnetostriction Filters have better selectivity characteristics than equivalent electrical filter circuits and, once adjusted, remain permanently tuned. They are operable over a wide temperature range and will withstand considerable shock and vibration.

These features make them ideal for any applications involving single or multiple narrow-band filter channels. For example, they are used on *Shock and Vibration Test Equipment* (for frequency analysis or, using feed back, for smoothing out wave forms); *Spectrum Analyzers*; *Underwater Sound Analysis Equipment* (for identifying vibration frequencies); *Telemetering Equipment*, *Oscillators* and *Wireless Paging Systems* (to actuate selected receivers).

Sample orders for Raytheon Magnetostriction Filters are available with no minimum quantity restrictions. For data sheets write Dept. 2527.



INDUSTRIAL COMPONENTS DIVISION
53 Chapel Street Newton 58, Massachusetts

CIRCLE 2 ON READER-SERVICE CARD

Features of Raytheon Magnetostriction Bandpass Filter Arrays

Unlimited combinations can be arrayed at accurately spaced frequency intervals — At 50 kc., center frequency can be adjusted within 0.3 cps.

More economical for arrays in 45 kc to 300 kc range — Priced from \$16 to \$39 per filter, depending on quantity and type.

Arrays are smaller and lighter — A bank of ten filters can be mounted on a 3" x 5" panel — total assembly weighs only ten ounces.

Higher Q and higher frequencies than toroidal coils — Q from 2000 to 15,000. Resonant frequencies from 45 to 300 kc.

Wide dynamic range — 40 to 55 db.

Stable over wide temperature extremes — Over range from -60°C to +80°C, maximum resonant frequency variation is only 8 ppm/°C.

Ideal impedances for transistor circuits — Single filter input impedances from 15 to 90 ohms, output impedances from 600 to 2000 ohms (depending on resonant frequency).

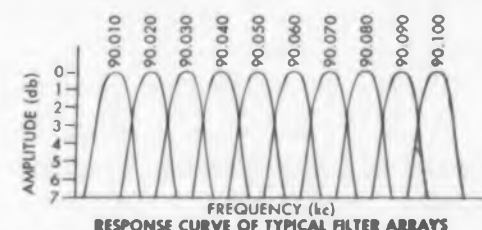

**SWEEPING
OSCILLATORS
for RADAR and
TELEMETERING SYSTEMS
ALIGNMENT 200 cycles-3800 mc
by KAY ELECTRIC**



Kay Vari-Sweep 880-A

- Wide Range, Wide Sweep
- High Output
- Fundamental Frequency
- Constant Output (Fast-Acting AGC)
- Continuously Variable Centers
- Fixed, Crystal-Controlled Markers
- All Electronic Operation

The Kay sweeping oscillators are a line of high level laboratory field test and production instruments designed for the alignment of radar and telemetering IF's and front ends, 200 cycles to 3800 mc.

Instrument	Cat. No.	Range	Sweep Width	RF Output	Markers	Price*
Ligna-Sweep SM SKV	935-A	200 cycles-220 mc	2 kc-12 mc customer selected	1.0 V rms AGC'd, 70 ohms	customer selected	\$995. (without crystals)
Vari-Sweep SM	880-A	2-220 mc (center)	Contin. Variable to 60% center freq. below 50 mc, 30 mc plus, above 50 mc.	1.0 V rms AGC'd, 70 ohms	None	\$795.
Vari-Sweep Model 10	866-A*	4-120 mc (center)		1.0 V rms AGC'd, 70 ohms	11 Fixed Crystals 1 Variable, Direct reading dial	\$885. (with crystals)
Vari-Sweep Model Radar	865-A*	10-145 mc (center)		1.0 V rms AGC'd, 70 ohms	11 Fixed Crystals 1 Variable, Direct reading dial	\$985. (with crystals)
Vari-Sweep Model 400	867-A	15-470 mc in 10 bands	Same as above to 400 mc; 20 mc max. above 400 mc	1.0 V rms into 70 ohms to 220 mc; 0.5 V rms to 470 mc; all AGC'd	None	\$850.
Mega-Sweep SM	110-A**	50 kc-950 mc	50 kc-40 mc	100 mv at 50 ohms	None	\$575.
Rada-Sweep SM	380-A*	2 Switched bands 20-40 mc; 50-70 mc	2 Switched bands, Wide 20 mc, Nar 3 mc	250 mv rms, 70 ohms	9 Fixed Crystals	\$450. (with 4 crystals)
Rada-Sweep Sr.	385-A	1-260 mc (center) 6 Switched bands	Approx. 70% of center freq.	5 V rms into 70 ohms	24 Fixed Crystals	\$650. (without crystals)
Magna-Sweep	3500	5-1000 mc 2200-3800 mc	Full range of swept band	Low band 0.1 V rms into 50 ohms; High 1.5 V into 50 ohms	±0.1% accurate direct reading digital wavemeter	\$4,950.

**Other Mega-Sweeps to 1200 mc, and with Markers

*wider sweep widths, additional crystal markers available on special order

† all prices F.O.B. Pine Brook, N. J.

SEE US AT THE IRE SHOW BOOTHS #3512, 14, 16, 18

WRITE FOR NEW KAY CATALOG

KAY ELECTRIC COMPANY
Dept. ED-2, Maple Avenue, Pine Brook, N. J. Capital 6-4000

© 1959 BY KAY ELECTRIC CO.

CIRCLE 3 ON READER-SERVICE CARD

We Need To Find The Right Problem	41
An Editorial	
Line-Type Modulator Design, Part 1	42
Step-by-step procedure for designing high-power pulse modulator—I. Limansky	
RFI Gasketing	46
RFI gasket properties, comparison of gasket materials and tips for proper type selection are presented—O. P. Schreiber	
Dissipative Filters For Switching Circuits	50
A comparison of various filter schemes plus design details for a simple dissipative device capable of 40 db or better attenuation—R. B. Schulz	
Computer Tape To Words . . . Fast	54
High-speed recording system puts characters on microfilm	
Good Design Is Good Business	56
Meet the industrial designer and follow his approach to knob design—P. Wrablica	
Resistance Ratios Simplify Impedance-Matching Network Design	58
A simple procedure for designing and understanding LC matching pads—A. C. Norwine	
Unique Pattern Provides Direct Digital Readout In A-D Converter	62
No supplementary coding needed to go from analog to digital	
Designing With Tunnel Diodes, Part 2	66
Measurement of tunnel diode characteristics and their relation to circuit design—U. S. Davidsohn, Y. C. Hwang, G. B. Ober	
Isomodulator Kills Double Moding	72
Does away with need for repeller modulation of klystrons	
Controllable Solid-State Timing Modules Can Implement Logic Functions	74
New timing modules can be adjusted and controlled externally to satisfy many timing and logic applications	
Rise, Storage And Fall-Time Meter	76
Rapid measurement of diode and transistor parameters on panel meters rather than scopes	
7 Questions That Can Shape Your Job Future	236
How to evaluate the career potential of an electronics company—E. B. Shea	
ELECTRONIC DESIGN News	4
Many Applications Await Thermoplastic Recordingp 4	No Change In TV Color Signal p 25
What's Holding Back Reliabilityp 8	X-Band Waveguide Has low Loss p 25
Radiation Detector Counts Nanosecond Pulsesp 10	Satellite Launched by NASA . . p 26

ELECTRONIC DESIGN News (Cont.)

News In Picturesp 12	Core Arrays Form Memory Stack p 27
Magnet-Twistor Memoryp 13	Boost Microdiode Reliabilityp 28
Transmitter Provides AM Stereo p 16	Negatives Transfer Circuitry ..p 29
Trucking Industry Moves To Set Up Private Microwave System p 17	Electroluminescencep 30
TV Sent Via Circular Waveguide p 17	Worldwide Cable Netp 31
Moletronicsp 18	Airborne Digital Timerp 32
Navy's Moon-Relay System ...p 22	FAA Expects 1000 VORTACS ..p 33
News Briefsp 23	

Ideas For Design 186

New Drafting Technique Prepares Printed Circuits Fasterp 186	Reduce Delay Time In Binary Countersp 192
Index Card Aids Breadboarding p 189	Summing Network Varies AC-DC Components of Saw-Tooth ..p 194
Terminal Plate Connects Common Wiresp 190	Photocell Indicatorp 196
Measure Slopes Quicklyp 192	Circuit Delays Pulse Trainp 196
Germanium Transistors Drive Solenoid Magnetp 197	

Engineering Data 78, 167

Flow Graph Rulesp 78	RC-RL Curves and Nomograms p 167
----------------------------	----------------------------------

Russian Translations 206

Semiconductor Sweep-Current Generatorsp 206	
---------------------------------------------------	--

German Abstracts 214

Bandpass Half Sectionsp 214	
-----------------------------------	--

ELECTRONIC DESIGN Digests 216

Delay-Line Oscillatorp 216	Barrier-Grid Tube Memoryp 218
Graphical Method Determines Radio Noise Characteristicsp 223	

Washington Report 35

Meetings 36

New Products 80

Services For Designers 164

New Literature 172

Patents 198

Books 204

Report Briefs 226

Letters 230

Careers 236

Your Career 240

Career Brochures 250

Advertisers' Index 252



ELECTRONIC DESIGN is published bi-weekly by Hayden Publishing Company, Inc., 830 Third Avenue, New York 22, N. Y.,
T. Richard Gascoigne, President; James S. Mulholland, Jr., Vice-President & Treasurer. Printed at Hildreth Press, Bristol,
Conn. Accepted as controlled circulation at Bristol, Conn. Additional entry, New York, N. Y. Copyright 1960 Hayden
Publishing Company, Inc., 34,400 copies this issue.



Microwave energy normally travels on a two-way street. Because power flow has the habit of being reciprocal, it often becomes vitally necessary for microwave systems engineers to isolate the load from the transmitter or to control power channeling.



Rantec **LOAD ISOLATORS** directionalize the

power flow with a minimum loss in one direction of propagation and with extremely

high loss in the other. Rantec manufactures a



large number of "off-the-shelf" **LOAD ISOLATORS** which range from low power to liquid-cooled high power units and cover broad band as well as specific frequencies.

Rantec engineers welcome the opportunity of solving specific problems or undertaking

special design projects.



calabasas, california

microwave ferrite components / antennas / r-f devices

CIRCLE 4 ON READER-SERVICE CARD

Many Applications Await Thermoplastic Recording

THE HIGH-RESOLUTION, wideband recording process recently announced by General Electric Co. could help designers solve many long-standing design problems in all areas of electronics when perfected. Some of these problems, as outlined by GE, are:

- Displays of radar, sonar and infrared projected in real time.
- Projected displays that make use of time-lapse photography techniques to show slow-moving images.
- Simplified optical correlation to extend the range of radars.
- Recording of radar and other wideband signals in defense and civilian applications.

- Efficient guidance systems based on convenient map-matching methods.

- Video recording offering high-resolution, instant playback in color and black-and-white.

The potential value of thermoplastic recording (TPR) to designers stems from the success with which it can combine fast processing with the storage capacity of photography. General Electric claims its TPR system will be able to:

- Record signals of great bandwidth—up to 50 mc—more than 10 times the bandwidth of magnetic recording techniques.

- Store data at great densities—40 million bits per square inch—more than 100 times the capacity of magnetic systems.



W. E. Glenn of General Electric adjusts the thermoelectric recorder he developed for high-density, immediate-play-back data storage. To enable his equipment to record color, Dr. Glenn designed a special electron gun and a Schlieren-type optical system. The electron gun is mounted in the vertical compartment to the left of the reels.

- Use relatively inexpensive plastic tape, on which an image can be seen with a viewer.

- Provide a tape record ready for viewing, reading or projecting in about 0.01 sec.

- Record on relatively simple equipment in color or black and white.

- Permit either optical or electrical readout.

- Erase and record on the same tape "as desired."

Where GE Stands in TPR

Most of the potential applications of TPR described by General Electric are intended for the armed services, reflecting the company's concentration on military development. GE reports that it plans to demonstrate a TPR system to the mili-

How GE's TPR Recorder Works

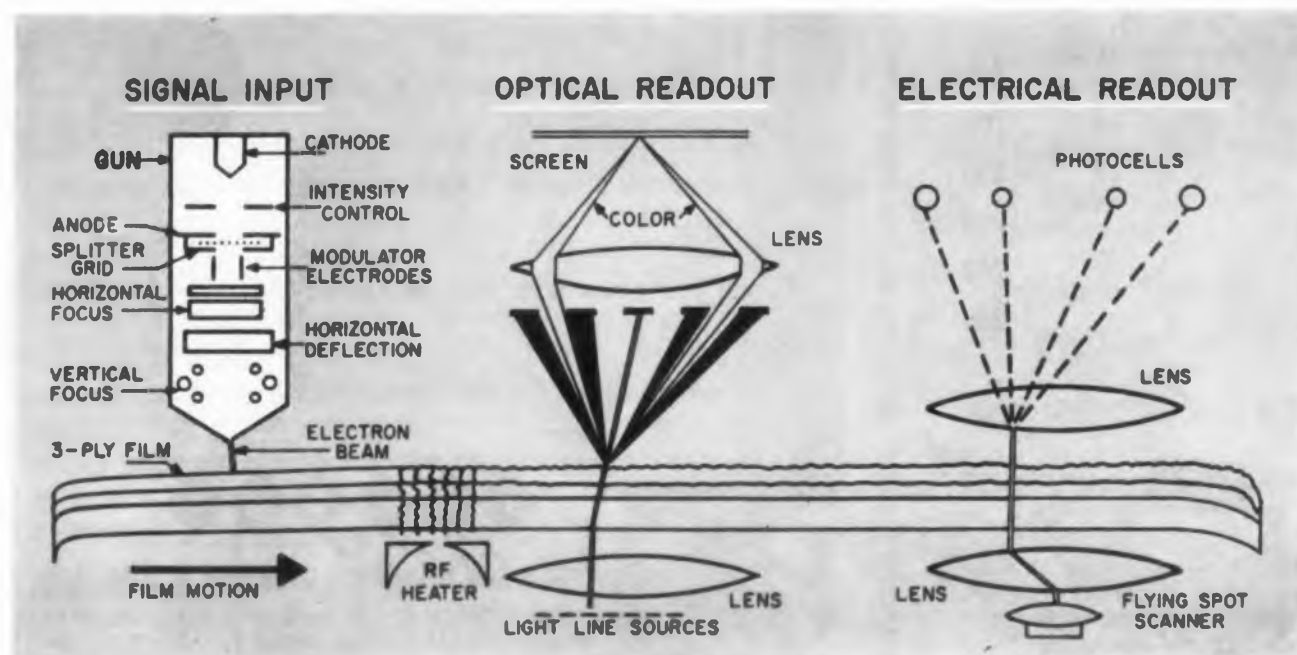

In brief, a special electron gun fed by digital or scanner input writes a charge in narrow bands on a moving film, which is coated with a low-melt plastic. The film is transported to an rf heater that melts the plastic coating, permitting it to be deformed by electrostatic and surface-tension forces.

Deformation produces ridges in the plastic coating proportional to the charge laid down by the beam of the electron gun. The ridges cool and form a diffraction grating that can be viewed or projected by suitable optics or read out by a flying-spot scanner.

Gun's Grid Structure is Special

Dr. W. E. Glenn, inventor of GE's TPR process, reports that an ordinary electron gun will do the job, but not as well as one designed with a special grid structure. In the GE system, the signal being

tary later this year. Commercial applications are "still several years away."

The only TPR device demonstrated so far is a laboratory model, which will be greatly refined. In this recorder, the electron gun writes in a difficult-to-maintain 0.1-micron vacuum. The vacuum must be continuously pumped. Film made during a demonstration of the laboratory model impressed observing engineers more with its potential than with its quality.

Other Companies Probe Electron Beam Process

Other companies, notably Ampex, are working on recording processes that use electron-beam writing. Thermoplastic, magnetic, and ferroelectric systems are under consideration. Already in use is a related process developed by the Swiss company Ediphor for closed-circuit color television. The Ediphor process uses an electron beam to write diffraction patterns on an impermanent oil film.

The electronics of the GE equipment are conventional except for the grid structure of the electron gun used, reports Dr. W. E. Glenn, who is credited with inventing the system. For recording in color, however, special optics designed by Dr. Glenn are employed. ■ ■

recorded modulates the electron gun, producing a beam that is divided by a splitter grid. The split beam is then modulated by a set of electrodes that control separation and amplitude of the separate beams.

This flexible control of the beam permits writing the diffraction-grating charge pattern necessary for color recording and playback.

To use the full potential of electron-beam precision, Dr. Glenn designed his recorder so that the electron gun writes in a vacuum. Continuous pumping holds the vacuum at about 0.1 micron, permitting a writing density of 40 million bits per square inch. Vacuum operation also provides faster processing and better eventual reproduction.

The character of the film is not critical, GE reports. At present, a standard film with a high



The KIN TEL Model 501 4-digit, over-ranging digital voltmeter measures DC from ± 0.0001 to ± 1000.0 volts with $0.01\% \pm 1$ digit (of reading) accuracy. An extra fifth digit in the left decade indicates "0" or "1" to provide ten times greater resolution at decade (1, 10, 100) voltage points than standard 4-digit voltmeters. Ranging and polarity indication are entirely automatic. The measured voltage, decimal point and polarity symbol are displayed on an in-line readout in a single plane—no superimposed outlines of "off" digits.

An adjustable sensitivity control permits decreasing sensitivity to allow measurement of noisy signals. Ten-line, parallel input printers can be driven directly, and converters are available for driving other types of printers, typewriters, and card or tape punches. The input may be floated up to 25 volts DC above or below chassis ground with no degradation in performance, and up to 250 volts DC with slight decrease in accuracy. Stepping-switch drive coils are energized with DC as in telephone-type service to provide long, trouble-free operation.

The 501 is one of a complete line of KIN TEL digital instruments. Others include AC converters, AC and DC preamplifiers, ratiometers, and multi-channel input scanners.

KIN TEL manufactures electronic instruments for measurement and control, and closed circuit TV. Representatives in all major cities. Write for detailed literature or demonstration.

5725 Kearny Villa Road, San Diego 11, California, Phone: BRowning 7-6700

CIRCLE 5 ON READER-SERVICE CARD

IMPORTANT SPECIFICATIONS

Display... Six decades display 5 digits (Left digit "0" or "1" only), decimal point, polarity symbol. Ranging and polarity indication are automatic. Projection system readout employs bayonet-base lamps with 3000-hour minimum life rating. Readout contains no electronic circuitry and can be remotely mounted.

Automatic Ranges... ± 0.0001 to ± 1000.0 volts DC in four ranges: 0.0001 to 1.9999; 02.000 to 19.999; 020.00 to 199.99; 0200.0 to 1000.0

Accuracy... $0.01\% \pm 1$ digit (of reading).

Input Impedance... 10 megohms on all ranges at null.

Reference Voltage... Chopper-stabilized supply, continuously and automatically referenced to standard cell.

Stepping-Switch Drive... DC voltage within stepping-switch manufacturers rating applied by transistor drive circuit at rate of approximately 20 steps per second.

Controls... Three: on-off; sensitivity; and mode of operation (standby, normal, print auto, print remote).

Printer Drive... Built-in for parallel input printers. Automatic or remote.

Dimensions and Net Weights... Control unit: 45 lbs, $5\frac{1}{4}$ " H x 19" W x 16" D. Readout: 10 lbs, $3\frac{1}{2}$ " H x 19" W x 9" D.

Price: \$2995

KIN TEL
A DIVISION OF
COHU
ELECTRONICS, INC.

CONSTANT CURRENT precision power supply



MODEL 351A

A general purpose laboratory instrument...

The Model 351A will satisfy the most exacting requirements for accuracy and stability. This is achieved by an advanced circuit design incorporating electronic regulation plus chopper stabilization against a standard cell reference.

DIRECT IN-LINE READOUT WITH ILLUMINATED DECIMAL POINT

SPECIFICATIONS

Output Current:	0-100 milliamperes in 1 microampere steps
Output Voltage:	100 volts maximum
Voltage Limiter: (Panel Switch Selected)	Provides maximum protection for meter calibration. Limiter in: output voltage will not rise above 600 mv. Limiter out: over voltage protection places instrument in standby condition when output voltage attempts to rise above 120 v.
Output Polarity:	Floating or negative grounded
Regulation vs. Line:	0.01% or 0.1u amp., whichever is greater, for 10% line voltage change
Regulation vs. Load:	0.01% or 0.1u amp., whichever is greater, for load change from zero to maximum
Calibration Accuracy:	0.05% or 0.5 uamp., whichever is greater
Current Resolution:	1 microampere
Stability:	0.005% per hour after short warm-up, 0.01% per day
Price:	\$845.00, f.o.b. Seattle, Washington

WIDE RANGE OF APPLICATIONS

8 3/4" rack panel, 19" wide, 14" deep

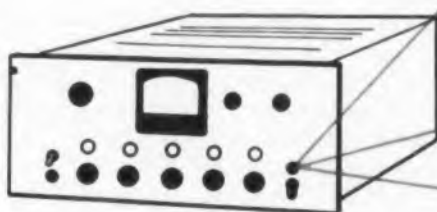

- ▶ CALIBRATION and TESTING of:
 - a. Instruments — Meters
 - b. Semiconductors
 - c. Torque motors
 - d. Bolometers
- ▶ An INVALUABLE AID to magnetic circuit development
- ▶ ALL CONSTANT current applications

Write us direct or contact our engineering representative in your area.

john fluke MANUFACTURING COMPANY, INC.



P. O. BOX 7161 • SEATTLE 33, WASH.

Prices and technical data subject to change without notice.

CIRCLE 6 ON READER-SERVICE CARD

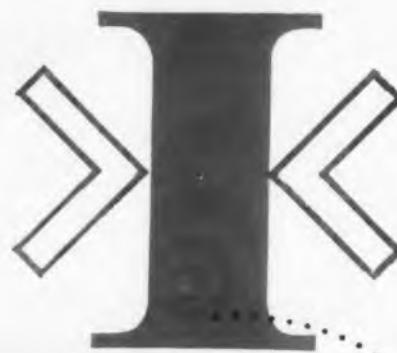

NEWS

melt point is used as a base. This is coated with a thin conducting layer and topped with a thin film of low melt point. The outer film of plastic is less than 0.5 mil thick. A channel less than 0.25 in. wide is sufficient for ordinary black-and-white recording.

As the electron beam scans the thermoplastic film it lays down a charge pattern that is a function of the information being stored. When the film is transported to an rf heater, its thermoplastic layer melts. Electrostatic forces between the charges on the film and the ground plane depress the film surface along the lines of charge until the forces are in equilibrium with the surface-tension restoring forces.

When it moves away from the heater, the film cools and the deformations or ridges are fixed. Once fixed the film is ready for monitoring or projecting. Immediate fixing is not necessary—the charge pattern can persist for days. Writing and fixing takes less than ten millisecc. Reheating and recoiling erases the ridges. By confining the rf heating fields, areas only a few mils square can be erased, reports Dr. Glenn.

Schlieren Optics for Viewing

Because the recording technique translates an original image to a series of ridges that vary in depth and spacing with the brightness of the original image, the viewing system must be able to retranslate ridge characteristics to tones. This is done in the GE process with a modified Schlieren optical system.

For color, a light is projected through a grating and then through a condensing lens before it passes through the film. The film's ridges break up the beam, passing it on to a second grating that matches the first. Wanted light passes through the gratings and is condensed by another lens onto a screen.

Smooth film sends light onto the bars of the second grating. Ridged areas diffract light through the grating's slots to a position on the screen corresponding to the light's position on the film and the grating. Grating spacing determines the color of the picture element; the amplitude of the grating determines the intensity of the diffracted light.

Grating for each of the primaries can be superimposed to provide colors that are the sum of primaries. The electron gun modulates the split electron beam to provide the necessary spacing and amplitude pattern.

Black-and-white images can be recorded and viewed more easily. The slots and light sources are made wide enough for the entire spectrum

UNITED STATES AND CANADIAN REPRESENTATIVES

ALBUQUERQUE, N. M. Gene French Co. 120 San Pedro S.E. Albuquerque, N.M.	MINNEAPOLIS, MINN. Pinkney & Hine Co. 1925 Nicollet Ave. Minneapolis 3, Minn.
ATLANTA, GA. Bivens & Caldwell, Inc. 3133 Maple Drive N.E. Atlanta 5, Ga.	NEW YORK, N. Y. G. Curtis Engel & Assoc. 210 So. Broad St. Ridgewood, N.J.,
BALTIMORE, MARYLAND Horman Associates, Inc. 3006 W. Cold Spring Lane Baltimore 15, Md.	ORLANDO, FLA. Bivens & Caldwell, Inc. P.O. Box 7942 Orlando, Fla.
BOSTON, MASS. Technical Instruments, Inc. 90 Main St. Reading, Mass.	PHILADELPHIA, PA. G. Curtis Engel & Assoc. P.O. Box 4383 Philadelphia 18, Pa.
BRIDGEPORT, CONN. Technical Instruments, Inc. 1115 Main St. Bridgeport, Conn.	PHOENIX, ARIZ. Gene French Co. 1644 W. Hatcher Rd. Phoenix, Ariz.
CHICAGO, ILL. Cozzens & Cudahy, Inc. 125 Old Orchard Arcade Skokie, Ill.	RICHMOND, VA. Bivens & Caldwell, Inc. P.O. Box 6514 Richmond 30, Va.
CLEVELAND, OHIO M. P. Odell Co. 26614 Center Ridge Rd. Westlake, Ohio	RIDGEWOOD, N. J. G. Curtis Engel & Assoc. 210 So. Broad St. Ridgewood, N. J.
DALLAS, TEXAS Wallace-Gluck Co. P. O. Box 13207 Dallas 20, Texas	SAN DIEGO, CALIF. McCarthy Assoc., Inc. 3460 Ingraham St. San Diego 1, Calif.
DAYTON, OHIO M. P. Odell Co. 2676 Salem Ave. Dayton, Ohio	SAN FRANCISCO, CALIF. McCarthy Assoc., Inc. 635 Oak Grove Ave. Menlo Park, Calif.
DENVER, COLO. Gene French Co. 3395 So. Bannock St. Englewood, Colo.	SEATTLE, WASH. Rush S. Drake Assoc. 1806 Bush Place Seattle 44, Wash.
DETROIT, MICH. M. P. Odell Co. 10531 W. McNichols Rd. Detroit 21, Mich.	ST. LOUIS, MO. Harris-Hanson Co. 2814 S. Brentwood Blvd. St. Louis 17, Mo.
HIGH POINT, N. CAROLINA Bivens & Caldwell, Inc. P. O. Box 5187 High Point, North Carolina	SYRACUSE, N. Y. J. D. Ryerson Assoc., Inc. P. O. Box 1400 Syracuse 1, N. Y.
KANSAS CITY, MO. Harris-Hanson Co. 7916 Paseo Ave. Kansas City 32, Missouri	TORONTO, ONT., CANADA Allan Crawford Assoc. P. O. Box 214 Willowdale, Ontario
LOS ANGELES, CALIF. McCarthy Associates, Inc. 1055 E. Walnut St. Pasadena, Calif.	VANCOUVER, B.C., CAN. Rush S. Drake Assoc. 1806 Bush Place Seattle 44, Wash.
WASHINGTON, D. C. Horman Associates, Inc. 941 Rollins Ave. Rockville, Md.	

to be passed by the optical system. The charge pattern is laid down in a television-type raster—film motion provides the vertical sweep, the electron gun provides the horizontal sweep.

Signal Readout with Scanner

A flying-spot scanner can be used to provide an electrical output. The scanner sends light of a single color through the film and lens system to a group of photocells placed to receive diffractions from different angles and at different spacing.

Analog and Digital Recording Possible

To record signals in analog form, the electron beam is modulated by the signal to be recorded. A single beam modulates intensity, a split beam modulates both intensity and grating spacing, as described above.

Dr. Glenn has this to say on recording digital data, "For binary digital data, a single split beam may be used. In this case, it is desirable to use only two colors, one for the 0's and another for the 1's. In this way all data bits appear as the presence of a single color. Since a dust speck scatters light randomly, it appears as white light. A coincidence in the 0 and 1 detectors can thus be made to reject dust. Coordinate data can be recorded as the absence of a color. Because coordinates can be recorded in with the data, high mechanical tolerances are not required to realize the high solution of the system."

GE states that the dust problem in recording high-density data with its system is no greater than with other systems. ■■



Frames of film produced by experimental model of thermoplastic recorder are about width of paper clip. This film was made by feeding signal directly from TV set if stage to recorder.

NEW 1E1 BANDPASS FILTER The new Bulova 1E1 Bandpass Filters give today's radar microscopic eyes. Shaving the broad frequency range of returning signals into tiny segments, they help reconstruct signals faithfully for maximum information, for accurate measurement of Doppler effect . . . all at greatly reduced noise levels.

With characteristic Bulova precision, bandwidths and insertion losses are closely controlled, so that many filters may be paralleled to cover an almost unlimited frequency spectrum.

Now in production for virtually all leading manufacturers in the radar field are filter packages of 200 cps bandwidth with crossovers at the 1/2 db. point, and with insertion losses equal to within 0.3 db. from filter to filter.

For full information on Bulova standard and custom design filters, on crystal, ovens or packaged oscillators, write Sales Engineering Department, Bulova Watch Company, Electronics Division A-1254, Woodside 77, N.Y.



Typical specification of a single filter in 10 K.C. spectrum:

Center frequency: 144.400 KC
 Lower 1/2 db. point: 144.330 KC
 Upper 1/2 db. point: 144.470 KC
 Lower 3 db. point: 144.300 KC
 Upper 3 db. point: 144.500 KC
 40 db. bandwidth: less than 2 KC
 Insertion loss: less than 1 db.
 Ripple in pass band: less than 1/2 db.
 Frequency variation of pass band: less than 10 cps
 over temperature range of 0°C. to +70°C.
 Size: 2 1/2" W x 2" D x 1 1/8" H
 Weight: less than 7 oz.

Visit our booth numbers 1719-1721 IRE New York City.
 CIRCLE 7 ON READER-SERVICE CARD

design engineering
...operational
...off-the-shelf



An Arnoux power supply going into a canister for the Atlas propellant utilization system.

Arnoux's fast moving story... What's New in power supplies

NEW POWER SUPPLIES FOR guidance flight control and fire control and airborne computers VCO's and SCO's rf amplifiers and transmitters precision reference-voltage sources missile checkout radar systems

Arnoux has consistently proved its versatility and reliability in providing either a few prototypes or thousands of power supplies—*quality in quantity*.

In fact, wherever reliability and design integrity are taken for granted, *there* you'll find Arnoux power supplies, static converters, and inverters.

For airborne applications and for GSE, Arnoux power supplies have these outstanding features: precision regulation... temperature stability... low ripple... tight packaging... light weight... and they meet, exceed, or are qualified under specification MIL-E-5272A.

For highly precise, static and dynamic regulation of line and load changes when accuracy is vital, Arnoux power supplies provide a wide range of output voltage and current. Depending on specific models, this range is from 5 to 500 vdc and from 30 ma to 15 amperes. Bulletin 102.

Arnoux Corporation

11924 W. Washington Blvd. • Los Angeles 66, California



ARNOUX
phonetically, say Are'new
POWER SUPPLIES

CIRCLE 8 ON READER-SERVICE CARD

NEWS

What's Holding Back Reliability?

Is it faulty coordination between industry and government, not enough money, too many people, slow exchange of data? Does anyone know?

L. N. Tolopko
Associate Editor

EVERYONE KNOWS that the big problem in reliability is how to apply existing know-how, but hardly anyone agrees on who is blocking action and what needs to be done. This is one conclusion carried away from the Sixth National Symposium on Reliability and Quality Control, which was held in Washington last month.

The keynote speaker, J. K. Sprague, president of Sprague Electric Co., outlined some of the issues clearly: "It has proved very difficult to get agreement" among organizations on "what their various responsibilities are." The organizations are the "Department of Defense itself down through the military departments, prime and subcontractors, and suppliers of parts and materials."

■ It is the responsibility of the DOD to emphasize to the entire military establishment that quality and reliability are the most important ingredients of weapons systems.

■ The military departments must develop "complete and uniform specifications, without loop-holes, which will apply the same set of ground rules to all suppliers." Also, they should disseminate "all information available to them on parts, materials and design practices as they bear on systems reliability."

■ The equipment producer must "instruct his systems people, including product designers, that they are to make an honest, all-out effort to achieve the reliability levels called out by their contracts."

■ "It is equally the responsibility of the military departments and the DOD to

bear an appropriate share of the cost" of appropriate environmental and quality-acceptance test equipment and personnel.

■ The system of open competitive bidding should "be modified by suitable restrictions on those contracts which require high levels of reliability. This would limit bidding to those manufacturers who have demonstrated their ability to produce to required reliability levels."

■ The Government's Qualified Product list is inadequate. It does "not guarantee that a given manufacturer either has a production capability, or, if he does, that he consistently maintains a satisfactory quality level in his production."

The Navy Takes Some Blame

The Navy is partly to blame for the lack of reliability in some of its equipment, said Vice-Admiral J. T. Hayward, who spoke at the symposium banquet. "We should have paid more attention to our homework on the components," he added. Components have been "overlooked completely in the glamour of the many large systems."

Is There Enough Data Exchange?

"An important thing really needed," said R. G. Fitzgibbons, Division Reliability and Quality Control Engineer, Raytheon Co., "is more data exchange of reliability." But, like others, Mr. Fitzgibbons was not sure who was more responsible for insufficient data exchange—government agencies or industry.

This point was made by another reliability engineer at the symposium, who stated that companies hold back on data

exchange not because of restraint-of-trade laws but in fear of sacrificing a potentially advantageous position. The engineer offered to give a reason a minute why companies don't distribute data—"and none of the reasons would be fear of restraint-of-trade laws."

Is the Industry Properly Coordinated?

If we had more coordination between the four tiers of the electronics industry, we could get more reliability, said C. M. Ryerson, general chairman of the symposium. He described the four tiers as the materials, parts, equipment and weapon-systems manufacturers. "What we need, perhaps," he said, "is a non-profit, impartial, independent agency that would coordinate these four tiers and act as a catalyst." The purpose of the organization would be to evaluate the reliability techniques and the products of companies.

There should be more coordination in government agencies, Mr. Ryerson said. There is no coordination, he added, between those who procure a product and those who maintain it. He deplored the fact that government contractors are often forced to specify components before a prototype unit has been tested and qualified.

Are There Too Many People?

"Man, we're being peopled to death," said a spokesman in the Department of Defense who preferred to remain anonymous. "It's so easy to criticize and say that other people are at fault. But it takes more than that to get reliable electronic equipment. It takes people. Everything, in the end, boils down to people. It's not bureaucracy, lack of foresight, red tape, lack of coordination—it's too many people.

"It takes time to educate them and time to train them about what a reliability program means. Outside the industry, who's interested in spending money on reliability? There's no hardware involved. Nobody will ever read about it.

"You don't get reliability by instituting programs for the military and industry to follow. You get it by persuading people how important it is. And that takes time—lots of time. We're getting there, though."

Is it the Same Old Problem?

"Time and money—that's what we really need," said George Peratino, reliability engineer, Bureau of Naval Weapons. "Reliability can't be achieved without additional funding. We need money to test prototypes."

from
this...



with **Tuf-Plate**



Miniaturization of electronic components put the pressure on circuitry to keep pace. Photocircuits took up the challenge and turned an idea into the space and weight saving reality of **Tuf-Plate** plated thru holes — reliably interconnecting conductor patterns on both sides of the circuit board.

Where even greater component density is required — up to 50% — Photocircuits now offers printed circuit boards with miniaturized conductor patterns using **landless Tuf-Plate** — another first by P/C.

The inset at left offers a visual comparison between outdated eyelets and new landless **Tuf-Plate**. Get the whole exciting **Tuf-Plate** story today — it's likely that conventional or landless — **Tuf-Plate** can save you space, weight . . . often at lower cost. Write Department A-1590, Photocircuits Corporation, Glen Cove, New York.

Photocircuits
C O R P O R A T I O N

Visit our Booth Numbers 2201-2203, I.R.E. Show, New York City
CIRCLE 9 ON READER-SERVICE CARD

FROM PHILCO... **2 NEW** SURFACE ALLOY SILICON TRANSISTORS



For Proven Performance
in High Speed Circuits
at High Temperatures

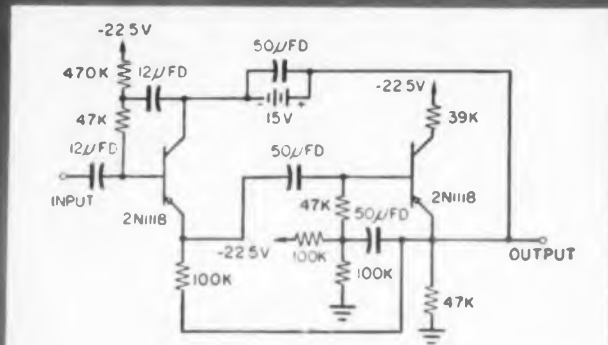

High Input Impedance Amplifier— $Z_{in} > 2$ megohms (25 C—125 C)

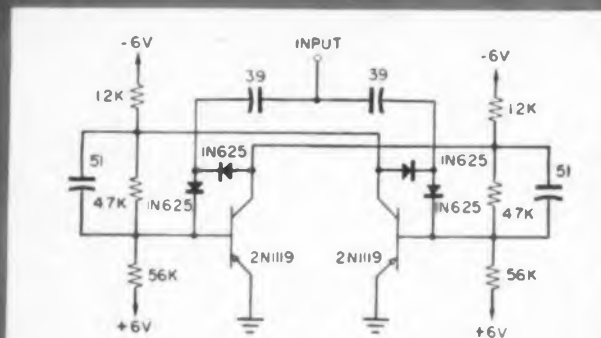

2 MCS Binary Counter—(-55 C to +125 C)

SAT* 2N1118 and 2N1119
offer 4 outstanding features:

1. Low Leakage Current
2. Very Low Saturation Resistance (Choppers, Switches)
3. High Base-emitter Breakdown Region
4. Controlled Input Characteristics

2N1428 and 2N1429 are Lower-priced Units with Comparable Characteristics for Low Voltage, High Beta Application.

*Trademark Philco Corp. for Surface Alloy Transistors

Philco continues its leadership in the Silicon high speed PNP field with these highly reliable field-proven SATs. In addition to their other superior characteristics, they have adequate frequency response to fill a large percentage of silicon transistor applications in both military and commercial circuits operating at high ambient temperatures. They are environmentally tested in accordance with MIL-T-19500 A. These two new types supplement and are the electrical equivalents of the widely used 2N495 and 2N496, offering the designer a choice of packages (TO-1 and TO-5). For very high speed switching applications, designers should consider Philco's NPN Diffused-base Transistor 2N1119. Write for complete information, Dept. ED260.

Immediately Available in Production Quantities . . . and 1-999 from your Philco Industrial Semiconductor Distributor.

PHILCO
LANSDALE DIVISION • LANSDALE, PENNSYLVANIA



NEWS

Tiny Radiation Detector Counts Nanosecond Pulses

A new approach to design of charged-particle detectors has resulted in a solid-state device that can count 10 million particles per second and provide energy resolution ranging down to 0.6 per cent.

Hughes Aircraft Co., which developed the novel detector, has already distributed several hundred experimental models to radiation laboratories for evaluation and expects to make available in a few weeks the first commercial units from a limited production run.

The detector is essentially a diffused pn junction device in which the junction is about 1 micron from the surface. The device operates with reverse bias and functions as an ionization chamber, detecting charged particles.

Applications are Varied

Because the device is tiny, fast, rugged, sensitive and linear, it is expected to be applied in:

- Military detectors—troops would be issued cigar-sized detectors that would be rugged and cheap.

- Inexpensive dosimeters could also be made with the tiny detector.

- Industrial process control—sensitivity of the device would provide high accuracy and would permit reduced use of radioactive material.

- Medical electronics—Hughes has demonstrated detector elements the size of a pin head and believes these cells may be lodged in living tissue to measure radiation dosage.

- Space instrumentation—The detectors can be made so small that Hughes says it is feasible to construct three-dimensional packages of thousands of them to measure types

◀ CIRCLE 10 ON READER-SERVICE CARD

miniature pulse transformers

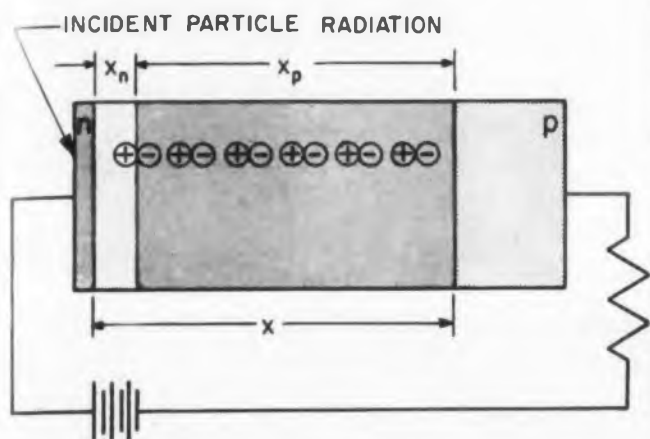

New and novel detector of charged particles is a pn silicon junction device in which the junction lies just 1 micron below surface to trap a maximum of particles. X_n and X_p show n and p depletion regions. X area is total depletion region. The detector is reported able to operate with extremely small power drain.

and characteristics of incident radiation. In such packages, the detectors arranged in coordinate array would signal the presence of a charged particle working its way through the array. This procedure would provide data for almost-instantaneous analysis of radiation, and would be a great improvement over the photographic plates now used in similar analyses.

Hughes predicts that the basic detecting cell could be sold for about \$10, once quantity production is started. Designers would then have an extremely stable, inexpensive device that would out-perform present charged-particle detection devices, some of which must be operated at liquid-air temperatures. Gain does not drift, in contrast with relatively unstable photomultipliers.

At present, the detectors do not respond to gamma rays, Hughes reports. However, the company is investigating how dc current changes under a large gamma flux, and hopes that its detector can be modified for use with individual photons.

Resolution is Very Great

Energy resolution of the detector, defined as the ratio of full width, in volts, of the pulse height distribution at half the maximum counting rate divided by the mean pulse voltage, is presently better than 1 per cent at 5.5 Mev for alpha particles, reports Hughes. This figure is the limit imposed by associated electronic systems. Voltage range is from 50 kv up. ■ ■

more than 800 standard units available

Sprague Miniature Pulse transformers give the circuit designer the flexibility he needs to meet the varied requirements of low-power, high-speed computers. Sprague literature details more than 800 standard units in a wide variety of mounting styles, shapes, and encasements for conventional or printed wiring board assembly. Many special types can also be furnished to match specific circuit and packaging requirements.

Sprague pulse transformers handle pulse widths of 20 millimicroseconds and wider...at repetition rates as

high as 10 megacycles...with pulse levels ranging from fractions of a volt to several hundred volts.

Typical circuits utilizing Sprague Pulse Transformers include *pulse amplifiers* (for current or voltage step-up, impedance matching, decoupling, pulse inversion and push-pull operation); *pulse shaping and differentiating*; *blocking oscillators* (in regenerative circuits of the triggered and self-triggered type); *general transistor circuits*.

For application assistance on your pulse transformer problems, write to Manager, Special Products Division, Sprague Electric Company, Union St., North Adams, Mass. A complete series of Engineering Bulletins covering Sprague's standard pulse transformers is available from Technical Literature Section, Sprague Electric Company, 347 Marshall St., North Adams, Mass.

SPRAGUE COMPONENTS:

MAGNETIC COMPONENTS • TRANSISTORS • RESISTORS • CAPACITORS • INTERFERENCE FILTERS • PULSE NETWORKS
• HIGH TEMPERATURE MAGNET WIRE • CERAMIC-BASE PRINTED NETWORKS • PACKAGED COMPONENT ASSEMBLIES
CIRCLE 11 ON READER-SERVICE CARD

SPRAGUE

THE MARK OF RELIABILITY



...and now for the sealing test!

If the pots you need *must* function in a dust or sand environment, you could build 'em yourself to make sure they stay clean! But before you move heaven and earth while testing your creation, exactly what have you planned, to give you a tight seal, yet low torque? And if that isn't enough of a problem, how do you keep foreign matter out of the bearings?

But why move heaven and earth, mostly earth, to test your own dirt-free pot, when Ace has the pots with the dust-free features? Special O-rings seal sand, dust and other foreign matter eliminating abrasion damage. Our wound nylon packing delivers excellent sealing with lowest torque. Also, a special silicone-type grease, located in shaft pockets, captures foreign particles before they ever get a chance to do any damage. So if grit's a problem for you, come to Ace for the answer. See your ACErep!



This 3" AIA Acepot (shown 1/3-scale), meeting all MIL spec's on sealing, incorporates these exclusive anti-dirt and dirt-trapping features. Mandrels are also fungicide-varnished, to insure long life.

ACE ELECTRONICS ASSOCIATES, INC.

99 Dover Street, Somerville 44, Mass.

SOMerset 6-5130 TMX SMVL 181 West. Union WUX

Acepot® Acetrim™ Aceset® Aceohm® *Reg. Appl. for

CIRCLE 12 ON READER-SERVICE CARD

NEWS IN PICTURES

Timepiece in Japanese-designed clock radio has spring wind-up to minimize battery drain. Pentron, U. S. distributor, reports the set's 9-v battery will give 150 hr of operation.



In radiation room at Sperry Gyroscope, Great Neck, N. Y., engineers test new infrared detection device. Eighty-six-ft long tunnel is painted completely black.

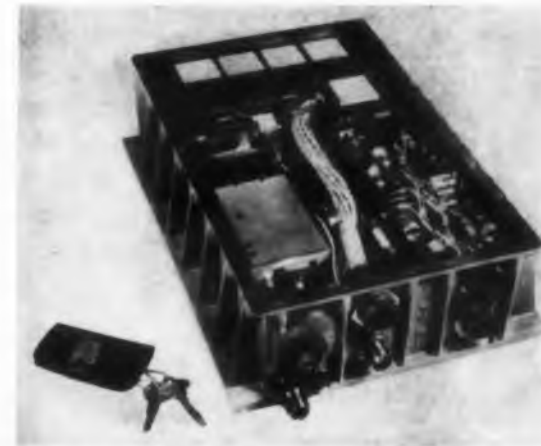
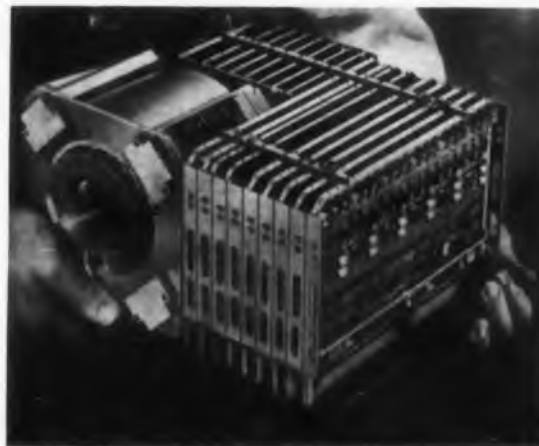

First photos of Centaur's space vehicle instrumentation show a digital guidance computer and an fm/fm telemetry system. The transistorized digital computer, designed by Librascope, Inc., (left) weighs 32 lb, occupies 0.55 cu ft. It will accept inputs from Centaur's inertial platform, perform the necessary guidance compilations, and provide steering signals to the missile's control system. The telemetry system was designed by Texas Instruments, Inc., to operate without adjustment for 500 hr continuously. In 0.5 cu ft, the 20-lb package houses a miniaturized sub-carrier oscillator, a 3.3-w transmitter, a 50-w power amplifier, and associated power supplies.

Japa-
clock
wind up
battery
U. S. dis-
the set's
give 50



Solid-state mixer-oscillator held by designer Dr. Vladimir Vodicka has demonstrated mixing gains of 40 to 60 db at a 2-mc bandwidth using a typical MADT transistor at 450 mc. Signal-to-noise ratio with a 1-mv received signal is better than 12 db, reports Lenkurt Electric Co.



SNAP-3 midget atomic generator is producing electricity after a year of continuous operation. The Martin Co. has developed and built eight SNAP-3 generators, which are now undergoing environmental and other tests.

SC-59-10

OUTSTANDING IN PERFORMANCE

type D



RESIN-COATED SILVERED MICA CAPACITORS

Sangamo Type D mica capacitors combine the excellent electrical performance characteristics of silvered mica with a multi-layer, protective case of high moisture-resistant thermo-setting resins.

temperature range

The Type D is designed to operate over the temperature range of -55°C to $+125^{\circ}\text{C}$ at rated working voltage without derating.

tolerances

Available in capacitance tolerance values of $\pm 20\%$, $\pm 10\%$, $\pm 5\%$, $\pm 2\%$, $\pm 1\%$ (or ± 1 mmfd, whichever is greater).

insulation resistance

The insulation resistance of these capacitors will exceed 3,000 megohms at 125°C .

moisture resistance

Insulation resistance shall be greater than 1000 megohms as measured in accordance with paragraph 2.6.2 of EIA specification RS-186-A, Method 2. Paragraphs 2.4 and 2.6.1 do not apply. The test shall continue for 10 cycles, as described in paragraph 2.5.

thermal and immersion cycling

Insulation resistance shall be greater than 3000 megohms after being subjected to temperature cycling between -55°C and $+125^{\circ}\text{C}$, as outlined in Method 102-A, Test Condition D, and followed by Method 104-A, Test Condition A, of MIL-STD 202A.

Write for Bulletin TSC-118C

**SANGAMO
ELECTRIC
COMPANY**

SPRINGFIELD, ILLINOIS

TYPE	DC WORKING VOLTAGE - VOLTS.	CAPACITANCE RANGE - MMF.
D-15	500	5-400
	300	5-800
D-20	500	100-2000
	300	100-4000
D-30	500	1000-10000
	300	1000-20000

CIRCLE 13 ON READER-SERVICE CARD

SMALLEST LIGHTEST CARCINOTRONS



with wide band sole tuning

Though it has just recently made its debut into the high society of Litton microwave tubes, this carcinotron (our model L-3298) has already been commended by the military for its exceptionally clean design. Every engineer concerned with upgrading the performance of ECM equipment will surely find much of interest in this medium-power tube, with which Litton takes a major stride toward truly simultaneous noise-jamming capability by affording faster tuning rates than any previously attainable.

The Litton family of eight electrically-compatible carcinotrons is the first to incorporate the critical capability of wide band sole tuning without frequency or power holes when the tube is operated into as much as a 1.5-to-1 mismatch. Litton carcinotrons are the first to use wider-than-normal-band RF output couplers, minimizing many system components such as antennae, waveguide plumbing, and load isolators.

We cite these firsts not for glory's sake, but rather for their meaningful contribution to more efficient system design, smaller size and lighter weight.

The notable suitability of these carcinotrons is not limited to ECM. You can also consider them for other military applications such as drivers for communications links—in fact, wherever medium-power tubes with extremely rapid tuning and low tuning power are required. Because of their mechanical and electrical compatibility the eight tubes in the family are interchangeable, as shown.

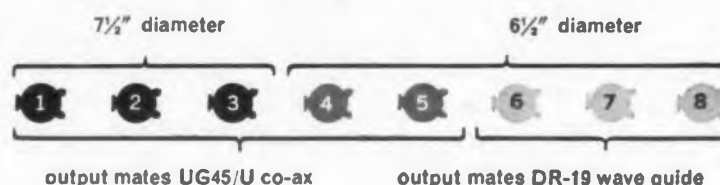

These versatile tubes are not just drawingboard products — you can order them now.

Write concerning voltage-tuned power oscillators of whatever nature to Litton Industries, Electron Tube Division, Office E23, 960 Industrial Road, San Carlos, California. Your request for our Carcinotron Catalog or for answers to your specific questions will be honored promptly.



LITTON INDUSTRIES Electron Tube Division

BARRATRON TRANSMITTING TUBES • MAGNETRONS • KLYSTRONS • TRAVELING WAVE TUBES • BACKWARD WAVE OSCILLATORS • CARCINOTRONS • GAS DISCHARGE TUBES • NOISE SOURCES • CROSSED-FIELD AMPLIFIERS • HIGH DEFINITION CRT • DIRECT-WRITING CRT • STORAGE TUBES • MICROWAVE FILTERS • DUPLEXERS • TR TUBES

**CAPABILITY
THAT CAN CHANGE
YOUR
PLANNING**



NEWS

Magnet-Twistor Memory Readied for Production

In the brief span of 14 months, Bell Laboratories and Western Electric have taken the Permanent-Magnet-Twistor memory out of the laboratory and prepared it for production. (*ED*, April 15, 1959, pp 35-45).

As described in *ELECTRONIC DESIGN*, the memory is a multilayer sandwich.

A pattern of 1-mil-thick Vicalloy I bar magnets is photo-etched on a plastic card (not shown in the adjoining drawing). The card lies over a grid of 60-mil wide copper strips which form parts of single-loop word coils.

Perpendicular to the word coils, an array of Twistor elements and current-return wires (not shown), embedded in Mylar film, form the next layer. This layer is followed by the other halves of the single-loop word coils. These are bonded to the mounting board.

In use, a pulse through a word coil generates a pulse in the Twistor if there is no magnet at the particular Twistor-word coil intersection. The Twistor can deliver a 1- μ sec long, 6-mv pulse to a 10-ohm impedance.

The memory suggests itself for program-store applications. As a random-access store, it has a 5- μ sec

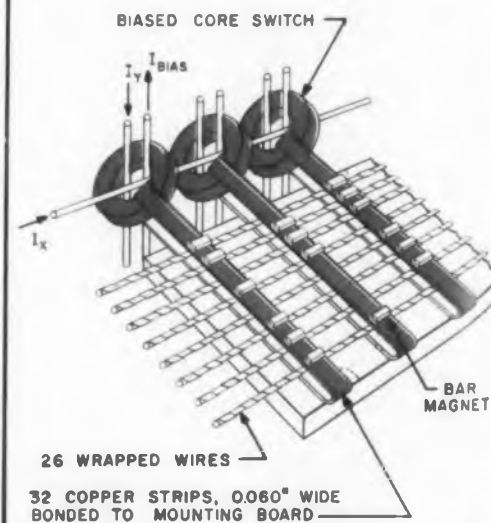

Twistor-permanent magnet memory provides rapid, random-access, non-destructive memory. Ferrite core switches (or transformers) provide access to the copper-strip word coils.

CIRCLE 14 ON READER-SERVICE CARD



Bell Labsmen H. L. Stadler and D. G. Clemons iron out some fine points of the Twistor memory. A partially assembled module is in the foreground, with a completed unit behind it.

access time. A new magnet card can easily be inserted in the Twistor memory to change a program.

To mass produce these memory modules, Bell Labs and Western Electric had to develop some unique manufacturing equipment. The tolerances required for photo-etching the magnet boards were far tighter than normal photo-etch tolerances.

Wrapping tape on the Twistors called for a specially designed machine that could wrap the low-strength permalloy around the 3-mil copper wire with high uniformity. The machine can deliver 300 ft of Twistor per hour.

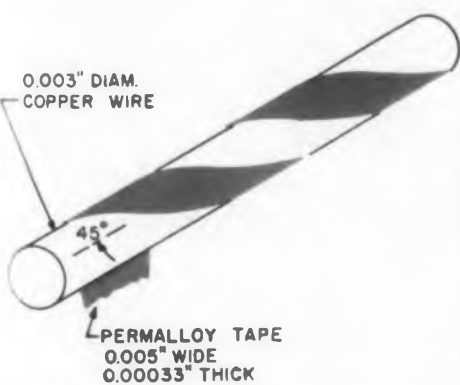

Basic Twistor has a barber-pole permalloy-tape wrapping around a copper wire. The tape is wrapped at a 45-degree angle for helical magnetization. Length of wire is 60 mils per bit.

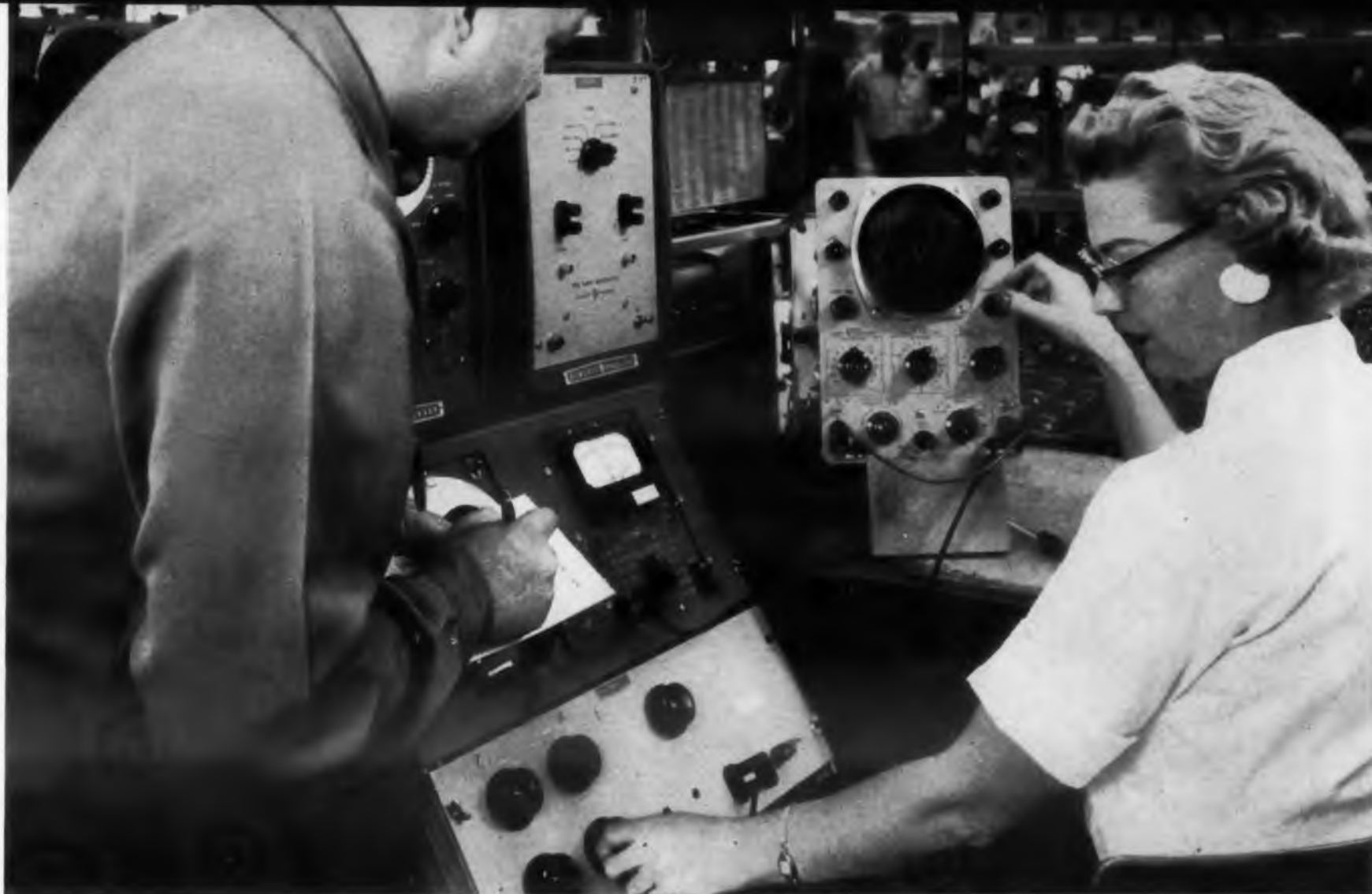

HEWLETT PACKARD specifies Tung-Sol tubes for high stability calibration generator

The Hewlett-Packard Voltmeter Calibration Generator calibrates high impedance voltmeters and oscilloscopes with extreme accuracy. An exceptionally stable source for a wide range of precision voltages, the premium instrument speeds up production and maintenance testing.

To assure high stability and low distortion performance, which are listed among the unit's principal advantages Hewlett-Packard selected Tung-Sol 6550's for the 400 cycle power amplifier. As Hewlett-Packard reports: "Tung-Sol's 6550 shows unusual insensitivity to load changes."

What this means, of course, is that under varying loads the 6550 drive, with its tight characteristics, holds to a minimum any change in the unit's already minimal distortion (less than 0.2%). In addition the 6550 helps to provide long-term stability.

Like all Tung-Sol components, the 6550's optimum performance and dependability stems from

Tung-Sol's deep-rooted component know-how. Every step in the manufacturing process is carefully disciplined. Stringent quality control guarantees uniformly high performance in any one lot or from lot to lot. And exhaustive life tests under severe overload assures adequate safety margins.

Maybe you're up against some exacting component requirements. If so, you'll be steering a wise course by getting in touch with Tung-Sol applications engineers. They're component experts who will gladly study your design and recommend the units that will do the job . . . precisely. Tung-Sol Electric Inc., Newark 4, New Jersey. TWX:NK193.

For prompt and competent technical consultation on Tung-Sol components call the Tung-Sol Commercial Engineering office near you. SALES OFFICES: Atlanta, Ga.; Columbus, Ohio; Culver City, Calif.; Dallas, Texas; Denver, Colo.; Detroit, Mich.; Irvington, N. J.; Melrose Park, Ill.; Newark, N. J.; Philadelphia, Pa.; Seattle, Wash. Canada: Montreal, P. Q.



 **TUNG-SOL**[®]

only
Grant
could
design
the
cost-
conscious
BUDGETEER

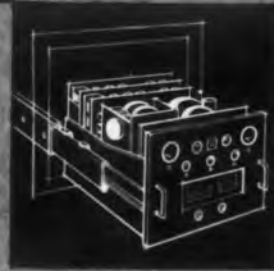

Only Grant's wide experience as the leading manufacturer of slides could yield the know-how needed to produce the Budgeteer! *The first low cost chassis slide with features found only in the most expensive slides.*

If your product or product-to-be must be designed or fabricated to a cost-conscious appropriation, you'd be wise to check the Budgeteer's features—features that can put the most advanced maintenance-efficiency ratings on the most modest budget jobs.

*full extension • parts interchangeability • quick-disconnect
• low cost • ball bearing action • 150 lb. load capacity*

Write for complete literature & prices.

The nation's first and leading manufacturer of slides

GRANT INDUSTRIAL SLIDES



GRANT PULLEY & HARDWARE CORPORATION

Eastern Division/ 21 High Street, West Nyack, N.Y.
Western Division/ 944 Long Beach Ave., Los Angeles 21, Calif.

CIRCLE 16 ON READER-SERVICE CARD

NEWS

Single Transmitter Provides AM Stereo in New System

AM stereo broadcasting, in which the listener may use two ordinary home receivers rather than special types, will be put in use shortly in Montreal, Mexico City and Venezuela.

A stereo adapter system, developed by Kahn Research Laboratories, Freeport, L.I., N.Y., can be installed on standard AM transmitters in a matter of hours without engineering modifications. A full carrier and two independent sidebands are developed with each sideband capable of separate modulation by each stereo channel. The resulting envelope complies with the spectrum requirements of conventional AM.

Independent upper and lower sideband demodulation is accomplished by tuning each receiver to the respective upper and lower sideband. Compatible monaural reception of stereo programs, with complete balance, is obtained by single-set owners tuning to the carrier in the usual way.

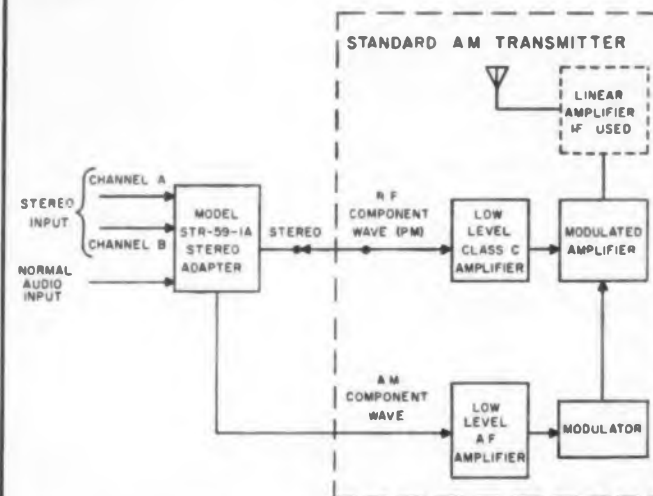

Stereo adapter develops two independent sidebands, which are individually modulated by the two stereo inputs. Each sideband of the envelope wave can be demodulated by a standard AM receiver. Stereo reception can be achieved by simply tuning two receivers to the respective upper and lower sidebands, reports Kahn Research Laboratories, developer of the system.

Trucking Industry Moves to Set Up Private Microwave System

The Executive Committee of the American Trucking Associations has approved a plan to help set up private microwave communications systems for motor carriers. The plan calls for:

- A study of trucker pioneering in the establishment of microwave systems. These groups include 60 companies in California, and about 20 carriers operating between Chicago and St. Paul.

- A survey of possible users to determine their interest in combining to develop such systems.
- The scheduling of meetings in New York and Chicago for carriers operating between these key cities. The Committee hopes to stimulate interest among the carriers by acquainting them with the advantages of microwave systems over lines leased from American Telephone and Telegraph and Western Union.

The Committee acted despite the suspension of microwave rights by the Federal Communications Commission pending its decision on an appeal by AT&T and Western Union. These companies are appealing the FCC decision that permitted the trucking industry and other private users to build and operate their own microwave systems.

Here's the Answer

The unlettered block diagram of an RFI gating arrangement, shown is Fig. 2, p 28 of the Feb. 3, 1960, issue of ELECTRONIC DESIGN, is not really classified information. Omission of the block functions is an error; the complete drawing is shown below.

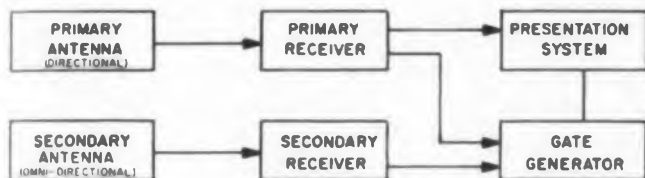

TV Sent Via Circular Waveguide



This picture of a live TV broadcast was transmitted by pulse code modulation through a 3600-ft loop of 275-in. diam circular waveguide developed by International Telephone and Telegraph Corp. In its waveguide system, IT&T uses the circular electric mode of the signal to hold down attenuation losses. Ultimately, the system may be capable of handling 400 TV channels or several hundred thousand telephone conversations, reports the company.

VARIAN ANNOUNCES



V 7405 FOR MODERN REFLEX KLYSTRON TUBES

A KLYSTRON POWER SUPPLY

EXTREMELY LOW RIPPLE • WIDE OUTPUT RANGE

This Varian reflex klystron power supply matches the quality of Varian klystrons themselves. Built to meet the exacting requirements of klystrons in critical applications such as low noise or cw doppler measurements.

Extremely good ripple characteristics, $50 \mu V$ rms beam and $20 \mu V$ rms reflector. Beam voltage can be accurately adjusted from 150 to 850 volts and reflector supply from 20 to 800 volts. 60 cps sine wave, and square wave or sawtooth modulation 300 to 3,000 cps with 1,000 cps vernier control. For complete data, address RADIATION DIVISION.



VARIAN associates

PALO ALTO 21, CALIFORNIA

Representatives throughout the world

KLYSTRONS, WAVE TUBES, GAS SWITCHING TUBES, MAGNETRONS, HIGH VACUUM EQUIPMENT, LINEAR ACCELERATORS, MICROWAVE SYSTEM EQUIPMENTS, ION & IFR SPECTROMETERS, MAGNETIC MAGNETOMETERS, STALOS, POWER AMPLIFIERS, GRAPHIC RECORDERS, RESEARCH AND DEVELOPMENT SERVICES

CIRCLE 17 ON READER-SERVICE CARD

E-W Custom Cooling



Conditions Unusual Configuration

Today's electronic systems invariably require specialized cooling equipment that is compact, lightweight, fits into unusual configurations, and still meets the most difficult environmental conditions (MIL-E-4970*).

Custom air-conditioning is our business at Ellis and Watts. For example, our MIL-AC air conditioning units can be square, oblong, L-shaped, T-shaped, curved, pyramid—virtually any shape your conditions require. They can be designed for integral mounting in electronic consoles or computer racks; or for use as adjacent or remote equipment to air condition entire systems.

MIL-AC units are self-contained, compact, lightweight, readily air-transportable. They can be designed to cool, heat, humidify, dehumidify, filter, and can incorporate air-cooled or water-cooled condensers. Units are manually or automatically controlled. We are staffed with specialists who will analyze your requirements, submit a proposal, complete your installation promptly and to your complete satisfaction.

Write for helpful load calculating Nomograph and other technical data for use in making time-saving preliminary calculations.

*Military specification dealing with the following climatic and environmental conditions: Temperature, humidity, altitude, salt spray, vibration, fungus, sunshine, rain, sand and dust, explosive atmosphere, acceleration and shock



Typical MIL-AC Unit. MIL-AC configurations, features and functions to suit your specific requirements.

ELLIS AND WATTS PRODUCTS, INC.



P.O. Box 33D, Cincinnati 36, Ohio

Ellis and Watts also design and build custom air conditioners, liquid coolers and heaters, dehumidifiers, wave guide dehumidifiers, laboratory temperature and humidity control units.

CIRCLE 18 ON READER-SERVICE CARD

NEWS

AF Lab Chief Says Molelectronics Handwriting is on the Wall

Component parts will be replaced by molecular electronics. And unless makers of resistors, capacitors and other parts start working on solid circuits they may be in for serious trouble.

This warning was sounded by Col. W. S. Heavner, chief of the Wright Air Development Div. Electronic Laboratory, Dayton, at an Air Force-Westerninghouse status meeting on molecular electronics last month.

In making his point, that standard parts, including diodes and transistors will gradually disappear, Col. Heavner said: "We are not using components such as these now, and we will never use them on this program."

Many Circuits Now Working

At the meeting, held in Washington, D.C., Westinghouse displayed about a dozen circuits fabricated by molecular techniques. Purpose of the demonstration was to show that the concept is feasible.

Among the working circuits displayed were amplifiers, both audio and video; multivibrators; switching circuits; and logic circuits. Most of the circuits consisted of a monolithic block of material about the size of a pinhead. Air Force and Westinghouse officials noted that the molecular elec-



These working molelectronic devices were displayed in Washington by Westinghouse last month: (top to bottom) an audio amplifier, a free-running multivibrator, and a two-stage video amplifier.

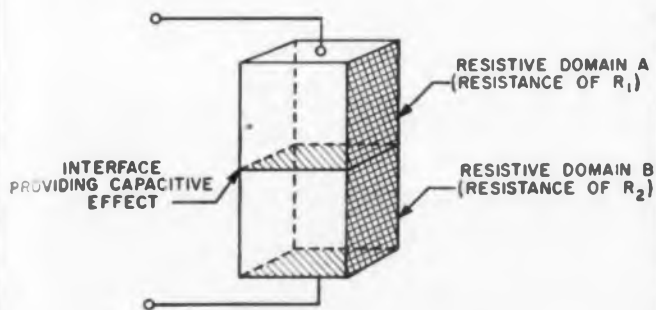

How two resistive domains are combined by Westinghouse to get a capacitive effect at the interface. The entire block forms a time-delay circuit.

tronics concept offers about a 1000 to 1 size reduction over transistors.

So far the Air Force has paid about \$2 million to Westinghouse on the program. Work will be accelerated to put working units in general use in 3 to 5 years. Westinghouse is now developing a molecularized transceiver to show that the concept can provide an integrated system in one block of material.

Motorola at Work on Solid Circuits

Motorola, which has started work on "molecular integrated devices," supports, in effect, Col. Heavener's position. In an ELECTRONIC DESIGN interview, Dr. D. E. Noble, vice-president of Motorola's Semiconductor, Military and Communications Div., said "Solid-state electronics, particularly microelectronics, offer the only promise for a sound solution to the problem of reliable equipment."

"We are already approaching a limit for complexity with an acceptable level of reliability," said Dr. Noble in commenting on the excessive number of interconnections and components in military equipment. "Continuing this line of development will lead us to the ultimate catastrophe—a system of maximum complexity which will never work." He added that only by abandoning the use of interconnected components can future high-performance, multifunction equipment be built.

Dr. Noble believes that solid circuits will not be mature enough to be put in wide use in electronics for some years. "Although the revolution in solid-state electronics has clearly begun, for the next few years integrated circuitry will be directed



Ac-to-dc power supply uses Seebeck effect for thermoelectric generation of electricity. The resistive domain is heated when ac passes through, thus heating the thermoelectric domain.

long-term stability... ONE YEAR

MODEL 1310N A-to-D CONVERTER/VOLTMETER

There's never any need for exasperating knob twiddling with a Franklin Model 1310N. Magic? No, just plain practical design. All operating potentials, including the line voltage, are regulated before they're put to work. What's more, there are no stepping switches, relays or other mechanical components to introduce noise or delays... it's all-electronic for whisper-smooth voltage conversion... and with a stability never before equalled. The brief specs tell more.

MODEL 1310N, ALL ELECTRONIC ANALOG-TO-DIGITAL CONVERTER/VOLTMETER..... \$2090*



request data sheet 2006

brief specifications

RANGES:	000.0 to 120.0 V dc. Input sensitivity: 0.1 V per digit. Matching amplifiers are available with minimum ranges of 1 mv per digit or 100 uv per digit.
RANGE AND POLARITY SWITCHING:	Optional automatic or manual (with amplifier).
ACCURACY (ABSOLUTE):	\pm one count (\pm 0.1% of full scale) after 10-minute warmup.
STABILITY:	Absolute accuracy is maintained for at least one year without calibration.

INPUT IMPEDANCE:	100 megohms.
READOUT TIME:	Maximum of 12.2 milliseconds to 120.0 volts full scale.
SPEED:	Up to 40 readings per second.
POWER:	100—125 V, 60 cps, 200 watts.
DIMENSIONS:	19" rack panel unit, 8 $\frac{3}{4}$ " H x 15" D.
WEIGHT:	Approximately 50 pounds.

*Prices are F.O.B. BRIDGEPORT, PENNSYLVANIA.



You count best when you count on FRANKLIN

CIRCLE 19 ON READER-SERVICE CARD



Laboratory thin-film deposition equipment is part of Motorola's molectronics program. The company believes sophisticated monolithic devices could be in use before 1975.

almost exclusively toward high-reliability military and space electronics requirements."

Sophisticated Units Before 1975

Dr. Noble predicted "Multilayer thin-film functional devices could be available between 1962 and 1965; integrated semiconductor devices between 1965 and 1970; and the more sophisticated monolithic forms some time before 1975."

Companies planning to work in solid circuits, Dr. Noble said, need four prime capabilities: a well-developed semiconductor facility; mastery of surface-passivation techniques; thorough competence in electronic ceramics like ferrites, ferroelectrics and piezoelectrics; and a fundamental research capability in "the thin-film art."

Navy's Moon-Relay System Ready Though Still Experimental

The Navy's moon-relay system is now ready for use during periods when solar conditions upset normal communications. Though still classified an experimental facility, the system has several times demonstrated its capability in communicating between Hawaii and Washington, D.C.

At present, the moon relay has a 4-channel multiplex-teletype capacity and is adaptable to sending and receiving pictures. Error rate is about 1 in 10,000. The number of channels that can be carried by time-sharing on a single antenna can be readily expanded, reports the Navy.

SILICONE NEWS from Dow Corning

As Environments Grow Tougher . . .

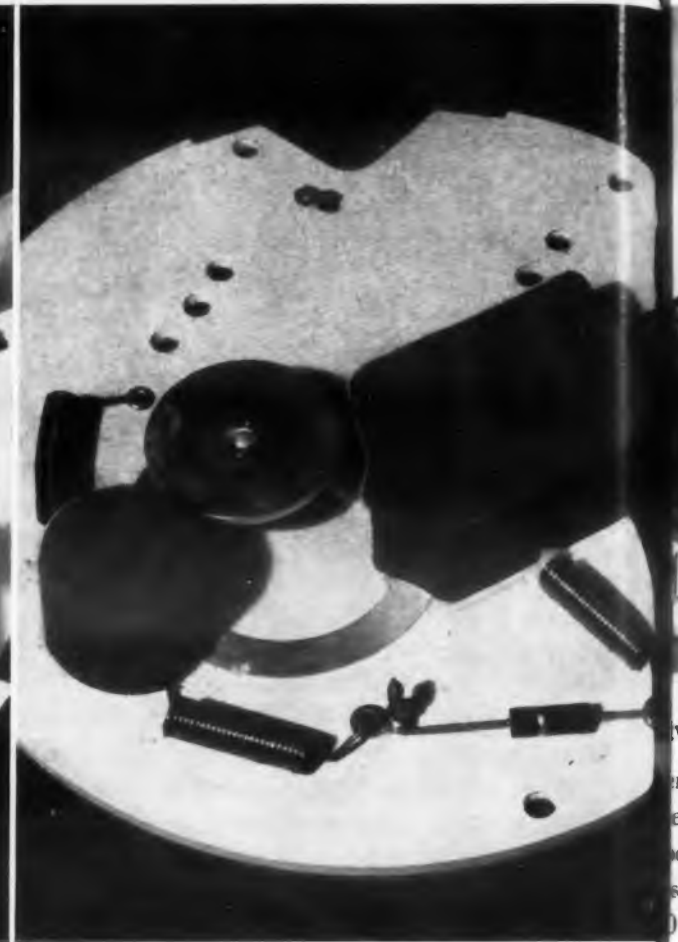
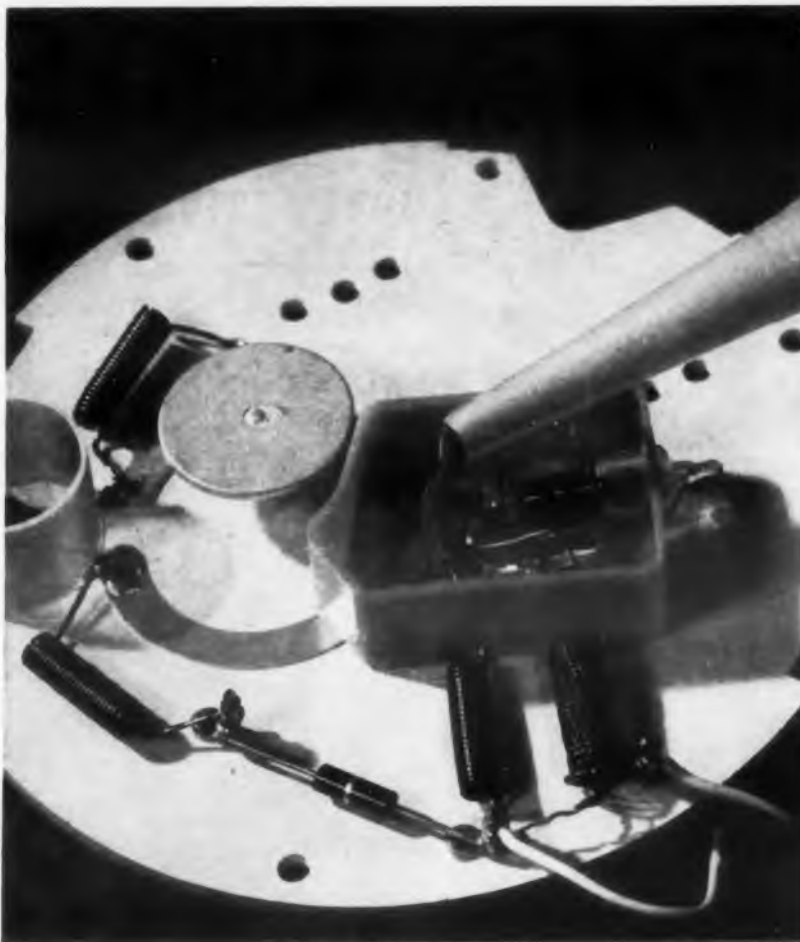

SILASTIC RTV SILICONE RUBBER

Supplies Both Physical and Electrical Protection

The ideal encapsulating material should prevent mechanical damage to sub-assemblies and at the same time improve electrical properties. It should retain these protective qualities in all operating environments and put no stress on delicate parts. Just such a material is Silastic® RTV, the Dow Corning silicone rubber that vulcanizes at room temperature.

Take the case of the Radio Sondes manufactured by the General Instrument Corporation, Newark, N.J. These meteorological instruments linked to integral transmitters are designed to be launched from aircraft at altitudes up to 60,000 feet and speeds up to 565 knots. This means reduced air pressure and a definite hazard of arcing and corona due to the high potentials involved. It also means slipstream shock and vibration at launch.

As shown in the photos, critical areas of these Radio Sondes are encapsulated with Silastic RTV, applied with a caulking gun into reusable retainer rings. By encapsulating the most vulnerable areas with Silastic RTV, excellent protection is achieved with no degradation of power factor.

Silastic RTV is easy to apply, has good dielectric and physical properties, resists moisture, arcing, corona, and oil. Rapidly changing ambients will not cause Silastic RTV to put excessive stress on fragile parts . . . it remains resilient and soaks up shock. Silastic RTV is available in different consistencies, set-up time can be varied from minutes to hours, dependent upon the RTV system.

Typical Properties of Silastic RTV

- Temperature range . . . (-70 to 260 C) -100 to 500 F
- Dielectric strength, volts/mil 300 to 500
- Surface resistivity at 50% relative humidity, ohms 2.8 x 10¹²
- Dielectric constant, 10⁶ cycles per second 3.5
- Dissipation factor, 10⁶ cycles per second 0.0005
- Moisture absorption after 7 days at room temperature, % + 3 to 5

Your nearest Dow Corning office is the number one source for information and technical service on silicones.



CIRCLE 800 ON READER-SERVICE CARD

Dow Corning

he silicones provide required service

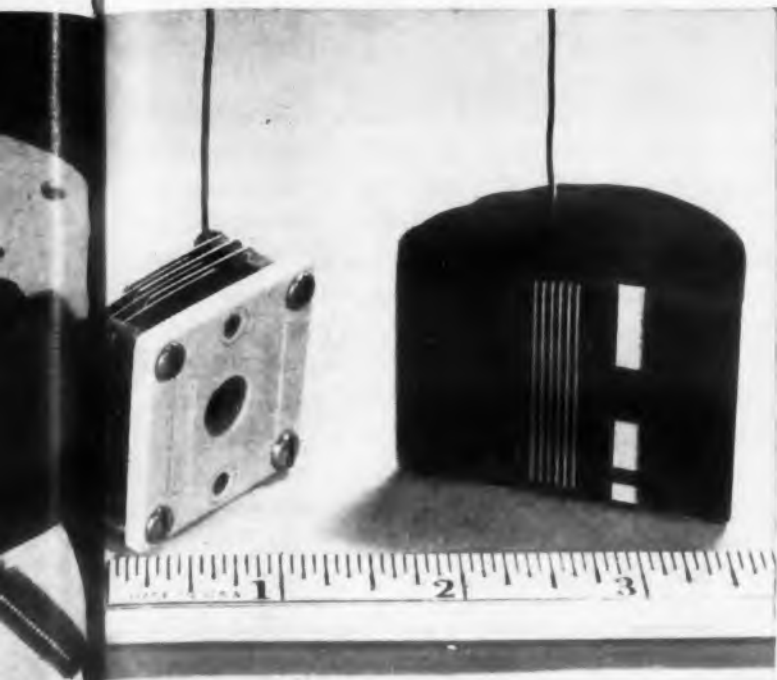

Solventless Resin For Top Heat Stability

When you need a rigid potting or encapsulating material, be sure the resin you choose is one that will keep its properties under adverse conditions. Dow Corning solvent-silicone resins will withstand temperatures above 260 C (500 F). With no solvent to evaporate, they set up to a continuous bubble-free mass. The capacitor in the picture is a good example. After potting with one of these thermosetting materials, it was sawed in half . . . notice the excellent bubble-free fill between plates. Solventless silicone resins are clear, tough solids; they accept a variety of fillers. Analyzed pot life is over 6 months.

CIRCLE 801 ON READER-SERVICE CARD

Highly Stable Diffusion Pump Fluids

Dow Corning silicone diffusion pump fluids resist oxidation when exposed to air at operating temperatures. They do not decompose into gums and tars . . . can be cycled countless times. They recover far faster than organics and have very short pump-down times.

These fluids produce vacua in the range of 10^{-5} to 10^{-7} torr of mercury, are chemically inert, non-corrosive, non-toxic, free from impurities.

Shown are vacuum pump jet assemblies that were tested for breakdown on various pump fluids. The pump operating on Dow Corning fluids still had not broken down after 100 cycles, with exposure to air between cycles!



A Varnish With Greater Heat-Resistance

Dow Corning 997 Varnish permits operation at temperatures up to 250 C . . . gives electronic and electrical equipment protection against overloads, moisture, many chemicals, corrosive atmospheres and other hazards.

The unit pictured is a servo motor that actuates controls in aircraft automatic pilots. Insulated throughout with high temperature materials, and dipped in 997 Varnish, such motors have proven much more reliable operation in United Airlines planes . . . running as long as 5 years without need for replacement, as against scheduled replacement after 1000 hours for Class A insulated motors.

CIRCLE 802 ON READER-SERVICE CARD



CIRCLE 803 ON READER-SERVICE CARD



First official photo transmitted from Hawaii to the continental U.S. by the Navy's moon-relay system shows effects of attenuation caused by 480,000-mi signal path.

Transmitter power is 100 kw conventional transmission, or 70 kw with frequency diversity. Each transmitter and receiver site uses an equatorially mounted, high gain, fully steerable dish-type antenna 84 ft in diameter.

Is a 1-in-10,000 Error Rate Enough?

The Navy calculates that its moon relay teletype system has an error rate of 1 in 10,000. But when the following moon-relayed message, sent by ELECTRONIC DESIGN's Washington correspondent, was received during a demonstration of the system, the Navy may have had second thoughts:

ELECTRONIC DESIGN MAGAZINE GETS ALL THE MATERIAL ENGINEERS WANT TO READ EVEN IF IT HAS TO GO TO THE MOON FOR IT!

However, it turned out that the system was blameless. Our correspondent is "not very good at operating a teletype."

Atmospheric Ducts May Carry Wideband Signals Over Oceans

"A transoceanic atmospheric duct capable of trapping and propagating radio waves at low loss" has been discovered by Navy and Air Force researchers. The duct, which was discovered during a study of world-wide atmospheric data, runs from Brazil to Africa.

The military researchers hope that investigation of atmospheric ducts might lead to extended-distance vhf and uhf communication, including duct-carried television.

In tests conducted by the Naval Research Laboratory and the Air Force Cambridge Research Center, 220-mc signals were sent from Brazil toward Africa over a distance of more than 1,400 mi with only 100 w of transmitter power.

Similar ducts are known to exist between California and Hawaii, Cape Verde (Africa) and Puerto Rico, and the Philippines and Australia.

INCORPORATION MIDLAND, MICHIGAN

branches: ATLANTA BOSTON CHICAGO CLEVELAND DALLAS LOS ANGELES NEW YORK WASHINGTON, D.C.

The beauty
of this Capacitor
is more than
skin deep!

**ACTUAL SIZE TYPE A
CAPACITORS**

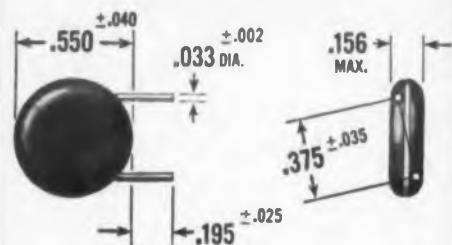

Allen-Bradley Type A capacitors are available in the most frequently used types and capacitance values.

General Purpose Type in capacitance values from 10 mmf to .01 mmf.

Stable Type in capacitance values from 10 mmf to 0.1 mmf.

Temperature Compensating Type in characteristics from N4700 to P100, and in capacitance values from 10 mmf to 510 mmf.

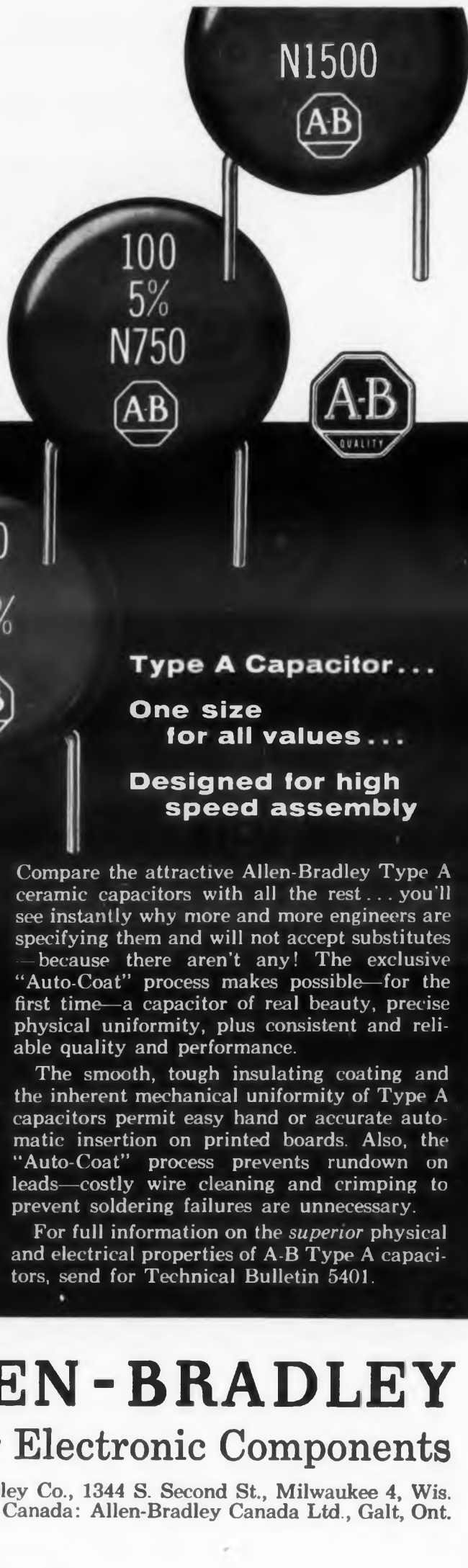

Type A Capacitor...

**One size
for all values...**

**Designed for high
speed assembly**

Compare the attractive Allen-Bradley Type A ceramic capacitors with all the rest... you'll see instantly why more and more engineers are specifying them and will not accept substitutes—because there aren't any! The exclusive "Auto-Coat" process makes possible—for the first time—a capacitor of real beauty, precise physical uniformity, plus consistent and reliable quality and performance.

The smooth, tough insulating coating and the inherent mechanical uniformity of Type A capacitors permit easy hand or accurate automatic insertion on printed boards. Also, the "Auto-Coat" process prevents rundown on leads—costly wire cleaning and crimping to prevent soldering failures are unnecessary.

For full information on the superior physical and electrical properties of A-B Type A capacitors, send for Technical Bulletin 5401.

ALLEN-BRADLEY
Quality Electronic Components

Allen-Bradley Co., 1344 S. Second St., Milwaukee 4, Wis.
In Canada: Allen-Bradley Canada Ltd., Galt, Ont.

NEWS

**Data Processing Specialists
Form International Group**

A permanent international forum for computer experts is now a reality for the first time. It is the International Federation of Information Processing Societies, newly formed with ratification of its statutes by technical groups in eleven nations.

The federation stems from the first International Conference on Information Processing, sponsored by UNESCO in Paris last June. As a result of the conference, a provisional bureau for the federation was established, with Isaac L. Auerbach, president of Auerbach Electronics Corp., Narberth, Pa., as chairman. Mr. Auerbach represents the National Joint Computer Committee of the U. S. Also named to the provisional committee were Prof. A. A. Dorodnicyn, USSR, and A. Van Wijnngaarden, the Netherlands, vice chairmen, and J. A. Mussard, UNESCO, secretary.

The federation statutes have been ratified by societies in Canada, Denmark, Finland, France, Germany, the Netherlands, Spain, Sweden, Switzerland, the United Kingdom, and the United States. In addition, Belgium, Israel, and Japan are forming national computer societies to qualify for membership.

The first meeting of the federation council is expected to plan for a second International Conference on Information Processing in 1963.

NBS Develops Unusual Ceramic

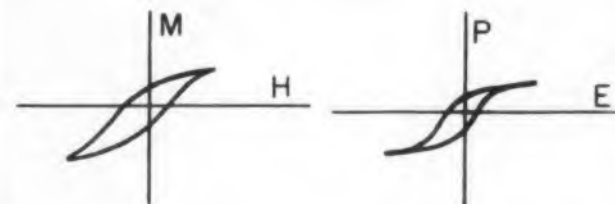

FERRIMAGNETIC HYSTERSIS LOOP OF BARIUM NIOBATE FERROELECTRIC HYSTERSIS LOOP OF BARIUM NIOBATE

A ceramic with both ferroelectric and ferrimagnetic properties has been developed by the National Bureau of Standards. The new material is a composition of the rare earths neodymium, samarium, europium, or gadolinium in one part of its structure, and varying amounts of iron in remaining parts. Since ferroelectricity and ferrimagnetism appear to be mutually dependent, the ceramic should have application in new electronic components where a coupling between dielectric and magnetic circuits is wanted or where a magnetic material having a high dielectric constant is desired, NBS reports. All ceramics developed for the program have shown both ferroelectric and ferrimagnetic properties in a single-phase crystalline form.

Curve of GaAs Tunnel Diode Shows Swing of 1.1v



Germanium Silicon Gallium arsenide

Curve of gallium-arsenide tunnel-diode shows much wider voltage swing than do curves of germanium and silicon tunnel diodes. GE reports the GaAs curve was made by a diode with a peak-to-valley current ratio of over 35:1. Shown on the scope is a voltage swing of 1.1 v—the horizontal scale is marked in 0.1-v increments, the vertical scale, in 5-ma jumps. GE has had gallium-arsenide tunnel-diodes working at 4400 mc and expects that for frequency the GaAs diode is "as good as germanium tunnel-diodes," which have been measured at 10,000-mc, "and may be better than germanium." The company expects to have samples ready for designers in about six months.

A fluff in *ELECTRONIC DESIGN*, Feb. 3 resulted in the odd statement that appears on p 7. The caption under the bottom illustration should read, "You can even join . . ."

NEWS BRIEFS . . .

. . . **THE NAVY'S EARLY WARNING**, over-the-horizon radar system, Madre, now being built near Chesapeake Beach, Md., will operate in the high-frequency band, between 3 and 30 mc. With average and peak power of only 100 and 5000 kw, and advanced correlation circuitry, the novel radar is expected to detect targets as far away as 2600 mi.

. . . **LIEMC**, a regional organization of the Long Island Electronic Manufacturers Council, has been formed to promote the electronics industry of that area of New York. Announced goal of the organization is a 100 per cent rise in the area's electronic sales in the next five years—from \$750 million last year to \$1.5 billion.

. . . **"THE CHEMISTRY** of aging in humans is related somewhat to the chemistry of aging in certain plastics," Johan Bjorksten, a plastics expert, told the Society of Plastics Engineers' 16th annual technical meeting. Mr. Bjorksten feels that polymer chemists may one day stumble upon the secret of the aging process.

PUTTING MAGNETICS TO WORK

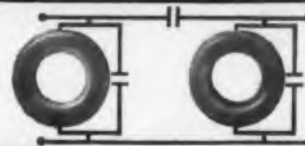

Smaller filters ease the squeeze!

Filter designers! First 160-mu moly-permalloy powder cores pack high performance into smaller space

Filter and inductor designers specify our 160-mu moly-permalloy powder cores for low frequency applications. Where space is precious, such as in carrier equipment and telemetering filters, the high permeability of these 160-mu cores eases the squeeze.

In many cases, 160-mu cores offer designers the choice of a smaller core. In others, because inductance is 28 per cent higher than that of 125-mu cores, at least 10 percent fewer turns are needed to yield a given inductance.

If Q is the major factor, 160-mu cores permit the use of heavier wire with a resultant decrease in d-c resistance.

Like all of our moly-permalloy powder cores, the 160's come with a *guaranteed* inductance. We can ship eight sizes from stock, with a choice of three finishes—standard enamel, guaranteed 1,000-volt breakdown finish, or high temperature finish. Further information awaits your inquiry. *Magnetics Inc., Dept. ED-78, Butler, Pa.*

MAGNETICS inc.

CIRCLE 21 ON READER-SERVICE CARD



Another Tinnerman Original...

Self-retaining "U" and "J" SPEED NUTS® cut assembly costs up to 50% or more!

If you are worried about rising assembly costs, let one-piece "U" and "J" SPEED NUTS keep costs down... and improve your product.

They can't fall off, once they've been pressed into screw-receiving position. No welding, staking or other secondary fastening devices needed. You eliminate lock washers—spring steel SPEED NUTS are self-locking, make vibration-proof attachments.

SPEED NUTS are ideal for blind assembly or hard-to-reach locations. Apply them *before* you paint panels without danger of paint-clogging. Or *after* porcelainizing, without damage to finishes. The "U" type is similar to the "J" type, shown above, but is used where full bearing surface on the lower leg is required.

A free Fastening Analysis can tell where SPEED NUT brand fasteners belong on your

products. Call your Tinnerman representative—he's listed in most major telephone directories. Or write to:

TINNERMAN PRODUCTS, INC.
Dept. 12 • P. O. Box 6688 • Cleveland 1, Ohio



NEWS BRIEFS

... **GERMANIUM TUNNEL DIODES** are in factory production on a pilot line at General Electric's Syracuse, N.Y., semiconductor plant. Type ZJ56, with a minimum peak-to-valley current ratio of 8:1, will sell for \$12.50 each; type ZJ56A, with a minimum ratio of 5:1 will sell for \$10 each. Production will increase with demand, reports GE.

... **CITED BY** Eta Kappa Nu as 1959's outstanding electrical engineer was Dr. E. A. Sack Jr. of Westinghouse. He received the citation for "his notable contributions to solid-state-device research and development, particularly in the field of electroluminescence, and his exceptional leadership in the civic and social life of his community."

... **THE PLASTIC TRANSISTOR** reportedly announced by the Soviet, which may be only a polyacrylonitrile that exhibits semiconduction, has led to disclosure here that many companies, both electronic and chemical, are investigating plastic semiconductor devices. The idea is to change the characteristics of a polymer by heating it, as the Soviet has done, or by radiation bombardment, to obtain p and n-type material. Researchers here report little progress and not much hope for plastic transistors competitive with conventional types.

CHANGES IN PRICES AND AVAILABILITY

... **SILICON DIODES** in the 1N690-1N693 series have been reduced in price by up to 37 per cent. Price for the 1N690 in 100-999 quantities has been reduced from \$4.45 to \$3.05. Other price reductions range from 32 to 37 per cent.

... **TANTALUM POWDER** has been reduced in price to \$30 per lb by Fansteel Metallurgical Corp. Large reductions have also been made in tantalum-oxide and tantalum-carbide prices.

... **TANTALUM CAPACITORS** have been reduced 5 to 10 per cent in price by Mallory Capacitor Co., partly as a result of recent price cuts in tantalum powder.

... **METAL-CLAD** solid-electrolyte tantalum capacitors have been reduced in price by 5 to 10 per cent by Sprague Electric Co. The price of ± 20 -per-cent-tolerance, Type 150D sintered-anode capacitors, Case size A has been reduced from \$0.86 to \$0.77 each.

Is your company making changes in prices or availability of its products? Send the details to **ELECTRONIC DESIGN**, 830 Third Ave., New York 22, N.Y.

No Change In TV Color Signal Urged By Group Studying Land Color Work

An EIA subcommittee studying the binary color theory advanced by Dr. E. H. Land, of Polaroid Corp., has recommended that the Federal Communications Commission color television signal be left unchanged "at this time." The group also urged that "Dr. Land and others be encouraged" to continue their basic studies.

The subcommittee reports that "since the FCC color television signal carries simultaneously the information for three-color reproduction and for the methods outlined by Dr. Land, and since it does not result in a large increase in the cost of receivers, it permits continued investigation of Dr. Land's method without deterioration of pictures reproduced by receivers making full use of the information present in the signal."

The group reports also that the methods outlined by Dr. Land, who contended that two colors would suffice to give an impression of full color, might result in a receiver based on the present FCC color television signal but using simpler display based on Dr. Land's techniques. The group believes that a transmitter designed exclusively for color pictures by Dr. Land's methods would be simpler than one built for the present FCC signal.

"However, the subcommittee states, "such a transmitter would be unable to transmit pictures having as faithful a color rendition as is possible by the present state of the art."

X-Band Waveguide Has Low Loss



A new waveguide with only 10 db attenuation per 1000 feet provides transmission of X-band energy over long distances reports the Airtron division of Litton Industries. The system is composed of three-inch copper tubing, flexible rubber-covered tubing and mode absorbers. A special transition converts rf energy from the standard rectangular waveguide to the TE₀₁ mode in the circular waveguides and reconverts the wave at the terminal.

◀ CIRCLE 22 ON READER-SERVICE CARD

ELECTRONIC DESIGN • February 17, 1960

NEW Ruggedized, STS- Grid Modulated 125 TWT



provides 2% duty cycle operation

This new pulsed traveling wave tube amplifier—the Sperry STS-125—offers 2% duty cycle operation for greater reliability in a broad variety of applications. An ideal driver for high duty cycle radars and for missile guidance radar, it has been subjected to severe environmental tests—including 4 G's of vibration and 15 G's of shock—with negligible performance variation. Its wide range of operating temperatures (−55°C to 90°C) suits it to storage and service in any climate.

The STS-125 also features grid modulation (2½% of beam voltage), dielectric liquid cooling, and unusually rugged metal ceramic construction. Operation is over a broad band (2:1 frequency bandwidth) at a minimum rated output power of 1 kilowatt.

Write for complete information and specific application data.

SPECIFICATIONS

Frequency Range	2.0-4.0 kmc
Rated Output Power	1 kw min
Input Power at Rated Output Power	½ w max
Small-Signal Gain	40 db nom
Gain at Rated Output Power	33 db min
Beam Power:	
Peak	25 kw
Average	500 w
Grid Voltage	300 with respect to cathode
Heater Current	3.2 a
Heater Voltage	6.3 vac
Pulse Length	10 u sec
Duty Cycle02
Cold Insertion Loss60 db min

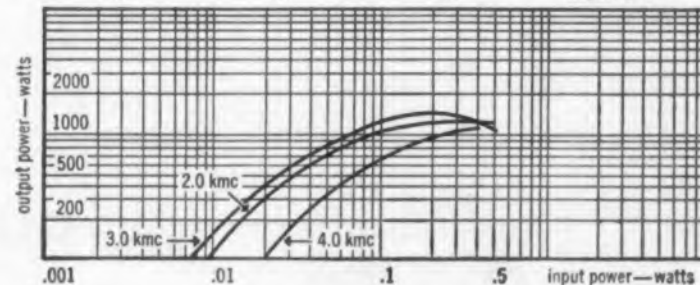
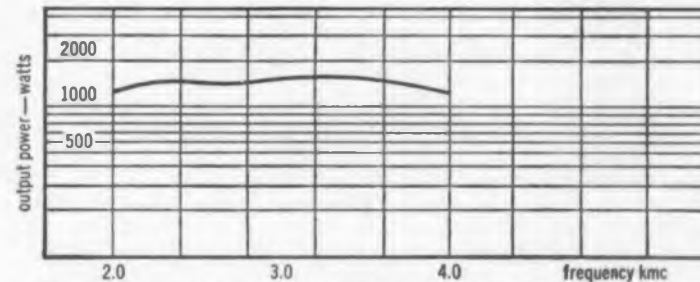
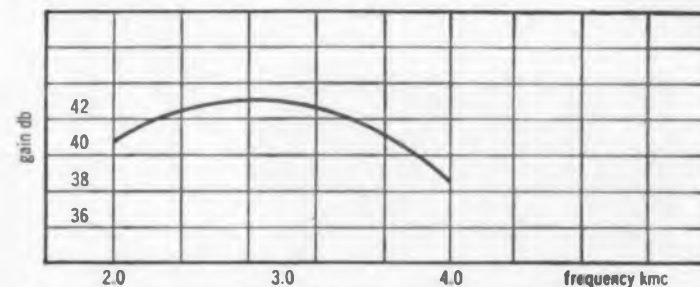

SPERRY

ELECTRONIC TUBE DIVISION, SPERRY GYROSCOPE COMPANY, GREAT NECK, NEW YORK, DIVISION OF SPERRY RAND CORPORATION
Address inquiries to Great Neck or Sperry offices in Brooklyn, Boston, Chicago, Philadelphia, Los Angeles and Montreal. Export Dept., Great Neck, N.Y.

◀ CIRCLE 23 ON READER-SERVICE CARD

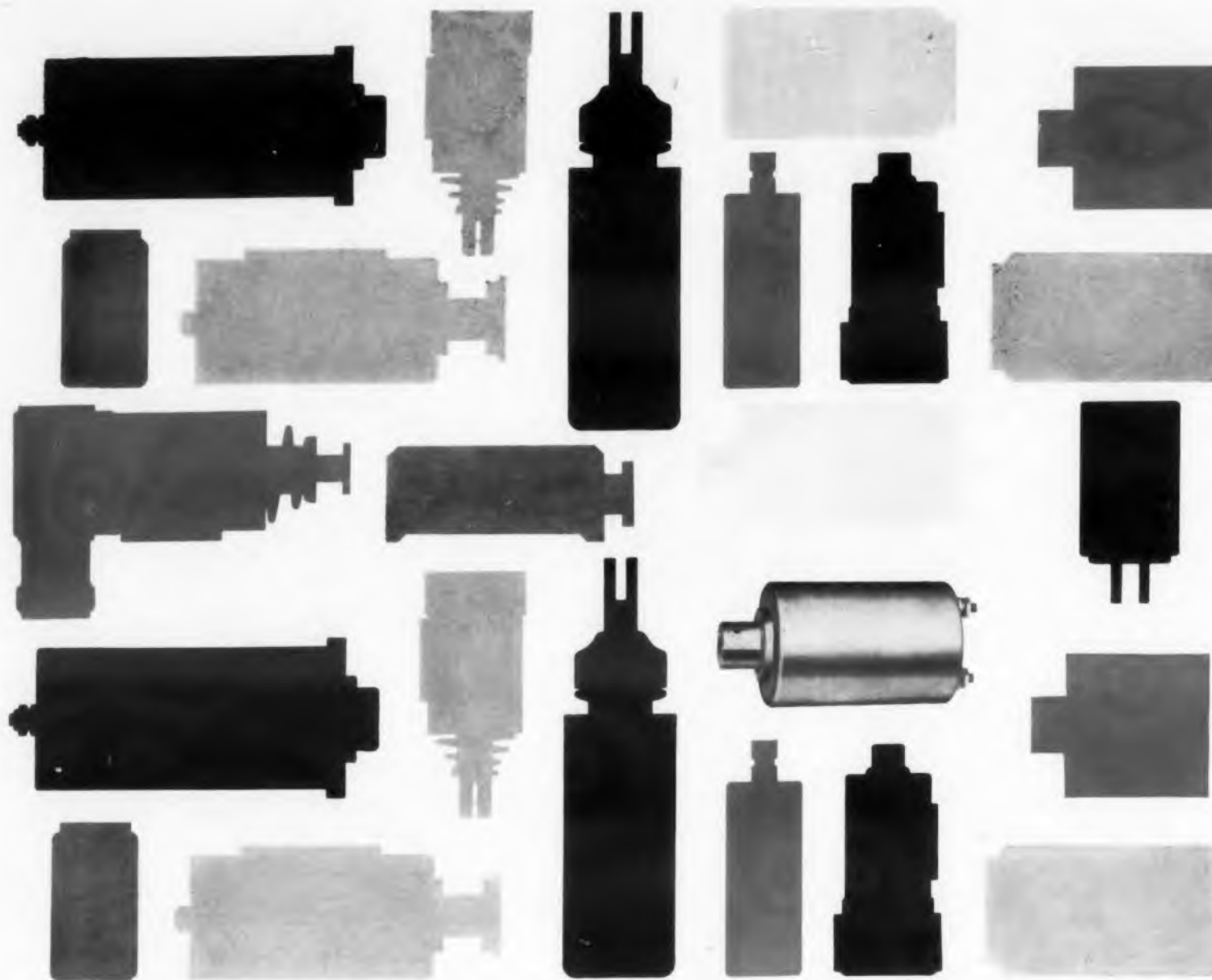

LET CANNON HELP YOU WITH YOUR DC SOLENOID PROBLEMS



Cannon has prepared a new engineering catalog containing valuable information about dc solenoids. Theory, principles of operation, and advantages of dc solenoids are presented simply and authoritatively. Write for your free copy to:

Cannon is one of America's largest producers of dc solenoids...a pioneer in engineering a wide range of special types, including hermetically sealed and high-temperature models. Multiple-strip solenoids for keyboard operation—locking types requiring no holding current—and miniature and sub-miniatures as small as 1/2 inch in diameter are now in standard production. If you have a problem involving dc solenoids, Cannon offers a complete selection...for any application.



CANNON ELECTRIC CO. 3208 HUMBOLDT STREET, LOS ANGELES 31, CALIFORNIA • PLEASE REFER TO DEPT. 438
CIRCLE 24 ON READER-SERVICE CARD

NEWS

Passive Communication Satellite Will be Launched by NASA

The National Aeronautical and Space Agency plans to orbit this spring the first of three 100-foot reflecting spheres for communications experiments. The objective: "to test the feasibility of a passive-reflector communication system on a global basis."

The launching and experiments have been dubbed Project Echo. Radio messages are to be relayed between Europe and the East Coast of the United States and between Hawaii and the West Coast by bouncing them off the orbiting sphere.

The sphere will be a Mylar balloon 0.0005 of an inch thick, coated with vapor-deposited aluminum to provide radio-wave reflectivity of at least 98 per cent up to frequencies of 4000 megacycles. Weighing about 150 pounds, the payload package will be carried deflated into a 900-mile-high, 120-minute orbit by a three-stage Delta launch vehicle.

When orbiting altitude is reached, the balloon will be exploded from its container and will start expanding under pressure from residual air. Pressure to complete expansion will be provided by

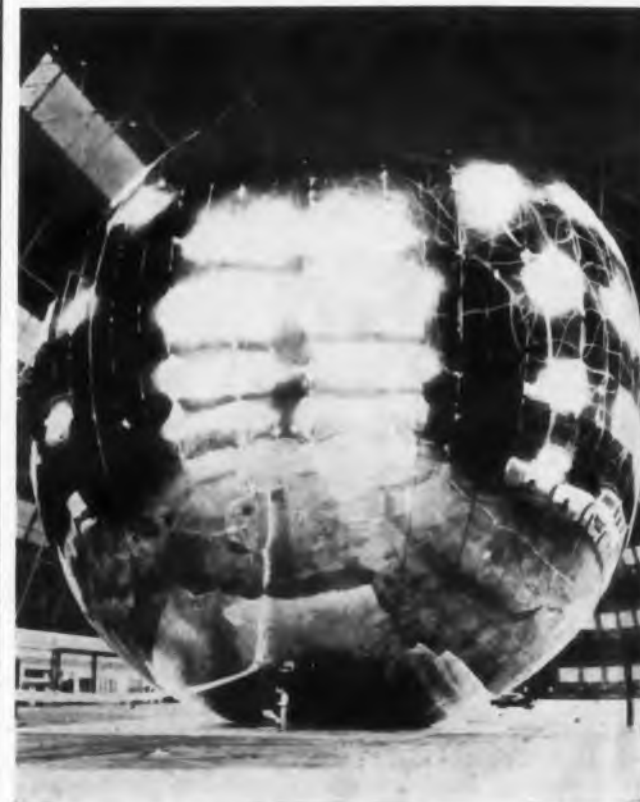

Balloon satellite for NASA's Project Echo is 100-foot in diameter and 0.0005 in. thick. The sphere is made of Mylar plastic and coated with vapor-deposited aluminum to provide very high reflectivity at frequencies up to 4000 megacycles.

water in the balloon; this water will turn to vapor when heated by the sun.

Receiver and transmission stations are now being prepared by Jet Propulsion Lab at its Goldstone Tracking Station in California and Bell Labs at Holmdel, N.J.

The Goldstone station, using an 85-foot-diameter dish moving in azimuth and elevation, will transmit on 2390 megacycles. The receiving antenna operating at 960 megacycles, will also employ an 85-foot dish.

Bell Labs will transmit a 960-megacycle signal from a 60-foot azimuth-elevation mounted paraboloid. At Holmdel, a special horn reflector, equivalent to a 28-foot paraboloid in terms of gain, will receive at 2390 megacycles.

Assuming an average transmitter power of 10 kilowatts at both facilities, NASA scientists calculate that the received signal level at 960 megacycles will range between -112 and -124 dbm at distances of 1500 to 3000 miles from the satellite.

Core Arrays Form Sturdy Memory Stack



This new magnetic memory stack, an assembly of core arrays, is designed for ruggedness. The MIL STAK units are unaffected by acceleration to 10 g and vibration to 200 cps, according to Telemeter Magnetics, Inc. The cores are wired on a molded plastic frame to form an array. After stacking, the wired arrays are interconnected by a locked-link method and encapsulated in polyurethane.



RHEEM / SILICON MESA TRANSISTORS

2N696 - 2N697

Utmost versatility, maximum reliability,
25 millimicrosecond switching, 5 ohm
saturation resistance, 2 watt dissipation

PRODUCTION QUANTITIES FROM STOCK



RHEEM SEMICONDUCTOR CORPORATION

A SUBSIDIARY OF RHEEM MANUFACTURING COMPANY
Dept. A1, P. O. Box 1327, Mountain View, California • YORKSHIRE 8-8391
Eastern Regional Office: 610 E. Palisade Ave., Englewood, N. J. • LOWELL 7-4336

6267

CIRCLE 25 ON READER-SERVICE CARD



MEASURE TIME; 0.1 μ sec ACCURACY!

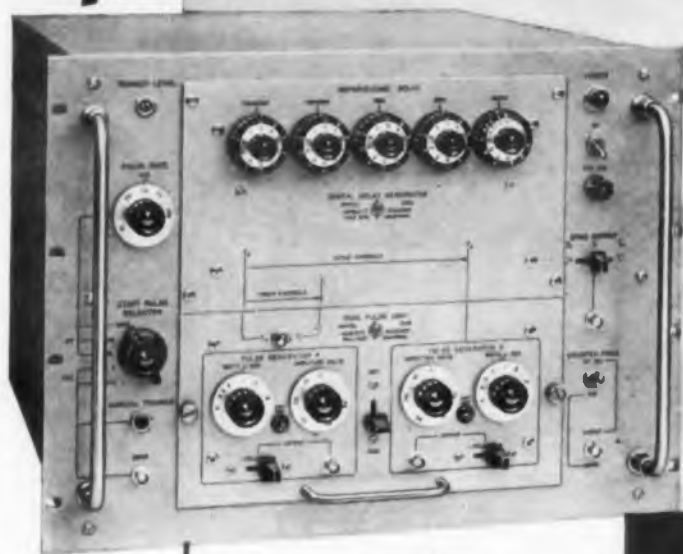

hp 218AR Digital Delay Generator produces crystal controlled pulses accurately spaced in time. It is a perfect slave to any pulse, even though random, and locks in constant phase during each counting period.



219A



219B



219C

Time measurement and pulse simulation in radar, loran, Tacan, DME, oscilloscopes, computers, fast gates, pulse code systems—almost any kind of time measurement single- or double-pulse simulation is now yours quickly and accurately with \odot 218AR Digital Delay Generator.

Built along strict military standards, \odot 218AR uses a pulsed crystal oscillator synchronizable in constant phase with an initial trigger pulse (zero time) and two positionable terminating pulses. Time is counted with a 1 Megacycle pre-

set counter, and two independent output pulses are available in any relationship.

PULSE GENERATOR PLUG-INS

For utmost versatility, output pulses are generated in various arrangements by three plug-in pulse generators. These include \odot 219A, supplying two positive pulses, \odot 219B providing two pulses, each positive or negative and variable in amplitude, \odot 219C, providing a high power pulse, positive or negative, digitally controlled as to delay and duration, variable in amplitude.

Condensed Specifications

(Basic 218AR Generator; plug-ins essential)

Time Interval Range:	1 to 10,000 μ sec	Recovery Time:	50 μ sec or 10% of interval, whichever is greater
Accuracy:	$\pm 0.1 \mu$ sec $\pm 0.001\%$	Sync Output:	50 v pos. pulse, 0.1 μ sec rise time
Digital Adjustment:	1 μ sec steps, full range	1 MC Output:	1 v pulses, 500 ohm impedance
Interpolation:	Variable 0 to 1 μ sec	Price:	-hp- 218A, \$2,000.00
Input Trigger:	Internal 10 cps to 10 KC; External 0 to 10 kc pulses, also sine wave		-hp- 219A Dual Trigger Unit, \$100.00
Jitter:	0.02 μ sec or less		-hp- 219B Dual Pulse Unit, \$450.00
	Data subject to change without notice. Prices f.o.b. factory		-hp- 219C Digital Pulse Duration Unit, \$350.00

HEWLETT-PACKARD COMPANY

1010K Page Mill Road • Palo Alto, California, U.S.A.

Cable "HEWPACK" • DAvenport 5-4451

Field representatives in all principal areas



World leader in precision electronic counting

CIRCLE 26 ON READER-SERVICE CARD

NEWS

Surface Passivation Process Boosts Microdiode Reliability

One reason for the order-of-magnitude improvement in the reliability of Pacific Semiconductor's microdiode (*ED*, Nov. 11, 1959, p 74) is the "chemical surface passivation" technique used in its production, the company reports.

In this process the silicon of the semiconductor is used to form an inert, stable molecular film over the surface of the diode. The device is hermetically sealed and is barely larger than the semiconductor crystal itself—about one-fortieth as large as the conventional computer diode.

According to Pacific Semiconductor's engineering manager, Elmo Maiden, conventional methods of constructing diodes require bottling the semiconductor in a glass jar and sealing the ends of the jar around the leads. This invites substantial production difficulties, he said, centered on parts tolerances, sealing temperature and glass-to-metal bonds. The company's approach is to sandwich a small diffused silicon die between two gold-plated ribbons.

The die-to-lead attachment is a silicon-to-gold eutectic bond, having a melting point at 370 C and made without flux. Both nickel and Kovar have been used as base leadwire materials. Generally Kovar is favored, because it matches the thermal expansivity of silicon. Gold plating the surface of the Kovar reportedly gives good corrosion resistance and power dissipation.

Power dissipation of the diode itself is helped by the relatively large area of ribbon-to-die contact on both sides of the pn junction.

In packaging, the silicon is passivated. Subsequent treatments molecular-bond semi-organic films to the surface matrix. There is no definite interface between the silicon crystal and its cover-



LEADS AND SILICON CRYSTAL

BARE ASSEMBLY

FINISHED MICRO-DIODE

Sandwich construction of Pacific Semiconductor's microdiode, said to eliminate bottling and to avoid production problems of parts tolerances, sealing temperature and glass-to-metal bonds, with resultant high reliability.

ing. Pacific Semiconductor says the entire process is controllable.

By limiting the package surface area and the number of packaging materials exposed to the device, the potential for foreign particle exchange between the silicon element and its housing environment is restricted. Thermodynamic changes are sharply restricted, too, says Mr. Maiden, since the chemical bonds tie up the surface-energy states. One source of degradation in conventional diodes is caused by mobile particles and thermodynamic changes on the surface of the diode, particularly under operating load, thermal shock or high-temperature storage.

Electrically, microdiodes are reported to perform as well as other computer diodes. But failure rates are said to be only 0.19×10^{-4} units per hour at 150-C storage, where failure is a one-time change in reverse leakage current. Power handling is reported exceptionally good. When the leads are soldered in a good heat sink close to the body, Mr. Maiden says, as much as 500 milliwatts can be dissipated. A normal rating for the microdiodes would be 250 milliwatts.

Any other silicon microminiature device, such as a transistor, could be made with the same process. The use of other materials would require a study of inert films incorporating molecules of the material to be covered.

Thin Negatives Transfer Circuitry



Negatives of thin, translucent paper stock are being used at Librascope to transfer circuitry patterns onto copper-clad glass epoxy-laminated boards. The company developed the process to reduce alignment and damage problems and to insure dimensional stability of the negative.

AMP taper technique points the way to greater reliability

Magnetic Amplifiers, Inc. of New York carefully manufactures its Static Inverters with a step-by-step quality control and testing program to build in the reliability required for aircraft and missile applications.

It found that AMP Taper Technique simplified this procedure. A high speed AMP Automachine pre-terminates circuit leads with crimp-type, pre-insulated solid Taper Pins. Components are then easily tested in the modular stage before final assembly. Crimping eliminates difficult soldering operations and the danger of burning wound components while Taper Technique permits checking and trouble shooting without destroying the main cable. After final assembly, when the Pins are inserted into the Blocks, this Technique provides rugged vibration resistance and operational reliability.

AMP solderless Taper Pins are made in formed and solid types, with or without pre-insulation and mate with a wide range of one or two piece stackable Taper Blocks. You'll find that AMP Taper Technique is ideal for your quality control or circuit density problems too.

Write for our new Taper Technique brochure.



Magnetic Amplifiers' 250VA Static Inverter Model SIS-425041

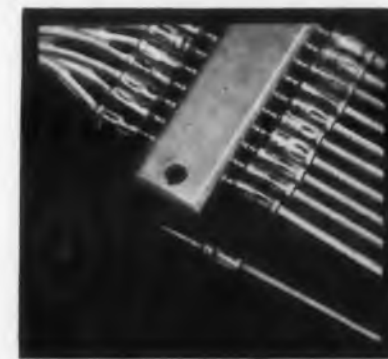

AMP Pre-Insulated Taper Pins and stackable Taper Blocks

AMP INCORPORATED

GENERAL OFFICES: HARRISBURG, PENNSYLVANIA

AMP products and engineering assistance are available through subsidiary companies in: Australia • Canada • England • France • Holland • Italy • Japan • West Germany
CIRCLE 27 ON READER-SERVICE CARD

NOW YOU CAN SPECIFY SPERRY FOR 2N327A 2N328A 2N329A 2N330A



SILICON PNP TRANSISTORS IN PRODUCTION QUANTITIES

Newly-added to the world's widest line of general-purpose PNP silicon transistors, these popular types are available immediately for your audio, switching and control applications.

More than an additional production source for these devices, you will find Sperry Semiconductor to be the source, with new standards of quality and reliability.

Like all other Sperry transistors, these units feature new low levels of I_{CO} and are baked at 200°C for 200 hours for utmost stability. For immediate delivery on the 2N327A series, contact the nearest Sperry sales office as listed below.

And don't forget these other recently-announced types for which you can now SPECIFY SPERRY:

2N1034	2N1219
2N1035	2N1220
2N1036	2N1221
2N1037	2N1222
2N1275	2N1223

SPERRY SEMICONDUCTOR DIVISION, SPERRY RAND CORPORATION, SOUTH NORWALK, CONNECTICUT
Call or write: Sperry Semiconductor, Wilson Avenue, SOUTH NORWALK, Conn., VOLunteer 8-1641; in NEW YORK PLaza 2-9885;
3555 W. Peterson Ave., CHICAGO 45, Ill., KEystone 9-1776; 2200 East Imperial Highway, EL SEGUNDO, Calif., OREGon 8-6226.

CIRCLE 28 ON READER-SERVICE CARD

NEWS

Tubeless Radars Predicted With Electroluminescence

"Within 10 years, electroluminescent radar displays will be available and so will displays for cockpit uses, image converters and displays in satellites. We'll be on the threshold of e-l TV, though it is unlikely such equipment will be much past the laboratory stages."

These prospects were outlined recently by Stephen Boyd, assistant chief engineer of the research group at Stromberg Carlson, San Diego, Calif., in an ELECTRONIC DESIGN interview.

Computer Savings Foreseen with E-L

One of the most interesting probabilities, Mr. Boyd suggested, was the construction of computers in which a large number of circuits would be e-l/photoconductor combinations. Logic circuits and control elements could then be built cheaply—15 or 20 cents for a flip-flop, a nickel for a photoconductor switch. No wiring would be needed between units—just a beam of light.

What's coming first? "By 1961 we could expect to see e-l devices with photoconductors applicable to bistable digital readouts," Mr. Boyd said. "The most likely use will be in missile and guidance equipment, but a possible use would be in digital voltmeters. A virtue of e-l readout is that the information is presented in a single plane."

Controlled-persistence displays will be available before the end of the year, Mr. Boyd reported. There is an off-possibility that displays fast enough for use on ppi scopes and radar systems will also be here, he added.

Right now small display devices—100 or 200-line resolution—are entirely feasible.

Light amplification units for tooling inspection should be available within the year, Mr. Boyd continued. Constant close inspection at low light intensities has been a serious occupational hazard for inspectors for years. Problems to be solved, however, include the graininess of present displays, Mr. Boyd noted.

Aerial photography was cited as another possibility for improvement through electroluminescence. It has been tried and in the past has not worked out very well; other techniques have so far proved more valuable. The main difficulty has been the lack of satisfactory photoconductors.

In the same general area are frequency converters to change ultraviolet and infrared radiation to visible light. The military possibilities of a direct-analog surveillance device that would allow the operator to see by ultraviolet, infrared or other frequencies make it likely that advances will be made in this direction, Mr. Boyd said.

Two Major Obstacles Outlined

But he noted two major areas of difficulty in achieving these improvements: the problem of switching controlled elements, and the present limited understanding of the basic materials. Not too much is known about the physics of electroluminescence. Advances in basic understanding, he suggested, will flow from present work in the field: from the development of adequate theoretical models and other theoretical work.

"We are now in the position of the copper-oxide rectifier of a few years ago," Mr. Boyd explained. "The Esaki diode is a shining example of what can happen if we have a good theoretical understanding of the device."

Production techniques must also improve, he said. Present element-by-element building of display surfaces cannot be competitive with other methods of display. But if elements could be formed on large areas by evaporation—a single crystal of cadmium sulfide over a large area, for example—a display better than anything available today could be built, he pointed out.

Switching looms as the biggest problem. The switching rates necessary for e-l TV are completely impracticable at present, Mr. Boyd asserted. Microminiaturization was cited as a help here. The amount of driving equipment necessary for switching will have to be reduced—which will take more fundamental work in the computer field. In this case, microminiaturization alone is not enough, Mr. Boyd said. Circuits have to be simpler; delay lines or ring counters might have to be used to switch elements on down the line.

Other problems to surmount involve reliability and life of the e-l panels. Brightness and efficiency must be increased.

Lighting to be First Big E-L Application

The big application of electroluminescence in the next few years will be as a lighting source, Mr. Boyd said—for homes, businesses, clock dials, radar consoles to facilitate maintenance and repair. Novel possibilities include the use of a twisted pair of phosphor-coated wires to direct traffic in theaters, signs of all kinds and do-it-yourself mosaic kits for light-giving murals.

Worldwide Cable Net to Link Entire British Commonwealth

The British are planning to link their entire Commonwealth with an undersea cable network capable of carrying slow-scan TV as well as telephony. First link is to be a Britain-to-Canada cable, scheduled for completion by 1961. The second tie, Canada to Australia, is due by 1964. Later will come links from Australia to Malaya, India, Pakistan and Ceylon. Those countries will be tied to Kenya, South Africa, and, finally, Britain.

ARNOLD: WIDEST SELECTION OF MO-PERMALLOY POWDER CORES FOR YOUR REQUIREMENTS

For greater design flexibility, Arnold leads the way in offering you a full range of Molybdenum Permalloy powder cores . . . 25 different sizes, from the smallest to the largest on the market, from 0.260" to 5.218" OD.

In addition to pioneering the development of the cheerio-size cores, Arnold is the exclusive producer of the largest 125 Mu core commercially available. A huge 2000-ton press is required for its manufacture, and insures its uniform physical and magnetic properties. This big core is also available in three other standard permeabilities: 60, 26 and 14 Mu.

A new high-permeability core of 147 Mu is available in most sizes.

These cores are specifically designed for low-frequency applications where the use of 125 Mu cores does not result in sufficient Q or inductance per turn. They are primarily intended for applications at frequencies below 2000 cps.

Most sizes of Arnold M-PP cores can be furnished with a controlled temperature coefficient of inductance in the range of 30 to 130° F. Many can be supplied temperature stabilized over the MIL-T-27 wide-range specification of -55 to +85°C . . . another special Arnold feature.

Graded cores are available upon special request. All popular sizes of Arnold M-PP cores are produced to a standard inductance tolerance of +

or -8%, and many of these sizes are available for immediate delivery from strategically located warehouses.

Let us supply *your* requirements for Mo-Permalloy powder cores (*Bulletin PC-104C*). Other Arnold products include the most extensive line of tape-wound cores, iron powder cores, permanent magnets and special magnetic materials in the industry. • Contact *The Arnold Engineering Co., Main Office and Plant, Marengo, Illinois.*

ADDRESS DEPT. ED-01

 **ARNOLD**
SPECIALISTS IN MAGNETIC MATERIALS

BRANCH OFFICES and REPRESENTATIVES IN PRINCIPAL CITIES • Find them FAST in the YELLOW PAGES

1187

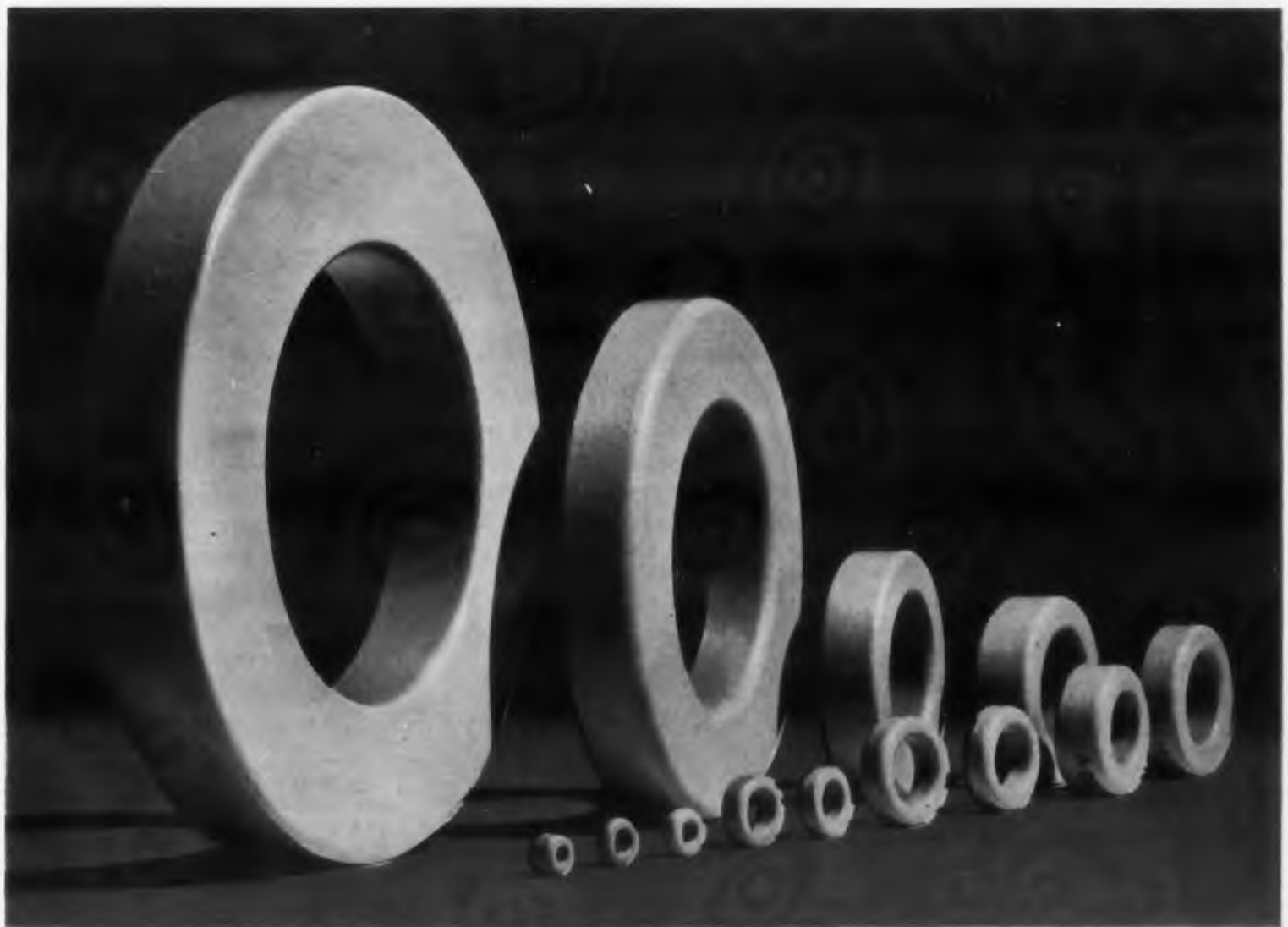

CIRCLE 29 ON READER-SERVICE CARD



EXTRA QUALITY AT NO EXTRA COST WITH BENDIX TRANSISTORS

Bendix Bulletin



Up-to-the-minute news about transistors

NEW DRIVER TRANSISTORS SWEEPING THE FIELD

Extra-versatile Bendix units beat high costs, design limitations over wide front

Called the "workhorse of the transistor industry," the new Bendix* Driver Transistor series is winning the nod from more and more engineers daily. These men find it the answer to audio frequency and switching applications requiring extra performance without extra cost.

Here is a special device for use where reliability, versatility, and low cost are primary requirements. The Bendix units combine higher voltage rating and high current gain with more linear current gain characteristics for low distortion and more efficient switching.

They're now in high production for rapid delivery in JEDEC TO-9 packages.

NEW BENDIX SEMICONDUCTOR CATALOG on our complete line of power transistors, power rectifiers, and driver transistors available on request. Write SEMICONDUCTOR PRODUCTS, BENDIX AVIATION CORPORATION, LONG BRANCH, N. J. For information about employment opportunities write personnel manager.

*TRADEMARK

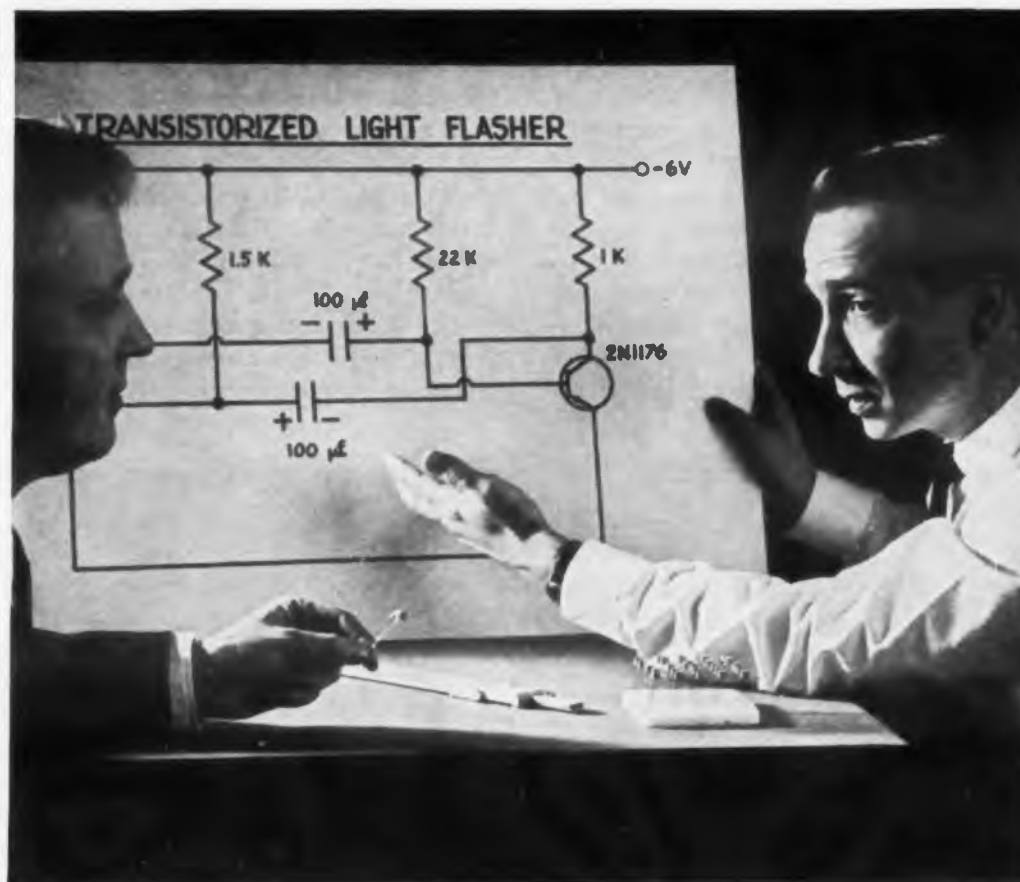

ENGINEERS KNOW the new Bendix Driver Transistor line-up meets an unusually wide range of circuitry applications. Bendix Applications Engineering Department suggestions on circuitry problems are helpful, too.

APPLICATION, PERFORMANCE DATA INDICATE BROAD USAGE

TYPE NUMBERS	MAXIMUM RATINGS					TYPICAL OPERATION		
	V _{ce}	I _c	P _c	T _j	T storage	h _{fe}	f _{αb}	V _{ce} (Sat)
	V _{dc}	mAdc	mW	°C	°C	I _c = 10 mAdc	I _c = 100 mAdc I _b = 10 mAdc	
2N1008	-20	300	400	85	-65 to +85	90	1.2 mc	0.15 Vdc
2N1008A	-40	300	400	85	-65 to +85	90	1.2 mc	0.15 Vdc
2N1008B	-60	300	400	85	-65 to +85	90	1.2 mc	0.15 Vdc
2N1176	-15	300	300	85	-65 to +85	65	1.2 mc	0.15 Vdc
2N1176A	-40	300	300	85	-65 to +85	65	1.2 mc	0.15 Vdc
2N1176B	-60	300	300	85	-65 to +85	65	1.2 mc	0.15 Vdc

Ideal for such applications as:

TRANSISTOR DRIVER • AUDIO AMPLIFIER (CLASS A OR B)
POWER SUPPLY • SERVO CONTROL • AUDIO OSCILLATOR
MOTOR CONTROL • RELAY DRIVER • POWER SWITCH

Visit us at the N.Y. IRE Show, Booth 2228
CIRCLE 30 ON READER-SERVICE CARD

SEMICONDUCTOR PRODUCTS Red Bank Division LONG BRANCH, N. J.



West Coast Sales Office:
117 E. Providencia Avenue, Burbank, California

Midwest Sales Office:
2N565 York Road, Elmhurst, Illinois

New England Sales Office:
4 Lloyd Road, Tewksbury, Massachusetts

Export Sales Office: Bendix International Division,
205 E. 42nd Street, New York 17, New York

Canadian Affiliate: Computing Devices of Canada, Ltd.,
P. O. Box 508, Ottawa 4, Ontario, Canada

NEWS

Two Signals Provided by Compact Real-Time Airborne Digital Timer

A newly developed airborne digital timing system said to be accurate to 1 part in 10⁷ provides both six-digit numerical clocks for visual reading and a video signal for audio and graphic recording. The unit was developed for data correlating. Its signal is a binary coded decimal (BCD), which furnishes real-time referencing.

The system may be started manually by inserting any chosen time, or automatically by synchronizing the time-generating process with U. S. time signal WWV or a suitable BCD transmission.

It automatically corrects for propagation delay time, insuring exact time relationship for correlation of data obtained simultaneously at any number of remote points. The unit, which can accommodate up to 20 remote clocks, weighs 78 pounds with one remote clock and one reader control.

The system, developed by Temco Overhaul & Aerosystems (Div. of Temco Aircraft Corp.), functions as its own decoder and readout device for previously recorded binary-coded video signals. It provides real-time display in decimal form to the nearest second with use of the remote reader control. Time referencing may be reduced below the one-second level with 0.1, 1, 10 and 100-millisecond markers. Temco engineers place

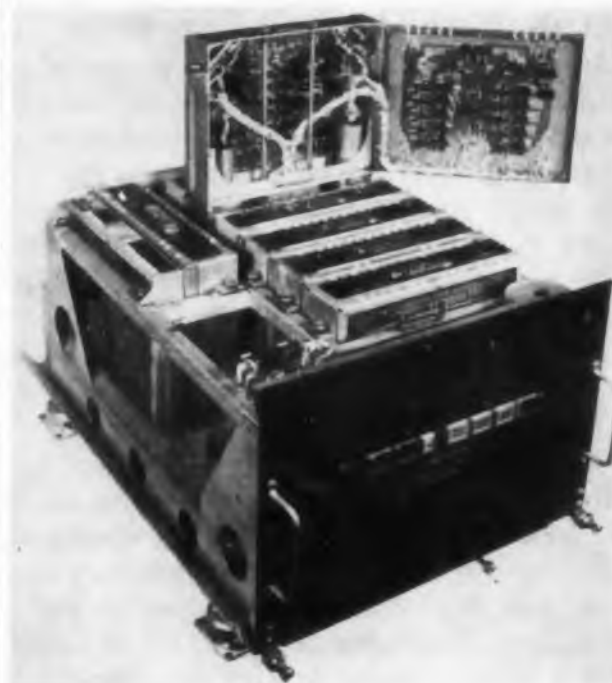

New airborne digital timing system provides visual six-digit numerical clocks as well as a video signal suitable for audio graphic recording.

system accuracy at one part in 10^7 and starting accuracy within two milliseconds of setting.

Five basic components make up the digital timing system: time-encoder, reader, remote clock, junction box, remote control and power supply.

FAA Expects 1000 VORTAC'S To Aid Air Navigation by 1965

The Federal Aviation Agency expects 1000 complete VORTAC facilities to be in operation as air navigation aids by 1965.

Last year the agency had 550 VOR's in operation and plans for 13 additional VOR's, 62 VORTAC's and about 150 VOR-to-VORTAC conversions.

Under its program to modernize air traffic control, the FAA is gradually introducing improved equipment and techniques. The agency is confident that the VORTAC system is superior for instrument flying and will have the immediate effect of expanding available air space and eliminating numerous points of traffic conflict.

The number of airport surveillance radars capable of detecting aircraft within a 50 to 60-mile radius at altitudes up to 25,000 ft will be increased by the FAA from the present 47 to 82 by the end of 1961. Both the long-range and the airport-surveillance radar systems will be equipped with radar-beacon capability.

The FAA had five long-range radars operating in 1958. It added eleven during early 1959 and had 24 more scheduled for later commissioning. These high-powered radars are capable of detecting aircraft up to a range of 200 miles and at 60,000 feet high.

The FAA hopes that three of its specially designed air-traffic, data-processing systems, now under development, can be established annually beginning in fiscal 1961.

These improvements and others lead the Electronics Industries Assn. to believe that the electronics portion of FAA's cumulative budget through 1970 will total more than \$1.6 billion, about 21 per cent of all cumulative spending.

The EIA forecast is predicated on an increase in FAA authorizations from the present yearly level of about \$530 million to \$700 million by 1970 and a rise in electronic spending from today's 15 per cent to 25 per cent by the end of the ten-year period.

The industry group also foresees at least a \$30-million sales potential for the electronics industry in equipment to be carried by nearly 110,000 non-military, non-commercial aircraft by 1970.

PERFORMANCE-PACKED $\frac{1}{2}$ " PRECISION POTENTIOMETERS

CLAROSTAT SERIES 57



UP TO 50K OHMS

Resistance range: 50 ohms to 50,000 ohms $\pm 5\%$. 1.5 watts @ 40°C.



COMPLETELY SEALED

Meets and exceeds military moisture and humidity requirements.

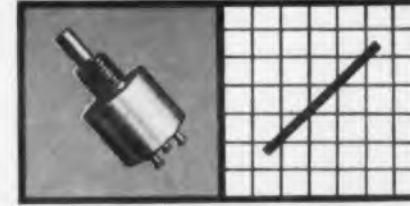

$\pm 2\%$ INDEPENDENT LINEARITY

$\pm 2\%$ deviation for actual angular displacements. Tops for $\frac{1}{2}$ " diameter potentiometers.



MINIMUM ELECTRICAL LEAKAGE

High dielectric materials employed throughout with nickel-silver body.

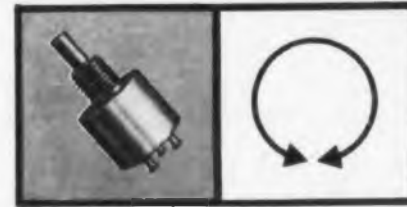

RESOLUTION

.08% resolution permits extreme accuracy in read-out and setting.



MECHANICAL/WELD TERMINATIONS

Windings terminated with tapered-pins and electronic weld. Terminals molded in place.

Write for complete details



CLAROSTAT MFG. CO., INC.

DOVER, NEW HAMPSHIRE

In Canada: CANADIAN MARCONI CO., LTD., Toronto 17, Ont.

direct
line
service

IMMEDIATE
DELIVERY!

Phone your local Clarostat Industrial Distributor for popular, standard Series 57 or military style RV-4 units... for fast delivery from local stock.

CIRCLE 31 ON READER-SERVICE CARD



NEW FROM CORNING

C-42 low-power, low-cost film-type resistor

What this Country needs is a good five-cent resistor—and here it is.

At the heart of the C-42 you'll find a glass core coated with a very thin film of metallic oxide. It's this construction that gives you the exceptional performance you've come to expect from metallic film-type resistors.

In every characteristic, this new C-

42 outperforms the requirements of MIL-R-11B; for example:

Load life stability (1000 hrs.): 5% max.—3% average

Humidity: 1% max. resistance change

Shelf life: 0.2% per year, maximum

Noise output: 0.1 microvolt per volt

Nominal length of the C-42 is $1\frac{1}{16}$ " \pm $\frac{1}{32}$ ". Power rating is 2 W at 70°C.

You can get the new C-42 in resistances from 200 ohms to 1.4 megohms.

These resistors are stocked by Erie Distributor Organization for immediate delivery in small quantities.

For data, write **Corning Glass Works**, 540 High Street, Bradford, Pa. Or contact our sales offices in New York, Chicago, or Los Angeles.



CORNING ELECTRONIC COMPONENTS

CIRCLE 32 ON READER-SERVICE CARD

WASHINGTON REPORT



Ephraim Kahn

... **ANTITRUST POLICY** is toughening at the Justice Department. Odds now favor adoption of a policy of fighting almost all merger cases through the courts instead of seeking a mutually agreeable compromise with the companies concerned. The Antitrust Division feels hampered by the belief of some courts that they, as well as the Justice Department, can arrange compromise settlements in antitrust cases. If the Supreme Court holds that the Justice Department has this discretion but that lower courts do not, the Justice Department will probably reverse its present tendency to refrain from consent settlements in antimerger cases. The Federal Trade Commission, another antitrust arm of the Government, apparently will not go along with any move to abandon consent agreements in merger cases.

... **PATENT PRACTICES** of a Federal agency have again been scored by a Congressional group. This is part of a drive, gaining steam among the lawmakers, to put tighter controls on the fruits of research paid for by the Government. In this case, exception is taken by the Senate patents subcommittee to an action by the Dept. of Health, Education and Welfare. It is accused of "virtually abandoning an established policy of patent dedication to the public." Instead, private companies are reported to have kept title to patents developed under research programs paid for by the Government, "subject to complex and untried provisions for compulsory licensing." Chairman Joseph C. O'Mahoney (D., Wyo.) of the Senate subcommittee asserts that Congress, not Government officials, should set standards for protecting the public interest in licensing.

... **ELECTRONICS SHARE** in the fiscal 1961 budget has been clarified a little, but not much, by the Defense Department. "Independent" electronics and communications devices are scheduled for about \$1.1 billion, up almost \$200 million. To this must be added the large amounts that will go for electronics incorporated in weapons systems and spending for R&D. Total spending for military electronics in the 1961 fiscal year could reach \$5.5 billion, about 20 per cent greater than the 1960 figure.

... TOP R&D projects will receive a special push from the Army. It has set up a super-priority program to help engineers and scientists crack the tough problems that won't yield to routine development. The new procedure will be invoked only for major items "necessary to the security" of the U.S. Note, too, that the Army also will give vigorous support to applied research "to facilitate the application of new basic knowledge to development programs, and to allow prompt, critical analysis of what it is possible to create with the knowledge available."

... INDUSTRIAL DISPERSAL program, designed to reduce plant vulnerability to enemy attack, has virtually gone by the board. Though Government buyers consider dispersion as one factor in placing contracts, its effect is marginal. Officials attribute this to such other factors as price and to "the fact that procurement is concerned primarily with capacities in place rather than new construction."

... DESIGNERS' ROLES in the development of weapons systems assume even greater importance as the military places greater stress upon cutting lead-times. Lt. Gen. Bernard Schriever, commander of the Air Research and Development Command, says it would be "costly in time and lead to early obsolescence should we follow a policy of not initiating a weapon-system development program until all subsystems of which it consists are fully developed and on the shelf."

... "THE GOVERNMENT is robbing our country of its full technological potential in the space race, because of its current attitude on patents and proprietary rights," Robert R. Lent, chairman of the Patent and Proprietary Rights Committee of the Strategic Industries Assn., told a press conference. He added that the Atomic Energy Act and the National Aeronautics and Space Act were "denying to individual citizens the fruits of their creative endeavors." The association holds that inventors have a constitutional right to the rewards of their inventions regardless of the sponsorship of detailed development. In the same vein, the Aerospace Industries Assn. told a House of Representatives subcommittee that the patent provisions of the space law were denying the National Aeronautics and Space Administration the freedom to promote U.S. space technology efficiently. "The law removes any incentive for a contractor to make inventions," an association spokesman said.

Resolution up to 800 lines per diameter possible with new HUGHES flat-face TONOTRON® Tubes!

These newest products of HUGHES are especially designed to give you dramatically improved resolution in applications such as: shipborne and ground based radar, sonar, air traffic control, instrumentation, industrial TV, and many others.

HUGHES flat-face storage tubes, now available in quantity, enable you to increase display capability by a factor of 4. Display readouts are easier and more accurate because of the new picture clarity, sharper focus and finer detail provided by the optically-flat face and high light output of these new TONOTRON® Tubes from HUGHES.

Write today for full information and engineering assistance on your applications: HUGHES, Vacuum Tube Products Division, International Airport Station, Los Angeles 45, California. For export information, please write: Hughes International, Culver City, California.

FEATURES:

- Axial writing gun
- Electrostatic focusing
- Electromagnetic deflection
- P20 aluminized phosphor

Creating a new world with ELECTRONICS

HUGHES

© 1960 HUGHES AIRCRAFT COMPANY
VACUUM TUBE PRODUCTS DIVISION

FIRST 7" & 10" FLAT-FACE STORAGE TUBES



another FIRST from HUGHES!

CIRCLE 33 ON READER-SERVICE CARD

NEW FROM NARDA

MEETINGS



Wide Range

KLYSTRON POWER SUPPLY— \$495.00

Model 438

Operates more Klystrons than any comparable unit!

This new Narda Wide Range Klystron Power Supply operates virtually all medium and low voltage Klystrons, as well as some high voltage tubes (at reduced power output). It literally operates more Klystrons, including Sperry and Varian tubes, than any other unit in its price range!

What's more, all components, including tube sockets, are operated within manufacturers' ratings. (Many other supplies exceed plate-cathode,

cathode-filament or socket-ground voltage ratings.)

Want more information about this new Power Supply that gives you greater versatility and longer trouble-free service at lower cost? Then write us for complete spec sheets. Ask, too, for your free copy of our complete catalog. Address: Dept. ED-6.

FEATURES

- 250-700 volt Beam Supply, 0-65 ma.
- 0-1000 volt Reflector Supply
- Accurate Ten-Turn Dial Calibration
- 5 mv max. Reflector Ripple
- Diode Protection Circuit
- Oil Filled Capacitors in High Voltage Filters
- Square Wave Modulation 0-150 Volts, 300 to 3000 cps.
- Saw Tooth Modulation 0-150 Volts, 30 to 180 cps.
- Sine Wave Modulation 0-150 Volts, 60 cps.



the **narda** microwave corporation

118-160 HERRICKS ROAD, MINEOLA, L. I., N. Y. • PIONEER 6-4650

CIRCLE 34 ON READER-SERVICE CARD

February

- 19-23 3rd International Electronic Parts Show, Paris, France
- *25-26 Scintillation Counter Symposium, AIEE, AEC, IRE, NBS, Washington, D.C.
- 29-3/2 Special Electronics Meeting, AMA, Statler-Hilton, New York, N.Y.

March

- 6-9 Gas Turbine Power and Hydraulic Conference, ASME, Hotel Rice, Houston, Tex.
- 9-11 Temperature Measurement Symposium, ISA, Deshler-Hilton Hotel, Columbus, Ohio
- 16-18 Electronic Industries Association Spring Conference, Statler-Hilton, Washington, D.C.
- 17-18 Synchro Design and Testing Symposium, Department of the Navy Bureau of Weapons, Department of Commerce Auditorium, 14th & Constitution Ave., N.W., Washington, D.C.
- *21-24 IRE International Convention, All PG's, Waldorf Astoria Hotel and New York Coliseum, New York, N.Y.
- 21-24 Electronic Representatives Association, Park Sheraton Hotel, New York, N.Y.
- 23-25 Ground Support Equipment Conference, ARS, Statler-Hilton, Detroit, Mich.
- 23-26 Electrical Industry Show and Lighting Exposition, EMEA, Shrine Exposition Hall, Los Angeles, Calif.
- 24-25 1st Annual Symposium on Human Factors in Electronics, IRE, New York, N.Y.
- 29-31 22nd Annual American Power Conference, Illinois Institute of Technology, Hotel Sherman, Chicago, Ill.

April

- 3-7 National Association of Broadcast Engineering Conference, Conrad Hilton Hotel, Chicago, Ill.
- *3-8 6th Nuclear Congress, New York Coliseum, New York, N.Y.
- 4-6 AIEE Southwest District Meeting, Houston, Tex.
- 5-8 National Aeronautic Meeting, Society of Automotive Engineers, Hotel Commodore, New York, N.Y.
- 5-9 Electrical Engineers Exhibition, Earls Court, London, England
- 6-8 Structural Design of Space Vehicles Conference, ARS, Biltmore Hotel, Santa Barbara, Calif.
- 7-8 Management Engineering Conference, SAM, ASME, Statler-Hilton Hotel, New York, N.Y.
- 12-13 14th Annual Spring Technical Conference held with American Rocket Society, Hotel Alms, Cincinnati, Ohio
- 18-19 3rd Annual Conference on Automatic Techniques, ASME, IRE, AIEE, Cleveland-Sheraton Hotel, Cleveland, Ohio
- 19-21 International Symposium on Active Networks & Feedback Systems, Department of Defense Research Agencies, Polytechnic Institute of Brooklyn, IRE, Engineering Societies Bldg., New York, N.Y.
- 20-22 Southwestern IRE Conference, Shamrock-Hilton Hotel, Houston, Tex.
- 20-22 National Symposium on Manned Space Sta-

tions, IAS, NASA, Ambassador Hotel, Los Angeles, Calif.

20-22 Electronic Conductivity in Organic Solids Conference, OOR & ONR, Duke University, Durham, N.C.

27-29 AIEE Great Lakes District Meeting, Milwaukee, Wis.

27-29 6th Annual ISA Southern Conference & Exhibit, Pensacola, Fla.

May

2-4 AIEE Northeastern District Meeting, Providence, R.I.

2-4 National Aeronautical Electronics Conference, PGANE-IRE and Dayton Section IRE, Dayton-Biltmore and Miami-Pick Hotel, Dayton, Ohio

2-5 6th National Flight Test Symposium, ISA, San Diego, Calif.

2-6 Western Joint Computer Conference, PGEC-IRE, AIEE, ACM, Fairmont Hotel, San Francisco, Calif.

3-5 8th National Conference on Electromagnetic Relays, Student Union Bldg., Oklahoma State University

5-6 1960 Conference on Protective Relaying, Georgia Tech's School of Architecture Auditorium, Atlanta, Ga.

9-11 National Symposium on Microwave Theory & Techniques, Hotel del Coronado, San Diego, Calif.

9-12 Instrument Automation Conference & Exhibit, ISA, Brooks Hall, San Francisco, Calif.

10-12 Electronic Components Conference, IRE, EIA, AIEE, WEEMA, Hotel Washington, Washington, D.C.

16-18 Guidance & Navigation Conference, ARS, Santa Barbara, Calif.

16-18 Electronic Parts Distributors Annual Show, Conrad Hilton Hotel, Chicago, Ill.

18-20 Electronic Industries Association, Annual Convention, Pick-Congress Hotel, Chicago, Ill.

23-25 9th National Telemetering Conference, ISA, AIEE, ARS, IAS, Miramar Hotel, Santa Monica, Calif.

23-25 IRE 7th Regional Technical Conference & Trade Show, Olympic Hotel, Seattle, Wash.

23-26 Design Engineering Conference & Show, ASME, Statler-Hilton Hotel, New York, N.Y.

*Includes meeting described herewith.

7th Scintillation Counter Symposium, Feb. 25-26

The program for the 7th Scintillation Counter Symposium is as follows:

Thursday, February 25—9:30 A.M.

Session I. Scintillators

The Organic Scintillation Process, J. B. Birks, Manchester University

Recent Contributions to the Theory of Scintillation in Organic Solutions, W. L. Buck, ANL

Rise-Time Characteristics of Organic Solution Scintillators, D. F. McDonald, Fordham University

Scintillation Response of Activated Ionic Crystals to Charged Particles, A. Meyer and R. B. Murray, ORNL

CsI(Tl) as a Gamma Ray Spectrometer, C. T. Schmidt, Harshaw Chemical Co.

New Cerium Activated Scintillating Glass, R. J.



A real heel might test a Fusite Terminal like this ...but he won't make it leak!

The adherence between glass and metal in a Fusite Hermetic Terminal is an easily demonstrated fact. There are several theories as to why our exclusive V-24M glass actually chemically bonds to the metal components. Cobalt and certain other metallic oxides in the glass oxidize the iron in the metal which is taken into solution. It is believed that through the solution of iron, a gradual decrease of the difference of thermal expansion between the glass and metal takes place at the glass-metal



interface. This inter-fusion of the two dissimilar materials gives Fusite Terminals their ability to withstand great mechanical and thermal shock and still pass Statiflux tests for glass cracks, hydrostatic pressure tests and helium mass spectrometer leak detection.

This fusion is reinforced by a strong compression of the metal ring around the glass made possible by a favorable thermal expansion balance of the glass, pins and housing.

The combination of fusion and compression provides a terminal so rugged that leaker rejection rate of components into which our terminal is fabricated is practically nil, even when roughly handled and subjected to extreme temperature changes.

Samples for your own testing are yours for the asking.

Write Dept. C-1.



THE **FUSITE** CORPORATION

6000 FERNVIEW AVE., CINCINNATI 13, OHIO

Woodford Mfg. Co., Versailles, Kentucky.

In Europe: FUSITE N. V. Koningsweg 16, Almelo, Holland

CIRCLE 35 ON READER-SERVICE CARD

Ginther, NRL

High Pressure Gas Scintillators, Charles Engelke, Columbia University

Thursday, February 25—2:00 P.M.

Session 2. Photomultipliers and Associated Electronics

Developments in Photomultipliers, Image Amplifiers and Scintillation Instruments, J. Sharpe, EMI

Photomultiplier Development Program at RCA Lancaster, R. W. Engstrom and R. M. Matheson, RCA Lancaster

Investigation of Cathode Uniformity and Transit Time Spread of PMT's, Y. C. Kim, Dumont

Development of Photomultipliers for Scintillation Counting, B. Linden, CBS

New Rugged High-Temperature Photomultipliers, J. P. Causse, Schlumberger Well Surveying Corp.

Dark Current in Photomultipliers, J. A. Baicker, RCA

A Three-Dimensional Analyzer using Digital Recording on Magnetic Tape for Gamma-ray Spectroscopy with NaI(Tl) Counters, J. R. Bird, J. R. Waters, F. H. Wells, AERE Harwell

Transistor Counting Systems for Scintillation Detectors, S. C. Baker, H. G. Jackson, D. A. Mack, LRL

Unscrambling Scintillation Spectrometer Data, W. R. Burrus, Ohio State University

A Portable Gamma Ray Spectrometer, A. R. Jones, Chalk River

Scintillator Counter Gamma-Spectra Unfolding Code for the IBM-650 Computer, H. I. West, B. Johnston, LRL

Friday, February 26—9:30 A.M.

Session 3. Scintillation Track Imaging

Present Status of Scintillation Chambers, George T. Reynolds, Princeton University

Present Status of Image Intensifier System, A. K. Mann, University of Pennsylvania

Image Intensifiers, W. L. Wilcock, Imperial College

Image Intensifiers for Nuclear Track Imaging, R. G. Stoudenheimer, J. C. Moor, H. L. Palmer, RCA Lancaster

Present Status of the Channeled Image Intensifier, Jay Burns, University of Chicago

A Nuclear Track Camera Employing Transmission Type Intensifiers, G. Goetze, H. Kantor, Westinghouse Research Laboratory

Bevatron Experience with a Homogenous Luminescent Chamber, L. W. Jones, K. Lai, R. Newsome, M. L. Perl, University of Michigan

Optical Properties of Fibers and Optical

Instruments that Stay Accurate



After More Than 600 Separate Inspections — One Panel Instrument

Sounds like a lot of inspecting, but it's one of the things that makes possible Simpson's fine panel instruments.

Take pivots, for example, which support the rotating armature of a meter movement. Because Simpson quality standards are so high, Simpson makes its own pivots which require more than 60 separate inspections during manufacture. Among these are 100% inspection under a 100X microscope and sampling inspection under a 400X microscope to check radius, cone angle, finish and other characteristics. One result is pivot points with a radius tolerance maintained to within .000010". Moreover, Simpson inspects each and every group of pivots for correct hardness so they won't deform under rough use.

Through such meticulous care as this, Simpson is able to offer you panel instruments with accuracy limits that are 100% guaranteed . . . instruments with conservative ratings on which you can rely . . . instruments that *stay* accurate . . . instruments you can specify with confidence.

Write for Catalog 2059A.

Simpson

ELECTRIC COMPANY

5202 West Kinzie Street • Chicago 44, Illinois
Phone: EStebrook 9-1121
In Canada: Bach-Simpson Ltd., London, Ont.

Coupling Systems, R. J. Potter, R. E. Hopkins,
University of Rochester

Friday, February 26—1:30 P.M.

*Session 4. Astrophysical and Space Applications
of Scintillation Counters*

Scintillation Counters in Rockets and Satellites,
C. McIlwain, State University of Iowa

Applications of Large Scintillation Detectors to
Cosmic Ray Investigations, G. W. Clark, MIT

Detector Systems for Auroral, Solar, and Radia-
tion Belt Particles, L. R. Davis, Goddard Space
Flight Center

Space Scintillator Detector Distinguishing be-
tween Protons and Electrons, S. D. Bloom, R. C.
Kaifer, C. D. Schrader, LRL

Design of a Gamma Ray Spectrometer Using
the Phoswitch Technique for Rejection of Charged
Particles, F. C. Jones, University of Chicago

A Solid State Ionization Chamber, S. S. Fried-
land, Hughes Aircraft Co.

Silicon p-n Junction Radiation Detectors, G. L.
Miller, Bell Laboratories

IRE International Convention, March 21-24

A program of 275 papers, covering the most re-
cent developments in the fields of all 28 IRE Pro-
fessional Groups, will be presented in 54 sessions
at the Waldorf-Astoria and the New York Coli-
seum. The high point of the 1960 IRE Interna-
tional Convention will be a special symposium on
"Electronics—Out of This World" to be held Tues-
day evening, March 22. The symposium will be
conducted by Ernst Weber, President of the IRE
for 1959, and a panel of leading space electronics
experts.

6th Nuclear Congress, April 3-8

The theme of the meeting will be—"What Will
the Future Development of Nuclear Energy De-
mand from Engineers?" This question will be ap-
proached through a series of reports, papers, and
discussions on a wide variety of subjects related to
the peaceful use of atomic energy. This at present
includes: plant construction and site location,
public health problems and federal-state regula-
tions, water supply and waste disposal, the use of
metal, ceramic and organic materials, problems of
fuel technology, development of nuclear stand-
ards, industrial applications of isotopes, nuclear
propelled aircraft and space vehicles, power re-
actors now, and in the next ten years, research
reactors and radiation facilities, progress in re-
actor instrumentation, advanced reactors and fuel
cycles. Chairman of the Nuclear Congress is Dr.
Clarke Williams, Nuclear Engineering Depart-
ment of the Brookhaven National Laboratory,
Upton, New York.

CIRCLE 36 ON READER-SERVICE CARD



INDUSTRIAL SEALED RELAYS—unmatched for reliability



The relay that doesn't know how to fail!

We got tired of waiting for this General Electric Miniature sealed relay to stop. It just kept switching . . . and switching . . . and switching . . . through more than 750 million no-load operations before we finally gave up and took it off test.

Frankly, we just don't have the time or patience to find out what its actual mechanical life really is. We're too busy *building* highly reliable relays for computer, machine tool, instruments, and other industrial electronics jobs.

But, this doesn't mean we're "asleep at the switch" and don't know *why* the G-E Miniature relay performs so remarkably. It all stems from a superior E-frame magnet making possible larger gaps and more overtravel . . . a molded stack for mechanical rigidity . . . Beryllium copper contact springs assuring long spring life . . . and, a knife-edge pivot which eliminates pivot wear.

Now don't get the idea that this re-

liable performance is confined to a mechanical-life test. To the contrary, this rugged relay is pre-conditioned to a life of "hard knocks." Built-in shock and vibration resistance (ranging to 50G's shock, and 10G's vibration at 5-500 cps) mean that the G-E Miniature can cope with just about any industrial demand. And, under typical conditions, a G-E Miniature relay will switch the coil of a similar relay through at least a hundred million operations. It can switch size "0" or "00" contactor coils more than 40 million times!

What's more, a General Electric industrial Miniature requires less than one watt of power—a significant benefit when a number of relays are in the circuit. And, operating times as short as 10 milliseconds are possible, accompanied by a sustained repetition rate of 2000 operations per minute!

Add to all of this the fact that a G-E

Miniature's small size saves valuable panel space . . . that it's not position-sensitive and can mount in any plane . . . that wiring is convenient . . . that the clearance and creepages on the header and socket meet NEMA requirements . . . and you know why the G-E Miniature sealed relay will out-perform any other type of relay in many industrial electronic applications.

Why not see your G-E Apparatus Sales Engineer today? He has all the details on the seven forms of General Electric Miniature sealed relays—each in a wide variety of terminations—for virtually every industrial switching need. Or, if you prefer, mail the coupon at right. General Electric Co., Specialty Control Dept., Waynesboro, Virginia.

Progress Is Our Most Important Product

GENERAL  ELECTRIC

Unique construction features give G-E Miniature relays unmatched reliability in industrial electronics jobs

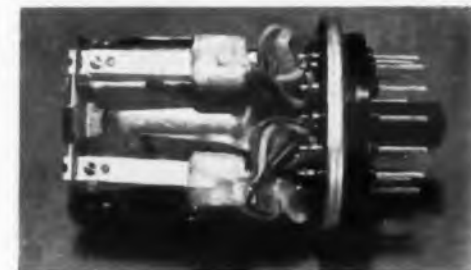

LONGER MECHANICAL LIFE of G-E industrial relays is due—in part—to G.E.'s exclusive use of molded contact stacks which won't loosen or shift to the degradation of relay performance.

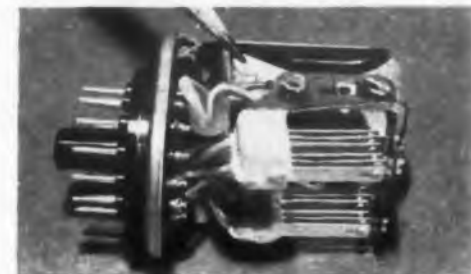

DEPENDABLE PERFORMANCE is contributed by the powerful G-E E-frame magnet—another exclusive design providing higher contact pressures, larger contact gaps, more contact overtravel.

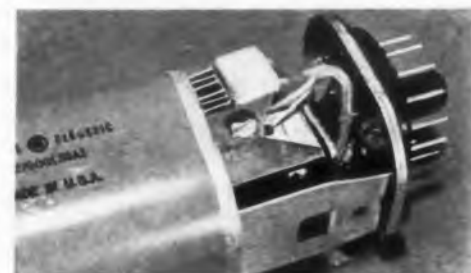

GREATER STABILITY of G-E relays is a result of G.E.'s unique support design with the relay actually supported by its can. Other relays use a cantilever support from the base only.

General Electric Company
Section A 792-15
Schenectady, New York

Please send me a free copy of Bulletin GEA-6665A, Sealed Relays for Industrial Application.

Name _____
Address _____
City _____
State _____

GENERAL  ELECTRIC

EDITORIAL

We Need to Find the Right Problem

The future of electronic companies will depend more on their marketing ability than on their technology, according to marketing experts. Right now there is more systems capability in the U.S. than there is demand for such service; more companies to design missiles than dollars to buy them. It is incumbent upon companies, therefore, to determine just what is needed and to organize themselves so that they can produce products fulfilling that need. Engineers will have to play a key role in determining this market.

This era which will be dominated by marketing is a fourth phase in history, according to Salvatore F. Divita, Consultant to the Director of Procurement, WPAFB. In the late 1800's it was the financier who was the dominant force; in the early 1900's and through World War II, it was the mass production expert. In the post war period it has been R&D, or technology. Now a company must do more than engineer a solution to a problem; it must first find the problem. This is not easy. What is the real problem of defense? It is not building every missile that has been conceived by engineers. The nation cannot afford it.

The need then is to find primary problems and not to be led astray by secondary ones. For example, the company that bases its future only on the need for mechanical inertial guidance devices may find itself without customers if dollars for missiles go instead into optical navigation systems for true space vehicles. Component manufacturers who do not envision the day of solid circuits may wither.

It is the marketing department that must find the problems facing the military services, government agencies such as the National Aeronautics and Space Administration, and the business world in general. And although the consumer may not have a major problem, he has wants and desires and these too the marketing department must find.

The engineer will play a vital role in finding problems, selling problems, and then selling solutions to problems. His analytical, problem-solving mind is needed. His skill in articulately explaining a complex problem or solution will determine how funds will be spent. He must be correct in his analysis or the nation's wealth will be wasted.

James G. Kuyper

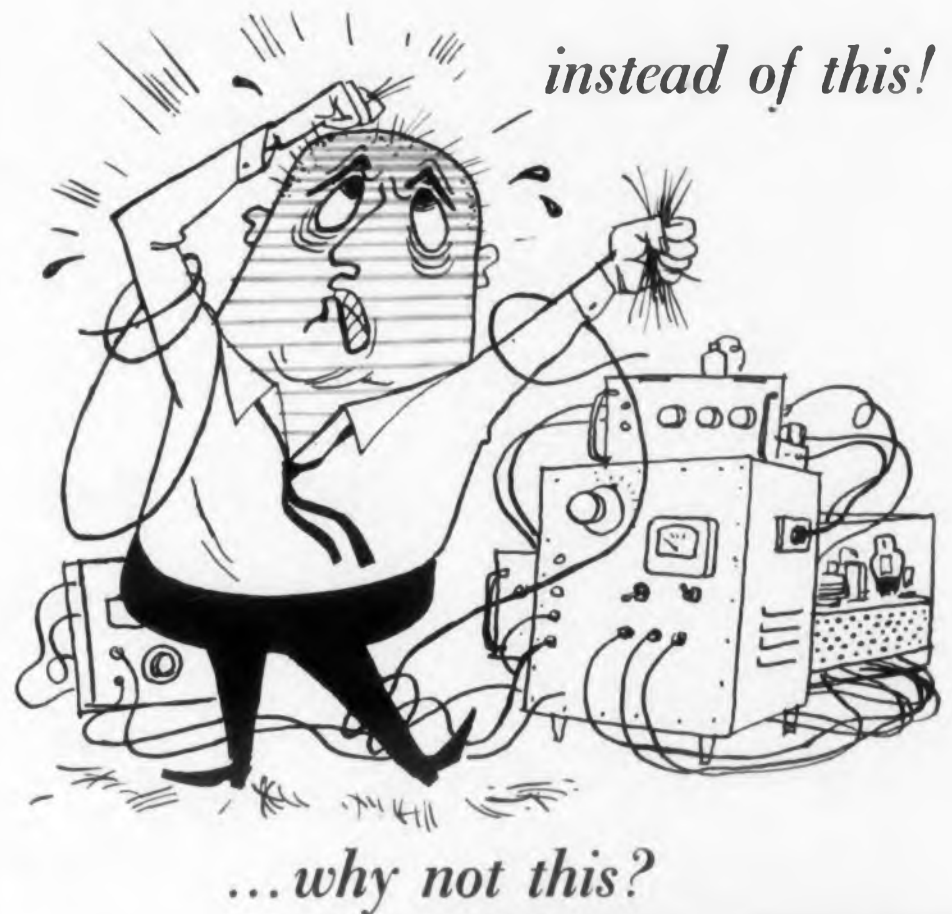

BEHLMAN

INVERTRON[®]

COMPLETELY ELECTRONIC AC POWER SOURCE

Lets you select the power you need, quickly and easily. No "re-engineering" or preparation of diagrams for proper connections. BEHLMAN INVERTRON conserves the valuable time of your engineering talent, simplifies procedure, saves space and makes work more productive.

For further information . . . WRITE or CALL Victoria 9-5733

BEHLMAN
ENGINEERING COMPANY

ELECTRONICS • MECHANICS • OPTICS
DESIGN • DEVELOPMENT • PROTOTYPE

2911 WINONA AVENUE • BURBANK, CALIFORNIA

Representatives in all principal cities and Canada

CIRCLE 39 ON READER-SERVICE CARD

This three-part article presents a step-by-step procedure for designing line-type modulators. These circuits are enjoying renewed interest as high-power pulse modulators because of their economical operation and intrinsic small size.

While exhaustive analyses are presented in the ample literature, author Igor Limansky feels that something more concrete is needed to save the designer from time-consuming calculations and false starts. This "something" is practical design experience. It is imparted in the nomographs and formulas of this series in sufficient detail to arrive at a roughed-out modulator design. This design can then be verified and refined by calculations to yield the final design.

The operation of the modulator can be divided into two separate phases: charging, and discharging of the pulse forming network. Part I of this series of articles is concerned with the discharging of the pulse forming network, while Part II is devoted to the charging circuit. Part III discusses the clipper diode, trigger circuit requirements, and provides a check-list for the complete modulator design.

How to Design a Line-Type Modulator

Part I—Discharge Circuit

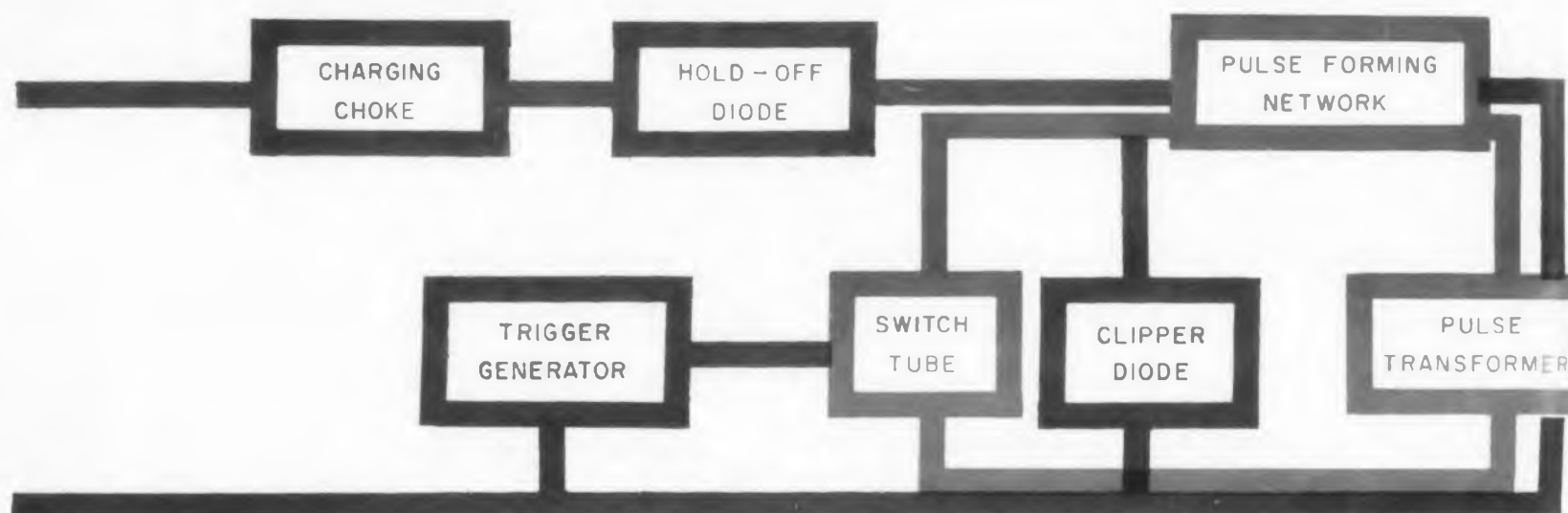

Igor Limansky*

Electronics Research and Development Section
The Martin Company
Baltimore, Md.

*Now with Special Electron Devices Section, Air Arm Div.,
The Westinghouse Corp., Baltimore, Md.



THE BASIC line type modulator circuit, using dc charging, is shown in Fig. 1. Designing a circuit of this type to fit a particular application is the subject of this series of articles. First, let us review the operation of the basic circuit.

The pulse forming network (PFN) is charged to a peak forward voltage e_{pv} , through the charging choke and hold-off diode. The switch tube, usually a hydrogen thyatron, then discharges the PFN into a load when triggered by a suitable pulse

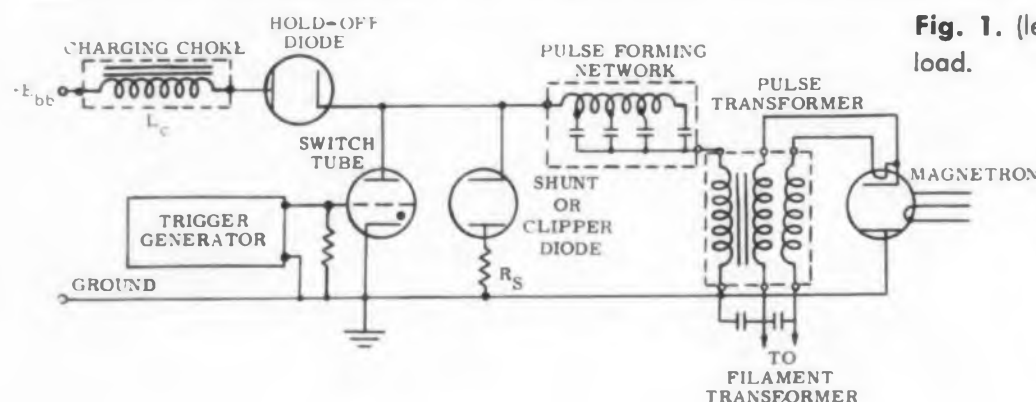

Fig. 1. (left) Basic line-type modulator circuit with magnetron load.

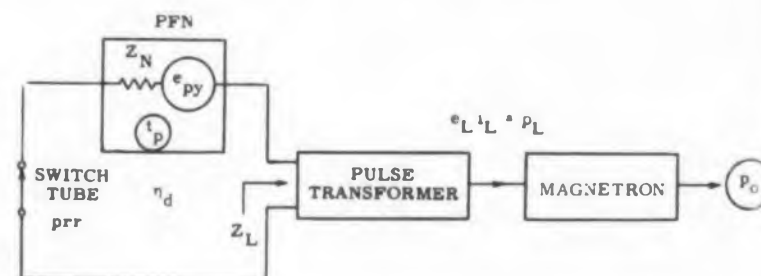

Fig. 2. Discharging circuit—functional diagram.

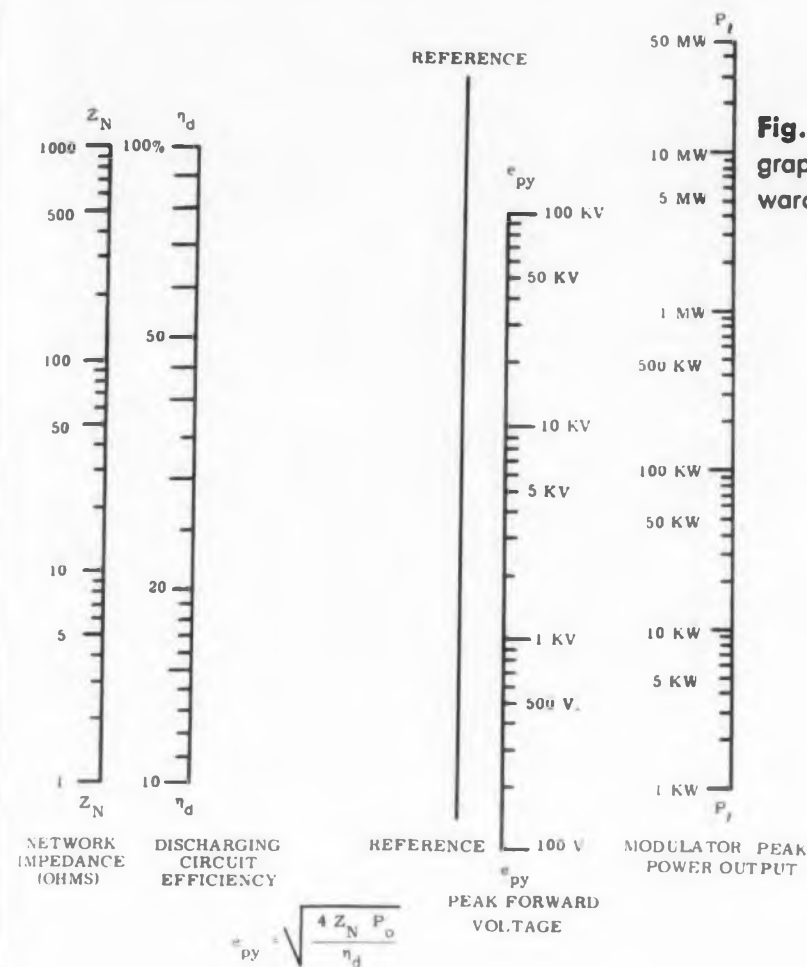

Fig. 3. (left) Use this nomograph to determine peak forward voltage e_{py} .

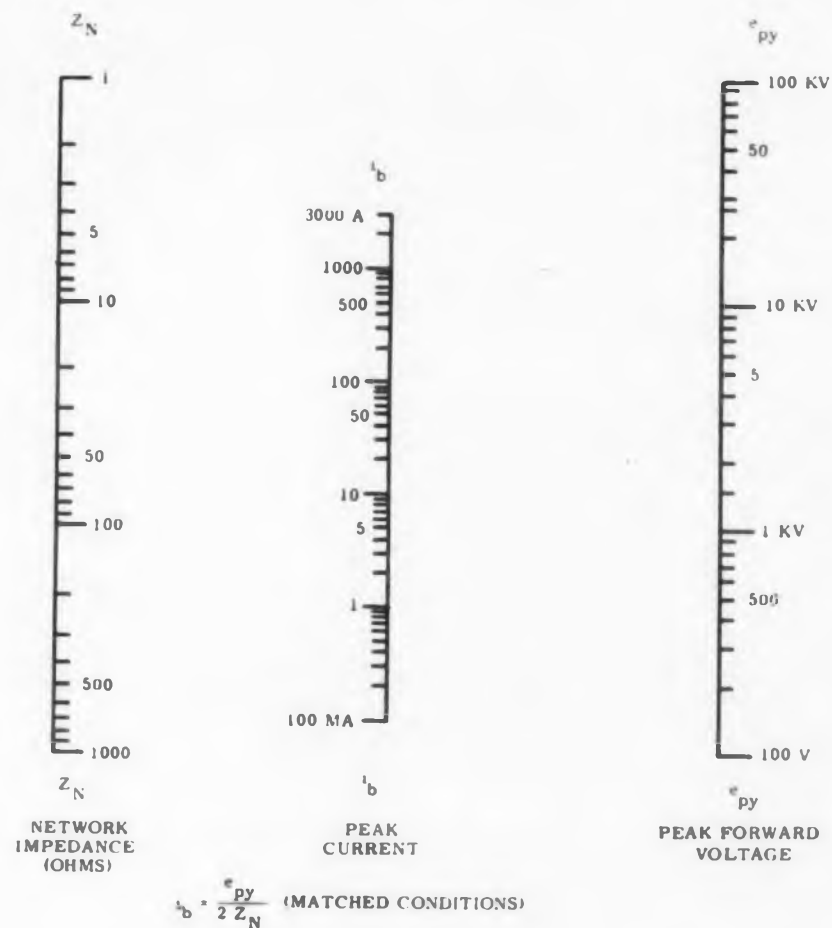

Fig. 4. (right) Given Z_N and e_{py} , determine peak current i_b from this nomograph.

from the trigger generator. The PFN and the pulse transformer determine the length and shape of the modulator output pulse.

Discharge Circuit Efficiency

The first step in designing a line-type modulator for a specific application is to determine the efficiency of the discharge circuit. The discharge of the PFN into the load is described functionally in Fig. 2. The energy in the PFN is connected to the pulse transformer and load through the switch tube. The discharge circuit efficiency η_d , determines the amount of energy available to drive the magnetron load. The efficiency of the magnetron, in turn, determines the power delivered to the output as microwave energy.

Often, the peak microwave power output, p_o , pulse repetition rate, pr , pulse width, t_p , and microwave frequency are the only parameters given the designer. In this case, the first step is to choose a suitable magnetron, and from its characteristic curves find the value of peak voltage e_L , and peak current i_L , necessary for proper operation. If loads other than a magnetron are involved, their i_L - e_L characteristics must be known. These values lead directly to the peak power output of the modulator p_L , through the formula:

$$p_L = e_L i_L \quad (1)$$

The discharging circuit efficiency η_d , includes

the pulse transformer efficiency, effect of mismatch between the PFN and load, and I^2R losses in the switch tube and circuitry. A value of 75 per cent is usually chosen² as representative of "normal" (say, 1 μ sec pulse width, 0.001 duty cycle) modulator operation.

Choosing a Switch Tube

The choice of a switch tube involves a choice of PFN impedance Z_N , and calculation of the conditions imposed on the switch tube by this choice. Four steps are needed for this calculation:

1. A value of network impedance Z_N , is chosen, and the peak forward voltage e_{py} , is determined using Fig. 3.

2. This value of peak forward voltage is used in Fig. 4 to determine the hydrogen thyratron peak current i_b .

3. All the values necessary to determine the hydrogen thyratron dissipation factor P_b , are now at hand. This value is a measure of anode heating, and limits the pulse repetition rate that may be applied to a thyratron having a certain combination of peak current and peak voltage imposed upon it.^{3,4} It is defined as:

$$P_b = e_{py} \cdot i_b \cdot prr, \quad (2)$$

and must not be exceeded for proper operation. The nomograph in Fig. 5 computes this value, and lists the Mil-E-1C values for various tube types.

4. One additional value must be computed to determine whether or not the hydrogen thyratron is operating within ratings. This value⁴ is called the hydrogen thyratron heating factor I_p , and is defined by:

$$I_p = \sqrt{I_b i_b} = i_b \sqrt{du}. \quad (3)$$

The peak current i_b , is known, and the duty cycle du , is merely

$$du = prr \cdot t_p, \quad (4)$$

where t_p is the pulse width. Hence, the heating factor may be obtained from Fig. 6. This nomograph also supplies the value of average current I_b , required later in the design.

These four steps may need to be repeated a number of times to permit the optimum choice of switch tube and PFN impedance.

An Example

At this point it would be useful to go through a sample calculation to point up the mechanics of the procedure. Assume that pulsed microwave power of 15 kw at a frequency of 9375 mc, 1.75 μ sec pulse width at a repetition rate of 1000 pps, is required for a certain application.

One possible candidate for a magnetron is the Sylvania 6027. From the manufacturer's characteristic curves (for a standard attached magnet of 5670 gauss) the peak voltage e_L , to be supplied by

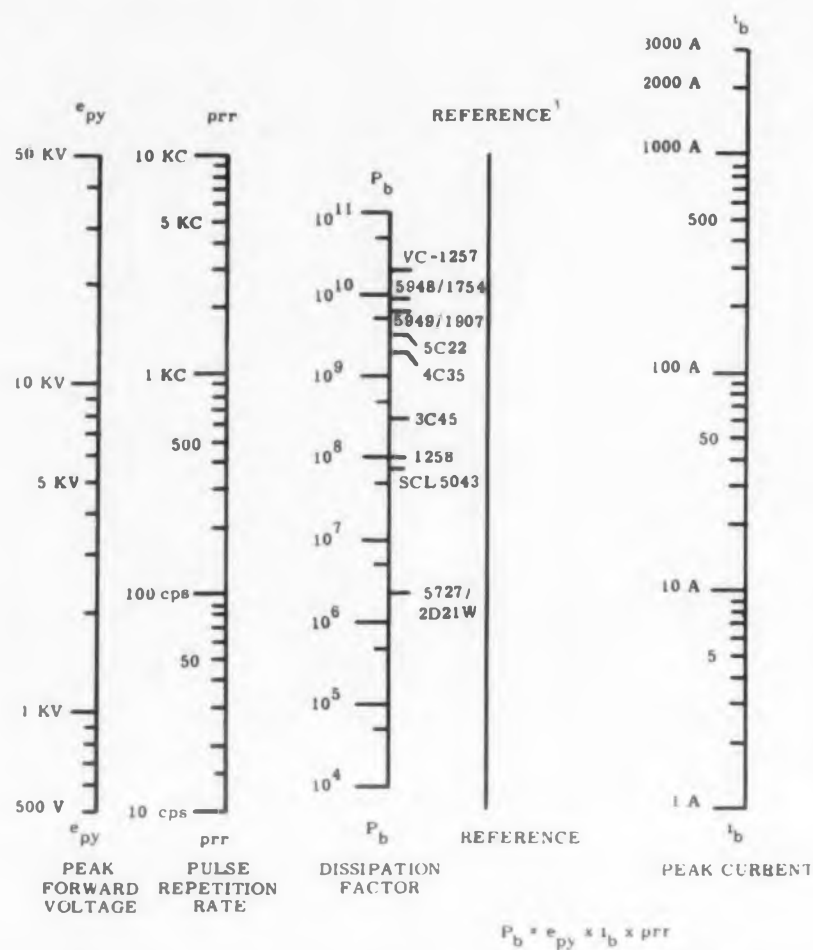

Fig. 5. Use this nomograph to determine dissipation factor p_b and to select the right thyatron switch tube.

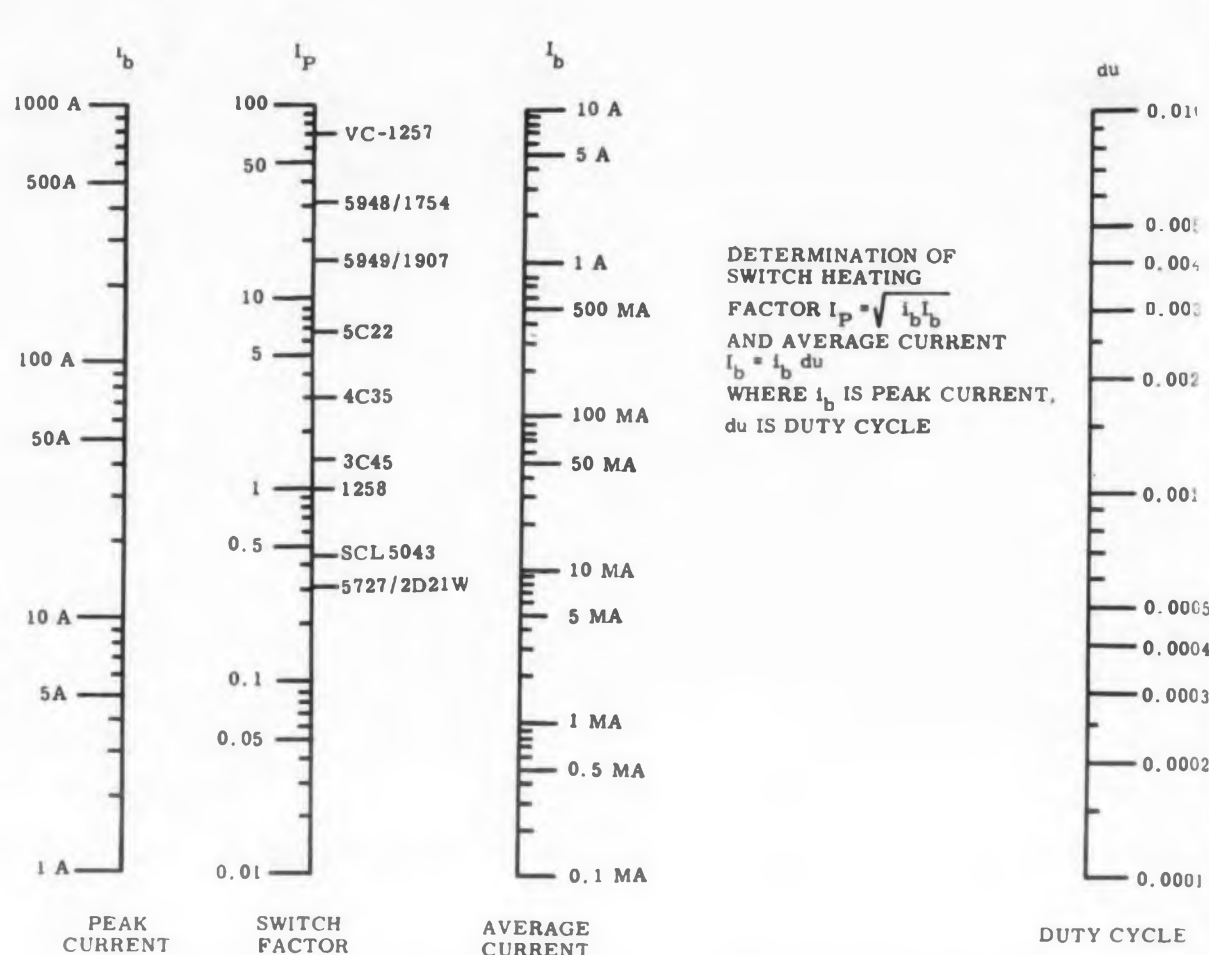

Fig. 6. Use this nomograph to determine switch-heating factor I_p and average current I_b .

Nomograph Mechanics

Two types of nomographs have been provided for the convenience of the designer: two and three-variable nomographs. The two-variable nomographs (Figs. 4 and 6) require a line drawn from the two variables on the outermost scales. This line will intersect the inner scale

at the value sought. In the case of Fig. 6, two inner scales are provided, but only one line connecting the variables on the outermost scales, is required.

The three-variable nomographs (Figs. 3 and 5) require two lines. One line is drawn from the two outer-

most scales, and determines a point of intersection on the reference axis. The other line is drawn from this point of intersection to one of the innermost scales. Intersection of the latter line with the other innermost scale will determine the value sought.

the modulator should be 6.6 kv, at a peak current of 4.4 amp. The power output of the modulator p_L , is therefore:

$$p_L = 6.6 \times 10^3 \times 4.4 = 29 \text{ kw.}$$

A commonly used value for the PFN impedance Z_N , is 50 ohms. Assuming a discharging circuit efficiency η_d , of 80 per cent, from Fig. 3, the peak forward voltage across the thyatron e_{py} , is 2.7 kv. Using Fig. 4 the peak current i_b , is 27 amp. From Fig. 5, the dissipation factor P_b , is 73×10^7 , while from Fig. 6 the heating factor L_p , is 1.1. The average current I_b , also from Fig. 6, is 47 ma.

The limiting factor may be seen to be the value of the peak forward voltage, indicating the use of the 3C45 hydrogen thyatron. The other values are comfortably below the maximum ratings of the 3C45.

One reason for using a 50-ohm PFN impedance

is, if the magnetron and pulse transformer combination is at a remote location from the PFN and switch tube, it will have to be supplied by a high-voltage pulse cable that must be matched to the load and PFN impedance. The standard impedance values for this application are nominally 50 and 70 ohms.⁵

Procedure for Mismatch Conditions

Although Fig. 3 and Fig. 4 are based upon formulas derived for matched conditions (i.e., PFN impedance, $Z_N = Z_L$, the input impedance of pulse transformer when loaded by magnetron), they may be used for mismatch conditions as well,⁶ by using the value given by the expression

$$Z_1' = \frac{(Z_N + Z_L)^2}{4Z_L} \quad (5)$$

as the "corrected" network impedance, in place

of Z_N in Fig. 3 and the value given by the expression

$$Z_2' = \frac{Z_N + Z_L}{2} \quad (6)$$

as the "corrected" network impedance, in place of Z_N in Fig. 4. Under matched conditions, when $Z_L = Z_N$, the above expressions reduce to the PFN impedance Z_N .

This adaptation is mentioned, since it is often desirable to design the modulator with a slight amount of negative mismatch (i.e., load smaller

⁶Only, however, if a clipper-diode circuit (described in Part III of this series) is present to discharge the inverse voltage left on the PFN. Otherwise, the peak forward voltage e_{py} , will be a function of the Q of the charging choke and the inverse voltage (see p. 424 of Radiation Lab. Series, Vol. 5, "Pulse Generators"). This design procedure assumes the eventual inclusion of a clipper-diode circuit.

(than PFN impedance), to insure that the thyatron is shut off at the end of the pulse. This mismatch should, of course, be within the Mil-E-1C ratings of the thyatron, and at most should be aimed at compensating for variations in manufacture of the PFN, pulse transformer, and magnetron. Therefore, if Z_L , as seen at the input of the pulse transformer, can be as much as 5 per cent high, and the PFN impedance can be 5 per cent lower than nominal, it is better to increase the PFN impedance 10 per cent (or decrease Z_L 10 per cent), so that in the worst case, the PFN and load are matched.

In our case, the PFN impedance would therefore become 55 ohms. The value of Eq. 5 would be 55.1 ohms, and from Fig. 3, e_{pv} would become 2.8 kv. Since Eq. 6 would be 52.5 ohms, from Fig. 4, i_b would become 27 amp. The average current I_b , needed at a later stage in the design, is found to be 47 ma (Fig. 6).

The value of peak inverse voltage left across the PFN, e_{pz} , should be checked against the tube ratings, and is given by the formula:

$$e_{pz} = e_{pv} \frac{Z_L - Z_N}{Z_L + Z_N} \quad (7)$$

For this case:

$$e_{pz} = 2.8 \frac{50 - 55}{50 + 55} = 0.13 \text{ kv}$$

Other Considerations

Through the procedure outlined so far, enough data have been collected to specify the type of hydrogen thyatron to be used, as well as the ratings of the pulse transformer and pulse forming network. Certain important considerations have been omitted from this design procedure.

For example, the pulse voltage rate-of-rise characteristics of the magnetron will determine the final design of the pulse transformer and the PFN, as will the imposition of unusual operating conditions such as large pulse width, or high duty cycle. The procedure described in these articles is intended to help the designer make a quick estimate of the basic modulator. He then must turn to the special problems of the particular application. ■ ■

References

1. Radiation Lab Series, Vol. V, "Pulse Generators"
2. See for instance, the example worked out on page 454 of the Radiation Lab Series, Vol V, "Pulse Generators."
3. S. Martin, "Operation of Hydrogen Thyatrons at Conditions Other than JAN Test," Technical Minutes, Third Hydrogen Thyatron Symposium, 27-28 May 1953, p. 118.
4. S. Goldberg, "Research Study on Hydrogen Thyatrons," Vol. II, Edgerton, Germeshausen and Grier, Inc., Boston, Mass., pp. 3-8, 27.
5. Armed Services Index of R. F. Transmission Lines and Fittings, ASES 49-2B, (Navyships 900-102B).



PUSH BUTTON PANEL controls operations rapidly, even at remote locations.



FLAT VACUUM PLATEN assures positive hold down of roll or sheet paper up to 12 1/2" width. Plot area, standard 10x15".



PRINTING FEATURES: Multiple symbol printing head—12 symbols... self contained ink supply. Pen System—capillary action; splatter-proof. Point joiner available.

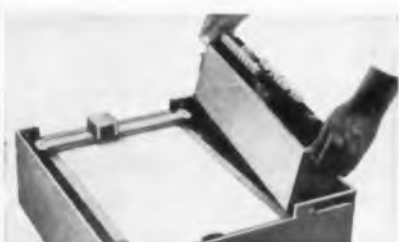

INTERCHANGEABLE MODULES add versatility... interchange with basic control section.



engineered for ease of operation...new

LIBRASCOPE X·Y PLOTTER

point plotting or continuous trace

Slimmer, flatter, push-button fast... Librascope's newest, most advanced plotter is the result of personally-conducted field research by Librascope engineers. Compact design permits rack mounting in groups, saves desk space. Many new conveniences have been added to answer your needs.



OPERATING INFORMATION

POWER: 115-volt, 60 cycle
—180 watts
INPUT: X and Y inputs isolated from each other and from ground.
INPUT RESISTANCE: 2 megohms nominal on most scales, 1 megohm per volt on .5 millivolts per inch to .1 volts per inch scales.

INPUT SENSITIVITY: .5 millivolts per inch to 50 volts per inch with calibrated push button scales at .5, .1, .5, 10 and 50 millivolts per inch and .1, .5, 1, 5 and 10 volts per inch. Vernier controls permit continuous sensitivity adjustment between fixed scales, permitting full scale plotting for any sensitivity.
ACCURACY: Static .1%, dynamic .2% at 10° per second.
PLOTTER CALIBRATION ACCURACY: .05% on all scales.
SLEWING SPEED: 20° per second.

For full details—dimensions, applications, list of accessory equipment, call our Sales Engineering Department or send for illustrated brochure on Model 210, XY Plotter.

For information on career opportunities at Librascope, write Glen Seltzer, Employment Manager.

LIBRASCOPE 100 E. TUJUNGA AVE. • BURBANK, CALIFORNIA • A DIVISION OF GENERAL PRECISION, INC.
CIRCLE 40 ON READER-SERVICE CARD

LIBRASCOPE

A
GENERAL
PRECISION
COMPANY

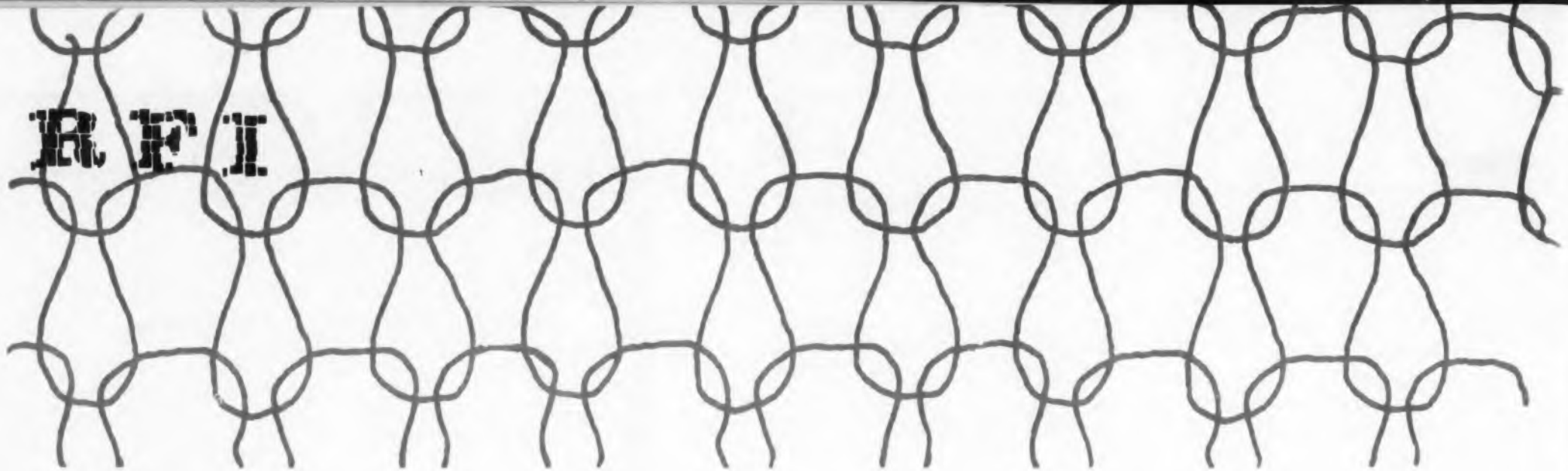

RFI Gasketing

O. P. Schreiber

Vice-President
Technical Wire Products, Inc.
Springfield, N. J.

To reduce RFI leakage in equipment, all seams, joints and openings must be sealed tight. Various schemes are discussed and practical methods of selecting materials and gaskets are outlined.



Paul Schreiber has devoted much time in the past ten years to the application of knitted wire mesh to rf gaskets. He is current Chairman of the Publications Committee of the IRE Professional Group on RFI and is in charge of engineering at Technical Wire Products.

SUCCESSFUL radio - frequency - interference control depends upon filtering to reduce conducted interference and shielding to minimize interference from radiated signals.

The Ideal Shield

A continuous boundary of an infinitely conductive material would be the ideal shield. This condition cannot be obtained in a practical situation; compromises on conductivity and continuity must be made. At all but the very lowest frequencies, any metal structure thick enough to be mechanically suitable will be thick enough and conductive enough to attenuate possible rf penetration through it. Obviously, in any practical situation, it will not be possible to make a completely continuous shield. The container will have to be in at least two parts for ease of manufacture and access, and openings must be provided for ventilation, indicating devices, controls and other access panels. The problem of maintaining rf tightness thus involves the re-establishment of continuity at all necessary seams, joints and openings.

Re-establishing Electrical Continuity

The re-establishment of electrical continuity in the rf shield is analogous to making joints fluid tight, usually solved by using a gasket. By definition, a gasket is made of a material which is impervious to the sealed fluid, resilient enough to conform completely to the irregularities of both surfaces and strong enough to resist the pressure differences. Thus joint integrity is maintained.

For example, the mating parts of the valve in the faucet of a kitchen sink could possibly be machined to such accuracy that a watertight seal could be obtained. It is far more practical, economical and reliable to use ordinary machining plus a replaceable, inexpensive gasket.

This same, simple, inexpensive and dependable solution can be used to re-establish continuity in a shield by using gaskets. Rf gaskets should be:

- Resilient enough to conform to the irregularities of both mating surfaces.
- Conductive enough to prevent penetration through them.
- Hard enough to contact both surfaces through nonconductive surface films.
- Truly resilient so that the gasket replacement is not necessary after every opening.

Various methods of creating gaskets, with their relative advantages and limitations, are outlined in Table 1.

RF Properties

Insertion loss is the most meaningful measure of an rf gasket's effectiveness. This term is defined as the reduction of rf leakage which results when an rf gasket is inserted into a previously un-gasketed joint, all other parameters remaining the same. Fig. 2 shows a typical insertion loss characteristic for a knitted-wire-mesh gasket. This curve shows that additional applied pressure above 20 psi does not produce much more insertion loss. Therefore 20 psi is suggested as a rule-

(continued on page 48)

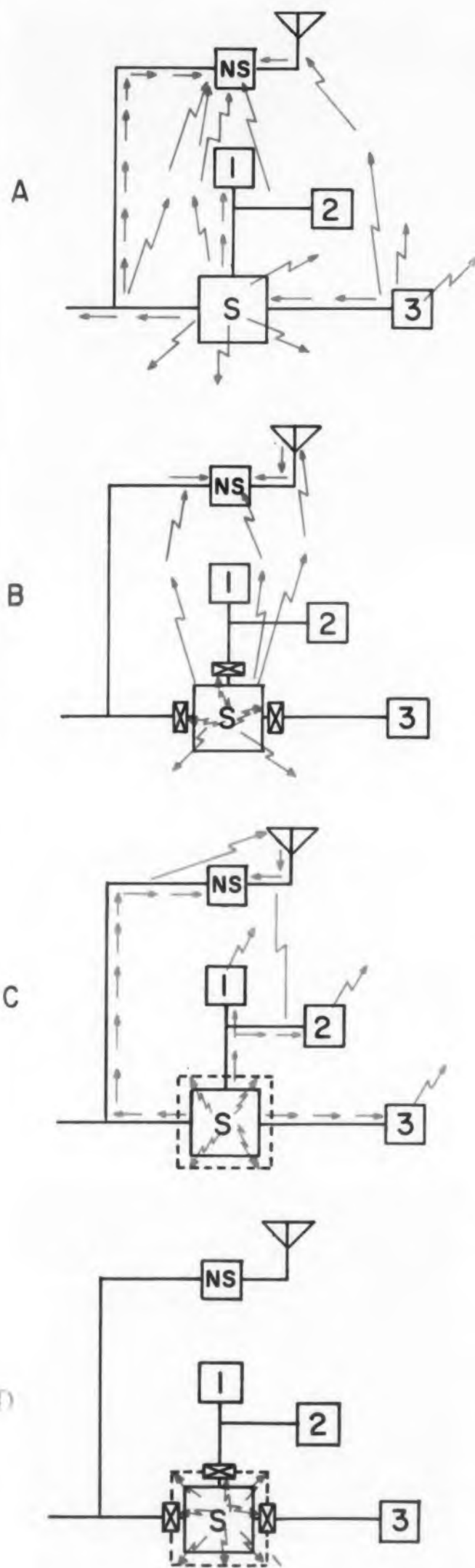

Fig. 1. (a) (left) RFI source S electrically connected to units 1,2,3, and noise-sensitive unit NS. RFI reaches NS not only as conducted energy but also as spurious radiation. (b) Conducted interference suppressed by the use of RFI. (c) Completely shielding the RFI source with an rf tight enclosure does not prevent conducted energy from reaching NS; in addition, radiated energy from the external wiring also reaches NS. (d) By application of filtering and shielding, complete RFI suppression is achieved.

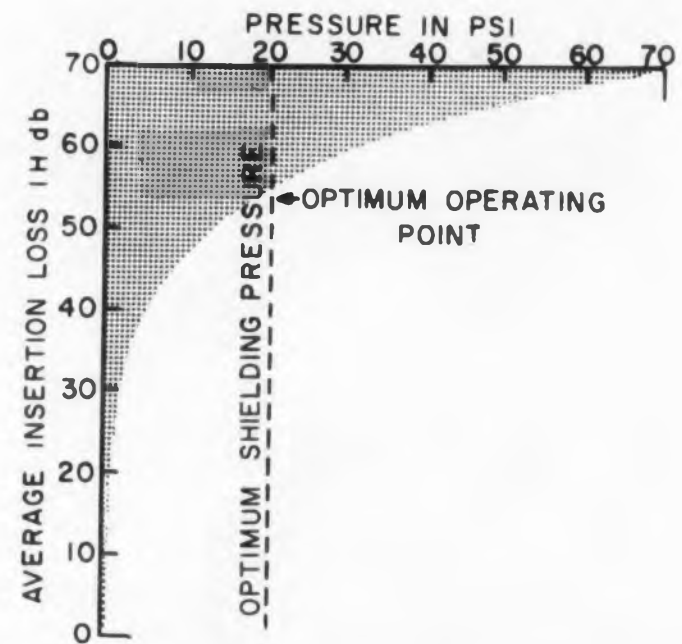

Fig. 2. (right) Typical shielding effectiveness curve for knitted wire mesh gaskets.

Table 1. Relative Merits of Various Gasket Materials and Methods

Material	Chief Advantages	Chief Limitations	Temperature Limiting Material	Remarks
Compressed Knitted Wire	Most resilient all-metal gasket. Most points of contact available in variety of thicknesses and resiliencies.	Not available in sheet form from which to cut odd shapes. Must be .040 or thicker.	Monel	Knitted wire mesh, with many loop-shaped springs interlocked in a hinge-like manner, combines resilience, flexibility, cohesion and conductivity.
Aluminum screen impregnated with Neoprene or silicone (Duolastic)	Combines fluid and rf seal. Thinnest gasket which can be cut to intricate shapes	Very low resiliency	Neoprene or Silicone	Woven aluminum wire cloth impregnated with neoprene or silicone ground down to expose the aluminum mesh on both surfaces. Known as Duolastic.
Metal over Rubber	Takes advantage of the resiliency of rubber or other elastomer used. Combines fair to good rf and pressure seal in least space.	When foil is used, it may crack or shift position.	Silicone	Metal can be knitted wire mesh, or foil.
Conductive Rubber or Plastic	Combines rf and pressure seal.	Generally poor rf properties.	Silicone	
Soft Metals	Cheapest in small sizes.	Cold flows.	Lead or Copper	
AEEL Gasket	Best "Break-through" on corrosion films.	Not truly resilient. Not generally reusable.	Brass or Stainless Steel	Made by puncturing a thin metal sheet in both directions with a nail, thus raising sharp points.
Armour Research Gasket	Combines fluid and rf seal.	Space consuming (1/4 x 1/2 in.) Cross-section for optimum shielding. Not commercially available.	Silicone	Many wires in a very open "V" shape with the angle between the legs at least 135 deg and so positioned that the "V" lies parallel to the mating surfaces, and imbedded in silicone.
Contact Fingers	Best suited for sliding contact	Easily damaged. Fewest points of contact.	Beryllium Copper	Contact strips usually made of beryllium copper with serrated fingers to make contact with an uneven surface.

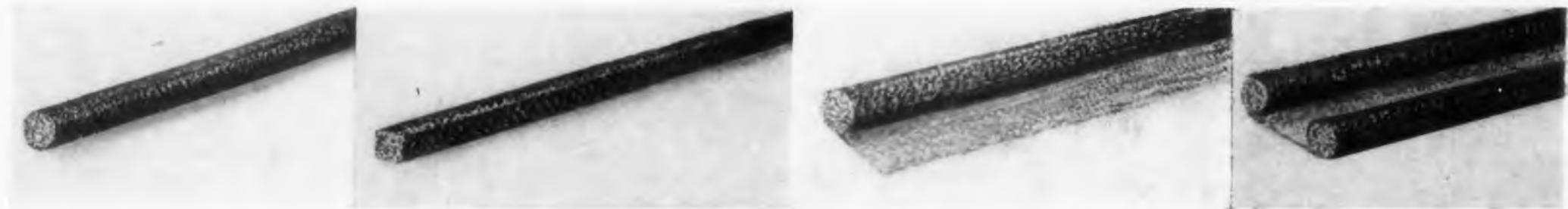

Fig. 3. RFI gasket strips are available in various configurations.

of thumb figure for desirable applied pressure. More or less pressure can be applied, of course, depending on insertion loss needed and available mechanical force.

RF Gasket Design

The basic purposes of an rf gasket is to make continuous contact with two irregular mating surfaces. It does this by being resilient and compressing until sufficient contact is made at all points. The degree of this irregularity, called total joint unevenness, is an important gasket design parameter and is defined as the largest distance between the mating surfaces when they are just touching at their closest points in the absence of a gasket.

Most rf gasket materials will take some com-

pression set and will not return completely to their uncompressed state when pressure is released. This affects re-use of the gasket. For this reason joints are classified as follows:

Class A—Permanently closed: The gasket is compressed only once, as in mounting a feed-through interference filter. Since the gasket will not be used after this one and final time, compression set is no problem, and maximum available pressure can be applied.

Class B—Fixed position: Both mating surfaces compress the gasket in the same manner and at the same points many times. Stated differently, the gasket goes through the same compression cycle on every compression. A door or hinged lid is a good example of a class B joint. The point of

maximum compression will take a set and on all subsequent compression cycles this point will again be the point of maximum compression. Unless the compression set is so severe that the surfaces barely make contact on recompression, gasket set is of minor concern in class B joints.

Class C—Completely interchangeable: In this class, the relative position of the two mating surfaces and the gasket may change from one compression cycle to the next. Interchangeable waveguide gaskets are a good example. The point of maximum compression, and therefore maximum set, on the gasket in one cycle may be at a point of minimum compression in some future compression cycle. Compression set is a very important consideration in Class C joints.

These factors are all considered in designing an rf gasket for a specific use and have resulted in some useful rule of thumb design aids when applied specifically to knitted wire mesh gaskets. These are tabulated in Table II.

Using Knitted-Wire-Mesh Gaskets

While knitted-wire-mesh gaskets could be made from almost any metal or alloy, Monel, aluminum and silver-plated brass are the most commonly used. Each has its advantages and limitations which are summarized in Table III. In most cases, the Monel will be present in much smaller total mass than the aluminum enclosure, which tends to reduce galvanic corrosion. Protective coatings on aluminum degrade the rf effectiveness of the gaskets; however, if unprotected aluminum gaskets are used, they will corrode. Therefore Monel

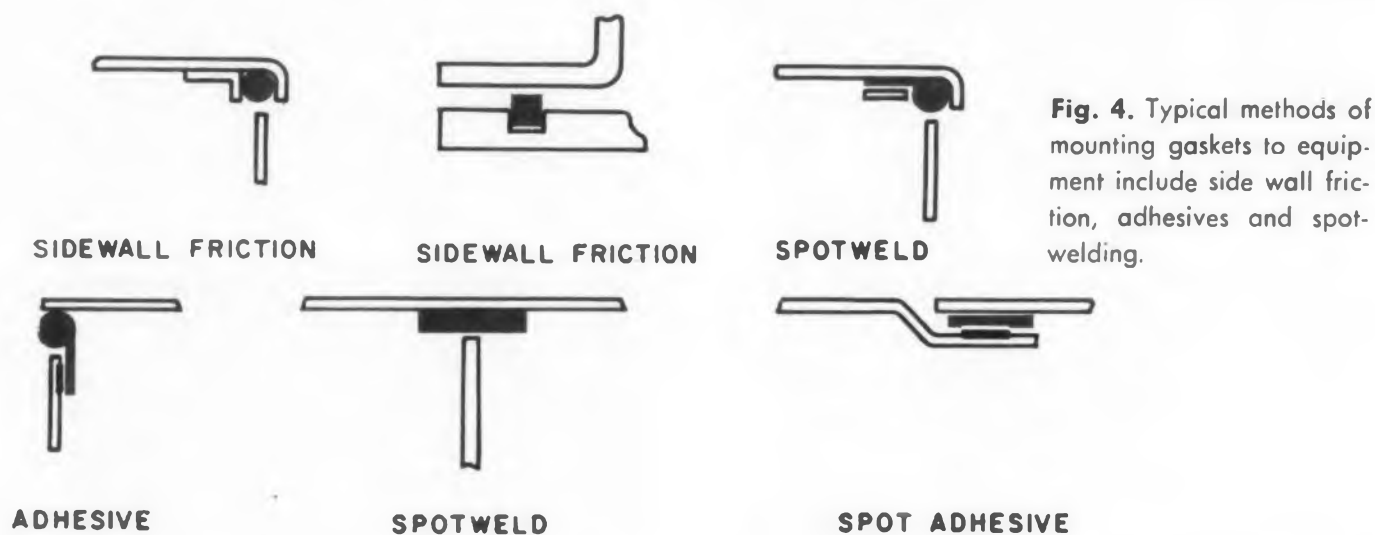

Fig. 4. Typical methods of mounting gaskets to equipment include side wall friction, adhesives and spot-welding.

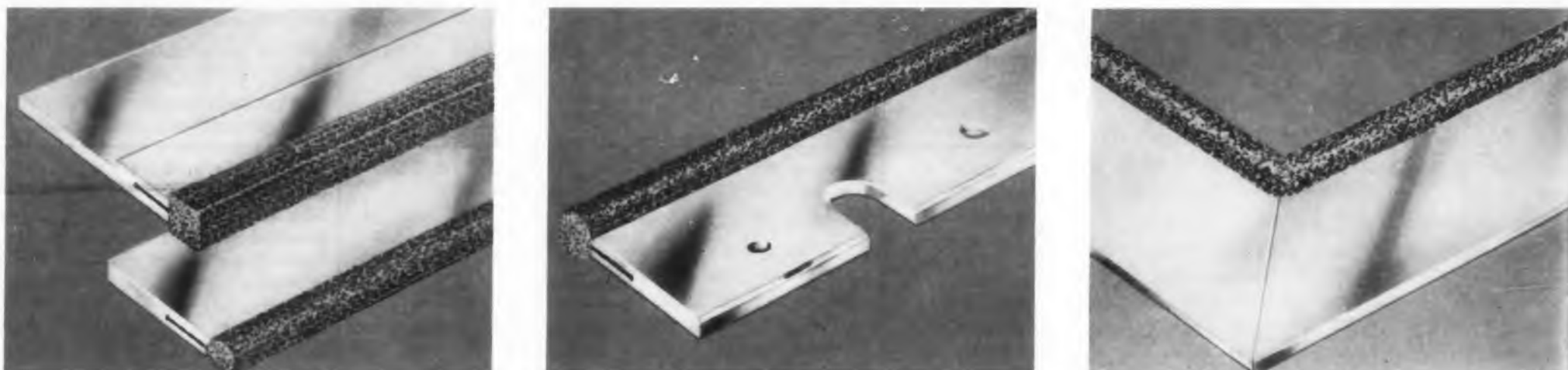

Fig. 5. Integrated assembly, combining a knitted-wire gasket strip and mounting frame, facilitates installation.

Table 2. "Rule of Thumb" Guide for Gasket Selection

Class of Joint	Minimum Gasket Height
A	2x Total joint unevenness
B	3x Total joint unevenness
C	4x Total joint unevenness

is generally a better choice for gasket material.

Protective finishes such as Iridite and Alodine are more or less nonconductive and since they can degrade the rf tightness of a joint, they should be eliminated wherever possible.

Forms Available

Five standard types of wire mesh RFI gasket strip are shown in Fig. 3. Typical round cross-section sizes are 1/16-, 1/8-, 3/16-, and 1/4-in. diameter with sizes to 1-in. diameter possible. Rectangular cross-section strips can be made in a variety of height and width combinations from 1/16 x 1/16 to 1/2 x 1/2 in.

The fins on strip types Fig. 3 c, and d are for ease of attachment. Some typical mounting methods are shown in Fig. 4. A new integrated product, combining a knitted wire gasket strip and mounting strip in a single unit is shown in Fig. 5. It can be attached directly by riveting, screws or spot welding, thus eliminating additional metalwork or hardware. ■ ■

Table 3. Comparison Between Materials Used For Knitted-Mesh Gaskets

Material	Advantages	Limitations
Monel	Highly corrosion resistant. Greatest tensile strength. Best surface hardness. Best rf properties in presence of corrosion.	Not compatible with aluminum enclosures.
Aluminum	Compatible with aluminum enclosures	Not corrosion resistant. Lowest tensile strength. Lowest surface hardness. Poorest rf properties. Takes greatest compression set.
Silver-plated Brass	Best rf properties, except in presence of corrosion. Least compression set.	Not corrosion resistant. Not compatible with aluminum enclosures.

NEW AEROGLAZE[®] CONFORMAL COATING ON



Carbofilm[®] RESISTORS

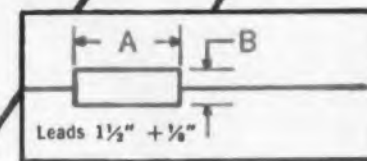
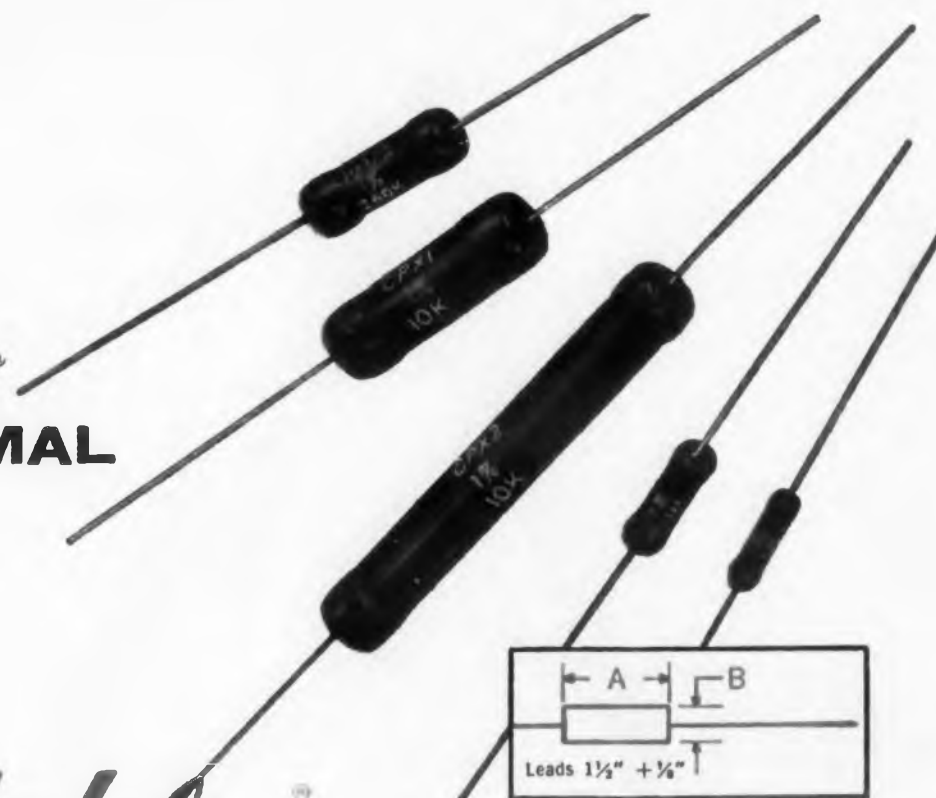

Exceed Painted Resistor Performance at NO Increase in Price!

Now... deposited carbon resistors with exclusive Aeroglaze conformal coating offer superior performance and greater mechanical protection over conventional painted units at NO increase in price.

Aeroglaze coating applied as a 100% solid eliminates weakened coatings through use of solvents and provides uniform sizes and appearance. Aeroglaze coating will meet all moisture requirements of MIL-R-10509B. Mechanical protection is superior to any other method and special tubes, sleeves and jackets are eliminated.

Aeroglaze resistors are available for immediate delivery in production quantities in the following ratings and sizes:



CPM CARBOMOLD RESISTORS
Encapsulated resistors in a strong reinforced moisture and heat resistant plastic for stability, precision and reliability. Available in 1/8, 1/4, 1/2, 1 and 2 watt sizes in MIL designations RN60B, RN65B, RN70B, RN75B and RN80B.



CPC CERAMIC-CASED CARBOFILM RESISTORS
Extra-rugged construction to meet all requirements of critical circuitry. Especially suitable for applications demanding maximum protection against exposure and extreme environmental conditions. Available in 1/8, 1/4, 1 and 2 watt sizes.

TYPE CPX-AEROGLAZE CARBOFILM RESISTORS						
Type	A ±%	B Max.	Watts	Res. Range	MIL Designations	Max. Volts
CPX 1/8	1 1/2	.125	1/8	5 ohms to 1 meg.	RN10	300
CPEX 1/8	1/2	.203	1/8	10 ohms to 2 meg.		350
CPSX 1/2	1/2	.203	1/2	10 ohms to 2.5 meg.	RN20	350
CPX 1/2	1 1/2	.250	1/2	10 ohms to 5 meg.		350
CPLX 1/2	1	.250	1/2	5 meg. to 7.5 meg.		500
CPX 1	1 1/2	.328	1	10 ohms to 15 meg.	RN25	500
CPX 2	2 1/2	.328	2	15 ohms to 50 meg.	RN30	1000



Write for new descriptive literature to...

AEROVOX CORPORATION

OLEAN, NEW YORK

CIRCLE 41 ON READER-SERVICE CARD



RFI

Dissipative Filters for Switching Contacts

The simple dissipative filter described is easy to design, simple to install, is much less expensive than conventional rf filters and has a useful radiation reduction value exceeding 40 db when properly applied.

Richard D. Schulz

Research Engineer
Armour Research Foundation
Illinois Institute of Technology
Chicago, Ill.

RADIO-FREQUENCY interference generated by the opening and closing of electrical contacts can be reduced by more than 40 db using a filter suppression technique involving low-cost components.

Basic Considerations

When a switch in an operative circuit is closed, current will flow through the switch contacts and when the switch is opened, current will cease to flow. For the present discussion, dc conditions will be assumed, and a later explanation will cover the same procedure applied under certain conditions of ac flow.

The electrical current flow during a switching operation is obviously a function of the circuit in which the switch is connected. Consider, for instance, an inductive circuit in which a switch is opened. There will be a tendency for current to continue flowing, and consequently, a tendency

for arcing to occur at the contacts of the switch as it is opened. On the other hand, for a circuit essentially capacitive, sparking is likely to occur upon closing of the switch contacts due to the tendency for the capacitance to discharge.

Frequently it is not realized that much of the cause of RFI from switching contacts is due not only to the connected circuit but also to the switch itself. In many makes of switches, particularly those which are toggle or snap action, a considerable amount of contact bounce exists at the make of contacts. Thus, instead of one switching operation, an entire sequence of switching operations occur and suppression techniques are rendered much less effective.

Conventional Suppression Techniques

Many techniques have been used to suppress RFI arising from switch contacts. One of these makes use of an inductance-capacitance combina-

tion in order to form a low-pass filter, as in Fig. 1a. Such filters are theoretically capable of good performance but actual practice proves them to be otherwise. Stray inductances and capacitances in such circuits cause resonances to occur at some frequencies and, any current component at these frequencies will accentuate the difficulty rather than suppress it. Since this type of filter can be made to appear inductive from the switch contacts, it is sometimes used to operate circuits that are primarily capacitive in nature.

For circuits that are primarily inductive, series R-C combinations across switching contacts, Fig. 1b, are frequently used in order to decrease the tendency for current to continue flowing through the contacts as they are opened. Such current results in ionization at the switching contacts and causes a very unstable and erratic conduction path with high resultant interference.

A technique often used to reduce keying tran-

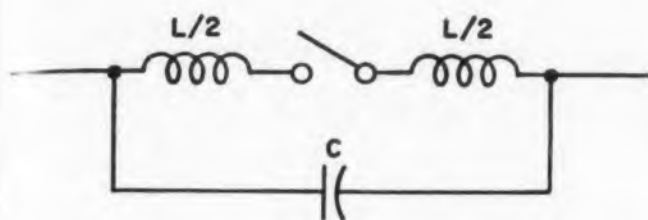

(a) L-C FILTER

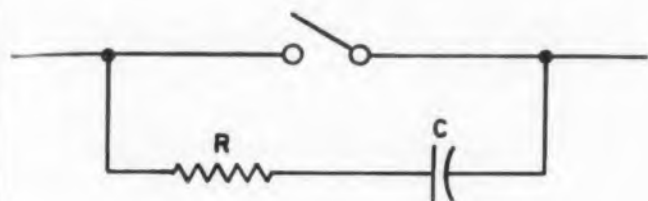

(b) CONVENTIONAL R-C FILTER

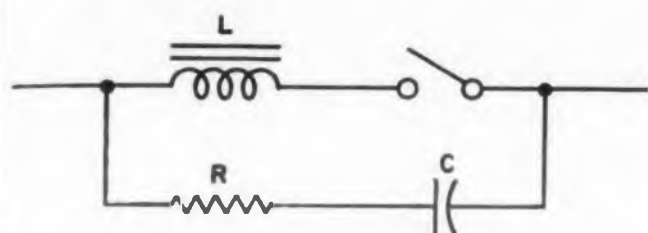

(c) KEYING FILTER

Fig. 1. Conventional suppression techniques.

sients at a transmitter is an R-L-C combination such as shown in Fig. 1c. The bulky inductance required for this approach is prohibitive in many miniaturized circuits.

Sometimes, nonlinear elements find use as suppression devices (for instance, transistorized switching*) and may also be used to reduce interference by approximately 40 db. Such approaches are more expensive and more complicated than the method to be described.

Dissipative Filtering

A dissipative filter, shown in Fig. 2, consists of a resistance $R/2$ in series with each switch contact and a capacitance C in parallel with the combination. It is obvious that use of the series resistance reduces somewhat the total current which is switched. However, the effect of reduced current flow is negligible compared to the effect of reduced rate of change of current.

It is obvious that the series resistance will affect the time constant of a connected circuit. For a capacitive circuit, the time constant will be increased by increasing the R-C product and, consequently, initial current on the make of contacts will increase less rapidly. Similarly, for an inductive circuit, the resistance will decrease the L/R

*R. G. Gray, Interference-Free Switching, ELECTRONIC DESIGN, Jan. 8, 1958, p. 102.

Great Moments In Electronics

(Never Before Recorded)



IMACHIN' TAKING A DOG'S VORD OVER MEIN!

If Professor von Bomb had run a frequency curve before torturing his dog, he might be out of captivity now. SIE's ARP-2A Audio Response Plotter records everything in the audio range in chart form in seconds — keeps the SPCA from the door.

Frequency coverage	20-20,000 cps
AC signal levels, linear	0-40 db
DC volts, linear	0-1 v
Maximum sensitivity	10 mv full scale

"Zing Out" loud and clear for the SIE representative.



Write today for prices and specifications.

SOUTHWESTERN INDUSTRIAL ELECTRONICS CO.
A DIVISION OF DRESSER INDUSTRIES, INC.

10201 Westheimer • P. O. Box 22187 • Houston 27, Texas • HO mestead 5-3471

CABLE: SIECO HOUSTON

TWX: HO-1188

CIRCLE 42 ON READER-SERVICE CARD



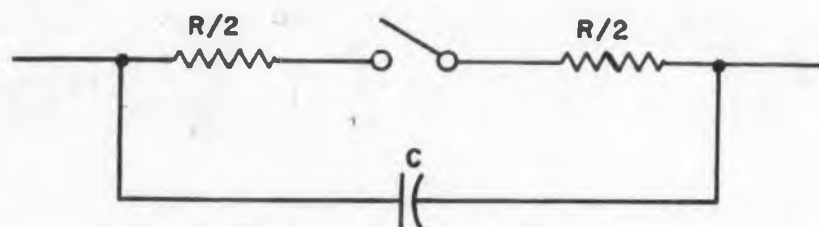

Fig. 2. Dissipative RC filter.

time constant and cause the current on break of contact to decrease more rapidly, with less tendency to arc. The capacitor performs the same function of absorbing current changes on opening of contacts as the series R-C configuration of Fig. 1b.

In actual use, the total resistance R is composed of two separate units $R/2$, each adjacent to one contact. The reason for so doing is to place dissipative units close to the contacts to keep to a minimum any radiation from leads. In this manner, both conducted and radiated interferences are minimized.

Design Procedure

The greater the series resistance, the greater would appear to be the reduction in radio interference accomplished with the suppression circuit. As a practical matter, the region of diminishing

returns occurs when the resistance is approximately 10 per cent of the total circuit resistance. Since a majority of circuits can tolerate a 10-per cent increase in resistance, the result of much experience with such circuits is to use this figure as a design criterion.

For those circuits where such a resistance would be prohibitive, other considerations may lead to a solution of the problem. In some instances, the original circuit resistance is separable such that 10 per cent can be removed from it and inserted at the switch contacts. On other occasions, it is possible to increase the driving voltage in a manner such that the increased drop across the suppression resistance R will be compensated.

When neither approach is feasible, it is always possible to reflect dissipation into the switch leads by means of a transformer. In this situation, a circuit modification corresponding to Fig. 3 may be

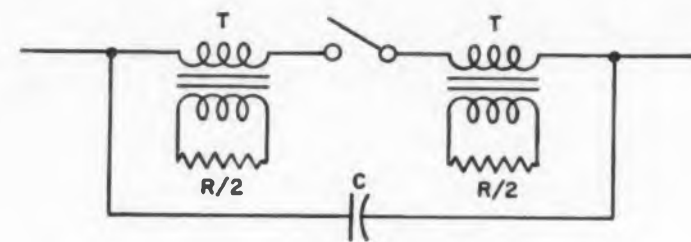

Fig. 3. Induced dissipation filter.

used. The transformer is designed to be lossy at radio frequencies.

One version used with success utilizes a 1/4 in. diameter, 1 in. long, soft iron core chosen deliberately to maximize hysteresis and eddy current losses. (Material from a common nail is excellent for this purpose.) Both primary and secondary are wound for 3/4 in. in the same direction and consist of 3 layers of closely-spaced No. 26 enameled wire. The secondary may be wound directly over the primary, separated only by a single layer of insulating tape.

This induced dissipation technique is less desirable than the others that may be applicable since some experimentation may be required to obtain the optimum number of turns.

The capacitor C used in the suppression combination is not at all critical in value. Experience indicates that a 0.25 mfd capacitor is optimum

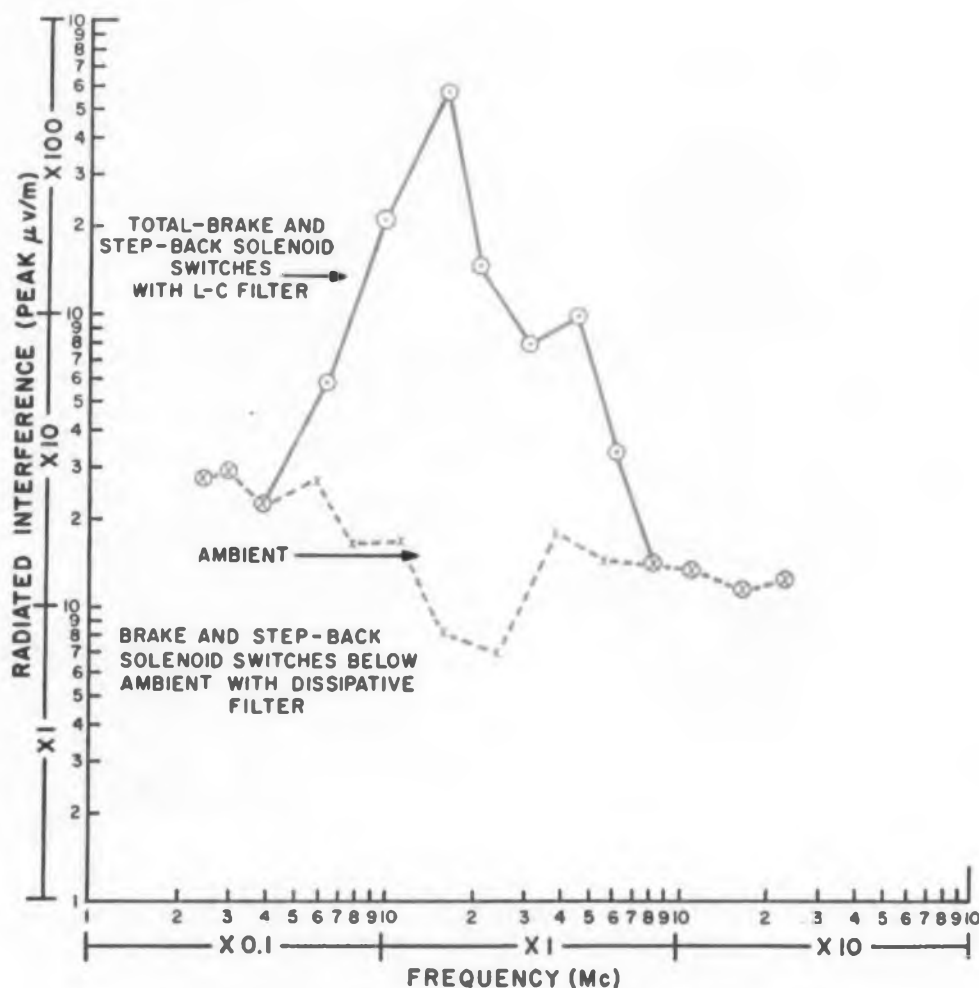

Fig. 4. Interference radiated from foot-switch of office dictation machine.

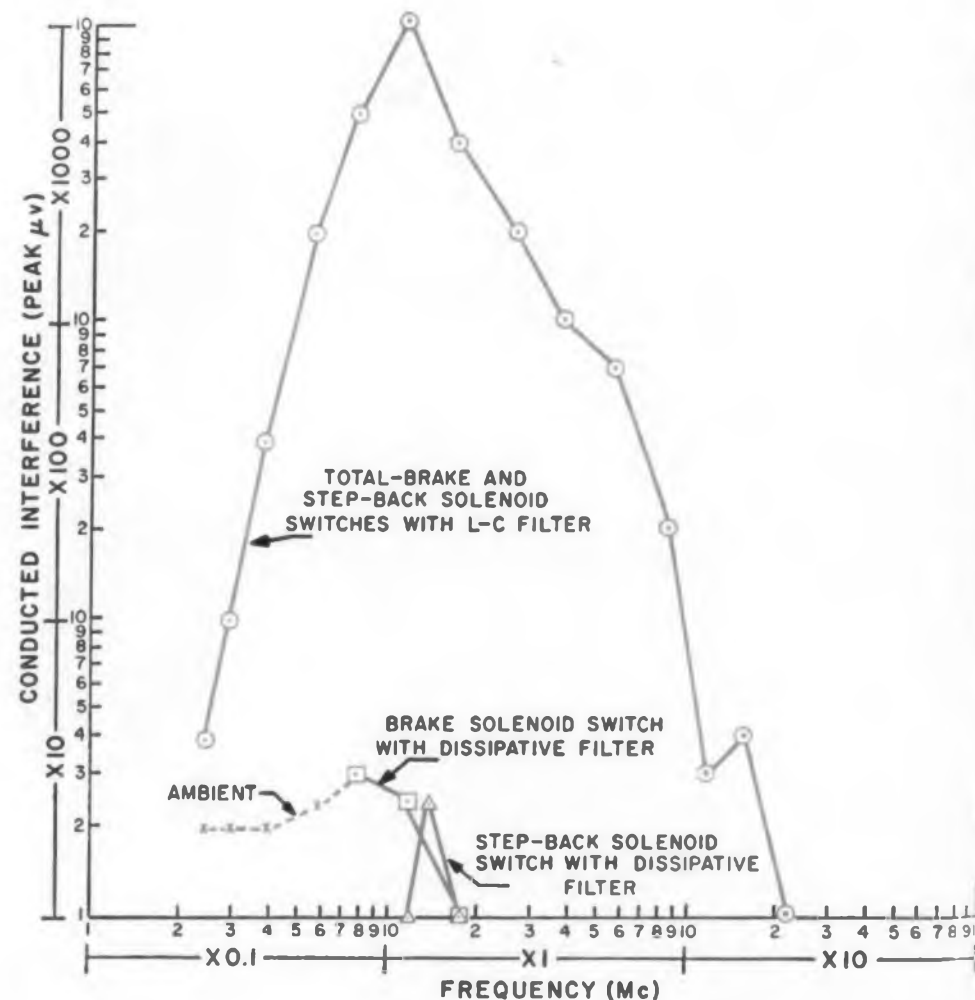

Fig. 5. Interference conducted from foot-switch of office dictation machine.

for most suppression requirements, although values as low as 0.05 mfd have been found useful for very high resistance circuits; values as large as 3 mfd have been found advisable for extremely low-resistance circuits.

An attempt to design the dissipative filter for ac operation may seem impractical since capacitor C will permit the flow of current in a circuit when the switch is opened. However, if the current can be kept low enough to prevent malfunction of the circuit, often the case for two-state devices such as relays, the technique may still be used.

Application of Suppression Circuit

The method by which components are physically connected into the circuit is extremely important in the overall effectiveness. It is necessary that all leads be kept quite short. In particular, capacitor leads to the resistor elements should be kept to 1/8 in. length if at all possible. The resistor leads should also be kept short, but are not quite so critical. Minimizing the radiating elements in this manner will render the circuit most effective.

Example of Results*

In order to illustrate the effectiveness of the dissipative R-C suppression technique, let us consider its application to a modern office dictating machine. Fig. 4 illustrates the benefits to be derived by the use of dissipative suppression circuitry to two different switches located in a foot switch of the equipment. The solid curve illustrates the total interference† coming from the various operations of these two switches, within a frequency range of 250 kc to 25 mc. In this case, some degree of suppression had already been achieved by use of the L-C filter of Fig. 1a. After change of the suppression techniques to use the dissipative filter of Fig. 2, the interference from each of the two switches was that illustrated by the remaining heavy lines. The maximum of the radiated interference at 1.2 mc was reduced from 600 $\mu\text{v}/\text{meter}$ to below the ambient level of 17 $\mu\text{v}/\text{meter}$ for each of the two switches, an improvement of well over 40 db. The corresponding curves of conducted interference are given in Fig. 5. The original conducted interference level of more than 10,000 μv has been reduced to less than 30 μv for each switch, again an improvement of well over 40 db. ■ ■

*With slightly reduced effectiveness, the suppression circuitry of Fig. 2 has been applied to high-current circuits permitting only approximately one ohm of resistance but, in this case, the capacitor C used was increased to the order of 3 microfarads. One such application has been for the suppression of interference due to thermostat operation in a commercial refrigerator where motor starting current was suppressed.

†Measured in accordance with military specification MIL-1-6910A.

THE WORLD'S FIRST

NEW!

HEAT RESISTANT

24K Acid Bright
GOLD

OROTHERM HT

Patent Pending



- Heat Resistance**
5 HOURS 400°C Minimum
- Hardness**
150+KNOOP
- Brightness**
MIRROR
- Control**
ONE ADDITION AGENT
- Temperature Range**
65°F to 115°F
- Operation**
BARREL or TANK

For complete information
Write, Wire, Phone or TWX



Technic Inc

ST 1-6100

P.O. BOX 965 PROVIDENCE, R.I.

7001 NO. CLARK ST. CHICAGO 26 ILL.

CIRCLE 43 ON READER-SERVICE CARD

DESIGN FORUM

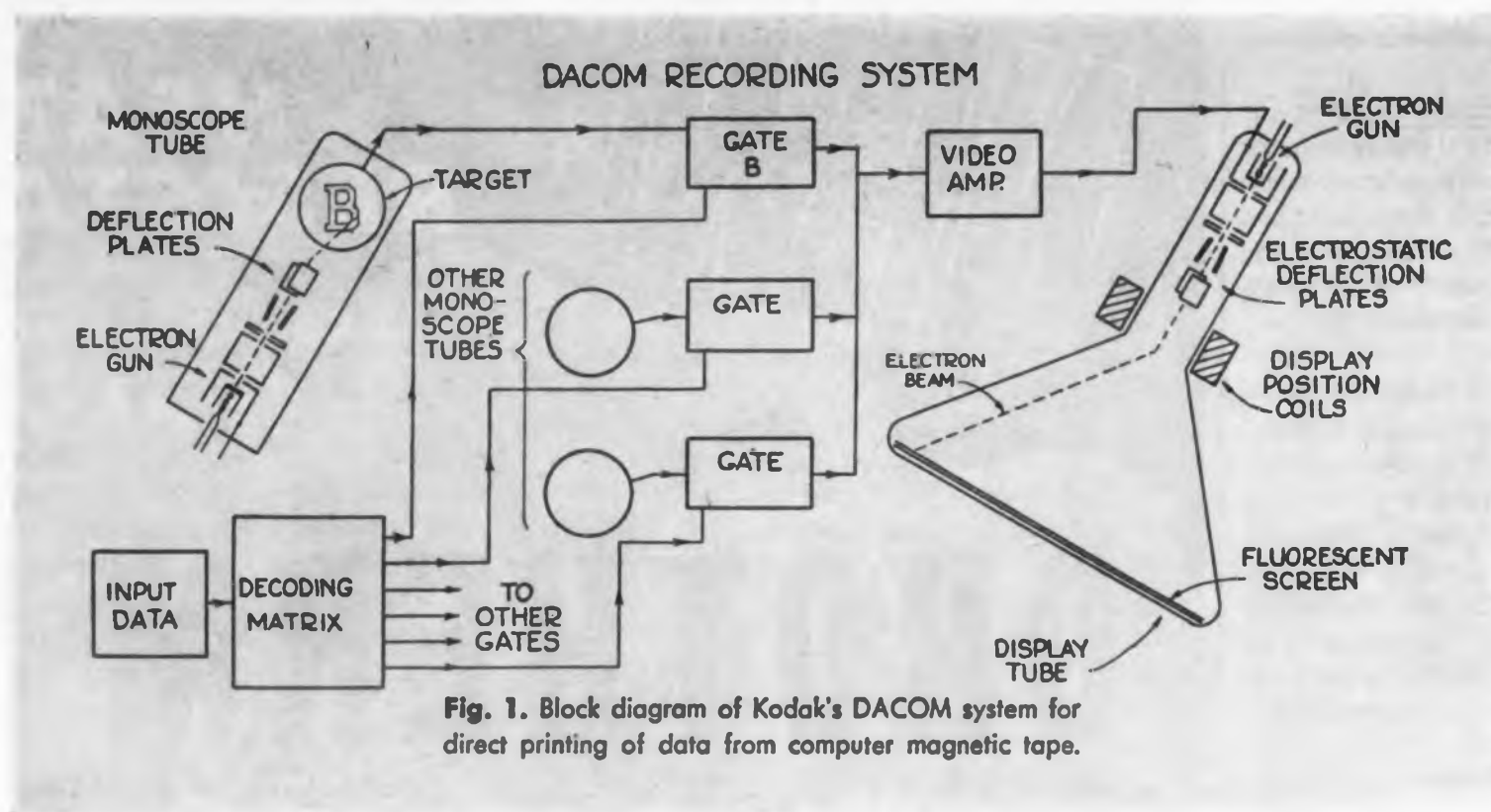

Computer Tape To Words . . . Fast

COMPUTER data stored on magnetic tape can be converted into the printed word at the rate of 16,500 characters per second. Eastman Kodak Co. has developed this high-speed recording system that reads computer tape and puts high-quality characters on microfilm. The system is called DACOM, for Datascope Computer Output Microfilmer. Recordak Corp., 415 Madison Ave., New York, Kodak subsidiary, will handle marketing of the new system.

Binary coded data is read by a standard magnetic tape reader and fed to a decoding diode matrix as shown in the block diagram, Fig. 1. Codes are standard computer codes. DACOM is designed for use at present with an IBM 705 computer. In the present system, seven channels (one for parity check) are fed into the matrix and 64 out.

At the present time a character generating monoscope tube is provided for each character to be displayed. Thus, all letters of the alphabet, numerals, and such characters as dollars-and-cents symbols, slant lines and special configurations are provided.

Target of the monoscope, Fig. 2, is an aluminum character on a carbon ink background. When this target plate is scanned by the electron beam, a video signal representing the character is produced, Fig. 3.

In operation, all the monoscope tubes are scanned once each time a tape code group is read. But only the output of the tube whose gate is energized is fed to the video amplifier. Fourteen scanning lines are used. Scanning rate is 2.5 microseconds for each of the 14 scanning lines. The same scanning signal is applied to both the monoscope and to the electrostatic deflection plates of the display tube.

From the video amplifier, the signal is fed to a specially designed cathode ray display tube. Screen persistence is necessarily very short. The scanning raster for each character image occupies a very small portion of the face of the display tube, Fig. 4. Thus the face of the display tube contains as many raster positions as characters to be copied on one page.

Position of any given character on the face of the display tube is determined by current applied to the magnetic deflection coils. Magnitude of this current is controlled by electronic step generators responsive to the magnetic tape input data.

Each time a new code comes in, the raster moves one position to the right. There can be a total of 130 characters in one line and 66 lines vertically. An entire page on the face of this 16 inch tube occupies about 8 x 9 inches.

Time required to write each complete line of characters is the time required to form each of

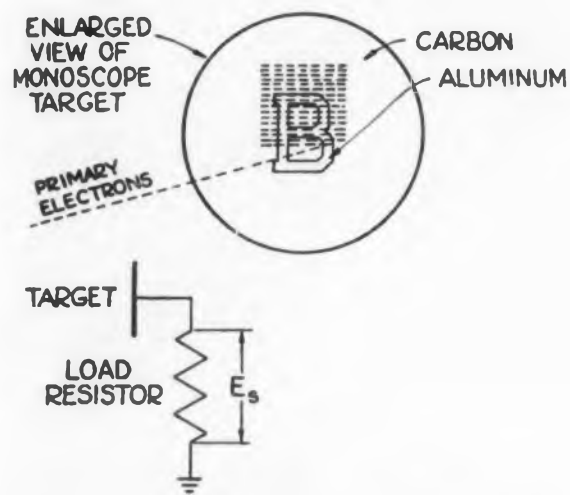

Fig. 2. Monoscope target showing scanning of one character.

the characters in the line plus two more character times. One of the extra character times is the end-of-line code; the other is a control code. The system will skip a line if so coded.

A 16mm microfilm camera is synchronized with the display. Each page occupies one frame on the film. An end-of-page code pulse advances the film. Kodak engineers admit that a continuous film advance would have made their job easier but they would have sacrificed flexibility of operation. The camera shifts immediately to the next frame as soon as the contents of the page has been displayed. Actual film advance time is 17 milliseconds.

A clever system of mirrors and flash-tube projectors permits printing of letterheads and ruled forms on each frame. The computer tape does not contain this information. Frame identification marks can also be added.

One of the features responsible for the system's

remarkable speed is that no delay is required at the end of a line. This system is a character-per-unit-time printer rather than a line-per-unit-time printer. Thus, after printing a shorter-than-full length line, the character positioning circuits go to the next line immediately. With every character position filled, the system prints about two pages per second. It can run as fast as 20 pages per second (the total film advance cycling time) where each page contains very little information. The system can print two million lines of characters in about 8 hours.

Quality of printing is a very important consideration. To achieve good speed of operation, only 14 scanning lines per character are used. But with so few scanning lines, quality of reproduction of the characters could suffer.

Therefore, Kodak attacked the problem, using the novel approach of designing the type to fit the scanning raster. A complete type style was designed so that a 4-per-cent variation in monoscope tube power supply centering voltage could be tolerated. Voltage variation is held to better than 1 per cent, however.

With the special typeface, all lines are reproduced with equal weight. Even periods look round, not elliptical. Overall appearance is that of a clean, good-quality printing job.

For maximum accuracy, 12 to 15 check circuits are incorporated in the system. A tape parity check channel is used and a check is made at the end of each line. Whenever an error occurs, a special symbol is printed on the film from one of the monoscope tubes. Nixie tubes on the operator's control panel give an indication of where the error occurred. The operator then decides whether to go back and check for defective tape or whatever else may have caused the error. ■ ■

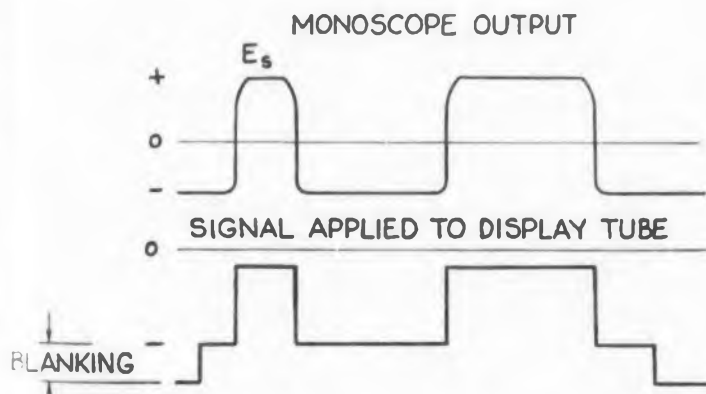

Fig. 3. Comparison of monoscope output signal and input signal to display tube.

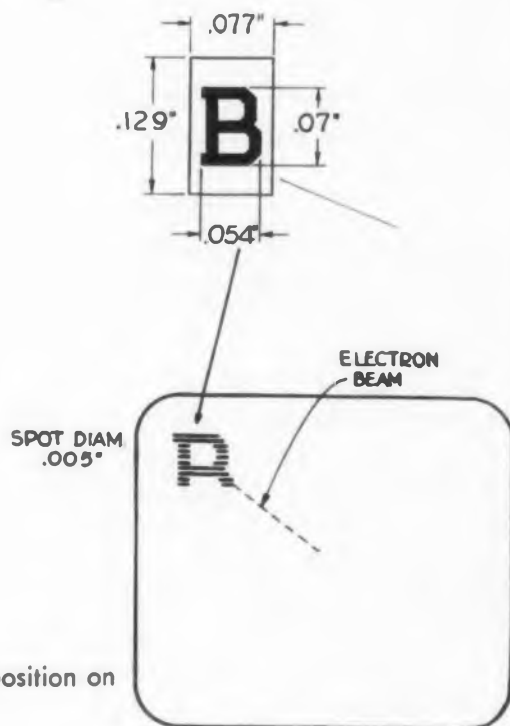

Fig. 4. Size of scanned character and one position on the face of the display tube.

LERMER PLASTIC CONTAINERS



Exceptional printing makes the difference...

Helps make the sale!

- Printed or decorated up to 4 colors on crystal clear, transparent or opaque colors
- Largest line of **RIGID** plastic containers
- 1/5 the weight of glass—greatly reducing ever-increasing shipping and handling costs
- Lightweight and shatterproof—with rigid wall protection
- Economical—with customer re-use value
- Also made of new high density polyethylene—Poly-Opal*. Are chemically inert, stain resistant and have lower permeability to moisture and gases than conventional polyethylene.

*T. M.

Write for full-color catalog, samples and prices.

LERMER PLASTICS, INC.



572 South Avenue
Garwood, New Jersey

PIONEERS AND SPECIALISTS IN
PLASTIC CONTAINERS SINCE 1919

CIRCLE 44 ON READER-SERVICE-CARD

An industrial designer discusses...

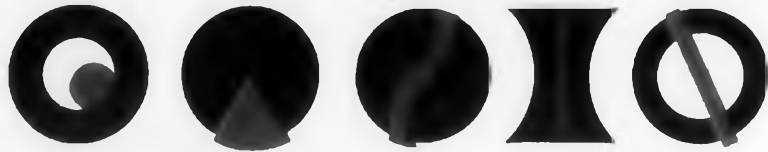

KNOBS

Good Design Is Good Business

Paul Wrablica

President

Paul Wrablica Associates

New York, N. Y.

The industrial designer has long passed the point where he is consulted for product appearance alone. He is a team member of a design group striving for most efficient production, simplified assembly and maintenance, human factor engineering and, of course, styling. Examples of knob design are discussed in terms of functional considerations and versatility of construction.

MOST RECENT member of industry's engineering team is the industrial designer. Formerly entrusted with the sole job of styling, he is now being called upon to introduce the human factor into the over-all design—considering man as an operating component in a complete system. In addition, he must apply knowledge of materials plus production techniques to achieve low cost fabrication at highest possible quality.

While appearance is obviously a key factor in consumer product design, increased attention is being focused on the need to modify laboratory and industrial equipment from the "black box" look to more sophisticated, functional styling. At the same time, serious consideration must be given to the human operator who will work with the product. Accessibility of jacks and terminals, convenience of knob placement, and visibility of dials and meters are but a few of the factors involved in formulating an industrial design solution.

To achieve fresh and attractive product appearance, the designer must be creative and have artistic talent; yet these qualities alone do not suffice. He must be aware of modern methods of manufacturing, component pricing, parts interchangeability, tooling problems and similar engi-

neering aspects in order to avoid excessive final costs and needless warehouse and stock inventories.

No more than does the engineer or draftsman work in a scientific vacuum, does the qualified industrial designer work in an aesthetic vacuum. What is desirable from a design point of view must be balanced against what is functionally necessary, what is commercially required, and what is economically feasible.

Knobs

In many of today's products, knobs are an example of the failure to correlate the appearance of an object with the function for which it is intended.

Knobs are a means of passing information to a machine—turning it on or off, making adjustments or selective switching. Often, the efforts of the unqualified designer lead to attractive styling devoid of any functional relationship to the equipment.

Working with the three basic shapes—circle, triangle and square—the designer must apply principles of form, plane, and line along with the embellishments of texture and color. The knob

created must suggest the equipment for which it will be used; the knob shape must suggest its application.

Is the knob to be pulled, pushed, rotated or flipped up and down? The knob itself should reflect the action demanded. As shown in Fig. 1, each shape signifies its function.

Series of experiments have been conducted, for example, on the design of knobs for aircraft cockpit controls. Testing was carried on with the subjects blindfolded and wearing heavy gloves. Knob designs have resulted which permit the pilot to recognize panel functions merely by touch.

Proper usage of color in knobs has become an increasingly important psychological factor in equipment design. In ultrasonic cleaning equipment, for example, a color band on the control dial could be used to indicate the degree of agitation—pale yellow for subtle mixtures changing to brilliant red for more active states.

For the smaller scale manufacturer who, of necessity, can only carry a limited stock of parts, one basic knob shape, as shown in Fig. 2, can be endlessly modified with refills, snap-ins and inserts of different shape and color. In this way, variety can be realized at low cost. ■ ■



Previous to establishing his own firm six years ago, Paul Wrablica served as design consultant for the U.S.A.F. and was head of the Training Aid Section, Mechanical Equipment School at Fort Belvoir, Va. Mr. Wrablica was formerly director of industrial design for Engineering Management Co., N. Y. and taught design at Pratt Institute, N. Y. He is presently a member of the Fulbright Committee on Education and is a director of the International Fine Arts Council.

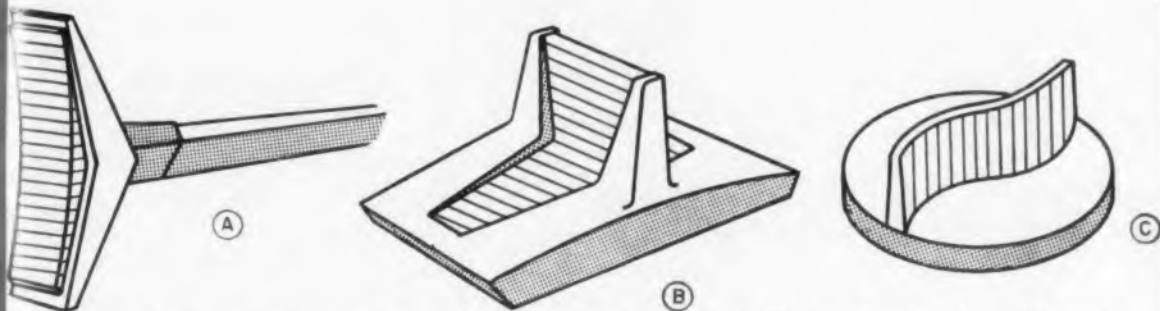
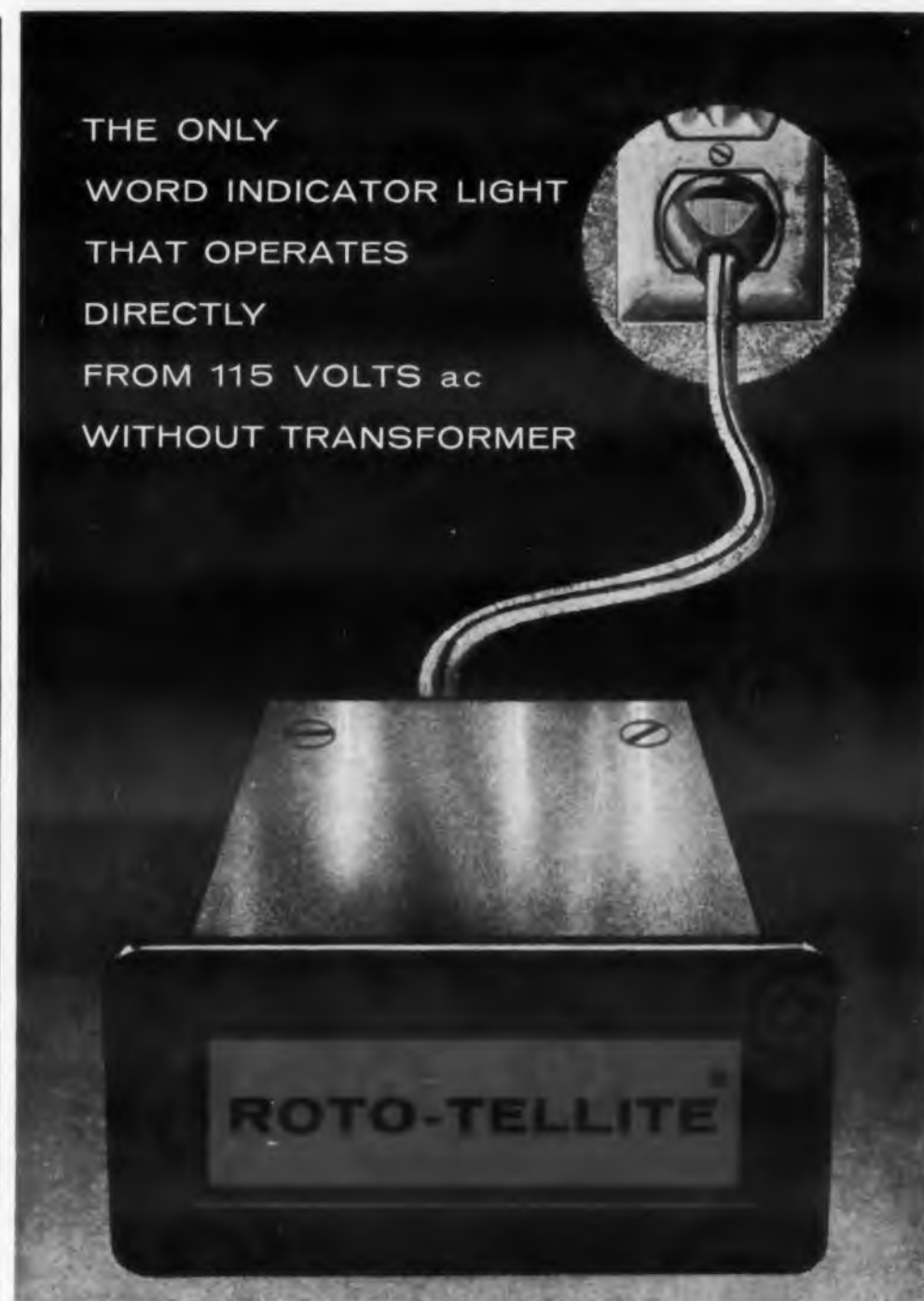

Fig. 1. Several examples illustrating how knob shape spells out its function—(a) push type for on/off switching (b) slide-switch knob (c) knob for rotary applications such as selector switches or potentiometers.

Fig. 2. One basic knob (B) can be modified by means of inserts to achieve a variety of appearances. This is of great advantage to the smaller manufacturer who may require a relatively small quantity of different knobs.



ROTO-TELLITE's advanced circuitry* eliminates the need for transformers; operates directly from 115v ac at any frequency. Master press to test and dimming features included. Uses standard MS-25237-327 bulbs. *Pat. applied for

- ☐ COMPLETELY QUALIFIED
- ☐ FAIL SAFE CIRCUITRY
- ☐ FLUSH MOUNTED
- ☐ FRONT REMOVABLE BULB AND LEGEND
- ☐ HORIZONTAL & /OR VERTICAL STACKING



Write for complete specifications
MASTER SPECIALTIES CO.
956 EAST 108th STREET
LOS ANGELES 59, CALIF.
 CIRCLE 45 ON READER-SERVICE CARD

Resistance Ratios Simplify Impedance-Matching Network Design

A. Courtney Norwine
Bell Telephone Labs., Inc.
Murray Hill, N. J.

"Why design from inexact nomograms," asks A. C. Norwine, "when it's so easy to design simple impedance transformers exactly?" Author Norwine feels that the much-neglected LC matching network makes an excellent experimental tool. "Making a single-winding coil," he says, "beats designing a transformer, especially for high-impedance ratios or for non-integral ratios. For example, a 12-turn coil in a ferrite cup core can help match 5000 ohms at 10 mc."

MANY ENGINEERS hesitate to use reactive coupling for impedance transformation. They feel that the bandwidth of these simple LC networks may be too narrow, the phase shift may be too great, and the effects of misterrmination and element tolerance may be too uncertain.^o

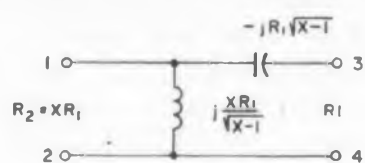
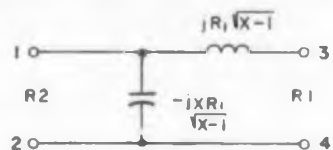

Fig. 1. Basic LC impedance transformers. (a) Type 1 with shunt inductor and series capacitor.



(b) Type 2 with shunt capacitor and series inductor.

In the special case of pure resistance source and load these factors can be understood much more readily if computations are based on resistance ratios rather than their absolute values. The fundamental relations are so simple that exact

^oOne of the early uses of reactance-coupled impedance transformers was disclosed by K. S. Johnson in his 1927 patent, No. 1628983.

values of elements can be calculated more easily than with a nomogram. A feeling for what to expect may be gained from the illustrations in this article.

Given any pure resistance source and load whose ratio is X , one can match impedances, providing maximum power transfer, by either form of the network of Fig. 1. The network will look like a pure resistance equal to each of the two resistances it faces. Theoretically, this occurs at only one frequency, but in most cases, bandwidth to the 3-db points is quite wide.

To match impedances, all that one has to remember is the simple pair of relationships in Fig. 1 and the fact that the shunt element is at the high-resistance end of the network. Either a series capacitor and shunt inductor or the opposite pair may be chosen, depending upon physical realizability or required terminal reactance.

Note that the series arm may be expressed as

$$\neq jA = \neq jR_1 \sqrt{X-1}$$

and the shunt arm as

$$\neq jB = \neq j \frac{XR_1}{\sqrt{X-1}}$$

Thus it is easy to see that maximum response does not occur at the frequency for which A equals B , but approaches that case for large values of impedance transformation ratio X . Hence, for large values of X , both $A = R_1\sqrt{X-1}$ and $B = XR_1/\sqrt{X-1}$ approach $R_1\sqrt{X}$.

Furthermore, in this form, some values of elements can be obtained by inspection. Thus for $X = 10$, $A = 3R_1$ and $B = 3.33R_1$. The readily remembered approximation that $A = B = R_1\sqrt{X}$ is in error 16 per cent for $X = 10$ but only one per cent for $X = 50$.

For easy reference other characteristics are summarized here and illustrated in the accompanying curves.

Impedance

Suppose that Type 1 of Fig. 1 has terminals 3 and 4 connected to KR_1 rather than R_1 , where K expresses the degree of misterrmination. Looking into terminals 1 and 2, we see

$$Z = XR_1 \left(\frac{KX + j\sqrt{X-1}(K^2-1)}{K^2(X-1) + 1} \right)$$

When $K = 1$, $Z = XR_1 = R_2$, as it should.

For the opposite type network in Fig. 1, with A , an inductance, and B , a capacitance, the reactive term in the expression for Z is negative. Any impedance looking into terminals 3 and 4 has exactly the same form if K expresses the accuracy of termination at the higher resistance R_2 end.

Since Z is in the form of $a \pm jb$ the two terms may be plotted as functions of mismatch K , with

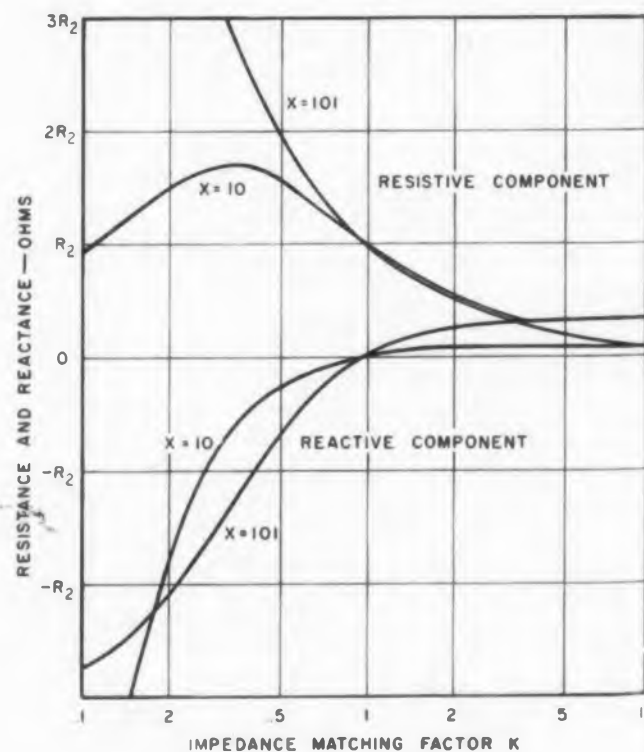

Fig. 2. Impedance variations as a function of mismatch, K , for two values of resistance ratio, X .

X as a parameter. These are shown for a Type 1 net in Fig. 2, for $X = 10$ and $X = 101$, with the terminating resistance from one tenth to 10 times normal value.

The resistance term of the input impedance tends to vary inversely with the output terminating resistance and the reactive component goes to zero for $K = 1$, the correct termination. For Type 2 the resistance component is exactly the same as for Type 1, but the reactive component is opposite in sign. An "incorrect termination" can be chosen deliberately, to introduce a reactive component that can compensate for an opposite reactance in the source or load. That, in fact, is the property used in the more general case for matching complex impedances.

For the resistive case, a ± 10 per cent termination error varies the effective network resistance about ± 8 per cent and varies its reactance about 6 per cent of the resistance value for $X = 10$. When X becomes as high as 100, these variations approach ± 10 per cent and 2 per cent.

Special Case. When X equals 2 the impedance simplifies to

$$Z = 2R_1 \left(\frac{2K \pm j(K^2 - 1)}{K^2 + 1} \right)$$

whose absolute value is $2R_1$ for any value of K , that is for any resistive termination. The input current changes in phase by plus or minus 90 degrees as K varies from zero to infinity. This was proposed years ago as a phase shifter of current.

Input-Output Voltage Ratio

Looking into the network, as in Fig. 3, from an

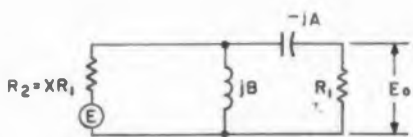

Fig. 3. Basic circuit for calculating E_0/E .

E volt generator, with internal resistance $R_2 = XR_1$, and with the correct termination R_1 , we find

$$\frac{E_0}{E} = \frac{1}{(X+1) - (X-1) \left(\frac{f_0}{f} \right)^2 \mp \frac{j2f_0}{f} \sqrt{X-1}}$$

the negative signs being for Type 1 and positive sign for Type 2 coupling.

When $f = f_0$, the absolute value becomes

$$\left| \frac{E_0}{E} \right| = \frac{1}{2\sqrt{X}}$$

which is the value obtained with an ideal trans-

THOMAS A.

EDISON

sealed thermostats

feature close control, lasting stability



Edison Sealed Thermostats are widely used in crystal ovens, electronic ovens and oscillator compartments—and many other electronic components adversely affected by temperature variations. Capable of maintaining temperatures within 0.2°C , Edison sealed thermostats offer these special features:

- Slow-make, slow-break principle, insures small temperature differential.
- Protective gas atmosphere minimizes effects of contact arcing under heavy loads, resulting in high stability.
- Radiant energy, and conducted or convected heat is rapidly transmitted to the bimetal by the highly conductive gas fill.
- Long bimetal arm is highly sensitive to temperature changes and assures accurate control, predictable performance.

For complete data on Edison Sealed Thermostats, write for Bulletin No. 3009B.

Thomas A. Edison Industries
INSTRUMENT DIVISION

53 LAKESIDE AVENUE, WEST ORANGE, N. J.

CIRCLE 46 ON READER-SERVICE CARD

Constantin

GLASS-TO-METAL SEALS ARE ...

leak proof

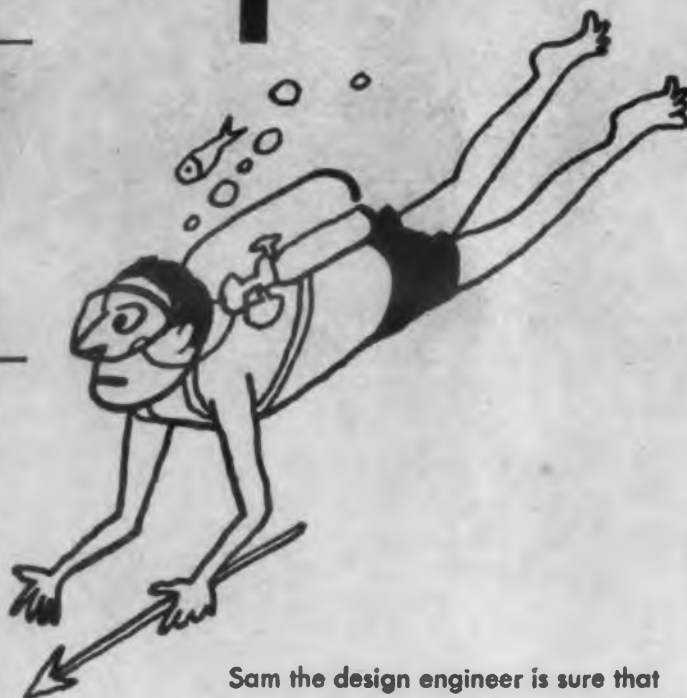

Sam the design engineer is sure that nothing — but nothing — is going to leak into his treasure chest, because it is well sealed.

He may never have to design another product for Davy Jones locker, but Sam knows that when he's concerned about critical sealing he can rely on Constantin glass-to-metal "leak proof" seals for all his needs — and he is confident that no matter what his requirement — multi-headers, all-in-one assemblies, transistor mounts, covers, single terminals, crystal mounts or all standard type seals — he can specify Constantin for

"Quality with Confidence"

WRITE FOR ADDITIONAL INFORMATION

L. L. Constantin & Co.

GENERAL OFFICES: ROUTE 46
LODI, NEW JERSEY

PLANTS:

ROUTE 46,
LODI, N. J.

MANUFACTURING
ENGINEERS

8TH AND CAPITOL STS.,
SADDLE BROOK, N. J.

CIRCLE 47 ON READER-SERVICE CARD

former coupling XR_1 to R_1 . When transmitting in the opposite direction, the same expressions apply if multiplied by the impedance transformation ratio X . That is, voltage step-up is obtained.

By equating the absolute value of the general expression to $0.707/2\sqrt{X}$, we can solve for the frequencies at which response is 3 db less than peak value. This occurs when

$$\left(\frac{f}{f_0}\right)^2 = \frac{(X-1)^2 \pm 2\sqrt{X}(X-1)}{X^2 - 6X + 1}$$

whose values are plotted in Fig. 4 for X from 1 to

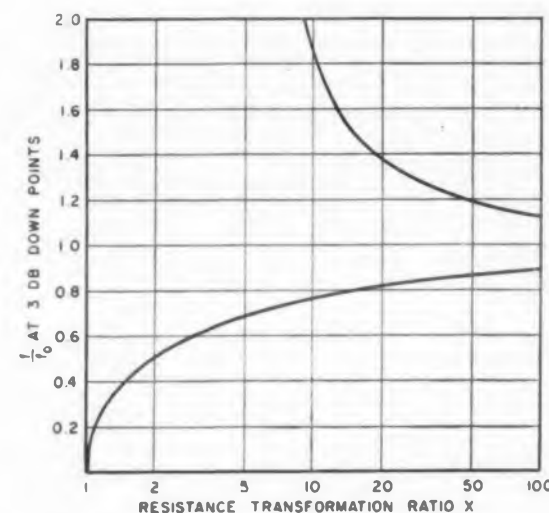

Fig. 4. Upper and lower 3-dB points as a function of resistance ratio X .

100. The 3 db bandwidth is extremely large for small step-up (or step-down) ratios, say, less than five. Even for a ratio of 100 this band is approximately 10 per cent of center frequency f_0 . That is, effective Q is

$$Q = \frac{f_0}{2\Delta f} = 5, \text{ approximately.}$$

In fact, for any ratio greater than 25, the effective value of Q is quite close to $\sqrt{X}/2$.

Phase Changes. For Type 1, the phase of E_o with respect to E is

$$\theta = \arctan \frac{2\sqrt{X-1}}{\frac{f}{f_0}(X+1) - \frac{f_0}{f}(X-1)}$$

which reduces to

$$\theta = \arctan \sqrt{X-1} \text{ at } f_0.$$

A similar expression applies to Type 2 coupling.

Perhaps most often one wants to know what phase change results if the applied frequency differs from the design value of f_0 . The representative value of one per cent error gives results

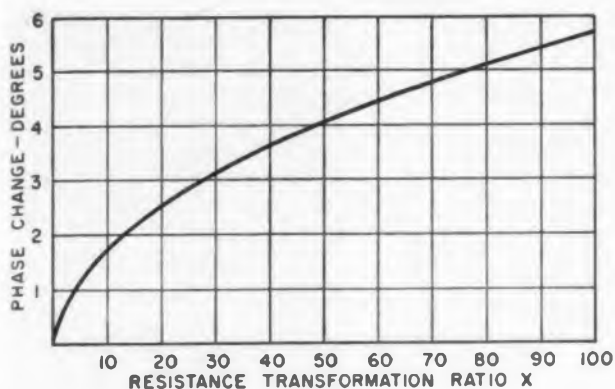

Fig. 5. Phase shift for 1 per cent frequency change.

as shown in Fig. 5 for different values of X .

For a step-up ratio of 15 the phase change is about two degrees, mounting to some five or six degrees when X reaches 100, which is appropriate for a tuned circuit with a Q of five.

For smaller frequency deviations the curves are almost identical to that of Fig. 5 if the ordinate is divided by the appropriate factor. Thus, for a 0.1-per-cent frequency change, the ordinate should be divided by 10.

Corresponding to these phase changes there are amplitude changes, but they are negligible for frequency changes of about one per cent, and X less than about 1000.

Element Changes

To evaluate the effect of errors or changes in elements, another expression for E_o/E may be derived. Using the error factor of Δ_1 for the capacitor and Δ_2 for the inductor in Type 1 coupling, for example, this comes out as

$$\frac{E_o}{E} = \frac{1}{(X+1) - \frac{\Delta_1}{\Delta_2}(X-1) - j\sqrt{X-1}\left(\frac{1}{\Delta_2} + \Delta_1\right)}$$

Allowing only one element at a time to vary we find for $X = 10$, an L or C variation of 10 per cent cuts transmission about one per cent and varies phase about eight degrees. For $X = 100$, and L or C variation of 10 per cent cuts transmission about 11 per cent and varies phase about 26 degrees.

If both reactances vary equally and oppositely we have the variable frequency case of section 2, for then $\Delta_1 = f_0/f$ and $\Delta_2 = f/f_0$. If they vary in the same direction there is a tendency for the imaginary component to vary and the real part to remain constant, with reduced effects on loss and phase.

In general we might say that the accuracy of elements becomes important for large values of X , but requirements are fairly lenient for step-up or step-down ratios of about 10. ■ ■

INCREASED RELIABILITY PLUS HIGHER OPERATING TEMPERATURES with Westinghouse Silicon POWER Transistors*



2N1015—2 amp
2N1016—5 amp

Westinghouse 2N1015 and 2N1016 Silicon Power Transistors offer positive, *proved* benefits to designers of inverters, series regulators, and A.C. Amplifiers.

INVERTERS...

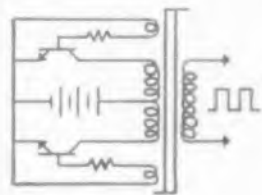

Extremely low saturation resistance (typical .3 ohms)

minimizes power losses in the transistor. High temperature (150°C T_j max.) operation permits compact inverter designs for missiles, aircraft, and other military equipment.

SERIES REGULATORS

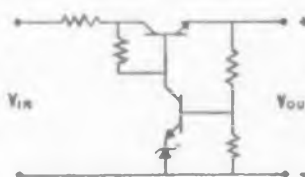

High voltage ratings and high temperature

operation, plus internal power dissipation of 150 watts made possible by low thermal resistance of .7°C/watt make the 2N1015 and 2N1016 an ideal choice for constant voltage and constant current regulators.

A.C. AMPLIFIERS...

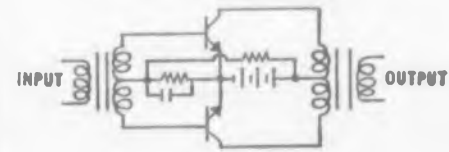

Perfect choice for high power audio and A.C. Amplifier applications, thanks to their high power dissipation capabilities and common emitter frequency response to 20KC.

PLUS TRUE VOLTAGE RATINGS...

guaranteed by 100% power testing. Means you can operate these transistors continuously at the V_{CE} listed for each rating without the risk of transistor failure.

Production quantities of Westinghouse Silicon Power Transistors are available in 2 and 5 ampere collector ratings. Both are available in 30, 60, 100, 150, and 200 volt ratings for immediate applications. Contact your local Westinghouse Apparatus Sales Office, or write directly to Westinghouse Electric Corp., Semiconductor Department, Youngwood, Penna.

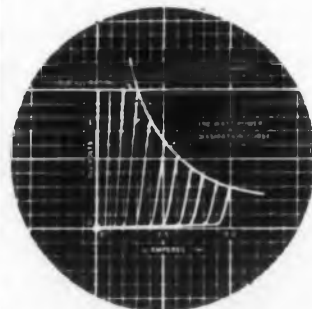

*Designed to meet or exceed military specifications and currently being used in many military, industrial, and commercial applications.

Type	V_{CE}^*	θ (min)	R_{θ} (max)	I_C A (max)	T_j max. operating	Thermal drop to case (max)
2N1015	30	10 @ $I_C = 2$ amp	.75 ohms @ $I_C = 2$ amp $I_B = 300$ ma	7.5	150°C	.7°C/W
2N1015A	60					
2N1015B	100					
2N1015C	150					
2N1015D	200					
2N1016	30	10 @ $I_C = 5$ amp	.50 ohms @ $I_C = 5$ amp $I_B = 750$ ma	7.5	150°C	.7°C/W
2N1016A	60					
2N1016B	100					
2N1016C	150					
2N1016D	200					

*TRUE voltage rating (The transistors can be operated continuously at the V_{CE} listed for each rating.)

YOU CAN BE SURE...IF IT'S **Westinghouse**

CIRCLE 48 ON READER-SERVICE CARD

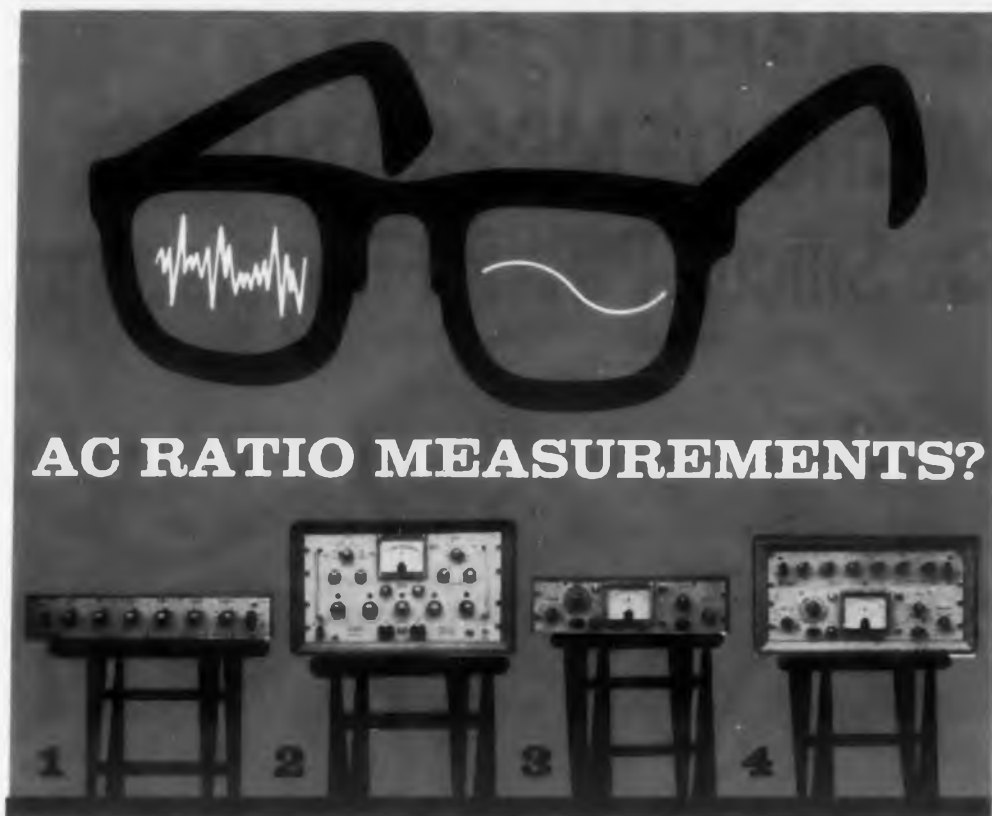

**THERE'S A
NORTH ATLANTIC INSTRUMENT
TO MEET YOUR REQUIREMENTS,
TOO...**

Now—from North Atlantic—you get the complete answer to AC ratio instrumentation problems—in the laboratory, on the production line, in the field.

Specialists in ratiometry, North Atlantic offers the only complete line of precision instruments to handle any ratio measurement task. All are designed to meet the most demanding requirements of missile age electronics—provide high accuracy, flexibility, component compatibility and service-proven performance. Some are shown above.

If your project demands total solution to ratio measurement problems, write for Date File No. 10J. It provides complete specifications and application data and shows how North Atlantic's unparalleled experience in ratiometry can help you.



1. RATIO BOXES:
Both laboratory standards and general duty models. Ratio accuracies to 0.0001%. Operation from 25 cps to 10 kc.

2. COMPLEX VOLTAGE RATIOMETERS
Integrated, single-unit system for applications where phase relations are critical. Accuracy to 0.0001%, unaffected by quadrature. Three frequency operation. Direct reading of phase shift in milliradians or degrees.

3. PHASE ANGLE VOLTMETERS*
Versatile readout system for all ratiometry applications, providing direct reading of phase, null, quadrature, in-phase and total voltage. Broad-band, single-, or multiple-frequency operation.

4. RATIO TEST SETS
Ratio reference and readout in one convenient package for production line and similar applications. Can be supplied with any desired combination of ratio box and phase angle voltmeter.

NORTH ATLANTIC INDUSTRIES, INC.
603 MAIN STREET, WESTBURY, N. Y. • EDGEWOOD 4-1122

CIRCLE 49 ON READER-SERVICE CARD

Shaft-to-digital converter as part of a servomechanism for voltage-to-digital conversion.



Unique Pattern Provides Direct Digital Readout In A-D Converter

CONVERSION of analog information to digital without supplementary coding or additional translation circuitry is possible with a novel direct-readout, printed commutator.

The pattern of the commutator supplies the digital signal for output-equipment operation. Extra coding or translation circuitry found in other shaft-to-digital converters is avoided. Design features include magnetic detenting and a lag-lead circuit, integral to the pattern.

Now in small production by its developer, International Business Machines Corp., the commutator is for use in computing or control operations, such as IBM's Automatic Production Recorder.

Difficulties Noted

Logical numerical progression is lacking to some degree in all shaft-to-digital converters, but especially in those using gearing. As multiple brushes move over the various paths of a commutator, it is difficult to ensure that at points of simultaneous digit change, such as from 19 to 20 or 299 to 300, the different brushes will simultaneously change their electrical connections.

Ingenious solutions have been proposed to correct the deficiency. One is the use of a *reflected code*, but the means for translating the reflected-binary code to straight binary are complicated and expensive. Another method of avoiding switching ambiguity is to read the higher-order digits with two brushes following the same electrical path.

One brush lags behind the other, establishing a lag-lead relationship. With two brushes, there are,

in effect, two possible higher-order digits. The lower-order digits are then able to change the higher-order value in accordance with their own transition from 9 to 0 or 0 to 9. Switching between brushes is usually accomplished by diode or relay circuitry.

Drawbacks here are that a number of diodes or relays are required for each commutator digit, and since there is inadequate output current from the diode circuits, some amplification is required to drive conventional output means.

Disadvantages Avoided

The printed circuit commutator designed by C. A. Walton of IBM includes two significant design innovations to avoid the disadvantages imposed by reflected codes or diode-relay switching. One innovation is a cyclic winding-in-and-out pattern for the units position, including an integral switching sector; and the other innovation is a pattern-controlled lead-lag brush arrangement. The two innovations together make it possible for the pattern to carry the total punching and printing currents.

The cyclic winding in-and-out is shown in Fig. 1. Note that four brushes (which in practice are arranged as two 180-degree opposed pairs) are necessary, the pair active being chosen by the "switching sector" at the center of the figure. The "On" pair connects the switching sector to either the 0 to 4 conductors or the 5 to 9 conductors. The "Off" pair is open circuited by the switching sector and therefore avoids the inadmissible connection to the returning 5 to 9 or 0 to 4 conductors.

The lead-lag brush arrangement, although well established in the commutator design art, is handled in a novel manner by this pattern. The choice of the leading or lagging brush is made not by diodes, relays, or auxiliary mechanisms, but by supplementary patterns integral with the commutator design.

The concept is illustrated by Fig. 2. As in other lag-lead designs, a lag circuit is associated with the 50-99 units position, and a lead circuit is associated with the 00-49 units position.

The lag-lead circuit choice is made by the split sector at the center of the figure. The sectors are connected through the insulating card to solid commons in the hundreds pattern.

The lag (50-99) sector in Fig. 2 is in line with the 50-99 digit positions of the units-tens tracks. The hundreds-digit circuit is then: hundreds common to lag-control sector to lag common—a solid ring around ring around the hundreds-pattern

Fig. 2. Schematic solution to ambiguity problem, using lag-lead brush configurations. Lag common, lead common and hundreds contacts are printed on reverse side of circuit board. Brushes on each side are aligned.

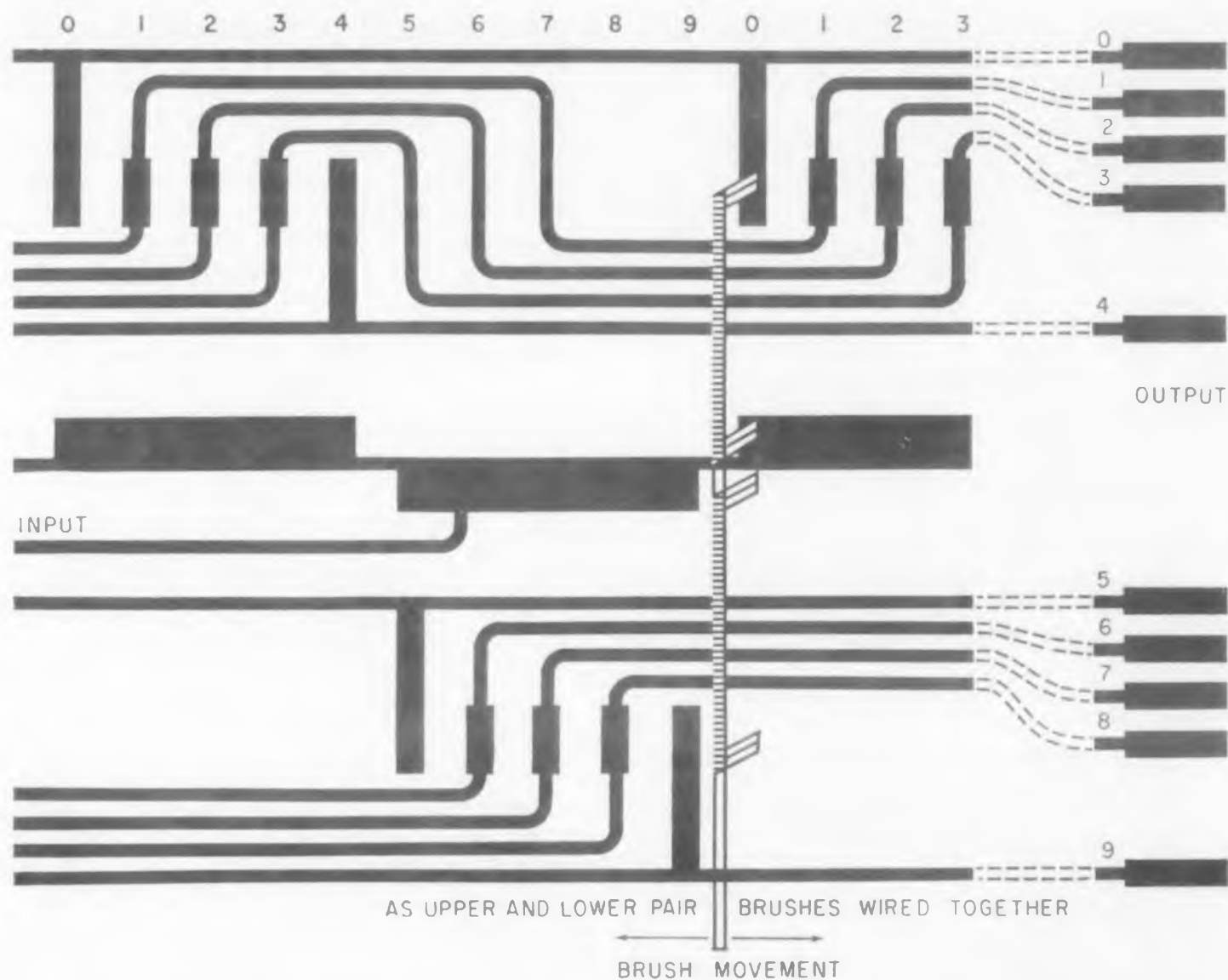
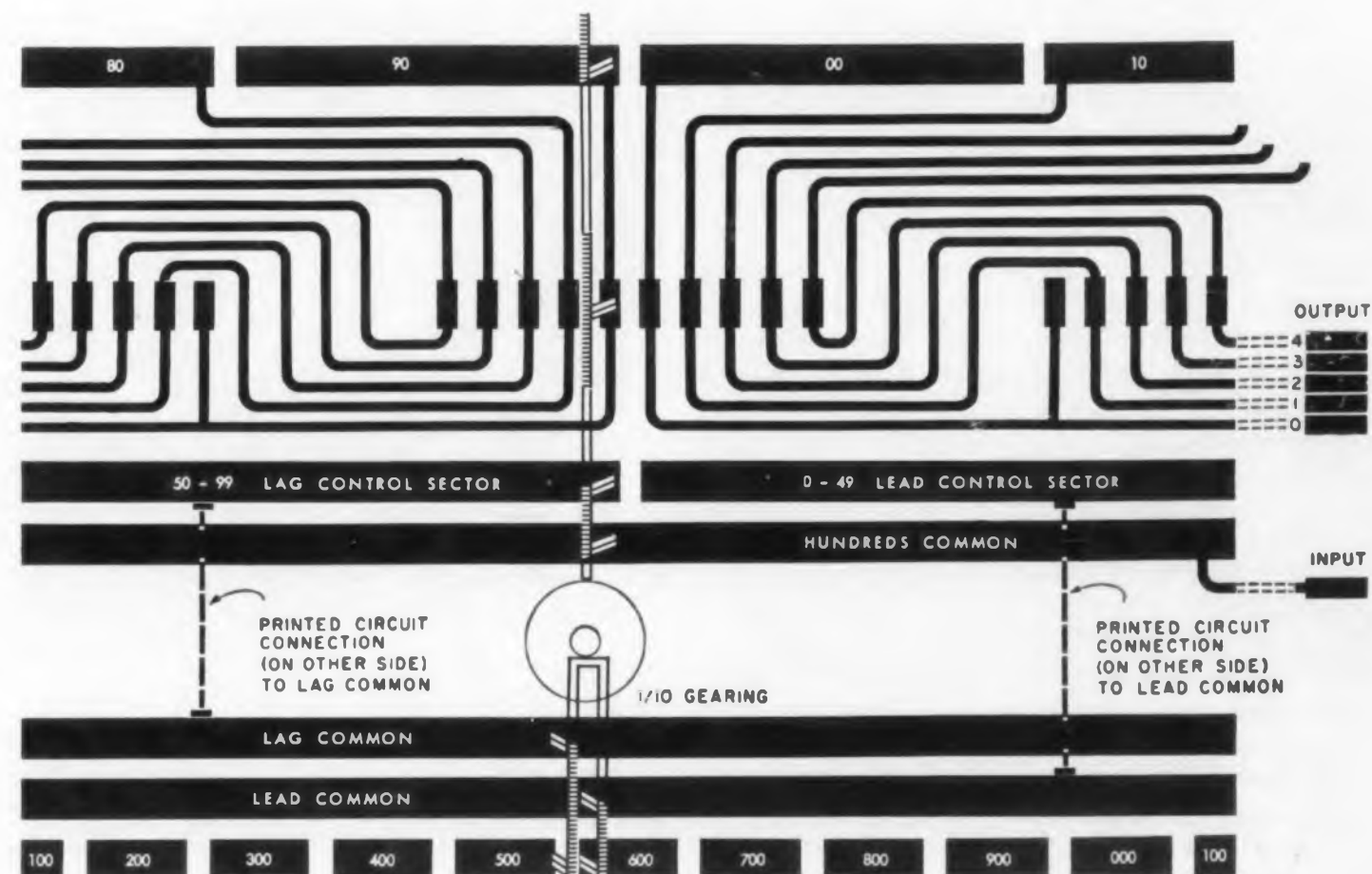

Fig. 1. Solution to commutator-design problem requiring four brushes.



shaft—to the 500 sector. The number readout is 599.

If the units-tens brushes rest on 00 rather than 99 (an intermediate units position is prevented by a magnetic detent), the hundreds-common input is connected through the brushes to the lead (0-49) sector, and the hundreds circuit is: hundreds common to lead-control sector to lead common—a second solid ring around the hundreds-pattern shaft—to the 600 sector. The number readout is 600.

Lag-Lead Arrangement

An actual arrangement for accomplishing a lag-lead operation, as above, is shown in Fig. 3. The upper righthand pattern for the most significant (thousands) digit closely resembles the layout of Fig. 2. Note the two internal solid rings, one for lag and one for lead. The outer data sectors are formed in a continuous repeating interlocking Z shape rather than in the rectangular shape of Fig. 2.

The Z shape, Mr. Walton says, forces the pattern, rather than the brushes, into lagging and leading positions. The consequent radial alignment of the brushes simplifies their manufacture: without the Z shape an angular displacement of about 18 degrees between them would be necessary.

A combination of the patterns of Fig. 3 and Fig. 4 allow a four-digit readout. The fourth and fifth paths from the center of Fig. 4 are the thousands lag-lead and hundreds lag-lead control sectors. These are each split at two-transition points, 99 to 00 and 49 to 50, respectively.

Thousands and More

Because all digits must be referred to the primary (units-tens) shaft in an isolated manner, a thousands lag-lead path is added—the fourth brush path of Fig. 4. This is done in two phases. The thousands lag-lead control sectors around the units-tens shaft are wired through the insulating board to the thousands lag-lead common sectors around the hundreds-digit shaft (lower left, Fig. 3).

Thousands-digit lag-lead brushes transfer the signal to a second thousands lag-lead control sector around the hundreds shaft. The interconnections are completed by through-wiring—since this is the only means of passing from the center of the hundreds pattern—to the thousands pattern (upper right, Fig. 3).

Magnetic Detenting Used

To ensure that the reading brushes do not fall between two conductors, a magnetic detenting method is used. The stop is produced when a sector of magnetic gear teeth—the detent magnet—attracts similar teeth on a 100-tooth detent gear. As the detent magnets are energized immediately

prior to a reading, the magnetic gear teeth send flux in and out of the detent wheel, causing tooth alignment. Simultaneously, because of an axial offset between magnets and the detent wheel, a vertical motion takes place which brings the brushes down onto the commutator pattern. Brush life is prolonged, because the brushes are raised above the pattern during slewing.

Another method sometimes used by IBM, Mr. Walton notes, involves a "check pattern." Ambiguity or non-validity of a point on the commutator pattern is signaled to a detent magnet. If it

is non-valid, a one-half-bit brush motion is used to bring the brushes into a valid area. Because the check pattern is an integral part of the commutator pattern, it is accurately aligned and costs almost nothing extra.

Applications Cited

The assembled patterns of Figs. 3 and 4 and the gear-tooth detent, together with brushes, gears and back and front plates, comprise an analog-to-digital converter capable of measuring shaft positions or displacements, such as length, when con-

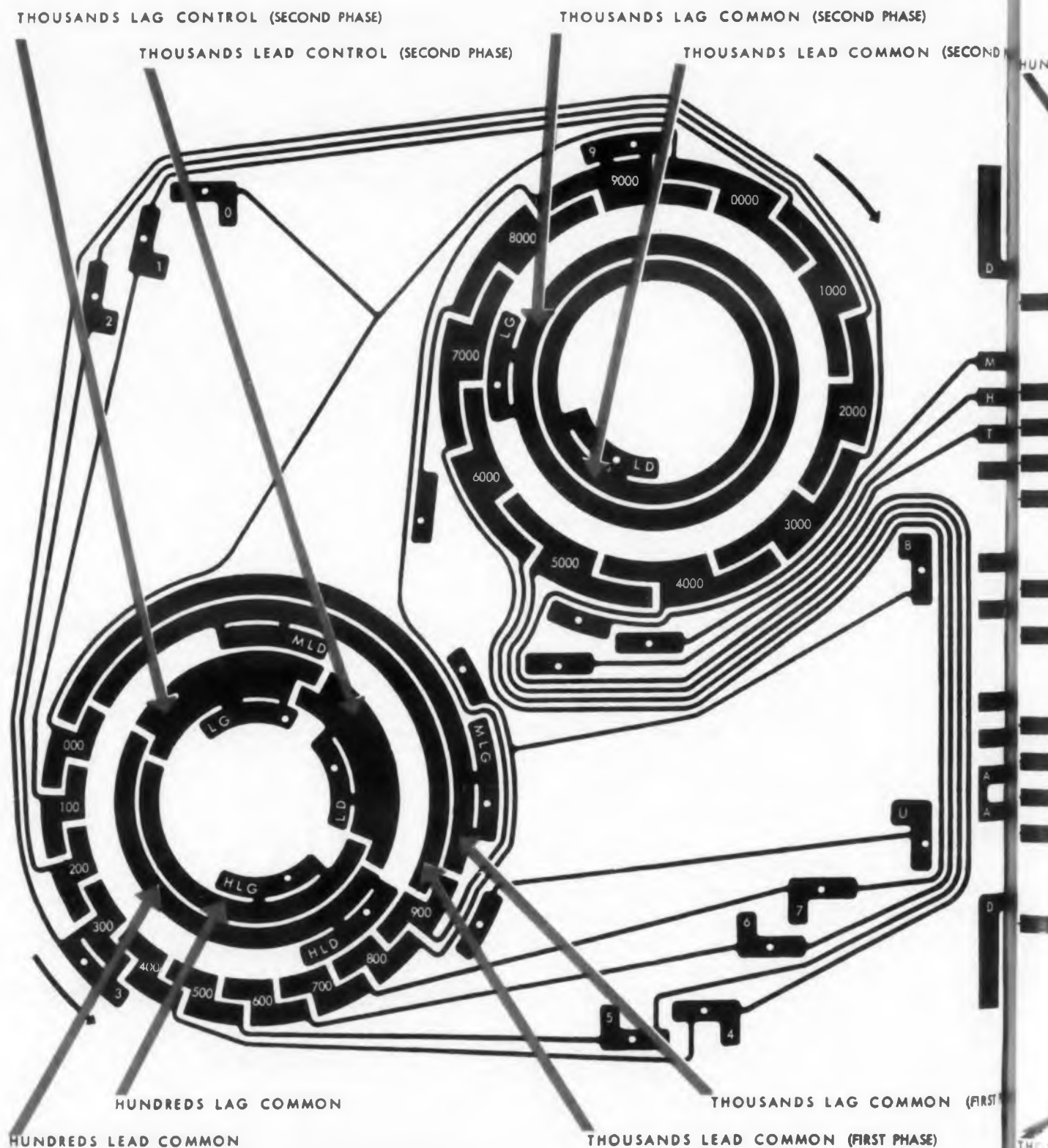

Fig. 3. An actual pattern showing hundreds and thousands digit tracks and lag-lead tracks for gearing backlash compensation. Two phases are used for thousands lead control. Counterrotation is used between the two patterns; it is impossible, in two dimensions, to interconnect two patterns advancing in the same direction.

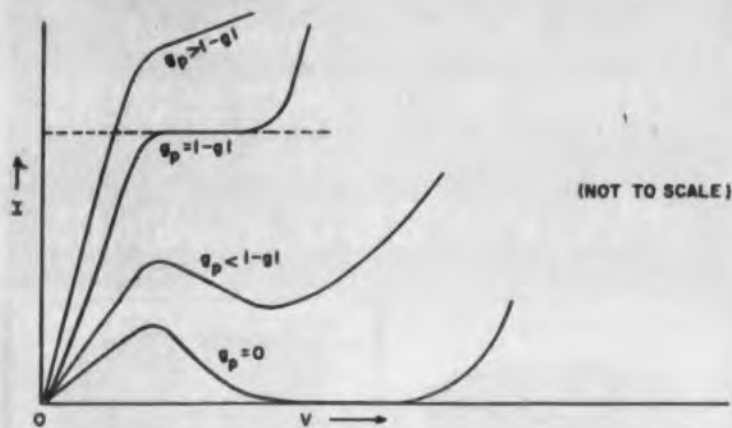

Fig. 15. Voltage vs. current for paralleled negative and positive conductances.

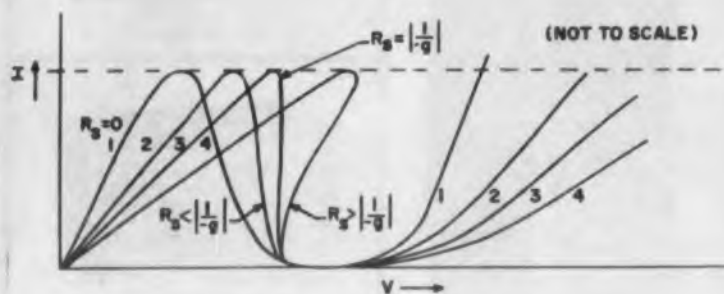
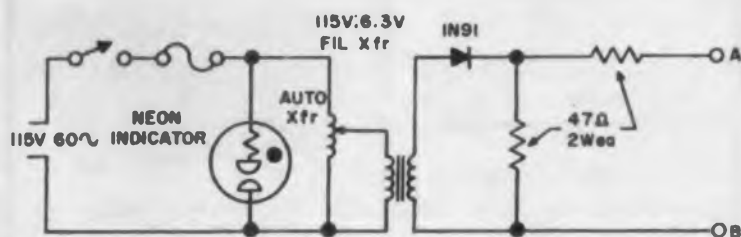

Fig. 16. Voltage vs. current for series connected negative and positive conductances.



NOTE:
SCOPE WITH AT LEAST 50 MV/INCH SENSITIVITY

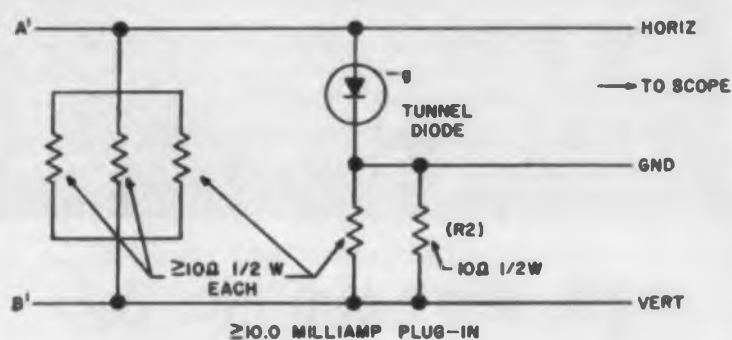
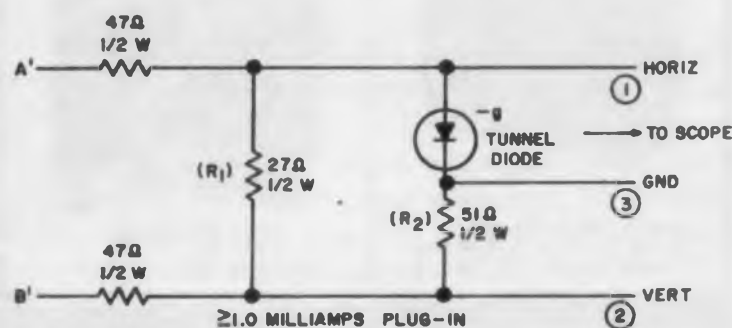

Fig. 17. Curve-tracer circuit and plug-ins.

Designing with Tunnel Diodes

Part 2

In Part 1 of this two-part series, the authors analyzed circuit and device stability and showed how this analysis leads into design procedures for practical high-frequency amplifiers.

It is also necessary to have a knowledge of the magnitude of the tunnel-diode parameters. Therefore, in this second part, the authors discuss methods of measuring these parameters and how stability considerations apply.

MEASUREMENT of tunnel-diode characteristics begins with the information available from the voltage vs current curve in Fig. 1 (Part 1, *ED*, Feb. 3, 1960, p50). We are interested in the peak and valley currents, (I_P , I_V) and the peak-to-valley current ratio, I_P/I_V for switching purposes. We would like to know the magnitude of the negative-conductance, and its rate of change with voltage, so that we can determine the maximum voltage swing consistent with "linear" operation.

We shall need to measure the diode capacitance in the negative-conductance region, and determine how it is affected by voltage. In the analysis of circuit stability, the need for this knowledge becomes obvious. As was shown, the limits of operating frequency and stability will be determined by the circuit inductance, and a knowledge of I_s will be mandatory. In addition, we will be concerned with methods of measuring R_s .

Before discussing the curve tracer, it is necessary to show the requirements for the circuit.

First consider a negative conductance paralleled with a positive conductance of various values.^{5, 6}

Since the voltage is common to both elements we will add the currents and the various curves of Fig. 15 will result. We see that only when $g > |-g_D|$ will we have a stable intercept for a current source; and that the variation in voltage

with current changes is largest when the $g_D = |-g_D|$ and decreases as g_D is increased.

Second, a similar approach may be applied for the series circuit as shown in Fig. 16. For increasing series resistance the current change for a change in voltage becomes progressively larger until $R_s = |-r_D|$. Increasing R_s beyond this point will generate a curve with no stable intercept for any voltage.

Obviously the curve-tracer circuit shown in Fig. 17 is a combination of both these first and second considerations, and $(R_1 + R_2)$ must be less than $(1/|-g|)$ for the curve to be displayed.

Curve Tracer

The circuit for a curve tracer suitable for 1- to 10-milliamp (I_P) tunnel diodes (by changing plug-ins) is shown in Fig. 17. Use an oscilloscope with at least 50-mv/in. sensitivity.

By using a simple calibration technique we can measure both I_P and I_V on the displayed curve. Fig. 18 shows the calibrator circuit.

Calibrate horizontal (voltage) on scope (with nothing attached) using terminals 1' - 3'. Attach curve tracer to scope and calibrate current by inserting calibrator terminals 2' - 3' into like-numbered terminals on the curve tracer (with no tunnel diode in test socket) and adjusting the vertical sensitivity for the desired deflection.

The approximate magnitude of $-g$ may be de-

terminated as shown in Fig. 15 by inserting a calibrated potentiometer in parallel with the tunnel diode and adjusting it for a horizontal line in the "active" voltage region of the diode. The principle is that of parallel positive and negative conductances discussed previously.

Defining the measured quantity (the required resistance of the pot)

$$R_p = \left| \frac{1}{-g'} \right|, \text{ then } \left| \frac{1}{-g_D} \right| = \frac{1 + R_s g'}{g'}$$

If $R_s \ll |1/g|$ we may neglect the error (that is $R_s g' \ll 1$)

Note that in the construction of this equipment one must take extreme pains to keep lead length to an absolute minimum; as the additional inductance may cause oscillations. When the tunnel diode is oscillating the characteristics appear as shown in Fig. 19.

I_P, I_V, V_P, V_V DC Test Set

A dc test circuit which will permit more precise measurements of I_P and I_V may be constructed as shown in Fig. 20.

Since the tunnel diode can switch at extremely high speeds, a capacitor is used to suppress the transient charging currents through the distributed capacitance of the 75-K ohm source resistor when voltage is being changed. The normally closed switch across the diode circuit is used for the same purpose when inserting the tunnel diode to check the current at which it switches to the high-voltage state.

The forward current of the silicon-diode clamp (which prevents the open-circuit voltage from appearing across the test socket at any time) is small enough at the operating voltage of a germanium tunnel diode that it may usually be neglected.

In operation, the forward current in the tunnel diode is increased until it switches, and the peak current required is read on the series milliammeter. The current is reduced very slightly and the diode reset with S_1 . The peak voltage may then be read on the dc vacuum-tube voltmeter.

S_2 adds series resistance to the circuit to reduce the current when measuring I_V . Switch S_3 is used to set the diode in the high-voltage condition by momentarily permitting two or three times the peak current to flow through it. After the diode has been switched, the forward current is gradually reduced until the voltage across the device drops back to the low-voltage condition. The "sustaining" current is measured, increased very slightly and the diode again set with S_3 . The valley voltage is then read on the vtm.

Measurement of Tunnel Diode Capacitance

The measurement of the capacitance of an

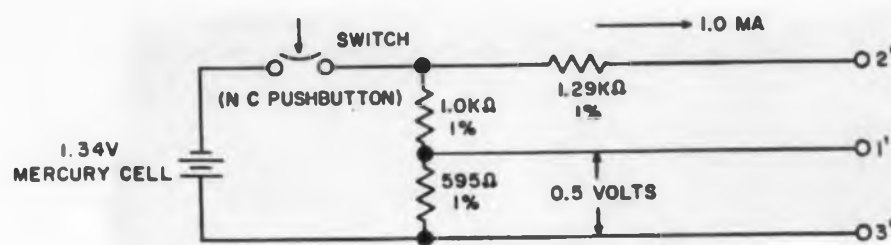

Fig. 18. Calibrator circuit for use with curve tracer.

Fig. 19. Tunnel-diode characteristic when oscillating.

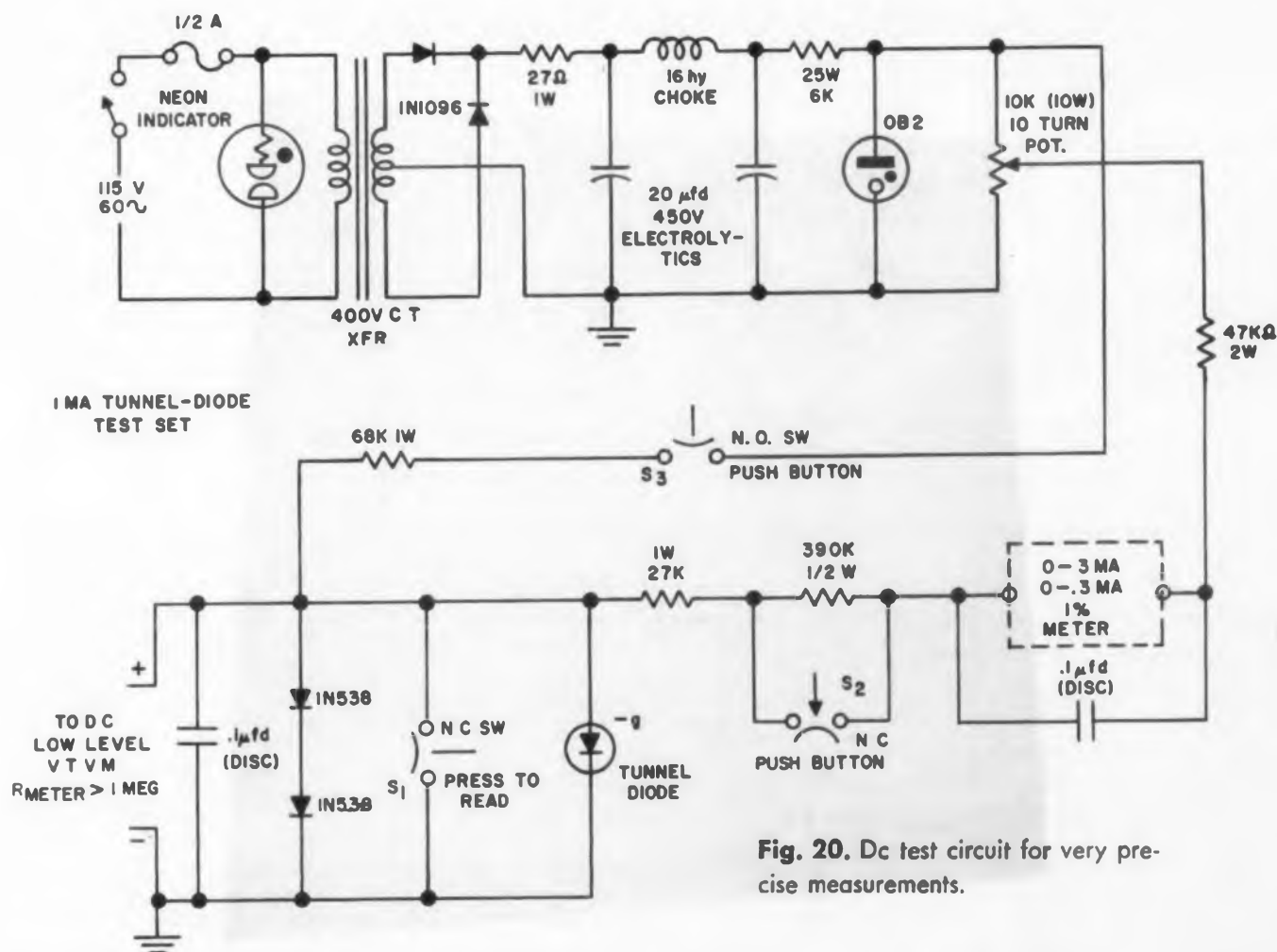
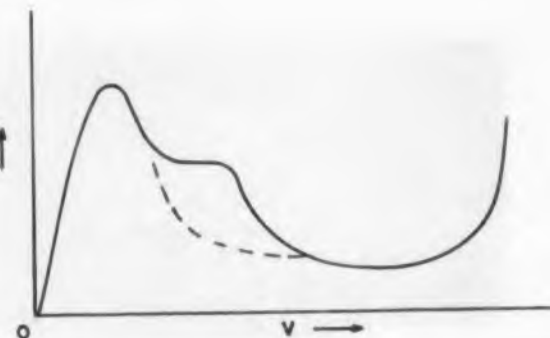

Fig. 20. Dc test circuit for very precise measurements.

active two-terminal device presents problems over and above those encountered in measuring a complex circuit alone.

Let us consider the latter for a moment; from the equivalent circuit of Fig. 2. (ED, Feb. 3, 1960, p 50) we can arrive at certain conclusions as to the proper measuring frequency and the test circuit requirements.

From the equations for the series impedance and the two critical frequencies discussed in the section on circuit stability (Part 1, ED, Feb. 3, 1960, p 50), we may define a measuring frequency

W_M and a $Q = WC/g$, such that

$$Z_{(w)} = R_s - \frac{1}{g(1 + Q^2)} + jw \left[l_s - \frac{C}{g^2(1 + Q^2)} \right]$$

Now at $W_C = \frac{g}{C}$ then $Q = 1$

$$\text{at } W_R, R_s = \frac{1}{g(1 + Q^2)}$$

$$\text{at } W_X, l_s = \frac{C}{g^2(1 + Q^2)}$$

Fig. 21. Test circuit for active element measurement (a), and its equivalent circuit (b) at measuring frequency ω_M .

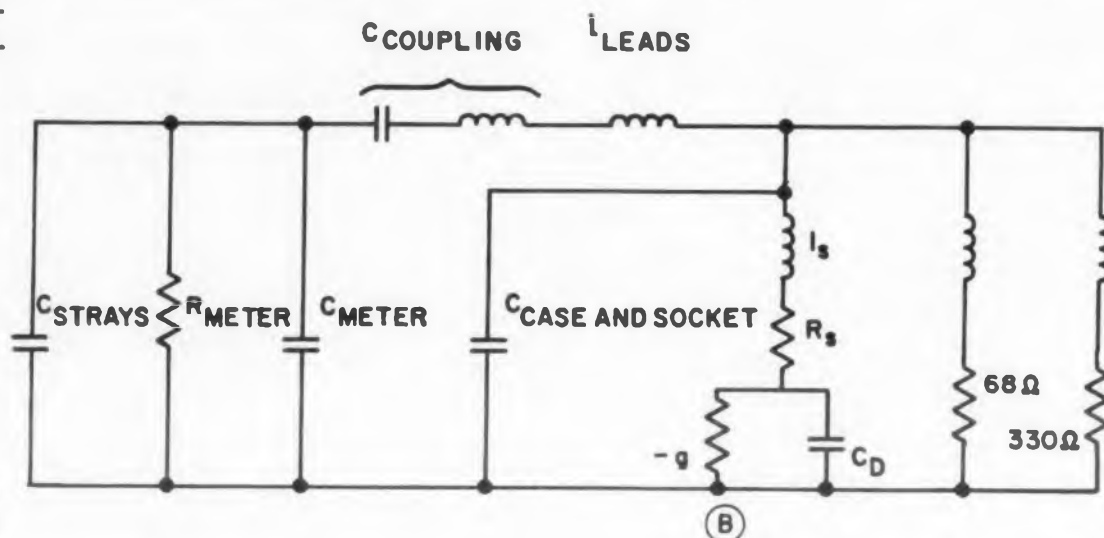
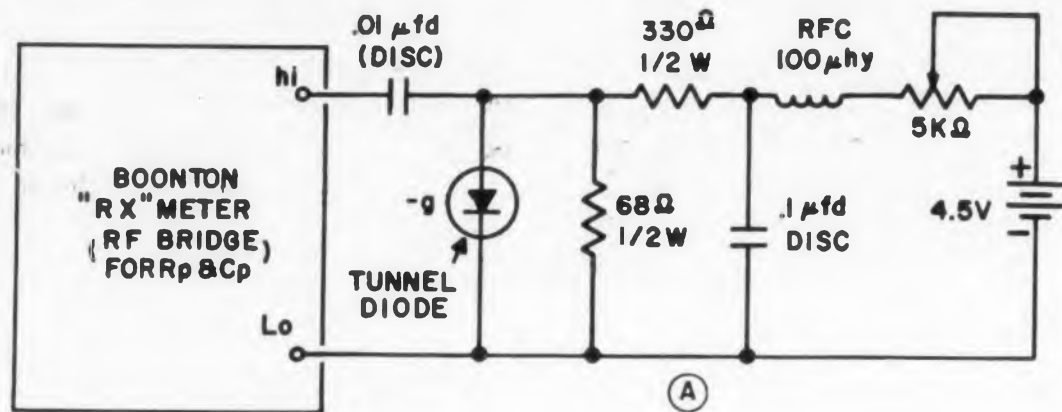

then at $\omega_M \ll \begin{bmatrix} \omega_C \\ \omega_R \\ \omega_X \end{bmatrix}$

The admittance of the circuit can be written as

$$Y = \frac{g^2 + \omega^2 C^2}{g^2 + \omega^2 [l(g^2 + \omega^2 C^2) - C]^2}$$

Since at ω_M , $g^2 \gg \omega_M^2 C^2$

then $Y \approx g + j\omega(C - l g^2)$

Now if $l g^2 \ll C$ the equivalent circuit is that of a capacitor and negative conductance in parallel. For the tunnel diode specified, this is only true

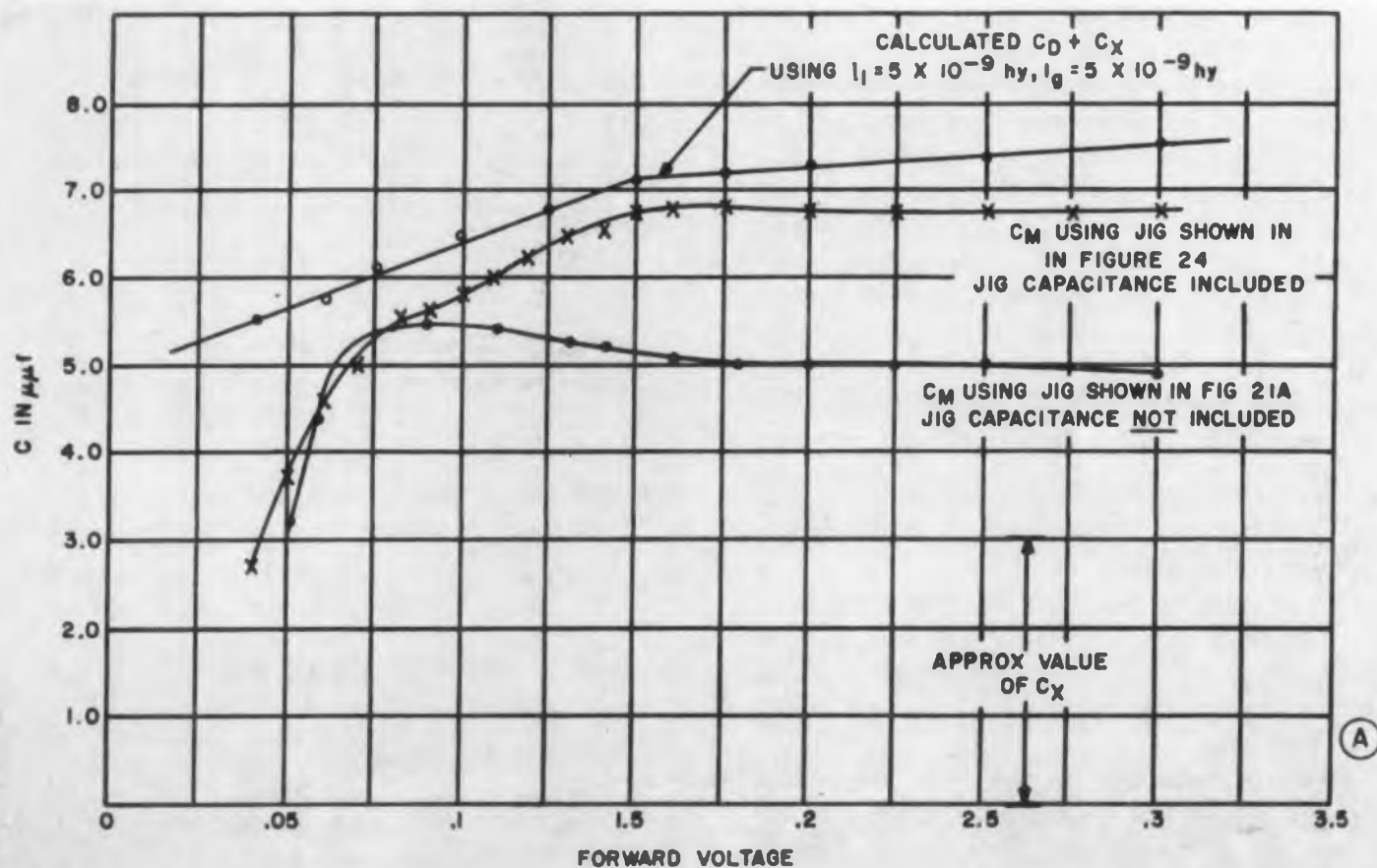

at the peak and in the valley region. Below the peak and in the negative-conductance region the apparent capacitance will be reduced. (However, we must consider the additional inductance of the connecting leads from the bridge to the device, as will be discussed later.)

The problem of active-element measurement, of course, includes the stability considerations discussed previously.

Now consider the test circuit shown in Fig. 21(a). The equivalent circuit at ω_M may be represented as shown in Fig. 21(b).

Aside from the problem of insuring a sufficiently low level of rf signal at the unknown in order that our measurements be "small-signal;" we see immediately that the analysis of poles and zeroes becomes extremely complex, and that if C_M is large enough with respect to lead inductance the device may oscillate at a very high frequency. This can be determined by monitoring the signal level at the device using a very sensitive rf voltmeter, or by touching the case of the tunnel diode and noticing if the measured values are affected. (The case is grounded at ω_M but not entirely so at the very high frequency of the oscillation.)

It may be of interest to note that when oscillations are present the apparent capacity measured on the bridge rises to several times the actual capacitance in the $-g$ region, as is shown in Fig. 22(b).

An alternate and more satisfying method involves the use of transmission line techniques.

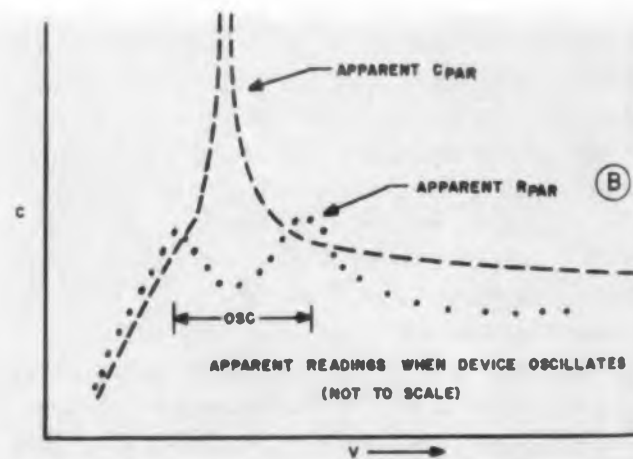

Fig. 22. Variation of capacitance with voltage (a), and apparent capacity when oscillations are present (b).

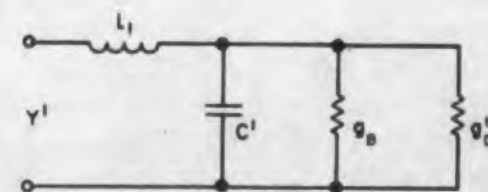
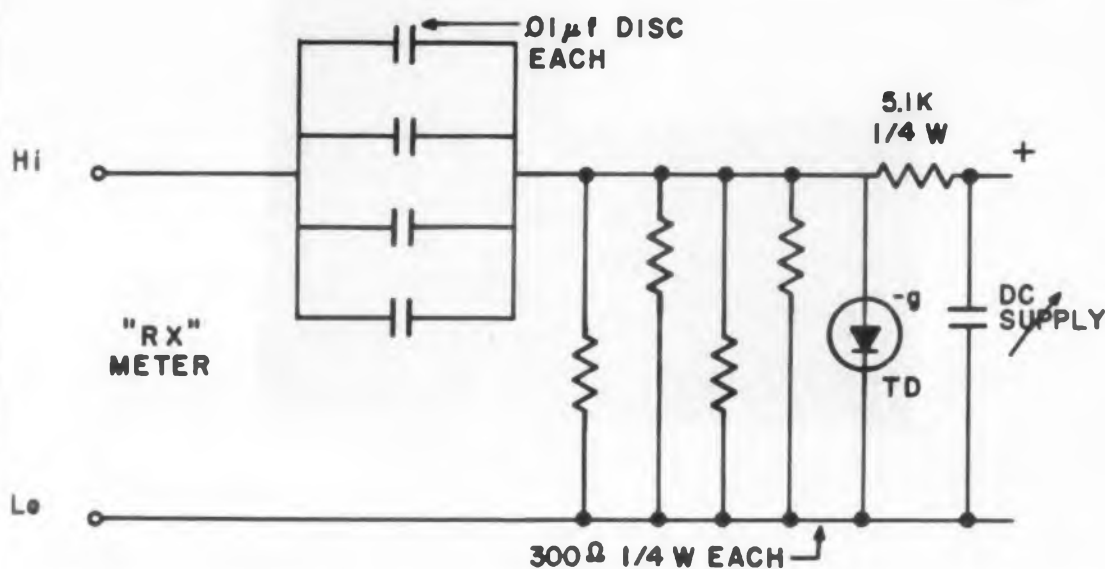
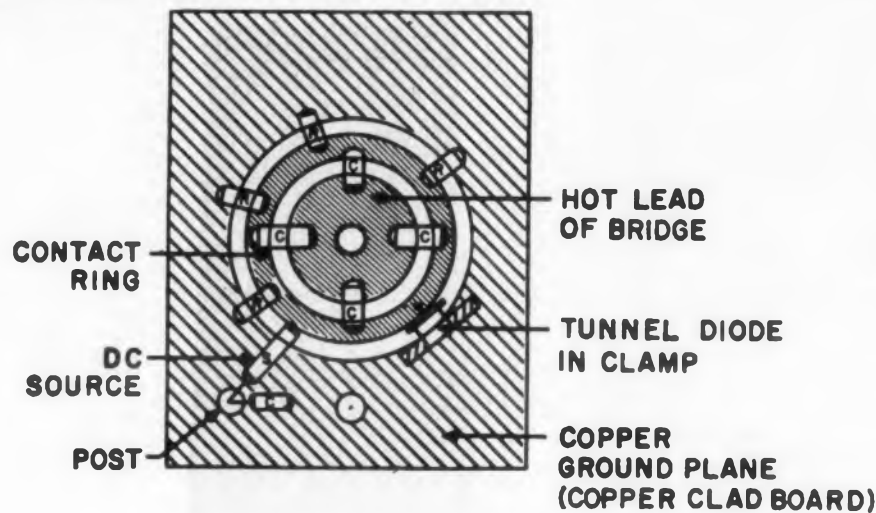

Fig. 23. Approximate circuit of rf bridge.

Fig. 24. Final test circuit for use with "RX" meter.



Namely the measurement of the reflection coefficient on a 50-ohm transmission line driven by a 50-ohm generator and terminated in the tunnel diode. From the relationship:

$$\Gamma = \frac{Z_X - Z_0}{Z_X + Z_0}$$

we can calculate the capacitance seen at the end of the transmission line. (Provided that

$\frac{1}{-g} \gg 50$ ohms so that the device can be biased in the active region. This limits the method to diodes of less than 2-2-1/2 ma for a 50-ohm system.)

Provided that lead inductance is kept to a minimum, the 50-ohm series resistance in the loop is constant to very high frequencies; and is usually large enough to provide a stable system, so that the probability of oscillation is greatly reduced.

We must still find equipment capable of making reflection coefficient measurements at sufficiently low frequencies and low levels to satisfy the requirements mentioned before. Fortunately such equipment is commercially available.¹⁰

The variation of capacitance with voltage for

a typical 1.0-ma tunnel diode is plotted in Fig. 22(a).

The reason for the variation in apparent capacity in the negative conductance region can be shown to be due to the additional inductance between the bridge and the tunnel diode and bias resistor. Defining the terminal values of the tunnel diode as

$$g'_D \text{ and } C'_D \quad (g'_D \approx g_D, C'_D \approx C_D - l_1 g_D^2)$$

then $C' = C'_D + C_{\text{case}} + C_{\text{strays}}$

The circuit of the bridge is approximately as shown in Fig. 23, where g_B is the conductance of the bias resistor. Let $g' = g_B + g'_D$ and notice that g_D varies with voltage as is obvious from the V/I curve, going from positive to negative and back to zero. Again then;

$$Y' \approx g' + j\omega(C' - l_1 g'^2),$$

$$Y' \approx (g_B + g_D) + j\omega[C_X + C_D - l_1(g_B + g_D)^2]$$

or $C \text{ measured} \approx C_X + C_D - [l_1(g_B + g_D)^2 + l_1 g_D^2]$ where $C_X = C_{\text{case}} + C_{\text{strays}}$

The final test circuit (for use with the RX meter) where l_1 has been kept to a minimum, is

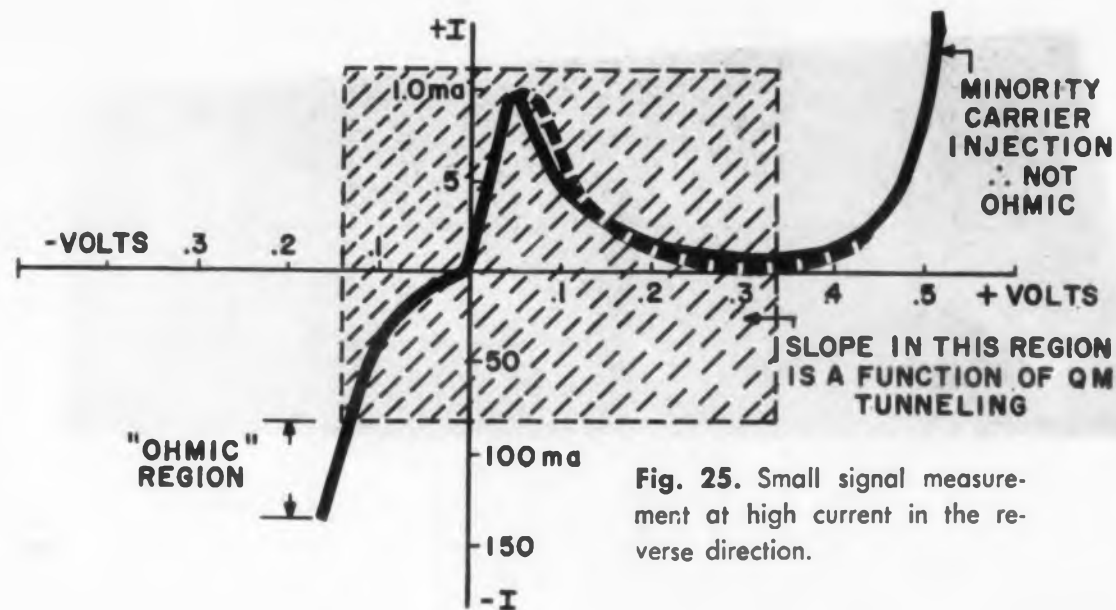

Fig. 25. Small signal measurement at high current in the reverse direction.

shown in Fig. 24 showing radial layout of components.

For the sake of simplicity and expediency, we suggest measuring the diode capacitance in the valley region at approximately 0.3 dc.

Measurement of R_g

Without resorting to microwave measurements, only approximate values of R_g can be measured. However, an estimate of the maximum value is readily determined.

Since R_g is the total internal resistance of the device, we are describing the contact and lead resistance as well as ohmic resistance of the semiconductor bulk.

Firstly, we may inspect the $V-I$ curve and note that (as in Fig. 16) an appreciable series resistance will shift the apparent V_p . This effect is often noticeable in very high current devices.

Secondly, we can make a small-signal measurement of slope in a region where the slope is not appreciably affected by changes in voltage.

At very low voltages and currents, the slope is affected by the same changes of the density of states that causes the negative-conductance region itself (conduction in the reverse direction is also due to quantum-mechanical tunneling) and is therefore not an induction of ohmic resistance.

We cannot measure at a high current in the forward direction since strong minority carrier injection will conductivity-modulate the bulk resistance and give erroneous results.

All that remains is a small-signal measurement at high current in the reverse direction, pictured in Fig. 25. Forward and reverse currents are not to the same current scale. The circuit used is as shown in Fig. 26.

By removing the dc supply, inserting a precision 5-ohm resistor in place of the tunnel diode, and

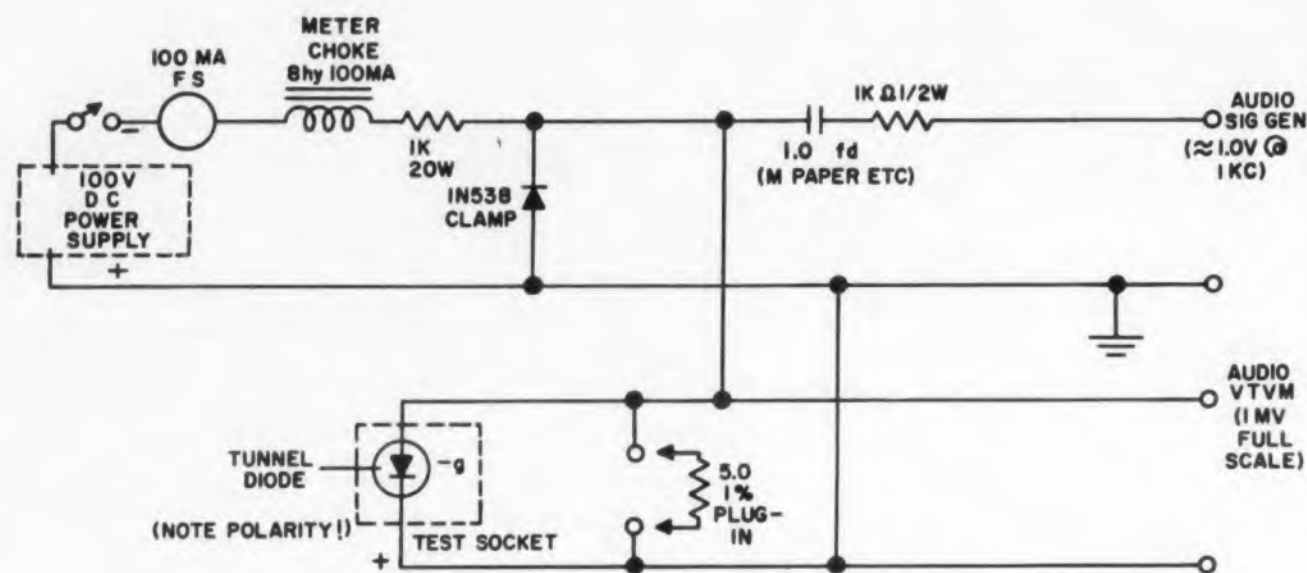

Fig. 26. Circuit for obtaining results shown in Fig. 25.

adjusting the signal level for a reading of 5 mv on the vtvm, we have a simple measurement of the slope in millivolts per ohm. By measuring at a reverse current 100 times larger than I_p we are reasonably sure that we are in the "ohmic" region.

The obtained reading is indicative of the maximum value of R_B and can only be conservative when used in our calculations.

Measurement of I_B

Of all of the required parameters, I_B has proven to be the most difficult to measure precisely. Our first measurement was made (using a General Radio admittance-meter at 500 mc) on an internally shorted case and allowing approximately 1/4-in. lead lengths. However, the measured value of 10 m μ hy is only of zero order significance, since we are concerned with the total circuit-as-it-stands inductance; which may be either much larger or appreciably smaller than the indicated values, depending on the circuit configuration.

For example—the inductance of even a 1/10-w resistor with the shortest possible leads is still significant; as is the lead inductance of even a high-frequency bypass capacitor; and we may certainly not neglect the leads of the socket should one be used.

In addition, the particular tunnel diodes being investigated have been designed to permit mounting in "microstrip" transmission lines with the case itself inserted into the ground-plane of the line. (The pellet is case mounted and two leads are attached to the junction material.) With both junction leads paralleled and connected to the strip line we estimate that the residual inductance is in the order of 2 m μ hy. (To date this has not been measured.)

We can attack this problem from another angle by examining the maximum frequency of oscillation.

Let us assume $W \left(= \frac{g}{C} \right) \ll W_X \ll W_R$

let: $Q = \frac{WC}{g}, \frac{c}{g} = \tau$

since at W (oscillation),

$$l = \frac{c}{g^2(1+Q^2)} \text{ then } l = \frac{\tau}{g(1+W_o^2\tau^2)}$$

and since $Q \gg 1$ then $l \cong \frac{1}{W_o^2\tau g}$, hence $l \cong \frac{1}{W_o^2C}$

Note that for the Bogey values given $g/c \cong 250$ mc, so that to calculate to within 10 per cent the inductance of the circuit from the frequency of oscillating frequencies must be above 750 mc.

We have not considered the Noise-Figure of the amplifiers designed, although a mention of some very promising results obtained may be found in the literature.^{7,8,9} Nor have we considered the innumerable applications of the tunnel diode in circuits where stability is deliberately violated, that is, oscillators, autodyne mixers, switching circuits and the like.^{2,3,5}

Our purpose has been to familiarize the circuit designer with a method of approaching the design of a two-terminal active-device amplifier; and show that even for such a device (which acts like an amplifier with very strong positive-feedback) one can design stable circuits. ■ ■

Appendix

For the circuit shown in Fig. 3(b) (Part 1, ED, Feb. 3, 1960, p 50), we can write the set of mesh equations:

$$\begin{cases} e_1 = R_T i_1 + L \frac{di_1}{dt} + \frac{1}{C} \int (i_1 - i_2) dt \\ 0 = -\frac{1}{g} i_2 - \frac{1}{C} \int (i_1 - i_2) dt \end{cases}$$

By Laplace Transformation

$$\begin{cases} E_1 = I_1 (R_T + LS) + \frac{1}{CS} [I_1 - I_2] \\ 0 = -\frac{1}{g} I_2 - \frac{1}{CS} [I_1 - I_2] \end{cases}$$

Re-arranging in Matrix Notation

$$\begin{bmatrix} \left(R_T + LS + \frac{1}{CS} \right) & \left(-\frac{1}{CS} \right) \\ \left(-\frac{1}{CS} \right) & \left(-\frac{1}{g} + \frac{1}{CS} \right) \end{bmatrix} \begin{bmatrix} I_1 \\ I_2 \end{bmatrix} = \begin{bmatrix} E_1 \\ 0 \end{bmatrix}$$

The currents can be solved as:

$$I_1 = \frac{\begin{vmatrix} E_1 & -\frac{1}{CS} \\ 0 & -\frac{1}{g} + \frac{1}{CS} \end{vmatrix}}{\begin{vmatrix} R_T + LS + \frac{1}{CS} & -\frac{1}{CS} \\ -\frac{1}{CS} & -\frac{1}{g} + \frac{1}{CS} \end{vmatrix}}$$

$$I_2 = \frac{\begin{vmatrix} R_T + LS + \frac{1}{CS} & E_1 \\ -\frac{1}{CS} & 0 \end{vmatrix}}{\begin{vmatrix} R_T + LS + \frac{1}{CS} & -\frac{1}{CS} \\ -\frac{1}{CS} & -\frac{1}{g} + \frac{1}{CS} \end{vmatrix}}$$

Let us examine I_1 ,

$$I_1 = \frac{E_1 \left(\frac{1}{CS} - \frac{1}{g} \right)}{\Delta}$$

where

$$\Delta = \left(R_T + LS + \frac{1}{CS} \right) \left(-\frac{1}{g} + \frac{1}{CS} \right) - \left(\frac{1}{CS} \right)^2$$

By simplification,

$$I_1 = E_1 \left[\frac{CS - g}{LC S^2 + (R_T C - Lg) S + (1 - R_T g)} \right]$$

Alternately, one can obtain this result directly by writing the input impedance at "X" of Fig. 3(b), and replacing jW by S .

$$Z(s) = R_T + sL + \frac{1}{sC - g}$$

$$I(s) = \frac{E_1}{Z(s)}$$

whence:

$$i_1(s) = E_1 \frac{CS - g}{CLs^2 + (R_T C - Lg)s + (1 - R_T g)}$$

Let the roots of the denominator be

$$S = \alpha \pm jW$$

Then $i_1(t)$ must contain a pair of terms:

$$\begin{aligned} i_1(t) &= K e^{(\alpha + jW)t} + K^* e^{(\alpha - jW)t} + \dots \\ &= 2[K]_{\text{real}} e^{\alpha t} \cos Wt + \dots \end{aligned}$$

The zero of $Z(s)$ in the right half S -plane indicates that α is positive and in general this term $e^{\alpha t}$ represents a growing function of time. The system is therefore unstable.

If the zeroes are $S = \pm jW$ it implies that:

$$i_1 = K e^{jWt} + K^* e^{-jWt} + \dots = 2(K)_{\text{real}} \cos Wt + \dots$$

This is a steady oscillation.

Note that the analysis is only for linear, or small-signal operation. Hence the parameters of the diode are assumed to be constant.

Nonlinear operations have been excluded here. In other words, a stable relaxation type oscillator, for instance, is a system which is unstable in nature. ■ ■

References

1. L. Esaki, *Phys Rev*, 109, 603 (1958).
2. H. S. Sommers, Jr., *Proc IRE*, 47, P 1201, 1959.
3. I. A. Lesk, N. Holonyak, Jr., U. S. Davidsohn, and M. D. Aarons, Germanium and Silicon Tunnel Diodes-Design Operation and Application, 1959 Wescon Conv Rec.
4. H. W. Bode, "Network Analysis and Feedback Amplifier-Design".
5. I. A. Lesk, N. Holonyak Jr., U. S. Davidsohn; "The Tunnel Diode-Circuits and Applications", *Electronics* Vol 32 #48 P 60, 1959.
6. J. W. Horton, A. G. Anderson, Full-Adder using Neg. Res. Diodes. *IBM Journal* July 1958.
7. K. K. N. Chang (Letters to Editor) *Proc. IRE* 47, P. 1268, 1959.
8. J. J. Tiemann and R. L. Watters, Noise Considerations of Tunnel Diode Amplifiers presented at the 1959 IRE-AIEE Solid State Devices Research Conference, Cornell University, June 17, 1959.
9. H. S. Sommers, et al Tunnel Diodes for Low-Noise Amplification, 1959 Wescon Conv. Rec.
10. (A) Operating Instruction Manual, VHF Z-G Diagraph, Model ZDU, Rhode and Schwarz, Munich, Germany.
- (B) R. P. Abraham and R. J. Kirkpatrick, "Transistor Characterization at VHF", *Semiconductor Products*, Jan., 1959.



INHERENT STABILITY

Assured in a DALOHM 750 or 1000 Trimmer Potentiometer

The ability to perform reliably under extreme conditions of heat and humidity is only one mark of the inherent stability that is standard in Dalohm trimmer potentiometers.

Stored on the shelf for months... or placed under continuous load... operating in severe environmental, shock, vibration and humidity

conditions... Dalohm precision trimmer potentiometers retain their stability because it has been "firmly infixed" by Dalohm design and methods of manufacture.

For all applications demanding trimmer potentiometers that meet or surpass MIL specifications, you can depend on Dalohm.

WIRE WOUND • SEALED • HIGH POWER • DALOHM TYPE 750 and 1000 TRIMMER POTENTIOMETERS

Miniature and standard sizes with completely sealed cases. Three terminal configurations provide the solutions for demanding design problems.

	750	1000
Rated at ...2 watts		2.5 watts
Resistance range10 ohms to 30K ohms	10 ohms to 50K ohms
Standard tolerance	... ± 5%	± 5%
Size180" x .300" x 1.000"	.180" x .300" x 1.25"
Screw adjustment	..17 ± 2 revolutions	25 ± 2 revolutions
Weight2 grams	2.5 grams

Write for Bulletins R-41A and R-44, with handy cross-reference file cards.

- Completely sealed
- Meets humidity requirements of MIL-STD-202A, Method 106A or MIL-E-5272A, Procedure 1
- End resistance is 3%, maximum
- Nominal resolution is from 0.1% to 1.2%
- Temperature coefficient is 50 PPM/° C.
- Meets load life requirements of MIL-R-19A
- Surpasses applicable paragraphs of MIL-R-12934A

SPECIAL PROBLEMS?

You can depend on DALOHM, too, for help in solving any special problem in the realm of development, engineering, design and production. Chances are you can find the answer in our standard line of precision resistors (wire wound, metal film and deposited carbon); trimmer potentiometers; resistor networks; collet-fitting knobs; and hysteresis motors. If not, just outline your specific situation.

from **DALOHM**
Better things in
smaller packages
DALE PRODUCTS, INC.
1328 28th Ave., Columbus, Nebr.

CIRCLE 51 ON READER-SERVICE CARD

PESCO STATIC INVERTERS

NO
TRANSISTORS

HIGHLY
RELIABLE

FEWER
COMPONENTS

SHORT
CIRCUIT
PROTECTED



A high degree of efficiency and reliability is assured by the new PESCO

Static Inverter developed by BORG-WARNER research.

Utilizing controlled rectifiers and no transistors, the new unit offers exceptional performance under space flight conditions.

Fewer components increase reliability. Operation at ambient temperatures of -55°C up to $+135^{\circ}\text{C}$ is possible without fans or coolers. Built-in short circuit protection, automatic or manual (local or remote) reset, is accomplished without fuses or circuit breakers. Other outstanding characteristics include:

Voltage Regulation to $\pm 1\%$; Frequency Regulation to $\pm .005\%$; Inherent sine wave output.



STATIC INVERTERS available from 250 VA to 3000 VA.



PESCO PRODUCTS DIVISION
Borg-Warner Corporation
3310 Vanowen Street • Burbank, California
24700 No. Miles Road • Bedford, Ohio

CIRCLE 52 ON READER-SERVICE CARD

Isomodulator Kills Double Moding

ELIMINATING the need for repeller modulation of klystrons or grid modulation of backward-wave oscillators, a new microwave modulator-isolator combination does away with measurement problems like double moding, frequency modulation, output power instability and broad spectra.

Built by Rantec Corp., Calabasas, Calif., the Model EXM-10 Isomodulator

is a self-contained package comprising a ferrite amplitude modulator, ferrite isolator and enough electronic circuitry to drive the modulator. It works off a 115-v 60-cps power outlet, requires no other input.

Using the Isomodulator with a cw klystron or a bwo signal source results in a clean, narrow spectrum containing only the carrier frequency and two sidebands.

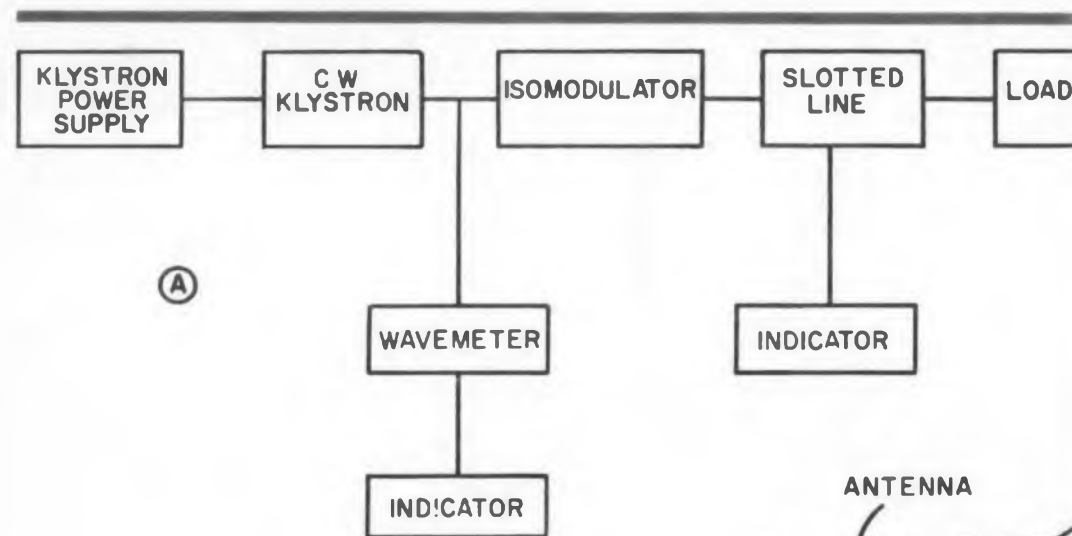

Two test setups with the Isomodulator: (a) shows a bench setup for measuring vswr; (b) is the unit's use with a circulator for measuring on-axis reflectivity.

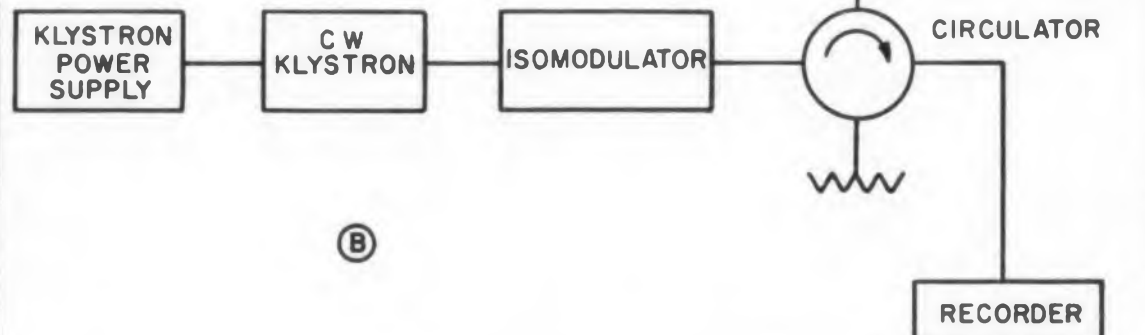



Used as a klystron or bwo modulator in vswr, reflectivity or insertion loss measurements, The Isomodulator does away with repeller modulation of klystrons or grid modulation of bwo's.

The isolator section combats frequency pulling and power fluctuation due to changes in load.

Two uses of the Isomodulator are shown in the drawing. In a standard bench setup for measuring vswr, the unit is inserted directly between the klystron or bwo and the slotted line.

Previously on-axis reflectivity measurements were made by using time sharing techniques to separate the transmitted and received signals, requiring specialized equipment. Using a circulator is possible, but requires extreme frequency stability and low spurious levels—reflections due to mismatch of the antenna-circulator connection have to be cancelled by some device like a slide-screw tuner.

A perfect match can be had at one frequency only. Any spurious signal not at the discrete frequency tends to mask the reflected signal being measured. Using the Isomodulator, says Designer Sam Rosen, Head of Rantec's Electronics Laboratory, reduces the spurious level and incidental frequency modulation to a point so low that the circulator-Isomodulator technique will measure reflectivity over a 40-db dynamic range.

Frequency range of the EXM-10 is 8.5 to 11.0 kmc; isolation is 15 db minimum. Modulation is from zero to 100 per cent. With no modulation, insertion loss is 4.5 db max. With 100 per cent modulation the output is the same as with repeller square-wave modulation within one db. Modulating frequency range is from 900 to 1100 cy.

Price of the EXM-10 Isomodulator is \$95; delivery is within 30 days of order.

For further information, turn to the Reader-Service Card and circle 101.

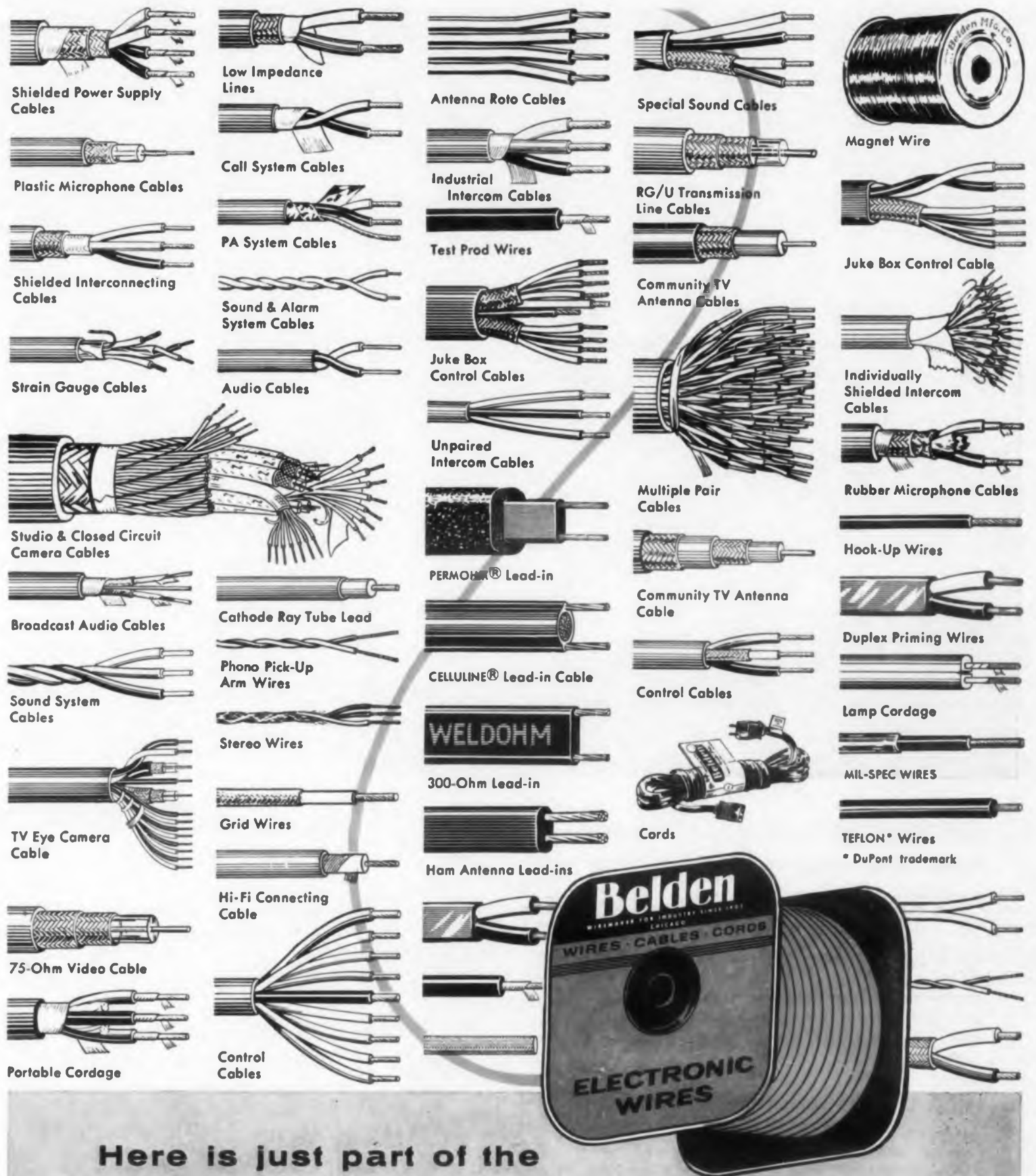

Here is just part of the
WORLD'S MOST COMPLETE LINE
of Electronic Wire and Cable!

Belden

WIREMAKER FOR INDUSTRY
SINCE 1902
CHICAGO

Available from Stock

One Wire Source for Everything
Electronic and Electrical

magnet wire • lead wire • power supply cords • cord sets • portable cordage • electronic wire
• automotive replacement wire and cable • aircraft wire • electrical household replacement cords

E-39

PERFORATED TAPE READER



new DYKOR® all-solid state photo-electric reader offers optimum reliability, faster stops and higher reading speeds...

For applications such as digital computers, machine tool control and tape conversion, the *fastest, most accurate* Tape Reader available is the unique DYKOR 3500. Built by pioneers in data processing technology, the 3500 provides *high reliability* at high tape speeds.

FEATURES . . .

- **STOPS FASTER**—Before the next character at 1,000 char./sec.
- **READS FASTER**—1,500 char./sec. (or faster if required).
- **RELIABILITY ASSURED**—By use of silicon photo-diodes, completely transistorized circuitry on etched circuit boards, simple integrated optical system with regulated lamp current.
- **VERSATILITY**—5, 6, 7 or 8-channel tapes handled interchangeably. Reads any standard tape material including oiled yellow Teletype paper.
- **SIMPLE HANDLING**—In-line load and unload.
- **CHOICE OF SINGLE OR DUAL SPEEDS.** Spooler unit available.



MODEL 4500—This DYKOR reel/strip Reader handles 8" or 10½" reels or strips interchangeably.

DIGITRONICS CORP.

103 Albertson Avenue • Albertson, L. I., N. Y. • Pioneer 7-5090

DIGITRONICS INVITES INQUIRIES FROM QUALIFIED ENGINEERS FAMILIAR WITH DIGITAL TECHNIQUES. SOME TERRITORIES OPEN FOR REPRESENTATION

CIRCLE 53 ON READER-SERVICE CARD

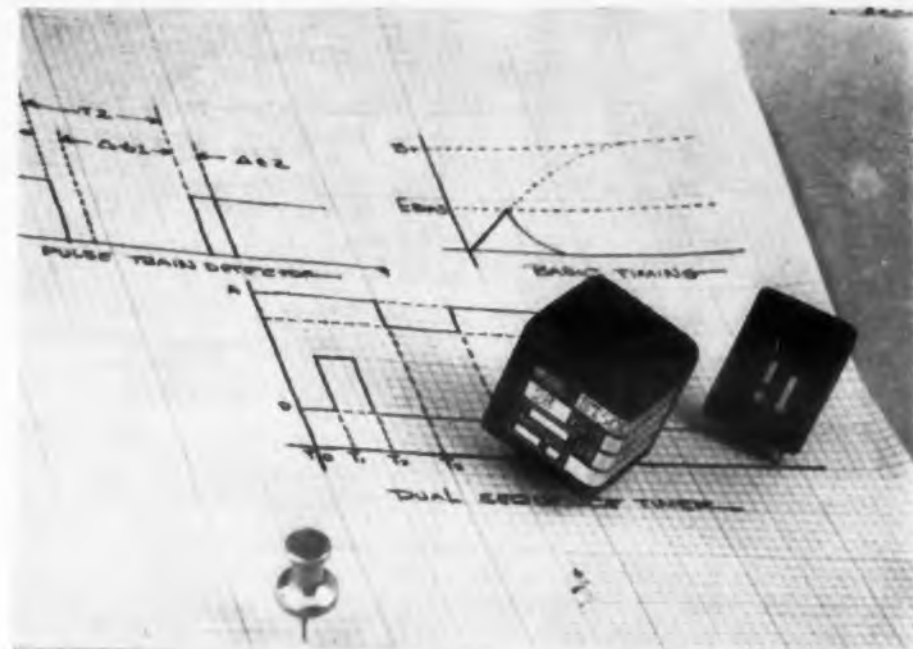

Precise time control in small packages. These modules can switch a load in 2 μ sec and can provide delays as long as 300 sec.

Controllable Solid-State Timing Modules Can Implement Logic Functions

NEW solid-state timing modules provide a wide variety of precise timing and logic functions. These modules are available with fixed or adjustable time delays ranging from 50 μ sec to 300 sec.

Control points can be brought out of the timers to satisfy many specific requirements. For example, one can fire a circuit before the completion of a timing cycle, one can recycle the timer at will, or one can prevent the unit from timing till a prescribed signal arrives.

In the adjustable units, the time delay can be varied over a 20 to 1 range. The manufacturer, Tempo Instrument Inc., Commercial St., Hicksville, N.Y., supplies equations and curves to help the user determine the external resistance required for a specific time delay.

The timers can operate with a supply voltage from 18 to 31 v dc. The supply must deliver 20 ma for the timer in addition to the load requirements which can

be as high as 100 ma.

Under worst conditions, such as ambient temperature as high as 125 C and maximum load current, the timer will deliver full supply voltage to the load minus the drop across an equivalent 20-ohm resistor.

Tempo guarantees the accuracy of maximum delay, available from 3 to 10 per cent, over the full voltage range, over a temperature range from -55 C to +71 C or +125 C, and under severe conditions of shock, vibration, and acceleration.

Available in a variety of package and terminal configurations, the units are all encapsulated in polyurethane foam and are hermetically sealed.

The versatility inherent in these modules allows them to be used for many applications such as counting, timing, pulse-train generation and sensing, repeat-cycle timing, programming, and sequencing. Used with standard external

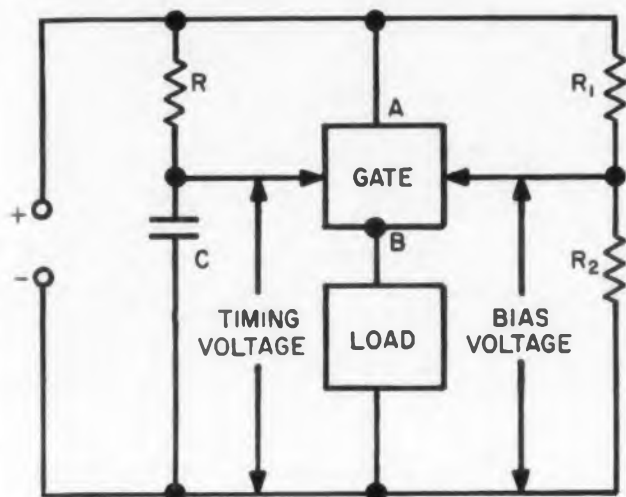

Basic configuration of the timing modules allows control flexibility.

gates, they can implement many types of logic functions.

Prices of the modules range from about \$100 to \$400 depending on requirements for high temperature operation, length of time delay, and timing accuracy. Modifications such as multiple outputs or multiple controls can raise the price.

Some of the standard units are available in 72 hours. Units designed to special requirements may require 4 to 6 weeks. The smallest modules in current production come in the size of a 1-in. cube and weigh about 1.3 oz. Before the end of March, a miniaturized module, 7/16 in. x 7/8 in. x 1 in., will be available, weighing 0.6 oz.

For more information, turn to the Reader-Service Card and circle 100.



Wired terminal boards of the timing module prior to encapsulation in polyurethane foam.

NOW \$825

A Full Four-Digit Voltmeter at a Pointer Meter Price!



FOR THE FIRST TIME you can have the accuracy, speed and reliability of an NLS digital voltmeter with full four-digit resolution . . . for the price of a quality pointer meter. That's the dramatic story of the new NLS V64! Only NLS high-volume production techniques make it possible. Use the low-cost, versatile V64 for a wide range of measuring jobs. See the V64 in action . . . contact NLS today!

BRIEF SPECIFICATIONS: Accuracy \pm (.02% of reading plus 1 digit) . . . full 4-digit resolution . . . measures DC voltages from one millivolt to 500 volts in steps of \pm 9.999/99.99/500.0 . . . one package design (5 1/4" high, 15 1/4" deep for 19" rack) . . . plug-in accessories permit measuring AC or low-level DC voltages . . . available from stock for immediate delivery.



Originator of the Digital Voltmeter

non-linear systems, inc.

DEL MAR (SAN DIEGO), CALIFORNIA

NLS — The Digital Voltmeter That Works . . . And Works . . . and Works!

CIRCLE 54 ON READER-SERVICE CARD

Time Control



with easy-to-use **EAGLE CYCL-FLEX** reset timers

A highly accurate and dependable easy-to-use timer, designed for mounting in control panels. Sealed dial protects timer when exposed to oil and dust conditions. Timer switches control four load circuits. Interlocking contacts are provided without the use of auxiliary relays. Synchronous motor drive insures accurate timing.

WRITE for descriptive Bulletin 120. Address Dept. ED-260.

EAGLE HAS 24 TYPES TIME-COUNT CONTROLS

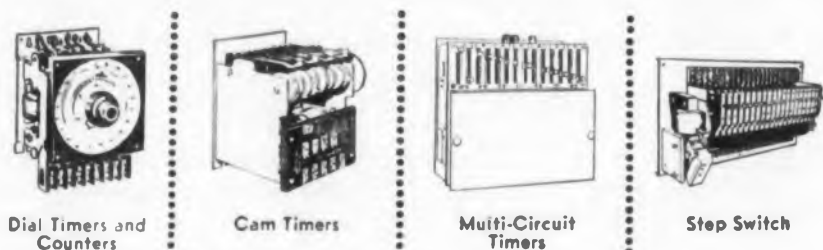

Dial Timers and Counters

Cam Timers

Multi-Circuit Timers

Step Switch

EAGLE  **SIGNAL COMPANY**
MOLINE, ILLINOIS
REPRESENTATIVES IN PRINCIPAL CITIES
CIRCLE 55 ON READER-SERVICE CARD



Rapid, Direct Readout With

Rise, Storage and Fall Time Meter

for Transistors, Diodes, High-Speed Devices

DIRECT readout of transistor rise, storage and fall time parameters is possible with a new meter designed to replace sampling scopes and fast pulsers. Semi-automatic provisions, such as automatic range selection and less than 100-msec readout response, limit test time to the speed of insertion of the units under test to the test socket; one transistor per second or better is possible as compared to about 20 seconds currently spent with scope displays.

Time parameters are displayed directly on panel meters as well as voltages at the rear of the instrument. Ranges extend from 10 μ sec full scale to 10 μ sec in four steps; accuracy is ± 7 per cent ± 5

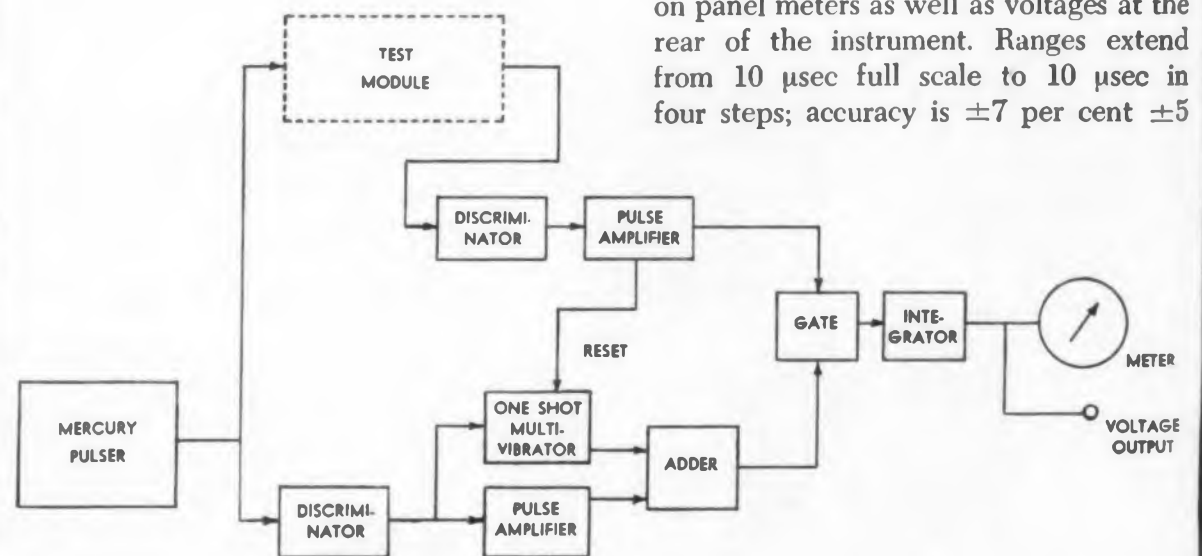

Block diagram of one of the three time measurement channels in the Model 140. Pulse amplifiers take 0.2-v input, produce 10-v/ μ sec output. To measure turn-on time of a transistor, discriminator at output of test transistor can be adjusted to conduct at 90 per cent of full amplitude.

Instrument front shows
direct-reading panel me-
ters to show rise, storage
and fall times in ranges
from 10 μsec full scale
to 10 μsec full scale

μsec. Relatively unskilled personnel are
needed for meter readout as compared to
the attention required for scope interpre-
tation.

Designed by E-H Research Laborato-
ries, Inc., 1922 Park Blvd., Oakland 6,
Calif., the Model 140 uses a mercury
switch to generate a fast-rising square
wave at 60 cps. The square wave is ap-
plied to the test module, such as a transis-
tor with the input to the base and the
output from the collector, as shown in the
block diagram.

At the same time, the mercury pulse is
applied through a voltage discriminator
to a fast pulse amplifier and a one-shot
multivibrator. The result is a steep-front
pulse of long duration. Similar circuitry is
triggered by the test module output via a
discriminator and is applied through a
gate together with the direct pulse. The
output width of the gate is integrated;
the current applied to the meter is a
linear function of time.

Instead of using a low resistance to
generate fast RCs, the Model 140 makes
use of a combination of fast diodes and
transistors. Sensing is accomplished by
using transistors as amplifiers to make
switching time a function of gain.

Three separate channels of time meas-
urement are provided, each containing
adjustable voltage discriminators for se-
lection of times of interest. For example,
to measure turn-on time of a transistor
(delay plus rise time), the discriminator of
one channel would be set to conduct at
90 per cent of full amplitude.

The Model 140 Meter, priced at
\$3750.00, includes one of three available
series preamplifiers; Model 141-PNP for
testing pnp transistors, 141-NPN, and
Model 141-DI for diode measurements.
Each preamplifier is separately available
at \$600.00. The equipment is applicable
to the measurement of transient response
of cables, pulse transformers, amplifiers,
delay lines and other high-speed devices.

For more information, turn to the
Reader-Service Card and circle 102.



RUGGED RELIABILITY ALWAYS ON HAND with American Electronics Synchros

You can depend on high performance and dependability at all times with the complete line of control synchros (transformer differential and transmitter), produced by the Instrument Division of American Electronics, Inc. Used as a family or independently in system applications, these units will operate over a temperature range of -55° to $+125^{\circ}\text{C}$... and can be supplied to operate up to 200°C .

Available in frame sizes from 8 to 25 these synchros meet and exceed the stringent standards of MIL-SPEC. 20708.

The key to proven reliability lies in the quality features engineered and manufactured into each unit. Greater stability and corrosion resistance is accomplished by stainless steel housings. Encapsulated unit construction and hermetically sealed windings are used to withstand the extremes of vibration and shock. Through-bore construction means fewer parts and less space in which damaging moisture may collect.

SIZE 11 ELECTRICAL DATA

	11E22M-81G (Transformer)	11E22M-01F (Transmitter)	11E22-81J (Differential)
PRIMARY	Stator	Rotor	Stator
INPUT (VOLTS)	11.8	115	11.8
TEST (VOLTS)	10.2	115	10.2
FREQUENCY (CPS)	400	400	400
Z _{R0} ROTOR IMPEDANCE (STATOR OPEN CIRCUITED) (OHMS)	3340 /79°	2000 /80°	107 /78°
Z _{S0} STATOR IMPEDANCE (ROTOR OPEN CIRCUITED) (OHMS)	570 /80°	18 /79.5°	92 /80°
MAX. NULL VOLTAGE (FUNDAMENTAL) (VOLTS)	.030	.015	.015
(TOTAL) (VOLTS)	.040	.020	.020
MAXIMUM ERROR (MINUTES)	3	3	3
TRANSFORMATION RATIO (R/S) ±4%	2.203	.103	1.154
PHASE SHIFT (DEGREES)	5	6	6
D. C. RESISTANCE (OHMS)			
STATOR	60	3	11
ROTOR	385	185	19.0



FOR INFORMATION ON
SIZE 8 AND OTHER SIZES
WRITE FOR
SPECIFICATIONS.

For complete
information on
the outstanding
performance of
the complete
line, write



AMERICAN ELECTRONICS, INC.

INSTRUMENT DIVISION

9503 WEST JEFFERSON BOULEVARD, CULVER CITY, CALIFORNIA
CIRCLE 56 ON READER-SERVICE CARD

THE AMCO MODULAR INSTRUMENT ENCLOSURE SYSTEM

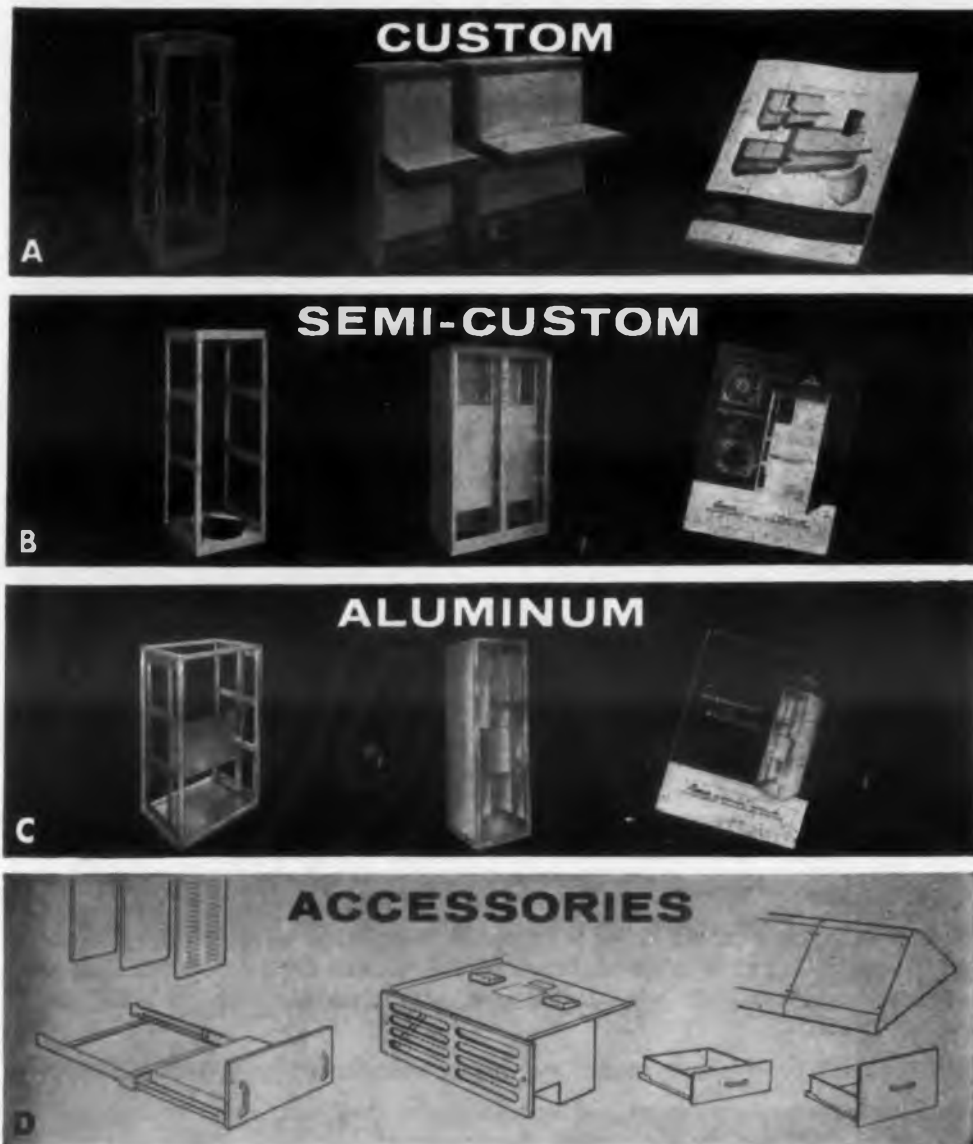

TWO COMPLETELY NEW LINES ADDED IN STEEL AND ALUMINUM TO GIVE 3 COMPLETE MODULAR FRAME LINES IN ONE OVER-ALL SYSTEM

- A Amco Custom Line.** Removable multi-panels and cowlings based on 19" increments of width. Custom, single-unit appearance for frames mounted in series—ideally suited for complex console arrangements. The 19 $\frac{1}{16}$ " width of frame saves space in series mounting of frames. Constructed of double-channel 16 gauge cold-rolled steel. Conforms to EIA mounting standards.
- B Amco Semi-Custom Line.** Removable multi-width cowlings provide a semi-custom, single-unit appearance for frames mounted in series. Extra rugged, wide box-type channel frames provide greater internal mounting area. 19" wide panels of any thickness can be recessed—from a flush-mounted position to any desired depth. Box type channel construction of 14 gauge cold-rolled steel. Conforms to EIA mounting standards.
- C Amco Aluminum Line.** This system of aluminum box extrusions and cast corners allows easy assembly of cabinets in any size from 7" to 20' in height, width or depth. Corners and extrusions

lock together by hand with built-in locking device. All sizes are standard. Ideal for stocking and odd-ball sizes. Cast and hardened corners of 356-T6 aluminum as described in Federal Spec. QQ-A-596a. Extrusions of 6061-T6 aluminum as described in Federal Spec. QQ-A-270a.

Amco Accessories. A full line of Amco integrated accessories such as blowers, chassis slides and mounts, lighting, doors, drawers, dollies and many more available for A, B and C shown.

Cost savings. All the above—or any part thereof—may be ordered under one combined discount schedule base determined by order dollar value. Orders received at one time with one delivery date may also be combined. Free pre-assembly by Amco provides additional savings in time and installation.

3 week delivery on all standard parts. We welcome inspection of our plant and facilities. Send for your free literature now.



AMCO ENGINEERING CO.

7333 W. Ainslie Street, Chicago 31, Illinois
CIRCLE 57 ON READER-SERVICE CARD

A Quick Summary Of Flow Graph Rules

PRESENTED here in one convenient form are the basic rules for flow graph analysis. The flow graph method of writing equations offers distinct advantages over standard equations. Flow graphs simultaneously display all of the equations of a system and can be read to obtain a broad view of the functional dependences. It can then be read in detail to obtain precise pieces of information.

The rules presented here are summarized from the four-part series, "Visual Engineering Mathematics" by T. R. Nisbet and W. W. Happ, which appeared in ELECTRONIC DESIGN, Dec. 9, Dec. 23, Jan. 6, and Jan. 20. Table 2 is a new table which was not included in the original series.

Note on Rule 6, Table 2. The procedure for evaluating Path $\times \Sigma$ non-touching-loops is as follows:

1. Write down the product of all the transmittances in the path concerned.
2. Erase the path from the flow graph.
3. Erase any loops that touch the path.
4. Regard what is left as a new flow graph and find the sum of the loops in the usual way.

The product of 1 and 4 gives the required answer.

Many subjects lend themselves to flow graph notation; some do not. The mathematical proof of the formula for an infinite series can be written in two lines from a simple flow graph. Transistor "h" parameters can be converted to "z" parameters by a single manipulation of the flow graph. Amperes, ohms, volts, and watts, however, cannot be embodied simultaneously in the same flow graph. ■ ■

Table 1. Fundamental Flow Graph Rules

ADDITION		$y = tx + uy$
		$y = tx - uy$
SUBTRACTION		$y = tx - uy$
MULTIPLICATION		$y = tx$
DIVISION		$y = \frac{tx}{1 - tu}$
IDENTITY OR UNIT TRANSMITTANCE		$y = x$
NEGATIVE UNIT TRANSMITTANCE		$y = -x$

Originality in design concepts...
your job... and **Centralab's**

**Economical
Versatile
Reliable...**

**MODEL 5
RADIOHM®**

**1/4 WATT
MULTIPLE MINIATURE
VARIABLE RESISTOR**

(Component Density: 16.2 per cu. in.)*

Table 2. Specific Flow Graph Rules





1 Feedback at a Node (See Eq [26])	Example 	Formula $s = p \left(\frac{1}{1 - gh} \right)$
2 Feedback About a Transmittance (See Eq [25])	Example 	Formula $s = p \left[e \left(\frac{1}{1 - gh} \right) \right]$
3 Reversal of Path Through Distributive Node (See Eq [16])	Example 	
4 Reversal of Path Through Contributive Node (See Eq [17])	Example 	
5 Topology Equation (for a Closed Flow Graph) (See Eq [34])	$\sum \text{loops} = \left[1 - \sum L_1 + \sum L_2 - \sum L_3 + \sum L_4 \dots \right] = 0$ where subscript denotes order of loop	
6 Nontouching Loop Rule (for an Open Flow Graph) (See Eq [37])	Transmittance between two nodes = T $T = \frac{\sum (\text{Path} \times \sum \text{nontouching loops})}{\sum \text{loops}}$	

Table 3. Active or Passive Network Parameters

z-PARAMETERS 	y-PARAMETERS 
h-PARAMETERS 	g-PARAMETERS 
a-PARAMETERS 	b-PARAMETERS 
MNEMONIC AID: ALWAYS DRAW VOLTAGE NODES ABOVE CURRENT NODES. ROTATE THE APPROPRIATE DIAGRAM UNTIL THE REQUIRED PARAMETER IS ON TOP. EXAMPLE: z-PARAMETERS	
	

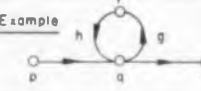
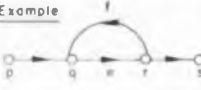
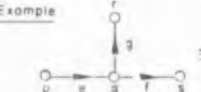

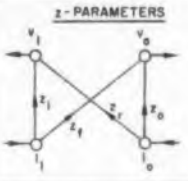
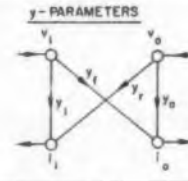
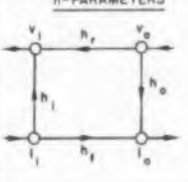
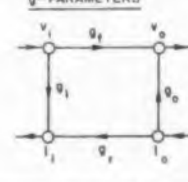
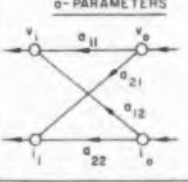
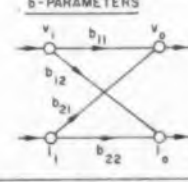
The Model 5 is a new proven design concept, not merely an improvement of an existing component. This is typical of CENTRALAB's approach to product design. It is available with up to 4 variable and 9 fixed resistors on a single steatite plate measuring 2 1/4" x 3/4" x 1 1/32", including knobs... proportionally smaller when fewer variable resistors are required. This remarkable increase in component density is another CENTRALAB "first," setting the example for the electronics industry.

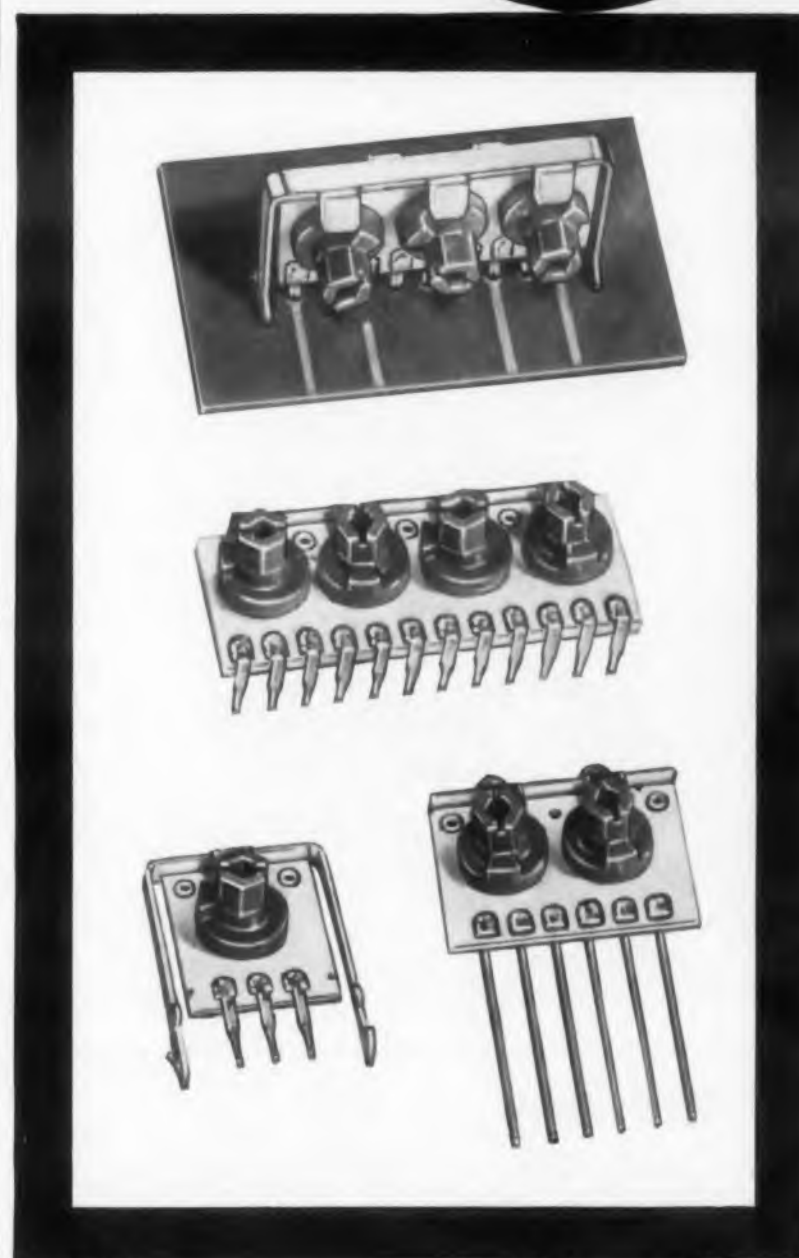
A WIDE RANGE OF MOUNTING STYLES AND TYPES

Model 5 Radiohms® are available with horizontal or vertical mounting brackets, plug-in terminals for printed circuit boards or wire leads for metal chassis.

SPECIFICATIONS

Resistance Range: 1000 ohms to 5 megohms, linear taper

Wattage Rating: 1/4 watt at 70°C. ambient

Breakdown Voltage: 1250 volts RMS, between adjacent sections and to bracket

End Resistance: Less than 1% of total

Initial Torque: 2 inch ounces average

Complete specifications and design data are given in CENTRALAB Bulletin EP-539; write for your copy today.

* Cubic inch, rather than cubic foot, is used to provide a more realistic and more readily visualized standard of comparison.

Centralab 

ELECTRONICS DIVISION OF GLOBE-UNION INC.
960B E. KEEFE AVE. • MILWAUKEE 1, WIS.
In Canada: 669 Bayview Ave., Toronto 17, Ont.

VARIABLE RESISTORS • ELECTRONIC SWITCHES • PACKAGED ELECTRONIC CIRCUITS • CERAMIC CAPACITORS • ENGINEERED CERAMICS
CIRCLE 58 ON READER-SERVICE CARD

NEW PRODUCTS

Covering all new products that might generally be specified by an electronics engineer engaged in the design of original equipment.

Reflex Klystron 716 Provides Minimum Of 3 Mw From 88,000 to 92,000 Mc

Type QK673 mechanically tuned reflex klystron oscillator is designed for operation in the 88,000 to 92,000-mc range and provides a minimum output of 3 mw. The rf output is through waveguides sealed by a mica window. Heater voltage is 2.5 v and heater current is 1.45 amp. Resonator voltage and current are 1400 to 1700 v and 40 ma. The unit has a dwarf octal base and cooling is by forced air.

Raytheon Co., Microwave and Power Tube Div., Dept. ED, Waltham 54, Mass.

Price & Availability: Delivery is 90 days from receipt of order, and price is \$4000. These will be changed as the unit gets into production.



Price and Availability

PRICE AND AVAILABILITY data is now being added, whenever possible, to the New Product descriptions that appear in *ELECTRONIC DESIGN*. This data will help you to:

- Evaluate the products more intelligently.
- Decide which products to buy now and which to wait for.
- Schedule your orders wisely.

—Get an insight into prices and savings for similar products.

Most manufacturers have been very cooperative in providing us with **Price and Availability** data. Since some of the data arrived after our deadlines, it was impossible to add it to all of the products. The data represents the latest information at the time of publication.



Variable Attenuators Available For K, V, Q, M and E Bands

717

These variable attenuators, although low in cost, are claimed to offer precision and accuracy nearly comparable to expensive, precision attenuators. They are designed for the K, V, Q, M and E bands. The direct-reading dial is accurately calibrated to within 1 db up to 10 db and 1.5 db up to 20 db over the entire waveguide frequency range. Maximum attenuation exceeds 25 db and minimum insertion loss is under 0.5 db. All models are well shielded.

Narda Microwave Corp., Dept. ED, 118-160 Herricks Road, Mineola, N.Y.

Price & Availability: All are available from stock. Price for the K and V bands is \$150 and \$180, respectively. Price is \$200 each for the Q, M and E bands.

Creative Microwave Technology

Published by MICROWAVE AND POWER TUBE DIVISION, RAYTHEON COMPANY, WALTHAM 54, MASS., Vol. 1, No. 9

NEW RAYTHEON MAGNETRONS FOR A WIDE RANGE OF APPLICATIONS



Transistor Amplifier 718 Has Servo, Audio, Pulse Applications

Model 207G germanium-transistor amplifier is designed for servo, audio, pulse applications. Its operating temperature range is -50 to $+50$ C; it measures $1\frac{1}{4}$ x $\frac{3}{4}$ x $\frac{3}{8}$ in. Open-loop gain is over 40 db and closed-loop gain is 10 to 26 db. Enclosed in a stainless steel case, it can withstand a vibration of 400 g at 2 kc without microphonic noise.

Taber Instrument Corp., Dept. ED, Tonawanda, N. Y.

Price & Availability: Price is \$89 each; availability data on request.

Tantalum Foil Capacitors 719 Operate From -55 to $+125$ C

The TH-type line of miniaturized tantalum foil capacitors is designed to operate in the temperature range of -55 to $+125$ C. Capable of operation at 150 v or less, they are available with plain or etched foil, and polar or nonpolar construction, insulated or not. The capacitors can be stored at temperatures of -55 C or lower. They are available for 10, 15 and 150-v operation in all 5 case sizes which are $\frac{3}{4}$, $1\frac{1}{4}$, $1\frac{9}{16}$, $2\frac{1}{4}$ and $2\frac{7}{8}$ in. in length.

Transistor Electronics, Inc., Dept. ED, Bennington, Vt.

Price & Availability: Prices range from \$2.34 to \$10.18 per thousand, depending on size. Five case sizes are kept in stock.

Designed for C-band systems requiring tunability, the RK-7156 magnetron has a minimum peak power output rating of 250 kilowatts over a frequency range of 5,450 to 5,825 megacycles. Applications include a flight-tested, revolutionary airborne weather radar system. The RK-7156 is in quantity production.

CIRCLE 832
Reader Service Card



RK-7156

* * *

X-band magnetron for airborne search radar provides one megawatt minimum peak power and 875 watts average



QK-624

power within a frequency range of 9,340 to 9,440 Mc. Designated QK-624, this pulsed-type tube is liquid cooled and should give at least 1,000 hours of reliable service.

CIRCLE 833
Reader Service Card

* * *

For ground-based and airborne radar systems, the RK-7529 magnetron provides a 2.0 microsecond pulse of 3.5 megawatts minimum peak power over 2,700 to 2,850 Mc. This liquid-cooled tube is interchangeable with other fixed-frequency S-band tubes operating at similar power levels.

CIRCLE 834
Reader Service Card



RK-7529

* * *

A one kilowatt beacon magnetron, the RK-7578 weighs only 14 ozs., yet will withstand vibrations of 15 G's at 20 to 2,000 cycles and shock up to 100 G's. It is



RK-7578

mechanically tunable and covers the 5,400 to 5,900 Mc range.

CIRCLE 835
Reader Service Card

* * *

Developed to withstand extreme environmental conditions, the RK-7449 magnetron is a lightweight, compact tube with a minimum peak power output of 45 kilowatts at the operating frequency of 24 kmc. The RK-7449 is required to withstand re-



RK-7449

peated shocks of 50G. Stable operation is guaranteed at vibration frequencies up to 2,000 c.p.s. with 30G applied.

CIRCLE 836
Reader Service Card

A Leader in Creative Microwave Technology



When requirements are rugged:

only Weston
RUGGEDIZED

Instruments
are so
consistently

RELIABLE



Sure, lots of instruments are offered for use under rough conditions. But how many make the grade? How many can you count on to give consistently dependable service over the years? And how many manufacturers provide a line of such instruments broad enough to satisfy a wide range of applications?

ONLY WESTON! Yes, not only does the Weston Ruggedized Line conform to the broadest range of MIL specs . . . it *delivers* the stability, accuracy and near-in-vulnerability that the most finicky user requires.

LOOK AT THESE NEW FEATURES!

Sturdy new plastic windows and advanced case design permit the use of *practical* zero correctors in all models. And the well-known Weston Ruggedized Instruments have now been expanded to include 250° scale instruments, with improved accuracy and legibility. Together with Weston exclusive up-front scales, this insures the utmost in readability. These features, and those listed at the right, are the reasons for the high recognition Weston Ruggedized Instruments have earned.

For full information, contact your local Weston sales office . . . or write to Daystrom-Weston Sales Division, Newark 12, N. J. In Canada: Daystrom Ltd., 840 Caledonia Rd., Toronto 19, Ont. Export: Daystrom Int'l., 100 Empire St., Newark 12, N. J.

WESTON

Instruments



WORLD LEADER IN MEASUREMENT AND CONTROL

Visit us at the Daystrom Booths
IRE Show, New York Coliseum, March 21-24

CIRCLE 59 ON READER-SERVICE CARD

NEW PRODUCTS

Time Code Generators

534

Accuracy is 3 parts in 10^8 per day



These solid-state-circuit time code generators have an accuracy of 3 parts in 10^8 per day or 1 sec per month. Model ZA-801 binary-coded decimal readout unit and model ZA-802 straight binary readout unit are available. Outputs are suitable for recording on oscillographs, strip-chart recorders, magnetic tape or as drivers for neon flash lamps. Time-of-day code and 8 pulse rates are produced. A serial binary code is supplied as a de level shift and am carrier. A complete unit, including power supply, it measures 7 x 19 x 16 in.

Electronic Engineering Co. of Calif., Dept. ED, 1601 E. Chestnut Ave., Santa Ana, Calif.

Price & Availability: Models ZA-801 and ZA-802 are priced at \$7650 and \$7050, respectively, plus tax, fob Santa Ana. Delivery time is 60 days.

DC Preamplifier

521

Low level, low noise



Model TDC-1 dc preamplifier is a low level, low noise amplifier for static or transient measurements of strain, pressure, flow, shock, or temperature. It can be used with strain gages, strain gage transducers, bolometers, resistance thermometers and thermocouples. A balanced, push-pull unit, it can drive an oscilloscope, a galvanometer, or a vtm. Voltage gains are 10 and 30; maximum gain positions are provided. The minimum input signal

is 100 mv for 1% linearity. Response is flat from dc to 15 kc. The unit has a self-contained battery. Dimensions are 3.75 x 3.25 x 2 in.

Ramapo Instrument Co., Inc., Dept. ED, 8 First St., Bloomingdale, N.J.

Price & Availability: Price is \$75 ea; quantity discounts are offered. Units are available from stock.

Terminals

533

For easy insertion and fastening



The Wrap-A-Wire terminals, for use in electronic assemblies, connectors for coil forms, and printed circuit boards are easily inserted and fastened, eliminating hand tie and soldering. Each terminal can take one or more wire leads. Special plating or material can be supplied to individual specifications.

Malco Manufacturing Co., Dept. ED, 4025 W. Lake St., Chicago 24, Ill.

Price & Availability: The product is available from stock; prices can be furnished.

Connector Insulator

530

Made of vinyl



The Zipboot is easily wrapped around a connector which terminates a cable. Made of 105-deg F vinyl with a shrinking factor of about 30%, it shrinks to a snug fit over the connector and the jacket of the cable. When the ends are sealed to the connector shell and cable jacket, it prevents moisture from penetrating the interior of the backshell. Thus, potting may not be necessary.

Zippertubing Co., Dept. ED, 752 San Pedro St., Los Angeles, Calif.

Price & Availability: Price varies with quantity and is furnished on request. The product is available from stock and can be delivered in 7 days.

THE INDUSTRY'S FIRST CHOICE

Microtom-atic®

for ultra-precision slicing and dicing of semiconductor materials

*Reg. T.M. — The DoALL Company. Microtom-atic is taken from the word microtome, defined by Webster as "An instrument for cutting sections."

Today more than 60% of all transistor elements are being cut on Microtom-atic machines. This industry-wide preference was won through sheer performance — dependable accuracy, high production rates, and trouble-free, continuous-duty operation.

Now the new Microtom-atic MTA-7 brings even greater accuracy and increased production at lower cost. Unique cross-feed mechanism co-ordinates mechanical and hydraulic movements to achieve ultra-precision indexing. Fracture-free cutting of extremely thin wafers with excellent parallelism is no problem on the MTA-7. Simple, accurate controls expedite setup with minimum waste and then the MTA-7 automatically repeats the indexing and cutting cycle until the crystal is completely sliced.

The new MTA-7 is extremely rigid throughout with heavy base, saddle, table and column construction. Long life and continued accuracy are assured through generous bearing areas, hand-scraped ways and positive, automatic lubrication of all contact areas and lead screws.

If your work involves slicing of hard, brittle and shock-sensitive materials, DoALL can help you. Call your local DoALL Sales-Service Store and discuss your problem. A corps of specialists and the DoALL Demonstration Test-Center are at your disposal.



Large silicon crystal being wafered on an MTA-7. Wafers .030" thick are being cut at 1 sq. in. per min. with parallelism between .001" and .002".



MT-2

Model MTA-7 provides index stroke from 0 to .100" per index with positive table rates as low as 1/16" per minute. Other models available.

DoALL diamond slicing wheels are produced by an exclusive process that insures positive rim bond to the core. These wheels deliver extreme accuracy . . . save time and materials.



The DoALL Company, Des Plaines, Illinois



THIS IS A TYPICAL DoALL STORE



CIRCLE 60 ON READER-SERVICE CARD



**"THIS RELAY
WILL GIVE US
300 MILLION
OPERATIONS, JOE"**

**HERE'S WHY P&B TELEPHONE TYPE RELAYS GIVE YOU
reliable performance over long life**

Armature Pin Bearing shows only .0005" increase in clearance after 300 million operations.



Husky Armature Arm prevents sagging or bending.

BS SERIES TELEPHONE TYPE

Measure the thickness of the BS series armature arm. You will find the cross section area is greater than ordinary relays of this type. Here is the kind of quality that spells dependability.

Observe that the stainless steel hinge pin runs the full width (not just half) of the armature, providing optimum bearing surface. This pin, operating in a stainless steel sleeve, shows only minimal wear during nearly a *third of a billion operations*.

Best of all, P&B quality costs no more. A whole new plant is being devoted to the production of high performance telephone type relays. Your nearest P&B sales engineer will be happy to discuss your relay problems. Call him today.

Heavy Duty Frame maintains dimensional stability, adds to relay's sensitivity.

BS SERIES ENGINEERING DATA

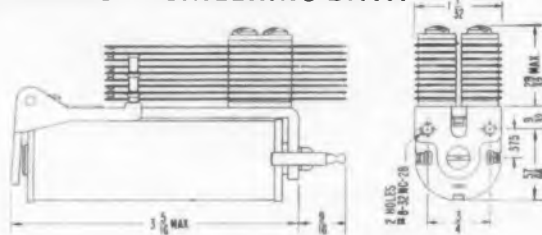

GENERAL:

Breakdown Voltage: 1000 volts rms 60 cy. min. between all elements.
Ambient Temperature: -55° to +85° C.
+125° C available on special order.
Weight: 9 to 16 ozs.

Terminals: Pierced solder lugs;
Coil: One #16 AWG wire
Contacts: Two #18 AWG wires
Enclosures: Dust covered or sealed

CONTACTS:

Arrangements: DC—up to 28 springs
AC—up to 24 springs
Material: 1/4" dia. twin palladium.
Up to 1/4" dia. single silver.
Other materials on special order.

Lead: 4 amps at 115 volts, 60 cycle resistive
Pressure: 15 grams minimum

COILS:

Resistance: 100,000 ohms maximum
Current: 10 amps maximum
Power: DC—50 Milliwatts per movable arm.
Greater sensitivity on special order.
AC—17.9 volt-amps.

Duty: Continuous

Treatment: Centrifugal impregnation
Voltages: DC—up to 300 volts with series resistor. AC—up to 250 volts, 60 cy.

MOUNTING: Two -8-32 tapped holes 3/4" o.c.
Other mountings on special order.



GS SERIES—Excellent sensitivity: 50 mw per movable arm minimum (DC). For applications requiring many switching elements in small space.



LS SERIES—Medium coil relay with short springs and light weight armature for fast action, reliability and long life.



TS SERIES—Short coil relay is available in AC and DC versions. Long life construction. Can be supplied (DC) with up to 20 springs (10 per stack).

P&B STANDARD RELAYS ARE AVAILABLE AT YOUR LOCAL ELECTRONIC PARTS DISTRIBUTOR



POTTER & BRUMFIELD

DIVISION OF AMERICAN MACHINE & FOUNDRY COMPANY, PRINCETON, INDIANA

IN CANADA: POTTER & BRUMFIELD CANADA LTD., GUELPH, ONTARIO

NEW PRODUCTS

DC Power Supply 517

Output current is 50 ma



Model RS450 power supply delivers two outputs of +300 to +400 v dc and -300 to -400 v dc, or a single output of 600 to 800 v. Output current is to 50 ma. Of modular design, the unit can be supplied for bench use or as a flat plate for installation in original equipment. Input is 105 to 125 v ac, 60 to 400 cps, internal impedance is less than 1 ohm, load regulation is 0.03%, line regulation is 0.02%, and ripple is 7 mv max peak-to-peak. Recovery time is less than 25 μsec.

Trans Electronics, Inc., Dept. ED, 7349 Canoga Ave., Canoga Park, Calif.

Price & Availability: Price is \$135.50 for bench type, \$130.35 for plate module. Delivery is from stock.

Gold-Antimony Alloy 543

Used in making semiconductor crystals

No. 1549 gold-antimony alloy imparts a controlled impurity into a semiconductor crystal, usually silicon, by evaporation techniques. The alloy is heated until the antimony boils off, creating an antimony atmosphere from which the crystal picks up the impurity required. Available in rod or whisker wire in diameters from 0.25 to 0.001 in. and in sheets as thin as 0.0015 in., the material consists of high-purity gold containing 1% antimony. Its homogeneity provides even release of the antimony.

Englehard Industries, Inc., Dept. ED, 113 Astor St., Newark, N.J.

◀ CIRCLE 61 ON READER-SERVICE CARD

Frequency Converter 514 Transmitter

Provides 9.96 kc



This transmitter, when furnished with an input signal of 1 w in the range of 108 to 118 mc, delivers an output signal of 50 w cw at 9.96 kc higher than the original input frequency. Stability is maintained within ± 10 cps. Spurious frequencies are suppressed down to at least 60 db; harmonic frequencies are held to about 80 db. The line voltage is 115 or 230 v at 55 to 65 cps. Over-all dimensions of the unit are 22 x 24 x 18 in.

Control Electronics Co., Inc., Dept. ED, 10 Stepar Place, Huntington Sta., N.Y.

Molding Compounds 536

Have soft flow, low pressure properties

These epoxy molding compounds combine soft flow and low pressure characteristics and make possible high-speed molding of a variety of electronic parts. They have a balance of physical, electrical, and chemical properties (characteristic of epoxies) in an easily-handled, single-component system. The material can be used to mold miniature parts.

American-Marietta Co., Adhesives, Resins, & Chemical Div., Dept. ED, Seattle, Wash.

Price & Availability: Standard compounds in stock. Experimental compounds made on order. Stock items delivered in 5 to 7 days, slightly longer for experimental compounds. Price is between \$1.50 and \$1.95 for various components when ordered in quantities of 400 or more.

CIRCLE 62 ON READER-SERVICE CARD

ABSOLUTE MAXIMUM RATINGS AT 25°C

Forward Current	I_f	50 mA
Minimum Breakover Voltage	V_{bo}	(TSW 30 30V) TSW 60 60V
Reverse Breakdown Voltage	V_r	(TSW 30 30V) TSW 60 60V
Storage Temperature		-65°C to 150°C
Ambient Temperature Range		-55°C to +125°C

SPECIFICATIONS AND TYPICAL CHARACTERISTICS (At 25°C Unless Otherwise Stated)

		Typical	Max.	Test Conditions
Saturation Voltage	V_s	1.0	1.5	Volts $I_c = 50$ mA
Forward Leakage Current	I_f	0.1	10	μA $V_r = 30V$
Reverse Leakage Current	I_R	0.1	10	μA $V_f = -30V$
Forward Leakage Current	I_f	20.	50.	μA at 125°C
Reverse Leakage Current	I_R	20.	50.	μA at 125°C
Gate Voltage to Switch "ON"	$V_{R\ On}$	0.7	1.0	Volts $R_L = 1K$
Gate Current to Switch "ON"	$I_{G\ On}$	0.1	1.0	mA $R_L = 1K$
Gate Voltage to Switch "OFF"	$V_{G\ Off}$	1.2	4.0	Volts $I_c = 50$ mA
Gate Current to Switch "OFF"	$I_{G\ Off}$	7.0	10.	mA $I_c = 50$ mA
Holding Current	I_H	2.0	5.0	mA $R_L = 1K$

SPECIALLY DESIGNED FOR:

- Miniaturized Memory Circuits
- Ring Counters
- Shift Registers
- Controlled Rectifier Driver
- Flip-Flop Equivalent
- Simplified Information Storage
- 0.3 μ second Switching

Transitron
announces a NEW computer element
for: Greater Reliability • Circuit Simplicity

THE TRANSWITCH

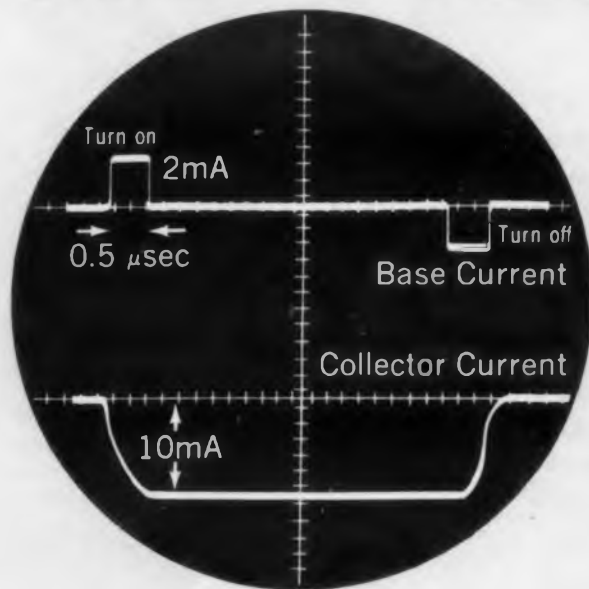

The TRANSWITCH is a new bistable silicon device that can be TURNED OFF with gate current.

This PNP latching device "remembers" its last gate signal. High current gain, both turn-on and turn-off, leads to greater circuit simplicity and inherent reliability. Excellent linearity of electrical parameters over a wide current range fulfills both low logic level and medium power needs.

Here is a unique device that replaces TWO transistors plus resistors in most bistable circuits and permits increased component density.

Furthermore, the transwitch is FAST... requiring only 0.3 microseconds to turn ON or OFF!

The TRANSWITCH is now available from TRANSITRON in the popular JEDEC TO-5 package, ready to solve your switch-on-switch-off requirements.

For further information, write for Bulletin TE-1357A

Transitron

electronic corporation • wakefield, massachusetts

"Leadership in Semiconductors" SEE YOUR LOCAL AUTHORIZED TRANSITRON DISTRIBUTOR FOR QUANTITIES FROM 1,000.



For research and more accurate production of hyperpure materials for semi-conductors—the new Lindberg Floating Zone Scanner



This newly developed Floating Zone Scanner is a product of Lindberg's technical staff, widely recognized for many significant developments in the application of heat to industry. Expertly designed, it provides more accurate and more precise production of semi-conductors as well as serving as ideal research equipment. Already, a number of important companies in the semi-conductor field are using this equipment for research and production. Lindberg Induction Heating Units have been specifically designed for use as research and production equipment for crystal growing and zone refining of semi-conductors and other materials. Write for our Bulletin No. 1600.

High Frequency Division

LINDBERG ENGINEERING COMPANY

2456 WEST HUBBARD STREET, CHICAGO 12, ILLINOIS
Los Angeles Plant: 11937 South Regentview Avenue, at Downey, California
In Canada: Birleco—Lindberg, Ltd., Toronto

LINDBERG *heat for Industry*

CIRCLE 63 ON READER-SERVICE CARD

NEW PRODUCTS

Relay Retainer 516

Height is from 1-5/8 to 2-5/8 in.



This relay retainer comes in five sizes with heights ranging from 1-5/8 to 2-5/8 in. The device consists of a post which screws through

one of the two socket-mounting holes in the standard microminiature relay socket; it also serves to secure the socket to the chassis with a spring loaded cap. The cap swings up and out of the way for servicing the relay. The unit is made of steel with a cadmium plate finish.

The Birtcher Corp., Industrial Div., Dept. ED, 4371 Valley Blvd., Los Angeles 32, Calif.

Price & Availability: The product is available from stock for two weeks delivery. Prices will be quoted on request.

Ultrasonic Cleaners 539

• Six types available

This series of ultrasonic cleaners includes: Sonic Duo Solve, a two-phase cleaner used cold to remove carbon, paint, and other contami-

Model 1245 with 1 Osc'r

\$930

Q MEASUREMENTS? ...
1 Kc to 300 Mc? ...

New Q Meter Model 1245 has widest frequency range ever, is direct reading in Q and ΔQ , and losses are so low that corrections are seldom required. Separate plug in oscillators add flexibility and economy. Does this one instrument cover all your Q measuring requirements?

Freq. Range	1Kc to 300Mc
Q Range	5 to 1000
ΔQ Range	to 50
Cap. Range	7.5 to 500 μ F
Oscillator 1246	40Kc to 50 Mc
Oscillator 1247	20 to 300Mc

Technical Brochure Freely Available



MARCONI
INSTRUMENTS



111 CEDAR LANE • ENGLEWOOD, NEW JERSEY

CIRCLE 64 ON READER-SERVICE CARD

ELECTRONIC DESIGN • February 17, 1960

nants; Sonic Solv, a metal and light soil remover; Sonic Copper Brightener; Sonic Acid Strip for acid cleaning of metal; Sonic Alka Strip for heavy duty cleaning of steel parts and magnesium alloys; and Sonic Aluminum Brightener.

Clarkson Labs, Inc., Dept. ED, 930 N. Darien St., Philadelphia 23, Pa.

Price & Availability: Available from stock. Delivered 5 days after order is received. Prices are: Duo Solve, \$2.75; Solv, \$2.35; Copper Brightener, \$4.00; Aluminum Brightener, \$2.75. All prices are per gal when ordered in 5-gal pails. Prices for Acid Strip and Alka Strip are \$34.50 and \$20.00 per hundred lb, when ordered in 25 lb drums.

Panel Meters 547

For military use

Built in accordance with MIL-M-10304A, these 2.5-in. panel meters come in 61 different models, includ-

ing voltmeters, ammeters, microammeters, and milliammeters. Accuracies of 2% full scale on dc models and 3% full scale on ac rectifier types are offered.

Beckman Instruments, Inc., Helipot Div., 2500 Fullerton Road, Fullerton, Calif.

Switching Diodes 545

Rated at 0.3 μ sec, 1/2 amp

Designed for operation to 175 C, the series 1N920-1N923 diodes provide 0.3 μ sec switching of 1/2-amp pulses with a peak power dissipation of 800 mw. Forward conductance is 500 ma at 1 v max drop, and leakage is 50 μ a max at 150 C. All units take 0.3 μ sec to return to 10 K when switched from a forward current, 2- μ sec pulse of 500 ma to a reverse voltage of -50 v with a loop impedance of 1 K.

Sperry Semiconductor Div., Sperry Rand Corp., Dept. ED, South Norwalk, Conn.

NEW! ENGRAVED Deep-Kut[®]

PIN & PEG STAMPS
are better than
ordinary rubber
3 ways

- ★ ENGRAVED Deep-Kut is Acid-Proof
- ★ ENGRAVED Deep-Kut Stamping gives Razor-Sharp impressions every time
- ★ ENGRAVED Deep-Kut has cushion-like resilience

Engraved Deep-Kut stamp faces are adaptable to any marking device. They can be used to stamp on every surface, metal, wood, fabric, paper, plastic, etc.

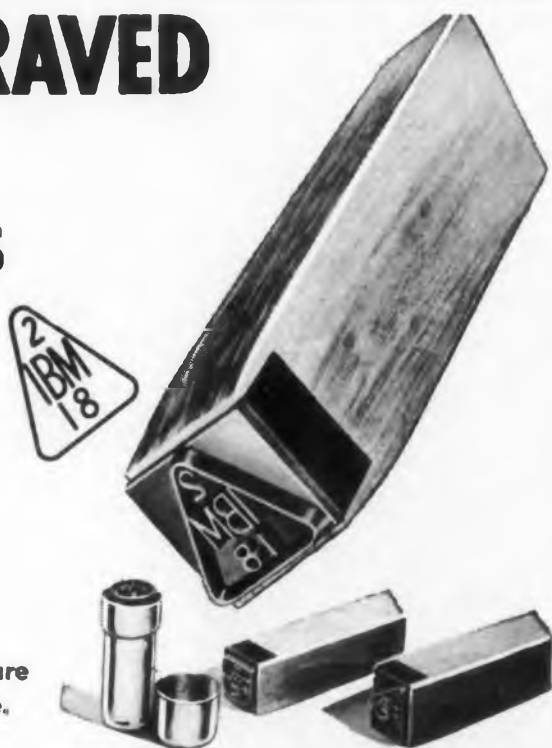

THE KRENGEL
INSPECTION POCKET STAMP

THE PIN & PEG

KRENGEL MANUFACTURING CO., INC. Tel. CO 7-5714		Dept. ED	
227 Fulton St., New York 7, N. Y.			
Please check the following		NAME	
FREE ENGRAVED Deep-Kut Sample & Price List	<input type="checkbox"/>	COMPANY	
Please have salesman call for appointment	<input type="checkbox"/>	STREET	
		CITY	
		ZONE STATE	

CIRCLE 65 ON READER-SERVICE CARD

For basic research, pilot plant studies and the more efficient production of semi-conductors—new Lindberg Diffusion Furnaces



Here is a new Lindberg Furnace designed specifically for basic research, pilot plant work, or production of solid state devices. It is offered in a variety of sizes and capacities to enable industries in the semi-conductor field to have higher powered equipment adequately insulated and designed for its specific use. With this type of furnace available, it is not necessary for industry to attempt to adapt ordinary furnaces to the highly specialized requirements of the semi-conductor field. For complete information on Lindberg's standard line of furnaces specifically designed for gaseous and solid diffusion uses write for our Bulletin No. T-1081.

Pilot Plant Equipment Division

LINDBERG ENGINEERING COMPANY
2456 WEST HUBBARD STREET, CHICAGO 12, ILLINOIS
Los Angeles Plant: 11937 South Regentview Avenue, at Downey, California
In Canada: Birleco—Lindberg, Ltd., Toronto

LINDBERG heat for industry

CIRCLE 66 ON READER-SERVICE CARD

PROJECT 70,000,000

Since their introduction more than ten years ago, CLARE Type J Relays, with their small size, twin contact design and superior performance, have been first choice of design engineers for applications where component failure is intolerable.

Sensational demand for these relays has resulted in numerous imitations. Similar in appearance and published specifications, many have been represented as "just as good" as the original CLARE Type J Relays.

An independent laboratory has just completed exhaustive tests of CLARE Type J Relays and copies made by other well known manufacturers.

The results are here. Tests of the CLARE relays were discontinued at 70,000,000 cycles... *with no contact failure whatsoever.* All the other relay groups showed failure of 10% of their contacts before the end of 60,000,000 cycles (see graph). Some had 22% contact failure at 5,000,000 cycles.

Let us tell you more about this important test. Call or write: C. P. Clare & Co., 3101 Pratt Blvd., Chicago 45, Illinois. In Canada: C. P. Clare Canada Limited, P. O. Box 134, Downsview, Ontario. Cable Address: CLARELAY.

CLARE RELAYS

FIRST in the industrial field



Independent tests*
prove There
are no copies
"just as good" as
CLARE J
type
RELAYS

CLARE RELAYS (8 Form C)	70,000,000 Operations No Contact Failures
BRAND X1 (8 Form C)	60,000,000 Operations 11 Contact Failures
BRAND X2 (8 Form C)	40,000,000 Operations 12 Contact Failures
BRAND X3 (8 Form C)	30,000,000 Operations 8 Contact Failures
BRAND X4 (8 Form C)	20,000,000 Operations 12 Contact Failures
BRAND X5 (8 Form C)	15,000,000 Operations 7 Contact Failures
BRAND X6 (8 Form C)	10,000,000 Operations 11 Contact Failures
BRAND X7 (8 Form C)	5,000,000 Operations 18 Contact Failures

*Failure of 10% of the total contacts involved eliminated any group from the test. Additional data available on request.

NEW PRODUCTS

Digital Readout 523

Life expectancy is 60,000 hr

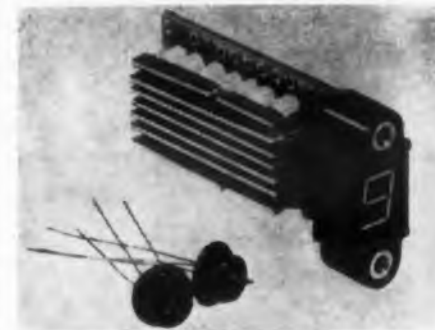

Model SGS-106 in-line, in-plane digital readout has a life expectancy in excess of 60,000 hr at 5.5 v. Miniature incandescent lamps provide legibility over distances, under ambient light, and from wide viewing angles. The characters displayed are 0 through 9. Over-all dimensions per digit are 9/16 x 1-1/8 x 2-7/8 in. Character size is 5/16 x 1/2 in. The unit weighs 1 oz and requires a maximum of 2 w.

I.D.E.A., Inc., Electronic Equipment Div., Dept. ED, 7900 Pendleton Pike, Indianapolis 26, Ind.

Price & Availability: Price is as low as \$45 ea for production quantity orders. Units will be available after April 1, 1960.

PNP Silicon Transistors 548

Have betas from 15 to 50

This series of pnp silicon high-speed switching transistors, designated types 2N1254 through 2N1259, provides betas from 15 to 50 and collector-to-emitter voltages from 15 to 50 v. Able to operate over the temperature range of -65 to +160 C, the units are of double diffused mesa construction. Applications are in digital computers, data processing systems, and if strips for missile telemetering systems. The transistor bodies are gold-plated, have TO-5 packages, and the complete units meet MIL-T-19500A.

Hughes Aircraft Co., Semiconductor Div., Dept. ED, Newport Beach, Calif.

◀ CIRCLE 67 ON READER-SERVICE CARD

Analog-to-Digital Converter 550

Compact design

Model M4 airborne analog-digital converter is claimed to be about 1/2 the size and weight of previous converters. A 12-bit, one-pole device, it performs conversion at an accuracy of ± 1 mv in 65 μ sec over the temperature range of -55 to $+70$ C. Available for 3-decimal digit as well as 12-bit binary conversion, the unit meets MIL-E-5400B and MIL-E-005272.

Packard Bell Computer Corp., Dept. ED, 1905 Armacost Ave., Los Angeles 25, Calif.

Price & Availability: Units are priced at \$9290. They are made on order and require from 90 to 120 days for delivery.

DC Power Supplies 535

Deliver 200, 400, and 600 ma

Models HB-2, HB-4, and HB-6 power supplies deliver 200, 400, and 600 ma. Variable output range is 0 to 325 v dc and regulation is 0.1% for line and load. Ripple is 3 mv rms. Units are convection cooled; their dimensions are 3-1/2 x 19 x 14-3/8 in.

Kepeco Labs., Inc., Dept. ED, 131-38 Sanford Ave., Flushing 55, N.Y.
Price & Availability: Models HB-2, HB-4, and HB-6 are priced at \$265, \$320, and \$365. They can be delivered in less than 60 days.

Cooling Systems 542

For airborne infrared detectors

For airborne infrared detectors, the following types of liquid nitrogen cooling systems are available: an integrally mounted cell; a liquid feed, vacuum insulated line; a liquid to high pressure generator; and a liquid feed, uninsulated line. Detector cells of each system are cooled by heat exchange with liquid nitrogen at -320 F.

Linde Co., Div. of Union Carbide Corp., Dept. ED, 30 E. 42nd St., New York 17, N.Y.



What's Dick Peterson doing in your shoes? As head of our Industrial Tube Applications Engineering Section, Dick Peterson is constantly putting himself in your shoes. It's his job to study new tube designs from your point of view in a variety of circuits under the most difficult conditions. Then he recommends design modifications to meet your most exacting requirements.

Recently Dick's group conducted a study to determine the most desirable characteristics for a beam power tube to be used in mobile and airborne communications equipment. After consultation with our Design Section, the basic characteristics of such a tube were agreed upon. These characteristics were incorporated in a design which was then evaluated for use in this type of equipment. On the basis of the evaluation, changes were recommended to assure top performance in rf service up to and beyond 175 Mc. Result: our new 7551 beam power tube for VHF driver and low-level power amplifier applications. Then Dick and his group helped an aircraft electronics manufacturer modify a circuit to take advantage of the full capabilities of this new tube.

Such continuous studies by Dick Peterson and his section are your assurance that even the newest RCA Industrial Receiving Tubes are thoroughly use-tested and proven before you get them. For more information on RCA Industrial Receiving Tubes, get in touch with your RCA Field Representative.



RADIO CORPORATION OF AMERICA
Electron Tube Division
Harrison, N. J.

ANOTHER WAY RCA SERVES YOU THROUGH ELECTRONICS

EAST: 744 Broad Street, Newark 2, New Jersey
Humboldt 5-3900

MIDWEST: Suite 1154, Merchandise Mart Plaza
Chicago 54, Illinois—Whitehall 4-2900

WEST: 6355 E. Washington Blvd.
Los Angeles 22, Calif.—RAYmond 3-8361

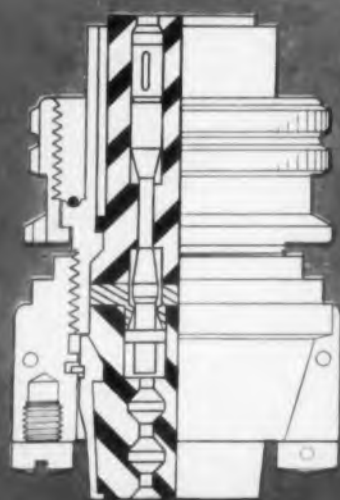

NEW POKE^R CONNECTOR

features
removable
POKE-HOME[®]
contacts

Like the Stub R, AMPHENOL's new POKE "R" lightweight environmental connectors offer "plus" features above and beyond the minimum established by specifications. It offers you the *added advantage of removable crimp type contacts* that simplify wiring, assembly, circuit modification and re-assembly if necessary.

Due to special design, Poke "R" will also pass "Altitude Immersion" in addition to meeting R requirements of MIL-C-5015D.



Check these other important features!

- 1 CRIMP TYPE CONTACTS eliminate solder and electrical problems from poor solder techniques.
- 2 OPEN INSPECTION . . . crimped contacts can be inspected before being poked home into connector.
- 3 FASTER ASSEMBLY . . . contacts shipped separately from connector . . . permitting fast crimp wiring by hand or machine.
- 4 EASE OF REPLACEMENT . . . removability of contacts allow re-location of circuits without replacing connector.
- 5 HIGHER ELECTRICAL SAFETY . . . using crimp contacts eliminates the chance of solder overflow to short contacts.
- 6 METAL TO METAL BOTTOMING provided by construction of grommet clamp reduces possibility of compression set.
- 7 LOWER ASSEMBLY COST . . . Grommet removal is not necessary for either assembly or disassembly, reducing handling and production time.
- 8 IMPROVED RELIABILITY of wire termination due to crimping of contact with AMPHENOL four-indent crimp.

THREE SHELL STYLES ARE AVAILABLE . . . MS3100, MS3101 AND MS3106 IN SIZES 10SL THRU 36.

Remember . . . AMPHENOL provides the best and biggest integrated line of connectors and cables in the world.

*Reg. T.M.



CONNECTOR DIVISION

1830 S. 54TH AVE., CHICAGO 50, ILLINOIS

Amphenol-Borg Electronics Corporation

NEW PRODUCTS

Linear Amplifier 669

Has high overload tolerance

Model 108 linear amplifier recovers from an overload signal of 4000 times in 8 μ sec. The instrument consists of two units: a preamplifier with a gain of 1, 3, or 10; and a main chassis containing a regulated power supply, an amplifier sub-chassis, and pulse height selector sub-chassis. The total gain of the amplifier is 7000. With preamplifier gains of 3 or 10, the maximum system gain is 21,000 to 70,000. The specified input is 29 mv or greater, positive and negative pulses. The instrument is used in the detection of radiation.

Interstate Electronics Corp., Dept. ED, 707 E. Vermont Ave., Anaheim, Calif.

Price & Availability: Model 108 is priced at \$750 and is available from stock.

Microwave Step Attenuators 665

Comes in values of 0.1 to 60 db

These microwave step attenuators, called Empower, have a range of attenuation values of 0.1 to 60 db, and are capable of handling 1 or 4 w of rf power. Both 6 and 12-position types are offered. The frequency range is from dc to 4 kmc. The units operate from an input of 28 v dc and are ruggedly constructed for reliable operation under extreme service conditions. Their applications include use in radioactive contaminated areas, on towers, or in equipment which requires the attenuator to have an inaccessible location. They are also suitable for rapid switching of attenuation values, for programmed applications, and for systems where the voltage sensitivity of a receiver is automatically determined by the prevailing signal strength.

Empire Devices Products Corp., Dept. ED, Amsterdam, N.Y.

Price & Availability: Delivery is from stock to 60 days. Price varies from \$575 to \$1250.

◀ CIRCLE 68 ON READER-SERVICE CARD



THE NATIONAL SCENE



CHOOSE FROM THESE MATERIALS...

Vulcanized Fibre: 10 standard grades; many special grades.

PHENOLITE® Laminated Plastic: over 80 standard and modified grades; paper, cotton fabric, nylon, asbestos, glass fabric, cotton and glass mat bases; phenolic, melamine, polyester, epoxy, teflon or silicone resins.

PEERLESS Electrical Insulation: coil, strip, corrugated.

Extruded Nylon, "Delrin", "Penton": rod, strip, tubing, special shapes.

Polyester Glass Mat: 4 standard sheet grades; custom molded shapes.

PHENOLITE Copper-Clad Laminates: 10 standard grades.

Combination Materials: Rubber-PHENOLITE; Rubber-Fibre; Wood-Fibre; Metal-Fibre; Asbestos-Fibre; PEERLESS-PHENOLITE.

BACKED BY THESE SERVICES...

Field Application Assistance
Complete Fabricated Parts Service
Stock Program for Immediate Shipment

BY CALLING THESE OFFICES...

Baltimore VALley 3-0393
Boston TWinbrook 4-3500
Chicago AUstin 7-1935
Cincinnati GARfield 1-0632
Cleveland ERievew 1-0240
Dallas DAvis 4-4386
Denver MAin 3-2077
Detroit UNiversity 3-3632
Griffin, Ga. 8-1308
Indianapolis WALnut 3-6381
Los Angeles RAYmond 3-0291
Milwaukee BRoadway 6-6995
New Haven LOcust 2-3594
Newark MITchell 2-6090
New York COrtlandt 7-3895
Philadelphia SHerwood 8-0760
Pittsburgh FAirfax 1-3939
Rochester Hillside 5-0900
St. Louis PArkview 5-9577
St. Petersburg 5-5505
San Francisco DAvenport 6-4667
Seattle MElrose 2-7298
Wilmington OLYmpia 5-6371

IN CANADA:

National Fibre Co. of Canada, Ltd.
Toronto LENnox 2-3303
Montreal AVenue 8-7536

NATIONAL
VULCANIZED FIBRE CO.
WILMINGTON 99, DELAWARE

In Canada:
NATIONAL FIBRE COMPANY OF CANADA, LTD., Toronto 3, Ontario

**"From transistor radios to computers—
one of National's 115 materials and grades will
give you optimum performance in your design."**

Why go on a wild goose chase from supplier to supplier for the special plastic material you need for your design? A time- and trouble-saving check with National gives you unbiased help and a material best suited to your property requirements.

National offers the broadest line of basic engineering materials in the industry . . . over 115 materials and grades. You can select the *one best material* to fit your design electrically . . . mechanically . . . chemically. For example:

If you are looking for a new printed circuit material with self-extinguishing properties against fire, National offers XXXP-475. It is made without costlier resins—can be punched at warm temperatures (130° F.—150° F.).

Vulcanized Fibre, extruded thermoplastics and PHENOLITE® laminated plastics offer a wide range of property combina-

tions, such as high electrical-mechanical values plus excellent water absorption and dimensional stability characteristics. Or, electrical properties plus rigidity and heat resistance. Or, electrical properties plus chemical resistance and dimensional stability under load.

You will also find three other important "properties" at National: an understanding of your needs; a willingness to work *with* you; and a facility to fill your requirements fast and efficiently.

You can obtain National materials in standard forms—sheet, tube, rod—in precision fabricated parts to your design, or special-molded polyester shapes. For objective assistance, contact your nearby National Sales Engineer today. Or write us direct, Dept. E-2, Wilmington, Delaware.

CIRCLE 69 ON READER-SERVICE CARD

NEW PRODUCTS

Decade Counter 518

For 150-kc operation

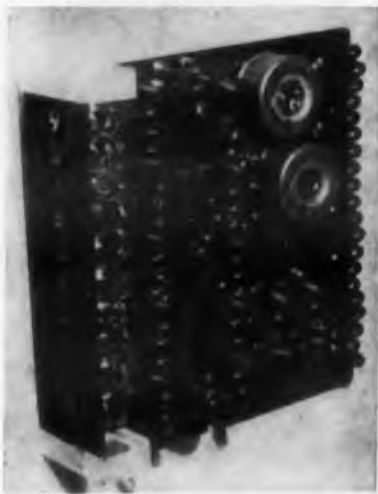

Model 1301 150-kc decade counter is designed for digital and test systems. It uses a binary-quinary cascaded circuit that employs seven transistors. A supply voltage of +100 v at 3 w is required. The unit has decade output, electrical zero reset, and plugs directly into a standard 10-pin printed circuit connector. It measures 3-9/16 x 1 x 3-1/4 in. and weighs 3-1/2 oz.

Robotomics, Dept. ED, 4624 E. Garfield, Phoenix, Ariz.

Price & Availability: Price is \$69 ea for 1 to 4, \$66 ea for 5 to 24, and \$62 ea for 25 to 99. Units will be in stock after March 1, 1960; delivery is in 7 to 14 days.

Cold Heading Machine 666

For the manufacture of electronic parts

The model 0 cold heading machine is for mass production of long thin pins, lead wires, and similar from 0.02 to 0.09 in. in diameter and electronic parts. It can handle wire produce headed parts to 2-3/8 in. long. From 60 to 100 pieces per min can be made. Equipped with a 1.5 hp motor drive, the machine measures 41 x 20 x 40 in.

REM Sales, Inc., Dept. ED, The Robert E. Morris Co., W. Hartford 7, Conn.

Price & Availability: Price is between \$5500 and \$6500. Delivery is about 150 days after receipt of order.

product of the pioneer

DU MONT

425



the most significant advancement in the state-of-the-art since DU MONT introduced the first commercial oscilloscope

the new
DU MONT
425

Only the very latest concepts known in the art of cathode-ray oscillography have been incorporated in the Du Mont 425 High Frequency Oscilloscope. This new scope will outperform any commercial oscilloscope in its class—now, yet its entire design concept is based on the future—the 425 will always be a modern scope.

By ease of operation, and elimination of chances of human error in making measurements, the 425 becomes simplified enough for a non-technical person to use. At the same time, with the extreme versatility provided by a series of plug-ins, and replaceable module construction, the 425 will satisfy every laboratory or scientific need within its range.

Such features as: simultaneous use of two plug-ins; digital ReadOut of measurement parameters; joystick control of traces; a unique, highly-accurate "two-dot" measurement system; replaceable, modular construction; a new "tailored" cathode-ray tube; output facilities to feed information to external recorders or systems—all of these features and more help establish the fact that the 425 will always be the most advanced, versatile oscilloscope commercially available.

Write for technical details

the result of 44,000 engineering hours!

a DC to 35 mc oscilloscope
with digital and printed ReadOut—
versatility exceeding all other scopes.



Within its range, every job requiring an oscilloscope can be accomplished with the 425. Each electronic circuit and mechanical facet has been designed for versatility—for present and future needs. From production line go-no-go gauging and external statistical recording of production records, to the most complicated laboratory or hospital investigation—the 425 Oscilloscope is the answer—for today and tomorrow.

- Digital ReadOut on two axes
- Simultaneous use of two of a selection of plug-ins
- Electronic switches on X, Y, and Z axes
- Accurately repeatable two-dot measurement system
- No selected tubes
- Joystick control of traces

SPECIFICATIONS

Rise Time—10 millimicroseconds
High Resolution Vertical Scan—5 cm
Main Time Base—
 Max Sweep rate—10 millimicrosecond/cm
 Max Sweep time—1 minute full scan
Delaying Sweep—
 Min delay—0.5 μ sec
 Max delay—10 sec.
Digital Readout Repeatability—0.5%
Accelerating Voltage—12 KV
 24 Calibrated Sweep Speeds
 Digital Contact Closure Output and 100 mv
 Analog ReadOut Output



A selection of plug-in circuits now—new ones coming.



Joystick manipulations of waveforms—establishing freedom for many other physical operations.



Direct, digital ReadOut of measurement parameters—reducing errors due to interpolations.



Unique, two-dot system of establishing waveform parameters to be measured—makes possible accurately repeatable readings.



Plug-in modular construction—mechanically arranged for easy access or replacement.



Entirely new cathode-ray tube—"tailor-made" to the requirements of the 425.

FOR STATISTICAL RECORDINGS

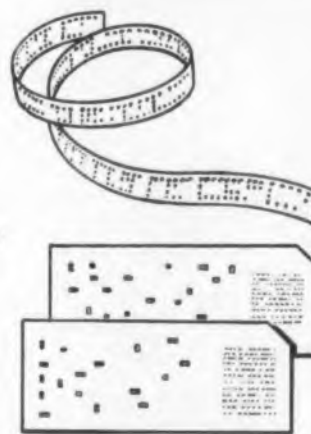

Output facilities on the 425 establish it as an analog to digital converter, or as a source of parameters for statistical recording of measurements on many types of external recording devices and systems.

Decade Frequency Source

532

Range is 100 kc to 1 cps



Type DLI-208 decade frequency source provides six switch-selected frequencies in decade steps from 100 kc to 1 cps. The unit consists of a 100-kc crystal oscillator, a 5-phantastron frequency divider, and a dc power supply. Two modes of operation are possible: in mode 1, the output is a continuous chain of negative pulses at the selected frequency; mode 2 provides for gating the output from a binary plate or similar sources. Application of 150 v to the gate control opens the gate and 75 v closes it. Stability is 1 ppm. The output is a 2- μ sec negative pulse of -70 v amplitude.

Electro Precision Corp., Dept. ED, P.O. Box 669, Arkadelphia, Ark.

Price & Availability: Price is \$370. The unit is available from stock and can be delivered in 10 days.

Accelerometers

511

Frequency range is 2 cps to 2.5 kc

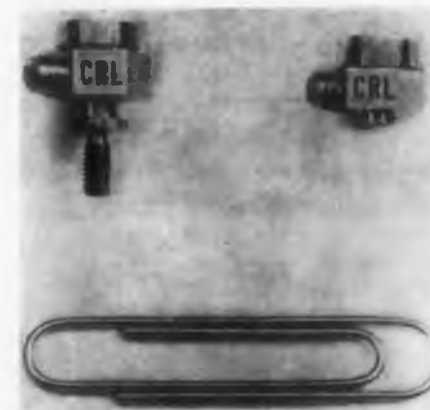

These miniature accelerometers, models 200 and 201, have a frequency range of 2 cps to 2.5 kc and an acceleration range of 0.03 to 40,000 g. Model 200 has a sensitivity of 20 mv per g and weighs 5.5 g. Model 201 has a sensitivity of 15 mv per g and weighs 2.7 g. Both units measure 0.437 x 0.345 in. They have low transverse response and may be used for extensive dynamic measurements without distortion due to loss of low or high frequency components. Detachable steel or phenolic studs permit either direct mounting or isolation of the accelerometer case.

Columbia Research Labs., Dept. ED, MacDade Blvd. and Bullens Lane, Woodlyn, Pa.

DU MONT[®]

WRITE for complete details

precision electronics is our business

ELECTRONIC TUBES / INDUSTRIAL TV / MILITARY ELECTRONICS / MOBILE COMMUNICATIONS / SCIENTIFIC INSTRUMENTS / AUTOMOTIVE TEST EQUIPMENT

Engineers interested in employment opportunities at Du Mont, contact the Industrial Relations Department.

Allen B. Du Mont

ALLEN B. DU MONT LABORATORIES, INC., CLIFTON, N. J., U. S. A.
INTERNATIONAL DIVISION • 515 MADISON AVENUE, NEW YORK 22, N. Y. • CABLES: ALBEEDU, NEW YORK
CIRCLE 70 ON READER-SERVICE CARD

T HIRTEEN I NDISPENSABLE C HARACTERISTICS

FOR Precision SERVO POTS

PRECISION SERVO POTENTIOMETERS HAVE ALL 13 FEATURES

*Your Assurance
of Superior System
Performance*

A few of the many applications of TIC Precision Servo Potentiometers are as input-output transducers in servo systems for airborne navigation and flight control, fire control, fuel control, shipboard gun directors, missile aiming and flight control, analog computing, air traffic control and telemetering.

TIC Precision Servo Potentiometers are available in 21 types with diameters from 1/2" to 3", giving design engineers a wide range from which to select. Included are single and multi-turn types with either wirewound or infinite resolution metallic film resistance elements, as well as types designed for ganging without a shaft.

And TIC Precision Servo Potentiometers are engineered to withstand the severe environmental conditions imposed by military equipment operation.

- 1 High Reliability
- 2 Low Torque
- 3 High Accuracy
- 4 Low Inertia
- 5 High Resolution (or Infinite in Film Type)
- 6 Wide Resistance Range
- 7 Low Phase Shift Over Wide Frequency Range
- 8 Low Noise Level
- 9 Highly Precise Non Linear Functions
- 10 Can Be Ganged
- 11 Long Life
- 12 Close Mechanical Tolerances
- 13 Withstand Extreme Environmental Conditions

Write or call for this new catalog on the TIC line of Precision Potentiometers - the most complete line on the market.



TIC TECHNOLOGY INSTRUMENT CORP.
555 MAIN STREET, ACTON, MASS.

SUBSIDIARIES: ACTON LABORATORIES, INC., ACTON, MASS. • ALTMAC CORP., CANTON, MASS.
TECHNOLOGY INSTRUMENT CORP. OF ARIZONA, TUCSON, ARIZ.
TECHNOLOGY INSTRUMENT CORP. OF ILLINOIS, FRANKLIN PARK, ILL.
TECHNOLOGY INSTRUMENT CORP. OF CALIFORNIA, NEWBURY PARK, CALIF.

CIRCLE 71 ON READER-SERVICE CARD



MFR1
Type MFR1 - encapsulated contact patented Metfilm ultra-reliable long life potentiometers



PVR05



PVR09 (ganged)



PVR15

Type PVR - new complete line of low torque high accuracy performance proved servo type precision potentiometers



M10T09

Type M10T09 - multi-turn 1, 5, 20-turn highly accurate precision potentiometers



C10-09 (ganged)

Type C10-09 - 10 turn may be ganged



RVBC2

Type RVBC2 - unibrad construction for development work



P1 1/4

Type P 1 1/4 - low cost commercial grade precision potentiometers

NEW PRODUCTS

Transistor Parameter Test Set 531

For npn and pnp transistors



Model 1803 transistor-parameter test set, for both npn and pnp transistors, measures the h-parameters for both the grounded emitter and the grounded base connections. Accuracy of the instrument is 3%. The collector leakage current can be read from 5 μ A to 1 mA. A wide range of parameter values and bias conditions can be preset by means of front panel switches. The unit is supplied with a steel cabinet and can be used in laboratory and production applications.

Dynatran Electronics Corp., Dept. ED, 178 Herricks Road, Mineola, N.Y.

Price & Availability: Price is about \$700 per unit. Delivery requires from 30 to 60 days.

Phase-Angle Voltmeter 527

For use to 4500 cps



Model VM-204 phase-angle voltmeter, designed to measure complex voltages where a number of test frequencies are used repeatedly, is for use at any of three frequencies from 60 to 4500 cps. Other frequencies can be supplied on special order. It reads null, phase angle, total, quadrature, and in-phase voltages directly. Voltage range is 1 mV to 300 V in 12 steps. Nulling sensitivity is 10 μ V. Designed for bench or rack mounting, the instrument measures 19 x 5.25 x 9 in. It can be used by semi-skilled personnel.

North Atlantic Industries, Inc., Dept. ED, 603 Main St., Westbury, L.I., N.Y.

Price & Availability: Prices will be quoted on request as the unit is made on order only. Delivery is in 30 to 45 days.

YOKE DISTORTION your problem?



Uniform magnetic fields
Produced in Celco
Precision
Deflection
Yokes
Minimize
**SPOT
DISTORTION**



Exclusive Celco core materials make it possible to achieve faster recovery times, minimum hysteresis, high linearities and maximum sensitivities.

Contact Celco Engineering Department for a fast solution to all your yoke problems.

Celco produces a complete line of standard or special commercial and military precision deflection yokes.

Celco

Constantine Engineering
Laboratories Co.

Main Plant: MAHWAH, N. J. DAvis 7-1123
• Pacific Division - Cucamonga, Calif. - YUkon 2-2688
• Central Division, Lanesboro, Pa. - ULYSSES 3-3500
• Southern Division, Miami, Fla. - Wilson 5-2164

CIRCLE 72 ON READER-SERVICE CARD

ELECTRONIC DESIGN • February 17, 1960

Corona Test Set 541

Shows corona charge and current

Composed of a high voltage section within an oil tank and a control cabinet for remote operation, this corona test set indicates apparent corona charge and relative corona current. The unit has a capacity of 8 kva, and may be used as a straight dielectric breakdown tester. Other uses of model CT50-8 include testing of high-voltage bushings, ceramic terminals, wire and cable, electrical insulating materials, transformers, and capacitors.

Peschel Electronics, Inc., Dept. ED, RFD 1, Patterson, N.Y.

Price & Availability: Made on order only. Delivery is 45 days after order received. Price is \$4200.

Relay 671

Has independent twin contacts

Designed for dc operation, type 5 telephone relay has twin-contact points of Palladium that have a combined rated current carrying capacity of 4 amp, 150 w. Operating speed is 1 to 2 msec, min. The coil is single or double-wound and can be provided with a choice of time delay features.

Lakewood Controls Corp., Dept. ED, Industrial Road, Crystal Lake, Ill.

Power Relay 667

Rating is 15 amp

Series ST dpdt power relay, for starting motors having up to 1 hp, has a contact rating of 15 amp at 115 v, 60 cps. Voltages can be 6 to 110 v dc and up to 440 v ac. The device features a one-piece, molded-base construction with shielded screw type electrical connections. Contact material is gold-flashed fine silver.

Line Electric Co., Dept. ED, 271 S. Sixth St. at 14th Ave., Newark 3, N.J.

Price & Availability: Price is \$6.25 or \$6.50, depending on unit ordered. Units will be available from stock in small quantities early in March. Maximum delivery time for items not in stock is 7 to 8 weeks.

CIRCLE 73 ON READER-SERVICE CARD ➤

NOW...
IN MINIATURE

SILICON CONTROLLED RECTIFIERS



actual size

... FROM SOLID STATE

For control circuit application in the
10 to 1250 ma output current range

- **HIGH SENSITIVITY**
only 2 mA input to control one ampere (continuous) at 100°C.
- **HIGH TEMPERATURE**
stable operation to 150°C.
- **LOW LEAKAGE**
10 uA cutoff current at full voltage.
- **SIMPLIFIED MOUNTING**
no need for insulating hardware — stud is electrically isolated.

Type	Maximum Anode Voltage (DC or Peak AC) ± Volts	Maximum Average Forward Current 100°C Case Amps	Maximum Gate Current to "Fire" mA	Gate Voltage to Fire + Volts	
				Min.	Max.
3B30S	30	1.0	2	.40	2.5
3B60S	60	1.0	2	.40	2.5
3B100S	100	1.0	2	.40	2.5
3B150S	150	1.0	2	.40	2.5
3B200S	200	1.0	2	.40	2.5

These devices offer significant circuit advantages in that they are specifically designed for operation in the 10 to 1250 mA current range. It is no longer necessary to derate higher power units, with attendant losses in efficiency.

The miniature SCR combines a current rating of 1 ampere at 100°C with extremely small size. It features high peak recurrent and surge current ratings. Switching efficiency up to 98% is practical. High gain, low loss control of loads up to 300 watts can now be achieved along with significant miniaturization. The internally insulated junction eliminates the need for external mica washers. Assembly is therefore simplified and reliability improved.

The miniature SCR is useful in applications such as AC and DC static switching, proportioning control, D.C. to D.C. converters, servo motor driving, squib firing, protective circuits, and related applications.

Encapsulated in the unique SSPI cold welded copper case, the SCR offers a high degree of mechanical ruggedness and long term reliability.

WRITE FOR BULLETIN C415-01

SOLID STATE Products, Inc.

ONE PINGREE STREET • SALEM, MASSACHUSETTS

PIONEER 3-2900

On display at
IRE
Booth 1519B

**NOW TEST
TRANSISTOR BETA
IN THE CIRCUIT
WITHOUT
POWER ON!**



New Sierra 219A Transistor Tester reads Beta directly in the circuit; also measures I_{CO} and Beta out of circuit. Simple operation, completely portable. Battery powered; easily used anywhere.

Consider the real advantages of testing transistors in the circuit. Downtime, and damage to transistors, is greatly reduced. Complete assemblies are quickly checked out. Quality control "ounce of prevention" is simplified during manufacture.

Beta is read simply and directly in or out of the circuit; a basic function of the Sierra 219A is to electrically isolate the transistor under test permitting accurate in-circuit tests. I_{CO} is measured on a straightforward dc basis; collector potentials of 3, 6, or 12 vdc may be selected.

For complete information and demonstration, telephone your Sierra representative now.

sierra

SIERRA ELECTRONIC CORPORATION

A Division of Philco Corporation

6251K BOHANNON DRIVE • Davenport 6-2060 • MENLO PARK, CALIFORNIA, U. S. A.
Sales representatives in all principal areas
Canada: Atlas Instrument Corporation, Ltd., Montreal, Ottawa, Toronto, Vancouver
Export: Frazer & Hansen, Ltd., San Francisco, Los Angeles

CIRCLE 74 ON READER-SERVICE CARD

DON'T TAKE IT OUT!



SPECIFICATIONS

Test Ranges:	Beta, 10 to 100, I_{CO} , 0 to 50 μ amp
Accuracy:	In-circuit $\pm 20\%$ for external loadings above 500 ohms Out-of-circuit $\pm 10\%$
Power:	Mercury or zinc-carbon battery; 1,000 hrs. average service life; meter indicates battery output
Temperature Range:	32° to 122°F for specified accuracy
Dimensions:	9" high x 7 $\frac{3}{8}$ " wide x 6 $\frac{1}{2}$ " deep; weight 16 pounds
Accessories:	Test leads supplied
Price:	\$250.00 f.a.b. factory Delivery from stock

Data subject to change without notice

NEW PRODUCTS

Band-Pass Filter

525

Frequency range is 1 to 10,000 cps



Model 720 band-pass filter is designed for operation over a frequency range of from 1 to 10,000 cps. The frequency is selected by a digital selection technique using a set of four dials. Gain settings of -20, 0, and +20 db are available. The filter sensitivity is adjustable with a maximum of $\pm 2.3\%$ to the 3-db down points. The filter offers 37 db rejection to the third harmonic with a maximum attenuation rate of 250 db per octave. This filter is suited for separation of closely spaced frequency components not necessarily harmonically related.

Dytronics Co., Dept. ED, P.O. Box 3676, Columbus 14, Ohio.

Price & Availability: Price of the unit is \$525. Delivery is in 21 days

Magnetic Tape System

526

For field use



This loop delay and reel storage magnetic tape system, designed for field use, consists of a continuous loop tape transport, a reel-type transport, a master control unit, and a power supply. It is for continuous monitoring and recording of analog data. The loop stores 30 sec of data before passing over to the reproducing, erasing and recording heads. Output of the reel-type transport can be transmitted at 600 ohms or can be switched to a 100-ohm output. The reel transport records two tracks on 1/4-in. magnetic tape at 7.5 in. per sec. Flutter is 0.25% rms max.

Consolidated Electrodynamics Corp., Dept. ED, 360 Sierra Madre Villa, Pasadena, Calif.

Price & Availability: The unit is made on order only. Information is quoted on request.

CIRCLE 75 ON READER-SERVICE CARD

ELECTRONIC DESIGN • February 17, 1960

High Permeability Powder Cores 445

For audio filter low frequency applications



These 160-mu moly-permalloy powder cores are for audio filter low frequency applications. They come in eight standard sizes, with OD from 0.5 to 1.57 in. and ID from 0.3 to 0.95 in. They offer an inductance 28% higher than that attained with 125-mu cores and have a higher Q. Fewer turns of wire are needed to yield a given inductance.

Magnetics, Inc., Dept. ED, Butler, Pa.

Price & Availability: Price is quoted on request; units are available from stock.

Capacitor

300-v foil-type

393

Designed for use in missiles, computers, and airborne equipment, this 300-v foil-type tantalum electrolytic capacitor is available in 7 case sizes and both polar and nonpolar construction. Capacitance change does not exceed 10% after 2000 hr operation at rated voltage and temperature. The maximum capacitance change at -55°C is 20%.

General Electric Co., Dept. ED, Schenectady 5, N.Y.

Dual Flip-Flop

Operates at speeds to 500 kc

502

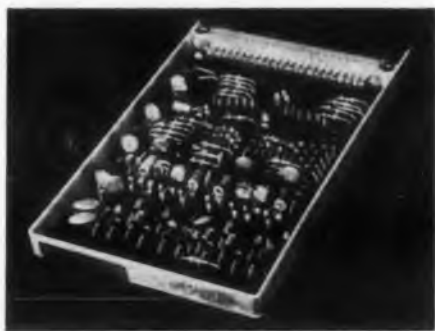

Type 4209 dual flip-flop, containing two identical flip-flops with built-in output amplifiers, operates at speeds to 500 kc. It is for use in buffer and control registers and other applications. Each flip-flop has a direct and gated input to the zero and one side; each also has one pulse gate internally connected to the gated one-input terminal. The static type flip-flops used have continuous dc output signals.

Digital Equipment Corp., Dept. ED, Maynard, Mass.

Distributed constant delay lines • Lumped-constant delay lines • Variable delay networks • Continuously variable delay lines • Pushbutton decade delay lines • Shift registers •

ESC EXTRA

Pulse transformers • Medium and low-power transformers • Filters of all types • Pulse-forming networks • Miniature plug-in encapsulated circuit assemblies

ESC DEVELOPS DELAY LINE WITH 170 to 1 DELAY TIME/ RISE TIME RATIO

**Model 61-34 Perfected
For Specialized
Communications Application**

PALISADES PARK, N. J.—An entirely new Lumped-Constant Delay Line, with a proven 170 to 1 delay time/rise time ratio, has been announced by the ESC Corporation, Palisades Park, N. J. The new delay line, known as Model 61-34, was specifically designed for a specialized communications application calling for the exceptionally high delay time/rise time ratio.

ESC, the world's leading manufacturer of custom built and stock delay lines, is already widely recognized in the electronics industry for its exceptional engineering advances. In October, 1958, ESC broke through an existing design barrier and produced a delay line with a 145 to 1 delay time/rise time ratio. It had been thought, prior to the announcement of the Model 61-34, that ESC had reached the ultimate in this type of delay line.



SPECIFICATIONS OF NEW DELAY LINE MODEL 61-34

Delay time/rise time ratio: 170/1

Delay: 200 usec.

Rise time: 1.16 usec.

Attenuation: less than 2 db

Frequency response: 3 db = 325 KC

50 taps with an accuracy of ± 0.2 usec. at each tap.

Complete technical data on the new unit can be obtained by writing to

ESC Corporation, 534 Bergen Boulevard, Palisades Park, New Jersey.

CIRCLE 76 ON READER-SERVICE CARD

Circle 75 on Reader-Service Card

ELECTRONIC DESIGN • February 17, 1960

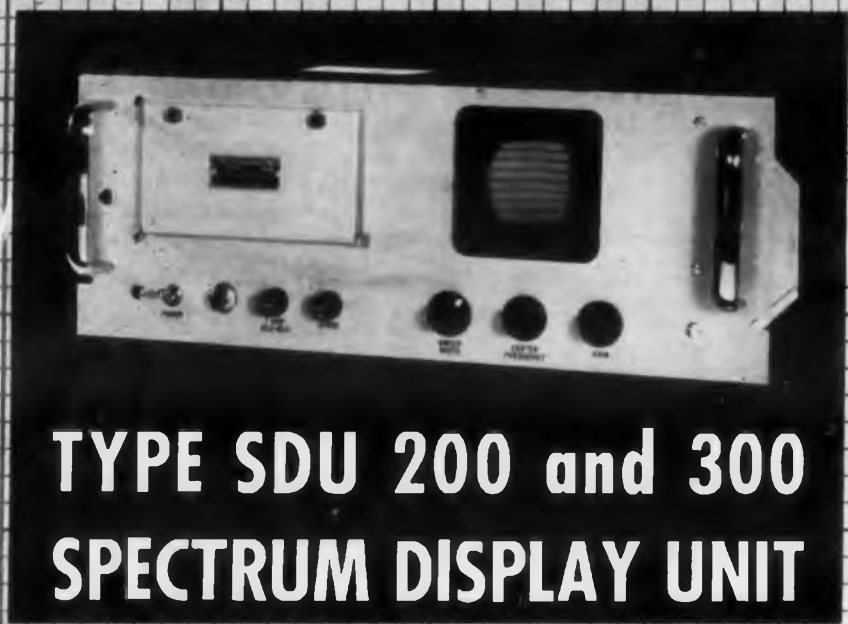

TYPE SDU 200 and 300 SPECTRUM DISPLAY UNIT

THE purpose of the Spectrum Display Unit is to provide a visual indication of the signal to which a receiver is tuned, as well as to provide a visual indication of signals in a band of frequencies above and below that being received. The signals are displayed on a cathode-ray tube. The CRT has a calibrated screen allowing both frequency and relative amplitude of received signals to be determined.

SPECIFICATIONS

Maximum Sweep Width—	
SDU-200	2 megacycles
SDU-300	3 megacycles
Input Center Frequency	21.4mc or 30.0mc
Second IF Amplifier Frequency	4.3 megacycles
Sensitivity for full deflection: 5 microvolts to receiver	
Resolution	approximately 20kc
Power Input	117v, 50-60cps, approximately 95w
Size	19" x 7" x 13"

NEMS·CLARKE CO.

A DIVISION
OF VITRO
CORPORATION
OF AMERICA



919 JESUP-BLAIR DRIVE
SILVER SPRING, MARYLAND
MUNICIPAL AIRPORT
MARTINSBURG, WEST VIRGINIA

PRECISION ELECTRONICS SINCE 1909

CIRCLE 77 ON READER-SERVICE CARD

NEW PRODUCTS

Cathode Ray Tubes

354

Dual-beam type



Designed to have a high resolution, types K1880P and K1917 dual-beam cathode-ray tubes are replacements for types 3ABP and 5AFP, respectively. Type K1880P 3-in. tube has a maximum line width of 6 mils when operated at normal accelerator and post accelerator voltages of 2 and 4 kv. The maximum line width of type K1917 5-in. tube, under the same conditions is 10 mils, according to MIL-E-1.

Allen B. Du Mont Labs., Inc., Dept. ED, 750 Bloomfield Ave., Clifton, N.J.

Tape Demagnetizer

702

Reduces residual sound level



Model HD-11 tape demagnetizer reduces the residual sound level of fresh unrecorded tape by 3 to 15 db, depending upon previous exposure to stray magnetic fields. It provides a 75 db min erasure of saturated magnetic tape. Dimensions of the unit are 3 x 5 x 8 in., and its weight is 8-1/2 lb. Reels from 5 in. through 10-1/2 in. in diam may be used with the unit.

Microtran Co., Inc., Dept. ED, 145 E. Mineola Ave., Valley Stream, N.Y.

Price & Availability: Units available through electronic distributors. List price is \$27.50.

Broadband Attenuators

444

Come in waveguide sizes of 2.6 to 18 kmc



Model 372 broadband precision attenuators are

TEST INSTRUMENTS for ELECTRICAL EQUIPMENT

Laboratory
Production
Maintenance



Voltage Breakdown Tests

Bench HYPOT® Test Sets, a-c and d-c models, have outputs to 30 kv. Separate 4 1/2" meters for test voltage and leakage current. Wide selection of models.

Model 424 Bench HYPOT® provides 0-5000 v d-c. For testing cables, condensers, coils, transformers, motors, and assemblies. Measures leakage current from 0.1 microampere to 100 microamperes over four scale ranges. Rapid testing of capacitors with output of 5 milliamperes under short circuit. Operates from 110-120 v 50/60 c outlet with long-life selenium high voltage supply.

Net complete \$497.50

● Insulation Materials Tester

Dielectric strength determined to laboratory precision. Interchangeable test fixtures for varnishes, porcelain, tape, acetate sheet, films, tubing and cloth. Write for Bulletin, Model 4501 HYPOT® Materials Tester.

● Insulating Oils Tester

New portable design, only 42 lbs., for testing insulating oils at point of application as well as in the laboratory. Test potential variable from 0 to 35 kv, with 2 kva rating. Write for bulletin Model 4505 HYPOT® Oil Tester.

● Measure Resistance to FIVE MILLION MEGOHMS

VIBROTEST® megohmmeters provide direct reading measurements to FIVE million megohms and higher with electronic power supply that eliminates tedious cranking. Write for bulletin "VIBROTEST".

● Test Electrical Grounds

VIBROGROUND® measures resistance to ground of electronic, telephone, and power equipment. Direct reading. Operates from self-contained battery. Write for Bulletin "VIBROGROUND".

● Special Instruments

A. R. I. engineers have developed instrumentation to meet many specialized research, development, and production applications. Your inquiry for special equipment will receive prompt attention.

Complete Catalog
Write today!

10-35.19



ASSOCIATED RESEARCH
Incorporated

3769 W. Belmont Ave., Chicago 18, Illinois
CIRCLE 78 ON READER-SERVICE CARD

offered in six waveguide sizes from 2.6 to 18 kmc with nominal attenuations of 10 or 20 db. Attenuation is a function of the coupling-hole array between two permanently-joined waveguide sections. The attenuation accuracy is better than ± 0.4 db from nominal. Variation across the band is less than ± 0.5 db from mean. The standing wave ratio is 1.05:1.

Hewlett-Packard Co., Dept. ED, 275 Page Mill Road, Palo Alto, Calif.

Price & Availability: Prices are \$115 to \$375, depending on the waveguide band. Availability data is furnished on request.

Crystal Mounts

590

Have high tangential sensitivity



These crystal video detector mounts provide a high tangential sensitivity down to 50 mc. Ranges covered are 50 to 120 mc, 120 to 300 mc, and 300 to 600 mc. Tangential sensitivity can be better than -55 dbm with selected MA408B or 1N23B crystals.

American Electronic Laboratories, Inc., Dept. ED, 121 N. Seventh St., Philadelphia 6, Pa.

Price & Availability: Price is \$80 ea; for orders of 16 to 30, \$65; and for orders of 31 to 50, \$60. Sample quantities are available for prompt delivery. Larger quantities can be delivered in 21 days.

Phase-Sequence Indicator

355

Operates on 24 to 480 v at 400 cps



Model K-6 phase-sequence indicator is especially designed for use with the current characteristics found in aircraft, missile, and military components. The device operates on 24 to 480 v at 400 cps. Upon pushing the safety button, the proper or improper connection of three-phase equipment is indicated by the direction a disc rotates within three round windows in the face of the instrument.

Knopp, Inc., Dept. ED, 1307 66th St., Oakland 8, Calif.

OUT-PERFORMS
WIRE WOUND...
YET SMALLER
IN SIZE,
LOWER IN COST

New Electra Precision Metal Film Resistor

Here is an entirely new achievement in electronic components; one of the biggest steps forward in years. This precision metal film resistor offers you precision and stability that formerly was available only in a wire wound resistor, yet it is much smaller in size, much lower in cost, also has far superior high frequency characteristics. Available in five sizes from $\frac{1}{8}$ to 2 watts, the new Electra Precision Metal Film Resistor meets or exceeds Mil-R-10509C, Characteristic C, and can be supplied in any of eight standard temperature coefficient tolerances. Why not let us supply you full details? Write today!

CHECK THESE OUTSTANDING TEST RESULTS

TEMPERATURE CYCLE

Initial	Final	% Change
236.9	236.9	0
237.0	237.2	0
236.3	236.2	0
237.1	237.1	0
237.2	237.4	0
236.8	236.8	0
236.9	236.9	0

MOISTURE

Initial	Wet	Dry
236.9	236.9	236.9
237.4	237.4	237.4
236.3	236.3	236.3
237.1	237.1	237.1
237.2	237.2	237.2
236.8	236.8	236.8
236.9	236.9	236.9

Electra

CIRCLE 79 ON READER-SERVICE CARD

NEW PRODUCTS

Voltmeter 392

Covers 110 to 130 v range

Calibrated from 110 to 130 v, in 1/2-v intervals, this voltmeter is intended for laboratories, and other industrial applications. The instrument uses a milliammeter element fed by a Zener diode circuit which spreads 110-130 v over 95% of the scale length. It is available for both 60 and 400 cps duty, and has a response time of 2 sec.

General Electric Co., Dept. ED, Schenectady 5, N.Y.

Price & Availability: Immediately available. Price on request.

Silicon Diode 391

For use as Ku-band mixer

Type IN918 silicon diode is a point-contact microwave mixer for use in the Ku-band frequency spectrum. Maximum conversion loss of the component is less than 7.5 db, and the output noise ratio does not exceed 2.5. Hermetically sealed in miniature glass envelopes, type IN918 operates at 16,000 mc.

Semiconductor Div., Sylvania Electric Products, Inc., Dept. ED, 730 Third Ave., New York 17, N.Y.
Price & Availability: Available from stock. Price is \$23 per unit in quantities of 1 to 9; \$18 per unit for 10 to 99; \$14.40 per unit for 100 and up.

Power Supply 378

Delivers 0.04 to 5 amp at up to 8 v

Model PCR-101 power supply delivers 0.04 to 5 amp at up to 8 v. The current output is constant with line variations from 105 to 125 v; this range may be shifted to 99 to 117 v or to 111 to 132 v. Designed specifically for laboratory use in battery development and electro-deposition, it can also be used in lamp and filament development, thermistors, diodes, meter calibration, low resistance measurement, and magnetic devices.

Industrial Measurements Laboratory, Dept. ED, 40 Great Jones St., New York 12, N.Y.

New "Beam-X" switch

outperforms all

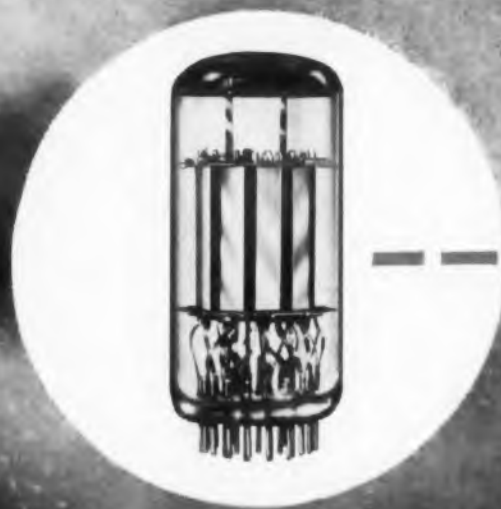

all solid state, vacuum & magnetic devices

IN MULTIPOSITION SWITCHING, COUNTING AND DISTRIBUTING

THE
BEAM-X*
IS AN
ALL-ELECTRONIC
MULTIPOSITION
SWITCH

The BEAM-X* eliminates
Multicomponent size
Multicomponent weight
Multicomponent power
Multicomponent cost
and
Multicomponent unreliability

A technological breakthrough in the design of Beam Switching Tubes eliminating external magnets and shields has resulted in a low cost revolutionary device. BEAM-X* outperforms all existing solid state, magnetic and vacuum components for electronic switching applications. In aircraft, missile, commercial instrumentation, control systems and other industrial applications, BEAM-X* offers far superior design flexibility and reliability than existing conventional components. BEAM-X* type BX-1000 is the first of a new family of multiposition electronic switches.



WRITE TODAY FOR TECHNICAL BROCHURE DESCRIBING THE OPERATION AND COMPLETE MECHANICAL AND ELECTRICAL APPLICATION DATA OF THIS NEW BURROUGHS BEAM-X* SWITCH.

ANOTHER ELECTRONIC CONTRIBUTION BY

Burroughs Corporation

ELECTRONIC TUBE DIVISION

Plainsfield, New Jersey

APPLICATIONS:
COUNTING • GATING • DISTRIBUTING • CONVERTING • GATING • MULTIFLEXING • SWITCHING
TIMING • SAMPLING • MEMORY • MATRIXING • PRESETTING • DECODING • DIVIDING

TRADE MARK OF BURROUGHS CORPORATION

Spdt Coaxial Switch 352

Weighs 1.25 oz



The type 90-01 spdt coaxial switch weighs 1.25 oz and is designed for 50-ohm cable. It can be directly inserted into a miniaturized circuit without adapters. Mating connectors are available for applications at, above, or below 400 mc. The vswr is less than 1.2 to 2 kmc and insertion loss is 0.5 db at 2 kmc. Operative life is 50,000 cycles minimum.

Microdot Inc., 220 Pasadena Ave., Dept. ED, South Pasadena, Calif. *Price & Availability: Price is below \$50 when ordered in quantity. The unit will be available from stock by Feb. 1 and it can be delivered 30 days after order received.*

Variable Frequency 386 Generator

Miniature, permanent-magnet type

Type 3200 variable frequency generator is a miniature permanent-magnet type generator which provides a two-phase ac output. The output voltage is 8 v rms at 3600 rpm into a balanced 10,000-ohm load. The useful range is 0 to 15,000 rpm, the distortion is 3% max, and the impedance is 300 ohms per phase at 3600 rpm. It is used as a reference generator to provide information on the rotational speed and angular position of a shaft, as in constant-velocity servo systems.

Cedar Engineering, Div. of Control Data Corp., Dept. ED, 5806 W. 36th St., Minneapolis 16, Minn. *Price & Availability: Price will be quoted on request. Standard units are immediately available; special units can be delivered in 2 to 4 weeks.*

Circle 80 on Reader-Service Card



recti/riter® recorders prove what every engineer knows . . . SIMPLICITY MEANS RELIABILITY

What simpler and more reliable actuating device can you employ in an amperage-voltage-frequency recording instrument than a d'Arsonval galvanometer . . . a trouble-free horseshoe magnet and a coil of wire? The same is true of the exclusive "recti/rite"® system . . . a simple, shock resistant trigonometric linkage that straightens the arc described by the galvanometer metering arm, changing curvilinear motion to rectilinear motion.

All the other "recti/riter" recorder features which contribute to this instrument's multi-industry acceptance and hardworking reliability are equally simple: The optional a-c or d-c drives couple directly with chart speed change gears to allow ten chart speeds; all routine operations and adjustments are performed "up front"; the non-corrosive, honed metal alloy pens, closed ink system, and large capacity ink well give you long, consistent writing performance.

With all their simplicity and reliability, "recti/riter" recorders are offered in extremely wide and useful Basic Recorder Ranges (Dual channel recorders offer combination of any two ranges):

Two Cycle Pen Response
 D-c Milliampere Ranges ¼ ma to 100 ma
 A-c Ampere Ranges 0.25 A to 25 A
 D-c Ampere Range .. 100 mv for use with standard shunts
 Expanded Scale A-c Voltage Ranges 80-130 V,
 160-260 V, 320-520 V
 A-c and D-c Voltage Ranges 10 V to 1000 V
 Frequency Ranges 50, 60, 400 cps

Five Cycle Pen Response
 D-c Milliampere Range 5 ma

Ask the TI engineer about *customized* recorders for your OEM applications. Don't settle for any recorder until you know all the facts on the complete "recti/riter" recorder line.



TEXAS INSTRUMENTS
 INCORPORATED

GEOSCIENCES & INSTRUMENTATION DIVISION
 3609 BUFFALO SPEEDWAY • HOUSTON 6, TEXAS • CABLE: TEXINS

The proved "recti/riter" recorder is a companion to the new "servo/riter" recorder.

"servo/riter" is a trademark of Texas Instruments

NEW PRODUCTS

Motor Generator 376

Weights 28 oz



Model V842-22 motor generator weighs 28 oz and has a rotor moment of inertia of 18 g-CM². Generator excitation current, measured at stall, is 0.8 amp. The 60-cps motor generator may be used in remote-control servo systems for weighing operations and dangerous processes, indication of water levels and gate valve positions, and automatic control of liquid levels and machine tool operations.

Kearfott Co., Inc., Dept. ED, 1500 Main Ave., Clifton, N. J.

Price & Availability: Delivery and price data on request.

Chart Recorder-Controller 382

Accuracies are 0.25%

This round chart recorder-controller has accuracies of $\pm 0.25\%$. Minimum accurate scale span is 1 mv dc. Response times available are 4, 10, and 24 sec, full scale. A Zener diode offers a constant voltage reference accurate to $\pm 0.05\%$. The temperature coefficient is 0.001% per deg C. The recorder is a null-balance, potentiometer type. The central portion of the recorder features trip switch cams that are individually adjustable; a single cam can be reset without upsetting the others. Concentric scale length is 27.5 in. and the dimensions of the entire unit are 17-11/16 x 16-3/16 x 17-1/16 in.

General Electric Co., Dept. ED, Schenectady 5, N.Y.

Price & Availability: After April 1, 1960, units can be supplied in 4 to 6 weeks. Price of the standard model is about \$750.

◀ Circle 81 on Reader-Service Card

Chassis For Electronic Equipment 422

Is 17-in. wide

This flexible chassis for electronic equipment is 17 in. wide and from 9 to 26 in. long. Side frames are made of 1/8-in. aluminum extrusions or 0.075-in. cold rolled steel. The chassis is designed to allow maximum opportunity for cooling air to circulate; components are accessible from top, bottom, sides and rear.

Electro-Pack, Inc., Dept. ED, 11505 Jefferson Blvd., Culver City, Calif.

Price & Availability: Prices begin at \$24. Delivery is in two weeks.

Metallized Paper-Plastic Capacitor 385

For operation from -55 to +125 C

Made for both military and industrial use, type MTWK metallized paper-plastic capacitors operate in the temperature range of -55 to +125 C without voltage derating. They can be used in power supply filter circuits, bypass functions, and applications where occasional momentary voltage breakdowns can be tolerated. They come in sizes of 200, 400, and 600 v dc.

Cornell-Dubilier Electric Corp., Dept. ED, South Plainfield, N.J.

Price & Availability: Units will be available from stock after July 1, 1960. Price can be quoted on request.

Wire Stripper 383

Has a continuously variable heat control

Model G thermal wire stripper has a continuously variable heat control for precise temperature adjustment required in stripping any size or type of plastic-insulated wire. Designed for production line operation, it can be used as a bench-operated tool or as a hand tool.

Western Electronic Products Co., Dept. ED, 655 Colman St., Altadena, Calif.

Price & Availability: Price is \$69.50 ea. The product is available from stock.

Circle 82 on Reader-Service Card >

it has everything...

VERSATILITY



FXR'S Model Z817A, UNIVERSAL MICROWAVE POWER SUPPLY

is a single power source for microwave tubes.

- Six individual floating power supplies can be interconnected in many combinations.
- Regulation is outstanding.
- Ripple is negligible.
- Voltages and frequencies can be preset with extreme accuracy.

WOULD YOU
LIKE THE
DETAILS?



FXR, Inc.

Design • Development • Manufacture

26-12 Borough Place
Woodside 77, N. Y.

Precision Microwave Equipment • High-Power Pulse Modulators • High-Voltage Power Supplies • Electronic Test Equipment

ERECTOR-SET SIMPLICITY

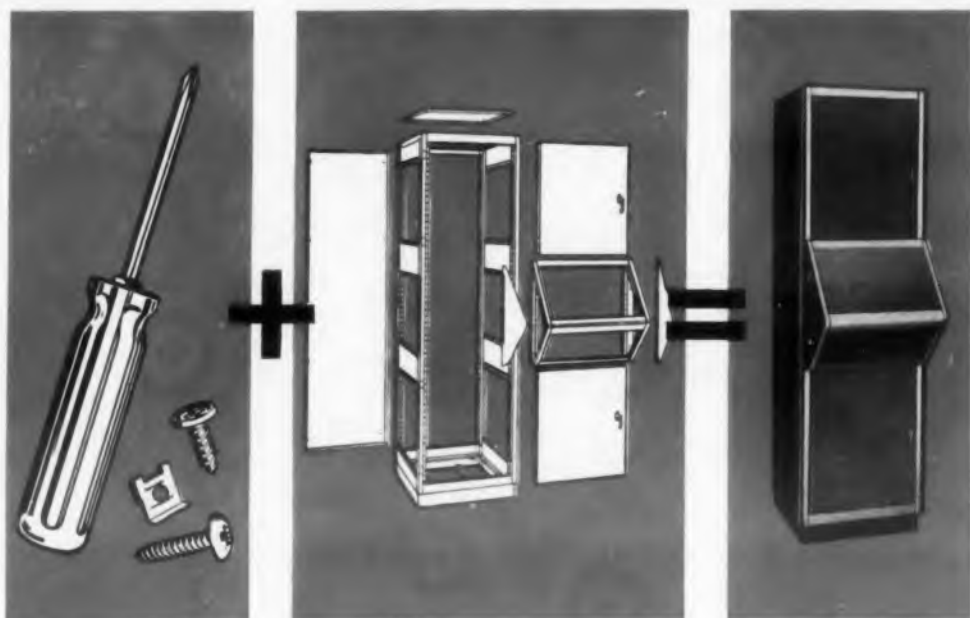

EMCOR® Pre-engineered CABINETS AND ENCLOSURES

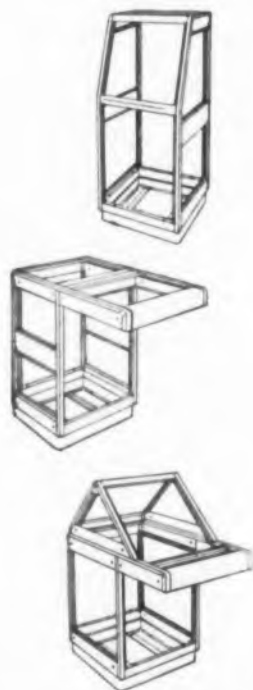

EMCOR pre-engineered cabinets and enclosures bring Erector-Set simplicity to control center construction. A Phillips Head Screwdriver and handy EMCOR hardware kit introduce an ease and flexibility never before attained in control center assembly, alteration or rearrangement. Costly modification of units of custom type construction is eliminated. EMCOR units with their exclusive combination of patented custom quality features bring a new concept to instrument housing. Advanced design, greater load carrying capacities, combined with modern fabricating techniques and high craftsmanship standards are just a few of the many reasons why dollar for dollar you get more from EMCOR. Take the guesswork out of your packaging problem, let EMCOR engineering know-how give you the solution. Your request for current information will be promptly answered.

Your copy of
Condensed Version
Catalog 106
Available upon Request



Originators of the Modular Enclosure System

ELGIN METALFORMERS CORP.
630 CONGDON, DEPT. 1221 • ELGIN, ILLINOIS

*Registered Trademark of Elgin Metalformers Corporation

VISIT US AT BOOTH 4420-4424 DURING I.R.E. SHOW, NEW YORK COLISEUM
CIRCLE 83 ON READER-SERVICE CARD

NEW PRODUCTS

VSWR Amplifier

372

Has nickel-cadmium batteries



Model 441B vswr amplifier is transistorized and battery operated; it has a built-in provision to show the state of battery charge. It uses nickel-cadmium batteries providing independence from line voltage fluctuations. Standard operating frequency is 1000 cps $\pm 1\%$ with plug-in networks available for 315 to 4000 cps and broadband applications. Bandwidth is 25 to 30 cps and range is 72 db.

Narda Microwave Corp., Dept. ED, 118-160 Herricks Road, Mineola, N.Y.

Price & Availability: Unit available from stock. Price is \$225.

Insulation Tester

360

Measures to 5×10^{16} ohms



Model 710H insulation tester is capable of measurements from 140 K to 5×10^{16} ohms. A direct reading instrument, it can be used for measuring insulation resistance in ceramics and insulating materials, and capacitor leakage. The upper half scale accuracy is 3%. Test potential range is 0 to 1000 v, continuously variable. Mercury cells provide voltage stability with less than 0.0005% change per hr at 1000 v. Repeatability is better than 0.2%. Weight of the unit is 40 lb.

Mid-Eastern Electronics, Inc., Dept. ED, 32 Commerce St., Springfield, N.J.

Price & Availability: Price is \$1495 fob Springfield, N.J. Delivery is in 45 days.

NEW

FROM

SF inc.



MODEL 722

Fault Finder USING REVOLUTIONARY NEW RADAR PRINCIPLE

The SF Model 722 Fault Finder presents a new and valuable approach to the solving of time-consuming cable fault problems. It has proven especially valuable in the aviation, broadcast and marine industries.

A true radar principle is used which obsoletes the use of the resistance capacitance method. With the radar principle, line condition is portrayed on a cathode-ray tube. It accurately defines the fault whether shorted, open or intermittent and indicates the distance from the instrument to the fault.

Model 722 is simple to operate and has a minimum of controls. An accuracy of 2% in ranging to a fault may be obtained.

SPECIFICATIONS

RANGE: 10 to 200 feet in cable with a constant of .66 — proportionately more or less in cable with a higher or lower constant.

MARKERS: Four markers appear when the "marker" switch is activated.

PULSE RATE: 2000 cycles per second.

PULSE AMPLITUDE: 350 Volts — .03 micro-second in duration.

WEIGHT: 12 lbs.

PRICE: \$375.00 f.o.b. Factory, Seattle, Wash.

Contact Factory or Field Representative for complete literature or demonstration and early delivery date.

* OTHER MODELS AVAILABLE WITH RANGES TO 100 MILES

Smith-Florence, Inc.
4228 23rd AVE. WEST, SEATTLE 99, WASH.

CIRCLE 84 ON READER-SERVICE CARD

Molded Fiberglass Insulation 381

Stands continuous temperatures to 300 F

This molded fiberglass insulation requires 1/3 of the cool air ordinarily needed for an astro-tracker used in a current high speed bomber navigation system. Able to stand continuous temperatures to 300 F, it replaces a sewn blanket-type assembly weighing about 4.5 lb. This insulation weighs 2.25 lb, is contour-fitted, and comes in several large sections.

Fibrous Glass Products, Inc., Dept. ED, Alpa Plaza, Hicksville, N.Y.

Price & Availability: Data will be furnished on request.

Mounting Clips 387

For diodes and rectifier cases

For top-hat diodes and rectifier cases with an 0.245 to 0.27 OD, these spring tempered mounting clips are made of beryllium copper. They may be secured by eyelets or rivets. Circuit contact is provided by an integral lug passing through the mounting surface for connection to printed circuit leads or for solder connection.

Atlee Corp., Dept. ED, 47 Prospect St., Woburn, Mass.

Timing Switch 384

For tracking and control of missiles

For the tracking and control of missiles, this timing system can be incorporated in missile range instrumentation to provide time references for the correlation of events and measurement of missile position and performance. It is composed basically of a master oscillator which serves as a time base, combined with an oscillator which is stable to 5 parts per 10,000,000,000 per day.

Hermes Electronics Co., Dept. ED, Cambridge, Mass.

Price & Availability: Units have a fixed price of \$12,000 ea. They are custom made and can be delivered in 90 to 120 days.

A PARTIAL LISTING OF INDUSTRY'S

WIDEST LINE! VOLTAGE REGULATOR SILICON DIODES

HERMETICALLY SEALED

1584 TYPES AVAILABLE



Write for this 6-page folder containing selection data on over 1584 Standard and Special Voltage Tolerance Zener Types. Request SR-260.

Ratings and Characteristics at 25°C

Nominal Zener Voltage and Typical Dynamic Impedance				Nominal Zener Voltage and Typical Dynamic Impedance			
Type Number	E_z (Volts)	I_z (MA)	Z_z (Ohms) @ I_z	Type Number	E_z (Volts)	I_z (MA)	Z_z (Ohms) @ I_z
A - 750 Mw Rated Basic Series (88 Closer Tolerance Types Also Available)				C - 3.5 Watt Rated Basic Series (88 Closer Tolerance Types Also Available)			
1N1507	3.9	35	14	1N1588	3.9	150	2.6
1N1508	4.7	30	12	1N1589	4.7	125	2.3
1N1509	5.6	26	5.2	1N1590	5.6	110	1.4
1N1510	6.8	22	1.5	1N1591	6.8	100	.58
1N1511	8.2	18	1.5	1N1592	8.2	80	.5
1N1512	10	15	1.8	1N1593	10	70	.7
1N1513	12	12	2.8	1N1594	12	50	1.4
1N1514	15	10	5	1N1595	15	40	3.4
1N1515	18	8	9	1N1596	18	35	6
1N1516	22	6	19	1N1597	22	30	9
1N1517	27	5	50	1N1598	27	25	13
B - 1 Watt Rated Basic Series (88 Closer Tolerance Types Also Available)				D - 10 Watt Rated Basic Series (88 Closer Tolerance Types Also Available)			
1N1518	3.9	80	9	1N1599	3.9	500	.84
1N1519	4.7	40	8.5	1N1600	4.7	400	.68
1N1520	5.6	35	5.5	1N1601	5.6	350	.3
1N1521	6.8	30	1.6	1N1602	6.8	300	.2
1N1522	8.2	25	1.1	1N1603	8.2	250	.25
1N1523	10	20	1.5	1N1604	10	200	.55
1N1524	12	15	2.4	1N1605	12	170	.95
1N1525	15	13	5.4	1N1606	15	140	1.5
1N1526	18	10	11	1N1607	18	110	2
1N1527	22	9	18	1N1608	22	90	3
1N1528	27	7	28	1N1609	27	70	4.5

FOR DETAILED TECHNICAL DATA, CIRCLE READER-SERVICE CARD NO. 85

SPECIFY THE LEADING LINE...

Choose from the most complete zener diode line in the industry... Contact your nearest Authorized Industrial Distributor for "off-the-shelf" delivery, or our Industrial Representative in your area.

INTERNATIONAL RECTIFIER



SYMBOL OF QUALITY IN SEMICONDUCTORS

INTERNATIONAL RECTIFIER CORPORATION: EL SEGUNDO, CALIFORNIA • PHONE OREGON 8-6281 • CABLE RECTUSA

NEW YORK CITY: 1580 LEMOINE, FORT LEE, N. J., WINDSOR 7-3311 • SYRACUSE, NEW YORK: 2366 JAMES STREET, HEMPSTEAD 7-8495 • CHICAGO, ILLINOIS: 205 W. WACKER DRIVE, FRANKLIN 2-3888 • CAMBRIDGE, MASS.: 17 DUNSTER ST., UNIVERSITY 4-6520 • ARDMORE, PENNSYLVANIA, SUBURBAN SQUARE BLDG., MIDWAY 9-1428 • BERKLEY, MICHIGAN: 1799 COOLIDGE HIGHWAY, LINCOLN 8-1144 • CANADA: 1581 BANK ST., OTTAWA, ONTARIO, REGENT 1-6880

Circle 85 on Reader-Service Card ▶

The Emerson Research Laboratories at Washington, D.C., directly-recorded this chart on a Honeywell Model 906 Visicorder. The chart shows a canceller test of a number of letters through a new mail-handling machine developed by Emerson for the U.S. Post Office Department.

In this test, the Visicorder took only 3 hours to reveal information that would have taken 3 weeks to get by any other means: what factors were responsible for the changing speeds of letters as they traveled through the machine at the rate of 30,000 letters per hour. Constant letter-travel speeds were necessary in order to register the cancellation mark on the stamp every time.

This Visicorder record revealed that motor speed variations, belt slippage and slippage of the letter in the drive rollers were responsible. A synchronous drive motor, a timing belt drive and a better grade of rubber in the drive rollers were added to solve the problem—at a vast saving in engineering time.



Milton Stovall, Emerson Project Engineer, uses the Visicorder to measure roller bounce caused by various letter thicknesses, and the consistency of letter speed through the new Emerson Automatic Mail Cancelling and Facing Machine.

...ds high-speed letter travel



Recent Models of the 906 Visicorder incorporate time lines and grid lines and record up to 14 simultaneous channels of data.



The NEW Model 1108 Visicorder, with many automatic features and the convenience of pushbutton controls, is ideal for intermediate uses requiring up to 24 channels of data.



The Model 1012 Visicorder is the most versatile and convenient oscillograph ever devised for recording as many as 36 channels of data.

The Honeywell Visicorder is the pioneer, completely proven, and unquestioned leader in the field of high-frequency, high-sensitivity, direct-recording ultra-violet oscillography. Here are some of the reasons why Visicorders provide the most accurate analog recordings available: constant flat response and sensitivity of galvanometers; grid-lines simultaneously recorded with traces to guarantee exact reference regardless of possible paper shift or shrinkage; flash-tube timing system for greater accuracy of time lines; superior optics for maximum linearity of traces.

No matter what field you are in . . . research, development, computing, rocketry, product design, control, nucleonics . . . the high-frequency (DC to 5000 cps) Visicorder Oscillograph will save you time and money in data acquisition.

Call your nearest Minneapolis-Honeywell Industrial Sales Office for a demonstration.

Reference Data: write for Bulletins 1108, 1012, and HC906B

Minneapolis-Honeywell Regulator Co.
Industrial Products Group, Heiland Division
5200 E. Evans Avenue, Denver 22, Colorado

75th
PIONEERING THE FUTURE
YEAR

Honeywell



Industrial Products Group

Cycle Timer

366

Contains 12 spdt switches



Type HYS repeat cycle timer measures 2.25 x 2.25 x 7 in. and contains 12 spdt independently adjustable and removable load switches. The time cycle is 90 sec. Built for ground support equipment, the timer withstands a vibration of 0.06-in., double-amplitude displacement from 5 to 55 cps and shock of 30 g for 11 msec. The cams have an OD measuring 1-1/8 in. which allows for time settings with 1% accuracy or better. The unit operates on 115 v 60 cps power.

Eagle Signal Co., Dept. ED, Moline, Ill.

Price & Availability: For example, one unit in the series is priced at \$198 ea in quantities to 99; for orders of 100 or more, the price is \$108.90. Price varies slightly with specifications. Units are made on order and can be delivered in 30 days.

Circuit Card Handles

377

Short-circuit and shock-resistant



Made of high impact plastic, these circuit card handles, called Pul-E-Ze, pull up to 70 lb and are short-circuit and shock-resistant. They automatically adjust for various board thicknesses by means of a flip action that grips cards tightly and releases easily. Designed to rest naturally in the grip of the hand, they may be used in labs, production, or field maintenance.

Products For Industry, A Div. of Western Lithograph Co., Dept. ED, 220 S. Rose St., Los Angeles 54, Calif.

Price & Availability: Immediate delivery. For quantities exceeding normal use, delivery is 3 to 4 weeks. Price per unit is \$10.50.

CIRCLE 86 ON READER-SERVICE CARD

Just off the Press!

Specifications on
all standard seals—

E-I Short Form
Catalogs

Bulletin SCT-59
on Single Lead
Terminals

Bulletin TCT-59
on Tubular
Terminals

—ask for your copies, today!

getting down to total reliability!

E-I

GLASS-TO-METAL
SEALS

— in commercial equipment and vital military programs

For proven reliability in severe environments, select your seals from the E-I standard line of application tested hermetic terminals. E-I offers designers the complete flexibility and economy of standardized production on all types of seals... from single lead terminals to sub-miniature closures. Proof of their reliability is the fact that leading manufacturers specify E-I for every type of seal application. Request catalog on standard types, or send drawings on seals for special requirements.

**ELECTRICAL
INDUSTRIES**

A Division of
Philips Electronics
& Pharmaceutical
Industries Corp.
MURRAY HILL, N.J.

Patented in Canada, No. 523,390;
in United Kingdom, No. 734,583;
licensed in U.S. under No. 2561520



SINGLE LEAD
TERMINALS



PLUG-IN
CONNECTORS



CUSTOM
SEALING



TRANSISTOR
CLOSURES



THREADED
SEALS



END
SEALS



MINIATURE
CLOSURES



MULTIPLE
HEADERS

CIRCLE 87 ON READER-SERVICE CARD

NEW PRODUCTS

Static Flip-Flop Tester

369

Requires — 16 v at 65 ma



Model FT-10 static flip-flop tester, consisting of control switches, a microammeter, and oscilloscope test points, requires —16 v at 65 ma and 1-mc clock pulses. The flip-flop to be tested is plugged into the female connector provided on the tester. The instrument can be mounted on any T-block slot.

Computer Control Co., Inc., Dept. ED, 983 Concord St., Framingham, Mass.

Price & Availability: Units are available from stock at \$450.

Temperature Controller

404



Has ± 1 F control stability

Available with standard temperature ranges of 200 to 600 and 0 to 200 F, model 8251-203 temperature controller has ± 1 F control stability. The unit is furnished with an anticipating section for closer control, and comes with a load relay rated at 25 amp, 230 v. All circuitry, except tubes and relay, is completely encapsulated in epoxy plastic. The box is suitable for wall mounting.

Electronic Processes Corp. of Calif., Dept. ED, 436 Bryant St., San Francisco 7, Calif.

Price & Availability: Available from stock; can be delivered 2 days after order received. Price is \$106 per unit; \$68.90 when ordered in quantities of 25; \$58.30 in quantities of 100.



Contact one of these PSI
Distributors for fast
delivery at factory prices!

ACK SEMICONDUCTORS, INC.
Birmingham, Alabama

ACK RADIO SUPPLY OF GEORGIA, INC.
Atlanta, Georgia

ALLIED RADIO CORPORATION
Chicago 80, Illinois

ALMO RADIO CORPORATION
Philadelphia 7, Pennsylvania

CRAMER ELECTRONICS, INC.
Boston 16, Massachusetts

DENVER ELECTRONIC SUPPLY CO.
Denver 4, Colorado

ELECTRO SONIC SUPPLY CO., LTD.
Toronto 5, Ontario, Canada

ELECTRONIC SUPPLY
Melbourne, Florida

ELECTRONIC SUPPLY CORP.
Pasadena, California

ELECTRONIC WHOLFSALERS, INC.
Washington 1, D.C.

ELMAR ELECTRONICS, INC.
Oakland, California

FERGUSON ELECTRONIC SUPPLY CO.
Detroit 38, Michigan

GENESEE RADIO & PARTS COMPANY, INC.
Buffalo 16, New York

GRAHAM ELECTRONIC SUPPLY, INC.
Indianapolis 25, Indiana

KIERULFF ELECTRONICS, INC.
Los Angeles, California

LEW BONN COMPANY
Minneapolis, Minn.

OIL CAPITOL ELECTRONICS
Tulsa 16, Oklahoma

PEERLESS RADIO DISTRIBUTORS, INC.
Jamaica 33, New York

PIONEER ELECTRONIC SUPPLY CO.
Cleveland 15, Ohio

RADIO SPECIALTIES COMPANY, INC.
Alamogordo, New Mexico

RADIO SPECIALTIES CORP.
Phoenix, Arizona

RADIO SPECIALTIES, INC.
Albuquerque, New Mexico

ROCHESTER RADIO SUPPLY CO., INC.
Rochester 5, N.Y.

SREPCO, INC.
Dayton 4, Ohio

STANDARD RADIO PARTS, INC.
Tucson, Arizona

STANDARD SUPPLY COMPANY
Salt Lake City 10, Utah

STERLING RADIO PRODUCT, INC.
Houston 1, Texas

SYRACUSE RADIO SUPPLY CO.
Syracuse, New York

TERMINAL ELECTRONICS INC.
New York 11, N.Y.

WHOLESALE ELECTRONIC SUPPLY
Dallas, Texas

WHOLESALE RADIO PARTS COMPANY
Baltimore, Maryland

extremely

FAST RECOVERY LOW CAPACITANCE

SILICON DIFFUSION COMPUTER DIODES

1N925 • 1N926 • 1N927 • 1N928

5 M μ sec RECOVERY! 4 μ f CAPACITANCE Max. @Zero volts!
500 mW DISSIPATION! DIFFUSED JUNCTION Ruggedness!

Electrical Specifications

TYPE NO.	MIN. SAT. VOLTAGE @ 100 μ A (volts)	MIN. FWD. CUR. 1.0 volt (mA)	MAXIMUM REVERSE CURRENT (μ A)		REVERSE RECOVERY CHARACTERISTICS			MAX CAP @ ZERO VOLTS (μ f)
			25° C	100° C	REVERSE RESIST. (Ohms)	MAX. RECOV. TIME* (μ s)	TYPICAL RECOV. TIME** (M μ s)	
1N925	40	5	1.0 (10v)	20 (10v)	20K	0.15	5.0	4.0
1N926	40	5	0.1 (10v)	10 (10v)	20K	0.15	5.0	4.0
1N927	65	10	0.1 (10v) 5.0 (50v)	10 (10v) 25 (50v)	20K	0.15	5.0	4.0
1N928	120	10	0.1 (10v) 5.0 (50v)	10 (10v) 25 (50v)	20K	0.15	5.0	4.0

*Switching from 5mA to -10 volts (R_i = 1K, C_L = 10 μ f)

**Switching from 5mA to -10 volts
(R_{loop} = 100 ohms, C_L = 8 μ f including diode capacitance)

These new Very Fast Recovery, Very Low Capacitance types are added to the broadest line of silicon diffused computer diodes in the industry . . . a complete line that also features these high performance PSI originations:

1N643 (MII-E-1/1171) 1N662 (MII-E-1/1139) 1N663 (MII-E-1/1140)
1N789 thru 1N804 High Conductance versions of previously available types.



Pacific Semiconductors, Inc.

A Subsidiary of Thompson Ramo Wooldridge, Inc.

10451 West Jefferson Boulevard, Culver City, California
CIRCLE 88 ON READER-SERVICE CARD

All types are immediately available in production quantities. Phone, wire or write one of these PSI sales offices for detailed information, prices and delivery schedules.

SALES OFFICES

NEW YORK - 2079 Wantagh Ave.,
Wantagh, L. I., SUNset 1-7470
TWX: WANTAGH NY 2320

BOSTON - 471 Washington Street,
Wellesley 81 • CEDar 5-0171

PHILADELPHIA - 320 Huntington
Pike, Rockledge • Pilgrim 2-8089
TWX: ROCKLEDGE PA 1064

BALTIMORE - 1811 North Rolling
Road, Windsor Building •
WIndsor 4-3622

MADEIRA BEACH, FLA. - P.O. Box
8215 • WAverly 1-9735

OTTAWA - 227 Lauier Ave., West •
CE 2-8504

CHICAGO - 6957 W. North Avenue,
Oak Park, Illinois • Village 8-0750
TWX: OPK 1547

DALLAS - 954 Magellan Circle •
P. O. Box 6067 • RiVerside 7-1258

DETROIT - 1204 No. Woodward,
Royal Oak • LiNcoln 8-4722

LOS ANGELES - 8271 Melrose Ave.
OLive 3-7850

PALO ALTO - 701 Welch Road,
Suite 305 • DAvenport 1-2240

PSI Authorized Distributors from coast-to-coast can supply up to 999 units at factory prices. See Distributor List in adjacent column.

NEW PRODUCTS

Digital-to-Analog Converter 356

Operates X-Y plotters



Series 4700 converter translates digital data from a variety of input devices into analog voltages to operate X-Y plotters. It also generates control signals for both the input devices and the X-Y plotter. Input from punched cards, punched paper tape, and magnetic tape is accepted. Output features include scaling, output multiplier, and symbol generation. The unit accepts coded data and automatically plots any of eight symbols; selection of the symbols can be manual or automatic. All circuitry is transistorized and the unit can operate to 55 C.

Electro Instruments, Inc., Dept. ED, 3540 Aero Court, San Diego 11, Calif.

Motor Generator 395

For industrial control systems

Model V841-22, 60-cps motor generator is designed specifically for use in industrial control systems. It may be used as a damping tachometer, rate generator, or as an integrator in industrial servo loops. Minimum no load speed is 3000 rpm, and stall torque is 5 oz-in.

Kearfott Co., Inc., Dept. ED, 1500 Main Ave., Clifton, N.J.

Price & Availability: Delivery and price data on request.

Frequency Standard 373

10 signals available



Providing a stability of $5/10^8$ parts per week and $3/10^8$ over short intervals, model 100ER frequency standard offers six sinusoidal frequencies of 10 and 100 cps, 1, 10, and 100 kc, and 1 mc. Four pulse signals of 10 and 100 cps, and 1 and



Select from the Line with **ADVANCED DESIGN**



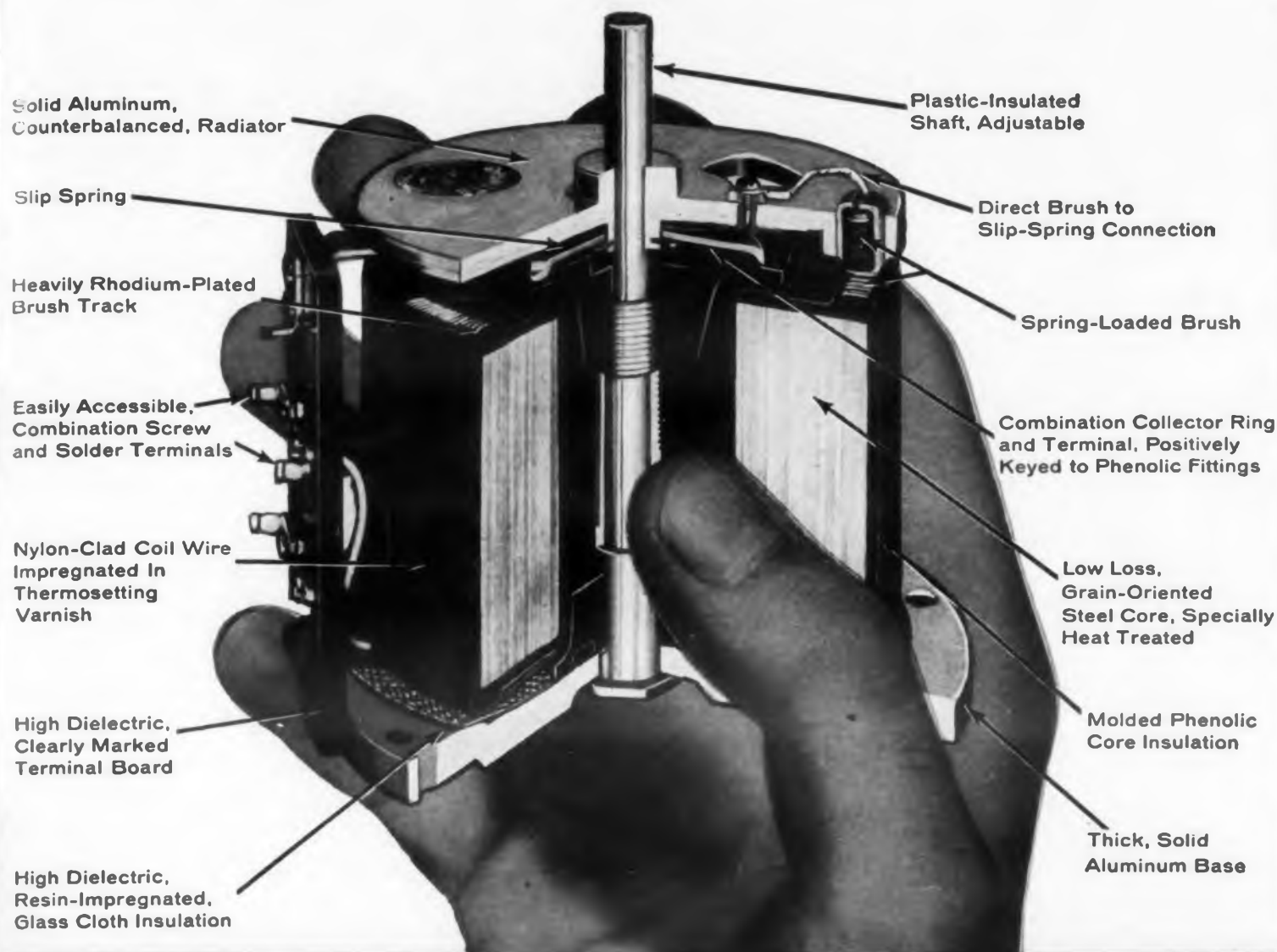

OHMITE® "v.t." VARIABLE TRANSFORMERS

By combining a fresh approach in design with traditional Ohmite quality, "v.t." variable transformers offer convenience features and performance not found elsewhere. They offer top efficiency and high output for their size. Through Ohmite's engineering design, a sizeable bonus in output is available in the "no-overvoltage" types where voltages above line voltage are not required. These units deliver rated output current at any brush setting . . . freedom from wave-form distortion . . . excellent regulation at any point within the rated load . . . unusually long life . . . smooth, maintenance-free operation. They are interchangeable with other makes. Adjustable shafts permit ready conversion to

table or panel mounting. Offered in a diversified choice of cased models.

Moreover, you can get fast delivery from stock on 35 different models covering ratings up to 10 amps. Or, if you desire, select your special requirements from the many modifications possible. Among these are special windings, custom enclosures (including "explosion-proof"), motor-driven assemblies, auxiliary switches, numerous shaft styles, special tandem units, and combination assemblies with other components.

On your next order for variable transformers, try the line with *advanced design*—Ohmite.

Write for Bulletin 151

OHMITE MANUFACTURING COMPANY

3643 Howard Street, Skokie, Illinois

RHEOSTATS • RESISTORS • RELAYS • TAP SWITCHES
R.F. CHOKES • VARIABLE TRANSFORMERS
TANTALUM CAPACITORS • GERMANIUM DIODES

Be Right with



CIRCLE 89 ON READER-SERVICE CARD

ELECTRONIC DESIGN • February 17, 1960

10 kc are also available. Rated load of the instrument is 50 ohms at 1 mc and 100 kc, and 5000 ohms at the lower frequencies. The unit measures 8-3/4 x 19 x 18 in. and weighs 35 lb.

Hewlett-Packard Co., Dept. ED, 275 Page Mill Road, Palo Alto, Calif.

Price & Availability: Availability is currently 10 weeks. Price is \$900.

Vertical Gyroscope

438

For aircraft and missile use



Model NV3705 Gyroscope is for aircraft and missile applications where reliable vertical accuracy under extreme environmental conditions is required. Made of non-magnetic cast stainless steel, it is a self-contained two-axis, torquer-erected type. Vertical reference is obtained by sensitive electrolytic switches. Pitch and roll displacements are referenced by synchro pick-offs on the gyro axis.

Iron Fireman Mfg. Co., Electronic Div., Dept. ED, 2838 S.E. Ninth Ave., Portland 2, Ore.

Data Plotting System

453

Provides graphical output from cards or tape



Model 3033D data plotting system provides graphical output of digital information from punched cards or paper tape. A digital-to-analog converter is self-contained in the unit. A 400-cps servo motor drives the pen. The keyboard is installed directly in the panel and 12 automatically selected symbols are used. The plotting board circuitry is transistorized.

Electronic Associates, Inc., Dept. ED, Long Branch, N.J.

Price & Availability: Price and time required for delivery will be quoted on request.

DAYSTROM PACIFIC

a complete source for precision

POTENTIOMETERS



MULTIPOT[®] POTENTIOMETERS: PRECISION MULTITURN POTENTIOMETERS AT A REASONABLE COST



SUBMINIATURE POTENTIOMETERS: FINEST WIRE WOUND POTENTIOMETERS FOR HIGH RELIABILITY IN MISSILE AND AIRCRAFT APPLICATIONS



SQUARETRIM POTENTIOMETERS: WORLD'S SMALLEST TRIMMERS

For complete specifications, write for Data File 888

DAYSTROM PACIFIC

a division of DAYSTROM, INC.

9320 LINCOLN BLVD., LOS ANGELES 45, CALIF.

NEW PRODUCTS

Aluminum Foil 379

For schematics and printed circuitry

This anodized aluminum foil, designated Metal-Cals, is for schematics and printed circuitry purposes as well as for product identification. It is resistant to salt and oil solutions and withstands abrasion with no loss of color or legibility. Made only on individual order, it can be supplied in sizes and shapes to fit individual applications. It comes in thicknesses from 0.0002 in.

C & H Supply Co., 415 E. Beach Ave., Inglewood, 3, N.J.

Price & Availability: Price depends on the size and colors used. Products having one color plus aluminum and measuring 2 x 1 in. are priced at \$5.59 per 100 in quantities of 1000; those measuring 2 x 1 in. are priced at \$5.59 per 100 in quantities of 1000; those measuring 2.5 x 1.5 in. are \$5.82 per 100 in quantities of 1000. Delivery time is 18 days.

Laminated Plastic 389

Flame-retardant

Fireban X is a flame-retardant paper-base laminated plastic that may be used for structural parts in radio, switchgear, terminal boards or panels, and insulating washers. Tensile strength of a sheet 1/8-in. thick is 20,000 psi, and dielectric strength is 25 kv. Operating temperatures range to 275 F. Essentially a Grade X laminate with a phenolic resin, the plastic comes in sheets 49 x 49 in. with thicknesses from 1/32 to 1 in.

Taylor Fibre Co., Dept. ED, Norristown, Pa.

Price & Availability: Delivery 1 week to 10 days after receipt of order. Price is slightly less than a dollar per lb in quantity orders.

Toroidal Ferrite Cores 622

For coincident-current magnetic memory devices

These toroidal ferrite cores are for use in coincident-current, magnetic memory devices. At a full

◀ Circle 90 on Reader-Service Card

driving current of 380 ma, type 228M1 has a switching time of about 1.3 μ sec. Type 228M1 has a switching time of about 1 μ sec at a full driving current of 600 ma.

Radio Corp. of America, Semiconductor & Materials Div., Dept. ED, Somerville, N.J.

Silicon Rectifiers 608

44 diode types available

Types 1N846 through 1N889 silicon rectifiers are divided into 4 basic groups, with maximum surge current rating of 0.5, 1.0, 1.5, and 2.0 amp. Maximum average rectified current ratings are 50, 100, 150, and 200 ma. The entire line is designed with the standard diode glass body. Temperature limitations for storage are -65 and $+200$ C.

Semiconductor Div., Hughes Products, Dept. ED, Box 278, Newport Beach, Calif.

Diodes 605

Switching and high-conduction types

Among the switching and high-conduction diodes available are: 1N645, 1N648, 1N643, 1N658, 1N659, 1N662, and 1N663. All diodes have a forward conductance up to 400 ma at 1 v, and low reverse leakage. Recovery time characteristic of the high-conduction diodes is 0.3 μ sec with a resistance to 400 K.

Sperry Rand Corp., Sperry Semiconductor Div., Dept. ED, South Norwalk, Conn.

Chart Recorder 607

Designed for lab use

Specifically designed for lab use, this recorder measures such variables as pressure, temperature, motion, flow, density, and electric power. The 4-position input selector switch provides for millivolt, volt, microampere, or milliamperere input. Span ranges of 0 to 2, 5, 10, 25, and 50 are offered. An alternate span, continuously adjustable from 0 to 2 and 0 to 50, is available.

The Bristol Co., Dept. ED, Waterbury 20, Conn.

Circle 925 on Career Inquiry Form page 239



HOW
FAR
CAN
A
MAN
SEE?

Optically as far as the first obstruction. For some, the same applies to mental vision. By seeing beyond the apparent obstacles, established theories or accepted principles, Fairchild Semiconductor Corporation has been able to achieve spectacular product innovations in transistors. Because of this faculty, the company has grown from an original nucleus of eight scientists to a complement of more than fourteen hundred in little more than two years.

From continuing research and development work through engineering, tooling, manufacturing and testing of products on the line, the success of Fairchild is built on the abilities of its men to see around the obstacles and move beyond. It has resulted in products more advanced than any others of their type and in a solid reputation for quality workmanship.

In a rapidly growing company with many challenging programs (e.g. current work on Esaki diodes and micro-logic circuits), there is a constant need for men who can see beyond the first obstacles. If yours is a relevant background and you find our approach attractive, we would like very much to hear from you.





ENGINEERING
REPORT
ON BENDIX COMPONENTS

NON-BUFFERED CASCADED RESOLVER CHAINS

FOR NAVIGATIONAL, GUIDANCE, AND FIRE CONTROL COMPUTERS

Newly-developed techniques enable Eclipse-Pioneer to solve coordinate transformation problems using size 10 (or smaller) resolvers with performance exceeding resolver chains using size 23 resolver and feedback buffer amplifiers.

Our design philosophy is based on the premise that all component parameters will be allowed to fluctuate with variations in excitation

voltage, frequency, and ambient conditions. All resultant signal variations can be closely predicted through digital computer analysis.

As a result of Eclipse-Pioneer's experience in utilizing resolver chains in its navigational systems, considerable data has been compiled which may be helpful in solving your problems. Write us today for complete information.

TYPICAL PROBLEM

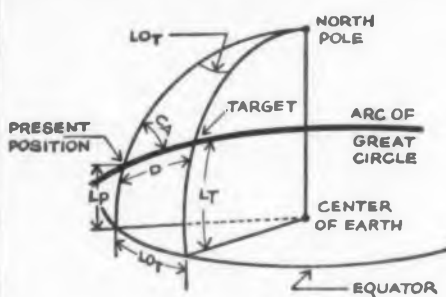

PROBLEM: Design a computer to provide an aircraft with continuous bearing and range information along the arc of a great circle.

C_A —Bearing
 LO_T —Longitude measured from present position to target
 LP —Latitude of present position
 LT —Latitude of target
 D —Great Circle distance from present position to target.

SOLUTION

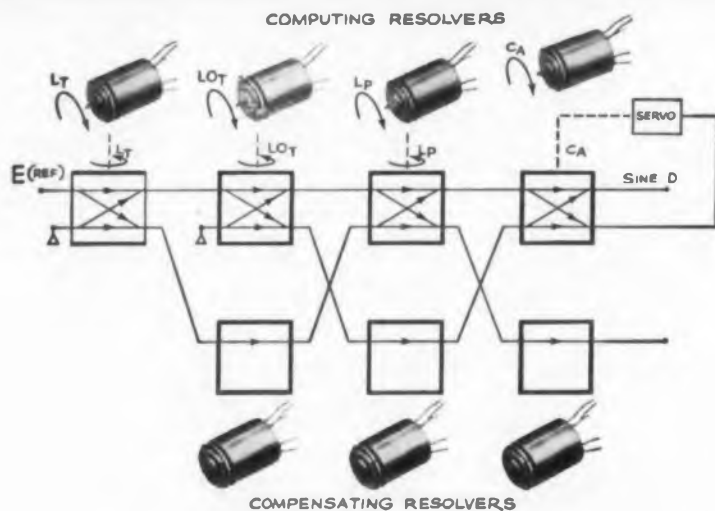

Eclipse-Pioneer Division
Teterboro, N. J.



District Offices: Burbank and San Francisco, Calif.; Seattle, Wash.; Dayton, Ohio; and Washington, D. C.
Export Sales & Service: Bendix International, 205 E. 42nd St., New York 17, N. Y.

CIRCLE 91 ON READER-SERVICE CARD

NEW PRODUCTS

Power Supplies

371

For portables and mobile use



These two power supplies are transistorized units suitable for portable and mobile transmitters and receivers. Model 12TP12 is a transmitter power supply which converts 10.5 through 14.5 v dc to 500 v dc at 240 ma (120 w), or 500 v dc at 150 ma and 250 v dc at 100 ma. Model 12TP3 is a receiver power supply which converts 10.5 through 14.5 v dc to 300 v dc at 100 ma (30 w), or 300 v dc at 70 ma and 150 v dc at 60 ma. Both units are circuit protected against transients and overloads.

Cornell-Dubilier Electric Corp., Dept. ED, South Plainfield, N.J.

Scrape Tester

602

Determines abrasion resistance of wire

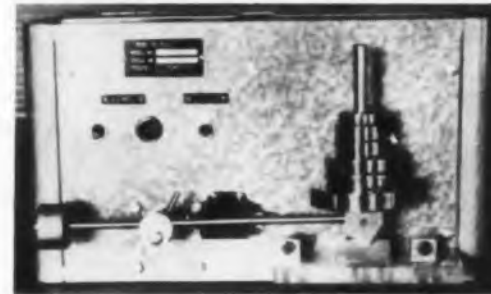

Model TS-2 scrape tester determines the abrasion resistance of film-insulated, high-temperature magnet wire. The device is equipped with an electrical circuit that detects failure and shuts off the instrument when the film is worn through to the copper. A mechanical counter indicates the number of scrapes which were required to abrade the wire sample. The scrape is done with a No. 11 steel needle; the length of the scrape motion in one direction is 3/8 in.

Peschel Electronics, Inc., Dept. ED, RFD 1, Patterson, N.Y.

Price & Availability: Made on order only. Delivery 30 days after order received. Price is \$550 per unit.



ENGINEERING
REPORT
ON OTHER BENDIX
COMPONENT PACKAGES

GEAR HEADS

Compact units that provide output motor speed reductions.



These easily detachable heads are available in various frame sizes, and supply reductions in ratios ranging from 7.22:1 to 42,471.90:1. Ball bearings are Class A. B. E. C. 5, or better, and gears are cut to AGMA Precision II tolerances, or better, with backlash held to 30 minutes, or better. Adaptable to variety of motors and motor generators. Write for details.

CODED COMMUTATORS

Shaft position-to-digital converters in miniature.



For use with digital control systems, data processing equipment, or computers, these small devices convert analog information to binary digital form. Size particularly suits them to airborne applications. Unit shown consists of 7-digit converter utilizing linear, doublebrush, natural binary code. Each track brush is split for better contact. Unambiguous output giving shaft resolution to 1 part in 128 can be provided. Ask for details on the many models available.

Manufacturers of
GYROS • ROTATING COMPONENTS
RADAR DEVICES • INSTRUMENTATION
PACKAGED COMPONENTS

Eclipse-Pioneer Division



Teterboro, N. J.

CIRCLE 92 ON READER-SERVICE CARD

ELECTRONIC DESIGN • February 17, 1960

Solderless Terminal

426

This solderless terminal uses an annealed, tin-plated brass sleeve to add extra barrel strength and permanently anchor the wire insulation to the terminal. The Avikrimp also employs a permanently attached nylon insulation sleeve which extends beyond the metal support sleeve, making no extra insulation necessary.

Waldron Electronics Inc., Dept. ED, 4625 W. 53rd St., Chicago 32, Ill.

Price & Availability: Available from stock. Prices range from \$7.12 per 100 to \$49.21 per 1000.

Side Grip Fastener

427

This fastener is adjustable for material thicknesses ranging from 0 to 15/16 in. Work may be held in the 1-1/16 in. deep-jaw throat or 3/8 in. deep-jaw heel. Zinc based alloy gripping jaws are provided for use on soft aluminum production parts.

Monogram Manufacturing Co., Kleko Clamp Div., Dept. ED, 8557 Higuera St., Culver City, Calif.

Price & Availability: Available from stock. Prices range from \$1.86 per unit for quantities of 1 to 11, to \$0.97 per unit for quantities of 250 and up.

Nylon Tubing

428

Continuous lengths of this nylon tubing are available in sizes from 0.01 x 0.06 in. to 0.28 x 0.5 in. Special sizes are available on request. Applications include flexible cable casing, heater and vent control cable casing, and wire cladding. The material is shipped in reel form.

Garlock Packing Co., Dept. ED, 440 Main St., Palmyra, N.Y.

Price & Availability: Units up to 1/2-in. OD available from stock. Prices on request.

Instrument Cam Assembly

429

Type 260 two-cam assembly has these combinations of rises: two sharp, two gradual, and one sharp and one gradual. Uses are in industrial and servo systems.

Gap Instruments Corp., Dept. ED, 116 E. Merrick Rd., Freeport, L.I., N.Y.

Price & Availability: Units are available from stock at a price of \$6 ea.

Internal Cushion Packaging Material

430

Called Resilo-Pak, this plastic material can be used from -85 to +175 F. Offered in thicknesses of 1/16 to 20 in. in increments of 1/16 in., it can be used as positioning material for electronic parts, radio tubes, and delicate instruments.

Armstrong Cork Co., Dept. ED, Lancaster, Pa.

RELIABLE CONNECTIONS



Eyelets give you unlimited opportunities for savings as connectors, fasteners, terminals, bushings, contacts for switches and hundreds of similar applications. Only with United Eyelets do you have such a wide choice of standardized sizes, special designs for cutting costs on unusual production problems, combined with a comprehensive line of the most versatile eyelet setting machines available.

In no other way can you get the flexibility obtainable with eyelets at comparable installed costs. Call or write us today for more information. Our national sales and service organization is ready to help with your most challenging problem.



NEW MINIATURIZED EYELETS as connectors and fasteners for low cost, high speed insertion in components, PW boards, miniature equipment. Designed for high speed automatic feeding with United Machines. Copper or brass.

CUT COSTS WITH SHEARED EYELETS as stand-off terminals. Set as many as 3000 terminals per hour. Cuts soldering time too.



NEW EYELET SELECTOR — FREE

Simplify design, purchasing, inventory, and production. Decide the hole size and grip, and set the calculator to find the exact eyelet you need. Send for your free copy today!



NEW FUNNEL FLANGE eyelets designed especially as connectors for PW boards. Solves two-sided circuitry and solder problems. Speeds insertion. Are fed and set automatically on United Machines.



Simultaneous multiple eyeleting from either or both sides of machine. Typical six eyelet application illustrated. 50 years' experience is your assurance of complete dependability.

United

UNITED SHOE MACHINERY CORPORATION
Boston 7, Massachusetts • Liberty 2-9100

Branches: Atlanta, Ga. • Chicago, Ill. • Cincinnati, Cleveland, Columbus, Ohio • Dallas, Texas • Harrisburg, Pa. • Johnson City, N. Y. • Los Angeles, Calif. • Lynchburg, Va. • Milwaukee, Wis. • Nashville, Tenn. • New York, N. Y. • Philadelphia, Pa. • Rochester, N. Y. • St. Louis, Mo.

CIRCLE 93 ON READER-SERVICE CARD

Still
the biggest
VALUE

in the smallest
package . . .

**THE ORIGINAL
"PP" TYPE
FANSTEEL
TANTALUM CAPACITOR**

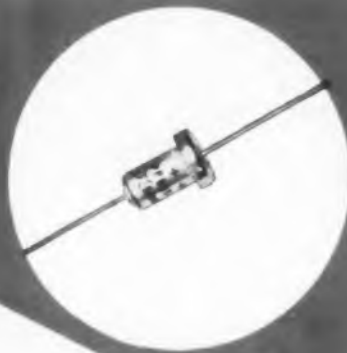

. . . still the biggest value . . . still the workhorse . . . still the most widely used of all tantalum electrolytic capacitors . . . the Fansteel "PP" Type capacitor. Here's why—

UNQUESTIONABLE RELIABILITY proved in millions of applications since their introduction in 1949 . . . exceptional SHOCK AND VIBRATION RESISTANCE because of special anode base support . . . meets MIL-C-3965B for grade 3 capacitor . . . outstanding LOW TEMPERATURE CHARACTERISTICS . . . operating range -55° to $+85^{\circ}\text{C}$ at full rated voltage . . . HIGH RATINGS IN MINIMUM CASE SIZES with outstanding frequency stability and negligible electrical leakage.

Get complete specifications, application data and typical performance curves in Bulletin 6.100.



C601A

FANSTEEL METALLURGICAL CORPORATION North Chicago, Ill., U.S.A.

CIRCLE 94 ON READER-SERVICE CARD

NEW PRODUCTS

**Frequency and Pulse Rate
Transducer**

600



Full range linearity
is $\pm 0.5\%$

The transistor amplifier megacycler, a self-contained frequency and pulse rate transducer, has a full range linearity of $\pm 0.5\%$ and a temperature sensitivity of 100 ppm per deg C. Special units have a linearity better than $\pm 0.1\%$ and a temperature sensitivity less than 50 ppm per deg C. Units operate with input signals as low as 0.1 μv ; the input voltage range is 10 mv to 5 v rms and the input impedance is 2000 ohms nominal. Standard outputs are: 0 to 5 v filtered, 0 to 200 ma filtered, and 0 to 1 ma unfiltered. Suitable for military applications, these units operate over the temperature range of -60 to $+71^{\circ}\text{C}$.

Pioneer Magnetics Inc., Dept. ED, 5858 Wilshire Blvd., Los Angeles 36, Calif.

Power Supply

362

Delivers 25 to 32 v dc



Model PS4019 heavy duty power supply is a general purpose source of 25 to 32 v dc and provides a load current of up to 1.5 amp. Input is from 105 to 125 v ac. Line voltage may vary ± 10 without affecting the output. The ripple and noise level at the output is less than 2 mv. The output voltage is kept within 0.2 v for load changes from 0 to 1.5 amp with the line constant. Output impedance is less than 0.2 ohms from dc to 100 kc. The supply is designed so that momentary or intermittent short circuits do not affect the life of components.

Power Sources, Inc., Dept. ED, Burlington, Mass.

Price & Availability: Price is \$585. Units can be delivered in 30 to 45 days after receipt of order.

**MINIATURE
CIRCUITS
TRANSISTORIZED**



ACTUAL SIZE

1.125" x 1.225" x .413"

DID YOU KNOW . . . That Walkirt has achieved package densities of over ONE MILLION PARTS PER CUBIC FOOT? The popular "cartridge" style module pictured above has "flown" with many Missiles and Satellites where small size and high reliability are mandatory. Nothing etched or deposited here . . . only standard components of proved reliability. We have hundreds of digital and logic circuits that are available in this popular package style which is a logical compromise between Micro-Miniaturization and cost. May we send you a price list and technical data? You'll be surprised at the performance, economy and the huge selection of Walkirt Circuit Modules.

Write for technical
information on **DIGITAL**
and **LOGIC** circuitry.



SALES OFFICES IN PRINCIPAL CITIES

WALKIRT

MINIATURIZATION SPECIALISTS SINCE 1948
141 W. HAZEL ST., INGLEWOOD 3, CALIF.

CIRCLE 95 ON READER-SERVICE CARD

ELECTRONIC HIGH-VACUUM PUMPS



liters per second
1
5
40
90
180
270
500
1000

THE KEY TO A TRULY CLEAN VACUUM, without fluids or other contaminants, is an UlteVac electronic pump. Can operate unattended for months or years on a sealed system; requires no traps, baffles, or refrigeration. Maintains vacuums of 10⁻⁹ mm Hg and below; power failure does not harm system since it is sealed after UlteVac starts. Serves as its own vacuum gauge. Operates in any position; no hot filaments, no cooling water.

Series 110
1 l./sec.



Series 327 • 270 l./sec.

ULTEK CORPORATION, only manufacturer devoted exclusively to ion pump technology, offers stock pumps 1 to 1000 liters/second capacity, plus sorption pumps, foreline traps, and SealVac fittings which provide easy-connecting rotatable flanges. Ultek invites comparison of product, service, and delivery time, on either standard or modified pumps and accessories. Literature on request—specify application.

Contact ULTEK, or its exclusive representative, Kinney Mfg. Div. of The New York Air Brake Co. Sales offices in major U.S. cities.

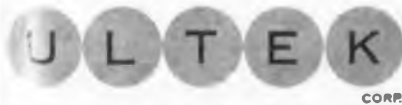

920 Commercial St. • Palo Alto, Calif. • DA 1-4117

Potentiometers 584

Shaft flange versions of the series 2 ac potentiometer are now available. The shaft coupling affords high mechanical accuracy in coupling the component to other elements in a system. Three mounting holes and an accurately machined slot locate a gear on the shaft.

Perkin-Elmer Corp., Dept. ED, Norwalk, Conn.
Price & Availability: Delivery 30 days after order received. Shaft flange assembly is \$15, not including potentiometer base price.

Miniature Probe 585

Designed for in-line use, type PR-11 probe provides quick make-and-break connections with a matching jack or test point. A gold-flashed probe 0.04 in. is at each end of the Teflon body.

Sealectro Corp., Dept. ED, 139 Hoyt St., Mamaroneck, N.Y.

Price & Availability: They are immediately available from stock. Price will be quoted.

Injection Molder 409

For experimental or prototype thermoplastic parts, the Unex-Jet injection molder has a shot capacity of 0.5 oz. or 0.75 cu in.

Hinchman Manufacturing Co., Inc., Dept. ED, 259R First Ave. E., Roselle, N.J.

Annunciator 558

The Panastat operates on standard ac or dc, maintains continuous duty at $\pm 20\%$ nominal voltage, and meets all class I, division II requirements. This solid state unit has low energy control circuits. Inductance is below 0.001 h.

Panellit, Inc., Dept. ED, 7401 N. Hamlin Ave., Skokie, Ill.

Epoxy Sheet 559

These sheets are used to make headers, strips, panels, mounting boards, and shells when encapsulating components in epoxy resin. Available in 8 x 8-in. and 12 x 12-in. sizes, they are 1/16, 1/8, 3/16, 1/4, 3/8, and 1/2 in. thick.

Republic Plastics Corp., Dept. ED, 2 Hixon Pl., Maplewood, N.J.

Subcommutator Channel Separator 560

Type SCS-1B decommutates ten duty-cycle channels, one of which is used as a full-scale reference channel. Outputs drive oscillographs, pen amplifiers, meters, and servo channels. Wave trains from 30 to 120 pps at 0 to 40 v are accepted.

Arnoux Corp., Dept. ED, 11924 W. Washington Blvd., Los Angeles 66, Calif.

New FANSTEEL Silicon Rectifier Stack Assemblies

Now you can get complete stack assemblies incorporating Fansteel's famous silicon rectifiers—35 amp. Type 4A or 22 amp. Type 6A—whose reliability and performance are assured through "white room" production and 100% testing.

Fansteel can now supply stack assemblies—bridge, center tap or doubler circuits— assemblies engineered and guaranteed for the application.

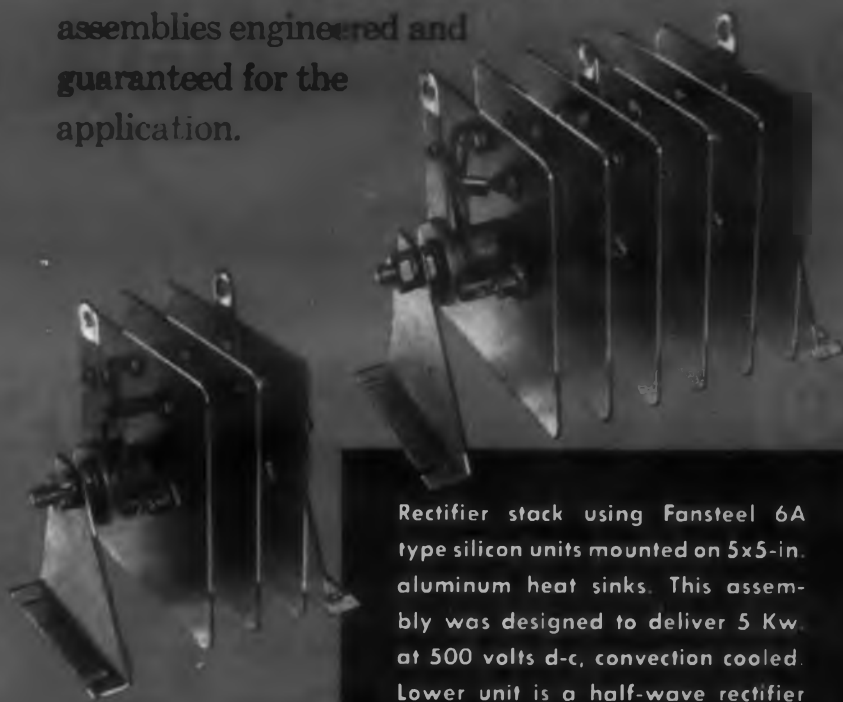

Rectifier stack using Fansteel 6A type silicon units mounted on 5x5-in. aluminum heat sinks. This assembly was designed to deliver 5 Kw. at 500 volts d-c, convection cooled. Lower unit is a half-wave rectifier stack, connected 1-3-1, using the same silicon units.

For complete information, call your local Fansteel representative . . . or contact Fansteel direct.



E602A

FANSTEEL METALLURGICAL CORPORATION North Chicago, Ill., U.S.A.

CIRCLE 97 ON READER-SERVICE CARD



on this oscillator and you cover a
frequency range from 0.001 cps to 100 kc!

Here's a combination of wide frequency range (0.001 to 100,000 cps), low distortion (less than 0.1%), and high stability (less than 0.05% drift per hour) — in one highly convenient oscillator. The Model 440-A also provides both sine and square waves *simultaneously* over this entire frequency range.

Three banks of push-button switches give positive control of frequency with ease, and reset accuracy of better than 0.01%. The frequency multiplier switch covers the entire range in six decade steps. A vernier control varies the frequency continuously by an amount equal to the increment between adjacent third-bank buttons. This time-saving push button feature insures freedom from error, and enables use of untrained personnel for routine checking.

The 440-A's wide range offers more measurement flexibility. Its constant signal-to-noise ratio allows effective use of small signals in low level applications. Its low distortion eliminates troublesome harmonics in precise measurements.

Other Krohn-Hite oscillators include log dial-tuning Models 400-A (0.009-1,100 cps); 420-A (0.35-52,000 cps); 430-AB (4.6-520,000 cps) and others. Write for full information on Krohn-Hite Oscillators, as well as Krohn-Hite Amplifiers, Filters and Power Supplies.



KROHN-HITE CORPORATION

580 Massachusetts Avenue • Cambridge 39, Mass.

Pioneering in Quality Electronic Instruments

CIRCLE 98 ON READER-SERVICE CARD

NEW PRODUCTS

Miniature Voltage Regulators 598

For severe environments



Made for operation in severe environments, these voltage regulators withstand ambient temperatures in the range of -55 to $+125$ C and meet MIL-E-5272. Output voltages are 35 to 150 v dc at load currents up to 500 ma. Regulation is 0.1% for input variations of $\pm 20\%$ and load variations from zero to full load. Units having 0.05% regulation are also available. Dimensions are 2.5 x 2.5 x 2.75 and weight is 15 oz. The units are transistorized.

Power-Tronics Systems, Inc., Dept. ED, 10 Pine Court, New Rochelle, N.Y.

Relay Meter 403

Is a measuring and controlling instrument



Measuring and controlling functions are housed in this one panel instrument. There is no physical interaction between functions. The measuring instrument comes in moving coil and single, electrodynamic movements, with accuracy of all movements at 1.5%. The controller consists of a maximum and minimum marker which can be positioned over the full scale. Holding-control, automatic-control, and pulse-control switching assemblies are available.

National Electronics, Dept. ED, Box 1237, Sheridan, Wyo.

Price & Availability: Made on order only. Delivery is 60 to 90 days, reduced to 4 to 5 weeks by April 1960. Price is between \$70 and \$150 when ordered in quantities of 1 to 5.

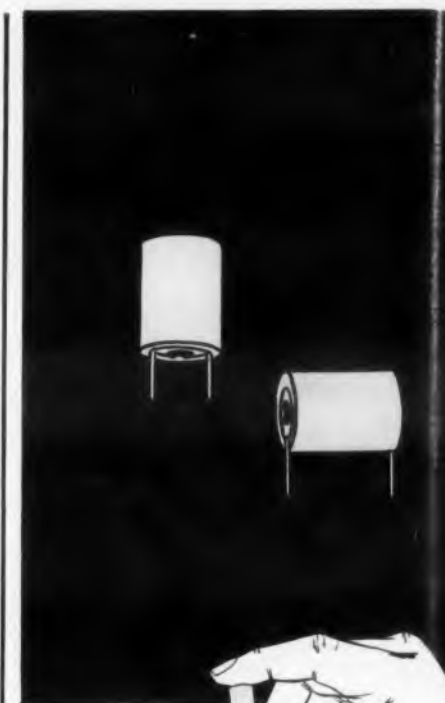

ACTUAL SIZE

New Miniature VARIABLE INDUCTOR

FOR VERTICAL OR HORIZONTAL
MOUNTING IN PRINTED
CIRCUIT BOARDS

This new, ultra tiny Variable Inductor with amazing subminiature characteristics, has stable inductance at extreme temperature variations and high reliability, along with light-weight and miniature size features.

- **INDUCTANCE RANGE:** 0.10 to 4700
- **INDUCTANCE ADJUSTABLE:** $\pm 20\%$
- **ENVIRONMENTAL:** Encapsulated in epoxy resin for protection against climatic and mechanical conditions.

WRITE TODAY
Free Descriptive
Literature Available



ESSEX ELECTRONIC
DIVISION OF
NYTRONICS, INC.

550 Springfield Ave., Berkeley Heights, N.J.
CRestview 3-9300

CIRCLE 99 ON READER-SERVICE CARD

ELECTRONIC DESIGN • February 17, 1960

Conduit and Voltage Markers 418

For use over a wide temperature range

For identifying communication equipment, these self-sticking conduit and voltage markers are stable over a wide temperature and humidity range. The printed legends are permanently protected from grease, oil, dirt, acids, and solvents. The markers are non-conductive.

W. H. Brady Co., Dept. ED, 727 W. Glendale Ave., Milwaukee, Wis.

Portable Oscilloscope Cart 556

Carries 500 lb

Able to carry 500 lb, model ICB-1 portable oscilloscope cart is made of 1-in. tubing and 5-in. swivel casters. The top deck measures 29-1/4 x 14 in. and has a 17-deg tilt. The cart weighs 52 lb.

Mobil-Tronics Co., Dept. ED, 3409 W. Venice Blvd., Los Angeles 19, Calif.

PNP Silicon Transistor 414

I_{co} is below 1 μa at 25 C

This pnp alloyed silicon transistor has a maximum I_{co} of 1 μa at 25 C and at -12 v. The maximum I_{co} at 125 C is 1 μa . Typical I_{co} values are 0.2 μa at 25 v and 0.2 μa at 125 C. The beta spread is from 10 to 25 and the maximum voltage rating is -25 v.

Crystalonics, Inc., Dept. ED, 249 Fifth St., Cambridge 42, Mass.

Miniature Jack 417

Guided-entry design

Type SKT-50 jack, an improved version of SKT-5BC, features a guided-entry design. This jack holds the probe more rigidly and offers greater electrical insulation properties. The contact is heavy gold-flashed beryllium-copper. The jack accepts a probe 0.08 in. in diam and 0.31 in. long.

Sualectro Corp., Dept. ED, 139 Hoyt St., Mamaroneck, N.Y.

CONTROL KNOBS • ELECTRICAL COMPONENTS • PANEL HARDWARE

For instruments that deserve the precision engineered look—



A. Five-way binding post. B. Standard test jack
C. Printed circuit test jack D. Subminiature fixed contact test jack E. Subminiature snap-in contact test jack F. Terminal board bracket G. Shaft lock H. Knob lock I. Captive closure hardware J. Fuse or resistor locking clip K. Pull handle

WRITE FOR FOLDER giving complete details on these and other Raytheon knobs and components designed to conform to military specifications . . . and to add to the appearance and performance of your precision equipment. Address Raytheon Company, Department 6836E, Newton, Massachusetts.



RAYTHEON COMPANY
Industrial Components Division
88 Chapel Street, Newton, Mass.

Excellence in Electronics

Circle 105 on Reader-Service Card ➤

RHEEM ONE-SOURCE ORDERING CONVENIENCE

OFFERS YOU INDUSTRY'S
MOST COMPLETE LINE OF
HIGH QUALITY
SILICON DIODES

selection broadest line of JEDEC
subminiature glass silicon diodes
including general purpose, high
conductance, switching and low power
rectifier types. Representative

types includes:

1N456 to 1N464—(A's included)

1N480 series—(A's and B's)

1N625 to 1N629, 1N643

1N658 to 1N663

delivery immediate availability
from production stock

RHEEM SEMICONDUCTOR CORPORATION

A subsidiary of Rheem Manufacturing Company

Dept. B2, P.O. Box 1327, Mountain View, California

YOrkshire 8-8391

Eastern Regional Offices: 610 E. Palisade Ave., Englewood, N. J.

LOwell 7-4336



CIRCLE 106 ON READER-SERVICE CARD

NEW PRODUCTS

Servo Amplifier

Has a 40 db power gain



Designed to receive signals from a synchro control transformer and to operate a 400 cps, 3.1 w per phase servo motor or equivalent, model 1800-0900 servo amplifier has a power gain of 40 db. The unit is potted and hermetically sealed. Power requirements are 28 v dc at 150 ma.

M. Ten Bosch Inc., Dept. ED, Pleasantville N.Y.

Price & Availability: Available about 6 weeks after order received. Price on request.

Shift Register

Operates to 300 kc



Model 308 shift register is a 5-stage transistorized unit capable of operating at frequencies up to 300 kc. Set and reset inputs, and One and Zero outputs are available for each flip-flop stage. Fabricated on a 5 x 6 in. glass-epoxy, printed circuit card 1/16-in. thick, the register requires -12 v. Standard output levels are -6.8 v for One and -0.2 v for Zero.

Navigation Computer Corp., Dept. ED, 162 Snyder Ave., Philadelphia 45, Pa.

Price & Availability: Available from stock. Delivery 30 days after order received. Price is \$14 per unit.

Circle 107 on Reader-Service Card

ELECTRONIC DESIGN • February 17, 1960

Positioner for Small Work 408

The Handy Hand, designed for welding or soldering small assemblies, holds up to 3 lb and clamps to any 2-in. table. It is rigid for working, but is quickly changed to any position.

Superior Welding Co., Dept. ED, 3410 E. 14th St., Los Angeles 23, Calif.

Displacement Transducers 407

Models DT500 and DT2000 measure linear displacement from 0.5 to 2 in. with a frequency response from 0 to 10,000 cps.

Photocon Research Products, Dept. ED, 421 N. Altadena Drive, Pasadena, Calif.

Frequency Response Slide Rule 406

Scale set No. 2 includes scales for non-minimum phase functions, quadratics with damping ratios in 0.05 increments to 0.95, and time function scales.

Boonshaft and Fuchs, Inc., Dept. ED, Hatboro Industrial Park, Hatboro, Pa.

Electronic Gage 582

Measures coatings of any type and thickness. In addition to measuring, it will compare the hardness and grades of metals and other materials. Unit is housed in an aluminum desk type cabinet.

Ferro Corp., Dept. ED, 4150 E. 56th St., Cleveland 5, Ohio.

Indicator Lamp 583

Designed for a life of 5000 hr, type 63L lamp was engineered to operate as a channel indicator light on TV receivers.

Chicago Miniature Lamp Works, Dept. ED, 1500 N. Ogden Ave., Chicago 10, Ill.

Push Button Switch 412

For use on hand-operated power equipment, model PBS two-circuit switch is rated for up to 600 v ac or dc. Operation is break-before-make.

Vemaline Products Co., Dept. ED, P.O. Box 222, Hawthorne, N.J.

Price & Availability: List price is \$9 ea; delivery is from stock.

Jacks 411

These molded nylon tip jacks have a metal shell which prevents stripping threads during assembly.

Herman H. Smith, Inc., Dept. ED, 2326 Nostrand Ave., Brooklyn 10, N.Y.

Teflon Terminals 410

Having a solid Teflon outer insulator, these terminals range in size from 11/64 to 1/2 in. in diam and from 15/16 to 3/4 in. above the mounting panel. They are supplied in any standard lead style.

Sphere Co., Inc., Dept. ED, 25 Amity St., Little Falls, N.J.

Circle 107 on Reader-Service Card

ELECTRONIC DESIGN • February 17, 1960

SNAP-IN...SNAP-OUT CONTACTS

**NO TOOLS
REQUIRED
REMI**

RE-ENTRANCY MINIATURE

REMI means the best in . . . REMovability, RELiability, REentrancy

- Mechanical stresses are confined between metallic elements rather than between metal and plastic insulation.
- Sleeve, which is part of connector block, allows for interchangeability of male and female contacts on the same connector, at will.
- Additional polarization and keying can be accomplished with ease by use of dummy pins.
- Contacts are removed from mating or terminal side of connector at your discretion without tools.
- Terminals are designed to meet all types of crimp-on requirements. Terminals can be provided with solder cup, turret, eyelet design.
- All REMI design features combine to offer the ultimate in reliability under extreme environmental conditions. Conforms to Mil Spec MIL-C-25955.



Individual contacts can be removed or replaced readily without tools.

Individual contacts are wire-crimped away from connector, facilitating operation.

Light hand pressure seats female or male contact firmly in sleeve. Sleeve acts as guide for mating male contact, assuring ease of connector mating and operational stability.

U.S. COMPONENTS, INC.

Associated with U. S. Tool & Mfg. Co., Inc.
454 East 148th St., New York 55, N. Y. CYpress 2-6525

Patents applied for

CIRCLE 108 ON READER-SERVICE CARD



what makes one
micro-miniature
relay more
reliable
than another?

answer:

**SEALED
CONTACT
CHAMBER**

NEW Couch Relay isolates Contacts from Contamination

Organic material can't contaminate the contacts in the new Couch Type 2M micro-miniature relay. They're hermetically sealed in a separate chamber — and without rosin flux.

Also contributing to reliability is Couch's patented rotary armature, pivoted on two sapphire jewels and virtually immune to present day levels of shock and vibration.

Designs like this, produced within an unusually narrow range of manufacturing tolerances, help explain why Couch relays are being called on to provide reliability in many complex systems.

Write for additional information.

ENGINEERING DATA:

Shock.....	.50G Min.
Vibration.....	.30G's to 2,000 CPS
Dielectric Strength.....	1000 Volts RMS Min.
Height.....	.875" max.
Width.....	.800" max.
Thickness.....	.400" max.
Weight.....	.18 ± 1 gram
Contact Arrangement.....	2 form C(2 PDT)



COUCH ORDNANCE, INC.

A Subsidiary of S. H. Couch Company, Inc.

3 Arlington St., North Quincy 71, Mass. Tel.: (Boston) BLuehills 8-4147

CIRCLE 109 ON READER-SERVICE CARD

NEW PRODUCTS

DC Voltage Regulator 420

Load is 60 ma max

Operating from an input of 28 ± 4 v dc, this solid state voltage regulator can handle a maximum load of 60 ma. It regulates at 4 v dc with less than 0.1% ripple. The regulation for combined line, load, and temperature changes is $\pm 0.5\%$. Output impedance is less than 0.5 ohms. Available in a hermetically sealed container, it complies with MIL-E-5272. The unit occupies 5 cu in. and weighs less than 7.5 oz.

Networks Electronic, Dept. ED, 14806 Oxnard St., Van Nuys, Calif. *Price & Availability: Units are available from stock. Prices will be furnished on request.*

Epoxy Resin 421

For high temperature service

For use in systems functioning at temperatures above 400 F, this epoxy novolac resin, designated D. E. N. 438, combines the physical and handling properties of conventional epoxies with the high temperature performance of phenolic resins. The applications include adhesives, structural laminates, filament-wound structures, printed-circuit boards, and electrical insulation.

Dow Chemical Co., Dept. ED, Midland, Mich.

Price & Availability: Available from stock, the product is priced at \$0.68 per lb.

Test Adapter 388

Gives single 1/2-wave sinusoidal surges

Adjustable between 5 and 75 amp at a maximum repetition rate of 4 per min, model 142 surge-test adapter supplies single, 1/2-wave sinusoidal surge currents. It may be used alone or with types 138A and 141A silicone rectifier test sets. Provisions are made to monitor the output through a 50-mv shunt with

an oscilloscope using the sync signal provided. The unit measures 21-1/4 x 8 x 16 in. and weighs 25 lb.

Wallson Assoc., Inc., Dept. ED, 912-914 Westfield Ave., Elizabeth, N.J.

Price & Availability: Delivery is 4 weeks from stock. Price is \$700 rack mounting, \$725 complete in self contained cabinet.

Framing Camera 380

Shutter speed is 0.1 to 10 μ sec

Model 1 framing camera weighs 40 lb and occupies about as much space as an oscilloscope. The electronic shutter has a speed range of 0.1 to 10 μ sec; other ranges can be supplied. Each of the four channels has an independent time delay adjustable from 1 to 1000 μ sec. Four photographs can be taken in sequence or simultaneously. A portable unit, this camera can be used in electrical discharge studies.

Abtronics, Inc., Dept. ED, Livermore, Calif.

Price & Availability: Price is \$8000 job Livermore, Calif. Delivery is in 30 days or less.

Crystal Slicer 390

Uses downward plunge cut

This crystal slicer combines a variable feed, downward-plunge cut with a synchronized automatic increment cross feed. It has Bijur mist-lubricated spindle construction that is good for 10,000 or more rpm, driven by balanced flat-belt pulleys and a 2-hp reversing motor. When plunge cutting is not desired, the machine may be equipped with automatic variable table feed.

National Distributors, REM Sales Inc., Subsidiary of Robert E. Morris Co., Dept. ED, Box 41, West Hartford 7, Conn.

Price & Availability: Made on order only. Delivery is within 60 to 90 days. For basic machine, price is under \$6000; accessories available at extra cost.

BOURNS

TRIMPOT®

Schweber

FOR
IMMEDIATE
LARGE
QUANTITY
DELIVERY
AT
FACTORY
PRICES

2000

Yes! Schweber can sell up to 2000 pieces of any model of BOURNS TRIMPOT® at factory prices.

Sizeable quantities are available for immediate shipment from stock from Schweber's warehouse.

Schweber

ELECTRONICS

60 HERRICKS ROAD, MINEOLA, L.I., N.Y.
PIONEER 6-6520 TWX G-CY-NY-580
CIRCLE 110 ON READER-SERVICE CARD

CIRCLE 111 ON READER-SERVICE CARD >

Bourns Trimpot® Trio

MODEL 236 MODEL 260 MODEL 200



MODEL 236 HUMIDITY-PROOF TRIMPOT

Completely sealed to meet Mil Specs for humidity, sand, dust and salt spray, this proved wirewound potentiometer dissipates 0.8 watt at 70 C., operates reliably at temperatures up to 135 C. Resistances from 10Ω to 100K. Choice of terminals and mounting types.

MODEL 260 HIGH-TEMP, HIGH-POWER TRIMPOT

A favorite Mil Spec wirewound unit for hot spots. Use it where you need dependable, continuous operation from -65 C. to +175 C. Dissipates 1.0 watt at 70 C. Resistances from 10Ω to 100K. Choice of terminals and mounting types.

MODEL 200 GENERAL-PURPOSE TRIMPOT

Up-to-the-minute version of the original wirewound Trimpot—used in more military and commercial programs than any other leadscrew-actuated potentiometer. Maximum operating temperature is 105 C. Dissipates 0.25 watt at 70 C. Resistances from 10Ω to 100K. Choice of terminals and mounting types.

 BOURNS
Bourns, Inc., Trimpot Division
6135 Magnolia Ave., Riverside, Calif.
Plants: Riverside, California
and Ames, Iowa

NEW PRODUCTS

Miniature Probe

437

Is easily inserted



Type PR-302 miniature probe provides greater ease of insertion and withdrawal. Similar to the PR-300 in-line plug, this probe takes the stripped wire end to its tip where it can be neatly dip-soldered without interfering with ready insertion and withdrawal. Also, the tip has a shoulder for gripping the probe, making it easier to push in or pull out of a Press-Fit jack.

Sealectro Corp., Dept. ED, 139 Hoyt St., Mamaroneck, N.Y.

High-Voltage Rectifier

365

Average plate dissipation is 800 w



Rated at 75 kv piv and 800 w avg plate dissipation, type 5973 high-voltage rectifier is suited for applications where low tube-drop-voltage is necessary. In radar applications, it can be used as a charging diode or limiter. It is also suitable for high-voltage power supplies used in dielectric or cable testing. As a rectifier, it operates at an average of 1.25 amp to 40 kc and 1 amp to 75 kv. As a limiter, it has a peak current of 20 amp at 75 kv.

PEK Labs, Inc., Dept. ED, 4024 Transport St., Palo Alto, Calif.

Price & Availability: Price is \$330 per unit. Small quantities are available from stock.

Computer Diodes

351

Switch in 4 μ sec max



The types 1N914 and 1N916 diffused silicon



THE NEW BONDEZE® WIRE

FOR SELF-SUPPORTING

COILS... PHELPS DODGE

Bondeze®

*A self-bonding wire—now
with improved and added properties!*

Improved in three important ways:

- Extra resistance of underlying film to temperature-pressure "cut-thru." Reduces shorts.
- Cracking negligible when solvent bonded.
- Underlying film gives better thermal life.

... and with this newly added property:

- Easy solderability . . . solders or dip-tins at low temperatures without cleaning or stripping. No damage to copper conductor.

Phelps Dodge S-Y Bondeze® magnet wire bonds turn to turn with a single application of heat or solvent. This important property, combined with improved thermal characteristics and easy solderability, opens a new and wider range of applications for self-supporting coils or bobbin-less coils and windings.

*Any time your problem is magnet wire, consult
Phelps Dodge for the quickest, surest answer!*

mesa diodes switch from 10 ma forward current to 6 v reverse in 4 m μ sec max. Designed for computer applications, they have a capacitance of 2 μ f max. For frequencies to 100 mc, both units provide a minimum rectification efficiency of 45% and have a guaranteed maximum leakage of 25 m μ amp at 20 v. They dissipate 250 mw at 25 C and have a piv rating of 75 v.

Texas Instruments Inc., Semiconductor-Components Div., Dept. ED, P.O. Box 312, Dallas, Tex. **Price & Availability:** They are available immediately. Price of the 1N914 is \$6 ea for 1 to 99, \$4.50 for 100 to 999. Price of 1N916 is \$8.04 ea for 1 to 99, \$6.02 for 100 to 999.

DC Power Supply

363

Delivers 125 to 150 v



Model PS4018 transistorized power supply provides a regulated source of 125 to 150 v dc for general purpose use. Operating from a nominal input of 105 to 125 v ac, it has a load current range of 0 to 1.5 amp. The output varies less than ± 0.2 v for line changes of ± 10 v, with load held constant. There is less than 0.2 v change in the output for load changes from zero to full rated current. Ripple and noise figure is less than 2 mv rms, efficiency is 65% of full rated load, and a 30-sec high voltage delay can be furnished on the unit.

Power Sources, Inc., Dept. ED, Burlington, Mass.

Jack Panels

402

3 types available

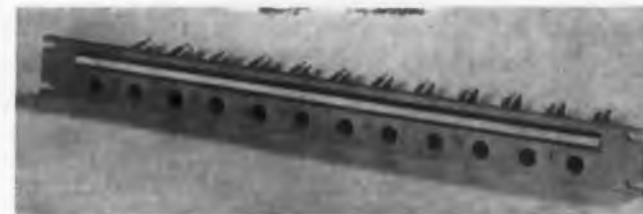

Types 921, 928, and 929 jack panels are made of aluminum and are all 19 in. wide. Type 921 is 1-3/4 in. high; both other types, although similar in construction to the 921, are 3-1/2 in. high. The 921 provides for 12 type 925 jacks, the 928, 24, and the 929, for 48 jacks.

Nems-Clarke Co., Dept. ED, 919 Jesup-Blair Drive, Silver Spring, Md.

Price & Availability: Delivered 14 days after receipt of order. Price of 921, \$130; 928, \$200; 929, \$325; 925 plug, \$5.75.

FIRST FOR
LASTING QUALITY
FROM MINE
TO MARKET!



PHELPS DODGE COPPER PRODUCTS

CORPORATION

INCA MANUFACTURING DIVISION

FORT WAYNE, INDIANA

CIRCLE 112 ON READER-SERVICE CARD

CABLE-bility!

TEFLON[®]

CABLES

largest selection, standards & specials

AMPHENOL pioneered Teflon extrusion; we researched, developed and perfected a technique of fabrication resulting in the finest Teflon dielectric cables available, cables capable of meeting the most exacting requirements of industry and the military.

Today, AMPHENOL Cable & Wire Division's Cable-bilities provide you with the largest selection of RG-/U and special Teflon cables anywhere. Whatever your Teflon requirement, AMPHENOL is your best source for (1) availability, (2) fastest delivery and (3) reliability, based upon pioneering and experience.

AMPHENOL Cable & Wire Division's leadership in Teflon cables is another example of Cable-bility at work!

AMPHENOL

REG. TM DUPONT

CABLE & WIRE DIVISION

S. HARLEM AVE. AT 63RD ST., CHICAGO 38

Amphenol-Borg Electronics Corporation

CIRCLE 113 ON READER-SERVICE CARD

NEW PRODUCTS

Test Set

405

For tachometer generators and servo motors



This test set tests a variety of tachometer generators and servo motors. It consists of a switching panel, a modular ac vtm with an accuracy of 2%, a modular 3-in. oscilloscope, and a sub-assembly phase shifter. Model TGSM-284 measures 28 x 21-3/4 x 12 in.

Building Blocks Electronic Co., Dept. ED, 2172 East 36th St., Brooklyn 34, N.Y.

Price & Availability: Made on order only. Delivery 4 weeks after order received. Price is \$1750 per unit.

Recording System

703

Measures environmental parameters



Designed to measure environmental parameters, model ES-102 recording system can be used with any transducing element having contact closures as the output presentation. It provides 24 channels for recording up to 20 events per sec, and one time channel for correlation. Typical system applications are in monitoring large control systems, transportation impact and temperature recorders.

Santa Barbara Instrumentation Corp., Dept. ED, 411 State St., Santa Barbara, Calif.

Price & Availability: Basic system available from stock. Unit made on order when special transducer is required. Delivery is 30 to 60 days after order received. Prices range from \$4000 up.

DO YOU
WANT
TO...

GENERATE PULSES

DELAY PULSES

WIDEN PULSES

REGISTER PULSES

COUNT PULSES

SUM PULSES

DO BINARY LOGIC

DRIVE TRANSISTOR CIRCUITS

New NAVCOR Series 300—completely transistorized 5" x 6" card modules available from stock to efficiently perform all major pulse generating and programming functions.

Write for Series 300 Bulletin

Navcor

NAVIGATION COMPUTER CORP.
1621 SNYDER AVE. PHILADELPHIA 45, PA.
PHONE: HOward 5-7700

CIRCLE 114 ON READER-SERVICE CARD

ELECTRONIC DESIGN • February 17, 1960

WIDEST

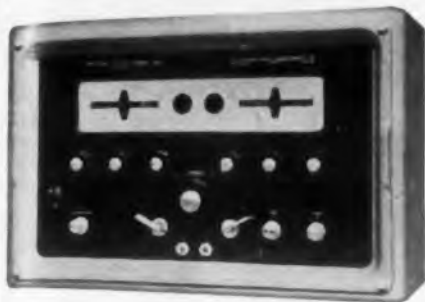

RANGE

Why other bridges can't match the accuracy, range or versatility of the Wayne Kerr Universal Bridge, Type B-221

- Measures Capacitance to 0.1%—0.002 μ f—11 μ f
 - Measures Conductance to 0.1%—10⁻¹—10⁻⁹mhos (10 Ω —100M Ω)
 - Measures Inductance to 0.1%—1mH—infinity
 - Frequency Range—50—20,000 cps (internal oscillator and detector for operation at 1000 cps)
- Extended range using Low Impedance Adaptor: 1 μ f to 250,000 μ f—50 μ Ω to 100 Ω —5 m μ H to 10mH
- Price—\$880 F.O.B. Philadelphia

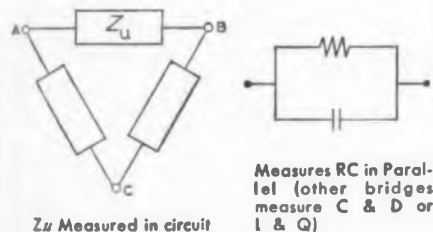

Wayne Kerr Universal Bridge, Type B-221 is a highly accurate transformer ratio arm bridge providing 2, 3 or 4-terminal measurement of impedance or transfer admittance over an extremely wide range. An impedance between any two terminals may be easily measured regardless of other impedances from either or both terminals and a third point. Measurement is unaffected by impedance of test leads.

OTHER INSTRUMENTS: Audio to VHF Bridges; Oscillators; Attenuators; Microwave Equipment; Vibration and Distance Meters; Waveform Analyzer.

Send for complete W-K-02 catalog showing other instruments.



WAYNE KERR CORPORATION

1633 Race St., Philadelphia 3, Pa.

Representatives in major U.S. cities and Canada

CIRCLE 115 ON READER-SERVICE CARD

ELECTRONIC DESIGN • February 17, 1960

Ferrite Single-Sideband Modulator

704



Conversion losses are less than 20 db

Model MX 200 ferrite single-sideband modulator produces frequency translations of the incoming signal by means of two ferrite balanced modulators. These units produce frequency offsets with conversion losses of less than 20 db. Operation from 9.6 to 10.6 kmc is possible with slight adjustments for carrier suppression. Sidebands not wanted are suppressed below 20 db over a 2% band without adjustment.

Rantec Corp., Dept. ED, Calabasas, Calif.
Price & Availability: Price is \$815. Delivery requires 45 days.

Subcarrier Oscillators

705

Three models offered



For use in extreme missile environments, these transistorized voltage-controlled oscillators come in three models to cover conventional signal, fractional-volt, and millivolt ranges. Type 1250 is used for signals of 0 to +3 v, 0 to +5 v, ± 1.5 v, and ± 2.5 v. Type 1251 operates with 0.25-v inputs and is compatible with 1/4-v output pressure transducers. Suitable for bridge instrumentation, type 1252 needs 20 mv for full deviation. All units operate from an unregulated 28-v source. They operate over the temperature range of -55 to +125 C and are able to stand 30-g random vibration, 150-g acceleration, and 200-g shock.

Tele-Dynamics, Inc., Dept. ED, 5000 Parkside Ave., Philadelphia 31, Pa.

Price & Availability: Units are available from stock and prices will be furnished on request. Type 1252 has a delivery time of 30 days.

SAUCER FAN

280 CFM



The Saucer Fan represents an entirely new design concept whereby the driving motor is built within the propeller hub limiting its axial length to the minimum measurement required by a highly efficient motor. Ideally suited for tightly packed electronic packages, where space is critical, the Saucer Fan will provide cooling air to the amount of 280 cfm. Power requirement is 115 vac. 50-60 cps, 1 ϕ .

The fan's pressure performance is tailored to the requirements of a modern, washable dustfilter. "Servo type" mounting flanges at each end of the venturi ring permit simplicity of mounting without loss of space. Direction of airflow may be easily reversed by turning the fan end for end. Electrical connections are made to a compact terminal block.

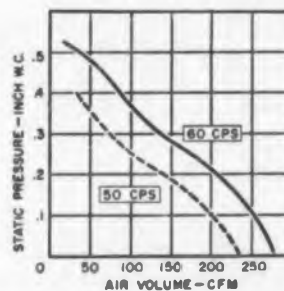

For complete technical details write to ...



ROTRON mfg. co., inc.

WOODSTOCK, NEW YORK

In Canada: The Niagara Electric Co., Hamilton, Ont.

CIRCLE 116 ON READER-SERVICE CARD



specify with
assurance
when you
specify

INDUSTRO

**pnp alloy junction germanium COMPUTER transistors
to MIL-T-19500A**

- Medium to high speed switching
- Medium gain
- Tight parameters
- Very linear current amplification factor

TYPE	V _{CE} R _{BE} =5K volts	f _{ab} typ mc	h _{FE} typ I _C =-10 ma V _{CE} =-0.25V	h _{FE} typ I _B =-10 ma V _{CE} =-0.35V	R _{sat} (typ) I _B =-10 ma I _C =-100 to -200 ma ohms
2N425	-30	4	30	20	2.2
2N426	-25	6	40	25	2.2
2N427	-20	11	55	25	1.3
2N428	-15	17	80	35	1.1

- Medium gain, fast switching
- High reliability at maximum ratings
- Tight parameters
- Low leakage current at high temperatures

TYPE	V _{CE} R _{BE} =1K volts	f _{ab} typ mc	h _{FE} typ I _C =-10 ma V _{CE} =-1V	I _{CBO} max V _{CB0} =-20V μa	I _{EBO} max V _{EB0} =-10V μa	V _{CEsat} typ I _C =-10 ma volts @ I _B
2N1284	-20	8	90	-6	-6	-1.5 -0.5 ma

Floating base replacement for 2N123

- General purpose HF switching
- Low leakage current at high temperatures
- Tight parameters
- High reliability at maximum ratings

TYPE	V _{CEX} V _{BE} =0.1V volts	f _{ab} typ mc	h _{FE} typ	I _{CBO} max V _{CB0} =-12V μa	I _{EBO} max V _{EB0} =-12V μa	C _{ob} typ μf
2N413	-25	2.5	30	-5	-5	12
2N414	-20	7	60	-5	-5	12
2N414B	-24*	7	60	-6 @ -20V	-5	12
2N416	-15	10	80	-5	-5	12
2N417	-12	20	140	-5	-5	12

*V_{BE}=0.2V

- High gain
- HF fast switching
- Low leakage current at high temperatures
- High reliability at maximum ratings

TYPE	V _{CEX} V _{BE} =0.25V volts	f _{ab} typ mc	h _{FE} typ I _C =-20 ma V _{CE} =-1V	I _{CBO} max V _{CB0} =-15V μa	I _{EBO} max V _{EB0} =-5V μa	V _{BE} max I _C =-20 ma V _{CE} =-1V
2N1344	-15	12	90	-10	-10	-0.6V

- Medium to high gain
- HF switching
- Low leakage current at high temperatures
- Tight parameters
- Very linear current amplification factor

TYPE	V _{CE} R _{BE} =1K volts	f _{ab} typ mc	h _{FE} typ I _C =-10 ma V _{CE} =-1V	h _{FE} min I _C =-200 ma V _{CE} =-0.35V	V _{CEsat} typ I _C =-50 ma volts @ I _B
2N1353	-16	3.5	70	10	-0.1 -5 ma
2N1354	-20	4.5	70	10	-0.1 -5 ma
2N1355	-25	8	80	15	-0.08 -3.3 ma
2N1357	-20	12	85	20	-0.07 -2.5 ma

Floating base replacement for 2N394, 2N395, 2N396, 2N397

• Special selection to customer parameters • 100% test to all parameters • For critical military and industrial applications • JEDEC 30 (TO-5 case) packaged for automatic assembly

INDUSTRO

TRANSISTOR CORPORATION

35-10 36th Avenue, Long Island City 6, N. Y. • EXeter 2-8000

IN CANADA: Canadian General Electric Co. Ltd.

EXPORT SALES: Roburn Agencies, Inc., 431 Greenwich St., New York 13, N. Y.

CIRCLE 117 ON READER-SERVICE CARD

NEW PRODUCTS

Modular Microwave Components 706

For the range of 1 to 2 kmc



These L-band components include hybrid rings, 3- and 20-db couplers, and a 25- to 50-ohm transformer. These modules are suitable for computers, as well as radar, communications, radio astronomy, and countermeasures amplification. They are designed to mate with broadband transitions, power dividers, right angle vertical and horizontal bends, crystal mounts, and terminations now used with other TRI-PLATE modules. They can be quickly connected by thumb-screws.

Sanders Associates, Inc., Dept. ED, 95 Canal St., Nashua, N.H.

Price & Availability: Hybrid rings: \$230 ea; 3-db couplers: \$250 ea; 20-db couplers: \$125 ea; transformers: \$40 ea. Delivery is in 30 days.

Silicon Rectifiers

364

Are stable at high temperatures



Offering stable characteristics at high temperatures, these silicon rectifiers are rated at 20 to 35 amp and 60 to 600 piv. They contain solders having a melting point in excess of 600 C. Reverse current is less than 5 ma and the maximum forward drop voltage at 25 C and at 20 amp dc is 0.65 v. The 11/16-in. stud construction houses a silver, heavy spring lead anode. These units are for power supply and magnetic amplifier applications.

Dallons Semiconductors, Dept. ED, 5066 Santa Monica Blvd., Los Angeles 29, Calif.

Price & Availability: Units are available from stock; price will be quoted on request.

Noise Generator

707

Uses a 6D4 as a noise source



Suitable for many types of electrical testing, type 1390-B random noise generator uses a 6D4 gas discharge tube as a noise source. Noise output is amplified in a 2 stage amplifier, which has noise-spectrum shaping filters controlled by a 3 stage front panel switch. The unit may be used to test noise interference, servo amplifiers, radar, and meter response. Cabinet measurements are 12 x 7 x 8 in.

General Radio Corp., Dept. ED, West Concord, Mass.

Price & Availability: Available from stock by March 1, 1960. Price is \$295 net, fob, West Concord, Mass.

Tuning-Fork Oscillator

708



Accuracy is $\pm 0.005\%$

Model DFO-51 transistorized tuning-fork oscillator is available at any frequency from 360 to 10,000 cps with an accuracy of $\pm 0.005\%$. An all-silicon transistorized package, it operates over the temperature range of -55 to $+125$ C with an output power of 3 v rms across a 10,000-ohm load. With a supply voltage of 20 and 30 v, it provides a sine wave with less than 10% distortion and an amplitude stability of $\pm 10\%$. The package size is 1.5 x 1.5 x 2.25 in., and the entire unit is hermetically sealed.

Delta-f, Inc., Dept. ED, 113 E. State St., Geneva, Ill.

Price & Availability: Standard units are immediately available from stock. Units with non-standard frequencies can be furnished in two to four weeks. Prices range from \$162 to \$172.

NEW!

E-H MILLIMICROSECOND PULSE GENERATOR

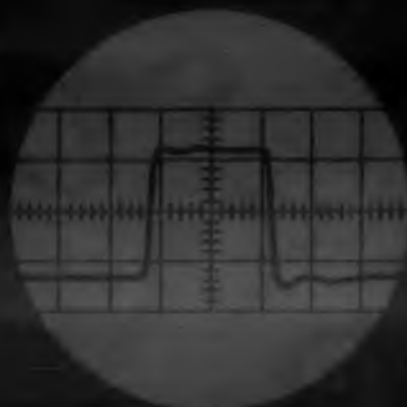

Model 120B f.o.b. Oakland, Calif. \$1275

- **RISE TIME OF LESS THAN 2.5 MILLIMICROSECONDS**
- **REPETITION RATE OF 10 cps to 10 Mc**

plus these other features

- **PRECISION PULSE WIDTHS** 2.5 to 25 millimicroseconds
- **INDEPENDENT OUTPUTS** Two fully controlled 0-8 volt outputs
- **FLEXIBLE** Internal or external drive, provision for external gating and single pulse operation

Here is a new all-electronic instrument with the performance features — and quality engineering — you need for advanced applications.

The 120B's fast rise time and high repetition rate make it unexcelled for general laboratory use in development, production and testing of diodes, fast transistors, cables, pulse transformers, delay lines and video amplifiers... for development and check-out work in the computer field, for rf applications, and in nuclear test work. *For more information on the 120B or other E-H pulse generators, write or wire E-H.*

SPECIFICATIONS

RISE TIME (10% to 90%)
Less than 2.5 millimicroseconds

PULSE WIDTH
2.5 to 25 millimicroseconds

REPETITION RATE (External or Internal)
10 cps to 10 Mc

OUTPUTS
(Two Independent Output Channels)
Amplitude, 0 to minus 8 volts (use E-H model ZT pulse transformer for polarity inversion and impedance matching)
Impedance, 93 ohms

TRIGGER OUTPUT
Positive 15 volt pulse

CONNECTORS
All BNC type

TRIGGER ADVANCE
120 millimicroseconds

EXTERNAL DRIVE
Delay, 50 millimicroseconds
Amplitude required, 3 volts rms

ELECTRONIC GATE
Gating time, less than 100 millimicroseconds
Amplitude required, positive 20 volts



E-H RESEARCH LABORATORIES, INC.

1922 PARK BLVD. • GLENCOURT 2-1314 • OAKLAND 6, CALIFORNIA

CIRCLE 110 ON READER-SERVICE CARD



CBS NPN SWITCHING TRANSISTORS GIVE YOU MISSILE RELIABILITY

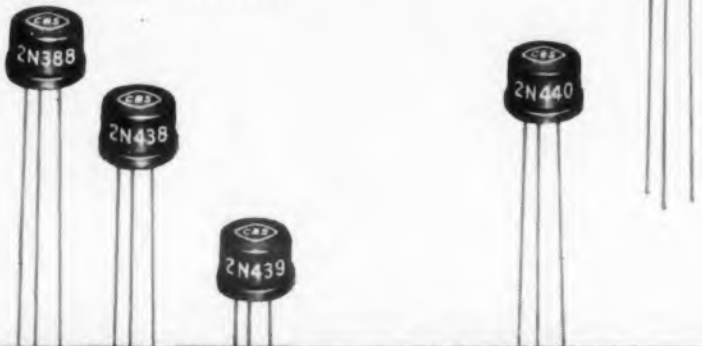

Here Are
Some
of the
Reasons Why . . .

Contamination is eliminated. Baking, surface treatment, electrical testing and package welding are all conducted in dry-boxes at a dewpoint temperature below -90°F .

Flat, even junctions avoid "hotspots." Precise control of time and temperature ($\pm 0.03\%$) of alloying process eliminates localized heating, gives long reliable life. Characteristics are more uniform.

Ruggedness exceeds MIL specification. Severe requirements for shock (1000 g, 1 ms), vibration (10 g, 100-3000 cps) and acceleration (20,000 g) are met by: electronic welding of formed lead wires, horizontal base tab, and welded JEDEC TO-9 case.



CBS NPN switching transistors have proved themselves in flight in many of our important "birds." They have been found to have the advantages of fast switching, high voltage, low cutoff current, and low saturation resistance. All 28 of these CBS transistors exceed the MIL-T-19500A specification.

This same proven reliability under the most adverse environmental conditions is yours for military or industrial core drivers, logic circuits or general switching functions. Write for complete data sheet E-353. Order from your local Manufacturers Warehousing Distributor.

Choose From . . .

2N306	2N357	2N388	2N439A	2N445	2N558	2N1000
2N312	2N358	2N438	2N440	2N446	2N634	2N1012
2N356	2N377	2N438A	2N440A	2N447	2N635	2N1090
2N356A	2N385	2N439	2N444	2N556	2N636	2N1091

More reliable products through Advanced Engineering



semiconductors

CBS ELECTRONICS, Semiconductor Operations • A Division of Columbia Broadcasting System, Inc.

Sales Offices: Lowell, Mass., 900 Chelmsford St., GLenview 4-0446 • Newark, N. J., 231 Johnson Ave., TAlbert 4-2450 • Melrose Park, Ill., 1990 N. Mannheim Rd., EStebrook 9-2100 • Los Angeles, Calif., 2120 S. Garfield Ave., RAYmond 3-9081 • Atlanta, Ga., Cary Chapman & Co., 672 Whitehall St., JAcKson 4-7388 • Minneapolis, Minn., The Heimann Co., 1711 Hawthorne Ave., FEderal 2-5457 • Toronto, Ont., Canadian General Electric Co., Ltd., LEnnox 4-6311

CIRCLE 119 ON READER-SERVICE CARD

NEW PRODUCTS

Coaxial Attenuator

587

Operates from 4000 to 12,000 mc



The AC series of coaxial attenuators, having an operating range of 4000 to 12,000 mc, are as short as 2.5 in. Maximum input power is 2 w avg, 3 kw peak. They are available in values of 3, 6, 10, and 20 db. Environmental requirements of MIL-E-5272B are met.

Microlab, Dept. ED, 570 W. Mount Pleasant Ave., Livingston, N.J.

Price & Availability: Units are available from stock. Prices range from \$30 to \$45.

Waveguide Switches

709

Two types available



These E-plane waveguide switches transfer the connection between waveguides directly or by remote control. Two types are supplied: a 2-way exchange, which switches a common waveguide to either adjacent waveguide; and a 4-way exchange, which switches two pairs of waveguides. Sizes range from 2.6 to 90 kmc. Each unit consists of a cylindrical housing, with waveguide flange connections brought out for the positions required. All units are plated nickel over silver over copper.

DeMornay-Bonardi, Dept. ED, 780 S. Arroyo Parkway, Pasadena, Calif.

Price & Availability: Price ranges from \$591 to \$919. For most items, delivery is two weeks from receipt of order.

RELIABLE SILICON TRANSISTOR SWITCHING

NON-SATURATED SWITCH WITH LONG-STORAGE-TIME TRANSISTOR

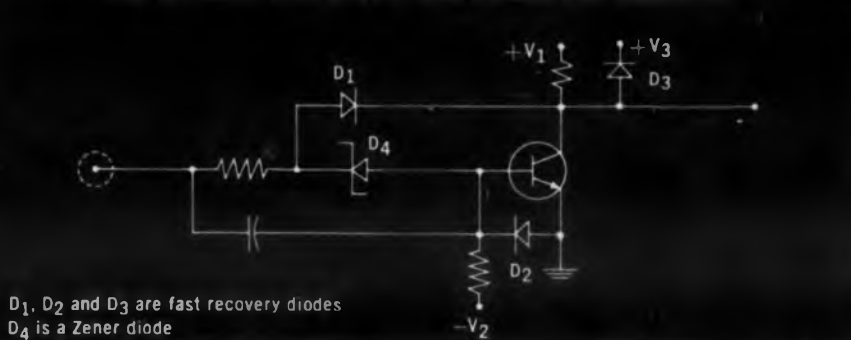

9 COMPONENTS REPLACED BY 4

SATURATED SWITCH WITH 2N1252 TRANSISTOR

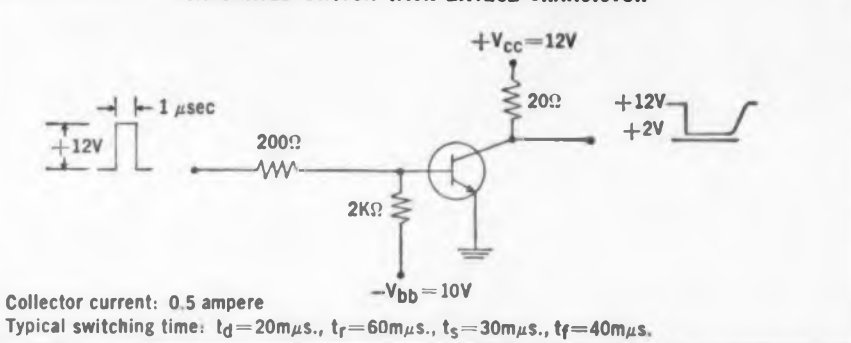

HOW? – By using Fairchild's 2N1252 or 2N1253 lowstorage silicon mesa transistors. The guaranteed low storage characteristic permits a simple saturating circuit to achieve switching speeds that previously required complex non-saturating circuits.

WHY? – Improved reliability and reduced cost – one semiconductor instead of five and fewer soldered connections. Power dissipation is only 1/3rd to 1/5th as great, making possible much higher component densities in packaging. Cost and reliability are improved all the way from development through volume production.

WHERE? – Switching circuits in general. The 2N1252 and 2N1253 are ideally suited to high-speed high-current switching applications such as magnetic-core drivers, drum and tape write drivers, high-current pulse generators and clock amplifiers. In addition, the transistors are applicable to medium-speed saturated logic circuits.

FAIRCHILD 2N1252 and 2N1253

Symbol	Characteristic	Rating	Min	Typ	Max	Test Conditions
h_{FE}	D.C. pulse current gain	2N1252 2N1253	15 30	35 45	45 90	$I_C=150mA$ $V_C=10V$
P_C	Total dissipation at 25°C case temperature	2 watts				
$V_{BE SAT.}$	Base saturation voltage			0.9V	1.3V	$I_C=150mA$ $I_B=15mA$
$V_{CE SAT.}$	Collector saturation voltage			0.6V	1.5V	$I_C=150mA$ $I_B=15mA$
h_{fe}	Small signal current gain at $f=20mc$	2N1252 2N1253	2 2.5	4 5.5		$I_C=50mA$ $V_C=10V$
I_{CBO}	Collector cutoff current			0.1μA 100μA	10μA 600μA	$V_C=20V$ $T=25^\circ C$ $V_C=20V$ $T=150^\circ C$
t_s+t_f	Turn off time			75μs	150μs	$I_C=150mA$ $I_{B1}=15mA$ $I_{B2}=5mA$ $R_L=40\Omega$ Pulse width=10ms

For full specifications, write Dept. B-2



545 WHISMAN ROAD • MOUNTAIN VIEW, CALIFORNIA • YORKSHIRE 8-8161 • TWX: MOUNTAIN VIEW CAL 122
New York Area: Pioneer 1-4770 • Syracuse: Granite 2-3391 • Philadelphia Area: Turner 6-6623
Washington D.C.: National 8-7770 • Chicago: Browning 9-5680 • Los Angeles: OLeander 5-6058

← CIRCLE 120 ON READER-SERVICE CARD

CIRCLE 121 ON READER-SERVICE CARD



The following Fairchild transistors are available from stock for same day shipment in quantities up to

1000
pieces per type.

Standard NPN: 2N696,
2N697. High Voltage NPN:
2N699. High Beta NPN:
2N1420. Low Storage
NPN: 2N1252, 2N1253.
Standard PNP: 2N1131,
2N1132. Mesa: 2N706.



60 HERRICKS ROAD, MINEOLA, L. I., N. Y.
TWX G-CY-NY-580U PIONEER 6-6520

At factory prices of course!

NEW PRODUCTS

Precision Switch

468

Has two-way adjustable roller-lever actuator



This adjustable-roller-arm enclosed switch comprises a basic 2HB-5 spdt precision snap-acting switch in a die-cast aluminum housing. The switch has a sealed overtravel plunger and is suitable for operation by either fast or slow cams or slide actuating devices. The basic switch is rated at 20 amp at 125, 250, and 480 v ac and can also be furnished with ratings of 3/4 hp at 125 v ac and 1-1/2 hp at 250 v ac.

Unimax Switch Div., The W. L. Maxson Corp., Dept. ED, Ives Road, Wallingford, Conn.

Circuit Board Holder

394

Adjustable to any width

Designed for use with model 344 work positioner, attachment No. 369 is a device consisting of horizontal bar on which are mounted 2 slotted vertical holders. Each vertical arm has a set screw that allows it to be adjusted to any desired width. Since the work positioner cannot be depressed below the horizontal, there is no need for a locking mechanism, and work pieces cannot slip from it.

Wilton Tool Mfg. Co., Inc., Dept. ED, 9525 Irving Park Road, Schiller Park, Ill.

Resistance Thermometers

357

For continuous operation at 1800 F



The MP series resistance thermometers, having platinum grids and lead wires, are for continuous

NOW Specify Honeywell life in any power

Features like these make Honeywell
first in Power Transistors!

- 1 Dynamically tested to insure highest quality
- 2 Listed minimum and maximum current gain specifications to aid designers
- 3 Stud-mounted for simple installation and reduced interface thermal resistance
- 4 Alloyed junction, germanium PNP transistors
- 5 Will operate at junction temperatures up to 95°C.
- 6 Solder terminals for wiring ease and high current carrying capability
- 7 Hermetically sealed for reliability and long life

For miniaturization and high power capabilities, Honeywell's complete line of power transistors is your best answer. Rugged, compact, versatile, Honeywell transistors give you smaller size per watt of power output. With a narrow span of character-

istics, you get superior electrical performance and high uniform power gain over a wide range of collector current values. For complete information, contact one of the Honeywell offices shown below, or write Honeywell, Dept. ED-2-34, Minneapolis 8, Minn.

Honeywell Semiconductor Products Sales Offices

UNION, NEW JERSEY • ORLANDO, FLORIDA • BOSTON, MASSACHUSETTS • LOS ANGELES, CALIFORNIA • TORONTO, ONTARIO
OTTAWA, ONTARIO • CHICAGO, ILLINOIS • MONTREAL, QUEBEC • GENERAL SALES, MINNEAPOLIS, MINN.

Honeywell Semiconductor Distributors

Peerless Radio Distributors, Inc. Jamaica, New York	Kierulff Electronics, Inc. Los Angeles, Calif.	Atlas Electronics, Inc. San Diego, Calif.	Flight Electronics Supply Corp. Inglewood, Calif.
Stark Electronics Supply Co. Minneapolis, Minn.	Electronic Industrial Sales, Inc. Washington, D. C.	T. F. Cushing, Inc. Springfield, Massachusetts	DeMambro Radio Supply Co. Boston, Massachusetts
Electronic Supply Co. Melbourne, Florida	Electronic Supply Co. Miami, Florida	Pioneer Electronic Supply Co. Cleveland, Ohio	
Allied Radio Corp. Chicago, Ill.	Elmar Electronics Oakland, Calif.	Electronic Wholesalers of Maryland, Inc. Baltimore, Md.	

ell reliability and long er transistor application!



High voltage (up to 80 volts), high current, high gain, low thermal resistance transistors. Designed for use in high-power amplifiers (servo, audio, etc.), power converters, switching circuits, voltage regulators, and other similar applications. Their small size and simple stud mounting give these transistors a power rating (per unit volume) higher than any other commercially available units. 2N538, 2N538A, 2N539, 2N539A, 2N540 and 2N540A; 2N1202, 2N1203, 2N1261, 2N1262 and 2N1263. For less critical applications at lower cost—the new 2N1501, 2N1502, 2N1503.



Highest current (30 amperes), lowest thermal resistance transistors. Designed for use in high-current voltage-regulators, high-powered DC converters and inverters, and other similar applications. Their low thermal resistance (typical: 0.36°C/watt; maximum: 0.7°C/watt) gives these transistors the highest dissipation rating of any commercially available units. 2N574, 2N574A, 2N575, 2N575A, 2N1157, and 2N1157A.



Tetrode power transistors. Designed for use in applications where exceptional linearity or stability is required. These transistors have two connections to the base layer. 3N45 and 3N46.



Low current transistors (1/2 ampere). Designed for use in servo amplifiers, audio amplifiers, and all other relatively low-current power applications. H3A and H4A.

Transistors approximately twice actual size

Honeywell



First in Control
SINCE 1885

CIRCLE 122 ON READER-SERVICE CARD

operation at 1800 F and intermittent operation to 2000 F. They are easily bonded with ceramic cement to flat surfaces. Type MP-100, the smallest unit, measures 3/8 x 7/8 in. The time constant is as low as 1 sec.

Arthur C. Ruge Associates, Inc., Dept. ED, Hudson, N.H.

Price & Availability: Price is \$50 ea for orders of 2 to 9 units and \$41.50 for orders of 10 to 49. The unit shown is available from stock.

Electric Utility Ovens

419



Temperature range is 37.8 to 260 C

These recirculating electric utility ovens offer a temperature range of 37.8 to 260 C. The automatic hydraulic thermostat has a response sensitivity of ± 0.5 deg C. A power selector switch controls wattage input of low, medium, and high temperatures. Fiberglass insulation 3-in. thick is used on all six sides of the ovens. All wiring is complete and is enclosed.

Blue M Electric Co., Dept. ED, 138th & Chatham St., Blue Island, Ill.

Price & Availability: Units are available from stock at a price of \$335 ea.

Monitor Panel

710

Accuracy is 0.1%



Designed for strain gage instrumentation, model ENO-2 monitor panel reads bridge excitation voltage and bridge unbalance to an accuracy of 0.1%. The voltage to be measured is compared with an equal voltage selected from a Zener diode regulated supply. A portion of this reference is selected by a precision potentiometer and an associated digital dial. When the meter reads, "null," the unknown voltage is equal to that indicated by the digital dial. Each meter is preceded by an integral differential dc amplifier.

Video Instruments Co., Dept. ED, 3002 Pennsylvania Ave., Santa Monica, Calif.

Price & Availability: Price is \$559. Units will be available from stock after January 20, 1960.

Explorer VI

is a
space laboratory
orbiting
around
the
earth
with
paddles
capturing
sunlight
for
power

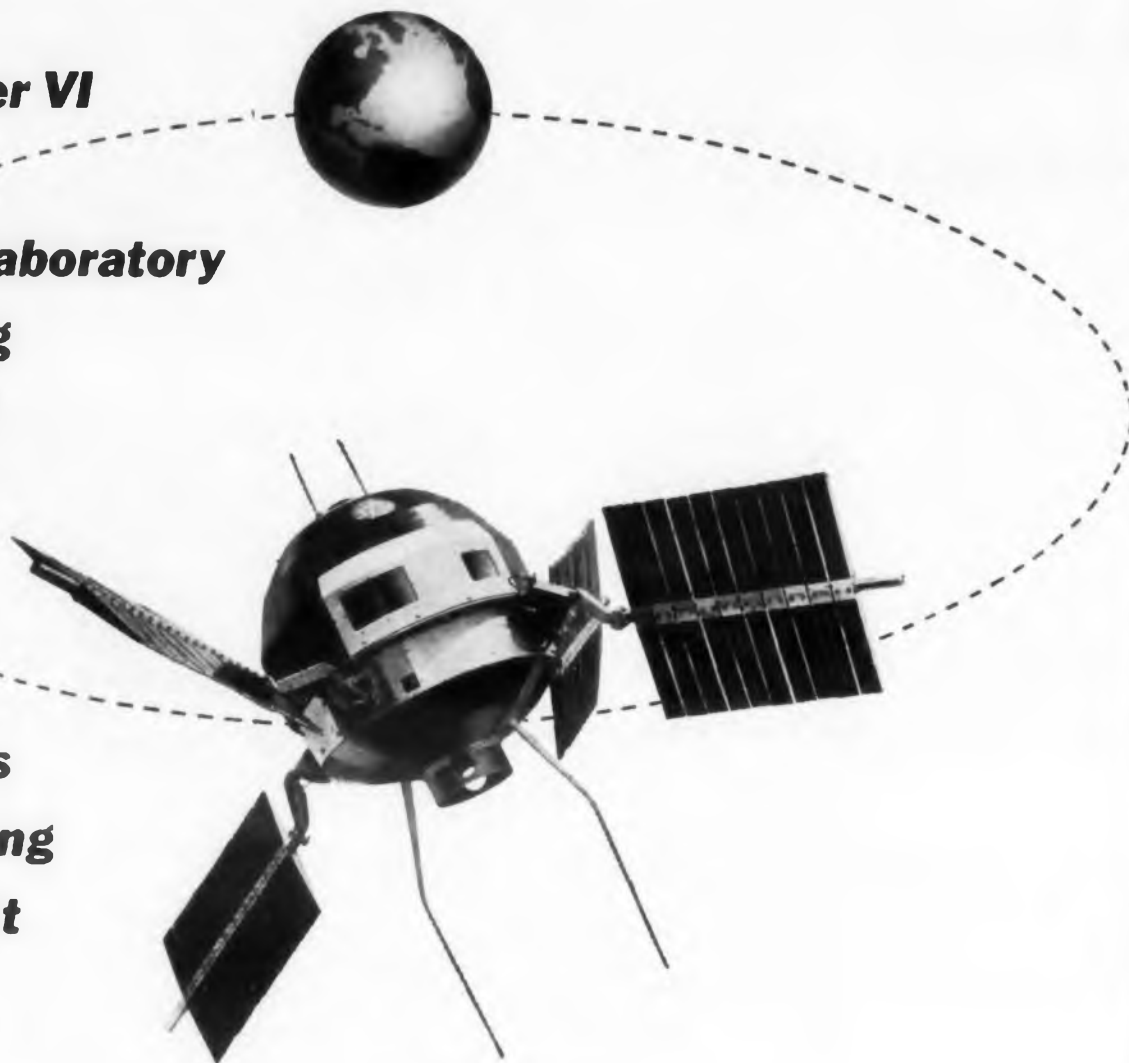

The scientific data that will some day enable us to probe successfully to the very fringes of the universe is being recorded and transmitted at this moment by the space laboratory Explorer VI, a satellite now in orbit around the earth ● This project, carried out by Space Technology Laboratories for the National Aeronautics and Space Administration under the direction of the Air Force Ballistic Missile Division, will advance man's knowledge of: *The earth and the solar system . . . The magnetic field strengths in space . . . The cosmic ray intensities away from earth . . . and, The micrometeorite density encountered in inter-planetary travel* ● Explorer VI is the most sensitive and unique achievement ever launched into space. The 29" payload, STL designed and instrumented by STL in cooperation with the universities, will remain "vocal" for its anticipated one year life.



How? Because Explorer VI's 132 pounds of electronic components are powered by storage batteries kept charged by the impingement of solar radiation on 8,000 cells in the four sails or paddles equivalent to 12.2 square feet in area ● Many more of the scientific and technological miracles of Explorer VI will be reported to the world as it continues its epic flight. The STL technical staff brings to this space research the same talents which have provided systems engineering and over-all direction since 1954 to the Air Force Missile Programs including Atlas, Thor, Titan, Minuteman, and the Pioneer I space probe.

Important staff positions in connection with these activities are now available for scientists and engineers with outstanding capabilities in propulsion, electronics, thermodynamics, aerodynamics, structures, astrophysics, computer technology, and other related fields and disciplines.

Inquiries and resumes are invited.

P.O. Box 95004

Los Angeles 45, California

Space Technology



Laboratories, Inc.

Write directly to Advertiser mentioning **ELECTRONIC DESIGN**

NEW PRODUCTS

Gyro

Has 2 degrees of freedom

375



Model Q2315 gyro, a two degree of freedom unit, has ac synchro transmitters at each gimbal axis to provide angular displacement data. Ac torquers at each gimbal axis permit command positioning or slaving of spin axis to desired reference position. Intermittent torquing rate is 360 deg per min; continuous torquing rate is 40 deg per min. The instrument has a squirrel-cage, induction-type motor for low power consumption at operating speed.

Kearfott Co., Inc., Dept. ED, 1500 Main Ave., Clifton, N.J.

Price & Availability: Delivery and price data on request.

VHF Preamplifier

Noise figure is 3 db at 85 mc

413



Designed for use in the range of 50 to 200 mc, model 1001 vhf preamplifier has a noise figure of better than 3 db at 85 mc and 4.5 db at 200 mc with a nominal gain of 30 db. The bandwidth is 10 mc. Input and output impedance is 50 ohms. The unit is fixed-tuned to the required frequency. The amplifier sub-assembly and integral power supply are mounted in a light-weight chassis on a standard-size rack panel protected by an easily removable dust cover. Standard type N connectors are used.

Community Engineering Corp., Dept. ED, P.O. Box 824, State College, Pa.

Price & Availability: Units are made on order only according to frequency requirements of the customer. Price is \$295 per unit; delivery is in 30 to 45 days.

How to design 250mw at 140mc transistorized power amplifiers

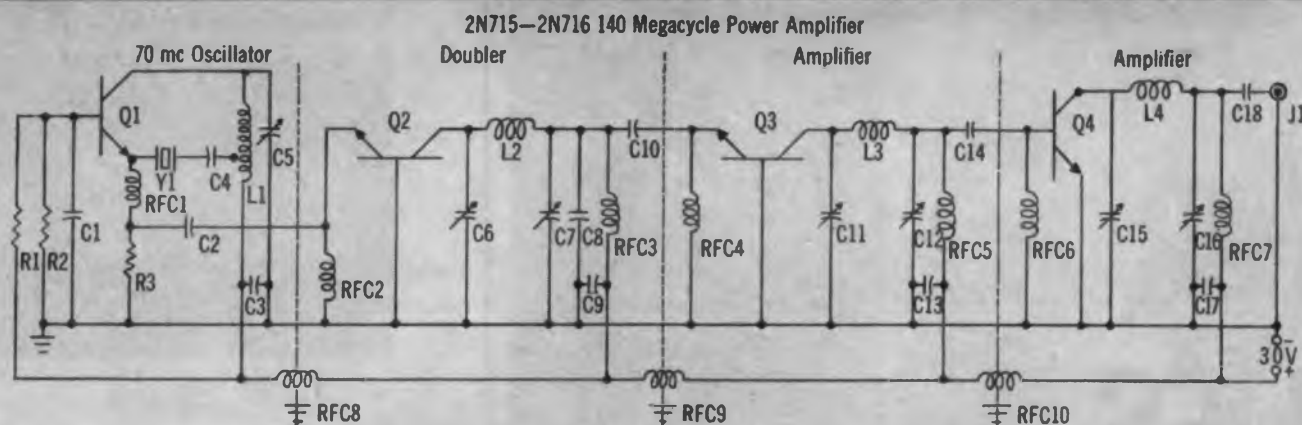

C1, C2, C3—001 μ f disc ceramic
 C4—20 μ f tubular ceramic
 C5, C6, C7, C11, C15—1.8-13 μ f
 C8—47 μ f silver mica
 C9, C10, C13, C14, C17, C18—500 μ f disc ceramic
 C12—7—45 μ f mica trimmer
 C16—3.2—50 μ f
 L1—8 turns #408 Airdux, tapped 2 turns from ground
 L2—4 turns #12 magnet wire, $\frac{1}{2}$ " D, $\frac{1}{4}$ " L
 L3—3 turns #12 magnet wire, $\frac{1}{2}$ " D, $\frac{1}{4}$ " L
 L4—3 turns #12 magnet wire $\frac{1}{2}$ " D, $\frac{1}{4}$ " L
 Q1, Q2, Q3, Q4—TI 2N716
 R1—5100 ohms, $\frac{1}{2}$ watt
 R2—680 ohms, $\frac{1}{2}$ watt
 R3—200 ohms, $\frac{1}{2}$ watt
 RFC1—47 μ h
 RFC2—4.7 μ f
 RFC3 through RFC10
 L2 μ h
 Y1—70 mc crystal

...with **NEW TI 2N716** silicon mesa transistors

Now... silicon high frequency transistors *specifically* designed for your VHF power circuits... another addition to the industry's broadest line of silicon mesa transistors (now 16 TI types!).

TI 2N715 and TI 2N716 *guarantee* 500-mw amplifier output at 70 mc and provide 100-mw typical power output at 200 mc.

These subminiature (TO-18) silicon units feature... 1.2-w dissipation at 25°C case temperature... 10-50 beta spread... collector reverse voltages of 50 and 70v... maximum collector reverse currents of 1.0 μ a (25°C) and 100 μ a (150°C).

Check the guaranteed specs below and take immediate advantage of advanced performance in your designs. Both units are ready for your orders in every TI distributor's stocks today, and in quantities of 1,000 and up from your nearest TI sales office.

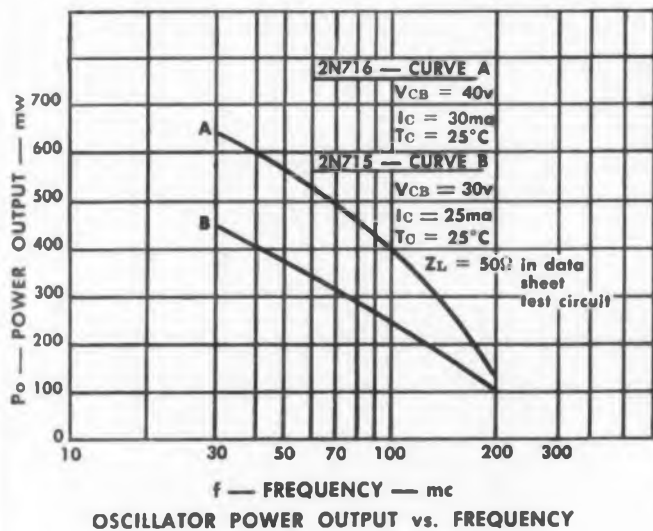

Tentative Specifications 2N715-2N716								
1	2	2			3			
Pc	Tstg	Vcb	Veb			Vce		
25°C	°C	v dc	v dc			v dc		
1.2	-65 to +175	+70 (2N716)	+5			+40 (2N716)		
		+50 (2N715)				+35 (2N715)		
		2N716			2N715			
Parameter	Test Condition	Min	Typ	Max	Min	Typ	Max	Units
**V _{EB0}	I _{EB0} = 100 μ a I _C = 0	5			5			v dc
***V _{CB0}	I _{CB0} = 10 μ a dc I _E = 0	50			70			v dc
*h _{FE}	V _{CE} = 10 v dc I _C = 15ma dc	10		50	10		50	
*V _{CE(sat)}	I _C = 15ma I _B = 3ma	1.2			1.2			v dc
C _{ob}	V _{CB} = 5 v dc I _E = 0 F = 1 mc		3	6		3	6	μ f
Amplifier Power Output and	(V _{CB} = 40 v dc I _C = 30 ma dc P (AC) = 500 mw F = 70 mc)				500 4	600 7.5		mw db
Transducer gain	(V _{CB} = 30 v dc I _C = 25 ma dc P (AC) = 300 mw F = 70 mc)	300	400					mw db

- This power rating for 1000 hours expected life at a case temperature of 25°C derated linearly to +175°C case temperature at the rate of .125°C per mw.
 - Maximum voltage ratings at an ambient temperature of +25°C.
 - V_{CE0}**: This is the voltage at which h_{FE} approaches one when the emitter-base diode is open circuited. This value may be exceeded in applications where the dc circuit resistance (R_{BE}) between base and emitter is a finite value. When the emitter-base diode has a reverse voltage applied, peak collector to emitter voltage equal to V_{CE0} minus V_{EB} may be allowed. Such conditions may be encountered in class B or C amplifiers and oscillators.
- *Pulse Measurement
 **Specify I_{EB0} on commercial data sheet
 ***Specify I_{CB0} on commercial data sheet

TEXAS



INSTRUMENTS
 INCORPORATED

SEMICONDUCTOR COMPONENTS DIVISION
 13500 N. CENTRAL EXPRESSWAY
 POST OFFICE BOX 312 • DALLAS, TEXAS

the first silicon transistor manufacturer

CIRCLE 123 ON READER-SERVICE CARD

CIRCLE 124 ON READER-SERVICE CARD

ONE ORDER TO

ALLIED

FILLS THE WHOLE BILL

...for All your
 ELECTRONIC
 SUPPLY
 NEEDS

**SAME-DAY
 SHIPMENT**

...next-day delivery
 (by air where required)

ON
 TEXAS
 INSTRUMENTS
 SEMICONDUCTORS

O.E.M.

PRICES ON

Silicon Transistors: 1-999
 Germanium Transistors: 1-999
 Silicon Diodes and Rectifiers: 1-999
 Carbon Film Resistors: 1-999
 sensistor Silicon Resistors: 1-499
 tan-TI-cap Tantalum Capacitors: 1-9

**ALLIED RADIO
 CORP.**

100 N. WESTERN AVE.
 CHICAGO 80, ILLINOIS
 HAYmarket 1-6800
 TWX: CG - 2898



REGATRAN[®] SEMICONDUCTOR POWER SUPPLIES...

Here's reliability . . . Since their introduction, over 24 months ago, not one Regatran has lost a series transistor due to short circuits or overloading.



Regatran Semiconductor Power Supplies are available in various ratings up to 0 to 60 V dc and 0 to 30 amperes, depending on model. Write for Bulletin 721.



© Regatran is a registered trademark of Electronic Measurements Company of Red Bank. Patents Pending.

CIRCLE 125 ON READER-SERVICE CARD

- transistorized
- short circuit proof
- super-regulated
- overload protected
- low output impedance
- lowest ripple
- High-speed regulation
- null balance control

- sensing mechanisms
- front panel calibration
- any grounding arrangement
- small size, light weight

NEW PRODUCTS

High-Mu Triode

595

Power output is 20 w



Type GL-6897 high-mu, coplanar ceramic lighthouse triode has a typical power output of 20 w at 1850 mc with 33% plate efficiency. It is rated at a plate current of 100 ma, a plate voltage of 600 v, and an rf drive power of 2.5 w. Designed for long life cw operation, it has been shock tested to 400 g and can be furnished to meet MIL-E-1/1037A. It has microwave frequency communications service applications in grounded-grid, power amplifier, oscillator, and frequency multiplier circuits. In such use, it operates to 2900 mc.

General Electric Co., Power Tube Dept., Dept. ED, Schenectady 5, N.Y.

Telemetering Discriminator

711

Linearity is 1% of bandwidth



Model A-115 telemetering discriminator has a linearity of within 1% of bandwidth and a sensitivity of 50 mv to 10 v. The basic chassis includes a limiter amplifier and a driver amplifier with a front panel meter for reading subcarrier deviation. A gain pot is incorporated to adjust the dc output level. Each chassis accepts a plug-in subchassis containing the band-pass filter, discriminator, and low-pass filter.

Deeco Instruments, Inc., Dept. ED, 14737 Armita St., Van Nuys, Calif.

Price & Availability: Until May 1, 1960, the unit will be made only on order and will require a delivery time of 30 days. Price is \$600.

Digital Readout

Has rear-projection operation

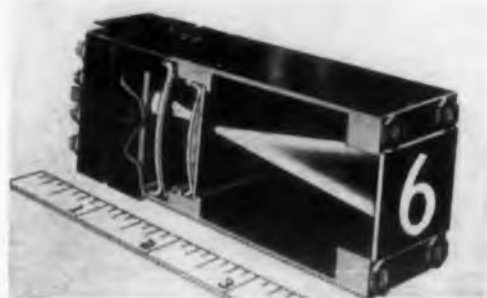

This miniaturized digital readout uses the rear-projection principle of operation. The light source comes from subminiature lamps, either No. 327, 328, or 330. Voltage is from 6 to 28 v. The aluminum case may be mounted on 1-in. centers; rear wiring to the unit facilitates installation. Approximate weight of the unit is 4 oz.

Industrial Electronic Engineers Inc., Dept. ED, 5528 Vineland Ave., North Hollywood, Calif.

Price & Availability: Available from stock in units or assemblies. Price is \$35 each, quantity prices on request.

Rotary Switch

Makes to 100,000 contacts per min

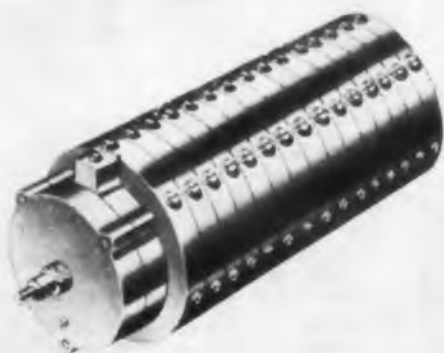

This rotary switch is able to make up to 100,000 contacts per min, with no contact bounce. Contact loss is less than 0.0003 ohms. Multiple sliding contacts reduce torque to a maximum of 1.3 oz-in. per modular wafer. Switches may have 1 to 101 contacts per modular wafer; operating voltages range from 1 to 208 v. Up to 16 modules can be mounted in a panel 6 in. deep. Units are light in weight; a 50-contact switch weighs 6.5 oz and measures 2.625 in. in diameter. Made to meet military requirements, the units stand 60 g shock and 50 g vibration from 0 to 2000 cps. Uses include diode and transistor circuitry control, telemetry and multiple circuit-testing readout; units can also be used with motor and gearhead motor drives.

Genge Industries, Inc., Products Div., Dept. ED, 1500 E. Colorado St., Glendale 5, Calif.

Price & Availability: Price will be furnished on request. Delivery is in two to six weeks.

712

Save this Guide to Oak Choppers

Lightweight side contacts

Leaf spring damping members

Side contact snubbers

Lightweight armature and patented amplitude limiter give remarkable phase angle stability and adjustment in any mounting and at low temperatures

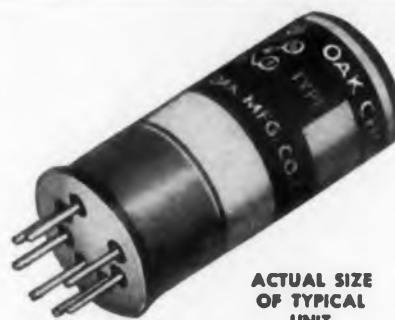

ACTUAL SIZE OF TYPICAL UNIT

No organic materials other than Teflon are used in switch unit

All contact insulation and supports are metal-to-glass construction

Oriented ceramic magnet (patented design) eliminates parts, gives remarkable simplicity and ruggedness



MINIATURE SERIES 600—MOST STABLE IN ITS CLASS

METICULOUS ENGINEERING combined with exhaustive testing provides a line of SPDT choppers which exhibit unusual stability and low noise. While the specifications shown here are necessarily abbreviated, they will help you make a preliminary appraisal. For complete details on any unit, send us the type number and a description of your application with its circuitry.

SERIES 600—MIL C4856, Class B, Type 1. Capacity between switch terminals and ground, 15 uuf average. Contact symmetry, within 10°. Weight, less than 1 oz.
SERIES M—MIL C4856, Class B, Type 1, Grade 2. Capacity between switch terminals and ground, 3-5 uuf. Contact symmetry: 0-500 cps, within 10°; at 1000 cps, within 20°. Weight, less than 3/4 oz.

MINIATURE SERIES M—SMALLEST, MOST RUGGED IN ITS CLASS

STANDARD MOUNTING AND TERMINAL STYLES—Modifications Available on Special Order

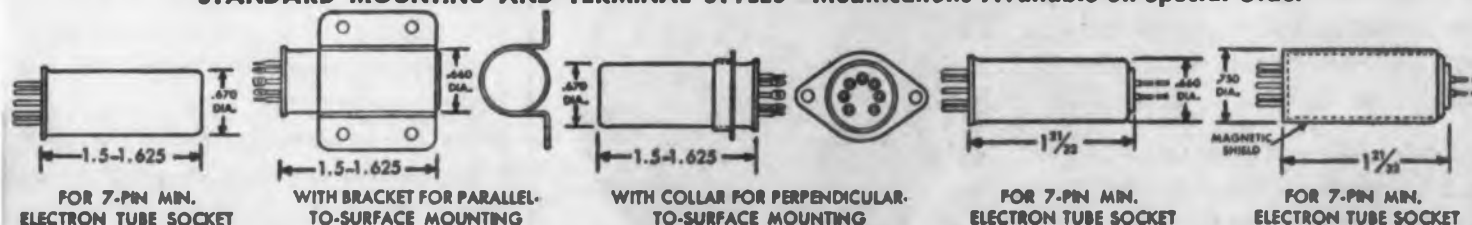

SERIES 600

SERIES M For Shock and Vibration Conditions

	Types { 607 NC-600 602 603	Type 610	Type 604	Type 612	Type 605	Types { 608 609 NC-600A	Types { MS-1 MS-2 MS-3
Nominal Drive Freq. and Voltage	400 ± 20 cps at 6.3 v	400 ± 20 cps at 6.3 v	380-500 cps at 6.3 v	400 ± 20 cps at 6.3 v	400 ± 20 cps at 6.3 v	60 ± 5 cps at 6.3 v Aperiodic from 10-100 cps	4-8 Volts, 10-1000 cps. Aperiodic. Coil Current 60 ma at 400 cps Coil Res. 85 Ohms
Phase Lag at Nominal Drive Freq. and Voltage	65° ± 5° at 400 cps (25° C)	65° ± 5° at 400 cps (25° C)	75° ± 10° at 400 cps (25° C)	90° ± 10° at 400 cps (25° C)	180° +10° -0° at 400 cps (25° C)	20° ± 5° at 60 cps (25° C)	10 cps: 10° ± 5° 60 cps: 15° ± 5° 400 cps: 55° ± 10° 1000 cps: 110° - 0° (25° C)
Contact Dwell Time at Nominal Drive Freq. and Voltage	150° min (25° C)	140° max (25° C)	150° min (25° C)	150° min (25° C)	160° ± 10° (25° C)	165° to 170° at 60 cps	160° to 170° (25° C)
Contact Rating Into Resistive Load (Maximum)	CONTINUOUS: 10 v at 2 ma INTERMITTENT: 15 v at 2 ma	CONTINUOUS: 50 v at 2 ma INTERMITTENT: 100 v at 2 ma	CONTINUOUS: 10 v at 2 ma INTERMITTENT: 15 v at 2 ma	CONTINUOUS: 10 v at 2 ma INTERMITTENT: 15 v at 2 ma	CONTINUOUS: 50 v at 2 ma INTERMITTENT: 100 v at 2 ma	CONTINUOUS: 15 v at 2 ma INTERMITTENT: 50 v at 2 ma	CONTINUOUS: 10 v at 1 ma INTERMITTENT: 12 v at 2 ma
Life Expectancy (Optimum Conditions)	Up to 5000 hours	Up to 1000 hours	Up to 5000 hours	Up to 5000 hours	Up to 5000 hours	Up to 10,000 hours	Up to 10,000 hours
Switching Speed With DC In Coil	Less than 1 Millisecond	Less than 1 Millisecond	Less than 1 Millisecond	Less than 1 Millisecond	Less than 1 Millisecond	Less than 800 Microseconds	Less than 200 Microseconds

OAK MFG. CO. 
1260 Clybourn Ave., Dept. D, Chicago 10, Illinois
Phone: MOhawk 4-2222

SWITCHES CHOPPERS VIBRATORS
ROTARY SOLENOIDS TUNERS
PACKAGED CIRCUITS

CIRCLE 126 ON READER-SERVIC CARD

The most complete single-turn pot line

Pick the single-turn pot to suit your circuit from the complete HELIPOT standard line... scaled from a compact 1/2" to a high resolution 3" diameter.

These singular single-turns come in both economy and all-metal models... so name your temperature... to 80°C... to 125°C... to 150°C.

Most models allow 8 cups to be ganged... standard linearity is $\pm 0.5\%$, with $\pm 0.10\%$ available for most... and, of course, you can have non-linears and spec models.

To help you single out the single-turn you need, we have prepared Data File C82. Write for it today.



Beckman® **Helipot**

Helipot Division of Beckman Instruments, Inc. Fullerton, California Engineering representatives in 29 cities

potentiometers
dials
delay lines
expanded scale meters
servomotors
breadboard parts

© 1966 B.I.I.

CIRCLE 127 ON READER-SERVICE CARD

60009

NEW PRODUCTS

Variable Stub Tuners

713

Frequency range is 2.5 to 90 mc

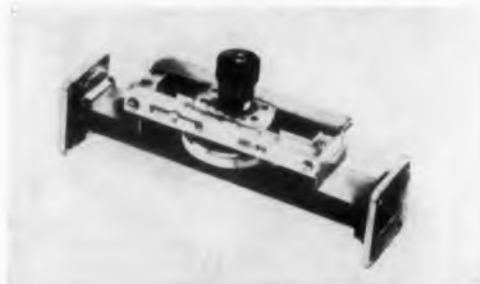

This line of variable stub tuners covers the frequency range of 2.6 to 90 mc. Units have calibrated position controls for insertion and probe travel. A vswr as high as 20:1 can be tuned out with an accuracy of 1.02. Flanges on all units meet Mil specs for each waveguide size. The tuners are used between a signal source and an attenuator to optimize impedance seen by the signal source. They can also be used to cancel reflections from other units in a test setup, to minimize reflection, and to measure reflection coefficients by the substitution method.

DeMornay-Bonardi, Dept. ED, 780 S. Arroyo Parkway, Pasadena, Calif.

Price & Availability: Prices range from \$162 to \$253, depending on waveguide size. Delivery is in two weeks.

Coating Machine

370

For selenium diodes



Completely automatic spray coating of selenium diodes and other small electronic components is possible with this machine. The coating is confined to the desired area by 2 traveling strips, while racks loaded with diodes move continuously through the spray station. The diodes, while in the racks, are spun to assure application of an even coating.

Conforming Matrix Corp., Dept. ED, 476 Factories Building, Toledo 2, Ohio.

Price & Availability: Unit is made on order only. Contact company for details.



Components and assemblies keep their "powder dry" with **GHS HERMETIC SEALING**

TIME

Stands Still For Reliability

Next time you plan a product for market or the military—think of this. A GHS hermetically sealed enclosure protects components and assemblies against 7 major causes of product failure for a lifetime of use... in fact, it would take over 30 years for less than a cc of air to penetrate it! Time virtually stands still... and the ravages of moisture, dust, corrosion, fungus, etc., cannot interrupt the fine quality and performance of your products originally designed into them. For complete reliability, we invite you to investigate the GHS system of product improvement with hermetic sealing.

NON-DESTRUCTIVE TESTING

MEGPOT



A highly efficient, portable Megohm-Meter and High Potential Test Set for rapid testing of components and insulation. 10 million megohms, 100, 200 or 500V DC, automatic charge and safety controls. Up to 5000V AC.

WRITE OR CALL TODAY FOR HERMETIC SEALING BROCHURE, AND MEGPOT BULLETIN NO. 158A



GENERAL HERMETIC SEALING CORP.

99 E. HAWTHORNE AVE. VALLEY STREAM, L.I., N.Y. VALley Stream 5-6363

ELECTRONIC SUB-SYSTEMS ■ MEGPOTS ■ GASEALS TOGGLE SWITCHES ■ HERMETIC SEALING SERVICES

CIRCLE 128 ON READER-SERVICE CARD

STRAITS TIN REPORT

News of developments
in the production
and uses of tin



Nontoxic, inert, malleable — all three are descriptive of tin. One of man's oldest metals, it is still vital in our modern economy. For example —

For product protection, 60.7% of all tin consumed in the U.S. is used in manufacturing tinplate, largely for containers. 135 industries package a total of over 2500 products in more than 42 billion cans annually!

For joining and sealing, 14.8% of all tin used is in alloy with lead to form solder.

For strength and corrosion resistance, 6.5% is consumed in the tin-copper alloy, bronze.

For anti-friction properties, 4.1% is consumed in the high-tin/lead alloy, babbitt, generic for bearing metals.

For protective coatings, tinning accounts for 3.9%. Hot-dipped tin provides a smooth, reflecting surface, particularly adaptable for food processing equipment.

For castability, white metal — alloys of tin, antimony, lead, bismuth, and copper — account for 3.2% of U.S. tin consumption.

Miscellaneous alloys use 4.2%; chemicals, 1.1%; and collapsible tubes, 1.5%.

There's no substitute for tin — and no substitute for Straits Tin from Malaya — recognized standard for quality and uniformity, available in reliable supply from sizeable reserves.



Write today for more data on these items or for a free subscription to TIN NEWS—a monthly bulletin on tin supply, prices and new uses.

The Malayan Tin Bureau
Dept. 15-B, 2000 K Street, N.W., Washington 6, D.C.
CIRCLE 129 ON READER-SERVICE CARD

Plastic Wire Markers 396

Made of vinyl plastic with a wire core, PLAS-TIES are used for tying coils of wire and cable, marking wire for storing and marking cables in circuits. Lengths from 2 in. and widths from 1/8 in. are offered. They are waterproof.

Plas-ties Co., Dept. ED, 624 Poinsettia, Santa Ana, Calif.

Price & Availability: Price, which depends on size of product as well as quantity ordered, will be quoted on request. As a guide, the 5/32 x 4 in. size is priced from \$1 to \$1.75 per 1000. Deliveries can be made in 10 days.

Terminals 397

NAS, AN, and MS type terminals are made of molded barrier design. Screws are used to fasten terminals to the board.

General Products Corp., Dept. ED, Union Springs N.Y.

Price & Availability: Certain types are available from stock, others are available in 30 days. Prices can be supplied.

Thermostat 399

Type AP thermostat permits cut-out of thermostatic control through manual operation of the adjusting stem. It provides positive make-break control of electrical circuits in response to temperature changes, and is designed for use with heating and ventilating equipment, and manufacturing machinery.

Norwalk Thermostat Co., Dept. ED, 52A Woodlawn Ave., N., Norwalk, Ohio.

Price & Availability: Made to customer specifications. Delivery 45 days after order received. Price is between \$0.45 and 0.55 when ordered in quantities of 10,000, exact price depending on customer requirements.

Blue Print Safe 400

Holds up to 1000 plans in a fire-proof, burglar-proof compartment. Prints are retained on 30 in. long removable steel plan holders for vertical filing. The safe weighs about 1000 lb, and measures 58-1/4 x 23-1/4 x 36-1/2 in. Inside dimensions are 53 x 19-3/8 x 30 in.

Momar Industries, Dept. ED, 4176 W. Montrose Ave., Chicago 41, Ill.

Correction Notice

The description of the torquemeter indicator on page 89 of the December 23rd issue should read: "They have a calibrating circuit that standardizes over-all electrical gain to within $\pm 0.5\%$ of full scale." The product is made by B & F Instruments, Inc., of Philadelphia, Pa.

COOLING

aircraft
electronic equipment



...a job for American-Standard
AIR-MOVING UNITS

Choose from many sizes and designs to prevent breakdowns from self-generated heat in sensitive electronic equipment. All units can be modified. Or units can be built to fit your requirements. For individual specification sheets, write, detailing your needs, or send for Bulletin 5412. American-Standard* Industrial Division, Detroit 32, Michigan.



Miniaturized vaneaxial fan—a typical unit for cooling electronic equipment in aircraft.

*AMERICAN-Standard and Standard are trademarks of American Radiator & Standard Sanitary Corporation



AMERICAN-Standard

INDUSTRIAL DIVISION

AMERICAN BLOWER PRODUCTS • ROSS PRODUCTS • KEWANEE PRODUCTS

CIRCLE 130 ON READER-SERVICE CARD



Two great Convair Jets
get reliable
connections through
GREMAR
connectronics™*

*© Greomar Mfg. Co., Inc.

General Dynamics corporation's CONVAIR Division specifies Greomar RF connectors for its new 880 commercial jet, the world's fastest airliner. For reasons of top reliability Greomar RF connectors are also on their military B-58. Here's why . . .

GREMAR CONNECTRONICS concentrates engineering, production and quality control on RF connectors only . . . guarantees 100% conformance to your most exacting specs.

GREMAR DELIVERS . . . by stocking America's most complete line of RF connectors and fittings . . . by maintaining a shelf stock of more than 500,000 assembled units . . . of over 2,000 types . . . and 4,000,000 component parts ready for assembly!

SPECIFY GREMAR for top-level reliability and performance in RF connectors. Write for literature on any series of standard RF connectors . . . or send us your specs on special requirements.



Specialized high potential test equipment developed by Greomar determines voltage breakdown point up to 25 KV, just one of the 142 separate quality checks that make Greomar RF connectors specified on every major missile program.

GREMAR
MANUFACTURING COMPANY, INC.
RELIABILITY THROUGH QUALITY CONTROL
Dept. B, Wakefield, Mass., CRystal 9-4580
CIRCLE 131 ON READER-SERVICE CARD

NEW PRODUCTS

Tube Socket

415



Can be used to 1000 mc

Type XV-100/6299 tube socket, designed to be used with GE's GL6299 uhf planar triode, permits tube removal without any shift in circuit elements. It can be used to 1000 mc or higher with no resonances over the band. The requirements of MIL-STD-170, MIL-E-16400, and MIL-E-5400 are met.

Instruments for Industry, Inc., Dept. ED, 101 New South Rd., Hicksville, L. I., N.Y.

Price & Availability: The product will be available from stock by Feb. 20, 1960. The price ranges between \$14 and \$25.

Miniature Tachometer Generator 597

Output is 14 w at 4200 rpm



This miniature tachometer generator is capable of delivering 14 w at 4200 rpm; various outputs may be specified. A two-pole, three-phase Y-connected stator and the permanent magnet rotor furnish alternating three-phase output power with a frequency proportional to rotor velocity. Smaller than previous models, the generator has been developed for jet engine use and designed and tested under MIL-G-26811.

Globe Industries, Inc., Dept. ED, 1784 Stanley Ave., Dayton 4, Ohio.

Here's
data
on the

New

DIAL HEAD AGASTAT®

time/delay/relays

These relays have recently been re-designed—improved in performance and appearance. So you'll want up-to-date specs.

This free folder gives complete details on all models. In it you'll find operating specs, timing ranges, contact capacities, dimensions, diagrams of contact and terminal arrangements, and data on mounting and installation accessories.

For your copy, write: Dept. A-34-224

AGA

ELASTIC STOP NUT CORPORATION OF AMERICA

Elizabeth, New Jersey

CIRCLE 132 ON READER-SERVICE CARD

NOW AVAILABLE HAYDON Switch CATALOG

12



Catalog No. 12 describes a number of basic snap-action switches and switch-actuator assemblies. Types of switches available are:

- Push button or plunger switches
- Toggle switches
- Lever or roller actuated switches
- Limit switches

Consult Haydon Switch engineering service for special switch requirements. For your Catalog No. 12, write to:

HAYDON Switch INCORPORATED
WATERBURY 20, CONNECTICUT

CIRCLE 133 ON READER-SERVICE CARD

ELECTRONIC DESIGN • February 17, 1960

Teflon Film Tape

581

Type 423 tape is a 2-mil Teflon film with pressure sensitive adhesive. It can be used in electrical applications where a class 180 C tape is required.

Permacel, Dept. ED, New Brunswick, N.J.

Communications Tower

714

Suitable for heights to 450 ft when guyed every 50 ft, No. 45 tower is constructed in an 18-in. triangular pattern with zig-zag steel bracing. Each section measures 10 ft.

Rohn Manufacturing Co., Dept. ED, 116 Limestone, Bellevue, Peoria, Ill.

Automatic-Reset Circuit Breaker

424

Made to respond to rising temperature and excessive current draw of the motor, this device has ratings from 0.1 to 15 amp at up to 230 v ac. It can be built into the motor or used remotely.

E-T-A Products Co. of America, Dept. ED, 6284 N. Cicero Ave., Chicago 46, Ill.

Price & Availability: The product is available from stock at a price of \$0.65 per 100.

Threaded End Seals

715

These threaded end seals are designed for use on capacitors and similar components. The hermetically sealed terminals are available in flared tubing types, lug types, and grooved flange types. All metal parts are tin-dipped to facilitate soldering.

Electrical Industries, Dept. ED, Murray Hill, N.J.

Radar Contacts

398

Made to increase the reliability of detection systems in military and commercial uses, these radar contacts can be used under environmental extremes. Self-lubricating, they will not stick or gum.

Morganite, Inc., Dept. ED, 3304-48th Ave., Long Island City 1, N.Y.

Punched-Card Sensor

554

For use in computers and automatic test equipment, this sensor statically reads all the information on a punched card simultaneously.

Taurus Corp., Dept. ED, 8 Coryell St., Lambertville, N.J.

Correction Notice

Types 7552 and 7554 high-mu triodes have a warm-up time of 12 sec, not 12 min as reported in the November 25th issue. They are made by Radio Corp. of America, Electron Tube Div., Harrison, N.J.

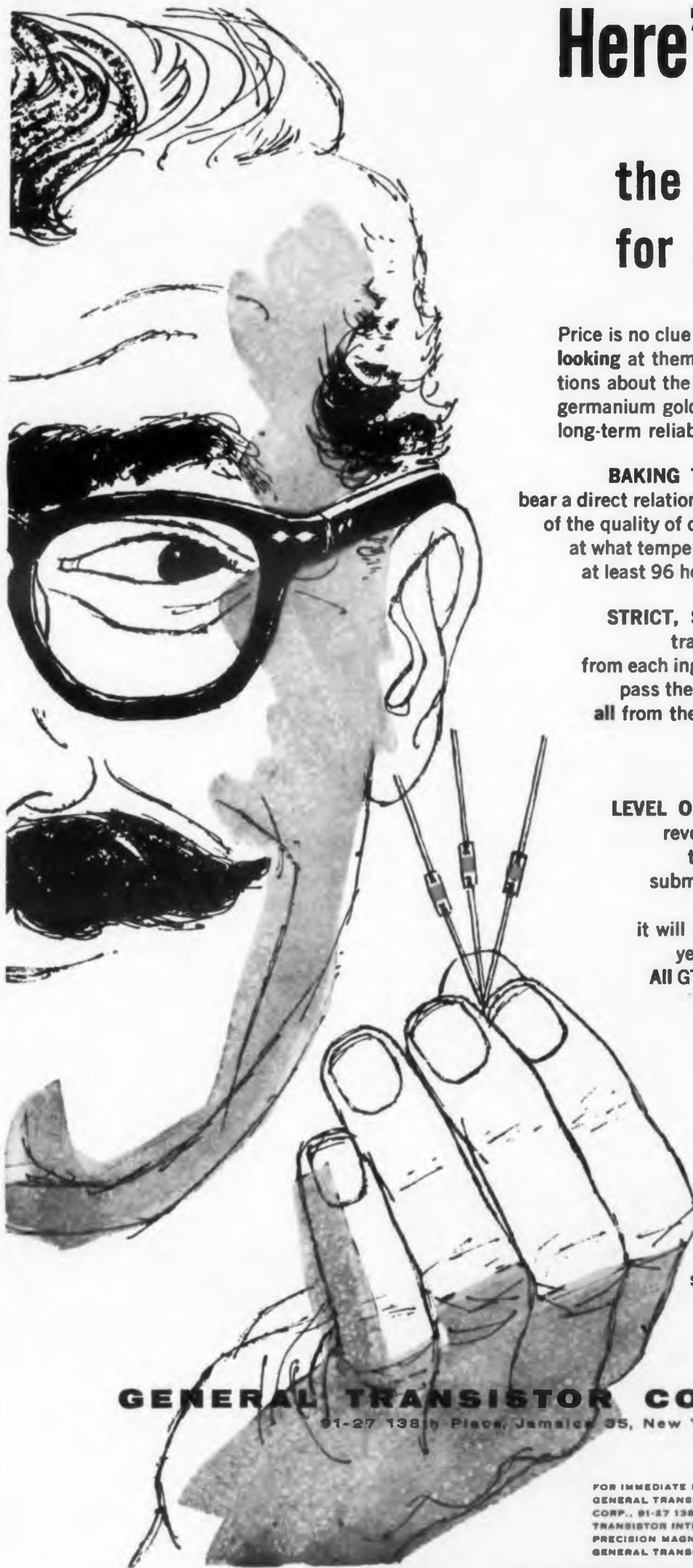

Here's how to pick the best **DIODES** for your money

Price is no clue when diodes sell for about the same, and just looking at them tells nothing. But if you ask the right questions about the three key factors in the production of quality germanium gold bonded diodes, you have your clues to more long-term reliability for your money. Here they are:

BAKING TIME AND TEMPERATURE

bear a direct relationship to long-term stability. You get a measure of the quality of diodes by asking: "How long do you bake, and at what temperature?" (All GT diodes are baked at 140°C for at least 96 hours—the highest and longest in the industry!)

STRICT, STATISTICAL, HISTORY LOGGING

traces the progress of every single wafer made from each ingot of germanium. At GT, if a few wafers fail to pass the stringent GT quality tests along the way, then all from the ingot are suspect and can be identified and pulled out. There are no "stowaways" in a shipment of GT quality diodes.

LEVEL OF TESTING STANDARDS

reveals the level of quality. Ask about "everyday" test standards. (In the GT Seal Test, diodes are submerged in a penetrant-dye solution for 24 hours under 75 psi. This test is so sensitive that it will reveal a leak so small it would take over 300 years for 1 cc of gas to diffuse through the case.) All GT quality tests—100% electrical, 100% shock and vibration, and 100% temperature cycling—are at the highest industry level... and as a final mark of quality, the color bands on GT Germanium Gold Bonded Diodes are baked on to stay.

GT is equipped to supply diodes tested to individual customer requirements, such as JAN Qualification Inspection Tests and many others.

To get the full measure of quality in Germanium Gold Bonded Diodes, see your GT representative; or write directly to the company with know-how NOW.

GENERAL TRANSISTOR CORPORATION

91-27 138th Place, Jamaica 35, New York



FOR IMMEDIATE DELIVERY FROM STOCK, CONTACT YOUR NEAREST AUTHORIZED GENERAL TRANSISTOR DISTRIBUTOR OR GENERAL TRANSISTOR DISTRIBUTING CORP., 91-27 138TH PLACE, JAMAICA 35, NEW YORK. FOR EXPORT: GENERAL TRANSISTOR INTERNATIONAL CORP., 91-27 138TH PLACE, JAMAICA 35, NEW YORK. PRECISION MAGNETIC RECORDING HEADS AVAILABLE FROM GENERAL TRANSISTOR WESTERN CORP., 6110 VENICE BLVD., LOS ANGELES, CALIF.

CIRCLE 134 ON READER-SERVICE CARD



FRAME GRID TUBES ARE PREFERRED

- FOR
- RADAR
 - TEST INSTRUMENTS
 - MICROWAVE COMMUNICATIONS
 - OSCILLOSCOPES

1

THE FRAME GRID IS APPLIED TO THE CONTROL GRID WHERE IT REALLY COUNTS, WHERE IT PROVIDES:

- BETTER VHF AND UHF TUBES
- HIGHER GAIN BANDWIDTH PERFORMANCE
- EXTREME UNIFORMITY
- LOWER NOISE

2

AMPEREX FRAME GRID TUBES—PROVEN FOR RELIABILITY BY MILLIONS OF TUBE HOURS (LESS THAN 0.1% PER 1000 HRS. FAILURE RATE)—ARE NOW IN FULL PRODUCTION TO MILITARY SPECIFICATIONS IN ONE OF THE WORLD'S MOST MODERN TUBE MANUFACTURING INSTALLATIONS—AMPEREX, HICKSVILLE, LONG ISLAND, N. Y.



THE AMPEREX FRAME GRID CONSTRUCTION IS UTILIZED IN A LINE OF PREMIUM QUALITY TUBES FOR MILITARY SYSTEMS REQUIREMENTS AND EXACTING INDUSTRIAL APPLICATIONS:



AMPEREX 5847 (MIL-E-1/467)
Reliable Broadband Amplifier Pentode

- plug-in replacement for Type 404A in existing equipment
- high figure of merit



AMPEREX 6680A (MIL-E-1/1218 NAVY)
Reliable, Ruggedized, Broadband Amplifier Pentode

- for similar applications as the 5847, but with improved base pin arrangement and higher transconductance
- figure of merit of 250 Mc as broadband amplifier
- saves entire stages in IF and video amplifiers
- improves signal-to-noise ratio
- preferred for new equipment design, particularly airborne applications
- long-life cathode



AMPEREX 6922 (MIL-E-1/1168 NAVY)
Reliable, Ruggedized, High-Gain Twin Triode

- for reliable radar cascade stages
- for high-speed computer operation
- for HF, IF, mixer and phase-inverter stages
- high transconductance ($G_m = 12,500 \pm 2500$)
- low noise
- long-life cathode
- new "dimple" anode



AMPEREX 5842 (MIL-E-1/466)
Reliable, High-Gain Single Triode

- plug-in replacement for type 417A in existing equipment
- for grounded grid amplifiers
- high figure of merit
- low noise
- high transconductance ($G_m = 25,000 \pm 5000$)

The frame grid is the closest approach to the ideal "Physicist's grid"—electrical characteristics but no physical dimensions.



AMPEREX FRAME GRID

The grid-to-cathode spacing tolerance is determined by the carefully controlled diameter of grid support rods (centerless ground) and by frame crossbraces between these rods. Extremely fine grid wire eliminates the "island effect" usually encountered in conventional tubes with equally close grid-to-cathode spacing. Rigid support of fine wires reduces mechanical resonance and microphonics in the grid.

It results in:

- higher transconductance per milliamper
- tighter G_m and plate current tolerance
- low transit time
- low capacitances
- lower microphonics
- rugged construction

For additional data write to
Semiconductor and Special Purpose Tube Division
Amperex Electronic Corp.,
230 Duffy Avenue, Hicksville, L. I., N. Y.
In Canada:
Rogers Electronic Tubes & Components,
116 Vanderhoof Avenue, Toronto 17, Ont.

NEW PRODUCTS

Flat Multiconductor Cable

361

Has low inter-conductor capacitance

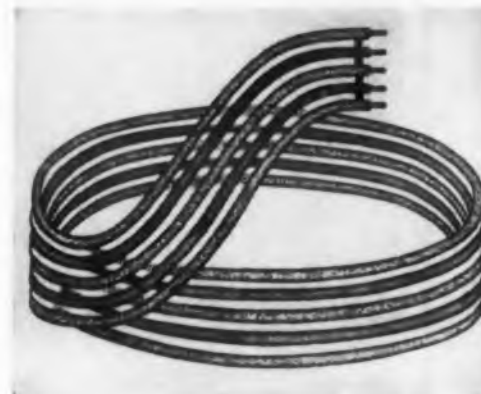

This flat multiconductor cable, called Verilocap, has a very low inter-conductor capacitance. Vinyl tubing which conforms to MIL-1-631C is used to separate the conductors. The spacing can be varied and different gages of wire can be incorporated in one cable.

Spectra-Strip Wire & Cable Corp., Dept. ED, P.O. Box 415, Garden Grove, Calif.

Price & Availability: The product is made on order only and price will be quoted on request. Delivery is about two weeks after receipt of order.

Position Encoder

452

Is accurate to 1 part in 1000

Type ADC-ST3-BCD binary-coded shaft position encoder is accurate to one part in 1000, per turn of the input shaft. An analog-to-digital converter, it provides three decimal digits in binary-coded decimal digits for each revolution of the shaft. It measures 6 in. in diam.

United Aircraft Corp., Norden Div., Dept. ED, Stamford, Conn.

Price & Availability: The price is \$750 fob Milford, Conn. Delivery time is 90 days.

Count Down Timer

358

Provides a 1-min interval



Model WC-601 count down timer provides a 1-min time interval from a 400 cps input, operating from 28 v dc. The dual gate output is arranged so that when one gate is closed, the other is open. When the time interval is initiated, the position of the gates will remain the same or can be reversed, depending on the header connections.

Electromechanical Components and Systems Capability



AIRESEARCH POSITIONING CONTROL SYSTEMS

One of the many types of high speed positioning control systems produced by AiResearch, the system above amplifies electric signals from an inertial guidance source and adjusts the control surfaces of the missile or drone to maintain a predetermined course.

AiResearch diversification and experience provide full capability in the development and production of electromechanical equipment and avionic controls for aircraft, ground handling, ordnance and missile systems.

A.C. and D.C. Motors, Generators and Controls • Inverters • Alternators • Linear and Rotary Actuators • Power Servos • Hoists • Electrical Pyrotechnics • Antenna Positioners • Positioning Controls • Temperature Controls • Sensors • Williamsgrip Connectors • Static Converters.

Your inquiries are invited.

THE GARRETT CORPORATION

AiResearch Manufacturing Division

Los Angeles 45, California

KLYSTRON POWER SUPPLY



with a

MEMORY

No more fiddling with reflector voltage adjustments when you switch between cw and square wave...because of just one of the typically advanced features of this low-medium voltage Klystron Power Supply.

Ever double-mode a Klystron? Not with our model 809! Again, the thoughtful engineering that goes into every PRD product assures the user of self-protection against errors.

Even little things like the built-in beam voltage and current meter prevent guessing and doubt during runs. And when it comes to 'scoping the Klystron...compare the CRT display of a tube powered by the 809 and you'll see for the first time what a really sharp trace looks like!

For complete details, send for our data sheet F-10.

P.S. In case you don't have our latest catalog, E-8...160 pages, chock-full of useful data...dash off a note on your company letterhead.

**POLYTECHNIC RESEARCH
& DEVELOPMENT CO., INC.**
202 Tillary St., Brooklyn 1, N.Y.
ULster 2-6800

CIRCLE 137 ON READER-SERVICE CARD
ELECTRONIC DESIGN • February 17, 1960

At the completion of the time interval, the gate positions are reversed.

Webcor, Inc., Dept. ED, 816 N. Kedzie Ave., Chicago 51, Ill.

Price & Availability: Units are made from stock modules to meet customer's requirements and can be furnished in 30 to 60 days from date of order. Price will be quoted on request.

Linear Variable Delay Lines 359

Are continuously variable from 0.05 to 1 μ sec



These linear variable delay lines will accept 1- μ sec elements and are continuously variable from 0.05 to 1 μ sec. Hermetically sealed, they meet environmental, shock, and vibration requirements of MIL-E-5400C for airborne material and electrical equipment. Case dimensions are 7-5/8 x 5/8 x 1-1/8 in. The units are suitable for most applications requiring varying delays in distributed constant lines.

A-1 Precision Products, Dept. ED, 3807 W. Jefferson Blvd., Los Angeles 16, Calif.

Price & Availability: Price is \$25 ea for orders of 10, \$10 ea for orders of 1000. Small quantities available from stock. Delivery is in 5 to 30 days.

Printed Circuit Connectors 434

Are rated at 3 amp

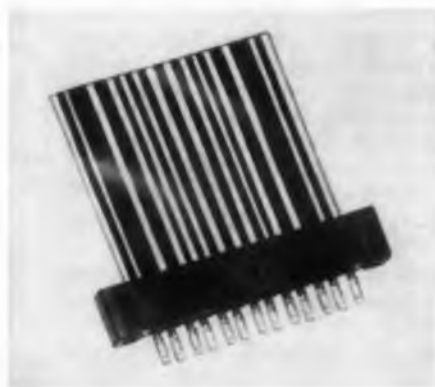

Series 600-4PCSC-13, 13-contact unit, and series 600-7-1, an 18-contact unit, are miniature printed circuit connectors rated at 3 amp. Contact material is spring-temper phosphor bronze, gold plate over silver plate. The 13-contact units are for 1/32-in. board or cable; the 18-contact units are for 1/32-in. board or cable.

DeJur-Amsco, Corp., Dept. ED, 45-01 No. Blvd., L.I.C. 1, N.Y.

Price & Availability: Delivery within 6 to 8 weeks. Prices on request.

Sealectro PRESS-FIT[®] GOES THE LIMIT TO GUARANTEE THE BEST TERMINAL

1

Over 1000
types of Teflon
terminals

The widest choice in the industry—one for every known application. Plus, an outstanding, fast design and sampling service for every new application.

2

Made to the
most rigid
tolerance

Every "Press-Fit" terminal is made to pre-determined tolerances engineered to do the job right, every time. Saves time, trouble and rejects in assembly operation.

3

With proper,
available
assembly tools

Punch and dies for large runs, special 2-step drills for small-run chassis preparation, and insertion tools for fast, accurate terminal installation.

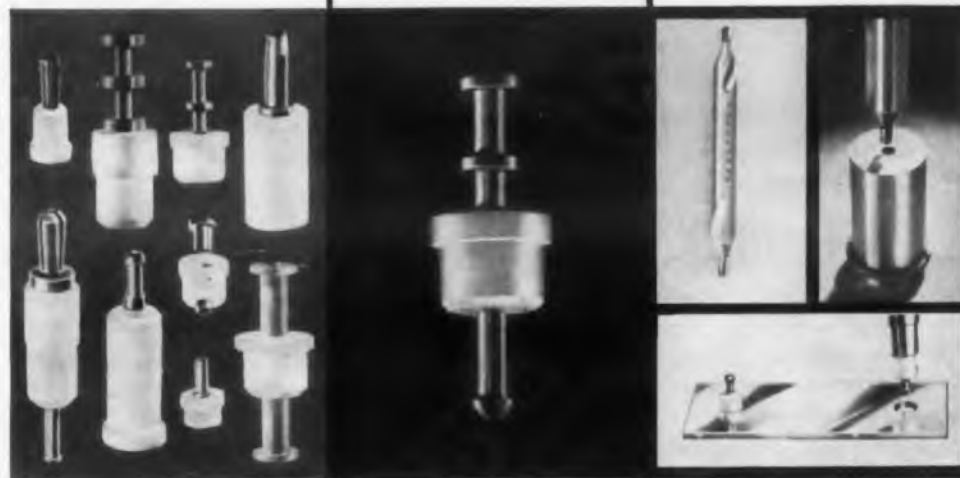

PRESS-FIT TEFLON TERMINALS The Complete Terminal System Concept

You buy more than a piece of hardware when you specify "Press-Fit" terminals—you buy a complete service that assures you the best terminal installed. Sealectro customer service in engineering, and delivery is the best in the industry.

Sealectro CORPORATION
139 HOYT STREET • MAMARONECK, N. Y.

PRESS-FIT **CONHEX**
TEFLON TERMINALS RF CONNECTORS

British Branch Sealectro Corporation,
Hersham Factory Estate, Lyon Road,
Walton-on-Thames,
Surrey, England.

CIRCLE 138 ON READER-SERVICE CARD



CLEVITE'S NEW SPACESAVER TRANSISTOR

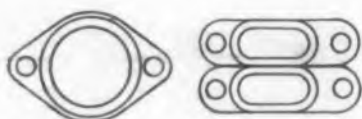

1/2 actual size

THREE AMPERE SWITCHING TYPES

TEST	CTP 1728	CTP 1735	CTP 1729	CTP 1730	CTP 1731	CTP 1736	CTP 1737	CTP 1733
Min BV _{ceo} @ 2 ma (volts)	40	60	80	100	40	60	80	100
Min BV _{ceo} @ 500 ma (volts)	25	40	55	65	25	40	55	65
Min BV _{ces} @ 300 ma (volts)	35	50	65	75	35	50	65	75
Max I _{cbo} @ 90°C @ Max V _{cb} (ma)	10	10	10	10	10	10	10	10
Max I _{cbo} @ 2 V (μa)	50	50	50	50	50	50	50	50
D. C. Current Gain @ 0.5A	30-75	30-75	30-75	30-75	60-150	60-150	60-150	60-150
Max V _{eb} @ 3.0 A (volts)	1.5	1.5	1.5	1.5	1.5	1.5	1.5	1.5
Max V _{ce} (sat) @ 3.0A, 300 ma (volts)	1.0	1.0	1.0	1.0	0.8	0.8	0.8	0.8
Min f _{ao} @ 3.0 A (kc)	20	20	20	20	15	15	15	15
Max Thermal Resistance (°c/w)	2.5	2.5	2.5	2.5	2.5	2.5	2.5	2.5

Compared with present power transistors of similar ratings, the new Clevite *Spacesaver* gives you important new advantages.

Better Switching — Its low base resistance gives lower input impedance for the same power gain and lower saturation resistance, resulting in lower "switched on" voltage drop. Its lower cut off current means better temperature stability in direct coupled circuits (such as regulated power supplies) and a higher "switched off" impedance.

Better Amplifying — Improved frequency response leads to higher audio fidelity, faster switching and improved performance in regulated power supply applications.

Better Mounting — The *Spacesaver's* simple rectangular configuration and low silhouette make it adaptable to a wide variety of mounting requirements where space is at a premium. In aircraft and missile applications, its low mass (half present type) improves shock and vibration resistance of lightweight assemblies.

A DIVISION OF

**CLEVITE
CORPORATION**

Phone for data and prices.

CLEVITE TRANSISTOR

254 Crescent Street Waltham 54, Mass. Tel: TWinbrook 4-9330

CIRCLE 139 ON READER-SERVICE CARD

NEW PRODUCTS

AC-DC Converter

Linearity is better than 0.1%



For flow measurement, tachometry, and other frequency measurement applications, model 320A ac-dc converter has a linearity of better than 0.1%. Selection of full-scale frequencies from 500 cps to 100 kc is made by changing a plug-in circuit board. Drift with temperature change is less than $\pm 0.1\%$ from -15 to $+55$ C. Signals as small as 5 v rms can be handled. The output signal level is ± 10 v with a ± 20 ma current capability. Output impedance is less than 0.25 ohms.

Vidar Corp., Dept. ED, 2107 El Camino Road, Palo Alto, Calif.

Price & Availability: Price is \$575; delivery is 90 days after receipt of order.

Shock Recording Accelerometer 594

For airborne equipment

Designed for recording shock on recovery parachutes, aircraft landing gear, missile shipping containers, and delicate instruments, model A 12 accelerometer responds to short duration shocks and indicates the greatest shock received on a permanent record. The standard range is ± 10 to 50 g linear and 5 to 125 g usable with an accuracy of ± 5 g. The ambient temperature range is -30 to $+200$ F. The unit weighs 8.5 lb and is 2.75 in. long.

Pace Engineering Co., Dept. ED, 13035 Saticoy St., North Hollywood, Calif.

Motor Driven Commutators 367

Speeds are 100 to 3000 rpm



The Mototator line of motor-driven commutators offers speeds of 100 to 3000 rpm with ac or dc motors. These units range from a 5-segment commutator with a 7/8-in. diam to a 50-segment commutator with a 5-in. diam. Any number of gangs can be mounted. Model MG 215, 18-seg-

ment commutator (shown) has a minimum life of 30,000,000 revolutions at 1000 rpm. It is driven by a 50-v dc motor.

Computer Instruments Corp., Dept. ED, 92 Madison Ave., Hempstead, L.I., N.Y.

Price & Availability: Units are built to customer specifications and prices are quoted on request. Delivery is in 45 days.

Magnetostrictive Delay Line 599

Delays range from 2 to 20 μ sec



Model VM-1020 variable magnetostrictive delay line provides delays from 2 to 20 μ sec. It accepts input pulse voltages of 5 v peak and input pulse widths of $1 \pm 0.2 \mu$ sec. The output pulse voltage is about 10 mv and spurious response is kept down, below 17 db. Input and output impedance is 700 ohms. Made to meet Mil specs, the unit is hermetically sealed and operates over the temperature range of -55 to $+85$ C. It weighs 3 oz and measures $5/8 \times 7/16 \times 7$ in.

Control Electronics Co., Inc., Dept. ED, 10 Stepar Place, Huntington Station, L.I., N.Y.

Shaft-Positioner Encoder 374

Provides 13-bit binary output



Model EP-13B shaft-position digital encoder has a 13-bit binary output, and uses a noncontacting magnetic readout. The readout method uses subminiature, ferrite toroids mounted above, but not touching, code tracks of magnetized spots on barium ferrite disks. Two disks are used, a 2^7 disk connected to a 2^6 disk through a 64 to 1 gear reduction.

Electro-Mechanical Research, Inc., Ascop Div., Dept. ED, Box 44, Princeton, N.J.

Price & Availability: Delivery about 90 days after order received. Price presently being determined.

EVERYTHING you need for fast, easy

SELENIUM RECTIFIER SELECTION

Over 1200 Rectifiers
Fully Described

48 Pages of Solid
Technical Data

Complete Information on

CIRCUITS

SIZES

DIMENSIONS

CURRENT RATINGS

VOLTAGE RATINGS

PRICES

INSTALLATION, etc.

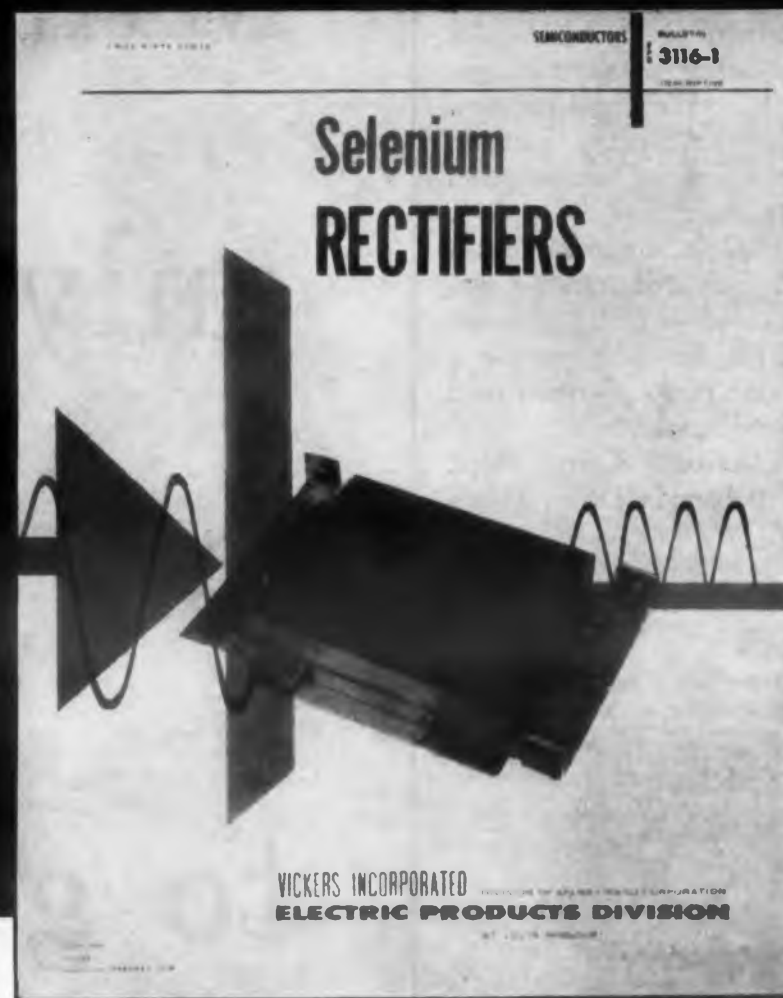

VICKERS® Grain-Oriented* SELENIUM RECTIFIERS

The unique characteristics of these rectifiers provide efficiency and economy unmatched by conventional rectifiers.

In Vickers rectifiers, the selenium is grain-oriented: crystals are aligned in the same direction, rather than in the random pattern found in ordinary rectifiers. The result? More working crystals, greater uniformity, better performance per square inch of cell area. Rectifiers provide higher current ratings without increase in cell size, and without danger of overloading; cost per watt of output is lower.

This 48-page bulletin gives you the complete story.

Send for Bulletin EPD 3116-1. Letterhead requests only, please



VICKERS INCORPORATED
DIVISION OF SPERRY RAND CORPORATION
ELECTRIC PRODUCTS DIVISION

1841 LOCUST STREET • SAINT LOUIS 3, MISSOURI

Sales ST. LOUIS—CEntral 1-5830 CHICAGO—JUniper 8-2125 CLEVELAND—EDixon 3-1359
Engineering DETROIT—KENwood 4-8070 NEW YORK—LEnnox 9-1515 LOS ANGELES—DAvenport 6-8550
Offices WASHINGTON, D. C.—EXecutive 3-2650 BOSTON (Representative)—CEdar 5-6815

CIRCLE 140 ON READER-SERVICE CARD

NEW PRODUCTS

Power Amplifiers 610 Use 4-cavity, water-cooled klystrons

These two power amplifiers, for use in scatter communications systems, space programs, and point-to-point data transmission systems, use 4-cavity, water-cooled klystron tubes. Model 216A has a power output of 10 kw. Model 217A is a 1-kw unit. Both units can be continuously tuned over a range of 1700 to 2400 mc, and provide a minimum gain of 40 db when used as broadband amplifiers.

Sierra Electronic Corp., Dept. ED, 3885 Bohannon Drive, Menlo Park, Calif.

Test Rack 630 For traveling wave tubes



Model TR-1 test rack for traveling wave tubes provides operating voltages for most low and medium power traveling wave tubes and their associated solenoids. The unit is for both laboratory and production line use. It has separate power supplies for the following: filament, helix, collector, anode, solenoid, and blower motor.

Menlo Park Engineering Dept. ED, 711 Hamilton Ave., Menlo Park, Calif.

Price & Availability: Information will be furnished on request.

Miniaturization means only active components G-E subminiatures used to give miniaturization

HOFFMAN TACAN: MEETS 780% - HIGHER AGREE* SPEC!

*Advisory Group on Reliability of Electronic Equipment, which has set a new standard of 150 hours mean-time-to-failure for TACAN.

General Electric subminiature tubes with heat-resistant glass have played a key role in advancing the reliability of Hoffman Electronics Corporation's new ARN-21C to nine times that of older TACAN equipment.



Compactness is a feature...transmitter, receiver, and electronic computer functions all are grouped in one "black box" that measures only 8 by 11 by 17 inches. Heat build-up necessarily is substantial.

In General Electric subminiature tubes, Hoffman found the answers to their pressing need for tubes that would stand up to heat with no sacrifice in reliability. 28 G-E subminiatures are used in the ARN-21C.

nsheat. Tubes are the
 tsthathat can withstand heat.
 sene new heat-resistant glass
 onwith reliability.



ACTUAL
SIZE

WHAT TESTS SHOW

Life tests of G-E subminiatures with new heat-resistant glass prove that high-temperature operation has no adverse effect on reliability. Check the total absence of failures with G-E type 6021 after 1500 hours at 250 C, against the high failure rate of ordinary 6021's under the same conditions!

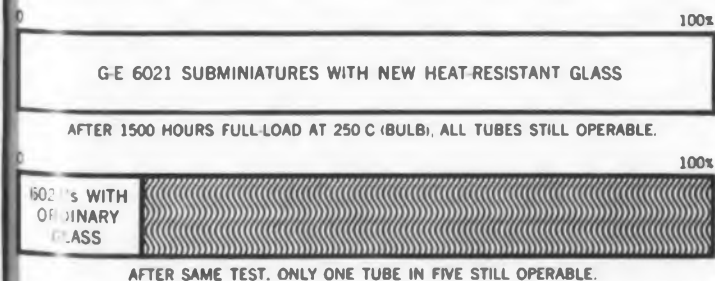

Type 6021 is a key tube in Hoffman's TACAN circuit. Glass electrolysis—cause of 90% of tube failures at high temperatures—has virtually been eliminated by General Electric in the 6021 and other subminiature receiving tubes.

SPECIFY FOR RELIABILITY

Small...smaller...smallest! The trend in electronic equipment is *down* in size, *up* in reliability requirement. Heat is the gremlin ready to play hob with your circuitry, unless you take steps to specify devices that are completely dependable when temperatures rise sharply.

General Electric subminiature tubes are proved performers at high temperatures. And their small dimensions give you the extra compactness you need to meet tight equipment size limitations. Telephone your nearest General Electric Receiving Tube Department office below!

NEW YORK
Wisconsin 7-4085, 6, 7, 8

CHICAGO
SPring 7-1600

LOS ANGELES
GRanite 9-7765

Progress Is Our Most Important Product

GENERAL  ELECTRIC

431-201

Detector Mount Heater 631

Operating life is 2000 hr



Model 184 detector mount heater raises the temperature of the crystal mounts from -62 to $+25$ C in 10 min in an ambient temperature of -55 C. The operating temperature range is -55 to $+100$ C. Minimum operating life without maintenance is 2000 hr.

American Electronic Laboratories, Inc., Dept. ED, 121 N. 7th St., Philadelphia 6, Pa.

Price & Availability: Sample quantities are available from stock. Normal time for delivery is 45 days. Prices are quoted on request.

Accelerometers 632

For operation at 500 F



These self-generating accelerometers, for operation at 500 F, have less than 3% cross-axis sensitivity. They are for missile and aircraft vibration testing and industrial measuring applications. Resonant frequency is 50 kc, internal capacity is 1600 μmf , and maximum acceleration is 5000 g. Standard models have sensitivities of 5, 10, and 20 μg .

Clevite Electronic Components, Dept. ED, 3405 Perkins Ave., Cleveland 14, Ohio.

Price & Availability: Units are available from stock at a fixed price of \$250 ea.

◀ Circle 141 on Reader-Service Card

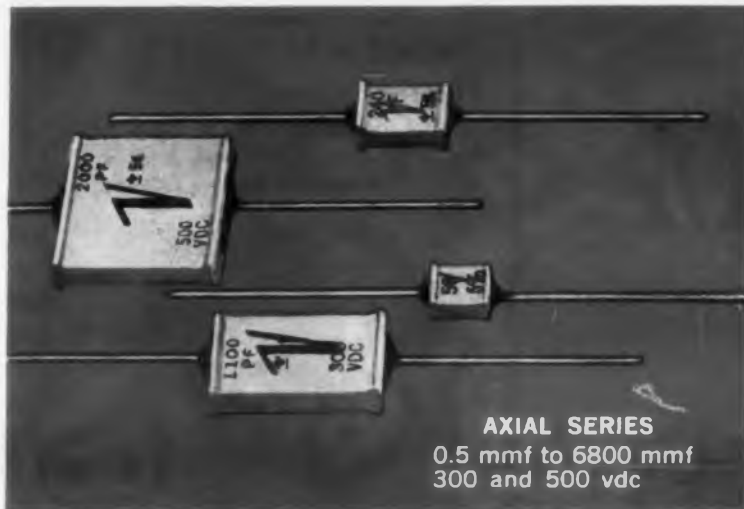

AXIAL SERIES
0.5 mmf to 6800 mmf
300 and 500 vdc

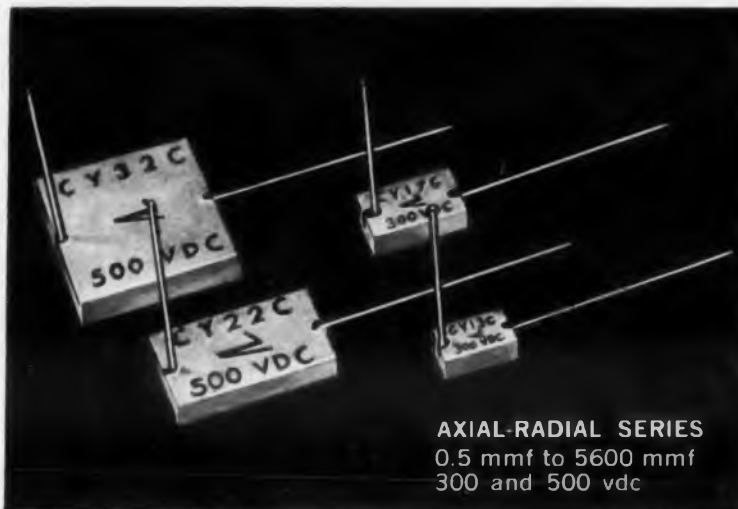

AXIAL-RADIAL SERIES
0.5 mmf to 5600 mmf
300 and 500 vdc

Vitramon[®]

SOLID STATE PORCELAIN CAPACITORS

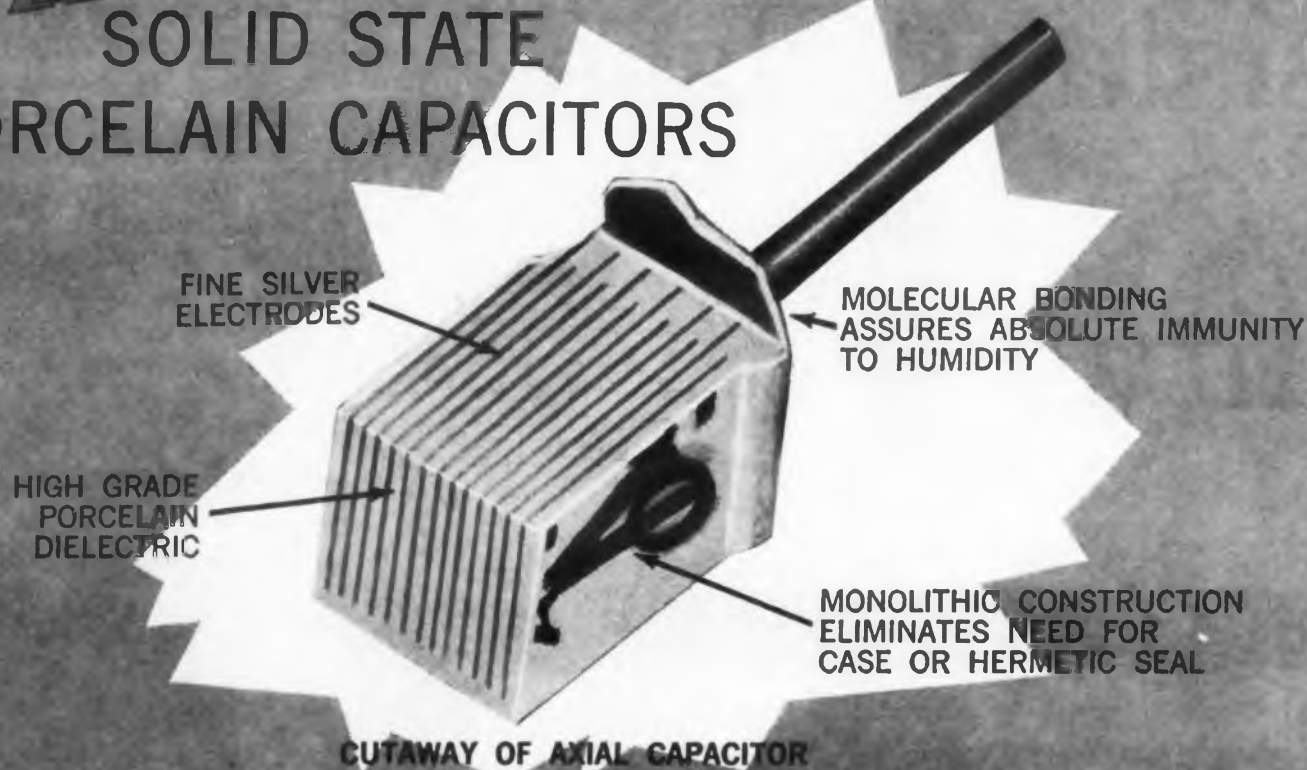

RADIAL SERIES
0.5 mmf to 1200 mmf
50, 100, 300 and 500 vdc



SOLID-STATE RELIABILITY MAKES THE DIFFERENCE

The exclusive "Vitramon" Process fuses fine silver electrodes within a solid block of dense dielectric porcelain to form an integral monolithic unit with outstanding electrical and physical properties.

The molecular bond of dielectric, electrodes and terminals assures absolute immunity to humidity, low loss, low noise and great stability over a temperature range of -55°C to 200°C .

True reliability is inherent in the solid-state construction of all "Vitramon" porcelain capacitors. They are used extensively where quality, precision and dependability are imperatives.

VITRAMON[®] INCORPORATED
P. O. Box 544 • Bridgeport 1, Connecticut

CIRCLE 142 ON READER-SERVICE CARD

NEW PRODUCTS

Toggle Switch

633

Rated at 5 amp



Specifically designed for miniature applications, this toggle switch is rated at 5 amp at 115 v ac and is capable of handling a 100% overload. Other features are: life, over 100,000 operations; contact resistance, 30 μohms ; insulation, over 100,000 meg; and voltage breakdown, 1000 v ac. Dimensions are $1/2 \times 3/8 \times 1/4$ in.

Alco Electronics, Dept. ED, 3 Wolcott Ave., Lawrence, Mass.

Price & Availability: Price of the spdt model is \$1.65 and price of the dpdt model is \$2.15. Units are available from stock.

Spectrum Synthesizer

634

Frequency range is 1 cps to 10 kc



This power spectrum computer has a dynamic range of about 8 decades of power for frequencies from 1 cps to 10 kc. Input signals, direct or from magnetic tape, are modulated into the pass-band of flat, triple stagger-tuned filters having fixed bandwidths of 1 to 100 cps. The filter output is squared and integrated to give the power density spectrum.

Applied Research Assoc., Dept. ED, 6541 N. Lamar, Austin, Tex.

Price & Availability: Price ranges from \$4800 to \$5800. Units are made to customer specifications and can be delivered in 90 days.

Trimmer Potentiometers

635

Shaft torque is 3 oz-in.



These trimmer potentiometers, designated Trim-quate, are easily mounted in two planes without additional brackets. They have a shaft torque of 3 oz-in. and a friction clutch to assure precise setting. They are adjustable from either side. Self-phasing segmented units can be easily ganged.

Subminiature Instruments Corp., Dept. ED, 3705 Sunnyside Drive, Riverside, Calif.

Price & Availability: Price is between \$7 and \$20 for all resistances and terminations when ordered in quantities of less than 10 units. Quantity discounts are furnished. All units are available from stock.

Motor Generator

636

For industrial control systems



For precise industrial control systems, model V846-001 motor generator can be used for remote control of weighing operations, and indication of temperature and machine tool operations. It has a no-load speed of 2900 rpm min and a stall torque of 3 oz-in. The rotor moment of inertia is 5.73 gm². The unit is constructed of corrosion resistant materials and is sealed to prevent entrance of dirt or dust.

Kearfott, Dept. ED, 1500 Main Ave., Clifton, N. J.

Price & Availability: Information is furnished on request.

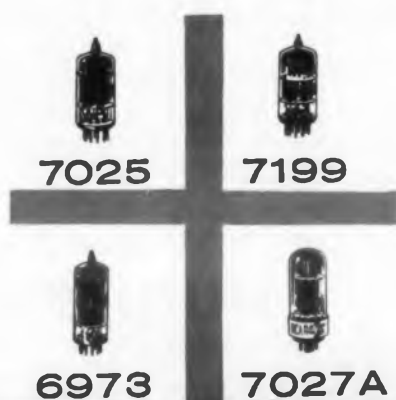

Balanced Line

...FOR TRUE HI-FI PERFORMANCE!

All the beauty and satisfaction of tube hi-fi performance—brilliance... quietude... power—can be yours when you design your amplifiers around the RCA "balanced" line of hi-fi tubes. Only four types—but a big PLUS FOUR that covers every high-fidelity application.

Your preamplifiers can have the *low-noise and low-hum* features of the RCA-7025 high-mu twin triode. For other low-level stages, you'll like the *versatility* of the RCA-7199, a sharp-cutoff pentode and medium-mu triode in one envelope. *Compact and powerful* best describes amplifiers using the miniature RCA-6973 beam-power tube—a pair in class AB₁ delivers up to 20 watts! And for that *power output deluxe* use the popular RCA-7027A beam-power tube—a pair in class AB₁ can deliver up to 76 watts with only 2% distortion.

Ask your RCA Field Representative about these four RCA tube types. For technical data, write RCA Commercial Engineering, Section IS B-18-DE3, Harrison, N. J.

ANOTHER WAY RCA SERVES YOU THROUGH ELECTRONICS



RADIO CORPORATION OF AMERICA

Electron Tube Division

Harrison, N. J.

EAST: 744 Broad Street
Newark 2, New Jersey
HUMboldt 5-3900

MIDWEST: Suite 1154
Merchandise Mart Plaza
Chicago 54, Ill. WH 4-2900

WEST: 6355 E. Washington Blvd.
Los Angeles 22, Calif.
RAYmond 3-8361

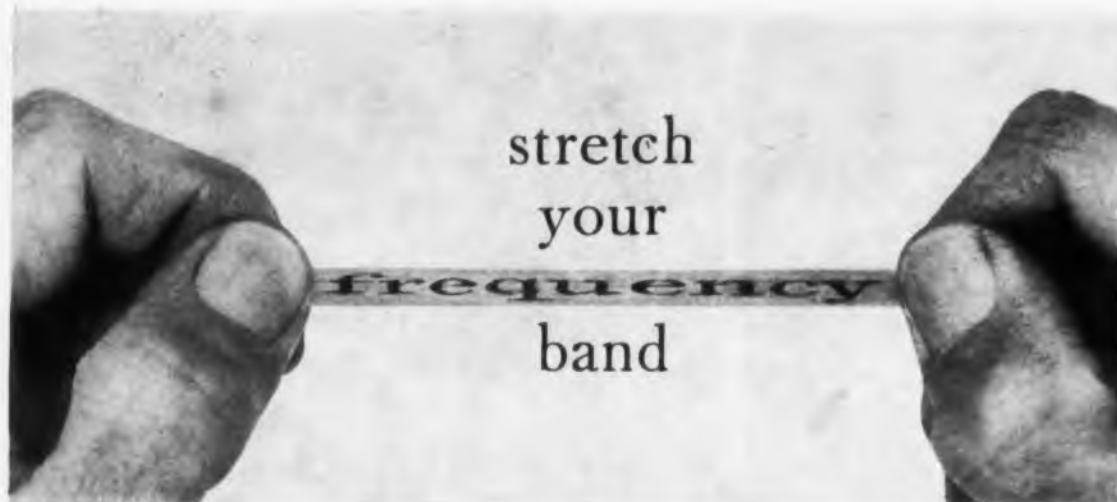

with new Hughes "20-20" Circulators!

With 20% bandwidth and over 20 db isolation, the new Hughes "Y" and "T" Circulators are ideally suited for microwave reception and transmission applications. They also give you small size and weight...without sacrifice in performance. C- and X-Band models are available today!

For information on the new "20-20" Circulators, or other advanced microwave components, please write Microwave Products Department, Advanced Program Development, Hughes Aircraft Company, Culver City 7, California. Or, phone UPTon 0-7111, Ext. 6919.

	Model C-201A	Model X-200A (Illustrated)
Frequency:	4.9-6.2 Kmc	8.0-9.8 Kmc
Isolation:	20 db	20 db
Insertion Loss:	0.3 db	0.3 db
Input VSWR:	1.10	1.20
Power Capacity:	10 Kw peak 100W avg (Min.)	3 Kw peak 50W avg (Min.)

ALSO AVAILABLE: Miniaturized S- and L- Band Coaxial Circulators. New, extremely small (1" x 2" x 8") circulators with bandwidths to 10%, over 20 db isolation, and 0.5 db insertion loss are now available.

Creating a new world with ELECTRONICS

HUGHES

© 1960, HUGHES AIRCRAFT COMPANY
MICROWAVE PRODUCTS



CIRCLE 143 ON READER-SERVICE CARD

NEW PRODUCTS

Shaft-Position Encoder

637

Output is 3600 quanta per revolution



Model C-804 shaft-position encoder provides an output of 3600 quanta per revolution in Datex code or 4096 quanta in Gray code. Under normal operating conditions, the unit has a life of over 10,000,000 operations. It uses an 8.5 in. disc, is capable of unlimited readout cycles, and has a sampling rate which is limited only by the readout device. The unit is 9 in. in diameter and 3.5 in. high, exclusive of the shaft.

Datex Corp., Dept. ED, 1307 S. Myrtle Ave., Monrovia, Calif.

Price & Availability: The standard unit is priced at \$950. Most models are available from stock.

Transistor Amplifier

638

Has low noise



Type VS-64A transistor amplifier has an rms noise voltage, referred to the shorted input terminals, of 50 m μ v, when used with a bandpass of 20 to 300 cps. A typical audio bandpass of 20 cps to 14 kc generates 160 m μ v noise voltage. Total bandpass of the amplifier is 2 cps to 180 kc; noise voltage with this bandpass is about 620 m μ v.

Millivac Instruments, Div. of Cohu Electronics, Inc., Dept. ED, Box 997, Schenectady, N. Y.

Price & Availability: Price is \$395; quantity discounts are offered. Delivery is in two to three weeks.

Video Amplifier

639

Range is 10 cps to 10 mc



Model 1660 video amplifier is for low-level signals in the range of 10 cps to 10 mc. Using a T-connector at the input, the amplifier becomes a high-input impedance-bridging amplifier suitable for sampling and amplifying signals from a coaxial input. Typical uses are amplification of weak TV signals and signal generator outputs. The unit is a non-inverting feedback type, having self-contained batteries. Voltage gain is 20 db, maximum input voltage without overload is 0.5 v rms, and maximum undistorted output is 1 v rms into a 75-ohm load. The amplitude distortion is less than 5% and the input noise level is less than 5 mv rms.

Interstate Electronics Corp., Dept. ED, 707 E. Vermont Ave., Anaheim, Calif.

Trimming Potentiometer

640

Resistance ranges are 10 ohms to 50 K

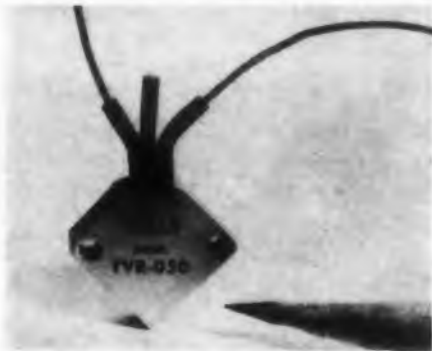

Designed for missile and telemetry applications, the TVR-050 series of trimming potentiometers offers 14 standard resistance ranges from 10 ohms to 50 K. These miniature units have a basic power rating of 1 w. Insulating boots on the leads reduce breakage and provide good separation. A molded plastic case is used for high dielectric strength; units meet Mil specs for temperature, vibration, shock, and humidity.

Wells Industries Corp., Basic Electronic Controls Div. Dept. ED, 6880 Troost Ave., N. Hollywood, Calif.

Price & Availability: Standard units are available from stock. Large quantities made to order can be delivered in about 30 days. Price is quoted on request.



FROM COW PASTURE...

TO CANAVERAL!

From the era of the "\$2 ride" to today's million dollar blast off's, the success of air vehicle performance has hinged on the reliability of components. Since 1933, Pesco products have been acclaimed for their proven dependability. As man prepares to meet the new challenges of flight, imaginative Pesco engineers are developing new concepts of reliability and . . . through creative engineering . . . are translating them into precision components to deliver volatile fuel, control the flow of hydraulic power, actuate guidance devices, generate and convert precise power, and cool vital working parts. Because today's high mach aircraft demand fail-safe operation, Pesco designs and builds components to *meet and exceed* all anticipated requirements to provide assured performance under critical operating conditions.

PESCO PRODUCTS ASSURE RELIABLE PERFORMANCE

FOR AIRCRAFT, MISSILES, AND SPACECRAFT



PESCO PRODUCTS DIVISION
BORG-WARNER CORPORATION

24700 North Miles Road • Bedford, Ohio

CONSULT PESCO FIRST FOR
YOUR SPECIALIZED REQUIREMENTS IN . . .

- STATIC INVERTERS
- FREQUENCY CHANGERS
- CRYOGENIC COMPONENTS
- ENVIRONMENTAL COOLING
- AUXILIARY POWER SYSTEMS
- ELECTRIC POWER GENERATION

EXPORT SALES: Borg-Warner International Corp., 36 South Wabash Avenue, Chicago 3, Illinois

CIRCLE 144 ON READER-SERVICE CARD

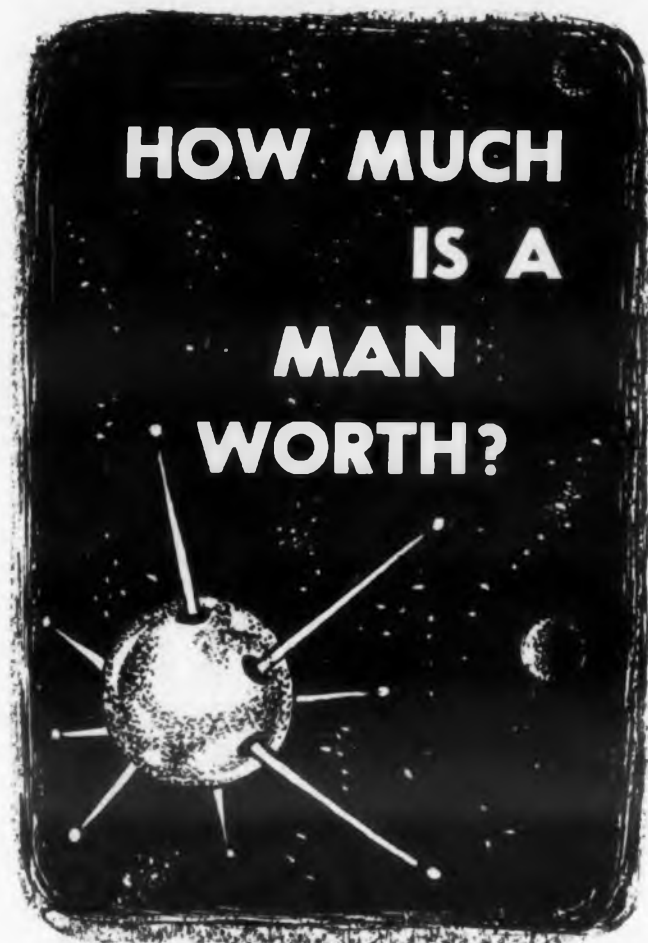

rustrak[®] MAC KEEPS TRACK

John Turner needed to record the signal of an earth satellite. Manpower was at a premium . . . new equipment budget was almost depleted . . . Turner's solution . . . the new Rustrak Miniaturized Automatic Chart Recorder. Because it was automatic, he needed no additional manpower; because it cost 1/2 the price of similar machines, he needed no additional budget allotment. Because it recorded on a chart, accurately and continuously, without smudges or smears, he had a complete, concise measurement of the satellite's signals at all times, at all points.

This is but one of hundreds of applications. Whatever your measuring or recording problem . . . send for the New Rustrak Miniaturized Automatic Chart Recorder.

You're always sure to be on the right track when the job is done by

rustrak[®] MAC
miniaturized —
automatic
CHART RECORDER
Send today for complete
specification sheet
and prices.



industrial co., inc.

DIMENSIONS:
3 3/8" w. x 5 3/8" h.
x 4 5/8" d.

130 SILVER STREET
MANCHESTER, N. H.

* Miniaturized Automatic Chart Recorder

CIRCLE 145 ON READER-SERVICE CARD

NEW PRODUCTS

Temperature Scanner

Monitors up to 50 points

641



This temperature scanner is a modular instrument which scans and monitors up to 50 assemblies of temperature-sensitive elements. If more than 50 points are required, additional scanners can be used. Each module may have a different temperature limit. The indicator sounds an alarm and lights the numbered module of any point exceeding the limit; the scanner continues to operate, regardless of how many points have exceeded the limit.

Tiptronic, Inc., Dept. ED, 510 E. Washington St., Chagrin Falls, Ohio.

Single Phase Inverter

Supplies 26 v ac

642



Designed specifically to supply 400-cps power to rate gyro packages, this single phase inverter is suitable for any application requiring small quantities of $26 \pm 1\%$ v ac power. The unit delivers 20 w at 400 cps $\pm 0.1\%$ with an input of 28 ± 4 v. Distortion is less than 4% and efficiency exceeds 60% at full load. Applicable portions of MIL-E-5272 are met. The unit occupies 20 cu. in.

Temco Aircraft Corp., Dept. ED, P.O. Box 6191, Dallas 22, Tex.

Price & Availability: Information will be furnished on request.



NEW LOW COST ELAPSED TIME INDICATOR

Unsealed, bakelite case design provides low cost. Self-starting synchronous motor drives 5-digit counter; records hours to 99999 or hours and tenths to 9999.9. Square Model 53 SET 3 1/2" also available. For 110 or 220 volt, 60 cycle AC. Standard ASA/MIL 3 1/2" mounting. Data on request. Marion Instrument Division, Minneapolis-Honeywell Regulator Co., Manchester, New Hampshire, U.S.A. In Canada, Honeywell Controls Limited, Toronto 17, Ontario.

Honeywell

75th YEAR PIONEERING THE FUTURE  First in Control SINCE 1885

CIRCLE 146 ON READER-SERVICE CARD

New Low-Cost PLUG & RECEPTACLE

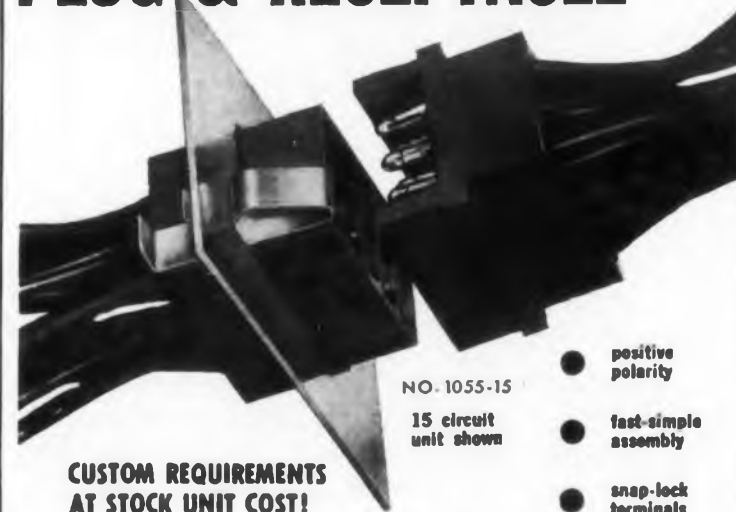

NO. 1055-15
15 circuit
unit shown

**CUSTOM REQUIREMENTS
AT STOCK UNIT COST!**

Unique molding method permits from 3 up to 60 circuit combinations made to your needs. Plug or receptacle accepts male and female terminals. *Minaturized*—a 15 circuit unit is only 3/4" wide and 1-1/16" long.

- positive polarity
- fast-simple assembly
- snap-lock terminals
- snap-clip panel mounting
- terminals automatically crimped to wires
- rated: 6 1/2 amp per connection 125/250 V a-c



MOLEX PRODUCTS COMPANY

9530 SOUTHVIEW AVENUE, BROOKFIELD, ILLINOIS
HUNter 5-3881

CIRCLE 147 ON READER-SERVICE CARD
ELECTRONIC DESIGN • February 17, 1950

DC Power Supply

643

Provides 4 to 36 v at 500 ma



Model UVS-100 voltage-regulated power supply provides 4 to 36 v dc at 500 ma. Transistor and Zener diode regulation is maintained at better than 1% against line and load change. Ripple is less than 5 mv. The output, continuously monitored by a voltmeter and milliammeter, is isolated from the input line and the chassis ground. The unit measures 4.75 x 4.5 x 6.25 in. Three supplies can be mounted on a single panel rack.

Matthew Labs., Dept. ED, 3344 Fort Independence St., New York 63, N. Y.

Price & Availability: Units are available from stock at a price of \$99.50 ea.

Frequency Counter

644

Range is from 1 cps to 1.2 mc



Model 521G frequency counter provides a five-place registration and has a range from 1 cps to 1.2 mc. Display time is adjustable to approximately 15 sec, or readings can be held until manually reset. The counter also has a front panel switch for selecting automatic gate times of 0.1 or 1.0, or the manual gate. With transducers, it provides measurement of such mechanical quantities as speed, rpm, rps, weight, pressure, temperature, and acceleration.

Hewlett-Packard Co., Dept. ED, 275 Page Mill Road, Palo Alto, Calif.

Price & Availability: Availability is currently 4 weeks. Price is \$650.

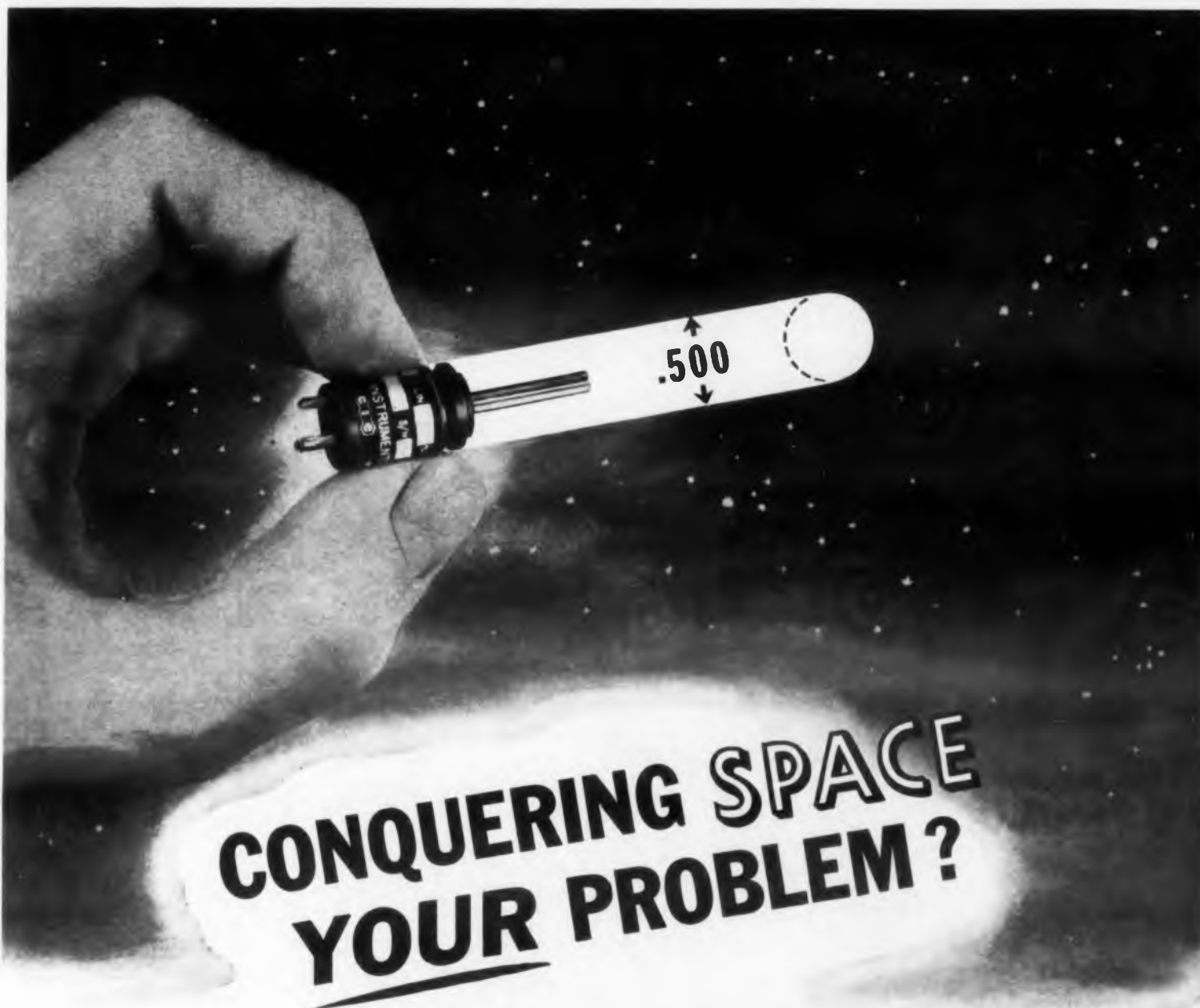

CONQUERING SPACE YOUR PROBLEM?

The NEW $\frac{1}{2}$ " **CIC** FILM POT IS THE ANSWER

LINEARITY 0.2% • INFINITE RESOLUTION • LONG LIFE

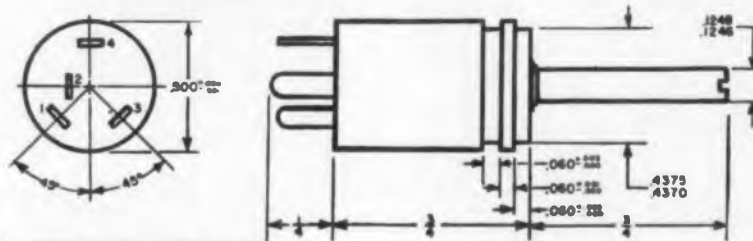

SPECIFICATIONS:

MODEL	50
RESISTANCE RANGE	500 Ω TO 150K
BEST LINEARITY OR CONFORMITY	0.2%
WATTAGE	1
GUARANTEED LIFE, REVS.	TO 30x10 ⁶

This subminiature film pot has much greater accuracy than comparable wire-wound types and features the reliability inherent in film pots. Now you can meet tight space requirements without sacrificing accuracy. Send us your specifications.

TERRITORIES OPEN FOR QUALIFIED SALES REPRESENTATIVES

FIRST IN FILM POTS



92 Madison Avenue, Hempstead, L. I., N. Y.

CIRCLE 148 ON READER-SERVICE CARD

Hermes Solid State BINARY TO DECIMAL CONVERTER

for converting any 4 bit code
to decimal illuminated display

Performs better



... Costs less

Binary to Decimal
Converter, Model 260,
shown approx. 1/2 size

\$95

(Nixie Bulb
not included)

Discounts for
quantity purchases

NO FALSE READOUTS

Relays and tubes eliminated

MAXIMUM RELIABILITY

100% solid state circuitry

LONG USEFUL LIFE

No preventive maintenance required

OPERATIONAL FLEXIBILITY

Variety of four bit codes can be converted

LATCHING CIRCUITS

Provide memory for binary information

Write for Technical Bulletin 260

Hermes



ELECTRONICS CO.

75 CAMBRIDGE PARKWAY, CAMBRIDGE 42, MASSACHUSETTS

CIRCLE 149 ON READER-SERVICE CARD

NEW PRODUCTS

Contact Switch 645

Is rated at 20 amp



For applications where repeated contact is required, this power contactor, called Mega-Switch, is rated at 20 amp. The contacts are between tungsten and mercury and are hermetically sealed in glass. Available in a range of voltages, the switch operates with low voltage on the primary side.

Energy Controls, Inc., Dept. ED, Geneva, Ill.

Price & Availability: Priced at about \$30 ea, units will be available from stock in March, 1960. Sample quantities are available.

FM-FM Commutator 646

Samples up to 180 channels



This fm-fm telemetering commu-

tator samples up to 180 MBB data channels at 5 rps. A 28-v dc motor drives all four poles through a precision gearing system. Two poles sample 30 channels per pole while the other pair samples 60 channels per pole. Over-all size of the unit is 3 x 3 x 6-11/32 in.

Instrument Development Labs., Inc., Dept. ED, 67 Mechanic St., Attleboro, Mass.

Price & Availability: Price is about \$2000 ea for orders of 25 units. Delivery time is 90 to 120 days.

Tape Recorder 647

For airborne applications



Developed for use in space vehicles where critical conditions prevail, model MTR-1200 tape recorder is completely self-contained and needs only external power for operation. Able to stand 200 g continuous acceleration, and vibration as per MIL-E-5272A, the unit operates from -50 to +200 F. The tape used can be 650 ft of 1-mil Mylar tape or over 800 ft of 3/4-mil pre-tensioned tape 1/2 or 1 in. wide. The tape speed is 0.25 to 60 in. per sec.

Leach Corp., Dept. ED, 18435 Susana Rd., Compton, Calif.

Strain Gage 648

Nominal resistance is 70 ohms

Type DA-101 semiconductor strain gage has a nominal resistance of 70 ohms and a gage factor of 115. Its over-all dimensions are 5/16 x 1/2 in. Other types have gage factors from 100 to 200.

Kulite-Bytrex Corp., Dept. ED, 50 Hunt St., Newton 58, Mass.

Price & Availability: Price is \$90 for a package of six units. Delivery is in 30 to 60 days.

NOW produce up to 6,000 welds per hour . . . automatically . . . with one operator.

TWEEZER WELD



Precision Resistance Welding Equipment

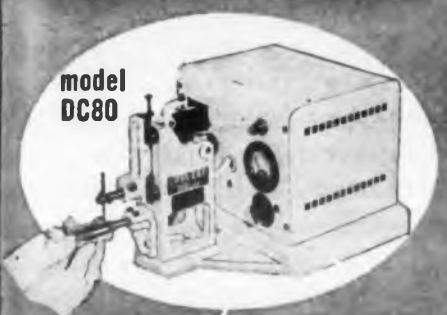

BENCH MOUNTED STORED ENERGY WELDER

- New TW5 low friction welding head
- Stored energy panel of 80 Watt second capacity
- Discharge time of 0.0008 to 0.0012 second
- Permits welding of difficult materials, i.e.: copper, silver, tungsten, etc.
- Reliable welds without discoloration, deformation, metallurgical change



COMPACT SYNCHRONOUS WELDING TIMER
6" wide
10 1/2" high
8 1/2" deep
model T-3

TRANS-SYNC WELD-TIMER

- 1 KVA capacity utilizing semi-conductors
- Also ideally suited with high speed automatic machinery
- Operates at a rate up to 1200 welds per minute . . . welds partially oxidized materials with ease
- Welding timer 1/2 cycle (8 milliseconds) to 10 cycles (160 milliseconds)

FEDERAL TOOL ENGINEERING CO.
1400 Pompton Ave.
Cedar Grove, New Jersey

WRITE FOR INFORMATION

Waveguide Switch

649

For S-band applications

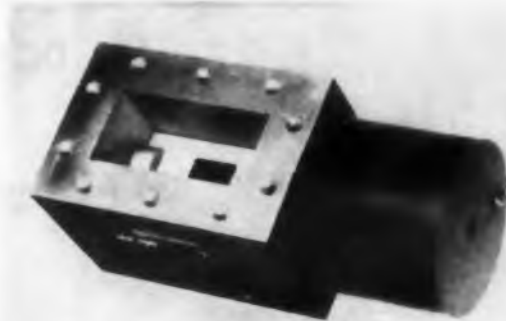

Model MA-788 rotary shutter is a magnetically operated waveguide switch for use in S-band applications. It provides 25 db attenuation in the closed position. In the open position, insertion loss is 0.2 db max and vswr is 1 max. Operating voltage is 20 to 29 v dc, current at 28 v is 560 ma, and coil resistance at 25 C is 50 ohms. The shutter operates at a temperature range of -40 to +100 C, and withstands vibrations of 5 g at 50 to 500 cps.

Microwave Assoc., Inc., Dept. ED, Burlington, Mass.

Price & Availability: Made on order only. Can be delivered 45 days after order received. Price on request.

Relays

650

Have up to 10 K coil resistance



This series includes R3H spdt, R6H dpdt, and R9H tpdt hermetically sealed overload relays. Coil resistances are available to 10 K. For 28.5 v dc operation, coil resistance is 425 ohms. Contact rating is 5 amp at 250 v ac, or 4 amp at 28.5 v dc. Operating temperature range is from -55 to +125 C, and the relays can withstand shock to 50 g. Dimensions are 1-5/8 x 1-27/64 x 2 in. high.

E.V. Naybor Labs, Inc., Dept. ED, Port Washington, N.Y.

Price & Availability: Made on order only and delivered 30 days after order received. Prices are between \$9.30 and \$17.40 for components when ordered in quantities of 500.

BY DEFINITION...

A PRECISE-POWER SET is a rotary electro-mechanical system, statically regulated, which performs **one or more** of the following functions:

Isolates the DC power system from static and/or transient power line changes.

Raises the power-line frequency, reducing the cost, size, and complexity of the system power supplies.

Performs the conversion to (regulated or unregulated) DC directly.

Multiple outputs are common.



BEST FOR LARGE ELECTRONIC SYSTEMS

Don't freeze your designs for large electronic power-supply systems until you have given mature consideration to the striking advantages obtained by interposing a PRECISE-POWER SET between the power line and your electronic-circuit loads.

Designers who worry about reliability, cost, size, and weight—particularly those working in the fields of computing, automation, telemetry, missile checkout and guidance, process control—will find our complete and authoritative 32-page technical bulletin S-59 of great interest.

Why pay for, make room for, suffer for the 25%-55% of excess power dissipation forced on regulated DC power supplies by power-line fluctuations, when a compact, maintenance-free PRECISE-POWER SET will pay for itself several times over, and virtually eliminate them?

Write today. The bulletin is free . . . and immediately available.



Partners in Power

ELECTRIC SPECIALTY CO.

201 SOUTH STREET, STAMFORD, CONNECTICUT
Flreside 8-6203



REGULATORS, INC.



CIRCLE 150 ON READER-SERVICE CARD

ELECTRONIC DESIGN • February 17, 1960

CIRCLE 151 ON READER-SERVICE CARD

155

product of the pioneer

DESIGNING A NEW INSTRUMENT?

YOU CAN USE A TUBE LIKE THIS!

SPECIFICATIONS FOR 3" CATHODE-RAY TUBE
FOR MODERN INSTRUMENTS

J1-22 CONTACT POST ACCELERATOR

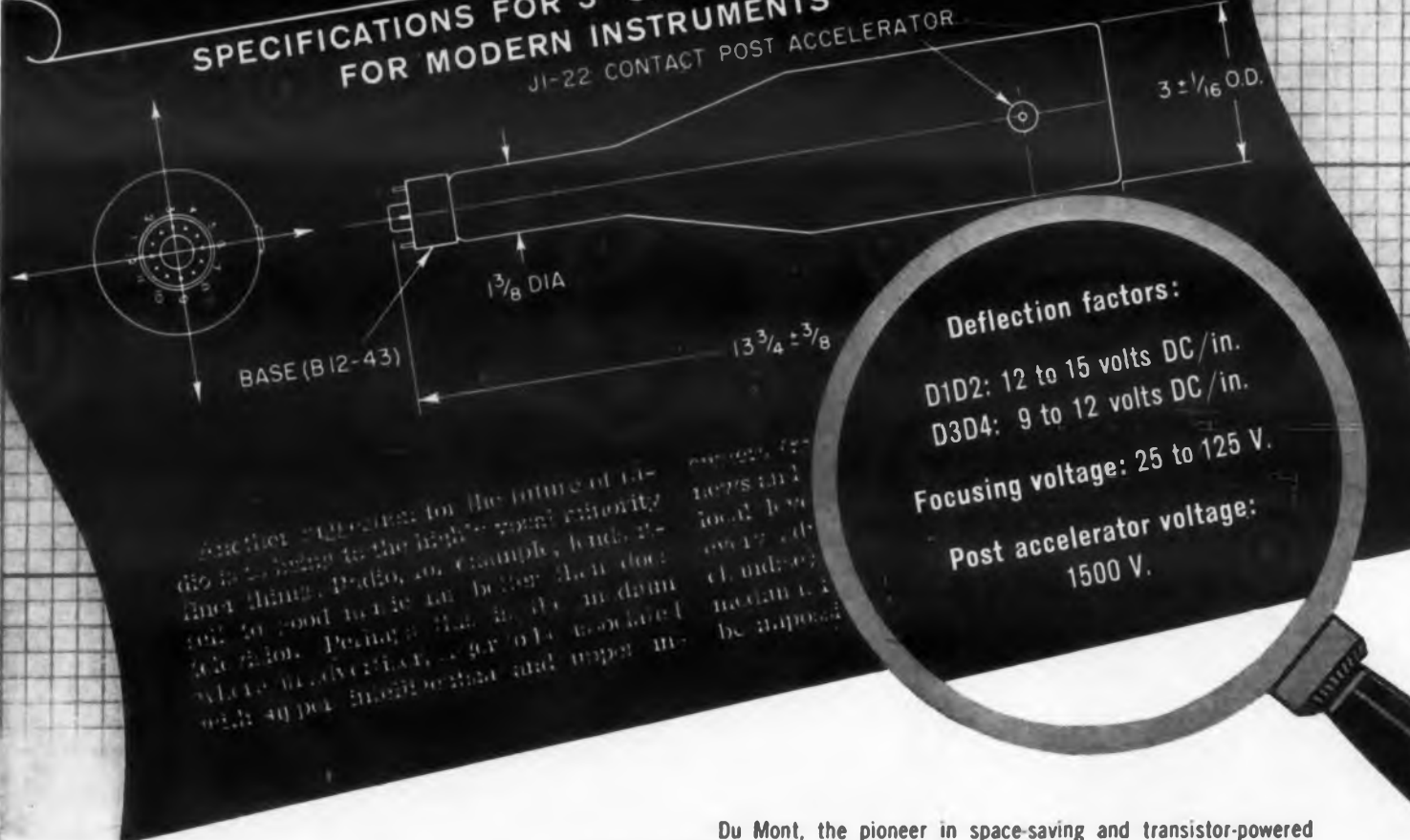

Another suggestion for the future of instruments is to bring to the high-voltage industry the same things that have made the radio, for example, and the television, perhaps that is the in demand where an over-voltage, or a high-voltage, with a per inch deflection and imper-

Du Mont, the pioneer in space-saving and transistor-powered cathode-ray tubes for radar, now makes possible the same inherent features in a fine instrument read-out tube. The Du Mont electrostatically deflected K1951 provides full scan with deflection voltages of 9-15 volts DC/in.

If your cathode-ray tube applications call for even greater compactness and power savings—consult the CRT Engineering Specialists at Du Mont. Daily advances in the state-of-the-art are being recorded for your benefit. A tube to fit your exacting requirements can be designed, developed and produced at Du Mont. Whatever your CRT requirements, check with Du Mont first.

WRITE for complete details

DU MONT®

precision electronics is our business

ELECTRONIC TUBES/INDUSTRIAL TV/MILITARY ELECTRONICS/MOBILE COMMUNICATIONS/SCIENTIFIC INSTRUMENTS/AUTOMOTIVE TEST EQUIPMENT

ALLEN B. DU MONT LABORATORIES, INC., CLIFTON, N. J., U. S. A.

INTERNATIONAL DIVISION • 515 MADISON AVENUE, NEW YORK 22, N. Y. • CABLES: ALBEEDU, NEW YORK
CIRCLE 152 ON READER-SERVICE CARD

NEW PRODUCTS

DC Power Supply

Output is 5 to 35 v



Designed for transistor circuit work and other applications where recurrent spikes and other transients would damage equipment, model PS 201 power supply delivers an adjustable output from 5 to 35 v at 2 amp max. Either the positive or negative terminal may be grounded or the output can be floating. The regulation is better than 0.1% and variation in output voltage is 30 mv max. Ripple is less than 1 mv. The unit weighs about 14 lb and occupies less than 1 sq ft.

Solidyne, Dept. ED, 7460 Girard Ave., La Jolla, Calif.

Pulse Generator

Gives pulses 0.1 to 10,000 μ sec wide



Serving as a source of single or recurrent pulses, model 4120B pulse generator provides main pulse widths from 0.1 to 10,000 μ sec. Rise time is from 0.03 to 0.5 μ sec, and the repetition rate may be varied from 500 kc to 0.5 cps. The unit may be used in the design of ac and dc amplifiers, memory and digital computers, video and pulse forming networks, and for checkout and test of pulse transformers and delay lines.

Electro-Pulse, Inc., Dept. ED, 11861 Teale St., Culver City, Calif.

Price & Availability: Can be delivered 42 days after receipt of order. Price on quote.

Temperature Control

653

Occupies 28 cu in.



This positioning and temperature controller, weighing about 1.1 lb and having a volume of less than 28 cu in., operates standard dc electric valves or positioning actuators. Using silicon rectifiers as the output device, it is a proportional pulse, modulating control. It is able to tolerate a wide variation of frequency and voltage. The input is 115 v, 400 cps; operating temperature range is -65 to +250 F.

Garrett Corp., Dept. ED, 9851 Sepulveda Blvd., Los Angeles 45, Calif.

Price & Availability: Units are available from stock. Price, which depends on complexity of application is furnished on request.

Resistance Set

654

Consists of 2 voltage divider networks



Consisting of two independent voltage divider networks suspended in an oil bath in a hermetically sealed case, model BMR-104S resistance set is designed for digital-to-analog conversion, and ratio and resistance synthesis. Each network has 13 primary standard resistors with values coded in binary sequence; total series resistance is 29,996.337 ohms. Both dividers are matched to within ± 0.1 ohms, over-all accuracy at 20 C.

Julie Research Labs, Inc., Dept. ED, 556 W. 188th St., New York 32, N.Y.

Price & Availability: Made on order only and is available in minimum sample quantities of 12. Delivery is 30 days. Prices are \$349.60 per unit for 10 to 19 units, \$314 per unit for 20 to 50 units.

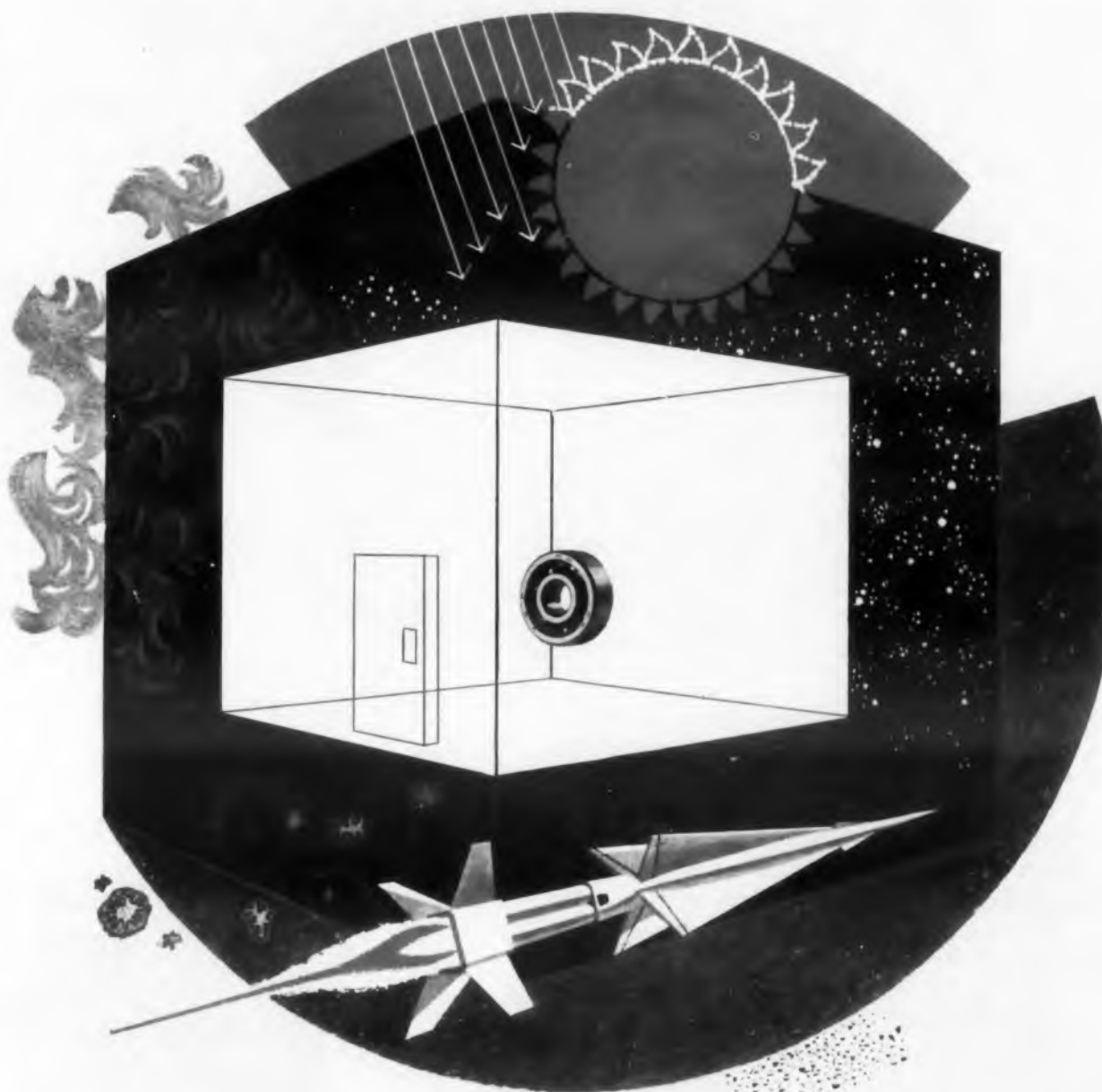

THOR
MACE
TITAN
HAWK
ATLAS
SNARK
NIKE B
BOMARC
NIKE ZEUS
SPARROW I
SPARROW II
SPARROW III
NIKE HERCULES
SIDEWINDER
REGULUS II
VANGUARD
PERSHING
BULL PUP
POLARIS
CORVUS
FALCON

N/D'S Unique "White Rooms" Improve Miniature Ball Bearing Reliability!

In these rooms the most infinitesimal air-borne contaminants are scientifically whisked from the air . . . away from superprecision miniature ball bearing parts.

New Departure introduced the White Room nearly twenty years ago. And today, New Departure's concept is a pace-setting standard in miniaturization industries. At N/D, miniature ball bearings are completely assembled in properly humidified, temperature controlled atmospheres that approach fantastic levels of cleanliness. The most advanced air filter systems available are employed. In addition, pressurized access air locks and individual counter-top pressurized chambers are used by N/D's skilled technicians during

final assembly and statistical inspections. Air-borne particles rarely ever touch bearing surfaces.

All N/D White Room equipment is of the most recent development and design—incorporating the highest order of today's technological know-how and reliability methods. These are just a few reasons why more and more major missile contractors rely on New Departure Miniature and Instrument ball bearings.

If you are working on a new miniature ball bearing application where reliability is critical, include an N/D Sales Engineer in your design discussions. Call or write Department L.S., New Departure Division, General Motors Corporation, Bristol, Connecticut.

N/D
NEW DEPARTURE
MINIATURE & INSTRUMENT BALL BEARINGS

proved reliability you can build around

CIRCLE 153 ON READER-SERVICE CARD

$$E = \frac{mc^2}{2}$$

Its Amazing Relationship To the Relativity Law

MORE than one reader has pointed out that there is a remarkable similarity between our new physical law $E = mc/2^*$, and Einstein's famous equation. We don't wish to appear presumptuous, but there is a relativity effect embodied in our new machine, the FR-600. Unfortunately this information has somehow leaked out and now there's the devil to pay. The marketing people got wind of it and blamed us for revealing the clue in our last paper on the Ips Corollary. It seems they think this information will play hob with their sales curve. We have committed ourselves, however, so there's nothing to do but make a clean breast of it.

As we pointed out, the FR-600, in many cases, can do the work of two machines. (Our engineering colleagues will remember that this is because the FR-600 can record 125 kc data at 30 ips, thus recording for 48 minutes on one 14-inch reel. This eliminates the need for a second stand-by machine or a dual transport in most data runs.) As you might expect, the marketing people were worried that this might cut sales in half, since one machine could do the work of two. That wasn't the half of it, however. Now it seems that the FR-600 lets all of our other analog recorders do the same thing. So, whether we like it or not, all our AR-200's, Model 800's, FR-100's and 1100's can record the same bandwidths at half the usual speeds — and record twice as long to boot. (The new engineer says this is because bandwidth is determined by the reproduce head and not the record head.)

So if you have an FR-600 to reproduce your data on you can record it at half the usual speed on all our other machines and get twice the recording time. There's no way we could stop you if we had to. As a result the marketing people are all up in arms. This will cut sales on all of our other machines in half, they say, since one machine can do the work of two. As far as we're concerned there's nothing to be done about it. The secret's out. We can only hope the profession won't abuse the privilege. A few communications from you in the field would certainly help the marketing people forget this whole ugly business.

(Regarding the answer to the trial problem in our first paper: If one of our readers has solved it would he please send us the answer in a plain envelope marked 'personal'.)

*We still have a few extra copies of the papers on $E = mc/2$ and the Ips Corollary.



AMPEX DATA PRODUCTS CO., 934 CHARTER ST., REDWOOD CITY, CALIF.

NEW PRODUCTS

Differential DC Amplifier

655

Bandwidth is dc to 25 kc

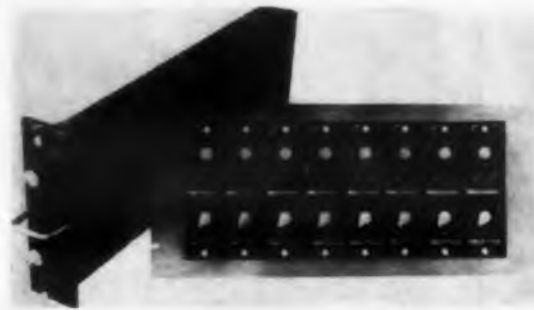

Model 516 true differential dc amplifier features a low noise of 14 μ v rms over the bandwidth of dc to 25 kc. It has an output of ± 100 ma at 10 v and a continuously variable gain to 1000 times. A general purpose instrument, it is chopper stabilized.

Allegany Instrument Co., Inc., Dept. ED, 1091 Wills Mountain, Cumberland, Md.

Phase Detector

656

Measures from 15 to 400 mc



For use from 15 to 400 mc, type 205B1 phase detector measures phase shift in radar if amplifiers, transmission networks, and radar tracking systems. Its accuracy is ± 0.05 deg or $\pm 1\%$ of the dial reading. Impedance is 50 ohms nominal for both input and output.

AD-YU Electronics Lab., Inc., Dept. ED, 249-259 Terhune Ave., Passaic, N.J.

Servo Control Assembly

657

Is completely prepackaged



This prepackaged modular servo control assembly consists of motor generator, gear train, synchro, and potentiometer. Type E-108A uses size 8 components. The motor generator is rated

Short Term Frequency Stability measured with High Accuracy



THE AIL TYPE 392B

Frequency Stability Tester for Checking Drift, Jitter, Jitter rate

- Checks L- and S- band oscillator performance
- Responds to input levels as low as -45 dbm
- Checks frequency stability to 1 part in 10^9 .

It is particularly useful for the measurement of MTI Stalo stability during the short time interval when Stalo drift may cause erroneous target information. It operates in the approximate bands of 1120 to 1700 mc and 2600 to 3200 mc. The AIL type 392B provides rapid design and production checks. Compact, lightweight and portable it is ideal for field testing.

Write for descriptive literature.



**AIRBORNE
INSTRUMENTS
LABORATORY**

DEER PARK, LONG ISLAND, NEW YORK
A DIVISION
OF CUTLER-HAMMER, INC.

CIRCLE 154 ON READER-SERVICE CARD

ELECTRONIC DESIGN • February 17, 1960

for 26 v per phase, or comes with 36 v center tap control phase. The gear train comes in any ratio up to 6000 to 1; the synchro has a 7-min accuracy; and the potentiometer is available in resistances up to 100 K.

John Oster Manufacturing Co., Avionic Div., Dept. ED, 1 Main St., Racine, Wis.

Micro-Microammeter 658

Covers 17 ranges down to 2 $\mu\mu$

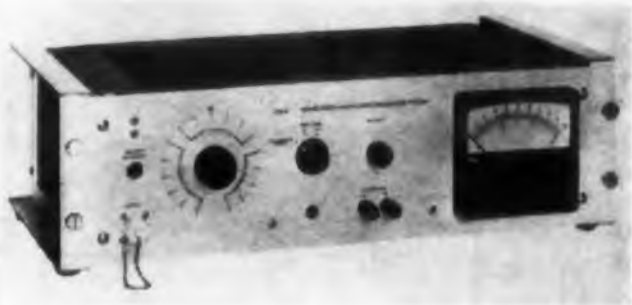

Model 414 micro-microammeter presents 17 ranges in steps of 1 and 3X. Accuracy is within 3% of full scale down to 10 $\mu\mu$. The instrument has a 5-v output at up to 1 ma, output noise of less than 1% of full scale peak-to-peak, and a response time of 0.2 sec.

Keithley Instruments, Dept. ED, 12415 Euclid Ave., Cleveland 6, Ohio.

Price & Availability: Price is \$280 ea. Units are available from stock; delivery time is 60 days.

Solenoid Lock 659

Prevents accidental change of setting

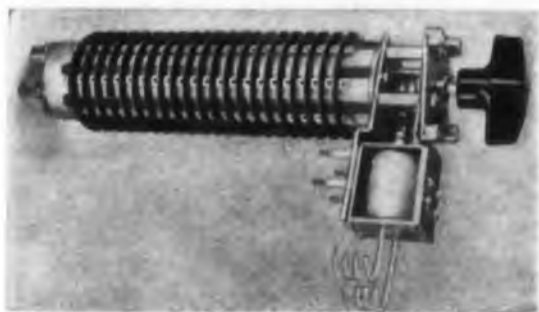

Designed for use where unauthorized or accidental changes of control settings are to be avoided, this solenoid locking mechanism can be furnished with type JR multi-pole rotary switches. Coils are available for 12, 24, and 115 v dc operation and can be impregnated to meet MIL-T-152. Release is effected by energizing the solenoid or, where fail-safe protection is required, by de-energizing it.

Electro Switch Corp., Dept. ED, King Ave., Weymouth, Boston 88, Mass.

Price & Availability: Made on order only. Delivery is approximately 60 days after receipt of order. Price is dependent upon individual customer requirements.

ALLIED CONTROL'S

NEW LINE OF

Sub-Miniature Telephone Type Relays

Now being manufactured entirely in the U.S.A., not only in its original West German design previously sold in this country by Allied Control Company, Inc. under an agreement with Siemens & Halske Company A.G. Germany but with variations to meet American requirements as well.



TYPE-T-134

H-1 3/16 • W-47/64 • L-1 11/64



TYPE-TAHQ

H-2 3/16 • W-17/16 • L-1 5/8



TYPE-TAH

H-1 19/32 • W-61/64 • L-1 11/32



TYPE-TAF

H-1 17/64 • W-41/64 • L-1 5/16



TYPE-TADO

H-2 • W-1 13/32 • L-1 13/32

PERFORMANCE CHARACTERISTICS

Contact Arrangement

Up to 12 springs maximum form A, B or C

Contact Rating

2 amperes resistive or 1 ampere inductive at 29 volts d-c or 115 volts a-c
Low level or 5 ampere contacts available on request

Standard Coil Voltages

Suitable coil resistances can be supplied for operation at any voltage within the range of 0.5 to 130 volts d-c

Coil Power

Nominal: 700 milliwatts
Minimum Operate Power: 60 to 150 milliwatts depending on application, contact arrangement and coil resistance.

Timing at Nominal Voltage

Operate time: 7.5 milliseconds maximum
Release time: 3.5 milliseconds maximum

Vibration

10-55 cps at .062 inch double amplitude
55-500 cps at a constant 10g

Shock: 25g operational

Enclosure

Open, dust cover or hermetically sealed

Weight

Open type 1.0 ounce maximum
Sealed type 2.0 ounces maximum



ALLIED CONTROL



ALLIED CONTROL COMPANY, INC., 2 EAST END AVENUE, NEW YORK 21, NEW YORK

CIRCLE 155 ON READER-SERVICE CARD

NOW!

9 CARBON FILM RESISTORS IN ONE CUBIC INCH . . .

matched to .01% in resistance . . .
1ppm/°C in temperature coefficient

Networks designed, developed and produced by Pyrofilm Resistor Company furnish circuit designers with a small size compact package of resistors for use in high precision circuits. As many as 9 one watt resistors in values up to 30 megohms can be packaged in less than 1 Cubic inch. Precise lead spacing is maintained for printed circuit applications.

Pyrofilm resistors are subject to close control at all stages, from pyrolytic deposition of the carbon film, to vacuum baking at 450°C before fusion sealing in glass, to 350°C aging of the completed resistors to assure perfection of the seals. The stability of Pyrofilm resistors is unmatched by any other form of carbon film resistor.

Typical applications for Pyrofilm networks are as voltage dividers for instrument input or reference voltage selection . . . feedback networks, whose ratio determines the gain of an amplifier . . . summing networks, for adding accurately known multiples of several input voltages.

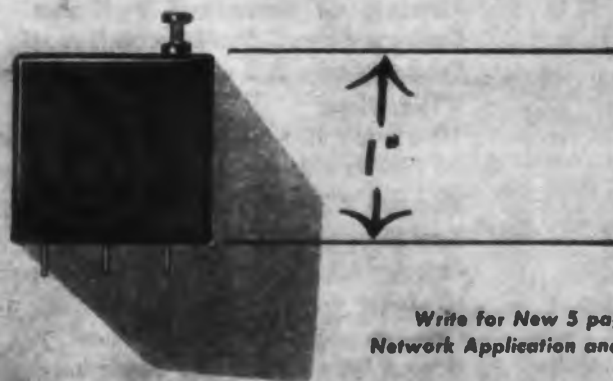

Write for New 5 page article on
Network Application and Configurations.

On Display at the 1960 I.R.E. Convention — Booth #2235

PYROFILM RESISTOR COMPANY, INC.

U.S. Highway #46 • Parsippany, New Jersey • DEerfield 4-8282

CIRCLE 156 ON READER-SERVICE CARD

NEW PRODUCTS

Snap-Action Switches

660

Come in three terminal styles



These miniature snap-action switches come with three kinds of solder-lug terminals as well as snap-on terminals, and terminals for printed circuit wiring. The solder-lug terminals include the short type with holes for wires up to No. 18, a single-turret lug, and a double-turret lug. The turret lugs are flat. The snap-on terminals fit quick disconnect female terminals. The printed circuit terminals fit 3/32-in. slots in wiring boards and have holes for connection of component leads.

W. L. Maxson Corp., Unimax Switch Div., Dept. ED, Ives Road, Wallingford, Conn.

Magnetic Recorder

661

Provides tape speeds up to 150 ips



Model 59 digital magnetic recording system provides tape speeds up to 150 ips, rewind speeds as high as 400 ips, and start-stop time of less than 3 msec. The transport mechanism uses all solid state circuitry, and handles tape by linear reel drive servo systems, eliminating the need for step servos. The system meets the requirements of MIL-E-4158A.

Cook Electric Co., Data-Stor Div., Dept. ED, 2700 Southport Ave., Chicago, Ill.

Price & Availability: Generally delivered 60 to 90 days after order received. Some versions can be delivered in 30 to 60 days. Price is dependent upon specifications.

"Telephone Quality" Stromberg-Carlson RELAYS



...to meet your
electromechanical
switching needs

These are the very same twin-contact relays proven outstandingly successful through many years of precise, exacting operation in the telephone industry.

The following regular types are representative of our complete line:

Type A: a general-purpose relay with up to 20 Form "A" spring combinations.

Type B: a gang-type relay with up to 60 Form "A" spring combinations.

Type BB: accommodates up to 100 Form "A" spring combinations.

Type C: two relays on the same frame. A must where space is at a premium.

Type E: same characteristics as the Type A, plus universal mounting arrangement. Interchangeable with many other makes.

Types A, B and E are available in high-voltage models (insulation withstands 1500 volts A.C.) for test equipment and other high-voltage applications.

Details and specifications are in our complete relay catalog, available on request. Write to Telecommunication Industrial Sales.

STROMBERG-CARLSON
A DIVISION OF GENERAL DYNAMICS
116 Carlson Road • Rochester 3, N. Y.

CIRCLE 157 ON READER-SERVICE CARD

ELECTRONIC DESIGN • February 17, 1960

Vane-Operated Limit Switch 482

Response time is about 0.001 sec

Designed for use in controlling machinery travel, this vane operated limit switch has a response time of about 0.001 sec. Providing the path of the vane is maintained, operation is consistent within ± 0.0025 in. Normal contact rating is 115 v ac, 0.2 amp make or break; maximum rating is 115 v ac at 0.75 amp. Having spst design, the switch meets JIC requirements. It measures $2-11/16 \times 2-3/4 \times 2-3/8$ in.

General Electric Co., Dept. ED, Schenectady 5, N. Y.

Price & Availability: Units are available from stock. Price is \$35.

Transducers 477

Use platinum film as sensing element

Using a molecular film of platinum as a sensing element, series TT temperature transducers operate from -453 to $+800$ F. The size of the element is as small as 0.125×0.04 in. Transducer output is up to 15 ohms per deg F, and it can withstand 40 g, 2500 cps specified.

Nacimo Products, Dept. ED, 1090 Morena Blvd., Box 248, San Diego 10, Calif.

Price & Availability: Units with certain configurations and resistance values are in stock. Delivery is 30 days. Price is between \$300 and \$400 when ordered in quantities of 25 or less.

Silver-Zinc Battery 353

For missile systems



Type 3381R-2 rechargeable silver-zinc battery is a 10-amp-hr unit with a nominal voltage of 28 v when discharging at 45 amp in 12 min. It can also be discharged at 60 amp or at lower rates. Its dry shelf life is 2 yr min. Designed to meet the requirements for missile electric power systems, it meets the test specifications of MIL-E-5272. The volume of the battery is 239 cu in. and the weight is 15 lb.

Yardney Electric Corp., Dept. ED, 40-50 Leonard St., New York 13, N.Y.

Price & Availability: Price quoted on request; units can be delivered within 90 days.



CERAMIC SPEAKER MAGNETS

INDOX V Can Cut...

- Magnet Costs 20%
- Speaker Weight 25%
- Speaker Length 46%

Performance Proven in Hundreds of Thousands of High-Fidelity Loud-speakers

A leading high-fidelity loud-speaker manufacturer realized the above savings when his Alnico speakers were redesigned to use INDOX V. Here is why he changed... and why you, too, may achieve substantial savings by changing to INDOX V.

INDOX V loud-speaker magnets are guaranteed to have a minimum energy product of 3.25 million BHmax. Made of highly oriented barium ferrite material, their energy level is comparable on an equivalent weight basis to that of Indiana's Hyflux ALNICO V — the most powerful magnet material available.

Now with INDOX V, designers and manufacturers can look forward to:

- Speaker assemblies that are less than half as deep
- Fewer magnet parts, simpler assemblies
- Less over-all weight, lower shipping costs

Yet the advantages of comparable Alnico magnets are retained:

- Highest sound level possible
- Best transient response, assuring a full range of tones and overtones
- Truest possible reproduction of sound



Indiana offers a wide range of INDOX V high-fidelity loud-speaker magnets... in both standard and special sizes.

Investigate the possibility of improving your loud-speaker designs with INDOX V. Indiana's experienced design engineers are available to help you solve your speaker design problems — at no cost or obligation to you. Write for Bulletin 18 M-2, today for more detailed information.

INDIANA STEEL PRODUCTS
Division of Indiana General Corporation
Valparaiso, Indiana

In Canada: The Indiana Steel Products Company of Canada Limited,
Kitchener, Ontario

**INDIANA
PERMANENT
MAGNETS**



offers the
excellent
electrical
advantages of
TEFLON*
plus these important
SERVICES

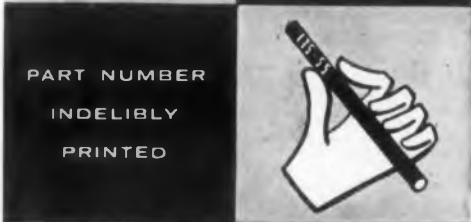

NOTE: PF TEFLON* advantages: good dielectric strength: (500 to 1000 volts/mil); low dielectric constant (2.0) and dissipation factor (0.0002) of any solid dielectric; no change of electrical properties with temperature (-25°C to +250°C) or frequency (60 cycles to 100 mc); zero moisture absorption; unaffected by any commercial chemical.

WRITE, WIRE OR CALL:

PENNSYLVANIA FLUOROCARBON COMPANY, INC.
1115 N. 38th Street, Philadelphia 4, Penna.
Evergreen 6-0603 • TWX PH 252

*TEFLON—du Pont trade name for tetrafluoroethylene resin
CIRCLE 166 ON READER-SERVICE CARD

ELECTRONIC DESIGN • February 17, 1960

Linear Motion Potentiometer 481

Size is 1/2 x 1-1/8 in.

Model 112 linear motion potentiometer, having an over-all size of 1/2 x 1-1/8 in., is available with strokes from 1/4 to 3 in. It contains two independent elements, either or both of which may be linear or conform to a required function. Where taps are needed, as many as 4 per in. per element can be supplied. Linearity is 0.2% the length of stroke, the resistance range is 250 ohms to 125 K per in. of stroke and resolution is 1/35,000 per in. of stroke. The temperature range is -55 to +150 C. Wattage is 1 w per in. of stroke.

Computer Instruments Corp., Dept. ED, 92 Madison Ave., Hempstead, L. I., N. Y.

Price & Availability: Prices will be quoted on request. Delivery is in 45 days or less.

Military Chassis 423

For electronic equipment

This military chassis for electronic equipment, built in accordance with MIL-STD-108 and MIL-E-2036, withstands vibration as per MIL-STD-167, and shock as per MIL-T-17113. Side frames are made of 3/4 x 3/4 x 1/8 in. aluminum extrusions. Mounting plate and rear panel are made of 1/8-in. aluminum and the front panel is 3/16 or 1/4-in. aluminum. Lengths available are 10, 14, and 18 in. Angular construction is used for maximum strength. All hardware is stainless steel.

Electro-Pack, Inc., Dept. ED, 11505 Jefferson Blvd., Culver City, Calif.

Price & Availability: Prices begin at \$57.60. Delivery is in two weeks.

Wire Stripper 606

Removes film or bonded insulation

Model 12 Twinwheel wire stripper is a power driven machine designed for the removal of enamel, Formvar, nylon, cerox, glass, Teflon, and other film and bonded type insulations of combinations of these insulations. It handles sizes from AWG No. 17 to No. 45, either single or stranded conductors. Stripping wheels measure 1-1/4 or 1-1/2 in. in diameter with either 1 or 2 in. wide fibre glass or wire wheels.

Carpenter Mfg. Co., Inc., Dept. ED, DeWitt 14, N.Y.

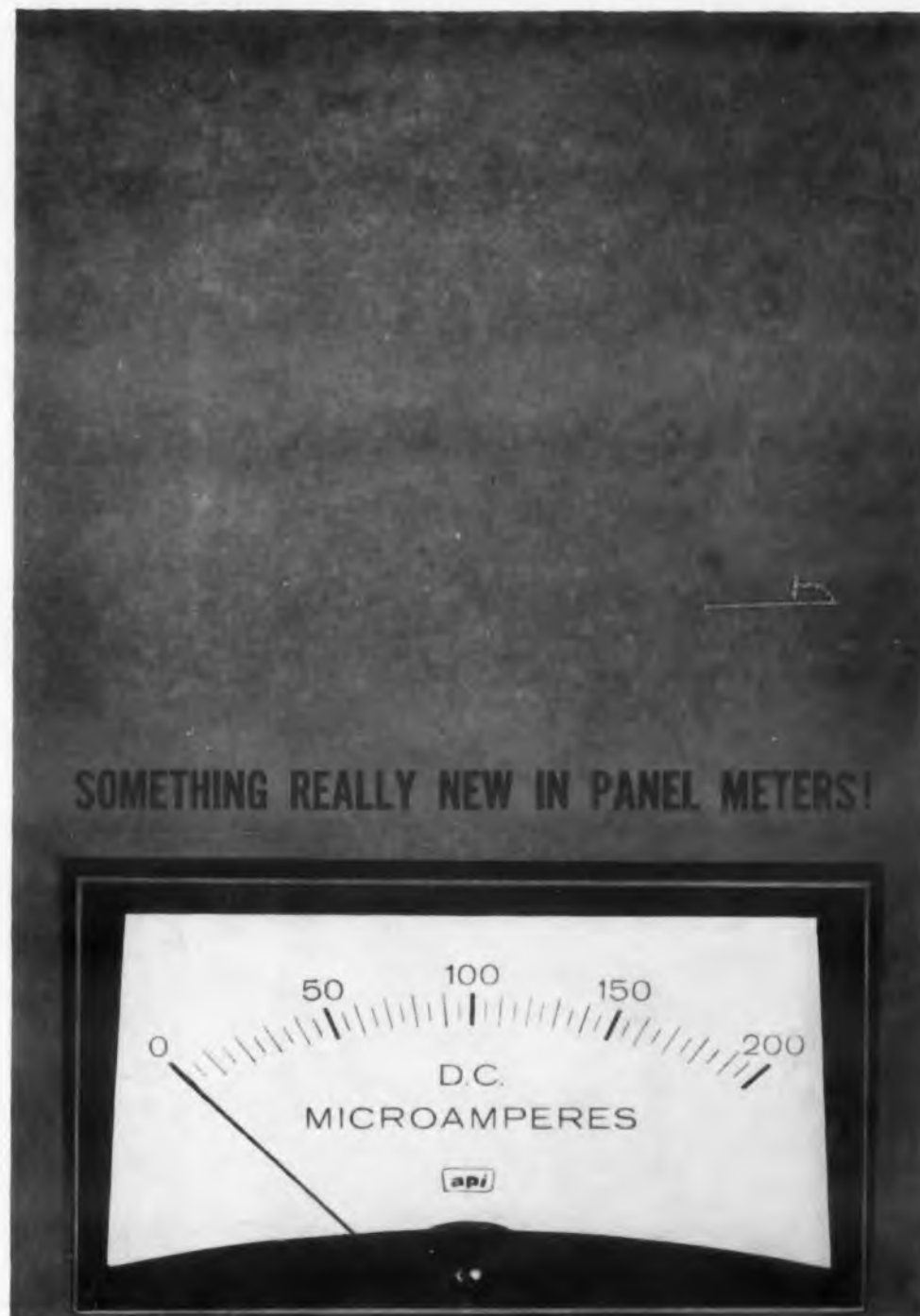

THIS SLIM-LINE, TRIM-LINE STYLIST

Have a look at the most distinctively different meter design in years. Start with styling (as your customers do): note the thoroughbred leanness, the crisply drawn detail, the overall look of precision. Consider function: see how the picture-window dial is recessed and angled back for easier reading. Ponder practicality: observe that the self-trimming case is installed with just a single panel cutout. Sample the specifications: choose from two sizes—Model 561, 5" x 2 7/8", and Model 361, 3 1/2" x 2"; both in satin-finish Bakelite; both available in standard microampere, ampere, millivolt and volt ranges, AC or DC. Prices and other data? Ask for Bulletin 107.



ASSEMBLY PRODUCTS, INC.
Chesterland 17, Ohio

CIRCLE 167 ON READER-SERVICE CARD

S.A. 2110

DOW*Now in magnesium and aluminum*

WELDING. Heliarc welding joins parts of this control central case. Dow facilities and personnel for welding are government certified.



DRAWING. This gyro cover is drawn in a single operation. It replaces a part which consisted of welded components.



ASSEMBLY of this 4-deck housing with rivets, bolts and welds precedes FINISHING with Dow Number 17 anodic treatment.

DOW FABRICATION PLANT SAVES WEIGHT, TIME, COSTS ON ICBM COMPUTER HOUSINGS

Working closely with the customer, Dow engineers suggested design modifications for a three-deck computer housing that yielded improvements in both production and application.

Over-all production costs were lowered 20%-30%, compared to the original design. Per-unit tooling costs were also lowered. The new design resulted in better load distribution and increased interchangeability of parts. Delivery schedules were speeded.

The use of magnesium permitted a weight savings of approximately one-third, weld joint efficiencies of 85% and more, and excellent resistance to thermal shock. The high damping capacity of magnesium alleviates vibration considerably.

Because we are working in both magnesium and aluminum, The Dow Metal Products Company can offer the best solution to weight problems. Dow's experience, plant facilities and quality control system have helped many firms solve tough application problems. Production capacity is now available for fabricated parts and assemblies of magnesium, aluminum and other metals.

For more information contact your Dow Sales Office or write today for illustrated brochure describing Dow fabrication facilities and services. THE DOW METAL PRODUCTS COMPANY, Midland, Michigan, Merchandising Dept. 1040BC2-17.

DOW**THE DOW METAL PRODUCTS COMPANY**

DIVISION OF THE DOW CHEMICAL COMPANY

CIRCLE 168 ON READER-SERVICE CARD

SERVICES FOR DESIGNERS**Digital Design Service 169**

Development of a general purpose computer program which generates wiring lists for newly designed digital equipment directly from the detailed logical design has been announced by Marc Shiowitz & Associates, Inc., an engineering consultant firm. Application of this new programming technique enables clients to receive complete point-to-point wiring lists within hours of logical design completion.

Design need only be carried as far as the logical equations which represent the internal operating functions. Manual preparation of schematic wiring diagrams or detailed wiring lists is not necessary.

Marc Shiowitz & Associates, Inc., Dept. ED, 1350 Crenshaw Blvd., Gardena, Calif.

Teflon Resins 170

Expanded facilities for the machining of Teflon fluorocarbon resins are announced by Chemplast, Inc., E. Newark, N. J. Finished parts can be machined either from standard shapes such as molded or extruded sheets, rods, and tubes, or from specially molded blanks. Typical machined components for the electronics industry include connector inserts, coaxial spacers, radomes, and antenna insulators.

Chemplast also machines nylon stock and Kel-F. In addition, the company supplies sheets, rods, tubes, and custom shapes of Teflon, wire coated with Teflon, and both colored and reinforced Teflon compositions.

Chemplast, Inc., Dept. ED, 3 Central Ave., E. Newark, N. J.

Research Facilities 171

A brochure citing the advantages of using outside independent research teams to help develop a company's programs has been made available by the Manhattan Physical Research Group. Outside research facilities, they say, bring a fresh and unbiased look to company research programs with relatively little red tape. MPRG has done work in nongyroscopic inertial guidance, nuclear reactors, optics, and missile ship-motion simulators.

Manhattan Physical Research Group, Dept. ED, 556 W. 191st St., New York 40, N. Y.

Measurement Instrumentation 172

Specializing in electronic measurement instrumentation, Telemetering Corp. offers complete research, development, and production facilities to meet customer requirements. Results of all services, whether in the field or at Telcor's facilities, are presented in report form with substan-

ERS
169
computer
newly
the de-
y Marc
ng con-
mming
complete
logical

tiating data. Trained personnel are available not only for the installation and testing of Telcor's products, but also to aid in the adaptation of standard models to unique applications.

Another service offered is production subcontracting. Personnel and facilities are available to assist in problems regarding prototype, pilot, or mass production of components.

Telemetering Corp., Dept. ED, Box 645, Mesa, Ariz.

Rapid Servo Construction 173

Gap Instrument Corp., Freeport, N.Y., has developed a servo construction system that permits rapid initial production as well as volume production.

The system depends on modular, jig-bored reference plates which can be stacked for maximum compactness, and are designed to accept standard, stock electrical, mechanical components and hardware. According to the firm, assembly of a unit having the compactness of an ultimate production unit proceeds directly from even a pencil sketch.

Gap Instrument Corp., Dept. ED, 116 E. Merrick Road, Freeport, L.I., N.Y.

Technical Literature 174

The firm's services range from conception of a direct-mail piece introducing a new transceiver through writing, illustrating and publishing a complex handbook on circuit design. At the clients' disposal are research, engineering-writing, layout, technical illustrating, and production staffs. It provides literature services that supplement conventional industrial agency capabilities. Folders, illustrated with photographs, describing the firm's services are available.

Miles-Samuelson, Inc., Dept. ED, 21 E. 26th St., New York, N. Y.

Plastic Moldings 175

A two-color, 12-page booklet discusses compression, transfer, and injection molding processes used by Continental-Diamond Fibre Corp. All molded parts produced by the company are made to requirements and specifications set forth by the customer.

Complete descriptions and a table of properties for nine molding materials are included in the booklet. A selection of typical parts are shown to illustrate the variety of parts produced for electrical applications.

Continental-Diamond Fibre Corp., Dept. ED, Newark, Del.

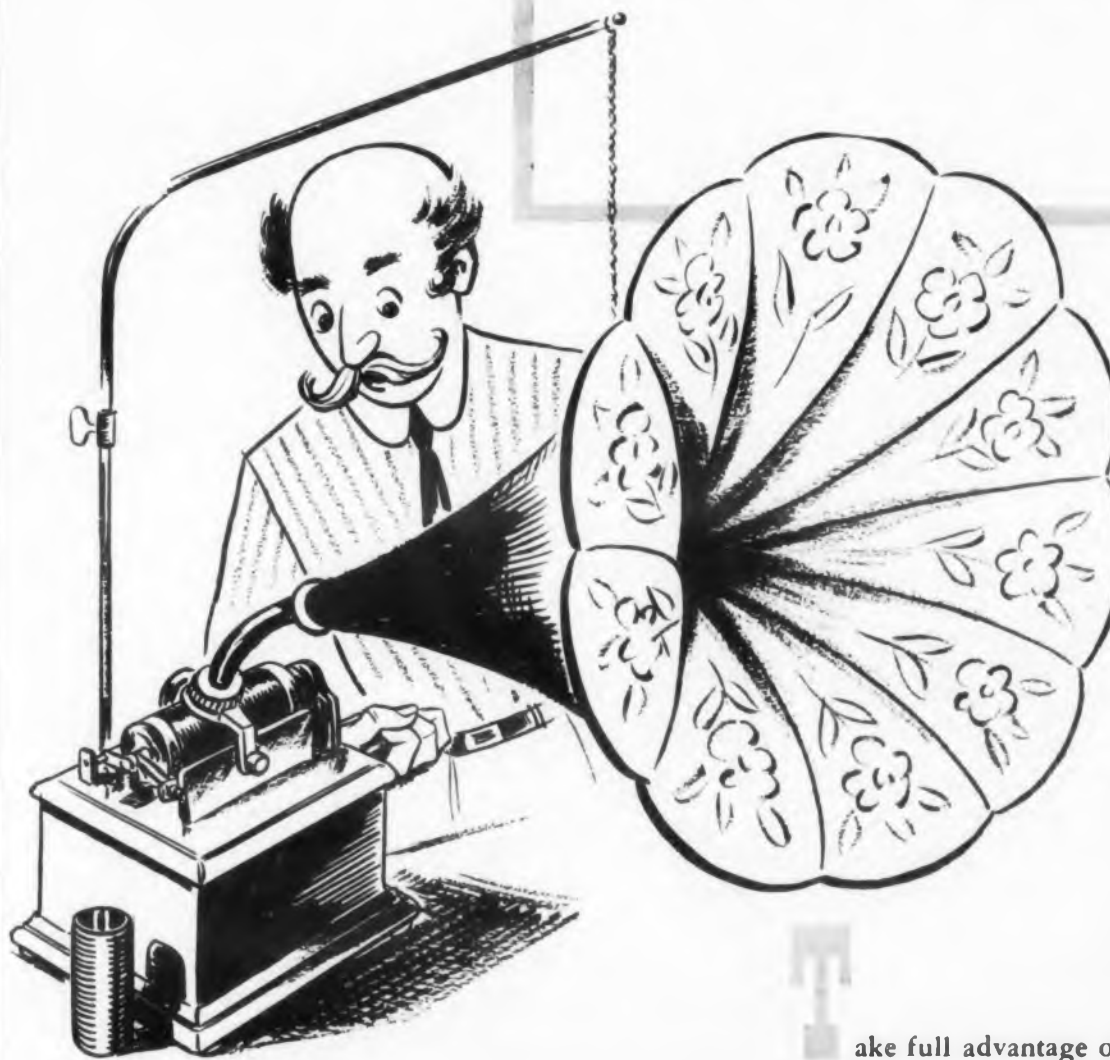

Take full advantage of the in-line digital presentation available with Borg Direct-Reading Microdials. Indexed accuracy is one part in a thousand. Microdials are designed to minimize human reading errors under forced fast reading conditions. Extremely rugged, Microdials meet military specifications. Large numerals are in direct contrast to their backgrounds. Curved, one-piece windows permit wide-angle viewing. Compact size requires minimum space. Available in three, four and five digit models. Finger-tip brake optional. Contact your nearest Borg distributor or technical representative, or write us for full information.

ASK FOR DATA SHEETS BED-A135 & BED-A136

BORG EQUIPMENT DIVISION

Amphenol-Borg Electronics Corporation
Janesville, Wisconsin



Micropot Potentiometers

• Turns-Counting Microdials

• Sub-Fractional Horsepower Motors

• Frequency and Time Standards

CIRCLE 176 ON READER-SERVICE CARD

MICRO-MASTER[®]
105/35 mm
Miniaturization
Process

 **PHOTACT[®]** – Photographic Papers, Cloths and Films 

 **HELIOS[®]** – Dry Diazo Papers, Cloths and Films 

 **ONYX[™]** – Moist Diazo Papers and Cloths 

 **BLUEPRINT PAPERS AND CLOTHS** 

 **DUPRO[®]** – Wash-Off Process Cloths 

 **MADURO[®]** – Brownprint Paper and Cloths 

 **STABILENE[®]** – Dimensionally Stable Drafting,
Scribing and Reproduction Film 

 **ALBANENE[®]** – Prepared Tracing Paper 

 **PROFILE AND CROSS SECTION PAPERS
AND CLOTHS, GRAPH SHEETS** 

 **PHOENIX[®]** – Moisture Resistant Tracing Cloth 

 **HERCULENE[®]** – Drafting Film 



The COMPLETE Line

for originals and reproductions

KEUFFEL & ESSER CO.

NEW YORK • HOBOKEN, N. J. • DETROIT • CHICAGO • MILWAUKEE • ST. LOUIS • DALLAS • DENVER • SAN FRANCISCO • LOS ANGELES • SEATTLE • MONTREAL
CIRCLE 177 ON READER-SERVICE CARD

SERVICES FOR DESIGNERS

Datacenters Rent Computers 178

Scientific and engineering organizations can now rent time by-the-hour on International Business Machines Corp.'s 709 computers at Datacenters in midtown New York and Poughkeepsie, N.Y.

The high speed and flexibility of the 709's make them ideally suited to the specific needs of scientific and engineering firms, according to Gilbert E. Jones, President of IBM's Data Processing Division. The systems can handle up to 42,000 additions or subtractions a second; multiplications or divisions are performed at speeds of up to 5000 a second.

Time at the Poughkeepsie center is immediately available. Customers may now reserve time at the midtown New York facility in the Time & Life Building in Rockefeller Center. Datacenter users supply their own programmers and operators. The hourly rate for a standard system at both locations is \$450. An off-hour rate of \$315 is effective after 6:00 pm.

Data Processing Div., International Business Machines Corp., Dept. ED, 112 E. Post Road, White Plains, N.Y.

Environmental Test Lab 179

An environmental test laboratory to serve the electronics, missile, and aircraft industries in southern California has been opened by Technology Instrument Corp. of Calif., announces President Joseph M. Looney, Jr. The facility is adjacent to leading centers of manufacturing, research, and development.

Shock, vibration, acceleration, temperature, pressure, humidity, corrosion, and life environments are provided in the lab.

Technology Instrument Corp. of Calif., Dept. ED, 850 Lawrence Drive, Newbury Park, Calif.

Printed Wiring 180

The recent merger of Electralab, Inc. and Printed Electronics Corp. has resulted in increased effectiveness in design, development, quality control, engineering, and sales.

Combined facilities, abilities, and experience of the new organization, called Electralab Printed Electronics Corp., are presented in a booklet illustrating the advantages of two plants now functioning as one expanded firm. A series of data bulletins on design, techniques, and application of printed wiring is now being prepared.

Electralab Printed Electronics Corp., Dept. ED, Industrial Center, Needham Heights 94, Mass.

UNIQUE HANDLEY POTENTIOMETER

permits *MANY METHODS
OF MOUNTING!**

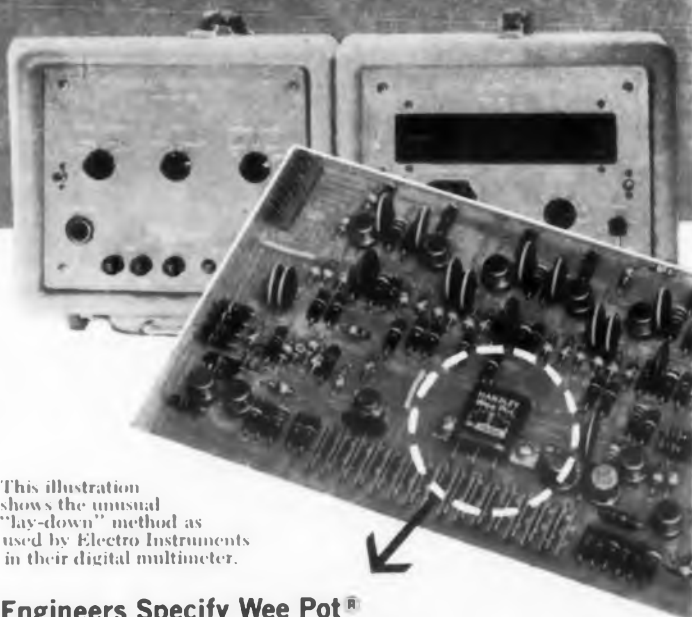

This illustration shows the unusual "lay-down" method as used by Electro Instruments in their digital multimeter.

Engineers Specify Wee Pot® For Their Numerous Applications

The Handley Wee Pot®, because of its mounting flexibility, unusual configuration and long leads, can be mounted in many ways...laid down, vertical, or even "suspended" above the board*. Furthermore, exacting engineers like Wee Pot's extreme accuracy, low impedance, and freedom from back-lash. Under 900 KC, inductive reactance is not measurable. The Wee Pot can be sealed to meet MIL-E-5272A.

*

THREE WAYS THE
WEE POT MAY BE
MOUNTED.

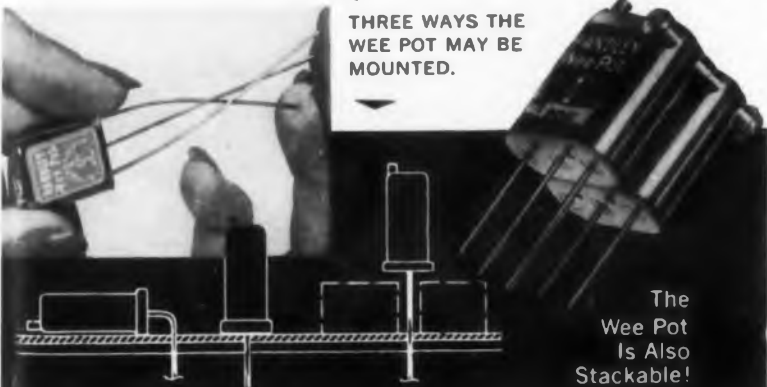

The
Wee Pot
Is Also
Stackable!

TEMPERATURE Wee Pot's temperature range is from -55° to 140 C with (1.3) watts at 40 C.

SHOCK Wee Pot withstands 50 G's meeting MIL-202... exceeding NAS 710 proc. III.

VIBRATION Wee Pot takes 30 G's at 11 milliseconds duration exceeding MIL-R-19.

ACCELERATION The Wee Pot withstands 100 G's at 11 milliseconds duration exceeding MIL-R-19.



HANDLEY POTENTIOMETERS

2030 Colorado Avenue, Santa Monica, California

CIRCLE 181 ON READER-SERVICE CARD

ELECTRONIC DESIGN • February 17, 1960

ELECTRONIC DESIGN ENGINEERING DATA

RC-RL Curves and Nomograms — III

Donald Moffat

Motorola, Inc.

Western Military Electronics Center
Phoenix, Ariz.

Multiple RC or RL sections pose loading problems not encountered in the simple, single sections discussed in Parts 1 and 2 of this three-part series (*ED*, Nov. 11 and Dec. 9, 1959). Here are curves, circuit analyses and nomograms to help in the design of multiple-section networks.

TRANSFER equations for single RC or RL sections, like those in Fig. 1, were given in Part I of this series (*ED*, Nov. 11, 1959, p153). The equations were restricted to sections with negligible loading, since the load produced by one section following an identical section is enough to reduce the usefulness of the equations.

A familiar example is the phase-shift oscillator, where we cannot obtain 180-deg shift simply by using three identical sections, each calculated for 60 deg. It is interesting to investigate the error that would result.

To shift 60 deg, equations for single sections (Fig. 2, of Part I) show that R_0C_0 should be 1.73 and attenuation 6 db per section. As a comparison, look at the actual transfer function for a three-section network:

$$\frac{e_o}{e_i} = \frac{1 \left[-\text{arc tan} \frac{6\omega RC - \omega^3 R^3 C^3}{1 - 5\omega^2 R^2 C^2} \right]}{\sqrt{\omega^8 R^6 C^6 + 13\omega^4 R^4 C^4 + 26\omega^2 R^2 C^2 + 1}} \quad (1)$$

An evaluation of this equation for $RC = 1.73$ shows that the angle is short more than 20 deg, and there is almost twice the attenuation expected. If there is enough gain to compensate the extra attenuation, the circuit will oscillate at a frequency that is in error by more than 40 per cent.

A little more mathematics will show that for 180-deg phase shift, RC should be 2.45, and then the attenuation will be 29.2 db. It is therefore easy to see that if Eq. 1 or the curves to be discussed later are used for the initial design, considerable time will be saved in final adjustments.

It should be emphasized that Eq. 1 is for three identical sections. If the values in the first section will permit it, loading effects can be reduced by increasing the resistance and reactance of each succeeding section by an order of magnitude.

In the same way, equations can be written for two and four sections. For two sections we have

$$\frac{e_o}{e_i} = \frac{1 \left[-\text{arc tan} \frac{3\omega RC}{\omega^2 R^2 C^2 - 1} \right]}{\sqrt{\omega^4 R^4 C^4 + 7\omega^2 R^2 C^2 + 1}} \quad (2)$$

and for four sections,

$$\frac{e_o}{e_i} = \frac{1 \left[-\text{arc tan} \frac{7\omega^3 R^3 C^3 - 10\omega RC}{\omega^4 R^4 C^4 - 15\omega^2 R^2 C^2 + 1} \right]}{\sqrt{\omega^8 R^8 C^8 + 19\omega^6 R^6 C^6 + 87\omega^4 R^4 C^4 + 70\omega^2 R^2 C^2 + 1}} \quad (3)$$

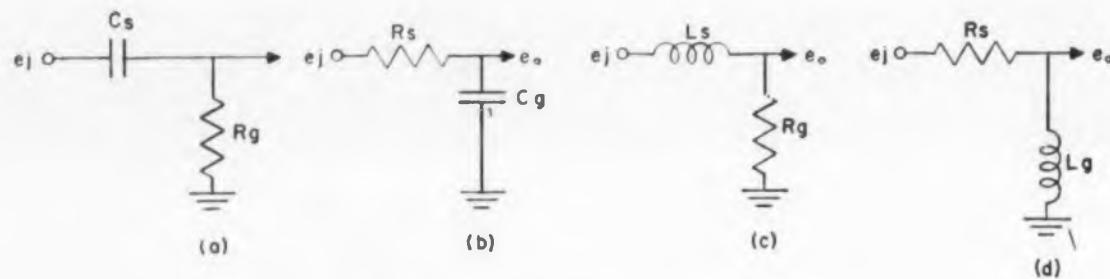

Fig. 1. Four simple transfer circuits.

Fig. 2 shows attenuation and phase shift for one, two, three or four sections. The abscissa is written in four ways; the subscripts on the circuits in Fig. 1 determine which abscissa heading is applicable.

Optimum Number of Sections

At extreme values of frequency, the phase shift will asymptotically approach 90 deg times the number of sections. In this way if 160-deg phase shift is required, it would be impossible with a single section—but the question still remains whether two, three or four sections would be most efficient.

A quick check on Fig. 2 shows there is prohibitive attenuation with two sections, but the decision

to use three or four sections must be examined in more detail. As an aid to this examination, the information in Fig. 2 is given in different form in Fig. 3.

A study of Fig. 3 suggests a rule of thumb for determining the optimum number of sections: use the minimum number of sections that will not average more than 30 deg per section.

Like any other rule, this one must be tempered with judgment. For instance at 100 deg, two sections would attenuate 12 db while three would attenuate 10 db. Unless the 2-db difference meant additional circuitry would have to be added for gain, it would be unwise from the standpoint of reliability to use three sections, involving two additional components.

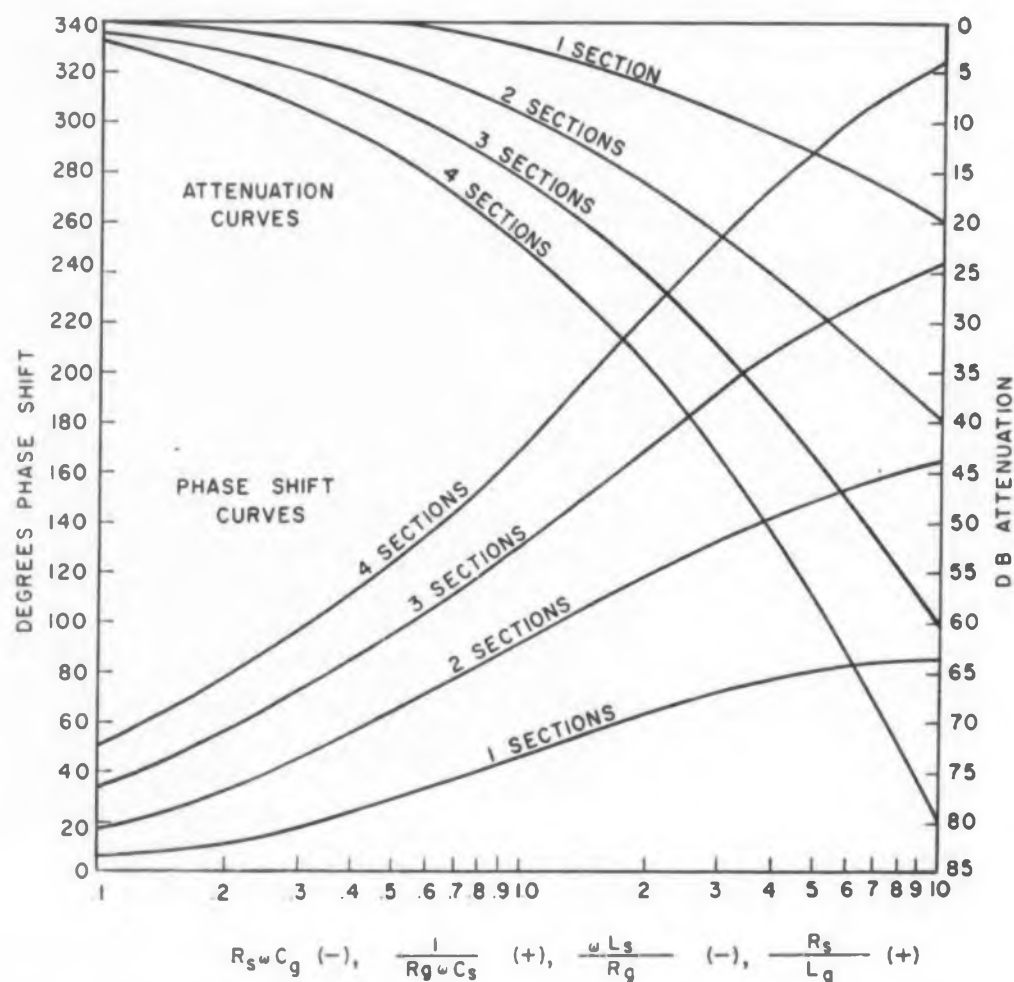

Fig. 2. Attenuation and phase shift for circuits made up of one, two, three or four sections.



What size is a quality fastener?

Here are two ELASTIC STOP® nuts. Each has the familiar red locking collar.* Each is self-locking, vibration proof and reusable. Both stop nuts will maintain an accurate adjustment anywhere on a bolt . . . each prevents liquid seepage along bolt threads and protects against thread corrosion. Finally, each has an unmatched record for quality, both in manufacture and performance.

But . . . one measures 1/10" across the flats; the other, 4". Between these two there are more than 530 different hex nuts in the ESNA line. Look to ESNA for a standard self-locking fastener to fit your special needs. Write Dept. S2257.



*The red locking collar is a Registered Trade Mark of ESNA

ELASTIC STOP NUT CORPORATION OF AMERICA

2330 Vauxhall Road, Union, New Jersey

CIRCLE 182 ON READER-SERVICE CARD



You ought to see what Power Sources is up to



POWER SOURCES, INC.

Burlington, Massachusetts

CIRCLE 183 ON READER-SERVICE CARD

ELECTRONIC DESIGN • February 17, 1960

a
NEW
CONCEPT
in
MICROWAVE
SWITCHING

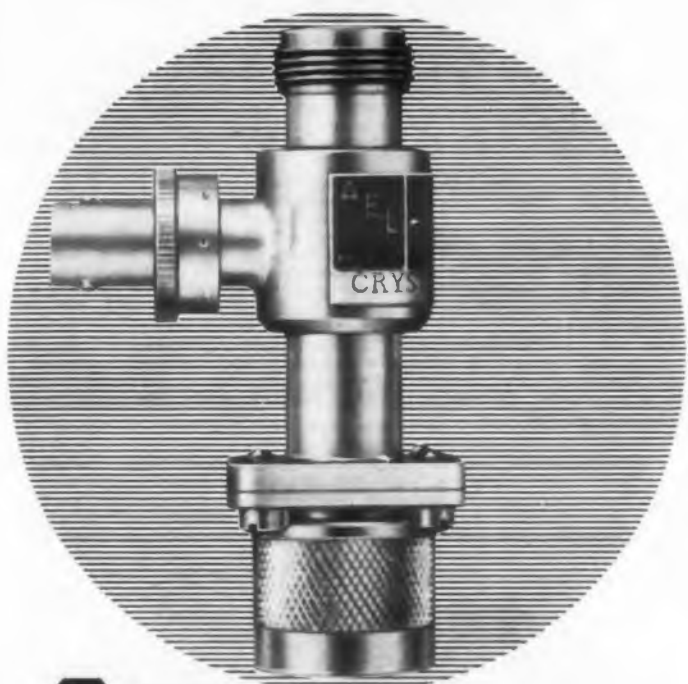

AEL
MICROWAVE COAXIAL
CRYSTAL SWITCH

CLOSED INSERTION LOSS
AS LOW AS $\frac{1}{2}$ db

A new concept in microwave switching developed at the American Electronic Laboratories, Inc., has resulted in the Microwave Coaxial Crystal Switch. Closed insertion loss as low as $\frac{1}{2}$ db. Open attenuation 20 to 30 db increased by series connection of switches if desired. The extremely low power requirement of as little as 16.5 milliwatts and high switching speeds of over 10 millimicroseconds make this switch a natural for high speed antenna lobe switching, microwave chopping for crystal video detection of RF, high speed commutation, and also as a high speed switching device for computers. Additional characteristics are its virtual independence of its switching characteristics to temperature over a range from -55° to $+71^{\circ}\text{C}$., its ability to dissipate up to 1 watt of power internally and its high degree of reliability.

MORE DATA ON REQUEST

Investigate the opportunities at AEL for creative engineers

AEL AMERICAN ELECTRONIC
LABORATORIES, INCORPORATED
121 N. 7th ST., PHILADELPHIA 6, PENNA.

In Canada contact: Conway Electronic Enterprises Regd., Toronto, Canada

CIRCLE 184 ON READER-SERVICE CARD

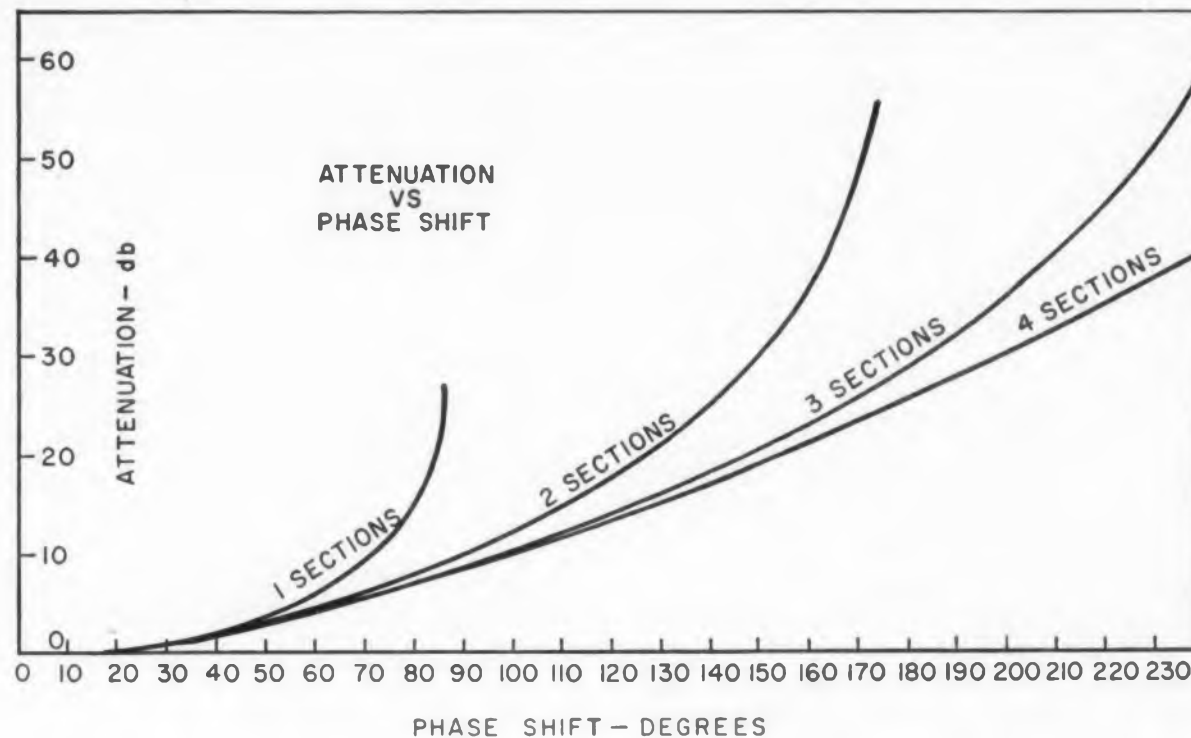

Fig. 3. Attenuation and phase shift for circuits described in Fig. 2. Curves part company every 30 deg.

Two more items are worth considering when deciding on the number of sections.

First is selectivity. Outside of the corner, roll-off will proceed at six db per octave for each section. If frequency discrimination is important, it might be worthwhile to add sections and increase the rate of attenuation of undesired frequencies.

Second is the rate of change of phase, which increases with the number of sections. If constant

phase shift is desired over a band of frequencies, every attempt must be made to reduce the number of sections.

RC Differentiator

For frequencies that are low compared with the corner frequency ($f_c = 1/2\pi RC$), the circuit of Fig. 1a will act as a differentiator. In the limiting case—dc—the circuit will be a perfect differentiator: there will be zero rate of change, and there

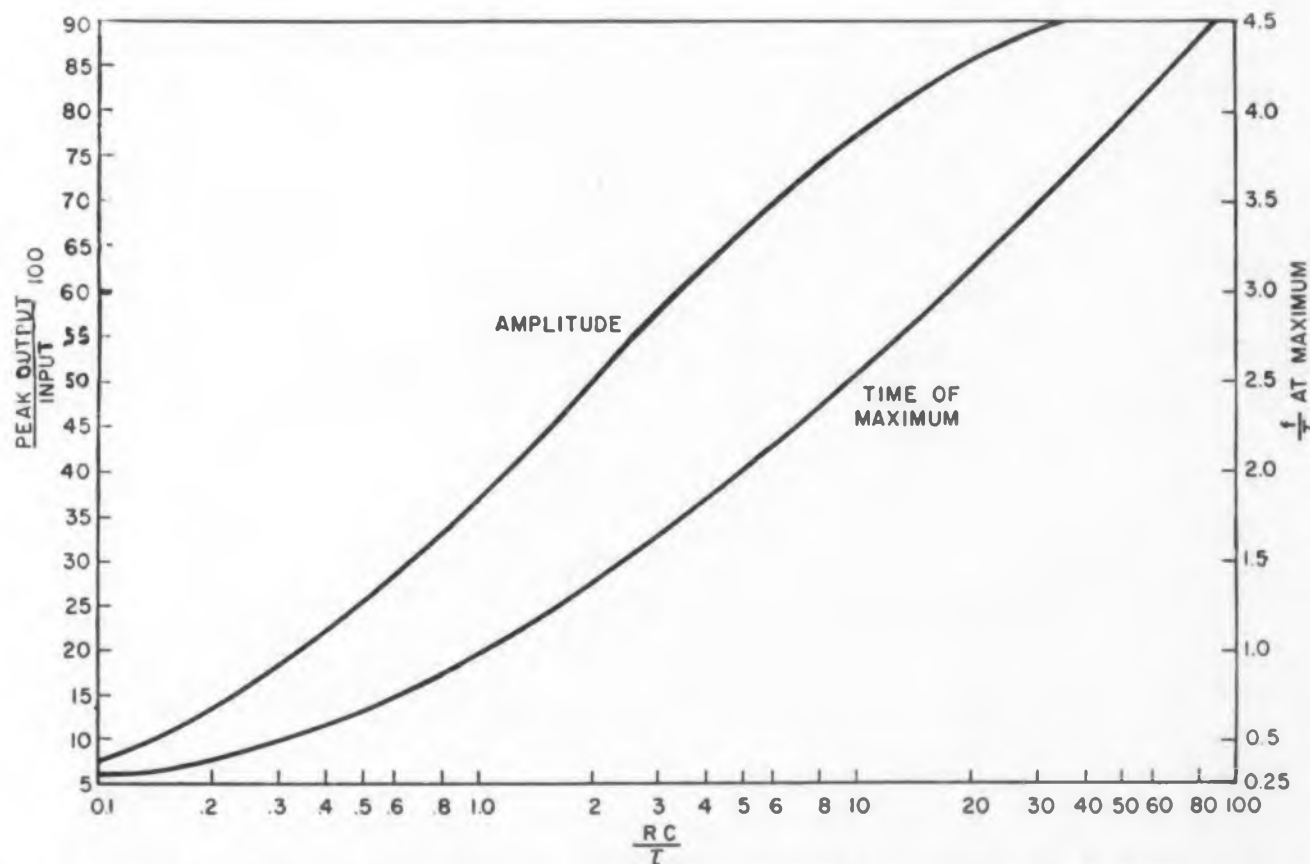

Fig. 4. Time and amplitude of pulse maximum varies directly with R_p and C_s , inversely with τ , in circuit of Fig. 1a.

will be zero output.

If a square wave is applied to such a circuit, the output will consist of a pulse at each jump in the input, followed by a return toward zero during the square wave. It is helpful to investigate the dependence of the pulse amplitude and rise time on R , C , and input rise time. Every voltage change must occur over a finite length of time, usually caused by charging of stray capacitances. A valid assumption therefore is that the square wave will be of the form

$$e_i = E(1 - e^{-t/\tau}) \quad (4)$$

Where τ is the time it takes to reach 63.2 per cent of its maximum, Millman and Taub¹ have shown that the output will follow the equation

$$e_o = \frac{En}{n-1} (e^{-x/n} - e^{-x}) \quad (5)$$

In this case $x = t/\tau$ and $n = R_p C_s/\tau$. As expected, the curve of this equation rises from zero to a maximum and then falls back toward zero. Further examination shows that the time of maximum will be $x = n \ln(n)/(n-1)$.

This tells us that the time of maximum varies with R_p and C_s and inversely with τ . Substitution of the above equation into Eq. 5 will give the pulse amplitude at maximum. Fig. 4 is a curve showing both time and amplitude of maximum.

If the objective is to pass a square wave rather than differentiate its edges, the time constant $R_p C_s$

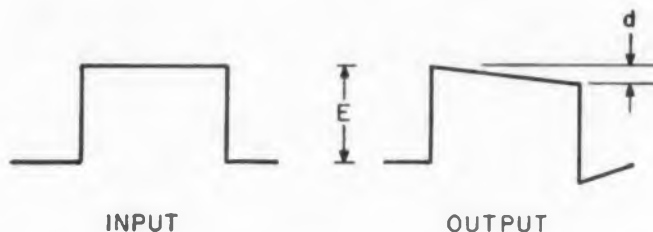

Fig. 5. Decay of square-wave when passed through an RC differentiator.

is made much larger than the duration of the square wave. The leading edge will rise to the same amplitude as the input, but then the top will decay according to

$$d = E(1 - e^{-t/RC}) \quad (6)$$

where the meaning of d is shown in Fig. 5. Expressed as a percentage tilt, this is

$$\text{Per-cent tilt} = (1 - e^{-t/RC}) 100.$$

Nomograms

With Nomogram 1 the designer can quickly determine per-cent tilt for a given circuit, or a suitable combination of R_p and C_s for a specified tilt. In the latter case, draw a straight line from the square-wave duration on the t scale to the specified value on the *Tilt Scale*. Then rotate a straight edge about the point where this line crosses the *Turning Scale*. Every combination of R and C joined by the straight edge as it rotates will result in the specified amount of tilt.

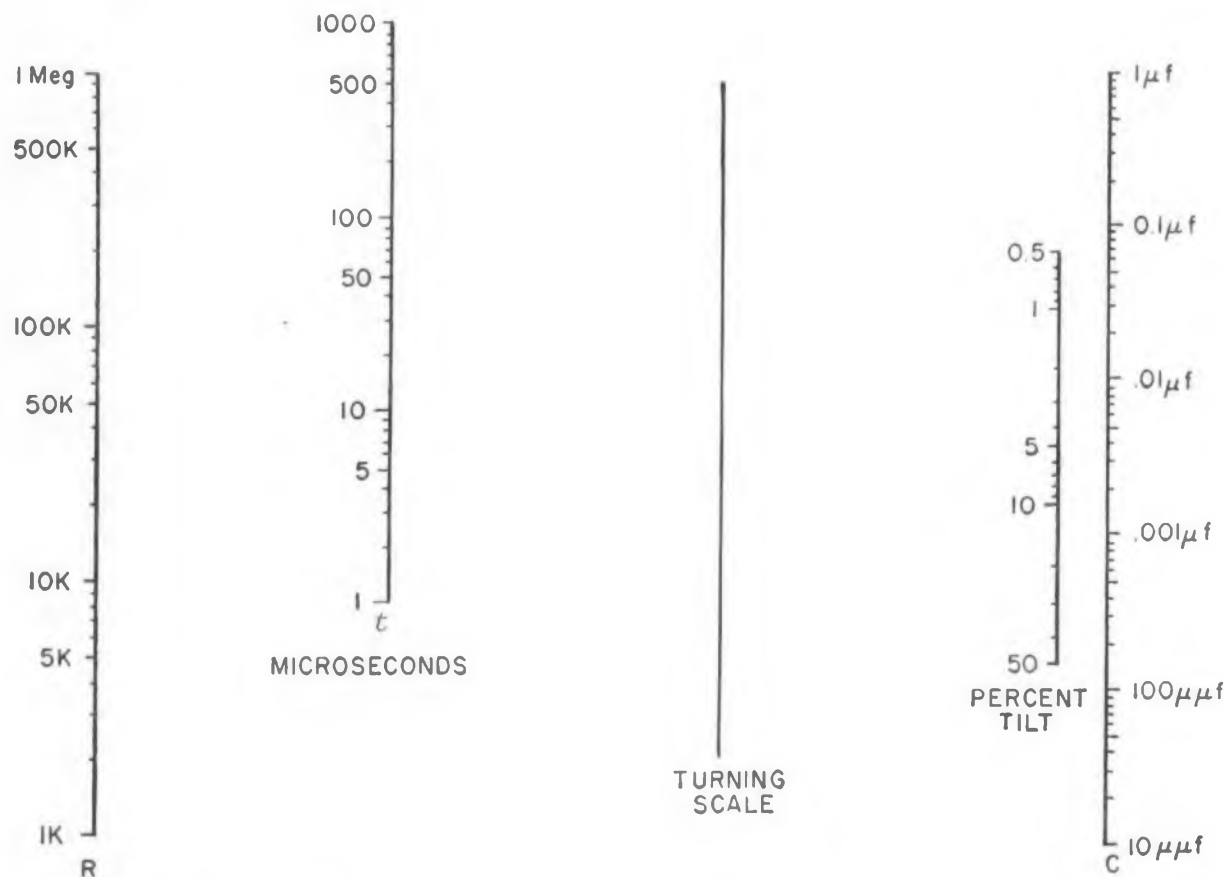

Nomogram to determine per-cent square-wave tilt for a given RC circuit, or a suitable combination of R_p and C_s for a specified tilt.



NEW CMC UNIVERSAL Counter Timer

CMC's new Model 2268 Universal Counter Timer has a functional panel layout that is human engineered to eliminate costly "cockpit" trouble. Inside, modular construction is used throughout to simplify maintenance and reduce weight. Circuitwise, 9 tubes have been eliminated lowering power drain, operating temperature and increasing reliability.

Direct reading, the 2268 measures frequency from 0 to 1.2 mc, time interval from 1 microsecond to 1 million seconds and period from 0 microsecond to 1 million seconds. Accuracy is ± 1 count \pm stability. Stability is 2 parts in 10^7 with an option to 5 parts in 10^8 . Sensitivity is 0.1 volt rms over entire range. Oscilloscope marker signals simplify start and stop trigger level adjustment for TIM of complex wave forms. Unit will drive the CMC fast digital printer and most other types of printers and data handling equipment. Price fob Sylmar, California: 1 mc Model 2268-\$1175.00; 220 kc Model 225C-\$900.00. For 4-page bulletin giving complete technical specifications, contact your nearby CMC representative or write directly to Computer Measurement Company, 12970 Bradley Ave., Sylmar, California, Dept. 6666.

CIRCLE 194 ON READER-SERVICE CARD

HEMINWAY
& BARTLETT

FLAT BRAIDED NYLON LACING TAPE

ties a knot
that holds tight!

Try this $\frac{1}{8}$ " Nylon Braided tape and you'll be convinced that *no other* tape ties so easy and fast...holds so tightly without slipping! Yes, for harness tying—be sure to specify Heminway & Bartlett's Nylon Braided Tape. Fungus-proof, of course! Meets Govt. Spec. Mil-T-713A.

Available in Nylon or Dacron—waxed, wax-free or resin-coated finish.

Sold nationally by Alpha Wire, New York

Write for full information and free samples!

THE HEMINWAY & BARTLETT MFG. CO.
Electronics Division: 500 Fifth Avenue, New York 36

CIRCLE 195 ON READER-SERVICE CARD

ELECTRONIC DESIGN • February 17, 1960

STAR STAINLESS DOWEL, COTTER & TAPER PINS

(18/8 & Series 400)
Dowel Pins (MS16555) from 1/8" to 3"
long, 1/16" to 1/2" dia. Tolerances:
Comm. ±.0005, Precision ±.0002. Cotter
Pins (AN380C, AN381) from 5/16" to
4" long, 1/32" to 1/2" dia. Taper Pins
(AN385) 1/4" to 5" long, 1/16" to
23/32" dia.

RIGHT OFF THE SHELF

This is just one of the many lines
in Star's stock of stainless steel
fastenings listed in our 1960
Catalog.

- STAINLESS STEEL 300 & 400 Series
- BOLTS & NUTS
- WASHERS • PINS
- AN & MS FASTENERS

Send for YOUR Catalog today,
letterhead please.



New
1960
catalog
Now
Ready



STAR STAINLESS SCREW CO.

CORROSION
RESISTANT

663 Union Blvd., Paterson 2, N.J.

Telephone: Clifford 6-2300

Direct New York phone: Wisconsin 7-6310

Direct Philadelphia phone: Walnut 5-3660

CIRCLE 196 ON READER-SERVICE CARD

DORSETT



Qualified Telemetry System MEETS MIL-E-5272 Environment

This is the Ryan Q-2C Firebee Drone's telemetering system... packaged by Dorsett engineers in a compact 8" x 13" x 5 1/4" configuration. These standard Dorsett telemetry components are used in the Model TMS-106 system: up to ten Model O-3 tube-type subcarrier oscillators, a Model PS-31 solid state power supply, an R-40 voltage regulator, a Model TR-4 PM transmitter, and a 25-watt A-25 amplifier.

For your telemetering requirement, whether missile, aircraft, drone, or balloon, DORSETT provides proved capabilities and facilities for the design and production of FM/FM, FM/PM, FM/FM/FM and PDM/FM systems and components. Geared to quantity production orders, DORSETT also provides close progressive technical liaison that assures customer satisfaction. Write today for specifications on proved-design DORSETT telemetry equipment.

DORSETT

Electronics Laboratories, Inc.

P. O. BOX 862

TEL. JE 4-3750 NORMAN, OKLA.

CIRCLE 197 ON READER-SERVICE CARD

ELECTRONIC DESIGN • February 17, 1960

When RC sections are used as filters, the cut-off, or corner frequency, is usually specified as the frequency at which attenuation is three db. Filters of one to four sections can be quickly designed with the aid of Nomogram 2. Draw a straight line through the selected number of sections and the desired cut-off frequency. Rotate a straight-edge

about the point where this line crosses the *Turning Scale*. Every combination of R & C connected by the straight-edge will yield the desired frequency response.

References

1. Millman and Taub, "Pulse and Digital Circuits," McGraw-Hill Book Co., New York, 1956, p35.

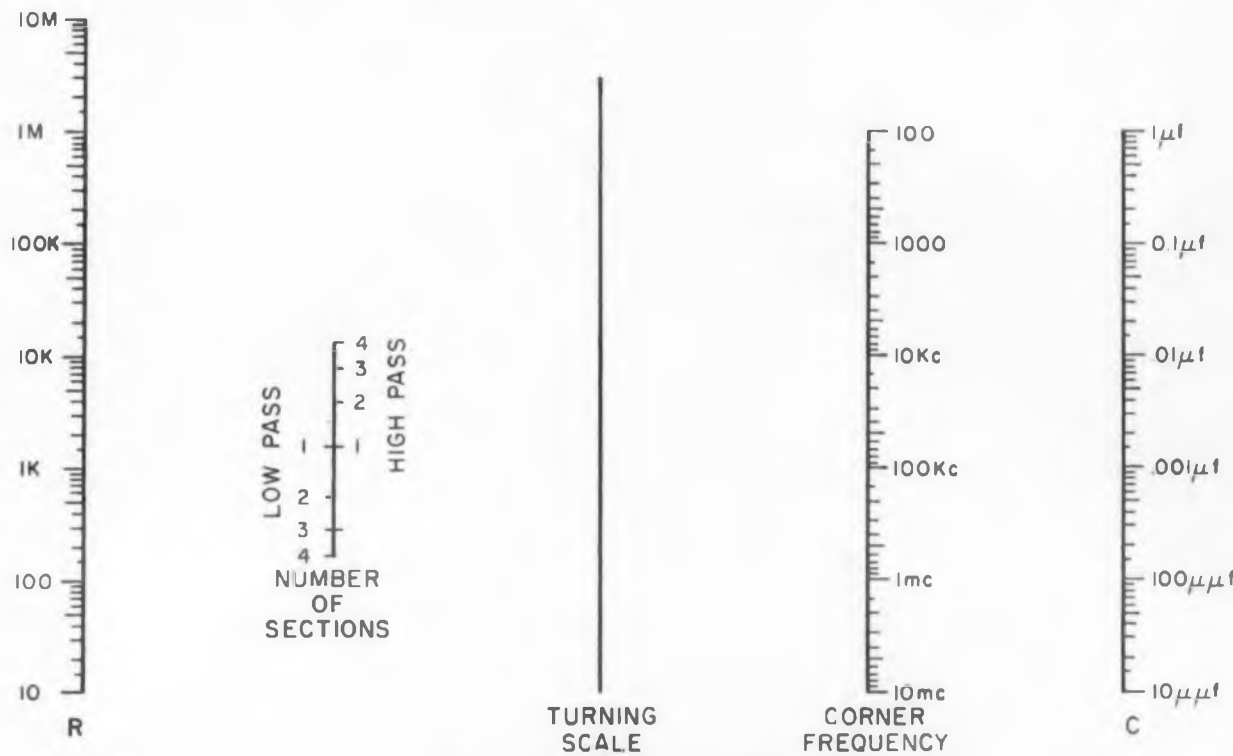

Nomogram to design RC filters.

Correction

The following nomogram is a corrected version of one published in Part I of this series (ED, Nov. 11, 1959, p 155):

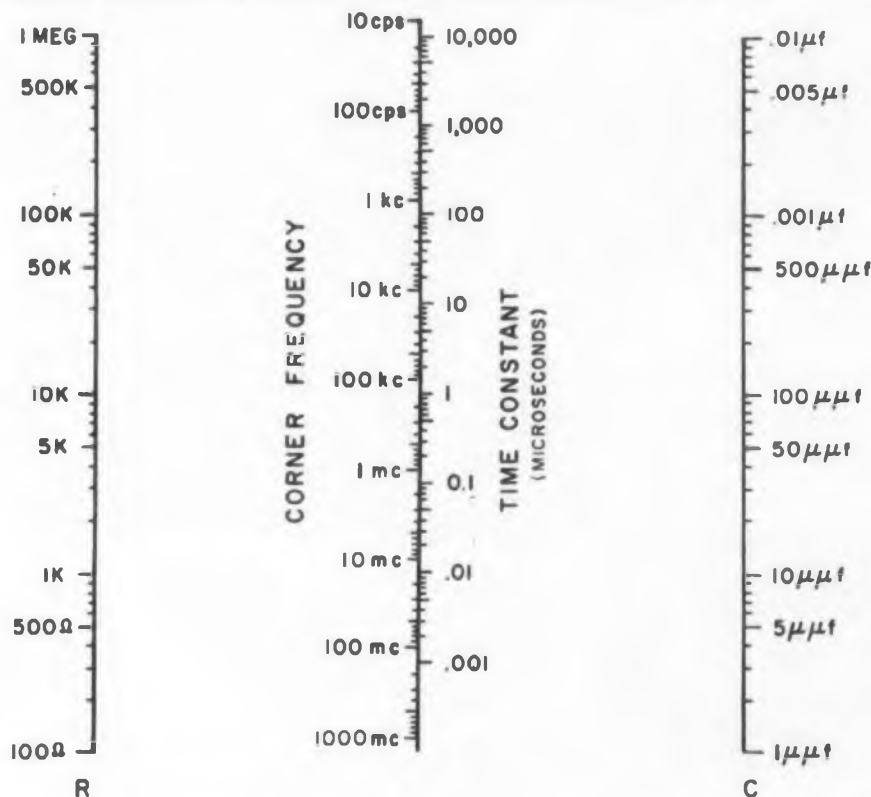

Nomogram of $R_p C_p - R_s C_s$. Both scales correspond to both sides of the equation.

size 5 motor generator—JUST OUT!



Here it is . . . the smallest—and lightest—motor generator combination in the industry today. And you can get it with the new Size 5 Gear Train, too. Weighing a mere 1.1 oz., the Size 5 develops a minimum stall torque of 0.11 oz. in. and has a free speed of 10,000 rpm. Units are available for 400 cycle operation with 26 or 33 control phase winding. The control phase is split for operation directly with transistor amplifiers.

Write for complete specifications. And be sure to get all the details on our new synchro line. Daystrom Transicoil Division, Worcester, Montgomery County, Pa. Phone: JUnio 4-2421.

In Canada: Daystrom, Ltd., 840 Calendon Rd., Toronto 18, Ont.

Foreign: Daystrom International Division, 100 Empire Street, Newark 12, N.J.

DAYSTROM

TRANSICOIL DIVISION

CIRCLE 188 ON READER-SERVICE CARD

NEW LITERATURE

Power Connectors 189

Bulletin No. PL-2 illustrates and describes the N-UP 121M power connector. The unit has a pivotally-mounted grounding blade which provides automatic ground connection when plugged into either 2 or 3 pole receptacles. Specifications include construction materials, electrical ratings, and wiring instructions. A.P.M. Corp., 252 Hawthorne Ave., Yonkers, N.Y.

Adhesive Applicator 190

An adhesive applicator that feeds solvent and water-based adhesives through a flexible hose directly into a brush under ordinary factory air pressure is described in this two-page bulletin. B. B. Chemical Co., Bostik Dept., 784 Memorial Drive, Cambridge, Mass.

Telemetry Systems 191

This two-page data sheet describes and illustrates several models of airborne telemetry systems. Types of systems include fm/fm and fm/pm. Specifications contain data on physical characteristics, outputs, power requirements, and applications. Dorsett Laboratories, Inc., Box 862, Norman, Okla.

Power Systems 192

Applications, engineering data, subsystems and system-component operating characteristics, and recommended standard system combinations of Precise-Power Sets are discussed in this 32-page bulletin. Sections are devoted to: Applications of Precise-Power Sets to Large Electrical Systems; Motor-Generators for AC-DC Power Conversion; Field Current Regulators for Motors, Alternators, and Generators; Sensing Elements; Signal Amplifiers; Power Amplifiers; and Control Systems and Switch-gear. Electric Specialty Co., 211 S. St., Stamford, Conn.

Components 193

Catalog No. 61, 512 pages, covers 20,000 items listed from stock. Some of the components included are: gears and gearheads, precision dials, vernier and disc dial sets, slip clutch assemblies, alligator clips, test leads, banana and tip plugs, jacks, adapters, and terminals. The catalog contains information on tolerances, materials, finishes, and prices of listed components. Sterling Precision Corp., Component Div., 17 Matinecock Ave., Port Washington, Long Island, N.Y.

Checkout Equipments

198

An rms to dc converter, a voltage to digital converter, a timer-counter, and a digital printer are the automatic checkout equipment units that are described in this four-page brochure. The units are designed to meet the requirements of MIL-E-4158B. Epsco, Inc., Equipment Div., 275 Massachusetts Ave., Cambridge 39, Mass.

Micromodule Wafers

The production of micromodule wafers is described in this four-page bulletin, No. MMW. From a photographic reduction, glass is chemically machined and converted into a ceramic. The process produces four stock wafers: end wafer with hole; end wafer without hole; standard wafer with hole; and a transistor wafer. Design properties and an enlarged dimension drawing are included in the bulletin. Write on company letterhead to Corning Glass Works, Receiver Bull Sales Dept., Dept. ED, Corning, N.Y.

Tape Recording Terms

199

This booklet contains a glossary of high fidelity and tape recording terms. The four-page booklet is entitled, "99 Tape Recording Terms." Minnesota Mining & Manufacturing Co., Dept. E9-520, 900 Bush Ave., St. Paul, Minn.

Audio Switching Transistor

200

Type 2N1120 germanium pnp audio switching transistor is described in this two-page data sheet that includes electrical and environmental test data, maximum ratings, and storage temperature and thermal resistance data. Bendix Aviation Corp., Semiconductor Div., Long Branch, N.J.

Heating Elements

201

The firm's facilities and products are illustrated and described in this brochure, eight pages. In addition to flexible band heaters and strip heaters, the firm manufactures resistors. H. W. Tuttle & Co., Tecumseh, Mich.

Waveguide Data Chart

202

Electrical and mechanical parameters for all waveguides in use today appear on this data chart. Some of the parameters covered are: cut-off frequency, theoretical attenuation for both brass and aluminum waveguides, and the waveguide wavelength from the lowest to the highest frequency in any given band. Military as well as EIA designation numbers are also listed. Narda Microwave Corp., 118-160 Herricks Road, Mineola, Long Island, N.Y.



SM TYPES



SL TYPES



S & R TYPES



MICRO-MINIATURE B SERIES



THE ONLY COMPLETE LINE OF BALANCED ROTARY RELAYS

VIBRATION RESISTANT RELAYS

The heart of every Hi-G RELAY is the ROTARY BALANCED ARMATURE, effectively designed to provide superior resistance to smashing shock and severe vibration. Permanent magnet stabilization allows full contact pressure, eliminating chatter and eventual relay failure. Standard vibration immunity of 20G to 2000 CPS. Special units to 50G or more. For constant dependability under extreme operating conditions — see Hi-G.

Write for new catalog No. 259
for complete information
and specifications



See Hi-G at the IRE Show
Booth No. 2227

Hi-G INC.

BRADLEY FIELD, WINDSOR LOCKS, CONN.

CIRCLE 203 ON READER-SERVICE CARD



RELAY RELIABILITY

...where it counts!

Best proof of Dunco Type FC-6 reliability is the fact that these sturdy little relays are specially designed to play important parts in all of the missile programs illustrated above—and several more besides.

Type FC-6 Relays are spotlessly clean. They have a new and outstandingly dependable contact material, and include unique design features that provide positive protection against extreme vibration and shock.

Dunco Bulletin FC gladly sent on request

Member, National Assn. of Relay Manufacturers

STRUTHERS-DUNN



Makers of the world's largest selection of relay types

STRUTHERS-DUNN, Inc., Pitman, N. J.

Sales Engineering Offices in: Atlanta • Boston • Buffalo • Chicago • Cincinnati • Cleveland • Dallas • Dayton • Detroit • Kansas City • Los Angeles • Montreal • New Orleans • New York • Pittsburgh • St. Louis • San Francisco • Seattle • Toronto

CIRCLE 209 ON READER-SERVICE CARD

NEW LITERATURE

Electronic Pumps 210

This two-page bulletin describes the model 150 electronic high-vacuum pumps with corresponding power supplies which operate the units in general laboratory applications as well as vacuum tube processing and thin film work. A calibration curve is included with pump current plotted against pumping pressures. Ultek Corp., 920 Commercial St., Palo Alto, Calif.

Diode Semiconductors 211

A 17-page booklet entitled "Applications of New and Recently Developed Diodes" covers topics such as varactor characteristics and measurements, varactor computers, silicon mesa computer diodes, the Esaki tunnel diode, and thermoelectric devices. Emphasis is placed on the use of varactors as modulators and harmonic generators. Microwave Association, Inc., Burlington, Mass.

Fabricated Insulation 212

The firm's complete line of fabricated electrical insulation is listed in this eight-page bulletin, No. 32. Products include precision slit insulation, wedges, slot insulation, and fabricated parts in a variety of materials, shapes and sizes. Fabricated products and operations are briefly described and illustrated. Inmanco Div. of Insulation Manufacturers Corp., 565 W. Washington Blvd., Chicago 6, Ill.

Choppers 213

Series 310 choppers, designed for continuous 400 cps operation at temperatures from -65 to $+125$ C, are described in bulletin No. C-52, a one-page data sheet. Mounting styles and phase angle ranges are given in tabular form. An outline drawing of the high temperature choppers is included. Airpax Electronics, Inc., Cambridge Div., Cambridge, Md.

Welch TWO-STAGE DUO-SEAL® High Vacuum PUMP

Run-In To Perfection

- DEPENDABLE PERFORMANCE
- QUIET OPERATION
- LONG LIFE

Choice of Two Speeds

Revolutions per minute	300	525
Vacuum, microns (0.0005 mm)	0.05	0.1
Capacity, liters/min.	33.4	58
Motor Horsepower	1/3	1/2

WRITE FOR OUR
PUMP CATALOG



Pat. No. 2,339,849

Pat. No. 2,337,849	No. 1405-B
No. 1405B. DUO-SEAL VACUUM PUMP, Motor Driven, 525-RPM. For 115 volts 60 cycles, A.C. Each	\$255.00
No. 1405H. Duo-SEAL VACUUM PUMP, Motor Driven, 300-RPM. For 115 volts 60 cycles, A.C. Each	\$230.00

For attached Belt Guard add \$17.50 to the above prices.

See our Pump Catalog for complete listing of this series high vacuum pumps.

W. M. WELCH SCIENTIFIC COMPANY
DIVISION OF W. M. WELCH MANUFACTURING COMPANY
ESTABLISHED 1880

1515 Sedgwick Street, Dept. ED, Chicago 10, Illinois, U. S. A.

CIRCLE 214 ON READER-SERVICE CARD

ELECTRONIC DESIGN • February 17, 1960

Soldering Equipment 218

This four-page folder contains information on the firm's line of electric heating elements. Soldering tools, crucibles, and pots are included in the illustrated bulletin. Vulcan Electric Co., Danvers, Mass.

Relay 219

Coil and contact ratings and dimensional drawings of the model RH relay appear in this one-page data sheet. The unit employs a nylon blade lifter for long life and dependable operation. An actual size photograph is included. Artisan Electronics Corp., 171 Ridgedale Ave., Morristown, N.J.

Motors 220

Design characteristics of shielded, dripproof motors are given in this four-page bulletin, No. 196. The motors are for use where adverse conditions of moisture, humidity, dust, oil, and chemicals prevail. Sterling Electric Motors, Inc., 5401 Telegraph Road, Los Angeles 22, Calif.

Servo Problem Calculator

This calculator permits solution of servo problems without lengthy calculations. It can be used to design and evaluate closed loop feedback systems such as servo drives, feedback amplifiers, power supplies, and radar loops. Typical problems solved include: system stability; effect of gain change on stability; determination of velocity and acceleration constants; gain and phase margins; and lead-lag networks. *Price of the calculator plus plotting paper is \$4.50. Control Aids Inc., Dept. ED, Box 207, Woodmere, Long Island, N. Y.*

RF Connectors and Cable 221

This 25-page reference guide lists rf cables and connectors, gives a cross reference between military and commercial code numbers, and contains descriptions and technical data on most types of commonly used connectors. Data on waveguides, waveguide flanges, and waveguide adaptors are also included. Western International Co., 45 Vesey St., New York 7, N. Y.

DIMCO-GRAY SNAPSLIDE FASTENERS

**PROVIDE VIBRATION-PROOF HOLDING
AND QUICK, FOOL-PROOF RELEASE!**

APPROVED UNDER ARMY-NAVY STANDARDS

Here's a simple, easy means of securely fastening assemblies to withstand shock or vibration, and yet allow quick removal for inspection or repair. Instant snap action engages or releases fastener . . . no tools are required! After installation, fasteners never need adjustment . . . even with repeated use.

Three sizes available for different load requirements. Large and medium sizes are made of corrosion-resistant stainless steel. Small size is made of nickel-plated brass. Stock parts fit various thicknesses of flanges and mounting plates . . . special parts can also be supplied.

WRITE FOR FULL DETAILS TODAY!

201 E. SIXTH STREET DAYTON, OHIO
CIRCLE 222 ON READER-SERVICE CARD

ELECTRONIC DESIGN • February 17, 1960



DRAFTING TRENDS



This versatile, easy-to-handle, adjustable triangle is made of yellow-tinted optical-grade acrylic plastic. A clean-cut oval track fitted with metal knurled knob assures ease of operation and lasting tight fit.

New combination protractor-triangle speeds up drafting

Architects, Engineers, Builders, Field Surveyors, Mathematicians—anyone who develops solutions to measurement problems indirectly to determine a wanted measurement graphically or mathematically—will find the Trig-Matk Adjustable Triangle a handy tool. It eliminates much of the graphic work necessary in estimating results or in checking for correct answers.

Versatility with accuracy

Basically the new Post Trig-Matk Adjustable Triangle is a mathematician's tool—accurate to three decimal places.

It combines the functions of a protractor and a triangle into a simple unit, with two fundamental trigonometric relationships of a right triangle. The Trig-Matk provides accuracy within 0.1% in problems dealing with any of the six trigonometric ratios of the sides of a right triangle.

The adjustable protractor has three sets of graduations. One set is graduated in half degrees, labeled *Degrees*, and permits the use of the Trig-Matk as a protractor setting for determining any angle from 0 to 90 degrees.

The second set of graduations, labeled *Slope*, shows directly the *Secant* trigonometric ratio of the angle indicated on the degree scale. The third scale, labeled *Rise*, indicates directly the *Tangent* trigonometric ratio shown on the degree scale.

Examples

This new tool has a host of drafting and engineering applications. Highway designers find the Trig-Matk very useful when making cross sections of roadways at ground level or below. By



An indicated angle of 40 degrees on the TrigMatk (1589) shows directly that the Rise is 8.4 to the base of 10.

setting the *Slope* scale to the degree desired, road-curve grades are automatically determined. The protractor can be used to determine the angle of highway ingress and egress lanes.

Structural Engineers will find the Trig-Matk Adjustable Triangle a simple tool, eliminating the use of both a scale and individual triangles. In addition to the time saved, many of the errors usually associated with the older method are avoided. The Trig-Matk design eliminates the need of frequent reference to handbooks for information on various bevels.

Two Bases

The Trig-Matk No. 1589-12 has a 12" base scale for handy calculation in terms of feet and inches. Number 1589-10 has a metric base scale of 10.

Keep posted on all the latest trends in drafting. Consult your local POST dealer, or write to Frederick Post Co., 3644 North Avondale Ave., Chicago 18, Ill.



SENSITIZED PAPERS & CLOTHS • TRACING & DRAWING MEDIUMS • DRAWING INSTRUMENTS & SLIDE RULES
ENGINEERING EQUIPMENT & DRAFTING SUPPLIES • FIELD EQUIPMENT & DRAFTING FURNITURE

CIRCLE 223 ON READER-SERVICE CARD



now available from G-L . . .

HIGH PERMEABILITY nickel alloy Magnetic Laminations

plus the *QUALITY,
UNIFORMITY and SERVICE*
that have made
G-L TAPE WOUND CORES
a standard in the industry

High permeability magnetic laminations, made to the most exacting standards in the industry, can now be obtained from G-L.

Transformer Laminations have the superior characteristics and uniformity-of-product associated with G-L magnetic tape wound cores. Controlled production techniques, careful selection of material, expert tooling and precision stamping assure you of the highest quality.

Magnetic Head Laminations are the result of improvements made by G-L on normal processing techniques to provide laminations with minimum burrs, improved stacking factors, reduced head dimensions.

Special Shapes are available from G-L for special applications. Our own tool and die shop is set up to do rapid prototype work.

Your inquiries are invited. Write, wire or call. Send us prints on your current requirements for an immediate quotation. Our illustrated magnetic laminations folder, TB-104, will be mailed upon request.

G-L ELECTRONICS

2921 Admiral Wilson Blvd., Camden 5, N. J.

Phone WOODLAWN 6-2780

Teletype TWX 761, Camden, New Jersey

NEW LITERATURE

Digital Components

229

This 12-page catalog includes specifications for digital components such as: counter-timers, frequency meters, time interval meters, digital printer, time code generator, decade counting units, and totalizing and preset counters. A list of optional equipment appears in the illustrated booklet. Computer Measurements Co., 12970 Bradley Ave., Sylmar, Calif.

Synchros and Resolvers

230

This 25-page handbook presents a detailed account of the application and measurement problems associated with synchros and control resolvers. It covers such topics as: What is a synchro; application problems; electrical zeroing procedures; electrical error measurement procedures; null measurement procedures; and phase shift and transformation ratio procedures. A synchro data chart is included. Theta Instrument Corp., 520 Victor St., Saddle Brook, N. J.

Coiling Operations

231

This 16-page manual describes the basic factors and variables involved in forming nickel-chromium resistance wire into helically coiled electric heating elements. Procedures for hand coiling operations, as well as a trouble-shooting chart are included in the illustrated brochure, entitled "Aids to Better Coiling." Hoskins Manufacturing Co., 4445 Lawton Ave., Detroit 8, Mich.

Plastic and Chemical Materials

232

A complete line of polycarbonate resins, phenolic resins, varnishes, and molding powders, and fused magnesium oxide is illustrated and described in this 12-page brochure. Physical, thermal, and electrical properties, in addition to molded and powder properties, appear in table form. Catalog No. CDC-370 includes suggested uses for the materials. General Electric Co., Chemical Materials Dept., One Plastics Ave., Pittsfield, Mass.

Slides in only **2** minutes

with this **BEATTIE**
OSCILLOTRON
using a Polaroid® Land back

Now you can project transparent slides of oscilloscope traces just minutes after recording with Polaroid® Land Projection Film, Type 46-L, used in this new Beattie Direct View Oscillotron. Also produces 60 sec. paper prints with the new, very fast Polaroid® 3000 Speed Film. Records up to 10 traces on a single frame and offers these many other advantages:

- Direct binocular view of CRT while recording.
- Non-reversed image.
- Camera swings back for easy access to lens and shutter, or lifts off completely. Can be rotated.
- Electric shutter-actuator available.
- Attaches easily to bezel of 5" CRT. Adaptable to other sizes. No special tools.

"Polaroid"® by Polaroid Corp.

B BEATTIE-
C COLEMAN inc.

1000 N. Olive St., Anaheim, California
Branch: 437 Fifth Ave., New York, N.Y.

Write today
for
full details



CIRCLE 228 ON READER-SERVICE CARD

CIRCLE 233 ON READER-SERVICE CARD

ELECTRONIC DESIGN • February 17, 1960

Uses of Choppers 238

Part 7 of the "Contact Modulator" series is entitled "Uses of Choppers in Systems." The 31-page booklet contains complete discussions and schematics of the chopper as used in precision operational amplifiers, digital tachometers, computer amplifiers, potentiometric and digital voltmeters, noise generators, and direction finding equipments. Airpax Electronics Inc., Cambridge Div., Cambridge, Md.

Transistors 239

A group of industrial transistors designed for applications in hf communications, control, instrumentation, navigation, and mobile equipment is described in this 12-page booklet. Characteristics tables, performance curves, and outline drawings are included. RCA Semiconductor & Materials Div., Somerville, N.J.

Phase Sequence Relays 240

Specifications and outline drawings of models P/N 2001, 02, and 03 phase sequence relays are contained in bulletin

No. 2001, four-pages. The relays offer automatic monitoring of 3 phase power and prevent the application of incorrect phase sequence to equipment. Master Specialties Co., 956 E. 108th St., Los Angeles 59, Calif.

Pressure Switches 241

Bulletin No. AV2015, two pages, describes subminiature pressure switches for switching circuits in response to gas and liquid pressure changes. Electrical data, contact ratings, dielectric strengths, and insulation resistances for 6 models are included. The Bristol Co., Waterbury 20, Conn.

Proximity Switch 242

Included in this four-page data sheet, No. 163, are photographs, dimensional drawings, and descriptive diagrams of sensitivity range, sensitivity envelopes, mounting requirements, and wiring instructions for the firm's proximity switch. The bulletin also contains operating and electrical characteristic data. Micro Switch Div. Honeywell, Freeport, Ill.

G-E WIRE SONIC DELAY LINES PROVIDE LOWER INSERTION LOSS HIGHER STORAGE RATE



Information storage up to 1.2 mc/s
Delay up to Ten Milliseconds
Adjustable Delay
Small Volume for Length of Delay
Shock and Vibration Resistant
Stable over Wide Temperature Range

Wire Sonic Delay Lines employ a special alloy wire as the delay medium. G.E. uses both piezoelectric and magnetostrictive transducers to provide the greatest possible range of system performance. Piezoelectric transducers assure *minimum insertion loss* for fixed inputs and/or outputs while the magnetostrictive transducers provide intermediate taps, both fixed and adjustable.

For complete development information write to Defense Industries Sales, Sect. 227-28A

GENERAL  ELECTRIC

DEFENSE ELECTRONICS DIVISION
HEAVY MILITARY ELECTRONICS DEPARTMENT, SYRACUSE, NEW YORK

CIRCLE 243 ON READER-SERVICE CARD

ELECTRONIC DESIGN • February 17, 1960



Tensolite's CABLE CAPABILITIES *did the rest!*

With solid core and air dielectric coaxial cable, and hook-up wire of several AWG sizes — all insulated with Teflon® — this complex cable is typical of the work Tensolite is doing in the exacting cable and cable assembly fields. Our design engineers were given the problem by a large manufacturer of ground checkout equipment. Jointly, their engineers and ours developed specs, and Tensolite took it from there. Tensolite translated these requirements, utilizing components manufactured in our own plants, into a highly reliable cable.

Many leading aircraft and electronic manufacturers are taking advantage of Tensolite's cable design and production facilities. We'd like to work with you on your high temperature cable problems. Contact your local Tensolite representative or write to:

Tensolite

INSULATED WIRE CO., INC.

A subsidiary of Carlisle Corporation

West Main Street, Tarrytown, N.Y.

Pacific Division:

1516 N. Gardner St., Los Angeles, Calif.

©DuPont

CIRCLE 244 ON READER-SERVICE CARD



NOW, FROM RIVERSIDE-ALLOY...

NICKEL WIRE IN PAY-OFF-PAK CONTROLLED TO $\pm .00025''$

Now from Riverside-Alloy you can obtain nickel and manganese-bearing nickel wire to tolerances as critical as plus or minus .00025" . . . in continuous lengths to 60,000 feet. Diameters .020" to .060" can be specified in Pay-Off-Pak at no additional charge. Credit for this product superiority goes to a new quality control unit used in conjunction with the Riverside-Alloy Pay-Off-Pak. Every inch of wire is continuously "miked" before entering the packing machines, assuring a controlled wire diameter.

Pay-Off-Pak, itself, gives you added benefits . . . ends the jumble of tangled wire, jammed machines and excess handling. Bright smooth finishes produced from the new Riverside-Alloy annealing process and drawing equipment are fully protected under all shipping and storage conditions.

Riverside-Alloy is the outstanding

source for the finest in precision nickel wire.

Write today: *Riverside-Alloy Metal Division, H. K. Porter Company, Inc., Riverside, N. J.*



Riverside-Alloy's PAY-OFF-PAK is one neatly coiled length of wire replacing as many as eight (10 to 30 lb.) individually-wound, exposed coils. Pay-Off-Pak means smoother, faster production right down the line.

RIVERSIDE-ALLOY **PORTER** METAL DIVISION

H. K. PORTER COMPANY, INC.

PORTER SERVES INDUSTRY: with Rubber and Friction Products—THERMOID DIVISION; Electrical Equipment—DELTA-STAR ELECTRIC DIVISION, NATIONAL ELECTRIC DIVISION, PEERLESS ELECTRIC DIVISION; Specialty Alloys—RIVERSIDE-ALLOY METAL DIVISION; Refractories—REFRACTORIES DIVISION; Electric Furnace Steel—CONNORS STEEL DIVISION, VULCAN-KIDD STEEL DIVISION; Fabricated Products—DISSTON DIVISION, FORGE AND FITTINGS DIVISION, LESCHEN WIRE ROPE DIVISION, MOULDINGS DIVISION, H. K. PORTER COMPANY de MEXICO, S. A.; and in Canada, Refractories, "Disston" Tools, "Federal" Wires and Cables, "Nepcoduct" Systems—H. K. PORTER COMPANY (CANADA) LTD.

CIRCLE 248 ON READER-SERVICE CARD

NEW LITERATURE

Instrument Cases 249

Reusable instrument cases for military and industrial use are listed in this catalog. Various kinds of protective packaging for electronic, optical, or mechanical devices are described. Detailed information is given so that an engineer may design a transit case to his own particular specifications. White Div., Zero Manufacturing Co., Palmer, Mass.

Binary Switches 250

Series TSB binary thumb-wheel switches are described and illustrated in this two-page data sheet. The switches show only one number at a time through a bezel window, and require 1/2 in. of panel space. Electrical specifications and dimensional drawings are included. Precision Products Div. of Chicago Dynamic Industries, Inc., 1725 Diversey Blvd., Chicago 14, Ill.

Instrument Translators 251

Models T-582 and T-583 instrument translators are presented in this two-page bulletin. The units are used with ac transducers, potentiometers, and some bridge-type, strain gage transducers in systems having a 28 v dc power supply and requiring a dc output signal. The bulletin contains specifications, a block diagram, and dimension drawings. Crescent Engineering & Research Co., Electronics Div., 5440 N. Peck Road, El Monte, Calif.

Gyro Indicating System 252

A remote vertical gyro indicating system intended as a standby unit to replace an aircraft's primary indicating system is described in this four-page booklet. The system is composed of an inverter, rate gyro, and 2-in. wide indicator. Engineering data and outline drawings appear in the brochure. Lear Instrument Div., 110 Ionia Ave., N.W., Grand Rapids 2, Mich.

From 350 to 450 CPS Frequency Range — SPECIFY CML NARROW BAND GENERATORS

WHERE
DEPENDABILITY
IS OF PRIME
CONCERN

This outstanding CML Narrow Band Generator, Model 1422-E, will meet the following specifications:

1. Regulated Voltage Output: Nominal 120 VAC. Variable from 90 to 130 volts.
2. Regulation: less than 1% change — no load to full load in better than 0.5 second.
3. Total Harmonic Distortion: Less than 2% at full load.
4. Noise and Hum Level: Better than 45 db below max. output.
5. Standard Frequency Ranges: Variable: 350-450 CPS. Fixed: 300 to 2000 CPS. Other ranges upon request.
6. Frequency Stability: 0.25% after 30 minute warmup. Fixed frequency models to .001%.



MODEL 1422-E

OUTPUT—250 VA

SIZE—11" h x 22" w
x 17" d

SHIP. WT.—150 lbs.

PRICE—Cabinet Model
\$900.00

Rack Mounted Models:
Standard 19" panels
with WE notching.

Write for Complete Catalog With All Details and Specifications



COMMUNICATION MEASUREMENTS LABORATORY, INC.

350 LELAND AVENUE, PLAINFIELD, NEW JERSEY

Tel. PL 4-5502

CIRCLE 253 ON READER-SERVICE CARD

ELECTRONIC DESIGN • February 17, 1960

Data Collecting Systems 258

A data collecting system called Collectadata is described in this 20-page brochure No. SP-8665. The system facilitates the collection of data at a central processing point from various points of origin. Sections cover equipment used, their applications, and system diagrams. Friden, Inc., One Leighton Ave., Rochester 2, N. Y.

Lock Nuts 259

Catalog No. 592, 20 pages, covers the firm's complete line of spring tempered steel lock nuts, including regular hex, integral washer, acorn, wing, and adjusting nut types. Details of design and locking principle, typical applications, dimensions, load ratings, materials, and finishes are given. The Palnut Co., 29 L Glen Road, Mountainside, N. J.

Capacitors 260

This 16-page catalog describes the Fil-Cap line of subminiature feed-through capacitors with current rating of 5, 10,

and 20 amp, with the 5-amp types designed to meet MIL-C-11693A. The catalog covers typical dissipation and power factor, insulation resistance, attenuation and capacity curves, and mechanical and electrical characteristics. A line of specialty capacitors is also described. Filtron Co., Inc., Marketing Dept., 131-15 Fowler Ave., Flushing 55, N. Y.

Connector Directory 261

Comprehensive listings of the most widely used electronic connectors are contained in this 16-page directory. Alphabetically arranged by manufacturers, all connectors are listed in numerical order. Prices are given for all included connectors. Allied Radio Corp., 100 N. Western Ave., Chicago 80, Ill.

Brazing Alloys 262

Compositions, melting points, and other data about the company's line of silver solder are given in this four-page brochure. Other brazing alloys are also described in the illustrated booklet. American Brazing Alloys Co., Box 11, Pelham, N. Y.

HOPKINS metallized paper capacitors

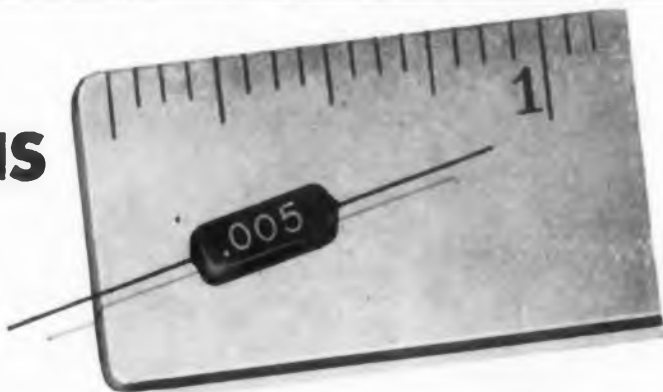

fit into compact circuitry

MICROMINIATURE SIZE — Hopkins phenolic-cased units rated .005 mfd., 200 volts are only .375" long x .180" wide x .110" thick. They're rectangular shaped for maximum space economy.

RELIABLE. These units withstand 125% of rated voltage for 1000 hours. The solid impregnant will not melt...insures a high dielectric constant. Leads are triple-tinned, copper-clad steel that resists high vibration.

QUALIFIED. Hopkins metallized paper capacitors are used in 17 different missile systems. Supplied in phenolic coated, molded, and hermetically sealed construction. Rated .005 to 20 mfd., 200 to 600 VDC. Prompt deliveries.



HOPKINS Engineering COMPANY

12900 Foothill Blvd., San Fernando, Calif.
Tel. EMpire 1-8691

CIRCLE 263 ON READER-SERVICE CARD

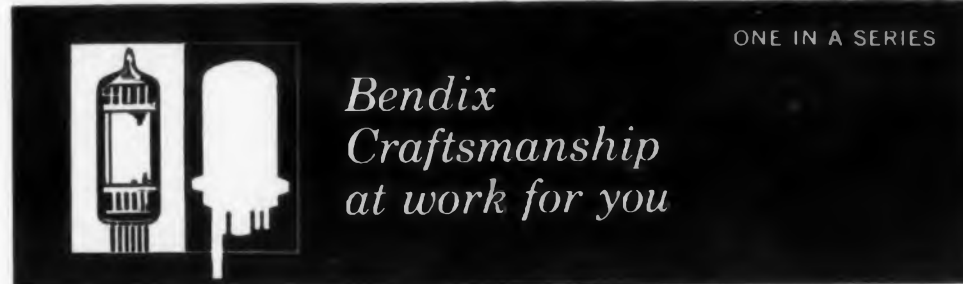

SPECIALLY BUILT HARD GLASS TUBES THAT WITHSTAND SEVERE CONDITIONS

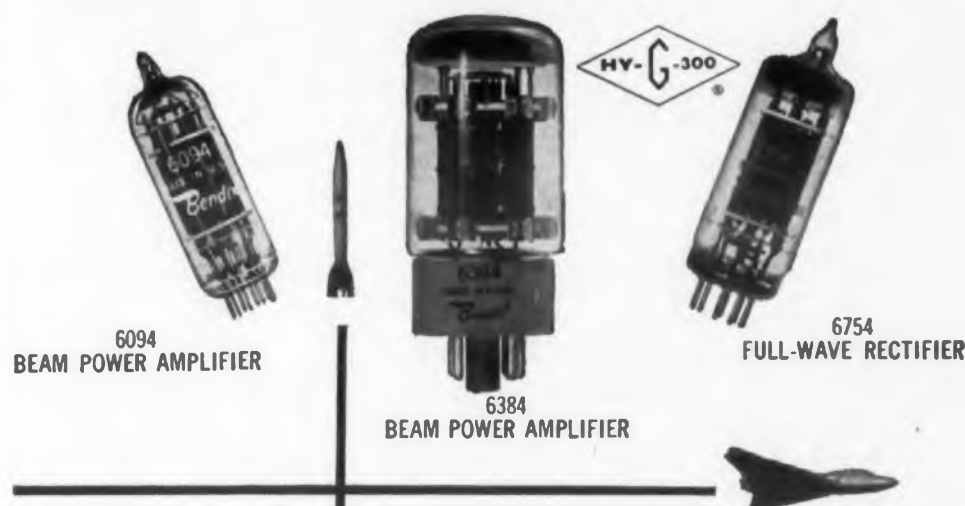

• Ideal for modern high-performance aircraft and missiles.

• Processing at higher vacuum and under the higher heat permitted by the hard glass reduces gas and contamination and provides greater operating stability at higher temperatures.

• Ceramic element separators prevent emission loss from high heat and vibration.

• Solid aluminum oxide heater-cathode insulator eliminates shorts, reduces leakage.

For complete line of tubes, write RED BANK DIVISION, BENDIX AVIATION CORPORATION, EATONTOWN, NEW JERSEY.

ELECTRICAL RATINGS*	6094 Beam Power Amplifier	6384 Beam Power Amplifier	6754 Full Wave Rectifier
Heater Voltage (AC or DC)**	6.3 volts	6.3 volts	6.3 volts
Heater Current	0.6 amp.	1.2 amp.	1.0 amp.
Plate Voltage (Maximum DC)	300 volts	750 volts	350 volts
Screen Voltage (Maximum DC)	275 volts	325 volts	—
Peak Plate Voltage (Max. Instantaneous)	550 volts	750 volts	—
Plate Dissipation (Absolute Max.)	14.0 watts	30 watts	—
Screen Dissipation (Absolute Max.)	2.0 watts	3.5 watts	—
Heater-Cathode Voltage (Max.)	≈ 450 volts	≈ 450 volts	≈ 500 volts
Grid Resistance (Maximum)	0.1 Megohm	.1 Megohm	—
Grid Voltage (Maximum)	5.0 volts	0 volts	—
Grid Voltage (Minimum)	-200 volts	-200 volts	—
Cathode Warm-up Time	45 sec.	45 sec.	45 sec.

*For greatest life expectancy, avoid designs which apply all maximums simultaneously.

**Voltage should not fluctuate more than ±5%.

MECHANICAL DATA	6094	6384	6754
Base	Miniature 9-Pin	Octal	Miniature 9-Pin
Bulb	T-6½	T-11	T-6½
Maximum Over-all Length	2½"	3½"	2½"
Maximum Sealed Height	2½"	2½"	2½"
Maximum Diameter	¾"	1½"	¾"
Mounting Position	Any	Any	Any
Maximum Altitude	80,000 ft.	80,000 ft.	80,000 ft.
Maximum Bulb Temperature	300°C	300°C	300°C
Maximum Impact Shock	500G	500G	500G
Maximum Vibrational Acceleration	50G	50G	50G

Visit us at the N.Y. IRE Show, Booth 2228

SPECIAL-PURPOSE TUBES DEPARTMENT

Red Bank Division

EATONTOWN, NEW JERSEY



West Coast Sales & Service: 117 E. Providencia Ave., Burbank, Calif.

Export Sales & Service: Bendix International Division, 205 E. 42nd St., New York 17, N. Y.

Canadian Distributor: Computing Devices of Canada, Ltd., P. O. Box 508, Ottawa 4, Ontario

CIRCLE 264 ON READER-SERVICE CARD



Effective component protection is hard to supply under conditions of violent acceleration, high ambient temperature, and vicious vibration. But in military electronic gear, transistors must get unflinching protection against these threats to reliable operation.

They get it, most fully, with **atlee** mounting clips.

atlee clips are provably better in three ways:

HOLDING POWER. Under severe shock and vibration, these clips actually mold themselves tighter to the transistors. There's no visible shifting or twisting, no lead-breaking resonance, and the dislodging force actually increases.

COOLING EFFICIENCY. With **atlee** clips, this approaches to within 10% of "infinity" — the ideal derating curve for a transistor with an infinite heat sink which keeps the case temperature from rising above the ambient level.

ELECTRICAL INSULATION. When required, these clips can be coated with Dalcoat B — an exclusive high-dielectric enamel that has twice the dielectric strength of Teflon but conducts heat as well as mica.

There are still more reasons why engineers who seek perfection choose **atlee** transistor clips. They know that Atlas E-E is the pioneering company in the development of component holders of all types, with unequalled years of specialized experience, and a complete line of clips for all case sizes and mounting requirements. They have learned it costs no more to get the best . . . and that Atlas E-E makes these "little things" as though they were the biggest things in the circuit.

DESIGN FOR RELIABILITY WITH atlee — a complete line of superior heat-dissipating holders and shields, plus the experience and skill to help you solve unusual problems of holding and cooling electronic components.



atlee corporation

(Formerly Atlas E-E Corporation)
47 PROSPECT STREET, WOBURN, MASSACHUSETTS

CIRCLE 268 ON READER-SERVICE CARD

NEW LITERATURE

Sweep Generators 269

A complete listing of the firm's line of sweep generators and accessories appears in this four-page, illustrated booklet. The instruments cover the entire frequency range from 1 to 2300 mc, in a variety of sweep widths and individual instrument ranges. Accessories described include plug-in markers, rf attenuators, and rf detector. Telonic Industries, Inc., Beech Grove, Ind.

Spray Technique 270

This eight-page booklet describes the firm's spray technique for cleaning components such as transistors, diodes, vacuum tubes, jewel bearings, pivots, electrical contact points, miniature slip-ring assemblies, high-fidelity transformers, dynamotor potentiometers, and other precision parts in the electronic, electro-mechanical fields. Cobehn, Inc., Passaic Ave., Caldwell, N. J.

Components and Systems 271

The firm's technical journal, which is devoted to the study and theory of electronic components and systems, is now available for general distribution. Volume 1, No. 1 contains articles titled "The Dual Between Vacuum Tubes and Magnetic Amplifiers" and "The Magnetic Amplifier as an Integrating Device." Airpax Electronics, Inc., Seminole Div., Fort Lauderdale, Fla.

Computer System 272

A transistorized, stored program, general purpose computing system is covered in this two-page bulletin, No. S-482. The basic system consists of the computer and a punched paper tape typewriter input-output unit. Storage capacity and access times of the RPC-4000 are included in the specifications. Royal McBee Corp., Data Processing Div., Port Chester, N. Y.



**CCO-7
PACKAGE OSCILLATOR**

STABILITY: ± 2 ppm

Compact transistorized package, including glass mounted crystal. Will hold ± 4 ppm over ambient range $-30^{\circ}\text{C. to } +80^{\circ}\text{C.}$ Request Bulletin # 516



**BPCO-1
OVEN AND CRYSTAL**

STABILITY: ± 0.004 ppm

Proportional control oven with transistorized circuitry. Supplied with glass mounted crystal for maximum stability under fixed ambient conditions. Request Bulletins # 503 and # 518.

TRIPLE CHOICE

for HIGH STABILITY AT ONE MEGACYCLE

**TCO-11C
OVEN PLUS
CRYSTAL**

STABILITY: ± 0.04 ppm

Plug-in oven and glass mounted crystal maintains stability over range $+10^{\circ}\text{C. to } +50^{\circ}\text{C.}$ Request Bulletins # 503 and # 508.



**Bliley
CRYSTALS**

BLILEY ELECTRIC COMPANY

UNION STATION BUILDING
ERIE, PENNSYLVANIA

CIRCLE 273 ON READER-SERVICE CARD

ELECTRONIC DESIGN • February 17, 1960

Servo Design Report

278

Photographs, illustrations, and schematic drawings explain the use of the Servolab packaged assembly of electronic and electromechanical components. Step by step, the six-page report describes how this synthesis and analysis system is used to solve complex servo problems. The dynamic characteristics of control systems and feedback loops are simulated, demonstrated, displayed, and completely analyzed in the report. No. SDH-2. Servo Corp. of America, 111 New S. Road, Hicksville, Long Island, N. Y.

Stepper Devices

279

Technical brochure SP9-1, 12 pages, describes the firm's stepper motors and pulsed stepping devices. Complete data are given for series 18100 motors, rotary stepping switches, pulse dividers, precision sequences, counters, interval timers, and positioning devices. Pulse profiles, schematic drawings, and application circuitry are included. A. W. Haydon Co., 232 N. Elm St., Waterbury, Conn.

Subminiature Connectors

280

Series SM subminiature connectors are described in this 12-page catalog containing specifications and dimension drawings. Guide pins and sockets, aluminum hoods, polarizing screwlocks, protective shells, and panel cutouts are included. The units meet the requirements of MIL-C-5015 and MIL-C-8384. DeJur-Amsco Corp., Electronic Sales Div., 45-01 Northern Blvd., Long Island City 1, N. Y.

Multivibrator Circuits

281

Detailed data on the design and operation of high speed flip-flop and multivibrator circuits using 4-layer diodes are given in this illustrated booklet No. AD-6, five pages. The booklet describes free-running, monostable and bistable circuits and a square wave generator circuit. Suggested circuit values are given and operations at high speeds and over wide temperature ranges are discussed. Shockley Transistor Corp., Customer Engineering, 1117 California Ave., Palo Alto, Calif.



with Chassis-Trak slides WEIGHT is no problem...

The slides above are only .250" thin and weigh only 9 lbs., yet they are supporting a man weighing over 200 lbs. This is a graphic illustration of rigid support at the full open position.

And, Chassis-Trak slides give smooth slide action! They are produced from cold rolled steel. The permanent-dry, dust-repellent finish is a special 400° "baked on" epoxy phenol formulation that eliminates maintenance... the longer you use Chassis-Trak slides, the smoother they operate.

A new design feature on Chassis-Trak slides increases the bearing area by almost 113% over previous models. This makes the slide even stronger, and is especially important on military or aircraft equipment, where extreme vibration or shock conditions exist.

Chassis-Trak slides are available in nine lengths, designed to support from 175 lbs. to 275 lbs. . . . in either the

"basic" model (pictured above), which tilts freely upward, or the "detent" model, which tilts and locks in seven different positions . . . and they are available from stock now!

Before making a slide selection, investigate the extra-strong, pencil thin slide that is built for standard racks and cabinets . . . Chassis-Trak.

"Detent" model, locked in one of seven different positions.



**chassis
Trak
inc.**

For further information contact:

525 South Webster, Indianapolis 19, Indiana
CIRCLE 283 ON READER-SERVICE CARD

Very Small Wire

Specialists in the Unusual

ELECTROPLATED

Unusual and difficult engineering problems may be solved, at times, by single or multiple electroplating of small wires . . . A wide variety of metals is available, both as the core wire and as the plate. Inquiries invited.

SINCE  1901

SIGMUND COHN MFG. CO., INC.
121 SOUTH COLUMBUS AVENUE
MOUNT VERNON, N. Y.



CIRCLE 282 ON READER-SERVICE CARD



Crystals are grown by a modified
Czochralski technique.

Large Diameter SILICON for INFRARED Cut Domes and Lenses



Silicon cut domes and lenses to 8" diameter, with IR transmission to 97% (coated), are now available in production and evaluation quantities. Diameters up to 19" will be available in the near future.

These significantly larger diameters can now be grown as a result of recent Knapic research and experimental growing programs. Temperature gradient, pressure, and impurity evaporation controls, as well as unique growing methods, are the result of original Knapic laboratory work.

Germanium lenses and domes are also available

SPECIFICATIONS

	SILICON	GERMANIUM
• Hardness	750-2000 (Knoop) Excellent	692 (Knoop) Excellent
• Index of Refraction	3.50 high	4.10 high
• Melting point	1420°c Excellent	958°c Fair
• Density	2.3 gm/cm ³	5.34 gm/cm ³
• Ease of finishing	Excellent—very hard	Good
• Transmission cut-off	About 20 microns Excellent	About 23 microns Excellent
• Reaction to Thermal Shock	Good	Good
• Thermal conductivity	Excellent	Excellent

TYPICAL INFRARED TRANSMISSION CHARACTERISTICS OF UNCOATED
KNAPIC-GROWN SILICON AND GERMANIUM

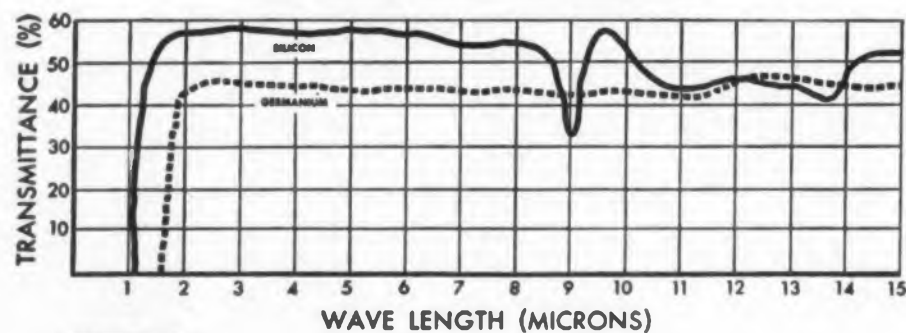

Also manufacturer of Silicon and Germanium crystals for
solar cell and semi-conductor devices.

Write for specifications sheet

Knapic Electro-Physics, Inc.

936-938 Industrial Avenue, Palo Alto, Calif. • Phone: DAvenport 1-5544
CIRCLE 288 ON READER-SERVICE CARD

NEW LITERATURE

VSWR Instrument 289

Model 712, an instrument for measuring the rf power and vswr of coaxial transmission lines, is illustrated and described in this two-page bulletin. Specifications include frequency range, nominal impedance, power range, and accuracy. M. C. Jones Electronics Co., Inc., 185 N. Main St., Bristol, Conn.

Tuners and Load Resistors 290

Data on the 150 series coaxial tuners, and the 601 and 603 series low power rf load resistors is contained in this bulletin, two pages. Specifications and illustrations of the components are given. M. C. Jones Electronics Co., Inc., 185 N. Main St., Bristol, Conn.

Meter-Relays 291

Schematics, dimension drawings, and illustrations of a line of expanded scale meter-relays appear in this 12-page catalog. Data on standard circuits, flutter cir-

cuits, and double contact automatic reset circuits are given. Ordering specifications include contact arrangements, contact rating and life, accuracy and temperature range, frequency range, and sensitivity, among others. Assembly Products Inc., Chesterland, Ohio.

Laminated Plastic 292

This two-page data sheet contains a description of a flame-retardant plastic laminate called Fireban X. Maximum and minimum property values, including physical, mechanical, and electrical properties, are given. Taylor Fibre Co., Norristown, Pa.

Capacitors 293

This four-page catalog, No. NPJ-110, describes type QE computer grade electrolytic capacitors. Performance characteristics include low temperature impedance, dc leakage current, dissipation factor, and surge test results. Aerovox Corp., New Bedford, Mass.

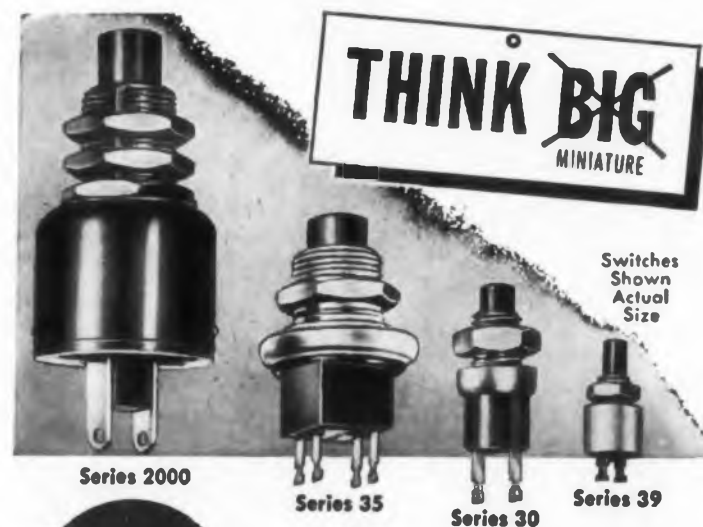

Grayhill
Push Button
Switches

From normal, conventional size to ultra-miniature — the Grayhill line of push button switches can meet virtually every requirement. Rated capacities range from 10 amp. to 1/10 amp. 115 V. AC resistive — and single or double pole, single throw, — silent or snap action styles and a solderless terminal style are available.

Write for Catalog

Grayhill
INC.

Copies of caption card
available on request

Phone: Fleetwood 4-1040
565 Hillgrove Ave., LaGrange, Illinois

"PIONEERS IN MINIATURIZATION"
CIRCLE 294 ON READER-SERVICE CARD

ELECTRONIC DESIGN • February 17, 1960

Hipot Tester

298

Model 570 high potential test set is described in this two-page data sheet. The unit has variable voltage ranges from 0 to 5000 v, with standard models from 0 to 3000 or 0 to 5000 v ac rms. Model 570RP, a companion line for rack panel mounting, is also described. General Hermetic Sealing Corp., 99 E. Hawthorne Ave., Valley Stream, Long Island, N. Y.

Resistors

299

Wirewound microminiature and printed-circuit resistors are covered in this 6-page folder, No. LC1066. Tables give wattage ratings, physical dimensions, and resistances of the 200 and 400 series components. Aerovox Corp., Cinema Engineering Div., 1100 Chestnut St., Burbank, Calif.

Plastic Tubing

300

Flexible plastic material is described in this four-page brochure. Strip-a-Tube consists of multi-cell vinyl tubes extruded together in a flat, tape-like form.

The illustrated booklet contains dimensional data and application notes. Electric Storage Battery Co., Jessall Plastics Div., Kensington 3, Conn.

Waveguide Windows

301

Frequency range, pressure differential, and overall dimensions for five types of ceramic, glass, and mica waveguide windows are listed in this two-page data sheet. Each type is illustrated by a drawing. Sylvania Electric Products Inc., Central Advertising Distribution Dept., 1100 Main St., Buffalo, N. Y.

Circuitry Planning

302

To assist design engineers plan and package circuitry, the firm offers this 20-page Quick Order Guide which lists off-the-shelf components used in making complete electronic systems. Also offered is a brochure entitled, "Alden Basic Building Blocks," which graphically describes the firm's method of modular construction of electronic units from off-the-shelf components. Alden Products Co., 159 N. Main St., Brockton, Mass.

FINGERTIP CONTROL GIVES VARIABLE SPEED WITH ZERO-MAX

A finger's touch instantly and accurately sets the control lever of your ZERO-MAX stepless variable speed drive anywhere from zero to 2000 RPM. These compact, low cost drives produce from 2 to 450 in.-lbs. of torque with 1800 RPM input motors of from $\frac{1}{8}$ to $\frac{3}{4}$ horsepower. They are available with or without reverse, gearhead, or motors. ZERO-MAX drives are priced from \$37.00. Write for our free 16-page catalog or refer to Sweet's Product Design File.

Representatives
in major cities

THE ZERO-MAX COMPANY

Subsidiary of Revco Inc., 1926 Lyndale Ave. S.,
Minneapolis 5, Minn., Phone: FR 4-5520

CIRCLE 303 ON READER-SERVICE CARD

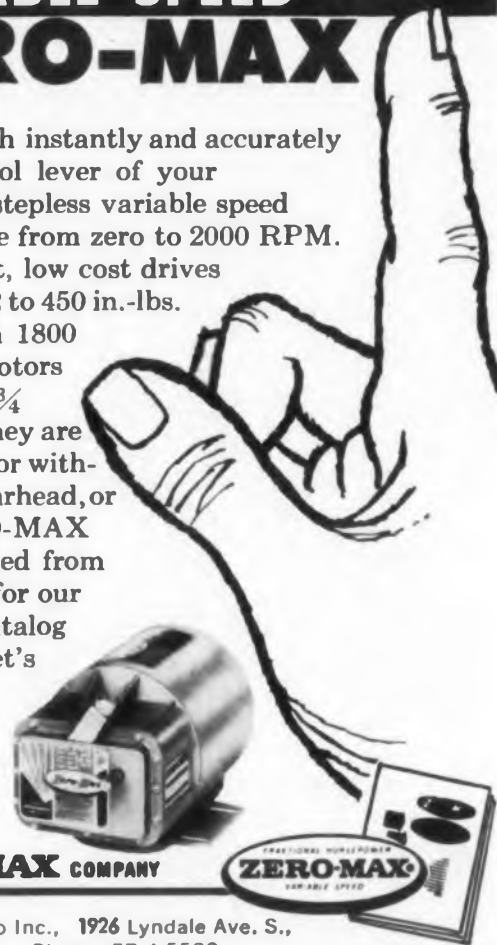

IMPULSE

A DIGEST OF NEW DEVELOPMENTS IN ELECTRONICS AND AUTOMATION

PUBLISHED BY ROME CABLE DIV. OF ALCOA, ROME, N. Y.
PIONEERS IN INSTRUMENTATION CABLE ENGINEERING

INSTANT MAIL. Not long ago, one of the wire services carried a story that should gladden the heart of letter writers from coast to coast. The big news is the use of microwave radio or coaxial cables for speeding letters to their destination. Naturally, much researching, development and experimental work are yet to be done before facsimile mail will be unveiled by Uncle Sam. However, as of December 1, a commercial service linking Washington, New York, Chicago, Los Angeles and San Francisco has been in operation. So *instant mail* joins the many other wonders and conveniences of the electronic world.

UHF GIVES WEATHER REPORT. High in the sky, all over the world, helium-filled balloons carry radio-sonde transmitters which telemeter changes in air pressure, humidity and temperature. All three measurements are converted into radio signals . . . and measuring and reporting goes on and on until the balloons burst at 20,000 feet. The UHF signals are picked up by a ground antenna and fed to an FM receiver which has a tapper bar that records on special graph paper. If your work involves telemetering, data recording, circuit-control testing, or computers, you probably will want a copy of Bulletin RCD-400. It covers the cable you can get from Rome for such purposes. Write to Rome Cable Corp., Dept. 1120, Rome, New York. Or contact the Rome representative in your area.

NAME THE TONE. Any tone imaginable can now be generated electronically with an electronic music synthesizer recently installed at Columbia University. The synthesizer produces musical sounds in response to code signals fed into the system on perforated tape. It will be used in a program of composition and research in electronic music, conducted by Columbia and Princeton Universities under a grant of the Rockefeller Foundation.

WHO PAYS FOR WHAT? New ground rules have been handed down for electronic contractors handling defense work. The new way to figure who pays for what goes into effect July 1, 1960, and covers both negotiated and fixed-price contracts. All the details are wrapped up in "Revision No. 50 Armed Services Procurement Regulation." You can get the whole story by sending 35 cents for each copy you want to the Government Printing Office, Washington 25, D. C.

CABLEMAN'S CORNER. To help you in replacing or reordering cable, it has become standard practice for most cable manufacturers to identify their cable in one of several ways. These include the stamping of solid conductors, the inclusion of marker threads or tapes within the cable structure, and surface printing or molding the insulations or jackets. Of these methods, the use of marker threads or tapes is the most popular. Manufacturers of Underwriters-labeled products are assigned specific colors for their marker threads, and most manufacturers extend the use of these same threads in other cable products whenever it is practical. Other information appearing on marker tapes often includes unit length markings and the date that the cable was manufactured.

These news items represent a digest of information found in many of the publications and periodicals of the electronics industry or related industries. They appear in brief here for easy and concentrated reading. Further information on each can be found in the original source material. Sources will be forwarded on request.

CIRCLE 304 ON READER-SERVICE CARD

The A. W. Haydon Co. designed this series of repeat cycle timers for engineers with tricky timing problems and tight budgets. The low unit price on quantity runs will surprise you...and the savings we can offer on very large volume production sometimes surprises us! ■ Yet there has been no sacrifice in quality...it's all in the design. Special spring switches are supported in molded contact blocks; cams, cam followers and gears are molded nylon for long service life and extremely quiet operation. Two printed circuit cables supply internal wiring to 12 output circuits, and parallel cam shafts provide two cycling speeds. ■ The A. W. Haydon Co. guarantees this repeat cycle timer for at least one year, con-

LONG LIFE LOW COST REPEAT CYCLE TIMERS

tinuous operation, and it will actually run for much longer. ■ The unit shown operates at 115V, 60 CPS, 2.5 watts power input. Its switch has been tested for 2 years (125 million cycles at 2 amps resistive 10VAC, 60 CPS) and is rated for 2.5 amp or a 7.0 amp inrush lamp load. ■ To be sure, other variations are available. A. W. Haydon will be delighted to quote these long life, low cost repeat cycle timers in any one of 125 standard speeds, 5 voltage ratings and 3 power supplies.

All have Jones type terminal plugs for fast installation, and a quick-change motor mounting for ease of motor replacement. A clear plastic dust cover helps reduce noise level to a whisper. Write for information on your particular requirement.

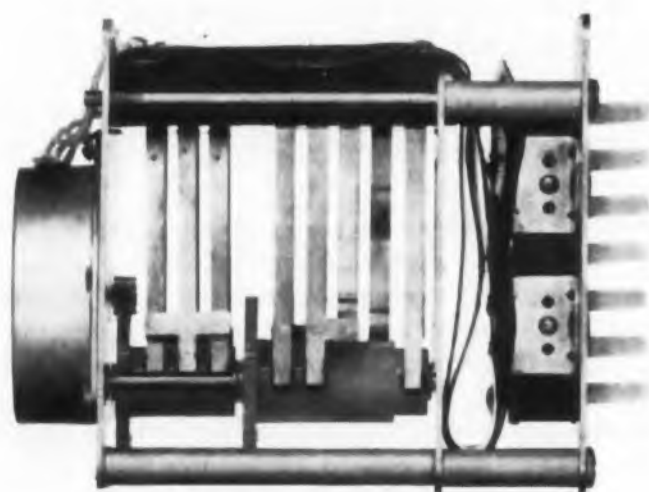

AWH HAYDON
THE COMPANY
227 North Elm Street, Waterbury 20, Connecticut
CIRCLE 308 ON READER-SERVICE CARD

NEW LITERATURE

Thermal Design 309

Technical report No. 7-8-9, four-pages, describes and analyzes thermal problems affecting electron tubes in modern electronic equipment. Applications of Thermion, a thermal analog tube, in quantitatively evaluating and experimentally alleviating these problems are presented. Research Council Inc., 1062 Main St., Waltham 54, Mass.

Panel Hardware 310

This four-page catalog describes and illustrates knob locks, test jacks, fuse and resistor clips, terminal board brackets, five-way binding posts, captive hardware, and pull handles. Dimension drawings are included. Raytheon Co., Industrial Apparatus Div., 100 River St., Waltham 54, Mass.

Spray Gun 311

Two metal spray guns are described in this illustrated brochure. The CA-30,

using compressed air, is for hard facing materials such as tungsten carbide compounds; the AL-20, which operates without air, sprays high temperature ceramic powders such as aluminum and zirconium oxides. Metallizing Co. of America, Inc., 3520 W. Carroll Ave., Chicago 24, Ill.

Components and Assemblies 312

Electro-mechanical components and assemblies are described in this four-page booklet. The firm's series of hysteresis, subminiature, and friction components are included. Military and industrial trainers also appear in the illustrated booklet. Carmody Corp., 2360 Wehrle Drive, Buffalo 21, N.Y.

Resistor Selector Chart 313

Rapid determination of values encountered in precision resistor applications can be made through use of this selector chart. Offered in the form of a

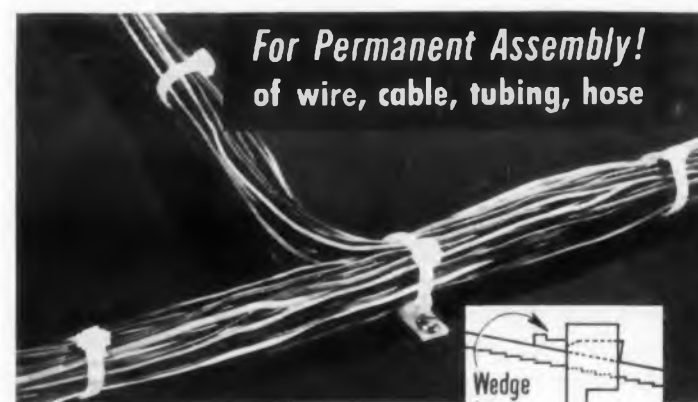

For Permanent Assembly!
of wire, cable, tubing, hose

Weckesser

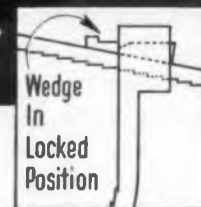

WEDGE LOCK BAND CLAMP...

once locked, it's got to be cut loose! Really permanent! Solid nylon. One size for diameters 1/8" to 1 1/4".

Separate Mounting Tab

...use only where and when needed. Can be pre-mounted for simplified planning. Solid nylon.

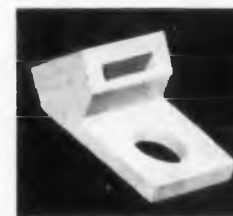

Try them... write for samples, prices, full information.
See Us At Booth 4003 I. R. E. Show - New York

Weckesser COMPANY

5703-05 Northwest Highway • Chicago 46, Ill.

CIRCLE 314 ON READER-SERVICE CARD

ELECTRONIC DESIGN • February 17, 1960

loose-leaf insert, the chart lists current, voltage, power, and resistance on four individual axes. The firm's Vamistor line of resistors is also described on the chart, No. Z-44-A. Daystrom, Inc., Daystrom-Weston Sales Div., 614 Frelinghuysen Ave., Newark 12, N. J.

Digital Test Equipment 318

The 3000 series digital test equipment is described in a four-page illustrated folder that includes mechanical, electrical, and logical characteristics. Units in the series are completely transistorized and interconnect with banana-jack patch cords. Digital Equipment Corp., Maynard, Mass.

Components 319

RFI filters, radar pulse packages, pulse forming networks, specialty capacitors, and delay lines are described in this 20-page brochure. The booklet also illustrates the activities of the various operating divisions, and the production capabilities of the firm. Filtron Co., Inc., 131-15 Fowler Ave., Flushing 55, N.Y.

Terminals and Connectors 320

The firm's complete line of solderless terminals and connectors is listed in this catalog, 13 pages. Among the items listed are: ring, spade, and hook tongues; butt connectors; rectangular and flanged spades; and 3 and 4-way connectors. Bulletin No. 5E9 includes dimension drawings and a cross reference chart. Waldom Electronics Inc., 4625 W. 53rd St., Chicago 32, Ill.

Digital Voltohmmeter 321

A digital voltohmmeter that is fully transistorized, contains no stepping switches or relays, and incorporates modular design, is described in this six-page folder. The unit can measure voltages and resistances, count external events, provide analog input to digital computers, and provide digital outputs from analog computers. Specifications include scale ranges, electrical outputs, and accessories provided. Epsco, Inc., Instruments and Equipment Div., 275 Massachusetts Ave., Cambridge 39, Mass.

GLENNITE® THERMISTOR DESIGN IDEAS

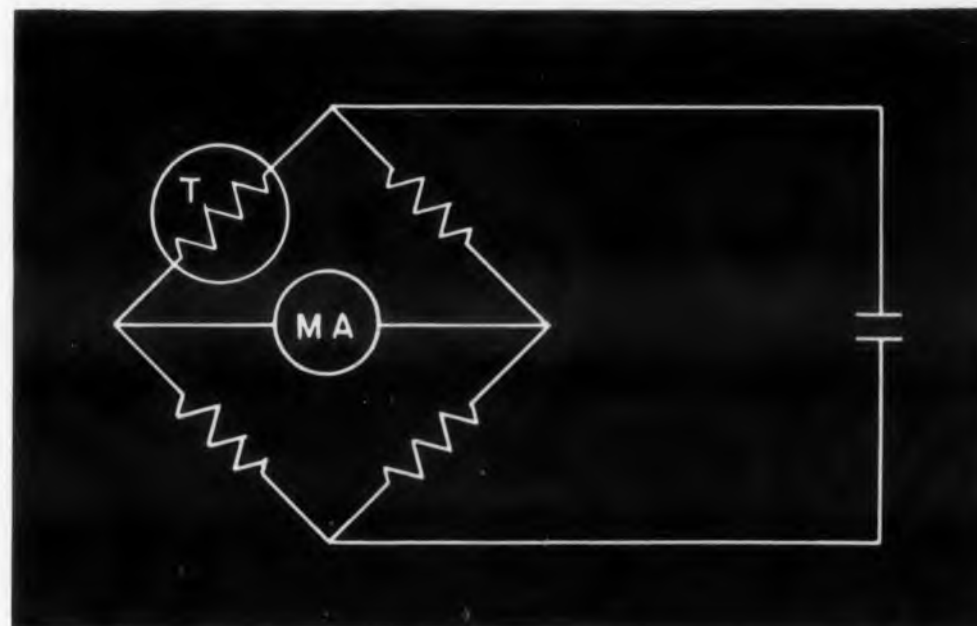

THERMOMETRY... electronically ...with instantaneous response

Glennite thermistors have been utilized for temperature detection from ocean floor to outer space. Temperatures of the earth directly below the ocean bed have been measured within $.01^{\circ}\text{C}$ to determine the nature of radiant heat at the ocean floor. Glennite thermistors have also been used to determine functional characteristics of missiles in outer space.

Thermistors are temperature sensitive resistors with high coefficients of resistance. Incorporated in properly calibrated electronic meters, they will give *instantaneous readings* with a high degree of accuracy — a response impossible to achieve by other thermometric means.

Mounted to specification, thermistors form one arm of a standard bridge circuit. A slight change in environmental temperature will cause a relatively large change in thermistor resistance. This in turn affects the current in the meter branch of the bridge. The meter or recorder can be calibrated to read temperature directly.

Thermometry is only one of many interesting applications for Glennite Thermistors. Other uses include time delay, fire control, voltage control, liquid measurement, etc.

Glennite wafer, bead and rod thermistors are available in a variety of resistance values, temperature coefficients and sizes to help you evaluate circuit problems. They may be obtained from your local distributor, or from Gulton Industries in bulk quantities.



Test Your Ideas With A Glennite Experimenter's Thermistor Kit

An inquiry on your company letterhead will make available to you a Glennite Experimenter's Kit for \$14.95. For those engineers who have had some experience with thermistors, comprehensive kits are available for \$49.95. For complete information, write directly to Gulton Industries, Inc.

Custom Made Thermistors To Your Specifications

Gulton will supply thermistors to your specifications with resistance values from 1 ohm to 10 megohms and temperature coefficients of resistance to -6.8% per degree C. Temperature range: -60° to $+500^{\circ}\text{C}$.

NEW

DEEP-ETCH

MATERIAL FOR CHEMICAL MILLING

Kodak Metal-Etch Resist . . .
speeds up,
simplifies,
opens new
chemical
milling
applications

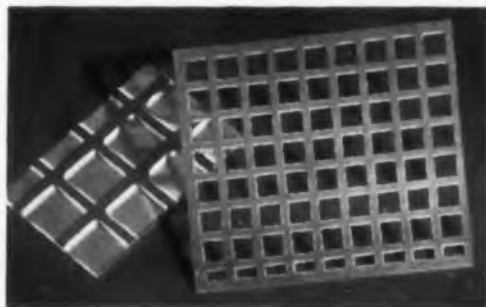

This photo sensitive resist ends time-consuming handwork, allows close-limit accuracy in deep-etch weight reduction and parts manufacture. Also reproduces fine-line detail as in plating, dial and nameplate making. Withstands acids, alkalis, electrolytic fluids . . . adheres well to aluminum, titanium, magnesium, stainless and other alloy steels. Makes volume production possible because of its high stability, strict uniformity. Send for detailed brochure: *Etching, Chemical Milling & Plating with Kodak Metal-Etch Resist.*



Text for this advertisement was set photographically.

No statement or suggestion is to be considered a recommendation or inducement of any use, manufacture or sale that may infringe on any patents now or hereafter in existence.

Graphic Reproduction Sales Division
EASTMAN KODAK COMPANY
Rochester 4, N. Y.

Kodak
TRADE MARK

CIRCLE 322 ON READER-SERVICE CARD

MATERIALS & CERAMICS DIVISION, Metuchen, New Jersey

Gulton Industries, Inc.

In Canada: Titania Electric Corp. of Canada Ltd., Gananoque, Ont.



CIRCLE 323 ON READER-SERVICE CARD

Continental Connector Announces NEW PRINTED CIRCUIT CONNECTORS

4 New Designs for Computer Applications

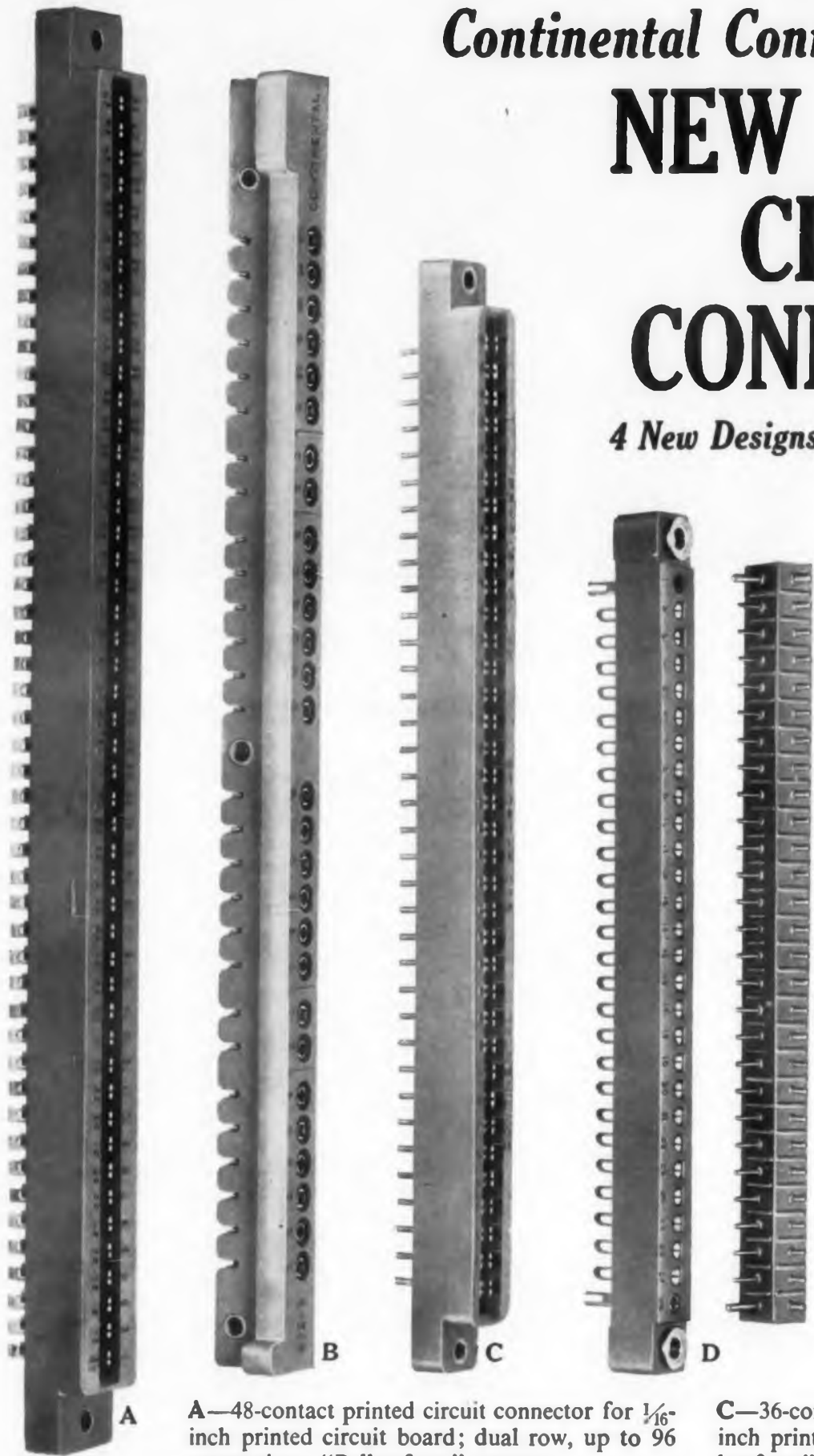

A—48-contact printed circuit connector for $\frac{1}{16}$ -inch printed circuit board; dual row, up to 96 connections. "Bellowform" contacts.

B—Test Point Connector. 28 closed entry contacts, threaded mounting inserts molded into body. For dip soldering to printed circuit board.

C—36-contact printed circuit connector for $\frac{1}{16}$ -inch printed circuit board, featuring new "Bellowform" contacts.

D—Right angle plug and socket for dip soldering to printed circuit board; floating mounting bushings, 28 contacts.



Continental Connectors

Proven reliability . . . high precision . . . choice of molding compounds. Write for details on complete line of printed circuit connectors to Electronics Division, DeJUR-AMSCO CORPORATION, 45-01 Northern Boulevard, Long Island City-1, N. Y. (Exclusive Sales Agents).

CIRCLE 328 ON READER-SERVICE CARD

IDEAS FOR DESIGN

New Drafting Technique Prepares Printed Circuits Faster

A NEW DRAFTING method for preparing printed circuit layouts outlines the lands and circuit paths with specially designed scribing instruments, and then strips them out through use of a photographic, resist-coated polyester-base film.

This technique eliminates opaquing and makes the usual inking and taping methods virtually



After the scribe master has been processed photographically, the film coating between each translucent line is peeled away, leaving the finished circuit paths and connection pads. Use of this peel-coat technique, eliminates time consuming opaquing of large areas.



H. A. Knowlton, left, drafting supervisor in the General Electric Company's Heavy Military Electronics Department, Syracuse, N. Y., describes new scribe method for preparing printed circuit layouts to R. Ferrara, design draftsman. Shown, step one to three, are the scribe master on which the circuit elements are outlined, the peel coat or intermediate negative, and the final master print, which is twice the size of the actual printed circuit board.

obsolete for preparing large numbers of complex printed circuit layouts. The scribing method is especially suited to jobs requiring irregular shapes, long runs, and complex grounding and shielding to separate high frequency leads from one another.

Highly Accurate Scribing Method

Briefly, this is how the scribe system works:

- 1) Standard circuitry is scribed on scribe-coat Stabilene Film. This is called the scribe master.
- 2) Photographically, peel-coat Stabilene film is exposed to the scribe master. This produces a line image on the photo-emulsion layer of the sheet. The area between each translucent line, not the line itself, is actually the circuit path desired.
- 3) While in the developer, these image lines are eaten away down to the peel-coat layer.
- 4) The sheet is then wiped with an alcohol dampened cloth, further dissolving the image lines through the peel-coat layer and down to the Mylar base. Valleys two layers deep result.
- 5) The photo-emulsion layer of the sheet is then washed away in a Clorox bath leaving valleys now only in the peel-coat.
- 6) Finally, the coating between each translucent line is peeled away leaving finished

Falcon missiles travel "first class" in containers secured by LINK-LOCK



Fourteen No. 2 LINK-LOCK fasteners → maintain a pressure-tight seal around cover of Falcon cases.



Before they take to the skies, Falcon air-to-air guided missiles are shipped or stored in containers sealed pressure-tight by Simmons LINK-LOCK fasteners.

These precisely engineered fabricated aluminum cases are produced to Hughes Aircraft Company specifications by the following companies: Vendorlor Manufacturing Co., Fresno, California; Allison Steel Manufacturing Co., Phoenix, Arizona; Avco Corporation, Crosley Division, Richmond, Indiana.

Features like these make the LINK-LOCK ideal for use on military cases made to rigid specifications as well as on inexpensive commercial containers:

- Impact and drop resistant.
- Positive-locking without springs.
- High preloading and high load carrying capacity.
- Compact design—lies flat open or secured.
- 3 sizes, for heavy, medium, light duty.
- Flexible engagement latch design... can be varied to suit different applications.

Write for Catalog #1762. Contains complete details of LINK-LOCK and other Simmons Fasteners with unlimited money-saving applications. Samples and engineering service available on request.

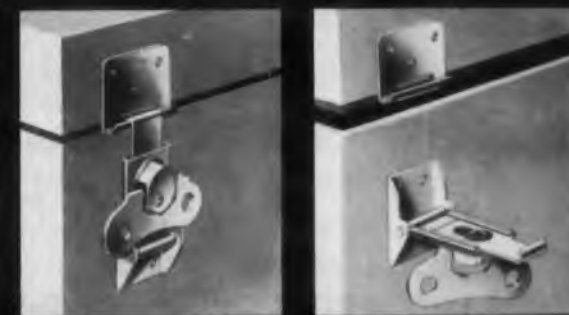

Half-turn applies high closing pressure, counter-turn disengages for opening. LINK-LOCK lies flat open or closed.

SIMMONS

FASTENER CORPORATION

North Broadway, Albany 1, New York

QUICK-LOCK • SPRING-LOCK • ROTO-LOCK • LINK-LOCK
DUAL-LOCK • HINGE-LOCK

See our 8-page catalog in Sweet's Product Design File

CIRCLE 329 ON READER-SERVICE CARD

JERROLD**WIDE BAND
PORTABLE
SWEEP
GENERATOR****NEVER BEFORE SO
VERSATILE AN INSTRUMENT
AT SO LOW A PRICE!****\$295⁰⁰**

Jerrold's Model 601 and 602 are unexcelled for laboratory and production field use—combining portability and ruggedness with precision performance and versatility usually associated with only the costliest laboratory equipment. NOW . . . FULL PRODUCTION ASSURES FAST DELIVERY!

ONE INSTRUMENT COVERS MOST COMMONLY USED I. F. FREQUENCIES

For frequency ranges 12 to 220 mcs . . . specify Model 601

For frequency ranges 4 to 112 mcs . . . specify Model 602

- All electronic . . . saturable reactor sweep circuit
- Fundamental frequency output on all ranges
- Output VSWR less than 1.1
- High output level adjustable by switch attenuators

*For full details write:***JERROLD****ELECTRONICS CORPORATION, Industrial Products Division**

Dept. ITE-3 Jerrold Building, Philadelphia 32, Pa.

Jerrold Electronics (Canada) Limited, Toronto

Export Representative: Rocke International, New York 16, N.Y.

CIRCLE 330 ON READER-SERVICE CARD

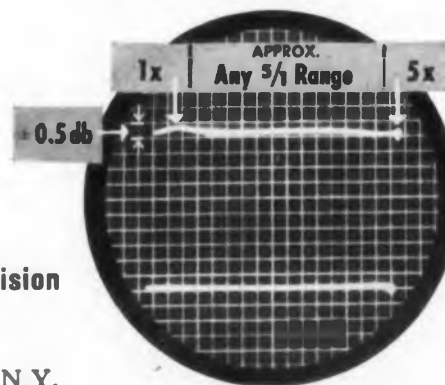
**H I G H
OUTPUT!**601 -1.0 Volt RMS into
50 Ω Load602 -2.5 Volt RMS into
50 Ω Load**W I D E
SWEEP WIDTHS!**As wide as 5 to 1
As narrow as 1% to 120%**F L A T
OUTPUT!**RF flat within ± 0.5 db**IDEAS FOR DESIGN**

circuit paths. This final master and file copy can then be further reprinted.

Three basic controls provide the new scribing system with a high degree of accuracy.

First, the steel alloy scribing points (shaped like phonograph needles) are made in graduated widths and cut extremely sharp, precise lines. The use of constant-width scribe points eliminates minute variations in circuit line widths often resulting from pen and ink work, where the amount of ink in a pen can alter the line thickness and clarity.

Second, the Stabilene film on which the scribing is done contains grid lines for accurate positioning of the board element. It has exceptional dimensional stability and permits precise reproduction. A restabilized Mylar polyester-base film developed by Keuffel and Esser, Stabilene maintains constant line character under extreme temperature and atmospheric conditions.

The scribing tools are equipped with unique spring-type shock absorbers. These instruments maintain the same accuracies on curved as well as straight lines, eliminating ragged circuit paths which make the finished board unusable. Unlike ordinary scribes or drawing instruments, these scribing devices "outline" a circuit line. Thus, two extremely accurate, separated lines are scribed into the film to outline what will later be a solid line.

In addition to its high degree of accuracy, this new scribing method is extremely flexible. For example, optimum use can be made of the board area since the width and length of runs, as well as pad (connection) sizes are not limited by standard tape sizes.

Using specially formulated fluids, drawing changes can be made easily during any one of the three steps: the original scribed layout, peel-coat negative (intermediate step), or the final layout.

An additional advantage of this new method is



Original drafting layout is done directly on Scribe-coat master which contains grid lines for accurate positioning of printed circuit board elements.

CRONAFLEX* DRAFTING FILM... BEST SURFACE YOU CAN USE



Specially designed scribing instruments equipped with unique spring-type shock absorbers are used to "outline" circuit paths and connection pads. These devices maintain precise accuracy on curved as well as straight lines.

that the printed circuit masters can be made in either positive or negative form, depending on which surface is to be stripped off.

Developed jointly by the Keuffel and Esser Company, Hoboken, N.J., and General Electric's Heavy Military Dept., this new technique will save the GE division many thousands of dollars annually. For example, use of this method in the preparation of 300 different circuit layouts, resulted in a saving of \$27,000. Company manufacturing experts also cite a recent production job involving several complex boards in which 30 hours were needed to prepare each printed-circuit layout using the new system as compared with 80 hours using the tape method, a saving of 50 hours per printed-circuit board. ■ ■

Index Card Aids Breadboarding

An index card can be used to hold components in place during initial breadboarding work. The idea is to draw the circuit, to the scale size of the components, on a suitably sized index card. The components are placed in their proper positions

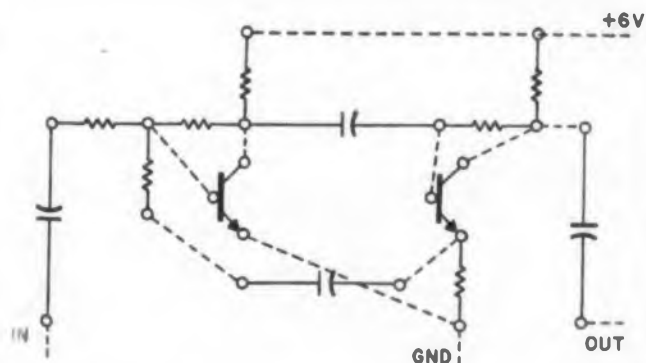

The schematic diagram is drawn on the index card, the components mounted and the soldered connections made with the card still in place.

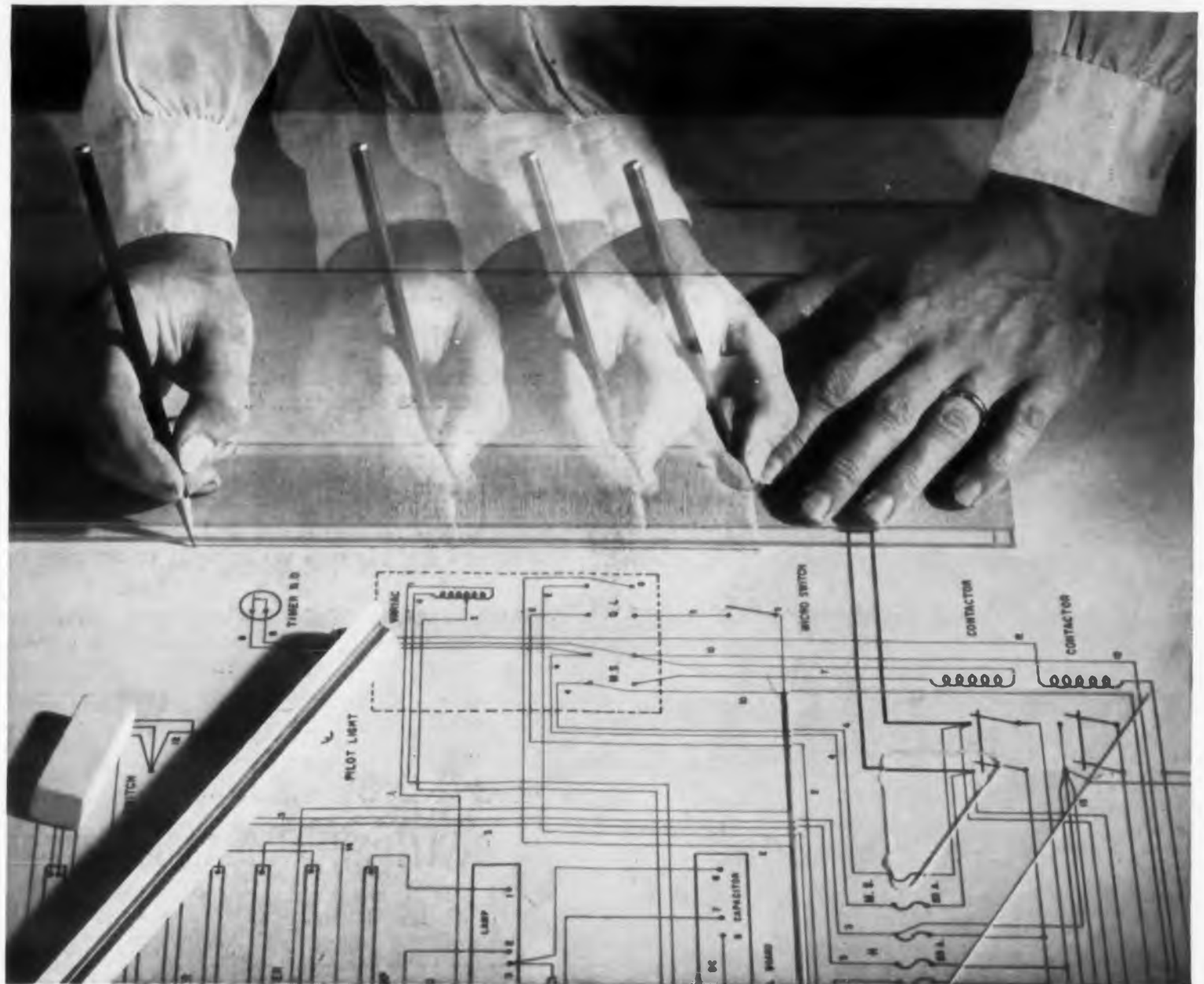

"Best surface" is a broad statement. But you can prove it to yourself by mailing the coupon below; we'll send you a sample of CRONAFLEX Drafting Film for testing.

It's best for several reasons: it's the only drafting film that's made by one manufacturer—Du Pont—from start to finish. This means that CRONAFLEX Drafting Film is consistently superior, because we control every manufacturing step. CRONAFLEX Drafting Film is an exclusive combination of an outstanding surface on Du Pont's tried and proven CRONAR* polyester film base.

The surface: ideal for pencil... erases easily... smear-resistant... clearer than cloth... you get faster print-through speed with greater uniformity... accepts recommended inks.

The base: holds size... flexible... unexcelled strength... moisture-resistant... easy to handle (.004" thickness)... lies flat.

CRONAFLEX Drafting Film is available matted one or two sides, in rolls or sheets.

Find out for yourself how good this new product really is. Just mail the coupon, and we'll send you some literature and a test sample.

Du Pont Photo Products
2432-A Nemours
Wilmington 98, Delaware

ED-2

Please send me more information about CRONAFLEX DRAFTING FILM, and a test sample.

NAME _____

COMPANY _____

STREET _____

CITY _____ STATE _____



Better Things for Better Living... through Chemistry

*Du Pont registered trademarks

This advertisement was prepared exclusively by Phototypography

CIRCLE 331 ON READER-SERVICE CARD

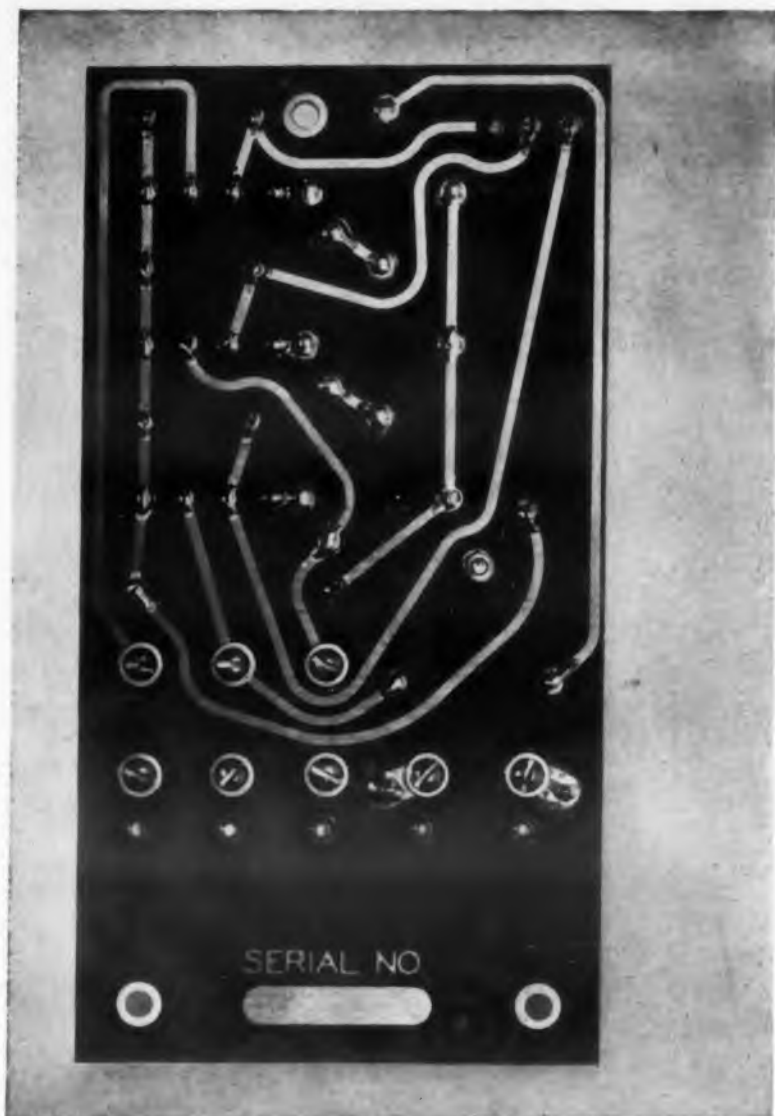

High strength-to-weight ratio. This printed wiring board for a phase failure relay (manufactured by Phase-Guard Co., Carnegie, Pa., and distributed by Stradley Engineering Co., Pittsburgh) was designed with CDF Di-Clad 28E (epoxy resin laminated with medium weave glass cloth) for high mechanical strength, very low moisture-absorption, and good insulation resistance. Details upon request.

How CDF Di-Clad[®] can solve your printed-circuit problems

The CDF line of copper-clad laminates in all grades is now known by a new name—Di-Clad. Di-Clad grades meet the varying needs of design, production, and operation of electronic equipment. Grades other than those described are also available.

Di-Clad 2350. An economy paper-base phenolic grade having good tensile, flexural, compressive, and impact strength. Adequate for most non-critical printed circuit applications. Can be cold punched and sheared up to 5/64 of an inch in thickness.

Di-Clad 112T. A Teflon* glass-fabric laminate offering the best dielectric properties over a wide temperature and frequency range.

Send us your requirements and let our engineers help you select the right grade for your application.

*Du Pont trademark for its tetrafluoroethylene resin.



CONTINENTAL-DIAMOND FIBRE

A SUBSIDIARY OF THE *Built* COMPANY • NEWARK 107, DEL.
In Canada: 46 Hollinger Road, Toronto 16, Ont.

TYPICAL Di-Clad PROPERTY VALUES

	Di-Clad 2350	Di-Clad 26 (NEMA XXXP)	Di-Clad 28 (NEMA XXXP)	Di-Clad 28E (NEMA G-10)	Di-Clad 112T Teflon*
BOND STRENGTH—0.0014" foil (lbs. reqd. to separate 1" width of foil from laminate)	6 to 10	6 to 10	6 to 10	8 to 12	4 to 8
MAXIMUM CONTINUOUS OPERATING TEMPERATURE (Deg. C.)	120	120	120	150	200
DIELECTRIC STRENGTH (Maximum voltage per mil for 1/16" thickness)	800	900	850	650	700
INSULATION RESISTANCE (Megohms) 96 hrs. at 35°C. & 90% RH (ASTM D257, Fig. 3)	500	150,000	600,000	100,000	75,000
DIELECTRIC CONSTANT 10 ⁶ Cycles	4.5	4.0	3.6	4.9	2.6
DISSIPATION FACTOR 10 ⁶ Cycles	0.040	0.026	0.027	0.019	0.0015
ARC-RESISTANCE (Seconds)	5	10	10	130	180
TENSILE STRENGTH (psi.)	18,000	16,000	12,000	48,000	23,000
FLEXURAL STRENGTH (psi.)	27,000	21,000	18,000	70,000	13,000
IZOD IMPACT STRENGTH edgewise (ft. lbs. per inch of notch)	0.80	0.45	0.42	12.0	6.0
COMPRESSIVE STRENGTH flatwise (psi.)	32,000	28,000	25,000	62,000	20,000
BASE MATERIAL OF LAMINATE	Paper	Paper	Paper	Medium-weave, medium-weight glass cloth	Fine-weave, medium-weight glass cloth
COLOR OF UNCLAD LAMINATE	Natural	Natural greenish	Natural	Natural	Natural

All these standard grades are available with 0.0014" and 0.0028" or thicker electrolytic or rolled copper foil on one or both surfaces. Other metal foils and other resin-and-base combinations can be supplied on special order.

*Du Pont Trademark

CIRCLE 332 ON READER-SERVICE CARD

IDEAS FOR DESIGN

and their leads are pushed through the card at the points shown by the large dots. Component and connecting leads can then be soldered together on the back of the card as indicated by the dashed lines of the schematic.

James Wightman, Harry E. Wood, Electrical Engineers, Lansdale Tube Co., Lansdale, Pa.

Terminal Plate Connects Common Wires

Connecting more than 3 or 4 wires to a common connecting point usually poses a problem. How can the wires be fastened securely to each

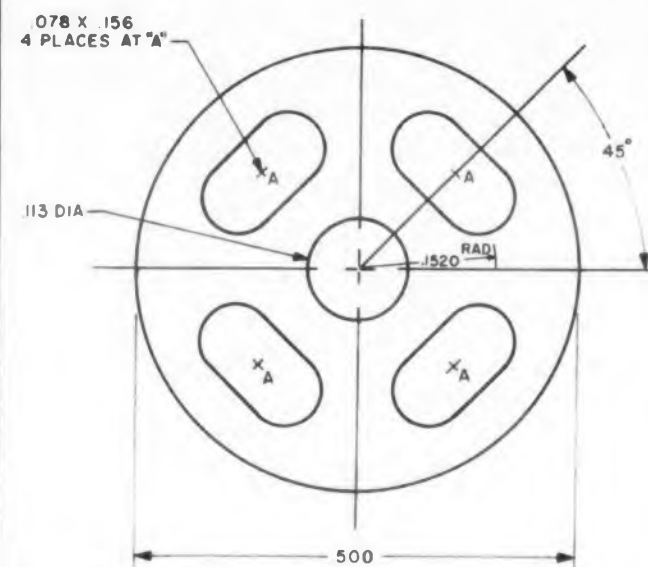

Fig. 1a. Multiple wire connections can be made to a terminal plate fashioned from a piece of metal.

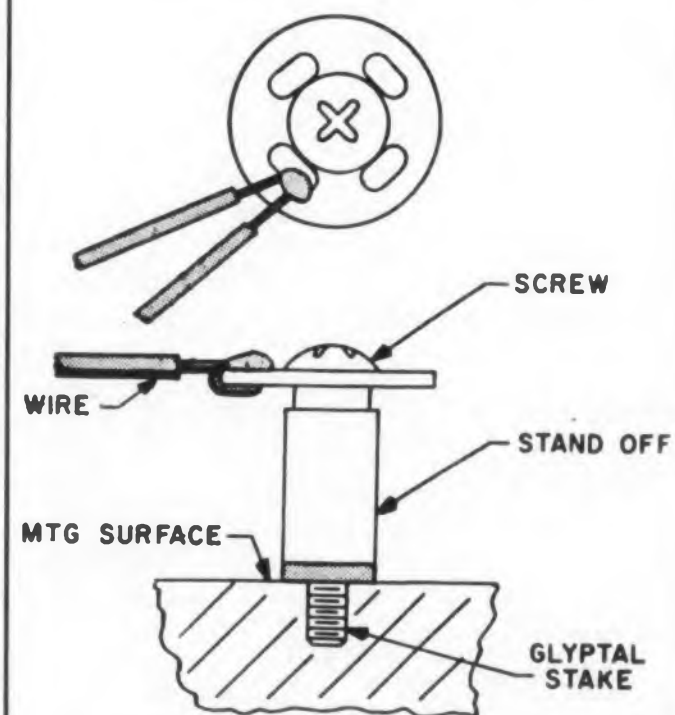

Fig. 1b. Wires are soldered to the plate which can be insulated from the mounting surface by a ceramic stand-off.

other without causing a messy, badly-soldered pile-up?

The usual methods use either a buss wire strung between two terminals or a terminal strip. A more compact and sturdier method is illustrated by the terminal plate shown in Fig. 1a. This plate can be cut from a piece of copper, or other conducting metal. Its thickness need be only about 0.032 in. Wires are connected to the terminal plate as shown in Fig. 1b. Note that the plate is insulated from the mounting surface by a ceramic stand-off. With the holes dimensioned and drilled as shown, up to 32 AWG #22 wires or 8 AWG #6 wires, or any comparable number of conductors can be securely held.

There are other ways in which the terminal plate can be used. Fig. 2a shows it soldered into

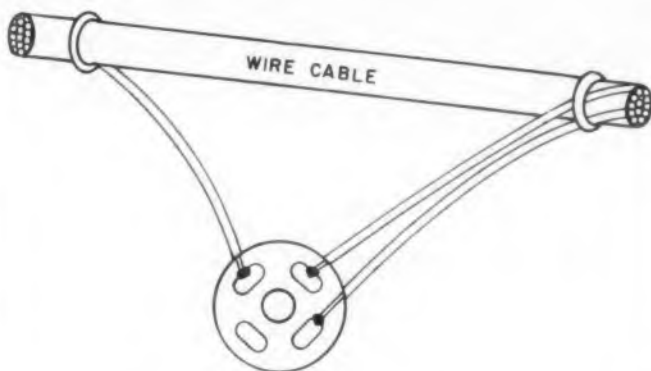

Fig. 2a. The terminal plate can be soldered into cables as part of the harness assembly.

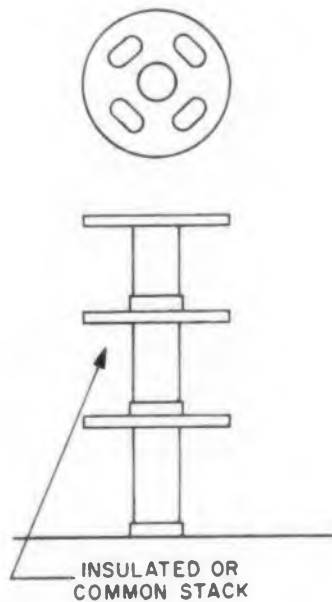

Fig. 2b. Terminal plates can be stacked on an insulated or common stack.

cables at the harness assembly. Or, the plates can be stacked, Fig. 2b, to accommodate a larger number of wires than a single unit can.

Stephen Szczygiel, Design Draftsman, General Electric Co., Utica, N.Y.

IF YOU INSTALL
LAMBDA POWER SUPPLIES NOW,
YOU KNOW THEY'LL
STILL PERFORM TO GUARANTEE IN

1960
1961
1962
1963
1964
1965



**BECAUSE ONLY LAMBDA GIVES
YOU A 5-YEAR GUARANTEE!**

Each Lambda Power Supply carries a written guarantee that warrants full performance to specified ratings for five full years.

Lambda, alone, offers this unprecedented guarantee because Lambda specializes in the design and manufacture of just one product — power supplies.

Each unit is built from the ground up to rigid quality standards in a modern, completely integrated plant. Nothing is overlooked to provide you with the finest performance. When you buy a Lambda Power Supply, you are assured of a unit that is conservatively rated —

a unit designed to provide continuous-duty service at all specified loads and ratings.

Lambda power supplies are available in a wide range of rack, portable and bench models for laboratory and production service. Of particular interest to electronic designers are:

L-T Transistor-Regulated Series..... 0-1 and 0-2 AMP, 0-32 VDC
Com-Pak Tube Regulated Series..... 200-400-800-1500 MA
0-200, 125-325, 325-525 VDC

Write for free 32-page catalog for complete specifications, dimensions, performance ratings and prices on Lambda's full line of tube-regulated and transistorized power supplies.



LAMBDA ELECTRONICS CORP.
11-11 131 STREET • COLLEGE POINT 56, N. Y. • INDEPENDENCE 1-8500

Watch for Lambda's exciting new solid-state power supply developments.

IRE SHOW — Booths 2318-2320

CIRCLE 333 ON READER-SERVICE CARD

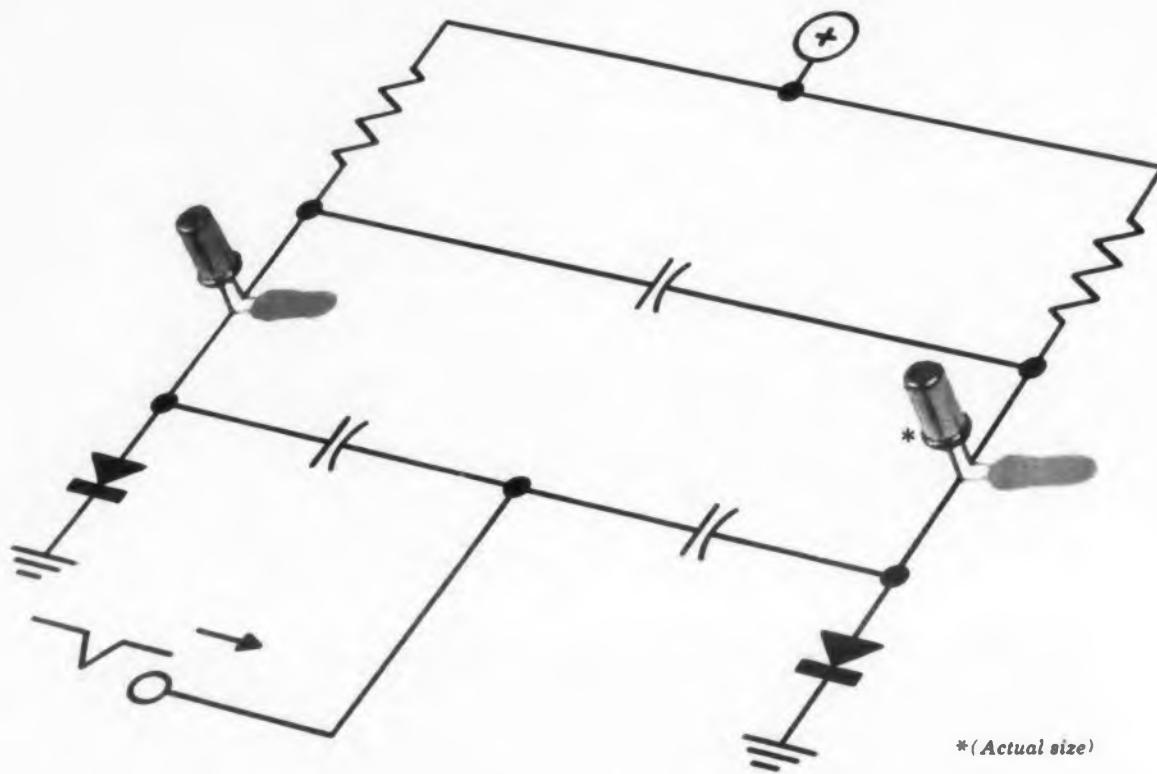

*SHOCKLEY 4-LAYER DIODES used in simple and inexpensive multivibrator circuit for high speed operation over a wide range of temperatures.

A NEW FLIP-FLOP CIRCUIT

A new and simple method for building flip-flop or multivibrator circuits is to use two (just two!) Shockley 4-layer diodes. After all, the 4-layer diode is a solid-state switch...just what's needed in a flip-flop.

Because of low cost, wide range of power handling, and high speed, 4-layer diodes can be used for many flip-flop applications - handling currents from a few milliamperes to 20 amperes...repetition rates as low as 1 cps to hundreds of kc...voltages from 20 to 200...temperature ranges from -60°C . to $+100^{\circ}\text{C}$.

There is circuit versatility, too. It can be triggered or free running. It can be designed so positive pulses

drive it to one side, negative pulses to the other; or so each pulse drives it to one side for a specified time then reverts automatically to the other side until the next pulse. Best of all - only 9 components are required...the free running flip-flop has only 7!

Our new Multivibrator Data Sheet will tell you more. Or, maybe you're interested in how the 4-layer diode can simplify and solve other circuit problems, such as pulse modulators, ring counters, alarm circuits, magnetic memory driving, d-c to a-c inverters, oscillators, detonators, or pulse amplifiers. Call your local Shockley representative or write Dept. 5-2.

Shockley TRANSISTOR CORPORATION

Stanford Industrial Park, Palo Alto, Calif.

A SUBSIDIARY OF BECKMAN INSTRUMENTS, INC.

CIRCLE 334 ON READER-SERVICE CARD



IDEAS FOR DESIGN

Measure Slopes Quickly

Investigation of the dynamic impedance characteristics of semiconductor diodes involves the measurement of the slopes of their characteristic curves. These slopes are not constant. The simplest method of displaying these curves is on an

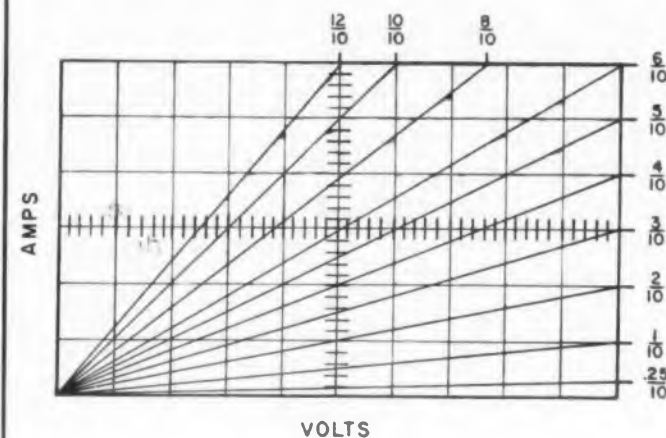

$$R = \frac{E}{I} = \frac{v/cm}{a/cm}$$

The differently sloped lines are scribed on a transparent piece of plexiglass which is placed over the crt screen.

instrument such as the Tektronix Scope 570, Characteristic Curve Tracer.

The value of each slope can be easily determined by scribing lines on a plexiglass reticle and placing it over the crt screen. In operation, the trace is moved on the screen until it matches the proper slope line, giving an immediate impedance reading.

Gerald Solomon, Engineering Techniques Dept., Burroughs Corp., Research Center, Paoli, Pa.

Reduce Delay Time In Binary Counters

Standard binary counters consist of a series of flip-flops, each triggered by the output of the binary which precedes it. If the flip-flops 1 through 4, Fig. 1, have the count 15 (1111), then at the next input trigger pulse these flip-flops are reset to zero in consecutive order, and flip-flop 5 is set to one. Note that flip-flop 5 is triggered after the propagation delay time through the previous flip-flops.

To offset or reduce this delay time, the following technique considerably reduces the delay to flip-flop 5. Any flip-flop in a binary counter undergoes a change only if all the previous flip-flops change from one to zero states. Therefore at the

count of 16, flip-flops 1 through 4 undergo a one to zero change. By introducing an "AND" gate



Fig. 1. Flip-flop 5 is triggered only after the first four flip-flops have been reset from 1 to zero.

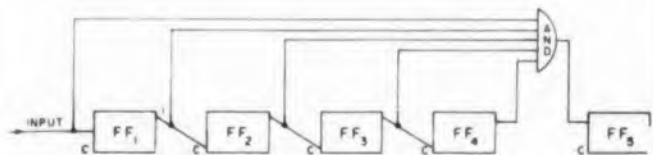

Fig. 2. The "AND" gate senses the outputs of the first four flip-flops. At the count of 16, both flip-flops 1 and 5 are triggered by the input pulse.

which senses the outputs of the first four flip-flops, at the count of 16, the input trigger pulse to the binary chain triggers flip-flop 5 along with flip-flop 1. This reduces the propagation delay time through the flip-flops and synchronizes flip-flops 1 and 5.

Reuben Wasserman, Hermes Electronics Co., Cambridge, Mass.

Missing Figure

The figure which should have appeared with an Idea for Design (ED, Jan. 20, 1960, p 120) by Lansing E. Tryon entitled, "An Uncomplementary, Exclusive-OR Circuit" was inadvertently not included with the article. The figure is shown below. Our apologies to Mr. Tryon and readers.

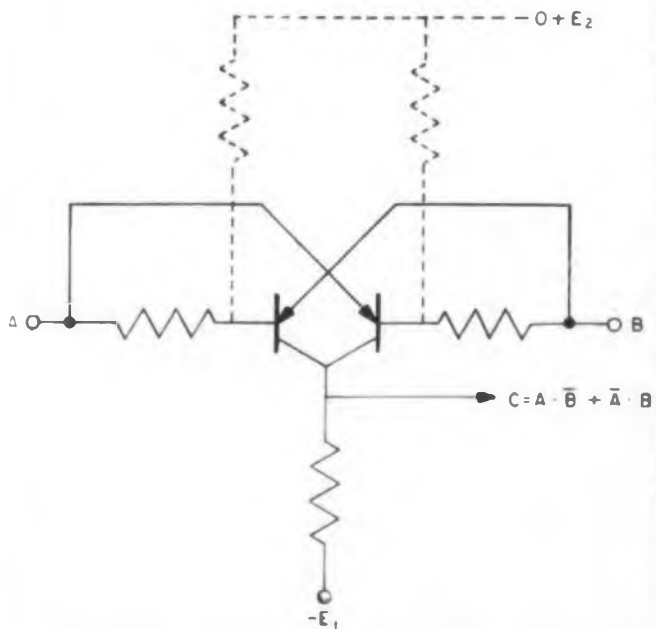

Mr. Tryon's Exclusive-OR circuit for two inputs does not require complementary transistors.

Packaging
circuitry
is like child's play
with Alden
Basic Building Blocks



THE PLUG-IN COMPONENT IDEA -
part of a continuing series

See it in action
Booths 1508, 1510
The IRE Show

A Alden plug-ins are beautifully, basically uncomplicated.

The design engineer starts with planning and layout. Alden offers him basic building blocks to solve that particular problem.

He wants to assemble his circuitry. Alden gives him everything he needs to tie that package up neatly — through a terminal card mounting system that unitizes circuitry in compact planes.

He is now ready to package his card-mounted sub-assemblies.

For this, Alden provides a variety of basic plug-in chassis, in which his circuitry is neatly deployed, function by function, in space-saving vertical planes. (That's it in the picture). These chassis plug in, lock, and eject with a half-turn of the wrist.

Where does he house his plug-ins?

He can go to his own standard racks. Or, Alden has basic "housing" units, called Uni-Racks, that help him there. (See the next Alden ad — look for our engineer friend).

All along the way, Alden makes servicing and trouble shooting simple. Tell tales to spot trouble automatically. Easily traceable interconnections, with all leads brought to a single check point, numbered and color coded for quick testing.

What does it add up to? Reliability in service.

We'll have more to say on this subject next time we appear on these pages.

Write now for Alden's 250-page handbook.

ALDEN

PRODUCTS COMPANY
2139 N. Main St., Brockton, Mass.



The Alden Basic Plug-in Chassis — with circuitry arranged in space-saving vertical planes for easy servicing, a typical chassis plugs in, locks, ejects with a half turn of the wrist.

CIRCLE 335 ON READER-SERVICE CARD



**Waters
new
pots
conquer
space**

Two new 1/2" Waters pots conquer a space problem for many a harassed space age engineer. Both require up to 25% less space behind the panel than pots having identical specifications. Available with terminals (shown), wire leads or printed circuit pins. Case lengths are only 3/8". The new APS 1/2 is designed for bushing-type mounting. The WPS 1/2, designed for servo mounting, is the smallest potentiometer available for general use in rugged servo applications. Both are capable of dissipating 2 watts continuously! Reliability test reports available. Write for Bulletin APS-160.



POTENTIOMETERS • SLOTTED TUNED COIL FORMS • RF COILS • CHOKES • POT HOOD® PANEL MOUNTS • TORQUE WATCH® GAGES • CONTROL METER/CONTROLLER • INSTRUMENTS

CIRCLE 336 ON READER-SERVICE CARD

IDEAS FOR DESIGN

Summing Network Varies AC-DC Components of Input Saw Tooth

The ac and dc components of a linear saw-tooth voltage wave can be varied by using a purely resistive summing network. Shown in Fig. 1, the network has fed into it the sawtooth voltage signal, V_s , the negative of the signal's dc level, E_4 , and a dc voltage which sets the new dc level, E_2 . Since no coupling capacitors are present, the circuit can be used for waveforms with very low repetition rates. Also, use of a summing network will bring about attenuation, but will cause no interaction of controls.

Assuming that the potentiometers used to vary voltages are zero impedance sources, the equivalent circuit of the network is as shown in Fig. 2. Summing the currents at the output junction:

$$\frac{E_1 - E_o}{R_1} + \frac{E_2 - E_o}{R_2} + \frac{E_3 - E_o}{R_3} + \frac{V_L - E_o}{R_L} = 0 \quad (1)$$

In terms of the output voltage, E_o , this becomes:

$$E_o = \frac{\frac{E_1}{R_1} + \frac{E_2}{R_2} + \frac{E_3}{R_3} + \frac{V_L}{R_L}}{\frac{1}{R_1} + \frac{1}{R_2} + \frac{1}{R_3} + \frac{1}{R_L}} \quad (2)$$

The voltages E_1 and E_3 are set by a dual potentiometer. They are equal to some fraction X of the total voltage across them. That is:

$$E_1 = X(V_s - V_{cc}) \quad E_3 = X(E_4 + V_{cc}) \quad (3)$$

Substituting Eq. 3 into Eq. 2 yields:

$$E_o = \frac{\frac{X(V_s - V_{cc})}{R_1} + \frac{X(E_4 + V_{cc})}{R_3} + \frac{E_2}{R_2} + \frac{V_L}{R_L}}{\frac{1}{R_1} + \frac{1}{R_2} + \frac{1}{R_3} + \frac{1}{R_L}} \quad (4)$$

It is readily seen that if $R_1 = R_3 = R$, the effects

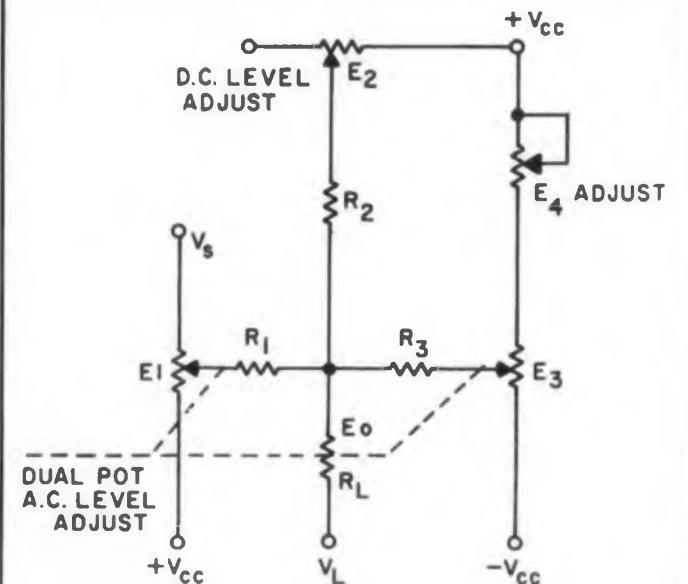

Fig. 1. Resistive summing network allows the ac and dc components of a saw-tooth voltage wave to be varied separately.

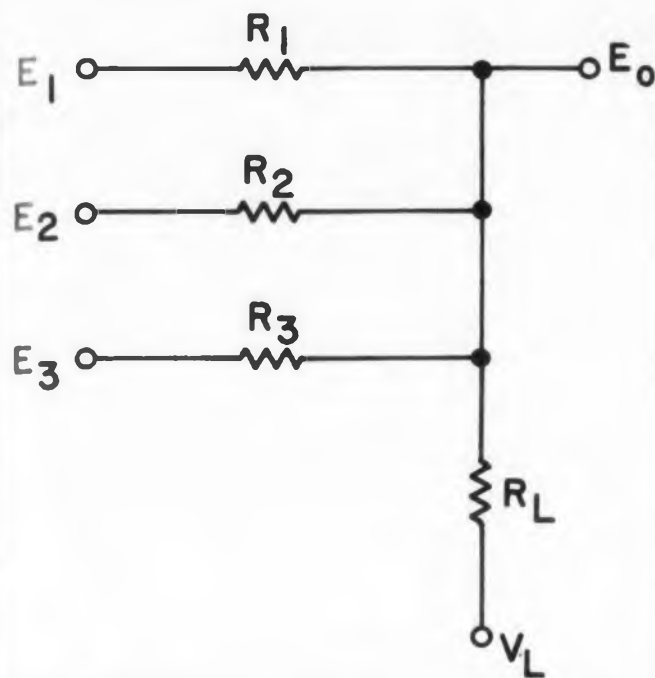

Fig. 2. Equivalent circuit of the summing network assumes that E_1 , E_2 , and E_3 are supplied by low-impedance sources.

of V_{cc} is eliminated from the equation. This value R is substituted into Eq. 4 and the signal, voltage, V_s is replaced with its ac and dc components ($V_s = V_{ac} + V_{dc}$):

$$E_o = \frac{\frac{X(V_{ac} + V_{dc})}{R} + \frac{X(E_1)}{R} + \frac{E_2}{R_2} + \frac{V_L}{R_L}}{\frac{2}{R} + \frac{1}{R_2} + \frac{1}{R_L}} \quad (5)$$

From this last relation it becomes apparent that if E_1 is set equal to the negative of V_{dc} , the dc component of the signal will also be eliminated. Substituting $E_1 = -V_{dc}$:

$$E_o = \frac{\frac{XV_{ac}}{R} + \frac{E_2}{R_2} + \frac{V_L}{R_L}}{\frac{2}{R} + \frac{1}{R_2} + \frac{1}{R_L}} \quad (6)$$

If, furthermore, R_2 is made equal to R , this equation simplifies to:

$$E_o = \frac{\frac{X}{R} V_{ac} + \frac{E_2}{R} + \frac{V_L}{R_L}}{\frac{3}{R} + \frac{1}{R_L}} \quad (7)$$

$$E_o = \frac{XV_{ac}}{3 + \frac{R}{R_L}} + \frac{E_2}{3 + \frac{R}{R_L}} + \frac{V_L}{1 + \frac{3R_L}{R}} \quad (8)$$

Assuming that $R_L > R$ and $V_L \approx 0$ yields the simple relation:

$$E_o \approx \frac{X}{3} V_{ac} + \frac{E_2}{3} \quad (9)$$

The ac and dc components of the input saw tooth are directly and independently variable.

R. L. Knox, Associate Engineer, Stromberg-Carlson Co., Rochester, N.Y.

This new Electro Instruments all-electronic Digital Voltmeter combines high conversion speeds, one digit accuracy, automatic ranging and polarity, high input impedance and 9 other features you want, in a single totally transistorized instrument!



MODEL 8409

Complete control of the voltmeter from remote locations makes it the ideal instrument for systems applications.

- 50 conversions per second average
- 3 ranges: 9.999/ 99.99/ 999.9 volts
- Automatic, manual and remote ranging
- 4 digit, in-line visual readout
- BCD and decimal electrical output
- Direct printer operation
- 5½" x 19" front panel
- Modular internal construction
- Provision for external reference voltage

ACCESSORY MODULES INCREASE ITS USEFULNESS

AC: All-transistorized Model 110; considerably faster AC/DC conversion than presently available models. Fully automatic ranging and direct AC voltage readout on the Model 8409.

Ohmmeter: All-transistorized Model KIM-000. Provides constant current through test resistor with negligible power dissipation. Voltage measurements made across resistor with fully automatic ranging and read out directly in ohms on the Model 8409.

Scanners, code converters, print control modules and many other accessories to solve all digital problems—from simple instruments to complex data logging systems—are available. Get in touch with your EI Sales Engineer today for complete information.

Electro Instruments, Inc. 3540 AERO COURT SAN DIEGO 11, CALIF.

Digital instruments for measuring AC/DC voltages, AC/DC ratios, resistances, capacitance, and frequency • X-Y Recorders • DC Amplifiers

CIRCLE 337 ON READER-SERVICE CARD

AD VESTRAM BIBLIOTHECAM!



ORDER YOUR FREE CATALOG NOW!

DRESSEN-BARNES CORP.

250 NORTH VINEDO AVENUE
PASADENA, CALIFORNIA
MURRAY 1-0643
TWX: PASACAL 8499

FOR YOUR LIBRARY!
THIS FREE CATALOG
COVERS OUR COMPLETE
LINE OF TRANSISTOR-
IZED, MAGNETIC AMPLI-
FIER, REGULATED AND
UNREGULATED, MODU-
LAR AND LABORATORY
TYPE DC POWER
SUPPLIES.

12 YEARS IN THE MAK-
ING. THIS NEW FREE
CATALOG INCLUDES IM-
PORTANT DESIGN DATA
PLUS A DC POWER SUP-
PLY SELECTOR CHART.
ORDER YOUR FREE COPY
NOW.

CIRCLE 338 ON READER-SERVICE CARD

small...but

mighty

COMAR'S SUB-MINIATURE TYPE SM



Less than an inch long Weighs less than 1/2 oz.

big relay performance in crystal can size

A high precision, efficient sub-miniature relay. Constructed to withstand severe vibration, heavy shock and temperature extremes. For control systems, missiles, computers, aircraft and similar applications requiring miniature size and dependable performance.

SEND FOR DETAILS NOW!

COMAR

ELECTRIC COMPANY
3349 ADDISON STREET
CHICAGO 18, ILLINOIS

RELAYS • SOLENOIDS • COILS • SWITCHES • HERMETIC SEALING
CIRCLE 339 ON READER-SERVICE CARD

Thyratron Provides Double & Triple Coincidence Control



KP-80, Actual Size

The KP-80 is a coincidence thyratron which may be used in double or triple control coincidence circuits, as well as conventional single-signal applications. Operating on the ion deflection principle (registered U.S. Patent Office), the KP-80 provides true symmetrical grid sensitivity in that large signals applied to one grid alone will NOT fire the tube, while small, low current signals applied simultaneously to both grids will cause conduction. The KP-80 is used as an "and" gate, a binary counter, for relay closure, etc. Because it combines many circuit functions, the KP-80 eliminates from 14 to 25 precision circuit components, thus reducing space and weight, and contributing to improved equipment reliability. The KP-80 is found in conveyor selection systems, coding & programming devices, automation control apparatus, etc. A subminiature version is also available (type KP-150) which also provides visual indication as well as double coincidence operation. For details on these and other special purpose electron tubes, contact:

KIP ELECTRONICS CORPORATION

Dept. 65, Box 562, Stamford, Connecticut
CIRCLE 340 ON READER-SERVICE CARD

IDEAS FOR DESIGN

A Cadmium Sulfide Photocell Indicator

The circuit shown is a photocell indicator for use in a burglar alarm system. It was designed to avoid the use of dc amplifiers.

Element *T* is a Hupp CdS, class 2 cell, and varies the frequency of the free running multi-vibrator in accordance with incident light variations. Fully illuminated, the oscillator produces a

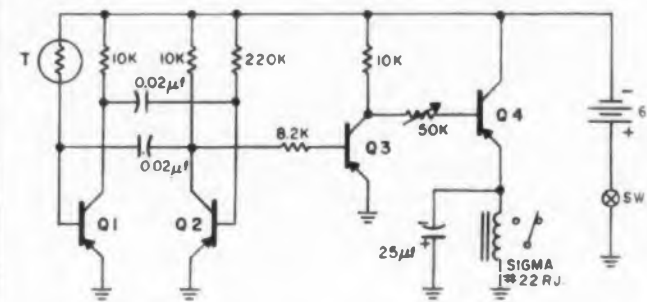

pulse train with about a 15% duty cycle. When the beam of light is broken, the duty cycle changes to 60-65%. Q_3 is an amplifier which drives the output emitter follower Q_4 . The relay is normally energized, but opens when power fails or the light beam is broken. The 25- μ f capacitor smooths the pulses on the relay coil. With a small focusing lens, the device operates well with an ordinary 2-cell flashlight over 200 ft away, even in the presence of rather high ambient light.

John Porter, President, Portronics, Inc., Tarzana, Calif.

Circuit Delays Pulse Train

A simple circuit was required which would delay a series of 4- μ sec negative pulses for about 1 μ sec. The circuit shown below is essentially a modification of the clever delay circuit by W. L. Rumple which appeared in the July 8, 1959 issue of ELECTRONIC DESIGN.

Initially the input terminal is at +10 v and sufficient current is flowing through R and the 9-v Zener diode to keep TR_1 saturated. Thus the collector of TR_1 is approximately at ground poten-

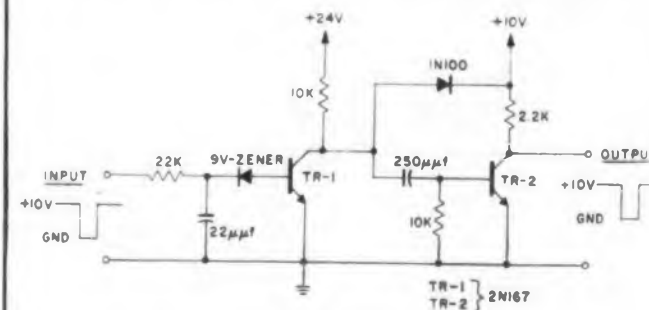

Resistor, capacitor and Zener diode combine to delay 4- μ sec pulse train by 1 μ sec.

nal. When a negative pulse appears at the input, the change of voltage at the collector of TR_1 is delayed about 1 μ sec by the R and C elements and the storage time of the Zener diode and the saturated transistor.

At the end of the pulse the input voltage again rises to +10 v. TR_1 will not conduct until C has charged to the Zener diode voltage, delaying the change of TR_1 's collector voltage by about 1 μ sec. The diode at the collector of TR_1 clamps this point and squares off the top of the waveform.

TR_2 is a combined clipping-inverting amplifier. The resultant output is almost identical to the input, but delayed by 1 μ sec.

Richard B. McWhirt, Electronics Scientist, Naval Research Laboratory, Washington, D. C.

Germanium Transistors Drive Solenoid Magnet

The circuit shown was designed to energize a high-current, high-voltage solenoid from a positive voltage supply. Two inexpensive, germanium transistors were substituted for the high priced silicon unit which might be called for in an ordinary design of such a driving circuit.

In choosing the circuit values, voltage divider R_3 - R_4 is selected to limit the collector voltage of T_1 to within its maximum rating. Resistor R_1 must be sufficiently small so that the input pulse saturates T_1 . When T_1 is saturated, R_3 is effectively shorted out, permitting a base current large enough to drive T_2 into saturation. The collector current of T_2 is limited by the dc resistance of the solenoid and the current-limiting R_5 . Diode D_1 is required to damp out any high voltage induc-

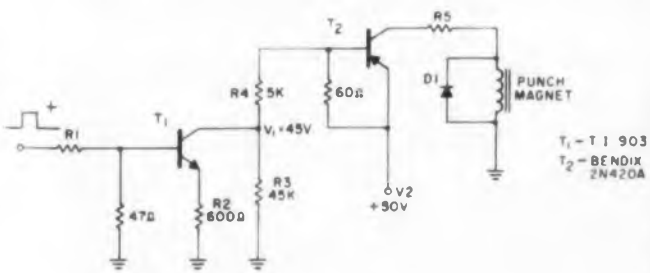

tive spikes appearing at the collector of T_2 when it is cut off. Emitter resistor R_2 is selected to set the cut-off threshold of T_1 .

To insure that the maximum collector dissipation rating is not exceeded, it is necessary to compute the collector power, taking into account the duty cycle. However, with the normally low duty cycles encountered in the usual application of such a device, V_{CE} and V_{CB} are often found to be more significant in transistor choice than the collector dissipation.

T. E. Cantor, Flight Test Engineer, General Precision Laboratory, Inc., Pleasantville, N.Y.

Available now - ceramic "extras" in more than 40 tube types



SMALLER SIZE



IMPACT SURVIVAL

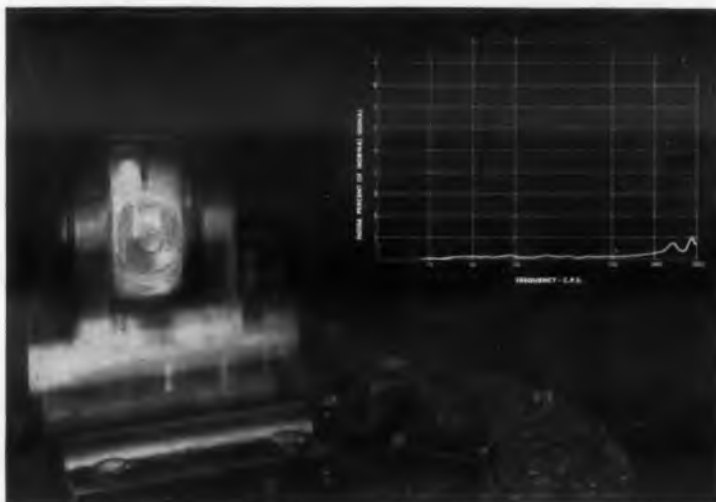

VIBRATION SURVIVAL



EXACT DIMENSIONAL UNIFORMITY



EXTREME HEAT SURVIVAL



LOWER DIELECTRIC LOSS

Superior performing Eimac ceramic negative-grid tubes and klystrons are available now for modern equipments.

EITEL-McCULLOUGH, INC.
SAN CARLOS, CALIFORNIA

Eimac First with ceramic tubes that can take it

CIRCLE 341 ON READER-SERVICE CARD



Cable address
EIMAC
San Carlos



DIEHL*

The growing family of
instrument servo components

60 cycle Servomotors (1, 3, 5 and 10 watts)
400 cycle Servomotors (3 and 15 watts)
60 cycle A.C. Tachometers
400 cycle A.C. Tachometers
D.C. Tachometers
Gear Reducers
Vacuum Tube Servo Amplifiers
SERVO POT (Combination of: Servomotor,
gear train, slip clutch and potentiometer)
Available separately or in any combination

DIEHL Instrument Servo Components have been developed to offer maximum performance, flexibility and reliability at minimum cost. These are the basic servo system building blocks which enable our military and industrial customers to satisfy the demands placed on them for higher over-all response, accuracy and economy. Write for full details concerning any of these components.

I.S.A. Conference
and Exhibit
Booth 673
International
Amphitheater
Chicago, Ill.
Sept. 21-25, 1959



DIEHL MANUFACTURING COMPANY
A SUBSIDIARY OF THE SINGER MANUFACTURING COMPANY

Somerville, New Jersey

• AC SERVO MOTORS • AC SERVO MOTORS WITH AC TACHOMETERS • DC SERVO SETS
• AC SERVO MOTORS WITH DC TACHOMETERS • AC AND DC TACHOMETERS • RESOLVERS

*A Trademark of DIEHL MANUFACTURING COMPANY

CIRCLE 342 ON READER-SERVICE CARD



PATENTS

Radio Frequency Window

Patent No. 2,894,228. Wilson S. Geisler
(Assigned to Varian Associates)

An inclined microwave window for vacuum sealing provides a long path for the *E* vectors. High resistance to breakdown exists since the window will fail only by dielectric puncture. In addition, the flange connections are folded and springy to compensate for thermal expansion.

A rectangular waveguide 1 has a circular dielectric aperture 9 in a square

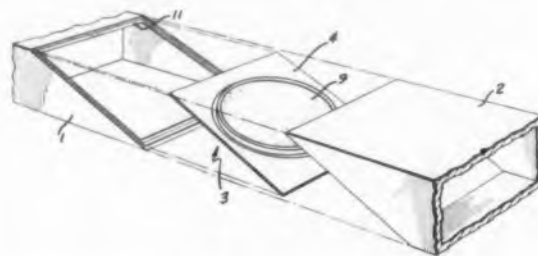

copper frame 4 inclined approximately 26 deg to the wide wall of the guide. Also, it is set at a convenient angle to the narrow wall.

The ceramic is bonded by a moly-man-

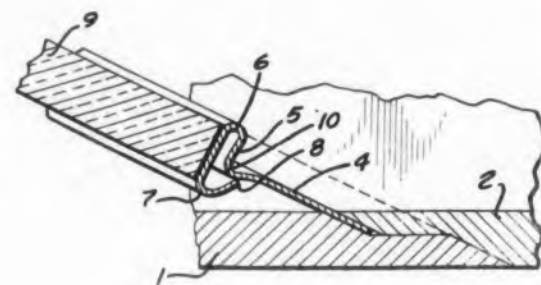

ganese joint and flexible flange 5 is silver soldered to the wall of the guide. To prevent reflections, the upper and lower walls of the guide may be internally tapered to a fine edge away from the flange.

... PRECISION BORING

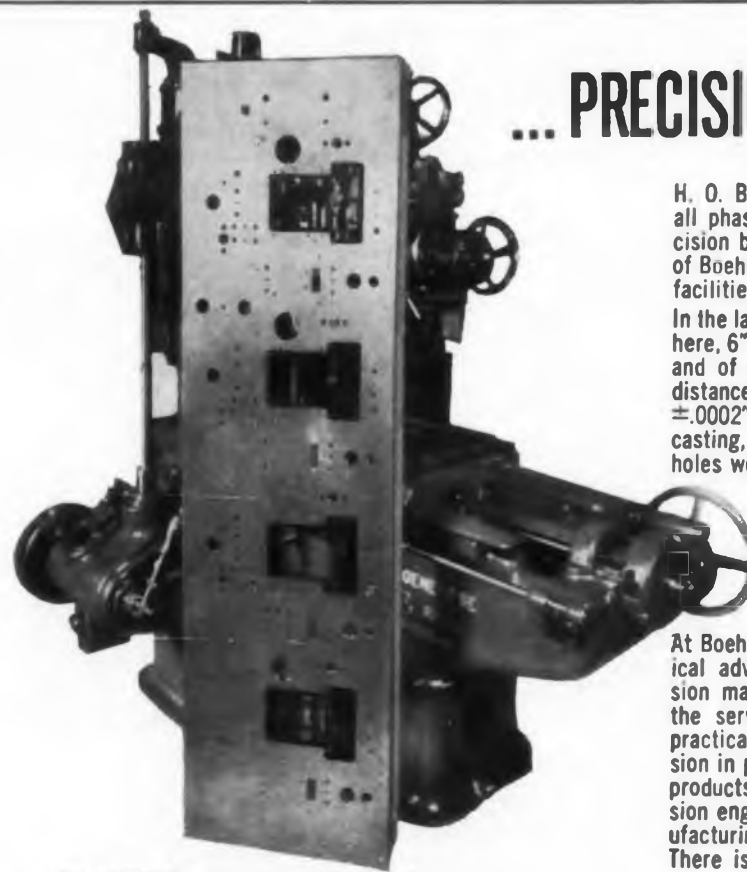

H. O. Boehme, Inc., specializes in all phases of precision work. Precision boring represents one facet of Boehme precision manufacturing facilities.

In the large, complex casting shown here, 6" deep, 20" wide, 6 feet long and of material $\frac{3}{8}$ " thick, center distances were held to limits of ± 0.0002 ". (Similarly, in the small casting, gear centers and line up holes were held to ± 0.0002 ".)

Swiss jig borers accurate to ± 0.0001 ", rotary tilt tables and other specialized equipment are part of our modern facilities.

At Boehme you obtain the economical advantages of modern precision manufacturing methods, plus the services of craftsmen whose practical experience assure precision in prototype or production-run products. Your inquiries on precision engineering, design, and manufacturing services are welcome. There is no obligation, of course.

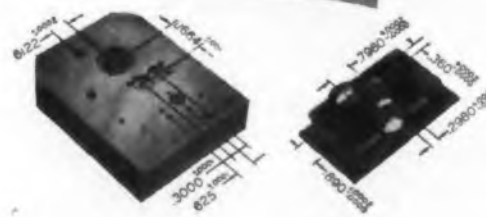

H. O. Boehme, Inc.

Contractors, Designers, Manufacturers
of Precision Electrical, Electro-
Mechanical and Electronic
Equipment since 1917

915 Broadway New York 10, N. Y.



CIRCLE 343 ON READER-SERVICE CARD

ELECTRONIC DESIGN • February 17, 1960

Radio Frequency Delay Line

Patent No. 2,916,615. F. J. Lundburg.
(Assigned to International Telephone and
Telegraph Corp.)

A delay line made of superconductive
material has extremely low attenuation
when operated at the temperature of
liquid helium.

Transmission line 9 sits in a helium

bath which is surrounded by liquid nitro-
gen between walls 12 and 13. A portion
of the signal from transmitter 8 is
coupled, after predetermined delay
through line 9, to the receiver 7 for mov-
ing target comparison. Several elements
and alloys suitable for cryogenic applica-
tions are tabulated.

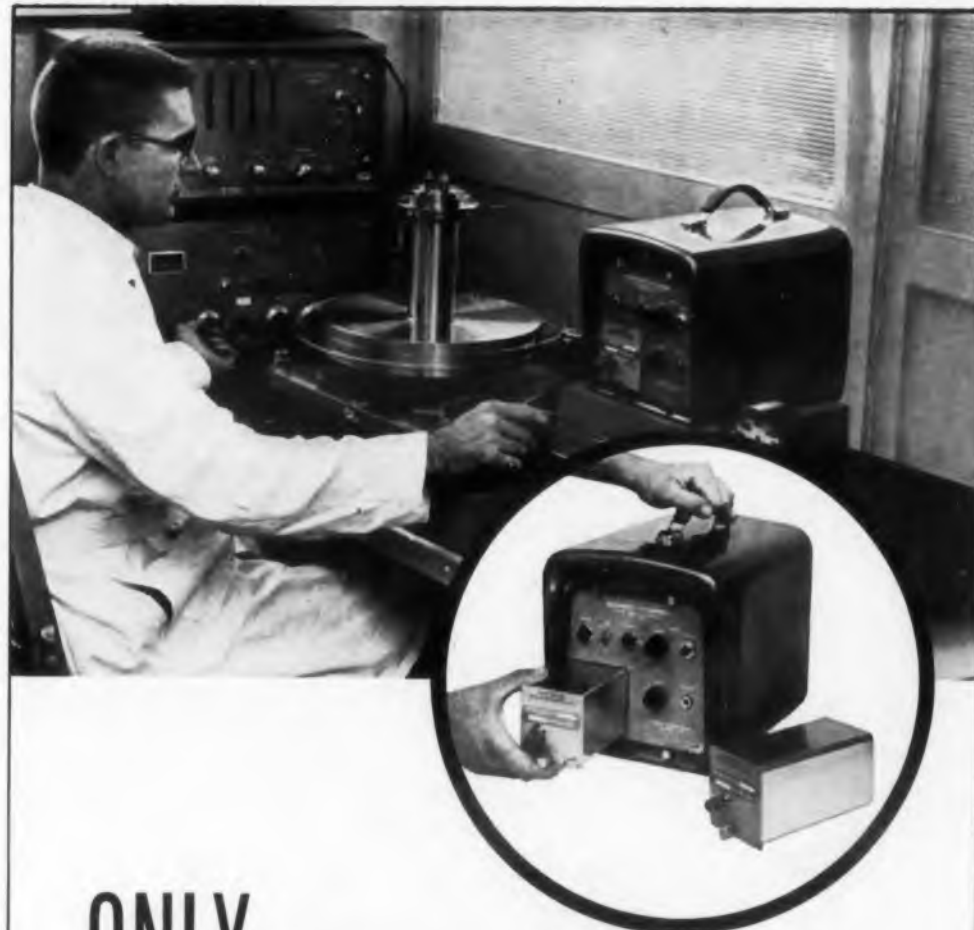
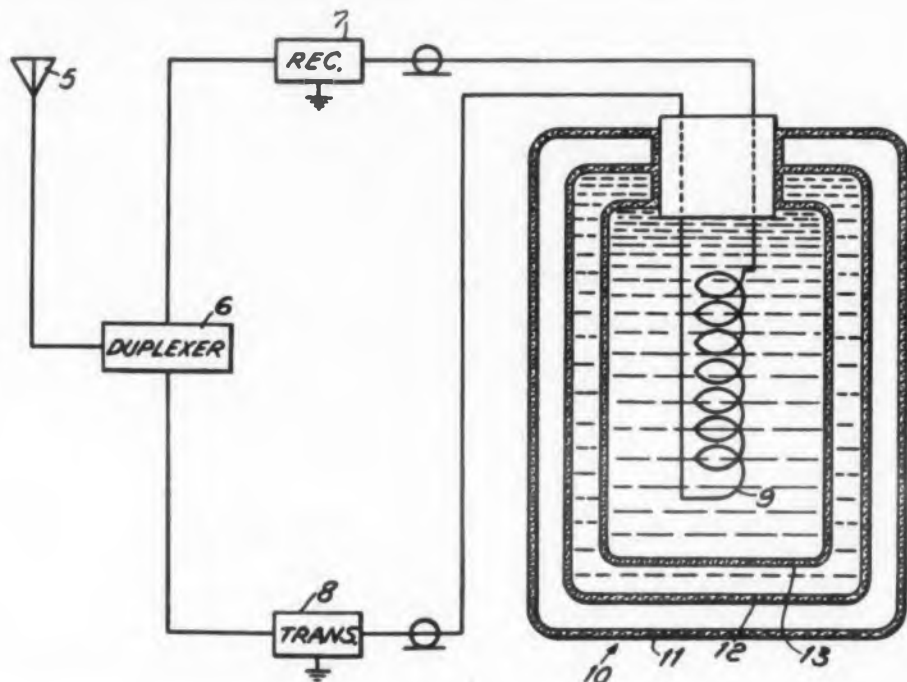

ONLY wiancko offers a
portable secondary standard
with digital readout

Q3403 exclusive features:

- ✓ Permits direct parameter measurements and calibration of transducers (pressure, force, accelerometers and temperature) in field, plant or laboratory.
- ✓ x2 and x4 plug-in frequency multiplier, coupled with bandwidth adjust provides greater accuracy due to increased resolution and real data capability—speedier testing and checkout.
- ✓ Readily interchangeable plug-in units for absolute, gage and differential pressure heads—ranges 5 to 10,000 psi.
- ✓ Head adapter permits use of Wiancko force rings, accelerometer, pressure pickups, or temperature bulbs—500 feet distant from Standard.

Accuracy: ± 0.05 percent full scale; ranges 0-2500 psi
 ± 0.08 percent full scale; ranges 3000-10,000 psi

For more information write for Product Bulletin 106A.

WIANCKO
ENGINEERING COMPANY



255 North Halstead Avenue • Pasadena, California

Precision with lasting reliability

Engineers! Designers!

**THERE IS NO SUBSTITUTE
FOR RELIABILITY!**

Specify—

**PERFORMANCE
PROVEN "MAG MOD"**

**MAGNETIC
MODULATORS**



For complete specifications and application data on "Mag Mod" Miniature and Standard Components, call or write.

Miniaturized design permits engineers to employ these new components in transistorized printed circuit assemblies and wafer type structures. All models offer maximum reliability, fully ruggedized construction and conform to MIL-T-27A specifications.

- COMPLETE RELIABILITY
- INFINITE LIFE
- FASTER RESPONSE TIME
- NEGLIGIBLE HYSTERESIS
- EXTREME STABILITY
(Ambient Temp. Range from -75° to $+135^{\circ}$ C)
- COMPACT SIZE
- LIGHTWEIGHT

Typical circuit applications for Magnetic Modulators are algebraic addition, subtraction, multiplying, raising to a power, controlling amplifier gains, mechanical chopper replacement in DC to fundamental frequency conversion, filtering and low signal level amplification.

**GENERAL
MAGNETICS • INC**

135 BLOOMFIELD AVENUE
BLOOMFIELD, NEW JERSEY
Telephone: Pilgrim 8-2400

CIRCLE 344 ON READER-SERVICE CARD

CIRCLE 345 ON READER-SERVICE CARD

Yes! 4000 to 6000 Terminations
per hour....

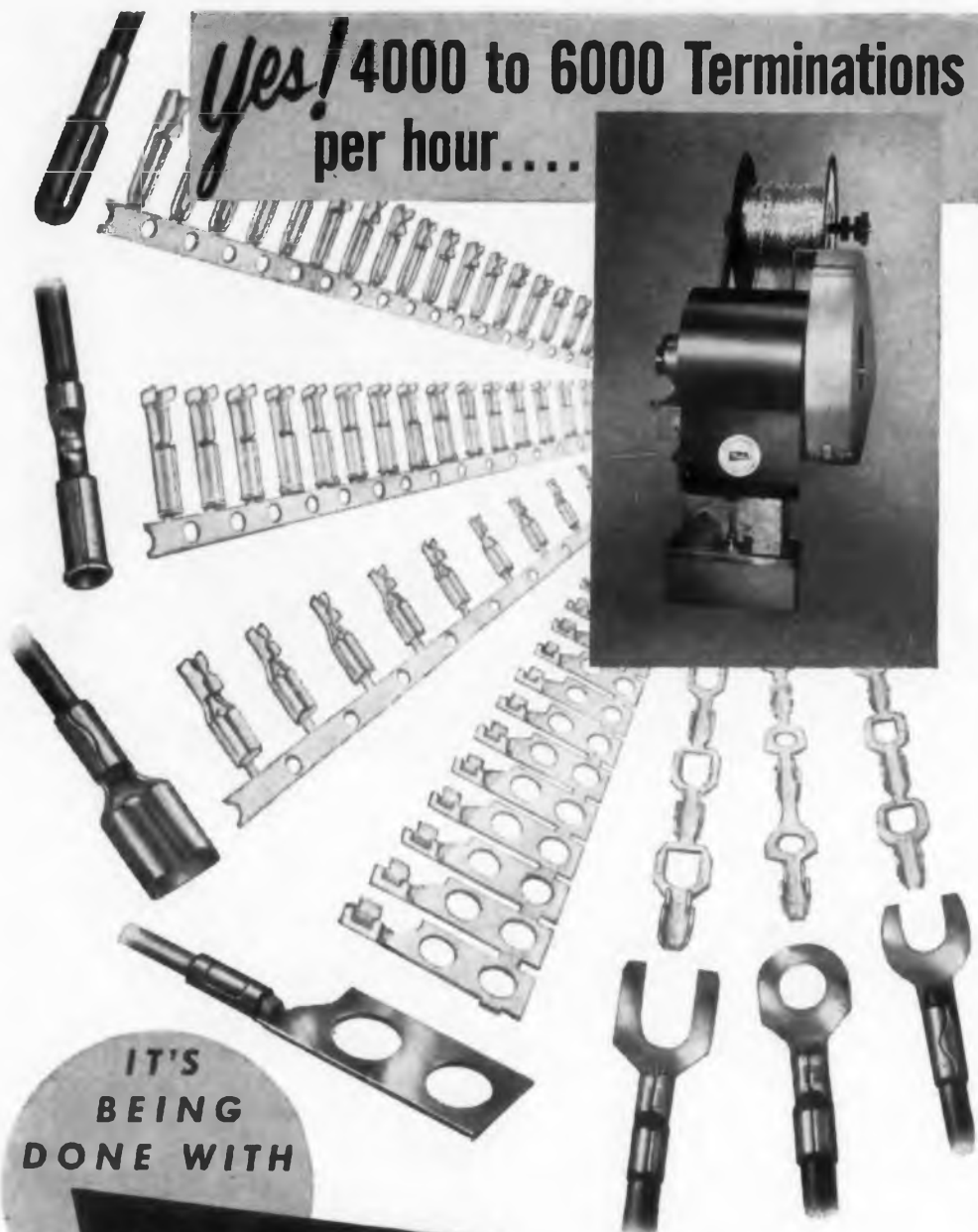

IT'S
BEING
DONE WITH

Malco

CHAIN
TERMINALS AND
MALCOMATIC®
ELECTRO-CRIMP MACHINES

This combination saves unlimited man-hours, speeds assemblies, reduces rejects and cuts production costs:

- 1 Malco quality terminals and receptacles are furnished on convenient spools—for electrical, electronic and military applications.
- 2 Malcomatic Electro-Crimp Machines assure fast, consistent and uniform crimping—are convenient, safe, fool-proof and easy to operate even for unskilled operators.

Photograph shows Malcomatic Electro-Crimp Machine Model M2—back feed type. Side feed type also available.

Malco

Request Bulletin 581. Send prints-specs for prompt quotation.

MANUFACTURING COMPANY
4027 West Lake Street Chicago 24, Illinois

CIRCLE 346 ON READER-SERVICE CARD

PATENTS

Current Supply Apparatus

Patent No. 2,906,941. S. J. Brolin. (Assigned to Bell Telephone Labs)

This current regulator consists of an array of transistors in shunt, connected to share a predetermined percentage of the load current.

If the voltage across the load decreases slightly, the base of transistor 26

becomes more positive. This increases its emitter current and also the emitter current of transistor 15. The larger voltage drop across resistor 12 causes increased emitter current in both transistors 16 and 17. These currents, combined with the current through transistor 15, are the load current required to reset the load voltage to the prescribed value.

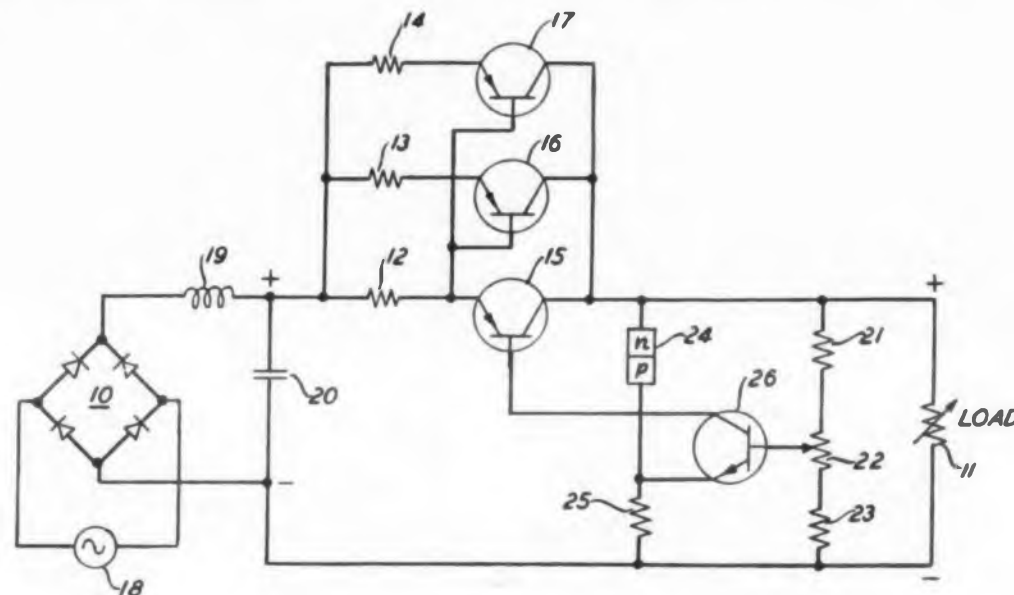

TAILOR THE TERMINAL TO THE BOARD



CAMBION Swaging Tools are designed to precisely seat and securely stake all CAMBION Terminals. For each type of terminal there's a CAMBION punch-and-anvil combination. Precision-machined from fine steel for long wear, standard sets are available for only \$5.00 each to match the following CAMBION Swaging Machines:

HAND SWAGERS for small volume staking. Can be used manually, in a kick press, or in a riveting machine. **PRESSURE SWAGERS** for normal production. These sturdy, hand-operated, cam-action rolling tools are easily adjustable for a wide range of board thickness. **HOPPER STAKERS** for high production. These semiautomatic stakers faultlessly feed and stake thousands of terminals without interruption at a rate of approximately 100 a minute. Write Cambridge Thermionic Corporation, 457 Concord Avenue, Cambridge 38, Mass. for full details on these and other products in the wide line of

CAMBION®

The guaranteed electronic components

CIRCLE 347 ON READER-SERVICE CARD

ELECTRONIC DESIGN • February 17, 1960

Suppressed Carrier Modulating System
 Patent No. 2,915,711. R. C. Stanford. (Assigned to The Hallicrafters Corp.)

The carrier frequency is suppressed in a modulation circuit consisting of passive elements connected in a bridged-T tuned to the carrier frequency. An audio modulating signal unbalances the nonlinear network so that the upper and lower sidebands appear in the output.

As illustrated, the shunt leg of the bridged-T circuit contains diode 24, biased through variable resistor 28. Capacitor 21 is adjusted to completely attenuate the carrier frequency. However, the audio signal unbalances the filter with respect to phase and the sidebands are fed through capacitor 33. Circuit components are tabulated for a carrier frequency of 5 megacycles.

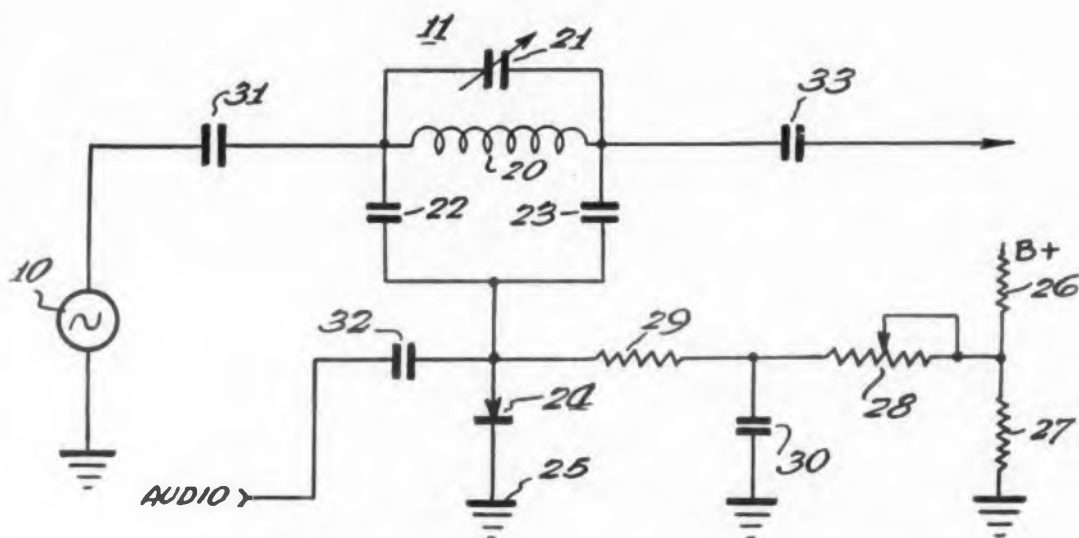

GEE-LAR KNOBS FOR IMMEDIATE DELIVERY

Fast Service is the big "plus" you get at GEE-LAR—the House of Knobs. Hundreds of styles, sizes and types, including deluxe Gold Inlay Knobs, are stocked . . . quickly shipped to you in any quantity. Best of all, your costs are always moderate . . . there's no charge for tooling or molds.

FAST SERVICE

Gee-Lar is geared for immediate deliveries. Get the facts today.

KNOBS FOR
 Television • Home Radios
 Phonographs • Clock Radios
 Auto Radios • Instruments . . .
 many others.

G-C ELECTRONICS CO.

Division of Textron Inc.

West Plant: Los Angeles 18, California
 Main Plant: Rockford, Illinois, U.S.A.

WRITE today for your big, free illustrated Gee-Lar Catalog. No obligation!

CIRCLE 348 ON READER-SERVICE CARD

ELECTRONIC DESIGN • February 17, 1960



FERRITE ISOLATOR

The all new Model WD-2106 Octave S-Band Isolator marks a revolutionary advancement in the microwave field by permitting the use of only one isolator for a full octave frequency range instead of covering the band in increments using a number of iso-

lators. Ideal for use in telemetry, radar systems and transponders, the new unit offers exceptional reliability, excellent isolation to insertion loss characteristics and compactness of design.

TYPICAL SPECIFICATIONS

MODEL	FREQ. RANGE	ISOLATION	INSERTION LOSS	V.S.W.R.
WD-2106	2.1-4.3 KMC	20 DB Min.	2.0 DB Max.	1.5 Max.
W-568-3A-2	12.5-18.0 KMC	20 DB Min.	1.0 DB Max.	1.15 Max.
W-177-1K-1	9.5 KMC ± 100 MC	25 DB Min.	.7 DB Max.	1.15 Max.
W-277-3A-3	5.2-5.9 KMC	17 DB Min.	1.0 DB Max.	1.15 Max.
W-668-1A-2	8.5-9.6 KMC	10 DB Min.	0.4 DB Max.	1.10 Max.

THESE ARE ONLY A FEW OF THE MANY AVAILABLE MODELS



KEARFOTT DIVISION

GP GENERAL PRECISION INC.

14844 OXNARD ST., VAN NUYS, CALIF.
 CIRCLE 349 ON READER-SERVICE CARD

NEW SILICON "PILL" VARACTOR

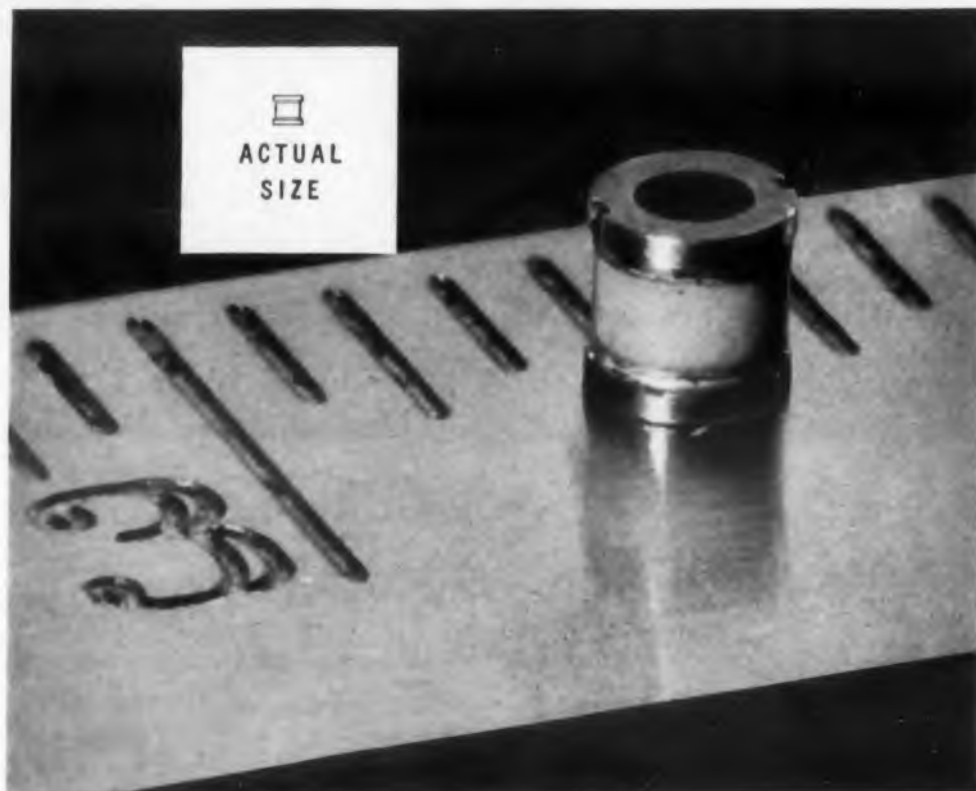

**GREATLY REDUCES THE PACKAGE
AS A FACTOR IN CIRCUIT DESIGN**

specifically developed for:

- amplifiers at the higher microwave frequencies (1000 mc and above)
- travelling wave parametric amplifiers
- microwave computers as sub-harmonic generators
- amplifiers in which stray susceptance effects must be minimized
 - applications of varactors to stripline circuits
 - modulators for frequency synthesis

Experimental quantities are available with these nominal specifications	TYPE NUMBER	CAPACITANCE TOLERANCE (Zero Bias)	TYPICAL Q AT 6 VOLTS
	MA-4255X	0.5-1.4 $\mu\mu\text{f}$	60-80
	MA-4256X	1.2-2.5 $\mu\mu\text{f}$	50
	MA-4257X	2.5-4.0 $\mu\mu\text{f}$	30

*Package shunt capacitance $\sim 0.2 \mu\mu\text{f}$. Series lead inductance $<10^{-9}$ henries.

Write or call:

MICROWAVE ASSOCIATES INC.
BURLINGTON, MASSACHUSETTS
BRowning 2-3000 • TWX Burlington, Mass. 942.
CIRCLE 721 ON READER-SERVICE CARD



PATENTS

Attenuation for Traveling Wave Tubes

Patent No. 2,911,599. W. Klein and W. Friz. (Assigned to International Standard Electric Corp.)

The radio frequency energy, in a TWT attenuator, is dissipated by capacitive rather than conventional conductive coupling.

The attenuator consists of a thin layer of carbon between two mica tubes. Helix 1 is contacted by mica tube 2 which carries the carbon deposit 3. A second mica tube 4 seals the carbon layer and insulates the carbon from the outer metal body 5. The thickness of carbon may be tapered to convenience and the structure is a rigid stable support for the lossy material.

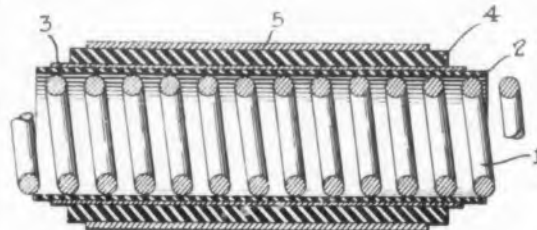

Microwave Test System

Patent No. 2,887,661. Dale C. Brocker. (Assigned to Sylvania Electric Products Inc.)

The power level of a pulsed microwave signal generator is kept constant by changing the pulse width according to pulse amplitude changes of the fundamental frequency component.

This device simplifies vswr reflectometer measurements, since its output power level is constant and independent of frequency.

The control circuit to maintain constant power applied to load 20 requires an amplifier 30, tuned to the fundamental frequency of the periodic pulses, and a diode 44, sensitive to changes in pulse amplitude. Diode 46 rectifies the error voltage to adjust the voltage on the grid of triode 50. This changes the cathode-coupled multivibrator pulse width in the proper sense to stabilize the power delivered to the load.



**ILLINOIS UP-RIGHT Miniature
Electrolytic Capacitors . . .**

Type SMTU finest for

TRANSISTORIZED CIRCUITRY

*Time Tested
Quality*

Aluminum cased, with exclusive patented hermetic sealing. Stable under temperature extremes — stable to shock and vibration. Guaranteed long life. Fully tested and approved. Millions now in use.



Type SMTUCN
Dual Common Negative
Separate Anodes

Compact construction permits exceptional space savings and economy which is highly desirable in modern transistor circuitry. One capacitor saves space where normally two individual capacitors were previously needed. These dual units are ideal for bypass, filtering or coupling where a common ground exists.

Temperature Range: -40 to $+65^{\circ}\text{C}$; also available -30 to $+85^{\circ}\text{C}$
Voltage Range: 3 to 250 volts

Type SMTUCP
Dual Common Positive
Separate Cathodes

These dual section common anode constructed capacitors have cathodes which are electrically separated and isolated. Unique construction with "floating" cathodes makes these ideal for coupling, filter and bypass circuits for "above ground" applications.

ILLINOIS

CONDENSER COMPANY
1616 NORTH THROOP STREET
CHICAGO 22, ILL. EV 4-1300

Write for
complete
technical
literature

Export Department: 15 Moore Street, New York 4, New York

CIRCLE 722 ON READER-SERVICE CARD

ELECTRONIC DESIGN • February 17, 1960

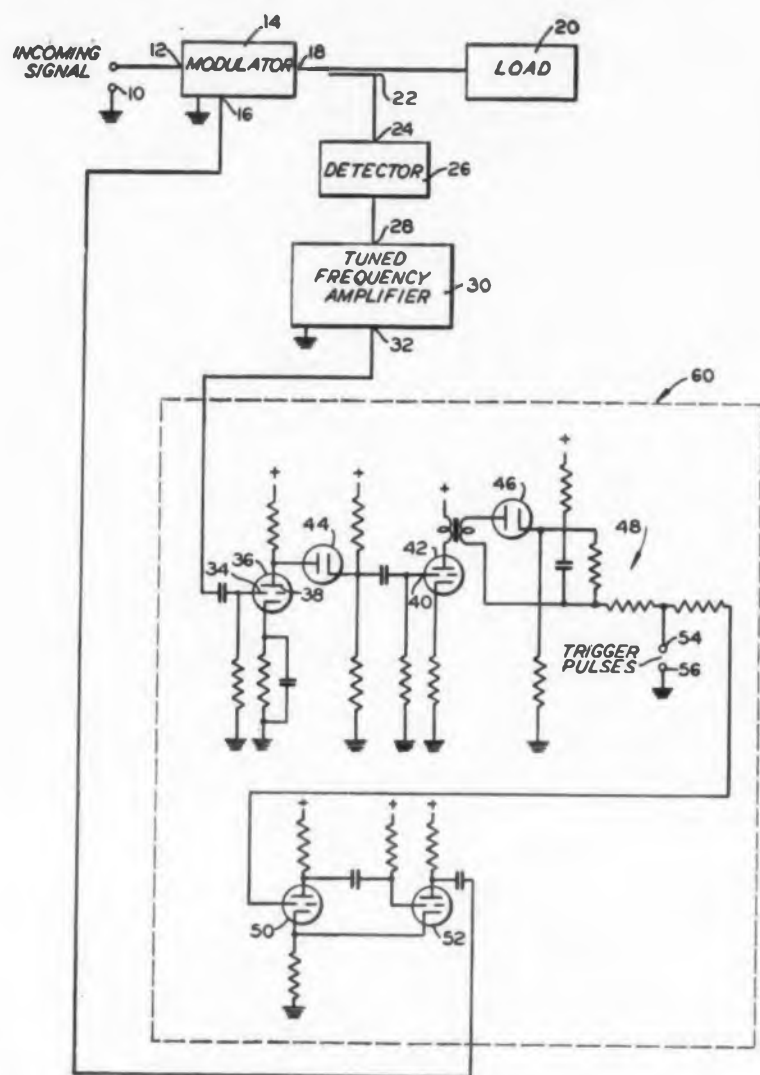

announcing the
availability
on the
American
market of

HIRSCHMANN

plugs • sockets
terminals

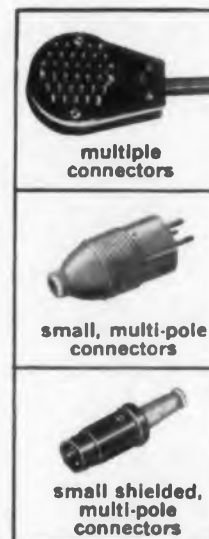

HIRSCHMANN precision made components, a standard of excellence in Europe for more than 30 years, are now available to meet your design, production and replacement needs from the Rye Sound Corp., its 20 sales offices and its national distributor organization. Hirschmann products are standard equipment on such well-known European brands as Norelco, Grundig, Nordmende, Blaupunkt, Lowe, Telefunken, Siemens, Braun, Uher and many others.

Hirschmann plugs, sockets and terminals offer two distinct advantages—American designed equipment for American consumption can use these products, and American designed equipment for European consumption can also use these products because they are designed to satisfy both American and European standards.

The Hirschmann line consists of miniature type plugs, connectors, and couplings for transistor and other small size applications, as well as standard sizes. The line includes multiple connectors from 2 to 36 poles, round types, flat types, wire mounts, panel mounts, wall mounts, etc. Depending upon the type of plug, they generally feature strain relief, axial and transverse wire connection, flexible sleeves, cord grips, unbreakable construction and shock-proofing.

Included also are spring-loaded and insulated test prods, plus flexible and rigid types, alligator clips, banana plugs, continental type electrical plugs, universal multi-function panel terminals, spade terminals. A complete 52-page catalog with detailed specifications dimensions and applications is available by writing to S. M. Scher

Exclusive U. S. sales agent

RYE SOUND CORP., 145 Elm Street, Mamaroneck, N. Y.
West Coast warehouse: 1113 El Centro, Hollywood 38, Calif.

Other precision Rye Sound products include: earphones, headsets, miniature microphones, sub-miniature components



Electro
ELECTRONIC EQUIPMENT

Model EFB
\$120 net

UPER FILTERED DC SUPPLY

Only one at this price with dual output of:

4 AMPERES AT 32 VOLTS • 8 AMPERES AT 16 VOLTS
Specially designed and constructed, using better-than-average components, for precision work in the laboratory . . . and for quality control operations.

- Less than 1/10% (10 mv.) AC ripple up to maximum load.
- Internal impedance: 4 ohms at 32 volts . . . 2 ohms at 16 volts.
- Continuously variable carbon brush-type auto transformer for smoother voltage control.
- Patented heat sink cooling, selenium rectifiers for longer life and overload protection.

Rack Mounted Model EFBR. . . \$145 net

Check its Performance at Your Distributor or . . .
send for Proof-of-Performance Chart and Bulletin EFB!

ELECTRO PRODUCTS LABORATORIES, 4501-U Ravenswood, Chicago 40

Canada: Atlas Radio Corporation Ltd., Toronto, Ontario

FOR TRANSISTOR DESIGN WORK

CIRCLE 723 ON READER-SERVICE CARD

CIRCLE 724 ON READER-SERVICE CARD

Psychlo-switch*

A multiple-strand precious metal brush fixed to a rotating arm . . .

engaging a flush printed circuit with nickel-rhodium plated conductors

. . . is a proven switching method.

Joined to the fast and durable Sigma Cyclonome® Stepping Motor . . .

results (obviously) in a fast and durable stepping switch, imaginatively entitled the Cyclo-switch. Since the principal component is the Cyclonome motor, all its characteristics apply to the Cyclo-switch: operation on magnetic reversals (no reciprocating parts), with each reversal producing exactly 18° of shaft rotation. The Cyclo-switch will seek out and stop at any one of its 10 and/or 20 positions on command. It will run at either constant or random rates, up to 240 steps/sec. Power required varies from 1 to 10 watts, depending on speed and the number of brushes.

Brushes and switch segments will carry 1.5 amps in 250 VDC circuits; applications controlling Sigma relays with 20-40 ma from 120 VDC, with proper arc suppression, have given long, trouble-free service. Life up to 75,000,000 revolutions with light loads is possible.

All sorts of combinations of decks, arms, wipers, brushes and delivery schedules are possible. The simple one-deck two-brush model shown lists for \$95; in production quantities the price drops down to about \$50. By now we hope you're interested in inquiring further about the Sigma Series 9C "Cyclo-switch."

*for psyncobated switching

SIGMA SIGMA INSTRUMENTS, INC.
97 Pearl St., So. Braintree 85, Mass.
AN AFFILIATE OF THE FISHER-PIERCE CO. (Since 1939)

CIRCLE 725 ON READER-SERVICE CARD



BOOKS

Beam and Wave Electronics in Microwave Tubes

Rudolf G. E. Hutter, D. Van Nostrand Co., Inc., 120 Alexander St., Princeton, N. J., 378 pp, \$9.75.

The basic physical operating principles of microwave devices, from klystrons and magnetrons to the most recent traveling wave tubes, are analyzed in this new work. By using the unifying principles contained in the coupled-mode theory, space-charge wave theory, and energy exchange, the author points up the similarities and differences between the various kinds of microwave tubes. The mathematical treatment is kept simple; it brings out clearly the relations between electron streams and the circuit elements characteristic of these tubes.

After discussing the limitations of con-

ventional tubes, the author schematically describes certain classes of microwave tubes. He then develops microwave circuitry in four chapters, including a full and new treatment of slow waveguides. The two succeeding chapters on beams in gaps and beams in drift regions provide a background for understanding the behavior of such tubes as two-cavity klystron amplifiers, velocity-jump tubes, electron-wave tubes, and resistance-wall amplifiers.

The principles of beam and wave electronics in longitudinal dc magnetic fields and in crossed fields are detailed. Next discussed is the conversion of dc energy to rf energy, which must be understood before physical pictures of microwave tube operation are plausible. These physical pictures are drawn, and the author traces the effect of the coupling of beam

PHASE DETECTORS

100 KC TO 1000 MC

ACCURACY $\pm 0.05^\circ$ or $\pm 1\%$



205B1: 15 mc to 400 mc.
205B2: 200 mc to over 1000 mc.
Minimum Input Signal: 20 uv.
Impedance: 50 ohms.
Resolution Time: 0.1 uus for 205B1; 0.01 uus for 205B2
205A1-A2: 100 kc to 15 mc
Resolution Time: 8 uus
Input Impedance: 1 megohm shunted with 12 uuf.



Type 205B1

Type 405



No amplitude adjustment, no frequency adjustment.

405: 8 cps to 100 kc.
405H: 8 cps to 500 kc.
405L: 1 cps to 20 kc.

Minimum Input Signal: 0.3V to 70V for 405 & 405L; 2V to 30V for 405H.

Phase Range: 8 ranges; 0-12°, 0-36°, 0-90°, and others to 360° full scale.

PHASE METERS

DIRECT READING
IN DEGREES

1 CPS TO 500 KC • ACCURACY 0.25°

AD-YU
FORMERLY
ADVANCE
ELECTRONICS LAB., Inc.
249-259 TERMUNE AVENUE
PASSAIC, NEW JERSEY

CIRCLE 726 ON READER-SERVICE CARD

ELECTRONIC DESIGN • February 17, 1960

modes and circuit modes on the operation of many of the tubes previously discussed. A final chapter then systematically explores the subject of noise, using concepts developed earlier in the book.

Analysis of Electric Circuits

Egon Brenner and Mansour Javid, McGraw-Hill Co., Inc., 330 W. 42nd St., New York 36, N. Y., 703 pp., \$9.50.

Here is an introduction to linear electric circuit analysis on the sophomore-junior level which utilizes the reader's background in calculus, but does not require or introduce advanced mathematics.

An integrated treatment of network response is provided by the early introduction and application of the notion of complex frequency, network functions and their poles and zeros without sacrificing conventional skills, such as the solution of ac circuit problems. The analytical and graphical skills which are developed will serve not only in the application of "electronic" and "power" circuits, but also in more advanced study of linear system analysis and synthesis.

Instead of the traditional division of circuit analysis into dc circuits, ac circuits

and transients, a general approach has been utilized to place dc and ac circuits in their proper perspective as important but special cases of circuit response. This general approach is made possible by first studying the simple circuits in detail. As a result, transients are not studied as a subdivision of circuit analysis but are integrated into the general problem of "response calculations." Thus, from the outset the relationships between transient and steady state response is made clear. The time domain behavior of circuit is emphasized so that the terms *impedance* and *admittance* have a broader meaning than in traditional books. In the chapter concerned with network functions both driving point and transfer functions are introduced.

This book contains an exceptionally large number of problems at all levels of difficulty, ranging from exercises to proofs of theorems. Many completely worked out numerical examples help to resolve the reader's numerical difficulties.

Egon Brenner, co-author of the book, is currently contributing the translated material for ELECTRONIC DESIGN's German Abstracts department.

Safe... Accurate Controlled Area Heat!

with Sherman HF Induction Heaters...

New Sherman Induction Heaters provide an extremely versatile tool for all manufacturing operations requiring controlled area heating. Modern 3 megacycle units supply instantaneous pinpoint heat with no contamination and no preheating, permitting a safer, more accurate and reliable method of sealing semiconductors, diodes and transistors, as well as soldering, brazing and heat treating. All Sherman Induction Heaters are designed for use on regular factory voltages and completely automatic units can be built to satisfy individual requirements.



Silver Soldering



Production Brazing



Automatic Production Unit



Write
for
detailed
literature.



SHERMAN INDUSTRIAL ELECTRONICS
Division of HF Induction and Dielectric Heaters

ELECTRONICS DEVELOPMENT, INC./STATE COLLEGE, PENNSYLVANIA

CIRCLE 727 ON READER-SERVICE CARD

ELECTRONIC DESIGN • February 17, 1960

TECKSTRIP®

IN SPECIAL SHAPES

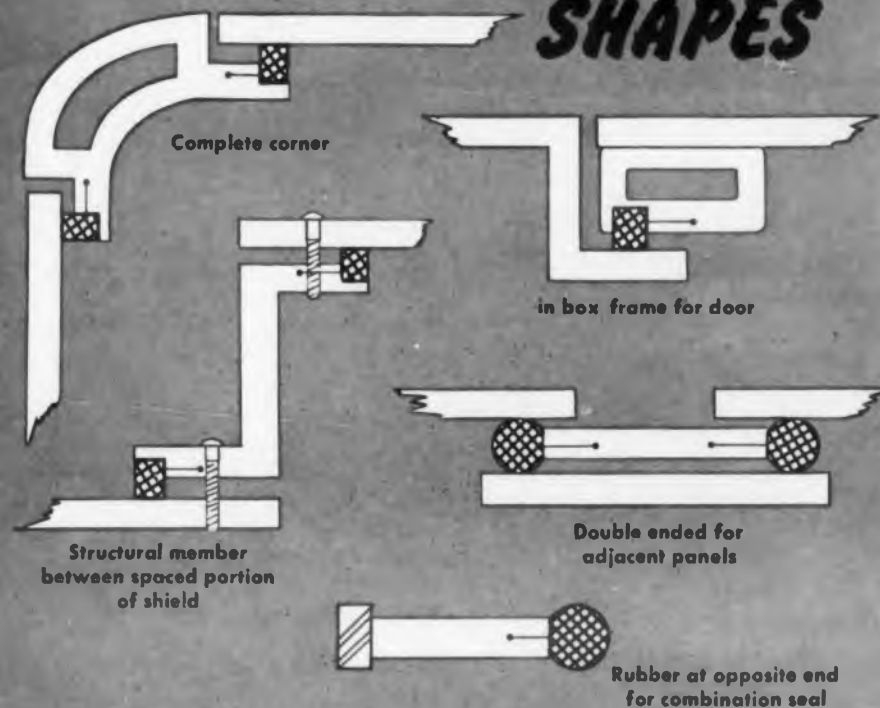

TO SOLVE DIFFICULT RFI* SHIELDING PROBLEMS

*Radio Frequency Interference

Basic Teckstrip, which combines a resilient RFI gasket and a rigid, easy-to-install aluminum mounting strip, can be made in special cross-sections to solve difficult shielding problems. These special shapes make possible savings in fabricating costs and greatly simplify gasket installation.

Now, *only from Tecknit* comes a complete RFI gasket engineering service to aid you in the solution of the "impossible" problems. Staffed by outstanding authorities in the field, Tecknit Design Service stands ready to develop cost reducing special Teckstrip for you.



Write today for a Problem Outline
Sheet and a copy of the new
Teckstrip Bulletin RF-9.



**Technical Wire
Products, Inc.**
48 Brown Avenue, Springfield, N. J.
Phone: DRexel 6-3010.
TWX: MLBN, 40

Technical Wire Products, Inc.
48 Brown Avenue, Springfield, N. J.

Gentlemen:

Send me complete information on Standard and
Special-Shape Teckstrips.

Company _____

Name _____

Address _____

City _____ Zone _____ State _____

CIRCLE 728 ON READER-SERVICE CARD

PS-803

Think about these 2 applications



Then you'll want a
DONNER NULL VOLTMETER

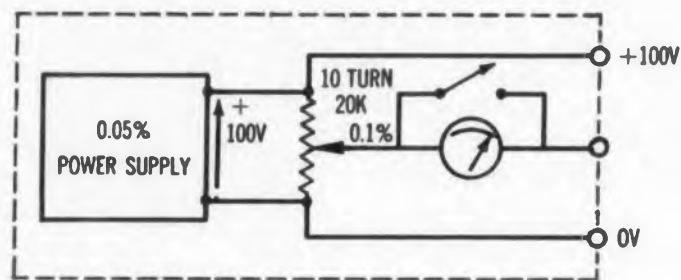

Functional Diagram, Donner Model 5002

Donner Model 5002 Null Voltmeter costs only \$245 for cabinet model.
\$230 for rack mount.

1 As a Sensitive 0.1% Direct Reading dc Voltmeter

In operation, the user measures voltage by simply twisting the ten turn precision potentiometer dial until the meter nulls. Voltage is read directly off the potentiometer dial to a resolution of 0.1%. Operation over a range of 0 to +100 volts or 0 to -100 volts without range switching. Features negligible loading over whole range with infinite impedance at null. The meter is protected against burnout from overvoltage.

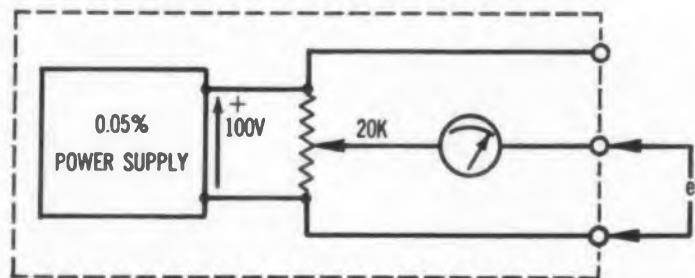

2 As a 0.1% Reference Power Supply

Generates any dc voltage in the range of 0 to +100 volts or 0 to -100 volts at 10 ma. Voltage can be set at 0.1 volt with a ten turn helical potentiometer with direct dial readout. Other features include stability of 0.1% in 8 hours, 0.5% per year. A source voltage of ± 100 volts ($\pm 0.1\%$) is always available for reference in addition to selected output voltage. Hum and noise is 2 mv rms maximum.

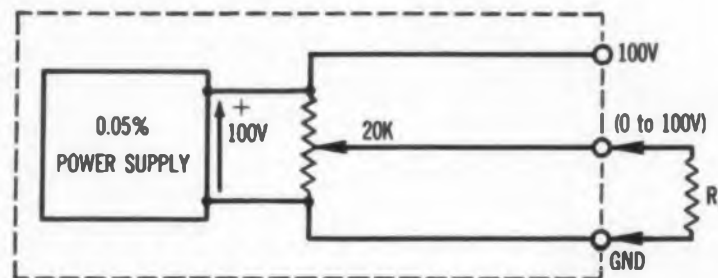

25

Your nearby Donner engineering sales representative will be happy to furnish you with complete information and arrange an opportunity for you to use the Donner 5002 in your own lab. For complete technical specifications please address Department 19.

DONNER SCIENTIFIC COMPANY

888 Galindo • Concord, California
Phone: MUIberry 2-6161

RUSSIAN TRANSLATIONS

J. George Adashko

Semiconductor Sweep-Current Generators

GENERATORS of linearly-varying currents are extensively used as sweep generators in cathode ray tubes with magnetic deflection. A vacuum-tube generator of linearly-varying current is usually a combination of a generator of trapezoidal or linearly-varying voltage, with an amplifier for the sweep current. The load of the amplifier is the deflection coil of the crt. This amplifier is frequently called the output stage of the sweep-current generator.

Mere replacement of the vacuum tubes by transistors involves several difficulties because of the specific properties of the transistors. Thus, to match the low input resistance of the output transistor with the large input resistance of the sawtooth voltage generator it is necessary to use matching devices such as a transformer or an emitter follower. These are somewhat difficult to design with satisfactory frequency characteristics.

The low input resistance of the output stage makes it impossible to obtain the time constant for the RC network which would be necessary for undistorted transmission of the trapezoidal pulse. This leads to a further deterioration of the frequency characteristics of the coupling circuits and to mismatch between the voltage generator and the output stage.

As a result, the nonlinearity of the deflection current increases sharply. In the case of stringent linearity requirements, this offsets the advantages of semiconductor equivalents of vacuum-tube sweep-current generators.

In this paper, we describe semiconductor sweep-current generators which are free of these shortcomings, and which generate the deflection current directly.

The high gain of a transistor amplifier with negative capacitive feedback insures a small (not more than five per cent) nonlinearity of the generated current, and high stability of the generator.

The Sweep-Current Generator

The proposed generator represents a combina-

tion of a generator proper, capacitive (wattless) negative feedback, and a commutating device that insures periodic charging and discharging of the capacitor. The generator proper consists of an RC integrating network and a transistor amplifier whose collector load is the deflection coil.

The principal requirement that must be met by a generator of this type is high linearity of the generated current. The linearity is determined largely by the generator proper, whose general circuit is shown in Fig. 1.

For convenience in the analysis, we show the amplifier load (the inductance of the deflection coil L_{col}) outside the two-port-network equivalent of a voltage amplifier with gain K_0 .

As can be seen from Fig. 1, the sweep-current generator proper differs little from analogous vacuum tube generators with wattless feedback. Its distinguishing feature is that the load of the amplifier is a coil with resistance r_{col} . To this, one may connect an additional active resistance, and the relatively small input resistance of the amplifier, resulting in the flow of input current i_1 .

The resistance r is used to obtain the voltage jump, which is essential for the generation of a linearly-increasing current.

From Fig. 1 we obtain the following equations in operator form

$$u_1(p) = -F_{col} + R [i_c(p) + i_1(p)] \\ = u_2(p) + u_c(p) - r i_c(p) \quad (1)$$

$$u_2(p) = -F_{col} + R_{col} i_L(p) + p L_{col} i_L(p) \quad (2)$$

$$i_c(p) = p C U_0 - p C u_c(p) \quad (3)$$

$$u_1(p) = -R_{in} i_1(p) \quad (4)$$

where U_0 is the initial voltage on the charged capacitor and R_{in} is the real part of the input impedance of the amplifier.

The input and output impedances of the transistor are assumed to be active. The voltages u_1 and u_2 of an inertialless amplifier are related as follows:

$$u_2(p) = -K_0 u_1(p) + Z_{out}(p) i_{out}(p)$$

where K_0 is the no-load gain of the amplifier.

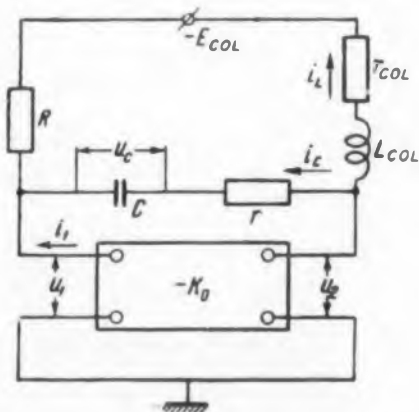
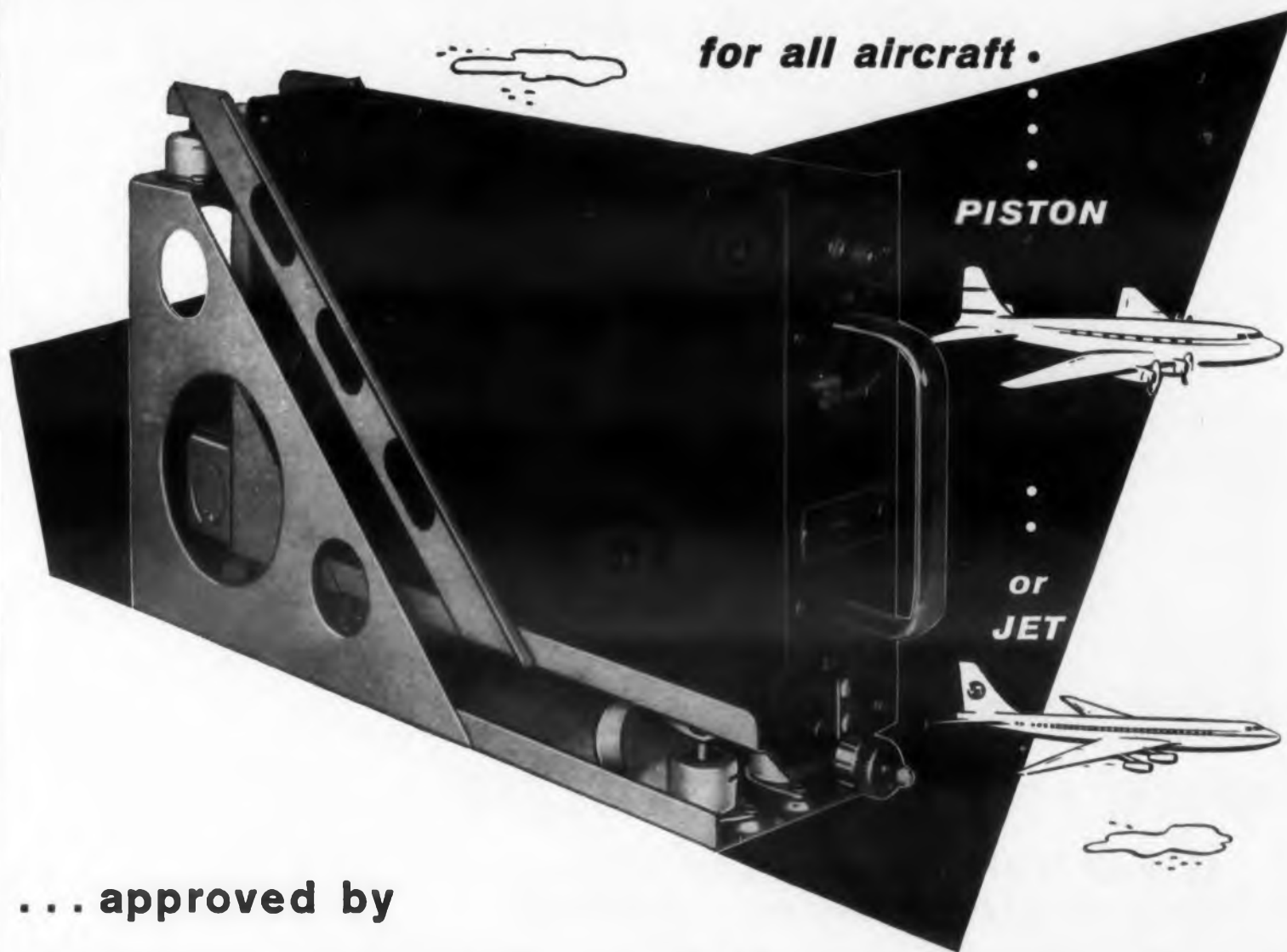

Fig. 1. General circuit of sweep-current generator.

MOUNTING SYSTEMS

for all aircraft •



... approved by

electronic equipment manufacturers for aircraft use

Here's why LORD is your best source for electronic mounting systems:

Complete line of ATR bases for both piston and jet aircraft . . . plus special systems.

Superior performance results from LORD's 35-year background in vibration/shock/noise control. This assures positive protection for radio transmitters and receivers, radar, Doppler, Loran, ILS, antennae, controls and other equipment.

Good delivery is insured by proved designs, qualified components and complete modern facilities for engineering, production and testing.

Why not prove it to yourself? Contact the nearest LORD Field Engineering office or the Home Office, Erie, Pa.

FIELD ENGINEERING OFFICES

ATLANTA, GEORGIA - Cedar 7-9247	KANSAS CITY, MO. - Westport 1-0138
BOSTON, MASS. - Hancock 6-9135	LOS ANGELES, CAL. - Hollywood 4-7593
CHICAGO, ILL. - Michigan 2-6010	NEW YORK, N. Y. - Circle 7-3326
DALLAS, TEXAS - Riverside 1-3392	PHILADELPHIA, PA. - Pennypacker 5-3559
DAYTON, OHIO - Baldwin 4-0351	SAN FRANCISCO, CAL. - EXbrook 7-6280
DETROIT, MICH. - Diamond 1-4340	WINTER PARK, FLA. - Midway 7-5501

"In Canada - Railway & Power Engineering Corporation Limited"

LORD MANUFACTURING COMPANY • ERIE, PA.

CIRCLE 730 ON READER-SERVICE CARD

SPECIFY LORD MOUNTING SYSTEMS:

Standard ATR systems for piston aircraft. Available in 1/4, 3/8, 1/2 and full sizes, short and long versions. Meet all applicable specifications including ARINC-404 shock and vibration requirements. Utilize proved Temproof Mountings.

Standard ATR systems for jet aircraft. Available exclusively from Lord with BTR (Broad Temperature Range) elastomeric mountings. Excellent all-altitude control of high-frequency vibration from -65° to +300°F.

Special mounting systems. Custom designed on complete systems basis to meet specific needs. Integrated bases can be furnished which combine equipment, connectors, components on a common structure. Extensive experience assures system will meet cost and performance goals.



FACTORY FRESH CERTIFIED PRECISION



APPCO PRECISION STOCK GEARS

32 TO 120 PITCH... A.G.M.A. PRECISION #1, 2 & 3
SEALED IN PLASTIC... DIRT AND SCRATCH-FREE

Made to exacting specifications. Held to tolerances which are Certified to precision-fit standard instrument bearings, shafting, etc. Then sealed in plastic free of dust, dirt or corrosion on a shipping tray which identifies each individual gear. The unsurpassed accuracy of APPCO Precision Gears arrive at your plant "factory-fresh" ready to use on the most critical assemblies.

APPCO Certified Precision Stock Gears are available in 32, 48, 64, 72, 96, and 120 diametral pitches of $14\frac{1}{2}^\circ$ and 20° pressure angles. Spur gears, pin or clamp hub type... flat or hubless... anti-backlash. Each is Certified to meet or surpass A.G.M.A. specifications. For complete technical data and catalog write to...

ATLAS PRECISION PRODUCTS COMPANY

Div. Prudential Industries, Inc.
Castor & Kensington Avenues
Philadelphia, Pa.

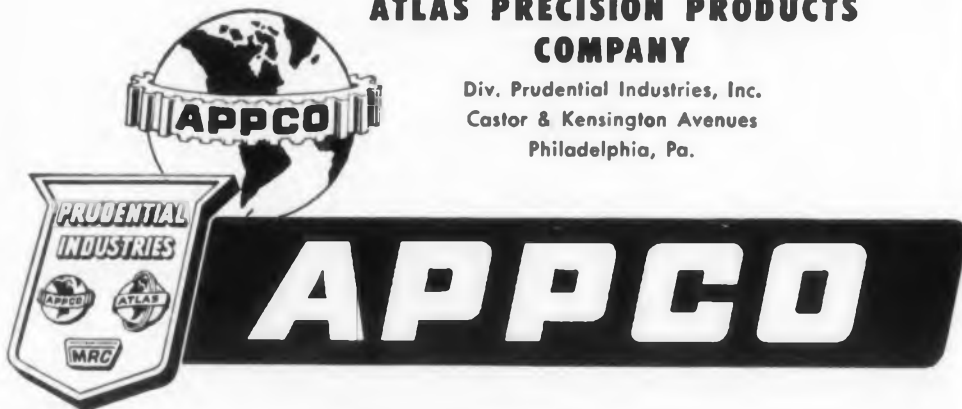

CIRCLE 731 ON READER-SERVICE CARD

RUSSIAN TRANSLATIONS

When $i_{out} = i_c = 0$, $Z_{out}(p)$ is the output impedance of the amplifier, the value of which is

$$Z_{out}(p) = \frac{(r_{cot} + pL_{cot}) r_i}{r_{cot} + pL_{cot} + r_i}$$

The resistance r_i is the internal resistance of the transistor. It is easy to show that the differential resistance of a capacitor discharging almost constant current is active and its value is

$$r_c = \frac{du_c}{di_c} \approx \frac{\Delta u_c}{\Delta I_c} = \frac{\Delta u_c}{\epsilon I_c}$$

active and its value is where Δu_c is the voltage drop u_c during the discharge of the capacitor (approximately equal to E_{cot}); $\epsilon = \Delta I_c / I_c$ is the non-linearity coefficient of the voltage u_c ; $I_c = E_{cot} / R$, the initial discharge current of the capacitor.

Consequently, $r_c \approx R / \epsilon \gg Z_{out}(p)$, since even when $R = 5 K$ and $\epsilon = 0.05$ we have $r_c = 100 K$ which is much greater than r_i .

One can therefore assume that the amplifier of the sweep-current generator operates at no load and

$$u_2(p) = -K_0 u_1(p). \quad (5)$$

Solving Eqs. (1) to (5) with respect to $i_L(p)$ under the condition $K_0 \gg 1$, we obtain

$$i_L(p) = E_{cot} \frac{K_0 R_{in} + R}{L_{cot} C R (r + K_0 R_{in})} \frac{1}{p^2 + 2\alpha p + \omega_0^2} + E_{cot} \frac{K_0 R_{in} r + r R + K_0 R_{in} R (1 - \xi)}{L_{cot} R (r + K_0 R_{in})} \frac{p}{p^2 + 2\alpha p + \omega_0^2} \quad (6)$$

where $\xi = U_0 / E_{cot} \approx 1$.

$$2\alpha = \frac{L_{cot} + C r_{cot} (r + K_0 R_{in})}{L_{cot} C (r + K_0 R_{in})}$$

$$\omega_0^2 = \frac{r_{cot}}{L_{cot} C (r + K_0 R_{in})} \quad (7)$$

Considering that in practice the following inequalities hold,

$$L_{cot} < C r_{cot} (r + K_0 R_{in}); \quad r < K_0 R_{in}, \quad (8)$$

then

$$\frac{\omega_0^2}{\alpha^2} \approx 4 \frac{L_{cot}}{K_0 R_{in} C r_{cot}} < 1,$$

and the system of Fig. 1 is aperiodic. Then

$$\left. \begin{aligned} \frac{p}{p^2 + 2\alpha p + \omega_0^2} &= \frac{1}{m - n} (e^{mt} - e^{nt}) \\ \frac{1}{p^2 + 2\alpha p + \omega_0^2} &= \frac{1}{\omega_0^2} + \frac{1}{m - n} \left(\frac{e^{mt}}{m} - \frac{e^{nt}}{n} \right) \end{aligned} \right\} \quad (9)$$



These interlocking building blocks have double meaning when compared with the Crosby-Teletronics Diode Tester (Model DT-257A) and the Millimicroammeter (Model MA-259). Just as the blocks fit together in basic construction, the two units work together to make possible production testing of static characteristics of silicon as well as germanium and selenium diodes.



left: Model DT-257A... \$295.00
right: Model MA-259... \$125.00
(less batteries)

Both shown in Model RA-81 Rack Adapter.

DT-257A Diode Tester — Separate forward and reverse power supplies with continuously variable outputs or pre-set regulated reverse potentials allow complete measurements or checks at selected operating points. The combination of controls and connectors with the circuits employed provide extremely accurate results with a minimum of operation. Accessory oven (Model OV-120) available... maintains fixed temperature of $65^\circ C$.

MA-259 Millimicroammeter — Measures the low reverse currents of silicon diodes when used as an accessory to the DT-257A. As a millimicroammeter, the instrument covers the range from 0.01 microamperes to 1,000 microamperes. It is completely self-contained and battery powered.

Complete specification sheets are available for both units. Your letter will bring them by return mail.

Crosby-Teletronics Corporation

54 Kinkel Street, Westbury, L. I., N. Y.
CIRCLE 732 ON READER-SERVICE CARD

UPGRADE YOUR EQUIPMENT with

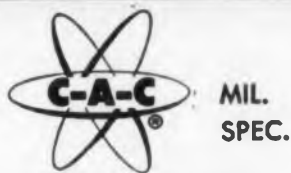

LAMINATED TRANSFORMERS and REACTORS



FILTER REACTORS



FILAMENT TRANSFORMERS



CONVERTER TRANSFORMERS

Because we custom design and build to your needs, we welcome the difficult assignments as well as the more common requirements. Quality—reliability are plus factors when you specify C-A-C.

COMMUNICATION ACCESSORIES COMPANY

LEE'S SUMMIT, MISSOURI

where m and n are the roots of the equation $p^2 + 2\alpha p + \omega_0^2 = 0$, the values of which are, for $\omega_0^2 \ll \alpha^2$, with (7) and (8) taken into account:

$$\left. \begin{aligned} m &\simeq -\frac{r_{col}}{L_{col} + r_{col}C(r + K_0R_{in})} \\ &\simeq -\frac{1}{C(r + K_0R_{in})} \\ n &\simeq -\frac{L_{col} + r_{col}C(r + K_0R_{in})}{L_{col}C(r + K_0R_{in})} \\ &\simeq -\frac{r_{col}}{L_{col}} \end{aligned} \right\} (10)$$

It is seen from Eq. (9) that the expression for i_L is the sum of two exponentials—one with a large time constant $C(r + K_0R_{in})$, and one with a small time constant L_{col}/r_{col} .

For the solution to contain only one exponential with a large time constant, we stipulate that the coefficient in front of the exponential with the small time constant must vanish. We then find from Eq. (6) to (10) that this takes place when

$$r = \frac{L_{col}}{Cr_{col}} + R(\xi - 1) \simeq \frac{L_{col}}{Cr_{col}} \quad (11)$$

The expression for i_L becomes in this case

$$i_L \simeq I_{eq}(1 - e^{-t/K_0R_{in}C}), \quad (12)$$

where

$$I_{eq} = \frac{E_{col}K_0R_{in} + r}{r_{col}R} \simeq \frac{E_{col}K_0R_{in}}{r_{col}R}$$

The coefficient of nonlinearity of the current i_L now becomes

$$\epsilon \simeq \frac{I_m}{I_{eq}} = \frac{T_{work}}{K_0R_{in}C},$$

where I_m is the amplitude of the sweep current.

Considering that $\mu_1 \approx \mu_2 \approx 0$ when $t = T_{work}$, we get

$$I_m \simeq \frac{E_{col}T_{work}}{r_{col}T_{work} + L_{col}}, \quad T_{work} \simeq \xi C(R - r) \quad (13)$$

and then

$$\epsilon \simeq \frac{R}{K_0R_{in} + R} \simeq \xi \frac{R - r}{K_0R_{in}}, \quad (14)$$

The value of the coefficient K_0 is determined by the collector load r_{col} , since in the case of linearly-increasing coil current the voltage drop across L_{col} is nearly constant and the role of the coil reduces thus to the role of a source of dc voltage.

It must be noted that the oscillations in a resonant circuit consisting of the coil L_{col} and its distributed capacitance do not occur at the start of the operation because of the strong negative feedback. Hence, there is no need for additional shunt-

TARZIAN M-500...

a high efficiency
silicon rectifier
commercially
priced

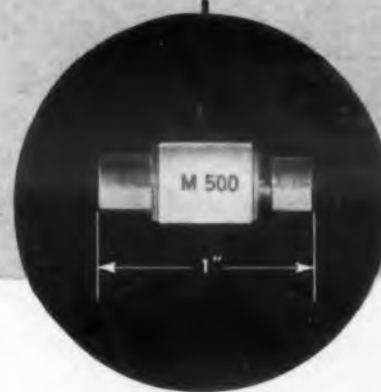

500-ma
ferrule rectifier
connects easily to standard clips

The Sarkes Tarzian M-500 silicon rectifier is rated at 500 milliamperes dc, with a peak inverse voltage rating of 400 volts. This was the first commercially priced silicon rectifier, and more M-500's are now in use than any similarly rated unit.

The Tarzian M-500 is a cartridge type rectifier with end ferrules that snap quickly and easily into standard clips. These silicon rectifiers are made by a special Tarzian process that provides optimum forward to reverse ratios and long, useful life.

For additional information, practical application assistance, and prices on the M-500, write to Section 4393A, Semiconductor Division, Sarkes Tarzian, Inc., Bloomington, Indiana.

M-500 Characteristics

DC amps (100° C)	Peak Inv. Voltage	Tarzian Type	Max. RMS Volts	Max. Recurrent Peak Amperes (100° C)	Max. Surge Amps 4MS	JEDEC No.
0.5	400	M-500	280	5	30	1N1084



SARKES TARZIAN, INC.
SEMICONDUCTOR DIVISION
BLOOMINGTON, INDIANA

In Canada: 700 Weston Rd., Toronto 9, Ontario
Export: Ad Auriema, Inc., New York City

CIRCLE 734 ON READER-SERVICE CARD

CIRCLE 733 ON READER-SERVICE CARD
ELECTRONIC DESIGN • February 17, 1960

R+5N+P=\$SAVINGS

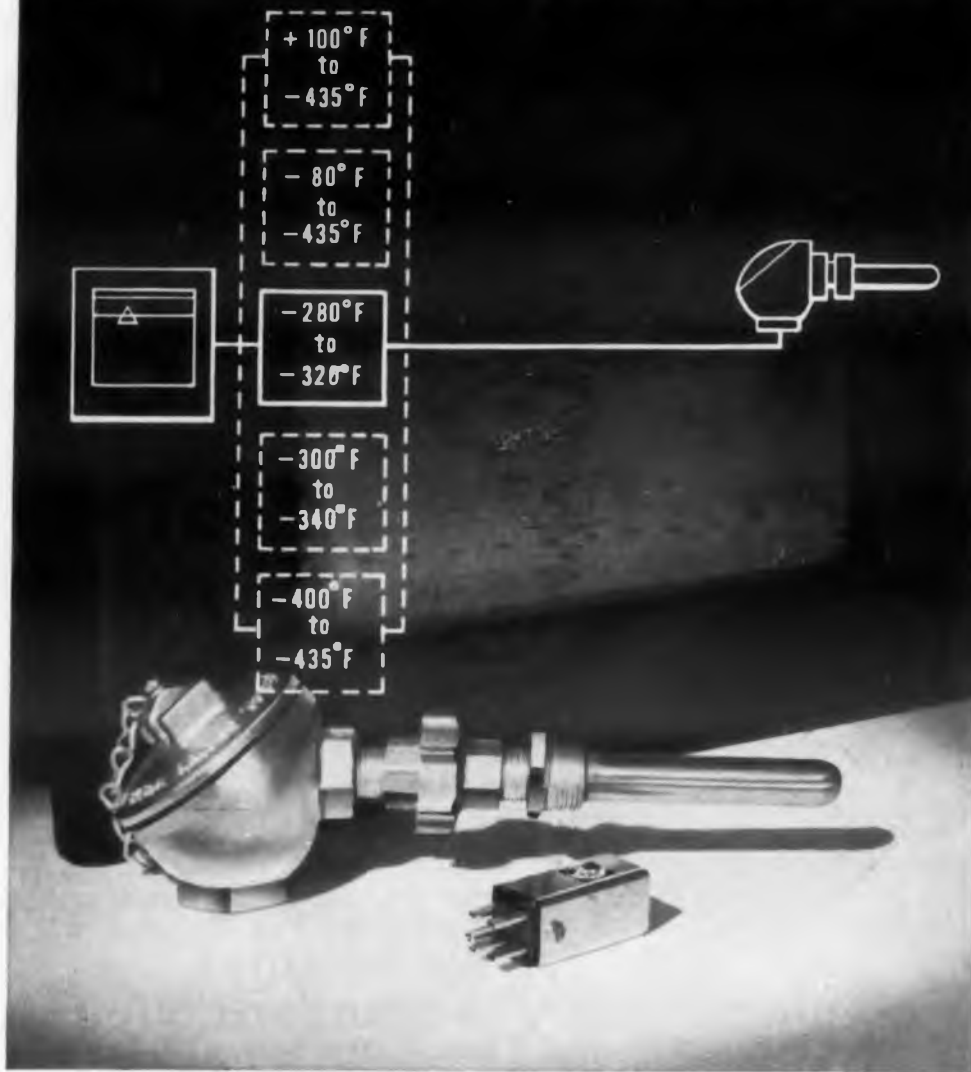

1 RECORDER Plus 5 NETWORKS Plus 1 PROBE EQUALS . . . INSTRUMENT DOLLARS SAVED !!!

REC's many Resistance Temperature Probes, when used with the Model 173 Plug in Trimming Network cover the entire temperature range from -435°F to $+100^{\circ}\text{F}$ and higher, with absolute accuracy and interchangeability of $\pm 0.1^{\circ}\text{F}$.

Standard Networks are available to adapt any probe to the temperature spans indicated above.

- PROBE AND NETWORK FITS MASTER CALIBRATION CURVE TO $\pm 0.1^{\circ}\text{F}$. . . ELIMINATES CALIBRATION . . . \$SAVINGS
- ONE PROBE FITS MANY INSTALLATIONS . . . FEWER SPARE PARTS REQUIRED . . . \$SAVINGS
- PROBE INTERCHANGEABILITY TO $\pm 0.1^{\circ}\text{F}$, ELIMINATES COSTLY RECALIBRATION . . . \$SAVINGS
- CHANGE PLUG IN NETWORK TO CHANGE TEMPERATURE RANGE. REDUCE SYSTEM MODIFICATION COST . . \$SAVINGS

Write for further information



**ROSEMOUNT
ENGINEERING
COMPANY**

4900 West 78th St. Minneapolis 24, Minn.

CIRCLE 735 ON READER-SERVICE CARD

RUSSIAN TRANSLATIONS

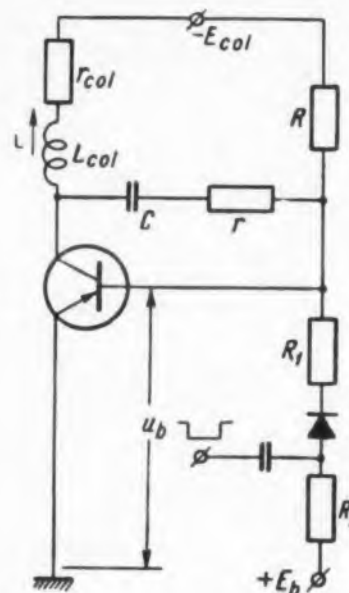

Fig. 2. Basic circuit of the simplest type of sawtooth current generator.

ing of the coil. The recovery time of the circuit thus becomes relatively short. The character of the recovery process is similar to that of the oscillation process, and this tends to reduce the recovery time further.

Practical Sweep-Current Circuits

The simplest of the proposed versions is the generator shown in Fig. 2. In the absence of a control pulse, the duration of which should be equal to the time of the working cycle T_{work} , the transistor is cut off, since

$$u_b = E_b - \frac{E_{col} + E_b}{R_1 + R_2 + R} (R_1 + R_2) > 0 \quad (15)$$

The capacitor C is charged to a voltage $U_0 \approx E_{col}$. Under the action of the control pulse the diode is cut off, and the transistor starts conducting. An almost linear discharge of the capacitor and an almost linear increase in the current i_c are initiated.

During the instant of termination of the control pulse, the diode starts conducting and the transistor is cut off. The capacitor starts charging.

To determine the nonlinearity coefficient ϵ , we express the quantities K_0 and R_{in} for the given generator in terms of the parameters of its circuit and of the transistor. Then, using the h parameters of a grounded-emitter transistor we get

$$K_0 \approx \frac{h_{21} r_{col}}{h_{11} (1 + h_{22} r_{col})} \approx \frac{h_{21}}{h_{11}} r_{col};$$

$$R_{in} \approx h_{11}$$

It is assumed here that the expression u_b is prac-

a measure of
perfection...
**IDEAL
PRECISION**
Panel Meters
*the complete line
for every application*



Here's the demand line that's setting sales records across the nation . . . engineered and produced to the highest standards . . . assembled in controlled atmospheric and climatic conditions . . . 100% inspected at every step of production to ensure highest quality and dependability.

- Accurate to within 2% of full scale
- All sizes and types available
- Scales to customers specifications

For complete information, write to

IDEAL

IDEAL PRECISION METER CO., INC.
214 Franklin Street, Brooklyn 22, N. Y.

Sold to Electronic Parts Distributors
exclusively through

WALDOM

WALDOM ELECTRONICS, INC.
4625 W. 53rd Street, Chicago 32, Ill.

CIRCLE 736 ON READER-SERVICE CARD

TUBE PROBLEM:

The Armed Forces needed a new version of the 6J4 reliable tube type which would provide a tube life of almost 1000 hours. Existing tubes of this type had an average life of only 250 hours. In addition, this new tube had to be produced under ultra-high quality control standards.

SONOTONE SOLVES IT:

By making improvements in the cathode alloy and setting up extremely tight controls in precision, manufacture and checking, Sonotone engineers produced a 6J4WA with a *minimum* life of 1000 hours... most running *much longer*.

RESULTS:

The Sonotone 6J4WA is one of three reliable tubes now being manufactured under U.S. Army Signal Corps RIQAP (Reduced Inspection Quality Assurance Program), monitored by the U.S. Army Signal Supply Agency. And the same rigid quality standards apply to Sonotone's entertainment type tubes as well.

Let Sonotone help solve *your* tube problems, too.

Sonotone

Electronic Applications Division, Dept. T25-20

ELMSFORD, NEW YORK

Leading makers of fine ceramic cartridges, speakers, microphones, tape heads, electron tubes.

In Canada, contact Atlas Radio Corp., Ltd., Toronto

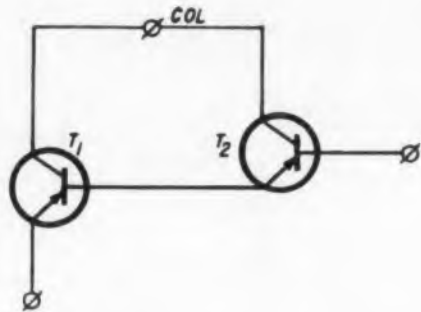

Fig. 3. A composite transistor.

tically independent of u_{col} ($h_{12} \approx 0$) and that, for power transistors, $h_{22}r_{col} \ll 1$.

We thus obtain on the basis of Eq. (14)

$$\epsilon \approx \frac{R(1 + h_{22}r_{col})}{h_{21}r_{col} + R(1 + h_{22}r_{col})} \approx \frac{R}{h_{21}r_{col}} \quad (16)$$

Considering that for power transistors we have $h_{21} > 45$ when the current I_m is much less than the maximum permissible current $I_{col\ perm}$, we can obtain $\epsilon \approx 2R/r_c$ per cent.

One can reduce the resistance R in this generator by increasing the voltage E_b and the capacitance C , but this leads to an increase in the recovery time.

To obtain a smaller coefficient ϵ it is possible to use a composite transistor, the diagram of which is shown in Fig. 3. Assuming $h_{12} \approx 0$, we find that for $h_{21} \gg 1$ its equivalent parameters will be

$$h'_{21} \approx h_{21}h_{212}, \quad h'_{11} \approx h_{21}h_{212}$$

In the case of identical transistors we obtain

$$\epsilon \approx \frac{R}{h_{21}^2 r_{col}} \quad (17)$$

When $R = 5\text{ K}$, $h_{21} > 40$, and $r_{col} = 250$ ohms, we get $\epsilon < \text{one per cent}$. While the first transistor must be a power transistor, a low power transistor can be used as the second transistor. It must be noted that when the coil is connected directly to the circuit the maximum amplitude of the sawtooth is determined by the relation

$$I_m \leq \frac{E_{col\ perm}}{r_{col} + L_{col}/T_{work}} \quad (18)$$

For fast sweeps, when T_{work} is small, the amplitude of the current I_m may be unacceptably low. In this case it is advantageous to use transistors connected in series (Fig. 4), where the lower transistor may be a composite transistor. Using the divider R_3, R_4 one sets the optimum operating conditions for the upper transistor. For this circuit it can be assumed that

$$I_m \leq \frac{2E_{col\ perm}}{r_{col} + L_{col}/T_{work}} \quad (19)$$

In this case, if the inequality $r_{col} \ll (R_3R_4/R_3 +$

The First...

wedge action relay

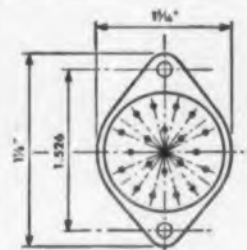
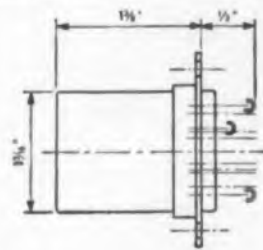

NEW MARK II RELAY

Insures **ULTRA-reliability** under most extreme environmental and operating conditions.

Revolutionary new **WEDGE ACTION** supersedes and surpasses "Wiping Action."

Contact pressure constantly increases during over-travel.

- Temperature range: -65°C to 200°C .
- Contact bounce: **NONE**.
- Operating vibration: 5 to 2,000 cps, 30 G's.
- Operating shock: 100 G.
- Contact rating: dry circuit to 2 amps.
- Extremely low contact resistance.

BRIEF DESCRIPTION: Six pole, double-throw, hermetically sealed. Meets and exceeds specifications MIL-R-5757C and MIL-R-25018.

PAT. NO. 2,866,046

Write for illustrated literature.

ELECTRO TEC CORP.

SLIP RINGS • SWITCHES
RELAYS

P. O. BOX 378, SOUTH HACKENSACK, N. J. BLACKSBURG, VA., ORMOND BEACH, FLA.



CIRCLE 738 ON READER-SERVICE CARD

NOW . . .
STALWART
PRODUCES
SYNTHETIC
RUBBER PARTS

formulated
with

VITON*

for unequaled resistance to

**OILS • CHEMICALS
SOLVENTS • FUELS
AND TEMPERATURES
OVER 400°F.**

At last . . . a high-strength flexible material that resists the effects of corrosive fluids at temperatures over 400° F.! Viton . . . a newcomer to the synthetic rubber family . . . provides unparalleled resistance to many solvents, hydraulic fluids, lubricants, acids, bases and fuels . . . successfully withstands ozone, weathering, and oxygen. Viton custom rubber parts are now being used in the automotive, aircraft/missile, petroleum, chemical and appliance industries. Now Stalwart's modern plants are prepared to compound, mold, extrude, cut, calender and splice Viton parts to meet your exact specification . . . deliver them on schedule. Stalwart also fabricates rubber parts from Neoprene, Hypalon, Hycar, Buna N and other synthetic rubbers. Injection molded plastic parts are available from Stalwart's Plastics Division. Write for specific information.

*Viton is a
trademark of the
DuPont Company

THE WORLD'S LARGEST PRODUCER OF
SILICONE CUSTOM RUBBER PARTS

STALWART
RUBBER COMPANY

CIRCLE 739 ON READER-SERVICE CARD



409 Northfield Road • Bedford, Ohio
Manufacturing facilities in Jasper, Georgia,
Warren and Bedford, Ohio

RUSSIAN TRANSLATIONS

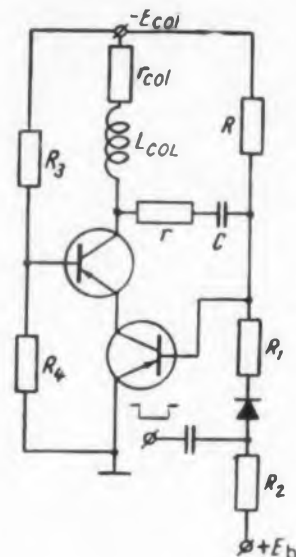

Fig. 4. Sweep-current generator with series-connected transistors.

R_4) is satisfied, we can use Eq. (7) for ϵ if a composite transistor is used.

Since power transistors usually fail by thermal breakdown, rather than voltage breakdown, one can recommend, in certain cases when I_m is much less than the permissible collector current $I_{col\ perm}$, that the generator operate if E_{col} exceeds the permissible collector voltage $E_{col\ perm}$.

Finally, one may construct a sweep-current generator operating in a self-oscillation mode. This would work like a semiconductor generator of linearly-varying voltages of the phantatron type. Its diagram is shown in Fig. 5.

When the capacitor is charged the transistor T_2 is in a mode close to saturation. The negative collector potential is such that transistor T_3 conducts and T_1 is cut off.

As the capacitor is charged, T_2 's collector potential decreases, causing T_3 to cut off and T_1 to conduct. This process is linear.

After linear discharge of the capacitor, the gen-

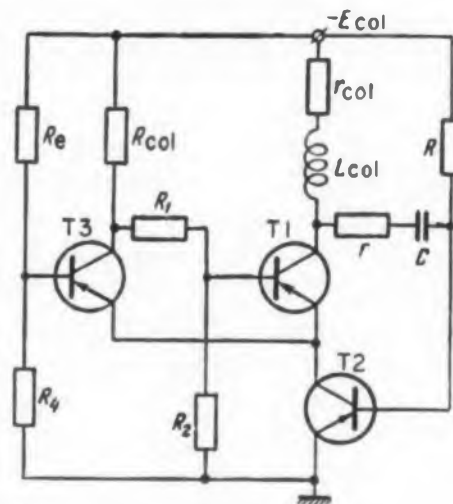

Fig. 5. A phantatron-like sweep-current generator.

Improved Miniature LATCH-IN RELAY



Class 11L

Made of two miniature telephone type relays mounted on a common base. The relay armatures are mechanically interlocked—when one is energized and pulls in it resets (releases) the other armature and becomes latched-in.

Aside from the interlocking armature and common mounting each relay is complete—the two relays can be furnished with entirely different contact arrangements and for operation from different voltages or currents.

The Class 11L Latch-in Relay is available for intermittent or continuous duty D.C. operation and for intermittent duty A.C. operation.



Also available for plug-in mounting



and with dust-tight or hermetically sealed enclosure.

Send for catalog describing the
Class 11L and the complete line
of reliable Magnecraft Relays.

MAGNECRAFT
Electric Company

3350 D W. Grand, Chicago 51, Ill.

CIRCLE 740 ON READER-SERVICE CARD

ELECTRONIC DESIGN • February 17, 1960

Precision I-F Attenuation

Continuously Variable
over 80 db Range



THE AIL TYPE 30

The AIL Type 30 Precision I-F Attenuator is a piston type attenuator operating in the waveguide below cutoff mode. It provides an attenuation range of 0 to 80 db above the minimum insertion loss to an accuracy of .005 db per db of increment.

Standard models are available at 30 mc and 60 mc center frequencies with nominal 50 ohms input and output impedances. Other frequencies and impedances are available on request.

The Type 30 is available in either cased, rack mounting or unmounted models.

Typical Applications

- Noise figure measurements
- Calibration of directional couplers
- Calibration of R-F Attenuators

Write for descriptive literature.

**AIRBORNE
INSTRUMENTS
LABORATORY**

DEER PARK, LONG ISLAND, NEW YORK
A DIVISION
OF CUTLER-HAMMER, INC.

CIRCLE 741 ON READER-SERVICE CARD

erator returns to its initial state because of the increase in the collector potential of T_2 and the associated conduction of T_3 . When T_3 conducts, transistors T_1 and T_2 operate under the same conditions as in the circuit of Fig. 4. Therefore, all the relations for this circuit hold also for the self-oscillator of Fig. 5.

To avoid oscillations in the charging of the capacitor, and to minimize the charging time, the parameters of the circuit must be calculated with:

$$\sqrt{\frac{L_{col}}{C}} \approx 0.5 (r_{col} + r + R_1 + R_2). \quad (20)$$

For a chosen coil and consequently for known values of L_{col} , r_{col} , and C , Eq. (20) is readily satisfied by choosing resistances R_1 and R_2 to reduce the load on the generator of control pulses. The charging time of the capacitor will always be less than

$$T_{charge} \approx (3 \div 5) C (r + r_{col} + R_1 + R_2). \quad (21)$$

Design Procedure

The design of a generator of linearly-varying current can be carried out in this sequence.

Using Eq. (16) and (17) as well as a specified coefficient of nonlinearity at known r_{col} , we determine the resistance R . Knowing L_{col} , we use Eqs. 11 and 13 to determine first C and then r . for known values of T_{work} , subject to the assumption that $\epsilon \approx 1$.

We determine the necessary value of $E_{col} \leq E_{col perm}$ from Eq. (13). The resistance $R' = R_1 + R_2$ is determined from Eq. (20) and is divided into two parts, such that $R_2 \approx 1.5 R_1$ to $2R_1$. After checking to see that Eq. (21) is fulfilled, we use Eq. (15) to calculate E_b .

Experimental investigations have confirmed the possibility of obtaining a highly-linear sweep current using transistors type P3 and P8. The composite transistor was made up of one power transistor and one low-powered transistor type P6.

The parameters of the circuits in Figs. 2 and 4 were as follows: $E_{col} = -30$ v, $R = 5$ K, $E_b = 5$ v, $R_1 = 150$ ohms, $R_2 = 500$ ohms, $R_3 = 2$ K, $R_4 = 5$ K.

The generators were made up of transistors types P8 and P6.

The parameters of the circuit of Fig. 5 are as follows: $R = 5$ K, $R_{col} = 1$ K, $R_1 = 2$ K, $R_2 = 5$ K, $R_3 = 2$ K, and $R_4 = 5$ K.

The transistors used for the generators were types P3B. The values of r and C in all cases changed in accordance with the parameters of the deflection coil to satisfy Eq. (11). ■ ■

[Translated from an article "Semiconductor Generators for a Linearly-Varying Current" which appeared in the October 1959 issue of Radiotekhnika i Elektronika (Radio Engineering and Electronics).]



NEW Time Delay Relays

INSTANTANEOUS RESET... VOLTAGE-TEMPERATURE COMPENSATED

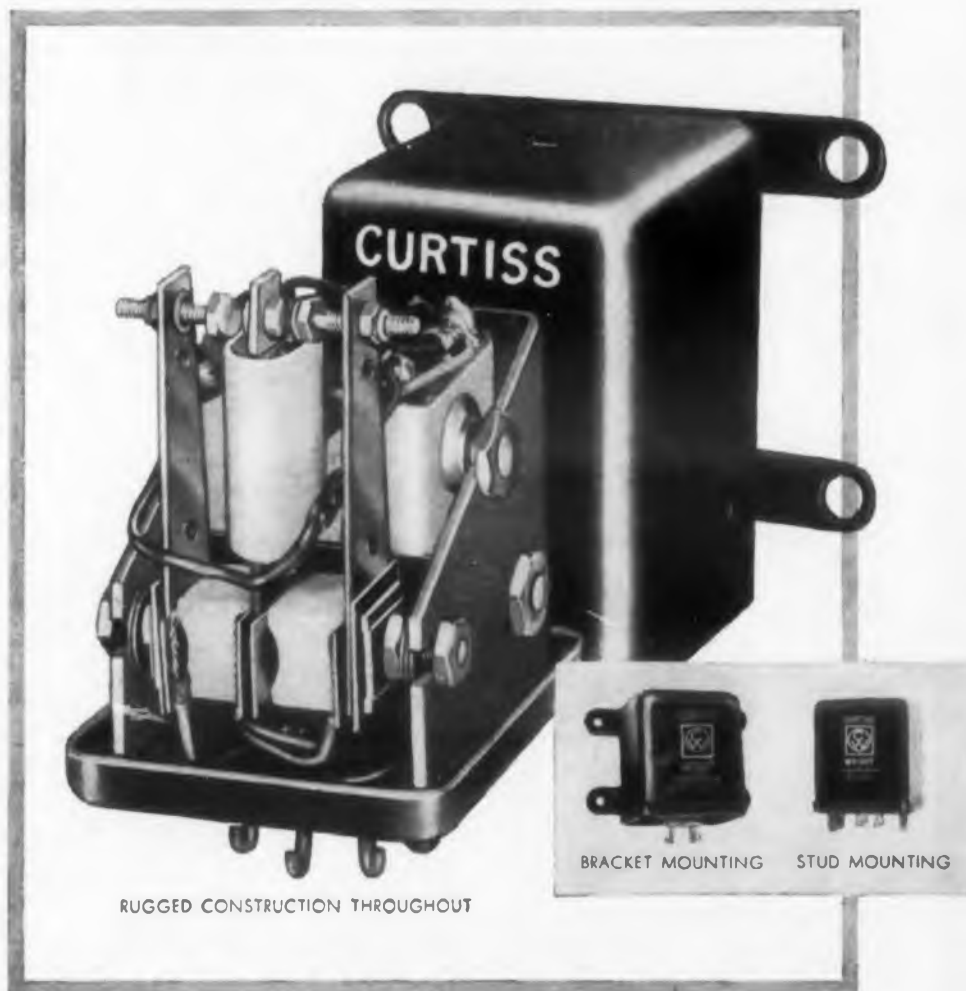

RUGGED CONSTRUCTION THROUGHOUT

Designed with an instantaneous reset feature, these relays provide the same time delay for a series of cycles when temperature and voltage vary.

They are pre-set from 3 to 180 seconds, are chatter-free and will withstand severe shock and vibration. Because of this unique combination of features, these relays are now being used in such new circuit applications as:

- Sequential timing for missiles
- Automatic reset on digital readout equipment
- Oscillator stabilization
- Overload protection
- Computer sequencing



"DM" SERIES STEPPING MOTORS

Curtiss-Wright Stepping Motors convert digital pulses into mechanical work or motion. Units are bi-directional with high starting torque.

Write for complete Components Catalog 260 to help you select Curtiss-Wright electronic components for use where dependability is of prime importance.

COMPONENTS DEPARTMENT • ELECTRONICS DIVISION

CURTISS WRIGHT

CORPORATION • EAST PATERSON, N. J.

TIME DELAY RELAYS • DELAY LINES • ROTARY SOLENOIDS • DIGITAL MOTORS • TIMING DEVICES • DUAL RELAYS • SOLID STATE COMPONENTS

CIRCLE 742 ON READER-SERVICE CARD

SPECIAL INTRODUCTORY OFFER
CIRCUIT DESIGNERS
PLUG-IN

TRANSISTOR
CHOPPER
KIT

GERMANIUM & SILICON



INCLUDES TRANSISTOR CHOPPER APPLICATION NOTES
CHOPPER SPECIFICATIONS

MODEL	50P	60P	70P
Type:	Germanium	Germanium	Silicon
Temperature Range:	-55°C to +85°C	-55°C to +90°C	-55°C to +150°C
Square Wave Drive Voltage:	to 15 v. peak-to-peak	to 30 v. peak-to-peak	to 8 v. peak-to-peak
DC Input Voltage:	to ±12 v.	to ±24 v.	to ±4 v.
DC Input Current:	to ±10 milliamperes	to ±80 milliamperes	to ±40 milliamperes
Chopping Frequency:	DC to 100 kcps	DC to 100 kcps	DC to 200 kcps
Alpha Cutoff Frequency:	900 kilocycles	One megacycle	5 megacycles
Temperature Drift:	3 uv rms/°F	1 uv rms/°F	2 uv rms/°F
Random Noise:	25 uv rms	10 uv rms	50 uv rms
Dimensions:	.50" x .75" dia.	.50" x .75" dia.	.50" x .75" dia.
Weight:	8 grams	8 grams	8 grams

SOLID STATE ELECTRONICS CO.
 15321 RAYEN ST. • SEPULVEDA, CALIFORNIA
 EMPIRE 4-2271

research, development, engineering
 specialists in solid state electronic
 devices, instruments, systems

CIRCLE 743 ON READER-SERVICE CARD

GERMAN ABSTRACTS
 E. Brenner

Bandpass
Half Sections

HIGH selectivity of bandpass filters requires the use of high-Q elements such as quartz crystals. These crystals pose certain special problems. In particular, when operating parameter design is used the filter is difficult to tune. In addition, elaborate computations complicate the design. Half-section design using image parameters simplifies the procedure and allows a certain flexibility because of the resulting cascading ease.

A basic half section is shown in Fig. 1. The signal terminal pair Z_2 represents a quartz crystal that has been shunted with an inductance L'_1 . The series resonant frequency of the crystal is f_1 and the circuit is antiresonant at f_0 and f_2 . The series arm, Z_1 , consists of two antiresonant circuits tuned to f_2 and f_2' respectively.

If f_1 is to influence the sharpness of cut-off at

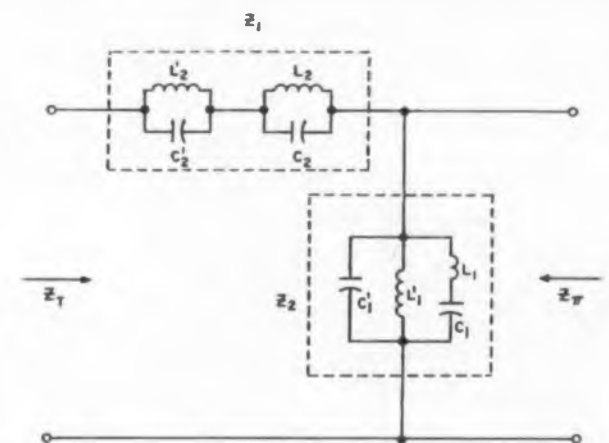

Fig. 1. Bandpass half section. The crystal is represented by $L'_1 - C_1 - L_1$.

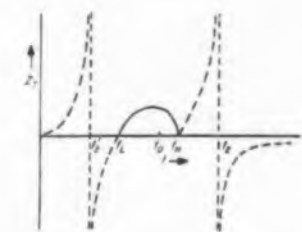

Fig. 2a. Image impedance on the Tee side.

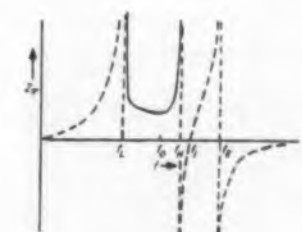

Fig. 2b. Image impedance on the Pi side.

the upper cut-off frequency, then f_2 is above the upper cut-off frequency and f_2' is below the lower cut-off frequency. If f_1 is to influence the lower cut-off frequency then f_1 and f_2 are below this frequency and f_2' is above the upper cut-off frequency.

The two image impedances have the frequency variation shown in Fig. 2. Between the two cut-off frequencies (f_l and f_u) the image impedances are real as indicated by the solid lines, Fig. 2. The element values are determined as follows. **Given:** The frequencies $f_l, f_u, f_2' < f_1 < f_2$ and the image impedance at the frequency that is the geometrical mean of the two cut-off frequencies ($f_m^2 = f_l f_u$), $Z_T(f_m) = Z_{Tm}$.

Calculate:

Normalized band, a :

$$a = \frac{f_u - f_l}{f_u + f_l}$$

Frequency variable, u :

$$u = a \frac{f^2 + f_m^2}{f^2 - f_m^2}$$

Evaluate: $u(f_2') = u_2'$; $u(f_2) = u_2$; $u(f_1) = u_1$

$$b_1^2 = 1 - u_1^2; (b_2')^2 = 1 - (u_2')^2$$

The image impedance ratio at $f = f_m$ is

$$\frac{Z_{Tm}}{Z_{\pi m}} = \frac{1}{2} (1 - u_1 u_2' + b_1 b_2')$$

and $u(f_0) = u_0$ is the frequency variable at the frequency at which $Z_T = Z_{\pi}$:

$$u_0 = \frac{1 + u_1 u_2' + b_1 b_2'}{u_2 - u_2'}$$

Obtain next, two parameters, K_1 and K_2 :

$$K_1 = \frac{(u_0 - a) b_1}{(u_2' - a)(u_2 - a)(u_1 - u_0)} \cdot 4\pi f_m a Z_{Tm}$$

$$K_2 = \frac{(u_1 - a)(u_0 - u_2')}{(u_0 - a)(u_2 - a) b_2'} \cdot 4\pi a f_m Z_{\pi m}$$

The element values are:

$$C_1' = 1/K_2; L_1' = K_2 f_1^2 / (4\pi^2 f_0^2 f_2^2)$$

$$L_1 = \frac{K_2 f_1^2}{4\pi^2 (f_2^2 - f_1^2)(f_1^2 - f_0^2)}; (2\pi f_1)^2 = 1/L_1 C_1$$

$$C_2' = \frac{f_2^2 - f_2'^2}{K_1 (f_0^2 - f_2'^2)}; (2\pi f_2')^2 = 1/L_2 C_2'$$

$$C_2 = \frac{f_2^2 - f_2'^2}{K_1 (f_2^2 - f_0^2)}; (2\pi f_2)^2 = 1/L_2 C_2$$

Two simple special cases may be deduced. If f_2' becomes zero, $u_2' = -a$ and L_2' is omitted. In the second case f_2' becomes infinite, $u_2' = a$, $L_2' = 1/K_2$ and C_2' is omitted.

Abstracted from an article by K. Stegemann, Nachrichtentechnik, Vol. 9, No. 11, November 1959, pp 502-505.

BASIC BUILDING BLOCKS FROM KEARFOTT



SIZE 11 SYNCHRONOUS MOTOR

Featuring pull out torque efficiency of 50% nominal with 3.4 watts input and 3 watts pull out power, this synchronous motor represents a major achievement in terms of performance for a unit of this extremely small size. Additional advantages made possible by Kearfott's unique design include resistance to environmental extremes, light weight construction and low unit cost. This motor and its variations are available in production quantities.

TYPICAL CHARACTERISTICS R172

Excitation:	Phase 1	Phase 2
Voltage	40V	40V
Frequency	400 CPS	400 CPS
Power	2.3 Watts	2.3 Watts
Current	0.157 Amps	0.157 Amps

Performance:

Synchronous Speed	8000 RPM
Stall Torque	0.2 In. Oz.
Pull Out Torque	0.35 In. Oz.
Pull In Torque	0.15 In. Oz.

Write for complete data.

Free Gyro



Vertical Gyro



Directional Gyro



Engineers: Kearfott offers challenging opportunities in advanced component and system development.

BASIC BUILDING BLOCKS FROM KEARFOTT



FERRITES

Kearfott's Solid State Physics Laboratory formulates, fires and machines permanent magnet ferrite materials of various compositions. Typical high-efficiency array utilizes Kearfott PM-3 ferrite material with specially designed pole pieces to produce a design both smaller and lighter than other arrays of equivalent magnetic field strength. Because magnets may be custom engineered to specific requirements, user is not restricted to stock magnet types, thereby providing greater latitude in parameters for focusing arrays. Pole pieces may also be provided according to specification, with the added assurance that, because of special Kearfott design techniques, B axial magnetic fields approximately 10% higher than those generally obtained in standard types may be produced.

TYPICAL CHARACTERISTICS

Peak Magnetic Field Strength	1200 gauss
Period	0.560 in.
Length	5.64 in.
Inside Diameter of Pole Pieces	0.400 in.
Outside Diameter	2.0 in.
Weight	3.2 pounds

Write for complete data.

BASIC BUILDING BLOCKS FROM KEARFOTT



ROTARY SWITCH

Kearfott's rotary switching devices for missile and aircraft systems are used to sequence or switch circuitry as a function of time or shaft position. Used in conjunction with sensitive relays or solid state switching techniques, high current loads can be handled. These switches consist primarily of shaft assembly and bearing mounted cylinder divided into conducting and non-conducting segments with continuous track for common input. Multiple conductor "broom" type brushes ride on each cylinder track while number of tracks and segmentation of each is function of the number of circuits and type of "on-off" sequencing required.

TYPICAL CHARACTERISTICS P1280-11A

Number of switching tracks:	2
Angular Segmentation (both referenced to 0° start):	
Track 1—Non-conducting about 0° + 50°	
Track 2—Conducting 0° -180° Non-conducting 180° -0°	
Mechanical Accuracy of Segmentation:	
±1° (better as required)	
Starting and Running Torque:	
0.1 oz.-in.	
Current Capacity:	
50 ma at 28V/Brush (suitable for any sensitive relay or solid state switching circuits)	

Write for complete data.

KEARFOTT DIVISION



GENERAL PRECISION INC.

LITTLE FALLS, NEW JERSEY

Midwest Office: 23 W. Calendar Ave., La Grange, Ill.
South Central Office: 6211 Denton Drive, Dallas, Texas
West Coast Office: 253 N. Vineland Avenue, Pasadena, Calif.

CIRCLE 744 ON READER-SERVICE CARD



NEW MINIATURE A.C. MOTOR

high output for commercial use

This a.c. synchronous motor costs you only about half as much as its miniature precision counterpart for military applications. In production quantities it is so economical that you can design it into good quality products that now use induction motors. And because you can put this bigger performance motor in smaller spaces, it gives you a head start in miniaturizing your design at the same time you improve product quality.

Vital statistics: This Type CMC motor has a starting torque of .7 oz. in. and a continuous duty torque of .7 oz. in. at synchronous speed. It is 1 1/4" in diameter by 2 5/8" long, and weighs 6 1/2 oz. The shaft is precision ground stainless steel, supported by ball bearings. The epoxy-sealed design provides good resistance to normal environmental conditions.

If you have hesitated to design with precision miniature motors in the past, now's your chance!

The Globe motor line includes both a.c. and d.c. models. Globe is pleased to work with you to provide the exact motor you need for your commercial, competitive product. Please write for Bulletin CMC. Globe Industries, Inc., 1784 Stanley Avenue, Dayton 4, Ohio. BAldwin 2-3741.

GLOBE INDUSTRIES, INC.

PRECISION MINIATURE A.C. & D.C. MOTORS. ACTUATORS,
TIMERS, STEPPERS, BLOWERS & FANS MOTORIZED DEVICES

GLOBE

CIRCLE 745 ON READER-SERVICE CARD

ELECTRONIC DESIGN

DIGEST of recent papers
and literature of interest to design engineers

Delay-Line Oscillator

A NOVEL USE for a variable delay line is illustrated in the schematic diagram of Fig. 1. The circuit uses the delay line as the feedback element of a triode oscillator. The delay line may be thought of as a phase-shift network having 180 deg phase-shift at a frequency corresponding to twice the delay time and its odd harmonics.

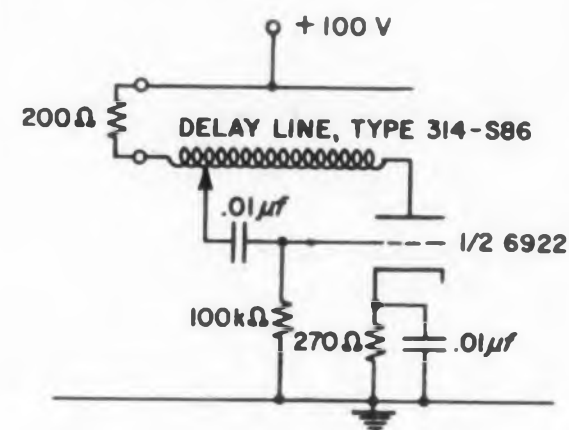

Fig. 1. Schematic of the delay-line oscillator.

A simpler physical picture of the circuit operation is obtained from a time-domain description. Let us assume that the triode is suddenly biased to cut-off by a negative voltage step at its grid. A positive voltage step will occur at the plate. This positive step travels down the delay line and is coupled back to the grid by the coupling capacitor, turning the triode on. A negative voltage step then occurs at the plate, which travels down the delay line, cutting the triode off, and the process repeats.

With a large value of coupling capacitor, the grid and plate voltage waveforms are essentially rectangular, and the amplitudes are fairly constant over the entire range owing to the on-off nature of the oscillations. With a small value of coupling capacitor, the oscillations are more nearly sinusoidal and smaller in amplitude.

The circuit shown, utilizing a General Radio Type 314-S86 Variable Delay Line (0 to 0.5- μ sec), oscillates readily up to about 30 mc. The grid

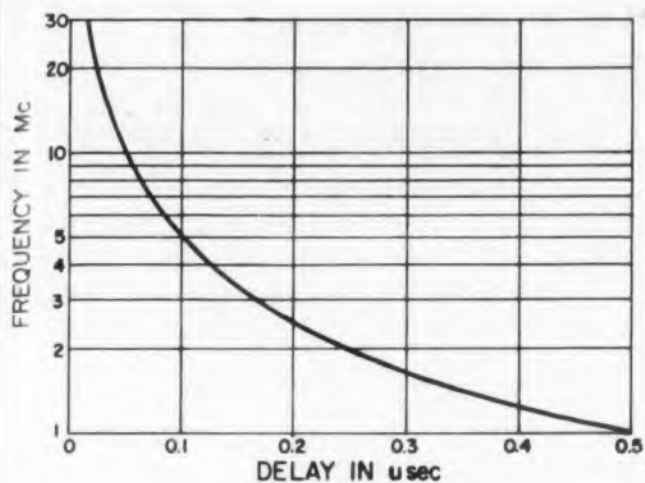

Fig. 2. Plot of frequency vs. delay setting.

voltage waveforms at frequencies of 1, 5, and 20 mc are shown in Fig. 3. The upper end of the frequency range is quite crowded because of the hyperbolic relationship between the frequency of oscillation and the shaft rotation of the linear delay line ($f = \frac{L}{2T}$). Up to about 20 mc, how-

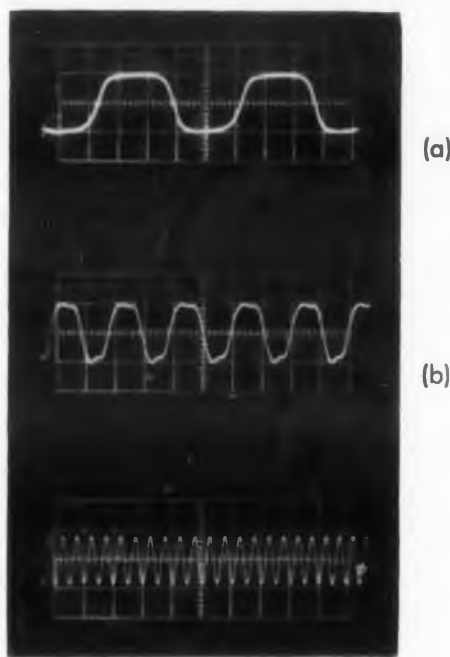

Fig. 3. Grid-voltage waveforms. (a) 1 mc. Vertical scale, 2 v/cm. Horizontal scale, 0.2 μ sec/cm. (b) 5 mc. Vertical scale, 2v/cm. Horizontal scale, 0.1 μ sec/cm. (c) 20 mc. Vertical scale, 2v/cm. Horizontal scale, 0.1 μ sec/cm.

ever, operation is quite smooth and uniform. The lower end of the frequency range is limited by the maximum delay of the line (1 mc for the Type 314-S86). Since the frequency of oscillation depends primarily upon the delay line and is relatively independent of the tube characteristics, it is quite stable at any particular setting of the line.

Reprinted from *Delay-Line Oscillator* by H. T. McAleer, *General Radio Experimenter*, Vol. 33, No. 11, November, 1959.

Announcing a new service from Hughes CIRCUIT COUNSELING

To help you meet the continually more complex problems of semiconductor circuitry, Hughes has created a Circuit Counseling activity. With its rapidly advancing technology, electronics—like the field of medicine—has come to rely on specialists. And now Hughes offers both present and prospective customers the services of CIRCUIT SPECIALISTS who are ready, willing, and able to tackle your circuit design problems—at absolutely no cost to you. This assistance, once requested, will come quickly. The Hughes Circuit Counselors will “hop a jet” and start to work on your problem within a matter of hours.

The Customer Technical Service Department is staffed by hand-picked men. Each member was especially selected for his wealth of experience in the field of digital, analog, video and RF circuit design for both small and complex systems. The knowledge of these specialists assures you of the proper application of semiconductor devices—thereby resulting in maximum system reliability.

To see a Hughes CIRCUIT SPECIALIST write, wire or phone: Customer Technical Service, Hughes Semiconductor Division, 500 Superior Avenue, Newport Beach, California. Phone: MADison 9-3271.

SEMICONDUCTOR DIVISION

HUGHES PRODUCTS

© 1959 HUGHES AIRCRAFT COMPANY

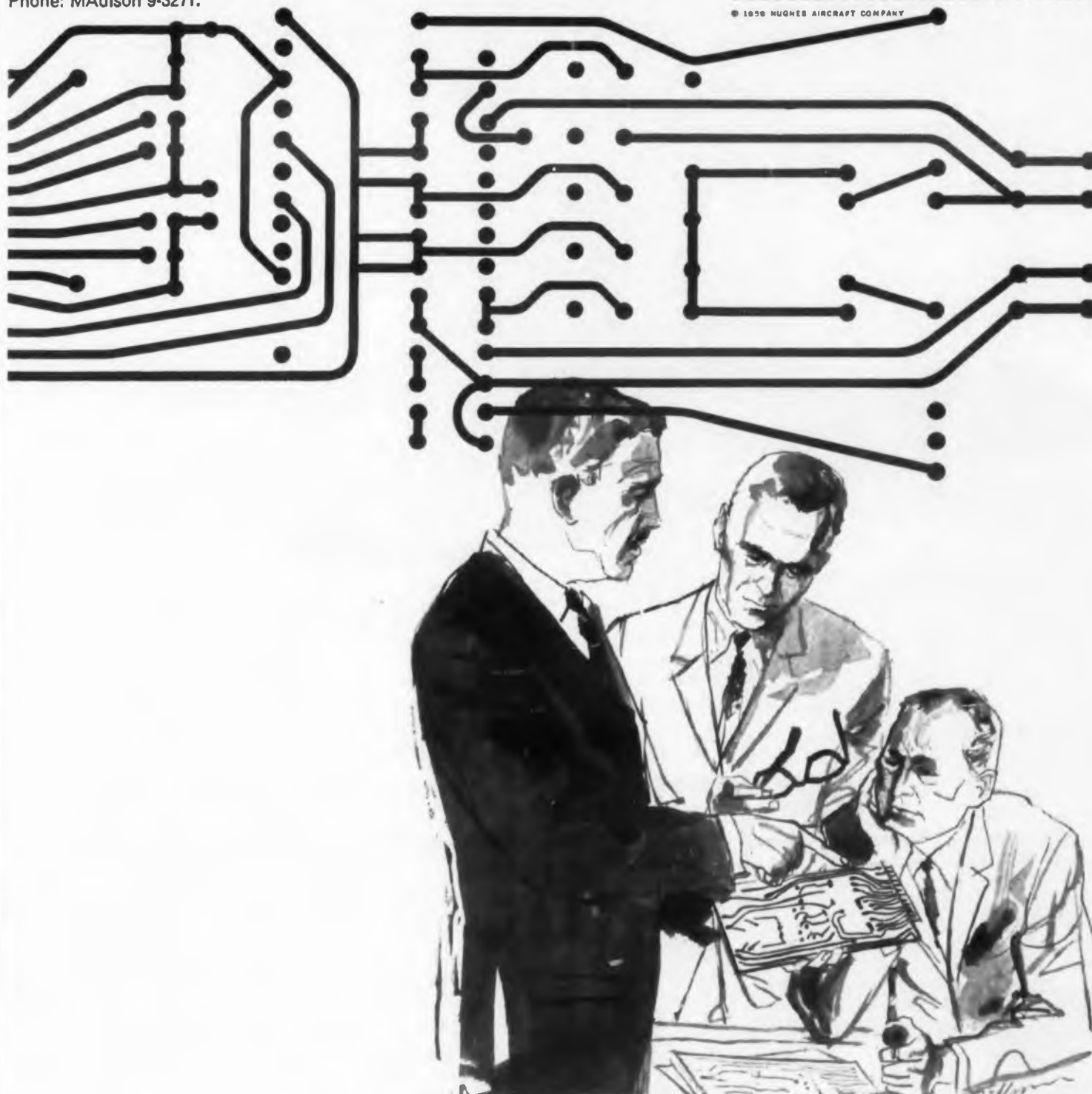

CIRCLE 746 ON READER-SERVICE CARD

SEVEN STANDARD SLIP RING SIZES **NOW** in stock!



FEATURES

Ring Envelope Diameters:

1", 1 $\frac{1}{4}$ ", 2 $\frac{3}{8}$ ", 4 $\frac{1}{8}$ ", 9 $\frac{1}{8}$ ", 10 $\frac{1}{2}$ ".

Hard coin silver rings and silver graphite brushes for excellent electrical properties and long life.

Fabricated construction (1) Provides superior resistance to shock, vibration, environmental conditions.

(2) Permits addition of rings when required.

Flat stacked assembly with rings mounted above and below each barrier provides maximum number of rings in shortest axial length for rated capacities.

Assemblies can be stacked on a common shaft to produce a multiple unit.

You'll want a copy of the new Breeze catalog 66 SR which contains complete details on these standard units. Catalog 66 SR also describes a wide range of custom units and incorporates a design guide section. Write for your copy today.



BREEZE CORPORATIONS, INC.

700 Liberty Avenue, Union, New Jersey • Telephone: MURdock 6-4000

Manufacturers of electrical, electro-mechanical and hydro-mechanical components and systems and fabricated metal products.

CIRCLE 747 ON READER-SERVICE CARD

ELECTRONIC DESIGN

DIGEST

of recent papers
and literature of interest to design engineers

A Barrier-Grid Tube Memory

THE BARRIER-GRID tube is a temporary memory device, having high speed reading and writing ability, but a comparatively small storage capacity.

Basically, it consists of a beam-forming electron gun and a non-conducting target the beam must strike. The target, instead of being a phosphor-coated face plate, is of special construction. It is built like a sandwich, having: (1) a fine-mesh grid through which the beam must pass (the barrier grid), (2) a mica plate which the beam strikes, and (3) a metal plate (the back plate).

Information is stored in the form of electric charges on the mica plate. The mica can be thought of as divided into discrete areas about the size of the diameter of the electron beam. Each of these areas may be charged to a positive or negative potential, and since the mica is a non-conductor, these potentials will remain essentially unchanged as long as the beam is turned off. Thus, each area will store a single binary digit or "bit" of information. Because the beam is small there may be as many as 16,000 such areas and each tube can thus store 16,000 bits of information.

Any of these areas can be selected by changing

the deflecting potentials while the beam is off so that when turned on, it will strike only the desired area. Because the sequence of areas selected can be completely arbitrary, this is known as a "random access" store. One of the principal circuit problems associated with the store is that of changing the deflecting voltages from one precise value to another in less than a microsecond.

Equilibrium Potentials Represent Binary Digits

When the beam strikes a selected area, secondary electrons are emitted. These secondary electrons may fall back to the area or may flow to the barrier grid, depending on the relative potentials. Thus, if the mica area is more positive than the



Fig. 1. Photograph of a barrier-grid tube. Sixteen thousand bits of temporary information can be stored here.

barrier grid, secondary electrons will return to the area. If the area is more negative than the grid, the electrons will go to the grid. Since the barrier-grid potential is held at a fixed value, the mica potential must adjust itself until the number of electrons leaving the area just balances the beam electrons arriving. This equilibrium potential of the mica is very nearly equal to the potential of the barrier grid and, because of the small area of the spots, is reached quite rapidly—under

IS THIS SLOWING YOU DOWN?



LOW CAPACITANCE

1.5 μf MAX. AT -3 VOLTS

CONTINENTAL'S COMPUTER SILICON DIODES

Newly developed by Continental, these diodes open possibilities of higher speed operation by minimizing the effect of shunt capacitance while providing fast recovery.

	CD2116	CD2117	CD2118	CD2119	Units
Max. Working Voltage	85	160	200	130	v
Min. Forward Current	4	6	50	10	mA
@ V_f	1.5	1	1	1	v
Max. Reverse Current @ 50V	.100	.050	.010	.010	μA
Max. Capacitance @ -3V	*1.5	*1.5	*1.5	*1.5	μf
Max. Recovery time	.15	.3	.3	.3	$\mu\text{sec.}$

*This extrapolates to 3 μf at 0 volts.
All diodes are "burned-in" at 200°C for 200 hours
Ratings and Specifications apply after "burn-in"

Four basic families, illustrated by the types in the table, have been developed to provide an optimum balance of characteristics for various computer functions. Each type

represents peak yields in its family so they are readily available in production quantities.

- LOW SHUNT CAPACITANCE
- FAST RECOVERY
- LOW REVERSE CURRENT
- 200 HOUR AT 200°C BURN-IN

These, like all Continental diodes, are manufactured by the Controlled Fusion Technique of junction formation which makes possible tight control of capacitance as well as other parameters.

The unusually low reverse currents, together with the "burn-in", give unequalled assurance of reliability.

Complete data on these types is available upon request. Your inquiry or request for technical assistance will receive prompt attention.



CONTINENTAL DEVICE CORPORATION

12515 CHADRON AVE., HAWTHORNE, LOS ANGELES CO., CALIF.

CIRCLE 748 ON READER-SERVICE CARD



KEEP A COOL HEAD...UAP CAN SOLVE YOUR ELECTRONIC CONTROL PROBLEM!

UAP has the specialized capabilities needed to analyze your overall problem; design the system technique; integrate components and sub-systems into complete operational systems to achieve specific functions such as *temperature, mechanical and mass flow* control.

Example: Temperature control was assigned to UAP for the new shipboard radar tracking system developed by Sperry Gyroscope, which includes a TV Camera developed by DuMont Laboratories. Components of UAP Mechanical Refrigeration System for temperature control of TV Vidicon tube and associated electronic equipment are: condenser and evaporator, semi-hermetically sealed compressor, blower, controls and chassis. The envelope is 14" dia. x 10" long, with half the diameter reserved for tube circuit. Capacity of 26-pound package is 275 watts at ambient 149° F. Meets MIL environmental specifications.

Send us your requirements:

UNITED AIRCRAFT PRODUCTS, INC., Dayton, Ohio
 (Contractual Engineering Offices: California, Gardena FA 1-4810; New York City MU 7-1283; Dayton, Ohio BA 4-3841; Canada, Montreal OX 7-0810)
 WESTERN DIVISION, UAP, Inc., Gardena, California



U-522477 Mechanical Refrigeration System



DIGEST

a microsecond. This high speed permits a short cycle time in the barrier-grid store.

The equilibrium potential of an area represents a bit of information, a binary 0, while a potential more negative than this can represent a binary 1. The process of charging an area to an equilibrium potential is used both in reading and writing.

For instance, to write a 0, the area is selected and the beam turned on. After a microsecond, the area is at equilibrium potential—it represents a 0. From observation of the current flowing to the barrier grid during this interval, it may be determined whether the area was previously a 1 or a 0. No pulse of charging current will be needed to reach equilibrium if the area was already at equilibrium, or was a 0.

Note that this process of reading is destructive in the sense that by the time the original state of the spot is determined it is at equilibrium potential and thus always represents a 0. For this reason, if a 1 is present and the system desires to continue to store this 1, it must be rewritten. This is done by first raising the backplate above its normal potential and again turning the beam on. The act of raising the backplate potential places a positive charge on the area, but the beam removes this charge in the process of charging the area to equilibrium. Once at equilibrium the beam is turned off, and then the backplate is restored to normal potential. This final action places a negative charge on the area and leaves it more negative than the barrier grid—a stored 1.

Three-Phase Operating Cycle

The tube operates on a basic cycle of three phases. During the first phase—DEFLECT—the beam is off, while the voltages on the deflecting plates are being changed from some previous value to one that will direct the beam to the desired spot. Immediately following this, the beam is turned on and the stored information is read—the READ phase. The final, or WRITE phase consists of writing the area, or spot, to its next potential.

These three phases take approximately equal times of 0.7 μ sec and, allowing time for circuit recovery, the cycle may be repeated every 2.5 μ sec. The switching system initiates each cycle by supplying an address in pulsed form, plus a "start" pulse. The start pulse may appear on any one of four leads, depending on what is to be done during the WRITE phase. The four operations are:

- (a) Write a 1,
- (b) Write a 0,

- (c) Rewrite the original information (REGENERATE).
 (d) Write the opposite of the original information (REVERSE).

Barrier Grid "Store"

The use of a barrier-grid tube thus requires appropriate circuitry to generate the reading and writing actions as well as to deflect the beam to the desired spot. This assemblage of tube and circuits is what constitutes the "store."

The barrier-grid store has four major divisions—the addressing or deflecting system, the tube and its direct control circuits, a sequential con-

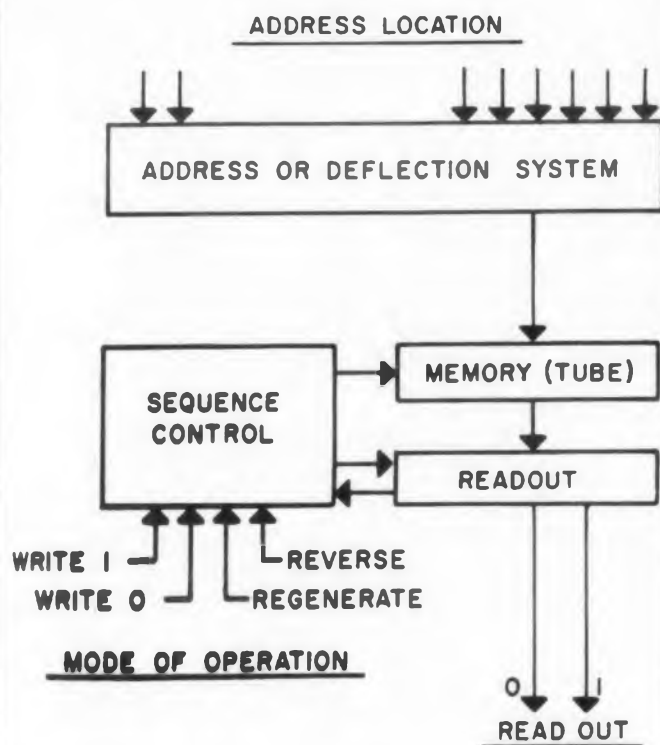
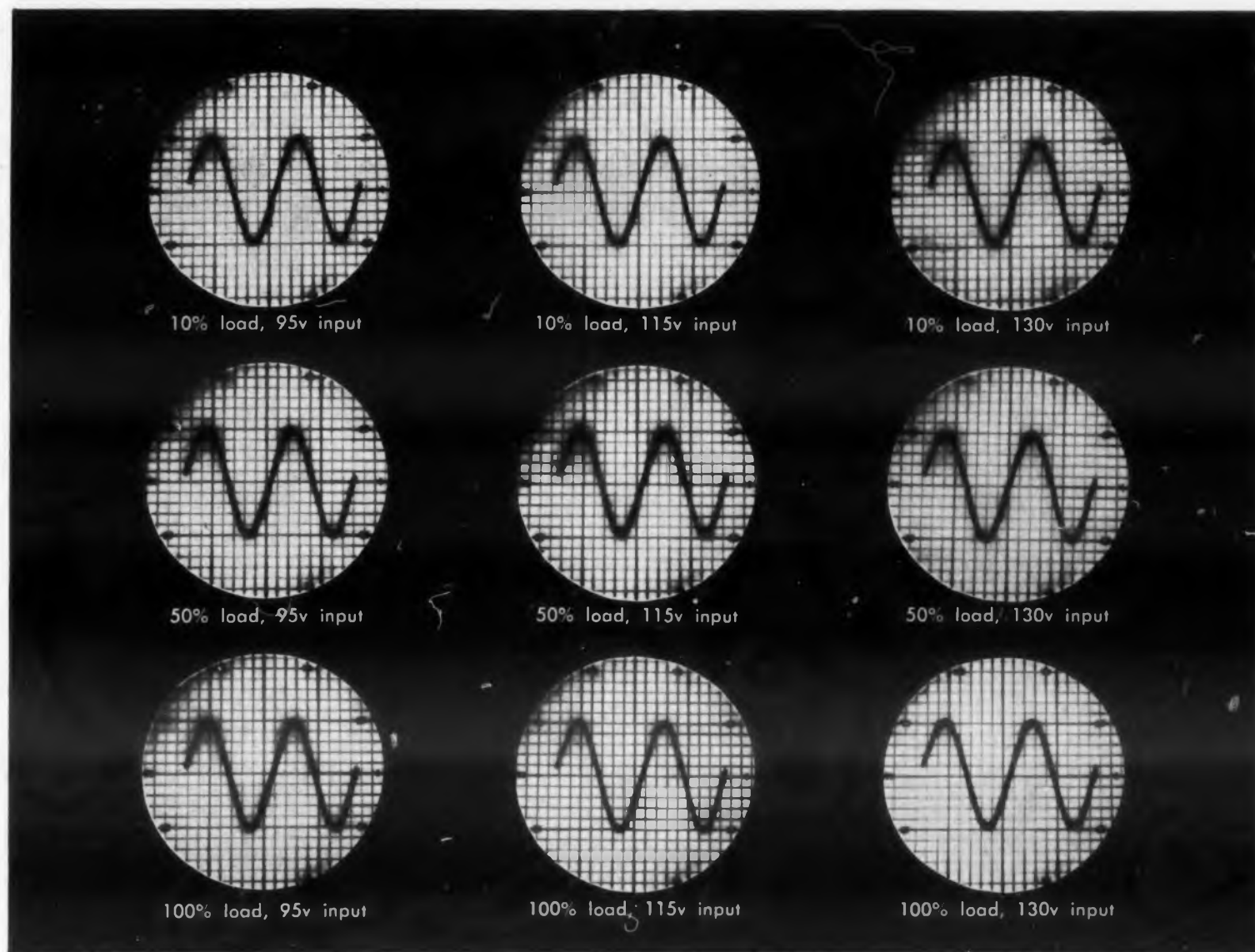

Fig. 2. Four major divisions of the barrier-grid store, and the circuits that link them. Memory (the barrier-grid store) receives its instructions from both the deflection system and sequential control.

control section, and a readout section. A basic block diagram of the store shown in Fig. 2 indicates the four circuits needed. The store receives each deflecting address in the form of parallel digital pulses. The deflection circuitry then must convert this digital input into the two voltages necessary to deflect the beam horizontally and vertically to the desired spot; it must do this rapidly and accurately.

The accuracy required permits the beam to deviate no more than a tenth of a spot diameter



Output wave shapes under varying input and load conditions. Sola Catalog No. 23-13-150 used in this test.

Sola's moderate-cost static-magnetic voltage regulator has sine-wave output



Sola now offers sinusoidal output in every standard-type regulator *with no price premium*. This development—a result of major design and production innovations—greatly widens the field of use for static-magnetic voltage regulation. The new standard sinusoidal design is now ideal for use with electrical and electronic equipment requiring a regulated input voltage with commercial sine wave shape—especially where harmonic-free supply had previously been too costly. The sinusoidal output also contributes to ease of selection and ordering, since this Sola stabilizer is virtually universal in application.

The Sola Standard Sinusoidal Constant Voltage Transformer provides output with less than 3% rms harmonic content. It automatically and continuously regulates output voltage within $\pm 1\%$ for line voltage variations of $\pm 15\%$. Average response time is 1.5 cycles or less. The new line includes nine stock output ratings from 60va to 7500va.

Besides the improved electrical characteristics, these units are substantially smaller and lighter than previous models. Size and weight reductions were accomplished without any loss of performance or dependability.

With the Sola Standard Sinusoidal Constant Voltage

Transformer you also get all the proved benefits of a static-magnetic regulator. It is simple and rugged. There are no tubes... no moving parts... no replaceable parts. Maintenance and manual adjustment are not necessary.

Its current-limiting characteristic protects against shorts on the load circuit. It is available in step-up and step-down ratios, allowing substitution for conventional, non-regulating transformers. These units can be used in any electronic or electrical application requiring a regulated sinusoidal power source where the peak power demand does not exceed the capacity of the constant voltage transformer. Circuit design formulae based on sinusoidal wave shape are directly applicable. Custom units to specific requirements are available in production quantities.

SOLA

SOLA ELECTRIC CO.

4633 West 16th Street

CIRCLE 750 ON READER-SERVICE CARD

Write for Bulletin CVS



A Division of
Basic Products
Corporation

Chicago 50, Illinois

Designing in miniature? Here's how to save space —

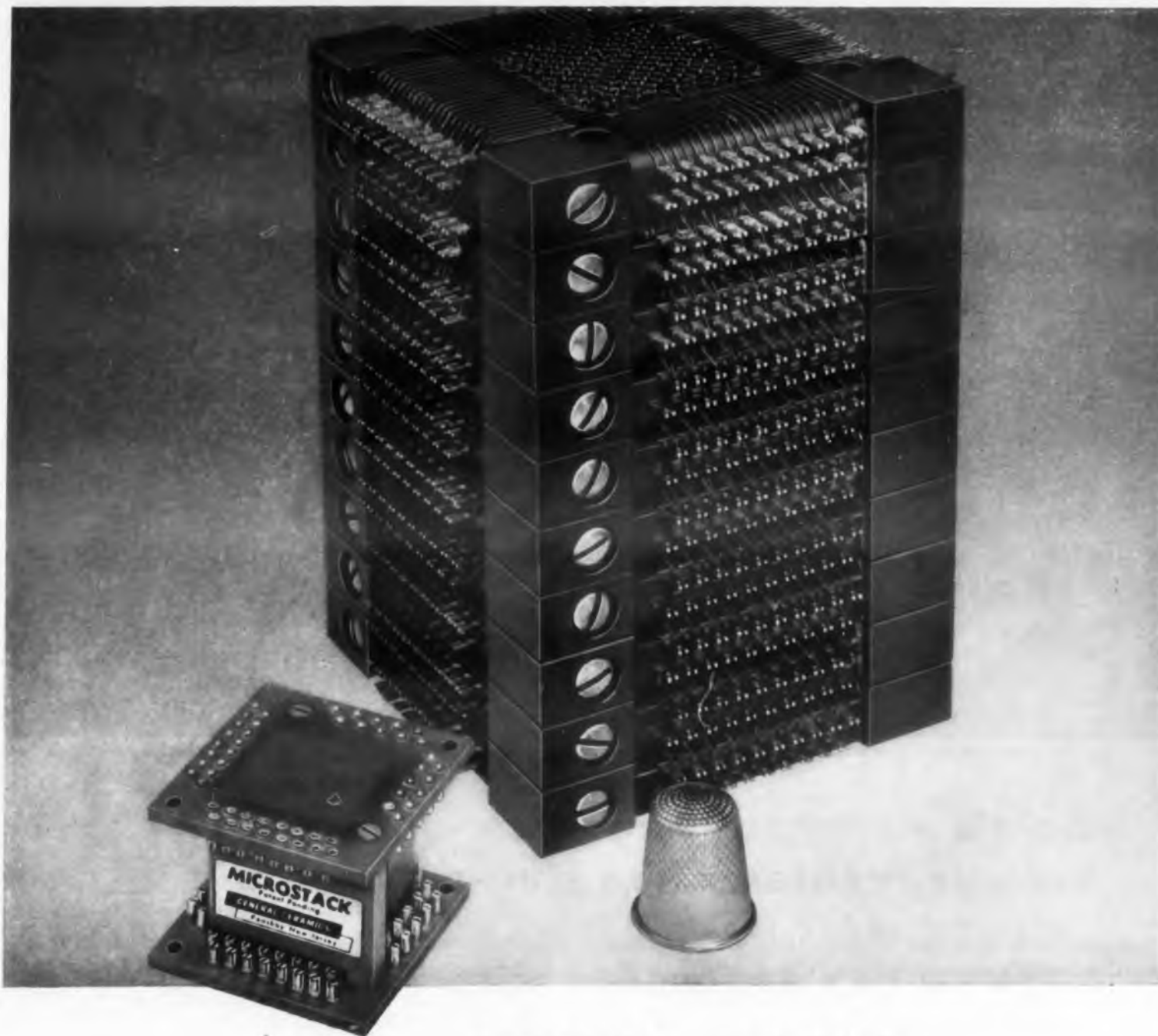

...90% of it!

New G-C MICROSTACK* for coincident current memory systems has a physical volume just 10% that of conventional stack. MICROSTACK shown with 2560 cores measures only 1.125" x 1.4" x 1.4", a reduction in size from 3½" x 3½" x 5".

This miniature stack consists of an array of 16 x 16 x 10. Solder connections are greatly reduced (from 1192 to 104), thereby substantially increasing reliability.

Noise level in the new MICROSTACK is as low as that of conventional types. The new MICROSTACK is available with all standard memory cores. Standard packages are available with coincident current wiring in 10 x 10 x 8, 16 x 16 x 8 and 32 x 32 x 8 arrays.

For further information, please write on company letterhead—address inquiries to Dept. ED.

* Trademark

GENERAL CERAMICS

ORIGINATOR OF THE SQUARE LOOP FERRITE

General Ceramics Corporation
KEASBEY, NEW JERSEY, U.S.A.

CIRCLE 751 ON READER-SERVICE CARD

DIGEST

from its desired location. For a large change in spot position this means accuracies exceeding 0.1 per cent. Since the beam must be within this final error limit before completion of the 0.7 μ sec DEFLECT phase of the cycle, it must move at very high speed.

The sequence-control section of the store generates the train of pulses needed to carry out the cycle. It provides these pulses at the proper times to integrate the operations of the addressing, tube and readout sections. In this section the operations are digital and may be carried out by the repeated use of small functional circuits as is done in other digital systems.

The basic parts of the readout section include an amplifier to raise the output signals of the tube to working level and detection circuits to pulse the proper output cable. Although the signals from the store can be low in amplitude initially, they should be relatively noise free to present no basic reading problem.

Deterioration of Stored Charges

Although the information stored in a barrier-grid tube is very stable when the beam is turned off, in normal operation the low-level "spray" of electrons within the tube causes a gradual deterioration of stored charges. This effect is most severe adjacent to spots where the beam appears most often, but all spots must be periodically rewritten for long-time storage. How often this must be done is governed by a figure called the Read-Around Number, or RAN.

The RAN indicates the largest number of times a given spot may be used before its immediate neighbors must be rewritten. In the present barrier-grid tubes, the RAN varies from spot to spot from a value of 150 to several times this value. To avoid interference between spots the switching system is arranged to rewrite all the spots within one second and never let the usage ratio of adjacent spots exceed 150.

Since a high order of reliability is essential to telephone systems, the "error rate" of the barrier-grid store is also an important factor. Specific tests on present stores have indicated that the error rate is less than one in ten billion. This is a very low probability of error, but the high speed of the store permits this many operations in less than a day. Thus, in actual systems two stores would normally be checked against each other. Under these conditions the probability of simultaneous errors is practically non-existent.

A number of barrier-grid stores have been built and operated for laboratory switching systems and

for the laboratory trial of an experimental electronic switching system. The accumulated experience with these stores has indicated that this form of memory can furnish highly reliable, high-speed storage at economical cost for future telephone switching systems.

Digested from Bell Laboratories Record, December, 1959, A Barrier-Grid Tube Memory, by T. S. Greenwood.

Graphical Method Determines Radio Noise Characteristics

AS NOISE, particularly atmospheric noise, is the limiting factor in radio reception, it is very important to be able to predict its characteristics under various conditions throughout the radio frequency range. Such a prediction, including an estimation of the possible interference to a given communications system, can be derived from an amplitude-probability distribution in which voltage levels are plotted against the percentage of time these levels are exceeded. However, although the amplitude-probability distribution is a particularly useful tool, its direct determination necessitates detailed measurements at all frequencies and at many locations. The complex equipment and the large number of per-

ENGINEERED COMPONENTS for the Electronic Industry

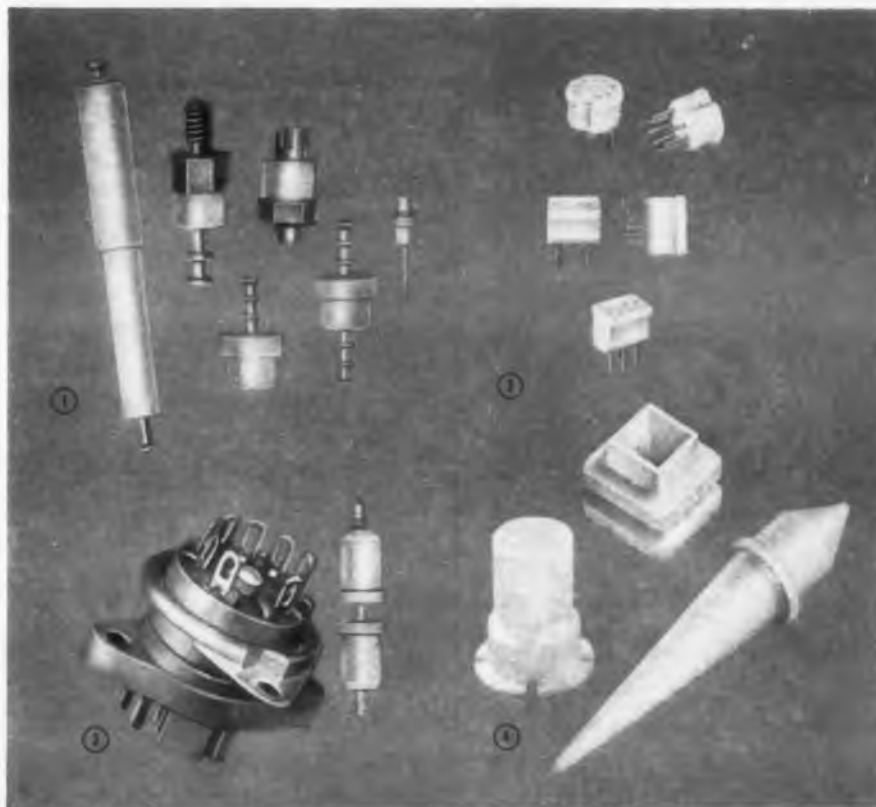

Garlock electronic components are skillfully engineered for high temperature, high voltage, high frequency service.

GARLOCK

ELECTRONIC PRODUCTS

WHERE RELIABILITY IS CRITICAL

1. Chemelec* Stand-Off and Feed-Thru Insulators are easy to install, resistant to heat and breakage, and—above all—reliable under severest conditions . . . ideal for critical electronic circuits such as missile guidance, fire control, tracking, radar systems. Teflon**—due to its excellent dielectric, mechanical and thermal properties—is used as the insulator body. And, Chemelec Compression-Mounted Stand-Off and Feed Thru Insulators are designed for easy installation. You simply press them into pre-drilled holes; they become self-fastening, requiring no additional hardware or adjustment. Available in compression-mounted, metal-base, miniature and sub-miniature types . . . standard R.M.A. colors, a wide range of sizes and terminal designs.

2. Chemelec Sub-miniature Tube and Transistor Sockets have body insulating material of Teflon; contact material of brass, silver-plated and gold flashed. Capacitance pin to pin .6 MMF—pin to $\frac{1}{8}$ " Chassis .7MMF. Chassis retention 50 lbs min. in $\frac{1}{8}$ " panel. Contact retention 4 oz. per pin.

3. Chemelec Connectors are Teflon-insulated for outstanding high frequency service. Once installed, they require no further adjustment or hardware. .040, .050, .064 pin size, female also in .080 size.

4. Plastic Stock Shapes and Intricate Parts, inserts, thin sections, threaded parts to precision tolerances are available. Excellent facilities and experience in compression and injection molding, extruding, machining of Teflon, Nylon, Delrin**, Kel-F† or other industrial plastics.

Garlock facilities and personnel are at your disposal for design and development of new electronic products.

Garlock maintains complete electrical, chemical, and physical laboratories staffed by top-flight research and development engineers.

Find out more about what Garlock offers. Contact the Garlock Electronic Products representative near you. Call him, or write for Catalog AD-169, Garlock Electronic Products, The Garlock Packing Company, Camden 1, New Jersey.

*Registered Trademark **DuPont Trademark
†Trademark, Minnesota Mining & Manufacturing

CIRCLE 752 ON READER-SERVICE CARD

Smallest MOLDED*
MICA CAPACITOR
73% Smaller†
Micamold Missilmite®
 for 55°C to 125°C operation

MEETS AND EXCEEDS MIL-C-5A
MEETS AND EXCEEDS MIL-C-11272A



*Pat. Applied For
 †73% smaller than CM-15

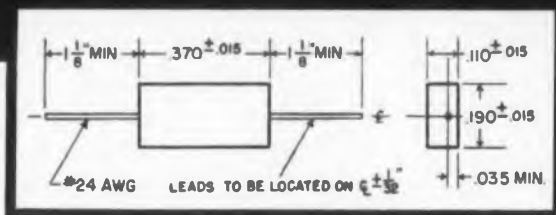

Micamold's Missilmite subminiature molded mica capacitors are the Smallest Molded Mica Capacitors Ever Produced...73% SMALLER! Due to radically new engineering design, new materials and assembly methods, Perfectly Symmetrical Missilmites MEET and EXCEED MIL-C-5A and MIL-C-11272A, Characteristics "C," "D" and "E." These subminiature molded mica capacitors will withstand operating temperatures of -55°C to +125°C (standard range is from -55°C to +85°C), and weigh only 1/2 gram.

Reliable and stable Missilmites permit greater design flexibility to the engineer, and are especially desirable in critical miniaturized assemblies. Recommended for use in missiles, delay lines, pulse networks, computers, transistorized assemblies...or wherever minimum size and weight, with stability, are required.



General Instrument Corporation
 also includes
 Automatic Manufacturing
 F. W. Sickles Division
 Radio Receptor Co., Inc.
 (subsidiary)

Send for Bulletin 114A to:

MICAMOLD ELECTRONICS MANUFACTURING CORP.

(Subsidiary of General Instrument Corp.)

65 GOUVERNEUR STREET, NEWARK, N. J. • HUmbolt 5-2100

VISIT OUR BOOTHS 1218-1224 at the IRE SHOW

CIRCLE 753 ON READER-SERVICE CARD

DIGEST

sonnel required to carry out these observations make continuous routine measurements virtually impossible.

The National Bureau of Standards Boulder Laboratories has found a solution to this problem in an empirical graphical method. With this method, it is only necessary to measure three statistical moments—the average noise power, the average envelope voltage, and the average logarithm of the envelope voltage. From these quantities, four parameters can be derived to describe completely the amplitude-probability distribution as plotted on special graph paper designed so that a Rayleigh distribution of thermal noise plots as a straight line. The curve is the usual plot of voltage in decibels against the percentage of time the level is exceeded.

As the initial step in developing this graphic method, it was found that the shape of the curve of over 100 recorded distributions, when plotted on the special paper, could be approximated by two non-parallel straight lines connected by the arc of the circle tangential to the two lines. The lower portion of this curve, representing low voltages and high probabilities, is composed of many random overlapping events, each containing only a small portion of the total energy. This portion of the curve approached the Rayleigh straight line distribution. The section representing very high voltages with low probabilities is, in general, composed of non-overlapping large pulses occurring infrequently. This section also was found to be well represented by a straight line.

Four parameters are needed to define this distribution: (1) a point through which the Rayleigh line passes; (2) a point; (3) a slope for the high-voltage, low-probability line; and (4) a parameter of some kind to determine the radius of the circular arc. Since four parameters are needed and only three statistical moments are measured, a dependency between two of the parameters was established. From experimentally measured distributions at eight frequencies and various bandwidths, a linear relationship was found between the radius of the circle and the slope of the high-voltage, low-probability line.

The experimentally measured distributions were then numerically integrated to obtain the three measurable moments, so that the relationship between the three moments and the four parameters could be determined. It is this relationship which allows measured moments to be used to plot the amplitude-probability distribution.

As a check on the accuracy of this method, the numerically integrated moments were compared



Time has brought decisive progress in the fight against cancer. Ten years ago one in four persons with cancer was saved. Today it's one in three. But time alone will not conquer cancer. Time plus research will. And research needs your dollars. Send your contribution today to "Cancer," c/o your local post office.

AMERICAN CANCER SOCIETY

to moments which had been recorded at the same time as the distributions. Approximately 60 sets of distribution measurements were analyzed to determine the error, which was largely introduced by the recorder. The standard deviation in the rms voltage values was about 1.1 db, with an average error of -0.14 db. Ninety per cent of the values were within 2 db of the mean.

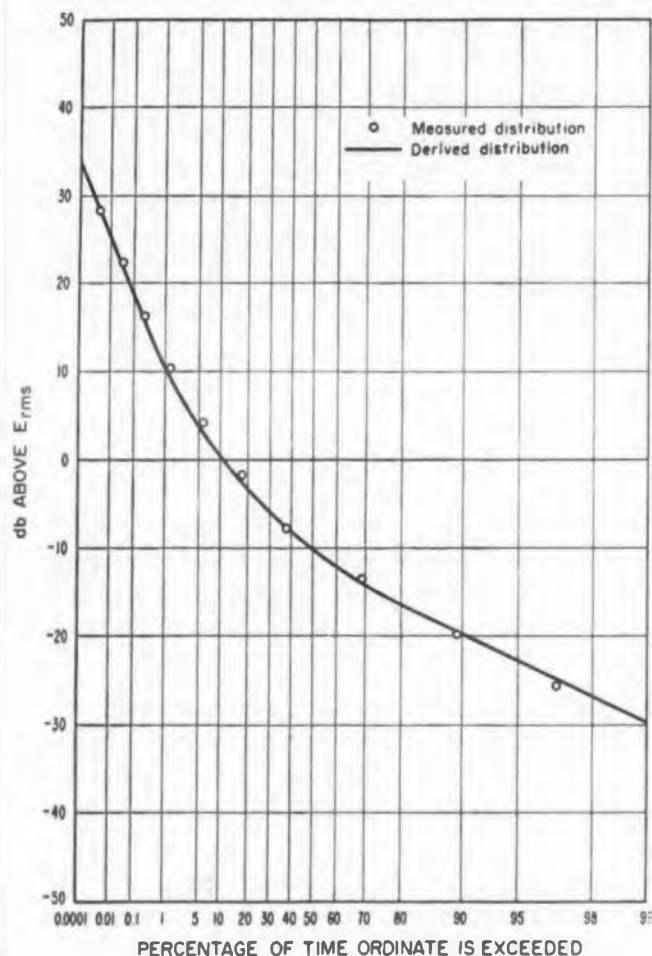

Graph illustrating the effectiveness of a graphical method developed by the National Bureau of Standards for obtaining the amplitude-probability distribution of atmospheric noise. The distribution predicted from three easily measured moments is seen to agree very closely with the distribution measured with complex equipment.

This method of obtaining an amplitude-probability distribution from the three measured moments results in a distribution which is valid only for the bandwidths in which the moments were measured. A study is now in progress to develop an accurate method of bandwidth conversion.

Digested from Technical News Bulletin of the U. S. Department of Commerce, National Bureau of Standards, Washington 25, D.C., November 1959.

Why Electronic Grade "A" Nickel is used in X-ray tube cathode head and nearly 400 other tube parts

SPRINGDALE, CONN. — Resistance to elevated temperatures and retention of critical dimensions and position of parts are important reasons why Machlett Laboratories specify Electronic Grade "A" Nickel for the cathode head of their Dynamax 20-DF X-ray tube.

The sharp focus of this tube, says Machlett Laboratories, depends largely upon accuracy of the contours and dimensions of the nickel cathode head, as well as on positioning of the filament within the focusing slots. On every exposure, millions of electrons are focused at the nickel cathode head, then slammed against a tungsten anode target spinning in a vacuum. The heat is so intense that the target material would vaporize if it were not spinning.



Nickel undistorted

Machlett's tube designers know how much Nickel contributes to longer tube life. For Nickel resists distortion at elevated temperatures, and its low vapor pressure plays an essential role in maintaining a high vacuum over a wide range of temperatures. Resistance to oxidation and ready fabrication are further aids to processing. The outstanding characteristics of Nickel reduce the problems of quality control.

Pertinent Literature: Write for Technical Bulletin T-15, "Engineering Properties of Nickel."

Circle 837 on Reader-Service Card

ELECTRONIC GRADE "A" NICKEL SOLVES 4 PROBLEMS IN NEW PULSE-MODULATOR 'HARD' TUBE

SPRINGDALE, CONN. — A high vacuum tube to pulse-modulate radio frequency generators for radar provides 1 megawatt output pulses with a peak driving power of 8 kilowatts. Developed for use in missile control equipment, and designated as the ML-6544, the new tube is being offered by Machlett Laboratories.



High magnetostrictive effect of Nickel proves useful in ultrasonic cleaners

NEW YORK, N. Y. — Because Nickel has a large magnetostrictive effect, it's used to energize many varieties of ultrasonic cleaners. In atomic energy installations, for example, these cleaners remove radioactive particles from equipment. They clean surgical instruments; even entire jet engines!

An ultrasonic cleaner, developed by American Time Products, is used to clean tiny parts for electronic equipment.

Grade "A" Nickel laminations are used in the transducer to produce high-frequency cavitation in cleaning and rinsing pots of this "Watchmaster" unit, developed by American Time Products, Inc., New York City.

ATP's chief engineer writes: "Grade 'A' Nickel enables us to produce a simple, economical transducer for converting electrical energy into high frequency vibration. The nickel transducer operates at elevated temperatures and withstands mechanical abuse and corrosive solutions, providing a long, stable life."

Nickel transducers operate up to 100 kilocycles per second, driving high impedance loads such as process liquids and cleaning solutions.

Pertinent Literature: "Design of Nickel Magnetostriction Transducers." Write for a copy.

Circle 838 on Reader-Service Card



ALLOY PRODUCTS

The tube design features a beamed oxide coated cathode structure, a rigid squirrel cage control grid, a shield grid internally connected to the cathode and a forced-air cooled anode. It operates with 18 KV D.C. on the anode, has a μ of 90, and develops 65 amps of plate current with a positive grid drive of 1200 volts.

The new tube, it is felt, reduces the shortcomings of older tetrode designs. The structure is radically different and quite rugged. The tube operates with stability at high voltages, and the amplification factor is high, therefore only a modest negative control grid voltage is needed for cutoff.

Grid and cathode supports of the ML-6544 are made of Electronic Grade "A" Nickel. Several other materials were considered before Nickel was finally selected, according to a spokesman for Machlett. One was rejected, he said, because it was costly, difficult to draw and too brittle. Another was too soft, and still another excessively expensive. Only Electronic Grade "A" Nickel was found to offer all of the desired properties as well as low cost. And Nickel is easily fabricated, joined, and outgassed. It has excellent mechanical properties and is highly resistant to oxidation and corrosion.

Pertinent Literature: Electronic grades of Nickel and Nickel Alloys — with their characteristics and uses — are fully described in our booklet, *Nickel Alloys for Electronic Uses*. Write us for a copy.

Circle 839 on Reader-Service Card

HUNTINGTON ALLOY PRODUCTS DIVISION
The International Nickel Company
67 Wall Street New York 5, N. Y.

call **FANSTEEL** for

**TANTALUM
SHEET**

get it

AS FAST...AS DEPENDABLE
as requisitioning from your own stock room

**IMMEDIATE DELIVERY
ON THESE THICKNESSES**

.002	.007	.020
.003	.010	.025
.004	.013	.030
.005	.015	.040

Write for our latest price bulletin 2.602 giving complete prices for both stock items and special mill runs.



Planning to use tantalum in your product? Already using it? In either case, you can count on immediate delivery from stock of Fansteel tantalum sheet.

A little over a year ago, we introduced an exclusive Fansteel service of stocking the more commonly used sizes of tantalum sheet. The demand was immediate. Now we've expanded our stocking program to include 7 more popular sheet sizes. To you it means that you'll get the tantalum you need... exactly as ordered... delivered when you need it.

And this Fansteel service will save you time and money by giving you the flexibility of quick deliveries and lower inventory costs.

MOLYBDENUM USERS get the same benefits from the Fansteel Molybdenum Sheet stocking program.

FANSTEEL

**HIGH TEMPERATURE
METALS**

FANSTEEL METALLURGICAL CORPORATION North Chicago, Ill., U.S.A.

CIRCLE 755 ON READER-SERVICE CARD

REPORT BRIEFS

Antenna Multicoupler Design

This is the fourth in a series of reports on the design of antenna-multicoupler systems for use where several transmitters and receivers are operated simultaneously with a single antenna system. The filter design formulas given in the third report in the series are used in the present report to show how the choices of the coupling capacitances, resonator parameters, and tuning methods in the narrow-band filters affect the extra-channel susceptance of the filters, which in turn affect the permissible number of channels for a given degree of mismatch. The present report also discusses the factors affecting the degree of isolation obtainable between the ports of the three-port strip-line multiplexing antenna described in the first report in this series. *Design Data for Antenna-Multicoupler Systems*, J. F. Cline and P. M. Sherk, Stanford Research Institute, Menlo Park, Calif., May 1958, 27 pp, Microfilm \$2.70, Photocopy \$4.80. Order PB 138731 from Library of Congress, Washington 25, D. C.

Crystal Oscillator Circuits

A complete design method is presented for the cathode coupled crystal oscillator, operating in the frequency range of 75 to 150 mc. Design information is presented in the form of graphs and tables. A reference circuit, having a single set of values for the frequency range covered has been devised, and by varying the circuit component values, performance has been determined and plotted. The resulting graphs are normalized with respect to the reference circuit component value and performance figures. In this way, output and crystal drive voltage variations were determined for specific changes in circuit parameters. The design method thus developed provides output prediction with an accuracy of approximately 10 to 15 per cent for changes in any one component. Accuracy of crystal drive voltage prediction is in the order of 20 to 30 per cent for the same conditions. Work on the capacitance transformer coupled oscillator using subminiature filament-type tubes has been completed, and performance of this oscillator at 105, 135, and 150 mc is presented. Investigation of the two selected oscillator circuits in the frequency range of 10 to 75 mc has begun and certain characteristics peculiar to the lower frequency circuits are discussed. *A Study of Crystal Oscillator Circuits*, H. E. Gruen and A. O. Plait, Armour Research Foundation, Chicago, Ill., Nov. 15, 1956-Feb. 15, 1957, 66 pp, Microfilm \$3.90, Photocopy \$10.80. Order PB 142865 from Library of Congress, Washington 25, D. C.

Magnetic Amplifiers

This report is a discussion of an improved method of shaping the frequency response of magnetic amplifiers. Transistor circuits furnish the power for lead or lag characteristics with negligible effect on magnetic amplifier gain or drift. *Transistor Circuits Alter Frequency Response of Magnetic Amplifiers*, James C. Taylor and Charles L. Wyman, Army (Rocket and Guided) Missile Agency, Redstone Arsenal, Huntsville, Ala., Feb. 10, 1958, 19 pp., Microfilm \$2.40, Photocopy \$3.30. Order PB 139260 from Library of Congress, Washington 25, D.C.

Electron Tube Cooling

This manual was prepared under the sponsorship of the Dept. of the Navy, Bureau of Ships as part of a continuing study of methods of cooling electronic equipment. The findings of investigations of the heat flow paths within and adjacent to vacuum tubes are presented, with the history of the development of the Thermatron diode. Its application to the study of vacuum tube cooling techniques is also discussed. In particular, it was found that bulb temperature is not a reliable index of the thermal condition of a glass vacuum tube. The Thermatron permits the measurement of plate temperature and is recommended for use in determining the thermal effectiveness of vacuum tube cooling techniques. *Development and Application of a Thermal Diode "Thermatron" for Use in Studying Methods of Cooling Electron Tubes*, James P. Welsh, Cornell Aeronautical Laboratory, Inc., Buffalo, N. Y., May 1, 1957, 70 pp., Microfilm \$3.90, Photocopy \$10.80. Order PB 143085 from Library of Congress, Washington 25, D. C.

Silicon Devices in Digital Systems

This report describes a group of circuits employing silicon semiconductor devices for use in digital systems operating in temperature environments between -55 degrees C and +100 degrees C. The designs emphasize simplicity, reliability, economy of power, versatility, and minimum sensitivity to variations among transistor parameters. These circuits have undergone extensive temperature tests within the prescribed limits, both as individual units and as components in logical sub-systems. Minimum specifications of circuit performance within these temperature limits are presented. *One-Megacycle Silicon Transistor Circuits Applicable to Airborne Digital Systems*, V. J. Sferrino and W. G. Schmidt, Lincoln Laboratory, Massachusetts Institute of Technology, Lexington, Mass., March 10, 1958, 33 pp., Microfilm \$3.00, Photocopy \$6.30. Order PB 139205 from Library of Congress, Washington 25, D. C.

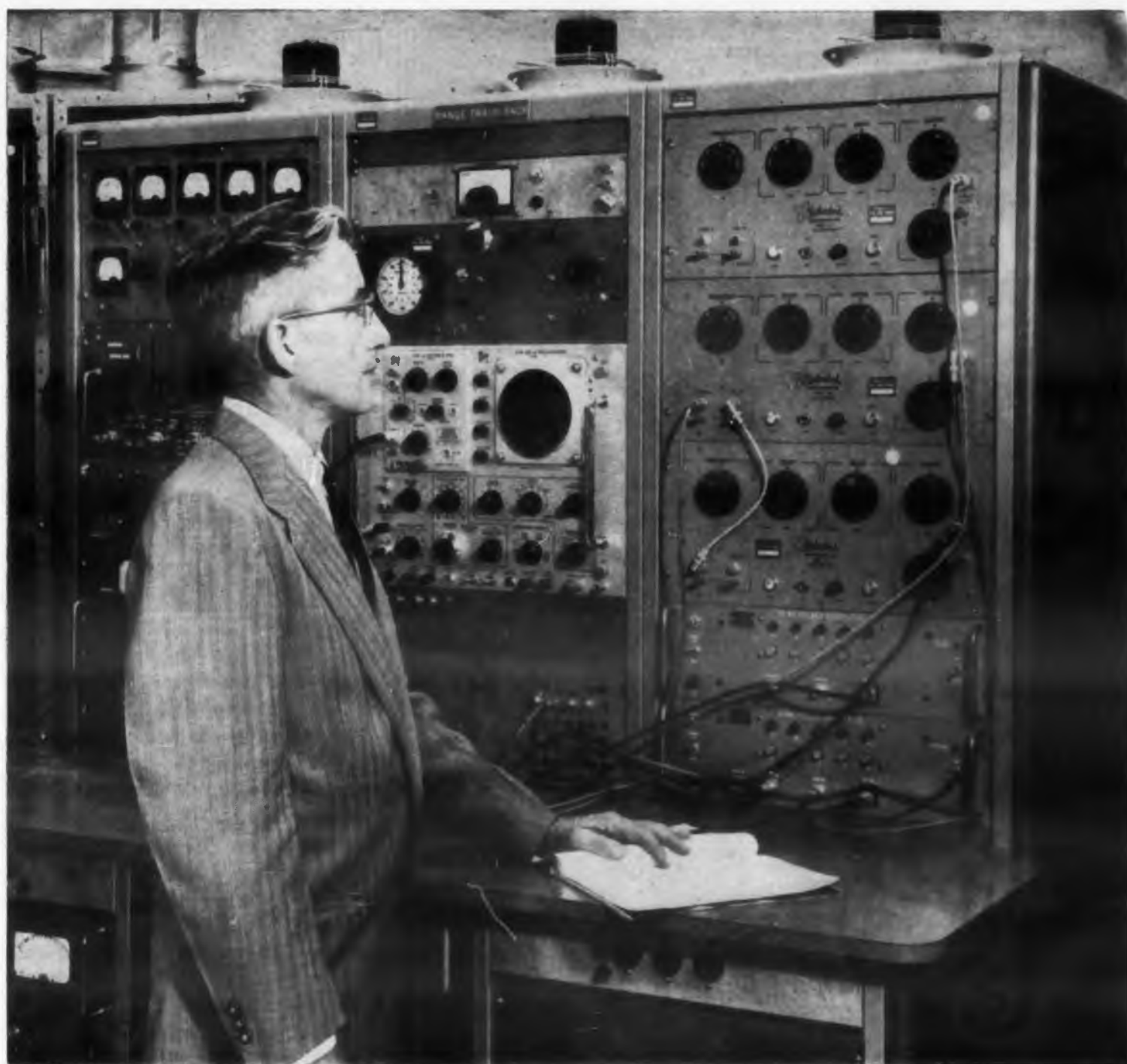

HUGHES CHOOSES RUTHERFORD

Mr. O. E. Kienow, head of the Receiver Group, Electronic Section, Tucson Electronic Laboratory of Hughes Aircraft Company, one of the outstanding electronic laboratories in the Southwest, has selected by critical evaluation the Rutherford Model B-7 Pulse Generator.

A point for point comparison of pulse generators of comparable rating shows that:

- The Rutherford Model B-7 Pulse Generator demonstrates less pulse jitter than any comparable instrument measured.
- Rise time characteristics compare favorably with instruments costing 50% more.
- Pulse shape and rise time are readily adjustable by means of a front panel control.
- The small size, for the output capability of this unit, is a major advantage in the construction of complex test equipment.
- The wide range of delays in this instrument makes it extremely versatile.

ENGINEERS: If your field is pulse circuitry design, a brighter future awaits you at Rutherford Electronics Company. Contact Mr. G. M. Stout, Personnel Director.

Rutherford
ELECTRONICS CO.

pulse generators • pulse systems • accurate time delay generators / 8944 Lindblade St., Culver City, California

CIRCLE 756 ON READER SERVICE CARD

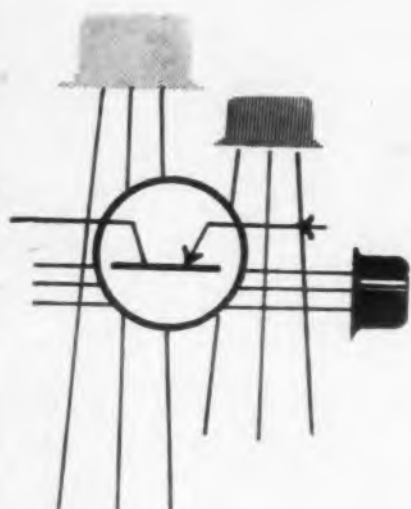

THE C112... Industry's Lowest Ico Silicon TRANSISTOR

MAX. $I_{co} = 1m\mu A$ at $25^{\circ}C$

MAX. $I_{co} = 1\mu A$ at $125^{\circ}C$

Through rigid process control and extreme junction cleanliness, Crystalonics now offers a P-N-P alloyed junction Silicon Transistor with extremely low I_{co} values. The low I_{co} is built into the transistor rather than obtained by selection. This is clearly shown in the I_{co} distribution diagrams taken on 650 typical units.

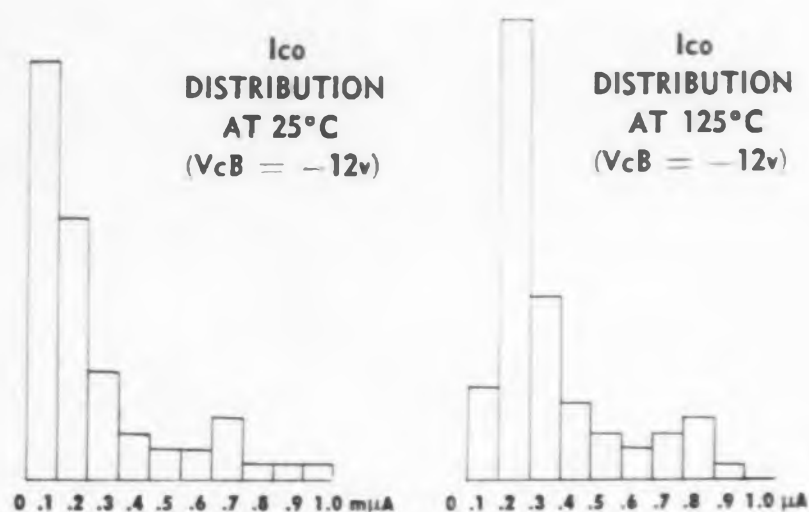

The main parameters of the C112 are as follows:

VcB	Vce	VeB	D.C. β	Max. I_{co} and IEO at $25^{\circ}C$	Max. I_{co} and IEO at $125^{\circ}C$
-25V	-25V	-20V	10-25	-1 m μA	-1 μA

All parameters can be held to tighter tolerances against specific requests.

The extreme unit cleanliness also ensures exceptional stability, and this transistor is recommended for applications requiring unusually reliable components.

THE C112 IS AVAILABLE FROM STOCK

Crystalonics, Inc. also offers symmetrical P-N-P Silicon Transistors and the 2N327A, 2N328A, 2N329A series of silicon units.

For full details, write or call

Crystalonics, Inc.

249 Fifth Street, Cambridge 42, Massachusetts
Telephone KIRKland 7-2750

CIRCLE 757 ON READER-SERVICE CARD

REPORT BRIEFS

Soldering Standards

These soldering inspection standards with illustrations have been established for use at the Diamond Ordnance Fuze Laboratories to assist in the determination of acceptable solder joints in electronic equipment. *Visual Inspection Standards for Soldering*, W. A. Atwell, Diamond Ordnance Fuze Laboratories, Washington, D.C., Apr. 18, 1958, 13 pp., Microfilm \$2.40, Photocopy \$3.30. Order PB 138892 from Library of Congress, Washington 25, D.C.

High Frequency Magnetic Amplifiers

An analysis of the amplistat circuit is presented based on a hysteresis loop in the shape of a parallelogram with flat top and sloping sides. The effect of loop width and rectifier reverse current on the control characteristics is determined qualitatively from the analysis. These effects are observed in the experimental results. A reactor design procedure is described based partly on the results of the analysis. Experimental data are presented for 1 and 5-watt amplistat circuits and for the self-saturating doubler circuit. The data include the control characteristic, power gain, time constant and figure of merit. Variations of these quantities with frequency, core material and rectifier type are shown. Most of the data are limited to 15 kc and lower but some data are given up to 40 kc. *High Frequency Magnetic Amplifiers*, Norman Balabanian and Joseph Dienst, Syracuse University, Research Institute, N. Y., Dec. 15, 1955, 91 pp., Microfilm \$5.40, Photocopy \$15.30. Order PB 138954 from Library of Congress, Washington 25, D. C.

Information Systems

Use is made of the channel capacity formula $C = W \log (1 + S/N)$, in comparing the relative effectiveness of increasing bandwidth or signal power on the channel capacity of an information system. Two cases are treated: (1) constant noise-per-unit bandwidth and (2) constant channel noise. It is shown for the first case that to avoid a saturation effect both bandwidth and signal power should be increased in such a way that $S/Wn = S/N$ is maintained approximately constant. For the second case, increasing signal power alone is more effective at low S/N whereas the relative effect of increasing bandwidth is independent of S/N . *Theoretical Capacity of Information Systems*, Charles F. Hobbs, Air Force Cambridge Research Center, Bedford, Mass., Dec. 1957, 11 pp., Microfilm \$2.40, Photocopy \$3.30. Order PB 139299 from Library of Congress, Washington 25, D.C.

assistant ENGINEER available

His name is STANPAT, and though he is not human he can swallow up your tedious re-drawing and re-lettering of standard and repetitive blueprint items for 24 hours a day if need be—without tiring. STANPAT is the remarkable tri-acetate sheet that is pre-printed with your specification and revision boxes, standard symbols, sub-assemblies, components and cross-sections . . . with adhesive front or back, waiting to be pressed into position in 15 seconds! Reproductions are unusually crisp and clear, guaranteed not to wrinkle, dry out or come off. STANPAT saves hundreds of hours in drafting time and money, allowing the engineer more time for creative work.

Already employed in numerous firms, STANPAT can go to work for you, too! Send us your drawing details now for quotation and free sample, no obligation.

so simple
1 to use:
PEEL the tri-acetate adhesive from its backing.

2 PLACE the tri-acetate in position on the tracing.

PRESS into position, will not wrinkle or come off.

STANPAT CO.
Whitestone 57, N. Y., U. S. A.
Phone: FLushing 9-1693-1611

Please quote on enclosed samples. Kindly send me STANPAT literature and samples. Dept. 136

Name _____

Title _____

Company _____

Address _____

19 years of service to industry

CIRCLE 758 ON READER-SERVICE CARD



S. S. White

MOLDED RESISTORS retain their values!

S. S. WHITE Molded Resistors retain their original values and never deteriorate due to age!

S. S. WHITE resistors serve dependably in hundreds of commercial... industrial... and scientific applications. They are characterized by low noise level... precision... stability... negative temperature and voltage coefficients. Non-hydroscopic base withstands temperature and humidity. They are compact, have excellent stability and mechanical strength.

For full details, write for our Bulletin 5409. We'll be glad to help you apply these high-quality, "all-weather" resistors to your product. Just drop us a line.

FIXED RESISTANCE VALUES
RANGE FROM 1000 OHMS TO
10,000,000 MEGOHMS!

65X Molded Resistor 1 watt
80X Molded Resistor 3 watts

S. S. White

S. S. WHITE INDUSTRIAL DIVISION
10 East 40th Street, New York 16, New York
Western Office: Dept. 28R
1839 West Pico Blvd., Los Angeles 6, Calif.
CIRCLE 759 ON READER-SERVICE CARD

Representing Transfer Functions

DeClaris has shown that the transfer function of a network consisting of resistors, capacitors, and one inductor has no more than one pair of complex conjugate poles. This thesis shows that for every transfer function representing a grounded two terminal-pair RLC network that has only one pair of complex conjugate poles, a grounded two terminal-pair network can be found which realizes the given function within a constant multiplier and which contains only one inductor. *New Techniques for Realization of Transfer Functions, Seifallah Louis Hakimi, Electrical Engineering Research Laboratory, University of Illinois, Urbana, Jan. 30, 1959, 78 pp., Microfilm \$4.50, Photocopy \$12.30. Order PB 143087 from Library of Congress, Washington 25, D.C.*

Spurious Microwave Energy

To reduce unwanted microwave rf radiations to a negligible value, filter specifications concerning stop band insertion loss, power handling capacity, and pass band characteristics were determined. The filter mechanisms which were selected for study were the coupled resonator filters, the corrugated waveguide filters, the higher mode resonance filters, and the absorptive type filters (1) based on directional couplers, (2) using ferrite materials and (3) using the leaky wall principle. Each of the types considered can find successful applications, but the leaky wall absorptive type is the most promising for use in high power systems and, therefore, was studied at greater length. Each type of filter is described and the advantages and shortcomings of each are discussed. *Measurement And Control of Harmonic And Spurious Microwave Energy, Vernon G. Price, Richard H. Stone, and John P. Rooney, General Electric Microwave Lab., Palo Alto, Calif., March 10, 1959, 113 pp., Microfilm \$6.00, Photocopy \$18.30. Order PB 142935 from Library of Congress, Washington 25, D. C.*

Coaxial Capacitor Circuits

Capacitor circuits representing a transmission line and feeding coaxially into an arc chamber are described. Inductances of approximately 1.1×10^{-9} are obtained for the complete circuit which includes capacitor, termination, and arc gap. Current pulses within the proximity of 26,000 amp with a pulse width of 18 μ sec are reported; the current rise is 2.8×10^{12} amp/sec. The complete apparatus weighs as little as 11 g. *Coaxial Capacitor Circuits With Extremely Small Inductance, Heinz Fischer, Air Force Cambridge Research Center, Bedford, Mass., May 1959, 15 pp., Microfilm \$2.40, Photocopy \$3.30. Order PB 142984 from Library of Congress, Washington 25, D.C.*



ANY
HIGH-VACUUM
CAPACITY
YOU WISH!

The 40 liter/second Vaclon® High Vacuum Pump, emphasized above, is just one of a great variety of Varian Vaclon Pump sizes available from stock. These include 1/2, 1, 5, 40, 100, 140, 280, 1000, 3000, 5000 and 10,000 liter/second capacities. Other sizes available on custom order.

All these pumps give extremely clean vacuums to below 10^{-10} mm Hg, have no moving parts or fluids, and operate without attention or service.

The Vaclon High Vacuum Pump is a fully electronic device and is a Varian "First." Unique both in principle and advantages, it has been accepted as an efficient, reliable laboratory and production tool by industries throughout the world.

A comprehensive brochure and technical data sheets are available by writing Vacuum Products Division.



COMPLETE VARIAN VACUUM
HIGH-VACUUM SYSTEM



VARIAN associates
PALO ALTO 21, CALIFORNIA

Representatives throughout the world

KLYSTRONS, WAVE TUBES, GAS SWITCHING TUBES, MAGNETRONS, HIGH VACUUM EQUIPMENT, LINEAR ACCELERATORS, MICROWAVE SYSTEM COMPONENTS, NMR & EPR SPECTROMETERS, MAGNETS, MAGNETOMETERS, STALOS, POWER AMPLIFIERS, GRAPHIC RECORDERS, RESEARCH AND DEVELOPMENT SERVICES

CIRCLE 760 ON READER-SERVICE CARD

**FIRST
IN
CLASS**



NIKE HERCULES

With deadly accuracy the U.S. Army's new Nike Hercules ground-to-air guided missile streaks out to meet an approaching enemy air force. Its nuclear warhead can wipe out an entire formation.

Western Electric selected Teflon* insulated wire for use in building the alert guidance and control systems of this faster, higher climbing Nike.

As leading specialists in high temperature insulated wires and cables, the men and women at Hitemp are proud of this choice, and the role Teflon wiring plays in giving America a strong new perimeter of defense.

HITEMP WIRES, INC.

1200 SHAMES DRIVE, WESTBURY, NEW YORK

*Du Pont's trade name for Tetrafluoroethylene

Visit our booth number 4213 IRE Show, New York City.
CIRCLE 761 ON READER-SERVICE CARD



LETTERS

Stop Feeling Sorry For Yourself

Dear Sir:

Your story of the Opinion Research Corporation survey among 622 engineers and scientists (*ED*, Nov. 25, 1959, p181) interested me greatly. The complaints put forth are not unique, but rather reflect a view which is nearly universal among corporate personnel. Whether one subscribes to the engineers' theories or those of management usually depends on which side of the question he is located. I happen to hold opinions which place me somewhere in between the majority viewpoints you express.

Let us analyze the situation more deeply. As in the old parable of the dog with the bone most of us tend to feel that the other fellow's reward is somewhat greater than ours. This is not necessarily true, but the individual's ego is assuaged if he feels that the sole reason which prevents his financial advancement is the peculiar salary policies of his employer. It is an attempt to fool one's self by placing the blame on the broad shoulders of the corporation rather than at a personal doorstep. Many of us play this little confidence game with ourselves.

One way to check the preceding statements is to check with friends who work for other companies. Ask them to reveal what they *think* you earn. Experience has taught that estimates from such sources are universally high. They usually will be twenty to fifty per cent over the true figure. Everybody feels that the other fellow is better paid.

As to being hemmed in by corporate pressures, this is a specious argument. None of us are contained to the point of constriction. There are certain budgetary necessities of course, without which no business could function. There are reports to be written which are of inestimable value. The days of an Edison or a Ford, puttering around in a workshop and working out of a hat, are gone forever. Modern systems and projects are too vast for this antiquated type of approach. It is time engineers took themselves in hand and expressed a willingness to comply with the framework that management has prescribed.

Creativity is a word which is being bruited about quite frequently these days. In fact, the

issue of ELECTRONIC DESIGN to which I refer has an article on this subject. Other magazines have taken up the cudgels and are declaiming loudly about a lack of and a suppression of "creativity". Most of the articles consist of an incomprehensible goggledygoon of psychological double talk. Natural and true creativity always comes to the surface regardless of the circumstances.

I will agree that knowing the right person is of definite help in stepping out of technical and into management work. I know of one corporation which is now headed by the son of the previous president. According to the publicity on this individual, his grades were "average" in college. This company has a policy which maintains that its hirelings must have been "superior" in academic standing. This man is president of the company, yet lacks the qualifications held mandatory for the lowliest trainee.

I saw another example on television. Groucho Marx was interviewing a man who was a vice-president of a large corporation. By coincidence, his name was a part of the company title, and further questioning elicited the information that his father was president and founder of the organization.

Groucho asked, "Do you think your family has anything to do with your being a vice-president?"

The man replied, "Positively not! I started at the bottom and worked up to this position."

The oddity is that this man imparted an aura of sincerity. In his mid-thirties at the time, he seemed to have deceived himself to the point where he actually believed that merit alone prompted his advancement. I was hoping that Groucho would ask how many other thirty-year-old vice-presidents existed in his company, but the interview was terminated at this point.

It is natural for management to feel that ability alone is responsible for their aggrandisement. To admit otherwise would be an admission of complicity by them. It is also natural for engineers to feel that connections, both family and social, are a concomitant part of advancement because they have seen many such cases.

However, two things have been neglected in the report. One is that there are many people totally without connection who do manage to get ahead. The second is the great factor of luck which is sometimes involved. There are many persons who were, by chance, transferred into a department which suddenly started to expand. Being there first, they naturally had preference when new managers were appointed.

There seem to be three rules in getting a promotion. One is to choose your parents carefully and only mix with those people who can be of help to you. Two is to possess a super ability which cannot remain hidden under any circumstance. Three is to be in the right place at the

wary
watchman
for



**B
M
E
W
S**

This giant early warning "watchman" is a prototype model—designed and built by Goodyear Aircraft under contract to the Radio Corporation of America for the U.S. Air Force. The project: BMEWS—Ballistic Missile Early Warning System. You get some idea of the size and capability of the Goodyear Aircraft components when you consider these facts:

- The concave tracking "dish" and rotating components weigh more than 200,000 pounds, *yet* it rotates and maneuvers with fluid ease and perfect balance.
- The supporting pedestal is three stories high, structured for the immense load it must carry, *yet* it is one of the most accurate mechanisms of its type ever made.
- The 140-foot-diameter radome can with-

stand gale-force winds and arctic storms, *yet* it offers almost complete electromagnetic transparency and requires no internal framework.

These achievements stem from Goodyear Aircraft's long experience in radar and radome design, development, fabrication and testing. Such experience provides an invaluable background *for virtually any radar system assignment*—from farseeing radar structures of unprecedented accuracy to massive radomes of advanced architecture.

Where can this experience solve a problem for you? WRITE for complete information to:

Goodyear Aircraft Corporation,
Dept. 916TN, Akron 15, Ohio

RADAR STRUCTURES AND RADOMES—
PRIME CAPABILITIES OF

GOODYEAR AIRCRAFT

Plants in Akron, Ohio, and Litchfield Park, Arizona

CIRCLE 762 ON READER-SERVICE CARD



Just as  Voltron combines its expanded scale network with API's meter relay to provide an **EXPANDED SCALE METER RELAY** that is 4 to 10 times more accurate and reliable . . .

Accuracy $\pm \frac{1}{2}\%$ of center scale

10,000,000 make break cycles, with 100% perfect contact
Eliminates problem of load isolation in measuring circuits

Low current and voltage inputs required

Many additional advantages . . . get complete details from either firm.

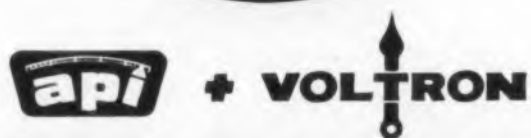
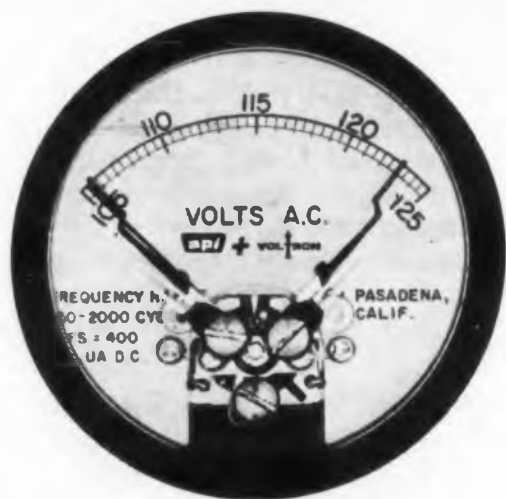

ASSEMBLY PRODUCTS, INC. Chesterland, Ohio
VOLTRON PRODUCTS, INC. 1020 S. Arroyo Pkwy., Pasadena, Cal.
CIRCLE 763 ON READER-SERVICE CARD

LETTERS

right time. All three are factors in professional and managerial advancement.

A great deal of the discontent noted in your article is the fault of the engineer himself. He seems to shine forth as a misanthropic, self-pitying clod. Of those interviewed, four-fifths felt underpaid, three-fourths felt hemmed in, and two-thirds felt that connections were in direct relation to success. The only one of these that I find valid is number three, and in that case, it is a partial agreement.

Engineers! Stop feeling sorry for yourselves! Pitch in, co-operate, meet management halfway and you'll be surprised at the joys and pleasures life can hold. A happy outlook makes a happy person.

Frederick J. Rex, Jr.
North Reading, Mass.

Flow Graph Analysis Clarified

Dear Sir:

My article, "Visual Engineering Mathematics," has stirred a lot of interest, judging by the number of requests for copies that I've received. A question which is often asked is how to evaluate the "Path x E non-touching loops" in a complicated flow graph. The full procedure is as follows:

1. Write down the product of all the transmitances in the path concerned.
2. Erase the path from the flow graph.
3. Erase any loops that touch the path.
4. Regard what is left as a new flow graph and find the sum of the loops in the usual way.

The product of 1 and 4 gives the required answer.

T. R. Nisbet
Lockheed Aircraft Corp.
Palo Alto, Calif.

Inside-Out Twin-T Described In Dual-Input Parallel-T Report

Dear Sir:

In a recent article in *ELECTRONIC DESIGN* ("Inside-Out Twin-T Varies Rejection Frequency," Oct. 14, 1959, p198), it is noted that a familiarity with the literature is strongly implied in the second paragraph.

I have enclosed copies of Naval Research Laboratory Report 4011 and reprints of the Proceedings of the National Electronics Conference,



E.M.I. MULTIPLIER PHOTOTUBES

For scintillation counters, spectrophotometry, flying spot scanning. The range of phototubes made by E.M.I. is one of the largest in the world. It includes end-window types of 1" to 15" diameter, with S10, S11, S13 and S20 cathodes, with 10 to 14 dynodes of venetian blind type or of box and grid or focused construction. Tubes for C¹⁴ and H³ Scintillation counting, also very low dark-current types, are an E.M.I. speciality. Tubes can also be produced to special order.

FULL DETAILS
OF ALL TYPES FROM:

H. L. Hoffman & Co., Inc.
35 OLD COUNTRY ROAD • WESTBURY • N.Y.
TEL: EDGEWOOD 4-5800

CIRCLE 764 ON READER-SERVICE CARD

ELECTRONIC DESIGN • February 17, 1960

1952 article "The Dual-Input Parallel-T Network" by the undersigned and Mr. Kenneth A. Morgan. Charles F. White, Consultant, Equipment Research Branch, Radar Division U.S. Naval Research Laboratory, Washington 25, D.C.

► In one step of developing the dual-input parallel-T network, a circuit identical to the one described by Mr. Howden in the referenced article was analyzed, Fig. 1. This circuit was then incorporated as part of the dual-input parallel-T network, Fig. 2.

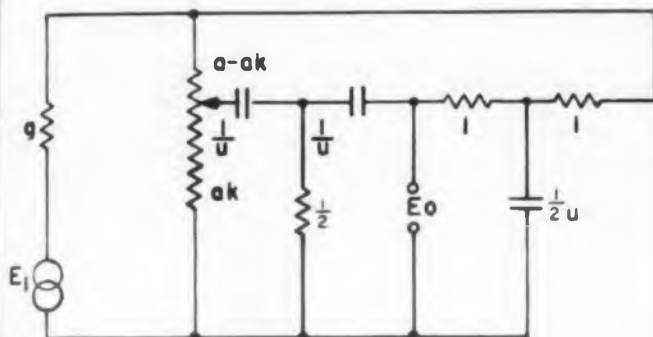

Fig. 1. An inside-out twin-T circuit was analyzed as part of an NRL program.

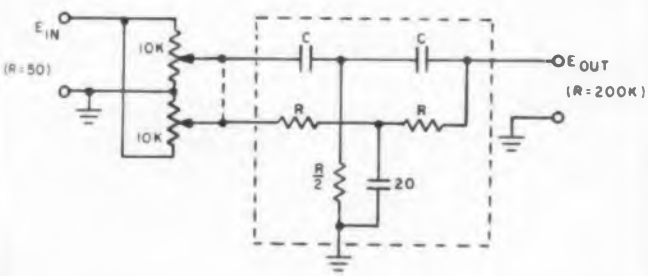

Fig. 2. Putting a conventional T and the inverted T together yielded the dual-input parallel T.

Don't Give Up the Project

Dear Sir:

I have been giving a bit of thought recently to one of the problems which I believe affects the security and progress of our country; namely, a project which is prematurely abandoned by individuals who are responsible for its successful completion.

There are the usual reasons given for leaving an incomplete project such as uninteresting work, unsatisfactory conditions, insufficient salary, better prospects and so forth. However, one should give considerable thought before leaving an undone project. I refer in particular to the military project.

There are many project engineers of military equipment who need to adopt a more positive

Electronic Products **NEWS**

by **CARBORUNDUM**
Registered Trade Mark



GLOBAR® Silicon Carbide Varistors create unique percussive effects in electronic organ

In the well known Thomas electronic organ, GLOBAR silicon carbide varistors perform a function as balanced modulators to produce instrumental percussive effects.

Clearly seen in the photo above, GLOBAR varistors are non-linear, voltage-sensitive resistors with the advantages of extreme ruggedness, small size and excellent performance characteristics. They are widely

employed for reducing arcing at relay contacts, suppression of RF interference, limiting voltage surges, back-voltage protection for diodes and transistors, and stabilization of rectifier circuits.

For types, ratings and other catalog data, write Global Plant, Refractories Div., Dept. EDV-20, The Carborundum Co., Niagara Falls, New York.

CIRCLE 804 ON READER-SERVICE CARD

Motorola protects radio tube filaments with GLOBAR® Thermistors

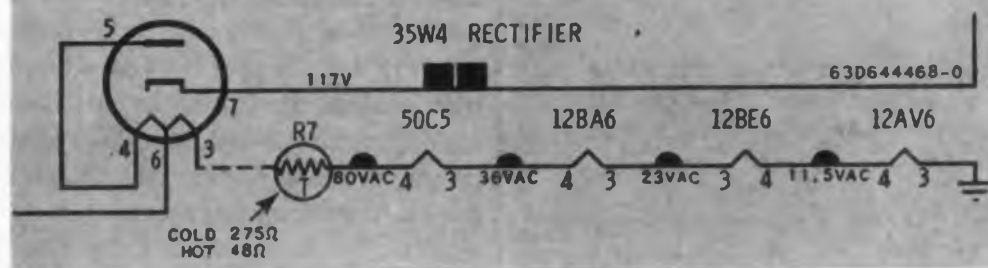

Motorola, Inc., protects the tube filaments of its table and clock radios, except for the low cost leader models, in a simple, inexpensive way. A GLOBAR silicon carbide thermistor is used in series with the tube filament string. Its negative temperature coefficient is utilized to limit the initial voltage surge during warm-up. Motorola expects tube life

to be prolonged up to ten times.

GLOBAR thermistors find many other applications where surge protection, time-delay operation, or temperature sensing and control are required. There is a wide range of sizes and ratings. Write: Global Plant, Refractories Div., Dept. EDT-20, The Carborundum Co., Niagara Falls, N. Y.

CIRCLE 806 ON READER-SERVICE CARD

Vacuum-Tight High Voltage Connector poses ceramic-to-metal sealing problem



The connector shown above is designed to meet severe space limitations which necessitate maximum voltage protection with a minimum of ceramic insulation.

The 1552 alumina insulator has a metallized coating for corona protection. The housing is heavy stainless steel.

Making the insulator to the required close dimensional tolerances, accurately centering the electrode in the housing, and then providing a vacuum-tight seal, were some of the problems Carborundum had to solve. To add to the difficulties, the center electrode had to be a special high conductivity material to provide sufficient current capacity.

Ingenious methods had to be worked out to seal this high expansion material to the ceramic. The complete assembly is hydrostatically tested for vacuum tightness, and withstands an electrical test of 30,000 volts. For help on your sealing problems, write Latrobe Plant, Refractories Div., Dept. EDS-20, Carborundum Co., Latrobe, Pa.

CIRCLE 805 ON READER-SERVICE CARD

LATEST INFORMATION ON KOVAR® ALLOY

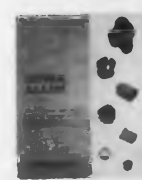

Kovar is the standard matched-expansion alloy for critical glass-to-metal sealing problems. A comprehensive bulletin gives technical data and information on available forms, shapes and sizes. Write Latrobe Plant, Refractories Div., Dept. EDK-20, Carborundum Co., Latrobe, Pa.

CIRCLE 807 ON READER-SERVICE CARD



For ceramic parts and metallized assemblies, Kovar alloy, ceramic resistors, varistors and thermistors... count on **CARBORUNDUM®**

CIRCLE 804, 805, 806, 807 ON READER-SERVICE CARD



Heart of the Control System

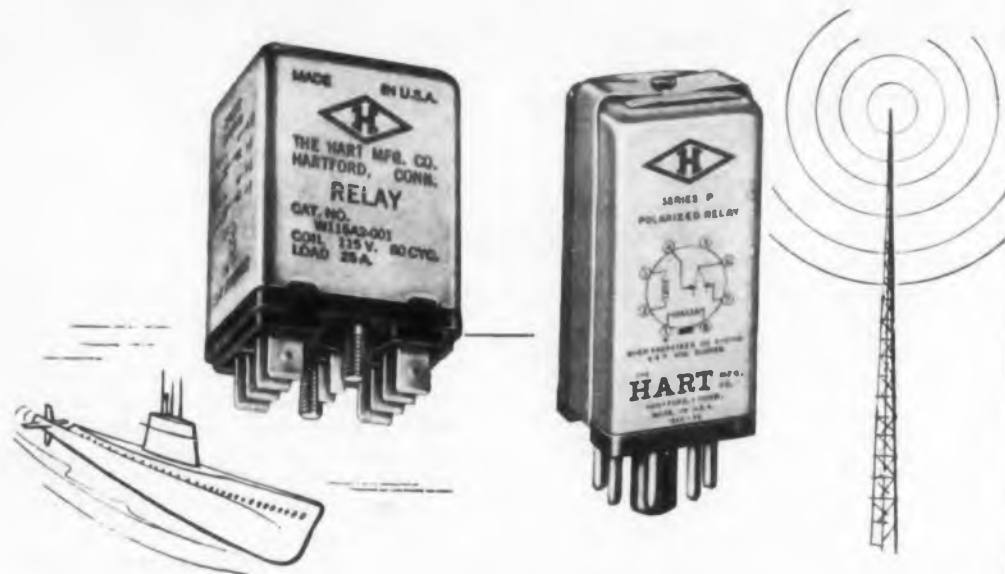

"DIAMOND H" Relays

Look into the heart of the control system for a missile, a computer, a nuclear submarine, or a great many other critical applications. You might be surprised how often you'll find "Diamond H" relays.

Unless, of course, you're one of the increasing number of engineers who've already selected "Diamond H" relays for a spot where they just have to work despite all sorts of adverse conditions.

Hart makes relays of three basic types: miniature, hermetically sealed, aircraft-missile relays (Series R/S); high speed, sensitive, polarized relays (Series P), and general purpose AC, DC relays (Series W).

Technical literature outlining the wide range of characteristics available with each type relay is yours for the asking. You'll find "Diamond H" engineers uncommonly adept at working out a variation of the basic designs to meet your set of specific requirements.

Tell us your needs . . . by phone, wire or letter.

THE HART MANUFACTURING COMPANY

210 Bartholomew Ave., Hartford 1, Conn.

CIRCLE 767 ON READER-SERVICE CARD

LETTERS

attitude with regard to the completion of their projects.

Whether we like it or not, experience that we amass with respect to a project is not simply transferable to another replacement. One cannot, during the last two weeks convey that which required two years to accumulate. The result then of changing positions usually advances the delivery date and increases the cost of the equipment. This is very detrimental on a national scale, especially when competing with a country that may not have this problem because its citizens are not free to change their positions arbitrarily.

We must exercise self-discipline, a readiness to complete a job before transferring to another, even though it seems that we will be overlooking an opportunity. Gentlemen, there is no better recommendation than a previous job done well. You have a friendship of the company you leave and the respect of the one you join.

There are, of course, extenuating circumstances which occasionally compel one to leave a job unfinished. This is understandable. Our concern is with individuals who show no sense of responsibility for a project for which they are, in fact, responsible.

Every engineer is to some degree, responsible for his duties. Each one has, in addition to his technical contribution to the project, an ethical obligation to insure that his project will not suffer because of his untimely departure from it.

No one, it is said, is indispensable to anything or anyone. That may be true but practically considered, dispensability is usually coupled with wasted time, cost and effort.

Every man knows his importance to a particular assignment. Unless he can honestly say that his departure will not materially affect the project, or unless he feels that his presence on another project would be more important to his country's welfare, he should make every attempt to remain at his job until it is completed.

Alfred W. Zinn
Farrand Optical Company
New York, N. Y.

About Soldering Flat Cables . . .

Dear Sir:

I have just finished reading the two articles "Making the Most of Flat Cables" in the Oct. 14

NOW
10
CASE SIZES

in plain and etched
tantalum foil
electrolytic capacitors



No more need to over-specify! **iei** offers 10 case sizes—twice as many as other manufacturers.

- Smaller sizes are available for most ratings.
- Low voltages (to 3 WVDC)—both plain and etched foil.
- Extremely close tolerances, down to $\pm 10\%$ on plain foil if desired.
- Plain and etched -55°C to 85°C .

All electrical connections welded. Lead wires have high resistance to stresses, bending. Cases fit tightly, for maximum vibration resistance, high reliability.

Prompt service on special capacitors. Engineering service available for adapting standard capacitors or designing new ones to meet special needs. **iei** also offers a full line of miniature and sub-miniature aluminum foil electrolytic capacitors.

Write for bulletin 41858. International Electronic Industries, Inc., Box 9036-C, Nashville, Tennessee.

iei

AN **SPS** COMPANY

where reliability replaces probability

CIRCLE 768 ON READER-SERVICE CARD

ELECTRONIC DESIGN • February 17, 1960



ARE YOU MEASURING . . .

- Actual life span of your equipment?
- Consumption of rated life of critical equipment or components?
- Mean-time-to failure?

You can reduce the odds against failure by constant monitoring and timely replacement of equipment approaching the end of assured performance . . . by thoughtful application of the . . .

WALTHAM SUB-MINIATURE ELAPSED TIME INDICATOR



MODEL
WT-1
Actual
Size

1 1/16" O.D. x 1 5/16" 3 OZ.

10,000 Hour Total Readout
(Easily Read to Closest Hour)
400 CPS

Whether it's for reliability and life testing, design or system analysis, utilization studies . . . or to continuously monitor and log critical equipment or components . . . when you incorporate the Waltham WT-1 in your plans, you add that "measure of reliability" so important for military acceptance.

The WT-1 meets MIL-E-5272A and is available "FROM STOCK"
Write Now for Bulletin 5001!

WALTHAM
PRECISION INSTRUMENT
COMPANY

Waltham 54, Massachusetts
CIRCLE 769 ON READER-SERVICE CARD

ELECTRONIC DESIGN • February 17, 1960

and 28 issues of ELECTRONIC DESIGN.

The articles were very informative, and I learned a good deal from them. I am particularly interested in the sliding chassis application.

A few points seemed to be missing, such as:

1. What damage is done to the flat cable by too long a solder application time?
2. Can they be hand-soldered by inexperienced help?

William R. Walker
Product Design Engineer
Acoustica Associates, Inc.
Los Angeles, Calif.

► It is a pleasure to reply to Mr. Walker's questions in his letter of Nov. 5.

1. No damage is done if heat is confined to a small area. This is easy if a small (50 watts or less) soldering iron is used. With flat conductors, there is less tendency for the insulation to shrink back than there is with round conductors, since heat is dissipated more rapidly and therefore does not carry as far along the conductor.

2. Inexperienced help will find it easy to hand-solder flat conductor cable. Insulation is stripped from one conductor at a time with a ball of solder on the tip of a hot soldering iron. This simultaneously tins the conductors. Connector terminals should also be tinned. It is convenient to hold conductors in position on the terminals by soldering the edge conductors first. Then the remaining conductors are easily soldered just by touching the joint with the iron. Further details on stripping, soldering and splicing are in our Engineering Bulletins 3, 4, and 5. These are available to anyone on request.

William Richter
Tape Cable Corp.
Rochester, N.Y.

Missing Negative

In a letter by Mr. Jack B. Meister (ELECTRONIC DESIGN, Jan. 6, 1960, p. 143), the important word "not" was dropped from the first line of the second paragraph. It should read: "I do not believe that calling for the title of a particular article, in which the uniterms are related in a very special way, that the situation would often be encountered where the random grouping of words in the other lists would correspond to an article in the file."

Gertsch
MICROWAVE
FREQUENCY
MULTIPLIER

MODEL FM-4A

-measures 100 to 30,000mc
generates 500 to 30,000mc
with high accuracy and stability

This phase-locked oscillator transfers the accuracy and stability of a VHF driver into the microwave region, giving continuous coverage.

You can drive the unit with Gertsch frequency meters FM-3, FM-6, or FM-7. Fundamental frequency range is 500 to 1000 Mcs, with harmonic output to at least 30,000 Mcs.

Ideal for calibration of cavity wavemeters . . . for precise measurements, or as an ultra-stable frequency source. Unitized construction. Adaptable for rack mounting.

Gertsch

Complete data
in Bulletin FM-4A.

GERTSCH PRODUCTS, Inc.

3211 South La Cienega Boulevard, Los Angeles 16, California / UPlon Q-2761 - VERmont 9-2201
CIRCLE 776 ON READER-SERVICE CARD

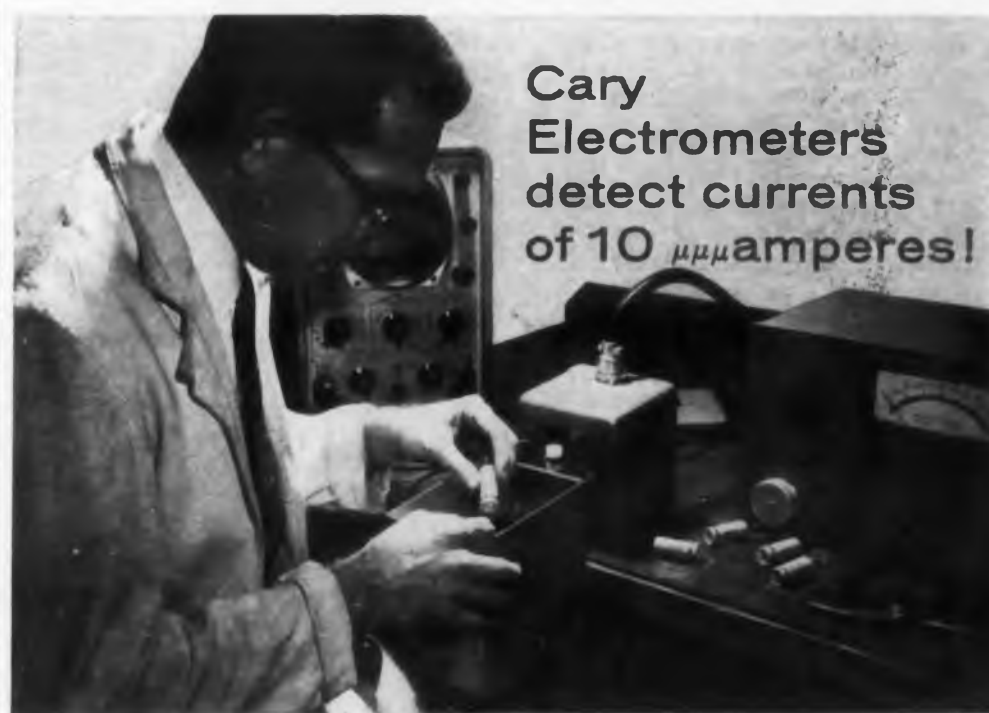

Cary
Electrometers
detect currents
of 10 μμμ amperes!

These accurate, sensitive instruments detect currents as small as 1×10^{-17} amperes; charges to 6×10^{-16} coulombs, voltages as low as 20 microvolts. Cary Electrometers provide proven unequalled performance and versatility for measuring charging phenomena, hysteresis and photo effects of semi-conductors and insulating materials. Applications include air ionization studies, measurement of ion currents in mass spectrophotometry, radioactivity measurements of solids, liquids, gases, and Hall effect studies.

For information on
Cary electrometers
and accessories,
write for data file RP 17-9



APPLIED PHYSICS CORPORATION • 2724 South Peck Road, Monrovia, Calif. .
CIRCLE 770 ON READER-SERVICE CARD



7 Questions That Can Shape Your Job Future

An Employment Counselor Tells How to Evaluate
the Career Potential of an Electronics Company

Eugene B. Shea

Manager of Electronics Div.
Cadillac Associates, Inc.
Chicago, Ill.

Eugene B. Shea started in the employment business part-time while studying mechanical engineering at the University of Minnesota after World War II. He received his B.M.E. in 1949, and three years later joined Cadillac Associates, executive and professional placement service.

The 37-year-old manager addresses his advice in this article to employees. But, off the record, he has some words for employers, too:

"The engineering shortage, particularly in electronics, is becoming more acute every day. Yet we still find companies using antiquated hiring techniques, including the promiscuous use of application blanks, preliminary interviews with junior personnel men and all of the many screening practices that were started during the depression of the Thirties. These are as outdated as the Model T.

"I predict that if the engineering shortage grows much more acute, engineers will soon have application blanks printed up and sent out to companies to complete, requesting information as to age of company, years in business, reputation in the industry, type of jobs available, salary levels, products of the company, etc."



DON'T accept a new job until you evaluate thoroughly the job potential of the concern you intend to join."

I have attempted to pound this simple axiom into the heads of hundreds of our engineering applicants, but from the unhappy mental state of so many that we encounter, the message still must not be "taking."

It is difficult to preach when you have been guilty of the same sins. I speak from bitter personal experience. I went through all the standard motivations after obtaining my engineering degree at the University of Minnesota.

Many new graduates—and even experienced men—make the same mistake every time in evaluating a job. I can't emphasize how serious this mistake can be for you. A false move can set your career back many years and deprive you of salary increases.

To evaluate a job, you must first evaluate the company. Far too many engineers negate their own scientific background by evaluating an opportunity solely in terms of salary, title, apparent prestige of the company name and opportunities for off-hour leisure. There are much more accurate methods of measurement. I recommend that my clients ask seven key questions, all designed to rate the company. Other questions may be added, but if you find favorable answers to most of these, you will at least be able to consider the next, more specific area, the job itself. Without

numerical order of merit, I suggest the following questions:

1. Is it a growing company? "Growing" has been much misused of late. Diversification doesn't always mean healthy growth. Expansion of a research department, sales or marketing staff frequently does. Is the opening you are applying for available as a result of seniority (because the man who had it 20 years has moved up), or are you to be part of a new section? If it is for the latter reason, you are on the right track.

2. How well-balanced is the company? Simply because a company makes a respected product or has a good engineering reputation doesn't mean that it is a good one to work for. A company may have the best engineering department in its field, but that engineering is useless if it has no marketing department to evaluate potential for a product or an inadequate sales division to sell it. Imbalance in any of these departments can mean problems for you if you decide to join a company.

3. What are the salary and promotion policies of the company? I have indicated earlier how fallacious it is to base your evaluation of a company solely on the basis of salary. The mistake most commonly made here is to place too high an emphasis on the starting salary, when what is most important is the salary curve. It might be a lower salary initially, but what is its progression? I can best illustrate this in terms of calculus and the following graph:

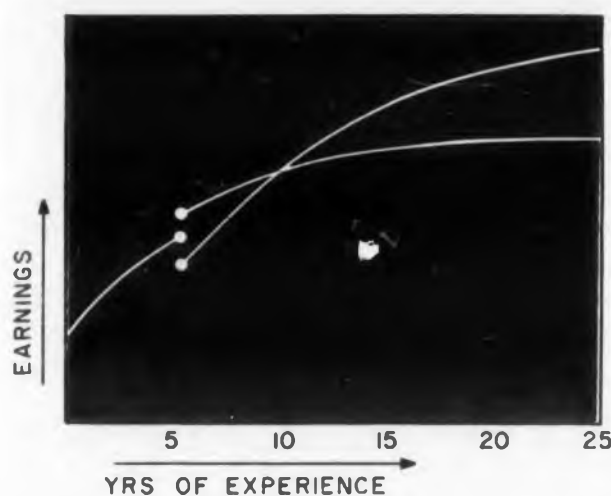

The curves represent salary potential. At point A you are changing jobs. Too many engineers are concerned with maximizing the ordinate (starting salary) rather than seeking the optimum ordinate and the maximum rate of slope of the curve. Obviously a higher slope rate will increase the integral of the earning curve (maximum income during one's entire working career). In other words, it may be better to accept a lower beginning salary if you know that it offers a greater future. In our diagram your earnings will obviously be greater in the long run on job 2 even though job 1 offers a higher starting salary.

Certainly other elements are important, too. Are you assured of a salary and job review on a regular basis? How does the company compare in salary with other organizations? Are there incentive programs? Bonus arrangements? How does the salary appear in relation to work load or responsibility?

4. What is the attitude of your potential associates and past employes toward the company? Talk to employes who are not concerned with your joining the company. Beneath the corporate gibberish you should be able to translate from remarks made by these men and those you will be directly working with the exact worth of the company to you.

Do these men reflect a distinct "company line?" This can be a depressing situation for an independent thinker. It frequently leads, too, to a lack of originality on the part of top management. No man wants to work as an automaton for a faceless corporation.

Seek out those who have left the concern. You'll have a harder time with them. You'll have to discount much of what they say, because they would not have left had they been satisfied with the company, but the research can be rewarding. Beneath this prejudiced view you can often gain valuable clues to the worth of a company. Try to separate verifiable facts from opinions.

Talk to competitors, not necessarily customers. This leads to the fifth question.

5. What is the demand for former employes



Build Your RADAR Career On This Solid Foundation!

The Weapons System Concept is one more step forward in a long series of "firsts" for the men who pioneered this field with the SCR-270, the first long range radar. In ground, shipboard and airborne radar, Westinghouse is the recognized leader in advanced programs and techniques. As Westinghouse builds new levels of accomplishment on this solid foundation, new career opportunities in radar development are created. Westinghouse-Baltimore invites inquiries from radar engineers with experience or interest in the following fields:

- Operations Research and Analysis
- Systems Development and Evaluation
- Transmitter and Receiver System Development
- Advanced Antenna Systems
- Molecular Electronics
- System Synchronization
- Data Processing
- Liaison and Field Engineering
- Advanced Displays and Monitoring
- Network Synthesis
- Microwave Systems
- Systems Reliability Prediction
- Advanced Systems Automated Test

SEND RESUME TO: Mr. A. M. Johnston, Dept. 233

Westinghouse

BALTIMORE

P. O. Box 746

Baltimore 3, Maryland

AIR ARM • ELECTRONICS • ORDANCE

CIRCLE 900 ON CAREER INQUIRY FORM

Men

who refuse to get lost in the crowd. Engineers with a yen for challenge . . . who intend to see their ideas put into motion. These are the special breed of determined, creative, thinking individuals who staff the government and industrial division of the Magnavox Company. And Magnavox needs more people like them . . .



To

fill present openings at the three Magnavox military and industrial plants. In Fort Wayne, Indiana, where families enjoy the good life of a growing Mid-Western community. In Urbana, Illinois, home of the University of Illinois which has one of the largest communications, physics and radar research centers. Or in America's largest electronic community, Los Angeles, California.



Do

engineering to develop advanced anti-submarine warfare systems in conjunction with the Navy Department. Projects on tap for the future offer experiences just as challenging and rewarding—not only in ASW, but in Communications, Missiles, Airborne Radar and Data Processing Equipment as well.



Phone Dick Eary (collect, of course) at Eastbrook 9721 in Fort Wayne or write him for complete information.

Magnavox



COMMUNICATIONS



RADAR



DATA HANDLING



ASW



MISSILES

THE MAGNAVOX CO. • DEPT. 251 • Government and Industrial Division • FORT WAYNE, IND.

CIRCLE 901 ON CAREER INQUIRY FORM

DESIGNING YOUR FUTURE

of the company? What reputation does the company have with its competition?

It is a depressing thought, but we in personnel have to be realists: the best job may deteriorate in one, five or 10 years. Bear in mind that some companies acquire reputations for being "hot" in the industry and that the demand for people from such organizations is excellent. Everyone hopes that the job he obtains will be his last, but this is a very unreliable assumption. We live in a mobile age. Three to four years, or seven to eight, are often the maximum you will spend in one corporation, particularly in engineering, unless you achieve high executive status. Don't join a "has-been" company that dooms you before you start.

6. In checking the reputation of the company, determine also the reputation of the person or concern that recommended the job to you. We happen to believe in the philosophy of the employment agency, because a reputable one will refer you only to jobs that it deems in your best interest to accept. But even in our own case, we insist that applicants check us out in every possible manner. Beware of an outfit that sends you out on a number of jobs. A blunderbuss approach can waste much of your time as well as cheapen your chances in the job market.

7. Any evidence of nepotism? Family-held companies are fast passing from the American business scene, and even in such organizations there is usually little evidence now of know-nothing "cousins" being hired to head departments. There is some evidence of nepotism at the upper executive level, and you should watch for it carefully here. The perils are obvious. In its most virulent form, the family can fill posts with incompetents, drain profits and block promotion of deserving people, including yourself. It isn't prevalent now—particularly in the electronics field—because of the extreme competition for efficient employees. Concerns staffed with incompetent relatives simply can't survive.

Finally, how does it add up? A growing company will provide a continuing line of new products for you to work on and your associates to market. This in turn will provide greater responsibility for you and greater salary to match it. The challenge will be continuing.

If you find a hole in the corporate armor through your investigation, evaluate it thoroughly. Don't feel that you have to take a job. Usually there are many openings for engineer specialists. What is important is your own career development. That should be your final criteria.

Having investigated and rated the company, you are now ready to evaluate the particular job offered to you. ■ ■

Advancement Your Goal?

Use New Form To Speed Action

ELECTRONIC DESIGN's new Career Inquiry Service form is designed to help engineers advertise themselves. This new service speeds applicants to the jobs they seek. It is the first such service offered in the electronics field and is receiving high praise from personnel managers.

To present your qualifications immediately to the personnel managers of companies that interest you, simply fill in the attached standardized short resume.

Study the employment opportunity ads in this section, and circle the numbers at the bottom of the form that correspond to the numbers of the ads that interest you.

ELECTRONIC DESIGN's Reader Service Department will act as your private secretary and type neat, duplicate copies of your standardized resume and send them to all companies you may select . . . the same day the resume is received. (ELECTRONIC DESIGN will detach the circle number portion of the form so that no company will know how many numbers you circled.)

The standardized resume will permit personnel managers to inspect your qualifications rapidly. If they are interested, they will get in touch with you directly. In the past much time has been lost through personnel-manager requests for resumes from applicants who proved ineligible.

MAIL CAREER INQUIRY SERVICE FORM TO
READER SERVICE, ELECTRONIC DESIGN, 830 THIRD
AVE., NEW YORK 22, N. Y.

After completing, mail career form to *ELECTRONIC DESIGN*, 830 Third Avenue, New York, N. Y. Our Reader Service Department will forward copies to the companies you select below.

4

(Please print with a soft pencil or type.)

Name _____ Telephone _____

Home Address _____ City _____ Zone _____ State _____

Date of Birth _____ Place of Birth _____ Citizenship _____

Position Desired _____

Educational History

College	Dates	Degree	Major	Honors

Recent Special Training _____

Employment History

Company	City and State	Dates	Title	Engineering Specialty

Outstanding Engineering and Administrative Experience _____

Professional Societies _____

Published Articles _____

Minimum Salary Requirements (Optional) _____

Use section below instead of Reader Service Card. Do not write personal data below this line. This section will be detached before processing.

Circle Career Inquiry numbers of companies that interest you

900 901 902 903 904 905 906 907 908 909 910 911 912 913 914 915 916 917 918 919 920 921 922 923 924
925 926 927 928 929 930 931 932 933 934 935 936 937 938 939 940 941 942 943 944 945 946 947 948 949

RADAR ENGINEERS and SCIENTISTS



Is Intensifying Its Activities in the Design and Development of Advanced Radar Systems and Techniques

Engineers and scientists with the ability to pursue independent activity will appreciate the opportunities available with The MITRE Corporation. Formed under the sponsorship of the Massachusetts Institute of Technology it is the primary function of this non-profit organization to provide the required technical support in the area of air defense.

As this systems responsibility accelerates, broad new areas in the design and development of advanced radar systems and techniques are constantly being investigated. MITRE's goal is major advances in:

RADAR TECHNIQUES

- Low Noise Devices
- Waveform Modulation Techniques
- Signal Extraction Theory
- Network Theory
- Delay Lines

RADAR DEVELOPMENT

- Electronic Circuit Design
- Microwave Components
- Anticlutler Devices
- Pulse Circuitry
- Antennas
- Semiconductor Circuit Design

RADAR SYSTEMS

- Space Radars
- Surveillance and Tracking Systems
- Multistatic Systems
- Advanced System Studies
- Early Warning Studies
- Active-Passive Systems

If you have experience or an interest in one of the above areas, we invite you to address your inquiries in complete confidence to Dana N. Burdette Personnel Director, Dept. 15-MT

THE MITRE CORPORATION
244 WOOD STREET — LEXINGTON 73, MASSACHUSETTS

CIRCLE 902 ON CAREER INQUIRY FORM

YOUR CAREER

NEWS AND NOTES

A new era of competition for the electronic industry has been pictured by Kenneth F. Julin, president of the Leach Corp. and chairman of the Domestic Trade Committee of the Los Angeles Chamber of Commerce.

The challenge, he says, stems from a rapidly changing technology, "already well-advanced under the impact of transition from manned aircraft to unmanned missiles and space vehicles. Both small and large companies will be affected," he adds.

"Smaller companies which prospered because of almost unlimited opportunities, despite often questionable management, will find themselves confronted with competition, ruinous to many from large, monolithic corporations," Mr. Julin predicts.

"The large companies, strong in potential and facilities, will find themselves confronted with equally grave problems in production because they lack the inherent flexibility of smaller manufacturers."

It may take a decade, the executive says, before large and small companies resolve the battle for survival "and learn that certain jobs can be performed better by large producers and other jobs better by smaller, highly specialized and flexible suppliers."

Mr. Julin also sees narrowing profits for electronic manufacturers despite their receiving a larger share of the defense dollar—possibly as much as 20 per cent larger. What will throttle profits chiefly, he says, is bristling competition in the face of rising costs, both for R & D and production.

• • •

A little bit of frustration in getting promotions is healthy in an employee, a University of Michigan study concludes.

The study, based on questionnaires given to more than 2,000 employes of an electronics manufacturer, was conducted by Dr. David Sirota of the university's Survey Research Center.

He found that moderate frustration in getting ahead was accompanied by better understanding of management philosophy, goals and operating procedures.

On the other hand, employes who were highly frustrated with promotional chances had the least information about the company, while those who were well-satisfied had only a medium amount.

ENGINEER-IMPROVEMENT COURSES AND SEMINARS

Below are courses and seminars intended to provide the engineer with a better knowledge of various specialties. Our grouping includes several different types of meetings: *National Courses*—those held on consecutive days and intended to draw attendees from all geographical areas; *One-Day Seminars*—one-day intensive seminars which move from city to city; and *Regional Lectures*—regional symposia or lecture series which generally run one night a week for several weeks.

National Courses

Establishing Long-Range Goals for R&D, AMA, Feb. 15-17, New York

One of the most complex and important problems confronting industry is the establishment of long-range goals for research and development. This group will discuss the reasons for establishing goals and the factors underlying their selection. It is intended for company presidents, executive vice-presidents, vice-presidents—research, and directors of research. Among the subjects for discussion will be: relating specific R&D goals to over-all company objectives, selection of product fields for concentration of the R&D effort, development of long-range goals in specific areas of R&D, use of commercial and market research to guide R&D planning, planning to meet the internal needs of the R&D organization, utilizing basic and applied research to achieve R&D goals, general need for more basic research, developing a stated long-range policy for the research department, and the importance of two-way communications.

One-Day Seminars

Creative Engineering Course, IEI, February 23

This one-day seminar has been especially designed for engineers and managers. It will combine formal instruction with informal discussion and case study. The presentation will be practi-

Will tomorrow be a challenge ... or a bore?



If you feel that your present job is not fully tapping your potential, here are 4 new career opportunities for Electronics Engineers that have every bit of the challenge you may be looking for . . .

1 *Site Systems Reliability Engineer:* This position calls for a seasoned engineer capable of integrating and directing on-site reliability assurance activities necessary to secure customer acceptance of the detection system. Unusual combination of technical ability, relations and communications (written and spoken) is

required. Desirable experience includes approximately ten years in design and field installation of transmitters on electronic systems with ability in both electronic and mechanical fields. Ability to motivate technicians for optimum performance is necessary. Salary structure is equal to the challenge.

2 *Radar Equipment Systems Specialist:* This position calls for a creative engineer capable of conceiving and directing the design of long-range radar systems. Desirable experience includes around ten years in

at least one of the following: radar systems design, antenna systems, R.F. components, radar receiver systems or radar data processing systems. Salary structure is equal to the challenge.

3 *Advanced Systems Engineer:* This position calls for a creative engineer capable of defining future defense and space detection problems as well as the ability to conceive and establish the feasibility of optimum systems solutions to these problems—making use of the most advanced techniques and understanding. He must recognize the need for and coordinate the development of new techniques and the exploration of

new phenomena in the area of detection systems. Background desired: Bachelor degree plus a combination of advanced training and several years experience in both the theoretical and practical aspects of detection systems engineering. A desire to work in the conceptual phase of system design with the analytical ability required to evaluate and demonstrate the effectiveness of proposed systems.

4 *Advanced Radar Systems Analysis and Development Engineer:* Engineers are needed who are able to visualize and define future defense and space problems—conceive advanced radar systems to solve them. An advanced degree and/or strong background in system analysis and design is essential. Assignments open

include: analyze and define requirements for advance detection systems and determine broader parameters for such systems, establish their feasibility; analyze long range missile detection systems and specify optimum configuration on the basis of utility, performance, cost and delivery.

All of these openings are on General Electric missile and satellite detection projects and will be filled with engineers having the capability and desire to make creative contributions.

Write in confidence to T. M. George,
Supervisor—Personnel Administration

Missile Detection Systems Section
HEAVY MILITARY ELECTRONICS DEPARTMENT

GENERAL ELECTRIC

SYRACUSE, NEW YORK

CIRCLE 903 ON CAREER INQUIRY FORM

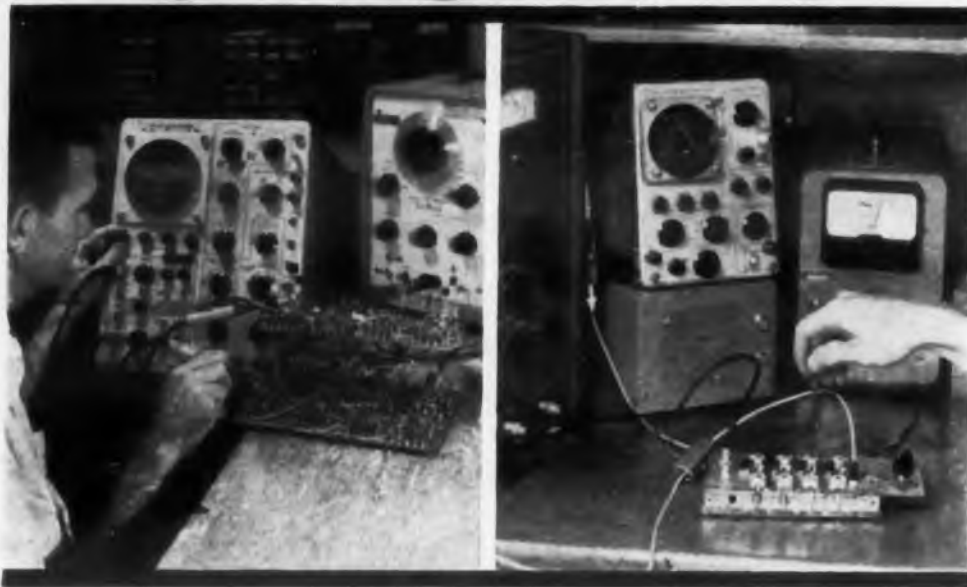
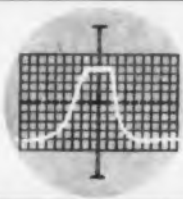
CAREER
OPPORTUNITIES
AT TI

CIRCUIT DEVELOPMENT ENGINEER

your future: a challenging opportunity with an industry leader

At Texas Instruments, your future is filled with specific, stimulating growth assignments in evaluating and characterizing transistors and special semiconductor devices. You'll participate in such transistorization projects as:

- AM, FM, and TV receivers
- audio and video, i-f and r-f amplifiers
- hi-fi and electronic organs
- nonlinear and switching circuits
- computer system logic
- servo and power amplifiers

With TI... receive liberal company-paid benefits, including profit sharing (over last several years, an average of more than 12% of base salary)... enjoy premium living in a moderate climate with excellent neighborhoods, schools and shopping facilities... work in a plant selected as one of the 10 outstanding U. S. industrial buildings of 1958.

Interviews will be held in your area soon. If you have an Electrical Engineering degree and/or knowledge of transistor circuitry, please send a resume to:

C. A. Besio, Dept. 200 -ED

For
immediate
Eastern
appointment,
contact
W. B. Budson
Dept. 200-B-ED
1141 E. Jersey St.
Elizabeth, N. J.

TEXAS INSTRUMENTS
INCORPORATED
SEMICONDUCTOR - COMPONENTS DIVISION
POST OFFICE BOX 312 • DALLAS, TEXAS

CIRCLE 904 ON CAREER INQUIRY FORM

CAREER COURSES

One-Day Seminars (Cont.)

cal and non-academic; it will concentrate on the problem of stimulating technical and supervisory people to use their creative facilities.

Only methods that have been proved successful will be discussed, and registrants will learn techniques that will help make them more creatively productive as individuals, as well as better able to obtain creative effort from others.

The seminar will be conducted by A. L. Simberg, Supervisor of R&D, AC Spark Plug Div., General Motors Corp., Feb. 23, at the Atlanta Biltmore Hotel, Atlanta, Ga. Mr. Simberg is familiar to our readers as author of three articles on obstacles to creativity. For further information on this seminar and the following two write to the Industrial Education Institute, 25 Huntington Ave., Boston 16, Mass.

Drafting and Design Conference, IEI, February 24-26

This conference presents an opportunity to learn the newest developments and techniques in drafting and design practices and the latest techniques for reducing costs and increasing output.

Group discussions are expected to present the facts and the perspectives by which engineering operations can be made to function more effectively, efficiently and economically. The conference will be conducted by Don Fuller, Director of the Institute's Drafting and Design Div., Feb. 24-26 at the Hotel Pick-Carter, Cleveland, Ohio.

Technical Writing One-Day Seminar, IEI, March 8th, 9th and 10th

This seminar is designed for people whose jobs include writing on technical subjects. It offers an excellent opportunity to learn the basic principles and practical application of techniques that can help the writer put his ideas on paper easier, faster and more clearly. The objective of the seminar is to give registrants a usable formula that will improve everything they write; a technique they can apply immediately to every job that involves writing on a technical subject.

Conducted by Robert Gunning, the one-day seminar will be held: March 8th, Hotel Pick-Carter, Cleveland, Ohio; March 9th, Hotel Sheraton-Blackstone, Chicago, Ill.; March 10th, Hotel Sheraton-Gibson, Cincinnati, Ohio.

ENGINEERS RESEARCH OPPORTUNITIES

Aeronutronic, a new division of Ford Motor Company, has immediate need for computer engineers to staff its new \$22 million Research Center in Newport Beach, Southern California. Here, you have all the advantages of a stimulating environment, working with advanced equipment, located where you can enjoy California living at its finest.

Look into these ground floor opportunities in research and development work that is challenging and exceptionally rewarding to qualified men.

Positions now open:

- Systems Engineer
- Magnetic Memory Engineers
- Communications Engineers
- Digital Computer Programmers
- Transistorized Circuit Engineers
- Logical Designers
- Circuit Engineers
- Mechanical Engineers
- Optical Engineers

Qualified applicants are invited to send resumes or inquiries to Mr. R. E. Durant, Aeronutronic, Box NJ-486, Newport Beach, California.

COMPUTER OPERATIONS

AERONUTRONIC

A DIVISION OF
FORD MOTOR COMPANY

Newport Beach
Santa Ana • Maywood,
California
Natick, Massachusetts

CIRCLE 905 ON CAREER INQUIRY FORM

A Message to
Computer Engineers
 Capable of Advanced Research
 and Development in
**TRANSISTORIZED
 AIRBORNE DIGITAL
 COMPUTING SYSTEMS**

Wide latitude is accorded the qualified individual team member at our Advanced Electronics Research and Development Laboratory. Under the direction of Dr. Arthur S. Robinson, a broad program of exploration is in progress in the development of new concepts in solid state airborne digital computers and digital control systems. This program is the logical extension of the Bendix developments which, in 1955, resulted in the first successful fully transistorized automatic flight control system.

If you find satisfaction in defining and solving advanced problems in computer technology, the work of this Laboratory has a great deal to offer. If you are currently qualified in one of the following areas...

- | | |
|---------------------------|-------------------------|
| Digital Systems Synthesis | Pulse Techniques |
| High Speed Switching | Input-Output Devices |
| Logical Implementations | Transistorized Circuits |
| Magnetic Memory | Micro-Miniaturization |
| | Logical Design |

...we suggest that you send a brief resume of your experience and educational background to Dr. Robinson, or telephone Engineering Personnel at ATlas 8-2000 in New Jersey, or BRyant 9-8541 in New York.

ECLIPSE-PIONEER DIVISION



AVIATION CORPORATION

Route 46 at 17, Teterboro, New Jersey

(Located in suburban New Jersey, 10 minutes from New York City)



YOUR CAREER!

Does it still hold its stimulating challenge? Are all of your abilities being utilized? Have you gone far enough, fast enough?

Today, Motorola's rapid expansion in the Chicago area has created an immediate need for experienced engineering talent. Never before have secure career opportunities been more abundant, challenging and rewarding—in a wide selection of electronic fields.

A picture-packed 36 page booklet is waiting for you. It details the work, the people, the living at Motorola. If you are sincerely seeking broader career opportunities and responsibilities, investigate Motorola immediately.

- Radar transmitters and receivers
- Radar circuit design
- Electronic countermeasure systems
- Military communications equipment design
- Pulse circuit design
- IF strip design
- Device using klystron, traveling wave tube and backward wave oscillator
- Display and storage devices
- 2-WAY RADIO COMMUNICATIONS
- VHF & UHF receiver
- Transmitter design and development
- Power supply
- Systems engineering
- Antenna design
- Selective signaling
- Transfer applications
- Crystal engineering
- Sales engineering
- Design of VHF & UHF, FM communications in portable or subminiature development
- Microwave field engineers
- Transistor switching circuit design
- Logic circuit design
- T.V. circuit design engineering
- Home radio design
- New product design
- Auto radio design
- Mechanical engineering
- Semi-conductor device development
- Semi-conductor application work

Also splendid opportunities in
 Phoenix Ariz., and Riverside, Calif.



MOTOROLA Inc.

Mr. L. B. Wrenn, Engineering Personnel Mgr., Dept. 8
 4501 Augusta Blvd., Chicago 51, Illinois

Without obligation, send copy of
 "Selecting an Engineering Career with a Future"



NAME _____

ADDRESS _____

CITY _____ ZONE _____ STATE _____

CIRCLE 907 ON CAREER INQUIRY FORM

CIRCLE 906 ON CAREER INQUIRY FORM



Look beyond the obvious...

... as you consider *your* future in the electronics industry. First, what is the obvious? It's obvious that you're in demand. You don't have to worry about getting your material wants satisfied.

But, when you look beyond the obvious, you realize that you want something more than simple "want satisfaction" out of your career. You want *pride*—pride in the importance of your personal, *individual* contribution.

At Melpar, where we are now working on 120 advanced defense and space exploration projects, we have significant opportunities for the professional engineer or scientist who wants to be proud of his contribution to advancing the state of electronic art.

Senior-level positions are available in the following areas at this time:

Reconnaissance Systems	Detection & Identification Systems
Airborne Equipment	Antenna & Radiation Systems
Ground Data Handling Equipment	Physical Sciences Laboratory
Simulation & Training Systems	Production Engineering
Communication & Navigation Systems	Quality Control
Ground Support Equipment	Field Service Engineering

INTERVIEWS ARRANGED IN YOUR LOCALE

For details wire collect or write to:
Professional Employment Supervisor

MELPAR INC.

A SUBSIDIARY OF WESTINGHOUSE AIR BRAKE COMPANY
3324 Arlington Boulevard, Falls Church, Virginia
In Historic Fairfax County
10 miles from Washington, D. C.

CIRCLE 908 ON CAREER INQUIRY FORM

CAREER COURSES

PAPER DEADLINES

Convention Program Chairmen have issued the following deadlines to authors wishing to have their papers considered for presentation.

March 21: Deadline date for papers for the **8th Annual Conference on Electromagnetic Relays** to be held May 3-5 at the Oklahoma State University, Stillwater, Okla. For detailed information write to *Professor Charles F. Cameron, National Association of Relay Manufacturers, P.O. Box 6, Stillwater, Okla.*

April 1: Deadline for 150-word abstracts for the **7th Annual Symposium on Computers and Data Processing** scheduled for July 28-29 in Estes Park, Colo. Papers should deal with components and devices, logic design, and philosophy of computer design. Send to: *W. H. Eichelberger, Denver Research Institute, University of Denver, Denver 10, Colo.*

May 1: Deadline for 100-200-word abstracts, together with complete text or detailed summaries for the **1960 Western Electronic Show and Convention** scheduled for Aug. 23-26 in Los Angeles, Calif. Send to: *Richard G. Leitner, Chairman of the Technical Program, WESCON Business Office, 1435 S. La Cienega Blvd., Los Angeles 35, Calif.*

May 16: Deadline for summaries of papers for the **8th Hot Laboratory and Equipment Conference** to be held simultaneously with the American Nuclear Society winter meeting scheduled for Dec. 11-14 in San Francisco, Calif. Papers may deal with all phases of hot laboratories and equipment for handling radioactive material; such as, design and construction of facilities and equipment, dry boxes, manipulators, shielding, operations, costs, etc. Write to *James R. Lilienthal, Los Alamos Scientific Laboratory, P.O. Box 1663, Los Alamos, N.Mex.*, for information regarding the form in which the summaries are to be prepared. Accepted papers will be due Sept. 1, 1960.

new openings in Florida with Vitro

 Vitro Laboratories' Florida operation, Vitro Weapons Services, is rapidly expanding its technical staff to operate the nation's newest missile test range, the EGLIN GULF TEST RANGE.

High level supervisory and staff opportunities exist at five Florida locations: 1. Fort Walton Beach; 2. Port St. Joe; 3. Tarpon Springs; 4. Naples and 5. Key West.

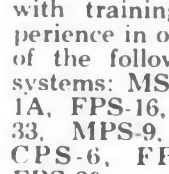

 ELECTRONIC ENGINEERS — with degree(s) and several years experience in Automatic Tracking Radar, Electronic Instrumentation, Phase Comparison Space Positioning Systems, Data Recording and Conversion, Telemetry or Missile Range Instrumentation.

 RADAR TECHNICIANS — with training and experience in one or more of the following radar systems: MSQ-1, MSQ-1A, FPS-16, Nike, M-33, MPS-9, SCR-584, CPS-6, FPS-3 and FPS-20.



 ELECTRONIC TECHNICIANS — with a solid background in electronics and several years experience in Telemetry, Data Converters, Oscillograph Recorders or Range Electronic Instrumentation.

For your opportunity to relocate in Florida with an electronics industry leader, address a confidential resume to D. D. Cox, Personnel Director, Vitro Weapons Services, 119 East Main Street, Fort Walton Beach, Florida, Dept. ED.

Vitro

LABORATORIES

DIVISION OF VITRO CORPORATION OF AMERICA
Other laboratories at West Orange, N. J.,
and Silver Spring, Md.

CIRCLE 909 ON CAREER INQUIRY FORM

ELECTRONIC DESIGN • February 17, 1960

**PAGES
MISSING
ARE NOT
AVAILABLE**

CONSIDERING A CAREER CHANGE?

WHY NOT GROW WITH ELECTRONIC DESIGN?

Expansion of our news department has created openings for men to cover news in the electronic industries.

As news-reporter for ED you would

- interview experts in all phases of electronics
- report on industry trends of significance to design engineers.
- post readers on latest electronic thinking gathered from technical conferences and plant visits.

If you are a "news hawk," if you like to know what is going on in the industry, and if you know electronics, you might very well be qualified for one of the staff openings in New York and Chicago.

Salary open.

Send complete resume to

Edward E. Grazda, Editor

ELECTRONIC DESIGN

Hayden Publishing Co., Inc.

830 Third Avenue

New York 22, New York

Extending existing modulation systems to make more space available in the spectrum, and possibly even broadening the useful spectrum . . . this is a fundamental problem in modern communications. It is the problem to which ITT Laboratories is devoting intensive effort.

At the low end we're designing a new type antenna for very low frequencies. With a conventional antenna this would require a tower more than three miles tall. On the top side — at the high end — we're making radiation pattern surveys for the super high frequency bands. Here the entire antenna consists of a few millimeters of number eighteen copper wire. We're matching these efforts with advances in componentry . . . for instance, the parametric amplifier and now the ingenious ferroelectric converter which converts solar heat to high voltage

electricity to power new satellite communications. If you are a communications engineer who would like to be associated with some of the most significant programs in modern communications development . . . if you would like to work with men who are stretching the spectrum toward direct current at the bottom and the cosmic rays at the top . . . write Manager Professional Staff Relations . . . tell him your interests, your background and the kind of work you would like.

ITT LABORATORIES

A Division of International Telephone and Telegraph Corporation



500 Washington Avenue, Nutley, New Jersey

Fort Wayne, Indiana • Palo Alto and San Fernando, California



BENDIX-PACIFIC

in Southern California

needs **ENGINEERS** *with*
DOCTORS' - MASTERS' - BACHELORS'
DEGREES

*for electrical, mechanical and systems work in fields of
 Instrumentation — Telemetry
 Anti-Submarine Detection Systems/Operations Research
 Missile and Aircraft Fluid Controls.*

Please send resume to MR. RALPH LAMM,
 DIRECTOR OF ENGINEERING

*Other High-Level Electronic
 Engineering Positions Available*



CIRCLE 916 ON CAREER INQUIRY FORM

CAREER OPPORTUNITIES BROCHURES



McDonnell Aircraft Corporation

"Introducing . . . McDonnell Aircraft Corporation" is a comprehensive 32-page illustrated brochure. McDonnell's widely diversified projects range from pure theoretical space studies to the practical design and final testing of all elements of airplane, helicopter, and missile systems.

Detailed discussions on the following divisions include: airplane engineering, missile engineering, helicopter engineering, general engineering, flight test, research, manufacturing and customer service.

Raymond F. Kaletta, Supervisor, Engineering Employment, McDonnell Aircraft Corp., Dept. ED, P. O. Box 516, St. Louis 66, Mo.

CIRCLE 870 ON READER-SERVICE CARD

FREE Monthly Electronics Opportunities Bulletin

*Shows where you could be
 in the electronics field*

CADILLAC. for thirty years the nation's largest Executive and Professional Placement Service, represents every "Blue Book" Electronics firm in America, over 350 in all. Their BEST jobs, at salaries from \$6,000 to \$75,000, appear monthly in our Electronics Opportunities Bulletin. Because you are an Electronics Engineer, BOTH the Bulletin and our COMPLETELY CONFIDENTIAL Placement Service are available to you absolutely FREE OF CHARGE.

For your free Bulletin, each month listing America's BEST Electronic jobs, send your name and address to:



EUGENE B. SHEA
 Executive Vice President

Cadillac Associates, Inc.
 29 East Madison Bldg.—Dept. E-2
 Chicago 2, Ill.

CIRCLE 917 ON CAREER INQUIRY FORM



YOU can help FIGHT CRIPPLING

Rehabilitation of the crippled is not accomplished in a day, a week or a month. It is a constant team process bringing together skills of medical science, abilities of therapists, understanding and guidance of other professional specialists and capable lay workers.

Moreover, it is a team that needs you. Since 1921 the Easter Seal program has been one of expansion in facilities and in numbers served because thousands of generous Americans recognized that through this all-inclusive teamwork, the handicapped have found a fuller, richer life.

Become a team member by sending your check TODAY!

National Society
 for Crippled Children and Adults
 2023 W. Ogden Ave., Chicago 12, Ill.

American Bosch Arma Corporation



In this 12-page brochure, the American Bosch Corp., introduces its four divisions located in Garden City, N.Y., Oak Lawn, Ill., Springfield, Mass., and Columbus, Miss.

Among its many activities the corporation designs, develops, and manufactures systems for the military, which include guidance, control, navigation, penetration, and detection. These integrated electronic systems combine the advanced arts of electronic, electro-mechanical, mechanical, and hydraulic engineering.

Howard G. Krogstad, American Bosch Arma Corp., Dept. ED, 7046 Hollywood Blvd., Hollywood, Calif.

CIRCLE 871 ON READER-SERVICE CARD

**PAGES
MISSING
ARE NOT
AVAILABLE**