

15 093

E  
L  
E  
C  
T  
R  
O  
N  
I  
C  
S

D  
E  
S  
I  
G  
N

SEPTEMBER 16, 1959



Storage tube writes PPI and TV raster simultaneously . . . p. 98

**GIVE YOUR PRODUCTS**

**MORE RELIABILITY AND BETTER PERFORMANCE WITH**

**-FREED QUALITY**

**MINIATURE PULSE TRANSFORMERS**

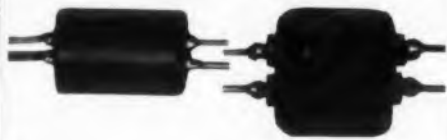

- Meets all requirements of MIL-T-27A
- Small size and weight
- Ideal for computer applications

CATALOG #	APPLICATION	TURNS RATIO
EPT-1		1:1
EPT-2	Impedance	2:1
EPT-3	Matching	3:1
EPT-4		4:1
EPT-5	and	4:1
EPT-6		5:1
EPT-7	Interstage	7:1.1
EPT-8	Coupling	5:1
EPT-9		3:1
EPT-11		1:1
EPT-12		1:1
EPT-13	Blacking	2:1
EPT-14	Oscillator	1:1.4
EPT-15	Memory core &	5:5.1PP
EPT-16	Current driver	3.3.3.3.1PP
EPT-17	Current driver	6:1
EPT-18	Current Transformer	1:1
EPT-19	Pulse Inversion	6:1:1

\*Supplied both molded and cased.

**LOW FREQUENCY HIGH "Q" REACTORS**  
Solve your low frequency selective problems by using **FREED QGC REACTORS**

- Available from stock
- Meets MIL-T-27A specifications
- Low hum pick-up
- Low voltage coefficient
- Low temperature coefficient
- High self resonant frequency

Inductors with maximum "Q" at very low frequencies can be supplied on special order.

CATALOG NO.	INDUCTANCE HY.	
QGC-1	100	
QGC-2	75	
QGC-3	50	
QGC-4	25	
QGC-5	10	
QGC-6	5	
QGC-7	1	
QGC-8	75	
QGC-9	50	
QGC-10	25	
QGC-11	10	
QGC-12	5	
QGC-13	1	
QGC-14	50	
QGC-15	25	
QGC-16	10	
QGC-17	5	
QGC-18	1	
QGC-19	10	
QGC-20	7.5	
QGC-21	5	
QGC-22	2.5	
QGC-23	1	
QGC-24	0.5	

**FREED QUALITY INSTRUMENTS**  
**FOR PRECISION LABORATORY TESTING**  
NO. 1110-AB INCREMENTAL INDUCTANCE BRIDGE  
NO. 1620 VARIABLE TEST VOLTAGE MEGOHMMETER



- Inductance: 1 Millihenry to 1000 Henry
- Maximum Direct Current: 1 Ampere



- Variable DC test voltage: 50 to 1000 volts
- Resistance range: .1 megohm to 4,000,000 megohms

**NEW**

**MINIATURE VARIABLE HIGH FREQUENCY INDUCTORS**

- Continuous Inductance Variation
- Hermetically Sealed Constructions
- Frequency Range 20 KC to 500 KC
- High Q
- Exact Tuning Without Trimmers
- High Self Resonant Frequency



Cat. #	NOMINAL IND. MHY.		AVERAGE Q	SELF RES. FREQ. MC
	MIN.	MAX.		
VHI-1	1.1	1.75	95	2.2
VHI-2	1.7	2.5	95	1.9
VHI-3	2.3	3.7	95	1.6
VHI-4	3.	4.5	100	1.4
VHI-5	4.	5.7	100	1.3
VHI-6	5.5	7.5	100	1.
VHI-7	7.	10.5	100	.9
VHI-8	10.	15.	100	.85
VHI-9	14.5	20.5	100	.6
VHI-10	20.	30.	100	.55

**NEW**

**HERMETICALLY SEALED CONSTANT VOLTAGE TRANSFORMERS.**

- Meets Military Specifications
- No Tubes
- No Moving Parts
- Accurate Regulations
- Fast Response
- Fully Automatic



Here at last is a hermetically sealed magnetic voltage regulator that will provide constant output voltage regardless of line and/or load changes.

CAT. #	INPUT VOLT.	LINE FREQ.	OUTPUT	
			VOLT.	VA.
MCV-620L	95-130 v	60 cps.	115	20
MCV-670L	95-130 v	60 cps.	115	70
MCV-6130L	95-130 v	60 cps.	115	130
MCV-670F	95-130 v	60 cps.	6.4	70
MCV-6130F	95-130 v	60 cps.	6.4	130
MCV-420F	95-130 v	400 cps.	6.4	20

**MAGNETIC AMPLIFIERS**

- Hermetically Sealed To MIL Specifications
- No Tubes
- Direct Operation from Line Voltage
- Fast Response
- Long Life Trouble Free Operation
- Phase Reversible Output

Power Gain 2 x 10<sup>4</sup>



Transistor Preamp. MAT-1 Wt. 10 oz.  
Mag. Amp. MAF-5 Wt. 18 oz.  
Motor

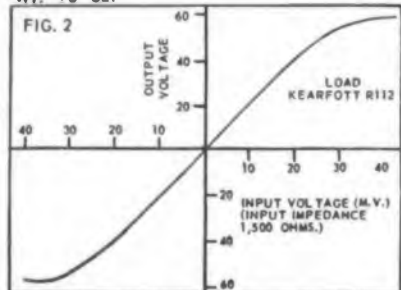

Send for **NEW TRANSFORMER AND INSTRUMENT CATALOGS**

**FREED TRANSFORMER CO., INC.**

1727 Weirfield Street Brooklyn (Ridgewood) 27, New York

HIGHLIGHTS OF ISSUE



**Multigun, Versatile Storage Tube Writes PPI, TV Raster At Same Time . . . . . 98**

Storatron, a multigun 10-inch storage tube with electrostatic focus and deflection, writes radial PPI scans and horizontal TV scans simultaneously. Storage time can be measured in hours.

**Oscilloscope Trace Recording With Polaroid Land Photography . . . . . 28**

Here, in the first of a three-part series, an expert on film joins an expert on oscillography to present an authoritative review of films and cameras for capturing scope traces on Land film.

**Design of Transistorized DC-to-DC Converters . . . . . 40**

Here is all the information needed and a straightforward procedure for designing ringing-choke type dc-to-dc converters.

**Use Current-Mode Flip-Flops For Really High-Speed Switching . . . . . 52**

For many applications, conventional transistorized switches just aren't fast enough. Author William Sick gives circuits to take full advantage of the switching speeds available with new high-speed mesa transistors.

◀ Circle 1 on Reader-Service Card

## NEWS

Products, Parts Share Honors At WESCON

## EDITORIAL

The Difference That May Not Be Worthwhile 27

## FEATURES

Oscilloscope Trace Recording With Polaroid Land  
Photography 28*A survey of Land films and cameras for oscilloscope trace photography* ..... K. P. Taschioglou, H. P. Mansberg

Transistorized Phantastron Circuit 34

*Improved stability and smaller size compared to the vacuum tube equivalent* ..... R. W. Cope

Helpful Tips On Liquid Cooling 36

*When and how to use liquid cooling* ..... A. G. Eades

Design Of Transistorized DC-to-DC Converters 40

*Full design procedures and data for ringing-choke dc-to-dc converters* ..... C. R. Turner

How The Inertia Damper Improves Servo Performance 46

*A simple presentation of the advantages and disadvantages of the inertia damper, and how it works* ..... F. E. Hagen

A Transistorized Zero-Crossing Detector 48

*Transistorized zero-crossing detector generates a negative pulse each time a sinusoidal input signal crosses zero* .. J. S. DenelsbeckUse Current-Mode Flip-Flops For Really High-Speed  
Switching 52*Current-mode switching circuits take full advantage of mesa transistors* ..... W. N. Sick, Jr.Ten-Inch Storage Tube Writes PPI and TV Raster at  
Same Time 98*Versatile storage tube opens many opportunities*Simple Test Jig Converts Curve Tracer For Use With  
Tetrode Transistors*Ideas For Design*Calculation Of Errors When Using Lissajous Figures For  
Frequency Comparison*Translation describes simple, quick Soviet method*

Applications Of Switching Transistors

*German Abstracts*

Lessening Of Diode Confusion Seen By Industry Leaders 90

*Report on suggestions and action to standardize diodes*

## DEPARTMENTS

Washington Reports	22	Engineering Data	73
Meetings	24	Books	76
Ideas for Design	56	New Literature	78
Patents	60	New Products	100
Russian Translations	62	Production Products	160
German Abstracts	64	Careers	170
Report Briefs	68	Career Brochures	174

Advertisers' Index 182

**Dependability  
and long life  
previously available  
only in  
high-cost relays...**

**G-V  
RED LINE  
low-cost thermal  
timing relays**



The sound design, sturdy construction and reliable operation long associated with G-V Hermetically Sealed Thermal Relays is available in a low-cost form, fully qualified for industrial control . . . light and inexpensive enough for electronic and communications circuits.

Delays of 2 seconds to 3 minutes • Energizing voltages - 6.3 to 230 AC or DC.

- **RUGGED STAINLESS STEEL MECHANISM**

Relay mechanism is of stainless steel, differential expansion type, used in all G-V Thermal Relays. All parts are welded into a single integral structure.

- **SHATTERPROOF—NO GLASS**

No glass is used in mechanism, encasing shell, or base. This avoids the danger of cracking or breakage in handling and use.

- **STEEL ENCASED HEATERS**

Heating elements are conservatively designed, wound with Ni-chrome wire on mica and encased in stainless steel, insuring long heater life even when energized continuously.

- **DUST TIGHT ENCLOSURE**

A dust tight metal shell completely enclosing the relay mechanism and contacts, crimped tightly to the base, provides complete protection for the structure.

- **TAMPER PROOF**

Time delay intervals are preset at the factory. Thus changes of delay interval in the field which might damage associated equipment are avoided.

- **DIRECTLY INTERCHANGEABLE**

Directly interchangeable with all other octal-size relays.



Available through Selected Distributors

**G-V CONTROLS INC.**

LIVINGSTON, NEW JERSEY

Write for Publication 131

U. S. PAT. 2,700,084 OTHER U. S. & FOREIGN PATENTS PENDING  
CIRCLE 2 ON READER-SERVICE CARD



# For Portable Communication...

## NEW RAYTHEON CK7246

### 1.25 VOLT SUBMIN TRIODE

## OPERATES TO 500 MC.

This Raytheon filamentary subminiature triode was developed under U. S. Signal Corps contract, and is now commercially available for use in battery-operated communications equipment. Circuit applications include:

- Superregenerative detector
- High frequency oscillator
- Class C amplifier
- Frequency multiplier
- Mixer

#### TYPICAL OPERATING CHARACTERISTICS Class A Amplifier

Filament voltage (dc)	1.25 v.
Filament current	150 ma.
Plate voltage	105 v.
Plate current	4.5 ma.
Grid voltage	-2.5 v.
Transconductance	2700 $\mu$ mhos
Amplification factor	22

#### Class C Oscillator (465 mc.)

Filament voltage (dc)	1.25 v.
Filament current	150 ma.
Plate voltage	105 v.
Plate current	6 ma.
Grid current	0.9 ma.
Power output	60 mw.

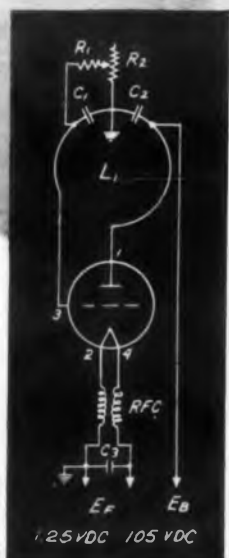

#### Typical CK7246 Circuit 465 mc. Class C Oscillator

$L_1$ : 1 turn No. 12 copper,  
 $\frac{3}{4}$  inch O.D.

RFC: bifilar wound  
8 turns #26 En.  
 $\frac{1}{8}$ " I.D., 1" long

$C_1, C_2, C_3$ : 250  $\mu$ f feed-thru  
button type

$R_1$ : 4.7K  $\frac{1}{2}$  w.

$R_2$ : 10K 2w pot.



## INDUSTRIAL TUBE DIVISION

55 CHAPEL STREET, NEWTON 58, MASSACHUSETTS

RELIABLE MINIATURE & SUBMINIATURE TUBES • GAS & VAPOR TUBES • CATHODE RAY TUBES • HARD-GLASS POWER TUBES

BOSTON: Blgelow 4-7500 • NEW YORK: Plaza 9-3900 • CHICAGO: National 5-4000 • LOS ANGELES: NOrmandy 5-4221

BALTIMORE: SOuthfield 1-1237 • CLEVELAND: Wlnton 1-7716 • KANSAS CITY: PLaza 3-5330

GOVERNMENT SALES • BOSTON: Blgelow 4-7500 • WASHINGTON, D. C.: MEtropolitan 8-5205 • DAYTON: BALdwin 3-8128

Small order and prototype quantities available directly from your local Raytheon electronic parts distributor

CIRCLE 3 ON READER-SERVICE CARD

#### STAFF

EDITOR: Edward E. Grazda; MANAGING EDITOR: J. A. Lippke; ASSOCIATE EDITORS: L. D. Shergalis, G. H. Rostky, H. Bierman; ASSISTANT EDITORS: T. E. Mount, D. S. Viebig, L. N. Tolopko, A. Corneretto, A. Caprioglio; CONTRIBUTING EDITORS: S. H. Hubelbank, E. Brenner, B. Bernstein, E. Kahn, B. B. Daien; EDITORIAL ASSISTANTS: M. S. Buckley, A. M. Sickler, A. R. Abramoff, R. N. Ross, R. M. Moore, D. Kartzman; ART DIRECTOR: R. A. Schulze; TECHNICAL ILLUSTRATOR: B. L. Armstrong; ART ASSISTANTS: C. Bank, M. J. Malatak; PRODUCTION MANAGER: T. V. Sedita; ASST. PRODUCTION MANAGER: H. DePolo; PRODUCTION ASSISTANT: M. C. Alexich, C. E. Moodhe; CIRCULATION MANAGER: N. M. Elston; ASST. CIRCULATION MANAGER: A. C. Lovett; READER-SERVICE: J. E. Medina.

#### CO-PUBLISHERS

T. Richard Gascoigne  
James S. Mulholland, Jr.

#### ADVERTISING REPRESENTATIVES

ADVERTISING SALES MANAGER: Bryce Gray, Jr.; NEW YORK: Owen A. Kean, Robert W. Gascoigne, Richard Parker, Blair McClenachan, James P. Quinn 830 Third Avenue, Plaza 1-5530; CHICAGO: Thomas P. Kavooras, Berry Conner, Jr., Fred T. Bruce 664 N. Michigan Avenue, Superior 1-8054; LOS ANGELES: Robert E. Ahrens Dorf, John V. Quillman, Stanley I. Ehrenclou 3275 Wilshire Blvd., DUNkirk 2-7337; SOUTH-EASTERN: Lucien Neff 15 Castle Harbor Isle, Fort Lauderdale, Florida, LOgan 6-5656.

#### SUBSCRIPTION POLICY

ELECTRONIC DESIGN is circulated only to qualified electronic design engineers of U.S. manufacturing companies, industrial consultants, and government agencies. If design for manufacturing is your responsibility, you qualify for subscription without charge provided you send us the following information on your company's letterhead: Your name and engineering title, your company's main products, and description of your design duties. The letter must be signed by you personally.

ANY ADDRESS CHANGES FOR OLD SUBSCRIBERS NECESSITATE A RESTATEMENT OF THESE QUALIFICATIONS. Subscription rate for non-qualified subscribers—\$25.00 per year U.S.A., \$30.00 per year all other countries. Single copy \$1.50.



ELECTRONIC DESIGN is published bi-weekly by Hayden Publishing Company, Inc., 830 Third Avenue, New York 22, N. Y., T. Richard Gascoigne, President; James S. Mulholland, Jr., Vice-President & Treasurer; and David B. Landis, Secretary. Printed at Hildreth Press, Bristol, Conn. Accepted as controlled circulation at Bristol, Conn. Additional entry, New York, N. Y. Copyright 1959 Hayden Publishing Company Inc., 36,150 copies this issue.



## Products, Papers Share Honors at WESCON

*Products for tomorrow's circuits and papers presaging systems for the "day after tomorrow" evenly split the attention of designers at WESCON 1959, held last month in San Francisco's Cow Palace.*



WESCON 1959, held beneath model of earth circled by satellite, was rated most successful ever.

### The Products

COMPONENTS and equipment at the almost 1000 exhibits reflected the demands of the space age. Visitors heard manufacturers tell designers about new levels of ruggedness, reliability, miniaturization, and extreme-environment tolerance. Some of the highlighted products:

- Binary computer modules by the Walkirt Co. that are built to a density of somewhat more than a million parts per cubic

foot, yet use standard parts. The units are 0.37 inches in diameter, 0.4 inches long and contain 23 standard parts. These newly announced modules added fuel to the continuing question of who is packaging parts to the greatest density.

- Biax magnetic computer components, shown by Ford's Aeronutronic Division, use interfering orthogonal fields to allow "multimegacycle" memory and logic operations. Signal-to-noise frequency of the device is about 100 to 1 in AND-gate use. *(continued on p. 4)*

### WESCON Show Stoppers: A Sampling of Highlights



**Sputtered thin-film resistors** made from tantalum or titanium can be formed in lines as narrow as 1 mil spaced 1 mil apart, make possible order of size reduction in printed circuit board shown by Bell Labs developer D. A. McLean.



**Dr. Smoot Horsley**, holding compensated avalanche diode he developed, discusses component's operation with Dr. William Shockley. The new diode is said to have an average voltage change of 0.043 per cent per degree C.



**Micromin transmitter**, pointed to at right, is powered by cells, left. Voice enters input at center. Varo Mfg. makes the 700 kc, 0.001-cu-in. unit using deposited circuitry equalling density of 10 million parts per cubic foot.



**Lumatron instrument** that permits viewing of repetitive millimicrosecond pulses on conventional scopes has rise time of better than 0.6 millimicrosec, sensitivity of 30 mv per cm. Calibrated sweep speeds reach  $0.5 \times 10^{-9}$  sec.



**H. Leslie Hoffman**, of Hoffman Electronics, received first annual WEMA medal of achievement from J. E. Chartz, WEMA president, and made a noteworthy speech pointing up need for better marketing techniques.



**Japanese Parametrons** make up Paramistor magnetic logical computing and memory modules that drew much attention at TDK Electronics Co. booth. Bistable ferrite Parametrons are capable of self limiting amplification.

NOW, FROM FAIRCHILD

# PNP SILICON MESA TRANSISTORS

A "MIRROR IMAGE" OF AVAILABLE NPN CHARACTERISTICS

Same high-speed switching capabilities with which Fairchild startled the industry are now available in PNP - 80 milli-micro-second rise time, 2 watts dissipation, 300° C. survival. Fairchild Silicon Transistors are multiple solid-state diffused. Their mesa construction affords excellent heat dissipation and extraordinary ruggedness.

Complementary symmetry within computer circuit designs now affords another technique for reducing number of components and increasing reliability. The advantages of complementary symmetry have been well known, but the high performance silicon transistors that could take advantage of the technique have not been available.

Direct replacement of germanium by silicon is feasible now that high performance silicon PNP mesa transistors are readily available. In silicon transistor circuits, you need no longer hesitate to make use of the particular advantages of PNP polarity. Availability is firmly assured.

**COMPETITIVE ADVANTAGES FOR YOUR DESIGNS** either in terms of price or functional efficiency are a likelihood that you should investigate. PNP silicon transistors with these speed-power characteristics have not been generally available, hence until now it has not been possible to design circuits using the complementary symmetry concept. Special attention will be given to inquiries received on company letterhead.

PNP - 2N1131, 2N1132

Symbol	Specification	Rating	Characteristics	Test Conditions
$V_{CE}$	Collector to Emitter voltage (25° C.)	30v		
$P_C$	Total dissipation at 25° C. Case temp.	2 watts		
$h_{FE}$	D.C. current gain		2N1131-15 to 45 2N1132-30 to 90	$I_C = 150\text{ma}$ $V_C = 10\text{v}$
$R_{CS}$	Collector saturation resistance		6 $\Omega$ typical 10 $\Omega$ max.	$I_C = 150\text{ma}$ $I_B = 15\text{ma}$
$h_{fe}$	Small signal current gain at f=20Mc		2.5 typical	$I_C = 50\text{ma}$ $V_C = 10\text{v}$

NPN - 2N696, 2N697

Symbol	Specification	Rating	Characteristics	Test Conditions
$V_{CE}$	Collector to Emitter voltage (25° C.)	40v		
$P_C$	Total dissipation at 25° C. Case temp.	2 watts		
$h_{FE}$	D.C. current gain		2N696-20 to 60 2N697-40 to 120	$I_C = 150\text{ma}$ $V_C = 10\text{v}$
$R_{CS}$	Collector saturation resistance		3.5 $\Omega$ typical 10 $\Omega$ max.	$I_C = 150\text{ma}$ $I_B = 15\text{ma}$
$h_{fe}$	Small signal current gain at f=20Mc		5 typical	$I_C = 50\text{ma}$ $V_C = 10\text{v}$

545 WHISMAN ROAD • MOUNTAIN VIEW, CALIFORNIA  
YORKSHIRE 8-8161



CIRCLE 4 ON READER-SERVICE CARD

## NEWS

### It Happened At W

**A truck strike** during the San Francisco show made the delivery of product displays touch and go for many exhibitors, but after efforts approaching the heroic, all but a few booths opened on time at the Cow Palace.

**An elaborate opening ceremony**, organized around a signal relayed from Explorer VI to Jodrell Bank in Great Britain to Los Angeles to the Cow Palace, was fouled when the signal couldn't make the last few miles from downtown San Francisco to the ceremony. The wrong tele-type plug was pulled.

**Every morning during WESCON** early-bird TV viewers could watch a panel show carried by a network station and offering electronic newsmakers, such as Dr. William Shockley of the Shockley Transistor Corp., Edward E. Grazda, editor of Electronic Design, and others. The program, sponsored by International Resistance Co., was so popular that the company is considering a similar show during the New York IRE Convention.

• An advanced telemetry system developed by Lockheed showed how 40,000 bits per second could be multiplexed over a single channel. The system is called PAM-FM (for pulse amplitude modulated-frequency modulated system).

• An attention-hogging, noise-generating tube for jamming systems, unveiled by Litton Industries. Called the Barratron and available in hydraulically tunable and fixed-frequency versions, the tube is a self-modulating device interchangeable with tunable magnetrons. Litton says that white noise coming from the Barratron is at least 10 times as effective for jamming as the power from a magnetron.

### The Papers

Though semiconductors, microwaves, and circuit theory accounted for most of the papers delivered and developments reported, outstanding advances were described in many other fields. Some highlight papers:

• B. M. Sifford of the Stanford Research Institute, discussing air-ground, meteor-burst military communications systems, pointed to design considerations for a low-power, vhf system. A reliable vhf system has been built with a range of 1300 miles, he said.



## ned At WESCON

The **Future Engineers Show**, popular last year when first made a part of WESCON, was even more popular this year and will be continued.

The **Industrial Design Competition**, a new WESCON feature, was very well-received, drawing heavy traffic to a colorful exhibit of award-winning products.

The **"new look" technical sessions**, though not always heavily attended, moved fast because of the three-paper limit. They were reported more generally informative because of the panels of experts and will probably be continued next year, say WESCON officials.

**Quotable quotes:** "Interconnection is the main bottleneck in solid-circuit development"—N. J. Doctor, Diamond Ordnance Fuze Labs. . . . "Sonar is going to higher power, lower frequencies to catch up with submarine capability"—D. R. Church, Acoustica Associates. . . . "The self-adapting computer could be with us in a decade"—J. H. Brick, W. L. Maxson Corp.

• R. O. Stone of the National Bureau of Standards told a session on reliability that design trends in miniaturization, printed circuitry, encapsulation and modular construction all pointed toward disposal-at-failure maintenance. Cost comparisons from a Navy aviation standard maintenance program and from a system based on expendable modules were cited to show that it is time for engineers to think about disposal-at-failure.

• N. L. Kruder of Burroughs, in another reliability paper, proposed a method of blending two design philosophies, each of which has successfully produced equipment. He proposed a method of finding the optimum compromise between two design philosophies: (1) By using parts conservatively, even though the parts count might be high, and (2) Keeping the part count down, even though parts might be worked hard.

• In a vacuum tube paper, two Hughes researchers, E. G. Todd and G. R. Brewer, reported that magnetron-type electron guns could produce a high-density hollow beam and offered advantages over other hollow-beam guns. They felt the disadvantage of the relatively strong magnetic field needed with magnetron-type guns could be compensated for by simplicity of design and construction of magnetic-field-system designs.

it's  
for  
the  
**BIRDS\***

**THE KERNEL**

... A New Microminiaturized Toroidal Inductor

The new Burnell & Co. MT 34 and MT 35 microminiature Kernel toroidal inductors are made to order for the engineer who isn't content with outer husk solutions but gets right to the core of second generation missile communication problems.

MT 34 microminiature Kernels can be supplied with inductances up to 500 mhy and the Kernel MT 35 is available in inductances up to 200 mhy. MT 34 Kernels are recommended for frequencies to 30 kcs and the MT 35 is applicable to frequencies up to 200 kcs depending on inductance values. Q for the MT 34 is greater than 55 at 25 kc and for the MT 35 more than 60 at 100 kcs.

Size of the MT 34 is .437" OD x 9/32", spacing between leads .3" x 1" L with a weight of .06 ounces.

The new microminiature Burnell MT 34 and MT 35 Kernels provide maximum reliability as well as considerable economy in printed circuit use. Completely encapsulated, the Kernels will withstand unusually high acceleration, shock and vibration environments.

Write for special filter bulletin MTF to help solve your circuit problems.

\*missiles

*Burnell & Co., Inc.*

PIONEERS IN microminiaturization OF  
TOROIDS, FILTERS AND RELATED NETWORKS

EASTERN DIVISION  
DEPT. 9-36  
10 PELHAM PARWAY  
PELHAM, N. Y.  
PELHAM 8-5000  
TELETYPE PELHAM 3633



PACIFIC DIVISION  
DEPT. 9-36  
780 MISSOURI ST.  
BURNING PASADENA, CAL.  
EVAN 1-3841  
TELETYPE PASADENA 7878

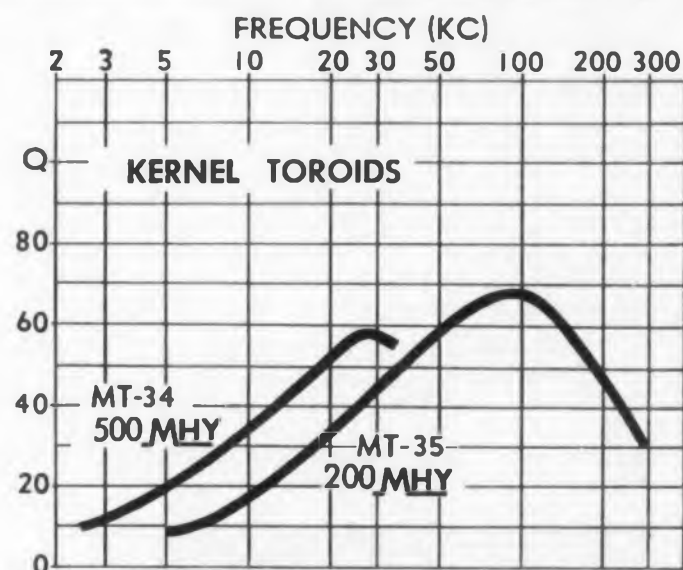

CIRCLE 5 ON READER-SERVICE CARD



# SAVE



**PEEL**  
the STANPAT from its  
backing.

# MONEY IN



**PLACE**  
the STANPAT into  
position on the tracing.

# DRAFTING



**PRESS**  
into position . . . will not  
wrinkle or come off.

# TIME . . .

with **STANPAT** pre-printed blueprint items

Incredible but true! If you STANPAT repetitive drawing details, you cut the time involved from 3 hours to 15 seconds. This means you can do 3600 STANPAT jobs in the time it takes to re-draw and re-letter one! That's why leading firms throughout the nation are turning to STANPAT, the remarkable tri-acetate that's pre-printed with designated blueprint items. Easily transferred to your tracings by an adhesive back or front, STANPAT relieves your engineer of time-consuming and tedious details, freeing him for more creative work.

STANPAT is available in two types of adhesive backs:

- A) Rubber base for standard drafting and tracing paper
- B) Resin base to prevent leaching for papers that contain oils.

But whatever the application may be, there's a STANPAT product for your specific needs. For further information and technical assistance, complete the coupon below and mail.



### STANPAT COMPANY

Whitestone 57, N. Y., U. S. A.  
Phone: FLushing 9-1693-1611

- Please quote on enclosed samples.
- Kindly send me STANPAT literature and samples. Dept. 133

Name \_\_\_\_\_  
Title \_\_\_\_\_  
Company \_\_\_\_\_  
Address \_\_\_\_\_

CIRCLE 6 ON READER-SERVICE CARD

## NEWS

### Reflectivity Tests to Affect Design of Future Radars

**T**HE NAVY is sponsoring studies of the reflectivity characteristics of various types of terrain to develop better radars and better radar mapping techniques.

The photo above, taken from a radar strip film made by Goodyear Aircraft for the Navy's Airborne Terrain Measurement Project, shows the types of radar returns that are being analyzed.

Goodyear Aircraft, which devel-

oped the ANTRAN and Pinpoint map-matching and guidance systems, is prevented by security restrictions from discussing the complete scope of the terrain measurement program—even such obvious goals as the generation of synthetic maps by prediction of radar returns from known types of terrain, and calibration of guidance systems.

The company hopes to develop radar mapping to the point where

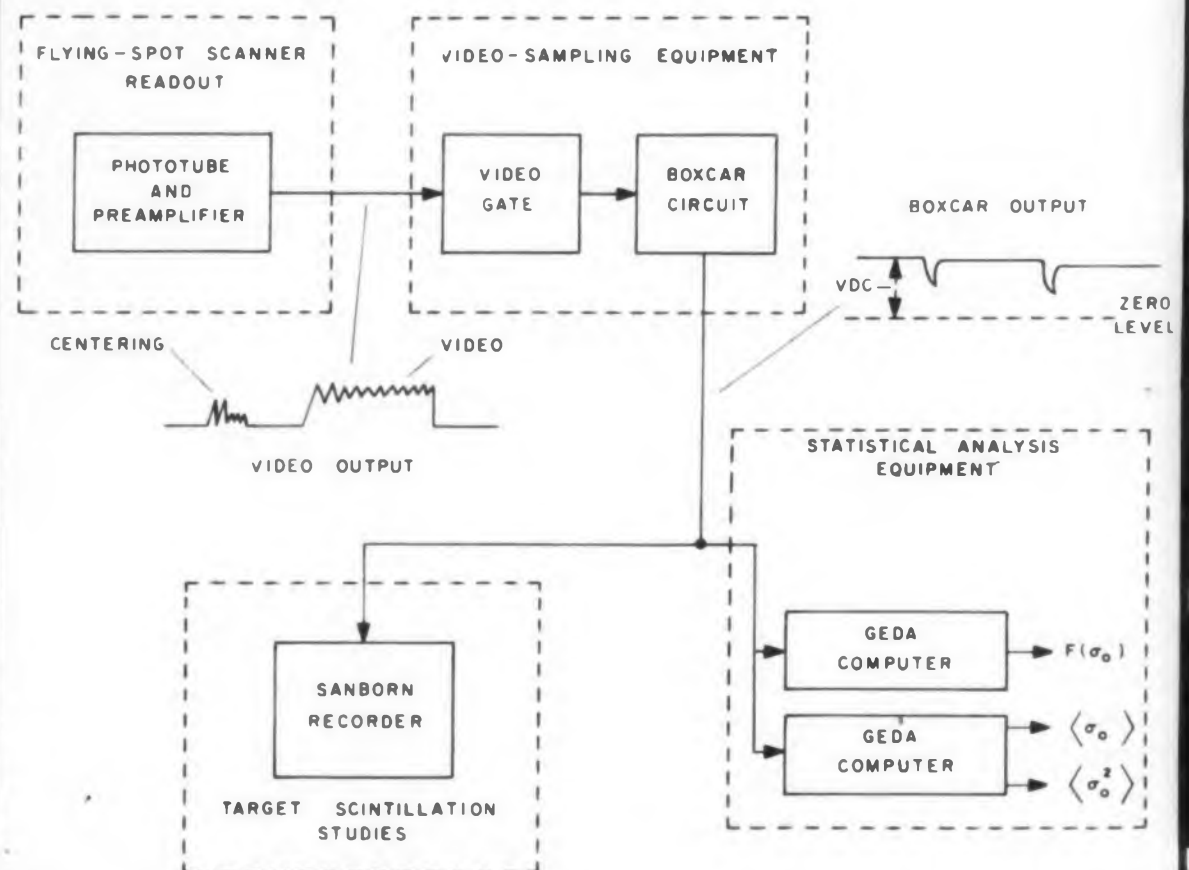

Data readout and analysis portion of the terrain measurement project is installed on the ground. Analysis starts with a line-by-line readout of the radar return. This is eventually transformed into a statistical description of the return by the computers.

it proves a suitable substitute for aerial photography. Goodyear has revealed some of its procedures and analysis techniques, made mostly

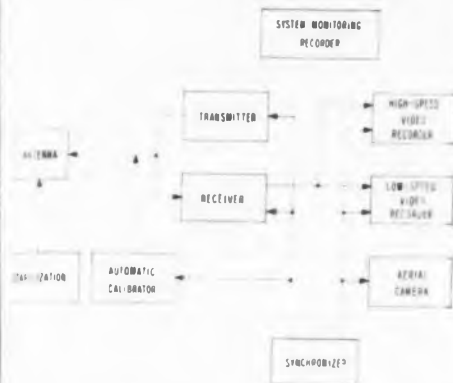

**Data-gathering system** is built around a calibrated strip-mapping radar, several radar recorders and a conventional aerial-mapping camera. The radar system transmits and receives through a three-axis stabilized antenna. Before each run, the automatic calibrator is programmed to inject signals into the waveguide system. The video is recorded on both recorders. Aerial photos are taken to establish the true aircraft ground track and thus the terrain covered by the radar.



part of metropolitan New York mapped by radar carried in low-speed plane.

Circle 7 on Reader-Service Card >

ANOTHER FIRST FROM PHILCO

# PHILCO MADT\* TRANSISTORS MAKE POSSIBLE THE WORLD'S FIRST BATTERY-POWERED PORTABLE TV



#### High Frequency MADTs\*

for tuner, video IF, sound IF



#### Alloy Junction Units

for sweep, synchronizing and audio stages



#### Special MADTs\*

(with revolutionary Philco cathode ray tube) for display circuits

Television breaks free from the electrical outlet! Philco's sensational new Safari plays *anywhere* without plugging in... and only Philco Transistors make it possible.

Philco Micro Alloy Diffused-base Transistors (MADT\*) for the tuner and IF stages are products of Philco's famous FAT Lines (Fast Automatic Transfer)... the first automatic transistor production lines in the world. They are the *only* transistors manufactured by mass production methods to meet the exacting standards of performance, uniformity and economy to make transistorized television a practical reality. Their excellent high frequency capabilities provide sensitivity and low noise performance comparable with conventional vacuum tube receivers.

This is another example of Philco's leadership in Transistor engineering and production. To meet *your* transistor requirements, consult Philco first. For complete information, write Dept. ED-959.

\*Trademark Philco Corp. for Micro Alloy Diffused-base Transistor

# PHILCO.

LANSDALE TUBE COMPANY DIVISION • LANSDALE, PENNSYLVANIA





# 10 Mc COUNTER

*does everything without plug-ins*

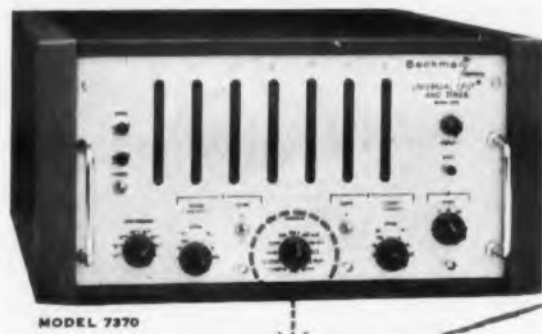

MODEL 7370

8 3/4"

## FUNCTION



Frequency counting to 10Mc with 0.1v sensitivity

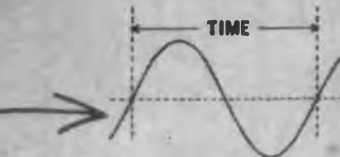
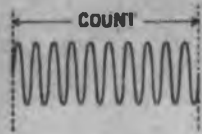

Period measurements in 0.1 μsec units

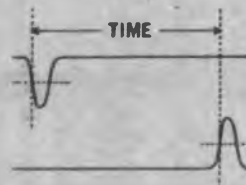

2-channel time interval measurements

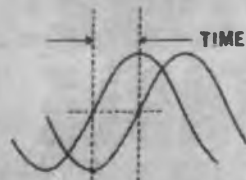

Phase difference measurements

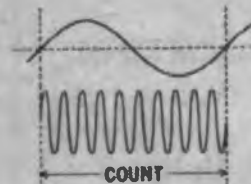

Frequency ratio measurements

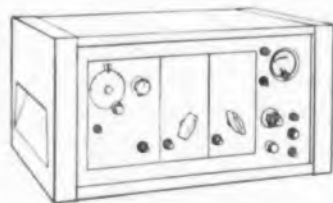

Add this heterodyne unit (Model 7570 Series) to measure frequencies up to 1000Mc.

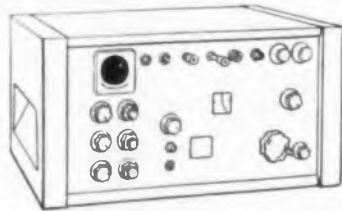

Or add this computing transfer oscillator (Model 7580) to get a counter display of frequencies up to 15,000Mc.

Complete specifications on Models 7370, 7570 and 7580 will be sent on request.

# Beckman

Berkeley Division

2200 Wright Avenue, Richmond 3, California  
a division of Beckman Instruments, Inc.

CIRCLE 8 ON READER-SERVICE CARD

## NEWS

(continued from p. 7)

with standard sensing, guidance, recording, and data-handling equipment instrumented to provide exceptional performance.

All data-gathering flights for the terrain-return program are made over carefully determined paths, so that terrain of specific characteristics comes within recording range. The radar strip map is recorded on film synchronized with the aircraft speed, and video recordings are made with a high-speed, line-to-line video recorder and a strip-map recorder for terrain identification.

Calibration signals of the same strength as return signals are generated in the microwave portion of the system and registered on each end of the video recordings. These are automatically inserted before and after each run.

The position of the aircraft during data runs is known at all times through films taken by an aerial mapping camera and through identifying pulses registered on the video recorders. Because the radar return is synchronized with the photographic strip, a radar mosaic that matches the aerial camera's photo mosaic is available for analysis. All data thus can be correlated in the laboratory by simply matching the identifying pulses as they appear on the video record with the corresponding aerial photos.

Data analysis is performed on copies of the original mapping film. Aerial photographs are plotted on large-scale topographical maps. Patches of terrain of similar nature are selected for analysis.

The first step in reducing the data in the laboratory is to read out the recorded video film line by line with a transmission-measuring device that incorporates a flying-spot scanner feeding a photomultiplier from a cathode-ray-tube light source.

The cathode-ray tube, sweep circuits, and film drive of the flying spot scanner are very similar to those used in the aerial recording system.

The video signal is range gated, corresponding to the particular depression angle desired. This circuit stores the amplitude of each pulse until the next arrives, resulting in a large bandwidth compression.

The output from the boxcar circuit is still the pulse-to-pulse variation of the radar return from a specific depression angle, but it now can be recorded on a conventional chart recorder.

The data gathered by the airborne equipment, which is converted to a video output signal in the laboratory readout system, represents the ratio of power received from the terrain to transmitted power. It now becomes possible to compare the power ratio of a specific patch of terrain to the calculated power ratio recorded on the data film. In this manner an accurate power ratio for the patch is obtained.



Two Goodyear GEDA computers are programmed to calculate the statistical description of the radar return. Information is fed directly to the computers from the video-sampling equipment.

Information developed by these techniques, according to Goodyear, will be added to information gained from other research and development programs to achieve the immediate goals of the terrain measurement project, which should lead to better mapping radars. ■ ■

### 5-Kilowatt British Fuel Cell Now in Production

An 800-pound array of Hydrox fuel cells stacked to provide a 5-kw, 24-v source of power is now in production in Great Britain.

The basic cell uses porous sintered nickel electrodes separated by a potassium hydroxide electrolyte to convert gas combustion directly to electricity. Charge gases are oxygen and hydrogen, fed in at a rate of 20 cubic feet per kilowatt hour for oxygen and half that rate for hydrogen.

The Cambridge University researcher who de-



Highly efficient, powerful British fuel cell is about 30 inches long. Bulky control equipment is not shown.

veloped the cell, Prof. F. T. Bacon, reports that efficiencies range to 65 per cent at outputs that equal from 7 to 20 hp. Operating temperature and pressure are 390 F and 400 pounds per square inch.

The Bacon cell, licensed to the Patterson Moos Division of Universal Winding Co., New York, for U.S. development, is being considered as an in-flight fuel source for the first manned U.S. space vehicle.

Miniature

## PROKAR® 'D' Molded Capacitors

--with improved moisture resistance and a new dual dielectric for 125 C operation without voltage derating

Sprague's new and improved PROKAR 'D' Molded Tubular Capacitors meet the need for *ever smaller* molded capacitors capable of withstanding 125 C operation in military, commercial, and industrial electronics.

Key to the new design is an improved processing technique which greatly increases moisture resistance. The new dual dielectric used in Type 150P Capacitors combines the dielectric strength of the highest grade capacitor tissue with the effective moisture resistance of plastic film, giving these miniature units high insulation resistance plus extended life at 125 C. The impregnant used is still the same exclusive high temperature organic material which marked a milestone in molded capacitor development for the original Prokar series.

The improved performance of PROKAR 'D' Capacitors is worth investigating—greater resistance to humidity, high insulation resistance (minimum of 10 megohm-microfarads at 125 C), moderate capacitance change with temperature, longer life, and improved reliability.

For complete specifications on Type 150P PROKAR 'D' Molded Tubular Capacitors, write for Engineering Bulletin 2300 to Technical Literature Section, Sprague Electric Company, 341 Marshall St., North Adams, Mass.

# SPRAGUE®

THE MARK OF RELIABILITY

SPRAGUE COMPONENTS:

CAPACITORS • RESISTORS • MAGNETIC COMPONENTS • TRANSISTORS • INTERFERENCE FILTERS • PULSE NETWORKS  
HIGH TEMPERATURE MAGNET WIRE • CERAMIC-BASE PRINTED NETWORKS • PACKAGED COMPONENT ASSEMBLIES

CIRCLE 9 ON READER-SERVICE CARD

## NEWS

### Longitudinal Baffling Improves Microwave Anechoic Chamber

An anechoic chamber designed primarily for testing uhf-absorbing materials has been built with its baffle edges parallel to its longitudinal center line. This design contrasts with more conventional darkrooms, in which the diffracting edges of transverse baffles lie in planes normal to the long axis of the room.

This design, according to the builders, Emerson & Cuming, Inc., of Canton, Mass., provides two major electrical advantages.



**Anechoic chamber** is about 120 feet long, 45 feet wide and 25 feet high. The room's frequency range is 900 mc through 50 kmc.

First, baffle-edge-diffraction effects are minimized, because the edges are parallel to the axial field components, which are relatively small in most instances. Unless a conventional transversely baffled room is excessively large in cross-section, several of the baffle edges are invariably illuminated by parallel fields comparable in amplitude to those illuminating the target area. The company reports that recent theoretical and experimental work indicates that under typical chamber illumination conditions the very existence of baffle edges parallel to radiation fields imposes a severe limitation upon the "darkness" of a darkroom. The quality of the absorbing material covering these edges is theoretically of little consequence. The longitudinal-baffle design significantly minimizes these limitations by making the baffle edges parallel to the weak axial field components.

Secondly, the residual and unavoidable reflections from longitudinal baffles impose no limitation on the distance between transmitter and target. A uniformly "quiet" volume, having dimensions subject to design control, surrounds the long axis of the chamber and extends to within a few

# Direct, automatic power readings



## SPECIFICATIONS

**Power Range:** 5 ranges, front panel selector. Full scale readings of .1, .3, 1, 3 and 10 mw. Also continuous readings from -20 to +10 dbm. (0 dbm = .001 watt). Power range may be extended with attenuators or directional couplers in microwave system.

**External Bolometer:** Frequency range depends on bolometer mount. Bolometers can operate at resistance levels of 100 or 200 ohms and can have positive or negative temperature coefficients. Any dc bias current up to 16 ma is available for biasing positive or negative temperature coefficient bolometers. Dc bias current is continuously adjustable and independent of bolometer resistance and power level range.

Suitable bolometers are:

Instrument fuses: -hp- G-28A and G-28B 1/100 amp fuse.

Barretters: Sperry 821, Narda N821B or N610B, PRD 610A, 614, 617 or 631C.

Thermistors: Western Electric D166382, Victory Engineering Co. 32A3, 32A5, Narda 333, 334.

**Accuracy:**  $\pm 5\%$  of full scale reading.

**Power:** 115/230 v  $\pm 10\%$ , 50/1,000 cps, 75 watts.

**Dimensions:** Cabinet Mount:  $7\frac{3}{8}$ " wide,  $11\frac{1}{2}$ " high, 14" deep. Rack Mount: 19" wide, 7" high,  $12\frac{1}{2}$ " deep.

**Weight:** Net 14 lbs. Shipping 32 lbs. (cabinet mount).

**Price:** \$250.00.

*Data subject to change without notice.*

**CW or pulsed power**  
**Wide frequency range**  
**No calculations**  
**Assured accuracy**  
**Operates with wide variety of bolometers**

## -hp- 430C Microwave Power Meter

Here is the finest, most dependable source of instantaneous microwave power readings available today. The -hp- 430C gives you power readings direct in mw or dbm and completely eliminates tedious computations or troublesome adjustment during operation. The instrument measures either pulsed or CW power on either waveguide or coaxial systems. Operation is entirely automatic, stability is extremely high, and the meter may be used with a wide variety of bolometer mounts having either positive or negative temperature coefficients. The broad nominal measuring range may be extended to higher powers by means of directional couplers and attenuators.

For measurements of CW or pulsed power, -hp- 430C uses either an instrument fuse, barretter or thermistor as a bolometer element. Operation may be at either 100 or 200 ohms. Power is read direct in milliwatts from 0.02 to 10 mw, or in dbm from -20 to +10 dbm.



**ELECTRONIC TEST INSTRUMENTS for**



**Use these precision -hp- instruments with  
-hp- 430C for greater coverage, convenience**

**-hp- 752 Multi-Hole Couplers**—For measuring average power 1 watt to 1 kw (with attenuator) in waveguide systems. Models cover all frequencies 2.6 to 40 KMC. Coupling factors of 3, 10 and 20 db available most bands. Directivity better than 40 db full range; accuracy of mean coupling  $\pm 0.4$  to 0.7 db. full range. Primary guide SWR less than 1.10. \$375.00 to \$100.00.

**-hp- 764-767D Dual Directional Couplers**—For wide band coax reflectometer and power measurements. Four models cover frequencies 216 to 4000 MC. 20 db attenuation, coupling accuracy 1 db. max. primary SWR 1.1 to 1.25; max. secondary SWR 1.2 to 1.5. Minimum directivity (216 to 940 MC) 30db; 26 db at higher frequencies. 50 watts CW capacity, 10 kw peak. Low insertion loss. \$160.00 to \$150.00

**-hp- 382A Precision Attenuators**—For measurements up to 5, 10 and 15 watts, this revolutionary new broad band instrument may be employed. -hp- 382A attenuates from 0

to 50 db, full range, independent of frequency. Phase shift constant with attenuation. Accuracy within  $\pm 2\%$  of db reading. Models cover frequencies 3.95 to 40.0 KMC, maximum dissipation 5 to 15 watts. SWR less than 1.15. \$500.00 to \$275.00.

**-hp- 370 Waveguide Attenuators** — Waveguide sections providing fixed amounts of attenuation. Used to extend power range of -hp- 430C. Models for frequencies 2.6 to 18.0 KMC, power dissipation 1.0 watts (1 kw peak), SWR 1.15; 3, 6, 10 or 20 db attenuation. \$75.00 to \$55.00.

**-hp- 487B Thermistor Mounts**—Simplify setups, save time and insure maximum accuracy in waveguide power measurements. Models cover frequencies 3.95 to 40.0 KMC with full range SWR of less than 1.5 (except K,R band, 2.0). Permanently installed negative temperature coefficient thermistors. No tuning, large overload factor makes burnout virtually impossible. \$225.00 to \$75.00.



-hp- 485 Detector Mounts



-hp- 382A Precision Attenuators



-hp- 476A Bolometer Mount

-hp- 752 Multi-Hole Couplers



-hp- 487B Thermistor Mounts



-hp- 477B Coaxial Mount

**-hp- 477B Coaxial Mount** — Thermistor mount providing full frequency coverage 10 MC to 10 KMC with SWR less than 1.5. Requires no tuning, uses long time constant elements for accuracy even on low duty cycle pulses. For use with 430C or other bolometer bridges providing negative temperature coefficient operation at 200 ohms. Requires 13 ma bias. Power range 0.02 to 10 mw. Uses Type N rf connector. \$75.00.

**-hp- 485 Detector Mounts** — Single tuning control accurately matches waveguide section to bolometer element; instrument also detects rf energy with crystal substituted for

bolometer element. Models for frequencies 2.6 to 12.4 KMC, SWR 1.25 to 1.5. All models employ crystal or barretter except P485 (thermistor only) and S485 (crystal only). \$170.00 to \$75.00.

**-hp- 476A Bolometer Mount**—Universal bolometer mount requiring no tuning, no adjustment. Frequencies 10 to 1,000 MC, instantaneous, automatic power readings 0.02 to 10 mw. SWR less than 1.15, 20 to 500 MC; less than 1.25, 10 to 1,000 MC. Uses four 1/100 amp fuses. Uses Type N rf connectors. \$85.00.

Prices f.o.b. factory. Data subject to change without notice.

**HEWLETT-PACKARD COMPANY**

4651K PAGE MILL ROAD • PALO ALTO, CALIFORNIA, U. S. A.

Cable "HEWPACK" • Davenport 5-4451

FIELD REPRESENTATIVES IN ALL PRINCIPAL AREAS



-hp- 764/7D Dual Directional Couplers

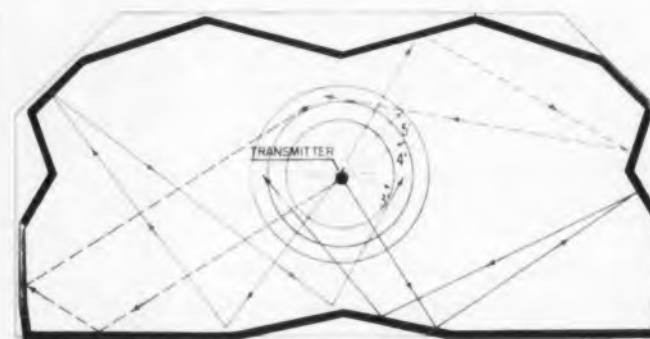

**Ray pattern in anechoic chamber** shows that energy originating on or near the room's long axis does not return to a central six-foot-diameter cylinder except after being bounced three times from microwave absorbing material.

feet of either end. In a transversely baffled room, an axially short quiet volume exists close to one end, and very elaborate baffling is required to permit a range of transmitter-to-target distances. Additional elaboration of shape and number of transverse baffles is necessary if the room is to be used for transmission in either direction, and still further design complications result if the room is used for both reflectivity and pattern work. In sharp contrast, the much simpler longitudinal-baffle chamber is equally good for transmission in either direction, and it is inherently satisfactory for both reflectivity measurement and pattern recording.

**NSF Translating Back Issues  
Of Soviet Technical Journals**

The National Science Foundation has arranged with the Program for Scientific Translations, an Israeli group, for the translation of back issues of Soviet publications.

Acting as a consultant for NSF in Israel is J. George Adhashko, a contributing editor of *ELECTRONIC DESIGN* and editor and translator of the *ED* Russian translations department.

**Magnesium Fluoride Material  
Improves Infrared Sensing**

A new material being developed for lenses and windows in infrared systems promised to pass up to 90 per cent of the energy directed at it.

The magnesium-fluoride material, called Irtran by its developer, Eastman Kodak, is translucent and is said to have such low surface-reflection losses that coating is unnecessary.

Kodak also reports that Irtran retains infrared transparency to 1200 F and should eliminate "hot window effect," which occurs when optical parts pass through atmosphere at high speed.

**COMPLETE COVERAGE, HIGHEST QUALITY**

CIRCLE 10 ON READER-SERVICE CARD

ELECTRONIC DESIGN • September 16, 1959



## NEWS

### Calibration Lag Shown by AF-Sponsored Survey

United States industry—electronics included—is being hindered by a “measurement pinch,” a new survey has revealed.

The Industry Calibration Survey points to specific areas—microwave measurement techniques, rf interference standards, electrical standards—where calibration methods trail both the state of the electronics art and the needs of the military services.

Sperry Gyroscope made the study for the quality control committee of the Aerospace Industries Association, under the sponsorship of the Air Force Materiel Command and with the cooperation of the National Bureau of Standards.

Some suggestions made in the survey:

- Nationally uniform calibration methods should be adopted.
- NBS calibration services should be expanded.
- Better communications and education in measurements and standards should be established.

### C-Band Radar Beacon Designed for Lightness

A 400-watt, C-band beacon for airborne tracking and identification applications has been designed into a 9.8-pound package that occupies only one-seventh of a cubic foot.

Except for a tunable magnetron and local oscillator, all stages in the device are transistorized, including a tunable duplexer, crystal mixer, if amplifier and detector, video decoder, modulator and power supply.

The beacon transmits a single rf pulse when it recognizes the correct radar-originated, coded interrogation signal. The unit ignores both off-frequency and incorrectly coded signals.



TWIST WIRES ...



DIP IN SOLDER ...

## Anaconda's Analac ready to solder magnet wire...is saving time and cost

A superior product is known by the companies that keep it. And many companies—from coast to coast—are doing just that with Anaconda Analac.

Here's why: Analac\* film-insulated, solderable magnet wire can be used similarly to Formvar or Plain Enamel—except that it is solderable without stripping!

Soldering by dipping, iron or gun produces a perfect joint—in just one second in finer sizes—without removing the insulation. Analac reduces labor, saves time and money wherever many soldered connections are made, or where insulation removal is hazardous.

Not only this, Analac has the excellent abrasion resistance and other good mechanical properties of the

enamel wire you're now using. It handles readily, performs well in high-speed winding.

Analac is colored a bright red with stable dye used many years for identical applications—making it highly visible even in finest sizes. This helps operators feel more secure, results in higher quality work. Distinctive color simplifies its identification, too, from nonsolderable wires.

Analac is available in an exceptionally large range of sizes. The Man from Anaconda will be glad to give you more information and help with a production run in your plant. See “Anaconda” in your phone book—in most principal cities—or write: Anaconda Wire & Cable Company, Magnet Wire Headquarters, Muskegon, Michigan.

\*Reg. U. S. Pat. Off. 57398 Rev.

ELECTRONIC DESIGN • September 16, 1959

POINT IS COMPLETED WITHOUT TRIPPING WIRE with Analac wire dipped in 60-50 tin-lead solder at 360°C (680°F). The insulation is removed at the temperature of molten solder.

# Analac

## and costs for many industries

See the Man from

# ANACONDA®

for ready-to-solder

# Analac

magnet wire



**1. STRONG JOINTS**—as strong as the same joints made in bare copper wire—are produced. Here in laboratory test, joint holds under high stress.

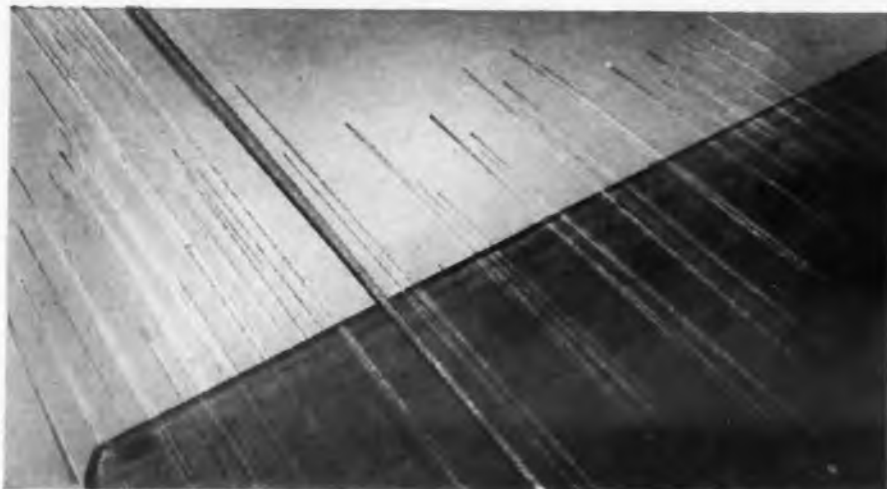

**2. EXCELLENT ABRASION RESISTANCE** of Analac is shown in this test. It has the same high windability normally associated with Formvar, Plain Enamel.



**3. MOLDED-PLASTIC CASES** — designed and developed by Anaconda—protect spools of Analac from damage during shipping. Result: no breaks due to bent spools.



**NEW CATALOG ON ANALAC**  
Yours for the asking.  
Mail coupon

**ANACONDA WIRE & CABLE COMPANY**  
Magnet Wire Headquarters,  
Muskegon, Michigan.  
Please send me catalog C-95A on  
Analac ready-to-solder magnet wire.

NAME & TITLE.....

COMPANY.....

ADDRESS.....

CITY, ZONE, STATE.....

## Micromodule Program Expanded by Army

The Signal Corps has awarded the Radio Corporation of America a \$2,388,939 contract to expand the company's miniaturization program by extending the range of element values and widening the variety of micro-elements.

Tunnel diodes and unipolar transistors are included in the expanded miniaturization program, which is based on RCA's micromodule concept.

## Navy Reissues Tips For Equipment Design

A revised check list for electronic designers is being offered by the Navy Electronics Lab. Handy tips on common design faults, the human factor and common causes of equipment failure are given in the 1959-60 edition of "Suggestions for Designers of Electronic Equipment."

Copies of the new edition, little changed from last year's but listing the latest documents for specifications and standards, may be obtained from the Commanding Officer and Director (Code 2460), U.S.N.E.L., San Diego 52, Calif.



**Bank of 1024 styluses** (at tip of pencil) is key to fast operation of Lockheed digital plotter that graphs performance data at rate of 4000 points per second. Unit is fed by magnetic tape from IBM 709.

← Circle 11 on Reader-Service Card

announcing

# A "CIRCUIT EQUIVALENT" COMPONENT with flip-flop characteristics

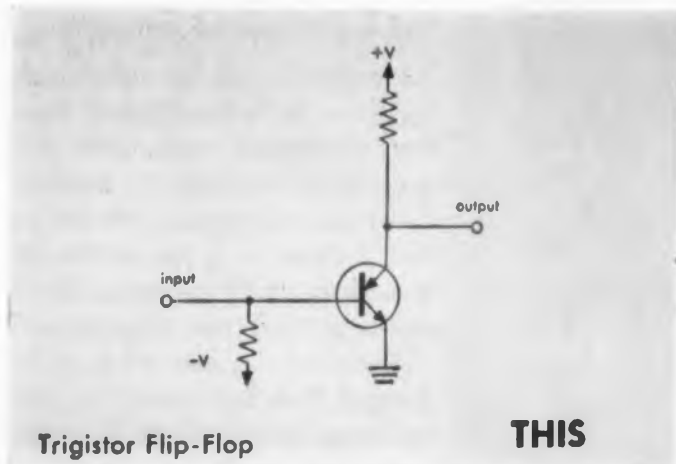

Trigistor Flip-Flop

THIS  
EQUALS

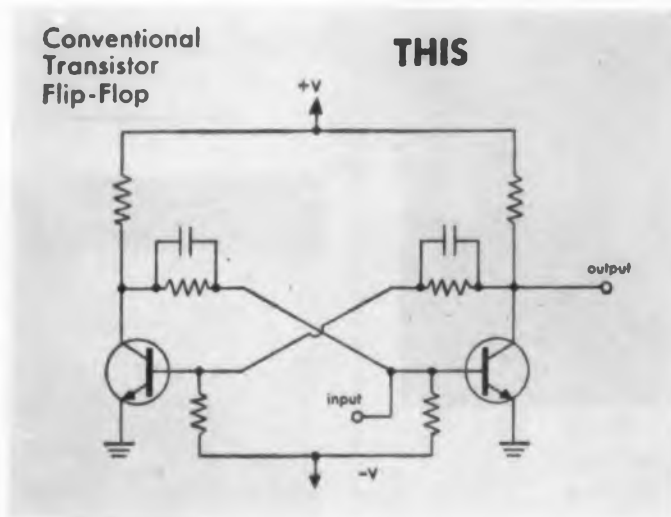

Conventional  
Transistor  
Flip-Flop

THIS

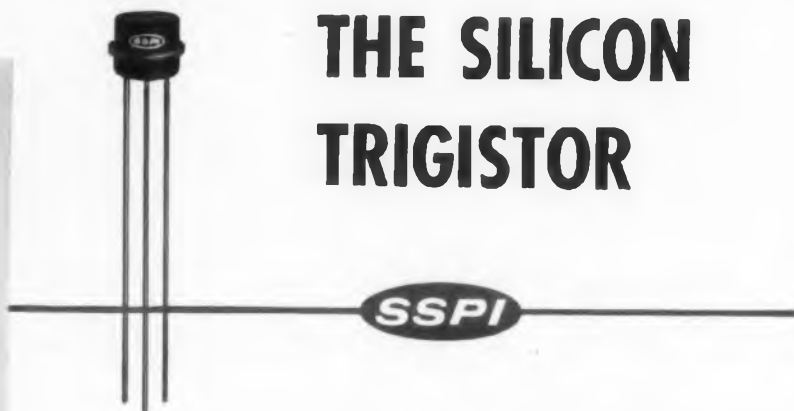

## THE SILICON TRIGISTOR

Advanced diffusion techniques at SSPI have produced the Silicon Trigistor — the first commercially available "Circuit Equivalent" semiconductor component, with characteristics comparable to the flip-flop or bistable multivibrator.

The Trigistor is a silicon PNP device with *triggered turn off* as well as triggered turn on control at its base. A low level positive trigger pulse applied to the base turns it on, and it remains on without sustaining base current. A negative trigger pulse on the base turns it off. The 3C Series is designed for bistable switching in the range of 1 to 8 mA collector current with collector voltage ratings to 60V.

Usually the Trigistor will perform the same function as two transistors plus several associated capacitors and resistors. Thus through circuit simplification both smaller size and higher reliability can be achieved.

Available now through your local SSPI representative or by contacting the factory direct.

Write for Bulletin C410-01

## NEWS

### British Transmitter Has Wideband Amplification Over Entire HF Band

A radical hf transmitter has been designed around a distributed amplifier that provides wideband amplification over a whole hf band and permits two or more simultaneous transmissions from one transmitter.

Solved by the design is the problem of stage-by-stage retuning of the hf amplifier to change frequencies — operational tuning is eliminated.

The design breakthrough was

### Wideband Amplification and Distributed Amplifiers

Wideband amplification is not in itself new. For many years amplifiers have been built having bandwidths of several hundred megacycles. But these normally represent only a small proportion of the mean frequency of operation. At the lower frequencies, television baseband signal amplifiers cover bandwidths from very low frequencies up to 5 or even 10 megacycles, at fairly high power levels.

To cover the hf band from 2 to 24 megacycles is not so easy, and when powers of the order of 1 kilowatt are required, sufficient freedom from spurious radiation is not easy to obtain. Such an amplifier will, for the lower frequencies of operation, amplify all harmonics generated at any point in the transmitter up to and including the twelfth harmonic — with no significant attenuation. Exceptional linearity is therefore required, since an harmonic content of —40 db corresponds to a distortion of one per cent, which is considered exceptionally good.

Though distributed amplifiers are common in low-voltage applications, (oscilloscopes, for instance), their use in wideband hf transmission is unusual. According to Marconi, the principle of distributed amplification has never before been successfully used in this type of application.

**SOLID  
STATE** Products, Inc.

ONE PINGREE STREET • SALEM, MASSACHUSETTS  
PHONE 53300





**Transmitter** with distributed, wide-band power amplifier is claimed to be only one in the world capable of transmitting on two or more different wavelengths at the same time.

achieved by engineers of Marconi's Wireless Telegraph Co. Ltd, England, and is incorporated in the company's HS113 transmitter, a 1 kw, hf unit consisting essentially of the distributed amplifier and its drive equipment.

The key problem that had to be solved to achieve wideband amplification from 2 to 24 mc was finding a way to get a high ratio of available current to effective anode capacitance; and the ratio had to be virtually independent of the load presented to the amplifier.

The solution was distributive amplification using an artificial transmission line in which the shunt capacitances were replaced by the tube capacitances.

In the distributed amplifier used in the HS113 transmitter, the inductance separating individual tubes (see schematic) effectively isolates the tube interelectrode capacitances while the anode currents contributed by individual tubes add up.

The input signal is applied to an artificial line in which the shunt capacitance is provided by the tube input capacitance. Each tube is thus driven in succession, the time delay depending on the properties of the artificial line.

The anodes feed a transmission line having characteristics identical

(Continued on p. 16)



**Avco // Crosley**

## Crosley Radar And . . . . . America's defense

Soon the latest in ground radar from Crosley will stand watch along the distant approaches to the North American continent. Since 1955 Crosley's radar engineers have been at work—designing, perfecting, improving this important new radar unit.

Now the FPS-26 ground radar is ready for production, and Avco's Crosley Division has been named prime contractor by the U. S. Air Force.

The huge radar—so new that it is still classified—will be housed in a radome more than 50 feet in diameter. It will be mounted atop a reinforced concrete tower more than 70 feet high and will consist of more than 300,000 parts, including some 3500 tubes and diodes.

Handling the design and production of complex, challenging radars is "old hat" to Crosley, prime contractor of the famous MPS-16 height finder radar now widely used by the armed forces. Similarly, Crosley now is prime contractor to the Air Force for the radar-directed fire control system that puts a 50-caliber "stinger" in the tail of the B-52 bomber.

Radar is just one example of Crosley know-how in both engineering and production—*designing* the best possible performance into the product . . . *producing* it on schedule, and at a reasonable cost.

Today Crosley is recognized as a leader, not only in radar, but in communications, marine electronics, electronic ground support, infrared, fire control systems, air traffic control, ordnance and missile arming and fuzing.

*For more information, write to: Vice President, Marketing-Defense Products, Crosley Division, Avco Corporation, 1329 Arlington Street, Cincinnati 25, Ohio.*

### ENGINEERS:

*Creative research and development engineers experienced in electronics, mechanics, weapons systems, and ordnance warheads are urged to investigate the wide range of opportunity at Crosley. Write to: Director—Technical and Scientific Personnel, Dept. L-99E, Avco/Crosley, 1329 Arlington Street, Cincinnati 25, Ohio.*



# Daven precision wire wound resistor...

Type 1282 actual size

makes other miniatures  
look like giants!

**DOWN, DOWN, DOWN** go the dimensions of Daven precision wire wound resistors. The latest: a micro-miniature resistor that is the **smallest ever made!** Developed for a major missile program to meet stringent space requirements without sacrificing reliability, this Type 1282 meets all specifications of MIL-R-93B, Amendment 3, except physical size.

Specify Type 1282, or other units in the Daven micro-

miniature family, for all of your small-size, high-reliability wire wound resistor requirements. Available in all tolerances and temperature coefficients.

Type	Diam	Length	Max Watts	Max Ohms
1250	1/4	1/2	.33	1 megohm
1273	1/4	5/16	.25	400K
1274	3/16	3/8	.25	250K
1282	1/8	1/5	.05	100K
1284	1/4	27/64	.25	1 megohm

Write today for complete information!

THE **DAVEN** CO.  LIVINGSTON, NEW JERSEY

TODAY, MORE THAN EVER, THE DAVEN © STANDS FOR DEPENDABILITY

## NEWS

(continued from p. 15)

to the artificial line; half the anode current of each tube contributes to the output load, the other half travels to a terminating resistor ( $R_t$  in the schematic) where it is dissipated.

The number of tubes and the anode voltage used are adjusted to permit optimum operation at the low-frequency end of the band

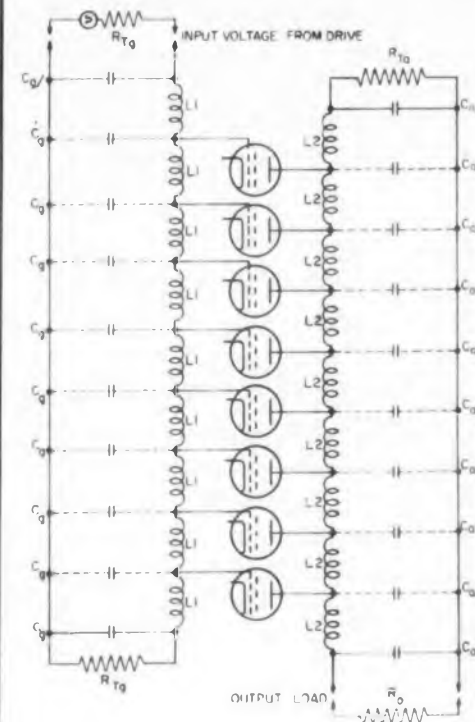

**Simplified version** of distributed amplifier that makes possible unusual performance new transmitter. Amplifier uses low-impedance tubes in parallel to handle considerable current swing with low-anode capacitance. Successful application of distributive amplification is why . . .

where half the developed power is dissipated in the terminating resistor.

Two stages of distributive amplification are used in the HS113 transmitter; the next to last operates Class A with a 26-db gain, the final stage operates Class AB with a 25-db gain.

In each stage two distributed amplifiers operate in push-pull to offset development of even harmonics and to improve over-all efficiency. The push-pull operation is gained by

◀ Circle 14 on Reader-Service Card

feeding  
from  
trans  
nique  
tion.

Acc  
the u  
pabili  
new f  
cut o  
switc  
trans  
prop

Back  
Tra

The  
siles  
detc  
thous  
ionos  
to rad

The  
tracki  
the O  
make  
cent  
clear  
the w

Key  
is the  
in roc  
High-  
hot ex  
after  
earth

toring  
signal  
tion o  
Nuc  
gener  
partic  
same

The  
station  
to 50  
results  
better  
station  
ful as  
under

Firs  
made  
ing sys  
scatter  
away-  
moves

ELECT



feeding two single-ended amplifiers from an unbalanced-to-balanced transformer. Special matching techniques eliminate out-of-step operation.

According to the manufacturer, the unit's multiple transmission capability permits transmission on a new frequency before the old one is cut off. Frequency is changed by switch; aerial commutation in the transmitter automatically selects the proper array.

### Back Scatter Radar Tracks Missiles Anywhere

The Navy has tracked Soviet missiles from the United States and detected nuclear blasts at ranges of thousands of miles by applying ionospheric back scatter techniques to radar tracking.

The experimental long-range tracking technique, developed by the Office of Naval Research, may make possible detection of 95 per cent of missile launchings and nuclear blasts occurring anywhere in the world.

Key to the research achievement is the fact that ionized exhaust gases in rocket trails reflect radar signals. High-frequency pulses bounced off hot exhaust gases can be picked up after scattering back between the earth and the ionosphere to a monitoring receiver. Main difficulties are signal identification and determination of accuracy.

Nuclear explosions, which also generate reflecting clouds of ionized particles, can be detected in the same way.

The Navy reports that detection stations with outputs as low as 15 to 50 kilowatts have given excellent results. However, more power gives better resolution and detail, and stations more than twice as powerful as the largest in operation are under construction or planned.

First successful trackings were made in 1957. But a complete tracking system based on the radar backscatter technique is at least a year away—and then only if research moves as fast as it has been moving.

## HOW RCA S-311 PLATE MATERIAL

# IMPROVES TUBE PERFORMANCE

Reduces possibility of gas runaway  
Lengthens shelf life  
Lengthens operating life  
Reduces interelectrode leakage  
Assumes more stable operation  
Improves heat dissipation  
Reduces secondary emission

here's why:

- S-311 is pure carbonyl-nickel having very low gas and contaminant levels.
- S-311 plate material has virtual dull-black-body characteristics and makes possible the design of plate structures having extremely efficient heat dissipation.

Give your designs the benefit of this combination of plate qualities. Get full information about the RCA tubes utilizing S-311 plate material from your local RCA Field Representative today.



**RADIO CORPORATION OF AMERICA**  
Electron Tube Division  
Harrison, N. J.

ANOTHER WAY RCA SERVES YOU THROUGH ELECTRONICS

EAST: 744 Broad St., Newark 2, N. J.  
HUMboldt 5-3900  
MIDWEST: Suite 1154,  
Merchandise Mart Plaza  
Chicago 54, Ill., WHitehall 4-2900  
WEST: 6355 East Washington Boulevard,  
Los Angeles 22, Calif., RAymond 3-8361

CIRCLE 15 ON READER-SERVICE CARD



# DIEHL\*

The growing family of  
instrument servo components

60 cycle Servomotors (1, 3, 5 and 10 watts)  
400 cycle Servomotors (3 and 15 watts)  
60 cycle A.C. Tachometers  
400 cycle A.C. Tachometers  
D.C. Tachometers  
Gear Reducers  
Vacuum Tube Servo Amplifiers  
SERVOPOT (Combination of: Servomotor,  
gear train, slip clutch and potentiometer)  
Available separately or in any combination

I.S.A. Conference  
and Exhibit  
Booth 673  
International  
Amphitheater  
Chicago, Ill.  
Sept. 21-25, 1959

DIEHL Instrument Servo Components have been developed to offer maximum performance, flexibility and reliability at minimum cost. These are the basic servo system building blocks which enable our military and industrial customers to satisfy the demands placed on them for higher over-all response, accuracy and economy. Write for full details concerning any of these components.



**DIEHL MANUFACTURING COMPANY**  
A SUBSIDIARY OF THE SINGER MANUFACTURING COMPANY  
Somerville, New Jersey

• AC SERVO MOTORS • AC SERVO MOTORS WITH AC TACHOMETERS • DC SERVO SETS  
• AC SERVO MOTORS WITH DC TACHOMETERS • AC AND DC TACHOMETERS • RESOLVERS

\* A Trademark of DIEHL MANUFACTURING COMPANY

CIRCLE 16 ON READER-SERVICE CARD



## NEWS



60-foot DEW-line radar antenna undergoing trials at test range of ITE Circuit Breaker Co. near Philadelphia. Dish is mounted on rotatable frame.

## Design News in Photos

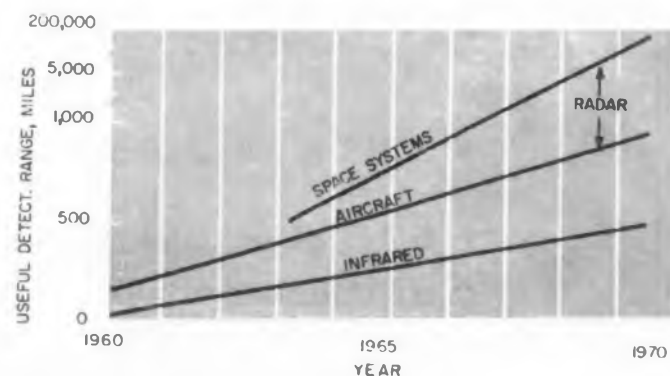

How detection range of various airborne systems will be extended over the next 10 years, according to Aerospace Industries Associates. Systems reaching 200,000 miles are predicted for 1970, provided progress is made in determining effects on signals of gases, aurorae, and cosmic interference.



ITT infrared tracker for satellites uses 19-inch collecting mirror focusing on a detector cell chilled to  $-300$  F. Cell is mounted halfway up tube, which oscillates until tracking mechanism locks onto satellite.



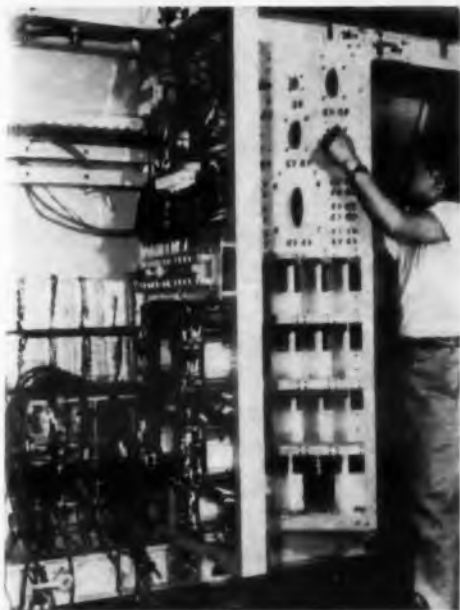

**Polaris-launching switchboard**, designed by Burroughs and being installed aboard nuclear submarine George Washington, will switch data and power to and from fire-control panel.



**Russian engineers**, members of the Computing Center of the Soviet Academy of Sciences, are told how IBM 305 operates at Moscow fair.



**28-foot dish** at the University of Texas has picked up moon-bounce signals originating in Great Britain.

Circle 17 on Reader-Service Card ➤



# MAXWELL MAGNETICS and MICROWAVE

Creative Imagination was for James Clerk Maxwell the catalyst that united a profound physical intuition and a formidable mathematical capacity in a brilliant formulation of electromagnetics—the basis of all today's practical electromagnetic applications.

At National Co. creative imagination is transmuting observed physical phenomena and mathematically formulated theory in such applications as long range microwave transmission—extending further our practical control of physical phenomena.

The implications of these new means of communications are manifold and the applications multitudinous.

National Co. is a community of minds and talents that enjoys the challenge and the prestige of success in such advanced fields as multipath transmission, noise reduction, correlation techniques for signal processing, Tropospheric scatter systems, Ionospheric scatter systems, molecular beam techniques, long range microwave transmission and missile check-out equipment using microwave and digital techniques.

National Co. has grown with the Tradition of New England electronics. Your needs and problems receive exceptional attention at National Co., because, here, *creativity is required, recognized and rewarded.*

Write or phone

*tuned to tomorrow* **National!**

National Company, Inc., Malden, Mass.

MANUFACTURERS OF MATERIEL AND EQUIPMENT FOR U.S. DEFENSE



End alternate chills and hot blasts. Shown in front of the thermistor wall unit and the furnace modulator valve are the tube type and transistorized amplifiers for the new Selectra home gas furnace control now in production at Maxitrol Company, Detroit, Michigan.

## Tung-Sol tubes and transistors help MAXITROL provide non-cycling home heating

Maxitrol Company's new Selectra electronic gas furnace control does away with fluctuations in room temperature. It continually adjusts the burner flame to exactly compensate for the heat loss in the home and it responds to temperature changes as low as 1/10 degree F. Selectra controls are available with either tube type or transistorized amplifiers which boost the signal from a thermistor in the wall unit to selectively energize a solenoid in the furnace modulator valve.

Depending on their design some gas burners must be ignited at maximum flame. On such burners the tube type amplifier using a Tung-Sol 2D21 thyratron is recommended. The tube warm-up period provides a 10-15 second delay during which time the solenoid cannot be energized, insuring ignition at maximum flame.

Transistorized Selectra amplifiers are recommended for burners which can be successfully ignited at less than maximum flame. Since there is no warm-up delay with the transistorized circuit, ignition may occur as low as 1/3 of full fire. For this unit, Tung-Sol supplies TS757, a high power transistor selectively inspected to provide extremely tight characteristics. The high reliability of these Tung-Sol transistors, say Selectra's designers, was largely responsible for this type of control being in production.

*Do you have an unusually demanding tube or transistor requirement?* Tung-Sol applications engineers stand ready to help you. You'll get utmost benefit from their experience by consulting them while your equipment is in the planning stage. Just call or write: Tung-Sol Electric Inc., Newark 4, N. J. TWX: NK 193



**ts TUNG-SOL®**

## NEWS

### New Navy-Civilian Board Mapping Air Standards

A new advisory board composed of civilian engineers and Navy officers is helping the Navy set up standards for reliable aeronautical equipment.

The unit, sponsored by the Navy Bureau of Aeronautics, is called BuAer-Industry Advisory Board on Reliability and Operational Design Requirements of Aeronautical Material. Rear Admiral L. D. Coates, assistant chief for research and development, is chairman of the board.

Standing committees were formed recently, and the group has begun full-scale operations. Among its goals are the mapping of:

- Requirements for maximum operational efficiency.
- Procedures for analyzing, testing, demonstrating and maintaining equipment.
- Interchange of technical information between military field and operational forces and industry.

The Navy has announced that it aims to have "a fair representation on the board of independent, small, medium and large business enterprises from different geographical areas and of different segments of the industry."

### Radar Suggested to Help Helicopters Fly 'Blind'

An advanced, pulsed radar in the millimeter wavelength range has been tentatively proposed as an obstacle sensor to permit helicopter flights in "blind weather."

This suggestion has resulted from a continuing study by Allen B. DuMont Labs, Inc., of Clifton, N.J., as part of the Army-Navy Instrumentation Program. Cooperating with DuMont is T.R.G., Inc., of Syosset, N.Y.

The helicopter radar sensor would have a very narrow antenna beam width and a field of view approach-

◀ Circle 18 on Reader-Service Card



## Precision Is The Standard At Coors

ing a hemisphere. Describing its anticipated operation, DuMont says:

"If the elements in the field of view are examined sequentially in time, the frame time required, due to the finite velocity of propagation, is approximately one second. Geometric distortion in the radar information will be introduced by translation and rotation of the aircraft during a single frame time, which distortion can be reduced through using information about the aircraft's motion to correct the data or by using a partially simultaneous scan to increase the frame rate."

The system would use a new type of radar display called ranged perspective. In such a display, intensity is varied as a function of the range to the object, so that depth perception is achieved.

Ordinarily helicopters encounter greater ground hazards than fixed-wing aircraft because of their low flights and landings in tight spots away from airports. Noting that planes other than helicopters might require sensors of different capability, the study recommends investigation of a building-block approach to instrumentation. This would provide a basic obstacle sensor for aircraft of limited performance, with supplemental components for the basic system in craft of higher performance.

### American Paper Wins British IRE Award

Two American scientists have made the "outstanding contribution on an engineering subject" published in the British IRE Journal during 1958.

For their paper, "New Developments in Silicon Photo-Voltaic Devices," Dr. Morton Prince and Martin Wolf will receive the Marconi Premium.

Dr. Prince is vice-president of research in the semiconductor division of Hoffman Electronics, and Mr. Wolf is the company's design head for solar cell products.

Circle 19 on Reader-Service Card ➤



Ceramic Wafers for Micro-Modules



Miniature Tube Envelopes

### Tube Envelopes

Coors makes high strength ceramic envelopes to extremely close dimensional tolerances and in a wide range of sizes for use in modern electron tubes. Certain of the Coors ceramic compositions were developed specifically to meet the rigorous operating conditions and reliability requirements to which high power, high frequency tubes are subjected.

Illustrated here is one of the miniature ceramic envelopes in regular production. Coors regularly produces many other sizes up to 10" O.D. Larger sizes can be manufactured.

Coors ceramics have outstanding electrical and physical characteristics. These properties are not affected by high outgassing or high operating temperatures.

**LOWER COSTS for Precision Ceramic Parts Through Quantity Production**—Coors has been able to make substantial reductions in manufacturing costs by stepping up production of high precision parts through automation.

All this adds up to these advantages for you: 1. Faster delivery on large quantity orders. 2. Precision parts—uniform and interchangeable, permitting you to use them on a production basis. 3. Prices that are correspondingly low.

For further information about Coors Space Age Ceramics and for a complete description of physical properties, write for Bulletin 858.

### Micro-Module Wafers

The hottest news in extreme miniaturization of electronic equipment is the micro-module—an amazingly small combination of sub-miniature electronic circuit components. The fundamental unit of a micro-module is the high alumina ceramic base plate—a tiny ceramic wafer, approximately 0.300" square x 0.010" thick. Upon this is deposited or metalized a component of a circuit—a resistor, capacitor, transistor, diode, etc. The micro-module is a combination of several of these elements in a small space to serve a specific circuit function—amplifier, oscillator, etc.

Coors is manufacturing these precision wafers in large quantity production runs for several manufacturers working on the same project. Coors holds all dimensions of the tiny ceramic wafer to extremely close tolerances so that the micro-elements produced from them are entirely interchangeable from manufacturer to manufacturer.



Ceramic-to-Metal Standard Terminal Insulators

### Standard Terminal Insulators

Coors furnishes *standard* terminal insulators—available from stock—in various ratings and, also, can manufacture custom made insulators to meet your specific requirements. In the range of standard sizes, metal parts are bonded to the ceramic by Coors High Temperature Metalizing Techniques, thus producing strong hermetic ceramic-to-metal seals. The result is standard terminal insulators available for a wide range of requirements—insulators that have superior electrical and mechanical characteristics. Production is on a large quantity basis—you do not pay a premium for high quality, precision terminals.

*Coors*  
COORS PORCELAIN  
COMPANY

600 Ninth Street, Golden, Colorado

# WASHINGTON REPORT



Ephraim Kahn

## Still Another Review Procedure for Procurement Programs

New communications programs proposed by the Armed Services are to be reviewed more intensively before being given a green light. The new review procedure will apply to all programs slated to cost \$100,000 or more, but research, development, test and evaluation projects are exempt, as are communications programs designed to serve tactical units, an aircraft, or a ship. Exemption in these cases appears to be based on the notion that the Assistant Secretary of Defense (Supply and Logistics), who has over-all charge of the review, should not have to concern himself with things that can properly be decided by lower-level executives.

New communications reviewers are "all interested elements" in the Office of the Secretary of Defense. If more than one Service is to be involved in the program, the Office of the Joint Chiefs of Staff will also participate, doubtless though its Communications-Electronics Directorate.

Rigorous screening by the individual Services can be expected before new communications programs are passed upward for high-level approval or disapproval. The reason for this is that the Service which makes the proposal must also undertake to commit funds to bring it into being.

### Emergencies Provide a Loophole

In an emergency, the Services can still jump the gun and undertake communications programs prior to final action by the Assistant Secretary. "Emergency conditions" are not to include "budgetary deadlines, inadequate advance planning, or normal expansions," declares the Defense Department Directive (No. 4630.1) that sets up the more elaborate review procedure.

When a new proposal is turned in to the Assistant Secretary, information will have to be given concerning its relationship to the communications facilities either planned by the Department or in existence. Time required for each phase of multi-phase programs must be stated, and the estimated cost of completing the program must be given.

Review in the Office of the Secretary will



MINOXO INDICATOR



SUPER-SENSITIVE DEOXO INDICATOR

for detection and measurement of oxygen or hydrogen impurities in other gases

**MINOXO INDICATOR** . . . measures traces of molecular oxygen in other gases—from 1 to 10 parts per million, and from 1 to 100 PPM. High sensitivity and rapid speed of response enable it to be used for laboratory investigation and production quality control.

**SUPER-SENSITIVE DEOXO INDICATOR** . . . measures oxygen or hydrogen present as impurities in other gases—from 2 to 200 parts per million oxygen and 4 to 400 parts per million hydrogen. Dual range permits measurement up to .25% oxygen or .50% hydrogen. Send for literature.

CHEMICAL DIVISION • 113 ASTOR STREET  
NEWARK, N. J.

CIRCLE 732 ON READER-SERVICE CARD

CHEMICAL  
DIVISION

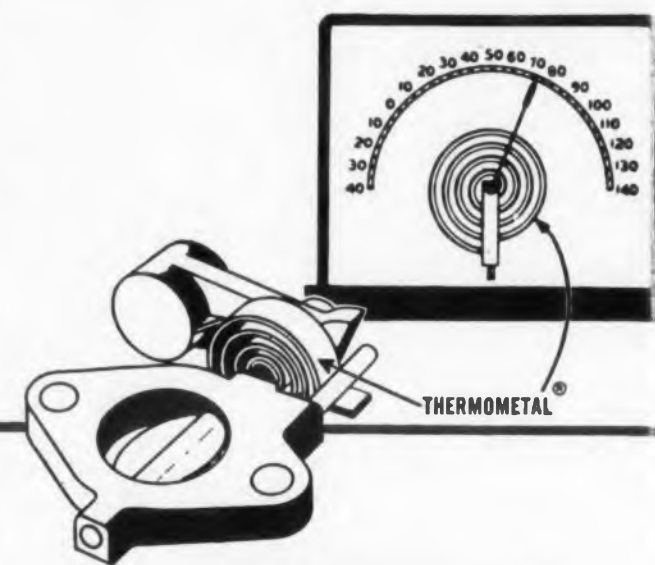

**THERMOMETAL®** for dependable temperature, electrical current and voltage control applications

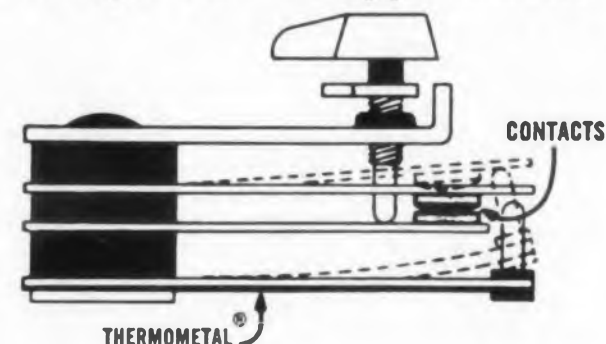

Leading manufacturers depend upon the outstanding performance of Thermometal in electrical appliances, thermal cutouts, heating controls and many other applications involving the indication and accurate control of temperatures, electrical currents, voltages, etc. Thermometal is supplied in strip form, rolled and slit to close tolerances and tempered to specification. Thermometal elements and sub-assemblies are also supplied to specifications, with or without contacts attached. Send for literature.

H. A. WILSON DIVISION • U.S. HIGHWAY 22  
UNION, N. J.

CIRCLE 733 ON READER-SERVICE CARD

H. A. WILSON  
DIVISION

WRITE FOR LITERATURE

DOMESTIC DIVISIONS: AMERICAN PLATINUM & SILVER DIVISION, AMERSIL QUARTZ DIVISION, BAKER CONTACT DIVISION, BAKER DENTAL DIVISION, BAKER SETTING DIVISION, BAKER PLATINUM DIVISION, CHEMICAL DIVISION, EAST NEWARK INDUSTRIAL CENTER, HANOVIA LAMP DIVISION, HANOVIA LIQUID GOLD DIVISION, IRVINGTON-BAKER REFINING DIVISION, D. E. MAKEPEACE DIVISION, NATIONAL ELECTRIC INSTRUMENT DIVISION, RESEARCH AND DEVELOPMENT DIVISION, H. A. WILSON DIVISION. COMPANIES ABROAD: ENGELHARD INDUSTRIES OF CANADA, LTD. TORONTO, ENGELHARD INDUSTRIES OF QUEBEC, LTD. MONTREAL, ENGELHARD INDUSTRIES, LTD. LONDON, ENGELHARD INDUSTRIES A. G. ZURICH, ENGELHARD INDUSTRIES PTY., LTD. MELBOURNE, SOCIEDAD SURAMERICANA DE METALES PRECIOSOS S. A. BOGOTA, INDUSTRIE ENGELHARD S. P. A. ROME, ENGELHARD INDUSTRIES OF SOUTHERN AFRICA, LTD. JOHANNESBURG. ASSOCIATED COMPANIES: ACME TIMBER INDUSTRIES LTD., SOUTH AFRICAN FOREST INVESTMENTS LTD., SOUTH AFRICA, AZOPLATE CORPORATION, CHARLES ENGELHARD, INC., NUCLEAR CORP. OF AMERICA, INC., U.S.A.





## fine wire for every application

Here, you will find a thoroughly dependable source for fine wire of ductile and non-ductile materials for every application. Special processes have been developed for bare drawing wire as fine as .0004". Where smaller fine wire is required, the Wollaston Process for ductile metals and the Taylor and Extrusion methods for non-ductile materials are employed. All standard fine wire requirements are stocked for prompt delivery. Full facilities are available for the production of fine wires made to your own specifications.

BAKER PLATINUM DIVISION • 113 ASTOR STREET  
NEWARK, N. J.  
CIRCLE 734 ON READER-SERVICE CARD

BAKER  
PLATINUM  
DIVISION



CIRCLE 732 THROUGH 735 ON READER-SERVICE CARD



## gold and rhodium plating for corrosion-resistant surfaces

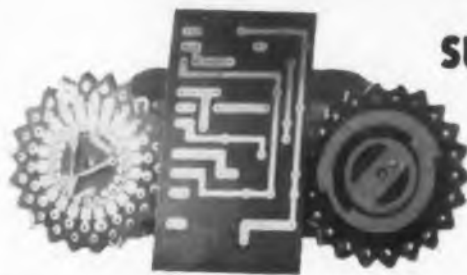

ATOMEX® is a 24k gold immersion solution that permits the deposition of a thin, dense, uniform layer of 24k gold on printed circuits and metallized plastics by means of a simple bath. The Atomex procedure is more permanent and less expensive than electroplating of comparable thickness. Costly analytical control is unnecessary.

**Rhodium**—a complete line of plating solutions are also available for high-reliability electrical and electronic applications. Rhodium is highly resistant to corrosive atmospheres, oxidation and arc erosion—reduces wear on moving surfaces—assures low noise level for moving contacts, no oxide rectification, low and stable contact resistance. Rhodium plating is indicated when a low-resistance, long-wearing, oxide-free contact is required. Send for literature.

CHEMICAL DIVISION • 113 ASTOR STREET  
CIRCLE 735 ON READER-SERVICE CARD

CHEMICAL  
DIVISION

"determine conformance with policies, feasibility, efficiency, and economy." If referral to the Joint Chiefs is necessary, they will concentrate on these points: (1) Does the proposal conform to strategic military needs? (2) Can an existing or planned Defense Department communications system do the job intended for the proposed program? (3) Should the program be revised, modified, or expanded so that it will meet needs of other organizations within the Defense Department? (4) Does the program fit in with the objectives of a joint communications network? (5) What economic and military factors must be considered in an assessment of the proposal?

### More Lead Time Coming to Permit Qualifying for Approved Lists

Makers of standard components and other items that are bought off the shelf or out of a manufacturers' stock should benefit from a change in the Armed Services Procurement Regulation that is supposed to help broaden participation by interested manufacturers in purchases from qualified product lists. Basic to this is provision for more publicity prior to issuance of invitations to bid. This is intended to enable suppliers to arrange to have their lines qualified, through tests, if they are not already listed.

### Aircraft Companies Still Getting Largest Share of Missile Money

Funds for missiles are flowing heavily into the coffers of the aircraft manufacturers, according to the Defense Department. In each of the past two fiscal years, about 50 per cent of each missile dollar has gone to an airplane company. In fiscal 1958, the Pentagon committed \$2,621.1 million for missiles; aircraft companies got \$1,234.8 million. In fiscal 1959, the proportion of funds received by aircraft makers held just about steady, but the dollar figure zoomed. The Defense Department's funding commitments for missiles came to \$3,477.7 million and aircraft firms shared \$1,788.2 million.

In the current year, a still greater increase is being made in missile funds. In fiscal 1960, missile defense, for example, will get twice as much as it did last year. Actual appropriation for procurement of missiles in fiscal 1960 is \$3.6 billion (about \$500 million less than last year). This money will be split among fewer programs, since some "which no longer appear technologically promising or which have been overtaken by events, will require less funding or no funds at all." Note, too, that missiles will get almost \$1.5 billion—or 40 per cent—of the total appropriation of \$3.8 billion for research, development, test, and evaluation.

# Need Better Electrical and Thermal Conductivity in a Glass-to-Steel Hermetic Terminal?

For most applications, solid 446 stainless alloy electrodes are best suited to our users needs. They are ideally suited to the perfect mating between our V24M glass and the pin. This fusion of glass and metal together with compression accounts for the rugged leak-proof character of Fusite Terminals under rough production handling and makes for easy solderability.



## CONSIDER THE PLUS OF COPPER CORED ELECTRODES

When your application indicates the need for greatly improved electrical or thermal conductivity, you still need not sacrifice these inherent Fusite advantages. At slight additional cost, any of our terminals can be ordered with electrodes that have a copper core of as much as 25% of the total electrode area. Copper cored wire has up to 10 times increased current carrying capacity, yet, you maintain nearly all the advantages of solid 446 stainless.

*Would you like to make tests?*

Write Department C-5

**THE FUSITE CORPORATION**

**6000 FERNVIEW AVE., CINCINNATI 13, OHIO**

Woodford Mfg. Co., Versailles, Kentucky.

In Europe: FUSITE N. V. Königsweg 16, Almele, Holland



CIRCLE 21 ON READER-SERVICE CARD

## MEETINGS

Calendar of Events

### October

- 6-9 High Temperature Symposium, Stanford Research Institute, Asilomar Conference Grounds, Calif.
- 7-9 Sixth National Symposium on Vacuum Technology, American Vacuum Society Inc., Sheraton Hotel, Philadelphia, Pa.
- 7-9 IRE Canadian Convention on Electronics and Nucleonics, Exhibition Park, Toronto, Canada.
- 12-14 Fifteenth National Electronics Conference, AIEE, Illinois Institute of Technology, IRE, Northwestern University, and University of Illinois, Hotel Sherman, Chicago, Ill.\*
- 13-14 National Technical Conference, Society of Plastics Engineers, Ambassador Hotel, Los Angeles, Calif.
- 22-23 Fifteen Annual National Conference on Industrial Hydraulics, Illinois Institute of Technology and Armour Research Foundation, Hotel Sherman, Chicago, Ill.
- 26-28 Sixth Annual East Coast Conference, IRE Professional Group on Aeronautical and Navigational Electronics, Baltimore, Md.
- 28-29 Michigan Industrial Electronics Exposition, Electronic Representatives, Inc., Detroit Artillery Armory, Oak Park, Michigan.\*
- 28-30 Annual Industry Display, Aircraft Electrical Society, Pan Pacific Auditorium, Los Angeles, Calif.
- 29-30 Fifth Annual Electron Devices, IRE Professional Group on Electron Devices, Shoreham Hotel, Washington, D. C.

\* Includes meetings described herewith.

### 5th National Communications Symposium, October 5-7

The requirements, progress, and challenge of communications will be stressed at the 1959 symposium. Sponsored by the IRE PGCS, the sessions will cover two major areas: (1) communications systems and (2) communications equipment and related techniques. Approximately 50 engineering and manufacturing concerns from the communications field will exhibit their products during the three-day meeting. The symposium will be held at the Hotel Utica, Utica, N.Y. Technical program chairman is Ralph L. Marks, Griffiss Air Force Base, Rome, N.Y.

### Value Engineering Symposium, October 6-7

The Electronic Industries Assoc. will sponsor this symposium at the University of Pennsylvania. Participating will be those industry members and military personnel acquainted with the successful use of value engineering tools. R. S. Mandelkorn of Lansdale Tube Co., a subsidiary of Philco Corp., is general chairman of the symposium.

### 4th IRE Canadian Convention, October 7-9

The Automotive Building at Exhibition Park, Toronto, Canada, will be the site of this convention. Over 100 papers covering the latest develop-

CIRCLE 22 ON READER-SERVICE CARD ▶

ELECTRONIC DESIGN • September 16, 1959



ments and techniques in electronics and nucleonics will be presented. Among the branches of the industry to be represented will be audio, components, computers, industrial electronics, transistors, and tubes. The Canadian Sections of the IRE are sponsoring the show. Eric L. Palin at Exhibition Park is general chairman.

#### 15th National Electronics Conference, October 12-14

Virgil H. Disney, president, reports that the NEC will hold its sessions at the Hotel Sherman in Chicago, Ill. Sponsored by the AIEE, Illinois Institute of Technology, IRE, Northwestern Univ., and Univ. of Illinois, the conference will include discussions on circuit theory, communications systems, microminiaturization, servo mechanisms, value engineering, and other topics.

#### Michigan Industrial Electronics Exposition, October 28-29

Electronic Representatives, Inc. will sponsor this show at the Detroit Artillery Armory, Oak Park, Mich. Exhibitors will include manufacturers of industrial electronic equipment and components as well as Michigan electronics representatives. Technical papers will be presented at sessions scheduled to run concurrently with the exhibitions. Show manager is R. G. Wood, 830 W. Vernor, Detroit 1, Mich.

#### 6th Annual East Coast IRE Aero-Electronics Conference, October 26-28

The classified sessions of the IRE PGANE conference, sponsored by the Air Research and Development Command, will cover: "Correlation Techniques of Data Processing," "Advanced Radar Techniques," and "Phased-Array Radars." Correspondence concerning clearance may be addressed to T. M. O'Connor, Security Coordinator, IRE ECCANE, Bendix Radio, Baltimore 4, Md. Unclassified sessions will be held concurrent with the classified presentations. The location of all sessions will be the Lord Baltimore Hotel, Baltimore, Md. Dr. R. C. Spencer of the Glenn L. Martin Co., Baltimore 3, Md. is Papers Chairman.

#### 5th Electron Devices Meeting, October 29-30

To be held at the Shoreham Hotel, Washington, D.C. The conference, sponsored by the IRE PGED, will present papers dealing with material of an applied or developmental nature in the field of electron devices. This should include electron tubes, semiconductor devices, masers, parametric amplifiers, and other solid state device configurations. John A. Hornbeck of Bell Telephone Labs, Murray Hill, N.J., is technical program chairman for the meeting.

◀ CIRCLE 22 ON READER-SERVICE CARD

ELECTRONIC DESIGN • September 16, 1959



Hammer drop typifies tough environmental testing that assures dependability of Sperry TWT amplifiers.

Tubes are built for rugged service — at SPERRY

## New high-power S-Band Traveling Wave Amplifier

2.0-4.0 kmc with 300 watts nominal output power

STS-101



### SPECIFICATIONS

Frequency Range.....	2.0-4.0 kmc
Small-Signal Gain.....	40 db
Output Power.....	300w (nom)
Saturated Gain.....	35 db
Beam Voltage.....	5.2-5.6 kv
Beam Current.....	380 ma
Heater Voltage.....	6.3 v
Heater Current.....	2.6 a
Helix Current (full).....	8 ma

Small-Signal Gain vs Frequency

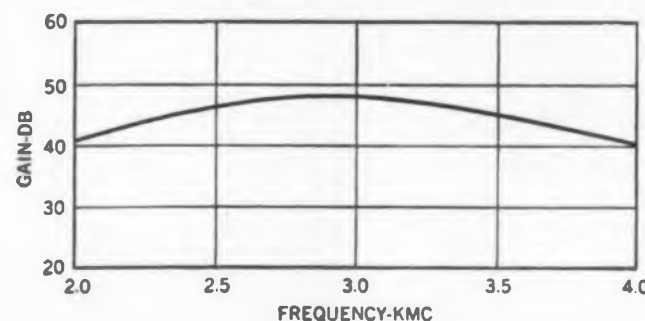

Saturated Power vs Frequency

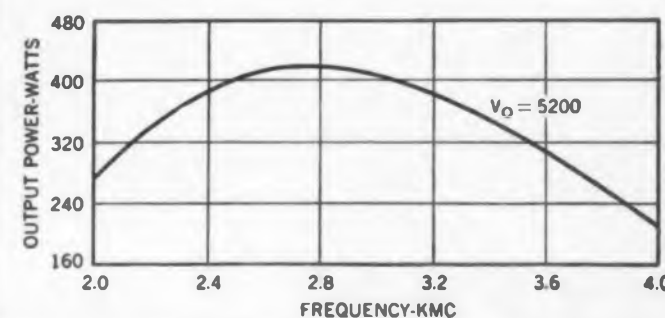

This new broadband, high gain cw traveling wave amplifier is the only tube in S-band — delivering 300 watts nominal — for service in microwave systems, high performance tracking radars, high frequency communications networks and other applications where high power and high gain in the 2.0 to 4.0 kmc

frequency range are desirable. This tube features rugged, all metal-ceramic construction for high performance aircraft environments and is short-circuit stable.

The STS-101 may well be suited to projects or problems you are working with now. Write for data regarding your application.

# SPERRY

**ELECTRONIC TUBE DIVISION, SPERRY GYROSCOPE COMPANY, GREAT NECK, NEW YORK, DIVISION OF SPERRY RAND CORPORATION**  
Address all inquiries to Great Neck or Sperry offices in Brooklyn, Boston, Philadelphia, Los Angeles and Montreal. Export Dept., Great Neck, New York

CIRCLE 23 ON READER-SERVICE CARD

# CRIMP

at bench...or at equipment



Precision hand, pneumatic, or automatic tooling guarantees uniform and complete crimp for each connection—a measurable quality control—at a high speed production rate.

# SNAP-LOCK

... in or out

Pins and sockets are easily and quickly snap-locked into plugs and receptacles. They may be removed with a simple extraction tool for circuit changes or checks.

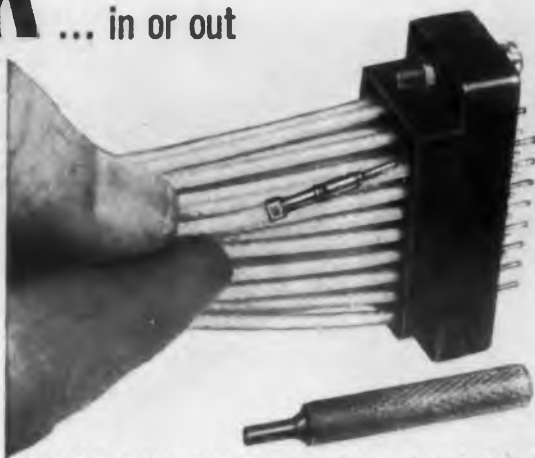

# CONNECT

... only 3 points of contact

The HYFEN method provides the minimum number of contacts—3—thereby reducing reliability problems. Exceeds the requirements of MIL-C-5015C and MIL-C-8384A.

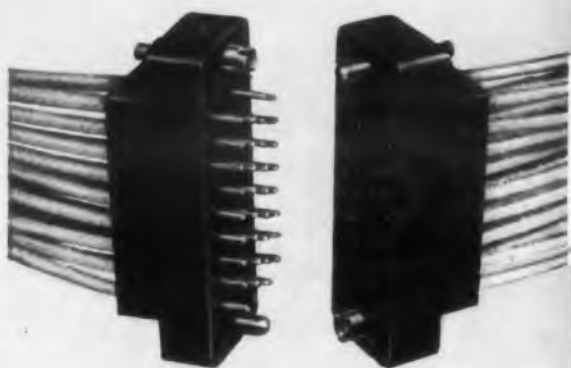
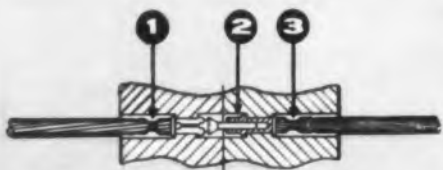

# HYFEN<sup>®</sup> connectors

with crimp-type snap-locked contacts

BURNDY's HYFEN method, already widely accepted in the industry, speeds the wiring of electronic harnesses and systems, and achieves greater dependability and versatility than has heretofore been possible. Crimp-type connections eliminate time-consuming solder operations and the disadvantages in the use of solder.

For complete information, write: OMATON DIVISION

# BURNDY

Norwalk, Connect.

In Europe: Antwerp, Belgium

Toronto, Canada

CIRCLE 24 ON READER-SERVICE CARD

## ACCEPTED! Hyfen Variations



ME rack and panel HYFEN connector, 8 or 26 place configuration. One-piece shell and one-piece block. Also available for coaxial or shielded cable.



Feed thru, modular design, multiple insert connector. 35 contact inserts can be removed from frame for easy contact insertion or removal. 5 or 8 insert frames available.



Printed circuit connector in either 31 or 45 plane configuration. Accommodates single wire or combinations of wire sizes.

HYFEN types illustrated are typical of those already supplied to the industry by BURNDY. HYFEN connectors are engineered to meet specific requirements. For other types or sizes, contact BURNDY.

Advertisement

## NEW PRODUCT

### Burndy YD Tool Modified For Faster Operation



As a result of wide customer acceptance of BURNDY Omaton Division's YD-2, a new version of this semi-automatic, portable, pneumatic crimping tool has been developed. The new edition, the YD-2-3 is a bench-mounted, foot-operated tool with a magazine holding almost eight times (533 contacts) as many contacts as the original version (70 contacts).

The YD was originally designed as a magazine-fed, hand-operated tool for work in and near electronic cabinets. The new version will produce a higher rate of contact installation, making it especially useful in harness wiring.

The bench-mounted, foot-activated, increased-magazine-capacity features will allow the contact installation rate of the YD-2 to be greatly increased. The YD-2-3 retains the features of automatic pre-positioning, feeding, and crimping of BURNDY's HYFEN<sup>®</sup>, STAPIN<sup>®</sup>, and CRAB-LOK<sup>®</sup>-MODULOK<sup>®</sup> lines of contacts. It also features color coded die sets matched with the color of contact-carrying strips. The plastic carry strips are automatically ejected from the tool after the contacts have been used.

BURNDY CORPORATION,  
Norwalk, Connect.

CIRCLE 25 ON READER-SERVICE CARD



# EDITORIAL

## The Difference That May Not Be Worthwhile

We live in an age of superlatives. Every new thing, it seems, including the latest electronic device, is the world's smallest fastest, most accurate, and most reliable. It is hardly enough to get there first with the mostest; today only the mostest mostest is accepted.

If anyone can see through such smokescreens and get to the substantial, it should be the engineer. By nature and training, he is a discriminating person. It is alarming, therefore, to see engineers caught in a race to design something just to claim a world's record.

We need top performance, yes, but the cost of winning by a nose may be wrecking our orderly processes for achieving progress. An example is provided by Mr. Harper O. North, president of Pacific Semiconductors, Inc. In telling why it might be difficult to standardize diodes (see p. 92 of this issue), Mr. North notes:

"Circuit designers these days are called upon to produce circuits which will out-perform their predecessors, and they call upon diode manufacturers for faster recovery time, increased power handling capacity, higher maximum temperature ratings and the like. Small improvements are gratefully received, and a new number is frequently generated as a result of improvement in any one of the areas specified."

Mr. North may or may not agree, but this editor thinks "small improvements" should not, as a rule, "be gratefully received."

We need significant or substantial improvements—preferably gains by an order of magnitude. A new circuit should show a quantum-like jump in performance, not an improvement discernible only with finely calibrated instruments.

Although engineers are not to blame for competing in design races that require photo finishes (they only follow orders), they should question their validity. The likely benefits of running the race at all should be questioned. Sponsors of such contests (mainly the military—most commercial product managers know what engineering isn't profitable) should be apprised in advance of the probable significance of the improvement, especially if the odds are against large gains being made. If special components and hairline adjustments are needed to produce the difference, the benefits are certainly suspect.

Engineers should constantly ask whether the difference is worthwhile.

*James G. Kuyper*

## LABORATORY ACCURACY...



AND IT'S  
*Portable*

MODEL

250-DA

## *Universal* Impedance BRIDGE

- **RESISTANCE:** 0 to 12 megohms in 8 ranges. Accuracy:  $\pm(0.1\%$  plus 1 dial division.)
- **CAPACITANCE:** 0 to 1,200 microfarads in 7 ranges. Accuracy:  $\pm(0.2\%$  plus 1 dial division.)
- **INDUCTANCE:** 0 to 1,200 henrys in 7 ranges. Accuracy:  $\pm(0.3\%$  plus 1 dial division.)
- Resolution of one part in 12,000 on each range.
- Stability over wide ranges of temperature and humidity provided by low temperature coefficient resistors and highest quality polystyrene and ceramic insulation.
- Operational convenience with unique ESI Dekadial® range and multiplier settings and simple switching.
- **PRICE: \$565.00.**

ask for our detailed  
catalog sheet  
C-16

esi

**ELECTRO-MEASUREMENTS, INC.**

7524 S. W. MACADAM

• PORTLAND 19, OREGON

# Oscilloscope Trace Recording With Polaroid Land Photography

This is the first of a three-part series on oscilloscope trace recording. This series should answer almost any question on scope trace photography.

**Kemon P. Taschioglou**  
Polaroid Corp.  
Cambridge, Mass.

**Hy P. Mansberg**  
Airborne Instruments Lab.  
Mineola, L.I., N.Y.



Kemon Taschioglou just could not help writing this article. An MIT electrical engineer studying technical and industrial applications of Land photography, he was overwhelmed with inquiries about photographing crosstraces. He got together with Hy Mansberg more than a year ago to make a complete study of the field. He's been practically living with cameras and with oscilloscopes ever since.



Hy Mansberg, during his 13 years at Allen B. DuMont Labs., combined his interests in optics, photography, and electronics. His work with CRT phosphors, film emulsions, camera lenses, and processing techniques helped him write many articles on scope trace photography. At AIL, his present work in medical electronics allows him to use many of the techniques which he contributed to the art of photo recording.

Table 1. Land Films and Their Characteristics for Oscilloscope Trace Photography.

Film Type*	Picture Size (Inches)	Base Stock	Description†	Trace Recording Applications	Remarks
42	3-1/4 x 4-1/4	Paper print	Wide range ASA 200.	Stationary traces.	Most economical, but recommended only for steady state traces.
46	2-1/4 x 2-1/4	Positive transparency	Wide range ASA 600.	Slides for projection, recording fine detail in complex waveforms. Simultaneous recording of slow and fast moving trace portions.	Originals for diazotype reproduction. Can be enlarged easily by conventional photography. Camera mirror inversion easily corrected by turning transparency over.
46-L	3-1/4 x 4 (lantern slides)				
47	3-1/4 x 4-1/4	Paper print	ASA 3000	High speed transients and stationary traces.	Fastest photographic material for crosstrace recording.

\*Type 44, with the same size as Type 42 and with ASA 400, is no longer manufactured. Type 32, which formerly had the same characteristics as Type 42, except for its 2-3/4 x 3-1/2 in. size, now has an ASA rating of 400. Few cameras are in use for this film size.

†All types: Medium contrast, panchromatic, eight exposures per roll. ASA rating is equivalent daylight exposure index.



## Part 1. Films and Cameras

**T**HE POLAROID® LAND photographic process is the most commonly used for oscilloscope trace recording for three important reasons: First, the finished picture comes right out of the back of the camera—no darkroom or processing facilities are needed. Second, the results are available in one minute. Third, it is easy to learn how to take the pictures.

At one time, the most common use of the Land Photographic process was in recording low frequency steady-state patterns as an aid to circuit development. Today, cameras and film are available for capturing millimicrosecond transients.

### Films

Table 1 lists all available Land films and their characteristics which are important for trace recording. There are two base materials used: (1) paper, which produces opaque positive pictures, and (2) transparent film, which produces slides for projection.

The paper prints are developed in the Land camera back in 60 seconds. After development for permanent protection, they require a plastic coating with a print coater enclosed in each package.

Transparencies require two minutes' development time in the back of the camera and require a 20-second bath in a hardening solution contained in a "Dippit," which is sold with the film. The transparencies are placed in plastic mounts for projection.

Positive prints are the most suitable materials for publication, although some journals will accept transparencies. For slides at lectures or seminars, the transparency film is ideal. However, for general work, positive prints have shorter development time, are easier to handle, and are more economical.

### Sensitivity vs. Writing Rate

Notice in Table 1 that all the films are panchromatic, so they can be used with all phosphors emitting light in the visible light range. The ASA exposure index is only an approximate indication of the relative sensitivity of each film for cro trace recording. "Maximum writing rate" is a more useful concept. It describes a film's ability to



## ...and now, **COAXICON fits a wider range of cable sizes**

COAXICON offers not only the fastest method of attaching disconnects to your shielded wire... it is not only the most reliable disconnect you can buy—for either free hanging or panel mounted applications... not only the most economical on the market... but... COAXICON now fits shielded cable sizes up to 1/4" O.D. with interchangeable contacts that permit a wide variation of inner conductor diameters in each cable size.

Further, COAXICON mounting clips accommodate a wide range of panel thicknesses for through-panel applications. Whether your requirements include RG type coaxial cable, standard coaxial cable or other shielded cable types, with solid or stranded conductors, look to AMP for the precise Coaxicon Disconnect you need.

If you're not now using the A-MP Coaxicon, send for literature today. It can solve many shielded circuit problems for you.

**AMP INCORPORATED**  
GENERAL OFFICES: HARRISBURG, PENNSYLVANIA  
A-MP products and engineering assistance are available through subsidiary companies in: Australia • Canada • England • France • Holland • Japan  
CIRCLE 27 ON READER-SERVICE CARD

\*Polaroid is a registered trademark of the Polaroid Corporation.



record the fastest possible transients, and is discussed in more detail in Part 2 of this article.

Type 42 is the most economical of all the Land films and it has the lowest maximum writing rate. It is largely used for recording stationary traces. With its high resolution, it can produce sharp records of complex waveforms or intensity modulated traces.

Type 47, ASA exposure index 3000, is the most versatile of all Land films in trace recording because its extra high speed permits shorter exposures, lower intensity cro settings, and smaller lens apertures. The results are sharper pictures containing more information.

### Oscilloscope Record Cameras

Seven major manufacturers produce specialized cameras using Land camera backs for cro work. Table 2 lists these manufacturers, the model numbers, and general features of the various cameras. Each manufacturer distributes cameras through his own distribution channels.

The cameras mount directly onto the standard five inch cro. They are designed to solve the problems of low light level and close-up photography. They provide accurate centering, maintain focus, and control stray light.

### Camera Backs and Viewing Systems

Basic considerations in choosing oscilloscope record cameras are the positions of the camera back and the viewing system. Three systems are commonly used.

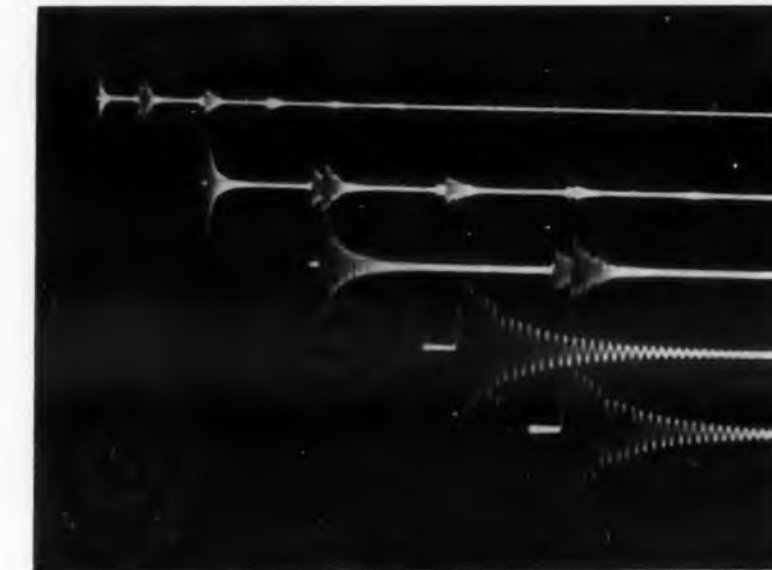

**Fig. 1.** (above) Multiple traces recorded on a single frame. Camera back is mounted with film's long dimension parallel to the horizontal axis of the display. Camera: Hewlett-Packard Model 196A.

1. Film plane parallel to the tube face with viewing at slight angle to the tube face. The major advantage of this system is that the picture is correctly oriented with no image reversal. On the other hand, viewing at an angle causes visual parallax and slight difficulty in seeing the edges of the crt screen. This system is found on DuMont's Model 353 and the cameras of Hewlett-Packard, Fairchild Camera and Instrument, Electronic Tube, Telechrome, and the Beattie-Coleman 12365.

2. Film plane perpendicular to the tube face with a beam splitter mirror permitting direct head-on view. This system is found on DuMont's Model 302 and Beattie-Coleman's Model 12445. Both cameras have comfortable binocular viewing. The mirror, however, reverses the image on the film.

3. Film plane parallel to the tube face with a swinging assembly so the camera back can be swung away from the crt face. The Edgerton, Germeshausen, and Grier cro-camera system using this technique employs a traveling wave crt. It is designed to display transients and repetitive phenomena in the millimicrosecond region. The trace is displayed on a 0.4 x 0.6 in. area and is viewed through a built-in 5X viewing lens when the camera back is swung out of the way.

The other camera using this system, Beattie-Coleman's Model 12365, has binocular angle viewing with the camera back swung into place, and direct head-on viewing when the camera and lens are swung away from the crt.

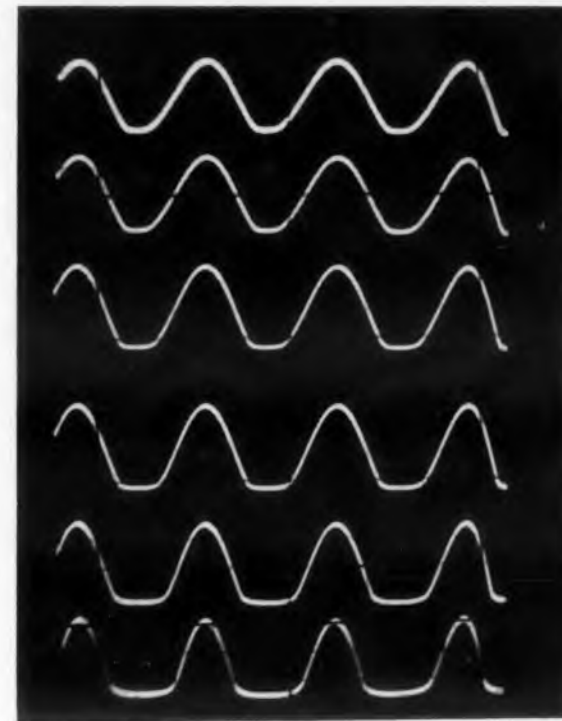

**Fig. 2.** (above) Multiple traces on a single frame. Camera back mounted with film's short dimension parallel to horizontal axis of the display. Camera: DuMont Model 302.

Camera backs are mounted with the long film dimension parallel, either to the horizontal axis of the crt, or to the vertical axis. The former mounting permits recording full width images, as with the picture in Fig. 1, made on Hewlett-Packard's Model 196-A. The latter mounting is combined with optical reduction, producing a format as shown in Fig. 2, which was made on DuMont's Model 302.

The beam splitter mirror found on some cameras separates the highly actinic blue from the yellow portions of light energy emitted by the crt. Only a negligible amount of actinic light is lost by sending some energy through the beam splitter to the observer.

### Image Reduction and Moving Backs

Some cameras have optical systems which reduce the image size on the film. Image reduction has two primary advantages: First, film usage is more economical, for more images can be recorded per frame. And second, there is a gain in the trace image illumination reaching the film for a given exposure and a favorable lowering of the effective writing speed on the film.

On the other hand, those cameras with no reduction (1:1 reduction ratio) make calibration on the picture much easier.

To take full advantage of the picture area available on each frame, Beattie-Coleman, DuMont, Fairchild, and Hewlett-Packard have designed cameras which permit multiple exposures. The first three manufacturers provide movable cam-



era backs. The Hewlett-Packard camera provides the same effect with a movable lens mount, recording multiple exposures as shown in Fig. 1.

#### Mounting and Focusing

All the cameras listed either mount securely to a flange provided on standard five-inch scopes or to a standard bezel which can be easily attached to the scope panel. Although the cro cameras are basically fixed focus types, adjustments are provided for positioning parts of the camera to compensate for variation in the exact position of the crt face. Such requirements arise from different crt face configurations, different crt positions in the cro, and the position of filters and gratitudes.

Precise focusing is important for recording detail in a complex trace or for recording highest possible writing speeds.

A sheet of ground glass in the back of an empty camera provides means for focusing. However, judgment must be used. The trace itself, lacking sharpness, is difficult to focus on, and the graticule scale is not precisely in the same plane as the trace. Hence, the engineer must decide whether to focus on the trace or the graticule, or he must compromise.

For focusing on the trace, a convenient trick calls for scribing fine pencil lines on the ground glass, then illuminating the ground glass from behind with a lamp or sunlight. This projects the image of the scribed line right onto the crt phosphor and provides an excellent image on which to focus.

#### Camera Settings

Settings for aperture and shutter speed are performed at the lens of the cameras, usually through trap doors, which must be closed during exposure. The camera of Electronic Tube Corp. is an exception. It provides a system for making settings outside of the camera. Some cameras require removal of the entire camera from the cro to make changes.

In this way, the camera lens is used in reverse; it projects the film plane onto the crt screen. Of course, any filter in front of the crt must first be removed.

#### Lenses

All the cameras, except for the specialized Edgerton, Germeshausen, and Grier camera, employ a lens-shutter combination with 75 mm Wollensak lenses. The low light levels of high speed transients usually require wide open apertures of  $f/1.9$  and  $f/2.8$ . The Hewlett-Packard camera uses a Wollensak lens with additional field correction and edge resolution. ■ ■

(See following page for tabulation of cameras.)

## No. 17 • Mars Outstanding Design Series

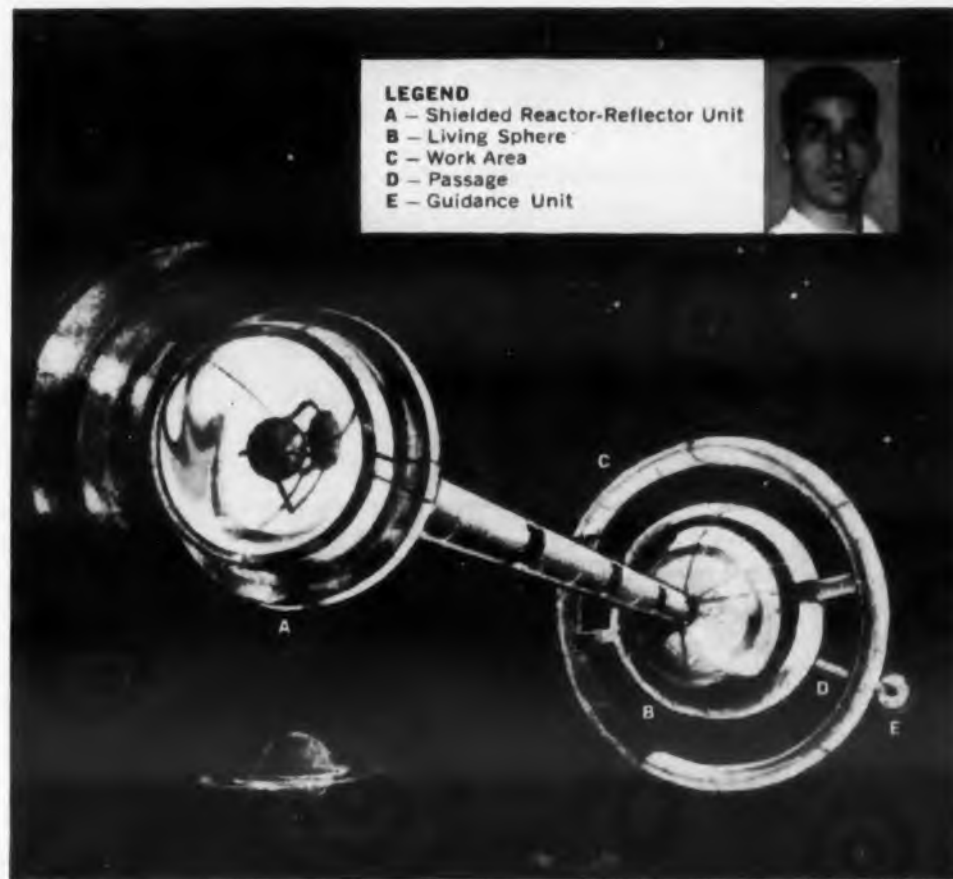

**LIGHT TRAVEL** — You may need to postpone your trip a half century or more but you will make up for lost time. So says Philip Schlesinger, of Buffalo, N. Y., who designed this light-powered space ship which will take you to distant space at almost the speed of light.

Based on Einstein's theory that matter can be converted into light, this Photon Powered ship derives its basic power from a small atomic reactor. The reactor is housed in a unit which also contains reflectors. Comparable to fluorescent screens, these convert the reactor heat, under great pressure, into light and thrust. The thrust is low, but extremely constant.

Launched disassembled inside a cargo rocket, the ship is assembled in space. It cannot land (a landing vehicle is provided for that purpose), but remains in orbit.

This is one more example of the creative contributions today's designers are making. To help them translate their pace-setting ideas from concept to reality, they require the best of drafting tools.

*In pencils that means MARS, long the standard of professionals.*

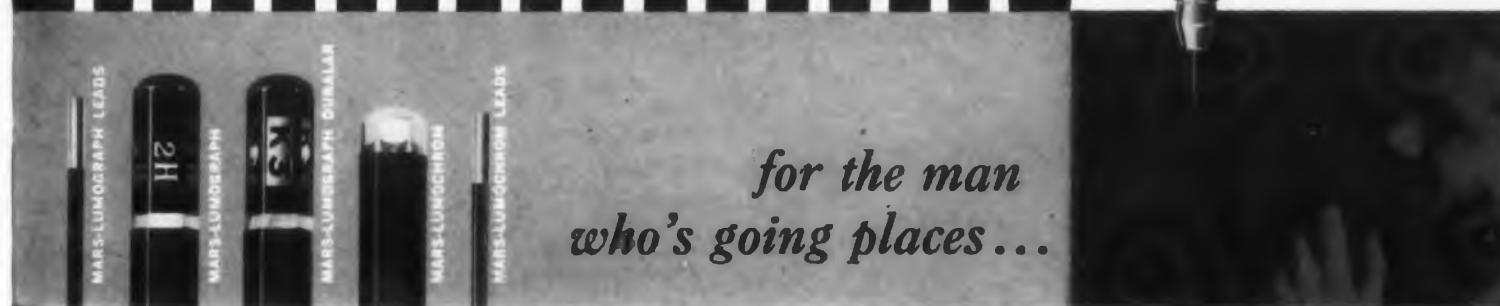

*for the man  
who's going places...*

*the pencil that's as good as it looks*

# MARS

Sold at all good engineering and drawing material suppliers • J. S. STAEDTLER, INC. • Hackensack, N. J.

CIRCLE 28 ON READER-SERVICE CARD



Among the famous imported Mars drafting products are: Left — 1001 Mars-Technico push-button lead holder. Above — 1904 Mars-Lumograph drawing leads, 18 degrees, EXB to 9H. Below — 2886 Mars-Lumograph drawing pencils, 19 degrees, EXEXB to 9H; 2830 Mars-Lumograph Duralar—for drafting on Mylar®-base tracing film — 5 special degrees, K1 to K5; Mars-Lumochrom colored drawing pencils, 24 shades. Not shown — Mars Pocket-Technico for field use; Mars pencil and lead sharpeners; Mars Non-Print pencils and leads.

Mars Products are available at better engineering and drafting material suppliers.

© T.M. FOR DUPONT'S POLYESTER FILM



Beattie-Coleman Model 12445



Beattie-Coleman Model 12365



DuMont Model 302



DuMont Model 353



E. G. & G. Model 710

Table 2. Oscilloscope Rec

Manufacturer	Model	Lens	Shutter	Camera Back Position	Orientation of Film's Long Dimension
Beattie-Coleman, Inc. 1000 North Olive St. Anaheim, Calif.	12445	Wollensak Raptar 75 mm, f/1.9	Alphax #3, 1 sec. to 1/100 sec., Time and Bulb.	Above line of view, perpendicular to crt	Parallel to crt horizontal axis
	12365	Wollensak Raptar 75 mm, f/1.9	Alphax #3, 1 sec. to 1/100 sec., Time and Bulb.	Parallel to crt, with swing-away assem- bly.	Parallel to crt horizontal axis
Allen B. Du Mont Laboratories, Inc. 760 Bloomfield Ave. Clifton, N.J.	302 (f/2.8)	Wollensak Raptar 75 mm, f/2.8	Alphax #2, 1/25 to 1/100 sec. and Bulb	Above line of view, perpendicular to crt	Parallel to crt vertical axis
	302 (f/2.8)	Wollensak Raptar 75 mm, f/1.9	Alphax #3, 1 sec. to 1/100 sec., Time and Bulb.		
	353 (f/2.8)	Wollensak Raptar 75 mm, f/2.8	Alphax #2, 1/25 to 1/100 sec. and Bulb.	Parallel to crt	Camera can be rotated 90 deg. for recording on both axes.
	353 (f/1.9)	Wollensak Raptar 75 mm, f/1.9	Alphax #3, 1 sec. to 1/100 sec., time and Bulb.		
Edgerton, Germeshausen & Grier, Inc. 160 Brookline Ave. Boston 15, Mass.	710 with Type CA-3 Polaroid Adaptor	Effective f/0.7	Manual movement of dark slide	Parallel to crt, with swing-away assem- bly	Parallel to crt vertical axis
Electronic Tube Corp. 1200 E. Mermaid Lane Philadelphia, Pa.	SM-200	Wollensak Raptar 75 mm, f/1.9	Alphax #3, 1 sec. to 1/100 sec., Time and Bulb.	Parallel to crt	Parallel to crt vertical axis
Fairchild Camera and Instrument Corp. 5 Aerial Way Syosset, L.I., N.Y.	F-296	Wollensak Raptar 75 mm, f/1.9	Alphax #3, 1 sec. to 1/100 sec., Time and Bulb.	Parallel to crt	Parallel to crt vertical axis
	F-286				
Hewlett-Packard Co. 275 Page Mill Road Palo Alto, Calif.	196-A	Wollensak Oscillo- Raptar 75 mm, f/1.9	Alphax #3, 1 sec. to 1/100 sec., Time and Bulb.	Parallel to crt	Parallel to crt horizontal axis
Telechrome Manufacturing Corp. 28 Ranick Drive Amityville, N.Y.	1521-A	Wollensak Oscillo- Anastigmat 75 mm, f/1.9	Alphax #3, 1 sec. to 1/100 sec., Time and Bulb.	Parallel to crt	Parallel to crt vertical axis



Cameras with Land Camera Backs.

Method of Viewing	Image Orientation	Reduction Ratio	Multiple Exposures Possible	Other Features
Binocular, dichroic mirror	Inverted	1:1	Sliding back with either 3 or 10 equally spaced exposures	Mounts on K-5 Periscope Assembly which takes other cameras as well.
Binocular, direct view	Normal	1:1	Sliding back with either 3 or 10 equally spaced exposures	
Binocular, dichroic mirror	Inverted	2.25:1	Sliding back with 3 position detent and scale markings for 9 exposures	Data card recording possible. Two full screen images can be recorded per frame.
Binocular, direct view peep hole	Normal	1:1	Sliding back with 3 position detent and scale markings for 9 exposures	Interchangeable camera back.
Separate Monocular viewer must be swung out of position. Enlarging viewing lens provided.	Normal	1:1	None	Designed for use with E.G.&G.'s traveling wave oscilloscope for recording extremely short pulses in the millimicrosecond range.
Binocular, direct view peep hole	Normal	1:1	None	
Binocular, direct view peep hole	Normal	1:1	None	
		2:1	Back can be positioned in two places.	
Binocular, direct view	Normal	1:0.9	Lens movable to provide 11 full width exposures	Camera back rigid. Two 6 cm x 10 cm grid scales can be recorded on one frame.
Binocular, direct view peep hole	Normal	1:1	None	



E. T. C. Model SM-200

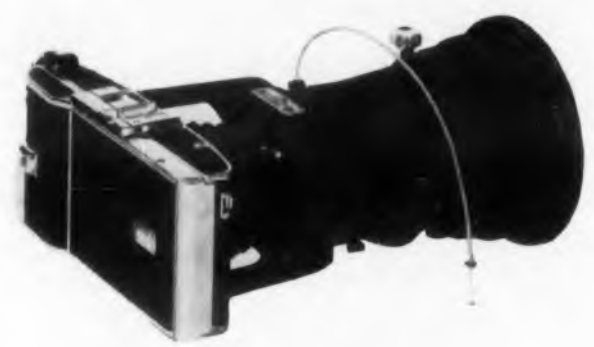

Fairchild Model F-296



Fairchild Model F-286

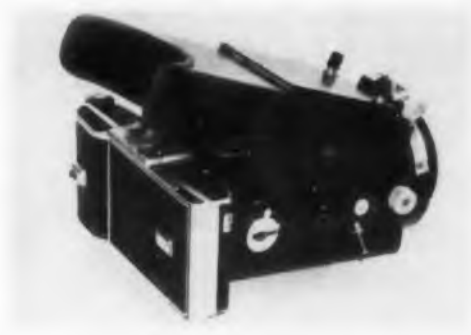

Hewlett-Packard Model 196-A



Telechrome Model 1521-A

# Transistorized Phantastron Circuit

Compact size and low weight can be achieved with a transistorized version of the phantastron circuit.

IN ADDITION to the obvious savings in size and weight, transistorized phantastron circuits offer better cycle to cycle time stability than conventional tube circuits. Less than one msec time jitter can be achieved, over a half-hour period, for a 200  $\mu$ sec gate an improvement in stability over the vacuum tube equivalent.

## Circuit Operation

When a negative pulse is applied to the trigger input, terminal A, (Fig. 1), the voltage at terminal C becomes a linear, positive-going waveform and the output at terminal B a negative gate. The durations of the positive going waveform and the gate are the same and are a function of the voltage  $V_1$ . The relationship between the gate length

and voltage  $V_1$  is fairly linear for the circuit in Fig. 1. Improved linearity is achieved by using the Darlington connection, illustrated in Fig. 2. Graphs of these characteristics are illustrated in Figs. 4 and 5.

During the time just preceding the trigger pulse, for the circuit in Fig. 1, there is zero current flowing through  $R_2$ , except for the  $I_{co}$  current of  $T_1$ . The positive bias (+3 v) is necessary to prevent the  $IR$  drop, caused by the  $I_{co}$  of  $T_1$  flowing through  $R_6$  and  $R_3$ , from exceeding the cut off level and turning on  $T_1$ . There exists a base current in  $T_2$  which is approximately equal to  $E_b/R_t$ ; however, the collector current of  $T_2$  is zero except for the reverse emitter current of  $T_1$ . During this time interval, just preceding the trigger pulse, the voltage at terminal B will be close to ground



Mr. Cope received his B.S.E.E. degree from Drexel Institute of Technology in 1954. Following graduation, he joined Bendix Radio and worked on radar receiver design. He is currently engaged in development work on airborne communication and navigation equipment.

potential since  $T_3$  is collector saturated. The voltage at terminal C will be  $V_1$  minus the  $I_{co}R_2$  drop of  $T_1$ .

Upon the application of a negative trigger to A,  $T_1$  begins to conduct; however, the conduction level is governed by the feedback to the base of  $T_2$  through  $C_1$ . The feedback is typical Miller feedback which is set to produce a linear increase in current through  $R_2$ , similar to that of the vacuum tube circuit. The waveform of terminal C is differentiated by  $C_2$  and  $R_4$  to produce a positive-gate voltage which turns off  $T_3$ .  $T_3$  being gated off produces a negative voltage at terminal B. This negative voltage, in addition to furnishing an output gate, is used to maintain  $T_1$  in the "turned on" state after the triggering voltage is removed.

When the combination of  $T_1$  and  $T_2$  both reach collector saturation, which is approximately

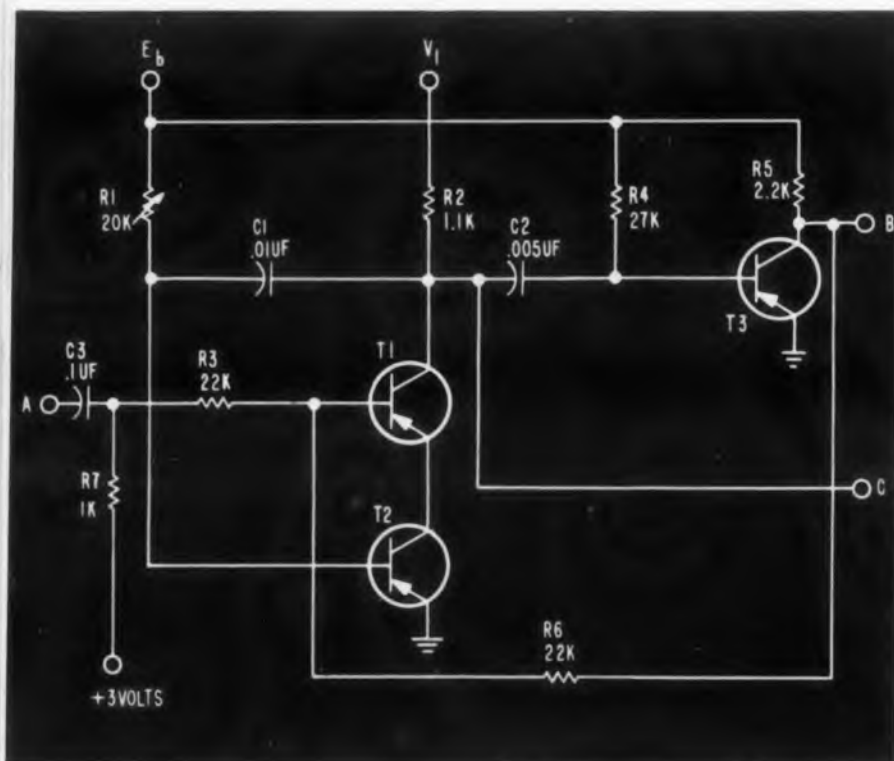

Fig. 1. Basic transistorized phantastron circuit.

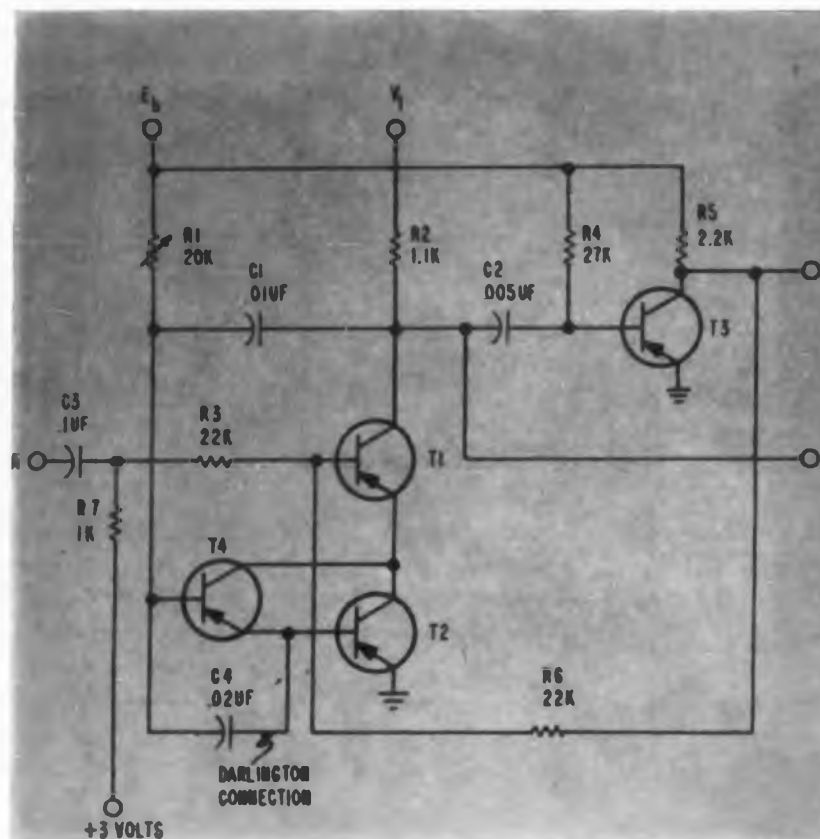

Fig. 2. "Darlington connection" circuit modification.



Fig. 3. Phantastron circuit for linear sweep at "C" with gate voltage applied to "A".



ground potential,  $T_{ii}$  turns back on; this removes the negative gate at terminal  $B$  and returns the circuit to its original state.

#### Test Results

The circuit illustrated in Fig. 2 was tested for variations of  $V_1$  vs gate length. The data is illustrated in Fig. 4. The sweep voltage produced of terminal  $C$  was estimated to have a linearity of approximately 1 per cent.

Fig. 5 illustrates the effect of variations in  $E_b$  on gate length with  $V_1$  and  $E_b$  tied together.

The simplified circuit illustrated in Fig. 3 provides a linear sweep in the case where a gate voltage is available; the length of the sweep is controlled by the gate length. ■ ■

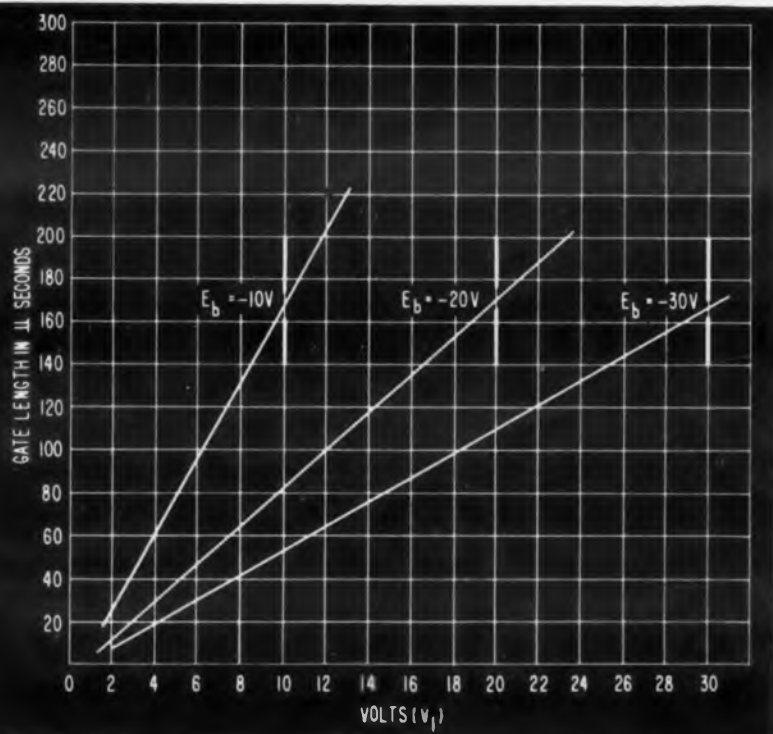

Fig. 4. Gate length vs. supply voltage  $V_1$  for circuit of Fig. 2.

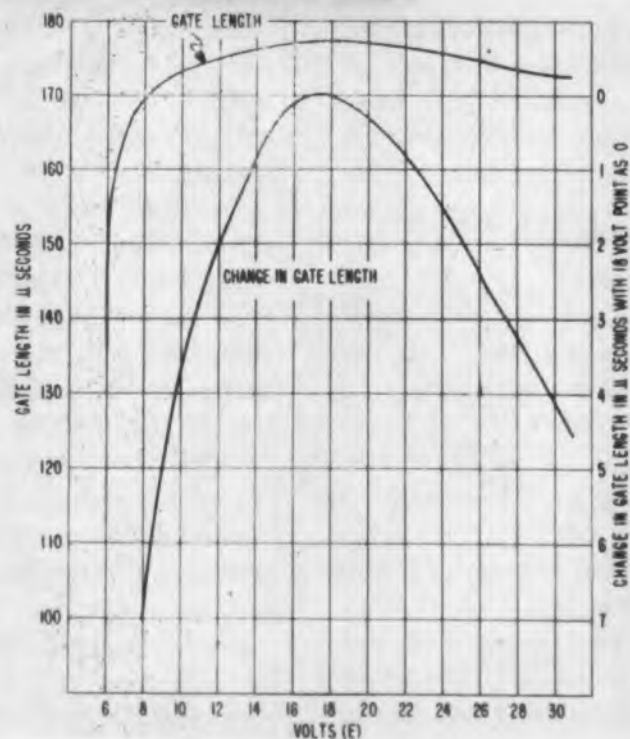

Fig. 5. Gate length and change of gate length vs. supply voltage for circuit shown in Fig. 3.

# To know all about COAXIAL SWITCHES

## TRANSKO

Transco makes more varieties of broad band Coaxial Switches than any other company. Here are some examples of our complete product line:

#### Y TYPE Solenoid Actuated SPST, SPDT



#### A TYPE

Solenoid Actuated  
SP3T,  
SP4T



#### AX TYPE

Solenoid Actuated  
Transfer



#### M TYPE

Manual  
SPDT to SP6T,  
DPDT &  
Transfer



#### E TYPE Motor Actuated SPDT to SP6T, DPDT & Transfer



#### L TYPE

Motor Driven  
Lobing  
Switch



Manufacturers and designers of microwave components and systems for transmission control. Send for complete product data.

Creative microwave engineers write for information about YOUR future with this progressive, well established firm.

#### YL TYPE Solenoid Actuated SPDT for RG117 U & Similar Cables



## TRANSKO

PRODUCTS INC.

12210 NEBRASKA AVENUE  
LOS ANGELES 25, CALIFORNIA

CIRCLE 29 ON READER-SERVICE CARD



## Helpful Tips on ... Liquid Cooling

Alan G. Eades  
Monsanto Chemical Corp.,  
St. Louis, Mo.

Military specifications or contracts sometimes dictate the requirements the cooling systems must meet. More often, the design engineer is on his own with neither examples to follow nor precedents to draw upon. In this article, author Alan Eades outlines an approach to liquid cooling intended to help the design engineer avoid trial and error in equipment design.

**E**ND USE of electronic equipment stipulates many of the cooling system's requirements. Components for aircraft or missiles will differ from ground support equipment. Operational time must be known—whether continuous or intermittent operation is required. Service life required is important. Heat from other related or nonrelated components could aggravate the heat dissipation problem so location of other components must be considered.

The design engineer will want to know:

- Atmospheric and climatic conditions
- Temperature extremes for both storage and operation.
- Maximum altitudes the equipment will reach.

A radar station in the desert may require different equipment design than one operating in the arctic.

### Initial System Evaluation

During initial evaluation, standards established for electronic operation should be correlated with those for the cooling system.

The most important consideration is the temperature profile for equipment operation, because from these profiles, the heat transfer required can be calculated. By specifying highest and lowest

temperatures the equipment can tolerate, the engineer will know what is required of the cooling system to maintain safe operating temperatures.

Possibility of "hot spot" areas should not be overlooked, because heat transfer efficiency in these areas can determine the success or failure of the over-all cooling system. Weight and space allowance should be definitely established before the cooling method is selected. Since they will be considered along with the calculated heat load, weight and space requirements bear heavily on the ultimate selection of cooling methods.

### Static Cooling

Static cooling is the dissipation of heat generated in an electronic component by normal convection flow. The fluid picks up heat from the component and transfers it to the outside case of the unit. Finally, the heat is conducted through the case into the main chassis or air frame and eventually to the surrounding air.

In a static cooling design, the object is to dissipate efficiently the heat from hot spots. If the fluid surrounds all the components, the heat from hot spot areas can be transferred immediately and uniformly to the fluid to give an efficient control of hot spot temperature. Static cooling will suffice,



however, only if the heat transfer requirements are not too high.

Certain synthetic fluids do not remain liquid at temperatures much above 200 F, and enter what is called the "vapor phase." These liquids accomplish heat transfer through boiling and require sufficient space within the container for vapor condensation and heat transfer to the case. The condensate then runs back down the sides and goes through the reflux phase again. This design usually requires more space and weight than a "liquid-phase" system.

Changing flight attitudes will affect the selection of liquid coolants in static applications. In static cooling, the liquid phase of the coolant must surround the heat source at all times. If the component tilts to an angle or enters a horizontal or upside-down position, the liquid falls to the bottom of the container and leaves the vital areas exposed. As a result, the component may overheat or even burn out. To use a liquid-vapor phase coolant in this manner requires more sophisticated design so that the unit remains in an upright position.

Straight liquid-phase coolants are generally used as a complete fill in static systems so that flight attitudes present no problems.



### Designing for Static Cooling

**Heat-load and heat-transfer calculations.** The first step in the design of any cooling system is the calculation of heat load and a determination of rate of the heat transfer required to dissipate it. In static systems, this is not as critical as in dynamic systems. Hot spot areas deserve special consideration. Sometimes the parts that produce the most heat can be spaced within the container to avoid an unnecessary heat build-up in any given area. When the heat load and desired temperature of operation are known, the container dimensions and a fluid volume can be specified.

**Container design.** A good container takes into account the volume of fluid needed to dissipate the heat load and how that volume will change with temperature or pressure. The container obviously must withstand the maximum temperatures and pressures that the system will develop. The ambient temperatures and pressures also must not be overlooked. Simple bellows, diaphragms, or a relief valve can be used to compensate for volume changes.

In systems containing relief valves or in those vented to the air, special care must be taken to prevent water or other contaminants from entering the system. To control moisture, a desiccant may be used as part of the relief system. Rather than a vented relief system which complicates the container design, internal bellows or diaphragms generally are used to compensate for changes in fluid volume. A blow-out plug in the container is a good safety precaution should electronic failure cause extreme heat generation.

**Heat Sinks.** The metal chassis itself is the basic heat sink for the container. Additional heat transfer may be obtained by placing fins on the exterior of the container. Some containers may have channels designed into the case exterior for forced air "cold plate" cooling.

**Prototype Production and Testing.** Heat transfer efficiency should be tested over the entire operating temperature range and under all anticipated conditions. If adequate heat transfer is lacking, the container dimensions and fluid volume may need modification. Minor design changes often are required before a static cooling unit is proven satisfactory. In this respect, static cooling is less advantageous than a dynamic system in which the effect of many variables can be predicted more accurately.

### Dynamic Cooling

In a dynamic system, the fluid is pumped in and around components through a sealed system of jackets and tubes. The fluid picks up heat from the components and carries it to the heat exchanger for dissipation. The precise temperature control makes dynamic cooling the most reliable system and, thus, the one to be used when the

**ONE INTEGRATED SOURCE**

**for Ceramic-to-Metal Seals**



Standard types of Alite high voltage bushings are available in various sizes and configurations.

In all phases of planning for ceramic-to-metal seals—from design to finished assembly—you can rely on ALITE for the know-how and "do-how" required to produce highest quality ceramic-metal components for critical applications.

High alumina Alite is the ideal material for making rugged, high performance hermetic seals and bushings. It has superior mechanical strength, high temperature and thermal shock resistance, plus reliable electrical characteristics. Our complete high temperature metalizing and bonding facilities assure delivery of the finest seals available—mass-spectrometer tested for vacuum-tightness.

Please contact us for valuable performance data and information regarding ceramic-to-metal applications . . . no obligation.

### INSIDE LOOK AT ALITE—



Fact-packed, illustrated Bulletin A-40 gives vital technical data and product information. Write today.

ALITE DIVISION

**U. S. STONEWARE**

AKRON 9, OHIO

New York Office  
60 East 42nd St.

12F-1  
CIRCLE 30 ON READER-SERVICE CARD

When  
it must  
not fail

Specify:

## BREEZE SLIP RINGS



For military or other critical uses, Breeze Slip Rings are custom designed and built to "perfectionist" standards. They offer high performance in the most exacting service.

From 2-ring to 500-ring assemblies . . . currents as high as 350 amps continuous at 220 volts and 700 amps overload at 220 volts. Special high voltage designs . . . radio frequency assemblies . . . high speed rotation for thermocouple and strain gage applications. Also segmented ring assemblies for accurate sequencing and timing. Consult us or write for literature.



**BREEZE**  
**CORPORATIONS, INC.**  
700 LIBERTY AVE., UNION, N. J.

BREEZE PRODUCTS: ACTUATORS • HOISTS • TRANSMISSIONS  
GENERATORS • STARTERS • STARTER GENERATORS • BELLOWS  
SLIP RINGS • HOSE CLAMPS • HITEMP FLEXIBLE TUBING

CIRCLE 31 ON READER-SERVICE CARD

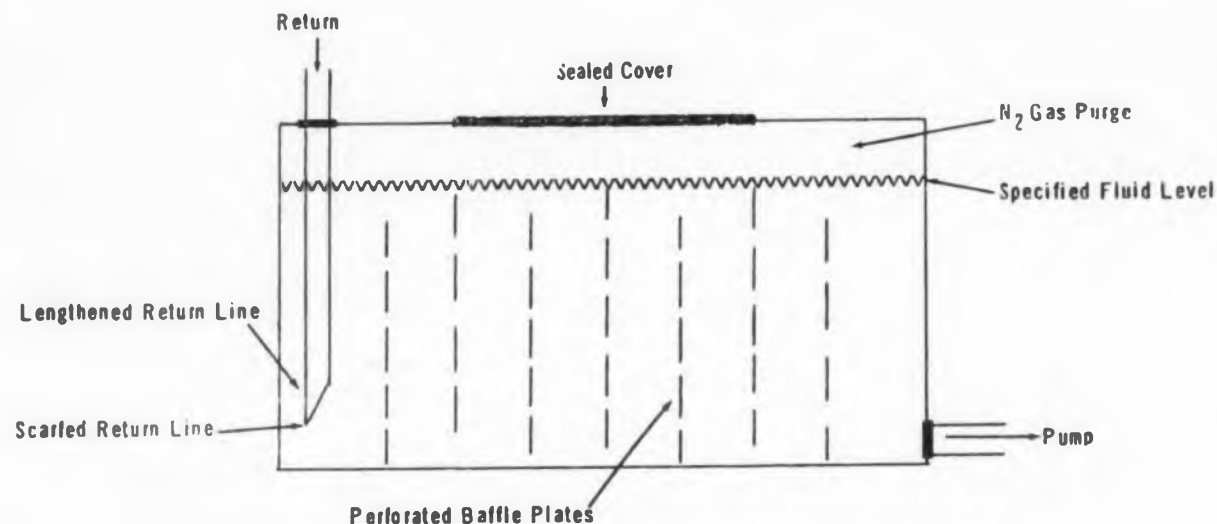

Typical cooling fluid reservoir design for a large system.

heat load is high or critical. When severe hot spots exist, dynamic fluid flow through the sensitive areas is especially effective in controlling temperatures.

In a dynamic system, the heat load in each area can be calculated and the system mechanically designed to dissipate the heat as required. Through mechanical design, all of the system's hot spot temperatures can be more reliably controlled—a significant improvement over static or forced air cooling. When constant temperature operation is required, or the equipment is large, or consists of a number of units, dynamic cooling is the most practical method.

A dynamic system can have two types of flow—turbulent or laminar. Turbulent flow imparts the best heat transfer efficiency and is used particularly for temperature control in hot spot areas. Vanes and fins designed into the equipment help give turbulence to the fluid in order to minimize contact time and temperature build-up in the fluid.

### Designing for Dynamic Cooling

As with static cooling, the first step is an accurate definition of heat load and the heat transfer requirements for each section of the component. Hot spot determinations should be exact, for, with this system, they can be precisely controlled.

Three factors—fluid film coefficient, temperature driving force, and surface area—are important to an evaluation of total heat transfer capacity as shown by the general heat transfer equation:

$$Q = hA\Delta T$$

$$= WC\Delta T$$

where:  $Q$  = total heat dissipation (Btu/hr)  
 $h$  = fluid film coefficient  
 $A$  = surface area  
 $\Delta T$  = temperature driving force

$W$  = flow rate of coolant (lb/hr)  
 $C$  = specific heat of coolant (Btu/lb/F)  
 $\Delta t$  = temperature rise of coolant (F)

**Fluid Film Coefficient.** The fluid film coefficient determines the heat transfer that takes place in a given area. With other factors constant, the higher a fluid film coefficient, the better the heat transfer of the system. Fluid properties, fluid temperature, flow rates and mechanical design all affect the film coefficient.

**Temperature Driving Force.** The temperature driving force is the mean temperature difference between the average skin temperature of the heat transfer area and the fluid temperatures at inlet and outlet. This can be measured for a whole system or for segments of the system.

**Surface Area.** The design engineer may have less leeway with surface area than with the fluid film coefficient and the temperature driving force. Though he usually cannot increase the system dimensions after the specifications have been drawn, he can use fins or grooves to increase the amount of area that the fluid will contact. In the heat transfer region, increasing the surface area will keep hot spot temperatures to a minimum and lower the amount of heat per unit area.

When calculations reveal that the three factors are properly balanced to dissipate the heat load, the cooling system characteristics (e.g., flow rates, pressure drops, necessary heat exchanger capacity) and the accessory system requirements will be defined. The design engineer can now integrate the unit into a complete cooling system.

**Selecting Accessories.** The complete system will contain the electronics to be cooled, a heat exchanger, reservoir, pump, motor and such other accessories as relief mechanisms, interlock systems and filters, for airborne applications the entire cooling system can be produced as a complete package, easily removed for servicing or replacement.



ment by quick-disconnect couplings. Synthetic liquids lend themselves especially to this "package concept" of electronic design, making possible much smaller, lighter units which, at the same time, are three to five times more efficient than forced air cooling systems.

In selecting the heat exchanger, it is important to be certain that it can accommodate the maximum heat load. The flow rate and pressure drop calculated for the system are the primary influences in pump selection. There must be adequate power available for the pump at all operating temperatures.

In reservoir design, it is important to avoid unnecessary foaming or air entrainment in the synthetic coolant since these cause inefficient heat transfer and ultimate system failure. Fig. 1 illustrates principles of a reservoir system design that apply to large systems as well as small packaged systems.

In Fig. 1, the dry nitrogen blanket at one or two psi above atmospheric pressure controls water contamination and entrainment of oxygen in the fluid—two main causes of trouble. Entrained air supplies an oxygen source to cause oxidation of metals; and at high temperatures, the metals are especially vulnerable. Nitrogen gas prevents any oxidation build-up of scale that could clog the system or slow down heat transfer. The dry nitrogen purge also keeps out water which might cause fluid degradation.

Fluid volume in the reservoir should be approximately three times the volume flow per minute. The return line should be well below the fluid level to keep foaming at a minimum. A line with a long scarfed end controls the fluid's entry into the reservoir and prevents unnecessary fluid turbulence.

Perforated baffle plates provide a "residence time" for a given unit of fluid volume which allows the fluid to reject entrained air or foam before returning to the pump line.

The pump feed line should be near the bottom edge of the reservoir and so placed that there is no direct fluid channel to the suction line from the return line.

**Component Positioning.** There are no standard arrangements for components; each complete system is laid out according to its own requirements. When the reservoir design is finished, the design engineer positions all components and specifies the connecting tube arrangement for all parts of the system.

The package concept might be applied to the large system just discussed, but it is more often used for miniaturized components. In applying the package concept, the design layout is basically the same. The only additional requirement is the integration of all the components into a single unit. ■ ■

# hp Audio, telemetry and low frequency oscillators

Pictured here are six of the most widely used oscillators in electronics. All employ the highly stable, dependable, accurate resistance-capacity circuit. They require no zero setting. Output is constant, distortion is low and frequency range is wide. Scales are logarithmic for easy reading; all are compact, rugged and broadly useful basic instruments. Brief specifications are given below; call your rep for demonstration or write direct for complete data on any instrument.

Model	Frequency Range	Calibration Accuracy	Output to 600 Ohms	Recommended Load	Maximum Distortion	Max. Hum & Noise †	Input Power	Price
200AB	20 cps to 40 KC (4 bands)	±2%	1 watt (24.5 v)	600 ohms	1% 20 cps to 20 KC 2% 20 KC to 40 KC	0.05%	65 watts	\$150.00
200CD	5 cps to 600 KC (5 bands)	±2%	160 mw 10 volts	600 ohms*	0.5% below 500 KC 1% 500 KC and above	0.1%	75 watts	\$170.00
200J	6 cps to 6 KC (6 bands)	±1% †	160 mw 10 volts	600 ohms*	0.5%	0.1%	100 watts	\$300.00
200T	250 cps to 100 KC (5 bands)	±1% †	160 mw 10 volts	600 ohms*	0.5%	0.03%	100 watts	\$450.00
201C	20 cps to 20 KC (3 bands)	±1% †	3 watts (42.5 v)	600 ohms**	0.5% †	0.03%	75 watts	\$225.00
202C	1 cps to 100 KC (5 bands)	±2%	160 mw 10 volts	600 ohms*	0.5% ‡	0.1%	75 watts	\$300.00

\*Internal impedance is 600 ohms. Frequency and distortion unaffected by load resistance. Balanced output with amplitude control at 100. Use line matching transformer for other control settings. \*\*Internal impedance approximately 600 ohms with output attenuator at 10 db or more. Approximately 75 ohms below 50 cps with attenuator at zero. †Internal, non-operating controls permit precise calibration of each band. ‡0.5%, 50 cps to 20 KC at 1 watt output. 1.0% over full range at 3 watts output. §0.5%, 10 cps to 100 KC. 1.0%, 5 to 10 cps. 2.0% at 2 cps. 3.0% at 1 cps. †Measured with respect to full rated output.

## HEWLETT-PACKARD COMPANY

1015K Page Mill Road • Palo Alto, California, U.S.A.  
Cable "HEWPACK" • Davenport 5-4451  
Hewlett-Packard S.A., Rue du Vieux Billard No. 1, Geneva, Switzerland  
Cable "HEWPACKSA" • Tel. No. (022) 26. 43. 36  
Field representatives in all principal areas

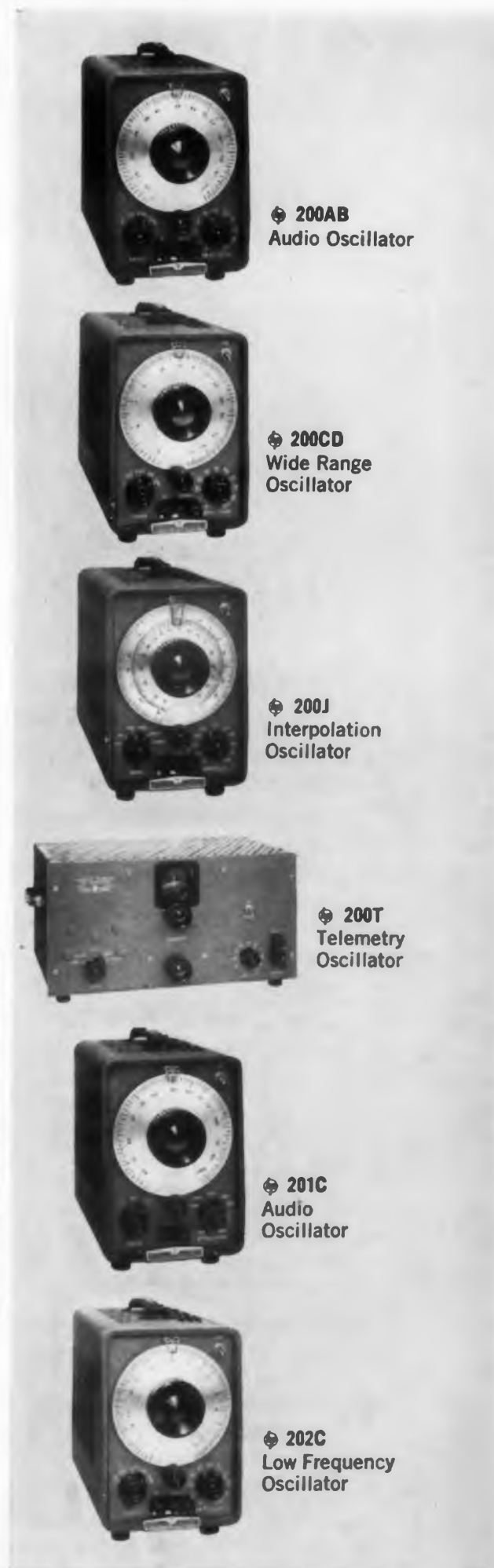

hp pioneered the world-famous resistance-capacity oscillator circuit

CIRCLE 32 ON READER-SERVICE CARD

# Design of Transistorized DC-to-DC Converters

## Part I — Ringing-Choke Circuit

A presentation of all necessary data and procedures required for the design of transistorized ringing-choke dc-to-dc converters. Typical values of magnetic parameters are tabulated and a step-by-step design example is covered. Also included is a section devoted to all necessary equations with their derivations. Part II will include design information for Transformer Coupled Converters.

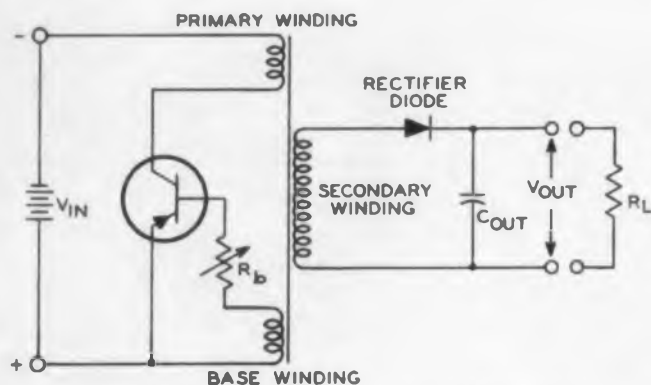

Fig. 1. (above) Basic circuit of ringing-choke-type dc-to-dc converter.

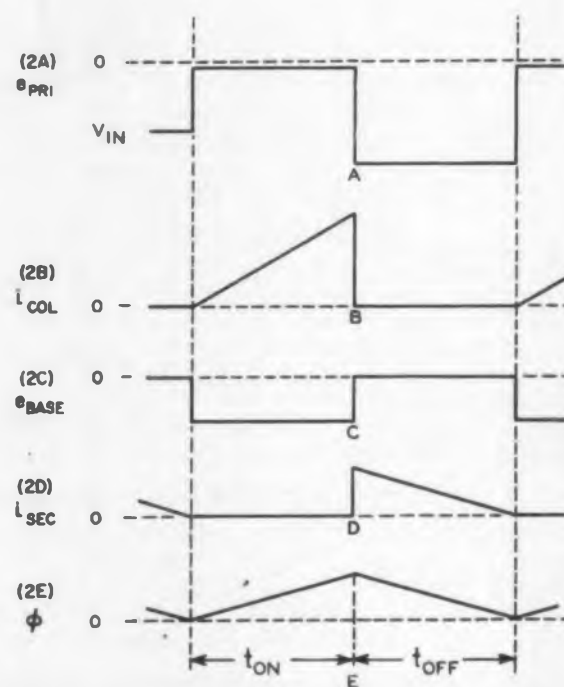

Fig. 2. (right) Typical operating waveforms in the ringing-choke-type converter circuit: (A) primary voltage; (B) primary current; (C) base-to-emitter voltage; (D) secondary current; (E) flux in transformer core.



Carl Turner is presently engaged in circuit and device development of industrial power transistors with special emphasis on silicon types. He also serves as RCA's representative on the JEDEC Committee on Power Transistors.

He believes the information presented will enable the circuit engineer, with a minimum of experience in dc-to-dc converters, to achieve a good design in a minimum of time.

### Carl R. Turner

Semiconductor and Materials Division  
Radio Corporation of America  
Somerville, N. J.

ALL NECESSARY design tools, plus a logical sequence of design steps, are presented to enable a circuit engineer to successfully complete a transistorized ringing-choke dc-to-dc converter project. Transistor requirements, suggested operating frequencies, transformer-core parameters and predicted circuit efficiencies are tabulated for a wide range of input and output conditions.

### Operation of Ringing-Choke Converter

Fig. 1 shows the basic circuit of a ringing-choke-type converter using a transistor and Fig. 2 illustrates waveforms obtained during an operating cycle.

Energy is drawn from the battery and stored in the inductance of the transformer during the conduction period ( $t_{on}$ ); this energy is delivered to the load during the "off" period ( $t_{off}$ ). At the start of  $t_{on}$  the transistor is driven into saturation (bottomed) and a substantially constant voltage (Fig. 2A) is impressed across the primary by the battery. This primary voltage produces a linearly increasing current (Fig. 2B) in the collector-primary circuit. This current induces substantially constant voltages in the base winding (Fig. 2C) and secondary winding.

The resulting base current, like the primary current, increases linearly and has a maximum



value determined by the base-winding voltage, the external base resistance  $R_b$ , and the dc input conductance of the transistor. Because the polarity of the secondary voltage does not permit the rectifier diode to conduct, the secondary is open circuited. During  $t_{on}$ , therefore, the load is supplied only by energy stored in capacitor  $C_{out}$ .

The collector-primary current increases until it reaches a maximum value  $I_p$  which is limited by the maximum base current and base voltage supplied to the transistor. At this instant, the transistor starts to move out of its saturated condition with the result that the collector-primary current and the voltage across the transformer windings rapidly decrease, and switch-off occurs.

At switch-off the circuit starts to "ring"—i.e., the energy stored in the transformer inductance starts to discharge into the stray capacitance of the circuit—with the result that the voltages across the primary, base and secondary windings reverse polarity. These reverse voltages rapidly increase until the voltage across the secondary winding exceeds the voltage across the output capacitor  $C$ . At this instant the diode rectifier starts to conduct and to transfer the energy stored in the inductance of the transformer to the output capacitor and load. Because the output capacitor tends to hold the secondary voltage substantially constant, the secondary current decreases at a substantially constant rate (see Fig. 2D). When this current reaches zero the transistor switches on again, and the cycle of operation repeats.<sup>1,2</sup>

#### Design Procedure

Following is a step-by-step procedure for the design of practical dc-to-dc converters of the ringing-choke type. The equations referred to are given in the Derivation section.

1. From the data given in Table I for the desired dc output voltage  $V_{OUT}$ , output power  $P_{OUT}$ , and dc input voltage  $V_{IN}$ , select a transistor type having the required maximum saturation resistance  $R_{SAT}$ , and the required minimum ratings for collector-to-base breakdown voltage  $V_{CBmax}$ , peak collector current  $I_C$ , and dissipation  $P_T$ . Also select a material, cross-sectional area  $A$ , and magnetic-path length  $l_i$  for the transformer core, and a suitable operating frequency  $f$ , and note the expected circuit-efficiency factor,  $\eta$ .

2. Determine the required secondary-to-primary turns ratio  $N_s/N_p$  (Eq. A16).

3. Determine the required primary inductance  $L_p$  (Eq. A9).

4. Determine the required number of turns for the primary  $N_p$  (Eq. A11).

5. Determine the ratio of conduction time  $t_{on}$  to total period of oscillation  $T$  (Eq. A7).

6. Determine the peak primary current  $I_p$  (Eq. A2).

(Continued on p. 44)

# DELCO RADIO

## NEW POWER TRANSISTORS



## MILITARY-COMMERCIAL

	2N1168	2N392	2N1011	2N1159	2N1160
$V_{cb}$ max.	50	60	80	80	80 volts
$I_c$ max.	5	5	5	5	7 amp.
$I_{co}$ ( $V_{oc}$ 2 volts) Typical 25°C.	65	65	65	65	65 μa.
HFE (3 amp.)	—	60-150	30-75	30-75	—
HFE (5 amp.)	—	—	—	—	20-50
AC Power Gain ( $I_c = 0.6$ amp.)	37 DB	—	—	—	—
$V_{ceo}$ ( $I_c = 1$ amp.)	40 typical	50 typical	60 min.	60 min.	60 volts min.
Thermal Gradient max.	1.5	1.5	1.2	1.2	1.2° c/w

Delco Radio rounds out its power transistor line with this new 5-ampere germanium PNP series. Types 2N1168 and 2N392 are specially designed for low-distortion linear applications, while 2N1159 and 2N1160 are outstanding in reliable switching mode operations.

Type 2N1011 is designed to meet MIL-T-19500/67 (Sig. C). It joins 2N665, MIL-T-19500/68 (Sig. C); 2N297A, MIL-T-19500/36 (Sig. C) and JAN2N174, MIL-T-19500/13A to provide a selection for military uses.

Write today for engineering data on Delco Radio's line of High Power Transistors.

**DELCO**  
DEPENDABILITY  
**RADIO**  
RELIABILITY

DIVISION OF GENERAL MOTORS  
KOKOMO, INDIANA

BRANCH OFFICES  
Newark, New Jersey  
1180 Raymond Boulevard  
Tel: Mitchell 2-6165

Santa Monica, California  
726 Santa Monica Boulevard  
Tel: Exbrook 3-1465

CIRCLE 33 ON READER-SERVICE CARD

# DCDC

## CONVERTER EQUATIONS

All references to transformer windings, circuit components, voltages and currents are for the circuit shown in Fig. 1. All references to time periods and waveforms are to those shown in Fig. 2.

The average value of the current in the transformer primary is:

$$I_{PAV} = I_{OUT} \left( \frac{V_{OUT}}{\eta V_{IN}} \right) \quad (A1)$$

Where  $I_{OUT}$  is the load current in amp

$V_{OUT}$  is the dc output voltage in volts

$\eta$  is the circuit-efficiency factor as given in Table I

$V_{IN}$  is the dc input voltage in volts.

Because of the triangular waveform of the primary current (see Fig. 2), the peak value of the primary current is:

$$\hat{I}_P = 2 I_{PAV} \left( \frac{T}{t_{ON}} \right) \quad (A2)$$

or

$$\hat{I}_P = \frac{2T}{\eta t_{ON}} \left( \frac{V_{OUT}}{V_{IN}} \right) I_{OUT} \quad (A3)$$

where  $T = t_{on} + t_{off}$  are expressed in seconds.

If the saturation resistance of the transistor ( $R_{SAT}$ ) and the resistance of the primary winding ( $R_{P \text{ winding}}$ ) are sufficiently small to permit the assumption that the full dc input voltage  $V_{IN}$  is impressed across the primary during  $t_{on}$ , the required primary inductance in henries may be determined from:

$$L_P \left( \frac{dI_P}{dt} \right) = V_{IN}$$

For the triangular current waveform shown in Fig. 2b:

$$\frac{dI_P}{dt} = \frac{\hat{I}_P}{t_{ON}} \quad (A4a)$$

Therefore,

$$L_P = \left( \frac{V_{IN}}{\hat{I}_P} \right) (t_{ON}) \quad (A5)$$

or, in terms of Eqs. A3 and A5:

$$L_P = \frac{\eta V_{IN}^2 t_{ON}^2}{2 V_{OUT} I_{OUT} T}$$

$$= \left( \frac{\eta V_{IN}}{2 P_{OUT}} \right)^2 \left( \frac{t_{ON}^2}{T^2} \right) \left( \frac{1}{f} \right) \quad (A6)$$

where  $f$  is the operating frequency in cycles per second, and is equal to  $1/T$

To evaluate Eq. A6, it is necessary to determine the ratio  $t_{on}/T$ . From Eq. A5:

$$t_{ON} = \frac{L_P \hat{I}_P}{V_{IN}}$$

During the "off" period  $t_{off}$

$$L_P \left( \frac{dI_{S'}}{dt} \right) = V_{OUT}'$$

where  $I_{S'}$  is the secondary current referred to the primary  $I_S (N_S/N_P)$

$V_{OUT}$  is the secondary voltage referred to primary  $V_{OUT} (N_P/N_S)$

$N_P$  is the number of turns on the primary

$N_S$  is the number of turns on the secondary

From Eq. A4a:

$$\frac{dI_{S'}}{dt} = \frac{\hat{I}_P}{t_{OFF}}$$

Therefore

$$t_{OFF} = L_P \left( \frac{\hat{I}_P}{V_{OUT}'} \right)$$

$$T = L_P \hat{I}_P \left( \frac{1}{V_{IN}} + \frac{1}{V_{OUT}'} \right)$$

and

$$\frac{t_{ON}}{T} = \frac{L_P \hat{I}_P \left( \frac{1}{V_{IN}} \right)}{L_P \hat{I}_P \left( \frac{1}{V_{IN}} + \frac{1}{V_{OUT}'} \right)} = \frac{V_{OUT}'}{V_{IN} + V_{OUT}'} \quad (A8)$$

$$= \frac{V_{OUT} (N_P/N_S)}{V_{IN} + V_{OUT} (N_P/N_S)}$$

By combining Eqs. A6 and A8 we obtain:

$$L_P = \left[ \frac{\eta V_{IN}^2}{2 P_{OUT} f} \right] \left[ \frac{(N_P/N_S)^2 V_{OUT}^2}{V_{IN}^2 + (N_P/N_S)^2 V_{OUT}^2 + V_{IN} V_{OUT} (N_P/N_S)} \right] \quad (A9)$$

The required primary inductance  $L_P$  can also be expressed in terms of the maximum permissible flux-density swing in the transformer core and other core parameters. The maximum permissible flux-density swing is given by:

$$\frac{\Delta\phi}{A} = \hat{I}_P \left[ \frac{4\pi N_P}{10} \right] \left[ \frac{1}{l_i/\mu_i + l_a/\mu_a} \right] \quad (A10)$$

where  $A$  is the cross-sectional area of the core in square centimeters

$l_i$  is the length of the magnetic path in centimeters

$l_a$  is the length of the air gap in centimeters

$\mu_i$  is the permeability of the core material

$\mu_a$  is the permeability of air (1).

The maximum-permissible flux-density swing may also be expressed as:

$$\frac{\Delta\phi}{A} = \frac{\phi_{MAX}}{A} - \frac{\phi_{RES}}{A}$$

where  $\phi_{MAX}$  is the saturation flux density for the core material  $\phi_{RES}$  is the residual flux density in the core. Inductance can be defined in terms of  $\Delta\phi$ , where

$$\Delta\phi = \frac{LI}{N} \times 10^8$$

Therefore,

$$L = \frac{N \Delta\phi}{\hat{I}} 10^{-8} \quad (A11)$$

Eq. A10 and A11 can be combined to provide the following expression for the required primary inductance:

$$L_P = \left[ \frac{4\pi N_P^2}{10^9} \right] \left[ \frac{1}{l_i/\mu_i A + l_a/\mu_a A} \right] \quad (A12)$$

The length of the air gap  $l_a$  should be adjusted to assure operation of the core near but not in the saturation region—i.e., at a maximum flux density slightly less than the saturation value for the core material used. The value of the flux density can be checked by means of Eq. A11.

The induced voltage in the base winding must provide a base-to-emitter voltage sufficiently large to supply the required peak primary current for any transistor of the type to be used in the circuit. The primary voltage at the end of  $t_{on}$  is:

$$V_P = V_{IN} - \hat{I}_P [R_{SAT} + R_{PWIND} + R_{SUPPLY}] \quad (A13)$$

The required number of turns for the base winding is:



$$N_s = \frac{N_p V_B}{V_{IN} - I_P (R_{SAT} + R_{PWIND} + R_{SUPPLY})} \quad (A14)$$

The required number of turns for the secondary  $N_s$  is determined from the input voltage  $V_{IN}$  output voltage  $V_{OUT}$ , number of turns on the primary  $N_p$ , and maximum allowable collector-to-base voltage  $V_{CBmax}$  (the value during  $t_{off}$ ) for the transistor:

$$V_{CBmax} = V_{IN} + (N_p/N_s) V_{OUT} \quad (A15)$$

$$\frac{N_s}{N_p} = \frac{N_p V_{OUT}}{V_{CBmax} - V_{IN}} \quad (A16)$$

The required number of turns for the secondary is, therefore:

$$N_s = \frac{N_p V_{OUT}}{V_{CBmax} - V_{IN}} \quad (A17)$$

The external base resistance  $R_B$  is necessary to compensate for differences in base-to-emitter voltage  $V_{BE}$  among individual transistors of the type used. The required value for this resistance is:

$$R_B = \frac{V_{BEmax} - V_{BE}}{I_B} \quad (A18)$$

where  $V_{BE}$  is the typical value of the base-to-emitter voltage required to provide the peak primary current  $I_P$  at a base current  $I_B$  for the transistor type used.

$V_{BE}$  is the typical value of the base-to-emitter voltage required to provide the peak primary current  $I_P$  at a base current  $I_B$  for the transistor type used,

$V_{BEmax}$  is the maximum of  $V_{BE}$  for the transistor type,  $I_B$  is the typical value of base current required to provide the peak primary current  $I_P$  at a base-to-emitter voltage  $V_{BE}$ .

To minimize transient losses during switch-off due to hole storage effects,  $R_B$  should be kept as small as possible.

The peak secondary current is given by:

$$\hat{I}_s = \hat{I}_p (N_p/N_s) \quad (A19)$$

The peak secondary voltage is given by:

$$\hat{V}_s = V_{OUT} + V_{IN} (N_s/N_p) \quad (A20)$$

To assure a substantially constant output voltage  $V_{OUT}$ , the output capacitor  $C_{OUT}$  should have a capacitance such that the time constant  $C_{OUT} R_L$  is at least 10 times larger than  $t_{on}$ .

$$R_L = V_{OUT}^2 / P_{OUT}$$

$$C_{OUT} R_L = 10 t_{on}$$

$$C_{OUT} \geq \frac{10 t_{on} P_{OUT}}{V_{OUT}^2} \quad (A21)$$

The optimum ratio of primary-to-secondary winding space  $K$  for the transformer, is:

$$K = \frac{1}{\sqrt{(N_s/N_p) (V_{IN}/V_{OUT}) + 1}} \quad (A22)$$

# BROWN CONVERTERS

put stable performance in your measuring and servo loops

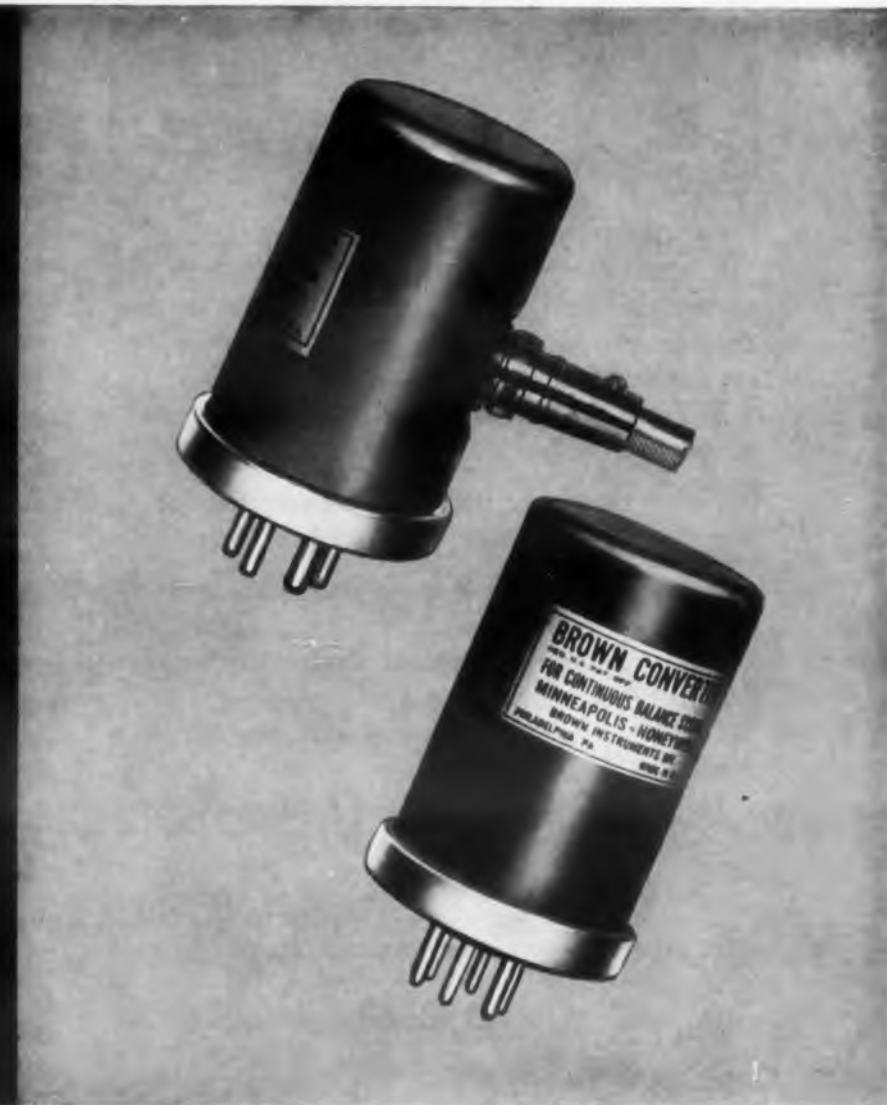

These synchronously-driven choppers handle d-c signals as small as  $10^{-8}$  volt. SPDT switching action. Sensitive, stable performance. Ideal for computers, servomechanisms, balancing circuits. Available with special features such as fungus proofing, grounded housing, mica-filled base, various contact percentages. Weight: 10 ounces. Prices from \$36.

Driving coils in 60-50, 40 and 25-cycle converters are energized by 6.3 volt a-c. 400-cycle converters use 18 volts. Other specifications on chart at right.

MINNEAPOLIS - HONEYWELL, Wayne and Windrim Avenues, Philadelphia 44, Pa.

ELECTRICAL CHARACTERISTICS					
Part No.	354210-2	354210-3	354210-1	354210-4	355081
Modulation Frequency	20-30 cycles	40-45 cycles	50-65 cycles	50-65 cycles	360-440 cycles
Switching Action (SPDT)	(Make-before-break) Each contact closed 55% of each cycle ( $\pm 2\%$ ) Other actions, as specified			(Break-before-make). Each contact closed 47% of each cycle	Each contact closed 57% of each cycle ( $\pm 7\%$ )
Driving Coil Requirements	6.3 v, 60 ma at rated frequency				18 v, 94 ma at rated frequency
Contact Rating	100 microwatts at 6 v max.; 1.0 ma max.				
Electrostatic Stray Pickup	2 x $10^{-10}$ volts per ohm of input circuit impedance				2 x $10^{-10}$
Electromagnetic Stray Pickup	Less than 2 x $10^{-6}$ volts, constant to within 2 x $10^{-7}$				2 x $10^{-6}$ volts constant to 2 x $10^{-6}$
Phase Shift	Output voltage lags driving phase by $17^\circ \pm 5^\circ$				Lags driving phase by $45^\circ$ to $50^\circ$
Symmetry	Within 2%				Within 7%
Shielding	Frame and coil shield, grounded through pin No. 2				Shell and coil shield, grounded through pin No. 2
Load Characteristics	Resistive or Inductive				
Vibration Resistance	Output voltage varies less than 2% with rates of vibration from 0 to 10g				
Weight	10 oz.				8.5 oz.
Special Features	Specify SS-8816-A for anti-fungus treated, vibration resistant wiring, hermetically sealed case. Also available with side plug for exciter coil connection.				All 400-cycle converters are treated as shown at left

## Honeywell



First in Control

CIRCLE 34 ON READER-SERVICE CARD

# DCDC

(continued from page 41)

7. Determine the maximum flux density in the transformer core  $B_{max}$  (Eq. A10). This flux density should not exceed the saturation value for the core material used. (See Table 2.)

8. From the published data for the transistor manufacturer, determine the maximum values of required to supply the peak primary current  $\hat{I}_p$ , base-to-emitter voltage  $V_{BE}$  and base current  $I_B$  required to supply the peak primary current  $\hat{I}_p$  determined in Step 6.

9. Determine the required number of turns for the base winding  $N_B$  (Eq. A14).

10. Determine the value of the external base resistance  $R_B$  (Eq. A18).

11. Determine the required number of turns for the secondary winding  $N_S$  (Eq. A17).

12. Determine the peak secondary current  $\hat{I}_s$  (Eq. A19) and peak secondary voltage  $\hat{V}_s$  (Eq. A20).

13. Select a rectifier-diode type capable of handling the peak secondary current  $\hat{I}_s$  determined in Step 12 and a peak inverse voltage rating greater than the peak secondary voltage  $\hat{V}_s$  determined in Step 12.

14. Determine a suitable minimum value for the output capacitor  $C_{OUT}$  (Eq. A21).

15. Select a transformer core having the magnetic-circuit parameters determined in Step 1, and adequate winding space. Determine the proper wire size for each winding from the peak current, the minimum transformer winding space, and the number of turns on each winding.

16. Determine the optimum ratio of primary-to-secondary winding space (Eq. A22).

## Typical Design Example

To illustrate the use of the design procedure given above, the design of a ringing-choke-type dc-to-dc converter having a power output of one watt and an output voltage of 150 volts, for use with a 12-volt dc source, is worked out below:

1. From the parameters shown in Table 1 for  $P_{OUT} = 1$  w,  $V_{OUT} = 150$ , and  $V_{IN} = 12$ , a suitable transformer core would be a ferrite core having a cross-sectional area  $A$  of 1.3 sq. cm, and a magnetic-path length  $l_i$  of 8.1 cm, such as Ferroxcube Part No. 9F520 ("E" type core, type 3C material). A suitable operating frequency  $f$  would be eight kc and the expected circuit efficiency would be 75 per cent.

The transistor used should have a saturation resistance  $R_{SAT}$  of not less than two ohms, a collector-to-base breakdown voltage  $V_{CBmax}$  of at least 35 v, at peak collector-current rating  $I_C$  of at least 400 ma, and a dissipation rating  $P_T$  at 55 C of at least 80 mw. A transistor meeting these requirements is the RCA 2N586. This transistor has a peak collector-current rating of 500 ma, a maximum saturation resistance of 2 ohms, a maximum collector-to-base voltage rating of 45 and a maximum dissipation at a case temperature of 55 C of 125 mw. The peak collector-current rating is not given in the published data for the RCA-2N586, and was obtained from the manufacturer. The maximum saturation resistance is not given specifically in the published data, but is easily determined from the maximum ratings for collector-to-emitter saturation voltage  $V_{CE}$  (-0.5) and collector current  $I_C$  (-250 ma.).

2. From Eq. A16 the required secondary-to-primary turns ratio for the transformer is:

$$\frac{N_S}{N_P} = \frac{V_{OUT}}{V_{CBmax} - V_{IN}} = \frac{150}{45 - 12} = 4.5$$

(Use of the 45-v rating of the RCA-2N586 for  $V_{CBmax}$ , instead of the 35 v specified in Table I, reduces the required step-up ratio).

3. From Eq. A9, the required primary inductance is

$$L_P = \left[ \frac{\eta V_{IN}^2}{2 P_{OUT} f} \right] \times \left[ \frac{(N_P/N_S)^2 V_{OUT}^2}{V_{IN}^2 + (N_P/N_S)^2 V_{OUT}^2 + (N_P/N_S) V_{IN} V_{OUT}} \right] \\ = \left[ \frac{(0.7) (13)^2}{(2) (1) (8) 10^3} \right] \left[ \frac{(150/4.5)^2}{(12)^2 + (150/4.5)^2 + (12) (150/4.5)} \right] \\ = 38.5 \text{ mh}$$

4. From Eq. A12, the required number of turns for the primary is:

$$N_P = \sqrt{\frac{L_P}{4\pi} \left( \frac{l_i}{\mu_i A} + \frac{l_a}{\mu_a A} \right)} \quad (10^9)$$

For an air-gap length  $l_a$  of 0.01 cm

$$N_P = \sqrt{\frac{38.5 \times 10^{-3}}{4\pi} \left( \frac{8.1}{1.3 \times 10^{-3}} + \frac{0.01}{1.3} \right)} \\ = 207 \text{ turns}$$

5. From Eq. A8, the ratio of conduction time to total period of oscillation is:

$$\frac{t_{ON}}{T} = \frac{V_{OUT} (N_P/N_S)}{V_{IN} + V_{OUT} (N_P/N_S)} = \frac{150/4.5}{12 + 150/4.5} \\ = 0.735$$

6. From Eq. A1 and A2, the peak primary current is:

$$\hat{I}_P = \left( \frac{2 P_{OUT}}{\eta V_{IN}} \right) \left( \frac{T}{t_{ON}} \right) = \frac{(2) (1)}{(0.7) (12) (0.735)} \\ = 0.327 \text{ amp}$$

7. From Eq. A11, the maximum flux density in the transformer core is:

$$B_M = \phi/A = \left( \frac{L_P \hat{I}_P}{N_P A} \right) (10^8) \\ = \frac{(38.5) (10^{-3}) (0.327)}{(207) (1.3)} = 4600 \text{ gauss}$$

this density does not exceed the saturation value of 4600 gauss for the type 3C ferrite used in the Ferroxcube 9F520 core.

8. From information provided for RCA transistor type 2N586, the typical values of  $V_{be}$  and  $I_b$  required peak primary current  $\hat{I}_p$  of 0.327 amp are, respectively, 0.9 v and 6.2 ma. The maximum values for these parameters are 1.3 v and 11 ma respectively, and are well within the maximum ratings for the 2N586.

9. From Eq. A14, the required number of turns for the base winding is:

$$N_B = \frac{N_P V_{BEmax}}{V_{IN} - \hat{I}_P (R_{SAT} + R_{PWIND} + R_{SUPPLY})}$$

Assuming that  $R_{PWIND} + R_{SUPPLY} = R_{SAT}$ , which is generally the case, the maximum value of  $R_{SAT}$  would be four ohms. Consequently,

$$N_B = \frac{(207) (1.3)}{12 - (0.3) (4)} = 25.2 \text{ turns (use 26 turns)}$$

10. From Eq. A18, the required value of the external base resistance is:

$$R_B = \frac{V_{BEmax} - V_{BE}}{I_B} = \frac{1.3 - 0.8}{62 \times 10^{-3}} = 80.6 \text{ ohms (use 82 ohms)}$$

11. From Eq. A17, the required number of turns for the secondary winding is:

$$N_S = \frac{N_P V_{OUT}}{V_{CBmax} - V_{IN}} = \frac{(207) (150)}{45 - 12} = 940.5$$

12. From Eq. A19, the peak secondary voltage is:

$$\hat{I}_S = \hat{I}_P (N_P/N_S) = 0.327/4.5 = 0.0727 \text{ amp} \\ \text{and from Eq. A20, the peak secondary voltage is:} \\ \hat{V}_S = V_{OUT} + V_{IN} (N_S/N_P) = 150 \\ + 12(4.5) = 204 \text{ v}$$

13. A diode rectifier capable of handling a peak secondary current of 0.0727 amp and a peak inverse voltage rating of more than 204 v is the RCA IN1763 silicon rectifier. The IN1763 has a maximum peak inverse voltage rating of 400 v and a maximum dc forward current rating of 0.5 amp.



**Table 1. Typical design parameters for ringing-choke-type dc-to-dc converters having output ratings up to 50 w.**

Application Requirements			Transistor Requirements				Recommended Parameters				
POWER OUTPUT ( $P_o$ ) WATTS	MAX. OUTPUT VOLTAGE ( $V_{OUT}$ )	DC INPUT VOLTAGE ( $V_{IN}$ )	SATURATION RESISTANCE ( $R_{SAT}$ ) MAXIMUM VALUE OHMS	COLLECTOR-TO-BASE BREAK-DOWN VOLTAGE ( $V_{CBmax}$ ) MINIMUM VALUE VOLTS	PEAK COLLECTOR CURRENT ( $I_C$ ) MINIMUM VALUE AMPERES	PERMISSIBLE DISSIPATION AT CASE OR FLANGE TEMPERATURE OF 55°C MINIMUM VALUE WATTS	Transformer Core			EXPECTED CIRCUIT-EFFICIENCY FACTOR ( $\eta$ )	
							MATERIAL	CROSS-SECTIONAL AREA (A) CM <sup>2</sup>	MAGNETIC-PATH LENGTH ( $l_m$ ) CM		OPERATING FREQUENCY (f) KILOCYCLES PER SECOND
1	250	6-10	2	25	0.5	0.1	Ferrite	0.5-1.5	2.5-10	1-8	0.75
	500	10-15	2	35	0.4	0.08					
	750	15-20	2	45	0.3	0.07					
5	250	6-12	1.5	30	3	1.5	Ferrite	0.5-5	2.5-12	1-5	0.75
	500	12-20	1.5	45	2	1	Si iron or grain-oriented Si steel	0.5-5	2.5-12	0.1-0.8	0.7
	750	20-28	1.5	60	1	0.5					
10	300	6-12	1	30	6	3	Si iron or grain-oriented Si steel	1-7.5	2.5-15	0.12-0.8	0.7
	500	12-18	1	45	4	2					
	750	18-28	1	60	2	1					
25	400	10-18	0.5	45	10	10	Si iron or grain-oriented Si steel	1-10	5-15	0.1-0.8	0.65
	600	18-26	0.5	60	6	5					
	750	26-36	0.5	80	3	2					
50	500	12-24	0.5	60	15	20	Si iron or grain-oriented Si steel	2-15	7.5-20	0.1-0.8	0.6
	750	24-36	0.5	80	8	7.5					

14. From Eq. A21, an output capacitor  $C_{OUT}$  capable of storing the energy required by the load and delivering this energy to the load during the conduction period  $t_{on}$  at a substantially constant voltage would be one having a capacitance

$$C_{OUT} \geq \frac{10 t_{on} P_{OUT}}{V_{OUT}^2}$$

From Step 5

$$t_{on} = 0.735 T = \frac{735 \times 10^{-3}}{8 \times 10^3} = 92 \times 10^{-6} \text{ sec}$$

From the initial conditions

$$P_{OUT} = 1 \text{ w} \quad V_{OUT} = 150 \text{ v}$$

$$C_{OUT} \geq \frac{10 (92 \times 10^{-6}) (1)}{22.5 \times 10^3} = 4 \times 10^{-8} = 0.04 \mu\text{f}$$

A RETMA standard value of 0.047  $\mu\text{f}$  would be suitable.

15. From the peak currents in the primary, secondary, and base windings, (the peak base current  $I_B$  is the maximum  $I_B$  required to produce the necessary value of  $I_p$ , the wire sizes based on the conservative rating of 700 circular mils per

ampere are:

$$\begin{aligned} \text{Primary} & \text{--- No. 26} & I_p & = 0.327 \text{ amp} \\ \text{Secondary} & \text{--- No. 32} & I_s & = 0.0727 \text{ amp} \\ \text{Base} & \text{--- No. 36} & I_B & = 0.011 \text{ amp} \end{aligned}$$

16. From Eq. A22, the optimum ratio of primary-to-secondary winding space would be:

$$K = \frac{1}{\sqrt{(N_s/N_p) (V_{IN}/V_{OUT}) + 1}} = \frac{1}{\sqrt{(4.5) (12/150) + 1}} = 0.86$$

**Table 2. Typical values of magnetic parameters for commercial transformer-core materials.**

Material	Max. Permeability ( $\mu_m$ )	Maximum Flux Density ( $B_m$ )—Gausses
Ferrite	1000	2000—5000
Silicon Iron	8500	10,000—15,000
Grain-Oriented Silicon Steel	30,000	15,000—20,000
"HiMu"-Type Nickel-Iron Alloy	70,000	15,000—20,000

To achieve the best coupling, the winding order with respect to the core should be: primary, base, secondary.

The foregoing design could have been improved by the use of a transformer core having a cross-sectional area greater than 1.3 sq. cm. Because such a core would have permitted the use of fewer turns on the primary, base, and secondary windings, and a larger window area or winding space, it would have been possible to use wires of larger sizes, and thus achieve a substantial reduction in copper loss with only a slight increase in core losses due to the larger core. ■ ■  
*Note: Part Two of the series will be devoted to the design of push-pull transformer-coupled dc-to-dc converters.*

**References**

1. L. H. Light and Prudence M. Hooker—"Transistor DC Converters", The Institution of Electrical Engineers Paper #1862R, April 1955.
2. L. H. Light—"The Design and Operation of Transistor DC Converters", Mullard Technical Communications, Vol. 2, #17, Feb. 1956.
- C. R. Eshelman—RCA Semiconductor Division, Somerville, N.J. Private Communication.

# How the Inertia Damper Improves Servo Performance

Frank E. Hagen

Daystrom Transicoil Corp.

Worcester, Montgomery County, Pa.

The inertia damper, so often used, so little understood, is the subject of Frank Hagen's third article in the servo series he is preparing for **ELECTRONIC DESIGN**. These articles are reprinted in Daystrom Transicoil Corp.'s "Servo Slants." Interested readers may write to the company for copies.

**I**NERTIA DAMPERS can increase the frequency response of servomotors without some of the drawbacks of drag-cup type viscous dampers. The inertially damped motor has the great advantage of circuit simplicity; it requires no special network to insure high frequency stability.

But inertia dampers are not unmixed blessings. They have their disadvantages. To see them in full light, one must first understand the role of damping in a servo system.

Fig. 1 is a simplified block diagram of an instrument servo. Here,  $\alpha$  is the sensitivity of the error detector,  $A$  is the amplifier gain,  $N$  is the gear ratio, and  $K_T/(Js^2 + fs)$  is the transfer function of the control motor.

With a given set of performance specifications, the systems engineer would select a group of these building blocks to

perform as required. If the required small signal frequency response is not too high, stability is no problem.

However, in a more sophisticated system, where very rapid response is necessary, mechanical oscillation may result. The limiting parameters establishing the frequency response ceiling with stable operation are the motor rotor inertia  $J$ , and its inherent viscous damping  $f$ .

The ratio  $J/f$  represents the time constant of the motor. Any decrease in its value allows the system frequency response to be increased.

## Viscous Damper Adds Friction

A method used to improve the frequency characteristics of a given motor is the application of a viscous damper. This usually involves coupling a drag cup to the rotor and placing it in the field of a permanent magnet. It establishes a fric-

tion term, proportional to speed, which adds directly to the inherent viscous damping of the motor.

Unfortunately, extending the frequency realm of the control motor by this method also introduces some negative results. The viscous damper takes mechanical power from the motor. This loss in power results in greater heat rise in the motor along with reduced free speed. Motor stall torque, of course, is not affected.

## Inertia Damper Is Selective

These shortcomings in viscous damper performance led to the inertia damper. If the permanent magnet itself is allowed to rotate on bearings, and is designed to have a high moment of inertia with respect to the motor rotor, it introduces a more selective type of damping.

To rapidly changing signals, or step functions, the high inertia magnet appears fixed, introducing a large viscous drag. However, with a fixed velocity input, the cup has sufficient time to drag the magnet around with it, removing the viscous term and allowing the motor to operate at higher free speed. In other words, viscous damping is introduced only when it is required.

This description of inertia damper operation is an oversimplification. To be of value to the servomechanism engineer, it must be analyzed mathematically.

Referring to Fig. 1, the motor transfer function is an outgrowth of the torque equation,

$$K_T e_c = J \frac{d^2 \theta}{dt^2} + f \frac{d \theta}{dt} \quad (1)$$

where  $e_c$  is the servomotor control winding voltage and  $\theta$  is the position of its rotor. If the inertia damper is added to the motor with drag cup damping coefficient  $D$  and magnet inertia  $I$ , Eq. (1) becomes:

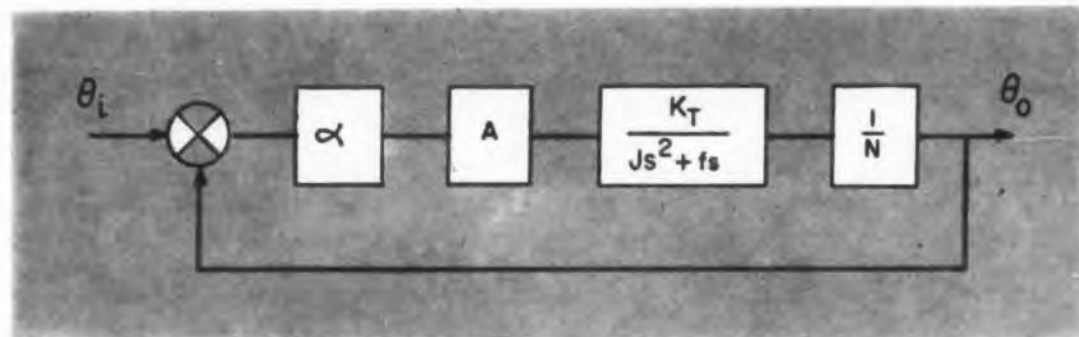

Fig. 1. Basic block diagram of an instrument servo.

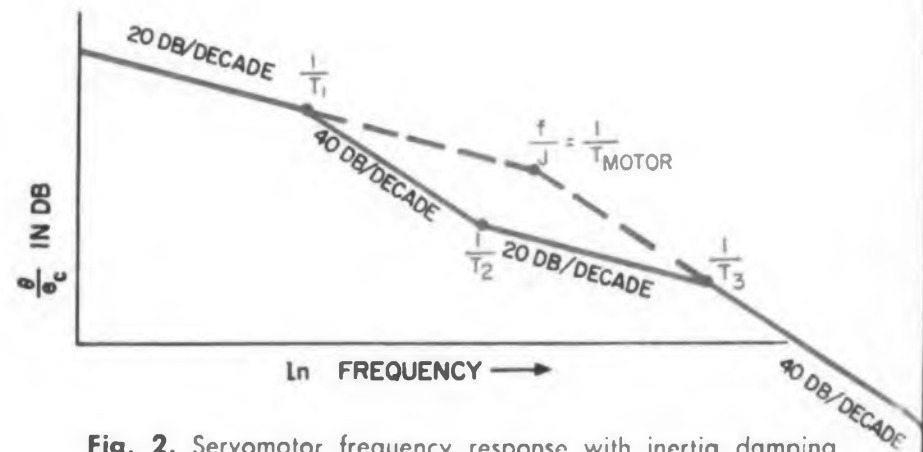

Fig. 2. Servomotor frequency response with inertia damping (solid line) and without (dotted line).



cent  $D$  and magnet inertia  $I$ , Eq. (1) becomes:

$$K_T e_c = J \frac{d^2 \theta}{dt^2} + f \frac{d \theta}{dt} + D \left( \frac{d \theta}{dt} - \frac{d \theta_M}{dt} \right) \quad (2)$$

where  $d\theta_M/dt$  represents the instantaneous speed of the magnet. In operational form, Eq. (2) becomes:

$$K_T e_c = Js^2\theta + fs\theta + Ds\theta - Ds\theta_M \quad (3)$$

Viewing the magnetic linkage between the drag cup and the magnet and equating torques:

$$D \left( \frac{d \theta}{dt} - \frac{d \theta_M}{dt} \right) = I \frac{d^2 \theta_M}{dt^2} \quad (4)$$

or in operational form:

$$Ds\theta - Ds\theta_M = Is^2\theta_M$$

$$\theta_M = \frac{Ds\theta}{Ds + Is^2} \quad (5)$$

The general form of the equation becomes:

$$\frac{\theta}{e_c} = \frac{(1 + T_2s)}{(1 + T_1s)(1 + T_3s)} K_T/f \quad (6)$$

For the systems engineer to evaluate this approach, it is helpful to present the open loop frequency response curves of a servomotor before and after inertia damping.

In Fig. 2, the dotted line represents the frequency response of the servomotor without the inertia damper. The motor corner frequency approximates the maximum stable response of a system incorporating this motor. The solid line is the frequency response of the motor with the inertia damper.

Corner frequency  $1/T_3$  represents an approximation of the maximum response attainable with an inertia damper under stable conditions. By proper design, this approach makes it possible to double the limiting frequency realm of a system.

Unfortunately, the inertia damper has several disadvantages. Its response to a position step function is characterized by one overshoot. This is caused by the inertia wheel dragging the rotor through its final agreement position before damping becomes effective.

What may be considered a second disadvantage is its lack of flexibility. The three corner frequencies are established in the design of the unit and cannot be externally varied. ■ ■

# FIRST DIGITAL VOLTMETER WITH THE FACTUAL FIFTH FIGURE

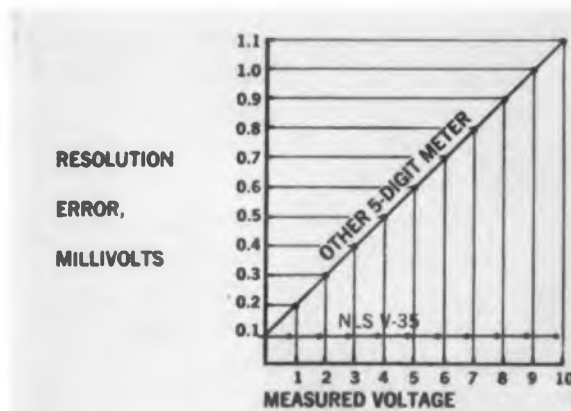

This chart shows the significant resolution error that results in other five-digit meters as compared to the NLS V-35 with the *factual fifth figure*.

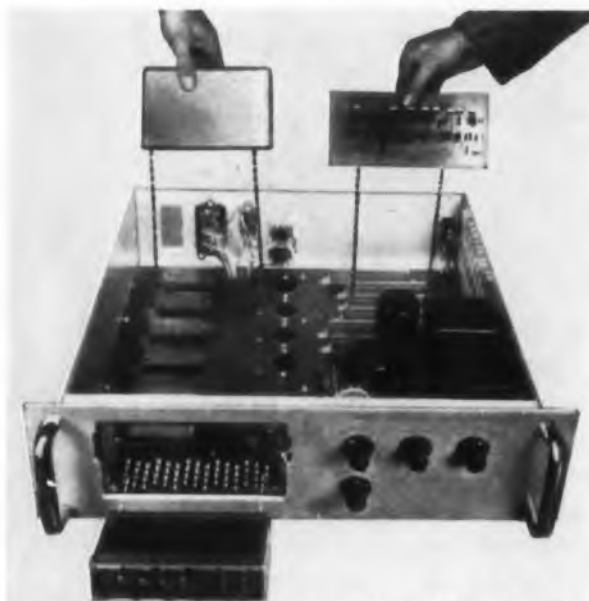

Compact, plug-in design of the NLS V-35

## The All-Transistorized NLS V-35

Here for the first time is a *true* five-digit voltmeter with a *factual* fifth figure. Increased accuracy of *full* five-digit resolution — 0.001% — results from the new mathematically perfect logic of the NLS V-35.

Other five-digit digital voltmeters require "desensitizing" to prevent oscillation of the least significant digit. This results in a resolution error of three to nine digits in the upper portions of each range as graphically displayed in the chart to the left. This comparison clearly shows the increased accuracy of the NLS V-35, made possible by full five-digit resolution.

In new logic . . . in all-transistorized circuitry, including logic . . . in new simplified design with *plug-in* circuit boards, *plug-in* oil-bathed stepping switches, and *snap-in* readout . . . the NLS V-35 leads its field. Write today for complete information.

### NLS V-35 Specifications

Measures Voltage from  $\pm 0.0001$  to  $\pm 999.99$ , Ratio from  $\pm .00001$  to  $\pm .99999$  . . . 10 Megohm Input Impedance . . . 0.01% Accuracy . . . Automatic Selection of Range and Polarity . . . And Measures Three Times Faster Than Any Other Stepping Switch Instrument.



Originators of the Digital Voltmeter

**non-linear systems, inc.**

DEL MAR (San Diego), California

NLS — The Digital Voltmeter That Works . . . And Works . . . And Works!



## Zero-Crossing Detector Generates Pulses Every 180 Degrees

John S. Denelsbeck  
U.S. Naval Air Development Center  
Johnsville, Pa.

Combination of two transistors can produce a pulse whenever the input waveform passes through zero. Called a zero-crossing detector, the circuit can be used as an encoder, a pulse generator or a frequency doubler.

UNIQUELY combining a center-tapped transformer and a logical transistor OR gate, a zero-crossing detector can generate two pulses, accurately spaced 180 deg apart, for each cycle of a sinusoidal input signal. The device is called a zero-crossing detector because it generates a pulse whenever the input waveform passes through zero. The detector utilizes a combination of two grounded-emitter amplifiers which are fed by input signals of opposite phase relationship. It was originally designed for use in a synchro shaft position encoder. However, the detector also has application as a composite pulse generator and as a frequency doubler.

### Generating Negative Pulses

A transistor zero-crossing detector, which will generate a negative pulse at each zero crossing of a sinusoidal input signal, is shown in Fig. 1. Negative pulses are obtained with pnp transistors and a negative power supply, while positive pulses may be obtained with npn transistors and a positive power supply.

The input signal is applied to the primary winding of transformer  $T_1$ . The center-tapped secondary winding provides two output signals 180 deg out of phase. The instantaneous voltages of these signals are therefore always opposite in sign, the negative excursion alternately providing base drive to either  $Q_1$  or  $Q_2$ . The transistors are connected in the grounded emitter configuration and will conduct when the base is more negative than the emitter. This permits each transistor to conduct for slightly less than one-half cycle.

Current flows constantly in the common-load resistor,  $R_3$ , alternately fed by transistors  $Q_1$  and  $Q_2$ , except when the signals pass through zero. During this short interval, one transistor will cease conducting immediately before zero is reached, while the other will commence immediately after.

Transistors  $Q_1$  and  $Q_2$  are connected in the grounded emitter configuration with the base-emitter junctions connected in series with the respective transformer output windings. See Fig. 1. Connected in this manner,  $Q_1$  and  $Q_2$  act as diodes if only the base-emitter junction is considered. Performing the diode function, they provide the secondary windings of the transformer with a low-impedance path to ground during the time that the base is biased negative with respect to the emitter. Therefore, each output winding will be returned to ground through the series path of a load-resistor and base-emitter junction during its respective negative half-cycles of operation. The resistors  $R_1$  and  $R_2$  provide constant load for the transformer output windings and also serve to limit the base current in the transistors. During the positive half-cycles, the reverse diode characteristics of the base emitter junctions block the flow of current in the output windings. Diodes  $D_1$  and  $D_2$  are connected opposite in polarity to the base-emitter junction to limit the reverse diode requirement of this junction, and to provide a more uniform loading of the transformer by permitting constant current flow in each output winding during the positive and negative half-cycles of operation.

In the circuit shown in Fig. 1, transistors  $Q_1$  and

$Q_2$  are operated in a saturated condition. Saturation, in this case, is defined in terms of the  $I_c R_3$  drop relative to the collector supply voltage,  $V_{cc}$ . When either  $Q_1$  or  $Q_2$  is supplying sufficient collector current so that the  $I_c R_3$  drop is approximately equal to the  $V_{cc}$ , and when any additional increase in base current,  $I_b$ , has no effect on the  $I_c R_3$  drop, then the transistor is operating in saturated condition. Fig. 2 illustrates the saturation characteristics of the transistor zero-crossing detector of Fig. 1. Transistors  $Q_1$  and  $Q_2$  are connected to form a logical OR gate and due to the nature of the inputs,  $Q_1$  and  $Q_2$  are alternately operated in the saturated condition for a half-cycle except for a small interval about the zero-crossing. The negative pulse is generated in this interval.

### Zero Crossing

A small portion of a sinusoidal input to the base of transistor  $Q_1$  is illustrated in Fig. 3. The varying input to  $Q_1$  is defined by  $K_{10}$ ,  $K_{11}$ ,  $K_{12}$ , and  $Z$ . Transistor  $Q_1$  is in the saturated condition during the  $K_{10}$  to  $K_{11}$  interval. The output of the circuit during this interval is represented by  $K_{10}$  to  $K_{11}$ .  $K_{11}$  represents the minimum amplitude of base-emitter voltage required to saturate transistor  $Q_1$ . This minimum voltage (0.3 v) is a function of the supply voltage, the load resistance, and the transistor characteristics. Transistor  $Q_1$  is conducting but not saturated during the  $K_{11}$  to  $K_{12}$  interval. This defines the rise time of the output pulse  $K_{11}$  to  $K_{12}$ .  $K_{12}$  defines the cutoff point of the transistor; that is, collector current will not



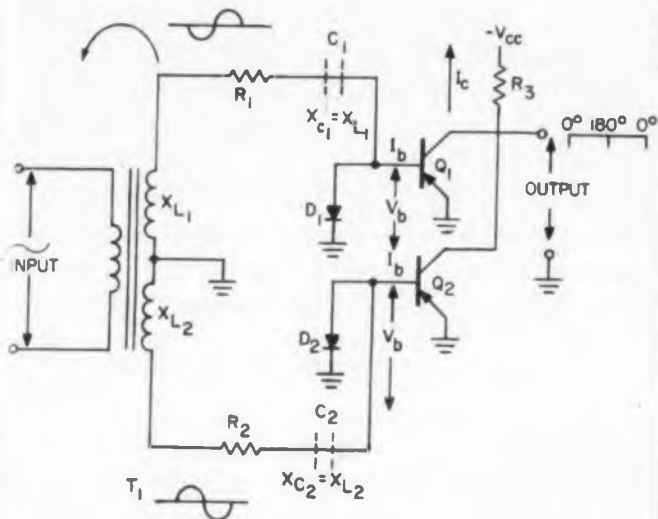

Fig. 1. Transistor zero-crossing detector.

flow for any voltage below  $K_{12}$ . Neither transistor will conduct during the  $K_{12}$  to  $K_{13}$  interval, during which the output pulse amplitude will be approximately at the supply, represented by  $K_{12}$  to  $K_{13}$  in Fig. 3. Transistor  $Q_1$  will then remain cut off for approximately one-half cycle. At point  $K_{13}$ , transistor  $Q_2$  will begin to conduct and will do so until it reaches saturation at point  $K_{14}$ . This interval defines the fall time of the pulse  $K_{13}$  to  $K_{14}$ . Transistor  $Q_2$  will be in a saturated condition for approximately one-half cycle. The operation will repeat, with  $Q_2$  cutting off and  $Q_1$  turning on. Hence, two pulses are generated for each cycle of a sinusoidal input.

#### Hole Storage Effect

It can be seen from Fig. 3 and the previous explanation that the center of the output pulse represents the position of the zero-crossing, and the width of the output pulse is inversely proportional to the slope of the input. If the amplitude of the input sinusoid is increased as defined by  $K_{21}$ ,  $K_{22}$ ,  $Z$ ,  $K_{23}$ , and  $K_{24}$  of Fig. 3, it is reasonable to assume that a narrower pulse (see  $K_{21}$ ,  $K_{22}$ ,  $K_{23}$ , and  $K_{24}$  of Fig. 3) with the same amplitude would be generated. As the amplitude of the input signal is increased, it would also be expected that the rise and fall times of the output pulse would approach the zero-crossing as a limit. Actually, however, as the amplitude of the input sinusoid is increased, the resultant output pulse does become narrower, but at the same time, it decreases in amplitude. This phenomena can be explained by the hole storage effect in transistors. The hole storage effect is, in short, the ability of a transistor to conduct collector current for a short interval of time after the removal of the base drive.

Consider that the input to  $Q_1$  is defined by  $K_{20}$ ,  $K_{21}$ ,  $K_{22}$  and  $Z$  in Fig. 3a.  $Q_1$  is in a saturated condition in the  $K_{20}$  to  $K_{21}$  interval. At  $K_{21}$ , the input to transistor  $Q_1$  goes below the voltage



## "YOU CAN'T PUT NIAGARA FALLS IN A SPACE SHIP."

Yet the power output of Niagara approximates that which is needed for an "Astronaut" to communicate with earth as he is millions of miles away heading for another planet. Challenging problems such as the development of an alternate source of power for communications are typical of the exciting work now being undertaken at Convair-Astronautics. The enormity and variety of these problems afford electronic engineers at Astronautics an opportunity to pursue tasks that are truly their own, providing an abundance of personal and professional satisfaction.

If you are an  
**ELECTRONIC ENGINEER**  
with a record of professional accomplishment there is an important position awaiting you at Convair-Astronautics — where the perimeter of man's knowledge is steadily being advanced.

Write now to: Mr. T. W. Wills, Engineering Personnel Administrator, Dept. 130-90

## CONVAIR / ASTRONAUTICS

Convair Division of

## GENERAL DYNAMICS

5625 Kearny Villa Road, San Diego, Calif.

necessary to keep the transistor in saturation. Because of the hole storage effect,  $Q_1$  remains in saturation for a period of time illustrated in Fig. 3b by  $K_{21}$  to  $T_1$ . The rise time of the output pulse,  $T_1$  to  $T_2$ , is illustrated on Fig. 3b. It can therefore be seen that the cutoff point of transistor  $Q_1$  is obscured in the output pulse and that the fall time,  $T_2$  to  $K_{24}$ , is realized at a lower amplitude because transistor  $Q_2$  is conducting  $K_{23}$  and reaches saturation at  $K_{24}$ . At higher amplitude input signals, the zero-crossing will not be in the exact center of the output pulse because of hole storage, but will be located closer to the rise time of the output pulse. This holds true until the slope of the input voltages becomes greater than the turnoff time of the transistors and the second transistor starts conducting before the first has been cut off. If the turnoff time equals the turn-on time of the transistor, the delays would cancel and the result would be that the center of the pulse would be the zero-crossing plus the delay in turn-off. The majority of transistors have a larger turn-off time than turn-on because of the storage of minority carriers in the base region or hole storage.

With high-frequency transistors, the errors introduced correspond to approximately 0.2 micro-

sec or 0.03 deg. It is expected that the error introduced by hole storage will not be appreciable since zero-crossing will always occur within the rise time of the output pulse. The initiation of the logical function performed by the output pulse will relate to threshold voltage level on the rise time. The error in defining zero-crossing is the difference between this threshold voltage point and actual zero.

#### Phase Shift

The circuit as described detects the zero-crossing of the transformer secondary or output windings. This would also represent the zero-crossing of the input signal if no phase shift existed between the transformer input and output windings. A phase shift is caused by reflected impedance presented by the nonlinear impedances presented by the diodes and the transistor base-emitter junctions and the inductive reactance of the output windings. The nonlinearity of the diodes and the transistor base-emitter junctions exists primarily during the time that the pulse is being generated. At all other times the nonlinearity approaches a constant and provides a pure resistive load for the output windings. If the input frequency is

constant, the inductive reactance of the output windings remains constant. Therefore, the phase angle between the input and output windings is a constant for identical transformers. This constant phase angle may be reduced to zero by adding series capacitors  $C_1$  and  $C_2$ , as indicated in Fig. 1, to each output winding where the capacitive reactance is made equal to the inductive reactance; thus the reflected impedance is resistive.

#### Selecting the Transformer and Diodes

The transformer for this circuit is selected to match the required input impedances. The only requirement on the transformer output windings is to supply the base current necessary to saturate the transistors. The original circuit contained a transformer with a low-impedance input and a 3:1 turn ratio. An identical transformer and a typical filament transformer were tested in this circuit and the output pulses were essentially the same.

Diodes  $D_1$  and  $D_2$  in Fig. 1 should have optimum forward characteristics. The original circuit contained zener-type silicon diodes. Zener diodes provide a constant loading for the output windings, and the zener breakdown voltage in the reverse direction serves to limit the transistor base

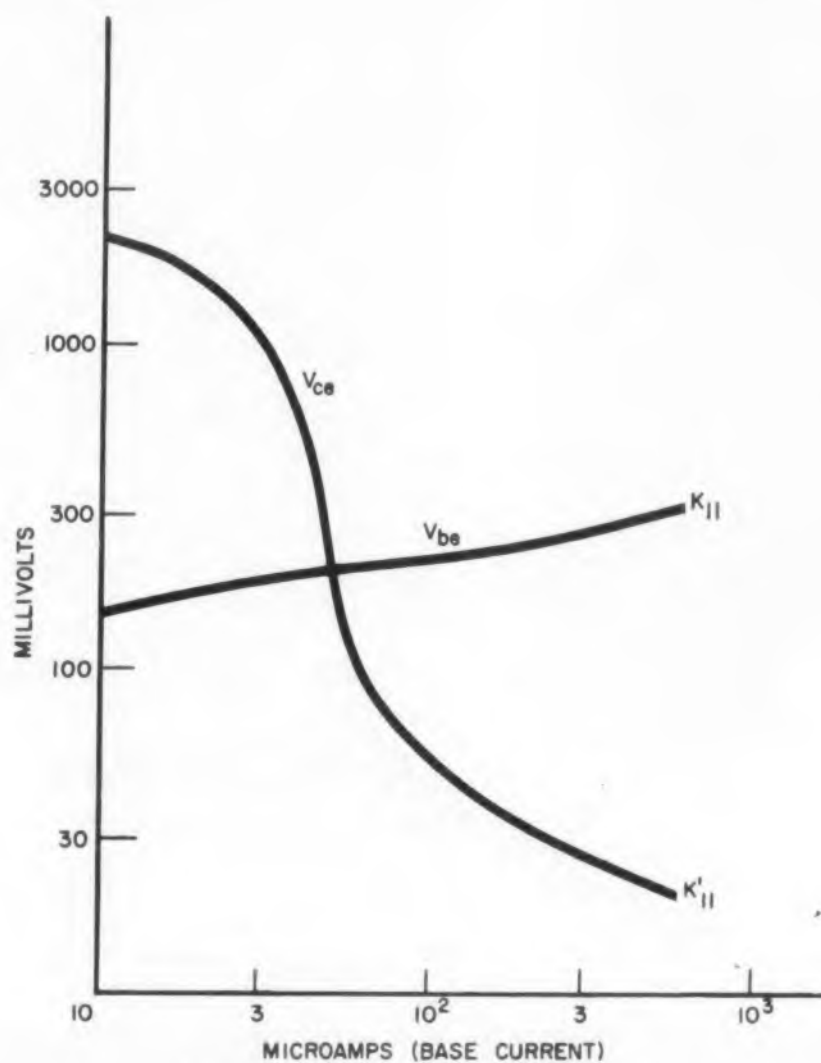

Fig. 2. Circuit saturation characteristics.

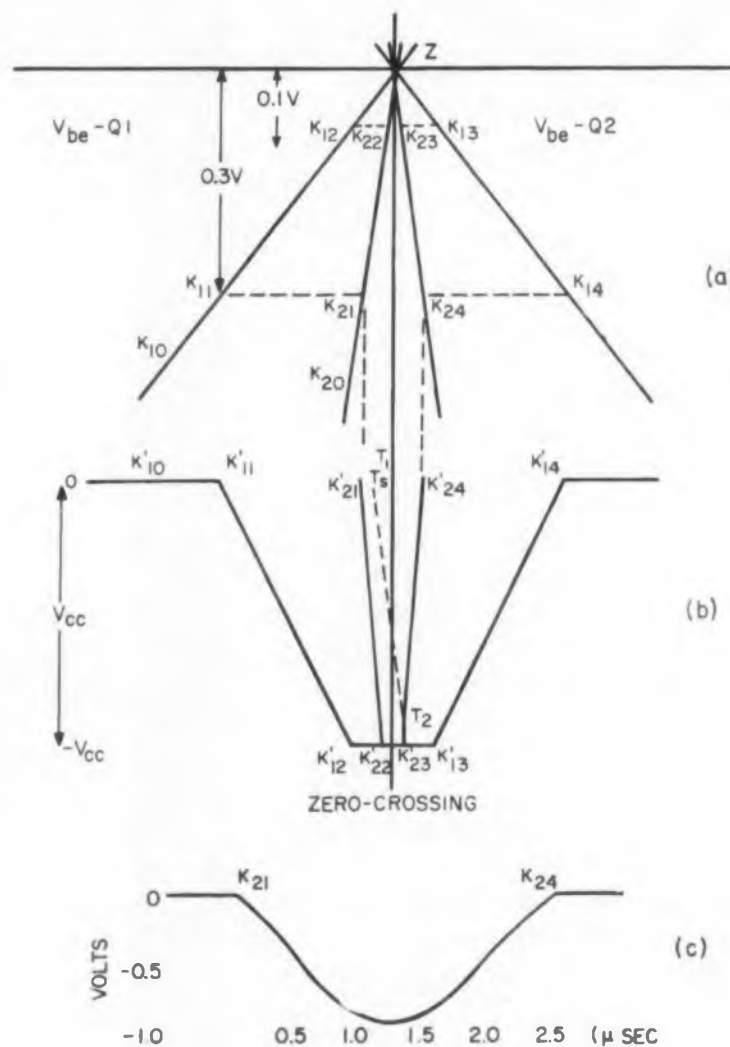

Fig. 3. Transformer output at zero crossing (e); output pulse (b) corresponding to transformer output; nominal 1 v pulse (c).



current. In this respect they provide protection for the transistors through the conducting half-cycles. Type SB-100 transistors were used in this circuit design. During the tests, capacitors  $C_1$  and  $C_2$  were added to compensate the phase shift due to the reflected impedance.

#### A Few Working Equations

The smallest pulse capable of being generated at a 400-cycle repetition rate without any transistor hole storage effects was 3 v in amplitude and 8 microsec wide at the baseline. As the pulse is made narrower, the amplitude of the pulse decreases proportionately because of hole storage. Since hole storage only affects the rise time of the pulse in this application, the zero-crossing will be located in the center of the 8-microsecond pulse. As the pulse is made narrower, the zero-crossing will be located within the rise time of the pulse. Knowing the input voltage,  $V_b$ , Fig. 1 and the minimum saturation point of the transistor  $K_{11}$ , Fig. 3, the hole storage time,  $T_s$ , and the position of the zero-crossing with respect to pulse rise time may be approximated from the following equations:

$$\theta = \arcsin K_{11}/V_b$$

$$W_c = 2 \theta k$$

$$T_s = W_c - W_m$$

where  $\theta$  = starting point of pulse with respect to sinusoidal signal

$k$  = conversion factor (degrees to micro-sec)

$W_c$  = computed baseline pulse with (micro-sec)

$W_m$  = measured baseline pulse width (micro-sec)

A nominal 1-volt pulse obtained from this circuit is shown in Fig. 3c. The initial point on the rise time leads zero-crossing by approximately 0.8 microsec. Since the threshold voltage level occurs on the rise time, zero-crossing is defined with an error of less than 0.8 microsec. Using a 400-cycle excitation frequency, the 0.8 microsec figure corresponds to an error less than 7 minutes of arc between zero-crossing and baseline rise-time point. Interchanging randomly selected transistors had little or no effect on the output pulse.

#### Extending The Frequency Range

A tape-wound toroidal core was constructed in an attempt to extend the frequency range of the detector. With this configuration, no attempt was made to cancel phase shift or determine true zero-crossing. Preliminary investigations indicate that the circuit will operate in the 500 kc range. The upper-frequency-range investigation was made primarily in terms of frequency multiplication, since the pulse repetition rate is equivalent to twice the input frequency. ■ ■

## FRICION ELIMINATED TO ACHIEVE

# *the Ultimate in Performance*

## FOR SPRING RESTRAINED

## ACCELEROMETERS



**TYPE LA-600**  
shown actual size

- Full Scale Range:  $\pm 1$  to  $\pm 40$  G
- Full Scale Output: to 25 volts
- Threshold-Resolution: 0.0001 G
- Damping Ratio:  $0.6 \pm .2$  typical from  $-65^\circ\text{F}$  to  $+250^\circ\text{F}$
- Natural Frequency: 16 to 100 cps
- Cross-Axis Sensitivity: 0.005 G per G maximum
- Shock: to 60 G
- Vibration: 10 G to 2000 cps
- Size:  $1 \frac{7}{8}$ " diameter,  $2 \frac{3}{8}$ " long
- Weight: 1.2 lbs. maximum



**TYPE LA-700**  
shown actual size

- Full Scale Range:  $\pm 1$  to  $\pm 60$  G
- Full Scale Output: to 25 volts
- Threshold-Resolution: 0.0001 G
- Damping Ratio: 0.6 at  $25^\circ\text{C}$  typical
- Natural Frequency: 5 to 30 cps
- Cross-Axis Sensitivity: 0.005 G per G maximum
- Shock: to 100 G
- Vibration: 15 G to 2000 cps
- Size:  $2 \frac{1}{32}$ " diameter,  $2 \frac{1}{16}$ " long
- Weight: 1.2 lbs. maximum

The virtual elimination of friction in both these new Honeywell linear accelerometers is made possible by a unique web spring suspension. This

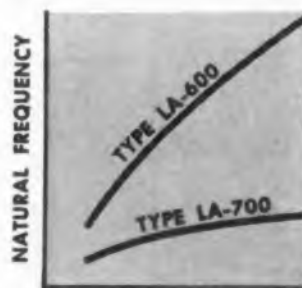

feature combined with an electro-magnetic pick-off permits resolutions of extremely low level inputs.

These two instruments span the entire range of dynamic performance.

The LA-600 with its magnetic damping is used for higher natural frequency applications. The LA-700 with its compensated fluid damping is designed for lower natural frequency applications. Write for Bulletins LA-600 and LA-700 to Minneapolis-Honeywell, Boston Division, 40 Life Street, Boston 35, Mass.

# Honeywell

**H** Military Products Group

CIRCLE 36 ON READER-SERVICE CARD

a new flexibility . . . versatility  
in electric heat

**WATLOW**  
*flexible*  
SILICONE RUBBER HEATERS



*Twist 'em! Bend 'em! Wrap 'em around!  
They're built to take it . . . and LAST!*

Because they're thin, flexible, and can be molded in any single plane shape, new WATLOW Flexible Silicone Rubber Heaters are the ultimate in versatility . . . applicable wherever heat up to 450°F. is needed.

#### ADAPTABLE TO ANY APPLICATION

Can be bonded to any surface to which rubber will adhere. Aluminum backing also available for unusual attachments.

#### A SHAPE FOR EVERY NEED

Round, square, long, short, with or without inside die-cuts — you name it and Watlow will make it.

#### LEAD WIRES WHEREVER YOU WANT THEM

Teflon-insulated, or any other, can be had from any edge or surface of heater.

#### DEPENDABLE HEAT

Finely wound nickel-chromium resistance wires are embedded in durable silicone rubber that's reinforced with fiberglass. It will last and last, and is waterproof, too!

#### WRITE for Illustrated Literature

Manufacturers of all types of electric heating units:  
Immersion • Cartridge • Cylindrical • Tubular • Strip

**WATLOW**

ELECTRIC MANUFACTURING CO.

1368 Ferguson Ave., St. Louis 14, Mo.

Mfd. by Watlow Electric Co. of California, a subsidiary



CIRCLE 37 ON READER-SERVICE CARD

## Use Current-Mode Flip-Flops For Really High-Speed Switching

William N. Sick, Jr.  
Texas Instruments Inc.  
Semiconductor Components Div.  
Dallas, Texas



William Sick needed fast—very fast transistor switching circuits. He tried some of the fastest switching transistors available but found that, in conventional circuits, they just weren't fast enough. His solution, current-mode switching, is presented here.

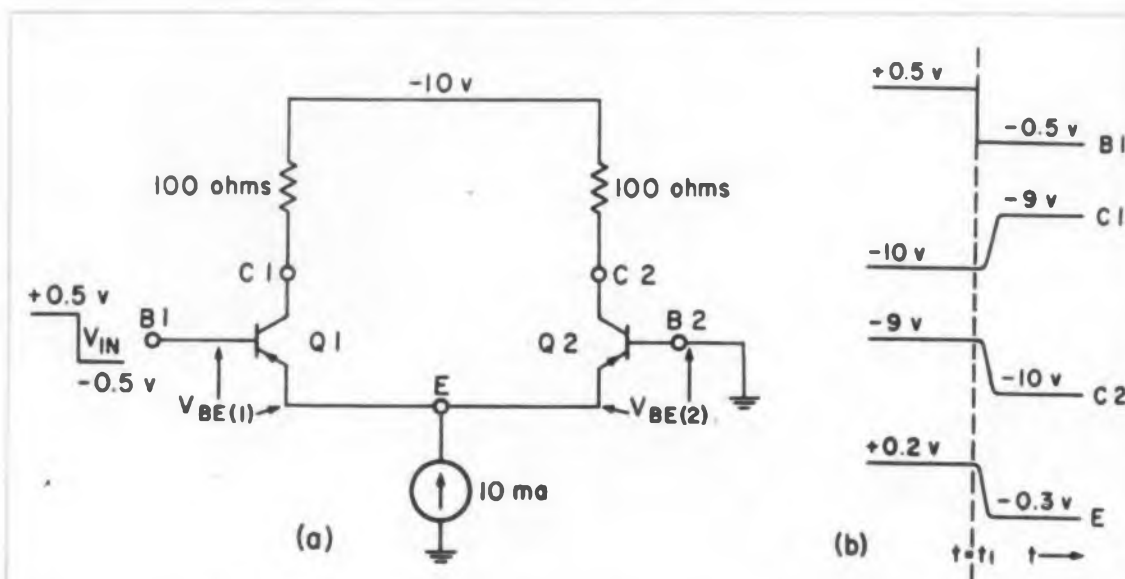

Fig. 1. Simplified current-mode switch (a), and the corresponding voltage waveforms (b).



CONVENTIONAL transistorized switching circuits just aren't fast enough. Present requirements for high-speed transistor switching circuits demand new techniques in switching circuit design.

The speed of conventional saturated transistor switching circuits is limited by:

- Carrier storage times in the transistor,
- Transistor output and input capacitance and stray circuit capacitance,
- Recovery time of diodes in the circuit,
- Alpha cutoff frequency of the transistor.

The switching speed of saturated circuits with new high-speed mesa switching transistors is almost always limited by a combination of the first three factors; so the full potential speed of these units is realized only in a different type circuit.

#### Current-Mode Switching

Fig. 1 shows a simplified current-mode switching circuit with its waveforms. Before time  $t = t_1$  transistor  $Q_2$  conducts 10 ma,  $V_E$  is approximately +0.2 v (assuming 0.2 v  $V_{BE}$  for germanium), and  $Q_1$  is biased off.

At  $t = t_1$ ,  $V_{in}$  falls from +0.5 v to -0.5 v. The base-emitter junction of  $Q_1$  becomes forward biased, and  $Q_1$  starts conducting. The emitter of  $Q_1$  (point  $E$ ) follows  $B_1$  down to about -0.3 v. This action cuts  $Q_2$  off, causing the full 10 ma current to suddenly switch from  $Q_2$  to  $Q_1$ .

Current-mode switching circuits use the full potential speed of switching transistors. The collector voltage of the transistor remains high enough to prevent saturation; thus minority carrier storage time is eliminated. The operating collector voltage can be chosen to give minimum output capacitance and maximum alpha cutoff frequency for the transistor.

No fast-recovery diodes are necessary. The input and output voltage swings are small, so the effects of transistor and stray circuit capacitances are minimized.

Since the transient response of the transistor is approximately the same as for common-base operation with a current step into the emitter, the full common-base frequency response of the transistor is realized. In addition, the current-mode circuits are highly immune to noise voltages and are insensitive to transistor parameter spreads and variations.

The current-mode technique can be applied to flip-flop design. If the bases of  $Q_1$  and  $Q_2$  in Fig. 1A are coupled to the opposite collectors, the resulting circuit will be a bistable flip-flop. Pull-over transistors can be added in parallel with  $Q_1$  and  $Q_2$  for inputs. Two current-mode flip-flops are described here.

#### 50 Mc Current-Mode Flip-Flop With 2N705's

Fig. 2A shows a 50 mc current-mode flip-flop

## 2,000 VOLT SINGLE UNIT DOUBLE DIFFUSED SILICON RECTIFIERS

TESTED  
APPROVED  
IN USE . . .

COLUMBUS  
SEMICONDUCTORS



#### SPECIFICATIONS AND RATINGS

DIODE NO.	PEAK INVERSE VOLTAGE	MAX. RMS VOLTAGE	MAX. D.C. CURRENT AT 25°C CASE TEMP.	MAX. 1 CYCLE SURGE CURRENT	FORWARD DROP AT 25°C	MAX. LEAKAGE AT 25°C @ RATED PIV	CORRESPONDING HOULARD STUD
	VOLTS	VOLTS	AMPS	AMPS	VOLTS	MICRO AMP	DIODE NO.
<b>TOP HAT AXIAL LEAD</b>							
1N2357	1400	900	.4	15	2	1	-----
1N2358	1500	1050	.4	15	2	1	-----
1N2359	1600	1120	.4	15	2	1	-----
1N2360	1800	1260	.4	15	2	1	-----
1N2361	2000	1400	.4	15	2	1	-----
<b>STUD 7/16"</b>							
1N2362	1400	900	1	15	2	1	1N2363
1N2364	1500	1050	1	15	2	1	1N2365
1N2366	1600	1120	1	15	2	1	1N2367
1N2368	1800	1260	1	15	2	1	1N2369
1N2370	2000	1400	1	15	2	1	1N2371
1N2362A	1400	900	5	20	2	1	1N2363A
1N2364A	1500	1050	5	20	2	1	1N2365A
1N2366A	1600	1120	5	20	2	1	1N2367A
1N2368A	1800	1260	5	20	2	1	1N2369A
1N2370A	2000	1400	5	20	2	1	1N2371A
1N2362B	1400	900	10	25	2	1	1N2363B
1N2364B	1500	1050	10	25	2	1	1N2365B
1N2366B	1600	1120	10	25	2	1	1N2367B
1N2368B	1800	1260	10	25	2	1	1N2369B
1N2370B	2000	1400	10	25	2	1	1N2371B

THESE HIGH VOLTAGE RECTIFIERS ARE PART OF AN EXTENSIVE LINE OF DOUBLE DIFFUSED SILICON POWER RECTIFIERS

COLUMBUS ELECTRONICS CORPORATION, 1010 SAW MILL RIVER ROAD, YONKERS, N. Y. — YO. 8-1221 — TWX-YONKERS, N. Y.-1369

CIRCLE 38 ON READER-SERVICE CARD

from stock  
in production  
quantities

Hermetically  
Sealed,  
Available in  
Axial Lead Top Hat,  
7/16" Stud and  
Insulated Stud

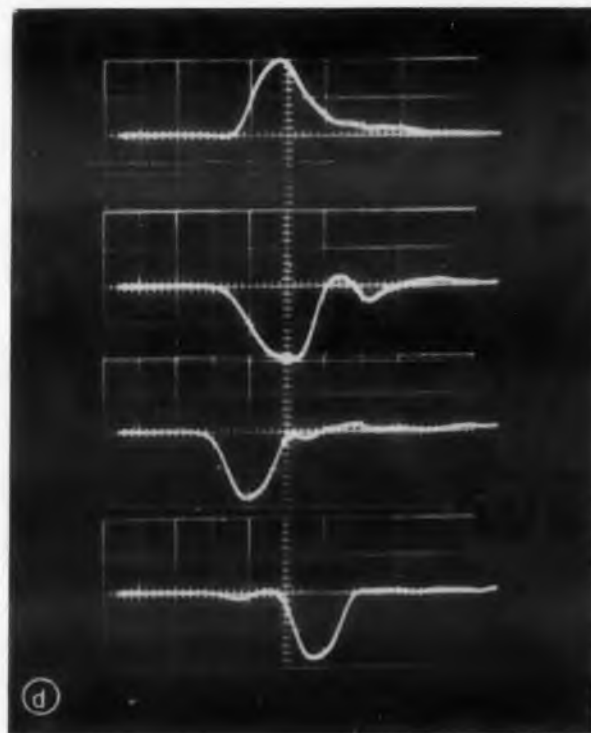
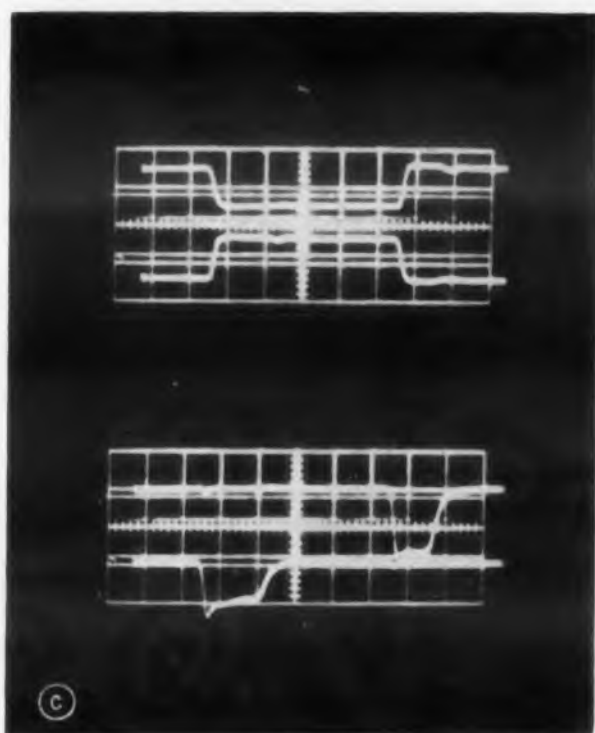
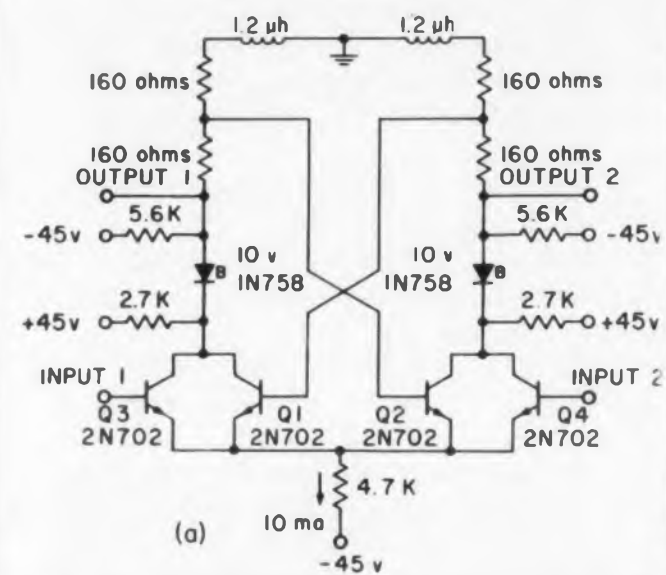
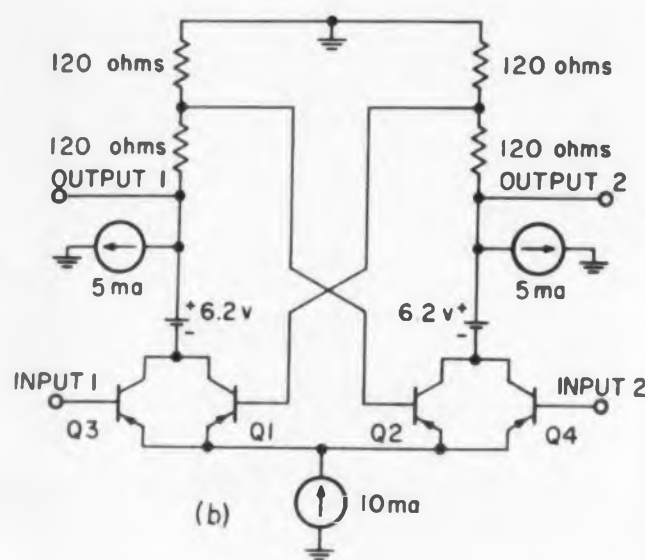
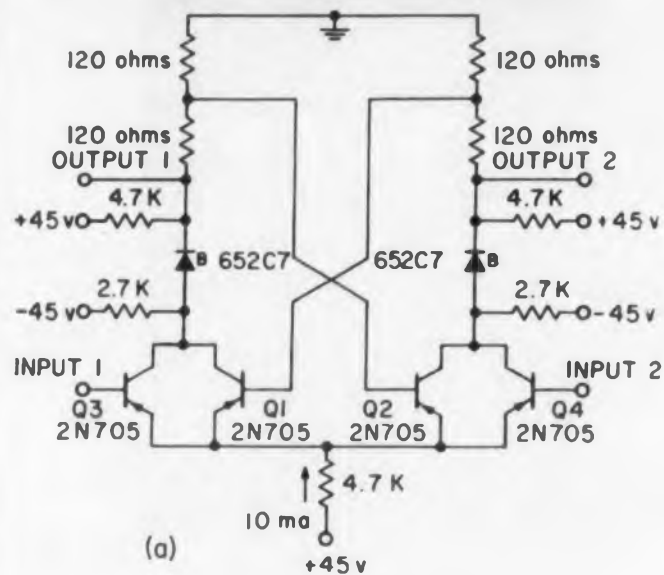

**Fig. 2.** 50 mc current-mode flip-flop using germanium 2N705's. (a) Schematic of the 50 mc flip-flop. (b) Equivalent circuit of the 50 mc flip-flop. (c) Waveforms for 2 mc operations at a temperature of 25 C. Reading from top to bottom, waveforms are at Output 2, Output 1, Input 2, and Input 1. Scope is a Tektronix 545 with 100  $\mu$ sec/cm on the time scale and 2 v/cm on the vertical scale. (d) Waveforms for 50 mc operation at a temperature of 25 C. Reading from top to bottom, waveforms are at Output 1, Output 2, Input 1, and Input 2. Scope is a Tektronix 517A with 10  $\mu$ sec/cm and 1 v/cm.

**Fig. 3.** (right) 25 mc current-mode flip-flop using silicon 2N702's. (a) Schematic of the 25 mc flip-flop. (b) 10 mc operation at 25 C showing, top to bottom, waveforms at Input 1, Input 2, Output 1, and Output 2. Scope is Tektronix 517A with H scale set at 25  $\mu$ sec/cm, V scale at 1 v/cm. (c) 25 mc operation at 25 C showing, top to bottom, Input 1, Input 2, Output 1, and Output 2. Scope is 517A with H = 10  $\mu$ sec/cm, V = 1 v/cm.

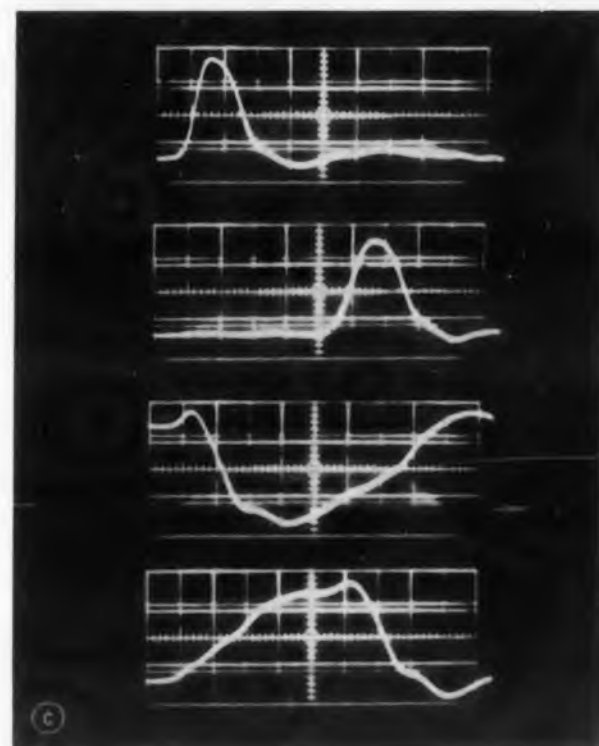
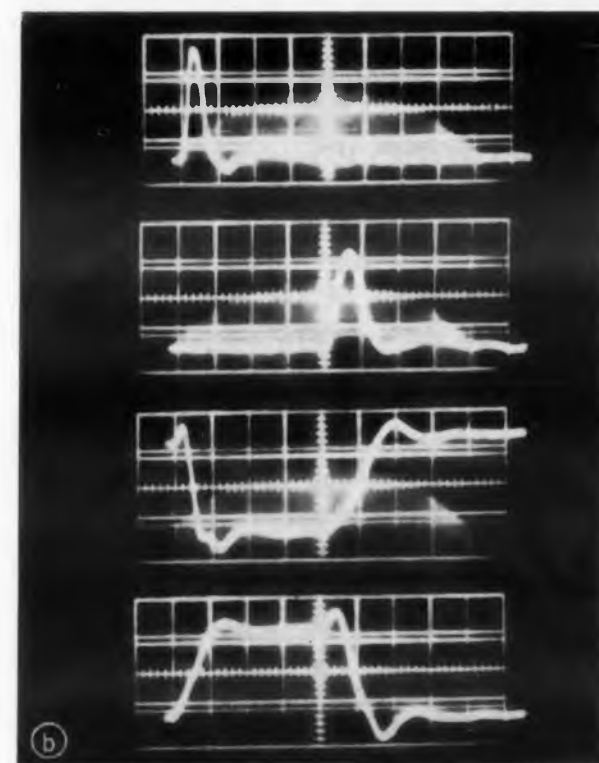



using four 2N705 germanium high-speed switching transistors. An equivalent circuit is given in Fig. 2B and photographs of the input and output waveforms in Fig. 2C.

Both the input and output voltages swing symmetrically, one volt about zero, so the output of one stage can be coupled directly to the input of the next stage. This is accomplished by using reference diodes as a voltage source to couple the collectors to their respective loads and by using two 5 ma current sources to provide a negative bias for the output of the off transistor.

The diodes are chosen to give the optimum operating collector voltage. The waveforms in Fig. 2C show operation of the circuit at 2 mc (500  $\mu$ sec separation of input pulses) and at 10 mc (20  $\mu$ sec separation of input pulses). The input pulses are about 10  $\mu$ sec wide and have rise and fall times of one to two  $\mu$ sec. The switching time of the circuit is somewhat better than shown in the photographs due to the 7  $\mu$ sec rise time limitation of the Tektronix 517A.

#### 25 Mc Current-Mode Flip-Flop With 2N702's

The schematic for a 25 mc current-mode flip-flop using four 2N702 silicon transistors is given in Fig. 3A. The operation of the circuit is essentially the same as that of the 50 mc flip-flop. The load resistors have been increased slightly from the values used in the 50 mc flip-flop to give the larger output voltage necessary to accommodate the larger  $V_{BE}$  spread in silicon units.

The input and output voltages swing 1.3 v about a zero volt center. Two 1.2  $\mu$ h peaking coils have been added to give sharp switching waveforms. Waveforms for operation at 10 mc and 25 mc (100 and 40  $\mu$ sec separations of input pulses) are shown in Fig. 3B and Fig. 3C respectively. Input pulses are about 30  $\mu$ sec wide with rise time of one to two  $\mu$ sec.

The circuit operated reliably at room temperature with a distribution of 2N702 standard production units. If operation over a wide temperature range is desired, the collector load resistors should be increased to give slightly more output voltage; this will allow for variations in  $V_{BE}$  over the temperature range.

These circuits were tested at no load, but their design allows for the input of an additional flip-flop to be connected to each output node.

If larger fan-out, operation over a wide temperature range, or appreciable variation in supply voltages is required, the load resistors should be increased and the maximum frequency reduced.

The two circuits described illustrate the very high-speed switching performance that can be obtained from current-mode circuits. These techniques have become a necessity to realize the full speed of diffused-base mesa transistors. ■ ■

compact, \$145, 150 ma

# TRANSISTOR POWER SUPPLY

prevents overload damage to transistors!

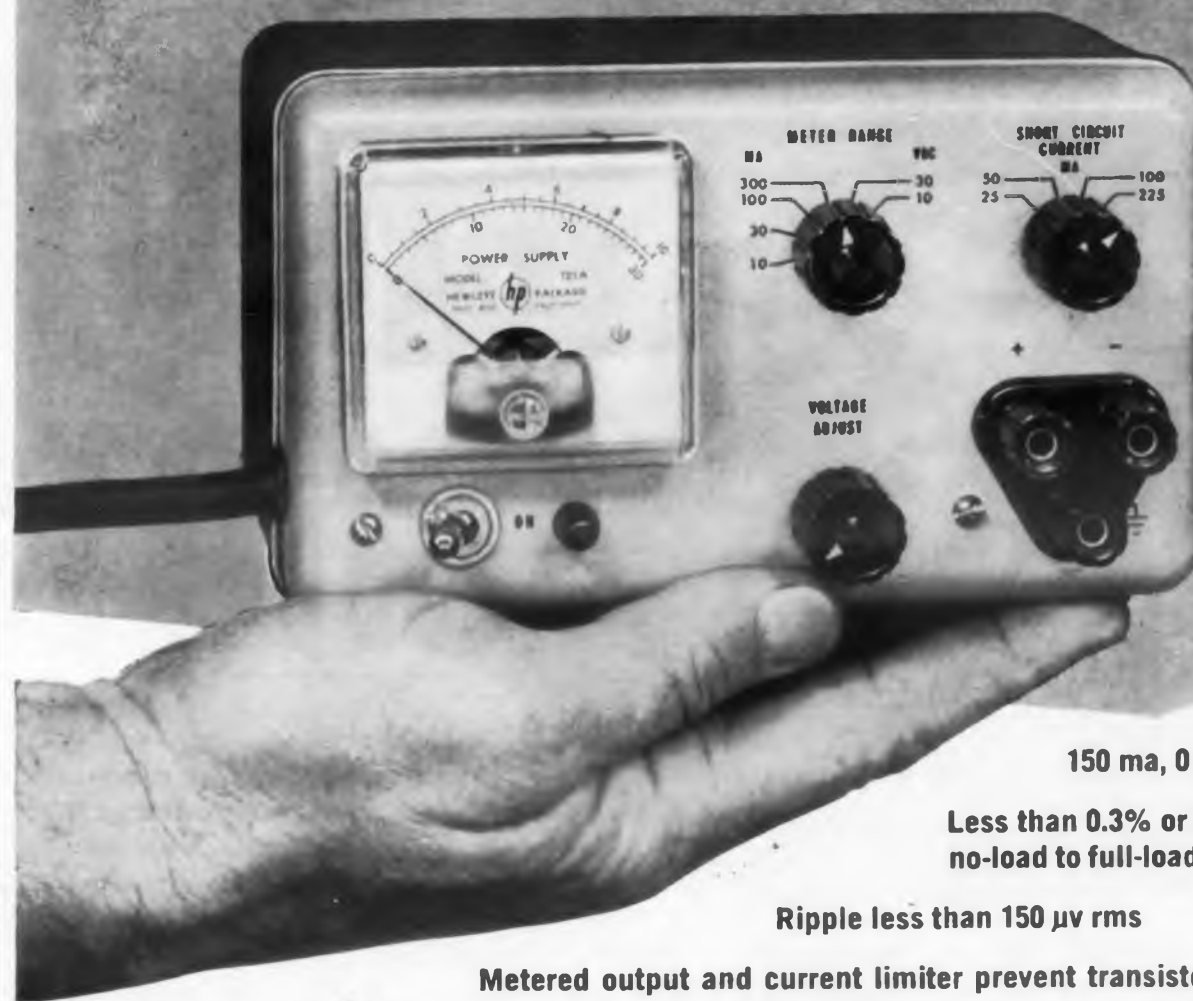

150 ma, 0 to 30 v dc, variable

Less than 0.3% or 30 mv change  
no-load to full-load

Ripple less than 150  $\mu$ v rms

Metered output and current limiter prevent transistor damage

## hp 721A TRANSISTOR POWER SUPPLY

Model 721A was designed from the chassis up to provide safe, precision test voltages for almost all types of transistors in use today.

An outstanding feature is an output limiter, holding current to 25, 50, 100 or 225 ma as selected on the front panel. Accidental overloads are eliminated.

Model 721A has a 3-terminal output for grounding either positive or negative terminals. It may be "stacked" on another voltage, and a front panel meter monitors either output voltage or current, eliminating extra equipment.

#### Other -hp- regulated and klystron supplies

Model	Characteristics	Regulation	Current	Voltage Range	Hum & Noise Level	Price
711A	General purpose dc supply	Less than $\pm 0.5\%$ or 1.0 v, no load to full load	100 ma	0 to 500 v dc; 6.3 v ac	Ripple less than 1.0 mv	\$250.00
712B	Heavy duty, 4 outputs, 0.1 msec transient response	Less than 50 mv no load to full load	200 ma (pos. dc)	0 to 500 v dc; -300 v dc fixed bias; 0 to -150 v dc variable bias; 6.3 v ac	Ripple less than 500 $\mu$ v	365.00
715A	Klystron supply; square wave, external modulation	Less than 1%, no load to full load	50 ma (at 400 v)	250 to 400 v dc beam; 0 to 900 v dc reflector; 6.3 v ac	Ripple less than 7 mv	300.00

Data subject to change without notice. Prices f.o.b. factory.

### HEWLETT-PACKARD COMPANY

1011K PAGE MILL ROAD • PALO ALTO, CALIFORNIA, U.S.A. • CABLE "HEWPACK" • DAVENPORT 5-4451  
Field Representatives in all Principal Areas

6637

Investigate  122A Dual Trace Scope, just \$625

CIRCLE 39 ON READER SERVICE CARD

## IDEAS FOR DESIGN

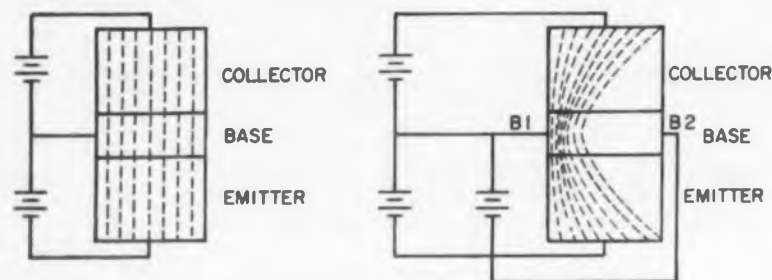

Fig. 1. Typical triode and tetraode transistor, showing the current path.

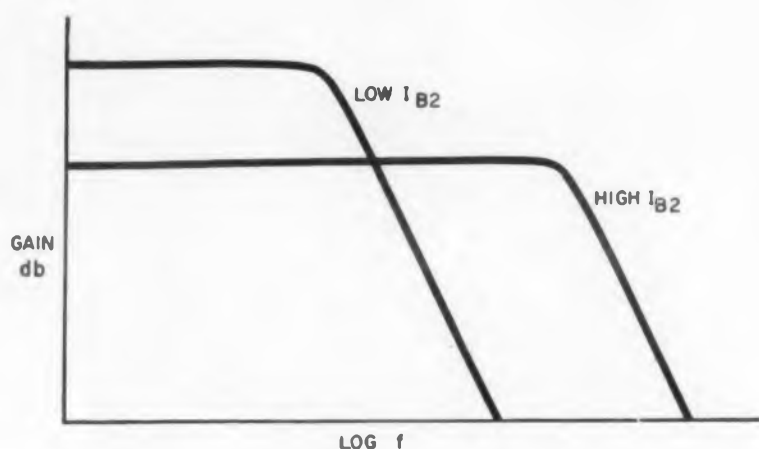

Fig. 2. Tetrode transistor gain and maximum frequency are affected by  $I_{B2}$ .

**T**ETRODE TRANSISTORS are becoming increasingly popular because they allow increase of  $f_{max}$  by application of a bias current through the base.

A method of converting a type 575 Tektronix transistor curve tracer to enable its use with tetrodes is described here.

A typical transistor is shown in Fig. 1. Transistor action is obtained by biasing the emitter-base junction in the forward direction.

The  $n$  type emitter injects into the  $p$  type base minority carriers or electrons which do not combine with holes in the  $p$  type base. These electrons cross into the collector, supplying the carriers needed for the reverse biased base-collector junction. The dotted lines in the figure show the electron path distribution in a typical triode transistor.

In an npn tetraode, Fig. 1, a second base terminal,  $B_2$ , is on the opposite side of the base from the normal first base terminal,  $B_1$ . Transistor action is identical with that of a triode connected transistor.

However, by applying a voltage across termi-

nals  $B_1-B_2$ , an auxiliary current,  $I_{B2}$ , flows through the base, setting up a transverse voltage drop. This concentrates the base activity at base terminal 1, causing the electron path to be displaced as shown in Fig. 1.

In a tetraode transistor, as  $I_{B2}$  increases, both  $r_b$ , the ohmic base resistance, and  $C_c$ , the collector diode barrier capacity, decrease. The output time constant  $r_b C_c$  is decreased, thereby increasing  $f_{max}$  and producing better high frequency performance. However, the low frequency beta decreases. The overall effect is to shift the gain versus frequency curve to the right as shown in Fig. 2.

### Simple Test Jig for Tektronix 575

The test jig shown in Figs. 3 and 4 can be used with the Tektronix 575 curve tracer to measure a tetraode's beta, and to observe its change as  $I_{B2}$  is varied.

A 3313 Elco 5-pin transistor socket was used in the test jig. Four of the pins are distributed equally on a circle, and the fifth is located next to one of the evenly distributed pins. As shown in

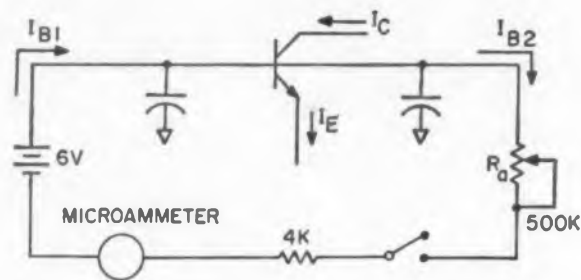

Fig. 3. Schematic of tetraode adaptor for Tektronix 575 transistor curve tracer. In this circuit  $I_B = I_{B1} + I_{B2}$ ;  $I_E = I_{B1} + I_C$ ; and  $B1-B2$ .

## Simple Test Jig Converts Curve Tracer For Use With Tetrode Transistors

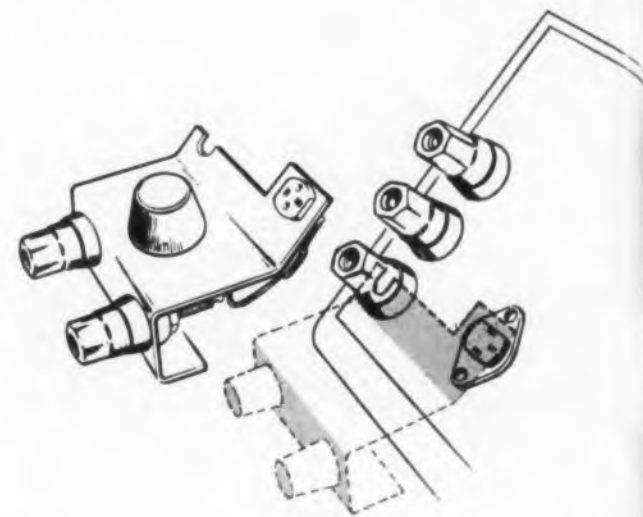

Fig. 4. Tetraode transistor test jig.

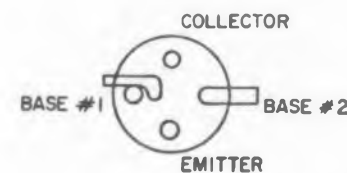

Fig. 5. Enlarged bottom view of transistor socket of the tetraode jig.

Fig. 5, the inner pin and the pin directly opposite are bent 90 deg flat against the face of the bakelite form.

The base 1 connection is made up of the bent pin and the one adjoining it. The base 2 connection is the other bent pin. The three remaining upright pins are filed down to fit into the curve tracer's transistor socket.

The external circuit supplies a variable bias current and provides monitoring of  $I_{B2}$ . The bypass capacitors are valued at 1000  $\mu\text{f}$ . Use of short leads in the external circuit is imperative to reduce 60-cycle pickup which may show up on the curve tracer.

The change in beta is easily observed on the curve tracer as  $R_a$  is varied. Beta is readily obtained by dividing collector current by base current for a specified operating point and value of  $I_{B2}$ .

The circuit can be applied to any type of curve tracer with slight modifications in mechanical construction of the jig.

A. J. Laconti, Engineer, Philco Corp., Government and Industrial Div., Philadelphia, Pa.



for reliability in heavy-duty  
power control... specify new

# LEACH POWER CONTACTORS



Your airborne and electronic high performance requirements dictated the design and construction of Leach Rotary Contactors—the new power control devices that operate with unequalled reliability under extremes of high temperature, altitude, shock and vibration.

These bi-polar, rotary mechanisms incorporate the balanced armature principle to help solve application problems of inverter control, motor control, motor reversal, and power transfer. Compact design achieves the advantages of small size and light weight to meet the needs of the aircraft, missile and electronic industries.

Leach Rotary Contactors meet and, in many cases, surpass the stringent requirements of MIL-R-6106.

*Write today for specifications and a complete description of operating characteristics. Ask for the new Leach Power Contactors Brochure.*

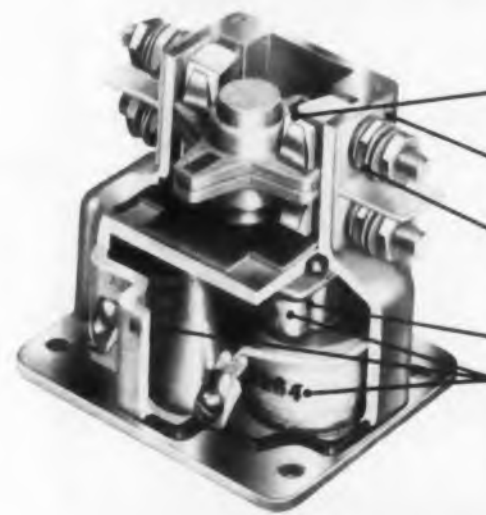

- Double-break contacts guarantee maximum circuit-breaking capacity.
- Lightweight, high dielectric strength materials are used throughout.
- Positive lock terminals guard against faulty operation caused by movement of terminals.
- Bi-polar rotary design.
- Balanced armature construction and dual coil design provide the most efficient magnetic circuit for maximum resistance to shock and vibration.

**RELIABILITY** → **LOOK TO LEACH**  
RELAY DIVISION... LEACH CORPORATION  
5915 AVALON BOULEVARD, LOS ANGELES 3

DISTRICT OFFICES AND FIELD REPRESENTATIVES IN PRINCIPAL CITIES OF U. S. AND CANADA • EXPORT: LEACH CORP., INTERNATIONAL DIVISION  
CIRCLE 40 ON READER-SERVICE CARD

# NPN switching transistors PROVE MORE RELIABLE than PNP

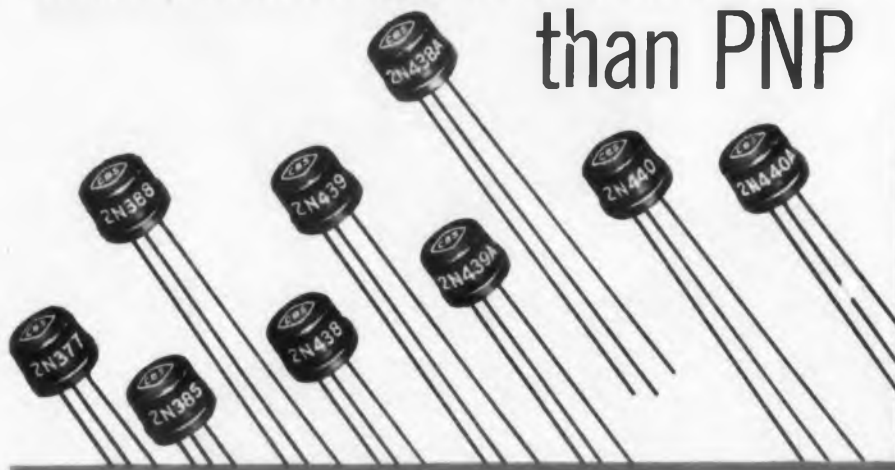

CBS NPN Switching Transistors

Type	Minimum $BV_{CRO}$ (Volts)	Dissipation @ 25°C (Milliwatts)	Minimum $h_{FE}$ @ $I_C$ (Ma)	Typical $f_{\alpha b}$ (Megacycles)	Application
2N306	20	50	16*	1	Audio Driver
2N312	15	75	25	10	Switching
2N356	20	100	20	100	Core Driver
2N357	20	100	20	200	Core Driver
2N358	20	100	20	300	Core Driver
2N377	25	150	20	200	Core Driver
2N385	25	150	20	200	Core Driver
2N388	25	150	30	200	Core Driver
2N438	30	100	20	50	Logic Circuit
2N438A	30	150	20	50	Logic Circuit
2N439	30	100	30	50	Logic Circuit
2N439A	30	150	30	50	Logic Circuit
2N440	30	100	40	50	Logic Circuit
2N440A	30	150	40	50	Logic Circuit
2N444	15	100	10*	1	Switching
2N445	15	100	20*	1	Switching
2N446	15	100	30*	1	Switching
2N447	15	100	50*	1	Switching
2N556	25	100	15	10	Core Driver
2N558	15	100	20	10	Core Driver
2N634	20	150	15	200	Switching
2N635	20	150	25	200	Switching
2N636	20	150	35	200	Switching
2N1000	40	150	25	100	Core Driver
2N1012	40	150	40	100	Core Driver

\* $h_{FE}$  (a.c. gain)

Operating and storage temperature,  $T_j = -65$  to  $+85^\circ\text{C}$

A comprehensive line of these reliable CBS NPN high-speed switching transistors is available now in production quantities. Check the table. Order types you need . . . or write for Bulletin E-353 giving complete data . . . today.

**CBS ELECTRONICS**, Semiconductor Operations  
A Division of Columbia Broadcasting System, Inc.

More reliable products through Advanced Engineering



## semiconductors

Sales Offices: **Lowell, Mass.**, 900 Chelmsford St., GLenview 4-0446 • **Newark, N. J.**, 32 Green St., MArket 3-5832 • **Melrose Park, Ill.**, 1990 N. Mannheim Rd., ESTebrook 9-2100 • **Los Angeles, Calif.**, 2120 S. Garfield Ave., RAymond 3-9081

CIRCLE 41 ON READER-SERVICE CARD

Some design engineers specify PNP switching transistors because they consider them inherently more reliable. Actually NPN transistors can give you superior reliability along with their well-known higher speed. Life tests covering hundreds of thousands of CBS NPN alloy-junction germanium switching transistors proved this during the past year. See graphs comparing these transistors with typical military-approved PNP transistors.

Comparative Life Tests  
NPN vs. PNP Switching Transistors.

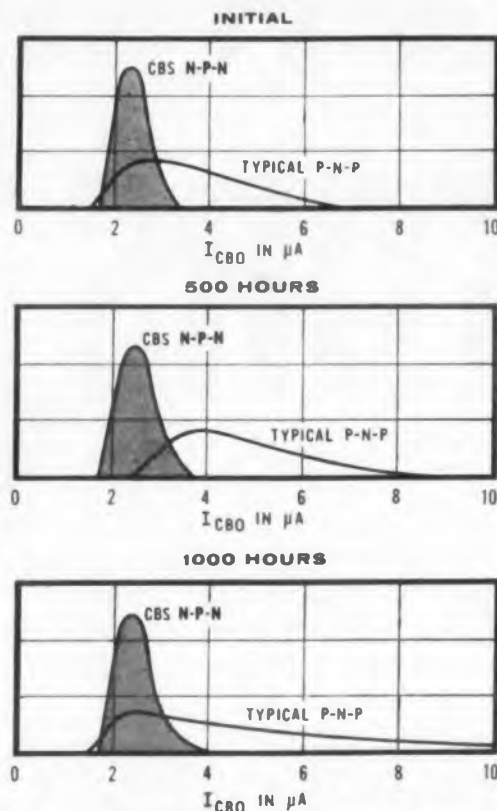

The superiority of CBS NPN transistors is achieved by special processing: For example, advanced surface chemistry techniques seal out moisture and contamination. Precise control of alloying produces high back voltages. Thorough bake-out stabilizes gain. The result is reliable NPN computer-type switching transistors featuring fast switching . . . high voltage . . . low cutoff current . . . and low saturation resistance . . . in a welded JETEC TO-9 package

## IDEAS FOR DESIGN

### Frequency Stabilized Oscillator Features Wide Range Tuning

Electronic oscillators can be stabilized by mechanical standards, such as quartz or tuning forks. But these standards have the disadvantage of being adjustable in frequency, only over very narrow limits. For many engineering applications it would be desirable to have a frequency stabilized oscillator which can be continuously tuned over a very wide range.

Such an oscillator is feasible if the mechanical standard is a continuously variable magnetostrictive delay line. The block diagram illustrates this. The sine wave oscillator, whose frequency is to be stabilized, generates a narrow pulse which feeds the input coil of the delay line.

The main tuning control of the oscillator is ganged to a mechanism which can vary the time delay of the line by varying the spacing between the coils. At any position of the tuning control the time delay of the line is equal to the period of the oscillator. For example, at a frequency of 10 kc, the time delay is 100  $\mu\text{sec}$  and the spacing between coils is about 20 in.

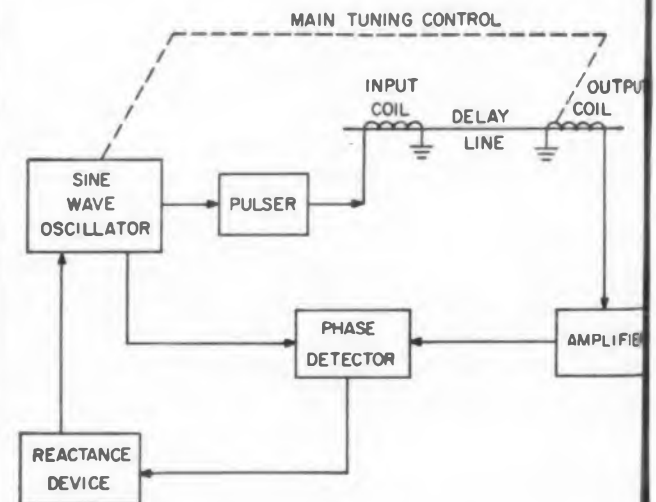

Frequency stabilized oscillator can be continuously tuned over a wide range.

The received pulse at the output coil of the delay line is amplified. It is then fed to a phase detector together with the sine wave signal from the oscillator. If the oscillator period is not exactly equal to the time delay of the line, a corrective voltage is obtained from the phase detector. This is fed to a reactance tube which can control and stabilize the oscillator frequency.

Arthur Rothbart, Senior Project Engineer  
Stephen J. Meyers, Junior Engineer, ITT Laboratories, Nutley, N. J.



## Monostable Multi With Near-Zero Recovery Time

Usually, the minimum recovery time for a monostable multivibrator is equal to the generated pulse width. The recovery time of the circuit shown here will be practically zero. It will also be independent of the generated pulse width.

This monostable multi consists of four major parts: two conventional type monostable multivibrators, a bistable multivibrator, and an "OR" circuit.

The circuit is based on the principle of alternate operation of *B1* and *B3*. After each operation, *B2*, a bistable multivibrator, alternates the power from *B1* to *B3* and vice versa. The starting trigger is applied to *B1* and *B3*. Assuming the initial condition is as shown in the figure, *B1* will generate the pulse, which will be applied to the "OR" circuit and the differentiator.

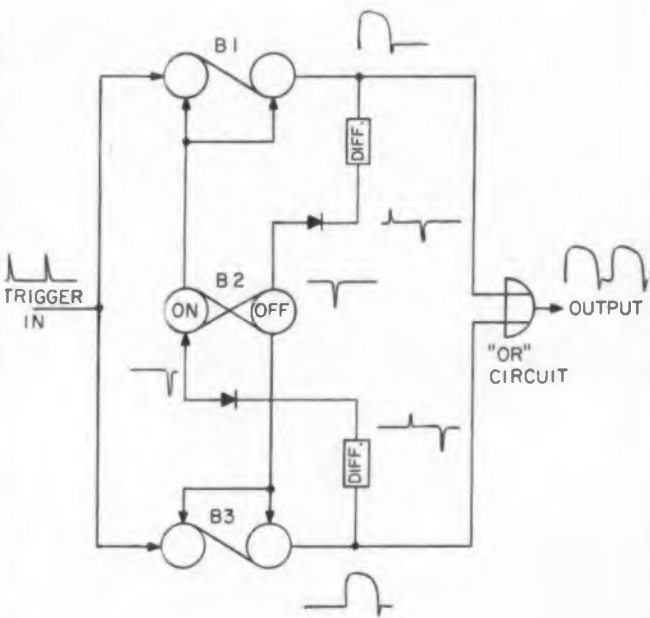

**Bistable multivibrator, *B2***, helps monostable multis, *B1* and *B3*, recover in tenths of a microsecond.

The negative pulse from the differentiator will "flip" *B2*, the bistable multivibrator. This action will remove power from *B1* and apply it to *B3*. The next pulse, generated by *B3*, will operate *B2* in the same manner as *B1* did. Both outputs will be added in the "OR" circuit.

The recovery time of such a circuit is practically zero. It depends solely upon the switching of *B2*, which usually is only a few tenths of a microsecond.

*Gleb Demjanenko, Electronic Design Engineer, Bell Aircraft, Inc., Buffalo, N. Y.*

*This unique "extra" fifth digit...*



The KIN TEL Model 501 4-digit, over-ranging digital voltmeter measures DC from  $\pm 0.0001$  to  $\pm 1000.0$  volts with  $0.01\% \pm 1$  digit (of reading) accuracy. An extra fifth digit in the left decade indicates "0" or "1" to provide ten times greater resolution at decade (1, 10, 100) voltage points than standard 4-digit voltmeters. Ranging and polarity indication are entirely automatic. The measured voltage, decimal point and polarity symbol are displayed on an in-line readout in a single plane—no superimposed outlines of "off" digits.

An adjustable sensitivity control permits decreasing sensitivity to allow measurement of noisy signals. Ten-line, parallel input printers can be driven directly, and converters are available for driving other types of printers, typewriters, and card or tape punches. The input may be floated up to 25 volts DC above or below chassis ground with no degradation in performance, and up to 250 volts DC with slight decrease in accuracy. Stepping-switch drive coils are energized with DC as in telephone-type service to provide long, trouble-free operation.

The 501 is one of a complete line of KIN TEL digital instruments. Others include AC converters, AC and DC preamplifiers, ratiometers, and multi-channel input scanners.

*KIN TEL manufactures electronic instruments for measurement and control, and closed circuit TV. Representatives in all major cities. Write for detailed literature or demonstration.*

### IMPORTANT SPECIFICATIONS

**Display**... Six decades display 5 digits (Left digit "0" or "1" only), decimal point, polarity symbol. Ranging and polarity indication are automatic. Projection system readout employs bayonet-base lamps with 3000-hour minimum life rating. Readout contains no electronic circuitry and can be remotely mounted.

**Automatic Ranges**...  $\pm 0.0001$  to  $\pm 1000.0$  volts DC in four ranges: 0.0001 to 1.9999; 02.000 to 19.999; 020.00 to 199.99; 0200.0 to 1000.0

**Accuracy**...  $0.01\% \pm 1$  digit (of reading).

**Input Impedance**... 10 megohms on all ranges at null.

**Reference Voltage**... Chopper-stabilized supply, continuously and automatically referenced to standard cell.

**Stepping-Switch Drive**... DC voltage within stepping-switch manufacturers rating applied by transistor drive circuit at rate of approximately 20 steps per second.

**Controls**... Three: on-off, sensitivity; and mode of operation (standby, normal, print auto, print remote).

**Printer Drive**... Built-in for parallel input printers. Automatic or remote.

**Dimensions and Net Weights**... Control unit: 45 lbs, 5 1/4" H x 19" W x 16" D. Readout: 10 lbs, 3 1/2" H x 19" W x 9" D.

Price: \$2995

5725 Kearny Villa Road, San Diego 11, California, Phone: BRowning 7-6700  
CIRCLE 42 ON READER-SERVICE CARD

**KIN TEL**  
A DIVISION OF  
**COHU**  
ELECTRONICS, INC.

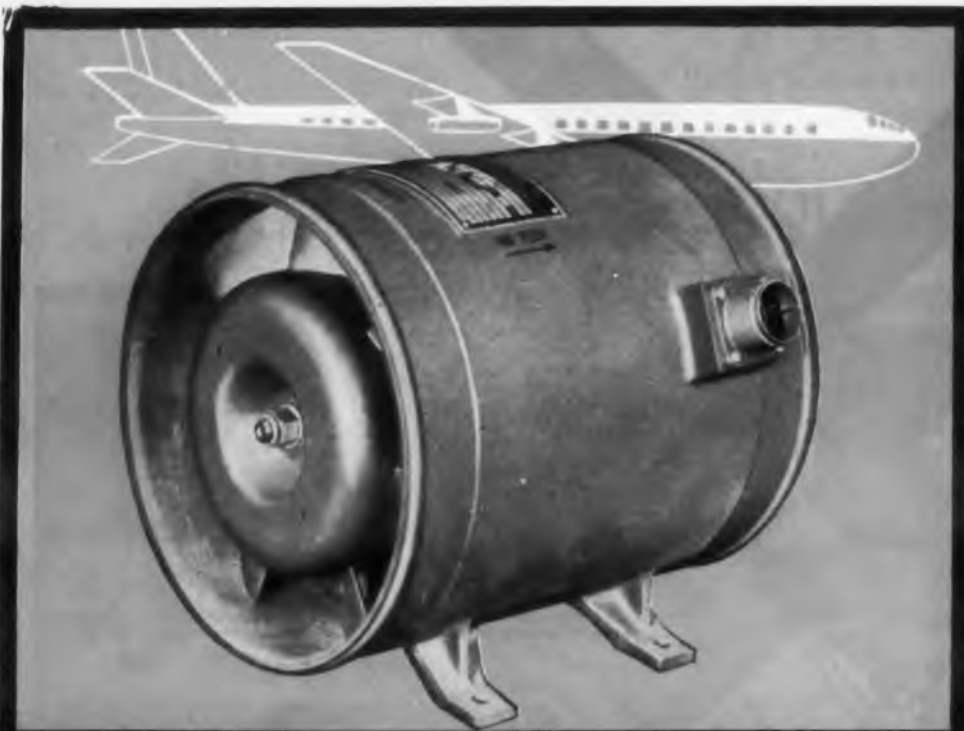

Design Flexibility with Economy

## Choose from over **340** Standard Joy Axivane® Fans

Over 340 models with 1300 designs give the aircraft designer the flexibility of custom fans with the economy of standard fans. Horsepowers as low as 1/500th, fan efficiencies as high as 86%, and pressures up to 70" WG are available.

Joy Axivane Fans meet most applicable government specifications being used by a majority of airframe and missile manufacturers, including Boeing, Lockheed, Martin, Douglas and North American. Joy Axivane Fans have only three basic parts, and motors are flange mounted inside the fans to permit mounting in ducts. This simplicity of design makes the fans lightweight and compact, yet vibration and shock resistant.

Special designs to meet unusual requirements also can be furnished to your specifications. Whatever your air movement problems, Joy can provide the solution. **Joy Manufacturing Company, Oliver Building, Pittsburgh 22, Pa.** In Canada: *Joy Manufacturing Company (Canada) Limited; Galt, Ontario.*



Write For Free Twelve Page Catalog 266-57

WSW 17382-266

# JOY

WORLD'S LARGEST MANUFACTURER OF VANEAXIAL TYPE FANS

CIRCLE 43 ON READER-SERVICE CARD

# PATENTS

## Semiconductive Switch

Patent No. 2,885,524. William Shockley. (Assigned to Bell Telephone Laboratories, Inc.)

The switch is essentially a back-biased diode element of monocrystalline silicon with four zones; adjacent zones have opposite conductivities. A pulse from the control source or light incident upon the middle junction causes the element to break down and the impedance changes to that of a pn junction in the forward direction.

The figure shows the pnpn element in series with battery 12A and the utilization circuit 13. The intermediate zones

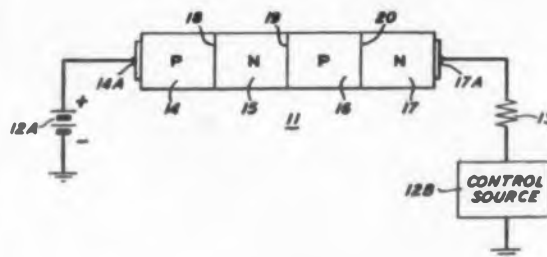

15 and 16 are floating and have inherent alphas which are low at low current density. One zone has an inherent alpha which increases with current density. Junction 19 breaks down when control source 12B delivers a signal pulse or when light is incident upon junction 19. The current density increases until the effective alpha of the element becomes unity. Low impedance is maintained until the applied voltage is decreased below breakdown. At this point the switch opens.

## Audio Frequency Amplifier

Patent No. 2,887,532. Richard E. Werner. (Assigned to Radio Corporation of America)

Distortion in an amplifier driving a direct radiator loudspeaker is reduced when the amplifier output impedance is the complement of the blocked voice-coil impedance. The blocked voice-coil im-

## PRECISION RELIABILITY QUALITY

### COMPLEX ELECTRONIC EQUIPMENT

Highest quality standards, low manufacturing costs. Complete Engineering services. Precision, reliability, and quality guarantee, an integral part of each equipment.

For computer, data processing, servo, and ground support systems. To Applicable MIL Specs.

# keystone

PRODUCTS COMPANY

904-6 23rd St., UNION CITY 2, NEW JERSEY  
UNION 6-5400

CIRCLE 44 ON READER-SERVICE CARD

ELECTRONIC DESIGN • September 16, 1959



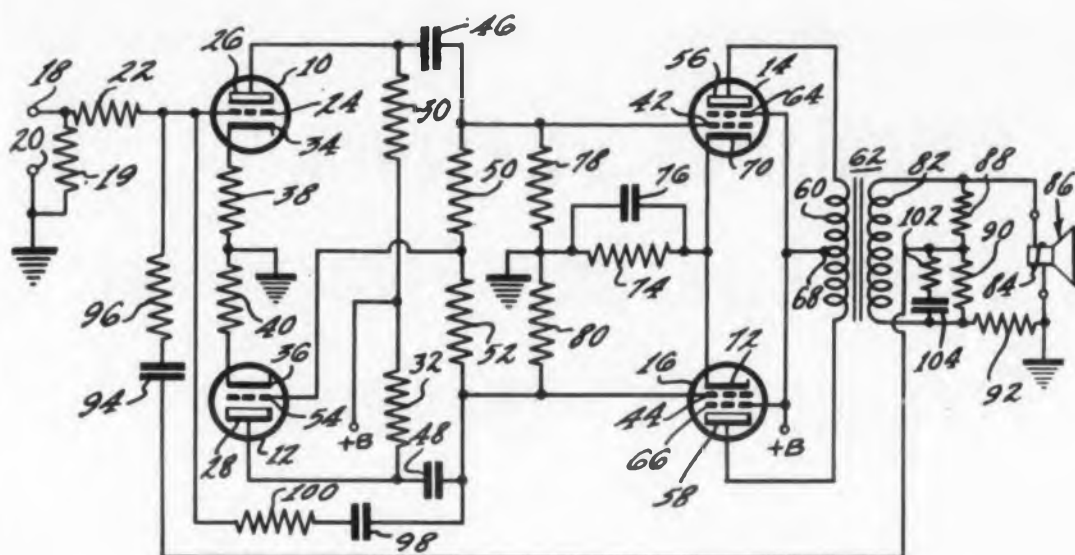

pedance is cancelled and, with proper mechanical loading, the speaker velocity is faithful reproduction of the applied signal. The cancellation is achieved by means of positive current and negative voltage feedback.

A bridge circuit is placed across the secondary of the output transformer. The elements of the bridge are resistors 88, 90 and 92 and the impedance of voice coil 84. With the bridge balanced against

the voice coil impedance, the voice coil impedance is cancelled. Mechanical motion of the speaker may be properly damped and the overall frequency response improved by capacitor 98 and resistor 100 connected in series as a single loop feedback across the phase inverter stage. The combination of capacitor 94 and resistor 96 in the overall feedback loop also improves the overall frequency response.

## JORDAN frequency band and voltage band SENSORS

—with solid state switches  
or miniature relays



- "fail safe"
- reverse polarity protection

- low operating power
- instant warm-up

	FREQUENCY SENSITIVE RELAY	AC VOLTAGE SENSITIVE RELAY	DC VOLTAGE SENSITIVE RELAY
	part No. AU-0158	part No. AU-0159	part No. AU-0160
Sensing band	390 to 410 cps	113 to 118 volts	25 to 30 volts
Accuracy	±5%	±3 volts	±1/2 volt
	<i>(Tighter tolerances also available)</i>		
Input	115 volts 400 cps	115 volts 400 cps	28 volts
Contact rating	2 amps	2 amps	2 amps
Operating Temperature	−55° C to +71° C	−55° C to +71° C	−55° C to +71° C
	<i>(Wider operating temperature ranges also available)</i>		
Environmental	MIL-E-5272B	MIL-E-5272B	MIL-E-5272B
Weight	6.5 oz.	6.5 oz.	6.5 oz.
Write for:	Bulletin 201	Bulletin 202	Bulletin 203
	<i>sensors also available to customer specifications</i>		

Other solid state devices, DC to DC converters, DC-AC sine wave inverters, programmers, time delays, static switches, timers, etc.

**JORDAN ELECTRONICS**

a division of THE VICTOREEN INSTRUMENT COMPANY  
3025 W. Mission Rd., Alhambra, Calif.

CIRCLE 45 ON READER-SERVICE CARD

## SUCCESSFUL LAUNCH...



There's solid assurance in the high accuracy of Howell Instrument's Ta'Pot®, the "tape-slidewire" potentiometer used as the key measuring unit to check, *before* launch, The Martin Company's USAF TM-76 "Mace" engine r.p.m. and temperature systems—and which is the go/no-go control *during* launch.

The Ta'Pot is a straight wire (or helically wound!), embedded within the edge of a polyester tape. With calibration printed on the tape, this 12-foot long slidewire pot has up to 1200 readout scale points; or it may be geared to an in-line counter, and servo-driven in either case. Or the Ta'Pot may be manually operated for exact readout of functions...or for control of functions...or for computer inputs. Electronic calibration of Ta'Pot slidewires regularly achieves better than 0.05% conformity to either linear or non-linear functions. *The Ta'Pot is presently used in test cells, in jet engine analyzers, in jet aircraft cockpits and in a host of other critical applications.*

**TAPOT**

**HOWELL INSTRUMENT COMPANY**

3101 Trinity Street, Fort Worth 7, Texas



CIRCLE 46 ON READER-SERVICE CARD



Why buy a weak link?

## GUARANTEE RELIABLE CONNECTIONS WITH **GREMAR**

**HEWLETT-PACKARD** and other top quality electronic test instrument makers who demand reliability and exceptional performance from their components, specify Greomar because:

**GREMAR CONCENTRATES** . . . on RF connectors only . . . focusing unique engineering, production and quality control facilities on standard and special connectors guaranteed to meet your specs.

**GREMAR DELIVERS** . . . stocks America's most complete line of RF connectors and fittings . . . maintains a shelf stock of more than 500,000 assembled units . . . of over 2000 types . . . and 4,000,000 component parts ready for assembly!

**GREMAR INVITES YOU** to evaluate its superior RF stock connectors and its unique ability to engineer units to your needs. Write for literature on all series . . . BN, BNC, TNC, C, SC, N, QDL, QDS, SM, HN, LC, LT, PULSE — or send us your specs on special requirements.



Gage calibration prior to checking thread dimensions is just one of 142 separate quality checks Greomar performs to insure utmost reliability.



# GREMAR

MANUFACTURING COMPANY, INC.

Dept. B. Wakefield, Mass., CRystal 9-4580

RELIABILITY THROUGH QUALITY CONTROL  
CIRCLE 47 ON READER-SERVICE CARD

## RUSSIAN TRANSLATIONS

J. George Adashko

# Calculation of Errors When Using Lissajous Figures for Frequency Comparison

M. I. Shatalov

**L**ISSAJOUS figures are used extensively for comparison of frequencies in electronic measurements. The two principal uses of Lissajous figures are:

- To tune a generator to a frequency that is in a fixed ratio to another frequency used as a comparison standard.<sup>1</sup>
- To determine the frequency deviation from standard frequency, when the ratio of the compared frequencies is not equal to an integer.

The former case is the best known. In the second case, absolute accuracy is attainable only at the simplest frequency ratio, 1:1. For this ratio, the error is the number of total cycles ( $k$ ) of the variation of the figure divided by the time ( $t$ ) in seconds during which the number of cycles is counted.

$$\Delta f = \frac{k}{t} \text{ cps}$$

At more complicated frequency ratios, difficulties frequently arise and errors are introduced in the calculation of the frequency error. One of the causes of these errors is that the chapters devoted to the use of Lissajous figures in several texts on radio measurements<sup>2,3</sup> contain inaccuracies.

The table shows the Lissajous figures for the most frequently employed frequency ratios. The instantaneous values of the lower frequency voltages are measured along the abscissa, and those of the higher frequency along the ordinate. All the figures are plotted for the case when the second oscillation leads the first. The phase shift corresponding to those figures, expressed in fractions of a cycle (degrees) of the higher frequency, is indicated for each group of figures. Under each group of figures is indicated the absolute phase shift, expressed in fractions of a period (degrees) of the lower frequency.

From this point on, the frequency ratio will be expressed in the form of a fraction  $m/n$ , where  $m$  and  $n$  are integers greater than 1. A ratio in the form 1/1 will be the particular case for which  $m = n = 1$ .

The Lissajous figures go through a complete frequency ratio, when the phase ( $\phi$ ) of the frequency proportional to  $m$  is changed by an angle

$$\phi_m = \frac{360^\circ}{n}$$

For the second oscillations we have

$$\phi_n = \frac{360^\circ}{m}$$

Consequently, a 360 deg change in the phase of the frequency proportional to  $m$  corresponds to  $n$  cycles of change in the shape of the figure, while a 360 deg change in the phase of the second frequency (proportional to  $n$ ) corresponds to  $m$  cycles of variation of the shape of the figure.

This makes it possible to find the general expression for the frequency error for any ratio  $m/n$ . If the frequency proportional to  $n$  is standard then the number of cycles of variation of the figure divided by the time should also be divided by  $n$ . Eq. 1 becomes

$$\Delta f_m = \frac{k}{tn} \text{ cps}$$

For the case where the frequency proportional to  $m$  is the standard, Eq. 1 becomes

$$\Delta f_n = \frac{k}{tm} \text{ cps}$$

For example, let us consider the use of Lissajous figures corresponding to a frequency ratio 2/3, and determine the error in a frequency of 66 cps, measured against a standard frequency of 100 cps. If  $k/t = 1$  change per second,  $\Delta f_{66} = 0.33$  cps.

If this frequency ratio is used to determine the errors in a frequency of approximately 150 cps against a standard frequency of 100 cps, the error for the same ratio  $k/t = 1$  becomes  $\Delta f_{150} = 0.33$  cps.

The cycle of the figure is usually timed from



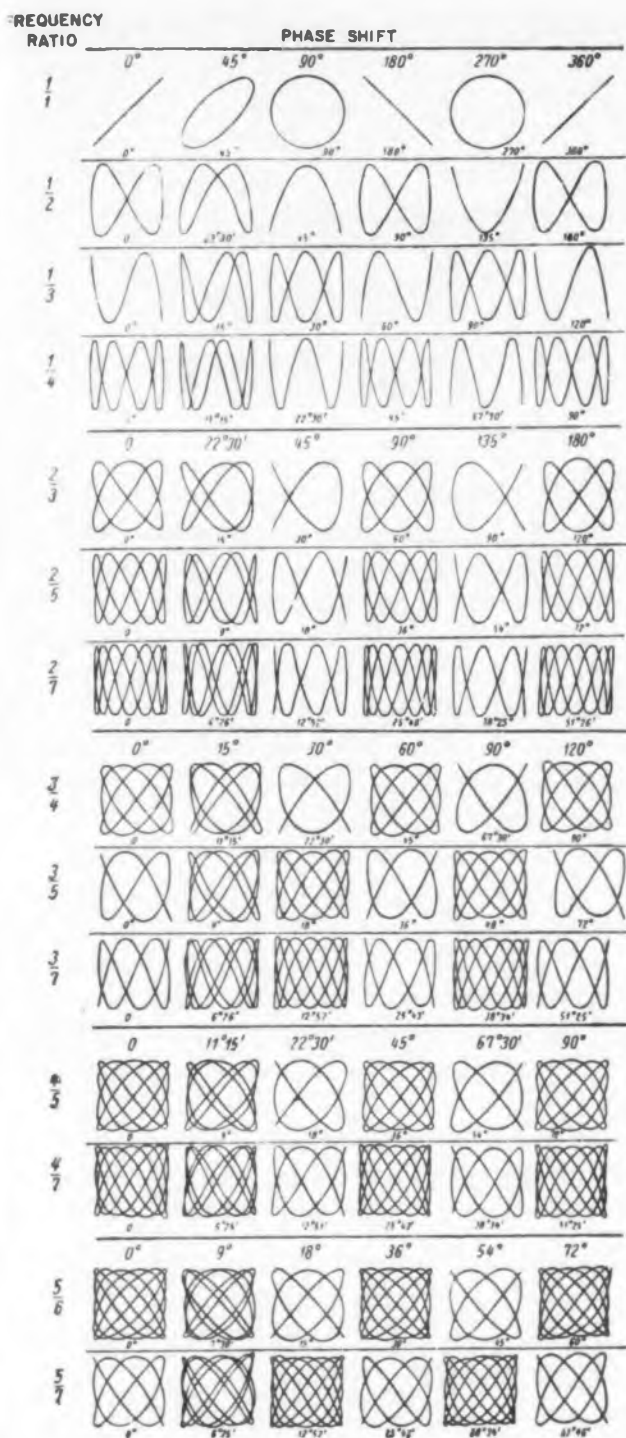

Lissajous figures for the most often used frequency ratios.

the simplest characteristic configuration for the given frequency ratio. These figures correspond to a phase shift (with regard to the higher frequency) of  $0^\circ$  or  $360^\circ/2m$ , if  $m$  and  $n$  are odd numbers, and  $360^\circ/4m$  or  $3 \times 360^\circ/4m$  if  $m$  and  $n$  are even numbers.

This article was taken from the Soviet journal Measurement Engineering, No. 3, March 1959.

#### References

1. G. A. Remez, Textbook of Basic Radio Measurements, 1955.
2. Terman and Pettit, Radio Measurements (Russian translation), 1955.
3. A. Hund, High Frequency Measurements, 1951.

Performance-  
Proved  
by more  
than  
2 years  
of  
dependable  
service

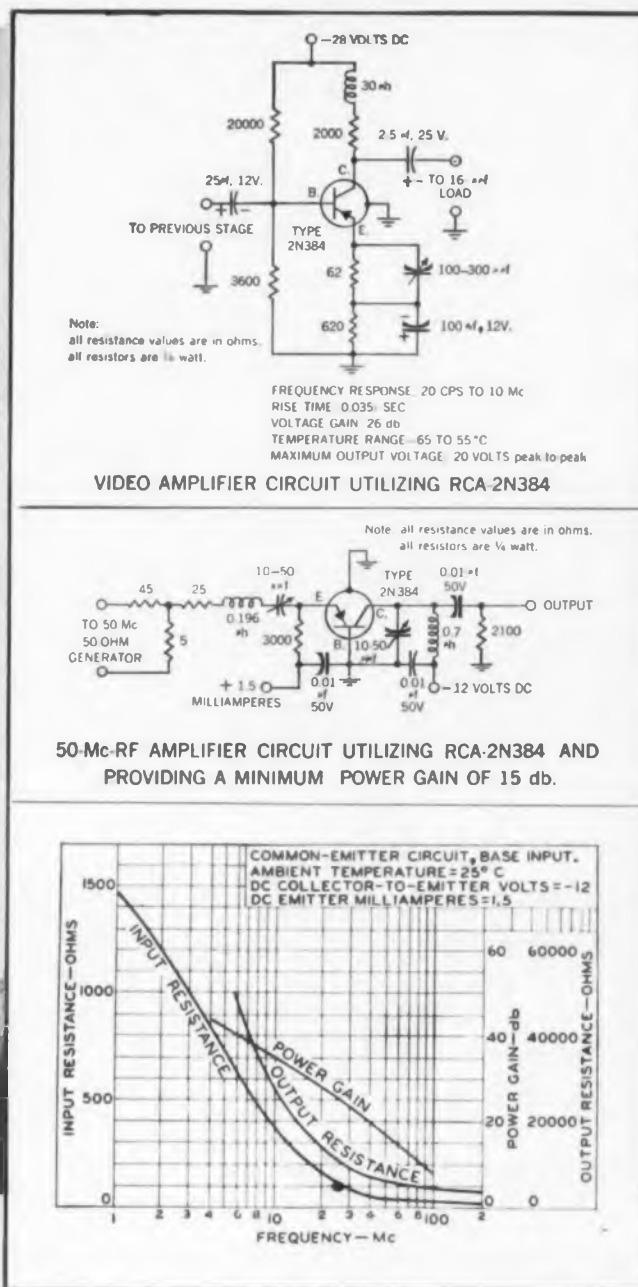

- Efficient operation up to 100 Mc. in rf-amplifier service and up to 125 Mc. in oscillator service.
- Enables practical design of rf, oscillator, video, and if circuits of transistorized radio, radar, marker-beacon and navigation receivers, and other electronic equipment.

Designers of transistorized *high-frequency* electronic equipment now have the advantages of local sources of supply for RCA semiconductor devices. Of particular interest is the news that RCA-2N384 VHF DRIFT TRANSISTORS of the germanium p-n-p type are immediately available through your local RCA Semiconductor Distributor.

RCA-2N384 features high collector dissipation, high transconductance, low input and output capacitance, and excellent high-frequency response. RCA-2N384 is especially popular for service in either linear-type or pulse-type video-amplifiers featuring fast rise time. Typical circuits and technical data for this outstanding unit are shown here.

Maximum Ratings Absolute Maximum Values					Characteristics At Ambient Temperature = 25°C	
Collector- to-Base Volts	Collector Milli- amperes	Transistor Dissipation Milliwatts			Small- Signal Current Gain	Alpha- Cutoff Freq. Mc
		At 25°C	At 55°C	At 71°C		
-40	-10	120	70	35	60	100

For other information on RCA-2N384 DRIFT TRANSISTOR—or on any RCA TRANSISTORS or SILICON RECTIFIERS—contact your local RCA SEMICONDUCTOR DISTRIBUTOR.



**RADIO CORPORATION OF AMERICA**  
Semiconductor Products - Distributor Sales Harrison, New Jersey

RCA-2N384



VHF

DRIFT

TRANSISTOR

... available from your local

RCA  
SEMICONDUCTOR  
DISTRIBUTOR

**The  
greatest  
possible  
potentiometer  
reliability  
because it's sealed!**

The greatest enemy of potentiometers is water vapor or humidity. In aircraft or missiles, where the equipment can breathe due to altitude and pressure changes, exclusion of water vapor is especially vital. Because Waters APW $\frac{1}{2}$  and WPW $\frac{1}{2}$  Potentiometers are completely sealed — absolutely watertight — they eliminate this common cause of failure. In addition, of course, the watertight construction seals out dust and other foreign particles. That's why more and more engineers are finding out that Waters watertight potentiometers are the best possible guarantee of potentiometer reliability.

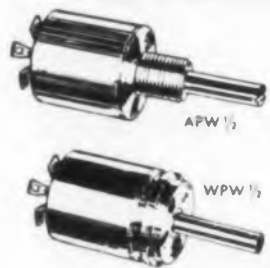

Designed specifically to be leak-proof in boiling water! Sealed against water immersion as specified in MIL-E-5272A and other military specifications by means of a double "O" ring shaft seal. The glass-to-metal terminal board is solder-sealed to the case. Available with 125°C or 150°C construction, mechanical rotation stops, special winding angles, values to 100K and tighter linearity tolerances. Can be supplied with optional split bushings and various shaft lengths. The WPW  $\frac{1}{2}$  features the same construction, but with a servo face. Write for Bulletin APW-359.



POTENTIOMETERS • SLUG TUNED COIL FORMS • RF COILS • CHOKES • POT HOOK<sup>®</sup> PANEL MOUNTS • TORQUE WATCH<sup>®</sup> GAUGES • CTROL METER/CONTROLLER • INSTRUMENTS  
CIRCLE 49 ON READER-SERVICE CARD

## GERMAN ABSTRACTS

E. Brenner

### Applications of Switching Transistors

THREE regions of operation may be defined for the thyatron-like characteristics of a switching transistor (Fig. 1). The high resistance portion of the characteristics is independent of external elements while the slope and the peak of the "active" portion (negative differential resistance) can be controlled with an external base resistance  $R_{ba}$ . The low resistance region can be controlled by the collector voltage  $V_c$  and the external collector circuit resistance  $R_{ca}$ .

The three fundamental pulse operations correspond to the three types of load lines sketched on Fig. 1b. Bistable operation at  $A_1$ - $A_2$  occurs for line I. Lines IIa and IIb result in monostable operation to  $A_1$  and  $A_2$  respectively. When the load line intersects the characteristics in the negative slope region, a stable operation results (Line III).

For bistable operation, the emitter circuit resistance  $R_e$  must be less than the differential resistance in the "active" region and a load line

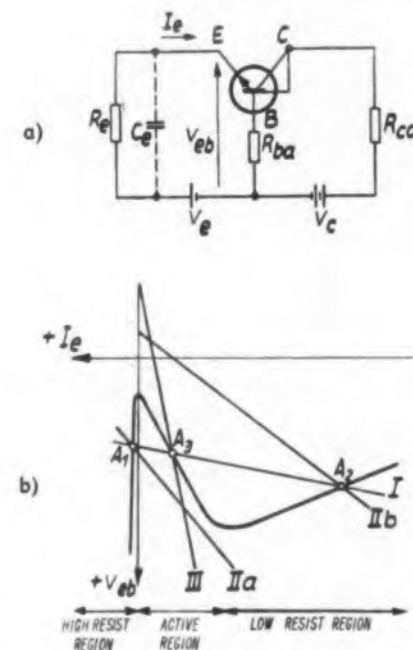

Fig. 1. Switching modes of the storing switching transistor.

- a) Basic circuit.  
b) Input characteristics with load lines corresponding to the three basic modes of operation.



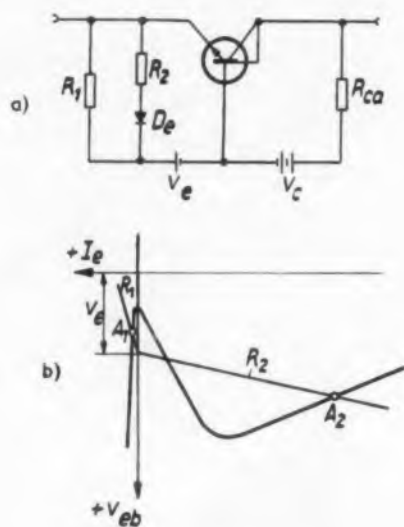

Fig. 2. Bistable switching circuit with high sensitivity.

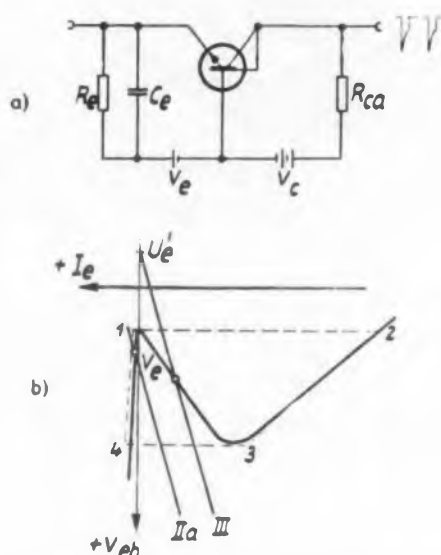

Fig. 3. Monostable switching circuit.

similar to  $I$  is chosen. Transitions from the high to the low resistance region are effected by using short (approx  $10^{-7}$  sec) negative pulses, emitter to base; with opposite polarity required to produce the reverse transition. Particularly high sensitivity is achieved if a diode circuit is connected on the emitter side as shown in Fig. 2.

In a typical monostable circuit, (Fig. 3), negative pulses produce the output gate since the load line intersection is in the high resistance region. The transistor moves in the  $V_{eb}-I_e$  plane along the path 1-2-3-4-1 in sequence as indicated. When the external collector resistance  $R_{ca}$  is much larger than the transistor resistance in the low resistance region but much smaller than  $R_e$ , the gate duration is approximated by

$$t_2 = R_{ca} C_e \ln(I_2/I_3)$$

In the original paper a variety of applications are cited. These include triangular and square wave generators, a temperature sensitive relay, a counter, a shift register and other pulse circuits.

Abstracted from an article by W. V. Muench and H. Salow, Nachrichtentechnische Zeitschrift, Vol. 12, No. 6, June 1959, pp 301-310.



Roller leaf actuator for rapid cam or slide actuation

Leaf type actuator for use where cam action is infrequent or not rapid

Lever type actuator for use with low operating force

Special bend provides extra-precise operation with small cams

Basic "SM" switches are available in over 300 different variations

Roller type actuator for use with two Type "SM" switches

Leaf type actuator for use with two Type "SM" switches

Integral leaf actuator for use with slow-moving cams and slides

Integral roller-leaf actuator for use with fast moving cams and slides

Roller lever actuator for high-speed, low-friction applications

Leaf type actuator with special bend to follow slow-moving cams or slides

## Ten different ways to actuate this small, dependable switch

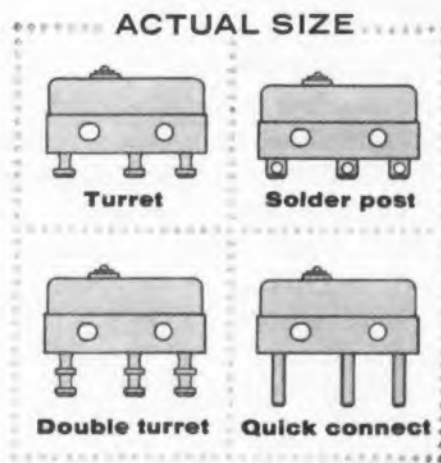

"SM" switches are available with these four kinds of terminals

Here are ten "SM" subminiature switches equipped with ten different integral and auxiliary actuators that contribute to the great versatility of these dependable, small switches. For ten years MICRO SWITCH subminiature switches have been the choice of designers who require switches of high electrical capacity which can be mounted in small space.

For complete information on the MICRO SWITCH lines of subminiature and sub-subminiature switches, we invite you to contact your nearby MICRO SWITCH branch office, or send for Catalog 63.

MICRO SWITCH . . . FREEPORT, ILLINOIS

A division of Honeywell

In Canada: Honeywell Controls Limited, Toronto 17, Ontario



# Honeywell

MICRO SWITCH Precision Switches

CIRCLE 50 ON READER-SERVICE CARD

You're looking  
at just one  
reason why  
engineers  
specify...

## HANDLEY WEEPOTS

The metal clad Handley Wee Pot offers many unusual design features... including a different configuration and long leads, many methods of mounting, high friction loading for minimum back-lash, extreme accuracy, low impedance, and the Wee Pot can be sealed to meet MIL-E-5272A. Inductive reactance is not measurable... under 900 KC. Exceeds NAS 710 for impedance. Other characteristics make the Wee Pot worth considering for your next design.

### ACCELERATION

Exceeds MIL-R-19. 100 G's at 11 milliseconds duration

### SHOCK

Exceeds NAS 710, proc. III withstands 50 G's meeting 202

### VIBRATION

Exceeds NAS 710, proc. III. 30 G's at 2000 r

### TEMPERATURE

Range is from -55 C to 140 C with 1.3 watts at 40 C



Here's another reason why engineers specify Weepot. . . except Handley Potentiometer wound to .000003" accuracy

When no winding machine was available to meet Handley's manufacturing standards, Handley developed its own winding machines so that Handley potentiometers may be wound to .000003, using wire as small as .0045 in diameter. Winding lengths are maintained at  $\pm 3$  millionths of an inch per 1000 turns.



These leads adjustable to many applications

HANDLEY,  
INC.

2030 Colorado Ave.  
Santa Monica,  
California

Write for more information—  
(or check the reader service card)

Attach to your letterhead

NAME \_\_\_\_\_

TITLE \_\_\_\_\_

CIRCLE 730 ON READER-SERVICE CARD

## REPORT BRIEFS

### Intensity Discrimination For Narrow Noise Bandwidths

Upon the assumption that the auditory system acts as an envelope detector, a series of hypotheses was stated predicting how intensity discrimination would be influenced by the variations in the stimulus envelope. The results indicate that discrimination was the same for stimuli whose envelopes are smoothed by the auditory system despite differences in frequency spectrum. For stimuli whose envelope fluctuations occur at a rate less than the integrating time of the auditory system, discrimination is degraded, increasingly so as bandwidth is reduced. However, differences in discrimination among bandwidths were eliminated when pulse duration was reduced sufficiently to preclude envelope variations. The results, in general, indicate that the envelope detects or model is a reasonable description of auditory discrimination. *Intensity Discrimination For Narrow Bandwidths of Noise*, R. M. Michaels, Naval Research Laboratory, Washington, D. C., Oct. 1958, 31 pp, Microfilm \$3.00, Photocopy \$6.30. Order PB 134206 from Library of Congress, Washington 25, D. C.

### RF Cable Power Ratings

An analysis is made of various methods of measuring power input to coaxial cables. A substitution calorimetric method was selected as the most suitable for determining the power rating of coaxial cables. Experimental power rating data is presented for selected polyethylene and particularly for Teflon coaxial cables. Curves of power handling capacity versus frequency over the range of 100 to 10,000 mc are given at standard conditions of ambient temperature of 104 F, sea level and unity standing wave ratio. These power ratings were established at a center conductor temperature of 175 F for polyethylene cables and 482 F for Teflon cables. This power rating data for standard conditions is further extended through charts and formulae to conditions of ambient temperature from -85 to 175 F for polyethylene and 482 F for Teflon, to conditions of altitude from sea level to 70,000 feet, and to conditions of vswr from 1:1 to 2:1. *Cable, Radio Frequency: Study of Power Ratings*, G. J. Mares, American Phenolic Corp., Chicago, Ill., Nov. 1955, 75 pp, Microfilm \$4.50, Photocopy \$12.30. Order PB 139924 from Library of Congress, Washington 25, D.C.



## RELIANCE

Technic's customers confidently depend upon the quality of our products... and the competent service behind them.

### OROSENE 999 ☆ 24 Kt Acid Bright Gold

The first NEW development in gold electroplating in over 100 years. It produces electroplates both hard and ductile using ONLY ONE addition agent operating at room temperature under POSITIVE and simple control. ☆ Patent Pending

### H.G. BRIGHT 23+ Kt GOLD

The only bright gold operating with less than 1/10 ounce free cyanide per gallon at room temperature, offering variable hardness to fit your specifications... at a non-premium price.

## Technic



INC

39 Snow Street  
Providence, R. I.  
JACKSON 1-4200

Chicago Office  
7001 North Clark Street

CIRCLE 731 ON READER-SERVICE CARD

ELECTRONIC DESIGN • September 16, 1959



## Diodes in Switching Circuits—I

This report is concerned with the study of negative resistance devices. A comparison is made of the few negative resistance diodes that are available at present. An attempt is made to search deeply into the various characteristics and to simulate negative resistance devices using transistor combinations. *Investigation of the Applications of Negative Resistance Diodes for Switching Circuits, Transistor Applications, Inc., Boston, Mass., June 1958, 58 pp, Microfilm \$3.60, Photocopy \$9.30. Order PB 137830 from Library of Congress, Washington 25, D.C.*

## Diodes in Switching Circuits—II

This report is concerned with the study and investigation of negative resistance devices and the following subjects have been covered. Measurements of switching time as a function of load resistance and of carrier storage time are presented. Some of the capabilities of negative resistance multivibrators are investigated. Modification of a negative resistance diode characteristic with a transistor is discussed. Determination of the  $V_E - I_E$  and  $V_C - I_E$  characteristic of a transistor having a negative resistance in the base circuit is explained. Measurements of actual  $V - I$  characteristics are presented. A four-layer diode flip-flop, having a great deal of tolerance to diode parameter and supply voltage variation, is described. *Investigation of the Applications of Negative Resistance Diodes for Switching Circuits, Transistor Applications, Inc., Boston, Mass., Dec. 1958, 38 pp, Microfilm \$3.00, Photocopy \$6.30. Order PB 139220 from Library of Congress, Washington 25, D.C.*

## Use of Physical Phenomena in Communications

The extensive development of radio communication has overcrowded existing facilities. This paper proposes a solution to relieve this condition through the use of phenomena other than present day radio for communications. The paper investigates communication through natural ducts by the use of low frequency radio, sound, light, heat and gamma rays. Areas in which experimental work is required are summarized. Estimates are made of the probable speed rates with which information may be transmitted by use of the cited phenomena. *Exploitation of Physical Phenomena for Communications, Joseph L. Ryerson, Rome Air Development Center, Griffiss AFB, N.Y., Oct. 1958, 19 pp, Microfilm \$2.40, Photocopy \$3.30. Order PB 138493 from Library of Congress, Washington 25, D.C.*

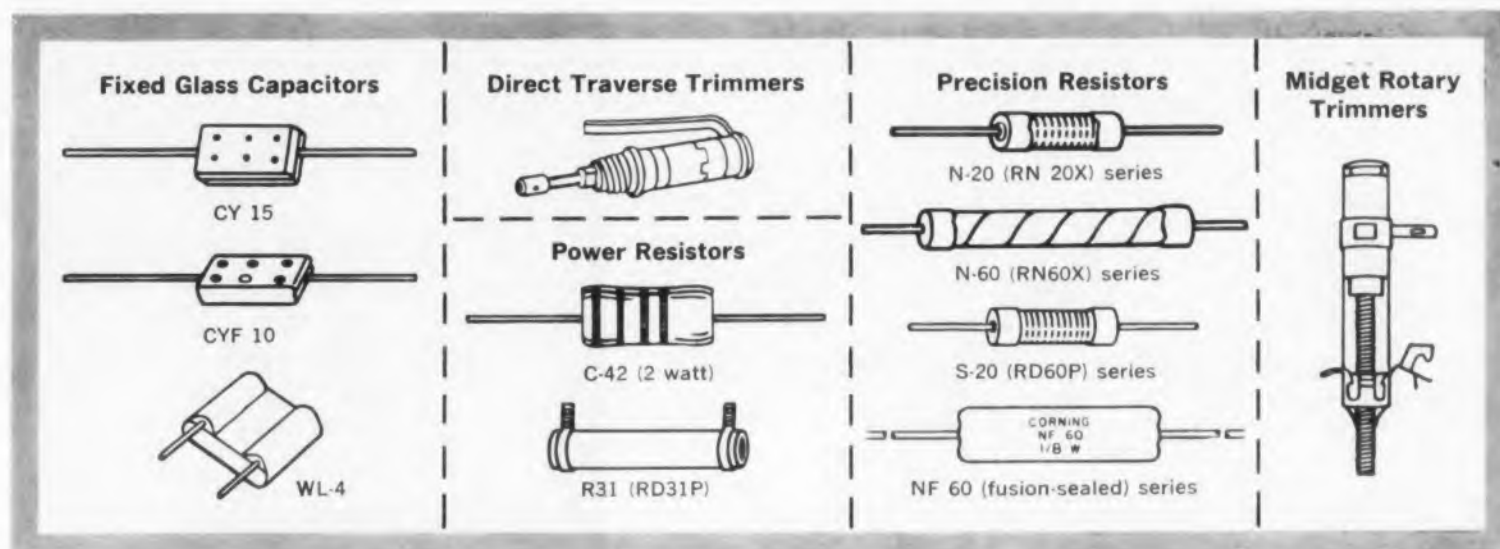

## CORNING COMPONENTS AT YOUR LOCAL ERIE DISTRIBUTOR

These franchised distributors can supply up to 1000 pieces of all Corning components at factory prices with no delay in delivery. Requirements for certificates of compliance or government source inspection can be met simply either by the distributor or at the Erie factory.

### Other Erie-Corning distributor benefits include:

- Complete stocks—over 1000 different styles and values—local delivery.
- Combined item purchases.
- Technical assistance—electronic technicians at all distributors.

### Check this list for the Erie-Corning distributor nearest you.

#### ARIZONA

Radio Specialties & Appliance Corp.  
917 North 7th Street  
Phoenix, Arizona  
Standard Radio Parts, Inc.  
218 North 1st Avenue  
Tucson, Arizona

#### CALIFORNIA

R. V. Weatherford Co.  
6921 San Fernando Road  
Glendale 1, California  
Newark Electric Co.  
4736 W. Century Blvd.  
Inglewood, California  
Federated Purchaser, Inc.  
11275 W. Olympic Blvd.  
Los Angeles 64, California  
Universal Radio Supply Co.  
1729 S. Los Angeles Street  
Los Angeles 15, California  
Elmar Electronics  
140 11th Street  
Oakland 7, California  
Zack Electronics, Inc.  
654 High Street  
Palo Alto, California  
Western Radio & TV Supply  
1415 India Street  
San Diego, California  
Pacific Wholesale Company  
1850 Mission Street  
San Francisco, California  
Zack Radio Supply Co.  
1424 Market Street  
San Francisco, California  
Peninsula Electronic Supply  
656 S. First Street  
San Jose, California

#### COLORADO

Denver Electronic Supply Co.  
1254 Arapahoe Street  
Denver 4, Colorado

#### DISTRICT OF COLUMBIA

Capitol Radio Wholesalers, Inc.  
2120-22 14th St., N.W.  
Washington, D.C.  
Electronic Wholesalers, Inc.  
2345 Sherman Avenue, N.W.  
Washington 1, D.C.

#### FLORIDA

Electronic Supply  
P.O. Box 935  
909 Morningside Drive  
Melbourne, Florida

Electronic Supply  
61 N.W. Ninth Street  
Miami, Florida

#### ILLINOIS

Newark Electric Company  
223 West Madison Street  
Chicago, Illinois

#### INDIANA

Ft. Wayne Electronics Supply  
3606 Maumee Avenue  
Ft. Wayne, Indiana  
Graham Electronics  
122 S. Senate Avenue  
Indianapolis 4, Indiana

#### IOWA

Deeco, Inc.  
618 First St., N.W.  
Cedar Rapids, Iowa

#### LOUISIANA

Electronic Parts Corp.  
223-225 N. Broad Street  
New Orleans 19, Louisiana

#### MARYLAND

Kann-Ellert Electronics, Inc.  
9 South Howard Street  
Baltimore 1, Maryland  
Wholesale Radio Parts Co., Inc.  
308-310 W. Redwood Street  
Baltimore, Maryland

#### MASSACHUSETTS

Cramer Electronics, Inc.  
811 Boylston Street  
Boston 16, Massachusetts  
Radio Shack Corporation  
730 Commonwealth Avenue  
Boston 17, Massachusetts

#### MICHIGAN

Ferguson Electronic  
Supply Co.  
2306 Puritan  
Detroit 38, Michigan

#### MINNESOTA

Stark Radio Supply Co.  
154 W. University Ave.  
(at Rice)  
St. Paul 3, Minnesota

#### NEW JERSEY

General Radio Supply Co.  
600 Penn Avenue  
Camden 2, New Jersey  
Federated Purchaser, Inc.  
1021 W. S. Route 22  
Mountainside, New Jersey

#### NEW MEXICO

Radio Specialties Co., Inc.  
209 Penn Avenue  
Alamogordo, New Mexico  
Radio Specialties Co., Inc.  
6223 Acoma Road, S.E.  
Albuquerque, New Mexico

#### NEW YORK

Federal Electronics, Inc.  
P. O. Box 208  
Binghamton, New York  
Radio Equipment Corporation  
312 Elm Street  
Buffalo, New York  
Davis Electronics Corp.  
204 Main Street  
Hempstead, New York  
Hudson Radio & TV Corp.  
37 West 65th Street  
New York 23, New York  
Interstate Electronics, Inc.  
227 Fulton Street  
New York 7, New York  
Milgray Electronics, Inc.  
136 Liberty, Room 320  
New York 6, New York  
Milo Electronics Corp.  
530 Canal Street  
New York 13, New York  
Terminal Radio Corp.  
236 West 17th Street  
New York 11, New York  
Rochester Radio Supply Co., Inc.  
600 East Main Street  
Rochester 5, New York  
Morris Distributing Co., Inc.  
1153 West Fayette Street  
Syracuse, New York  
Valley Electronic Labs, Inc.  
1415-19 Oriskany Street, W.  
Utica, New York  
**NORTH CAROLINA**  
Dalton-Hege Radio Supply Co.  
912 West 4th Street (Rear)  
Winston-Salem, North Carolina  
**OHIO**  
The Sun Radio Company  
110 East Market Street  
Akron 8, Ohio

Hughes-Peters, Inc.  
1128 Sycamore Street  
Cincinnati 10, Ohio

Hughes-Peters, Inc.  
111-117 East Long Street  
Columbus 15, Ohio

Radio & Electronic Parts Corp.  
3235 Prospect Avenue  
Cleveland 15, Ohio

Srepco, Inc.  
314 Leo Street  
Dayton 4, Ohio

#### OKLAHOMA

Oil Capitol Electronics Corp.  
923 East Fourth Street  
Tulsa, Oklahoma

#### OREGON

United Radio Supply, Inc.  
22 N.W. Ninth Avenue  
Portland, Oregon

#### PENNSYLVANIA

Herbach & Rademan, Inc.  
1204 Arch Street  
Philadelphia 7, Pennsylvania

Cameradio Company  
1121 Penn Avenue  
Pittsburgh 22, Pennsylvania

Fred P. Pursell  
1221-27 N. Washington Ave.  
Scranton 9, Pennsylvania

#### TENNESSEE

Electra Distributing Co.  
1914 W. End Avenue  
Nashville 4, Tennessee

#### TEXAS

Central Electronics  
4117 Maple Avenue  
Dallas 19, Texas

Busacker Electronics  
Equipment Co.  
1216 West Clay Street  
Houston 19, Texas

#### VIRGINIA

Priest Electronics, Inc.  
821 West 21st Street  
Norfolk 10, Virginia

#### WASHINGTON

Seattle Radio Supply, Inc.  
2117 Second Avenue  
Seattle 1, Washington

**ERIE** Electronics Distributor Division  
ERIE RESISTOR CORPORATION  
Erie, Pennsylvania

CIRCLE 59 ON READER-SERVICE CARD

If you have this problem, investigate

# GRIP-EZE®

—an example of Phelps Dodge's  
realistic approach  
to Magnet Wire research

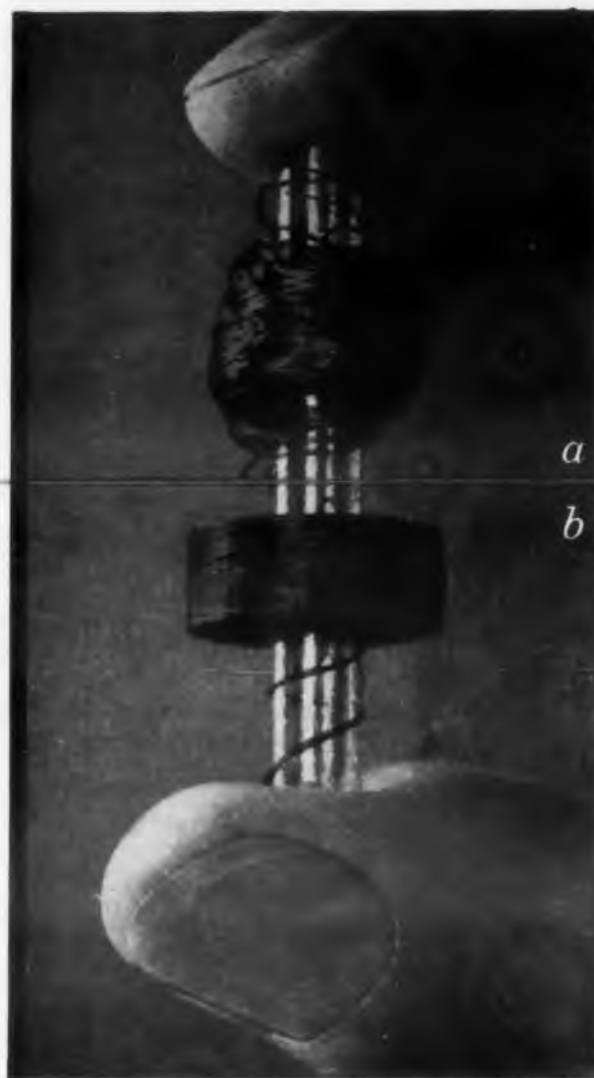

**THE PROBLEM:** To develop a solderable film-coated wire without fabric for winding universal lattice-wound coils without adhesive application.

**THE SOLUTION:** Phelps Dodge Grip-eze—a solderable film wire with controlled surface friction for lattice-wound coils that provides mechanical gripping between turns and keeps wire in place.

**EXAMPLE:** Coils wound with (a) conventional film wire; (b) Grip-eze. Note clean pattern of Grip-eze as compared to fall-down of conventional film wire.

*Any time your problem is magnet wire, consult Phelps Dodge for the quickest, surest answer!*

FIRST FOR  
LASTING QUALITY  
—FROM MINE  
TO MARKET!



**PHELPS DODGE COPPER PRODUCTS  
CORPORATION**

**INCA MANUFACTURING DIVISION**  
FORT WAYNE, INDIANA

CIRCLE 52 ON READER-SERVICE CARD

## REPORT BRIEFS

### Tropospheric Radio Wave Propagation

This report describes the results of an experimental investigation of the short-time statistics which characterize beyond-the-horizon radio wave propagation. Specifically, the probability distribution and the period of stationarity of the received signal are treated. The data were analyzed by means of statistical techniques, including an  $F$  test and a goodness-of-fit test. Experimental and analytical procedures are described in detail, as are the results obtained. A tabulation of the basic data and a complete sample calculation are also included. *Short-Time Statistics of Tropospheric Radio Wave Propagation*, R. G. Finney, General Electric Research Laboratory, Schenectady, N.Y., June 1958, 47 pp, Microfilm \$3.30, Photocopy \$7.80. Order PB 136053 from Library of Congress, Washington 25, D.C.

### Ruby Maser Action

In an endeavor to find paramagnetic materials suitable for maser applications, the electron-spin resonance properties of ruby ( $Al_2O_3:Cr$ ) were investigated. Evidence of oscillations and amplifications was obtained. *Maser Action In Ruby*, G. Makhov, C. Kikuchi and others, University of Michigan, Ypsilanti, June 1958, 8 pp, Microfilm \$1.80, Photocopy \$1.80. Order PB 135368 from Library of Congress, Washington 25, D. C.

### Electron Dynamics

The object of this report is to demonstrate the value of the hydrodynamical approach to electron dynamics (as opposed to the individual-particle approach) and to furnish a hydrodynamical "unified electron tube theory." By "tube" is meant any system in which the unperturbed electron beam or cloud, and the electromagnetic fields, have cylindrical or planar symmetry. This definition covers a large variety of devices. Because of the hydrodynamical approach, the theory can cope with solid beams, not only filaments or sheets of electrons. Also, strong coupling is covered by the theory. Qualitatively, the generative properties of electron clouds or beams are readily demonstrated, while qualitative analysis is reduced to the integrand of a single first-order differential equation for the electron admittance across the beam or cloud. *Electron Dynamics*, O. Buneman, Stanford Electronics Laboratories, Stanford University, Calif., Aug 1958, 25 pp, Microfilm \$2.70, Photocopy \$4.80. Order PB 136588 from Library of Congress, Washington 25, D.C.



## Symmetric Spherical Antenna

Equations suitable for numerical calculation of the characteristics of a symmetric spherical antenna have been detailed using the basic theory developed by S. A. Schelkunoff for a biconical antenna. Equations for ohmic loss in the antenna region and over the hemispherical caps have been developed. Calculations of input impedance, radiated power, and radiation efficiency for an electrically small antenna have been made, and the results shown in graphical form. *Method of Computing The Characteristics of a Symmetric Spherical Antenna*, J. Herman, *Diamond Ordnance Fuze Laboratories, Washington, D. C., Aug. 1957, 19 pp, Microfilm \$2.40, Photocopy \$3.30. Order PB 137402 from Library of Congress, Washington 25, D. C.*

## Tropospheric Scatter

A primary task of the project has been the recording of the signal strengths received at Syracuse, N. Y., from a transmitter at Lexington, Mass., 248.9 miles away. The transmitter operated at a carrier frequency of 915 mc. A study was made of the correlation between propagation data and meteorological conditions in the transmission path. The relative behavior of certain antennas for scattered signals and line-of sight signals was compared. *The Lexington-Syracuse Tropospheric Scatter Propagation Link*, J. Dienst, L. A. Mullin and others, *Syracuse University Research Institute, N.Y., Nov. 1957, 89 pp, Microfilm \$4.80, Photocopy \$13.80. Order PB 136470 from Library of Congress, Washington 25, D. C.*

## Meteor Scatter

This report is divided into three main parts. The first is a review, extension and discussion of the mechanism of radio scattering from meteor ionization trails under all combinations of low and high electron line density, long and short radio wavelength, and back and forward scattering. The second part consists of a review and discussion of the number distributions of echo amplitudes and durations, and a discussion of the diurnal and seasonal variations in the number and directions of arrival of meteor particles. In the final part the information on echo characteristics and meteor rate and radiant variations is used to obtain a description of the total fluctuating signal propagated over various paths by means of scattering from numerous meteor ionization trails. *Meteor Scatter*, V. R. Eshleman, *Stanford Electronics Laboratories, Stanford University, Calif., Aug. 1958, 48 pp, Microfilm \$3.30, Photocopy \$7.80. Order PB 136878 from Library of Congress, Washington 25, D. C.*

# EVERYTHING

IN

## Low-Power Switches

### ROTARY



MINIATURE: 8, 10, and 12 positions; up to 18 contacts per wafer.

Series A



SMALL: Up to 12 positions in phenolic, Mycalex, or steatite insulation.

Series F



ADAPTABLE: 8, 10, 12, and 14 positions; many variations; economical.

Series J, K, N



GENERAL PURPOSE: Up to 12 positions; 30°, 45°, 60° throw.

Series H



LOW COST: Up to 12 positions; staked or strut screw construction.

Series QH



18-POSITION: Single or double .eyelet fastening of clips.

Series L



24-POSITION: 15° throw handles complex circuits.

Series MF



LOW COST: 2 to 5 positions; fits in limited space.

Series 50, 53



SIMPLE SWITCHING: Up to 5 positions combined with AC switch.

Series 52, 54



SIMPLE SWITCHING: Up to 4 positions; numerous variations.

Series 20



LEVER OPERATED: 2 to 5 positions; numerous versions using std. wafers.

Series 185



CONCENTRIC SHAFTS: Dual and triple shafts with many wafer types.

FOR PRINTED CIRCUITS: Special lug designs for direct insertions.

## Endless Variety from Standing Tools



SOLENOID SWITCH: Oak wafers with G. H. Leland type of Rotary Solenoid.

### SLIDE



2-POSITION: Shorting type with floating slider.

Series 70

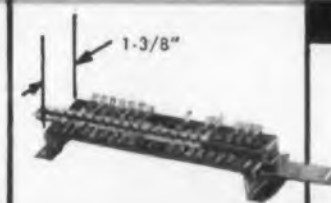

COMPLICATED SWITCHING: 2 to 4 positions; up to 20 poles; very thin.

Series 150

### ROTARY SLIDE



COMPACT—2 to 4 positions; max. switching in min. space.

Series 160

### PUSHBUTTON



SINGLE BUTTON—1 to 4 poles; spring return and push-push.

Series 170, 175

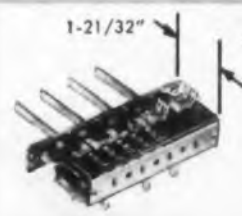

SIMPLER CIRCUITS: 3 to 12 buttons; very adaptable unit.

Series 80

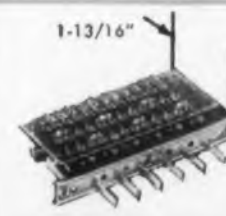

COMPLICATED CIRCUITS: 1 to 18 buttons, up to 32 contacts each.

Series 130

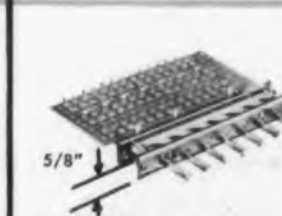

ULTRATHIN: 1 to 12 buttons; up to 14 contacts per button.

Series 131

## Quick Solutions for Busy Designers

# OAK MFG. CO.

1260 Clybourn Ave., Dept. D, Chicago 10, Illinois  
Phone: MOhawk 4-2222

Designing a low-power switch can sometimes turn into a real tussle. Before this happens, call in Oak specialists. From a vast store of past designs and experience they are able, many times, to offer a readymade solution... whether it be for a standard unit, something unusual, or a complete package of circuitry. The result is the exact switch you need, representing top engineering and optimum economy.

CIRCLE 53 ON READER-SERVICE CARD

take a card  
...ANY card!

...and you'll see why  
**Acheson's EMRALON®**  
is providing new  
application stories.

The recent introduction of 'EMRALON' surface coatings has literally "opened the door" for scores of manufacturers seeking the unparalleled properties of du Pont's tetrafluoroethylene (TFE) but handicapped by the high fusing temperature. With 'EMRALON' 310\*, a one hour cure at 300°F. is all that is necessary. For substrates even more sensitive to heat, there is air drying 'EMRALON' 320†. In either case, these versatile new coatings provide excellent adhesion, low coefficient of friction, toughness and corrosion resistance. What's more, 'EMRALON' can be applied by conventional paint spray equipment.

Why not test 'EMRALON' 310 or 'EMRALON' 320 on your application. Send for an introductory package complete with data sheet. The cost is only \$4.25 prepaid for enough material to coat 5,000 sq. in. of surface. (\$4.50 west of the Rockies) Write today!

**ACHESON COLLOIDS COMPANY**

Dept. ED-59, Port Huron, Michigan

Gentlemen: Your new 'EMRALON' surface coatings suggest themselves as possibilities for a current design problem. Send an introductory package to me promptly.

- 'EMRALON' 310 (bake type)     Check enclosed  
 'EMRALON' 320 (air-dry)     Please have your service engineer call  
 Bill me on Order No. \_\_\_\_\_     Send descriptive literature

NAME: \_\_\_\_\_ TITLE: \_\_\_\_\_

COMPANY: \_\_\_\_\_

ADDRESS: \_\_\_\_\_

CITY: \_\_\_\_\_ STATE: \_\_\_\_\_

APPLICATION: \_\_\_\_\_



\*'EMRALON' 310 is manufactured under exclusive license from E. I. du Pont de Nemours & Co. (Inc.) under U. S. Patent 2,825,706. Not licensed for use or for sale for use in providing electrical insulation.  
†'EMRALON' 320 — Patent applied for

**ACHESON Colloids Company**  
PORT HURON, MICHIGAN

A division of Acheson Industries, Inc.

Also Acheson Industries (Europe) Ltd. and affiliates, London, England

CIRCLE 58 ON READER-SERVICE CARD

REPORT BRIEFS

**Tachistoscope**

A multi-field electronic tachistoscope is described which has variable duration, sequence, and intensity controls. In addition, the device may be cycled automatically, or be made to run through a single cycle manually. Each viewing field can be illuminated for durations ranging from 1 msec to 3 sec during automatic operation. The upper limit of the exposure duration may be increased to any desired value greater than 3 sec by means of a manually operated switch. Other provisions are described which control intensity of the illuminated or trans-illuminated stimulus materials. *A Multi-Field Electronic Tachistoscope, Paul A. Kolers, Aero Medical Lab., Wright-Patterson AFB, Ohio, Dec. 1958, 11 pp, \$.50. Order PB 151689 from OTS, Washington 25, D.C.*

**Limited Clipped Integration**

Limited clipped integration is a method for improving radar video presentation. It effectively eliminates noise and interference from the video output, working ideally on signals from which ground clutter has been removed. With a feedback gain of one and a memory of three it is especially valuable for use with automatic computers. In an area where jamming is most severe, its reliability has been proved by three years of operation. Economical and practical, its addition to existing radars is a simple matter. *Limited Clipped Integration, John P. Castelli, Air Force Cambridge Research Center, Bedford, Mass., July 1958, 20 pp, Microfilm \$2.40, Photocopy \$3.30. Order PB 140163 from Library of Congress, Washington 25, D.C.*

**Transistor Test Set**

A small versatile transistor test set was designed to measure collector cutoff current ( $I_{CO}$ ), emitter cutoff current ( $I_{EO}$ ), and the dc large-signal common-emitter current gain ( $H_{FE}$ ). A wafer polarity switch is included to accommodate both pnp and npn transistors.  $I_{CO}$  and  $I_{EO}$  are measured at 2.68 v which are supplied by 2 mercury cells, the only power source of the instrument. In measuring  $H_{FE}$ , the 2.68 v are included in the collector-to-emitter circuit as the collector supply voltage. A 134 K resistor, in series with the 2.68 v, supplies a 20- $\mu$ a constant base current. A 20- $\mu$ a meter is used in measuring  $I_{CO}$  and  $I_{EO}$ . A shunt resistor, used when  $H_{FE}$  is being measured, converts 20  $\mu$ a to 2 ma. *A Simple Transistor Test Set, Harry V. Wood, Army Signal Engineering Laboratories, Fort Monmouth, N.J., Aug. 1957, 9 pp, \$.50. Order PB 151300 from OTS, Washington 25, D.C.*



 VITREOUS-ENAMELED  
RESISTORS



## “SNIP OR CLIP” TAB TERMINALS

Snip the lead, or clip the tab . . . get the exact terminal type you need! Save space and eliminate the need to stock two types of resistors. This unique feature is on General Electric 5-, 10-, and 20-watt resistors. For your vitreous-enameled resistor catalog, follow reader service instructions below. General Electric Co., Roanoke, Va.

784-12

*Progress Is Our Most Important Product*

**GENERAL  ELECTRIC**

CIRCLE 56 ON READER-SERVICE CARD

ELECTRONIC DESIGN • September 16, 1959

### Properties of Semiconductors, I

The temperature dependences of lifetime, injection ratio, and resistivity in p-type silicon crystals were measured by the use of the pulse decay method. At high temperatures the dependence of lifetime and injection ratio on emitter current and sweeping field is identical with that which one observes at room temperature. *Electronic Properties of Semiconductor Materials, J. Maczuk, B. P. Fabricand, Moore School of Electrical Engineering, University of Pennsylvania, Philadelphia, Pa., June 1957, 31 pp, Microfilm \$3.00, Photocopy \$6.30. Order PB 136089 from Library of Congress, Washington 25, D. C.*

### Properties of Semiconductors, II

Results are obtained which show the dependence of surface state energy levels under a point contact on temperature, injecting voltage, and sweeping field in a p-type 250 ohm-cm crystal. Time constants for the filling and emptying of surface states for different voltages are also found. These results are obtained by observing the carrier disturbances under a point contact by a pulse method previously described. A theory of the behavior observed is presented. *Electronic Properties of Semiconductor Materials, J. Maczuk, B. P. Fabricand, Moore School of Electrical Engineering, University of Pennsylvania, Philadelphia, Pa., Sept. 1957, 23 pp, Microfilm \$2.70, Photocopy \$4.80. Order PB 136088 from Library of Congress, Washington 25, D.C.*

### Properties of Semiconductors, III

The contact resistance of rhodium-silicon metallic contacts varies asymmetrically with cooling of the crystal below room temperature. *Electronic Properties of Semiconductor Materials, J. Maczuk, B. P. Fabricand, Moore School of Electrical Engineering, University of Pennsylvania, Philadelphia, Pa., Dec. 1957, 27 pp, Microfilm \$2.70, Photocopy \$4.80. Order PB 136087 from Library of Congress, Washington 25, D.C.*

### Transistor Measurements

A method is shown whereby four measurements made directly on commercial bridges may be used to find the admittance parameters of a transistor in any orientation, common-base, common-emitter, or common collector, merely by taking appropriate sums of the measured quantities. *Transistor Measurements Using the Indefinite Admittance Matrix, J. P. Paddock, Stanford Electronics Laboratories, Stanford University, Calif., Aug. 1957, 31 pp, Microfilm \$3.00, Photocopy \$6.30. Order PB 136434 from Library of Congress, Washington 25, D.C.*

# FACILITIES

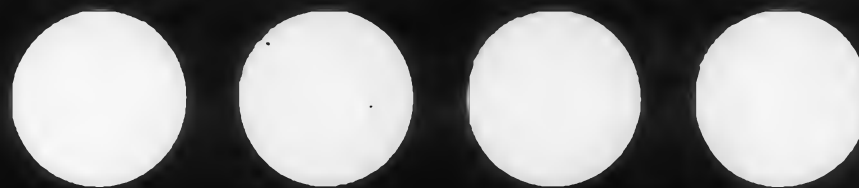

Bryant's production facilities are unique in the field of computer products manufacture.

Our multi-million dollar research and manufacturing resources assure you of the utmost precision and dependability of Bryant magnetic drums and read-record heads.

Full details are in our new descriptive brochure.

Write for your copy.

Bryant Computer Products Division  
a division of Bryant Chucking Grinder Co.,  
P. O. Box 620 Springfield, Vermont.

CIRCLE 57 ON READER-SERVICE CARD



## STEPPER SYNCHRO POSITIONER

Accuracy: Within 6 min. of arc when driven by either motor.

Incremental shaft rotation: 2 degrees.

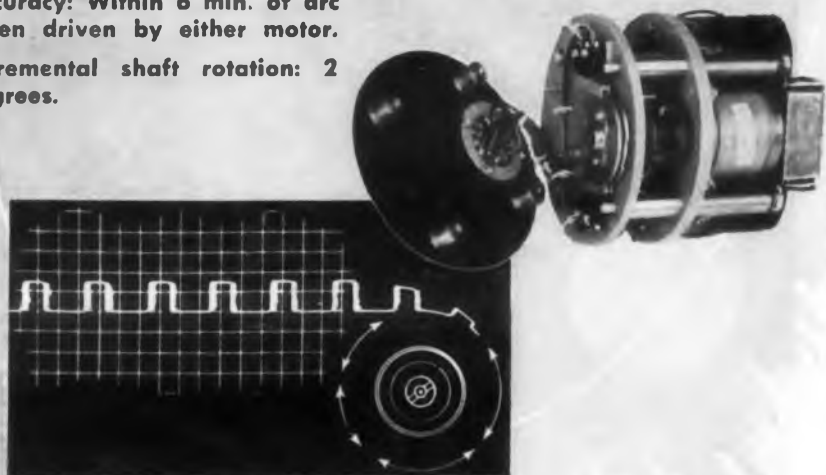

This is one of the many applications for the Stepper Motor — a device for translating electrical pulses into accurate, bi-directional, incremental shaft displacements.

The Synchro Positioner uses two Stepping Motors, an Autosyn differential, and a built-in pulse generator. One motor positions the Autosyn Shaft in coarse increments in either direction, while the other motor, using a different gear ratio, positions the same shaft in vernier increments in either direction. As the reset command signal is of steady-state type, the built-in pulse generator permits use of the driving motors for the reset function.

### STEPPER MOTORS CORPORATION

Subsidiary of California Eastern Aviation, Inc.

7443 West Wilson Avenue • Chicago 31, Illinois

• WEST COAST • 11879 W. FLORENCE AVE. • CULVER CITY, CALIF.

CIRCLE 54 ON READER-SERVICE CARD

## REPORT BRIEFS

### Meteor-Scattering Communication

This report is divided into two sections. The first describes a type of antenna mount which ensures that both the transmitting and the receiving antennas have the optimum polarization for radio transmission via radio waves scattered from a small region of ionization, such as a meteor trail. The mount is an equatorial form with the polar axis along the line joining the two stations, and the antenna should be polarized parallel to the declination axis. The second section of the report describes a mechanical analog for predicting the optimum directions for pointing the antennas used in meteor scatter communication, subject to the assumption that there is some ecliptic concentration of meteor radiants. *Research In Meteor-Scattering Communication*, W. E. Deeds, Tennessee University, Engineering Experiment Station, Knoxville, Tenn., Sept. 1957, 16 pp, Microfilm \$2.40, Photocopy \$3.30. Order PB 135889 from Library of Congress, Washington 25, D. C.

### Trough Waveguide Radiators

In a trough waveguide loaded by equi-spaced posts on its center fin, the phase velocity of the dominant mode can have a phase velocity greater or less than that in freespace. The radiation from this periodic structure can be controlled by lowering the sidewall of the trough waveguide until the tops of the posts protrude above it. At any phase velocity close to that of freespace, radiation patterns are endfire, with polarization parallel to the center fin. Under conditions of large post spacing, the phase velocity in the postloaded trough waveguide can be predicted to a good approximation on the basis of the analysis presented. Measurements show that the phase velocity is essentially independent of the height of the sidewalls and that the attenuation constant (not evaluated in the theory) is a function of both the wall height and the number of posts per unit length of guide. Measured patterns of a post-loaded trough waveguide show the expected endfire characteristics over a wide frequency range. The combination of two trough waveguide radiators and a stripline hybrid junction produce a monopulse antenna with endfire sum and difference patterns. *Trough Waveguide Radiators with Periodic Posts*, Walter Rotman and Nicholas Karas, Air Force Cambridge Research Center, Bedford, Mass., Dec. 1958, 32 pp, Microfilm \$3.00, Photocopy \$6.30. Order PB 140158 from Library of Congress, Washington 25, D.C.



### CHOOSE FROM THESE MATERIALS...

**Vulcanized Fibre:** 10 standard grades; many special grades.

**PHENOLITE® Laminated Plastic:** over 80 standard and modified grades; paper, cotton fabric, nylon, asbestos, glass fabric, cotton and glass mat bases; phenolic, melamine, polyester, epoxy

**PEERLESS Electrical Insulation:** coil, strip, corrugated.

**Extruded Nylon:** 2 grades; rod, strip, pressure tubing, special shapes.

**Polyester Glass Mat:** 4 standard sheet grades; custom molded shapes.

**PHENOLITE Copper-Clad Laminates:** 10 standard grades.

**Combination Materials:** Rubber-PHENOLITE; Rubber-Fibre; Wood-Fibre; Metal-Fibre; Asbestos-Fibre; PEERLESS-PHENOLITE.

### BACKED BY THESE SERVICES...

Field Application Assistance  
Complete Fabricated Parts Service  
Stock Program for Immediate Shipment

### BY CALLING THESE OFFICES...

Baltimore.....	VALLEY	3-0393
Boston.....	TWinbrook	4-3500
Chicago.....	Austin	7-1935
Cincinnati.....	GARfield	1-0632
Cleveland.....	ERieview	1-0240
Dallas.....	DAvis	4-4386
Denver.....	MAin	3-2077
Detroit.....	UNiversity	3-3632
Griffin, Ga.....		8-1308
Indianapolis.....	WAlnut	3-6381
Los Angeles.....	RAymond	3-0291
Milwaukee.....	BRoadway	6-6995
New Haven.....	LOcust	2-3594
Newark.....	MItchell	2-6090
New York.....	COrtlandt	7-3895
Philadelphia.....	SHErwood	8-0760
Pittsburgh.....	FAirfax	1-3939
Rochester.....	HIllside	5-0900
St. Louis.....	PArkview	5-9577
St. Petersburg.....		5-5505
San Francisco.....	DAvenport	6-4667
Seattle.....	MElrose	2-7298
Wilmington.....	OLympia	5-6371

#### IN CANADA:

National Fibre Co. of Canada, Ltd.  
Toronto.....LEnnox 2-3303  
Montreal.....AVenue 8-7536



WILMINGTON 99, DELAWARE

In Canada:

NATIONAL FIBRE COMPANY OF CANADA, LTD., Toronto 3, Ontario

CIRCLE 55 ON READER-SERVICE CARD

CIRCLE 658 ON READER-SERVICE CARD



NEW! METHODE  
**"RELI-ACON"**  
 CONNECTORS  
 for  
 Immediate Delivery!

FD-700 Series



3/32" and 1/8"  
**CARD  
 RECEPTACLES  
 MIL-C-21097**

Locking Device  
 (optional)

**"RELI-ACON"  
 PAIRED  
 CONNECTORS**

for smooth mating  
 rack and panel and  
 cable to chassis  
 connections



MOR-600B Series



**"RIGHT ANGLE"  
 MALE CONNECTORS**  
 with pin termination

threaded mounting grommets



Write for detailed information and illustrated brochure

**METHODE** Manufacturing Corporation  
 7447 W. Wilson Ave., Chicago 31, Ill.

CIRCLE 51 ON READER-SERVICE CARD

← CIRCLE 658 ON READER-SERVICE CARD

ELECTRONIC DESIGN ENGINEERING DATA

## Coil Redesign Nomograph



**Paul Shapiro**  
 Texas Instruments Inc.  
 Dallas, Texas

In the course of his design and development work, Paul Shapiro has often been burdened by tedious computations involved in coil redesign. He therefore undertook, and successfully completed, the presented nomograph project to enable quick and accurate determination of wire size during coil redesign.

**W**HEN coil redesign is necessary, keeping size constant, the following nomograph offers a quick and accurate solution provided one new parameter is known as a function of an existing parameter. The need to consult tables, find absolute values of wire area or diameter, and calculate ratios from known values is eliminated.

### Typical Example

As an example, let us consider a coil to be redesigned for ten times its present resistance. Let the present resistance be 40 ohms; the wire size be #37; the number of turns be 700. The point is noted where the resistance per coil line crosses the ratio 10. This point is on the number increase line of +5. Therefore #37 +5 = #42 wire.

For +5, the number of turns has a ratio of approximately 3.1 as shown by the nomograph. Therefore the new number of turns shall be  $700 \times 3.1 = 2170$  turns. If the original wire area, diameter, or resistance per unit length is known, and the new values are required, these also can be obtained by noting where the respective lines cross +5. ■ ■

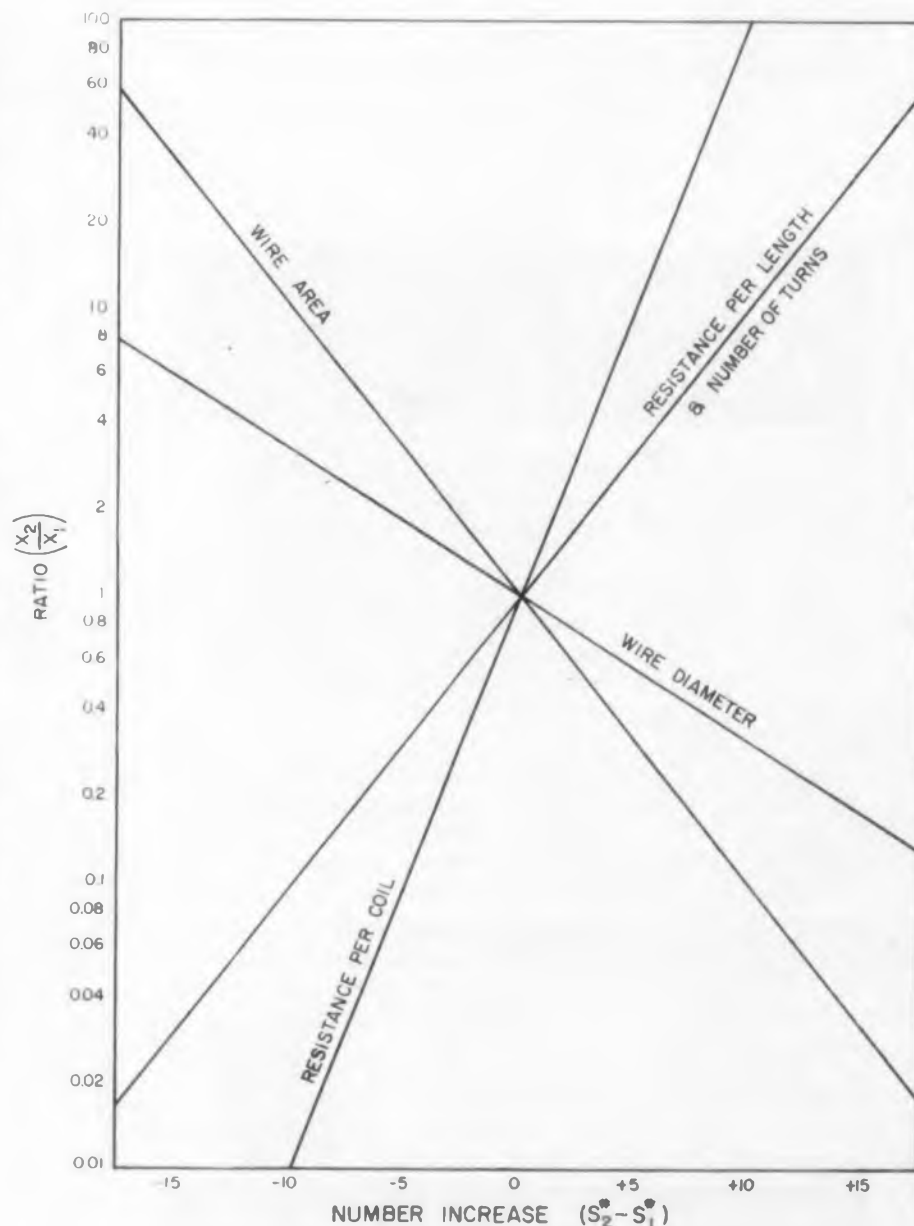

# Now from CMC— SOLID STATE DCU's



1 mc and 220 kc

Computer Measurements Company's high reliability transistorized DCU's are ideally suited to industrial and weapons system applications.

Models 100T (0-220 kc) and 111T (1 mc) measure 1" W x 4 3/4" H x 3 1/4" D and weigh only 6 ounces. Power requirements are —18 v at 170 ma, —6 v at 2 ma. Direct reading from 0 to 9 with either vertical numeral panels or Nixie readout, these units may be connected in cascade to obtain any total count required. 1-2-2-4 binary coded decimal output is available to drive digital recorders, etc. Model 100T — \$130.00; 111T — \$175.00. Quantity discounts and special OEM prices on request.

CMC solid state DCU's are part of the most complete line of decade counting units available from one source. Write for DCU catalog Dept. 199.



**Computer Measurements Co.**

A Division of Pacific Industries, Inc.  
12970 Bradley Avenue  
Sylmar, California

CIRCLE 60 ON READER-SERVICE CARD

## High Quality Coil Forms For All Electrical Applications

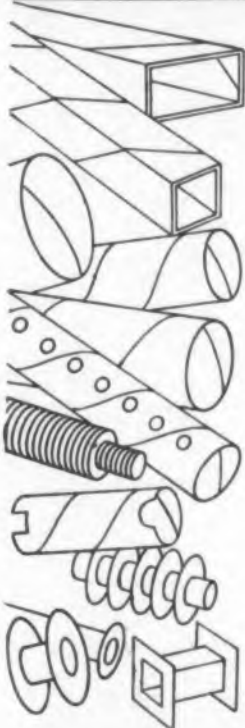

**SQUARE AND RECTANGULAR TUBES**—Choice of any dielectric material or combinations. Any length, shape or size. Especially recommended for Class A, B and H temperature ranges.

**ROUND TUBES**—Any decimal size up to 8". Fabricated from dielectric kraft, fish paper, acetate, DuPont Mylar, Johns-Manville Quinterra, fibre glass, other materials or combinations.

**RESINITE PHENOLIC IMPREGNATED**—Feature the highest resistivity of any resinated product. Furnished in any shape or size—plain, embossed or internally threaded, also in fly-back transformer forms.

**BOBBIN ASSEMBLIES**—Fabricated to specification in any dielectric material for Class A, B and H temperature ranges. Supplied with metal, asbestos, plastic or fibre flanges.

Request catalog and prices. Ask about Precision's complete coil form service.



**PRECISION PAPER TUBE CO.**

2055 WEST CHARLESTON STREET • CHICAGO 47, ILL.  
CIRCLE 61 ON READER-SERVICE CARD

## REPORT BRIEFS

### Single Sideband Carrier Telephone Channels

Polyphase modulation is shown to be a technique suitable for producing single sideband telephone channels. This technique is capable of providing superior channel bandpass and envelope distortion characteristics. In this report the main limitations of polyphase modulation are analyzed, and the characteristics obtained from an experimental channel are discussed. *The generation of Single Sideband Carrier Telephone Channels by Polyphase Modulation, Joseph Mensch, Rome Air Development Center, Griffiss AFB, N.Y., June 1958, 17 pp, Microfilm \$2.40, Photocopy \$3.30. Order PB 137673 from Library of Congress, Washington 25, D.C.*

### Transistor High-Frequency Equivalent Circuits

The conclusion is reached that a simple equivalent circuit can serve as a valuable link between transistor device parameters and the quadripole parameters often sought by circuit designers. It has been demonstrated that it is feasible to characterize a group of transistors by means of a set of mean device parameter values, although the study has also shown that the variability of the device parameters is such that to include 95 per cent of all transistors in a group, the range of parameters is usually three to one. *Statistical Study of Transistor High-Frequency Equivalent Circuits, R. L. Walker, Stanford Electronics Laboratories, Stanford University, Calif., Sept. 1957, 90 pp, Microfilm \$4.80, Photocopy \$13.80. Order PB 136433 from Library of Congress, Washington 25, D.C.*

### Thermal-Velocity Effects in Electron Beams

The design of convergent Pierce-type electron guns has been well systematized, for the solid pencil-beam case, by Pierce and other workers. Because of the growing importance of two-dimensional sheet or strip beams and hollow beams in microwave devices, a need has arisen for design data applicable to these cases. The purpose of this report is to present data on space-charge-limited flow, applicable to the design of convergent Pierce guns for strip beams. *Thermal-Velocity Effects in Two-Dimensional Electron Beams, C. B. Crumly, Stanford Electronics Laboratories, Stanford University, Calif., Feb. 1958, 53 pp, Microfilm \$3.60, Photocopy \$9.30. Order PB 138515 from Library of Congress, Washington 25, D.C.*

Now!  
get  
complete  
data on



## MINIATURE AGASTAT® time / delay / relays

This free folder contains complete specs on 24 models of the miniature AGASTAT Time Delay Relay for missile, aircraft, computer, electronic and industrial applications. They're small as 1-13/16" x 4-7/16" x 1 1/2", with adjustable timing ranges starting at .030 and as high as 120 seconds.

The folder gives operating and environmental specs, coil data, contact capacities, dimensions, diagrams of contact and wiring arrangements. Write: Dept. A33-425.

AGA  
Division

ELASTIC STOP NUT CORPORATION OF AMERICA

Dept. A33-924, Elizabeth, New Jersey

CIRCLE 62 ON READER-SERVICE CARD

FOR HIGH TEMPERATURE WORK

NEW! NON-SLIP FINISH ON

HEMINWAY  
& BARTLETT

## TEFLON COATED FIBERGLAS TAPES

Withstand temperatures up to  
600 in 1/4" and 1/8" widths

## LACING CORDS AND TAPES OF NYLON and DACRON

are available in wax, wax-free  
and resin-coated finishes

- Fungus-proof
- Tie easy, fast and tight
- Extra Strong
- Knots won't slip

Sold nationally by Alpha Wire, New York

Write for full  
information and  
free samples!

THE HEMINWAY & BARTLETT MFG. CO.  
Electronics Division: 500 Fifth Avenue, New York 36

CIRCLE 63 ON READER-SERVICE CARD

ELECTRONIC DESIGN • September 16, 1959



# PRINTED CIRCUITS BY SCREEN PROCESS

If you are now screen printing electronic circuits or are interested in details of the most efficient, economical labor-saving methods in this expanding field, let us demonstrate, at your plant, how our products can give sharper, more precise printed images with closer tolerance and at a savings of time and money.

#### Distributors of

- ≡ NU-SOL PHOTO-EMULSION
- ≡ DIAPRINT SCREEN CHASE
- ≡ TET-STEEL WIRE CLOTH
- ≡ NITEX SCREEN CLOTH
- ≡ WORNOW PROCESS PAINT



## KRESSILK PRODUCTS, INC.

73 MURRAY STREET, NEW YORK 7, N. Y.

CIRCLE 64 ON READER-SERVICE CARD

### New Subminiature Tubes Control High Energy Discharges



KIP-104  
Actual Size

The KP-104 represents one of a family of subminiature, cold cathode, arc-discharge pulse tubes (Krytrons) suitable for switching pulse currents from 10 to more than 1000 amperes. The KP-104 combines trigger and timer functions in that it provides a high anode hold-off voltage (2-3K), requires low input power (less than 0.1w), has short anode delay times (time from triggering till tube discharge = 0.5 microsec.) and negligible "jitter" (variation in delay) averaging less than 0.05 usec. The KP-104 (and other models) are useful for relay, timer, trigger, pulser, series regulator, time delay, and other applications. The KP-130, also subminiature, will control circuits up to 1100 amperes at 2500 volts with an anode delay of 0.2 microsec., and may be used to replace a trigger tube, timer tube, and spark gap. All tubes operate in light and dark; have exceptional environmental capabilities.

For details on these and other special purpose electron tubes, write

#### KIP ELECTRONICS CORPORATION

Dept. 92, P.O. BOX 562, STAMFORD, CONNECTICUT.

CIRCLE 65 ON READER-SERVICE CARD

ELECTRONIC DESIGN • September 16, 1959

### Coaxial Attenuators

This report describes the design and development of a set of four ruggedized attenuators rated at 3, 6, 10, and 20 db, and designated as CN-333 (XW-1)/U, CN-334 (XW-1)/U, CN-336 (XW-1)/U, and CN-335 (XW-1)/U respectively. The attenuators fit directly into a 7/8 in. coaxial line and may be used with military summation bridges AN/URM-22 and AN/URM-23 for field measurements of radar system power. The frequency range covered is from dc to 4.0 kmc, and power up to 10 kw peak and 5 w average can be handled by using the appropriate attenuator. The voltage standing wave ratio is 1.30 or less throughout the operating range. *Design and Development of Ruggedized Coaxial Attenuators, Vincent Kapfer, Rome Air Development Center, Griffiss AFB, N.Y., July 1958, 35 pp, Microfilm \$3.00, Photocopy \$6.30. Order PB 137553 from Library of Congress, Washington 25, D.C.*

### Single Sideband Generation: 1.5 to 30 Mc

This manuscript is the fourth and final report covering an engineering research study of high-level single sideband generation and the construction of two experimental models of a radio transmitter providing single sideband operation over the frequency range of 1.5 to 30 mc and having a peak power capability of 500 w. The report consists, in the main, of an instruction manual. The operation of the high-level transmitter is described, and a detailed description of its component parts, including all circuit diagrams, is given. Instructions are outlined for installation and for initial and frequency-change tune-up. The results of various tests, together with test techniques, are presented. *Methods and Equipment for High Level Single Sideband Generation in the Frequency Range of 1.5 to 30 Mc, Stanford Research Institute, Calif., Mar. 1950, 134 pp, Microfilm \$6.90, Photocopy \$21.30. Order PB 139285 from Library of Congress, Washington 25, D.C.*

### Transverse-Field Klystron

The need for improved low-noise beam amplifiers makes desirable the investigation of new types of beam devices. The work reported here concerns the noise characteristics of a transverse-field klystron. A theory of operation is developed which includes expressions for tube transconductance, beam loading, and noise figure. Three low-frequency experimental klystrons were built to test the theory. *Investigation of the Transverse-Field Klystron, B. Frank, Stanford Electronics Laboratories, Stanford University, Calif., May 1958, 84 pp, Microfilm \$4.80, Photocopy \$13.80. Order PB 138514 from Library of Congress, Washington 25, D.C.*

## Q: What is a Kodak Ektron Detector?

**A:** It is a semi-conductive resistor. The photosensitive area can be laid down in any pattern. Response extends to 3.5 microns in the infrared. Unaffected by vibration; high signal-to-noise ratio.

**Q:** What can it be used for?

**A:** For such applications as an infrared sensor in weapons systems, and in instrumentation for process control, analysis, and safety.

**Q:** How can I get the facts about spectral response, types, availabilities, and the like?

**A:** By writing for a new brochure called "Kodak Ektron Detectors."

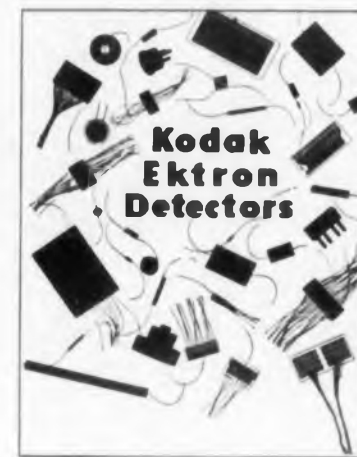

Write to:

Apparatus and Optical Division  
EASTMAN KODAK COMPANY, Rochester 4, N. Y.

CIRCLE 66 ON READER-SERVICE CARD

FOR FASTER ASSEMBLY WORK...  
**56 SIZES** 1/8" to 3"  
**Hi PLASTIC CLAMPS**  
LOOP-TYPE

Perfect insulators for mounting single or group wires, tubing, etc. . . unaffected by age, moisture, corrosion, shock, vibration. Use as clamp, strain relief, clip, hanger fastener, strap, etc.

**MILLIONS IN USE!**



Women Assemblers Like 'Em



Easy To Open . . . Snap Back in Shape!

ASK FOR FREE SAMPLES! Specify Type and Size



MAIL TODAY FOR 1959 "Hi" CATALOG

NAME \_\_\_\_\_

FIRM \_\_\_\_\_

ADDRESS \_\_\_\_\_

CITY \_\_\_\_\_ STATE \_\_\_\_\_

**HOLUB INDUSTRIES, Inc.**

468 ELM STREET • SYCAMORE, ILLINOIS

CIRCLE 67 ON READER-SERVICE CARD

Where only the **best**  
is good enough . . .



MODEL 440-A

## Krohn-Hite oscillators are used

In basic electronic instruments for lab or test work, *less* than the best may be a dangerously bad bargain. Unexpected limitations — of reliability, range, precision — can throw out weeks of work on today's jobs, and can make tomorrow's tougher jobs untouchable.

The *best* instrument of its type is probably a bit more expensive, but it's worth buying . . . because you can believe in it today, and will rely on it tomorrow. An example is the Krohn-Hite Model 440-A wide range push-button oscillator. Here are some facts about it.

**FREQUENCY RANGE:** 0.001 cps to 100 kc, continuous coverage.

**CALIBRATION ACCURACY:**  $\pm 1\%$  from 1 cps to 10 kc,  $\pm 3\%$  from 0.01 to 1 cps and from 10 kc to 100 kc.

**RESETABILITY:** exact for push-button resetting, subject only to drift of less than 0.05% per hour.

**SINE WAVE OUTPUT:** 10 volts rms open circuit, 100 milliwatts into 1000 ohms; amplitude constant within  $\pm 0.25$  db from 0.1 cps to 10 kc.

**SINE WAVE DISTORTION:** less than 0.1% from 1 cps to 10 kc, less than 1% from 0.01 to 1 cps and from 10 kc to 100 kc.

**SQUARE WAVE OUTPUT:** 10 volts peak to peak open circuit, 5 volts peak to peak across 1500 ohms; amplitude constant within  $\pm 1\%$  at any frequency; rise time less than 0.5 microsecond.

There's a lot more you should know about the 440-A . . . and about the other Krohn-Hite oscillators, tunable electronic filters, power supplies and amplifiers. In all of them, you'll find the same far-ahead engineering, design and construction. Because K-H instruments *are* good enough even for tomorrow's most critical work, they are increasingly chosen today where reliability and precision are needed.

Write for your free copy of the new Krohn-Hite Catalog.



**Krohn-Hite** CORPORATION

580 Massachusetts Avenue, Cambridge 39, Mass.  
CIRCLE 68 ON READER-SERVICE CARD



## BOOKS

### Advances in Semiconductor Science

H. Brooks, Editor, Pergamon Press Inc.,  
122 E. 55th St., New York 22, N.Y., 553  
pp, \$15.00.

Papers presented at the Third International Conference on Semiconductors held at the University of Rochester, Aug. 18-22, 1958, have been logically arranged according to sessions in this book.

The opening session deals with trends in semiconductor research and properties of various semiconductors. A discussion of band theory, recombination and impurity centers, and surfaces follows. Dislocations, excitons, and transport are then considered.

A section entitled "General" covers the

effect of pressure on the properties of germanium and silicon and the magnetic susceptibility of semiconductors. The sections that follow discuss optical properties, ionic crystals, thermal conduction and thermomagnetic effects, semiconducting compounds, and large band gap semiconductors.

### Technology of Printed Circuits

Paul Eisler, Academic Press Inc., 111  
Fifth Ave., New York 3, N.Y., 405 pp,  
\$12.00.

Special emphasis is given to the production of electronic circuits by the foil

**DIMCO-GRAY**

## SNAPSLIDE FASTENERS

**PROVIDE VIBRATION-PROOF HOLDING  
AND QUICK, FOOL-PROOF RELEASE!**

APPROVED UNDER ARMY-NAVY STANDARDS

Here's a simple, easy means of securely fastening assemblies to withstand shock or vibration, and yet allow quick removal for inspection or repair. Instant snap action engages or releases fastener . . . no tools are required! After installation, fasteners never need adjustment . . . even with repeated use.

Three sizes available for different load requirements. Large and medium sizes are made of corrosion-resistant stainless steel. Small size is made of nickel-plated brass. Stock parts fit various thicknesses of flanges and mounting plates . . . special parts can also be supplied.

WRITE FOR FULL DETAILS TODAY!

**DIMCO-GRAY** COMPANY

201 E. SIXTH STREET DAYTON, OHIO  
CIRCLE 69 ON READER-SERVICE CARD

ELECTRONIC DESIGN • September 16, 1959

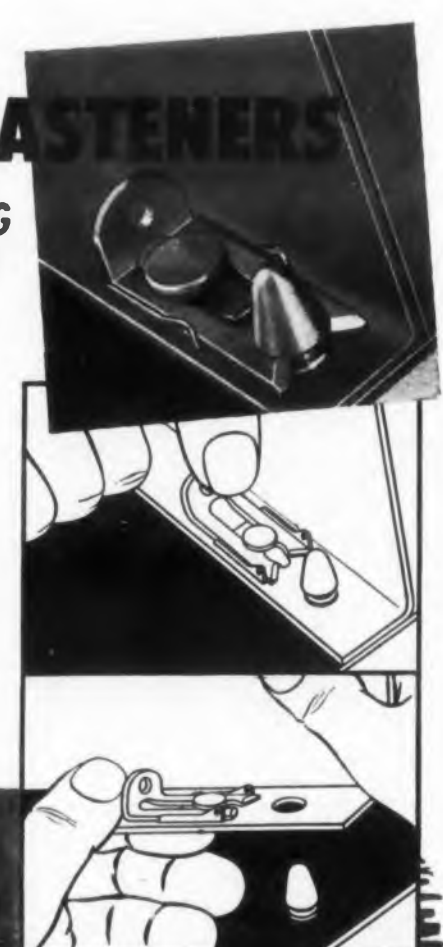



technique, while other techniques of pre-fabrication are covered briefly.

The book opens with an account of the invention and development of printed circuit techniques and the principles of method selection. A detailed explanation of printed circuit production follows with a description of a typical production line. Suitable printing methods, plating and the foil technique, protective coatings, flow- and dip-soldering and potting are discussed. Chapters are also devoted to laboratory routine and the design of printed circuits. The completion of the circuit by the insertion of conventional components is followed by details of the detection and tracing of faults and an account of automatic assembly in the electronics industry.

Miniaturization, an outline of printed components, a survey of microwave printed circuits and an assessment of the place of printed circuits in the electronics industry complete the main text.

#### Mathematics Dictionary

Glenn James, Robert C. James, Editors,

D. Van Nostrand Co., Inc., 257 Fourth Ave., New York 10, N.Y., 546 pp, \$15.00.

This revised and enlarged edition is essentially two books in one—explicit definitions entirely in English of more than 7000 mathematical terms, concepts and relationships, and multilingual indexes giving their Russian, German, French and Spanish equivalents. You can find the English meaning of a term in another language in these indexes and then its definition in the body of the book.

The coverage of terms is broad, ranging from elementary terms in arithmetic through calculus, basic terms in differential geometry, theory of functions of real and complex variables, advanced calculus, differential equations, to the theory of groups and matrices, theory of summability, point-set topology, integral equations, calculus of variations, analytic mechanics, theory of potential and statistics.

Tables and an extensive list of mathematical symbols appear in the appendix, while formulas of many kinds are given in the context.

# 5x10<sup>-10</sup>/Day

## With Laboratory Standard JKFS-1100T

# FREQUENCY STANDARDS

### Fully Transistorized, with Double Proportional Control Oven

Today's most advanced design, with each unit aged in and calibrated directly with WWV at Washington, D. C. **Input:** 24 to 32V DC. **Output:** 1V into 50 ohms at 1 MC and 100 KC. **Dimensions:** 6.0"H x 4<sup>1</sup>/<sub>16</sub>"W x 12<sup>1</sup>/<sub>2</sub>"D. **Power Supply Unit:** operates from 115V AC, with 12-20-hour self-contained stand-by batteries. Fully automatic switch-over. Dimensions: 6.0"H x 3<sup>3</sup>/<sub>16</sub>"W x 12<sup>1</sup>/<sub>2</sub>"D. Write for literature on JKFS

## 1100T



### THE JAMES KNIGHTS COMPANY, Sandwich, Illinois

CIRCLE 70 ON READER-SERVICE CARD

ELECTRONIC DESIGN • September 16, 1959

# IMPULSE

## A DIGEST OF NEW DEVELOPMENTS IN ELECTRONICS AND AUTOMATION

PUBLISHED BY ROME CABLE CORPORATION, ROME, N. Y.  
PIONEERS IN INSTRUMENTATION CABLE ENGINEERING

**ELECTRONIC AUTO MECHANIC.** The toughest of all automotive problems—servicing—is close to being solved! Ordnance control engineers are conducting a study of automatic checkout equipment that will inspect the engine, transmission and other vital parts of Army tanks. That means that some day you may be able to take your car to a neighborhood garage for a check-up and get a reading from an electronic computer which indicates what should be replaced. The computer will interrogate the vehicle with a number of stimuli and use logic and computer circuitry to isolate specific faults.

**FIFTH LARGEST INDUSTRY.** Still the fifth largest manufacturing group in the U. S. during 1958, the electronics industry totaled \$7.9 billion in aggregate sales for the year, \$13.3 billion when distribution, servicing and broadcasting are included. Some 1500 manufacturers are major equipment assemblers, 2400 are component manufacturers and 700 are producers of switches, wire and other electronic hardware. Military electronic equipment accounted for \$4.1 billion of the \$7.9 billion total—an increase of \$200 million over 1957. Industrial users bought \$80 million more than in 1957 for a total of \$1.6 billion. The industry as a whole now employs 700,000 persons, 100,000 of whom are engineers.

**MIGHTIER MITES NEEDED.** Miniaturization alone is not enough, engineers were told at a recent conference. Micromodules must be made more reliable than present construction permits—"to achieve an average part failure rate of 0.1 percent per 1000 hours," as it was stated. Now it's reported that a push will be made toward greater use of molecular electronics, which might accomplish this. Molecular electronics ideas center around construction of electronic systems by building homogeneities in various materials into discrete electronic functions. Work is already in progress on growing germanium crystals as flat ribbon-type units and doing the same with silicon.

**193 CONDUCTORS IN ONE JACKET!** That's just one of the cables Rome lists among its "typical" multi-conductor cable constructions, now available to answer "special" needs. A wide range of cable constructions, from 2-conductor to 193-conductor, is charted in the new Rome Cable Bulletin on Instrumentation Cables, RCD-400. You'll want to check this list before placing special orders. Get your copy by writing IMPULSE, c/o Rome Cable Corp., Dept. 11-9, Rome, New York.

**MEASURING THE MOON.** Researchers at one large university have blue-printed their version of a radar space observatory for measuring the surface of the moon. The vehicle would be 150 feet long, six feet in diameter, weigh less than two tons, and orbit about 100 miles above the moon's surface. A nuclear power source would supply three to five kilowatts of power. Radar would transmit ten signals of varying frequencies to probe depth of moon's top layer, determine firmness of second layer and compose an electronic picture of the contour of the moon.

**CABLEMAN'S CORNER.** The words "They said it couldn't be done" are as applicable to the wire and cable industry as they are to other fields. Each day we find ourselves confronted with new, and in most cases more complex, problems. As new materials and manufacturing techniques are developed, we find that the complex problems of today are solved and in production tomorrow. As an example, for years it was stated that the application of an extruded, tight-fitting, lead-cured neoprene jacket over a cable assembly composed of polyethylene-insulated conductors was an impossibility. The curing temperatures for neoprene were far above the melting point of polyethylene. Yet today many thousands of feet of this type of cable construction are in actual use, performing under all types of environmental conditions. Keep in touch with your Rome Cable Specialist for new developments. Our number is Rome 3000.

These news items represent a digest of information found in many of the publications and periodicals of the electronics industry or related industries. They appear in brief here for easy and concentrated reading. Further information on each can be found in the original source material. Sources will be forwarded on request.

CIRCLE 71 ON READER-SERVICE CARD



# A RADICALLY NEW LAMINATE

UNIQUE COMBINATION  
of PROPERTIES

## Exclusive New Resin Formulation (Patent Applied For) Developed by the Richardson Research Laboratory

Here is a radically new and different series of laminated insulating materials known as the "MARK TEN" series. This series of laminates has unique properties which are *chemically built-in* and are not degraded during normal manufacturing processes. Rigidity and flexural strength are **high as** compared with other cold punch laminates. Intricate shapes can be punched at room temperatures and lower.

Now a true cold punch laminate, the first grade in this series and identified as "MARK TEN" 10-01, is available both plain and copper-clad. Exceeding NEMA XXXP and MIL-P-3115B Type PBE-P requirements, "MARK TEN" 10-01 has excellent stability in both dimensions and electrical properties over a wide temperature range.

## Outstanding Combination of Properties for Copper-Clad

As a copper-clad laminate, "MARK TEN" 10-01 introduces the most unusual combination of properties ever known to the laminated plastics field. Besides being a true cold punch material it has unusual resistance to organic cleaning compounds . . . it withstands blistering in solder at 500°F for 40-60 seconds or at 550°F for 10-20 seconds . . . and it averages 7-9 lbs. bond strength.

This "MARK TEN" laminate is chemically engineered with the printed circuit manufacturing process in mind and is designed for most efficient production of printed circuits as well as other products.

"MARK TEN" 10-01 is Richardson's latest addition to its well known line of INSUROK® laminates.

You are invited to request further information and a sample. Write . . . or phone today . . . Chicago phone MA 6-8900.

Typical part punched from "MARK TEN" at 60°F.



\* TRADEMARK OF THE RICHARDSON CO.

## the RICHARDSON COMPANY

LAMINATED AND MOLDED PLASTICS

Founded 1858

DEPT. 41 • 2682 LAKE ST. • MELROSE PARK, ILL. • SALES OFFICES IN PRINCIPAL CITIES

CIRCLE 72 ON READER-SERVICE CARD

## NEW LITERATURE

### Ferrite Devices 73

These two catalog sheets summarize electrical and physical data on coaxial ferrite isolators and ferrite circulators. One of the sheets describes 23 types of coaxial ferrite isolators covering frequencies from 1 to 11 kmc. Sylvania Electric Products, Inc., Central Advertising Distribution Dept., 1100 Main St., Buffalo, N.Y.

### Potentiometer Catalog 74

This is a catalog of single turn, wire-wound precision potentiometers from 1/2 to 3 in. diam. Complete specifications such as size and dimensions, mechanical and electrical properties, are given. Maurey Instrument Corp., 7924 S. Exchange Ave., Chicago 17, Ill.

### Transformer Brackets 75

Hypersil core brackets of extruded aircraft aluminum are described in this two-page data sheet. Included are complete sizes and combinations available from stock, and a quantity price list. The brackets fit all standard hypersil core transformers and have hole sizes ranging from 0.157 to 0.213 in. Olympic Products Co., Inc., Alpha, N.J.

### Mercury Switches 76

Newly revised Catalog 90b describes the standard line of mercury switches. Included are photographs, dimensions, electrical ratings, drawings, application information and complete technical data. Data is given in tabular form. Micro Switch, Div. of Minneapolis-Honeywell Regulator Co., Freeport, Ill.

### Pulse Generator 77

One-page bulletin 3022-9 describes a 256-step precision pulse generator model PPG-256. Included are specifications and performance data, principle of operation, suggested uses, and features of this instrument. Victoreen Instrument Co., 5806 Hough Ave., Cleveland 3, Ohio.

### Shock and Vibration Isolators 78

Bulletin 59-04, four pages, discusses the factors involved in choosing shock and vibration isolators. Pictures of the various types, graphs, and a table of load ratings are included. Barry Controls, Inc., 700 Pleasant St., Watertown 72, Mass.



**RE: Transistor, TV, and Radio Coils 79**

Catalog 60, 44 pages, offers specifications and pricing information on 1300 standard transistor, TV, and radio coils, plus an expanded listing of industrial coils and chokes. Fully illustrated, it includes a separate part-number index and price list, a cross-reference of original parts to the firm's equivalents, and 117 if and rf schematic diagrams. Listings on color TV items also appear. J. W. Miller Co., 5917 S. Main St., Los Angeles 3, Calif.

**74 Transformer 80**

A small 50 w transformer that meets military environmental specs is described in this data sheet. Technical specifications and dimensional drawings are included. Arnold Magnetics Corp., 4613 W. Jefferson Blvd., Los Angeles 16, Calif.

**Power Inverter 81**

Two-page data sheet gives specifications for the firm's transistorized regulated power inverter which is used to drive ac gyros and other ac devices from a battery source. A unique circuit which creates an anti-hunting effect is described. Dimensional diagrams and a picture of the model also appear. Arnold Magnetics Corp., 4613 W. Jefferson Blvd., Los Angeles 16, Calif.

**Microwave Equipment**

A 320-page, hard-cover book, this catalog discusses microwave measurements. It provides comprehensive theory, plus practical help on applications. Drawings of test setups are supplied, together with instructions on test procedures using units in the firm's line of precision test equipment. The catalog contains an expanded handbook section giving the latest tabulations on available microwave tubes and their characteristics, on conversion factors and other pertinent data. Write on company letterhead to DeMornay-Bonardi, Dept. ED, 780 S. Arroyo Parkway, Pasadena, Calif.

**Marking Equipment 83**

This 12-page catalog describes methods and equipment for marking all types of electrical and electronic products. A product index, ranging from wire lead components to panels and chassis, guides the manufacturer to the best marking method. Equipment described in this illustrated catalog ranges from high production machines with marking speeds up to 8000 units per hr to a compact, economical, hand-operated marker. Markem Machine Co., Keene 45, N.H.

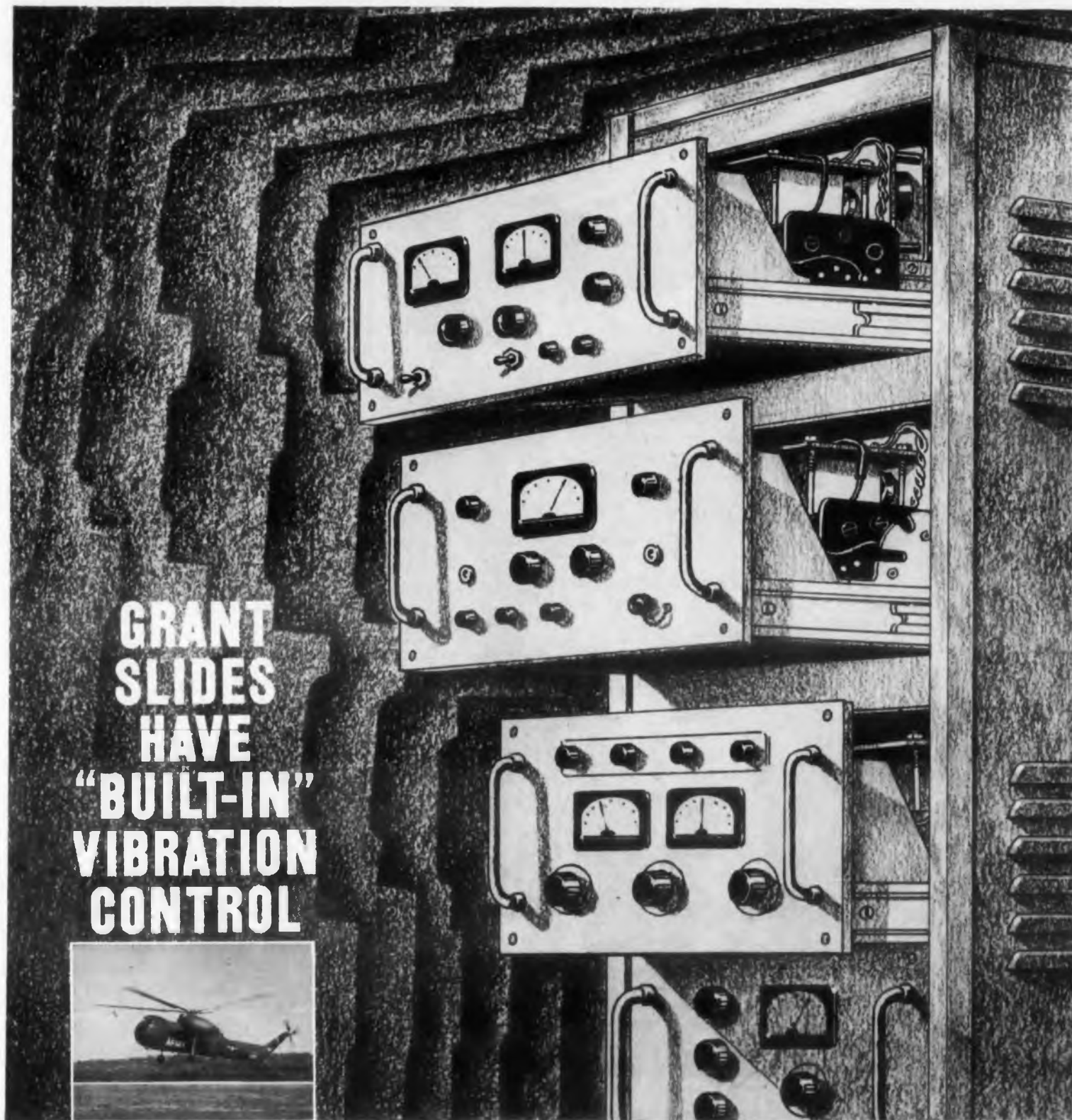

**GRANT  
SLIDES  
HAVE  
"BUILT-IN"  
VIBRATION  
CONTROL**



From the aluminum extrusions, to the stainless steel balls, the patented "ball retainer" the exclusive "Shok-Loks" and the precision assembling and fitting, Grant Slides are constructed with an absolute maximum of strength and serviceability. Pilot windows on the Sikorsky helicopters are mounted on Grant Slides — which operate continuously well under the most severe vibratory conditions.

*We'll be pleased to send you your complete Grant Catalogue.*

*The nation's first and leading manufacturer of slides*  
**GRANT INDUSTRIAL SLIDES**



GRANT PULLEY AND HARDWARE CORPORATION

21 High Street, West Nyack, New York  
944 Long Beach Avenue, Los Angeles 21, Cal.

CIRCLE 84 ON READER-SERVICE CARD



## GOLD-CLAD STAINLESS TUBING CURBS CORROSION IN REACTOR

Photo pictures insertion of gold-clad stainless steel heat exchanger into gold-clad power reactor at AEC's Los Alamos Scientific Laboratory. Completely successful in recent operational tests, the unique reactor is designed to produce superheated steam in a single pass. This is the second experimental reactor using uranyl phosphate fuel—the first unit failed because of excessive corrosion in the heat exchanger. Gold-cladding now protects all structural parts in contact with the extremely corrosive solution.

Will clad metals solve *your* corrosion problems? Investigate the BISHOP line of clad metals. BISHOP was the first company to successfully produce gold-clad stainless tubing . . . coupon brings data. Use it.

CIRCLE 725 ON READER-SERVICE CARD



## NEW BISHOP TUBE MILL OPENS



Sketch shows new BISHOP facilities adjacent to the present tube mill in East Whiteland Township, west of Paoli, Penna.—completing the first stage in BISHOP's long range expansion program. This two-story structure will contain over 165,000 square feet of floor space. BISHOP platinum mechanical manufacturing operations also move to the East Whiteland plant.

CIRCLE 726 ON READER-SERVICE CARD

## BISHOP NOW DRAWING .002" WALL TANTALUM TUBING

Tantalum tubing with paper-thin wall thicknesses is now being supplied by BISHOP on special order. Sizes range from .062 in. OD x .002 in. wall to 1.5 in. OD x .125 in. wall. Columbium (niobium) tubing down to .002 in. wall has been produced and is also available. Can tubing of these "exotic" metals be the answer to any of your design problems? Check with BISHOP . . . use the coupon.

CIRCLE 727 ON READER-SERVICE CARD

# J. BISHOP & CO.

*platinum works*

FOR HELPFUL DATA USE THIS HANDY COUPON

- Tubular Products Bulletin No. 12
- Platinum Products Catalog No. 4
- Clad Metal Data
- Special Tubing Data

Check information you'd like and mail to  
J. BISHOP & CO.,  
55 King St., Malvern, Penna.

Name \_\_\_\_\_  
Position \_\_\_\_\_  
Company \_\_\_\_\_  
Address \_\_\_\_\_  
City \_\_\_\_\_ Zone \_\_\_\_\_ State \_\_\_\_\_

*Tubular Products Division*

55 KING STREET, MALVERN, PENNA.

*Niagara 4-3100*

**THIS IS THE BISHOP LINE:**  
Products of all the Platinum Metals...  
Small diameter Stainless Steel,  
nickel and special alloy tubing

CIRCLE 725 THROUGH 727 ON READER-SERVICE CARD

## NEW LITERATURE

### Diodes

85

Four-page article "Two Terminal PNP Switches" describes a pnpn semiconductor diode which functions as a regenerative switch that can be either reverse or forward biased with the same direction of current flow. This device has application as a talking path in an electronic telephone switching system, or in pulse generators, logic elements, and photosensitive devices. Bell Telephone Laboratories, Inc., 463 W. Street, New York, N.Y.

### Numerical Positioning Control

86

Bulletin 1531, six pages, describes the firm's line of pre-engineered point-to-point numerical positioning control packages. Specifications, performance, and auxiliary functions are given, and dimensions and internal structure are illustrated by drawings and photographs. General Electric Co., Schenectady 5, N.Y.

### Printed Circuit Connectors

87

This double-fold catalog SF156UPCC describes a series of two-unit connectors for use in printed circuitry. It contains electrical and mechanical specifications, dimensional drawings, and basic design features on draw-pull type and screwlocking type connectors. U. S. Components, Inc., 454 E. 148 St., New York 55, N.Y.

### Synchro Differential

88

Two-page data sheet 801-D4 describes a size 8 synchro differential line. Information includes dimensioned and schematic drawings, photos, and tables of electrical and mechanical specifications. These synchro differentials weigh less than half an ounce. Daystrom, Inc., Daystrom Transicoil Div., Worcester, Montgomery County, Pa.

### Crucibles

89

Four-page illustrated brochure KTM-9 presents information on tungsten and molybdenum crucibles. These crucibles are designed for high temperature research where a high melting point metallic container is required. Kulite Tungsten Co., 1040 Hoyt Ave., Ridgefield, N.J.

### Thyratrons

90

Four-page bulletin PA-223 explains how thyratrons differ from conventional amplifier types. The mechanism of ionization, the critical characteristic curve, and the effects of temperature on ionization time and tube life are discussed. Installation precautions are also given. CBS-Electronics Advertising Service, Parker St., Newburyport, Mass.



## Electric Motors

Four-page brochure SB 186 describes the firm's drip-proof, weather-proof integral horsepower electric motors. Included are ratings, dimensions, construction features of the motors, and motor breakdown illustrations. Write on company letterhead to Marathon Electric Mfg. Corp., Dept. ED, Randolph and Cherry Sts., P.O. Box 630, Wausau, Wisconsin.

## Coil Winding Machines 92

This two-page illustrated catalog sheet describes four coil winding machines. Included are a high production multiple deflection yoke winder, a multiple flyback winder, a gearless multiple transformer winder, and an electrically controlled precision high speed bobbin winder. Geo. Stevens Mfg. Co., Inc., Pulaski Rd. at Peterson, Chicago 46, Ill.

## Time Savers 93

This 34-page illustrated booklet lists 59 ideas to increase drafting and engineering efficiency. "Time Saving Tips for the Draftsman and the Engineer" contains drafting shortcuts, engineering data tips, board timesavers and calculating ideas. Frederick Post Co., Reader-Service Div., 3650 N. Avondale Ave., Chicago 18, Ill.

## Count Rate Meters

Four-page bulletin 3025-9 describes the firm's line of count rate meters. Electrical and physical specifications are given for linear, log, and differential count rate meters. Included are suggested uses and applications, and circuit descriptions. Write on company letterhead to Victoreen Instrument Co., Dept. ED, 5806 Hough Ave., Cleveland 3, Ohio.

## Selenium Rectifiers 95

This illustrated eight-page catalog, "Selenium Slims," contains descriptions, data, and electrical and physical specifications for the firm's line of glass or phenolic tube cartridge rectifiers. Included are dimensional outlines and circuit diagrams. Syntron Co., 283 Lexington Ave., Homer City, Pa.

## Potting Compounds 96

Two-page data sheet 110-B describes the uses of the company's line of epoxy resin potting compounds. Also included is information on typical physical properties of five P-series compounds. Bason Industries, Inc., 192 Pleasant St., Watertown 72, Mass.



# SMALL A. C. MOTORS

Consider the many advantages of using precision miniature a.c. motors. Output performance equals that of larger conventional motors—so you can offer smaller, lighter, more compact designs than your competitor. And you can offer superb reliability. When you design around precision miniature motors, their price in quantity is competitive with larger ordinary motors. Globe is the largest precision miniature motor specialist and is working with people like you right now to gain these benefits.

Get in touch with Globe early in the design stage. Very probably Globe has already made a motor close to your requirements. You'll receive a recommendation for your specific job, and get custom prototypes promptly.

Globe's induction and hysteresis-synchronous a.c. motors provide up to 4.5 oz. in. of torque—up to 200 in. lbs. with a planetary gear reducer! Sizes start at one inch in diameter, and can include such special features as integral brakes, clutches, speed reducers, etc. Please request Bulletin ACM. GLOBE INDUSTRIES, INC., 1784 Stanley Avenue, Dayton 4, Ohio, BALDWIN 2-3741.

**GLOBE INDUSTRIES, INC.**

PRECISION MINIATURE A.C. & D.C. MOTORS, ACTUATORS  
TIMERS, GYROS, STEPPERS, BLOWERS, MOTORIZED DEVICES

**GLOBE**

CIRCLE 97 ON READER-SERVICE CARD

## HOLTZER -CABOT



R-24 Motor

### Synchronous and Induction Capacitor Type Motors



R-25 Motor

**R-24.** Typical applications for this reversible, 4-pole induction motor are in servo mechanisms, as a balancing motor in recording instruments or as a control motor for voltage regulators. It has low rotor inertia for fast response applications. When operated 2 phase, it can be controlled electronically; or operated single phase as a permanent split capacitor motor.

**R-25.** Typical uses are for recording instruments, dictating and adding machines. Approximately 2½" in diameter, it is available in either induction or synchronous construction with reversible rotation.

Both the R-24 and R-25 are available with gear case speeds from 1/2 to 3600 RPM, torque ratings up to 75 oz. inches or higher, and single phase, 2 or 3 phase.



HOLTZER-CABOT MOTOR DIVISION  
NATIONAL PNEUMATIC CO., INC.  
125 Amory Street, Boston 19, Mass.

GENTLEMEN: Please send me data sheets on  
the Holtzer-Cabot R-24 and R-25 Size Motors.

Please have representative call \_\_\_\_\_  
(date)

Name \_\_\_\_\_

Company \_\_\_\_\_

Street \_\_\_\_\_

City \_\_\_\_\_ Zone \_\_\_\_\_ State \_\_\_\_\_

CIRCLE 98 ON READER-SERVICE CARD

## The Second Annual INSTRUMENT MOTOR SYMPOSIUM

sponsored by

### Holtzer-Cabot Motor Division

National Pneumatic Co., Inc. will be held in Chicago during the week of the ISA Instrument-Automation Conference and Exhibit.

**Theme:** "Today's Trends — Tomorrow's Motors"

**Speakers:** Nationally-known instrument and motor design specialists. Open discussion will follow the prepared remarks.

**When:** 8:00 - 10:00 p.m., Tuesday, September 22.

**Where:** Palmer House, Chicago

**How to Register:** Members and guests of the ISA may register at Holtzer-Cabot's exhibit (#368) at the International Amphitheatre on Monday or Tuesday or by writing earlier to the Symposium Chairman: R. H. Matthews, Chief Engineer, Holtzer-Cabot Motor Division, National Pneumatic Co., Inc., 125 Amory Street, Boston, Massachusetts.

## NEW LITERATURE

### Low Temperature Field 99

This 44-page book discusses developments in low temperature chemistry, solid state physics, superconductivity, metallurgical research, maser research, and microwave spectrometry. Included in this illustrated book are engineering drawings and performance curves of a line of dewars and containers. Technical data on liquid helium, hydrogen, and nitrogen are also presented. Hofman Laboratories, Inc., 5 Evans Terminal, Hillside, N.J.

### Electrodes 707

These data sheets describe a line of electrodes, including mild steel, low-hydrogen, and iron powder types. Information is given on welding characteristics, current, welding procedures, physical properties and chemical analysis of deposited metal, and typical applications for each electrode. Chemetron Corp., National Cylinder Gas Div., 840 N. Michigan Ave., Chicago 11, Ill.

### Computer 708

The Univac solid-state computer is fully explained and described in this 12-page booklet, U1770. This system provides high-speed processing, compactness, accuracy, and reliability. It can be operated in an area of 575 sq ft. Remington Rand, Div. of Sperry Rand Corp., 315 Park Ave. S., New York 10, N.Y.

### Potentiometer 102

Performance characteristics and electrical and mechanical specifications of a precision ac potentiometer are given in this two-page illustrated data sheet. A schematic of a computing circuit is also given as an example of the application of this unit. Perkin-Elmer Corp., Vernistat Div., Norwalk, Conn.

### Cryogenerators 103

This six-page illustrated folder describes four types of cryogenerators. Included are dimensional information, operating principles, refrigeration capacity vs condensing temperature curves, and applications. North American Philips Co., Inc., Cryogenics Div., 100 Stevens Ave., Mount Vernon, N.Y.



**NOW...**

**smaller than ever**  
**TYPE LK rectangular**  
**High Voltage**

**CAPACITORS**

If you require a smaller capacitor with much longer life, find out about our Type LK. Designed for 4 times the life of MIL-C-25A with case sizes as much as 80% smaller.

For full details write for Bulletin LK.

**FREE!** Have you received our pocket size "Comparator" and "Conversion chart?" Write today!

Other advantages include:

- superior resistance
- better power factor
- withstands greater overloads
- may be operated to 125°C
- voltage ratings from 600 to 50,000 volts



**Plastic Capacitors, INC.**  
2620 N. Clybourn Chicago 14, Illinois DI 8-3735

CIRCLE 104 ON READER-SERVICE CARD

ELECTRONIC DESIGN • September 16, 1959



**Waveguide Chart****105**

A circular adjustable waveguide chart indicates RETMA and JAN standards for rectangular waveguides and flanges. One side of the chart indicates all RETMA specifications for the frequency range of 960 mc to 110 kmc. The other side shows JAN specifications for 1.12 to 90 kmc. Information such as waveguide type, flange number, and type of material is automatically shown in an indicator window. Polytechnic Research & Development Co., Inc., 202 Tillary St., Brooklyn 1, N.Y.

**Void-Free Encapsulation****106**

Technical bulletin 101 discusses improved casting techniques for void-free encapsulation of electrical components. This six-page booklet describes problems encountered in evacuation systems, problems caused by improper mold design, and problems arising from poorly selected resin systems. Solutions treated are: post-degassing of atmospherically filled units, pre-degassing vacuum casting, and pressure stalling. Automatic Process Control, 1170 Morris Ave., Union, N.J.

**Electroplating****107**

"Selective Plating with the Dalic Process" is a four-page illustrated brochure which describes a process of electroplating selected areas without using immersion tanks. Applications are included. Sifco Metachemical, Inc., 935 E. 63 St., Cleveland 3, Ohio.

**Multi-Channel Amplifier****108**

A six-channel amplifier for use in vibration analysis systems is described in this two-page bulletin. Complete operating specifications, a plot of response vs. frequency, and a discussion of special applications are included. Columbia Research Laboratories, MacDade Blvd. and Bullens Lane, Woodlyn, Pa.

**Potentiometers****109**

This catalog describes single turn, wire-wound precision potentiometers from 0.5 to 3 in. diameter. Size, mechanical requirements and electrical properties are covered. The units are useful for high reliability applications in aircraft, missile and ground support equipment. Maurey Instrument Corp., 7924 S. Exchange Ave., Chicago 17, Ill.

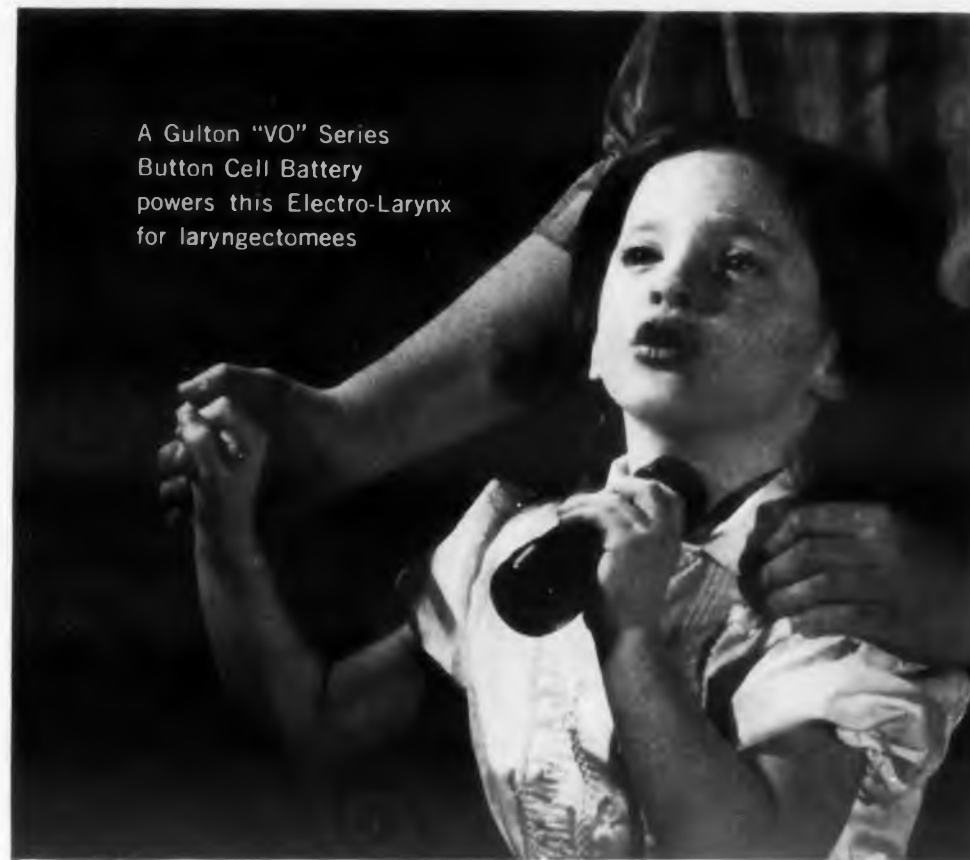

A Gulton "VO" Series Button Cell Battery powers this Electro-Larynx for laryngectomees



## Dependable...long-lived...rechargeable

This child holds a voice in her hand... the Kett Electro-Larynx. A push of a button sets a column of air vibrating in her throat, gives sound to words formed with mute lips.

The Electro-Larynx will prove a boon to thousands of people who cannot speak for one reason or another. To give it a reliable, long lasting, sealed rechargeable source of power, Kett Engineering Corp. chose a Gulton "VO" series sealed nickel cadmium button cell battery.

**How Can You Use These Batteries?**

Here is a partial list of the many ways imaginative engineers are employing Gulton button cell batteries: transistorized radios, prosthetic devices, missiles, flashlights, photoflash power packs—*wherever small size, large capacity, light weight, long life, no maintenance, complete reliability, and easy recharging are desired.*

**Most Complete Line Available**

"VO" cells are available in capacities of 100, 180, 250, 500 and 1750 mah; have a nominal 1.2 voltage; can be packaged in any combination to meet your voltage specs. Patented sintered plate construction provides exceptional cycling characteristics; highest capacity per unit size. Like more information? Write us for Bulletin No. VO-110.

Available from stock—  
GLENNITE BATTERY DISTRIBUTORS  
92-15 172nd Street, Jamaica, New York



## Gulton Industries, Inc.

Alkaline Battery Division, Metuchen, New Jersey

CIRCLE 111 ON READER-SERVICE CARD

KAY
KAY

### KAY Vari-Sweep

MODEL 400  
10-BAND, 15-470 MC SWEEPING OSCILLATOR

**SPECIFICATIONS**

<p><b>Freq. Range</b> (for Sweeping or as Continuously Tuned CW Signal Source): Fund. freq., 15-470 mc, cont. variable in 10 switched overlapping bands. Direct-reading freq. dial.</p> <p><b>Sweep Width:</b> 60% of center freq. to 50 mc; at least 30 mc max, 50-400 mc; approx. 20 mc max above 400 mc.</p> <p><b>Sweep Rate:</b> Cont. variable, 10-40 cps; locks to line frequency.</p> <p><b>RF Output:</b> 1.0 V rms (metered) into nom 70 ohms (50 on request) to 220 mc; 0.5 V rms to</p>	<p>470 mc. AGC'd flat throughout to <math>\pm 0.5</math> db.</p> <p><b>Attenuators:</b> Switched 20, 20, 10, 6 &amp; 3 db plus cont. variable 6 db.</p> <p><b>Sweep Output:</b> Reg. sawtooth in sync with oscillator. Approx. 7.0 V amplitude.</p> <p><b>Power Supply:</b> Input approx. 100 watts, 117 V (<math>\pm 10\%</math>), 50-60 cps. 8+ electronically regulated.</p> <p><b>Dim. &amp; Weight:</b> 9 1/8" x 19 1/2" x 13", 34 lbs.</p> <p><b>Price:</b> \$795.00, f.o.b. factory.</p>
---	---

### KAY DRD Attenuators

(DIRECT READING DIGITAL)

1-119 db Attenuation in 1-db Steps

**SPECIFICATIONS**

<p><b>Impedance In &amp; Out:</b> Choice of 50, 70, or 90 ohms; others on special order.</p> <p><b>DB Switched:</b> 119 db in 1-db steps.</p> <p><b>Attenuation Steps:</b> 10 db &amp; 1 db.</p> <p><b>Insertion Loss:</b> Zero at low freq; approx. 0.1 db at 250 mc, 0.2 db at 500 mc.</p> <p><b>Max. Total Error (incl. above):</b> 1.0 db at 250 mc; 2.0 db, 250-500 mc; better at lower freq. and/or lower attenuation.</p>	<p><b>Freq. Range:</b> DC-500 mc; useful to 1000 mc.</p> <p><b>SWR:</b> 1.2:1 to 250 mc; 1.4:1 max, 250-500 mc.</p> <p><b>Max. Power:</b> 1/2 watt.</p> <p><b>Switches:</b> Silver contacts set in teflon.</p> <p><b>Resistors:</b> 1% Carbon Film.</p> <p><b>Dim. &amp; Weight:</b> 5" dia. x 2 1/4", 4 1/4 lbs.</p> <p><b>Price:</b> \$195.00, f.o.b. factory.</p>
--	--

Write for  
1959-A Catalog  
Dept. ED-9

**KAY ELECTRIC COMPANY**

Maple Ave • Pine Brook, N. J. • Capital 6-4000

KAY
KAY

CIRCLE 110 ON READER-SERVICE CARD



Effective component protection is hard to supply under conditions of violent acceleration, high ambient temperature, and vicious vibration. But in military electronic gear, transistors must get unfailing protection against these threats to reliable operation.

They get it, most fully, with **atlee** mounting clips.

**atlee** clips are provably better in three ways:

**HOLDING POWER.** Under severe shock and vibration, these clips actually mold themselves tighter to the transistors. There's no visible shifting or twisting, no lead-breaking resonance, and the dislodging force actually increases.

**COOLING EFFICIENCY.** With **atlee** clips, this approaches to within 10% of "infinity" — the ideal derating curve for a transistor with an infinite heat sink which keeps the case temperature from rising above the ambient level.

**ELECTRICAL INSULATION.** When required, these clips can be coated with Dalcoat B — an exclusive high-dielectric enamel that has twice the dielectric strength of Teflon but conducts heat as well as mica.

There are still more reasons why engineers who seek perfection choose **atlee** transistor clips. They know that Atlas E-E is the pioneering company in the development of component holders of all types, with unequalled years of specialized experience, and a complete line of clips for all case sizes and mounting requirements. They have learned it costs no more to get the best . . . and that Atlas E-E makes these "little things" as though they were the biggest things in the circuit.

**DESIGN FOR RELIABILITY WITH atlee** — a complete line of superior heat-dissipating holders and shields, plus the experience and skill to help you solve unusual problems of holding and cooling electronic components.

**ATLAS E-E** CORPORATION  
47 PROSPECT STREET • WOBURN, MASS.

CIRCLE 112 ON READER-SERVICE CARD

## NEW LITERATURE

### Magnetic Recording 113

Methods of reducing signal dropouts in magnetic tape are discussed in bulletin No. 37. The four-page bulletin is called Sound Talk, illustrated with photo-micrographs of common types of coated-in tape flaws and photographs showing the effect of small dust specks on recorded data tracks. Minnesota Mining and Manufacturing Co., 900 Bush Ave., St. Paul 6, Minn.

### Electric Eyes 114

Applications for electric eyes in the process industries are given in bulletin No. 522. Using the problem and solution technique, the bulletin covers usual and unusual installations that have been made for instant and accurate monitoring of process flows. Descriptions of standard and special instruments, and drawings of sample tanks and look boxes are included. Photomation, Inc., 96 S. Washington Ave., Bergenfield, N.J.

### Tape Vault 115

Illustrated data sheet 147 provides complete technical specifications on walk-in Netic Co-Netic magnetically shielded recording tape storage vault. This vault prevents stray magnetic fields from damaging magnetic tape recordings. Perfection Mica Co., Magnetic Shield Div., 1322 N. Elston Ave., Chicago 22, Ill.

### Encoders 116

Illustrated bulletin No. 319 fully describes the C-100 and C-200 series of shaft position encoders. Mechanical, physical, and electrical specifications are given, as well as installation and adjustment instructions. Dimensional diagrams are also provided. Datex Corp., 1307 S. Myrtle Ave., Monrovia, Calif.

### Circuit Board 117

Catalog sheet 901-B, 2 pages, describes a circuit board for circuit analysis and electronic training. Physical and dimensional specifications are given, as well as instructions on assembly and applications. Plastic Associates, 185 Mountain Rd., Laguna Beach, Calif.

## MILLER small, adjustable R. F. COILS

— built with top quality materials, impregnated with moisture-resistant varnish, and 100% tested to exacting specifications.

#### SUB-MINIATURE RANGE:

— 15 items, with inductances from .17 to 300 microhenries. Form dimensions: 3/16" diameter x 5/8" long. Mounting hole: 11/64".

#### MINIATURE RANGE:

— 15 items, from .4 to 800 microhenries. Form dimensions: 1/4" diameter x 7/8" long. Mounting hole: 3/16".

#### STANDARD RANGE:

— 13 items, from .9 to 2100 microhenries. Form dimensions: 3/8" diameter x 1-1/16" long. Mounting hole: 1/4".



Immediate deliveries on larger quantities from the factory. Over 400,000 catalog items carried regularly in stock. Smaller quantities from any leading parts distributor. Miller R.F. coils are competitively priced.

Specials — send us your requirements for a prompt quotation. We also build to Military Specifications. Write for the Miller industrial catalog.



**J. W. MILLER COMPANY**  
5917 S. Main St., Los Angeles 3, Calif.

CIRCLE 118 ON READER-SERVICE CARD



**Microwave Equipment**

119

This 12-page booklet illustrates and describes a line of millimeter wave components and instruments which generate, detect and measure microwave frequencies up to 140 kmc. Performance characteristics, precision construction features, and dimensional drawings are supplied for transmission line components, detectors, power absorbing units, phase shifters, and accessories. DeMornay-Bonardi, 780 S. Arroyo Parkway, Pasadena, Calif.

**Amplifiers**

120

Five two-page bulletins describe a complete line of miniature, lightweight amplifiers and power supply for magnetic tape recording. Electrical, environmental, dimensional, and mechanical specifications are given on: a miniature analog record amplifier, bulletin 1592; an analog record amplifier with microphone preamplifier, bulletin 1593A; a pdm record amplifier, bulletin 1594A; an fm record amplifier, bulletin 1595; and a power supply, bulletin 1597. Consolidated Electrodynamics Corp., 360 Sierra Madre Villa, Pasadena, Calif.

**Iron Tubing**

121

Ingot iron tubing is described in two-page bulletin No. 18. Tables are provided which list the nominal chemical analysis, mechanical and physical properties, standard production limits and standard tubing tolerances. Applications for this tubing include magnetrons and other power tubes, cold cathodes, pencil-type thermocouple protection tubes and low temperature muffle tubes for strand annealing wire. Superior Tube Co., 1521 Germantown Ave., Norristown, Pa.

**Wire Markers**

122

This four-page brochure describes a line of self-adhering markers for all size wire, cable and harness identification. Included are descriptions of a variety of stock and special markers for use in high temperature applications, or markers which are resistant to water, oils, solvents, and fungus. Descriptions are also given of preprinted insulation sleeving and tubing. Western Lithograph Co., Westline Products Div., 600 E. Second St., P.O. Box 2980, Term. Annex, Los Angeles 54, Calif.

*Engineers! Designers!*  
**THERE IS NO SUBSTITUTE  
FOR RELIABILITY!**

*Specify—*  
**PERFORMANCE  
PROVEN "MAG MOD"**

# MAGNETIC MODULATORS

Actual  
Size



For complete specifications and application data on "Mag Mod" Miniature and Standard Components, call or write.

Miniaturized design permits engineers to employ these new components in transistorized printed circuit assemblies and wafer type structures. All models offer maximum reliability, fully ruggedized construction and conform to MIL-T-27A specifications.

- COMPLETE RELIABILITY
- INFINITE LIFE
- FASTER RESPONSE TIME
- NEGLIGIBLE HYSTERESIS
- EXTREME STABILITY  
(Ambient Temp. Range from  $-75^{\circ}$  to  $+135^{\circ}$ C)
- COMPACT SIZE
- LIGHTWEIGHT

Typical circuit applications for Magnetic Modulators are algebraic addition, subtraction, multiplying, raising to a power, controlling amplifier gains, mechanical chopper replacement in DC to fundamental frequency conversion, filtering and low signal level amplification.

## GENERAL MAGNETICS • INC

135 BLOOMFIELD AVENUE  
BLOOMFIELD, NEW JERSEY  
Telephone: Pilgrim 8-2400

# One source for all types of nylon rod

Choose exactly the properties you need. Garlock's Plastics Division, The United States Gasket Company, makes many varieties of Chemiseal® Nylon Rod, each with different qualities for different applications. For example:

## TYPES

General purpose nylon, High Melting Point, Good Machinability.

Excellent weather-resistant nylon; Maximum Stiffness.

Nylon with low melting point, Low Moisture Absorption for special mechanical and electrical parts.

Nylon with high impact strength and resilience for parts requiring exceptional toughness.

Guaranteed bubble-free. Chemiseal Nylon Rod greatly reduces rejects . . . costs no more than ordinary nylon. Available in diameters  $\frac{1}{16}$ " through 3".

It's to your advantage to use this one source for all nylon rod. Find out why by contacting your local Garlock representative, or write

THE GARLOCK PACKING COMPANY, Palmyra, N.Y.

For Prompt Service,  
contact one of our 26 sales offices  
and warehouses throughout  
the U.S. and Canada.

# United States Gasket

Plastics Division of  
**GARLOCK**



CIRCLE 123 ON READER-SERVICE CARD

CIRCLE 124 ON READER-SERVICE CARD

## CANNON ELECTRIC improves contact performance with SEL-REX Bright Gold Alloy S-42

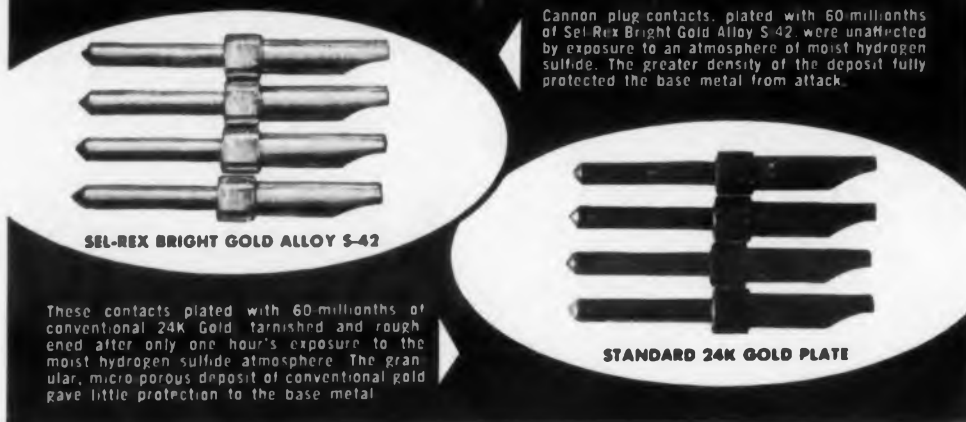

Cannon plug contacts, plated with 60 millionths of Sel-Rex Bright Gold Alloy S-42, were unaffected by exposure to an atmosphere of moist hydrogen sulfide. The greater density of the deposit fully protected the base metal from attack.

These contacts plated with 60 millionths of conventional 24K Gold tarnished and roughened after only one hour's exposure to the moist hydrogen sulfide atmosphere. The granular, microporous deposit of conventional gold gave little protection to the base metal.

Contacts used in world-famous Cannon Plugs must be capable of withstanding corrosion and tarnish, in addition to the punishing effects of repeated engagement and disengagement. The photographs, taken by Cannon in their own laboratory, show why conventional 24K gold plate failed to meet the requirements of this application.

Both samples were plated with 60-millionths of gold over silver plate, and were photographed after an hour's exposure to an atmosphere of moist hydrogen sulfide. The contacts plated with 24K gold tarnished and roughened—those plated with Sel-Rex Bright Gold Alloy S-42 retained their original mir-

ror-bright finish.

Says Cannon, "At Cannon Electric, Sel-Rex Bright Gold Alloy S-42 has been instrumental in solving wear and tarnish problems encountered in connectors used in aircraft, and intricate missile and electronic components."

The foregoing is just another of our many case histories which prove that: "From Missiles and Rockets to Misses and Lockets—there's a Sel-Rex Precious Metal Plating Process to help you make your product better, more salable."

For other case histories, technical information and application data, ask for ML-1.



PRECIOUS METALS DIVISION  
**SEL-REX CORPORATION**  
NUTLEY 10, NEW JERSEY

Manufacturers of Exclusive Precious Metals Processes, Metallized Power Rectifiers, Airborne Power Equipment, Liquid Clarification Filters, Metal Finishing Equipment and Supplies.

CIRCLE 125 ON READER-SERVICE CARD

PROCESSED  
SPECIALTY  
TAPES  
CUT  
COSTS,  
EASY  
TO USE



write now for  
descriptive literature

**M&C**  
4932 Disston Street, Phila., 35, Pa.

PRODUCTS CO.

4932 Disston Street, Phila., 35, Pa.

"LEADERS IN CREATIVE TAPE APPLICATIONS"

CIRCLE 126 ON READER-SERVICE CARD

For the design or production engineer, here are exciting, innumerable applications of precision die-cut, pressure sensitive tapes, which do away with ink. Whether you need fast master layouts, want to reduce drafting time or make fast prototypes—here are proved in operation clean die-cuts, and connector strips. NEVER, BUT NEVER, HAS A ROLL BEEN RETURNED. Check your special needs and order today.

### PRINTED PANEL CIRCUIT PADS

Just remove pad from liner—no dispenser needed. Pull down liner exposing die-cut for easy pick-off. You name the design—circle, multi-circle, elbow, teardrop, fillet adapter and other standard forms. (Or forms made to your specifications). Every die-cut shape is clean and sharp—tolerance plus or minus .002 . . . 1,000 die cut pads per roll, assortable to make quantity. Hundreds of dies in stock. Available in black, black and white, or red. (24 to 48 hour service.)

### PRECISION DIE CUT MASKS

Actually cut labor costs 300-500% Available either in individual pieces with "Butter-Fli" backing or in roll-form with pull down liner for easy pick-off. Just two simple steps; remove backing from mask—apply to work area. Any shape—any size—any amount. Every die cut shape is clean and sharp. Choose from 300 different tapes or specify your own design. (24 to 48 hour service.)

### CHART & GRAPH TAPES

1/32" to 6" width rolls. Pressure sensitive adhesive backing for easy application. Available in 14 colors. (24 to 48 hour service.)

### TOLERANCE WIDTHS—PRODUCTION ROLLS

Over 300 different pressure sensitive tapes always in stock. SPECIAL TOLERANCE PRODUCTION WIDTHS FROM .020 AND UP. Full length rolls—60 yards - 72 yards, etc. Guaranteed tolerances. (24 to 48 hour service.)

Mfrs. of the most complete tape specialty line for industry.

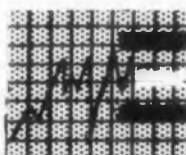
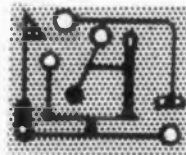

## NEW LITERATURE

### Welded Assemblies 127

Eight-page brochure "Welded Assemblies" describes the firm's welded assembly technique for high density packaging of electronic components. The packaged assemblies, miniaturized into modular sticks, are encapsulated with plug-in terminals. Illustrations of various types are provided. Raytheon Co., Industrial Tube Div., 55 Chapel St., Newton 58, Mass.

### Thermocouples 128

This three-page reprint, "Thermocouples Made Practical," describes the origin of common mode voltages and the errors these signals introduce into typical measuring systems. A method of reducing common mode voltage by increasing the rejection ratio via a low impedance bus bar is discussed. Cohu Electronics, Inc., Kin Tel Div., 5725 Kearny Villa Rd., San Diego 11, Calif.

### Wire and Cable Terms 129

A pocket-sized booklet, "Glossary of Wire and Cable Terms," lists alphabetically common terms, expressions, and units used in the electrical wire and cable industry. Write on company letterhead to Standard Wire and Cable Co., Dept. ED, 3440 Overland Ave., Los Angeles 34, Calif.

### Random Signal Meter 130

Bulletin No. 55 describes model TBM-2 random signal meter, a true rms voltmeter with long averaging time, high peak factor, and extended frequency response. This meter is used for high accuracy random signal power measurement, filtered or broadband. Flow Corp., 85 Mystic St., Arlington 74, Mass.

### Knob Catalog 131

Four-page bulletin 59-3 illustrates and describes a line of knobs for military and commercial applications. Complete specifications are given on five sizes, six styles, three shaft diameters and two finishes. National Radio Co., Inc., Melrose 76, Mass.

bring yourself up-to-date on

# PROTECTIVE SURFACE COATINGS

for  
electronic  
applications



### CHARACTERISTICS

Complete, detailed chemical, mechanical, thermal and electrical properties of HumiSeal coatings in this handy chart. Also Selector Chart to determine coating best suited for a specific job.

### HOW TO USE

Up-to-the-minute tips on how to use protective coatings for electronic applications.

For your FREE Copies write on your company letterhead.

**COLUMBIA TECHNICAL CORPORATION**

61 08 31st AVENUE - WOODSIDE 77, N. Y.

CIRCLE 132 ON READER-SERVICE CARD

ELECTRONIC DESIGN • September 16, 1959



**129 Magnetic Clutches 133**

A line of magnetic clutches and clutch brakes is described in this four-page catalog. Environmental, electrical, and mechanical specifications are given, along with short descriptions of each model. Dimensional diagrams and illustrations are also provided. Dynamic Instrument Corp., 59 New York Ave., Westbury, N.Y.

**130 Control Systems 134**

"Instrumentation and Control," eight pages, describes and illustrates instruments for five process variables: pressure, flow, temperature, level, and gas analysis. A universal electronic recorder and all-electric combustion control systems are also described. The Hays Corp., Michigan City, Ind.

**131 Transistor Mounting Kits 135**

This one-page data sheet describes transistor mounting kits. Dimensional diagrams and exploded-view drawings are provided. Kits are available with anodized aluminum or Teflon-coated fiberglass insulators. Bendix Aviation Corp., Semiconductor Products, Red Bank Div., Long Branch, N.J.

**Test Systems 136**

Automatic testing, microwave and antenna test instrumentation, radome testing systems, and flight simulation equipment are covered in this 12-page illustrated catalog. Electrical and physical specifications are provided for a variety of testers, including tape-programmed circuit, card-programmed component, and cable testers. California Technical Industries, 1421 Old County Rd., Belmont, Calif.

**Packaged Circuits for Hi-Fi 137**

Bulletin 42-739, four pages, describes 29 packaged circuits that the firm has designed and produced specifically for stereo and monophonic high-fidelity applications. Included are rumble and scratch filters, phono equalizers, compensation and tone circuits, as well as amplifiers and output stage circuits. The schematic drawing of each packaged circuit shows the values and tolerances of the components in it. Performance curves are shown where applicable. Globe-Union, Inc., Centralab Div., 900 E. Keefe Ave., Milwaukee 1, Wis.



*"Is seat of pants Amerikan spacemen is flying by. Is not knowing of Reeves-Hoffman's . . ."*

### NEW HIGH PRECISION CRYSTAL FOR FREQUENCY MEASUREMENT

WRITE FOR BULLETIN RH-5MC.



Designed for use as frequency standards, Reeves-Hoffman's new 5mc, high precision crystals offer exceptionally long term frequency stability,  $\pm 0.0001\%$ , with aging of less than one part per  $10^8$  a week! These units are available in hermetically sealed glass T5 1/2 enclosures with pigtail leads or 9-pin Bakelite bases. They are manufactured to meet the most exacting military and commercial standards for frequency measurement.

DIVISION OF DYNAMICS CORPORATION OF AMERICA  
CARLISLE, PENNSYLVANIA

CIRCLE 138 ON READER-SERVICE CARD



## MAX is no match for our MIN

*Proving one man's maximum is another man's minimum*

Coy modesty may be a becoming trait, but not if you want to sell rectifiers—so we boldly take aim with a few revealing contrasts . . . Brand "U" boasts their 1.5 amp rectifier leaks *only* 2000  $\mu$ amps at 400 volts, whereas we *scrap* any 6 amp diode that leaks 500  $\mu$ amps at 600 volts ( $150^\circ\text{C}$ ). It will pay you to look closely at the *typical* comparisons sampled below, especially since you can buy such superior Bradley rectifiers at lower prices than the also-rans. Why not get the extra Bradley margin of reliability?

Write us your diode requirements. We will send you applicable data sheets.

#### LEAKAGE

- Bradley 6 amp: 100  $\mu$ a @ 600 v ( $150^\circ$ )
- Brand U 1.5 amp: 2000  $\mu$ a @ 400v
- Brand V 1.5 amp: 300  $\mu$ a @ 400v
- Brand W 1.5 amp: 150  $\mu$ a @ 400v
- Brand W 3 amp: 500  $\mu$ a @ 400v

- Bradley 6 amp: 1.0  $\mu$ a @ 600 v ( $25^\circ$ )
- Brand W 1.5 amp: 20  $\mu$ a @ 400v
- Brand W 3 amp: 50  $\mu$ a @ 400v
- Brand X 3 amp: 10  $\mu$ a @ 200-600v
- Brand Y 1 amp: 2  $\mu$ a @ 500v

#### SWITCHING TIME (Recovery Time)

- Bradley — 6 amp (not  $\mu$ a): 2  $\mu$ sec
- Brand X — 1200  $\mu$ a: 2  $\mu$ sec



**BRADLEY SEMICONDUCTOR CORPORATION**

*Formerly Bradley Laboratories Inc.*

**Bradley**

275 WELTON STREET, NEW HAVEN 11, CONNECTICUT  
CIRCLE 139 ON READER-SERVICE CARD

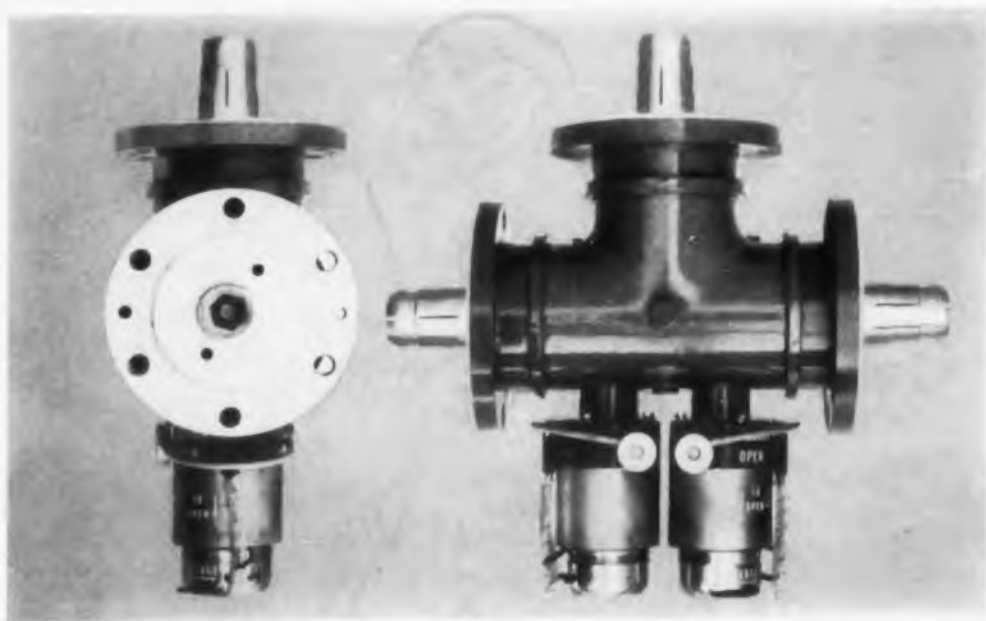

## Now - Quick, Reliable Remote Coaxial Switching

Jennings vacuum coaxial relays were specially designed to solve the problem of remote switching of 3/8 inch coaxial lines for television, communications, and radar transmitters at high frequencies and high power levels. Aided by their vacuum dielectric these coaxial relays offer:

**Low contact resistance** that remains permanently low.

**Consistent and reliable** low loss operation without maintenance problems.

**Unprecedented safety factor**—Contacts are not damaged if the relay is accidentally switched hot, because there is very little arcing during current interruption.

### SPECIFICATIONS

SPDT RC21F (above) Impedance—50 ohms Frequency range—0 to 600 mc.  
VSWR—1.03 at 200 mc. and 1.09 at 600 mc. Power rating—3 megawatt peak  
20 kw average at 500 mc. Insertion loss—0.05 db max.



Simple fittings are available for use with the RC10 coaxial relay that permit assembling multiple units in crossbar networks in a minimum of space. The network illustrated includes 47 switches and associated fittings which allows 3 transmitters to be switched to any of 4 antennas or to trunking output left and right, and to dummy load termination.

SPST RC10 Impedance—50 ohms Power rating—50 kw average to 60 mc.  
Frequency range—0 to 100 mc. VSWR—1.02 max. at 30 mc. 1.05 max. at 60 mc.

Write today for further details on Jennings complete line of vacuum relays.

**Jennings** RADIO MANUFACTURING CORPORATION  
978 McLAUGHLIN AVE., P. O. BOX 1278 SAN JOSE 8, CALIF.  
CIRCLE 140 ON READER-SERVICE CARD

## NEW LITERATURE

### Step-Servo Motors 141

This data sheet provides mechanical and electrical specifications for ten different step-servo motors. Sizes 5, 8, 11, 15 and 23 are included. These motors are designed for digital-to-analog conversion in 45 deg reversible increments up to 120 pulses per sec. Induction Motors of California, 6058 Walker Ave., Maywood, Calif.

### Frequency Converter 142

Four-page bulletin 2024 describes a broad range frequency converter for 15 to 40,000 cps inputs. Complete electrical and dimensional specifications are given, including frequency ranges and linearities at various output ratios, output current at various linearities, accuracies, filtering, time constants, and power requirements. George L. Nankervis Co., 15300 Fullerton, Detroit 27, Mich.

### Rectangular Connectors 143

Specifications, outline dimensions and general information on miniature rectangular connectors for heavy duty power applications are given in this series 200 four-page brochure. Contact arrangements include coaxial, No. 16 and No. 18 awg wires. DeJur-Amsco Corp., Electronic Sales Div., 45-01 Northern Blvd., Long Island City 1, N.Y.

### Power Amplifier 144

This two-page illustrated bulletin describes the firm's model 1012 power amplifier. Electrical and physical specifications are given, including a graph of output voltage vs. load impedance. The frequency range of the amplifier is from 0 to 12.5 meg, with a drop-off of 6 db at the upper limit. Technitrol Engineering Co., 1952 E. Allegheny Ave., Philadelphia 34, Pa.

### Masking 145

Four-page illustrated catalog M-24 describes a line of masking aids for painting or plating operations. Included are illustrations and specifications for masking tape discs in sizes from 1/8 in. in diam, discs for anodized surfaces, taper and self-threading plugs, and narrow masking tape. By-Buk Co., 4314 W. Pico Blvd., Los Angeles 19, Calif.

### Toggle Switches 146

Data sheet 160 describes a series of precision pull-to-unlock toggle switches. Included are photographs, dimensional drawings, electrical ratings, and performance characteristics. These switches have a positive locking device which holds the toggle lever in a set position. Minneapolis-Honeywell Regulator Co., Micro Switch Div., Freeport, Ill.

### Photoelectric Control Catalog 147

Bulletin GEA-6822, 16 pages, describes the firm's line of photoelectric controls used for counting, sorting, signaling, detecting, or limiting. Included are descriptions, specifications, and pricing data on the self-contained relay, transistorized relay, high-speed relay, long-distance relay and electronic timer. General Electric Co., Schenectady 5, N.Y.

### Magnetic Clutch 148

This two-page data sheet describes the C-18 magnetic clutch. General specifications, average characteristics, and special requirements of this unit are given. The clutch has as much as 400 per cent more output torque than conventional clutches of comparable size. Guidance Controls Corp., 110 Duffy Ave., Hicksville, N.Y.

### Power Supply 149

Detailed electrical and physical specifications on a transistorized power supply are offered in two-page bulletin No. S-2-19. The unit is designed to develop from 26 to 2000 v dc at 100 w output power from an input of 28 v dc. Included are dimensional drawings and ordering information. Arnold Magnetics Corp., 4613 W. Jefferson Blvd., Los Angeles 16, Calif.

### Soldering Guide 150

"A Guide to Preform Soldering," 8 pages, provides information on solder preforms and their use. Included are data on the range of preform shapes, the alloys from which they are made, and their use in automated production processes. Also described are heating methods, flux selection, metals characteristics and alloy selection. Alloys Unlimited, Inc., 21-01 43 Ave., Long Island City 1, N.Y.



## Nomogram for Fractional Horsepower Motors and Transmissions

Merkle-Korff Gear Co.  
213 N. Morgan  
Chicago 7, Ill.

**T**HE RELATIONSHIP between torque, rpm, and hp for motors is given by:

$$\text{hp} = \frac{\text{rpm} \times \text{torque (lb-ft)}}{5252}$$

$$= \frac{\text{rpm} \times \text{torque (lb-in.)}}{63,025}$$

The accompanying nomogram is useful as a time-saver during design work involving fractional horsepower motors and transmissions.

For additional copies, turn to the Reader-Service Card and circle 716.

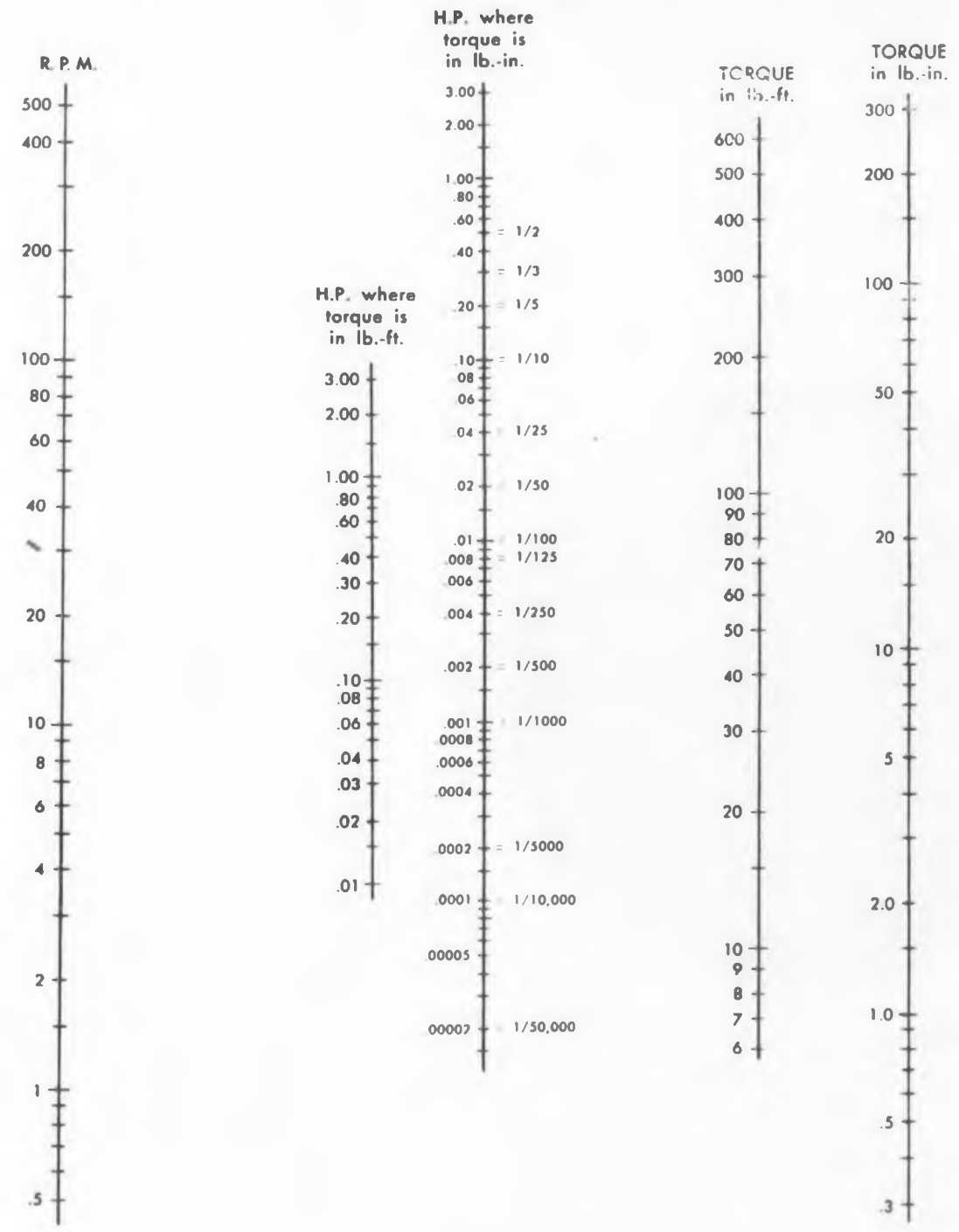

- 46 Plastic Resins 736**  
Eight-page catalog presents basic information on Cycolac plastic resins. Mechanical, electrical, thermal and impact strength properties for types T, H, L, and C are given. Borg-Warner Corp., Marbon Chemical Div., Box 68, Washington, W. Va.
- Power Supplies 737**  
Bulletin HVVC-95, two pages, describes constant current and constant voltage switch-over regulated power supplies. Electrical and mechanical data are provided. Matthew Labs, 3344 Fort Independence St., New York 63, N.Y.
- Film Capacitors 738**  
Six-page bulletin 2036A provides electrical and dimensional characteristics of miniature capacitors which use a polyester film dielectric. Included are capacitance change and dissipation factor vs temperature graphs. Sprague Electric Co., North Adams, Mass.
- Conversion Factors 739**  
This wall chart of conversion factors includes common conversions as well as some that are difficult to locate in manuals. Examples are atmospheres to kg/cm<sup>2</sup>, cm/sec to mi/hr, and quintals to pounds. Precision Equipment Co., 4411E Ravenswood Ave., Chicago 40, Ill.
- Fasteners 740**  
Technical file folder describes aircraft, missile, and electronic fasteners. It provides data on the precision, accuracy, and dependable service of screws, bolts, and stop-nuts. Century Fasteners Corp., 88 Sanford St., Brooklyn 5, N.Y.
- Transistor Choppers 741**  
Transistor chopper applications are discussed in this two-page bulletin. An equivalent switching circuit and two coupling circuits are given, as well as circuits showing the use of choppers in a stable dc amplifier and a fast response position servo system. Solid State Electronics Co., 8158 Orion Ave., Van Nuys, Calif.
- Transistor Chopper 742**  
This two-page data sheet describes model 70 silicon transistor electronic chopper for high temperature applications. Mechanical and electrical information and typical applications are provided. Solid State Electronics Co., 8158 Orion Ave., Van Nuys, Calif.

of  
hes.  
onal  
per-  
hes  
nich  
ion.  
Co.,  
  
47  
ibes  
rols  
de-  
rip-  
on  
ized  
re-  
ctric  
  
148  
the  
fca-  
ecial  
The  
nore  
ches  
trols  
?  
  
149  
ecifi-  
pply  
No.  
elop  
tput  
ded  
ering  
orp.,  
s 16,  
  
150  
," 8  
older  
data  
lloys  
use  
Also  
elec-  
y se-  
1 43  
  
959

*a direct line*  
from **AEL**



The AEL "138"... A TRULY UNIVERSAL PULSER

- SINGLE OR RECURRENT PULSES
- PULSE PAIRS OR PULSE TRAINS
- PULSE WIDTHS FROM 1  $\mu$  SEC. TO 1 SEC.
- REVERSIBLE POLARITY
- 35 VOLTS into a 50 OHM LOAD
- ALL TYPES OF SYNCHRONIZATION
- REPETITION RATES FROM 1/2 CYCLE PER SEC. TO 250 KC/s

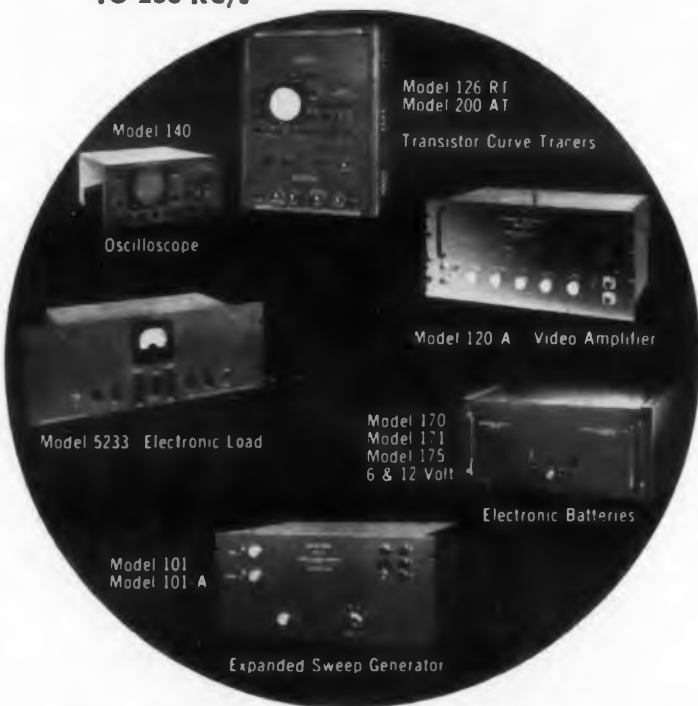

AEL offers a complete ENVIRONMENTAL TESTING FACILITY for your components or assemblies... PLUS a top-notch team of electronic and mechanical engineers to assist in solving your problems in instrumentation, communication or telemetry systems and microwave propagation and transmission.

• Investigate the opportunities at AEL for creative engineers

**AMERICAN ELECTRONIC LABORATORIES, INC.**

121 N. 7TH ST. PHILADELPHIA 6, PENNA.  
CIRCLE 183 ON READER-SERVICE CARD

## Lessening of Diode Confusion Seen By Industry Leaders

Industry executives expect Electronic Industries Association to get cooperation so that new diode type numbers are not issued indiscriminately. EIA has established a new Standards Lab to comparison-test diodes.

Industry leaders were quick to praise ELECTRONIC DESIGN's recent diode report as accurately describing the imbroglia over too many types ("Diodes—Choice Performance, but Difficult Choice," June 10, 1959). They were equally quick to express confidence that the industry's associations, the Electronic Industries Association (EIA) and the National Electrical Manufacturers Association (NEMA), would tighten requirements in registering new diodes. And the user is certainly not blameless for encouraging too many diode types, according to manufacturers.

In describing the situation that has led to the present mammoth list of diode types for designers, ELECTRONIC DESIGN editors found the problem too complex technically and too fraught with economic and political ramifications to be solved readily. But an analysis of the problem has made it clear that industry will have to take forthright steps to unscramble the diode classification or the military may move in.

### The Problem Again In Brief . . .

Here is the problem, as originally reported in ELECTRONIC DESIGN:

- The introduction of over 1500 new diodes last year brings the total to an unwieldy 4000.
- Of the 4000 types, many are too much like previously announced units to warrant a new number.
- Of those that are different, the degree of difference of many is still too slight to justify their existence as separate types.
- Published characteristics are unreliable guides to diode selection, since manufacturers do not measure characteristics alike.
- Industry's progress in standardizing test procedures has been lagging.
- Spokesmen for leading companies admit they have not been submitting data to EIA in the recommended form that would permit comparison.

Top executives in the diode industry and top civilian authorities in the Department of Defense were asked by the magazine what they thought could be done. Their replies are presented here in summary form; detailed letters follow in full.

The problem was posed to executives in the diode industry in the following manner:

"In the enclosed issue we recommend that industry move forward with more deliberate speed in establishing standard test conditions and parameter definitions. This will mean that one diode can be compared to another and a realistic interchangeability list can be compiled. It will also mean that fewer new type numbers need be assigned. We also recommend that EIA be given the power to refuse to list new types if they do not differ significantly from older registered types, and that the standardization of common types be encouraged. We would like to know how you feel about our description of the problem and what solutions you recommend."

### Suggestions and Answers . . .

- The new EIA Standards Lab and current activity of the Joint Electron Device Engineering Council (JEDEC) may lead to elimination of many types. Government may have to take the initiative and standardize some diodes and rectifiers.
- Standard formats for reserving and registering types will clear up confusion. The JS committees of JEDEC are working on this. Formats are in existence for some types. EIA reports "good cooperation" from manufacturers.
- EIA should tighten registration procedures sufficiently to preclude attempts by less reputable diode manufacturers to use EIA numbers as sales gimmicks.
- Periodic reviews of diode lists by member companies might result in agreement to drop certain types.
- Military practice of updating preferred lists



is a step in the right direction.

- Registration rules should be revised, so that minor product variations use existing numbers. Differences can be noted by letter suffixes.

- Users will have to accept JEDEC's standardized formats and recommended test procedures in writing specifications for diodes.

- Users should work with manufacturers in using types suggested by manufacturers as "standards."

- Users should specify EIA registered types and not demand specials that require separate "house" numbers.

- Small quantity users should follow the lead of large companies and accept their standard types.

#### Recent Activity

Last month the nation's two major trade associations with an interest in the semiconductor industry, EIA and NEMA, announced an integrated program to tackle the areas of technical standards. The cooperative standardization program will be conducted through JEDEC.

The Armed Services Electro Standards Agency (ASESA) sends representatives to JEDEC committee meetings. ASESA guides and assists industrial efforts to develop semiconductor devices for military applications.

Since May, EIA has been operating a Standards Lab under the direction of G. F. Hohn. The Standards Lab is concerned with coding systems, comparisons of different diode types, and standardized test measurements. Mr. Hohn reports that manufacturers are now following the standard formats for submitting data and that standardized test methods may soon evolve.

Civilian spokesman for the Department of Defense told ELECTRONIC DESIGN, in a meeting called by the Office of the Director of Defense Research and Engineering, that they are now working up a list of standardized semiconductors, which include diodes. To keep abreast of rapid developments in the field they will also publish lists of latest types which show promise of replacing earlier types.

Faced with the problem of evaluating new devices while also reducing the total number of parts being used in military equipment, the military is looking into the problem of revising its method of managing the preparation of specifications. Of great concern to it is the problem of reducing the cost of getting reliable data, and new specifications call for standard test methods.

Despite signs of progress to make the diode



# NEW

## Low Cost Transistorized DC Power Supply (width: 8", height: 4½", depth: 14")

NJE answers the engineers' quest for a low cost transistorized power supply that is fully capable of remote sensing and remote programming—a power supply impervious to overloads or short circuits.

These compact, flexible NJE power supplies are designed in a new "half rack" modular

concept suitable for laboratory bench use or in rack installations\* as a component part of your equipment. They are also capable of series or parallel operation.

Component derating and construction conform to the highest commercial practices.

<i>Check these specs!</i>	MODEL TR-18-2	MODEL TR-36-1
Voltage Range	0-18 VDC	0-36 VDC
Current Range	0-2 amps	0-1 amp
Load Regulation (0-100%)	±0.05% or ±2 mv	±0.05% or ±2 mv
Line Regulation (±10%)	±0.1% or ±3 mv	±0.1% or ±3 mv
RMS Ripple	1 millivolt	1 millivolt
Internal Impedance (DC-20KC)	0.1 ohm max.	0.2 ohm max.



#### WRITE TODAY FOR COMPLETE TECHNICAL DATA

Models in stock subject to prior sale • \$250 each net; quantity discounts available • \*Suitable front panels for rack mountings are available on order (single supply panel, Model RP1 \$15 each net; dual supply panel, Model RP2 \$15 each net)

**NJE CORPORATION**  
20 Boright Avenue • Kenilworth, New Jersey  
BR. 2-6000 • TWX Cranford, NJ 51 • FAX-FFP

CIRCLE 184 ON READER-SERVICE CARD

## USE ELECTRONIC COUNTERS AS DIGITAL VOLTMETERS

### with SYSTRON'S NEW MODEL 1230 VOLTAGE to TIME CONVERTER

#### FEATURES:

#### PROVIDES:

The development of Systron's new Model 1230 now makes it possible to convert any existing period or time counter into a precision high speed digital voltmeter. Connects directly to Systron Models 1010, 1040, 1043 and 1031 to provide an IN-LINE readout ( $\pm 10,000$ ) of DC voltages.

Systron manufactures IN-LINE Counters for laboratory, military and industrial applications, as well as complete Data Processing and Control Systems tailored to meet individual specifications.

Write today for complete specifications of Model 1230 and your free copy of our new Short Form Catalog . . .



#### SPECIFICATIONS MODEL 1230

Input Voltage Ranges: 0 to -1, -10 and -100v DC Option A - -10 and -100 millivolts full scale Option B - -1000 volts	Errors: Conversion - -0.05% of full scale
Indication: NIXIE IN- LINE, -10,000 (on Model 1031)	Input Impedance: 1 Megohm (standard ranges) Option A - 100,000 ohms
Conversion Time: .010 seconds Time between pulses Option C 100 seconds (100KC counters)	Polarity: Automatic polarity sensing
	Price: Model 1230 \$1095.00 Option A 895.00 Option B 180.00 Option C 100.00



**SYSTRON**  
CORPORATION

**SYSTRON CORPORATION**  
950 GALINDO STREET • CONCORD, CALIFORNIA

Representatives in  
Principal Cities

CIRCLE 185 ON READER-SERVICE CARD

## BENDIX SR RACK AND PANEL CONNECTOR

*with outstanding resistance  
to vibration*

The Bendix type SR rack and panel electrical connector provides exceptional resistance to vibration. The low engagement force gives it a decided advantage over existing connectors of this type.

Adding to the efficiency of this rack and panel connector is the performance-proven Bendix "clip-type" closed entry socket. Insert patterns are available to mate with existing equipment in the field.

Available in general duty, pressurized or potted types, each with temperature range of  $-67^{\circ}\text{F}$  to  $+257^{\circ}\text{F}$ .

Here, indeed, is another outstanding Bendix product that should be your first choice in rack and panel connectors.



#### FEATURES:

Resilient Insert • Solid Shell Construction • Low Engagement Forces • Closed Entry Sockets • Positive Contact Alignment Contacts—heavily gold plated Cadmium Plate—clear irridite finish • Easily Pressurized to latest MIL Specifications.

**SCINTILLA DIVISION**  
SIDNEY, NEW YORK



Export Sales and Service: Bendix International Div., 205 E. 42nd St., New York 17, N. Y.  
Canadian Affiliates: Aviation Electric Ltd., 200 Laurentian Blvd., Montreal 9, Quebec.  
Factory Branch Offices: Burbank, Calif.; Orlando, Florida; Chicago, Illinois; Teaneck, New Jersey; Dallas, Texas; Seattle, Washington; Washington, D. C.

CIRCLE 186 ON READER-SERVICE CARD

user's job easier, real improvement may be slow in coming for two basic reasons. The military is not interested in forcing standardization on industry because it does not want to interfere with technical progress in the field. Industry associations must operate on the basis of getting voluntary cooperation from the industry, as any attempt to pressure the industry into conformance could be construed as action in violation of anti-trust laws. This risk is being avoided at the expense of standardization.

Hope therefore lies mainly in the voluntary adoption of recommendations that will be forthcoming from JS Committees.

### Letters Received

#### Standard Needed Says NEMA

Dear Sir:

I am writing this letter to discuss the problem of diode selection which you described in the June 10, 1959 issue of ELECTRONIC DESIGN.

In the 4000 available types there are three separate devices: diodes, rectifiers, and Zener diodes. Before going further it is necessary to distinguish between a semiconductor diode and a semiconductor rectifier. While it could be argued that any two terminal asymmetrical semiconductor is a diode, in defining the scopes of the JEDEC (Joint Electron Device Engineering Council) Committees, the JEDEC Semiconductor Council found it necessary to write two pragmatic definitions which would distinguish between the two. Essentially, a diode is used to handle information; a rectifier is used to convert ac to dc. While some devices can be used for both purposes, over 90 per cent of all types fall into one or the other category.

Twenty four per cent of all JEDEC registered devices are diodes; 37 per cent are rectifiers; 39 per cent are Zener diodes. The basic cause of confusion is the lack of standardization. The semiconductor industry recognizes this and is taking steps to solve it through JEDEC. The National Electrical Manufacturers Assoc. (NEMA) and Electronic Industries Assoc. (EIA) Semiconductor Sections have asked the JS Committees to develop standard registration formats for all semiconductor devices. At present, a manufacturer can register a device by submitting his own commercial data sheets to the EIA Engineering Office which administers JEDEC for EIA and NEMA. It is anticipated that in the future, all devices will be registered on standard formats using the same definitions and basis of ratings.

To clarify the confusion that exists concerning rectifiers, three things are needed: (1) standard format, (2) standard voltage and current ratings, (3) mechanical standardization. The JS-1 Commit-



ee on Power Rectifiers is working on a standard format. By using a standard current and voltage rating the entire industry could use the same series of ratings of current and voltage. For example, all devices might be rated at 5, 10, 25, 50, 75, 100 v, etc. The manufacturer could specify his devices in one of these voltages and the designer could use the devices in accordance with his requirements. This is also on the agenda of JS-1. The JS-10 Committee on Mechanical Rectifiers has started a mechanical standardization program on rectifiers. These programs are being co-ordinated with ASEA (Armed Services Electro Standards Agency) and the Industrial Control, Industrial Automatic Systems, and Power Rectifier Equipment Sections of NEMA. In this way, user and manufacturer are working together to develop realistic standards satisfactory to all.

Another reason why there are so many type numbers is because of the large number of regulating devices (mistakenly called Zener Diodes), which are on the market. Standardized formats and packages will minimize JEDEC registrations, but the problem with regulating devices is that the voltage rating of a number of devices with nearly the same avalanche voltage cannot be grouped together. For example, any rectifier with a peak inverse voltage over 0 v may be rated at 10 v. However, a given Zener diode has a unique avalanche voltage and can be used at only one voltage. A manufacturer must have a code for identifying his product. It requires 38 voltage ratings and 38 numbers to market a line of regulating diodes in a given package to cover the range from 5 to 200 v in 10 per cent steps. . . .

The basic problem with diodes is again lack of standardized formats and method of specification, but it is further complicated by the lack of standardization among the users. Most large users of diodes have their own internal standards department, and each one has his own definitions and symbols. The JS-2 Committee on Signal Diodes has also been asked to prepare a standard format. Here, however, unless the users use this format also, the number of types and overlapping specifications will continue to increase because no diode manufacturer will turn down business because a customer hasn't written the specification on a standard format.

The only way the number and type of diodes and rectifiers will be minimized is through joint co-operation between the manufacturers and users. Standardization of definitions, ratings, and packages will benefit the entire industry and is the only solution to the confusion described in your article.

Philip D. Goodman, Chairman NEMA  
Power Semiconductor Components Section  
(Continued on p. 94)

FOR RADAR AND  
MISSILE TRACKING

ANOTHER

VARIAN FIRST

INTERNAL CAVITY PULSE AMPLIFIER  
KLYSTRON with 75 KILOWATTS  
average output

- RUGGED
- NON CRITICAL
- HIGH PERFORMANCE
- SINGLE PUSH BUTTON OPERATION

1.25 MEGAWATTS PEAK POWER

Varian's VA-842 is the world's largest internal cavity Klystron. It produces the tremendously high average power of 75 kilowatts for long pulse radar and missile tracking. Features include a pulse duration time of 2000 microseconds; tunable frequency range of 400 to 450 megacycles; 40 db stable RF power gain.

Varian makes a wide variety of Klystrons and Wave Tubes for use in Radar, Communications, Test and Instrumentation, and for Severe Environmental Service Applications. Over 100 are described and pictured in our new catalog. Write for your copy—address Tube Division.



VARIAN associates  
PALO ALTO 31, CALIFORNIA  
Representatives throughout the world

KLYSTRONS, TRAVELING WAVE TUBES, BACKWARD WAVE OSCILLATORS, HIGH VACUUM PUMPS, LINEAR ACCELERATORS, MICROWAVE SYSTEM COMPONENTS, R. F. SPECTROMETERS, MAGNETS, MAGNETOMETERS, STALOS, POWER AMPLIFIERS, GRAPHIC RECORDERS, RESEARCH AND DEVELOPMENT SERVICES

CIRCLE 187 ON READER-SERVICE CARD

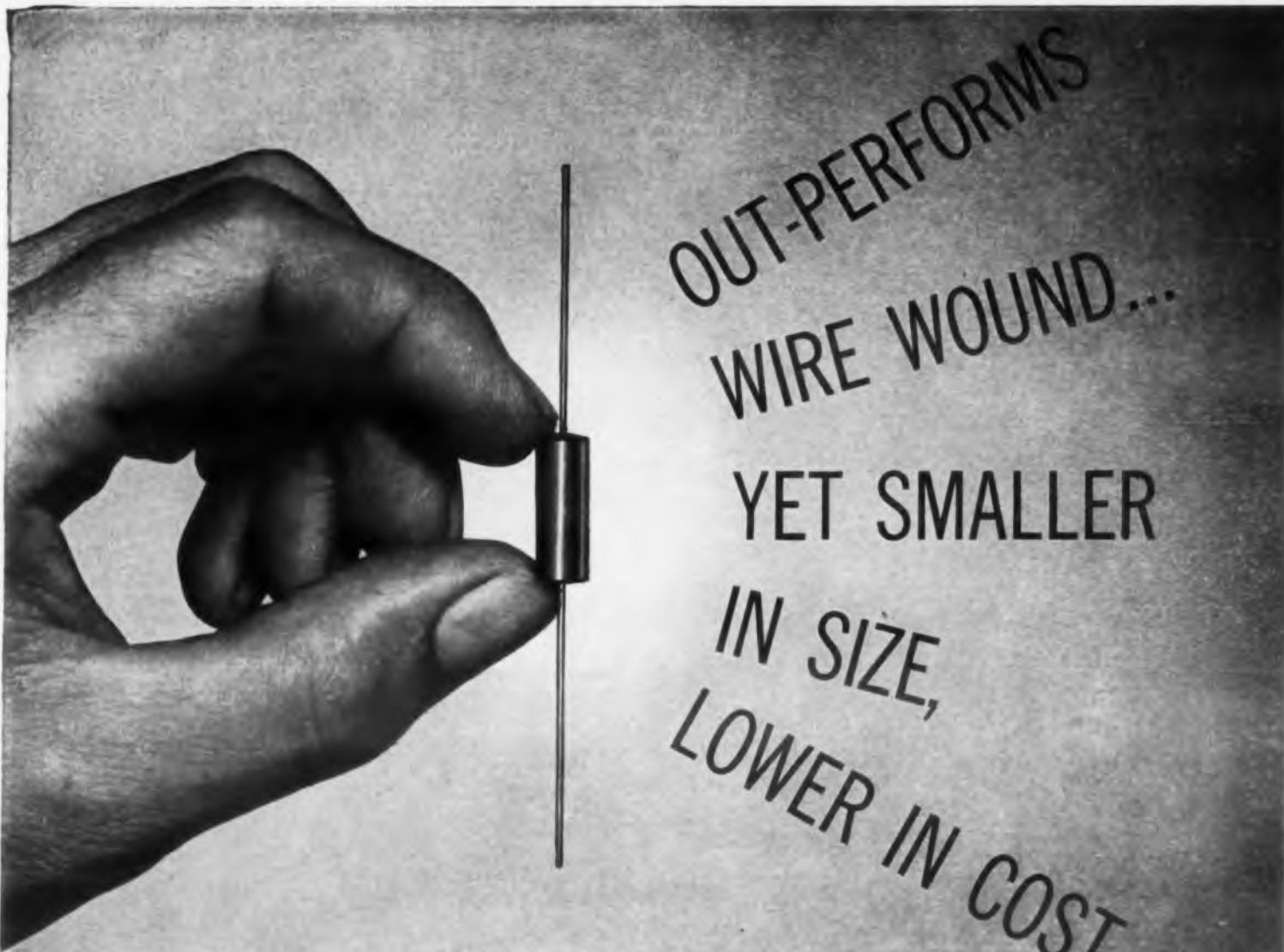

OUT-PERFORMS  
WIRE WOUND...  
YET SMALLER  
IN SIZE,  
LOWER IN COST

## New Electra Precision Metal Film Resistor

Here is an entirely new achievement in electronic components; one of the biggest steps forward in years. This precision metal film resistor offers you precision and stability that formerly was available only in a wire wound resistor, yet it is much smaller in size, much lower in cost, also has far superior high frequency characteristics. Available in five sizes from  $\frac{1}{8}$  to 2 watts, the new Electra Precision Metal Film Resistor meets or exceeds Mil-R-10509C, Characteristic C, and can be supplied in any of eight standard temperature coefficient tolerances. Why not let us supply you full details by return mail. Write today!

### CHECK THESE OUTSTANDING TEST RESULTS

MIL-R-10509C (TYPICAL DATA) 337K 30P/3

TEMPERATURE CYCLE			MOISTURE			LOAD LIFE 135°C		
Initial	Final	% Change	Initial	Wet	Dry	Initial	Final	% Change
236.9	236.9	0	236.9	-21	-04	237.4	237.4	0
237.5	237.5	0	237.4	0	0	237.5	237.5	0
238.1	238.1	0	238.1	0	0	238.0	238.0	0
237.1	237.1	0	237.1	5	0	237.0	237.0	0
237.9	237.9	0	237.9	0	0	237.8	237.8	0
236.6	236.5	-04	236.2	-04	04	236.2	236.2	0
236.9	236.6	-04	236.0	-04	04	236.0	236.0	0
237.4	237.4	0	237.4	-04	04	237.4	237.4	0
237.7	237.2	-05	237.7	-04	04	237.7	237.7	0
237.7	237.7	0	237.7	-04	04	237.7	237.7	0

*Electra*

MANUFACTURING

SEE ELECTRA DISPLAY AT WESCON SHOW--BOOTH 2903-2905

CIRCLE 188 ON READER-SERVICE CARD

## No Clear Cut Solution

Dear Sir:

As a member of the diode and transistor manufacturing fraternity, I have read with considerable interest the article in the June 10, 1959 issue of *ELECTRONIC DESIGN* entitled, "Diodes—Choice Performance . . . But Difficult Choice." I would say that you have described the problem well but intentionally more from the point of the user than from that of the supplier. A reputable and more responsible diode manufacturer depends more upon technological advancement in the registration of new types than upon sales gimmicks designed to deceive, to confuse, and to represent his product as something different. He, too, deplors the existence of the array of diode types from the standpoint of inventory and the high cost of testing diodes to unusual specifications, to say nothing of the wide variety of equipment required and the investment it represents.

Aside from lacking the time required to push vigorously for standardization, however, a diode manufacturer sees several basic facts which work against such standardization. They are the following:

1. Semiconductor device technology is still in the growth stage, and today's premium diode is tomorrow's reject. The rate of growth of the technology is decreasing perceptibly, but new materials and techniques can set it climbing once more. Really new devices require new numbers. The problem lies in how to get rid of the old ones.

2. Premium diodes cannot yet be made with high yield to difficult specifications. In some cases, to meet the specifications of the user, the diode manufacturer must be satisfied with yields as low as ten per cent. Those units failing to meet the tight specification must then either be charged to the premium spec customer or sold under another number. This procedure is perfectly legitimate inasmuch as the majority of the "rejects" may be highly reliable and comparable with diodes which are "premium" by other standards. In short, the analogy to 6v6 tubes is a poor one, at least for the foreseeable future.

3. At the request of major customers, even reputable diode manufacturers will register units only slightly different from existing types if a major customer requires large numbers of units and wishes to establish a second source for the identical type.

4. Circuit designers these days are called upon to produce circuits which will out-perform their predecessors, and they call upon diode manufacturers for faster recovery time, increased power handling capacity, higher maximum temperature ratings, and the like. Small improvements are gratefully received, and a new number is frequently generated as a result of improvement in



any one of the areas specified.

5. A retention of old types on procurement lists of the military poses a problem, but the logistics and supply problem of the military is an even greater one, and spares have a habit of perpetuating themselves.

I can offer no dramatic solution to the problem. Having been on past EIA standardization committees for diodes, I am aware of the difficulties which that organization faces in attempting to establish consistency among manufacturers without creating very serious and costly problems for certain member companies. The industry is experiencing growth pains, and cleaning house completely seems out of the question. EIA has tightened and should tighten registration procedures sufficiently to preclude attempts by the less reputable diode manufacturers to employ EIA numbers as sales gimmicks. Perhaps periodic reviews of diode lists by member companies would result in agreement to drop certain types. Without a change in EIA rules, however, the vote must be unanimous. The military practice of updating JAN and preferred lists is certainly a step in the right direction.

Harper Q. North, President  
Pacific Semiconductors, Inc.

### The User is Responsible Too

Dear Sir:

The diode problem covered in your June 10th issue of ELECTRONIC DESIGN has been one of increasing concern to me for quite some time. The rapid advance of the "state of the art" in semiconductors coupled with increased reliability, conductance, speed, and subminiaturization demands from industry have necessitated a rapid successive introduction of many new diode types. I am confident that these necessary types could be capably dealt with by the user through industry standardization of test procedures and parameters.

Through JEDEC, the industry has recently taken two steps that I am certain will be of assistance in this matter:

1. It has evolved a standard registration format for diodes, and EIA will have the authority to refuse registration unless registration is requested in accordance with this format. Accordingly, all diodes registered in the future will be more easily cross-referenced because of their being categorized to the same format and test procedures.

2. It will require that EIA charge both members and nonmembers for the service of registration. The amount of the charge has not yet been decided upon, but it is their desire to make it sufficient to deter manufacturers from indiscriminate registration of devices that are actually not unique.

The problem that we have been incapable of

(Continued on p. 96)

## STACKPOLE Coldite 70+<sup>®</sup> fixed composition RESISTORS

Today's slickest looking resistors . . . and every bit as good as they look! Unmatched for load life and moisture resistance. They're approved resistors—direct from a MIL-R-II approved manufacturer. And now, for the first time, you can get such resistors in a full line of RC-42 (2-watt); RC-32 (1-watt) and RC-20 (1/2-watt) types IMMEDIATELY from distributors' stocks at rock-bottom prices!

# Now! PICK 'EM OFF DISTRIBUTORS' SHELVES!

- ... for military prototypes, small runs, production emergencies or "hurry-up" projects
- ... in any standard value or tolerance
- ... at lowest prices in lots up to 1,000 resistors of a value

Complete stocks—and we mean *complete*—in the hands of the 28 selected Stackpole distributors listed below help you handle every job with highest quality resistors,

fully proved and accepted for critical applications. Equally important, you actually get them at less than factory prices in lots up to 1,000 of a value!

#### BALTIMORE, MD.

Kann-Ellert Electronics, Inc.

#### BATTLE CREEK, MICH.

Electronic Supply Corp.

#### BIRMINGHAM, ALA.

MG Electrical Supply Co.

#### BOSTON, MASS.

Sager Electrical Supply

#### BROOKLYN, N. Y.

Electronic Equipment Corp.

#### CLEVELAND, OHIO

Pioneer Electronic Supply Co.

#### DALLAS, TEXAS

Wholesale Electronics Supply Co.

#### DAYTON, OHIO

Srepco, Inc.

#### DENVER, COLO.

Denver Electronics Supply Co.

#### GLENDALE, CALIF.

R. V. Weatherford Company

#### INDIANAPOLIS, INDIANA

Radio Distg. Co.

#### KANSAS CITY, MO.

Burstein-Applebee Co.

#### MELBOURNE, FLORIDA

Electronic Supply

#### MIAMI, FLORIDA

Electronic Supply

#### NEW YORK, N. Y.

Harvey Radio Co.

#### PHILADELPHIA, PA.

Almo Radio Co.

#### SAN DIEGO, CALIF.

Radio Parts Co.

#### SCRANTON, PA.

Fred P. Pursell

#### SEATTLE, WASH.

C & G Radio Supply Co.

#### ST. LOUIS, MO.

Interstate Supply Co.

#### SYRACUSE, N. Y.

Morris Electronics of Syracuse

#### TACOMA, WASH.

C & G Radio Supply Co.

#### WASHINGTON, D. C.

Electronic Wholesalers, Inc.

#### WATERBURY, CONN.

Bond Radio Supply Co. Inc.

#### WEST PALM BEACH, FLA.

Goddard Distributors, Inc.

#### WICHITA, KANSAS

Interstate Electronic Sup. Corp.

#### WILBRAHAM, MASS.

Industrial Components Corp.

#### WINSTON-SALEM, N. C.

Dalton-Hege Radio Supply

... and G-C/STACKPOLE, TOO!

Attractively packaged by G-C Electronics for service replacement uses, Coldite 70+ Resistors are also available through over 800 G-C distributors.



CIRCLE 189 ON READER-SERVICE CARD

# NERVE CENTER

*for teleprinted messages*



Interior view of van above

## **Kleinschmidt teletypewriters move up with the U. S. Army, operating without interruption under combat conditions**

Constant contact, *in print*, between combat headquarters and widely-dispersed field units! Developed in cooperation with the U. S. Army Signal Corps, Kleinschmidt teletypewriters in this mobile communications center are capable of sending and receiving thousands of teleprinted messages a day. Operation is fast, accurate, dependable, simple. In

recognition of proved performance, Kleinschmidt equipment for the U. S. Army is manufactured under the Reduced Inspection Quality Assurance Plan. Now Kleinschmidt experience points toward new accomplishments in electronic communications for business and industry. The new concepts, new applications are virtually unlimited.

# KLEINSCHMIDT

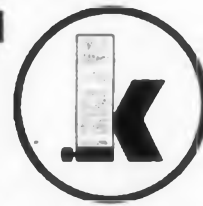

**DIVISION OF SMITH-CORONA MERCHANT INC., DEERFIELD, ILLINOIS**

Pioneer in teleprinted communications systems and equipment since 1911

CIRCLE 190 ON READER-SERVICE CARD

handling is that of the usage of non-EIA or "House Numbers", and the blame here may well lie more with the user than with the diode manufacturer. In order to do business, the supplier conforms to the demands of his customers and a multiplicity of specific "House Number" devices are born.

Texas Instruments has consistently urged usage of standard products.

True standardization, therefore, will not come from the supplier alone but can only come from the user. We have consistently striven for standardization by introducing such types as the five-device IN645 series, that effectively replaces over five hundred earlier types of glass diodes. In this instance, we have widely circulated information on this series' replacement capability and stressed to our customers the advantages of standardization on as few types as possible. I feel it is now clearly up to the component users to take positive action: to build strong component standards groups, approve only EIA registered types, and demand conformance within their organizations.

This, coupled with efforts of the industry through JEDEC as previously outlined, can bring the situation under control. It would immediately reduce the choice to EIA registered types, eliminating over half of the presently available type numbers, and standards could concentrate upon the selection of the most versatile of EIA types for standardization. As this "large user" standardization progressed, their heavy demands for only the few most versatile types would force manufacturing obsolescence of the remaining non-competitive devices by the industry. The small user who cannot afford a large standards group would then find that only those types standardized upon by the large companies would be available for his use, and his present dilemma would cease to exist.

Standardization is certainly in the best interest of our company and our entire industry . . .

Clyde Rockland,  
Head of Marketing, Texas Instruments,  
Dallas, Texas

## **No New Number For Variations**

Dear Sir:

We would like you to know that your issue of June 10 has received considerable attention in our Engineering and Marketing Departments. The problem of diode standardization is acknowledged as a most important problem in our industry, and we are among those seeking a satisfactory solution. We might add that publicizing the problem, as you have done, may be one of the most important contributions to greater standardization.

Your recommendations in paragraph two of your letter\* of June 11 are appropriate and their acceptance would undoubtedly contribute to



solution of the problem.

In line with your recommendation on EIA registrations, we are of the opinion that EIA registration rules need revision to encourage use of a given number for minor product variations, to permit judicious use of letter suffixes, etc.

We do not concur with one statement regarding EIA registration of new types. The statement is: "When questioned on this, (deliberately aim at registering new types), marketing and sales executives have asserted that late type numbers signified advances and better products. To list old types in the new brochure would be poor practice, they argued."

Upon release of new CBS types we do use existing numbers where possible in recognition of the standardization problem, of customer acceptance of types where more than one source exists, and general concurrence with EIA policy. We do not agree that new numbers alone will sell a product. It is our additional experience, however, that the customer often requests modifications to existing types, perhaps tightening some parameter. Some of this is state of the art development, as you indicated, and is a healthy condition. In some cases, however, the sales engineer should urge further consideration on the part of the customer, selling the standardization, manufacturing experience, and proven reliability.

We feel your issue of June 10 has been of service to the industry, and we hope that our comments will be of assistance to you in your future efforts.

Robert G. Marclusio  
CBS Electronics

(Letter previously published ED, July 22)

Dear Sir:

I certainly agree with the comments you have made in your letter of June 11th, relating to the problem of nonstandardization of diode types. The staff report on diodes in the June 10th issue of ELECTRONIC DESIGN has certainly emphasized the complexity of the problem.

The EIA Standards Laboratory and the JEDEC activity are both turning their attention to the matter of standardizing test characteristics and tightening requirements for registering diode types. I hope that this activity will result in the elimination of many of the diodes currently on the market. Because of the nature of the support that EIA enjoys, it may be difficult for EIA to exercise direct veto power in this activity. It may be necessary for the Government to take the initiative of standardizing a very small number of diodes and rectifiers.

The need for standardization is obvious, and we have seen it done in many other component fields. You are to be commended for this initiative. I hope these efforts prove to be fruitful.

Charles Weyl, President  
International Resistance Co.



All of the CAMBION Shielded Coil Forms shown above are available unwound, or wound precisely to your specifications.

## New fields to conquer?

Running into increasingly severe requirements for electrostatic and electromagnetic shielding of coils? You can meet them precisely and save space at the same time with CAMBION® Shielded Coil Forms. Extremely compact, these rugged unitized components provide complete protection against interference in miniature circuits. They're particularly effective where interaction of adjacent fields must be prevented. You can really pack 'em into tight spots!

CAMBION Shielded Coil Forms are available from stock to cover a broad range of fixed and variable types for both conventional and printed circuits. Variable types have advanced-design locking arrangement for positive protection against detuning. Chassis-mounted and flange-mounted types with choice of paper base phenolic, Polypenco, or Kel-F forms. Single and double-tuned types. "Top-hat" type forms have rugged, lightweight alodized aluminum housings for flange mounting. Other types have nickel-plated

brass housings; the completely dependable shielded coil forms for today's rigorous service conditions.

For further details, contact your local CAMBION Distributor or write Cambridge Thermionic Corporation, 457 Concord Avenue, Cambridge 38, Mass. On the West Coast: E. V. Roberts and Associates, Inc., 5068 West Washington Blvd., Los Angeles, California. In Canada: Cambridge Thermionic of Canada, Limited, Montreal, P. Q.

CAMBION Capacitors are subminiature units with advanced design tuning that permits wide capacity ranges. Supplied complete with single mounting studs and lock for tuning element. Stand-off type capacity elements are epoxy-embedded for maximum resistance to moisture.



# CAMBRIDGE THERMIONIC CORPORATION

# CAMBION®

The guaranteed electronic components



CIRCLE 191 ON READER-SERVICE CARD

now...capacitors  
as dependable as  
the time and tides



MILITARY "CPM" SERIES in accordance with Spec. MIL-C-14157A  
300, 400, 600 volts DC Working

Uninsulated Body Type CPM08

Insulated Body Type CPM09

MILITARY & INDUSTRIAL "TWK" SERIES  
in accordance with MIL-C-26244 (USAF)  
200, 300, 400, 600 volts DC Working

Uninsulated Body Type TWKN  
(equivalent to MIL-CPV08)

Insulated Body Type TWKP  
(equivalent to MIL-CPV09)

CAPACITANCE: .001 mfd. to 1.0 mfd. TEMPERATURE RANGE: -55°C to +125°C.

**Cornell-Dubilier Certified High-Reliability Capacitors** meet performance expectations for new environments and new complex military and industrial electronic equipment. These capacitors meet or surpass the exacting requirements of MIL-C-14157A and MIL-C-26244 (USAF). Each production lot is furnished with certified test data covering the stringent test program detailed in the specification.

When designing electronic equipment where *failure can't be tolerated* specify Cornell-Dubilier High-Reliability Capacitors. Write on your company letterhead for High-Reliability Bulletins 188A-1 and 188A-2 to Dept. ED-1, Cornell-Dubilier Electric Corporation, South Plainfield, New Jersey.



Consistently Dependable  
**CORNELL-DUBILIER**  
CAPACITORS

CIRCLE 192 ON READER-SERVICE CARD

## Storage Tube Writes

### PPI and TV Raster at Same Time



**Tube face of Storatron** has 42-inch radius of curvature. Neck can be thickened to house up to 15 writing guns.

This 10-inch storage tube, incorporating two guns that write simultaneously, a PPI scan and a TV raster, can store signals for as long as several hours and can be adjusted for highlight brilliance exceeding 500 foot lamberts.

Designed originally for missile-tracking and air-traffic operations, the Storatron can be engineered into a wide variety of circuits to record non-recurring events or to assemble either sequential or random data on a programed basis.

For instance, one gun of the Storatron may be used to integrate the echoes from a radar and to display them as high-intensity images on the face of the tube with a marked improvement in signal-to-noise ratio.

This improvement would result from the tube's ability to display a wide range of half-tones. The noise would be random and would be displayed in an rms fashion. The echoes proper would always appear at the same place and would build up with each scan of the target. The half-tone capability would improve an essentially all-black and all-white picture.

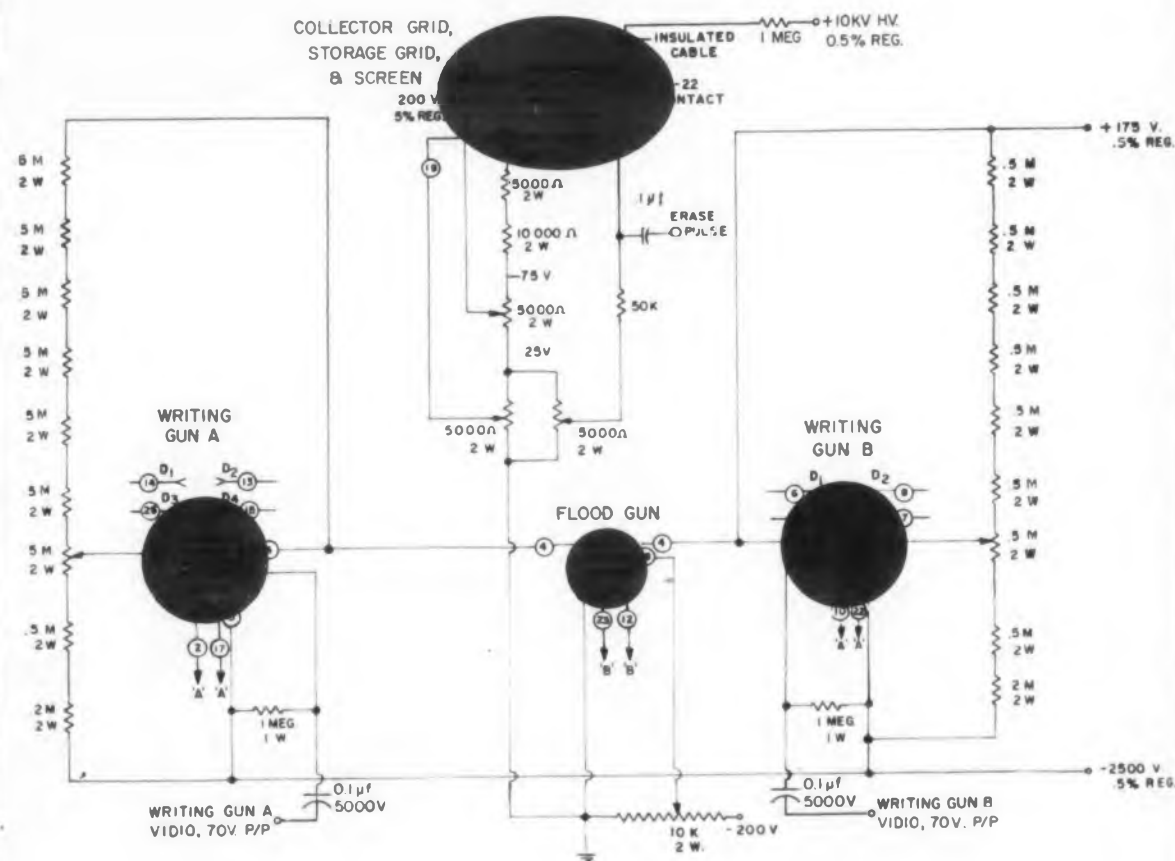

Two guns of charge-loss storage tube are deflected in parallel.



The second gun could write in information from other sources, such as another radar, a fire-control computer, written instructions locally inserted for target identification; or past history, such as flight path of the target under surveillance.

From time to time additional information might be written in by one or both guns in tabular form to indicate linear or angular velocity, momentum, or acceleration of particular targets.

Developed by the Electronic Tube Division of Allen B. DuMont Labs, Inc., of Clifton, N.J., the K1878 tube has electrostatic focus and deflection, 500-line resolution, and a half-tone range of six discernible shades.

The Storatron operates as a charged-loss, electrical-in, optical-out tube, using a flood gun to charge its grid. Electrostatic focus and deflection are used to provide the flexibility to display waveforms of any type or shape. For other applications, magnetic versions are available.

Two examples show how the Storatron might be used to solve radiation problems in medical electronics:

A short burst of high-intensity X-rays could be picked up by an X-ray-sensitive, photo-conductive camera mounted on an aluminum window. The resulting image could then be written into storage on the tube for long-time review without exposing the patient to extensive X-rays.

A second method of studying radioactivity could be used with a patient who had been given a tracer material, such as radio-iodine. All parts of the patient's body could be scanned mechanically with a scintillation scanner. The output of the scanner's multiplier could be written into the Storatron to display a complete picture of the patient's radioactivity.

#### Applications Are Many

Other applications suggested by DuMont engineers include:

Study of frequency response of quadripoles, characteristics of vacuum tubes and semiconductor devices, transient behavior of regulated power supplies, voltage variations across relay coils and switching contacts, relay operating times, and load variations in power lines.

In computer work the Storatron could be used to study pulse distortion in binary storage registers, to plot data on analog computers, and to compare various solutions directly.

The tube is available now in 10-inch versions, with a tube face radius of curvature of 42 inches. It is being developed in a 21-inch version, with a radius of curvature of 32 inches.

Through present models include only two guns, the company reports that as many as 15 could be incorporated in thicker-necked tubes.

For more information on this device, turn to the Reader-Service Card and circle 100.

## How analog techniques assure accuracy in



## vibration test systems



MB Electronics, manufacturer of complete complex motion testing systems, uses modern analog computer techniques to reproduce actual vibrational environments met in the operation of aircraft and missiles.

The MB Model T88 Complex Motion Console, which puts all the system controls within easy reach of a single operator, utilizes 10 Peak & Notch Equalizers

— each containing 8 K2-W analog DC amplifiers by

Philbrick. The equalizers are the key to test system accuracy. They adjust to the exact inverse electrical

equivalence of the mechanical system resonance, and

automatically provide the mass offset required for any table loading

condition by assuring a flat frequency response identical to that of the input voltage.

This is a special application, true. But it may provide the spark of an idea as to how you can use analog techniques — and efficient Philbrick plug-ins — to your advantage. Write for freely given opinions on your particular problem.

GEORGE A. **PHILBRICK** RESEARCHES, INC.  
285 COLUMBUS AVE., BOSTON 16, MASS. TEL. COMMONWEALTH 6-5375

### The analog way is the model way



**MODEL K2-W** — an efficient foolproof high gain operational unit for all feedback computations, fast and slow. A number of special varieties are also in quantity production. **\$24.00**



**MODEL K2-P** — offers long-term, sub millivolt stability, by itself or with the K2-W. High impedance chopper-modulated input. Filtered output to drive balancing grid or follower. **\$60.00**



**MODEL K2-WJ** — If the rigors of your application deserve a JAN-ized form of K2-W, the K2-WJ is now available. 5751 tubes and MIL standard components are used throughout at no increase in size. **\$58.00**

ALL K2 PLUG-INS RUN ON PLUS AND MINUS 300 VDC AND 6.3 VAC. SOCKET WIRING IS SIMPLE AND STANDARDIZED. CIRCLE 193 ON READER-SERVICE CARD

# NEW PRODUCTS

*Covering all new products that might generally be specified by an electronics engineer engaged in the design of original equipment.*



## Secondary-Emission Pulse Tube Has 5 $\mu$ sec Rise Time

A rise time of less than 5  $\mu$ sec with a 1-amp pulse is obtained with this secondary emission pulse tube. Currents as high as 1 amp and rep rates up to 300 kc are possible as a result of its high dissipation capabilities. Designated 7548, this 9-pin miniature tube has a transconductance of 25,000  $\mu$ mhos at 18 ma, and a gain-bandwidth product of 350. A maximum plate voltage in pulse service of 1000 v dc is possible. This tube has a life expectancy of 5000 hr.

CBS Electronics, Dept. ED, 100 Endicott St., Danvers, Mass.

CIRCLE 194 ON READER-SERVICE CARD

## Motion Sensing Device Measures $10^{-7}$ in.

The Metrisite motion sensing device allows measurements as small as  $10^{-7}$  in. Reactive force of the instrument is a fraction of a milligram; linearity from zero to full range is 0.1%. Outputs as high as 100 v are available; full-scale operation of a rectified-type meter is possible without use of an amplifier. Units are produced which measure directly either angular or linear movement, eliminating complex mechanical linkages. These devices meet military environmental shock and vibration tests, and may be adapted to a variety of configurations from subminiature to sizes capable of measuring over 4 in. of linear motion.

Brush Instruments, Dept. ED, 37 and Perkins, Cleveland 14, Ohio.

CIRCLE 195 ON READER-SERVICE CARD



## Metal Film Mica Attenuator Elements

Metal film mica attenuator elements have electrical and environmental characteristics that compare favorably with metallized glass elements. They are made of thin mica, upon which is deposited a pure metal film 6 millionths of an inch thick. The elements are used in variable attenuators above 18 kmc. They minimize slot width, reducing rf leakage. Standard mica sheets are available from 0.001 to 0.005 in. thick, with resistivities from 24 to 400 ohms per square. Elements can be hand cut to customer requirements.

Filmohm Corp., Dept. ED, 48 W. 25th St., New York 10, N.Y.

CIRCLE 196 ON READER-SERVICE CARD



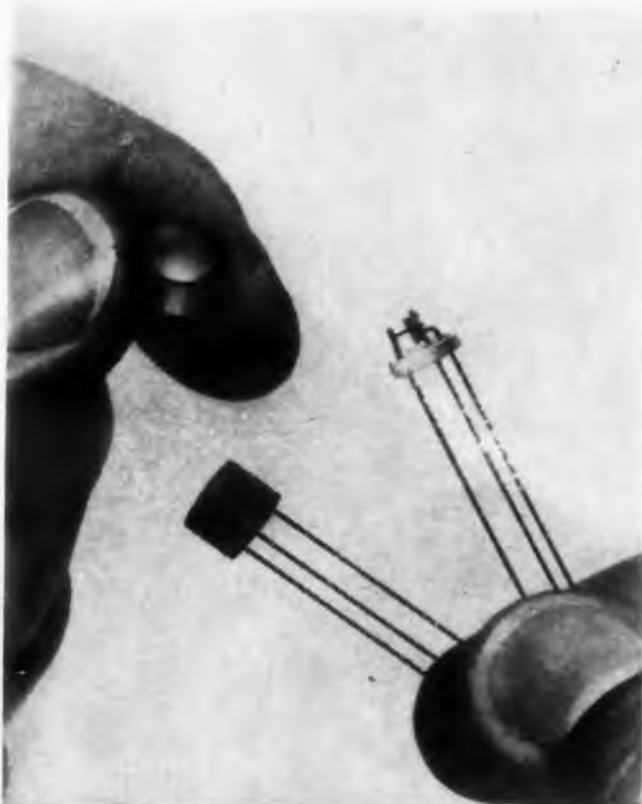

### Fifty-Cent Germanium Transistors

Germanium alloy junction transistors are available for as low as \$0.50. These general-purpose units have a direct glass-to-metal seal between the case and the header. Pnp types 2N1372 through 2N1381 dissipate 250 mw, have a 200 ma collector current, and operate to 100 C. The 2N1380 and the 2N1381 have a typical dc beta of 100; 2N1372 through 2N1379 have dc betas ranging from 30 to 300. The transistors are available with collector-to-base voltage ratings of 12, 25, or 45 v. Six pnp entertainment types include 2N1273 and 2N1274 with collector dissipation of 150 mw, collector current of 150 ma, and a typical beta of 50; the 25-v 2N1370 and the 45-v 2N1371 with betas of 80; and 2N1382 and 2N1383 with collector dissipation of 200 mw and 200 ma collector current. The entertainment types have a maximum junction temperature rating of 85 C.

Texas Instruments, Inc., Semiconductor Components Div., Dept. ED, P.O. Box 312, Dallas, Tex.

CIRCLE 197 ON READER-SERVICE CARD

### Tape Recorder Occupies 14 cu in.

This airborne tape recorder weighs 10-1/2 oz, and occupies 14 cu in. It will register information on 1 to 16 channels on a continuous tape. Able to withstand over 2000 g of shock, it consumes 1-1/2 w. This unit may be used to record space flight data and transmit it back to earth receivers. Electronic accessories, including transistor timing oscillators, bias oscillators, dc amplifiers, and battery packs are available.

Leach Corp., Dept. ED, Los Angeles, Calif.

CIRCLE 198 ON READER-SERVICE CARD

*first in  
Performance  
Reliability  
and Quality*

# Kepeco

## TRANSISTORIZED V.R.P.S.\*

\*VOLTAGE  
REGULATED  
POWER  
SUPPLIES



Model SC-32-2.5

0.01% REGULATION  
STABILITY

MODEL	DC OUTPUT VOLTS	DC OUTPUT AMPS.
SC-32-0.5	0-32	0-0.5
SC-32-1	0-32	0-1
SC-32-1.5	0-32	0-1.5
2SC-32-1.5	0-32	0-1.5
DUAL OUTPUT	0-32	0-1.5
SC-32-2.5	0-32	0-2.5
SC-32-5	0-32	0-5
SC-32-10	0-32	0-10
SC-32-15	0-32	0-15
SC-60-2	0-60	0-2
SC-60-5	0-60	0-5
2SC-100-0.2	0-100	0-0.2
DUAL OUTPUT	0-100	0-0.2
SC-150-1	0-150	0-1
SC-300-1	0-300	0-1

Model  
SC-18-2M



0.1% REGULATION  
STABILITY

MODEL	DC OUTPUT VOLTS	DC OUTPUT AMPS.
SC-18-0.5	0-18	0-0.5
SC-18-1	0-18	0-1
SC-18-2	0-18	0-2
SC-18-4	0-18	0-4
SC-36-0.5	0-36	0-0.5
SC-36-1	0-36	0-1
SC-36-2	0-36	0-2
SC-3672-0.5	36-72	0-0.5
SC-3672-1	36-72	0-1

the most  
complete  
line of  
POWER  
SUPPLIES

0.02% REGULATION  
STABILITY

COMPACT PACKAGE TYPE

MODEL	DC OUTPUT VOLTS	DC OUTPUT AMPS.
PSC- 5-2	0- 7.5	2
PSC-10-2	7.5-12.5	2
PSC-15-2	12.5-17.5	2
PSC-20-2	17.5-22.5	2
PSC-28-1	22.5-32.5	1
PSC-38-1	32.5-42.5	1

**Kepeco**  
offers more than  
120 standard voltage  
regulated power supplies  
covering a wide range  
of transistor, tube  
and magnetic types.

For complete specifications,  
write for Brochure B-591

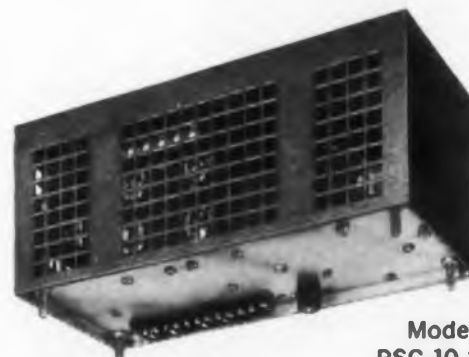

Model  
PSC-10-2



*first in  
Performance  
Reliability  
and Quality*

# Kepeco INC.

131-38 SANFORD AVENUE • FLUSHING 55, N.Y. • INDEPENDENCE 1-7000

CIRCLE 199 ON READER-SERVICE CARD

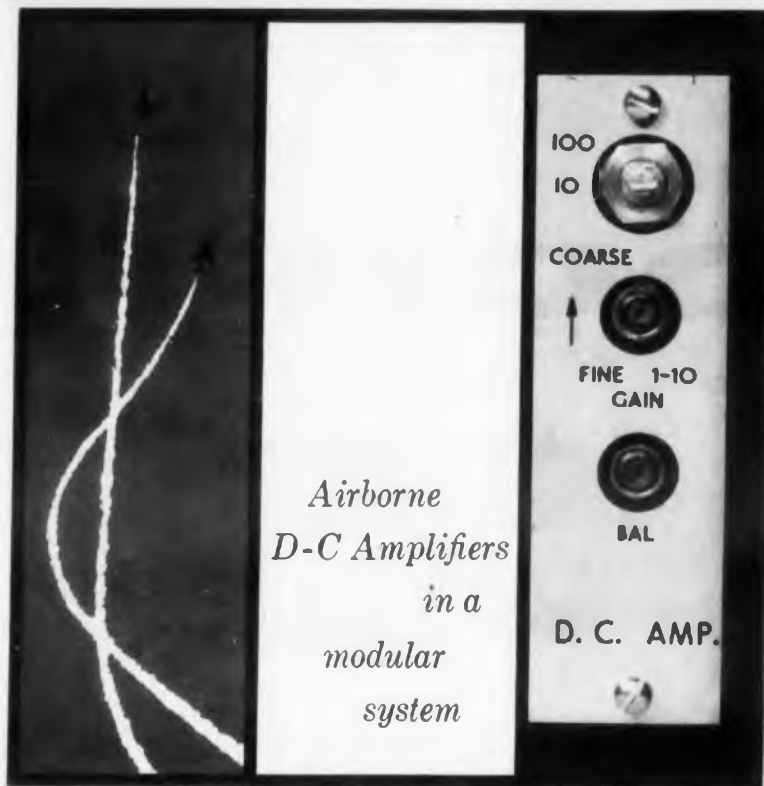

...the Neff **SCAMP** System

D-C, A-C, and Carrier Amplifiers can be combined in this miniature airborne system. The Signal Conditioning AMPlifier (SCAMP) System is completely transistorized, operates from any unregulated 28-volt d-c supply, produces 0-5 volts from millivolt inputs. *Performance is unmatched by any other equipment*



Each D-C, A-C, or Carrier Amplifier measures only 1 1/4" wide, 3 1/16" high, and 4 3/16" long. *WRITE* for full information... including the complete line of amplifiers and power supplies for ground and airborne use.

**NEFF**

**instrument  
corporation**

2211 E. Foothill Blvd., Pasadena, Calif.

CIRCLE 200 ON READER-SERVICE CARD



Ready for 100 g shock.

## Tiny, Self-Torquing Accelerometer Takes 100 G Shock

**T**HE SMALLEST LINEAR accelerometer on the market certainly has a claim to fame. But this unit, Fairchild's TA-400, boasts more than size alone. Even in its most sensitive range of 1/4 g, it can withstand 100 g shock, and vibration of 20 g from 50 to 2000 cps.

Only 7/8 inch long and 15/16 inch in diameter, the hermetically-sealed TA-400 weighs less than 2.5 ounces. A product of Fairchild Controls Corp., 225 Park Ave., Hicksville, N.Y., it claims high sensitivity, low null, low friction levels, and very small cross talk, in addition to its other

important features.

### 'Don't Rock the Boat'

Perhaps most unusual is its self-torquing feature. Additional taps on the pickoff windings allow a small external voltage to be superimposed on the pickoff. This voltage allows one to check the operation and calibration of the accelerometer easily and quickly.

Previously, to check accelerometers and gyros mounted in planes and missiles, it was necessary to actually rock or tilt the entire vehicle.





**Linear accelerometer** (shown almost twice actual size) has unusual resistance to shock and vibration.

The accelerometer's unusual shock and vibration resistance is due to several factors. Most important is the fact that the gimbal axis is supported by two pivots and jewel bearings rather than one.

The pivots and jewels absorb all but the compression and tension forces, which the torsion bar can well handle. (Most accelerometers use only one bearing and the torsion bar for supporting the mass.)

Cross talk, which depends on the g range and the percent of full range used, is never more than 4.5 per cent of full scale. This low level is due to the design which limits the maximum displacement of the mass to a mere 2-1/2 degrees.

A null as low as 15 mv, a friction level no more than 0.3 per cent of full scale, and a husky output of 6 v into a 10 K load help round out the unusual features of this accelerometer.

Leaving nothing undone, Fairchild engineers have turned the pickoff inside out. In essence, it is a variable transformer with the windings static, and thus, easier and cheaper to manufacture. The iron mass rotates around the windings.

For more information on this unusual component, turn to the Reader-Service Card and circle 101.

Circle 201 on Reader-Service Card ➤



## THIS VOLTAGE STABILITY PROBLEM HAD TO BE SOLVED

## FOR CIRCUIT RELIABILITY IN A JET ENGINE TEMPERATURE INDICATOR

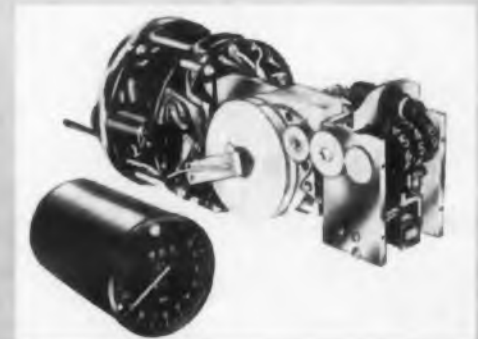

*Hoffman Zener Voltage Reference Elements were the solution*

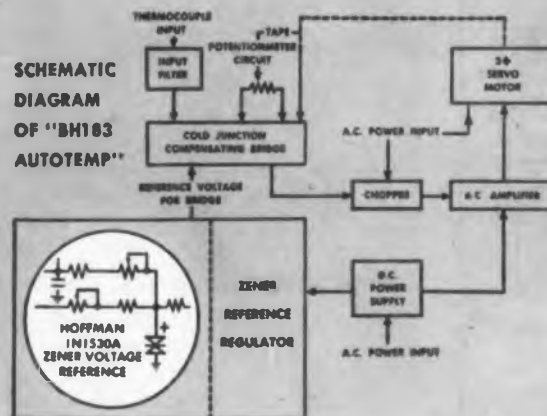

Engineers of the B & H Instrument Company, Fort Worth, Texas, required an extremely reliable voltage reference device for their BH183 AutoTemp jet engine temperature indicator, used in the Lockheed Electra. . . . They chose a Hoffman 1N1530A Zener Reference Element, because of its STABLE characteristics even when subjected to widely varying environmental conditions.

The low 8.4 volt, zener operating voltage of Hoffman 1N430 and 1N1530 Zener Reference Elements, makes them uniquely suited for use in circuits which are operating at a low D.C. voltage level (from 10 to 30 volts). The units have a voltage stability of  $\pm 0.1\%$ , or less, over a temperature range from  $-55^{\circ}\text{C}$  to  $+100^{\circ}\text{C}$ , at 10mA.

There are over 180 Hoffman Zener Devices available . . . now in the widest possible range of voltage and power dissipation ratings. Write us . . . tell us your problem . . . the Hoffman semiconductor sales engineer in your area will provide the solutions.

If you need a job in electronics done quicker and better, contact

**Hoffman Electronics**  
CORPORATION  
SEMICONDUCTOR DIVISION  
930 PITNER AVENUE EVANSTON, ILLINOIS



## PACKAGE YOUR INDUSTRIAL ELECTRONIC CONTROLS

LIKE THIS

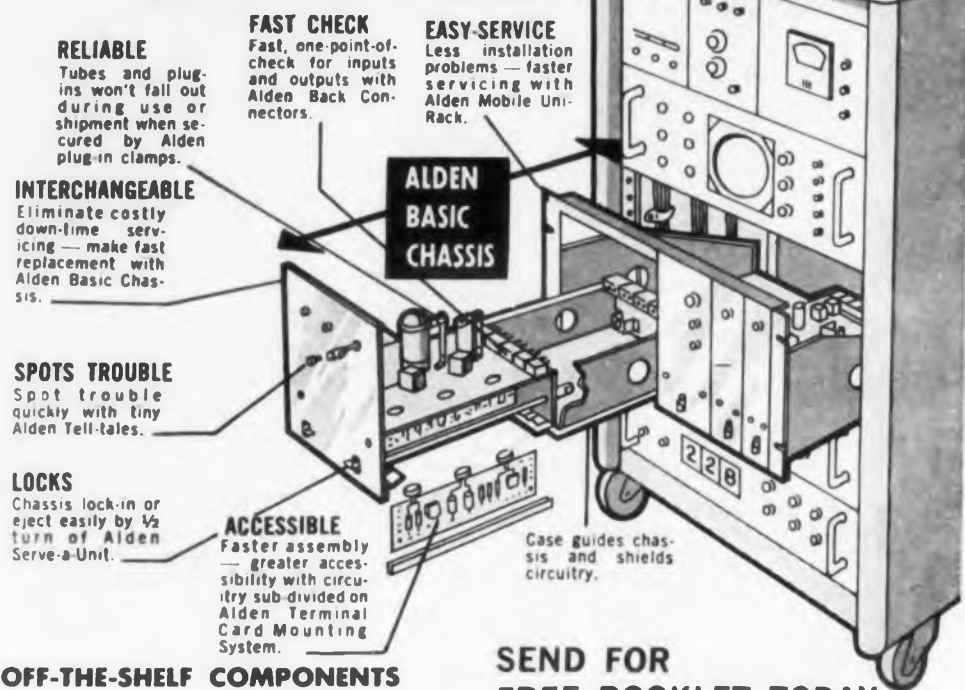

### OFF-THE-SHELF COMPONENTS

Now — you can lay out and package a unit or system — breadboard to production — with standard "off the shelf" Alden Electronic Packaging components for plug-in, modular construction. Especially suited for building engineering models, prototypes, custom instruments, test gear, controls, etc. Used widely by private and government labs, universities, and industry.

### SEND FOR FREE BOOKLET TODAY

New QUICK ORDER GUIDE gives prices and specs on most popular Alden packaging components plus 3 "Get Started Packaging Kits."

ALDEN PRODUCTS CO., 9139 N. Main Street, Brockton, Mass.  
CIRCLE 202 ON READER-SERVICE CARD

## NEW \$49.95 KIT MOVES YOU FROM SCHEMATIC TO CIRCUIT FAST & RELIABLY!



Here's an all-in-one tool for prototype and small production runs that makes it simple to organize and mount circuitry in compact, planes. It quickly swages Alden terminals, eyelets, brackets and tube sockets, and punches .101" terminal holes in Alden XXP phenolic cards or any 1/16" cold punch card. You can make up circuitry turrets in minutes — complete with terminals, brackets and sockets.

Does ALL these operations:

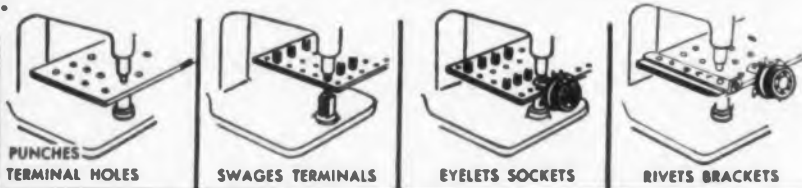

Makes ALL these parts:

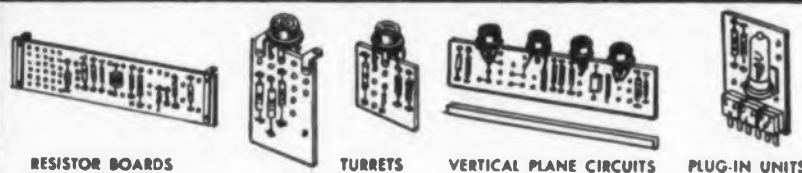

SAVE \$10 on kit over individual part prices. Contains Alden Universal Staking Tool and assortment of prepunched terminal cards, terminals, tube sockets, brackets and eyelets to get started immediately. Order Kit #42 — \$49.95 complete.

ALDEN PRODUCTS CO., 9139 N. Main Street, Brockton, Mass.  
CIRCLE 203 ON READER-SERVICE CARD

## Barratron ECM Tube Jams Radar



Tunable Barratron tube supplies broad-band white noise.

**W**HITE NOISE generated by the Barratron tube is at least ten times as effective as that produced by the magnetron.

Barratron tubes are high-power transmitting tubes capable of supplying broad-band white noise. Available in either tunable or fixed frequency models, their main application is in enemy counter-measure (ECM) jammers. Produced by Litton Industries of Beverly Hills, Calif., these tubes have many advantages over tubes presently available for this application.

The majority of systems now operational use tunable cw magnetrons. Although the magnetron itself is an efficient, compact device, the required associated circuitry and

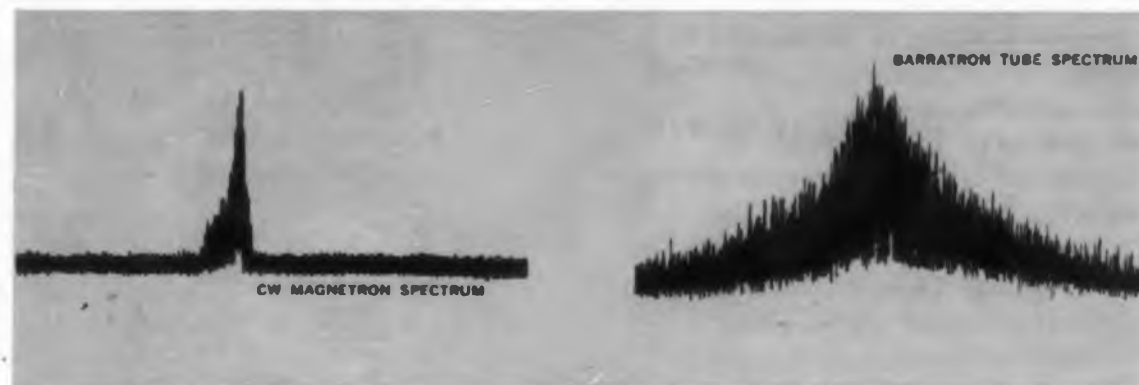

Artist's rendition of crt displays of Barratron tube spectrum and cw magnetron tube spectrum.



equipment to control it, produce an efficient and complex jammer. The tunable Barratron requires no modulator or noise generator chassis and the fixed frequency tube requires no tuning circuitry or modulator. Since the Barratron tube efficiency is comparable to that of the magnetron, the elimination of the associated equipment results in a compact and reliable jammer. The most important advantage over the magnetron is in the quality of the jamming signal—the white noise is ten times as effective as that produced by the magnetron.

Although other tube types are being developed that will be more effective as jamming tubes, they are less efficient than the magnetron or the Barratron. They also require several power supplies and external modulating circuitry. Some of these tubes are difficult to manufacture. The Barratron, however, is very similar to the cw magnetrons now in production, so that tested techniques, trained personnel and available tools can be used. This should result in a unit cost less than that of the magnetron and considerably less than that of the other tubes.

The tunable Barratrons are designed so that they are physically and electrically interchangeable with the tunable magnetrons now in use. They may be used in jammers now in use with a minimum of adjustment and/or modification. Units can be supplied to cover from uhf to well into the microwave frequencies.

The fixed frequency tubes are intended for applications in new equipment. For the first time, barrage jamming power may be developed in useful amounts from a small unit.

The Barratron tubes may be used in jammers that can be automatically or operator-controlled, depending on the nature of the mission or the space allowed for equipment. Both versions of the tube can be used in either spot or barrage jammers.

For more information on this tube, turn to the Reader-Service Card and circle 717.



# HUDSON



## -the Standard Line that's Deep-Drawn to Precision Standards\*

\*The Most Complete Line in the Industry, too!

### DESIGNERS!

For precision quality at commercial prices, consult the new HUDSON catalog. Call or write for this cost and time-saving handbook, today!



HUDSON STANDARD CASES AND COVERS offer a quick, economical solution to your military and commercial closure problems. Components of mu metal, nickel-silver, aluminum, brass, copper, steel and stainless steel are available in any required finish.

HUDSON STANDARD TOOLING saves you time and money on all but the most unusual closure applications. Check your requirements with HUDSON engineers, now!

**Hudson Tool & Die Co. Inc**  
18-38 Malvern St., Newark 5, New Jersey

Telephone: Market 4-1802  
Teletype: NK 1066

*Precision Metal Components for Electronics, Nucleonics, Avionics and General Industrial Applications*

3 MODERN PLANTS TO SERVE YOU



CIRCLE 204 ON READER-SERVICE CARD >



ESSEX EPOXY-ENCAPSULATED, HIGH RELIABILITY

# MODULAR DELAY LINES

ESSEX DELAY LINES ARE NON-FLAMMABLE!



available for  
BASE  
MOUNTING  
STACKED  
MOUNTING  
PRINTED  
CIRCUITS

Write today, on your company letterhead, for detailed specification sheet describing ESSEX high-reliability modular Delay Lines.



Essex modular Delay Lines provide greater freedom, versatility, and latitude because these compact units can be mounted both horizontally and vertically — stacked in series on common mounting screws for higher delays.

Essex provides lines from a fraction of a microsecond to several thousand microseconds delay . . . impedances from 50 to several thousand ohms . . . bandwidths up to 25 MC.



**ESSEX ELECTRONICS**  
A MEMBER OF THE **NYTRONICS** GROUP

550 SPRINGFIELD AVE., BERKELEY HEIGHTS, N. J. • CRestview 3-9300  
CIRCLE 205 ON READER-SERVICE CARD

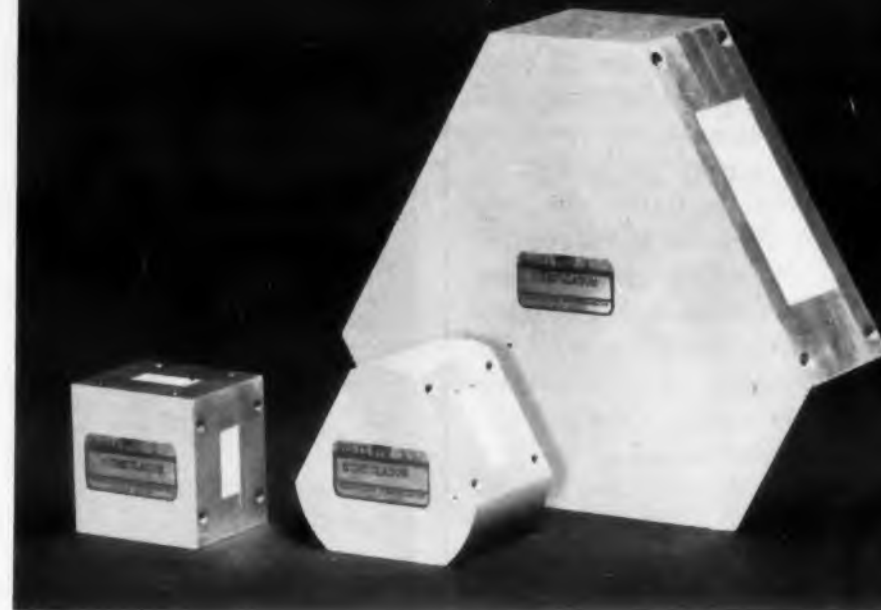

New line of circulators operating on a field displacement principle are smaller, lighter, give better isolation and less insertion loss than conventional circulators.

## Get Better Insulation with Lighter, Smaller Circulators

**A**TENTH THE SIZE and weight of conventional microwave circulators, a new line of Y, T and Cross type circulators give 0.5 db insertion loss and 20 db isolation—with 60 db isolation often achievable.

While conventional circulators

operating at X band may weigh as much as five pounds and occupy a volume of 40 cu in., the Cascade Y model weighs one pound and takes up about four cu in.

The configuration of these circulators is simpler—no transitions are needed—and leads to lower costs and greater reliability. No precision cast folded hybrid Ts are required.

Circulators now available on the shelves of Cascade Research Div. of Monogram Precision Industries, 5245 San Fernando Road, Los Angeles 39, Calif., cover X and S bands. Custom designs are available at all frequencies from 1000 to 75,000 mc. The field displacement units can handle power peaks of 100 kw and average powers of 100 w over a frequency band of five per cent or more. Maximum vswr is 1.2.

Particularly suited to parametric amplifier and maser applications because of their small size and weight, the circulators are useful in other areas: airborne attenuators, directional couplers for antennas,

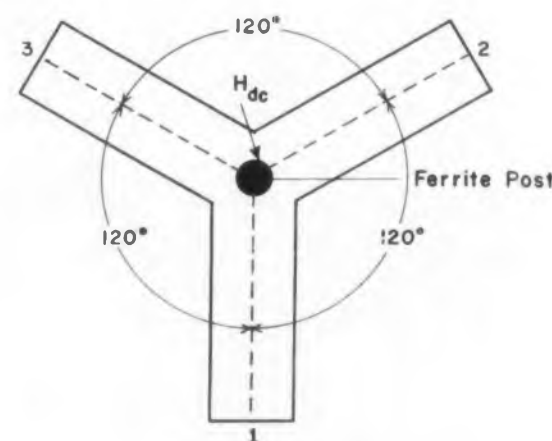

Y-Type Circulator

**Fig. 1.** Three-fold symmetry of Y type circulator is designed to make the structure appear the same when looking into any one port. But energy entering one port comes out the adjacent port.



fast nonreciprocal switches and radar duplexers. They can be used in place of high power cw isolators, since one port can be terminated in a matched load.

#### Design is New

Former circulators depended on Faraday rotation or the nonreciprocal propagation obtainable in waveguides partially loaded with ferrite. Disadvantages of the first type are that they require transitions from circular to rectangular waveguide, a longitudinal magnetic field and are very lossy at high peak power levels. Bandwidths are comparatively narrow. In the second case two hybrids and a large transverse magnet are required—making the circulator large and heavy, particularly at the lower frequencies.

Herman Chait of Cascade Research and Thornton Curry, both working at the Naval Research Laboratory, recently discovered the principles used to build the new circulators. Called the field displacement method to distinguish it from Faraday rotation or differential phase shift, it is used to design symmetrical Y or Cross, or asymmetrical T circulators. See Fig. 1.

The Y type consists of an H-plane junction—three identical waveguides joined to form a symmetrical Y-shaped figure. The Cross type is similar to the Y, except the angle of intersection of the guide is 90 deg instead of 120 deg.

The junction region contains a symmetrical distribution of transversely magnetized ferrite. Since the magnetized ferrite is an anisotropic medium, the junction is not symmetrical electrically. The asymmetrical field distribution occurs because the rf magnetic field is elliptically polarized in planes parallel to the broad faces of the guide and in opposite sense to either side. Since the effective rf permeability of the magnetized ferrite depends on the strength of polarization, the two sides of the loaded waveguide are electrically dissimilar.

For further information on these microwave circulators, turn to the Reader-Service card and circle 715.

CIRCLE 206 ON READER-SERVICE CARD ➤

STABLE  
VOLTAGE  
FOR LIFE...



# NEW ULTRA-STABLE ZENER DIODES

Type	SPECIFICATIONS			RATINGS		
	Voltage Range at $I_z = 7.5$ ma at 25°C (Volts)		Temp. Coefficient <sup>2</sup> (-55°C to +100°C) at $I_z = 7.5$ ma (%/°C)	Maximum Dynamic <sup>3</sup> Resistance at 25°C at $I_z = 7.5$ ma (ohms)	Operating and Storage Temperature Range (°C)	Max. Operating Temp. at $I_z = 7.5$ ma (°C)
	Min.	Max.				
1N821	5.9	6.5	± 01	15	-65 to +150	+125
1N822 <sup>1</sup>	± 5.9	± 6.5	± 01	15	-65 to +150	+125
1N823	5.9	6.5	± 005	15	-65 to +150	+125
1N824 <sup>1</sup>	± 5.9	± 6.5	± 005	15	-65 to +150	+125
1N825	5.9	6.5	± 002	15	-65 to +150	+125
1N827	5.9	6.5	± 001	15	-65 to +150	+125

<sup>1</sup>Double anode types.  
<sup>2</sup>Determined by measuring a change of voltage from -55°C to +25°C and a change of voltage from +25°C to 100°C.  
<sup>3</sup>The Dynamic Resistance is measured by superimposing a small A.C. Signal upon the test D.C. Current.  
 (Iac RMS = 1/10 Ioc Test)

1N822 and 1N824 types meet all specifications, including temperature coefficient, in both directions.

This new line of subminiature silicon voltage references features a combined lower dynamic resistance and voltage stability exceeding that of any standard cell.

Manufactured by diffusion, these devices offer temperature coefficients as low as 0.001% °C. Unique single piece construction enables the reference to maintain excellent voltage stability when subjected to severe thermal shocks. Axial lead design and hermetically sealed glass encapsulation insure a rugged unit capable of providing long term reliability over wide ranges of environmental conditions.

These new subminiature references are also available in double anode types for symmetrical clipping applications.

Send for bulletin TE-1352.

<i>Select from the nation's broadest line of regulators and references, including these types:</i>	Rating	Type Number
	250 MW	SV5 - SV24
	250 MW	1N708 - 1N745
	400 MW	1N746 - 1N759
	750 MW	SV804 - SV824
	1 WATT	1N1765 - 1N1802
10 WATT	SV904 - SV924	

Contact your nearest authorized Transistron industrial distributor for in-stock quantities 1-999.

# Transistron



electronic corporation • wakefield, massachusetts

"Leadership in Semiconductors"

friend or foe?

**The way to know** — An ominous shadow over ocean or wasteland... an unidentified "blip" on a radar scope! A challenge from an airborne AN/APX-7 interrogating unit spurts into the ether. In microseconds a reply identifies the potential marauder as friendly. The absence of such a reply alerts the protective and retaliatory might of the nation.



CIRCLE 743 ON READER-SERVICE CARD

**ENGINEERING BEYOND THE EXPECTED**  
Packard Bell's reputation as a leading designer and foremost producer of IFF (identification, friend or foe) equipment is indicated by the fact that both the AN/APX-7 and the AN/APX-6, which returns the reply, are products of our Technical Products Division. Advanced development, company-sponsored, has recently produced miniaturized IFF modules which operate up to 200°C.

### PACKARD BELL ELECTRONICS

Technical Products Division  
12333 W. Olympic Blvd.  
Los Angeles 64, Calif. • BR. 2-6141

## NEW PRODUCTS

### Attenuator

Adjustable



Type 609 adjustable attenuator provides settings from 0.3 to 30.0 db at vswr values from 1.05 to 1.15. Shielding properties provide interference-free operation at low rf levels. Constructed of RG-67/U aluminum waveguide, and equipped with standard flange connectors, the unit weighs 3-1/2 oz. The frequency range is 8.2 to 12.4 mc; insertion length is 3-1/2 in. The instrument is finished in Iridite.

Waveline, Inc., Dept. ED, Caldwell, N.J.

CIRCLE 744 ON READER-SERVICE CARD

### Waveform Synthesizer

Uses plug-in units



Type 200 waveform synthesizer permits almost unlimited configuration by using different plug-in units which control small segments of the total waveform. With type A variable slope unit, the amplitude and slope of each of 50 increments, may be independently varied without interaction. When used with type C variable width unit, the synthesizer produces 50 output pulses with independently variable width as well as amplitude. Over-all amplitude and waveform duration may be varied over a wide range with both auxiliary units.

Exact Electronics, Inc., Dept. ED, 504 Hughes Bldg., 115 S.W. Fourth Ave., Portland 4, Ore.

CIRCLE 745 ON READER-SERVICE CARD





### Convection Ovens

Temperature range is 150  
to 1200 F

These mechanical convection ovens have a temperature range of 150 to 1200 F and maintain an actual control point of  $\pm 2$  deg F. Interiors are stainless steel construction. Four standard sizes, from 1 to 11 cu ft, are available. The requirements of MIL-H-6088A are met.

Blue M Electric Co., Dept. ED, 138th and Chatham St., Blue Island, Ill.

CIRCLE 746 ON READER-SERVICE CARD

### Terminal Blocks

Available in six- and ten-terminal sizes



Designed for connection between printed circuits and external wiring, type 399 six- and ten-terminal blocks are made of glass-fiber-filled diallyl phtalate as specified in MIL-L-19833. The insulation resistance is  $5 \times 10^6$  meg,  $2 \times 10^5$  meg after 3 hr at 280 F, or  $2 \times 10^6$  meg after 30 days at 80 F. Working voltage is 1550 v dc.

Kulka Electric Corp., Dept. ED, 633-643 S. Fulton Ave., Mt. Vernon, N.Y.

CIRCLE 747 ON READER-SERVICE CARD



### DC Motor

Has 1-3/4 hp

Designed for actuator service, model 49EC1, a 26 v dc motor, has 1-3/4 hp and is compound wound, reversible type. Its speed is 10,500 rpm and the brake has a static torque of 500 oz-in. It conforms to MIL-M-H609A. Dimensions are 7 in. length and 4 in. diam.

Western Gear Corp., Dept. ED, 132 W. Colorado Blvd., Pasadena, Calif.

CIRCLE 748 ON READER-SERVICE CARD

# REPORT CARD FOR A DELAY LINE...



ESC was the first to provide complete laboratory reports with each delay line prototype—containing submitted electrical requirements, photo-oscillograms (which indicate input and output pulse shape and output rise time), the test equipment used, and an evaluation of the electrical characteristics of the prototype. ESC

was also the first company devoted exclusively to the design and manufacture of custom-built and stock delay lines... for all military and industrial applications.

Whatever the application, ESC can design and build precisely the delay line you need—easily, efficiently and exactly as specified.



# ESC

**CORPORATION** 534 Bergen Boulevard, Palisades Park, New Jersey

Distributed constant delay lines • Lumped-constant delay lines • Variable delay networks • Continuously variable delay lines • Pushbutton decade delay lines • Shift registers • Pulse transformers • Medium and low power transformers • Filters of all types • Pulse-forming networks • Miniature plug-in encapsulated circuit assemblies

CIRCLE 749 ON READER-SERVICE CARD

# RELIABLE CONNECTIONS



... with  
**LOW COST EYELETS**

Eyelets give you unlimited opportunities for savings as connectors, fasteners, terminals, bushings, contacts for switches and hundreds of similar applications. Only with United Eyelets do you have such a wide choice of standardized sizes, special designs for cutting costs on unusual production problems, combined with a comprehensive line of the most versatile eyelet setting machines available.

In no other way can you get the flexibility obtainable with eyelets at comparable installed costs. Call or write us today for more information. Our national sales and service organization is ready to help with your most challenging problem.



**NEW MINIATURIZED EYELETS** as connectors and fasteners for low cost, high speed insertion in components, PW boards, miniature equipment. Designed for high speed automatic feeding with United Machines. Copper or brass.

**CUT COSTS WITH SHEARED EYELETS** as stand-off terminals. Set as many as 3000 terminals per hour. Cuts soldering time too.



**NEW EYELET SELECTOR — FREE**

Simplify design, purchasing, inventory, and production. Decide the hole size and grip, and set the calculator to find the exact eyelet you need. Send for your free copy today!



**NEW FUNNEL FLANGE** eyelets designed especially as connectors for PW boards. Solves two-sided circuitry and solder problems. Speeds insertion. Are fed and set automatically on United Machines.



Simultaneous multiple eyeleting from either or both sides of machine. Typical six eyelet application illustrated. 50 years' experience is your assurance of complete dependability.

## United

**UNITED SHOE MACHINERY CORPORATION**  
Boston 7, Massachusetts • Liberty 2-9100

Branches: Atlanta, Ga. • Chicago, Ill. • Cincinnati, Cleveland, Columbus, Ohio • Dallas, Texas • Harrisburg, Pa. • Johnson City, N. Y. • Los Angeles, Calif. • Lynchburg, Va. • Milwaukee, Wisc. • Nashville, Tenn. • New York, N. Y. • Philadelphia, Pa. • Rochester, N. Y. • St. Louis, Mo.

**CIRCLE 750 ON READER-SERVICE CARD**

## NEW PRODUCTS

### Printed Networks

Ceramic base



Bulplate printed ceramic-base networks are used in radio and TV receivers, and hi-fi; networks for special applications are also available. Included are detector-pentode coupling, diode filter, fm discriminator, automatic gain control, phase comparator, vertical integrator, tone control compensation, audio multivibrator, and photo-multiplier tube divider networks. They operate at temperatures up to 85 C; units rated to 105 and 125 C are also available.

Sprague Electric Co., Dept. ED, N. Adams, Mass.

**CIRCLE 751 ON READER-SERVICE CARD**



### Spectrum Analyzer

Narrow band

Model 123 narrow band, rf spectrum analyzer may be used to determine the spectra of spurious am and fm modulations at frequencies close to carrier. Applications include analytical work on the performance of oscillators and systems developed for continuous wave doppler radar. The instrument can be supplied for frequency ranges of 5.4 to 14.1 kmc; a single unit may be used with several rf heads to cover more than one band. The spectrum analyzer range is 500 cps to 90 kc. The resolution is 70 cps and the am sideband power can be measured down to  $-135 \pm 2$  db with respect to total signal power level.

Ferranti Electric Inc., Dept. ED, 95 Madison Ave., Hempstead, L.I., N.Y.

**CIRCLE 752 ON READER-SERVICE CARD**



## Resistance Comparator

Has an accuracy of  $\pm 0.2\%$

The resistance comparator checks the values of resistors for sorting or matching purposes. It has an operating range of 50 ohms to 2 meg and an accuracy of  $\pm 0.2\%$  or better. The types of measurements possible with this unit include reading the per-cent deviation from a standard value, checking unknowns against upper and lower limits, and trimming series resistors to a standard value.

Technitrol Engineering Co., Dept. ED, 1952 E. Alleghany Ave., Philadelphia 34, Pa.

CIRCLE 753 ON READER-SERVICE CARD

## Digital Indicator and Printer

Records liquid fuel weights



Model 177 digital indicator and printer records liquid fuel weights in missiles. The instrument gives continuous monitoring and permanent periodic recording at rates up to two readings per sec. Controls are provided for run and calibration selection. Accuracy is better than 0.1% of reading.

Gilmore Industries, Inc., Dept. ED, 13015 Woodland Ave., Cleveland 20, Ohio.

CIRCLE 754 ON READER-SERVICE CARD

## Correction Notice

It was erroneously reported in the August 19 issue, p. 121, that the three-range analog frequency meter, model T-4, had an accuracy of  $\pm 17\%$ . This instrument, manufactured by Jones-Porter Instrument Co., Inc., of Milburn, N.J., has, in fact, an exceptional  $\pm 0.25\%$  accuracy.

CIRCLE 755 ON READER-SERVICE CARD

# CLARE relays and stepping switches

## INSURE ACCURACY, INCREASE RELIABILITY, REDUCE SIZE of

## PRATT & WHITNEY'S Numerical Control...

Pratt & Whitney's Numerical Control is a fully automatic, ultra-precise means of translating blueprint data into a series of machine positions. Applied to jig borers and other precision Pratt & Whitney machine tools, settings are made quickly, with high reliability to .0001" accuracy.

In operation, the Planning Engineer transfers to a Numerical Planning Chart all dimensional data from the blueprints which are necessary to determine the positions. Ordinary clerical help then punch these data into a tape. Machine positionings are then controlled by the tape or, when required, by a dial on the Operator's Console.

Here is what P&W's Mark H. Sluis has to say about the vital part played by Clare Relays and Stepping Switches:

"In the 4EA Numerically Controlled Jig Borer, punched-tape information is decoded by Clare Type J Relays and fed to a storage bank of 25 Clare Type 11 Stepping Switches. The selection of the proper storage switch is accomplished by a distributor—a Clare Type 26 Stepping Switch. In addition to storing the required command data for the slide positioning of this machine, logic circuitry comprises some 115 Clare Type J Relays.

"For ultra-reliability of the digit-selection circuitry, a dozen Clare Type HG4 four-pole Mercury-wetted Contact Relays are utilized.

"Through use of the Clare relays and stepping switches, our circuitry has increased in reliability, and a large contribution was made which enabled us to realize a 6:1 size reduction of the control system."

For complete information on Clare Relays and Stepping Switches contact C. P. Clare & Co., 3101 Pratt Blvd., Chicago 45, Illinois. In Canada: C. P. Clare Canada Ltd., P. O. Box 134, Downsview, Ontario. Cable Address: CLARELAY

# CLARE RELAYS

First in the  
Industrial Field



One of five banks of Clare Type J Relays in P&W Numerical Control. At left, in cylindrical can, a Clare Type HG4 Mercury-wetted Contact Relay.

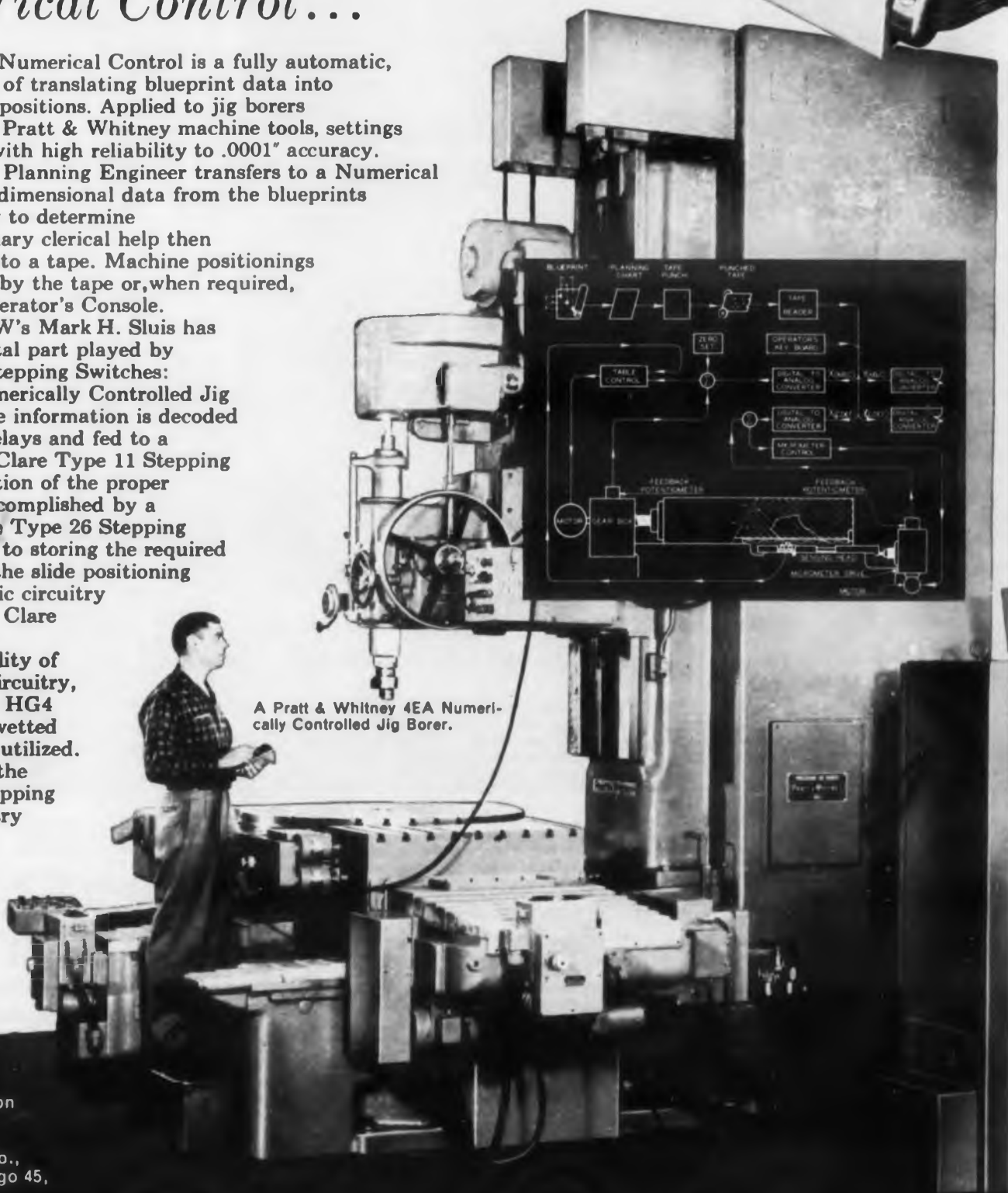

A Pratt & Whitney 4EA Numerically Controlled Jig Borer.

s are  
works  
e. In-  
filter,  
phase  
com-  
multi-  
tem-  
125 C

dams,

izer

lyzer  
rious  
se to  
k on  
evel-  
e in-  
es of  
with  
The  
The  
ower  
h re-

lison

959

# THE AMCO MODULAR INSTRUMENT ENCLOSURE SYSTEM



**CUSTOM**



**SEMI-CUSTOM**



**ALUMINUM**

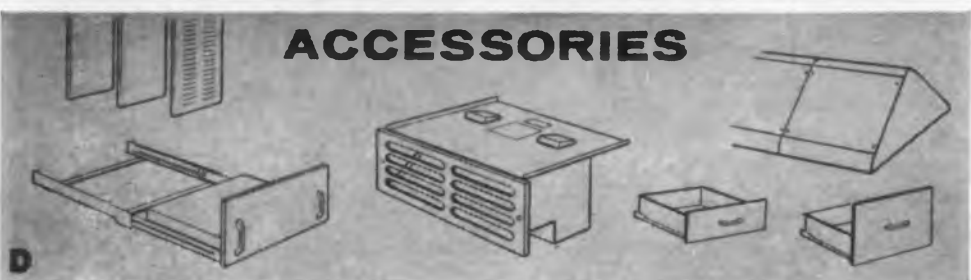

**ACCESSORIES**

## TWO COMPLETELY NEW LINES ADDED IN STEEL AND ALUMINUM TO GIVE 3 COMPLETE MODULAR FRAME LINES IN ONE OVER-ALL SYSTEM

**A Amco Custom Line.** Removable multi-panels and cowlings based on 19" increments of width. Custom, single-unit appearance for frames mounted in series—ideally suited for complex console arrangements. The 19<sup>1</sup>/<sub>16</sub>" width of frame saves space in series mounting of frames. Constructed of double-channel 16 gauge cold-rolled steel. Conforms to EIA mounting standards.

**B Amco Semi-Custom Line.** Removable multi-width cowlings provide a semi-custom, single-unit appearance for frames mounted in series. Extra rugged, wide box-type channel frames provide greater internal mounting area. 19" wide panels of any thickness can be recessed—from a flush-mounted position to any desired depth. Box type channel construction of 14 gauge cold-rolled steel. Conforms to EIA mounting standards.

**C Amco Aluminum Line.** This system of aluminum box extrusions and cast corners allows easy assembly of cabinets in any size from 7" to 20" in height, width or depth. Corners and extrusions

lock together by hand with built-in locking device. All sizes are standard. Ideal for stocking and odd-ball sizes. Cast and hardened corners of 356-T6 aluminum as described in Federal Spec. QQ-A-596a. Extrusions of 6061-T6 aluminum as described in Federal Spec. QQ-A-270a.

**D Amco Accessories.** A full line of Amco integrated accessories such as blowers, chassis slides and mounts, lighting, doors, drawers, dollies and many more available for A, B and C shown.

**Cost savings.** All the above—or any part thereof—may be ordered under one combined discount schedule base determined by order dollar value. Orders received at one time with one delivery date may also be combined. Free pre-assembly by Amco provides additional savings in time and installation.

**3 week delivery on all standard parts.** We welcome inspection of our plant and facilities. Send for your free literature now.

SEE US IN BOOTH # 3616-3618

**AMCO ENGINEERING CO.**

7333 W. Ainslie Street, Chicago 31, Illinois

CIRCLE 755 ON READER-SERVICE CARD



## NEW PRODUCTS

### Pressure Transducers

Ratings are 0 to 100 through 0 to 5000 psig



Used to measure full system differential pressures at each port, models SP2-399 and SP2-517 pressure transducers have ratings from 0 to 100 through 0 to 5000 psig. The sensitivity is 2 to 4 mv per volt. The temperature range is -28 to +275 F and compensation can hold the thermal zero shift to less than  $\pm 0.01\%$  of full scale per deg F. Model SP2-399 has a four-conductor pigtail and model SP2-517 is furnished with a pigmy connector. The units use two half-bridge elements connected in a full bridge with all active legs. Errors from non-linearity and hysteresis combined are less than 1%. Nominal bridge impedances are 350 to 900 ohms.

Standard Controls, Inc., Dept. ED, 1130 Poplar Place, Seattle 44, Wash.

CIRCLE 756 ON READER-SERVICE CARD

### Linear Motion Potentiometer

Operates at -65 to +500 F



Model 113 linear motion potentiometer operates at temperatures of -65 to +500 F. It gives precise electrical indication of mechanical position when used with hydraulic actuators, pneumatic valves, and linkage components. The unit operates with a high level ac or dc signal, requiring no amplification for use in recording, control, and telemetering circuits. The resistance element termination, designated Silverweld, is a metal-to-metal bond. Resistances available are: 1000, 2000, 5000, 10,000, and 20,000 ohms. Resolution is from 0.0013 to 0.0035 in., travel range is to 1.31 in., and power rating is 4 w at 40 C. Dimensions are 1/2 x 5/8 x 2-1/2 in.

Bourns, Inc., Dept. ED, P.O. Box 2112, Riverside, Calif.

CIRCLE 757 ON READER-SERVICE CARD

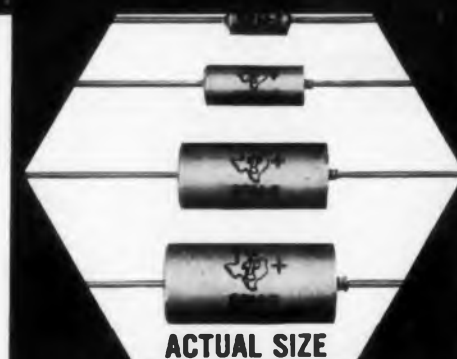

ACTUAL SIZE

# NEW

## TI HIGH-RELIABILITY TANTALUM CAPACITOR SERIES FROM

### Lafayette Radio



YOUR AUTHORIZED TI DISTRIBUTOR

125°C operation  
standard  $\pm 10\%$  tolerance

SRM capacitors meeting the most exacting reliability standards are now yours through advanced TI processing techniques and 100% testing of pre-aged units.

134 ratings from 1-330  $\mu$ f, 6-35 v. Exceeding all existing MIL specs over a full range of industry-standard ratings and case sizes, the subminiature SRM series features . . . new low dc leakage limits and long operating and storage life . . . standard  $\pm 10\%$  tolerance . . . operation from -80°C to +125°C . . . ruggedized construction . . . reverse voltage capabilities . . . nominal voltage derating required at 125°C.

For your highest reliability requirements, specify Texas Instruments premium performance solid tantalum capacitors.

TI semiconductors and components are available off-the-shelf at factory prices in the following quantities:

1-999 silicon transistors germanium transistors silicon diodes and rectifiers carbon film resistors. sensistor silicon resistors: 1-499 tan-TI-cap tantalum capacitors: 1-99.

## Lafayette Radio

Department TI-D  
BOSTON 10, Mass.  
110 Federal St.  
HU 2-7850

JAMAICA 33, N.Y.  
165-08 Liberty Ave.  
AX 1-7000

PLAINFIELD, New Jersey  
139 W. 2nd St.  
PL 6-4718

NEWARK 2, New Jersey  
24 Central Ave.  
MA 2-1661

NEW YORK 13, N.Y.  
100 6th Ave.  
WO 6-5300



## Pressure Switch

Weights 4 oz

The 1580 pressure switch weighs 4 oz max, and is 3 in. long by 1.5 in. at its widest diameter. Ambient operating temperature range is -65 to +300 F. It is factory-set to actuate at any desired pressure level within the range of 0.5 to 4000 psi. The unit is environmentally sealed by O-rings at each end of the aluminum housing.

Haydon Switch, Inc., Dept. ED, Waterbury 20, Conn.

CIRCLE 334 ON READER-SERVICE CARD

## Servo Amplifier and Power Supply

Control wide range of ac servo motors

These servo amplifier and power supply units control a wide range of ac servo motors with mechanical power outputs up to 10 w. The amplifier accepts low level ac signals from transducers and from an ac feedback tachometer. Output power is available at various impedance levels through a combined matching and isolation transformer. Pilot lights indicate input and output voltage, and separate fuses protect the ac supply line from filament and dc voltage circuit overloads.

Seneca Falls Machine Co., Electronics Div., Dept. ED, 19 Fyfe Bldg., Seneca Falls, N.Y.

CIRCLE 335 ON READER-SERVICE CARD

## Epoxy Resin Kit

Requires no refrigeration

Model PPC kit contains TC-459 flexible epoxy resin in preproportioned cartridges for use in potting junctions and connectors. Requiring no refrigeration, the resin is mixed in the cartridge prior to use in either standard Semco or Pyle sealant guns. The resin is non-toxic and practically odorless. Cartridge resin capacity is 175 g. The kit weighs 8 oz.

Electronic Production & Development, Inc., Chemical Div., Dept. ED, 205 S. Beverly Drive, Beverly Hills, Calif.

CIRCLE 336 ON READER-SERVICE CARD

CIRCLE 337 ON READER-SERVICE CARD >



## Engineers tuning EIMAC klystron amplifier at WESCON find it non-critical, reliable

For one of the few times outside field applications and test installations, engineers had an opportunity to tune an Eimac Klystron amplifier on the air during WESCON in San Francisco in August.

The klystron amplifier was operated at 800 megacycles with output power of one kilowatt. Engineers tuning this equipment were impressed with the simplicity of its non-critical operation. Participants found Eimac's external cavity klystrons as easy to tune as a lower frequency negative-grid amplifier.

This dramatic demonstration featured

the same type of Eimac Klystron already famous for outstanding long-life, reliability and performance in such troposcatter systems as Dew Line, White Alice and Texas Towers.

An animated display depicting the effect of velocity modulation on electron flow illustrated the circuit isolation and thermal safety factors that make klystrons ideal for UHF microwave applications.

A wide selection of Eimac klystrons, reflex klystrons, traveling wave tubes and negative grid tubes were displayed. Exhibits of Eimac's advanced work in

traveling wave tubes were of particular interest to engineers confronted with rugged environmental applications.

For detailed information on latest Eimac developments, write to our Amateur Service Department for your copy of "What's New With The Electron... 1959."

**EITEL-McCULLOUGH, INC.**



SAN CARLOS, CALIFORNIA

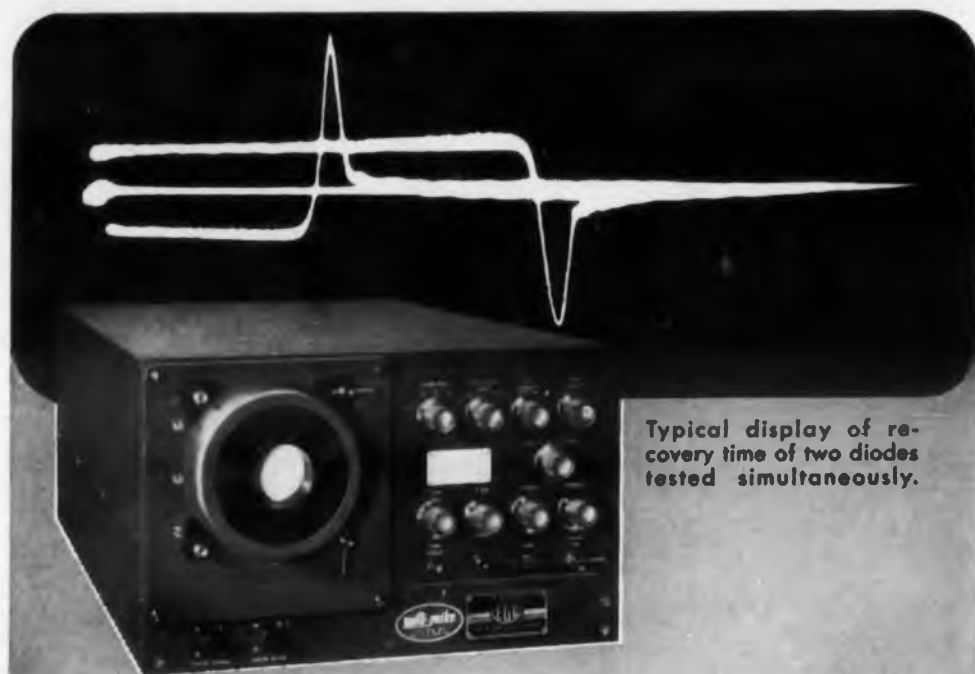

Typical display of recovery time of two diodes tested simultaneously.

# 2 FROM 1

GET DUAL POSITION OPERATION FOR QUALITY CONTROL TESTING OF FAST RECOVERY DIODES WITH THE **EG&G MILLI-MIKE OSCILLOSCOPE**

Now two operators can use the same EG&G Type 2236A Milli-Mike Oscilloscope at the same time. It's like getting two oscilloscopes—(EG&G Oscilloscopes)—for the price of one!

#### TYPE 2236A PERFORMANCE DATA

	Vertical (TW)	Horizontal
Sensibility	.054 v / trace width	0.30 v / trace width
Nominal Spot Size (trace width)	0.002 inch	
Deflection	27 v / inch (nominal)	150 v / inch
Frequency Response	DC to greater than 3,000 mc (-3db at approx. 2,000 mc)	
Input Impedance	50 or 100 ohms	
Writing Speed	3 x 10 <sup>11</sup> trace widths / sec.	

The EG&G Milli-Mike Oscilloscope—one of a family of millimicrosecond instruments—is now being used to solve problems in measurement of high speed semiconductors, decay times of scintillators, discontinuities in transmission lines and as a synchroscope in high resolution radar systems. For information on this and other millimicrosecond pulse techniques, write to Application Engineering Group.

**milli-mike** **EDGERTON, GERMESHAUSEN & GRIER, INC.**

160 BROOKLINE AVENUE, BOSTON 15, MASS. 1622 SOUTH "A" STREET, LAS VEGAS, NEV.

CIRCLE 338 ON READER-SERVICE CARD

## NEW PRODUCTS



### Direct Current Solenoids

Both pull and push types

This line of dc solenoids consists of the P series comprising the pull type and the Q series comprising the push type. The pull capacity when used without protective switch ranges from 4 lb at 0.5 in. stroke to 100 lb at 7 in. stroke. The pull with protective switch ranges from 10 lb at 1-1/4 in. stroke to 600 lb at 7 in. stroke. These units are available bottom mounted, top mounted, or wall mounted. Rated up to 750 v, their diameters range from 2.25 to 12 in. with overall height from 3-3/16 to 17-3/16 in.

Trombetta Solenoid Corp., Dept. ED, 329 N. Milwaukee St., Milwaukee 2, Wis.

CIRCLE 339 ON READER-SERVICE CARD

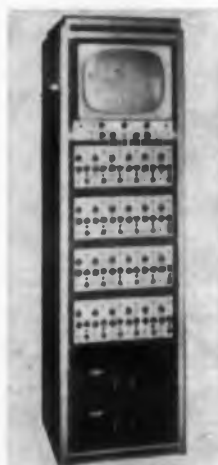

### Oscilloscope

Displays to 24 channels

Model RM-24 oscilloscope uses a 17 in. persistent cathode ray tube to display up to 24 channels simultaneously. Applications for the unit are studies in time and motion, stress, strain, vibration, pressures, and analog functions. All input circuits are dc with 10 mv per in. sensitivity. Response is from dc to 3500 cps. Time is calibrated from 100 μsec per cm to 1 sec per cm; the time base features both recurrent and triggered sweep. An external power supply with regulated dc sources is provided either for external mounting with rack model or internal mounting with console model.

Rycom Instruments, Div. of Railway Communications, Inc., Dept. ED, 9351 E. 59th St., Raytown, Mo.

CIRCLE 340 ON READER-SERVICE CARD

# DURANT

(BOOTH 817 — ISA SHOW)  
**DIGITAL**

## READ-OUT COUNTERS

Model "Y" SERIES



Model "D" SERIES

for **MISSILE TRACKING, RADAR CONTROLS, COMPUTERS, NAVIGATION INSTRUMENTS, GAUGING INSTRUMENTS, and ANY other indicator applications.**

- Meets military specifications.
- High speeds, lower torque, lower moment of inertia for long life.
- Nylon wheels with legible figures, nylatron pinions.
- Single, 1 1/2, or double width wheels.
- One-piece aluminum die cast frame.
- Base mounting. Threaded mounting holes may be in frame top or ends.
- Right or left hand drive, clockwise or anti-clockwise rotation.
- "Y" Series, single or dual bank types.
- Component parts can be purchased separately to meet design requirements.

*Your answer to an infinite number of variable demands for PRECISION CONTROLS.*

Send for Catalog No. 400

**DURANT**  
MANUFACTURING COMPANY

1993 N. Buffum Street  
Milwaukee 1, Wisconsin

9 Thurbers Avenue  
Providence 5, R. I.

REPRESENTATIVES IN ALL PRINCIPAL CITIES  
CIRCLE 341 ON READER-SERVICE CARD





### Photovoltaic Readout Matrices

Response time is about 10  $\mu$ sec

These silicon photovoltaic readout matrices have a response time of about 10  $\mu$ sec. Typical current generated is 300  $\mu$ a for 0.01 sq in. of active cell area at 1000 ft-c illumination. The units can be supplied in single cell or multiple cell assemblies. They are made for use in computer and data processing equipment.

International Rectifier Corp., Dept. ED, 1521 E. Grand Ave., El Segundo, Calif.

CIRCLE 342 ON READER-SERVICE CARD

### Repeat Cycle Dial Timers

Explosionproof

Miniature series 306A Duo-Set dial timers control two independently adjustable load circuits, eliminating the need for two timers. They are contained in explosionproof cases that meet NEMA specifications of Class I, Group D and Class I, Groups E, F, and G. Repeat accuracy is 0.33% and load ratings are 10 amp at 115 v ac, 5 amp at 230 v ac, or 0.25 amp at 115 v dc. A knob sets time intervals from 1/2 sec to 4 hr in a wide selection of dial ranges, and timing ranges may be altered in 2 min by changing the timer motor and dial.

Automatic Timing & Controls, Inc., Dept. ED, King of Prussia, Pa.

CIRCLE 343 ON READER-SERVICE CARD



### Switches

Toggle-actuated

The 5300 series toggle switch assemblies are available with from 1 to 8 pole, double-throw contact arrangements. Toggle actuation can be either 2 or 3 position, in various combinations of positions. The switches are rated at 5 amp resistive, 3 amp inductive, at 30 v dc and 115 v ac. Three terminal designs are available: solder hole type, turret type or double turret type. Any toggle switch assembly can be furnished with either the standard type of bushing or the panel seal version.

Haydon Switch, Inc., Dept. ED, Waterbury 20, Conn.

CIRCLE 344 ON READER-SERVICE CARD

### PUTTING MAGNETICS TO WORK

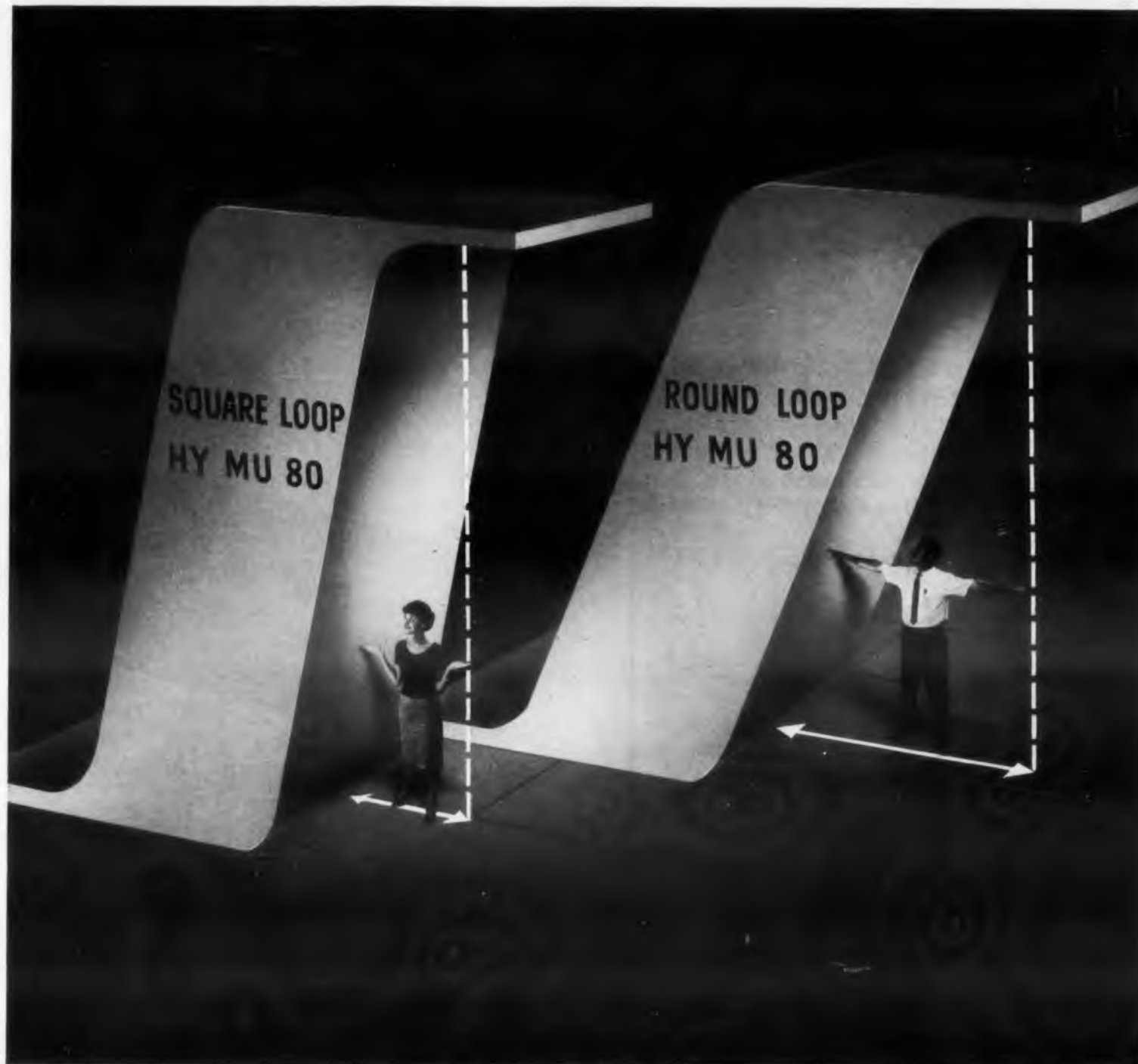

## Vive la différence in Hy Mu 80!

For greater sensitivity—Magnetics, Inc. makes Round Hy Mu 80 for more output at low flux densities  
For greater gain—Magnetics, Inc. makes Square Hy Mu 80 for more voltage amplification

There's an important difference in the two basic kinds of Hy Mu 80, Round Loop and Square Loop. By taking advantage of it, you design magnetic amplifiers with better performance and efficiency characteristics. We stock standard tape wound cores made of *both*, to be sold at non-premium prices. We want you to order the right kind.

Round Hy Mu 80 is demanded when flux densities are down around the 10 to 50-gauss level. Its high initial permeability results in great sensitivity. It also means fewer windings, thus smaller sizes. Combine higher inductance, great sensitivity and small size, and if you are a designer of devices like low level transformers or thermocouple amplifiers, then you want Round Hy Mu 80 tape cores.

On the other hand, if you design sensitive high gain magnetic amplifiers you need Square Hy Mu 80. The transfer curve is so

linear and so nearly vertical that a minute change in input produces an extremely sharp response. When only a small bias supply is available, you get a lot more amplifier per dollar. Preamplifier designers are among our best customers.

*So vive la différence!* Order the right Hy Mu 80 for your needs. We'll supply either, and what's more, we'll supply them quickly. Want the full story? Write Magnetics, Inc., Dept. ED-71, Butler, Pennsylvania.

**MAGNETICS inc.**

CIRCLE 345 ON READER-SERVICE CARD

## NEW PRODUCTS

### Power Supply Has 130 to 500 v dc output



Model UHR-211 power supply has an output voltage of 130 to 500 v dc at 0 to 1000 ma at any voltage setting and at any line voltage over the operating range. Regulation is less than 0.004% plus 0.004 v. Ripple is less than 0.2 mv rms.

Krohn-Hite Corp., Dept. ED, 580 Massachusetts Ave., Cambridge 39, Mass.

CIRCLE 346 ON READER-SERVICE CARD

### Inverter Test Console

#### Checks out missile and aircraft equipment

Built on a movable dolly relay rack with two 19 in. rack panels 53 in. high, the model W-1400 inverter test console monitors dc input, current, voltage, and ripple and ac current, voltage, power, distortion, and phase rotation. Its nominal 28 v dc output, which can be varied from 0 to 36 v, will operate any piece of aircraft or missile equipment up to 50 amp. The unit contains a load bank section that can load inverters up to 750 va, three-phase at 400 cps or 375 va, single-phase at 800 cps.

Electrosolids Corp., Dept. ED, 13745 Saticoy St., Panorama City, Calif.

CIRCLE 347 ON READER-SERVICE CARD



### Amplifiers

#### Ac transistor type

Available in four models, these germanium transistor plug-in ac amplifiers have gains of 300 or 1000. Frequency response is flat from 60 cps to 10 kc or 1 to 30 kc. Input impedance is greater than 50 K, temperature range is 32 to 140 F, and gain is adjustable externally over a  $\pm 20\%$  range. Model S-10001-P, pictured here, is typical of this series. Other models are available with frequency response flat from 60 cps to 200 kc.

Plug-in Instruments, Inc., Dept. ED, 1416 Lebanon Rd., Nashville, Tenn.

CIRCLE 348 ON READER-SERVICE CARD

# Design around Mallory

## for new



**For Miniaturization**—Small and light enough to carry anywhere, the Comptometer Coronet enables business men on the go to dictate wherever they travel. Six long-lasting RM-12R Mallory mercury batteries provide portable power, in compact space, for as much as 24 hours of continuous dictation.

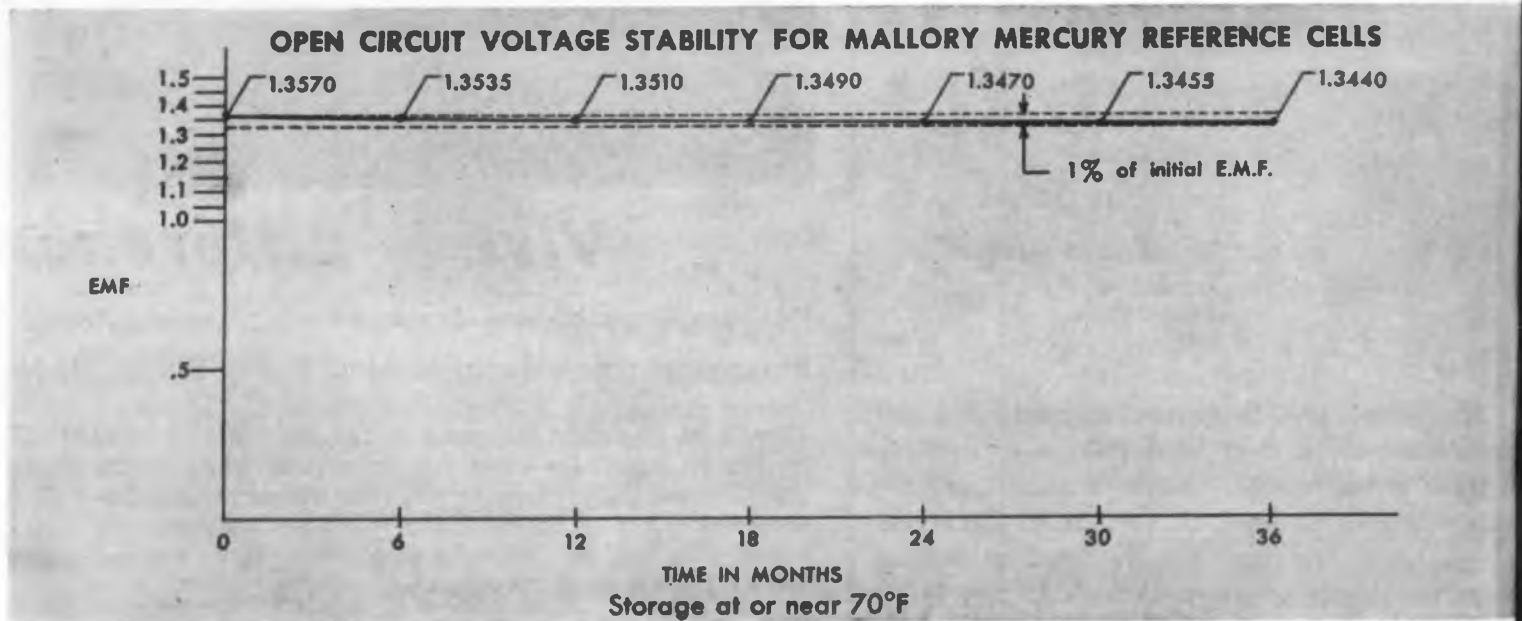

**For Steady Output**—Highly constant output voltage of mercury batteries makes them valuable as reference sources in instrument circuits. The curve shows how open circuit voltage keeps within 1% of original value during 36 months storage. Exceptionally high accuracy can be obtained for short run service under load, as in missile telemetering, by calibration prior to use in the intended circuit.



# y Mercury Batteries

## miniaturization, stability, dependability

You can put extra performance in your battery-powered products by applying the unique performance of Mallory mercury batteries in your new designs. Pioneered and perfected by Mallory, mercury batteries give you features unequalled by any commercial dry cell.

**Want smaller size?** Mercury batteries have high energy-to-volume ratio, can be miniaturized without loss of performance.

**Want greater convenience?** Long lasting mercury batteries greatly reduce frequency of battery change.

**Want dependability?** Mallory mercury bat-

teries last up to four times longer in service than conventional types . . . can be stored for up to six years without appreciable loss of capacity. They operate over wide temperature ranges.

**Want stability?** Output stays so constant that they can be used as reference voltage standards. Constant voltage discharge is ideal for transistor circuitry.

The applications pictured here are typical of the ways that Mallory mercury batteries are adding new values to self-powered products. Let's get together on how we may help you, too . . . either by applying our line of standard batteries or by developing custom-made packs for you.



Mallory Battery Co., Cleveland, Ohio  
a division of

P. R. MALLORY & CO. Inc.  
**MALLORY**

In Canada, Mallory Battery Company of Canada, Ltd., Toronto 4, Ontario



**For Dependability**—"Atronic Pacer/Monitor"—pocket-size electronic heart stimulator, made by Atronic Products, Inc., supplies pulses that prevent heart slowdown in cardiac patients . . . lets them live useful lives away from a hospital bed. Life-saving impulses are powered by Mallory mercury batteries, which deliver constant power for months in this critical service.

CIRCLE 349 ON READER-SERVICE CARD

**For Long Life**—Mallory mercury batteries have been used as a primary power source for the telemetering transmitters in the U. S. satellite program. In the Pioneer IV space probe, they powered radio transmission up to 407,000 miles, the greatest distance over which a radio signal has ever been received . . . and they far exceeded life expectations in Explorer and Vanguard flights.

## Synchronous Motors

### Permanent magnet type

Series 500 permanent magnet type synchronous motors are available in speeds from 1/60 to 10 rpm and in clockwise or counterclockwise models. They are offered with two different lubricating systems. In the standard type, the pinion rotates on a fixed shaft and is lubricated by an oil reservoir in the pinion. In the instrument type, a reservoir lubricating system in the core of the motor continuously bathes the rotor shaft in oil. The units are designed for 115 v, 60 cps operation.

Controls Company of America, Industrial and Commercial Controls Div., Dept. ED, 9555 Soreng Ave., Schiller Park, Ill.

CIRCLE 350 ON READER-SERVICE CARD



## Rate Gyro

Withstands temperatures  
from -50 to +400 F

This sub-miniature rate gyro, embodying eddy current damping, withstands a range of temperature ambients from -65 to +400 F. This single degree of freedom instrument has an output governed by the rate range and the natural frequency. Rate ranges of 10 to 200 deg per sec are available. Power requirement for the three phase hysteresis motor and the single phase microsyn is 26 v. Frequency range is 400 to 1000 cps. The unit is 2 in. long and 3/4 in. in diam, and is hermetically sealed.

Telecomputing Corp., Whittaker Gyro Div., Dept. ED, 16217 Lindbergh St., Van Nuys, Calif.

CIRCLE 351 ON READER-SERVICE CARD

## Power Supplies

### Stepping type

These power supplies provide 115 v or line voltage automatically stepped in plus and minus steps. The time cycle is adjustable from 1 to 60 min; the step voltage is adjustable from 1 to 20%. Operation is on 50 to 60 cps power. The output is metered for continuous voltage readings. Three models are available with the following capacities: model 250, 500 w; model 251, 1500 w; and model 252, 2500 w.

Research Industrial Laboratory of Electronics, Dept. ED, Roslyn, Pa.

CIRCLE 352 ON READER-SERVICE CARD

another first from **ELECTRO TEC**



## GIANT PRECISION SLIP RING ASSEMBLY for the David Taylor Model Basin

**WHAT IT DOES** — At the David Taylor Model Basin, where "Scale models of today are ships and aircraft of tomorrow," a new addition to the Hydromechanics Laboratory is under construction. Highly specialized and radical hull designs are to be tested in a 260 foot diameter tank. A pylon in the center of the tank supports a 135 foot arm. Below a traveling carriage suspended from the underside of this arm, hull designs are subjected to intricate maneuvers. All stress, torque and other measurements go through the pylon for transmission to computers on the shore. Means was required for the uninterrupted transmission of electrical information through a rotating joint. The slip ring provided by Electro Tec meets the high standards of precision required. Weighing roughly 5,000 lbs., the 16 foot high slip ring assembly consists of 137 circuits for signal, control and power. One power section for operation above 600 V. will conduct 3,000 amperes.

Many other unique problems have been solved with Electro Tec slip rings.\* In contrast to the David Taylor giant are units as small as .039 inches in diameter containing 6 circuits. Write for information on individual components or complete assemblies to precise electrical, mechanical and environmental specifications.

\*Pat. No. 2,696,570 and other patents pending.

Write Electro Tec Corporation on all your slip ring requirements.

**ELECTRO TEC CORP.** *Products of Precision  
Craftsmanship*

P. O. BOX 378 SOUTH HACKENSACK, N. J. • BLACKSBURG, VA., ORMOND BEACH, FLA.

CIRCLE 353 ON READER-SERVICE CARD

## NEW PRODUCTS

### Swinging Inductors

172 different models

Each of 172 different models of swinging inductors is available in these three basic forms: open construction, encapsulated and can-type. Encapsulated and can-type are designed to meet or exceed MIL-T-27A.

Magnetic Circuit Elements, Inc., Dept. ED, 3722 Park Place, Montrose, Calif.

CIRCLE 354 ON READER-SERVICE CARD

### Switch

Has under 0.2 cu in. static volume

Model 6208 switch has a static volume of less than 0.2 cu in. Factory preset range of the unit is 0.4 to 1 mach; other models are available with up to 3 mach. Electrical contact rating is 2 amp at 30 v dc and 3 amp at 115 v ac. The switch

operates on 28 v dc at 35 ma. It is hermetically sealed, weighs 0.75 lb, and measures 2 in. in diam and 3 in. in length.

Aero Mechanism, Inc., Dept. ED, 13918 Saticoy St., Van Nuys, Calif.

CIRCLE 355 ON READER-SERVICE CARD

### C-Band Transmitter System

Has 2 kw min rf power output

Combined with various klystrons, the model 208T self-contained power amplifier covers an extensive frequency range. With the company's VA804 klystron, it covers 4400 to 5875 mc; with the VA805, 5875 to 6425 mc; and with the VA806, 7125 to 8500 mc. In standard units, rf power output is 2 kw cw min and rf power input is 10 to 100 mw. Modifications can be produced to give higher output powers. The amplifier is housed in a compact, three-door cubicle.

Levinthal Electronic Products, Dept. ED, Stanford Industrial Park, Palo Alto, Calif.

CIRCLE 712 ON READER-SERVICE CARD

designed for the 21st Century

AVAILABLE NOW

Mil-C-26244 or Mil-C-14157A—Dearborn Deltaply 44 and Deltaply 57 capacitors.

Subminiature High Voltage—70 styles operate at 125°C. 75 to 80% smaller Dearborn Deltaply 70.

Teflon capacitors to Mil-C-26086—Dearborn Deltaply 200.

New, Negative T.C. capacitors, greatest stability and smallest size ever produced, ask for information on specific values and voltage you desire.

**DEARBORN ELECTRONIC LABORATORIES**  
1421 No. Wells Street • Chicago 10, Illinois

CIRCLE 356 ON READER-SERVICE CARD

ELECTRONIC DESIGN • September 16, 1959



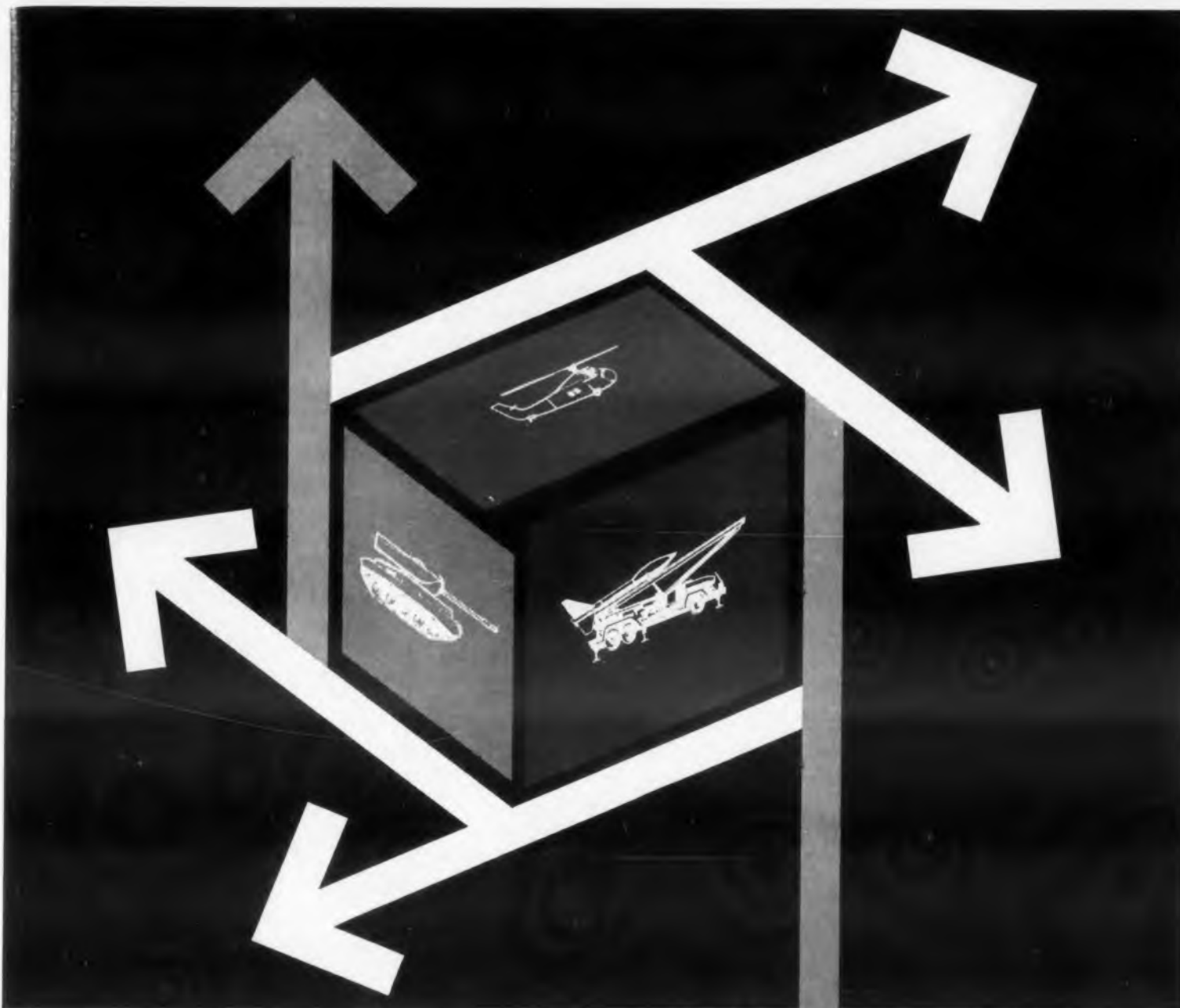

*How to put wings on a warehouse*

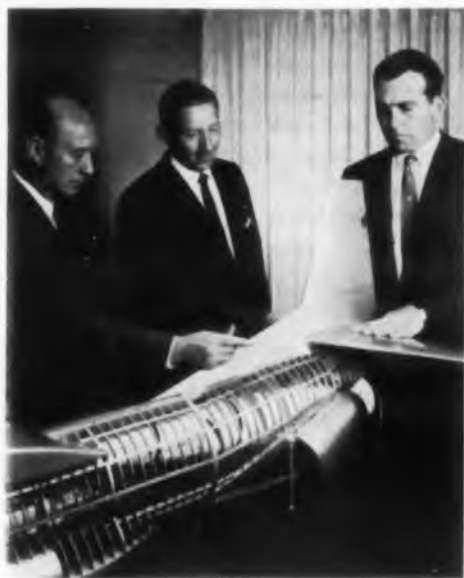

Giving overseas air bases what amounts to local warehouse service on important parts is an Air Force objective. Its present system has slashed delivery schedules up to *20 times*... saved taxpayers several *billion* dollars over the past decade. To improve it further, Douglas has been selected to develop specifications for a comprehensive Material Handling Support System involving better communications, control, cargo handling and loading, packaging and air terminal design. Douglas is well qualified for this program by its more than 20 years in all phases of cargo transport. Air logistics is only one area of extensive Douglas operations in aircraft, missile and space fields in which outstanding openings exist for qualified engineers.

Schuyler Kleinhans and Charles Glasgow, Chief Engineers of the Santa Monica and Long Beach Divisions, go over air transport needs relating to advanced cargo loading techniques with **DOUGLAS**  
Donald W. Douglas, Jr., President of

JETLINERS ■ MILITARY AIRCRAFT ■ CARGO TRANSPORTS ■ MISSILE SYSTEMS ■ SPACE SYSTEMS ■ AIRCOMB ■ GROUND-HANDLING EQUIPMENT

CIRCLE 902 ON CAREER INQUIRY FORM PAGE 173



Put wings on your future, too.

**DOUGLAS AIRCRAFT COMPANY  
MISSILES AND SPACE SYSTEMS**

has immediate openings in the following fields—

**Electrical and Electronics:**

Control System Analysis & Design  
Antenna & Radome Design  
Radar System Analysis and Design  
Instrumentation  
Equipment Installation  
Test Procedures  
Logic Design  
Power System Design

**Mechanical Engineering —**

**Analysis and Design of the following:**

Servo Units  
Hydraulic Power Systems  
Air Conditioning Systems  
Missile Launcher Systems  
Propulsion Units and Systems  
Auxiliary Power Supplies

**Aeronautical Engineering:**

Aerodynamic Design  
Advanced Aerodynamic Study  
Aerodynamic Heating  
Structural Analysis  
Strength Testing  
Dynamic Analysis of Flutter and Vibration  
Aeroelasticity  
Design of Complex Structure  
Trajectory Analysis  
Space Mechanics  
Welding  
Metallurgy

**Physics and Mathematics:**

Experimental Thermodynamics  
General Advanced Analysis in all fields  
Computer Application Analysis  
Computer Programming and Analysis  
Mathematical Analysis

For full information write to:

**Mr. C. C. LaVene**  
**Box 601-E**  
**Douglas Aircraft Company, Inc.**  
**Santa Monica, Calif.**

**DATICO** "digital automatic tape Intelligence check out" is made by the Nortronics Div. of Northrop Corporation for the U. S. Air Force and U. S. Army Rocket & Guided Missile Agency. This money and man saving tool provides rapid weapon system evaluation. Note Camloc Chassis Latches.



**IT'S EASY** to  
open ■ close ■ carry ■  
connect & disconnect  
plug-in chassis



with

**CAMLOC**

multi-function  
**CHASSIS LATCHES**



Thirty-eight strong, simple, attractive Camloc multi-function Chassis Latches are used on the 24 equipment filled plug-in chassis that make up DATICO, the military's new universal automatic field service checkout system. Here is a perfect example of designed-in fastener serviceability, flexibility, ease of handling and economy in interconnected "black-box" systems. When the Camloc push-button handles are released and pulled down, the chassis is automatically disconnected and ejected. Then the latch becomes a carrying handle. When replacing the equipment the latch firmly pulls the chassis back in place, making perfect, automatic reconnection of multiple-pin units. It is quick, safe, reliable, vibration-proof. Camloc Chassis Latches consist of only two parts—a handle and a fork—mounted with standard screws. Several handle and fork designs are currently available, all interchangeable. Write for Camloc's new Bulletin 35L today.

"Specialists in Fasteners for Industry"

CAMLOC FASTENER CORP. • 61 SPRING VALLEY RD., PARAMUS, N. J.  
WEST COAST OFFICE: 5410 WILSHIRE BLVD., LOS ANGELES, CALIF. • SOUTH WEST OFFICE: 2509 W. BERRY ST., FORT WORTH, TEXAS

CIRCLE 357 ON READER-SERVICE CARD

## NEW PRODUCTS

### Thermal Circuit Breaker

Reacts to ambient temperature only

Designed to eliminate the danger of open circulating due to current generated heat, the Fil-Therm protector interrupts line current to an equipment when the ambient temperature at the installation point reaches a preselected level. Unaffected by the current passing through it, the 0.15 oz unit senses the ambient cutoff temperature from its mounting structure or by convection. Its nonmetallic, nonconductive sensing element has operation sensitivities up to  $\pm 3\%$  of the rated temperature. The unit is available in a range from 100 to 2500 F and is good for ac or dc circuitry of any voltage or frequency. It meets MIL-E-5272A and can carry continuous currents to 10 amp, surge currents to 25 amp.

Filtron Co., Inc., Dept. ED, 131-15 Fowler Ave., Flushing 55, N.Y.

CIRCLE 358 ON READER-SERVICE CARD

### Ceramic Receiving Tubes

Four types available



These ceramic receiving tubes are available in four types. For use as detector, mixer, or instrument probe, type 7266 high frequency diode has 600 v peak inverse voltage rating and 10 ma steady-state peak plate current. Output is 1 v dc min. Type 7486 triode, for uhf oscillator and class C power amplifier, has the following maximum ratings: 1 w plate dissipation, 250 plate v, 2 ma dc grid current, and 10 ma dc cathode current. Type 7462, a print board version of the 7707 high amplification uhf triode, has these maximum ratings: 250 plate volts, 50 v negative dc grid, 1 w plate dissipation, and 10 ma dc cathode current. Type 7296 high amplification triode is for vhf and low uhf oscillator, mixer or amplifier service and has these maximum ratings: 3.3 w plate dissipation, 330 v plate voltage, 100 v peak negative grid voltage, and 5 ma dc grid current.

General Electric, Receiving Tube Dept., Dept. ED, Owensboro, Ky.

CIRCLE 359 ON READER-SERVICE CARD

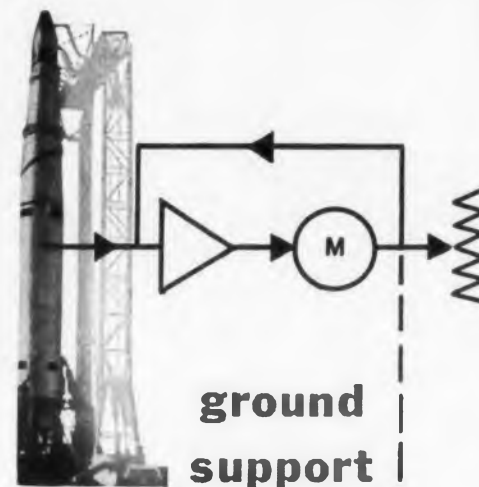

ground support instrumentation

for **RATIO TEMPERATURE RPM**



**NORTH ATLANTIC SERVO INDICATORS**

are self-contained null-balancing measurement systems designed to indicate or monitor virtually any quantity that can be expressed as a voltage. Their high accuracy (to 0.05%) and fast response (as little as 0.2 second full scale) meet the most critical ground support requirements.

Ratio indication is unaffected by changes in transducer excitation. Compact, single-package design permits remote dolly, console, or rack mounting, maximum application flexibility.

Available, to specifications, for particular function, range or input signal, with dial, counter or dual pointer display, auxiliary output for repeating, signaling or control. For full data, write for bulletin.



Model SBI-201, 7" x 3" dia., used in missile prelaunch monitor system to indicate position of control surfaces.

**NORTH ATLANTIC industries, inc.**  
603 Main Street, Westbury, N.Y.  
Edgewood 4-1122

CIRCLE 360 ON READER-SERVICE CARD

ELECTRONIC DESIGN • September 16, 1959





## Capacitance Standards

Three-terminal type

These three-terminal capacitance standards are available in both fixed and variable types. The fixed units, types 1403 standard air capacitors, are rated at 0.01, 0.1, 1, 10, 100, or 1000  $\mu\text{f}$ . The following models of variable capacitors are also available: type 722-CB, rated at 50 to 1100  $\mu\text{f}$ ; 722-CC, rated at 5 to 100  $\mu\text{f}$ ; and 722-CD, rated at 0.5 to 11  $\mu\text{f}$  and 0.05 to 1.1  $\mu\text{f}$ . The capacitors are equipped with coaxial connectors and mating connectors.

General Radio Co., Dept. ED, W. Concord, Mass.

CIRCLE 361 ON READER-SERVICE CARD

## Epoxy Laminating Resin

Suited for potting and encapsulating

Used with Hardener 9012, Epocast 28 forms a structural resin for laminating glass fibers or a casting resin suited for potting and encapsulating electrical components. The resin and hardener mixture has a pot life of three days at 75 to 80 F. It displays good thermal stability and uniform dielectric properties over a broad range of temperatures.

Furane Plastics, Inc., Dept. ED, 4516 Brazil St., Los Angeles 39, Calif.

CIRCLE 362 ON READER-SERVICE CARD



## Precision Potentiometer

Wirewound

Designed for operation to 165 C, this precision wirewound potentiometer measures 3/4 in. and is for standard servo mounting. Its features include: power rating of 3 w at 65 C, standard linearity of 0.3% to 0.25%, completely welded construction, flush glass sealed terminals, and stainless steel front and rear ball bearings.

Ace Electronics Association, Inc., Dept. ED, 99 Dover St., Somerville, Mass.

CIRCLE 363 ON READER-SERVICE CARD

## Microwave Component News

from SYLVANIA

## New line of X-band magnetrons, servo-tunable over 1100 mc

M4164, M4193, M4163  
cool without special ducts

These three rugged new magnetrons, like the familiar 6874 and 7006, feature the same size, accessible mounting points, and high reliability of the fixed-frequency 4J50. The unique tapered-pin tuner, already proven highly successful in severe applications of the 6874 and 7006, has been incorporated in this line. Servo-tuning without a special oversized gear box and no change in outline is available in all five types on request. Easy tuner-dial readability and ruggedness, flexibility of tuner location, and standard through-bolt lug mounting from the top are regular benefits featured by Sylvania. 1.5 mismatch at full power and atmospheric pressure is made possible by a new window design. Fin placement permits cooling without special ducting.

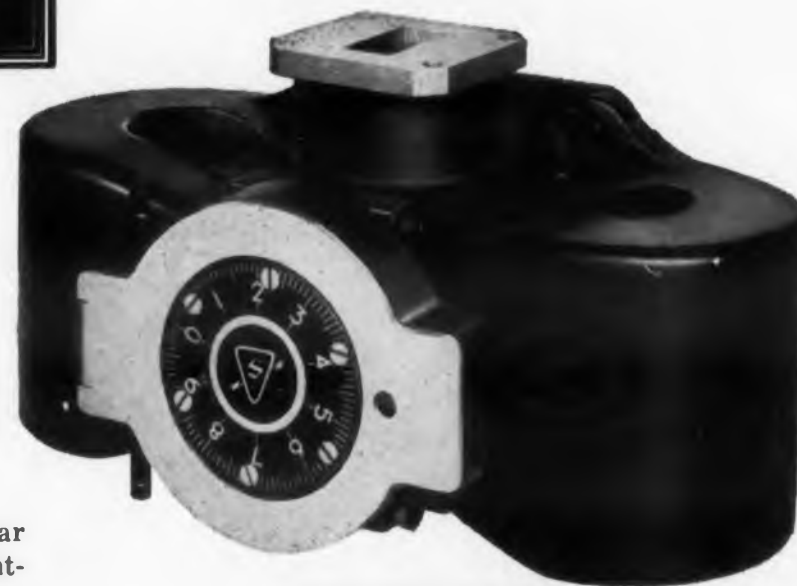

### SPECIFICATIONS

TYPE	FREQUENCY RANGE, MC	AVER. POWER		STATUS
		AT 1 US MIN., WATTS	RRV KV/US	
M4163	8500-9600	190	180	Pilot production
M4164	8500-9600	200	200	Pilot production
M4193*	8500-9600	200	225	Pilot production
6874	8800-9400	190	180	In production
7006	9000-9600	190	225	In production

\*Has leading edge mode stability specification.



## New ruggedized beacon magnetron delivers 100 watts peak power

Addition of TNC connector improves output

Sylvania type 7503 is a beacon magnetron specially ruggedized for missile applications. An advanced-design version of the 7098, the new tube delivers a minimum peak power of 100 watts and employs a TNC output connector which increases efficiency. Since the connector feeds into a broad-band coupler, it eliminates the need for adjusting for optimum power when the frequency is changed. The tubes withstand a 500 g, 1 millisecond shock. Additional ruggedness has been designed into the mounting bracket and tuner structure to increase the outstanding reliability of the tube.

For more information write your nearest Sylvania tube sales office or Sylvania Electric Products Inc., Special Tube Operations, 500 Evelyn Ave., Mountain View, Calif.

# SYLVANIA

Subsidiary of  
GENERAL TELEPHONE & ELECTRONICS



CIRCLE 364 ON READER-SERVICE CARD



## ...and now for a spot of welding!

Still at it? Trying to improve potentiometer reliability by building 'em yourself? Well, you're on the right track about one thing — welding's a sure way to eliminate a lot of operational headaches — like gassing contamination of contact metals at high temperature, from organic solder flux. No chance of "cold joints", either, to increase circuit resistance. No soldered connections to come loose under vibration and shock. Welding is the way to reliability!

But why set the wife's drapes afire to get a reliable, all-welded pot? Utilizing welding techniques, Ace produces reliable potentiometers operable at temperatures exceeding 150°C. and able to withstand 50 G's at 2000 cycles. All this, plus extremely low contact resistance and longer rated life. All taps, end connections, resistance elements, contact assemblies and terminal leads are specially prepared beforehand — then welded with pure nickel or palladium silver. So, for built-in reliability through sounder construction techniques, see your ACErep!

This 2" AIA Acepot® (shown 1/2-scale) incorporates all these exclusive welding construction features, for superior reliability.

**ACE** ELECTRONICS ASSOCIATES, INC.  
99 Dover Street, Somerville 44, Mass.  
SOMerset 6-5130 TXM SMVL 181 West. Union WUX

Acepot® Acotrim® Acoset® Aceohm® \*Reg. Appl. for  
CIRCLE 365 ON READER-SERVICE CARD

## NEW PRODUCTS



### Discriminator Filter

Weights 11 oz

Type MR 3.1-100-10 pulse width discriminator filter weighs 11 oz and measures 1-5/8 x 1-7/8 x 2-3/4 in. The unit is designed for use as an anti-jamming component for pulse sensory radar and beacon type systems, and in systems requiring pulse width encoding, decoding, and pulse go/no-go operation. An input pulse which lasts for a specified time produces an output of maximum amplitude. For example, for a pulse length of 3.1  $\mu$ sec the output is 3.1 v and the input is 1.5 v. Pulses shorter than 2.5  $\mu$ sec and longer than 3.7  $\mu$ sec are attenuated by a minimum of 15 db. Solid state components are incorporated in the unit.

Mini-Rad, Inc., Dept. ED, 7416 E. Varna St., N. Hollywood, Calif.

CIRCLE 366 ON READER-SERVICE CARD

### Delay Lines

Epoxy encapsulated



Designed for missile and airborne applications as well as for commercial use, these tapped delay lines are epoxy encapsulated. Series C has a rise time of 1/30 of delay time; series K, 1/14 of delay time. For the two types, delay tolerance is  $\pm 2\%$  or  $\pm 0.01 \mu$ sec, thermal coefficient of delay is 0.005% per deg C, working voltage is 300 v dc, and temperature range is -65 to +125 C. Standard units have 10 taps equally spaced, but the taps may be arranged as required. These units meet the requirements of MIL-STD-202A.

The Artronic Instrument Co., Dept. ED, 11232 Triangle Lane, Silver Spring, Md.

CIRCLE 367 ON READER-SERVICE CARD



TEST  
INSTRUMENTS

for

LABORATORY/PRODUCTION

### Sensitive Detection of Microwave Energy



## PRECISION TEST RECEIVER

The AIL Type 130 Precision Test Receiver (30 and 60 Mc standard units available) is a versatile instrument combining a high gain, low-noise figure receiver and a secondary standard of attenuation. It can be used wherever accurate measurements of the differences of r-f and i-f power levels are required. A few typical applications are: noise-figure measurement, measuring characteristics of directional couplers, calibration of r-f attenuators and measurement of selectivity characteristics.

Detailed literature is available on request.



AIRBORNE  
INSTRUMENTS  
LABORATORY

1345 NEW YORK AVENUE  
HUNTINGTON STATION, L. I., N. Y.

A DIVISION OF CUTLER-HAMMER, INC.

CIRCLE 368 ON READER-SERVICE CARD

ELECTRONIC DESIGN • September 16, 1959



## Signal Conditioning System

Has plug-in etched circuits

The NE-10 signal conditioning and balance panel system has an etched plug-in for each transducer channel. In addition to plug-ins for strain gage type transducers, units can be supplied for signal conditioning other types of transducer outputs including thermocouples and potentiometers, for entry into either oscillograph or tape recording systems. Unit measures 3-5/16 x 6 x 8 in. and contains provisions for 10 channels.

Kauke and Co., Inc., Dept. ED, 1632 Euclid St., Santa Monica, Calif.

CIRCLE 369 ON READER-SERVICE CARD

## Silicon Rectifiers

Have 2.5 and 12 amp ratings

These Redtop insulated base silicon rectifiers have 2.5 and 12 amp ratings. They meet military environmental specs and can withstand vibration of 20 g to 2000 cps and 50 g shock. The 12 amp rectifier has a surge rating of 240 amp and a leakage of 2  $\mu$ a at 25 C, and is 1-5/64 in. long.

Bradley Semiconductor Corp., Dept. ED, New Haven 11, Conn.

CIRCLE 370 ON READER-SERVICE CARD

## High Voltage Test Set

Provides 50 kv ac at 2 kva

Model KB50-2AC high voltage test set provides 50 kv ac at 2 kva. Used for dielectric testing, this two-piece set has low waveform distortion and direct metering at high voltage output for high accuracy regardless of regulation or type of load. The main unit weighs 140 lb and measures 14 x 21 x 23 in. The single high voltage bushing protrudes 9 in. to facilitate entrance into test cage. The control cabinet weighs 38 lb and measures 17 x 9 x 12 in.

Peschel Electronics, Inc., Dept. ED, R.F.D. 1, Patterson, N.Y.

CIRCLE 371 ON READER-SERVICE CARD

CIRCLE 372 ON READER-SERVICE CARD

# CONSIDER...



## this rugged Video Telemetering System

THIS REMARKABLE NEW television system gives you the power of sight where human eyes cannot go. It can be directed outward for observation, or inward to "watch" internal operation from a range of 1,000 miles line-of-sight.

Capable of operation under extreme environmental conditions, and packaged

for use under conditions requiring limited space, weight, and power, the Model 701 includes such features as: transistorized circuitry, 525 line, 30-frame fully interlaced picture, crystal controlled EIA synch, and high sensitivity.

Weight of the complete unit is under nine pounds. Total volume is less than

119 cubic inches. Its critical-design requirements are typical of all LEAD products. Each can be modified to meet many different requirements. Tell us what yours are. Contact our Marketing Branch, Lockheed Electronics & Avionics Division, 6201 E. Randolph St., Los Angeles 22...OVERbrook 5-7070.

*Requirements exist for staff and supervisory engineers*

# LOCKHEED ELECTRONICS & AVIONICS DIVISION

*Look to Lockheed for LEADership in Electronics*

## NEW PRODUCTS



### Regulator Amplifier

For power supplies

Model S-20004-P, plug-in germanium transistor regulator amplifier is used in power supplies with outputs of 11 to 15 v and with currents from 0 to 2 amp. Power supplies using this regulator amplifier have better than 0.1% line and load regulation and ripple is less than 2 mv peak-to-peak. The amplifier delivers 150 ma min and operates in a circuit with 15 to 35 dc unregulated. The basic current drain is less than 30 ma, the gain is greater than 2000, and the operating temperature is 32 to 135 C. Other models are available for use with 24 v power supplies.

Plug-In Instruments, Inc., Dept. ED, 1416 Lebanon Rd., Nashville, Tenn.

CIRCLE 373 ON READER-SERVICE CARD

### Plugboards

Made of 1/16 in. epoxy paper

These plugboards are made of 1/16 in. epoxy paper material with 0.062 in. holes on alternate intersections of A 0.1 in. grid. A 16-pin connector attached to the leading edge mates with a contact receptacle. The plugboards may be hand wired to provide prototypes for final printed circuit cards.

Vector Electronic Co., Dept. ED, 1100 Flower St., Glendale 1, Calif.

CIRCLE 374 ON READER-SERVICE CARD



### Variable Resistors

Have metal ceramic resistance element

Series 600 variable resistors employ a metal ceramic resistance element. These units offer a resistance range of 100 ohms to 5 meg, linear taper. Power ratings are 3/4 w at 85 C, 1/2 w at 125 C, and zero load at 175 C. Temperature range is -63 to +175 C; temperature coefficient is 250 to 500 ppm per deg C. Load life is 1000 hr for 3/4 w at 85 C or 1/2 w at 125 C, 350 v max. Rotational life, after 25,000 cycles is 7.5%. The requirements of MIL-R-94B are exceeded.

Chicago Telephone Supply Corp., Dept. ED, 1142 W. Beardsley Ave., Elkhart, Ind.

CIRCLE 375 ON READER-SERVICE CARD

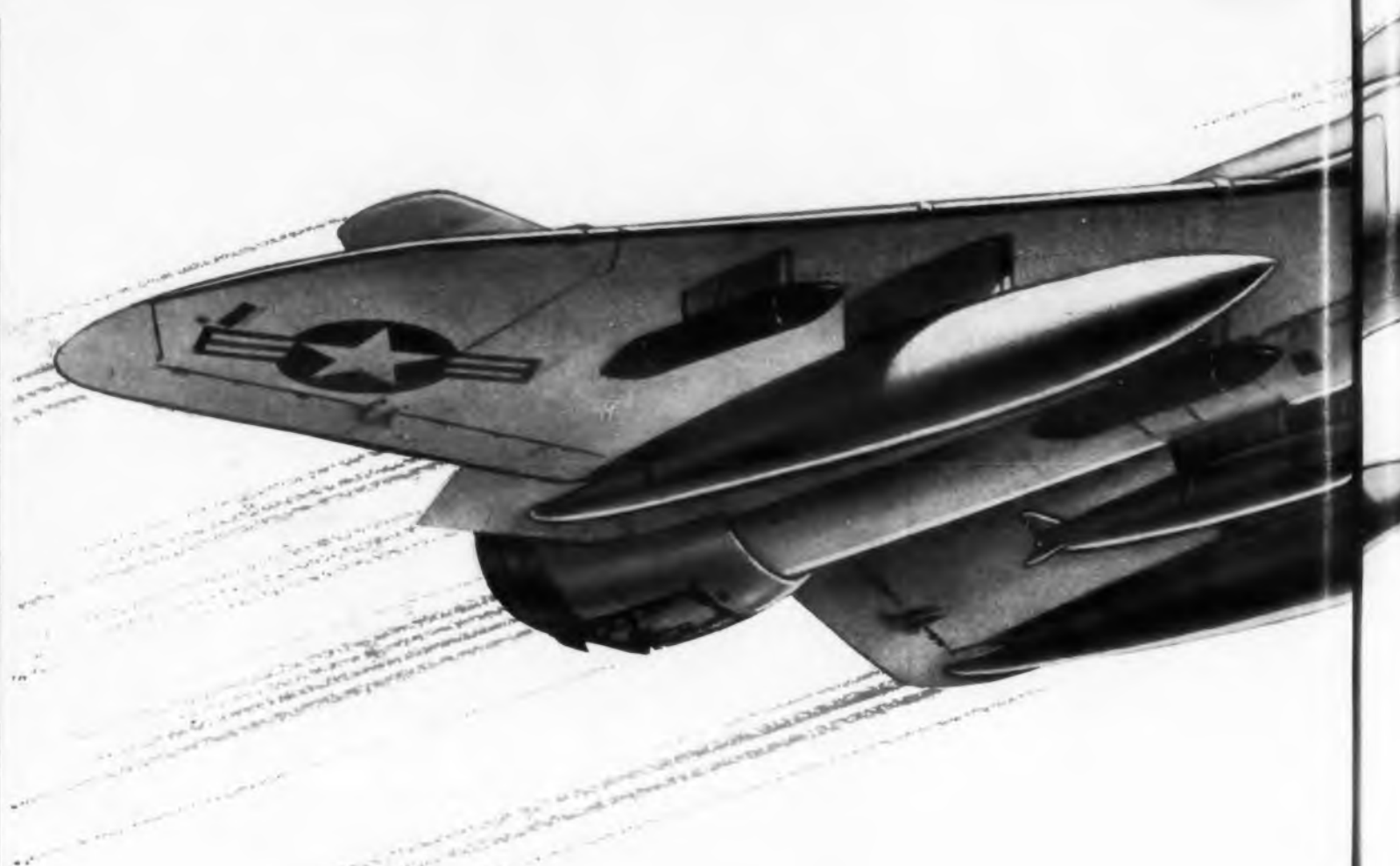

# FAIRCHILD SENSING DEVICES

*...proven in flight*



**FAIRCHILD**  
**CONTROLS CORPORATION**  
COMPONENTS DIVISION

225 Park Ave., Hicksville, L. I., N. Y. • 6111 E. Washington Blvd., Los Angeles, Cal.  
A Subsidiary of Fairchild Camera and Instrument Corporation

GYROS  
PRESSURE  
TRANSDUCERS  
POTENTIOMETERS  
ACCELEROMETERS





### FAIRCHILD TP-300 PRESSURE TRANSDUCER

Senses altitude to compensate for the "tuck under effect\*" during transonic flight of the F4D Skyray supersonic high altitude Navy and Marine Corps interceptor manufactured by the Douglas Aircraft Company, Inc.

**THE PROBLEM:** Douglas needed an accurate altitude transducer with both linear and non-linear outputs, having the capability of field adjustment to vary altitude settings.

**THE SOLUTION:** Fairchild, drawing on the engineering skills that makes them the foremost manufacturer of precision potentiometers, provided a 3" diameter pressure transducer having dual pot pick-offs with tap accuracies as low as  $\pm 0.1$ " Hg. and end point tolerances of  $\pm 0.3$ " of Hg. The design permits convenient field adjustment by phasing of the windings. Vibration and acceleration errors are minimized by counterbalanced construction.

\*The "tuck under effect" is an aerodynamic phenomena which causes the plane to pitch down while passing through the sound barrier.

**H**igh performance aircraft and missiles require thousands of separate components. As the tempo of technology increases, higher speeds, higher temperatures, higher stresses make it mandatory that each component have higher Reliability.

Fairchild Reliability is fast becoming an industry standard. Fairchild sensing devices are built with close dimensional and design control for reliability under shock and vibration. Fairchild quality control continuously samples production for compliance with engineering specified standards. In addition there is 100% incoming, line, and final inspection.

The Reliability, or in a phrase, *predicted excellence*, of Fairchild's sensors is documented and data can be furnished with each production lot covering the stringent test program detailed to the specs and beyond.\*

For more information write Dept. 27 ED.

*Testing beyond the specs is Fairchild's Safety Factor for Reliability in performance.*



### TYPE 910 PRECISION POTENTIOMETERS

The linear motion type shown is one of many high reliability types available. Also single-turns, multi-turns and special designs. Functional accuracy over life is guaranteed — Fairchild's "Safety Factor" for reliability.



### TA-100 ACCELEROMETERS

Economical, pendulous accelerometer with torsion bar suspension and reliable pot pick-off. Accuracy values as low as  $\pm 1/2\%$ . Acceleration range from  $\pm 1/4$  to  $\pm 50$  G from 4-40 cps.



### RG-100 SUB-MINIATURE RATE GYROS

15/16" dia. by 2" long. Has uniform constant damping within  $\pm 15\%$  from  $-40^\circ$  to  $+200^\circ$  F. Takes 100 g's of shock, at low maximum rates.



### TP-100 NEW 1-INCH PRESSURE TRANSDUCER

Withstands 35 g 2,000 cps vibration, 75 g acceleration, 50 g shock. 0-5 to 0-350 psia, g or d, with resolution as low as .25%. Also available in 2" and 3" sizes with linearities as low as 0.5%. Other types for pressures up to 10,000 psi.

## Environmental Test Chambers

Measure 18 x 18 x 18 in.

Model 3 environmental test chambers offer 18 x 18 x 18 in. clear specimen space. Temperature ranges are  $-100$  to  $+240$  or to  $+350$  F and can be extended down to  $-120$  and up to  $+500$  F. Humidity can be included.

Tenney Engineering, Inc., Dept. ED, Union, N.J.

CIRCLE 377 ON READER-SERVICE CARD

## Power Supply Transistorized



Model 62AR transistorized power supply has a stability of  $\pm 0.1\%$  regulation for six months, a reliability of better than 0.95 for one year when used 8 hr per day, and a life expectancy of ten years. Input is 115 v ac, 60 or 400 cps, 1 phase. Output is 26 v dc at 1 to 0.5 amp. Load regulation is 1 mv max for load changes of zero to full load and line regulation is 0.5 max for  $\pm 10\%$  variations in line voltage or frequency. Ripple is less than 1 mv rms. The output is floating. Also available are dc to dc units and three phase input units.

The Daven Co., Dept. ED, Livingston, N.J.

CIRCLE 378 ON READER-SERVICE CARD

## Function Generator

Provides over 37 waveforms

Model LF 51 function generator provides over 37 different waveforms for testing servomechanisms, vibration studies, and for programming automatic systems and analogue computation. Sine waves with frequencies from 500 to 0.0005 cps are generated with less than 1% harmonic distortion. Maximum voltages are 150 v peak to peak. Ramps, triangular waves, sawtooth, and trapezoidal functions are available singly or repetitively. One-half or one complete cycle may be obtained. A prepulse may be used to start recording equipment. The unit withstands 40 g in any direction. It includes 16 modules plus a power supply housed in a rack mounting cabinet.

Marconi Instruments, Dept. ED, 111 Cedar Lane, Englewood, N.J.

CIRCLE 379 ON READER-SERVICE CARD

CIRCLE 376 ON READER-SERVICE CARD

from  
**Instrument Calibration**  
HEADQUARTERS

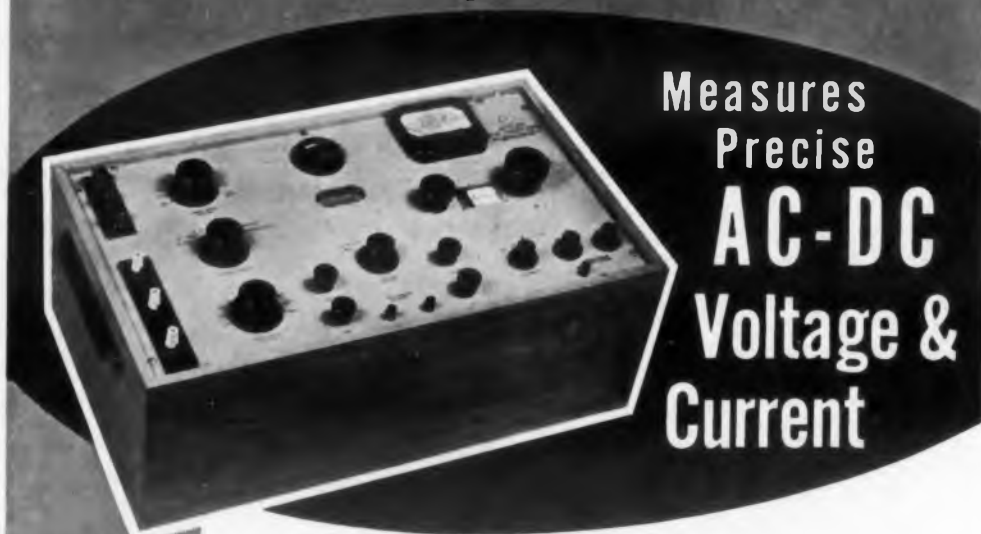

Measures  
Precise  
**AC-DC**  
Voltage &  
Current

**Model 1605**  
\$2450.

**A Self-Contained Laboratory Standard Facility**

The Model 1605 AC-DC Calibration/Transfer Standard is a multi-function instrument capable of measuring AC and DC voltage and current up to 1500 volts and 15 amperes. It includes a precision four-digit readout potentiometer, laboratory standard cell, precision voltage multipliers, precision shunts hermetically sealed in oil, light beam galvanometer, AC monitoring meter, thermal converter and all necessary batteries and controls. DC measurements utilize the potentiometer or the potentiometer in conjunction with the voltage multipliers or shunts. For AC measurements the potentiometer and/or multiplier-shunt arrangement is used with the compensated AC-DC transfer element.



Model 829 alone. The Model 1605 may also be used to calibrate the Model 829. The 829/1605 combination provides a calibration system which will handle your requirements, for current and voltage measurements to an accuracy of better than 0.1%, from DC to 400 cps.

**LIMIT OF ERROR**

DC: 0.05% with correction factors;  
0.1% direct reading.  
AC: 0.065% with correction factors;  
0.13% direct reading.  
(AC accuracies are to 50 kc  
on most ranges.)

**For Owners of the  
RFL Model 829 AC-DC  
Instrument Calibration Standard**

The Model 1605 may be used in conjunction with the Model 829 to calibrate instruments having greater accuracy requirements than that supplied by the

*Performance is rigidly guaranteed.  
Price is net, f.o.b. Boonton, N.J.  
and subject to change without notice.*



For additional information, including application data, write or phone DE 4-3100. Demonstrations available by local representatives.



**Radio Frequency**  
LABORATORIES, INC.  
Boonton, New Jersey, U.S.A.

CIRCLE 380 ON READER-SERVICE CARD

**NEW PRODUCTS**



**Servo-  
mechanism  
Repeaters**

Have two speeds

This line of two-speed servomechanism repeaters have size 15, 11, and 8 components. The overall servo package comprises three sections: the mechanism, the amplifier, and the chassis. The first section includes motor, feedback elements, output transducer, and gearing. The amplifier is selected from the basic types to suit size, weight, and performance requirements. The chassis contains all special purpose parts. Accuracies to 4 ft, temperatures to 125 C, and damping and slew speeds to suit the application are typical performance characteristics. MIL-E-5272 environmental specs are met.

Superior Mfg. & Instrument Corp., Dept. ED, 154-01 Barclay Ave., Flushing 55, N.Y.

CIRCLE 381 ON READER-SERVICE CARD



**Circuit Modules**

Resistive type

Types P-202 and P-201 resistive type circuit modules are designed for use in transformation ratio measurements, servo system alignment, synchro bridge nulling, and transducer calibration. For use in ac ratio measurements, the P-202 module is a self-contained resistance summing network. Resistances available are 10,000 ohms to 1 meg with ac match between arms from 0.01 to 0.002%. Arms are matched at 400 cps for total or combined effects of both real and reactive components. Power rating is 0.25 w. The unit is a plug-in type, has four binding terminals, and measures 2-3/4 x 1-7/8 x 1-1/2 in. Type P-201 reference isolation module will accommodate signals from 1.25 to 150 v and has an input impedance of 100,000 ohms.

North Atlantic Industries, Inc., Instrument Div., Dept. ED, 603 Main St., Westbury, N. Y.

CIRCLE 382 ON READER-SERVICE CARD



**ENGINEERED  
ELECTRONICS  
COMPANY**  
506 East First Street  
Santa Ana, California

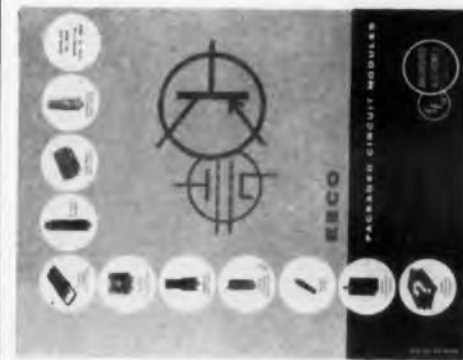

**HAVE YOU REQUESTED YOUR COPY OF OUR**  
**NEW CATALOG?**  
Write us today on your company letterhead

CIRCLE 383 ON READER-SERVICE CARD



## Limit Signalling Comparator

Nine gage heads available

Limit signalling comparator model 765 is used for small lot inspection or spot checking of production runs. Nine different gage heads are available permitting direct readings ranging from 0.00005 in. per dimension with the A-1 to 0.001 in. per dimension with the A-20. Full scale deflection of the meter is a direct 20 v change in the gage output, providing for greater accuracy and repeatability than circuits requiring signal amplification.

Radio Corp. of America, Industrial and Automation Div., Dept. ED, 12605 Arnold Ave., Detroit, Mich.

CIRCLE 384 ON READER-SERVICE CARD

## Continuity and Leakage Tester

Uses audio signal

Audiotone continuity and leakage tester produces an audio tone, the frequency of which depends on the resistance of the element being tested. It has a range of from 0 to 100 meg; maximum current is 300  $\mu$ a. Self contained, it has a shelf-life battery, no vibrating contacts, no adjustments.

Peschel Electronics, Inc., Dept. ED, R.F.D. 1, Patterson, N.Y.

CIRCLE 385 ON READER-SERVICE CARD

## Analyzer

Has high resolution

Model TA-18 high resolution analyzer produces an instantaneous spectral display of all telemetering subcarrier channels at one time. A three point marker shows center frequency and end frequency on each channel. A separate camera mount can be slaved to any of the 18 channels for a permanent record. This unit has automatic optimum resolution on each channel and a 40 db dynamic range. Resolution is 2 to 500 cycles.

Probescope Co., Inc., Dept. ED, 8 Sagamore Hill Drive, Port Washington, N.Y.

CIRCLE 386 ON READER-SERVICE CARD

CIRCLE 417 ON READER-SERVICE CARD



213,149,873  
cycles

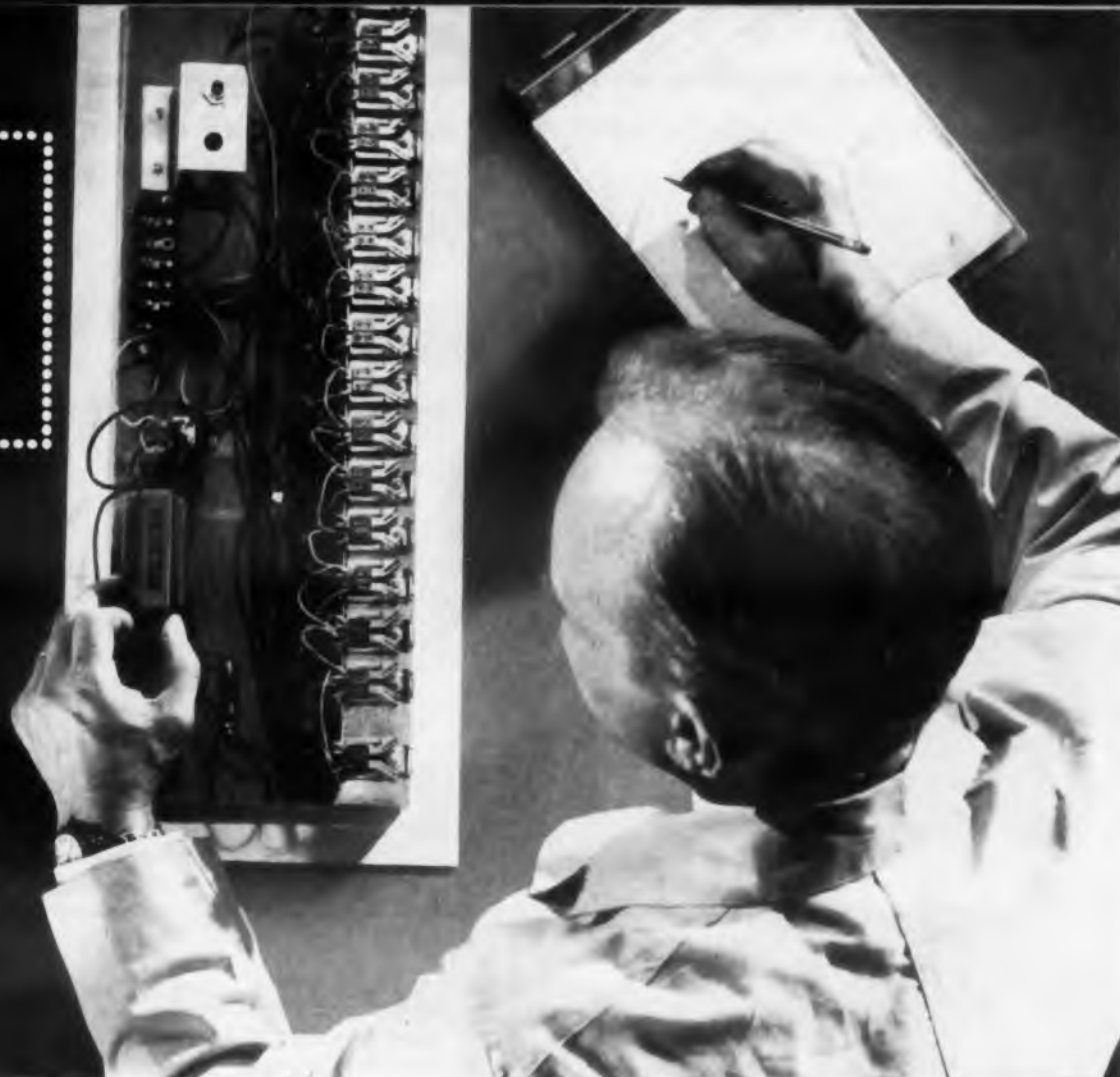

## Test proves reliability of P&B's LS telephone type relay

These 16 LS relays, wired into a self-cycling chain, each operated 213,149,873 times before the test was discontinued. This test was made for a nationally prominent manufacturer and the certified results are available upon request.

Here is proof of the inherent reliability of P&B telephone type relays... and of the kind of performance you can expect when you specify them. LS relays are available with up to 20 springs (10 per stack) and are adaptable for printed circuit mounting.

Whenever multiple switching of loads up to 4 amperes is required, the LS can usually meet space, weight and—importantly—price considerations. Get full information today by calling or writing Zeke R. Smith, vice president, Engineering, or contact your nearest P&B representative.

### LS ENGINEERING DATA

#### GENERAL:

**Breakdown Voltage:** 1,000 volts rms 60 cy. min. between all elements.  
**Ambient Temperature:**  $-55^{\circ}$  to  $+85^{\circ}$  C.  
**Weight:** 3 to 4 oz.  
**Dimensions:**  $1\frac{1}{2}''$  W. x  $2\frac{3}{4}''$  L. x  $1\frac{1}{2}''$  H. (4 Form C)  
**Enclosures:** Sealed or dust cover (W can)  
Sealed or dust cover, up to 6 Form C, single contacts (D can)  
**Mountings:** Four #6-32 tapped holes  $\frac{3}{4}''$  x  $\frac{3}{16}''$  o.c. Other mountings available.

#### CONTACTS:

**Arrangements:** 20 springs (10 per stack) max.  
**Material:**  $\frac{1}{16}''$  dia. twin palladium. Other materials available for specific applications.  
**Load:** 4 amps @ 115 volts 60 cy. resistive.

#### COIL:

**Resistance:** 55,000 ohms max.  
**Power:** 65 mw DC per movable standard (50 mw possible); 3.5 watts max. at  $25^{\circ}$  C.  
**Voltage:** Up to 200 volts DC.

#### TERMINALS:

**Contacts:** Three #18 AWG wires.  
**Coil:** Three #20 AWG wires.  
Available with octal plug, taper tabs or printed circuit pins.

P&B STANDARD RELAYS ARE AVAILABLE AT  
YOUR LOCAL ELECTRONIC PARTS DISTRIBUTOR



#### TS RELAY

Short coil relay is available in AC and DC versions. Long life construction. Can be supplied (DC) with up to 20 springs (10 per stack).



#### GS RELAY

Excellent sensitivity: 50 mw per movable arm minimum (DC). For applications requiring many switching elements in small space.



#### SS RELAY

Long coil provides high sensitivity (25 mw per movable arm) and room for slugs for pull-in delays (150 milliseconds max.) or drop-out delays (600 milliseconds max.).

### FREE

#### LS DETERMINATION DATA

Send today for booklet containing certified results of recent test described above. Data includes test circuit, interim and final measurements.



# POTTER & BRUMFIELD

DIVISION OF AMERICAN MACHINE & FOUNDRY COMPANY, PRINCETON, INDIANA

IN CANADA: POTTER & BRUMFIELD CANADA LTD., GUELPH, ONTARIO

Are you looking for neat, fast, economical fabrication?

## **PLUG-IN // INSTRUMENTS'** **MODULAR HARDWARE** *is the answer!*

Engineers and designers requiring ready-to-use plug-in blank printed circuits, chassis modules with matching mounting frames, rack mounting chassis and frames and chimney chassis look to Plug-In Instruments for their needs.

*If you need.*

• Standard digital and analog Plug-In circuits or Plug-In blanks for quick and convenient fabrication of vacuum tube and transistor circuits.

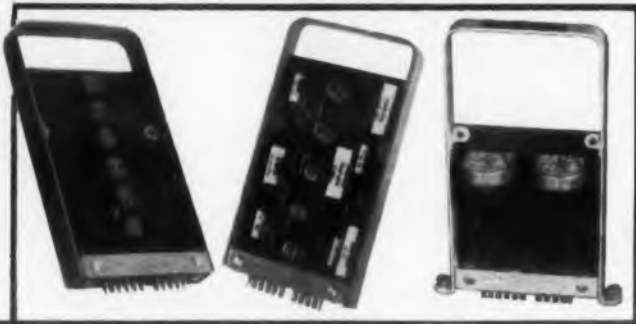

• Rack-Mounting frames and chassis with facilities and space for plug-in circuits, electronic components, meters, controls and switches.

• Blank chassis modules for rapid assembly of flexible electronic equipment designed to allow in-operation checks and adjustments when used with mating mounting frame.



• Chimney Frames with excellent cooling characteristics and slide or rigid mounting for assembling multiple plug-in circuits.

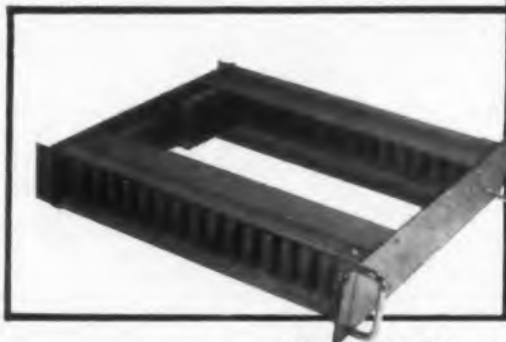

Contact, for complete details

### **PLUG-IN // INSTRUMENTS, INC.**

1416 Lebanon Road Nashville, Tenn.

CIRCLE 387 ON READER-SERVICE CARD

## NEW PRODUCTS

### Differential Amplifier

Completely solid state

Designed for use with strain gages, thermocouples, and other low signal level devices. Redcor model 261 differential amplifier is completely solid state. Noise from all sources is less than 10  $\mu$ v at a 200 kc bandwidth. Input impedance is as high as 100 meg and common mode rejection is 120 db. The unit has no moving parts.

Packard Bell Computing Corp., Dept. ED, 12333 W. Olympic Blvd., Los Angeles 64, Calif.

CIRCLE 388 ON READER-SERVICE CARD



### Delay Line

Lumped constant type

Designed for missile application, model 31-6 lumped constant delay line has a time delay of 3  $\mu$ sec. Its delay-to-rise time ratio is 15:1 and characteristic impedance is 1200 ohms. Operating temperature range is  $-55$  to  $+125$  C. The unit measures 3 x 1 x 1 in.

ESC Corp., Dept. ED, 534 Bergen Blvd., Palisades Park, N.J.

CIRCLE 389 ON READER-SERVICE CARD

### Pressure Pickup

Retains accuracy at 10,000 psi

A chamber type, unbonded strain gage pressure pickup, the model 4-326 retains its accuracy up to 10,000 psi absolute or sealed gage. It has provisions for adjustment of bridge balance, temperature compensation, and sensitivity in a chamber isolated from the sensing element. The unit operates from  $-320$  to  $+300$  F, withstands severe shock, and retains good output characteristics through acceleration, linear vibration, acoustical noise, and varying altitude. Transducers with nominal output sensitivity of 40 mv are obtainable for ranges between 0 to 100 psi and 0 to 10,000 psi.

Consolidated Electrodynamics Corp., Transducer Div., Dept. ED, 360 Sierra Madre Villa, Pasadena, Calif.

CIRCLE 390 ON READER-SERVICE CARD

## Get the Facts About These Cost Saving Terminals and Cable Clamps

### STANDOFF AND FEED THROUGH TERMINALS

Low cost and high electrical specs. have made these the most popular in the industry. Choice of over 100 varieties—fork, single and double turret, post... standard, miniature, sub-miniature... molded or metal base... wide variety of body materials and plating combinations.

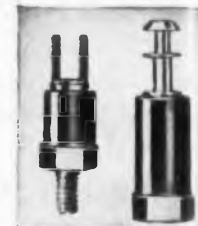

Request Catalog SFT-1

CIRCLE 709 ON READER-SERVICE CARD  
**STRAPLOCK\* CABLE CLAMPS**



"Straplocks" reduce installation time to a minimum, reduce inventories and simplify production. Special self-locking stud eliminates nuts, bolts, lockwashers. Tough molded Nylon construction assures excellent electrical and mechanical performance. "Straplocks" provide a positive, vibration-proof, insulated and heat-resistant support for fastening electrical cables to either wood or metal cabinets and panels. Simply push "Straplocks" into a  $\frac{1}{4}$ " hole, lay in cables and fasten adjustable strap to fit.

Request details \*Patented  
CIRCLE 710 ON READER-SERVICE CARD

### POINTER KNOBS

A military and industrial favorite by reason of price and practicability. Supplied in attractive black, satin-finished phenolic.



Request details

CIRCLE 711

**WHITSO, INC.**

9326 Byron Street, Schiller Park, Illinois  
(Chicago Suburb)





# new!



## L&N's 4232-B High Precision Guarded Wheatstone Bridge measures to 11,111 megohms

Already, standardizing laboratories are using this L&N Wheatstone Bridge as their prime measuring instrument for all d-c resistance measurements. In the manufacture of high quality resistors, it is being used for making accurate measurements on a semi-production basis.

Unique design features, never before obtainable in a bridge of this accuracy, include guarding to prevent errors resulting from leakage during adverse humidity conditions, and rheostat dial values direct-reading in digits.

**List No.—4232-B High Precision Guarded Wheatstone Bridge.**

**Range—1 ohm to 11,111 megohms.**

**Ratio Arms—Plug and block controlled. Values: 1, 10, 100, 1000, 1000', 10,000, 10,000' and 100,000 ohms.**

**Rheostat—10(10,000 + 1000 + 100 + 10 + 1 + 0.1) ohms.**

**Certificate—L&N Certificate, supplied with each bridge, gives following data: Ratio Resistors: measured values of each resistor given to 0.001% at 25 C. Values will give ratios that are correct to within 0.005%, except 100,000 ohms and 1 ohm, which provide ratios correct to within 0.01%. Rheostat Dials: measured values for each position of 10,000, 1000, 100, 10, 1 and 0.1 ohm dials given at 25 C. Rheostat settings of 200 ohms or more are correct to within 0.005%; below 200 ohms, correct to 0.01 ohm.**

**Limits of Error—Overall error at 25 C with minimum of 1000 ohms in rheostat arm:  $\pm(0.01\% + 0.001 \text{ ohm})$  up to 1.11 megohms.  $\pm 0.02\%$  above 1.11 megohm to 111 megohms.  $\pm 0.2\%$  above 111 megohms to 1111 megohms.  $\pm 2\%$  above 1111 megohms to 11,111 megohms.**

**Case—Metal; 19" x 10 1/2" x 9 1/2" for 19" relay rack mounting. Wt. is 33 1/2 lbs.**

**Price—\$2100.00 f.o.b. Phila. or North Wales, Pa. (subject to change without notice). Order List No. 4232-B from L&N 4908 Stenton Ave., Philadelphia 44, Pa.**



CIRCLE 392 ON READER-SERVICE CARD

## Solder Dispensing Tool

For hard-to-reach wiring locations

Designed for applications in deep chassis and in crowded, hard-to-reach wiring locations, this solder dispensing tool is operated by a fingertip, knurled control. The probe tip provides the back-up for the solder at the point of application and provides for retraction of wire solder. Interchangeable probes in straight and angle-form are available; probes are interchangeable by a bayonet-type attachment. The main body of the unit contains a supply of wire solder for several hours plus all working parts. Entire assembly is put together with a single screw.

International Electronic Research Corp., Dept. ED, 145 W. Magnolia Blvd., Burbank, Calif.

CIRCLE 393 ON READER-SERVICE CARD



## Tape Reader

Uses a latch-interlocked cam system

The FR-2 tape reader uses a latch-interlocked cam system for read and feed, achieving long life whether character-by-character or continuous reading is employed. The unit will operate at  $-65 \text{ F}$ , with shock and vibration forces up to 20 g. It operates at rates up to 60 codes per sec; slewing is possible at speeds up to 300 codes per sec. Reader contact closures of up to 240 deg of drive shaft rotation are provided for readers operated at speeds up to 30 codes per sec; up to 180 deg are provided for readers operated up to 60 codes per sec. The unit is caable of 5, 6, 7, or 8 level operation.

Soroban Engineering, Inc., Dept. ED, Box 1717, Melbourne, Fla.

CIRCLE 394 ON READER-SERVICE CARD

## Tape Programmer

Has bidirectional drive

Made for use in military check-out systems, model 3277 tape programmer has bidirectional drive. Character reading rates are up to 200 per sec. Tapes are up to 1 in. wide; the 6 in. reels can hold 500 ft of Mylar tape or 300 ft of paper tape. Input power requirements are 28 v dc and 115 v 400 cps. The controls for data playback are self-contained in the unit. Its dimensions are 11 x 17 x 11 in. and its weight is about 50 lb. It meets the requirements of MIL-E-16400.

Potter Instrument Co., Inc., Dept. ED, Sunnyside Blvd., Plainview, N.Y.

CIRCLE 395 ON READER-SERVICE CARD

## GLENNITE THERMISTOR DESIGN IDEAS NO. 8

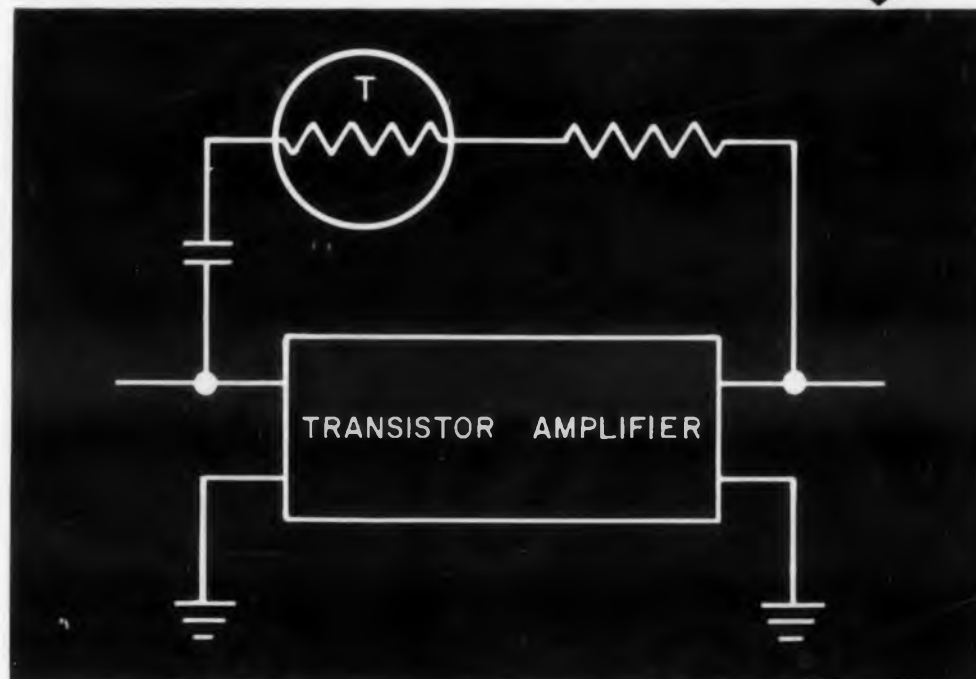

## HOW TO KEEP POWER GAIN CONSTANT ON TRANSISTORIZED AMPLIFIERS

Maintaining constant power gain on transistorized amplifiers has always been a problem for computer design engineers. Recent work with Glennite Thermistors has provided a simple yet effective solution.

Glennite Thermistors are temperature-sensitive resistors with high negative coefficients of resistance. When a temperature increase in the amplifier circuit above causes increase in power gain, a wafer type thermistor in feedback circuit serves to maintain constant power gain.

The negative temperature coefficient of the thermistor results in decreased resistance as temperature increases. The resulting degenerative feedback compensates for power gain, maintains constant voltage output.

Transistor gain control in computers is only one of many interesting ways in which versatile Glennite Thermistors are used as economical solutions to problems of temperature control, time delay, measurements and analyses.

Glennite wafer, bead and rod thermistors are available in a variety of resistance values, temperature coefficients and sizes to help you evaluate circuit problems. They may be obtained from your local distributor, or from Gulton Industries in bulk quantities.



Test Your Ideas With  
A Glennite Experimenter's  
Thermistor Kit

An inquiry on your company letterhead will make available to you a Glennite Experimenter's Kit for \$14.95. For those engineers who have had some experience with thermistors, comprehensive kits are available for \$49.95. For complete information, write directly to Gulton Industries, Inc.

Custom Made  
Thermistors  
To Your  
Specifications

Gulton will supply thermistors to your specifications with resistance values from 1 ohm to 10 megohms and temperature coefficients of resistance to  $-6.8\%$  per degree C. Temperature range:  $-60^\circ$  to  $+500^\circ \text{C}$ .

MATERIALS & CERAMICS DIVISION

## Gulton Industries, Inc.

Metuchen, New Jersey

In Canada: Titania Electric Corp. of Canada Ltd., Gananoque, Ont.

CIRCLE 396 ON READER-SERVICE CARD



## NEW PRODUCTS

### Connector

#### Non-reversing hermaphrodite

This non-reversing hermaphrodite connector acts as both plug and socket at either end. Any connector of this type can be plugged into another regardless of polarity or change in conductor path. The unit is designed to handle up to 26 circuits. Of waterproof construction, it measures 2.5 in. in diam. and 7 in. long. All electrical contacts are gold-plated.

Specialty Electronics Development Corp., Dept ED, Syosset, N.Y.

CIRCLE 397 ON READER-SERVICE CARD



### Relays

#### Polarized, dpdt

Series 32 polarized, dpdt relays measure 0.8 x 0.4 x 0.9 in and weigh 18 g. These units employ magnetic latching and are hermetically sealed. The vibration rating is 30 g to 5000 cps and the temperature range is  $-65$  to  $+125$  C. Standard operating sensitivities are 50 mw for the single coil units and 100 wm for each coil of the dual coil units. Operating time is from 2 to 20 msec, depending on overdrive. Contact ratings are 2 amp for silver contacts and 0.5 amp for gold alloy contacts. Mounting styles include plain can, stud, flange or plate mounting. Connections can be J hook solder terminals, 8 pin plugs for single coil or 10 pin plugs for dual coil, or 3 in. connecting wires.

Sigma Instruments, Inc., Dept. ED, 170 Pearl St., S. Braintree 85, Mass.

CIRCLE 398 ON READER-SERVICE CARD

### Relay Control Amplifier

#### Has go/no-go control system

Made for industrial process control and monitor systems, this relay control amplifier has a high accuracy go-no-go control system. Its sensitivity is 1  $\mu$ v. Stability is  $\pm 1$   $\mu$ v. It contains a circuit that offers protection against open input circuits or failure of any amplifier component. Operating power supply is  $115 \pm 10$ v, 50 to 60 cps. The unit weighs 6.5 lb and measures 4.5 x 3.75 x 6 in.

Thermo Electric Co., Inc., Dept. ED, Saddle Brook, N.J.

CIRCLE 399 ON READER-SERVICE CARD



THE RAW MATERIALS OF PROGRESS



## USING FLUOROCHEMICALS, TRANSFORMER DWARFED

Our age of miniaturization drops a challenge to the makers of electrical components—size and weight must go down. By using a 3M fluorochemical inert fluid, FC 75, as a dielectric coolant, the Raytheon Manufacturing Company has developed a transformer of improved electrical performance—reduced in volume by 75% and by 50% in weight. The miniaturized transformer is shown above, dwarfed by its old-fashioned counterpart. The reason? FC 75 permits the use of a much smaller transformer core and coils. And it reduces the space needed for insulation.

It has high dielectric strength, high heat transfer capability, is self-healing. It has wide liquid range with a pour point of  $-148^{\circ}\text{F}$  and low viscosity. It is thermally stable in excess of  $800^{\circ}\text{F}$ . As an evaporative coolant it is all these: nonexplosive, nonflammable, nontoxic, odorless, non-corrosive. Check the other properties at the right—then investigate FC 75, as well as the other 3M Chemicals made for the electronics industry: KEL-F<sup>®</sup> Molding Powders, KEL-F<sup>®</sup> Dispersions, KEL-F<sup>®</sup> Elastomers, Cardolite NC 513, KEL-F<sup>®</sup> Oils, Waxes and Greases, Acids and Alkanes.

CHEMICAL DIVISION

MINNESOTA MINING AND MANUFACTURING COMPANY

... WHERE RESEARCH IS THE KEY TO TOMORROW







**3M FLUORO-CHEMICAL FC 75** pours at  $-148^{\circ}\text{F}$ . It has a wide liquid range of  $-148^{\circ}\text{F}$  to  $212^{\circ}\text{F}$  at atmospheric pressure, with low viscosity. In addition, it offers these useful properties: high dielectric strength of 37KV; self-healing, maintaining dielectric strength after repeated high voltage arcing. Compatible with most materials used in high temperature equipment. Thermally stable in excess of  $800^{\circ}\text{F}$ , it prevents development of hot spots in equipment. Prevents sludge formation due to hydrolysis or oxidation.

## OVERDWARFED 75%

ability,  
ar point  
able in  
l these:  
, non-  
—then  
ls made  
owders,  
lite NC  
alkanes.

For free literature write on your company letterhead, specifying product interest, to 3M Chemical Division, Dept. WD-99, St. Paul 6, Minnesota.



**3M CHEMICAL DIVISION, MANUFACTURERS OF:**  
Acids • Resins • Elastomers • Plastics  
• Oils, Waxes and Greases • Dispersion  
Coatings • Functional Fluorochemicals  
• Inert Liquids and Surfactants.

CIRCLE 400 ON READER-SERVICE CARD

**DOUBLE BLOWER.**—Model B3-32 is powered by a 115 v ac, single phase 60 cps motor. Its output is 100 cfm per blower at 3300 rpm. Overall length is 8 in., greatest diameter is 5 in.

Electro Products Div., Western Gear Corp., Dept. ED, 132 W. Colorado Blvd., Pasadena, Calif.

CIRCLE 401 ON READER-SERVICE CARD

**VERTICAL FILE.**—Combines the advantages of vertical filing with convenience of handling one sheet at a time. Each sheet is attached to an aluminum hanger and 150 sheets, up to 42 in. wide, can be filed in one lineal foot. It is available in a wall-mounted unit or steel cabinet.

Plan Hold Corp., Dept. ED, 5202 Chakemco St., South Gate, Calif.

CIRCLE 402 ON READER-SERVICE CARD

**BACK CONNECTED POWER SWITCH.**—No. 4201-V-12 series is rated at 15 amp plus at both 125 v ac at 3/4 hp and 250 v ac at 1 hp. Switches are available in screw, solder, and spade quick disconnect terminals.

Sargent Electric Corp., Dept. ED, 630 Merrick Rd., Lynbrook, N.Y.

CIRCLE 403 ON READER-SERVICE CARD

**SILVER-CADMIUM BATTERIES.**—Have 0.1 to 300 ampere-hour-capacity. The Silcad cell may be used for television receivers and transmitters, portable lighting, and missile and satellite electronic facilities.

Yardney Electric Corp., Dept. ED, 40-50 Leonard St., New York 13, N.Y.

CIRCLE 404 ON READER-SERVICE CARD

**SPRING-LOADED CONTACT PLUG.**—Series PL-20 probe provides positive through-connection from practically zero to a maximum of 2.5 oz, necessary for its full travel of 0.187 in. Contact probe is of plunger type and is activated by axially applied pressure.

Sealectro Corp., Dept. ED, 610 Fayette Ave., Mamaroneck, N.Y.

CIRCLE 405 ON READER-SERVICE CARD

**SNAP SWITCH.**—Cam-Flip switch operates under severe conditions of vibration as high as 20 g over a frequency range of 10 to 4000 cps. Mechanically, it can take over  $3 \times 10^7$  actuations; for silver contacts passing 10 amp, it can take over  $25 \times 10^6$  electrical actuations.

Torres Engineering Co., Inc., Dept. ED, South Hackensack, N.J.

CIRCLE 406 ON READER-SERVICE CARD

**SPEED REDUCERS.**—Designed for torques up to 350 oz-in., in ratios from 1:1 to 360:1, they are equipped with precision ball bearings or oilless bronze bearings. Shaft sizes are 1/8, 3/16 and 1/4 in.

PIC Design Corp., Dept. ED, 377 Atlantic Ave., East Rockaway, N.Y.

CIRCLE 407 ON READER-SERVICE CARD

**AUTOMATIC VOLTAGE REGULATORS.**—Series IET Stabiline regulators are completely transistorized and have no moving parts.

Superior Electric Co., Dept. ED, Bristol, Conn.

CIRCLE 408 ON READER-SERVICE CARD

# Two G-E Glow Lamps that give you a choice of

# CRITICAL OPERATING VOLTAGES

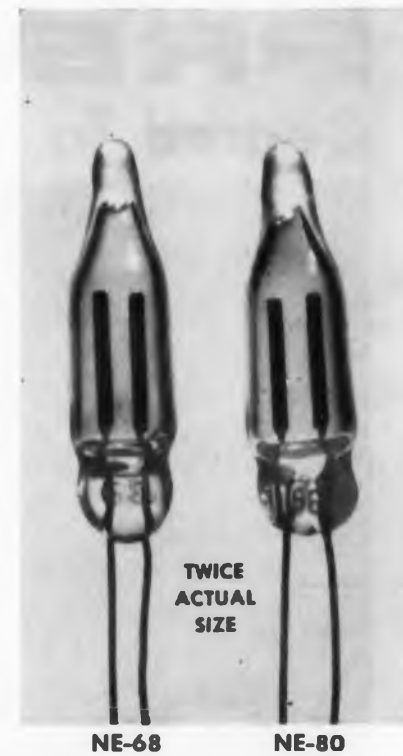

Here are two pre-tested and stable components engineered by G.E. for your circuit requirements

**G-E NE-68**—This pre-aged glow lamp has an operating voltage range of from 52 to 65 volts d-c. Its leads are plated to insure easier soldering and its performance in darkened areas is improved by a mildly radioactive additive. The lamps are also treated by the G-E Dri-film process for high leakage resistance under humid conditions. Polarity is indicated by a *blue* dot adjacent to the anode lead.

narrower operating voltage tolerance than the NE-68 (range: 50-58 volts d-c). This glow lamp offers uniform operation within predetermined limits. It employs a mildly radioactive additive and has been treated by the G-E Dri-film process, providing a leakage resistance of 100 megohms or greater under humid conditions. G-E NE-80 serves well in circuitry requiring a close tolerance on operating voltage, such as voltage regulators and voltage references. Polarity is indicated by a *yellow* dot next to the anode lead.

**G-E NE-80**—(Similar to the G-E NE-68)—Pre-aged, stabilized glow lamp with a

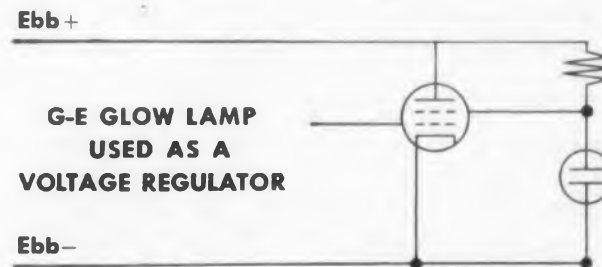

### DIRECT CURRENT CHARACTERISTICS

	NE-68	NE-80
Starting Volts. . . . .	60-90-volts d-c	(Max.) 80-volts d-c
Operating Volts. . . . .	52-65-volts d-c	50-58-volts d-c
Extinction Volts (in series with .25 megohm or more)	50-volts d-c	50-volts d-c
Design Current . . . . .	0.3 m.a.	0.1 m.a.
Leakage Resistance (at high humidity) . . . . .	100 megohms	100 megohms
<b>NE-68 Life</b> Change in operating volts at 0.3 m.a. is 5-volts in 6,000 hours		
<b>NE-80 Life</b> Operating Voltage to stay within above limits for 2,000 hours when operated at 0.1 m.a. Starting Voltage—Not more than 5-volts change from initial, in 2,000 hours at 0.1 m.a.		

Choose the General Electric Glow Lamp best for your circuit application. For further information, write for "Glow Lamps as Circuit Control Components". General Electric Co., Miniature Lamp Dept. M-902, Nela Park, Cleveland 12, Ohio.

*Progress Is Our Most Important Product*

**GENERAL  ELECTRIC**

# PRECISION

## Geared To Your Product Needs

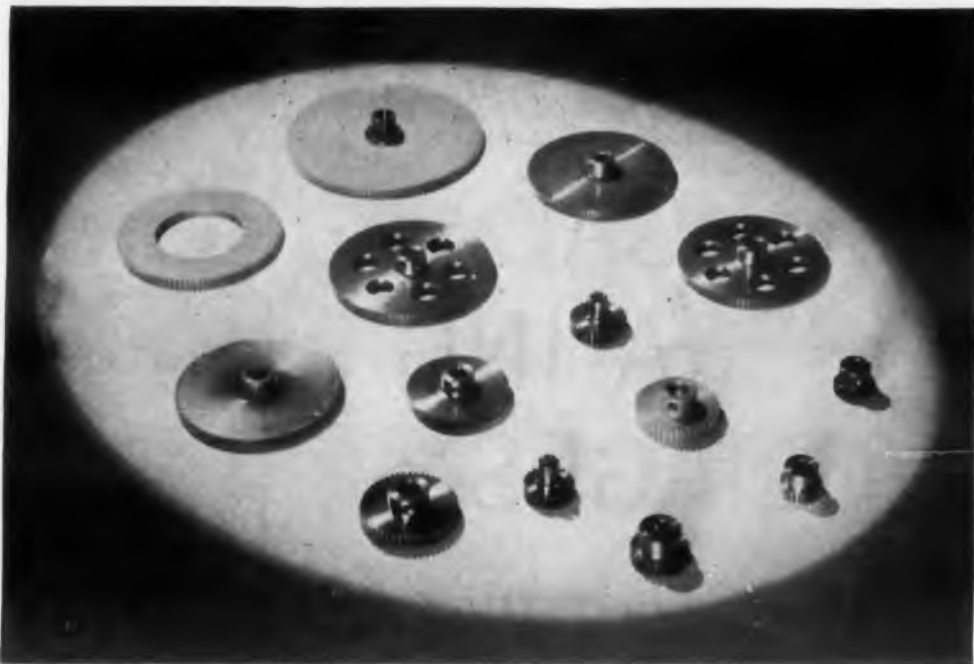

### APPCO *Certified* STOCK GEARS

32 TO 120 PITCH . . . A.G.M.A. PRECISION #1, 2 & 3

Every tooth a masterpiece in finish and motion . . . every gear to the most exacting A. G. M. A. precision standards . . . all meet Government specifications —that's the quality of APPCO Certified Precision Stock Gears. The precision of every gear Certified to assure engineers and production men of their exact requirements for every precision product.

APPCO Certified Precision Stock Gears are available for quick deliveries in 32, 48, 64, 72, 96 and 120 diametral pitches of 14½° and 20° pressure angles. Each gear designed with dimensions proportional to their diametral pitch for minimum weights and space considerations.

The fine precision and certified testing permits the use of APPCO Gears in precision assemblies of all types—airborne, shipboard, missile or stationary. APPCO Gears are usable in the engineering prototypes or breadboard design . . . will qualify uniformly for use in actual model pre-production or production manufacturing areas. Each gear is completely sealed on a shipping tray with plastic cover . . . always "factory fresh" and free of dust, corrosion and scratches.

Put extra precision into your products. Write for APPCO catalog to Atlas Precision Products Co., Castor and Kensington Avenues, Philadelphia 24, Pennsylvania.



GET FREE CATALOG



Division of  
**PRUDENTIAL INDUSTRIES INC.**

CIRCLE 409 ON READER-SERVICE CARD

## NEW PRODUCTS

### Linear Accelerometer

Has range of  $\pm 0.5$  g to  $\pm 50$  g

Having a range of  $\pm 0.5$  g to  $\pm 50$  g, this linear accelerometer operates on ac power and provides an ac output proportional to the applied acceleration. The unit is gas damped with the nominal damping ratio between 0.1 and 2; the damping ratio changes less than 2% per 10 deg F. The operating temperature is  $-60$  to  $+160$  F. Output impedance is 500 ohms max. The total accuracy envelope is better than  $\pm 2\%$  of full scale output. The unit meets applicable requirements of MIL-E-5272A. It measures 2.75 in. by 2 in. in diam and weighs less than 1 lb.

Genisco, Inc., Dept. ED, 2233 Federal Ave., Los Angeles 64, Calif.

CIRCLE 410 ON READER-SERVICE CARD

### Galvanometer

Electronic



For use as a dc null detector, linear deflection indicator, microvolt-ammeter or inverting dc amplifier, model 204A electronic galvanometer is capable of measuring voltages from  $1 \mu\text{v}$  to 10 v or currents from 100  $\mu\text{a}$  to 1 ma. Input impedance is 10 K on all ranges. Inverse feedback is 50 db. The unit includes a chopper stabilized amplifier. Transistors and printed circuits are used throughout. This portable unit measures 9.5 in. high, 6.5 in. long, and 12 in. in diam. Model 204AR, for rack-mounting, measures 5.25 in. high, 19 in. wide, and 11 in. in diam.

Kin Tel, Div. of Cohu Electronics, Inc., Dept. ED, 5725 Kearny Villa Rd., San Diego 12, Calif.

CIRCLE 411 ON READER-SERVICE CARD

### Monitor Kinescope

Has aluminized screen

Type 8HP4 glass monitor kinescope has a 7-3/16 x 5-3/8 in. aluminized screen and a filter-glass faceplate. Employing 90 deg deflection, the unit has an over-all length of 10.25 in. and weighs about 2.5 lb. Made for TV monitor equipment, this unit has an electron gun which employs electrostatic focus and does not require an ion-trap magnet. The projected screen area is 35.5 sq in.

Radio Corp. of America, Electron Tube Div., Dept. ED, Harrison, N.J.

CIRCLE 412 ON READER-SERVICE CARD



measure down to

**0.03  $\mu\text{v}$**

The Keithley 150 sets a new standard of sensitivity for dc voltmeters. Typical uses include output measurements from strain gages, thermopiles and ion chambers, as well as Hall effect studies, corrosion work and molecular weight analysis.

Functions and measurement spans of the 150 are: dc voltmeter, 1 microvolt to 1 volt full scale; ammeter,  $10^{-3}$  to  $10^{-10}$  ampere full scale; dc amplifier, gains of 10 to  $10^7$ ; and null detector, with 0.5 to 2 second response. Features include:

- zero stability as a voltmeter within 0.1 microvolt per day; as an ammeter, within  $2 \times 10^{-11}$  ampere per day.
- zero suppression up to 100 times full scale.
- optional floating or grounded input.
- short term noise within 0.03 microvolt peak to peak (0.006 microvolt RMS).
- rugged construction, relative insensitivity to vibration, 60-cycle fields, or thermal EMF's.

Write today for your copy of Keithley Engineering Notes, Vol. 7 No. 1 describing the Model 150.

**KEITHLEY**  
INSTRUMENTS, INC.

12415 Euclid Ave., Cleveland 6, Ohio

CIRCLE 413 ON READER-SERVICE CARD

ELECTRONIC DESIGN • September 16, 1959



## Power Supply

### Regulated

This power supply converts 3 phase, 115 v  $\pm 10\%$ , 400  $\pm 5\%$  cps to 28 v dc with  $\pm 0.5$  v regulation, at any combination of loads with magnetic amplifiers. Continuous full load capacity is 200 amp; maximum ripple is 1.5 v peak-to-peak. It will sustain high overloads and complete short circuits for about 2 sec with a recovery response in 2 sec. The unit complies with Procedure 1 of MIL-E-5272A without shock mounts or vibration isolators. Its size is 12-7/8 x 11-1/4 x 8-1/2 in., its weight, 51.5 lb.

Aerotronics Controls Co., Dept. ED, 3424 W. 48th Place, Chicago 32, Ill.

CIRCLE 414 ON READER-SERVICE CARD

## Electrolytic Capacitors

### Miniature, tubular

Designed for use in industrial equipment and limited space assemblies, type PTT electrolytic capacitors operate at a temperature range of  $-30$  to  $+65$  C. Ratings of 3, 6, 10, 12, 15, 25, and 50 wvdc are available. Protection against humidity is provided.

Aerovox Corp., Dept. ED, New Bedford, Mass.

CIRCLE 415 ON READER-SERVICE CARD

## Delay Line

### Magnetostrictive

Model MF-40 solid state, magnetostrictive delay line has a delay of 40  $\mu$ sec. Other models in the same series have from 5 to 200  $\mu$ sec delay. All models withstand vibration to 500 cps at 15 g and shock to 50 g. Operating temperature is  $-55$  to  $+100$  C with a coefficient of less than 200 ppm per deg C. Input-output impedances are from 5 to 200 ohms with carrier or pulse frequencies to 1 mc. Insertion loss is 54 db. Taps can be supplied and spaced as close as 3  $\mu$ sec with or without an adjustment feature.

Control Electronics Co., Inc., Dept. ED, 10 Stepar Place, Huntington Sta., L.I., N.Y.

CIRCLE 416 ON READER-SERVICE CARD

Circle 901 on Career Inquiry Form page 173 >

# Engineers seeking stimulating careers set a course to Link...in Binghamton, New York

*Set sail on a well-charted course!* Engineers with a circumspect eye on the future choose their place of employment only after careful, soul-searching deliberation. Link Aviation, Inc., Binghamton, N.Y., has all the necessary ingredients for stimulating careers:

*The company* - As the pioneer and leading producer of electronic flight simulators, Link has greatly expanded its capabilities in fields such as automatic control, optical and visual display systems and data processing. For example, Link is now the world's largest producer of analog computing equipment.

*Working environment* - Management men are engineers. They understand your work and point of view. This kind of administration provides engineering thinking right up to policy level.

*Living environment* - Binghamton, N.Y. is a delightful place to live. Located at the tips of the famous Finger

Lakes, Link-Binghamton abounds in year-round recreation...boating, fishing, hunting, water skiing and camping. Charming homes, modern schools, and convenient shopping centers are in abundance.

*Additional benefits* - include excellent salaries, generous hospital, health, retirement and profit-sharing benefits, and graduate level courses underwritten by Link.

*The positions* - Openings exist for engineers qualified in the following fields: analog and digital computer components and systems, radar simulation, advanced circuit development, ASW/AEW systems simulation, fire control computer design, optical systems development.

*Hoist anchor now! Write to*  
Mr. A. J. Darrah, Link Aviation, Inc., Binghamton, N.Y.

A subsidiary of  
General Precision  
Equipment  
Corporation

**LINK**

A  
GENERAL  
PRECISION  
COMPANY

LINK AVIATION, INC.



# FOOL-PROOF low amp E-T-A

## miniature CIRCUIT BREAKER

### SAFE—

overload and short circuit protection for transformers, solenoids, relays, motors and other electric and electronic applications.

### POSITIVE—

trip-free mechanism protects breaker under overload conditions.

### ACCURATE—

wide range of precisely calibrated ratings to extremely sensitive tripping limits.



Model 45-700-P

CURRENT RATINGS—  
50 milliamps to (min)  
25 amp (max)  
240 V a-c, 24 V d-c

Write for  
literature

Experience the outstanding advantages of  
modern E-T-A circuit breaker protection  
—for complete information, write to—

# E-T-A

**PRODUCTS CO. OF AMERICA**  
6284 N. Cicero Ave. Chicago 46, Ill.

CIRCLE 418 ON READER-SERVICE CARD

Here's a new  
twist  
in time-savings!



fasteners by  
**FASTEX**

Send for this free catalog that shows you how to untwist time consuming screw driving with FASTEX® ¼ (yes, one-quarter) turn "Q" Fasteners. Tells all about the three types that cover every application. Write for Quick Fastener booklet today!

## FASTEX

195 Algonquin Road, Des Plaines, Illinois  
In Canada: SHAKEPROOF-FASTEX,  
Division of Canada Illinois Tools Ltd., Toronto, Ont.  
A DIVISION OF ILLINOIS TOOL WORKS



CIRCLE 419 ON READER-SERVICE CARD

## NEW PRODUCTS

### Ultrasonic Cleaner

Operates at 400 kc

Model VT-700 ultrasonic cleaner operates at 400 kc with frequencies ranging down to 20 kc. Its applications include cleaning assembled tele-type mechanisms, gear trains, valves, porous metal filters, blind holes, and potentiometer parts. The cleaning containers are 12 in. in diam and 12 in. deep with a 24 qt capacity. Barium titanate transducers are alternately driven by a 700 w rf generator. The unit is made of stainless steel.

McKenna Laboratories, Dept. ED, 2503 Main St., Santa Monica, Calif.

CIRCLE 420 ON READER-SERVICE CARD

### Power Supply

Has 0 to 20 v output



Model 806A rack-mounted power supply has an adjustable output of 0 to 20 v at load currents to 2 amp. Input power is 105 to 120 v, 50 to 440 cps. Error sensing is possible from either front or rear terminals; remote error sensing is available on the rear terminal strip. Remote programming is provided. The unit employs a wideband transistorized feedback amplifier. The transient recovery time is 50 µsec max for a 100% step change in load current. Protection against short circuits and overloads is included.

Harrison Laboratories, Inc., Dept. ED, 45 Industrial Rd., Berkeley Heights, N. J.

CIRCLE 421 ON READER-SERVICE CARD

### Fuse

Current-sensitive

This current-sensitive fuse withstands temperatures from -100 to +400 F, vibration of 10 to 500 cps at 15 g max, and shock of 50 g for 11 msec. Glass-enclosed and hermetically sealed, the fuse is humidity proof. Units are filled with nitrogen or other specified gases. Outside ends of the terminals are flexible copper alloy leads, straight cut-offs, or flattened and pierced lugs. Fast, medium or slow blowing-operating time is provided.

Networks Electronic Corp., Dept. ED, Van Nuys, Calif.

CIRCLE 422 ON READER-SERVICE CARD

## NEW FROM NARDA



Model  
10001  
\$4700.

High Power

# MICROWAVE MODULATOR

accepts over 40 magnetrons!

Here's the first of a series of new products from Narda's recently-established High Power Electronics Division! A high power Microwave Modulator that permits installation inside the unit of any of more than 40 magnetrons! Complete, compact and self-contained, it accepts magnetrons covering 3,200 mc to 35,000 mc, with peak outputs from 6 KW to 120 KW. Model 10001 features a completely interlocked circuit, with all high voltage leads and connections internal, for maximum safety; solid state high voltage bridge rectifiers for longer life and reduced heat output (prolonging life of other components, too); and built-in meters and viewing connectors for all principal parameters.

Other features are shown below. For complete specs and a list of at least 40 magnetrons suitable for use with the 10001, write Narda's High Power Electronics Division (HPED) at Dept. ED-7.

## SPECIFICATIONS

High voltage supply: Continuously variable from 0 to 4 KV at 100 ma; Magnetron filament supply: Cont. variable from 0 to 13 volts at 3 A; Rep. rate generator range: Cont. variable from 180 to 3000 pps; Pulse width: 1 microsecond at 70% points, rise time 0.15 microseconds, max. slope 5% (other pulse widths available); Size: 38" h, 22" w, 18" d. Weight: 150 lbs.

Complete 1959 catalog available on request.

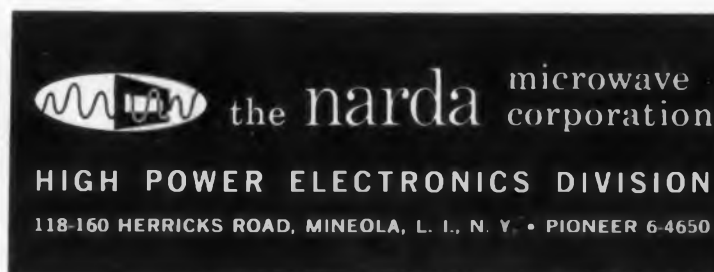

CIRCLE 423 ON READER-SERVICE CARD

ELECTRONIC DESIGN • September 16, 1959



# NEW FROM NARDA



**Wide Range  
KLYSTRON POWER SUPPLY—\$475<sup>00</sup>**

Model 438

## Operates more Klystrons than any comparable unit!

This new Narda Wide Range Klystron Power Supply operates virtually all medium and low voltage Klystrons, as well as some high voltage tubes (at reduced power output). It literally operates more Klystrons, including Sperry and Varian tubes, than any other unit in its price range!

What's more, all components, including tube sockets, are operated within manufacturers' ratings. (Many other supplies exceed plate-cathode,

cathode-filament or socket-ground voltage ratings.)

Want more information about this new Power Supply that gives you greater versatility and longer trouble-free service at lower cost? Then write us for complete spec sheets. Ask, too, for your free copy of our complete catalog. Address: Dept. ED-6.

### FEATURES

- 250-700 volt Beam Supply, 0-65 ma.
- 0-1000 volt Reflector Supply
- Accurate Ten-Turn Dial Calibration
- 5 mv max. Reflector Ripple
- Diode Protection Circuit
- Oil Filled Capacitors in High Voltage Filters
- Square Wave Modulation 0-150 Volts, 300 to 3000 cps.
- Saw Tooth Modulation 0-150 Volts, 30 to 180 cps.
- Sine Wave Modulation 0-150 Volts, 60 cps.

### Radio Interference Filter

Carries 150 amp continuously

Designed for use in missile systems, this 100 v dc radio interference filter has a continuous current rating of 150 amp and will carry 300 amp for 1 hr at 125 C. Its mechanical and electrical characteristics fit MIL-M-8069 for dc aircraft, and its radio interference characteristics meet MIL-I-6181B. The unit will withstand 125 C continuously, 150 C for 24 hr, and 250 C for 15 min.

Genistron, Inc., Dept. ED, 2301 Federal Ave., Los Angeles 64, Calif.

CIRCLE 425 ON READER-SERVICE CARD



**Power Supplies**  
Two types available

Designed for airborne use, these two types of power supplies are transistorized. For type 150S003-2, input is 102 to 124 v ac at  $400 \pm 20$  cps, output is 150 v dc, and ripple is 150 mv peak-to-peak. It measures 2.31 x 2.06 x 3.13 in. and weighs 13 oz. For type PS 272, input is 24 to 32 v dc, output is 180 v dc, and ripple is 0.5% rms. This unit measures 1.85 x 1.85 x 2.75 in. and weighs 16 oz. Both models meet MIL-E-5272A requirements.

Arnoux Corp., Dept. ED, 11924 W. Washington Blvd., Los Angeles 66, Calif.

CIRCLE 426 ON READER-SERVICE CARD

### Converter

Doubles plotting speeds

This converter permits the direct use of digital magnetic tape as input to automatic graph plotters and similar voltage devices. It eliminates the necessity of transferring data from tape to punched cards, and doubles plotting speeds. The unit has solid-state circuitry, a point density selector, parity check, automatic file and record run-up, and provision for omitting records which contain specified characters.

Benson-Lehner Corp., Dept. ED, 11920 W. Olympic Blvd., Los Angeles 64, Calif.

CIRCLE 427 ON READER-SERVICE CARD



the **narda** microwave corporation

118-160 HERRICKS ROAD, MINEOLA, L. I., N. Y. • PIONEER 6-4650

CIRCLE 424 ON READER-SERVICE CARD



# HOW VERSATILE IS VERSATILITY?

... As versatile as the tools we use. *Yesterday's* youth, to whom the utility knife represented the ultimate in a wondrous tool of versatility, is *today's* scientist, engineer, technician . . . requiring comparable versatility in instrumentation to help him do his job. No tools are more versatile than *dependable Cubic digital instruments* — the line with measurement applications limited only to the imagination.

Every phenomenon of science and nature that can be converted to a usable DC voltage level — pressure, temperature, depth, volume, salinity — every electronic and electrical phenomenon, countless weights and measures and elements of time and space . . . all provide realistic applications for Cubic instrumentation. For fast, accurate, dependable measurement, combined with superior versatility — you can rely on Cubic digital systems.

Incoming inspection, quality control, environmental performance testing, chemical and other process control monitoring, strain system measurement, production line testing, telemetering system calibration, electronic instrument calibration, research and development laboratory work are among the countless uses for a Cubic digital system.



**CUBIC CORPORATION**

5575 Kearny Villa Road, San Diego 11, California

Electronic Engineering

With a Dimension for the Future

CIRCLE 428 ON READER-SERVICE CARD



DC Voltmeters, Control Units, DC Pre-Amplifiers, AC Converters, Ohmmeters, Scanning Systems, Ratio-meters, Printer Controls and Chronometers, all with Cubic's superior design and construction features, are available for easy insertion into "systems that design themselves."

Clear visual display, outputs for printed records of measurement, remote readouts and the new "voice" dimension of the Cubic Talking Meter combine for even greater versatility. And each Cubic unit is a fine instrument of superior design and construction with unique features that provide dependable operation, long life and easy routine maintenance.

The skill and experience responsible for the superiority of Cubic's Space Age electronic tracking systems are also important components of Cubic's digital instruments . . . yours for an easier job — done faster, better and with greater assurance.

## NEW PRODUCTS

### Mil Counter

Weights under 4 oz

Designed for use in guidance systems and navigation equipment, this mil counter weighs under 4 oz and measures about 2.2 in. in length. One revolution of the driveshaft registers 10 mils in 1/4 mil increments on the face of the instrument. The numerals, available in standard enamels or fluorescent, count to 6399. Minimum life of the counter is 1,000,000 rotations at 1200 rpm. It operates over a temperature range of  $-55$  to  $+85$  C. At minimum temperature, 1 oz-in. torque is required; at room temperature, 0.5 oz-in. It passes humidity and standard 50 hr salt spray tests and meets military requirements for shock, vibration, and corrosion resistance.

Veeder-Root, Inc., Dept. ED, 70 Sargeant St., Hartford 2, Conn.

CIRCLE 429 ON READER-SERVICE CARD

### Microwave Wattmeter

For 10 to 10,250 mc range

Designed for power measurements in the 10 to 10,250 mc range, model 1300 wattmeter is powered by a mercury cell battery. It provides power measurement ranges of 0 to 1 mw and 0 to 10 mw, or  $-10$  to 0 dbm and 0 to 10 dbm. Its accuracy is  $\pm 5\%$  of full scale and rated battery life is over 100 hr. Its dimensions are 6 x 2-3/4 x 2-1/8 in.; its weight is approximately 1 lb. Input to the unit is a male type N connector.

Radar Measurements Corp., Dept. ED, 190 Duffey Ave., Hicksville, N.Y.

CIRCLE 430 ON READER-SERVICE CARD

### Germanium Photodiode

Has integral lens

TP-55 germanium photodiode features an integral lens which concentrates light on the sensitive portion of the junction area. Made for use in either the visible or infrared portions of the spectrum, it has applications such as punched-card or tape reading in either computing or control systems and continuous-process monitoring. Sensitivity is approximately 30 ma per lumen at 20 C ambient temperature. Operation is to 50 C max ambient temperature, and working voltage is 50 v max. Dark current is less than 5  $\mu$ a. The sensitive surface is less than 1 mm<sup>2</sup>, and the overall dimensions are 0.087 x 0.394 in. with leads approximately 19/32 in. It is hermetically sealed.

Nucleonic Products Co., Dept. ED, 1601 Grande Vista Ave., Los Angeles 23, Calif.

CIRCLE 431 ON READER-SERVICE CARD



**MINIATURE BEAM POWER PENTODE.**—Type 7189 has maximum plate voltage rating of 450 v, 9-pin miniature base, and 6.3 v heater that draws 760 ma. Mounts in any position. Two units operating in push-pull with peak af input of 29 v provide 24 w with under 4% distortion.

CBS-Hytron, Dept. ED, Danvers, Mass.

CIRCLE 713 ON READER-SERVICE CARD

**VINYL INSULATION SLEEVING.**—Transparent Resinite EP-69C is fungus resistant, stays flexible to -75 F and stable to +185 F. Self-extinguishing in 6 sec.

Bordon Chemical Co., Resinite Dept., Dept. ED, Santa Barbara, Calif.

CIRCLE 432 ON READER-SERVICE CARD

**MINIATURE TRANSISTOR TRANSFORMERS.**—About 1/2 cu. in., Veri-Miniatures weigh 0.16 to 0.25 oz. Available in molded, open frame, or plug-in tab mounted construction.

Microtran Co., Inc., Dept. ED, 145 E. Mineola Ave., Valley Stream, N.Y.

CIRCLE 433 ON READER-SERVICE CARD

**MYLAR TUBES.**—Thin-wall coil forms bonded with cement that holds when the Mylar shrinks at 400 F. Suitable for shrinking onto coils, heavy wires, bus bars, and capacitor cans. In 0.002 to 0.006 in. wall thicknesses and any ID, OD, or length.

Precision Paper Tube Co., Dept. ED, 2035 W. Charleston St., Chicago 44, Ill.

CIRCLE 434 ON READER-SERVICE CARD

**CABLE FAULT LOCATING SET.**—Accurate to within 1/8 in. Available in several ranges for shielded multiconductor cables that normally require dielectric test of from 3 kv or less to 25 kv or higher.

Peschel Electronics, Inc., Dept. ED, Towners, Patterson, N.Y.

CIRCLE 435 ON READER-SERVICE CARD

**MULTIMETER.**—Model 102F has fused meter, five ac and dc ranges to 3000 v, 3 ac and dc current ranges, and 2 resistance ranges to 1 meg. A 4-1/2 in. version, model 103F, is also available.

Electronic Measurements Corp., Dept. ED, 625 Broadway, New York 12, N.Y.

CIRCLE 436 ON READER-SERVICE CARD

**MOBILE INDUSTRIAL ULTRASONIC CLEANERS.**—Wheel mounted systems with 1 to 75 gal tank capacities and 50 to 2500 power ratings. Operate on 115 or 220 v ac.

Acoustica Associates, Inc., Dept. ED, 26 Windsor Ave., Mineola, N.Y.

CIRCLE 437 ON READER-SERVICE CARD

**POTENTIOMETER CHECKER AND CALIBRATOR.**—Portable, self-contained Treasure Chest has 0.1% accuracy over range of 0 to 1.01 v as well as standard range of 0 to 101 mv.

Thwing-Albert Instrument Co., Dept. ED, Penn St. at Pulaski Ave., Philadelphia 44, Pa.

CIRCLE 438 ON READER-SERVICE CARD

## Some Ideas

A year of relentless testing has produced a small library of interesting facts about HERCULENE (T.M.) Drafting Film. What follows is a consensus of drafting-room experience with HERCULENE—by K&E and its customers—with some up-to-date recommendations for using it. Take the matter of . . .

### Shiny Back vs. Pencil Back

A basic question is: do you need a double-surfaced drafting film? We make HERCULENE Drafting Film both ways, of course—with a single surface (shiny back) and double surface (pencil back). It's our recommendation that you use pencil back HERCULENE only if it's your practice to make basic drawings on one side, changes on the other. For most other uses, shiny back is preferable. (At first, the double-surface film was chosen by many drafting rooms because it lay flatter on the board than shiny back. This is no longer true. K&E research labs have come up with a fully effective anti-curl treatment.) Especially in filing, shiny back HERCULENE presents fewer problems. The clean non-abrasive back won't smudge the face of the sheet underneath, even in a heavy stack of tracings. If you'd like to compare a few sheets, please let us know.

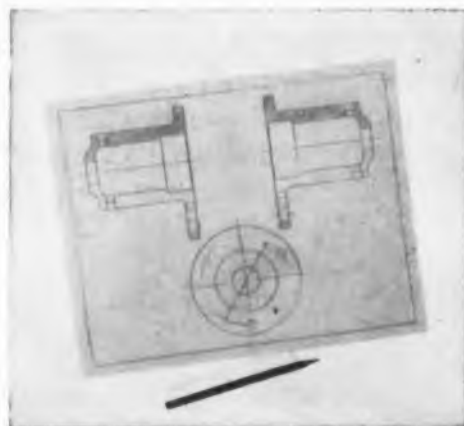

Note sharp clear lines made by Duralar pencil on HERCULENE Drafting Film.

### Plastic Pencils and the HERCULENE Surface

Not just a handy catch-phrase, when K&E puts its exclusive "engineered surface" on a drafting material, the result is an exact, uniform tooth for sharp pencil drawing, inking and typing. With HERCULENE Drafting Film, however, an entirely new type of plastic (non-graphite) pencil yields especially good results. Quite a few of our customers have reported favorably on the well-known Staedtler "Duralar" brand. Duralar pencils come in five hardnesses, are non-smudging and have generally good covering power, sharpness and erasability. After about 20 prints, the Duralar lines show up consistently better than those made by a regular pencil, since graphite lines tend to lose density.



for your file of practical information on drafting and reproduction from

KEUFFEL & ESSER CO.

### Wet That Eraser!

The erasing qualities of HERCULENE Drafting Film are excellent, but (as with the pencils) we've discovered it's a new type of vinyl eraser that gives the best results. Examples of these non-rubber type erasers are the Richard Best "TAD" and the Eberhard Faber "RACE KLEEN"—both available from your K&E dealer. With vinyl erasers, pencil lines whisk off. Even stubborn ink and typing can be removed easily, with no damage to the surface. Here's a tip on how to do this:



Moisten the eraser slightly. It becomes no more abrasive, but a lot more "erasive." Moistening is a must when removing Duralar lines or typing after exposure to heat. (Incidentally, don't use electric erasing machines, steel erasers or typewriter erasers.) When erasing large areas, certain chemical eradicators work fine too. Our suggestion: use Vythene or a very light application of a denatured alcohol such as Solox, both of which can be applied with a cotton swab or clean cloth.

### The Cleaner the Better

HERCULENE Drafting Film was designed for ink work, and its ink take is unexcelled. But like all films, its non-absorbency makes a few preparations advisable. The surface should be cleaned thoroughly before inking. Quickest and most effective way to do this is with the ABC Draftsman's Dry-Clean pad, which will remove finger marks and "traffic film" simply by rubbing the pad over the surface. Pouncing will also work well. A damp cloth is all right for general cleaning, but does not do the best job of preparing the surface for ink.

Inking over graphite pencil lines comes out best when done over light lines, drawn with a harder grade of pencil. A good way to remove excess graphite is to go over the drawing with an ABC pad. Inks vary in their usefulness on HERCULENE. We've tested several, and you're welcome to these results as well, on request.



### After Typing, Please Pounce

Typed impressions on HERCULENE Drafting Film are crisp and sharp, but may take a while to dry because the film's surface doesn't "swallow" ink readily. A light pouncing right after typing will dry the ink and fix the lines—giving you uniform permanent contrast.

A new typewriter ribbon will produce the best impressions. At K&E we've tested a healthy variety of ribbons and we'd be pleased to send you the results on request.

### Outstanding Advantages Proved in Tests

We're pleasantly amazed at the short time it took for HERCULENE Drafting Film to become an accepted "staple"—along with ALBANENE® Tracing Paper and PHOENIX® Tracing Cloth. Actually, it's a rare drafting room by now that has not tested HERCULENE during its first year on the market. The findings: All properties considered, HERCULENE stands up better than any other drafting film. It has great resistance to heat, aging and abuse. Its exclusive "engineered surface" plus its tough, durable Mylar® base provide superior pencil and ink take, fine erasability, remarkable dimensional stability...a combination we're proud to call unbeatable!

The K&E dealer near you has HERCULENE now. Stop in and see him.

KEUFFEL & ESSER CO., Dept. ED-9, Hoboken, N. J.

Please send further information about HERCULENE Drafting Film. I'd like samples too.

Name & Title \_\_\_\_\_

Company & Address \_\_\_\_\_

CIRCLE 439 ON READER-SERVICE CARD





**SCOPE CART.**— Model 20-4 provides cabinet space for auxiliary equipment and is hip-high with a 15 deg slanted top to bring scope screen and adjustments within easy reach. It is mounted on rubber-tire casters.

Northeastern Engineering, Inc., Dept. ED, 25 S. Bedford St., Manchester, N.H.

CIRCLE 445 ON READER-SERVICE CARD

**HIGH TEMPERATURE RESISTANCE THERMOMETERS.**—Model MH 100, 200, and 400 Stikons measure up to 800 F, can be bonded to flat surfaces with 1/2 in. curvature radius. Up to 15 ma may be used before self-heating error reaches 1%.

Arthur C. Ruge Associates, Inc., Dept. ED, Hudson, N.H.

CIRCLE 446 ON READER-SERVICE CARD

**WELDING GUN.**—Model WG-201 is hand-size and weighs 10 oz. It may be used to weld thermocouples and strain-gages to metal surfaces. It also may be used with stored energy or ac welding power supply systems. A welding tip, 0.25 in. diam, RWMA class 2 is provided.

Pacific Scientific Instruments Lab., Dept. ED, P.O. Box 25115, Los Angeles 25, Calif.

CIRCLE 447 ON READER-SERVICE CARD

**PLASTIC TEMPERATURE INDICATORS.**—Temp-Plate labels are backed with adhesive, register given surface temperature between 100 and 700 F with  $\pm 1\%$  accuracy. For detecting hot spots on radar panels, other critical points.

Pyrodyne, Inc., Dept. ED, P.O. Box 49972, Los Angeles 49, Calif.

CIRCLE 448 ON READER-SERVICE CARD

**MINIATURE POWER PENTODES.**—Types 6BQ5 and 8BQ5 are 9-pin units for use in the audio output stage of radio and television receivers and in phonographs. They have a high power sensitivity, and a single unit can deliver a maximum signal power output of 5.7 w with a peak af grid no. 1 voltage of 6.2 v in class A1 amplifier service. Respectively, they have 6.3 v, 760 ma and 8 v, 600 ma heaters.

Radio Corporation of America, Electron Tube Div., Dept. ED, Harrison, N.J.

CIRCLE 449 ON READER-SERVICE CARD

**NONREPRODUCIBLE DIAZO TYPE PAPER.**—Easily readable phantom blue images on type 206 PBT prints simplify engineering drawing, do not reproduce.

Frederick Post Co., Dept. ED, 3650 N. Avondale Ave., Chicago 18, Ill.

CIRCLE 450 ON READER-SERVICE CARD

**MOLDED NYLON MACHINE SCREWS.**—Available with binding, round, fillister, flat, and washer heads. In sizes from No. 4-40 to 1/4-20 and all standard lengths to 1 in. Choice of Phillips or slotted head.

Richco Plastic Co., Dept. ED, 4445 W. Fullerton Ave., Chicago 39, Ill.

CIRCLE 451 ON READER-SERVICE CARD

# WHEN YOU'RE REACHING FOR THE MOON

When you're designing a new missile gyroscope . . . a new computer . . . a new telemetering device . . . a new *anything* that calls for precision instrument ball bearings . . . you do well to turn to Fafnir. For no matter what your problem is . . . temperature extremes, low torque, load-life, low vibration or noise levels . . . Fafnir can help you solve it. Fafnir has the *diversity* — a wide variety of ball bearing types, designs, materials, and tolerances — and the uniformly high standards of *quality* to meet your needs precisely. The Fafnir Bearing Company, New Britain, Conn.



Three varieties of retainers available to you in Fafnir precision instrument ball bearings. From left: ribbon-type steel (for low torque), composition (for high speeds), and iron-silicon-bronze (for high-speed, high-temperature applications).

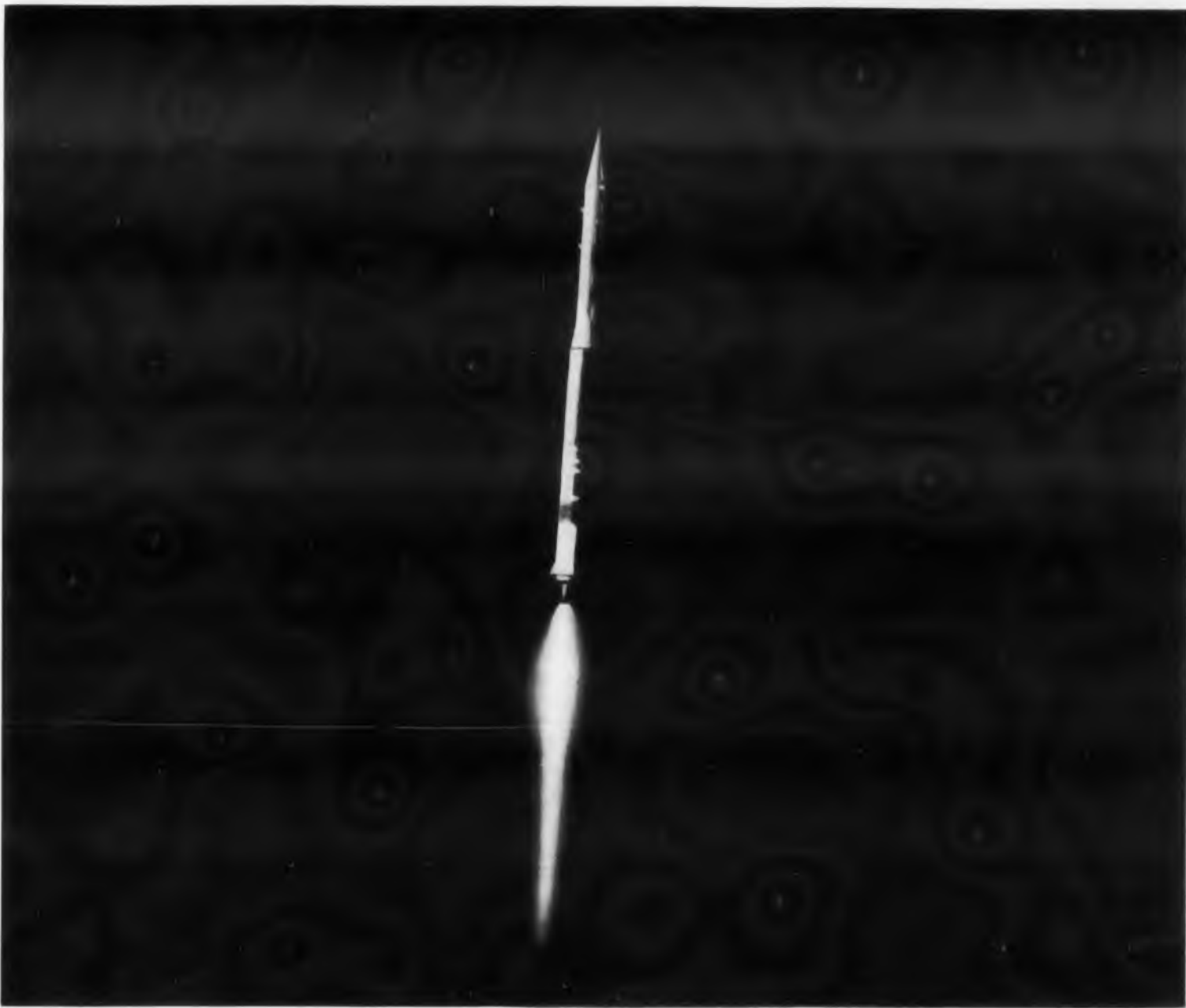

**FAFNIR**  
BALL BEARINGS

CIRCLE 452 ON READER-SERVICE CARD

# Dual Beam

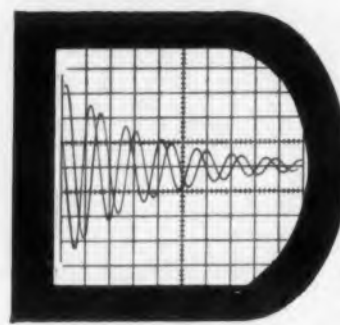

**DUAL DISPLAY ON LINEAR TIME BASE**—Comparison of waveforms at two points in a ringing circuit. This kind of display is useful in many types of investigation.

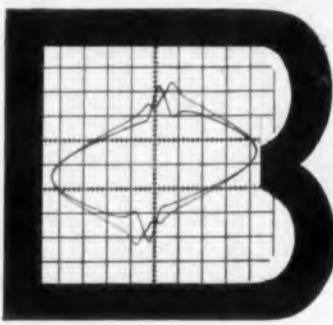

**DUAL BEAM X-Y CURVE TRACING**—Typical production test application: display of EI loops of two transformers manufactured under identical conditions.

## Type 502 Tektronix Oscilloscope

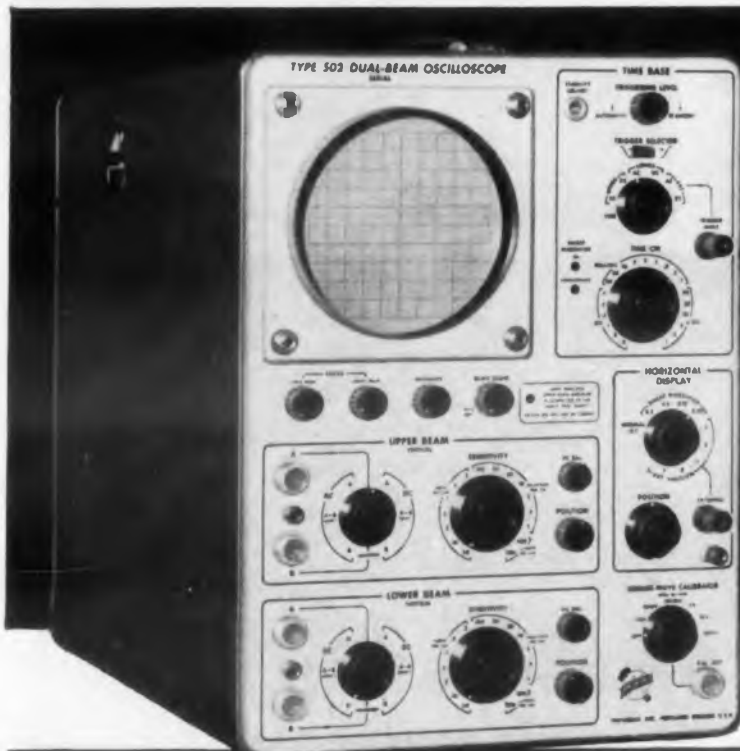

**TWO-GUN CATHODE-RAY TUBE.**

**200  $\mu\text{v}/\text{cm}$  SENSITIVITY, BOTH BEAMS.**

**DIFFERENTIAL INPUT, ALL SENSITIVITIES.**

**2, 5, 10, and 20 TIMES SWEEP MAGNIFICATION.**

**X-Y CURVE TRACING with TWO BEAMS**—(horizontal input sensitivity to 0.1 v/cm).

**SINGLE-BEAM X-Y CURVE TRACING at 200  $\mu\text{v}/\text{cm}$ , BOTH AXES.**

**EXTRA FEATURE**—Both amplifiers have transistor-regulated parallel heater supply.

### Here are a few uses for the Type 502:

**IN ELECTRONICS**—Use the Type 502 as a general-purpose oscilloscope and also to show simultaneously the waveforms at any two points in a circuit, e.g. input and output, opposite sides of a push-pull circuit, trigger and triggered waveform, etc.

**IN MECHANICS**—Display, compare, and measure outputs of two transducers on the same time base; plot one transducer output against another—pressure against volume or temperature for instance; measure phase angles, frequency differences, etc.

**IN MEDICINE**—Display, compare, and measure stimulus and reaction, or the outputs of two probes, on the same time base; use differential input to cancel out common-mode signals, or to eliminate the need for a common terminal; use in routine investigations, etc.

**IN ALL FIELDS**—The Type 502 can save you more than its cost in time—in as little as one application!

## Tektronix, Inc.

P. O. Box 831 • Portland 7, Oregon  
Phone CYPRESS 2-2611 • TWX-PD 311 • Cable: TEKTRONIX

**TEKTRONIX FIELD OFFICES:** Albertson, L.I., N.Y. • Albuquerque • Atlanta, Ga. • Bronzville, N.Y. • Buffalo • Cleveland • Dallas • Dayton • Elmwood Park, Ill. • Endwell, N.Y. • Houston • Lothrop Village, Mich. • East Los Angeles • West Los Angeles • Minneapolis • Mission, Kansas • Newtonville, Mass. • Orlando, Fla. • Palo Alto, Calif. • Philadelphia • Phoenix • San Diego • St. Petersburg, Fla. • Syracuse • Towson, Md. • Union, N.J. • Washington, D.C. • Willowdale, Ont.

**TEKTRONIX ENGINEERING REPRESENTATIVES:** Hawthorne Electronics, Portland, Oregon.; Seattle, Wash.; Mytronic Measurements, Denver, Colo.; Salt Lake City, Utah.

Tektronix is represented in 20 overseas countries by qualified engineering organizations.

### TYPE 502 CHARACTERISTICS

#### HIGH-GAIN AMPLIFIERS

200-microvolts/cm deflection factors, both dc-coupled and ac-coupled. 16 calibrated steps from 200  $\mu\text{v}/\text{cm}$  to 20 v/cm.

Passbands—dc-to-100 kc at 200  $\mu\text{v}/\text{cm}$ , increasing to dc-to-200 kc at 1 mv/cm, dc-to-400 kc at 50 mv/cm, and to dc-to-1 mc at 0.2 v/cm. Vertical response at the lower sensitivities varies according to switch position as follows: 0.5 v/cm—dc-to-300 kc; 1 v/cm—dc-to-500 kc; 2 v/cm—dc-to-1 mc; 5 v/cm—dc-to-300 kc; 10 v/cm—dc-to-500 kc; 20 v/cm—dc-to-1 mc.

Differential Input, Both Channels—Rejection ratios: 1000-to-1 at 1 mv/cm or less, 100-to-1 at 0.2 v/cm, 50-to-1 at 5 to 20 v/cm.

Constant Input Impedance, 1 megohm, 47  $\mu\text{f}$ , both channels.

#### WIDE-RANGE SWEEP CIRCUIT (Common to both beams)

Single-knob control for selecting any of 22 accurately-calibrated sweep rates from 1  $\mu\text{sec}/\text{cm}$  to 5 sec/cm.

Sweep Magnification—2, 5, 10, and 20 times, accurate within the maximum calibrated sweep rate.

Automatic Triggering—fully automatic, or preset with amplitude-level selection when desired. Sweep can also be operated free-running.

#### X-Y CURVE TRACING OPERATION

Horizontal-input amplifier permits curve-tracing with both beams simultaneously at sensitivities to 0.1 v/cm. For curve-tracing at higher sensitivities (to 200  $\mu\text{v}/\text{cm}$ ) with one beam, one of the vertical amplifiers can be switched to the horizontal-deflection plates.

#### OTHER FEATURES

Amplitude calibrator, 1 mv to 100 v in decade steps—square wave, frequency about 1 kc.

3-kv accelerating potential on new Tektronix 5" dual-beam crt, 8-cm by 10-cm linear-display area, each beam, 6-cm overlap.

Electronically-regulated power supplies.

Price... \$825 f.o.b. factory

CIRCLE 453 ON READER-SERVICE CARD

## NEW PRODUCTS

### Power Supplies

12 models available



These power supplies are available in 12 different models with voltage ranges to 125 v dc and current ranges to 5 amp. Output of each unit is continuously variable over full range. Regulation and stability are better than 0.05% and ripple is 1 mv rms or less. Voltage sensing is furnished on all models. The units are available in steel cabinet or rack mounted models.

Kaiser Electronics, Inc., Dept. ED, 2 Monroe St., Union, N.J.

CIRCLE 454 ON READER-SERVICE CARD

### Pulse Transformer

Provides 100 kv

This high power pulse transformer operates a transmitter tube at 100 kv with pulse durations up to 6  $\mu\text{sec}$ . The bifilar secondary carries 5 amp. Power output is 15 megawatts at 100 kv; step-up ratio is 1:7. Primary impedance is 13 ohms and the pulse repetition frequency is up to 600 pps. The unit weighs 40 lb and measures 9 x 9 x 9 in.

Stavid Engineering, Inc., Dept. ED, Plainfield, N.J.

CIRCLE 455 ON READER-SERVICE CARD

### Power Supply

Short circuit proof



Model ME 36-5M power supply has a fast-acting relay that energizes an internal circuit breaker when the current reaches a preset value. It is set at the factory at 120% of rated current. The supply operates from a source of 95 to 125 v, 60 cps power, regulated to  $\pm 0.5\%$ . Output voltage is continuously variable from 0 to 36 v dc with regulation of 0.1% or 0.01%. The unit is designed for continuous duty at full load. Ripple is 1 mv rms max.

Mid-Eastern Electronics, Inc., Dept. ED, 32 Commerce St., Springfield, N.J.

CIRCLE 456 ON READER-SERVICE CARD



**THERMISTOR THERMOMETERS.**—Have accuracies up to  $\pm 0.14$  C or  $\pm 0.25$  F. Their response times are less than 1 sec in liquids and 2.2 sec on surfaces. Ranges covered are from  $-328$  to  $+845$  F. Thermophils operate on standard ac lines. Probes are available in lengths up to 5 ft, 3 in.

Atkins Technical, Inc., Dept. ED, 1276 W. Third St., Cleveland 13, Ohio.

**CIRCLE 457 ON READER-SERVICE CARD**

**SELF-STICKING CIRCULAR MASKS.**—Are used to mask off index holes, component mounting holes and areas on printed circuits where solder is unwanted. From 1/4 in. to 3/4 in. OD, they are made from pressure-sensitive B-540 tape and can withstand a 700 F dip soldering temperature for 6 sec.

W. H. Brady Co., Dept. ED, 727 W. Glendale Ave., Milwaukee 9, Wis.

**CIRCLE 458 ON READER-SERVICE CARD**

**DRAFTING MACHINE.**—Neoglides is designed for use on any board at any angle without need of adjustment. It has an enclosed counterweight unit which provides positive counterbalancing at all angles. Major moving parts have nylon wheels.

Charles Bruning Co., Dept. ED, Mount Prospect, Ill.

**CIRCLE 459 ON READER-SERVICE CARD**

**DIGITAL CHRONOMETERS.**—Give real and relative time, direct time readout in 1 in. edge-lighted numerals, and output contact closures for systems control, printers and recorders or total systems programming. They are available in 12, 24, 100 and 1000 hr models.

Cubic Corp., Dept. ED, 5575 Kearny Villa Rd., San Diego 11, Calif.

**CIRCLE 460 ON READER-SERVICE CARD**

**TEMPLATE COMPASS.**—D-1 ball bearing action compass is used to make circles from 1/4 to 2 in. There is a row of template holes from 1/16 to 15/16 in. diam.

F. & H. Manufacturing Co., Dept. ED, 817 N.W. 23rd Ave., Portland 10, Ore.

**CIRCLE 461 ON READER-SERVICE CARD**

**VACUUM CABINETS.**—Series 600 are used for storage of electronic sub-assemblies, where they are protected from dust or moisture. They are available in complete assemblies from two to eight with controls and single vacuum pump, and have racks for eight 12 x 18 in. trays of parts.

General Vacuum Corp., Dept. ED, 400 Border St., East Boston 28, Mass.

**CIRCLE 462 ON READER-SERVICE CARD**

**HIGH VOLTAGE POWER SUPPLY.**—N-413 provides 100 to 5000 v dc continuous, 10 ma Maximum. It is standard cell referenced; combined noise and ripple is less than 50 mv peak to peak.

Hamner Electronics Co., Inc., Dept. ED, Princeton, N.J.

**CIRCLE 463 ON READER-SERVICE CARD**

**LABORATORY STOP CLOCKS.**—Models K15110, K15120 have timed outlets on front panel, permitting the automatic timing of any 115 v, 60 cps load up to 3 amp. K15120 has socket which permits remote, manual, or automatic control. Both models have 4-1/4 x 4-9/32 x 4-1/2 in. instrument cases.

A. W. Haydon Co., Dept. ED, Waterbury, Conn.

**CIRCLE 464 ON READER-SERVICE CARD**

**100 "G" SYNCHRO**

*Uniquely Designed to Withstand 100 "G" Shock Test... 20 "G" Vibration Test from 10 to 2500 Cycles... 20 "G" Acceleration Test...*

BURTON BROWNE ADVERTISING

- $-55^{\circ}\text{C}$  to  $+85^{\circ}\text{C}$  temperature range. Higher if desired.
- 26V rotor excitation.
- .210 amps, 2 watt.
- 40 millivolts null voltage.
- $11.8 \pm .5\text{V}$  max. stator output voltage.
- 35 + J145 rotor impedance.
- Withstands 10 lbs. lead pull test.
- Aluminum housing.

A complete line of synchros in sizes 8, 10, 11 and 15 is offered for your CX, CDX, CT, TX, TDX, TR and RS applications.



Type 4073-07.

**Oster**®

**Other Oster Synchros For Hi Temp Applications**

Distinctive Oster features such as stainless steel housing and temperature stabilization are available for hi temp units.

*You are invited to consult Oster engineers on your synchro requirements.*

**OTHER PRODUCTS INCLUDE:**

- |             |                    |
|-------------|--------------------|
| Servos      | Computers          |
| Resolvers   | Indicators         |
| Motor Tachs | Servo Mechanisms   |
| DC Motors   | Servo Torque Units |

**John Oster**

**MANUFACTURING CO.**

*Your Rotating Equipment Specialist*  
**Avionic Division**  
 Racine, Wisconsin

**EASTERN** 310 Northern Blvd. • Great Neck, Long Island, New York  
**OFFICE** Phone: HUter 7-9030 • TWX Great Neck N.Y. 2980

**WESTERN** 5333 South Sepulveda Blvd. • Culver City, California  
**OFFICE** Phone: EXmont 1-5742 • UPTon 0-1194 • TWX S. Mon. 7871

*Engineers For Advanced Projects:* Interesting, varied work on designing transistor circuits and servo mechanisms.  
 Contact Mr. Robert Burns, Personnel Manager, in confidence.

CIRCLE 465 ON READER-SERVICE CARD

## transistorized power supplies



**POSITIVE SHORT-CIRCUIT PROTECTION**  
Fully protects supply and load. No switching transients.

**HIGHEST RELIABILITY** through conservative design and selected quality components.

**SENSIBLE DESIGN** for optimum convection cooling to insure no derating and longest component life.

Models available in standard battery voltages for bench, panel or chassis mounting.

UTILITY model: fixed voltage output.

GENERAL-PURPOSE model: wide-range selectable output.

LABORATORY model: wide-range continuously-variable output.

SPECIAL Designs: to your requirements.

Write for complete engineering data on these and other Reflectone power supplies—tube and transistor types—for OEM, laboratory, general industrial or special applications.

**REFLECTONE**

THE REFLECTONE CORP. • STAMFORD, CONN.  
CIRCLE 466 ON READER-SERVICE CARD

## NEW PRODUCTS

### Programming Systems

Offer from 110 to 5500 contacts

These circuit programming systems have modular construction which permits expansion of the system in two directions, offering from 110 to 5500 contacts in a variety of contact configurations. Patchcord, permanent, or multiple contact patchcord programming is possible.

Virginia Electronics Co., Inc., Dept. ED, River Rd. and B & O Railroad, Washington 16, D.C.

CIRCLE 468 ON READER-SERVICE CARD

### Silicon Power Rectifier

Has voltage ratings to 600 piv

This silicon power rectifier has voltage ratings up to 600 piv and current ratings to 18 amp dc at 100 C ambient with a forward voltage drop of less than 0.8 v. Hermetically sealed, it has a silver anode lead and solid copper base for high thermal and electrical conductivity.

Semiconductor Corp. of America, Dept. ED, 16629 Gramercy Place, Gardena, Calif.

CIRCLE 469 ON READER-SERVICE CARD

### Breadboard Kit

Contains 10 printed boards

Used to construct prototype circuitry, the Cirkit contains 10 basic printed boards which cover all circuit functions for analog and digital circuitry. It provides increased flexibility and permits rapid circuit tracing. The boards may be used in temperature testing.

Dynex Inc., Dept. ED, 324 Langton Ave., Los Altos, Calif.

CIRCLE 470 ON READER-SERVICE CARD

### Heat Sink

For silicon rectifiers

This insulated heat sink provides heat dissipation in silicon rectifiers. It consists of an oxygen-free copper tab brazed to an alumina insulator which is, in turn, brazed to any oxygen-free copper stud. The rectifier is soft-soldered to the tab. The capability of the heat sink exceeds the maximum temperature requirements of -60 to +200 C. It can handle up to 2000 v.

Advanced Vacuum Products, Inc., Dept. ED, Stamford, Conn.

CIRCLE 471 ON READER-SERVICE CARD

For centuries  
angles have been  
read directly

...Now

they can be read  
photoelectrically  
and the information  
transmitted  
in digital form.

W. & L. E. Gurley, Troy, N. Y.



The Gurley Shaft Position Encoder

Write for Bulletin 8600-E

CIRCLE 472 ON READER-SERVICE CARD

## CABLE Connector

FOR RG-117/U CABLE



The Tamar USAF approved Captive Pin Connector embodies a captivated center conductor and dimensionally stable Teflon dielectric. Can be supplied in assemblies guaranteed to your specs., 100% tested for power and VSWR.

SPEC. SHEETS AVAILABLE UPON REQUEST

**TAMAR ELECTRONICS, INC.**  
1805 COLORADO AVE. • SANTA MONICA, CALIF.

CIRCLE 467 ON READER-SERVICE CARD

## Newest MINIATURE FLEXIBLE COUPLING

Life Saver size - only 7/16" x 3/4"



Tinymite Coupling  
Actual Size

Low cost for general application. Thousands of uses. 1/2" dia. x 1/2" long. For 1/4" and/or 3/8" shafts. No backlash. Insulating nylon center piece.

Renbrandt offers a complete line of ultra-compact, precision-made couplings featuring zero backlash, low inertia and high flexibility

Typical is the newest shown above which is Life Saver size. Specifications: bores in any diameter from 1/8" through 3/8", compensates for misalignments of ±5° angular and ±.015" linear, torque 30 inch ounces, weight .19 ounce, moment of inertia as low as .006 ounce inches<sup>2</sup>, materials and finishes to applicable government or MIL specs.

Long-life Renbrandt Couplings will solve many problems where space and weight are at a premium. Others available in a wide variety of sizes for 1/8" through 1/2" shafts.

Send for catalog or send your requirements for quotes. Prompt delivery.

*Renbrandt*

**Renbrandt, Inc.**  
6-B Parmelee St.  
Boston 18, Mass.

Telephone: Highlands 5-8910

CIRCLE 473 ON READER-SERVICE CARD

ELECTRONIC DESIGN • September 16, 1959



**HEAM POWER TUBE.**—Withstands shock, fatigue, low-frequency vibration, and variable-frequency vibration tests. Designed for pulse-modulator applications, type 7358 delivers a peak plate current of 3 amp during a pulse length of 30  $\mu$ sec with a duty factor of 0.003 and a plate-supply voltage of 2000 v.

Radio Corp. of America, Electron Tube Div., Dept. ED, Harrison, N.J.

CIRCLE 474 ON READER-SERVICE CARD

**DOUBLE CIRCUIT SWITCH.**—Is rated at 15 amp, 125 v ac; 10 amp, 250 v ac. This series 755 switch makes or breaks two circuits simultaneously, and is not sensitive to vibration or shock. The case and plunger are molded phenolic, and the switch blades are brass.

Controls Co. of America, Industrial & Commercial Controls Div., Dept. ED, 9555 Soreng Ave., Schiller Park, Ill.

CIRCLE 475 ON READER-SERVICE CARD

**CAP NUTS.**—Are available in steel, brass and aluminum in sizes No. 4 through 1/2 in.

Jacobson Nut Manufacturing Corp., Dept. ED, Kenilworth, N.J.

CIRCLE 476 ON READER-SERVICE CARD

**VIBRATION INTERFEROMETER.**—Is used for precision calibration of accelerometers. It consists of an interferometer, multi-beam stroboscopic slit assembly with white light source, and a vibrator. Frequency range is 450 to 10,000 cps. Double amplitudes over a range of 1 to 1000  $\mu$ in. can be determined to an accuracy of  $10^{-6}$  in. or 1%

Gaertner Scientific Corp., Dept. ED, 1201 Wrightwood Ave., Chicago 14, Ill.

CIRCLE 477 ON READER-SERVICE CARD

**PRESSURE SENSITIVE TAPE.**—Is available in 0.002, 0.003, or 0.004 in. thick Teflon film with a 0.004 in. adhesive covering, in widths from 1/4 to 12 in. Known as type LT, it is unaffected by temperatures up to 250 F.

Dilectrix Corp., Dept. ED, Allen Blvd., Farmingdale, N.Y.

CIRCLE 478 ON READER-SERVICE CARD

**POTENTIOMETER.**—Has a power rating of 1 w and a maximum operating temperature of 175 C. Wirewound, model 220 is available in resistances from 100 ohms to 20 K and measures 3/16 x 5/16 x 1 in.

Bourns, Inc., Dept. ED, P.O. Box 2112, Riverside, Calif.

CIRCLE 479 ON READER-SERVICE CARD

**SOLDER BALLS.**—Can be loaded into jigs and rolled into place automatically. Available in diameters from 0.002 through 0.125 in. and dimensionally accurate to  $\pm 0.001$  in., these spheres assure a correct volume of solder.

Alloys Unlimited, Inc., Dept. ED, 21-01 43 Ave., Long Island City 1, N.Y.

CIRCLE 480 ON READER-SERVICE CARD

**ELECTROLYTIC CAPACITOR.**—This electrolytic capacitor is a multi-section, common-positive type. It offers high-purity materials, all-welded construction, low leakage and power factor.

Syncro Corp., Electronic Div., Dept. ED, Hicksville, Ohio.

CIRCLE 481 ON READER-SERVICE CARD

ELECTRONIC DESIGN • September 16, 1959



## BASIC REQUIREMENTS for outer space

The space/missile era has made it essential for today's components and systems to function precisely in environments that are literally out-of-this-world. Such stringent requirements can only be met by companies long experienced in component design and with proved records of imaginative engineering. Kearfott, long the leader in servo component design and production, has consistently looked into the future to anticipate the increased performance characteristics missile components must supply. As a result, it has not only developed an entirely new generation of precision components but established the ability to create radically new concepts in sensors and control elements.

**THE PROBLEM: HIGH ACCURACY**

**THE SOLUTION:** Synchros with maximum error from electrical zero of 20 seconds. Tachometers with linearity .05% over the speed and temperature range.

**THE PROBLEM: HIGH AND LOW TEMPERATURE**

**THE SOLUTION:** Servomotors, synchros and tachometers are now available for the temperature range of  $-54^{\circ}$  C to  $200^{\circ}$  C with new developments soon to increase the range to  $400^{\circ}$  C.

**THE PROBLEM: RADIATION RESISTANCE**

**THE SOLUTION:** Kearfott servomotors, synchros and tachometers operate at  $200^{\circ}$  C and can withstand radiation of  $10^8$  through  $10^{10}$  roentgens.

**THE PROBLEM: SHOCK AND VIBRATION**

**THE SOLUTION:** All Kearfott components can be supplied to function as required during or after 20 g's shock or 2000 cps vibration.

**THE PROBLEM: MINIATURIZATION**

**THE SOLUTION:** Size 5 synchros and servomotors. Size 8 components are outstanding examples of Kearfott's ability to combine miniaturization with precise performance.

**THE PROBLEM: LONG LIFE**

**THE SOLUTION:** Components are being developed which will operate continuously for 12 months in a total vacuum, the environment of outer space.

Representative of Kearfott's ability to look ahead are such current areas of development as Solid State Transducers and Control System Components. **You can take advantage of Kearfott's long-established know how in developing precision components for today — and tomorrow — by writing for details concerning your specific requirements.**

**Engineers:** Kearfott offers challenging opportunities in advanced component and system development.



**Kearfott**

A  
GENERAL  
PRECISION  
COMPANY

KEARFOTT COMPANY, INC., LITTLE FALLS, N. J.

A subsidiary of General Precision Equipment Corporation  
Sales and Engineering Offices: 1500 Main Avenue, Clifton, N. J.  
Midwest Office: 23 W. Calendar Avenue, La Grange, Illinois  
South Central Office: 6211 Denton Drive, Dallas, Texas  
West Coast Office: 253 N. Vinado Avenue, Pasadena, California

CIRCLE 482 ON READER-SERVICE CARD

molded  
**Black Nylon**  
screws  
and nuts

Insulate and Fasten  
without bushings,  
washers, etc. In Stock  
2-56, 4-40, 6-32, 8-32,  
10-32 and 1/4-20.



**Black Nylon**  
"NyGrip"  
cable  
clips

Light-weight non-  
conducting support  
for wiring, tubing, etc.  
In Stock 1/16" to  
1 1/2" Dia.

Free samples • write **WECKESSER CO.**

5703-05 Northwest Highway • Chicago 46, Ill.  
CIRCLE 483 ON READER-SERVICE CARD

Now—20 TIMES  
**BRIGHTER**  
Neon Indicator  
Light Assemblies!

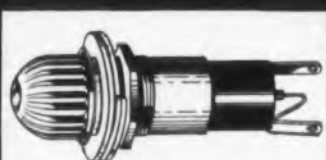

TYPE No. 101N-022

This DRAKE Assembly — No. 101N-022 — is ideal for use with the new G.E. NE-51H High Brightness Neon Glow Lamp, for 125V AC operation. According to the manufacturer, the lamp gives 20 times more illumination than old style neons. Since useful life is 5000 hours, replacement is made easy with Unit No. 101N-022; bulb flickering warns of time to change. Less than 1/4 watt power required for operation.

No. 101N-022 has built in 22,000 ohm resistor — is available with plain or fluted glass or plastic domed lenses, solder or screw terminals. Also available for 250V application (Unit No. 101N). Commercial units are UL listed. This style can be supplied to meet MIL specs.



★ SEND FOR FREE SAMPLE,  
DATA SHEET, and Quick-  
Reference Catalog of other  
Assemblies and Lampholders  
in the big DRAKE line.

**DRAKE**  
MANUFACTURING COMPANY  
4624 N. OLCOTT AVENUE • CHICAGO 31, ILLINOIS

**MINIATURE LIGHTING SPECIALISTS**

CIRCLE 484 ON READER-SERVICE CARD

NEW PRODUCTS

**Strain Gage Preamplifier**

Has 25 kc carrier frequency

Designed for use with strain gages and other transducers, type Q preamplifier has carrier frequency of 25 kc, frequency response of dc to 6 kc, and rise time of about 60  $\mu$ sec. Strain sensitivity, with a gage factor of about 2, is continuously variable from 10  $\mu$ in. per in. per major graticule division to 10,000  $\mu$ in. per in. per division. The maximum sensitivity with four active arms and a gage factor of 2 is 2.5  $\mu$ in. per in. per division. One of four external bridge arms can be used with the unit. A total lead capacity unbalance of 300  $\mu$ f across any bridge-arm can be balanced out with a front panel control.

Tektronix, Inc., Dept. ED, P.O. Box 831, Portland 7, Ore.

CIRCLE 485 ON READER-SERVICE CARD

**Sweep Generators**

Four models available

These sweep generators are available with the following frequency ranges: model SP-99, 1400 to 1900 mc; SP-100, 1000 to 1500 mc; SP-101, 1500 to 2000 mc; and SP-102, 1700 to 2300 mc. In each case, the sweep width may be varied from 100 to 0.25 mc. Sweep rate is 50 or 60 cps. The swept output is flat within  $\pm 10\%$  over the entire frequency range. Power output is approximately 1 v, peak to peak, into 50 ohms. A 0 to 10 db attenuator is provided.

Telonic Industries, Inc., Dept. ED, Beech Grove, Calif.

CIRCLE 486 ON READER-SERVICE CARD

**Tube and Transistor Tester**

Has snap-in socket panels

The portable model 6000 tube and transistor tester has a snap-in master socket panel that accepts types normally encountered in electronic service work. An 11-pin socket that accommodates special tubes is located beneath the master plate, and alternate plates for foreign tubes can be provided. Tube quality evaluations are read directly on scales of 0 to 3000, 0 to 6000, and 0 to 15,000  $\mu$ hos, and tube reserve capacities can be determined by turning a selector control on the panel. Five neon lights automatically indicate shorts and leakage, while pushbuttons can be depressed to show gas content in microamperes and filament continuity. Line voltage is constantly indicated and quickly adjusted.

Hickok Electrical Instrument Co., Dept. ED, 10525 Dupont Ave., Cleveland, Ohio.

CIRCLE 487 ON READER-SERVICE CARD

new way to make  
products better,  
more efficient...

**ACE** PRECISION  
**NYLON BALLS**

Precision manufactured from DuPont Nylon Resin to close tolerance of  $\pm .001$  on diameters and .001 on sphericity, Ace Nylon Balls give design flexibility and production economy. Light in weight... tough at low temperatures... stable at high temperatures... resistant to corroding chemicals such as sulphuric acid, etc... almost abrasionproof... these mass-produced balls have hundreds of industrial applications. Come in 14 standard sizes from 1/8" to 3/4".

Complete facilities for fabrication of plastic parts for all industries. Estimates submitted promptly on receipt of blueprints or specifications.

Write for samples. Bulletin N. price list. TODAY.

EXTRUSION MOLDERS AND FABRICATORS

**ACE PLASTIC COMPANY**  
91-58 Van Wyck Expwy., Jamaica 35, N.Y. JAMAICA 3-5500

CIRCLE 488 ON READER-SERVICE CARD

One of a series

Let's get clear on —  
**WHAT ENGINEERS DO**

Simply stated, engineers apply the sciences to give people use of nature's materials, forces.

Scientists make it known. Engineers make it useful.

Scientists split the atom; engineers design and build the atomic power plants.

All science known would benefit nobody if not applied by engineers to manufacturing, construction, mining, agriculture or the generation of power.

These are the great engineered industries— all based on scientific knowledge.

Engineers plan, design, produce, maintain and operate. To repeat: Scientists make it known. Engineers make it useful.



**Engineers Joint Council**  
29 West 39th St., N. Y. 18, N. Y.

For information call Pennsylvania 6-9220



**INSULATING COMPOUNDS.**—Are used for potting, encapsulating, and insulating electronic components. They can be cured at temperatures ranging from 250 to 300 F and require no catalyst. These compounds are available filled or unfilled, and have low viscosity.

Viking Resin Products, Inc., Dept. ED, 115 Broad St., Waverly, N.Y.

**CIRCLE 489 ON READER-SERVICE CARD**

**HEAT GENERATORS.**—Model L4C induction generator provides 1/2 kw to heat metals. Model C-63 dielectric generator provides 1/2 kw to heat non-conductors. Both are available with control over power output and time cycles. They operate from 110 v ac, and weigh less than 80 lb each.

Reeve Electronics, Inc., Dept. ED, 609 W. Lake St., Chicago 6, Ill.

**CIRCLE 490 ON READER-SERVICE CARD**

**CLAMP.**—Is used to mount motors, potentiometers, synchros, and other servo-type components. Called No. 2014, it is available in two sizes, and meets MIL-E-5400 specs.

Precision Mechanisms Corp., 577 Newbridge Ave., East Meadow, N.Y.

**CIRCLE 491 ON READER-SERVICE CARD**

**READOUT.**—Displays word messages. Operating on a rear projection principle, it contains a condensing lens which has twelve messages, determined by the user, printed on it. The unit measures 3-1/4 x 5-1/4 x 11-1/2 in.

Industrial Electronic Engineers Inc., Dept. ED, 3973 Lankershim Blvd., N. Hollywood, Calif.

**CIRCLE 492 ON READER-SERVICE CARD**

**SILICON RUBBER COMPOUNDS.**—Used for void filling, cushioning and vibration damping. Sponge compounds RTV-120 and RTV-160 cure at room temperature and are resistant to temperature extremes, weather, ozone and sunlight.

General Electric Corp., Silicone Products Dept., Dept. ED, Waterford, N.Y.

**CIRCLE 493 ON READER-SERVICE CARD**

**MINIATURE CLAMPS.**—Used to secure or separate wire groups. Its components are a nylon cradle and a Neoprene clip. These cradleclip units will accommodate diameters of 5/32 to 1/4 in.

Electrovert Inc., Dept. ED, 124 E. 40 St., New York, N.Y.

**CIRCLE 494 ON READER-SERVICE CARD**

**THREE-GEAR DIFFERENTIAL.**—Has a backlash of 8 min of arc and breakaway torque of 0.3 oz-in. Its tumbling circle is 1.380 in., and maximum recommended load at 2500 rpm is 75 oz-in. Overall length is 1.888 in. and shaft diameter is 0.1847 in.

Dynamic Gear Co., Dept. ED, 20 Merrick Road, Amityville, N.Y.

**CIRCLE 495 ON READER-SERVICE CARD**

**AVC AMPLIFIER.**—Maintains a constant output within  $\pm 1$  db with input changes of 30 db. Its frequency response is  $\pm 1$  db from 20 to 20,000 cps; overall gain is 35 to 38 db with a signal-to-noise ratio of 60 db. It measures 19 x 7 x 8-3/4 in.

Amplifier Corp. of America, Dept. ED, 398 Broadway, New York 13, N.Y.

**CIRCLE 496 ON READER-SERVICE CARD**

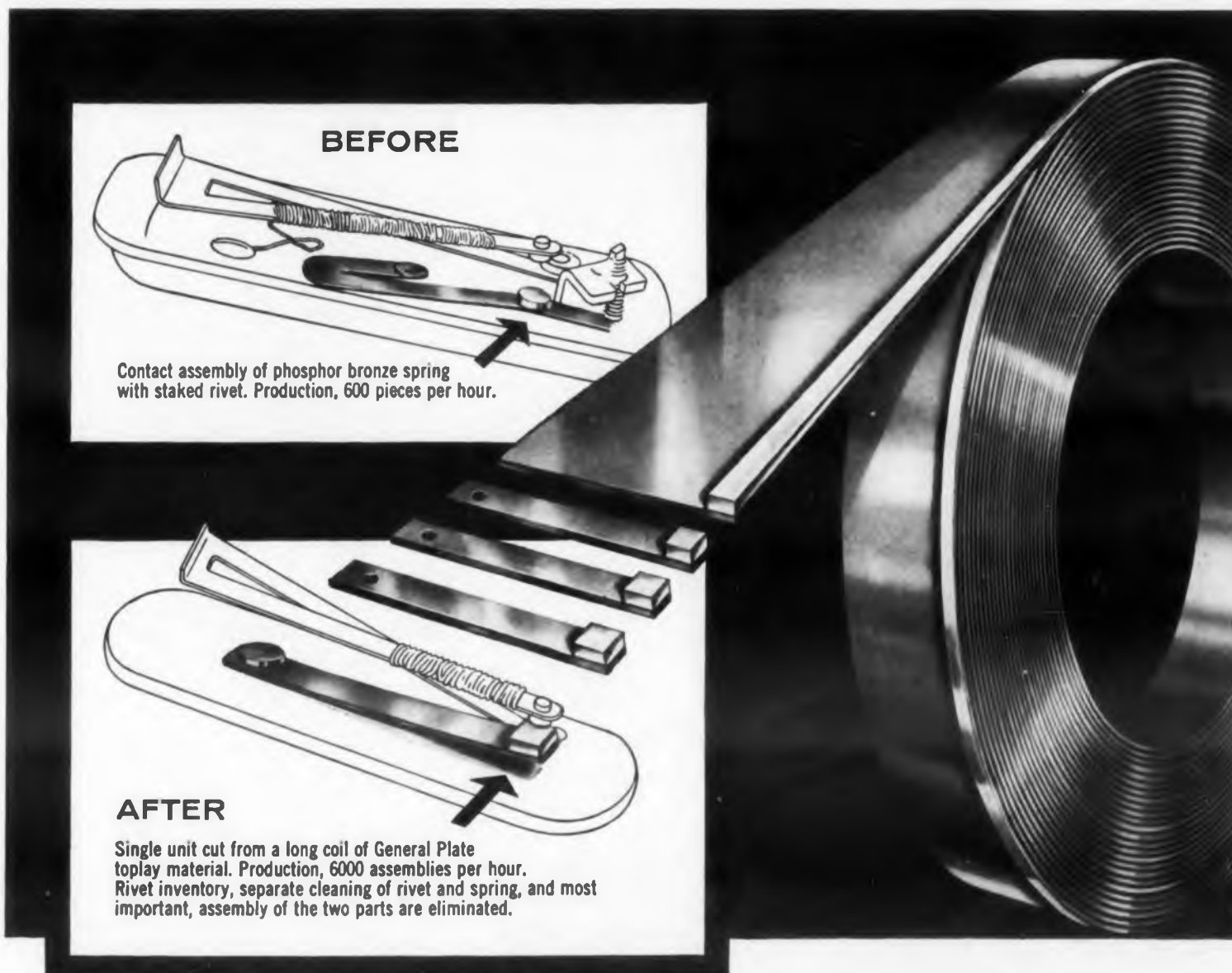

**BEFORE**

Contact assembly of phosphor bronze spring with staked rivet. Production, 600 pieces per hour.

**AFTER**

Single unit cut from a long coil of General Plate toplay material. Production, 6000 assemblies per hour. Rivet inventory, separate cleaning of rivet and spring, and most important, assembly of the two parts are eliminated.

## GENERAL PLATE TOPLAY MATERIAL ENABLES KING-SEELEY CORPORATION TO Increase Contact Assembly Production 900%



Recently King-Seeley Corporation, long a leading manufacturer of instrument panel gauges and other automotive equipment, redesigned the contact assembly in the constant voltage "CV" voltage regulator, a component of

their constant voltage gauge systems. The old design called for blanking of a phosphor bronze spring, cleaning and finally staking of a General Plate rivet. By changing to General Plate toplay contact material the operation called for simply cutting off and cleaning. Expensive assembly operations were eliminated. The result . . . an increase in production of contact assemblies by 900%.

General Plate clad contact materials make it possible to manufacture complete contact assemblies to close tolerances by single blanking and forming operations. Compare this to other methods whereby the contacts and supporting members are fabricated separately and then assembled.

Let us make an electrical contact cost analysis on products you want to automate. Find out how General Plate clad electrical contact materials can be put to work for you. Write now.



General Plate Clad Contact Materials . . . Single and double inlay, overlay and toplay provide better electrical performance, longer operating life and lower fabrication costs.

### METALS & CONTROLS

709 FOREST STREET ATTLEBORO MASS., U.S.A.

A DIVISION OF TEXAS INSTRUMENTS INCORPORATED

General Plate Products: Clad Metals • Electrical Contacts • Truflex® Thermostat Metal • Platinum Metals • Reactor Metals • Radio Tube & Transistor Metals

**CIRCLE 497 ON READER-SERVICE CARD**



for extremely high  
accuracy digital  
angle data...

## BALDWIN<sup>®</sup> Shaft Angle Encoders



To process data  
from shaft angles  
into electrical dig-  
ital form, Baldwin  
produces 13, 16 and  
18 digit encoders of  
highly advanced designs.

These encoders employ  
photoelectric readout and give  
complete information in one  
revolution of the input shaft,  
without the use of gearing.  
Contact our Encoder Engineer-  
ing Department for detailed in-  
formation on models to meet  
your requirements.



Baldwin 16-digit, 9-1/16" dia.  
encoder having accuracy of  $\pm 1$   
part in 65,536. Data in Bulletin  
No. 1158.



Baldwin 18-digit, 21"  
dia. encoder having  
accuracy of  $\pm 1$  part  
in 262,144. Data in  
Bulletin No. 1258.

Baldwin Model B/M907 -10 Pro-  
grammer and Power Supply is available  
for supplying power and programming  
signals to the encoder models shown. This unit  
meets military requirements.



INDUSTRIAL PRODUCTS DIVISION  
**the Baldwin piano co.**  
1804 GILBERT AVE., CINCINNATI 2, OHIO  
CIRCLE 498 ON READER-SERVICE CARD

## NEW PRODUCTS



Oven  
Transistorized

For crystals and components, type BPCO-1 transistorized proportional oven has a temperature stability of  $\pm 0.02$  C over the ambient range of 10 to 50 C. The oven operates on a 26 v supply and can be furnished with operating temperatures of 70 to 85 C. The heat chamber measures 1-1/8 in. in diam and 2 in. long. Seated height is 4 3/4 in. above octal base; the cross section is 2-1/8 x 2-1/8 in.

Bliley Electric Co., Dept. ED, Union Station Bldg., Erie, Pa.

CIRCLE 499 ON READER-SERVICE CARD

**ADAPTERS.**—Permit exact tube circuit current measurement in operating equipment without cutting leads. Available in 7, 8, and 9 pin types, they are inserted in the tube socket between chassis and tube. A test prod is provided.

Vector Electronic Co., Dept. ED, 1100 Flower St., Glendale 1, Calif.

CIRCLE 500 ON READER-SERVICE CARD

**LEAD EXTRACTOR.**—Removes insulated lead wire from braided shields. Similar to a hypodermic needle, it ejects the wire from a breakout in the shield produced by the tube point. It is available in five sizes to process shielded wires from 30 to 14 AWG.

Technical Devices Co., Dept. ED, 2340 Centinela Ave., Los Angeles 64, Calif.

CIRCLE 501 ON READER-SERVICE CARD

**FM TUNER.**—Has an avc sensitivity of better than 2.5  $\mu$ v for 20 db quieting. Completely shielded, model FA-331 BB has an amplification of 450, and a noise figure of 3 db. It features printed circuits and can be supplied with afc.

Sales Engineering Associates, Dept. ED, 46 N Second Ave., Mount Vernon, N.Y.

CIRCLE 502 ON READER-SERVICE CARD

**PICTURE TUBE.**—For cathode-drive applications. Type 24BAP4, 24 in. 110 deg, has an electron gun with improved cathode-drive sensitivity, and requires no ion-trap magnet. This directly viewed, rectangular glass tube has a spherical Filterglass faceplate, an aluminized screen, and a 1-1/8 in. diam neck.

Radio Corp. of America, Electron Tube Div., Dept. ED, Harrison, N.J.

CIRCLE 503 ON READER-SERVICE CARD

# MORE! OF EVERYTHING YOU WANT IN A TUBE and TRANSISTOR CHECKER

1. *Electronamic*<sup>®</sup> Tube Performance Checker
  2. Comprehensive Transistor Checker
  3. Complete Crystal Diode Tester
  4. CR Tube Beam Current Tester
  5. Functional VR Tube Tester
  6. Direct Reading Gas Tester
- ... plus Free Tube and Transistor  
Test Data Subscription Service for one full year!



## ... AT A PRICE THAT MAKES SENSE THE *PRECISION* MODEL 10-60

1. Positive, all-inclusive tube performance testing ... not limited to mutual conductance alone.
2. Widespread  $I_{cbo}$  ranges cover all types of transistors—low, medium and high power n-p-n and p-n-p types.
3. Crystal diode tests: 22 selected DC voltages for forward and reverse current tests.
4. Cathode ray tubes tested for true beam current.
5. Tests voltage regulator tubes for regulation at manufacturer's specified current limits.
6. Special gas test circuit indicates troublesome gas content directly on sensitive 5 1/2" meter.

Model 10-60: Complete with 5 window hi-speed geared roller chart unit and technical manual. . . . Net Price \$195.00

Model 10-40: Physically and electrically similar to the Model 10-60 but without transistor and crystal diode testing facilities. . . . Net Price \$149.50

- Available and on display at leading electronic parts distributors. Write for complete *PRECISION* catalog.
- *PRECISION* Test Equipment carries a full year warranty!

**PRECISION**  
Apparatus Company, Inc.  
70-31 84th St., Glendale 27, L. I., N. Y.  
Export: 458 Broadway, New York 13  
Canada: Atlas Radio Corp., Toronto 18

CIRCLE 504 ON READER-SERVICE CARD



NOW AVAILABLE FROM  
GENERAL ELECTRIC . . .

## TRANSISTORIZED C-BAND BEACON



1/7 cubic ft.—9.8 lbs.\*

Here's how you can save design, development and production costs. G.E.'s transistorized C-Band Beacon, originally designed and tested as a spaceborne tracking aid for ballistic missile applications, is now available for tracking and identification of all types of missiles, drones and aircraft. Extremely compact (9.8 lbs., 9.63 x 7.00 x 3.88 inches), G.E.'s transistorized C-Band Beacon offers you such outstanding advantages as a guaranteed High Peak Power Output with extremely Low Power Consumption, Proven Reliability in a Single Package (Power Supply Included), and Single or Double Pulse Interrogation. And, this beacon is available within four months of your order. Get more information today about this unusual beacon package.

\*\$9995.95 in quantities of 20; (Lower prices for Large Quantities)

SEND FOR THIS FREE  
DESCRIPTIVE  
BULLETIN



P. E. Laliberte, Mgr.  
Missile Sales, Section B229-1  
General Electric Company  
LMED, French Road  
Utica, New York

- Please send me your descriptive bulletin  
 Please have your sales engineer contact me

Name \_\_\_\_\_  
Title \_\_\_\_\_  
Company \_\_\_\_\_  
Address \_\_\_\_\_  
City \_\_\_\_\_ State \_\_\_\_\_

GENERAL ELECTRIC

CIRCLE 505 ON READER-SERVICE CARD

**MARKING PENCIL.**—Writes on any surface. Available in seven colors, it is the same size as a standard writing pencil, and may be used in laboratories, manufacturing and drafting.

J. S. Staedtler, Inc., Dept. ED, 340 DiCarolis Court, Hackensack, N.J.

CIRCLE 506 ON READER-SERVICE CARD

**SWITCHING JACK.**—Has glass melamine insulation. Called type 317G, this jack retains its rigidity and maintains spring tension under adverse humidity conditions.

National Tel-Tronics Corp., Dept. ED, 52 St. Casimir Ave., Yonkers, N.Y.

CIRCLE 507 ON READER-SERVICE CARD

**STEPPING-TYPE PROGRAMMER.**—Available on 35 mm film with photo-electric readout. More than 50,000 characters in eight channels are available on a 100 ft roll. No external tape punch is required.

Ameco Electronics Corp., Dept. ED, 37 E. 18 St., New York 3, N.Y.

CIRCLE 508 ON READER-SERVICE CARD

**TIME DELAY SWITCH.**—Is rated at 8 amp, 125 v ac; 4 amp, 250 v ac. Called type 700, its time delay is pneumatically controlled and can be adjusted from 3 to 40 sec. Contacts are silver; the case is molded phenolic and the switch blades are beryllium copper.

Controls Co. of America, Industrial & Commercial Controls Div., Dept. ED, 9555 Soreng Ave., Schiller Park, Ill.

CIRCLE 509 ON READER-SERVICE CARD

**CHASSIS SLIDE.**—Has extended-position locking, a quick-disconnect mechanism, and 150 lb load rating. This three-section steel ball bearing slide, model 324, meets military specs.

Grant Pulley & Hardware Corp., Dept. ED, 944 Long Beach Ave., Los Angeles, Calif.

CIRCLE 510 ON READER-SERVICE CARD

**CONSOLE.**—Provides convenient housing for servotest equipment, and working surface for use as a plotting desk. Among the items it can house are a decade oscillator, a components indicator, converters, and a mechanical reference generator.

Solartron, Inc., Western Div., Dept. ED, 10761 Burbank Blvd., N. Hollywood, Calif.

CIRCLE 511 ON READER-SERVICE CARD

**BEAM POWER TUBE.**—Has a 26.5 v heater, and is used in aircraft service as an rf power amplifier and oscillator, af power amplifier, and modulator. Called the 7357, it has a maximum plate dissipation rating of 25 w, and can withstand severe shock and vibrations.

Radio Corp. of America, Electron Tube Div., Dept. ED, Harrison, N.J.

CIRCLE 512 ON READER-SERVICE CARD

**OPEN AND SHORT CIRCUIT TERMINATIONS.**

—Known as TO and TS series, respectively, they present identical electrical lengths. Phase difference is less than 0.1 cm over the frequency range from dc to 13,000 mc. They are provided with male or female connectors of type N, BNC, TNC, C, or HN. Overall length is 1.2 in.; weight is 0.6 to 1.6 oz.

Microlab, Dept. ED, 71 Okner Pkwy., Livingston, N.J.

CIRCLE 513 ON READER-SERVICE CARD

# kintronic\*

## "just

\*  
manufacturers of  
advanced design

## PRECISION POTENTIOMETERS

## grewed"



With all due apologies to Topsy of Uncle Tom's Cabin, that is. But grewed we have . . . until today Kintronic possesses one of the most complete facilities for the production of potentiometers. Equipment, engineers, assemblers, quality control standards that add up to development and manufacture of precision potentiometers for every requirement. An almost unlimited variety of pots designed to accurately function under the severest of conditions.

Standard lines, specials to specific requirements, from 1/8" up, single and multi-gang pots in all sizes and types, logarithmic and hyperbolic function units in all sizes . . . and then some.

"Unitized Construction" . . . obtains smooth, accurate performance in the very high temperature classification . . . reliability even at 225°C!

"Dynamic Balance" potentiometers . . . advanced design highly successful pots providing low mass, low inertia, long life, exceptional stability under extremes of shock, vibration and acceleration.

The "know-how", giant facilities and backing of Chicago Aerial Industries, Inc., Kintronic's parent company.

Get complete information data sheets today. See how Kintronic wide range performance fits your individual needs.



division of Chicago Aerial Industries, Inc.

10134 PACIFIC AVENUE, FRANKLIN PARK, ILLINOIS  
CIRCLE 514 ON READER-SERVICE CARD



EVERYTHING  
UNDER  
CONTROL

## GUARDIAN'S *New Catalog*

FEATURES COMPLETE INFORMATION  
COIL VALUES SWITCHING ARRANGEMENTS ENCLOSURES  
DIMENSIONAL DRAWINGS CONTACT CAPACITIES PHOTOS  
TERMINAL HEADERS



HERMETIC  
SEALING  
MOUNTING  
INFORMATION  
CIRCUIT  
DIAGRAMS

Contains the  
feature story  
of  
Guardian  
Hermetic  
Sealing

Aircraft  
Catalog "D"



Series 2005  
5 Amperes  
6 P.D.T.



Series 3005  
10 Amperes  
4 P.D.T.



Series 1005-2-3  
3 Amperes  
D.P.D.T.

Series 3205  
10 Amperes  
4 P.D.T.



## GUARDIAN

First with the latest in aircraft controls—Guardian offers this new catalog of aircraft, missile, military and industrial controls. Completely detailed information contained in this catalog will guide your selection of highly reliable relays, contactor units, gun grips, multiple control switches, intervalometers, special electromagnetic devices and hermetically sealed controls.

Write on your company letterhead for catalog "D"

**GUARDIAN ELECTRIC**  
MANUFACTURING COMPANY  
1622-K W. WALNUT STREET, CHICAGO 12, ILLINOIS  
CIRCLE 515 ON READER-SERVICE CARD

## NEW PRODUCTS

### Self-contained Recorders

For high acceleration applications

Multiple recording accelerometer MRA-440 and triaxial recording accelerometer TRA-200 are made for such uses as tests of rocket motors, impact sleds, and switch actuation. Having eight sensing elements, model MRA-440 directly senses and records data concerning the response spectrum of the motion. Its operating temperature is  $-50$  to  $+300$  F. It measures  $2\frac{1}{2} \times 7\frac{1}{16}$  in. and weighs 3 oz. Model TRA-200, having three sensing elements, directly senses and records data concerning the acceleration-time history of the motion along each of the mutually perpendicular axes. It has an operating temperature of  $-50$  to  $+160$  F, measures  $2\frac{1}{16} \times 1\frac{11}{16} \times 1\frac{7}{8}$  in., and weighs 6 oz. No connections to external devices are required for either model, although model TRA-200 requires external power.

Leach Corp., Dept. ED, 8435 Susana Rd., Compton, Calif.

CIRCLE 516 ON READER-SERVICE CARD

### Terminal

Four-in-one type

This multi-terminal has four separate terminals mounted in one base, cutting costs and installation time. It is 1 in. long and  $\frac{3}{8}$  in. in diameter. Other pin types are available.

Taurus Corp., Dept. ED, 8 Coryell St., Lambertville, N.J.

CIRCLE 517 ON READER-SERVICE CARD

### Display Storage Tube

Has 3.8 in. display diam

Type 7448 direct view display storage tube has a 3.8 in. display diam, a maximum diameter of 5.38 in., and an over-all length of 13.64 in. The display has a brightness of about 2750 ft-L when the unit is operated with 10,000 v on the screen. Writing speed is about 300,000 in. per sec. The writing gun employs electrostatic focus and deflection; the viewing gun produces an electron stream which is neither focused nor deflected. All connections are made to the 14 pin base and to the four recessed caps on the envelope. Applications of the unit include fire-control radar, airplane-cockpit radar display, airport surveillance, transient studies, data transmission, and visual communications.

Radio Corp. of America, Electron Tube Div., Dept. ED, Harrison, N.J.

CIRCLE 518 ON READER-SERVICE CARD

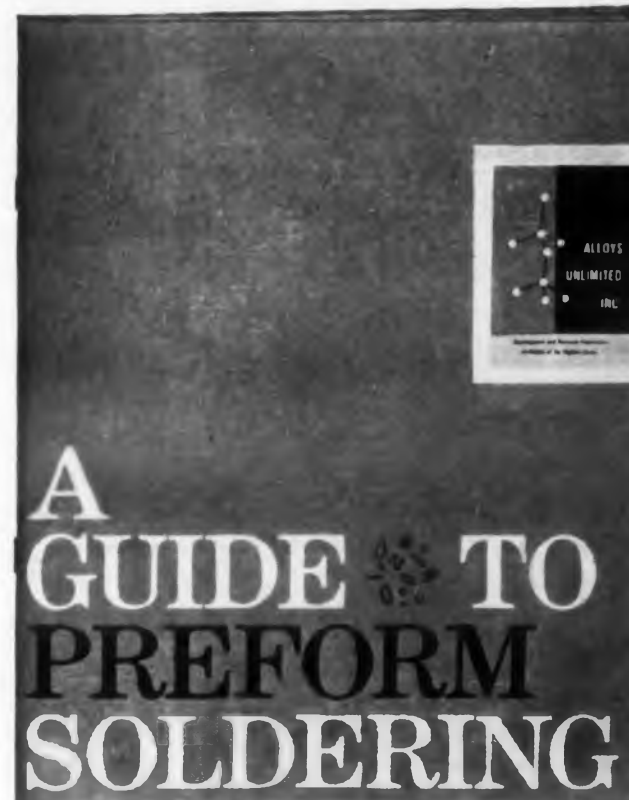

## FREE! NEW 8 PAGE GUIDE

Complete information on solder preforms, their selection and use. Technical diagrams. Send for your copy today.

21-01 43rd AVENUE, LONG ISLAND CITY 1, N.Y.



CIRCLE 519 ON READER-SERVICE CARD

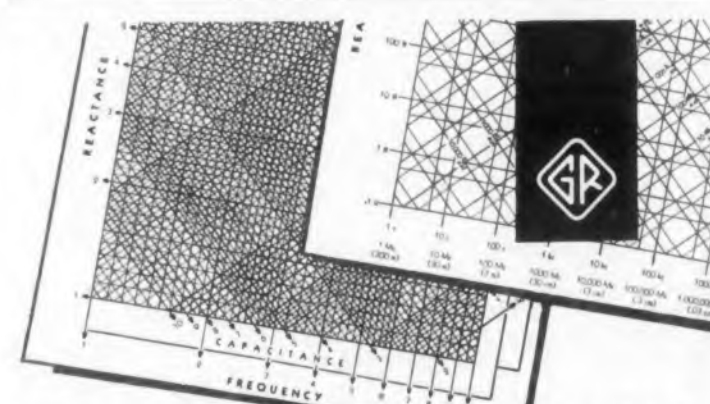

## G-R REACTANCE CHART ... It's For Free!

To two or three significant figures you can find:

Reactance of a given inductance and capacitance at a given frequency.	Ranges:
	1 cycle to 1,000,000 Mc.
Resonant Frequency of a given inductance and capacitance	.1 $\mu\text{f}$ to 10,000 $\mu\text{f}$ .1 $\mu\text{h}$ to 10,000 h .1 ohm to 10 megohms

Single decade enlarged 7 times for accuracy

Two Sizes: Wall Chart 22" x 17"

Notebook Chart for standard 3-ring binder

Write for your copy. PLEASE specify size desired.

With the Compliments of

## GENERAL RADIO COMPANY

WEST CONCORD, MASSACHUSETTS

Broad Avenue at Linden, Ridgefield, N. J. NEW YORK AREA 1000 N. Seward St. LOS ANGELES 38  
8055 13th St., Silver Spring, Md. WASHINGTON, D. C. 1150 York Road, Abington, Pa. PHILADELPHIA  
1182 Los Altos Ave., Los Altos, Calif. SAN FRANCISCO 6605 W. North Ave., Oak Park, Ill. CHICAGO  
In CANADA: 99 Floral Parkway, TORONTO 15

CIRCLE 520 ON READER-SERVICE CARD

ELECTRONIC DESIGN • September 16, 1959



**HIGH POWER SSB ADAPTER SYSTEM.**—Permits standard high frequency, high level am transmitters to be converted to SSB operations without modification. Model SSB-58-1A is designed for high frequency voice, facsimile and multi-channel FSK teletype operation from 10 kw to 1 megawatt.

Kahn Research Labs., Inc., Dept. ED, 22 Pine St., Freeport, N.Y.

CIRCLE 521 ON READER-SERVICE CARD

**AUDIO SWEEP GENERATOR.**—Has precise logarithmic sweep, low noise, and negligible drift. Conventional markers are not used. The unit measures 14-1/2 x 8-1/4 x 8 in. and weighs 10 lb.

Star Valley Electronics, Inc., Dept. ED, 145 Social Hall Ave., Salt Lake City, Utah.

CIRCLE 522 ON READER-SERVICE CARD

**BRUSH BLOCK ASSEMBLIES.**—For digitalizers, encoders, switching commutators and slip ring assemblies. Brushes are grouped in tandem of three and six wires per track to assure electrical continuity. These molded, broom-type assemblies have spring temper gold alloy brush wires capable of carrying up to 100 ma per track.

Airflyte Electronics Co., Dept. ED, 535 Avenue A, Bayonne, N.J.

CIRCLE 523 ON READER-SERVICE CARD

**INSTRUMENT TRANSLATOR.**—Is used with linear variable differential transformers and other ac electro-mechanical transducers. This single-channel, phase selective translator, model 83F, operates from 115 v, 60 cps power, supplies a 3 kc carrier to the transducer, and presents a dc signal which may be used with an external indicator.

Crescent Engineering and Research Co., Dept. ED, 5440L N. Peck Rd., El Monte, Calif.

CIRCLE 524 ON READER-SERVICE CARD

**PRINTING SYSTEMS.**—Print numbers, letters or symbols at speeds up to 5000 lines per minute on pre-printed forms. Called S-C 5200, these units use a shaped beam tube and a xerographic printing process in place of high speed mechanical parts.

General Dynamics Corp., Stromberg-Carlson Div., Dept. ED, San Diego 12, Calif.

CIRCLE 525 ON READER-SERVICE CARD

**GEARS AND CLAMPS.**—Are available in stainless steel and anodized aluminum in standard diametral pitches 48 through 120, with consecutive tooth selection range from 20 through 120 teeth. These clamp hub type precision gears are manufactured to AGMA precision class 1 and 2 tolerances in 1/8, 3/16 and 1/4 in. bore sizes.

U. S. Gear Corp., Dept. ED, 81 Bay State Road, Wakefield, Mass.

CIRCLE 526 ON READER-SERVICE CARD

**SHAFT LOCKING DEVICES.**—For bushing mounted controls with No. 1/4-32 or 3/8-32 threaded bushings. Variations of shaftlocks, and tapered, acorn, and jam nuts are available.

Waters Manufacturing, Inc., Dept. ED, Wayland, Mass.

CIRCLE 527 ON READER-SERVICE CARD

New Lord BTR Mountings provide all the advantages of elastomeric mountings, plus . . .

- broad temperature operation from  $-65^{\circ}$  to  $+300^{\circ}$  F.
- extreme environmental resistance
- excellent all-attitude characteristics
- efficient isolation of frequencies to 2000 c.p.s.
- high internal damping



## new BTR mountings\* protect reliability of advanced aircraft components

Achieving the high component reliability specified for today's advanced aircraft often requires control of severe vibration, shock and noise. Special techniques, materials and systems must be employed to keep vital equipment within their fragility envelopes.

Typical of the advanced materials required in mounting systems for the high-performance aircraft shown here are Lord's new BTR Elastomeric Mountings. These broad temperature range isolators provide excellent shock and vibration protection under extreme environmental conditions. Incorporation of BTR mountings in the suspension system simplifies design providing maximum economy and assures better performance and higher reliability.

Aircraft and missiles of the future will introduce new vibration and shock problems. Lord has the engineering background plus the research and production facilities to meet these challenges in mounting system design.

For further information contact your nearest Lord field engineer or the Home Office, Erie, Pa.

PAT. APPLIED FOR

**F-100 "Super Sabre":**  
BTR Mountings provide all-attitude protection for fire control system.



**F-102 "Delta Dagger":**  
Stabilizing equipment protected by standard miniature BTR Mountings,



**F-105 "Thunderchief":**  
Special BTR Mounting system used with integrated electronic system.



**F-106 "Delta Dart":** Stabilizing equipment and transducer protected by standard BTR Mountings . . . standby compass mounted on special BTR bases.



**B-58 "Hustler":** Special BTR Mountings used to protect high-speed bombing radar.



#### FIELD ENGINEERING OFFICES

ATLANTA, GEORGIA - Cedar 7-9247  
BOSTON, MASS. - Hancock 6-9135  
CHICAGO, ILL. - Michigan 2-6010  
DALLAS, TEXAS - Riverside 1-3392  
DAYTON, OHIO - Baldwin 4-0351  
DETROIT, MICH. - Diamond 1-4340

KANSAS CITY, MO. - Westport 1-0138  
LOS ANGELES, CAL. - Hollywood 4-7593  
NEW YORK, N. Y. - Circle 7-3326  
PHILADELPHIA, PA. - Pennypacker 5-3559  
SAN FRANCISCO, CAL. - EXbrook 7-6280  
WINTER PARK, FLA. - Midway 7-5501

\*In Canada - Railway & Power Engineering Corporation Limited

**LORD MANUFACTURING COMPANY • ERIE, PA.**

CIRCLE 528 ON READER-SERVICE CARD

relays designed especially for

## VIBRATION and SHOCK

The rotary-balanced armature design of Hi-G relays assures efficient operation of these important components even under severe vibration and shock — up to 20 or 30G out to 2000 cps. By design, very little momentum is built up in moving parts. For more complete information on the complete line of Hi-G relays, send for New 1959 Hi-G CATALOG.



### HI-G THE ONLY COMPLETE LINE OF ROTARY BALANCED RELAYS

Hi-G offers complete engineering and production facilities to manufacture relays for specific applications. Your inquiries are invited.



S & R TYPES



SL TYPES



SM TYPES

BALANCED  
HI-G  
ROTARY

HI-G INC.,

BRADLEY FIELD/WINDSOR LOCKS, CONN.

CIRCLE 529 ON READER-SERVICE CARD

## NOW...VTVM's for all applications

... panel-mounted ...  
small-size  
ELECTRONIC  
VOLTMETERS



SEND FOR CATALOG 10A which gives complete specifications and prices on panel-mounting, relay-rack and plug-in models.

Build accuracy into all your equipment, test and production alike, with Metronix DC and AC Electronic Voltmeters.

These Metronix instruments are no larger than conventional voltmeters, cost little more. They offer higher accuracy because they don't load the circuit. In AC applica-

tions, they respond accurately over a frequency range of 20 CPS to 100 KC.

Selective, step-ranges run from 0-10MV, to 0-300V AC, and 0-1 to 0-1000V DC. Metronix Electronic Voltmeters can be furnished in MIL-spec, rack-mounting and plug-in models.

Metronix INC

A SUBSIDIARY OF

ASSEMBLY PRODUCTS, INC.

Chesterland 17, Ohio

api

S.A. 1978

CIRCLE 530 ON READER-SERVICE CARD

## NEW PRODUCTS

### IF Amplifier

Has a gain of 85 db

Model A-107 transistorized if video amplifier has a center frequency of 30 mc, a gain of 85 db, and a bandwidth of 4.5 mc. The sensitivity time control is adjustable from 0 to 400  $\mu$ sec, and the instantaneous automatic gain control has 30 db compression and a 2  $\mu$ sec time constant. The noise figure is 8 db, and a 40 db manual gain control is provided. The unit measures 2 x 3 x 6 in.

Strand Engineering Co., Dept. ED, P.O. Box 76, Ann Arbor, Mich.

CIRCLE 531 ON READER-SERVICE CARD

### Tape Perforator

Punches up to 300 coded characters per sec

The GP-2 super-speed tape perforator can punch up to 300 coded characters per sec in standard communication paper or Mylar tape. The basic recording cycle allots 1/3 of a cycle to tape transport and 2/3 to punch pin penetration of the tape. Models are available for perforating 5, 6, 7, or 8 hole tapes. All internal parts of the punch are lubricated by a splash of oil bath system.

Soroban Engineering, Inc., Dept. ED, Box 1717, Melbourne, Fla.

CIRCLE 532 ON READER-SERVICE CARD

### Audio Line Amplifier

Handles up to 50 headsets

Adaptable to missile sites, rocket and ballistic firings sites, wind-tunnel experiments facilities, and environmental testing facilities, model CA-5 audio line amplifier handles up to 50 headsets in parallel. Audio impulses applied to any of the 50 microphones in parallel are transmitted to all connected headsets. A 20 db compression circuit provides for constant output in the headsets at all amplitude levels of speech.

Flite-Tronics, Inc., Dept. ED, 3314 Burton Ave., Burbank, Calif.

CIRCLE 533 ON READER-SERVICE CARD

### Magnetic Tape

Moisture-resistant

Designed for computer use, this moisture-resistant magnetic tape is available in two thicknesses of mylar backing. Type C-1 has a 1 mil backing; and a length of 3600 ft. Available in shorter lengths, type C-2 has a 1.5 mil backing. The tape is supplied on a precision reel.

Ampex Magnetic Tape, Dept. ED, 934 Charter St., Redwood City, Calif.

CIRCLE 534 ON READER-SERVICE CARD

## SOMETHING NEW IN SLOTTED SECTIONS



Actually, this is a new kind of Standing Wave Detector, which completely makes obsolete the 8-foot monsters, for impedance and VSWR measurements from 100 to 1000 mc/s.

The PRD Type 219 is only 8 inches long and weighs a "pocketable" four and one-half pounds.

As if these facts were not startling enough, the 219 also features:

- Direct reading of VSWR
- Direct reading of angle of reflection coefficient
- Direct reading of reactive component sign
- Matched load for self-calibration supplied
- Adaptability to most coaxial lines, including the LT and new TNC series
- Low cost
- Rugged construction

Listed below are a few of the important specifications.

Frequency Range:	100 to 1000 mc/s
Residual VSWR:	Less than 1.03
Minimum Input Signal:	Approx. 1V at 100 mc/s; 0.1V at 1000 mc/s for measuring a matched load
Characteristic Impedance:	50 ohms
Detector:	Crystal included
RF Input Connector:	BNC jack
RF Output Connector:	Type N jack supplied. Connector types available include types C, BNC, LT, TNC, 7/8" coax.
Audio Output Connector:	BNC jack
Dimensions:	8" L x 5" W x 5 3/4" H
Weight:	4 1/2 pounds

f.o.b. Brooklyn, New York

Note to owners of the new PRD Catalog, E-8: Don't bother reading this ad. All these details and more can be found on page B-13. If you are unfortunate enough not to own a copy of this designers' workbook, send your request on your company letterhead please.

If all you want are specifications on the 219, fill out the inquiry card in this magazine.



POLYTECHNIC RESEARCH  
& DEVELOPMENT CO., INC.

Factory & General Office:  
202 Tillary St., Brooklyn 1, N. Y.  
ULster 2-6800

Western Sales Office:  
2639 So. La Cienega Blvd., Los Angeles 34, Calif.  
Texas 0-1940

CIRCLE 535 ON READER-SERVICE CARD

ELECTRONIC DESIGN • September 16, 1959



## POLAR PATTERN RECORDING SYSTEM



### Measures Antenna Radiation Patterns

AIR's Type 116R Polar Pattern recording system precisely records directional characteristics of electromagnetic, acoustic, thermal, atomic, and light radiation patterns. It traces, in polar coordinates, a continuous inked plot of input voltage vs angular position.

Precision performance is assured by low internal noise, high sensitivity, accurate turntable drive and exact pen response.

Available accessories include a new automatic relative power computer and a square root amplifier.

Write for details.



CIRCLE 536 ON READER-SERVICE CARD

**DUAL-CHANNEL BALANCE CONTROLS.**—Type AD47, 15/16 in. in diam. 1/2 w carbon controls are for insertion on the input side of an amplifier, or between preamplifier and amplifier. Panel and rear units are of same resistance value and taper. Balance is achieved by turning a single knob.

Clarostat Manufacturing Co., Inc., Dept. ED, Dover, N.H.

CIRCLE 537 ON READER-SERVICE CARD

**UHF COMMAND RECEIVER.**—Model 2610 operates with 28 v dc input voltage at a preset frequency from 400 to 450 mc. Frequency modulation is  $\pm 350$  kc at 50 cps to 15 kc. Sensitivity is 7.5  $\mu$ v for 6 db signal plus noise-to-noise ratio with 15 kc audio bandwidth. Output is 3 v rms into 1500 ohms and image rejection is 50 db. Size is 2 x 7-3/4 x 2-5/8 in. Applications are in drone and missile guidance, range safety command, telemetering, and communications.

RS Electronics Corp., Dept. ED, P.O. Box 368, Station A, Palo Alto, Calif.

CIRCLE 538 ON READER-SERVICE CARD

**PLIERS.**—Made for wiring electronic assemblies, four types are available. Type 219 is an oblique cutting plier. Type 325 is a spring adjusting plier for light work and type 326 is a spring adjusting plier for heavy work. Type 330 is a long nose plier for forming loops.

Mathias Klein & Sons, 7200 McCormick Rd., Chicago 45, Ill.

CIRCLE 539 ON READER-SERVICE CARD

**TERMINAL BOARD.**—Is used for high density packaging. It meets military vibration specs; its shock-absorbing characteristics reduce component failure. Solder or crimp components may be used.

Beam-Tronics, Inc., Dept. ED, P.O. Box 2335, Anaheim, Calif.

CIRCLE 540 ON READER-SERVICE CARD

**TIME CYCLE CONTROLLER.**—Model C1C500 has ten pilots which may be operated simultaneously or in any sequence. Each pilot performs up to 24 operations. Intervals between operations are 4 sec or more. Timing discs range from between 0 and 15 min to between 0 and 360 min.

The Bristol Co., Dept. ED, Waterbury 20, Conn.

CIRCLE 541 ON READER-SERVICE CARD

**PAPER TAPE UNIT.**—Allows model E101 computer to accept data from either one of two readers. Coupled with model A531 input unit, it provides the programmer with completely automatic control of two tapes.

Burroughs Corp., ElectroData Div., Dept. ED, 460 Sierra Madre Villa, Pasadena, Calif.

CIRCLE 542 ON READER-SERVICE CARD

**RELAY.**—Series 5D1C has operating characteristics of series 51C. The unit is polystyrene enclosed; mounting is 8 pin. Operation is dc.

Kurman Electric Co., Dept. ED, 191 Newel St., Brooklyn 22, N.Y.

CIRCLE 543 ON READER-SERVICE CARD

## EDDYSTONE TUNES 19-500 Mc.



19-165 Mc  
Model 770R

150-500 Mc  
Model 770U

EDDYSTONE Receivers have die-cast frames and turrets, condensers milled from solid, silky fly-wheel tuning with no backlash. Sensitivity, selectivity and image rejection are controlled and guaranteed. These precise laboratory instruments monitor telemetering, aircraft and mobile radio. They have been chosen for tracking "Explorer" and "Discoverer" Satellites.

- ★ Continuous coverage in 6 bands
- ★ Receive FM or AM
- ★ Continuous duty cycle
- ★ Accurate freq. cal. 34 foot vernier
- ★ 2.5 and 600  $\Omega$  outputs, with muting
- ★ Effective noise limiter
- ★ IF and AF gain controls
- ★ Table-top or rack mounting

Exclusive U. S. Sales & Service:



111 CEDAR LANE • ENGLEWOOD, NEW JERSEY

CIRCLE 544 ON READER-SERVICE CARD

HEATHKIT

## NEW! An ELECTRONIC ANALOG COMPUTER

for \$199<sup>95</sup>



### HEATHKIT EC-1 COMPUTER KIT

- Simulates Mechanical Problems, Processes and Conditions
- Solves Mathematical Problems (Add, Subtract, Divide, Multiply, Integrate, Differentiate, get Transfer Functions)
- In a Class by Itself, but Compares in Functions to Computers Costing Over \$1000.00

Complete information is available; mail the coupon — or see your nearest authorized Heathkit dealer.

### HEATH COMPANY

a subsidiary of Daystrom, Inc.  
Benton Harbor 60, Michigan

Please send complete information on the EC-1 Computer and your latest Free Heathkit Catalog.

NAME \_\_\_\_\_

ADDRESS \_\_\_\_\_

CITY \_\_\_\_\_ ZONE \_\_\_\_\_ STATE \_\_\_\_\_

All prices F.O.B. Benton Harbor, Mich. Prices and specifications subject to change without notice.

CIRCLE 545 ON READER-SERVICE CARD

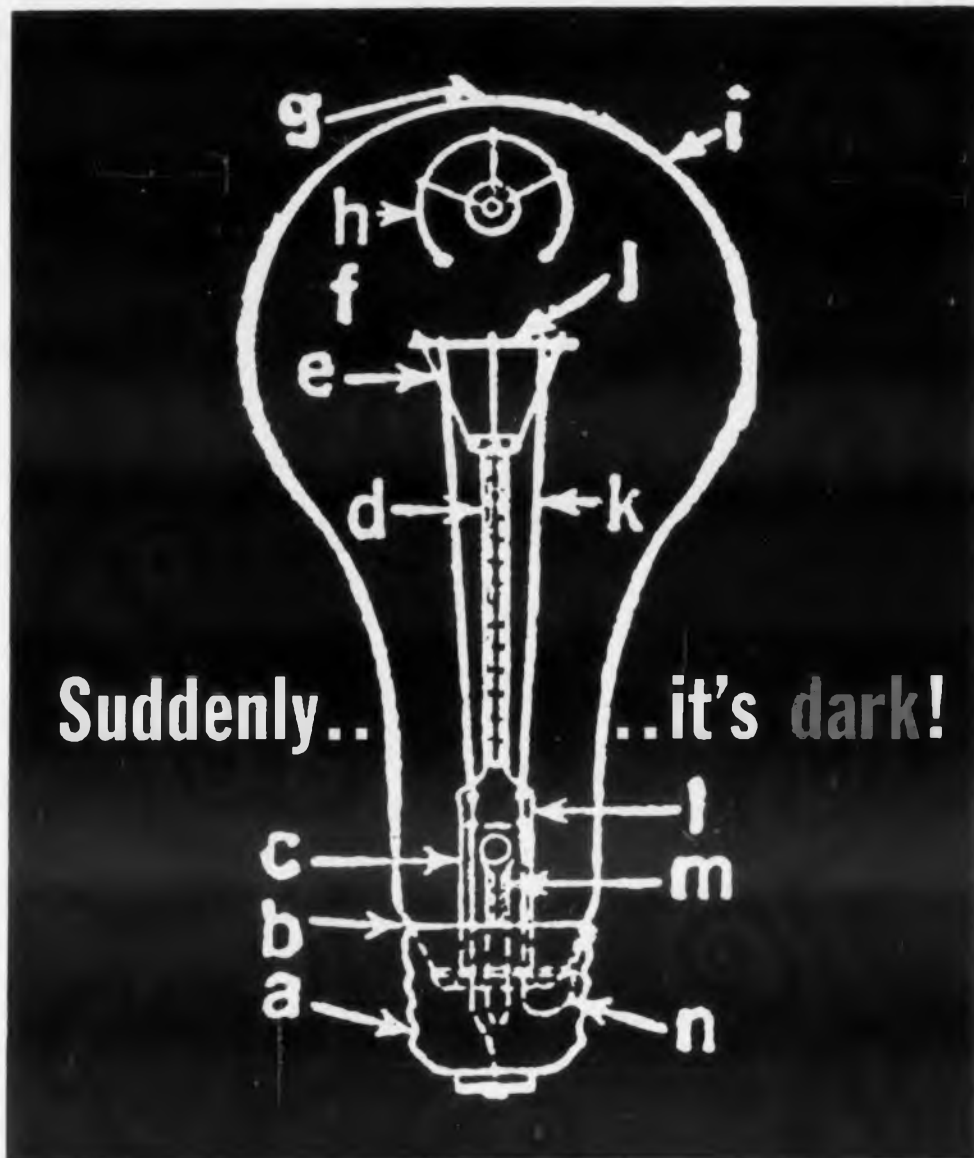

A pretty dark situation, indeed—when a *single* electron tube failure can shut down an equipment or entire production line test facility! Use IERC's new set of a, b, c's to help you get improved electronic equipment reliability. **a.** The practice of replacing tube failures in manner and attitude like that of replacing a light bulb is neither protection nor cure against a continuing high rate of electron tube failures! **b.** Downtime, labor replacement costs often add up to 10 times the tube cost! **c.** You can actually increase tube life up to 12 times by specifying and using IERC Heat-dissipating Electron Tube Shields! The full facts, in the form of **d.** complete product literature, **e.** test reports, **f.** engineering data and **g.** tube shield application guides, especially prepared to help you "see the light," are available on request—write today!

Patents 2807659, 2766020 or Patents Pending.  
Cross-licensed with North American Aviation, Inc.



**International Electronic Research Corporation**  
145 West Magnolia Boulevard  
Burbank, California



Foreign Manufacturers: Europelec, Paris, France. Garrard Mfg. & Eng. Co., Ltd., Swindon, England.  
CIRCLE 546 ON READER-SERVICE CARD

## NEW PRODUCTS

### Keyed Video Signal Generator

Covers 90 kc to 10 mc range

A keyed composite video signal generator, the model V-233A incorporates a phase-locked sine wave variable-frequency oscillator for all frequencies from 90 kc to 10 mc. The oscillator phase locks to horizontal blanking pulses and is followed by a keying amplifier which adds clean blanking and, if desired, sync pulses. The unit has an internal 15.75 kc square wave generator and may also be driven from external triggers. It has its own regulated power supply and a meter function switch that selects black-level to peak white or sync tip-to-peak white measurements.

Foto-Video Labs, Inc., Dept. ED, 36 Commerce Rd., Cedar Grove, N.J.

CIRCLE 547 ON READER-SERVICE CARD

### Power Amplifier

Provides 10 w from dc to 1 mc

Power amplifier model DCA-10 delivers a continuous power output of 10 w from dc to 1 mc and has a frequency response that is flat within  $\pm 1$  db over the full range. Voltage gain is continuously variable to a maximum of 10; harmonic distortion is less than 0.1%; and output hum and noise are less than 10 mv. The unit has good dc level stability, low output impedance, and good output regulation.

Krohn-Hite Corp., Dept. ED, 580 Massachusetts Ave., Cambridge 39, Mass.

CIRCLE 548 ON READER-SERVICE CARD

### Power Transistors

Rated to 100 v

These complementary pairs of npn-pnp germanium power transistors eliminate input and output transformers in push-pull circuits. They also simplify the application of negative feedback. Designed for audio, control, voltage regulation, servo, and computer use, they have ratings to 100 v and exceed MIL-T-19500A specifications. The npn types 2N235, LT-5191, LT-5191L, LT-5192, LT-5192L, LT-5193, and LT-5193L are, respectively, the counterparts of npn types 2N326, LT-5165, LT-5165L, LT-5163, LT-5163L, LT-5164, and LT-5164L. All types have a maximum collector current of 3 amp, a minimum large-signal current gain of 30, and a maximum thermal resistance of 3 C per w.

CBS Electronics, Dept. ED, 100 Endicott St., Danvers, Mass.

CIRCLE 549 ON READER-SERVICE CARD



**Printed Circuit  
Reliability  
through Quality  
Control**

If your printed circuit is vital to the flight of a guided missile it must not fail. It may even undergo a 100% inspection at every stage of manufacture.

Bureau quality control is more than a method of inspection. It is also a check on the causes of rejects to weed them out. Our production techniques eliminate even "acceptable" flaws because we are striving to produce *perfect* boards. This is why Bureau circuits, whether tested 100% or on a scientific-sample basis, are consistently better than statistics predict. To put reliable circuits into your product, investigate the Industrial Division of the Bureau of Engraving, Inc.



Member of the Institute of Printed Circuits

**BUREAU OF ENGRAVING, Inc.**

Industrial Division

502 South 4th St.

Minneapolis 15, Minn.

Telephone Federal 9-8721



CIRCLE 550 ON READER-SERVICE CARD

ELECTRONIC DESIGN • September 16, 1959



# NEW!

## FROM C.C.C.\*

# 1

## MINIATURIZED POWER SUPPLY FOR D. C.



Hermetically sealed — engineered for reliability — built for long life and smallest size in range. Oil-impregnated for stability—lightweight and compact.

Selenium rectifiers — no tube replacement. Pos or neg terminal can be grounded to case. Long-life capacitors. Standoff high voltage terminals for safe operation.

Heavy steel cases plated and painted. Low ripple of 1%. Input 117 v. AC, 60 cycles. Also for 400 cps.

TYPE	OUTPUT VOLTAGE	MA	SIZE	WEIGHT
251 NR	2 KVDC	5	2½ x 3¾ x 3¾	2.75#
551 NR	5 KVDC	5	2½ x 3¾ x 3¾	3.25#
1051 NR	10 KVDC	5	3¾ x 4¾ x 6½	8# 10 oz.
1551 NR	15 KVDC	5	3¾ x 4¾ x 6½	9# 10 oz.

# 2

## TYPE PAS CAPACITORS BUILT FOR RUGGED DUTY



Heavy wall Pyrex glass with metal end caps. With the glass case serving as insulator, this is a light weight and compact unit with high capacity per volume at high voltages. Standard and extended temperature ranges.

Typical sizes: .25 mfd 1000 VDC; length 2¼, diam. 1½; .01 mfd 15000 VDC; length 3½, diam. 1½.

WRITE FOR LITERATURE



**CHICAGO  
CONDENSER  
CORPORATION**

3255 W. ARMITAGE AVE., CHICAGO 47, ILLINOIS

CIRCLE 551 ON READER-SERVICE CARD

**PRECISION METERS.**—Have bifilar-suspension movement. The following models are available: microammeters, milliammeters, ammeters, millivoltmeters, voltmeters, megommeters, multi-range meters to 23 ranges, and voltammeters for current and voltage in the same instrument.

Greibach Instruments Corp., Dept. ED, 315 North Ave., New Rochelle, N.Y.

CIRCLE 552 ON READER-SERVICE CARD

**VERTICAL GYROSCOPE.**—Type NV3203 is for use in target and surveillance drone aircraft. Available in ac or dc, it provides potentiometer pick-offs on both roll and pitch axes to indicate displacements from vertical.

Iron Fireman Mfg. Co., Electronics Div., Dept. ED, 2838 S.E. Ninth Ave., Portland 2, Ore.

CIRCLE 553 ON READER-SERVICE CARD

**FREQUENCY CALIBRATOR.**—Has reference frequency accuracy of  $\pm 0.01\%$ . Model 521 has input frequency range of 1 to 80 kc, IRIG channels 5 to 13, A, C, and E inclusive. It measures 19 x 12-1/4 x 12 in.

Fenske, Fedrick & Miller, Inc., Dept. ED, 12820 Panama St., Los Angeles 66, Calif.

CIRCLE 554 ON READER-SERVICE CARD

**POWER TRANSISTOR SOCKETS.**—Solderless, they are available in several plug-in configurations on small fiberglass-epoxy insulators. Solder connections may be made to the socket before handling the transistor.

Grinnell-Harris Electronics, Inc., Dept. ED, 4130 Temple City Blvd., Rosemead, Calif.

CIRCLE 555 ON READER-SERVICE CARD

**ALPHANUMERIC TYPEWRITER.**—Is used with the firm's model G-15 digital computer. Data entering and leaving the computer via the typewriter can be identified with alphabetic information and special symbols.

Bendix Aviation Corp., Computer Div., Dept. ED, 5630 Arbor Vitae St., Los Angeles 45, Calif.

CIRCLE 556 ON READER-SERVICE CARD

**ADHESIVE FELT DOTS AND WASHERS.**—Are available in brown, and are 1/8 in. thick and 1 in. in diam. Applications include cushioning, silencing, insulating, and dustproofing.

J. B. Dawn Products, Dept. ED, 3905 S. 64th Place, Chicago, Ill.

CIRCLE 557 ON READER-SERVICE CARD

**THERMAL SWITCH.**—Can be calibrated up to 1750 F; minimum calibration temperature is -20 F. Hermetically sealed but field-adjustable, the Spec-Stat is a probe type unit with an A/N 10 SL4P connector head. It is rated at 1.5 amp at 28 v dc, 110 v ac, resistive loading.

Control Products, Inc., Dept. ED, 306 Sussex St., Harrison, N.J.

CIRCLE 558 ON READER-SERVICE CARD

**COAXIAL RF PLUGS.**—Have vswr less than 1.1 up to 11 kmc. Series TNC plugs are available in aluminum and are 35% lighter than non-aluminum types.

Cannon Electric Co., Dept. ED, 3208 Humboldt St., Los Angeles 31, Calif.

CIRCLE 559 ON READER-SERVICE CARD

## TWO RELAYS IN ONE



### a time-delay relay and a load carrier, too

Kind of small, this Heinemann Type A Relay. Weighs only three ounces. Yet, it can do *two* jobs for you. In addition to providing a controlled time delay (anywhere from ¼ to 120 seconds), it can serve as a load carrier, itself. The relay may be energized continuously. This simplifies things nicely. You don't have to use auxiliary lock-in circuits or load relays—not unless you need more than three amps' contact capacity.

D.P.D.T. switching is clean and decisive, just as it should be for healthy operation. The timing element is hermetically sealed, and this, too, keeps the relay in top form throughout its long service life.

Cost? Definitely calculated to win favor and influence your buying decision. Check on it, you'll see.

FOR DETAILED SPECIFICATIONS, REQUEST BULLETIN 5003.

**HEINEMANN**

**ELECTRIC COMPANY**

156 Plum St., Trenton 2, N. J.



CIRCLE 560 ON READER-SERVICE CARD

D.A. 1070

# Quick-Opening Fasteners

## Selecting Small Fastenings for Metal Closures

*"Use captive fasteners wherever feasible . . . Avoid the use of loose washers and loose nuts . . . Fasteners on equipment covers should be operable either with no tools or with standard hand tools"\**

*(John D. Folley, Jr. & James W. Altman, Research Scientists, American Institute for Research)*

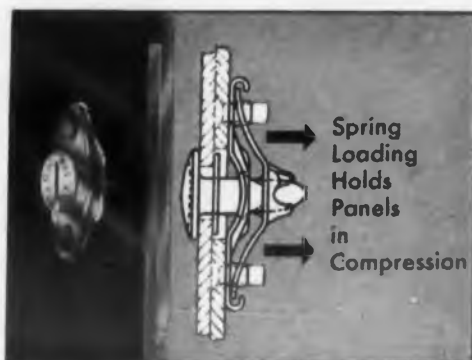

### Quarter-Turn Fastener

Lion Fasteners open and close with a  $\frac{1}{4}$  turn, hold sheets tightly under the compression of a rugged spring. Quickly operated and fully retained in the outer panel, they are approved under U. S. Government military specifications. Stud and receptacle float for easy alignment and simplified hole preparation. Flush, oval, wing, knurled, ring, and key head styles available. Sizes—No. 2, No. 5, and High Strength for extra heavy duty.

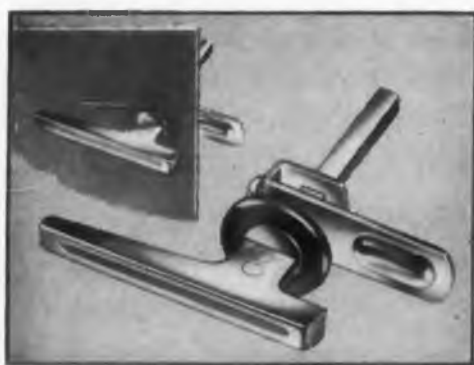

### Cabinet Latch

Just drill a hole, push the fastener stem through, and slide the special push-on

clip into place. No welds, screws, bolts or rivets: the fastener is permanently installed in seconds!

Adjustable to any grip length or panel thickness, the pawl is fixed in place by a single set screw. The fastener's brightly finished knob is set off by a plated washer. Also furnished with screwdriver operated flush head.

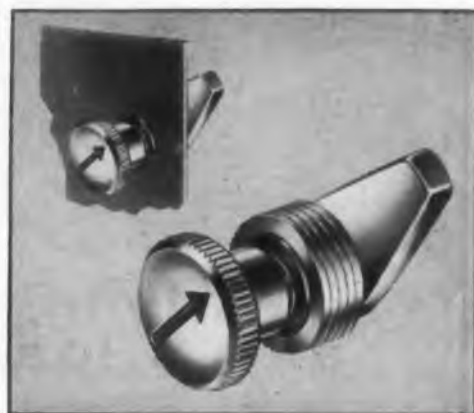

### Spring Tension Latch

For fastening slide-out drawers and hinged panels the Southco Arrowhead Latch is recommended. It locks or opens with a quarter turn yet occupies less than  $\frac{1}{2}$ " inside space.

Doors are held under spring tension—a push against the arrowhead knob relaxes this tension, allows operation with fingertip ease. Drill a single hole for installation—no fastening to the door is necessary. No striker plate is needed.

Pawl stop is eliminated—arrowhead shows at a glance exact position of pawl.



### Adjustable Panel Latch

Small doors and panels can be fastened with greatest speed and lowest cost with the Southco Adjustable Latch.

The entire fastener is quickly installed through two holes punched in the door; no bolts or rivets are needed.

It operates with a quarter turn, requires no striker plate. An extra twist after the nylon pawl is engaged pulls up the door to form a seal and eliminate vibration.

Available with wing, knurled, or Phillips head.



### Free Fastener Handbook

Send for your free copy of Fastener Handbook No. 9, just released. Gives complete engineering data on these and many other special fasteners. Forty-eight pages, in two colors.

Write on your letterhead to Southco Division, South Chester Corporation, 235 Industrial Highway, Lester, Pa.

**SOUTHCO FASTENERS**  
LION

© 1956

CIRCLE 561 ON READER-SERVICE CARD

## NEW PRODUCTS

### Infrared Transmitting Material

Retains high transparency at 800 C

Available in optically polished domes, prisms, and flats sealed to metal, Irtran type AB-1 is an infrared transmitting material that offers enhanced transparency as far as 8 microns wavelength. Designed to withstand re-entry heating effects, it transmits over 90% of impinging energy from 3 to 6 microns and retains its high transparency at 800 C and beyond. It also withstands thermal shock, weathering, humidity, and abrasion. Refractive index is 1.301 at 6.7 microns, while microwave characteristics are close to those of natural mica for insertion losses and reflection in the 9 and 10 kmc range.

Eastman Kodak Co., Apparatus & Optical Div., Dept. ED, Rochester 4, N.Y.

CIRCLE 562 ON READER-SERVICE CARD

### Signal Tracer Generator

For audio, if, or rf testing

A combination signal tracer and generator, the model 802 can generate its own signal for audio, if or rf testing. It also incorporates a noise locator circuit for checking noisy components, a magic eye tube for visual signal detection, and a speaker for aural signal detection. It uses separate high gain rf and low gain audio input channels and generates a 400 cps signal for audio and a 455 kc modulated signal for if testing. This signal can also be used for an rf modulated signal of 910 kc.

Electronic Measuring Corp., Dept. ED, 625 Broadway, New York 12, N.Y.

CIRCLE 563 ON READER-SERVICE CARD

### Silicon Transistors

Two npn types

Types 2N699 and 2N1252 are both npn diffused silicon mesa transistors. The 2N699 is a 2 w unit with a 120 v collector-to-base rating that permits wide voltage swings in amplifier and oscillator circuits. At 150 ma collector current, maximum base saturation voltage is 1.3, collector saturation voltage is 2 v, and dc current gain ranges from 40 to 120. A typical gain-bandwidth product of 120 mc gives good broadband video response. The 2N1252 is a low storage unit for use in high current saturated switching circuits. Storage plus fall times are 150 msec at 150 ma collector current and dc current gain range is 15 to 45. Five-megaphone operation is typical in detl saturated circuitry.

Fairchild Semiconductor Corp., Dept. ED, 545 Whisman Rd., Mountain View, Calif.

CIRCLE 564 ON READER-SERVICE CARD

\* Quotation from "Designing Electronic Equipment for Maintainability"; Machine Design, July 12, 1956.



**FULL RANGE SPEAKER.**—Model SK-128 consists of an 8 in. woofer and a 2 in. tweeter integrally mounted on dual axes. Frequency response is 40 to 16,000 cps,  $\pm 3$  db. Power rating is 20 w integrated program material; impedance is 8 ohms; and cone resonance is 45 to 65 cps.

Lafayette Radio, Dept. ED, 165-08 Liberty Ave., Jamaica 33, New York, N.Y.

CIRCLE 565 ON READER-SERVICE CARD

**ELECTRIC PUNCH PRESS.**—This 15-lb portable unit is designed to punch any shape hole, by using a different punch and die. It can be used on stainless steel, brass, plastic, and laminated or welded sheets not exceeding 1/8 in. thickness.

Modern Manufacturing Co., Inc., Dept. ED, 680 Davisville Rd., Willow Grove, Pa.

CIRCLE 566 ON READER-SERVICE CARD

**ENGRAVED DIALS.**—Available in a variety of diameters, engravings, and shaft sizes, with pinned or split clamp type flubs, these M1 type dials are aluminum black anodized. All engraving is filled with Mil spec white filler. Standard diameters are 1-1/2, 3, and 4 in.; bores are from 0.12 to 0.25 in.

Pic Design Corp., Dept. ED, 477 Atlantic Ave., E. Rockaway, L.I., N.Y.

CIRCLE 567 ON READER-SERVICE CARD

**RE-USEABLE CONNECTOR SEAL.**—These one-piece seals provide metal-to-metal contact of faying surfaces. Low fastening torques are required. Distortion beyond elastic limits is prevented by controlled confinement of seal gland.

Parker Seal Co., Div. of Parker-Hannifin, Dept. ED, 10567 Jefferson Blvd., Culver City, Calif.

CIRCLE 568 ON READER-SERVICE CARD

**LOOP CURRENT CONTROL.**—These two models are for use as current normalizers in dc teleprinter signal loops. Type 238 model 1 is for use in loops requiring 60 ma, and model 2, for loops requiring 20 ma. Both models have a calibration control. Input impedance changes to maintain constant current.

Northern Radio Co., Inc., Dept. ED, 147 W. 22nd St., New York 11, N.Y.

CIRCLE 569 ON READER-SERVICE CARD

**METRIC CIRCLES TEMPLATE.**—Type 240 has 37 circles from 2 to 30 mm in diam. Circles from 2 to 10 mm are in increments of 0.5 mm, and from 11 to 30 mm in increments of 1 mm. Size is 7 x 4 in.

Rapidesign, Inc., Dept. ED, P.O. Box 429, Burbank, Calif.

CIRCLE 570 ON READER-SERVICE CARD

**SONIC ANALYZER AUXILIARY.**—Designated unit C equips the LP-1a analyzer with these factors: continuously adjustable if bandwidth from 10 cps to 1 kc with 10 sec scan interval, adjustable if bandwidths in steps of 10, 30, 100, 300, and 1000 cps with continuously adjustable linear sweep width, adjustable smoothing filter, and voltage calibration reset.

Panoramic Radio Products, Inc., Dept. ED, 514 S. Fulton Ave., Mount Vernon, N.Y.

CIRCLE 571 ON READER-SERVICE CARD

PLAIN FLANGE BRACKET STUD

POWER REQUIRED - MODEL 650  
300 MW. FOR 5 MILLISECONDS  
at 6, 12, 24 and 48 V. D.C.

CONTACT RATINGS -  
2 A. at 28 V. D.C.  
OR 115 V. A. C.

VIBRATION IMMUNITY -  
30 G'S UP TO 2000 CPS

SHOCK - 100 G'S

MINIMUM LIFE - 100,000 OPERATIONS

## Micro-Miniature Latching Relays by Iron Fireman

### 5 MS PULSE AT 300 MW:

This very short burst of power and the shock and vibration immunities shown above are features of the newest addition to the Iron Fireman line of micro-miniature relays.

The model R650 relay was designed specifically to meet requirements when operating power is at a pre-

mium and ruggedness and dependability are essential.

Conforming to and exceeding the test specifications of MIL-R-5757C, the performance and reliability of the R650 relay is assured by the use of high temperature materials and a unique permanent magnetic structure.

Complete performance data available on request. Write to the address below.

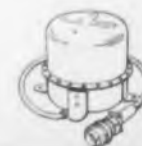

IRON FIREMAN *Electronics* DIVISION

2838 S. E. NINTH AVENUE, PORTLAND 2, OREGON

CIRCLE 572 ON READER-SERVICE CARD

# Now you can deep draw and bend molybdenum sheet at room temperature!

... with General Electric's new High-Ductility (HD) Molybdenum Sheet

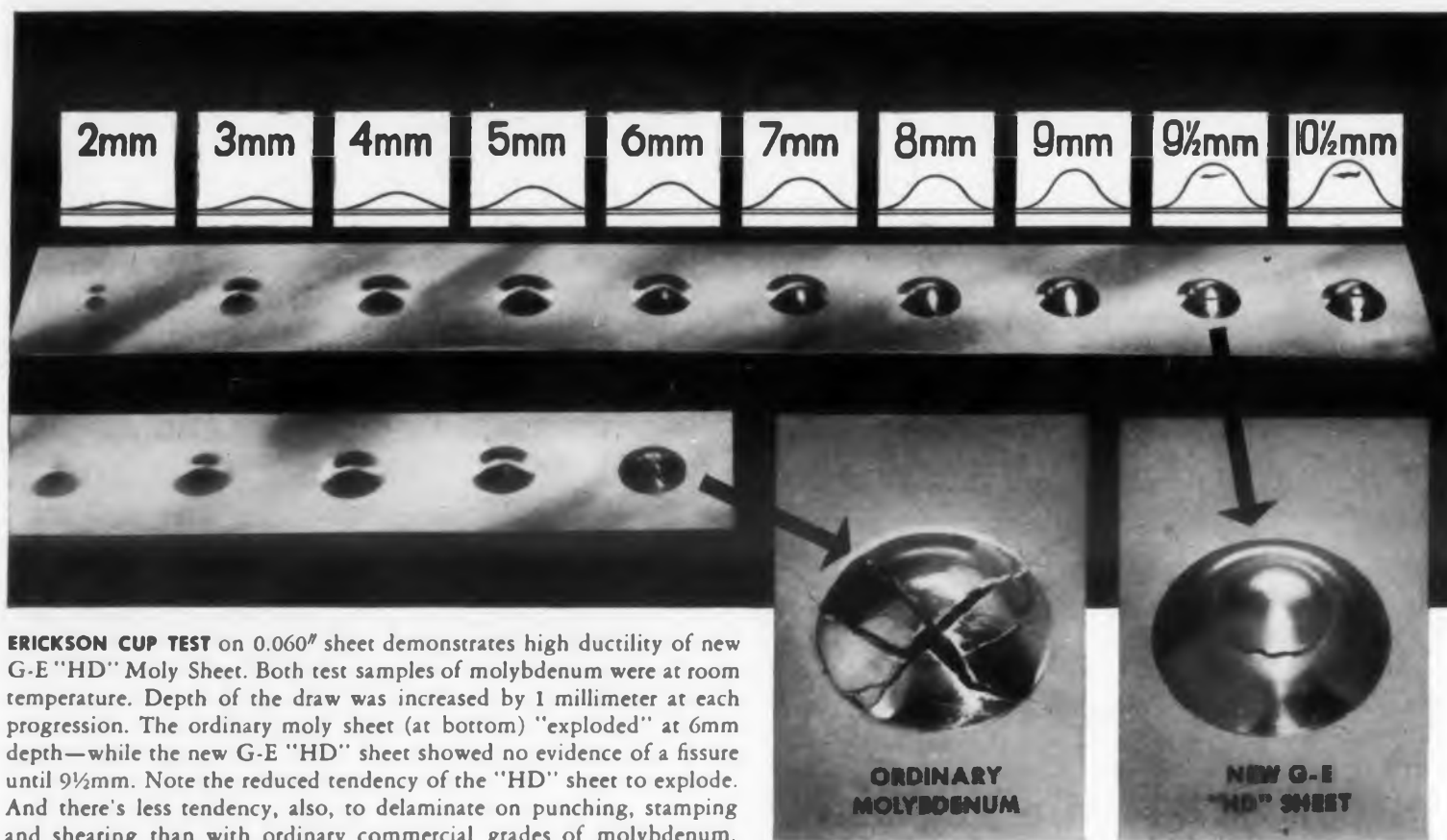

**ERICKSON CUP TEST** on 0.060" sheet demonstrates high ductility of new G-E "HD" Moly Sheet. Both test samples of molybdenum were at room temperature. Depth of the draw was increased by 1 millimeter at each progression. The ordinary moly sheet (at bottom) "exploded" at 6mm depth—while the new G-E "HD" sheet showed no evidence of a fissure until 9 1/2mm. Note the reduced tendency of the "HD" sheet to explode. And there's less tendency, also, to delaminate on punching, stamping and shearing than with ordinary commercial grades of molybdenum.

**DRAW IT! FORM IT! PUNCH IT!**—all without preheating! General Electric's new "HD" Moly Sheet can take it—and you can do all these operations in thicknesses previously impossible . . . or requiring up to 1000°F preheating. Even in cases where small amounts of heat may be needed, it's always less than with ordinary molybdenum sheet.

**TIME SAVER, MONEY SAVER!** The improved ductility of General Electric's new "HD" Molybdenum Sheet is of particular significance in sheet thicknesses of 0.020" to 0.125"—as used in electronic tubes and semiconductor

diodes, rectifiers and similar products. It has a high melting point (2622°C, 4752°F), low vapor pressure, and excellent strength at elevated temperatures. So it will be of great value to any company using refractory metals.

**PLAN ON G-E "HD" SHEET** Available in commercial quantities, so there's no better time than right now to get all the facts about this new kind of molybdenum. Write: General Electric Co., Lamp Metals and Components Dept. ED-9, 21800 Tungsten Road, Cleveland 17, Ohio.

## BENDS WITHOUT CRACKING . . . EVEN WITH NO PREHEATING!

Ordinary 0.060" thick molybdenum broke at a 20° bend (see photo at left). The G-E "HD" sheet of same thickness shows no sign of cracking at 90°. Actually this new G-E Moly Sheet is so ductile you can bend it up to 180° without damage!



*Progress Is Our Most Important Product*

**GENERAL  ELECTRIC**

CIRCLE 573 ON READER-SERVICE CARD

## NEW PRODUCTS

### TV Stabilizing Amplifier

For monochrome signals

For monochrome signals, the model V-43A stabilizing and clamping amplifier mounts in 5-1/4 in. of rack space and draws less than 200 mils of regulated B+. It provides two independent video signal outputs and a clipped sync output to drive a local genlock or sync slave. Input signal levels down to 0.25 v peak-to-peak can be used with the equipment. The stabilizing amplifier has a 10 mc bandwidth and flat frequency response to 8 mc. Differential gain is under 0.25 db and differential phase is less than 0.3 deg. A fast acting, noise immune keyed clamp maintains black level constant.

Foto-Video Labs., Inc., Dept. ED, 36 Commerce Rd., Cedar Grove, N.J.

CIRCLE 574 ON READER-SERVICE CARD

### Tube Tester

Measures dynamic mutual conductance

Tube tester model 550 measures true dynamic mutual conductance under actual operating conditions. Equipped with a wide variety of sockets, it affords a quick check of most TV and radio tubes for shorts, grid emission, gas content, and leakage. It also shows tube condition in micromhos and on a good-bad scale. The unit is 15-1/2 x 15 x 6-1/4 in., weighs 16 lb, and operates on 105 to 125 v ac, 50 to 60 cps. It has a 4-1/2 in. plastic meter, 7- and 9-pin straighteners on the panel, and a circuit for automatic line voltage compensation.

B & K Manufacturing Co., Dept. ED, 3726 N. Southport Ave., Chicago 13, Ill.

CIRCLE 575 ON READER-SERVICE CARD

### Pressure Transducer

Measure 1 x 1 x 1 in.

Series 401 miniature pressure transducer measures 1 x 1 x 1 in. and weighs 2.25 oz. It withstands vibration of  $\pm 35$  g at frequencies to 5000 cps. It employs a diaphragm capsule which actuates the wiper of a precision potentiometer. Both the transducer and the potentiometer are available for absolute, differential, and gage pressures from 0 to 5 and 0 to 400 psi, and for differential pressure from  $\pm 3$  to  $\pm 200$  psi. Standard nominal potentiometer resistances are 2000, 2500, 5000, 7500, and 10,000 ohms. Electrical connection is made either by soldering terminals or a pigmy receptacle.

Colvin Laboratories, Inc., Dept. ED, 360 Glenwood Ave., E. Orange, N.J.

CIRCLE 576 ON READER-SERVICE CARD



**HEAT RADIATORS.**—Reduce transistor temperatures by providing an increased radiating surface. The Transicool heat radiator is made of high conductivity copper for maximum conduction of heat; aluminum is also available. These units are available in sizes to fit all JEDEC-30 packaged transistors.

Mark Company, Dept. ED, Taunton, Mass.

**CIRCLE 581 ON READER-SERVICE CARD**

**ZENER DIODE SUBSTITUTION BOX.**—For use in breadboard circuitry, model B offers a selection of 11 basic 10 w silicon zener diodes covering 3.6 to 30 v range.

International Rectifier Corp., Dept. ED, 1521 E. Grand Ave., El Segundo, Calif.

**CIRCLE 582 ON READER-SERVICE CARD**

**CONTROL CONNECTORS.**—Are available for applications up to 600 v. Constructed of Neoprene, they may be obtained in three styles: oval, round, and dual round, with from 2 to 12 poles. They are crushproof, corrosionproof, waterproof and dirt-proof.

Joy Manufacturing Co., Electrical Products Div., Dept. ED, 1201 Macklind Ave., St. Louis 10, Mo.

**CIRCLE 583 ON READER-SERVICE CARD**

**TEMPERATURE INDICATOR.**—Is available in nine ranges covering -30 to +350 F. Called model 116, it is portable and thermistor actuated. The thermistor sensing probes are interchangeable and are accurate to 0.5 F under 100 F, and 0.5% of reading over 100 F. The indicator may be used with model 119 channel selector for readout of ten temperature points.

Fenwal Electronics, Inc., Dept. ED, Mellen St., Framingham, Mass.

**CIRCLE 584 ON READER-SERVICE CARD**

**PRECISION POTENTIOMETER.**—Has conductive plastic resistance element. It is environmentally protected against shock, vibration, acceleration, moisture and humidity. Models are available in standard sizes and configurations, linear and nonlinear.

Ace Electronics Association, Inc., Dept. ED, 99 Dover St., Somerville 44, Mass.

**CIRCLE 585 ON READER-SERVICE CARD**

**SOLDER WASHER.**—Rosin flux-filled, this solder washer eliminates the need for separate fluxing. The solder-flux-solder construction provides instantaneous fluxing around the entire periphery of the washer. They are available in all standard combinations of tin, lead, cadmium, antimony, and silver.

Alpha Metals, Inc., Dept. ED, 56 Water St., Jersey City 4, N.J.

**CIRCLE 586 ON READER-SERVICE CARD**

**PIEZOELECTRIC CERAMIC.**—Type SS10 replaces SS9. Dielectric constant is 600; Curie temperature is  $\pm 145$  C. Over temperature range of 13 to 45 C frequency changes less than 0.1%.

Solar Manufacturing Corp., Dept. ED, 4553 Seville Ave., Los Angeles 58, Calif.

**CIRCLE 587 ON READER-SERVICE CARD**

## A new division of The Dow Chemical Company—

# THE DOW METAL PRODUCTS COMPANY

Here's significant news for everyone who has an interest in metals and metal fabrication. The Dow Chemical Company, pioneer developers of Magnesium and Magnesium products, is now broadening its activities in metal working. A new division, THE DOW METAL PRODUCTS COMPANY, has been formed to specialize in the semi-fabrication and fabrication of not only

Magnesium, but aluminum and other metals. This new division has excellent production facilities, plus knowledge gained through Dow's many years' experience in the metal working field. Facilities include plants for the manufacture of rolled and extruded products, sand and permanent mold castings, die castings, and fabricated assemblies.



**THE DOW METAL PRODUCTS COMPANY**

DIVISION OF THE DOW CHEMICAL COMPANY

MIDLAND, MICHIGAN

**CIRCLE 588 ON READER-SERVICE CARD**

## TERMINALS and CONNECTORS FOR HIGH PRODUCTION APPLICATIONS



- Save Wiring Time
- Speed Production
- Cut Assembly Costs

**MINIATURE TUBULAR TERMINALS**—Save time and labor in printed circuit assembly. Snap in instantly and hold firmly until permanently soldered.

**RECEPTACLES AND CONNECTORS**—Fit quickly and firmly. For use with Malco Tubular Terminals and for similar quick connect and disconnect applications.

**WRAP-A-WIRE TERMINALS**—Quickly inserted. Exclusive staked clinch-type feature locks terminal firmly until permanently soldered.

**SOLDER LUGS AND INTERLOCK CONNECTORS**—Especially designed for production line assembly operations. Interlocks are ideal for interlocking printed circuits or flybacks, as speaker lead connectors or as transformer mounting lugs.

**SPECIAL TERMINALS AND CONTACTS**—Malco Manufacturing Company has complete facilities to furnish practically any design or construction to fit individual requirements.

**MALCOMATIC\* MACHINES**—Designed for high volume production, these machines automatically insert, crimp or stake. They pay for themselves in time and labor costs, greatly speed assembly.

\*Request Bulletin 581. Send b/p or specs and annual requirements for quote.

\*Registered Trade Name

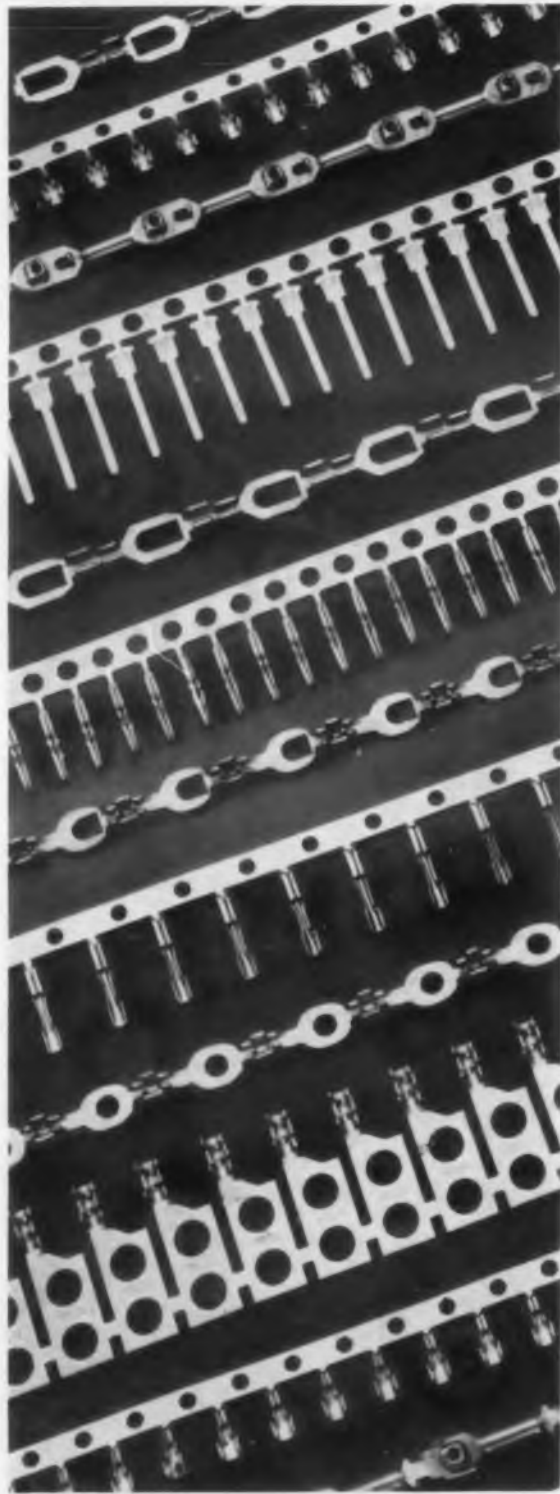

# Malco MANUFACTURING COMPANY

4027 WEST LAKE STREET

CHICAGO 24, ILLINOIS

CIRCLE 589 ON READER-SERVICE CARD

## NEW PRODUCTS

### Miniature Brakes

Three types available

These miniature brakes are available in three types. Type BA-130-E has 110 oz-in. static torque, 3.5 w power consumption, and 1.439 in. OD. Type BA-100-E has 30 oz-in. static torque, 2 w power consumption, and 1 in. OD. Type SAB-181-E has 15 lb-in. static torque, 4 w power consumption, and 1.812 in. OD. Speed is 4000 rpm for the three models. They can be supplied to brake either when energized or de-energized; coils are available for 6, 12, 28, 48, and 100 v dc. The units are made to be mounted directly to small motors and gear train housings.

Dial Products Co., Dept. ED, 19 Cottage St., Bayonne, N.J.

CIRCLE 590 ON READER-SERVICE CARD

### Silver-Zinc Batteries

Have high environment resistance

Exceeding the environmental resistance requirements of MIL-E-5272A, P-Series silver-zinc primary batteries have temperature ranges from -85 to +225 F. Voltages range from 1.4 to 495 v, supplying currents from 100 ma to over 1000 amp. The units operate in any position and have a cell construction that virtually eliminates gassing. They are hermetically sealed and incorporate a fail-safe detection circuit to warn of premature activation. Double ignition circuits prevent failures due to shorts or open circuits. Rectangular, circular, sector, or special shapes can be supplied.

Cook Batteries, Dept. ED, 3850 Olive St., Denver 7, Colo.

CIRCLE 591 ON READER-SERVICE CARD

### Bench-model Oven

Temperatures to 1000 F

This bench-model oven provides temperatures from 125 to 1000 F. Electric resistance heaters are located in all six walls, including roof, floor, and door and are thermally weighted to produce temperature uniformity. Offering maximum work space of 4 cu ft and occupying minimum bench space of 34 x 33 in., this oven has readily-accessible front panel-mounted temperature controls. Operating at 230 v at 11 amp max, the oven will heat from room temperature to 1000 F in 3.5 hr. Two wire shelves are included.

American Instrument Co., Inc., Dept. ED, 8030 Georgia Ave., Silver Spring, Md.

CIRCLE 592 ON READER-SERVICE CARD

## This package can end your worries about silicon processing . . .



Inside this box you'll find doped silicon single crystal slices from Allegheny.

Who needs them? You do . . .

If you wish to increase production without tying up capital in facilities for slicing, lapping, etching and such.

If you'd like to avoid being dependent on just one source of supply.

You solve either (or both) of these problems with Allegheny's new service because you get single crystal slices that are ready for use.

These slices from vertically pulled or float zoned crystals are doped to range with 99.999% group III and/or V elements. Standard thicknesses from .005" to .020" and diameters from 1/4 to 1 1/2 inches.

As for lapping, this we do to your specification. If you wish, we prepare one or both sides for diffusion. Otherwise slices are etched, cleaned and dried before being delivered to you.

Details? We'll provide answers to your questions, promptly.

*NOTE: You'll find that Allegheny devotes its efforts exclusively to producing ultra-pure silicon in every form. You might also be interested in more facts about bulk, billets, rods, doping alloys, seeds or special forms.*

If so, write, wire or phone:

Allegheny Electronic Chemicals Co.  
207 Hooker-Fulton Bldg., Bradford, Pa.  
252 North Lemon St., Anaheim, Calif.

## ALLEGHENY

ELECTRONIC CHEMICALS CO.

Producers of semiconducting materials for the electronics industry.

CIRCLE 593 ON READER-SERVICE CARD

ELECTRONIC DESIGN • September 16, 1959





New  
space-saving,  
lightweight

## differential DC amplifier

*amplifies low-level  
telemetry signals  
with high efficiency*

**Smallest size available**—only 2½" long x 1¾" square. Weighs only 8 ounces. ±10 millivolts "in"... ±5 volts "out."

**Excellent linearity.** From null to 5 VDC output, the linearity is 0.5%. From null to 2.5 VDC, it's 0.25%.

**High stability**—1% of gain and null value in 5 minutes from a cold start. Unit is stable over the full environmental range, and over power input variations.

**Sources floating**—input, output and power sources are completely isolated from one another.

**Meets MIL-E-5272A** for humidity, vibration and shock. Designed with magnetic amplifier reliability.

Write for complete data.



**NETWORKS  
ELECTRONIC  
CORPORATION**

14806 Oxnard Street, Van Nuys, Calif.  
Telephone: STate 2-3114

CIRCLE 594 ON READER-SERVICE CARD

**ANALOG INTEGRATOR.**—Eliminates graphic analysis by automatic summation of the area under a curve being electrically recorded. The integral value can be read on the instrument meter and an output is provided to allow direct recording of the information.

Massey Dickinson Co., Dept. ED, 11 Coker St., Watertown, Mass.

CIRCLE 595 ON READER-SERVICE CARD

**HIGH-VOLTAGE PROBE.**—Is rated at 12 kv dc or rms, 250 kv peak. Designed for use with oscilloscopes, type P1000 has an attenuation ratio of 1000 to 1, a risetime of 12 musec, and a frequency response from dc to 30 mc. Input impedance is 25 µf paralleled by 100 meg. The probe is 12 in. long, and has a 12 ft cable.

Tektronix, Inc., Dept. ED, P.O. Box 831, Portland 7, Ore.

CIRCLE 596 ON READER-SERVICE CARD

**RECEPTACLES.**—Used with 3/32 and 1/8 in. printed circuit boards, Reli-Acon card receptacles are available with threaded mounting inserts and with vibration resistant card locking clips. The units meet the environmental requirements of MIL-C-21097.

Methode Manufacturing Corp., Dept. ED, 7447 W. Wilson Ave., Chicago 31, Ill.

CIRCLE 597 ON READER-SERVICE CARD

**EDGE-LIGHTED PLASTIC PANELS.**—Meet MIL-P-7788 specs. A coating process is used which makes these panels scratch-resistant and results in maximum visibility by day or night. Sizes, shapes and markings are made to specifications.

National Radio Co., Inc., Dept. ED, 37 Washington St., Melrose 76, Mass.

CIRCLE 598 ON READER-SERVICE CARD

**TEFLON FILM.**—Is used in waveguides of radar systems. Called Railon, it does not bulge, distort under pressure, or leak. This 5 mil film is bondable with conventional adhesives, has a burst strength in excess of 30 psig, a tensile strength of up to 40,000 psi, and an elongation of under 200%.

Radiation Applications, Inc., Dept. ED, 370 Lexington Ave., New York 17, N.Y.

CIRCLE 599 ON READER-SERVICE CARD

**RIGID COAXIAL LINES.**—Are made of aluminum and meet the 3 megawatt MIL-I-28800 spec for radio interference. They may be obtained in various standard designs or custom units.

Telerad Mfg. Corp., Dept. ED, 1440 Broadway, New York 18, N.Y.

CIRCLE 600 ON READER-SERVICE CARD

**BRUSH COMMUTATOR.**—Model 550A-1 has 30 shorting channels and a speed of 5 rps. It combines small size with ease of maintenance and simplicity of design.

General Devices, Inc., Dept. ED, P.O. Box 253, Princeton, N.J.

CIRCLE 601 ON READER-SERVICE CARD

CURTISS  WRIGHT

## PRECISION COMPONENTS



### TIME DELAY RELAYS

For military applications — "H" and "S" Series

You can meet the shock and vibration conditions specified by today's military applications with the "H" Series thermal time delay relay. They are small in size, of rigid construction and manufactured with thorough quality control and testing to assure conformity to the highest standards. The "S" Series has a single pole, double-throw contact arrangement with long life.

#### FEATURES:

Time delays from 3 to 180 seconds  
Temperature compensated  
Miniature • Hermetically sealed  
Meets rigid environmental specifications



### New DIGITAL MOTORS

Stepping motors for high reliability applications. Meet the requirements of assured reliability and long life for aircraft, missile and automation systems.

**FEATURES** | Bi-directional • Positive lock • Dynamically balanced • Simplicity of design • High pulsing rate.

### New ULTRASONIC DELAY LINES

Enables development engineers to employ new concepts in existing and projected applications. Low in cost, small in size and simple to operate.

#### SPECIFICATIONS

Delay range..... 5 to 6000 microseconds  
Tolerance..... ± 0.1 microsecond  
Signal to noise ratio..... Greater than 10:1  
Input and output impedance..... 50 to 2000 ohms  
Carrier frequency..... 100 kc - 1 mc  
Delay to pulse rise time..... Up to 800:1

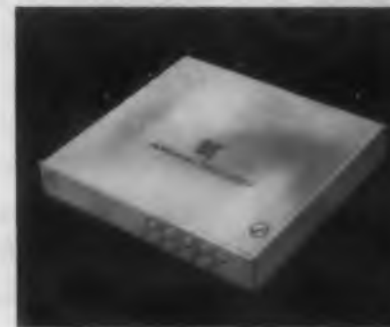

WRITE FOR COMPLETE COMPONENTS CATALOG 159

ELECTRONICS DIVISION

# CURTISS-WRIGHT

CORPORATION • WEST CALDWELL, N.J.

CIRCLE 602 ON READER-SERVICE CARD

**NIKE HERCULES**

**ATLAS**

**BOMARC**

**RELAY RELIABILITY**

**TITAN**

**...where it counts!**

Best proof of Dunco Type FC-6 reliability is the fact that these sturdy little relays are specially designed to play important parts in all of the missile programs illustrated above—and several more besides.

Type FC-6 Relays are spotlessly clean. They have a new and outstandingly dependable contact material, and include unique design features that provide positive protection against extreme vibration and shock.

*Dunco Bulletin FC gladly sent on request*

Member, National Assn. of Relay Manufacturers

**STRUTHERS-DUNN**

Makers of the world's largest selection of relay types

STRUTHERS-DUNN, Inc., Pitman, N. J.

Sales Engineering Offices in: Atlanta • Boston • Buffalo • Chicago • Cincinnati • Cleveland • Dallas • Dayton • Detroit • Kansas City • Los Angeles • Montreal • New Orleans • New York • Pittsburgh • St. Louis • San Francisco • Seattle • Toronto

CIRCLE 603 ON READER-SERVICE CARD

## NEW PRODUCTS

### Miniature Thermostat

Has 1 F sensitivity

Designed for cooling and high limit control, the model 32411 thermostat makes contact on temperature rise. It is 1/3 the size of a common sugar cube and has exposure limits of -65 to +325 F with an inherent sensitivity to 1 F. The unit is hermetically sealed and withstands 500 cps vibration with 10 g acceleration. It is made of corrosion resistant stainless steel and has a current rating of 2.5 amp, 115 v ac or 2 amp, 28 v dc.

Fenwal Inc., Dept. ED, Pleasant St., Ashland, Mass.

CIRCLE 604 ON READER-SERVICE CARD

### Pulse Power Calibrator

Has  $\pm 0.5$  db accuracy

The model PCX-1 pulse power calibrator is a precise instrument for calibrating pulse power measuring devices in the 925 to 1225 mc frequency range and for measuring power between -10 and +63 dbm. It has an accuracy of  $\pm 0.5$  db for power measurements and  $\pm 0.1$  db per 30 db for attenuation measurement.

General Communication Co., Dept. ED, 677 Beacon St., Boston-15, Mass.

CIRCLE 605 ON READER-SERVICE CARD

### Radar Tubes

Have fast sweep characteristics

Available in 10, 12, and 16 in. sizes, these fast sweep radar tubes provide high resolution, deflection uniformity, and reduced deflection defocusing. Their jump-sweep capabilities permit complete accurate surveillance of fast moving objects. The 16-in. unit, type K1754P, has a minimum useful screen diameter of 14-1/2 in. Typical operating conditions are: accelerator voltage, 10 kv; focusing electrode, 3 to 3.5 kv; grid No. 1, 150 to 260 v; modulation, 40; and line width, 0.015 in.

Allen B. Du Mont Labs, Inc., Electronic Tube Div., Dept. ED, 750 Bloomfield Ave., Clifton, N.J.

CIRCLE 606 ON READER-SERVICE CARD

### Relay

Mercury-wetted

Type HG6F mercury-wetted relay has a flat, rectangular design and measures 3.64 x 3.125 x 1.046 in. Six switches are mounted on a printed circuit panel. The unit is protected against dust, corrosive fumes, and explosive atmospheres. Contacts are rated at 5 amp, 500 v dc or rms.

C. P. Clare & Co., Dept. ED, 3101 Pratt Blvd., Chicago 45, Ill.

CIRCLE 607 ON READER-SERVICE CARD

## Using Thermistors

Edited by  
FENWAL ELECTRONICS, INC.

**STABLE THERMISTORS PERMIT HIGH CONTROL ACCURACY WITH SIMPLE CIRCUITRY**

Circuit shown for the Fenwal Electronics' Model 150 Temperature Controller is typical. It has a sensitivity of 0.001°C throughout its working range!

New, extremely stable, probes permit full exploitation of thermistors' inherently high sensitivity to temperature change.

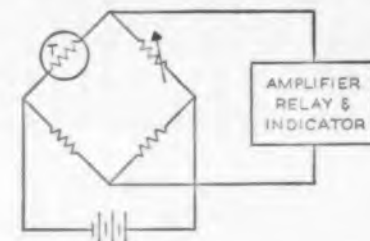

Fenwal Model 150 Thermistor Controller

Operating characteristics of the new probes are precisely predictable and repeatable over the entire control range. Furthermore, the large change in resistivity of a probe in response to a small temperature change greatly simplifies circuit design. (Resistance can change as much as 4000 ohms — or more — for a change of only 1° in temperature.) In most cases, a standard resistance bridge circuit is ample for measurement of signal output.

For full details on thermistors, send for Catalog EMC-2. Further details on Model 150 also available on request. Write FENWAL ELECTRONICS, Inc., 38 Mellen Street, Framingham, Mass. And simplify your circuit design problems with a G200 Experimental Kit of thermistors. Available from Fenwal Distributors or the Framingham plant.



Making Precision Thermistors  
to Make Your Design Ideas Come True

CIRCLE 608 ON READER-SERVICE CARD

ELECTRONIC DESIGN • September 16, 1959



## COMPUTING COMPONENTS FROM Librascope

Shaft-to-digital encoders meet rigid requirements



Librascope shaft encoders meet and surpass rigid requirements of airborne analog-to-digital translation. Shock, vibration and temperature extremes do not affect their continuous, noise-free operation.

**THEY'RE DIRECT:** A simple one-step means of digitizing analog data.

**THEY'RE RELIABLE:** Multi-million turns at high speeds with constant contact resistance.

**THEY'RE VERSATILE:** 14 basic models in wide range of capacities; special function codes built-in to simplify computer requirements.

For full details on Librascope encoders write for Catalog E11-1

OUTPUT CODE	MODEL NO. @	TOTAL CAPACITY	RESOLUTION PER TURN
PARALLEL BINARY (LINEAR)	740 743	10 bits (1024) 13 bits (8192)	1024 128
SERIAL BINARY (LINEAR)	707 713 717 719	7 bits (128) 13 bits (8192) 17 bits (131,072) 19 bits (524,288)	128 128 128 128
SERIAL BINARY (SIN-COS)	757† 758†	7 bits per quadrant* (4 quadrants) 8 bits per quadrant* (4 quadrants)	512 1024
BINARY CODED DECIMAL (8-4-2-1)	723 724 733 734 735	2,000 20,000 3,600 36,000 360,000	200 200 200 200 200
GRAY	708	8 bits (256)	256

@All models available with internally mounted isolation diodes for sequential multiplexing applications.

†Available in hermetically sealed servo-driven package as Models 757-S and 758-S.

\*Including limit 1 and polarity information. Sine and cosine functions generated simultaneously and independently. One turn of shaft generates 4 quadrants of information.

LIBRASCOPE

GENERAL PRECISION COMPANY

A SUBSIDIARY OF GENERAL PRECISION EQUIPMENT CORPORATION  
LIBRASCOPE, INC. Commercial Division  
100 East Tujunga Avenue • Burbank, California

CIRCLE 615 ON READER-SERVICE CARD

**FLAT-HEAD SOCKET SCREWS.**—Are available with either hex or spline sockets in alloy or stainless steel, in sizes from No. 0 through No. 3. Part of the Dyna-Mite line, they are recommended for precision applications.

Bristol Co., Dept. ED, Waterbury 20, Conn.  
CIRCLE 616 ON READER-SERVICE CARD

**BUTTON-HEAD SOCKET SCREWS.**—Are available with either standard hex or spline sockets in alloy or stainless steel, in sizes No. 0 through No. 3. Part of the Dyna-Mite line, they are recommended for resistance to shock and vibration.

Bristol Co., Dept. ED, Waterbury 20, Conn.  
CIRCLE 617 ON READER-SERVICE CARD

**TRANSDUCERS.**—Variable reluctance pressure types, they are made in seven pressure ranges from 0-50 to 0-5000 psi. Type PDH-4 has a sensitivity of 100 mv per v per fs; PDH-4C has a 50 mv per v per fs sensitivity.

Crescent Engineering & Research Co., Dept ED, 5440 N. Peck Rd., El Monte, Calif.

CIRCLE 618 ON READER-SERVICE CARD

**DELAY LINES.**—Have improved temperature stability. Temperature coefficient of delay is 5 ppm per deg C for the fixed and some of the adjustable magnetostrictive delay models, and 25 ppm per deg C for other adjustable models.

Deltime, Inc., Dept. ED, 608 Fayette Ave., Mamaroneck, N.Y.

CIRCLE 619 ON READER-SERVICE CARD

**RESETTABLE REVOLUTION COUNTER.**—Forward shaft revolutions add 10 counts, reverse revolutions subtract 10 counts in this four-digit, knob reset counter. It is 1-3/4 in. wide, 2-3/4 in. long, 1-1/2 in. deep and can handle speeds up to 12,000 cpm.

General Controls Co., PIC Automation Controls Div., 8078D McCormick Blvd., Skokie, Ill.

CIRCLE 620 ON READER-SERVICE CARD

**MINIATURE PRESSURE TRANSDUCER.**—P series, variable reluctance diaphragm type. They are rugged, have high sensitivity, fast response, and can be used for both dynamic and static pressure measurements.

Hidyne Instrument & Engineering Co., Dept. ED, P.O. Box 257, Tullahoma, Tenn.

CIRCLE 621 ON READER-SERVICE CARD

**SPEED CONTROLS.**—Have infinitely variable speed drive with vernier dial for precision speed setting. Available with motors up to 1/4 hp, 115 v, 60 cps.

Humphrey, Inc., Humphrey Products Div., Dept. ED, 2805 Canon St., San Diego 6, Calif.

CIRCLE 622 ON READER-SERVICE CARD

**CRYSTAL-CONTROLLED TUNERS.**—XT series, pre-set to 12 frequencies in the 20 to 200 mc range. Can be used in monitoring am or fm broadcasts, network relaying, and scatter propagation studies.

Karg Laboratories, Inc., Dept. ED, 30 Meadow St., South Norwalk, Conn.

CIRCLE 623 ON READER-SERVICE CARD

## GENERAL ELECTRIC VOLTAGE REGULATION IDEA FILE

By C. A. NEUMANN



FOR RADAR ENGINEERS

### General Electric Inductrol\* regulators accurately control current to transmitter tube focus coils

Power input to transmitter tube focus coils on radar systems must be very closely regulated to assure proper operation of the tubes. The circuit below illustrates a typical application with a General Electric Inductrol voltage regulator accurately controlling the input to the focus coils.

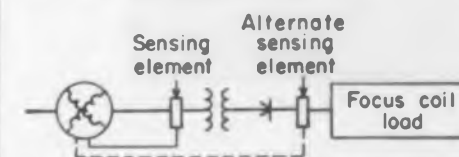

In low-voltage power supply circuits the Inductrol regulator functions to control voltage. In focus coil applications, however, the Inductrol regulator is now called upon to precisely control the d-c current.

Here again, the ability of an induction voltage regulator to perform this regulation function can best be shown by the following example:

Maintain constant d-c current at any level within range of 9.5 amps to 6.3 amps. Corresponding d-c voltage levels for these current limits are as follows: @ 9.5 amps DC—200 volts DC; @ 6.3 amps DC—98 volts DC; max. load—1.9 kw. Regulator must withstand 25 times normal current (for 2 sec.) and introduce no harmful waveform distortion.

Input line supply: three-phase, 60 cycles, 208Y volts, with ± 10% voltage variation.

Rectifier: full wave, three-phase, silicon rectifier bridge, with system regulation of approximately 8%.

TO COMPENSATE FOR SYSTEM REGULATION, the regulator must be capable of delivering a maximum of  $200 \times 1.08 = 216$  volts DC.

Using the proper conversion factors for a three-phase, bridge rectifier circuit, the corresponding d-c current

and voltage values for the d-c counterparts will be as follows:

Voltage:  $216 \times .74 = 160$  volts AC line to line

$98 \times .74 = 72.5$  volts AC line to line

Current:  $9.5 \times .82 = 7.8$  amps AC line

The range of regulation the Inductrol regulator must introduce into the circuit results in a requirement of plus and minus approximately 40% voltage range from the mid-point level of the output voltage range required. This considers input line variations and system regulation. Since the range of voltage output of the regulator (72.5 to 160 volts AC) is below the input voltage of 208 volts, a unique design technique in winding construction must be used for best economy. The sketch shows the basic regulator schematic circuit.



Further calculation will show that the regulator rating required to meet this focus coil requirement will be approximately

$$44 \text{ volts} \times 7.8 \text{ amps} \times \sqrt{3} = 0.6 \text{ kva}$$

With this unique winding arrangement for these very special loads, it becomes possible to perform the desired voltage regulation without need for a separate stage of voltage transformation. In addition the Inductrol regulator will withstand 25 times normal current and does not introduce harmful waveform distortion.

For more information, write Section 425-22, General Electric Co., Schenectady 5, N.Y.

\*Registered trademark of General Electric Co. for Induction Voltage Regulator.

Progress Is Our Most Important Product

GENERAL ELECTRIC

CIRCLE 624 ON READER-SERVICE CARD

# LOOK WHAT FANSTEEL'S DOING WITH TUNGSTEN NOW!



Tungsten cup being drawn preliminary to shaping into missile hardware.

## BIGGER TUNGSTEN NOZZLE THROAT INSERTS

Now made up to 4" flange diameter, 3" long, with wall thicknesses of 0.060"! Incredible six months ago... possible today... routine tomorrow at Fansteel!

## AND... THESE TUNGSTEN CUPS NOW AVAILABLE FROM EXISTING DIES:



Fansteel will help you investigate the possibility of adapting Tungsten in your product. Call in the Fansteel man.

- $\frac{1}{8}$ " I. D. x .060" wall x  $1\frac{1}{4}$ " deep
- $1\frac{3}{4}$ " I. D. x .060" wall x  $\frac{1}{2}$ " deep
- $1\frac{1}{2}$ " I. D. x .060" wall x  $\frac{3}{8}$ " deep
- $1\frac{5}{16}$ " I. D. x .125" wall x  $\frac{3}{4}$ " deep
- $1\frac{1}{16}$ " I. D. x .125" wall x  $\frac{7}{8}$ " deep
- $1\frac{1}{8}$ " I. D. x .040" to .060" wall x  $2\frac{5}{16}$ " deep
- 2" I. D. x .060" to .080" wall x 5" deep
- 2 $\frac{1}{2}$ " I. D. x .125" wall x 2" deep
- $3\frac{5}{16}$ " I. D. x .125" wall x  $1\frac{1}{8}$ " deep
- $4\frac{1}{2}$ " I. D. x .125" wall x  $1\frac{1}{4}$ " deep

**FANSTEEL**

HIGH TEMPERATURE  
METALS

FANSTEEL METALLURGICAL CORPORATION North Chicago, Ill., U.S.A.

CIRCLE 625 ON READER-SERVICE CARD

## PRODUCTION PRODUCTS

### Name, Numbering, and Lettering Head

For hot stamping

Hot stamping head model 441 is a 25 to 35 wheel numbering head that also does trademark and name stamping in any combination. It is supplied with a thermometer and a thermostatic heat control that provides proper stamping temperatures. The cartridge type heating element is mounted in the center shaft which is oversize to afford stamping strength under heat stress. This plugs into any ac line. An adjustable tape feed guide allows the use of roll leaf foil in any hot stamping press with automatic roll leaf feed. Overall size is 6 x 8 x 6 in.

The Acromark Co., Dept. ED, 411 Morrell St., Elizabeth, N. J.

CIRCLE 626 ON READER-SERVICE CARD

### Resolver Test Stand

For precise shaft positioning

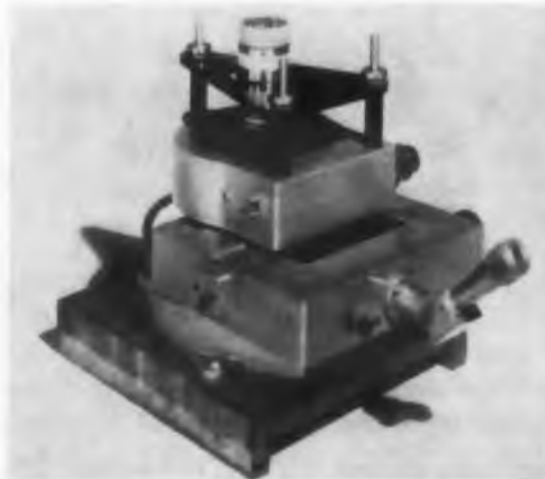

Designed for use in production tests of resolvers, synchros, potentiometers, and other such equipment, the model 7530 test stand is a precision shaft positioning device. It consists of an optical coincidence reading system with  $\pm 2$  sec absolute accuracy, a rack and gear for precise shaft positioning, and an adaptor plate and coupling. In use, the test unit is mounted on the adaptor plate and its shaft is connected to the positioning shaft by a miniature flexible coupling. The shaft system is then quickly adjusted to any approximate angular position by means of the rapid drive disc. Accurate final positioning is accomplished with a slow motion drive. The true angular position of the shaft is read directly to the nearest second of arc.

W. & L. E. Gurley, Dept. ED, 514 Fulton St., Troy, N.Y.

CIRCLE 627 ON READER-SERVICE CARD

## NEW! BEATTIE-COLEMAN PROGRAMER

...provides

**4.2**  
HOUR  
PROGRAM  
on 13 channels



160 feet of punched Mylar tape is accommodated in the new Beattie-Coleman MLPR-13 Programmer, providing a completely random program of 252 minutes duration on 13 channels. Extremely accurate time control with no cumulative error. Available in five speeds:  $\frac{1}{6}$ ",  $\frac{1}{4}$ ",  $\frac{1}{2}$ ",  $1\frac{1}{2}$ ", and 3" per sec. Weighs less than 5 lbs., is easily removable for loading. Programs can be initiated or altered in a few minutes. Compatible with most missile guidance systems.

Write for complete data on the MLPR-13 and other multi-channel Beattie-Coleman Programers for either repeat cycling or random operation.

**B BEATTIE-**  
**C COLEMAN inc.**

1000 N. Olive St., Anaheim, California  
Branch: 437 Fifth Avenue, New York, N.Y.

CIRCLE 628 ON READER-SERVICE CARD



## BUILT-IN RELIABILITY



Low  $R_{cs}$  ( $0.05\Omega$ ) at high temperatures insured by large ring emitter-base area. Leakage currents minimized by all welded construction . . . no contaminating solders or fluxes used!



High current-carrying capacity and maximum safety against over-heating provided by heavy 90-mil emitter lead.

## GERMANIUM TRANSISTOR APPLICATION NOTES

### 630 WATT DC-TO-DC POWER CONVERTER 90% EFFICIENT

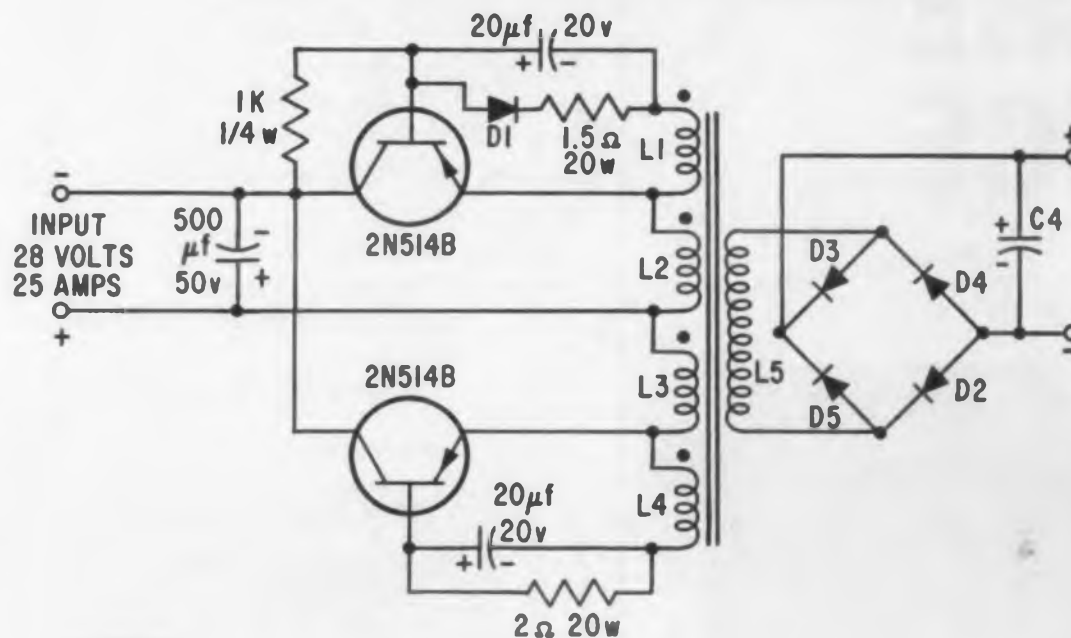

#### NOTES

L5 may be wound according to the output voltage desired, allowing about 0.639 turns per volt. The wire size should be large enough to allow one circular mil per millampere. The output current and load will then determine D2, D3, D4, D5, and C4.  
L2, L3—17 turns each #10 bifilar wound  
L1, L4—4 turns each #16

Core-type 50022-2A Magnetics, Inc.

Q1, Q2—2N514B 80 volt 25 amp each mounted on a minimum of 200 sq in. of  $\frac{1}{4}$ " aluminum for operation up to 50°C.  
D1—1N1124 mounted on a minimum of 1 sq in. of exposed aluminum  $\frac{1}{16}$ " thick. Operation to 50°C.  
Frequency about 1 kc.

## REDUCE YOUR COMPONENT COSTS WITH ONE TI POWER TRANSISTOR!

Save on overall costs and *up your circuit reliability* by selecting one *specific* TI germanium power transistor for your high power circuitry job. The need for transistor paralleling is greatly reduced . . . and, in many applications, eliminated . . . with TI's newest high current alloy-junction power transistor series. If you are using two types in parallel for a 25-amp job, save by using *one* TI high current alloy-junction transistor! Ranging from 10 to 25 amps in 40, 60, or 80 volt types, all

units feature guaranteed gain at maximum rated currents and 1.5 volts  $V_{CE}$ . For your high current switching applications, all types highlight typical switching times at 25°C of 12.0 usecs ( $t_{on}$ ) and 7.0 usecs ( $t_{off}$ ).

Contact your nearest Texas Instruments sales engineer for applications assistance or your nearby TI distributor for off-the-shelf delivery at factory prices. For high reliability, high performance, and a full year product guarantee, you can rely . . . on TI!

#### maximum ratings at 25°C

	2N511	2N511A	2N511B	2N512	2N512A	2N512B	2N513	2N513A	2N513B	2N514	2N514A	2N514B	units	
$V_{CBO}$	Collector-to-Base Voltage ( $I_C = -5\text{ma}$ , $I_E = 0$ )	-40	-60	-80	-40	-60	-80	-40	-60	-80	-40	-60	-80	v
$V_{CEX}$	Collector-to-Emitter Voltage ( $V_{BE} = +0.2\text{v}$ , $I_C = -5\text{ma}$ )	-40	-60	-80	-40	-60	-80	-40	-60	-80	-40	-60	-80	v
$V_{EBO}$	Emitter-to-Base Voltage ( $I_E = -5\text{ma}$ , $I_C = 0$ )	← -30 →			← -30 →			← -30 →			← -30 →			v
$I_C$	DC Collector Current	← -10 →			← -15 →			← -20 →			← -25 →			a
$I_E$	DC Emitter Current	← 10 →			← 15 →			← 20 →			← 25 →			a
$I_B$	Base Current	← -5 →												a
	Total Dissipation	← 80 →												w
$T_J$	Junction Temperature	← 95 →												°C

germanium and silicon transistors  
silicon diodes and rectifiers  
solid tantalum capacitors  
precision carbon film resistors  
silicon resistors

## TEXAS



## INSTRUMENTS

INCORPORATED  
SEMICONDUCTOR-COMPONENTS DIVISION  
13500 N. CENTRAL EXPRESSWAY  
POST OFFICE BOX 312 • DALLAS, TEXAS



## TEXAS INSTRUMENT SEMICONDUCTORS

From  
**NEWARK ELECTRIC CO.**

Your Authorized  
TI Distributor

TI semiconductors are *USE-PROVED* by thousands of customers and *GUARANTEED* for one full year! Now available at *Factory Prices* in 1-999 quantities:

Silicon transistors, germanium transistors, silicon diodes and rectifiers and carbon film resistors.  
semiconductor silicon resistors: 1-499  
tan-TI-cap tantalum capacitors: 1-99

**FREE**  
Newark Electric's all-new,  
1959 INDUSTRIAL ELECTRONICS CATALOG #69

Order now for your copy of this 388-page reference to the newest electronic devices, including Texas Instruments complete line of semiconductors and components



CIRCLE 630 ON READER-SERVICE CARD

← CIRCLE 629 ON READER-SERVICE CARD

# RECTIFICATION MAKES THE DIFFERENCE



- **More than doubles count life**

- **Provides reliable operation from 25/40/50/60 cycles**
- **Broadens range of permissible line voltage variation**

— these great improvements, achieved through built-in rectification of AC models —

Make possible the unmatched count life ratings of CE-800 and PIC-600 performance from AC Service not even counters shown below. Assure CE-800 and PIC-600 performance from AC Service not even approached by non-rectified counters

**In addition to the above PIC manufactures Endurance Rated counters for every purpose, including**

- Stroke and Revolution Counters
- Automatic Batch Counters
- A complete line of Actuating Switches for Electric Counters.

Whatever your needs see your PIC Representative or Distributor or write for literature.



CE-800 Electric Counter  
200 million count life  
from 25/40/50/60 cycles and DC



Sensitive Actuating Switch  
100 million count life  
one of several developed especially for counter actuation



PIC-600 Electric Counter  
50 million count life  
from 25/40/50/60 cycles and DC

**PIC** Manufacturers of Counters, Switches, Relays, Actuators and Automatic Valves  
**Automation Controls Division**  
**GENERAL CONTROLS CO.**  
8072 McCormick Boulevard, Skokie, Illinois

Representatives and Distributors in Principal Cities of United States and Canada  
CIRCLE 631 ON READER-SERVICE CARD

## PRODUCTION PRODUCTS

### Component Inserting Machine

For printed circuit assemblies

The model C bench machine inserts and clinches axial lead components into printed wiring boards. It can handle resistors and diodes as small as 1/4 w when the leads are taped and accommodates body lengths up to 1-1/8 in. and diameters up to 0.375 in.

United Shoe Machinery Corp., Dept. ED, 140 Federal St., Boston 7, Mass.

CIRCLE 632 ON READER-SERVICE CARD

### Precision Furnaces

For semiconductor manufacture



Designed for the transistor and semiconductor industries, these precision furnaces are available with maximum temperature ranges of 1850, 2200, and 2600 F. Temperature uniformity is obtained through multiple zone heating and precise temperature selection can be provided with saturable reactor controls. The units may be supplied with controlled preheat and cooling zones.

Hevi-Duty Electric Co., Dept. ED, 2040 W. Wisconsin, Milwaukee 1, Wis.

CIRCLE 633 ON READER-SERVICE CARD

### Scrubbing Machine

For printed circuits

In one operation, this machine scrubs, rinses, and dries printed circuits and laminates, preparing them for masking, etching, and soldering. At a rate of 5 to 15 ft per min, it removes all surface dirt and oxides, removes with a dip all photoresists after etching, prepares plates for effective soldering, and delivers the plates clean and dry. The unit circulates pumice slurry continually and evenly over the working area and brushes without harming fine printing. It handles laminates 1/16 to 1/8 in. thick and up to 14 in. wide. It occupies a 3 x 4 ft area and comes in models that scrub one or both sides in one pass.

The Fuller Brush Co., Machine Div., Dept. ED, Hartford 15, Conn.

CIRCLE 634 ON READER-SERVICE CARD

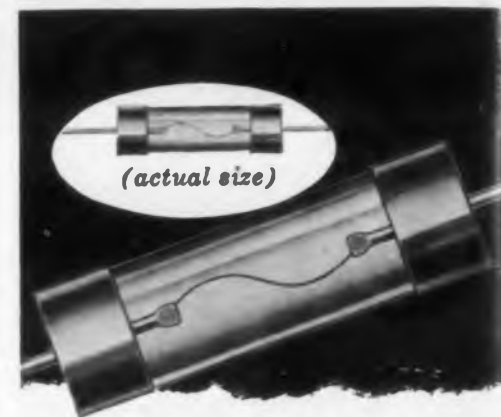

new **NETWORKS**  
current-sensitive  
**SEALED FUSE**

**99.99% functionally reliable, and 100% humidity proof**

Hermetically sealed by Networks' patented metal-to-glass sealing process, this fuse is guaranteed to meet any specified resistance to atmospheric conditions. Unit, in addition, is built for high shock and vibration resistance, and long life.

**Heat-dissipating.** Fuse is dimensioned to dissipate heat produced by the maximum rated current under any special blowing time and temperature conditions.

**Fast or slow operation.** Units are supplied with quick, or medium blowing-operating time. Or you can get slow-burning fuses with high time-lag... fuses that withstand heavy surges and instantaneous peaks, but blow quickly under short circuits.

**ENVIRONMENTAL CAPABILITIES:**

**Temperature:** -100°F to +400°F  
**Vibration:** 10 to 500 cps at 15 G's max.  
**Shock:** 50 G's for 11 ms duration

**Terminal ends (outside) are flexible copper alloy leads... straight cut-offs, or flattened-and-pierced lugs.**

Our engineering department will be pleased to work with you on special fuse requirements.

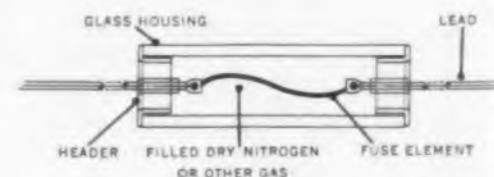

**NETWORKS**  
**ELECTRONIC**  
**CORPORATION**

14806 OXNARD STREET • VAN NUYS, CALIFORNIA  
STATE 2-3114

CIRCLE 635 ON READER-SERVICE CARD

ELECTRONIC DESIGN • September 16, 1959





**DELIVERED  
OFF-THE-SHELF  
From  
MILGRAY**

**Your Authorized  
TI Distributor**

ALL TI semiconductors are in stock, ready to be rushed to you NOW! There is no delay when you order from MILGRAY.

You know you are getting maximum reliability when you specify Texas Instruments semiconductors, USE PROVED by thousands of customers and GUARANTEED for one full year by TI.

DIAL RECTOR 2-4400 for fast delivery at factory prices in the following quantities:

Silicon Transistors: 1-999

Germanium Transistors: 1-99

Silicon Diodes and Rectifiers: 1-999



CIRCLE 636 ON READER-SERVICE CARD

## Dioxide Sealing Machine

Has six stations

For making the final seal on glass diodes, the model 3130 semiautomatic sealing machine has a production capacity of 300 to 500 diodes per hr. It measures 6 x 5 x 3 ft and consists of six complete individual sealing machines with pull-out sections for easy maintenance. A sensitive contact device indicates and stops the motion of the cat whisker.

Kahle Engineering Co., Dept. ED, 3322 Hudson Ave., Union City, N.J.

CIRCLE 637 ON READER-SERVICE CARD



**Vacuum Oven**  
Dries printed circuits

Designed with ambient temperature ranges from 200 to 300 C, this vacuum oven console can dry printed circuits, transistors and other electronic parts. Vacuum evacuation is as low as 1 micron. In less than 2 min it is down to 300 microns. The equipment includes a heavy duty vacuum pump, a micron gage and an indicating-controlling thermostat. Chamber measures 15 in. wide, 18 in. deep and 15 in. high.

Electric Hotpack Co., Inc., Dept. ED, 5074 Cottman Ave., Philadelphia 35, Pa.

CIRCLE 638 ON READER-SERVICE CARD

## Electric Oven

Sets Teflon insulated wire markings

The model HS electric oven permanently sets markings on Teflon insulated wires and cables. It incorporates a variable speed motor drive that draws the wires through the oven into a self-coiling wire pan. This process permits safe low temperature marking with the company's dry Teflon foil. The heat setting operation subjects the wire to a minimum flash high temperature exposure above the gel and vaporization point of Teflon. The effective sintering action is confined to the outer skin of the insulation, thus protecting dielectric values.

Kingsley Machine Co., Dept. ED, 852 Cahuenga, Hollywood, Calif.

CIRCLE 639 ON READER-SERVICE CARD

# 2 IMPORTANT TOOLS FOR HIGH VACUUM PRODUCTION—



## PW-600 HIGH VACUUM PUMPING SYSTEMS

Speedy evacuation of chambers, tanks, bell jars, tubes, furnaces or other equipment to pressures in the low micron region plus maximum utility and flexibility signalize these KINNEY Pumping Systems. Readily moved from one station to another, PW Pumping Systems, because of a unique Rotatable T-Manifold, may be quickly converted to High Vacuum Evaporators. Factory tested to attain pressures to  $5 \times 10^{-4}$  mm Hg. without coolant in the cold trap... pressures below  $5 \times 10^{-7}$  mm Hg. with coolant in the trap.

Ask for Bulletin 4000.1



## R-2H HIGH VACUUM EVAPORATOR

A superior unit for performing highly specialized work in optical filming and research investigations. The conventional flat base plate is replaced by a cylindrical stainless steel chamber—permitting introduction of many more and varied feed-throughs, such as: precise optical measuring equipment. This is an advanced design evaporator with extra pumping capacity and liquid nitrogen cold trap, attaining ultimate pressures of  $5 \times 10^{-4}$  mm Hg. It is capable of producing multi-layer films under monitored control of reflection and transmission.

Ask for Bulletin 4100.1D

## KINNEY MFG. DIVISION THE NEW YORK AIR BRAKE COMPANY

3561-J WASHINGTON STREET • BOSTON 30 • MASS.

Please send me  Catalog on Kinney Pumps

Pumping System Bulletin 4000.1

Evaporator Bulletin 4100.1D

Name \_\_\_\_\_

Company \_\_\_\_\_

Address \_\_\_\_\_

City \_\_\_\_\_ Zone \_\_\_\_\_ State \_\_\_\_\_

WRITE FOR NEW  
LITERATURE ON  
KINNEY PUMPS  
AND EQUIPMENT

CIRCLE 640 ON READER-SERVICE CARD



Another Tinnerman Original...

## Cost-cutting Tubular **SPEED CLIP**<sup>®</sup> takes positive "bite" to hold assemblies tight!

In seconds, you can front-mount trim, name plates, grilles, knobs, insulation, with Tubular **SPEED CLIPS**. And at interesting savings in assembly time and costs!

Snap these quality spring-steel fasteners into holes in metal, plastic or wood. Then press the mounting studs, nails or rivets into the clips to complete the attachments...anywhere along your assembly line.

As the **SPEED CLIP** is inserted, spring fingers compress, then expand behind the panel to lock tight. The rolled-in end permits easy entrance, but bites hard into the stud to prevent back-off or vibration-loosening.

Tubular **SPEED CLIPS** are available for a full range of stud sizes and panel thicknesses. Permanent lock or removable types.

Check your Sweet's Product Design File (Section 8/Ti) for data on Tubular **SPEED CLIPS** and

other **SPEED NUT** brand fasteners. Then call your Tinnerman representative for samples and additional information. If he isn't listed under "Fasteners" in your Yellow Pages, write to:

**TINNERMAN PRODUCTS, INC.**  
Dept. 12 • P. O. Box 6688 • Cleveland 1, Ohio



## PRODUCTION PRODUCTS

### Vibratory-Feed Staking Machine

Handles up to 115 solder terminals per min

Designed for bench operation at 115 v ac, vibratory-feed machine positions and stakes up to 115 solder terminals per min in perforated panels. It permits accurate lugging of flat panels with throat lengths of 3 in. or less. The unit has a nonjamming feed mechanism that delivers parts to an exact predetermined location and an independent velocity control knob that assures constant production.

Cambridge Thermionic Corp., Dept. ED,  
Concord Ave., Cambridge 38, Mass.

CIRCLE 642 ON READER-SERVICE CARD

### Portable Cyclic Tester

Weights 22 lb



The Test-All, a packaged universal tester, weighs 22 lb. It is used to perform a variety of test functions, including life testing, duty cycle tests, temperature rise, or load tests. It provides simple, reliable testing at any duty cycle from 0 to 100% on any time basis from seconds to hours. Nine standard dial timing ranges are available.

Automatic Timing & Controls, Inc., Dept. ED,  
King of Prussia, Pa.

CIRCLE 643 ON READER-SERVICE CARD

### Vacuum Coater

For short run production

The model 3142 vacuum coater is designed for short run and small lot vacuum metallizing operations on plastic, glass, and metal parts. It consists of a horizontal coating chamber 24 in. in diameter and 30 in. long mounted on a cabinet which contains the electrical system, the controls, and an external pumping system. The 10-in. diffusion pump and the 30 cfm rotary gas ballast pump provide high speeds so that cycle times are short.

NRC Equipment Corp., Dept. ED, 160 Chambermont St., Newton 61, Mass.

CIRCLE 644 ON READER-SERVICE CARD

CANADA: Dominion Fasteners Ltd., Hamilton, Ontario. GREAT BRITAIN: Simmonds Accessories Ltd., Treforest, Wales. FRANCE: Simmonds S. A., 3 rue Salomon de Rothschild, Suresnes (Seine). GERMANY: Mecano-Bendy GmbH, Heidelberg.

CIRCLE 641 ON READER-SERVICE CARD



**CANNON  
PLUGS**

**Schweber**

**FOR  
IMMEDIATE  
LARGE  
QUANTITY  
DELIVERY  
AT  
FACTORY  
PRICES**

**2500**

**Yes!** You can now order up to 2500 each of such popular Cannon Connector types as Miniature D, KO, DPD, DPA, DPX, etc. Immediate shipment at factory prices.

**Schweber**

**ELECTRONICS**

HERRICKS ROAD, MINEOLA, L.I., N.Y.  
PHONE 6-6520 TWX 6-CY-NY-580  
CIRCLE 645 ON READER-SERVICE CARD

ELECTRONIC DESIGN • September 16, 1959

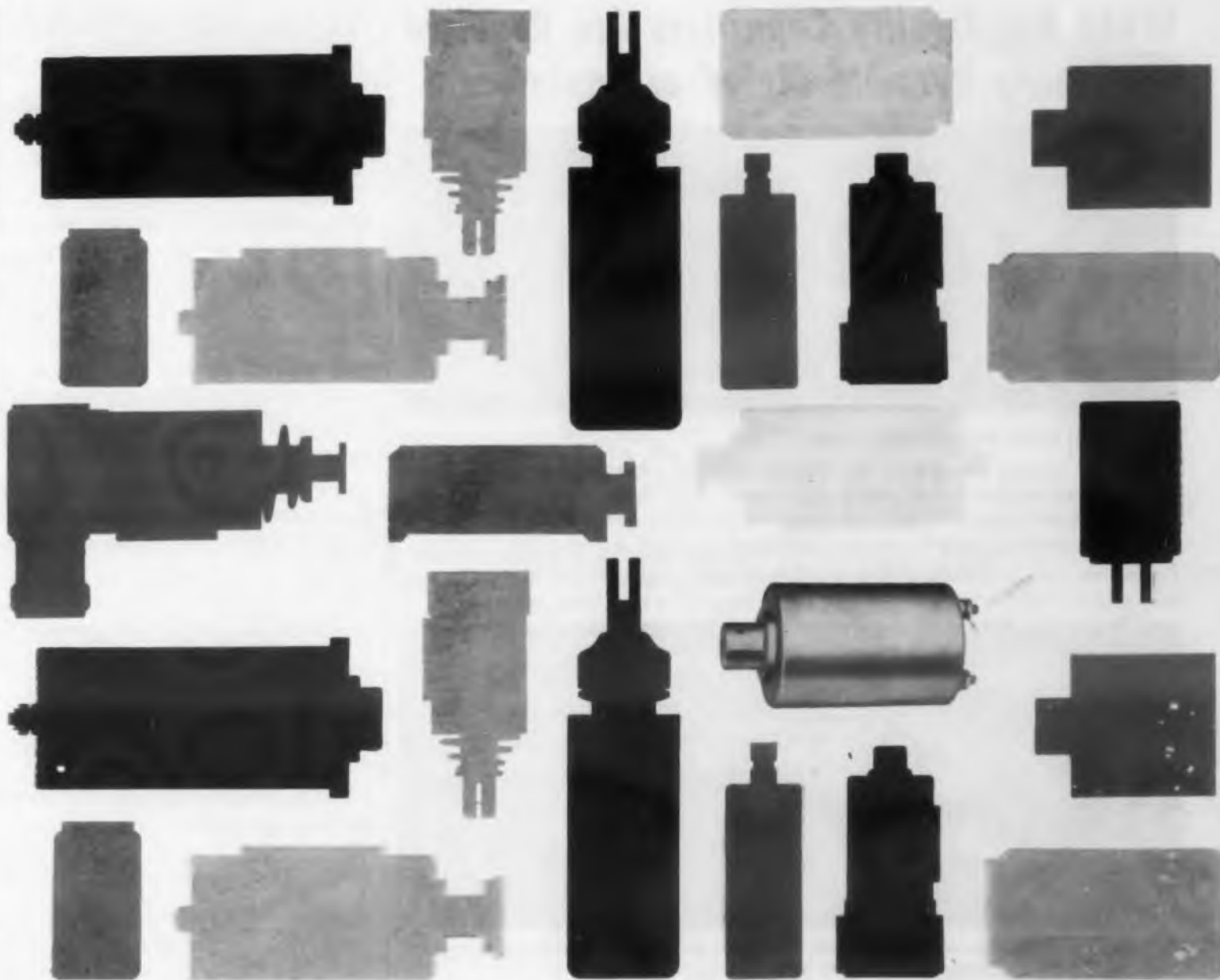

**LET CANNON  
HELP YOU  
WITH YOUR  
DC SOLENOID PROBLEMS**

Cannon is one of America's largest producers of dc solenoids...a pioneer in engineering a wide range of special types, including hermetically sealed and high-temperature models. Multiple-strip solenoids for keyboard operation—locking types requiring no holding current—and miniature and sub-miniatures as small as 1/2 inch in diameter are now in standard production. If you have a problem involving dc solenoids, Cannon offers a complete selection...for any application.

**CANNON  
PLUGS**



Cannon has prepared a new engineering catalog containing valuable information about dc solenoids. Theory, principles of operation, and advantages of dc solenoids are presented simply and authoritatively. Write for your free copy to:

**CANNON ELECTRIC CO. 3208 HUMBOLDT STREET, LOS ANGELES 31, CALIFORNIA • PLEASE REFER TO DEPT. 000  
CIRCLE 646 ON READER-SERVICE CARD**

## When Top Quality Capacitors Are Required Specify Pyramid Mylar<sup>®</sup> or Tantalum

UP TO 1000 MFD-VOLTS IN LESS THAN 2/100  
OF A CUBIC INCH

... PYRAMID TANTALUM CAPACITORS

Miniaturized to provide maximum space economy.

New Pyramid Tantalum slug capacitors have cylindrical cases and contain a non-corrosive electrolyte. Due to the special construction of materials used in the manufacture of Pyramid Tantalum slug capacitors, these units are both seep and vibration proof. In addition, this type of capacitor assures long service life and corrosion resistance—made to meet MIL-C-3965 Specifications.

Commercially available immediately, these new Pyramid Tantalum capacitor units have an operating range between  $-55^{\circ}\text{C}$  to  $100^{\circ}\text{C}$  for most units without any de-rating at the higher temperature.

PYRAMID MYLAR...  
...  $-30^{\circ}\text{C}$  to  $+125^{\circ}\text{C}$  ...  
SMALLEST FILM CAPACITORS MADE!

Pyramid new Mylar capacitors have extremely high insulation resistance, high dielectric strength and resistance to moisture penetration.

Commercially available immediately, Pyramid Mylar capacitors have an operating range between  $-30^{\circ}\text{C}$  to  $+125^{\circ}\text{C}$  with voltage de-ratings above  $+85^{\circ}\text{C}$ . Pyramid wrapped Mylar capacitors—Series Nos.: 101, 103, 106 and 107 have the following characteristics:

Construction Styles:	Basic No.	Type Winding	Shape
	101	Inserted Tabs	Flat
	103	Extended Foil	Flat
	106	Inserted Tabs	Round
	107	Extended Foil	Round

**Tolerance:** The standard capacitance tolerance is  $\pm 20\%$ . Closer tolerances can be specified.

**Electrical Characteristics:** Operating range for Mylar capacitors—from  $-55^{\circ}\text{C}$  to  $+85^{\circ}\text{C}$  and to  $+125^{\circ}\text{C}$  with voltage de-rating.

**Dissipation Factor:** The dissipation factor is less than 1% when measured at  $25^{\circ}\text{C}$  and 1000 CPS or referred to 1000 CPS.

Insulation Resistance:	Temperature	IR x mfd	Maximum IR Requirements
	$25^{\circ}\text{C}$	50,000	15,000 megohms
	$85^{\circ}\text{C}$	1,000	6,000 "
	$125^{\circ}\text{C}$	50	300 "

Pyramid Mylar capacitors are subject to the following tests:

**Test Voltage**—Mylar capacitors shall withstand 200% of rated D.C. voltage for 1 minute at  $25^{\circ}\text{C}$ .

**Life Test**—Mylar capacitors shall withstand an accelerated life test of 250 hours with 140% of the voltage rating for the test temperature. 1 failure out of 12 is permitted.

**Humidity Test**—Mylar capacitors shall meet the humidity requirements of MIL-C-91A specifications.

Complete engineering data and prices for Pyramid Mylar and Tantalum Capacitors may be obtained from Pyramid Research and Development Department.

DU PONT REGISTERED TRADEMARK

CAPACITORS—RECTIFIERS  
FOR ORIGINAL EQUIPMENT—  
FOR REPLACEMENT

ELECTRIC CO.  
NORTH BERGEN, N. J.

EXPORT: 458 Broadway, N. Y. 13, N. Y. • CANADA: Wm. Cohen, Ltd.—7000 Park Ave., Montreal

CIRCLE 647 ON READER-SERVICE CARD

## PRODUCTION PRODUCTS

### Ultrasonic Cleaner

For small parts

Ultrasonic cleaner model 200 provides high energy density for small part cleaning. Driving elements cover 43% of the bottom in the 1 gal stainless steel tank, and actual radiating surface is 12 sq in. The 115 v ac, single-phase, 60 cps generator is designed for continuous operation and delivers an average power output of 60 w, peaks of 240 w. The unit includes a 0 to 60 min timer and provision for remote control of equipment.

National Ultrasonic Corp., Dept. ED, 111 Montgomery Ave., Irvington 11, N.J.

CIRCLE 648 ON READER-SERVICE CARD

### Etch-Cleaning Machine

For transistors, diodes, small parts

For etch-cleaning transistors, rectifiers, diodes, and other small parts, this machine will process 1200 to 2400 units per hr. It performs stream etching, quenching, and first rinse operations on the standard glass diode first-seal. The unit consists of a 12-station indexing wheel and an array of nine ball-socketed jet nozzles mounted in a tank with the manifolds and tubing connections all below the water level. The index mechanism is controlled by an adjustable timer so that the etching cycle can be varied at will. The unit requires 30 x 22 in. of table top and 115 v ac.

C<sub>L</sub> Machines, Subsidiary of Carman Labs, Inc., Dept. ED, 10 Carman Rd., Bedford, Mass.

CIRCLE 649 ON READER-SERVICE CARD

### Printed Circuit Etcher

Etches two sides at once

For prototype printed circuit work, the model 200 etcher has a variable spray nozzle pattern and a 7 to 12 gal etchant sump capacity. With ferric chloride or chromic acid, it simultaneously etches both sides of boards up to 10-3/4 x 13-3/4 in. Line widths are obtainable to 0.003 in. The unit is 29 x 25 x 26 in. and operates from 115 v ac, 60 cps power. It is transparent so that work can be viewed in process. A quartz-cased immersion heater can be supplied as optional equipment.

Centre Circuits, Inc., Dept. ED, P.O. Box 165, State College, Pa.

CIRCLE 650 ON READER-SERVICE CARD

a measure  
of  
perfection...



IDEAL  
PRECISION  
Panel Meters  
*the complete line  
for every application*

IDEAL Panel Meters are assembled in controlled atmospheric and climate conditions and 100% inspected at every step of production to insure highest quality and dependability.

- D'Arsonval movements guarantee minimum accuracy of 2% (full scale).
- Rugged construction means trouble-free, long-lived service.
- Durable plastic meter cases provide greater clarity, easier readability.
- Beauty of design enhances your product.

For more information on the entire IDEAL line, write for Catalog No. 32.

Sold to Electronic Parts Distributors exclusively through Waldom Electronics, Inc., 4627 West 53rd Street, Chicago 32, Illinois.

IDEAL

IDEAL PRECISION METER CO., INC.  
126 Greenpoint Ave., Brooklyn 22, N. Y.

CIRCLE 651 ON READER-SERVICE CARD

ELECTRONIC DESIGN • September 16, 1959



# THE STANDARD 2" BLOWER you've been waiting for!

Dean & Bensons

## POW AIR New HP & HF Series

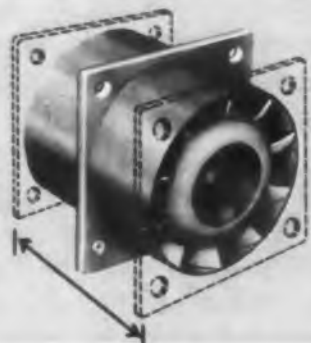

Flange location anywhere

1. Lightweight Aluminum alloy construction for clean aerodynamic surfaces and rigid construction.
2. Square or round flange located at your option, anywhere along the blower housing.
3. Slip out AC or DC motor allows for easy and inexpensive maintenance without replacing entire unit.

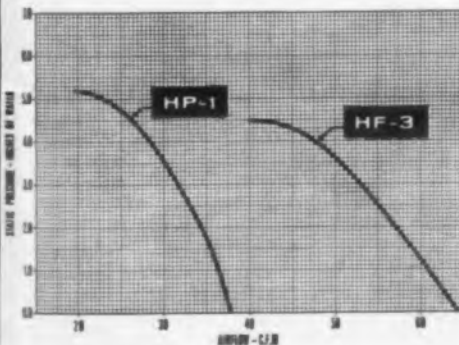

**POW AIR** performance opens the door to a tighter system design for weight and size reduction.

### DEAN & BENSON RESEARCH

Division of Benson Manufacturing Co.  
Kansas City 1, Mo.

CIRCLE 652 ON READER-SERVICE CARD

### Wire Feeder

Handles 50 to 36 gage

With adjustable tensioning from 0.1 to 2.5 oz, the Kinetrol wire feeder speeds dereeling of 50 to 36 gage wire. Accurate tensioning is maintained despite winding speed variation, permitting irregular formers to be wound without breakage or strain.

Scopes Co., Inc., Dept. ED, P.O. Box 56, Monsey, N.Y.

CIRCLE 653 ON READER-SERVICE CARD

### Tubular Riveting Machine

For small assemblies

An automatic, high-speed electric riveting machine, the model 500 feeds and sets all types of tubular rivets from the smallest sizes up to 5/16 in. in diam and 1/2 in. in length. Interchangeable feeding tracks and dies convert it into an eye-letting machine. Designed for light assemblies, the unit may be used for fabricating and fastening printed circuits and electronic components.

Eyelet Tool Co., Inc., Dept. ED, 236 Broadway, Cambridge 39, Mass.

CIRCLE 654 ON READER-SERVICE CARD

### Insulated Wire Printer

Marks up to 300 ft per min

The model 482 plastic tube and insulated wire printer accurately prints in color at speeds up to 300 ft per min and repeats markings at 9 in. intervals. It incorporates an adjustment lever for varied cable sizes, tube diameters, and flattened thicknesses. Dies are easily interchanged and fine printing adjustment is made by set-screw positioning of a hand lever. Screw adjustments also supply the proper ink feed.

The Acromark Co., Dept. ED, 403 Morrell St., Elizabeth, N.J.

CIRCLE 655 ON READER-SERVICE CARD

### Circuit Board Power Drill

Leaves no burrs

Leaving no burrs, the model 100-26 circuit board drilling machine drills more than 24,000 holes a day. It allows holes with 0.004 in. walls, and each hole is within 0.001 in. of true position. Printed circuit boards can be drilled individually or in stacks of up to five. The unit has a 0.02 to 0.25 diam drill capacity, a 1-1/4 in. spindle travel, and a 0 to 450 lb drill thrust. It measures 2 x 3 x 4 ft and operates on 60 cps, 115 v ac current.

Nationwide Engineering Service, Inc., Dept. ED, 6138 Washington Blvd., Culver City, Calif.

CIRCLE 656 ON READER-SERVICE CARD



## VOLTRON now offers —a portable wattmeter for refined, low-power measurements of gyros, synchros and servomotors

- Rugged Taut Band Suspension
- Full-Scale Range: 0-1.2 Watt
- Low Power Factor
- Voltage drop across current coil as low as 0.2% of input voltage, permitting accurate measurements without the need for correction factor.

### SPECIFICATIONS:

**CONSTRUCTION** Meter consists of d'Arsonval type D.C. milliammeter and one A.C. power to D.C. current transducer for each phase. Taut band suspension eliminates the static friction and the delicacy of conventional jewels and pivots. Solid state circuit components are used in the transducer.

**INPUT VOLTAGE** 26/115 ± 10%

**WATTAGE RANGE** 26 volt input — 1.2/3/12/30  
115 volt input — 1.2/3/12/30/120

**FREQUENCY RANGE** Flat from 50 to 2000 cycles

**ACCURACY** 1.0% of full scale watts

**PHASE** 1, 2, or 3 phase. The 3-phase meter is suitable for 3-phase, 3-wire, or 3-phase 4-wire measurements.

**POWER FACTOR** 0.1 to 1.0 Lag or Lead.

**WAVE FORM FACTOR** Calibrated for use with both sine and square wave. For distorted waveforms, the error will be less than 2% for 5% harmonic distortion.

**ERROR DUE TO POWER CONSUMED IN:**

VOLTAGE CIRCUIT: 0%		
CURRENT CIRCUIT: Max. Error (% watts indicated)		P.F.
	0.2	1.0
	2.0	0.1
	linear between these values	

**OVERLOAD** VOLTAGE CIRCUIT: 100% continuous overload without damage  
CURRENT CIRCUIT: 25% at 0.1 PF continuous without damage

**SIZE** 8 1/2" x 12" x 4"

**WEIGHT** 15 lbs.

<b>ORDERING INFORMATION</b>	Model No.	PW-1	PW-2	PW-3
	PHASE	1	1/2	1/2/3
	PRICE	\$385.00	\$485.00	\$585.00

**DELIVERY:** From stock subject to prior sale.

**TERMS:** Net 30. FOB: South Pasadena, Calif.

### VOLTRON Products

1010 Mission St., South Pasadena, California

CIRCLE 657 ON READER-SERVICE CARD

# reprints

## TO HELP YOU IN YOUR DESIGN WORK

These reprints are offered to you by Electronic Design

In answer to the many requests of our readers, ELECTRONIC DESIGN offers these 2 valuable reprints for your files to keep you up-to-date on the most current developments.



### CONNECTIONS

16 page comprehensive report from the Feb 18th issue concerning the latest advancements in the field: • Connections Between Equipment • Connections Inside Equipment • RF Connections. Included are such items as cable connectors, connectors used with rack mounted equipment, printed circuited connectors, terminal blocks. Read ELECTRONIC DESIGN's findings on this enormous field of electrical connections.

Circle 250 on Reader Service Card

### MICROELECTRONICS

ELECTRONIC DESIGN offers this important 12 page staff report from the April 29th issue to keep readers alerted to the newest techniques, processes and the current status of developments in microminiaturization. The growth is phenomenal—2 years ago microelectronics was in the laboratory stage. Now it is causing a revolution in electronic packaging.

Circle 251 on Reader Service Card



For single copies, circle the correct Reader Service Number and you will be sent a handy coin card for your remittance. For multiple copies fill out the coupon below.

MAIL TO DEPT. C-9/16 ELECTRONIC DESIGN, 830 THIRD AVENUE, NEW YORK 22, N. Y.

#### CONNECTIONS

.... 1 copy	\$0.50
.... 5 copies	2.00
.... 10 copies	3.50
.... 25 copies	7.50

#### MICROELECTRONICS

.... 1 copy	\$0.50
.... 5 copies	2.00
.... 10 copies	3.50
.... 25 copies	7.50

Please send me: ..... copies of Connections Report  
 ..... copies of Microelectronics  Please Bill  Cash Enclosed

Name .....

Address .....

City ..... Zone ..... State .....

## YOUR CAREER NEWS, NOTES, NOTIONS

Men competent to hire engineers are in a short supply as are engineers, according to the Cadillac Associates Inc., large recruiter of technical personnel. Because of inexperience and antiquated techniques in hiring, Cadillac reports the average cost of recruiting electronic engineers by company personnel is now in excess of \$300 per man and is steadily rising.

To make the task of company recruiting easier Cadillac is offering seminars for industry to improve efficiency. One firm reports greatly improved results.

Chief way of getting more engineers is not to bring up the subject of salary early in the interview.

According to Eugene B. Shea of Cadillac, salary is a secondary factor in an engineer's decision to accept or reject an offer. Shea puts it this way: "Salary is the most misunderstood and controversial subject in employment. Of the 17 factors in job satisfaction salary is eighth in importance among men happy with their jobs, but an employee who is unhappy with his job rates salary as first in importance. Of course all prospective employees have some dissatisfaction with their job or they would not be candidates."

Shea explains that salary is the most important tangible factor in a man's job picture. A candidate can never be sure a new company will provide the more important intangibles so the salary becomes the only factor capable of quantitative measurement.

For this reason Shea advises recruiters never to discuss salary until a candidate is assured of the hiring firm's ability to give him the type of work he wants and the recognition he needs.

It is no surprise to find that recruitment costs are high. One reason is the long time it takes to fill vacancies. In general, recruitment officers are reconciled to a very long lead time (six months or more) for filling high level openings. Thirty to forty-five days are more typical lead times for average engineering openings.

• • •

Complete study of U. S. Patent System being offered by the Government Printing Office. Complete set, consisting of over 21 special reports prepared for the Congressional Job Committee on Patents, Trademarks, and Copyrights, is available for \$4.30. Order Catalog No. Y4.J 89/2:R 27/3 No. 1-21. Of special interest to inventors are reports No. 1, Proposals for Improving the Patent System (30 pp 15¢) and No. 15, An Economic Review of the Patent System (89 pp 25¢).



A regional employment office serving eight northeastern states has been opened in Elizabeth, N.J., by Texas Instruments, Inc. Harry Laur, former personnel administrator of the company's semiconductor components division in Dallas, heads the office at 1141 E. Jersey St. Being sought for positions in Texas are electronic, mechanical and industrial engineers, physicists, chemists and experts in business administration, marketing and finance. The states covered are New York, New Jersey, Connecticut, Massachusetts, Rhode Island, Pennsylvania, Delaware and Maryland, and the District of Columbia.

"Speaking and writing about creativity has almost become a national pastime during the last five years. You cannot pick up a magazine or a newspaper today without finding the word creativity mentioned somewhere . . . Books of all sorts have appeared which aim at fostering creativity. This is a new trend."

With this broad observation, seven Harvard students plunge into their own broad summary of American industrial efforts to foster creativity ("Individual Creativity and the Corporation," Manufacturing Group 25, Harvard Graduate School of Business Administration). Their report, described as "submitted in partial fulfillment of the requirements in Prof. George F. Doriot's course in manufacturing," covers theory of creativity, popular creative devices and the roles of business and education.

In an age in which many businesses lean toward conformity and group orientation, the individual survives handsomely in this study as the fount of creative thought. Examples:

- Brainstorming is not a substitute for individual thinking but a supplementary method for coaxing new ideas from the individual.

- Taking a problem away from the individual who has conceived it is risky, because it removes a major asset: the enthusiasm of the person who thought of the idea. "In many cases, the enthusiasm and drive of the man who considers the problem as his baby is more important than knowledge in the subject."

- Mechanical aids for listing alternate approaches, such as morphological analysis (in which all possible attributes of a problem are set up in a table), only stimulate the imagination. The individual must still overcome all of the personal blocks to creativity.

The study lists tips for management to encourage creative output. Education comes in for its share of criticism, too.

The authors conclude that "action is possible within the [business] organization to increase creativity and that this can be done without breaking the organization apart." ■ ■



## ADD A "NEW DIMENSION" TO YOUR CAREER!

Your career advances by degrees . . . professional degrees. At Westinghouse-Baltimore, you can enjoy stimulating project activities . . . plus the opportunity to advance your career in the Westinghouse Graduate Study Program. In affiliation with The Johns Hopkins University, the University of Maryland, and other leading universities, qualified engineers are assisted in their work toward graduate degrees. This program is described in "New Dimensions" . . . the story of Westinghouse-Baltimore.

### Current Career Openings Include:

Microwave Systems & Components	Test Equipment Design
Radar Systems	Ferret Reconnaissance
Network Synthesis	Electronics Instructors
Analogue and Digital Computer Design	Communications Circuitry
Airborne Electronic Counter-Measures	Field Engineering
Infrared Systems Development	Technical Writing
Solid-State Devices & Systems	Electronic Packaging
	Experimental Psychologists
	Other positions open for Electrical & Mechanical Engineers and Physicists

Write for "New Dimensions" . . . the informative brochure that takes you behind the scenes at Westinghouse-Baltimore today.

For a confidential interview, send a resume of your education and experience to: Mr. A. M. Johnston, Dept. 955, Westinghouse Electric Corporation, P. O. Box 746, Baltimore 3, Maryland.



# Westinghouse

## BALTIMORE

CIRCLE 903 ON CAREER INQUIRY FORM

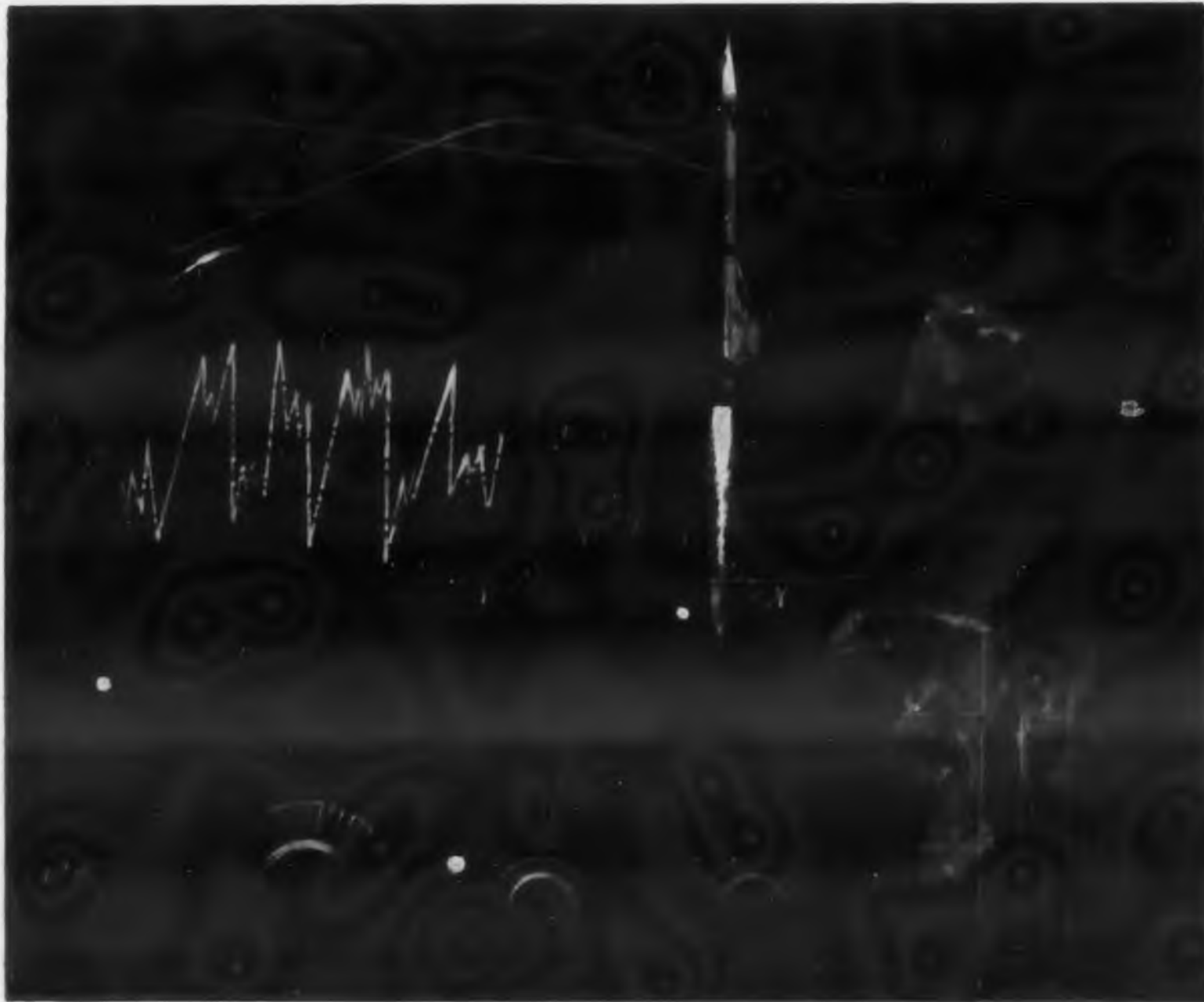

## WE MAKE THE SYSTEMS WORK

Almost unique in the world of the electronics industry, Federal Electric Corporation serves as a complete engineering service organization for the government, for industry and for its parent organization, International Telephone and Telegraph Corporation. A central engineering department, at Paramus, provides a professional staff for systems and application engineering, layout and installation planning, equipment and systems evaluation — and publications services.

Our job is "making the systems work". After complex electronic equipment or systems are designed and built, they must be installed by experts, properly aligned, tuned and tested to assure operation at peak performance. Then they must be continuously maintained to assure dependability. In some cases teams must be provided to operate the equipment, or to train

the user to operate it. All this we do — exercising complete management responsibility.

Prime examples of Federal projects are the DEW Line of radar stations across Canada and Alaska and the White Alice communication system in Alaska. In many parts of the world FEC has installed and tested TACAN and ILS systems for military and commercial use. Today Federal is also engaged in engineering operations connected with missile test ranges in Florida and California. From the Arctic Circle to Spain Federal Electric is keeping systems working.

*For further information regarding positions in our Systems Engineering staff, at Paramus, and field engineering assignments in the U.S. and abroad, write W. F. Duffy, Professional Placement.*

## FEDERAL ELECTRIC CORPORATION

An Associate of International Telephone and Telegraph Corporation  
Paramus Industrial Park, Paramus, New Jersey

CIRCLE 904 ON CAREER INQUIRY FORM



## CAREER OPPORTUNITIES BROCHURES



Hazeltine Corporation

### Hazeltine Corporation

The Hazeltine Corporation presents a brief company history and states its position in the fields of electronics and electro-mechanical technology in this 16-page illustrated brochure. Hazeltine's various commercial products include radio, monochrome and color television, medical, office equipment, photographic and transportation. Designing, developing and producing equipment and systems in defense electronics—including airborne early warning, combat surveillance, navigational, IFF, anti-submarine warfare, data processing and computer—are covered.

An organization chart depicting company facilities and a pamphlet announcing the establishment of a new center and laboratories are given.

Vice President, Government & Commercial Dept., Hazeltine Electronics Div., Hazeltine Corp., Dept. ED, Little Neck 62, N.Y.

CIRCLE 870 ON READER-SERVICE CARD

Avco



The Avco Research Center at Wilmington, Mass., is the home of the Avco Research and Advanced Development Division. Its objective is to provide an integrated establishment, attractive to scientists and engineers. Facilities, present projects and future aims are illustrated and briefly discussed.

Avco Research Center, Dept. ED, Wilmington, Mass.

CIRCLE 871 ON READER-SERVICE CARD



# Advancement Your Goal? Use New Form To Speed Action

ELECTRONIC DESIGN's new Career Inquiry Service form is designed to help engineers advertise themselves. This new service speeds applicants to the jobs they seek. It is the first such service offered in the electronics field and is receiving high praise from personnel managers.

To present your qualifications immediately to the personnel managers of companies that interest you, simply fill in the attached standardized short resume.

Study the employment opportunity ads in this section, and circle the numbers at the bottom of the form that correspond to the numbers of the ads that interest you.

ELECTRONIC DESIGN's Reader Service Department will act as your private secretary and type neat, duplicate copies of your standardized resume and send them to all companies you may select . . . *the same day the resume is received.* (ELECTRONIC DESIGN will detach the circle number portion of the form, so that no company will know how many numbers you circled.)

The standardized resume will permit personnel managers to inspect your qualifications rapidly. If they are interested, they will get in touch with you directly. In the past much time has been lost through personnel-manager requests for resumes from applicants who proved ineligible.

Mail Career Inquiry Service form to Reader Service, ELECTRONIC DESIGN, 830 Third Ave., New York 22, N. Y.

After completing, mail career form to *ELECTRONIC DESIGN*, 830 Third Avenue, New York, N. Y. Our Reader Service Department will forward copies to the companies you select below.

19

(Please print with a soft pencil or type.)

Name \_\_\_\_\_ Telephone \_\_\_\_\_

Home Address \_\_\_\_\_ City \_\_\_\_\_ Zone \_\_\_\_\_ State \_\_\_\_\_

Date of Birth \_\_\_\_\_ Place of Birth \_\_\_\_\_ Citizenship \_\_\_\_\_

Position Desired \_\_\_\_\_

### Educational History

College	Dates	Degree	Major	Honors

Recent Special Training \_\_\_\_\_

### Employment History

Company	City and State	Dates	Title	Engineering Specialty

Outstanding Engineering and Administrative Experience \_\_\_\_\_

Professional Societies \_\_\_\_\_

Published Articles \_\_\_\_\_

Minimum Salary Requirements (Optional) \_\_\_\_\_

Use section below instead of Reader Service Card. Do not write personal data below this line. This section will be detached before processing.

Circle Career Inquiry numbers of companies that interest you

900 901 902 903 904 905 906 907 908 909 910 911 912 913 914 915 916 917 918 919 920 921 922 923 924  
925 926 927 928 929 930 931 932 933 934 935 936 937 938 939 940 941 942 943 944 945 946 947 948 949

*important  
news  
for*

## **ELECTRONIC ENGINEERS**

- ▶ ELECTRONIC SUPPORT EQUIPMENT DESIGN ENGINEERS
- ▶ RADAR SYSTEMS ENGINEERS
- ▶ INFORMATION THEORY
- ▶ SERVO ENGINEERS
- ▶ COMPUTER ENGINEERS
- ▶ RELIABILITY ENGINEERS
- ▶ ELECTRONIC PACKAGING ENGINEERS
- ▶ FIELD SERVICE ENGINEERS

Emerson emphasizes the systems approach, encouraging engineers to explore and contribute in many diversified areas. This climate of creative freedom has paid off in solid achievements.

Our Electronics and Avionics Division is daily influencing the "state of the art" in fire control systems. We are making extensive refinements in development and production of analog and digital computers, automatically programmed data processing systems, transistorization and other solid state electronic applications to advanced airborne and ground based projects.

Emerson's genuine atmosphere of creative freedom and diversification is augmented by excellent salaries, both undergraduate and graduate educational programs, beautiful and convenient suburban location, and other benefits. Moving expenses are fully paid.

If your talents can be better utilized by assuming greater responsibility with accompanying long-range and immediate opportunities—you owe it to your future to contact us at once! Send complete resume to Mr. R. L. Middleton.



*Talent  
Grows at  
Emerson Electric!*

Electronics & Avionics  
Division

**EMERSON  
ELECTRIC**

8100 W. Florissant  
St. Louis 36, Mo.

CIRCLE 905 ON CAREER INQUIRY FORM

# **This is Martin- Activation**

**KEY TO MISSILE OPERATION**

*A New Division of The Martin Company*

The Activation Division is organized to provide the facilities for the design, development, testing, and maintenance of check out and launch complexes for space vehicles and weapon systems bases throughout the world.

It offers to a select group of engineers an opportunity that is indeed unique in today's engineering specialties. It offers the challenge of not only devising a plan, but also of developing, testing, and seeing that plan put into operation.

Among the qualifications for individuals we are seeking to be included the willingness to relocate, the desire to create, to participate in the development and product operation. TO THIS TYPE OF MAN, MARTIN-ACTIVATION offers the opportunity for great personal advancement and recognition with a company which has proven technical ability.

**MARTIN**  
ACTIVATION



The following engineering specialties are needed immediately:

**Project Engineering**

To provide project direction and coordination for activation installation and check-out launch programs.

**Test Operation Engineering**

To supervise and technically direct instrumentation programs implemented through instrumentation design and test experience.

**Planning Engineering**

Logistic integration support requirement for determining plans for accomplishment and integration of training facility and service requirements for associate contractors at field sites.

**Installation Design Engineers**

For technical direction of engineers and designers in the preparation of schematics and specifications of electrical-electronic equipment including interconnection, cabling, raceways, or instrumentation installations.

**Specification and Test Procedures Engineering**

To investigate the design engineering of check-out and launch installation facilities and to compile electrical and electronic component information as well as provide special study information necessary to produce test specifications and test procedures.

**Electrical Engineering Design Checkers**

To be responsible for interpreting and checking electronic schematic designs concerning installations for checkout and launch systems and possess working knowledge of MIL specifications relating to console equipment, cabling, raceways for power control and signal circuits or instrumentation installation design.

**Mechanical Design Engineering**

To work in the design engineering categories pertaining to large hydraulic mechanical mechanisms, Cryogenic, propellant, and high pressure gas, piping, and air-conditioning systems.

For detailed information regarding a position with Martin Activation write direct to: Mr. Dean Pearson, Manager of Employment, The Martin Company, [Activation Division], P. O. Box 2371, Denver, Colorado.

**MARTIN**  
ACTIVATION

CIRCLE 906 ON CAREER INQUIRY FORM

**CAREER OPPORTUNITIES**

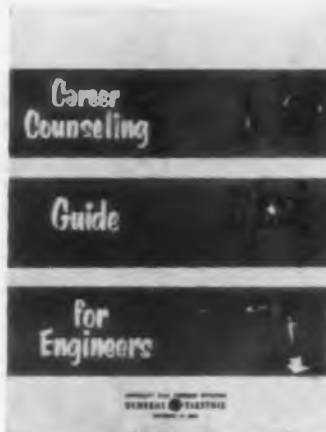

**General Electric Company**

"Career Counseling Guide For Engineers" provides some basic facts about the eight major engineering activities and about the people usually successful in each of them. Using this information as a guide, the engineer should be able to determine the area for which he is best suited.

An evaluation of personal attributes divided into four sections entitled Interest, Education, Experience, and Personal-Social Characteristics is included. At the close of each section the engineer is asked to evaluate his qualifications for each of the major engineering functions.

General Electric's aim in this brochure is to aid the engineering graduate in planning his career and to help the more experienced engineer to more thoroughly examine his present situation and possible future opportunities.

W. N. Mendell, Executive Placement Specialist, General Electric, Flight Propulsion Div., Bldg. 100, Dept. ED, Cincinnati 15, Ohio

CIRCLE 872 ON READER-SERVICE CARD



**Automatic Electric Company**

"Engineers . . . A Place To Work, A Place to Grow" is a 16-page illustrated brochure depicting the opportunities and advantages existing at Automatic Electric. The research and development work in all phases of communication place the engineers in a close relationship with the operating telephone industry.

An on-the-job training program in the various engineering departments is offered to the interested applicant. Present openings, company benefits and community facilities are listed.

A. L. Strouse, Jr., Public Relations Dept., Automatic Electric Co., Dept. ED, Northlake, Ill.

CIRCLE 873 ON READER-SERVICE CARD

Expanding the Frontiers of Space Technology in

**TELEMETRY**

Telemetry at Lockheed has been brought to a high degree of successful application in the integration of circuits and components into high-performance systems. A completely sub-miniaturized FM-FM system has been developed, along with a complete PAM-FM system characterized by highly efficient band-width utilization, low power consumption and economy of size and weight. This represents a significant achievement in the field of high capacity telemetry.

Other Lockheed designed and developed equipment is successfully providing highly accurate telemetered information on temperature, pressure, acceleration, vibration, thrust, vehicle attitude and other conditions during actual hypersonic flights.

**ENGINEERS and SCIENTISTS**

Lockheed Missiles and Space Division has complete capability in more than 40 areas of science and technology. Its programs reach far into the future and deal with unknown environments. It is a rewarding future with a company that has a record of continual progress. Engineers and scientists of outstanding record are invited to join us in contributing to the nation's progress in space technology. If you are experienced in one of the above areas or in related work, please write: Research and Development Staff, Dept. I-1-21, 962 W. El Camino Real, Sunnyvale, California. U.S. citizenship required.

**Lockheed**

**MISSILES AND SPACE DIVISION**

Systems Manager for the Navy POLARIS FBM; DISCOVERER, SENTRY and MIDAS; Army KINGFISHER; Air Force Q-5 and X-7

SUNNYVALE, PALO ALTO, VAN NUYS, SANTA CRUZ, SANTA MARIA, CALIFORNIA  
CAPE CANAVERAL, FLORIDA  
ALAMOGORDO, NEW MEXICO \* HAWAII

CIRCLE 907 ON CAREER INQUIRY FORM

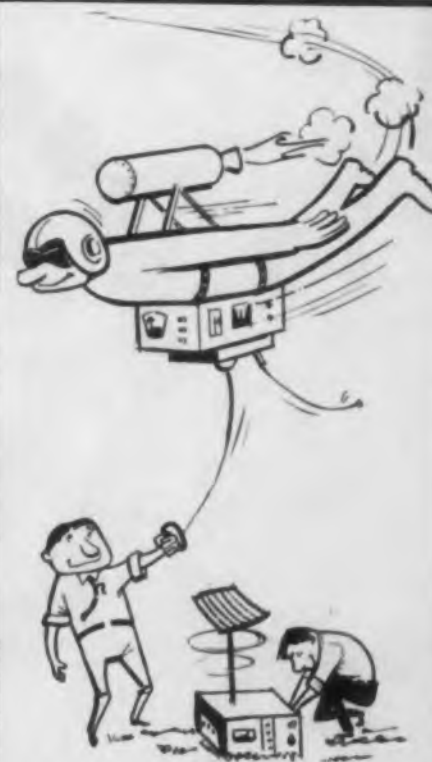

It's a new automatic flight control system.

This one isn't operational yet, but maybe you could lend us a hand in exchange for things like salary and

**LRCP\***

General Electric's **ARMAMENT AND CONTROL SECTION** in Johnson City (Binghamton) New York, has 14 openings for men with degrees and/or experience in mechanical engineering, electrical (electronics) engineering—also in mathematics and physics.

Some of the product areas include airborne defense systems, automatic flight control systems (not in any way similar to the cartoon), inertial navigation systems, analog and digital computers, gyros, fluid controls, servo controls and many more.

General Electric has the right combination for developing your career potential. "Long Range Career Potential."

Let's trade facts. Tell us about your education, experience and interests. We'll send you details about where you'll fit into the Armament and Control Section.

Write in confidence to:  
Mr. R.C. McConnell, Div. C221-2  
Armament and Control Section  
General Electric Company  
600 Main Street  
Johnson City, New York

ARMAMENT AND CONTROL SECTION  
**GENERAL ELECTRIC**  
JOHNSON CITY, NEW YORK

CIRCLE 908 ON CAREER INQUIRY FORM

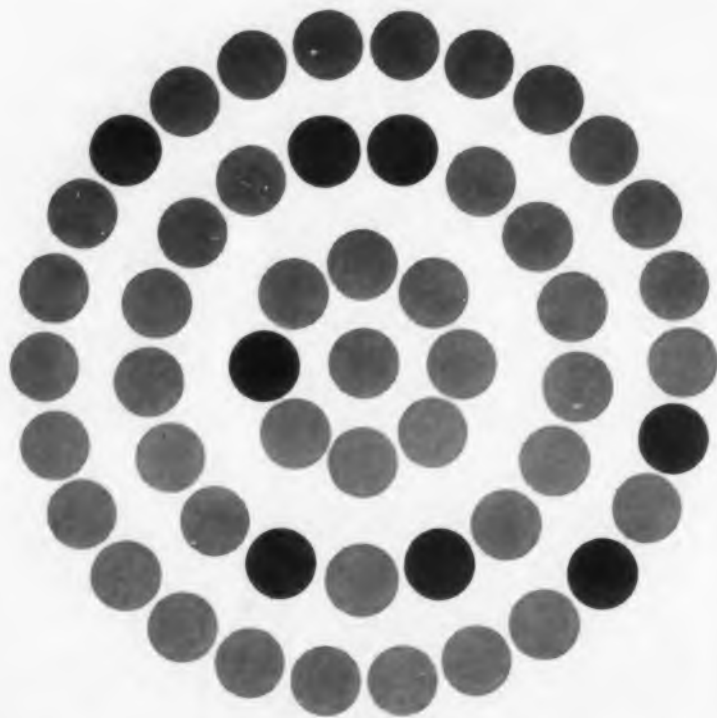

**At MOTOROLA in PHOENIX...  
There's an uncommon opportunity to  
BE RECOGNIZED in engineering circles**

It's the nature of us humans to be stimulated... to do better work... when others in the same profession know about our accomplishments. At Motorola in Phoenix, the *project approach* assures the engineer that his sparks will not be smothered by anonymity. Every Motorola engineer is provided responsibility commensurate with his ability; his contributions as a member of a project team form the basis for his career advancement. Motorola, heavily engaged in diversified electronics research and production, encourages each engineer to carry his idea through to practical reality. If you are attracted by a creative atmosphere such as this — and by the sunny atmosphere of the nation's most enjoyable climate — write to Mr. Kel Rowan, Department B-6.



**MOTOROLA**

Western Military Electronics Center 8201 E. McDowell Rd., Scottsdale, Arizona



### OPPORTUNITIES

Electronic Engineers, Mechanical Engineers, Physicists — SYSTEM ANALYSIS, DESIGN AND TEST — Radar • Missile Guidance • Navigation • Combat Surveillance • Communications • Field Engineering • Data Processing and Display — CIRCUIT DESIGN, DEVELOPMENT AND PACKAGING — Microwave • Pulse and Video • Antenna • Transistor • R-F and I-F • Servos • Digital and Analog TECHNICAL WRITERS AND ILLUSTRATORS, QUALITY CONTROL ENGINEERS, RELIABILITY ENGINEERS

Motorola also offers opportunities at Riverside, California and Chicago, Illinois

CIRCLE 909 ON CAREER INQUIRY FORM

## New Phase of Programmed Expansion in R&D Affords Speeded Professional Development at SYLVANIA'S WALTHAM LABORATORIES

TRADITIONALLY, professional growth parallels organizational expansion. Here at the Waltham Laboratories, engineers and scientists are afforded the opportunity to participate in advanced programs, where professional advancement is as rapid as their ability to contribute to new areas of electronics technology. Working in small groups, individual contributions are quickly recognized.

The recent merger of Sylvania and General Telephone has further broadened the base for creative men to optimize their career potential at the Waltham Laboratories.

### TYPICAL OF THE ADVANCED PROGRAMS OF INTEREST TO THE WALTHAM LABORATORIES ARE

- ANALOG/DIGITAL DATA PROCESSING EQUIPMENTS
- METEOROLOGICAL SATELLITE SYSTEMS
- MISSILE DETECTION RADARS • SPACE VEHICLE COMMUNICATIONS
- MISSILE & SATELLITE DETECTION & TRACKING SYSTEMS
- ARTILLERY/MISSILE LAUNCHING SITE LOCATORS

### IF YOU ARE EXPERIENCED IN ANY OF THE FOLLOWING AREAS CONTACT US IMMEDIATELY

- Advanced Systems Analysis • ECMs & Ground Support Equipment
- Radar Systems Design & Analysis • Micro-Electronics
- RF Circuit Design & Development • Plasma Physics
- Real-Time Data Processing • Electromagnetic Propagation
- Systems Guidance & Simulation Studies • Quality Control
- Electronic Systems Techniques • Product Engineering
- Operations Research & Mathematical Analysis
- Microwave & Antenna Advanced Development
- Electronic & Electromechanical Packaging • Reliability Engineering
- Transistorized Pulse & Digital Circuit Design

Send your resume in strict confidence to:  
Mr. Brooks Fenno, Dept. 8F

Waltham Laboratories / SYLVANIA ELECTRONIC SYSTEMS  
A Division of

**SYLVANIA**

Subsidiary of  
GENERAL TELEPHONE & ELECTRONICS

100 First Avenue — Waltham 54, Massachusetts

CIRCLE 910 ON CAREER INQUIRY FORM





**MEMO FROM:** Fred Pfisterer  
 SUPERVISOR, SYSTEMS ANALYSIS SECTION  
**TO:** George B. Callender, Technical Personnel  
**SUBJECT:** Jobs Open for SYSTEMS ANALYSTS (12)



George:

Where are my analysts? They're urgently needed. To work on systems analysis and feasibility studies, conception and development of new electronic systems, which must be optimum with respect to performance, manufacturability and cost. (Current assignments applicable to AIR WEAPONS CONTROL SYSTEM 212L.)

*P.S. Good, solid design experience is what we need — fresh, positive approaches to analysis of large scale, computer-based systems! Fred*

SYSTEMS ANALYSTS,  
 EE, Physics, Math, whose training  
 and experience (3 years or more)  
 fit the above requirements, are invited

to forward their resumes to George Callender, Div. 76-SMK

HEAVY MILITARY ELECTRONICS DEPARTMENT

**GENERAL ELECTRIC**

Court Street, Syracuse, New York

CIRCLE 911 ON CAREER INQUIRY FORM



It's a new inertial navigation system.

This one isn't operational, but maybe you could lend us a hand in exchange for things like long range career potential and

**IBOM\***

General Electric's **ARMAMENT AND CONTROL SECTION** in Johnson City (Binghamton) New York has 14 openings for men with degrees and/or experience in mechanical engineering, electrical (electronics) engineering—also in mathematics and physics.

Some of the product areas include engine control systems, inertial navigation systems (none like the cartoon), transistors and magnetic controls, microwave, ground support equipment, inertial equipment and many more.

General Electric has the right combination for developing your career potential. \*Increases Based On Merit.

A complete brochure about our section is available in exchange for your resume information. Write in confidence to:

Mr. R.C. McConnell, Div. C221-3  
 Armament and Control Section  
 General Electric Company  
 600 Main Street  
 Johnson City, New York

ARMAMENT AND CONTROL SECTION  
**GENERAL ELECTRIC**  
 JOHNSON CITY, NEW YORK

CIRCLE 914 ON CAREER INQUIRY FORM

177

**FREE — \$1,000**

—worth of professional service,  
 because you are an electronics engineer

CADILLAC, for thirty years the nation's largest Executive and Professional Placement Service, represents every "Blue Book" Electronics firm in America, over 350 in all. Their BEST jobs, at salaries from \$6,000 to \$75,000, appear monthly in our Electronics Opportunities Bulletin. Because you are an Electronics Engineer, BOTH the Bulletin and our COMPLETELY CONFIDENTIAL Placement Service are available to you absolutely FREE OF CHARGE.

For your free Bulletin, each month listing America's BEST Electronics jobs, send your name and address to:



**EUGENE B. SHEA**  
 Electronics Division  
**Cadillac Associates, Inc.**

29 East Madison Building—  
 Dept. E-2  
 Chicago 2, Ill.

CIRCLE 912 ON CAREER INQUIRY FORM

ELECTRONIC DESIGN • September 16, 1959

## ENGINEERS AND SCIENTISTS

you can have your cake and eat it too . . .  
 in wonderful Minnesota

Do you now have a good position but feel as if you and your family would be happier in a more advantageous part of the country? At the Mechanical Division of General Mills in Minneapolis you can have both—a challenging, rewarding position in the field you like best and an environment renowned for its cultural, social and recreational advantages.

Right now it's Indian summer here. Our people are enjoying myriad colors in the woods—and fall fishing. Soon they'll go hunting pheasants, ducks, geese, deer. Later they'll go skiing and on sleigh ride parties.

We have a fine school system with a low pupil-teacher ratio—and the University of Minnesota. We have a famous Symphony—and excellent art centers. We have beautiful stores, residences, parks—and an unhurried, friendly way of life.

Senior and associate level positions immediately available to you in these fields:

- Electronic Circuit Design
- Micro-wave Development
- Atmospheric Physics
- Digital Computer Logic
- Advanced Digital Computer Systems Design
- Advanced Pulse and Video Circuit Development

- Advanced Inertial Navigational System Development
- Optical and Infra-Red Equipment Engineering
- Research Physics
- Advanced Digital Computer Circuit Development
- Nuclear Handling Equipment
- Balloon Systems and Components

If you have 2 or more years experience in any of the above fields, send for more facts. We'd like to tell you about the people you'd work with—recognized leaders in fields of advanced technology. About our vital defense and industrial projects (where security permits), about our modern labs and about long-range security with one of the nation's most stable companies. We'll keep your inquiry in confidence.

G. P. Lambert, Manager  
 Professional Employment

**MECHANICAL  
 DIVISION**



2003 E. Hennepin  
 Minneapolis 13, Minnesota

CIRCLE 913 ON CAREER INQUIRY FORM

# ELECTRONIC DETECTION...

*tremendous challenge to  
creative engineers in a  
field whose growth must  
parallel the space age*

... At General Electric, detection system engineering has become a profession in itself—offering electronic engineers financial and career opportunities not found in many other electronics fields.

Advanced radar detection systems offer probably the most effective method of determining location, direction, and speed of in-flight missiles or aircraft. And the General Electric Company has played—and continues to play—a leadership role in the conception, design, and development of advanced radar detection systems for science and National Defense.

In line with this role General Electric needs more qualified personnel. Right now General Electric needs electronics engineers, mathematicians, data processing specialists with the capabilities to make positive contributions toward the solution of urgent defense problems.

But unlike many companies, General Electric offers qualified personnel—with a minimum of three years in radar design and development or related phases—career opportunities with the growth potential for which they have been looking.

If this challenge interests you compare General Electric's self-development opportunities in the privacy of your own home. Write for this brochure today.



Compare self-development opportunities at General Electric

- Please send me your brochure describing your self-development program.
- I am enclosing my resume for your consideration.

T. M. George, Supervisor  
Personnel Administration  
Section C228-5  
Missile Detection Systems Section  
General Electric Company  
Syracuse, New York

NAME \_\_\_\_\_

DEGREE \_\_\_\_\_

ADDRESS \_\_\_\_\_

CITY \_\_\_\_\_ STATE \_\_\_\_\_

MISSILE DETECTION SYSTEMS SECTION  
HEAVY MILITARY ELECTRONICS DEPARTMENT

GENERAL  ELECTRIC

ENGINEERS

## A FINER CLIMATE



## TO WORK IN...



## ...TO LIVE IN

*At Sylvania's  
Mountain View Operations  
in California*

(SAN FRANCISCO BAY AREA)

*you'll discover  
more than just one  
kind of climate.*

**PROFESSIONAL CLIMATE**—Advanced programs will challenge your technical creativity. You'll make major contributions in the fields of electronic defense, radar, communications and data processing systems. Because Sylvania is one of the nation's fastest growing electronics organizations, there are an unusual number of growth opportunities.

**LIVING CLIMATE**—You and your family will enjoy the healthful atmosphere and sunny climate of the San Francisco Peninsula. You'll find plentiful housing, excellent shops, fine schools and year round recreation.

### Openings in:

System Studies / Circuit Design / Computers & Data Handling / Electronic Packaging / Development Engineering / Concept & Planning / Advanced ECM Circuitry / Equipment Development / Product Engineering / Tube Engineering / Tube Application Engineering / Mechanical Engineering / Tube Production Engineering / Theoretical Physics / Experimental Physics / Mathematics / Microwave Engineering / Engineering Writing / Tube Research Engineering

*You may communicate in confidence  
to Wayne L. Pearson*

**MOUNTAIN VIEW OPERATIONS**

Mountain View Operations / SYLVANIA ELECTRONIC SYSTEMS  
A Division of

**SYLVANIA**  
Subsidiary of  
GENERAL TELEPHONE & ELECTRONICS

P.O. Box 188  
Mountain View, California

◀ CIRCLE 915 ON CAREER INQUIRY CARD



electronic engineers

FACTS

AND

FALLACIES

### ABOUT CAREERS IN COMMERCIAL COMMUNICATION SYSTEMS

*ideas worth re-examination,  
from General Electric's  
Communication Products Department*

#### TECHNICAL CHALLENGE

Many of the engineers we talk with are genuinely amazed at the sophistication of the systems under development here. Far from the "bread boxes" filled with routine circuitry they expected, they find advanced electronic systems utilizing parametric and tunnel effect devices, transistor and miniature tube circuitry, piezoelectric and electromechanical filters, etc.

#### SCOPE OF PROJECTS

Don't anticipate a narrow range of products and opportunities here. CPD's diversified product line includes complete Microwave Radio Relay, Mobile and Personal communication systems, to name only a few. Work in these areas has found application in other projects for the Military, e.g., developing a 24 channel SSB Tropospheric scatter system. Our continued expansion is from a broad and stable base.

#### SHARE IN MANAGEMENT ASPECTS

Rather than confining your activities to the technical aspects of your project exclusively, you have the opportunity to operate in management areas as well. Here you would be making broad decisions, based on the results of idea interchange between you and your counterparts in Marketing, Product Planning, Manufacturing, Field Service, etc. This exposure to both engineering and management functions is seldom found elsewhere in industry.

*but* this is only part of the CPD story. Learn more about the opportunities and advantages awaiting you, both on and off the job, by mailing your resume today to Mr. Arthur Guy at the address below.

#### IMMEDIATE OPENINGS IN THESE AREAS

**MICROWAVE:** R.F. Circuit Design, Multiplex Equipment, Systems Design. **ADVANCE ENGINEERING:** Microwave Circuitry, Plumbing, Antennas, Solid State Devices. **MOBILE SYSTEMS:** Transmitter Design, Receiver Design, Product Production Engineering, Equipment Mechanical Design. **AUTOMATIC TEST EQUIPMENT:** Design and Development.

Forward your resume in confidence to Mr. Arthur Guy, Dept. 76-M1  
COMMUNICATION PRODUCTS DEPARTMENT

**GENERAL  ELECTRIC**

Mountain View Road, Lynchburg, Virginia

CIRCLE 916 ON CAREER INQUIRY FORM

ELECTRONIC DESIGN • September 16, 1959

### ELECTRICAL-ELECTRONIC ENGINEERS interested in Electrical Component Design and Packaging

Expanding programs at Boeing in connection with Minuteman, the Air Force's advanced, solid-propellant, ICBM, have created a number of outstanding openings for engineers and scientists in the field of Electrical Component Design and Packaging. These are challenging assignments with the Electronic Sciences Section of Boeing, an industry leader in the development of advanced systems.

Openings include assignments in:

1. *Analysis of performance and reliability of components under various environmental conditions for electrical power distribution systems and electronic equipment.*
2. *Detail studies of component packaging in vehicle and ground equipment.*
3. *Detail design of electrical power distribution system components.*

If you are interested in the analysis, design and demonstration of electrical components and packaging techniques, you'll find in these openings all the scope you need to develop your career potential to the fullest. You will also enjoy a host of benefits at Boeing, including a retirement plan, paid vacations, insurance programs and an opportunity to participate in company-paid graduate study programs.

Write today to:

Mr. Stanley M. Little  
Corporate Employment  
Administrator  
P. O. Box 3822 - ESA  
Boeing Airplane Company  
Seattle 24, Washington



**BOEING**  
...environment for  
dynamic career growth

CIRCLE 917 ON CAREER INQUIRY FORM

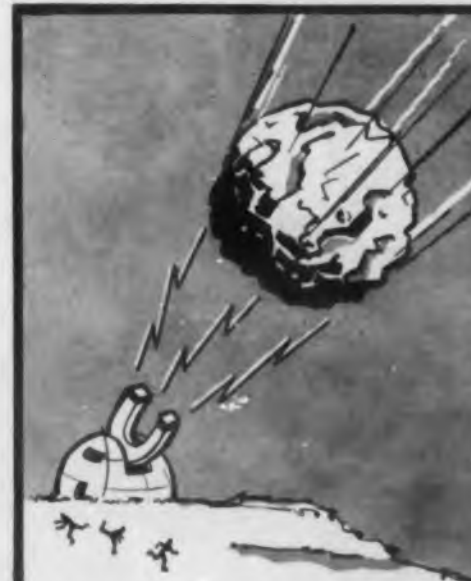

It's a new transistorized  
magnetic control.

This one works . . . but not the  
right way. Maybe you could  
lend us a hand in exchange  
for things like employee  
benefits and

**GPTL\***

General Electric's **ARMA-  
MENT AND CONTROL SEC-  
TION** in Johnson City (Bing-  
hamton) New York, has 14  
openings for men with de-  
grees and/or experience in  
mechanical engineering, elec-  
trical (electronics) engineer-  
ing, mathematics and physics.

Some of the product areas  
include transistor and mag-  
netic controls (none like the  
asteroid-pulling device illus-  
trated), analog and digital  
computers. Career position  
openings include project lead-  
ers, technical writers, engi-  
neers in development, circui-  
try design, packaging, stress  
and vibration, systems, qual-  
ity control and others.

*General Electric has the right  
combination for developing  
your career potential. "Good  
Place To Live (ask the Chamber  
of Commerce).*

#### MAIL COUPON TO:

Mr. R.C. McConnell, Div. C221-4  
Armament and Control Section  
General Electric Company  
600 Main Street  
Johnson City, New York

Send me more information. My  
job interest is .....

Name .....

Degree (year) .....

Address .....

(Street or Route)

(City) (Zone) (State)

My resume is enclosed.

ARMAMENT AND CONTROL SECTION  
**GENERAL  ELECTRIC**  
JOHNSON CITY, NEW YORK

CIRCLE 918 ON CAREER INQUIRY FORM



**ADVANCED RECONNAISSANCE** system developments at **Melpar** provide unusual opportunities for the technical advancement of participating professional personnel. Technological challenge in an area vital to our national defense assures our engineers and scientists that their contributions will have lasting significance. **Melpar's** reconnaissance systems engineering department has achieved national recognition for its outstanding accomplishments in the fields of acquisition, processing, and interpretation of intelligence. Techniques resulting from our deep probes into advanced aspects of electronics, optics, and physics are being quickly translated into operational equipment for the armed forces.

*Positions in the following areas offer particular challenge at this time:*

Reconnaissance Systems	Detection & Identification Systems
Airborne Equipment	Antenna & Radiation Systems
Ground Data Handling Equipment	Chemistry Laboratory
Simulation & Training Systems	Applied Physics Laboratory
Communication & Navigation Systems	Production Engineering
Ground Support Equipment	Quality Control

**Melpar's** remarkable growth continues to create attractive opportunities for the exceptional engineer and scientist. Your own intellectual dimensions govern remuneration and assignments.

INTERVIEWS ARRANGED IN YOUR LOCALE

For Details  
Wire Collect or Write to:  
Professional  
Employment Supervisor

**MELPAR INC**

A SUBSIDIARY OF WESTINGHOUSE AIR BRAKE COMPANY  
3307 Arlington Boulevard, Falls Church, Virginia  
In Historic Fairfax County  
10 miles from Washington, D. C.

CIRCLE 919 ON CAREER INQUIRY FORM

Scheduled to open about the first of the year, Republic's new Research & Development Center at Farmingdale, Long Island, New York, will comprise seven different laboratory facilities. Included are an Electronic Development Laboratory and a Guidance and Control Systems Laboratory. These modern facilities will contain the most up-to-date equipment obtainable for the research, development and test of advanced astrionic and avionic systems, equipments and components.



**ELECTRONIC ENGINEERS...**

■ You can be one of the R&D men who'll help guide exotic projects at Republic Aviation's new \$14,000,000 Research and Development Center

**IN-AT-THE-BEGINNING OPPORTUNITIES** at Republic's new Research Center encompass the electronic aspects of a wide diversity of projects and investigations, from space probes to ballistic missiles, from high Mach aircraft to helicopters, from automatic ground control equipment to exotic detection systems. Today Republic's dynamic expansion in research and development activities offers you assignments where you can win technical renown — and rapid personal advancement — in any of these areas:

■ INERTIAL GUIDANCE & NAVIGATION ■ SYSTEMS ENGINEERING ■ DIGITAL COMPUTER DEVELOPMENT ■ INFORMATION THEORY ■ TELEMETRY-SSB TECHNIQUE ■ RECEIVER & TRANSMITTER DESIGN ■ JAMMING & ANTI-JAMMING ■ RANGING SYSTEMS ■ GROUND SUPPORT EQUIPMENT ■ DOPPLER RADAR ■ COUNTERMEASURES ■ RADOME & ANTENNA DESIGN ■ MICROWAVE CIRCUITRY & COMPONENTS ■ AIRBORNE NAVIGATIONAL SYSTEMS ■ MINIATURIZATION-TRANSISTORIZATION ■ PROPAGATION STUDIES ■ INFRARED & ULTRA-VIOLET TECHNIQUES

Address your resume in confidence to:  
Mr. George R. Hickman  
Engineering Employment Manager, Dept. 12J-3



**REPUBLIC AVIATION**

Farmingdale, Long Island, New York

CIRCLE 920 ON CAREER INQUIRY FORM



## ENGINEERS RESEARCH OPPORTUNITIES

Aeronutronic, a new division of Ford Motor Company, has immediate need for computer engineers to staff its new \$22 million Research Center in Newport Beach, Southern California. Here, you have all the advantages of a stimulating environment, working with advanced equipment, located where you can enjoy California living at its finest.

Look into these ground floor opportunities in research and development work that is challenging and exceptionally rewarding to qualified men.

### Positions now open:

- Systems Engineer
- Magnetic Memory Engineers
- Communications Engineers
- Digital Computer Programmers
- Transistorized Circuit Engineers
- Logical Designers
- Circuit Engineers
- Mechanical Engineers
- Optical Engineers

Qualified applicants are invited to send resumes or inquiries to Mr. R. E. Durant, Aeronutronic, Box NJ-486, Newport Beach, California.

### COMPUTER OPERATIONS

## AERONUTRONIC

A DIVISION OF  
FORD MOTOR COMPANY

Newport Beach  
Santa Ana • Maywood,  
California



## How far can an engineer go at AC?

In a company so deeply involved in space age instrumentation projects . . . where you can grow through the finest "in house" training . . . where a new advanced R & D group is now operating—here, at AC, you can go as far as your imagination and initiative will take you.

**Three advanced education programs** can help you enhance your professional status. These are offered in addition to AC's educational assistance programs for men who wish to study for advanced degrees in nearby universities.

**Program A**—for recent graduate engineers—gives you a solid foundation in the theory and application of inertial guidance systems and servomechanisms.

**Program B**—for experienced engineers—consists of upgrading studies in inertial guidance, servomechanisms, environmental problems, engineering math and physics, plus advanced state-of-the-art courses.

**Program C**—for all engineering supervisors—involves management training developed by a team of AC executives and University of Chicago industrial relations experts.

**AC's new R & D Group** is devoted to the Research and Development of advanced systems and components. Current programs include many vital projects. Interplanetary navigation and guidance. Digital computer development. Advanced inertial sensors. Passive electromagnetic detection, surveillance and navigation systems. Guidance systems for ballistic missiles, space vehicles and aircraft.

**If you are a graduate** in the electronics, math, physics, electrical or mechanical fields, or if you have an advanced degree, you may be able to participate in these programs. For more details, write the Director of Scientific and Professional Employment, Mr. Robert Allen, Oak Creek Plant, Box 746, South Milwaukee, Wisconsin.



Inertial Guidance Systems • Afterburner Fuel Controls • Bombing Navigational Computers • Gun-Bomb-Rocket Sights • Gyro-Accelerometers • Gyroscopes • Speed Sensitive Switches • Speed Sensors • Torquemeters • Vibacall • Skyphone

SPARK PLUG ⚙ THE ELECTRONICS DIVISION OF GENERAL MOTORS

CIRCLE 922 ON CAREER INQUIRY FORM

CIRCLE 921 ON CAREER INQUIRY FORM

**marion**

advancement  
in instrument  
design



ACTUAL  
SIZE

### MM-1 MEDALIST<sup>®</sup> meter

Today's most readable, modern miniature meter. Shielded—no error from magnetic panels. Rugged Marion Coaxial mechanism. Max. weight 1.6 oz. In all standard ranges, various colors. Single hole mounting. Data on request. Marion Instrument Division, Minneapolis-Honeywell Regulator Co., Manchester, New Hampshire, U.S.A.

\*T.M. Reg. U.S. Pat. Off. U.S. & Foreign Patents  
Copyright © 1959, Marion

**marion**  
meters



CIRCLE 700 ON READER-SERVICE CARD

NEW!

MICROMINIATURE  
INCANDESCENT  
INDICATOR LAMP  
OPERATES DIRECT  
FROM OUTPUT OF  
TRANSISTOR!

**CIRCUIT COMPONENT: INDICATOR FOR TRANSISTOR CIRCUITS . . . OPERATES ON LESS THAN 1.5 VOLTS!**

- Precision Made . . . high vacuum, long life . . . especially designed for computer and military applications!
- Microminiature indicator lamp operates directly from output of a transistor.
- Rapid on-off cycling!
- Designed to meet the requirements of transistorized circuits and other applications!
- Special purpose lamps designed to specifications!

**ESSENTIAL DATA  
LAMP NO. A59**

Design Volts . . . . . 9 to 1.5

Design Milliamperes . . . . . 20 to 50

Max. Milliamperes at Design Volts . . . . . 50

Tested Lab Life at Design Volts more than 1,000,000 cycles

Response . . . . . 1/100 Sec.

Bulb . . . . . .050" Dia. x .110" L.

Contacts . . . . . 2—.005" Dia. Platinum Leads

**COMPONENTS CORP.**  
67 Illinois Ave., Paterson, N. J.

CIRCLE 701 ON READER-SERVICE CARD

## ADVERTISERS' INDEX September 16, 1959

Advertiser	Page
AGA Div. of Elastic Stop Nut Corp.	74
AMP, Inc. . . . .	29
Ace Electronics Associates . . . . .	122
Ace Plastic Co. . . . .	144
Acheson Colloids Co. . . . .	70
Aeronutronic Systems, Inc. . . . .	181
Airborne Instrument Lab., Inc. 122,	151
Alden Products Co. . . . .	104
Allegheny Electronic Chemicals Co.	158
Alloys Unlimited . . . . .	148
Amco Engineering . . . . .	112
American Electronic Labs., Inc. . . . .	90
Anaconda Wire & Cable Co. . . . .	12, 13
Atlas E-E Corp. . . . .	84
Atlas Precision Products . . . . .	132
Baldwin Piano Co. . . . .	146
Beattie-Coleman, Inc. . . . .	162
Bendix Aviation Corp., Scintilla Div.	92
Berkeley, Div. of Beckman Instru- ments, Inc. . . . .	8
Bishop & Co., J. . . . .	80
Boeing Airplane Co. . . . .	179
Bomac Laboratories, Inc. . . . .	184
Bradley Semiconductor Corp. . . . .	87
Breeze Corporations, Inc. . . . .	38
Bryant Chucking Grinder Co. . . . .	71
Bureau of Engraving, Industrial Div.	152
Burdy Corporation . . . . .	26
Burnell & Co., Inc. . . . .	5
CBS Semiconductors . . . . .	58
Cadillac Associates, Inc. . . . .	177
Cambridge Thermionic Corp. . . . .	97
Camloc Fastener Corp. . . . .	120
Cannon Electric Co. . . . .	167
Chicago Condenser Corp. . . . .	153
Chicago Aerial Industries, Inc. . . . .	147
Clare, C. P. & Company . . . . .	111
Columbia Technical Corp. . . . .	86
Columbus Electronics Corp. . . . .	53
Computer-Measurements Co. . . . .	74
Convair/Astronautics . . . . .	49
Coors Porcelain Co. . . . .	21
Cornell-Dubilier Electric Corp. . . . .	98
Crosley Div. AVCO Mfg. Corp. . . . .	15
Cubic Corp. . . . .	136
Curtiss-Wright Corp. . . . .	159
Daven Co., The . . . . .	16
Dean & Benson Research . . . . .	169
Dearborn Electronic Co. . . . .	118
Deleo Radio, Div. of General Motors Corp. . . . .	41
Diehl Mfg. Co. . . . .	18
Dimco-Gray Company . . . . .	76
Douglas Aircraft . . . . .	119
Dow Metal Pmts. Co. . . . .	157
Drake Manufacturing Company . . . . .	144
Durant Manufacturing Company . . . . .	114
ESC Corporation . . . . .	109
ETA Products Co. of America . . . . .	134
Eastman Kodak Company . . . . .	75
Egerton, Germeshausen & Grier, Inc. . . . .	114
Eitel-McCullough, Inc. . . . .	113
Electra Manufacturing Co. . . . .	94
Electro-Measurements, Inc. . . . .	27
Electro Tec Corp. . . . .	118
Electronic Tube Div., Sperry Gyro- scope Co., Div. of Sperry Rand Corp. . . . .	25



## FOR FASTER ASSEMBLY!

One way to speed up production is to use solder that's prefabricated to the job . . . the right size, shape, alloy and flux. KESTER SOLDERFORMS are doing a big job in reducing labor and material costs in electronic and other applications . . . will greatly speed up production for you.

## KESTER SOLDERFORMS

WRITE TODAY for sample assortment and full details on KESTER SOLDERFORMS.

### KESTER SOLDER COMPANY

1414 Wrightwood Ave., Chicago 39, Ill.  
100 Newark St., Newark, N. J. • Anaheim, Cal. • Brantford, Ont.



OVER 60 YEARS' EXPERIENCE IN  
SOLDER AND FLUX MANUFACTURING

CIRCLE 702 ON READER-SERVICE CARD

WHITE METAL

extruded this complex  
spool member in  
magnesium alloy  
AZ-31B. It has three  
radial support arms,  
interconnecting hub  
& external shell.  
Cylindrical surface  
takes high finish.  
2-1/16" OD; 0.12" wall.

## see WHITE METAL for your complex MAGNESIUM alloy EXTRUSIONS

WHITE METAL . . . and WHITE METAL alone . . . has the engineering experience and integrated magnesium facilities to turn many "impossible" designs into reliable, spec-meeting extrusions . . . at lower cost.

Versatile WHITELIGHT magnesium gives you a virtually unlimited choice: any length, any shape, any alloy, any finish.

Call on our Sales Engineers for help in solving your complex shape problems. No obligation, of course. WRITE, WIRE OR PHONE TODAY!

Send for fact-filled brochure on properties, uses, etc. of WHITELIGHT MAGNESIUM

**WHITE METAL ROLLING & STAMPING CORP.**  
114 Moultrie St., Brooklyn, N. Y. • Phone: EV 9-1344  
Plants: Warsaw, Ind. & Brooklyn, N. Y.  
One of the World's Largest Producers of Magnesium Alloy Mill & Finished Products

CIRCLE 703 ON READER-SERVICE CARD

ELECTRONIC DESIGN • September 16, 1959



Advertiser	Page
Emerson Electric Mfg. Co. ....	174
Engelhard Industries, Inc. ....	22, 23
Engineered Electronics Company ..	126
Eric Resistor Corp. ....	67
Essex Electronics ....	106

Fair Bearing Co. ....	139
Fairchild Controls Corp. ....	124, 125
Fairchild Semiconductor ....	18
Fansteel Metallurgical Corp. 24, 25,	162
Fastex Div., Illinois Tool Works ...	134
Federal Electric Corp. ....	172
Fenwal Electronics, Inc. ....	160
Forbes & Wagner, Inc. ....	138
Freed Transformer Co., Inc. ...	Cover II
Fusite Corp. ....	24

G.V. Controls, Inc. ....	1
General Electric Co., Armament & Controls Section ....	175, 177, 179
General Electric Co., Heavy Military Dept. ....	177
General Electric Co., Miniature Lamp Dept. ....	131
General Electric Co., Lamp Metals & Components ....	156
General Electric Co., Missile Detection ....	178
General Electric Co., Missile Sales ..	147
General Electric Co., Resistors ....	71
General Electric Co., Communica- tions Pds. ....	179
General Electric Co., Voltage Regulators ....	161
General Magnetics, Inc. ....	85
General Mills, Inc. ....	177
General Motors Corp., AC Spark Plug Div. ....	181
General Plate Div., Metals & Controls Corp. ....	145
General Radio Co. ....	148
Globe Industries, Inc. ....	81
Grant Pulley & Hardware Corp. ....	79
Gremar Mfg. Co., Inc. ....	62
Guardian Electric Mfg. Co. ....	148
Gulton Industries, Inc. ....	83, 129
Harley, W. & L. E. ....	142

Handley Inc. ....	66
Heath Co. ....	151
Heinemann Electric Company ....	153
Heminway & Bartlett Mfg. Co. ....	74
Hewlett-Packard Company ....	10, 11, 39, 55
Hi-G, Inc. ....	150
Hoffman Semiconductor Div., Hoff- man Electronics Corp. ....	103
Holtzer-Cabot Div., National Pneu- matic Co. ....	82
Holub Industries, Inc. ....	75
House Adv. ....	144, 170, 183
Howell Instrument Co. ....	61
Hudson Tool & Die Co., Inc. ....	105
Hudson Tool & Dye Co., Inc. ....	105

Industrial Precision Meter Co., Inc. ....	168
Industrial Instruments, Inc. ....	138
International Electronic Research Corp. ....	152
Iron Fireman Mfg. Co., Electronic Div. ....	155

Jennings Radio Mfg. Corp. ....	88
Jordan Electronics ....	61
Joy Mfg. Co. ....	60

# FOR TIMELY DESIGN INFORMATION

ELECTRONIC  
DESIGN



In *Electronic Design*, engineers find not only more new products, but *all* the new products of significance to electronic engineers in their work. 26-time publishing frequency brings this information quickly to the engineer's attention, timed to a fast-moving industry. *Electronic Design* is more up-to-the-minute, more complete, more helpful, and easier to read than any other electronic publication. No wonder more and more engineers read *Electronic Design* first!

ELECTRONIC  
DESIGN

a HAYDEN publication

830 Third Avenue, New York 22, N. Y.

## The Landing of the Puritans

On the banks of Gitchee Goomie,  
Lake the white men call Atlantic  
Heap big redskins going frantic,  
Radar got no Bomac tubes!\*

See the Pilgrims land on rock there!  
See them cross the sky blue water!  
Redskins know they hadn't oughter,  
But radar got no Bomac tubes!

Beat the drum, call heap big powow,  
Call the braves from heap big teepee,  
Get um chief to put on toupee —  
Radar got no Bomac tubes!

Fixum Cavity, Bald Eagle!  
Get um faulty Klystron going!  
Heap big white men come a-rowin  
And radar got no Bomac tubes!

Storm Cloud, get those fingers flying!  
Mend with rawhide, patch with sticks  
Too late now to get um "fix" . . .  
Radar got no Bomac tubes!

Redskin radar rests in ashes,  
White men use um wood for fire, now.  
Price of real estate is higher now . . .  
Radar had no Bomac tubes!

On the banks of Gitchee Goomie  
Different people now are living,  
Every year they give Thanksgiving  
Radar had no Bomac tubes!

No. 15 of a series . . . BOMAC LOOKS AT RADAR THROUGH THE AGES



\* Today, Bomac makes the finest microwave tubes  
and components since the Pilgrims landed

# Bomac

LABORATORIES, INC.

Leaders in the design, development and manufacture of TR, ATR, Pre-TR tubes; shutters; reference cavities; crystal protectors; silicon diodes; magnetrons; klystrons; duplexers; pressurizing windows; noise source tubes; high frequency triode oscillators; surge protectors.

Offices in major cities—Chicago • Kansas City • Los Angeles • Dallas • Dayton • Washington • Seattle • San Francisco • Canada: R-O-R Associates Limited, 1470 Don Mills Road, Don Mills, Ontario • Export: Maurice I. Parisier, 741-745 Washington St., N. Y. C. 14, N. Y.

© BOMAC 1959

Advertiser	Page
Kay Electric Co. . . . .	83
Kearfott Co., Inc., Little Falls Div. . . . .	143
Keithley Instrument Co. . . . .	132
Kepco, Inc. . . . .	101
Kester Solder Co. . . . .	182
Keuffel & Esser . . . . .	137
Keystone Products Co. . . . .	60
Kinney Mfg. Co., The New York Air Brake Co. . . . .	165
Kintel, A Div. of Cohu Electronics, Inc. . . . .	59
Kip Electronics Corp. . . . .	75
Kleinschmidt Div. of Smith-Corona Marchant, Inc. . . . .	96
Knights, James Co., The . . . . .	77
Kressilk Products, Inc. . . . .	75
Krohn-Hite Corp. . . . .	76

Lafayette Radio . . . . .	112
Leach Corp. . . . .	57
Leeds & Northrup Co. . . . .	129
Librascope, Inc. . . . .	161
Link Aviation, Inc. . . . .	133
Lockheed Aircraft Corp., Missile Systems Div. . . . .	175
Lockheed Electronics & Avionics Div. . . . .	123
Lord Mfg. Co. . . . .	149

M & C Products Co. . . . .	86
Magnetics Inc., Components Div. . . . .	115
Malco Tool & Mfg. Co. . . . .	158
Mallory, P. R. Co. . . . .	116, 117
Marconi Instrument Co. . . . .	151
Marion Instrument, Div. Minneapolis-Honeywell . . . . .	182
Martin Co., Activation Div. . . . .	174, 175
Melpar, Inc. . . . .	180
Methode Mfg. Co. . . . .	66
Metronix, Inc. a Subsidiary of Assembly Products, Inc. . . . .	150
Micro Switch, Div. of Minneapolis-Honeywell . . . . .	65
Miller Co., J. W. . . . .	84
Milgray Electronics, Inc. . . . .	165
Minitron Components . . . . .	182
Minneapolis-Honeywell Co., Boston Div. . . . .	51
Minneapolis-Honeywell Co., Industrial Div. . . . .	43
Minnesota Mining & Mfg. Co., Chemical Products Div. . . . .	130, 131
Motorola, Inc., Western Military Electronics Center . . . . .	176

NJE Corp. . . . .	91
Narda Microwave Corp. . . . .	134, 135
National Co., Inc. . . . .	19
National Vulcanized Fibre Co. . . . .	72
Neff Instrument Corp. . . . .	102
Networks Electronic Corp. . . . .	159, 164
Newark Electric Co. . . . .	163
New York Air Brake Co. . . . .	165
Non-Linear Systems, Inc. . . . .	47
North Atlantic Industries, Inc. . . . .	120

Oak Mfg. Co. . . . .	69
Oster, John Mfg. Co. . . . .	141

Packard-Bell Electronics Corp. . . . .	103
Phelps Dodge Copper Products Co. . . . .	68
Philco Corp., Landsdale Tube Div. . . . .	7
Philbrick, George A., Researches, Inc. . . . .	19

◀ CIRCLE 704 ON READER-SERVICE CARD