

MAY 1, 1957

ELECTRONIC DESIGN

B 653460

JUN 10 1957

2

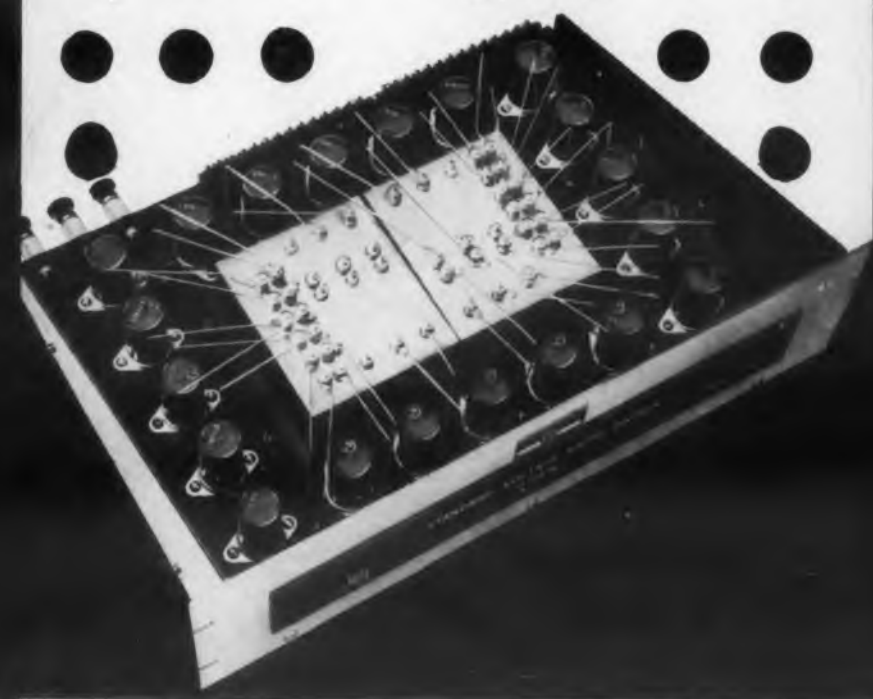

Type MEF



Type MEC



FEATURES

• Available in 1/2 and 1 watt ratings • Metallic resistive film accurately controlled and applied to special high quality ceramic cores • Designed to surpass characteristic A of specification MIL-R-10509B • Low noise level independent of range • Voltage coefficient can be disregarded

Here are molded metal film resistors that set new standards of performance—units that will withstand full load at 125° C. ambient to zero at 175° C. In addition to high initial accuracy, these new MIL type units combine a stability on load and a low, controlled temperature coefficient never before available in film resistors. They also provide low inductance and shunt capacitance plus excellent high frequency characteristics.

Small in size and weight, IRC precision metal film resistors can replace precision wire wound resistors in many applications. They are available in five temperature coefficient spans for maintaining or controlling resistance over wide temperature ranges. They can be used where high stability must be obtained under difficult load and humidity conditions. You'll also want to investigate them for high frequency applications. Send for complete details.

Insulated Composition Resistors • Deposited and Boron Carbon Precursors • Power Resistors • Voltmeter Multipliers • Ultra HF and Hi-Voltage Resistors

Wherever the Circuit Says

Low Wattage Wire Wounds • Resistance Strips and Discs • Selenium Rectifiers and Diodes • Hermetic Sealing Terminal • Insulated Chokes • Precision Wire Wounds • Potentiometers



SEND TODAY FOR COMPLETE DETAILS

INTERNATIONAL RESISTANCE CO. Dept. 264, 401 N. Broad St., Philadelphia 8, Pa.; In Canada: International Resistance Co., Ltd., Toronto, Licensee
CIRCLE 1 ON READER-SERVICE CARD FOR MORE INFORMATION

Staff

Editor Edward E. Grozda

Managing Editor J. A. Lipke

Associate Editors E. T. Ebersol, Jr.
G. H. Rostky

Assistant Editors S. Dresner
P. J. Lahey
T. E. Mount
D. S. Viebig
E. T. Blake

Contributing Editors S. H. Hubelbank
J. M. Monstream
J. G. Adashko
R. D. Thornton
E. Brenner
A. Nadell

Editorial Assistants M. J. Madden
F. Muehleck
M. S. Buckley
C. Hanly
B. Zaltman

Art Director S. Sussman
Asst. Art Director R. A. Schulze

Production Manager T. V. Sedita
Asst. Production Manager M. W. Baron
Business Manager P. L. Canfield
Circulation Manager S. Buffinton

Co-Publishers

T. Richard Gascoigne
James S. Mulholland, Jr.

Advertising Sales Manager

Bryce Gray, Jr.

Advertising Representatives

New York: Owen A. Kean
19 E. 62nd St. Robert W. Gascoigne
TEmpleton 8-1940 Harley F. Macomber

Chicago: Thomas P. Kavooras
664 N. Michigan Ave. Berry Conner, Jr.
SUperior 7-8054 R. Nelson Jolliffe

Los Angeles: Robert E. Ahrens Dorf
5720 Wilshire Blvd. Earl W. Wilken
WEbster 8-3881 John Quillman

Subscription Policy

ELECTRONIC DESIGN is circulated only to qualified electronic design engineers of U. S. manufacturing companies, industrial consultants, and government agencies.

If design for manufacturing is your responsibility, you qualify for subscription without charge provided you send us the following information on your company's letter head: Your name and engineering title, your company's main products, and description of your design duties. The letter must be signed by you personally. Any address changes for old subscribers necessitates a restatement of these qualifications.

Subscription rate for non-qualified subscribers—\$12.00 for 1 year only.

Hayden Publishing Company, Inc.
19 East 62nd Street
New York 21, New York

ELECTRONIC DESIGN

Contents

Vol. 5, No. 10

May 15, 1957

| | |
|--|-----|
| Relay Operated Voltage Divider (Cover) | 26 |
| Editorial | 4 |
| Engineering Review | 5 |
| Washington Report | 16 |
| Features | |
| Cooling Packaged Electronic Equipment I, A. Hay | 22 |
| The Cryotron—A New Computer Device, S. Parker | 28 |
| Direct-Printed Circuits | 32 |
| Oscillator Design Techniques Using Conductance Curves, K. Pullen | 34 |
| Transformer Design Nomograph II, M. Berger | 38 |
| Extra-High Resistivity Potentiometer Wire | 40 |
| Broadband Ceramic Klystron | 44 |
| Miniature One-Shot Power Supply | 44 |
| Rigidized Flexible Waveguide | 50 |
| Determining Transistor Reliability, B. Reich, H. Wood | 52 |
| Design Forum | |
| Modular Instruments | 42 |
| Background for Design | |
| Performance and Packaging of Modulators, M. Zinn | 46 |
| Ideas for Design | |
| Transistorized Sawtooth Amplifier | 112 |
| Surge Limiting Device | 114 |
| Russian Translations | |
| What the Russians Are Writing | 130 |
| German Abstracts | |
| A New Photocell for Infra-Red | 134 |
| Ionization Chamber Time Delay Relay | 136 |
| Abstracts | |
| Transistors in a Reactor Field | 138 |
| Transistorized Phase Discrimination | 139 |
| Portable Frequency Standard | 140 |
| Interference Control Through Design | 142 |
| Microwave Noise Generation | 144 |
| Departments | |
| Letters to the Editor | 18 |
| Meetings | 20 |
| New Products | 56 |
| New Materials | 98 |
| New Literature | 100 |
| Report Briefs | 116 |
| Patents | 120 |
| Books | 126 |
| Standards & Specs | 146 |
| Careers Section | 148 |
| Advertisers' Index | 153 |

ELECTRONIC DESIGN is published semi-monthly by Hayden Publishing Company, Inc., 19 E. 62nd Street, New York 21, N. Y., T. Richard Gascoigne, President; James S. Mulholland, Jr., Vice-President & Treasurer and David B. Landis, Secretary. Printed at Hildreth Press, Bristol, Conn. Acceptance under section 34.64 P. L. & R. authorized. Copyrighted 1957 Hayden Publishing Company, Inc. 30,000 Copies this issue.



BIG NEWS...IN SEALED THERMOSTATS!

G-V's Series C8 is Undamaged By 150 G Shock, Vibration up to 2000 Cycles, Exposure to -100°F. and +300°F.

This new series of electrical thermostats is specially designed to meet the difficult operating conditions of electronic and aircraft applications. Operating points, regardless of setting, are not changed by exposure to temperatures from -100°F. to +300°F. Shocks up to 150 G for 3 milliseconds, vibration of 25 G up to 1000 cps, and vibration of 10 G up to 2000 cps do not damage these thermostats or change their setting.

Hermetically Sealed But Rapid in Response

Sealed in a metal shell which is also its sensing element, the G-V Series C8 Thermostat responds as rapidly as a laboratory thermometer. Temperature settings may be made at the factory or by the user. Contacts are rated at 5 amps. 115 volts AC, or 3 amps. 28 volts DC, non-inductive load. Differential is about 1°F. Insulation test is 1250 v. between circuit and shell, and insulation resistance is over 100 megohms. These thermostats are suitable for direct control of heaters and for over-temperature and under-temperature indication, alarm, or cut-off.

**Available In Numerous
Convenient Mounting Forms**

WRITE...

for Bulletin with complete technical and application data.



G-V

G-V CONTROLS INC.
18 Hollywood Plaza • East Orange, N. J.

CIRCLE 2 ON READER-SERVICE CARD FOR MORE INFORMATION

new and unique!



**Eliminate
Breadboard Layout!
SPEED DESIGN OF TRANSISTOR CIRCUITS
With the SPRAGUE TRANSIMULATOR**

Bring transistor circuits to life in a matter of minutes with the Sprague LF-1 Transimulator. This new instrument lets you simulate any amplifier stage, a-c or direct-coupled, short of high power audio output; also multivibrator, switching, phasing, push-pull, Class A and B, and many others using cross-coupled Transimulators . . . whether the circuit is common or grounded emitter, base, or collector . . . whether the transistors are PNP, NPN, or Surface Barrier. You can simulate circuits stage-by-stage for cascade operation . . . or use a separate Transimulator for each stage to get simultaneous multi-stage operation.

Bring Circuit Diagrams To Life In Minutes

Everything you need for RC amplifier circuits is built right into the LF-1, including coupling capacitors . . . bias and load resistors . . . battery voltage supplies . . . Base Collector—Voltage Divider stabilization circuits . . . 5-way binding posts for transformer coupling and metering.

Whether you're designing audio circuits or switching circuits, you'll get a true picture of operating parameters minutes after you've drawn the circuit diagram . . . without wasting valuable time with breadboard and soldering gun.

Pays For Itself In A Matter Of Weeks

An ideal laboratory instrument, Transimulators are inexpensive enough to justify several on every bench. You can even use the LF-1 to test transistors *in the circuit* . . . the only real proof of design parameters. And a complete step-by-step instruction manual makes operation fast, simple, and easy.

FEATURES OF THE LF-1 TRANSIMULATOR

- TRANSISTORS—PNP and NPN Junction, and Surface Barrier.
- CIRCUITS—Common or Grounded Emitter, Base, Collector.
- RANGE—Audio, up to 100 kc.
- TRANSISTOR POWER—Through medium power audio output.
- BATTERY SUPPLY—Separate bias and load. 1.5, 3, 4.5, 6 volts d-c. Polarity Reversing Switch.
- COUPLING—2 μ f and 20 μ f Direct, and Ext. C. posts, on both Input and Output.
- BIAS RESISTANCE—Up to 555,000 ohms continuously variable.
- LOAD RESISTANCE—Up to 277,500 ohms continuously variable.
- EMITTER RESISTANCE—Up to 2,500 ohms variable. Series resistor and bypass capacitor can be added.
- BASE COLLECTOR STABILITY—Up to 250,000 ohms variable. Series resistor and bypass capacitor can be added.
- VOLTAGE DIVIDER STABILITY—Up to 50,000 ohms variable.
- 5-WAY BINDING POSTS—For meters, transformer coupling, external supply voltage, degeneration, bypass, coupling, signal input and output, almost any connection required.

only \$7950 NET

SPRAGUE®

SPRAGUE PRODUCTS COMPANY, NORTH ADAMS, MASSACHUSETTS

CIRCLE 3 ON READER-SERVICE CARD FOR MORE INFORMATION

Editorial

Tavern Talk on the Engineering Shortage

(Scene: Engineers at a bar before a P.G. meet.)

"There wouldn't be any shortage of engineers if the government wouldn't reward companies who failed on a contract."

"What are you saying, Harold?" asked Steve incredulously. Harold had spoken earnestly. As a director of research, his words carried weight.

"Simply this," Harold snorted, "you can fail to produce on a contract, and not only do you get paid, but you get another contract the next day because you have the available manpower."

Steve challenged, "Come on, it's not that bad."

"Maybe not," Harold agreed, "but take the WYZ Company. They made only eggbeaters until they bought up that tiny development outfit that made radio-controlled model airplane kits. They beat the bushes till they got 75 engineers. Then they put that retired admiral on their payroll and now they're designing guided missiles.

"But my main point is this, there is no reward for good work. You can build hardware that's no good, or come up with research reports which say nothing, yet, if you tell the government you tried and it's the nature of the beast that there's no solution, your word is accepted. They can't tell the difference. What's tragic is that your hardware may go into production if you assert it's good. Some kids right out of college can build a fire control system for jets that works, yet it could have been better if older experienced brains had checked the design. What's even worse, research in some promising direction gets stopped because of a negative report. If top scientists had done the research in the first place, results would have been different."

"But, Harold, all you're saying is that there is a shortage."

"No. If the Government knew enough to cancel a few contracts and not to give the contractor another chance, if he doesn't have any proven ability in that field, the demand for engineers would be less. Responsible companies could absorb responsible engineers from these subsidized companies, which should not be in the field anyway, and some responsible work could be done."

"I guess you're right," Steve mused, "Right now we can job hop, picking up a grand or so doing it whenever somebody else wants some missile or systems engineers. Say, how about this idea for controlling job hoppers? They should pay a 90 per cent income tax on their salary gain if they change jobs before a year is out. This would prevent unscrupulous companies from pirating and taking on more government contracts than they can reasonably do." "Have we got time for another round? Guess not."

Engineering Review

For more information on developments described in "Engineering Review," write directly to the address given in the individual item.

Rapid Data Transmission

High-speed data transmission for the business world will be made possible by an experimental device, tentatively called a Data Subset. Capable of transmitting 1000 words per minute, the device meets the increasing demand for communication between information processing machines. The experimental data transmission set, recently built by Bell Telephone Labs., N.Y., is suited to any data-generating or data-processing device that can place its output on a magnetic tape. In a properly encoded form, the transmission set will accept this tape and transmit the data at great speed over telephone lines to another tape at the receiving end.

The tape contains a series of magnetized spots arranged according to an add-parity check code.



Information in verbal, digital or other form, can be fed on tape into this device for transmission at the rate of 1000 words per min over conventional telephone lines. Called the Data Subset, the system will enable the rapid communication of vast amounts of information between data processing centers. Information from computers, typewriters or other business machines can be coded on the tape previous to transmission.

The code for any unit of data—a digit, a letter of the alphabet, or any arbitrary symbol—will have seven positions. In each of the seven positions there will be either a *zero* or a *one*, but in the entire series of seven there must always be either three or five *one's*. A *one* corresponds to a spot on the tape magnetized in one direction, and a *zero* corresponds to a spot magnetized in the reverse direction. If by error a code group does not have either three or five *one's*, a data subset will detect the error and will take steps so that it can be rectified. The output of the magnetic tape feeds into the amplifier and modulator section. Here, an oscillator generates a 1200-cy carrier which is amplitude modulated by the code signals. If an encoding error is encountered, the set will send out a special symbol that will be recorded on the receiving tape.

At the receiving end, an avc circuit helps insure accuracy by evening out the energy levels of the incoming 1200-cy pulses. A detector circuit converts these to dc pulses that magnetize the appropriate spots on the receiving tape. Another check circuit is meanwhile verifying again the three-or-five-out-of-seven accuracy. This is necessary because an error might have been introduced along the transmission path.

In operation, the tape will be removed from the computer, typewriter or other business machine where it has been prepared. It will be placed directly into the data subset without rewinding. Information, therefore, will actually be transmitted backwards. This has its advantage since the correction symbol will precede the erroneous line and will cause the data subset to skip that line.

One important advantage of the system is that transmission can be accomplished at times when telephone lines are not normally busy. The semi-automatic nature of the machine, which makes this possible, may become particularly helpful to the business world as its communication load increases.



Only Pretending: This is an artist's conception of a device that will simulate the roll and pitch of a ship at sea while simultaneously launching a missile. It will be used by the Navy to determine the limiting conditions of firing a missile off a moving platform. The size of the simulator-launcher, to be built by the Loewy-Hydro-press Div. of Baldwin-Lima-Hamilton Corp., Pa., is necessary to maintain this motion during actual firing.

vacuum's most reliable component
 Now receiving universal acceptance

BEAM SWITCHING TUBES

WHERE

Megacycle Decade Counter
 Transfer Storage Counter
 Time Base Generator
 Frequency Divider
 Events Per Unit Time
 Preset Counter
 Beamplexer
 Pulse Height Analyzer
 Automation Systems
 Beacon Transponder
 Teletype Decoder
 Microsecond Delay Generator
 Machine Control
 Sorter
 Sampler
 Computers
 Analog to Digital Converter
 Memory Core Matrix Addressor
 Radar
 Loran
 Data Handling

WHY

Only device with 10 individual constant current outputs.
 May perform the functions of 20 or more tubes or transistors.
 Achieves performance not practical by other techniques.
 Reliability and performance at all speeds.
 Compatible with tubes, transistors, cores, thyratrons, relays, Nixie numerical indicator 6844, and other devices.

PLUS

Shock: 375g
 Temperature: -60° to +150°
 Vibration: 20g
 Speed: up to 20 mc
 Life: up to 50,000 hours
 Power: minimum input—useful output

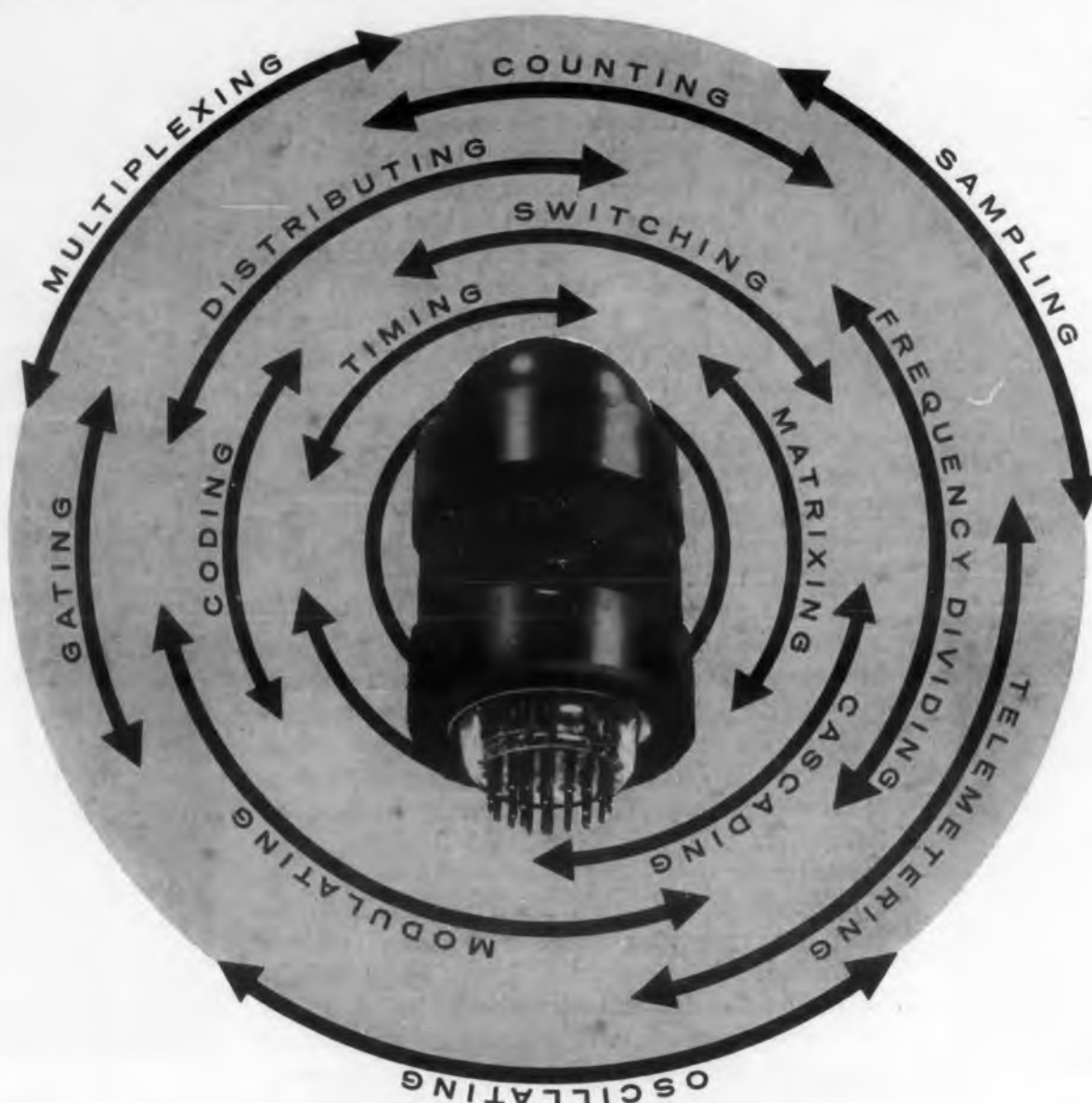

FOR FURTHER INFORMATION WRITE ...

Electronic Tube Division

BURROUGHS CORPORATION
 Plainfield, New Jersey

Engineering Review

Standard Saturable Reactors

A standard line of 22 mass-produced saturable reactor assemblies has been announced by "Control," a new division of Magnetics, Inc., of Butler, Pa. Reactors of 240 and 120 v 60 cy are available, with 11 standard sizes in each range. Power output ranges from 50 to 2000 w, with three amp-turns being required for control of the smallest unit. The establishment of this new division has resulted from the demand for mass-produced saturable reactors as opposed to custom-ordered devices.

Gadget for Tired Drivers

A novel rear-vision mirror that is automatically adjusted to prevent a motorist from being blinded by following headlights is the latest contribution to the road-weary. The Mirrotron, as the new mirror is called by its developer, the Instrument Research Co. of 22 Anselm Terrace, Brighton 35, Mass., is activated by a miniature photocell which measures the light being reflected from the mirror into the driver's eyes.

Light striking the photocell is converted to an electrical impulse which, when amplified, operates the mirror when the glare would be blinding. The driver can adjust the point at which the mirror switches from the normal to dim position by a small dashboard control similar to a radio volume control.

Highway Engineering Productivity

Electronic computers are finding new uses in highway location and design. In addition to traffic analyses including origin and destination surveys and route analyses, the computers can be used for traverse calculations, earthwork computation, determination of excavation and embankment volumes.

In California, where some engineers are still reluctant to make use of the computation facilities, 50,000 traverse courses and 200 to 400 miles of earthwork computations are made per month.

◀ CIRCLE 4 ON READER-SERVICE CARD

CIRCLE 5 ON READER-SERVICE CARD ▶

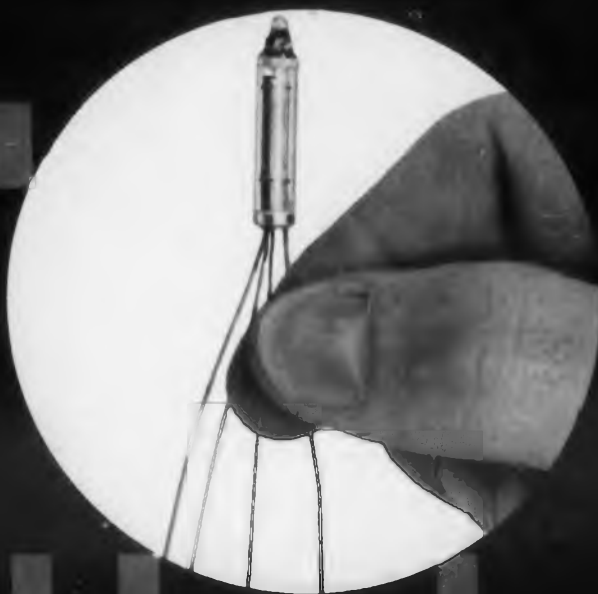

**The tube that makes
present computer
indicator system designs
obsolete...**



AmpereX 6977

subminiature indicator tube

Monitors Transistorized Circuits

- with higher information density
- with simpler associated circuitry
- without ionization- and deionization-time problems
- with increased circuit protection
- with lower power requirements
- with lower cost per unit
- with ultra-compact assembly on printed circuit boards

The AMPEREX 6977 is a high-vacuum filamentary subminiature indicator triode which gives a bright blue-green indication when the control grid is at zero potential. It has been developed specifically for transistorized computers, where its high input impedance and small signal requirements enable it to monitor the transistor circuits without loading them and affecting their operation. It replaces the conventional and much more expensive high voltage transistor and neon lamp combination so far used in transistor computers for the same purpose. Since its high input impedance permits the use of a series grid resistor, it will not short out the transistor circuit if it should ever fail. Manufactured with special computer tube techniques, the 6977 is designed for 20,000 hours life.

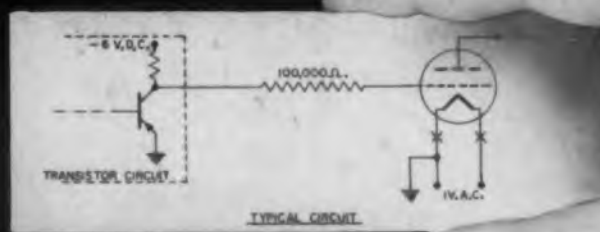

Heater voltage is only 1 volt, 30 ma, AC or DC. The anode will draw only 0.5 ma from a 50 volt DC supply during the zero bias "on" condition. A 3.0 volt DC voltage is sufficient to cut off plate current and light. Write for data sheet to Semiconductor and Special Purpose Tube Division, AmpereX Electronic Corp., 230 Duffy Avenue, Hicksville, L.I., N.Y.



AmpereX

about products and services for the computer industry



*no other transmitting tube
but the*

Amperex® 6939

gives you

*5.5 watts useful power in load (ICAS)
up to 500 Mc at maximum ratings
in a miniature envelope*

*unsurpassed for low-power UHF
transmitter applications... saves entire stages
in original equipment design*

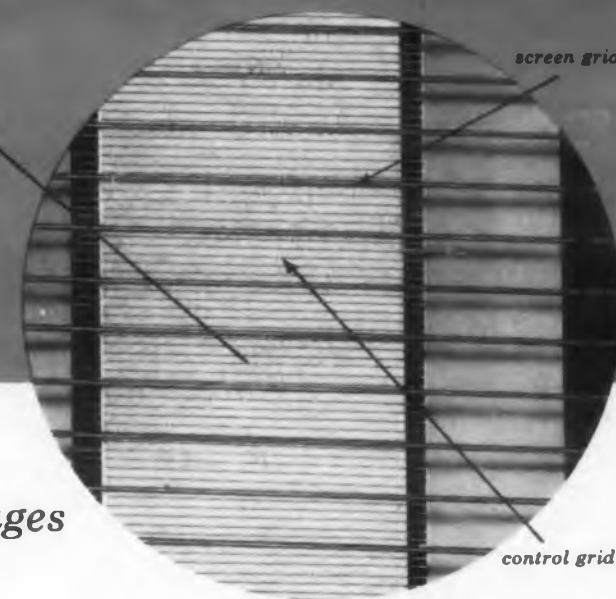

| AMPLIFIER, CLASS C, FM | Operating Conditions | |
|-------------------------|----------------------|----------|
| | C.C.S. | I.C.A.S. |
| Frequency | 500 Mc/s | 500 Mc/s |
| Plate Voltage | 180 V | 200 V |
| Screen Grid Voltage | 180 V | 200 V |
| Control Grid Bias | -20 V | -20 V |
| Plate Current | 2x27.5 mA | 2x30 mA |
| Screen Grid Current | 11 mA | 13 mA |
| Control Grid Current | 2x1 mA | 2x1 mA |
| Driving Power | 1.0 W | 1.0 W |
| Plate Input Power | 2x5 W | 2x6 W |
| Plate Dissipation | 2x2.1 W | 2x2.25 W |
| Screen Grid Dissipation | 2 W | 2.6 W |
| Output Power | 5.8 W | 7.5 W |
| Useful Power in Load | 4.5 W | 5.5 W |

The Amperex 'FRAME-GRID' CONSTRUCTION insures extreme accuracy of interelectrode spacing, the secret of the 6939's brilliant performance. The relatively massive metal frame acts as a heat-sink, safely limiting control-grid temperature.

Write for detailed data sheets to Communications Tube Division, Amperex Electronic Corporation, 230 Duffy Avenue, Hicksville, L. I., New York.

ask Amperex



... for applications engineering assistance on your communications tube problems

Engineering Review

Strain Gage Problems Studied

A new organization has been formed, called the Western Regional Strain Gage Committee, which is composed of aircraft manufacturers and governmental agencies located within the western region of the United States. Some 30 divisions of 14 industrial units are represented at the semiannual committee meetings. The purpose of the committee is to advance the art of measurements utilizing strain gages and strain gage devices through the interchange of ideas and experiences.

The group, which was founded early in 1956, operates as an independent unit and is not affiliated with other societies or organizations. Round-table discussions center around such items as fundamental properties of strain gage materials, strain gage applications under high and low temperature problems, new requirements in strain gage properties or construction which users need in their applications, and general problems associated with strain gage measurements.

Tubes, Even Transistors, Obsolete

At the International Symposium on the Theory of Switching, Harvard University, several predictions were made concerning the future of tubes and transistors in large scale computers.

Dr. Theodore H. Bonn of the Remington Rand Div. of Sperry Rand saw the vacuum tube as obsolete for computers now being designed by the newer transistors and magnetic amplifiers. A second speaker, Dr. Herbert Callen, looked even further into the future and foresaw the eventual decline of the transistor in favor of new ferromagnetic films, which will carry the speed of switching to as little as one-billionth of a second.

Dr. Callen predicted a time when the upper limit of computing speed would be limited only by the time necessary for a pulse to travel from one point in a computer to another. The thin ferromagnetic film switch is theoretically capable of this speed equal to the speed of light.

CIRCLE 6 ON READER-SERVICE CARD >

< CIRCLE 5 ON READER-SERVICE CARD

DU PONT
REG. U. S. PAT. OFF.

ELECTRONIC DESIGN

LOWEST DIELECTRIC LOSS AND HIGHEST TENSILE STRENGTH

TEFLON

NEWS

Remarkable properties of Du Pont TEFLON® resins provide rugged, low-loss insulation for wiring

Use of TEFLON® promotes miniaturization of electronic parts

Owing to the high dielectric strength of Du Pont TEFLON—ratings are 500 to 4,000 volts per mil—insulation on wires can be exceedingly thin. Hence the heating due to current overload, which is always a critical factor with thin conductors, has less of an effect on TEFLON than on any other wiring insulation. Because TEFLON can operate hotter, it permits many miniaturization projects which would not be feasible without it. Miniaturization of coils, capacitors, brushes and other components is frequently possible because of the remarkable properties of wire insulated with TEFLON. TEFLON has opened up new fields of use for magnet wire, hookup wire, lead wire, coaxial cable and resistance wire. Tubing of TEFLON is available down to hairlike diameters. The coupon will bring more information.

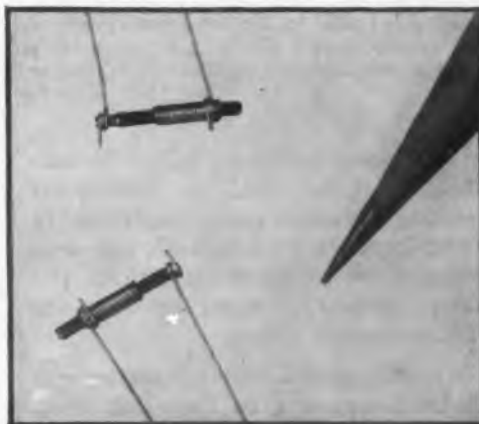

These small capacitors use TEFLON as the dielectric. Their degree of miniaturization is shown by comparison with end of lead pencil.

TEFLON®

is a registered trademark . . .

TEFLON is the registered trademark for Du Pont tetrafluoroethylene resins, and should not be used as an adjective to describe any other product or any component part; nor may this registered trademark be used in whole, or in part, as a trade name for any product.



Socony Mobil photo

"Datatron" solves the complex numerical problems of modern industry and commerce. Intricate wiring of the electronic computer is protected by slip-on insulation of Du Pont

TEFLON 6 tetrafluoroethylene resin. (Computer by ElectroData Corporation, Pasadena, Calif.; "spaghetti" tubing supplied by Pennsylvania Fluorocarbon Co., Inc., Philadelphia, Pa.)

Designers of the Datatron high-speed digital computer took no chances with ordinary wiring insulation. Heat generation in this equipment cannot damage or age the sleeveings of Du Pont TEFLON used to protect the conductors. TEFLON retains its toughness, flexibility and electrical characteristics to a rated 500°F. Soldering-iron temperatures will not burn or melt insulation of TEFLON. In assembly operation, TEFLON does not undergo shrinkage during soldering.

Other properties of this remarkable engineering material are often equally valuable in electronic devices. The arc resistance of TEFLON tetrafluoroethylene resin is outstanding. Its power factor of less than 0.0003 from 60 cycles to 3,000 megacycles guarantees low dielectric losses in high-

frequency equipment. The volume resistivity of TEFLON is greater than 10^{18} ohm-cm, even after prolonged soaking in water. Surface resistivity is greater than 10^{17} ohms at 100% relative humidity. Applications are often based on the exceptionally low coefficient of friction of TEFLON. For example, "spaghetti" tubing is easily slipped over long conductors. Parts made of TEFLON will pass any salt-spray test. In fact, TEFLON is one of the most chemically inert materials known. Many electronic products depend on TEFLON to meet stringent MIL specifications.

The components you specify or design may well be improved by the use of protective, durable TEFLON. Further information can be obtained by mailing the coupon.

SEND FOR INFORMATION

For additional property and application data on Du Pont TEFLON tetrafluoroethylene resins, mail this coupon.

E. I. du Pont de Nemours & Co. (Inc.), Polychemicals Dept.
Room 18515, Du Pont Building, Wilmington 98, Delaware.

Please send me more information on Du Pont TEFLON tetrafluoroethylene resins. I am interested in evaluating this material for _____

Name _____

Company _____ Position _____

Street _____

City _____ State _____

Type of Business _____

In Canada: Du Pont Company of Canada (1956) Limited, P. O. Box 660, Montreal, Quebec

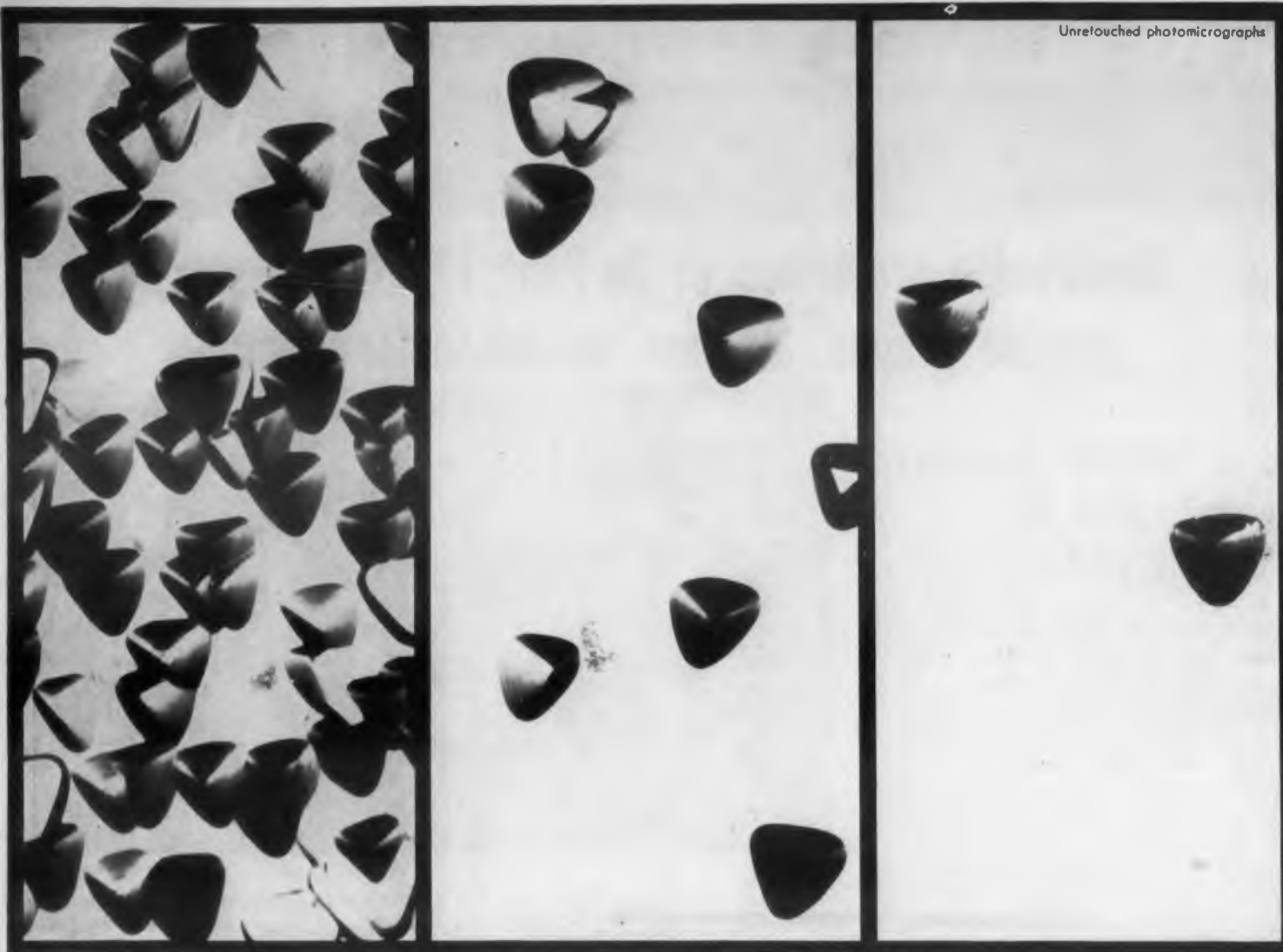

1952 Germanium crystals average many of these triangular "dislocations" or imperfections, here magnified 200 diameters.

1954 Processing improvements are bringing dislocations under better control, but density can be further reduced.

1957 Mechanized growing of CBS single crystals has uniformly minimized dislocations. Density is that of purest diamonds.

How more-perfect crystals improve transistor performance

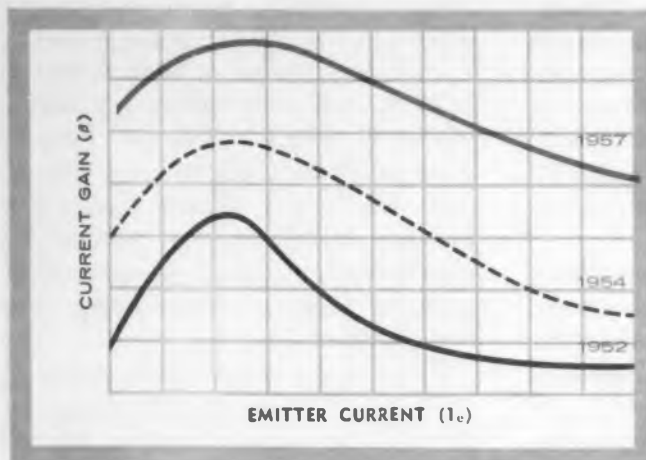

BETA Note the higher Beta or current gain (other factors being equal) derived from today's perfected CBS germanium crystals. Beta is used as just one concrete example of many important performance factors improved by CBS-Hytron's better crystal processing methods.

How does CBS grow uniformly dislocation-free crystals with uniform resistivity? By precise checking of the "seed" for orientation and dislocation density. By growing the single crystal in smoothly operating, shock-proof mechanized furnaces. By automatic temperature control and a uniform temperature gradient throughout the growing period. Research and development advances like these are constantly at work to make CBS transistors better.

And you can see the difference in quality that is built not tested into CBS transistors: In crystal photomicrographs. In Beta and other figures of merit. And in actual performance. Try CBS transistors and see for yourself.



semiconductors

CBS-HYTRON

Semiconductor Operations, Lowell, Mass.

A Division of Columbia Broadcasting System, Inc.

Reliable products through Advanced-Engineering

CIRCLE 7 ON READER-SERVICE CARD FOR MORE INFORMATION

200-Mile Microwave Links

A microwave system for the Air Force employing the principles of tropospheric scatter will permit single communication links up to 200 miles in distance. Operating at frequencies in the 7125 to 8500 mc band, development of the system has resulted in the design of a four-cavity klystron amplifier rated at 2000 w continuous power.

Developed by Philco Corp., Pa., the microwave system consists of two 28-ft parabolic antennas each of which has a gain of 54 db and projects a narrow beam-width of three tenths of a degree. The resulting high directivity is effective in reducing interference from aircraft in or near the scattering volume. Receivers have been improved because of the demand for lower receiver noise levels. As there is little correlation between signals received at points more than 100 wavelengths apart, the use of two receivers for diversity reception greatly increases the probability of finding a useful signal at one of the receivers. The outputs of the two receivers are combined in a diversity combiner which has eliminated the switching transient problem. For military use, the narrow beam-widths are expected to reduce the chance of signal interception, and the smaller number of stations necessary for the 200-mile jumps should lessen the chance of damage by enemy action.

Ionized Food for the Army

Preservation of fresh food by radiation instead of cooking or freezing will be studied by the Army in a \$7.5 million ionizing radiation center at Stockton, Calif. Heart of the new center will be a giant electron linear accelerator built by Varian Associates. The machine, highest average power electron accelerator ever to be built, is slated for delivery in October, 1958.

Fresh foods for front line troops without need of refrigeration may become routine if the studies prove successful. The new accelerator will handle food packages up to six inches thick. These packages, containing such perishable foods as uncooked pork, chicken and vegetables, will be passed through the accelerator beams on a conveyor belt. They then may be stored many months without refrigeration because the accelerator's ionizing radiation destroys bacteria in the food.

Implemented by the Secretary of the Army and the Quartermaster General, the pilot production plant construction follows a recent program of feeding irradiated food to human volunteers. Frequent medical examinations of the volunteers have revealed no harmful effects from their irradiated diet.

Fluid Drop Acts as Switch

A switching device so tiny that a hundred million of them would fit on a surface one inch square are to be used in the memory circuits of large computers.

A paper given at the International Symposium on the Theory of Switching at Harvard University described the switch as a tiny droplet of light-sensitive fluid. The switch is similar to other two-state switching devices, except that the process here is chemical rather than electrical or mechanical. The fluid is photochromatic; that is, the drop may be changed from one state to another by exposure to different colors of light. The time necessary for this action is about one one-thousandth of a second.

The analogy between the chemical nature of this switch and the chemical nature of the brain was mentioned. Usually the physical or circuitry-network aspects of the brain are stressed rather than the chemical aspects. It was pointed out that the new fluid switch in some ways resembled these latter aspects.



The "Century Lamp" is Lit: An electric light bulb, a replica of Thomas Edison's first practical lamp, is expected to keep burning for more than 100 years on top of a desk once used by Edison. The bulb will glow night and day in the GE Research Lab during its long term of duty. Ralph J. Cordiner, president of GE, is switching on the lamp with a key which will be entrusted for safekeeping to the company's top research scientists. To housewives who may wonder why they cannot purchase bulbs like this and thus save many unnecessary trips to the neighborhood store, Mr. Cordiner remarked that the bulb is actually inefficient compared to ones commonly used, due to the materials used in its construction.

If you have this problem, investigate

GRIP-EZE®

—an example of Phelps Dodge's
realistic approach
to Magnet Wire research



THE PROBLEM: To develop a solderable film-coated wire without fabric for winding universal lattice-wound coils without adhesive application.

THE SOLUTION: Phelps Dodge Grip-eze—a solderable film wire with controlled surface friction for lattice-wound coils that provides mechanical gripping between turns and keeps wire in place.

EXAMPLE: Coils wound with (a) conventional film wire; (b) Grip-eze. Note clean pattern of Grip-eze as compared to fall-down of conventional film wire.

Any time magnet wire is your problem, consult Phelps Dodge for the quickest, easiest answer!

FIRST FOR
LASTING QUALITY
— FROM MINE
TO MARKET !



PHELPS DODGE COPPER PRODUCTS
CORPORATION

INCA MANUFACTURING DIVISION
FORT WAYNE, INDIANA

CIRCLE 8 ON READER-SERVICE CARD FOR MORE INFORMATION

Engineering Review

Engineers as Managers

Fundamental intelligence, emotional stability, an understanding of people combined with ability to cope with their problems, integrity, health and enthusiasm were recently outlined as the fundamental requisites of the manager. A. J. Morgan, of the University of Dayton Research Center, went on to say before an AIEE meeting early this month, that the engineer has most of these qualities as well as some of the following executive abilities. He enumerated these as logical thinking, creative thinking, sense of money, organization of time and social sensitivity. The engineer, by reason of his training, possesses at least three of these fundamentals; fundamental intelligence, logical thinking and creative thinking, and he should thus maintain a distinct advantage over other candidates for a managerial position.

The vital interest in continuing the technological advances in modern civilization was mentioned. This interest stems not only from the comfort that these advances have given civilization, but from preserving what has been gained and what might be gained. If such an interest in technological advances continues to exist, it was concluded that this endeavor will require well trained and qualified management personnel with a greater technical background than was required in the past.

"Milk Bowl" Effect, Problem for Pilots

When an aircraft reaches a certain altitude, it no longer has the benefit of scatter lighting from the sun's rays. Instead sunlight becomes entirely direct and of very high intensity, with little of the light reflected into the pilot's cockpit. The resulting effect is that of looking from within a dark tunnel over a bright white sea of light, thus the name of the "milk bowl" effect.

The intensity of light to which the pilot is subject at this altitude often approaches 8000 ft-L, which, when compared to the usual illumination inside the cockpit, creates a blinding contrast. This contrast, coupled with the fact that the light source is from below—a particularly vulnerable region for the eye—results in extreme difficulty for the pilot in reading his instruments.

This problem, along with the general subject of lighting the modern commercial aircraft, was discussed in a paper given by Philip E. Massie of Day-Ray Products, Inc., Calif., at an Air Transportation Conference of the AIEE. According to the paper, attempt has been made to bring up aircraft meter panel illumination to 125 ft-c. This will still give a maximum brightness ratio of 65 to 1 between outside glare and cockpit lighting, but the normal ratio is not expected to reach this maximum.

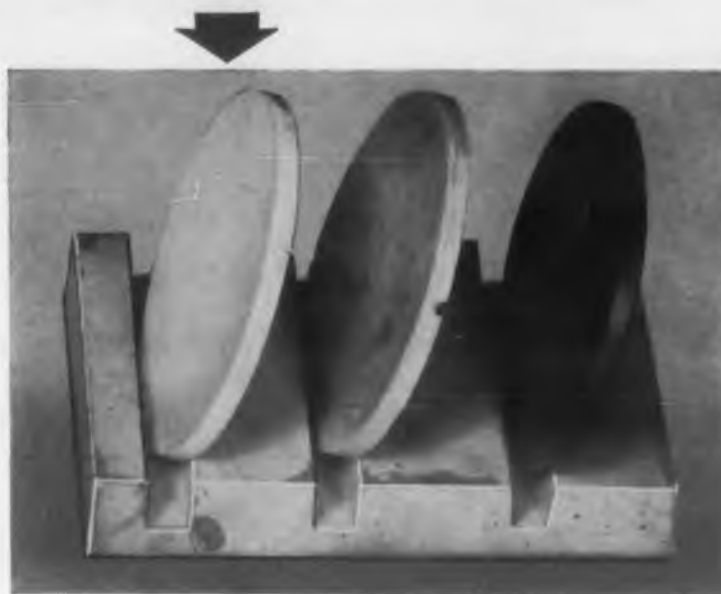

START OF SLUMP TEST

SUPRAMICA* 560 ceramoplastic insulation (Left) is to be compared with SUPRAMICA* 555 ceramoplastic (Center) and MYCALEX 410* glass-bonded mica — the best available materials with comparable properties.

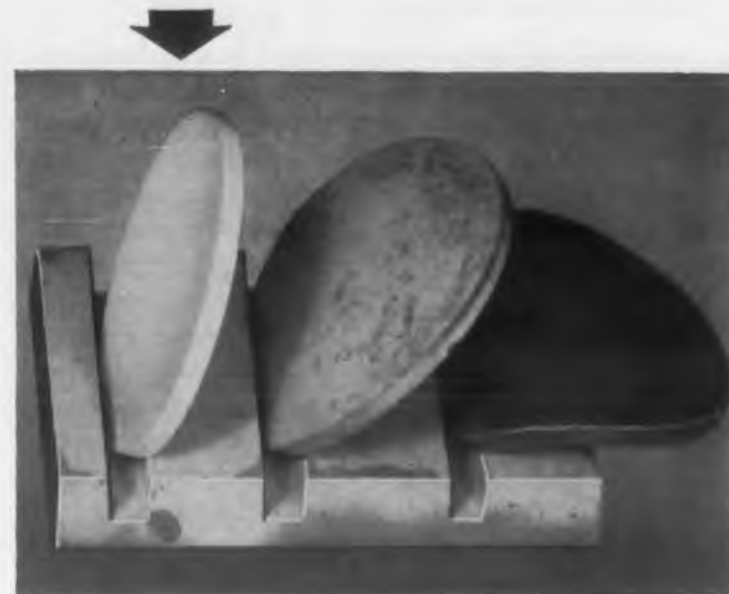

30 MINUTES AT 550°C

SUPRAMICA 560 is unaffected — SUPRAMICA 555 shows a slight tendency to slump — MYCALEX 410 shows a marked slump.

SUPRAMICA* 560 ceramoplastic

LIGHTWEIGHT MATERIAL CAN BE MOLDED WITH FRAGILE INSERTS

SUPRAMICA 560 ceramoplastic will free your designs from many of the functional limitations imposed by conventional insulating materials. Manufactured exclusively by Mycalex Corporation of America, SUPRAMICA 560 has the electrical and physical properties to meet exacting high-temperature insulation specifications — in applications where no other material can be used!

Proof of this high temperature performance is shown by these unretouched photographs of an actual "slump" test (Above). The characteristics listed at the right demonstrate the versatility of SUPRAMICA 560 ceramoplastic.

Lighter in weight than any comparable material — specific gravity similar to that of aluminum or mineral-filled polyesters — SUPRAMICA 560 is the perfect insulation for relay bases, connectors, tube sockets and many other parts in high-temperature components.

MYCALEX CORPORATION OF AMERICA precision molds this revolutionary new material for your product needs. Send for complete information.

SPECIFICATIONS: SUPRAMICA 560 ceramoplastic

| | |
|-----------------------------|--|
| DISSIPATION FACTOR, 1 MEG. | 0.003 |
| DIELECTRIC CONSTANT, 1 MEG. | 6.8 |
| LOSS FACTOR, 1 MEG. | 0.020 |
| VOLUME RESISTIVITY, OHM-CM | 10. ¹⁴ |
| SPECIFIC GRAVITY | 2.9 (Comparable to Aluminum or Mineral-Filled Polyester) |
| SAFE OPERATING TEMP. | |
| CONTINUOUS | 500°C |
| SHORT-TIME | 600°C |
| WATER ABSORPTION | NIL |
| HARDNESS, ROCKWELL M | 125 |
| THERMAL EXPANSION | 12.4 x 10 ⁻⁷ (Same as SAE 1010 Steel) |
| FLEXURAL STRENGTH, PSI | 15,000 |
| INSERTS | WILL ACCEPT ALL MOLDED-IN VARIETIES |

*SUPRAMICA, MYCALEX, and 410 are registered trade-marks of MYCALEX CORPORATION OF AMERICA. 555 is a trade-mark of the MYCALEX CORPORATION OF AMERICA. SYNTHAMICA is a trade-mark of SYNTHETIC MICA CORPORATION, a subsidiary of MYCALEX CORPORATION OF AMERICA.



CIRCLE 10 ON READER-SERVICE CARD FOR MORE INFORMATION

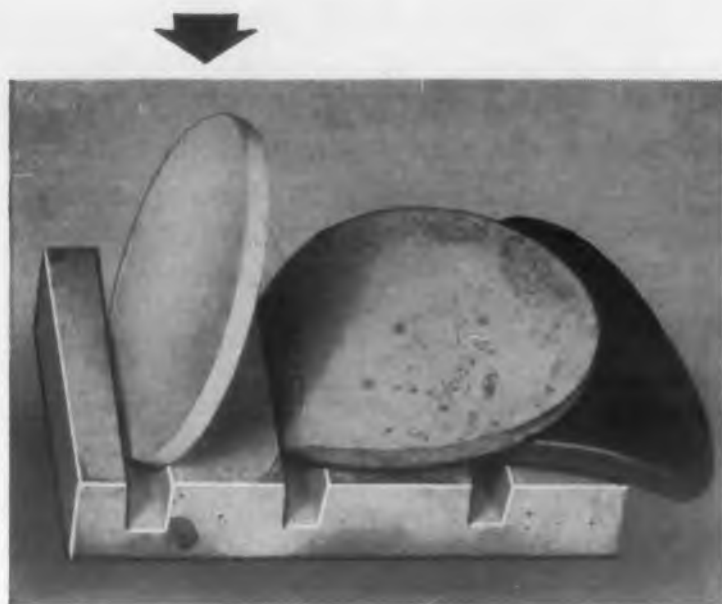

75 MINUTES AT 550°C

SUPRAMICA 560 remains unaffected — SUPRAMICA 555 has cracked and shows a definite slump — MYCALEX 410 shows foaming and complete slump.

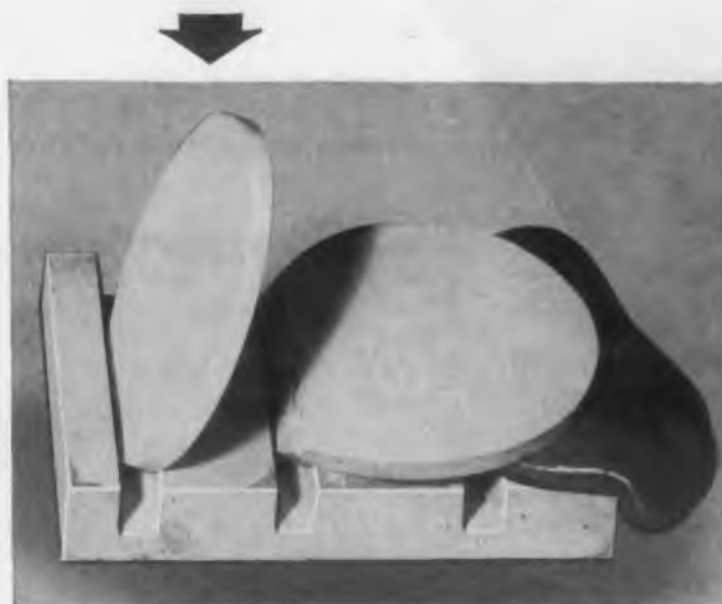

75 MINUTES AT 550° PLUS 15 MINUTES AT 650°C

SUPRAMICA 560 ceramoplastic still shows NO NOTICEABLE EFFECT — SUPRAMICA 555 has completely cracked through — MYCALEX 410 has foamed and collapsed.

INSULATION FOR CONTINUOUS OPERATION AT 500°C

TEMPERATURE ENDURANCE TEST ON MOLDED COMPONENTS



SUPRAMICA 555
ceramoplastic



SUPRAMICA 560
ceramoplastic



MYCALEX 410
glass-bonded mica

BEFORE
TEST



LENGTH 5.5%
WIDTH 4.1%



LENGTH 0.4%
WIDTH NO CHANGE

DIMENSIONAL INCREASE DURING TEST



LENGTH 12%
WIDTH 18% FOAMING

AFTER
75 MINUTES
AT 550°C
PLUS 15
MINUTES
AT 650°C

MYCALEX
CORPORATION OF AMERICA

GENERAL OFFICES AND PLANT:
CLIFTON BOULEVARD
CLIFTON, NEW JERSEY

EXECUTIVE OFFICES:
30 ROCKEFELLER PLAZA
NEW YORK 20, NEW YORK

SALES OFFICES:
CHICAGO — DAYTON
LOS ANGELES — MIAMI
WASHINGTON

WORLD'S LARGEST MANUFACTURERS OF GLASS-BONDED MICA AND CERAMOPLASTIC PRODUCTS

CIRCLE 10 ON READER-SERVICE CARD FOR MORE INFORMATION

Navy X-Rays Weapons

The installation of a new two million-v X-ray unit will make possible the nondestructive testing of defense materials and structures for the Navy. Casting will be evaluated with the X-ray unit before being sent to shipyards that build missiles or nuclear-powered vessels. Since disassembly for inspection will not be necessary, operation of the installation is expected to effect major savings in the over-all costs of quality control.

The unit, built by General Electric's X-Ray Dept. in Milwaukee, is housed in a newly erected concrete building that is large enough to permit entry of an entire railroad car or large truck. Construction required 1200 cu yd of concrete. A well, extending the length of the building, contains paving and trackage to allow railroad cars and trucks to enter carrying items of major size or weight. Safety is emphasized throughout—the wall separating the control and exposure rooms is concrete 4 ft thick, with radiation traps and lead-lined doors added for fullest protection. Other walls are a full 2 ft in thickness. A 66-ton door which closes the main entry whenever the unit is in operation measures 2 ft in thickness, stands 18 ft high, and is 21 ft wide.

Material handling is facilitated by a separate 10-ton crane capable of handling almost any item likely to require the service of this installation. The Navy's Bureau of Ordnance already has initiated several programs that involve the new two million-v unit. In most cases these programs provide for nondestructive testing of assembled items, as opposed to previous requirements for destructive testing or the dismantling of test items, which necessitated reassembly before returning them to stock.



The massive concrete walls of this building house a two million-v X-ray machine for inspecting large weapons. To be used by the Navy, the unit is expected to save time and expense by making it unnecessary to disassemble articles for inspection.

*No Dimensional
change*

*part
after part
after part*

NEW

 **Textolite®**

COLD PUNCH 11572

New General Electric Textolite 11572 is an outstanding XXX-P high IR laminate designed to provide extremely close tolerance punching at normal room temperature, with no cracking or delamination.

The cold fabricating quality, plus outstanding product uniformity, eliminates dimensional variations from piece to piece . . . permitting the use of automatic assembly equipment.

Common degreasing solvents have no effect on G-E Textolite 11572 in standard etching practices. For example G-E 11572 withstood exposure to hot trichloroethylene up to 15 minutes.

This new cold punch laminate is recommended for electronic applications using high voltage at radio frequencies. G-E Textolite 11572 exceeds NEMA XXX-P standards and meets military specifications MIL-P-3115-PBE-P. 11572 is available in unclad or copper-clad form with 1 or 2 oz. copper on one or both sides for precision printed wiring.

Progress Is Our Most Important Product

GENERAL  ELECTRIC

**When the properties have to be right . . .
Specify G-E Textolite®**

General Electric Company
Laminated Products Dept.
Sec. EDL-55, Coshocton, O.

Please have your
representative call.

Please send me complete information on
G-E Textolite® 11572 Cold Punch Laminate.

Name _____
Title _____
Firm _____
Street _____
City _____ Zone _____ State _____

CIRCLE 11 ON READER-SERVICE CARD FOR MORE INFORMATION

Glowing Phosphors provide Flat Light Source

A coating of phosphors suspended in oil between a metal and glass plate provide a two-dimensional source of light. The method, called "Rayescent" lighting, which is made possible by the phenomenon of electroluminescence, is currently being developed by the Westinghouse Lamp Division who have created a subsidiary organization to investigate the possibilities of the field.

Although electroluminescence is by no means a newly discovered phenomenon, it did not reach the level of feasible application until recently. The advantage of deriving light from glowing phosphors is that the metal-and-glass panels can be built directly into the walls, ceilings, or even floors, of a building. The "Rayescent" panels produce a cool, shadowless light which can be easily varied in respect to the brightness or color by turning a dial.

Research in electroluminescence has revealed other sources of light. One potentially important discovery is the possibility of deriving light from silicon carbide. In certain crystals of this material, there are locations which mark boundaries between areas having different concentrations of impurity. Electrons traveling across these boundaries lose energy in the form of light. This requires only a small potential of dc current as compared to the high frequency ac at high voltages necessary in a "Rayescent" panel.



Dr. John W. Coltman, manager of the electronics and nuclear physics department of the Westinghouse Research Laboratories, demonstrates how a weak source of light can control the much greater brightness of a "Rayescent" panel.

The panel, about one-eighth of an inch thick, consists of a coating of phosphors suspended between a metal and glass plate.



Nuclear Reactor Exhibited: The world's first mass-produced nuclear reactor, the AGN 201, has been demonstrated by Aerojet-General Nucleonics of San Ramon, Calif. Over 12,000 people saw the reactor at the Nuclear Congress in Philadelphia this March.

Some 200 scientists and engineers, including visitors from 20 "Atoms for Peace" countries were given the opportunity to sit at the control console and have complete and safe control over a nuclear chain reaction of fissioning and splitting uranium atoms.

Aid for Landing Aircraft

A device, called the Instrument Display Projector, provides at a glance essential information to pilots for completing an instrument landing, while at the same time allowing visual contact outside the airplane. Components of the system are a 1½-in. diam cathode ray tube; a mirror system; collimating optics, or optics that make light rays parallel, and a trichroic combining glass that uses a color contrast principle to enhance definition of the reflected image. With the color separation principle and conventional cathode ray tube, the instrument is capable of obtaining suitable image definition against a bright sky background.

An example of actual application of the instrument, developed by Autonetics Div. of North American Aviation Inc., would be the presentation of instrument landing system data for transport aircraft. In this case, the cathode ray tube image would reproduce the cross-pointer indication, artificial horizon, and a moving pip denoting deviation from desired approach speed. With this information appearing on the windshield display, the pilot could simultaneously assimilate such data and maintain visual contact with the runway. In operation, the cathode ray tube's image is reflected by the mirror system to the collimating optics and then to the color-separating combining glass. The combining glass is interposed in the pilot's line of vision immediately in front of the cockpit windshield.

Since the display is focused to infinity, flight data reproduced on the cathode ray tube appear to the pilot as a bright image suspended in space. As a result, the pilot has no eye accommodation problem, or one that would require him to transfer his visual attention from the tube image to objects outside the airplane.

Varian Strip Chart Recorders

POTENTIOMETER PERFORMANCE* AT MODERATE COST

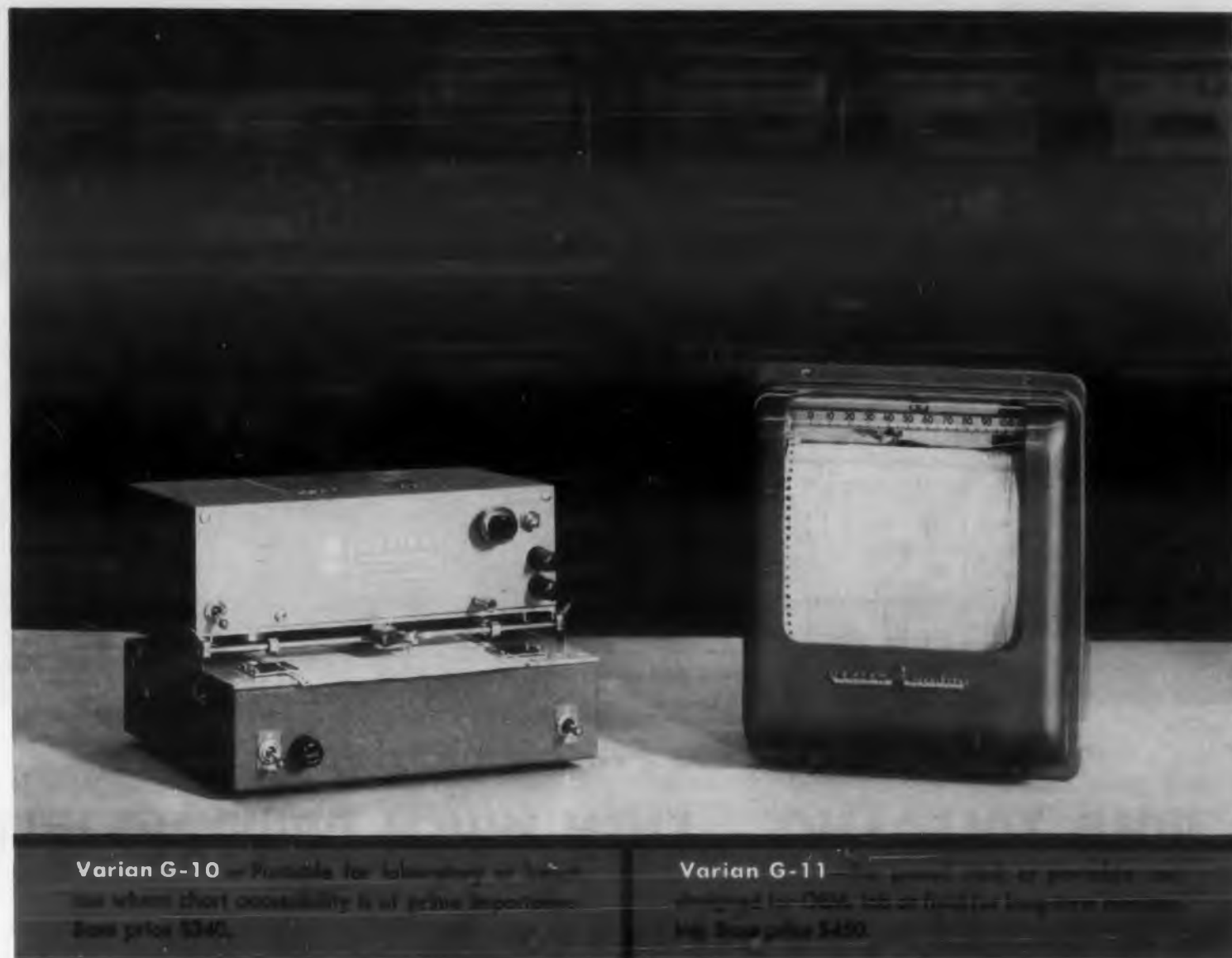

Varian G-10

Varian G-11



The servo-balance potentiometer method has long been used in expensive recorders to achieve superior stability, sensitivity, ruggedness and high input impedance. Use of servo balancing systems assures full realization of these inherent advantages by providing ample power independent of the source being measured. Now Varian offers you recorders of moderate cost using this time-proven principle.

VARIAN SPECIFICATIONS:

- Spans as low as 10 mv
- Limit of error 1 %
- Maximum source resistance 50K ohms or higher
- Balancing times: 1 second or 2.5 seconds on G-10; 1 second on G-11

WRITE TODAY FOR COMPLETE SPECIFICATIONS



PALO ALTO 21, CALIFORNIA

Varian Associates manufactures Klystrons, Traveling Wave Tubes, Backward Wave Oscillators, Linear Accelerators, Microwave System Components, R. F. Spectrometers, Magnets, Magnetometers, Stalos, Power Amplifiers and Graphic Recorders and offers research and development services.

CIRCLE 12 ON READER-SERVICE CARD FOR MORE INFORMATION

TI PROGRESS REPORT ON PRECISION
DEPOSITED CARBON RESISTORS . . .



TI MIL-Line Precision Resistors

HOLD TOLERANCE...EVEN WHEN DRIPPING WET!

Soaking wet, dried out, or 'shook up' — TI MIL-Line deposited carbon resistors still far exceed MIL-R 10509B . . . emerge from one acceptance test after another — by major electronics manufacturers — with performance records that have not been equalled. *It's the seal that makes the difference* . . . an exclusive Texas Instruments process that snugly wraps these precision resistors in tough jackets of a special coating with high dielectric strength.

For ease in design, production, and maintenance

. . . for improving the reliability and saleability of your products, the moisture resistance of TI deposited carbon MIL-Line resistors is just *one* field-proven factor. You also get a choice of 1, 2, or 5% tolerances . . . high stability over wide temperature ranges and under full load . . . low negative temperature coefficients . . . negligible voltage coefficient and noise levels . . . long shelf-life . . . wide selection of sizes and resistance values . . . reasonable prices . . . and, if desired, reel-type packaging for automation.



Here is a typical TI reel pack designed to speed production. TI precision deposited carbon resistors are mass produced and packaged in five sizes from 1/2 watt to 2 watts with resistance values from 25 ohms to 30 megohms.

For complete data, write for
Bulletin DL-C 539.

TEXAS INSTRUMENTS
INCORPORATED
6000 LEMMON AVENUE DALLAS 9, TEXAS

CIRCLE 13 ON READER-SERVICE CARD FOR MORE INFORMATION

Engineering Review

Wire's Frequency Measures Air Speed

A new technique for measuring vital flight test data is being utilized in the testing of Convair F102A all-weather supersonic jet interceptors at Edwards Air Force Base, Calif. Called a Vibrotron Absolute Pressure Transducer, it is capable of measuring altitude and airspeed through changes in the tension exerted upon a 2-1/2 in. wire about the thickness of a human hair. Tension variations on the fine wire are sensed as extremely precise frequency changes which are readable as numerical indications at ground level.

The Transducer, developed by Borg-Warner Corp., Calif., consists of a fine wire stretched between a diaphragm and an anchor point within a magnetic field. The length of the wire and the tension exerted upon it determine the frequency at which it vibrates. When pressure changes resulting from variations in altitude or airspeed expand the diaphragm, the latter in turn reduced the tension on the wire and this tension change is then detected as a frequency change.

In actual operation during flight testing, two Vibrotron Transducers are utilized, one which senses total pressure and a second which senses static or barometric pressure. When these pressure signals are amplified and transmitted to ground level stations, the static pressure signal indicates altitude. Then by mechanical methods, the static pressure indication is subtracted from the total pressure indication to establish a plane's airspeed.

Trade Shows Challenged

A questionnaire was recently prepared by the RETMA Trade Show Survey Committee to determine the cost of exhibits to manufacturers and their opinion as to the value of trade shows. The survey is the result of the committee's alarm at the rising number of industry exhibits and shows throughout the nation. The value of such shows is questionable and it is the committee's intent to ascertain their actual effectiveness and utility.

Electronic Metal Detector

RCA has placed on the market a new type of metal detector specially developed for continuous electronic inspection of textile fabrics in production. The first production model of the textile inspector has been installed by Klopman Mills, Inc. of High Point, N. C. It can spot dot-size stray metal in strip material traveling at 10 to 1000 ft per min and can trigger alarm systems, stop production lines, activate warning signals or mark contaminated areas on the fabric.

The metal detector uses special coils to produce a high-frequency electromagnetic field which is distorted by stray metal. Field distortion creates an electrical signal which is fed to a control unit, amplified and used to trigger the alarm system.

The unit, which should protect product and production equipment, also is expected to have important applications in continuous inspection of plastics processed in sheet form.

Launch It-Yourself Rockets

Small, high-altitude rockets may shortly become commonplace university research tools for investigating the stratosphere. The great demand for trained scientists in the fields of rocket technology, telemetering techniques and upper atmosphere research has turned a number of universities toward high-altitude rocket research. This would make possible teaching advanced work which will gain in importance as means are developed for projecting vehicles into the space around the earth.

Maryland University, in collaboration with Republic Aviation Corp., has designed the Terrapin high-altitude sounding rocket, a 200-lb midget consisting of a modified ABL Deacon first stage and a Thiokol T-55 second stage which, in line with university requirements, is a low-cost vehicle that has the great advantage of being easily launched. This is the beginning stage of a small-rocket upper atmosphere program which will investigate many important high-altitude phenomena, such as cosmic rays, solar radiation, micrometeors, the earth's magnetic field, the day airglow and night airglow, the aurora, magnetic storms and others.

CIRCLE 14 ON READER-SERVICE CARD ►

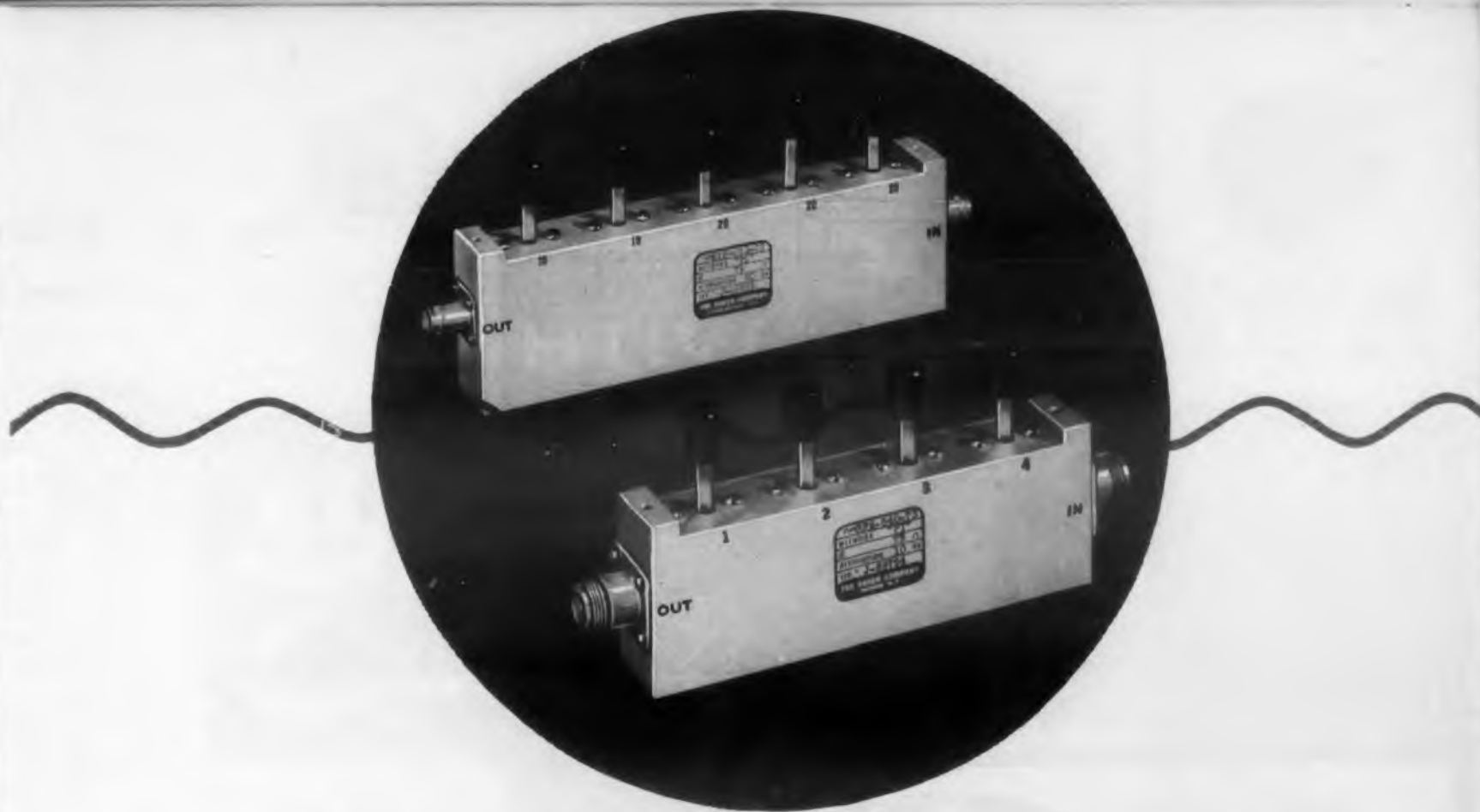

FOR ACCURATE ATTENUATION OVER A WIDE FREQUENCY RANGE...

RF Attenuators by **DAVEN**

These units are used in signal generators, wide-band amplifiers, pulse generators, field intensity meters, micro-wave relay systems, and repeater stations. They find application as laboratory standards, test equipment, and for checking out all types of instruments.

Daven RF Attenuators are available, in combination, with losses up to 120 Db in two Db steps; or 100 Db in one Db steps. Due to their internal circuitry and construction, they have a zero insertion loss over the frequency range from DC to 225 megacycles.

Standard impedances are 50 and 73 ohms, with special impedances available on request. Resistor accuracy is within $\pm 2\%$ at DC. An unbalanced circuit is used which provides constant input and output impedance. The units are supplied with either UG-58/U or UG-185/U receptacles or Coaxial lead terminations. Individual units with single-section cavities can be obtained.

Many of these types are available for delivery from stock.



Solenoid actuated RF Attenuators are also available in various decibel combinations and any number of steps up to 5.

| TYPE | LOSS | TOTAL Db | STANDARD IMPEDANCES |
|---------------|-----------------------|----------|-----------------------------------|
| RFA & RFB 540 | 1, 2, 3, 4 Db | 10 | 50/50 Ω and 73/73 Ω |
| RFA & RFB 541 | 10, 20, 20, 20 Db | 70 | 50/50 Ω and 73/73 Ω |
| RFA & RFB 542 | 2, 4, 6, 8 Db | 20 | 50/50 Ω and 73/73 Ω |
| RFA & RFB 543 | 20, 20, 20, 20 Db | 80 | 50/50 Ω and 73/73 Ω |
| RFA & RFB 550 | 1, 2, 3, 4, 10 Db | 20 | 50/50 Ω and 73/73 Ω |
| RFA & RFB 551 | 10, 10, 20, 20, 20 Db | 80 | 50/50 Ω and 73/73 Ω |
| RFA & RFB 552 | 2, 4, 6, 8, 20 Db | 40 | 50/50 Ω and 73/73 Ω |

Other Db loss combinations are available.

Write for complete information



THE **DAVEN** CO.

524 West Mt. Pleasant Ave.
Route 10, Livingston, N. J.

12 STAGES WITH STABILITY



Du Mont 12-stage Multiplier Phototubes provide the high gain of 12 stages plus outstanding stability to assure uniform results over long-term use. Du Mont 12-stage Multiplier Phototubes are available in 2", 3", 5", 12" and 16" sizes.

You can always count on Du Mont Precise Photoelectronics to do the job right — every time.

DU MONT[®]
Precise PHOTOELECTRONICS

Industrial Tube Sales, ALLEN B. DU MONT LABORATORIES, INC. 2 Main Ave., Passaic, N. J.
CIRCLE 15 ON READER-SERVICE CARD FOR MORE INFORMATION

Washington Report

Herbert H. Rosen

Airways Control Board Proposed

President Eisenhower has sent to Congress a bill in which is recommended the establishment of the Airways Modernization Board. As an independent agency, it would be "responsible for developing and consolidating the requirements for future systems which are needed to accommodate the future air traffic in the U.S. Other responsibilities include systems engineering, and the evaluation and selection of such aids as will best serve the needs of aviation."

The plan was proposed, and presented virtually word for word, by the President's Special Assistant for Aviation Facilities Planning, Edward P. Curtis. He and his staff have made exhaustive studies for the past year. They found that our air traffic system is antiquated and under strength, but not for lack of scientific ideas. "In fact, an over-abundance of electronic systems have been developed in the laboratories to improve our terminal and enroute operations. Most of these have been shelved and never used," Mr. Curtis said. He cited the principal cause as the setting up such bodies as the Air Navigation Development Board with broad responsibilities but no authority to implement its recommendations.

The Airways Modernization Board will have such authority. It will specify new systems which will best serve all air navigation and traffic control. However, the Board will not have the authority to develop or procure the final ground or airborne equipments to be used in operations. Nor will it usurp the powers and authority of the Civil Aeronautics Administration, especially in light of its current expanded program aimed at equipping the airlines for the jet transport age. There are indications, as well, that a final report from Mr. Curtis will make some sweeping recommendations for changes in the Federal Government organization of aviation matters.

Frank D. Newbury Resigns

Apparently bending to the attacks of the research community, Frank D. Newbury, Assistant Secretary of Defense (Research and Engineering), has resigned from his job. His office was established only last Feb. 25 when the research and engineering functions of the Department of Defense were

merged into one secretariate. Newbury has been a defense assistant secretary since 1953, when he left Westinghouse (and semi-retirement as a consultant) to help Charles Wilson set up a new secretariate for applications engineering. At the same time, Donald Quarles came in from Sandia Corp. to organize a similar secretariate for research and development. Quarles has more recently assumed the position of Deputy Secretary of Defense, the number-two job in the department.

Newbury's appointment to the research and engineering post precipitated an avalanche of derision from that portion of the scientific community believing he would relegate research to a secondary position. Although no final organization had been disclosed, feelings ran high that research programs in the Department of Defense would be largely curtailed or eliminated in favor of engineering programs leading to a weapon or system.

With the statement that he had originally agreed to stay for only six months (it stretched into four years), Newbury said it was past the time for him to bow out. Sources close to the Secretary say that the 76 year old engineer felt that the battle between research and engineering was just too much. A successor will be named some time in May.

Signal Corps and Industry Sponsor Reserves

A new twist in the military reserve program has been revived by the U.S. Army Signal Corps with the help of private industry. Last month Chief Signal Officer Maj. Gen. J. D. O'Connell and B. M. Grimes, Superintendent of the American Cable and Radio System in Washington, signed an agreement that established the 262nd Signal Company. By the agreement, ACR employees may become members of the Signal Company and hold their meetings in a training center supplied and maintained by the ACR. This idea of industry-service cooperation goes back to the Civil War. More than 400 units were in operation after World War II. But apparently the whole concept collapsed after that and has only recently been revived. This latest agreement with ACR marks the ninth in the Signal Corps. Most of the others are in the New York City area.

Members of the Signal Company have all of the benefits, rights, and responsibilities of any other reserve soldier. They will be "asked" to participate in the two-week summer drills common to such organizations. Eventually, they will be briefed on all of the new techniques and equipment being used in the Signal Corps. According to Brig. Gen. K. F. Zitzman, Chief of Personnel Training, "the (concept) offers a new kind of challenge to the tested relationship between the Communications-Electronics industry and the Army Signal Corps—for the first time in history we have a requirement for a large and truly ready reserve force."



Type F: Miniature 12-position, 30-60° throw, can be mounted in 1-5/16" circle; phenolic, Mycalex or steatite.



Type H: Standard 12-position; 1-7/8" diameter; 15-30-60° throw; phenolic, Mycalex or steatite.



Types J, K, N: 1-17/32" diameter; provides for flexibility of layout; interchangeable sections, phenolic or steatite.



Type L or DL: Using dual eyelet fastening; 18-position; mounts in 2-9/32" circle, phenolic, Mycalex.

Special Switches



Multiple Shafts combined to operate snap switches and potentiometers; many different section types.



Type MF: 24-position switch may be mounted in 2-5/16" circle; in phenolic insulation.



Series 20: Simple switch for tone controls, band switching, and talk-listen circuits.



For Printed Circuits: Special lug design for insertion into printed circuit boards.

an INFINITE VARIETY
from standard parts



SWITCHES
CHOPPERS
ROTARY SOLENOIDS*
SPECIAL ASSEMBLIES
VIBRATORS

OAK

MFG. CO.

Dept. D, 1260 Clybourn Ave., Chicago 10, Ill.
Telephone: MOhawk 4-2222

*Manufactured under License from G. H. Leland, Inc.

• No matter what you need in low-current switches, you are most sure to find it in an OAK switch design. In the last 25 years, OAK has produced over a quarter billion switches—rotary, slider, pushbutton, plug, and door switches—in thousands of variations. Why not take advantage of OAK's unmatched, switch engineering background . . . production facilities . . . and huge inventory of tooling?

WRITE FOR your copy of the OAK Switch Catalog which covers the most popular of OAK's standard switches.

Type 160 Rotary Slider: 7/8" height allows shallow chassis; leads are readily accessible.



Type 183: New lever-operated version of the standard Oak rotary switches.



Type 130 Pushbutton: Available with from one to 24 buttons, 32 contacts each button.



Type 80 Pushbutton: Very adaptable. Used in communication equipment; economical for less complex applications.

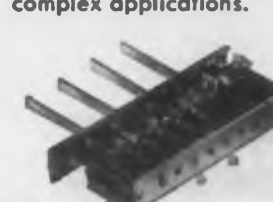

CIRCLE 16 ON READER-SERVICE CARD FOR MORE INFORMATION

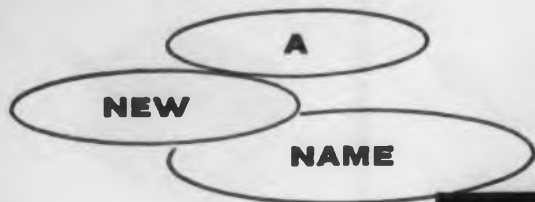

KINTEL

for **KAY LAB** products

The same company, the same engineering and manufacturing facilities, the same world-wide staff of field engineers, but a new name more descriptive of the Company and its products.

LOOK FOR **KINTEL** ON:



UNIVERSAL DC
MICROVOLT METERS

INDUSTRIAL TELEVISION
EQUIPMENT

MICROVOLT LEVEL
BROADBAND DC
AMPLIFIERS

BROADCAST TELEVISION
EQUIPMENT

ABSOLUTE DC POWER
SUPPLIES AND
METER CALIBRATORS

On these and many other electronic products the name **KINTEL** means outstanding instruments and television equipment.

KINTEL
[KAY LAB]

Representatives in all major cities

Write, wire, phone today for demonstration

ELECTRONICS FOR COMMUNICATION • MEASUREMENT • CONTROL

5725 KEARNY VILLA ROAD • SAN DIEGO 11, CALIFORNIA • BROWNING 7-6700



Government Needs Engineers

Dear Sir:

There are many challenging job opportunities in engineering and physical sciences at the Diamond Ordnance Fuze Laboratories (DOFL), Washington, D.C. These research and development laboratories are a part of the Ordnance Corps, Department of the Army, and paid advertising for the purpose of recruiting personnel is not allowed. Your magazine reaches many engineers, physicists, chemists, mathematicians, and others in the field of physical science and engineering. As an additional informational service to such people, we believe you may wish to publish this letter in your Editors Column, as an announcement of employment opportunities.

The program at Diamond Ordnance Fuze Laboratories concerns interesting and vital defense work and practically every field of the physical sciences and engineering are utilized. Such typical fields are, electronics, physics, mechanics, applied mathematics, chemistry and optics. Research is carried on in such relatively new fields as microwaves, ferrites, transistors, printed circuits, and plastics. The programs include system analysis; invention and investigation of new approaches to fuzing, circuits, and mechanisms. There is work involving the design, development, laboratory and field testing of a new fuze or other related devices.

A qualified scientist or engineer coming to the Diamond Ordnance Fuze Laboratories can often choose the type of work preferred. There are good opportunities for advancement for those who demonstrate their professional growth, and there are college level courses both at the Laboratories and in nearby universities to help one advance in his field. The Diamond Ordnance Fuze Laboratories will pay the major part of such tuition costs, and allow time for attendance at such courses.

Employment applications (Standard Form 57) are available from any of the Civil Service Commission offices or post offices, or directly from Civilian Per-

Letters to the Editor

sonnel Office, Diamond Ordnance Fuze Laboratories, Washington 25, D.C.

Lawrence P. Conners, Chief
Civilian Personnel Office
Washington, D.C.

Dear Sir:

I am writing to ask if there is any possibility of your magazine helping government laboratories. I am an engineer at the Rome Air Development Center which has a significant role in the development of Air Force electronic equipment and techniques. It is important that RADC engineers contract to have industry's engineers work on the "right" jobs. To recognize what these "right" jobs are and formulate the best approach to their solutions requires a caliber of engineer at least as high as that of industry—and requires engineers in sufficient numbers.

Our government laboratories cannot spend funds for advertising to attract the quality and numbers of engineers they need.

In my opinion, RADC has a critical shortage of engineers—and the consequences of this shortage are more costly to the nation than the equivalent shortage of engineers in industry. . . . I am not representing RADC in this letter, but am writing as a private citizen.

Incidentally, I believe your magazine provides a valuable service to the industry.

William J. Blinn
Rome Air Development Center
Rome, New York

Correction

On page 50 of the April 1 issue, the "Improved Noise Blanker" produced by Hoover Electronics Co. appears with the photo of another product from the same company. Illustrated is the Subcarrier Oscillator designed for use in telemetering systems.

EDISON RELAYS FOR AIRBORNE AND OTHER ELECTRONIC CONTROL EQUIPMENT

One of the oldest names in relays continues to improve the state of the art. For your specific design problems there is an Edison relay you can rely on for maximum performance and durability. The millions of Edison relays in use today are your assurance of reliability.

SENSITIVE MAGNETIC RELAY



Polarized operating characteristic of this magnetic d-c Relay makes it ideal for use as a null detector in ordinary bridge circuits. It can operate directly from a thermocouple or photocell. Both coils brought out to separate pins in base make it easy to calibrate and overhaul and versatile to apply. Hundreds of thousands of these relays are now in use in airborne control equipment.

SPECIFICATIONS

Contacts: SPST or SPDT normally open or closed. Rated for 1/2 ampere at 28 volts d-c.

Hermetically sealed: Model 220

Gasket sealed: Model 219

Vibration and shock resistant: relay unenergized will withstand shock of 50g's in all planes without damage or change in calibration

Closing current: contacts close on input currents from 30 microamperes d-c to 12.5 milliamperes d-c. Lower closing currents available in special circumstances.

Coils: Formvar-coated copper. Resistances from 0.5 ohm to 23,600 ohms. Normal closing power may be increased 10,000 times without adverse effects.

Weight: .15 lb. max.

Seated height: 2 1/2" max.

Base: plug-in, printed circuit or solder hook

For more information, write for Bulletin #3037

NEW EDISON MINIATURE TIME DELAY RELAY MODEL #250



Specially designed for missile and jet aircraft applications, this vibration resistant unit incorporates the following design features:

- 1) virtual elimination of contact chatter up to 1500 cps at 10 g's.
- 2) no resonance to 500 cps.
- 3) ambient compensation between -65° C and +85° C . . . operation at higher temperatures when necessary.
- 4) contacts rated for 1 ampere at 27.5 VDC or 3 amperes at 115 volts AC.
- 5) extra-rigid construction for exceptionally high contact pressure.
- 6) can be mounted in any position without affecting operating characteristics. 7-pin plug-in or solder hook base.
- 7) hermetically sealed.

For more information, write for Bulletin #250.

STANDARD OCTAL TIME DELAY RELAY MODEL #501



10 years of Edison research and engineering have produced a widely-accepted line of hermetically sealed Thermal Relays . . . more than one-half million have already been manufactured for use in cathode protection circuits, autopilots, gyro stabilizers and other electronic equipment.

SPECIFICATIONS

Time delays: 2 seconds to 300 seconds

Heater voltages: 6.3, 26.5, and 117 (intermediate voltages available in special circumstances)

Heater input: 5 Watts nominal (continuous excitation)

Contacts: SPST normally open or closed. Rated for 8 amperes max. at 450 volts a-c or d-c.

Ambient: compensated for -80° C to +85° C

Shock: resists impact of 50g's

Vibration: resists 1/8" overall amplitude at 55 cps

Tolerances: heater voltage: positive contact operation with variation of ±10%.

Operating time at 25° C: ±15% max.

Weight: 1 1/4 to 2 1/4 oz.

Seated height: 3 1/4"

Diameter: 1.275" max.

Base: Intermediate octal

For more information, write for Bulletin #3007.

McGraw
EDISON

Thomas A. Edison
INDUSTRIES

INSTRUMENT DIVISION WEST ORANGE, N. J.

CIRCLE 18 ON READER-SERVICE CARD FOR MORE INFORMATION

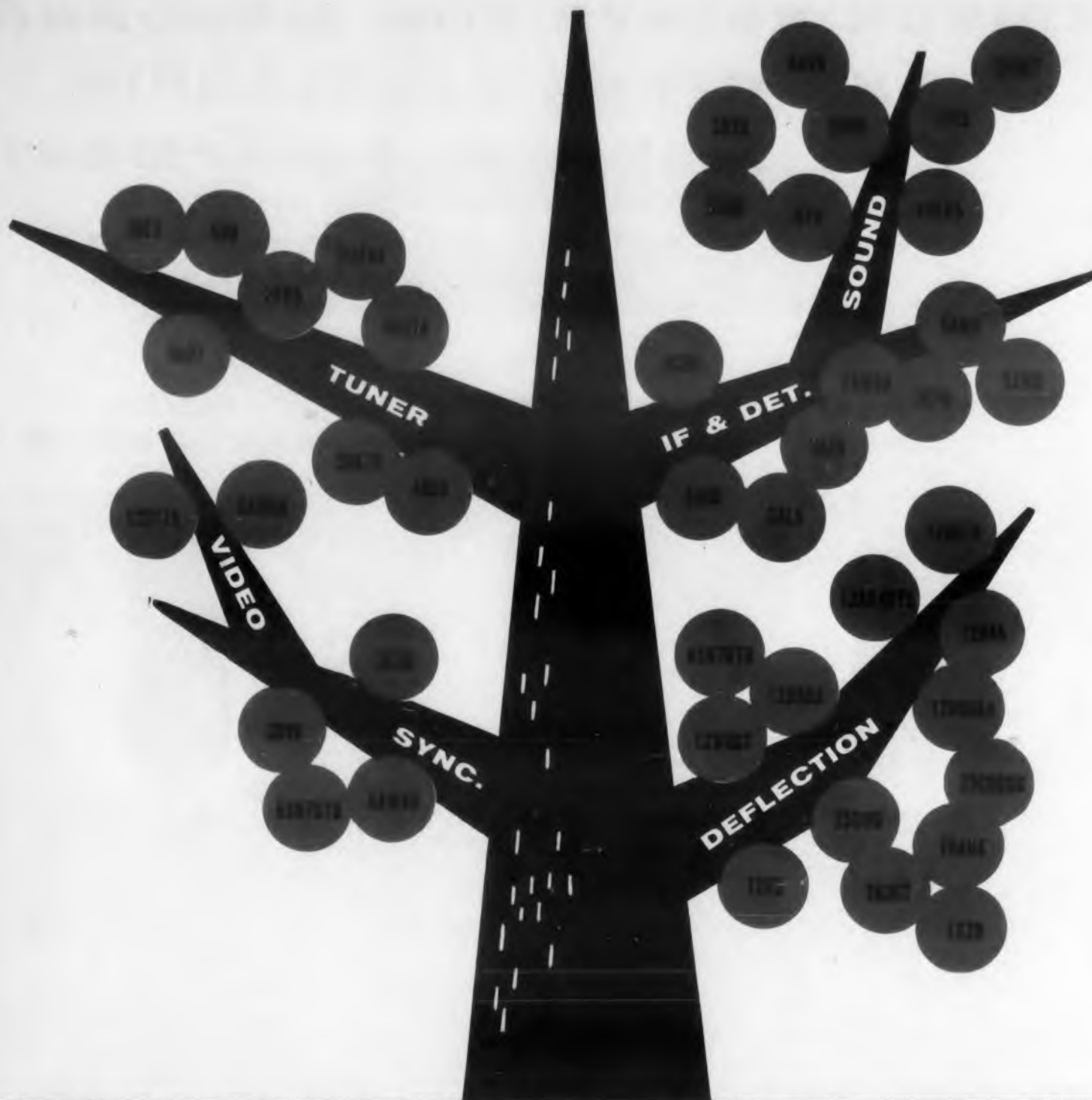

The first family of 600 ma Series-String TV Tubes

In 1953, Tung-Sol became the leading proponent of 600 ma series heater tubes for TV receivers. This program was made possible through advanced designs in heater and cathode structures that would permit controlled heater warm-up time.

The success of this pioneering led further to the development of series-string tubes for 450 and 300 ma currents. These are designed for sets using smaller numbers of tubes.

In all, nearly one hundred of these types have been introduced, indicating the complete success of the

CIRCLE 19 ON READER-SERVICE CARD FOR MORE INFORMATION

series-string design principle.

Tung-Sol is currently supplying all of the series-string tube types required for replacement service as well as for initial equipment production.



TUNG-SOL®
ELECTRON TUBES

TUNG-SOL ELECTRIC INC., NEWARK 4, N. J.

Meetings

May 16-18: Eighth Annual Conference and Convention, American Institute of Industrial Engineers

New York City, Hotel Statler. For information write to AIIE, P.O. Box 8, Substation 135, The Bronx 53, New York.

June 6-7: First National Symposium on Production Techniques

Hotel Willard, Washington, D. C. Sponsored by the IRE Professional Group on Production Techniques. Discussions will be held on "How to Prepare For and Implement Automation" and "Military Problems in Electronic Automation." Papers will be presented on "Designs for Production." For information, write to IRE, 1 E. 79th St., New York 21, N.Y.

June 8-12: Technical Career Conference

Sherman Hotel, Chicago. Sponsored by the Technical Career Council. For more information write Marcus W. Hinson, Technical Career Council, 19 S. LaSalle St., Chicago 3, Ill.

June 10-11: Second RETMA Symposium on Applied Reliability

Syracuse, N.Y., Hotel Syracuse. Symposium emphasizes the practical aspects of achieving reliability. Sessions will be held on mechanical design, selection and use of components, proof of mature design and case histories of reliable and unreliable designs. A panel discussion is planned on industry vs. military responsibility on contract and specification control for reliability. Advance registrations will be handled by the RETMA Engineering Office, Rm. 650, 11 W. 42nd St., New York 36, N.Y.

June 10-14: Fifth Annual Technical Writers' Institute

Rensselaer Polytechnic Institute, Troy, N.Y. Designed for those who supervise technical writing in business, industry and the professions. Sessions on manuals and instruction books, reports, technical promotion, training programs, industrial films and graphic and illustrative aids. For additional information, write Jay R. Gould, Director, Technical Writers' Institute, Rensselaer Polytechnic Institute, Troy, N.Y.

June 27-29: Thirteenth Annual Meeting of the Institute of Navigation

Washington, D.C. For more information, write to Peter C. Sandretto, Federal Telecommunication Laboratories, Nutley, N.J.

Aug. 20-23: Wescon (Western Electronic Show and Convention)

Cow Palace, San Francisco, Calif. Sponsored by the San Francisco and Los Angeles Sections representing the Seventh Region IRE and West Coast Electronic Manufacturers Association. For more information write to Don Larson, Business Manager, 342 N. LaBrea Ave., Los Angeles 36, Calif. For those interested in submitting papers, check the paper deadlines at the end of this section.

Sept. 4-6: Special Technical Conference on Magnetic Amplifiers

Penn Sheraton Hotel, Pittsburgh, Pa.

Oct. 31-Nov. 1: Third Annual Technical Conference of the Professional Group on Electron Devices, IRE.

Shoreham Hotel, Washington, D.C. Those interested in submitting papers should check the paper deadlines at the end of this section. For more information, write W. M. Webster, RCA Semiconductor Div., Somerville, N.J.

Paper deadlines

Aug. 1: Deadline for papers proposed for the Oct. 31-Nov. 1 conference of the Professional Group on Electronic Devices, IRE, in Washington, D.C. Abstracts should be submitted to the program chairman, W. M. Webster, RCA Semiconductor Div., Somerville, N.J. Subject matter should concern developmental techniques and devices, such as electron tubes and transistors, rather than basic research or circuit applications.

Correction

Appendix I of "Production Design of Compensated Attenuators," January 15, page 41, should be corrected as follows:

Equation (3) of appendix 1 should read

$$K = (R_1 + R_2) / R_2$$

The tolerances assigned to C_1 and C_2 should be $(n_1 \times 100)$ percent and $(n_2 \times 100)$ percent, respectively.

Near the bottom of page 41 of appendix 1, the limit should be $K \geq 100$. At the bottom of the same page the extreme right hand term should be epsilon to the power $(-1 + m + n_2 + mn_2)$ rather than the product.



POWER TRANSISTORS

- High power ratings
- High power gain
- Rugged, compact mechanical design
- Welded, hermetically sealed package for stability and long life
- Excellent heat dissipation characteristics

Now Clevite can supply you with power transistors that fit your needs for audio applications, portable power supplies, etc., from a full line of six types. All are available in production quantities. All are rated at 25 watts continuous operation with infinite heat sink — 15 watts with 36 sq. in. heat sink.

Clevite Power Transistor packaging is compact. Hermetic sealing under carefully controlled conditions insures stability and long life. Low thermal resistance between collector junction and large copper flange insures excellent heat conduction from the package to the heat sink.



CLEVITE
TRANSISTOR PRODUCTS

241 Crescent St., Waltham 54, Mass. TWinbrook 4-9330

Clevite Divisions: Brush Electronics Co. • Cleveland Graphite Bronze Co. • Clevite Harris Products Inc. • Clevite Research Center • Clevite Ltd.

CIRCLE 20 ON READER-SERVICE CARD FOR MORE INFORMATION

MILITARY TYPE 2N297

The only power transistor covered by actual military environmental test standards for vibration, shock, life, temperature, moisture resistance, etc.

FOR COMPLETE DETAILS
WRITE FOR DATA SHEET B-214

OUTLINE SPECIFICATIONS FOR COMMERCIAL POWER TRANSISTORS

| TYPE | 2N268 | CTP 1111 | 2N257 | CTP 1104 | CTP 1109 | CTP 1108 | Units |
|--|-----------------|-----------------|-----------------|-----------------|-----------------|-----------------|-------|
| Instantaneous Collector-to-Base Voltage (absolute maximum) | -80 | -80 | -40 | -40 | -20 | -20 | Volts |
| Junction Temperature (absolute maximum) | 85 | 85 | 85 | 85 | 85 | 85 | °C |
| Average Total Power Dissipation (with inf. heat sink @ 25°C) | 25 | 25 | 25 | 25 | 25 | 25 | Watts |
| Average Total Power Dissipation (with 36 sq. in. heat sink @ 25°C) | 15 | 15 | 15 | 15 | 15 | 15 | Watts |
| Power Gain | 28 ^a | 23 ^a | 30 ^a | 23 ^a | 27 ^b | 20 ^b | db |
| Frequency Cutoff | 6 | 4 | 7 | 4 | 6 | 4 | kc/s |

^a $V_{cc} = -14V$; $I_c = 500$ ma; $R_L = 30 \Omega$ (choke coupled); $R_E = 10 \Omega$

^b $V_{cc} = -7V$; $I_c = 500$ ma; $R_L = 15 \Omega$ (choke coupled); $R_E = 10 \Omega$

For Commercial Power Transistor Details
Write for Data Sheet B-211

This is Part I of a two-part article on electronic equipment cooling. The subject of cooling is taking on increased importance as efforts are made to miniaturize and "force" more equipment into smaller and smaller packages. In this first part of the article, the author presents basic design principles of cooling and describes methods of natural air convection and metallic conduction. In the second part, to follow in the next issue of *Electronic Design*, other methods of cooling, including forced air cooling, will be described in detail to offer the designer means of making a selection for his particular application.

Cooling Packaged Electronic Equipment

I—Basic Design Principles

A. Donald Hay, Chief Engineer

McLean Engineering Laboratories
Princeton, N. J.

MOST electronic systems produce an appreciable amount of heat. If this heat is not purposefully removed, the temperature of the electronic components may well rise to the point where accuracy of calibration is impaired, the life of components is materially reduced, or the equipment fails. Thus the thermal design is as important as the circuit design, and both must be well executed.

The electronic engineer or physicist is normally much more familiar with circuit design than thermal design. An attempt will be made to survey the methods of cooling electronic components. Recommendations will be made indicating which type of cooling should be used, as a function of heat dissipation and other factors. Emphasis will be placed on forced-air cooling, as this requires engineering and covers the greatest proportion of the systems. The design methods will be explained so that a large proportion of the cooling problems may be solved by the electronics engineer. Sufficient background material will be given so that, if the cooling problem is to be turned over to another engineer or group, the electronics designer will know basically how the cooling design should be made and the terms used. A detailed explanation of heat transfer calculations cannot be made, but references to texts and manuals which elaborate on many of the methods described will be given.

Design Parameters

The designer must know at what temperature the components should operate and the maximum tem-

perature, and often humidity, allowed. A series of electronic components is being developed which can, and indeed often must, operate at several hundred degrees centigrade. The upper limit for tubes is found in tube manuals, often about 100 C, and for common electronic parts other than tubes, 85 C. One common specification is that the air temperature surrounding the electronic equipment shall not exceed 10 C above the room ambient temperature, for normal room temperatures.

Thermal Design Principles

Several physical principles will be mentioned, since a knowledge of the processes depends upon their understanding. The rate of heat transfer in any given configuration is controlled by a difference in temperature. The heat flows from the hot substance to the cooler substance. If the transmitted heat is not removed from the cooler substance (of finite size), it will increase in temperature, thus decreasing the heat transmitted unless the temperature of the hot substance is also increased. This indicates that the thermal design should not be considered safe unless the designer can trace the flow of heat from the source through paths of adequate carrying capacity to an adequate "sink" to absorb the heat. The sink is normally a large body of air or water. If the temperature of the air in a room is controlled it may be considered a sink, while an uncooled electronic chassis may not.

Heat may be transferred from one substance to another by means of conduction, convection, radia-

tion, or a combination of two or more of these methods.¹ Evaporation and condensation are characterized by a change of state. The basic equation is the same as for convection. For conduction and convection, the heat transfer is proportional to the difference in temperature between the two points under consideration. For radiation, it is proportional to the difference of the fourth power of the absolute temperatures. Because radiation often occurs simultaneously with conduction and convection, acceptable methods² have been developed to approximate the total heat flow by using only the first power of the temperature in order to simplify the solution.

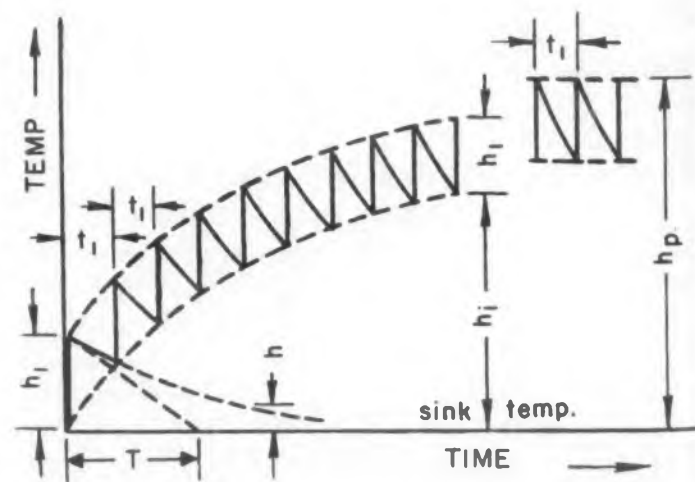

Fig. 1. Periodic Heat Pulses

Most heat flow calculations are based on one of the following rates of heat flow with respect to time. The most common is steady flow. Here the rate of heat flow is constant and the temperature at each point under consideration remains constant. Many of the equations found in literature apply only to a steady-flow analysis. Some electronic circuits involve short pulses of energy which dissipate heat, such as repeated condenser discharge. This condition is shown in Fig. 1.

The temperature after the pulse will drop exponentially. The convenient measure of this transient decay is the time constant, T , after which time the initial temperature ($h_i + h_1$) has dropped to $(1/e)$ of its original value. Mathematically,

$$h = (h_i + h_1) e^{-(t/T)}. \quad (1)$$

From this the initial slope of the curve is $-(h_i + h_1)/T$, as may be seen in Fig. 1. T is dependent upon the mass and specific heat of the hot body and upon the impedance of the thermal path in removing the heat. It may be computed from physical properties or found by measuring the transient by testing the equipment while recording the decay or by using equation (4).

The initial heat pulse raises the temperature of the equipment an amount h_1 above the sink temperature. At the end of n pulses the equipment temperature will be

$$h_1 \sum_{i=0}^{n-1} e^{-(i t_1/T)} = h_1 \frac{[e^{-(n t_1/T)} - 1]}{[e^{-(t_1/T)} - 1]}.$$

The maximum temperature, when n goes to infinity is

$$\frac{h_p = h_1}{[1 - e^{-(t_1/T)}]}. \quad (2)$$

The expansion of the exponential

$$e^{-(t_1/T)} = 1 - \frac{t_1}{T} + \frac{t_1^2}{2! T^2} - \frac{t_1^3}{3! T^3} + \dots$$

The substitution of the first two terms of the expansion for $e^{-(t_1/T)}$ in equation (2) gives

$$h_p = h_1 (T/t_1), \quad (3)$$

but this is accurate only for $t_1/T < 0.3$ as may be seen in Table 1.

Table 1. Functions Of The Critical Ratio, t_1/T

| t_1/T | $e^{-(t_1/T)}$ | $1 - (t_1/T)$ | $1 - e^{-(t_1/T)}$ | R* |
|----------|----------------|---------------|--------------------|----------|
| 0 | 1 | 1 | 0 | 1.00 |
| 0.1 | 0.905 | 0.9 | 0.095 | 1.05 |
| 0.3 | 0.742 | 0.7 | 0.258 | 1.16 |
| 0.5 | 0.607 | 0.5 | 0.393 | 1.27 |
| 1.0 | 0.366 | 0 | 0.634 | 1.58 |
| 1.5 | 0.223 | -0.5 | 0.777 | 1.93 |
| 2.0 | 0.135 | -1.0 | 0.865 | 2.31 |
| 3.0 | 0.050 | -2.0 | 0.950 | 3.16 |
| ∞ | 0 | $-\infty$ | 1.000 | ∞ |

* $R = (t_1/T) / [1 - e^{-(t_1/T)}]$



If you're miniaturizing . . . you'll save space, time and money with Allen Minicaps and Minisets (#0 thru #3 dia.)

These miniature Allen Hex Socket Cap and Set Screws will let you scale down your product sizes even farther. They're made from Allenoy special alloy steel — so strong that you can safely specify fewer screws or smaller sizes.

Allen Minicaps and Minisets are tiny, but very tough! — true Allens, with deep, clean, strong sockets and uniform Class 3A threads. Minicaps have the Allen knurled "Grip-Head" and are trimmed both on top and under the head, for tighter fit and better appearance. Minisets have the improved

small-cup Allenpoint that drives deeper and holds tighter.

Because sockets are uniformly true hexagon shape, the key or driver fits tight — makes starting much easier, saves a lot of time in assembly.

Diameters of these miniatures run from #0 through #3. Minicap lengths run from $1/8$ " through $1/2$ ", and Miniset lengths from $1/16$ " through $1/4$ ". Also standard in stainless steel. Your Industrial Distributor has them now. He'll show you why these Allens — like all Allens — hold tighter and last longer. Or write for information and samples.

Use Minicaps and Minisets wherever you need dependable fastening in very small assemblies:

TV, radio and telephone equipment • Guided missiles, rockets
• Panel meters • Electro-mechanical devices and servo-systems
• Computers • Control and operating mechanisms for relays
• Cameras • Instruments

Stocked and sold by leading industrial distributors everywhere

ALLEN MANUFACTURING COMPANY

Hartford 2, Connecticut, U.S.A.



CIRCLE 21 ON READER-SERVICE CARD FOR MORE INFORMATION

Table II. Comparison of Methods of Cooling

| Method of Removing Heat within Unit | Maximum Heat Dissipation | |
|-------------------------------------|---|--|
| | Watts/in. ² (for 40 C rise) | Watts/in. ³ (sealed units) |
| Free air (nat. convection) | 0.25 | 0.15 |
| Plastic embedment | — | 0.25 |
| Metallic conduction | — | 2-5 |
| Forced air cooling | 2 | 7 |
| Direct liquid cooling | 4 | 10 |
| Vaporization cooling | 7 | 20 |

Table III. Useful Dimensionless Ratios

| Symbol | Name | Formulae |
|--------|--------------|---|
| Pr. | Prandtl No. | $\frac{cu}{k}$ |
| Nu. | Nusselt No. | $\frac{h_c L}{k}$ |
| Gr. | Grashof No. | $\frac{g B \Delta t L^3 \rho^2}{\mu^2}$ |
| Re. | Reynolds No. | $\frac{L V \rho}{\mu}$ |

Table IV. Engineering System of Units
Free and Forced Convection Equations

| Symbol | Nomenclature | Units |
|--------|---|---|
| h_c | Convection coefficient of heat transfer | Btu/(hr-ft ² -F°) |
| L | Characteristic length | ft |
| k | Thermal conductivity | Btu/(hr-ft ² -F°/ft) |
| g | Acceleration due to gravity | 4.17 x 10 ⁸ ft/hr ² |
| B | Coefficient of thermal expansion | cu ft/(cu ft-°F) |
| ρ | Density | lb/cu ft |
| μ | Viscosity | lb/(ft-hr) |
| c | Specific heat at constant pressure | Btu/(lb-F°) |
| V | Velocity | ft/hr |

The above pulsed heating may be compared with the same equipment under steady state operation where the same average heat is dissipated. For equilibrium the heat emission or dissipation must equal the heat removed from the equipment. The pulsed input heat in watt-seconds equals $KMC_p h_1$, where K = heat conversion factor; M = weight; C_p = specific heat; and h_1 = temperature rise. The average rate of input heat equals $KMC_p h_1/t_1$ with no heat removal. At equilibrium the rate of heat removal must equal this. From equation (1) the rate of temperature drop is the slope of the curve with no heat supplied or h_s/T where h_s is the new steady state temperature above the sink temperature. The rate of heat removal equals $KMC_p (h_s/T)$. Therefore for heat balance $KMC_p (h_1/t_1) = KMC_p (h_s/T)$,

giving the equation

$$h_s = h_1 (T/t_1). \quad (4)$$

A comparison of equations (3) and (4) shows that for values of $t_1/T < 0.3$ the maximum temperatures of pulsed and steady heating are about equal, and heating calculations based upon average heating would be safe. For pulsed circuits with values of $t_1/T \geq 0.3$ equation (2) should be used, or equation (4) used and the right side multiplied by R of Table 1.

A variation of heat pulses is called transient heat flow. It consists of a single cycle approximated by an exponential curve on time-temperature coordinates, as for the heat pulse. The normal application is in determining the warm-up time or cooling time for a piece of equipment, and the same equations

apply. Periodic heat flow is often treated in a similar manner to transient heat flow. If the heat is caused to flow through a non-homogeneous conductor, the analysis becomes difficult and the graphical methods³ or analog computers⁴ are very often used.

Some electronic components are sealed so that dust and moisture cannot enter to harm the parts, while other components are open to the convection of air for economy, ease of maintenance, and often better cooling. There are several ways to cool either kind of packaging. The basic methods are shown⁵ in Table II and commented upon below. The numbers apply to packages approximately ten inches on a side and should not be applied to components which vary greatly from these dimensions as do transistors. If the external surface area of the device limits the thermal resistance to heat flow, the recommendations of dissipation in watts per square inch should not be exceeded. The tabulated values are only guides. The heat flow should still be analyzed by calculation.

Natural Air Convection

Consider first the cooling provided by the natural convection of free air. If the unit is sealed and has little vertical height, the natural convection currents within the unit will be small and the heat transfer will depend mainly on air conduction, radiation, and metallic conduction. Whenever a unit is sealed hermetically, it is important that dry air is enclosed (instrument air) in order to avoid moisture condensation within the unit when the temperature drops below normal. If the seal is not perfect, it is well to pressurize the unit slightly with instrument air admitted through a regulating valve. The transfer of heat through the gaseous conduction may be increased by employing a gas with a high thermal conductivity such as helium or hydrogen. The radiation is normally quite small, but on aluminum base the heat transfer by radiation may be approximately doubled in going from an etched or light anodized surface to a dark anodized surface or black crackle lacquer. The heat removal by metallic conduction is especially important for sealed units using natural convection, and use should be made of the available opportunities.

Usually the first thermal resistance that impedes the release of heat is the film coefficient which surrounds the normally small heating surface. Subsequent resistances, or impedances, are usually smaller. The basic equation for the free convection film coefficient for any fluid is:

$$Nu. = c(Gr.)^m (Pr.)^n.$$

The constant c is from 0.35 to 0.71; the values of m and n are about 0.25 and are tabulated in heat

transfer texts.^{5,6} The equation relates the pertinent dimensionless ratios so useful in fluid mechanics and thermodynamics. Those mentioned here are shown in Table III. Inspection will show the inclusion of the gas properties needed to create natural convection currents and carry heat.

Open units usually create a more effective "chimney effect" to cause the circulation of gas caused by different densities and temperatures of gas. Graphical solutions have been developed to determine the heat transferred by natural convection and radiation.^{5,6} These save much time in executing the thermal design.

Plastic Embedment

Table II shows that sub-assemblies may be potted or embedded in plastic with only a slight increase in heat dissipation. The potting is usually done for protective purposes, but the embedment materials currently available cannot withstand temperatures over 185 C. The heat transfer may be improved by incorporating metal heat conductors in the plastic.

Metallic Conduction

All electronic components must be held by some means, and, through the use of good heat conductors to support the components, much heat can be effectively drawn toward a cool sink. Several principles should be kept in mind. Miniature tubes dissipate much heat, and this may be conducted away through a proper heat shield-support and through short leads. The shield should conform to the tube shape and touch as much of the cylindrical shape as possible to avoid air films with associated thermal resistance.⁵ For best results the shield should be screwed into or soldered to the chassis to provide a good heat path. The chassis should be metal, preferably aluminum or copper, to conduct the heat toward the sink. The same principles apply to resistors, but they dissipate less heat than tubes. For best results provide short, sturdy, tight-fitting, metallic paths for the heat to follow. If convenient, attach the assembly to the hull of a ship or its equivalent to acquire a good heat sink.

References

1. *Heat Transmission*, W. H. McAdams, McGraw-Hill Book Co. Inc., 1954.
2. *Industrial Heat Transfer*, F. W. Hutchinson, The Industrial Press, 1952.
3. *Refrigeration and Air Conditioning*, B. F. Raber and F. W. Hutchinson, John Wiley and Sons, Inc., 1945.
4. Application of Difference Techniques to Heat Flow Problems Using the Electronic Differential Analyzer," R. M. Howe, AIR-10, Dept. of Aeronautical Engineering, University of Michigan, 1954.
5. "Guide Manual of Cooling Methods for Electronic Equipment," Navships 900, 190, No. 27X, Supt. of Documents, U. S. Govt. Printing Office, \$2.00, 1955.
6. "Heat Transfer in Miniaturized Electronic Equipment," Navships 900, 189, No. 26X, Supt. of Documents, U. S. Govt. Printing Office, \$1.25, 1955.

"now I can service
our Sphygmomanometer*
thanks to Formica® XXXP-36"



This sphygmomanometer — or *automatic blood pressure recorder, if you prefer — demonstrates how manufacturers of electronic products cut field service cost with Formica copper clad laminates.

Through its cold fabricating grades, Formica contributes the dimensional stability and accuracy essential for absolute interchangeability of components.

For example, with the circuit uniformity that Formica XXXP-36 provides, Colson Corporation, Elyria, Ohio, now services its automatic blood pressure recorder by phone and mail. Formerly skilled technicians had to be sent out from the factory.

And that's not all. Formica XXXP-36 also offers 1,000,000 megohms insulation resistance, low moisture absorption, translucency, watermarking . . . and uniform color from lot to lot.

Why not design your products to get the full benefit of printed circuitry? You can with Formica copper clad. And remember, Formica gives you the widest choice of base laminates, including over 12 grades made of paper and nylon, glass and cotton cloth . . . impregnated with epoxy, phenolic and melamine resins. For complete information, send today for Copper Clad Technical Data, form 688, Formica Corporation, a subsidiary of American Cyanamid, 4512-7 Spring Grove Ave., Cincinnati 32, Ohio.

Save your engineering time—use our engineering staff

Formica-4, the complete laminated plastics service, cuts your engineering time—reduces component parts cost—and assures delivery for mass production schedules.

Subsidiary of



- (1) Application engineering
- (2) Research
- (3) Fabricating
- (4) Customer stock service

FI-1424

CIRCLE 22 ON READER-SERVICE CARD FOR MORE INFORMATION

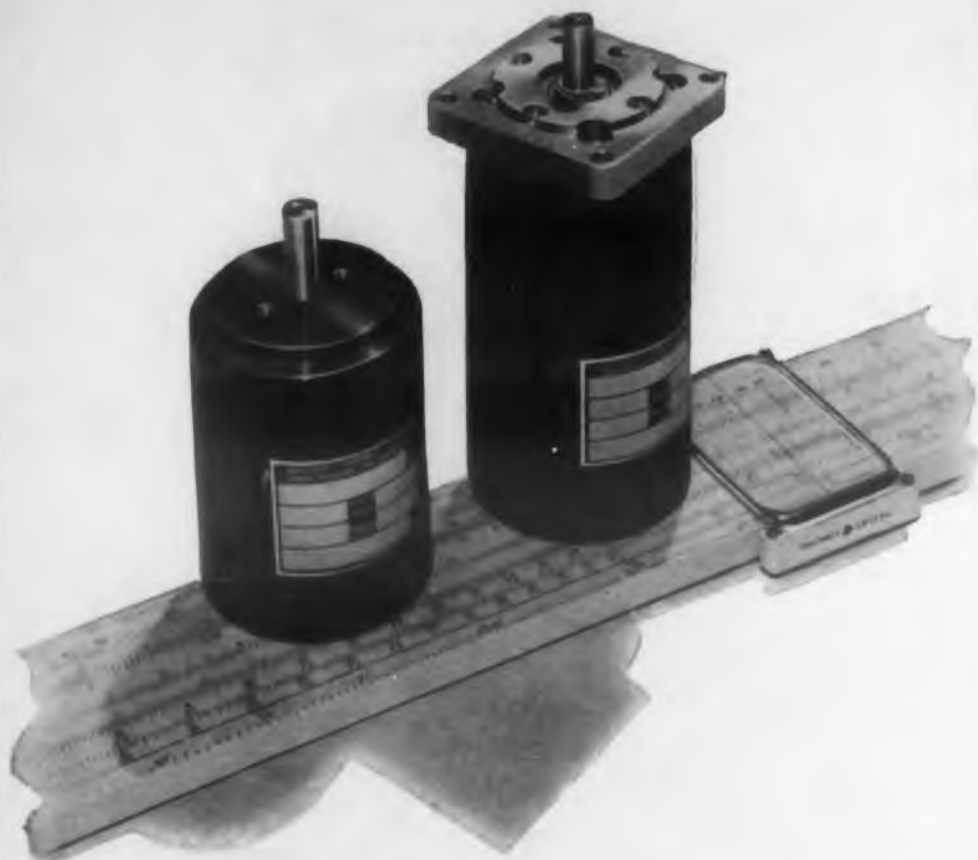

NEW A. C. MOTOR LINE GIVES YOU 10^5 STANDARD VARIATIONS

From Globe you can get fast delivery of complete miniature power systems designed around new FC motors—115 or 200 V.A.C., 60 or 400 cycles—induction, hysteresis, or dual speed rotors, wound 3 phase, 2 pole or 4 pole; 2 phase, 2 pole or 6 pole; single phase with a matched capacitor. Units are designed to meet MIL specs; operating characteristics and configuration can be modified.

Package can include integral gearing, either planetary or spur. Choose from 102 standard ratios from 4:1 to 3,000,000:1. Choose from 408 stand-

ard speeds. Gear units range in length from 1.043" to 1.953". WRITE FOR FC BULLETINS.

Globe's small AC motor packages are built around units 1.07" dia., 1.25" dia., and the newest 1.675" dia. x 2.250" long. Standard modifications in type, winding, gearing, and performance offer you millions of combinations at reasonable cost. Globe also makes D.C. governed and gear reduced motors, servo motors, actuators, timers, generators, gyros, blowers, fans, and control systems. **GLOBE INDUSTRIES, INC.** Dayton 4, Ohio



FC INDUCTION 115V 400 cps 3 phase 4 pole

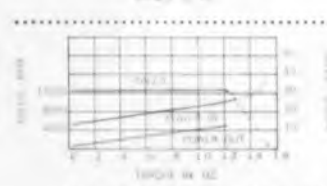
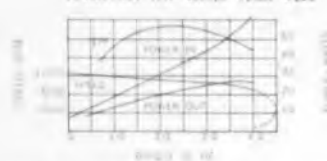

FC HYSTERESIS 115V 400 cps 3 phase 4 pole

CIRCLE 23 ON READER-SERVICE CARD FOR MORE INFORMATION



High Accuracy Relay

Accuracy ten times greater than hitherto available is provided by a new relay operated voltage divider. This highly stable reference standard with a resistance and ratio accuracy of 0.001 per cent is particularly suited to experimental applications. It is useful as a programmable standard in automatic measurement or readout. In combination with suitable circuitry it is the heart of an automatic reading digital voltmeter, current meter, ratiometer or bridge.

The unit, developed by Julie Research Labs., 556 W. 168 Street, New York 32, N.Y., may be set up manually from a switch bank, or it may be programmed automatically from punched cards or tape.

Highly accurate and stable resistors, her-

metically sealed in a metal case which provides electrostatic shielding and isolation from environmental effects, are connected to twenty relays by aerial bus wiring to maintain high leakage resistance. Overall resistance available as a voltage divider or rheostat is 100 K with a resolution of one ohm. The temperature coefficient is 5 ppm per deg C.

The relays in the instrument will operate in 10 msec, making the instrument suitable for automatic control. Using auxiliary equipment, the voltage divider may be time shared to perform several functions as the occasion demands. The instrument is available with the relays coded in a five-decade binary or binary-coded decimal form.

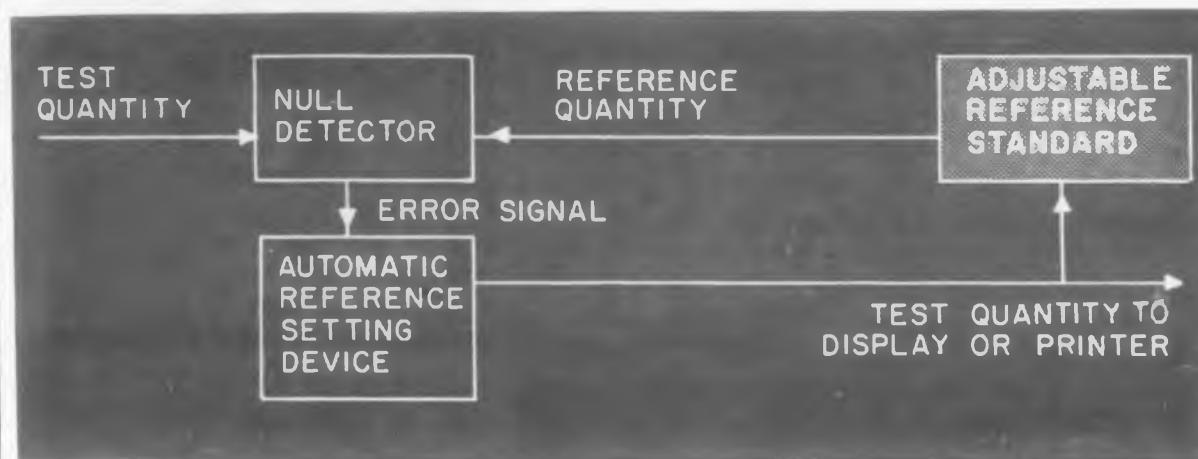

Fig. 1 For automatic test quantity measurement, the null detector generates a signal representing the difference between the unknown and the voltage divider output. A reference setting device re-adjusts the divider till the error vanishes.

Operated Voltage Divider

In experimental applications, where test quantity magnitude is important, the divider is used with a null method as in Fig. 1. Here, in a closed loop system, an error signal is fed to the automatic reference setting device whose coded output is sent to the relay operated voltage divider which is used as an adjustable reference standard. This generates a quantity equal in magnitude to the test quantity. The coded output of the reference setting device is a representation of the test quantity and may be read out or printed.

Fig. 2 shows the use of the divider in a calibrated error detector. The divider is used here, also, as an adjustable reference standard. The theoretically desired test

quantity is programmed into the reference setting device by card, by tape reader, or manually from a keyboard. The reference standard generates the reference quantity which is compared with the test quantity by an error detector. This generates the error quantity which is read out or printed. This method is desirable in automatic testing since the error is presented directly, obviating the need for additional computation to obtain error plots.

The instrument, called the RVD-105A comes in a fully shielded chassis which mounts in a standard 19 in. relay rack, is 5½ in. high and 12 in. deep. For more information on relay operated voltage divider, circle 24 on the Reader's Service Card.

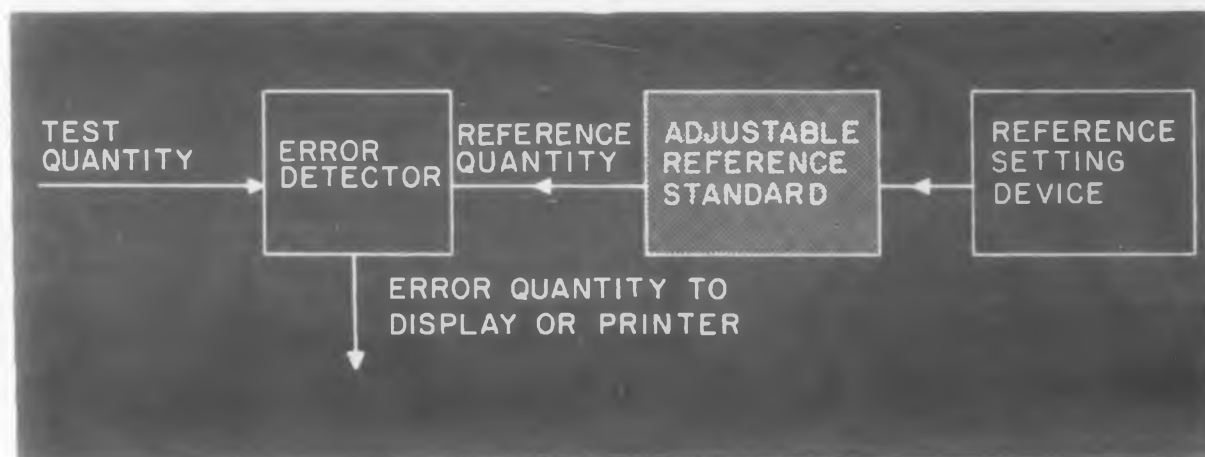

Fig. 2 Automatic measurement of error or deviation is facilitated when the voltage divider is used in this calibrated error detector arrangement.

**1
WIRE
WITH
400 LIVES**

New "High Strength" wire with
400% longer "flex-life"
25% greater "tensile strength"

THE PROBLEM: Stranded hook-up wire users are experiencing excessive, costly and often dangerous conductor breakage, especially in the smaller, more susceptible conductor sizes (32 AWG to 24 AWG).

THE SOLUTION: A brand new mechanically improved, non-magnetic conductor, called "High-Strength" wire, has been developed by Hitemp Wires, Inc. Exhaustive tests of the new wire, which meets the requirements of MIL-W-16878, show tremendous improvement over conventional stranded wire... a truly amazing average of 400% longer "flex-life" and 25% greater "tensile strength." Another giant step by Hitemp to meet the growing needs of America's industrial and defense requirements.

Write today for full information!

HITEMP WIRES, INC.
26 Windsor Avenue, Mineola, New York

CIRCLE 25 ON READER-SERVICE CARD FOR MORE INFORMATION

**4 NEW
design aids
providing
working data
for every
ELECTRONIC
CABLE
Problem**

available from Pacific Automation Products, a company established to provide a product as well as a service, which utilizes a 30,000 sq. ft. factory and an experienced staff of qualified engineers and technicians to design, manufacture and install custom made neoprene jacketed cable for the vast electronic industry.

Engineers and technologists are invited to investigate career opportunities with us. Submit resume for interview.



Pacific Automation Products, Inc.

CHapman 5-6871 • TWX: GLN 7371

1000 AIRWAY, GLENDALE 1, CALIF.

137 Walnut Hill Village, Dallas, Texas • Fleetwood 2-5806

CIRCLE 26 ON READER-SERVICE CARD FOR MORE INFORMATION

**CABLE
SPECIFICATIONS**

"Design Engineering Specification"
Bulletin No. PAP-C-101.
Comprehensive 19-page engineering
manual describing materials,
construction, design criteria,
specification conformance, performance,
identification, documentation and other
important features determining
correct cable for your specific
application.



**CABLE
AS A COMPONENT**

"Electronic Cable as a Systems
Component" Bulletin No. 656.
Generously illustrated pamphlet
describes design and production of
electronic cable in bulk and assemblies.
Connectors and hardware; cable break-
outs; environmental requirements;
voltage rating, testing; cable
procurement data — are some
of the subjects covered
in this bulletin.

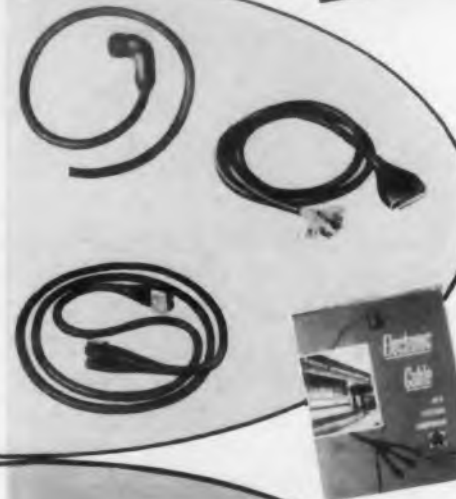

CABLE SYSTEMS

"Engineered Cable Systems"
Bulletin 357. Illustrated brochure
describing Pacific Automation
Products' pioneering in the use of the
Systems Concept to coordinate cable
design with the development of complex
electronic systems. Liaison engineering
teams cooperating with systems
design groups establish cable as
integral part of system, super-
vising cable construction
concurrently with
development of
other elements.



CABLE ACCESSORIES

"Extension and Adapter Sleeves
for Cable/Connector Compatibility"
Bulletin 257. Illustrated bulletin on
aluminum adapters designed and
manufactured by Pacific Automation
Products, which for the first time
provide a means of attaching
any size AN connector to
any size cable, with
assured reliability.



The Cryotron— A New Computer Device

S. R. Parker
Dept. of E.E.
The City College
New York, N. Y.

The Cryotron is a new type of computer element which has recently been developed by Dudley A. Buck at M.I.T. It is small, light, and dissipates little power. It is estimated that a large-scale digital computer could be packed in about one cubic foot, exclusive of cooling and terminal equipment, and dissipate about one-half watt. This bit packing density and power requirement is far better than could be expected with any other present-day computer element. Because of this the Cryotron holds promise of becoming one of the major components of future digital computers, and Cryotron research is now being conducted in many industrial laboratories throughout the country.

CRYOTRON operation is based upon the phenomenon of superconductivity and the fact that this conductivity can be destroyed by the application of a magnetic field. Superconductivity was discovered by H. K. Onnes at Leiden in 1911 who noticed that the electrical resistance of metals disappears (zero ohms) at temperatures close to absolute zero. The fact that the resistance becomes truly zero can be demonstrated by Professor S. C. Collins of M.I.T., who has a lead ring in which an electric current of several hundred amperes has been flowing without any change in magnitude, from the time it was induced three years ago. It was also noted by Onnes and his coworkers that the transition temperature at which superconductivity takes place is a function of the magnetic field which may be present. The transition temperature approaches absolute zero as the magnetic field is increased. This effect is independent of the orientation of the magnetic field with respect to the superconductor. Figure 1 shows how the superconductive transition temperature of Tantalum varies with the magnetic field. It can be seen from this curve that if the temperature

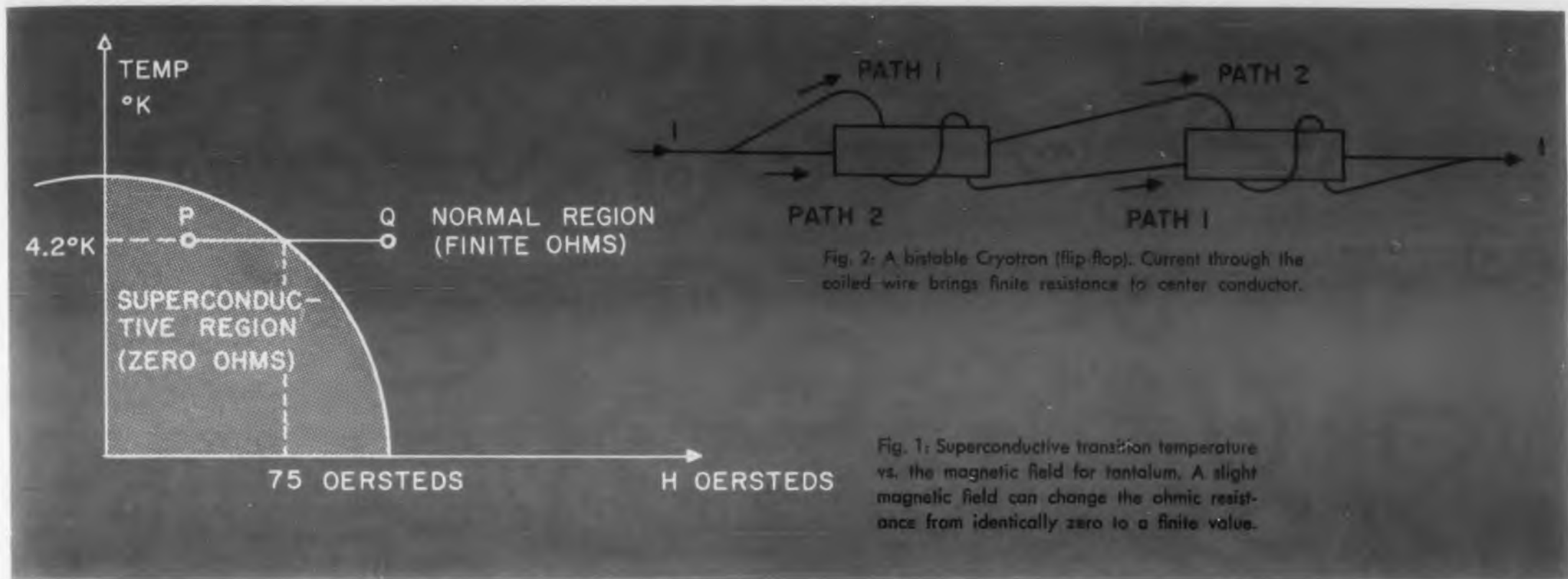

is held constant and the magnetic field varied, the ohmic resistance of the Tantalum can be changed from identically zero to a finite value. This is equivalent to traversing the horizontal line PQ in the figure. The zero and finite resistance represented by points P and Q are used as the two stable states for a binary digital computer element.

In a typical Cryotron, the resistance being controlled is a one inch 9 mil. diameter Tantalum wire. Tantalum has been used because its superconductivity can be controlled by small magnetic fields

(50 to 100 oersteds) at a temperature of 4.2 K which is conveniently the boiling point of liquid Helium at atmospheric pressure. Thus, the Cryotron can operate in an open bath of liquid Helium. The other wires used in the Cryotron are made of Niobium which has a high transition temperature compared with Tantalum, and remains superconductive over the entire range of magnetic field variations. A single Cryotron gate unit consists of approximately 250 turns of insulated Niobium wire (3 mil. diameter) wound around the 1 inch Tantalum wire. The

Niobium winding functions as a control winding. When the current through it gets greater than about 100 to 200 ma, there is enough of a magnetic field present to cause the resistance of the 1 inch Tantalum wire to switch from zero ohms to approximately 8 milliohms. The Tantalum wire functions as a switch or gate controlled by the control winding; the ratio of open to closed circuit resistance being infinite.

Figure 2 shows two Cryotron gate units wired as a bistable (flip-flop) element. The control winding

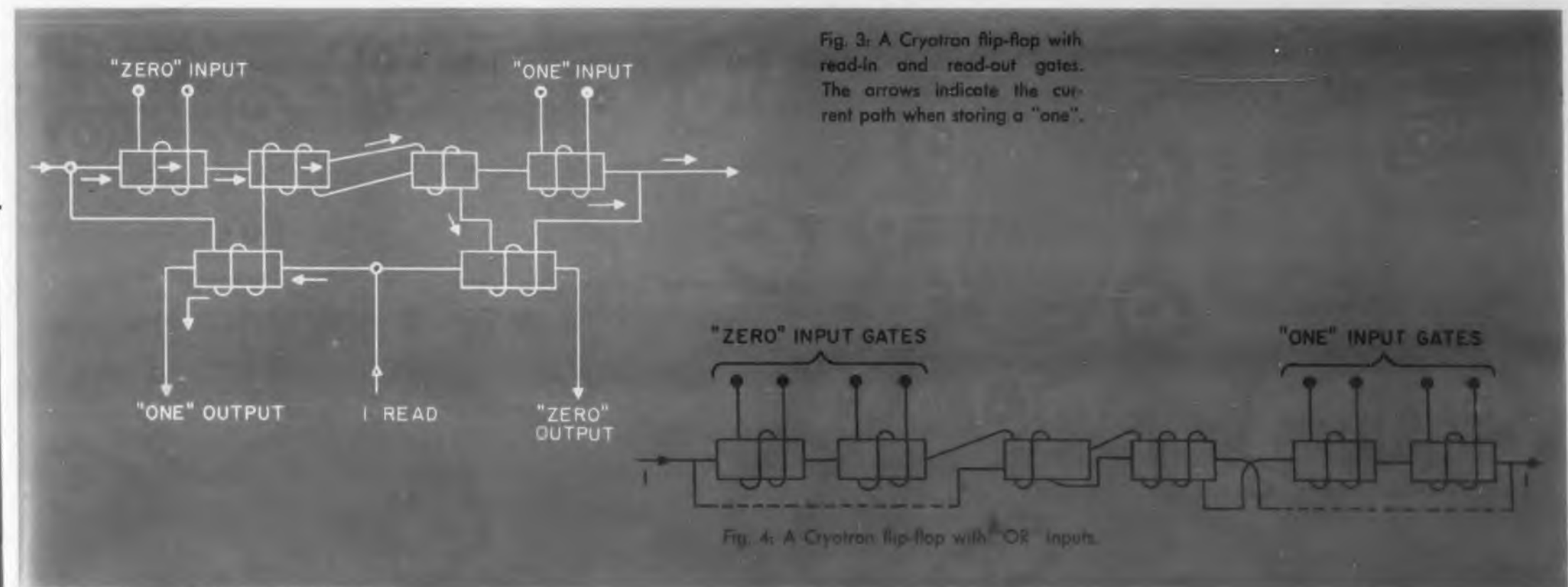

For the highest degree of *Accuracy*
in **AIRBORNE TEMPERATURE INSTRUMENTATION**

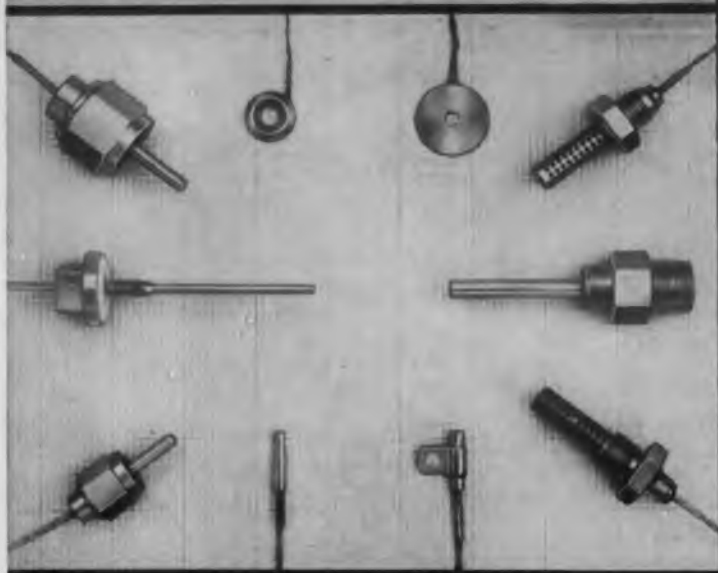

**HIGH OUTPUT • RESISTANCE-TYPE
TRANSDUCERS**

Arnoux high resistance temperature probes are designed for telemetering and other applications requiring high signal levels. Models are available in a wide variety of physical configurations for measuring surface, fluid, and air temperatures.

- Output up to 5 volts without amplification.
- -320°F to $+500^{\circ}\text{F}$ range with $\pm 2\%$ linearity. (Special units are available up to 1600°F .)
- Nominal resistance values: 100 to 20,000 ohms.
- May be used in AC or DC Bridge circuits.
- Meets MIL-E-5272A specifications.
- Calibration curve supplied with each probe.

When used with ARNOUX miniaturized companion "TME" system, 20K transducers provide 5 volts output for as little as 150°F change.

Write for Bulletin 300

**MINIATURE MULTI-CHANNEL
TEMPERATURE MEASUREMENT
SYSTEM . . . full scale output 5 volts**

ARNOUX "TME" is a completely self-contained system designed for operation with ARNOUX special resistance-type transducers. Models are offered in 7, 14, and 20 channel capacity. The unit contains two precision mag-amp type, regulated D.C. power supplies, series connected with common neutral, for excitation of the transducers in half bridge circuitry.

- Power requirement: 115 volts, 400 cps.
- Power consumption: 20 channel model requires less than 20 watts.
- Balance and attenuation controls for each channel.
- No vacuum tubes or transistors used.
- Output voltage and impedance characteristics — directly compatible with F.M. sub-carrier and P.W.M. coder input requirements.
- System stability: within 1% throughout MIL-E-5272A environmental.
- Dimensions: 20 channel model: $7'' \times 4\frac{1}{4}'' \times 3''$, wt. $5\frac{1}{2}$ lbs.

Write for Bulletin 500

ARNOUX . . . *foremost* in
TEMPERATURE MEASUREMENT EQUIPMENT . . .
**. . . TRANSDUCERS, ACCESSORIES AND
CUSTOM ENGINEERED SYSTEMS.**



Designers and Manufacturers of Precision Instrumentation

11024 W. WASHINGTON BOULEYARD • LOS ANGELES 66, CALIFORNIA

CIRCLE 27 ON READER-SERVICE CARD FOR MORE INFORMATION

of one unit is connected in series with the center Tantalum wire or gate of the other unit and vice versa. If the combination is connected to a constant current source, the current can flow continuously only in one or the other of two possible paths as shown in the figure. Once a current path is chosen it creates a resistance in the alternate path thereby blocking current flow in the alternate path. This in turn assures zero resistance in the chosen path and the current flow is firmly established. The flip-flop can be placed in any desired state by adding a Cryotron gate in series with each side of the flip-flop. Pulsing one or the other of these input gates places finite resistance in one side of the flip-flop and causes the current path to switch accordingly.

The status of a Cryotron flip-flop can be sensed by the addition of two more Cryotrons, placed with their control windings in series with the control winding of the flip-flop elements. One or the other of the sensing Cryotron gates will always be in the superconductive state depending upon which one has its control winding in the conducting half of the flip-flop.

Figure 3 shows a Cryotron flip-flop arrangement with read-in and read-out Cryotron gates. The arrows indicate the current path when storing a "one."

Various other types of computer elements can be made from Cryotrons. An "or" operation for setting the flip-flop can be obtained by adding any number of Cryotron input gates in series. In this way, any one of the input gates can be used to set or reset the flip-flop (Figure 4). Similarly, an "and" operation may be obtained by shunting the control windings of the input gates with other Cryotrons as shown in Figure 5. It can be seen that current will flow through the input gate control winding and set or reset the flip-flop only if all of the shunt gates are resistive. If any one of the inputs is absent its gate will act to bypass the input gate control current. In this connection it should be noted that in the case of two parallel superconductors the current divides inversely as their inductances. Figure 6 illustrates a Cryotron decoding switch to convert a 3 bit binary input into an octal output. It can be seen that, depending upon the 3 bit binary input, one and only one of the Tantalum gate elements will have zero magnetic field and be superconductive. The output current will then flow through this element.

The Cryotron operates at the temperature of liquid Helium; however, this operating temperature can be achieved relatively easily today and Helium liquifier units are commercially available. The bath of liquid Helium is held in a thermos type container with liquid Nitrogen in the jacket. The cooling unit recirculates the Helium and the Nitrogen.

The average power dissipation of a Cryotron unit is of the order of one-tenth milliwatts. Batteries are used as the power supply for most Cryotron work today. The current drain is usually large (the voltage requirement is small) and eventually special

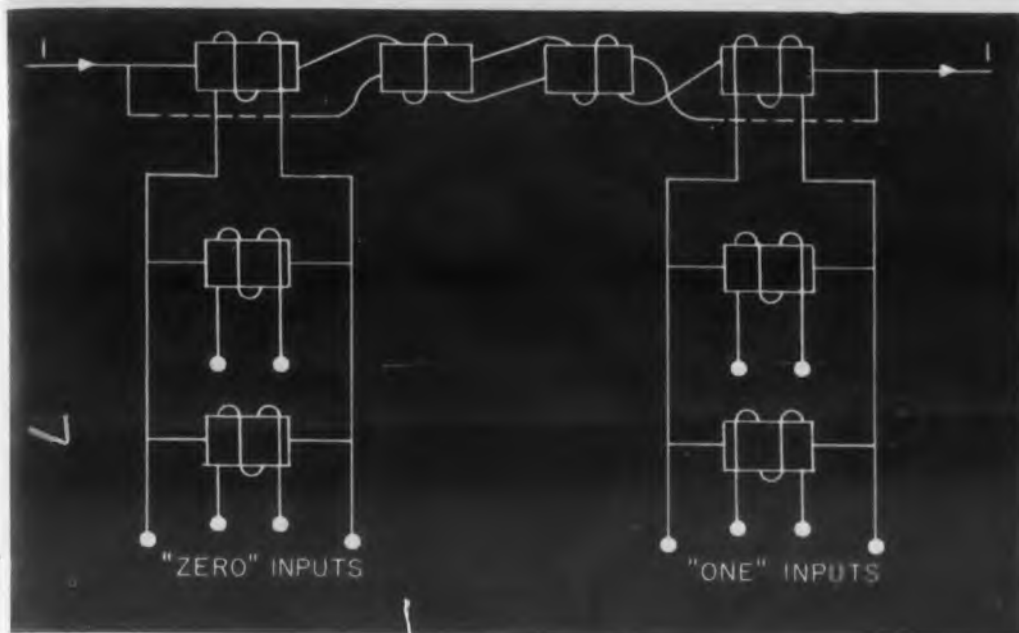

Fig. 5—A Cryotron flip-flop with "AND" inputs.

power supplies will be necessary.

One of the major disadvantages of the Cryotron is that switching time is but slightly faster than relay speeds, a far cry from the megacycle requirements of modern day computers. However, this problem is being studied and it appears to be only a matter of time before higher speeds will be achieved. Reports from the laboratories indicate that switching speeds up to 10 kc have been obtained and that millimicrosecond switching time is held within the realm of possibility.

Note: Many of the theoretical ideas and applications discussed here are based on the work of Dudley A. Buck and his paper which is listed among the references.

Bibliography

- D. A. Buck, "The Cryotron—A Superconductive Computer Element," IRE; April 1956
 D. Schoenberg, "Superconductivity," Cambridge University Press, Cambridge, England; 1952
 F. London, "Superfluids," John Wiley & Sons, Inc., New York, N.Y., vol. 1; 1950
 B. Serin, "The Magnetic Threshold Curve of Superconductors," ch. VII, "Progress in Low-Temperature Physics," edited by C. J. Gorter, Interscience Publishers, New York, N.Y.; 1955
 T. E. Faber, "The phase transition in superconductors II. Phase propagation above the critical field," Proc. Roy. Soc. A, vol. 219, pp. 75-88; 1953.
 A. B. Pippard, "Kinetics of the phase transition in superconductors," Phil. Mag., vol. 41, p. 243; 1950.
 T. E. Faber, "The phase transition in superconductors III. Phase propagation below the critical field," Proc. Roy. Soc. A, vol. 223, pp. 174-194; 1954.
 C. A. Swenson and A. G. Emalle, "Low-temperature electronics," Proc. IRE, vol. 42, pp. 408-413; Feb., 1954.
 W. H. Keeson, "Helium," The Elsevier Press, Inc., New York, N.Y.; 1942.

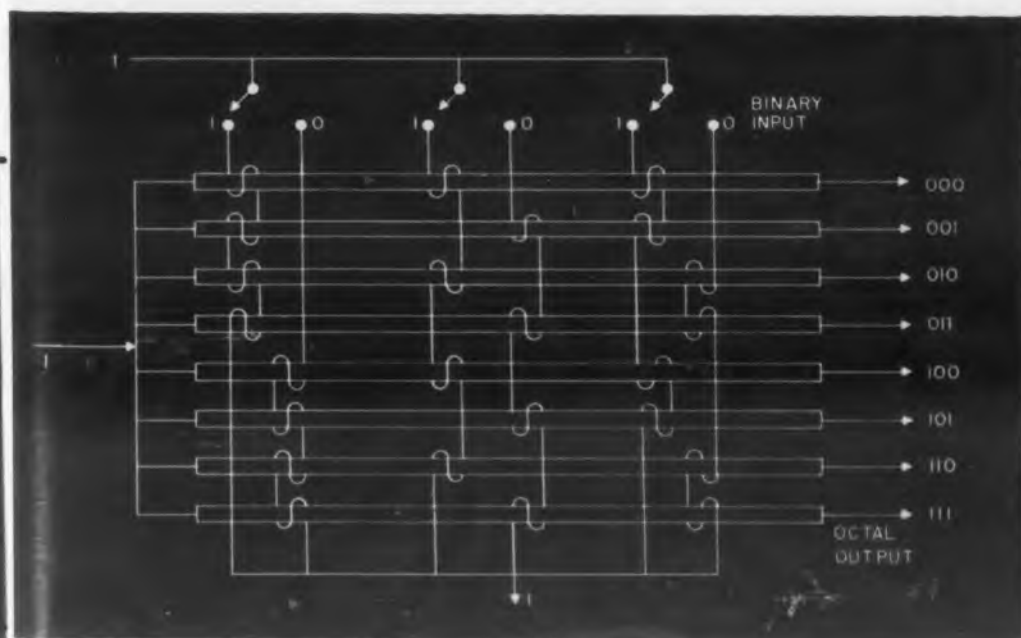

Fig. 6—A Cryotron decoding switch is convert a three-bit binary input into an octal output.

WHAT MAKES A LOW FREQUENCY VTVM STABLE & ACCURATE?

CHECK THESE FEATURES . . .

✓ The instrument should have an *electronically regulated power supply* which assures high stability at very low frequencies. (The instrument should *not* be battery-operated; internal battery resistance varies and is liable to create instability, or even motorboating).

✓ It should have *individual range calibration* to minimize overlap-errors between ranges.

✓ It should *not require switching* for alternate meter or amplifier operation to facilitate simultaneous wave-shape-observation while measurements are being made.

The new Millivac MV-02 B vacuum tube voltmeter (2 cps-250 KC, 3 mV — 1 KV full scale, 2% accuracy) fulfills these three important requirements. It has many other, unusual features which make it the finest low frequency VTVM available on the market today.

Write for complete literature.



MILLIVAC

INSTRUMENT CORPORATION
BOX 997, SCHENECTADY, N. Y.

Tomorrow is our yesterday

CIRCLE 28 ON READER-SERVICE CARD FOR MORE INFORMATION



MV-02 B



REAR CALIBRATION
PANEL

rotor bearing preload micrometer

measures effective gyro rotor bearing preload without physical contact

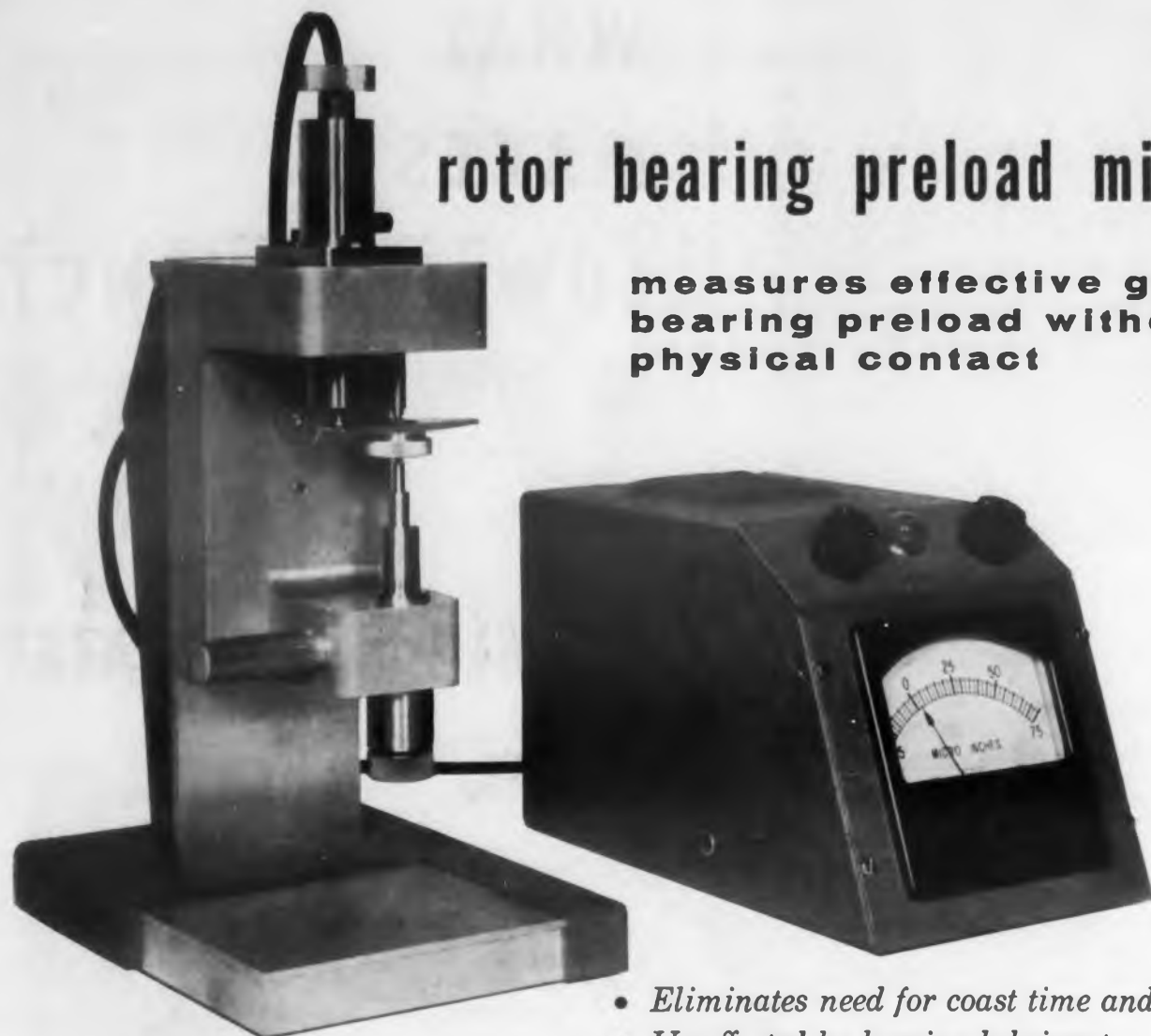

- Eliminates need for coast time and acceleration tests.
- Unaffected by bearing lubricant.
- Amazingly compact and portable.
- Rugged construction for production line service.
- Sensitivities as high as .000005 inch per division.

THE DECKER MODEL 104-1 ROTOR BEARING MICROMETER provides a positive and accurate means of measuring effective bearing preload . . . a prime factor in rotor performance.

Accurately measuring axial movements to known standards, the micrometer simplifies one of the most difficult jobs in rotor assembly . . . obtaining pre-

scribed bearing preload. Benefits gained include a reduction in rotor assembly time . . . less need for skilled labor . . . no chance of bearing damage during run-in . . . and fewer rejections due to improper preload.

Simple adapter assemblies quickly convert the unit for handling many types of rotors, ranging in size from less than $\frac{1}{2}$ " diameter to $3\frac{1}{4}$ " diameter.

Complete information on this unique new instrument is in Data Sheet 104-1, available upon request to the Technical Literature Section.



decker

AVIATION CORPORATION

1361 Frankford Ave., Philadelphia 25, Pa., PHONE GARfield 5-2300

CIRCLE 29 ON READER-SERVICE CARD FOR MORE INFORMATION



Fig. 1. Direct-printed circuits on cylindrical and conical surfaces. Circuits can be printed inside or on both sides of tube. The truncated cone is a depolarizing element of a discone-type antenna.

Direct-Printed Circuits

FOR THE design engineer with difficult space requirements to cope with, these direct-printed circuits may be of particular value. They can be made to conform to almost any degree of flexibility or geometric.

These circuits are not etched; they are printed directly on a base material, using silver inks. The inks will bond well to cellophane, cellulose acetate and butyrate, vinyl chloride and acetate, acrylics, styrenes, polyesters, Mylar, CR-39 resin, phenolics, epoxies, silicones, melamines, Kel-F, Teflon, mica, ceramics, glass, paper and wood (in case you have any wooden circuits). Manufactured by the J. Frank Motson Co., Flourtown, Pa., the circuits have a wide variety of applications from printed antennas to rotors, commutators and wave guides, can be used in ambients up to 500 F.

Three basic silver inks are used. The K59 and C93 type inks (see Table) require heat to harden, while the C37 ink hardens at room temperature. Circuits printed with K59 may be dip- or iron-soldered. Each type of ink can be modified without changing its essential properties to meet flexibility, resistivity and bond requirements. By substitution of carbon for silver, square resistivities of 20 ohms to 100 meg may be obtained.

A comparison of copper-clad stock with Motson printed circuits shows that 0.0013 in. clad stock has about 50 times the conductivity of 0.001 in. K59 ink, the thickness usually applied. Solder-dipping of the silver ink reduces this difference to a 10 to 1 ratio, while electro-plating can provide conductivity

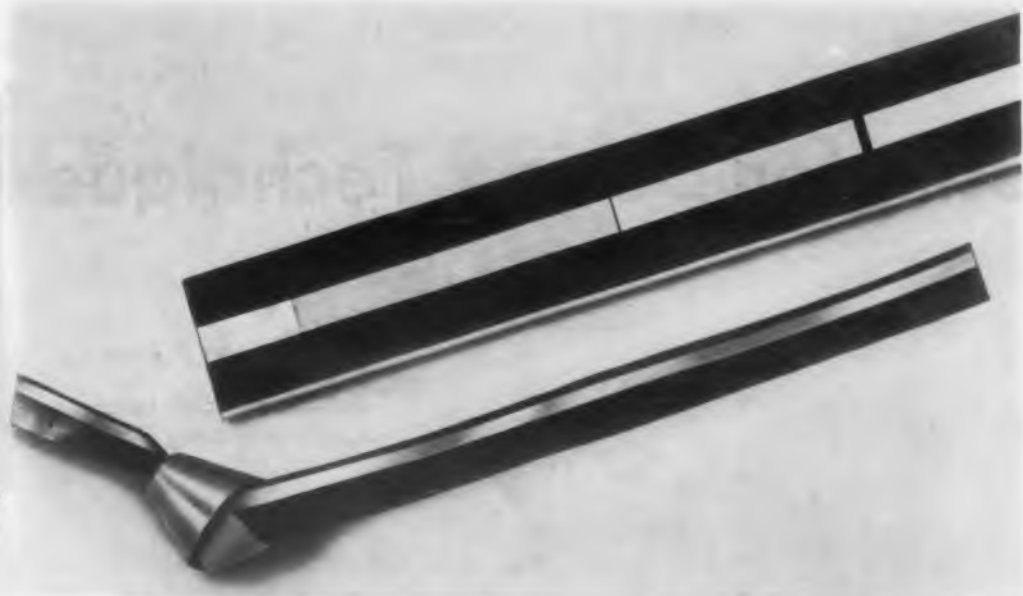

Fig. 2. Microwave strip line filter (top of photo) consists of solderable silver printed on both sides of Teflon material. The spaces between strips are accurate to 2 mils and the front-to-back register is held to within 5 mils. In the bottom of the photograph the flexibility of a circuit printed on 5 mil Teflon and plated with ductile copper is shown.

Printed Circuits

equal to that of clad stock. The peel strength of soldered K59 ink is approximately 12 lb per in.

In general, the thickness range of the ink deposit is between 0.0002 and 0.0018 in. and can be held within ± 10 per cent in critical applications. Pattern tolerance can be held to ± 0.001 in. in special cases.

Note that the inks themselves are not for sale. They were developed by the Motson Co. for use in the manufacture of direct-printed circuits.

For further information on these circuits, turn to the Reader's Service card and circle 30.

Properties of Basic Conductive Inks

Square and volume resistivities depend somewhat on cure temperature, with higher temperatures giving lower resistivities.

| Ink Types | K59 | C93 | C37 |
|--|-----------|-----------|--------------|
| Heat stability, F | 500 | 300 | 180 |
| Minimum curing temp, F | 350 | 200 | 70 |
| Organic solvent resistance | Good | Good | Poor |
| Water resistance | Very Good | Very Good | Fair |
| Aliphatic hydrocarbon solvent resistance | Very Good | Very Good | Good |
| Resistance—50 per cent H ₂ SO ₄ | Very Good | Very Good | Fair |
| Resistance—ethanol | Very Good | Good | Poor |
| Square resistivity, 0.001 in. thick, ohms per square at 70 F | 0.016 | 0.03-0.05 | 0.05-0.30 |
| Per cent rise in resistivity with 100 F rise in temperature | 11-14 | 10-12 | 10-14 |
| Volume resistivity, ohm-cm x 10 ⁻⁵ | 4.1 | 7.0-11.7 | 11.7-70 |
| Load carrying capacity at 110 v. Amps per 0.060 in. line 0.001 in. thickness, on glass | Over 8.0 | Over 8.0 | Over 8.0 |
| Scratch resistance (on glass) | Very Good | Very Good | Fair to Poor |



NEWEST PRINCIPLE

No wonder the new Silic-O-Netic Time Delay Relay has aroused such interest. It offers basic advantages as a delay device unequalled in its low price range.

The Silic-O-Netic Relay provides delay with no mechanical linkages . . . no mechanism to speak of. . . only one moving part, and that part is hermetically sealed, forever free of dirt and dust. It operates on a positive change in magnetic flux which is sharply defined as the movable core touches the pole piece. Moreover, the new Type A model has high speed contacts, affords good contact pressure.

in TIME DELAY RELAYS

Heinemann Silic-O-Netic Relays are already being used in dozens of volume applications where absolute dependability is essential. They are well worth your investigation.

Write for Bulletin T-5002

IT'S DIFFERENT...

No thermal elements . . . no aging, no fatigue . . . long life stability.

Small size . . . Overall dimensions: $2\frac{1}{16}''$ x $1\frac{3}{16}''$ x $2''$.

Delay periods . . . $\frac{1}{4}$ to 120 seconds.

Low cost . . . achieved in 20 years of solenoid manufacturing experience.

HEINEMANN

ELECTRIC COMPANY

156 Plum St., Trenton 2, N. J.



CIRCLE 31 ON READER-SERVICE CARD FOR MORE INFORMATION

Oscillator Design Techniques

Keats A. Pullen, Jr.

Ballistic Research Laboratories
Aberdeen Proving Ground, Md.

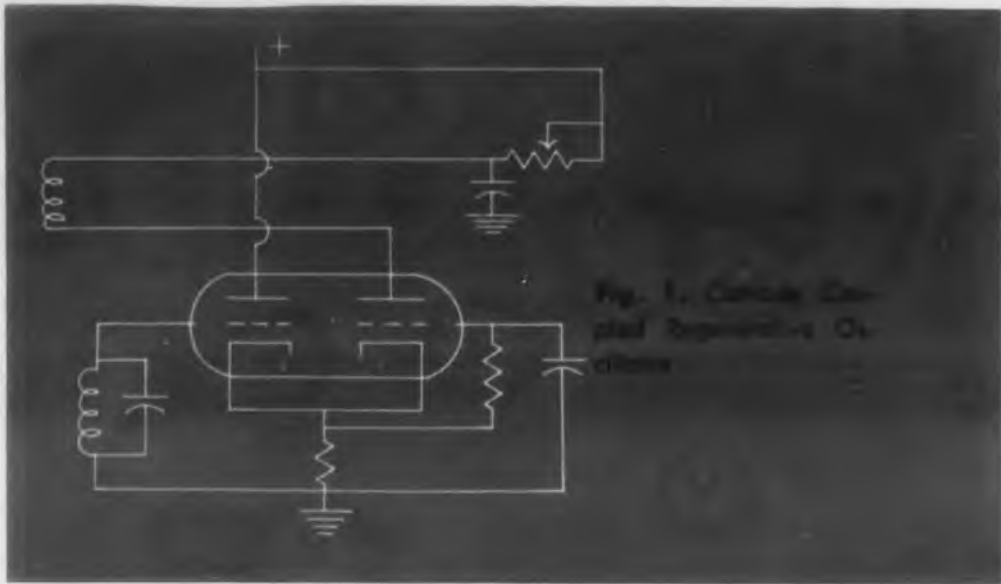

THE DESIGN of oscillators requires the design of two elements, first an amplifier, and second a frequency selector circuit. The amplifier must be able to provide enough amplification to offset the loss in the frequency selector circuit. The frequency selector circuit, on the other hand, must provide maximum feedback with the proper phase angle at the desired oscillation frequency. A corollary requirement is that the effective Q of the frequency selector circuit should be as high as possible in order to provide the best possible frequency stability. This requirement means that the effect of rectification and conductance loading on the frequency selector circuit should be reduced to the lowest possible value in all oscillators.

Notes on Oscillator Theory

The development and maintenance of oscillation in oscillators have been shown to result from amplification

of noise by the oscillator circuit.¹ Theoretical non-linear mechanics analyses² show that two types of conditions can produce oscillations in a non-linear circuit. In the first of these, a phase plane plot of resonant circuit current against the derivative of the current will show two things: that a limit cycle will be formed and that establishment of a set of conditions corresponding to any point in the phase plane within the limit cycle will degenerate in time to a point cycling around the limit cycle (oscillation). In the type two oscillatory condition, establishment of conditions corresponding to part of the area within the limit cycle does not lead to operation on the limit cycle, whereas establishment of conditions in the other parts of the area within the limit cycle does produce operation around the limit cycle.

Electronically, most oscillators are of the type one, or completely unstable, variety. Motorboating ampli-

fiers frequently are of the type two, or semi-stable, variety. Such an amplifier does not motorboat until it has been shocked into vibration. Physically, the difference between the two conditions may be described as follows. If the overall loop amplification of the amplifier is greater than unity at the nominal starting condition and all other positions within the limit cycle, and gradually reduces to unity due to some cause—such as rectification biasing—as the oscillation amplitude builds up, the type one condition may be said to exist. If, on the other hand, the loop gain is somewhat less than unity and stays less than unity for small changes in operating conditions, in a given area, but builds up to greater than unity for a reasonably large change of operating condition, the type two condition exists. If the amplification is only slightly greater than unity at its highest point on the limit cycle (the average value is unity over the entire cycle), the cycle is

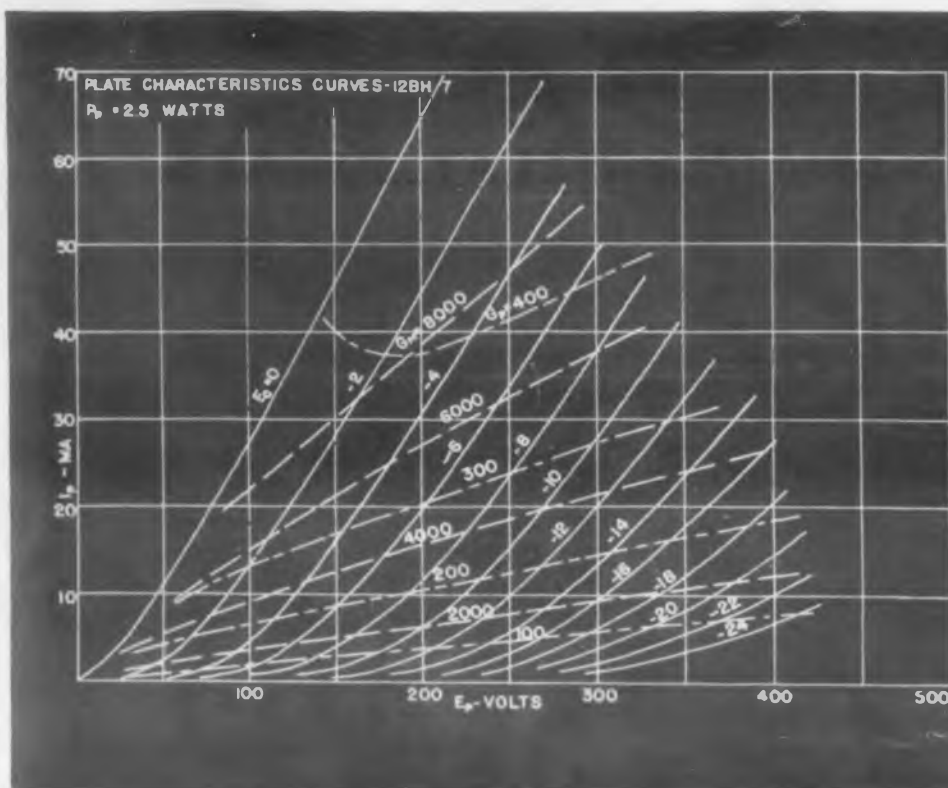
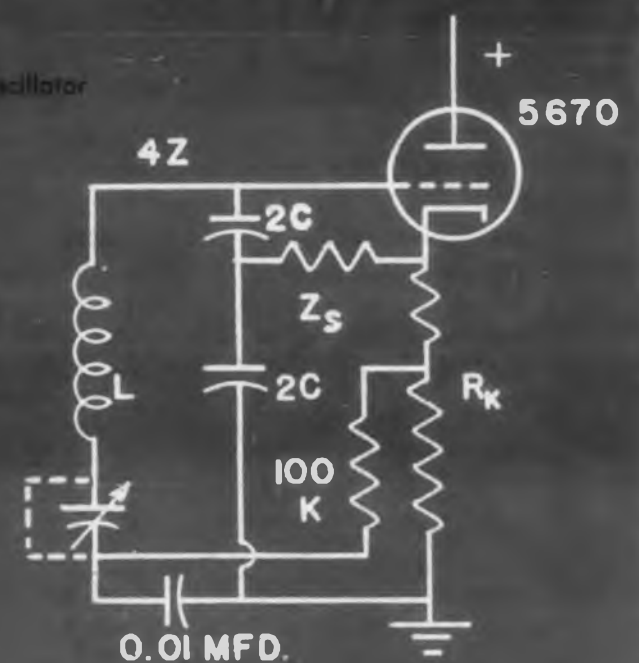

Fig. 2. 12BH7 tube characteristic curves

Fig. 3. Q Multiplier Oscillator



Using Conductance Curves

approximately circular and sinusoidal waveforms can be obtained at the preferred frequency. The smaller the variation of loop gain from unity at different points along the limit cycle, the smaller is the distortion and the better the frequency selecting network Q.

A Special Regenerative Detector and Oscillator³

The following design may be used as a regenerative detector with a 5670/2C51W dual triode, or as a power oscillator with a 12BH7 dual triode (Fig. 1). This circuit is a modification of the tuned grid oscillator or regenerative detector. Tickler to tuned circuit feedback is made as loose as possible to minimize loading. The tuned circuit feeds a cathode follower to minimize direct loading. Limiting of amplitude is obtained by rectification biasing the grounded grid amplifier. The rectification loading then does not affect the tuned circuit Q.

The voltage amplification of this cathode coupled amplifier is approximately

$$VA = \frac{g_{m1} g_{m2} Z_K Z_L}{1 + (g_{m1} + g_{m2}) Z_K} \quad (1)$$

or the forward admittance is

$$Y_f = \frac{i_e}{e_{uc}} = \frac{g_{m1} g_{m2} Z_K}{1 + (g_{m1} + g_{m2}) Z_K} \quad (2)$$

For the feedback circuit,

$$e_c = Q_c K_{cp} \frac{n_c}{n_p} X_p i_p \quad (3)$$

If, now

$$Q_c K_{cp} \frac{n_c}{n_p} X_p \cdot \frac{g_{m1} g_{m2} Z_K}{1 + (g_{m1} + g_{m2}) Z_K} > 1 \quad (4)$$

then oscillation will start. If the build-up of oscillation causes more loss of g_{m2} than g_{m1} increases, then the overall loop gain will drop as the amplitude of oscillation increases. Adjustment of either K_{cp} or X_p , the plate coil reactance, will permit adjustment of the loop amplification to approximately unity. Then, adjustment of the plate supply voltage for the grounded grid stage permits adjustment of regeneration as a regenerative detector.

Assume that a 12BH7 tube (Fig. 2) is to be used in a power oscillator at 30 mc. A 100 v plate supply is being used. Assume further that the grid tuned circuit Q is 200, the coupling from plate to grid 0.01, the plate circuit reactance 400 ohms. The cathode follower grid is returned to a point 80 ohms down from the cathode. The plate to grid turns ratio is unity. The value of e_c/i_p from eq 3 is then 800 ohms. Since the value of eq 2 at initiation is 0.00191, the overall initial amplification is 1.5. (Grid to cathode bias on the grounded stage is zero at initiation. Based on the resulting plate current for the grounded grid stage, the bias and transconductance for the cathode follower may be found.) Oscillation develops immediately. If, now, 2 v rectification bias were developed at one instant as the oscillation builds up, the cathode follower bias would then be about -2.1 v. The overall loop amplification is 1.37.

Repeating the process for a grounded grid amplifier bias of -3 v, the cathode follower bias would be -1.8 v. The loop gain is now 1.26. At -4 v bias on the grounded grid amplifier, the cathode follower bias is -1.7 v, and the loop gain 0.89. Consequently, oscillation will limit at a bias of about -3.7 v on the grid of the amplifier triode. The output of the oscillator in the cathode circuit will be about 6 to 7 v peak to peak.

The Q Multiplier Oscillator⁴

The Q multiplier oscillator, one version of which is called the Clapp Oscillator, is another high Q and high stability oscillator. The equation for oscillation in this oscillator (Fig. 3) is

$$\frac{g_m R_k}{[1 + (g_v + g_p) R_k]} \geq \frac{1}{2} + \frac{Z_s}{2Z} \quad (5)$$

Since the value of $g_m R_k / [1 + (g_m + g_p) R_k]$ required for oscillation slightly exceeds one half, tapping the cathode resistor for the grid return is indicated.

Amplitude limitation in the Q multiplier is not by rectification loading. It is obtained in this oscillator by effective reduction of tube transconductance. The left hand side of Eq. 5 becomes, on the average, smaller as the amplitude rises. The amplification follows one of the equations,

Effective transconductance

$$\approx \frac{1}{4} (g_{m_{min.}} + 2 g_{m_{mean}} + g_{m_{max.}}) \quad (6)$$

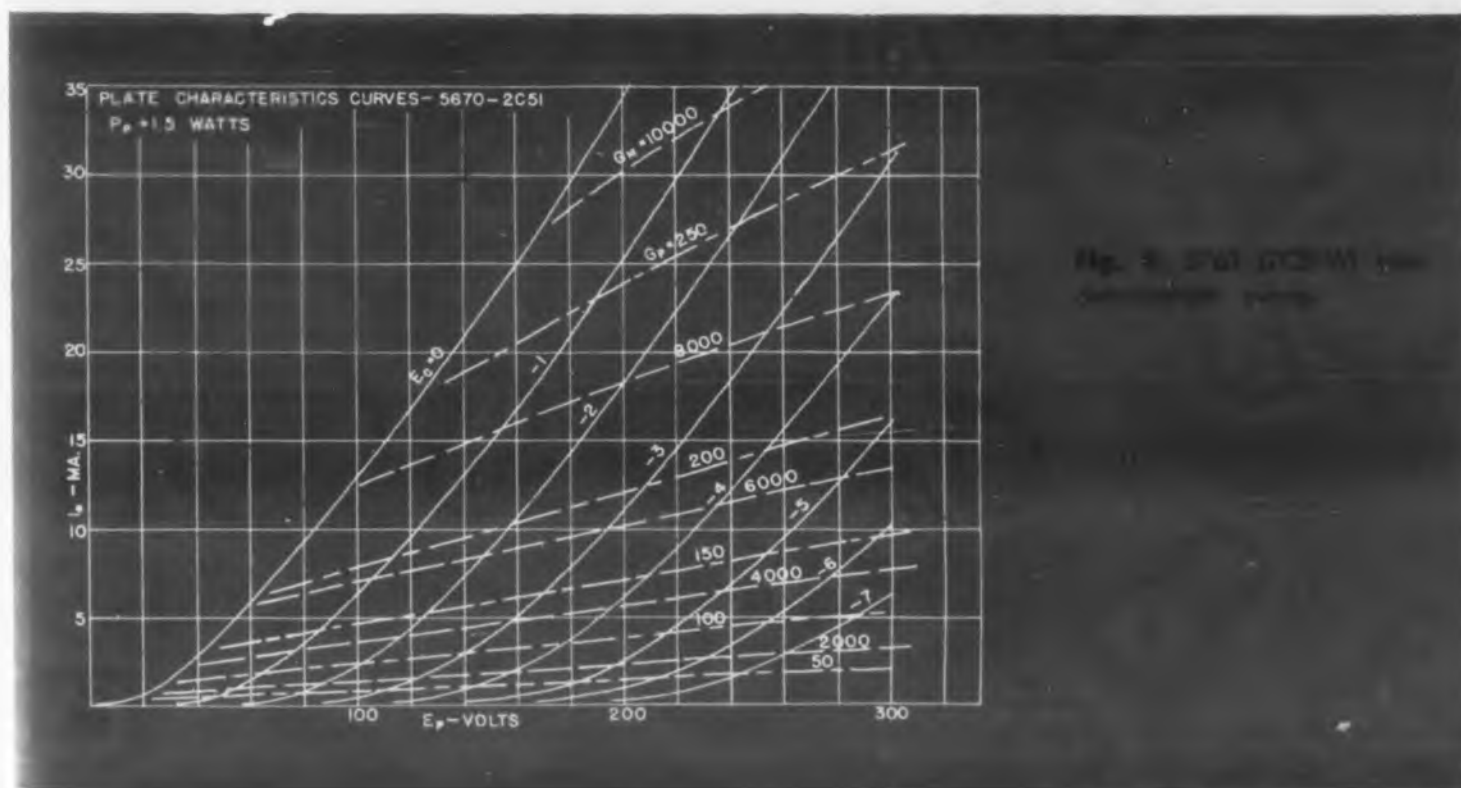

Fig. 2. 5670-2C51 tube characteristics.

or Average Amplification

$$\approx \frac{1}{4} (VA_{min.} + 2VA_{mean} + VA_{max.}).$$

For sake of an example, assume that one section of a 5670 dual triode be used for the oscillator (Fig. 4). Take the total R_k as 1000 ohms, the net bias as -1 v, and the supply voltage as 100 v. The left hand side of eq 5 has the value of 0.84, since $g_m = 6000 \mu\text{mhos}$ and $g_p = 170 \mu\text{mhos}$ at the chosen operating point. At a bias of -2 v the amplification is 0.67, and at zero bias 0.86. Average amplification for a swing from 0 to -2 v then is 0.80. The value of the ration $Z_s/2Z$ then has the value 0.3 for a 2 v peak to peak oscillation amplitude. Assuming a Q of 300, a grid-to-ground capacitance of 500 μmf , and a frequency of about 30 mc, the tuned circuit impedance is 1500 ohms. The value of Z_s then is 900 ohms. The grid dc return lead should be returned to a point 140 ohms below the cathode. Oscillation would just start with a Z_s of 1020 ohms. If the oscillator were adjusted near this point and the signal were then detected, a regenerative type detector would result.

An RC Oscillator

The design of RC oscillators requires the acceptance of a series of compromises. The first of these compromises involves the oscillator loop amplification without degeneration. Stability requires a large amplification; frequency response requires a relatively smaller loop amplification. Whereas operation to very high video frequencies requires small capacitance in the frequency selection variable capacitor, low frequency operation requires a large capacitance in the

variable capacitor. In either case, the loading of the frequency selector circuit must be small compared to the loading of the other impedances in the circuit if frequency stability is to be obtained. Where small magnitude of oscillator distortion is a paramount consideration, one must hold the oscillator frequency selector circuit loading to a very small level.

An oscillator, offering a good combination of impedance levels with reasonable gain and a low source impedance for the frequency selective circuit, is shown in Fig. 5. A suggested tube for use with this oscillator is the 12BY7 (Fig. 6). If the oscillator is to operate from 10 cps to 1 mc, R_L may be 10,000 ohms, and R_{k2} may be 200 ohms. R_{k1} would be a thermistor having a positive coefficient and a resistance under full tube cathode and signal current of about 65 ohms. Using a dual 40 to 400 μmf tuning capacitor, a 100 kc to 1 mc oscillator decade would require 4000 ohm tuning resistors. The total resulting load on the cathode follower is approximately 8000 ohms.

Using 12BY7 tubes with 120 v from screen to cathode and a bias of -0.5 v, a nominal transconductance of 15,000 μmhos is developed. The approximate equation governing operation of this oscillator is

$$R_1 = \frac{R_2 (1 - 2R_2/R_L) - 3/g_{m1} (X_{p1} + X_{c21}) g_{m2} X_{p2} R_L - 3R_2/g_{m2} X_b R_L - R_2/g_{m1} (X_p + X_{c21}) R_L}{2 + 3R_2/R_L + 3/g_{m2} X_{p2} R_L} \quad (7)$$

Substituting gives $R_1 = 65$ ohms for a ratio of $E_p/E_{ct} = 1$.

The frequency range of this oscillator may be extended somewhat. In order to extend the range, it is necessary to redesign the cathode follower to have a

lower output impedance. Paralleling two 12BY7 tubes for the cathode follower and using the usual grid series damping resistors of 50 ohms resistance will permit R_2 to have a value of 100 ohms, and R_1 about 32 ohms. With a load resistance R_L equal to 3900 ohms, an oscillator capable of operating up to about 3 mc will result. The tuning resistance for the highest frequency decade then is 1300 ohms. The 2800 ohm parallel load, on the 132 ohm cathode follower output, will not upset oscillator operation.

Since the approximate plate current in all tubes is 34 ma, the load resistance voltage drop is 130 v. Including a plate to cathode voltage of 120 v and a cathode to ground voltage of about 12 v, the total required supply voltage is 262 v. The screen resistors for each tube have a resistance of 18,000 ohms. The parallel screens of the cathode follower may have a 9100 ohm resistor and two 50 ohm decoupling resistors to provide the current supply to the screens. The screen to cathode bypasses may consist of ceramic discap capacitors backed up by large paper or electrolytic capacitors. The bias voltages for the two (or three) control grids should be obtained by use of high resistance voltage dividers across the respective cathodes. The dividers should be adjusted to provide the required 0.5 v bias on the respective tubes.

A Three Phase RC Oscillator

The phase shift oscillator is frequently used as a means of generating audio or video frequency voltages. Establishment of a 3ϕ phase shift oscillator requires arrangement of a symmetrical closed circuit amplifier having RC frequency selection circuits. A possible oscillator configuration is shown in Fig. 7.

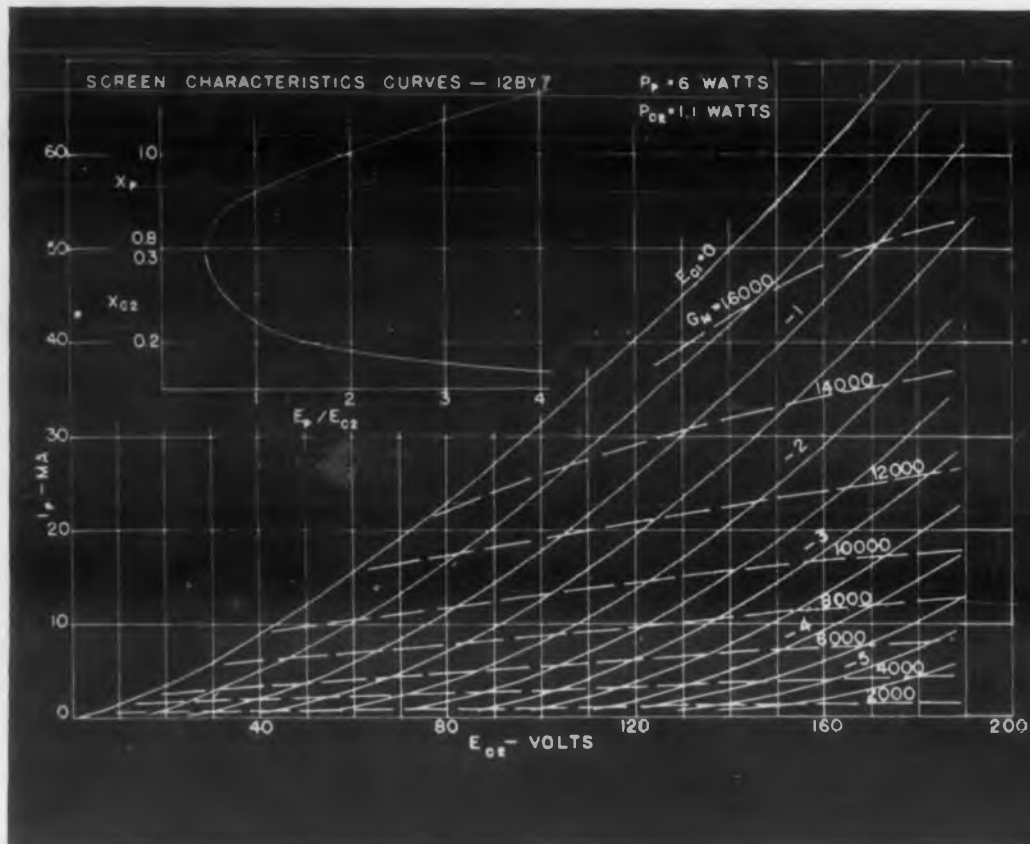

Fig. 6. 12BY7 tube characteristic curves

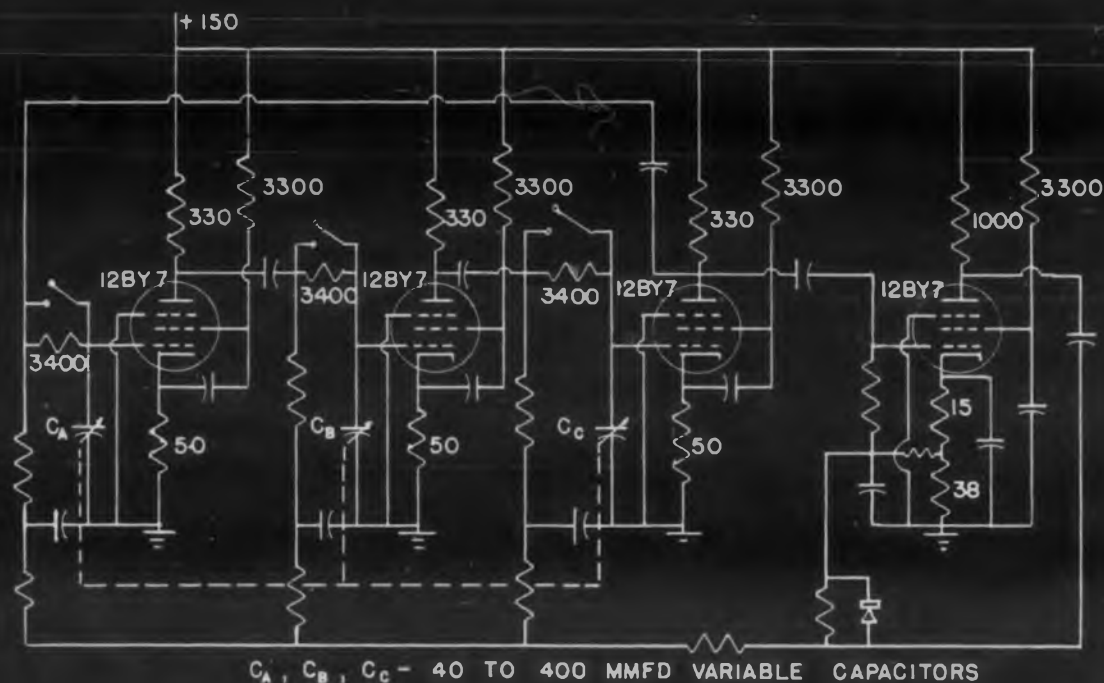

Fig. 7. A phase shift R-C oscillator

This oscillator will produce a 3ϕ output with approximately equal voltages on the phases. In addition, it has an amplitude control circuit to stabilize its output amplitude.

The tube used in this oscillator, as in the last, is the 12BY7. The screen to cathode voltage is chosen as 120 v, the cathode to control grid voltage as -0.5 v. Typical part values are shown. The amplifier aids in regulating the output voltage to constant amplitude.

A modification of Fig. 7 can be used to produce an oscillator capable of operating to a considerably higher frequency. This oscillator has its frequency selective circuit include the plate load resistor of each tube in parallel with the tuning capacitance. The only change required to provide this modified circuit is to short the tuning resistance position directly to the plate.

A 3ϕ output may be obtained at any frequency in the frequency range of the oscillator by use of three low impedance low gain amplifiers, one coupled to each oscillator tube plate.

An estimate of the oscillation amplitude may be obtained for the three phase oscillator. The nominal amplification of the avc amplifier in accordance with the parts values listed is thirteen. The overall gain per stage of the oscillator with no avc is

$$VA = \frac{-g_m X_p R_L}{2 [1 + g_m (X_p + X_{c2}) R_k]} = -1.16 \quad (8)$$

To reduce the VA to unity per stage, a reduction of transconductance to approximately $10,760 \mu\text{mhos}$ is required. A total bias of -1.8 v is required to produce this reduction of transconductance. An oscillator signal voltage output of approximately 0.14 v will generate the required bias.

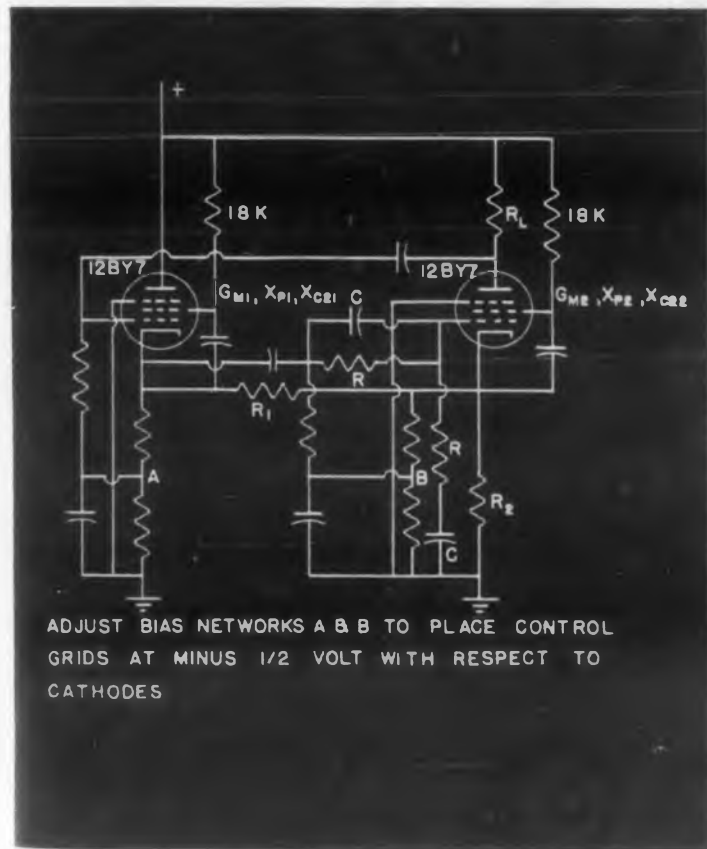

ADJUST BIAS NETWORKS A & B TO PLACE CONTROL GRIDS AT MINUS 1/2 VOLT WITH RESPECT TO CATHODES

Fig. 5. An R-C oscillator

Basic Requirements for Oscillator Stability

Some of the requirements for construction of a stable oscillator have already been noted in the sample designs. In view of the importance of oscillator stability, however, a review of some of the requirements for stability appears to be in order.

No circuit can be any more stable than its basic components and design permit. Coils must be rugged and must be temperature compensated. Capacitors must be mechanically and electrically stable and compensated as required to match other components in the circuit. Wiring should be rigid, well supported and securely soldered. Leads carrying signal voltage should be as short as possible. Tubes should be held securely in place.

The second requirement is a high effective Q for the frequency determining element. The effective Q is a function of both the basic Q of the frequency determining element and the loading effects of the circuit. The effective Q of the frequency selective circuit may be adversely affected by tube plate or screen conductance, by grid rectification or transit time loading, or by the effect of externally reflected loads. Since the cancellation of loss in the frequency control circuit and initiation by noise is based on the effective Q including all these loading factors as broad-banding elements, minimizing coupled losses from all sources is evidently of considerable importance in both amplitude and frequency stability.

The loop gain of the stabilized oscillator should be self adjusting to a value of unity. In addition, the variation of amplification over the signal excursion range should be as small as possible. Oscillators having a large gain variation as a function of rf signal voltage become much more sensitive to the effects of noise synchronization and external signal synchronization. This is because the avalanche effect increases very rapidly as the loop amplification increases from unity instantaneously.

Conclusion

Only a few typical sample oscillators could be considered in the space available. An effort has been made to select oscillator circuits possessing properties of interest designwise, and to develop the application of conductance curve techniques to show the simplicity of design by this method.

References

1. Oscillator Frequency Indeterminacy, Leon Riebmán, IRE National Convention 1951, Paper 180.
2. Non-Linear Mechanics, Minorsky, Edwards Brothers, 1944.
3. An Advanced Regenerative Circuit, Irving Gottlieb, *Radio and Television News*, Vol. 49, No. 5, May 1953, p. 48.
4. An Inductance-Capacitance Oscillator of Unusual Frequency Stability, J. K. Clapp, *Proceedings of the IRE*, Volume 36, Number 3, p. 356. See also A Simplified Negative Resistance-Type Q Multiplier, H. E. Harris, IRE National Convention 1948, Paper 10.
5. Notes on UHF Oscillator Design, K. A. Pullen, *Tele-Tech*, February, 1953.

DIT-MCO Circuit Analyzers Eliminate Human Error in Electrical System Testing!



Harness Room, Pacific Mercury Television Mfg. Corp., Sepulveda, Calif.

Non-Technical Workers Can Make Absolutely Accurate and Complete Tests of the Most Electrically Complex Wiring!

Successful electrical system ring-outs once depended on the skill, judgment, technical know-how (and often the guessing ability) of the test operator. And errors still slipped by even the most experienced. Now, DIT-MCO has removed that human error element from testing. The Circuit Analyzer takes full responsibility for every test. No wiring flaw . . . short circuit, lack of continuity, excess leakage . . . can slip past its watchful detector unit. Nothing is left to the operator's discretion. That's why average production workers can conduct thorough, completely accurate tests in a fraction of the time it formerly took. Here are just a few of the DIT-MCO features that make fool-proof testing possible:

- **AUTOMATIC** . . . entire operation, from detecting to pinpointing location of errors, is automatic
- **ACCURATE** . . . Analyzer STOPS whenever an error is present. Operator can't miss a flaw!
- **VERSATILE** . . . checks for every type of error, in the most complex circuitry without modification!

Partial List of DIT-MCO Users:

AiResearch Manufacturing Company of Arizona ● American Bosch Arma Corp. ● American Machine & Foundry Co. ● Amphenol Electronics Corp. ● Autanetics, a Division of North American Aviation, Inc. ● Bell Aircraft Corporation, Texas Division ● Bendix Aviation Corp. ● Boeing Airplane Co. ● Cessna Aircraft Co. ● Chance Vought Aircraft, Inc. ● Convair ● Douglas Aircraft Company, Inc. ● Dukane Corp. ● Electronic Products Corp. ● Fairchild Aircraft Division ● Farnsworth Electronics Co. ● Frankford Arsenal ● General Electric Co. ● General Mills, Inc., Mechanical Division ● General Precision Laboratory, Inc. ● Goodyear Aircraft Corp. ● Grumman Aircraft Engineering Corp. ● Hazeltine Electronics Division, Hazeltine Corp. ● International Business Machines Corp. ● Lockheed Aircraft Corporation, Missile Systems Division ● Martin, Baltimore ● Minneapolis-Honeywell, Aeronautical Division ● Motorola, Inc. ● Northrop Aircraft, Inc. ● Pacific Mercury Television Mfg. Corp. ● Radio Corporation of America ● Radioplane Company ● Raytheon Manufacturing Co. ● Servomechanisms, Inc. ● Sikorsky Aircraft ● Sperry Gyroscope Co. ● Summers Gyroscope Co. ● Temco Aircraft Corp. ● The Swartwout Company, Autronic Division ● Trans World Airlines ● U. S. Naval Ordnance Laboratory, White Oak ● Western Electric Co. ● Westinghouse Electric Corp.

Write for full details on how DIT-MCO can help you make your product better, faster, at less cost:

DIT-MCO, INC., Electronics Division

Box 05-20 911 Broadway, Kansas City, Missouri

CIRCLE 33 ON READER-SERVICE CARD FOR MORE INFORMATION

Get unprecedented performance—

See for yourself why the new
LEACH BALANCED-ARMATURE RELAYS
outperform all other types in resistance
to shock, acceleration and vibration



ONE-PIECE DIE CAST ALUMINUM HOUSING for maximum strength and vibration resistance with minimum weight.

MAGNET COIL wound with Teflon insulated magnet wire on one-piece Kel F bobbin assures reliability at elevated ambients.

DUAL COIL construction is the most efficient magnetic circuit for minimum height and maximum resistance to vibration and shock.

BIFURCATED CONTACTS assure high reliability in contact making circuits. Overtravel and high contact pressures produced by the pivoted armature result in immunity to shock and vibration.

ARC BARRIER of Kel F molded construction provides long arc path for use on 3 phase ac circuits, prevents phase-to-phase flashover.

BALANCED-ARMATURE DESIGN. In a *Balanced-Armature* construction, shock and vibration forces cannot cause the relay armature to move. This eliminates faulty operation of contacts due to vibration and shock forces.

HEADER AND CONTACT ASSEMBLY features simplified construction which eliminates internal wiring, lowers lead resistance, provides maximum resistance to vibration. Contacts and working parts are readily accessible throughout assembly, so that Leach is able to measure contact gap, contact pressure and overtravel, prior to sealing, on 100 per cent of production. Customers are assured of maximum performance from every production relay. Patent Pending.

MEETS ALL REQUIREMENTS OF THE MOST EXACTING OPERATING ENVIRONMENTS

The Leach Balanced-Armature Relays meet or exceed requirements of MIL-R-5757, MIL-R-6106, MIL-E-5272. Typical ratings include: vibration, 20 G's to 500 cps (higher ratings available); shock and acceleration, more than 50 G's; temperature, -50° to $+125^{\circ}\text{C}$; life, 50,000 continuous operations minimum at rated load; coils, any resistance to 10,000 ohms—also available for 115 vac, 400 cps operation.

Write today for your copy of the *Leach Balanced-Armature Relay Catalog*.

LEACH CORPORATION | LEACH RELAY DIVISION

5915 AVALON BOULEVARD, LOS ANGELES 3, CALIFORNIA

DISTRICT OFFICES AND REPRESENTATIVES IN PRINCIPAL CITIES OF U. S. AND CANADA
CIRCLE 34 ON READER-SERVICE CARD FOR MORE INFORMATION



Transformer

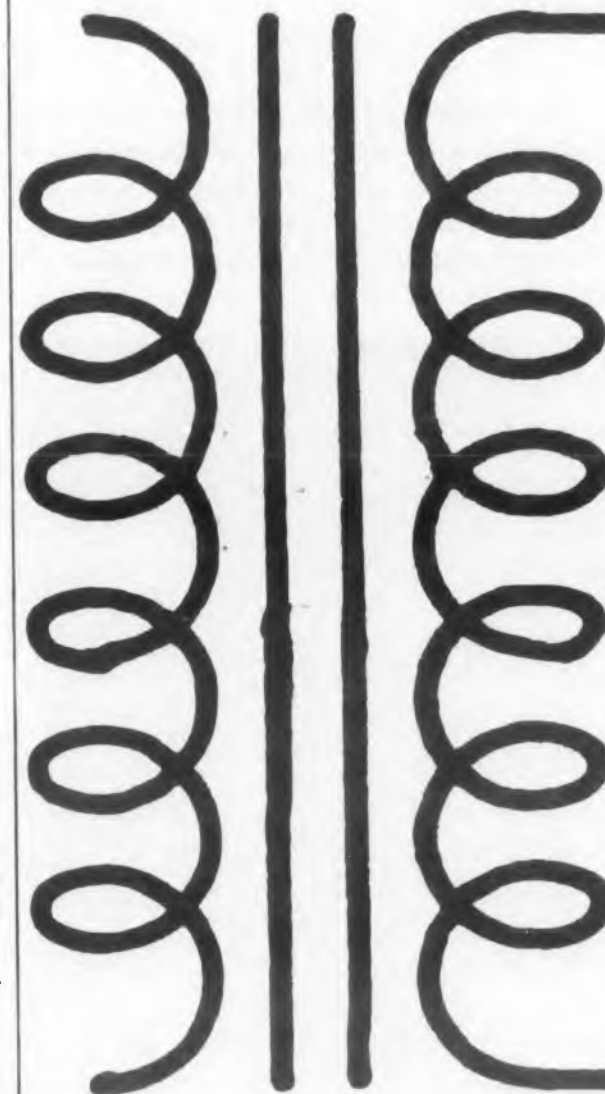

Design Nomograph – II

Martin Berger

Minitran Corp.

5 Oliver Street

Newark, New Jersey

SECOND in the series of five transformer design nomographs is this 60 and 400 cps capacitance and inductance reactance chart. Not only does it give reactance of known component values readily, but it provides a handy means for determining the capacitance needed to tune a given inductance to resonance or vice versa.

Direct readings can be made from the nomograph without need for a straight-edge. For capacitances or inductances in other units than given on the charts, apply the *K* factor as indicated. For example: What is the reactance of a capacitor of 10 μmf ? This capacitance is not on the chart but can be expressed as 10 μf divided by 10^6 . Thus, *K* is 10^6 . The reactance for 10 μf is read off the chart as 267 ohms. Applying the *K* factor as indicated, the reactance for 10 μmf is $KX = 10^6 \times 267$ or 267 megohms.

REACTANCE NOMOGRAPHS



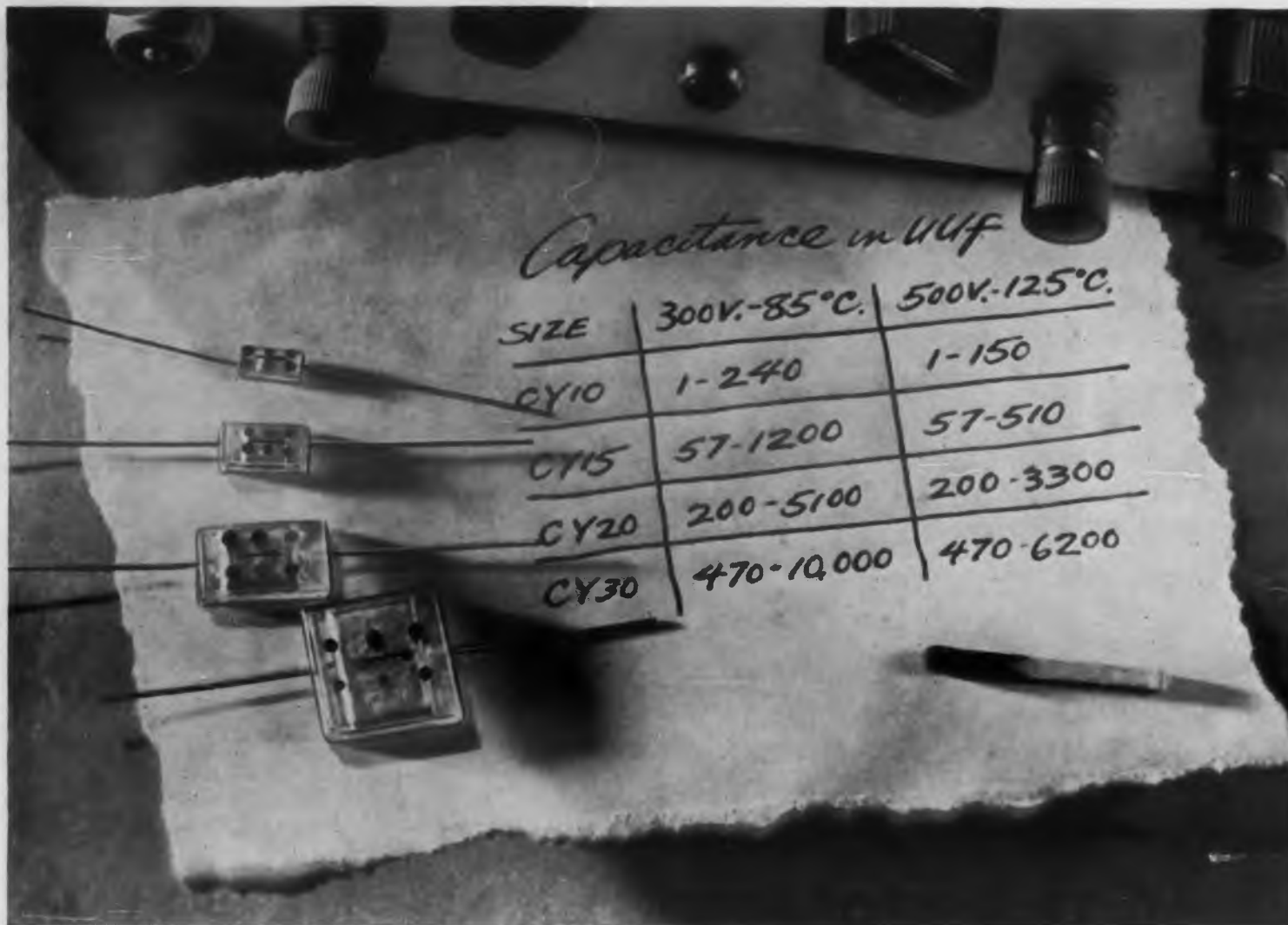

uuf for *uuf*, the smallest, most stable, fixed capacitors you can buy—Here's why...

These are *glass* capacitors—probably as much as one-third smaller than those you're used to; certainly much lighter.

Though made with glass, they are *not* fragile. In fact, the layers of glass dielectric, the metal foil plates and the leads are fused into a surprisingly rugged, inseparable unit.

This unusual construction, developed at Corning offers you these advantages:

Small size, light weight. If you're at work on guided missiles, fire controls, computers, and similar devices, you can cut valuable ounces and inches from your assemblies with these capacitors. See table above for some indications.

Exceptional stability. After a load life test at 50% more than rated voltage at

85° C., the average change in capacitance of these units is less than 0.4% after 1,000 hours, less than 0.6% after 10,000 hours.

Very low drift. This drift is so slight that it's generally within the normal error of measurement. Taking MIL-C-11272A as a standard, capacitance drift is less than 0.1% or 0.1 *uuf* (whichever is greater).

Predictable, retraceable TC. The difference in TC between any units at any given temperature is less than 15 ppm/°C. It is well within the limits of 140 ± 25 ppm/°C. from -55° C. to +85° C. and referred to 25° C.

Low loss. Even at elevated temperatures, the dielectric loss is relatively low. Dissipation factor at 1 kc. and 25° C. is about 0.055% and independent of capacitance.

Other electronic products by Corning Components Department: Glass Film Type Resistors*. LP, LPI, H, R, N, S, HP and Water Cooled Styles. Direct Traverse and Midget Rotary Trimmer Capacitors*. Metallized Glass Inductances, Delayline Coil Forms, Bushings, Enclosure Tubes, Rectifier Tubes and Attenuator Plates.

Bulletin shows performance charts. Bulletin CD-1.00 contains charts and other data on these capacitors. Circle this magazine's service card for a copy or write us direct at Corning.

Ask for information on these other Corning Capacitors:

Medium Power Transmitting—CY60 and CY70. Ideal for mobile RF transmitters.

Canned High Capacitance—Provide the advantages of rugged glass design to your specifications.

Subminiature Tab-Lead—Up to 90% less volume compared to pigtail types. To your specifications.

Special Combinations—The performance and benefits of glass in infinite shapes, sizes and leads. To custom order.

*Distributed by Erie Resistor Corporation

| Size | 300 V. -85° C. | 500 V. -125° C. |
|------|----------------|-----------------|
| CY10 | 1-240 | 1-150 |
| CY15 | 57-1200 | 57-510 |
| CY20 | 200-5100 | 200-3300 |
| CY30 | 470-10,000 | 470-6200 |

Corning means research in Glass



CORNING GLASS WORKS, 97-5 Crystal Street, Corning, N. Y.

Electronic Components Department

CIRCLE 35 ON READER-SERVICE CARD FOR MORE INFORMATION

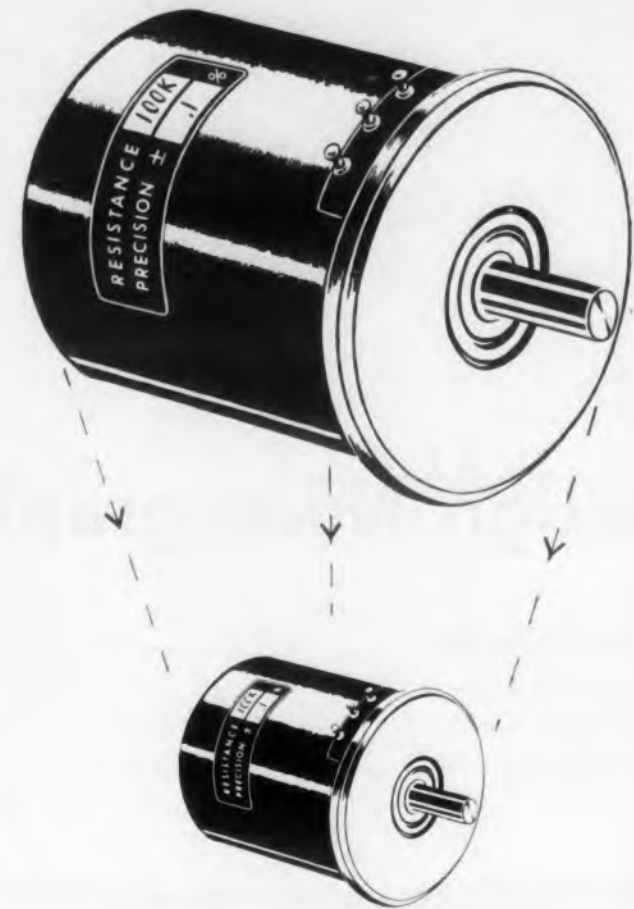

Precision potentiometer is miniaturized with High Resistance Wire.

Extra-High Potentiometer

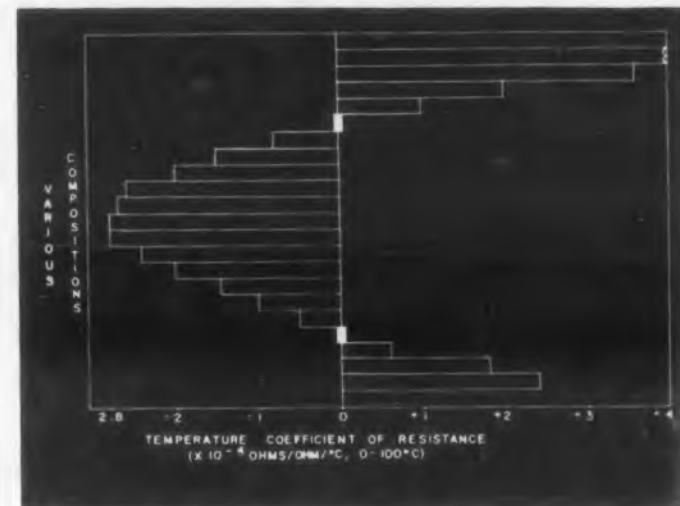

Twenty-one different temperature coefficients of resistance are available. Coefficient of the potentiometer wire may be set to compensate for temperature variations of other circuit components.

POTENTIOMETER wire resistances up to 1100 ohms per circular mil foot—more than twice that previously obtainable—are possible using a new precious-metal alloy. This increased resistance will enable designers to substantially decrease the size of potentiometers and other wire wound components. Composition of the alloy can be varied to give both positive and negative temperature coefficients.

Developed by Baker and Company, Inc., 113 Astor St., Newark 2, N.J. the palladium-gold-iron alloys contain approximately 90 per cent precious metal. Twenty-one different temperature coefficients of resistance ranging from 4×10^{-4} ohms/ohm/deg C, 0-100 C, through zero to -2.8×10^{-4} are available to the designer (see chart). By specifying the proper temperature coefficient, resistance fluctuation of other circuit components caused by changes in temperature can often be offset by the potentiometer.

Resistivity Wire

Good Linearity

All constituents of the alloys are in solid solution, resulting in good linearity. After suitable heat treatment, the resistivity is so stable that prolonged heating at 200-250 C will not affect it. As would be expected from precious-metal alloys, the new compositions have good corrosion resistance up to temperatures of 1100 F—a major consideration in precision instruments.

In some potentiometers, the higher resistivities will enable designers to avoid the use of very fine wire—which often adds to production costs—without describing coil resistance. Wear tests with a 20 gram load on the contact have produced only negligible wear after 2,000,000 cycles. The highest resistance commercially available in precious-metal alloys heretofore was 550 ohms per circular mil foot, the highest in base-metal about 800 ohms per circular mil foot.

For further information on this potentiometer wire, turn to Reader's Service Card and circle 36.

Small Parts—like these



Cost Much Less

Parts shown are actual size.

—when Grayhill-Moldtronics makes them!

Grayhill-Moldtronics can, through its own "automation in molding", considerably reduce your cost for small components of thermo-setting plastic.

The excessive tooling costs for molded parts induced Grayhill to design its own completely automatic molding press.

The Grayhill method of transfer molding, plus the unique and highly efficient design of the new Grayhill presses proved so successful on Grayhill's own requirements that an entire battery of these presses is now in operation, serving many manufacturers of electrical and electronic components.

For quantities of 50 to 200,000 thermo-setting plastic parts, with overall dimensions not exceeding $1\frac{1}{8}'' \times 1\frac{1}{8}'' \times \frac{7}{8}''$, Grayhill-Moldtronics can make substantial reductions in your costs. Mold capacity is limited to approx. .4 oz., or .5 cubic inch of molded material—this material being divided between 2, 4 or 6 cavities.

New methods of secondary operations, such as the assembly of inserts, will permit further economies.



View of a portion of the molding department showing a battery of Grayhill Presses in operation.



Submit your drawings, or blue prints
for a prompt quotation.

MOLDTRONICS INC.

565 Hillgrove Avenue, La Grange, Illinois

Phone: Fleetwood 4-1040

CIRCLE 37 ON READER-SERVICE CARD FOR MORE INFORMATION

Rack

Stack &

Carry

Modular Instruments

SPECIFICALLY designed to be mounted or stacked without sacrifice of space, efficiency or performance, these instruments are the latest addition to the modular concept. The policy of rack mounting developmental circuitry has been generally accepted. These modular instruments can add the necessary equipment to the rack to make the installation complete.

How to mount the small, less-than-width, unit has been an awkward problem. In attempting to rack-adapt instruments, most companies have mounted them on a 19 in. panel leaving part of the panel blank. This space is not wasted in the modular system since the instruments are made in either 1/6, 1/3, 2/3 or full rack width. By combining these fractional modules the user can assemble the desired combination of test instruments for his specific needs and yet utilize the full rack width.

To meet the basic requirements of a standard test facility, Teletronics Laboratory, Inc., 54 Kinkel St., Westbury, L.I., N.Y., provides the following modular instruments:

| | |
|---------------------------|---|
| Audio VTVM | 10 cps to 200 kc, 10 mv to 300 v |
| AC-DC VTVM | 1.5 to 1500 v |
| Multimeter | 1.5 to 5000 v |
| Audio Oscillator | 10 cps to 100 kc, .5 percent distortion |
| Regulated DC Power Supply | 150 to 350 v, 100 ma |
| AC Power Supply | 0 to 135 v, 3 amp |
| Frequency Meter | 10 cps to 100 kc |
| Step Attenuator | 42 db, 6 Steps 2010-6-3-2-1 |

It was recognized that many users would have equipment of their own design special to their needs which they would like to mount in the system. Modular cases, panels, and chassis identical to those used for the modular instruments are available thus preserving the functional benefits of the system and

insuring a neat, uniform, completely organized appearance.

How The Rack Works

A rack adapter 19 in. wide by 8-3/4 in. high is used to mount the instruments. Made to fit the



Fig. 1 Modular instruments 1/6, 1/3, 2/3 and full rack width mount conveniently in 19 in. standard rack.



Typical bench assembly using test instruments (top) and modular instruments (bottom). Both assemblies contain the same equipment.





Fig. 2 Instruments can be simply stacked upon one another. For semi-permanent installations, a locking strip and stand are available.

standard 19 in. relay rack, it comes in a single frame or with a supporting shelf for the longer, heavier instruments. Since the smallest module is 1/6 of the rack adapter width, the 1/6 width is used as spacing increments for mounting screw pairs. A 1/6 unit is held by one screw top and bottom (Fig. 1); a 1/3 size by two screws top and bottom. Panels, regardless of size, fit side by side and flush with one another to form a neat, compact assembly.

How the Stack Works

The bench rack is used in many cases because it is the only way of stacking equipment. Since all units have the same form, height and modules of width, the instruments can be simply stacked upon one another (Fig. 2). For semi-permanent installations a strip is available which locks two layers of instruments together using the same screws used for rack mounting. Also for convenience a stack pedestal is available which raises and tilts the assembly. The instrument is fastened to this mount by the usual mounting screws. Power strip, switch, and pilot light are incorporated to provide convenient power for the whole assembly.

Carry

The smaller units have a strap handle which may be removed for permanent rack or stack installation. The heavier, larger units have permanent handles which are conveniently recessed to prevent interference with the rack or stack installation.

Other items are planned to expand the utility of the system. A complementary low and a high frequency oscillator will soon be announced, and it is expected that at least six more instruments will be added to the system this year. For information on these instruments, turn to Readers Service Card and circle 38.

Now! Simplify pulse-forming circuits with new Westinghouse **WL-6954**

Designed for:



Guided Missiles



Airborne Communications



Radar



Test Equipment



Closed Circuit TV

GATING CIRCUIT
WITH TYPE WL-6954

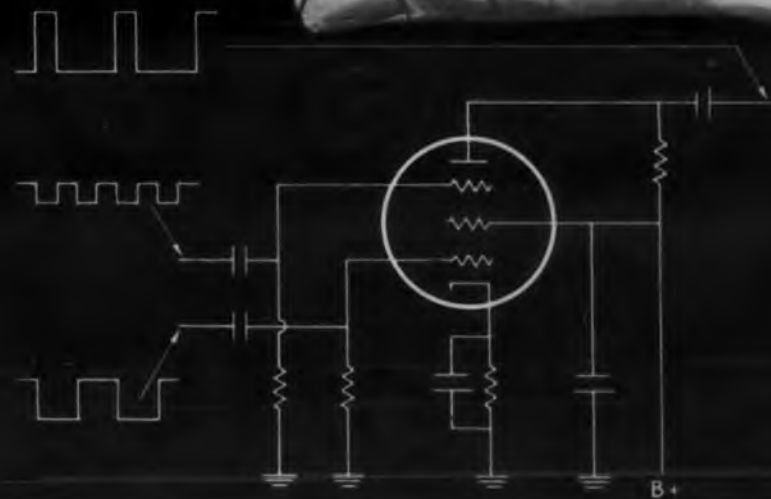

NEW SHARP CUT-OFF DUAL-CONTROL PENTODE OFFERS EXCEPTIONALLY HIGH TRANSCONDUCTANCE

The new Westinghouse WL-6954 is a 7-pin miniature pentode designed for application in Military and Industrial equipment as a gating, coincidence, mixing or delay tube.

Built to high standards of reliability, it meets MIL-E-1C vibration test specifications. It permits simplification of pulse-forming circuits and has the advantage of high transconductance from Grid 3 to Plate.

The WL-6954 is available in production quantities

YOU CAN BE SURE...IF IT'S

Westinghouse

ELECTRONIC TUBE DIVISION • ELMIRA, N. Y.

CIRCLE 378 ON READER-SERVICE CARD FOR MORE INFORMATION

for immediate delivery. It's one more reason why—when you want highest quality tubes for Military or Industrial purposes—you'll find it wise to check Westinghouse.

SAMPLE ORDERS INVITED! IMMEDIATE DELIVERY.

CLIP AND MAIL COUPON

Commercial Eng. Dept., Electronic Tube Div.
Westinghouse Electric Corp., Elmira, N. Y.

Please send me complete data on your new
WL-6954 pentode.

NAME _____

COMPANY _____

ADDRESS _____

ED-5-1

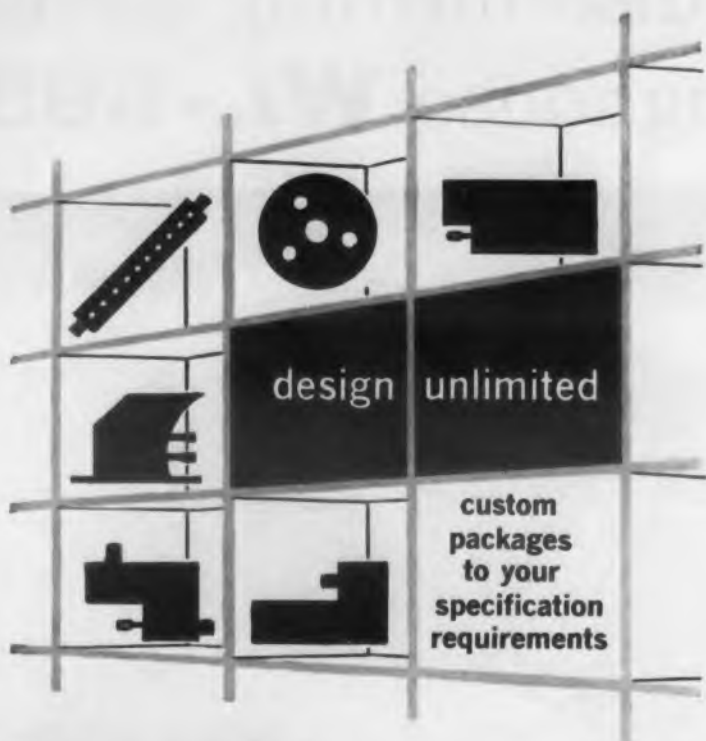

edcor *hermetically sealed . . .
sub-miniature and bathtub type*

Paper-Foil Capacitors

Our specialty is the design and building of custom capacitors to specification . . . prompt delivery assured.

edcor engineers have an unlimited wealth of experience and electronic know-how in the design of precision capacitors. Utilizing advanced modern equipment, improved production techniques and quality control measures, to meet critical operational requirements . . . at savings to you.

UNLIMITED SELECTION . . . of tubular sizes, bathtub cases, mounting styles and circuit configurations are available in edcor PAPER-FOIL CAPACITORS, to MIL C-125A.

*highest
reliability
and quality
control at
low cost*

Our field Sales Engineers will welcome the opportunity to discuss your particular capacitor requirements. For the address of the office nearest you, or for complete technical data, write, Sales Engineering Dept., U.S. Electronics Development Corp., 1323 Airway, Glendale 1, California.



U S

edcor

U. S. Electronics Development Corporation
1323 Airway, Glendale 1, California

CIRCLE 39 ON READER-SERVICE CARD FOR MORE INFORMATION



A REFLEX klystron with ceramic insulation, the ZV1009 has a continuously variable output frequency from 1,500 to 6,000 mc. The external cavity, pulseable, broadband tube is intended as an improvement and replacement for klystron tubes 6B1B and 5836. It can be used in any appropriate cavity, such as the one designed for a 5836 tube.

Designed for operation at high temperatures by the Polarad Electronics Corp., 43-20 34th St., Long Island City 1, N.Y., the ceramic envelope permits elevated cavity temperatures much higher than equivalent glass tubes, eliminating the need for blower cooling. The heater operates at 6.3 v, the control grid at 10 v (relative to cathode), the accelerating potential at 325 v (relative to cathode), and the repeller at -45 to -320 v for $n=2$ repeller mode. The repeller voltage can be tracked over the entire band in the 2-3/4 repeller mode.

Due to its rugged internal construction, the tube is virtually non-microphonic. It is completely hard-soldered and is equipped with standard four-pin connections. For more information about this product, turn to Reader's Service Card and circle 40.

Miniature One-Shot Power Supply

A N OUTPUT of 28 v at 700 w is produced by this miniature silver zinc battery for a period of 2 min. When current is required, a signal actuates a simple fluid transfer system which, in as little as 100 msec, fills the battery cells with electrolyte and thus initiates battery output. The power available is sufficient to supply all the electronic equipment on guided missiles, and rockets.

Electrolyte for the battery, manufactured by Frank R. Cook, 36 So. Santa Fe Drive, Denver 23, Colo., is carried in a separate tank within the hermetically sealed main case. A highly simplified design is used in the fluid transfer system which increases reliability and eliminates the need for maintaining a vacuum. A double set of electrically-ignited gas generators produces all of the pressure required.

The battery is connected directly to the load at the time of installation in the missile. Activation is thus accomplished under full load. In a typical application the battery performs as follows: (1) voltage is applied to the activation circuit. (2) 0.5 sec later the voltage is within 4 per cent of its steady-state value, where it remains within ± 2 per cent during the next 2 min. (3) at 3 min, the battery is exhausted but the "flight" is over.

Uses for this battery are primarily found in missile auxiliary power supplies, piloted aircraft emergency power units, torpedoes and many classified applications. Several models are in production, in-

Broadband Ceramic Klystron

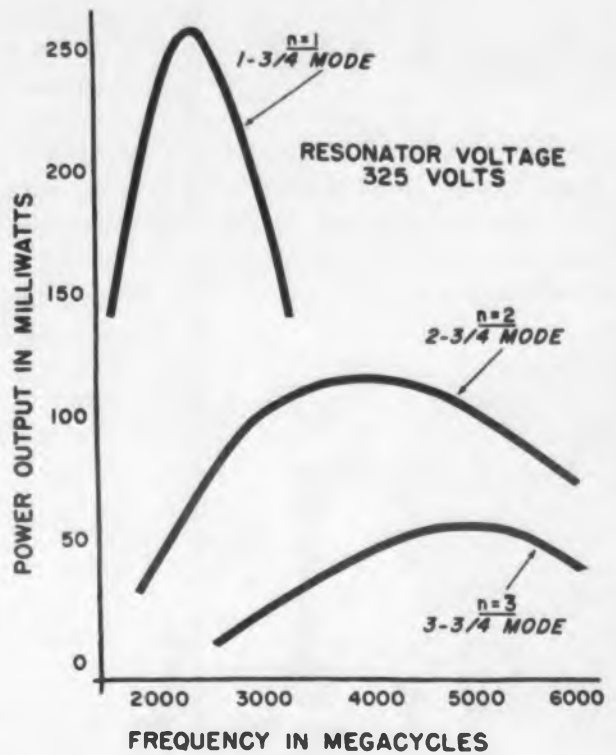

Average power characteristics of ZV1009 klystron.

cluding a combination 7 V "A" supply and 495 V "B" supply in which 362 cells are filled uniformly in 150 msec. Shelf-life is conservatively estimated at 5 yrs. Operating ambient temperature is between -65 and 240 F.

Peculiar to the silver-zinc cell, exhaustion times of 0.5 min to many weeks can be provided at high efficiency. The long shelf life, flat voltage characteristic, and the ability of the silver-zinc cell to yield all of its energy over a very brief period makes this an ideal portable power source in many one-shot applications.

For further information on this miniature power supply turn to Reader's Service Card and circle 41.

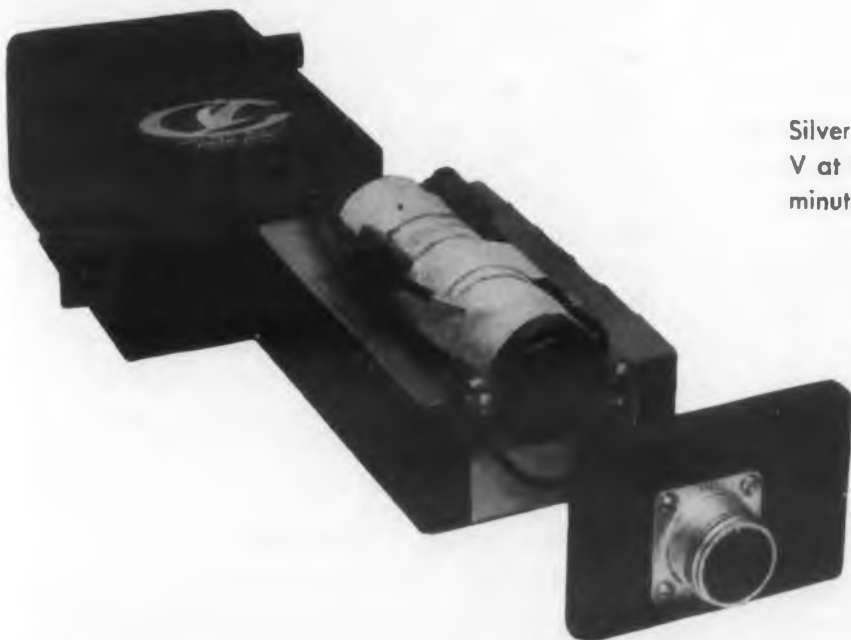

Silver zinc battery provides 28 V at 700 W for a period of 2 minutes.

CIRCUIT

INSTRUMENTS INC.

helical

POTENTIOMETERS

carry a lot of power for their size



(actual size)

You'll find these Type HM Potentiometers are big in one way, small in another. And that pretty well describes CIRCUIT INSTRUMENTS too. This progressive company is big enough to engineer advanced potentiometers and special features. At the same time, it's small enough to offer unusual production flexibility. You get the benefit in better service and faster delivery.

TYPE HM
POTENTIOMETER

THE OUTPUT YOU WANT...

with resistances from 1,000 to 100,000 ohms, tolerances from $\pm 5\%$ to $\pm 0.5\%$, linearities from $\pm 0.5\%$ to $\pm 0.1\%$, 5 or 10 turn models, and power ratings of 3 or 4 watts.

THE SIZE YOU WANT...

a mere 1" in diameter by $\frac{1}{4}$ " or $\frac{1}{8}$ " in case length. To meet installation requirements, Type HM Potentiometers are also available with flexible or turret type terminals and standard or slotted shafts.

CIRCUIT

INSTRUMENTS INC.

Subsidiary of
INTERNATIONAL RESISTANCE CO.

CIRCUIT INSTRUMENTS INC.

Dept. D

P.O. Box 1438, 2801 Anvil St., North St. Petersburg 1, Florida

Send data sheets on Helical Sub-Miniature Servo
Moisture Sealed Hermetically Sealed High Temperature
High Precision Potentiometers.

NAME _____

COMPANY _____

ADDRESS _____

CITY _____ STATE _____

CIRCLE 42 ON READER-SERVICE CARD FOR MORE INFORMATION

Background for Design

This is the second of a series of two articles reviewing radar modulators and their requirements. The first, appearing in the April 15 ELECTRONIC DESIGN, discussed the circuit requirements and operational factors the design engineer must consider in order to solve his particular problem. Modulator devices fall into three basic classes: hard-tube, line-type, and passive modulators. Operational factors may limit the free choice of any of these three classes. Further limitations may be imposed by performance and packaging factors, since in the first case one must live with these requirements, having no other choice, while in the second case these factors may in themselves force a decision on the type of modulator device.

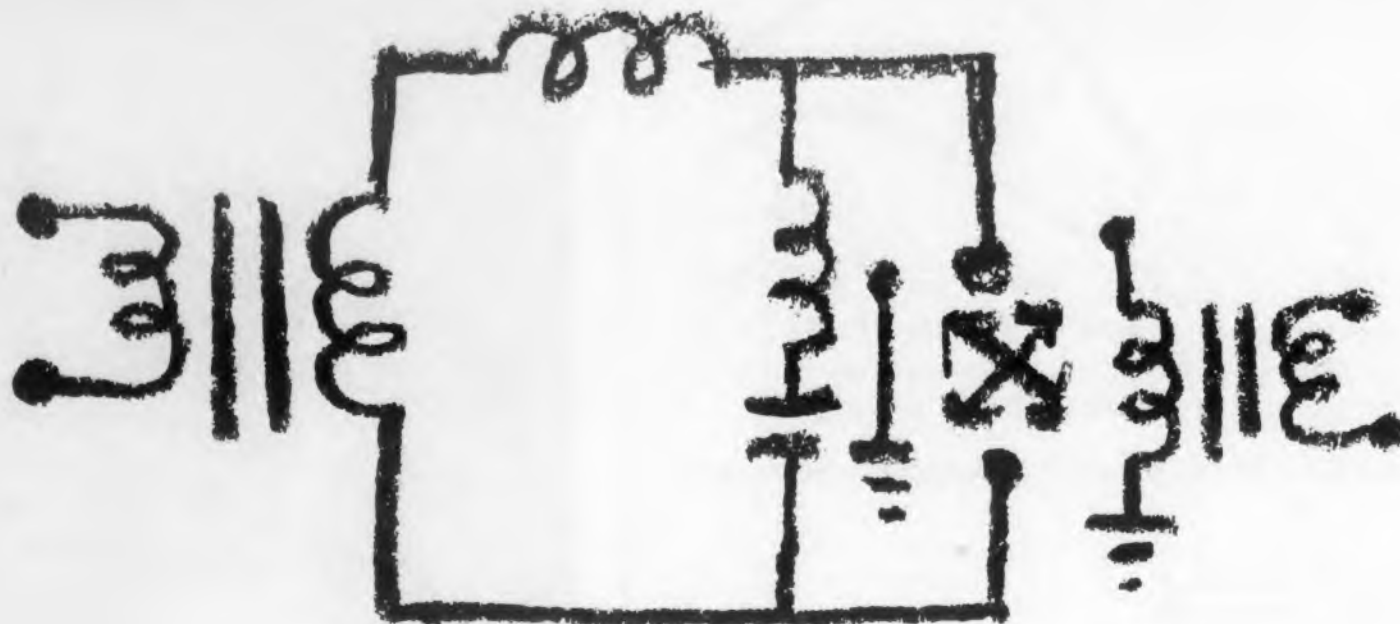

Performance and Packaging of Modulators

M. H. Zinn
Signal Corps Engineering
Laboratories

EVERY radar system must be capable of performing one or more functions within certain tolerance limits dependent upon the end use of the equipment. A number of these factors (the list is not necessarily all-inclusive) that will affect the ability of the modulator device to meet system performance requirements are:

- Time jitter and time drift in the modulator device
- Warm-up time
- Versatility, or the ability to operate at different pulse and repetition rates
- Ability to switch information in addition to single pulse
- Ability to meet ambient conditions

These performance requirements may dictate the particular type of device that can be chosen, even though all types are freely available. On the other hand, the choice of suitable operating and packaging factors may permit a device, which is apparently limited in any one of the characteristics, to operate satisfactorily within system tolerance limits.

Time Jitter

The hard-tube modulator clearly provides no basic problem with respect to time jitter, although jitter can be introduced by poor wiring techniques, particularly in the driver stages. A gas tube operating in a line-type modulator, on the other hand, can introduce jitter into the circuit. In the hydrogen thyratron this time jitter is maintained within usable limits and can be minimized by proper attention to grid drive and plate supply ripple. Furthermore, the nature of the time jitter is known. It appears essentially as a line-frequency modulation of the time position of the pulse. We can, therefore, calculate the effect of jitter on a pulse-to-pulse basis and predict the performance of the thyratron in a system where this characteristic is critical.

In the ignitron or pool cathode device, jitter is a definite problem, since it occurs in this type of tube as a random phenomenon. It can be alleviated to some extent by using multiple grids in the tube

to form a plasma, which can then be used as the ion source for the next step in the discharge and thereby minimize some of the statistical fluctuations. In the magnetic modulator, when it is self-triggering, there is no problem in jitter. The pulse duration may vary in position over wide ranges, but since the output pulse is used as the reference point for all the time bases there is effectively no jitter in the system. This type of operation limits the equipment engineer in what he can do with his system and may severely cut down the tactical versatility of the equipment with respect to such items as the minimum range possibilities and other features. Many modulator engineers consider the use of a self-triggered system (also possible with any other type of modulator) as a return to the pre-historic days of radar.

Time Drift

Time drift is an important characteristic since it affects range accuracy of the equipment. The hydro-

gen thyratrons and gas-discharge devices, in general, present a problem with respect to time drift. It can be minimized to some extent by proper circuitry, but this will add to the total size, weight, and complexity of the equipment. Good stability can be achieved by the use of compensating circuits to maintain a constant time delay of the output pulse, either with respect to the input or between two successive pulses where sequential firing is used. The two remaining classes of modulator devices should have little or no trouble due to this characteristic.

Warm-up Time

The ability to get on the air quickly when one needs to is an important characteristic of many equipments, but the problems are not necessarily restricted to the switching device. The limitations may be as great in the final rf tube as in the switch tube. All that is necessary is to make the two units compatible with respect to both the time required to heat the cathodes to operating temperature and the time required to raise the voltage to its full operating level. Thus, although the passive modulator and cold cathode gas discharge device may appear to have a basic advantage, the hot cathode gas tube and hard-tube modulator may adequately meet requirements.

Versatility

Versatility is an important factor as far as performance is concerned. Many of the systems in the field today operate at two, three, four, and possibly more combinations of pulse duration and repetition rate, each of these operating conditions perhaps serving a different function with respect to range, definition, resolution, and use with moving target indicators. Where available in the equipment, these conditions are usually chosen by the operator as desired. This can be done very easily with the hard-tube modulator where such switching can be accomplished at low power levels. In the line modulator it is a little more troublesome. Individual networks operating at the desired output level are required and possibly individual charging inductors as well, but this has been accomplished and is standard practice in the field today. With the passive-element modulator one is, however, generally limited in repetition rate to the supply frequency of the complete system. Possible exceptions to this can be obtained by using two-phase, three-phase, and six-phase circuits. These require a generator capable of operating at the greatest number of phases desired, permitting operating at specific multiples of the basic applied frequency. As far as the writer knows, present plans incorporating passive-element modulators and at least one equipment where this device is presently used, involve operation that is restricted to a single repetition rate.

for highest accuracy . . .



PRECISION RESOLVERS

by *Reeves*
INSTRUMENT CORPORATION

including the **NEW SIZE 11** miniature

The new Size 11 miniature resolvers, now in commercial production, compare in performance with the standard Size 23 and Size 15 Reeves units, long accepted as the precision standard of the industry. Functional accuracy of 0.05% in the Size 23 and 0.1% in the Size 15 and Size 11 are achieved in standard production without culling. Even higher accuracies can be obtained on special order.

Both compensated and uncompensated units can be supplied in any frame size. Special units are also available for use as phase shifters or for high frequency use. For the best in resolvers, bring your requirements to Reeves!

Write for resolver catalog RICO 57.

REEVES CONTINUOUS RESOLVER CHECKER



Provides continuous 360° check on resolver functional accuracy, and yields permanent record of results.



7RV57

REEVES INSTRUMENT CORPORATION

A SUBSIDIARY OF DYNAMICS CORP. OF AMERICA, 223 EAST 91st ST., NEW YORK 28, N.Y.

CIRCLE 45 ON READER-SERVICE CARD FOR MORE INFORMATION

Whatever type of lacing cords
and tapes you are now using...

consider the advantages of

NYLON and DACRON

HEMINWAY
& BARTLETT

**NYLON FLAT BRAIDED TAPES
NYLON LACING CORDS
DACRON FLAT BRAIDED TAPES
COST MUCH LESS THAN YOU THINK!**

- Fungus-proof
- Stronger, abrasion-resistant
- Ties easier, faster, tighter
- Knots will not slip
- Higher heat resistance and stability.

GOVT. APPROVED!

Nylon tapes and cords meet new
Govt. Spec. Mil-T-713A
Dacron tapes have Air Force approval

FREE! Write today for free samples of tapes and cords

The Heminway & Bartlett Mfg. Co., ELECTRONICS DIVISION, 500 5th Ave.,
N. Y. 10017. Offices: Chicago, Philadelphia, Boston, Cincinnati, San
Francisco, Los Angeles, Detroit, Charlotte, N. C., Greenville, N. C.,
Lynchburg, Va. Foreign Agent: Turner, Halsey Co., Inc., 40 Worth St., N. Y.

CIRCLE 379 ON READER-SERVICE CARD FOR MORE INFORMATION

Cut Power Transformer Costs . . . with

GTC'S

**NEW DESIGN
and
PRODUCTION
TECHNIQUES**

through
**HIGH HEAT
DISSIPATION**

- ★ Cut Costs over conventional designs yet still improve quality.
- ★ Provide superior shielding—totally encased construction.
- ★ Longer Life — potted to withstand severe humidity conditions.
- ★ Highest commercial quality appearance.



We invite your inquiry.



GENERAL TRANSFORMER COMPANY
serving industry since 1928

18240 Harwood Avenue, Homewood, Illinois
(Suburb of Chicago)

CIRCLE 44 ON READER-SERVICE CARD FOR MORE INFORMATION

Codability

Another performance characteristic that is becoming more and more important today is the ability to transmit a group of pulses to provide coded information. The hard-tube modulator is extremely well suited for this type of application, since all that is necessary is to feed the modulator a train of pulses at a low power level. Line modulators may be used to provide coded pulse operation, within certain limitations. First, one must generally use individual tubes and individual modulator circuits to provide each pulse. Second, there is a limit on how closely the pulses can be formed. When the second tube fires, the output voltage across the load appears as inverse voltage on the first tube, which has already completed its firing. If the second pulse is too close to the point at which the previous pulse stopped, additional inverse power of considerable magnitude can be dissipated in the first tube, and this process will be repeated in succeeding tubes. The passive-element modulator would also require multiple circuits for coded operation, with phase delays of some type provided in the supply side of equipment. The writer is not certain of the effect an inverse voltage pulse across the load would have on the circuit that fired previously. Certainly it will have some effect and might tend to precipitate ringing. The trouble is that this inverse voltage obviously cannot be clipped since it is the useful output of the modulator.

Ambient Conditions

Any device that dissipates power will have some limitations with respect to ambient temperature. The real question involved is how much auxiliary equipment must be utilized to maintain the device within rated temperature over the desired range of ambient temperature. It is not possible to make a complete comparison because of the wide range of power levels possible with these devices. In general, considering an ambient temperature range of -55°C to 90°C , hydrogen thyratrons require no auxiliary equipment (reservoir types do require an ac voltage supply to maintain the desired pressure); ignitron devices require air or water cooling or heating to maintain a portion of the envelope within a temperature range considerably narrower than the ambient; hard tubes, as a function of the power level, require no cooling, air cooling, or water and air cooling; the passive modulator should be susceptible to being designed for no external cooling although it may be necessary to use oil immersion and/or air cooling at higher power levels in order to minimize size. With respect to shock and vibration ambient, again a comparison is difficult, although the passive-element device should be superior while a liquid pool device such as the ignitron should be the poorest.

Packaging Factors

Every radar system used in the field must meet, within limits determined by the particular end use, specific size, weight, and, in many cases, shape requirements. The factors that determine the final package requirements are:

- Size and weight of the modulator device itself
- Drive requirements of the modulator
- Over-all efficiency of the modulator
- Impedance level of the modulator supply
- Need to include features to take care of deficiencies in the switch with respect to performance factors

Again, assuming that a free choice of modulator device is still possible, the effect of the packaging factors is dependent on the type of application. Thus, in a fixed land-based system, the packaging requirements may exercise little or no influence on the choice, while in an airborne or extremely portable equipment it may be the sole determining factor.

Size and Weight of the Modulator Device

A gas tube designed for use in a line-type modulator generally is considerably smaller than a hard tube designed to switch an equivalent power. This factor has been improved further in the newer designs of hydrogen thyratrons using ceramic-metal construction. The passive-element modulator cannot be compared by itself against other modulator devices, since the inductive elements that perform the switching cannot be separated easily from the capacitive elements that store energy. The over-all modulator, however, is comparable with a line-type modulator at power levels where passive-element devices have been used to date.

Drive Requirements

The drive requirements of the gas-tube switches, in general, are very much lower than those of a hard-tube modulator, although some of the margin may have to be sacrificed in order to buy improvements in performance factors. Although the drive requirements for a hard-tube modulator may be reduced by driving it with a gas tube, this can be done only by sacrificing some of the performance factor advantages of this type of device. A self-triggering passive-element modulator will obviously require no drive. As indicated in the previous discussion, this may not be an over-all advantage. In addition, the requirements for biasing elements with dc power to control triggering or for shaping, may result in a device with poor total efficiency.

Over-all Efficiency

Considering the switch itself for the moment, it can be stated as a general fact that, for comparable power levels, the power lost in a gas tube switch will be less than that lost in a hard-tube switch. The efficiency of a passive-element modulator, con-

sidering the switching section only, will be a function of the number of stages. Based on data indicating that a stage efficiency of 85% is a reasonable design figure, the efficiency of a two-, three-, or four-stage switch would be comparatively low compared with the other switches alone. In order to determine over-all efficiency, the remaining components of the modulator—such as the power supply, charging choke, network or storage capacitor (included in switch for the case of the passive-element modulator), and pulse transformer when used—must be considered. Using extremely rough assumptions on the efficiency of each of these components, the over-all efficiency of a hard-tube modulator not requiring a pulse transformer is comparable to that of either the line-type or single-stage passive modulator with pulse transformer. A two- or three-stage passive-element modulator would be considerably less efficient than either of the others, and if it were possible to use a line-type modulator without a pulse transformer this would be the most efficient. If drive or biasing requirements are considered in the over-all efficiency calculations, the line-type modulator with a gas-tube switch must be considered superior with respect to efficiency, even with a pulse transformer output. The estimate of power supply efficiencies used for the passive-element modulator did not include electronically generating the supply frequency. This would cut the over-all efficiency even further.

Impedance Level of Power Supply

The size and weight of the power supply for the modulator often represents a large fraction of the total size and weight of the modulator. The ability of a line-type modulator or a passive-element modulator to operate at half the stored voltage plus operation at a higher ratio of current to voltage, generally leads to a smaller and possibly lighter power supply design. In the case of the passive-element modulator or ac charging line-type modulator, this advantage is further increased by the elimination of the dc rectification. The importance of this power supply size factor in the choice of modulator device can be minimized by the use of oil immersion of the rectifier components.

Performance Deficiencies

This factor is listed only to emphasize the point that, while it is possible to overcome many apparent operational deficiencies of a switch, the process will usually result in an increase in size of the modulator. A complete evaluation of the individual problem is required before one can arrive at a final choice of modulator device.

This article appeared originally in the A.G.E.T. News Bulletin, Dept. of Defense, Vol. 1, No. 2, Apr. 1957.

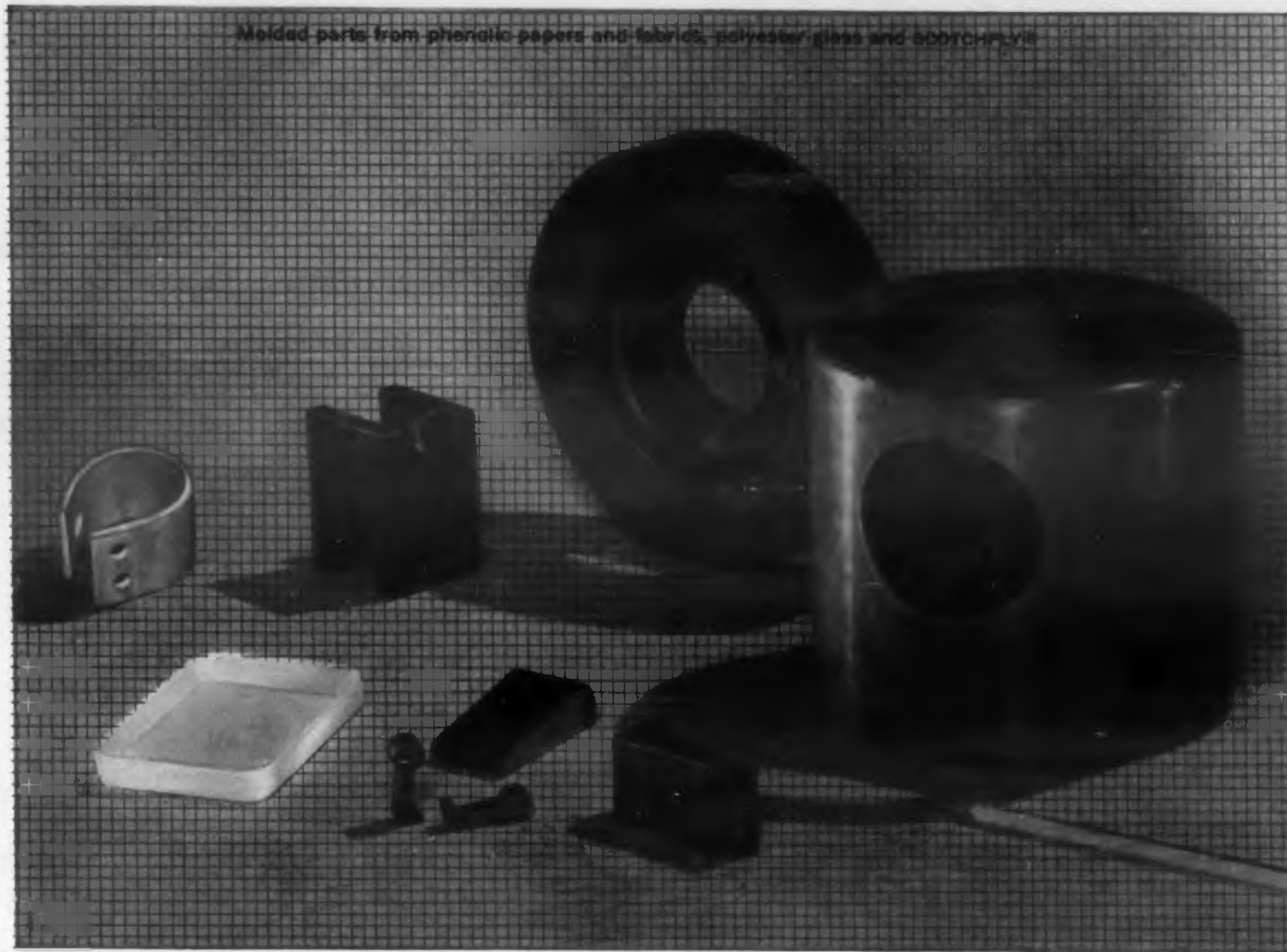

For better molded laminates...

LET MICA MOLD IT

MICA's greater knowledge of materials, molding know-how, ability to vary materials as required, and problem-solving abilities pay off.

For savings, let MICA mold it. Our knowledge of base materials and molding methods, our undivided responsibility for quality of both materials and workmanship, and our specialized equipment save time and assure consistency, accuracy and prompt delivery.

For special applications, let MICA mold it. Our molding materials include LAMICOID® phenolic papers and fabrics, polyester glass and SCOTCHPLY® epoxy glass. These materials offer light weight, high strength and stability, chemical resistance, insulating properties, heat resistance and low moisture absorption. This wide range of properties meets many different application requirements.

For special processing, let MICA mold it. We are fully equipped to mold parts of intricate

shape or difficult contours by matched metal die compression molding. Our facilities include complete fabricating equipment for further machining and finishing of molded parts.

For creative engineering, let MICA mold it. We are prepared to apply our knowledge of base materials, molding and fabricating methods, and application experience to the design and manufacture of prototype or experimental materials and parts.

For prompt quotation on your needs, send us your prints and specifications. We can also supply machined parts from paper, linen, canvas, nylon, asbestos and fibrous glass base materials. A MICA representative will be happy to give you any engineering assistance needed.

SCOTCHPLY® is a registered trademark of Minnesota Mining and Manufacturing Co.

MICA INSULATOR COMPANY
763 Broadway, Schenectady 1, New York

A Subsidiary of Minnesota Mining and Manufacturing Company
CIRCLE 43 ON READER-SERVICE CARD FOR MORE INFORMATION



How to Meet Tougher Specifications for Shock and Vibration Protection in Jets and Missiles

You've got to design to tougher specifications for combined shock and vibration isolation if you're going to protect the reliability of electronic controls in today's high-performance jets and missiles. Faster accelerations, zero-length launching, and extreme maneuverability combine to impose shock and vibration loads far beyond current MIL specs. *These severe operating conditions must be reduced to a predictable environment suitable for electronic equipment.*

Isolator Requirements

Higher shock inputs require more stiffness in the isolator, to store more energy for a given deflection, so there will be less energy to dissipate if the isolator bottoms. Higher vibration amplitudes call for greater clearances and minimum transmissibility at resonance. And vibration protection under high-g sustained acceleration demands a combination of these characteristics.

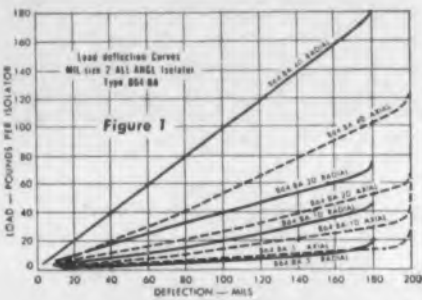

Use of Performance Curves

The characteristics of an isolator having the stiffness necessary for handling the shock and sustained accelerations of jet and missile take-offs is shown by the curves of Figure 1. These curves can be used in choosing the proper isolator for operation under the expected service conditions, since they show both the deflection of isolators under a wide range of loadings and the maximum allowable deflection due to the combination of static load, sustained acceleration, and vibration amplitude.

A transmissibility at resonance well below three — considered exceptionally low — is shown by the curves of Figure 2. The measurements for these

curves were made with a 27-pound load supported on four 10-pound isolators, with double-amplitude vibration input of 80 mils. These curves, showing performance for both base and bulkhead mounting, also indicate that the isolator satisfies the need for *consistent operation in every attitude of flight, launching, and maneuvering.*

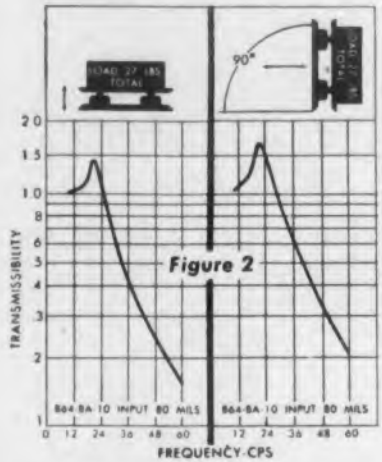

Figure 3 illustrates the construction of the B64 isolator that provides the performance characteristics shown by the curves, yet is dimensionally interchangeable with MIL-size mounts of comparable load ratings.

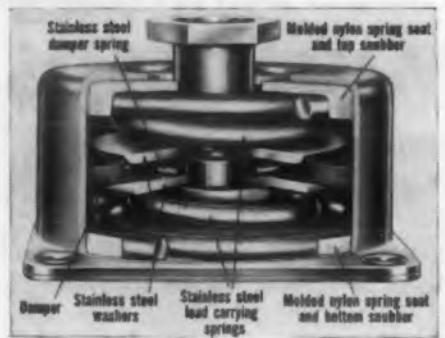

Figure 3

Additional Design Data

Other curves of isolator characteristics, and data on their use in designing for predictable environment in jets and missiles, are contained in Barry Bulletin 57-2. This bulletin fully describes the complete line of ALL-ANGL Barrymount isolators in standard MIL sizes. Write today for your free copy.

BARRY

CONTROLS

INCORPORATED

SALES REPRESENTATIVES
IN ALL PRINCIPAL CITIES

775 PLEASANT STREET, WATERTOWN 72, MASSACHUSETTS

CIRCLE 46 ON READER-SERVICE CARD FOR MORE INFORMATION



Uncoated flexible guide (top). Coated guide in its rigidized position (bottom).

Smoothing the rigidizing compound using a light flow of air from an air dryer to make it run.

Rigidized Flexible

FLEXIBLE waveguide can be rigidized by applying a paste-like compound which hardens into a strong, lightweight jacket. Complicated assemblies, difficult or impossible to make in one piece of rigid waveguide, can be readily fabricated, using this technique. Besides saving tooling costs, it eliminates superfluous flanges and reflections from joints.

The compound, developed by Technicraft Laboratories Inc., Thomaston, Conn., is particularly advantageous for small quantities which would not justify bending tools. It is tough and has relatively



Rigidizing compound is brushed on flexible waveguide. Complicated assemblies can be easily fabricated using this technique.



Waveguide

high tensile strength. Rigidized assemblies will withstand impact tests which seriously dent RG-67/U aluminum waveguide. Pressure-tight, they will withstand as much internal gas pressure as their equivalent rigid guides. The coating can be painted, if desired.

Useable over a temperature range of from -67 F to $+300$ F, coated assemblies subjected to 20 hours exposure at -55 C, showed no ill effects. As far as has been ascertained, the compound is practically impervious to acids, alkalis, oils and common solvents. U-shaped rigidized X-band flexible waveguide assemblies both 180 deg E-plane bends and 180 deg H-plane bends, when subjected to vibration and shock per Spec Mil-5422 C (ASG) showed no evidence of damage.

Transmission Characteristics

For a complex, small X, rigidized flexible waveguide assembly, of 12 in. overall length, typical characteristics are: VSWR, 1.06 max over the frequency range 8500 to 9600 mc; over the range, 8200 to 12,400 mc, VSWR 1.08 max, attenuation 0.12 db max; pressure 60 psi. In small X size, the average weight of the rigidized flexible waveguide is 5-1/4 oz per ft. compared with 8-1/2 oz per ft. for RG-67/U, aluminum. The weight differential in favor of rigidized flexible waveguide is more favorable when flanges are added. Assemblies are available in K_u and X bands. Small X rigidized seamless-corrugated assemblies may be made with a multiplicity of bends with centerline radii as sharp as 5/8 in. for E-plane bends, and 1-1/8 in. for H-plane bends.

For further information on this rigidized waveguide, turn to Reader's Service Card and circle 47.

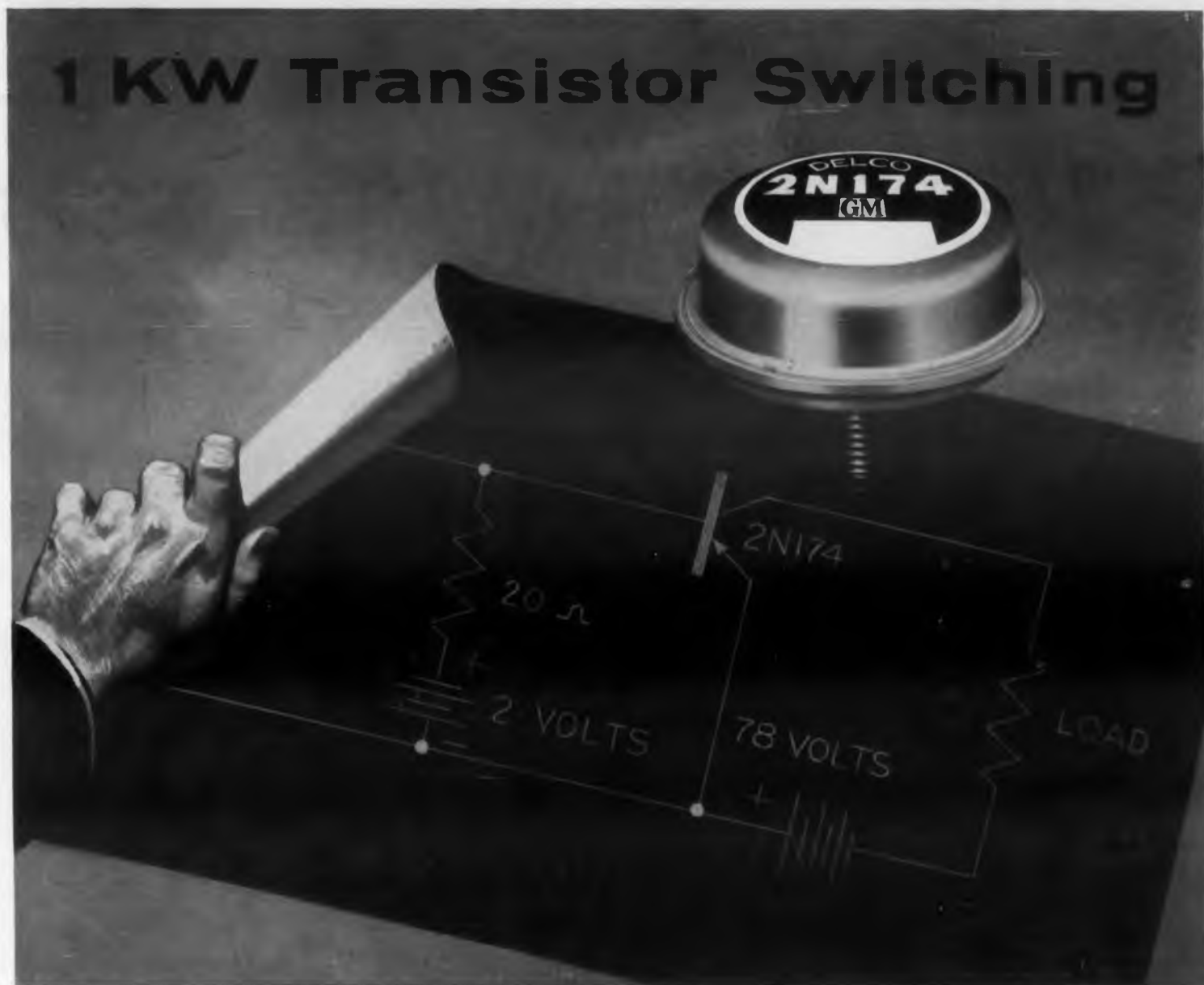

Industry's Highest Power Transistor

Eliminate arcing at switch points. Stop switch deterioration while increasing the efficiency and reliability of all electronic control equipment!

A single Delco 2N174 transistor can switch 1 kw with one watt of control power.

Because transistor switching eliminates arcing, switch life is longer and more reliable.

This switching performance is possible because of the excellent electrical characteristics of the 2N174; in particular, the high collector breakdown voltage, extremely high maximum collector current, and very low input impedance.

You may employ Delco 2N174 high-power transistors with confidence in their reliability and uniformity. These transistors, normalized to retain better performance characteristics

regardless of age, are currently being produced by the thousands every day. Write for engineering data.

| Power Switching Characteristics | |
|---------------------------------|-----------------|
| Switching Power | 1000 watts |
| Current in "on" position | 13 amperes |
| Input Control Power | 1 watt |
| Power Gain | 30 db |
| Dissipation in "on" position | 8 watts |
| Switching time | 60 microseconds |

DELCO RADIC

DIVISION OF GENERAL MOTORS
KOKOMO, INDIANA

CIRCLE 48 ON READER-SERVICE CARD FOR MORE INFORMATION

Editor's Note: This article compares the results of operating and non-operating life tests in an effort to reduce the problem of component over-specification. The authors consider this an interim report on the subject, and it is intended to stimulate the presentation of more information and data by other investigators. Transistor engineers can do a great deal by writing realistic specifications before too many precedents are established.

Determining Transistor Reliability

IN DESIGNING military systems, the reliability of a component has to be designed and built into it, but the customer has little direct control over designs and processes except through specification on the completed item. Because of this lack of control, specifications are redundant and excessive, and the cost of an item can increase as much as 300 percent in an attempt to guarantee reliability through over-specification. Since one of the most costly tests are operating life tests, these were studied to determine if simplification could be achieved in military specifications.

Experimental Results

Three different types of PNP alloy junction power transistors were evaluated under operating and non-operating conditions to indicate a measure of reliability. The data taken indicates that the beta degradation under both conditions is quite similar. The I_{co} parameter variation seems in general more difficult to explain. In one instance close correlation between operating life and storage life was noted. In another case the storage effects appear to impose more severe degradation with respect to this parameter. In still another case mechanical failures were noted under the operating condition.

The samples chosen for these tests were selected from a screened lot of transistors by removing non-hermetically sealed units. Operating junction temperatures were set to approximately coincide with the shelf life storage temperature.

The first type of unit evaluated contained a nitrogen back fill. Storage and operating junction temperature were held at 85 C. Figs. 1 and 2 are graphs showing the variations of the collector cut-off current, (I_{co}) and current gain, (β) as a function of time under both the operating and non-operating conditions. It is noted that both parameters seem to vary in a parallel manner under both conditions. The curves represent an average of all the data taken at various time check points.

The second type of unit evaluated was one which contained a dry air back fill. During the course of the investigation two mechanical failures were noted under

the operating life tests. The failures, occurring after 320 hours, consisted of units which developed open emitters apparently due to improper soldering of the emitter lead to the emitter electrode. Figs. 3 and 4 indicate average curves on the variations of collector cut-off current and current gain against the time of study.

It is noted that the current gain variations are similar under both conditions. In the case of the collector cut-off current, comment on variation beyond the 320 hour point is deferred because of the failures noted.

The final series of tests were run on units containing a nitrogen back fill but do not represent the same units

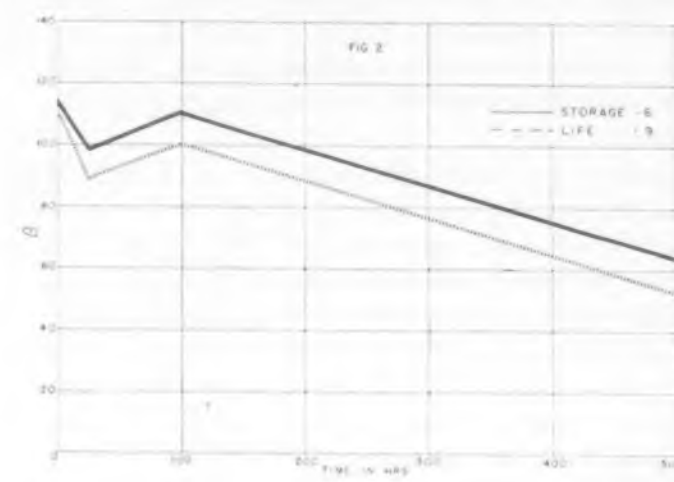
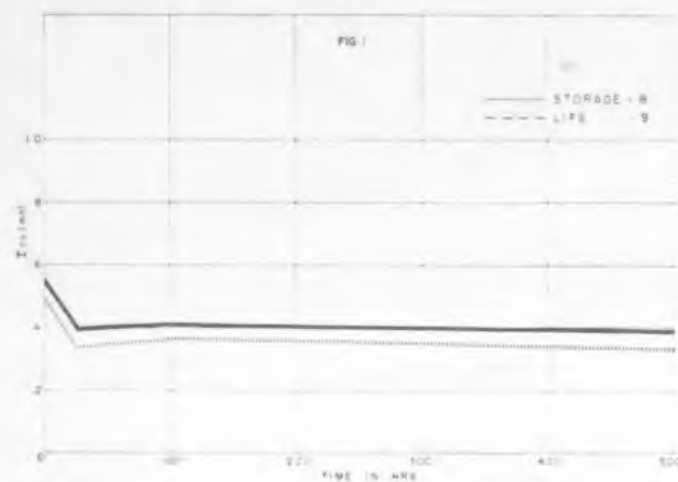

Figs. 1 and 2: Graphs showing the variations of collector cut-off current (I_{co}) and current gain (β) as a function of time under both operating and non-operating conditions. These units have a nitrogen back fill.

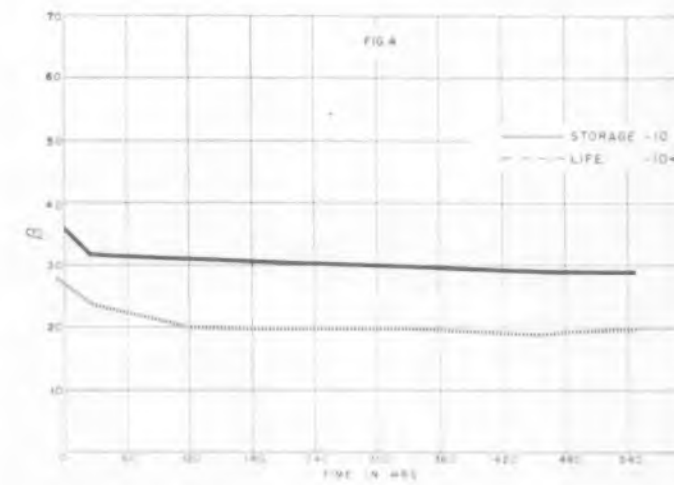
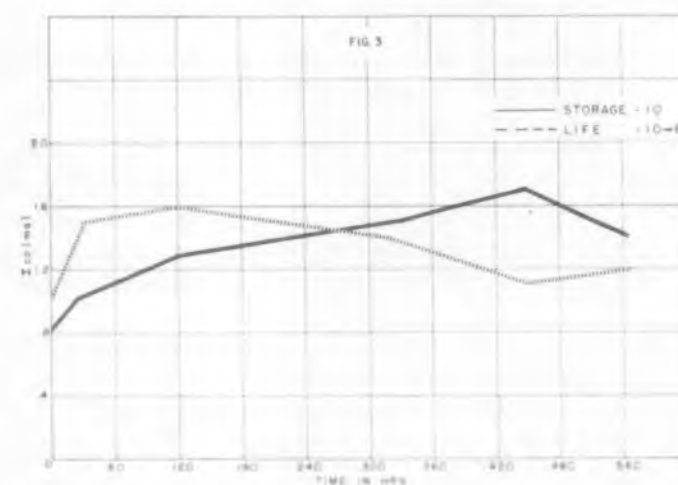

Figs. 3 and 4: Average curves on the variations of collector cut-off current and current gain against time for units with a dry air back fill.

Operating vs Non-Operating Methods

Bernard Reich and Harry V. Wood

Signal Corps Engineering Labs.
Fort Monmouth, N. J.

previously discussed. Fig. 5 and 6 exhibit the variations of parameters as a function of time. It appears from Fig. 5 that the storage condition imposes a greater degrading effect on the device than does the operating test. With respect to the current gain characteristic, a parallel degradation appears to exist.

Life Test Considerations

Consideration must be given to determine a reasonable operating life test. Little is known on exactly how any particular device will be used, so that the basic specification does not spell out the life test except in general terms. If the device is to be used as an amplifier, switch, or oscillator, then possibly the type of test should follow the application. When a device is tested on the basis of usage, however, the test circuitry involved may become cumbersome.

In the past transistor life tests have been carried out as a continuous d-c operating life test for a specified period, or a similar test with an "on-off" cycle. Under a recent reliability program conducted at the Signal Corps Laboratories different types of life tests were performed including high temperature shelf storage tests, d-c operating tests, switching tests, and voltage pulsing tests. It was found that in all the studies performed, temperature seemed to be the common degrading environment. It was also noted that voltage would enhance radical failure on those units which did not have a good hermetic seal or permitted moisture to enter through the leads.*

In comparing operating and non-operating reliability studies, it was decided to compare d-c operating life tests and high temperature storage life tests. These tests were chosen because of the common practice of the military in using them for reliability information. This particular discussion is centered about power transistors, although the information is applied to other types of transistors.

*See "Report on Power Transistors for Converters", B. Reich, ELECTRONIC DESIGN, March 15, 1957.

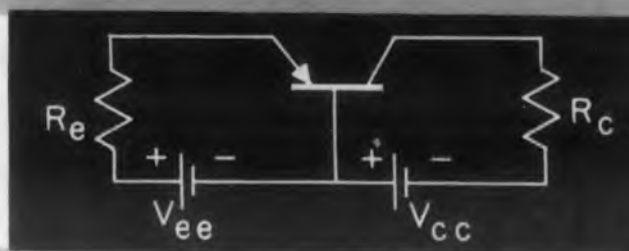
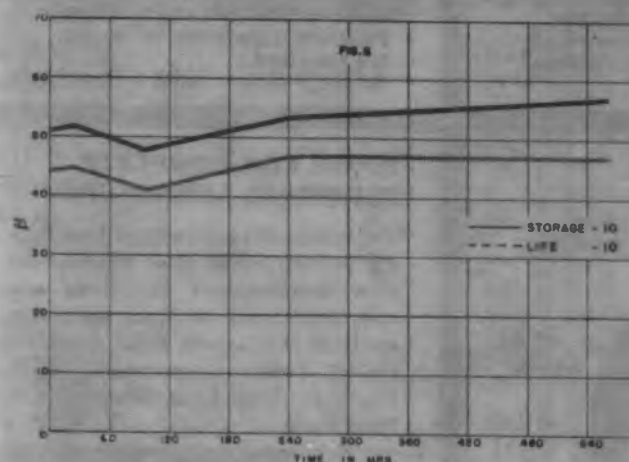
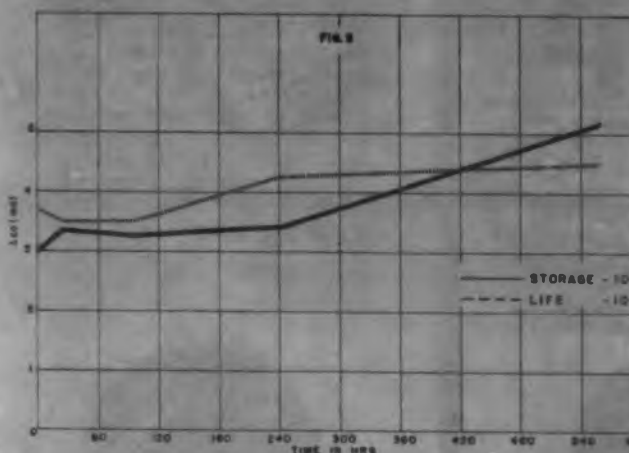

Fig. 7: Diagram of life test circuits used to gather data.



Figs. 5 and 6: Variation of parameters as a function of time. These units have a nitrogen back-fill but are different from those of figs. 1 and 2.

Having your ups and downs?

... if they involve Deposited Carbon Resistors

DALOHM

has the answer!

All Dalohm products are carefully designed and skillfully made to assure you of supreme quality and dependability, plus the widest versatility of application.

You can depend on



Outstanding examples of the Dalohm line are these deposited carbon resistors, made for accurate performance where carbon composition resistors are not suited or wire wound resistors too expensive.

TYPE DC

Pure crystalline carbon film bonded on ceramic rods of special material; provide precision resistance values, low voltage coefficient, low capacitive and inductive characteristics in high frequency applications, extremely high stability and economy.

- Resistance ranges from 10 ohms to 50 megohms
- Tolerance 1% or higher as specified
- Five wattages— $\frac{1}{8}$, $\frac{1}{4}$, $\frac{1}{2}$, 1 and 2; seven physical sizes

Write for Bulletin R-24A



Essentially the same as type DC except hermetically sealed in a non-hydroscopic ceramic envelope to provide absolute protection against thermal shock, salt water immersion and humidity.

Write for Bulletin R-27A

TYPE DC-5

For extremely high resistance where maximum stability is a prime factor in high voltage applications. Powered at 5 watts; high voltage up to 20,000 VDC; resistance range 1 megohm to 200 megohms; tolerance 1% or up to 10% on request.

Write for Bulletin R-28

JUST ASK US

Write for the complete Dalohm catalog of precision resistors, potentiometers and collet-fitting knobs.

If none of our standard line fills your need, our staff of able engineers and skilled craftsmen, equipped with the most modern facilities, is ready to help solve your problem in the realm of development, engineering, design and production. Just outline your specific situation.

DALE PRODUCTS, Inc.

1328 28th Avenue

Columbus, Nebraska, U.S.A.

*In Canada: Charles W. Pointon, Ltd.
6 Alcina Ave. Toronto, Ont.

*Export Dept: Pan-Mar Corp.
1270 Broadway New York 1, N.Y.

CIRCLE 49 ON READER-SERVICE CARD FOR MORE INFORMATION

DeJUR precision potentiometers

...THE ONE
BEST ANSWER
TO YOUR
DESIGN
PROBLEMS

SERIES C-050

SUB-MINIATURE ¼" • SEALED
CONSTRUCTION



ACTUAL SIZE

- One piece nickel plated bronze case and bearing.
- Electrical rotation—320°; Mechanical rotation—325°, or continuous 360°
- Voltage breakdown—1000 volts AC.
- Threaded bushing mounting.

SERIES C-078

MINIATURE ¾" • GANGED MUL-
TIPLES • INDEPENDENT PHASING



ACTUAL SIZE

- Unit height ¾"; weight ½ oz.
- Independent linearity: ± 1% is standard.
- Linear or non-linear windings on flat card; res. tol. — ± 5% std., ± 1% on order.

SERIES C-158

INTERMEDIATE 1½" • GANGED
MULTIPLES • INDEPENDENT
PHASING



¼
ACTUAL SIZE

- Independent linearity: ± 0.5% of total resistance is standard.
- Linear or non-linear windings std., ± 1% on order.
- on flat card; res. tol. — ± 5%
- Rotation: electrical — 320°. Mechanical—325°.

SERIES C-200 (sleeve bearing) BC-200 (ball bearing)

IN-FIELD GANGING • UNLIMITED
MULTIPLES • ADJUSTABLE TAPS



2" DIAM.

- Resistance ± 5% standard; to ± 1% on special order.
- Linearity: ± 0.5% independent linearity is standard; ± 0.3% on special order for C-200; ± 0.2% on special order for BC-200.
- Mounting: Servo type or single hole mounting with optional non-turn device.

SERIES C-300

SINE-COSINE



3" DIAM.

- Independent brush contacts produce accurate sine and cosine outputs.
- Function accuracies of ± 1% are standard.
- Multiple ganged units are available.

SERIES KS-200 (sleeve bearing) K-200 (ball bearing)

LONG FUNCTION ANGLES • CLAMP
PHASING • HIGH RESOLUTION



2" DIAM.

- Resistance: linear, on triple Formvar copper mandrel.
- Independent linearity: ± 0.5% is standard; ± .1% on order.
- K-200 pots are completely enclosed and may be used as single or multiple ganged units.

SERIES HP-200, HP-300, HP-500

HIGH RESOLUTION • LONG
FUNCTION ANGLES • GANGING
MULTIPLES



2", 3", 5"
DIAM.

- Linearity: ± .5% standard to ± .1% on order.
- Resistance: ± 5% standard to ± 1% on order.
- Rotation: 360° mechanical; 356° ± ½° electrical standard.

WRITE FOR COMPLETE TECHNICAL LITERATURE

Our engineering department can supply prototypes to meet unusual design specifications for tests and approval. Send us your specs for analysis. Electronic Sales Division, DeJUR-Amsco Corporation, 45-01 Northern Blvd., Long Island City 1, New York.

You're
always
sure
with

DeJUR

PRECISION POTENTIOMETERS

Based on previous experience, it was decided that the junction temperature was the most important parameter of the transistor for reliability considerations. The operation junction temperature can be related to the dissipated power by the following expression:

$$T_j = T_c + \Theta P_t \quad (1)$$

where T_j is the junction temperature in degrees C, T_c is the case temperature in degrees C, P_t is the total power dissipated in watts, and Θ is the thermal resistance in degrees C/watt between the junction and the case.

In order to conduct a satisfactory life test and minimize the variability of thermal resistance which may vary by as much as three to one in a lot of devices, it is necessary to conduct life tests in the following manner. Examination of Eq. 1 indicates two methods of obtaining an operating junction temperature. For the sake of discussion, it is assumed that an operation junction temperature of 90 C is satisfactory. If the case temperature is maintained at 25 C the ΘP_t component must add an additional 65 C. If the design value of thermal resistance, Θ , of a power transistor is 3 C/W, then it would be necessary to supply approximately 22 w per device. If any number of transistors are set up on a life test the amount of power that would have to be supplied would be considerable. If on the other hand the case temperature were maintained at 75 C then 5 w of power would have to be supplied per device to achieve the desired junction temperature. As stated previously the value of Θ can be quite variable in presently available devices. To operate at a specified junction temperature with a minimum of error, introduced by Θ , the ΘP_t component of T_j (Eq. 1) should be smaller than the T_c component.

In addition to this type of test where the case is held at a constant temperature it is also possible to conduct tests where the transistor is mounted in a position where natural convection occurs. The desired value of T_j is then obtained by successive thermal measurements on the case. This type of arrangement is not as useful as the one previously discussed since variations in mounting may result in varying operating junction temperatures.

The previous discussion indicates some of the considerations involved in setting up an operating life test. In contrast to this it is a simple matter to set up a storage oven to a desired temperature level and subject devices to this environment for a specified period of time. In addition the amount of equipment necessary to set up a life test rack is considerable in comparison to the requirements of a high temperature shelf life type of test. The question to be resolved is whether the tests conducted yield information which is identical or serves the same ultimate purpose.

CIRCLE 570 ON READER-SERVICE CARD >

CIRCLE 50 ON READER-SERVICE CARD FOR MORE INFORMATION

COMMUNICATIONS ENGINEERS

HEARD ABOUT RECENT TECHNOLOGICAL ADVANCES IN SYNCHRONOUS DETECTION?

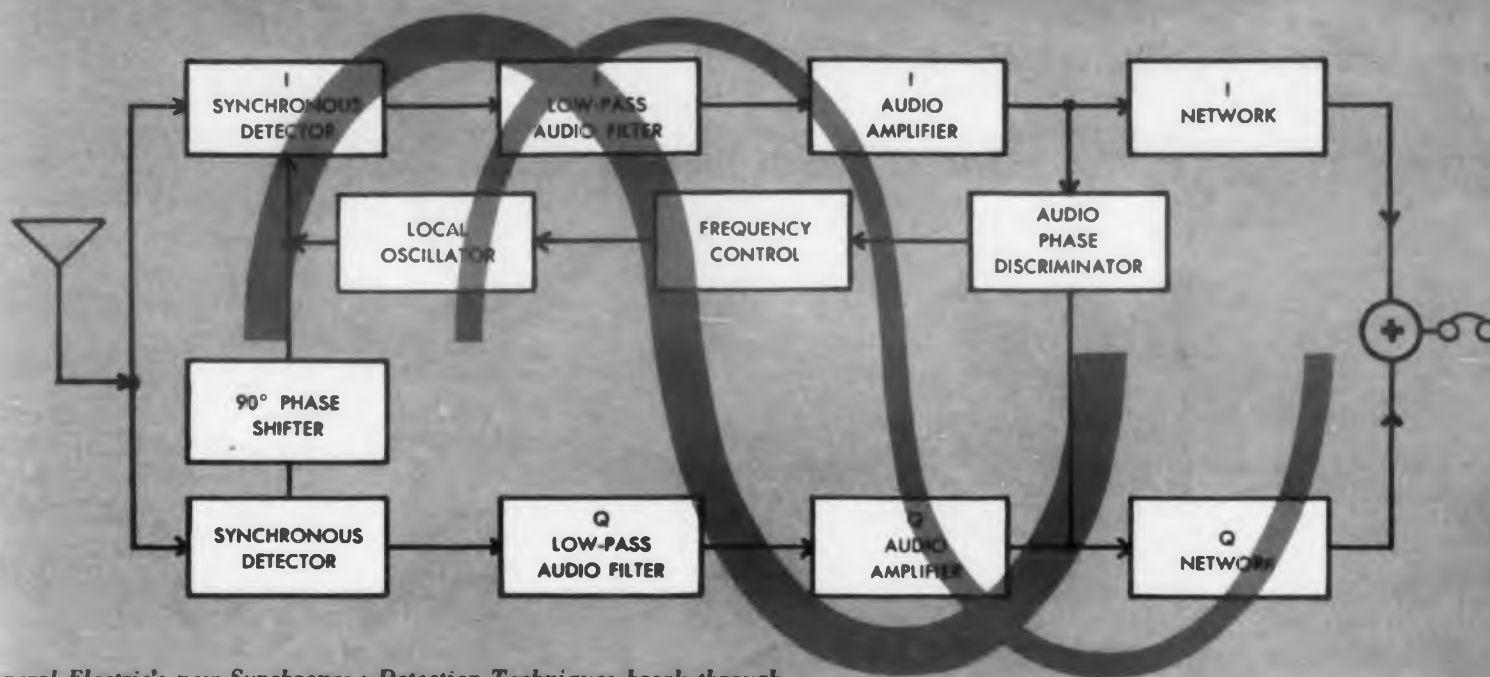

General Electric's new Synchronous Detection Techniques break through with an exclusive control channel, which phase locks the local oscillator.

New, Long Range Development Programs Starting at the Light Military Electronic Equipment Department of G.E.

Communications men know that forms of synchronous detection have been understood, built, even tested, for years. However, unsolved problems hindered successful development. Now General Electric's research staff has achieved a significant technological breakthrough, with their new Synchronous Detection-Double Side Band System.

So impressive was the demonstration of the G-E prototype equipment, that the go ahead signal was given for a projected 3-year program to develop Synchronous Detection to the product stage.

If the potential of this new communications system arouses your interest, there are opportunities now to join the special group forming at Light Military Department in Utica, N. Y., to work on circuit, system and related problems. The successful completion of this program will usher in new, large scale commercial, as well as military applications.

To find out about current openings on the Synchronous Detection program — and on other advanced projects at Light Military Department (airborne portion of Data Link, ECM systems, IR equipments and advanced radar), MAIL IN THIS CONVENIENT POSTCARD. 

We'll send you our brochure with the full technical story of "Synchronous Communications SAM — DSB." Also further information about how we work and how we live in Utica, N. Y.

LMEE

LIGHT MILITARY ELECTRONIC EQUIPMENT DEPARTMENT

GENERAL  ELECTRIC

FRENCH ROAD, UTICA, NEW YORK



BUSINESS REPLY CARD

First Class Permit No. 579 Utica, N. Y.

MR. JOHN STERNBERG

GENERAL ELECTRIC COMPANY

LIGHT MILITARY ELECTRONIC EQUIP. DEPT.

FRENCH ROAD

UTICA, N. Y.



ENGINEERS

PUT IT TO A FAMILY VOTE



The all 'round advantages of selecting a career with the Light Military Electronic Equipment Department of General Electric, in Utica, will stand the test of your family's round-table discussion.

FROM YOUR POINT OF VIEW...it means working on some of the most advanced electronic projects in the industry, in such areas as: IR equipments, radar, airborne fire control, guidance and countermeasures systems. It means a career with a company where the professional man is highly regarded and highly rewarded for original thinking.

FROM YOUR WIFE'S POINT OF VIEW...it means being welcomed into the life of our friendly community. The Newcomer's Club will seek you both out. And this suburban-country area has many activities engineers' wives enjoy; bridge clubs, civic groups, PTA and a very active Community Theater.

FROM YOUR CHILDREN'S POINT OF VIEW...they'll whoop for joy when they hear about the outdoor fun all year...swimming, canoeing, scouting. Your son can be a Little Leaguer, if he wants. Come Winter, there is skiing, skating and tobogganing right in Utica. This is famous hunting and fishing country...just the ticket for an outdoor man and his family.

← **JUST FILL IN THE POSTCARD AND MAIL IT TODAY. Find out now what part of our operation has the highest career potential FOR YOU. We will answer you promptly and send the illustrated brochures listed on the postcard.**

LMEE

LIGHT MILITARY ELECTRONIC EQUIPMENT DEPARTMENT

GENERAL  ELECTRIC

FRENCH ROAD, UTICA, NEW YORK

Dear Mr. Sternberg:
Please send me your free brochure, "Synchronous Communications SAM-DSB" and details on job opportunities at Light Military Department.

NAME _____

ADDRESS _____

CITY & STATE _____

Present Job Title _____

Degree (s) _____

I am proficient in the following technical fields _____

My professional interests are _____

PHONE _____

Year Received _____

In comparing an operating life test to a storage test it is often stated that units which are operating under bias conditions may show a tendency toward run away. It has also been pointed out that storage life is not comparable to operating life. No comment is made on this hypothesis, however some mention should be made on the matter of transistor stability which may obviate a conclusion of this sort. In order for a transistor to be stable under operating conditions in a life test circuit certain stability requirements have to be met. It has been shown that stability is maintained if

$$SI_s < \frac{13}{V_c \Theta} \quad (2)$$

where I_s is the reverse saturation current, S is the circuit stability factor as outlined by Shea, Θ is the thermal resistance in degrees C/watt, and V_c is the collector voltage.

The stability of the transistor can be determined by knowing the applicable transistor parameters, I_s and Θ , and circuit parameters S and V_c . Failures which occur due to instability cannot be used as an argument against storage tests if the above circuit conditions are not met.

The life test circuit used for the tests is shown in Fig. 7. Under these conditions the S factor of the circuit is approximately equal to unity. The value of V_c used is 28 v. A typical power transistor has a reverse saturation component of 0.050 ma at 25 C. If it is desired to operate the junction at 85 C, I_s can be calculated to be approximately 3.2 ma at 85 C. In addition, if the thermal resistance value given by the manufacturer is in the range of 5 degrees C/w, the calculations turns out to be from Eq. 2:

$$1 \times 0.003 < \frac{13}{28 \times 5} = 0.093$$

Under these conditions, thermal run away would not be exhibited.

Overall conclusions on transistor reliability testing cannot be reached from the data presented in this report, since the samples were small and are not representative of all different transistor types. It appears however from the data presented that operating life tests may be quite useful as a design check, and for routine reliability evaluation storage life tests will be sufficient. More experimentation would seem to be in order to verify this preliminary data.

References

1. Reliability of Power Transistors in d.c. to d.c. Converters, B. Reich, presented at the Transistor Reliability Symposium on 17 September 1956.
2. H_s, H_c, H_t Power Transistor Specification, Transistor Division, Minneapolis-Honeywell Regulator Co., Minneapolis, Minn.

CIRCLE 570 ON READER-SERVICE CARD ►

WELL I'LL BE DIPPED...better
...because the NEW **AMP** SNAPIN

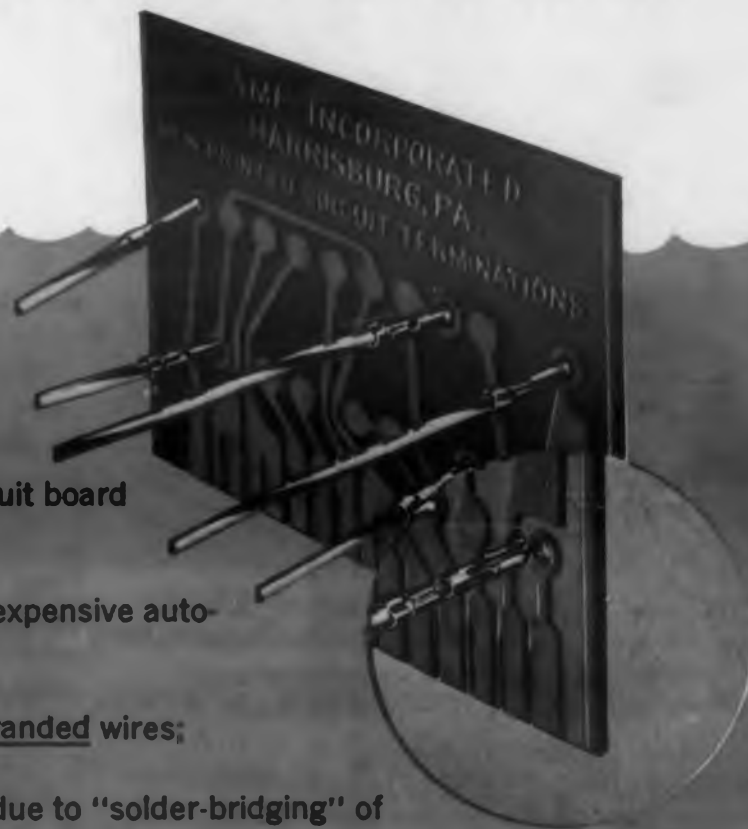

- Gets leads to the printed circuit board in one assembly operation;
- Eliminates an investment in expensive automation equipment;
- Can be applied to solid or stranded wires;
- Eliminates danger of shorts due to "solder-bridging" of insecure leads;
- Has construction details that promote good capillary flow of solder during the dipping process;
- Is self-retaining, with no damage to the printed circuit board during pre-assembly operations;
- Is self-aligning—no further positioning or deformation is required.

Write today for additional information on the NEW A-MP SNAPIN, the AMP-EDGE Connector and other A-MP products designed for printed circuit applications.

AMP INCORPORATED

GENERAL OFFICE:

3512 Eisenhower Boulevard, Harrisburg, Pennsylvania

AMP

Wholly Owned Subsidiaries: Aircraft-Marine Products of Canada Ltd., Toronto, Canada • Aircraft-Marine Products (Great Britain) Ltd., London, England • Societe AMP de France, Le Pre St. Gervais, Seine, France • AMP—Holland N.V. 's-Hertogenbosch, Holland

Distributor in Japan: Oriental Terminal Products Co., Ltd., Tokyo, Japan

CIRCLE 51 ON READER-SERVICE CARD FOR MORE INFORMATION

New Products



Blocking Oscillator
3/4 In. Cube

A complete blocking oscillator circuit for generating trigger pulses, including a subminiature pulse transformer, transistor, capacitor, resistor, and crystal diode, has been packaged in a three-quarter inch molded cube. The DuMont Pulse-Cube produces a pulse of 3 μ sec duration with a rise time of 0.06 μ sec. Amplitude is from ± 8 v to -3 v peak. Variations of the unit offer fixed repetition rates of 25 kc, 1 kc, or a variable repetition rate from 400 cps to 24 kc. When operating at a 25 kc repetition rate and a 3 μ sec pulse width, the unit can run for approximately 1,000 hrs on a miniature 6 v mercury cell.

Available either as a free-running blocking oscillator or as an externally triggered type, the pulse-cube can be furnished as a plug-in or as a solder lug type. The operating temperature range is from 55 to 60 deg C.

Allen B. DuMont Labs. Inc., Dept. ED, 760 Bloomfield Ave., Clifton, N.J.

CIRCLE 52 ON READER-SERVICE CARD FOR MORE INFORMATION



Sweep Operated Relay
To Observe Transients

In the study of single transient phenomena with an oscilloscope, the Sweep Operated Relay will be found useful by initiating the transient at a convenient pre-set portion of the trace on the face of the cathode-ray-tube. Visual observation is achieved by setting the scope to repetitive sweep. The unit

will then initiate the transient at a pre-set portion of the sweep cycle.

The unit consists of a dc amplifier which compares the sawtooth voltage from the scope against an adjustable reference voltage. When the instantaneous value of the sawtooth voltage exceeds the reference voltage the amplifier actuates a relay which in turn initiates the transient to be studied. Input impedance is 10 meg shunted by 50 μ f. Frequency range is 0 to 20 cy—up to 35 cy at reduced accuracy for relay output, or pulsed output through audio frequency range. Unit will initiate the transient on the same point of the cathode ray tube within the thickness of the trace.

Engelhardt Eng. Co., Dept. ED, 38 Burrill Ave., So. Norwalk, Ct.

CIRCLE 53 ON READER-SERVICE CARD FOR MORE INFORMATION



Vibration Meter
For Quick Inspection

The Model 305 Portable Vibration Amplitude Meter is a self-powered instrument for seeking out vibration and establishing acceptable tolerances in production, inspection and maintenance. The 24 oz weight of the instrument makes it convenient for use in usually inaccessible places. It is operated on either "A" or "B" Mallory or Ever Ready batteries. The meter is calibrated directly in three ranges of 0.1, 1, and 10 mils full scale reading.

International Research & Development Corp., Dept. ED, 797 Thomas Lane, Columbus, Ohio.

CIRCLE 54 ON READER-SERVICE CARD FOR MORE INFORMATION



1 F Amplifier
High G Type

Developed to withstand 20 G vibration at 2000 cps, these units utilize ruggedized subminiature tube in a specially cast chassis designed for high heat conduction and minimum chassis resonance. Specifications of the 1F64D are 60 mc center frequency, gain 65 db, bandwidth 10 mc. 1F64 amplifiers with other gain or bandwidth specifications can be supplied.

Lel Inc., Dept. ED, 380 Oak St., Copiague, L.I., N.Y.

CIRCLE 55 ON READER-SERVICE CARD FOR MORE INFORMATION



AC to DC Converter
Directly Proportional

Used for conversion of ac to dc for measurement, recording and telemetering, the converter provides a dc output of 0 to 12.5 v, directly proportional to the peak alternating input. Range of input is from 10 cps to 200 kc at 0 to 25 v peak to peak. Linearity is better than one per cent, with an accuracy range of 0.1 per cent of calibration. Initially developed for guided missile application, it weighs 8 oz.

Nacimco Products, Inc., Dept. ED, 2300 National Ave., National City, Calif.

CIRCLE 56 ON READER-SERVICE CARD FOR MORE INFORMATION

Silicon Power Rectifiers

From 100 Ma to 3 Amp.

A series of silicon diodes and medium power rectifiers covering the current range from 100 ma to 3 amp, these components are stud mounted and hermetically sealed.

United States Dynamics Corp., Dept. ED, 1250 Columbus Ave., Boston, Mass.

CIRCLE 57 ON READER-SERVICE CARD

Medium-Temperature Solder

428-435 F Eutectic

Adapted to applications that require high creep strength without high temperature application, a recently developed solder melts in the range 428-435 F. While its creep strength is less than that of silver solders, the material withstands creep indefinitely under usual stress loads, and its use eliminates the risk of distortion resulting from excessive heat in application. Low conductivity resulting from oxide films also is eliminated where this solder is used. Designated #38 alloy, the solder is self-annealing, has a tin base, ready flow and good wetting properties. Its manufacturer's Alpha 200L flux is recommended for use with it. Melting may be accomplished by iron, resistance tools, flame or induction heating. The solder comes in solid wires, in diameters from 0.032 to 0.125 in.

Alpha Metals, Inc., Dept. ED, 56 Water Street, Jersey City 4, N.J.

CIRCLE 58 ON READER-SERVICE CARD

Identification Name Plates

Adhere Without Screws

Name plates which identify panel components, motors, terminal boxes or other equipment are fastened in place by a special adhesive on the back of each plate, which forms a strong, permanent bond. It is a heat-resisting bond, and may be applied to any surface. The plates are available in either fibre or aluminum. A line of standard markings, and a standard plate size (3/8 x 1 in.) make lower prices possible.

E. C. P. Corp., Dept. ED, 6808 Wade Park Ave., Cleveland 3, Ohio.

CIRCLE 59 ON READER-SERVICE CARD

CIRCLE 60 ON READER-SERVICE CARD >



Case history number 7

PISTON CAPACITORS AT WORK

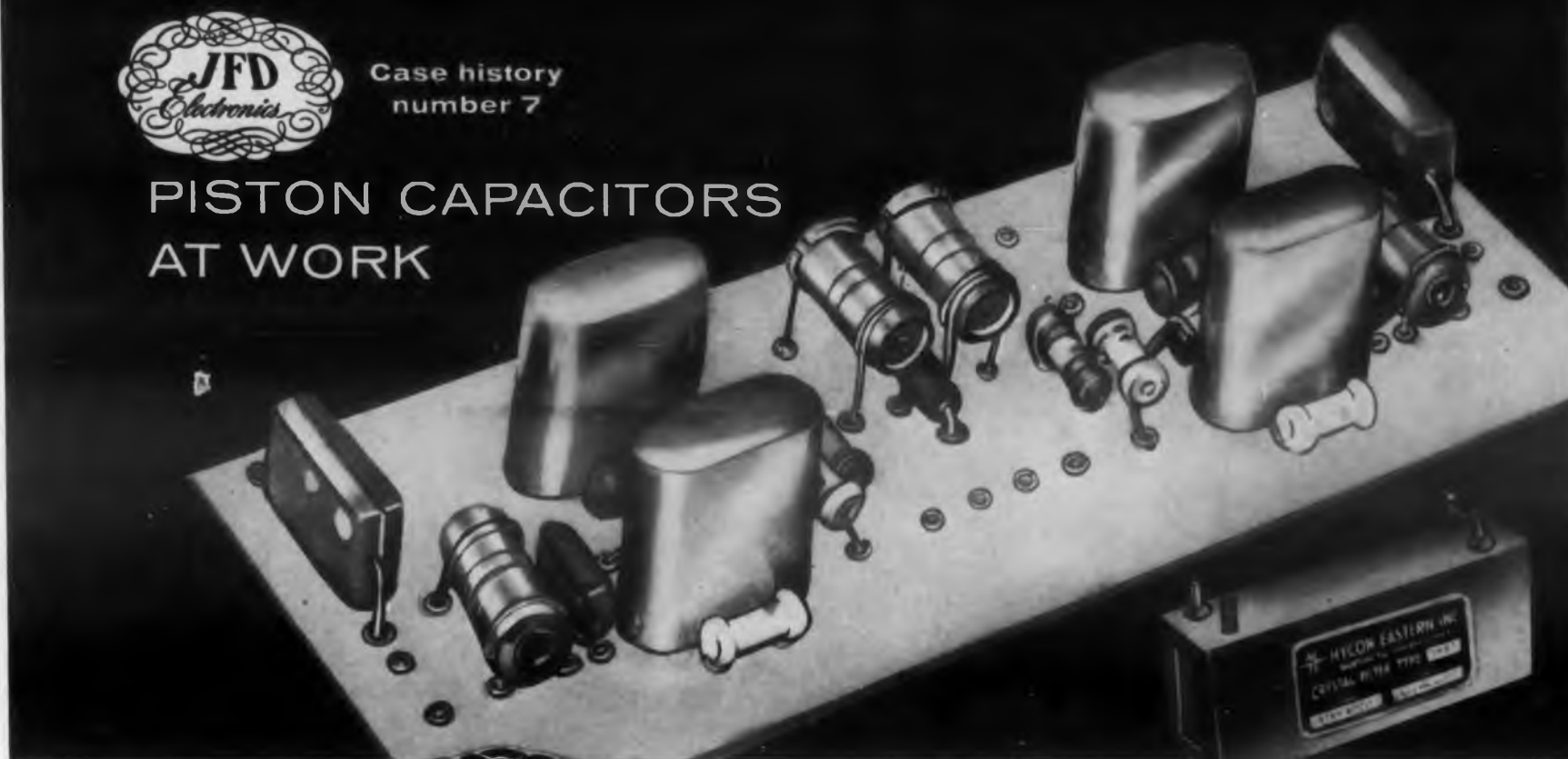

actual size



MODEL VC9GW*
(0.8 to 8.5 mmf-glass dielectric-invar rotor)
patent pending



TELE METERING



COMMUNICATIONS

TRIMMERS PROVIDE QUICKER,
MORE ACCURATE ALIGNMENT,

GREATER STABILITY IN HYCON CRYSTAL FILTERS

Shown 1/2 size
Crystal Filter Model 13MA

HYCON EASTERN, Inc., Cambridge, Mass., elected to use JFD Variable Trimmer Piston Capacitors because of the following advantages:

1. Convenient, smooth tuning adjustment.
2. Stability with temperature variation.
3. Stability under conditions of vibration and shock.
4. Ease of mounting on printed wiring boards.

These are some of the reasons why JFD VC9GW Trimmers are specified in Hycon Eastern Crystal Filters noted for their high stability, extremely sharp cut off and linear transfer characteristic. Used in single side band communication systems, Hycon Eastern Crystal Filters are available to select either the lower or upper side band. In VHF and UHF receivers Hycon filters provide all the required selectivity at the first intermediate frequency, thereby eliminating the complexity of multiple conversions.

JFD Trimmer VC9GW is one of many precision capacitors available to provide the stability, shock resistance, ultra linear tuning and wide operating temperature range necessary in your critical circuits.

Its sub-miniature size is also a welcome asset where space saving is a must in printed or chassis circuits.

Why don't you take advantage of JFD Variable Trimmer Piston Capacitors in solving your circuit tuning problems?

Write for literature



ELECTRONICS CORPORATION,

1462-62 STREET,

BROOKLYN, N.Y.

GO FORWARD WITH JFD ENGINEERING!



Typical of the scientific technology that is behind Triplet's world wide reputation for reliability—these jewel pivot bearings are so minute that 1000 do not even half-fill this one-half inch bottle and every jewel is perfectly balanced with more painstaking care than the watch-makers' art.

Triplet current catalog offers more than 15,000 available types and ranges of clear plastic front and conventional design black plastic panel meters.

The identical careful accuracy and high reliability is available in the complete Triplet line of VOMs, VTVMs, scopes and other test equipment.



TRIPLET

TRIPLET ELECTRICAL INSTRUMENT COMPANY
Bluffton, Ohio

Over half a century of experience

*one
important
little detail
100 times
enlarged!*



Burton Browne Advertising

New Products

I-F Amplifier Tube

For 12 V Operation

Designed to operate with plate and screen voltages supplied directly from a 12-v battery, an automotive service-type miniature pentode, designated 12CN5, has the characteristics for i-f amplifier service. It is equipped with a 7-pin miniature button. Heater, plate and screen grid are designed to operate satisfactorily at the varied voltages obtainable from a nominally 12.6 v storage battery. Heater current is 0.450 amp, plate resistance 40,000 ohms, transconductance 3800 μ mhos and typical plate current 4.5 ma.

CBS-Hytron, Dept. ED, Danvers, Mass.

CIRCLE 62 ON READER-SERVICE CARD

Mass Production Delay Lines

1.0 Microsecond or Less

Distributed parameter delay lines designed for mass production in a continuous process have been put on the market. Not only does the continuous process mass production technique reduce the cost of these delay lines, but it also insures stability and uniformity. They are designed for time delays of 1.0 microsecond or less.

International Resistance Corp., Dept. ED, 401 North Broad Street, Philadelphia, Pa.

CIRCLE 63 ON READER-SERVICE CARD

Frequency Calibrator

For Telemetry

Either manual or automatic channel and frequency point switching can be had with this 7-point frequency calibrator, designated Model TMC-307. The instrument is accurate within 0.02 per cent. It furnishes seven equally spaced frequencies per channel. End limits of the lower two are ± 7.5 per cent; of the upper five ± 15 per cent. Other limits and spacings can be supplied to order. The calibrator takes 10-1/2 in. panel space and is suggested for miniaturized ground station equipment.

Panoramic Radio Products, Inc., Dept. ED, 10 S. Second Ave., Mount Vernon, N.Y.

CIRCLE 64 ON READER-SERVICE CARD

◀ CIRCLE 61 ON READER-SERVICE CARD

Metal Film Resistors

Low L and C

Characterized by low inductance and low capacitance, a new line of metal film resistors designated Types MEC and MEF has been made available. These units feature high accuracy and stability, low and controllable temperature coefficients. They are suited to high frequency applications.

International Resistance Co., Dept. ED, 401 North Broad St., Philadelphia, Pa.

CIRCLE 65 ON READER-SERVICE CARD

Frequency Analyzer

Tracks Frequency Components

Frequency components are tracked and a visual plot of component frequency vs component amplitude is provided by a test instrument designated Synchronous Frequency Analyzer Model SF-1. It is particularly intended to track components derived from rotating or oscillating sources, and is expected to prove very helpful in dynamic balance analysis.

Panoramic Radio Products, Inc., Dept. ED, 10 S. Second Ave., Mount Vernon, N.Y.

CIRCLE 66 ON READER-SERVICE CARD

Motor-Driven Time Switches

With Nylon Gear Trains

Nylon gears, pinions and shafts are featured in three new off-peak control time switches, for longer life and reduced maintenance. These new models, designated Types TGW 5, 6 and 7, replace the maker's former models T-43, TGW-1 and TGW-2. No lubrication is needed. Aluminum studs and shafts replace brass parts formerly used, and the on-off triggers and arms are of single-unit construction. Contact block assemblies are molded. Contacts have been made larger. A marker arrow permits checking motor synchronism. The current rating of the TGW 5, formerly the T-43, has been raised from 20 to 35 amp.

General Electric, Dept. ED, Schenectady 5, N.Y.

CIRCLE 67 ON READER-SERVICE CARD

CIRCLE 68 ON READER-SERVICE CARD >

Allied's New MHJ Relay Built for Shock and Vibration

10-55 cps at 0.125 inch double-amplitude • 20-2000 cps at 0.05

Here are the facts:

Contact Ratings

Low level up to 7 amperes non-inductive or 1 ampere inductive at 27 volts d-c or 112 volts a-c

Terminal Arrangement

MHJ-12D 4 PNT
MHJ-18D 6 PNT

Temperature

From 65°C to plus 125°C

Vibration

10-55 cps at 0.125 inch double-amplitude
55-2000 cps at 20g

Operating Shock: 100g

Altitude

Sea level to 80,000 feet

Weight

MHJ-12D 3.0 ounces
MHJ-18D 4.3 ounces

Insulation

1000 megohm minimum

Dielectric Strength

1000 volts rms at sea level
450 volts rms at 70,500 feet

Initial Contact Resistance

20 ohm maximum at 27 to 112 volts

Operate Time

15 milliseconds or less
at rated voltage at 25°C

Release Time

5 milliseconds or less
at rated voltage at 25°C

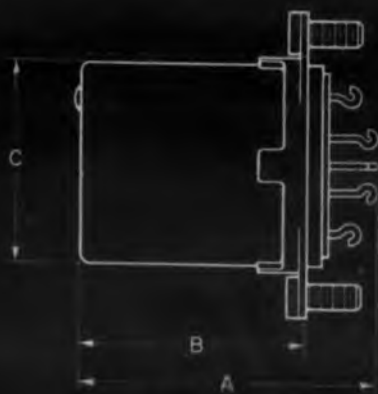

MOUNTING = 6-32 NC-2A THD. (2) STUDS

| | A | B | C | D | E | F |
|------------------|------------|-------|-------|---------|-------|-------|
| MHJ-12D (4 Pole) | 1 3/4 max. | 1 3/8 | 1 3/8 | 1 2 1/2 | 1.405 | 1 1/8 |
| MHJ-18D (6 Pole) | 1 3/4 max. | 1 3/8 | 1 3/8 | 1 3/8 | 1.562 | 1 3/4 |



ALLIED CONTROL



ALLIED CONTROL COMPANY, INC., 3 EAST 42ND AVENUE, NEW YORK 17, N. Y.

B.F. Goodrich



Best long range investment for indoor antenna testing and free space chambers

Manufactured to Military Specifications ... B. F. Goodrich Microwave Absorbers provide the most accurate reflection-free rooms for the measurement of microwave antenna patterns. As a result of thorough quality control and factory testing, B. F. Goodrich Microwave Absorbers consistently duplicate free space conditions indoors better than any other product.

In addition to outstanding electrical qualities, our absorber is light-weight, fire-retardant, easy to install. It will not deteriorate in performance when walked upon and has excellent water and weather resistant properties.

The material is currently being produced in a number of thicknesses providing broadband operation as low as 50 megacycles. Material can be furnished

| List of Available B. F. Goodrich Broadband Absorbers | | | |
|---|-------------------|-----------|---|
| Designation | Lowest Frequency* | Thickness | Maximum Reflection |
| 12 CM | 2500 mc | 1½"-2" | 2% |
| 12 CM - 1% | 2500 mc | 1½"-2" | 1% |
| 12 CM - 30db | 2500 mc | 1½"-2" | 0.1% at 9375 or other selected point in X-band. 2% over most of the band. |
| 6 CM | 5000 mc | 1" | 2% |
| 30 CM | 1000 mc | 3½"-4" | 2% |
| 30 CM - 1% | 1000 mc | 3½"-4" | 1% |
| 60 CM | 500 mc | 7"-8" | 2% |
| 60 CM - 1% | 500 mc | 7"-8" | 1% |
| 100 CM | 300 mc | 10"-11" | 2% |
| 200 CM | 150 mc | 26" | 2% |
| 600 CM | 50 mc | 69" | 2% |
| 8 CM-glass fiber | 3600 mc | 1"-1½" | 2% |
| 4 CM-glass fiber | 7500 mc | ¾" | 2% |

*All perform up to 30,000 mc

having less than 0.1% reflection at specific frequencies. For darkroom use, a special white compound can be applied to the surface of the pads to increase light reflectance.

When you're investing thousands, start right—specify B. F. Goodrich—the company with the *longest* experience and record for *consistently* high quality microwave material.

For new booklet on these absorbers write B. F. Goodrich Sponge Products, a division of The B. F. Goodrich Company, 394 Derby Place, Shelton, Connecticut.

B.F. Goodrich

SPONGE PRODUCTS

CIRCLE 69 ON READER-SERVICE CARD FOR MORE INFORMATION

New Products

Wirewound Resistors Non-Inductive



Completely non-inductive, the NS type resistors are wirewound, power resistors of miniature size. Silicone sealed, they offer protection from salt laden air and humidity and have high dielectric strength. Available in five wattages, 2, 3, 5, 7, and 10 w and six physical sizes, the NS resistors have a maximum continuous operating temperature of 275 C. Resistance range is 1 ohm to 37 K, depending on size and tolerance. Temperature coefficient is 0.00002 per deg C. They are available in tolerances of .05 per cent, .1 per cent, .25 per cent, .5 per cent, 1 per cent and 3 per cent.

Dale Products Inc., Dept. ED, Columbus, Neb.

CIRCLE 70 ON READER-SERVICE CARD FOR MORE INFORMATION



Constant-Output Amplifier For Synchronous Motors

This constant voltage power amplifier is designed to supply a constant output voltage at frequencies ranging from 40 to 1000 cy within 1 db for the operation of power equipment requiring up to 150 va at 115 v ac. Its main function is to furnish power to induction and synchronous motors by the amplification of a specific frequency for operation of these motors or equivalent loads. The amplifier automatically compensates for varying input line voltages, variable loads, and varying power factors ranging from 0.7 to unity, leading or lagging.

The amplifier is capable of delivering a maximum of 220 w at less than 5 per cent distortion. Its output load regulation is better than 10 per cent and its a-c line stabilization is better than 5 per cent. With a gain of 56 db, a signal-to-noise ratio of 54 db and an input impedance of 10,000 ohms, it may be coupled to any signal generator, tuning-fork or crystal-controlled oscillator. A screw-driver slotted control is provided on the front panel to adjust the output voltage and to accommodate input signal levels ranging from 0.8 to 20 v. Hum and noise level is less than 1.0 v. A \odot to 150 rectifier type a-c voltmeter, mounted on the front panel, indicates the output voltage.

Amplifier Corp. of America, Dept. ED, 395 Broadway, New York 13, N.Y.

CIRCLE 71 ON READER-SERVICE CARD FOR MORE INFORMATION

Rectangular Panel Meters

Efficient Design

Modern design for more efficient reading, is featured in a line of rectangular panel instruments. Designated Wide-View, these instruments have open-faced covers for wide-angle readability, and longer scale lengths than conventional instruments. Scale length of the new 2-1/2 in. size is as long as the scale of a conventionally designed 3-1/2 in. meter. The durable plastic cover is formed in one piece. Two movements are available, the standard magnet type and the self-shielded core magnet type. Three sizes are available—2-1/2 in., 3-1/2 in. and 4-1/2 in.

Simpson Electric Co., Dept. ED, 5200 W. Kinzie Street, Chicago 44, Ill.

CIRCLE 72 ON READER-SERVICE CARD

Resin Process Equipment

Fiberglass Plastic

A range of standard and special tanks, fume ducts, hoods, towers, trays and other process equipment has been made available in a new plastic resin. Price range is comparable to that of polyester process equipment, but the new resin offers greater fire resistance, resistance to chemical corrosion and strength than polyester resins; is equally light in weight, and will not support combustion. It is reinforced with fiberglass. Designation is Haveg 6610.

Haveg Industries, Inc., Dept. ED, Wilmington, Del.

CIRCLE 73 ON READER-SERVICE CARD

Thermoplastic Spray Unit

For Metals

For spray coating of metallic targets, the Mark III utilizes a modified polyethylene powder to provide a coating up to 3/16 in. thick. For fluidizing, other finely divided thermoplastic resins may be used in addition to polyethylene.

American Agile Corp., Dept. ED, 5461 Dunham Rd., Maple Heights, Ohio.

CIRCLE 74 ON READER-SERVICE CARD

CIRCLE 75 ON READER-SERVICE



NOW . . . ONLY 3-WEEK SHIPMENT* on General Electric's full-line of sealed relays

Improved production techniques now make it possible for General Electric to offer its complete line of standard-listed hermetically sealed relays—including the amazing micro-miniature—on only 3-week shipment from order date!

And what's more—General Electric is equipped to provide you rapid service on samples and prototypes.

FOR ALL ELECTRONIC SYSTEMS

G-E miniature, sub-miniature, and micro-miniature relays combine small size with unusual reliability under severe temperature, shock, and vibration conditions—making them ideal for all radio, radar, fire control, navigational equipment, and industrial electronics jobs.

Though initially designed for military applications, more and more G-E sealed relays are being used for industrial jobs. Their extreme reliability and small size now are utilized by industrial designers. Resistance welding and other industrial electronic circuitry is being simplified and miniaturized with G-E sealed relays.

WIDE RANGE OF COIL RATINGS, HEADER TYPES, AND MOUNTINGS

Whatever your small sealed relay needs—you'll find the answer with one of the many forms of these three models:

Miniature: Standard, current-sensitive, and voltage-sensitive models; in 2, 3-, or 4-pole double-throw and 6-pole normally open forms. Rated 5 amps at 28 volts d-c at 85C. 3-amp make-before-break forms and 125C forms available.

Sub-miniature: 2 amps; .651 in. in diameter, 1.6 in. long; weighs one ounce. Unaffected by vibrations of 10 to 55 cps at .12 in. maximum excursion or 55 to 500 cps at 15Gs acceleration. Withstands shock tests in excess of 40Gs. Operates in ambients of 125C.

Micro-miniature: Weighs only 0.5 oz., measures .36 in. by .80 in. by .88 in. Rated 2 amp resistive at 28 v d-c or 115 v a-c. Also available in current-sensitive models. Standard relays withstand ambients of 125C, and 20Gs acceleration at 50 to 500 cps. Contact your G-E Apparatus Sales Office, or mail coupon. Specialty Control Dept., Waynesboro, Va.

*Average shipment time for all standard-listed relays. Actual time: MICRO-MINIATURE (up to 100 units—2 weeks, 100 to 1000 units—4 weeks); SUB-MINIATURE (up to 100 units—3 weeks, 100 to 1000 units—5 weeks); MINIATURE (up to 100 units—1-2 weeks, 100 to 1000 units—3 weeks).

MAIL TODAY FOR G-E RELAY DATA

General Electric Co., Sect. F792-6,
Schenectady 5, N. Y.

- Miniature—Bulletin GEA-6213
- 2PDT Sub-miniature—Bulletin 6412
- Micro-miniature—Bulletin 6346
- HAVE G-E SALES ENGINEER CALL

NAME.....
COMPANY.....
ADDRESS.....
CITY..... STATE.....

GENERAL  ELECTRIC

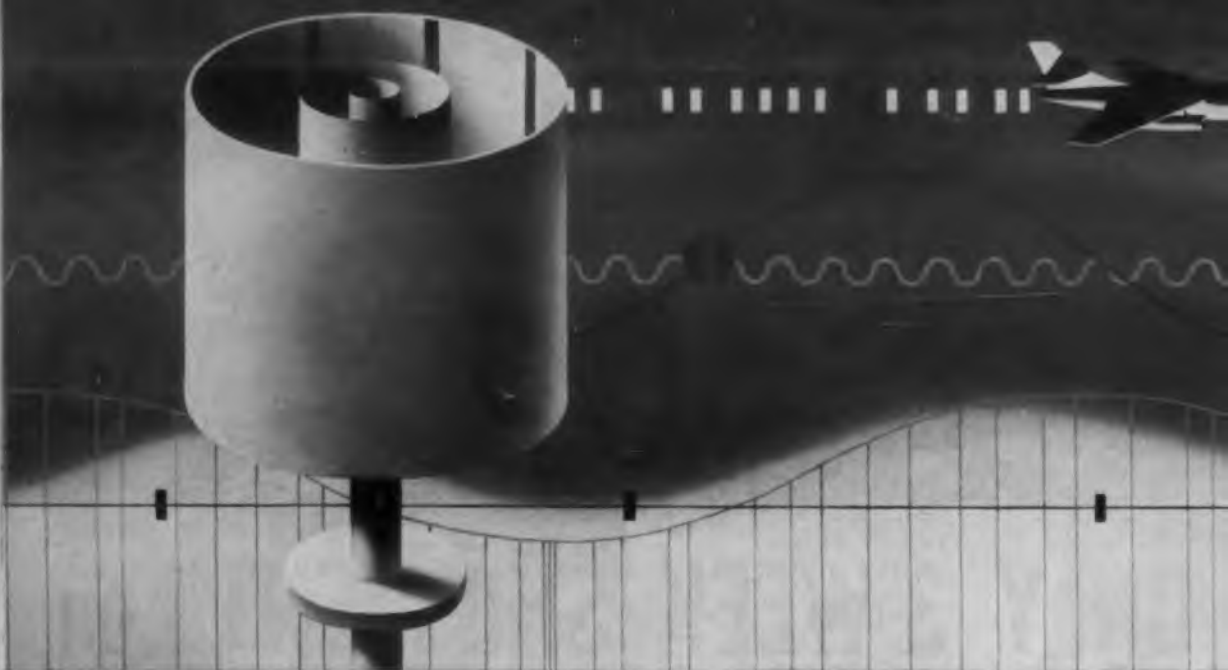

Eimac X676 Modulating Anode Klystron

Shaped RF Pulse, 30 KW Peak Power Output for 955-1220 mc Air Navigation Systems

Designed for air navigation systems, the Eimac X676 three cavity, air cooled klystron will deliver 30 KW peak power output in the 955 to 1220 mc range. With a power gain of 35 db, this tube has an efficiency of 40 per cent.

A typical air navigation systems requirement is a shaped RF pulse output to eliminate spectrum interference in adjacent channels. The Eimac X676 conservatively meets the 60db requirement of the CAA's air navigational system without using critically tuned, expensive filters in the RF output transmission line. The modulating anode permits pulsing the beam current while keeping the accelerating voltage constant. Also, the modulator circuit for this application is quite simple.

The RF cavities are external to the vacuum system and detachable from the klystron. The user may purchase spare tubes without buying additional tuning and focusing assemblies.

For the design engineer, the features of the X676 simplify circuitry — for the equipment operators the X676 provides reliable, long-lived performance at moderate cost.

For further information about the Eimac X676 Modulating Anode Klystron, consult our Application Engineering Department. Also available are two highly informative booklets; "The Care and Feeding of Klystrons" and "Klystron Facts . . . Case Four".

EITEL-M^CCULLOUGH, INC.
S A N B R U N O C A L I F O R N I A

Eimac First in high power amplifier klystrons

Typical Pulse Operation X676

| | | | | |
|---------------------------|----------|-------------------------|----------|-------------------------|
| DC Beam Voltage | 24 KV | Power Output | 32 KW | Power Gain |
| DC Beam Current | 3.3 Amps | Driving Power | 10 watts | Average Power |
| Power Input | 80 KW | Efficiency | 40% | |

New Products

Crystal and Oven Package

4 kc to 125 mc

Combined into a single hermetically sealed plug-in unit is an all-glass vacuum mounted crystal, plus integral temperature stabilizers for high precision frequency control at 75 or 85 C. High reliability over the frequency range of 4 kc to 125 mc is provided.

Bliley Electric Co., Dept. ED,
Union Station Bldg., Erie, Penna.

CIRCLE 77 ON READER-SERVICE CARD

Power Supply Filter

Ripple 8 Mv

Designed for use in conjunction with its manufacturer's Model MR532-15A d-c power supply, a filter section designated Model M-709 reduces the power unit's output ripple to 8 mv or less. Addition of the filter section to the power supply increases its use in precision testing. The filter section is built for standard 19-in. rack mounting; its overall dimensions being 8-3/4 x 10 x 19 in.

Perkin Engineering Corp., Dept. ED, 345 Kansas St., El Segundo, Calif.

CIRCLE 78 ON READER-SERVICE CARD

Non-Linear Function Generator

Relates Function to Rotation

With applications in the non-linear servo field, in computers and in the correction of non-linear transducers, an adjustable non-linear function generator has been put on the market in four production models. The instrument consists of a function adjusting assembly, and an interpolating potentiometer. A total of 100 taps is connected to a 31-pole, 100-position, printed circuit switch. Any of the 31 poles can be switched to any of the 100 taps, and the potential of each of the 31 poles can be adjusted to within one-half of one per cent of the input voltage. These generators have been miniaturized to about one-half the size of the prototype displayed by their maker a year ago.

Perkin-Elmer Corp., Dept. ED,
Main Ave., Norwalk, Conn.

CIRCLE 79 ON READER-SERVICE CARD

◀ CIRCLE 76 ON READER-SERVICE CARD

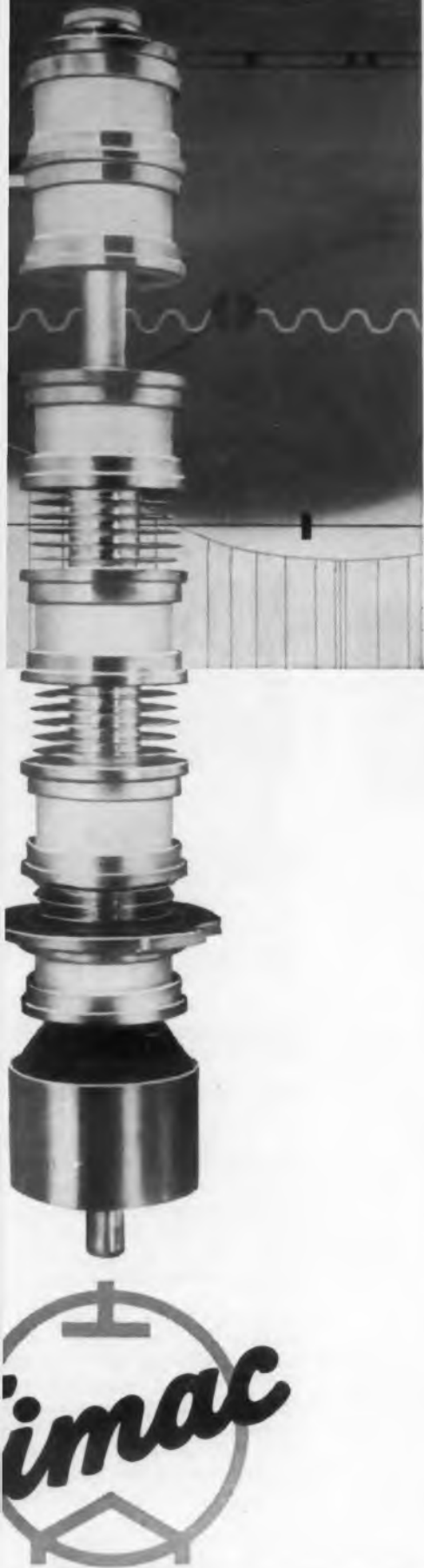

..... 35 db

..... 1 KW

High Power Transistor

PNP Alloy Junction

Capable of handling 2 w in Class A, 9 w in Class B push-pull—a recently announced germanium transistor is serviceable not only as an output stage, but also can be used for switching. In the latter application its switch power is 26 w max. Power gain in switching or as a push-pull stage is 25 db; as a Class A amplifier it is 33 db. Collector supply voltage in all applications is -14 v dc. The collector current in Class A operation is -360 ma, dc, the zero signal dissipation 4.4 w. In Class B operation zero signal collector current is -50 ma, dc; max signal collector current -500 ma, dc, and peak collector current -1.5 a, dc. Because of the very narrow spread between upper and lower limits of characteristics these transistors can be used without preselection. Designation is 2NI55.

CBS-Hytron, Dept. ED, Danvers, Mass.

CIRCLE 80 ON READER-SERVICE CARD

Tension-Free Wound Resistors

Give Added Reliability

Low-tension winding techniques give these resistors exceptional stability and high accuracy over longer periods of time. All windings are heat-cycled and aged to further insure stability. Designated the Series CB, the units are available in standard resistance ranges of 150 K to 8.0 megohms. They perform reliably over an ambient temperature range of -55 to +85 C. Windings are coated and filled with a resin-base varnish to permit normal operation under conditions of high humidity. Most types are rated for full wattage up to 85 C, and can be made to dissipate four times their rated wattage, over a lower resistance range, through the use of glass-insulated wire. Low inductive effects of the reverse-pi wound resistance wire maintains tolerance up to a frequency of 30 kc. Standard tolerances are 1, 0.5, 0.25 and 0.1 per cent.

Kelvin Electric Co., Dept. ED, 5907 Noble Ave., Van Nuys, Calif.

CIRCLE 81 ON READER-SERVICE CARD

CIRCLE 82 ON READER-SERVICE CARD

... pack higher wattage into less space with

NEW
MINIATURE

OHMITE®

THIN-TYPE

power resistors

ACTUAL SIZE

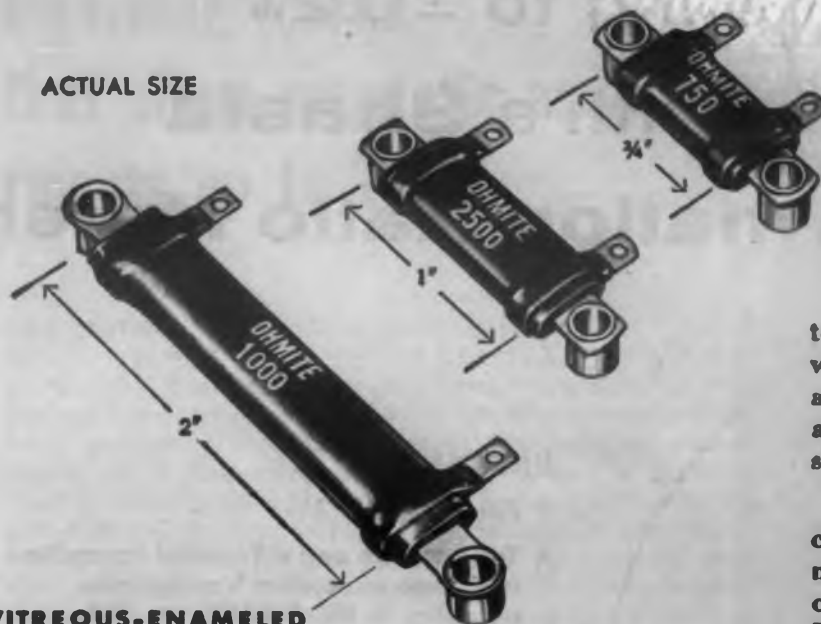

VITREOUS-ENAMELED COVERING holds winding rigidly in place... protects winding from damage.

UNIFORM WINDING prevents "hot spots" and resultant failures.

STRONG, CERAMIC CORE provides a solid base for winding. Core unaffected by cold, heat, or high humidity.

INTEGRAL MOUNTING BRACKETS distribute heat more evenly throughout resistor and conduct heat away.



The new Ohmite *miniature* thin-type power resistors are now available in three wattage sizes in a wide range of resistance values; two wattage sizes are available from stock; also three wattage sizes available from stock in the standard thin-type resistor... see (*) table below.

Designed especially for use in modern electronic circuitry where space is at a premium, these new miniature units have all the timeproven superiority of standard Ohmite vitreous-enameled resistors. They are only 1/8" thick and 3/8" wide, and range in length from 3/4" to 2".

Because of their compact design, the new Ohmite *miniature* thin-type resistors pack higher wattage into less space. The stacking bracket allows mounting close to the surface and a hollow stud provides for convenient stacking of two or more units. The miniature thin-type rises only 11/32" above the mounting surface; stack mounted, four units are less than 1 1/8" in height. Shown in photograph are: 1 Standard Thin-Type Resistors with Unit Brackets; 2 Standard Thin-Type Resistor with Stacking Brackets; 3 Miniature Thin-Type Resistors.

Write on company letterhead for Bulletin 138-B.

| MINIATURE THIN-TYPE RESISTORS | Length of Core | Width of Core |
|----------------------------------|----------------|---------------|
| Watt Rating | | |
| * 10 | 3/4" | 3/8" |
| 15 | 1" | 3/8" |
| * 20 | 2" | 3/8" |
| INTERMEDIATE THIN-TYPE RESISTORS | | |
| 20 | 1" | 13/16" |
| 30 | 1 1/2" | 13/16" |
| STANDARD THIN-TYPE RESISTORS | | |
| * 30 | 1 1/4" | 1" |
| * 40 | 2" | 1" |
| * 55 | 3 1/2" | 1" |
| 65 | 4 3/4" | 1" |
| 75 | 6" | 1" |

Now available from stock...

2 miniature sizes:

10 and 20 watts

3 standard sizes:

30, 40, and 55 watts

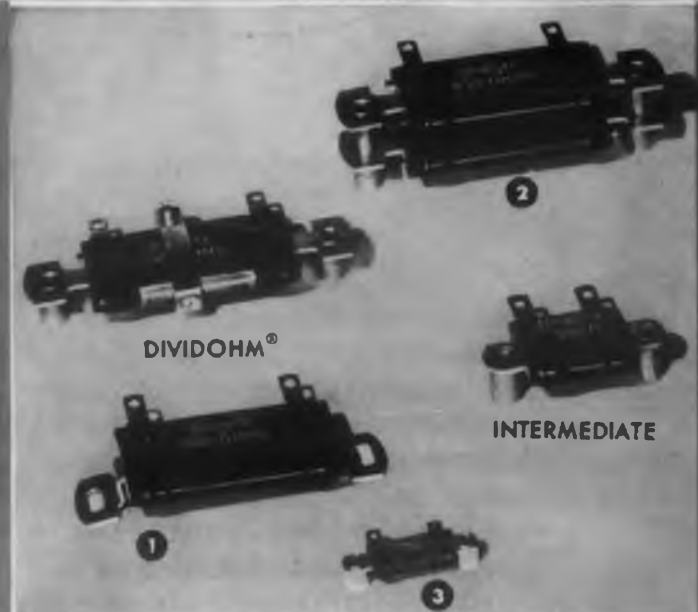

WATTAGE RATINGS ARE BASED ON THE RESISTOR MOUNTED ON A HORIZONTAL STEEL PANEL .040" THICK BY 10" SQUARE. RATINGS SHOULD BE REDUCED APPROXIMATELY 15% FOR NONMETALLIC MOUNTING SURFACE.

BE RIGHT WITH

RHEOSTATS • RESISTORS • RELAYS • TAP SWITCHES • TANTALUM CAPACITORS
OHMITE MANUFACTURING COMPANY • 3643 Howard Street, Skokie, Illinois

OHMITE®

Working with Synchros?

Rapid testing to $\pm 0.2\%$

accuracy with a **Shasta**
Transformation Ratio Meter



FEATURES:

- ★ Accuracy $\pm 0.2\%$
- ★ Tests synchro and differential transmitters and receivers, control transformers, according to MIL-5-12472 par. 4.7
- ★ Simple to operate — reads directly in % deviation
- ★ High (10,000 ohm/volt) input impedance
- ★ Portable, light weight

DESCRIPTION:

The SHASTA Model 100 Transformation Ratio Meter is an RMS-reading, expanded scale voltmeter designed to indicate the deviation in primary and secondary voltages of synchros, etc., directly in percent of error. It provides the fastest, simplest means of determining ratio error yet devised. Wide divisions on the expanded scale reduce readout errors.

APPLICATIONS:

Simplicity of operation makes the Model 100 ideal for production testing and inspection of synchro transmitters and receivers, differential transmitters and receivers, control transformers and similar components. Nominal primary and secondary voltages are 57.3, 78.0, 90.0, 105.0 and 115.0; design may be modified to accommodate other desired voltages between 35 and 300.

If your work involves the testing of synchros and similar components, you'll be hours and dollars ahead with a SHASTA Transformation Ratio Meter. Write for technical bulletin today; please address Dept. SE. 5.

Beckman

Shasta Division

P. O. Box 296, Station A
Richmond, California
Telephone LA 5230

S-23

CIRCLE 83 ON READER-SERVICE CARD FOR MORE INFORMATION

New Products

Lattice Network
For Digital Storage



This lumped constant electromagnetic network is specifically developed and designed for digital storage and uses only 1.2 elements per bit, providing stable characteristics without extreme tolerances on the individual elements. Hermetically sealed units can be supplied for any capacity up to 30 bits at digit rates up to 5 mc, for satisfactory operation over a temperature range of -20 to $+70$ C.

Ferranti Electric, Inc., Dept. ED, 30 Rockefeller Plaza, New York 20, N.Y.

CIRCLE 84 ON READER-SERVICE CARD FOR MORE INFORMATION



Varitron Camera
For Computer Readout

This camera provides a permanent film record of the summation to computations performed by computing devices. It is designed to pick up computer readout directly from the cathode ray tube presentation, thereby eliminating any time lag. Summations recorded on film by the Varitron require a minimum amount of storage space, provide an immediate record for present or future use, and may be enlarged for detailed study at any time.

Special field-flattening optics correct distortion. The precision micrometer lens focusing mount permits precise focusing, which is necessary to maintain accurate image dimension and configuration. The Beattie Varitron camera holds 100 ft of 35 mm film which is automatically advanced by an electrical drive mechanism. Exposures may be made at regular, predetermined intervals or at random intervals, if so desired.

Photographic Products Inc., Dept. ED, 1000 N. Olive St., Anaheim, Calif.

CIRCLE 85 ON READER-SERVICE CARD FOR MORE INFORMATION



Telemetering Filters Miniature

A line of subminiature, lightweight telemetering filters have a size of 2 cu in. or less per unit. Telemetering filters for channels 1 through 6 are 1.562 x 0.75 x 1.187 in.; weight is 71 grams (± 1 gram). Channels 7 through 18 are 1.375 x 0.75 x 0.75 in.; weight is 36 grams (± 1 gram).

Completely cast in an epoxy-filled resin, all units are hermetically sealed and will meet all applicable MIL Specifications for immersion, shock and environmental tests. All channels will pass 20 g at 2000 cy for 2 hr. Temperature range is -55 to $+85$ C. Channel points have standard Johns Hopkins band-pass telemetering call-outs. All units are made to plug into standard 4-pin Winchester sockets. Standard input impedance is 20 K and output impedance is 100 K. This can be varied to meet customers' specific application requirements.

Aerovox Corp., Dept. ED, Pacific Coast Div., 2724 Peck Rd., Monrovia, Calif.

CIRCLE 86 ON READER-SERVICE CARD FOR MORE INFORMATION



AC Motor 102 Ratios

A line of standard motors for 115 or 200 v ac, 60 or 400 cps, measures 1.675 in. diam, and up to 4.5 in. long. The motors are wound for single phase (with a capacitor) or two phase operation, two, four, or six pole, and three phase, two and four pole. Motors can be furnished with integral planetary gear reducers, offering 102 ratios between 4 to 1 and 3 million to 1. By varying the speed of the basic motor, up to 306 standard output speeds are available.

Type FC gear reduced motors are supplied with induction or hysteresis rotors: the former produces up to 3.5 in.-oz of torque, the latter, operating at synchronous speed, produces up to 1.2 in.-oz of torque.

Globe Industries, Inc., Dept. ED, 1784 Stanley Ave., Dayton, Ohio.

CIRCLE 87 ON READER-SERVICE CARD FOR MORE INFORMATION

You can now get...

Hipermag* cores that slash magnetic amplifier rejects up to 75%

The greatest single advance in giving you reactor cores of such proved reliability is the new Roberts Dynamic Test—an exclusive Westinghouse development. Using the constant-current flux-reset method, this test literally measures magnetic properties of the core under simulated operating conditions in half-wave, saturable reactors. The Roberts Test is the only method that offers practical performance-matched cores required for high-precision magnetic amplifiers.

You get data on (1) peak flux density, (2) peak differential permeability, (3) loop squareness and (4) d-c control magnetizing force at four points on the dynamic B-H curve. Test values can be used directly as constants in amplifier design.

The Roberts Test actually eliminates core testing and matching in your plant—performance is now predictable. Westinghouse cores assure you, as never before, of the performance you design into your product.

Also available is a full line of Hipersil® and Hiperthin cores for electronic applications.

Call your Westinghouse representative or write, Specialty Transformer Department, Westinghouse Electric Corporation, P. O. Box 231, Greenville, Pa.

*Trade-Mark
J-70796

YOU CAN BE SURE...IF IT'S

Westinghouse



Production line Roberts Test and performance matching at Westinghouse eliminate costly and complicated testing at your plant.



CIRCLE 88 ON READER-SERVICE CARD FOR MORE INFORMATION

time
tested
shock
mount

The critical moving coil in Weston ruggedized instruments is insured against shock damage by these shock absorbing springs in back of each jewel bearing . . . another Weston ruggedized first!



The entire instrument movement is then cradled on a shock mount of specially formulated rubber . . . assuring continuous dependable operation in severest service.



WESTON
Ruggedized
PANEL INSTRUMENTS

CIRCLE 90 ON READER-SERVICE CARD FOR MORE INFORMATION

Equipment builders can't afford to compromise on instrumentation where service requirements call for instruments that will function dependably under severe impact, shock, moisture or temperature extremes. That's why *approved* Weston ruggedized instruments are so widely preferred. Their sound basic design . . . the *extra* values built-in . . . have proved their superiority under the most rigorous field conditions, providing unmatched performance that more than justifies their cost. *Expanded facilities now make Weston ruggedized instruments readily available for A-C or D-C needs* in a variety of sizes and ranges. For the complete story, consult your local Weston representatives, or write . . . WESTON Electrical Instrument Corp., Newark 12, N. J.



New Products



Wire Clamp
Quick Installation

Designed to secure wire bundles, installation of wire in this U-shaped clamp involves only two quick operations—placing the wire inside the clamp, and manually pushing a keeper over the notched edges where it locks with high holding power. To release for adding or removing wires, the technician merely presses the horns together and lifts off the keeper.

Units are available in sizes starting at 3/16 in., weighing 0.001 lb, and extending to a 2-1/2 in. size weighing 0.052 lb. Sizes are reckoned across the horns. The smaller size will secure 58,000 cir mils of wire, and the larger size 8,570,000 cir mils. Clamps have mounting holes on the bottom, and may be fastened permanently.

Dakota Engineering, Inc., Dept. ED, 6641 Crenshaw Blvd., Los Angeles 43, Calif.

CIRCLE 91 ON READER-SERVICE CARD FOR MORE INFORMATION



Bathtub Capacitor
High Temperature

Base size in this new Type SBXM series is 1-1/8 x 1 in. with heights of 1/2 in. and 11/16 in. Ratings are 0.1 to 2.0 μ f at 200, 400 and 600 v dc working. The Type SBXM capacitors are designed for operation over the temperature range for -55 to +130 C and are provided with high-temperature glass-to-metal seals, with solder lug terminals. They are hermetically sealed after Polykane impregnation and fill, and conform to MIL-C-25A humidity, inversion, vibration and shock environmental test requirements for paper capacitors.

The Type SBXM capacitor is for use in equipment where capacitors with short current path and low rf impedance characteristics are needed. Power factor does not exceed 1.5 per cent at 25 C.

Cornell-Dubilier Electric Corp., Dept. ED, South Plainfield, N.J.

CIRCLE 92 ON READER-SERVICE CARD FOR MORE INFORMATION



Power Supply Strain Gage Type

Model 7P01 single or multiple channel power supplies have these specifications: 115 v, 60 cy input; 10 v dc output, adjustable from 9 to 11 v dc with a 10-turn potentiometer; output voltage changes less than ± 0.05 per cent due to temperature change from 0 to 0.45 C; output voltage changes less than 0.1 per cent due to 2 per cent change in load current; output ripple is less than 300 μ v rms, isolated from ground as follows: insulation resistance to ground—10,000 meg, ac pickup voltage to ground—5 μ v peak.

Western Gear Corp., Dept. ED, Electro Prods. Div., 132 W. Colorado St., Pasadena 1, Calif.

CIRCLE 93 ON READER-SERVICE CARD FOR MORE INFORMATION



Meter Relay High Sensitivity

The Model 126 very high sensitivity meter-relay measures 1 x 1-1/4 x 2-1/4 over-all and fits a 9-pin miniature socket. The meter-relay has a moving coil armature which rotates in the flux gap of an Alnico magnet. The moving element rotates on polished pivots in vee cup jewels. The pointer is a contact of solid iridium-platinum alloy. A locking coil in the moving element develops additional torque to drive the contacts together with considerable pressure.

Range and accuracy are 50 μ a to 10 amp and 10 mv to 500 v at 2 per cent. It ranges down to 0.2 μ a (12,000 ohms) and 0.1 mv (5 ohms) at reduced accuracy. Millivolt ranges may be internally compensated to operate directly from thermocouples. Ac ranges will monitor line voltage or work on the output of a tachometer generator to check rpm. Microampere meter-relays are null detectors for checking voltages in regulated power supplies. The instrument is supplied for both ac and dc.

Assembly Products, Inc., Dept. ED, P.O. Box XX, Palm Springs, Calif.

CIRCLE 94 ON READER-SERVICE CARD FOR MORE INFORMATION

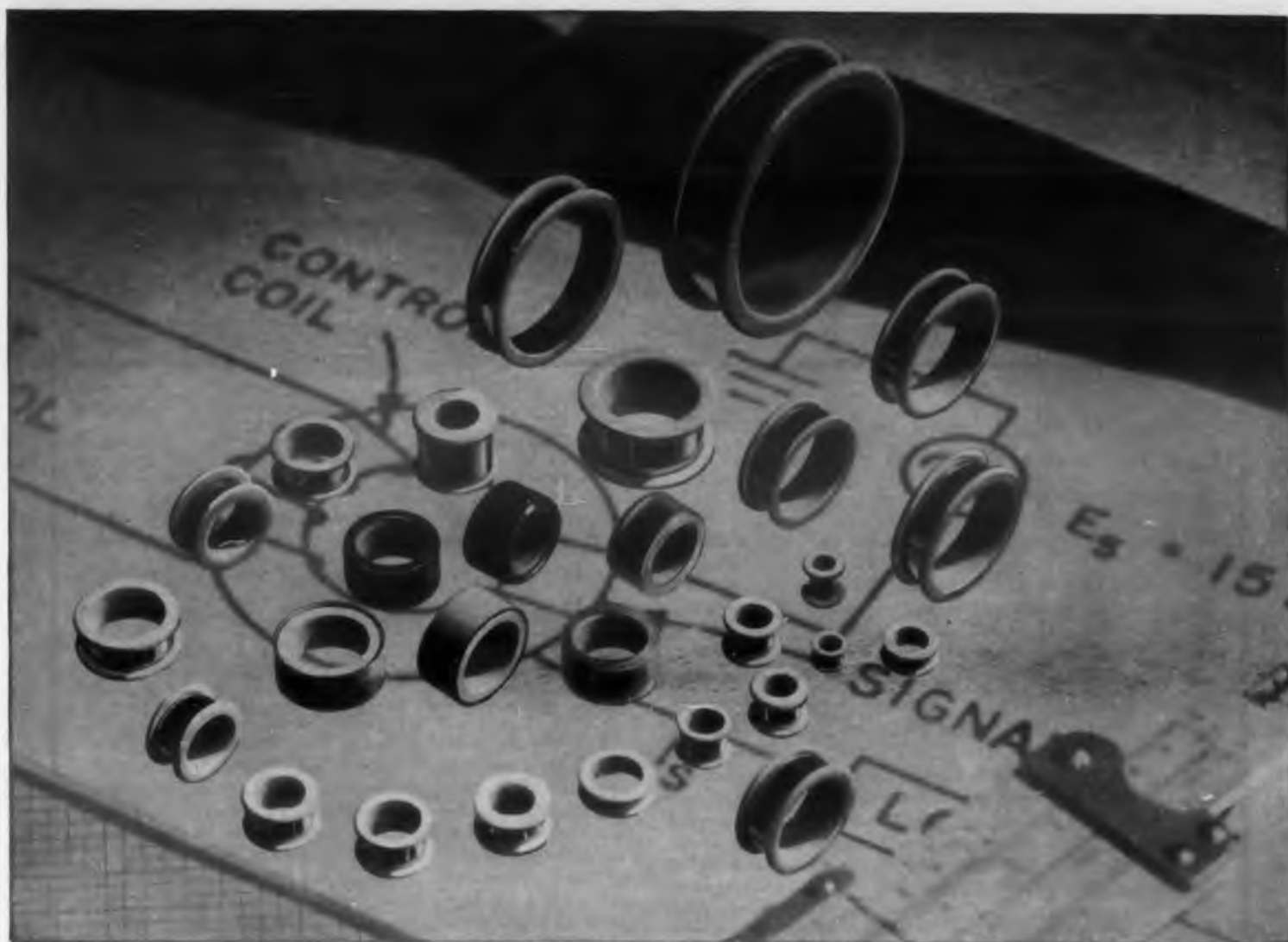

In BOBBIN CORES, you need PRECISION *and precision is the word for ARNOLD*



Ultra-thin tape for bobbin cores is rolled to high precision standards for thickness and finish on our own 20-high Sendzimir cold reducing mill, beta-ray controlled.

Write for BULLETIN TC-108 "TAPE-WOUND BOBBIN CORES FOR COMPUTER APPLICATIONS"

Includes essential data on applications and properties, fabrication and testing of Arnold Bobbin Cores; lists standard sizes, etc.

ADDRESS DEPT. ED-75

For use in shift registers, coincident current matrix systems, pulse transformers, static magnetic memory elements, harmonic generators and similar equipment, Arnold Bobbin Cores meet the most exacting requirements.

Quality and uniformity? *You'll find them no problem*—because, as a fully integrated producer with highly modern facilities, we're able to maintain close control over every step.

Arnold Bobbin Cores are available in a wide range of sizes, tape thicknesses, widths and number of wraps depending on the ultimate use of the core. Magnetic materials usually em-

ployed are Deltamax, Permalloy and Supermalloy, in standard thicknesses of .001", .0005", and .00025". Core properties include quite rectangular hysteresis loops, relatively low coercive values and high saturation densities, plus the ability to shift in a few microseconds from negative remanence to positive saturation, and vice versa, under conditions of pulse excitation. • Let Arnold supply your requirements for Bobbin Cores—or other tape-wound cores, powder cores, permanent magnets, etc.—from the most complete line of magnetic materials in the industry.

THE ARNOLD ENGINEERING COMPANY

Main Office & Plant: Marenco, Illinois
 Separate Pacific Division Plants 441 East 57th Street, Los Angeles, Calif.
 District Sales Offices:
 Boston: 290 Berkeley St. Los Angeles: 3435 Wilshire Blvd.
 New York: 350 Fifth Ave. Washington, D.C.: 1911 L St., N.W.

CIRCLE 95 ON READER-SERVICE CARD FOR MORE INFORMATION

TECHNIQUES and DEVELOPMENTS in oscillographic recording

FROM
SANBORN

RECORDING METHOD USED IN SANBORN DIRECT WRITERS, AND A REVIEW OF THEORETICAL AND ACTUAL ERROR FACTORS

Figure 1 shows the basic scheme by which Sanborn oscillographic recording galvanometers produce graphic records of electrical signal values. If the rapid deflection action of the heated ribbon tip stylus is visualized when current flows in the coil, it can be seen that a straight line at right angles to the chart length is recorded on the chart, at the point where the chart is drawn over a knife edge. The trace, therefore, is a true rectangular co-ordinate graph.

Since this is essentially a process of expressing coil (or stylus) deflection angles in terms of distances on a chart, the trigonometry of the situation (Fig. 2) must be examined to ascertain the accuracy of the method. Initially, and when θ is small, the tangent and the angle are almost equal numerically. The expression $D = R \tan \theta$ can, therefore, be rewritten $D = R \theta$ (approx.). To the extent this latter expression is true, deflection distances (rather than deflection

angles) are an accurate measure of signal values. But to determine the extent of error resulting from using this approximation, the following data have been calculated*, using a chart width of 25 mm either side of zero ("D" in Fig. 2) and effective stylus length of 100 mm ("R" in Fig. 2) in the series expansion for the tangent func-

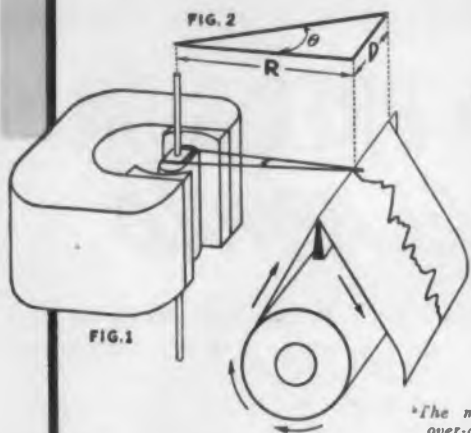

*The mathematics involved here, as well as a discussion of fixed length stylii, design parameters affecting over-all galvanometer performance, etc., are contained in an article by Dr. Arthur Miller "Sanborn Recording Galvanometers", published in the May 1956 Sanborn RIGHT ANGLE. Copies are available on request.

tion. Error as a function of deflection then becomes:

| D mms | Radians | Theoretical Error ϵ | Corrected Error δ | Corrected Error in mms |
|-------|---------|------------------------------|--------------------------|------------------------|
| 10 | .10 | .0033 | 0 | 0 |
| 15 | .15 | .0075 | .004 | .06 |
| 20 | .20 | .0133 | .010 | .20 |
| 25 | .25 | .0209 | .018 | .45 |

When the recording system is calibrated, that calibration is often made on the basis of a one centimeter deflection from the chart center, or by means of a two centimeter deflection starting one centimeter below chart center and finishing one centimeter above chart center. In either case the deflection at one centimeter from chart center is accepted as the standard, and, therefore, is without error. The foregoing table can therefore be corrected by subtracting .0033 from each of the error terms to show the error, δ , to be expected in actual use. The final column in the table shows this error in mms.

Since the active length of the stylus increases as θ increases, deflection D increases more rapidly than θ . All positive error terms in the series expansion bear this out, but the error terms would occur as predicted only if the galvanometer produced deflections exactly proportional to coil currents (that is, ideal spring properties in the torsion rods and uniformity of magnetic field). Pole tips in Sanborn galvanometers are proportioned so that in maximum deflections, galvanometer sensitivity decreases slightly, the compensation resulting in actual linearity better than that predicted in the table.

RECOGNIZE A "150" RECORD BY THESE THREE FEATURES...

1% Linearity

... resulting from use of current feedback Driver Amplifier in each channel, high torque galvanometers of new shorted coil frame design. Coil current of 10 ma develops 200,000 dyne cm torque, sensitivity is 10 ma/cm deflection.

Rectangular Coordinates

... save analysis time, simplify interpretation and correlation of multi-channel records. No waveform curvature, negative time lines, etc.

Permanent Inkless Traces

... made by hot nichrome ribbon tip of stylus on heat-sensitive Sanborn Permapaper. Clear, smudge-proof traces that clearly reveal minute signal changes.



Call on Sanborn engineers for help with your oscillographic recording application in the 0-100 cycle range. Descriptive literature is also available on request, providing data on Sanborn 1-, 2-, 4-, 6- and 8-channel Systems, choice of 12 interchangeable plug-in Preamplifiers, Separate and Supplementary Instruments.

**SANBORN
COMPANY**

Industrial Division
175 Wyman Street, Waltham 54, Mass.

CIRCLE 96 ON READER-SERVICE CARD FOR MORE INFORMATION

New Products



Dry Circuit Tester
Checks Relays

These relay test sets pass low-current, low voltage signals thru the contacts of relays to be used for grid switching applications while the relays are energized. Individual contacts can be monitored for research into the dry circuit phenomena or all contacts can be connected in series for production lots. The Model R-3C passes 30 μ a thru the contacts with an open circuit voltage of 30 mv. The Model R-4C passes 1 μ a through the contacts with an open circuit voltage of 5 μ a. The test relay is energized once per second, and a counter records the number of times a failure is encountered. Test sets of various sizes are available to test from one to twenty-four relays simultaneously.

Fleetwood Labs. Inc., Dept. ED, 300 Victory Blvd., New Rochelle, N.Y.

CIRCLE 97 ON READER-SERVICE CARD FOR MORE INFORMATION



Soldering Pencil
Long Life, 50 w

A soldering pencil equipped with a long-life 1/4 in. tip, rated at 50 w, is capable of doing the work of 100 w soldering irons, yet weighs but 2 oz. A stainless steel alloy for element housing plus a unique design in ventilation insures a comfortable handle and maximum soldering efficiency. Tip and element are separate parts and are both replaceable independently, without returning to the factory. Designed and recommended for constant-duty, it operates on ac or dc, any cycle. Available for 110 or 220 v.

Hexacon Electric Co., Dept. ED, 299 W. Clay Ave., Roselle Park, N.J.

CIRCLE 98 ON READER-SERVICE CARD FOR MORE INFORMATION



Power Absorber
13,500 W

The power absorber operates at 13,500 w continuous duty, and has a weight of 1 lb per kw absorbed. Air is drawn in through circumferential slots in the casing, and flows over V-section resistors. The motor and fan can be operated either as part of the load, or from an independent power source. The power absorber is fully protected against overloading.

Sun Electric Corp., Aeronautical Div., Dept. ED, 6701 S. Sepulveda Blvd., Los Angeles, Calif.

CIRCLE 99 ON READER-SERVICE CARD FOR MORE INFORMATION



Counting Circuits
Plug-In

Plug-in P Series, and C Series comprise a line of transistorized counting circuits for telemetering frequency determination, time internal origination, sequencing, counting and scaling, and similar operations. The former, a plug-in package fits standard 7 pin miniature socket and can be conveniently retained with a standard tube shield. The latter, C Series cartridge, a rectangular flat configuration for permanent installations, features high space density stacking and miniature styling.

The lines are comprised of a binary counter, types PM 6003 and CM 6003, which has use as a binary or as a flip-flop; type PM 6023 and CM 6023 trigger which will convert a sine wave or other wave shape into a fast rising pulse suitable for driving the binary counter and other circuits; a delay multivibrator, types PM 6013 and CM 6013, which is a nominal 3 us delay circuit; specifically designed to provide delayed feedback or reset pulses to the binary counter; and a dual emitter follower amplifier, types PM 6033 and CM 6033, which is a circuit that can be coupled directly to transistor counter output.

Walkirt Co., Dept. ED, 141 W. Hazel St., Inglewood, Calif.

CIRCLE 100 ON READER-SERVICE CARD FOR MORE INFORMATION

Making drawing board dreams come true!



Radio Receptor

Germanium Diodes



You electronic engineers show limitless imagination and ingenuity, but to help translate ideas into reality you need extra special components, such as Radio Receptor Gold Bonded Diodes. Right now they are being used successfully by many top-flight companies whose circuits require high forward conductance coupled with other stringent characteristics — and the ability to take a beating under grueling conditions.

A complete range of RRco. diode types is available — and if you haven't found the type *your* circuit calls for, no doubt we can make it specially for you. So, if diodes can possibly help your project, consult our engineers without obligation. Write Dept. D-5.



Semiconductor Division
RADIO RECEPTOR COMPANY, INC.

Subsidiary of General Instrument Corporation

240 Wythe Avenue, Brooklyn 11, N. Y. • EVERgreen 8-6000

Radio Receptor Products for Industry and Government: Selenium Rectifiers • Germanium Diodes
Thermatron Dielectric Heating Generators & Presses • Communications, Radar & Navigation Equipment

CIRCLE 101 ON READER-SERVICE CARD FOR MORE INFORMATION

SKL introduces

NEW ULTRA WIDE-BAND AMPLIFIER

for fast rise pulse reproduction

320 Mc



MODEL 206

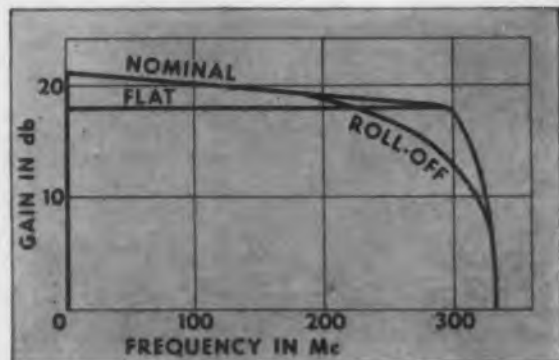

SPECIFICATIONS

Bandwidth:
300 Mc at 3 db point

Gain:
18 to 20 db depending on plug-in accessory

Rise Time:
Less than .002 μ seconds

Output:
Panel switch selects
(a) Linear: 5 volts, rms
(b) Pulse: 30 volts, negative
(c) High Pulse: Greater than 100 volts, negative, open circuit

Gain Regulation:
 ± 0.5 db for line voltage between 105 and 125 volts

Gain Control:
Panel control varies gain 6 db

Phase:
Linear to 300 Mc

Impedance:
180 ohms input, 200 ohms output

Size:
19" wide, 8 3/8" deep, 7" high

Power Requirements:
115 volts, 60 cycles

Write for Bulletin 206-1

Here is another advance in the art . . . Spencer-Kennedy's new Ultra Wide Band Amplifier, Model 206. Now for the first time fast-rise-time pulses can be faithfully reproduced by providing a stable 20 db gain over a 320 Mc band! . . . Although nominal gain for Model 206 is 20 db, sloping to 18 db at 300 Mc and 14 db at 320 Mc, flat and gradual roll-off characteristics are readily available by means of small, inexpensive plug-in accessories (see curves above). Three output modes . . . linear, pulse and high pulse . . . are selectable by means of a front panel switch. Integral regulated power supply and rack mounting are also provided. Applications include amplification of the following: short fast-rise-time pulses from pulse generators, input to wide-band vacuum tube voltmeters, output of scintillation detectors, multi-channel VHF signals, wide-band IF signals, narrow band IF signals with wide range for choice of center frequency. Model 206 also serves ideally as a distribution amplifier for wide band receiving systems feeding multiple diverse channel receivers.

SKL

**SPENCER - KENNEDY
LABORATORIES, INC.**

1320 SOLDIERS FIELD ROAD
BOSTON 35, MASS.

CIRCLE 102 ON READER-SERVICE CARD FOR MORE INFORMATION

New Products



**Pyrometers
Easily Read**

These medium resistance pyrometers (4 ohms per mv) are available in 21 standard ranges. Meters are 3-3/4 and 4-1/2 in. wide, and may be read accurately from all angles because they have been redesigned with mirror scales to cut down parallax effect. Maximum sensitivity for a pyrometer connected to one thermocouple is 300 F for full scale deflection. Standard ranges begin with -400 to +100 F and go up to 0/3000 F. Full scale accuracy of 2 per cent is standard, although 1 per cent may be obtained at extra cost. These pyrometers may be thermistor-compensated to maintain accuracy in spite of ambient changes. They are furnished with compensation for changes in cold junction.

Assembly Products, Inc., Dept ED, Chesterland, Ohio.

CIRCLE 103 ON READER-SERVICE CARD FOR MORE INFORMATION

Air Dux Coils For Pi Output

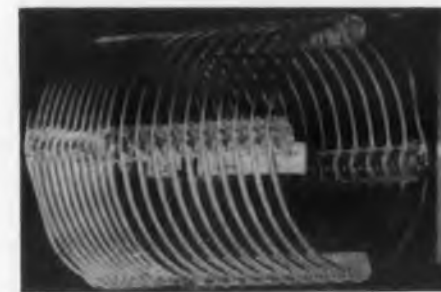

A series of air dux coils designed primarily for modern pi output circuits may also be used in conventional LC output circuits, interstage and oscillator circuits. Available in two series: indented and variable pitch. Indented coils make connecting of taps by clips or soldering easy, and variable pitch coils offer complete ease in obtaining the proper inductances at high frequencies. Pi air dux coils are adaptable to a wide range of tube and load impedances in either high or low power transmitters. Each coil is made with bright tinned copper wire and low loss polystyrene coil supports, and comes complete with plastic mounting strip.

Illumitronic Engineering, Dept. ED, 680 E. Taylor St., Sunnyvale, Calif.

CIRCLE 104 ON READER-SERVICE CARD FOR MORE INFORMATION



Test Load High Amperage

The Hi-Amp unit is said to deliver a heavy test load with a minimum of wattage and a continuously adjustable secondary current, from zero to a maximum of 240 amp. The high ampere capacity permits the simulating of starting currents for large and small motors to check relays under these conditions. A wide range of voltages on each tap permits dropping the current from starting value to normal by simply adjusting the vernier control. The momentary overload rating is 200 per cent of normal. Total weight of the unit is 111 lbs.

Sittler Corp., Dept. ED, 16 North Ada St., Chicago 7, Ill.

CIRCLE 105 ON READER-SERVICE CARD FOR MORE INFORMATION



Wires and Cables Teflon Insulation

The Series T line of wires and cables for high temperature applications encompasses hook-up wires, miniature coaxial and coaxial cables and multiconductor cables. Extruded as well as spirally wound and fused Teflon insulations are offered in a range of 14 colors and/or spiral striping, on solid, standard and special strandings of silver plated copper wire conductors of from AWG 32 through AWG 10. Hook-up wires with extruded Teflon insulation comply with MIL-W-16878B specifications and have a rating of from -90 to $+250$ C. Hook-up wires with spirally wound and fused Teflon insulation are manufactured to the MIL-W-16878B specifications for temperatures to 250 C, and feature a free-stripping and extra flexible construction. All hook-up wires can be shielded and jacketed to individual specifications. Miniature coaxial cables with either extruded or spirally wrapped and fused Teflon jacketings are offered in wide ranges for high impedance as well as low capacitance applications.

Times Wire and Cable Co., Dept. ED, Wallingford, Ct.

CIRCLE 106 ON READER-SERVICE CARD FOR MORE INFORMATION



Section of department making stators for Bendix synchros and motors



SHOP AT THE BENDIX "SUPERMARKET" TO TAKE ADVANTAGE OF MASS SYNCHRO PRODUCTION FACILITIES

EXTERNAL SLIP RING AUTOSYNS®

Bendix external slip rings replace ordinary fixed leads where it is desired to rotate the stator in addition to, or instead of, the rotor. Individual mechanical and electrical requirements determine location

and configuration of these external rings.

As can be seen from the few examples below, many variations are possible in Bendix External Slip Ring Autosyns.



Three external stator rings in face of Autosyn.
Two external rotor rings.



Rotor and stator rings mounted concentrically with outside diameter of housing.
Rotatable gear mounted to Autosyn.



Rotor and stator take-offs are by means of brushes riding on these external rings.

Fast delivery of practically any type synchro at minimum cost. Isn't that what you want from your synchro supplier?

If so, consider how well Bendix fills the bill. First, as a virtual "supermarket" for synchros, we maintain mass production that means minimum unit prices, even to small-quantity buyers. Second, we produce virtually all types of synchros as *standard items*, meaning you can get delivery fast—*immediately*, in most cases.

Finally, Bendix synchros are built to exacting precision standards that equal . . . or exceed . . . those of any other synchros made.

Let our vast experience and mass production facilities go to work on *your* synchro needs, too!

District Offices: Burbank, Calif., Dayton, Ohio, Seattle, Wash.
Export Sales and Service: Bendix International Division, 205 E. 42nd St., New York 17, N. Y.

Eclipse-Pioneer Division

Teterboro, N. J.



CIRCLE 107 ON READER-SERVICE CARD FOR MORE INFORMATION

RICHARDSON — plastics for electronics

... laminated—molded



COPPER-CLAD INSUROK

Choice of various grades. Copper bonded to one or both sides. Outstanding electrical properties after humidity conditioning. High flexural and tensile strength. Holds metal inserts and lugs securely. Excellent bond strength and heat resistance.



FABRICATION

Complete facilities for punching or machining precision parts from laminated INSUROK to your specifications in any quantity—for electrical or mechanical applications.



MOLDED PLASTICS

Parts molded from standard or special plastics materials as required for your product, including newest plastics. Produced by compression transfer or injection processes. Metal inserts molded in position.



LAMINATED INSUROK

Available in sheets, rods, and tubes in NEMA and special grades. Properties to meet practically any electrical or mechanical requirements. Many sizes and thicknesses.

technical services

Experienced Richardson engineers will analyze your requirements and help you select the material, and best manufacturing process for your needs . . . and when your requirements are unusual, Richardson offers extensive background for developing special plastics materials for your product. Also, Richardson is equipped to provide complete facilities and techniques for molding, laminating, molded laminates, and fabricating. You are assured the correct material and process for each application. These research, design, and engineering services are yours without cost or obligation, of course. Write or phone, today.

Write for 12-page booklet

"INSUROK® Laminated Plastics—Molded Plastics"

The
RICHARDSON COMPANY
LAMINATED AND MOLDED PLASTICS

Dept. 16, 2682 Lake Street
Melrose Park, Ill.

CIRCLE 108 ON READER-SERVICE CARD FOR MORE INFORMATION

New Products

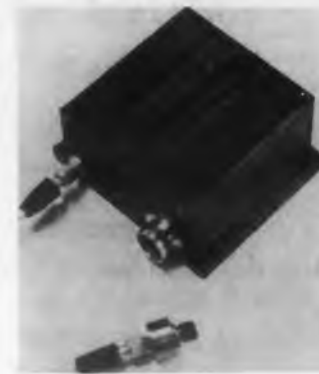

Accelerometer
For 450 F Use

The Glennite AD series are designed for continuous operation at temperatures up to 450 F with no temperature compensation and no external cooling required. Each amplifier and cathode follower is individually potted with a plastic compound to insure performance under extreme conditions. The filament in the amplifier may be set for operation at either 6.3 or 26 v. Four systems are available, the AD-1, AD-5, AD-10 and AD-14 with the AD-5 and AD-14 systems having a wider acceleration range and higher frequency response. Glennite connectors and cables are supplied.

Gulton Industries, Inc., Dept. ED, 212 Durham Ave., Metuchen, N.J.

CIRCLE 109 ON READER-SERVICE CARD FOR MORE INFORMATION

Analog Field Plotter

Dry Paper Type



This dry paper type field plotter is for use in solving complex two-dimensional field problems. It has been used to solve mathematical functions, including orthogonal plotting, electrostatic and electromagnetic fields, gas and liquid flow and heat transfer problems. Excellent results may be obtained in establishing design criteria involving electrostatic patterns around wires, insulators and shields, and also in determining flow patterns in wing and propeller design, wind tunnels, turbine blades, pump and valve body, piping design and model work. The plotter provides a visual and permanent record of such problems.

Sunshine Scientific Instrument, Dept. ED, 1810 Grant Ave., Philadelphia 15, Pa.

CIRCLE 110 ON READER-SERVICE CARD FOR MORE INFORMATION



Sampling Switch Miniature

A miniaturized version of the Type A Sampling switch weighs only 7 oz and measures 2-11/16 x 1-13/16 x 1-11/16 in. The two-pole 30 contacts per pole switch will provide 60 channels in make-before-break operation. A filtered 27.5 v dc motor rotates the switch at 2.5 rps providing a sampling rate of 150 samples per second.

Applied Science Corp. of Princeton, Dept. ED, Princeton, N.J.

CIRCLE 111 ON READER-SERVICE CARD FOR MORE INFORMATION



Time Acceleration Switch For Missiles

An acceleration-time integrating switch for missile and rocket applications actuates when sustained acceleration in excess of the internal bias is applied. It is hermetically sealed and conforms to Air Force environmental specifications. An observation window and reset feature facilitate laboratory testing. The switch can be adapted to a wide range of acceleration and time parameters to satisfy specific requirements. Contact closure occurs in the presently available unit when the missile or rocket has reached a velocity of approximately 460 ft per sec under conditions of sustained accelerations between 4 and 15 g. The pictured unit is approximately 3 cu in., and weighs approximately 9 oz.

The Magnavox Co., Dept. ED, 2131 Bueter Rd., Fort Wayne, Ind.

CIRCLE 112 ON READER-SERVICE CARD FOR MORE INFORMATION

MICROWAVE PROGRESS

Impedance Measurements in the 100—1000 mc/s Range

Trying to understand the workings of a woman's mind is like measuring impedance in the 100—1000 mc/s range... both are fraught with difficulties.

While we haven't, as yet, made any progress on the first problem, we have solved the impedance measurement difficulties with our Type 219 Rotary Standing Wave Detector.

Basically, the 219 consists of a coaxial Tee junction. One arm is fed by the generator. The other two arms are terminated, respectively, by a variable capacitor and by the unknown impedance. Vertically above the Tee junction, is a concentrically mounted round cutoff tube which contains the pickup structure.

It can be shown mathematically that an elliptically polarized field exists in the cutoff tube; and if the variable capacitor is adjusted such that at any frequency its normalized susceptance, as seen at the junction, is equal to unity, then the ratio of the major and minor axes of the ellipse is equal to the VSWR of the load. Further, the geometrical orientation of the major and minor axes of the ellipse with respect to the Tee junction is determined by the angle of the reflection coefficient. A rotating probe samples the elliptical field, and with suitable detection, indicates values of E_r max (electric field vector corresponding to the major axis of the ellipse), and E_r min (minor axis vector), and ϕ (angle of reflection coefficient). The ratio of E_r max to E_r min is the VSWR of the unknown impedance. The dominant mode in the cutoff tube is the TE_{11} and other modes are eliminated by a mode filter consisting of a series of thin parallel blades mounted in the cutoff tube.

You can obtain additional discussions on the 219, including Theory of Operation, Instrument Accuracy, and Applications, by requesting our PRD Report Vol. 3 No. 2C.



Polytechnic Research and Development Co., Inc.

202 Tillary Street • Brooklyn 1, N. Y. • Tel: UL 2-6800
Cable Address: MICROWAVE, NEW YORK

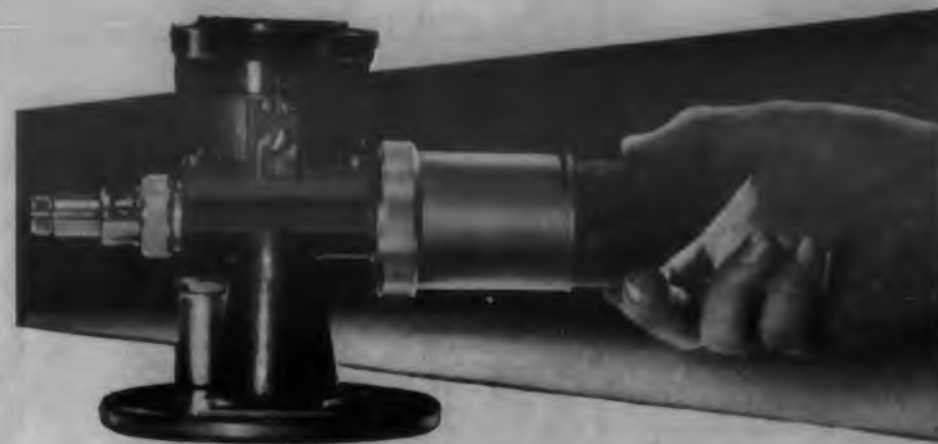

PRD Rotary Standing Wave Detector for the 100 to 1000 mc/s Range

- Small, Compact, Lightweight*
- Direct Reading of Reflection Coefficient Angle
- Direct Measurement of VSWR
- Non-Ambiguous Display of Inductive or Capacitive Components

Now, a simple-to-use, easy-to-handle standing wave detector for impedance measurements in the 100 to 1000 mc/s range! A turn of the calibrated top drum dial to minimum indication enables you to read the VSWR, and the angle of the voltage reflection coefficient directly in electrical degrees, and, with the 219, you can immediately determine the character of the reactive component as inductance or capacitance (+ or -).

SPECIFICATIONS

Frequency Range: 100 to 1000 mc/s
Residual VSWR: Less than 1.03
Minimum Input Signal: Approx. 1V at 100 mc/s; 0.1V at 1000 mc/s for measuring a matched load.
Characteristic Impedance: 50 ohms
Detector: G.E. G-7 crystal included
RF Input Connector: BNC Jack
RF Output Connector: Type N Jack. Other interchangeable connectors available.
Audio Output Connector: BNC Jack
*Dimensions: 8" long x 5" wide x 5 3/4" high
*Weight: 4 1/2 pounds
Price: \$525. FOB Brooklyn, N. Y.

For additional details on PRD 219 Rotary Standing Wave Detector, contact your local PRD Engineering Representative or write to Technical Information Group, Dept. 7.

CIRCLE 113 ON READER-SERVICE CARD FOR MORE INFORMATION

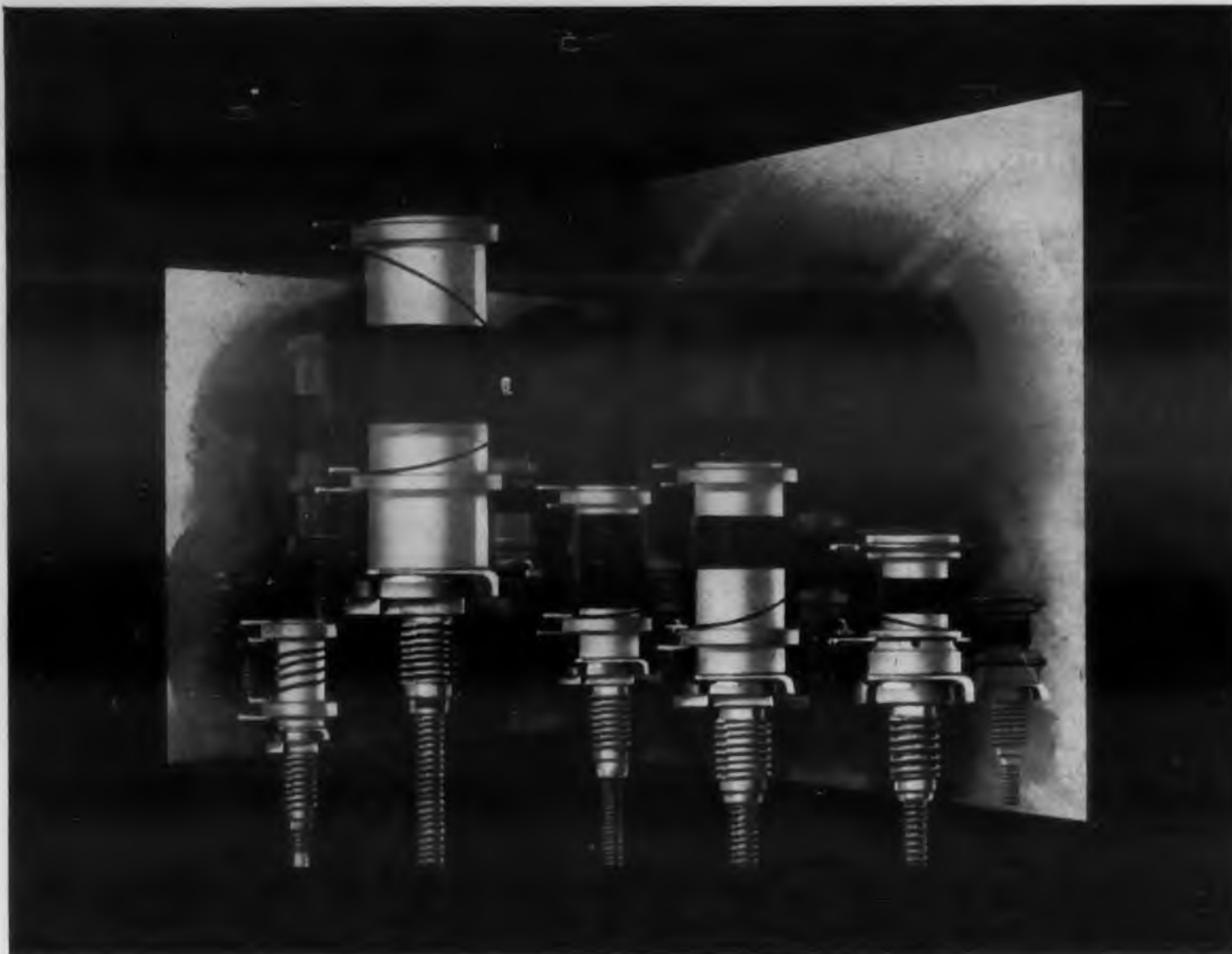

CTC coil forms with Perma-Torq* Tensioning Device are designated PLST, PLS-6, PLS-5, PLS-7, PLS-8 and are factory assembled to mounting studs. The units are completely interchangeable with CTC's LST, LS-5, LS-6, LS-7 and LS-8.

Reliability is their family resemblance

Here's a reliable family of coil forms ready to meet your specifications. These Perma-Torq Tensioning Devices on CTC coil forms allow locking of tuning cores while still tunable — and you can depend upon them to do their job well.

This built-in dependability is a result of CTC's unique design plus quality control — that meets or betters government specifications.

Perma-Torq is a compression spring of heat treated beryllium copper, that has a very high resistance to fatigue and keeps coils tuned as set — even under extreme vibration and shock. The device also allows for immediate readjustment — without removal or loosening of any mounting nut or locking spring.

Quality control and features like the above are just two of the reasons why CTC can offer you guaranteed standard or custom electronic components — whose performance you can rely upon.

CTC researchers and practical experts are always available to help you solve your component problems. For

all specifications and prices, write Cambridge Thermionic Corporation, 457 Concord Ave., Cambridge 38, Mass. West Coast stocks maintained by E. V. Roberts and Associates, Inc., 5068 West Washington Blvd., Los Angeles 16, and 61 Renato Court, Redwood City, California.

CTC miniature shielded coil forms are rugged and perfect for "tight spots." The LS-9 is $\frac{1}{16}$ " diameter $\frac{1}{2}$ " high. LS-10 is $\frac{3}{16}$ " diameter x $\frac{1}{4}$ " high. The LS-11 is $\frac{1}{16}$ " x $\frac{17}{22}$ ". The LS-14 is double ended and is $\frac{1}{2}$ " OD, 1 and $\frac{1}{4}$ " overall in length. All are highly shock resistant with mechanically enclosed protected coil windings. The units are ideal for use with IF strips or as RF coils, oscillator coils, etc. Available as coil form assemblies or wound to your specifications.

*Patent pending.

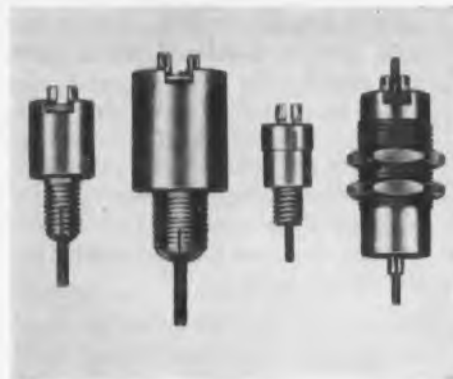

CTC

CAMBRIDGE THERMIONIC CORPORATION

*makers of guaranteed electronic components
custom or standard*



CIRCLE 115 ON READER-SERVICE CARD FOR MORE INFORMATION

New Products



Filtration Unit
3 to 10 Gal Per Min

The MIK filtration unit is designed to remove physical impurities from electronic wash waters and demineralized waters. The unit makes possible the production of physically pure water on a large scale. Capacities range from 3 to 10 gallons per min and the filter removes all physical impurities larger than the rated density of the cartridge. MIK permanent cartridges are available in the following densities: 25, 10, 1 and 0.1 microns.

Heico Inc., Dept. ED, 25 North Sixth St., Stroudsburg, Pa.

CIRCLE 116 ON READER-SERVICE CARD FOR MORE INFORMATION

Spectrum Analyzer
10 CPS Resolution



Designed for applications requiring high resolution, such as investigations of side bands caused by low modulating frequencies, single side band transmissions, teletype etc., the SB-12 Panalyzer can be used to observe signals anywhere in the spectrum up to 1,000 mc by means of an external signal generator and an internal aperiodic mixer which translate the spectrum segment to be analyzed down to the 450-550 kc input band of the Panalyzer. The SB-12 also permits examination of signals closely adjacent in frequency. Maximum sweepwidth is 100 kc continuously reducible to 0 kc. Scan rate is adjustable in steps of 30, 5, 1, and 0.1 cps. Resolution ranges from 3.2 kc to 10 cps. AFC is provided for narrow sweepwidths.

Panoramic Radio Products Inc., Dept. ED, 10 So. Second St., Mt. Vernon, N.Y.

CIRCLE 117 ON READER-SERVICE CARD FOR MORE INFORMATION



Servomotor Dampers
For Diehl FPE-25

Need for tachometers, networks, or other bench-engineered means of stabilization is eliminated by a new line of viscous-coupled-inertia dampers. They are primarily intended for use with Diehl FPE-25, 5-w servomotors. High velocity and torque constants, with good stability, are provided by these dampers. They need only the simplest form of servo amplifiers. Each is factory adjusted to specified time constants within the range 0.02 seconds to 1.20 seconds. Mountings are available for tapered or straight shafts, with or without integral pinion.

Feedback Controls, Inc., Dept. ED, 899 Main Street, Waltham 54, Mass.

CIRCLE 118 ON READER-SERVICE CARD FOR MORE INFORMATION

DC to DC Converter Lightweight



A series of dc to dc power converters for portable, aircraft, and vehicular electronic equipment is transistorized for lightweight, efficient operation. Standard units are available for 12 and 28 v inputs, in a number of nominal output voltages from 120 to 2100 v, and in power outputs up to 500 w. Custom engineered combinations of input and output voltages and higher power ratings are available on special order as high as 12 amp or 100,000 v. Typical of this series is Model UAC 500/28/400 ma, which delivers 200 w (500 v at 400 ma) from 28 v dc input, weighs only 2 lb, and comes in a compact 6 x 3 x 3 in. package.

Regulation is available to 0.25 per cent, and efficiency under special conditions to 98 per cent. Standard operating temperature range is -40 to +71 C, but higher temperatures are available.

UAC Electronics, Dept. ED, Div. of Universal Transistor Products Corp., 143 E. 49th St., New York 17, N.Y.

CIRCLE 119 ON READER-SERVICE CARD FOR MORE INFORMATION



Silicone News

FOR DESIGN ENGINEERS



Silicones Assure Top Performance Of All Mercury Outboard Motors

New evidence to the versatility of Dow Corning silicone compounds comes from Kiekhaefer Corp., Fond du Lac, Wisconsin, manufacturer of the "Mark 75," world's most powerful production outboard motor.

To help keep this and the other eleven new Mercury motors in top operating condition despite rugged service, Kiekhaefer coats several rubber, ceramic and metal parts in every motor with a paste-like silicone dielectric compound. Exceptionally resistant to heat, cold, oxidation and moisture, the silicone compound protects and preserves rubber, serves as a light lubricant, and helps prevent shorts in the electrical system. Since this Dow Corning silicone compound remains serviceable from -70 to 400 F, it stays in place to minimize maintenance and to assure long, trouble-free service.

No. 124

Silastic Seals Help Make Glass Heat Exchangers Maintenance-Free

With superior resistance to heat and compression set, Silastic® — the Dow Corning silicone rubber — has helped Corning Glass Works to engineer low maintenance into their new Pyrex modular shell-and-tube heat exchanger.

Mass produced for off-the-shelf delivery, these glass heat exchangers are designed for processing corrosive and metal-sensitive liquids. Any number of standard sections can be combined into a single, efficient heat exchange unit. Maintenance is almost nil due to the glass construction and the efficiency of a Silastic seal between the shell and tube.

Here's how it works: a resilient Silastic gasket is put under pressure by tightening the flange bolts of the sections. Completely contained between the tubes and a retainer ring, the Silastic in turn, forces a Teflon "protector" sheet to form a permanent, leakproof seal against the tube ends. Resilience and positive pressure are maintained by the Silastic part despite expansion and contraction at operating temperatures as high as 375 F.

That's the kind of serviceability you can



expect from seals backed by these typical Silastic properties:

- Temperature range, F ----- -130 to 500
- Tensile strength, psi ----- 600 to 900
- Elongation, % ----- 150 to 300
- Tear strength, lb/in ----- 40 to 75
- Compression set, %, at 300 F ----- 25 to 50
- Hardness range, Durometer ----- 20 to 80
- Weather, ozone and corona resistance ----- Excellent

U. S. PAT. OFF.

No. 125

Heat Resistant Silicone Enamel Improves Heater, Cuts Costs

Paints and enamels made with Dow Corning Silicones not only solve the problem of keeping an attractive finish on hot metal surfaces, but frequently effect noteworthy savings in production costs as well. For example—

Five years ago, Temco, Inc., Nashville, Tenn., switched from a vitreous finish to a silicone enamel for the upper grille of their gas-fired wall heaters.

The heater normally operates at 350 F, but a blocked flue can quickly boost this temperature to 500 F. Temco has used the silicone enamel on over 25,000 units without a single custo-



mer complaint about loss in color, gloss or adhesion. Because the silicone coating remains flexible and does not require high-temperature firing, production savings have been tremendous. Rejects due to chipping and warping have been virtually eliminated. Even handling and shipping costs have been reduced.

The enamel used in this application is a brown Sicon finish formulated with Dow Corning Silicones by Midland Industrial Finishes Company. A single coating is sprayed on the steel grille and baked 20 minutes at 350F. No. 126

ATLANTA • BOSTON • CHICAGO • CLEVELAND • DALLAS • DETROIT • LOS ANGELES • NEW YORK • WASHINGTON, D. C.
Canada: Dow Corning Silicones Ltd., Toronto; Great Britain: Midland Silicones Ltd., London; France: St. Gobain, Paris

CIRCLE 120 ON READER-SERVICE CARD FOR MORE INFORMATION



For the latest news of silicones and to learn how silicones can help solve your design problems, be sure to visit BOOTH 406 at the Design Engineering Show.

Design Edition 32

DOW CORNING CORPORATION - Dept. 4717

Midland, Michigan

Please send me 124 125 126

NAME _____

TITLE _____

STREET _____

COMPANY _____

CITY _____ ZONE _____ STATE _____

**EPOXY
COATED**

**Good-ALL
CERAMIC DISC
CAPACITORS**

**A BETTER DISC CAPACITOR BECAUSE IT'S
PROTECTED FOR LIFE with Good-All's
tough, durable Epoxy coating.**

**HIGH VOLTAGE
BREAKDOWN STRENGTH**

Epoxy bonds securely to the ceramic edge and blocks leakage or actual breakdown.

DURABLE AND ATTRACTIVE

This tough, durable coating is a glossy red color. No wax is needed to add further protection.



MOISTURE RESISTANT

Complete encapsulation in Epoxy keeps moisture out. Lead entries are tightly sealed.

COMPETITIVE COST

Good-All Epoxy coated discs are available at no premium cost over types with conventional coating.

Condensed Table of Widely-Used Stock Types

| DISC TYPES | CAPACITY RANGE | MAXIMUM DIAMETER | STANDARD TOLERANCES | APPLICATION NOTES | | |
|---|-------------------------------------|------------------|---------------------|--|-----------|------------|
| TRANSISTOR TYPE "H" | .00047-.001 MFD | .250" | GMV +80% -20% | FOR MAXIMUM SPACE SAVING. RATINGS UP TO 200 VDC | | |
| | .0015-.005 | .375" | | | | |
| | .006-.01 | .437" | | | | |
| | .015-.02 | .500" | | | | |
| | .022-.05 | .660" | | | | |
| BY-PASS TYPE "B" | .00047-.001 MFD | .290" | GMV +80% -20% | MEET ALL REQUIREMENTS OF RETMA CLASS 2, 25Z | | |
| | .0015-.002 | .400" | | | | |
| | .0022-.0047 | .570" | | | | |
| | .005-.02 | .660" | | | | |
| | .022 | .790" | | | | |
| STABLE TYPES "E" & "EE" | 100-330 MFD | .290" .400" | ±20% ±10% ±5% | Temperature Stability* in the Range From -25°C to +85°C is: Type "E" +5% to -15% Type "EE" 0% to -10% *Compared to 25°C reading | | |
| | 331-1000 | .400" .570" | | | | |
| | 1001-1500 | .570" .660" | | | | |
| | 1501-2000 | .660" | | | | |
| | 2001-3300 | .790" | | | | |
| 3301-5000 | .890" | | | | | |
| TEMPERATURE COMPENSATING TYPE "A" | MAXIMUM DIAMETER FOR CAPACITY SHOWN | | | | | |
| | Temperature Coefficient | 1/4" | 5/16" | 1/2" | 5/8" | 3/4" |
| | NPO | 2-12 MMF | 13-22 MMF | 28-60 MMF | 61-75 MMF | 76-110 MMF |
| | N150 | 2-15 | 16-30 | 31-60 | 61-75 | 76-110 |
| | N220 | 3-15 | 16-30 | 31-75 | 75-100 | 101-140 |
| | N330 | 3-15 | 16-30 | 31-75 | 76-100 | 101-140 |
| | N470 | 3-20 | 21-40 | 41-80 | 80-120 | 121-170 |
| | N750 | 5-25 | 26-50 | 51-150 | 151-200 | 201-290 |
| | N1400 | 15-50 | 51-100 | 101-200 | 200-250 | 251-470 |

Write for a complete brochure. Samples for tests against your specifications will be supplied upon request.



GOOD-ALL ELECTRIC MFG. CO. OGALLALA, NEB.
A leading manufacturer of tubular and ceramic disc capacitors



CIRCLE 121 ON READER-SERVICE CARD FOR MORE INFORMATION

New Products



Tube Tester
Automatic

The concept of automatic, high-speed tube testing has been produced in the Model 123A Cardmatic Tube Testing Machine. Preselected voltages on screen, plate, grid or filament are tabulated on vinyl type cards which are inserted into the machine. These cards trip an automation mechanism to make all electrical connections necessary for testing of any receiver tube. An infinitely large number of exactly controlled voltages (formerly possible only in laboratory type testers) are furnished for testing tubes in special purpose circuits. Unusually low 0.22 rms signal used on the grid permits testing of the newer sensitive tube types without distortion. Tubes are checked within seconds and the simplified operation permits even unskilled personnel to run laboratory-accuracy tests on a production line basis.

Hickok Electrical Instrument Co., Dept. ED, 10581 Dupont Ave., Cleveland 8, Ohio.

CIRCLE 122 ON READER-SERVICE CARD FOR MORE INFORMATION



Frequency Meter
3 to 100,000 Cps

This transistorized unit provides accurate direct frequency measurements from 3 to 100,000 cps in nine separate ranges. Accuracy is independent of input voltage waveform and amplitude. The instrument's sensitivity to short pulses minimizes lost counts when measuring the average frequency of random events. For tachometry and vibration indications, an output connector on the Model 503 provides all operating voltages for the Model A-503-1 and A-503-2 phototransistor pickups. These pickups allow the speed of rotating machinery or the frequency of vibrating parts to be sensed by means of interrupted light.

Cubic Corp., Dept. ED, 2841 Canon St., San Diego 6, Calif.

CIRCLE 123 ON READER-SERVICE CARD FOR MORE INFORMATION



**Servo Amplifier
Plug-In**

The Model 1800-0500 is a high temperature, miniaturized, hermetically sealed, plug-in transistor servo amplifier. It is primarily intended to receive signals from a syncho control transformer and to operate a size 15, 400 cy, 6.1 w servo motor (Kearfott Type R110-2) or equivalent. The amplifier is designed to exceed the environmental requirements of Specification MIL-E-5400A. Input-power requirements are 100 v dc at 100 ma and 28 v dc at 12 ma.

M. Ten Bosch, Inc., Dept. ED, Pleasantville, N.Y.

CIRCLE 124 ON READER-SERVICE CARD FOR MORE INFORMATION



**Mass Spectrometer
For Low PPM Range**

Problems of analyzing extremely small amounts of gaseous mixtures, or liquids capable of being vaporized, can be solved with a mass spectrometer designed for both laboratory and industrial use. Known as the Type 21-611 Mass Spectrometer, it has a mass range from 2 to 80 with resolving power adequate for separation of adjacent peaks up to about mass 35. Mass numbers appear linearly with time on a large, motor-driven dial, making mass marking unnecessary. A manual override on the motor drive permits the operator to turn quickly to any mass number of interest, or to start and stop the automatic scan at any desired point. High sensitivity makes possible the detection of gas impurities in the low ppm range. Modular design permits the control unit to be separated from the analyzer unit and grouped with other essential elements necessary for observing related phenomena. This new mass spectrometer weighs 115 lb, and is suitable for bench, rack, or trailer mounting, with the analyzer and control modules either stacked or separated.

Consolidated Electrodynamics Corp., Dept. ED, 800 N. Sierra Madre Villa, Pasadena, Calif.

CIRCLE 125 ON READER-SERVICE CARD FOR MORE INFORMATION

ONE SOURCE

for ALL your
Ceramic Resistor
requirements

Global[®]

1. Temperature control
2. Temperature compensation
3. Time delay
4. Surge suppression

1. Reduction of arcing at relay or motor governor contacts
2. Stabilization of rectifier circuits by limitation of peak voltage
3. Voltage control in electronic circuits
4. Protection of solenoids in direct current circuits

1. Antenna terminators
2. Dummy antennas
3. Parasitic oscillator suppressors
4. Power resistors for applications such as radio transmitters and inductive heating units



GLOBAL[®] Ceramic Resistors... like these recent designs... are engineered by Global resistor specialists to meet the particular electrical, thermal and packaging requirements of *your* circuit.

OVER THIRTY YEARS of experience in the development and manufacture of special-characteristic Ceramic Resistors, plus complete engineering facilities and an experienced engineering staff, are at your service to solve your special resistor requirement problems.

A GLOBAL DIVISION Sales Engineer will be glad to discuss your application. Or send details of your problem direct. Write Global Division, The Carborundum Company, Dept. ED 87-75, Niagara Falls, N.Y.

Global

**Ceramic
Resistors**

by **CARBORUNDUM**

CIRCLE 126 ON READER-SERVICE CARD FOR MORE INFORMATION

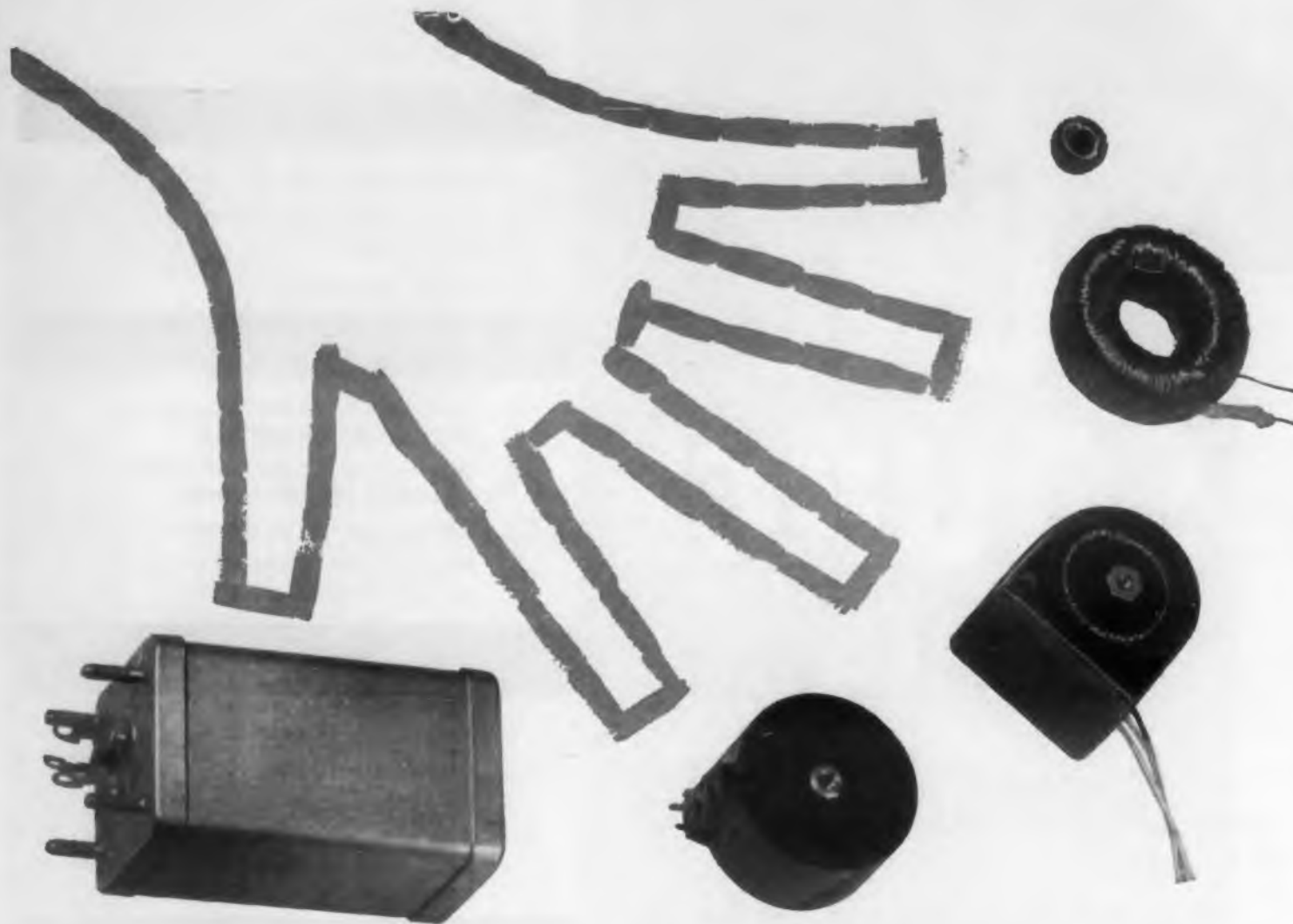

toroids and toroid engineering at your fingertips

Barker & Williamson *had* to wind toroids!

Years ago, B&W was well on the way to an outstanding reputation in filter engineering and manufacture. But the company experienced considerable difficulty in buying toroids to match the requirements set by filter engineers. The situation just about forced B&W to secure a toroid winding machine. Experiments with it soon proved that perfect toroids *could* be wound, but only if certain conditions were met. The raw materials had to be controlled to the point of perfection. The operator had to have more than average skill. And most important, the operator had to *want* to meet specifications.

With the toroid problem licked, B&W filter engineering attracted increasing filter design and manufacture contracts. More winding machines were installed to handle larger toroids and smaller toroids than had ever before been wound. New operators had the desire for perfection instilled in them.

But the engineers weren't satisfied. They were,

and still are, on the trail of better methods for packaging and encapsulating toroids for installation apart from other circuit components. Even today, with encapsulated toroids an accepted component, an entire group is engaged in a thorough study of encapsulation techniques and materials, and their effect on toroid performance.

That's one of the reasons why B&W now finds itself known as much for the toroids it winds for customer use as for the complete filters it provides.

However you want *your* toroids . . . plain, encased, encapsulated, or in-the-filter . . . you'll find working with B&W a refreshing experience. Here is a toroid winding department ready, able, and willing to meet your specification down to the dots and crosses . . . backed by a group of engineers skilled in defining problems wherever they exist . . . solving them as they arise.

Detailed information on B&W toroids and filters is yours on request. Or we can have a filter engineer at your desk, working with you to exceed requirements, at any time convenient for you.

New Products



Magnet Wire Kit For Experimental Use

A wide variety of gage sizes in Class HT Teflon coated Magnet Wire is now being offered in a single kit. This teflon magnet wire kit was designed specifically for use in research and development projects where small quantities of different gage sizes are needed for prototype and experimentation.

The kit contains an assortment of 12 miniature spools of teflon coated magnet wire in gage sizes 20 through 42 awg. This wire conforms to Type III, MIL-W-19583 (Navy) Specifications.

Tensolite Specialties, Inc., Dept. ED, 198 Main St., Tarrytown, N.Y.

CIRCLE 128 ON READER-SERVICE CARD FOR MORE INFORMATION

IF Band-Pass Filters For Single Conversion



A standard line of i-f band-pass crystal filters for improved design of single conversion receivers in the hf and vhf bands are stated as retaining all the advantages of multiple conversion performance at a lower cost.

Model 2215 KA is designed for voice utilizing a 2800 cy 6 db bandwidth. Model 2215 KB has a band of 250 cy and is of primary interest in cw reception. These units are electrically and mechanically interchangeable and may be cascaded in any combination to achieve selectivity. Both models may be incorporated between the mixes and i-f amplifier of a single conversion receiver. No padding or transformation networks are required between the two filters since they are designed to operate at the same impedance level. Some of the features of these filters are: smooth pass band, no spurious responses, reduced birdies and cross modulation, cw and phone filters interchangeable, single conversion and SSB reception. Both of these filters are currently being delivered from stock at a price of \$44.50 each.

Hycon Eastern, Inc., Dept. ED, 75 Cambridge Parkway, Cambridge 42, Mass.

CIRCLE 129 ON READER-SERVICE CARD FOR MORE INFORMATION

CIRCLE 131 FOR G.E. SPREAD AD

B&W

BARKER & WILLIAMSON, INC. BRISTOL, PA.

CIRCLE 127 ON READER-SERVICE CARD FOR MORE INFORMATION

THE MARK OF QUALITY



introducing the new

Microverter

a-c d-c chopper

extremely low driving power

low noise level

excellent stability

long contact life

rugged construction



Here's the new Barber-Colman Type NYZA Microverter specifically engineered to meet the more exacting chopper requirements of today's applications.

It can be used to convert a low level d-c signal (such as 10 microvolts produced by thermocouples and photocells) into a low level a-c signal, which can be further amplified to operate various kinds of control apparatus in null balance servo systems, industrial instruments, and other automatic controls.

The Microverter may also be used as a synchronous rectifier to convert low level a-c signals to d-c without loss. An important new field of application is chopper-stabilized operational amplifiers where minimum amplifier drift is important.

Low noise level of the Microverter is due to: (1) Extremely low driving power required—2-volt coil will operate at 4 milliamperes (approximately 4 milliwatts); (2) load circuit members isolated from the magnetic field of driving coil; (3) contacts thermodynamically symmetrical to eliminate stray thermal emfs.

This new hermetically sealed chopper features excellent stability under shock and vibration, long operating life, rugged construction. *10,000 hours' service life has been achieved* at contact load of 1 ma at 1 volt d-c, resistive.

SPECIFICATIONS OF A TYPICAL MICROVERTER

| MODEL NYZA 6192 | |
|---------------------------|--|
| d-c coil resistance | 215 ohms |
| Drive voltage | 2 volts |
| Drive frequency | 60 cycles per second |
| Dwell time | 45 plus or minus 3 percent |
| Balance | Within 2 percent average; 6 percent maximum |
| Phase angle (nominal) | 74 degrees at 60 cps |
| Contact rating | 2 volts at 2 milliamperes resistive load |
| Contact noise | 10 microvolts maximum when operated into 1000 ohm resistive load |
| Ambient temperature range | 30° F. to 130° F. |

HELPFUL NEW DATA SHEET

Includes Barber-Colman Microverter description, specifications, and schematic diagrams for typical applications. Write today for your free copy or contact the nearest Barber-Colman engineering sales office: Baltimore, Boston, Chicago, Cleveland, Dayton, Fort Worth, Los Angeles, Montreal, New York, Philadelphia, St. Louis, Seattle.

BARBER-COLMAN COMPANY

Dept. Q, 1883 Rock Street, Rockford, Illinois, U. S. A.

Electrical Components • Aircraft Controls • Small Motors • Automatic Controls • Air Distribution Products •
Industrial Instruments • Overdoors and Operators • Molded Products • Metal Cutting Tools • Textile Machinery

CIRCLE 381 ON READER-SERVICE CARD FOR MORE INFORMATION

General Electric announces



GENERAL ELECTRIC VITREOUS-ENAMELED RESISTORS are available in both fixed and adjustable types. Most requirements can be met with immediate shipment from stock. Additional units with a wide variety of mounting arrangements are available for special applications.

GENERAL  ELECTRIC

a new line of...

vitreous enameled resistors

General Electric presents a new line of enameled resistors designed for dependable, long-lasting service. These new resistors—rated from 5 to 218 watts—are ideal for both industrial and electronic applications.

RELIABLE PERFORMANCE THROUGH PRECISION MANUFACTURING

Maximum equipment-performance and long resistor life are assured with G.E.'s new line of resistors because:

- Low-temperature-coefficient wire means stable operation.
- Elimination of "hot-spots" reduces resistor burnouts.
- Special enamel coating is moisture and acid resistant.
- Wire junctions are silver brazed for positive connection.

NEW CATALOG SIMPLIFIES SELECTION AND ORDERING

To aid you in selecting the right resistors for your specific applications, General Electric's new easy-to-use resistor catalog puts complete information on performance, ratings, dimensions, mounting arrangements, and ordering instructions right at your fingertips.

For complete information on General Electric's new enameled resistors, contact your nearest General Electric Apparatus Sales Office. For your copy of the new G-E resistor catalog, GEA-6592, write Section 784-5, General Electric Company, Schenectady, N.Y.

Industry Control Department, Roanoke, Virginia

Progress Is Our Most Important Product

GENERAL  ELECTRIC

HEARD EVERYWHERE
Lowell[®]

Every Advantage in Every Application!

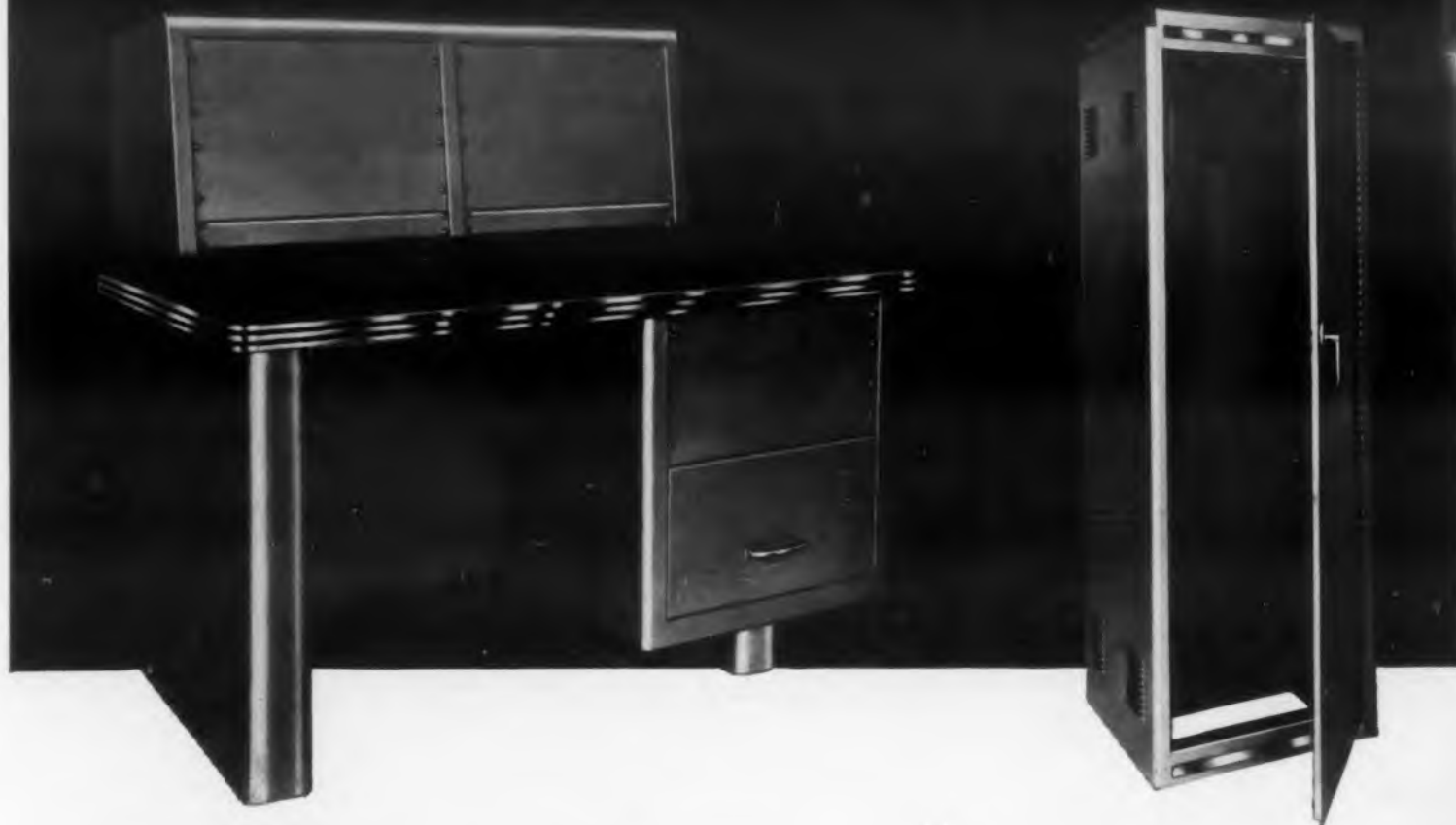

LOWELL CONSOLES

- Immediate Delivery
- Low Price
- Custom-design Flexibility
- Controls May Be Conveniently Located
- Equipment Is Well Protected
- Single, Double and Triple Pedestal Units With Turrets
- Handsome Styling
- Sturdy Construction

LOWELL RACKS

- Versatility
- Low Price
- Durability
- Transmitter Racks for 19", 24", and 30" Panels—18½" and 24" Deep
- Cabinet Relay Racks in Standard, Round Corner and Deluxe Models
- Deluxe Desk Cabinet Racks in Hinged Door or Solid Back type
- Channel and Table Type Relay Racks

For Industry . . . Schools . . . Airports . . . For Broadcasting . . . Recording . . . Testing Apparatus

Lowell has a complete line of electronic housings and equipment . . . over 200 models. Write for complete catalog and specifications.

Manufacturer of famous Lowell "ear level" sound speaker baffles, protective enclosures, intercom equipment



MANUFACTURING COMPANY

3030 Laclede Station Road, St. Louis 17, Missouri
In Canada: Atlas Radio Corp., Ltd., 50 Wingold Ave.,
Toronto 10, Ontario

CIRCLE 382 ON READER-SERVICE CARD FOR MORE INFORMATION

New Products



Limit Switch
Heavy Duty

The heavy duty limit switch No. 1230 is a ruggedized mechanism normally closed (single-pole, single throw), double break action actuated by a 35-lb force. Featured in the switch design is the instantaneous snap-action of the contacts regardless of the speed of the actuating mechanism. The superfast acting contacts open within 1/8 in. depression travel from the fully extended position. Tests and operation of over 20,000 cy while interrupting 50 amp of current at 28 v dc and an L/R ratio of 0.005 (ambient conditions) gave no evidence of malfunction nor critical wear. Additional tests with 500 cy of operation interrupting 300 amp (six times normal rate) of current at 28 v dc with similar L/R ratio of 0.005 providing the same reliable results.

Dynamic testing of 2000 cy with both electrical studs under 50 lb load in six major axes, the nuts under a torque load of 65 lb and a 150 lb static load to the plunger with switch on normal mountings, provided the same reliable operating characteristics.

Janco Corp., Dept. ED, Burbank, Calif.

CIRCLE 134 ON READER-SERVICE CARD FOR MORE INFORMATION



Solenoids
Custom-Designed

This line consists of 17 models to provide 34 widely differing specifications. Pull and/or push capacities range up to 45 lbs., sizes from 1-3/8 by 1-3/8 in. to 3 x 3 in., stroke lengths fractional to 2 in. Double shading coils provide high sealed pull without hammer or excessive ac hum. Electrical characteristics are thoroughly uniform. Units are compactly engineered to extremely close tolerances. Rugged construction provides long service-life.

Dormeyer Inc., Dept. ED, 3418 N. Milwaukee Ave., Chicago 41, Ill.

CIRCLE 135 ON READER-SERVICE CARD FOR MORE INFORMATION

◀ CIRCLE 131 FOR G.E. SPREAD AD



"FRONTIER IGNORANCE"

... areas into which scientific and engineering knowledge has not yet penetrated.

When Sir Isaac Newton got conked on the head with an apple, *frontier ignorance* gave way to laws of gravity. Christopher Colombo too, broke through a physical and mental *frontier ignorance* barrier on his first trip out.

The *frontier ignorance* barrier in the electronic equipment engineering field will be resolved as requirements for new electronic applications are established. We feel certain that as these barriers are pushed back by engineering ingenuity, there will be an ever increasing need for the control of the operating temperature of equipment which is yet to be designed. UAP is already in the field of cooling electronic equipment with heat dissipating systems for existing electronics.

Our original thinking applies to the dissipating of the heat which is inherent with the operation of electronic equipment. The development of more powerful and more complicated electronic systems is going to perpetuate and possibly aggravate the generated heat problem. For these problems which are yet to be created... we are sure that our 27 years as heat exchanging specialists will fit into penetrating the existing electronic *frontier ignorance* barrier.

UAP CONTRACTUAL ENGINEERING OFFICES:

Dayton, Ohio Michigan 3841 North Hollywood, Calif. STANley 7-7423
New York Murray Hill 7-1283 Montreal, Canada ELwood 4131

a famous family of aircraft essentials since 1929



Ambient Installation



Refrigerated Air Duct Installation

UNITED AIRCRAFT PRODUCTS, INC.
1116 BOLANDER AVENUE, DAYTON, OHIO

CIRCLE 136 ON READER-SERVICE CARD FOR MORE INFORMATION

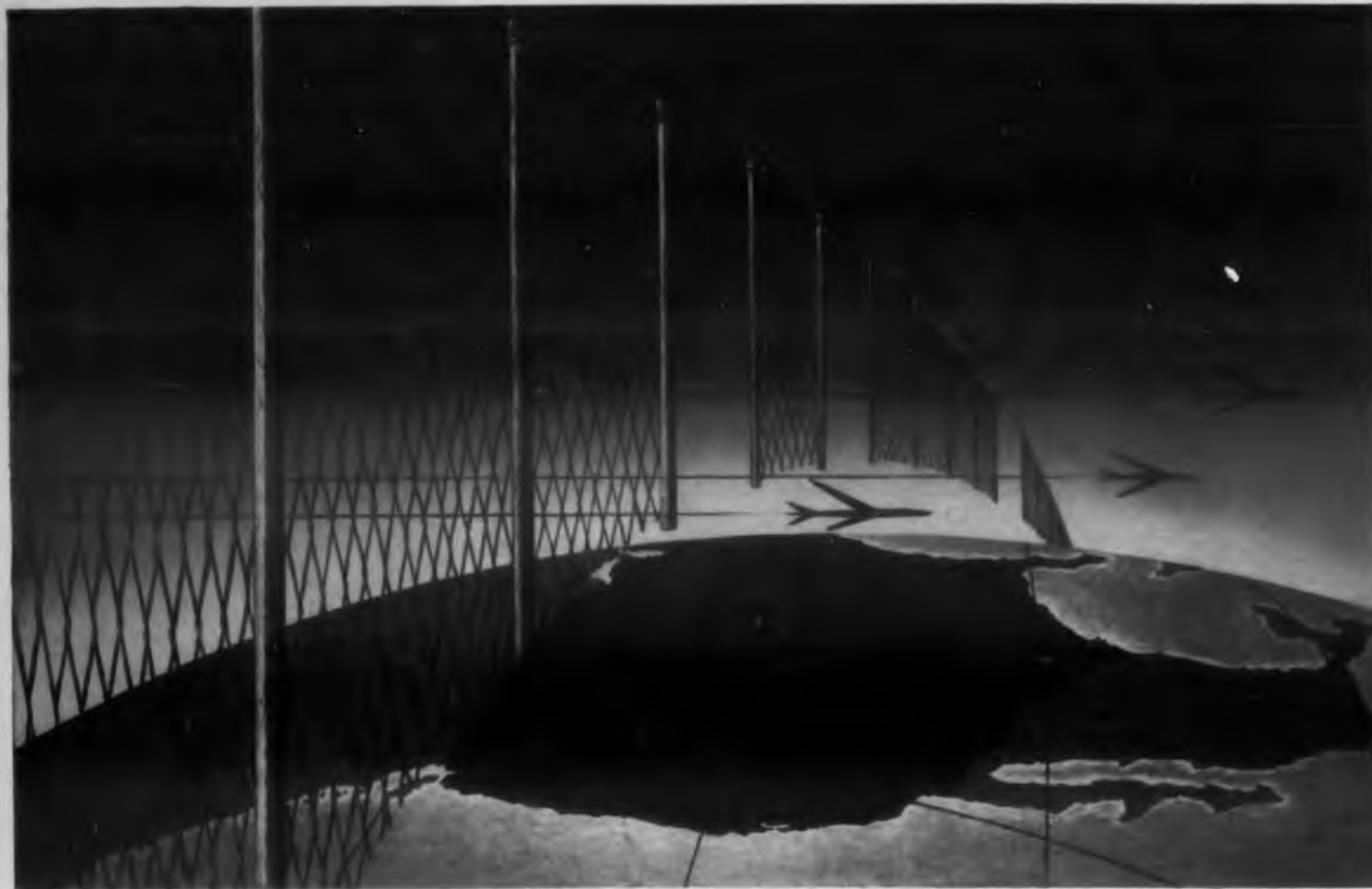

FILLING THE GAPS IN FREEDOM'S FENCE

The possibility of low-level bombers, slipping through the continental radar fence, has been the cause of much concern in our Air Defense Command. But a new "gap filler" radar eliminates the shadow areas caused by the earth's curvature and irregularities of terrain . . . helps give instant warning of the approach of intruding aircraft.

Vital in the chain of "gap filler" radar sites is a Varian Type VA-87 klystron amplifier, sending out a million-watt pulse of power a thousand times a second on a 24-hour-a-day basis. It provides the absolute dependability necessary to our national security. Result—a radar that will operate fully automatically, for prolonged periods of time, with neither operating nor maintenance personnel at the radar site.

Complete dependability is a characteristic of *all* Varian klystrons, along with extreme ruggedness, frequency stability, and outstandingly long life in service. Write the Varian application engineering department for complete specifications on the Type VA-87, or ask your Varian representative for a copy of the Varian Catalog.

Varian is now building more than 1,000 VA-87 klystron amplifiers for the United States Air Force, for use in the AN/FPS-18 gap filler radar systems being manufactured by Bendix Aviation Corp.



VA-87C

Frequency range: 2800-2900 Mc
Peak power output: One megawatt
Duty cycle: .003
Power gain: 60db

THE
MARK OF
LEADERSHIP



VARIAN associates
PALO ALTO 21, CALIFORNIA

Representatives in all principal cities

KLYSTRONS, TRAVELING WAVE TUBES, BACKWARD WAVE OSCILLATORS, LINEAR ACCELERATORS, MICROWAVE SYSTEM COMPONENTS, R. F. SPECTROMETERS, MAGNETS, MAGNETOMETERS, STALOS, POWER AMPLIFIERS, GRAPHIC RECORDERS, RESEARCH AND DEVELOPMENT SERVICES

CIRCLE 137 ON READER-SERVICE CARD FOR MORE INFORMATION

New Products

Suppression Capacitors

5, 15 and 25 amp

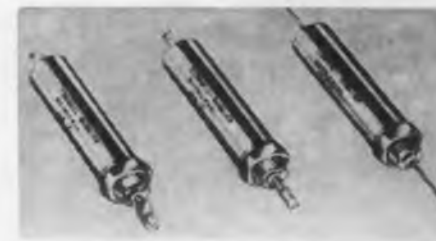

A 25-amp rating has been added to this line of miniature three-terminal NFT feed-through capacitors for rf noise suppression. The capacitors are intended for easy installation in a chassis, bulkhead, or other partition. The units afford minimum contact resistance to ground and minimum mutual coupling between input and output terminals, with attenuation characteristics similar to those obtained in applications using low-pass rf noise filters. Reactance closely follows the reactance curve of an ideal capacitor through all frequencies up to 1000 mc.

Cornell-Dubilier Electric Corp., Dept. ED, South Plainfield, N.J.

CIRCLE 138 ON READER-SERVICE CARD FOR MORE INFORMATION

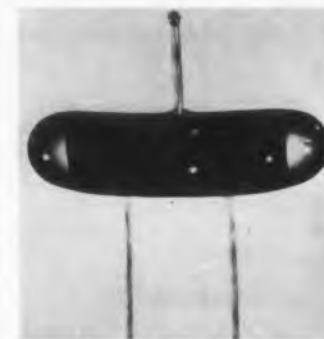

Level Switches
Off-on and Proportional

These arc-shaped gravity sensor devices, unlike mercury-filled levelers, are made for both off-on and proportional control in both vertical and lateral directions. When filled with a special electrolyte, the switches indicate level and deviation from level within tenths of degrees. Made to conform to military temperature specifications, the switches can withstand temperatures up to 200 C. They have operated perfectly at -60 C and lower.

The switch is made of glass tubing, ground to an exacting spherical, radius of curvature. One hollow and two solid platinum leads are sealed with precise spacing into its surface. Electrolyte is inserted through the hollow lead, which is then arc-welded closed. Calibration is made during the filling operation.

Corning Glass Works, Dept. ED, Corning, N.Y.

CIRCLE 139 ON READER-SERVICE CARD FOR MORE INFORMATION



Modular Oscilloscope Interchangeable Units

Four modules comprise this complete oscilloscope, which is available in portable case or standard relay rack-mount. A series of interchangeable amplifiers and sweep generators can be combined with basic CRT and power supply modules to provide general purpose low frequency oscillography, high frequency pulse observation, phase-shift measurement or other desired applications. Designated the Model 200, the unit incorporates direct reading amplitude and time calibrations, sweep expansion and driven and recurrent sweeps. Modules may be purchased individually or preassembled into standard high or low frequency units.

Advanced Electronics Mfg. Corp., Dept. ED, 2025 Pontius Ave., Los Angeles 25, Calif.

CIRCLE 140 ON READER-SERVICE CARD FOR MORE INFORMATION



Stop Clock Electrical Reset

This electrical stop clock features instantaneous electrical reset (1/10 sec) and accuracy of 0.02 of 1 per cent. Designated Type 691 Time Totalizer, a dust-tight commercial model and a military version are offered. The military unit is hermetically sealed and designed to meet stringent vibration, shock and environmental specs. Type 691 is available for either local or remote reset.

Load switches rated 5 amp to 250 v ac resistive, operated from cams on either fast or slow pointer shafts, can be supplied. Number of pulses per second or minute, and duration of pulses are factory set. With switches on both fast and slow pointer shafts (wired in series) it is possible to use the 691 as a highly precise time delay or interval timer. Available ranges are 60 sec in 1/100 sec, 60 min in 1/1000 min and 60 min in seconds. Ratings include all standard voltages at 50 and 60 cy, 115 v 400 cy (with d-c clutch) and various d-c voltages.

Cramer Controls Corp., Dept. ED, Centerbrook, Conn.

CIRCLE 141 ON READER-SERVICE CARD FOR MORE INFORMATION



CRUCIBLE PERMANENT MAGNETS

give maximum energy . . . minimum size

Crucible *prescription-made* Alnico permanent magnets provide *consistently higher* energy products.

This means greater design freedom . . . more compact products for manufacturers of high-fidelity sound equipment, instruments, controls, motors, and other magnet equipped devices.

Crucible has been a leading producer of

these quality magnets ever since Alnico alloys were first developed. You can get them sand cast, shell molded, or investment cast to meet every size, tolerance, shape and finish need.

Next time you need top quality magnets, or help with magnet applications, call Crucible. *Crucible Steel Company of America, Henry W. Oliver Building, Pittsburgh 30, Pa.*

CRUCIBLE

first name in special purpose steels

Crucible Steel Company of America

CIRCLE 142 ON READER-SERVICE CARD FOR MORE INFORMATION

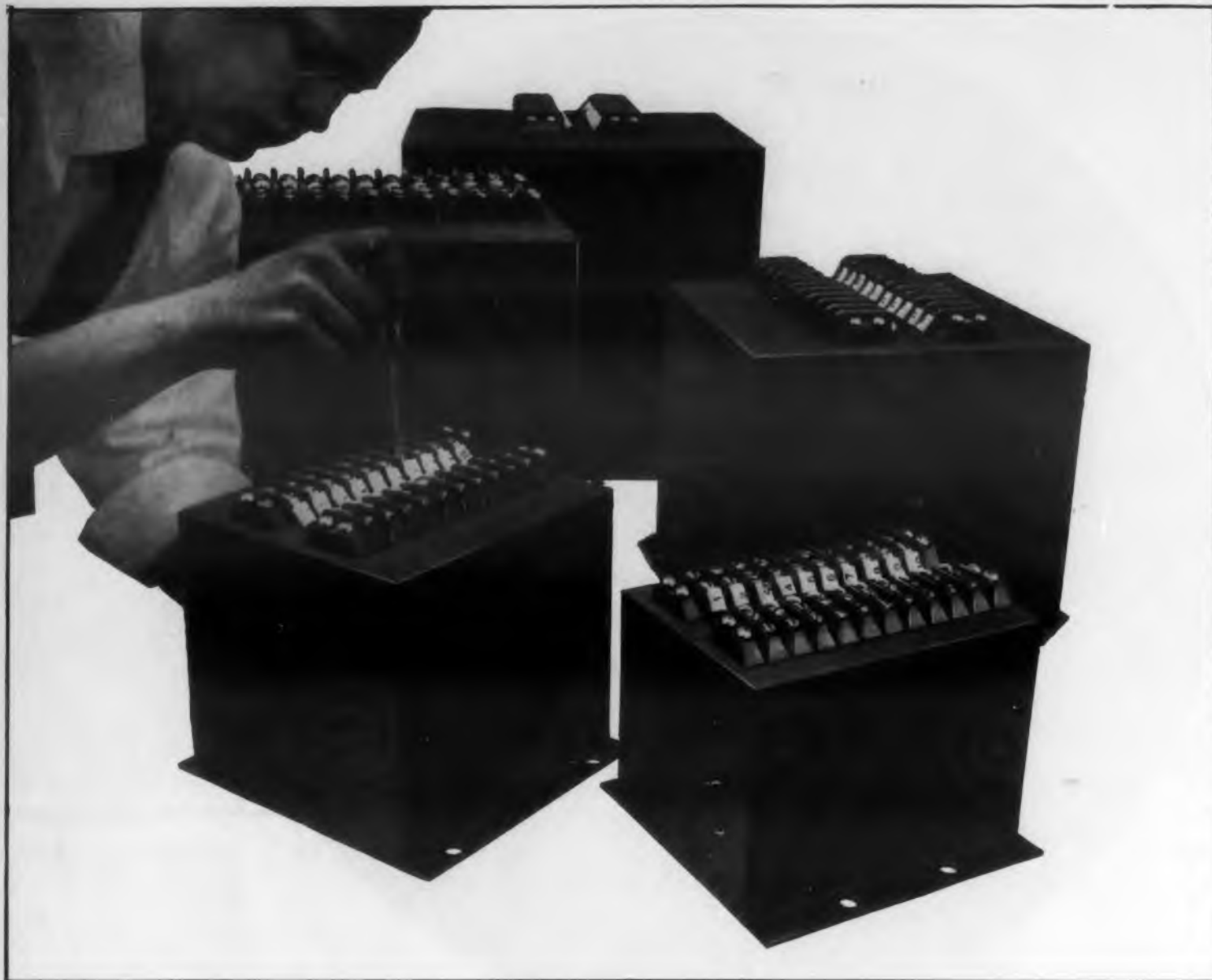

Now--CONTROL offers you standardized saturable reactors

If you're a design engineer who would be delighted with industrial components which are sensitive and, under normal operation, last virtually forever with no maintenance or servicing, then you'll welcome CONTROL's *standard* lines of saturable reactors.

With CONTROL reactor assemblies and magnetic amplifiers, you know complete physical and operating characteristics—a copy of our Catalog R-10 awaits your request. And, delivery is fast because sub-assemblies of these units are stocked, awaiting your control-winding specifications.

CONTROL reactors are available for both 120- and 240-volt 60-cycle operation. There are eleven standard sizes in each voltage range. They have extremely high gain. Six ampere-turns control nearly 2,000 watts in the largest size. Power outputs range from 50 to 2000 watts, with only 2 ampere-turns required for control of the smallest units.

In addition to higher gain, smaller exciting current, and fewer ampere-turn characteristics, CONTROL reactors have a 40 to 1 cut-off ratio. They are totally enclosed so that the high performance toroidal cores used are protected, and the entire assembly has the ruggedness required for long life.

CONTROL offers the same convenience of standardization in use of high permeability magnetic devices that you've enjoyed with other components. Add to this convenience ruggedness and freedom from maintenance which is unmatched, and you'll welcome CONTROL to your design picture. Write for complete details and literature today. CONTROL, Dept. ED-37, Butler, Pennsylvania.

Reliability begins with

CONTROL

A DIVISION OF MAGNETICS, INC.

CIRCLE 143 ON READER-SERVICE CARD FOR MORE INFORMATION

New Products



Vacuum Tube Voltmeter

Stable

Long-time stability and accuracy are achieved in this vacuum tube voltmeter through the use of balanced circuits, liberal inverse feedback and precision components. The instrument measures dc (plus or minus) from 1 to 1000 v in seven ranges, ac from 1 to 300 v rms in seven ranges, and resistance up to 500 megohms by means of seven multipliers. Accuracy of d-c voltage measurement is ± 2 per cent full scale; a-c voltage measurement, ± 3 per cent full scale. Frequency response is ± 1 db from 10 cps to 700 mc. Input impedance for d-c measurement is 100 megohms to minimize loading of the measured circuit. Input capacitance of the a-c probe is kept extremely low (1.2 μf) to maintain high input impedance up to 700 mc. The instrument operates on 110 to 120 v 60 cps 20 w power.

Acton Labs., Inc., Dept. ED, Acton, Mass.

CIRCLE 144 ON READER-SERVICE CARD FOR MORE INFORMATION



Precision Switches

Miniature

The No. 5300 series switches measure only $25/32 \times 17/32 \times 1/4$. Two No. 5302 switches can be mounted, activator to activator and operated in a 1 in. diam tube. The important feature of these sub-miniature precision switches is that they can be ganged together in infinite numbers to perform multiple switching functions in confined areas.

Each switch in the 5000 series is available according to specifications as SPNO, SPNC or SPDT. The characteristics are 5 amp resistive at 28 v dc; 5 amp resistive at 115 v ac. They will operate satisfactorily at -65 deg as well as $+250$ deg.

Haydon Switch, Inc., Dept. ED, Waterbury, Conn.

CIRCLE 145 ON READER-SERVICE CARD FOR MORE INFORMATION

ELECTRONIC DESIGN • May 15, 1957

Contact Tape Simplifies Production

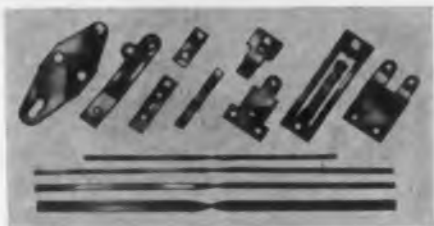

Contacts formed from electrical contact tape facilitate the assembly of component parts into one integral unit. Tape introduces automation to the manufacture of contact assemblies by machine feeding contacts through the welding process. Tape is preformed to finished shapes with close tolerance limits. This shape is maintained during the assembly process, resulting in precision subassemblies. Contact material facings need not be any thicker than actually required for the expected life, thus saving precious metal. Clad electrical contact tape assemblies require less contact volume for required electrical and thermal values, and approximately 70 per cent of the face area of rivets for equivalent electrical capacity. They are rolled to finished form and normally supplied with a serrated base metal backing to facilitate welding.

Metals & Controls Corp., Dept. ED, General Plate Div., Attleboro, Mass.

CIRCLE 146 ON READER-SERVICE CARD FOR MORE INFORMATION

Phase Standard Measures Shift



Designed for calibrating phase meters and other phase measuring instruments, this phase standard can also be used with an oscillograph to measure the phase shift in electronic circuits or to calibrate precision phase shifters. It converts an externally supplied signal (20 cps to 20 kc) into two sinusoidal signals whose phase relationship can be varied from 0 to 360 deg in four revolutions of a single control. Phase angle accuracy is ± 1 deg from 20 cps to 10 kc; ± 3 deg from 10 to 20 kc. Inherent distortion is less than 1 per cent; over-all distortion is dependent upon the externally supplied signal. The 0.5- to 5-v output of the instrument varies less than ± 2 per cent with phase shift. A self-contained electronic-regulated power supply can accept 105 to 125 v, 50 to 60 cy.

Acton Labs., Inc., Dept. ED, Acton, Mass.

CIRCLE 147 ON READER-SERVICE CARD FOR MORE INFORMATION



and you put Synthane laminated plastics to work



Automatic Circuit Recloser Parts made from Synthane sheet and tube provide insulation for high voltages.

Think of the many conveniences available simply by plugging into an electrical outlet.

On both sides of the outlet Synthane laminated plastics are at work in power generation and distribution, home appliances and other electrical equipment.

You find Synthane laminated plastics in circuit breakers, buss bar coverings, transformers. Synthane laminated plastics are important insulators in toasters, ranges, food mixers. Synthane is at work in thermostats, voltage regulators, power tools.

Synthane is valued in electrical appli-

cations chiefly for its high dielectric strength, low moisture absorption and low dissipation factor plus its additional properties of dimensional stability, machinability and mechanical strength. Synthane is available in over 30 standard grades in sheet, rods, tubes or you can avail yourself of our complete fabricating services.

For more information about the many properties of Synthane and how you can benefit by using Synthane materials and fabricating services, write for our product catalog. Synthane Corporation, 42 River Road, Oaks, Pennsylvania.



DIELECTRIC STRENGTH



IMPACT STRENGTH



HEAT RESISTANCE



LIGHT WEIGHT

SYNTHANE

... industry's unseen essential

SYNTHANE CORPORATION, 42 RIVER ROAD, OAKS, PA.

CIRCLE 148 ON READER-SERVICE CARD FOR MORE INFORMATION

DEARBORN CIRCUIT MINIATURIZING

HIGH VOLTAGE GLASS TUBULARS



From Dearborn come two new glass tubular capacitors: Type GML operates up to 85°C. without derating over the range .002 mfd-1000 VDC to .03 mfd-12,500 VDC. Type GTL operates up to 125°C. without derating over the range .001 mfd-2000 VDC to .03 mfd-10,000 VDC.

These complex-dielectric, oil-filled capacitors introduce a new high in reliability, a new high in insulation resistance, and a new concept in miniaturization in these voltage ranges. The endseals are tiny metal rings permanently bonded to the glass, and metal discs soldered to the rings. This rugged, leak-resistant seal offers maximum creepage distance between terminals.

WRITE FOR BULLETIN RL-4

Dearborn

electronic laboratories

1421 NORTH WELLS ST., CHICAGO 10, ILL.
CIRCLE 149 ON READER-SERVICE CARD FOR MORE INFORMATION

New Products



**Variable Resistor
For Printed Circuits**

Series U52 is a two-section side-by-side variable resistor which snaps instantly into place on printed circuit panel or on separate supporting bracket, without need for mounting hardware or additional operations. Mounts parallel to printed circuit panel with shafts perpendicular or can be mounted on separate supporting bracket with shafts parallel to printed circuit board. The control is easily removed for servicing due to specially designed clip-off mounting supports and terminals. Quarter-in. diam molded phenolic shafts for finger or screwdriver adjustment are available in three styles. Resistance range is 250 ohms through 10 megohms and rotation angle 300 ± 5 deg.

Chicago Telephone Supply Corp., Dept. ED, Elkhart, Ind.



**Wave Analyzer
Measures Harmonics**

Model CF-83 is a precision harmonic wave analyzer capable of measuring the amplitude of signals and harmonics from 10 to 500 kc. It is essentially a highly tuned frequency selective detector designed for voltage measurements on carrier telephone systems as well as precise measurement of the harmonic content of various types of waveforms. The linearity of response is sufficient to permit measurements of harmonics at least 60 db below the fundamental. Its lightweight rugged construction makes possible precise measurements for field as well as laboratory use. This instrument features a precision rf attenuator to insure accurate measurements down to the microvolt region. A rugged 12 to 1 antibacklash gear reduction system allows for ease of tuning with no sacrifice in resetability.

Mack Electronics Division, Inc., Dept. ED, 1120 S. 2nd St., Plainfield, N.J.

CIRCLE 151 ON READER-SERVICE CARD FOR MORE INFORMATION

Miniaturization...



in a Nutshell...

You may never build a circuit on or in a nutshell, but you—and a lot of other manufacturers—do have miniature and sub-miniature designs to contend with as a part of the modern electronic trend.

Mallory sub-miniature components help make these tiny circuits possible. Mallory, for example, pioneered the Mercury Battery—known 'round the world for its ability to perform... for its tiny size... and for its constant-voltage discharge rate, ideal for transistor circuitry.

Mallory manufactures four distinct lines of sub-miniature capacitors—from premium grades for performance under the most exacting conditions—to the newest TT series, low-cost aluminum-cased electrolytics, ideal for commercial applications. The new tiny TNT Capacitors measure .145" dia. by only $\frac{3}{16}$ " long!

When your problems are "small"—in physical size, look to Mallory for sub-miniature components. Ask the Mallory application engineers for capacitor specifications and assistance.

P. R. MALLORY & CO. INC.
Indianapolis 6, Indiana

P. R. MALLORY & CO. Inc.
MALLORY

CIRCLE 152 ON READER-SERVICE CARD



**FIRST OMNIBUS
ON THE
TRANSISTOR ART**

**TRANSISTOR ENGINEERING
REFERENCE HANDBOOK**

by H. E. Marrows

Covering transistor performance characteristics, operating specifications, manufacturing processes, applications, testing, sources, etc. Related components—electrical characteristics, physical dimensions, sources, etc.

The most complete handbook for use in engineering, scientific research and manufacturing of transistor devices. Authoritative—informative—up-to-the-minute.

The content of the handbook

Section 1: Chronology, transistor materials, structure and fabrication of all types of transistors; characteristics of all types of junction transistors; special bibliography on transistors.

Section 2: Numerical index of transistor types, data sheets showing physical specifications, electrical specifications, typical operating parameters, characteristic curves, performance curves of all types of transistors.

Section 3: Index of related components (capacitors, transformers, batteries, thermistors, miscellaneous items) designed for use with transistors . . . showing physical specifications, electrical specifications, manufacturers' type number and part number. List of transistor test sets.

Section 4: Commercial application of transistors with schematic diagrams.

Section 5: Directory of manufacturers making transistors and components designed for use with transistors.

Large 9" x 12" coated paper for easy readability. Each section individually indexed.

#193 Cloth Bound, 288 pp., \$9.95

Read These New Rider Books

... Up-to-the-Minute — Authoritative — Informative

PICTORIAL MICROWAVE DICTIONARY

by Victor J. Young & Merideth W. Jones

A pictorial dictionary serving as a ready reference which defines and explains present day microwave terminology. Derivation, explanation, definition are combined for complete coverage of microwave activity.

#188, soft cover, 116 pp., \$2.95

BASICS OF PHOTOTUBES & PHOTOCELLS by David Mark

Explains the principles and practices surrounding phototubes and photocells with the utmost in visual presentation.

#184, soft cover, 136 pp., \$2.90

INTRODUCTION TO PRINTED CIRCUITS

by Robert L. Swiggett

Comprehensive text on Printed Circuits by an authority in the field covers thoroughly the various manufacturing processes used. Numerous practical applications discussed. Explains maintenance techniques peculiar to printed circuits.

#185, soft cover, 112 pp., \$2.70

FUNDAMENTALS OF TRANSISTORS by Leonard Krugman

Explains the BIG thing in electronics today—the transistor! Written by one of the pioneers in transistor development, this book deals with basic operation, characteristics, performance and application.

#160, soft cover, 144 pp., \$2.70

Buy these books at your electronics parts jobber or bookstore, or mail this coupon today for prompt delivery.

Add state and city sales tax where applicable. Canadian prices 5% higher.

JOHN F. RIDER PUBLISHER, INC.

116 West 14th Street, New York 11, N. Y.

Enclosed is \$____ Please rush books checked

— #193 Transistor Engineering Reference \$9.95

— #188 Pictorial Microwave Dictionary \$2.95

— #184 Basics of Phototubes & Photocells \$2.90

— #185 Introduction to Printed Circuits \$2.70

— #160 Fundamentals of Transistors \$2.70

Name _____

Company _____

Address _____

City _____ Zone _____ State _____

ED-5

CIRCLE 153 ON READER-SERVICE CARD



**Stepping Motor
Bi-Directional**

This stepping motor is completely balanced and meets all standard shock and vibration requirements. The output shaft is positively locked into position after each actuation and cannot be rotated by external forces. Angular accuracy is within $\pm 1/2$ deg. Although it is ordinarily manufactured to move bi-directionally in 36 deg steps (10 steps per revolution), it may be supplied in various other configurations. Maximum pulse rate is up to 60 per sec. The torque is approximately 5 in. oz in the 1-1/2 in. diam x 2-1/2 in. length motor.

Nemeth Inc., Dept. ED, 2223 So. Carmelina Ave., Los Angeles 64, Calif.

CIRCLE 154 ON READER-SERVICE CARD FOR MORE INFORMATION



**Impedance
Angle Meter
For Lower Values**

This low impedance angle meter Type 314 measures low values of complex impedances in polar form. Impedance and phase angle of the unknown are determined by equating its voltage drop to that across a standard impedance of adjustable value, with the same current applied to both. A four-terminal arrangement, wherein current and voltage terminals are provided for the unknown impedance, nullifies the effect of lead impedance and insures accurate measurement. The instrument has two dials from which results are read. One dial is calibrated in absolute magnitude of impedance in ohms; the other dial is calibrated in phase angle and dissipation factors. Operating over a frequency range of 30 to 1000 cps, the Type 314 has an impedance magnitude range of 0.001 to 1000 ohms in six steps with an accuracy of ± 1 per cent, a phase-angle range of 0 to 90 deg (lead or lag) with an accuracy of ± 1 deg, and a dissipation-factor range of 0 to infinity. External oscillator input voltage can be 0 to 10 v; input impedance is 0.5 megohm.

Acton Labs., Inc., Dept. ED, Acton, Mass.

CIRCLE 155 ON READER-SERVICE CARD FOR MORE INFORMATION

**where
reliability is
not a
liability...**

There are times when sacrifices must be made in some product features in order to allow for the perfection of other features. However, in the EPR resistor *nothing* has been denied, no feature has been neglected — every material and method used in its creation is aimed at making it the most dependable and durable resistor available for continuously unailing service.

Write for New Engineering Handbook of Precision Wire Wound Resistors.

EASTERN
PRECISION
RESISTOR CORP.

675 Barbey Street
Brooklyn 7, N. Y.

EPR



YOU GET
Lighter Operating Pressure
WITH THESE
NEW ACRO
PRECISION SWITCHES

NEW MODEL CM Snap Action

The big features of this new, small Acro precision switch are long life and light operating pressure—lighter than any other switch of its type. Having snap action parts of beryllium copper and contacts of fine silver, the CM offers extremely good repeatability and will deliver millions of actuations *without failure*. It can be ganged for multi-pole applications, will operate in a temperature range of 160°F., and is designed for use where positive control is required and slow actuation inherent.



NEW MODEL CS Non-Snap Action

Operation of the Acro CS switch is through rotary motion (either clockwise or counter-clockwise), with a spring bias provided for quick return. Available in normally open and normally closed models, this new switch also operates by very light pressure and will give extra long mechanical and electrical life. It's designed for use where rapid actuation is inherent and contacts are protected against vibration or shock in the "at rest" position.



Both the Acro CM and CS Switches are furnished with a choice of integral actuators to suit individual applications!

Literature and engineering data furnished without obligation!



Robertshaw-Fulton

CONTROLS COMPANY

ACRO DIVISION

Columbus 16, Ohio

In Canada: Robertshaw-Fulton Controls (Canada) Ltd., Toronto

CIRCLE 157 ON READER-SERVICE CARD FOR MORE INFORMATION

New Products



DPST Switch No Current in Spring

This switch is a lever-actuated, double-pole, single-throw, normally closed switch. Over-all size is 1-7/8 x 1-1/2 x 3/4 in. Its principal feature is that the parts necessary to the mechanical operation of the switch, including the spring, do not carry electric current. The mechanical or upper part of the switch is separated from the electrical or lower part by a division inside the switch case which is made of nonconducting, nonabsorbent plastic material.

Because mechanical and electrical parts are completely separate, the dangers resulting from loss of tension and failure in the spring due to overheating and metal fatigue have been eliminated. Since these parts in the Tait switch do not conduct electricity, better, high-quality materials can be used. Contact points are heavy silver and are self-cleaning; steel parts are cadmium plated to resist moisture.

The Tait Mfg. Co., Dept. ED, 500 Webster St., Dayton 1, Ohio.

CIRCLE 158 ON READER-SERVICE CARD FOR MORE INFORMATION



Low Cost Reducer Offers 19 Ratios

This speed reducer for fractional horsepower motors offers an inexpensive solution to the problem of obtaining any of the following speed reduction ratios: 15:1, 20:1, 30:1, 48:1, 60:1, 225:1, 300:1, 400:1, 450:1, 600:1, 720:1, 900:1, 960:1, 1200:1, 1440:1, 1800:1, 2304:1, 2880:1 and 3600:1. Available from stock in the first five ratios, these reducers may be paired in 14 different combinations to produce the additional ratios indicated. The unit combines a precision molded nylon gear with a precision machined steel worm. Bearings are of sintered bronze. Size of unit: 2-5/8 in. wide, 1-3/8 in. deep, 3-3/8 in. high.

Rampe Mfg. Co., Dept. ED, 14915 Woodworth Ave., Cleveland 10, Ohio.

CIRCLE 159 ON READER-SERVICE CARD FOR MORE INFORMATION



Malaya's tin industry is now in a stronger position than that of any other country. Although there has been a decrease in the output of the European-managed dredges, the production of Chinese gravel pump mines has increased in compensation. Malaya's total production of tin-in-concentrates in 1956 was the best for any postwar year—62,295 long tons.

★ ★ ★

The Government of the State of Selangor in the Federation of Malaya recently decided to permit the development of a rich new tin-mining area of about 10,000 acres in the Kuala Selangor district.

★ ★ ★

Tin and tin-zinc solders are most commonly used in the electrical industry for small aluminum-copper connections. Tin-zinc base solders are also finding favorable acceptance for heater cores and engine radiators.

★ ★ ★

A weldable high-strength ternary alloy (92½% titanium, 5% aluminum, 2½% tin), which has become commercially available in sheets, plates, bars and billets, is finding widening use in aircraft manufacture, especially in jet engines and air-frames.

★ ★ ★

In recent tests by the Tin Research Institute two organotin compounds, triethyltin hydroxide and tributyltin acetate, showed great promise in preserving manila and sisal ropes immersed in seawater. Organotin compounds are already being used by industry for stabilizing PVC plastics and chlorinated rubber paints, preventing decomposition of synthetic chlorinated insulating oils, treatment of worms and larvae in poultry and cattle, preventing mould growth on decorators' paints, and slime control in paper manufacture. That's quite a list, and it's still growing steadily.



Ask us to send you TIN NEWS, a monthly letter. It will keep you posted on tin supply, prices, new uses and applications.

The Malayan Tin Bureau

Dept. 13E, 1028 Connecticut Ave., Washington 6, D.C.

CIRCLE 160 ON READER-SERVICE CARD



STANDARDS

ENGINEERS

*for primary standards
laboratory*

At Hughes we are conducting fundamental research and development and production engineering in the fields of radar systems, guided missiles, digital and analog computers, microwave tubes, semiconductor products and other activities requiring use of many types of test equipment. This activity is supported by an outstanding Primary Standards Laboratory equipped for electrical, mechanical and physical certifications.

Those with extensive experience in the measurement of electrical and physical quantities to a high degree of accuracy and who wish to join in the establishment of new techniques to further increase the accuracy and application of such measurements will find a satisfactory outlet for these abilities at Hughes.

Scientific Staff Relations

HUGHES

Research and Development Laboratories

HUGHES AIRCRAFT COMPANY

Culver City, California

CIRCLE 552 ON READER-SERVICE CARD



Threaded Inserts Self-Locking

The self-locking principle used in these inserts provides a locking action on both internal and external threads. They will withstand temperatures ranging from -70 to above 250 F, and can be re-used many times without appreciable reduction in torque.

A tough resilient nylon pellet is permanently imbedded in the body of each insert. The pellet projects beyond the external threads, and, when engaged, is compressed into the internal threads. The torque on the outside thread is always greater than that on the inside. Thus, the insert won't turn when a screw is installed or removed. Because the nylon pellet attempts to regain its original shape when deformed, it actually "grows" into the threads. Thus, the longer it is installed the greater the torque.

Nylok Corp., Dept. ED, 611 Industrial Ave., Paramus, N.J.

CIRCLE 161 ON READER-SERVICE CARD FOR MORE INFORMATION

Shock Mounts Center of Gravity



All the models within this series are basically a radial cushion center-of-gravity mounting system incorporating Met-L-Flex resilient elements. All-metal construction in accordance with such applicable military specifications as MIL-E-5400, MIL-T-5882 and MIL-T-5796, assures durable and dependable service of the vibration and shock mounting system within this series. Vibration and shock requirements are tested in accordance with military specifications MIL-E-5272, MIL-C-172B and MIL-E-5272A.

Dimensions and load ratings vary from 1.8 to 8.5 in. diameter and 5 to 50 lb respectively. To mount the equipment either clamp fasteners or four pre-spaced mounting holes are used to simplify replacements of the mounted equipment for maintenance and to accommodate many of the instruments and equipment currently used in military and commercial aircraft.

Robinson Aviation, Inc., Dept. ED, Teterboro, N.J.

CIRCLE 162 ON READER-SERVICE CARD FOR MORE INFORMATION

in a
other
a de-
bean-
n of
s in-
total
s in
year

elan-
cent-
nt of
about
angor

com-
y for
ions.
nding
cores

alloy
num.
mmer-
bars
use in
in jet

search
ts, tri-
n ac-
erving
in sea-
re al-
stabi-
nated
mposi-
ulating
vae in
mould
l slime
That's
eadily.

you TIN
hly letter.
ou posted
rices, new
ations.

reau
on 6, D.C.
CARD

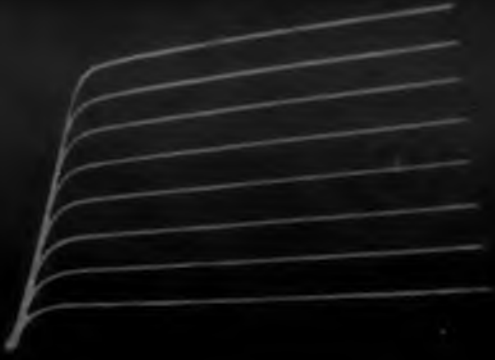

Actual unretouched photo

Transistor evaluation your problem? The **CUBIC** Curve Tracer, Model 504 eliminates time-consuming set-up. The 504 is a 5¼-pound precision laboratory instrument that gives you instantaneous evaluation of the dynamic qualitative characteristics of low power

PNP/NPN transistors. Used with any oscilloscope, it presents an 8-curve family of collector voltage vs. collector current, determined by electronically stepped values of base drive. Manual step control provides precise quantitative analysis of operating characteristics.

Conceived to meet the military trend towards transistorization

Available immediately from stock \$32500



5575 KEARNY VILLA ROAD, SAN DIEGO 11, CALIFORNIA
CIRCLE 163 ON READER-SERVICE CARD FOR MORE INFORMATION

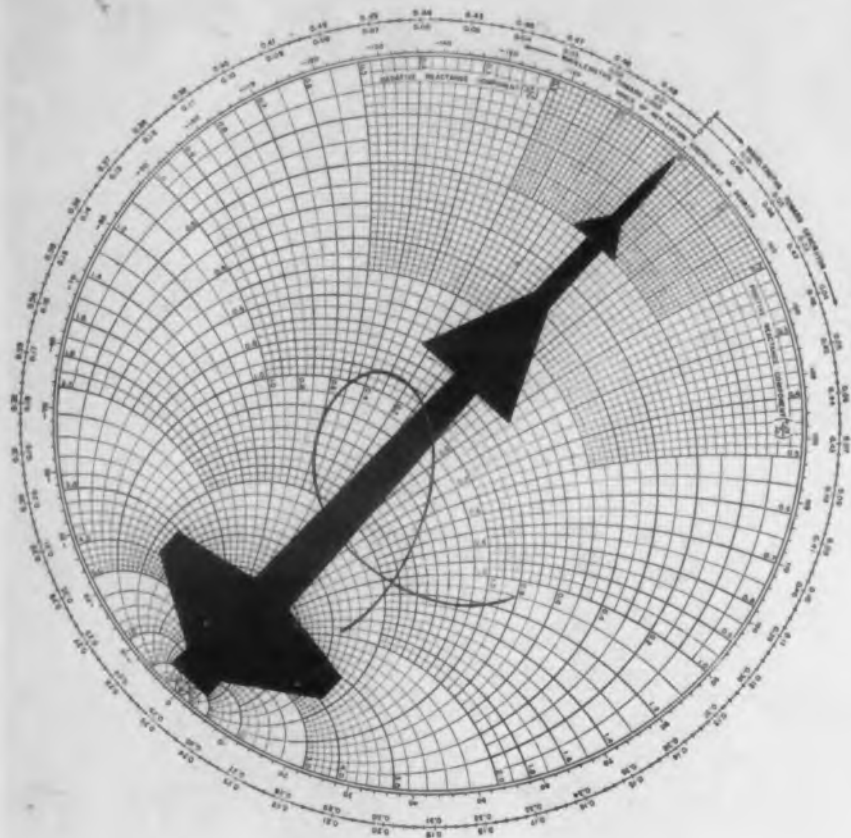

WRAP IT UP WITH TRANSCO ANTENNAS

TRANSCO offers a single, competent source for all—or any part of your antenna program



Here is a technical staff *and* producing facilities. Here, too, are 10 years' experience in supplying a wide variety of approved antennas. We can serve you in Design, Development, Production Engineering and Manufacturing—all, or any combination.

STUDY AND DESIGN. We have experienced engineers who draw on broad knowledge. Their designs reflect a firm grasp of practical applications.

DEVELOPMENT. Once a satisfactory approach has been chosen, a test sample is "wrung out" in TRANSCO'S radiation lab, RF lab and environmental lab.

PRODUCTION ENGINEERING—often the missing link—eliminates production delays. We're after design producibility, with a staff of liaison people that keeps design and production on the same track.

PRODUCTION. TRANSCO has the capability to support your own requirements. We maintain the highest standards of quality.

Transco is an active contributor to the ICBM and IRBM programs.

TRANSCO PRODUCTS, INC.

the finest in RF system components

12210 NEBRASKA AVENUE, LOS ANGELES 25, CALIFORNIA

REPRESENTATIVES IN MAJOR AREAS

CIRCLE 165 ON READER-SERVICE CARD FOR MORE INFORMATION

New Products



Accelerometer
Gold-Plated

The Model GLH accelerometer is a precision, potentiometer-type instrument, relatively inexpensive, and particularly suited for aircraft and guided missile flight and fire control systems. Balanced range Model GLH instruments are available in ranges between ± 1 and ± 8 g, or up to ± 30 g with reduced damping. Frequency response is characterized by a very close approximation to a second-order first-degree system (single degree of freedom spring mass system with near-pure viscous damping), usually desired in guided missile and aircraft applications. Unbalanced range instruments and special ultra-sensitive units with ranges as low as ± 0.1 g can also be supplied.

Ratio of resistance unbalance varies directly with the magnitude of acceleration applied. Travel of the mass in all directions other than the sensitive axis is substantially restrained. Gold plating provides a good, long-lasting exterior surface protection and permits a superior hermetic seal.

Genisco, Inc., Dept. ED, 2233 Federal Ave., Los Angeles 64, Calif.

CIRCLE 166 ON READER-SERVICE CARD FOR MORE INFORMATION



Switches
27/32 in. Deep

This switch line, series SH, has much shallower depth than heretofore available. The series SH units may be adapted to any of the standard single pole per deck and two pole per deck, up to 15 positions shorting per pole. Additional decks may be added with an increase of only $3/4$ in. in depth per deck. The switch panel can be made with either XXXP phenolic or silicone fiberglass (GSG). All parts are plated to withstand 200 hour salt spray. Rotors, contacts and slip rings are solid silver alloy. Shaft material in stainless steel.

Daven Co., Dept. ED, 530 W. Mt. Pleasant Ave., Livingston, N.J.

CIRCLE 167 ON READER-SERVICE CARD FOR MORE INFORMATION

here's where we fit into your components picture

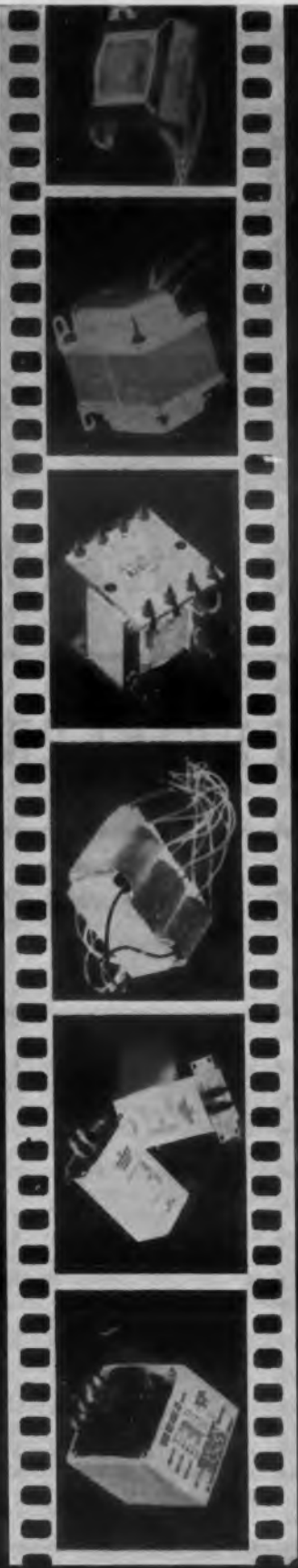

saturable reactors
self-saturating transformers
industrial transformers

Chicago Electronic

ENGINEERING CO., INC.
3223 WEST ARMITAGE AVENUE
CHICAGO 47, ILLINOIS

CIRCLE 168 ON READER-SERVICE CARD

HIGH VOLTAGE BREAKDOWN TEST



... proves
Johnson tube sockets
are built to take it!

**Eliminate special set-up charges!
Pick the tube socket you need from
Johnson's 3 basic grades . . .**

STANDARD—These are commercial grade sockets for general requirements. Bayonet Sockets equipped with porcelain bases, glazed top and sides. Phosphor bronze contacts .0002 cadmium plated. Nickel-plated hardware. Bayonet shells are etched aluminum. Wafer Sockets equipped with glazed steatite base—DC200 treated. Contacts are plated brass with steel springs. Shielded types equipped with etched aluminum shields.

INDUSTRIAL—Superior in quality to "Standard" types, equipped with glazed steatite bases, DC200 treated. Phosphor bronze or beryllium copper contacts and springs, .0005 silver-plated. Fungus resistant cushion washers under contacts. Aluminum bayonet shells and shields for wafer types, iridite No. 14 treated.

MILITARY—Top quality for military requirements. Glazed L4 steatite bases, DC200 treated. Bayonet Sockets equipped with beryllium copper contacts .0005 silver-plated. Hot tin-dipped solder terminals—brass bayonet shells, .0003 nickel-plated. Threaded hardware .0002 nickel-plated—unthreaded hardware .0003. With fungus resistant cushion washers under contacts. Wafer Sockets equipped with phosphor bronze contacts and beryllium copper springs, silver-plated .001. Hot tin-dipped solder terminals. Fungus resistant, glass base melamine cushion washers under contacts. Aluminum shields on shielded types, No. 14 iridite treated. Entire socket protected for 200 hour salt spray test.

Complete specifications . . .
Write for your copy of
Socket Standardization
Booklet 536, today!



E.F. Johnson Company
3412 Second Ave. S.W. • Waseca, Minnesota

CIRCLE 169 ON READER-SERVICE CARD



**Ultrasonic
Transducers
For High Temp**

These transducers are designed for use in high temperatures environment, i.e. irradiating high temperature solutions, degassing molten metals; and for developing high amplitude ultrasonic motion, i.e. drilling, grinding, particle disintegration. Featuring internally biased, water-cooled, 400 w average to 1600 w peak power magnetostrictive driving elements operating at 25 kc per sec, these transducers can be driven singly or in groups by appropriately rated standard ultrasonic generators from 400 w to 10 kw and above.

Acoustica Assoc., Inc., Dept. ED, Glenwood Landing, N.Y.

CIRCLE 170 ON READER-SERVICE CARD FOR MORE INFORMATION



**Digital Voltmeter
Low Level**

This instrument makes possible measurement of low level d-c voltages from thermocouples, strain gages, and transducers and displays this information in digital form. Identified as the Model 460 series digital voltmeter, the unit will be available in either a rack mount or portable bench type package. Range is ± 0.001 to ± 9.999 mv; sensitivity of 3 to 5 μ v and accuracy of ± 0.1 per cent of full scale. Principal applications for this equipment include reading and recording outputs of strain gages, thermocouples and other low-level transducers—automatic data logging systems—industrial process monitoring—automatic testing systems and the calibration of other voltage measuring, recording or plotting devices.

Non-Linear Systems, Inc., Dept. ED, Del Mar, Calif.

CIRCLE 171 ON READER-SERVICE CARD FOR MORE INFORMATION

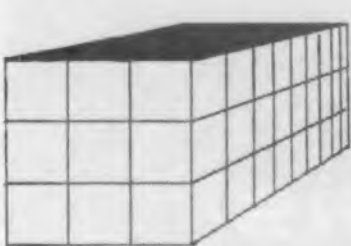

cores
+
engineering
+
\$ economy
+
 **volume**
=
the leader

**ENGINEERED
ECONOMY*
IRON CORES
of course!**

We are proud as the originators of **ENGINEERED ECONOMY* IRON CORES** that we have been able to reduce the prices of our products so tremendously in the past few years. This has been achieved through constantly increasing volume production, reduction of costs through improved manufacturing techniques and the use of automation. We now have better and more uniform quality than ever before.

*trademark

**Also, custom iron cores
to your specifications.**

Now, you can select from over 19 types of **ENGINEERED ECONOMY* IRON CORES** where previously we had to produce over a hundred. Fewer varieties enables us to stock more and sell at lower prices. We invite your inquiry.

Copyright 1956
Radio Cores, Inc.

Radio Cores, Inc.



9540 Tulley Avenue Oak Lawn, Illinois

CIRCLE 172 ON READER-SERVICE CARD FOR MORE INFORMATION

It's just part of the Victoreen story...



an entirely **new**
concept in
power supply regulation with
CORONA TYPE
VOLTAGE
REGULATORS

Victoreen Corona Type Voltage Regulators are approved by the military.

Superior voltage regulation and greatly extended current ranges—that's *part* of the Victoreen story. But it doesn't stop there. Use of these new glass or metal corona regulators means you can eliminate complex circuitry regulators. Fail-safe feature gives protection not afforded by other forms of regulators.

Improved Regulation results from new electrode structures and improved processing for greater

dynamic resistance, greater protection, simplified circuits.

Improved Current Rating increases scope of applications.

Improved Life Expectancy results from even better processing, even more rigid selection of materials.

Improved Ruggedization means these regulators withstand more rigorous adverse environments longer.

AA-5421



Get the full story on the new Victoreen voltage regulators.

Write for your free copy of Form 3003-7 today.

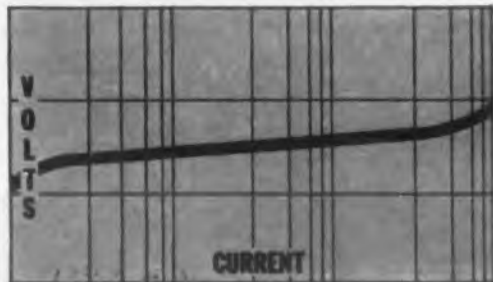

The  *Victoreen Instrument Company*
Components Division

5806 Hough Avenue, Cleveland 3, Ohio

CIRCLE 173 ON READER-SERVICE CARD FOR MORE INFORMATION

New Products



Test Point Jack
Strong Grip

This test point jack combines resilient Teflon insulation with resilient beryllium-copper contacts. Although designed for standard 0.080-in. test probes, it takes an oversized 0.083-in. without deforming, or holds a 0.077-in. pin with minimum of 2-oz retention. Regardless of chassis thickness, the insertion and extraction ease remains unimpaired with the floating contacts.

Beryllium-copper rod is machined for the one-piece metal insert in the Teflon insulator body. The four-leaf floating contact provides maximum and lasting spring temper. The beryllium-copper is heat treated after machining, and no pretempered stock is used. The metal insert is gold-over-silver plated.

Sealectro Corp., Dept. ED, 610 Fayette Ave., Mararoneck, N.Y.

CIRCLE 174 ON READER-SERVICE CARD FOR MORE INFORMATION



Crystal Oven
For New CR Types

This BHC-18 crystal oven series is specifically designed for the new military CR types utilizing the sub-miniature HC-18/U holder. The BHC-18 units will conform to the military warm-up requirement of 3 minutes. The 10 and 15 crystal oven will stabilize within ± 2 C. over an ambient of -55 C to below reference temperature. This series is available in units capable of housing a single crystal, 2 crystals, 10 crystals and 15 crystals. The operating voltage for the 10 and 15 crystals units is 6 v to 115 v ac or dc. The single unit oven is available from 6 to 24 v ac or dc.

Bulova Watch Co., Electronic Div., Dept. ED, Woodside 77, N.Y.

CIRCLE 175 ON READER-SERVICE CARD FOR MORE INFORMATION

**Motor driven
variable transformers
for**

REMOTE CONTROL



Adjust-A-Volt
M 3012

(One of 22 basic models)

Where you need accurate and positive remote control of variable voltage, you'll get the results you want from one of the twenty-two basic motor driven models available in the Adjust-A-Volt series.

Single units or up to 6-gang assemblies, with load ratings from .35 to 28 KVA—115V or 230V input—will help you solve many application problems where "long distance" push-button or switch operation is required.

Typical in the series is the M3012 shown above. This is a compact, rugged transformer with high performance value. Maximum load rating is 6.0 KVA; output 0-135V or 0-115V; maximum current output, 30.A.

All models equipped with standard 115V, 60 cycle motors, or lower voltage motors if specified. Travel speeds of 6, 13, 26 or 45 seconds are available. Clockwise and counterclockwise limit switches are standard features. Units are enclosed in a well ventilated case, protected with a grey wrinkle finish. Militarized 60 cycle or 400 cycle units available.

*Send for the catalog describing
the complete Adjust-A-Volt line.*

STANDARD

ELECTRICAL PRODUCTS CO.
2240 E. THIRD ST., DAYTON, OHIO

CIRCLE 176 ON READER-SERVICE CARD



Quality Fasteners by Southern

- Save you time—
start fast, hold tight
- Lower rejects—
do not mar or damage
- Boost safety—
no injuries from
obstinate performance

Why not take advantage of Southern bolts and screws, precision built of finest metal, for faster production, greater economy and safety?

WOOD SCREWS • STOVE BOLTS • MACHINE SCREWS & NUTS • A&B TAPPING SCREWS
DOWEL SCREWS • WOOD & TYPE U DRIVE SCREWS • HANGER BOLTS • ROLL THREAD CARRIAGE BOLTS

For free samples and Stock List write Box 1360-ED, Statesville, North Carolina.



Warehouses: NEW YORK • CHICAGO
DALLAS • LOS ANGELES

CIRCLE 177 ON READER-SERVICE CARD



D-C Amplifier Transistorized

Maximum drift of the Model 71 differential d-c amplifier after warm-up is only 3 mv. Response is from dc to 50 kc. Input impedance is 0.5 megohm and output is either differential or single-ended at low impedance without superimposed d-c level. Gain is adjustable in four steps up to 500 times and linearity is better than ± 2 per cent. Transient response is ideal because of essentially gaussian fall-out permitting reproduction of square waves without overshoot or ringing.

The unit, only 3-1/2 in. wide, 6 in. high and 12 in. deep, weighs 10 lb. The Model 71 may be operated from 105 to 125 v ac or from mercury batteries. The units are also available for rack mounting and can be arranged for mounting five amplifiers in 7 in. of rack space.

Video Instruments Co., Inc., Dept. ED, 2340 Sawtelle Blvd., Los Angeles 64, Calif.

CIRCLE 178 ON READER-SERVICE CARD FOR MORE INFORMATION



Pulse Height Analyzer Dekatron-Tube Storage

This instrument utilizes dekatron, glow-transfer tubes and four-digit registers to store pulse height information in any of 20 channels. Counting rates up to 10^6 cpm can be accepted with no data distortion. Total instrument dead-time is 500 μ sec. Base line drift is less than 1 per cent per day.

Components include: a preamplifier for photomultiplier-crystal detector, a nonoverloading amplifier, an amplitude digitizer, a dekatron storage unit, a decade scaler (1000) with 500 to 1500 v HV supply, and 42-in. high cabinet. Also available are 40, 80 or 100 channel instruments.

Tullamore Electronics Lab., Dept. ED, 6055 S. Ashland Ave., Chicago 36, Ill.

CIRCLE 179 ON READER-SERVICE CARD FOR MORE INFORMATION

Electronic Designers:

OVER 240 MODELS OF JOY FANS...

**... Designed especially for
your applications**

LIGHTWEIGHT because they are made of aluminum or magnesium castings produced in Joy's own foundries.

COMPACT design—with motor mounted inside the fan—permits installation anywhere... even inside a duct.

EFFICIENT vaneaxial design provides more air per given size than any other type fan.

Joy's vaneaxial design is rugged and simple. The outer casing, the vanes, and motor mounts are cast in one piece... vibration free. Experience as the world's largest manufacturer and supplier of vaneaxial fans to G. E., Hallicrafters, Lear, Motorola, R.C.A., Raytheon, Sylvania, means Joy has the background to help you with your problems.

Joy has a complete line of fans... over 240 standard models with custom designs available to your specifications... fans from 1/500th hp up. Let us help... Write *Joy Manufacturing Company, Oliver Building, Pittsburgh 22, Pa.* In Canada: *Joy Manufacturing Company (Canada) Limited, Galt, Ontario.*



**Write for FREE
Bulletin 135-57**

WSW 16348-138

JOY

**WORLD'S LARGEST MANUFACTURER
OF VANEAXIAL-TYPE FANS**

CIRCLE 180 ON READER-SERVICE CARD FOR MORE INFORMATION



this man knows what's **INSIDE**
his **BLACK BOX FILTER**

He's taking advantage of a new trend spearheaded by Sprague toward unitized filter assemblies. Sprague's individual cylindrical filter elements can be taken from the shelves, wired in any configuration which available space dictates, and used! Black boxes, when used at all, serve only as "wrappers".

Now many of your most complex r-f interference problems can be solved in this way. It reduces inventory problems and cuts your manufacturing costs. Order the elements and package them yourself in your system, or else Sprague can do the packaging for you.

Even if unitized filter assemblies do not add up to the answer to your

problem, you're sure to benefit from Sprague's library of more than four thousand proved filter designs... three laboratories for filter research and development... complete facilities for interference measurement and control... field consulting service... and mass production facilities on the East and West Coasts.

If you, too, have an interference problem, pick up your phone and call your nearest Sprague Electric Field Engineering Laboratory. They are located at 12870 Panama Street, Los Angeles 66, Calif. (TEXas 0-7531); 224 Leo Street, Dayton 4, O. (ADams 9188); 347 Marshall Street, North Adams, Mass. (MOhawk 3-5311).

see **SPRAGUE**[®] for filters

CIRCLE 181 ON READER-SERVICE CARD FOR MORE INFORMATION

New Products



Data Amplifier
Zero Drift

Infinite common mode rejection, zero drift and 0.1 per cent accuracy and linearity are features of the Type 190 Data Amplifier. Designed for d-c amplification of thermocouple, strain gauge and similar signals, the Type 190 has a standard voltage gain of 1000, adjustable if required. Employing a new chopper circuit, the amplifier provides true differential amplification with complete rejection of d-c common mode signals, and a rejection ratio of the order of a million for a-c signals. Stability of the Type 190 is excellent, with no zero-point drift and gain remaining constant within 0.1 per cent over 1000 hours of operation, even with voltage variations of ± 10 per cent.

For strain gauge use, the differential input of the Type 190 allows a single battery to be used to excite a number of bridges, thus simplifying installation. With thermocouples, differential input eliminates errors due to multiple grounds, particularly where the same thermocouple is used simultaneously in several circuits.

Offner Electronics Inc., Dept. ED, 5320 N. Kedzie Ave., Chicago, Ill.

CIRCLE 182 ON READER-SERVICE CARD FOR MORE INFORMATION



Electronic Rack
Removable Sides

Basic unit of this Multi-Rack is a heavy gauge, welded steel frame with rear door, front door or both. Removable sides are sold separately. Doors with polished trim and handles are hung on loose-pin hinges for easy removal.

Panel mounting angles are adjustable from front to back. Louvres on any side, door or top, and rectangular or round opening in top can be provided at no extra cost. Bottom of the rack has a rectangular cut-out for cables. Made in 18 or 24 in. deep models, Multi-Rack is available in primer coat, two-tone grey enamel, black or grey wrinkle finish.

Wyco Metal Products, Dept. ED, 6918 Beck Ave., No. Hollywood, Calif.

CIRCLE 183 ON READER-SERVICE CARD FOR MORE INFORMATION

SPECIFY

Chassis-Trak

ROLLER BEARING
CABINET
SLIDES

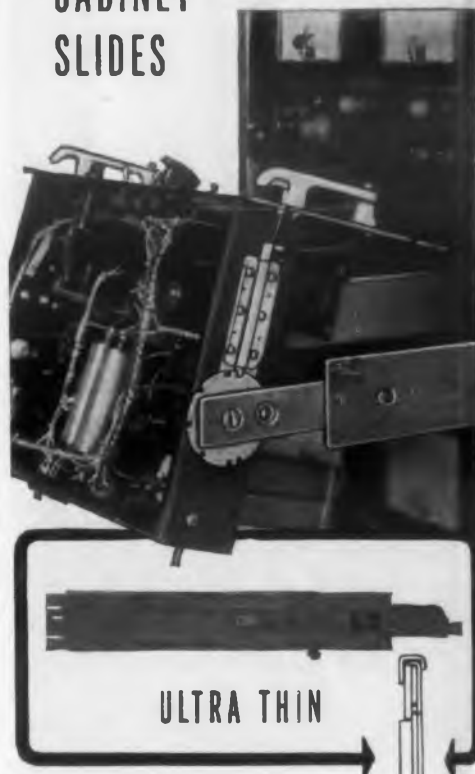

New Chassis-Trak roller bearing slides make your electronic equipment more accessible . . . faster and easier to service. Chassis Trak's ultra thin design, wider bearing rollers support up to 175 lbs. with chassis extended. Rollers assure permanent, smooth slide operation.

PLUS:

- Ultra thin slide design (.350") for maximum use of cabinet interior
- Permanent, dust-repellent, dry lubricant finish
- High corrosion resistance
- Easy installation
- 8 stock lengths, standard width
- Push button emergency chassis removal

WRITE: DEPT. 2ED

Chassis-Trak, Inc.

525 S. WEBSTER AVENUE
INDIANAPOLIS 19, IND.

CIRCLE 184 ON READER-SERVICE CARD

to solve
"insoluble"
problems...

EXPLORE

the unique properties of **PRECIOUS METALS**

Precious metals are finding extraordinary applications in industry and the laboratory, even to the extent of providing answers for many long-standing problems. Electroplating offers an efficient method of exploring and exploiting such characteristics as the unique and diverse properties of gold, which are not found in combination in any other form. Technic Inc. equips you with controlled electroplating apparatus and solutions that eliminate variables, assure precise performance reproducible as often as required.

TECHNIC ENGINEERING

Technic engineers consult on exploratory projects and collaborate in problem solving. They design and install controlled electroplating equipment, stand by until performance is assured.

TECHNIC PRODUCTS

Potassium Gold Cyanides, Concentrated Aqueous & Dry • Rhodium, Platinum & Palladium Electroplating Solutions • Immersion Tin • Protectox Anti-Tarnish • Flame Flux

TECHNIC EQUIPMENT

Electroplating Systems • Germanium Diode Rectifiers • Turbomatic Agitators • Electroplating Barrel Units • Automatic Technic Timers

TECHNIC BIBLIOGRAPHY

"Electroplated Gold"; "Precious Metal Electroplating Data: Gold, Rhodium, Palladium, Platinum, Silver, Nickel"; "Electroplated Platinum"; "Electroplated Palladium"; "Electroplated Rhodium"; "Analysis of Gold & Gold Alloy Solutions".

Write for authoritative Technic publications, many containing data assembled nowhere else. We serve as consultants on experimental projects as well as on regularized operations. Consult us without obligation.



TECHNIC, INC.

39 Snow Street, Providence, R. I.

JACKSON 1-4200

Chicago Office—7001 North Clark Street

THE LARGEST ENTERPRISE OF ITS KIND IN THE WORLD

CIRCLE 185 ON READER-SERVICE CARD

Modulated RF Sources

from 50 to 90 omc



The output of these rf sources is at least 200 mw peak power into 50 ohms with 100 per cent square wave modulated internally at 1000 cps. Stability is ± 0.2 db per hour for constant load, and ± 0.02 db per hour using an internal feedback circuit with external probe or coupler. This equipment achieves the amplitude stability required for precise rf measurements. By means of an external directional coupler and internal feedback, the incident power is held constant over a wide range of load impedances, thereby simulating a constant impedance source equal to the coupler impedance. If a voltage probe is used instead, the voltage is kept constant simulating a zero impedance source.

Weinschel Engineering, Dept. ED, Kensington, Md.

CIRCLE 186 ON READER-SERVICE CARD FOR MORE INFORMATION



Servo Rate Generator Custom-Wound Motor

This 20-oz servo-mounted unit consists of a servomotor and rate generator contained in one housing and rotating on the same shaft. Designated Model 18 MG 490/460, it is a size 18, 115-v, 400 cps instrument which meets the specifications of Navy Bureau of Ordnance MK 16 MOD 1, and the first of a new family of similar units. The housing is stainless steel, 3.680 in. long and 1.750 in. in diam. Motor and generator fixed windings can be provided for any standard carrier voltage supply, and motor control windings may be custom built for input from various amplifiers. Power requirements of a standard unit are: motor fixed phase 9.2 watts; motor control phase 9.6 watts; generator excitation, 5.4 watts. Rotor inertia is 5.73 gm/cm²; minimum torque at stall 2.35 oz-in., and acceleration at stall 29,000 rad./sec². Duty is continuous at stall for ambient temperatures between -55 C and +125 C; maximum operating temperature, 200 C.

Beckman Helipot Corp., Dept. ED, Newport Beach, Calif.

CIRCLE 187 ON READER-SERVICE CARD FOR MORE INFORMATION

NEW!

*1/2-inch
wire-wound*



ACTUAL SIZE

UP TO **250 K**

PRECISION POTENTIOMETERS

Now YOU CAN specify a Waters pot for miniaturized designs that require potentiometers up to 250K. In the reliability-proved construction of the AP-1/2, these new, higher values give you:

- **Resistances — 10 ohms to 250 kilohms**
- **Ganging — up to four units**
- **Three mounting styles — plain-bushing, split-bushing, or servo**
- **Three terminal styles — radial, axial, or wire-lead**
- **Automation models — for printed circuits**

General specifications: Centerless-ground, stainless-steel shaft can be sealed with O-ring; gold-plated, fork-type terminals standard; 2% standard linearity for 50K and above — 5% for lower values; temperature range -55 to +105C, to 125C on order; 2 watts at 80C; anodized aluminum body 1/2" diameter x 1/2" long — 5/8" long for 100K and 250K; corrosion-resistant-alloy bushing; all electrical connections spot-welded or soldered; furnished with stops or for continuous rotation. *Write for data sheet on these dependable 1/2" potentiometers.*

COMING SOON!

Complete new family of
Waters precision potentiometers

WATERS MANUFACTURING, inc.
Wayland, Massachusetts
Mail address: P.O. Box 368, So. Sudbury, Mass.



APPLICATION ENGINEERING OFFICES IN PRINCIPAL CITIES

CIRCLE 188 ON READER-SERVICE CARD FOR MORE INFORMATION

a
**quarter-turn
fastener**

for thin material and
miniaturized
equipment

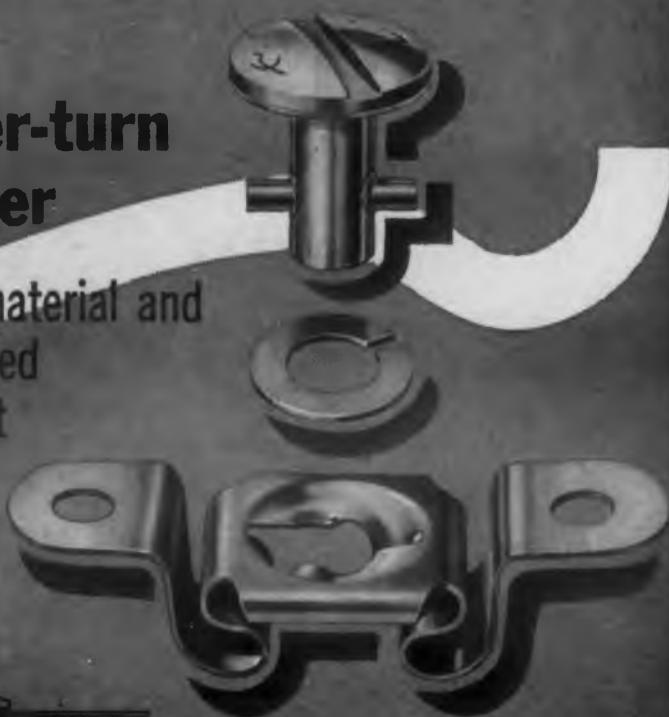

CAMLOC *low cost/light weight*

5F series

Camloc's new small, lightweight 5F Series features high strength-weight ratio plus the quick-operating advantages of a 1/4-turn fastener...in a size and weight that offers new design possibilities to original equipment manufacturers! Particularly adaptable to thin materials and miniaturized equipment like airborne electronics, small electro-mechanical and computing devices and communications components. Ideal for attaching lightweight components in "packaged" equipment or for holding access panels on everything from washing machines to radar units.

Offered in many
different head styles.
Complete specifications
will be sent to
you on request.



FASTENER CORPORATION
61 Spring Valley Road, Paramus, N. J.

**WEST COAST OFFICE: 5410 WILSHIRE BLVD., LOS ANGELES, CAL.
FORT WORTH OFFICE: 2509 W. BERRY ST., FORT WORTH, TEXAS**

CIRCLE 189 ON READER-SERVICE CARD FOR MORE INFORMATION

New Products

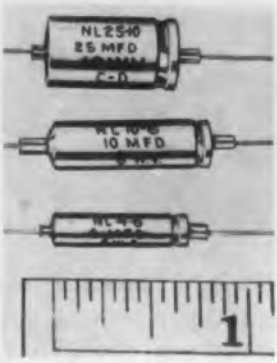

Aluminum Foil Capacitors For Printed Circuits

Designed expressly for transistorized and printed circuits and other compact or miniaturized low-voltage d-c equipment, the Type NL electrolytics meet the demand for compactness in bypass, filter and coupling applications. Available in d-c working voltages of 1, 3, 6, 10, 15, 25 and 50 v, in capacitances from 1.0 to 200 μ f, and in sizes from 3/16 x 1/2 in. to 3/8 to 1 in., these units can be operated within the temperature range of -20 to $+85$ C.

Capacitors are compression-sealed and resistant to moisture and humidity. Terminal leads are tinned copper wire. The positive lead is connected to the anode through the rubber bushing of the compression seal, and the negative lead is grounded to the aluminum can. Also available with outer plastic insulating sleeve where physical contact with adjacent components is a design requirement.

Cornell-Dubilier Electric Corp., Dept. ED, South Plainfield, N.J.

CIRCLE 190 ON READER-SERVICE CARD FOR MORE INFORMATION



Field Power Supply High Reliability

For use with mobile computers and amplifiers, this unit is built with all Mil Spec components for high reliability. Designated Model 3-150XHS, it mounts at any angle, withstands high humidity, and is fungus-proofed. Output voltage is nominally set at 300 v dc, but may be varied from 275-325 v dc by means of screw-driver-adjusted potentiometer. Current is 0-150 ma max. For 325 v d-c/150 ma output regulation is 100 mv change NL to FL. For line voltage change of 105-125 v ac, with same output, regulation is 100 mv change max. Ripple is below 3.5 mv rms for 325 v d-c/150 ma outputs. Unit measures only 12-1/2 in. in length and 5 in. in width. Height above chassis is 5-1/2 in. below chassis: 2 in.

Dressen-Barnes Corp., Dept. ED, 250 N. Vinedo Ave., Pasadena, Calif.

CIRCLE 191 ON READER-SERVICE CARD FOR MORE INFORMATION

Doing it Yourself?



It's Easier to
Standardize on

Jeffers R.F. Choke Coils

You can eliminate tedious, expensive hand assembly from miscellaneous forms and wires by using completely assembled standard Jeffers R. F. choke coils. You will save time, labor and money by stocking the broad range of Jeffers coils just as you do resistors, capacitors and other similar electrical components.

Jeffers coils are made of highest quality materials... using insulated copper wire windings encased in husky molded jackets. All windings are soldered to leads... no chance of shorted end turns.

Enjoy the benefits of superior, standardized components in your circuits. Jeffers Electronics offers you a full line of R. F. choke coils with a complete range of inductance values...ready for immediate delivery. Write today for our specification sheets.

Other Jeffers Products
fixed composition capacitors

Other Speer Products
for the Electronics Industry
anodes • contacts • resistors
discs • brushes • molded notched coil forms
battery carbon • graphite plates and rods
*Patented



JEFFERS ELECTRONICS
DIVISION
SPEER CARBON COMPANY
Du Bois, Pennsylvania

Other Speer Divisions:
Speer Resistor, Speer Carbon Products,
International Graphite & Electrode

CIRCLE 192 ON READER-SERVICE CARD

broadband secondary phase standard



- PHASE ANGLE VARIABLE FROM 0-360 DEGREES
- 20-20000 CPS RANGE
- HIGH ACCURACY OF PHASE ANGLE OVER FULL RANGE
- EXTREMELY STABLE
- EASY TO OPERATE

ALI's Type 709-A Broadband Secondary Phase Standard is an efficient, easy-to-use instrument for precisely calibrating phase meters and other phase measuring instruments that operate at audio frequencies. With a sine-wave input of 20 to 20000 cps, the type 709-A will supply two sinusoidal voltages whose phase relationship can be varied smoothly from 0 to 360 degrees by means of a single control. Accuracy of the phase angle is $\pm 1^\circ$ from 20 cps to 10 kc and $\pm 3^\circ$ from 10 kc to 20 kc. In conjunction with a phase null indicator such as an oscilloscope, the Type 709-A can be used to measure phase shift in electronic circuits, to calibrate precision phase shifters, or as a phase meter.

Write today for full details on this remarkable instrument.

ACTON
LABORATORIES, INC.
33 Main St., Acton, Mass.
Colonial 3-7756

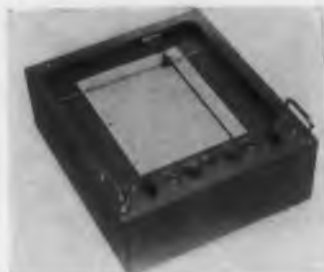

X-Y Recorder
Sensitivity 10 mv/in

This x-y recorder draws curves in Cartesian coordinates. The unit has a sensitivity of 10 mv per in.; input resistance is 10,000 ohms; power requirements—115 v, 60 cps, 100 w. Standard 8-1/2 x 11 graph paper is used. Full chart visibility at all times. Writing speed 7.5 in. per sec.

Mandrel Industries, Dept. ED, Instrument Div., 5134 Glenmount Drive, Houston, Tex.

CIRCLE 194 ON READER-SERVICE CARD FOR MORE INFORMATION

Temperature Probes Thermistor Type



The Model 108, 110 and 119 temperature probes use thermistors as a temperature sensing element. They are specially designed for environments where small size and dependable operation is of importance. They are available with nominal resistance at 25 C from 1000 ohms to 1/2 megohm or more. The resistance tolerance is ± 20 per cent, as supplied by thermistor manufacturers. Maximum operating temperature is 500 F, and the thermistors have been aged for two weeks at this temperature. All electrical connections are coated against water entry except for the terminals themselves. The sensing element is insulated from ground and is calibrated at 0 and 100 C. Power dissipation for typical operating conditions for 0.5 C temperature rise is 0.6, 1.3, and 0.8 milliwatts for models 108, 110 and 119 respectively. The time constant for the Model 108 is 7 sec when quickly applied to a plate of aluminum. The time constants for Model 110 and 119 probes are 0.5 and 4.0 sec, respectively, when immersed in slowly agitated water. The Model 108 probe is particularly intended for measurement of surface temperature and the others are for gas or liquid temperature, and may be used with highly corrosive fluids. The probes are fungus resistant and will survive the vibration tests of MIL-E-5272, procedure 1, extended to 2000 cps.

Rosemount Engineering Co., Dept. ED, Rosemount, Minn.

CIRCLE 195 ON READER-SERVICE CARD FOR MORE INFORMATION

CIRCLE 193 ON READER-SERVICE CARD

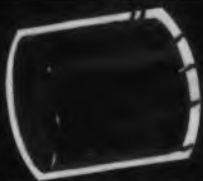

a new measure



in Celco



precision

TOROIDAL COMPONENTS



Whether it's a complex 10 winding magnetic amplifier or a simple choke . . . at Celco each toroid is precision-made. New core materials are used in Toroidal magnetic amplifiers, reactors and transformers to achieve maximum performance.

At Celco, the proper matching of cores, winding, handling, impregnation, encapsulation and electrical history of the final assembly is carefully controlled to maintain the original design characteristics.

Our years of design, development, and production know-how are available for application to your specific TOROIDAL problems.

* For immediate attention,
call DAVIS 7-1123
— or write today.

Celco

Constantine Engineering Laboratories Co.
MAHWAH, NEW JERSEY

CIRCLE 196 ON READER-SERVICE CARD FOR MORE INFORMATION

To the engineer capable of original thinking...

Highly accurate AiResearch electronic amplifier used in precision analogue computer networks. Built to withstand 50 G's vibration, has over 20 megohm input impedance and less than 1 ohm output impedance.

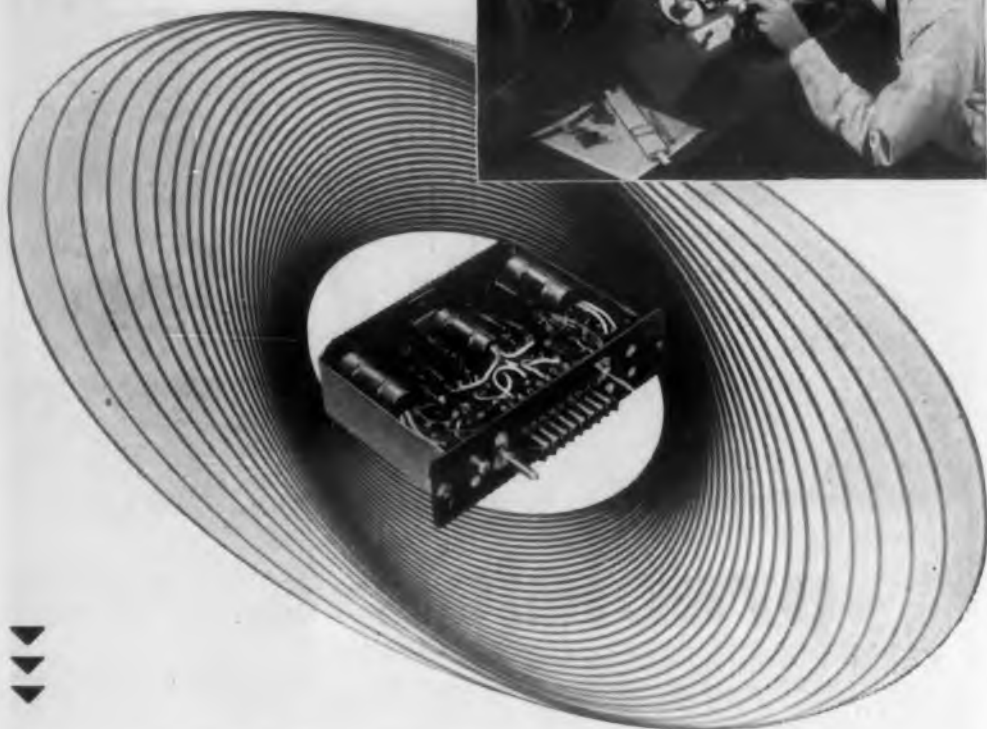

▼
▼
▼

The Garrett Corporation has built an outstanding reputation for pioneering because of engineers whose minds are not shackled to the past... or even the present. We concentrate on the future.

If you're the sort of engineer to whom an obstacle is only a challenge, you'll be interested in working with us. You'll have the finest research and laboratory facilities at your disposal... have your choice of location among the Los Angeles, Phoenix and New York areas.

All modern U.S. and many

foreign aircraft are Garrett equipped. We have pioneered such fields as refrigeration systems, pneumatic valves and controls, temperature controls, cabin air compressors, turbine motors, gas turbine engines, cabin pressure controls, heat transfer equipment, electro-mechanical equipment, electronic computers and controls.

We are seeking engineers in all categories to help us advance our knowledge in these and other fields. Send resume of education and experience today to: Mr. G. D. Bradley



9861 S. SEPULVEDA BLVD., LOS ANGELES 46, CALIFORNIA

DIVISIONS:

**AIRESEARCH MANUFACTURING, LOS ANGELES • AIRESEARCH MANUFACTURING, PHOENIX
AIRESEARCH INDUSTRIAL • REX • AERO ENGINEERING
AIRSUPPLY • AIR CRUISERS • AIRESEARCH AVIATION SERVICE
CIRCLE 553 ON READER-SERVICE CARD FOR MORE INFORMATION**

New Products



Video Dummy Load

Non-Inductive

Available with fixed resistances from 5 to 200 ohms, the Model G6A dummy load can also be supplied with tapped resistances as shown. A 0.1 ohm non-inductive monitoring resistor is included for measuring pulse current. Time constant of the unit is less than 0.05 μ sec.

Using ordinary tap water as a coolant, the load can dissipate up to 50 kv average power with 9 gpm of water flow and a 21 C water-temperature rise. Peak power capability is 100 mw and maximum energy per pulse 500 w-sec.

Weighing approximately 30 lbs. (exclusive of cabinet), the unit has dimensions as follows: 49 in. overall length, 3 in. outside diam glass tube with 5 in. diam flanges.

Levinthal Electronic Products, Inc., Dept. ED, 885 Stanford Ind. Pk., Palo Alto, Calif.

CIRCLE 197 ON READER-SERVICE CARD FOR MORE INFORMATION

Flush Latch

Leak-proof



A flush latch that eliminates the need for contoured shims features a leak-proof seal of fuel-resistant rubber. Silicone rubber gaskets are provided for high temperature conditions. The over center toggle allows for positive locking with minimum deflection. Available for all door types, the latch is designed for door and access panels on both aircraft and ground handling equipment. The latch is constructed of stainless steel, with the exception of the buttons which are an aluminum alloy. Weight of the latch is 1 oz. Simplified installation is inexpensive, requiring no specially shaped cut-outs.

Missile-Air, Dept. ED, 1108 W. 135 St., Gardena, Calif.

CIRCLE 198 ON READER-SERVICE CARD FOR MORE INFORMATION

LIBRASCOPE X-Y PLOTTERS offer the highest accuracy in rapid graphic presentation for data handling. In ever expanding areas of application — in scientific laboratories, industrial, engineering and business offices—wherever automatic plotting is important.



Model 200-A
Potentiometer Transducer type

NEW LIBRASCOPE X-Y PLOTTERS



Model 200-B
for DC signal inputs

Optional accessory input chassis provide for changing from one type of input to the other. A complete line of accessories — keyboards, binary, punched card and punched tape converters—make the new series of Librascope X-Y Plotters ideal for any point plotting or curve tracing assignment.

ACCURACY: Static—1%
Dynamic—5% at 5"/sec.

RESPONSE: 1 second full scale

PLOTTING AREA: 10"x 15"

**Absolutely drift free—High Input Impedance
Reliable new ink feed system.**

Send for new
8 page brochure.



LIBRASCOPE

A SUBSIDIARY OF GENERAL PRECISION EQUIPMENT CORPORATION

808 WESTERN AVENUE • GLENDALE, CALIFORNIA

CIRCLE 199 ON READER-SERVICE CARD

*An Engineer
Speaks Out...*



**...about a Very Unusual
AM-FM-c.w. VHF Receiver**

It's called the Servoflight* 5200 VHF Communications Receiver. It's unusual because it's the only VHF receiver for both laboratory work and communication field use that includes all of the following features:

- maximum sensitivity - less than 2 micro-volts input will produce a 10-db signal plus noise-to-noise ratio over entire frequency range of 50-200 mc
- high frequency stability - less than 0.08% drift over line voltage range of 105-125 volts . . . over ambients of -10°C to +60°C temperature and 0 to 95% humidity
- less than 50 micro-micro watts radiated local oscillator power
- continuous tuning over entire frequency range without switching
- automatic noise limiter
- exclusive squelch circuit
- patented, directly-calibrated 72° band-spread dial with a resolution of 0.2%
- excellent spurious and I.F. rejection
- antenna trimmer

All these features are integral parts of the 5200 Receiver. In addition, there are special outputs for the operation of external equipment to facilitate use of the 5200 Receiver as a component in complete communication, monitoring, telemetering, and direction finding systems. Power input required is 125 watts from 115/230V, 50/60 cycle source.

Howard Busman

Senior Development Engineer



Send for the full story on the Servoflight* 5200 VHF Communications Receiver. Just address your request on your company letterhead, to: Dept. HBC. *t.m.



20-20 Jericho Turnpike
New Hyde Park, L. I., N. Y.

CIRCLE 200 ON READER-SERVICE CARD



Oscilloscope
20 mv/cm Sensitivity

The Model 411A oscilloscope is a general-purpose, precision laboratory-type instrument. It has a bandwidth of d-c to 10 mc. It has a sweep speed range of 0.1 μ sec to 0.1 sec per cm. Six plug-in units provide versatility in application. Useful in the laboratory are the sweep delay, the gated marker generator and the dual trace plug-in units. Sensitivity is 20 mv/cm, and rise time is 0.035 μ sec.

Laboratory for Electronics, Inc., Dept. ED, 75 Pitts St., Boston 14, Mass.

CIRCLE 201 ON READER-SERVICE CARD FOR MORE INFORMATION

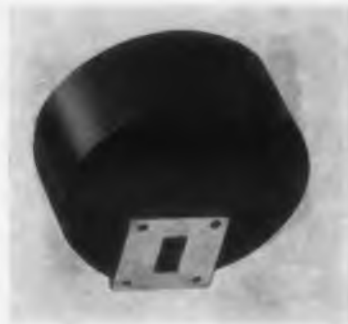

Ferrite Isolator
Resonant Absorption

Long line effects are minimized, AFC performance improved, system reliability increased and mechanically adjusted phase shifters eliminated by a new 100 kw resonant absorption miniature Ku band ferrite isolator. By furnishing isolation between magnetron and rf energy reflected from line mismatches, the isolator insures optimum magnetron spectrum and power output. Its action is based on the principle of resonant absorption of rf energy. The ferrite material is mounted directly on the wave-guide wall, which, in conjunction with the full waveguide opening, permits the rapid conduction of heat away from the waveguide. This miniature oscillator thus operates at high power levels in a small space, without forced air cooling. Frequency range is 16,000 to 17,000 mcs with a minimum isolation of 15 db and a maximum insertion loss of 0.4 db. Peak power is 100 kw; average power 100 watts into a 2 to 1 mismatch load. When terminated by a matched load, the isolator presents an inherent VSWR to the magnetron of the order of 1:10. Operating range is guaranteed at -55 C to +100 C; and vibration characteristics conform to MIL-E-5272A.

Airtron, Inc., Dept. ED, 1103 West Elizabeth Ave., Linden, N.J.

CIRCLE 202 ON READER-SERVICE CARD FOR MORE INFORMATION



New!

Acetrim* sub-miniature
precision **TRIMMERS**
for **PRINTED CIRCUITS**

Here is another new development from Ace . . . sub-miniature precision wire-wound trimmers especially for printed circuits. Designed and produced to meet your tightest specifications, the new Acetrim has flat or round tabs to facilitate production assembly. Just plug into printed circuit board, secure, and dip solder.

Ace delivers reliability

Modern mass production techniques assure delivery to meet your schedules . . . rigid quality controls assure highest standards of performance-reliability.

Acetrim — write for Technical Data Unit #563.

Acepot — 1/2" sub-miniature precision wire-wound linear potentiometers from 10 ohms to 250K. $\pm 3\%$ standard. Write for Technical Data Unit #564.

Nonlinear Acepot — precision wire-wound nonlinear potentiometers for

sine-cosine and square-law functions and other applications. High resolution, close conformity. Write for Technical Data Unit #572.

X-500 Acepot — 1/2" sub-miniature precision potentiometers for extreme temperatures of -55° C. to 150° C. 10 ohms to 250K. Write for Technical Data Unit #571.

*trademarks applied for

ACEPOT*
ACETRIM*

ACE ELECTRONICS ASSOCIATES, INC.

Dept. ED, 101 Dover St. • Somerville 44, Massachusetts

Telephone: 50menset 6-5130

• Engineering Representatives in Principal Cities

CIRCLE 203 ON READER-SERVICE CARD FOR MORE INFORMATION



... Ask a man
who has used them

*Elco
Screws
are
Good
Screws*

PIPE PLUGS These vital items are produced economically and accurately at ELCO by the cold-heading roll-threading method. The leak-proof "Dry-Seal" design is an ELCO specialty. Modified designs are engineered and produced to order. Second operation work is available, such as vent holes, safety wire holes, etc. ELCO Pipe Plugs are stocked in steel, stainless steel, aluminum, bronze, and brass. Write for our stock list.



| | |
|--------------------------|----------------|
| WOOD SCREWS | PIPE PLUGS |
| MACHINE SCREWS | STOVE BOLTS |
| MACHINE SCREW NUTS | CAP SCREWS |
| TAPPING SCREWS | LAG SCREWS |
| THREAD-CUTTING SCREWS | DRIVE SCREWS |
| PHILLIPS AND SEMS SCREWS | SPECIAL SCREWS |
| COLD HEADED PRODUCTS | |

WE ALSO SPECIALIZE IN MAKING ANY OF OUR PRODUCTS
OF THE FOLLOWING MATERIALS

| | | |
|-----------------|----------------|------------------|
| Stainless Steel | Copper | Monel |
| Bronze | Silicon Bronze | Aluminum |
| Brass | Ambrac | Special Analysis |

ELCO TOOL AND SCREW CORPORATION
1948 BROADWAY • ROCKFORD, ILLINOIS

CIRCLE 205 ON READER-SERVICE CARD FOR MORE INFORMATION

New Materials

Polycarbonate Resin

Toughness, impact strength, heat resistance and dimensional stability are properties of a new molding compound called Lexan. The discovery and initial development of the polycarbonate resin was announced recently by General Electric Co. According to the announcement, Lexan resin is being made in small lots at the company's applied research laboratory at Pittsfield, Mass., and is being evaluated in the form of molding compound, extrusion compound, film, varnish and coatings. Early studies indicate that Lexan resin can be made in a variety of transparent or opaque colors, with parts showing good surface hardness and gloss. Properties of the polymer suggest its use in such applica-



Nails molded from the new polycarbonate resin can actually be driven into a piece of lumber. The thermoplastic compound, called Lexan, has exceptional impact strength and rigidity, and may be expected to take the place of cast metals, ceramics and other plastics in some applications.

tions as electronic components in general, controls, forms, decorative and functional appliance parts, gears, housings, structural parts, handles, drawers, rollers, and telephone accessories.

The excellent electrical characteristics, high thermal stability, low water absorption, and high tensile strength of Lexan make it suitable for use as an electrical insulating material. The chemical properties are characterized by stability to water and dilute mineral and organic acids. The resin is insoluble in aliphatic hydrocarbons, partially soluble in aromatic hydrocarbons, and soluble in chlorinated hydrocarbons. It is slowly decomposed by alkaline substances.

Performance of New Resin

| | |
|-----------------------------------|------------------------------|
| Impact Strength, notched Izod | 12-16 ft-lb/in. |
| unnotched Izod | >50 ft-lb/in. |
| Tensile Impact | 600-900 ft-lb/cu in. |
| Tensile Yield Strength | 8000-9000 psi |
| Tensile Ultimate Strength | 9000-10,500 psi |
| Flexural Strength | 11,000-13,000 psi |
| Water Absorption, 24 hr Immersion | 0.3% |
| Indentation Hardness, Rockwell | M70 |
| Specific Gravity | 1.20 |
| Arc Resistance | 100-140 sec |
| Dielectric Strength, short time, | |
| 1/8 in. thickness | 400 v/mil |
| Dielectric Constant, 60 cy | 2.80 |
| 10 ⁶ cy | 2.85 |
| Power Factor, 60 cy | 0.009 |
| 10 ⁶ cy | 0.0095 |
| Volume Resistivity | >6 x 10 ¹⁵ ohm-cm |
| Heat Distortion Temperature, | |
| 264 psi | 280-290 F |
| 66 psi | 283-293 F |
| Mold Shrinkage | 0.005-0.007 in./in. |
| Melting Point (crystalline) | 514 F |

Properties of Lexan Polycarbonate: These values were determined at room temperature on injection molded samples unless otherwise indicated. Each test was made using the appropriate standard method for testing materials. Ultimate properties of the new polymer may vary from those listed, since the compound is not yet available for field applications.

The molding compound is not presently available for field evaluation. The present limited quantities of the resin are being used in a controlled testing program designed to provide information needed to arrive at a decision on large scale commercialization. One commercial form which the compound will take will be that of cylindrical pellets suitable for molding.

Significantly, the original polycarbonate chemistry on which Lexan polymer is based grew out of research efforts directed at a new, improved insulating material. The affinity between electrical and chemical research has been demonstrated in many previous discoveries in the chemical field. Among these are mica mat, silicone elastomers, resins, and fluids, and irradiated polyethylene. Like polycarbonate resins, these products have traced a pattern of discovery leading to development and application in a wide variety of products not always related to their originally intended use as electrical insulating materials.

Phosphor Bronze Strip Greater Fatigue Strength

A fine grain phosphor bronze strip has been designed for fatigue strength and forming properties by the Riverside-Alloy Metal Div., H. K. Porter Co., Inc., Riverside, N.J. Called Flexograin, the strip has better surface condition after forming in situations of severe bending. It never exhibits the orange-peel effect common to coarse grained phosphor bronze and other copper alloys. The improvement in fatigue resistance is of particular value in parts subject to alternating stresses or vibration, such as relay springs, bellows, electrical contact springs, and diaphragms. Formability permits use of a harder, stronger strip for a part that requires severe forming in its production.

Soldering Flux Low Temperature

Although soldering is usually done in the range of 360 to 500 F, it is frequently necessary in certain types of work to use alloys with melting points ranging down to 150 F. For such applications, this new type of noncorrosive soldering paste has been developed. The flux, called Amco No. 261, is entirely free of chlorides and rosin compounds. It is active at low temperatures and has a long life. Thus, when used with conventional solders, the cleaning action will begin about 150 F and continue right up to the melting point of the regular solder. Because it is active over a longer period, Amco No. 261 is as effective at the higher temperatures as a more corrosive flux would be.

American Solder & Flux Co., 19th and Willard Sts., Philadelphia 40, Penna.

CIRCLE 206 ON READER-SERVICE CARD FOR MORE INFORMATION



CIRCLE 207 ON READER-SERVICE CARD FOR MORE INFORMATION

"INDIUM"

performed to your specifications . . .

Indium or indium alloys in ingots, sheets, wire, powder, ribbon, and pellets (disc or spherical) are supplied by us to leading U.S. manufacturers of electronic equipment. These and other forms prepared to your own requirements are available in two grades: Tadanac High Purity - approximately 99.999% In Tadanac Standard Grade - guaranteed 99.97% In As one of the world's leading primary producers of indium, we apply the services of our Research and Development Division to assist our customers in obtaining the full benefits of this most versatile metal.

| Other high purity TADANAC BRAND METALS | |
|--|--------------------|
| Zinc - 99.9995% | Lead - 99.9998% |
| Bismuth - 99.9998% | Cadmium - 99.9999% |
| Silver - 99.9999 % | |

Our prices include custom's duties, and we handle all customs procedures.

For further information or quotations contact:

COMINCO
THE CONSOLIDATED MINING & SMELTING COMPANY OF CANADA LIMITED.
Metal Sales Division
215 ST. JAMES STREET WEST, MONTREAL, CANADA
5762-ME

PROBLEM #3

Design a miniaturized 400 cycle power transformer for airborne operation, with a three phase primary and three secondaries: three phase, two phase and single phase. Transformer to operate in an ambient temperature ranging from -55°C to $+85^{\circ}\text{C}$. The maximum allowable temperature rise to be 40°C over ambient. Transformer to operate at altitudes up to 50,000 feet. Dimensions cannot exceed 5" high, by $2\frac{1}{2}$ " wide, by $2\frac{1}{2}$ " long. (a) 30V, three phase, at 1.8A with .5 lagging power factor, (b) 30V, single phase, at .4A with .7 lagging power factor, and (c) 115V single phase, in quadrature with (b) $\pm 5^{\circ}$, at .47A with .7 lagging power factor. Secondaries (a) and (b) to be loaded continuously with (c) loaded intermittently. All secondary windings to be ended in four terminals. Construction to be in accordance with applicable parts of MIL-T-27, Grade 1, Class A. The above are given as maximum dimensions and minimum performance requirements, greatest possible improvement in size, weight and performance requested.

SOLUTION BY PEERLESS

Power Transformer, three phase, 400 cps to one phase, two phase, and three phase

Construction: Grade 1, Class A, to MIL-T-27

Ambient Temperature Range: -55°C to $+85^{\circ}\text{C}$

Temperature Rise: 35°C

Primary: Three terminal, three phase, 115V, 380-420 cps, per phase

Secondaries: Total of four terminals

(a) 30V, three phase at 1.8A and .5 lagging power factor.

Continuous duty.

(b) 30V, single phase at .4A and .7 lagging power factor.

Continuous duty.

(c) 115V, single phase, at .47A, .7 lagging power factor

and in quadrature with (b) within $\pm 1^{\circ}$

Weight: Two pounds

Dimensions: H: $4-1/32" + 1/8"$ seven terminal header; W: $2-1/32"$; L: $2-9/32"$

Experience in designing transformers to meet and exceed the most unusual and difficult specifications gives the Peerless engineering staff unique qualifications that speed the solution of every transformer problem. This background combines with rigid quality controls and advanced production techniques throughout the Peerless plant to achieve uniform quality and dependability in all Peerless products.

Consult Peerless for the best solution to your quality transformer requirements.

PEERLESS
Electrical Products



A DIVISION OF



1515 S. Manchester Ave., Anaheim, Calif. • 161 Sixth Avenue, New York 13, N.Y.

CIRCLE 208 ON READER-SERVICE CARD FOR MORE INFORMATION



A New Broad Band



Model
W177-2C-1

FERRITE ISOLATOR

for Laboratory
Test Bench Use

*Use this Ferrite
Isolator in your
microwave setup
for maximum
frequency stability.*

Typical Performance Curves

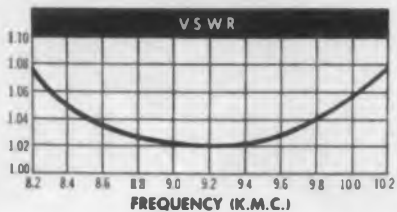
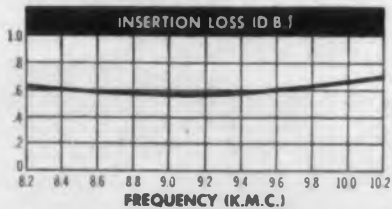
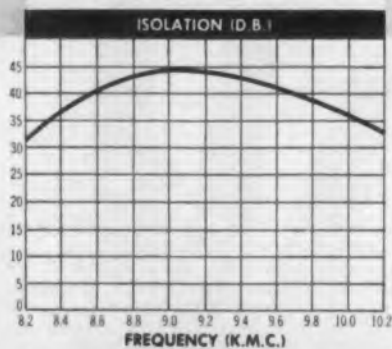

CHECK THESE FEATURES:

Broad Band—Usable from 8.2 to 10.2 KMC

High Isolation—A minimum of 25 db over the band

Insertion Loss—Less than 1 db

Small & Compact—Only 2½ inches long—weighs only 1½ lbs.

Flanges—Cover type. Mates with UG39/U flanges. Will absorb up to 10 watts reflected power

Price—\$135.00 each f.o.b., Van Nuys, Calif.

Delivery—From stock

Order—Model W177-2C-1

For custom-made isolators for specific radar & microwave application, you can depend on the skill of the Kearfott organization.

Kearfott, Western Division, has complete facilities for waveguide production, with qualified experts to assist in solving your problems. Let us help you.



For detailed information, ask for bulletins on new Ferrite Isolators and Radar Test sets.



Eastern Office:
1378 Main Ave.
Clifton, N.J.

Midwest Office:
188 W. Randolph St.
Chicago, Ill.

South Central Office:
6115 Denton Drive
Dallas, Texas

Western Area Office:
253 Vinedo Ave.
Pasadena, Calif.

Kearfott COMPANY, INC.
LITTLE FALLS, NEW JERSEY
WESTERN DIVISION
MICROWAVE DEPARTMENT
14844 OXNARD ST. - VAN NUYS, CALIF.

SALES OFFICES

CIRCLE 209 ON READER-SERVICE CARD FOR MORE INFORMATION

New Literature

Retaining Rings

210

The 1957 catalog and application idea manual of two-turn, coil action retaining rings is now available. It gives application and specification data covering standard catalog sizes and special designs for specific applications. Illustrations and data, showing coil spring action is included. Thompson Products Inc., Piston Ring Div., (Ramsey Corp.,) St. Louis 8, Mo.

Semi-Conductor Aids

211

Aids for engineers in the electronic and allied industries involved in design, development, production or application of semi-conductors have been printed.

They include a periodic chart of the elements, with chart of physical properties of pure elements used in semi-conductor production. A complete list of all metals and alloys used plus equilibrium phase diagrams for ten or more popular doped alloys are included. Anchor Metal Co. Inc., 966 Meeker Ave., Brooklyn 22, N.Y.

Electric Brake

212

An electric brake for ac motors is described in a pamphlet just released. Typical applications, performances, performance curves, specifications and the advantages of this type of brake are given in full detail. American Rectifier Corp., 95 Lafayette St., New York 13, N.Y.

Portable Beta Tester

213

Portable Beta tester for transistor measurements is described in Bulletin TP 106-1 now available. It notes the tester, Model KT-1, can be used for rapid measurement of basic transistor characteristics in quality control testing, circuit design, incoming inspection and trouble shooting, and is self-contained, utilizing a 1 kc oscillator and mercury cell power supply. Battery life of the mercury cell is approximately 750 hrs. Also included in the bulletin is complete electrical and mechanical data. Baird-Atomic, Inc., 33 University Rd., Cambridge 38, Mass.

Vinyl Laminates

214

Vinyl-to-board and vinyl-to-metal laminates and the process for securing them are featured in a recent bulletin. Illustrations and six colorful samples enhance the four-page folder. North East Laminates, Inc., Osgood St., Methuen, Mass.

Precision Wire-Bound Resistors

215

Series CB precision wire-wound resistors which feature tension-free windings are presented in Bulletin CB-2. The two pages contain complete specifications, photographs, dimensional drawings and descriptive information. Kelvin Electric Co., 59 Noble Ave., Van Nuys, Calif.

NBS Radio Stations

216

An eight-page brochure describes function, applications and recent improvements of National Bureau of Standards radio stations WWV and WWVH. The brochure also describes the model 9 WWV Receiver recently introduced. Bellman Instruments, Inc., Shasta Div., P. O. Box 296, Sta. A, Richmond, Calif.

Wire Wound Resistors

217

Tubular and flat power wire wound resistors are depicted and described in Catalog Data Bulletin C-1b. The comprehensive 12-page treatment covers construction characteristics, coating, winding, insulation identification, mechanical strength, terminals and brackets. Photographs and detail charts and graphs illustrate the booklet. International Resistance Co., 401 N. Broad St., Philadelphia 8, Pa.

Sequential Weather Transmission

218

Sequential transmission of weather messages with the D-658-G/B 18-in. Chart Transmitter and the D-789-A Switching Unit is explained in Provisional Publication 8749. The illustrated two-page text presents detailed descriptions and specifications of both instruments along with a discussion of their functions in the system. Muirhead Co., Ltd., Beckenham, Kent, England.

Research Facilities

219

Bulletin S-1053, "An Approach to Inter-
active Research," describes laboratory fac-
ilities for contract research. It outlines in-
vestigations directed toward the creation,
development and application of precise
solid and fluid processing techniques and
materials to improve both the rate of pro-
duction and the quality of the products of
the industry. Replete with photographs, the 24-
page booklet illustrates research methods
and resultant production processes and
equipment. Selas Corp. of America,
Pittsburgh, Pa.

Over-Temperature Recorder 220

An overheat-time recorder for aircraft jet
engines is described in an eight-page bro-
chure. Block schematics and diagrams show
how the recorder automatically logs any
single, multiple group or range of engine
temperatures. The publication analyzes the
method for monitoring engine temperature
and explains the operation of a time-tem-
perature recorder system. Each of the sys-
tem's three basic components are illustrated
and described. Avien, Inc., 58-15 Northern
Blvd., Woodside 77, N.Y.

Oscillogram Reader

221

Bulletin CR-187 provides information on
the use and operation of an oscillogram
reader. Also described in the two-page il-
lustrated sheet is a variety of accessory and
output equipment. Coleman Engineering
Co., Inc., 6040 W. Jefferson Blvd., Los An-
geles 16, Calif.

Binder for Relay Bulletins

222

A durable three-ring loose-leaf binder is
offered along with a series of product en-
gineering bulletins. The bulletins provide
detailed descriptions, tables and dimen-
sional drawings on standard, enclosed and
hermetically sealed relays. Phillips Control
Corp., 59 W. Washington St., Joliet, Ill.

Extrusion Presses

298

Aluminum extrusion presses are described
in a six-page bulletin 340C now available.
The illustrated bulletin gives detailed
description of the presses with design fea-
tures and services offered to the extrusion
industry. Watson-Stillman Press Div., Far-
rel-Birmingham Co., Inc., Roselle, N.J.

Introducing
the Aristocrat
of **CABINET
RACKS!**

POR Series

**CONTACT
YOUR LOCAL
DISTRIBUTOR
OR SEND
FOR SHEET
NO. S-108**

SEE OUR DISPLAY AT
BOOTH 874 — MAY PARTS
SHOW IN CHICAGO

NEW and DIFFERENT

PREM-O-RAK
by **PREMIER**

AVAILABLE IN 20 DIFFERENT SIZES —
FROM 7" to 35" PANEL SPACES
BOTH 15 1/4" and 18" DEEP FOR
STANDARD 19" PANELS

- Shipped knocked down for easy assembly, storage and shipping.
- Handsomely finished in two-tone Gray and Brown Hammer-tone.
- Both front and rear of top have attractive ball corners.
- Panels may be mounted on both front and rear if desired.
- Interlocking removable top and rear panels made of perforated metal and held by captive screws.
- Panels fit into 1/2" recess. Base supplied with 4 rubber feet.
- Components may be mounted on base before assembly of rack into a complete unit.
- Screws for assembling not visible from outside.

PREMIER
METAL PRODUCTS CO.

DEPT. ED, 337 MANIDA ST.
NEW YORK 59, N. Y.

Western Sales Office:
988 Market St., San Francisco 2, Calif.
Phone: GRaystone 4-1069



CIRCLE 299 ON READER-SERVICE CARD FOR MORE INFORMATION

**This is
your answer
where quality
and size are
prime factors**

Centralab's Model 3 Radiohm®

The Centralab Model 3 Radiohm, with its exclusive Interfused Composition Element, provides unbelievable wattage dissipation, yet is smaller than a dime.

This miniature rotary potentiometer, with its rugged element, is ideally suited for high-temperature operations in both commercial and military applications.

Advanced design features offer you both standard and locking-type bushings. Each is available with sealed construction to meet today's demand for a unit that can be potted.

For immediate delivery in ratings from 1,000 ohms to 2.5 megohms, ask your local Centralab distributor for the JP and JL Series.

typical
watt-hour
rating

Only 10% maximum resistance change, when used at . . .

- 1 watt for 1-1/2 hours
- 3/4 watt for 35 hours
- 1/2 watt for 80 hours
- 1/3 watt for 300 hours
- 1/4 watt, continuous rating

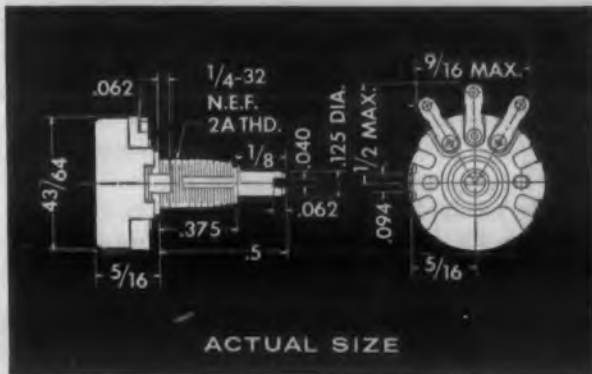

*Write today for
Technical Bulletin EP-63,
for complete engineering data.*

Centralab

**A DIVISION OF
GLOBE-UNION INC.**

*960C E. Keefe Ave.
Milwaukee 1, Wis.*

In Canada:

*804 Mt. Pleasant Road
Toronto, Ontario*

CIRCLE 300 ON READER-SERVICE CARD FOR MORE INFORMATION

GROOV-PIN FASTENERS

for Products Improvement

GROOV-PINS
Press Fit Fasteners



TAP-LOK® INSERTS
For Strong Threaded Connections



Defy Vibration – Shock

Reduce Assembly Time and Cost

No Reaming – No Tapping

GROOV-PINS The pioneer of all fasteners of this type, Groov-Pins are locking press fit fasteners which have proven their practical usefulness in a multitude of applications throughout more than 25 years. They hold well under conditions of shock and vibration, and eliminate the need for special hole preparation . . . reaming, peening, tapping, milling. Only a straight drilled hole is needed. Pins may be driven by hand, air cylinder or hydraulic press. They are usually cut from cold rolled steel (or other metals where conditions require) into which longitudinal grooves are rolled or pressed to deform the pin stock within controlled limits. When the pin is forced into a hole, the constraining action of the hole wall causes displaced material to flow back and effect a locking fit within its elastic range.

TAP-LOK INSERTS These internally and externally threaded bushings of steel or brass were designed as permanent fasteners to increase thread holding strength in comparatively weak materials . . . aluminum, magnesium, plastics, wood, etc. Their unique self-tapping feature substantially reduces assembly time and cost, by eliminating separate tapping operations, hole preparation, secondary staking. They withstand vibration without loosening and permit application of standard threaded fasteners without danger of stripping threads. The increased shear area obtained allows full utilization of the tensile strength of threaded fasteners. Used widely as original equipment, they are also excellent for salvage, and repair of stripped threads.



GROOV-PIN CORPORATION

1125 Hendricks Causeway

Ridgefield, New Jersey

Representatives in principal cities throughout the U. S. A.

IN CANADA: Metal and Wood Fastening Devices Co., Valois, Montreal

CIRCLE 223 ON READER-SERVICE CARD FOR MORE INFORMATION

New Literature

Coaxial Connectors and Cables 224

Illustrated listings of all available coaxial connectors and cables are presented in Catalog 7. Mechanical and electrical characteristics are given, and a brief comprehensive description prefaces tables listing each type. The 42-page booklet also contains cross reference numbers of government designations and other leading manufacturers. Progress Electronics Co., 296 Broadway, New York 7, N.Y.

Permanent Magnets 225

Catalog PM-121, superseding PM-100, covers a variety of cast Alnico 5 and sintered Alnico 2 permanent magnets. It offers information on magnetic and mechanical properties, approximate tolerances, and magnet assemblies. Also presented in the illustrated booklet are ordering information and sales and service offices. General Electric Co., Metallurgical Prods. Div., Detroit 32, Mich.

Hi-Fi Catalog Service 226

This catalog service provides subscribers with descriptions, specifications and illustrations of the products of more than 228 manufacturers of high fidelity and sound equipment. Prices for all products cataloged are listed alphabetically by manufacturer. The accompanying index pinpoints the location of more than 5000 products. The cost of this subscription service is \$15 per month. United File-O-Matic, Inc., Audiofile Div., 60 Madison Ave., Hempstead, N.Y.

Solenoids and Coils 227

With graphs, diagrams and photographs to illustrate, a recent catalog offers 8 pages of detailed information on solenoids, coils and electrical components. Bobbin and layer wound coils, resin molded coils, metal enclosed coils and wiring harnesses are some of the products covered. Anderson Controls, Inc., 2777 Mannheim Rd., Des Plaines, Ill.

Seamless Tubing 228

Tabbed and of file-folder size is a recent booklet describing seamless tubing and production processing and facilities. Separate sections on mechanical seamless carbon or alloy tubing, aircraft seamless tubing and electric resistance welded tubing contain lists of industrial applications together with minimum-maximum size range tables. A standard table of gauges and decimals is included for reference purposes. Copperweld Steel Co., Ohio Seamless Tube Div., Shelby, Ohio.



Beckman

Servomotor- Rate Generator

Snug as two bugs in their unitized stainless steel housing, motor and generator work hand-in-hand on the same shaft . . . to improve response characteristics of suffering servo systems.

Where the trouble is in the dynamics of your system components, watch this purposeful pair roll up their sleeves and go to work. The high torque-to-inertia motor, for instance, responds quickly and accurately to error signals . . . with acceleration at stall up to 100,000 radians/sec.² Signal-to-noise ratio of the linear generator is 25:1 or better. Aiding and abetting each other in their dedicated mission, they'll operate continuously at stall and at total unit temperature from -55°C to 200°C.

Right now, our corrosion-resistant, completely encapsulated Servomotor-Rate Generators are available in sizes 11, 15 and 18. (We'll soon add size 8; eventually, other sizes.) We've got descriptive literature available too. It's data file 535.

Beckman® Helipot

Corporation
Newport Beach, California
a division of Beckman Instruments, Inc.
Engineering representative
in principal cities

1037

CIRCLE 229 ON READER-SERVICE CARD

SANDERS MINICUBE BLOWER

*ruggedly
constructed
for use on aircraft
and guided
missiles*



Sanders Minicube Blower contains miniature blower and motor in a 1" cube. A single package, it is designed for use on aircraft and guided missiles operating under severe environmental conditions. It is operable over wide ranges of altitude, acceleration and temperature, and suitable for many exacting applications.

Sanders Minicube Blower can be used to eliminate hot spots in subminiature equipment

prevent fogging of lens or viewing glasses of Klystrons and other electronic tubes and devices

maintain uniform flow of air in restricted spaces

SPECIFICATIONS

| | |
|----------------------------------|--------------------|
| Flow: 3 cubic feet of air/minute | Speed: 22,000 RPM |
| 100 cps, 4 watts | Size: 1" x 1" x 1" |
| Model 1: 6 volts | Weight: 1 oz. |
| Model 2: 26 volts | |

For detailed specifications, write Dept. ED-12



CIRCLE 230 ON READER-SERVICE CARD

Radiation Protection Services

231

Bulletin 407 is a 4-page description of services for health and safety precautions against the hazards of radioactivity. The services outlined are accountability (for SS nuclear materials management); criticality precautions (for fuel element fabrication); and complete health physics services. Additional services are also described, among them research and development, equipment procurement and consulting. Drawings illustrate the text. Nuclear Science and Engineering Corp., P.O. Box 10901, Pittsburgh 36, Pa.

Heaters and Heating Devices

232

Heaters and heating devices for 1957 are cataloged in Bulletin GEC-1005H. The publication contains information on such products as redesigned cartridge heaters, miniature soldering irons, aluminumized steel sheath strip heaters, and new ratings and configurations of finned tubular heaters. Also described are ceramic-to-metal and plastic resin hermetic seals. In the 16-page power requirements section, each heating process is described. Typical application problems are solved to give heating requirements in both a long and a short form method. Long form calculations give answers more precisely, for applications where the exact amount of heat required is critical. Short form calculations give adequate accuracy for ordinary heating requirements. The booklet also contains data, specifications, operating information, and list prices. Listed are immersion, strip, cartridge, tubular, finned tubular, and railroad switch heaters; also unit heaters, soldering irons, soft metal melting pots, oven equipment, and control. Graphs, photographs, and dimensional diagrams illustrate the catalog. General Electric Co., Schenectady 5, N.Y.

Analytical Lab Instruments

233

"Instrumentation for Analysis" is the title of a 16-page catalog of laboratory analytical instruments. The text describes a line of infrared and ultraviolet spectrophotometers, monochromators, flame photometers and vapor fractometers. It also covers accessories and instrument components available for use with these units. Brief treatment is given to process control instruments. Perkin-Elmer Corp., Norwalk, Conn.

Manufacturing and Research Facilities

234

Manufacturing facilities for electronic test equipment component parts and for complex custom electronic devices are outlined in a brochure of 12 pages. Also described are facilities for electronic research and development. A generous number of photographs illustrate the text. Laboratory for Electronics, Inc., 75 Pitts St., Boston 14, Mass.



Higher and still higher levels of reliability! That's what you can expect from Electra's Hermetically-Sealed Deposited Carbon Resistors. Sealed with a special silver alloy inside an impervious ceramic sleeve, you get maximum precision and stability plus maximum protection against such extreme conditions as: High temperature, radical temperature changes, high humidity, rough handling and exposure to chemicals. And it's available in sizes as small as the $\frac{1}{8}$ th watt shown below in actual size.

Sealed-in Reliability

IN SMALL SIZES

ELECTRA

DEPOSITED CARBON
RESISTORS

HERMETICALLY SEALED

Eleven Sizes to Choose From

Get all the facts on Electra's complete line of Hermetically Sealed Deposited Carbon Resistors. Eleven sizes from $\frac{1}{8}$ through 2 watt, with a wide resistance range in all sizes. We'll be happy to send you information too, on Electra's complete line of Standard Deposited Carbon Resistors and our Molded (plastic encapsulated) Deposited Carbon Resistors. **Write today.**

4051 Broadway, Phone: WE. 1-6864
Kansas City, Mo.



Electra

CIRCLE 235 ON READER-SERVICE CARD FOR MORE INFORMATION

875 T

POTENTIOMETER

2 watts at 150°C

+ 200°C rating

+ giannini engineering skill!



Now—the little pot
with a big power rating

... is available for high temperature applications. Rated to operate in ambient temperatures as high as 200°C, this 3/8" diameter precision wirewound potentiometer will dissipate 2 watts at 150°C—and even more at room temperature!

Providing linearity and resolution usually found only in much larger units, the 875T represents the finest achievement in subminiature design as well as high temperature operation. It is truly representative of the engineering skill and creative ability of Giannini engineers... craftsmen in the art of precision instrument manufacture.

SPECIFICATIONS:

Resistance: 500Ω to 100,000 Ω per section
Power: 2 watts per section at 150°C
Temperature Rating: -55°C to 200°C
Linearity: ±0.5% or better

Resolution: 0.25% to 0.06%
Torque: 0.1 oz-in per section
Multiple Ganging: up to 4 units — one shaft
Dimensions: 0.875" diameter by 0.75" long

Giannini

NEW JERSEY DIVISION

"Where reliability counts"

G. M. GIANNINI & CO., INC. • 918 E. GREEN ST., PASADENA, CALIF.

CIRCLE 236 ON READER-SERVICE CARD FOR MORE INFORMATION

New Literature

Metal Stampings

237

With photographs and concise text, Bulletin No. 80 describes precision metal stampings and deep-drawn parts. The 4-page folder lists materials and finishes used for the parts along with a range of sizes. Johnson & Hoffman Mfg. Corp., 31 E. 2nd St., Mineola, N.Y.

Strain Gage Apparatus

238

The Model BL-1516 strain gage apparatus for measuring both static and dynamic strain is described in a catalog sheet of 4 pages. The illustrated literature covers operational and design features of the instrument along with its specifications. It also contains information on standard and optional accessories which may be used with the basic instrument. Brush Electronics Co., 3405 Perkins Ave., Cleveland 14, Ohio.

Potentiometers

239

Life expectancy figures and noise ratings for 1 13/16 in. diam series A (ten-turn), C (three-turn) and T (single-turn) precision potentiometers and additions to Data Sheets 54-03 and 54-52 just released.

Extensive tests have resulted in the establishment of a life expectancy of 2,000,000 shaft revolutions for each series. The maximum noise ratings for Series A and C has been set for 250 mv while Series T has a 7/8 in. diam potentiometer set at 100 mv. Each series is rated at 100 rpm with 1 milliamp of slider current. Helipot Div., Beckman Instru. Corp., Newport Beach, Calif.

Silicone Rubber

240

A 48-page booklet entitled "1957—Silicone Rubber, a basic-up-to-date report on a highly versatile elastomer" is now available.

The booklet, including 38 graphs and figures, reprints three papers given by chemists at the recent Silicone Rubber Symposium held in six aircraft centers across the country. The papers discuss basic chemistry, properties due to this chemistry, and considerations and compromises involved in compounding silicone rubber for fabrication. The booklet will serve as a basic reference on material and will supply design engineers with background necessary when considering the material for extreme temperature applications. (Available for \$1.00) The Connecticut Hard Rubber Co., 407 E. St., New Haven 9, Conn.



The Curtiss-Wright "SNAPPER"

NEW CONCEPT... ADVANCED DESIGN
IN THERMAL TIME DELAY RELAYS

- Eliminates chatter with snap action
- Single-pole, double throw contacts
- Wide ambient range (-65°C $+100^{\circ}\text{C}$)
- For military, commercial and industrial applications
- Metal envelope (7 or 9 pin) miniature or (8 pin) octal
- Glass envelope in 9 pin miniature
- Preset time delays in metal from 3 to 90 seconds, glass from 5 to 60 seconds

Write to Thermal Devices Department
for latest data sheets



CIRCLE 241 ON READER-SERVICE CARD

MICRO-MICROAMMETERS

412 Log Model indicates from 10^{-13} to 10^{-7} ampere on a single six-decade scale

STABILITY, economy, and fast response are all combined in this versatile logarithmic instrument. Typical uses of the new Keithley 412 include reactor control, radiation monitoring, materials testing, and measurement of other widely varying micro-currents from sources of one volt or more.



KEITHLEY MODEL 412
LOG MICRO-MICROAMMETER

FEATURES include a single range of six decades from 10^{-13} to 10^{-7} ampere, accuracy of 0.2 decade, zero drift within 0.5 decade in eight hours, and response time of less than 2 seconds to 90% of currents larger than 10^{-13} ampere with 5000 mmf across the input.

IT'S SIMPLE to set up and use. The sole operating control is the on-off switch. It has only three calibration potentiometers, and reads out on a six-inch illuminated meter.

CONNECTORS furnished include a 216-volt tap for polarizing ion chambers and a single-ended 6-volt output that drives both 50-millivolt and 5-milliamperere recorders. The instrument is furnished for bench or rack mounting.

NEW CATALOG B contains detailed data on the 412 and all other Keithley Instruments. A request on your company letterhead will bring your copy promptly.



**KEITHLEY
INSTRUMENTS, INC.**
12415 Euclid Ave., Cleveland 6, Ohio

CIRCLE 242 ON READER-SERVICE CARD

Welding Movie

243

"Modern Methods for Joining Metals" is a 20-min. sound and color movie of welding processes and applications. Treated in a generally nontechnical manner and filmed at leading metal fabricating companies, the picture illustrates the importance of the welding engineer in industry. It shows the many factors involved in electric welding, and how research, development and engineering serve to provide increasingly better methods and equipment. Arrangements to see this film can be made by contacting the nearest Linde office, or by writing to Linde Air Products Co., Div. of Union Carbide and Carbon Corp., 30 E. 42nd St., New York 17, N.Y.

Conversion Chart

244

Conversions common and uncommon are tabulated on an 8 x 12 in. wall chart. The reference table, intended mostly for electro-mechanical engineers converts, among many others, inches to centimeters, watts to horsepower, cubic feet to liters, microns to meters, and quintal to pounds. Precision Equipment Co., 3714 N. Milwaukee Ave., Chicago 41, Ill.

Subminiature Tubes

245

To the 4th edition of "Reliable Subminiature Tubes" six cathode types have been added. Also new to this edition are specification and microscopic inspection improvements. An introductory section of the 117-page catalog contains a detailed discussion of tube reliability and quality control with a variety of quality tests described.

In the listings, each tube type is minutely analyzed with descriptive text and extensive mechanical and electrical data. Graphs and diagrams show characteristics and dimensions. Listed are pentodes, triodes, double triodes and gas diodes for various applications.

In the "Application Notes" maximum ratings are discussed and notes on individual types are presented. Here also is a chapter on temperature ratings. The price for this book is \$1.00. Raytheon Mfg. Co., Special Tube Div., 55 Chapel St., Newton 58, Mass.

Transformer Catalog

246

Over 700 transformers, 117 of them new, are described and illustrated in a 1957 General Catalog, TR-57. Toroids, pulse, transistor, hermetically sealed, geophysical, power, filament and audio transformers, chokes and television components are some of the items listed. Triad Transformer Corp., 4055 Redwood Ave., Venice, Calif.

FRAHM®

ROC REED

OSCILLATOR CONTROLS

FEATURES

- High accuracy
- Stability of frequency control
- Self starting
- Infinite service life
- Integral, sealed, magnetically shielded
- Standard octal tube pin connectors
- Small, light weight

CIRCUIT
COMPONENTS FOR
ELECTRIC OSCILLATORS
MAINTAIN OSCILLATOR
OUTPUT FREQUENCY
WITHIN CLOSE LIMITS
ALSO USED AS
ELECTRO-MECHANICAL
BANDPASS FILTERS

APPLICATIONS

- Electrical and Acoustical Measurements
- Electrical Communication Systems (Selective Calling)
- Remote Operation and Supervisory Control of Machinery and Apparatus
- Electrical Computers and Telemetry Systems
- Electro-Mechanical Bandpass Filters

Frahm Oscillator Controls, Type ROC, make possible the design and construction of inexpensive, precision tone generators that are small and light weight. These generators will have accurate output frequency and output voltage with very nearly sinusoidal wave shape.

They can be made with any one nominal control frequency between 20 and 1100 cps. They will control the output frequency of circuits, under specified conditions, constant within $\pm 0.15\%$ of the nominal control frequency.

We particularly encourage your inquiries and correspondence on special applications and problems. If you haven't explored these Frahm Oscillator Controls we'll be glad to send you complete specifications, characteristics, etc. Write for Bulletin 34-ED.

B-706

JAMES G. BIDDLE CO.

ELECTRICAL TESTING INSTRUMENTS • SPEED MEASURING INSTRUMENTS

LABORATORY & SCIENTIFIC EQUIPMENT

1316 ARCH STREET, PHILADELPHIA 7, PA.

CIRCLE 247 ON READER-SERVICE CARD FOR MORE INFORMATION

LIFE IS NO PROBLEM

WITH **TIC** PRECISION
POTENTIOMETERS

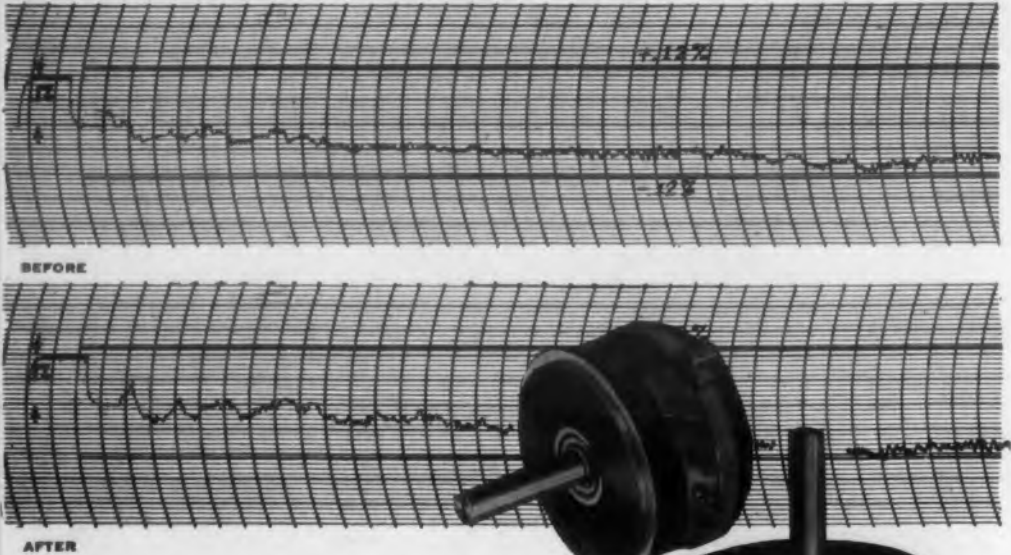

Take for instance a recent test report on the TIC Type ST20, a 2-inch, low-torque, ball-bearing precision potentiometer. The life test was conducted on a standard 6500 ohm unit. At 30RPM the ST20 was subjected to 700,000 cycles, reversing direction every 30 minutes. The linearity graphs shown above show the before and after of the ST20's independent linearity. *As can be seen, the linearity change is imperceptible.*

Some of the change in linearity after the life cycling can be attributed to change in effective resolution due to contact wear. Other results from the life test indicate less than 100 ohm equivalent noise resistance except for one spot, where it was less than 1000 ohms. The 1000 ohm spot was of such short duration that the linearity recording did not pick it up. **Test Summary: The ST20 will perform with only infinitesimal degradation for over 700,000 cycles.** If it's long life at full precision performance, that you want, specify precision potentiometers by TIC.

TECHNOLOGY INSTRUMENT CORP.

555 Main Street, Acton, Mass. COlonial 3-7711
West Coast Mail Address, Box 3941, No. Hollywood, Calif. POplar 5-8620

CIRCLE 249 ON READER-SERVICE CARD FOR MORE INFORMATION

New Literature

Magnet Wire Trade Name Directory 250

Directory (16 pages) of current magnet wire trade names as used throughout the electrical industry is now released. Included in this comprehensive directory are various trade name designations as used and submitted by twenty magnet wire manufacturers, and a brief general description of the physical, chemical and electrical characteristics and application common to the ten general classifications of magnet wire. An easy-to-read chart is also included giving a complete resume of trade names by magnet wire types, and manufacturer. Magnet Wire Div., Essex Wire Corp., Ft. Wayne, Ind.

Water Bath Unit 251

A 2-page data sheet describes a self-contained unit for laboratory water baths that combines a heater, stirrer, and circulator with a built-in pneumatic control system and temperature indicator. Illustrations show the unit and some accessory equipment. Arthur S. LaPine & Co., 6001 S. Knox Ave., Chicago 29, Ill.

Portable Water Bath Cooler 252

A page of data has been issued to describe a portable cooler for laboratory water baths. Illustrations and performance data are included. Arthur S. LaPine & Co., 6001 S. Knox Ave., Chicago 29, Ill.

Hook-Up Wires 380

Series 100 and 110 hook-up wires made of silver plated copper conductors for continuous operation at 600 v in a -60 to $+200$ C temperature range are covered in two single-page data sheets. Both sheets contain a description, an illustration, a specification table and a list of performance requirements. Philadelphia Insulated Wire Co., 200 N. 3rd St., Philadelphia 6, Pa.

Precision-Drawn Cases 253

Services for supplying standard and special precision-drawn cases and covers are announced in a 4-page folder. Photographs illustrate a number of available items. Hudson Tool & Die Co., Inc., 18 Malvern St., Newark 5, N.J.

Screw Machine Products 254

Facilities for making beryllium copper screw machine parts are outlined in Bulletin A-57. The 1-page treatment includes photographs showing a variety of manufactured parts. Instrument Specialties. Co., Inc., 232 Bergen Blvd., Little Falls, N.J.

THE SIZE 15 TELESYN[®] RESOLVER

from FORD INSTRUMENT



- Extremely accurate computing unit
- Resolves input voltages into sine and cosine components
- Miniature size
- Lightweight
- Rated 1-24 volts, 400 cps input.

The FICo Size 15 *Telesyn* Resolver is available in models with transformation ratios of 1:1, 4:1 and 8:1. It is widely applicable in such units as analog computers, angle data transmission systems, and similar equipment.

FREE — Fully illustrated data bulletin gives specifications and performance information. Please address Dept. ED.



FORD INSTRUMENT COMPANY

Division of Sperry Rand Corporation
31-10 Thomson Ave.
Long Island City 1, N. Y.



CIRCLE 255 ON READER-SERVICE CARD

for the development
of reliable
automatic control
and computing devices



ATCOTRAN

**DIFFERENTIAL TRANSFORMER
EXPERIMENTAL KIT**

The research engineer can set up and operate seven different standard differential transformers... coils, armatures, and shafts... to convert precise variations in position to a proportional electrical signal. Range covers from $\pm .01''$ to $\pm 2.5''$. Flexure plate and clamp, which positions coils, and demodulator are included.

Kit also contains 32-page **TRANSDUCER HANDBOOK** containing the most complete and up-to-date information on the theory, development, and application of differential transformers. Profusely illustrated with charts, drawings and circuits.

List price of Kit contents is \$324.00. Introductory offer...

only \$189.50

Order your Atcotran Experimental Kit today.

AUTOMATIC TEMPERATURE CONTROL, INC.
SUBSIDIARY OF SAFETY INDUSTRIES, INC.
5239 Pulaski Avenue, Phila. 44, Pa.

Please send me an Atcotran Differential Transformer Experimental Kit and invoice \$189.50 against our purchase order

No. _____

NAME _____

COMPANY _____

ADDRESS _____

CITY _____ STATE _____

CIRCLE 256 ON READER-SERVICE CARD

Insulated Wires and Cables 257

Insulated wires and cables are the subject of a 6-page folder. For each type listed, there is an illustration and a short description. Military hook-up wire, multiple conductor cable, coaxial cable, microphone, photoelectric cell cable, miniature wire and cable, flame retardant high voltage wire and high frequency lead wire are among those mentioned. Chester Cable Corp., Chester, N.Y.

High Temperature Insulation 258

"High Temperature Insulation" is a 12-page guide which describes the requirements established for Class H and Class C insulation and materials that meet these specifications. Micanite, Samica, Isomica, and laminated plastic and empire coated glass cloth are fully discussed with suggestions for application. Complete data on essential electrical, physical and mechanical characteristics are tabulated at the end of the booklet. Mica Insulator Co., Schenectady 1, N.Y.

Disc Type Thermostats 259

Punched for insertion in standard 3-ring binders, Bulletin 3000 describes a line of bimetal disc type thermostats for electronic, appliance and industrial applications. With a schematic diagram to illustrate, the 2-page text explains the operating principle of the units. It also provides performance data, ratings, dimensions, and construction details. Both hermetically sealed and semi-enclosed styles are covered. Photographs illustrate mounting arrangements. Stevens Mfg. Co., Inc., Lexington, Ohio.

Teflon Spaghetti Tubing 260

Bulletin BR-4A is a 2-page story on engineering thin wall Teflon tubing as an insulation sleeving for electric and electronic components. The dielectric, handling and performance advantages of the tubing are listed along with applications and electrical and physical property data. Illustrations and a specification table of 26 different sizes are also presented. The Polymer Corp. of Pennsylvania, 2140 Fairmont Ave., Reading, Pa.

Electrical Resistance Heating Material 261

Complete data on an ultra high-temperature electrical resistance heating material for continuous use at temperatures to 1600 C are contained in an illustrated booklet of 16 pages. In addition to a description of the electrical, chemical and physical characteristics of this cermet material, the brochure suggests designs and specifications for the construction of laboratory high-temperature furnaces. The Kanthal Corp., Amelia Place, Stamford, Conn.



Honeywell's Variable Inlet Diffuser Controls Keep the "Hustler" Hustling

ENGINEERS
SCIENTISTS

WORK ON ADVANCED
PROJECTS LIKE THIS

As mach numbers advance, even fractional errors in inlet-air diffuser positioning reduce thrust tremendously.

Yet a fixed diffuser designed for optimum pressure at a given high mach number may be so inefficient at a lower mach number as to render it impossible for aircraft to reach design speed.

In the U.S.A.F.'s first supersonic bomber, Convair's B-58 Hustler, this problem was solved by Honeywell's variable inlet-air diffuser systems—the most accurate known. They are automatically controlled to the proper parameters to achieve maximum pressure recovery and mass air flow matched to engine requirements.

The Challenges to Come!

Variable inlet diffuser systems are just one of 114 research and development projects in which Honeywell Aero is engaged. These projects are in the basic areas of:

INERTIAL GUIDANCE • FLIGHT CONTROL SYSTEMS • LIQUID MEASUREMENT SYSTEMS • VERTICAL, RATE AND INTEGRATING GYROS • DIGITAL AND ANALOG COMPUTERS • JET ENGINE CONTROLS • AIR DATA COMPUTERS • BOMBING COMPUTERS
TRANSISTOR AMPLIFIERS • INSTRUMENTATION

Each of these projects offers exceptional career opportunities for capable engineers and scientists.

And Honeywell's rapid growth assures you of early advancement. Engineering personnel at Honeywell Aero has tripled in the last 5 years, is still growing faster than the avionics industry average. Supervisory positions open quickly, are filled from within. The first-rate salary you start with at Honeywell is *just the start*.

Write today!

For more information concerning these opportunities, send your inquiry or résumé to: Bruce D. Wood, Technical Director, Dept. TA20C, Honeywell Aero, 1433 Stinson Boulevard, Minneapolis 13, Minn.

Honeywell
Aeronautical Division

CIRCLE 568 ON READER-SERVICE CARD FOR MORE INFORMATION

ALBANY, N. Y.
 E. E. Taylor Co.
BALTIMORE, MD.
 Kann-Ellert Electronics Inc.
BINGHAMTON, N. Y.
 Morris Distributing Co. Inc.
BOSTON, MASS.
 DeMambro Radio Supply
BUFFALO, N. Y.
 Radio Equipment Corp.
CANTON, OHIO
 Video Wholesale Inc.
CEDAR RAPIDS, IOWA
 Gifford-Brown Inc.
CHICAGO, ILL.
 Newark Electric Co.
CLEVELAND, OHIO
 Pioneer Electronic Supply Co.
COLUMBUS, OHIO
 Hughes-Peters Inc.
DALLAS, TEXAS
 Wholesale Electronic Supply
DAYTON, OHIO
 Srepco Inc.
DES MOINES, IOWA
 Radio Trade Supply Co.
EL PASO, TEXAS
 Midland Specialty
HAGERSTOWN, MD.
 Zimmerman Wholesalers
HARTFORD, CONN.
 R. G. Scoll & Co., Inc.
INDIANAPOLIS, IND.
 Redefeld Co., Inc.
INGLEWOOD, CALIF.
 Newark Electric Co.
JAMAICA, N. Y.
 Norman Radio Dist. Inc.
JOHNSTOWN, PA.
 Baker Radio Electric
JOPLIN, MISSOURI
 Four State Radio Supply
KANSAS CITY, MO.
 Burstein-Applebee Co.
LAFAYETTE, LA.
 Ralphs Radio Electronic Supply
LANSING, MICH.
 Offenauer Co.
LOUISVILLE, KY.
 Sutcliffe Co.
MANSFIELD, OHIO
 Wholesaling Inc.
MILWAUKEE, WIS.
 Radio Parts Co., Inc.
MOUNTAIN SIDE, N. J.
 Federated Purchaser
NEWTON, MASS.
 Leonard Greene Shaw Co.
NEW YORK, N. Y.
 Arrow Electronics Inc.
NEW YORK, N. Y.
 Electronic Center
NORFOLK, VA.
 Radio Equipment Co.
OAK PARK, ILL.
 Melvin Electronics Inc.
OKLAHOMA CITY, OKLA.
 Electronic Supply Co.
PASADENA, CALIF.
 Electronic Supply Corp.
PHILADELPHIA, PA.
 Alme Radio Co.
RICHMOND, VA.
 Meridian Electronic Equip. Co.
SAGINAW, MICH.
 Saginaw Distributors Inc.
ST. LOUIS, MO.
 Van Sickle Radio Corp.
SCRANTON, PA.
 Fred P. Pursell
SEATTLE, WASH.
 Western Electronic Supply Co.
SPRINGFIELD, ILL.
 Suter T. V. Supply Inc.
SPRINGFIELD, MASS.
 Soundco Electronic Supply Co.
SYRACUSE, N. Y.
 Morris Distributing Co., Inc.
TAMPA, FLA.
 Thurow Distributors, Inc.
TRENTON, N. J.
 The Dragon Co.
TULSA, OKLA.
 S & S Radio Supply Co.
TUCSON, ARIZ.
 Elliot Electronics Inc.
UTICA, N. Y.
 Beacon Electronics
WASHINGTON, D. C.
 Electronic Wholesalers Inc.
WATERBURY, CONN.
 Bend Radio Supply
WICHITA, KAN.
 Interstate Electronic Supply Corp.

When you need
fixed resistors
in a hurry...

...for breadboards or prototypes
...for small production runs
...for production emergencies

**ORDER FROM
THESE LOCAL
STACKPOLE
DISTRIBUTORS**

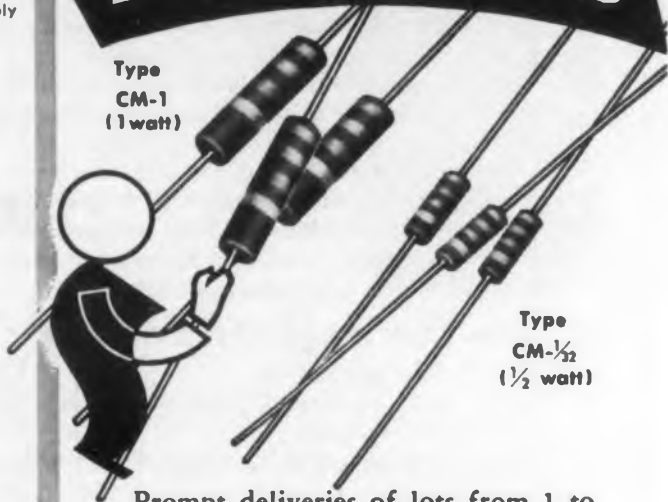

Prompt deliveries of lots from 1 to 1,000—all military and RETMA preferred resistance values and tolerances. Fixed composition types that meet or surpass critical performance requirements.

**STACKPOLE
RESISTORS**

First choice of leading users
since the early days of radio.

Distributors' Division
STACKPOLE CARBON COMPANY
26 Rilttenhouse Place, Ardmore, Pa.

CIRCLE 262 ON READER-SERVICE CARD FOR MORE INFORMATION

New Literature

Machined Components 264

Components precision-machined from industrial plastics are shown in a four-page brochure just issued. Important properties of plastic, such as Teflon, Kel-F, Nylon, and styrenes are given. Applications are indicated and some typical machined plastics applications in the electronic, aircraft, instrument, mechanical and other fields are illustrated. Tri-Point Plastics, Inc., 175-177 I. U. Willets Rd., Albertson, L.I., N.Y.

Aperture Mask for Color TV 265

Aperture masks for color television picture tubes are illustrated and described in Data Memorandum No. 5, just published.

Data Memorandum No. 5 illustrates the principal steps in the manufacture of aperture masks, which is essentially a photo-etching process which produces tapered holes measuring .010 in. on one face of the mask and .015 in. on the opposite. Most tolerances are held to plus or minus .0006 in., but closer tolerances are possible. Superior Tube Co., Norristown, Pa.

Electronic Relays 266

Electronic relays, open and hermetically sealed, are described in an eight-page engineering Bulletin No. 1050 now available. Complete information on applications, construction and engineering specifications of these electronic relays is presented in concise outline form. Details include coil voltage, resistance and wattage, contact forms available and approximate weight. Dimensional drawings and circuit diagrams are shown for the eight groups of relays featured. Essex Wire Corp., Ft. Wayne, Ind.

Teflon and Glass Yarns 267

Fluorglas, a material combining Teflon and glass, and the yarns, threads and fibers made from it are illustrated and described in a folder of 8 pages. The electrical, chemical and physical properties of the material are listed along with specifications and uses for yarn, continuously coated fabric, woven fabric and lacing tape. Tables show available yarn sizes and weights. Dodge Fibers Corp., Hoosick Falls, N.Y.

Why Print **BROKEN** Circuits?



CONTINUOUS *Silk Screen Printed Circuits* **everytime** with **Nelco Acid Resist Lacquer!**

NELCO leads all stop-off lacquers for silk screen printing on metal or plastic laminates. Note these superiorities:

- Highest resistance to etching acids
- Exact reproduction of design
- Complete retention of deposited image
- Quick air-dry, no baking process

- Easy to apply, easy to remove

Send for Data Sheet on Nelco Stop-Off
Lacquer — fully tested, fully developed!

Chemical Products

CORPORATION

King Philip Road
East Providence, Rhode Island



FORMULATORS OF CABLE, INDUSTRIAL AND OTHER SPECIALTY COATINGS SINCE 1922

CIRCLE 263 ON READER-SERVICE CARD FOR MORE INFORMATION

Fine Pitch Gears

268

An illustrated brochure entitled "Precision Fine Pitch Gears" has been released. The brochure discusses precision gears as compared to commercial gears and methods and equipment employed. Quality control measures required for accuracy and close tolerances are also stated. Still another section is devoted to recommended gear data formats used in requesting quotations and cost estimates. Precision Gear Dept., Fairchild Camera and Instrument Corp., Robbins Lane, Syosset, L.I.

Die-Cast and Molded Products

269

Assembled in the "Services and Products Bulletin" are nine catalog sheets with complete listings of all 67 available types of zinc alloy die-cast and thermoplastic molded products. Section I of the bulletin deals with small parts made to customer specifications. Section II covers standard stock products, among them bobbins, insulators, bushings and a diversity of fasteners. All product types are illustrated. Gries Reproducer Corp., 125 Beechwood Ave., New Rochelle, N.Y.

Strain Gage Balance

270

Series D six-component internal strain gage balance is described in detail in an illustrated four-page brochure now available.

The balance is of the floating-frame type, and primary frames consist of an inner rod which fastens to the model support, and a cylindrical outer case which is inserted into and attached to the model. The brochure contains a chart of sizes and ranges, and a cutaway drawing of the balance. Performance evaluation is discussed in detail. E. F. Ward, Task Corp., 1009 E. Vermont Ave., Anaheim, Calif.

Fotoform Glass

271

The four types of Fotoform glass—how they are made, how they differ, their specific and potential uses—are described in an illustrated folder of four pages. Form EPFF-1 presents design and production data for these glasses and cites their latest mechanical and electrical applications in the electronic and allied industries. Corning Glass Works, Electrical Prods. Div., Corning, N.Y.



Teflon connectors, hermetically sealed,

FOR TEMPERATURES FROM **-100** TO **+500 F**

No other material, natural or synthetic, compares with DuPont Teflon for toughness, chemical inertness, high dielectric strength. It will not char or carbonize from arcing; stands thumping shocks and vibration; will not warp or loosen at jet engine heats or sub-zero climates. Made by a revolutionary new molding process. Every manufacturer of high frequency radio, radar and other electronic equipment should write for details.

The **Joelin** manufacturing company

20 Lufbery Avenue
Wallingford, Connecticut

CIRCLE 273 ON READER-SERVICE CARD FOR MORE INFORMATION

A NEW PRECISION INSTRUMENT



for the
Accurate Measurement of

CATHODE- INTERFACE RESISTANCE

.....
in all types of
receiving tubes

ACCURACY: 3% at two ohms,
(whichever is larger)

RANGE: 0 to 1100 ohms

Manson's new Cathode-Interface Resistance Test Set uses the Wagner two-frequency method, in conjunction with a sensitive VTVM circuit. Resistance is read directly from the dials controlling the precision decade resistances. The equipment is entirely self-contained, and designed for bench-top use.

.....*For full details, ask for Bulletin D.*

Manson offers to Engineers and Technicians a rewarding present and attractive future in suburban Connecticut.

MANSON LABORATORIES

207 Greenwich Avenue

DAvis 4-6739

STAMFORD • CONNECTICUT

Design and Production of Specialized Electronic Equipments

CIRCLE 272 ON READER-SERVICE CARD FOR MORE INFORMATION

A. R. C. CERAMIC INSULATED TERMINAL BOARDS



Resist Arcing, End Flash-Over Damage

These high performance components were developed to insure reliability in our own airborne equipment. They have a wide variety of other electronic applications.

Made of special ceramic material and silicone coated, they are extremely resistant to moisture and heat and are fungus-proof. Because

they furnish no continuous path for a short, arcing is minimized. Even in the event of a flash-over, there is no permanent damage to the part, as with phenolic boards. Longer life and fewer replacements mean lower true cost. Their type of construction permits positive, neat connections at terminals. Write for detailed literature.

Dependable Airborne Electronic Equipment Since 1928

AIRCRAFT RADIO CORPORATION
BOONTON, NEW JERSEY



CIRCLE 274 ON READER-SERVICE CARD FOR MORE INFORMATION

NEW! H-LAB TRANSISTORIZED POWER SUPPLIES



MODEL 800-A
Twin 2-30 Volts
@ 1.0 Amps.

MODEL 800-B
2-30 Volts
@ 2.5 Amps.

MODEL 800-A

Features:

* Short circuit and overload protection, with *Automatic reset* * Continuously variable * Less than 500 microvolts ripple * Less than .01 volts output voltage variation from N.L. to 1.0 amps.

Write for complete catalog of H-Lab Power Supplies



HARRISON LABORATORIES, INC.
45 Industrial Road, Berkeley Heights, N. J.

CIRCLE 275 ON READER-SERVICE CARD FOR MORE INFORMATION



Write today for your free copy of this technical paper



ask for data file 525



Measurement and Correction of Phase Shift in Copper-Mandrel Precision Potentiometers

BY STANLEY SCHNEIDER,
FRED HIRAOKA
AND CLARENCE GAULDIN
Research and Engineering Division,
Helipot Corporation



Beckman Helipot Corp., Newport Beach, Calif.
a division of Beckman Instruments, Inc.

1082

CIRCLE 276 ON READER-SERVICE CARD FOR MORE INFORMATION

New Literature

Radiography on Subminiature Tubes 277

In "Radiography in Production Control and Inspection of Subminiature Tubes," Eric A. Kolm describes techniques used at Raytheon Mfg. Co. Reprinted from a technical magazine, the six-page article deals with the basic requirements for precision radiography. Smallness of X-ray source, stability of X-ray tube voltage and adequacy of target cooling are some of the factors covered. The author also discusses ability to mass-radiograph and properly treat geometrical accuracy between X-rays and electron tubes. Illustrations show radiographs made of subminiature electron tubes with the method described. Drawings give details for the film holder, the electron tube holder and the production inspection installation. Another drawing illustrates the geometric relationship between film, X-ray source and specimens. Philips Electronics, Inc., Instruments Div., 750 S. Fulton Ave., Mount Vernon, N.Y.

Differential Transformer 278

"Notes on Linear Variable Differential Transformers," copyrighted in 1955, is available as Bulletin AA-1A. The 18-page text explains techniques involved in the use of an LVDT for accurate determination and control of mechanical quantities in scientific and industrial operations. With graphs, diagrams and line drawings to illustrate, it discusses at length the characteristics, environmental factors, installation, operation and application of the unit. The comprehensive study, with more than 40 subject headings, covers mechanical and electrical features, mechanical frequency response, velocity measurement, linearity and linear range, sensitivity and output, impedance, resolution, phase characteristics, forces and tolerances. Schaevitz Engineering, P.O. Box 505, Camden 1, N.J.

A-C and D-C Relays 279

Comprehensive construction and application details for a-c and d-c general purpose relays are given in Bulletin 1060. Complete contact construction, arrangement and ratings are charted along with maximum dimensions for front and rear mounting positions. Featuring the 98000 Type a-c and d-c general purpose relays, the eight-page brochure also contains information on special construction and the 97000 Type designed for application requiring additional coil power and increased relay contact actuating force. The booklet is generously illustrated with photographs and extensive engineering drawings which give all dimensions for the many contact forms available. Essex Wire Corp., Logansport, Ind.

"Best Suited" for HIGH TEMPERATURES

VARGLAS SILICONE CLASS M TUBING and SLEEVING

for applications requiring prolonged heat endurance at temperatures up to 260°C.

Varglas Silicone tubing and sleeving were developed by Vargflex for applications involving continuous operating temperatures up to 260°C. Exceptional stability is combined with the following qualities . . .

- Flexibility**—Sharp turns and 90° bends cause no cracking or peeling—no loss of dielectric strength.
- Dielectrically-Strong**—All Grades conform to NEMA and MIL-I-3190 Standards.
- Moisture-Resistant**—including resistance to salt water, mild alkalis and acids.
- Flame-Resistant**—Standard burning test is 45 seconds to burn 1 inch. Can be made self-extinguishing on special order.
- Cold-Resistant**—Excellent resistance to chafing and abrasion, flexible to -35°C.*

*For temperatures down to -65°C., and for applications requiring extraordinary flexibility, we recommend our new Varglas Silicone Rubber sleeving and tubing. Inquiries invited.

Send for FREE SAMPLES
Write today for free folder containing 25 different test samples of Vargflex insulating sleeving, tubing, lead wire and tying cord.



Vargflex CORPORATION
Divisions of
Thermal Insulating
Tubing and Sleeving

Vargflex Sales Co., 306 N. Jay St., Rome, N. Y.

CIRCLE 280 ON READER-SERVICE CARD FOR MORE INFORMATION

flexible couplings with ZERO BACKLASH



Series #1
Actual Size

- precision-made
- low inertia
- high flexibility
- versatile
- long life
- moderate cost
- meet JAN-MIL specs

For exacting requirements, you're sure of best results with precision-made Renbrandt Flexible Servo-Couplings. They have zero backlash and low inertia . . . and they do not introduce velocity variations between driving and driven shafts. Available in a variety of sizes for 1/16" through 1/2" shafts in all combinations. Widely used for servo-mechanisms, computers, and for all precision applications.

Specify Renbrandt Flexible Couplings. Fast delivery on prototype or production orders. Send for complete catalog.



Tinyrite Coupling
Actual Size

Low cost for general application. Thousands of uses. 1/2" dia. x 11/16" long. For 1/4" and/or 3/16" shafts. No backlash. Insulated.

Renbrandt, Inc.
98B Kirkland Street
Cambridge 38, Mass.
Tel.: TRowbridge 6-6560

Renbrandt

CIRCLE 281 ON READER-SERVICE CARD FOR MORE INFORMATION

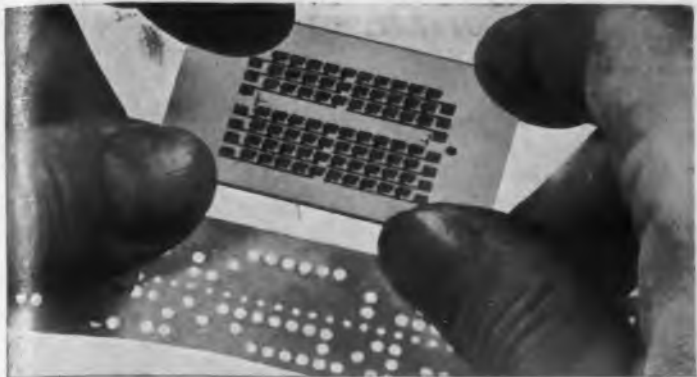

The small dots are photosensitive resistors connected by gold conductors.

This 70-cell photosensitive resistor "reads" a punched tape . . .

What do you want to read?

The Kodak Ektron Detector makes possible new techniques for reading punched tapes, cards, code wheels, and the like. The lead sulfide photosensitive elements can be laid down in all sorts of complex and exact arrays and mosaics. Units are characterized by a broad signal response from 0.25 microns in the ultraviolet to 3.5 microns in the infrared, a high signal-to-noise ratio, stability under vibration, and small size. For a booklet giving detailed information on Kodak Ektron Detectors, write Military and Special Products Sales,

EASTMAN KODAK COMPANY
Rochester 4, N. Y.

Kodak

CIRCLE 282 ON READER-SERVICE CARD FOR MORE INFORMATION

GRC small nylon coil bobbins



NOW available from stock

NOW Gries offers a wide variety of nylon produced at low cost—ready for use. Stock coil bobbins from stock. Automatically mass sizes from 1/4" diameter x 1/4" long minimum up to 7/8" diameter x 1/2" long—round, square, rectangular, oval shapes. Check Gries for your bobbin needs—either from stock—or to your size, shape and material specifications on special order.

WRITE TODAY FOR SPECIFICATION SHEET

See us at Booth 421

Design Engineering Show
May 20-23, N. Y.

GRIES REPRODUCER CORP.

World's Foremost Producer of Small Die Castings

40 Second St., New Rochelle, N. Y. New Rochelle 3-8600.

CIRCLE 283 ON READER-SERVICE CARD FOR MORE INFORMATION

Wide range of shapes and sizes

1-pc. Nylon molding speeds winding

Irregular shapes and special materials to order

Accurate, uniform, ready-for-use

GRIES

Polyethylene Insulation 284

Originally presented at the 1957 AIEE Winter Meeting, "Polyethylene for Higher Voltage Cables" is available in booklet form. In the article, author Robert C. Graham presents detailed information on the development and use of polyethylene as an insulation and jacket material for power cables used on a-c circuit voltages from 2300 through 33,000. Sections are devoted to polyethylene insulation and sheath characteristics; cable design, manufacture, and specifications; installation; price comparison; the use of polyethylene on cables rated higher than 15 kv; and the future of polyethylene as an insulation material. Coded RCT 700, the eight-page bulletin contains four photographs and three cutaway cable sketches and graphs and tables. It is punched for notebook insertion. Rome Corp., Rome, N.Y.

Pulse Calibrator 285

The Type 1810 pulse calibrator, an instrument designed for accurately measuring current and voltage pulse amplitudes, pulse durations and rise time, is fully described in a technical brochure. The 4-page pamphlet shows how the calibrator operates, illustrating and explaining actual waveforms obtained from different applications of the unit. Complete operation theory for the chopper and calibrator sections is given along with specifications. Burroughs Corp., Electronic Instruments Div., 1209 Vine St., Philadelphia 7, Pa.

Aircraft Thermocouples 286

A recently expanded catalog, Bulletin A, presents a line of aircraft thermocouples and aircraft thermocouple assemblies. It contains illustrations, specifications and ordering charts and points out applications. Three basic types of reciprocating aircraft engine thermocouples—engine-cylinder-bayonet, gasket, and blind rivet—are discussed in full. The 10-page booklet also offers information on MIL-Spec thermocouples, AN firewall quick disconnects, AN resistors and AN extension lead assemblies. Thermo Electric Co., Inc., Saddle Brook, N.J.

Grinding Cemented Carbides 287

Graphic test results of grinding cemented carbide cutting tools are presented in Engineering Bulletin No. 104. Comparative removal rates and wheel costs in grinding carbides with the electrolytic method and conventional grinding methods are given. Two charts are reproduced. One shows stock removal rates in cubic inches per minute for seven examples of grinding. The other indicates wheel costs in dollars per cubic inch of carbide removal for four grinding methods. Anocut Engineering Co., 661 W. Washington Blvd., Chicago 6, Ill.

PANEL SPACE LIMITED? SPECIFY

DIALCO 2-Terminal

Sub-Miniature Pilot Lights

COMPACT

RUGGED

OMNIDIRECTIONAL

PLASTIC DOMES

COMPLETELY

INSULATED

Also available with "Taper-Tab" quick-connect terminals

BACK of panel insertion

OR FRONT of panel insertion

△ Dimming and
◁ Non-dimming types

Also

1-Terminal Pilot Lights

for use on grounded circuits. Available with binding screw or soldering terminal.

DIALCO's expanded line of sub-miniature lights conform to all applicable Mil Specs. Use T-1 3/4 midget incandescent lamps—1.3 to 28 V. Spring mounted *Lens-with-Message* is readily positioned after installation... Mount from back of panel in 15/32" clearance hole; or from front of panel in 17/32" hole... 7 lens colors... Shown approx. actual size (top to bottom): No. 134-3830-375-6... No. 101-3830-951... No. 101-5030-951... No. 109-3830-111... No. 111-3830-111... No. 107-1930-951.

Complete details in Brochures L-156 A and L-157.

SAMPLES ON REQUEST—AT ONCE—NO CHARGE



Foremost Manufacturer of Pilot Lights

DIALIGHT
CORPORATION

46 STEWART AVE., BROOKLYN 37, N. Y. • HYacinth 7-7600

DIALIGHT CORP., 46 Stewart Ave., Brooklyn 37, N. Y.

Send brochures on Sub-Miniatures Selection Brochure Pilot Light Catalogues

Name Position

Company

Address

CIRCLE 288 ON READER-SERVICE CARD FOR MORE INFORMATION

NEW!

LIGHT BODY SYLVANIA PHOSPHORS FOR 110° PICTURE TUBES

- More uniform color
- Good screen adherence
- Faster settling schedules
- Available immediately



Developed especially to solve the difficult screen settling problems encountered in the new wide-angle black-and-white picture tubes—these new Sylvania phosphors offer advantages for conventional tubes, as well.

The new lighter body color absorbs less illumination, resulting in both high screen brightness and more uniform color distribution. The phosphors are available over a wide color range to meet all requirements. Their even settling characteristics also help to produce more uniform screen brightness; better wet and dry film strength.

An important improvement in particle size distribution and uniformity can result in still another important advantage... faster settling schedules.

The whole settling system may, in fact, be benefitted through a lower reject rate as well as a higher production rate.

Sylvania produces a wide range of phosphors for fluorescent lamps, mercury vapor lamps, and cathode ray tubes—as well as phosphors for black-and-white and color TV picture tubes. Your Sylvania sales engineer will be glad to discuss specific phosphor and settling chemical requirements with you.

For your files, write for: *Sylvania Phosphors*. This information-packed publication contains data on Sylvania phosphors for every application.

SYLVANIA ELECTRIC PRODUCTS INC.
Tungsten and Chemical Division, Towanda, Penna.

TUNGSTEN • MOLYBDENUM • CHEMICALS • PHOSPHORS • SEMICONDUCTORS

SYLVANIA

Lighting • Radio • Electronics • Television • Atomic Energy

CIRCLE 296 ON READER-SERVICE CARD FOR MORE INFORMATION

Ideas for Design

Transistorized Sa

The Problem

In developing a horizontal output amplifier for a general purpose oscilloscope, using transistors, it was desired to pass sawtooth wave-forms at frequencies up to 40 kc. In order to obtain sufficient voltage output from the transistor to drive the deflection plates, it was necessary to use a step-up transformer. The requirement was for a transformer with at least a 5:1 step-up ratio and reasonably flat response from 20 cycles out to at least 250 kc. No such unit was available commercially, and it sounded like a difficult and possibly expensive design project, to build up such a transformer.

Solution

As an alternate solution to the problem, two horizontal output transformers were used, a UTC A-24 for the low and middle frequencies, and an Argonne AR-104 for the high frequencies. Once a switch-over frequency had been determined, switching one or the other transformer into the output circuit is accomplished by extra contacts on the usual sweep frequency range switch. Thus, two comparatively inexpensive transformers are used to perform the

Transistorized horizontal deflection amplifier

Get \$10.00 plus a by-line for the time it takes you to jot down your clever design idea. Payment is made when the idea is accepted for publication. Full information and an "entry blank" can be obtained by circling 548 on the Reader's Service Card.

Sawtooth Amplifier

function of one expensive, and unavailable, unit. A second advantage of this arrangement is that it permits great flexibility in the choice of the means used to drive and terminate each transformer, as well as in the choice of feedback arrangements. These quantities can then be optimized for a particular frequency range. The horizontal output transistor, a GE 2N76, is shown as V-5 in the accompanying schematic diagram and S-1A, and S-B are ganged with the sweep frequency control. The switch-over frequency was 4 kc. Joseph Chernof, Sr., *Electronic Engineer, Bell Aircraft Corp., Buffalo, N.Y.*

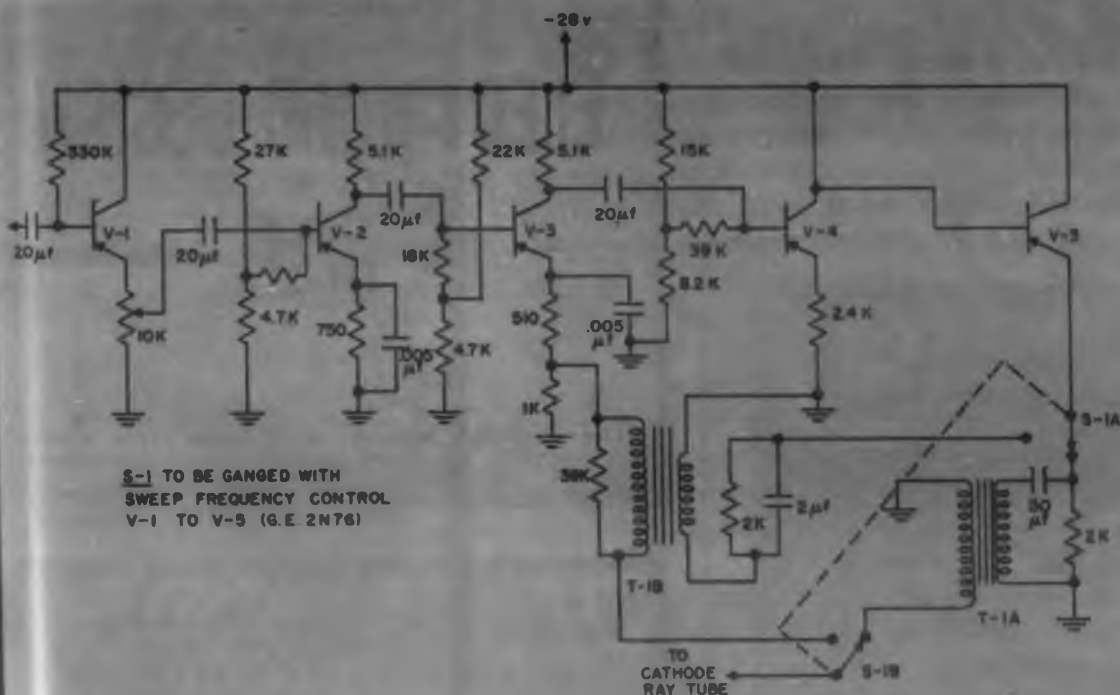

AT LAST a completely new kind of regulator!

**ACTUALLY THREE REGULATORS IN
ONE—PLUS MULTIPLE SENSING!**

The APR 1010 combines many new regulation and sensing systems in one versatile package. Here's flexibility of operation never before possible... saves space, eliminates instrument duplication, means greater economy in engineering operations.



- RMS VOLTAGE REGULATION
- AVERAGE REGULATION
- PEAK REGULATION
- FIVE PRINCIPAL SENSING ARRANGEMENTS

1. Internal
2. External
3. Remote
4. Constant Current
5. DC

ELECTRICAL CHARACTERISTICS:

| | |
|---|--|
| Input | 95-130 VAC, 1 ϕ (50 or 60 cps \pm 10%) |
| Output | 115 VAC, adj. 110-120V |
| Regulation accuracy (RMS, average, or peak, switch selected) | \pm 0.1% against line \pm 0.1% against load |
| Distortion | 3% max. |
| Load | 0-1000VA |
| P.F. range | Unity to 0.7 lagging |
| Recovery time | 0.1 sec. |

WRITE FOR COMPLETE TECHNICAL DATA.



SORENSEN & COMPANY, INC. • STAMFORD, CONN.

CIRCLE 297 ON READER-SERVICE CARD FOR MORE INFORMATION

MORE DESIGN FREEDOM

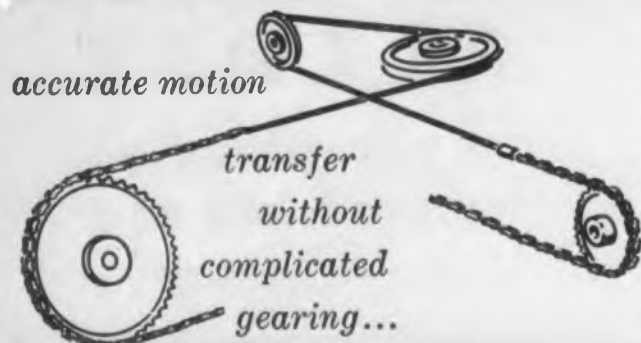

SIERRA MINIATURE MECHANICAL CHAIN AND SPROCKETS...

Provide precise, positive motion transfer through several planes simultaneously with no cable slippage...no complicated gearing. Unlimited center-to-center selection for miniature and sub-miniature assemblies in servo systems, gyro systems, special cameras, electronic equipment, and small precision instruments. Less weight, cost, maintenance—wider tolerances. Designed to operate around minimum 7-tooth sprocket with root diameter of .250 inches. Chain pitch .1475 inches; Weight .45 oz. per lineal ft. Material: stainless steel, or other materials, including non-magnetic beryllium copper.

NEW CATALOG



Contains useful application data, specifications, tables on chain pitch and sprocket sizes, suggestions for calculating center-to-center distance. Write for yours today.

123 E. Montecito Avenue,
Sierra Madre, California



T. M. REG.

CIRCLE 302 ON READER-SERVICE CARD FOR MORE INFORMATION

NEW 550°F. LOW HEIGHT NUTS for electronic applications

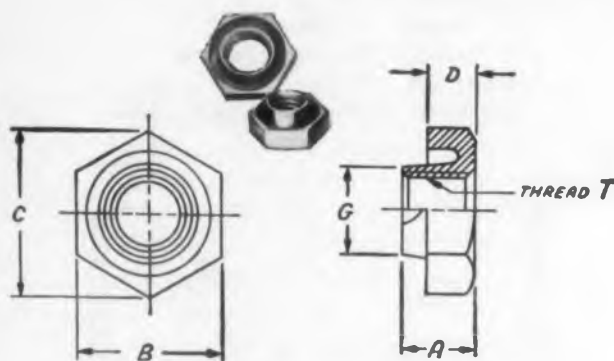

| PART | RANGE OF SIZES | | |
|--------------|----------------|-----------|-------------|
| | A | B | THREAD |
| LHTE & LHMT | | | |
| Sizes 4/40 | .117 | .252-.240 | 4-40NC-3B |
| Thru 5/16-24 | .258 | .502-.490 | 5/16-24NF-3 |

For electronic applications where vibration-proof security at high operating temperatures is needed. These low height all-metal ELASTIC STOP® nuts have AN approval for operation up to 550°F. Cadmium plated, heat treated carbon steel. For design information and complete specifications, write:

Elastic Stop Nut Corporation of America
2330 Vauxhall Road, Union, N. J., Dept. N-24-557.

CIRCLE 304 ON READER-SERVICE CARD FOR MORE INFORMATION

Ideas for Design

Surge Limiting Device

The Surgistor, a combination of a resistor and a thermal relay, is claimed to triple the life of all TV tubes. This simple device, inserted in series with the power line, reduces the current drawn by electronic equipment for about 10 sec before applying full voltage.

The cold resistance of vacuum tube filaments is about one-seventh of the hot resistance. Hence, when electronic equipment is first turned on, there is a rush of current which greatly exceeds the current drawn in normal operation. Though most modern vacuum tubes are designed to withstand this "inrush current," with no deleterious effects, the Wuerth Tube-Saver Corporation, 9125 Livernois Ave., Detroit, Mich., manufacturers of the Surgistor, maintains that at least 50% of all damage to tubes is caused by the instantaneous surge of current when the power is initially switched on. The Surgistor is claimed to increase tube life 65 to 360%, as well as lengthening the life of selenium and silicon rectifiers, electrolytic capacitors and other components.

The device is designed for use with 117 v equipment drawing 100 to 300 w. Its theory of operation is simplicity itself. The resistive element is a wire, tightly wound on a glass fiber core. The element is sealed in a ceramic case. On one end there is a bracket which positions the relay's stationary contact. On the opposite end, another bracket anchors the bi-metal blade and moving contact. When the equipment is first turned on the fixed resistance heats up, reducing the voltage across the equipment and heating the bi-metal blade. As the internal resistance of the circuit rises due to filament warm-up, the voltage drop across the equipment increases.

In about 10 sec the contacts of the bi-metal strip close, shorting out the fixed resistor and allowing full voltage across the equipment. Line current through the 0.2 ohm resistance of the strip generates enough heat to keep the contacts closed.



ARNOLD TOROIDAL COIL WINDER

sets up quickly... easy to operate...
takes wide range of wire sizes

SPECIFICATIONS:

- Min. finished hole size: .18 in.
- Max. finished toroid O.D.: 4.0 in.
- Winding speed: 1500 turns/min.
- Wire range: AWG 44 to AWG 26
- Dual, self-checking turns counting system
- Loading (wire length) counter
- Core range: 1/4" I.D. to 4" O.D. to 1 1/2" high

LABORATORY USE

- Change wire and core size in 45 sec.

PRODUCTION USE

- 1500 turns per minute
- Insert core and load in 20 sec.

write or telephone for literature

ARNOLD MAGNETICS CORP.
4615 W. Jefferson Blvd., Los Angeles 16, Calif.
REpublic 1-6344

CIRCLE 303 ON READER-SERVICE CARD FOR MORE INFORMATION

another ELECTRONIC DESIGN first

The "Career's Section" with home reply service only obtained in ELECTRONIC DESIGN—most timely and most complete of any electronic publication.

Miniature Pressure Transducers for operation to + 400°F.



Temperature compensated
over 465°F. interval

0.01%/°F. thermal coefficient of
sensitivity from -65° to +400°F.

0.01%fs/°F. thermal zero shift
from -65° to +400°F.

No cement or resin pressure seals

Homogeneous sensing diaphragm
surface

Statham unbonded strain gage
transduction

Minimum response to vibration
or acceleration

Pressure adapters for closed
line applications

Absolute Pressure Transducers
0-5 to 0-500 psia - Model PA260TC

Gage Pressure Transducers
0-5 to 0-500 psig - Model PG260TC

Differential Pressure Transducers
0-5 to 0-500 psid - Model PL260TC
± 2.5 to ± 25 psid - Model PM260TC

When the transducer is a
Statham, pressure
measurements at elevated
temperature are made with
accuracy and confidence.

Complete specifications available upon request.

Please wire or telephone us collect
whenever we may be of service.

Statham
LABORATORIES

12401 W. Olympic Blvd., Los Angeles 64, Calif.

CIRCLE 306 ON READER-SERVICE CARD



Simplified Potting

A simplified way for potting electrical connectors on missile and aircraft wiring harnesses has been developed at Chance Vought Aircraft. A mold of aluminum formerly was used to form the polysulfide plastic resin base around the connectors. The resin either stuck to the metal and had to be scraped off; or, if a petroleum coating was smeared inside the mold, this had to be wiped off after each operation.

By making the mold of chrome-plated steel, the resin does not stick. To keep the molten resin from leaking through the mold and fouling up the electrical points on the open face of the connector, the mold with the connector in it is dipped in cellulose acetate butyrate plastic. This forms a cap which seals off the exposed portion and can easily be peeled off and remelted after each operation.

This new method of potting the connectors saves an estimated 10 minutes work on each dipping and eliminates messy molds.

Three Bolts Do the Work of Four

Three bolts, positioned 120 degrees apart around a common center, can provide as stable a joint as the conventional pattern of four bolts arranged symmetrically. Savings in assembly, made possible by fewer holes to drill and fill, often make the three-bolt joint more desirable. Savings in cost of fasteners are also significant.

Holding capacity lost in using fewer bolts is made up by using stronger ones. This alternative still permits savings in the cost of fasteners. For example, either four 3/4-in. bright cap screws or three 3/4-in. high tensile bolts may be used to carry an 80,000 pound load safely. But three of the high strength bolts cost less than four of the cap screws.

In terms of holding power, the stronger the bolt, the less it costs. Engineers at Russell, Burdsall, & Ward Bolt and Nut Co. calculate that a dollar's worth of holding power in high tensile bolts cost \$1.50 when bright cap screws are used and \$1.65 with machine bolts.

BUILT TO THE ACCURACY YOU REQUIRE

Kearfott Series R900 Synchros

... are not selected, but are built to the specific degree of accuracy required. The accuracy of each class and the distribution of errors within each class, is a function of rigid quality control. The curves below indicate the degree of accuracy of three classes of synchros. The distribution of errors in each class is indicated in the cross-hatched area beneath each curve.

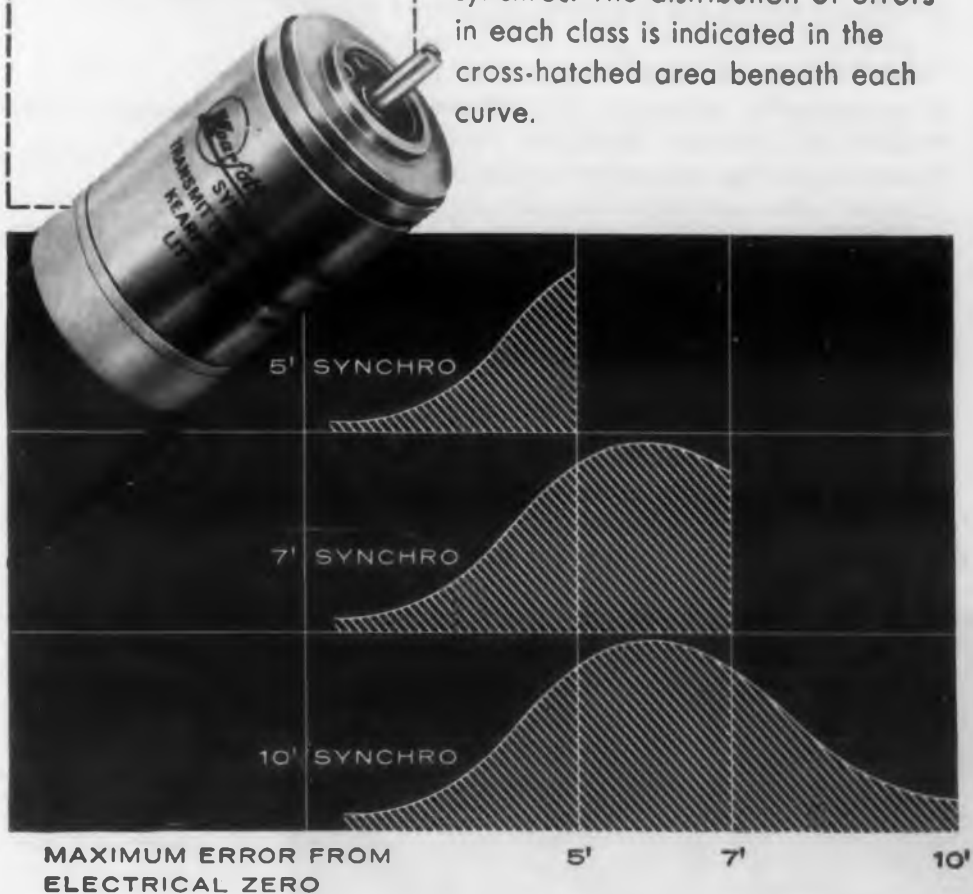

Kearfott Series R900 Synchros are characterized by high accuracy, corrosion resistance and new high temperature stability. Units available for early delivery.

KEARFOTT COMPONENTS INCLUDE:

Gyros, Servo Motors, Synchros, Servo and Magnetic Amplifiers, Tachometer Generators, Hermetic Rotary Seals, Indicators and other Electrical and Mechanical Components. Kearfott Systems include Directional Gyro Compass Systems, Three Gyro Stable Platform Systems and Inertial Navigational Systems.

Send for bulletin giving data of components of interest to you.



KEARFOTT COMPANY, INC., LITTLE FALLS, N. J.

Sales and Engineering Offices: 1378 Main Avenue, Clifton, N. J.

Midwest Office: 188 W. Randolph Street, Chicago, Ill. South Central Office: 6115 Denton Drive, Dallas, Texas

West Coast Office: 253 N. Vinado Avenue, Pasadena, Calif.

CIRCLE 307 ON READER-SERVICE CARD FOR MORE INFORMATION



what...

**7-minute delivery
of etched, anodized
metal nameplates?
Sounds impossible, BUT...**

with Miller Dial's revolutionary new Fotofoil Kit, short run problems for nameplates, dials, panels, schematics and templates, are solved in just 7 minutes...and it's all done in your own plant! Fotofoil Kit requires no darkroom, skilled technicians or photographic equipment. This self-contained kit includes all necessary chemicals, equipment and Fotofoil to produce top quality product identification...in just a few easy steps! Fotofoil is supplied in all standard anodized colors and thicknesses from .003. Designed for "crash" programs, research and development departments, prototype models.

Write dept. ED-5 today for complete information



**MILLER DIAL &
NAME PLATE CO.**

4400 N. TEMPLE CITY BLVD., EL MONTE, CALIF.
Offices in principal cities

CIRCLE 308 ON READER-SERVICE CARD FOR MORE INFORMATION

**LET US
MAKE
YOURS...**

COILS
CLIPS
TERMINALS
CONNECTORS
from the material
of your choice

and, of course, all types of springs, wire forms, small stampings
Send for booklet — "Spring Design and Selection — in brief"

**ASSOCIATED
SPRING
CORPORATION**

General Offices: Bristol, Connecticut

CIRCLE 309 ON READER-SERVICE CARD FOR MORE INFORMATION

Report Briefs

Lovotron Gap Switch

The construction of a triggered gap switch which operates at voltages as low as 1 kv and handles currents up to 5×10^5 amperes is described. The switch is designed to operate on single pulses. Time jitter is of the order of 0.1 μ sec between successive pulses. PB 121061 Lovotron: A Low Voltage Triggered Gap Switch, E. H. Cullington, W. C. Chace, R. L. Morgan, US Air Force. Air Research & Development Command, Cambridge Research Center. Geophysics Research Directorate, Cambridge, Mass. Sep 1955. 19 pp, \$0.50.

Damping Devices

A bibliography of the literature on damping devices for mechanical vibrations published between 1924 and August 1956. The references cover studies of vibration damping by increasing the mechanical impedance of the system, by energy dissipation, or by tuned attachments, and of vibration isolation by vibration dampers, connection damping, and material damping. PB 121299 Devices For Damping Mechanical Vibrations, A Bibliography, M. Benton, Naval Research Lab., Dec. 1956, 101 pp. \$2.75.

Spiraled Waveguides

The discussion is based on some simplifying assumptions about the field distribution in the neighborhood of the solenoid. A simple boundary condition is used that represents an idealized case and enables a rigorous solution of Maxwells' equation in terms of a superposition of TE and TM guided waves. In this idealized case the field inside the solenoid is completely isolated from the field inside the window. Separate solutions are found independently for both fields and there is no coupling between them. For an actual spiral these ideal conditions could not be met. PB 123148 Spiraled Coils As Waveguides, L. Brillouin. Harvard University. Cruft Lab, Cambridge, Mass. Mar 1947, 23 pp, Microfilm \$2.70, photostat \$4.80.

THERMOSTAT BOSSES SIZABLE ELECTRICAL LOADS WITHOUT RELAYS.



Snap-action THERMOSWITCH® units in wide use without relays, handling loads up to 20 amps, 115-220 volts A.C., or 10 amps, 125 volts, D.C.

Fenwal design of liquid-filled sensing element assures minimal heat transfer path, fast response, control to within $\pm 2^\circ\text{F}$.

Models available to control single or multiple circuits. Low-cost tailor-mades assembled from stock parts. Thousands of variations possible.

Designers — write for details to Fenwal Incorporated, 175 Pleasant St., Ashland, Mass.

Fenwal

Controls Temperature . . . Precisely

CIRCLE 310 ON READER-SERVICE CARD FOR MORE INFORMATION

BIG PLUS in PRECISION POTS



RL-270A-1 Precision Potentiometer . . . one of five sizes from 1 1/2" to 5" diameter. Non-metallic housing has high dimensional stability, withstands -70F to +300F.



RL-270B-2 shows ganging which is available on all RL-270B models. Gemwell design requires only 1/8" per section, and external clamps provide unlimited phasing.

Gamewell Blue Line RL-270 A&B SERIES



RL-270A-5 is the largest in the Blue Line series. As with others, it is usually supplied with 3-hole mounting. Servo and threaded-bushing type mountings are available. Also many special features . . . send us your requirements.



Special RL-270A-5 with 48 taps, shows maximum number. Allows 47 equal resistance sections, while maintaining guaranteed linearity of $\pm 0.1\%$. Total resistance of 500,000 ohms, resolution of 0.0075%.

RL-270A and B Series available in many special variations. Write for catalog and specifications and prices on your specific requirements.

THE GAMEWELL COMPANY
Newton Upper Falls 64, Mass.



PRECISION POTENTIOMETER DIVISION

CIRCLE 311 ON READER-SERVICE CARD FOR MORE INFORMATION



another
product surprise
from



**Beckman
Differentials**

Our differentials, for use in servo systems and analog computers, are ready, willing and available... now!

Proud members of our large family of standard electro-mechanical breadboard parts, Beckman differentials come in three shaft diameters: 1/8", 3/16" and 1/4" ... all as low in backlash as they're high in accuracy.

Gleason-Coniflex stainless-steel bevel gears mean good tooth-to-tooth action; gears are cut to AGMA Precision Class 2. Breakaway torque is low... ball bearings, preloaded... end-gear runout tolerances, minute.

A handsome new family album fully describes and illustrates our complete line of standard parts ... ask for data file 555.

Beckman
Helipot Corp., Newport Beach, Calif.
a division of Beckman Instruments, Inc.
Engineering representatives in principal cities.

1038

CIRCLE 312 ON READER-SERVICE CARD FOR MORE INFORMATION

Radiological Health Handbook

This radiological health handbook contains a glossary of radiological terms and sections on physical, chemical and mathematical data, radioisotopes, decay, radioassay, and radiation protection. A table of isotopes also is included. PB 121784, *Radiological Health Handbook*, S. Kinsman, R. A. Taft Sanitary Eng. Center, Public Health Service, OTS, U.S. Dept. Commerce, Washington 25, DC, January 1957, 356 pp, \$3.75.

Control System Nulls

The major result of this report is a formula for null voltage of a synchro control system, consisting of a transmitter and transformer, in terms of its impedances. It is found that the error and null voltage (more precisely, the null voltage ratio) are conjugate parts of the same complex function of the impedances. PB 120852, *Part II, Null Voltages in Control of Systems*, by G. H. Weiss and J. H. Rosenbloom, January 1953, 46 pp Mi \$3.30, ph \$7.80, LC, Washington 25, D.C.

Analysis of Synchros

In a linear lumped parameter analysis, the action of synchros is completely defined in terms of their impedances and a single-frequency voltage source. The impedances are Fourier series in terms of the angular position of the rotor. Necessary and sufficient conditions for an errorless synchro control system and formula for the error of an individual synchro are derived in terms of the impedances. An elementary introduction to matrix and tensor analysis to the extent required to develop these results is also included. PB 120921, *Part I, Linear lumped parameter analysis of synchros*, J. H. Rosenbloom, U.S. Naval Ordnance Lab., White Oak, Md. LC, Washington 25, D.C., Feb. 1951, 51 pp, \$3.60 Mi, \$9.30, ph.

Variance Analysis Equations

Computational formula are presented for a statistical method for distribution-free, or non-parametric, tests of hypotheses concerning both main effects and interactions in multi-factor experimental designs. The formulae reduce computational errors by resulting in an integer numerator and an integer denominator for each component at the last step in the computational process. The statistical method and formulae may be especially useful in cases of multi-factor analysis-of-variance designs in which the assumptions are not met by data. PB 121698, *Computational Formulae for a Distribution-Free Test of Analysis-of-Variance, Hypotheses*, E. A. Alluisi, Ohio State University and OSU Research Foundation for Wright Air Development Center, OTS, Dept. Commerce, Washington 25, DC, July 1956, 17 pp, \$50.

In Modern Design

Koiled Kords

play an important part

The use of KOILED KORDS retractile cords on more and more communications and industrial equipment in the past ten years has proved their claim of safety and convenience.

Designers have found KOILED KORDS invaluable in solving many wiring problems.

CAN YOU USE
KOILED KORDS?

Our years of experience with KOILED KORDS is available to you, without obligation, for help in solving your wiring problems.

Write for catalog today.



KOILED KORDS, THE ORIGINAL RETRACTILE CORDS, ARE THE RESULT OF 17 YEARS OF RESEARCH, DEVELOPMENT AND USE.

KOILED KORDS is a trademark of Koiled Kords, Inc.

CIRCLE 314 ON READER-SERVICE CARD FOR MORE INFORMATION

NEW SUB-MINIATURE

Toggle-actuator Unimax USMB-1 switch — panel-mounting in less than 1/2 square inch.

•Reliable, precision, snap-acting, SPDT, fully-enclosed switch for use in miniaturized apparatus.

•Rating: 2 1/2 a. 30 v d-c, inductive; 4 a. 30 v d-c, resistive; 5 a. 125/250 v a-c.

•Furnished to meet commercial standards. Also available for high-temperature use up to 275°F. and to meet Military Specification MIL-S-6743.

FREE DATA SHEET on all Unimax sub-miniature switches and actuators available on request.

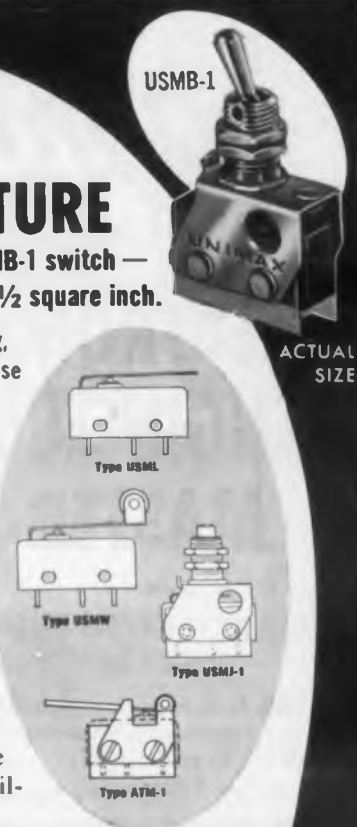

UNIMAX SWITCH

Division The W. L. Maxson Corporation
400 WES ROAD, WALLINGFORD, CONNECTICUT

CIRCLE 313 ON READER-SERVICE CARD FOR MORE INFORMATION



small
package...
high
performance!

WOW/FLUTTER METER

MODEL 2800 This portable Wow and Flutter Meter reads RMS flutter directly with minimum number of operating adjustments. Two stage limiting gives 5% accuracy at any input amplitude between 0.1-50 volts at 3 kc (5-50 volts at 1 kc). Tuning indicator gives fail safe assurance that accurate readings are obtained. Usable wow/flutter readings from approximately 0.02% to 3% in three scales. Output filter selects wow, flutter, or wow/flutter, 3 kc constant frequency test signal output for recording. Meets or surpasses all IRE-SMPTE-ASA standards. Model 2800, \$295 FOB Concord. Write for technical data.

DONNER SCIENTIFIC COMPANY

824 Galindo Street
Concord, California



CIRCLE 317 ON READER-SERVICE CARD FOR MORE INFORMATION

LATEST NEWS ABOUT ELECTRONIC PRODUCTS FROM SUPERIOR TUBE

NICKEL CATHODES FOR ELECTRON TUBES. Now five *Cathaloy** available. Exclusive Superior Tube alloys. They simplify selection, prolong tube life, greatly improve performance. Also six other standard alloys, plus special alloys as requested.

DISC CATHODES FOR TV PICTURE TUBES. Three types: standard narrow neck to permit shortening the tube and reducing neck diameter, and miniature for 3-gun color TV picture tubes. All with "E" dimension controlled to $\pm .0005$ in.

GLASS SEALING ALLOYS. Wide choice of metals for virtually any type glass. Many special alloys available on order. Sizes from .012 to $\frac{3}{8}$ -in. OD.

FABRICATED TUBULAR PARTS. Special facilities to do complete job of making close-tolerance tubular parts. They save you handling costs. Wide choice of different analysis metals. Just send drawing.

APERTURE MASKS.** Both round and rectangular aperture masks for color television. Produced in the cupronickel and other alloys, 500,000 holes are made in the mask by the photoetching process.



NEW FREE CATALOG. Complete information on Superior Tube electronic products. Write for your copy, plus Data Memorandum No. 5 (Aperture Masks) and Data Memorandum No. 15 (Glass Sealing Alloys). Write Superior Tube Company, 2050 Germantown Ave., Norristown, Pa.

*Cathaloy is a trademark of Superior Tube Co., Reg. U.S. Pat. Off.
**Manufactured by Superior Tube Co. under license from Buckbee Mears Co., St. Paul, Minn.

Superior Tube
The big name in small tubing
NORRISTOWN, PA.

Johnson & Hoffman Mfg. Corp., Mineola, N.Y.—
an affiliated company making precision metal stampings and deep-drawn parts

CIRCLE 318 ON READER-SERVICE CARD FOR MORE INFORMATION

Report Briefs

Near-Zone Paraboloid Fields

The field structure produced when the feed is displaced from the focus with the feed horn axis remaining parallel to the reflector axis is described. Experimental results have been compared with theoretical geometrical optic principles and with theoretical intensity patterns resulting from the theory of aberrations as developed by Nijboer. In discussing the effects of geometrical aberrations upon the intensity pattern it is shown that various types of phase variation over the aperture have the same effect upon the intensity patterns. *PB 123426 Near-Zone Fields of Paraboloid Reflectors, D. G. Dalley, California, Div. Electrical Eng. Electronics Research Laboratory, Antenna Group, Berkeley, Calif. Oct. 1955. 80 pp, Microfilm \$4.50, photostat \$12.30.*

Thermistor Circuits

Methods are developed for the accurate determination of the linear parameters of this circuit in this report. In order to obtain the complete data of the thermistor it is only necessary to determine its thermal time constant and three points on a static U-1 characteristic. A simple method for measuring the thermal time constant is described. Measured data for a number of thermistor types are presented. The paper gives a convenient method for the investigation of static and dynamic small amplitude problems in thermistor circuits. Applications to the analysis and synthesis of such circuits are given. *PB 122885 Small Signal Behavior of Directly Heated Thermistors: A Study of Thermistor Circuits, Part 2, N. Bjork and R. Davidson. Chalmers University of Technology, Gothenburg, Sweden. 1955 44 pp, Microfilm \$3.30, photostat \$7.80.*

Transistor Amplifier Design

This report describes a method of multistage wide-band transistor amplifier design incorporating constant resistance ladder networks in the external feedback path. The method described allows one to synthesize the feedback amplifier without the use of equivalent circuits for the transistors. This is done by approximating the measured amplifier gain function without feedback with a rational function of frequency and then applying unilateral feedback theory in the design of the feedback path. By use of constant resistance ladder networks in the feedback path interaction effects are eliminated. The results of some design experiments are discussed. *PB 121556 Transistor Feedback Amplifier Design, George L. Benning. California University. Division of Electrical Engineering. Electronics Research Lab., Berkeley, Calif. Oct. 1955. 29 pp, \$0.75.*

CORNING HIGH-POWER RESISTORS



are now available from your
ERIE-CORNING
distributor



Corning High-Power, High-Frequency Resistors are designed for long-life service and are remarkably stable regardless of moisture and humidity. They are available within the range of 10 ohms to 1 megohm, in tolerances as close as 1%, ratings of 7 to 115 watts, and are non-inductive.

Now, these resistors are available from stock in all RETMA values from the same Erie-Corning Distributors who supplied you with Corning Glass Capacitors.

Other styles and types of Corning resistors may also be ordered through these Erie-Corning Distributors.

For complete service information and prices
... see your Erie-Corning Distributor.

ERIE
electronics

ERIE ELECTRONICS DISTRIBUTOR DIVISION
ERIE RESISTOR CORPORATION
ERIE, PA. - LONDON, ENGLAND - TRENTON, ONTARIO

CIRCLE 319 ON READER-SERVICE CARD FOR MORE INFORMATION

Coming!

the new
ELECTRONIC ENGINEERS MASTER



a companion volume to
The Radio-Electronic MASTER

EEM is a new comprehensive catalog and buying guide for electronic components, materials and services sold direct to manufacturers and end users. Here's how engineers and purchasing agents can qualify for a FREE copy.

- 1 Write to us on your company letterhead indicating your title or position.
- 2 List the name of the chief engineer and purchasing agent of your division or company.

ELECTRONIC ENGINEERS MASTER
60 Madison Avenue, Hempstead, N. Y.



GEE-LAR KNOBS FOR IMMEDIATE DELIVERY

Fast Service is the big "plus" you get at GEE-LAR—the House of Knobs. Hundreds of styles, sizes and types, including deluxe Gold Inlay Knobs, are stocked . . . quickly shipped to you in any quantity. Best of all, your costs are always moderate . . . there's no charge for tooling or molds.

FAST SERVICE
Gee-Lar is geared for immediate deliveries. Get the facts today.

KNOBS FOR
Television • Home Radios
Phonographs • Clock Radios
Auto Radios • Instruments . . .
many others.

GEE-LAR MFG. CO.
Division of G-C-Textron Inc.
400 South Wyman Street • Rockford, Illinois

WRITE today for your big, free illustrated Gee-Lar Catalog. No obligation!

QUICK SERVICE

ON STAINLESS STEEL FASTENINGS IS STAR'S SPECIALTY

AN DRILLED FILLISTERS
BOLTS
CAP SCREWS
CAP SOCKETS
DOWEL PINS
COTTER PINS
MACHINE SCREWS
NUTS
PIPE FITTINGS
SET SOCKETS
SHEET METAL SCREWS
STUD BOLTS
TAPER PINS
WASHERS
WOOD SCREWS

7,000 sizes and types
RIGHT OFF THE SHELF*
always available . . . you can order Right from this book in any quantity . . . for immediate delivery!
Write, wire, phone TODAY for your copy of the New Star Catalog!

* Stainless Star says "Star's screws have clean, bright and shiny heads"

LOOK TO STAR, the one-source resource for quick service on stainless steel fastenings.

STAR STAINLESS SCREW CO.
663 Union Blvd., Paterson 2, N.J.
Telephone: Little Falls 4-2300
Direct New York phone: Wisconsin 7-9041

CIRCLE 321 ON READER-SERVICE CARD FOR MORE INFORMATION

ELECTRONIC DESIGN • May 15, 1957

X-forms in Variance Analysis

Usual analyses of variance procedures depend on assumptions which may not be fully met by experimental conditions. This difficulty often may be decreased by transforming the collected data before making the tests or estimates. This study investigates the theory of various transformations, including square-root, reciprocal, logarithmic, and square-root of the log. Objective tests for use as criteria for determination of the proper type of transformation are also examined. *PB 121716, Notes on the Use of Transformations in the Analysis of Variance, E. G. Olds, T. B. Mattson, and R. E. Odeh, Carnegie Institute of Technology for Wright Air Development Center OTS, U.S. Dept. of Commerce, Washington 25, DC, July 1956, 34 pp, \$1.00.*

Acoustic Wattmeter

The author has constructed a device which gives pointer indications of acoustic intensity over a 50 db range at any frequency between 90 and 10,000 cps. The theory of operation of the apparatus is discussed; the design, construction and testing of the various components is described; and the report concludes with a brief account of the operation of the acoustic wattmeter as a whole. *PB 124311 Acoustic Wattmeter, Theodore J. Schultz, Harvard University, Acoustics Research Lab. Nov. 1954 107 pp, Microfilm \$5.70, photostat \$15.80.*



Time / Frequency Calibrator

A Compact, Inexpensive, Accurate Secondary Frequency Standard

- ★ Crystal-controlled fundamental frequencies at 10 kc, 100 kc, 1 Mc and 10 Mc; usable harmonics to 1,000 Mc
- ★ High stability of 1 ppm/°C after 1 hour warm-up, when used with Type 1201-A Power Supply
- ★ New crystal mixer circuit produces and detects beats over entire 1,000 Mc range, with self-contained audio amplifier locates calibration points for r-f oscillators without additional equipment
- ★ Internal video amplifier makes available accurately known multivibrator square waves, supplying timing pulses at intervals of 0.1, 1.0, 10 and 100 μ sec for triggering oscilloscope sweeps and pulse-generating equipment.

Type 1213-C Unit Time/Frequency Calibrator: \$195
Type 1201-A Regulated Unit Power Supply: \$85

Write For Complete Data

GENERAL RADIO Company

275 Massachusetts Avenue, Cambridge 39, Massachusetts, U.S.A.

Broad Avenue at Linden, Ridgfield, N. J. NEW YORK AREA 920 S. Michigan Ave. CHICAGO 5
8055 13th St., Silver Spring, Md. WASHINGTON, D. C. 1150 York Road, Abington, Pa. PHILADELPHIA
1000 N. Seward St. LOS ANGELES 38 1182 Los Altos Ave., Los Altos, Calif. SAN FRANCISCO

CIRCLE 322 ON READER-SERVICE CARD FOR MORE INFORMATION

Designers—Engineers:

ADVAC TERMINALS

—will solve your toughest hermetic seal problem with a wide margin of safety!

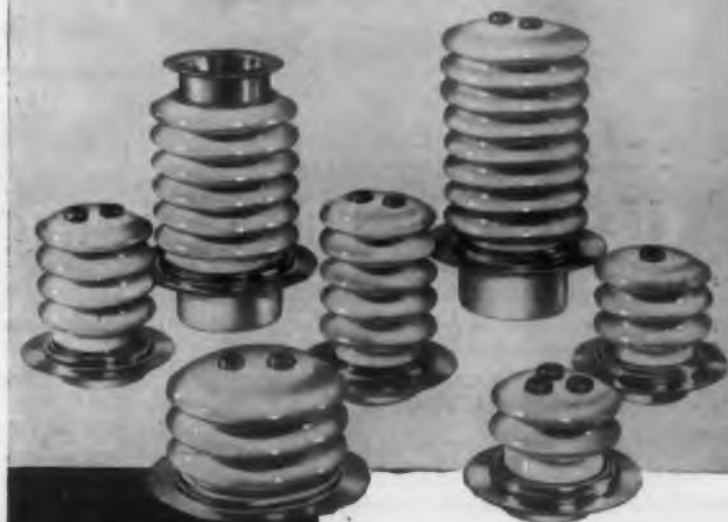

OUTSTANDING DESIGN ADVANTAGES INCLUDE —

- ▶ Immunity to Thermal Shock
- ▶ High Mechanical Strength
- ▶ Maximum Voltage 65,000 V.
- ▶ Adaptable for Brazing, Welding or Soft-soldering

Specify ADVAC for temperatures to 1400° F, pressures to 2000 P. S. I.

ADVAC Hermetic Seals are produced under an exclusive process that provides a superior seal capable of withstanding gruelling environmental conditions. Advac terminals feature a metallized high grade alumina construction that provides a super-strength seal. Performance-proven in critical commercial and military applications, ADVAC seals are available in standard types or custom designs for special requirements.

NEW BULLETIN — contains complete information on the ADVAC line. Address inquiries to Dept. DN.

ADVAC TERMINALS ARE PRODUCTS OF —

ADVANCED VACUUM PRODUCTS • INC

430 FAIRFIELD AVENUE, STAMFORD, CONN.

Telephone: DAvis 4-2148

A DIVISION OF GENERAL CERAMICS CORPORATION
CIRCLE 323 ON READER-SERVICE CARD FOR MORE INFORMATION

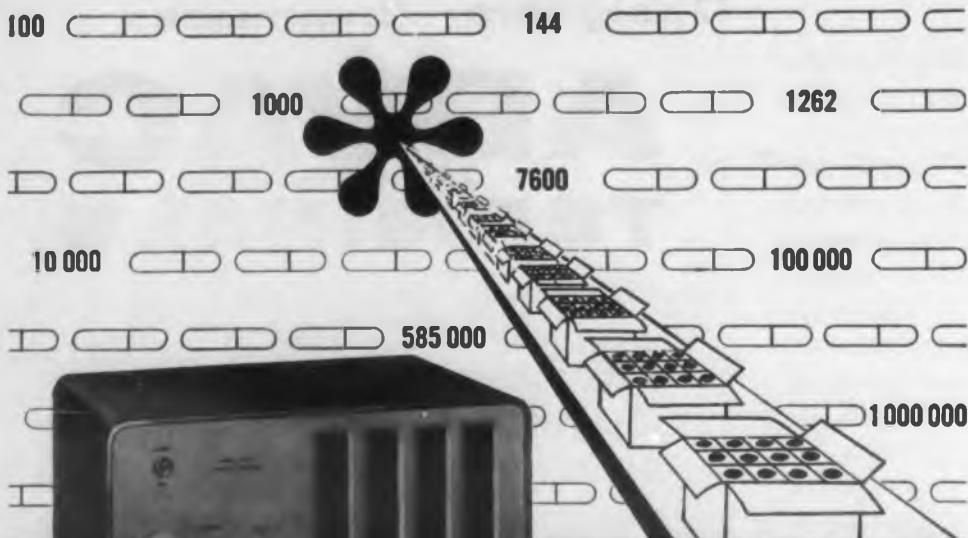

Model
314 A
\$495.00

Automatically count
and control to
1,000,000 events

Advanced Design

ELECTRONIC PRESET CONTROLLER

The CMC Model 310 Series Preset Controllers are designed as high speed direct reading electronic counters of the coincident type which will control any operation or activate an alarm after a preselected total count has been reached.

*A few of the many applications are batching and packaging of pills, bottles, bottle caps, canned goods, pen points, machine parts, electronic com-

ponents, etc., in exact preselected quantities; controlling the exact length of stock in cutting operations; and control of high speed machinery. Any electrical, mechanical or optical events which can be converted into electrical impulses can be counted and controlled. Devices to effect this conversion may be photo-cells, magnetic coils, switches, and suitable transducers for pressure, temperature, velocity, acceleration, displacement, etc.

| SPECIFICATIONS | | | | | | FEATURES |
|---------------------------------------|--|------|--------|---------|-----------|--|
| | 312A | 313A | 314A | 315A | 316A | |
| Decades | 2 | 3 | 4 | 5 | 6 | COINCIDENT TYPE ABSOLUTE ACCURACY DIRECT SETTING DIRECT READ-OUT EXCEPTIONAL VERSATILITY HIGH SPEED RELIABLE RUGGED ECONOMICAL SMALL SIZE |
| Count Capacity | 100 | 1000 | 10,000 | 100,000 | 1,000,000 | |
| Counts per Second | 0 to 100,000 (as totalizing counter) | | | | | |
| Recycling Rate | 50,000 counts per second (as preset counter) | | | | | |
| Input Sensitivity | 0.05 volts rms: 10-100,000 cps 0.07 volts rms: 1-10 cps Positive Pulse Rise Time: 1/2 volt or more per sec. | | | | | |
| Input Impedance | 0.5 megohm, 50 mmf | | | | | |
| Accuracy | Absolute | | | | | |
| Output | 60 volt positive pulse, 10 microseconds duration (negative pulse optional) | | | | | |
| Output Relay Contacts | 5 amps, 117 volts, non-inductive load Normally open or normally closed (with indicator lamp) Can be switched out | | | | | |
| Relay Hold Time | Automatic: Continuously variable from 0.1 to 1 second Manual: Lock until release | | | | | |
| Auxiliary Power | 6.3 volts ac @ 3 amps; +225 volts dc regulated @ 50 ma; -150 volts dc regulated @ 5 ma. | | | | | |
| Power Requirements | 117 volts ± 10% 50-60 cycles 100-150 watts depending on model | | | | | |
| Dimensions | 13" W x 8 3/4" H x 13" D 16 1/4" x 8 3/4" x 13" | | | | | |
| Net Weight | 20 to 28 lbs. depending on model | | | | | |
| Finish | Panel: Light grey baked enamel Case: Dark grey baked enamel | | | | | |
| Data Subject to Change Without Notice | | | | | | |

The direct reading Model 101A Preset Decade Counting Unit is designed to provide an output pulse at a selected number at rates in excess of 50,000 counts per second. They are capable of counting at a 100,000 cps rate if reset is not required. These units are readily connected in cascade in order to emit a pulse at any desired count. Typical applications are batching, sorting, packaging, automatic counting and control, frequency division, generation of precise delays, etc.

Model 101A \$75.00



Write for complete catalog and prices.

Computer-Measurements Corporation

5528 Vineland Avenue, North Hollywood, Calif. Dept. 76E

22-14

CIRCLE 325 ON READER-SERVICE CARD FOR MORE INFORMATION

Patents

Cathode Input Amplifiers

Patent No. 2,756,283. H. M. Bach. (Assigned to Radio Corporation of America)

Cathode input amplifiers are commonly used in high frequency receivers and usually as a part of the antenna connection which feeds into the cathode of a three element amplifier. Where such a tube has its grid connected to ground, undesired cross modulation is encountered particularly from strong signals which are substantially higher or lower in frequency than the signal which is to be received. The amplifier illustrated amplifies the desired input signal but not the undesired frequencies and thereby eliminates cross modulation.

The usual cathode input amplifier includes a triode 10 having a cathode resistor 13 with the input being applied across this

resistor. The control grid is grounded and the plate impedance is an inductor 15. To this well known circuit the patentee adds a filter or frequency selective unit 17 in parallel with the cathode resistor. The control grid is connected with a center tap of this filter. The illustrated filter is a low pass unit with the impedance between the control grid and cathode being a capacitor 21 and the impedance between the control grid and ground being a resistor 22. These impedances are selected to provide a low impedance for the undesired frequencies and a high impedance for the frequency which is to be received and amplified. With this circuit the tube functions as an amplifier for the desired frequency and for undesired frequencies the control grid is connected with the cathode and functions as a diode and hence without gain.

Portable... Versatile...

for temperature testing up to 600° F.

Statham
MODEL
TC-4
TEMPERATURE TEST CHAMBER



For ambient temperature tests in the LABORATORY or on the PRODUCTION LINE, the Model TC-4 Temperature Test Chamber is ideal. The wide operating range of the Model TC-4 Test Chamber, from -65° F to +600° F, affords great versatility in testing applications. Interchangeable extra trays may be ordered for greater convenience and elimination of loading delays.

RANGE: -65° F to +600° F.
HEATER: Two 750 watt finned strip heaters.
Coolant: Dry ice, 15 lbs. capacity.
CONTROL: Adjustable thermostat and selectable heat inputs.
LOAD CAPACITY: 600 cubic inches of test materials.
POWER: 115V, 15 amp., 50-60 cycle.
OVERALL SIZE: 48" x 16½" x 12".
WEIGHT: 62½ lbs.

\$700.00
F.O.B.
LOS ANGELES

Statham
DEVELOPMENT CORPORATION
12411 W. Olympic Blvd.
Los Angeles 64, California

CIRCLE 326 ON READER-SERVICE CARD FOR MORE INFORMATION

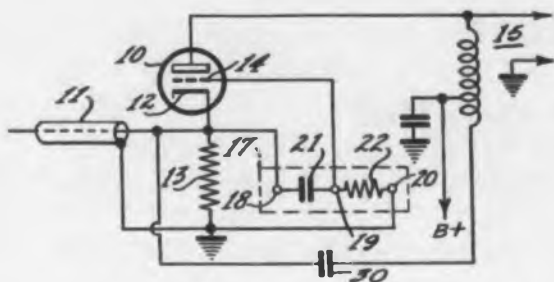
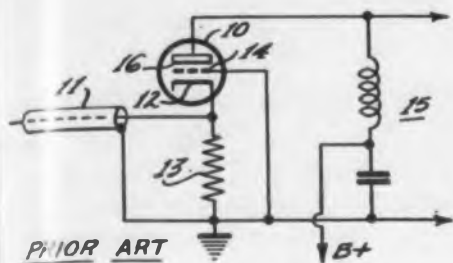

The impedance represented by the capacitor 21 and resistor 22 may be substituted by other impedances depending upon the frequencies which are to be attenuated. The patent illustrates a circuit in which the capacitor 21 is substituted by a conductance and the resistor 22 is substituted by a capacitor to form a high pass filter so that lower frequencies are amplified. In another circuit the capacitor 21 is substituted by a parallel tuned circuit and the resistor 22 is substituted by a series tuned circuit. This is a band pass filter so that only those frequencies in the desired frequency range are amplified. In another form of the circuit the impedance network 17 may be connected between the anode and ground with the control grid being connected to the center terminal between the impedances of the network. These circuits overcome the cross

modulation difficulties, which have been experienced with the cathode input amplifiers heretofore used.

Signal Phase-Correcting System

Patent No. 2,776,428. N. A. Hassler, H. R. Jurman and C. F. Fragola. (Assigned to Sperry Rand Corporation)

There are many signal sources, the output of which is a signal of a noisy character. The purpose of the circuit described is to provide an output signal which is a smooth version of the noisy input signal and is both proportional to the input signal and substantially in phase therewith. The circuit necessarily effects a predeterminable phase lag so that the circuit includes means for advancing the phase of the signal by an amount sufficient to compensate at least to some extent for the phase lag.

INSURE TOP INSTRUMENT Performance

with *Bird* jewel assemblies

Made under rigid quality-control throughout manufacture. Bird complete jewel assemblies come ready to install . . . saving production time . . . eliminating rejects . . . cutting costs.

Bird jewels are custom mounted to your specifications, by skilled craftsmen. All assemblies are thoroughly inspected . . . carefully packaged . . . shipped to meet critical production schedules.

And the cost — far less than trying to make the same assemblies in your own plant — actually only pennies to insure perfect performance for your instruments.

Why not discuss the use of jewel bearings or special assemblies with the Bird engineering staff — they are always at your service for all types of jewel bearing problems — no obligation of course.

For information on Bird Jewel Assemblies write for Bulletin 5.

Over 40 years of serving industry with Quality jewel bearings

Richard H. Bird & Co., Inc.

1 Spruce Street, Waltham 54, Mass.

SAPPHIRE AND GLASS JEWELS, PRECISION GLASS GRINDING,
JEWEL MOUNTING AND ASSEMBLY, SAPPHIRE STYLII

CIRCLE 327 ON READER-SERVICE CARD FOR MORE INFORMATION

NEW PHAOSTRON EXPANDED SCALE AC Voltmeter

Available now from distributors in 90V to 130V Range, AC Rectifier Type in all custom styles and sizes.

3½" or 4½" rectangular meter

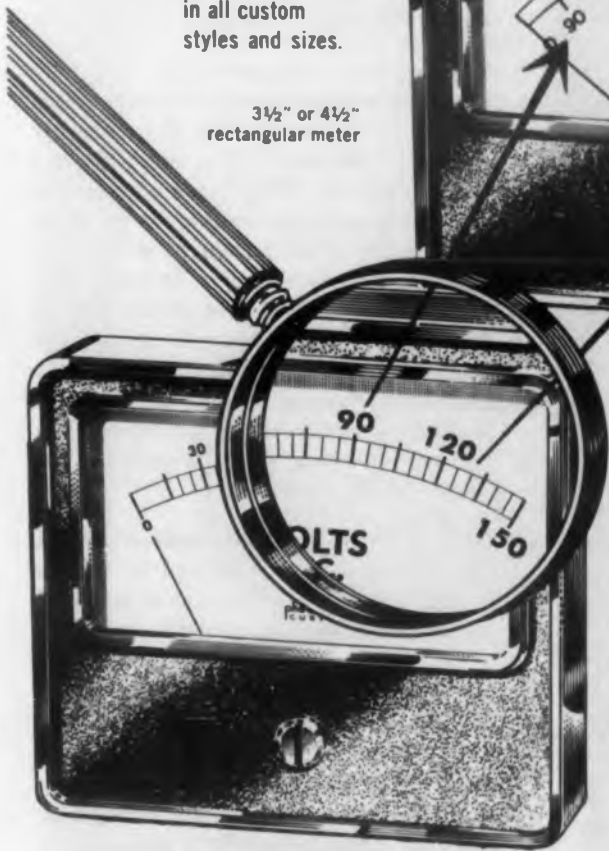
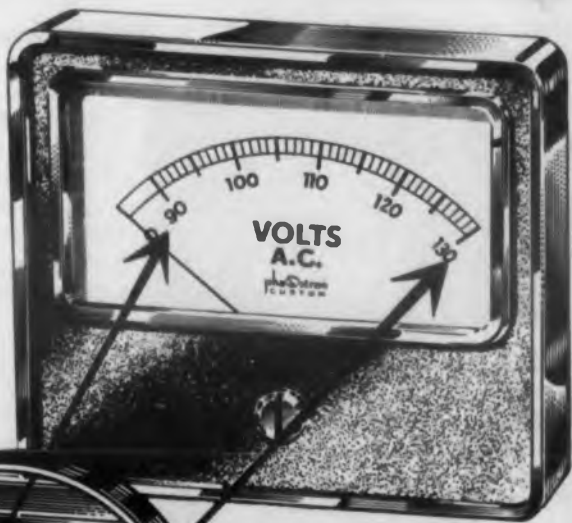

NOW! . . . all the time-tested proven Phaotron features **PLUS UP TO TEN TIMES GREATER READABILITY** for greatly increased accuracy!

2½" or 3½" square meter



6" rectangular meter



2½" or 3½" round meter

Phaotron has squeezed down that under 90V portion of the scale, where you don't need it, and expanded the section where you need it most—between 90 and 130V. Precisely calibrated 1 volt scale increments provide greater reading accuracy. Wide frequency range—linearity—true rms reading and Phaotron craftsman construction.

Phaotron Custom Panel Meters, with expanded scale, 90V to 130V AC rms, are available in nine types at your Parts Distributor. For special requirements for AC or DC expanded scale meters, write to Product Development Dept. for practical recommendations.

All meters available with illuminated dial on special order

PHAOSTRON

PHAOSTRON INSTRUMENT & ELECTRONIC CO., 151 PASADENA AVE., SOUTH PASADENA, CALIF.
CIRCLE 328 ON READER-SERVICE CARD FOR MORE INFORMATION

HIGH POWER SSB LINEAR AMPLIFIER— SIMPLER, SMALLER, AND MORE EFFECTIVE WITH JENNINGS VACUUM COMPONENTS



POWER CUBICLE ● CONTROL CUBICLE ● RF CUBICLE
TYPE MS WESTINGHOUSE LINEAR AMPLIFIER



Tank and output tuning capacitors and relays



Jennings capacitors have been the standard for years in high power transmitter design. Now engineers are finding that Jennings vacuum relays are an extremely flexible tool for switching all levels of dc, rf, and 60 cycle power, making possible new concepts of transmitter design.

Westinghouse engineers have skillfully used both vacuum capacitors and vacuum relays in this new Type MS 30 KW Linear Amplifier designed for single sideband communications. They have utilized the low minimum capacities and the accurate resetability of small variable vacuum capacitors to tune the pi network tank circuit and for input and output tuning. Jennings Type R5C vacuum relays have also been used in the tank circuit to switch load connections so that the tuning range could be extended without using any tap switches or sliding contacts carrying circulating tank currents.

The ingenious use of these modern vacuum components has thus helped to reduce both the complexity and size of this high performance amplifier while permitting it to be automatically or manually tuned over the entire frequency range of 4.0 to 26.5 mc.

Our 1957 catalog summary contains many new vacuum components to help simplify transmitter design. Please send for your copy.

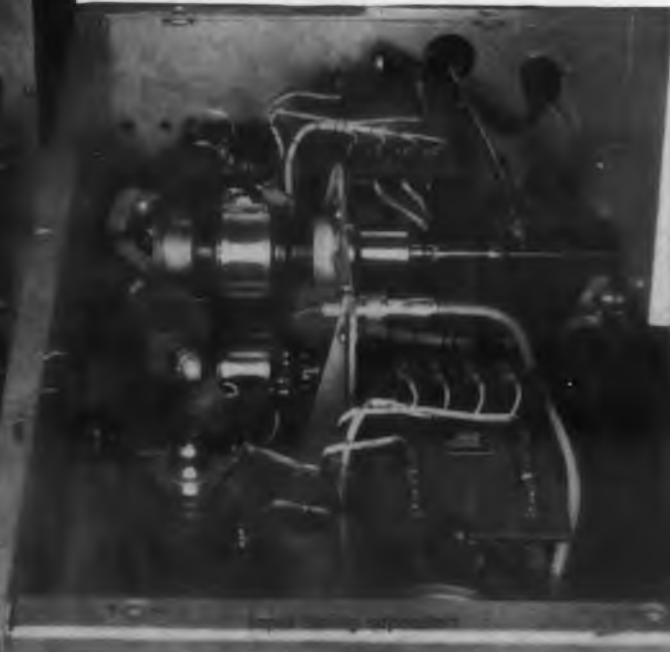

JENNINGS RADIO MANUFACTURING CORP. 970 McLAUGHLIN AVE. P.O. BOX 1278 · SAN JOSE 8, CALIF.

CIRCLE 329 ON READER-SERVICE CARD FOR MORE INFORMATION

Patents

Synchronizing Circuit

Patent No. 2,761,895. R. M. Snyder. (Assigned to International Telephone and Telegraph Corp.)

In a synchronizing circuit such as the one used for interlace scanning in television, it is necessary that the sweep frequency ratio between the horizontal and the vertical sweep circuits be accurately controlled. The patent discloses a circuit in which it is not necessary to maintain a precise ratio in fre-

quencies. The circuit is shown diagrammatically in the figure. The circuit which achieves this result is relatively simple.

A sine wave oscillator 1 is used, of any known type, but it is desirable that it be crystal controlled. The output of the oscillator is coupled to a full wave rectifier of two triodes through a transformer. The grids of the two triodes are connected to the secondary winding of the transformer with the center turn grounded so that a wave of

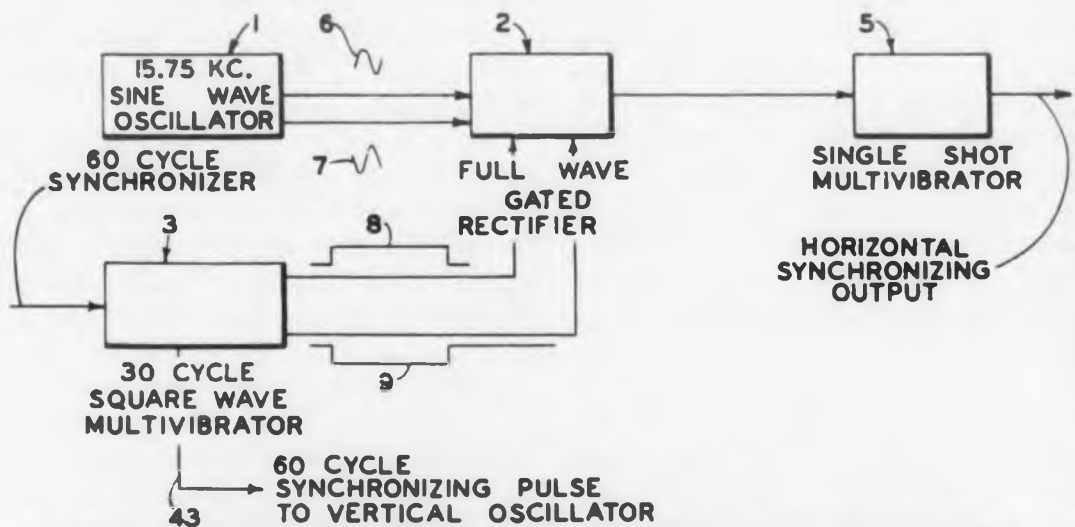

** build reliability into every circuit*

Specify ***BIRTCHER KOOL KLAMPS** (T.M. REG)

MATERIAL
Heat treated silver, alloy or Beryllium ± 25 .

FINISH
Silver none, beryllium copper silver plated to Navy Spec. 46P5

SIZES
Modifications available for all sub miniature and miniature tubes and components.

THE BIRTCHER CORPORATION

INDUSTRIAL DIVISION

4371 Valley Blvd.,
Los Angeles 32, Calif.

Write for catalog

Excessive heat is the number one cause of tube failure. Birtcher KOOL KLAMPS, made of 99 1/2% pure tempered silver, can reduce tube temperatures by as much as 40 C while holding them secure against shock and vibration. Available also in beryllium copper where temperature is less critical.

CIRCLE 330 ON READER-SERVICE CARD FOR MORE INFORMATION

the same frequency but 180 deg out of phase is applied to the control grids.

The potential on the plates of the rectifier tubes are controlled by a 30 cps multivibrator of any known type having two triodes which generate two square waves 180 deg out of phase. The output of one multivibrator tube is applied to the plate of one of the rectifier tubes and the plate of the other multivibrator tube is connected with the plate of the other rectifier tube so that the output of each rectifier tube is alternately gated to pass a sweep control signal. The output of each rectifier tube controls a signal shot multivibrator 5 which generates the signal for control of the sweep of the cathode ray tube. Since one sine wave is 180 deg out of phase with the other, the control of the sweep generator signal will give a signal for interlace scanning.

Pulse Amplitude Selector

Patent No. 2,775,693. T. W. Berwin. (Assigned to Collins Radio Company)

A selector circuit which determines which one of a plurality of incoming signals has the largest amplitude has varied applications. The circuit uses a one-shot multivibrator which receives a triggering pulse each time that a determination is to be

made. The multivibrator tube has a cathode circuit of a cathode resistor and parallel condenser. The circuit also makes use of a plurality of trigger circuits, each consisting of a pair of tubes. One of each pair of tubes of the trigger circuits is coupled to the cathode of the multivibrator tube. The plate of the other tube of each trigger circuit is provided with an output terminal and one of these output terminals receives an output indicative of which of the input signals has the largest amplitude.

Cathode Ray Sweep Correction System

Patent No. 2,774,910. Emil Sanford. (Assigned to Allen B. Du Mont Laboratories, Inc.)

Geometrical distortion in a cathode ray tube deflection system exists because of differences in the center of curvature of the tube screen and of the sweep of the beam. The circuit corrects for this distortion by generating a first sawtooth deflecting signal and a second sawtooth deflecting signal. An integrating circuit integrates the first sawtooth signal to provide a parabolic waveform as a correcting signal. The parabolic waveform is then used to modulate the amplitude of the second sawtooth signal which is applied to the cathode ray tube.

WIDE BAND SWEEP GENERATOR...



JERROLD MODEL 900

FEATURES:

- OUTPUT AGC CONTROLLED
- COMPLETE VOLTAGE REGULATION
- INTERNAL DETECTOR
- INTERNAL OSCILLOSCOPE PREAMPLIFIER
- INTERNAL MARKER AMPLIFIER

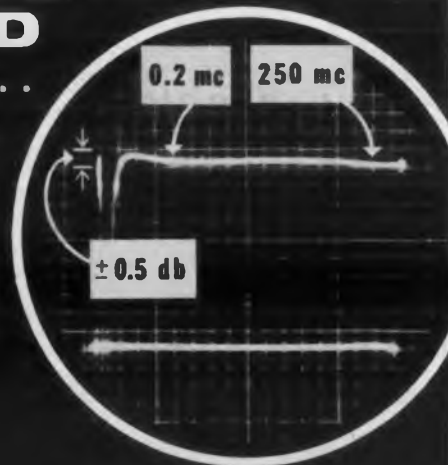

SWEEP WIDTHS—AS WIDE AS 300 MC. RANGE FROM—200 KC TO 1,000 MC.

SPECIFICATIONS

VHF SWEEP RANGE

Center frequency continuously variable from 0.2 MC to 250 MC. Sweep Width continuously variable from a minimum of 0.1 MC, at any center frequency setting, to a maximum of 250 MC at a center frequency setting of 125 MC.

UHF SWEEP RANGE

Center frequency continuously variable from 275 MC to 900 MC. Sweep Width continuously variable from a minimum of 0.1 MC, at any center frequency setting, to a maximum of 100 MC at a center frequency of 275 MC, and to a maximum of 300 MC at a center frequency of 850 MC.

For complete information on the Model 900 and other special test equipment, write to



SOURCE IMPEDANCE

50 ohms—VSWR less than 1.2.

OUTPUT VOLTAGE

0.3 volts RMS.

MAX. OUTPUT VOLTAGE VARIATION AT MAX. SWEEP

VHF Range— ± 0.5 db.

UHF Range— ± 3.0 db.

FREQUENCY MODULATION

60 cycle sinusoidal

JERROLD
ELECTRONICS CORP.
PHILADELPHIA 3, PA.

CIRCLE 331 ON READER-SERVICE CARD FOR MORE INFORMATION

The Key is VERSATILITY...

| | |
|---|------------|
| Output (hp) | 1/3 |
| Speed (rpm) | 3400 |
| Duty | continuous |
| Field Voltage | 70 |
| Field current (amps) | 0.470 |
| Armature voltage | 230. |
| Armature full load current (amps) | 1.25 |
| Stalled torque (lb. in.) | 72. |
| Armature circuit resistance (ohms) | 15.4 |
| Armature circuit inductance (henries) | .0015 |
| Theoretical acceleration at stall (radians/sec. ²) | 25,400 |
| Armature inertia (lb. in. ²) | 1.10 |
| Weight | 13.5 |

The above values are valid for DC operation.



the **NEW**

DIEHL

DC CONTROL MOTOR

The newly developed FD87 DC flange mounted motor features a separately excited shunt motor with internal armature compensation. Torque is directly proportional to the armature current and it can be readily driven by full-wave or half-wave thyatron controlled rectifier circuits.

Note especially the high acceleration constant.

One of many applications is in the machine tool and metal fabricating fields as a positioning servomotor.

Send for additional engineering data.



DIEHL MANUFACTURING COMPANY

Electrical Division of THE SINGER MANUFACTURING COMPANY
Finderne Plant, SOMERVILLE, N. J.

ED

other available components

- AC SERVO MOTORS
- AC SERVO MOTORS WITH AC TACHOMETERS
- DC SERVO SETS
- AC SERVO MOTORS WITH DC TACHOMETERS
- AC AND DC TACHOMETERS
- RESOLVERS

BOOTH 132—DESIGN ENGINEERING SHOW, NEW YORK COLISEUM, May 20-23

CIRCLE 332 ON READER-SERVICE CARD FOR MORE INFORMATION

do you use time delay relays?



Illustrated above are a few of the many environmental conditions which these compact timers are designed to withstand. More rigid requirements frequently can be met upon special consideration.

Do you require ADJUSTABILITY?
No Problem!

Do you require HERMETIC SEALING?
No Problem!

Do you require BOTH? NO PROBLEM for the

A. W. HAYDON Company

The A. W. Haydon Co. offers a complete line of
ADJUSTABLE — HERMETICALLY SEALED TIME DELAY RELAYS
for operation under adverse environmental conditions

Write for Bulletin AWH TD401
Bulletin AWH TD401 Describes
6400 Series — DC units
11400 Series — AC units
24300 Series — 400 cycle units
Nominal Range of Adjustment: 8-1
Timers supplied with:
AN connector
Hermetic Adjusting Knob
Glass Window and Calibrated Dial



The
A. W. HAYDON
COMPANY
227 NORTH ELM STREET
WATERBURY 20, CONNECTICUT

Design and Manufacture of Electro-Mechanical Timing Devices

CIRCLE 333 ON READER-SERVICE CARD FOR MORE INFORMATION

Design Electronic Controls for RELIABILITY IN SERVICE with Alden Components for PLUG-IN UNIT CONSTRUCTION



Be sure your Engineers are working with the Alden Handbook of plug-in unit design. Presents complete line of basic components of tremendous flexibility for adapting your equipment to plug-in construction.

REQUEST FREE 250-PAGE "ALDEN HANDBOOK"

1. Utilize your circuitry in compact vertical planes using Alden Terminal Card Mounting System.



You can use Alden Terminal Mounting Card with Alden Miniature Terminals, Jumper Strip and Sockets staked to accommodate any circuitry—making complete units ready for housing. Components snap into unique Alden Terminals, are held ready for soldering.

YOUR COMPLETED CIRCUITS FOR PLUG-IN PACKAGE OR CHASSIS

2. To mount this vertical circuitry, ALDEN PLUG-IN PACKAGES AND CHASSIS give tremendous variety with standard components



Alden components provide standard plug-in or slide-in housings—with spares, your circuits become units replaceable in 30 seconds.

3. Give chassis easily traceable interconnects and 30-second replacement with ALDEN SERVE-A-UNIT KIT

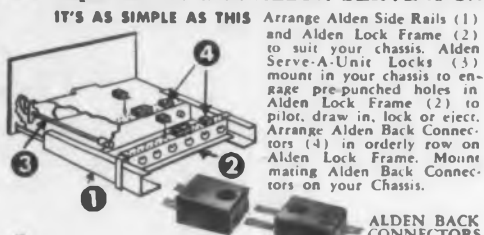

IT'S AS SIMPLE AS THIS

Arrange Alden Side Rails (1) and Alden Lock Frame (2) to suit your chassis. Alden Serve-A-Unit Locks (3) mount in your chassis to engage pre-punched holes in Alden Lock Frame (2) to pilot, draw in, lock or eject. Arrange Alden Back Connectors (4) in orderly row on Alden Lock Frame. Mount mating Alden Back Connectors on your Chassis.

GIVING YOU 1) Chassis that plugs in, locks and ejects with half turn of the wrist. 2) leads so beautifully organized, accessible and identified that non-technical personnel can service.

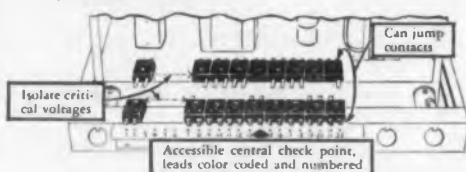

4. Assign to each unit ALDEN SENSING ELEMENTS — to spot trouble instantly!



5139 N. Main St., Brockton 64, Mass.

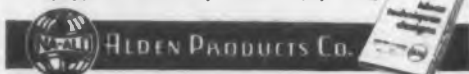

From Alden's Line of Ready-made Components for Unitized Plug-in Unit Construction.

CIRCLE 334 ON READER-SERVICE CARD FOR MORE INFORMATION

Patents

Color Television Receiver Apparatus
 Patent No. 2,763,716. K. E. Farr. (Assigned to Westinghouse Electric Corporation)

A color television signal is made up of a monochrome signal component (E_y) and two color difference signal components ($E_r - E_y$) and ($E_b - E_y$). The green color in-

formation is transmitted by these two latter signals and no separate signal is required for this color. A color television signal is transmitted in this form so that when the program is not in color the receiver will reproduce the picture in monochrome. By adding the monochrome signal to the color

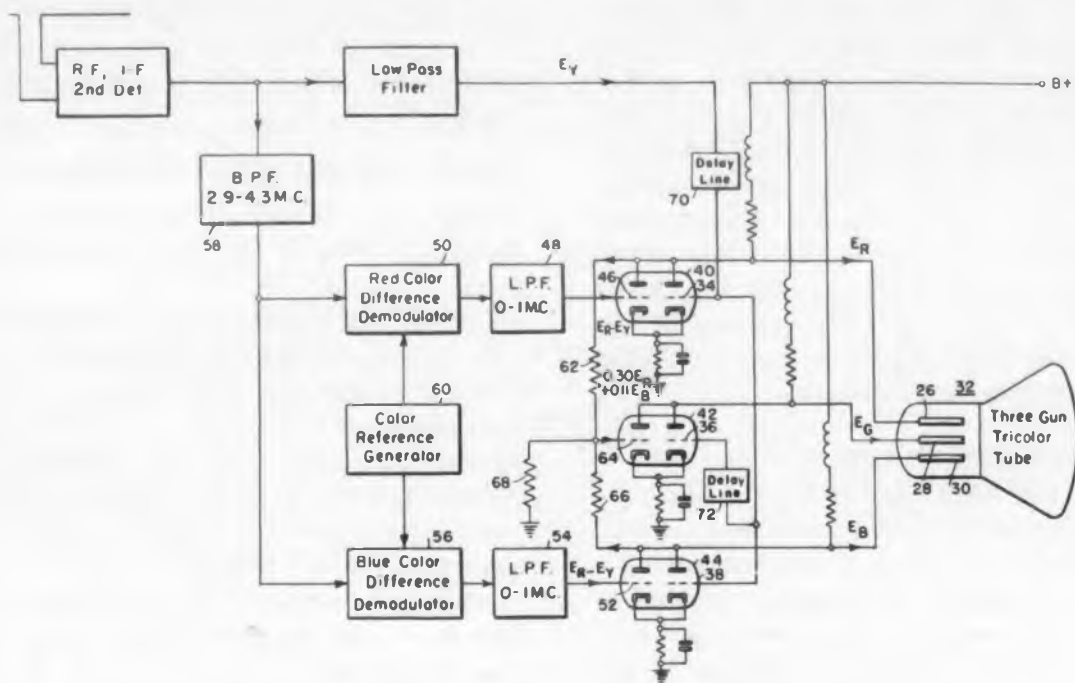

highly reliable field power supply

-built with all
Mil. Spec. components

This small, compact unit supplies dependable power for mobile computers and amplifiers. Regulation is excellent, and there's low ripple. Unit mounts at any angle... withstands high humidity, and is fungus-proofed. Literature on request.



specifications

OUTPUT VOLTAGES:
 Nominal factory setting is 300 VDC. May be adjusted from 275-325 VDC by means of screwdriver-adjusted potentiometer.
 Current: 0-150 Ma max.

REGULATION:
 For 325 VDC/150 Ma output: 100 Mv change NL to FL.
 For line voltage change of 105-125 VAC (at 325 VDC/150 Ma output): 100 Mv change max.

RIPPLE:
 For 325 VDC/150 Ma outputs, ripple is below 3.5 Mv RMS.

DIMENSIONS:
 Length 12½"; Width 5"; Height above chassis 5½" - below chassis 2".

dressen-barnes

DRESSEN-BARNES CORP., 250 N. Vinedo Ave., Pasadena, Calif.

CIRCLE 335 ON READER-SERVICE CARD FOR MORE INFORMATION

difference signal, the color signal is obtained. In the prior receiver circuits the monochrome signal (Ey) was applied to the control grid of each of the three electron guns of the picture tube and the color difference signal was applied to the cathode of its respective gun. The green color information was derived from the red and blue signals through a mixer and inverter which signal was then applied to the cathode of its gun. This method of reproduction is called an internal matrixing system.

The circuit devised by the patentee differs from the prior circuits in that each of the two color difference signals is applied to the control grid of its respective triode 38 and 40. The green signal is derived from the output of these two triodes by applying them to the control grid of a triode 42. The monochrome signal is applied to the control grids of each of three triodes whose plates are connected to the plates of the color triodes and the resultant signal is fed to the respective guns of the picture tube. A delay line 70 and 72 are required in the monochrome circuit connections. This circuit provides external matrixing which enables more effective control of the picture to be secured.

Electrical Translator and Methods

Patent No. 2,773,925. Bernard J. Rothlein and Frieda A. Stahl. (Assigned to Sylvania Electric Products Inc.)

In the operation of transistors it is beneficial to have a localized inhomogeneity in the germanium crystal. The patentee secures this characteristic by exposing the surface of the germanium to the action of a particle of zinc at a relatively high temperature of 600 to 800 degrees centigrade. The germanium is then gradually cooled and etched so as to remove any reaction products of the zinc and the germanium.

Automatic Frequency Control

Patent No. 2,774,877. Lowell E. Norton. (Assigned to Radio Corporation of America)

A simple frequency stabilization system is described having two or more radio-frequency oscillators. The oscillators are coupled to a gas cell having therein a molecularly resonant gas at a low pressure. A circuit component is coupled to the gas cell from which a separate frequency control signal is derived for each of the oscillators. The separate control signals are then applied through coupling means to the oscillators to stabilize their frequencies.



Now you can select the sine-cosine potentiometer that best fits your needs —balancing size against functional conformity. On all of these units, an exclusive new winding technique eliminates wire changes and tapping and shunting. The results are longer life and greater accuracies than previously obtainable.

NEW SINE-COSINE POTENTIOMETERS

These new all-metal-case sine-cosine potentiometers are easily ganged. The 3" diameter (Type 753) has resistance range up to 45K ohms per quadrant, functional conformity of $\pm 0.35\%$ peak to peak, standard. The 2" unit (Type 754) has resistance range up to 25K ohms per quadrant and a functional conformity of $\pm 0.65\%$, standard. The 1 1/8" (Type 741) has resistance range up to 12K ohms per quadrant and a functional conformity of $\pm 1\%$, standard.

Write for complete specifications. Dept. 140-85N, Fairchild Controls Corporation, Components Division:

EAST COAST
225 Park Avenue
Hicksville, L.I., N.Y.

WEST COAST
6111 E. Washington Blvd.
Los Angeles, Calif.



shown actual size

FAIRCHILD
PRECISION POTENTIOMETERS
and COMPONENTS

CIRCLE 336 ON READER-SERVICE CARD FOR MORE INFORMATION

GENERAL ELECTRIC

VOLTAGE REGULATION IDEA FILE

by C. A. Neumann



ENGINEERING DESIGN IDEA: A.C. Controls D.C.

General Electric Inductrols*, a-c induction voltage regulators, can control d-c voltage or current. Here's how:

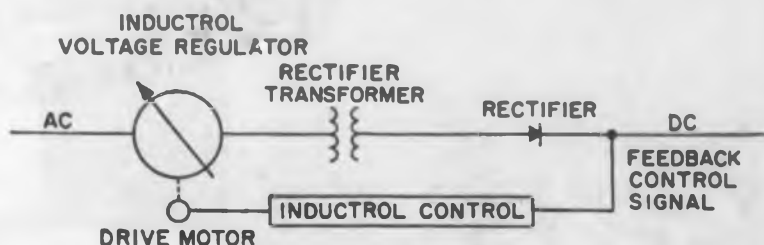

Inductrols compensate for a-c line variations, rectifier aging effects, regulation as d-c load current varies, hold voltage (or current) to $\pm 1\%$.

DESIGN BENEFITS: Inductrol's drift-free controls always keep voltage settings at desired level. Cost is low.

RADAR APPLICATION IDEA:

New England radar manufacturer uses three single-phase Inductrols to give precise phase-angle control, hold voltage to $\pm 1\%$. A three-phase, motor-operated, manually-controlled Inductrol is used for tube warm-up. Power can be increased by raising voltage from 0 to 600 in either two seconds or 30 seconds.

DESIGN BENEFITS: Easy-to-install Inductrol introduces no waveform distortion into electronic systems.

COMPUTER APPLICATION IDEA:

Massachusetts computer manufacturer got line stability and proper tube warm-up by using both voltage stabilizer and voltage regulator. One Inductrol now does both jobs.

DESIGN BENEFITS: Inductrol voltage regulators have an excellent space factor, require little maintenance. They neither affect, nor are affected by, system power factor.

HEAT TEST IDEA:

Boston electronics firm uses battery of infrared quartz lamps to simulate missile in-flight heat conditions. Lamps, energized suddenly on this 208-volt circuit produced rapid heat, but lack of warm-up time caused expensive lamp mortality. A complicated and expensive wiring-switching arrangement was considered, discarded in favor of 3-phase automatic Inductrol voltage regulator.

DESIGN BENEFITS: Inductrol voltage regulators have no brushes to maintain or replace; are rugged, designed for long life; are extremely accurate and reliable.

FOR MORE INFORMATION write Section 425-8, General Electric Company, Schenectady 5, N. Y.

* Trade mark of General Electric Company for Induction Voltage Regulators.

Progress Is Our Most Important Product

GENERAL  ELECTRIC

CIRCLE 337 ON READER-SERVICE CARD FOR MORE INFORMATION

PLUG
IN
with
BLUE
Ribbon
CONNECTORS

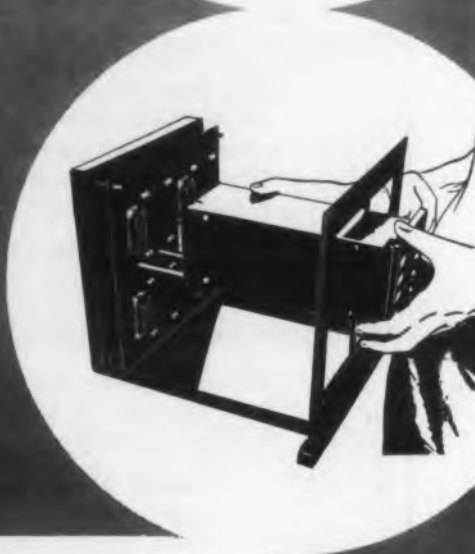
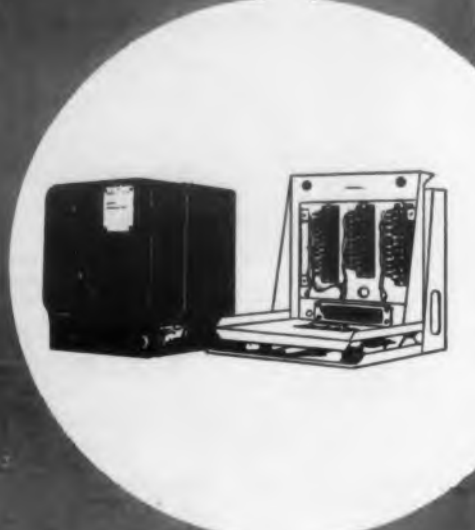
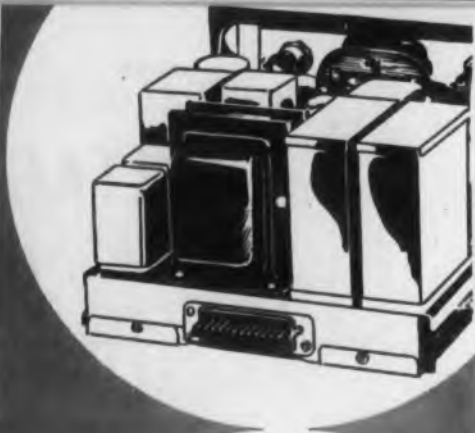

AMPHENOL's Blue Ribbon connectors have gold-plated "ribbon"-like contacts and diallyl phthalate dielectrics. They are available with guide pin or contact barrier polarization and as inserts with mounting plates or in keyed shells. Up to 32 contacts are provided in standard size connectors and as many as 50 in new Micro-Ribbon versions.

In hundreds of rack & panel applications, Blue Ribbon connectors are providing reliable, quick connection for plug-in sub-assemblies. Performance proved, Blue Ribbons can do an equally efficient job for you.



AMPHENOL ELECTRONICS CORPORATION
Chicago 60, Illinois
AMPHENOL CANADA LTD., Toronto 8

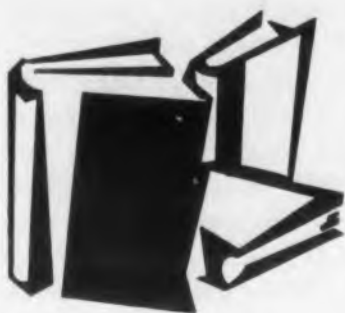

Books

Electrical Measurements and Their Applications

Walter C. Michels. *D. Van Nostrand Co., Inc., 120 Alexander St., Princeton, N.J., 331 pages, \$6.75.*

Reviewed by E. A. McGinnis

Professor Michels has tackled the almost impossible task of covering the very broad field of Electrical Measurements together with applications in a single text book. He includes a description of most electrical measuring devices along with applications. In the case of basic measuring instruments

his description is complete and is accompanied by the necessary theory.

Even though this text would appear to be written specifically for use in the classroom; it will be a valuable edition to the library of the average test or design engineer. The complete choice of experiments and the thorough description of how to perform these experiments, will serve as a good reminder of the uses and limitations of the basic electrical instruments. The explicit development of the theory underlying the basic instruments makes available in one book the types of instruments, how they are applied, and why they work. Engineers in

Machlett ML-6623

A New Forced-Air Cooled Triode

For 2kW to 5kW Industrial Electronic Heaters and
For AM Broadcasting



Machlett Laboratories, Inc., offers the designer a new type 6623 transmitting tube for power amplifiers and oscillators in the 2kW to 5kW power level. Particularly suitable for induction heaters in this power range, the ML-6623 provides rugged structural components designed to meet heavy duty requirements. The Machlett ML-6623 incorporates the same rugged electrode support assembly extensively proven by the ML-5736. Brazed radiator construction is used to prevent anode hot-spotting and its unwanted effects. Quick final "seal-in" by r-f heat provides a contaminant-free stress-free tube.

Maximum ratings of 5.0kVdc plate voltage and 5.0kW plate input apply at frequencies to 30mc. Large radiator on ML-6623 reduces air-flow requirements to 150cfm at 0.9" water

for full dissipation. Low power thoriated tungsten filament operates at 6.0 v., 60 amps.

Machlett Laboratories, Inc., 1063 Hope Street, Springdale, Connecticut
CIRCLE 339 ON READER-SERVICE CARD FOR MORE INFORMATION

◀ CIRCLE 338 ON READER-SERVICE CARD

the field will find it invaluable as a reference text and will in many cases find enclosed in its covers the answers to their measurement problems or at least an approach to the solution of a difficult measuring problem.

Teachers will of course welcome this text. Of particular interest to the teacher of Electrical Measurements or any related laboratory course will be the first chapter on laboratory practice and precision of measurements. The author goes into some detail on how data should be handled and explains how the reliability of data can be ascertained. It is hard to find any fault with the choice of experiments or with the presentation of the related theory and applications.

This book should also prove to be a very valuable book to the student whether or not it is selected as the text for the course he is taking. It is complete and it is very clearly written. Sufficient theory is given for most of the experiments so that the reader can get more than just a superficial knowledge of the instruments covered. The experiments contained in the text are valuable not only when performed but also if only a description of the experiment is read.

The volume contains many illustrations

of late model electrical instruments. The use of late model illustrations instills confidence in a book within a field that is continually and rapidly changing.

The title of the book is misleading although essentially correct. The author covers not only what we consider to be strictly electrical measurements but also goes into some detail on electronic instruments. His applications include use of electrical and electronic measuring instruments in acoustics. He gives a complete description of many of the basic measurements in microwaves with sufficient explanation of the underlying theory that the average engineer regardless of his specialty will understand the measurements. As evidence of the "up-to-dateness" of the book, one section is devoted to the discussion and description of measurements in nuclear physics.

To cover so many topics so well in a book of only 320 pages is a tribute to the organizational ability of the author. This book is one of the better bargains in either the text book or reference book field and would be a welcome addition to the library of any technical man.

E. A. McGinnis is Assistant Professor of Physics at the University of Scranton, Pennsylvania.

Write for the complete new **ENGINEERING BULLETINS—** **PHILLIPS RELAYS**



IN PERMANENT BINDER

Ready for your reference files now —latest set of Phillips Relay engineering bulletins in durable ring binder. Easy-to-read, comprehensive folders provide relay characteristics, features, dimensional drawings and stock listings. Additional folders will be sent you as available. Start your own relay file today.

PHILLIPS CONTROL CORPORATION • 59 W. Washington St., Joliet 4, Ill.
CIRCLE 340 ON READER-SERVICE CARD FOR MORE INFORMATION



There's an **EASIER** way...

with **HELI-COIL** Screw Lock Inserts



NOW—ALSO AVAILABLE IN 4-40 SIZE

**Internal Lock Holds Screws Without
Lock Wiring, Lock Nuts or Plate Nuts**

Design and fastening problems are simplified with one-piece stainless steel *Heli-Coil* Screw-Lock Inserts, now available in 4-40 size. They protect the tapped hole, lock the screw without cumbersome external locking devices, meet Military specifications for impact and vibration even after repeated dis-assembly. Internal spring pressure prevents screw rotation. Easily installed, Screw-Lock Inserts eliminate nuts, provide the answer to threaded fastening problems in miniature sub-assemblies.

Mail coupon for complete data.

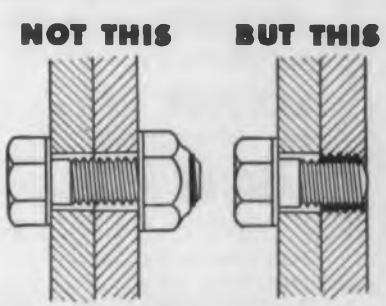

See the *Heli-Coil* Screw-Lock Insert demonstrated at the Design Engineering Show.

HELI-COIL CORPORATION

*Reg. U.S. Pat. Off.

HELI-COIL CORPORATION
405 Shelter Rock Lane, Danbury, Conn.

- Send me complete design data on *Heli-Coil* Screw-Lock Inserts.
- Send design manual on standard *Heli-Coil* Screw Thread Inserts.
- Send "*Heli-Call*," your case history periodical.
- Who is my local *Heli-Coil* Applications Engineer?

NAME _____ TITLE _____
 FIRM _____
 ADDRESS _____
 CITY _____ ZONE _____ STATE _____ 

IN CANADA: W. R. WATKINS CO., LTD., 41 Kipling Ave. S., Toronto 18, Ont.

CIRCLE 341 ON READER-SERVICE CARD FOR MORE INFORMATION

MARCONI ACCURACY



Model
791C

NEW FM DEVIATION MONITOR

WIDER modulation frequency range is a feature of Marconi Deviation Monitor Model 791C, 50 cps to 35 kc.

HIGHER carrier frequencies are covered, 4 to 540 Mc in 6 ranges.

LONGER life is not claimed. No Marconi Deviation Monitor has yet worn out.

LOWER price, yet still Marconi precision.

Brief Specification

| | |
|---------------------------|---|
| Frequency Range | 4 to 540 Mc |
| Mod. Freq. Range | 50 cps to 35 kc |
| Deviation Ranges | 0 to ± 5 , ± 25 , ± 75 , ± 125 kc |
| Accuracy | 3%, crystal standardized |
| Harmonic Distortion | Less than 0.2% |
| Tubes | 6AK5, 6C4, 6CD6, 571B, 6AL5, OB2, 5Z4G |

Price \$720.00 Delivery Immediate

The Marconi range of FM test instruments includes:

- Signal Generator Model 1066/1 10 to 470 Mc
- Signal Generator Model 995A/2 1.5 to 220 Mc
- Signal Generator Model 913 22 to 176 Mc
- Deviation Monitor Model 928 for Telemetry
- Ruggedized Deviation Monitor Model 934 2.5 to 500 Mc
- Eddystone Receiver Model 770R 19 to 165 Mc
- Eddystone Receiver Model 770U 150 to 500 Mc



MARCONI instruments
44 NEW STREET • NEW YORK 4, N. Y.

CIRCLE 342 ON READER-SERVICE CARD FOR MORE INFORMATION

Books

Differential Equations Applied in Science and Engineering

Harold Wayland. D. Van Nostrand Co., Inc., 120 Alexander St., Princeton, N.J., 353 pages, \$7.50.

Prepared primarily for advanced students, it has been the author's purpose to analyze the mathematical solution of physical problems so that the processes may be viewed in their entirety. Commencing with the translation of physical concepts into mathematical language, the work proceeds through formal solutions to consideration of the physical reasonableness of results.

To the central theme of partial differential equations many topics from advanced calculus have been added. Particular attention is given to vector analysis. The techniques of formulating the most important vector expressions in orthogonal curvilinear coordinates are presented in some detail. Separation of variables is stressed as a method of solving differential equations under given boundary conditions. Other

topics are power series expansions, special functions, expansion in series of orthogonal functions, and integral transforms.

Quality Control for Plastics Engineers

Edited by Lawrence M. Debing. Reinhold Publishing Corp., 430 Park Ave., New York 22, N.Y., 142 pages, \$4.95.

Assuming the reader has no prior knowledge, this book introduces the subject of statistical quality control in plastics. Referring specifically to examples of application currently used in the plastics industry, the text explains basic statistical procedures as a means of achieving the highest possible standards of performance. There are chapters dealing with control charts, process capability studies and specifications, sampling methods to assure adequate inspection, correlation, and experimental design. Written by a team of experts, the volume is the first in a series of technical works to be sponsored by the Society of Plastics Engineers.

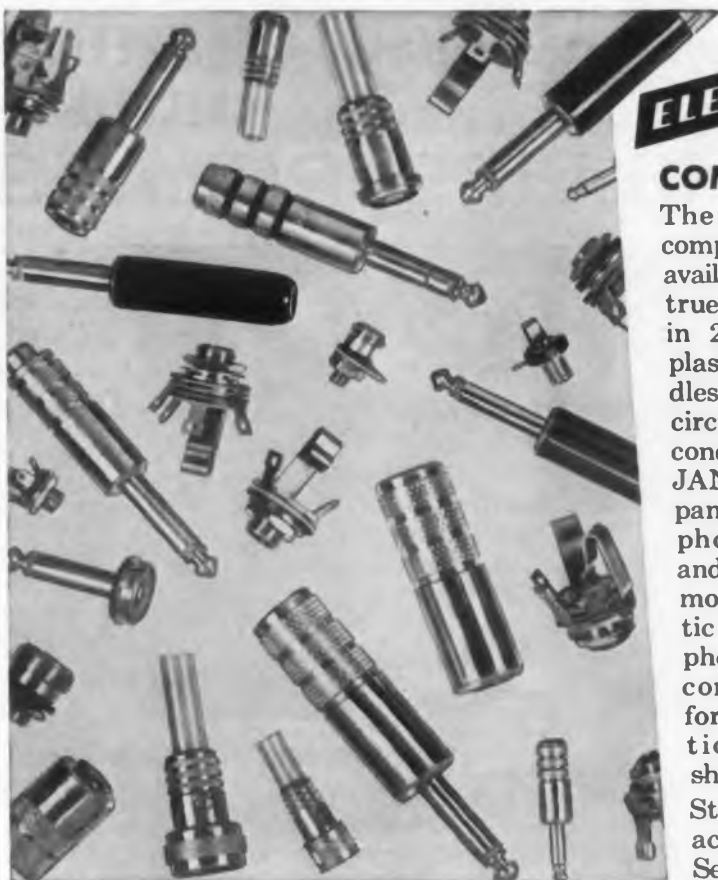

ELECTROCRAFT CONNECTOR COMPONENTS

The line of connector components as shown is available in standards and true miniatures. Plugs in 2 and 3 conductor plastic or shielded handles. Open and closed circuit jacks, 2 and 3 conductor, regular and JAN models. Cord and panel mounted microphone connectors. 2 and 3 conductor cord mounted jacks. Plastic or shielded handle phone plugs, 2 and 3 conductor. Adaptors for modifying connections in plastic or shielded handles.

Sturdily made to exacting specifications. Send for bulletin.

ELECTROCRAFT

Richards Electrocraft, Inc.

3755 North Kedzie Avenue, Chicago 18, Illinois



CIRCLE 343 ON READER-SERVICE CARD FOR MORE INFORMATION

ELECTRONIC DESIGN • May 15, 1957

Frequency Modulation

L. B. Arguimbau and R. D. Stuart. John Wiley & Sons, Inc., 440 Fourth Ave., New York 16, N.Y. 96 pages. \$2.00.

This monograph is largely based on experience gained by the writers in the Research Laboratory of Electronics of the Massachusetts Institute of Technology. It is a high level treatment on frequency modulation with special emphasis on its noise-eliminating ability. For the most part, circuits are considered from a steady state alternating current point of view. The book treats fm from its most fundamental definition to its application in television.

Frequency-Modulated Radio

K. R. Sturley, The Macmillan Co., 60 Fifth Ave., New York 11, N.Y. 120 page \$3.00.

Principles of frequency modulation are explained in terms that can be readily understood by the technician and repairman. General principles, theory, design, construction and servicing of vhf/fm receivers are discussed. Each stage of a vhf/fm receiver is analysed in detail and a chapter is devoted to the special features of combined

am/fm receivers. A section on alignment problems, and the location of faults with a minimum of test equipment should prove of particular interest to the repair technician. The author is affiliated with the British Broadcasting Company and information given on transmitters is taken from those used in the BBC vhf broadcasting service.

Foundations of Radio

M. G. Scroggie, Philosophical Library, Inc., 15 East 40 St., New York 16, N.Y. 349 pages, \$10.00.

Starting with the most elementary principles, this sixth edition of M. G. Scroggie's book, remains an excellent introduction to radio. Except where it is absolutely necessary, the treatment is essentially non-mathematical. Fundamental laws of electricity and radio, the theory of valves, transmitters and all types of modern receivers are described. An introduction to the techniques of television and radar is also given. Mr. Scroggie's frequently humorous and painstakingly lucid treatment of his subject should appeal to the beginner. It could very well appear redundant to the experienced technician or engineer.

Brew Delay Lines meet exacting specifications

Whatever your delay line requirements, from prototype to large scale manufacture of production units, Brew offers you the design-engineering experience and complete facilities to supply your most exacting specifications.

Brew Delay Lines are custom made to your requirements and are available covering an extremely wide range of characteristics. A Laboratory Report accompanies every prototype showing your specifications and the characteristics of the prototype.

Send us specifications on your requirements or send for your copy of catalog 54.



Richard D. Brew and Company, Inc.

design

development

manufacture

Concord, New Hampshire

CIRCLE 344 ON READER-SERVICE CARD FOR MORE INFORMATION



When it has to be heated rely on Safeway Woven Heat Elements

... and the "it" can be just about anything from a simple tray to the curing blankets for honeycomb structures.

Safeway Woven Heat Elements are custom tailored to fit specialized requirements of many applications. A single aircraft, for example, may need upwards of 80 different heating and de-icing elements, all of which are made by Safeway. Other applications are on helicopter rotors, rocket tubes, missile launchers, and on a wide variety of molds, dies, tanks, ovens and dryers in industry.

If you have a problem that requires heat, let Safeway engineers study your requirements and—without obligation to you—submit an appropriate recommendation.

*For your copy
of a fact-filled folder,
write to:*

Safeway

**HEAT
ELEMENTS
INC.**

680 Newfield Street • Middletown, Connecticut
CIRCLE 345 ON READER-SERVICE CARD FOR MORE INFORMATION



Free
Data File

#111

...FREQUENCY MEASUREMENTS
AND HOW TO MAKE THEM

Covers Berkeley EPUT* meter techniques for low and medium frequencies; Berkeley EPUT* and heterodyne techniques for RF, VHF and UHF; preset counter and time interval meter techniques for rapid low frequency measurements; measurement of rpm, flow, pressure, temperature and strain; setting up a standard of frequency, and nuclear counting techniques.

Write today for your free copy; please address Dept. D5.

Beckman
Berkeley Division
Richmond 3, California
a division of Beckman Instruments, Inc.

*Trademark

128

CIRCLE 346 ON READER-SERVICE CARD FOR MORE INFORMATION

no limit on shape versatility... economy!
when you use

**KESTER
SOLDERFORMS®**

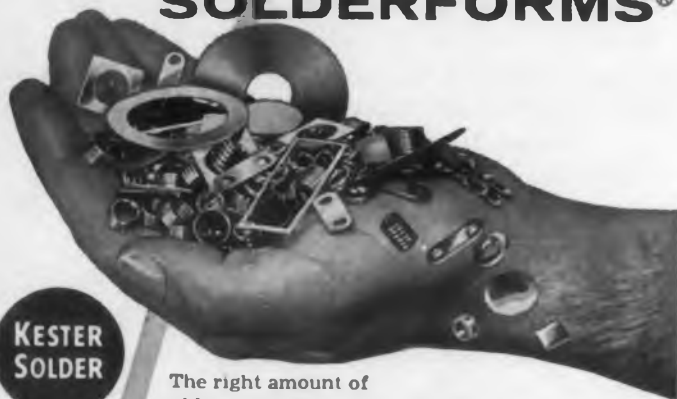

KESTER
SOLDER

The right amount of solder every time when you use Kester Solderforms in your assembly operation. Produce better looking and more efficient products as well as greatly increase speed of manufacturing.

WHERE TO USE KESTER SOLDERFORMS

Capacitors • Switches • Resistors • Transformers
Relays • TV and Radio Tuners • Gauges • Small
Metal Assemblies and Controls... many, many others.

WRITE TODAY for free samples and complete information

KESTER SOLDER

COMPANY 4266 Wrightwood Avenue, Chicago 39, Illinois
Newark 5, New Jersey • Brantford, Canada

CIRCLE 347 ON READER-SERVICE CARD FOR MORE INFORMATION

Russian Translations

What the Russians are Writing

J. George Adashko

Contents of Radiotekhnika i Elektronika
No. 8, 1956

THIS issue is devoted in its entirety to semiconductors and its applications in engineering. It contains several papers delivered at the 8th All-Union Conference on semiconductors, held by the USSR Academy of Sciences in Leningrad on November 14-20 in 1955. Participating in this conference were more than 1,000 people, including scientists from China, Poland, Rumania, Hungary, Czechoslovakia, and East Germany.

This issue contains several papers read in the sessions on semiconductor electronics and semiconductor instruments, photoelectric phenomena, magnetic phenomena in semiconductors. Other papers read in these sessions will be published in future issues of "Radiotekhnika i Elektronika."

Status of our Knowledge of Semiconductors and Problems Remaining to be Solved (Opening Remarks), A. F. Ioffe, (4 pgs).

Historical review, emphasizing that more than 10,000 articles on semiconductors were published during the last 30 years, and that their number increases at very high rate. He also points out that the volume of production of equipment containing semiconductors has reached dimensions commen-

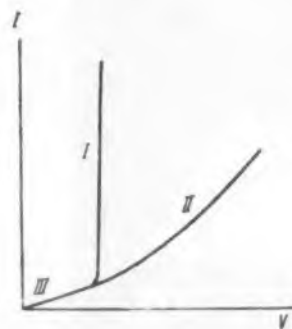

Fig. 1: Proposed current-voltage characteristics of metal probe to semiconductor contact.

surate with other important branches of electronic engineering. This is a good reason for analyzing in detail the strong and weak points of the modern status of semiconductors and for indicating paths that further progress in this field is to follow. He mentions contributions of many Soviet scientists to the art and concludes that the existing theoretical and experimental foundations are insufficient for exhaustive development of semiconductor technology. Shows, for example, that a tremendous quantity of heat that presently can not be converted into useful work in furnaces and in heat engines could be converted, using semiconductor thermocouples, into useful work. Mentions also the possibility of using semiconductors to tap solar energy.

Behavior of Semiconductors in Strong Electric Fields, Iu. K. Pozhela, (7 pgs, 8 figs).

In strong electric fields, near the break-down threshold of the semiconductor, the voltage-current characteristic of a metal-semiconductor junction can assume two forms (Figure 1). Curve II is obtained when the increased conductivity is local and restricted to the region where the additional carriers, produced by the increased field, are located. Curve I occurs when the strong electric field produces mobile pairs of carriers, and if the potential applied to

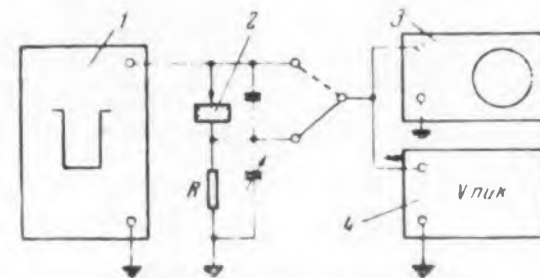

Fig. 2: Set up used to measure current-voltage characteristics: 1—source of rectangular voltage pulses; 2—specimen; 3—oscillograph; 4—peak voltmeter.

the metal is such that the electron-hole pairs move into the semiconductor, the region of increased concentration will move into the semiconductor, modulating the conductivity of the entire region near the contact, and increasing sharply the current flowing through the contact. Thus curve I depends on the polarity of the applied potential, while curve II does not.

Figure 2 shows the experimental set-up used for the investigation. Reference is made to work by E. J. Ryder, *Physical Review*, 1953, 90, 5, 766, Navon, Bray, and Fan, *Prog. IRE*, 1952, 40, 11, 1342, and Dunlop, *Physical Review*, 1955, 97, 3, 615.

Principal Theories and Several Results of Investigation of Germanium Diodes and Triodes.
B. M. Vul, (12 pgs, 9 figs).

Gives the fundamental theory and some particular results of investigations on Germanium diodes and triodes performed in the P. N. Lebedev Physics Institute of the USSR Academy of Sciences. Covers some fundamental equations, the capacitance of the p-n junction and the field intensity in it, the current through a p-n junction, elementary theory of transistors and certain measurement results. Makes numerous references to American papers.

Parameters and Constructions of Certain Russian Transistors, A. V. Krasilov, (8 pp, 9 figs, 3 tables).

An abstract of this article will appear in a coming issue of Electronic Design.

Industrial Types of Thermistors and Fields of their Application, B. T. Kolomiets, I. T. Sheftel, E. V. Kurlina, and G. I. Pavlova, (9 pp, 12 figs, 2 tables).

An abstract of this article will appear in a coming issue of ED.

Transients in Transistors, E. I. Adirovich, V. G. Kolotilova, B. V. Malin, (6 pp, 4 figs).

Contains a straightforward theory, leaning heavily on work by Schaffner and Suran (*Journal of Applied Physics*, 1953, 24, 11, 1355) and Shea (*Principles of transistor circuits*, New York, 1953). Of interest is the experimental results on several Russian transistors, using a rectangular pulse of 1 ma amplitude and 10 microsecond duration at a repetition rate of 10 kc.

Frequency Characteristics of Germanium Junction Type Diode at Low A-C Voltages, S. G. Kalashnikov, N. A. Penin, K. V. Iakunina, (13 pgs, 11 figs, 3 tables).

Semiconductor diodes are presently used to rectify currents in many frequency ranges. The limiting frequencies at which a noticeable reduction in the rectification coefficient occurs vary from 10^2 – 10^3 to 10^{10} – 10^{11} cycles, depending on the type of the diode, on the properties of the semiconductor, and on the operating conditions (silicon and germanium crystal detectors). An investigation of the causes of the frequency dependence of the rectified

30% Elongation and

Regain with high dielectric strength offered by new Westinghouse insulation

New Silicone Rubber-Coated Bias-Woven Glass,* for All Class "H" applications

You just can't buy a more resilient Class "H" insulating material than Westinghouse Silicone Rubber-Coated Bias-Woven Glass Cloth and Tape. Its unique combination of physical and electrical properties makes it the ideal insulation for a wide variety of applications.

Continuous, bias-woven glass fabric, of course, is the secret of "9495's" amazing elongation and regain, as well as high dielectric and tensile strength. Silicone rubber imparts high heat resistance and flexibility. *Put them together in one tape* and you get another Westinghouse exclusive.

Westinghouse offers you a complete line of quality insulation plate, tape, resins and varnishes. If you have an insulation problem why not call your nearest Westinghouse representative. Or, mail the coupon below for the new *Leadership Line Catalog*.

J-06635

*Pat. Pen.

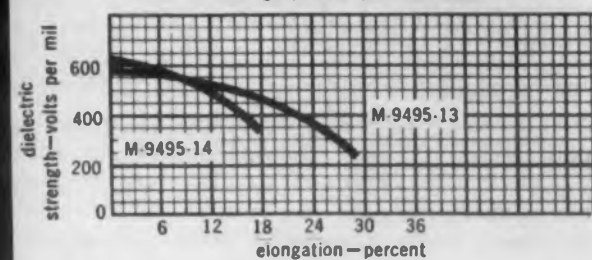
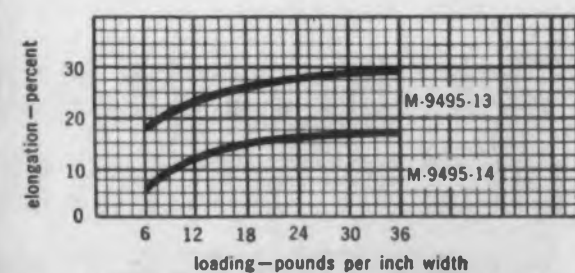

YOU CAN BE SURE...IF IT'S

Westinghouse



Westinghouse Electric Corporation ED-5-57
MICARTA Division, Trafford, Pa.
Please send me your Leadership Line Catalog on Westinghouse flexible insulation, tapes, resins and varnishes.

NAME _____
TITLE _____
COMPANY _____
ADDRESS _____
CITY _____ STATE _____

CIRCLE 348 ON READER-SERVICE CARD FOR MORE INFORMATION

HY-G-300

ELECTRON TUBES FOR SURVIVAL

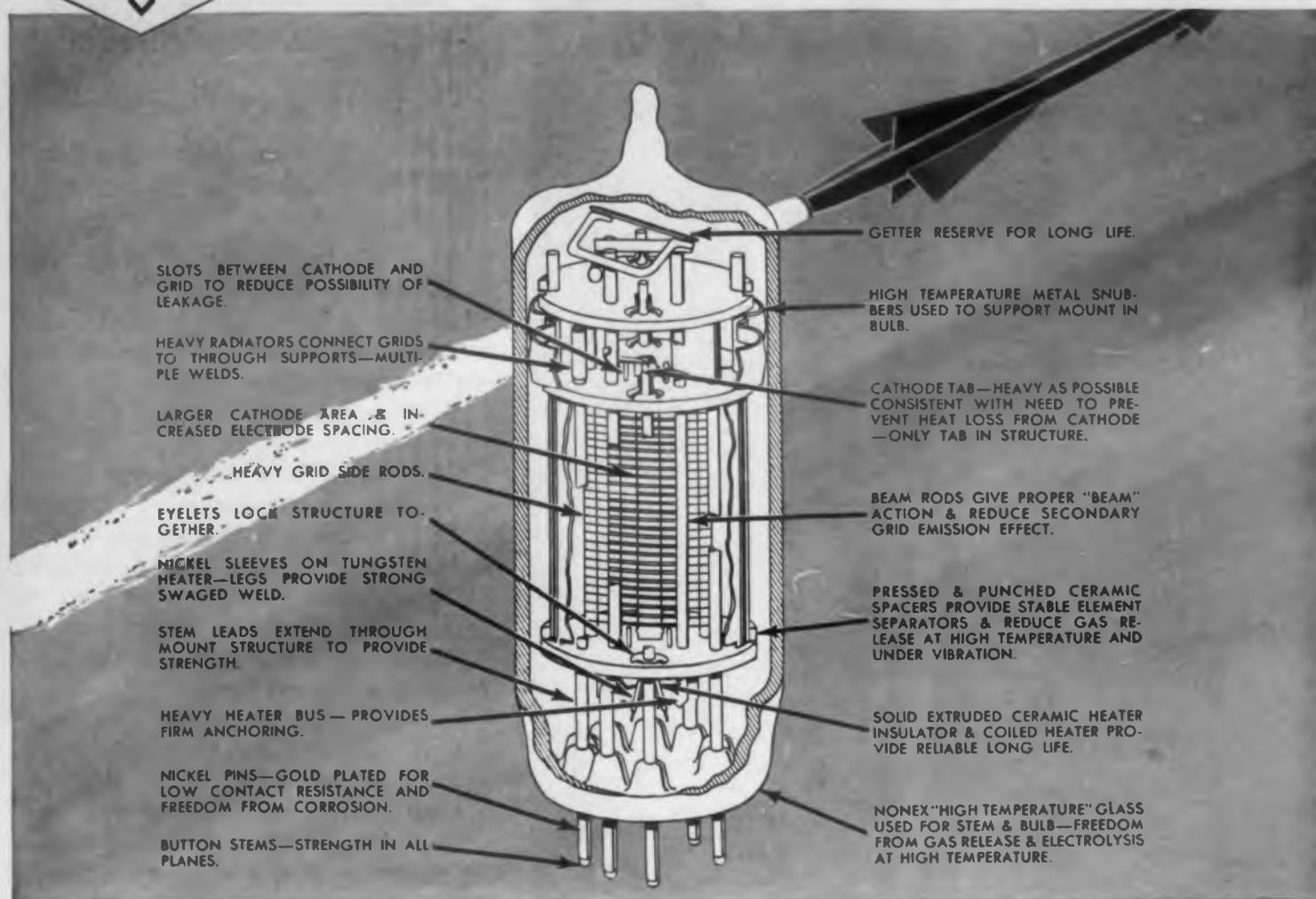

SLOTS BETWEEN CATHODE AND GRID TO REDUCE POSSIBILITY OF LEAKAGE.

HEAVY RADIATORS CONNECT GRIDS TO THROUGH SUPPORTS—MULTIPLE WELDS.

LARGER CATHODE AREA & INCREASED ELECTRODE SPACING.

HEAVY GRID SIDE RODS.

EYELETS LOCK STRUCTURE TOGETHER.

NICKEL SLEEVES ON TUNGSTEN HEATER—LEGS PROVIDE STRONG SWAGED WELD.

STEM LEADS EXTEND THROUGH MOUNT STRUCTURE TO PROVIDE STRENGTH.

HEAVY HEATER BUS—PROVIDES FIRM ANCHORING.

NICKEL PINS—GOLD PLATED FOR LOW CONTACT RESISTANCE AND FREEDOM FROM CORROSION.

BUTTON STEMS—STRENGTH IN ALL PLANES.

GETTER RESERVE FOR LONG LIFE.

HIGH TEMPERATURE METAL SNUBBERS USED TO SUPPORT MOUNT IN BULB.

CATHODE TAB—HEAVY AS POSSIBLE CONSISTENT WITH NEED TO PREVENT HEAT LOSS FROM CATHODE—ONLY TAB IN STRUCTURE.

BEAM RODS GIVE PROPER "BEAM" ACTION & REDUCE SECONDARY GRID EMISSION EFFECT.

PRESSED & PUNCHED CERAMIC SPACERS PROVIDE STABLE ELEMENT SEPARATORS & REDUCE GAS RELEASE AT HIGH TEMPERATURE AND UNDER VIBRATION.

SOLID EXTRUDED CERAMIC HEATER INSULATOR & COILED HEATER PROVIDE RELIABLE LONG LIFE.

NONEX "HIGH TEMPERATURE" GLASS USED FOR STEM & BULB—FREEDOM FROM GAS RELEASE & ELECTROLYSIS AT HIGH TEMPERATURE.

WHY BENDIX* HY-G-300 ELECTRON TUBES ARE BEST FOR EXTREME SHOCK, VIBRATION AND TEMPERATURES!

From the standpoint of design features (see above), these reliable hard glass tubes offer the superior quality needed to survive today's severe environmental demands.

Specifically, Bendix HY-G-300's are designed to withstand the following environmental conditions—bulb temperatures up to 300° C; vibration up to 20G's over the range of 5-2000 cycles; and shock of 200G's having 20-millisecond duration.

For full information about the HY-G-300 line . . . the surest answer to electron tube applications in jet aircraft, missiles and rockets . . . write RED BANK DIVISION, BENDIX AVIATION CORPORATION, EATONTOWN, NEW JERSEY. *TRADEMARK

West Coast Sales and Service: 117 E. Providencia, Burbank, Calif. • Export Sales and Service: Bendix International Division, 205 E. 42nd St., New York 17, N. Y. • Canadian Affiliate: Aviation Electric, Ltd., P. O. Box 6102, Montreal, Que.

HY-G-300

TUBES ARE AVAILABLE FROM STOCK

| Bulb Size | Dbt. Triodes Volt Amp. | R. F. Pentodes | Gate Pentodes | Rectifiers Full Wave | Beam Power | Power Triodes Passing |
|-----------|------------------------|----------------|---------------|----------------------|--------------|-----------------------|
| T-12 | — | — | — | — | — | 6080WB 6082A |
| T-11 | — | — | — | — | 6384 6889 | — |
| T-9 | — | — | — | 6853 | — | — |
| T-6½ | 6851 6854 6900 | 6582A | 6486A | 6754 | 6094 | 6877 6900 |

| Retma Type No. | Retrofit For | Generic Type | E _f | I _f | Bulb | Bendix Type No. |
|----------------|----------------|--------------|----------------|----------------|------|-----------------|
| 6080WB | 6080 6080WA | 6080 | 6.3 | 2.5 | T-12 | TE-46 |
| 6094 | — | 6A05-6005 | 6.3 | 0.6 | T-6½ | TE-18 |
| 6853 | 6106 5Y3 | 5Y3 | 5.0 | 1.7 | T-9 | TE-45 |
| 6384 | 6AR6 6098 | 6AR6 | 6.3 | 1.2 | T-11 | TE-27 |
| 6854 | 6385 | 2C51 5670 | 6.3 | 0.5 | T-6½ | TE-47 |
| 6486A | 6486 | 6AS6 | 6.3 | 0.25 | T-6½ | TE-43 |
| 6582A | 6582 | 6AK5 | 6.3 | 0.25 | T-6½ | TE-44 |
| 6754 | 412A | — | 6.3 | 1.0 | T-6½ | TE-36 |
| 6851 | 5751 | — | 6.3 | 0.5 | T-6½ | TE-42 |
| 6877 | — | Half of 6080 | 6.3 | 0.8 | T-6½ | TE-48 |
| 6900 | 5687 | 5687 | 6.3 | 0.9 | T-6½ | TE-54 |
| 6889 | — | — | 6.3 | 1.2 | T-11 | TE-52 |
| 6082A | 6082 | 6082 | 26.5 | 0.6 | T-12 | TE-55 |

Red Bank Division



CIRCLE 349 ON READER-SERVICE CARD FOR MORE INFORMATION

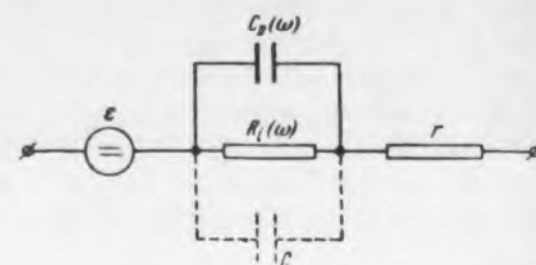

Fig. 3: Equivalent circuit of semiconductor diode, where the frequency-dependent component is much greater than the fixed component.

current in semiconductor diodes is therefore of great interest.

Figure 3 shows the equivalent circuit of the semiconductor diode where the frequency-dependent component $C_D(\omega)$ is much greater than the fixed component C . The frequency dependence is due first of all to the frequency dependence of the total impedance of the p-n junctions, owing first of all to the injection of carriers, and leading to the so-called diffusion junction capacitance C_D , and also due to displacement currents (intrinsic or charged capacitance C of the junction).

Figure 4 shows the circuit used to measure the rectified voltage at no load, while Figure 5 shows the bridge for measuring the total impedance of the diode.

The experiments have confirmed that the above equivalent circuit is valid for frequencies at least from 1 kc to 10 mc, and that the theoretical assumptions made on the basis of this circuit have been fairly well corroborated in practice.

Properties of Germanium Detectors with Fused Contact at Very High Frequencies, N. A. Penin, N. E. Skvortsova, (9 pgs, 10 figs).

Report on an experimental investigation of the capacity and resistance of the blocking layer of Germanium detectors with point contacts in the frequency range from 1,000 to 6,000 megacycles at various positive bias currents. It is found that the capacitance and resistance of the blocking layer vary in inverse proportion to the square root of the frequency. It has been established that the capacitance and conductivity of the blocking layer at very high frequencies varies linearly with the positive bias current.

The data obtained are in good agreement with the diffusion theory of p-n junctions, taking the injection of unbalanced charged carries into account.

Investigation of Break-Down of Junction-Type Germanium Diodes, B. M. Vul, A. P. Shotov, (6 pgs, 6 figs).

Study of break-down of p-n junctions, prepared by the method of fusing Indium in n-Germanium and by the method of diffusing antimony in p-Germanium. It is established that in all the p-n junctions the break-down is of the electric type, due to

the shock ionization, provided the voltage is applied in the form of short pulses. If d-c voltage is applied, the break-down character is different, and may be electric, thermal, or thermoelectric, depending on the structure of the p-n junction and on the conditions under which the heat is carried away. In some transistors, the electric break-down data can be used to determine the coefficient of shock ionization. Reference is made to an article by S. L. Miller in *Physical Review* 1955, 99, 1234 and by McKay and McAfee, *Physical Review*, 91, 1079, 1953.

Surface Recombination and its Effect on the Characteristics of Semiconductor Devices, A. V. Rzhanov, (7 pgs, 3 figs, 1 table).

The speed of volume recombination of excess carriers is one of the most important criteria of the quality of the material and of the degree of its suitability for the preparation of semiconductor devices for radio and other purposes. Surface recombination, unlike volume recombination, depends not only on the properties of the material, but also on the geometric parameters of the device and on the technological methods used in its manufacture. This article reports on investigations made in 1953-1954 in the Electrophysica Laboratory of the Physics Institute of the Academy of Sciences which show a very close relationship between the speed of surface recombination and the size of the surface potential barrier, and which emphasize the great importance of future research on methods of processing the semiconductor surfaces so as to insure sufficiently stable surface potential barriers of the desired height.

Investigation of Rectifying Properties of Point-Contact Germanium Diodes, K. B. Tolpygo, V. A. Pomenko, (13 pgs, 8 figs, 2 tables).

Derives the theory of the p-n junctions for hemispherical contacts and compares the results with those obtained for junction-type diodes. The experimental procedure is described and it is established that diodes with high values of inverse current and resistance are obtained using high-resistivity Germanium ($\rho = 25-20$ ohm-centimeter) by using strong electric forming. However, the transfer characteristic of such diodes are poor, and diodes with

higher detection efficiency at low voltage and with good transfer characteristics are obtained using low-resistivity germanium (2-4 ohm cm) and weak forming (forming current of 0.2 amp).

Good agreement with theory was obtained for saturation currents at room temperature, and also for the temperature dependence of the parameters of diodes made of high-resistivity germanium. The theory does not explain, however, the noticeable reduction in temperature coefficients of the parameter at temperatures of 0-100 C in the case of diodes made of low-resistivity Germanium. A good qualitative and quantitative agreement was obtained for the current-voltage characteristic above 100 mv (up to 1-2 volts) as predicted by the theory.

Other articles of interest in this Issue:

Electrochemical Method of Improving the Quality of the p-n Junction in a Selenium Rectifier Cell, L. Iu. Belenkova, I. Kh. Geller, D. N. Nasledov, F. M. Tartakovskaia, (6 pgs, 4 figs).

Photo-Electronics of Organic Compounds, A. N. Terenin, (8 pgs, 2 figs);

New Views on the Mechanism of Photo Conductivity and Phosphorescence, N. A. Tolstoi, (9 pgs, 5 figs);

Volume Photoelectric EMF in Semiconductors, V. E. Lashkarev and V. A. Romanov, (3 pgs, 1 fig, 1 table);

Magnetic Viscosity of Nickel-Zinc Ferrites, I. A. Lednev, R. V. Telesnin, (7 pgs, 9 figs);

Effectiveness and Characteristics of p-n Junction Photocell, V. S. Vavilov, L. S. Smirnov, (8 pgs, 9 figs);

Spectral Distribution of the Internal Photoeffect in Several Systems of Sulfides, Selenides, and Tellurides, N. A. Goriunova, B. T. Kolomiets, (7 pgs, 16 figs);

Internal Photoelectric Effect in Semicrystalline Cadmium Sulfide, B. T. Kolomiets, A. O. Olesk, S. G. Pratushevich, (5 pgs, 6 figs);

Features of the Long-Time Components of Photoconductivity of Cuprous Oxide, Iu. I. Gritsenko, V. E. Lashkarev, (7 pgs, 4 figs);

Photoresistors of Cadmium Selenide, B. T. Kolomiets, S. G. Pratushevich, (3 pgs, 3 figs).

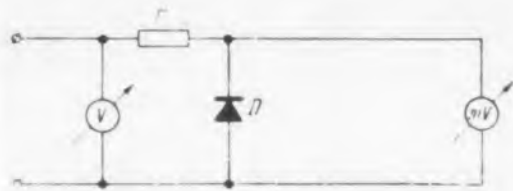

Fig. 4: Circuit used to measure the rectified diode voltage at no load.

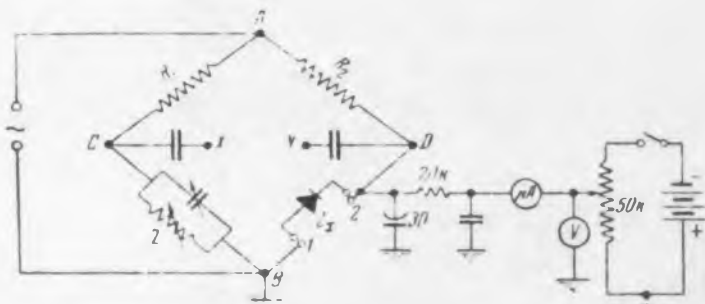
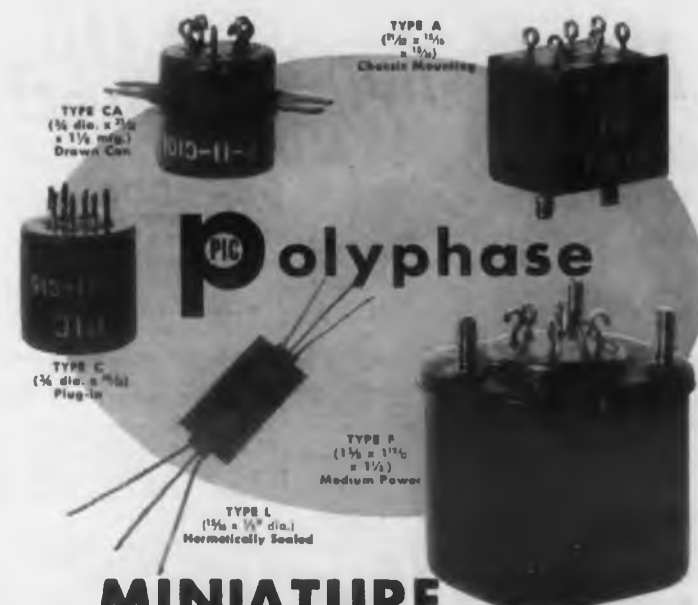

Fig. 5: Bridge for measuring the total impedance of the diode.



MINIATURE PULSE TRANSFORMERS

- FOR:
- PULSE COUPLING
 - BLOCKING OSCILLATOR
 - ISOLATION
 - COMPUTER CIRCUITS
 - TRANSISTOR CIRCUITS
 - MIL-T-27A SPECS

Catalog listed pulse transformers available for quick delivery. Choose from a wide range of electrical characteristics in various case types. Potted, encapsulated, and hermetically sealed units to meet MIL-T-27A specs. Prompt engineering design service on transformers to your specifications. Pulse transformer kits for experimental circuit design available. Write for specification bulletins.

POLYPHASE Instrument Company
Bridgeport, Pennsylvania

CIRCLE 351 ON READER-SERVICE CARD FOR MORE INFORMATION

Weckesser

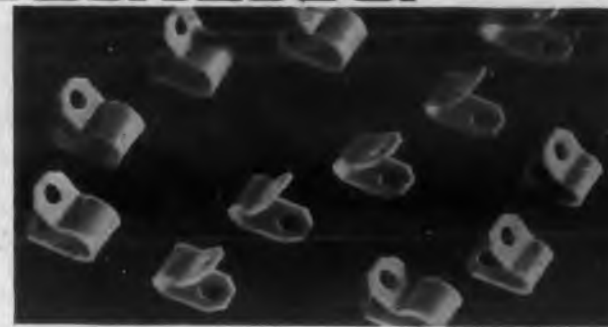

Cable Clamps of TEFLON*

Advantages:

- Excellent Dielectric Properties
- Chemical Inertness
- Heat Resistance
- Toughness and Flexibility
- Non-Adhesive Characteristics
- Low Coefficient of Friction
- Zero Moisture Absorption
- Weather Resistance

Write for size and price bulletin.

*Dupont T M

Weckesser COMPANY

5703-05 Northwest Highway

Chicago 30, Ill.

See us at the Coliseum, Booth 1214, DESIGN ENGINEERING SHOW

CIRCLE 350 ON READER-SERVICE CARD FOR MORE INFORMATION

New Improved J.I.C. Wiring Boxes!

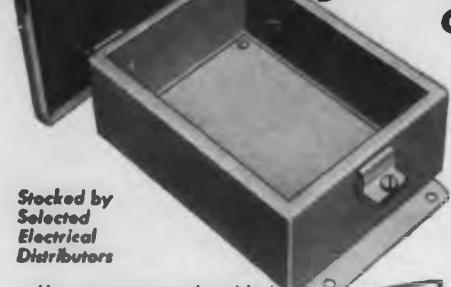

OIL-PROOF DUST-PROOF

- Easy to open! Just loosen clamp screws a few turns!
- Clamp screws captivated, cannot be lost or mislaid.
- External mounting feet of heavy 12 gauge steel, welded, cannot come loose.
- Available with or without removable panel.
- Panel mounting spacers are integral with box—no holes—no leaks.
- JIC and Underwriters Laboratories approved.
- Attractive grey hammer-tone baked enamel finish.
- Special sizes, finish and special construction if you desire.

Stocked by Selected Electrical Distributors

- Heavy gauge steel, welded seams, all sides flanged.
- Neoprene gasketed cover. No oil, water or dust can enter.
- Cover clamps on box, has no screw holes to leak oil or water.
- Cover chained to box, cannot be lost or mislaid.

Look what you get!

SPECIFICATIONS

Write us today!

| BOX SIZE | PANEL SIZE | DEPTH COVER TO PANEL | GAUGE STEEL |
|---------------|-----------------|----------------------|-------------|
| 4 x 4 x 3 | No Panel | No Panel | 16 |
| 6 x 4 x 3 | 4 7/8 x 2 7/8 | 2 3/4 | 16 |
| 6 x 6 x 4 | 4 7/8 x 4 7/8 | 3 3/4 | 14 |
| 8 x 6 x 3 1/2 | 6 3/4 x 4 7/8 | 2 7/8 | 14 |
| 10 x 8 x 4 | 8 3/8 x 6 7/8 | 3 3/4 | 14 |
| 12 x 10 x 5 | 10 3/4 x 8 7/8 | 4 3/4 | 14 |
| 14 x 12 x 6 | 12 3/4 x 10 7/8 | 5 3/4 | 14 |
| 16 x 14 x 6 | 14 3/4 x 12 7/8 | 5 3/4 | 14 |

Hoffman ENGINEERING CORPORATION
Dept. ED-51, Anoka, Minnesota

CIRCLE 352 ON READER-SERVICE CARD FOR MORE INFORMATION



TEMP-R-TAPE®

pressure sensitive TEFLON tape
for Class H insulation, low friction facing

Temp-R-Tape, Teflon with a silicone polymer adhesive backing, provides 1500 vpm dielectric strength, low power factor, a temperature range of -100°F to 400°F (-75°C to 200°C), and a slippery, low friction surface. As an easy-to-apply dielectric or low friction facing. Temp-R-Tape is being designed into electrical and electronic units, aircraft and general industrial applications. $1/4"$ to $12"$ wide, .006" or .013" thick.

FREE SAMPLE and folder—write, phone or use inquiry service

A PRODUCT OF **CHR** THE CONNECTICUT HARD RUBBER CO., NEW HAVEN 9, CONN.

CIRCLE 353 ON READER-SERVICE CARD FOR MORE INFORMATION

Abstract—German

A New Photocell For Infra-Red

E. Brenner

THE conventional photocell for the red region of the visible spectrum uses a Caesium cathode. Above wavelengths of about 1.2 microns (μ) the spectral sensitivity of such cathodes virtually vanishes. A lead-sulphide photoconductor has been developed for use in the infrared region of the spectrum. The type 61SV photocell (Valve Corp., Hamburg) uses a lead sulphide semiconductor whose resistance, in the presence of infrared radiation is proportional to the intensity of the radiation. Comparative spectral sensitivity for lead-sulphide and Caesium-Silver-Oxide are shown in Fig. 1.

For applications (measurements, relay activation, etc.) a dc potential is applied to the tube through a load resistor (R_L in Fig. 2). When the intensity of the incident radiation varies, then the resistance variation produces proportional voltage variations across the load resistor; these signals can then be amplified as with conventional phototubes.

A material difference between vacuum phototubes and the photoconductor cell lies in the fact that in the latter the output signal is linearly related to the supply voltage at constant illumination. Within the operating range, the photoconductor acts as a linear resistance.

Exactly as for phototubes, the sensitivity of photoconductors is specified in μa per lumen. With 200 v applied to the cell and an incident radiation of 0.05 lumen on the effective area, the rating is

$N = 3.5 \text{ ma/lumen}$ at a source color temperature of 2700 K. This rating corresponds to about 150 times the rating of a vacuum phototube with emitting cathode at the same wavelength.

In Fig. 2 the linear characteristics with the radiated power are shown up to 0.05 lumen. For supply voltages of 100 v and 250 v several typical load lines are shown. The effective area illuminated was 6 x 6 mm.

An important characteristic of the infrared sensitive device is temperature dependence. Fig. 3 shows a curve which describes this property. The graph shows relative rms output voltage (normalized with respect to output at 200 C as a function of source temperature. For the test the cell is illuminated through a rotating disk which has holes punched in it.

The sensitivity is also a function of the ambient temperature. With a black source at 200 C sensitivity, N between -10 and $+50$ C, is approximated by the formula

$$N = N_r (1.4 - t/50)$$

where N_r is the sensitivity at room temperature (20°C) and t is the ambient temperature in degrees C. High ambient temperatures result in greatly reduced sensitivity, hence artificial cooling is often required. Abstracted from an article by E. Suchel, *Electronische Rundschau*, Nov. 1956, pg. 296.

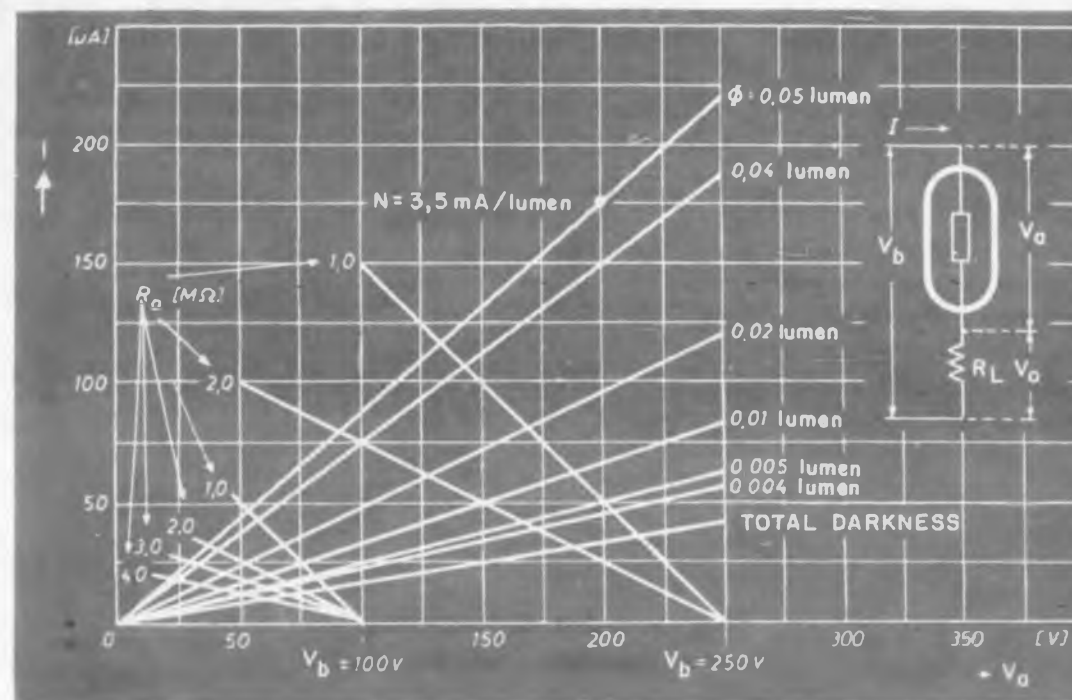

Fig. 1: Relative spectral sensitivities for a lead-sulphide photoconductor (61SV) and a Caesium-Silver oxide photocell.

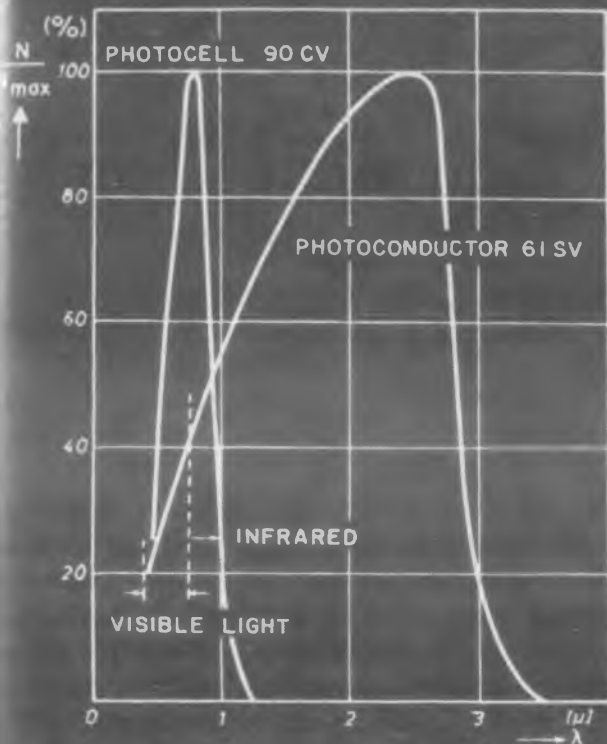

Fig. 2: Characteristics of the 61SV with constant incident power.

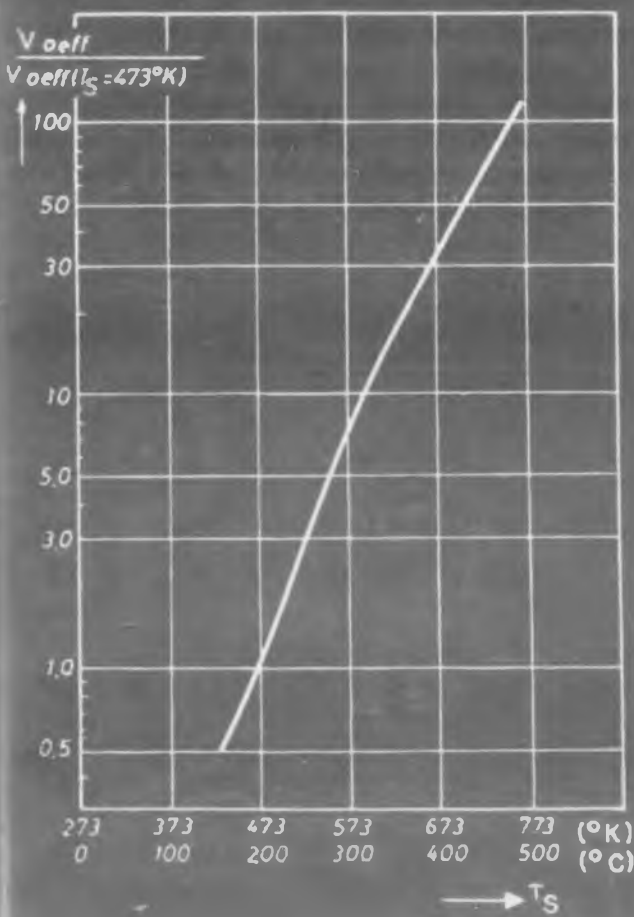
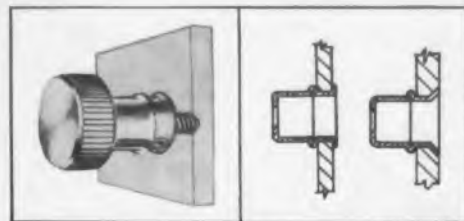

Fig. 3: Relative sensitivity as a function of temperature.

SELECT CLOSURE HARDWARE TO IMPROVE UTILITY, APPEARANCE, AND TO LOWER COST

QUICKLY INSTALLED SOUTHCO CAPTIVE PANEL SCREWS END MISALIGNMENT PROBLEM . . .



Simplicity of design contributes to clean, distinctive appearance and fast, low-cost installation. Stand-off is slipped into panel hole and secured by flaring. Screw is passed through stand-off and made captive by vinyl o-ring.

"Floating" screw design eliminates costly close tolerance manufacture and permits easy engagement regardless of panel distortion encountered under adverse use conditions.

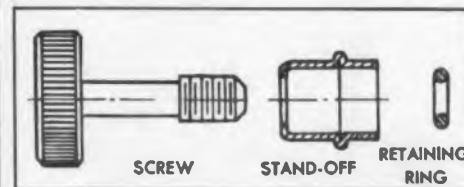

SPECIFICATIONS

Material: Screw is brass, chrome plated; can be supplied in stainless steel. O-ring is vinyl plastic. Overall length of screw: $1\frac{3}{16}$ " Depth of screw head: $\frac{1}{4}$ "

Sizes:

| SCREW HEAD DIAMETER | THREAD SIZE |
|---------------------|--------------------------|
| $\frac{3}{4}$ " | $\frac{1}{4}$ -20 |
| $\frac{5}{16}$ " | $\frac{1}{4}$ -20, 12-24 |
| $\frac{3}{16}$ " | 10-24, 10-32 |

Length of thread: $\frac{3}{8}$ "

Screw head is supplied plain, as shown, or slotted for screw driver.

PRE-ASSEMBLED PAWL ADJUSTS TO DESIRED THICKNESS AND PRESSURE



This neat, compact Southco panel and door fastener is supplied assembled, requires but two rivets or bolts for low cost installation. It is available in three models—large, intermediate and midget.

The unique feature of Southco Pawl Fasteners is the fact that, by merely turning the knob, the pawl is adjusted to a wide range of frame thicknesses. This assures a tight grip without precision setting regardless of variations in frame or door dimensions or changes that are produced by wear or warping of sheets.

Pressure exerted by the pawl on the frame is controlled in the same way, by merely turning the knob. Against gasketed frames, pressure can be easily applied to compress the gasket.

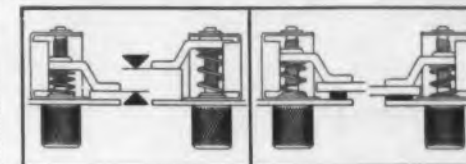

SPECIFICATIONS

Knob: Cadmium or chromium plated steel.

Head Styles: Protruding ribbed or knurled knob; flush screw driver slotted for large size only.

| | LARGE | INTERMEDIATE | MIDGET |
|---------------------|-------------------|-------------------|-------------------|
| Knob diameter | $\frac{7}{8}$ " | $\frac{5}{16}$ " | $1\frac{1}{2}$ " |
| Total width | $2\frac{1}{2}$ " | $1\frac{3}{4}$ " | $1\frac{1}{8}$ " |
| Total height | $1\frac{3}{4}$ " | $\frac{7}{8}$ " | $\frac{25}{64}$ " |
| Back of panel depth | $1\frac{3}{32}$ " | $1\frac{1}{4}$ " | $\frac{7}{8}$ " |
| Knob length | $1\frac{1}{8}$ " | $1\frac{1}{16}$ " | $\frac{3}{2}$ " |

FAST, HAMMER-DRIVEN BLIND RIVETS CUT INSTALLATION TIME

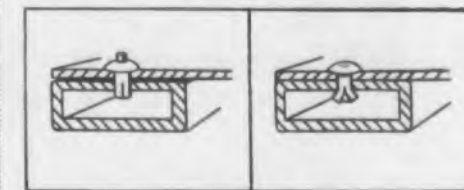

You "hit-the-pin" and the rivet's in. No special tools to limit production or require maintenance, no bucking, no finishing. For blind or open applications, Southco Drive Rivets save time, reduce costs.

Automatic "pull-up" action assures uniform, tight grip.

Southco Rivets are made of aluminum or cadmium plated steel with cadmium plated or stainless steel pins. Diameters are from $\frac{1}{8}$ " to $\frac{1}{4}$ ", grip range is from $\frac{1}{16}$ " to $\frac{3}{8}$ ".

Increased widespread use is due to low installed cost and elimination of down time and maintenance associated with fasteners requiring special tools.

FREE!

Fastener Handbook

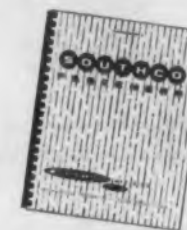

Send for your free copy of Handbook No. 7, just released. Gives complete data for designers on these and many other specialty fasteners. 52 pages, in two colors.

Write on your letterhead to Southco Division, South Chester Corporation, 235 Industrial Highway, Lester, Pa.

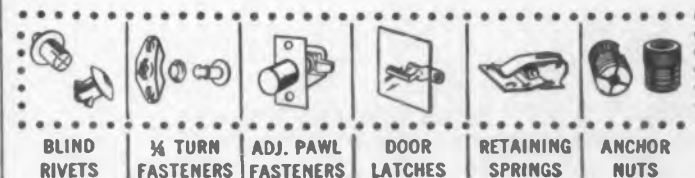

BLIND RIVETS | $\frac{1}{4}$ TURN FASTENERS | ADJ. PAWL FASTENERS | DOOR LATCHES | RETAINING SPRINGS | ANCHOR NUTS

SOUTHCO FASTENERS

©1957

LION

CIRCLE 354 ON READER-SERVICE CARD FOR MORE INFORMATION

NEW hot-molded composition Variable Resistors

for high temperature
applications



TYPE K
available in
resistance values
up to 5 megohms.



Type K single unit with short shaft and lock-type bushing.



Type K triple unit control with plain short shaft.



Type K dual element control with concentric shafts.

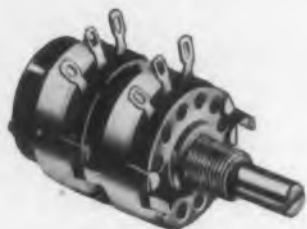

Type K dual element control with 125 v line switch.



Type K single unit variable resistor with long shaft.

The new Type K Allen-Bradley variable resistor was developed primarily for use in high operating temperatures—so common in military applications. For the *first* time, a variable resistor is available with a conservative rating of 2 watts, operating in 100°C ambient temperatures, as the graph below shows. However, the new Type K control performs reliably at a temperature of 150°C—under “no load” conditions . . . while at temperatures of 70°C, it is *ultraconservatively* rated at 3 watts.

The new Type K control has *all* the features of the old reliable workhorse—the Type J Bradleyometer. With the *hot-molded* resistance type element, control is smooth and without abrupt resistance changes, and “noise” characteristics are extremely low, even after long use. Send for Bulletin 5200A.

Allen-Bradley Co.
1344 S. Second St., Milwaukee 4, Wis.
In Canada—Allen-Bradley Canada Ltd.
Galt, Ont.

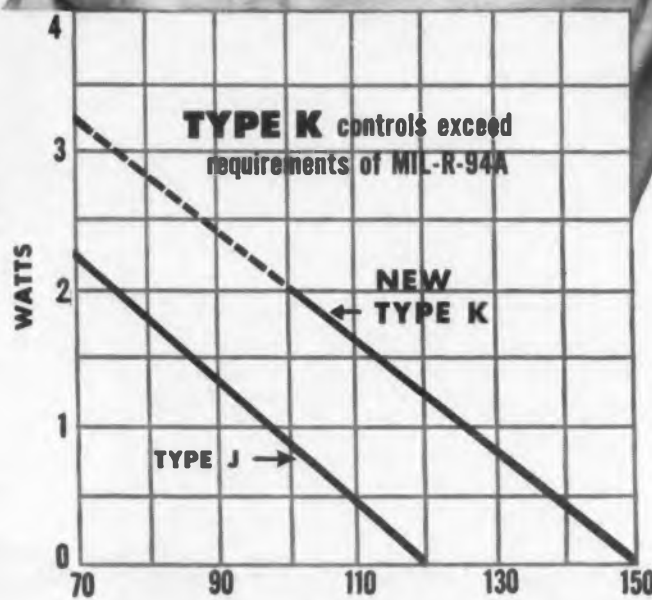

COMPARISON BETWEEN TYPE K AND TYPE J VARIABLE RESISTOR POWER RATINGS VS. AMBIENT TEMPERATURE

Abstract—German

Ionization Chamber

TO OBTAIN time delays of more than about three minutes, the ordinary R-C circuit is not suitable. Precision potentiometers above about 10 megohms and reasonably large capacitors above 20 μf with dielectrics for the required voltages are not available. The conventional time delay relay circuit which employs a cold cathode triode as shown in Fig. 1, is restricted to delays ranging from fractions of seconds to about three minutes, if the box marked R is an ordinary resistance.

If the resistance R in Fig. 1 is replaced by an appropriately designed ionization chamber then time delays up to several hours are possible with a rather small capacitance. Such an ionization chamber usually consists of two parallel plates. On one plate a radiator such as a Radium mixture is mounted. Alpha rays ionize gases with sufficient intensity so that usable currents can be obtained. In the presence of about 10^{-5} gms of radium about 10^{-8} amp can be obtained with a chamber potential of 100 v.

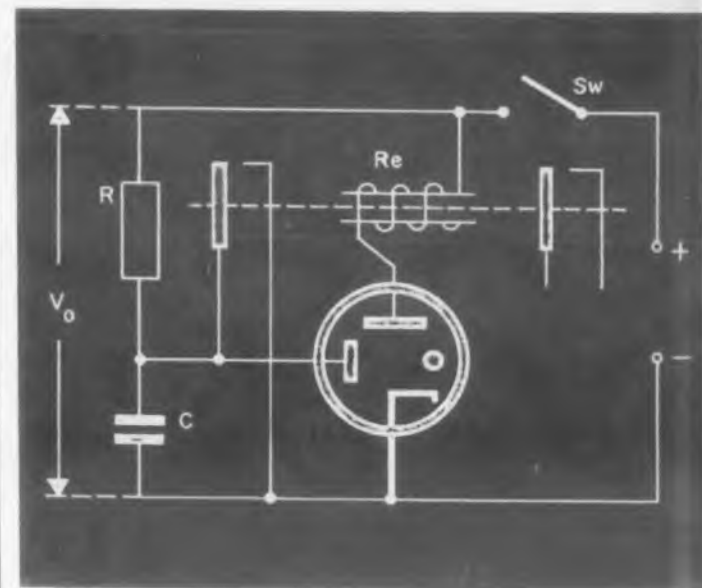

Fig. 1: Basic circuit of time-delay relay with cold-cathode triode. The usual resistance R can be replaced with an ionization chamber.

ALLEN-BRADLEY
ELECTRONIC COMPONENTS

QUALITY

CIRCLE 355 ON READER-SERVICE CARD FOR MORE INFORMATION

Time Delay Relay

E. Brenner

The alpha rays ionize the air so that conduction takes place. The current which is collected depends on the applied potential and the spacing of the plates. As spacing is increased a maximum is reached as shown in Fig. 2. Similar behavior is noted if the gas pressure in the chamber is varied. The effect of temperature, which is slight, as well as the effect of humidity can be compensated by pressure adjustment.

The ionization chamber exhibits a saturation phenomenon; beyond a critical voltage the current is independent of potential. This is a distinct advantage since a 10 percent fluctuation of supply voltage produces timing errors of about 15 percent in RC circuits while the corresponding error with the ionization chamber is less than 3 percent. Commercial time delay relays in the 20-30 min. ranges, made by Elesta A. G., Bad Ragaz, are cited as examples of application of the ionization chamber. *Abstracted from an article by H. Jucker, Electronische Rundschau, vol. 11, no. 1, Jan. 1957, pg. 13.*

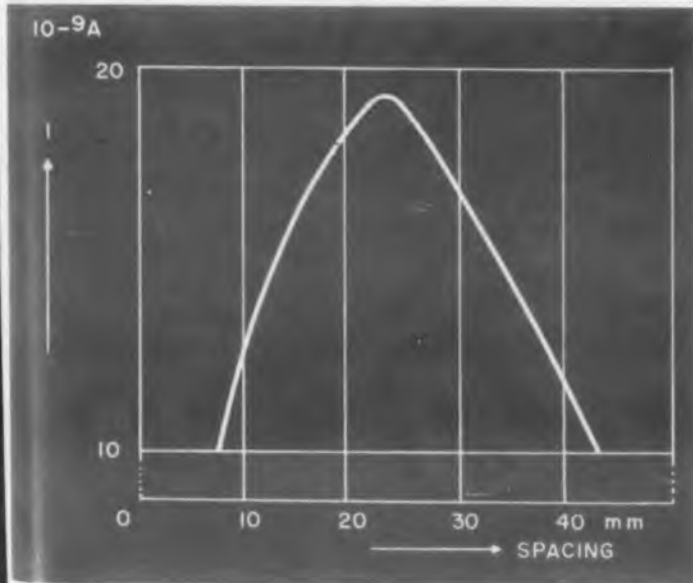

Fig. 2: Ionization current as a function of electrode spacing. A maximum spacing can clearly be reached.



AMPLIFIERS

applications unlimited...

You can employ Brown Amplifiers for any number of measuring, balancing, and positioning applications. Use them, for instance, in computer or integrator circuits, or for photometer shutter movement, grid bias adjustment, null positioning or coordinate transformation.

The Brown Amplifier amplifies a d-c or a-c microvolt input signal sufficiently to drive one field of a two-phase balancing motor. Three stages of voltage amplification are followed by the power output-phase discriminator stage, which supplies the required power for the motor.

Brown Amplifiers have extremely low stray pickup, excellent stability, adjustable sensitivity and fast response. They have been proved in thousands of *ElectroniK* precision instruments.

MINNEAPOLIS-HONEYWELL REGULATOR Co., Industrial Division, Wayne and Windrim Avenues, Philadelphia 44, Pa.—in Canada, Toronto 17, Ontario.

SELECT FROM THESE BASIC MODELS

| Gain | Sensitivity (Microvolts) | Nominal Input Impedance (Ohms) |
|------------------|--------------------------|--------------------------------|
| 10^6 | 4.0 | 400, 2,200, 50,000* |
| 4×10^5 | 1.0 | 400, 7,000 |
| 12×10^4 | 0.4 | 400, 2,200, 7,000 |
| 40×10^3 | 0.1 | 2,200 |

*Special for high impedance sources.

POWER SUPPLY
115 v., 60 cycles (fused power line)

OUTPUT
2 to 18 ma. into 12,000 ohm load

SENSITIVITY
Continuously variable screwdriver adjustment. Recessed slot protects setting

ORDER NOW! Write or phone for immediate quotation. Fast, dependable delivery. Priced as low as \$98.50. (Even more attractive prices on quantity purchases.)

MOUNTING
Operation unaffected by mounting position

OPTIONAL FEATURES
(a) thermocouple burnout protection, (b) without desensitizing adjustment, (c) parallel T feedback, (d) velocity damping, (e) special connecting cables and plugs, (f) without tubes, shields, and converter, (g) for 25 cycles, (h) 220-110 volt transformers.



ELECTR-O-VANE PRECISION SWITCH

Less than 2 gram-inches of torque actuates this high-precision SPDT switch. Switching action occurs with from 0.00025 to 0.0025 inches of movement of the actuating lever . . . always occurs at precisely the same spot. Use it as a non-loading limit switch in machine tools . . . as a cutoff switch on automatic weighing equipment . . . as a no-load safety switch in process equipment . . . for accurate counting without contact under conveyor belts . . . and wherever you want precision switching with minimum force. Prices from \$60.50. Write for Specifications S800-1.



Honeywell

BROWN INSTRUMENTS

First in Controls



TEST CLAMPS

—Lock Like A Vise!
—Easily And Quickly Attached!
—When Attached—STAY PUT!



Handy For:

- Clamping Waveguides.
- Test Instruments.
- Radio Antenna or Ground.
- Connecting Portable Equipment.
- Cable Splicing.

NEED SPECIAL CLAMPS

In Large Quantities?

We have in the past engineered special clamps for electronic applications. Your inquiry is invited. No obligation.

Yes, hundreds of uses. Attached in a jiffy. Just a slight twist of the large finger-tip safety knob exerts tremendous pressure for heavy current conduction on constant and intermittent duty. Available with solder and solderless lugs in 7 sizes 0 to 300 Amps.

WRITE FOR FREE DESCRIPTIVE BUL. NO. 7

TRICO FUSE MFG. CO. Milwaukee 12, Wis.
In Canada—IRVING SMITH LIMITED—Montreal

CIRCLE 357 ON READER-SERVICE CARD FOR MORE INFORMATION

Terminal Connecting Strips

For Faster, Better Wiring
Of Multiple Connections
To Terminal Blocks

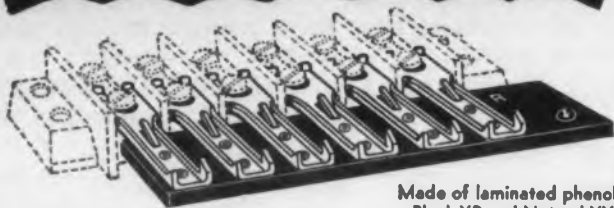

Showing No. 650 Strip connected (but not wired) to our No. 600 Terminal Block

Made of laminated phenolic:
Black XP and Natural XXXP
Lugs are of .031 thick brass.
Hot-tinned for easy soldering.

Here is a practical device to simplify wiring work and to assure correct connections. Cable is attached at either end of strip with clamp. Each wire is soldered to terminal lug at raised nib. Pointed ends are clamped over insulation, holding wire fast. Work can be done at bench, or anywhere. Connect to matching terminal block by sliding spade-type lugs under binder screws and tightening. Lugs are double eyeletted and fit snugly between high barriers, so cannot shift. Uprturned ends of lugs act as extra 'lock'. Supplied flat, or with 90° angle (A), with cable mounting hole at left (L) or right (R) of strip.

For further information contact our Engineering Department

REQUEST CATALOG



KULKA ELECTRIC MFG. CO., Inc.

633 - 643 SOUTH FULTON AVENUE • MOUNT VERNON, N. Y.

Manufacturers of Electrical Wiring Devices

CIRCLE 358 ON READER-SERVICE CARD FOR MORE INFORMATION

Abstracts

Transistors In A Reactor Field

TRANSISTORIZED electronic equipment designed for use in the presence of the full fission spectrum of a nuclear reactor should take into account the following effects of the field: 1. transient effects due to flux density—mostly noise—and gamma heating, 2. semipermanent effects due to integrated flux, and 3. permanent effects remaining after annealing.

To test these effects during in-pile operation a transistorized crystal video set, consisting of a silicon crystal detector and a 2-stage germanium transistor amplifier, was used. It was found that a noise effect was present while the device was in a flux field above that which was provided by integrated flux. Annealing the transistors after irradiation generally tended to improve the operation. In cases such as gain, however, this was not always true. Tentative limits for flux density and total integrated flux for no appreciable degradation in the operation

of the crystal video receiver of 10^8 nv and 10^{13} nvt, respectively, may be chosen. Fig. 1 shows that in the 2-stage receiver amplifier an appreciable increase in noise voltage and reduction in gain appears just one order of magnitude of time-integrated flux higher.

It was noted that I_{co} was higher while transistors were in the flux field and recovered somewhat when removed. The change in temperature due to gamma heating was not sufficient to account for the change in I_{co} , and the latter may be due in part to the production of hole and electron pairs by the gamma flux. *Abstracted from Dynamic Effects of a Nuclear Reactor Field Upon Transistors, a paper by R. L. Riddle, presented at the Symposium on Nuclear Radiation Effects on Semiconductor Devices and Materials, sponsored by the Working Group on Semiconductor Devices, Office of the Asst. Secretary of Defense, Research Development, February 1957.*

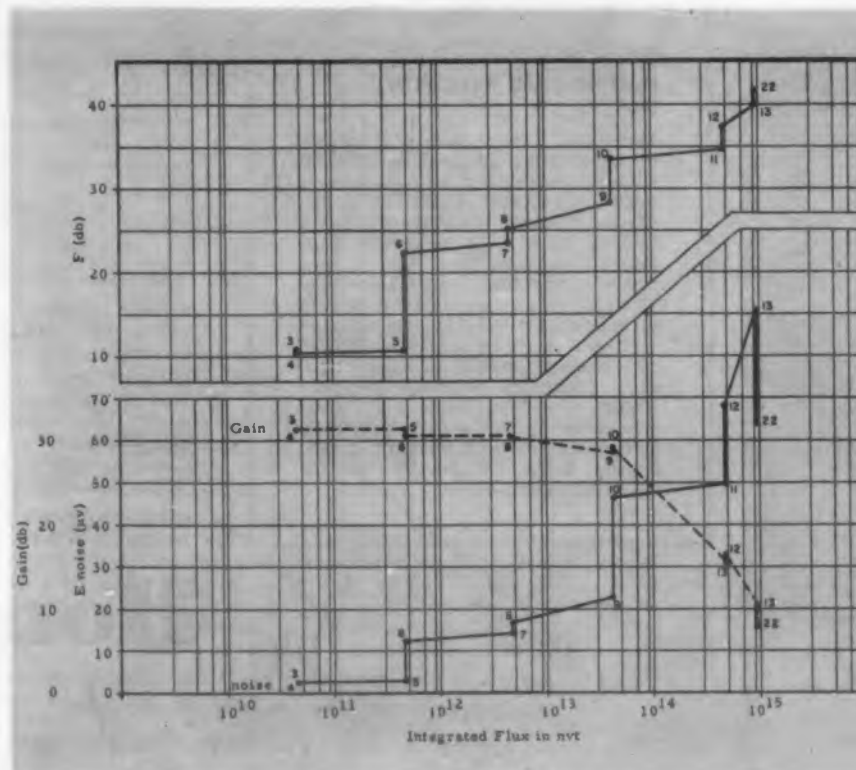

Fig. 1. Transistor amplifier parameters. Upper curve is the noise figure. Lower curves represent gain and noise voltage measured against total time-integrated flux.

Transistorized Phase Discriminator

USING recent, randomly selected silicon junction transistors, a phase discriminator with high sensitivity and temperature stability was designed. Operation between 125 C and -55 C was tested, and a reasonably flat power gain of 25 db over the entire range noted.

Former attempts at phase discriminator design using germanium transistors were unsuccessful due to the adverse sensitivity of the transistors to temperature variation. Subsequent developments in silicon transistors led to the design of this unit, which was proved to be stable with respect to temperature. The transistors used were npn silicon junction; the diodes, shown in Fig. 1, were also silicon junction types.

This full-wave discriminator uses a phase reversible signal source coupled by a transformer with a voltage stepdown ratio of about 12 to 1 on each side of the center-tapped secondary. For most efficient operation with the 3 terminal or split-load shown in Fig. 1, it is essential that the input signal

be in phase or 180 deg out of phase with the power supply, and at the same frequency. If this is not the case current will flow in both arms of the load simultaneously, reducing the current differential. Conversion of the full wave discriminator with a 3 terminal load to a 2 terminal load results in a considerable loss of useful power due to bleeder resistors which dissipate five-sixths of the total power output. A respectable useful power, however, can be obtained depending upon the maximum ratings of the transistors. The way the transistors operate in the full wave circuitry permits power outputs much greater than the maximum effective power dissipated in each.

This discriminator will produce a phase sensitive dc output capable of driving a magnetic amplifier or energizing relays, heating coils and hydraulic valves, for aircraft applications. *Abstracted by Sol Prenskey from Transistorized Phase Discriminators by A. N. DeSautels, a paper presented at the AIEE Winter General Meeting, January 1957.*

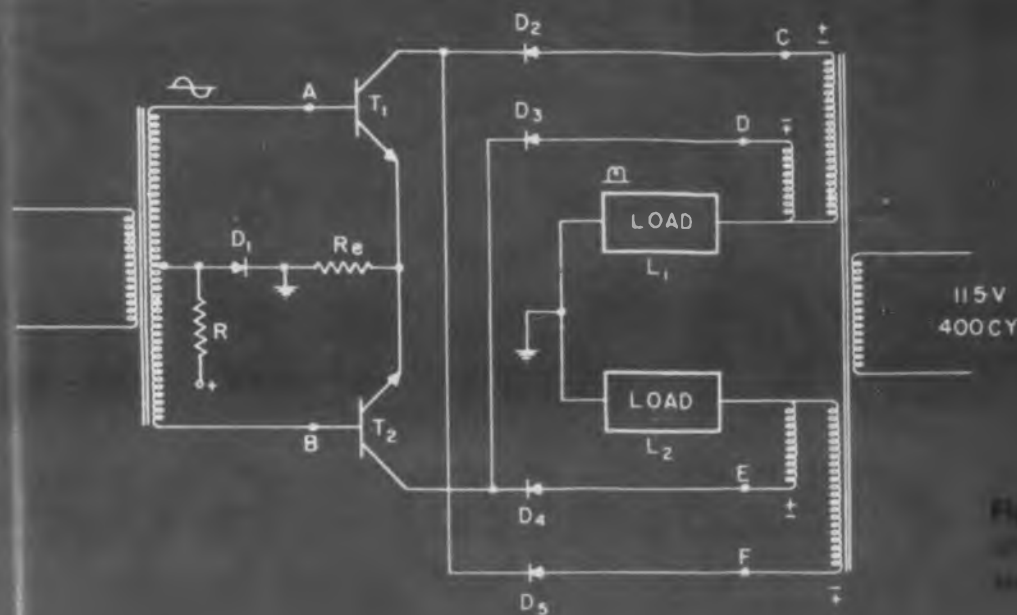

Fig. 1. Full wave discriminator with three-terminal load.

check
the spec
on this

GORN PRINTED CIRCUIT CONNECTOR

No. of contacts—6, 8, 10, 12, 15, 18, 22, 38.

Material: Body—molded plastic per spec. MIL-P-14 Type MME, contacts and polarizing pin—phosphor bronze or beryllium copper.

Contacts and polarizing pin—silver plate .0002 plus gold plate .00003 min.

Wire size: No. 16 or 17. AWG.

Breakdown voltage between contacts, at sea level, mated with printed board 1200 volts DC.

Polarizing pin may be located in any slot desired.

Contacts will mate with printed circuit boards from .061 to .071 thick.

For further information, write:



CIRCLE 359 ON READER-SERVICE CARD FOR MORE INFORMATION

HIGH-CURRENT, REGULATED DC POWER SUPPLY

Typical standard design rated at 125 volts, 2 amperes is mounted on standard 19" relay rack chassis only 5 1/4" high.



Unique, simple design provides compact size, low weight, and moderate price in proportion to power output and performance.

The Sola Constant Voltage DC Power Supply provides exceptional performance under intermittent, variable, pulse, or high-amperage loads. Its regulation is within $\pm 1\%$ for line voltage variations of up to $\pm 10\%$. Six stock models are available in ratings as shown below:

All Inputs 100-130 Volts, 60 cps

| Catalog Number | Output Rating | | | Efficiency Approx. % | Ripple Voltage (rms.)-% of Total | Approx. Shipping Weight Each Pounds |
|----------------|---------------|-------|------|----------------------|----------------------------------|-------------------------------------|
| | Watts | Volts | Amps | | | |
| 28156 | 144 | 24 | 6.0 | 72 | Less Than 1% | 45 |
| 28120 | 192 | 48 | 4.0 | 77 | Less Than 1% | 45 |
| 28152 | 250 | 125 | 2.0 | 82 | Less Than 1% | 55 |
| 28106 | 300 | 150 | 2.0 | 80 | Less Than 1% | 50 |
| 28193 | 200 | 200 | 1.0 | 76 | Less Than 1/2% | 45 |
| 28192 | 250 | 250 | 1.0 | 81 | Less Than 1/2% | 55 |

Also, design and assembly service is offered on special ratings to meet specific requirements of equipment manufacturers. Request Bulletin 31E-CV-235 for further technical information and prices from: SOLA ELECTRIC CO., 4633 W. 16th Street, Chicago 50, Illinois.

CIRCLE 360 ON READER-SERVICE CARD FOR MORE INFORMATION



RCA-WV-98A . . . ALL-NEW SENIOR VoltOhmyst . . . incorporates all the important time-proved performance features of the earlier Senior VoltOhmyst including direct peak-to-peak readings of complex waveforms. The new Senior VoltOhmyst includes an improved circuit providing greater accuracy, and a BIG full-vision meter face with the easiest-to-read scales ever designed into a VTVM! Complete with WG-299B DC/AC-Ohms probe and cable, instruction booklet **79.50***



RCA-WV-77C . . . ALL-NEW JUNIOR VoltOhmyst . . . one of the greatest values in vacuum-tube volt-ohmmeters. Embodies several new design features in addition to operational characteristics which have made earlier versions of the instrument the choice of thousands in radio and TV servicing, industry, electronics, communications, broadcasting, and in the armed forces. Complete with WG-299B DC/AC-Ohms probe and cable, instruction booklet **59.50***



RCA-WV-87B . . . MASTER VoltOhmyst . . . features a 27 sq. in. meter with mirror scale. Its easy-to-read peak-to-peak scales are particularly useful for TV, radar, and other types of pulse work. Has accuracy and stability necessary for many laboratory applications. Current ranges from 0.01 ma. to 15 amperes. Complete with probes and cables, including: WG-299C DC/AC-Ohms probe and cable, alligator clip, clip insulator and instruction booklet . . . **137.50***

*User Price (optional)

Accurate • Stable • Reliable • Portable • Easy-to-set-up • Easy-to-read

“VoltOhmyst®”

describes the finest test instruments for **SERVICING . . . LABORATORY . . . PRODUCTION TESTING**

Modern engineering, testing, and production techniques demand test instruments with practical operating features. The VoltOhmyst instruments are “packed” with practical features which make them especially suited for operation over extended periods under rigorous production-line conditions. Features include: electronically protected meters; accuracy unaffected by normal line voltage fluctuations; easy-to-read expanded scales; one zero setting holds for all voltage and resistance ranges; accessory probes extend dc ranges to 50 KV, and extend frequency response to 250 Mc.

Factory-built, factory-tested, and calibrated to laboratory standards, each VoltOhmyst is the finest VTVM for the money. For the VoltOhmyst to fit your needs, see the chart at the right.

| CHOOSE THE VoltOhmyst THAT SUITS YOUR NEEDS | | | |
|---|--------------------------|--------------------------|--------------------------|
| Features | Master VoltOhmyst WV-87B | Senior VoltOhmyst WV-98A | Junior VoltOhmyst WV-77C |
| Measurements: | | | |
| DC Voltage | 0.02-1500v | 0.02-1500v | 0.05-1200v |
| AC (rms) Voltage | 0.1-1500v | 0.1-1500v | 0.1-1200v |
| AC (peak-to-peak) Voltage | 0.2-4200v | 0.2-4200v | — |
| Resistance | 0.2-1000 meg. | 0.2-1000 meg. | 0.2-1000 meg. |
| Current | 10 uamp.-15 amp. | — | — |
| Accuracy:** | | | |
| DC Current | ±3% | — | — |
| DC Voltage | ±3% | ±3% | ±3% |
| AC Voltage | ±3% | ±3% | ±5% |

**At full-scale points
†For positive voltages, ±5% for negative voltages



RCA Ultra-Sensitive DC Microammeter, WV-84A, For Reading Extremely “Feeble” Currents.

WV-84A measures minute currents from 0.002 to 1000 ua—in six ranges! It can be used as a very high-resistance voltmeter—up to 1005 megohms on 100-volt range. And, the WV-84A can be used as a megohmmeter for measuring resistance up to 90,000 megohms. \$110.00* less batteries.

Well-suited for applications in such fields as biology, nucleonics, chemistry, and electro-mechanics—as well as electronics—the WV-84A is completely portable, with a self-contained battery power supply.



RADIO CORPORATION of AMERICA

COMPONENTS DIVISION

CAMDEN, N. J.

For technical details on the precision built VoltOhmyst line, call your RCA Distributor!

CIRCLE 361 ON READER-SERVICE CARD FOR MORE INFORMATION

Abstract



REQUIRING only periodic connection to a commercial power line, this compact frequency standard may prove valuable for airborne use and in other cases where a stable but portable frequency source is required.

The principle of the latent-heat stabilization method for controlling enclosed-space temperature is applied in this unit. Using diphenyl at its 70°C double-point—the temperature where it exists as a mixture of solid and liquid—a temperature stability of a few hundredths of a deg C is obtained. The oscillator stability is ±1 part in 10⁷ over a period of several hours.

The apparatus consists of a transistor crystal-controlled oscillator and a two stage transistor buffer amplifier shown in Fig. 1 and 2, which are operated continuously from four small mercury cells contained in the bottom compartment of the standard. All components of the circuit are enclosed in the diphenyl oven which maintains them at a constant temperature.

Surrounding the diphenyl is an electric heating coil controlled by a microswitch. When the diphenyl is heated it increases in volume and presses against the bottom of bellows located in the inner compartment. This movement of the bellows closes the microswitch and opens the heater circuit. The heat can be adjusted to operate at varying degrees of temperature by a shaft which controls the height of the upper contact point of the microswitch. Heat losses from the oven are reduced by a heat radiation shield and a vacuum insulation space.

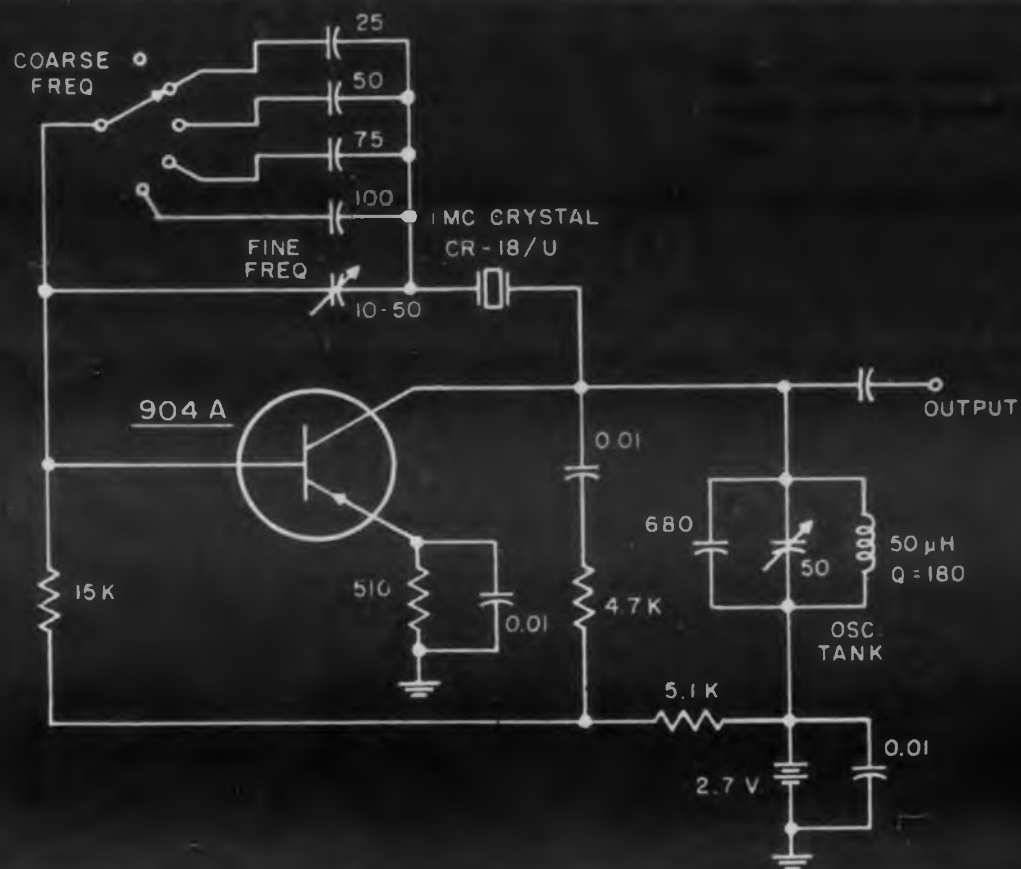

After the oven temperature has been stabilized at the double-point temperature of the diphenyl, the unit may be disconnected from the power source which supplied the initial heat, and operated for several hours on temperature without external power connections.

External coarse and fine frequency controls are provided on the developmental model to adjust the oscillator frequency. The oscillator tank capacitor can also be adjusted for best output voltage; and the oven temperature can be varied. An inexpensive, commercial 1 mc quartz crystal is used to control

the frequency of the oscillator. The output voltage is about 400 mv into a 600 ohm load.

Silicon junction transistors were chosen for the oscillator and amplifier because of their ability to operate at temperatures up to 150 C, whereas germanium transistors cease operation around 80 C. The overall efficiency of the oscillator and amplifier is around 78 per cent since the input power from mercury cells is 7 mw and matched load output power is 5.4 mw.

Abstracted from an NBS Summary Technical Report Portable Frequency Standard, March 1957.

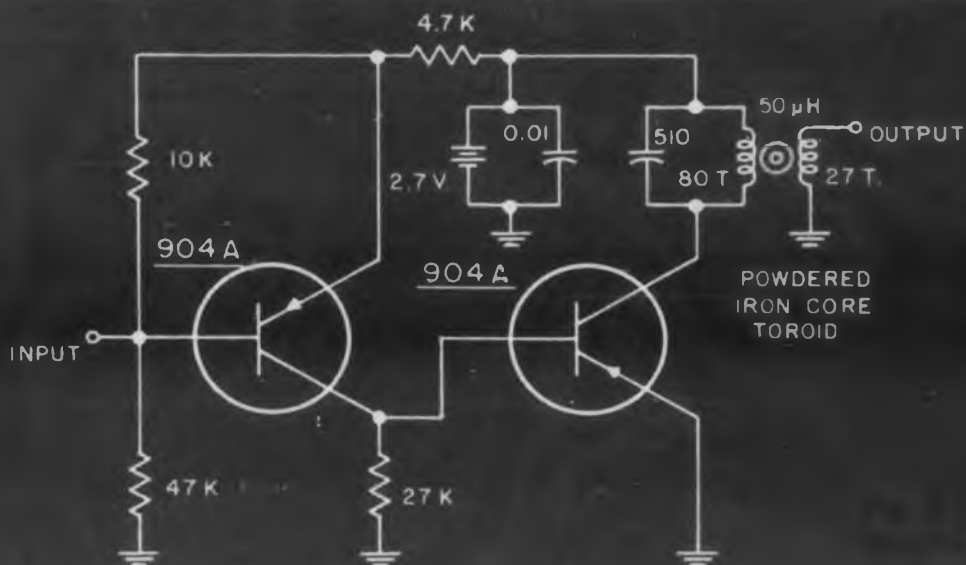

There's no need to compromise or improvise with ordinary stock relays. Comar can supply whatever combination of switches, contacts, coils, leads and mountings you need. Custom-made to match your product, installation is easier, performance is better, cost is surprisingly low. Inquiries invited.



RELAYS • SOLENOIDS • COILS • SWITCHES • HERMETIC SEALING
CIRCLE 362 ON READER-SERVICE CARD FOR MORE INFORMATION

Specify standard **FLEXLOC** microsize locknuts

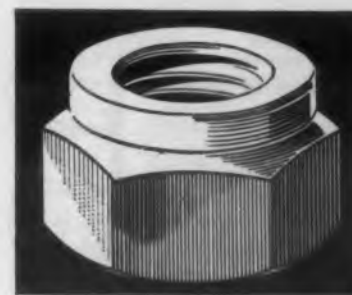

- One-piece, all-metal construction
- Resilient locking section
- Controlled locking torque
- Lock and stop nut in one
- Every thread carries its full share of the load
- Made to Class 3B fit

Smaller than regular FLEXLOCs of the same nominal diameter, FLEXLOC microsize locknuts make possible smaller mating joints and flanges. Standard materials are brass (plain or cadmium plated) and aluminum (plain or chemically treated), for temperatures to 250°F; alloy steel and 18-8 stainless steel, for temperatures to 550°F. They are available in sizes #0 through #4 at your industrial distributor's. See him for details. Or write for literature, samples, information on other materials. Flexloc Locknut Division, STANDARD PRESSED STEEL CO., Jenkintown 12, Pa.

STANDARD PRESSED STEEL CO.
FLEXLOC LOCKNUT DIVISION **SPS**
JENKINTOWN PENNSYLVANIA

CIRCLE 363 ON READER-SERVICE CARD FOR MORE INFORMATION

Send for FREE SAMPLE PACKET of the three new
MUELLER "70 SERIES" ALLIGATOR CLIPS
Low-cost, streamlined clips

with **SNAP!**

THIS IS AN ACTUAL
 HIGH SPEED SEQUENCE PHOTOGRAPH
 OF A NEW "70 SERIES" ALLIGATOR CLIP

which is taking 1/2500th second to snap shut upon a wafer. Talk about acceleration!—the upper jaw hits 60 MPH in three-eighths of an inch. The upper jaw and flying wafer fragments have been caught in many images along their paths of movement.

Photographed by means of a special process, it graphically illustrates the "snap" in Mueller's traditionally snappy springs. These springs provide a mean, corrosion-cutting bite for perfect test connections.

THE NEW "70 SERIES" ALLIGATORS FEATURE:

Simple, direct, streamlined design, and lower cost than the famous "60 Series".

Faster, easier connection, whether screw type or soldered.

A new patented hinge, and cord strain relief ears.

WRITE FACTORY TODAY FOR FREE
 SAMPLE PACKET SHOWN ABOVE



Mueller Electric Co.

1580H East 31st Street • Cleveland 14, Ohio

CIRCLE 364 ON READER-SERVICE CARD FOR MORE INFORMATION

**A NEW DIMENSION IN
 DESIGN MATERIAL...**

**PRECISION BORE
 GLASS TUBING**

**Wilmad Offers Unheard-Of Accuracy
 and Low Cost**

Design Engineers are constantly searching for new materials to reduce costs and improve performance. Wilmad has helped make glass a "new" material by producing precision bore tubing of uniform accuracy with amazing tolerance limits. Wilmad Precision Bore Tubing can be used in making product components, instrument assemblies or sub-assemblies, wave guide tubes, manometers, rotameters, viscosimeters, barometers, McLeod gauges, dilatometers, burettes, dash pots, capacitors, diodes . . . in virtually hundreds of precision applications in industry.

Learn how precision bore glass tubing can improve your product. Let our engineers help you determine how Wilmad Glass Tubing can solve your design problems.

Write for our new bulletin on Precision Bore Tubing.



WILMAD GLASS CO., INC.

Landisville, New Jersey

CIRCLE 365 ON READER-SERVICE CARD FOR MORE INFORMATION

Interference Control Through Design

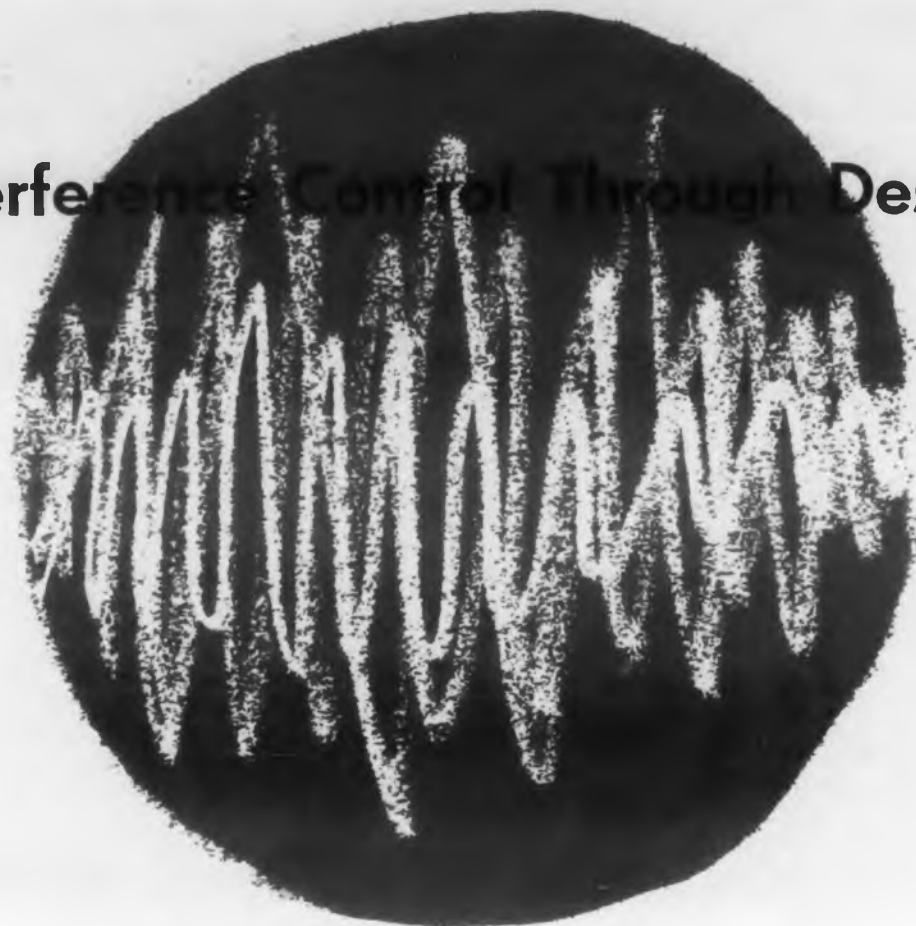

GREATER reliability, improved performance, longer life and less maintenance for any given piece of equipment will result from interference-free design. From a cost point of view, the price of applying filters, capacitors, compressors, and other interference suppression devices is substantially higher than the cost of the time expended in designing the equipment to be interference-free.

Consider a hypothetical communications transmitter. It is required to cover a specific frequency range and to deliver a specified amount of rf power to an antenna. There are size and weight limitations placed upon the complete unit, and it should not require more than so many of ac input power.

The job of designing this transmitter is given to an engineer who elects to use tubes in the final amplifier that require forced air-cooling. To reduce the number of frequency multiplying stages, he also decides to triple in the final rf stage, and to work all preceding multiplying stages to their maximum power limits. To reduce the size and weight of the power supply unit, he uses tubes all of the same heater voltage—which is a good idea—but he grounds one side of the heater winding of the power transformer and runs a single lead to all tubes in the transmitter. The effective forced air-cooling of the final amplifier tubes requires a minimum of air-flow. The space available in the transmitter for a blower is so small that only a small high-speed

blower can be used. The speed of the blower is over 10,000 rpm, and the motor is of necessity of the ac/dc universal type with brushes and a commutator. The design of this transmitter is now frozen.

Attempts are made to suppress the interference. A filter is placed in the input power line adjacent to the terminal board. In an effort to reduce the radiation of crystal harmonics from the antenna, a band reject filter tuned to one-third the transmitter output frequency is placed in the final amplifier tank circuit. The blower motor creates such a high level of interference that the power line filter is ineffective. An attempt is made to insert another filter in the leads of the blower motor, and the only kind that fits in the space available is one that uses metallized capacitors which, in themselves, have been found a source of interference.

Because of keying in the stage following the crystal oscillator, and because of radiation of rf power under key-up conditions, break-in operation of the transmitter is impossible. The frequency multiplying stages generate numerous harmonics, and the filter in the final tank circuit is not fully effective. In short the transmitter is highly unsatisfactory.

This case does not seem to be a serious exaggeration of the difficulties that could be presented in the production of such a transmitter. Designwise the engineer could have done a number of things

to correct these problems before their inception. He could have included more low-level frequency multiplying stages so that tripling in the final would be unnecessary. He could have used twisted-pair filament leads to cancel the inductive fields. Compartmentizing low power stages providing effective shielding isolation between stages in the common filament bias and plate supply leads would have helped appreciably. If forced air-cooled tubes were required, enough space should have been allowed near the tubes for adequate ac induction-motor driven blower to supply cooling air.

In order to further reduce the harmonic and spurious frequency content of the transmitter output, each stage succeeding the oscillator should be tuned. Parallel tuning, or pi-network coupling is preferable from an interference point of view since it minimizes the transfer of off-frequency signals. Over-driving low power stages will cause them to produce undesired harmonics, so it is necessary that the transmitter design include enough low-power stages, operating well within their ratings.

Other factors that are simply good engineering practice but which are often neglected include making the cabinet or case an effective shield, and routing the internal leads within the chassis. Once a transmitter case has been incorrectly designed, usually no amount of patching up will make it an effective shield. Inside, laced cables look fine, but tying low-level and high-level r-f leads together can cause many spurious radiations in a transmitter output. Low-level leads should not be laced into cables, but should be run direct, and in many instances shielded. Both ends of the shielding may be grounded. Leads that do not terminate in a unit should not be routed through it, where they could transmit interference either into or out of the unit.

If undesired, frequencies are eliminated in the low-power stages of a transmitter, the design of the final amplifier stage and antenna coupling units will be greatly simplified, because then their only functions will be to amplify a given frequency and transfer it into the antenna.

A naval laboratory, recently commenting on interference says engineering designs for radars in current use do not fully exploit known techniques for: the reduction of interference from high-power modulators; the limitation of pulsed rf radiation spectrum to minimum bandwidth, including the reduction of harmonic radiation, and the rejection of spurious responses in the radar receivers, which may be traced to lack of adequate rf preselection as well as inadequate rf shielding and decoupling.

Abstracted from a paper, The Control of Interference Through Basic Design, L. W. Thomas, Bureau of Ships, Department of the Navy, presented at the ARF Third Conference on Radio Interference Reduction, February 1957.



FIXED VITREOUS ENAMELED RESISTORS

As the world's largest producers of wire-wound resistors, we offer the finest quality . . . the fastest service from stock or to specifications . . . and the assurance that you are receiving the best value in vitreous enameled resistors.

FIXED VITREOUS ENAMELED RESISTORS are available from 3 watts to 200 watts . . . with a large variety of special mountings.

The next time you need resistors, send us your requirements and find out why we are growing so rapidly . . . are truly the TOP line in the world! Our latest catalog is available upon request.



General Sales Office: 2800 N. Milwaukee Avenue, Chicago 18, Ill.
Factory: Huntington, Indiana

Division of
Model Engineering
& Mfg., Inc.

MANUFACTURERS: Power Rheostats, Fixed Resistors, Adjustable Resistors, "Econohm" Resistors, "Tru-rib" Resistors
CIRCLE 366 ON READER-SERVICE CARD FOR MORE INFORMATION



We always ship on time
. . . and we expedite for you



**TRU-OHM POWER
RHEOSTATS**

In stock or to exacting
specifications . . . from 25
to 150 watts. We invite
your inquiry.

NEW!!

COPPER CLAD REXOLITE FOR PRINTED CIRCUITS

COMBINES THE EXCELLENT ELECTRICAL AND CHEMICAL PROPERTIES OF
REXOLITE 2200 IN AN EASILY ETCHED MATERIAL

Copper Clad Rexolite features--

- Easily etched using conventional methods
- Can be cold or hot punched
- Readily soldered with low melt alloys
- Offers high impact strength and good tensile strength
- Especially suited for applications requiring strain and excessive abuse.
- Bonding of copper to Rexolite is strong to withstand mechanical abuse in fabrication and usage

Availability--

1 or 2 ounce copper on one or two sides
Standard Sheet: 34" x 34"
Thickness: .031" to .125"

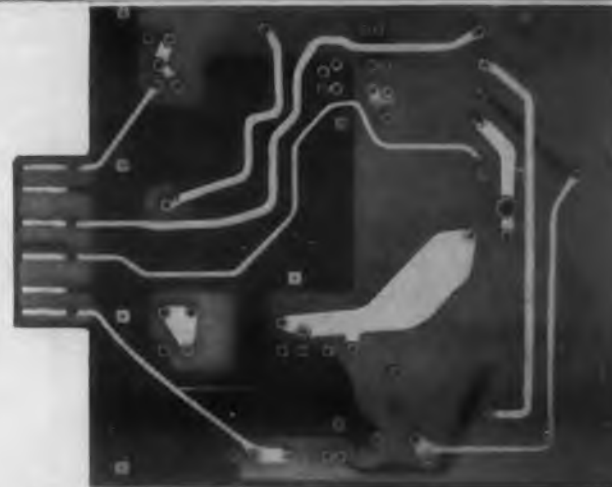

Write for Complete Technical Data
ELECTRONICS DIVISION

THE REX CORPORATION

210 HAYWARD ROAD, WEST ACTON, MASS.
CIRCLE 367 ON READER-SERVICE CARD FOR MORE INFORMATION



You've doubled the demand for HIPERSIL CORES...

now Westinghouse
doubles production capacity

Anticipating mushrooming expansion of both industrial and defense electronics, Westinghouse has doubled its production facilities for Hipersil® cores. A good indication of the increased usage of Type "C" Hipersil cores is the findings of a recent survey . . . more than 35% of all military transformers under 2 kva now use Hipersil cores.

Among the new applications in components being constantly added are many specifications that can be met only by Hipersil cores, with such unique properties as:

- Oriented grain direction, with 100% coincidental flux.
- Highest permeability, lowest loss.
- 100% active in carrying flux.
- Lowest possible core volume and weight for high-temperature transformers.
- Greater mechanical, electrical and magnetic stability.

It is these properties that make the Hipersil core the foundation for better transformers—smaller, lighter, more efficient—at lower cost.

So again at Westinghouse the increased demand for a superior product has led to expanded production facilities. Enlarged facilities mean one-plant availability of a complete line of Hipersil cores—from 0.001 to 100 lbs.—in a full range of gauge thicknesses for all frequencies. Three stocking locations . . . Boston; Greenville, Pennsylvania and Los Angeles . . . mean you get better service.

Westinghouse also makes a complete line of Hipermag* cores and Hiperthin* cores for any electronic applications.

Want a prettier profit picture? Send for the *Type "C" Hipersil Core Design and Application Manual*. Write to Westinghouse Electric Corporation, P. O. Box 868, Pittsburgh 30, Pennsylvania.

J-70798

*Trade-Mark

YOU CAN BE SURE...IF IT'S Westinghouse 

CIRCLE 369 ON READER-SERVICE CARD FOR MORE INFORMATION

Abstract

Microwave N

A GOOD quality noise source useful for radar jamming, and producing signal strengths of the order of $1\mu\text{w}$ per mc over several hundred mc in the 3 to 4 kmc range was designed. There is no repetitive component; the signal is random. The source does not have any severe sputtering limitation on tube life since no electrodes are used.

Using rare gas excitation, this high power cw r-f discharge noise source generally has less efficiency than dc arc discharge sources, squegging oscillators or rotating commutator types, but the advantages gained through randomness of signal and lengthier tube life are believed to make use of the method worthwhile. In the design of this equipment a gaseous discharge was produced in a quartz tube inserted into a wave guide and excited by microwave power at approximately 1850 mc. The gases used for experiment were helium, neon, argon and xenon; pressures ranged from 0.05 to 5 mm Hg. Driving power up to 300 w was applied and a steady state glow discharge resulted.

Measuring equipment was set up to test the equipment as shown in Fig. 1. A fairly bulky set-up, the operational device would of course be smaller, the only sizable component being the r-f driving source. The results of measurements showed that noise output was not significantly dependent on the type of gas used, but that it was dependent on pressure, being maximum at low pressure near the limit of a stable discharge. Such limiting pressure discharges were characterized by two properties—the mean free path for electron-atom collisions became comparable with the mean free path for electron-wall collisions; and the ionization became sufficient to make electron-electron and electron-ion collisions important.

While $1\mu\text{w}$ per mc—83 db above room kT—over a 200 mc band in the S-band region was obtained using a well-filtered 1 kw cw magnetron, broadband noise of the same strength and roughly flat over a range from 3 to 4 kmc was obtained when the drive was not filtered in the S-band.

Noise Generation

For testing and measuring purposes the filter was necessary since there is a strong fm component as well as extraneous cw power in the output of the magnetron, and it was desired to measure only the noise originating in the discharge tube.

Effective electron temperatures measured by probes were found to be as high as 35 ev; the highest measured electron densities at the center plane of the tube were about 10^{12} per cm^3 corresponding to 0.03 per cent ionization. Densities were probably higher in the portion of the tube nearest the driving power input. *Abstracted from Noise Generation In High-Power Microwave Gas Discharges. Roger C. Jones and Walter J. Graham, OTS PB 121338 U.S. Dept. of Commerce, Wash. 25, D.C.*

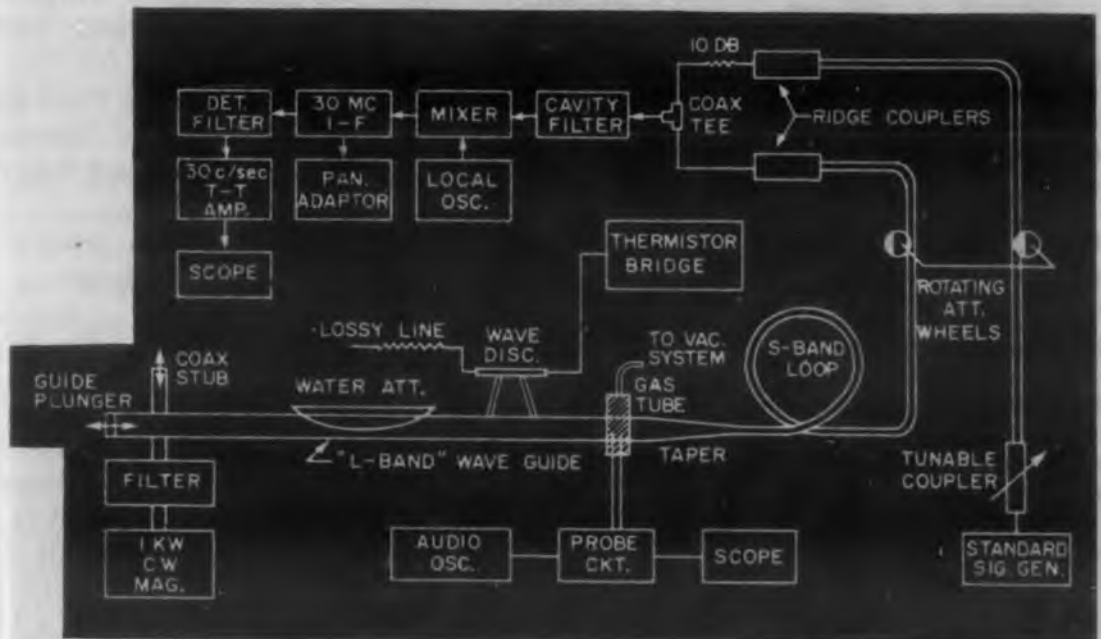

Fig. 1. Block diagram of experimental equipment. The set-up consists of the rf driving source and filters, experimental tubes, microwave radiometer, and the vacuum system and gas supply.



BOURNS TRIMPOT® MODEL 230 HUMIDITY-PROOF

Guaranteed to meet MIL Specs

This completely sealed TRIMPOT is manufactured and tested to meet Military Humidity Specification MIL-E-5272A (10 days).

Model 230 features a power rating of 0.4 watt at 50°C and a maximum operating temperature of 135°C. It is available from stock in standard resistance values from 10 ohms to 20,000 ohms.

In addition to reliable performance under severe humidity and salt spray conditions, this instrument will maintain accurate settings during extreme vibration, acceleration and shock encountered in aircraft and missiles.

Each TRIMPOT is individually inspected for compliance to guaranteed specifications, and is subjected to rigid quality control sampling tests to verify conformance to all specifications. 25-turn screwdriver adjustment, self-locking shaft, space-saving rectangular configuration and subminiature size are features also found in other Bourns TRIMPOT models. (Size: $\frac{3}{8}$ x $\frac{3}{8}$ x $1\frac{1}{2}$).

Send for catalog sheet 230.



BOURNS LABORATORIES, INC.

General Offices: 6135 Magnolia Ave., Riverside, Calif.
Plants: Riverside, California — Ames, Iowa

COPR. BI

TRIMPOT • LINEAR MOTION POTENTIOMETERS • PRESSURE TRANSDUCERS AND ACCELEROMETERS

CIRCLE 371 ON READER-SERVICE CARD FOR MORE INFORMATION

Radio Telescope at Harvard University's Agassiz Station Observatory.



**Simultaneous detection
of 20 signals from
neutral hydrogen . . .**

Banks of Hycon Filters . . . Section of Radio Telescope Receiver designed and built by Ewen Knight Corporation.

another problem solved by **HYCON FILTERS**

Extending man's view into the depths of the universe is a giant new Radio Telescope at Harvard University's Agassiz Station Observatory. Astronomers are reconstructing the spiral structure of our Milky Way by measuring Doppler Shift of radio signals originating from neutral hydrogen.

ELECTRICAL SPECIFICATIONS - NARROW BAND SERIES

Frequency range: 10 Kc - 30 Mc

Relative Bandwidth: .02% to .5% of center freq.

| | Type 11 | Type 22 | Type 44 |
|---------------|---------|---------|---------|
| Shape Factor: | 8 | 3 | 1.8 |

Playing a vital role in the Radio Telescope Receiver which makes these measurements possible are Crystal Filters designed and manufactured by Hycon Eastern. Hycon Filters were selected for their accuracy, stability and selectivity. Spaced at 100 Kc intervals from 5.5 Mc to 9.5 Mc, these Type 11 Filters from Hycon's Narrow Band Series have a 3 db bandwidth of 5 Kc and insertion loss of less than 3 db.

Hycon Eastern is currently producing Crystal Filters in the 10 Kc to 30 Mc range. Because they make possible a reduction in the number of conversions, Hycon Filters are finding wide application in mobile and fixed radio receivers and transmitters.

Write for Crystal Filter Bulletin F.



HYCON EASTERN, INC.

75 Cambridge Parkway Dept. F, Cambridge 42, Mass.

Affiliated with HYCON MFG. COMPANY, Pasadena, California

MANUFACTURERS OF
Hycon Filters, Ultra Stable Oscillators,
Magnetic Tape Indexing, and Search Units

CIRCLE 372 ON READER-SERVICE CARD FOR MORE INFORMATION

Standards and Specs

Sherman H. Hubelbank

Connectors

MIL-C-25516(USAF), CONNECTORS, ELECTRICAL, MINIATURE, SHIELDED OR UNSHIELDED, ENVIRONMENTAL RESISTANT TYPE, GENERAL SPECIFICATION FOR, 26 NOVEMBER 1956

This spec covers the requirements for a series of miniature, moisture proof, shielded or unshielded connectors suitable for use with capacitance-type fuel-quantity gage electrical systems.

RETMA Standards Proposals

The following RETMA Standards Proposals are being circulated for comment. Although the official comment period may have expired, you are encouraged to contact the Radio-Electronics-Television Manufacturers Association Engineering Department, 11 West 42nd Street, New York 36, N.Y., if you are vitally interested in any proposal.

S.P. 531, RADIATION RATING OF TELEVISION AND F.M. BROADCAST RECEIVERS, RETMA standard REC-129-D (Rescission of)

S.P. 532, POLARIZED DRY ELECTROLYTIC CAPACITORS FOR GENERAL USE, RETMA standards RS-154 (Additions)

S.P. 533, TERMINATING AND SIGNALING EQUIPMENT FOR MICROWAVE COMMUNICATIONS SYSTEM: PART I, RETMA Standards Proposal S.P. 516 (Revision)

S.P. 534, ELECTRON TUBE BASES, CAPS AND TERMINALS, RETMA Standard ET-103D, (Revision)

Resistors

MIL-R-11B, RESISTORS, FIXED, COMPOSITION (INSULATED), AMENDMENT 1, 14 DECEMBER 1956 . . . The marking and workmanship test, previously listed in Group B acceptance tests are now included in the Group A tests, where they are spelled out with their defect classifications. The voltage coefficient, dielectric strength, terminal strength and effect of soldering test have been changed from Group B to Group C, and are to be performed monthly. The balance of the Group C tests, previously specified on a quarterly basis are now to be performed semi-annually.

Transformers

RETMA RS-183, OUTPUT TRANSFORMERS FOR RADIO BROADCAST RECEIVERS, MARCH 1957

Minimum mechanical and electrical requirements to be included in purchase specs are covered by this standard. Also included are definitions and various methods of testing and measuring output transformers. Copies of this standard are available for 5 cents from Radio-Electronics-Television Manufacturers Association, 11 West 42nd Street, New York 36, N.Y.

RETMA RS-181, IRON CORE CHARGING INDUCTORS, MARCH 1957

This standard covers iron core charging reactors for use in radar transmitters and similar equipment where long life, reliability, and continuity of operation is essential. A charging inductor is an inductor placed in the charging circuit of a pulse-forming network. This standard, developed from Standards Proposal 514, is a revision of TR-127. Copies of this standard are available from RETMA, 11 West 42nd Street, New York 36, N.Y. for 60 cents per copy.

MIL-T-27A, TRANSFORMERS AND INDUCTORS (AUDIO, POWER, AND PULSE), SUPPLEMENT 1C, 17 DECEMBER 1956

This supplement lists 34 Military Standards which are now a part of the spec.

RETMA

RETMA PUBLICATION No. 2A, BASING DIAGRAMS FOR ELECTRON TUBES

This second addendum lists those tube types registered during 1956 with the new basing diagrams. Copies of this publication are available from the RETMA Engineering Office, 11 West 42nd Street, New York 36, N.Y., for \$1.00 per copy.

RETMA RS-135, ELECTRICAL PERFORMANCE STANDARDS FOR MONOCHROME TELEVISION STUDIO FACILITIES

A new resolution chart is being circulated by RETMA as part of Standards Proposal 536. This chart will be incorporated in the revised standard with the material previously issued and approved in Standards proposal 475.

Inductors

RETMA RS-175, AUDIO INDUCTORS, DECEMBER 1956
Iron-core inductors which are employed for frequency discrimination elements or for filters other than power supply applications are covered by this standard. The frequency range of the inductors is not limited to the region of audio frequencies. This standard is a revision of TR-122. Copies of this standard are available from RETMA, 11 W. 42nd Street, New York 36, N.Y. for 50 cents each.

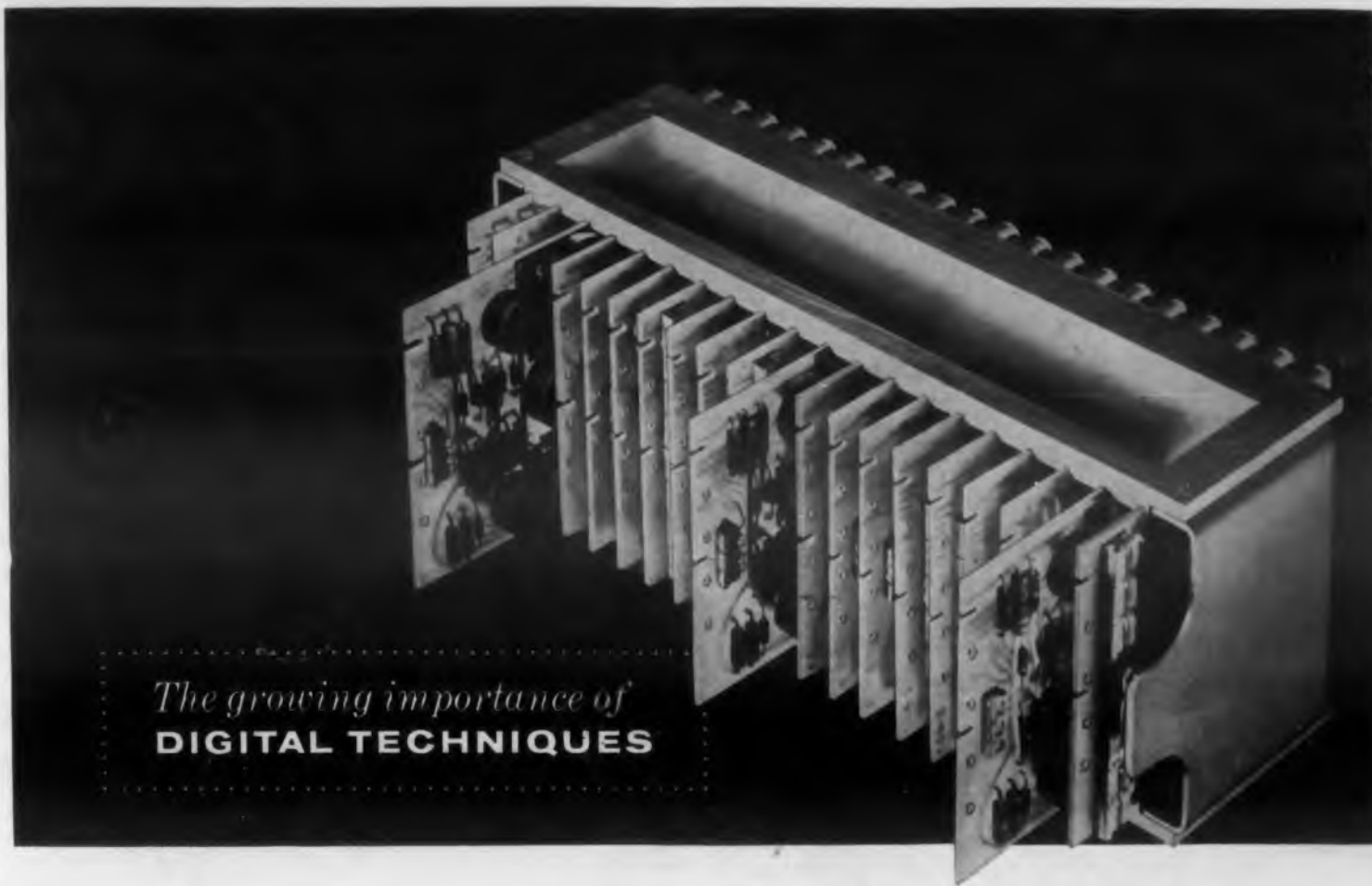

The growing importance of
DIGITAL TECHNIQUES

As recently as ten years ago it was just becoming evident that digital techniques in electronics were destined to create a new and rapidly growing field. Today, incorporated in electronic computers and other equipment, they constitute one of the most significant developments in scientific computation, in electronic data processing for business and industry, and in electronic control systems for the military. In the near future they are expected to become a major new factor in industrial process control systems.

The digital computer for scientific computation is becoming commonplace in research and development laboratories. Such machines range from small specialized units costing a few thousand dollars, to large general purpose computers costing over a million dollars. One of these large computers is a part of the Ramo-Wooldridge Computing Center, and a second such unit will be installed the latter part of this year. The digital computer has not only lightened the computation load for scientists and engineers, but has made possible many calculations which previously were impracticable. Such computers have played a major role in the modern systems engineering approach to complex problems.

Electronic data processing for business and industry is now well under way, based on earlier developments in electronic computers. Data processors have much

in common with computers, including the utilization of digital techniques. In this field, teams of Ramo-Wooldridge specialists are providing consulting services to a variety of clients on the application of data processing equipment to their problems.

The use of digital techniques in military control systems is an accomplished fact. Modern interceptor aircraft, for example, use digital fire control systems. A number of Ramo-Wooldridge scientists and engineers have pioneered in this field, and the photograph above shows a part of an R-W-developed airborne digital computer.

These, then, are some of the aspects of the rapid growth which is taking place in the field of digital techniques. Scientists and engineers with experience in this field are invited to explore openings at The Ramo-Wooldridge Corporation in:

Automation and Data Processing
Digital Computers and Control Systems
Airborne Electronic and Control Systems
Guided Missile Research and Development
Electronic Instrumentation and Test Equipment
Communication Systems

The Ramo-Wooldridge Corporation

5730 ARBOR VITAE STREET • LOS ANGELES 45, CALIFORNIA



CIRCLE 569 ON READER-SERVICE CARD FOR MORE INFORMATION



Match your
interests to this check list of
ENGINEERING OPPORTUNITIES
with
Admiral

Research and development projects, now in progress, have gained for Admiral a commanding lead in certain broad areas of military and civilian electronics. A number of challenging opportunities exist, and one of them may closely match your special interests and past experience. Examine the following check list.

RADAR—L band radar, beacon coding and decoding, pulse train generating and processing circuits. Airborne radar in X band range.

ELECTRONIC COUNTERMEASURES—Analysis, development and design, employing advance radar techniques.

MILITARY TV—Airborne and ground systems, including receivers, transmitters, cameras, antennas, sync generating systems and displays.

TELEVISION, VHF AND UHF—Tuner design, deflection circuitry, design of low noise wide band front ends and I.F. circuits.

NUCLEAR ENGINEERING—Evaluation of nuclear radiation damage to electronic components. Work involves experimentation with reactors and 20,000 curie cobalt source. Development of radiac techniques and instrumentation.

PALO ALTO RESEARCH—Development of new technologies opens door on a program of advanced research in aeronautical electronics. Experienced and intermediate level engineers send resume and salary requirements to *R. M. Jones, Admiral Corporation, 901 California Ave., Palo Alto, Cal. . . .* for California openings only.

Current openings offer excellent income and opportunity for rapid advancement. Complete employee benefit program includes retirement plan, paid group insurance, college tuition refund plan and ideal working conditions. On-the-job training for junior and intermediate engineers. Write, summarizing your education and experience to *W. A. Wecker, Personnel Division.*

Admiral Corporation

3805 ARMITAGE AVE., CHICAGO 47, ILL.

CIRCLE 555 ON READER-SERVICE CARD FOR MORE INFORMATION

EMERSON ELECTRIC

ELECTRONICS AND AVIONICS DIVISION

NEEDS ENGINEERS!

- Electronic Engineers (radar, computer, servo)
- Electronic Packaging Engineers
- Electronic Test Equipment Designers
- Electrical Engineers
- Liaison Engineers (electronics background)

EXCEPTIONAL OPPORTUNITIES, RAPID ADVANCEMENT,
FASCINATING WORK ON ADVANCED PROJECTS . . . B-58
HUSTLER, F-101 VOODOO AND MANY OTHERS!

- Top-level salaries
- Full scale long range expansion program underway
- Big company benefits, small company individuality
- Liberal group insurance and retirement plans
- Excellent air conditioned facilities
- Fully paid transportation and moving expenses to St. Louis

Emerson's Electronics and Avionics Division projects include the B-58 fire control system, servo mechanisms, computers, radar assemblies, mortar tracking devices, missiles and rockets, F-101 Voodoo structures, other electronic fire control systems and supersonic airframe structures, and aircraft components.

Emerson Electric is a medium size company (5000 employees, 850 engineers) and a national leader since 1940 in design, development and manufacture of electronics and avionics products. Our Commercial Division, established 1890, produces a complete line of fans, motors, air conditioners, heaters, welders and power tools. This perfect balance of electronic, aircraft and consumer production assures stability and security in your career at Emerson.

We're ideally located in beautiful, suburban St. Louis, noted for its unusual friendliness. Our people enjoy relaxed town and country living, with easy access to metropolitan stores, entertainment, cultural, medical and educational facilities. Driving time to work is 5 to a maximum of 30 minutes, unhampered by traffic congestion. St. Louis combines the four seasons into a delightful 'national climate' with low averages of 30.6° in Jan. and high of 79.3° in Aug. Only one day reached 100° in 1956.

YOUR FUTURE IS OUR BUSINESS!

Write us, and include a brief resume of your education, business background and approximate salary requirements. Send to R. L. Middleton, Employment Manager.

ELECTRONICS AND AVIONICS DIVISION

EMERSON ELECTRIC

8100 W. Florissant

St. Louis 21, Mo.



CIRCLE 556 ON READER-SERVICE CARD FOR MORE INFORMATION

ELECTRONIC DESIGN • May 15, 1956

CIRCLE 55

ELECTRON



ENGINEERS, SCIENTISTS:

What did they say the last time you had an **IDEA?**

At Decision, we talk to hundreds of engineers, and many report how frustrating it is when they make a good constructive suggestion and are gently reminded that "ideas" are the responsibility of others. (Strangely enough, these same companies often talk about "creative engineering" in their recruiting ads.) Fortunately this attitude is not typical of most progressive companies today.

We know many companies who encourage and appreciate creative thinking . . . who know that youth, inspiration and progress all go together.

Whether you're thinking seriously about changing jobs or not, Decision can improve your job perspective confidentially and at no cost to you. We will send reproductions of your resume (without your name) to the hundreds of top ranking firms—our clients—who pay us to find good men. And, we will enter your name and resume in our unique Decision/Register, which we search daily to find engineers for specific job openings.

DECISION/INC

Publishers of the authoritative
Engineers' Job Directory

FIND OUT ABOUT COMPANIES WHO
NEED YOUR IDEAS.
MAIL THIS COUPON NOW!

CONFIDENTIAL

Oliver P. Bardes, President
DECISION/INC
Management Consultants
1672 First National Bank Bldg.
Cincinnati 2, Ohio

Dear Mr. Bardes:
I do have good ideas, and I want
to find out who needs them!

NAME _____

TITLE _____
(or job interest)

STREET _____

CITY _____

STATE _____

CONFIDENTIAL



MECHANICAL ENGINEERS are using their skills in the design and development of new mechanisms required for business machines and for those mechanical products which are associated with electronic data processing equipment.

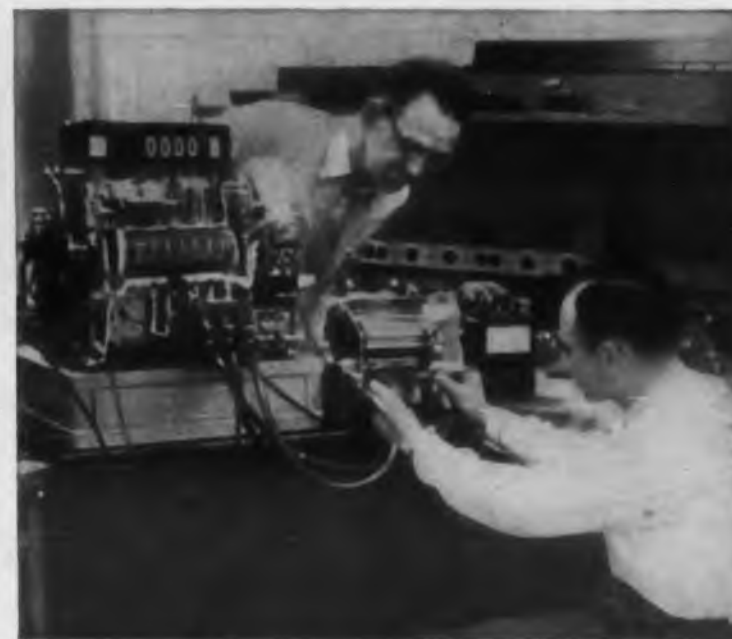

ELECTRO-MECHANICAL ENGINEERS are constantly faced with the problems of capturing information from the various input devices and converting this information into a usable form for subsequent use in data-handling equipment.



ELECTRONIC ENGINEERS enjoy an unparalleled freedom in the development of new types of circuitry and components which are necessary to maintain leadership in the competitive field of record-keeping automation.



COMPUTER ENGINEERS backed by the company's computer research since 1938 are developing an economical, flexible digital computer to meet the requirements of all record-keeping applications.

ENGINEERING UNLIMITED

AT ONE OF THE WORLD'S MOST SUCCESSFUL CORPORATIONS

If you are looking for a challenging opportunity with an established company which has tripled its sales in ten years—one that offers excellent starting salaries as well as permanent positions . . .

Act at once! Send resumé of your education and experience to Employment Department, Technical Procurement Sec. K The National Cash Register Company, Dayton 9, Ohio.

NCR

THE NATIONAL CASH REGISTER COMPANY

CIRCLE 557 ON READER-SERVICE CARD FOR MORE INFORMATION

CIRCLE 558 ON READER-SERVICE CARD FOR MORE INFORMATION

DAKERS



GOING OUR WAY?

ENGINEERS and PHYSICISTS are going one direction at MOTOROLA... UP!

We, at Motorola, know where we're going—and we're confident about getting there. If you, too, believe there's plenty of room at the very top—why not join us? You'll be teaming up with men of vision in an organization that respects creativeness as well as hard work. We think you'll grow with the challenging assignments at Motorola—missile guidance, radar, microwave, and the many other pioneering projects.

Motorola's continuing expansion program offers excellent opportunity for advancement to match your abilities. But, just as important to an engineer or physicist, the daily challenge to the imagination will bring the strong sense of accomplishment you seek.

If you're an electrical engineer, mechanical engineer, or physicist (senior or junior level), and looking for more important assignments in:

CHICAGO, ILLINOIS

Two-Way Communications

- Receivers and Transmitters
- Power Supply
- Antenna design
- Systems Engineering
- Portable Communications Equipment

Microwave

- Pulse Circuit Design
- Systems Design
- Circuit Design

Field Engineers

- Microwave Maintenance
- Airborne Radar

Transistor Applications

**Radio Sales and
Field Service Engineers**

For Assignments with a FUTURE UNLIMITED write Dept. No. _____

MOTOROLA, inc

Engineering Personnel Mgr., 4501 W. Augusta Blvd., Chicago 51, Illinois

CIRCLE 560 ON READER-SERVICE CARD FOR MORE INFORMATION

**TELL YOUR
PERSONNEL MANAGER
ABOUT
ELECTRONIC DESIGN'S
"CAREER'S SECTION"**

If your company is trying to attract skilled electronic design, development or research engineers, tell your Personnel Manager about ELECTRONIC DESIGN. Here is a concentrated audience of 25,000 engineers ready to read about the advantages offered by your plant.

Remember, more than 5,500 ELECTRONIC DESIGN readers inquire every issue—many of them will be interested in your job opportunities.

You can reach them in ELECTRONIC DESIGN'S "Career's Section."

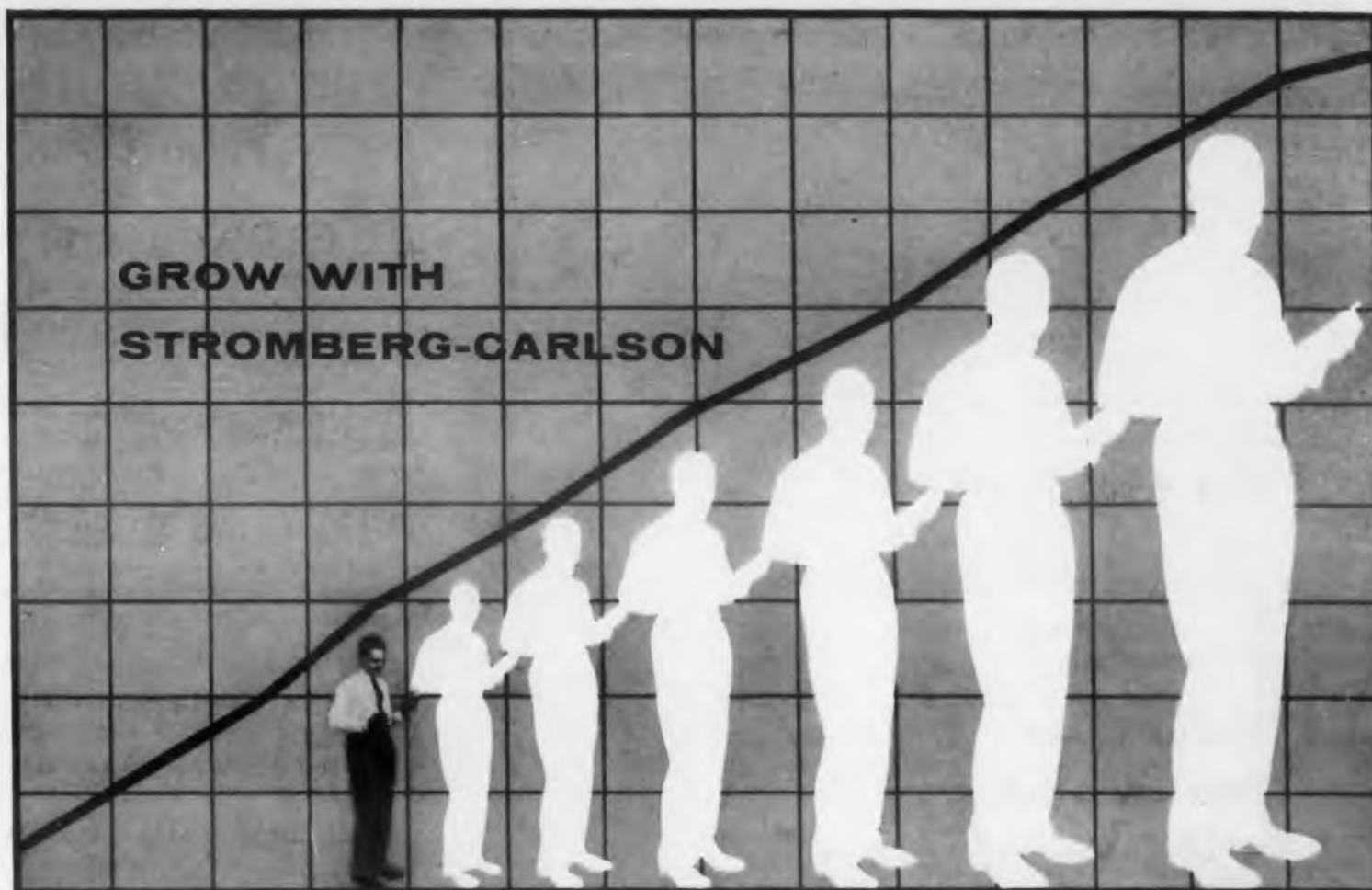

Electronics Engineers— Chart your personal and professional growth with STROMBERG-CARLSON

Your growth curve in Stromberg-Carlson's booming Electronics Division goes steadily—and rapidly—upward. Here's why:

1. The company itself is one of the "hottest" in the electronics industry today.
2. Three-times expansion of the Electronics Division means rapid advancement for you right from the start.
3. Liberal management attitudes encourage your own initiative . . . your ideas don't get lost in the shuffle.

In addition to opportunities for personal and professional growth, we offer challenging, interesting work. Check this list of assignments to see where you fit best:

Components and
Specifications
Countermeasures
Data Systems
Digital Techniques

Field Engineering
Microwave Circuits
Navigational Systems
Radar
Transistor Engineering

Communication Systems
Missile Guidance Systems
Sales Engineering
Systems Test Equipment
Writers—Technical

Send your letter or resumé now to
R. W. HOLMES, Electronics Engineering



STROMBERG-CARLSON COMPANY
A DIVISION OF GENERAL DYNAMICS CORPORATION

52 Carlson Road, Rochester 3, N. Y.

CIRCLE 561 ON READER-SERVICE CARD FOR MORE INFORMATION



ROCHESTER... a great place to live



New Community War Memorial is the scene of major league sports, ice shows and other spectacles.



Nearby lakes provide outstanding facilities for boating, swimming, fishing and other water sports.



University of Rochester is among the country's finest institutions, as are the city's public and private primary and secondary schools.

**ENGINEERS
for
GUIDANCE
and
NAVIGATION
SYSTEMS**

ZEST-

*a level of enjoyment reached
in the professional life of engineers
participating in Sanders'
forward-thinking environment.*

Please address inquiries to D. H. Johnson

SANDERS ASSOCIATES, INC.
NASHUA NEW HAMPSHIRE 

CIRCLE 562 ON READER-SERVICE CARD FOR MORE INFORMATION

Product Engineering
for ICBM and IRBM

ICBM and IRBM operational environments impose unusual product engineering requirements. Particularly, electronic systems must be packaged to withstand extremes of temperature and vibration. Advanced product engineering is required to assure the necessary high reliability levels. As a result, the general field of electronic packaging is an essential aspect of R-W's overall systems engineering and technical direction responsibility for the Air Force Ballistic Missile programs.

Major elements of this activity include structural analysis... shock and vibration... materials application... and mechanical and electronic component design. The responsibilities of the product engineering group include developing design criteria and investigating new packaging techniques.

Inquiries regarding these opportunities in product engineering at R-W are invited, and should be addressed to: Mr. W. J. Coster

The Ramo-Wooldridge Corporation

5730 ARBOR VITAE STREET • LOS ANGELES 45, CALIFORNIA

CIRCLE 564 ON READER-SERVICE CARD FOR MORE INFORMATION

**AVIONICS
OPPORTUNITIES**

*In Sunny, Tropical
San Diego, California*

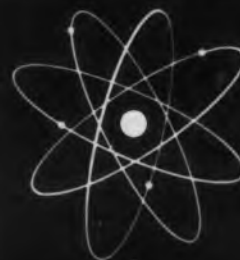

SYSTEMS ENGINEERS
SYSTEMS ANALYSTS
(engineering and mathematics)
CIRCUITRY DESIGN ENGINEERS
SERVO DESIGN ENGINEERS
COMPONENT PACKAGING ENGINEERS
(mechanical and electrical)
ETCHED CIRCUIT DRAFTSMEN
MICROWAVE TECHNICIANS

FOR **NEW**
AIRBORNE
NAVIGATIONAL
SYSTEMS

MISSILE
GUIDANCE
SYSTEMS

HELICOPTER
INSTRUMENTATION

AIRCRAFT
CONTROL
SYSTEMS

Work on these challenging projects at RYAN
Live in beautiful San Diego—a year-round playground

WRITE TO ENGINEERING PROFESSIONAL PLACEMENT

 **RYAN AERONAUTICAL COMPANY**
2704 Harbor Drive, San Diego 12, California

CIRCLE 563 ON READER-SERVICE CARD FOR MORE INFORMATION



KENNETH STEPHANZ - Chief Engineer, Vacuum Tube Department: from B.E.E. at Ohio State in '48, has advanced at Federal from junior to chief engineer, is typical of career-minded Federal engineers.

Recognition, advancement, security and hard work

"In my nine years at Federal I think I have discovered the key to success — the right choice of company and hard work," says Ken Stephanz. "It takes an engineer and a company to make a career. You must know what you want to do, what direction you want to move in. Then you must answer a tough question . . . What company offers me greatest opportunity to develop my talents, to build a career and have a happy personal life? The rest is up to you. The rewards are great — recognition of your efforts and abilities, chance for advancement, and financial and job security.

"True, there are other considerations — location, work of your choice, living conditions, association with capable engineers, company prestige and growth potential. Engineers at Federal find that this company provides all these advantages. In fact, you will find that Federal, a member of the world-wide IT&T System, presents unusual opportunities for the ambitious engineer."

The markets for Federal's many products will keep the Company growing, assuring a bright future for Federal and its engineers. The broad scope of engineering projects opens to you a wide choice of assignment. When you join Federal you join a stable, dynamic organization, a leader in the electronics industry.

Join the IT&T Team



For information of engineering opportunities and assignments write to Mr. J. Connington, Technical Placement Director.

Federal Telephone and Radio Company

A DIVISION OF INTERNATIONAL TELEPHONE AND TELEGRAPH CORPORATION

100 Kingsland Road, Nutley, New Jersey

CIRCLE 565 ON READER-SERVICE CARD FOR MORE INFORMATION

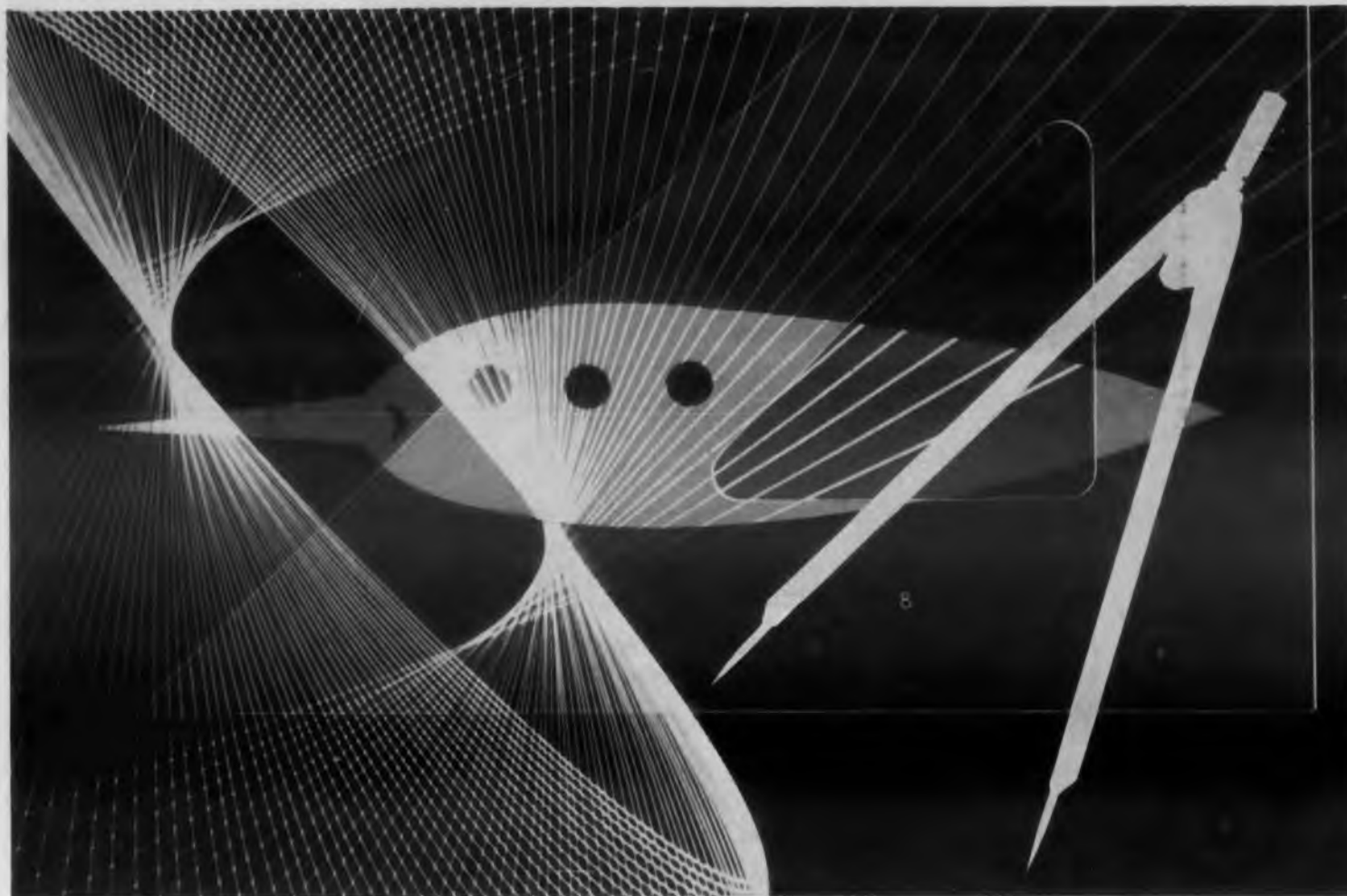

Creative Engineers:

Work where the breakthroughs are being made in every major field of Electro-Mechanics

As a creative engineer, you belong at the front-line of your field... where tomorrow's scientific battles are being won... where you can help win them.

For more than a decade, AUTONETICS has been at the forefront of electro-mechanical technology... building up the unique stockpile of experience and developing the advanced techniques and tools that can make your professional victories possible at AUTONETICS today.

Just a few specific results of AUTONETICS' pioneering are: the MG-4 Fire Control System for NATO's F-86K Sabre Jet; Flight Control elements for the F-100 Super Sabre; *Numill*, a new magnetic-tape controlled machine-tool system capable of performing complex milling and drilling operations automatically; *Recomp I*, a new portable, high-speed, completely transistorized digital computer; and inertial guidance systems for both airplanes and missiles.

Today, our programs are gathering speed, broadening scope. New engineering methods have been developed to cut lead time. System and component evaluation is being accelerated with automatic checkout equipment. Packaging is being designed and systems micro-minaturized to fit the cramped confines of sleek missiles and jets.

YOUR OPPORTUNITY EXISTS AT EVERY LEVEL of creative engineering from Preliminary to Performance Test—because Autonetics is one of the few companies in the world that can design and quantity-produce complete automatic control systems for both the military and industry.

LET US KNOW what kind of creative engineering interests you (please include highlights of your education and experience). Write today to: Mr. A. N. Benning, Administrative and Professional Personnel, Dept. 358-ED5, AUTONETICS, 9150 E. Imperial Highway, Downey, California.

Autonetics



A Division of North American Aviation, Inc.

AUTOMATIC CONTROLS MAN HAS NEVER BUILT BEFORE

CIRCLE 566 ON READER-SERVICE CARD FOR MORE INFORMATION



Assistant Chief Engineer Norman F. Parker joined Autonetics in 1948 after receiving his DSc from the Carnegie Institute of Technology. Dr. Parker has been recognized nationally for his work in Inertial Navigation, and was chosen recently to present a paper on that subject at a NATO conference in Italy.



Jack Wittkopf was Associate Professor of Electrical Engineering at Oregon State for 6 years before he joined Autonetics in 1951. Now Group Leader in computers and electronics, Jack lives with his wife and four children in Autonetics' home town of Downey, California, where his spare time activities include photography and ham radio.

ADVERTISING INDEX

May 15, 1957

| Advertiser | Page |
|--|---------|
| AMP, Inc. | 55 |
| Ace Electronics Associates | 97 |
| Acro Div., Robertshaw Fulton Controls Co. | 86 |
| Acton Laboratories, Inc. | 95 |
| Admiral Corp. | 148 |
| Advanced Vacuum Products Co. | 119 |
| Aircraft Radio Corp. | 109 |
| Alden Products Co. | 124 |
| Allen-Bradley Co. | 136 |
| Allen Manufacturing Co. | 23 |
| Allied Control Co. | 59 |
| Amperex Electronic Corp. | 6, 7 |
| Amphenol Electronics Corp. | 126 |
| Arnold Engineering Co. | 114 |
| Arnold Magnetics Co. | 67 |
| Arnoux Corp. | 30 |
| Associated Spring Corp. | 116 |
| Automatic Temperature Control Co. | 107 |
| Barber-Colman Co. | 78 |
| Barker & Williamson, Inc. | 78 |
| Barry Controls, Inc. | 50 |
| Bendix Aviation Corp. Eclipse Pioneer Div. | 71 |
| Bendix Aviation Corp. Red Bank Div. | 132 |
| Berkeley Div. Beckman Instruments, Inc. | 130 |
| Biddle, James G. Co. | 105 |
| Bird, R. H. & Co. | 121 |
| Birtcher Corp. | 122 |
| Bourns Laboratories | 145 |
| Brew, Richard D. & Co., Inc. | 129 |
| Burroughs Corp., Electronic Tube Div. | 8 |
| CBS-Hytron | 8 |
| Cambridge Thermionic Corp. | 74 |
| Camloc Fastener Corp. | 94 |
| Carborundum Co., The | 77 |
| Celco Constantine Engineering Laboratories | 95 |
| Centralab Div., Globe Union, Inc. | 101 |
| Chassis-Trak Corp. | 92 |
| Chemical Products Corp. | 108 |
| Chicago Electronic Engineering Co., Inc. | 88 |
| Circuit Instruments, Inc. | 44 |
| Clevite Transistor Products | 21 |
| Comar Electric Co. | 141 |
| Computer-Measurements Corp. | 120 |
| Connecticut Hard Rubber Co., The | 134 |
| Consolidated Mining & Smelting Co., of Canada Ltd. | 98 |
| Corning Glass Works | 40 |
| Crucible Steel Co. of America | 81 |
| Cubic Corp. | 87 |
| Curtiss-Wright Corp. | 104 |
| Dale Products, Inc. | 53 |
| Daven Co., The | 13 |
| Dearborn Electronics Co. | 84 |
| Decker Aviation Corp. | 33 |
| Decision, Inc. | 149 |
| De Jur Amsco Corp. | 54 |
| Delco Radio Div. of General Motors Corp. | 5 |
| Dialight Corp. | 11 |
| Diehl Manufacturing Co. | 123 |
| DIT-MCO, Inc. | 37 |
| Donner Scientific Co. | 113 |
| Dow Corning Corp. | 73 |
| Dressen-Barnes Corp. | 124 |
| Du Mont, Allen B. Laboratories, Inc. | 14 |
| Du Pont, E. I. de Nemours & Co. Plastics Div. | 7 |
| Eastern Precision Resistor Corp. | 89 |
| Eastman Kodak Co. | 111 |
| Edison, Thomas A., Inc. | 10 |
| Eitel-Mc Cullough, Inc. | 86 |
| Elastic Stop Nut Corp. | 114 |
| Elco Tool & Screw Co. | 90 |
| Electra Mfg. Co. | 103 |
| Electronic Engineers Master | 118 |
| Emerson Electric Mfg. Co. | 148 |
| Erie Resistor Corp. | 110 |
| Fairchild Controls Corp. | 125 |
| Federal Telephone & Radio Corp. | 150 |
| Fenwal, Inc. | 110 |
| Ford Instrument Co., Inc. | 100 |
| Formica Corp. | 29 |
| G-V Controls, Inc. | 3 |
| Gamewell Co. | 116 |
| Garrett Corp. | 90 |
| Gee Lar Mfg. Co. | 119 |
| General Electric Co., Apparatus D.v. | 61, 125 |
| General Electric Co., Coshocton, Ohio | 12 |
| General Electric Co., Industry Control Dept. | 78, 79 |
| General Electric Co., Light Military Div. | 54, 55 |
| General Radio Co. | 119 |
| General Transformer Co. | 46 |
| Giannini, G. M. & Co. | 104 |
| Globe Industries, Inc. | 20 |
| GoodAll Electric Mfg. Co. | 70 |
| Goodrich, B. F. Sponge Products | 60 |
| Gorn Electric Co. | 135 |
| Grayhill Moldtronics, Inc. | 41 |
| Gries Reproducer Corp. | 111 |
| Groov-Pin Corp. | 100 |
| Haydon, A. W. Co., Inc. | 124 |

Name and Title

Company

(Print or type all information)

Company Address

For Change of Address: Old Company Name

| Old Company Address | | | | | | | | | | City | | | | | | | | | | Zone | | State | |
|---------------------|-----|-----|-----|-----|-----|-----|-----|-----|-----|------|-----|-----|-----|-----|-----|-----|-----|-----|-----|------|--|-------|--|
| 10 | 20 | 30 | 40 | 50 | 60 | 70 | 80 | 90 | | 300 | 310 | 320 | 330 | 340 | 350 | 360 | 370 | 380 | 390 | | | | |
| 1 | 11 | 21 | 31 | 41 | 51 | 61 | 71 | 81 | 91 | 301 | 311 | 321 | 331 | 341 | 351 | 361 | 371 | 381 | 391 | | | | |
| 2 | 12 | 22 | 32 | 42 | 52 | 62 | 72 | 82 | 92 | 302 | 312 | 322 | 332 | 342 | 352 | 362 | 372 | 382 | 392 | | | | |
| 3 | 13 | 23 | 33 | 43 | 53 | 63 | 73 | 83 | 93 | 303 | 313 | 323 | 333 | 343 | 353 | 363 | 373 | 383 | 393 | | | | |
| 4 | 14 | 24 | 34 | 44 | 54 | 64 | 74 | 84 | 94 | 304 | 314 | 324 | 334 | 344 | 354 | 364 | 374 | 384 | 394 | | | | |
| 5 | 15 | 25 | 35 | 45 | 55 | 65 | 75 | 85 | 95 | 305 | 315 | 325 | 335 | 345 | 355 | 365 | 375 | 385 | 395 | | | | |
| 6 | 16 | 26 | 36 | 46 | 56 | 66 | 76 | 86 | 96 | 306 | 316 | 326 | 336 | 346 | 356 | 366 | 376 | 386 | 396 | | | | |
| 7 | 17 | 27 | 37 | 47 | 57 | 67 | 77 | 87 | 97 | 307 | 317 | 327 | 337 | 347 | 357 | 367 | 377 | 387 | 397 | | | | |
| 8 | 18 | 28 | 38 | 48 | 58 | 68 | 78 | 88 | 98 | 308 | 318 | 328 | 338 | 348 | 358 | 368 | 378 | 388 | 398 | | | | |
| 9 | 19 | 29 | 39 | 49 | 59 | 69 | 79 | 89 | 99 | 309 | 319 | 329 | 339 | 349 | 359 | 369 | 379 | 389 | 399 | | | | |
| 100 | 110 | 120 | 130 | 140 | 150 | 160 | 170 | 180 | 190 | 400 | 410 | 420 | 430 | 440 | 450 | 460 | 470 | 480 | 490 | | | | |
| 101 | 111 | 121 | 131 | 141 | 151 | 161 | 171 | 181 | 191 | 401 | 411 | 421 | 431 | 441 | 451 | 461 | 471 | 481 | 491 | | | | |
| 102 | 112 | 122 | 132 | 142 | 152 | 162 | 172 | 182 | 192 | 402 | 412 | 422 | 432 | 442 | 452 | 462 | 472 | 482 | 492 | | | | |
| 103 | 113 | 123 | 133 | 143 | 153 | 163 | 173 | 183 | 193 | 403 | 413 | 423 | 433 | 443 | 453 | 463 | 473 | 483 | 493 | | | | |
| 104 | 114 | 124 | 134 | 144 | 154 | 164 | 174 | 184 | 194 | 404 | 414 | 424 | 434 | 444 | 454 | 464 | 474 | 484 | 494 | | | | |
| 105 | 115 | 125 | 135 | 145 | 155 | 165 | 175 | 185 | 195 | 405 | 415 | 425 | 435 | 445 | 455 | 465 | 475 | 485 | 495 | | | | |
| 106 | 116 | 126 | 136 | 146 | 156 | 166 | 176 | 186 | 196 | 406 | 416 | 426 | 436 | 446 | 456 | 466 | 476 | 486 | 496 | | | | |
| 107 | 117 | 127 | 137 | 147 | 157 | 167 | 177 | 187 | 197 | 407 | 417 | 427 | 437 | 447 | 457 | 467 | 477 | 487 | 497 | | | | |
| 108 | 118 | 128 | 138 | 148 | 158 | 168 | 178 | 188 | 198 | 408 | 418 | 428 | 438 | 448 | 458 | 468 | 478 | 488 | 498 | | | | |
| 109 | 119 | 129 | 139 | 149 | 159 | 169 | 179 | 189 | 199 | 409 | 419 | 429 | 439 | 449 | 459 | 469 | 479 | 489 | 499 | | | | |
| 200 | 210 | 220 | 230 | 240 | 250 | 260 | 270 | 280 | 290 | 500 | 510 | 520 | 530 | 540 | 550 | 560 | 570 | 580 | 590 | | | | |
| 201 | 211 | 221 | 231 | 241 | 251 | 261 | 271 | 281 | 291 | 501 | 511 | 521 | 531 | 541 | 551 | 561 | 571 | 581 | 591 | | | | |
| 202 | 212 | 222 | 232 | 242 | 252 | 262 | 272 | 282 | 292 | 502 | 512 | 522 | 532 | 542 | 552 | 562 | 572 | 582 | 592 | | | | |
| 203 | 213 | 223 | 233 | 243 | 253 | 263 | 273 | 283 | 293 | 503 | 513 | 523 | 533 | 543 | 553 | 563 | 573 | 583 | 593 | | | | |
| 204 | 214 | 224 | 234 | 244 | 254 | 264 | 274 | 284 | 294 | 504 | 514 | 524 | 534 | 544 | 554 | 564 | 574 | 584 | 594 | | | | |
| 205 | 215 | 225 | 235 | 245 | 255 | 265 | 275 | 285 | 295 | 505 | 515 | 525 | 535 | 545 | 555 | 565 | 575 | 585 | 595 | | | | |
| 206 | 216 | 226 | 236 | 246 | 256 | 266 | 276 | 286 | 296 | 506 | 516 | 526 | 536 | 546 | 556 | 566 | 576 | 586 | 596 | | | | |
| 207 | 217 | 227 | 237 | 247 | 257 | 267 | 277 | 287 | 297 | 507 | 517 | 527 | 537 | 547 | 557 | 567 | 577 | 587 | 597 | | | | |
| 208 | 218 | 228 | 238 | 248 | 258 | 268 | 278 | 288 | 298 | 508 | 518 | 528 | 538 | 548 | 558 | 568 | 578 | 588 | 598 | | | | |
| 209 | 219 | 229 | 239 | 249 | 259 | 269 | 279 | 289 | 299 | 509 | 519 | 529 | 539 | 549 | 559 | 569 | 579 | 589 | 599 | | | | |

For Personnel Ads Only
(Nos. 550-599)

HOME ADDRESS

City

Zone

State

| Advertiser | Page |
|---|---------------|
| Heine Electric Co. | 33 |
| Harris Laboratories, Inc. | 110 |
| Heli-C 1 Corp. | 127 |
| Heli-C Corp., Div. of Beckman Instruments, Inc. | 102, 110, 117 |
| Hemiray & Bartlett Mfg. Co. | 48 |
| Hewlett-Packard Co. | 155 |
| HilTen Wires, Inc. | 27 |
| Hoffm Engineering Co. | 134 |
| Hugh Aircraft Co., Research & Development Div. | 87 |
| Hycor Eastern, Inc. | 146 |
| International Resistance Co. | 2 |
| JFD Manufacturing Co. | 57 |
| Jennin's Radio Mfg. Corp. | 122 |
| Jerrold Electronics Corp. | 123 |
| Jochlin Mfg. Co. | 109 |
| Johnson, E. F. Co. | 89 |
| Joy Manufacturing Co. | 91 |
| Kay Lab see Kin Tel | 18 |
| Kearfoot Co., Inc. Little Falls Div. | 115 |
| Kearfoot Co., Inc. Western Div. | 100 |
| Keithley Instrument Co. | 105 |
| Kester Solder Co. | 130 |
| Kin Tel (Kay Lab) | 18 |
| Koiled Kords, Inc. | 117 |
| Kulka Electric Mfg. Co. | 138 |
| Leach Corp. | 38 |
| Librascope, Inc. | 96 |
| Lowell Mfg. Co. | 79 |
| Machlett Laboratories | 126 |
| Magnetics, Inc., Components Div. | 82 |
| Malayan Tin Bureau, The | 86 |
| Mallory, P. R. & Co. | 84 |
| Manson Laboratories | 109 |
| Marconi Instrument Co. | 128 |
| Mica Insulator Co. | 49 |
| Miller Dial & Name Plate Co. | 116 |
| Millivac Instrument Corp. | 31 |
| Minneapolis-Honeywell Regulator Co. Aero Div. | 107 |
| Minneapolis-Honeywell Regulator Co., Industrial Div. | 137 |
| Model Engineering & Mfg. Co. | 143 |
| Motorola, Inc. | 150 |
| Mueller Electric Co. | 142 |
| Mycalex Corp. of America | 10, 11 |
| National Cash Register Co., Recruitment Div. | 149 |
| North American Aviation, Inc. | 154 |
| Oak Manufacturing Co. | 17 |
| Ohmite Mfg. Co. | 63 |
| Pacific Automation Products, Inc. | 28 |
| Peerless Div. Altec-Lansing Corp. | 99 |
| Phaotron Co. | 121 |
| Phelps Dodge Copper Products Co. | 9 |
| Phillips Control Corp. | 127 |
| Polyphase Instrument Co. | 133 |
| Polytechnic Research & Development Co. | 73 |
| Premier Metal Products Co. | 101 |
| Radio Corp. of America | 140, 156 |
| Radio Cores | 89 |
| Radio Receptor Co. | 69 |
| Ramo-Wooldridge Corp. | 147, 152 |
| Reeves Instrument Corp. | 47 |
| Reubrandt, Inc. | 110 |
| Rex Corp., The | 143 |
| Richards Electrocraft, Inc. | 128 |
| Richardson Co., Inc. | 72 |
| Rider, John F. Publisher, Inc. | 85 |
| Ryan Aeronautical Co. | 152 |
| Rufway Heat Elements, Inc. | 129 |
| Ruborn Co. | 68 |
| Randers Associates, Inc. | 103 |
| Randers Associates, Inc., Personnel | 152 |
| Servo Corp. of America | 97 |
| Sarta Div. of Beckman Instruments, Inc. | 64 |
| Serra Engineering Co. | 114 |
| Sola Electric Co. | 139 |
| Sorenson & Co., Inc. | 113 |
| Southern Screw Co. | 91 |
| Southco Div. South Chester Corp. | 135 |
| West Carbon Co., Jeffers Electronics Div. | 94 |
| Seacer-Kennedy Laboratories | 70 |
| Seague Electric Co. | 4, 92 |
| Seckpole Carbon Co., Jobbing Div. | 108 |
| Standard Electrical Products Co. | 90 |
| Standard Pressed Steel Co. | 141 |
| Star Stainless Screw Co. | 119 |
| Statham Development Corp. | 120 |
| Statham Laboratories, Inc. | 115 |
| Stromberg-Carlson Co. | 151 |
| Superior Tube Co. | 118 |
| Tennessee Electric Products, Tungsten & Chemical Div. | 112 |
| Tuthane Corp. | 83 |
| Tubnic, Inc. | 93 |
| Technology Instrument Corp. | 106 |
| Texas Instruments, Inc. | 14 |
| Turbo Products | 88 |
| UNICO Fuse Mfg. Co. | 138 |
| Wahlert Electrical Instrument Co. | 58 |
| Wing-Sol Electric Co. | 20 |
| Wimax Switch Div. | 117 |
| Wing Aircraft Products | 79 |
| W. S. Electronics Development Corp. | 45 |
| Wflex Corp. | 110 |
| Wright Associates | 13, 80 |
| Worren Instrument Co. | 90 |
| Waters Mfg. Co. | 93 |
| Wicks Co. | 133 |
| Winghouse Electric Corp., Industrial Tube Div. | 43 |
| Winghouse Electric Corp., Industrial Micarta Div. | 131 |
| Winghouse Electric Corp., Specialty Transformer Div. | 65, 144 |
| Winston Electrical Instrument Co. | 66 |
| Wm. Glass Co. | 142 |

not just "new"
but
a new
KIND of
OSCILLOSCOPE



-hp- 130A Low Frequency Oscilloscope

High sensitivity, dc to 300 KC
21 direct reading sweep times
Sweeps 1 μ sec/cm to 15 sec/cm
Easy to use
"Universal" automatic triggering
5% voltmeter, millivoltmeter

This totally new production and laboratory instrument obsoletes previous concepts of oscilloscope convenience, usefulness and reliability.

Horizontal and vertical amplifiers are similar. Sensitivity is 1 mv/cm or 10 mv full scale deflection. Amplifiers have wide pass bands, dc to 300 KC. Input circuits are balanced on 5 most sensitive ranges. Single-ended input may be dc or ac coupled. Amplifiers are stable; gain may be standardized by an internal 1,000 cycle square wave. Sweep times are highly linear, may be set and read directly. In most cases -hp- 130A needs no preamplification to present transducer signals as a brilliant, high resolution trace.

A special feature is the "universal" automatic triggering system where one preset condition provides optimum triggering on almost all input signals.

Brief Specifications

Input Amplifiers: (Similar Vert. and Horiz. Amps.). Sensitivity 1 mv/cm to 50 v/cm; 14 calibrated ranges, 1-2-5-10 sequence plus continuous vernier. Pass band dc to 300 KC; ac or dc coupling. Balanced input on 1, 2, 5, 10 and 20 mv/cm ranges.

Sweep Range: 1 μ sec/cm to 15 sec/cm. 21 sweeps: 1-2-5-10 sequence, 5% accuracy.

Triggering: Internal, line voltage or external 0.5 v or more. Pos. or neg. slope, +30 to -30 v trigger range.

Preset Trigger: Optimum setting for automatic stable triggering.

Amplitude Calibration: 1 KC square wave. 5% accuracy. Price: \$650.00

For the complete story on a really new oscilloscope, call your -hp- representative, or write direct.

HEWLETT-PACKARD COMPANY

4054K Page Mill Road • Palo Alto, California, U.S.A.

Cable "HEWPACK" • Davenport 5-4451

Field engineers in all principal areas



also offers -hp- 150A High Frequency Oscilloscope, dc to 10 MC, sweeps 0.02 μ sec/cm to 15 sec/cm. Rise time 0.035 μ sec.

CIRCLE 375 ON READER-SERVICE CARD FOR MORE INFORMATION

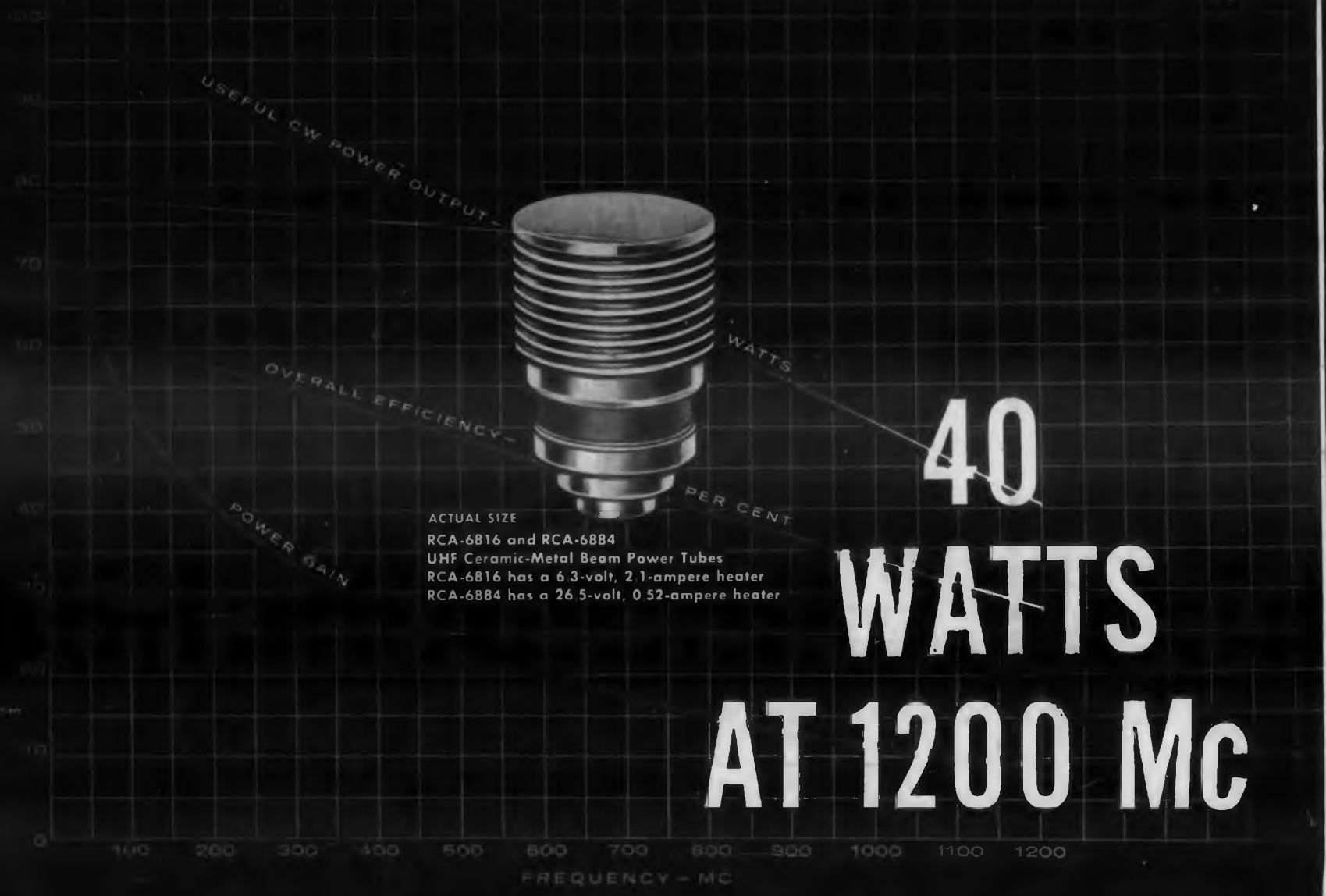

For extremely compact and efficient UHF transmitter designs... RCA-6816 and RCA-6884, small-size, light-weight Ceramic-Metal beam power tubes have high power sensitivity and high efficiency at relatively low plate voltage.

These tubes feature low-inductance rf electrode terminals—insulated from each other by low-loss, high-strength ceramic bushings—are particularly well-suited for UHF oscillator, frequency multiplier, and power amplifier applications.

Technical bulletin on the RCA-

6816 and RCA-6884 is available from RCA Commercial Engineering, Section E-18 Q2, Harrison, N.J. For sales information contact the RCA Field Representative nearest you.

East: HUmboldt 5-3900
744 Broad Street
Newark 2, N. J.

Midwest: WHIttehall 4-2900
Suite 1181
Merchandise Mart Plaza
Chicago 54, Illinois

West: RAYmond 3-8361
6355 East Washington Blvd.
Los Angeles 22, Calif.

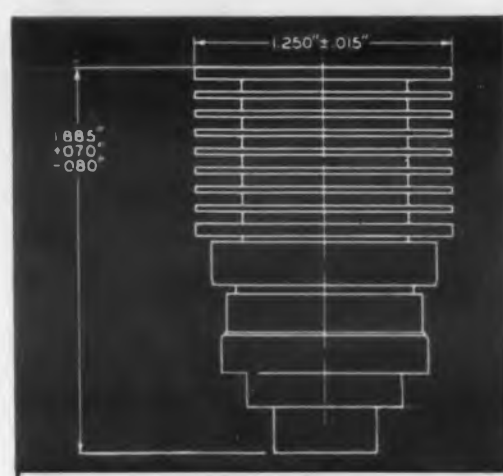

TYPICAL CCS OPERATION OF RCA-6816 AND -6884
RF Power Amplifier, Oscillator—Class C Telegraphy
and
RF Power Amplifier—Class C FM Telephony

| | at 400 Mc | | at 1200 Mc |
|-------------------------------|-----------|-----|------------|
| DC Plate Voltage | 400 | 900 | 900 volts |
| DC Grid-No. 2 Voltage | 200 | 300 | 300 volts |
| DC Grid-No. 1 Voltage | -35 | -30 | -22 volts |
| DC Plate Current | 150 | 170 | 170 ma. |
| DC Grid-No. 2 Current | 5 | 1 | 1 ma. |
| DC Grid-No. 1 Current | 3 | 10 | 4 ma. |
| Driver Power Output (approx.) | 3 | 3 | 5 watts |
| Useful Power Output (approx.) | 23 | 80 | 40 watts |



RADIO CORPORATION OF AMERICA
Tube Division Harrison, N. J.

CIRCLE 376 ON READER-SERVICE CARD FOR MORE INFORMATION

← CIRCLE 376 ON READER-SERVICE CARD