

Can We Control Sex ?

In this Issue

Jan.

WRNY
PUBLICATION

25 Cents

Science and Invention



See Page 798

164 PAGES

This big catalog places before you one of the country's largest — and most complete stock of radio kits, parts, accessories and consoles as well as one the season's outstanding lines of both A.C and D.C receivers. Every set builder — every dealer, in fact all those interested in radio should send for their copy of this immense catalog.

WHOLESALE PRICES

On Everything in RADIO

RADIO

MODERN RADIO SETS
ACCESSORIES KITS AND PARTS

1929

RADIO SERVICE

Allied Service will prove a revelation to you in what radio service can really be. Allied Executives backed by years of training in radio, are practical men. They know radio. Their vast experience has built up around them an organization trained to serve. Months of effort have built up a tremendous reserve of stock that makes for prompt shipments; and this stock is new stock comprising the season's pick of such prominent manufacturers as Silver-Marshall, Tyrman, Aero, Hammerlund-Roberts, etc.

SET BUILDERS!

Set Builders, Amateurs and so-called "Hams" will delight in the *unusual variety and remarkable values* that are offered in standard kits and parts. Tremendous stocks — *real organization* — prompt shipping service all combine to make Allied your ideal source of supply.

RADIO DEALERS!

The live radio dealer — the man who keeps pace with the rapid advance of radio — will find much of *real interest* in the Allied Catalog. New A.C Sets, D.C Sets, Dynamic and Magnetic Speakers, Television equipment, in fact everything an impatient radio public is demanding.

Write for Catalog Now!

CONFIRM
WHOLESALE
PRICES

ALLIED RADIO CORPORATION

711 W. LAKE ST. CHICAGO, ILL.

Allied Radio CORPORATION

711 W. LAKE ST. Dept. D-3 CHICAGO

Have you the Courage to take it?



—This \$2,000,000 Guarantee of a Job and Raise

Of course you'd like to earn \$50 or \$75 or \$100 a week—you'd like to do more interesting work—you'd like to get into a line that offers a real future—but do you know how to go about getting these things?

If you have been thinking of "taking a course" but have held back because you were afraid you didn't have education enough to learn better-paid work—if you have hesitated to take the risk that it would actually land you in the better position and increase your salary—then here's the best news you ever heard in your life!

I want to tell you about DRAFTING, and show you that it offers you everything in pay and opportunity that you could hope for. I want to show you that a fine Drafting job is now easily within your reach. And I want to set before you an amazing plan which we have worked out with the co-operation of some of the biggest employers and engineers in America, to prepare you at home, in spare-time, get you the job and raise your pay—absolutely without risk of a penny on your part.

Come Into DRAFTING!

Thousands of men—not a bit smarter than you, with no more schooling or experience—have gone from poorly paid positions as clerks, mechanics, building trade workers and laborers into Drafting positions paying \$50 to \$100 a week, with our help. Now with a job and a raise waiting for you as soon as you are ready for it, all it takes is the COURAGE to go after it—now if you remain in the rut it's because you choose to, not because you have to.

3 Drafting Lessons Actually FREE to show you how interesting and simple Drafting is

Maybe you think Drafting is "over your head"—that it takes artistic talent or some ability you haven't got. In that case you have a pleasant surprise coming to you. For I'll be glad to send you the first three lessons from our home-training to show you that the drawing of plans is purely mechanical, easily learned and the most interesting kind of work you ever tackled. It takes little enough courage to look into this wonderful opportunity—just mail the coupon and see for yourself how you like Drafting and our guaranteed way to get into it.



Get this "No-Risk" Plan!

I wish I had the room here to tell you all about DRAFTING—how it has become the most important branch of every kind of manufacturing and building construction work—how fascinating the work is—the fine bunch of fellows you'll work with—the big salaries paid—the wonderful chances for advancement. How, while Drafting is white-collar office work, it is hooked up closely with big projects and big men, and offers the thrill that goes with making plans which govern every move of the men who do the work. All this inside dope takes a 36-page book to describe and I'll be glad to send you a copy free when you mail the coupon for my no-risk job and raise plan.

O. C. Miller
Director Extension Work.

THE AMERICAN SCHOOL

Dept. D-1294 Drexel Ave. and 58th St., Chicago, Ill.

Please send without cost or obligation, 3 Drafting Lessons, 36-page book with the inside dope about Drafting and your no-risk plan and guarantee to prepare me, to place me and raise my pay, or no cost.

Name.....
St. No.....
City..... State.....
Age..... Occupation.....



"Only one other man and I, of six taking California State Board examination for Architect, passed. Then I realized the thorough and practical training given by American School. In 18 months I have gone from tracer to Chief Draftsman, in charge of all architectural and engineering work in one of the oldest offices here."

R. L. WARREN,
Los Angeles, Calif.



"When I started American School training in the Spring of 1915 I was working 14 hours a night, seven nights a week for \$1.83 a night. That Fall I got a job in the Engineering Dept. of a large firm near here. Today I work 5 1/2 days a week and my salary is larger than I ever dreamed of when I began that course in Mechanical Drafting."

B. H. SEAVERNS,
South Bend, Ind.

Science and Invention

Formerly *ELECTRICAL EXPERIMENTER*
COMBINED WITH "THE EXPERIMENTER"

EDITORIAL, ADVERTISING AND GENERAL OFFICES:
230 Fifth Avenue, New York City

Published by Experimenter Publishing Company, Inc. H. Gernsback, Pres.;
S. Gernsback, Vice-Pres. and Treas.; Irving S. Manheimer, Sec'y
Publishers of *SCIENCE AND INVENTION*, *RADIO NEWS*, *RADIO*
LISTENERS' GUIDE and *AMAZING STORIES*



Vol. XVI
Whole No.
189

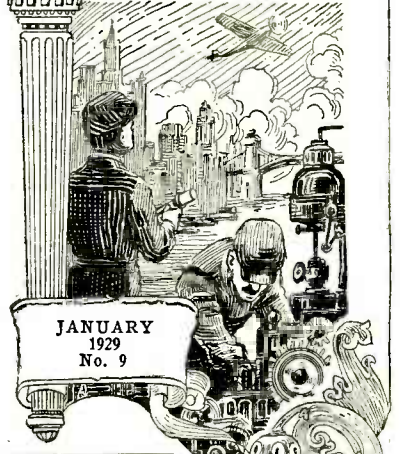

JANUARY
1929
No. 9

Editorial Staff

HUGO GERNSBACK, *Editor-in-Chief*.
H. WINFIELD SECOR, *Managing Editor*.
T. O'CONNOR SLOANE, Ph. D.,
Associate Editor
JOSEPH H. KRAUS, *Field Editor*.
PAUL WELKER, *Radio Editor*.
S. GERNSBACK, *Wrinkles Editor*.

Astronomy—
Dr. Donald H. Menzel, Ph.D., Lick Observatory;
W. J. Luyten, of the Harvard College Observatory.
Entomology and Allied Subjects—
Dr. Ernest Bade, Ph.D.
Physics—
Dr. Harold F. Richards, Ph.D., Ernest K. Chaplin,
M.A., Dr. Donald H. Menzel, Ph.D.
Chemistry—
Raymond J. Wallis, Dr. Ernest Bade, Ph.D., Dr.
William Lemkin.

Contributing Editors

Automotive Subjects— George A. Luers
Radio— A. P. Peck, Herbert Hayden.
Magic and Psychic Phenomena—
Joseph Dunninger, Joseph F. Rinn, Edward Merlin.
Foreign Correspondents—
Dr. Alfred Gradenwitz, Germany; Dr. H. Recher,
Germany; C. A. Oldroyd, England; S. Leonard Has-
tin, England; Count A. N. Mirzoeff, France; Iliubert
Slouka (Czecho-Slovakia); P. C. van Petegem, Hol-
land; Richard Neumann, Austria.

IN FEBRUARY ISSUE

World's Largest Bridge

Further details of the new span across the Hudson which will connect New York and New Jersey.

Mechanical "Lungs"

A new device which will save lives of submarine wreck victims.

Insect Cradle Builders

Dr. Ernest Bade tells an interesting story of how the insects protect the young and defenseless.

Can We Control Sex?

The third article of a series dealing with sex control. The results of questionnaires sent to leading doctors will also be published.

Electric Fish

Strange denizens of the deep which kill their prey by electric shock and produce potentials as high as 600 volts.

CONTENTS OF THIS ISSUE

GENERAL SCIENCE			
Editorial	793	Electrical Problems	831
By Hugo Gernsback		By Ricardo Ludeke	
Can We Control Sex?	794	HOME MOVIES	
By Prof. Thomas Hunt Morgan		How a Negative Film Becomes Positive	810
Neon Beacon Penetrates Fog and Gives Wind Direction	798	By Don Bennett	
By H. Winfield Secor		Home Movies—A Monthly Department	826
Scientists and Architects Build Latest Movie Palace	804	Conducted by Don Bennett	
Largest Vehicle Tunnel	806	New "Effect" Device for Movies	828
By Harry Bercoovich		By Herbert C. McKay	
Lining an Eight Inch Gun	808	Home Movies in New Role	829
By Edna McDonald Serrom		TELEVISION	
World's Longest Bridge	811	Outdoor Radiovisor	840
Scientific Toys	812	By S. R. Winters	
Earthquakes and Seismographs	816	Flexible Neon Tube Mount	841
By Father John W. Tynan, S. J.		RADIO	
Inventions Wanted	818	Surveying with Radio	842
Can You Find Hidden Fire Hazards?	819	By L. L. L. Dilley	
Motor Hints	820	A.C. Set Hints	844
Conducted by George A. Luers		By Paul L. Welker	
Scientific Questions	822	Apartment House Aerial	845
Magic—A Monthly Feature	823	By S. R. Winters	
By Dunninger		Radio Aids Police	845
Readers Forum	838	New Radio Devices	846
Scientific Humor	848	Radio Oracle	847
Latest Patents	849	AUTOMOTIVE	
The Oracle	850	Motor Hints	820
Patent Advice	862	HOW-TO-MAKE-IT	
AVIATION		Artistic Letter Boxes	821
Neon Beacon Penetrates Fog and Gives Aviator Wind Direction	798	By Joseph H. Kraus	
The Graf Zeppelin Dissected	800	Model Department	824
By Augustus Post		A Simple Hall Stand	832
CHEMISTRY AND ELECTRICS		By J. E. Lovett	
The Chemistry of a Plant	819	Electric Thermostats	833
Waxes and Oils	830	By Herman R. Wallin	
By Dr. Ernest Bade, Ph.D.		How-To-Make-It Department	834
		Wood Turning for the Amateur	835
		Wrinkles, Recipes and Formulas	836
		By S. Gernsback	

HOW TO SUBSCRIBE FOR "SCIENCE AND INVENTION." Send your name, address and remittance to Experimenter Publishing Co., 230 Fifth Ave., New York City. Checks and money orders should be made payable to Experimenter Publishing Co., Inc. Mention magazine desired, inasmuch as we also publish *RADIO NEWS*, *AMAZING STORIES* and *RADIO LISTENERS' GUIDE*. Subscriptions may be made in combination with the other publications just mentioned at special reduced club rates. Send postal for club rate card. Subscriptions start with the current issue unless otherwise ordered. ON EXPIRATION of your subscription we enclose a renewal blank in our last number to you, and notify you by mail. Then, unless we receive your order and remittance of a renewal, delivery of the magazine is stopped.

SCIENCE AND INVENTION is published on the 10th of each month. There are 12 numbers per year. Subscription price is \$2.50 a year in U. S. and possessions. Canada and foreign countries, \$3.00 a year. U. S. coin as well as U. S. stamps accepted (no foreign coin or stamps). Single copies, 25c each. All communications and contributions to this journal should be addressed to Editor, *SCIENCE AND INVENTION*, 230 Fifth Ave., New York City, N. Y. Unaccepted contributions cannot be returned unless full postage has been included. ALL accepted contributions are paid for on publication. *SCIENCE AND INVENTION* Monthly. Entered as second-class matter May 10, 1924, at the Post Office at New York, N. Y., under the act of March 3, 1879. Additional entry at Dunellen, N. J. and San Francisco, Calif. Title Registered at the Patent Office. Copyright, 1928, by E. P. Co., Inc., New York. The Contents of this Magazine are copyrighted and must not be reproduced without giving full credit to the publication. *SCIENCE AND INVENTION* is for sale at all newsstands in the United States and Canada. European Agents, S. J. Wise Et Cie, 40, Place Verte, Antwerp, Belgium.

ADVERTISING REPRESENTATIVES

New York Office:
Rhodes & Leisenring,
624 Graybar Building

Chicago Office:
Rhodes & Leisenring,
307 North Michigan Avenue

A HANDY RULE FOR YOU

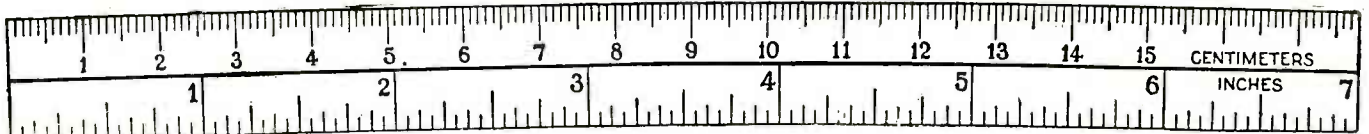

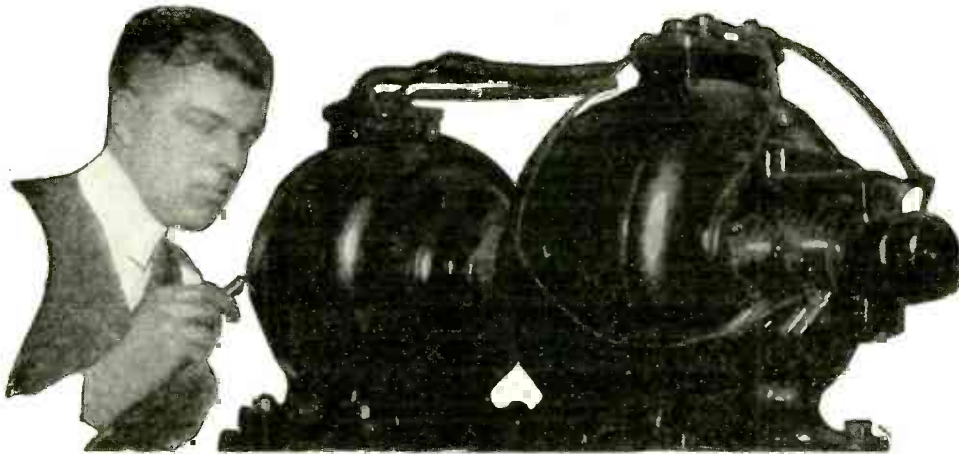

I Learned ELECTRICITY This Amazingly Easy Way

Why spend your life waiting for \$5 raises in a dull, hopeless job? Now . . . and forever . . . say good-bye to 25 and 35 dollars a week. Let me show you how to qualify for jobs leading to salaries of \$50, \$60 and up, a week, in Electricity—NOT by correspondence, but by an amazing way to train, that makes you a practical electrician in 90 days! Getting into electricity is far easier than you can imagine!

Learn-By-Doing' in 90 Days

LACK of experience, age or advanced education bars no one. I don't care if you don't know an armature from an air brake—I don't expect you to!

I don't care if you are 16 years old or 40

Don't let lack of money stop you. Most of the men at Coyne have no more money than you have. That's why I have worked out my astonishing offers.

Earn while you learn

Many of my students earn a good part or all their living expenses and should you need this assistance we will help you. Then, in 12 brief weeks, in the great roaring shops of Coyne, I train you as you never dreamed you could be trained . . . on one of the greatest outlays of electrical apparatus ever assembled . . . real dynamos, engines, power plants, autos, switchboards, transmitting stations . . . everything from doorbells to farm power and lighting . . . full-sized . . . full operation every day! Nowhere else in the world can you get such Big-Pay-Job training!



I Prepare You for Jobs Like These

Here are a few of hundreds of positions open to Coyne-trained men. Our free employment bureau gives you lifetime employment service.
Armature Expert, \$50 a wk. & up
Substation Operator, \$65 a wk.
Auto Electrician, \$60 a wk. & up
Inventor Unlimited
Maintenance Engineer \$50 a Week and up
Service Station Owner \$60 a Week and up
Radio Expert, \$60 a week & up

Not a Correspondence School

Learn by doing . . . all real actual work . . . no dull books, no baffling charts, but building real batteries . . . winding real armatures, operating real motors, dynamos and generators, wiring houses, etc., teaching you far more than the average ordinary electrician ever knows. That's how we fit you immediately to hold Big-Pay electrical jobs after graduation.

Many BIG-PAY Jobs to Suit You

Don't worry about a job. Coyne training settles the job question for life. Big demand for Coyne trained men often exceeds supply. Our employment department gives you lifetime service. Two weeks after graduation, Clyde F. Hart got a position as electrician with the Great Western R. R. at over \$100 a week.

FREE Employment Service

COYNE is your one great chance to get into electricity. Every obstacle is removed. This school is 29 years old—Coyne training is tested—proven beyond all doubt—endorsed by many large electrical concerns. You can find out everything absolutely free. Simply mail the coupon and let me send you the big, free Coyne book of 150 photographs . . . facts jobs . . . salaries . . . opportunities. Tells you how many earn expenses while training and how we assist our graduates in the field. This does not obligate you. Act now!

Now In Our New Home

This is our new, fireproof, modern home, wherein is installed thousands of dollar's worth of the newest and most modern Electrical Equipment of all kinds. We now have a larger amount of floor space devoted to the exclusive teaching of practical electricity. Every comfort and convenience has been arranged to make you happy and contented during your training.



Get this FREE Book

**\$60 to \$200 a Week
Jobs Not Unusual**

We can point to many Coyne men making up to \$600 a month. \$60 a week is only the beginning of your opportunity. You can go into radio, battery or automotive electrical business for yourself—and make \$3000 a year and up.



H. C. Lewis, Pres.
COYNE ELECTRICAL SCHOOL, Dept. 19-83
500 S. Paulina St., Chicago, Ill.

Dear Mr. Lewis:

Without obligation send me your big free Book and all details of Free Employment Service, Radio and Automotive Courses, and how many "earn while learning." I understand I will not be bothered by any salesman.

Name

Address

City State

COYNE ELECTRICAL SCHOOL
H. C. LEWIS, Pres., Dept. 19-83
500 S. Paulina Street Established 1899 CHICAGO, ILLINOIS

INDEX TO ADVERTISERS

	Page		Page
A			
Adams, John T.	873	Givens Chemical Co.	866
Allied Radio Corporation Inside Front Cover		Goerz American Optical Co., C. P.	864
American School of Aviation 884		H	
American School 785-860		High School Home Study Bureau 870	
American School of Music 891		Hobart Bros. Co. 872-890	
American School of Photography 881		Hotel Manger 856	
American Telephone & Telegraph Co., The 873		Hotel McAlpin 884	
Andrews, Frank 858		I	
Anita Institute 856		Ideal Aeroplane & Supply Company, Inc. 856	
Ansonia, The 875		Illinois College of Photography 860	
Artee Radio Sales & Mfg. Co. 859		Independent Electric Works 891	
Art and Nature 888		Inkograph Co., Inc. 891	
Audel & Co., Theo. Inside Back Cover		International Correspondence Schools	
Automatic Rubler Company 877		International Typewriter Exchange 854	
Aviation Institute of U. S. A. 887		J	
B			
Bliss Electrical School 856		Jenkins Corporation 872-881	
Battle Stories Magazine 896		K	
Boice, W. B. & J. E. 871		Karas Electric Co. 893	
Bureau of Inventive Science 864		Kelsey Co., The 888	
C			
Campbell Co., The Wm. 890		L	
Chemical Institute of N. Y., Inc. 790		Laboratory Materials Co. 872	
Coleman Electrical Co. 871		Lacey & Lacey 864	
Coleman, Watson E. 862		Lancaster & Allwine 864	
Conn Ltd., C. G. 864		Landon School, The 876	
Cox, S. J. 881		La Salle Extension University 856-866	
Coyne Electrical School 787		Lederer School of Drawing 893	
Cyko Mailing Service 889		Le Pages' Craft League 867	
D			
Deagan, Inc., J. C. 856		Liederman, Earle E. 883	
Delta Specialty Co. Back Cover		Lincoln Airplane School 879	
Detroit School of Lettering 854		Mc	
Dobe, Fred'k W. 877		McCathran, Irving L. 871	
Douglas, Lyle 889		McGraw-Hill Book Co., Inc. 869	
Dryer, Prof. J. A. 872		McSweeney Electrical School 860	
Dubilier Condenser Corporation 855		M	
Dynamic Mfg. Co. 881		Mann & Benton 890	
E			
Educator Press 856		Marvel Mfg. Co. 893	
Evans & Co., Victor J. 865		Mason, Fenwick & Lawrence 864	
F			
First Hawaiian Conservatory of Music, Inc. 866		Meccano Co., Inc. 856	
Fisher Mfg. Co., Adam 864		Metal Cast Products Co. 889	
Franklin Institute 875-881		Metal Arts Co. 856	
Franklin Publishing Company 889		Meyer Both Company 891	
G			
Gaston Manufacturing Co. 877		Midwest Radio Corporation 791	
Gerstner & Sons, H. 871		Miller, Carl 862	
Gilson Slide Rule Co. 877		Miller, Monroe E. 864	
H			
		Miniature Ship Models, Inc. 860	
		Mount Carmel Mfg. Co. The 888	
		Munn & Company 862	
		N	
		National Automotive 870	
		National Radio Institute 789	
		National Salesmen's Training Ass'n 792	
		National School of Visual Education 885	
		O	
		O'Brien, Clarence A. 863	
		Oil Burner Co. 871	
		P	
		Parks Woodworking Machine Co., The 888	
		Patterson, Arthur R. 879	
		Patterson, Arthur R. ???	
		Perfect Breather Co. 858	
		Perfect Penmanship Institute 882	
		Pines Chemical Co. 860	
		Piccadilly, The 866	
		Plymouth Rock Squab Co. 852	
		Polachek, Z. H. 864	
		Polk & Company, R. L. 893	
		Popular Book Corporation 861	
		Popular Chemistry Co. 876	
		Porter Chemical Co., The 890	
		Press Guild, Inc. 891	
		R	
		Radio Association of America 860	
		Radio Institute of America 851	
		Radio Specialty Co. 881	
		Randolph & Co. 862	
		Rawner Radio & Television Co. 871	
		Renuzit System, The 890	
		Roat and Lohman 877	
		Ross-Gould, Inc. 858	
		Royal Sales Co. 882	
		S	
		School of Engineering of Milwaukee 889	
		Socket Power Laboratories 898	
		South American Service Bureau 864	
		Speedo Manufacturing Co. 864	
		Strongfort Institute 853	
		T	
		Tamblyn, F. W. 864	
		Tarbell Systems, Inc. 870	
		Townsend Laboratories 852	
		Treasure Sales Co. 884	
		Triple-X Magazine 857	
		U	
		U. S. Model Aircraft Corp. 889	
		Underground Aerial Systems 879	
		V	
		Ventrilo Company 884	
		W	
		Whirlwind Mfg. Co. 860	

Now! in limp, suede leather binding

S. Gernsback's

Radio Encyclopedia

THE most valuable of Radio Books—S. Gernsback's Encyclopedia—now the most beautiful. This foremost Radio Encyclopedia is now offered in this luxurious new binding to meet the demand for a more handsomely bound volume. The limp suede leather edition sells for \$5.00. The Keratol-leather stiff binding still can be had for \$2.00.

Remember—this is an encyclopedia—not a dictionary! It took over two years of intensive labor to compile it. It is the first Radio Encyclopedia ever published.

S. Gernsback's Radio Encyclopedia contains the

meaning of every word and phrase used in the entire Radio Art. Every circuit, part and apparatus is thoroughly explained. A complete cross index is just one of the many features of this remarkable book.

There are 1,930 definitions—549 diagrams, photographs and drawings—all simple and easily understood. The book is nearly 1 inch thick and measures 9x11 inches.



S. GERNSBACK
230 Fifth Ave., New York City
Kindly send me one copy of the
Radio Encyclopedia. I will pay post-
man.

Limp suede leather binding
\$5.00 plus postage.

Keratol-leather binding
\$2.00 plus postage.
(check which binding you want)

Name.....

Address.....

Town.....

Estate.....

SEND NO MONEY

Simply pay the post-man on delivery.
Over 25,000 copies in the stiff binding already sold.

S. GERNSBACK, 230 FIFTH AVENUE, NEW YORK CITY

I Will Train You at Home to Fill a Big-Pay Radio Job



**Here's the
PROOF**



**Has Made \$10,000
More in Radio**

"I can safely say that I have made \$10,000 more in Radio than I would have made if I had continued at the old job. When I enrolled with you I didn't know a volt from an ampere. I advise all ambitious young men to get into Radio. There is no greater opportunity."

Victor L. Osgood,
931 Cranford Ave.,
Bronx,
New York City.



**\$375 One Month in
Spare Time**

"Recently I made \$375 in one month in my spare time installing, servicing, selling Radio Sets."

Earle Cummings,
18 Webster St.,
Haverhill, Mass.



\$450 a Month

"I work in what I believe to be the largest and best-equipped Radio shop in the Southwest and also operate KGFL. I am averaging \$450 a month."

Frank M. Jones,
922 Guadalupe St.,
San Angelo, Tex.

If you are earning a penny less than \$50 a week, send for my book of information on the opportunities in Radio. It's FREE. Clip the coupon NOW. A flood of gold is pouring into this new business, creating hundreds of big pay jobs. Why go along at \$25, \$30 or \$45 a week when the good jobs in Radio pay \$50, \$75, and up to \$250 a week? My book, "Rich Rewards in Radio," gives full information on these big jobs and explains how you can quickly become a Radio Expert through my easy, practical home-study training.

**Salaries of \$50 to \$250 a Week
Not Unusual**

Get into this live-wire profession of quick success. Radio needs trained men. The amazing growth of the Radio business has astounded the world. In a few short years three hundred thousand jobs have been created. And the biggest growth of Radio is still to come. That's why salaries of \$50 to \$250 a week are not unusual. Radio simply hasn't got nearly the number of thoroughly trained men it needs. Study Radio, and after only a short time land yourself a REAL job with a REAL future.

**You Can Learn Quickly and
Easily in Spare Time**

Hundreds of N. R. I. trained men are today making big money—holding down big jobs—in the Radio field. Men just like you—their only advantage is training. You, too, can become a Radio Expert just as they did by our new practical methods. Our tested, clear training makes it easy for you to learn. You can stay home, hold your job, and learn quickly in your spare time. Lack of education or experience are no drawbacks. You can read and write. That's enough.

**Many Earn \$15, \$20, \$30 Weekly
on the side while learning**

My Radio course is the famous course "that pays for itself." I teach you to begin making money almost the day you enroll.

My new practical method makes this possible. I give you SIX BIG OUTFITS of Radio parts with my course. You are taught to build practically every type of receiving set known. M. E. Sullivan, 412 73rd Street, Brooklyn, N. Y., writes: "I made \$720 while studying." Earle Cummings, 18 Webster Street, Haverhill, Mass.: "I made \$375 in one month." G. W. Page, 1807 21st Ave., Nashville, Tenn.: "I picked up \$935 in my spare time while studying."

Your Money Back If Not Satisfied

I'll give you just the training you need to get into the Radio business. My course fits you for all lines—manufacturing, selling, servicing sets, in business for yourself, operating on board ship or in a broadcasting station—and many others. I back up my training with a signed agreement to refund every penny of your money if, after completion, you are not satisfied with the course I give you.

**ACT NOW—64-page
Book is FREE**

Send for this big book of Radio information. It won't cost you a penny. It has put hundreds of fellows on the road to bigger pay and success. Get it. Investigate. See what Radio has to offer you and how my Employment Department helps you get into Radio after you graduate. Clip or tear out the coupon and mail it RIGHT NOW.

J. E. SMITH, President
National Radio Institute
Dept. 9MV
Washington, D. C.

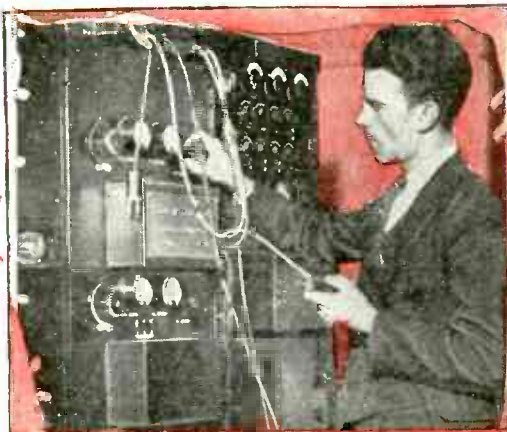

**You can build
100 circuits with
the six big outfits
of Radio parts
I give you**

**3 of the 100 you
can build**

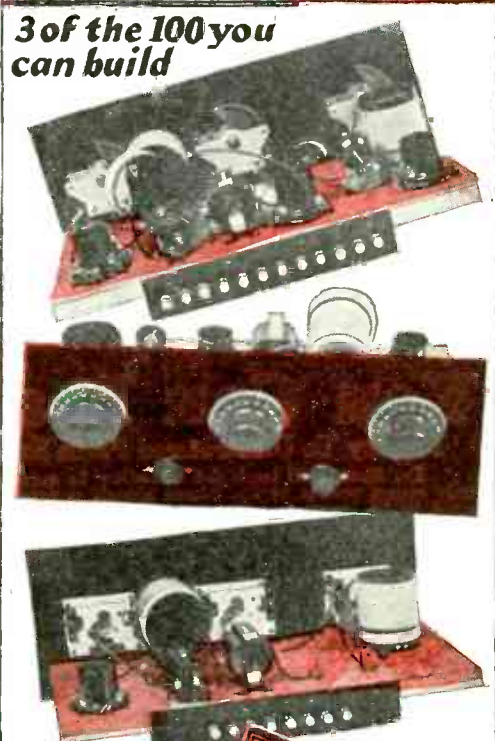

**Find out quick
about this
practical way
to big pay**



Mail This FREE COUPON Today

J. E. SMITH, President,
Dept. 9MV, National Radio Institute,
Washington, D. C.

Dear Mr. Smith: Kindly send me your big book "Rich Rewards in Radio," giving information on the big-money opportunities in Radio and your practical method of teaching with six big Outfits. I understand this book is free, and that this places me under no obligation whatever.

Name..... Age.....
Address,
City..... State.....

Employment Service to all Graduates

Originators of Radio Home Study Training



Dr. T. O'Conor Sloane will teach you **CHEMISTRY** Right in your own Home

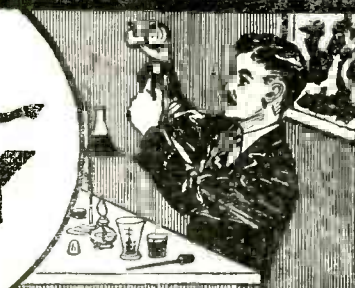

Good Chemists Command High Salaries



T. O'CONOR SLOANE,
A.B., A.M., LL.D., Ph.D.
Noted Instructor, Lecturer and Author. Formerly Treasurer American Chemical Society and a practical chemist with many well known achievements to his credit. Not only has Dr. Sloane taught chemistry in the class-room but he was for many years engaged in commercial chemical work.

Industrial firms of all kinds pay tempting salaries to get the right men. Salaries of \$10,000 to \$12,000 a year are not unusual for chemists of exceptional abilities. Chemistry offers those who are ambitious and willing to apply themselves conscientiously the greatest opportunities of any vocation. Why be satisfied with small pay and hard, thankless work—learn the profession of Chemistry and your salary will depend only upon your own efforts and your own abilities.

The work of the chemist is extremely interesting. If you are fond of experimenting, if you like exciting and fascinating work, take up Chemistry. To the man who is dissatisfied with his present job, to the young man just deciding on his life work, Chemistry holds alluring charms, and countless opportunities. If you want to earn more money, the way is open through our course in Chemistry.

Now Is The Time To Study Chemistry

Never before has the world seen such splendid opportunities for chemists as exist today. The war has awakened the United States to the need of trained chemists and chemical engineers. Everywhere the demand has sprung up. In factories, mills, laboratories, electrical shops, industrial plants of all kinds, chemistry plays a vital part in the continuation and expansion of the business. In every branch of human endeavor the need for chemists has arisen. No profession offers such alluring opportunities and the next ten years are going to show the greatest development in this science that this country has ever seen. Those who have the foresight and ambition to learn chemistry now will have the added advantages and greater opportunities afforded while the chemical field is growing and expanding.

ten years are going to show the greatest development in this science that this country has ever seen. Those who have the foresight and ambition to learn chemistry now will have the added advantages and greater opportunities afforded while the chemical field is growing and expanding.

You Can Learn At Home

Ability To Understand Plain English The Only Requirement

Dr. Sloane will teach you Chemistry in a practical and intensely interesting way. Our home study course written by Dr. Sloane himself is practical, logical and remarkably simple. It is illustrated by so many experiments that are performed right from the start that anyone, no matter how little education he may have, can thoroughly understand every lesson. Dr. Sloane teaches you in your own home with the same individual and painstaking care with which he has already taught thousands in the class room. He will, in addition, give you any individual help you may need in your studies. This personal training will be of inestimable value to you in your future career.

Experimental Equipment Given to Every Student



We give to every student without additional charge, this chemical equipment including fifty pieces of laboratory apparatus and supplies and thirty-nine different chemicals and reagents. The fitted heavy wooden box serves not only as a case for the outfit but also as a laboratory accessory for performing countless experiments. Full particulars about this special feature of our course are contained in our free book "Opportunities for Chemists."

DIPLOMA AWARDED TO EACH GRADUATE

Upon graduation each student is awarded our Diploma in Chemistry, certifying that he has successfully completed his studies. Your name on this certificate will be a source of pride to you all your life, as well as an aid to obtaining a position in Chemistry.

Easy Monthly Payments

You do not have to have even the small price of the course to start. You can pay for it in small monthly amounts or earn it as many others are doing. The cost is very low, and includes even the Chemistry outfit—there are no extras to buy with our course. Write us and let us explain how you can qualify for a trained technical position without even giving up your present employment.

MAIL THE COUPON FOR FREE BOOK

Your name and address on the coupon will bring you by return mail our interesting free book, "Opportunities for Chemists," and full particulars about the course and what it will do for you. You owe it to yourself to get this book. Send the coupon right now while it is fresh in your mind. Or just write your name and address on a postal card and mail it to us. But whatever you do, act today!

What Well-Known Authorities Say About Our Course

From Hudson Maxim,
"Dr. Sloane has done a much-needed work in a much better way than anything of the kind has, heretofore, been done."

"Dr. Elcano has a remarkable faculty of presenting Science for self-instruction of the student in such a clear and understandable way as to be most readily grasped and assimilated."

"I, therefore, unreservedly recommend and place my highest indorsement on his work."

From Dr. W. W. de Kerlor,
"I can not recommend your course too highly and I congratulate both you and Dr. Sloane on same."

From John A. Tennant,
"This is something which has long been needed. Your long experience in the teaching of chemistry . . . assurance that the course will be practical as well as plain to the untrained students."

What the Students Say:

"Your course has been worth \$50,000 to my concern."

"This is just like reading some fascinating fiction story."

"I have just been made Assistant Chemist of my concern."

"You may be pleased to learn that I have re-entered the laboratory of my former employers as their chief chemist. The work under my care involves several hundred thousand dollars a year."

"I am going to keep right at the study, for it has helped me greatly. It is really the knowledge I have gained from it that made it possible to hold the job I have at present."

"Let me state that I have obtained a new and better position; this is with the Heller and Merz Aniline Dye Co. in their main laboratory. Thanks to your course I am well prepared and able to hold same."

"I now have a fine position as chemist at the Du Pont Dye Works. It was thru your course alone that I have been so successful."

"I have written to different people about your course and they speak very highly of same."

"If I don't learn it isn't your fault for I find that your lessons contain a whole lot."

(Names and addresses on request)

CHEMICAL INSTITUTE OF NEW YORK

Home Extension
16-18-D-East 30th St.,
Division 1
New York, N. Y.

Please send me at once, without any obligation on my part, your free book "Opportunities for Chemists," and full particulars about the Experimental Equipment given to every student. Also please tell me about your plan of payment.

NAME

ADDRESS

CITY..... STATE.....

S&I-1-27

Don't Wait—Mail the Coupon NOW!

CHEMICAL INSTITUTE of NEW YORK, Inc.

16-18-DEAST 30TH STREET Home Extension Division 1 NEW YORK, N. Y.

FACTORY TO YOU—SAVE 50%—COMPARE WITH COSTLIEST OUTFITS BEFORE YOU BUY

Enjoy a powerful new **Miraco** ^{set or complete outfit} **30 DAYS FREE** AC Electric or Battery



3 Year Guarantee

Get Our Send No Money 9th Anniversary Offer!

Built like, Looks like, Performs like a \$200 set

Marvelous new 3-year guaranteed, lighted 1-dial control. All metal Super Shielded Miraco set, removed from cabinet. Front switch, phonograph pick-up connection and all latest features. Built in power section on AC models.

The Latest, Finest and Costliest Construction

\$49.88
COMPLETELY ASSEMBLED

NEW LOW FACTORY PRICES SAVE 50%
Wide Selection of Beautiful Cabinets AC or Battery Sets
30 DAYS HOME TRIAL

A popular walnut Hi-Boy Console, with drop-leaf desk. Beautiful two-tone finish. Rare bargain!

Richly designed, genuine walnut console of finest type. Electro-dynamic or magnetic power cone, or long air column speaker. Marvelous value.

A new-type arm-chair console. Genuine walnut. Very pretty. Low priced. Electro-Dynamic or Magnetic-Power Speakers.

Beautifully graceful Spinet console, genuine two-tone walnut. Choice of speakers. Also comes in Electric Phonograph-Radio Combination.

At right, a Lo-Boy console, walnut finish, that costs little. A gem!

Metal or wood compact style cabinets. Wood cabinets in walnut or new shaded silver-chrome finishes. Cathedral Electro-Dynamic or Magnetic-Power Speaker to match!

8 tube *one dial* Electric Lighted

MIRACO

TRADE MARK REGISTERED

CATHEDRAL TONED, SUPER SELECTIVE, POWERFUL DISTANCE GETTERS

Celebrating its 9th successful year, America's big, old, reliable Radio Corporation springs a genuine sensation in high-grade sets. With its latest, Super-powered, 1-dial Miracos—the All Electric wholly self-contained, hum-free, AC-8 and AC-9, using AC tubes or the new 8-tube models

hum-free operation, tremendous "kick" on distant stations and razor-edge selectivity—with its costly sturdy construction, latest features, including phonograph pick-up connection, ease of tuning, beauty, and economy—a Miraco will make you the envy of many whose radios

BIG DISCOUNTS
Exclusive Territory to User-Agents on **BATTERY OR AC ELECTRIC OUTFITS**

for batteries or Eliminators—you are guaranteed values and savings unsurpassed in the fine set field. Compare a Miraco with highest-priced radios, for 30 days in your home. Surprise and entertain your friends—get their opinions. Unless 100% delighted, *don't buy it!* Return everything—the complete outfit—at our expense. Your decision is final—absolutely!

cost 2 to 3 times as much! Many thousands of Miracos—bought after 30 day home comparisons—are cutting through locals and getting coast to coast with the tone and power of costly sets, their delighted users report. Miracos are laboratory-built with finest parts, and embody 9 years' actual experience in constructing fine sets. Approved by Radio's highest authorities.

Only exceptionally fine radios, of the very latest approved type, at rock-bottom prices, could possibly back up so liberally unconditional a guarantee. Send coupon now for **Amazing Special Factory Offer!**

Deal Direct with Big Factory
Everything reaches you splendidly packed and rigidly tested to insure your instant enthusiasm. Enjoy the outfit 30 days—then decide. Liberal 3-year guarantee on each set. Play safe, save lots of money, and insure satisfaction by dealing direct with Radio's old, reliable builders of fine sets—9th successful year.

Don't Confuse with Cheap Radios
With its rich, clear Cathedral tone, **Miraco Outperforms 'em All In Chicago** On the Miraco Unitone, to start with, will say: I got to date 61 stations outside of Chicago, from the Pacific Ocean to the Atlantic Ocean, and from Anchorage, Alaska, to the Gulf of Mexico, and I tried the set with 3 different antennas. That is an outside aerial 152 feet, an inside aerial 20 feet, and

light socket. I want to say that your set does outperform the other sets I have. I put it up against a World Record Super 9 and beat that one. Then I put it up against a (names expensive make), and beat that one. Next I put it up against a Neurodyne and beat that one. HARRY KOPP, 6555 South Peoria Street, Chicago, Illinois.



AC-8—\$71.50
Unbeatable value in a 3-year guaranteed Super Shielded Metal Chassis.



Also New, More Powerful Battery Sets

The newest and latest in battery operated sets, designed with same advanced features used in electric sets! Same wide choice of cabinets. Highest quality, amazingly low priced!

MIDWEST RADIO CORPORATION, 409-RJ Miraco Building, Cincinnati, Ohio
BEAUTIFULLY ILLUSTRATED CATALOG, AMAZING SPECIAL FACTORY OFFER, TESTIMONY OF NEARBY USERS—All the proof you want—of our honesty, fairness, size, financial integrity, radio experience and the performance of our sets—including Amazing Factory Offer—sent with catalog.



Free!

MIDWEST RADIO CORPORATION
Pioneer Builders of Sets—9th Successful Year
409-RJ Miraco Bldg., Cincinnati, Ohio

THIS COUPON IS NOT AN ORDER

WITHOUT OBLIGATION, send free catalog, Amazing Special Factory Offer, testimony of nearby users, etc. User Agent Dealer
 Check here if interested in an **EXCLUSIVE TERRITORY PROPOSITION**
NAME _____ ADDRESS _____



Bet you \$150⁰⁰ (against a 2¢ postage stamp) I can make you a **BIG MONEY** Salesman!

Only this isn't a bet or a gamble—but a clean-cut sure thing business proposition. Read this guarantee of a million dollar institution. That we will make you a hard-hitting DYNAMIC Salesman—give you \$150 for learning—under a money-back penalty of satisfaction of which you are judge and jury. Here is your one chance to learn selling and get into a real selling job without risking a penny!

**All you need is
AVERAGE ability**

Maybe you wonder if you can learn the "mysteries" of selling. Perhaps you think it takes some natural born qualities you lack. *Not a bit of it!* I'll set before you the records of *hundreds* of men—mechanics, clerks, building trade men—store keepers, farmers, laborers, bookkeepers, chauffeurs. Men with no more brains, no more education, no more experience than you have. And I'll show you in black and white, with names and addresses and exact figures, how they have doubled and trebled their incomes with our help! Men **JUST LIKE YOU**, I tell you. And I'm prepared to guarantee the same opportunity to you.

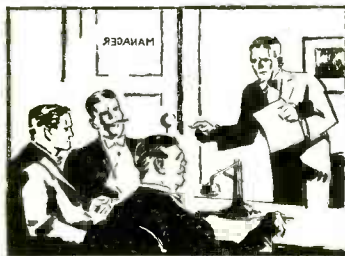

Big money—big deals—the chance to travel and meet important people are yours in the work that's as thrilling as a "game"—selling.

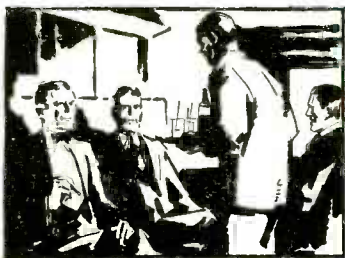

Our salesmen put it this way. "Say, they're paying me \$9000.00 this year to have FUN!" No work offers the joy and the freedom and the independence of selling. And the sky's the limit for your earning capacity.

Jobs, Good Pay and Selling Experience now a part of this training

N.S.T.A. announces the most sensational advance in sales training in all its 22 year history. We have arranged with MILLION DOLLAR companies, in many different lines of business to employ our students—in spare-time—give them a chance to apply their instruction, and get real experience on the firing line. For 3 months of this part-time work you must make *at least* \$150.00, under the money-back agreement shown above. You can't beat that for a winning combination of theory and practice.

Read this amazing FREE BOOK and double your pay!

That sounds funny—but here are the sober facts: That simply *reading* this wonder-book has proved the turning point in the lives of THOUSANDS of ambitious men. And I promise you it will open your eyes to the opportunities within your easy reach in selling that you never dreamed were possible. That's your end of this \$150 bet—the 2c stamp it takes to send in your name.

**NATIONAL SALESMEN'S
TRAINING ASSOCIATION**
Dept. 301A, National Salesmen's Training Ass'n Bldg,
NORTH DEARBORN at ELM, CHICAGO, ILLINOIS

\$150

DOUBLE MONEY BACK BOND

A Positive Guarantee of \$150⁰⁰ Earnings

PLUS

Absolute Satisfaction or Tuition Refunded

\$150

National Salesmen's Training Association

Incorporated as a School of Salesmanship

Chartered as an Educational Institution in 1907

The attached Application for Membership in the NATIONAL SALESMEN'S TRAINING ASSOCIATION is accepted with the understanding that immediately after you complete the lessons, sales talks, lectures, examinations, training in SPECIAL LINES, etc., which are included in the Course WE AGREE that you will earn a guaranteed sum of at least **ONE HUNDRED AND FIFTY DOLLARS (\$150.00)** in spare time employment with one or more of the great companies co-operating with us, provided you follow Companies' instructions in a reasonable manner and devote at least 100 hours to such selling work within 3 months after completing the printed portions of the Course.

FURTHER, WE AGREE if upon completion of the Course and availing yourself of all Training and Service privileges as outlined in this Application for Membership, you are not thoroughly satisfied, we will cheerfully refund to you the entire amount of tuition paid. You alone shall be the sole judge as to the worth and value of the Training and Service received.

MONEY BACK PENALTY In accordance with the above, or if you are not entirely satisfied with the Training received, we agree to refund the entire tuition on request, providing request for a refund is received within 30 days from completion of the conditions of this guarantee, and providing the terms of your Application for Membership attached have been fully complied with.

By *Chas. Michel* President

600 Per Cent Increase
"My earnings are now six times as great as when I enrolled. I have changed my line from clothing to advertising. The consultation of your experts has been worth as much to me as the training."
L. H. Lundstedt, 6228 Irving Ave., Chicago, Ill.

\$7,286 As Salesman
"I was a clerk earning \$1,000 a year when I enrolled. Last year I made \$7,286. I now own my home, drive a nice car and am able to give my family the things I always wanted to."
J. Walsh, Box No. 1586, Springfield, Mass.

Back of this Agreement Million Dollar Association

Called by noted sales executives the foremost sales training institution in America. *Now in our 22nd year.* Over 100,000 members. Originators of the guarantee of \$150 for learning—of the idea of making actual selling a part of our training.

We take all the RISK!

Perhaps you have been *afraid* to strike out into a new line and make a new start. Perhaps you haven't known how to go about getting yourself a better kind of work and more money. Now here, *ready-made*, is the service you need. The best-paid line you ever dreamed about, *selling*. Training good enough to guarantee with a Double Money-Back Bond. Employment service that means something—calls for over 50,000 salesmen last year. And \$150 cash earnings for learning. The greatest offer ever made to ambitious men. Certainly not a dime do you risk. Certainly now you have no excuse for sticking in the rut of small pay and hard work. Reach out, right here and now—put your name and address on the coupon, and I'll do the rest.

Chas. Michel
President

National Salesmen's Training Association

Dept. 301A N. S. T. A. Bldg., Chicago, Ill.

Please send **FREE** and without obligation your wonder-book "The Secrets of Modern, Dynamic Salesmanship" and your guarantee of \$150.00 cash for learning.

Name.....

St. No.....

City..... State.....

Occupation..... Age.....

Please say you saw it in SCIENCE and INVENTION



EDITORIAL

"Those Who Refuse to Go Beyond Fact Rarely Get as Far as Fact" - - HUXLEY

THE SIXTH SENSE

By Hugo Gernsback



MOST people are under the impression that the human being is endowed with only five senses. There is, however, a well defined *sixth sense* which science has recognized for a long time. As a matter of fact, its recognition dates back more than a century.

The first one to call attention to this sixth sense was Sir Charles Bell, a Scottish physiologist. His epoch making work has been discussed in a recent book entitled, "The Sixth Sense," by Dr. D. F. Fraser-Harris, M.D.; D.Sc.; F.R.S.E.. Bell announced his new doctrine in physiology on February 16, 1826, in a paper read before the Royal Society entitled, "On the Nervous Circle which connects the Voluntary Muscles with the Brain."

The sixth sense, in a few words, may be summarized as the "Muscular Sense." This muscular sense, according to Dr. Fraser-Harris, is our awareness of the state of activity of our muscles, the appreciation of the degrees of tension or strain or resistance to the action of a muscle or group of muscles. It is technically called "kinaesthesia." In other words, the sense related to muscular movement.

Before Bell made this announcement, he had sometimes previously come to certain conclusions which are fully accepted today. He discovered that there are two classes of nerves in the human body, those that connect the nervous system to certain tissues and those which come from the tissues and lead into the nervous system. Bell, on examining carefully the nerves which connect the muscles, found that not all of them really went into the muscles. Instead, some went the opposite way. These he termed *sensory* nerves of the muscle. He then further reasoned that if a muscle is endowed with sensory nerves, then the muscle itself must be the source of a sense, which is the muscular sense.

In his paper to the Royal Society, he stated as follows: "The profuse supply to muscles of nerves, whose office it is to convey sensation in addition to motor nerves through which motion is exhibited."

He furthermore says that "two nerves are necessary to a muscle, one to excite action, the other to convey the sensation of that action and that the impression runs only in one direction; for instance, the nerve that carries will outward can receive no impression from without, the nerve that conveys inward a sense of the condition of the muscle cannot convey outward."

One of the most interesting phenomena of the sixth sense is our ability to judge weights and

practically every other voluntary muscular movement. A few examples will show this clearly. You see on the floor a heavy weight labeled 100 lbs. and you are asked to lift it. You will make an effort to lift it, knowing instinctively about how much 100 lbs. is. You will brace yourself against the floor and make an effort to lift the weight. But, if now, some trickster had substituted a hollow shell for the weight; in other words, if the weight is merely a dummy, a curious thing happens. Your hand, which has grasped the handle of the weight, is sure, in almost every case, to strike your chin, or fly up into the air most ludicrously, and in many cases you will be upset by the effort for which you prepared yourself and which effort did not materialize.

If you are going to pick up a heavy pitcher of water the sixth sense will bring the proper muscular activity into play even before you lift the pitcher. If you have to lift a sheet of paper, or a feather, an entirely different action comes into play by the muscles.

The same thing happens in all of our movements, practically all day long, and is of particular interest in the various sports. Those who have a highly developed sixth sense usually excel in sports, such as tennis, baseball and others, because their sixth sense is far more accurate than that of their opponent.

A good billiard player, for instance, must have a most excellent sixth sense, because it requires his muscular coordination to be of a most delicate order. An eighth or a quarter of an ounce too much weight put behind the cue, and even less, forms the difference between success and failure, as far as the billiard player is concerned.

And while we may not realize it, because we are too familiar with it, the sixth sense is just as important as any other of our senses. As Dr. Fraser-Harris points out, muscular sensations constitute what have been called "guiding sensations," that is, sensations which literally guide us in grading the intensity of the output of energy for muscular effort. Thus, for instance, as we chew our food, the sensations of the degrees of resistance which the teeth encounter against the food guide us in regard to the further kind of chewing required—energetic if much resistance has been encountered, slight if there is little.

The same is the case with common walking. In *locomotor ataxia*, the muscular sensations become enfeebled and the man walks by putting out too much energy. This gives rise to the high-stepping stamping gait characteristic of that disease.



Prof. Thomas Hunt Morgan, B.S., M.S., LL.D., Ph.D., professor of biology at the University of California, and whose name is inevitably connected with the subjects of heredity, experimental embryology, zoology and sex.

Sex is normally determined by an automatic internal mechanism

Can We Control Sex?

"Even if we could control sex who would want a son with the chromosome constitution of a daughter, or a daughter who has the make-up of a boy," says Prof. Morgan.

FOR two thousand years, as far as the written records go, men have wondered how it happens that the same number of boys and girls are born. It is a matter of absorbing interest to every parent; and in countries where the inheritance of titles or wealth follows the male line, the sex of the expected child is a matter of vital importance to others besides the parents. It is no wonder, therefore, that many superstitions have grown up concerning the rôle of the mother, and even of the father, in relation to the sex of the unborn child. Quackery here flourished where ignorance prevailed, and if the discovery of the method by which sex is regulated has done no more than sweep into discard the countless vagaries of the past, we should rejoice that science can now, at least, insist that false hopes be not encouraged, and do away with practices that were based on fallacious reasoning.

Even if modern science places beyond our reach all desire to tamper with a fundamental law of our being, we may willingly accept so beneficent a gift of nature, insuring on the average that equal numbers of the two sexes are constantly produced. The selfish desire of the individual is far less important than that the human race should run its appointed course with no great disturbance in the number of men and women.

It may be instructive to pass in review some of the many futile guesses that have been made in the past; for they show that the plausibility of an *a priori* argument may be wide of the mark. It is extraordinary, too, that among the thousands of attempts to solve the problem not even one approximated the truth, although the situation is in reality a very simple one. The failure to make even an approximate guess, we now realize, was due to total ignorance of time and place at which sex is determined.

A very ancient view, discussed by Aristotle, held that the materials out of which the eggs of the female and the semen of the male are made; are produced by the meeting in the reproductive organs of the elements of all parts of the body. In this way a formal attempt was made to "explain" the likeness of the children to their parents. As a sort of cor-

The Subject of Sex Control

IN the previous issue of this publication there appeared the first article on the subject of Sex Control. This was the first of a series of three manuscripts on this topic.

In the present article, we are fortunate to present another eminent scientist lecturer and experimenter whose name is unmistakably linked with the subject of sex and heredity. His experiments along these lines for years alone would cause his statements, conclusions and predictions to be of inestimable value to lay reader and scientist alike.

It will be remembered that in the December number we also published a questionnaire, copies of which were sent to 587 of a selected list of physicians, obstetricians and scientists, whose work makes them familiar with this more than interesting topic. Their findings on the question, "Can We Control Sex?" will be printed in the February issue, which will also contain the last of this series of articles. In the present article, Prof. Morgan explodes a few more of the pet superstitions with which the subject of sex control has been infested.

ollary to this view it seemed a good guess that the sex of the offspring had something to do with the right and left sides of the body. Since the male was assumed to be the more active or potent agent, it was natural to ascribe to him the difference that was efficacious. Hence it was af-

firmed that the materials from the right testis produce males and those from the left, females. The refutation of this generalization was known to Aristotle, who pointed out that cases were known where a man, partially mutilated in war, had produced both daughters and sons. Ludicrous as this supposition now appears to us, nevertheless within the last twenty years more than once it has been argued that the eggs

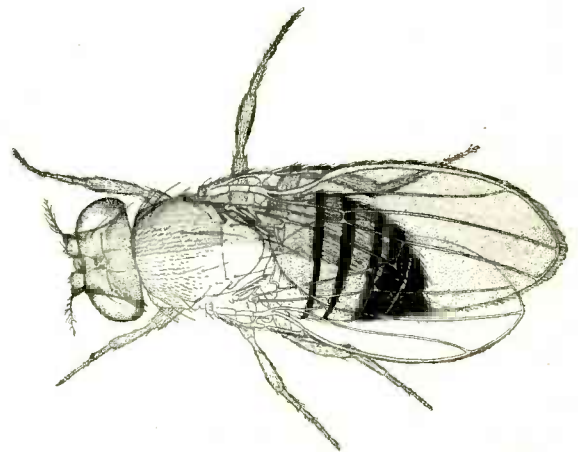

Fig. 1. A Gynandromorph of the fruit fly *Drosophila* that is male on the left side and female on the right. The male of this species is smaller than the female, and this is true also for the left side of the Gynandromorph. Notice particularly on the left side a small sex comb on the foreleg, the smaller left wing, and the male markings on the left side of the abdomen.

Theories of Sex control are numerous

By
Professor THOMAS HUNT MORGAN,
B.S., M.S., LL.D., Ph.D.

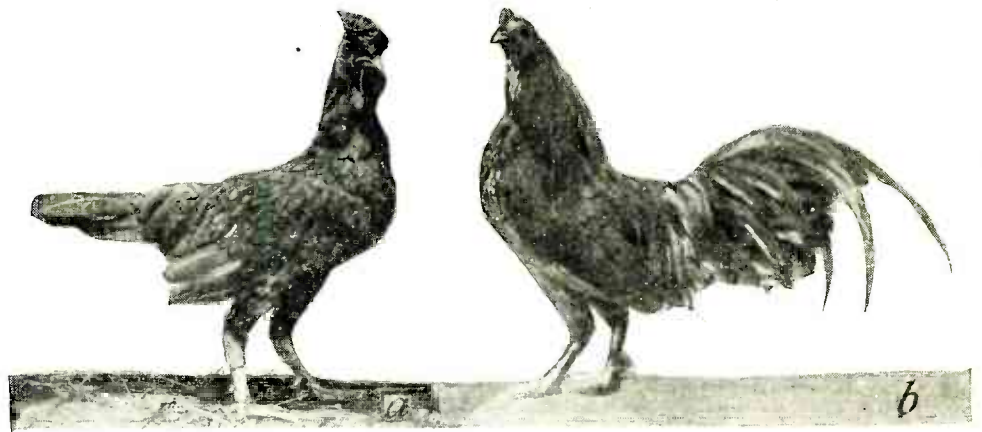

Fig. 2. To the left, a, there is a photograph of a hen feathered male Sebright which, after castration, develops the full cock plumage as seen in b. This must mean that in the Sebright race some substance is formed in the male glands similar to that normally found only in the ovary of the female. When the testes is removed from the Sebright male, his full genetic construction then appears. It is quite evident that there is a vast difference between the two chickens illustrated in a and b, yet before operation b was identical with a.

from the right side produced boys, and those from the left girls. Assured results were guaranteed by one writer if the prospective mother at the time of procreation assumed a posture supposed to be compatible with the reception of the right or left egg as it passed from the right into the ovarian tube. Ignorant as to what actually occurs during the ripening and expulsion of the eggs from the ovaries, it was not difficult to appeal to the credulous, anxious for a son or a daughter.

More illusive is the theory that male and female eggs are alternately produced by the ovaries. By proper timing of the menstrual periods from the last one (when a child of known sex was born) it was claimed that the sex of the next child could be predicted. Aside from the difficulty of sufficient knowledge of each active period and of the fate of the egg then set free, the erroneousness of this view is patently manifest in the light of recent work, showing that the differential factor is not in the eggs but in the sperms of the male.

At one time a certain amount of interest was aroused by a generalization based on the assumption that the male is the more active sex, more katabolic; while the female is the passive or anabolic sex. It was argued that any condition during the development of the embryo, outside or inside, which was in one or the other direction, determined the sex of the embryo. Aside from the vagueness of the assumption that such a difference exists

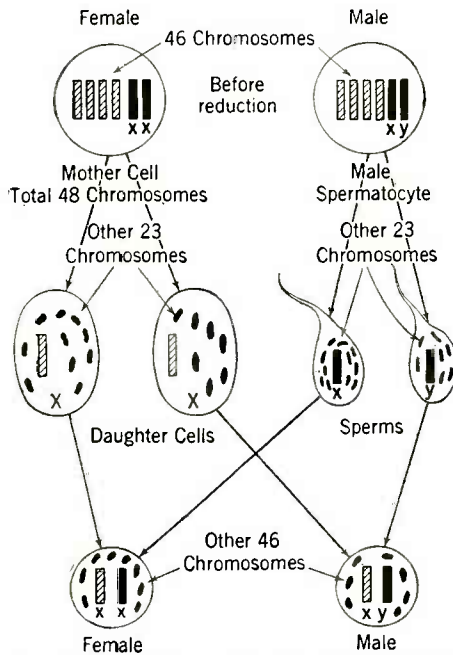

Fig. 3. The illustration is identical with that in Fig. 5, but has been changed in the manner of presentation, so that it can be more readily understood by the lay reader. It shows in particular the process of reduction. Refer to the caption under Fig. 4 for further details.

between the male and female there is no guarantee that the sex of the child could be influenced by such agencies. Many subsequent experiments on other animals, including mammals, led to entirely negative results.

Belonging to this general category is a still older view that the sex of the child will be that of the more vigorous parent. Disconcertingly vague as to what constitutes greater vigor, the suggestion would seem to call for families all sons or all daughters, according to the relative vitality of the parents, unless it be assumed that vitality waxes and wanes with the changes of the moon. Here, too, may be catalogued another suggestion, namely, that the age of the parent determines sex—an old male and a young female should bear more females, and vice versa. The statistics collected could scarcely be said to support the interpretation. Were it true, we should have long since found out

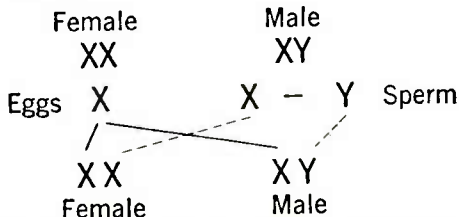

Fig. 4. This diagram technically represents the same action taking place in Fig. 5. Just before the final stage in the ripening of the germ cells (both the eggs and sperm) the chromosomes in each germ cell come together side by side, and as the cell divides half go into one daughter cell and the other half into another. The result, the mature eggs and sperms will therefore, after division, contain only half as many chromosomes as originally. When the sperm joins the egg the correct number of chromosomes is restored. Importance is attached to the X and Y chromosomes.

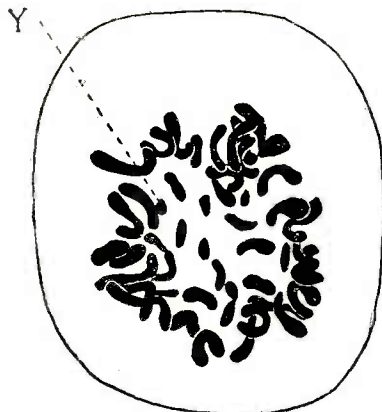

Fig. 5. This shows the chromosomes in a sperm, with the dotted line indicating the Y chromosome. Note that in the diagram immediately above this one, the X and Y chromosomes are accentuated in size, but actually the differentiation would be as here shown.

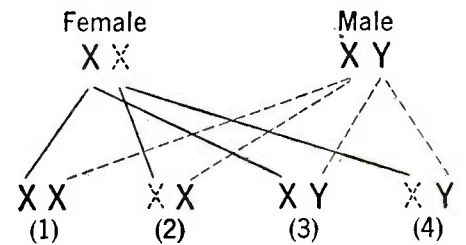

Fig. 6. Here the X chromosome, carrying the gene for haemophilia is stippled. The other X is represented by solid lines. Here half the eggs carry the black X, half the stippled X. There are also two classes of sperms, half carry X, half carry Y. If any egg can be fertilized by any sperm, there will result two kinds of females, one normal XX, the other carrying in from her mother one stippled X, and the normal X from her father. The former female has escaped, and will have only normal descendants, if mated to a normal person. The other female is affected, and although she is not a bleeder, being saved by the normal X, she will transmit the malady to one-half her sons. Coming now to the sons of the affected female, it is apparent that half the sons will get the normal X, and the other half, the affected X, chromosome. These latter are the bleeders; the former will have only normal descendants. For other combinations, see the chart on the fourth page.

how to have more sons or daughters by suitable marriages.

Far more numerous than these theories that depend on internal factors are those that contend that sex in man is determined by the external conditions which surround the prospective mother. Feeding has played the main rôle in this field, and royal personages have listened to claims of charlatans who guaranteed a male heir.

The question is frequently asked whether it is true or not that after a great war more sons are born than daughters. The statistics that were once collected have a very questionable value. It is the emotional appeal of this generalization that makes it popular with those who believe that the human world is organized on a divine plan of compensation—after a devastating war!

A great deal of information has been collected concerning the relative numbers of males and females in different strata of human society. The differences, when found, are interpreted as due to differences in nourishment. It has been claimed more than once that relatively more males are born to poorer parents, and more females to richer ones. At best the differences are slight and open to errors of interpretations of many kinds. Moreover, equally good statistics can be appealed to that show no such differences, or even a difference in the opposite direction. After all, when such small differences are involved it is absurd to suppose that the determination of sex could rest on such a variable element, for while food conditions vary so enormously, the equality of sex shows very slight fluctuations.

The Internal Mechanism of Sex Determination

THE discovery of the real mechanism of sex determination was not made by a single biologist, or in a single day,

Can We Control Sex?

(Continued from previous page)

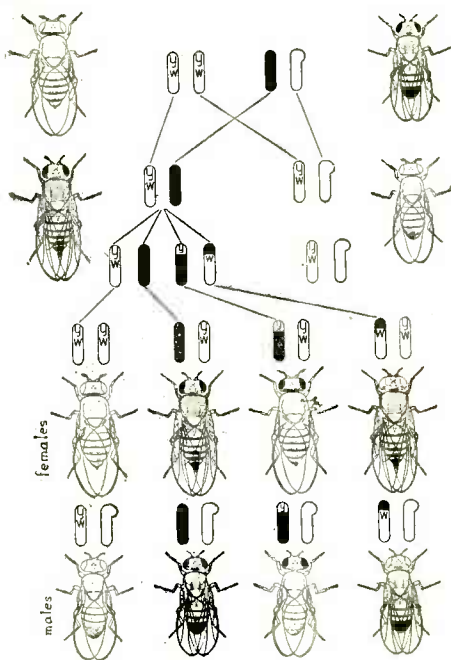

Fig. 7. This diagram shows the inheritance of two sex linked characters in the fly *Drosophila*. A yellow female fly with white eyes is mated to a gray male with red eyes. The sons, as seen in the second line, are like the mother; the daughters like the father. The eight flies below show the redistribution of the two pairs of sex linked characters, namely, white eyes and yellow wings. The roots in the middle of the diagram show how these characteristics are transmitted through the chromosomes.

but was the result of a series of discoveries by different observers between 1902 and 1909. The explanation turns on a still earlier discovery, namely that in every cell of the body there is a definite number of small threads or rod-shaped bodies called *chromosomes*—so called because they stain deeply in certain differential dyes. These chromosomes, present also in the germ-cells, carry the hereditary elements of the egg-cells and the sperm-cells. When the egg is fertilized by the sperm, two sets of chromosomes come together into a new set. If such a process were to continue indefinitely it may appear that the chromosomes would pile up in enormous numbers in later generations. This is avoided by an extraordinary process called reduction. Just before the final stage in the ripening of the germ-cells (eggs and sperm) the chromosomes in each germ-cell come together, side by side, and, as the cell divides, half go into one daughter cell, half into the other. As a result, the mature eggs and sperms come to contain only half as many chromosomes as originally present. Fertilization restores the full number. (See Figs. 3, 4, and 10.)

The crucial discovery turned on the occurrence of a differential pair of chromosomes called the X- and the Y- chromosome. The female contains two X's, the male an X and a Y. When the sperm cells undergo reduction, the X goes to one sperm and the Y to the other. When the egg-cells undergo reduction each egg retains one X. When the sperm containing an X enters an egg, a female (XX) is produced; when a sperm containing the Y enters an egg a male (XY) is produced. These two chromosomes are generally different in size and in consequence their history can accurately be followed. These are matters of direct observation and not of theory.

This is shown graphically in Figures 3 and 4.

Fig. 8. The diagram below illustrates the inheritance of color blindness in man. The letters in the circle refer to the chart on the corresponding page, in event that the reader wants to compare the transmission of inherited characteristics. The male with the color-blind eyes is indicated by the dotted circle. The female who distinguishes between red and green is shown by the divided circle half black and half cross-line. The offspring of such a male by a normal female are normal F₁. If two individuals of the pedigree of those at F₁ are mated, there will be three normal offspring to one color-blind son.

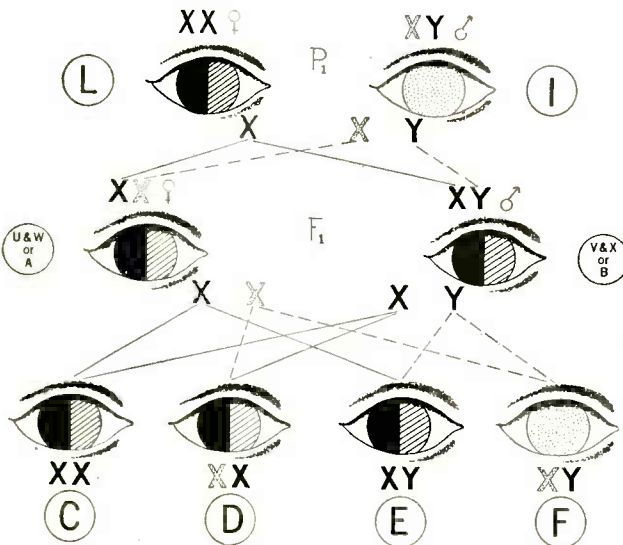
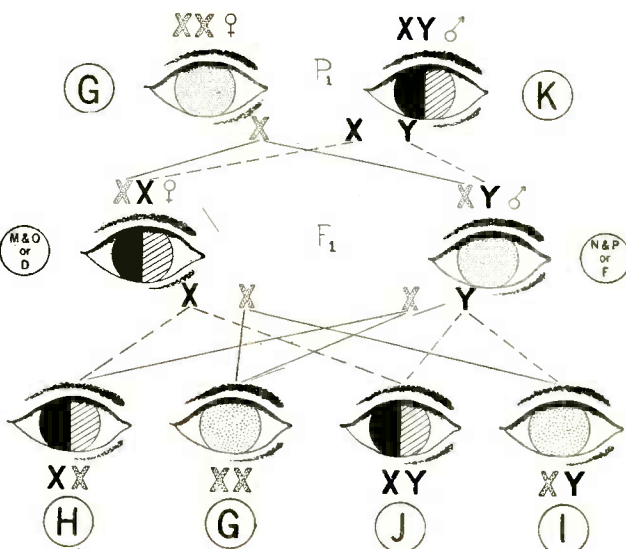

Fig. 9. The diagram below illustrates the reciprocal cross of that shown in the diagram below and to the left. Here a color-blind female is mated to a normal male at F₁. The sons of this mating are color blind, like the mother. The daughters are normal, like the father. If these offsprings should mate or if individuals with this identical kind of descent were to mate, the sons and daughters would be normal and color blind in equal numbers. It is, of course, obvious that there could be three or four color-blind sons in succession, but a scientist does not take his figures from one, but from hundreds of matings.



In the human species 48 chromosomes (Fig. 5) are present. The female has two X-chromosomes, the male one X- and one Y-chromosome. Each mature egg has 24 chromosomes, each with one X; each mature sperm has 24 chromosomes; half of them containing a Y-, and the other half an X-chromosome.

There is a variation of the XX-XY mechanism in some animals, due to the absence of the Y-chromosome. The male contains one less chromosome than the female. He produces two kinds of sperm, one with an X and one without an X. The former (with one X) fertilizing the egg produces a male. According to some observers—a Belgium and a Japanese—the Y-chromosome is absent in man, but according to American observers a small Y-chromosome is present. I think the latter

is the more probable view. In any case, the mechanism is the same.

The Evidence from the Inheritance of Sex Linked Characters

WHEN Gregor Mendel's paper was re-discovered in 1900 (it had been published in 1865 but its significance not realized) a new era in the study of heredity began, and it was soon found that a certain type of hereditary transmission could be explained if the elements (genes) of the characters in question are carried in the X-chromosome. An excellent example of this is given in the transmission of a malady called haemophilia, or bleeding, in man. It has been known for a long time that this dreadful malady is transmitted by normal mothers to some of her sons, but not to her daughters. The (Continued on page 882)

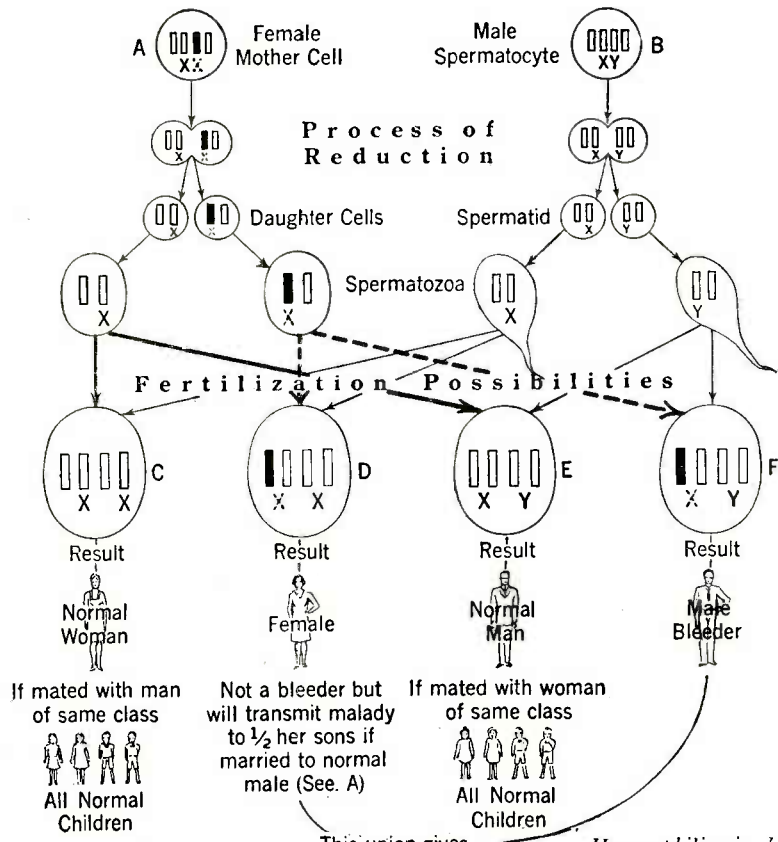
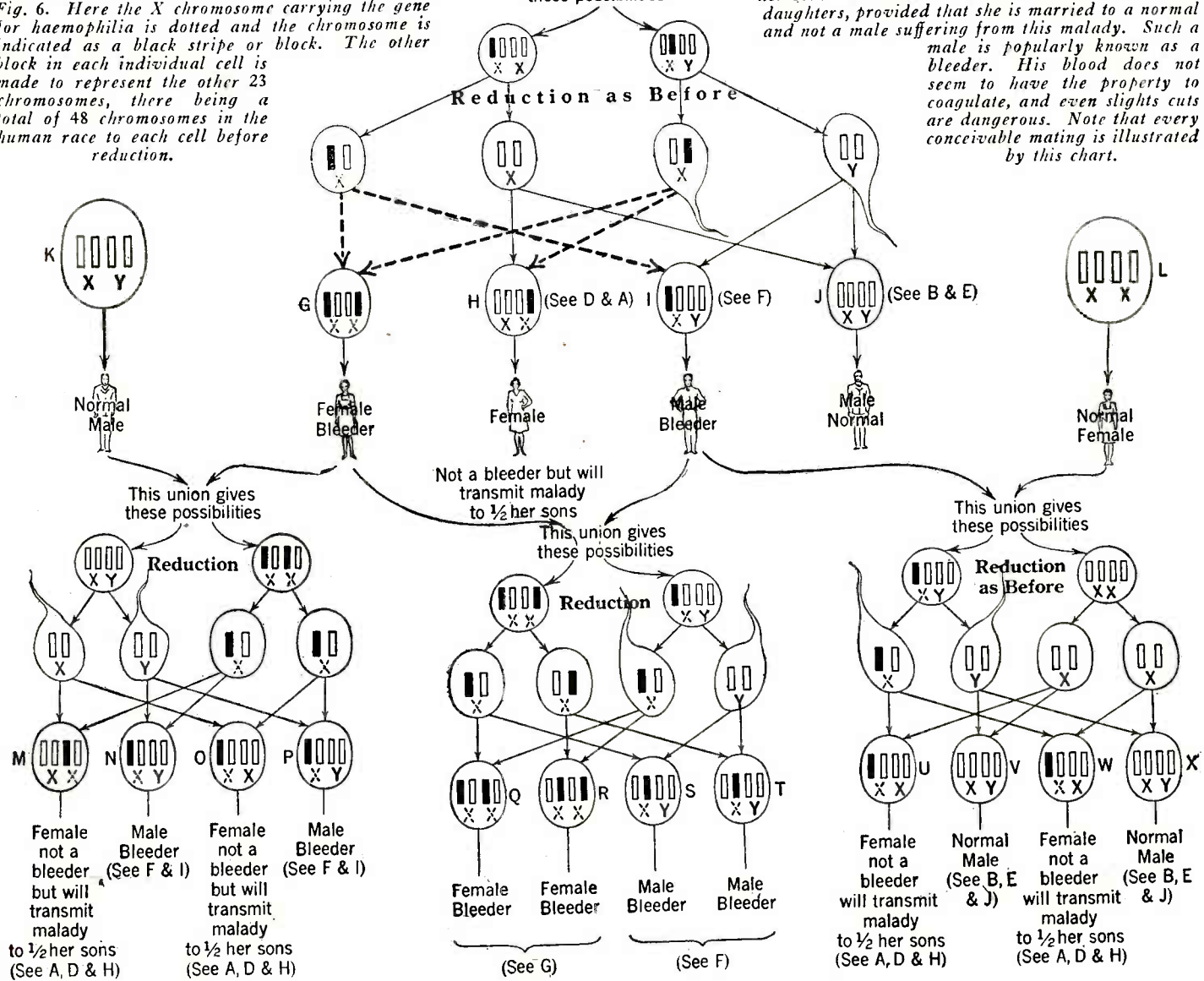

Fig. 10. This diagram reproduces the action in Fig. 6. Here the X chromosome carrying the gene for haemophilia is dotted and the chromosome is indicated as a black stripe or block. The other block in each individual cell is made to represent the other 23 chromosomes, there being a total of 48 chromosomes in the human race to each cell before reduction.

Haemophilia is handed down by the mother to her sons. She does not transmit the disease to her daughters, provided that she is married to a normal and not a male suffering from this malady. Such a male is popularly known as a bleeder. His blood does not seem to have the property to coagulate, and even slight cuts are dangerous. Note that every conceivable mating is illustrated by this chart.



Female not a bleeder but will transmit malady to 1/2 her sons (See A, D & H)

Female not a bleeder but will transmit malady to 1/2 her sons (See A, D & H)

Female Bleeder, Female Bleeder, Male Bleeder, Male Bleeder (See G)

Female not a bleeder will transmit malady to 1/2 her sons (See A, D & H)

Normal Male (See B, E & J)

Female not a bleeder will transmit malady to 1/2 her sons (See A, D & H)

Normal Male (See B, E & J)

Neon Beacon Gives Aviator

It is often difficult for an aviator to tell the direction of the wind. This is particularly true on foggy nights. Beacon can be seen at great heights.

By

H. WINFIELD SECOR

Here is a photograph of the municipal airport at Cleveland, Ohio, showing a close-up view of the new Neon beacon installed there. Note that even at this distance it looks like an airplane.

THERE is no doubt but that everything is being done to aid commercial flying in the United States. In the field of aviation the advance is continuous and while not as rapid as one might hope, it is nevertheless persistent.

This publication attempts to portray the latest strides taken in aviation whether they pertain to airplanes or lighter-than-air craft; safety devices, landing fields, beacons or many of the ramifications of the aeronautical field.

It may be remembered by the reader that this publication was the first one to publish details concerning the Graf Zeppelin and also to give to the reading public full information concerning the spectacular flight from Friederichshafen, Germany, to Lakehurst, New Jersey. To the best of our knowledge no other magazine published this story in as early an issue as the December number, which was out on the newsstands throughout the country on November the 10th, considerably less than a month after the flight was completed. This point is emphasized to show the reader that everything is being done to bring the information of new discoveries and new inventions to his attention at the earliest possible moment.

New Landing Tee

THE front cover of this issue illustrates a scene in which the landing Tee has come in good stead. With the ground practically obscured by a heavy veil of fog, the Tee stands out as a blaze of light. The green and red lights indicate the port and starboard sides. The Tee itself shows the aviator how to light, indicating how he can nose into the wind. At a distance this signal looks practically like an airplane. As the plane approaches the ground the aviator will not find it difficult to make out a few of the landmarks. From an altitude he must know where the field is, for fear of running into a bank or cliff, or perhaps a large building. There is no way of telling him what to do, nor can he possibly know when, where and how to land unless he is warned of the nature of the ground on which he is to make a three point landing.

It has been quite well established that the red beam from a Neon lamp is far more penetrating than even the most powerful searchlight. This light has a peculiar characteristic which makes it very easily seen at a great distance. The green color disappears considerably before the red.

Details of the Landing Tee

AS will be observed in the photograph, this landing Tee is quite large. Its actual dimensions are thirteen feet long and nine feet wide along the top of the Tee. It is made entirely of twenty-six gauge galvanized iron with two reinforcing trusses lengthwise. There are three tube channels which house the Neon tubes although but two of them contain tubes. These channels are open at both ends. The Tee is pivoted about the center point of balance, which happens to be four feet and three inches from the top or cross member of the Tee. Here a 2 $\frac{1}{8}$ -inch shaft is to be found. This turns on a semi-

thrust ball bearing and a radial ball bearing. In order to further counter-balance the cross-member of the Tee, the transformers which supply the current to the Neon tubes are mounted in the tail end. Balancing weights are fitted into each wing in sheet metal boxes.

The Tee itself is painted with bands of chrome yellow, while black sections are found between adjacent yellow stripes. The Neon tubes are red and green. The red tube is divided so that it goes to either side of the rudder. Thus the red tube is on the right (starboard) side of the plane and the green tube on the port or left side. There is a third channel for the housing of a tube still further to the right of the red tube, and this is made available for a yellow lamp when the same becomes available.

The electrical connections to this wind Tee are made through copper rings on a split wood pulley. The pulley is mounted on the shaft and the current is supplied to the rings by brushes. There are but four well-insulated wires delivering current to the apparatus and this current supply is controlled by a double-throw switch in the office.

The indicator is illuminated by current from a 110-volt 60 cycle A.C. circuit, which source of supply is delivered directly through the brushes to the transformer mounted in the

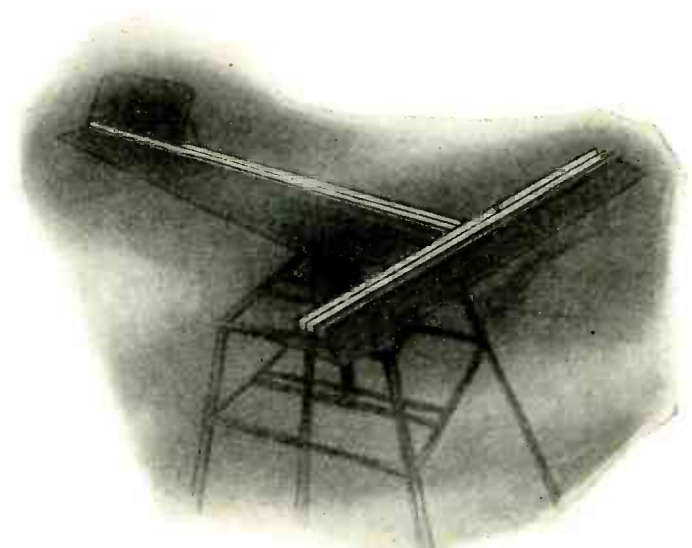

This shows the airplane landing Tee as it would appear on a foggy night. It will be observed that there are two long Neon tubes on the top part of the Tee, and also two on the bottom or vertical portion, assuming that we are describing the Tee in an erect position. One of the Neon tubes produces a green light. The one on the right side is red, as is also the extreme top tube.

Pierces Fog; Wind Direction

This beacon swings on pivots and always presents the correct position for landing. From a distance the beacon looks like another airplane.

tail. There is one transformer for the red tubes and one for the green. The entire landing Tee consumes approximately ½ K.W. per hour. The current passing through the tubes is twenty-five milliamperes at 10,000 volts.

By way of further information it may be mentioned that this Tee is erected on a steel structure and swings eight feet above the roof of the N.T.C. hangar at the Municipal Airport at Cleveland. This Tee was designed and constructed by the Cleveland office of the Bellows-Claude-Neon Company, and the exclusive photograph illustrated on this page was taken expressly for SCIENCE AND INVENTION Magazine by Claude Neon Lights Inc.

In Constant Service

TO decrease the amount of elapsed time of a fair size journey, a great part of the flying must be done during darkness. To further aid such flying at night it must be made reasonably safe for aviators. All kinds of beacons and lights help materially in this safety factor, but beacons alone are not enough, nor are searchlights or any other source of illumination. The aviator must know where the nearest airport is and must be guided to that airport by signs which are not only readable in the daytime, but clearly distinguishable even at night. To be still better, these signs should be of such a nature that they will not be obliterated by even the heaviest of fogs or the most inclement of weather conditions. The aviator cannot ordinarily take a chance and fly down towards hazy land markings.

The reader will well remember how Commander Byrd fran-

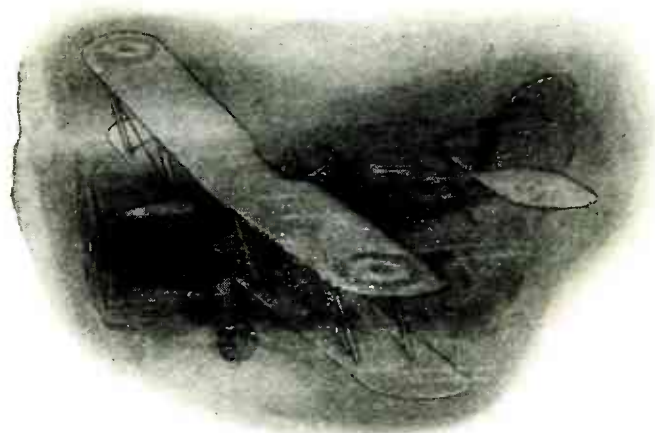

Aviators find it very easy to read this signal while flying at great heights and in most unfavorable flying conditions. Neon lights possess the peculiar property of penetrating fog to a greater extent than do even the most powerful searchlights. Even a student aviator can understand this signal.

tically called for his bearings when lost in a heavy fog after completing his journey across the Atlantic to France. The reader will also recollect how the plane was brought down near the shore and smashed while landing; whereas had a suitable marker been available, a marker which could penetrate the fog, the flight would have been absolutely safe, not only for the occupants, who fortunately escaped injury, but also for the plane itself.

The need for markers is thus evident to even the lay reader. But markers are not sufficient. The aviator must know the direction of the wind. He must land *nose into the wind*, and of what use is a pennant, a flag or any other form of a wind indicator which cannot be seen? In so far as the pilot is concerned, it might just as well not exist, if he cannot make use of it when he needs it the most. Hence the reason for this wind Tee, which serves a dual purpose. Already requests for further details of this invaluable aid to aviation have been received from forty different flying fields. It is not at all doubtful but that these Tee beacons will soon find their place on every flying field in this country as well as abroad.

Looking Forward

OF course the present wind Tee is only a miniature in comparison with those which the future will bring. Others will dwarf this particular wind direction indicator into significance. Larger buildings will have the names of the towns written on their roofs in bold, fog-piercing Neon letters; the letters themselves being twenty or more feet in height and made of gas-filled tubes. Illuminated arrows will point to municipal airports or the arrows themselves may be made in the form of monster tubes.

A suggestion which comes to mind now would be the illumination of air lanes with arrows of red or green showing the north and western routes, whereas the green arrows would indicate southern and eastern air lanes. When trails become too numerous, it is just as easy to mark air trails as it is to mark our highway systems. Large illuminated numbers would indicate the trail the aviator is following.

Up to the present time, all of the neon beacons consist of long tubes that must be placed in an advantageous position to be seen by the aviator. Very little has as yet been done with searchlights in which the neon lamp takes the place of the carbon arc. It has been reported that automobilists can see the road better if they cover their headlights with pieces of cheesecloth, when driving through areas where fog is heavy. It is not conceivable that there must be some kind of a filter that will make available the thousands of candlepower obtainable with our modern searchlights?

Lastly, we must not lose sight of the fact that vertical searchlights have not even been put to a thorough test. These beams can be seen for a hundred miles or more, even from the earth's surface. Their spots of illumination on the clouds must, of course, be seen by the aviator. The next step is to make these beams produce their guiding signal in any kind of weather. This will also be done, thanks to neon.

This is the age of surprising developments in aviation and the commercialization of flight.

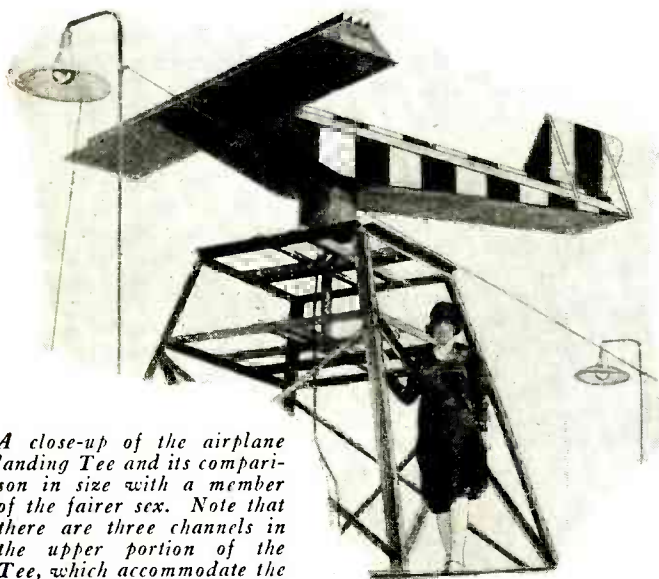

A close-up of the airplane landing Tee and its comparison in size with a member of the fairer sex. Note that there are three channels in the upper portion of the Tee, which accommodate the Neon tubes. Only two of them are used at present.

From this photograph, the pivotal point of this direction signal can be seen. Note the cable leading up to the commutator, where the current is taken off by brushes and fed to the transformers in the tail. Also observe the tail structure, which keeps the signal headed into the wind.

By
AUGUSTUS POST

Mr. Post, the Author of the Present Authoritative Article, Is One of the Foremost Aeronautical Authorities in the World, and Was Former Secretary of the Aero Club of America.

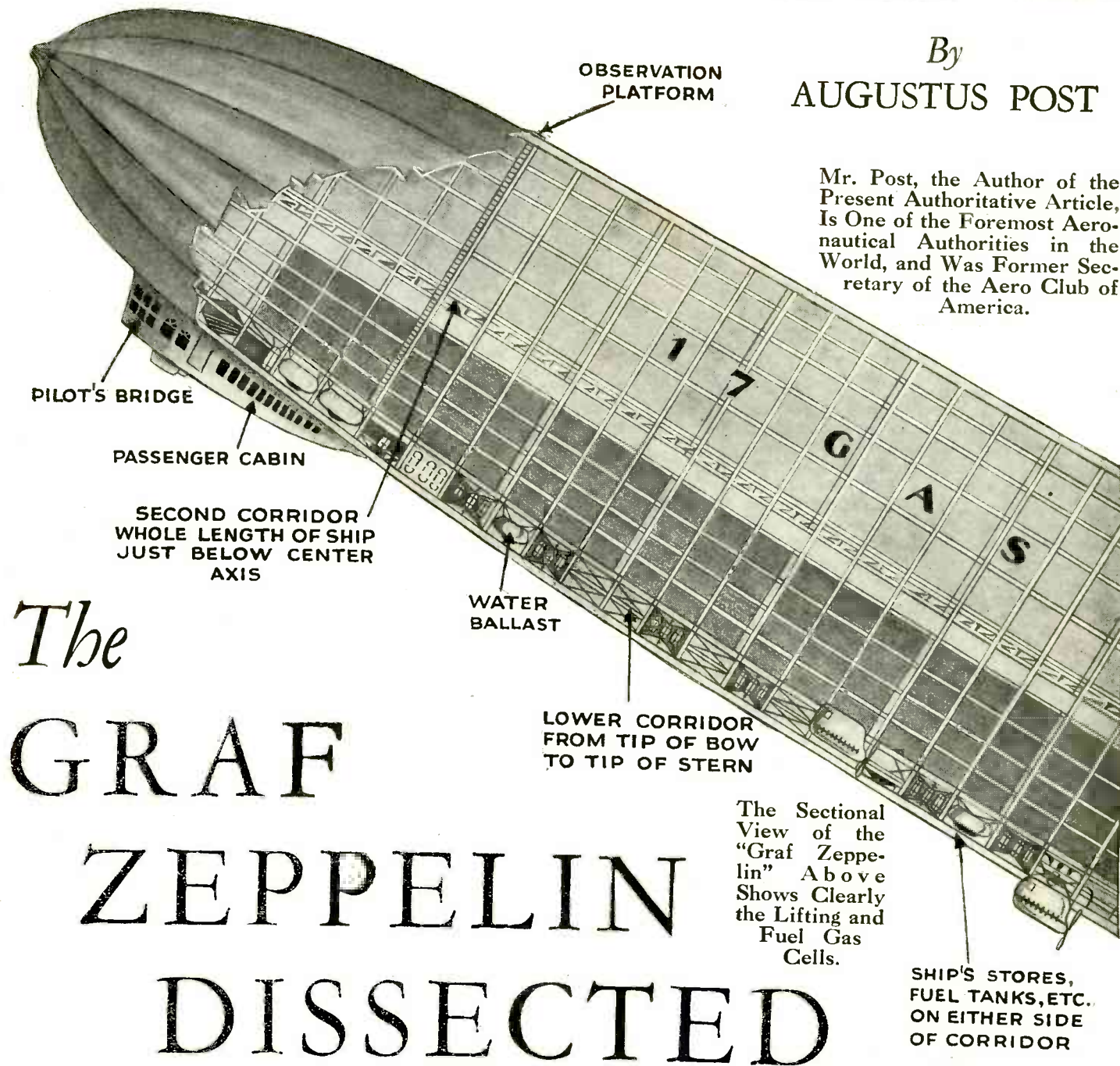

The Sectional View of the "Graf Zeppelin" Above Shows Clearly the Lifting and Fuel Gas Cells.

SHIP'S STORES, FUEL TANKS, ETC. ON EITHER SIDE OF CORRIDOR

The GRAF ZEPPELIN DISSECTED

Landing of the "Graf Zeppelin"

AT dusk on the afternoon of Monday, October 15th, over the landing field of the U. S. naval air station at Lakehurst, New Jersey, after her voyage in the air lasting four days and thirty-eight minutes, covering over six thousand three hundred miles from Friederichshafen, Germany. The largest airship in the world drifted slowly down from the sky in a gentle glide to earth; she soon reached the spot indicated by smoke signals on the ground, placed in the center of a large V with its apex toward the direction from which the light wind was blowing, and marked by squads of sailors placed in landing position along each leg of the V. Suddenly the engines, which had been noiseless up to this moment, started up with an impressive roar, full speed astern, gradually checking the momentum of the ship like a great ocean liner coming to her pier. When she came to a stop, a small trap door opened in the bow about halfway from the bridge to the nose and a coil of rope shot down to the ground about 100 feet below. Soon a second rope followed and later a third, shorter than the others but with branching parts or *crow's feet* at its end, each small branch rope having a "toggle" or hand cross-piece of wood for the ground crew to hold on to. The landing crew seized the long ropes and rove them through pulley blocks made fast to the

control rails of the landing gear. They then began to walk away, hauling the nose of the airship to the ground. When the shorter hand lines could be grasped, other sailors pulled down on them until the bumper, underneath the gondola or passengers' cabin, rested upon the ground. The wind was blowing ten miles an hour, and while the decision was being made whether to bring the airship into the hangar or not, the ground crew held the "Graf Zeppelin" pointed into the wind on the field in front of the hangar, while the Custom House officials and the committees of welcome went on board. The decision was finally made to moor the ship to the stub mast. This is a mast about 70 feet high, smaller than the large mooring tower, 162 feet high, which is used by the "Los Angeles" when the winds are in the wrong direction for taking her into the hangar.

The stub mast used for mooring is on the western side of the field. It has a winch to haul in the mooring cable and is equipped with pipes to service an airship with gasoline, oil and water. It is being equipped with yaw-booms such as those used on the naval ship *Patoka* for steadying the airship and keeping it headed into the wind. A track encircles this stub mast upon which the rear motor gondola can rest and swing around with the changing direction of the wind. A movable mooring mast is being constructed so that it can be moved to any part of the field upon caterpillar treads.

World's Largest Dirigible Has Range of 7,000 Miles and a Pay Load Capacity of 30,000 Pounds.

Author Meets Dr. Eckener and Lady Hay

DR. ECKENER said that although he required 111 hours and 38 minutes to make this voyage, he had enough gasoline to continue on for 65 hours more had it been necessary. Of the blau gas he had enough to last for 35 hours, and could have kept going 30 hours longer by changing to a gasoline mixture for fuel. Commander Rosendahl was very frank in his statement that transatlantic flights are feasible, although a larger ship would be much more practical, and he no doubt referred to the new airships being built by England and those already contracted for by the United States Navy.

It was my good fortune to be able to greet Dr. Hugo Eckener and congratulate him upon the success of this momentous voyage and afterwards to talk with the passengers, among whom was the charming Lady Grace Drummond Hay, whose fascinating personality radiated the joy that seemed to be the keynote of the whole occasion. She said:

"I enjoyed my trip immensely and am ready to go back

Author Meets Captain Eckener and Other Celebrities

AUGUSTUS POST, the author of the present article describing the technical details of the famous *Graf Zeppelin*, which has safely returned to its German home airport at Friedrichshafen, had the pleasurable experience of being at Lakehurst, N. J., when the giant visitor from the skies arrived from Germany. Mr. Post, who knows personally practically all of the leading aeronautical people, congratulated his friend, Captain Hugo Eckener, and he also learned many details of the construction and operation of the *Graf Zeppelin* from the other experts on the trip to America. Our readers will enjoy the accompanying article, coming as it does from the pen of Mr. Post, as he is a practical balloonist and airplane pilot himself, and knows whereof he speaks from actual experience. Mr. Post was the official observer and timer at the first airplane flights of the Wright Brothers at Fort Myer, Virginia, in September, 1908.

much of food. We had frankfurters and eggs. I was with the ship while almost every rivet and bolt was being put into it, and I knew all of the officers, and was at Friedrichshafen during most of the time that the ship was building, so I felt a deep affection for the 'Graf Zeppelin.'

This is the way Lady Grace Drummond Hay described to me her voyage across the Atlantic Ocean after 111 hours sailing about 2,000 feet above the water, covering the "pretzel" route over Bermuda and arriving at the Atlantic coast over Norfolk, Virginia, and sailing over the eastern capitals of the United States, and landing at the gigantic airport to receive the warm welcome extended on behalf of the United States by official naval representatives, Rear Admiral William A. Moffet, Chief of the Bureau of Aeronautics, Navy Department; Edward P. Warner, Assistant Secretary of the Navy in Charge of Aeronautics, and William McCracken, Jr., Assistant Secretary of Commerce for Aeronautics.

This interview was in the flight commander's rooms of the dirigible hangar at Lakehurst, where the passengers were being examined by the Customs' officers for entry into the United States just exactly as is done on all trans-oceanic surface liners. While waiting for the baggage to be brought down from the hold of the ship, friends of the passengers crowded around and the passengers had an opportunity to talk of their experiences in this the first of commercial air travel trips by dirigible from Europe to America. Colonel Emilio Herrera, representative of a Spanish company that are considering running a line of airships from Spain to the Argentine, and who has been negotiating for charter of the "Graf Zeppelin" for flights to South America, was very enthusiastic about his experiences on the voyage. He expressed the hope that he would be able to make the crossing between Spain and South America with as great success as the voyage from Friedrichshafen to New York. For many years, he said, we have been studying the question of air routes, and continental airports, where dirigibles of large size, even as large as ten

(Continued on next page)

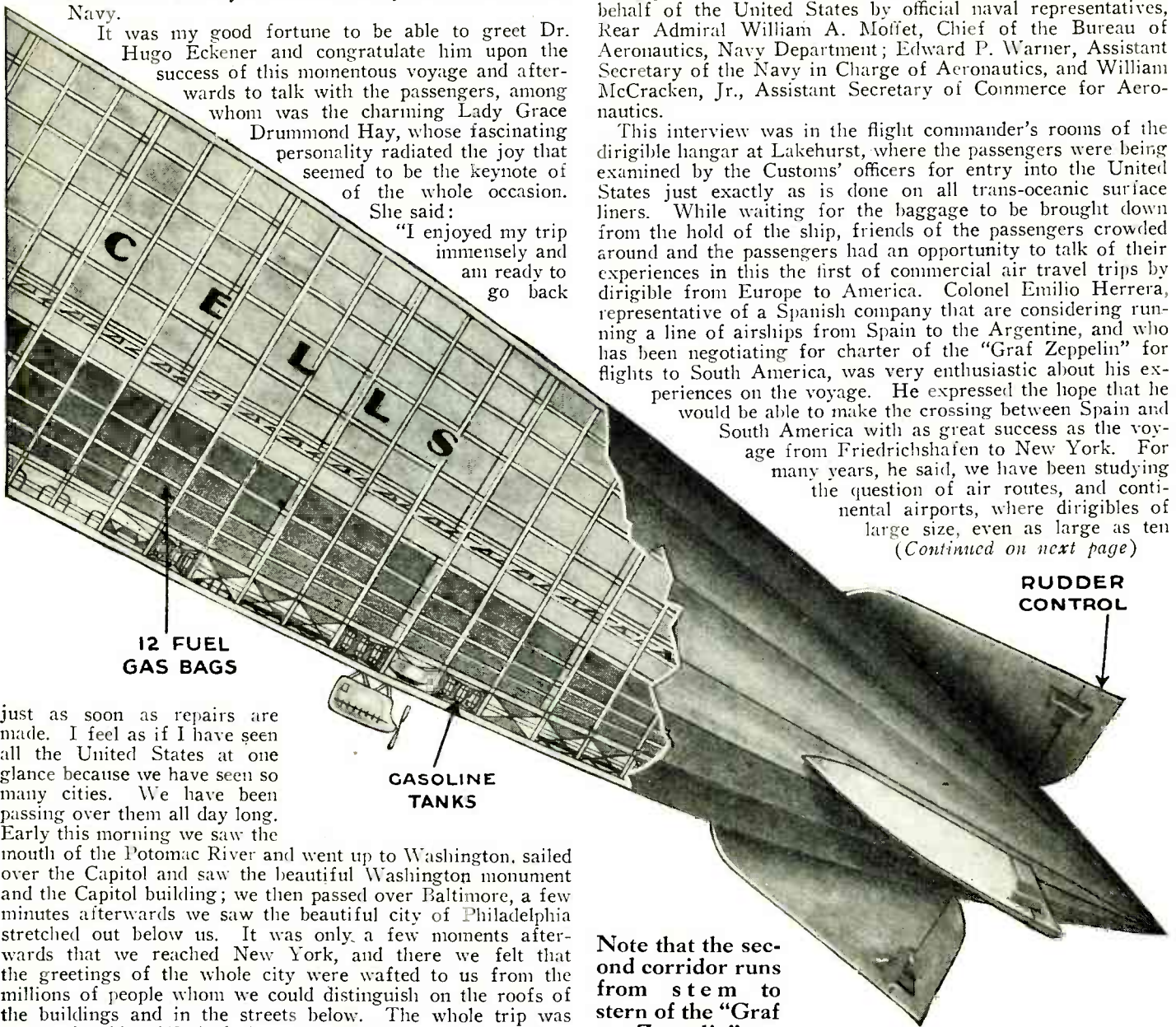

just as soon as repairs are made. I feel as if I have seen all the United States at one glance because we have seen so many cities. We have been passing over them all day long. Early this morning we saw the mouth of the Potomac River and went up to Washington, sailed over the Capitol and saw the beautiful Washington monument and the Capitol building; we then passed over Baltimore, a few minutes afterwards we saw the beautiful city of Philadelphia stretched out below us. It was only a few moments afterwards that we reached New York, and there we felt that the greetings of the whole city were wafted to us from the millions of people whom we could distinguish on the roofs of the buildings and in the streets below. The whole trip was most enjoyable. We had plenty to eat, although I didn't think

Note that the second corridor runs from stem to stern of the "Graf Zeppelin"

and fifteen million cubic feet, may be docked and cared for while the passengers and the cargoes from the airships may be taken to different parts of the continents by airplane or subsidiary lines. These continental airports would be located in the great aeronautical centers of the world, such as England, France, Ger-

THE GRAF ZEPPELIN DISSECTED

(Continued from previous page)

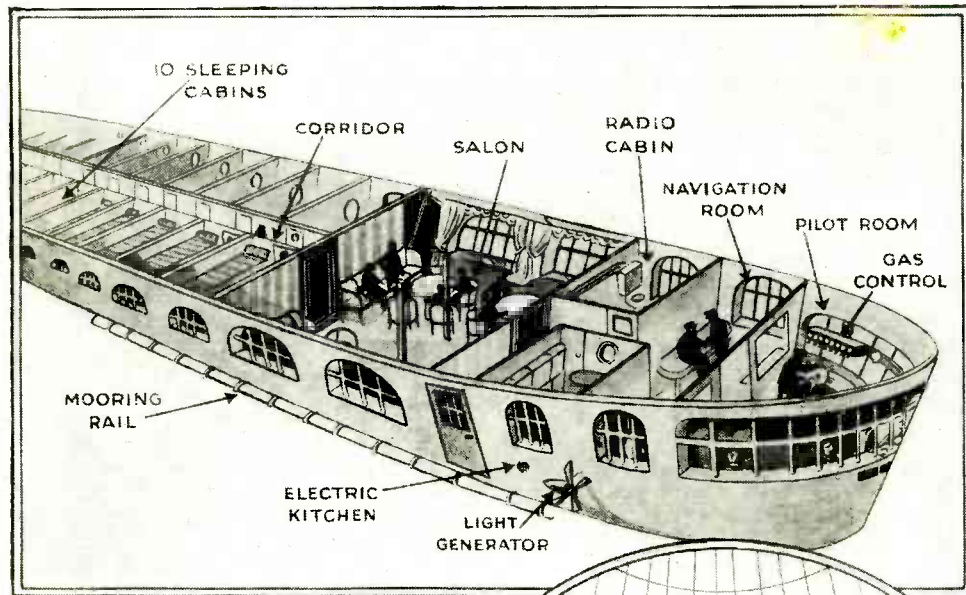

Exceptional picture above shows pilot room, dining salon, and passengers' cabins aboard the "Graf Zeppelin," which recently completed a successful round trip from Germany to America and return.

many and Italy. Mammoth dirigibles would go to India and Japan, Australia, South Africa, Canada, the United States, and South America. American dirigible lines would radiate from the western shores of the United States across the Pacific, to Japan, and to the south along the west coast of South America via Panama.

Giant English Dirigibles

THE English dirigibles R-100 and R-101 are to be 6,500,000 cubic feet capacity. A friend of mine who has just returned from Karachi, India, tells me that the hangar there will be larger than the hangar at Lakehurst, and will be able to house two of these mammoth dirigibles. The next airships of the Zeppelin company are to be 7,500,000 cubic feet capacity with added efficiency of operation. The English government have already practically perfected plans for a dirigible of 10,000,000 cubic feet capacity. As dirigibles increase in size, their efficiency and airworthiness becomes marked, and the great distances that can be covered on their voyages makes them an important factor in terrestrial transportation.

In a conversation with Rear Admiral William A. Moffett, Chief of the Bureau of Aeronautics of the Navy Department on the field at Lakehurst, he said he was looking forward to the perfection of a heavy fuel motor which combined with the use of helium gas would eliminate another one of the chief sources of danger, namely the fumes from gasoline fuel. The first crossing of the Atlantic by steamship was made in 1838, only ninety years ago; what will a century of airship travel accomplish? The Great Western Steamship Com-



At left, map shows "Graf Zeppelin's" route to and from America. Picture below shows airship is three city blocks long or equivalent to the height of the Woolworth Building. New Yorkers had a chance to actually see this comparison.

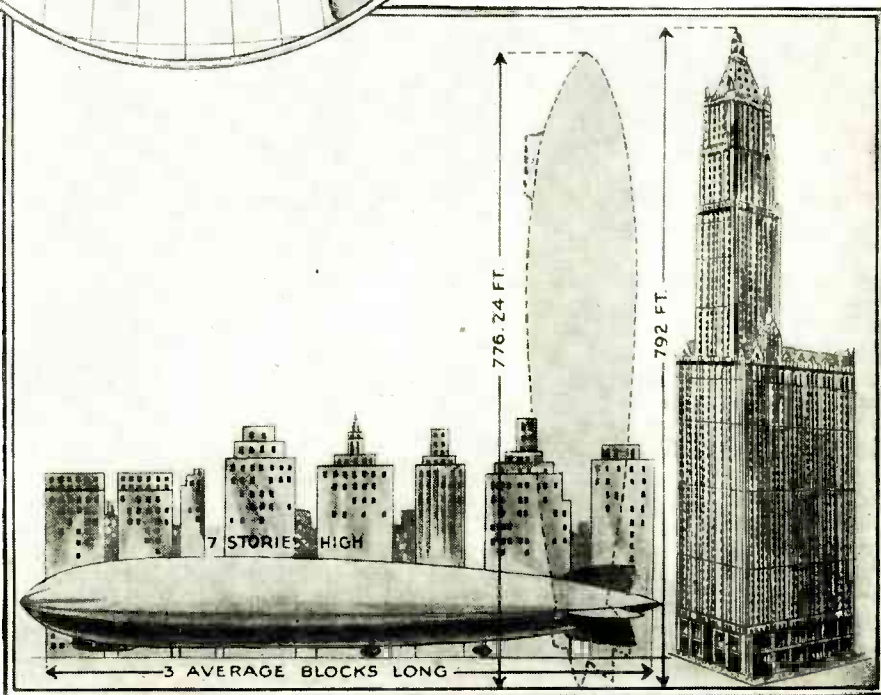

pany of Bristol, England, sent its coal-burning side-wheeler "Great Western" with seven passengers to New York on April 8th, 1838. At the same time Mr. J. Laird of Birkenhead, England, bought the Cork-London steamer "Sirius," which left Cork on April 4th, and crossed in seventeen days; the "Great Western" crossed in thirteen days, and they entered New York Harbor almost abreast. Mr. Samuel Cunard founded the line of his name, in 1840, and the steamship developed in speed, luxury and comfort to the floating palaces of today.

The Birth of the Zeppelin Idea

IT is only by a glance at the past achievements of the Zeppelin airships that we may realize their future possibilities. Count Ferdinand von Zeppelin was the originator of the rigid type in a practical form. He was sixty years old when he started carrying out his dream, conceived during the early period of his life, when as a soldier he ascended in Professor Lowe's balloon, used by the northern army during the siege of Richmond. I had the pleasure of meeting him in Germany when representing America in the Gordon Bennett balloon races in 1908.

The first ship, LZ-1, of 11,300 cubic meters capacity, was flown over Lake Constance (Bodensee), in July, 1900, and it is eminently fitting that the latest airship, the LZ-127, should bear the name of "Graf Zeppelin," embodying as it does so completely and faithfully the ideas and principles originally laid down, but with successive improvements in materials, construction, and engi-

neering design. Landing on the fourth anniversary of the arrival of the LZ-126, now the "Los Angeles," the points of improvement are clearly seen and suggestive of future developments. To one who saw the arrival of the LZ-126 without passengers or freight, it was to me the most significant fact that twenty passengers who paid at the rate of \$3,000 for their tickets disembarked and nearly a ton of cargo, that paid a freight rate of \$5.00 a pound, together with fifteen sacks of mail containing 28,124 letters, 37,590 postal cards, and 2,627 pieces of registered mail, were taken "down" from the hold of the ship.

To witness the passengers disembark from the first cabin gangway and to talk with them about their voyage; to see the immense truckloads of baggage and freight come out of the hatchway below the center of the ship, tells more vividly than any figures can, of the great progress made in the last four years.

Dimensions of the "Graf Zeppelin"

THE dimensions of the airship are 776.24 feet in length, 98.44 feet in diameter, 110.56 feet in height above the ground. The rated gas capacity is 3,708,043 cubic feet. The useful lift under normal atmospheric conditions, that is to say, the total weight which she will lift from the ground, is about sixty tons metric. Deducting the weights of fuel, crew, etc., from this figure, she will normally be able to carry a paying load of about fifteen tons—for instance, twenty passengers and twelve tons of mails and freight—over a distance of about 6,000 miles at an average speed of sixty-five to seventy miles an hour.

Photo at right shows badly damaged stabilizer fin of "Graf Zeppelin" on arriving at Lakehurst, N. J. Below—one of U. S. Navy's proposed new airships, the GZ-1, compared with "Los Angeles," and an army semi-rigid, the RS-1, and a pony blimp.

The "Graf Zeppelin" is of the characteristic Zeppelin type of rigid airship, its framework being made up of longitudinal and transverse girders. If these were placed end to end, they would cover a distance of ten miles over the ground. It is cigar shaped and covered with strong, lightweight cotton fabric, doped with a lacquer of metal powder. The entire cover has been sandpapered and doped to obtain the smoothest possible



The photo above shows the "Graf Zeppelin" as she sailed majestically over Philadelphia on her way to Lakehurst, N. J. The damage to the stabilizer fin shown in center photo was plainly visible to the city dwellers.

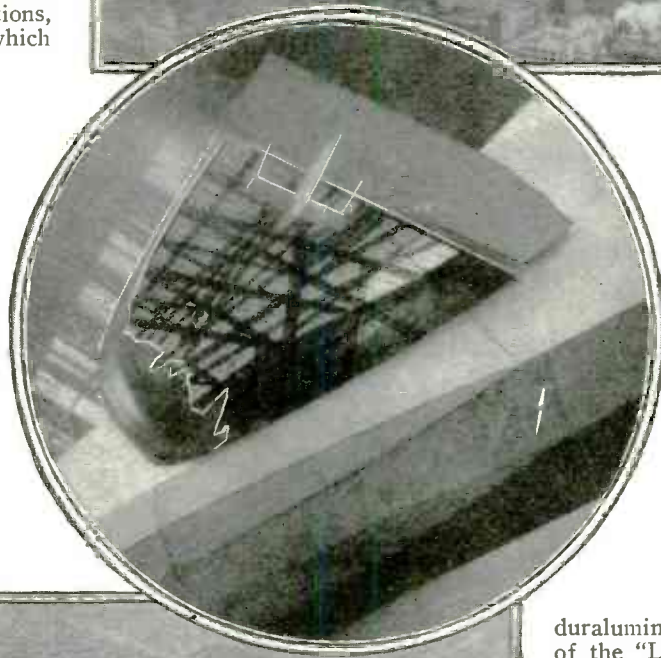

surface, thus offering the minimum resistance or skin friction in the air.

The principal features of advance in the construction of the "Graf Zeppelin" over the "Los Angeles" consists of its being about one-third larger in size and includes the improvement in the construction of the metal girders of the framework, giving approximately twenty per cent more strength proportionately to the same weight of the duralumin over that used in the construction of the "Los Angeles." The entire structure is the size of an ocean liner, but does not weigh more than a harbor tug boat. The interior is divided the same as the "Los Angeles" into seventeen compartments, containing the gas cells for the lifting gas. These cells are made of cloth lined with gold-beaters' skin, the inner membrane of the large intestine of cattle, to make them gas-tight. To each of these cells are attached valves by means of which a portion of the gas may be released when it is desired to make the ship heavier in order to descend. Along the lower keel of the hull from the bow to the stern, is the corridor called the "cat walk," giving communication to all parts of the ship with cross walks to the motor cars on either side. The ship's service rooms are placed on each side of this "cat walk"; here also are the fuel tanks, ballast tanks, engine stores, general provisions, and various rooms for the airship crew, men's room and sleeping accommodations; there are compartments also for freight in different sections so that it may be possible to change the loads in order to trim the ship. Above this corridor and extending along the entire (Continued on page 860)

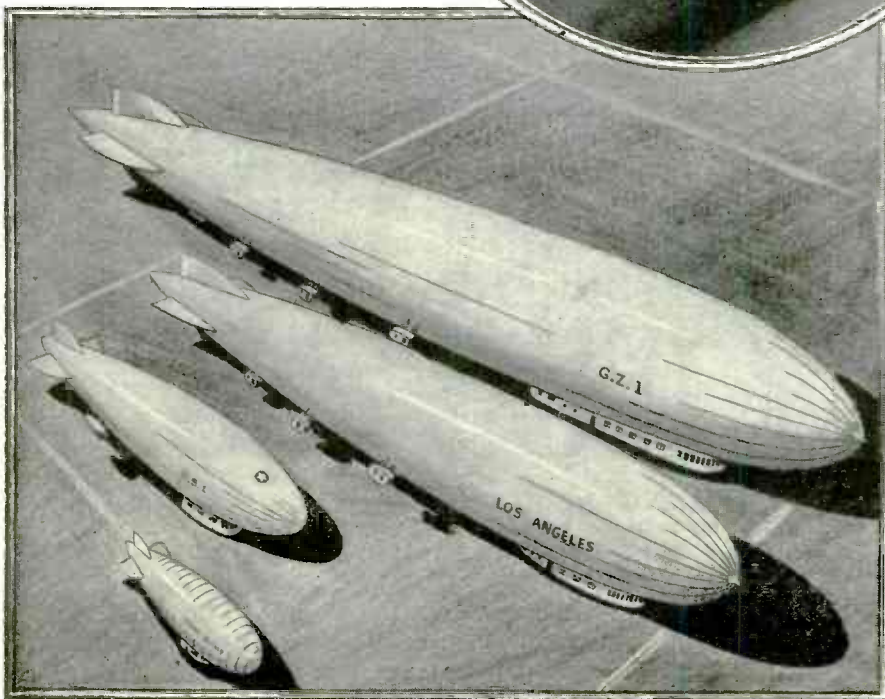

Scientists and Architects

Newest Theatre Has Many Interesting Features Both from the Artistic and Scientific Standpoint. Air Supply System is Interesting Feature. Rising Platforms and Lifts Also Used in Fox's Brooklyn Theatre.

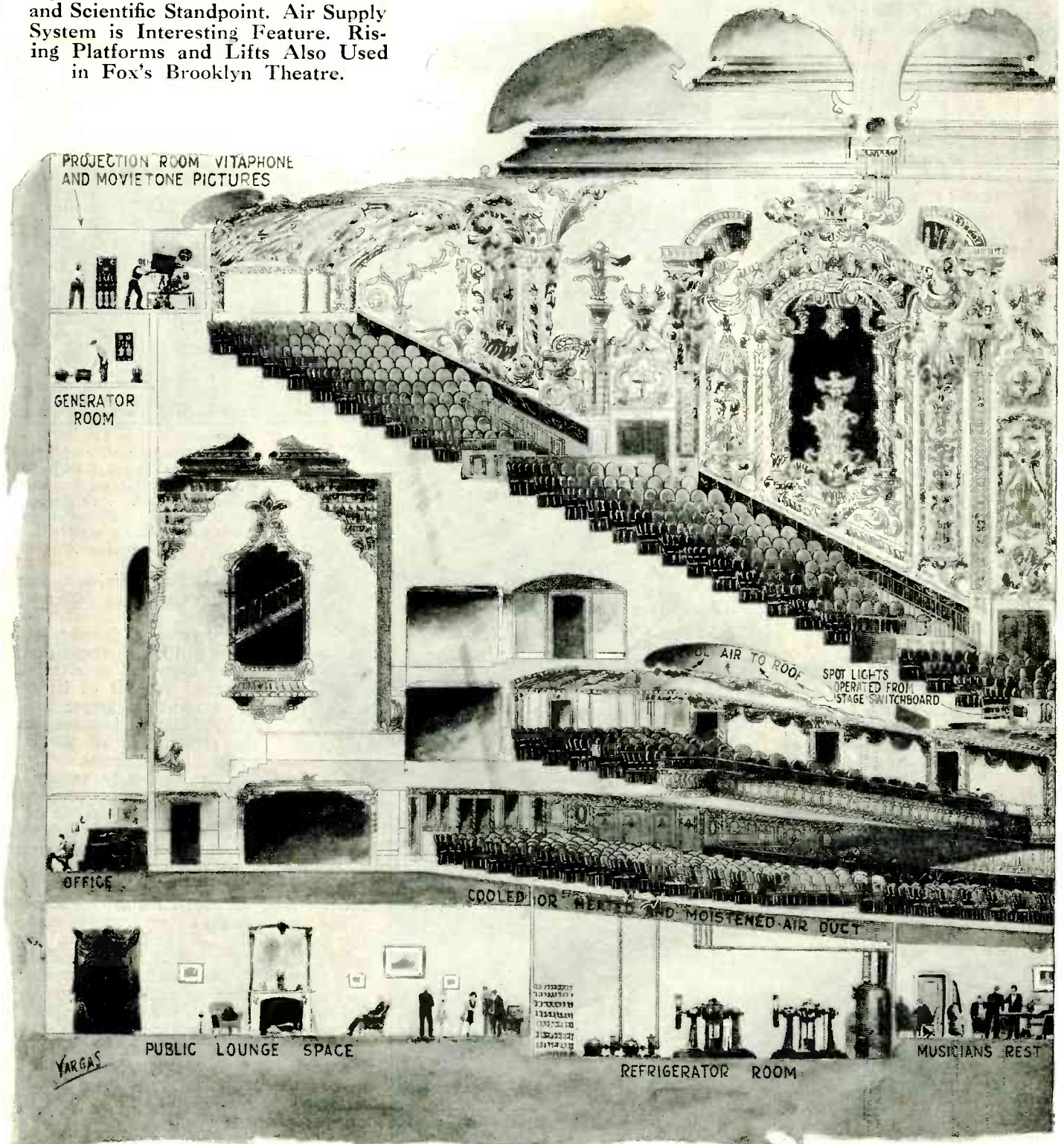

Public lounge, generator room, projection room, ventilation air duct, refrigerator room, spot lights, and musician's rest room, are shown above.

A NEW cathedral dedicated to the motion picture god, which contains the newest in both science and art, has recently been opened by William H. Fox in Brooklyn, New York. The illustration appearing here shows the features of the new theatre. The musicians' rest room, public lounge

space, refrigerator room and organ fan room, are placed beneath the orchestra in the basement. Fresh air is drawn in from the roof, it is next heated or cooled, depending upon the season of the year and properly moistened. Outlets are arranged in the floor and the foul air escapes to the roof through

Build Latest Movie Palace

Equipment Provided for Both Vitaphone and Movietone Sound Pictures with Speakers Mounted on Rising Platform. Broadcasting Studio with Remote Control and Amplifiers Placed in Upper Portion of Building.

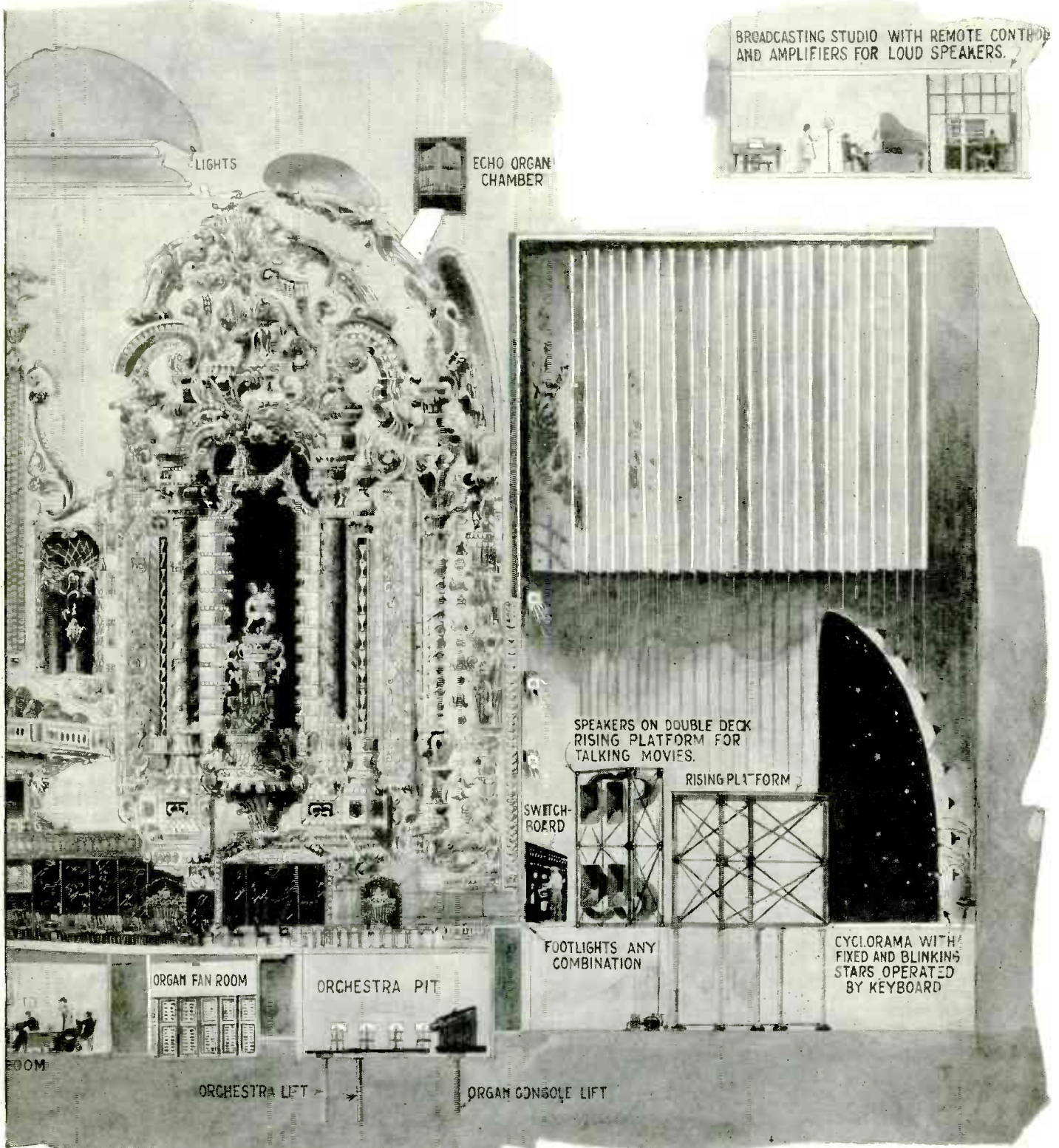

Organ chamber, orchestra pit on the left above. Details of the arrangement for talking movies, the cyclorama and rising platforms on the right above.

openings in the ceiling which contain concealed lights, greatly adding to the appearance. A portion of the foul air remains and is drawn up again to the fresh air inlet, so that the incoming air is not too cold. All the lights are controlled from a switchboard back stage. The spotlights are placed on the

front of the first balcony. A cyclorama with fixed and blinking stars operated by a keyboard aids in producing many novel stage effects, as well as those produced with the rising platform. Any combination of footlights is obtainable. Both the organ and the orchestra are placed (Continued on page 884)

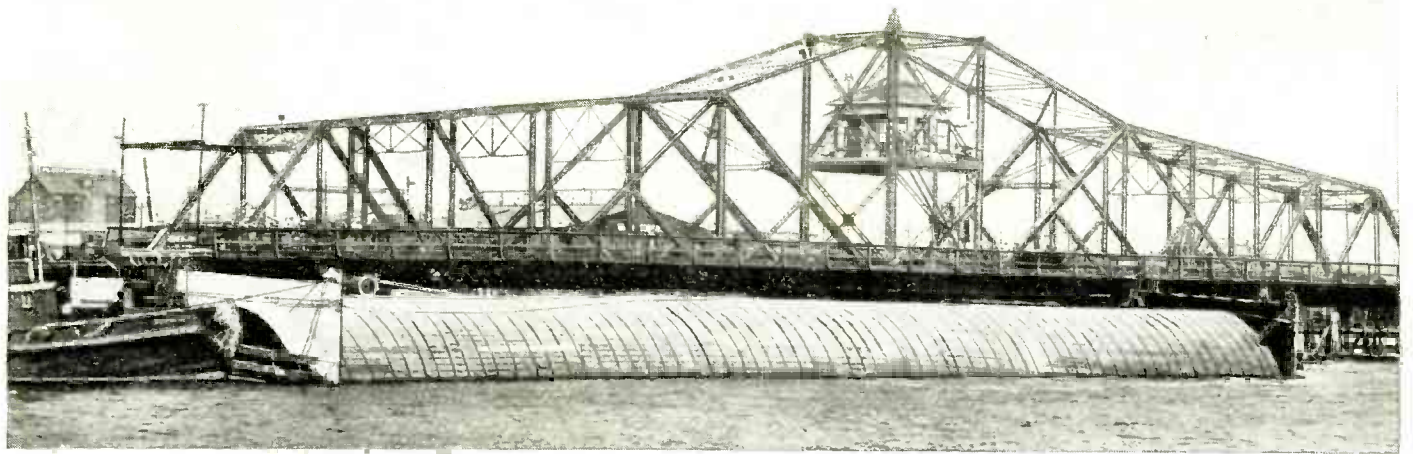

One of the huge tunnel sections being towed into position. The new vehicular tunnel between Oakland and Alameda, California has the largest diameter of any underwater subway yet built. Its outside diameter is 37 feet; it has a 24 foot roadway with two 3 ft. sidewalks.

Largest Vehicle Tunnel

By

HARRY BERCOVICH

Thousands of Motor Vehicles can now pass under water between Oakland and Alameda

THE widest underwater subway in the world has just been completed between Oakland and Alameda, California.

It crosses under the Oakland estuary and the novel methods used in constructing the project have created nationwide interest among engineers. The subway is known as the "George A. Posey Tube." It is named after the surveyor of Alameda County, who prepared the plans and specifications.

Although there are longer underwater subways, this tube has a larger diameter than any yet built. Its outside diameter is 37 feet and it has a 24 foot roadway with two sidewalks 3 feet each in width. The tube is 4,476 feet long and cost approximately \$4,000,000.

Twenty years ago city officials and business men of Alameda County first started "talking tube." The cities of Oakland and Alameda needed a quick and easy transportation connection. Only cat boats and small craft could pass under the old bridges. Traffic was being delayed. So the Alameda County Board of Supervisors authorized the County Surveyor to prepare a survey and estimate of the work.

The survey was made, but for years the construction of the tube was held up because of legal difficulties.

Three years ago a contract was awarded to the A. J. Crocker Construction Company and actual work was started on the tube. An unusual plan was conceived for its construction. The tube was to be built in twelve

giant sections in the Hunters Point Drydock, San Francisco, and towed across San Francisco Bay, link by link, then sunk into place.

The method was pronounced extremely precarious. Some engineers declared the feat could not be accomplished successfully.

But the engineers were confident of their plan—and the twelve huge segments comprising the underwater distance of the tube were towed across the bay by tugs. Each section weighed 4,500 tons and was 205 feet long.

The tubes were lowered into place on piers by means of cables and were held in place by hydraulic pressure. When the links were placed in position, connecting points were sealed with asphalt and fiber and concrete was poured all around.

It was a difficult task to sink the tube links with precision because the sections were slanted toward the center of the stream on a four and one-half per cent grade. There was also a slight curve in the tunnel, which made every precaution necessary to preserve a perfect balance.

To construct the segments at the drydock, \$400,000 worth of special equipment was used. Another item was a six and one-half months lease of the dock, which ran to \$200,000. A crane with a spread of 121 feet had to be designed to handle the huge sections, and each of the twelve tube sections. (Continued on page 887)

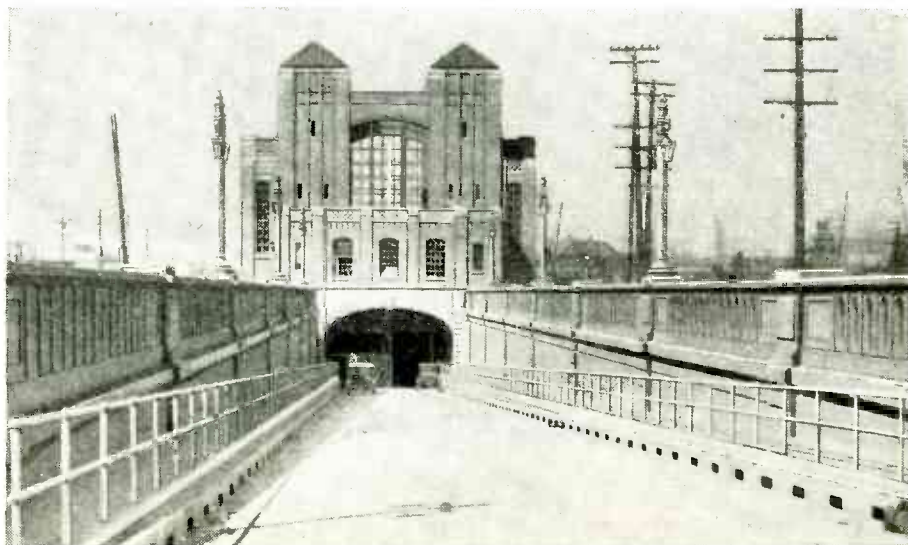

This picture shows one entrance to the new vehicular tunnel which joins Oakland and Alameda, California. The tunnel is known as the "George A. Posey Tube." The tube is ventilated by an extra large air vent, almost one-third of the tube's diameter, through which fresh air enters. Above the roadway are passages serving as outlets for foul air.

Ventilation Problem Successfully Solved

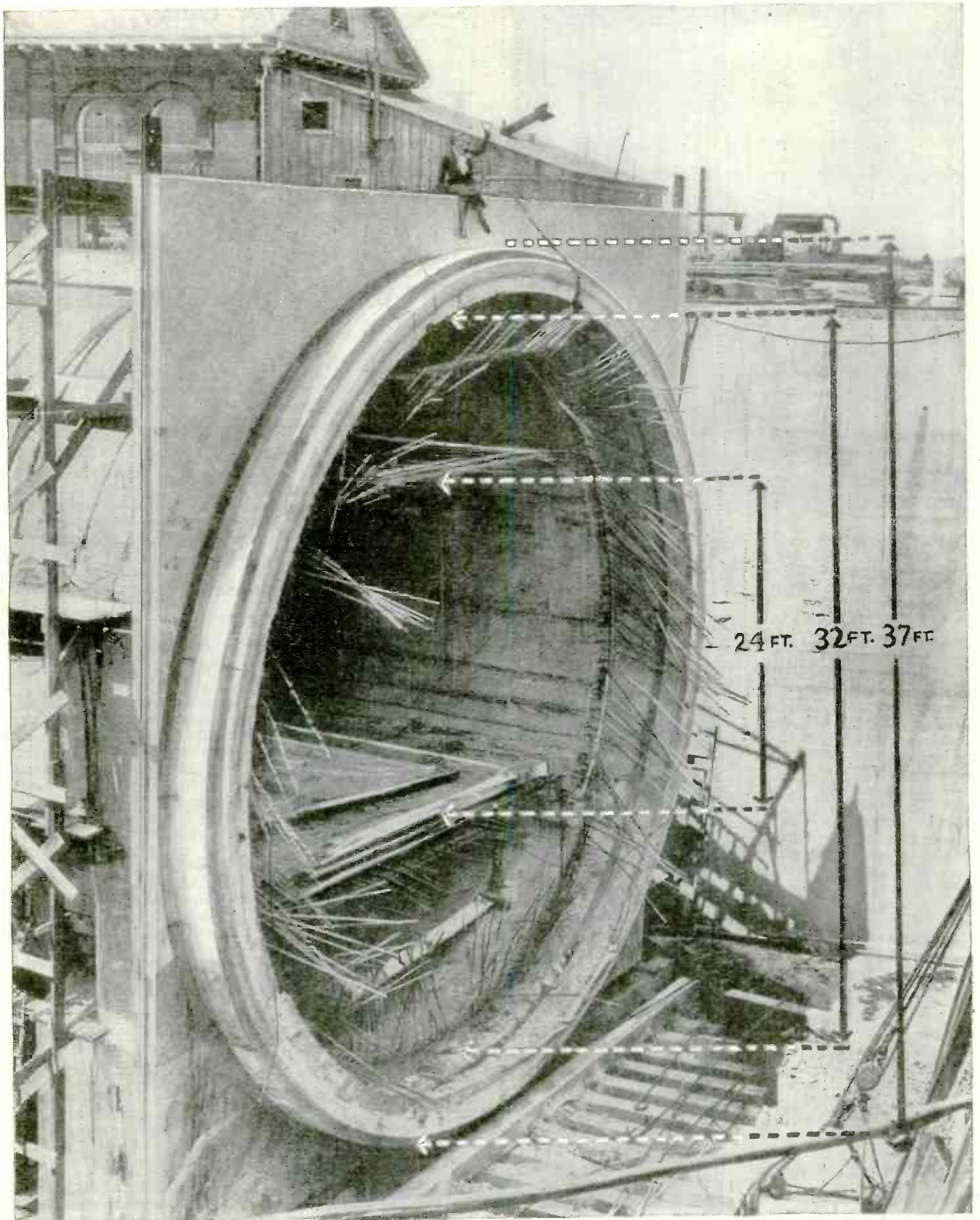

The huge diameter of the new San Francisco vehicular tunnel is made apparent when one notes the comparative size of the girl

seated on top of the tube. This large vehicular tunnel was built in sections; the sections were lowered into position and then joined.

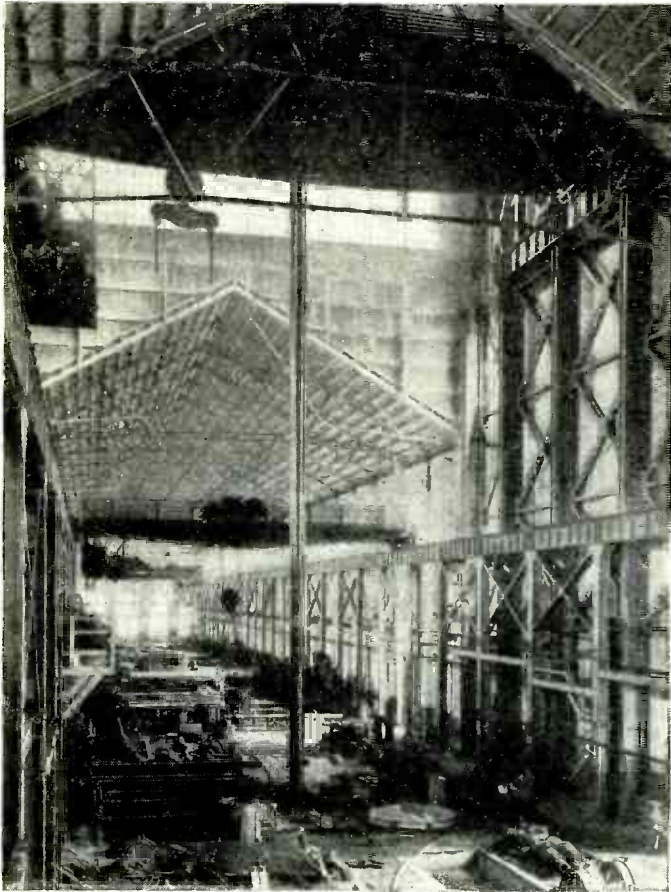

Photo courtesy U. S. Army Ordnance

Above is a 16 inch, 50 calibre liner about to be assembled in a large gun. The seating of the liner has to be a speedy operation. After the liner is placed in the gun, a gradual heating goes forward from the breech to the muzzle.

VERY early one chilly morning recently I was a privileged and interested spectator at a very unusual and important undertaking. I witnessed the lining of an eight-inch cannon.

At the Watervliet Arsenal, near Troy, New York, this cannon, which has been in process of manufacture for five months or more, had reached the stage where its exterior body was ready to receive its interior support, otherwise known as its liner. The lining of a big gun is a most delicate undertaking, requiring the most expert knowledge and skill on the part of those entrusted with the work. At the Watervliet Arsenal the men directly in charge and actively employed in the making of big guns, have been there for over thirty years. They are known to be the finest makers of cannon in the United States. On this particular morning the cannon on which they were working was one in which the Arsenal took a special pride. Experts had pronounced it to be without a flaw. But the fact that the gun was flawless was not their special reason for

How Big Guns are Lined, thus Increasing their Life. The Liner is Shrunk into the Exterior Body of the Gun.

Lining a n

By

EDNA MACDONALD SERREM

pride—it was their habit to turn out perfect specimens of gun manufacture. This cannon, however, seemed to everyone who had had a hand in its making to be one even above their high average of accomplishment.

Cannon Liner Shrunk-In

THE liner of a cannon is shrunk into the exterior body. The place where this shrinking-in is done is known as a shrink pit. A shrink pit is a square-shaped hole about one hundred feet deep by thirty feet square. It contains cylindrical electrical furnaces which stand in upright formation. The spaces between the furnaces are provided with racks built to hold long parts of the cannon, such as jackets and liners, which are ready to be swung on a crane into the furnace for the shrinking process.

How Gun is Heated

THE roof over the shrink pit is raised, allowing a track for a crane which is high enough to swing the gun clear of the floor. Our gun had been heated to 600 degrees, and kept at that heat for twenty-four hours. This heat causes the gun to expand so that the inner diameter becomes greater than the outer diameter of the liner at normal temperature. Then the liner, which has been filled with water to keep it cold, is raised out of the rack by the crane and swung down into the heated gun. At the same temperature, the diameter of the liner is greater than the inner diameter of the gun, so that the liner can only be slipped into the gun when the gun is expanded with heat. After the liner is inside the gun, a gradual heating of the liner from the breech to the muzzle goes forward. The accompanying illustration explains this cooling and heating process.

Hydraulic Press

THE seating of the liner has to be a speedy operation so that the inlet (A) can be connected, thus allowing an immediate flow of water for keep-

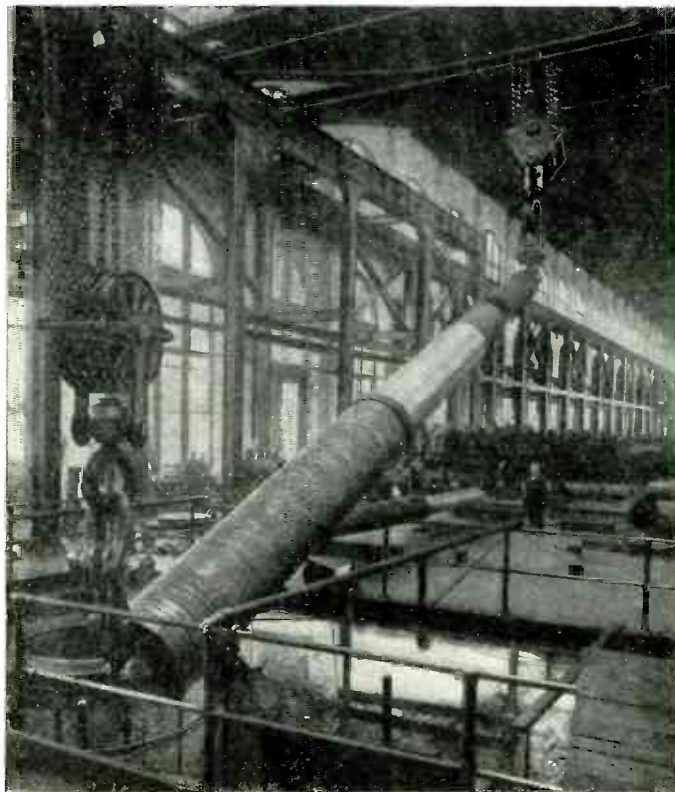
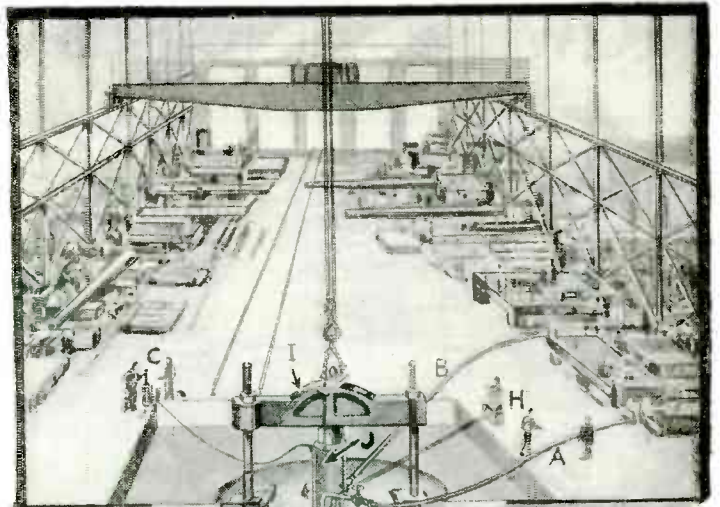

Photo courtesy U. S. Army Ordnance

The above photograph shows a partly built up 16 in. gun being lowered into the shrink pit preparatory to being lined.

The Shrink Pit and Its Purpose are Described Here. The Gun is Kept in a Pit, At a Heat of 600°F. for 24 Hours

Eight Inch Gun



ing the liner cool. The water runs through A, then up through the water-tight liner and out through B, valves on E not yet having been opened. As soon as the cooling system is operating, the hooking is screwed out and a hydraulic press is put on head I by a crane; pipe connections with a hydraulic pump C, which stands beside the pit, are swiftly made, and oil is pumped into the press in one-half minute. The pressure exerted on the liner has been estimated at around two hundred tons. The pump is manipulated by one man. The press is put on because the liner, which tapers a few inches from breech to muzzle, in the expansion due to the heat of the gun, might force its way up and out of position.

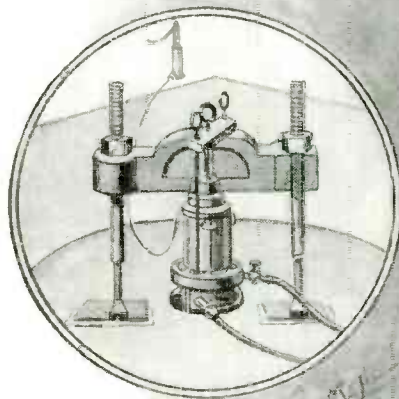

Not until the press is adjusted and can produce the required pressure, is the top valve of pipe G opened, and the breech of the liner allowed to be heated and to expand. From that time on the valves on pipe G are opened in succession, from top to bottom, a specified time allotted between each opening, thus allowing the liner the gradual heating from breech to muzzle. The liner is now left to expand as it will, until it finally does what the gun-makers term *freezes* to the outer covering—the original exterior.

The illustration at the right shows the shrink pit which contains cylindrical electric furnaces. A close-up view of the top portion is also shown. All letters are referred to in the text.

The furnace is then shut down, and the whole gun is permitted to cool. As the whole gun cools, all members shrink to their original dimensions; but as the liner is larger in diameter than the hole in which it has been placed, it is consequently subjected to considerable compression throughout its length. This results in the added strength to withstand the shock of discharge, and is the purpose of the shrinkage method of construction.

Reasons for Using Lining

ALL cylindrical parts of a gun—jackets, hoops, lock-rings, etc., are shrunk on the original tube of steel, making the gun elastic, and giving it a superlative degree of strength.

The very finest steel (Continued on page 889)

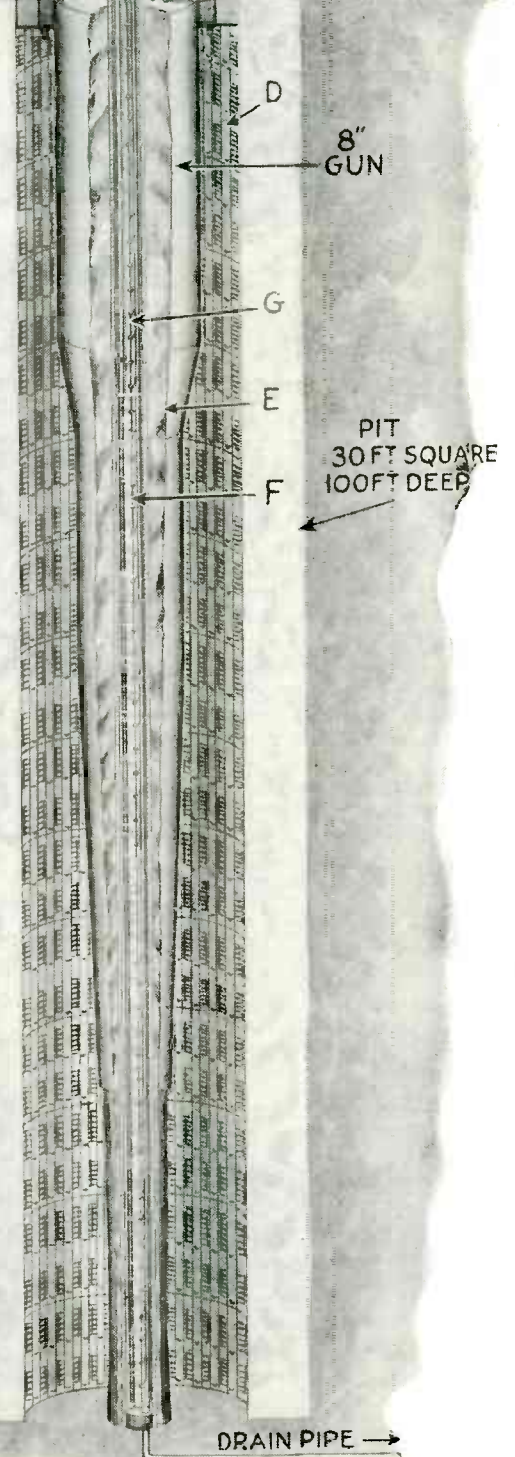

How a Negative Film Becomes Positive

One Film Serves Two Purposes

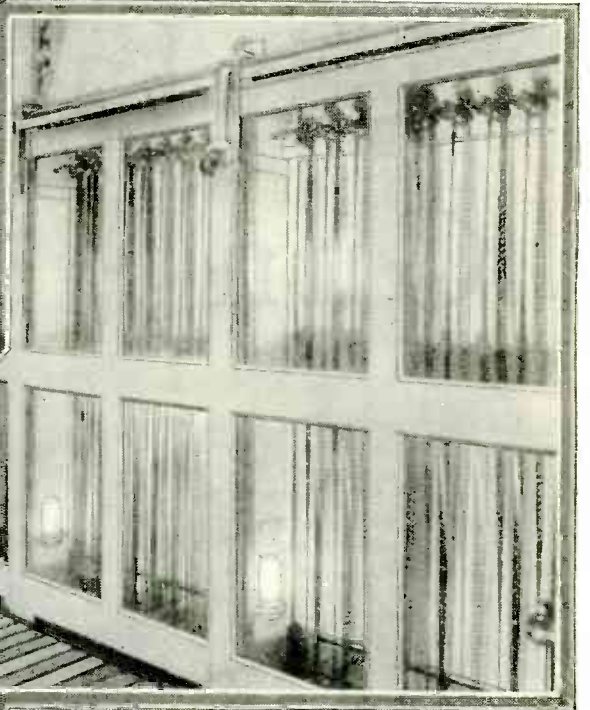
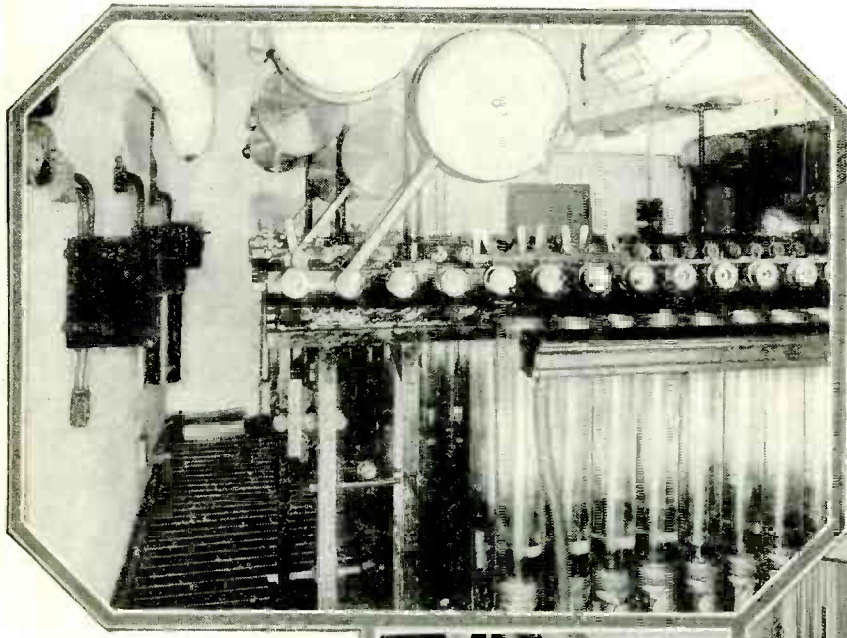

By
DON
BENNETT

A HUNDRED or so years ago, Daguerre put in his camera a silver plate sensitized with iodine. After many minutes exposure, minutes which demanded absolute rigidity from the sitter, the plate was removed from the camera and put in a dark cupboard over a dish of quicksilver. When the mercury had ceased to act, the plate was removed from the cupboard and a picture was on its surface.

Last week sister took her amateur movie camera out to the country club with her and shot a hundred

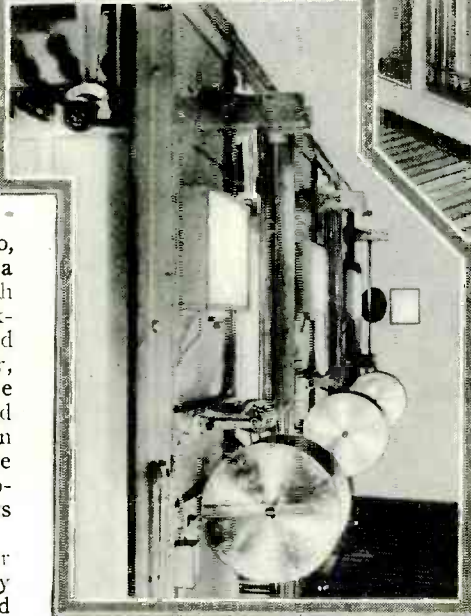

The photographs above show a large developing apparatus with glass tubes holding the chemical solutions. The film moves at a steady rate of speed and is fed from the spool into the first group where it is developed to a negative. From the time the film is placed in the machine until it leaves the drying cabinet, it is not touched by human hands.

feet or so of the family at golf. What a difference! And yet, there is a similarity between the two events, for both Daguerre's plate and Sister's film were finished as positives. A negative is of no practical use, it is only a means toward an end. The (Continued on page 852)

Training Dogs Of War

The photo below shows trained dogs with German soldiers. All are equipped with gas masks.



The photo below shows a dog trained to carry a telephone cable over dangerous ground.



MAJOR MOST conducts a training school for dogs in Berlin. These dogs are then turned over to the army and are skilled in following

Above—a device for making footprints.

footprints which have no human scent made by using the wheel shown in the photo. They also assist in carrying telephone cables and are schooled in warfare.

World's Longest Bridge with 300 ft. lift

Details of New Coastal Highway Link Over James River

Below — dimensions of the new bridge are given. The lift span is 300 ft. long.

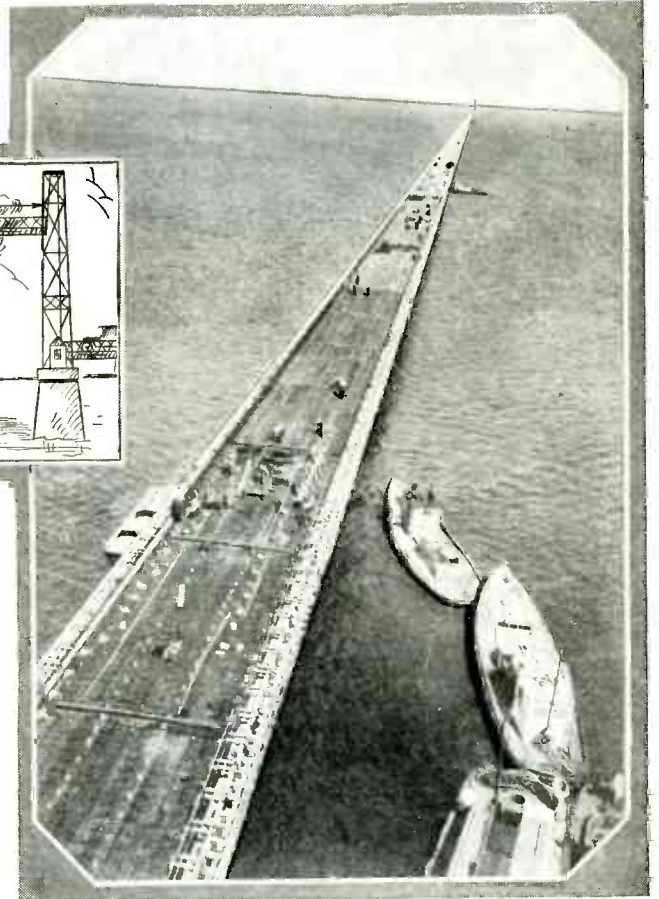
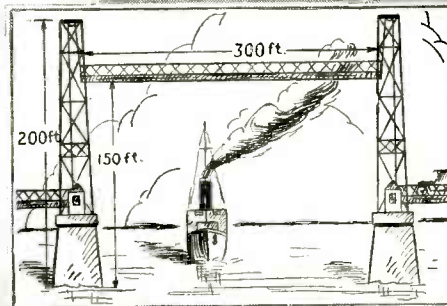
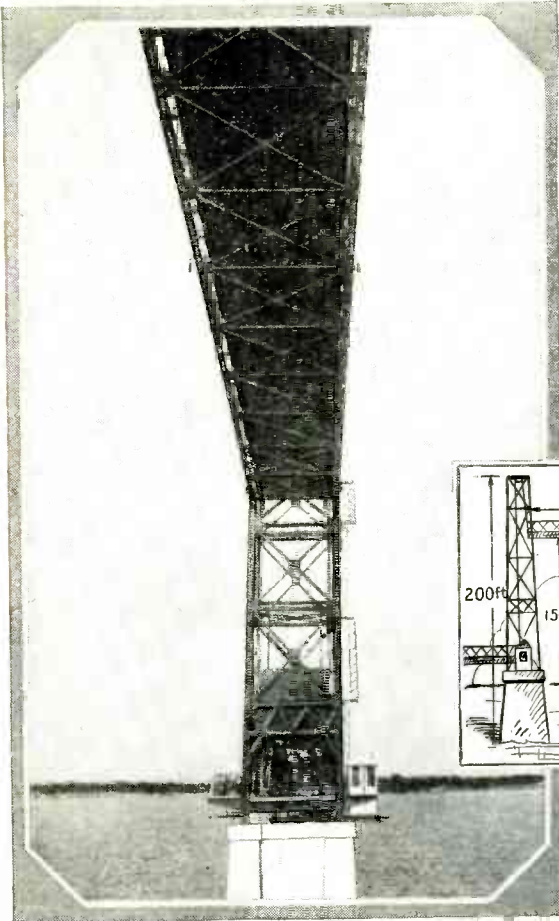

The above photograph shows the largest lift span in the world, which is 300 ft. long and raised 150 ft. above the river's surface.

A birds-eye view of the Newport News-James River bridge appears above. The normal height of the bridge roadway above high water is 50 feet.

THE longest bridge in the world was recently completed and spans the James River, at Newport News. It has the largest lift span in the world, which is 300 feet long and raised to a height of 150 feet above water level. This section permits the passage of river traffic below. The bridge is 5½ miles long and closes a gap in the Atlantic coastal highway, making a direct road down to the Virginia peninsula. It was built in the record time of eight months and was opened to traffic in mid November.

Combination Switch Lock for Your Car



The above photograph shows the switch lock for automobiles. Ten thousand combinations are possible.

A NEW switch lock for automobiles, with which one can obtain ten thousand combinations, has recently appeared on the market. The combinations may be changed by the owner. It can be installed at any convenient place

on the instrument board, and is connected as shown in the wiring diagram. The switch can be operated in the dark by counting the clicks as the small wheels are turned. —Name of manufacturer furnished upon request.

The illustration at the right shows how easily the lock may be installed in any automobile. One of the leads to the old switch is cut, and B and C are connected, and the other end of C is connected to A.

The combination switch lock is not at all difficult to install and one does not need a knowledge of auto mechanics or electricity to place it on the instrument board. Only four operations are required when making the change from the old lock to the new, as illustrated in the drawing below.

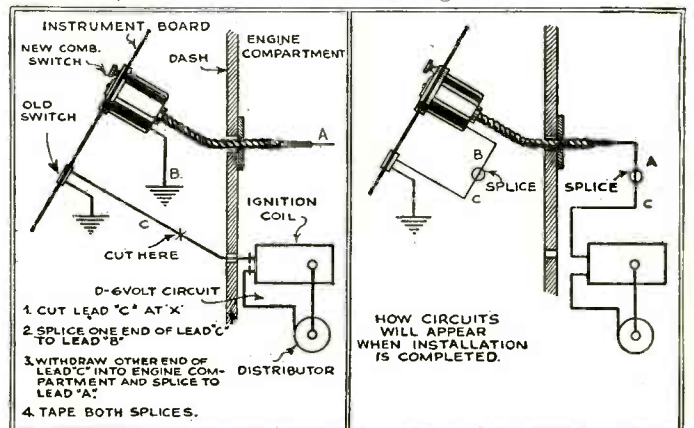

Science Toy

Latest playthings made possible through the aid of science. Working models of airplanes and other various motorized toys are pictured here.

Newest games and playthings which employ

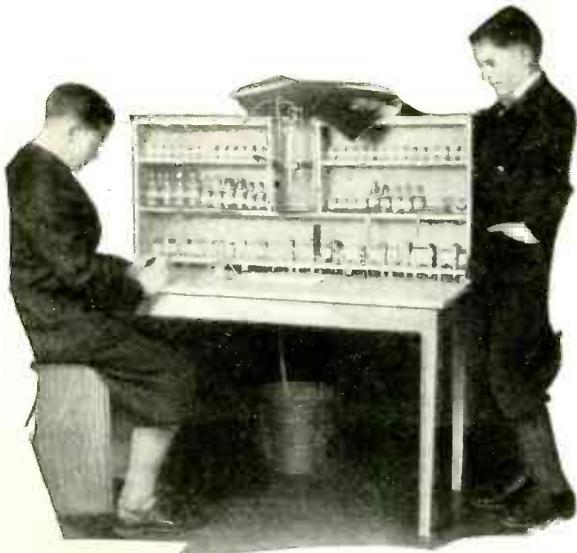

Above is an amateur chemical laboratory containing many different substances with which the student can perform experiments and further his knowledge of this subject.

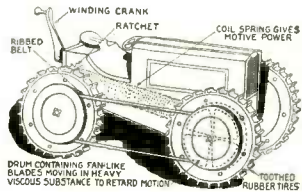

The illustration at the right shows the construction of a toy tractor which employs a coil spring for motive power.

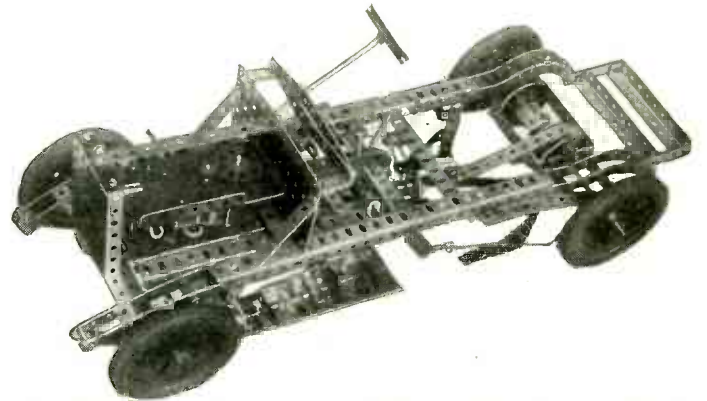

An automobile complete in every detail and powered by an electric motor is shown here. This is made with a mechanical construction outfit. A mirror is placed beneath it in order to show the details of the clutch and transmission.

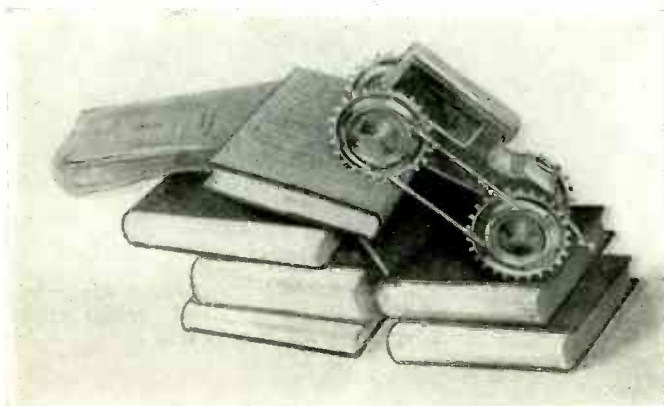

The tractor will readily climb large obstructions placed in its path, as shown in the above photo.



A flying model of an airplane with demountable wings driven by a rubber band motor and capable of actual flight is shown above.

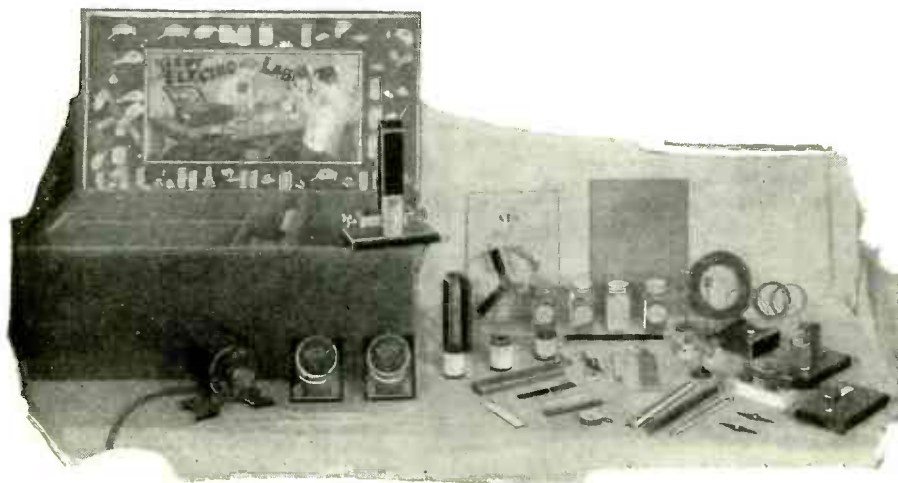

An amateur electric laboratory outfit for the student and experimenter is shown above with parts supplied.



The amateur electric outfit permits one to make all sorts of experiments and to build motors and magnets. For the school boy who is interested in electricity, no better Christmas gift could be given.

Invades Land

Electricity plays an important part in this year's stock of toys. Chemistry sets and magnetic games also provide much amusement for the children.

scientific principles for their operation

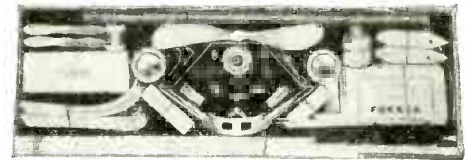
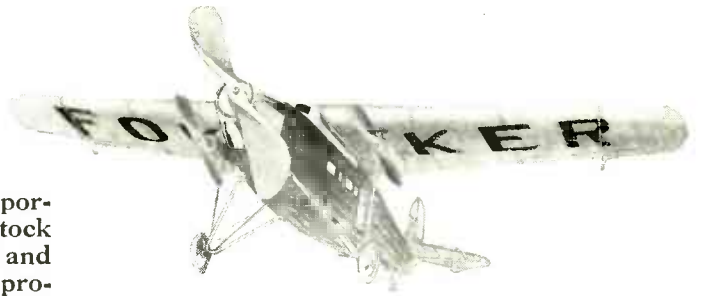

Above—a flying model Fokker monoplane, and photo of the kit from which it was built in a short time.

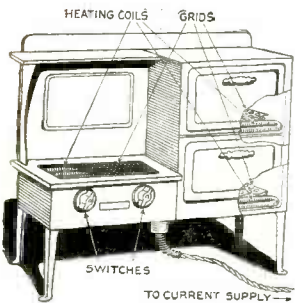

A small electric stove similar to a gas range is shown above. Electric heating coils are used for cooking the food. The switch at the left controls the current supply to the outside cooker, and the right-hand switch controls the heating coils in the oven and broiler. The illustration at the left shows the placement of heating coils and grids. The model is of sturdy metal construction and is finished in black and white enamel, similar to large stoves.

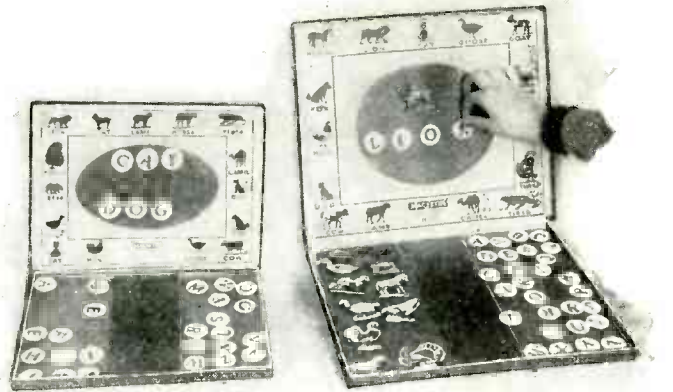

Magnetic toys which use magnetized letters and pictures of animals that cling to a sheet of iron is shown above.

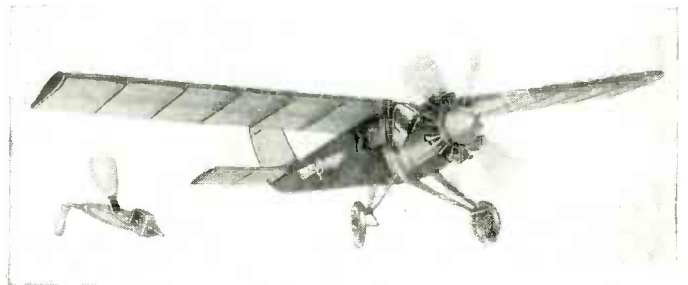

The above model airplane uses a rubber band motor, which is taken out and wound with the device shown at the left. A dummy engine is used with drive shaft and propeller removable.

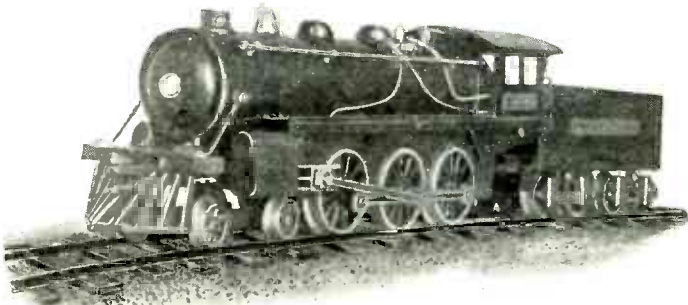

An electric locomotive with tender is shown above. These are exact replicas of the originals, and the locomotive is driven by a six-volt electric motor. A single drive is used, but the six wheels are linked together, making all of them drive wheels.

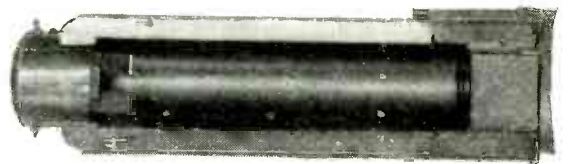

The above photograph shows a view of the locomotive with top removed. The heavy electric driving motor can be seen. The metal top is easily removable from the chassis.

Manufacturer's names furnished on request.

Measuring the Speed of Atoms

*Machine Also Assorts
and Counts Invisible
Particles*

By
DONALD H.
MENZEL, Ph.D.
Lick Observatory

The effect of a single atom has been detected and its properties and characteristics are well known, although no one has ever seen one

THE idea that everything material in this universe is built of atoms has now passed the stage where it can be called mere theory; experiments have established it on so firm a footing that its reality can scarcely be questioned. It is true that no one has seen or ever will see an atom, for this unit is smaller than the light-waves by which objects are made visible to the eye, but we have, nevertheless, successfully detected the effect of a single atom in many other ways; its properties and characteristics are now so well known that an examination of the atom is quite unnecessary.

It is impossible to conceive of the smallness of an atom or molecule. In a thimbleful (one cubic centimeter) of air at ordinary temperature and pressure, we count no less than 27 billion, billion (27 followed by 18 ciphers) of them and yet they are no more crowded than a single tennis ball in a good-sized trunk. A container the size of a pinhead will hold so many molecules that if we removed one thousand of them every second, it would take us ten thousand years to empty the receptacle. With plenty of space for motion, the individual particles are all speeding about in random directions, colliding with one another, rebounding, and off again on another track. Their velocity is by no means negligible. In the air surrounding us the molecules are flying at an average speed of more than a mile per second. It is sometimes said that they move faster in warm air than in cold, but this statement is not quite correct; it is like saying that we have rain in wet weather for, in truth, just as the rain causes the dampness, so does the average molecular speed determine the temperature of the aggregate which the particles compose.

In the foregoing paragraph, the use of the word *average* implies that not all the molecules are moving with the same velocity. In fact, in the atomic traffic jam I am describing, where each individual experiences many thousand collisions a second, such a condition is obviously very unlikely. Some of the molecular population will be moving more slowly, others faster than the mean. Yet, with the chances of collision so imminent, the probability of finding a motionless atom or one of extreme speed

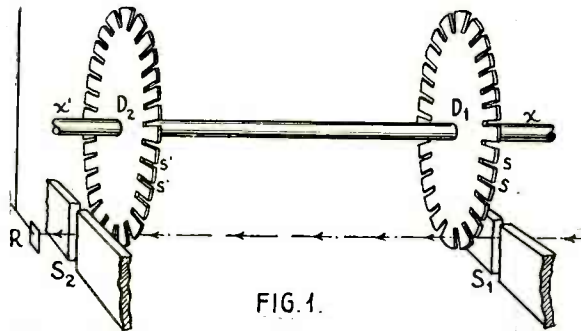

FIG. 1.

The principle of the experiment may be best understood by reference to the schematic diagram in Fig. 1. Suppose a stream of gas is emerging from the slit S1 into a highly evacuated space. Some of the molecules will have such velocities that they will pass through the radial slits, S, S . . . in the periphery of the rotating disc D1; in particular, a few will continue through the second rotating disc, through the second fixed slit S2 and impinge on the mechanical detecting system R, a radiometer. The molecules of this group, however, will no longer be of all velocities. Since their time of passage from D1 to D2 must be such that they will find a slit in D2 in front of S2, the beam will consist of molecules of one or more definite ranges of velocity, depending on the dimensions of the apparatus and the speed of rotation of the discs.

IT is possible to conceive of the smallness of an atom or a molecule, yet, a machine has been made which actually measures the speed of atoms and sorts out the fast from the slow-moving ones. Although no one has seen an individual atom, its properties and characteristics are well known and are further brought to life by this relatively huge device, which is used to measure the velocity of extremely small and delicate moving particles such as the atom. Read this interesting story of the latest addition to atomic science.

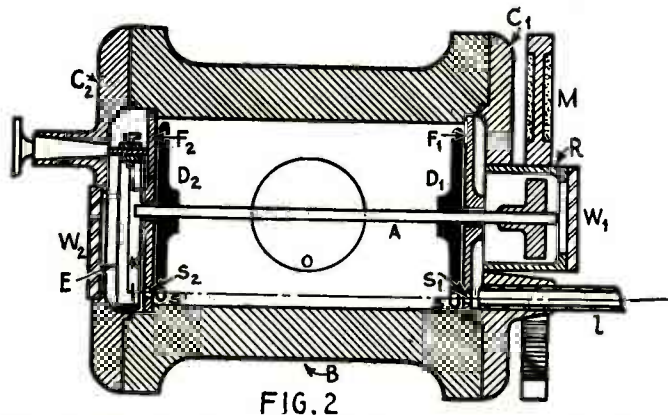

FIG. 2

The drawings in Fig. 2 represent the apparatus as realized. Inside the cylindrical bronze casting B are two flanges, F1 and F2, on each of which is a sapphire bearing accurately aligned along the axis of the cylinder. These bearings carry the shaft A, on which are mounted two duralumin discs with radial slits cut in their peripheries. Also on the shaft A is the rotor R of the electromagnetic driving system. It is actuated by stator M. The glass window W1 gives a view of the rotor from the outside, thus allowing the speed to be measured. Gas is fed in through the glass tube 1 to the slit S1 and evacuation is through O to a rapid diffusion pump. E is the radiometer mount with a suspension L and the delicate movable system K. This system carries a small mirror, illuminated through the window W2.

is also small. About 1860, J. Clerk Maxwell, famous English physicist, examined the problem mathematically and determined a formula for the relative distribution of velocities among the atoms of any gas.

"Maxwell's law," as we have come to call the equation, has been of great importance in the development of many physical theories of today. Since no means were at hand to check the formula by experiment, we have had to accept it axiomatically—without proof. A few months ago, however, Costa of Woonsocket, R. I., and Smyth and Compton of Princeton came to realize the fact that the technique of handling atoms has progressed to such a point that it is now possible to separate the atoms of various velocities and measure their quantities. Accordingly, they designed an apparatus for the purpose, the principle of which is demonstrated in the accompanying diagram.

Two toothed wheels are fastened solidly to the same shaft so that they may be rotated together by a high-speed motor. The compartment in which they are found is highly evacuated and placed next to the chamber which contains the gas to be studied. The connection is made by the slit S1, which permits the molecules of the gas to escape from the original container and enter the vacuum chamber between the teeth of the wheel D1. The particles this far on their path

through the apparatus are, undoubtedly, a fair sample of the gas under examination both as to velocity and the relative number of each speed. The atoms which leave via the toothed openings in D2 and slit S2 are, however, of a definite range of velocity, for only those which are moving with the specific speed which takes them across the distance D1-D2 so that they will find at the exit a slit instead of a tooth will escape. By changing the number of revolutions per minute of the wheel, atoms of various speeds may be selected and separated from the aggregate.

A means of detecting the molecules must be provided. The device which was employed is known to physicists by the name of "radiometer" which is, in principle, a sort of windmill or better weather-vane of minute proportions. A fine quartz thread, Q, is the

(Continued on page 893)

Ben Day, An Artist's New Accessory Described Here.



Above is a sheet of celluloid which has been treated with black dots on a white background.

Above is an ordinary drawing before it has been treated with the new Ben-Day or stipple process.

Here is the same illustration which has been treated with the black stipple.

New Stippling Process for Drawings

By means of a clever invention, it is possible to quickly stipple drawings by simply placing sheets of treated celluloid over them and erasing dots where desired

Illustration of a Simple Stippling Method Results in Delicate Shading.

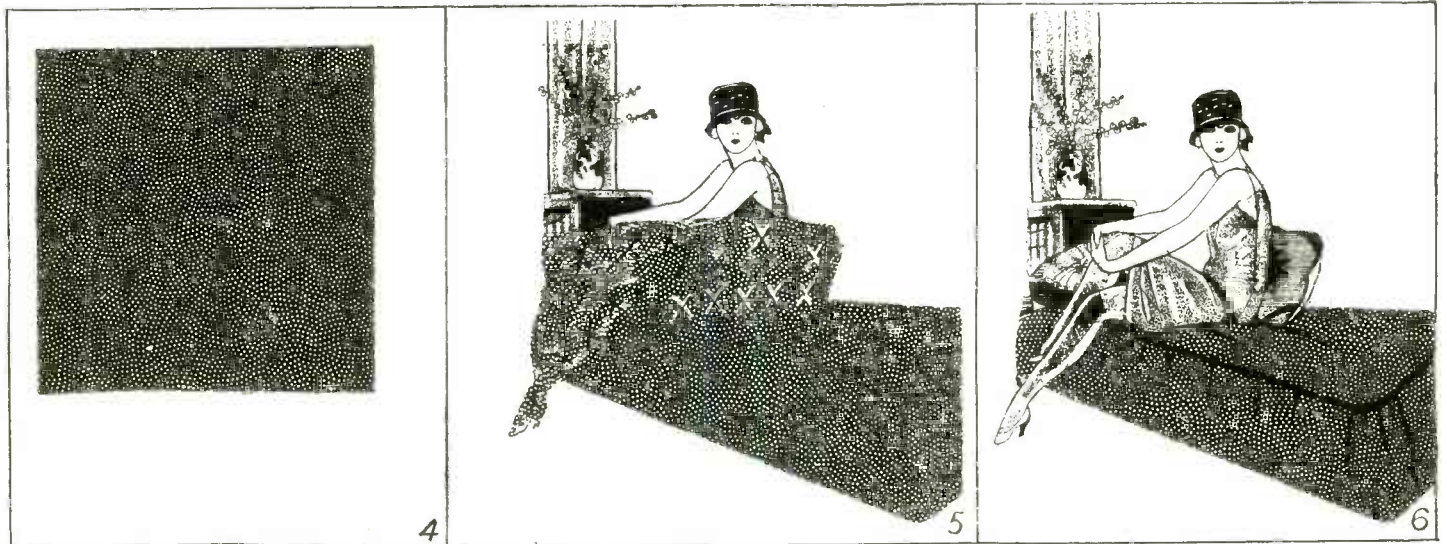

A sheet of black celluloid upon which white dots have been placed. This is placed on drawing and dots erased where black is to show.

Above, the original drawing shown in Fig. 2 has been overlaid with the white and black stipple. The X's show the portions which have to be erased.

The finished illustration is shown above. Note the various shaded combinations which can be obtained by the use of this process.

A NEW drawing and photo-engraving accessory has recently been invented. This process is really a new stippling process and consists briefly of two sheets of celluloid upon which white or black dots have been placed. The black dots are placed upon a white background, and the white dots upon a black background. The black spotted stipple is

placed upon the original illustration and the dots erased where white is to show through. The white dotted stipple is placed over this and white dots erased where black is to show. A step by step illustration of this process is shown here. Better illustrations and more delicate shading can be obtained by using this white and black stipple.

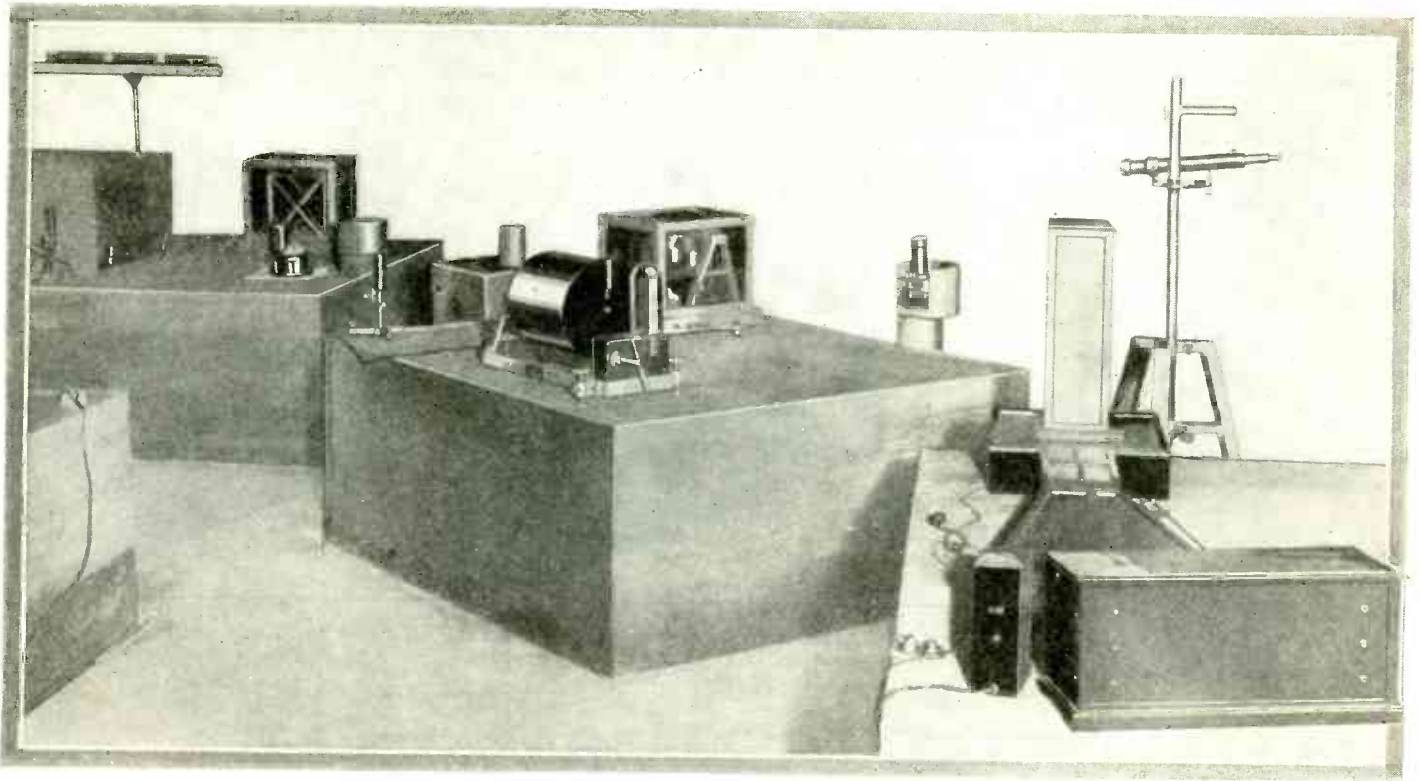

The above photograph shows the new and improved seismic station which has been erected at Fordham University, in New York City. The present equipment comprises instruments for recording both the horizontal and vertical motion of the earth.

These instruments will magnify the earth movement 1,000 times. This is necessary because the most violent earthquake registered at Fordham showed a displacement on the record of two inches which, when reduced to ground movement, equals about 1/50 inch.

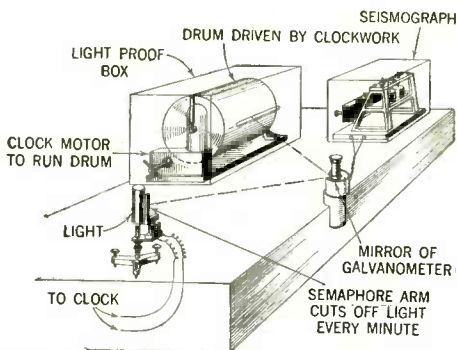

The above diagram shows how the apparatus works. Light reflected from a galvanometer mirror falls upon a sensitized sheet, producing a record of the quake.

Earthquakes

Seismographic Stations Record Earthquake Shocks by Electricity

THE study of seismic phenomena, or seismology, as it is more commonly called, is perhaps one of the most misunderstood of the later sciences, especially with respect to its purpose and ultimate aim. From newspaper reports and the interest displayed by their representatives, one would gather that the erection of a new seismological observatory was for the sole purpose of issuing last-minute reports on all earthquake catastrophies.

While in numerous instances such information can be supplied, it must be remembered that this is but a very secondary purpose and rather a concomitant circumstance than a real end in itself.

The installation of a seismograph at any university or government observatory has as its purpose the furthering of scientific knowledge by a type of research that may benefit at least five different sciences individually, as well as the general populace of the world.

First of all to the geologist there are perhaps no phenomena that will reveal more than do earthquakes. The study of these quakes may explain either the internal workings of a volcano, if the quake be of volcanic origin, or if it be tectonic in nature,

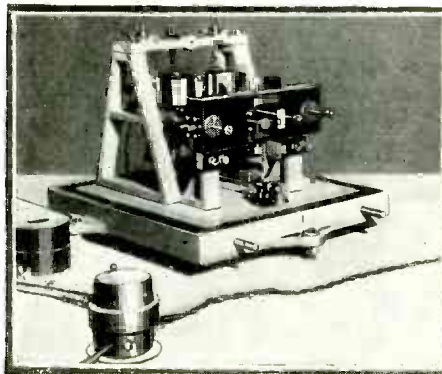

The electrical seismograph is shown in the above photograph. Its construction may be seen in the illustration below.

locity of the earthquake wave as it travels from strata to strata.

The physicist may verify and confirm his speculations concerning the transmission of energy in elastic media, and may test his formulæ for the various moduli of rocks, using as it were, the entire globe for his laboratory.

The meteorologist may investigate the relations between the fluctuations of barometer and thermometer, and the periodicity of quakes.

The drawing below shows the pendulum and small coil which moves between permanent magnets, producing an electric current subsequently fed to the galvanometer.

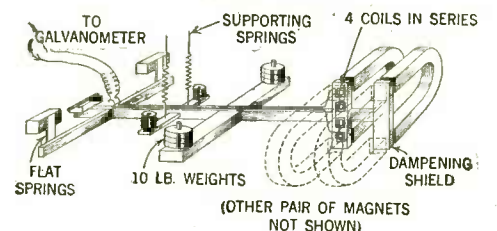

it may lead to the discovery of various unknown rocky structures, if the student observes carefully the reflections and changes in ve-

The Study of Seismic Phenomena Accomplished With Two Types of Instruments, One Mechanical in Nature and the Other Electrical. New Instruments Developed Enable Accurate Study to Be Made.

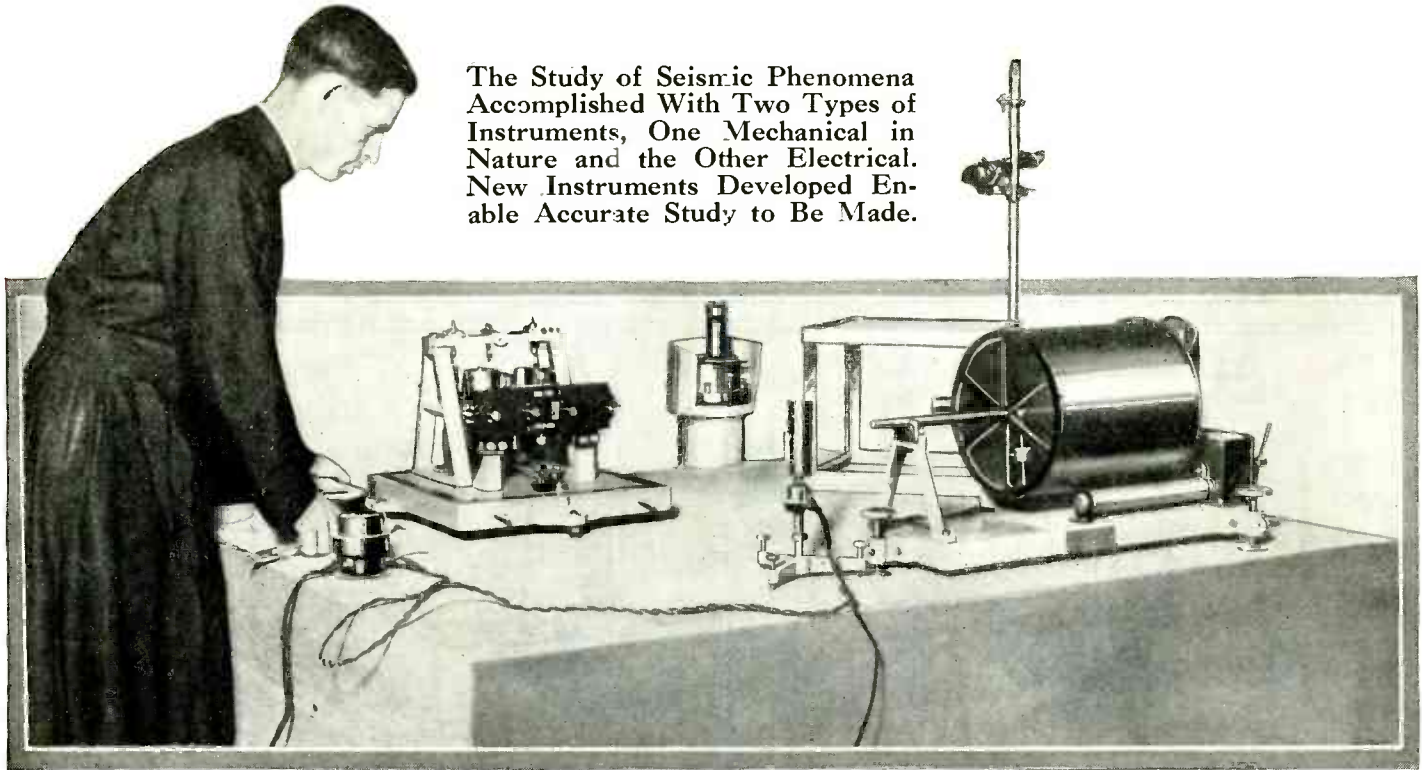

Father John W. Tynan, S. J., working on the installation at Fordham University. The apparatus is resting upon a huge concrete block. The pendulum appears at the left, with galvanometer and the mirror situated at the back of the block.

The drum containing the sensitized paper may be seen directly above. This is turned by a clock motor located on the right-hand side of the drum support. The light and shutter which cuts off illumination once every minute is seen just to the left of the drum.

and Seismographs

By FATHER JOHN W. TYNAN, S. J.

New and Enlarged Equipment Installed at Fordham University Described Here

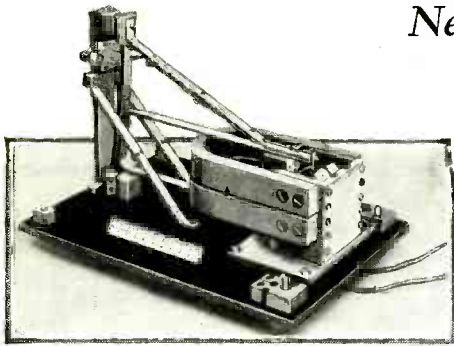

Above is one of the electrical seismographs which has been developed by the United States Bureau of Standards.

The illustration below shows the seismograph building at Fordham University. The instruments rest upon cement blocks with free floating floors.

The speculator on the evolution of our universe has a superabundance of material culled from the seismogram with which to bolster up his old, or evolve his new theories of the formation of the earth on which we live.

And last, but not least, mathematics has opened up to it a new field in which to make its theoretical reasoning more practical.

Purpose of Seismographs

TO record the fact of the occurrence of an earthquake is not therefore the main object for which a seismograph is built (a wireless or cable dispatch will, in many cases, give much more definite information

of the nature desired by the public), but the purpose of this instrument is to amplify and reduce to a graphic form the motions of the earth, so that the student of seismology may in this way have a permanent record, an autograph, as it were, of the tremors, vibrations and waves that constitute seismic phenomena, and may be able by means of this record, to study the nature, causes, characteristics and effects of earthquakes.

The first accurate and scientific definition of an earthquake was given by Robert Mallet. An earthquake is the transit of elastic waves from a center of impulse, through the crust and surface of the earth; sometimes

(Continued on page 835)

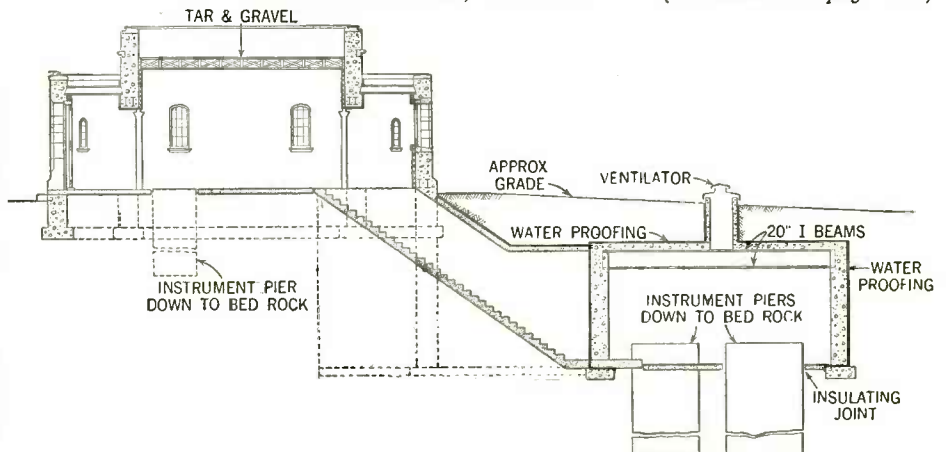

INVENTIONS WANTED

Money Making Schemes and Ideas Presented Here

A "guiding line" to inventors is published by the Institute of Patentees, in London, and is known as "What's Wanted." The illustrations reproduced here represent some of the more important needed inventions mentioned in this booklet. Some of the schemes pre-

sented here may seem a bit far-fetched, but with the astonishing rate at which we are progressing today, it does not seem inconceivable that many of the items classed as impossible now will actually be in use within a short period of time.

New Devices Which are Needed by the World Today



1 An invention which will reproduce spoken words on a typewriter.

2 Producing electricity other than by mechanical motion.

3 A device for preventing smoke from permeating the room.

4 A revolving brush for cleaning the shoes at home.

5 A non-poisonous freezing mixture of small manufacture cost.

6 An automatic four wheel brake for baby carriages.

ILLUSTRATED here are a number of ideas which if properly perfected will make a fortune for the lucky inventor. These are only a few of the many which are needed at the present time. Often, the simplest inventions are the most profitable. The scope for inventors is larger than ever and increases as our knowledge is broadened. Fig 1 shows a needed invention that will transmit the words spoken into a microphone to a typewriter, which will automatically reproduce them. Fig. 2 shows the need for a means of producing electrical energy in reasonable quantities, other than by mechanical motion. Fig. 3 shows an atmosphere purifier which prevents tobacco smoke from permeating the room when the windows cannot be kept open, or a device to consume or absorb this smoke. Fig. 4 shows a revolving brush by a small electric

motor for polishing the shoes. This is to be used in the home. A chemical freezing mixture which will not affect metals and is non-poisonous would find much application and is shown in Fig. 5. Fig. 6 depicts an automatic wheel brake for baby carriages which will lock all four wheels when pressure of the hand is released. An attachable alarm for a pocket wallet as a means for foiling pickpockets is shown in Fig. 7. Fig. 8 shows a fool-proof motor car gear which will not clash when gears are shifted and might automatically change itself as the grade varies. Fig. 9 illustrates a method of stopping ships from rolling more than a few degrees in the roughest weather. A long needed invention is illustrated in Fig. 10. This is a sensitized printing paper for photographs which will "print" in actual colors when exposed and developed. Among the inventions shown here, undoubtedly the most fantastic is that illustrated in Fig. 11. This is a radio loud speaker which will automatically translate any foreign language into English, or vice versa. This should not be too large and readily attachable to any receiver without

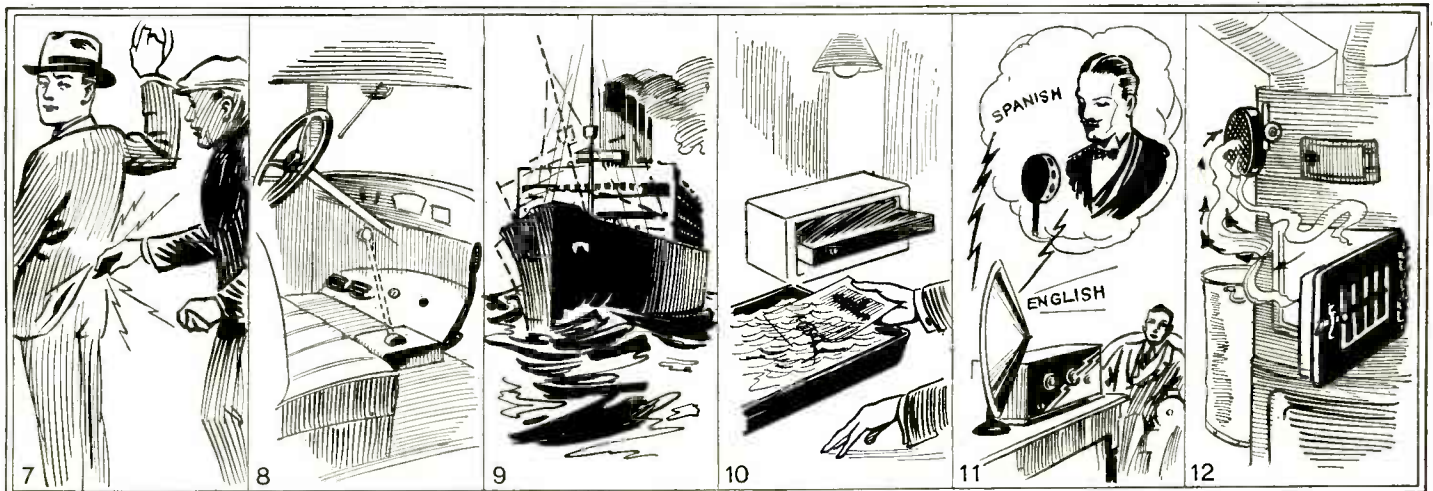

7 A pocket alarm for pickpockets.

8 Fool-proof motor car gears.

9 A method of stopping ships from rolling.

10 Paper for printing photographs in colors.

11 Speaker for translating languages into English.

12 A method for neutralizing coal gas.

additional apparatus. At Fig. 12 is shown a quick and effective method of neutralizing escaping coal gas coming from the furnace. The device should act automatically if possible, whenever the gas leaks out. The English list is worth studying.

At Fig. 12 is shown a quick and effective method of neutralizing escaping coal gas coming from the furnace. The device should act automatically if possible, whenever the gas leaks out. The English list is worth studying.

Can You Find Hidden Fire Hazard?

What is Wrong with the House Illustrated Below? There Are at Least Thirty Causes of Fire Shown.

THE campaign for fire prevention has always stressed carelessness as one of the major causes for fire. The National Board of Fire Underwriters in their paper *Safeguarding America Against Fire*, illustrate some of the most common fire hazards; these will be found in the house shown at the right. These causes of fire fall under the heading "Preventable." Emphasis is placed upon false economy in building construction. Buildings should be so constructed so that they can resist fires until the local fire department arrives. One per cent of the number of fires is responsible for sixty-six per cent of the total loss. These figures were obtained by making a study of fires in the largest cities of the United States. Fires of \$10,000 and over were considered large, and although they were only one per cent of the total number, they produced sixty-six per cent of the total loss. In the last two years, poor building construction has caused serious loss of life through fires. In many of the recent large fires a few dollars spent on equipment or construction would have prevented the loss of human lives and thousands of dollars. Overheated flatirons, neglected rubbish, faulty flues, defective house wiring, and a host of other similar causes have been blamed for the fire loss in this country. This could have been prevented by proper building construction. If any of the fire causes shown in the illustration are at present a menace in your home they should be remedied and removed immediately for proper protection. Carefully study your own house and you will doubtless find any number of fire hazards.

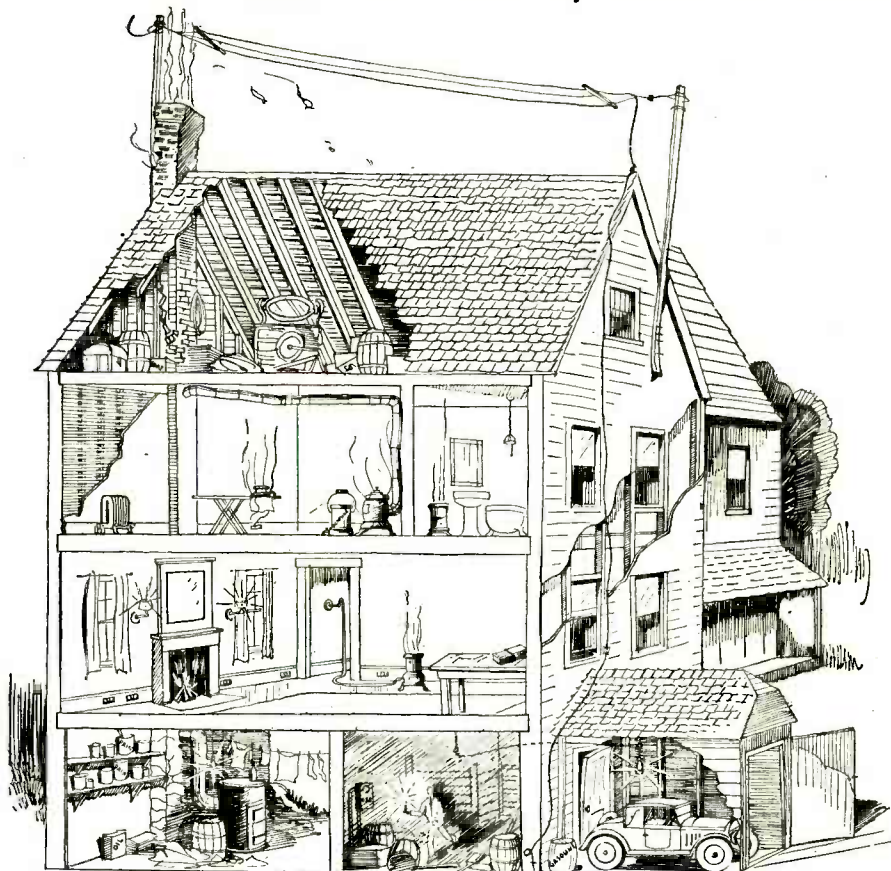

Examine the above drawing and see if you can find all the fire hazards which have been included in the house. There are at least thirty specific causes of fire pictured here. If you will look carefully, you are sure to find something.

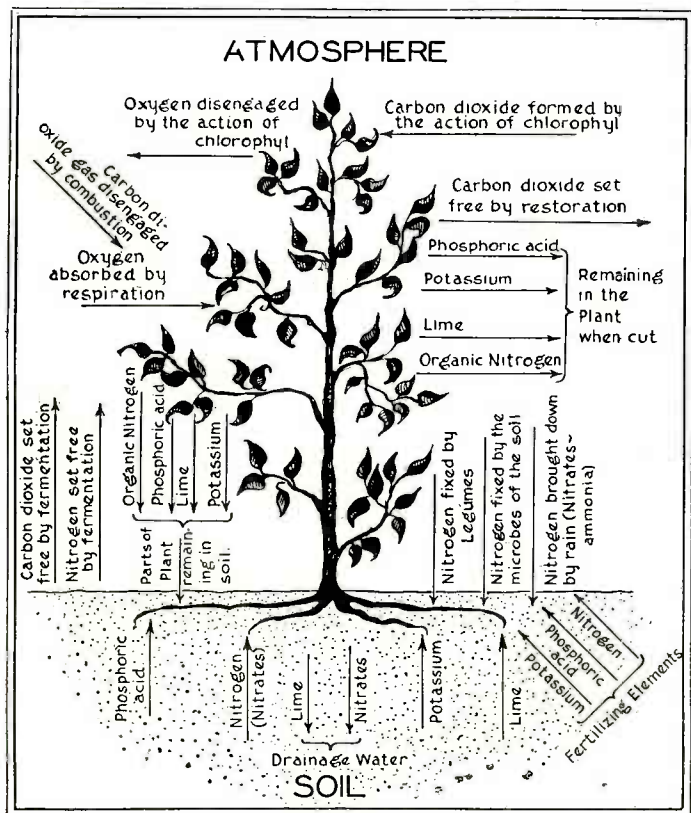

The Chemistry of a Plant

The Life History of the Organism of the Plant Shown Clearly in Diagram Giving the Function of Different Parts

THE diagram shows in what is literally picturesque form, the many chemical actions which go on in plant life. The leaf of a plant seems a very innocent and rather ornamental thing. In the fall automobilists desecrate our forests by taking the branches with the beautiful autumn color to their houses. How many of them know or even think that each leaf is a wonderful chemical laboratory. By means of its chlorophyll, it absorbs nutriment from the air, decomposes the carbon dioxide of the air, the carbon going to build up the frame of the tree or plant, the leaf-action being affected by light. Sometimes the leaves of a tree are metaphorically speaking, called its lungs of the plant. The roots of the plant have also very complicating chemical processes to carry out. They play their part, in assimilating the nitrogen aided by bacteria of the soil. The plant draws its supply of water by the roots and the great superficial area of the leaves exhales moisture, so that the two elements, leaves and roots, must balance each other in order to maintain a healthy condition. A tree is sometimes endangered by having too great a quantity of roots, and digging a trench around it to cut off a quantity of the roots will restore it. Water is constantly rising through the root and evaporates into the air from the leaves, so that more water goes up hill, as we may term it in a forest than goes over Niagara. The Romans had a theory that one tree sent its roots down to the same distance that it sent its highest branches into the air. We know now that many plants and trees perform this feat and better it.

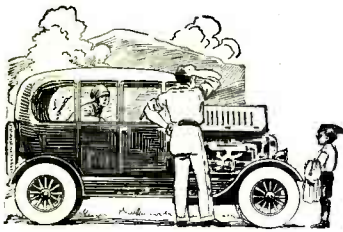

MOTOR HINTS

Conducted by GEORGE A. LUERS

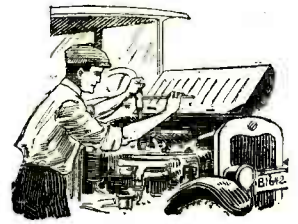

Valuable Hints for the Car Owner During the Cold Winter Months

Adding a Baggage Top

MATERIAL required are two dozen snap fasteners, and sufficient square yards of pantasote or rubberized fabric top covering, to cover the roof of the car. The fabric is seamed on the four sides and corners cut with a "V" and seamed.

This baggage carrier, as will be evident from the sketch, is fully detachable and does not disfigure the car.

The small pins, that are a part of the snap fasteners, remain on the car, ready for replacement of the carrier without delay.

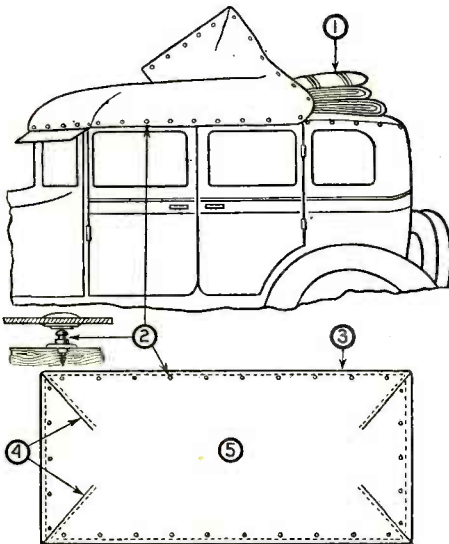

In the above illustration 1, bedding, tents, blankets, bags, and the like stored away under a baggage top, 2, snap fasteners on all edges, 3, pattern for baggage top, 4, seams, 5, rubberized fabric top covering. The baggage carrier is detachable and will not disfigure the car.

DO YOU KNOW—

black tire paint is the best winter protection for all tires, including the spare. This is made of 1/8 lb. lampblack, 1/8 lb., flake graphite and 1/2 pint of shellac, mixed. Apply with a brush, thinning with alcohol, as required.

Faulty Starter Switch and Wiring

The driver of a car, having difficulties with run-down batteries, may find in the attached sketch the cause and cure for this trouble.

One owner made repeated visits to the battery service station for reason of discharged batteries. Normally the circuit tested free of grounds; however, when the battery was recharged, it was only a matter of a few days when the battery would be too low to start. The owner finally traced the trouble to *intermittent grounds in the starting switch*. As a means to prevent a ground through the switch and into the frame of the car, the body of the switch was insulated from the car frame, using the method shown in the attached sketch. This consists of layers of hard parchment paper under the switch body, washers under the bolt-heads and small sleeves around the bolts, of shellacked parchment paper.

Shortly after this repair, the battery failure started again. This was traced to the wire connecting the battery to the switch. The jolting of the car brought a section of the wire, where the insulation was broken, in contact with the car frame. To avoid further trouble from this source, a casing was made for the

wire, of a short length of rubber wash hose.

These methods which are shown in the sketch will serve the needs of any car owner, without expense, as the material is usually available in the garage or home. An hour or less of work will be required to put these on the battery wire and switch.

Repairs to Leaking Floats and Broken Gas Lines

It is not difficult to locate a broken gas or oil line. The repair of this part, however, is troublesome, inasmuch as the break is usually under the car and adjacent to some part of the frame. Two good repair methods for the copper piping are shown. (Continued on page 890)

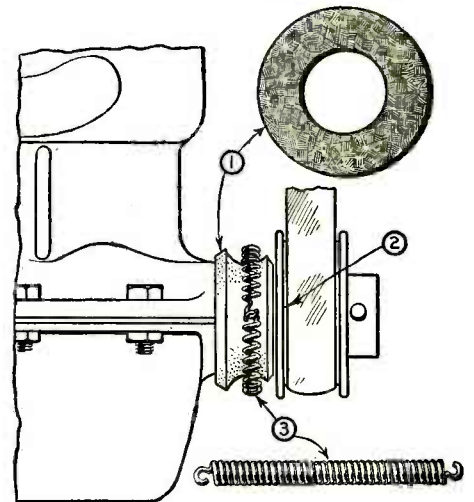

In the above illustration, 1, is a heavy felt washer, 2, front bearing of engine, and 3, spring with hook ends. This simple oil seal will prevent leakage and protect the fan belt.

The starter switch and wiring are often the cause of a run down battery. The illustration at the right shows at 1, starter switch, 2, fibre washer, 3, parchment paper, 4, five layers of parchment paper, 5, car storage battery, and 6, a length of rubber hose encasing wire to starter switch.

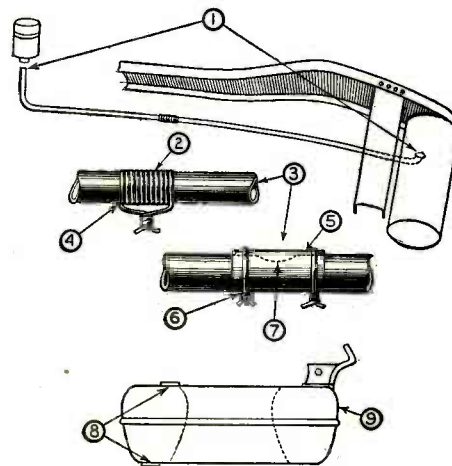
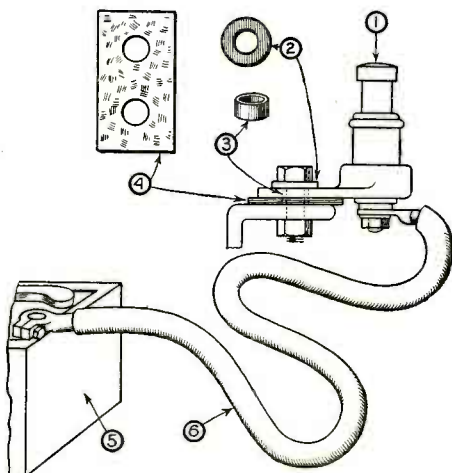

Repairs on leaking floats and gas lines can be made as shown at the left, 1, indicates that the gas lines have been disconnected, 2, copper wire, 3, shows two repair methods, 4, solder, 5, shim brass, 6, wire holder, 7, brass sweated to pipe, 8, shim brass sweated over hole, and 9, vacuum tank or carburetor float.

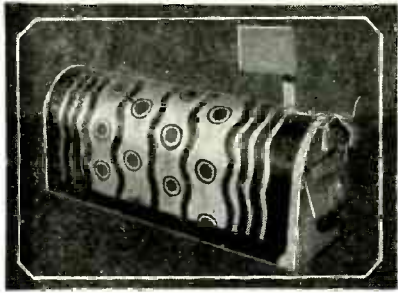

A few meaningless wavy lines and spots circumscribed with lines change the appearance of a common letter box.



The painting on this letter box is sort of fantastic. It represents a house within a stone enclosure.

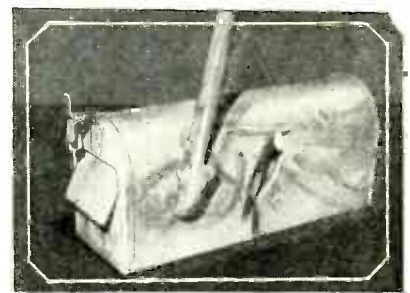

Mr. Bird is the owner of this letter box. Note the bird painted thereon and the signal flag converted into a twig.

How Rural Letter Boxes Can Be Beautified

Artistic LETTER Boxes

By JOSEPH H. KRAUS

WHILE rural boxes are serviceable, no one can when stretching the imagination, possibly accuse them of being artistic. Nevertheless, even such a simple article can be made an object of beauty and character. There are many ways to effect simple changes at a comparatively slight expense. A little patience, a small amount of ingenuity, and an idea to instill some definite meaning into the inanimate letter box is the prime requisite.

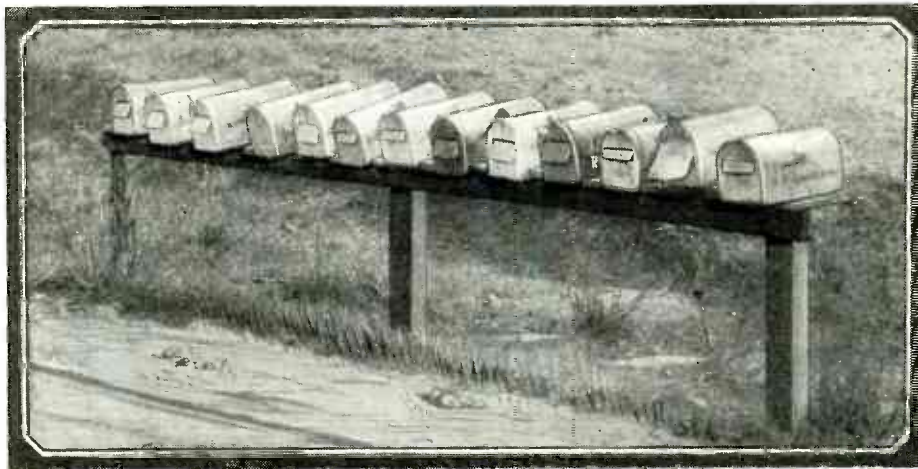

A group of letter boxes of this nature, along what might otherwise be a picturesque roadway is an eye-sore to everyone visiting the locality. However, since boxes are a necessary nuisance, being put there for convenience of the rural mail service, as well for the residents in the vicinity. By spreading them further, or putting them on separate posts, and painting or decorating in accordance with the suggestions on this page, they can be made both attractive and interesting.

The expense is of minor import. Paints can be purchased in very small cans, amply sufficient to decorate several letter boxes. Thin strips of brass or copper are easily available, and are, likewise, inexpensive. Of course, this striping is not at all necessary in carrying out some of the decorative plans. It is seen in the letter box resembling a pirate's treasure chest.

Metallic cements and various other (Continued on page 858)

Only a few of the pleasing effects obtainable have been illustrated here as examples of what can be done to beautify the lowly post box with a few cans of paint and several brushes.



The owner of the letter box at the left advertised the fact that he went out to California, and actually arrived there. A little paint and the trick was done.

David Gray considers that mail is a most valuable treasure, so accordingly he redesigned a letter box into the shape of a pirate's treasure chest.



Southern home cooking even extends its welcome from the mail box indicated in the photograph below. The cook is at the door inviting you.

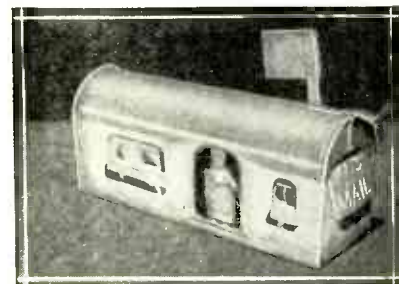

An ardent yacht enthusiast permitted his artistic ability to portray itself on the box below. Needless to say, the appearance is much improved.



Our thoughts bring us back to the Orient, when we see a letter box decorated in the manner below. No change has been made in the original construction.

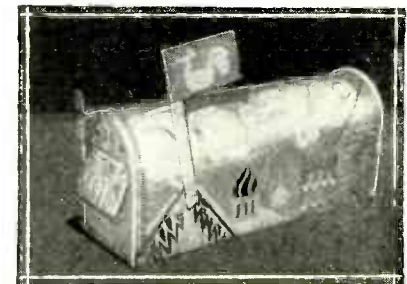

Did You Ever "See" a Voice?

SOUND can now be seen and light heard by means of equipment developed by John Bellamy Taylor, consulting engineer, of the General Electric Co., at Schenectady, New York. The equipment used is a photophone utilizing the newly developed amplifiers and photo-electric cells. In demonstrating the photophone, the inventor uses phonograph records with the sending apparatus.

A phonograph pick-up is connected to an amplifier, the output of which is led to two fine wires on either side of which is a small magnet. A small mirror attached to the wires, thus vibrates with the voice or sound. A beam of light sent through a lens is focused on the mirror. The varying light beam passes through a condensing lens and strikes a photo-electric cell, where it is converted into electric energy, which is amplified and caused to reproduce sound again through a loud speaker. The voice, as well as phonograph programs, can be sent over a light beam. The tiny mirror is only one thousandth of an inch in area and receives light from an ordinary automobile headlight incandescent lamp. The difference between sending sound over a beam of light and by means of radio is one of degree. The transmission is the same in both instances except that different transmitting and receiving apparatus is used. When using light as a transmitting medium, frequencies as high as several hundred trillion per second give wavelengths of a fifty-thousandth of an inch. Radio waves

Sound is now made visible and light can be heard by means of apparatus developed at the General Electric Labs. The light of a match produces a crackling sound and a small flashlight makes a noise similar to a siren.

spread out in all directions, but the beam of light is essentially directional and by using a beam-forming lens or a reflector, it can be sent over distances without much of a spread. Because light waves are so short they will not pass through obstructions as will radio waves, and will only pass through transparent objects. Mr. Taylor has been able to send sound

over a beam of light during the day across a street and at night the beam may be projected three or four miles. A light beam as a system of communication where radio or wire communication is impractical or impossible, may well be used during the time of war. The illustration reproduced here shows in simple picture form the essential parts of the light beam transmitter.

In 1893 Alexander Graham Bell, the inventor of the telephone, used small pieces of charred cork enclosed in glass tubes placed in the focus of a parabolic mirror. The earliest photophonic receivers seemed to respond to the heating effects of a

beam of light, rather than to the pure action of the light alone. In order to increase the range, parabolic mirrors should be employed at both the receiver and the transmitter. The transmitter is sometimes made in the form of a powerful arc searchlight. With arrangements such as these, it has been found possible to transmit speech from 15 to 20 miles in good weather. This system of voice transmission was one of the first "wireless" telephone schemes used.

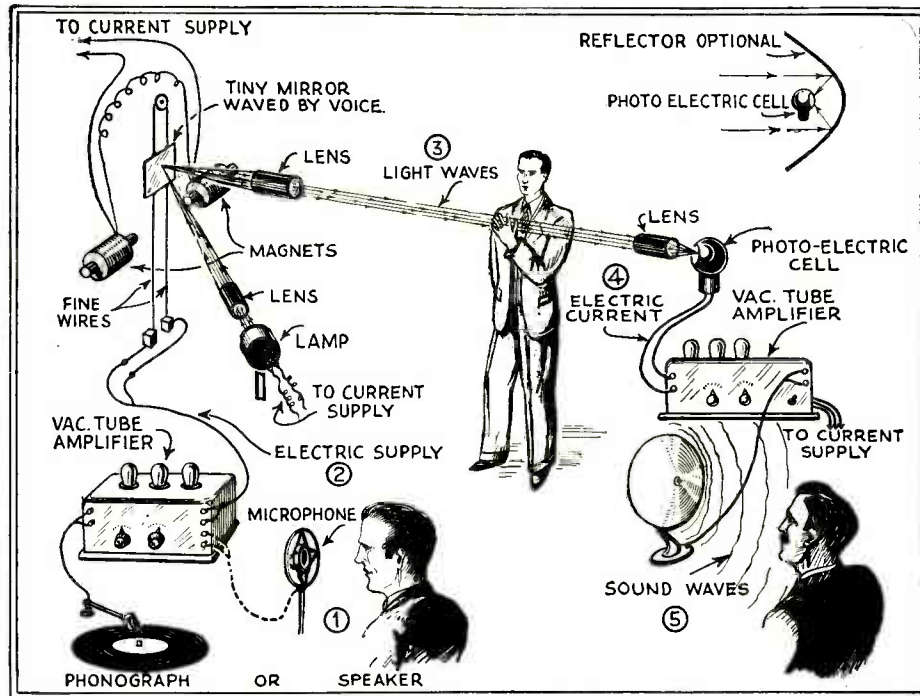

The above illustration shows the principle used, which is nothing more than the photophone. Phonograph records are used at the transmitter shown at 1, and the energy 2, is sent over a light beam shown at 3. Here it strikes a photo-electric cell, which transforms the light impulses into electrical energy, 4. This electric current is amplified and reproduced in the usual manner as shown at 5.

CAN YOU ANSWER THESE QUESTIONS?

1. What is the sixth sense? (See page 793.)
2. When a woman, who is herself not a bleeder, marries a normal man, will the sons or daughters be bleeders? (See page 794.)
3. How is the rare gas neon now used to indicate to aircraft the direction of the wind at a landing field? (See page 798.)
4. The Graf Zeppelin contained how many bags for fuel gas? What number of bags for lifting gas? (See page 800.)
5. What is the diameter of the largest vehicular tunnel in the world and where is this tunnel located? (See page 806.)
6. Can you explain how the steel lining of a modern 8-inch cannon is shrunk into place? (See page 808.)

Form Your Own Answers Before Turning to Page Indicated

7. How is "home movie" negative film stock developed into "positive" film, ready for projection? (See page 810.)
8. Do you know that a sensitive electric galvanometer is now employed to record earthquakes in distant parts of the earth? (See page 816.)
9. Name twelve greatly needed inventions which would make fortunes for the successful inventors. (See page 818.)
10. Do you know how words are spelled out, letter by letter, in trick movie titles? (See page 826.)
11. What do you know about the simple chemistry of waxes and oils? (See page 830.)
12. How would you locate trouble on your alternating current radio receiving set? (See page 844.)

INTERESTING TRICKS FOR ANY ENTERTAINER

Tricks for Amateur,
Parlor, Lyceum and
Professional Entertainer

MAGIC

By
DUNNINGER

NUMBER SIXTY-FIVE OF A SERIES

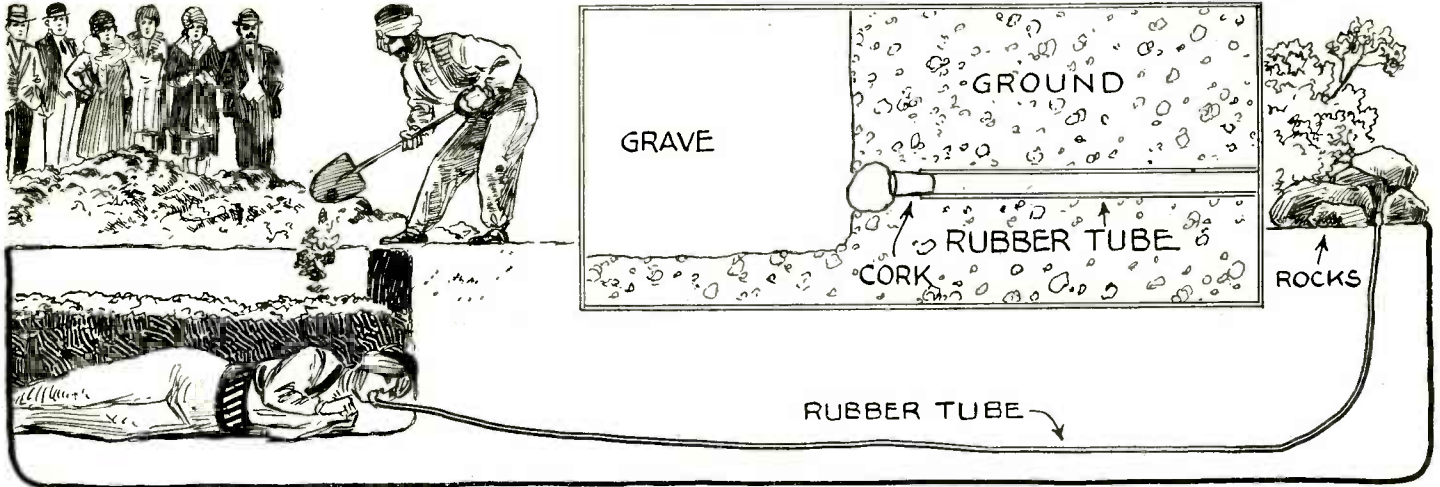

In this illustration we find a version of a "Hindu Burial." It will be observed that the grave although seemingly unprepared has been dug at a spot where the subject can easily get at a rubber hose leading through the ground and terminating in a pile of rocks some distance from the burial spot. He can breathe through this tube

for several hours. It will be noticed that the end of the tube near the grave is corked and then covered by a small stone making it easy to locate the tube yet effectively concealing it from those who may be curious enough to examine the grave. There are, of course, other ways of performing this trick, but this is one of the simplest.

The Flying Coin

THE requirements for this trick consist of an unprepared glass tumbler, a paper cylinder which can be made up just before the trick is presented and a rather thick book. All of these articles are passed for inspection. When returned to the wizard he places the tumbler on the book and then covers this with the paper tube. He next asks someone for a half dollar which should be marked and then handed to the magician. The magician stands twenty to thirty feet away from the cylinder and invisibly tosses the coin into the glass. It is there heard to fall with a very distinct clink. The effect is accomplished by aid of a metal tube housing a spring and coinholder which when released tosses the coin upward and into the glass as indicated by the dotted lines.

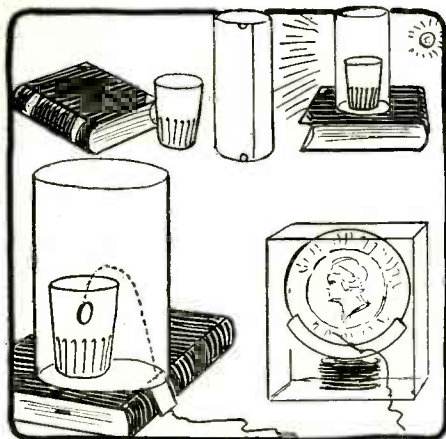

In this effect a glass is placed on a book then covered with a cylinder and a coin previously vanished invisibly leaps into the glass.

The Haunted Cigarette Box

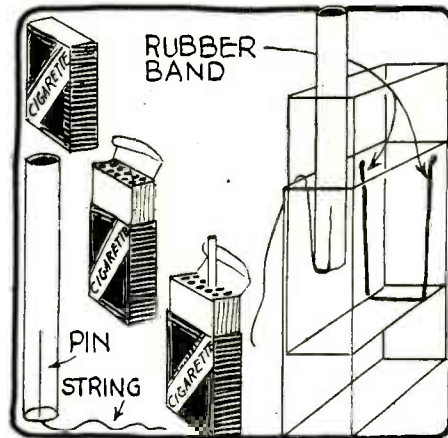

Here is a trick which anyone can prepare at practically a moments notice. The box arises automatically and after that a cigarette moves up from it.

THIS is an exceptionally good pocket trick, quite amazing in effect, and requires but very little preparation. A request for a cigarette is a rather common occurrence and with this in mind the magician has prepared beforehand for something bound to startle his spectator. In effect, the magician takes a pack of cigarettes from his pocket, makes some mysterious passes over the top, the box rises, opens, and a cigarette pushes its way out of the center. The only paraphernalia required is a rubber band, a piece of black thread and a pin. The rubber band is threaded through the outside cover of the cigarette box as indicated and one of the cigarettes is prepared with the thread and pin. Releasing pressure on the cover causes the contents to rise and pushing the box forward brings the cigarette out of the package.

The Mystic Envelope

THIS effect can be converted from one form of presentation to another. Either the card can be changed to an envelope or the envelope can be converted to a card. We will describe but one form of presentation. A deck of cards is shuffled and a card removed. This is found to be the deuce of diamonds. The index only is shown to the spectator. He calls the card aloud and at the same instance an assistant presents the magician with an envelope. Quick as a flash, the envelope changes to a card which happens to be the missing two of diamonds and on looking through the deck it is not found therein. The flap of the envelope permits of the rapid card change. The illustration shows why the deuce cannot be found. It was previously removed from the deck and the index of the tray of diamonds changed to a deuce. This card is forced.

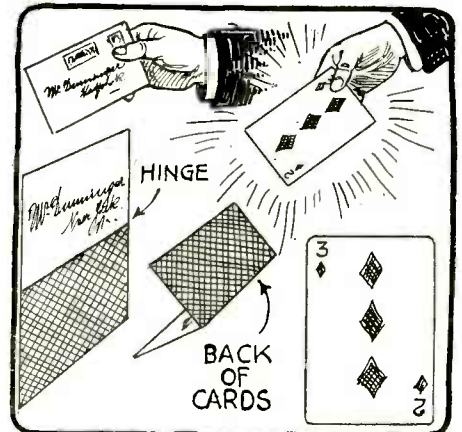

This diagram indicates how an envelope can be made so that it is converted almost instantaneously to a card.

MODEL DEPARTMENT

Steam Roller Wins Prize Cup Award

MR. HARRY L. WOODSON wins the January model trophy with his working model of a steam roller shown here. It is entirely of metal construction and complete even to the extent of a reversing lever, pressure gauge indicator and safety valve. The fuel tank is placed at the rear and gasoline is fed by pressure to the steam boiler. Two cylinders are provided with a cock for starting and stopping. The model can be steered by turning small hand wheels at the front which operate on the forward roller. A reversing lever and a condensation drain have also been provided details of these will be seen in the drawing. A gear drive operates on the rear roller as shown in the photo. The item was constructed of scrap parts.

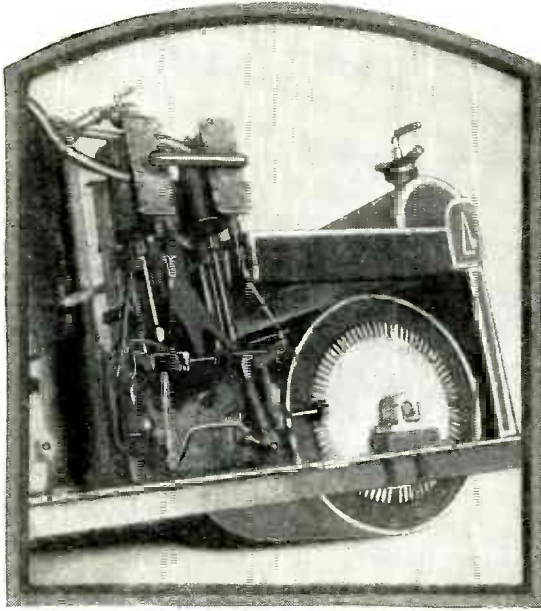

Above—details of engine.

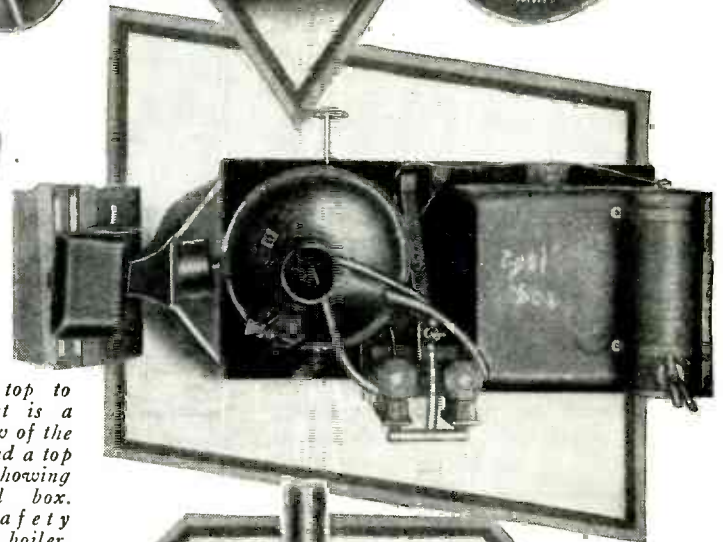
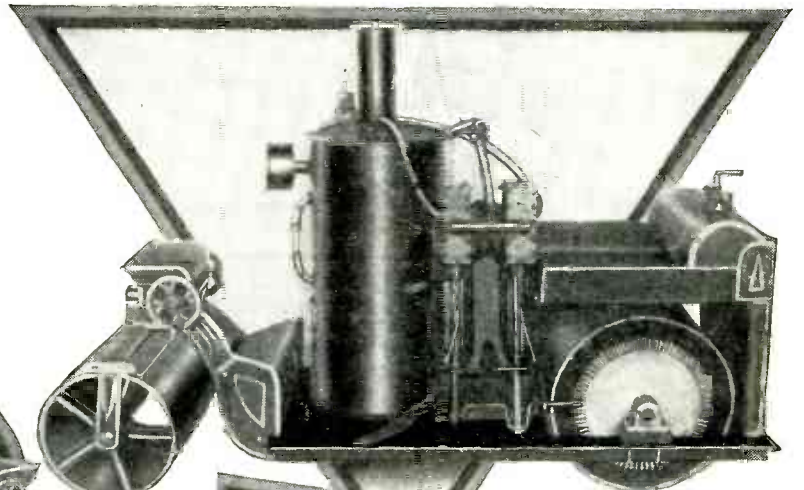

At the top to the right is a side view of the roller, and a top view showing the tool box. Note safety valve on boiler. The arrangement of the cylinders is clearly shown in this photograph.

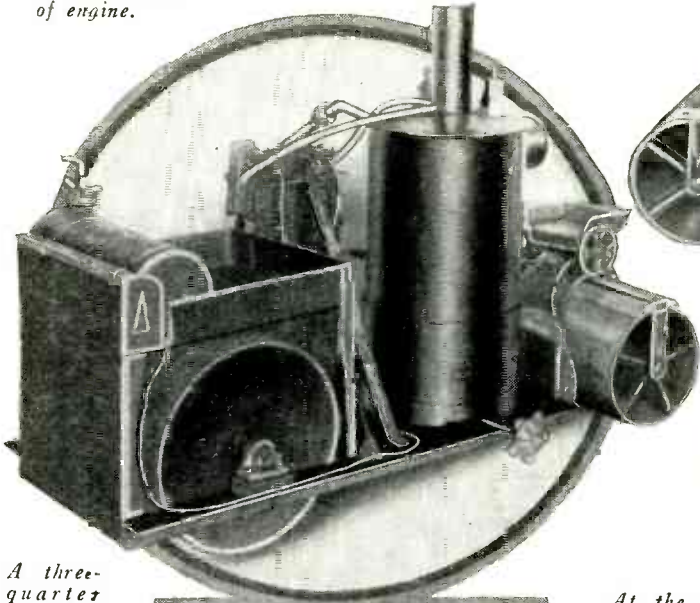

A three-quarter rear view showing the fuel tank and feed line appears in the above photo.

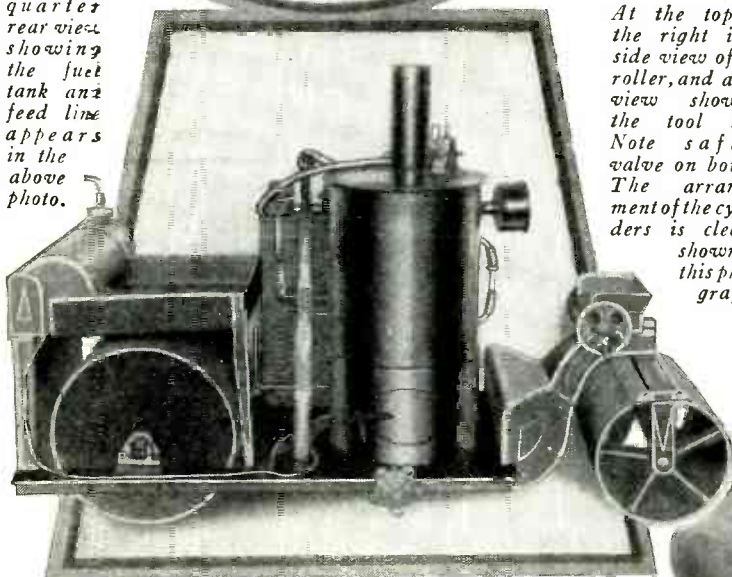

The above illustration shows the placement of the pressure gauge which was made from an old oil-pressure indicator.

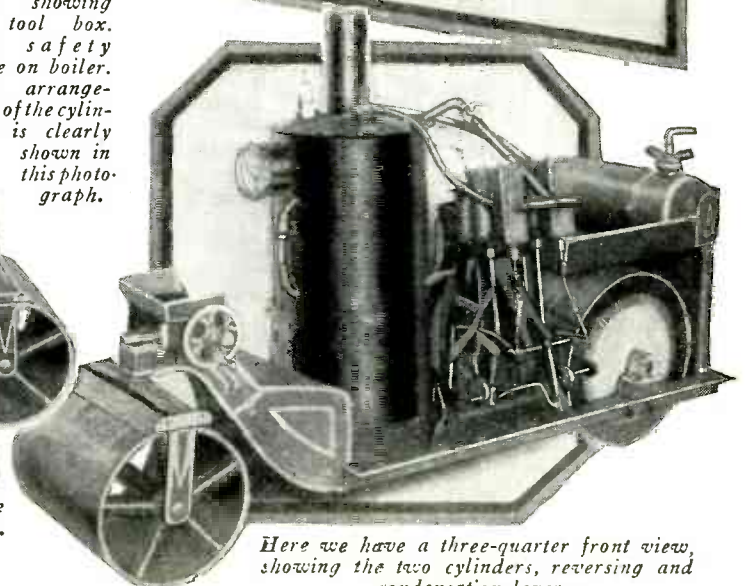

Here we have a three-quarter front view, showing the two cylinders, reversing and condensation levers.

Details for Constructing Steam Tractor Model

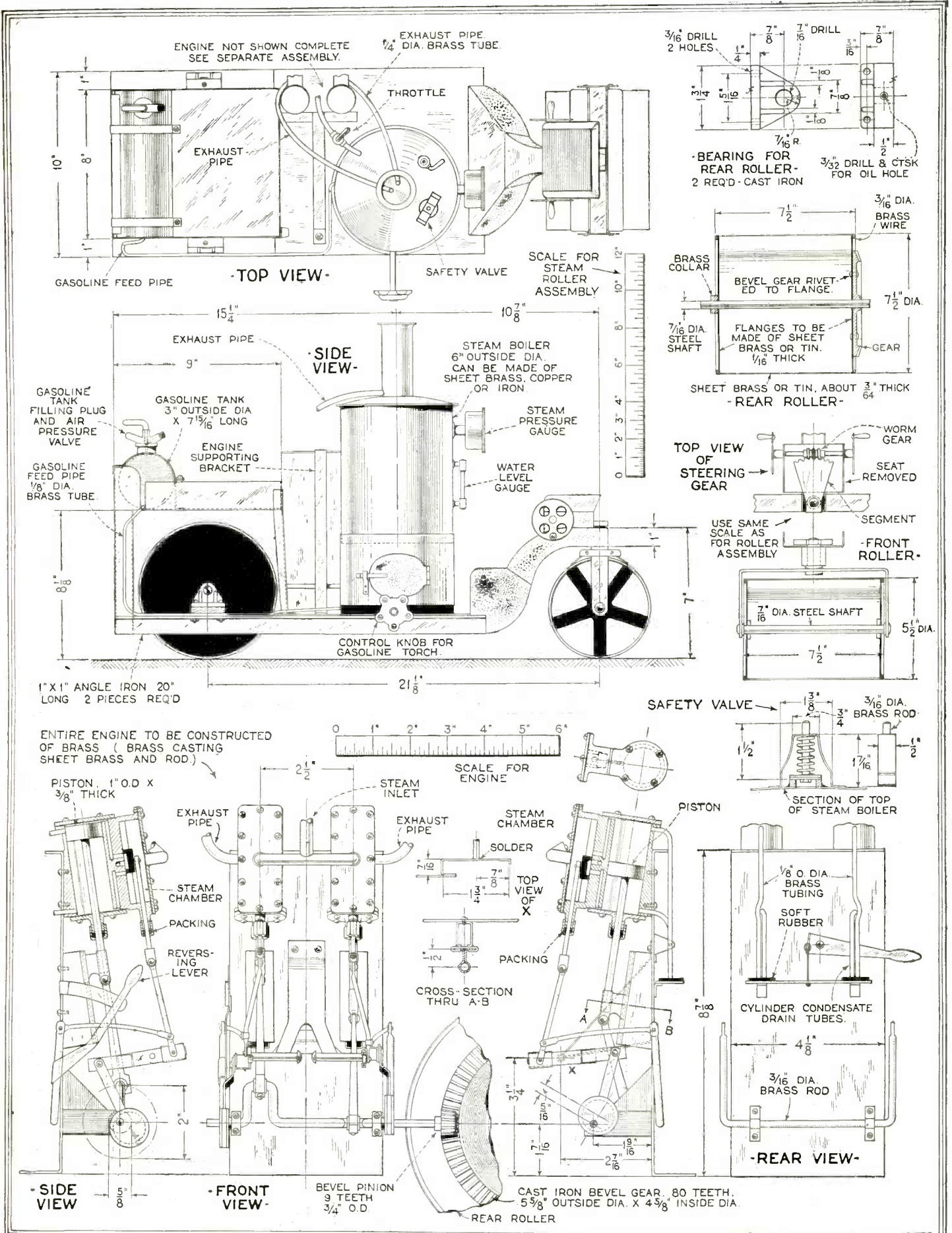

The illustration above gives the essential details for the construction of the steam tractor model which won the prize in this month's model contest. Most of the material is easily available in any store. Two

scales are provided for checking dimensions, and the builder can call upon his own ingenuity to aid him in completing minor details. Rules for model contest will be found on page 893.

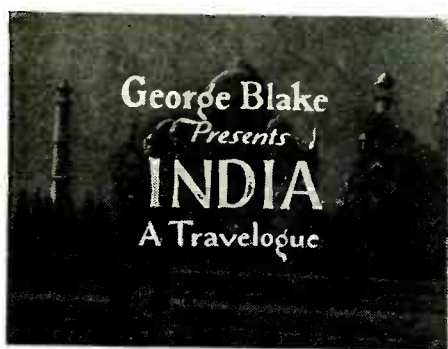

Fig. 1. A "negative" art title, to be used with negative or reversal film.

How to make trick and unusual titles for the home film. Animated titles which have a background in action and tricks with paper letters, form a means of giving a professional touch to the amateur moving-picture. The "spelling word" effect in which the letters are jumbled and finally resolve themselves into a title is here explained for the amateur movie fan.

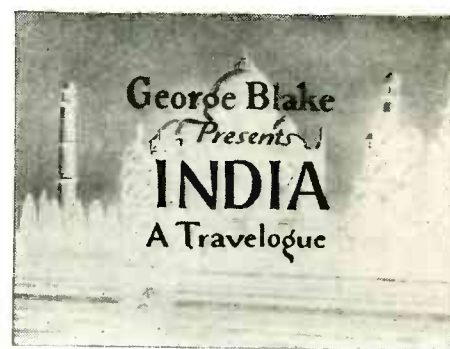

Fig. 2. A still picture photostated in the reversed color.—Courtesy Kodascope Ed. Service.

Home Movies

"Main titles" similar to those seen in professional films can be produced rather easily, with no artistic ability required.

"THERE seems to be only one thing wrong with my titles, Mr. Jones, and that is that the letters are not clear white on the screen. They seem grayish and indistinct. Why is it?"

"That's probably caused by over-development, Mr. Blake. Leaving the film in the developer too long causes the clear places to develop out and become gray. Develop a test strip and project it before you develop all your film."

"I have titles all through my films but it seems to me I should have a 'main title' to make them seem more nearly like the professional films. I am not an artist by any stretch of the imagination and it seems hopeless to me."

"I wouldn't say it was hopeless. You see there are several easy methods of making an artistic main title without any artistic ability. Perhaps the easiest of all is to take a still picture that fits the subject and letter the title on in white ink (Fig. 1). This is set up on your title easel and photographed with the regular reversal film, allowing about five feet of film. Fade in and fade out with the diaphragm of the lens, using one foot to fade in and one to fade out. This leaves your title in the clear for about eight seconds, which is plenty long enough. If you can't hand-letter and want to print the title with your type, have a photostat made of the still picture to the exact size. Then print your title on with type as if the picture were just a plain card. You will find it best to back the picture up with a piece of card so as to get a good even impression. Photograph this exactly the same as your other titles but develop it separately. (Fig. 2.)

Animated Titles

"THIS main title can be made more interesting by having the background in action. No, it is not as difficult as it sounds. All you need do is determine the amount of film you need for the title and then go out and shoot whatever background you want. Cut your exposure in half; if the scene calls for f:11 give it f:16. For a scenic film

Conducted By
DON BENNETT

The regular titles which appear throughout the body of the film can be "dressed up," producing many novel effects.

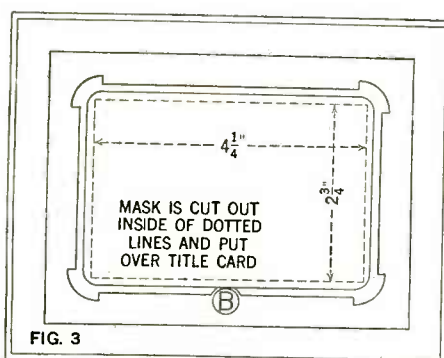

FIG. 3

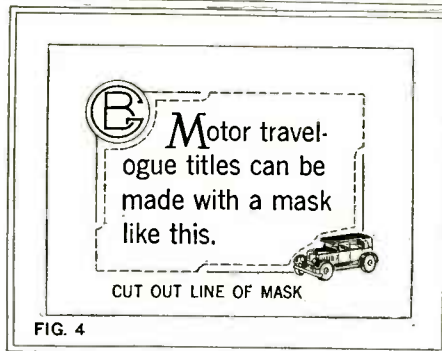
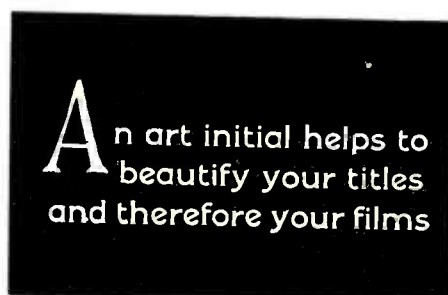

FIG. 4

A fancy art title of rather ornate design bearing the maker's monogram and a descriptive sketch is shown above in Fig. 4. Fig. 3 shows a title having a simple line border around it. These borders are drawn on a piece of paper with color reversed.



Above is an example of an art initial title which helps to beautify the home film.

a waterfall or brook makes an ideal title background. Keep the background as dark as possible, avoiding sky or brilliant water shots. It might be well to fade in at the beginning and fade out at the end. When you return home go into the darkroom and rewind your film to the point where you started. With this in mind it is well to have your background shot at the beginning of a roll, as the paper leader is a perfect mark for locating where to start on your title.

"With the film in place for the second shot, set up what is known as a *negative card*, that is, a black card with white letters. This cannot be printed on your press but must be either hand-lettered or else a photostatic copy of one of your printed cards. Give the regular exposure for this card, fading in and out at the proper places. You must make note, of course, of the proper footages, where you start and stop, and you must be careful to reset the footage dial when re-threading. When the film is returned from the finishing laboratory you will have a nice animated main title that should excite admiration among the members of your audience."

What to Put on Titles

"WHAT should be on the main title, Mr. Jones, in addition to the name of the picture?"

"Nothing. All credit lines should be carried on a second title which may or may not have the same background as the main title. The two titles should properly dissolve into each other but as this is difficult with amateur cameras, we simply fade-out on one and fade-in on the other. If you decide to use the background only on the main title, shoot the following titles plain. Do not use different backgrounds."

"How can I dress up my regular titles, those that are scattered through the body of the film?"

"There are several ways. You can initial them by leaving a space on the left-hand side of the two top lines of the title and putting the initial in by hand, or you

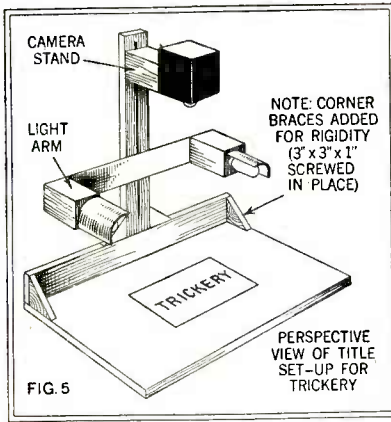

Fig. 5. The title outfit is shown above and it requires only a little patience to make trick titles with a set-up of this nature. The easel lies flat on the table and the camera points down on it.

Trick titles are, for the most part, easy to make, it requiring only a little patience to make them. First, we must turn our title outfit up on end so that the easel is flat on the table and the camera points down at it (Fig. 5). There is only one thing that you must watch here and that is the right-side-up position of your titles. As I explained to you some time ago, when the camera is held upside down, the picture will show in reverse motion on the screen, providing, of course, that you turn the piece of film around and splice it in so that the subject is right side up on the screen.

Tricks with Paper Letters

WE take advantage of this peculiarity in making trick titles; we don't build up to a title, we make it perfect first and then destroy it! Let us take an example. On this white card we will lay out these black paper letters to form the word 'Trickery.' We do not gum them in place, simply lay them in their proper position on the easel with the top of the word toward the camera pedestal. This will make it look upside down in the camera finder. Expose two and one-half feet of film on the set-up. Now the work begins. All movements of the camera from this point on are made by *single exposure*.

"Take a needle and sink it into a cork. This gives you a tool for moving the letters around without the danger of leaving fingermarks on the picture. With your needle, pull the 'I' down until half of it projects below the rest of the letters. Make one exposure. Pull it down until it is clear. Make another exposure. Swing the bottom of it to the right until it reaches an angle of about thirty degrees. Make one exposure. Swing it to an angle of forty-five degrees. Make an exposure. Now pull it down about a third of its length along this forty-five degree line. Make an exposure. Pull down another third, make another exposure. Continue this for six moves. Then swing the bottom again until it reaches an angle of about thirty degrees to the horizontal. Make an exposure. Swing it another fifteen degrees to the horizontal and make an exposure. Now swing it until it lies flat. Make three exposures (Fig. 6).

"Now swing it again, this time using what was the bottom as a pivot and push the top to the right until it becomes vertical. This should take about five frames, each frame constituting a single exposure. Now push it up vertically until it is level with the bottom of the other letters. This should take five frames. Let it rest there for two frames. Pull it down a fraction, make an exposure, push it back up and make an exposure and repeat this three times. Then pull it down at a slight angle from the vertical toward the right, making single exposures all the way, moving the letter about one-third its length at each step until finally it moves out of range.

"Now pull the 'K' down one-half its height and make an exposure. Pull it down until it is level and pull the 'T' down

can have a border around. This border can be just a simple line around (Fig. 3) or it can be an ornate affair bearing your monogram and a descriptive sketch (Fig. 4). These borders are drawn on a piece of paper with *color reversed*, that is, the lines will photograph in the opposite color and the black lines of the mask will show white on the screen. These masks are cut out in the center to permit the title itself to register through them.

"Trick titles are always interesting and carry an audience appeal that will show itself in the question that will be asked you, 'How did you ever do it, Mr. Blake?'

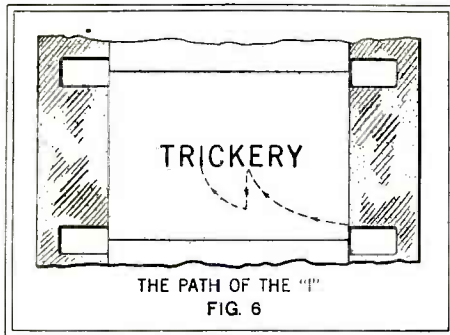

Fig. 6. The above illustration shows the path taken by the "I" when the jumble of letters finally formed the word "Trickery." A full description of the procedure is found in the text.

half-way. Make an exposure. Move the 'K' another space, the 'T' a space and pull the 'Y' down half-way. Make an exposure. Continue this with each letter and make their paths cross, that is, have the 'Y' go to the left, the 'T' to the right, all moving towards the bottom all the time, but necessarily at the same speed. Let the 'C' spin in several circles when it is about half-way to the bottom. All the letters finally disappear at the bottom and sides and the blank card is exposed for about a foot (Fig. 7).

"It sounds like a lot of work to get fifteen or twenty feet of film but it is really very simple and the effect is worth it. Here is what happens:

The "Spelling Word" Effect

ON a black screen there suddenly appear white letters. They are not in order or sequence; it is impossible to combine them. Some move stolidly upwards, some dart from side to side, one a 'C' executes a waltz and then jumps upwards. Look! they are grouping themselves into a word. What is it? 'TRICKERY.' Where's the 'I'? Oh, here it comes. Look at the dumb thing, it tries to squeeze in between the 'K' and the 'E.' Just look at it. It bumps its foolish head against the line but those others won't move. Ah, here it backs off, it discovers a place alongside the 'R' and slowly swings over toward its haven, then hesitates and finally, in one mad rush, it leaps into place. There! The word is 'TRICKERY.'

"An amusing effect is to have two of the letters bump each other several times on the way up, only to back off and start upwards again each time. One letter can reach the position upside down and then drop out and return to the position right-side up. Any number of amusing situations can be worked out.

"For a distinctive title for your personal films I would take a title such as:

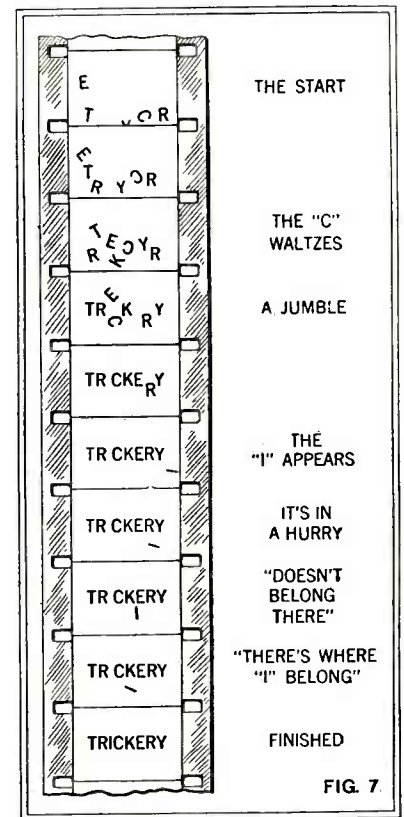
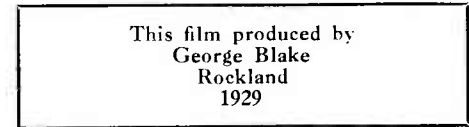

Fig. 7. The manner in which the word "Trickery" is formed with black paper letters upon a white card is well illustrated above. The "spelling word" effect adds much to the amateur film in the nature of a novelty.

Have it start as a jumble of letters that mill around, moving from side to side of the screen and finally resolving themselves into the title. When it first becomes clear, have it read, 'Produced by 1929.' Then let 1929 circle out and around as George Blake comes up the other side into its proper position. This title is made by reverse camera, the same as the other title.

"Set up the title properly, then slide 1929 to the right and George Blake to the left. Have them move in a column around the word 'Rockland,' until they occupy each other's places, and then slowly mix them together, until all the letters are in a jumble in the center of the screen. Then slowly turning the mass around, move them all over the card and finally condense them into as small a space as (Continued on page 879)



This photograph shows the start of an iris produced by an amateur with apparatus shown below. The fancy masks and light filters are pieces of apparatus that cannot be omitted from amateur equipment.

AS the usual amateur appears to have a deep interest in making photoplays for home consumption, a new effect set has been placed upon the market to enable him to secure many of the screen effects which would otherwise be impossible for him to obtain.

This set consists of a sliding base which supports the camera and the focussing microscope. The front of the base carries two supporting rods which in turn support the effect set proper. This consists, at the front, of a mask box for holding various paper, cloth or celluloid masks. Behind this is a large size professional iris diaphragm for circle effects, behind this we find a slot for the use of the professional effect filters. The whole is supported upon two vertical rods. The mounting is such that the position of the whole may be adjusted vertically or horizontally. This set carries a leather bellows, not unlike a camera bellows which extends toward the lens, acting as an effectual lens hood. This makes possible more

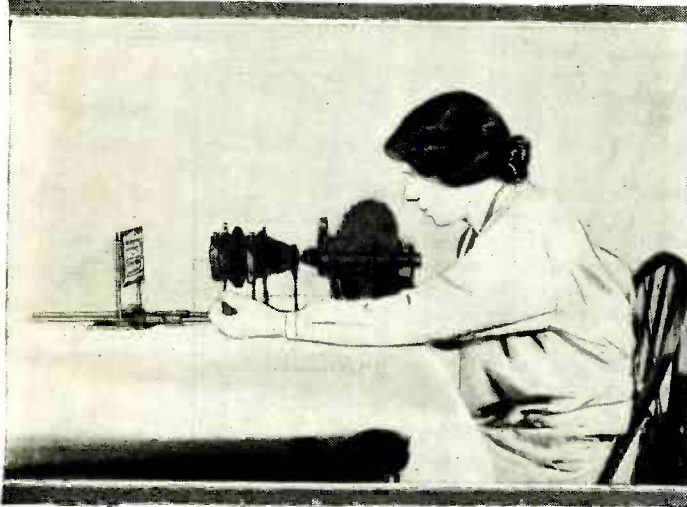

Above—Making an iris title with the new title stand. The sliding base which supports the camera and the focusing microscope are visible. Note leather bellows acting as a lens hood.

New "Effect" Device for Movies

By

HERBERT C. MCKAY

Latest apparatus enables the amateur cine fan to produce professional results with home photoplays. All kinds of titles can be made with new stand. Fancy masks, light filters, circle-in and circle-out can be made easily with this new device.



The above photograph was taken with a "club" mask supplied with the new movie set. A mask box is provided for holding various paper, cloth, or celluloid masks and a diaphragm for circle effects.

brilliant and sparkling films than would otherwise be possible.

The camera and focussing microscope are controlled by a handle which will slide them from side

to side, placing the microscope or camera lens behind the mask set opening. In this way the focussing is done directly by the eye, allowing exact composition which is so essential in this type of work.

Fancy masks, light filters, circle-in and circle-out are made easily with this device. It is a bit of apparatus that cannot be omitted from the equipment of the amateur who is making photoplays.

The short support rods may be removed and long rods substituted for making a "title stand." This carries an adjustable easel which takes title cards 4 x 5 inches. Double titles, masked titles, iris titles, animated titles, in fact any kind of titles may be easily made with this title stand.—Name of manufacturer supplied upon request.



The new effect set complete and in use is shown above. Note the special mounting which permits the camera to be adjusted by a handle which allows any vertical or horizontal position.

Tests Show Teaching Films Highly Successful

A TEST made with 11,000 children in twelve cities to determine the value of teaching with motion pictures has proven them to be a great success. 107,870 test papers were written by the children during the test period. One group was taught with motion pictures and the other without, they used the same text-books and took the same examinations, and at the end of the experiment the average of those taught with films was shown to be 24 per cent higher than that of the children taught in the regular way.

It is claimed by the educators who conducted the tests that failures of children in school can be materially reduced, and

taking Chicago as an example, they claim that the plan would result in a monetary saving of about \$3,000,000 yearly.

The experiment was conducted by the Eastman Kodak Company under the sanction of a committee of the National Educational Association. Sixteen millimeter "amateur standard" film was used, the same as is used in most home projectors. The subjects covered included geography, showing principally the products and industries of various parts of the world, and general science, showing the principles of air, water and minerals. A few of the titles of these instructional films are: "Hot Air Heating"; "Purifying Water"; "Wisconsin Dairies."

Home Movies IN NEW RÔLE

How to Take Underwater Movies and Photographs of Wild Life

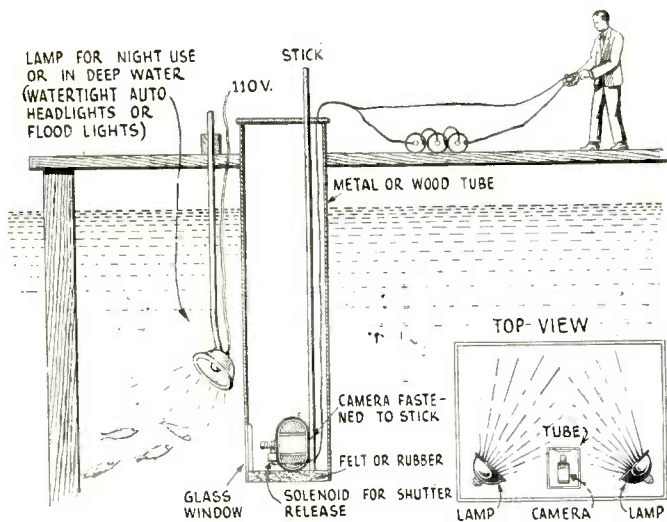

One arrangement of the underwater camera is shown above. On dark days or when photographing at considerable depths, artificial light will be necessary.

made at home, while the results obtained more than justify any time which may be spent preparing the necessary equipment.

Underwater photography can be accomplished with an amateur movie camera, such as that shown in the photographs. This is especially adapted for work of this nature because of its size and shape, and also, the position of the release. The first requirement for taking underwater movies is a tube for holding the camera which will fully protect it

from any moisture. The tube can be made of metal or wood coated on the inside with some water-proof com-

Details of the electro-magnet and its armature as arranged to actuate the shutter and motor-release button on the movie camera, are shown in the drawing at the right.

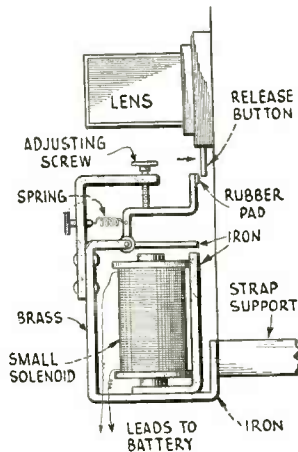

pound. Its size, of course, will depend upon the dimensions of the camera and the depth at which the movies are to be taken. On the bottom is placed a felt or rubber pad upon which the camera rests. A glass window is provided in the tube for the lens and should be absolutely watertight. The camera is fastened to a stick for raising and lowering. The release on the camera may be controlled in either one of two ways, that is, either electrically or manually.

Electrical Release

FOR releasing the shutter and motor of the movie camera electrically, a solenoid will be required as shown in the illustration which gives all the necessary details. Some of them will vary with individual requirements. This electro-magnet is strapped to the camera and when energized an electric current will attract the small iron armature which in turn pulls down the solenoid release lever which presses against the release button. A rubber pad is provided to

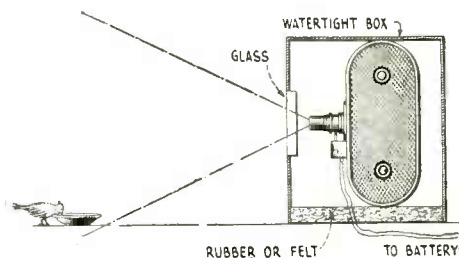

The magnetic release for actuating the control button on movie cameras will be found very useful in photographing birds, cats and dogs, as the picture herewith shows.

prevent damage to the button. The solenoid should be small and operate on three or four dry cells. A switch is provided for releasing and stopping the camera by making or breaking the circuit supplying current to the solenoid. Small electro-magnets from toy telegraph outfits or doorbells are powerful enough to be used for the purpose described here.

Manual Release

THE manual release consists of a pivoted metal lever and two pulleys mounted upon a metal support. This is strapped to the camera as is the electrical release. As will be seen in the illustration, when the control cord is pulled, the lever will push the release button, thus starting the camera. Exact details as to size will (Continued on page 877)

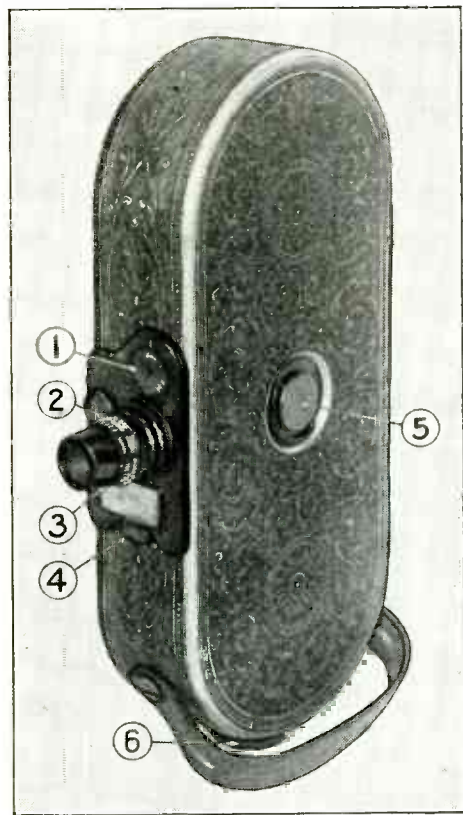

A popular model of home movie camera well adapted to the experiments here described. 1, is button turned by coin which changes view finder for other types of lenses; 2, lens openings in triplicate on lens barrel; 3, safety button; 4, motor release button; 5, camera lock for reloading; 6, tripod socket.

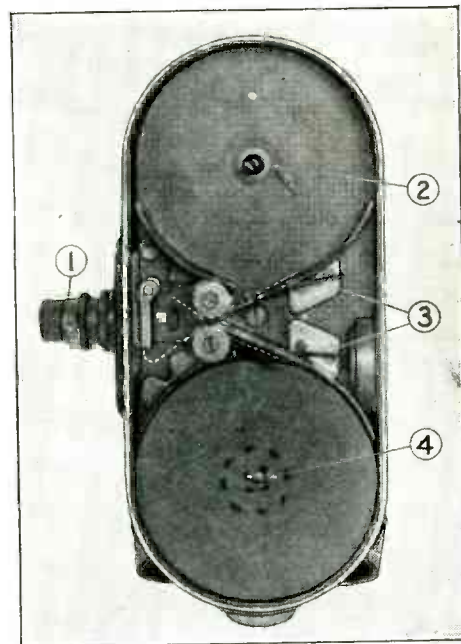

Interior view of popular home movie camera illustrated at left. 1, lens barrel; 2, stud on which reel of new film is placed; 3, release levers permitting easy threading of film around guides and sprockets, as shown by dotted line; 4, stud holding take-up reel.

EXPERIMENTAL CHEMISTRY *and* ELECTRICS

WAXES *and* OILS

By

DR. ERNEST BADE

THE vegetable, non-volatile or fixed oils together with the fats and waxes are compounds of fatty acids with glycerine and they may be of animal or vegetable origin. Of oils, the most common are cottonseed oil, linseed oil and olive oil, and of the fats tallow and lard. In the waxes, the glycerine is replaced by a simple alcohol but of higher series combined with the fatty acid. In this class we have spermaceti, a product of the whale, and beeswax.

This group is of great commercial importance and enters into our daily life. It is found in candles, soap, paints and cosmetics. The edible oils were probably the first to be made on a large scale by Phenicians and Egyptians, who gathered the fruit of the olive tree to make olive oil. Other oils were later developed and used for illumination and soaps. It was Pliny who described the first oil press.

The oils and fats are arbitrarily divided into these two types, the former being liquids, the latter solids, but all kinds and conditions are not covered by this simple division. Therefore the two types have been divided into four classes, the non-drying oils, the drying oils, train oils and the hard fats, the latter being compounds containing palmitic acid.

The acids from these compounds may be obtained by saponification and acidification of the soap obtained. The saponification is easily carried out by means of a caustic alkali, such as sodium or potassium hydroxide dissolved in water. The oil or fat is heated, the caustic solution added and the mixture is well stirred. When saponification is complete, the acid, usually hydrochloric acid, can be added directly, whereby the alkali is torn from the fatty acid, the fatty acid being liberated and, since it is insoluble in water, it rises to the surface. It can be removed by decantation. For rapid saponification the caustic alkali is dissolved in alcohol.

The quality of a soap can be determined by estimating the free alkali in it, for free alkali is objectionable in toilet soaps. Dissolve a small portion in alcohol. Add a drop or two of phenolphthalein indicator. If

the solution turns red, free alkali is present. The amount of moisture a soap contains is estimated by weighing and heating a sample to 110°C until the weight remains constant.

An ester is a salt of an organic base. The acid may be organic or inorganic.

Cocoonut oil consists primarily of the glycerine ester of lauric acid, but other esters are also present such as capric caprylic and myristic among others, but they all give reactions similar to the ester of lauric acid when saponified. A small quantity of soap may be made by heating 30 grams of cocoonut oil with 6 grams of sodium hydroxide in 15 cc. of water. Add the caustic alkali solution slowly while stirring. When creamy, add about 25 cc. water and salt. This precipitates the soap, and when cold, filter through muslin, and press into a cake. To obtain the lauric acid, dissolve the soap in a little water and add hydrochloric acid. Here the sodium of the soap is taken up by the acid forming sodium chloride, the lauric acid being displaced. The acid is insoluble in water and floats on the surface.

Butter may be substituted for the cocoonut oil and, after saponification, the soap is placed in a flask. Then acidify the soap and the butyric acid is set free, which is then obtained by distilling the mixture in the flask, the volatile fatty acid collects in the distillate as a dilute solution—a simple operation.

Any of the glycerine esters of the fatty acids may be prepared by this general method, even the acid of linseed oil is thus obtained. Here it may be mentioned that the linseed oil acid dissolves resins much more readily than linseed oil itself, especially the harder copals and it has been successfully used to make the harder varnishes.

A curious complex containing two fatty acids, with glycerine and phosphoric acid is known as lecithin. At times the acid radicals may be the same, at others they may be different, as for instance, oleic and palmitic acids. This peculiar substance may be obtained from the yolk of a hard-boiled egg. Grind the yolk fine, and extract (Continued on page 887)



Above—filtering off the soap through a piece of fine cloth. Cheese cloth may be used for the purpose.

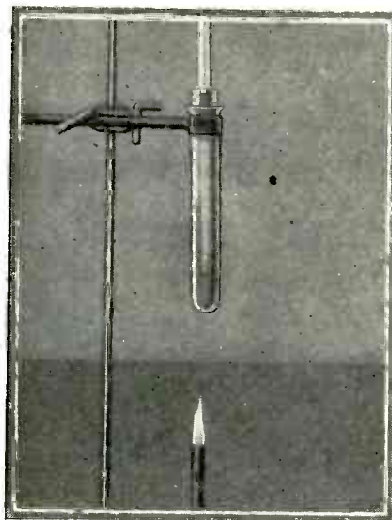

Above—determining the melting point of wax with the melting point tube. The purity of beeswax is thus indicated.

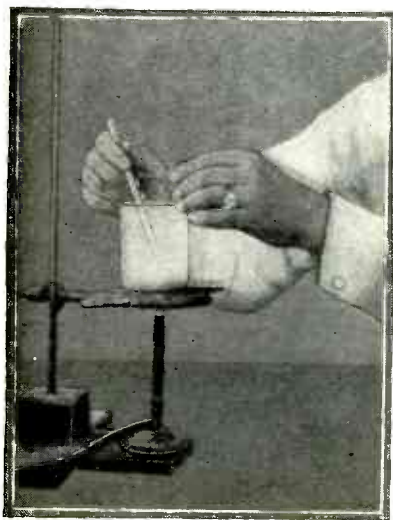

Heat 30 grams of cocoonut oil with 6 grams of sodium hydroxide and 15 c.c. of water, add the caustic slowly while stirring the oil and water as shown in the above photograph.



Free lauric acid which floats on top of the water can be obtained by dissolving the soap in water and adding hydrochloric acid. Lauric acid is found in cocoonut oil.

A Few "Brain Teasers" for the Electrical Student. Read Each Question Carefully and Then Go To It.

<p>No. 1—How will the three groups of lamps A, B and C light, when connected to the line? All are 50-watt 220-volt bulbs.</p>	<p>No. 2—If a lamp is arranged as shown, with the wire wound around a column, is it better to use alternating or direct current?</p>	<p>No. 3—What will happen if the primary of the transformer is connected to a direct current instead of alternating current circuit.</p>	<p>No. 4—Two wires connected first in series and then in parallel, one of copper and the other niguelin, behave peculiarly. How do you explain this?</p>
<p>No. 5—If you wanted to construct a transformer and have on hand the wire, iron core, and an electric lamp, how would you do it?</p>	<p>No. 6—Above—Which of the ammeters shows the greatest scale deflection, and what reading does the voltmeter give?</p>	<p>No. 7—If oil or grease is applied to the antenna switch, so that the contact is poor, what will happen while listening?</p>	<p>No. 8—Is it possible to completely charge a 180-volt battery connecting it to the 200-volt line as shown above?</p>

Question One

THREE groups of lamps are connected as shown in the diagram. The lamps are all the same, being 50 watt 220 volt bulbs. How will the three groups, A, B and C, light?

Answer to Question

Group A, being connected in parallel, give normal light. Group B, which is connected in series, gives a dim light, and Group C, having only one side connected to the lines, gives no light at all.

Question Two

Suppose the lamp is to be lighted and the wire is wound around a pole as shown. Will it be better to use alternating current or direct current?

Answer to Question

The windings will act as an impedance, therefore direct current is to be preferred, as this will give more brilliant light because the ohmic resistance is not affected by the windings.

Question Three

What will happen if the primary of the transformer is connected to the direct current lighting circuit, instead of an alternating current source?

Answer to Question

If the ohmic resistance is great, there will be a flow of constant current through the primary, and no current will be induced in the secondary. If the resistance is small, the fuses will blow out and the wire of the transformer may burn out.

Electrical Problems

By

RICARDE LUDEKE

Question Four

If you connect two wires, one of copper and the other of niguelin, in series to a battery, the niguelin becomes incandescent while the copper remains practically cold, but connecting the same wires in parallel, it is the niguelin which remains cold while the copper wire becomes very hot. How do you explain this?

Answer to Question

The heat generated in a conductor depends on the resistance and the square of the current which flows through the conductor.

$$\text{Heat} = R \times I^2 \text{ (Joule's law)}$$

In the first case the current is constant, and the same for the copper and niguelin wire, but since the resistance of niguelin is higher the heat is greater in this wire. Connected in parallel the current which flows through the conductors is greater in the copper wire (having less resistance) than in the other and being directly proportional to the square of this current, it will generate more heat in this wire than in the niguelin, regardless of the higher resistance of the latter.

Question Five

If you want to construct a transformer which steps up 110 volts to 550 volts and you only have at hand the wire, the iron core and an electric lamp, and you know nothing about calculations, diagrams, etc., how would you proceed to determine the exact windings of the primary and secondary?

Answer to Question

Knowing that the impedance of a good transformer must be such that no current flows through the primary if the secondary is open, you begin winding, (Continued on page 856)

THE CONSTRUCTOR

Electric Thermostats

By HERMAN R. WALLIN

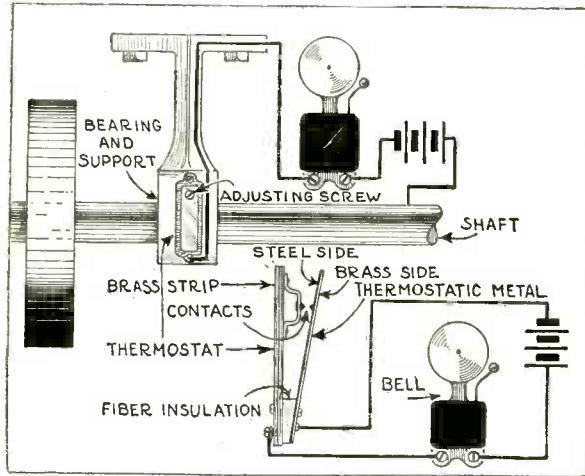

The above illustration shows a thermostat used for detecting overheated bearings on shafts in remote places.

A NEW metal known as "thermostatic metal" has recently been put on the market but its properties and uses are not generally known. However, it can be put to use in a variety of ways. Some uses have been illustrated here, and others will undoubtedly suggest themselves to the experimenter. The metal is obtainable in any size and consists of a strip of steel and a strip of brass rolled together to form one sheet. When heated the metal bends in an arc with the steel on the inside, due to the difference in co-efficient of expansion between the two metals. Various thicknesses can be obtained for use with different temperatures. One use for a thermostat is the detection of overheated bearings. The thermostat is fastened to the frame of the bearing and is connected with a red light or bell placed in a conspicuous position. When the bearing becomes hot, the contacts of the thermostat will close, thus giving a warning signal. One of the wires may be grounded to the shaft and any number of bearings protected in this manner.

Constructing a Thermostat

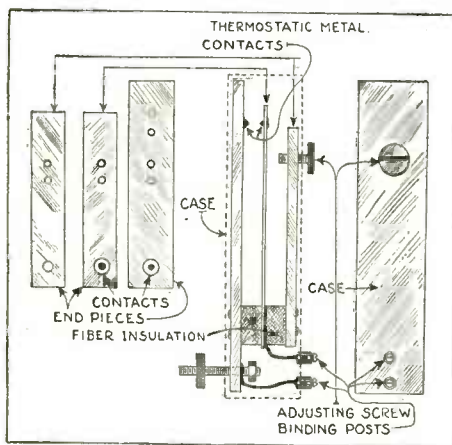

The illustration at the left gives the constructional details of a simple thermostat. Contacts are hammered to the thermostatic metal and one of the supports. The outer support has an adjusting screw, although this is not essential.

The illustration at the right gives the details of an experimental self-adjusting arc which can be made without using complicated apparatus. Thermostatic metal is used for one of the upright supports. Slate or marble is employed for the base.

Self-Adjusting Arc

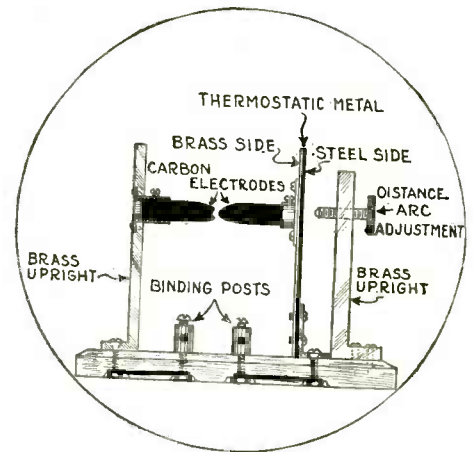

THE thermostat can be used in conjunction with any heating device to break or make a circuit. A simple device of this type uses a piece of thermostatic metal about 1½ in. long, and for general purposes can be made as shown in the illustration. In use, contacts which are hammered to the metal and one of the supports, are separated about ¼ in. When heat is applied the metal bends inwardly.

A PRACTICAL use for the simple thermostat shown here is in the automobile for detecting an overheated radiator. The device is fastened to the radiator on the inside under the hood. The distance between the contacts is adjusted by spreading them apart for the required temperature. This can be determined after a few trials. A small panel light such as used on radio sets is installed on the dashboard and serves as a visual indicator when the radiator becomes too hot. This small 6-volt bulb is connected in series with the battery and thermostat as shown below. If desired, one side of the thermostat may be grounded to the metal frame of the car, thus doing away with one wire. The thermostat should be housed in a metal box for protection and the adjusting screw may be allowed to project through to the outside for added convenience. For higher temperatures thicker strips of thermostatic metal can be obtained. A popular size, however, being strips ¼-in. thick. Two binding posts for making the necessary connections should be placed on the metal case separated therefrom with a suitable insulator.

Overheated Radiator Indicator

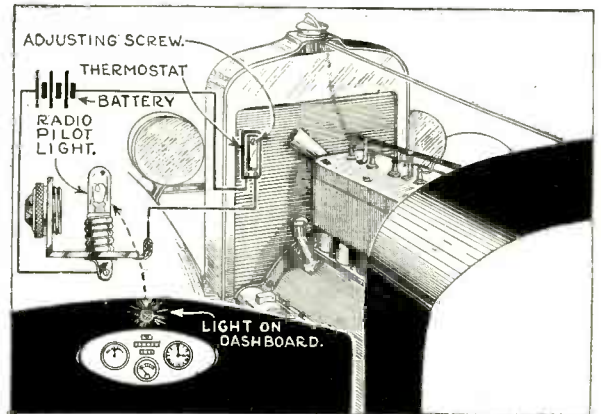

Above—A thermostat as overheated radiator indicator.

A SELF-ADJUSTING arc can be made by attaching one of the carbons to a strip of thermostatic metal. An adjusting screw is placed just in back of this upright and is set so that when the thermostatic metal is bent back and touches the screw, the distance between the electrodes is just right. Normally, the carbons touch each other, but when the current is turned on they separate.

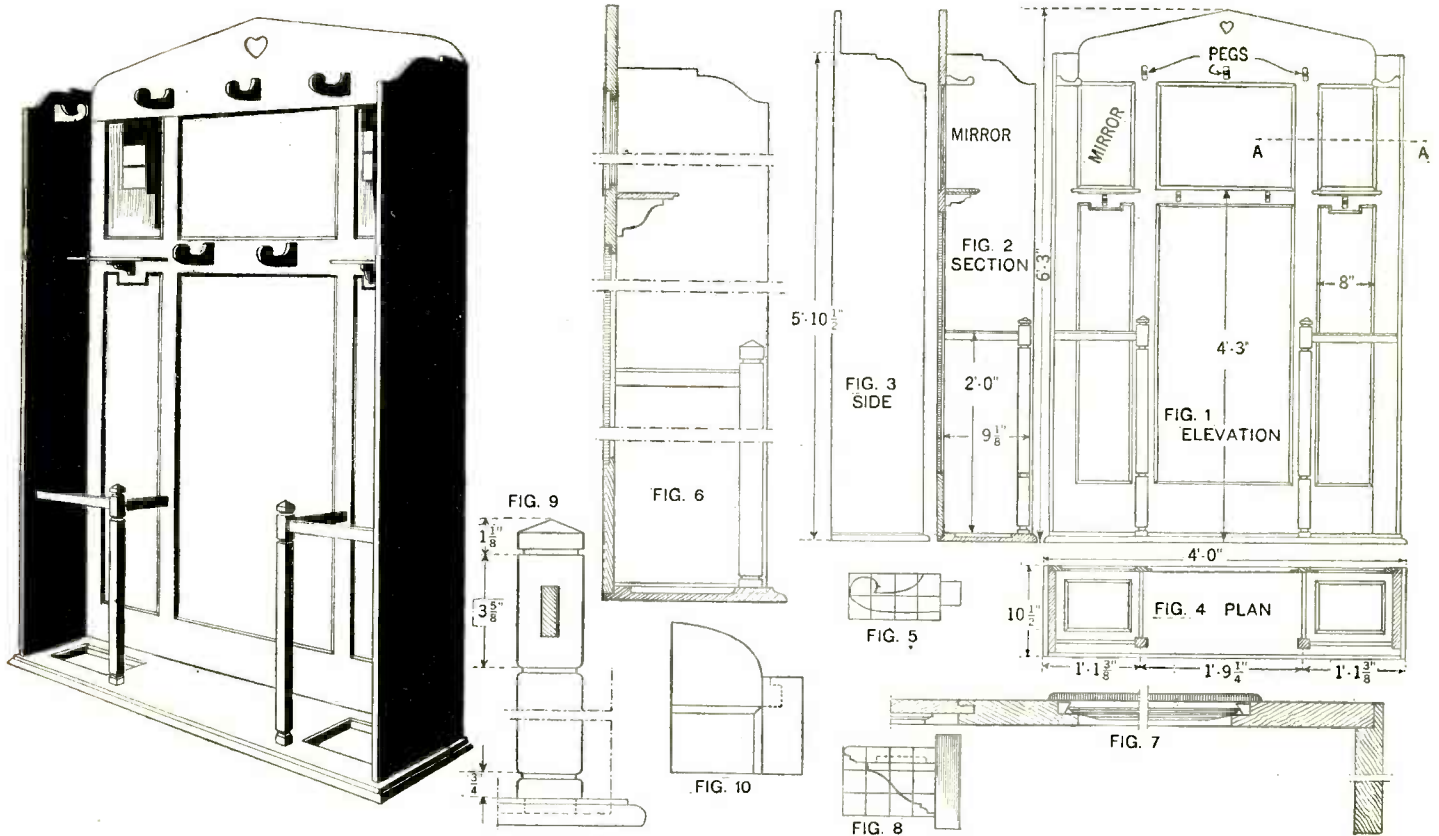

The hall stand illustrated above has been designed so that coats may be hung clear of umbrellas, an advantage seldom obtained with the usual type of stand. It can be constructed either with oak, stained antique, or with cypress, stained and French polished, if cost is a consideration.

All details for the construction of the hall stand will be found above. Figs. 1 and 3 illustrate the side elevations and Figs. 2 and 4 show a section and plan of the stand. An enlarged section is given at Fig. 6, and Fig. 7 shows a horizontal section taken through AA on the front elevation.

A Simple Hall Stand

By J. E. LOVETT

THE hall stand here illustrated and described has been designed so that coats can be hung clear of the umbrellas, an advantage seldom obtained with the usual type of hall stand.

The fitment would look well carried out in oak, stained to an antique color and wax polished or, alternatively, the timber could be left natural color with a skin of polish to protect the grain. If, however, cost is a consideration, cypress, stained and French polished, could be employed. Figs. 1 and 3 illustrate the front and side elevations, while figs. 2 and 4 show a section and plan of the stand. An enlarged section is given at fig. 6, and fig. 7 shows an enlarged horizontal section through AA on the front elevation. The construction is simple and easily followed from the drawings.

The back framing and moulded ends are $\frac{7}{8}$ in. thick, the latter being rebated $\frac{5}{8}$ in. by $\frac{3}{4}$ in. to take the former as shown in fig. 7. The ends are also gained into the base, which is $1\frac{1}{4}$ in. thick and moulded on three edges (see fig. 9). The two end stiles are $3\frac{5}{8}$ in. broad, and the inner stiles 3 in. broad, the latter being tenoned into the top and bottom rails.

The shaped top rail is $\frac{7}{8}$ in. thick, and is 8 in. deep at the center. It is tenoned into the outside stiles as shown at fig. 10, and has a heart-shape cut in the center as illustrated. The mid rails of the end panels are cut of 4 in. by $\frac{3}{8}$ in. stock,

DETAILS IN BRIEF

ILLUSTRATED and described here is a hall stand of practical design. It is best made with oak or cypress and contains ample room for umbrellas and coats. Complete details will be found in the drawing. Two side mirrors are also provided and two small shelves are supported under each for hats. Openings are made in the base to take the pans for the umbrella stands.

reduced to 3 in. broad, while the center rail is 3 in. broad by the same thickness.

These rails are all tenoned into the stiles. Where the side mirrors are fixed, the stiles and rails are rebated, the mirrors being wedged into position and covered at the back with three-ply boarding (see fig. 7). The bottom rail is $7\frac{3}{4}$ in. broad, tenoned into the end stiles and screwed into the rebate formed on the back edge of the base.

Two small shelves $\frac{5}{8}$ in. thick and 9 in. long, supported on two ornamental brackets $\frac{5}{8}$ in. thick, are fixed under the mirrors. A detail of the brackets is furnished at fig. 8. Sinkings are made in the base to take the pans for the umbrella stand.

The panels are $\frac{1}{2}$ in. thick, tenoned into the framing, and a $\frac{3}{8}$ in. by $\frac{3}{8}$ in. moulding is planted on the face of the framing as shown in fig. 7.

Hanging pegs cut from $\frac{3}{4}$ in. stock (see fig. 5) are tenoned and glued into mortises cut in the back rails. The umbrella stand is framed with $1\frac{1}{2}$ in. by $1\frac{1}{2}$ in. posts cut to shape as shown in fig. 9, and these are tenoned into the base, while the rails are $1\frac{1}{2}$ in. deep by $\frac{3}{4}$ in. thick, rounded on the top and tenoned into the posts and intermediate stiles.

By accurate work the stand can be put together with glued joints with perhaps some screws or dowels.

HOW TO MAKE IT

Repairing Spark Plugs

It sometimes happens that the side electrode in a spark plug loosens and falls down. It then works its way out of the

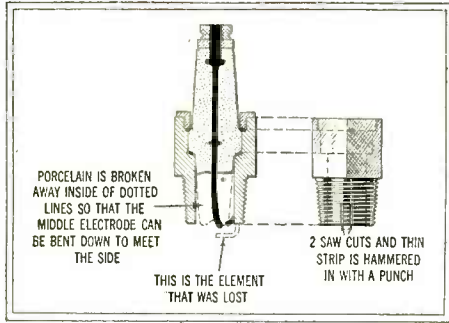

When one of the elements of a spark plug breaks away, the plug can be repaired as illustrated above. The porcelain must be broken away as shown, and the center electrode bent down.

exhaust. A repair can be effected by breaking the porcelain away from the bottom of the center, as shown by the dotted lines in the illustration. This enables the center electrode to be bent near the side of the plug. Two saw cuts are then made in the base of the plug and the thin strip that is left between the cuts is then bent towards the center, thus creating a new spark gap. The repaired plug can be used for some time and this is a good kink to remember when a breakdown of this nature occurs on roads remote from garages.—Harold Armistead.

Drawing Silhouettes

The illustration at the right shows how a silhouette can be drawn entirely by directions given over the telephone or by letter. The ruled paper is also shown.

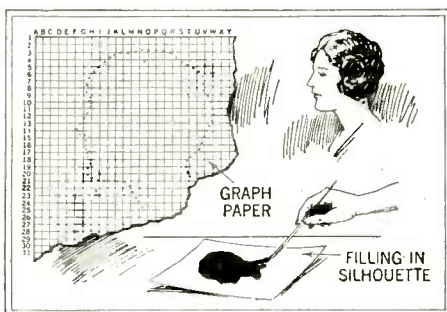

A paper is ruled off in squares with the lines designated by numbers and letters. The picture is placed beneath and a dot made where it touches or intersects one of the lines on the paper.—L. B. Robbins.

Insulation Test

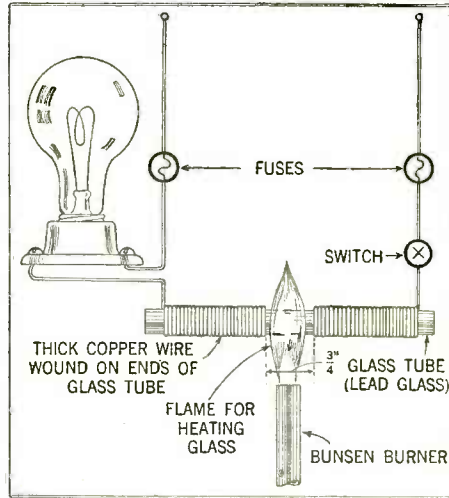

Glass can be tested for its insulating properties as shown above. Two coils of wire separated about 3/4-in. are wound on a glass tube. When tube is heated glass becomes conductive.—C. A. Oldroyd.

Gate Closer

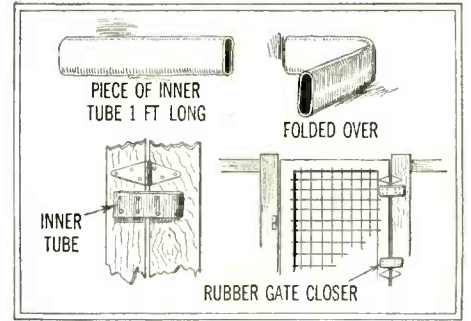

An automatic gate closer can be made from an old inner tube, as shown above. Two pieces, each 1 ft. long, are folded over. When the gate is swung open, the rubber straightens out and closes it.—L. B. R.

Egg Tester

A PORTABLE egg tester can be made with a box of thin wood measuring 6" x 3" x 2". This is cut through lengthwise and one part hinged for a cover. An oval hole slightly smaller in size than the average egg is cut in one end of the cover and lined with felt. Directly under it, a small flashlight bulb is mounted and two flashlight cells inserted in the other end of the case. Contact is made by the circuit breaker, which consists of a piece of light spring brass shaped as indicated. To test an egg, slip the hook off the contact spring and place the egg in the hole. This pushes over the spring and lights the lamp.—L. B. Robbins.

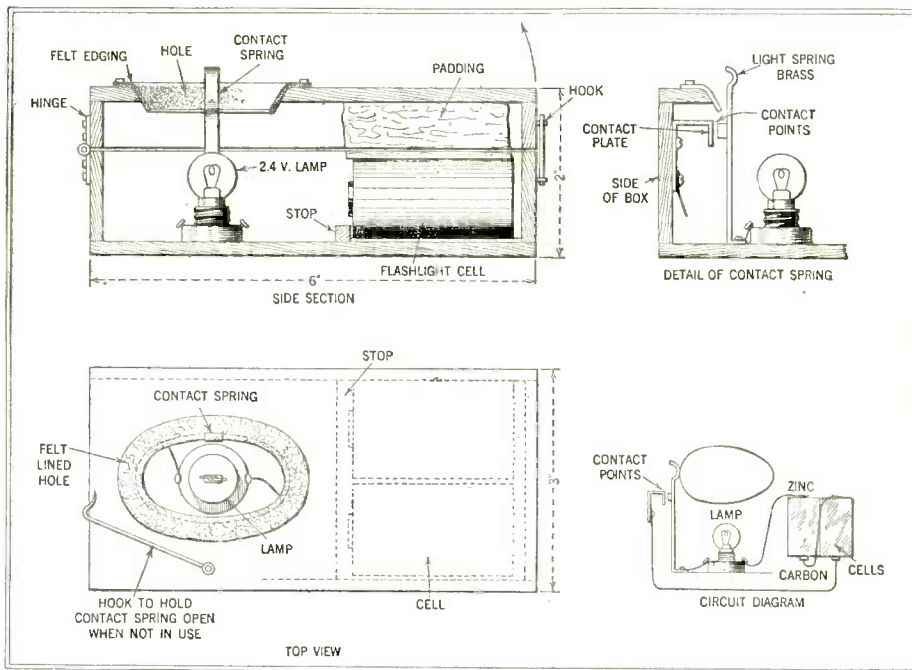

The above illustration gives the necessary constructional details for the pocket egg candling outfit. Contact is made by the circuit breaker shown.

Trick Lightning Photograph

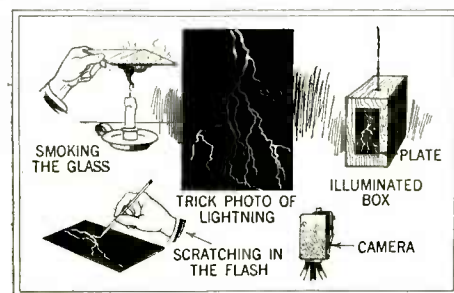

The illustration at the left shows the various steps in making a photograph of lightning. A piece of glass is smoked and scratched to imitate a flash.

Smoke a piece of glass and scratch the figure of a lightning flash on it. Place in the end of a box with light behind. Expose plate for three minutes. This idea is useful to the amateur still and movie photographer.—L. B. R.

WOOD-TURNING

By H. L. WEATHERBY

Article Number 7 in a Series

Split Turning

THIS month we offer another very practical turning novelty in the form of split turning; without which knowledge the craftsman's store of information on the subject of turning would be incomplete. Many are the articles of furniture and novelties where this method is used. Applied decorations to furniture are often worked up in this manner and the pattern maker uses it altogether in the making of turned split patterns.

The Treasure Chest

As a practical application of this method we suggest making a chest, either in miniature as illustrated, or by multiplying all dimensions by four, a clothes chest of ample proportions will be the result. The chest, from which the photographs were made is truly a treasure of a chest as well as a chest for treasure; and the turning comes in making the applied decorations. A tray may be added and it may be used for some of the family silver, or it can be used as a sewing or work box. As a receptacle for odds and ends of keepsakes and old letters it fills a need; or, as a final suggestion, it can be lined with cedar and fitted up as a humidior. Everyone has uses for a box of this sort in one way or another; and, if well made it will add to the furnishings of any room.

The Construction

THE box should be made only from well-seasoned hard wood and a natural wood two-color combination will add to its appearance.

- Material according to the following list should be secured.
- 2 pieces for front and back $\frac{3}{8}$ in. x $5\frac{1}{4}$ in. x 12 in.
 - 2 pieces for ends $\frac{3}{8}$ in. x $5\frac{1}{4}$ in. x $6\frac{1}{2}$ in.
 - 1 piece for top $\frac{3}{8}$ in. x 7 in. x $12\frac{1}{4}$ in.
 - *2 pieces for bottom and sub-top, $\frac{3}{8}$ in. x $5\frac{3}{4}$ in. x $11\frac{1}{4}$ in.
 - 2 pieces for top and bottom moulding, $\frac{1}{4}$ in. x $\frac{3}{8}$ in. x 12 in.
 - 2 pieces for turned columns, $\frac{3}{4}$ in. x $1\frac{1}{2}$ in. x 7 in.
 - 1 piece for raised oval, $\frac{1}{2}$ in. x 3 in. x 4 in.
 - 1 piece for feet, $1\frac{1}{2}$ in. x $1\frac{1}{2}$ in. x 4 in.

Hinges, lock, nails, and screws.
 * The drawing does not indicate the sub-top and it may be omitted where well seasoned wood is used.

If a two-color combination is desired it would be well to use black walnut for all parts, excepting the applied decorations, which consist of the half columns, the raised oval, the feet, and the moulding; all of which may be made of maple or some other light colored hard wood.

Preparation for Turning

As a preliminary to turning, the two pieces indicated as material for the columns should (Continued on page 885)

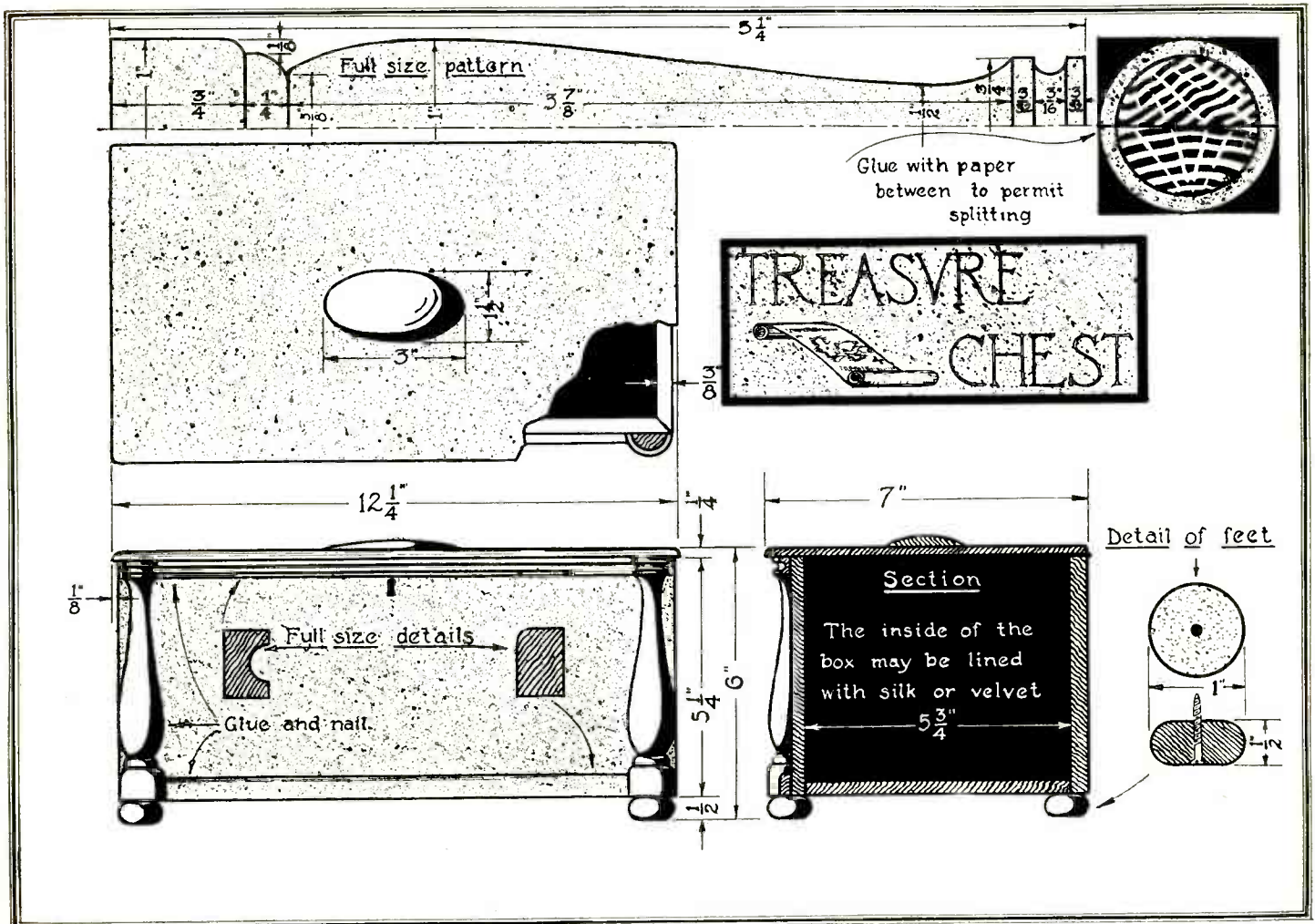

A detailed pattern for constructing a treasure chest appears above. This can either be made in miniature or by multiplying all dimensions by four, a clothes chest of ample proportions will result. A tray may be added if desired.

There are many articles of furniture and novelties which require split turning in their construction. A practical application of this is well illustrated in the above chest. Applied decorations to furniture are often made in the same manner.

WRINKLES, RECIPES

Wire Scraper

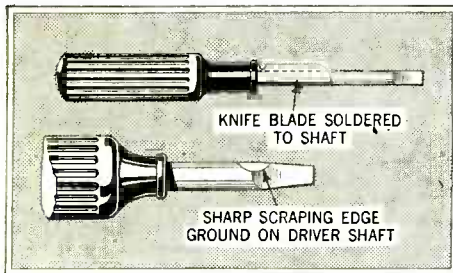

Grind the shaft of a screw driver flat and solder a knife blade to it. A notch filed near the end of the blade serves for scraping the wire after the insulation has been stripped off with the knife. Another method particularly adaptable with short bladed screw drivers is also illustrated above. At the shoulder of the blade a sharp scraping edge is ground, the grinding being done from both sides until a knife-like edge is formed. This makes an excellent wire cleaner.—T. R. Hart.

Cigarette Holder

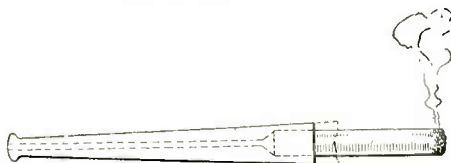

A cigarette holder can easily be made from a broken pipe stem as shown. A hole is made with a five-sixteenth inch drill to a depth of five-sixteenth inch. The outer edge is then filed flat and the cigarette holder is finished. By using a beveled five-sixteenth inch drill after the regular drill, the cigarette will be held more tightly in the holder. Edward Stoll.

Smoking Glass

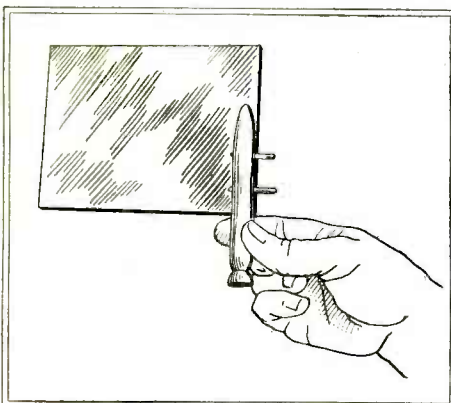

When smoking glass for observing eclipses, a holder as shown above proves useful. The glass is slipped between the legs of a clothespin and wedged in securely with pieces of matchstick. In this way, the smoked surface is preserved intact.—F. W. Bentley, Jr.

Polishing the Brass Work

In these days of "nickle-plated garishness" there are a few who still appreciate the real richness of polished brass work.

But it sure takes "elbow grease" to keep this up to its "beauty face" in the usual manner.

Try the following. It will beat any of the metal polishes you can buy, works quicker and easier, no scrubbing and scouring, just a wiping on, and a little rubbing, and — presto, — it shines like a twenty dollar gold piece. (Yes, there really used to be such things, though they seem to be practically extinct these days, in favor of the "long green.")

Fill an 8-ounce bottle a little less than half full, of a mixture of three parts of prepared chalk to one part of common salt. On this, pour two ounces of "acetic acid No. 8" (the dilute 30% acid usually sold when you call for acetic acid), or $\frac{3}{4}$ ounce of the stronger, so-called "glacial acetic acid." Fill bottle nearly full with clear water, leaving room for shaking. Shake well, and allow to settle.

For use, shake well, and with a soft rag, smear a little of the cream on the work to be polished, let it dry on for a moment, and clean off by rubbing lightly and briskly with the rag. For very dingy spots, rub while still wet, and till dry. Then wipe off with a fresh rag, dampened with clear water, then with a dry rag.

Severe cases may require a trifle more cream, and a bit more rubbing, but ordinarily the action is almost instantaneous.

The action of the salt and acid cuts the oxide which dims the surface, and the chalk cleans this away.—Contributed by Charles A. Pease.

A Hair Brush Hint

It is annoying to find that the bristles of one's favorite hair brush are getting soft and every time they are washed they get worse. This state of affairs can be set right by putting a penny's worth of common alum in a quart of boiling water and leaving it to dissolve. When the liquid is quite cold place it in a basin just a little larger than the brush and immerse the bristles in such a manner so as to avoid wetting the back and handle. The water should be just high enough to cover the bristles and the brush should remain in the solution about half an hour after which it may be taken out and placed bristle down on a folded towel. The same solution can be used for several brushes.—Contributed by S. Leonard Bastin.

Removing Heat Marks

White marks on polished tables which are caused by heat may be removed in the following way. Rub the affected part with a hard paraffin wax candle and then cover with blotting paper and press with a warm iron. Repeat the operation if the mark does not at once disappear. Rub well with a soft cloth and the polish will not be in any way affected.—Contributed by S. Leonard Bastin.

Label Moistener

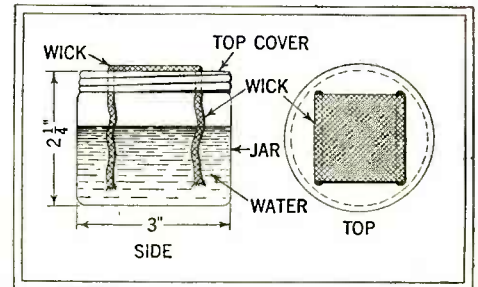

An excellent moistener for labels and the like can be made from an old jar equipped with a metal screw cover, such as that shown above. Two slots are punched in the cover and a wick passed through them with its two ends hanging down into the jar. The receptacle is filled with water and the wick is in this manner always in a moist condition. The label simply has to be rubbed over the surface of the wick for moistening. A wick about $1\frac{1}{2}$ in. wide is satisfactory for general use.—Henry Kazwecki.

Foot Stool Legs

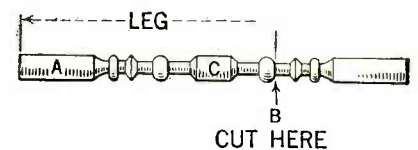

The above illustration shows how to make foot stool legs and the like from stairway balusters. Starting from the end marked A, cut off at point B. The point marked C is made to hold the cross rails by use of dowel pins or mortise and tenon joints. Some balusters can be cut in half and make two legs each. These should be used with low stools. Balusters of the type shown above will make a leg having a ball at the bottom.—John Maras.

Pull Chain Kink

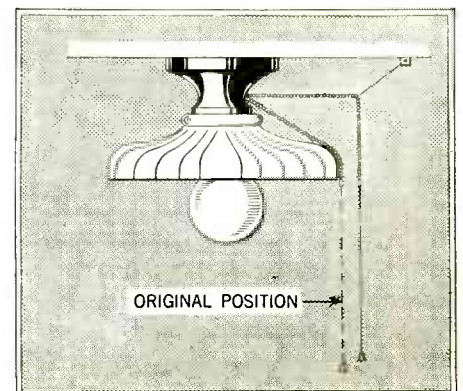

Often the beads of a metal pull chain catch when the chain is pulled downward. A small piece of cord attached to the ceiling and tied to the chain will remedy this nuisance. Thus, it is not necessary to reach way up when turning on the light.

—J. M. Morgan.

and FORMULAS

Edited by
S. GERNSBACK

File Cleaner

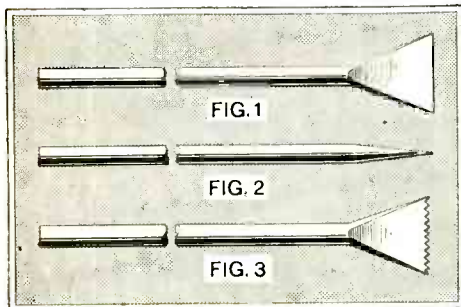

A self-sharpening file cleaner can be made from a piece of heavy wire flattened as shown in Fig. 1. This forms a sharp edge as illustrated in Fig. 2. This edge when rubbed rapidly across the file to be cleaned will have teeth cut as shown in Fig. 3. These will fit the contour of the file teeth and clean them of all accumulations. A cleaner of this sort is self-sharpening. A number of blanks as shown in Fig. 1 can be kept in the tool box for future use.
—Charles A. Martin.

Polarity Indicator



A test tube sealed at both ends with wires inserted and filled with a solution of ammonium chloride makes a good polarity indicator. Bubbles appear at the negative pole.—Ernest E. Joyce.

Ammeter

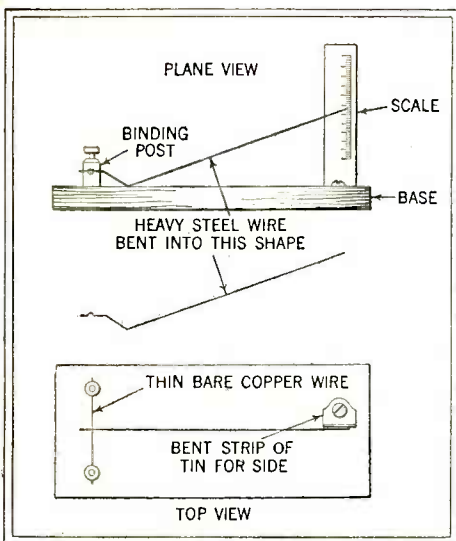

A hot-wire ammeter can be built as illustrated. Following is a table of wire sizes for different scale meters. 0-2 amp.—No. 44, 0-5 amp.—No. 42, 0-10 amp.—No. 36, 0-15 amp.—No. 34, 0-25 amp.—No. 28. A heavy steel wire is bent around the copper wire for a pointer with scale made from a strip of tin.—D. Pollack.

Preparation of Sulphuric Acid

A very simple and quick method of preparing sulphuric acid in the home is as follows:

Burn a few sulphur matches, catching the fumes in a small bottle. After this has been done pour into the bottle about a half inch of Hydrogen Peroxide, which is found in most all home medicine cabinets. Shake the bottle well until most of the sulphur fumes have been dissolved by the peroxide. The result will be a dilute solution of sulphuric acid. If a stronger acid is wished it can be made by using a quantity of sulphur in place of the sulphur matches.—Contributed by A. Michael.

Protective Wire Window Screen

A coat of white or light colored paint applied to the outside of window screens will prevent anyone from seeing into the house, while not obstructing the view from inside.—Contributed by Clifton Ash.

Artificial Ivory

An excellent artificial ivory can be made from equal parts of powdered egg-shell and powdered isinglass dissolved in alcohol to form a paste. Warm the vessel in which the paste is mixed by setting it in a pan of hot water. This paste gives interesting results when spread over modeled clay statuettes.—Contributed by Edward Weber.

Artist's Modeling Clay

A permanent plastic clay may be made by mixing dry clay with turpentine, or similar bodies, and then adding vaseline or petroleum residues rich in vaseline. The proportion of clay to the vaseline varies according to the desired consistency of the product, the admixture of vaseline varying from ten to twenty per cent. It is obvious that the hardness of the material decreases with the amount of vaseline added, so that the one containing the most vaseline will be the softest.

By the use of various varieties of clay and of various percentages of vaseline admixtures, the plasticity as well as the color of the mass may be varied.

Some modelers simply knead the dry clay with glycerin and cover it with a rubber cloth, moistening it every few days to keep it in a plastic condition.

"Sculptor's putty," used for a similar purpose, is made by mixing 200 parts of dry clay with 100 parts of wheat flour; this mixture is then stirred into 300 parts of melted white wax. If desired, the mass may be colored at pleasure.—Contributed by Marvin Limeberry.

Staining Furniture Scratches

By applying Iodine with a small brush over scratches on furniture a real benefit will result. Not only will the stain match the color but the scratch will hardly be noticed. Of course this only applies to such colors as Oak, Walnut, Mahogany, etc.—Contributed by Fred J. Miller.

Repairing Razor Case

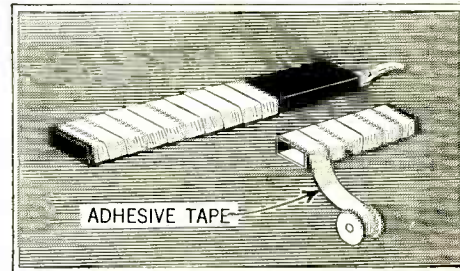

The life of an ordinary razor case can be increased by winding adhesive tape over it so as to overlap as indicated. This should be done while the case is still in good condition. The ordinary cardboard case when treated in this manner is held together firmly over a long period of time, and its serviceability is materially increased.—J. Estolas (Reporter Number 12,825).

Drafting Aid

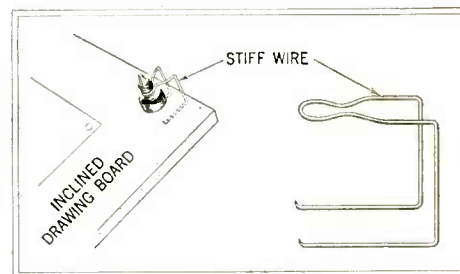

The simple device illustrated above will keep the ink bottle from slipping off an inclined drawing board. A piece of stiff wire is bent in the shape shown and hooks firmly to the end of the board. The looped portion holds the bottle.—J. Estolas.

Pliers as Calipers

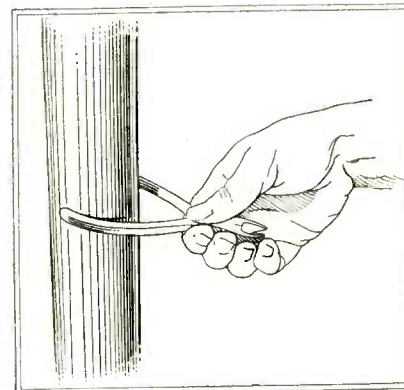

A pair of pliers used as shown will enable the diameter of a circular object to be measured when a pair of calipers is not available. The pliers are grasped firmly at the jaws and the handle used to encircle the object. The distance between the ends of the handles is then measured and will be found to be quite accurate enough for average use.—Raymond B. Wailes.

READERS FORUM

SCIENCE AND INVENTION desires to hear from its readers. It solicits comments of general scientific interest, and will appreciate opinions on science subjects. The arguments pro and con will be aired on this page. This magazine also relishes criticisms, and will present them, whether

caustic or not. So if you have anything to say, this is the place to say it. Please limit your letters to 200 words or less, and address your letters to Editor—The Readers Forum, c/o Science and Invention Magazine, 230 Fifth Avenue, New York City.

Geysers

Editor, SCIENCE AND INVENTION:

I read with considerable interest the article on GEYSERS by Joseph H. Kraus in the October issue, and am now interested to learn whether the theory I offer herein has been considered before and if so why it was discarded. I would be inclined to believe that the time intervals of the spouting of the geysers operating as suggested by Mr. Kraus would be very uncertain, as he is depending on a very stable condition; namely, the pressure of the weight of water holding the pressure of the steam in check.

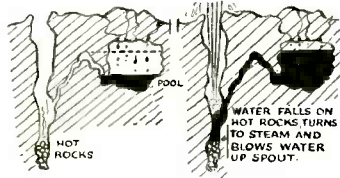

It seems to me that the very regularity of some of the geysers, including Excelsior, which spouts every eight years, would lead to a theory in which instability has

no part, and I suggest the siphon theory.

The water accumulates in a subterranean basin with a channel running from near the bottom of the pool in an upward direction to a level just below the surface of the pool when the basin is full and then down again to a place below the level of the bottom of the pool where it opens into the main channel of the geyser. When sufficient water has accumulated to flow over the high part of the channel, it starts a siphon which drains the pool. This water rushes through the channel and plunges down the geyser neck onto the hot rocks where it is immediately converted into steam with such pressure as to throw the rest of the incoming water high into the air. There will not be another such eruption until sufficient water has again accumulated in the pool to again start the siphon, and the intervals would be governed by the size of the pool and the amount of water seepage to it.

M. C. VAN DER VOORT,
Montreal, Canada.

(This theory of the operation of geysers has been quite thoroughly cast aside. In the first place, a geyser operating as indicated is devoid of water until at the time of eruption. Therefore, examination of the tube reveals it to be dry and also indicates a large quantity of heat coming out of the mouth. The action of such a geyser could not possibly be hastened by dropping stones into the mouth, nor would such a vast quantity of water, in some cases 5 feet in diameter and 200 or more feet high, be hurled upward instantaneously, nor would this water be warm.

Assume that you have an intermittent siphon and that this siphon suddenly pours over. The water would have to enter the funnel of the geyser at a very great speed. This water, coming in contact with the hot rocks, would be evolved into steam only for the fraction of a moment when the water touches those rocks. Immediately thereafter the rocks will have cooled sufficiently, and the remaining water would be cold enough to prevent further steam formation in great enough quantity to drive up this column of water. Again, after such eruption, the geyser would give off vast quantities of steam, and a great quantity of heat. It is therefore quite evident that the siphon theory does not hold.—EDITOR.)

Heredity

Editor, SCIENCE AND INVENTION:

A group of Italians living in Brooklyn would be very much obliged to you if you would be so kind as to enlighten us on the following questions: What is the reason that most of the European people are white skinned, the Africans black, and the Chinese yellow? Is it true that the so-called white people have benefited more than any other race

in evolution, in social or intellectual positions? Will the North American Negro in time become equal in color and brains to the White North Americans?

ANTHONY DI BLASI,
Brooklyn, N. Y.

(The questions which you ask are rather difficult to answer and of course open to constant scientific discussion and dispute. There is probably no more reason why the Africans are black, the Chinese yellow and the European white than there is why one collie is brown, another white, and another mottled. The process of selection, atmospheric conditions, climate, inherited and acquired characteristics, and perhaps above all, the sun, had much to do with this in the evolutionary stage and preceding that, a change in the ancestral stock may have been the prime cause. The original stock was probably of yellowish tint. Living under the tropical sun, man becomes quite dark-skinned. Should he bring up children in that region, those children become dark-skinned.

Should there be marriages between the darker groups, it is possible that every fourth child might be fair, whereas the others might be dark. If the dark intermarried with dark people, the strain of darkness may be maintained. If one of these dark children married a light or fair person, the offspring would be either light or dark. All of this deals with the Mendelian theory of heredity which has been quite well established.

Taking not the individual case, but the mass average, it is quite

definitely established that the white race has benefited more than the black in the course of evolution, and that the white race is undoubtedly superior to the black and yellow, in the general average intellect and in general social status. Your question as to whether the North American negro "in time" will become equal in color and brains with his white cousin is rather difficult to answer. "Time" is very indefinite. If you refer to the next hundred or thousand years, the answer is in all probability—no. If you refer to the next million years, or two or three million years, there may at that time be no differentiation in color among the races of the entire world. If yellow races intermarry with the white, the white with the black, etc., and with transportation more rapid, thus shortening the distance between the tropical and frigid countries, it is conceivable that "in time" this world might be of one color and one great family.

Wars and calamities might bring this about even sooner. Supposing that the yellow race should suddenly overrun Europe. It is perfectly natural that their white cousins would marry these people. Some children that are then brought into the world would be crosses between the two, some would be white and some yellow. Inter-marriage would make for further changes and equalizations.—EDITOR.)

Witchcraft

Editor, SCIENCE AND INVENTION:

Up to a few years ago, there was a great belief in witches, and hearing a story the other evening, I decided to write you. I can vouch for the veracity of the person who told me the tale (she is my mother). As to the truthfulness of the person who told her, I'm not so sure. This was supposed to have happened forty years ago.

An old woman who was supposed to have the power to bewitch people, especially children, arrived at a certain house and asked the name of their child. Upon procuring this information she left.

At 12:00 o'clock that evening there was a loud yell from the child. Her father rushed to her room, and after questioning her, learned that she had seen an enormous black cat climbing up the bed-post. Twenty-four hours later, another shriek, this time from his sick wife who slept in a room by herself. She claimed that something had crawled on her bed and that she had hardly been able to draw her breath. Her husband not believing in witches, decided to sleep in the same

THE EDITOR'S MAILBAG

room. The next night around midnight he gave a yelp and gasping gurgles, as though being strangled. His wife called him by name, and the "witch" left. (They are supposed to do so upon hearing the bewitched person's name being called. It is also thought that a witch will not enter a room where a light is left burning). This proved conclusively that this old woman had bewitched them all. What do you think?

JOHN P. YODER,
Lancaster, Pa.

(You are perfectly right in your thought that witchery and witchcraft is just a "lot of bunk." There is no one in this entire world who can have power over another to the extent of making that person dream or think of things when the individual supposedly so wills it. Even in hypnosis, the subject cannot be made to think of anything the hypnotizer wills. Thought transference has definitely been disproven, and while SCIENCE AND INVENTION Magazine has posted an award of \$5,000.00 for such proofs of thought transference, and while that award has been published yearly, for the past five years, no one has as yet come forth to collect it.

It is very likely that the girl's story was the result of a vivid dream. It stimulated in her superstitious parent a trend of thought along the same line. Some dreams are so realistic that the individual dreaming them actually believes he has played the part. Sometimes a man will dream that he is being chased by an animal, and awake so exhausted that he can scarcely talk.

Witchcraft stories always thrill us, but it is not necessary that we believe the same. Furthermore, how could anyone bewitch the father when he wasn't there when the questions were asked?

Noxious fumes and small quantities of poison gases frequently induce discomfiting dreams. Non-combusted gases from an open fireplace, from a leaky flue, or from innumerable other sources might be the causative factors.—EDITOR.)

A Frozen or Torrid World

Editor, SCIENCE AND INVENTION:

Why is it that a great majority of the writers of the predictions of the end of the world dwell on the idea of it being a frozen waste.

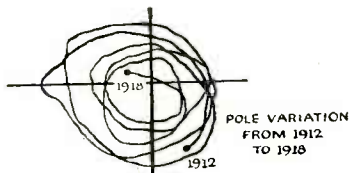

Are there any indications that this will be so—do the present day happenings point in this direction?

In my idea there are more indications of the world being too hot to live upon.

From what we are told, there was once a Glacial Age, but there is no Glacial Age now,

which in my mind is an indication that the world's position is closer to the sun or that surface is becoming warmer (due to internal heat) than it was a thousand years ago.

Are we to understand that we are going back to the Glacial Age?

I think myself, as we read of the fierce heat waves striking human beings down each day of the hot seasons of the year, their toll becoming larger every year, that this is a fair indication that we are not returning to a Glacial Age.

As you wrote in answer to an earlier letter to the Readers Forum—man may, in the coming generation, be able to live without water—believe me, Mr. Editor, this world will be an inferno when there is no water or protecting clouds to quench the burning heat of old Sol.

A. R. CANN,
Victoria, B. C., Canada.

(The reason that most writers dwell upon the idea that when the end of the world will come it will demonstrate to us a vast frozen waste is quite clear when one considers that the Glacial Age was only a recent occurrence in comparison with the Age of Terrific Heat. Of course, if heat suddenly came from an outside source, all of the rivers would go up in the form of vapor. This vapor would form clouds, blocking out further heat, and would also be changed in state to rain, only to fall and cool conditions again.

Insofar as the protection of clouds from our present sun is concerned, there is very little protection found in higher altitudes, such as those at Switzerland, where the heat beats down all day long. Yet the Alps Mountains are always covered with ice. There is only one possibility of heat destroying all of the vegetation on this earth, and that is if this earth should collide with a heavenly body or if the sun should happen to be acclaimed by another fiery body much greater in mass than the sun. This has not yet occurred, nor can we see any indication of it in geological history, or can our telescopes observe the star in space.

On the other hand, we have had a Glacial Age; ice still exists in vast quantities at the poles. There is nothing to prevent a gradual

shift of the earth around its axis, making what now constitutes the equator the North Pole, and vice versa (the earth is constantly shifting, as is proven by the researches made during the past ten or fifteen years). The first Glacial Age may have been due to this instability of polar positions. Lastly, the sun is constantly losing heat. We conjecture that if it continues to lose heat at the same rate as now, and if it does not rebuild itself by some exceptionally large meteors which may fall into the caldron; in some millions of years from now this world will be without a sun. But in a million years, anything can happen.—EDITOR.)

Magnets for Lifting Sub

Editor, SCIENCE AND INVENTION:

Have been reading quite a few articles in the past few months in regard to the S-4 submarine, the salvaging, rescue work, and since numerous ideas have been advanced for safety devices such as hooks on the sub's sides, and many others not seeming to meet with the Naval Authorities' approval, as they claim that the more weight, the less efficient the submarine becomes, it would seem up to the inventors

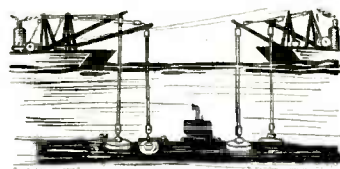

to work out ways and means to facilitate rescue work, in case of a future accident such as befell the S-4 and its crew.

I should like to know if it would be possible to use electro-magnets, such as are used for loading iron on freight cars, to raise the submarine. I realize that one magnet could not accomplish this, but could not four or more do so? Could a ship be built with a hollow space through its centre from bow to stern, with a number of magnets operating on electric winches, to raise the submarine up into the hollow space where workmen provided with acetylene torches could quickly cut into its steel shell and rescue the men within? A diver could go down and direct the surface ship by telephone where and when to lower magnets, and also to a certain extent help in placing them.

LOUIS F. KEE,
St. Augustine, Fla.

(It is not possible to lift a submarine by means of four or five, or even a dozen electro-magnets of a size convenient to handle. The only chance of doing so would be to place electro-magnets all over the hull, practically completely covering the same. You see, the metal shell is very thin and no great stress can be placed on any plates, for fear of tearing them off. We see no advantage in this, inasmuch as divers would have to go down at the bottom to place those magnets and it would be just as easy to employ chains as magnets with a greater assurance of safety. Electro-magnets require that a cable with current supply be led to them, making the operation doubly difficult. Lifting cables would also have to be led to the electro-magnets. The slightest momentary cut-off of current would drop the submarine to the bottom again, perhaps completely smashing it, undoubtedly losing it and positively necessitating the replacement of the magnets.

There are several methods by which the members of the submarine crew can escape to safety. One of the latest consists of a gas mask-like apparatus which can be donned in a very few seconds and with which the entire crew can escape. After the crew is safe, salvage operations can take as long as necessary and any method can be employed. You must remember also that submarines do not always sink close to the costly salvage vessels which serve little purpose in war.—EDITOR.)

Proud of S. & I. Trophy

Editor, SCIENCE AND INVENTION:

I received the cup yesterday and desire to express my appreciation to yourself and to the judges of the "MODEL CONTEST." The cup certainly is a beauty and well worth the many hours spent in constructing the model which is its own reward for the time spent. So I feel that I have been doubly repaid. To anyone in doubt as to whether to enter the contest, I would say that the thrill of unpacking that cup is worth many times the effort spent in building any kind of model. I cannot begin to tell you how proud I am of the cup, but in closing, will say that I hope to see many interesting models in your department in the future as I have in the past.

M. L. HUGHETT,
Perry, Okla.

(We are very glad that you liked the cup and glad that you were so thrilled at receiving the same.

We now wish to again call attention to the MODEL DEPARTMENT, and to tell our readers not to fail in sending in their models. Don't put this off, but do it now!—EDITOR.)

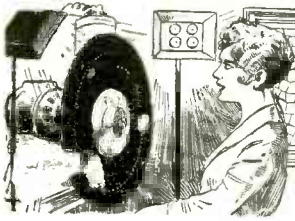

Radiovision



Latest Developments in the Television Art Include a Disc-less Receiver and Instrument Using Karolus Cell for the Reception of Pictures. C. Francis Jenkin's Apparatus Used for Transmission and Reception of Outdoor Scenes.

Liquid Light-Cell

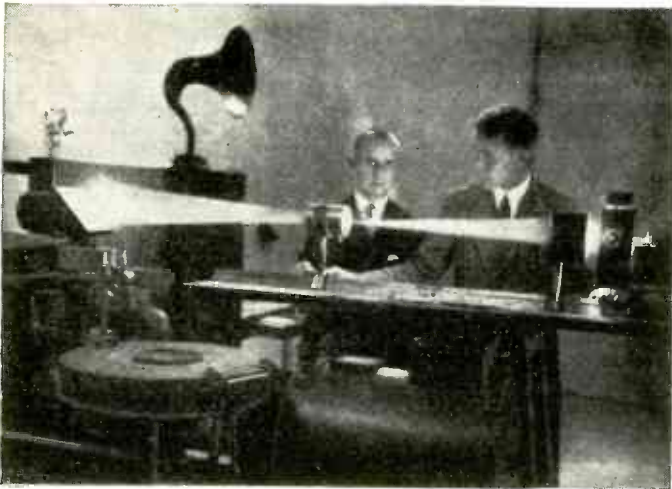

The above photograph shows a new European system of television which uses a Karolus cell. This contains a solution of nitro-benzol in which two metal plates are placed. Nitro-benzol is doubly refracting under electric tension.

Disc-less Television

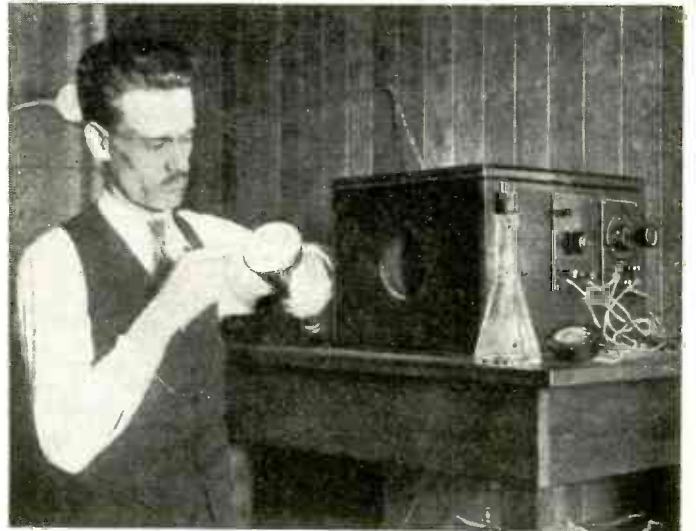

The above photograph shows P. T. Farnsworth, who has developed in a San Francisco laboratory a new system for receiving television images. The instrument involves two new fundamental principles and can be manufactured to sell for about \$100. The apparatus has no moving parts and requires only half the wave-length band used in present methods of television.



The Farnsworth machine shown above will transmit 20 pictures per second and give excellent image detail it is said. Patents have been granted on the new system.

Outdoor Radiovisor

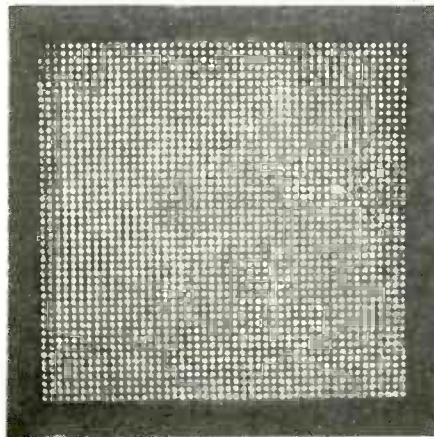

The photograph at the left shows the holder containing 2304 tungsten grid lamps used at the receiving end. A segmented commutator is used for connecting each one of the tiny lamps successively. At the transmitter, the same number of small light sensitive cells are used with a similar segmented commutator.

C. FRANCIS JENKINS, undoubtedly known to many of our readers, has been responsible for the development of a television system which reproduces pictures of excellent detail. At the present time 2,304 light sensitive cells with commutator containing the same number of segments are used at the transmitter and a segmented commutator with the same number of small tungsten lamps at the receiver. Approximately 12 stages of vacuum tube amplification will be used between transmitter and receiver. The system has primarily been designed for use in theatres and public halls. The slight lag in the extinguishing of the tungsten lamps smoothes over the picture. Outdoor scenes can be broadcast with this system.—S. R. Winters.

The drawing at the right shows the transmitter and receiver grid with commutators. Each one of the cells represents $1/2304$ th part of the so-called elementary area. When the system is used approximately 12 stages of amplification will be employed between transmitter and receiver.

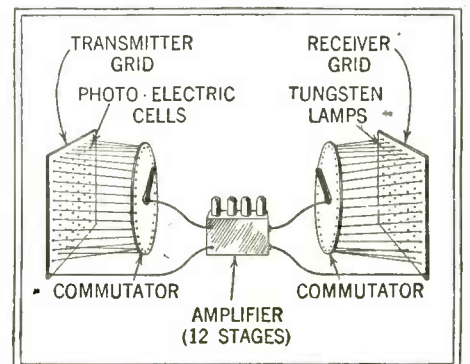

Complete Television Receiver

A New Television Set Shown Here

ONE of the first complete television receivers has recently appeared on the market and is shown in the photograph herewith. A sliding panel or visor and a disc containing three spirals of holes for 24, 36 or 48 line pictures, enable it to be used for almost all stations broadcasting images by simply adjusting the visor and the neon lamp to coincide with the correct set of holes. The speed of the motor is controlled by adjusting two rheostats mounted near the bottom, on the front of the receiver. By this means, it is possible to synchronize the speed of the receiver motor with that at the broadcasting station by simply turning a knob. The television receiver is connected to the output of the detector tube of any good short-wave or broadcast wavelength receiver. The audio amplifier of the set is not used, as a three stage resistance coupled amplifier is mounted within the television cabinet. The amplifier plays an important part



The photograph shows a view of one of the first complete manufactured television receivers. It is contained in a walnut cabinet measuring 26 in. x 26 in. x 13 in.

and one of the resistance coupled type, such as that used, has a considerably higher frequency range than the average, and gives excellent picture production free from distortion. The receiver has been mounted in a walnut finished cabinet measuring 26 in. x 26 in. x 13 in. Because of its low price, the instrument is well within the reach of anyone desiring to experiment with television. It offers a wide range in this field because of its flexibility, as it may be used for reception from stations using 48, 36 and 24 hole discs.

Vibration from the receiving disc is eliminated by the arrangement adopted by the manufacturer which places the scanning section and amplifier in the cabinet. In this way, it is removed from the set. The perfection of the received image depends upon the strength and quality of the transmitted signal and upon how well it is reproduced by the receiving set.—Name of maker furnished upon request.

Flexible Neon Tube Mount

By HENRY TOWNSEND

A SIMPLE yet flexible mounting for the neon lamp in television receivers is illustrated here. An ordinary pipe flange is used to build the device and a rod of metal or wood or a piece of pipe of small diameter is arranged to slide up and down through the hole in the pipe flange.

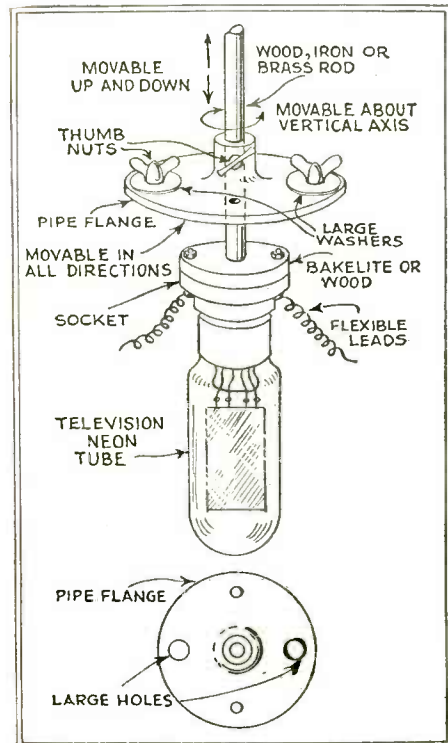

The above drawing shows the flexible neon tube mount which allows the tube to be moved up and down and about its vertical axis.

are loosened, the flange can be shifted in any vertical direction. By loosening the thumb-nut holding the rod, it is possible to

have the flat surface of the neon tube cathode presented to the scanning disc. This arrangement is particularly valuable when a new tube is installed because the placement of the elements in individual tubes varies to a certain extent. The clamping screw for holding the vertical rod is threaded into the side of the pipe flange. A further advantage of this style of mounting lies in the fact that the neon tube may be moved up and down to suit any diameter disc without moving the motor.

If a sufficiently large flange is obtained or are made from a piece of brass and a hub formed or sweated to it, then the hole in the television cabinet may be cut large enough so as to enable the experimenter to remove the neon lamp, complete with its socket, for replacing a new neon lamp.

The constructor is cautioned not to mount the television receiver in the same cabinet with the scanning portion, otherwise the vibration of the motor will introduce a noise which will manifest itself in a series of horizontal lines being drawn across the picture. The receiver and amplifier should be placed on a separate support.

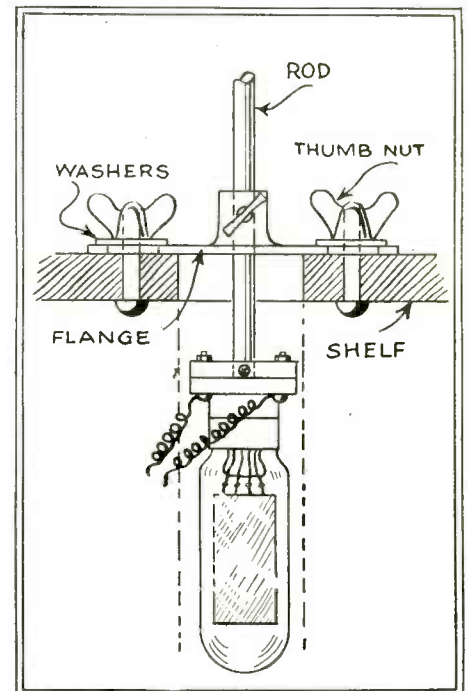

The above illustration shows how the flange is attached to the shelf with thumb-nuts which can be loosened for shifting the tube.

are loosened, the flange can be shifted in any vertical direction. By loosening the thumb-nut holding the rod, it is possible to

RADIO DEPARTMENT

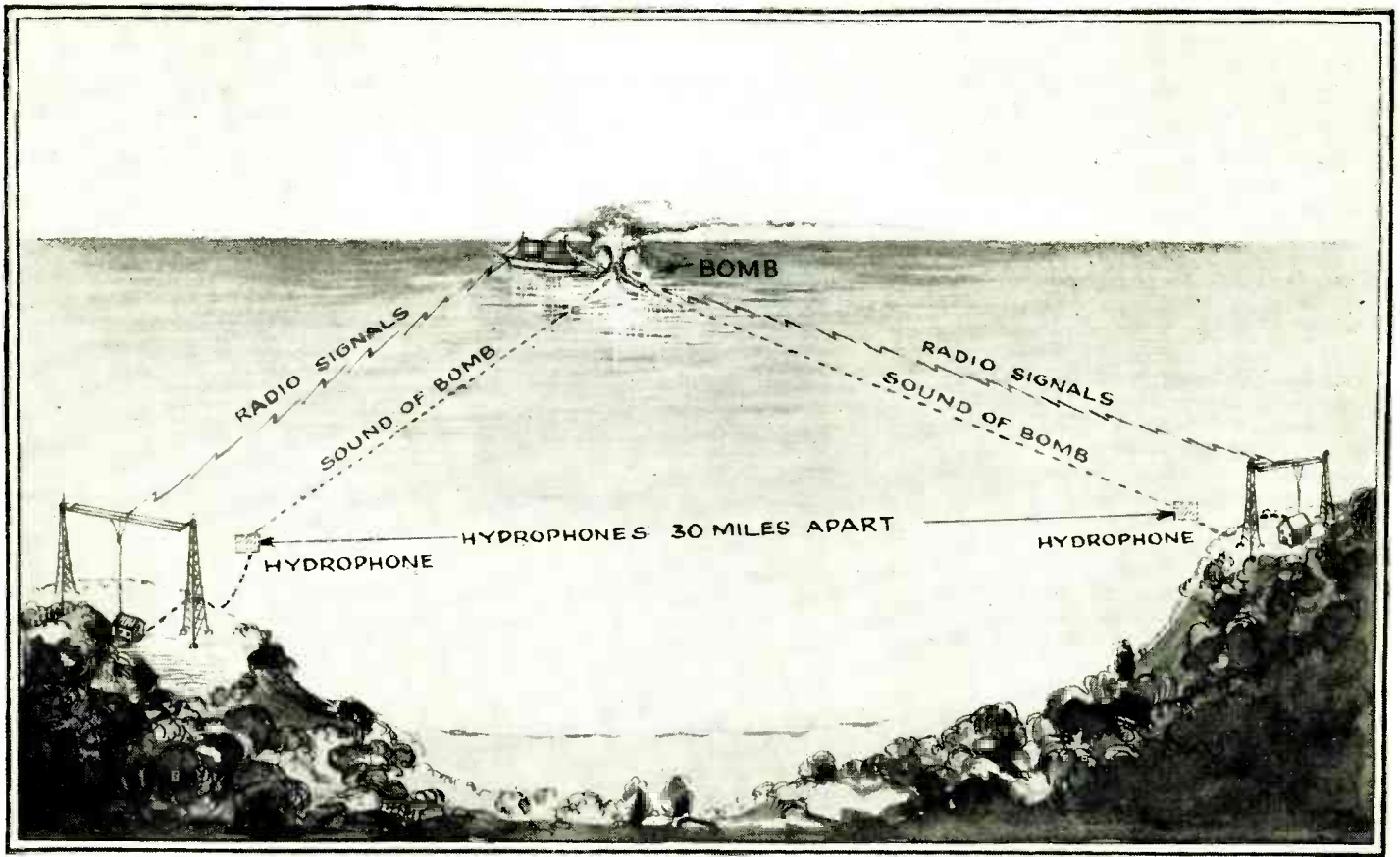

The above illustration shows the radio method of charting.

A hydrophone box is used in conjunction with each station.

SURVEYING *with* RADIO

By L. L. L. DILLEY

Ocean Depths Determined

THE United States Coast and Geodetic Survey have employed a method called "Radio Acoustic Ranging" for over five years. It is used to determine exactly the position of the survey ship during hazy or foggy weather or when the ship is working out of sight of land.

The purpose of the survey is to chart the coast lines with soundings at regular intervals out to a certain depth. On the Pacific coast there will soon be a completion of the general work out to 1,000 fathoms, or 6,000 ft., which is over a land mile deep.

The ship comes to within 15 fathoms of the shore and works at right angles to the shore line. Up to 50 fathoms the lines are run fairly close together to get every fluctuation of sea bottom surface. From 50 to 100 fathoms the surveying lines are farther apart. At 100 fathoms the ship is offshore from 15 to 25 miles. Here visual fixtures by using a sextant and signals on shore, are taken. On clear days "Radio Acoustic Ranging" is used as far out as 100 fathoms to 1,000 fathoms depth but on hazy days its use is limited to 50 fathoms.

Hydrophones

IN using the radio method there are two shore stations set out by the ship

A new electric sounding machine called the "Fathometer" enables the ocean's depth to be accurately determined. A method of radio acoustic ranging has been used for over five years in the United States Coast and Geodetic Survey for charting the coast lines.

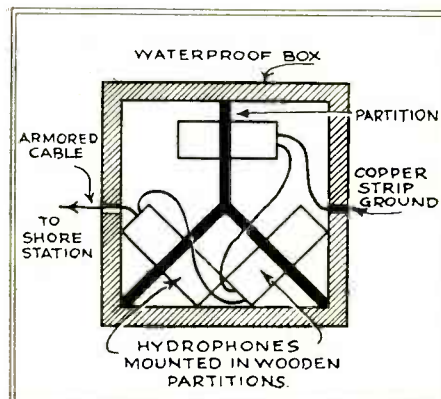

The hydrophone box is shown in cross-section above.

about 35 miles apart. Each of these stations is fully equipped with a transmitter, receiver, and a three stage bomb audio amplifier. Offshore, about a thousand yards is a queer shaped contrivance as shown in the illustration. This is a box containing three hydrophones. A hydrophone is really an absolutely waterproof microphone. This box is placed in about 8 fathoms of water. The hydrophones are connected in series with one side grounded to the frame of the hydrophone box. The other side runs to the shore station amplifier through a heavily armored and waterproof cable. When the ship is out of sight of land or the land is obscured by fog she must have some way of telling exactly where she is to do accurate surveying. This is where the "Radio Acoustic Ranging" comes in.

Bomb

THERE is aboard the ship a large amount of TNT (the same as that used in the war) from which bombs are prepared in different size cans by a Special Electrician or "Dynamite" as he is called by the crew. These cans are in pint and quart sizes and are used according to the amount of powder needed which is generally determined by the distance the ship is from the shore

stations. "Dynamite" fixes up a bomb with TNT and a cast iron weight. Then he puts on a fuse and detonator and at a given signal drops it overboard. The exact time and the log reading are taken at that instant.

Use of Radio

In the ship's radio shack is a tape machine, or chronograph, as it is called, which records seconds with one pen and underwater sounds and radio signals with the other. As the bomb explodes, the chronograph pen makes a dash on the tape. The seconds are recorded by another pen. After the bomb explodes, the ship operator informs the two shore stations and they turn on their amplifiers to receive the sound impulse from the bomb. The amplifiers are used to step up the sound of the bomb received by the hydrophones, to such volume as to trip a relay and start an automatic key. The automatic key is a metronome tripped by a relay. The bomb signal comes in, trips the relay and the automatic key. The operator throws over his switch and three radio dashes are sent back to the ship. Both shore stations must be tuned to exactly the same frequency so the ship's receiver can hear both stations without a change in the dial setting. These three radio dashes from each shore station are recorded on the chronograph tape and the exact time is noted. As sound travels under water about 1477 meters

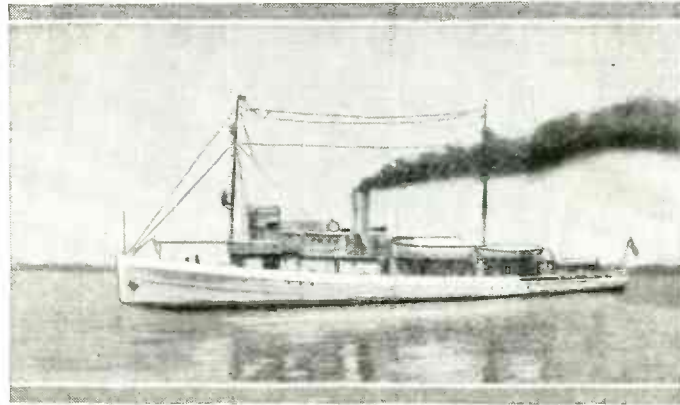

The U.S.S. Pioneer which was employed in the radio coast survey work is shown in the above photograph. The antenna is clearly visible. The author of this article was employed on board as radio operator. When the ship is working out of sight of land, or when the weather is hazy or foggy, the radio sounding method is used. In the ship's radio shack is a chronograph which records seconds with one pen and underwater sounds and radio signals with another. After the bomb explodes, the ship operator informs the shore stations and they turn on their amplifiers to receive the sound impulse.

per second the distance to both stations is found and the exact position of the ship is located on the chart.

Difficulties Experienced

Of course, this was an ideal bomb reception. There are many things which go to disrupt the harmony at both ship and shore stations. At the shore station there are quite often water noises due to tugs and trawlers, that come in through the amplifier so strong that the bomb impulse cannot be heard. Then, too, a transformer in the amplifier often burns out for they are subject to frequent heavy surges of current. On the ship, the shore stations' signals do not always come in together, due to the ship's swinging. The static also is so bad sometimes that it causes the chronograph relay to chatter, which makes it hard to tell just where the bomb and station dashes are. In spite of these difficulties the method is very accurate. With the new electrical sounding machine, called the "Fathometer," as much as 2,000 miles of sounding is covered in a week, which is much better by far than in the old days when 900 miles was considered very good.

The illustration appearing here shows the placement of shore stations and hydrophones when using the radio survey method. A cross-sectional view of the waterproof box housing the three hydrophones is also shown in the illustration on the opposite page.

RADIO set builders are unceasingly looking for novel and artistic effects in receiver and loud speaker design. Illustrated here is the newest of the magnetic type speakers which employs a diaphragm made of thin strips of wood. Veneer is admirably suited for the construction of such a cone if the radio fan wishes to try his hand at it. The veneer strips are cut in a wedge shape, so that when glued together, a circular diaphragm is formed. About the outer

**VENEER - WOOD
SPEAKER**

The Latest Addition to the Magnetic Type of Loud Speaker Employs a Cone Made Entirely of Ten Thin Strips of Wood

edge of the speaker a supporting rim is placed. If the speaker is to be of the fixed edge type, the cone will naturally be fixed to this rim, preferably through the medium of a piece of chamois or leather. If of the free-edged type, the rim is lined with felt with cone free to move. The unit is fastened to the rim at the back of the speaker as shown. From the apex small wooden strips radiate and are glued to the ten large ones.

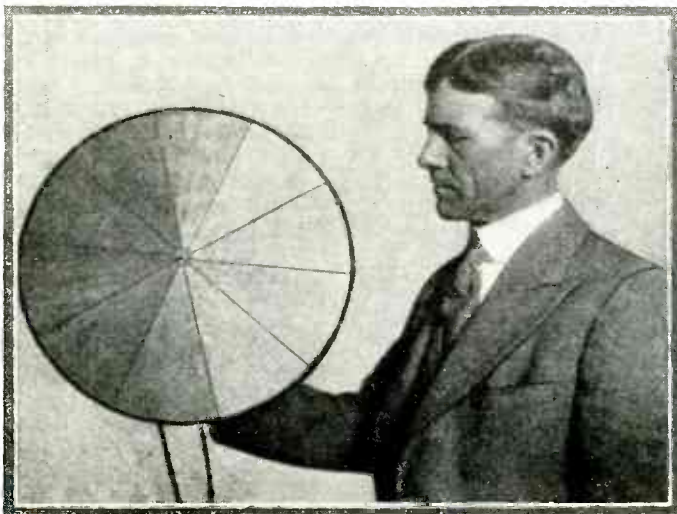

The above photograph shows a front view of the new wood diaphragm speaker. The strips of wood are cut wedge shaped and arranged like the spokes of a wheel. A supporting band is placed about the periphery of the speaker.

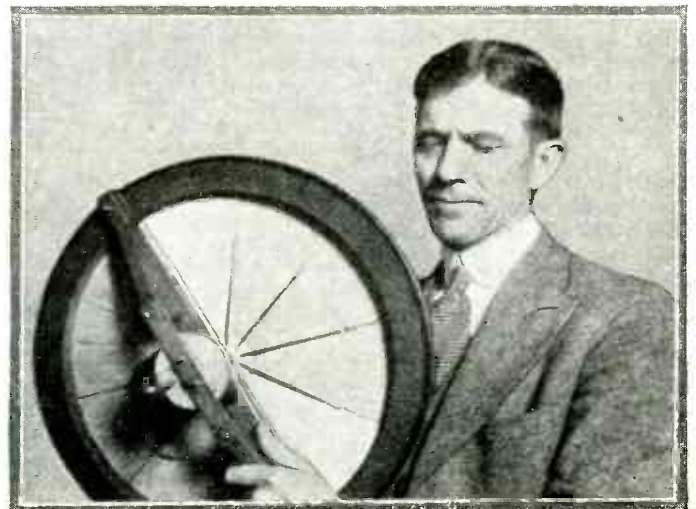

A rear view of the all-wood speaker appears in the above photograph. The unit is mounted upon a strip placed across the back and fastened to the rim on either side. Small wooden spokes radiate from the apex to each one of the ten strips.

A. C. SET HINTS

By
PAUL L. WELKER

Causes and Cures for Hum in A.C. Receivers Discussed from All Angles. Testing A.C. Tubes and "B" Eliminators, Controlling Line Voltage and Other Important Factors Which Insure Satisfactory Set Operation

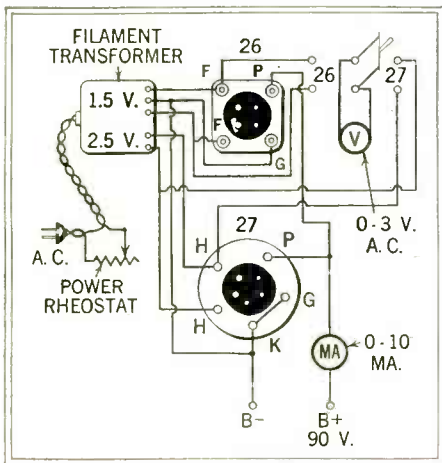

A diagram of an A.C. tube tester for 226- or 227-type tubes appears above. A switch enables the voltmeter to be thrown across either filament terminals.



The above photograph shows a manufactured A.C. and D.C. tube tester and rejuvenator. The pointer is varied to obtain different filament voltages.

ELECTRIC set operation is winning increased popularity as each day passes. All manufacturers are now making A.C. models as well as battery and D.C. jobs and the home radio constructor has also been bitten by the A.C. bug. The joy of complete electric operation, however, has many times been mitigated, due to an annoying hum which defied eradication because all possible causes had not been taken into consideration in a goodly portion of the cases. Therefore, in the space allotted, the possible causes and elimination of this radio bugbear will be discussed, and a few important hints for more efficient A.C. operation cited.

Practical A. C. Operation

Light socket operated receivers have recently come into their own. They now are enjoying wide popularity but in many cases an annoying hum has persisted in home-constructed receivers of this type. It is the purpose of this article, therefore, to enable the set builder to construct a successful A.C. operated receiver as well as to give pointers for more efficient and satisfactory operation of all socket power sets. The elimination of hum is treated with in detail.

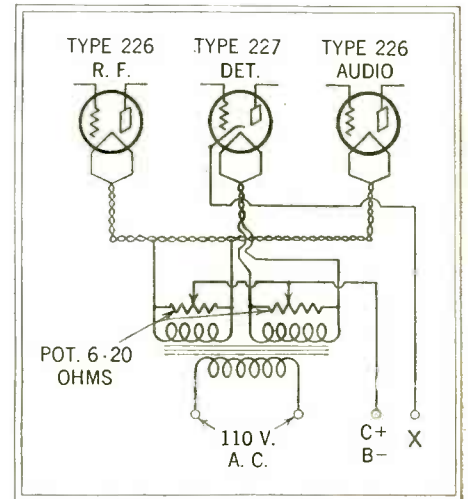

The above illustration shows 227- and 226-type tubes used in combination. The cathode has been marked with an X, further explained in the text.

Practical Suggestions

Testing Poor Tubes

WORNOUT or faulty tubes often cause trouble in A.C. sets, as well as in battery receivers. When the set becomes noisy or volume is weak, it is well, among other things, to test the A.C. tubes for electron emission. The diagram of a simple tube tester for this sort of work will be found on this page, as well as photos of manufactured A.C. tube and set testers. Filament and plate current can be determined with this outfit. The electronic emission value thus obtained is a satisfactory indicator of the condition of the tube. A switch serves for testing either 226 or 227 type tubes. Filament voltage is controlled by a power rheostat in series with the line. The meter is first switched in and the power rheostat adjusted until required voltage is obtained.

226 and 227 Type Tubes

TUBES of the 226 and 227 type afford satisfactory results if the proper precautions are taken. With respect to freedom from hum, the ripple voltage as shown by curves plotted in the laboratory, is a combination of 60 and 120 cycle components with higher harmonics present to a small

extent. Comparisons show that hum introduced by the A.C. filament supply is no greater than that given by some types of plate supply units. This is audible only a few inches from the speaker if proper design has been followed.

One of the factors which enters into successful A.C. operation especially with the 226 type tubes, is the electrical balance in the filament circuit. Diagrams have been published showing filament circuit balance obtained by using a center tapped filament transformer winding. Correct balance is rarely ever accomplished in this manner because the center tap is not always at the electrical center of the winding. Aside from this, however, the filament of each individual tube varies and separate balance is usually necessary. It is essential for the grid and plate returns to be connected to the center or neutral point of the A.C. supply system, particularly when using the 226 as an audio amplifier. The grid return may be made to the center point of a resistor connected across the filament terminals or a low resistance potentiometer, 6 to 20 ohms, as shown, can be employed allowing for variations in individual tubes. The grid return with a 201A type tube is more critical than with a 226 but the return with a 227



A new A.C. tube and set tester appears in the above photo. All types of A.C. tubes can be used in this instrument. A harness is provided for testing those tubes having cathode connected to one side of the heater element.

(Continued on page 890)

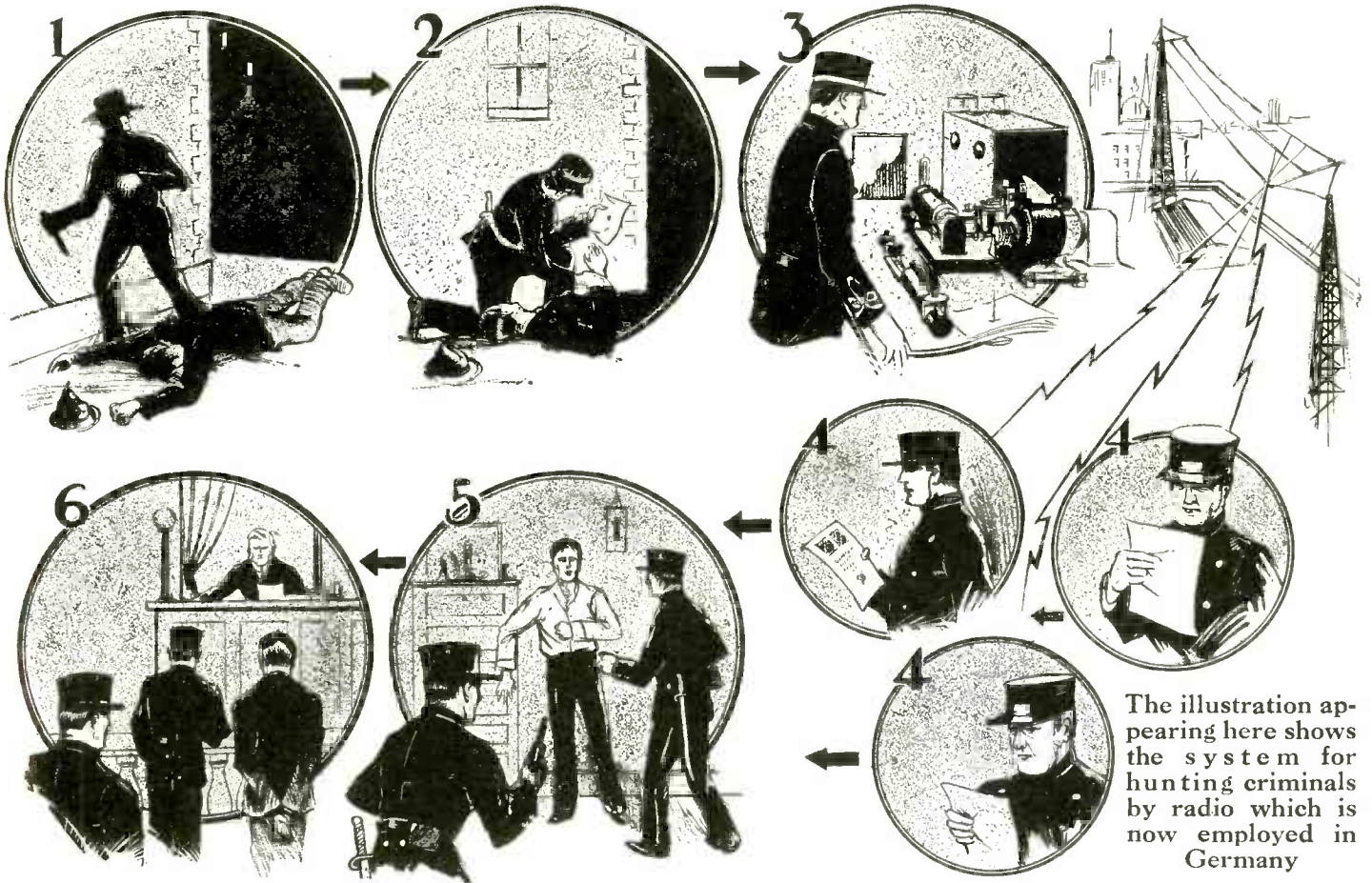

The illustration appearing here shows the system for hunting criminals by radio which is now employed in Germany

How Radio Drag-net Aids Police

A SYSTEM for hunting criminals with the help of radio is now used by the German police. The method will probably extend throughout Europe. Within a few minutes, the police are enabled to send an accurate description as well as the fingerprints of the suspect to any part of the country. Within a short time provision will also be made for transmitting the photographs of criminals when such are avail-

able. This system is particularly valuable in preventing criminals from leaving the country as all stations on the border are notified immediately and keep a sharp lookout. The illustration appearing here shows the crime committed, the finding of the clue, the transmission of description and fingerprints, the reception of same by various police departments, the capture of the criminal and finally, his sentence.

Apartment House Aerial

By S. R. WINTERS

TWO new patents on the subject "Multiple Channel Radio Receiver" have recently been assigned to the American Tel and Tel. Co. The invention makes it possible to use only one antenna with a number of sets and yet allow each set to be tuned to a different wavelength. The antenna is aperiodic and is connected to a radio frequency amplifier, the output of which is led to the various apartments and connected to a tuned detector and amplifier. The occupants are thus enabled to tune to any desired station. This method has been illustrated here as well as an optional arrangement which places a jack strip in the apartment with the radio receiving sets tuned

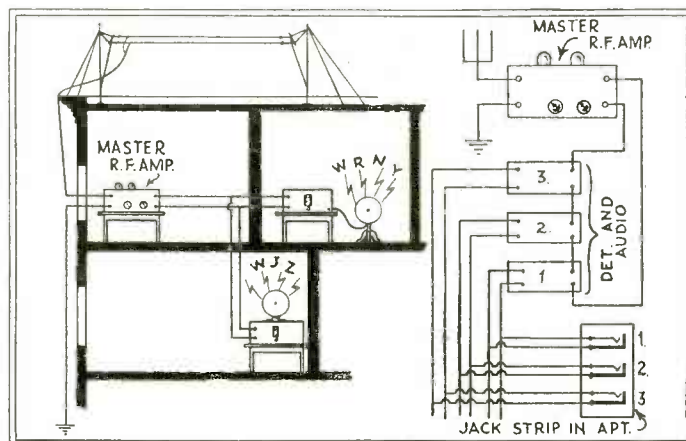

The above illustration shows the apartment house antenna. The aerial is aperiodic and is connected to a master radio frequency amplifier. It is possible to have either the set itself or a jack strip in the apartment as shown.

to various stations by the attendant to give a selection of programs. In this case, it is simply necessary to plug the speaker in any one of the jacks. The tuning of the circuits of the individual channels need not be changed as they can be set to the desired wavelength. In the jack circuit there is a resistor which is equivalent to the impedance of the receiving unit being used so that no fluctuations in volume are experienced by other listeners when an individual switches from one channel to the other. Battleships of the U. S. Navy are also equipped with multiple channel radio receivers.

An up-to-date apartment house has to be fitted with a connection for each apartment.

NEW RADIO DEVICES

FOR the radio fan who is interested in the reception of short-wave broadcasts and more especially for the television enthusiast, a Chicago radio manufacturer is making a complete short-wave kit using three sets of interchangeable plug-in coils. These coils cover the following short-wave bands: 57 to 133 meters, 31.5 to 68 meters, and 15 to 33.5 meters. Straight line frequency condensers are used with vernier dials having a gear ratio of 63 to 1. Needless to say, the condensers and coils are of low loss construction. Care has been exercised in the design so that the parts are placed in a position where there is a minimum of metal near the fields of the coils and near the variable condensers. This precaution taken in short-wave sets will avoid the so-called dead spots. The right-hand condenser, looking at the set from the front, controls regeneration and the left dial tunes in the stations. The primary coil is permitted to swing out at right angles so that the coupling can be loosened if necessary, to clear up dead spots which may be due to the characteristics of the antenna system. The wiring and actual assembly is not at all difficult and full plans are furnished with the panel and sub-panel for the convenience of the set builder.



The above photograph shows a front view of the short-wave receiver. The two dials control the tuning and regeneration condensers. The knob at the left is the detector rheostat. The filament switch is situated on the right-hand side.

Variable Condenser

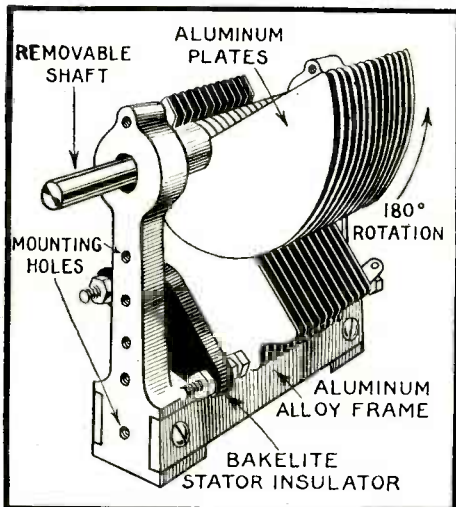

The above illustration shows a variable condenser of recent design which employs plates of aluminum and a special alloy aluminum frame of strong construction. The rotor shaft is removable, and several mounting holes are provided on both of the uprights of the condenser frame.

A MASSACHUSETTS manufacturer has brought out a variable condenser of low-loss design and rigid mechanical construction. The plates are of aluminum and the frame of an aluminum alloy. The stator plates are insulated from the rotor at both ends by a triangular piece of bakelite. Provision has been made for ganging two or more of the condensers by incorporating a removable shaft. The condensers are well suited for tuning with a drum control.

Short-Wave Receiver

Coils for covering the various short-wave bands are supplied and are readily plugged in a special mount.

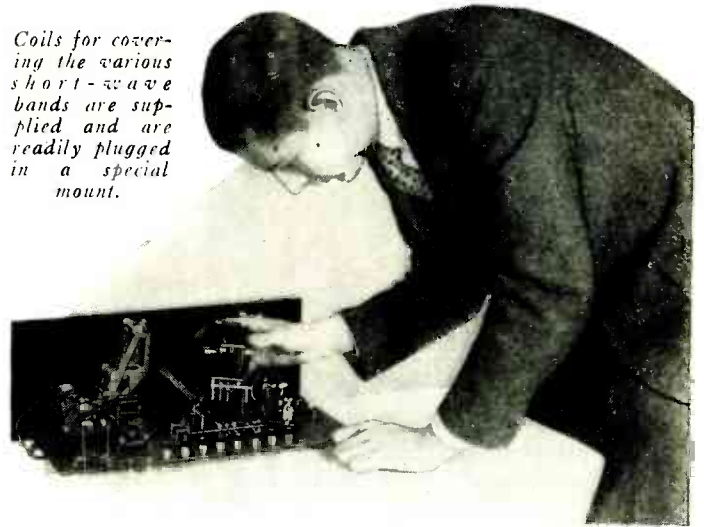

A rear view showing the layout of parts appears above. Looking at the set in this position, the two audio transformers are at the left, then the two audio frequency tube sockets next the plug-in coil mount and the detector socket at the extreme right. Binding posts are arranged on the rear of the sub-panel. The set is admirably suited for the reception of short-wave television signals.

Floor Cord

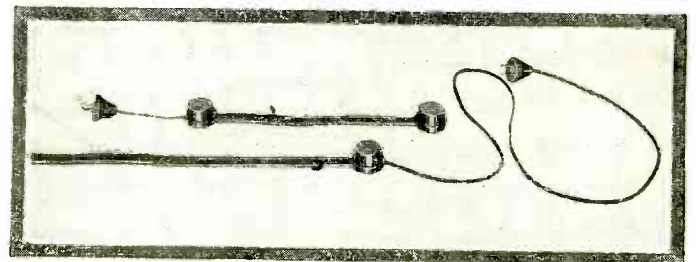

The above photograph shows the flat extension cord for use under a rug and a small cord of the same type for placing under a table scarf. The two leads which run through the cord are separated about one-half inch.

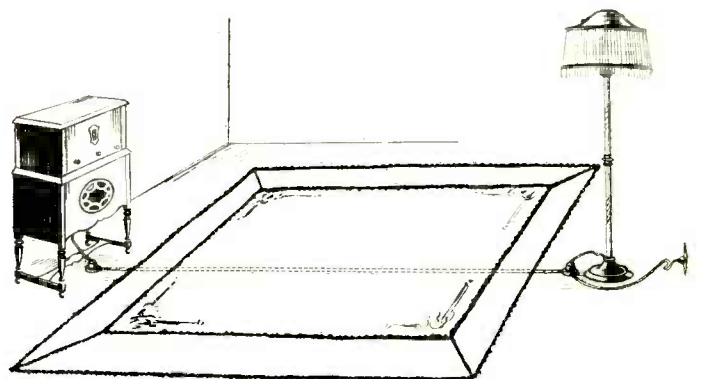

The above illustration shows the floor cord in use with a radio receiver. The leads going to the light socket are provided with an unbreakable soft rubber plug, and the receptacles attached to either end of the cord are of pure bakelite. The flat cord can be shortened to fit the rug by removing the screw holding the washer to the bottom of the receptacle and cutting to the desired length. When placed under a rug it is impossible to detect the cord.

Names of manufacturers supplied upon request.

RADIO ORACLE

A. C. Screened Grid R. F. Stage

While there are many topics of interest to the radio enthusiast, which could be covered on this page, the editor finds it necessary to devote this space to items of timely interest.

(660) J. C. Fort, Syracuse, N. Y., writes:

Q. 1. Will you kindly publish a diagram showing how I may add a stage of radio frequency amplification to my present receiver using an A.C. screened grid tube?

A. 1. On this page you will find a schematic diagram showing how a stage of tuned radio frequency using an A.C. shielded grid tube may be added to your present receiver. SW is a panel or relay switch, R.F.C. is a 125 millihenry radio frequency choke, R₂ is a 10 ohm potentiometer. It will be noticed that a 1 megohm resistor has been placed in the C-lead, so that any voltages induced in this lead which would constitute a regenerative feed-back are bypassed to the cathode through a condenser connected as shown. A .1 or .05 mf. condenser is suitable. Theoretically, the impedances in the grid and plate return circuits should preferably be non-inductive, but practically this is unnecessary. For the grid circuit, a non-inductive resistance of about 1 megohm and a condenser can be used as a filter as illustrated. It will be necessary to shield the radio frequency stage from the rest of the receiver and it is also good practice to shield the detector if this has not already been done. The coil L₂ should be wound with fine wire, No. 30 to No. 36 D.C.C. being the most satisfactory. The number of turns on L₂ will be about one-half the number of turns on the secondary and these should be close wound near the grid end of L₃.

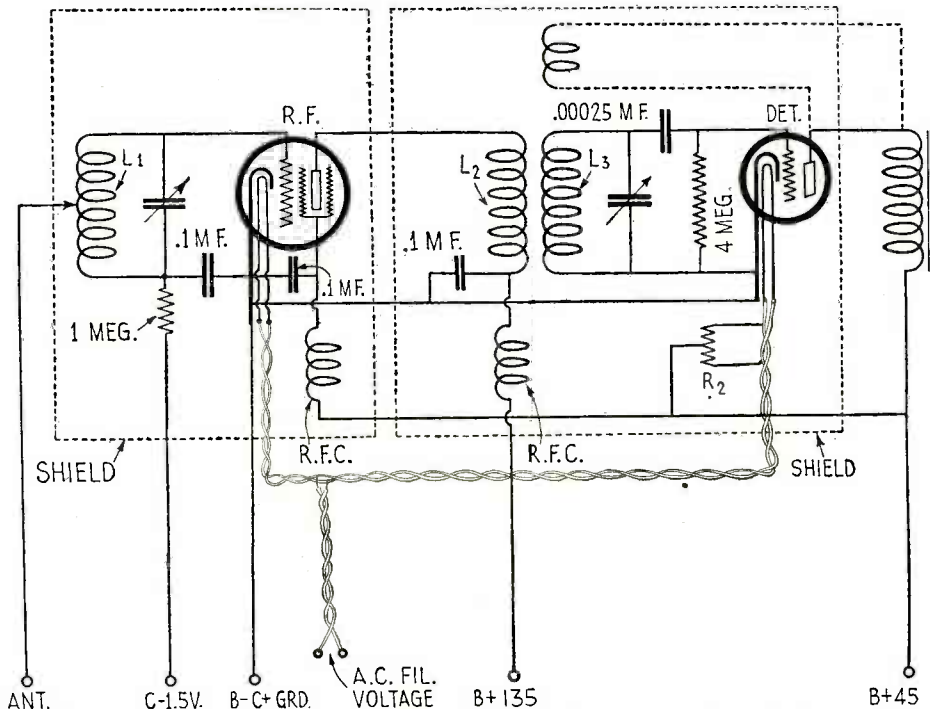

Above—schematic diagram of amplifier stage of A.C. screened grid, radio frequency.

Broken Television Image

(661) H. F. Ehret, Port Chester, New York, writes:

Q. 1. Why does a broad pink band extend across the entire WRNY television image, showing the forehead and eyes above the band and the balance below? If the top and bottom could be brought together, the picture would be complete.

A. 1. Owing to the fact that the four last holes on the spiral of the 48-hole disc on WRNY's television transmitter are blanked off and reserved for synchronizing purposes, it is possible that a pink band across the picture will be seen, but this can only separate two complete pictures from one another. That is, the pink band will be noted at the bottom of the picture, and whenever the received image is out of the frame, the pink band may be anywhere up and down the diaphragm opening in the front of the disc.

The only thing that we can think of that would cause a pink band that would separate two halves of the face would be the fact that two or more holes on your receiving disc are out of alignment, that is, not properly laid out in a true spiral. This would cause a pink band to manifest itself in the manner you describe.

Weather Effects on Radio

(662) Alfred Heller, Brooklyn, New York, asks:

A. 1. Will you summarize briefly the effects which weather has upon radio reception

A. 1. Briefly, effects of the weather upon radio reception as determined by recent studies may be summed up as follows:

1—If a line connecting the receiving station with the broadcasting station crosses the intervening points of equal pressure (isobars) at right angles, reception will be at its best.

2—The closer the isobars are to each other, the stronger will be the reception.

3—The more nearly the transmitted waves parallel the isobars, the weaker will be the reception and fading will usually occur.

4—Reception in a low pressure area tends to be somewhat weaker than in a high pressure area.

5—Reception is accompanied by static when the transmission crosses any part of a warm, humid, low pressure area, or crosses an area adjacent to a humid low pressure area where temperatures are above freezing.

6—Reception is weaker when the transmitted waves cross from one pressure area into another, than when they travel only within one area.

7—Rainy or stormy weather does not necessarily affect reception except that it may be the indication of an unfavorable pressure distribution.

Reception can be as good in bad weather as in good weather, providing that the pressure distribution is right.

8—The strength of reception for any station is a factor of both its location within a pressure area and its position with respect to the broadcasting station.

9—Temperature does not influence reception except that it may be an indication of pressure distribution and strength of convection circulation as follows:

a—Reception is better in winter than in summer because the cyclones and anti-cyclones are more intense in the winter.

b—Reception is better when temperatures are low.

c—High temperatures favor strong convection, which causes static.

d—In poorly defined high pressure areas reception is poor.

10—Shallow or flat pressure areas favor much static.

Further information concerning the effects of weather conditions upon radio reception will be found in an interesting little booklet published by Taylor Instrument Companies, Rochester, New York, for which no charge is made.

Rectifying Element

(663) H. McCurdy, Baltimore, Md., asks:

Q. 1. Can you give me any data on the rectifying element which is known as the Sulfotron valve. Notice of this recently appeared in a foreign technical magazine.

A. 1. The rectifier mentioned above is similar in operation to the dry ones made in this country and is formed with a hollow aluminum body, the bottom of which is a plug of insulating material. An aluminum rod runs through this and touches a copper rod which extends through the top. These two electrodes are kept in contact by a spring and the cavity of the rectifier is filled with a solution of sulphate. This coats the copper electrode with a conductive layer of copper sulphate. When the copper rod becomes the anode this gives very little current resistance. When the aluminum rod is the anode a coating of sulphate of aluminum is deposited thereon, which offers high resistance. Thus, the rectifier allows the current to flow from the copper to the aluminum and offers an infinite resistance to the passage of current in the opposite direction. The element will last for 500 hours. At the present time this is all the information which we have available concerning this rectifier.

SCIENTIFIC HUMOR



SURE WORKED

Some years ago, when the gland treatment for rejuvenation was attracting considerable attention, an old man went to a famous surgeon, and asked him whether he could make him into a youth of eighteen.

"I can," said the surgeon, "but it will cost you fifty thousand dollars."

The old man agreed to pay, and the surgeon performed the operation, which was quite successful. But he was not so successful in trying to collect the bill. He threatened to sue, and the old-young man said:

"You can't sue me now, because I am under age. And if you say that I am not under age, I'll sue you for fraud."

—Adolph F. Lonk.

CAUSE AND EFFECT

QUESTION: "Why does Mr. Mason use a heavy roller on a part of his garden?"

ANSWER: "Because he wants to raise mashed potatoes."—James Wade.

AXE ME NO QUESTIONS

A man's mother-in-law, who lived with him and her daughter, was very ill, and the doctor said:

"I'm afraid that you will have to send her to a warmer climate."

The man went out and came back in a few moments with an axe.

"You do it, doctor," he said, "I haven't got the heart."—Adolph F. Lonk.



PERPETUAL MOTION (?)



Dear Editor: "I am getting only twenty-five miles per gallon with my car. How can I increase this?"

Answer: "Push your car up hill and coast down the other side."
—Gerald Branum.



HOW SHOCKING

First Prize—\$3.00

As Rastus was led to the electric chair, an attendant asked him if he had a request to make.

"Well, boss," replied Rastus sadly, "Ah knows I'se goin' on a tough ride, and maybe I could use one of dese here shock absorbers."—Ronald McGaghran.

ALL jokes published here are paid for at a rate of \$1.00 each; \$3.00 is paid for the best joke submitted each month. Jokes must have a scientific strain and should be original. Write each joke on a separate sheet of paper and add your name and address to each. Unavailable material cannot be returned.

NOW ARISE

"Sedentary work," said the professor, "tends to lessen the endurance."

"In other words," butted in a smart student, "the more one sits, the less one can stand."

"Exactly," replied the professor, "and if one lies a great deal, one's standing is lost completely."—Adolph F. Lonk.

SCIENY SIMON SCIENTIST

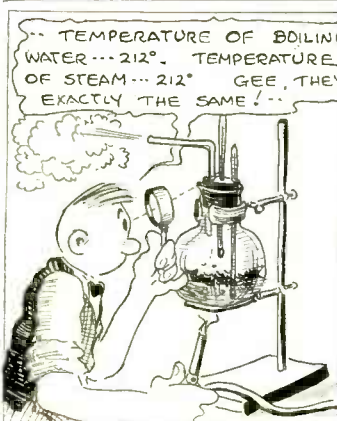

TEMPERATURE OF BOILING WATER... 212°. TEMPERATURE OF STEAM... 212° GEE, THEY'RE EXACTLY THE SAME!...



OUCH!!

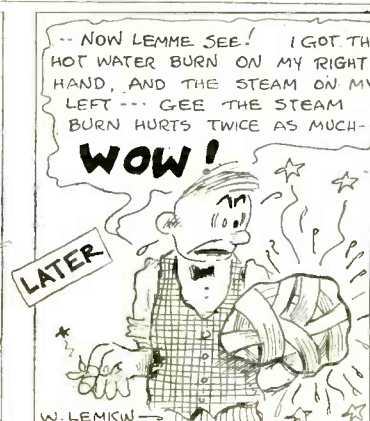

NOW LEMME SEE! I GOT THE HOT WATER BURN ON MY RIGHT HAND, AND THE STEAM ON MY LEFT... GEE THE STEAM BURN HURTS TWICE AS MUCH... WOW!

LATER

W. LEMKOW

SCIENCE LESSON NO. 26 FIVE STEAM CONTAINS MORE HEAT ENERGY THAN AN EQUAL QUANTITY OF BOILING WATER, EVEN THOUGH THEY ARE BOTH AT THE SAME TEMPERATURE. THIS IS BECAUSE OF THE LATENT HEAT OF THE STEAM WHICH IS THE AMOUNT OF HEAT REQUIRED TO CHANGE IT FROM LIQUID TO VAPOR FOR THAT REASON STEAM PRODUCES A MORE SEVERE BURN THAN DOES BOILING WATER

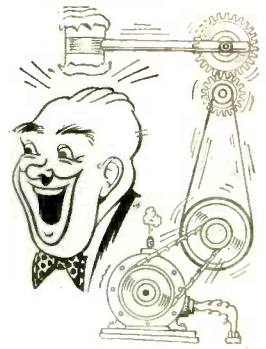

JOKES ON US?

Smith and Jones were discussing inventor Highbrow.

"He's got plenty of science, but not much inventive ability," said Jones.

"Right," answered Smith, "but tell me what is the difference between his work and a perpetual motion bug's work?"

JONES: "Dunno—what?" SMITH: "One is science without invention, and the other is invention without science."

JONES: "That's good. Now you tell me what you would have if you combined the two?"

SMITH: "Search me." JONES: "Why the best magazine going—SCIENCE AND INVENTION."—David J. Gibson.

GAS OR ALCOHOL

HE: "He's an old flame of yours, isn't he?"

SHE: "Yes. Just look at him. About half-lit now!"—Gene Sorenson.

PHYSICALLY PERFECT



CEDRIC: "Just think, I am composed of magnesium, potassium and a dozen other elements."

CELIA: "How wonderful! I just simply dote on big, elemental men."—Fred Meeks.

NOT SILENT

HUBBY: "What do you mean by waking me out of a sound sleep like that?"

WIFE (sweetly): "But, my dear, it was such a distressing sound."
—Gene Sorenson.



LATEST PATENTS

Radiation Receiving Conductor



No. 1,683,270, issued to Marcia Estabrook Taylor. The above invention is a radio receiving antenna wound on a collapsible frame, such as an umbrella. It can be rotated to give directional effects.

Air or Seaplane Station

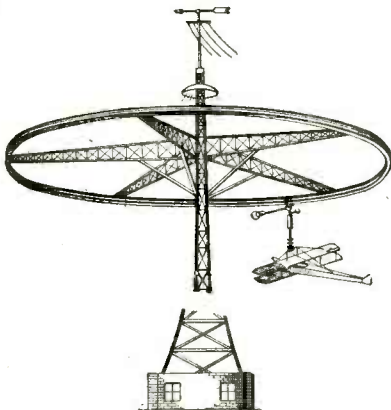

No. 1,686,298, issued to George A. Uhl. The aircraft station shown above has a number of grapple arms which engage the plane both for starting and terminating the flight.

Toy

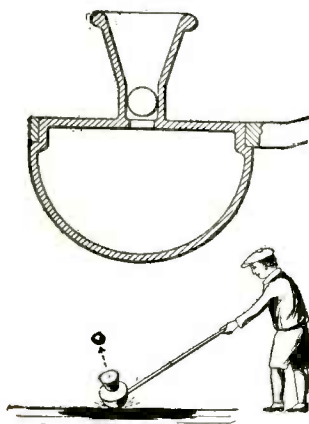

No. 1,667,123, issued to Karl Koller. The device shown above is a toy made in hollow form with an opening by which air is discharged from the device upon being hit, forcing a ball out of the opening. A funnel-like extension enables the direction of the ball to be controlled by the operator.

Notice to Readers:

These illustrated and described devices have recently been issued patent protection but are not as yet, to our knowledge, available on the market. We regret to advise that it is impossible to supply the names and addresses of inventors of the devices to any of our readers. The only records available, and they are at the Patent Office at Washington, D. C., give only the addresses of the inventors at the time of application for a patent. Many months have elapsed since that time, and those records are necessarily inaccurate. Therefore, kindly do not request such information, as it is practically impossible to obtain up-to-date addresses.

Cataract Absorber

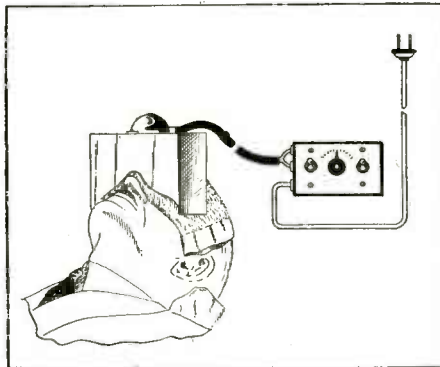

No. 1,681,654, issued to Albert Asleson. This invention provides a heating pad for suitably treating a cataract of the eye. Its efficacy seems doubtful.

Method of Treating Trees

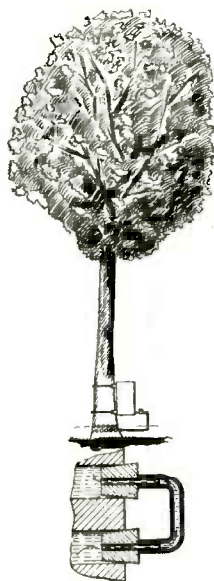

No. 1,682,760, issued to James E. Laffin. By means of the arrangement shown above, living trees can be treated with suitable colors for dyeing the wood or preservatives can be applied. Two chambers terminate at the junction of the sapwood and heartwood and communicate with the capillary system of the tree. A supply of liquid is kept in the chambers.

Electrically-Illuminated Artificial Tree

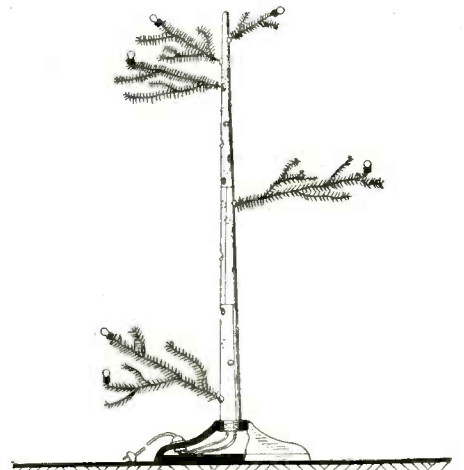

No. 1,677,972, issued to Emanuel S. Marks. The tree shown above has a number of branches on the end of which are placed electric lamps.

Golf Practice Device

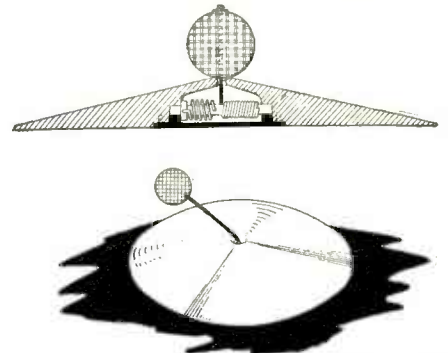

No. 1,670,290, issued to James Aldrich. The invention shown above provides a means for practicing golf drives with a dummy ball which will automatically return to its driving support.

Boat Race Indicator

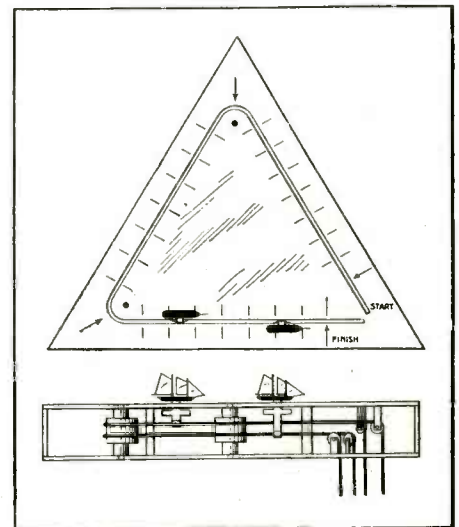

No. 1,680,040, issued to John Hays Hammond, Jr. The device shown here is an indicator for a boat-race or other speed contest and has a model representing each of the contestants. A guide path is provided for the models.

THE ORACLE

Prismatic Glass

(2287) George Pintz, Toledo, Ohio, writes:

Q. 1. If possible, will you publish an illustration showing how prismatic glass increases the natural lighting of buildings.

A. 1. The function of prismatic glass is to redirect the rays which reach it so that they are redistributed in such a way as to give the interior of the room a far bigger light proportion than it would have if ordinary window glass were used. Generally more of the light is used. The drawing shown here illustrates how the prismatic glass increases the lighting from obstructed windows. The edges of the prisms are placed horizontal. The prisms refract the light so as to direct it into the room.

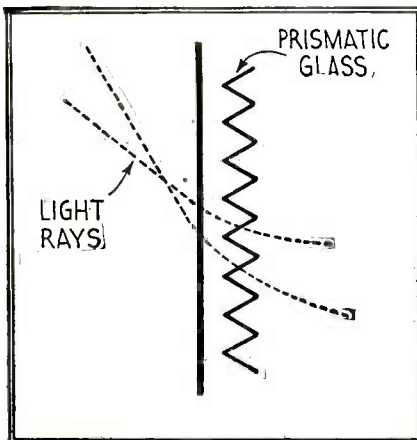

The above illustration shows how the light rays are refracted by prismatic glass and so directed into the interior of the room.

Correction Notice

(2288) Bernard Sunshine, Brooklyn, New York, writes:

Q. 1. I wish to call your attention to a misprint which occurred in the August issue of SCIENCE AND INVENTION, in the electrical department in my article entitled, "A Switch-board for Experimenters," as printed under the heading "Operation" No. 2, for bulb in "series" it states: "No. 2 place switch arm, shown in black, on left-hand contact and close switch on its RIGHT hand. Also, No. 4, care should be taken that the SPST switch on right of central switch (black) is not closed accidentally, etc. This should read as follows: No. 4, care should be taken that the SPST switch on LEFT of central switch (black) is not closed accidentally, etc. In the third paragraph you mention as instruments: 1, DPST switch; 2, SPDT switches, etc. This should read as follows: 1, DPST switch; 2, SPST switches, etc.

Black Fog

(2289) B. Zimmerman, Atlantic City, N. J., asks:

Q. 1. Can you give me some information concerning black fog and the cause for its formation?

A. 1. This form of fog occurs in cold weather over the open surfaces of rivers. Winter fog on the comparatively warm water of the river always appears when the temperature falls to 11 degrees F. This fog rises in columns and hairlike forms. Black fog, however, only occurs at sub-zero temperature and appears to be a precipitation of heavy semi-fluid water particles which seem to absorb the sun's rays. It is preceded by a white fog early in the morning, which is known to rise upward to a height of 1,200 ft. When the sun rises,

The "Oracle" is for the sole benefit of all scientific students. Questions will be answered here for the benefit of all, but only matter of sufficient interest will be published. Rules under which questions will be answered:

1. Only three questions can be submitted to be answered.
2. Only one side of sheet to be written on; matter must be typewritten or else written in ink; no penciled matter considered.
3. Sketches, diagrams, etc., must be on separate sheets. Questions addressed to this department cannot be answered by mail free of charge.
4. If a quick answer is desired by mail, a nominal charge of 50 cents is made for each question. If the questions entail considerable research work or intricate calculations, a special rate will be charged. Correspondents will be informed as to the fee before such questions are answered.

white fog disappears and the color changes to yellow and then rapidly to an opaque black. It is the action of the sunlight which causes this transformation. The white colloidal particles are changed to a deep, heavy, black form. Additional information concerning the formation of fogs and mists will be found in a book entitled, "Ice Engineering," by Prof. H. T. Barnes or in almost any good weather book.

Colored Gold

(2290) Carl Fagan, Ansonia, Conn., writes:

Q. 1. Will you please publish the composition of the various colored golds which are used at the present time.

A. 1. The colors imparted to gold are produced by the careful preparation of an alloy. Green gold consists of gold, silver and cadmium, and sometimes copper is also added. The degree of the green color depends upon the percentage of the metals used with the gold. Pale yellow gold consists of gold and silver and dark yellow of gold, silver and copper. Pale red gold consists of gold, silver and a large amount of copper. Dark red gold consists of gold and copper only, and grey gold of gold, silver and steel. This grey color can be changed to blue by employing 1/3 parts of gold and 1 part of steel. White gold alloys are made from nickel, traces of iron, palladium, silver and zinc. Gold is also alloyed with aluminum for use in the manufacture of cheap goldware. Its color resembles that of pure gold, and remains unchanged in air. This alloy contains a quantity of copper.

Electric Stethoscope

(2291) C. B. Parsons, McKeesport, Pa., writes:

Q. 1. Will you give me some information about the multiple electrical stethoscope which is used at the present time in hospitals and clinics?

A. 1. The development of the vacuum tube amplifier resulted in the improvement of the ordinary stethoscope. The amplifier amplifies greatly over a wide band of frequencies from 40 to 5,000 cycles. The development of electrical filters makes possible the suppression of sounds outside of the band of frequencies to which one is listening. The transmitter or microphone is of electro-magnetic type and one end is held directly against the patient's flesh. It is not acted upon by sound waves in the air and thus the amount of extraneous noise picked up is held to a minimum. To take care of the slight movement of the hand and to avoid noises due to the friction of the fingers on the transmitter case, this portion of the apparatus is provided with a gum rubber holder which absorbs any movements of the patient and hand tremors of the doctor. For delivering the amplified sounds to the ears of the listeners, a small telephone receiver is used and has a

special cap which fits the tubing of an ordinary stethoscope.

Clinometer

(2292) H. L. Collonas, Ironwood, Michigan, asks:

Q. 1. Will you please describe the construction of a simple device for measuring angles between the horizontal and a slope in surveying land.

A. 1. On this page you will find illustrated a simple device used for the above purpose known as a clinometer. A piece of board is marked with a semi-circle and graduated in degrees by a protractor. Every 10 degrees are marked by figures. A piece of string is tied to a small weight and suspended as shown. When the upper and lower edges of the instrument are horizontal mark the line taken by the string which should so fall that the zero degree and the center are on this line. When horizontal the clinometer will show zero degrees. It is best to draw the scale on a piece of

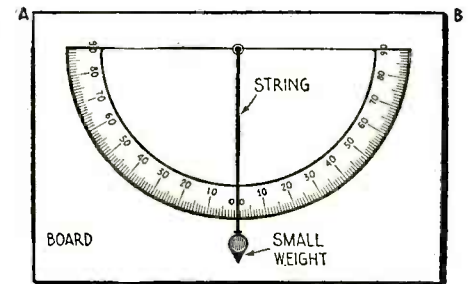

A simple clinometer can be constructed as illustrated. A piece of board is marked off in degrees with a protractor. A pointer is made with a small weight and a piece of string suspended as shown.

paper and then paste it on the board. If B is kept stationary and A lowered through an angle, the pointer will mark that angle. To sight an object look along the upper edge of AB.

Sub-Sea Tunnel

(2293) Jack Mussbaum, Bronx, New York, asks:

Q. 1. Do you think that in the future attempts will be made to tunnel the Atlantic Ocean from New York to England?

A. 1. We very much doubt whether there is even a remote possibility that in the future engineers will attempt to build a tunnel under the Atlantic Ocean from New York to England or Ireland. From the present aspect it seems more probable that dirigibles and large hydro-airplanes will take care of the high-speed passenger traffic across the oceans, and we do not believe that steamships will become obsolete for twenty-five years at least.

At the present time the economics of aerial transportation are not down to the point that they should be for comparison with the cost of transporting freight, and the average class of passenger traffic across the oceans. Some new method of driving the aircraft will have to be perfected, which will provide a more economical transportation rate.

One of the main objections to a trans-Atlantic sub-sea tunnel for trains from America to Europe, would be the fact that if a leak should occur for one reason or another, the passengers would lose their lives, unless some very elaborate means were provided for precluding this possibility. Of course, there are many schemes which could be worked out to this end, but we believe that the cost of building such a tunnel would alone prove a prohibitive factor.

"How I Laughed Myself Into Success in Radio"

by Howard Clark,

"I'm sitting on top of the world! My bank account is growing fatter every day . . . my home is all paid for . . . I've just ordered a new car . . . and my wife and I can at last enjoy life in real style. It sure feels great to be earning big money. And to think how it all came about!"

. . . .

IT happened on a rainy Monday night. I was reading a magazine while Mary was clearing away the supper dishes. Suddenly a funny cartoon caught my eye . . . and I laughed out loud

"Jim, you make me sick!" she cried. "How can you laugh while I'm nearly dying of weariness!"

"But Mary dear—"

"Don't dear me, you idiot!"

I was alarmed. "Great heavens, what's wrong?"

"Wrong?" she screamed, "here I drudge all day, do my own housework, wash all the clothes, take care of the baby, and worry about your meals. I never get a moment of freedom . . . and haven't a decent thing to wear even to church . . . yet you never seem to care!"

I was ashamed!

A feeling of shame swept over me. So that was why she seemed so "moody" the last few days! Like a good sport she had suffered in silence until she couldn't keep it in any longer. Poor kid!

For hours after Mary had gone to bed that night I kept staring into space. What a mess I had made of our lives . . . What a slave I had made of her.

Listlessly I kept thumbing the pages of the magazine . . . thinking . . . thinking. Was there no way out of it?

Then suddenly . . . as if by some kind act of Providence . . . I stopped before a story. It told of a fellow who had made quite a fortune in an uncrowded profession. Fascinated, I read on. It told of the brilliant opportunities in the radio industry . . . of the big incomes fellows like myself were earning . . . and of the ease with which expert radio training could be acquired. But what impressed me most was the



fact that success was practically assured by means of a new home-study laboratory method sponsored by three of America's great corporations.

With gigantic enterprises like these behind a school I needed no greater guarantee . . . so without a second's further hesitation I tore the coupon and mailed it.

A lucky event that changed my life

It sure was my lucky day, when the first lessons came in. I never dreamed that learning radio was so easy. I didn't know the first thing about it when I started. Yet before many months were over I was able to solve many of the problems which command big pay.

Each subject was explained in simple word and picture form. It carried me along like a novel. From magnetism and electricity the lessons took me step by step through trouble-finding and repairing—through ship and shore and broadcasting apparatus operation and construction—through photoradiograms, television and beam transmission.

I didn't have to give up my regular job. I stayed right at home and learned

during my spare time. I actually learned by doing. With the lessons I received a complete, expensive storehouse of apparatus with which I was able to build radio circuits and sets of almost every description. Yet it cost me absolutely nothing extra.

As a result of this practical, technical working out of big radio problems with a fine home-laboratory, I was able to earn good money even before I had completed my course! And it wasn't long before I was able to quit my regular work entirely. . . and branch out for myself in big paying radio jobs.

Today, I have more work than I can take care of. And I often make more money in a day than I used to earn in a week.

Read this thrilling Free Book

Howard Clark's story is typical of the success which scores of other men have achieved . . . through the "big-league" training given by the home-study course of the Radio Institute of America . . . the only school in America sponsored by RCA, General Electric and Westinghouse.

Radio needs you. Manufacturers, dealers, broadcasting stations, ships . . . all need trained radio experts. The pay is big. The opportunities are limitless . . . The work is thrilling! Find out all about it. The Institute has prepared an interesting, illustrated booklet telling you all you want to know about this vast industry and about the remarkable home-study course that can fit you for a brilliant radio career. Just mail the coupon below . . . the booklet is absolutely free. Radio Institute of America, 326 Broadway, New York.

Mail this coupon

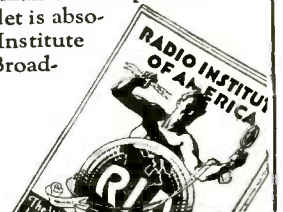

Radio Institute of America
Dept. MA-1 326 Broadway, New York

Gentlemen: Please send me your big FREE 50-page book which tells about the great opportunities in Radio and about your famous laboratory-method of radio instruction at home.

Name.....

Address.....

Hawaiian Guitar

GIVEN

Worth \$20

to our Students

This Hawaiian Guitar expert and professor wants the opportunity to welcome you as a student so you will quickly learn how to play Hawaiian Guitar—yes, you will be able to play just like the native Hawaiians. To get you started and help your musical success which will bring you popularity, you will receive a beautiful Hawaiian Guitar, the same as the one pictured, when you enroll. Our short cut method of instruction will enable you to play a piece almost from the first lesson. Rush coupon for full particulars today and we will reserve a Hawaiian Guitar for you.



Learn to Play Quickly

With our short cut method of instruction you will quickly learn how to play Hawaiian Guitar which will bring you popularity and social success. You learn to play from notes. If you never had any musical training, you will quickly get on, because our experts have perfected a course of home instruction which is as simple as learning A,B,C's.

PICTURE and PHONOGRAPH RECORD METHOD EASY We don't depend upon your success, but we furnish pictures of our professors playing, diagrams, charts and phonograph records for each lesson. This practically brings our professors from our studio to your home and enables you to listen to their playing just as if they were actually in front of you. To prove this is easy, we will send you your first lesson free.

RUSH COUPON — Send No Money
So positive are we that you will become one of our students, we will send free without obligation, our first lesson. Also receive our free big book which gives particulars about our course. Write for your free book and your free lesson today.

HAWAIIAN STUDIO No. 55019
of New York Academy of Music
100 Fifth Avenue, New York, N. Y.
Please rush your free book, "How to Learn Hawaiian Guitar" and my first lesson. Also reserve a Hawaiian Guitar for me. This obligates me in no way whatever.

Name

Address

How a Negative Film Becomes Positive

By Don Bennett
(Continued from page 810)

end is a positive that can be seen and enjoyed.

For many years the use of motion picture equipment by the amateur was restricted to a very few who could afford the expensive equipment and even more expensive upkeep. When the first narrow-gauge amateur cameras made their appearance they used the negative and positive process, requiring the purchase of two strips of film, one a negative and the other a positive, and laboratory charges for the finishing of both films. And only one film—the positive, could be used.

It was soon realized by the manufacturers that the expense of the negative-positive process would prevent the widespread adoption of amateur movie equipment. They developed the reversal process, so-called because it consists of developing the image on the film to a negative and then reversing the colors, so that they assume the right appearance to the eye. You all understand, of course, that a white dress against a dark background will show black against white on a negative. The problem was to have

run through a second group of tubes where all the excess developer is washed away by running water. The film then passes into the third group where the developed negative, metallic silver, is bleached away. (See Fig. 2-b). This leaves the balance of the emulsion to be developed as a positive. The bleaching agent, you understand, acts only on the developed part of the emulsion, the remainder is unaffected.

The bleaching solution is washed away in a fourth group of tubes, and the film then reaches the heart of the apparatus, the timing mechanism. You see if the film was not exposed to sufficient light when the exposure was made, the emulsion left on the film after the bleaching process would be very thick. When this thick emulsion was blackened, by a process to be described a little later, it would mean that the projected picture would be very dark and the result on the screen unsatisfactory. To overcome this a timing apparatus was devised, although at first this timing was done by expert operators who viewed the film as

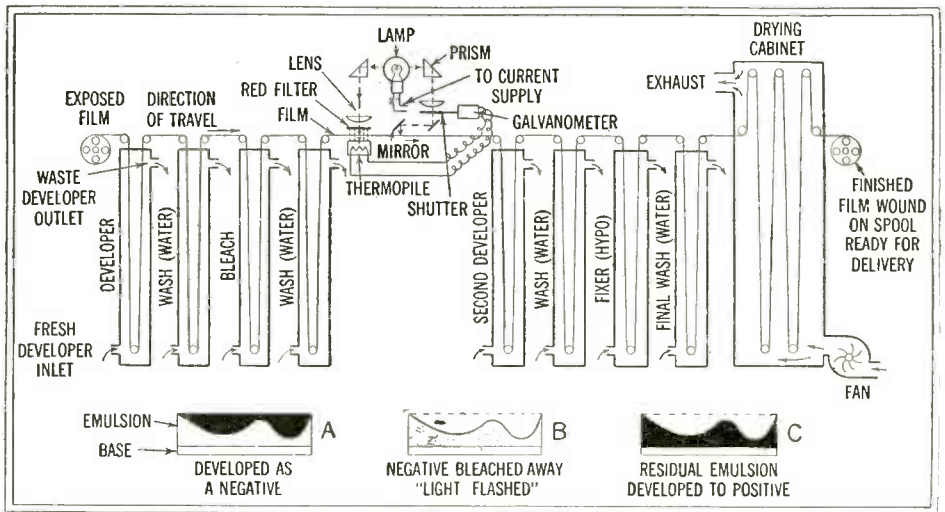

Fig. 1 above shows the construction of the automatic film developing and reversal process apparatus.

the white dress show white on the piece of film that came from the camera. This eliminated the expense of the second piece of film and the extra laboratory work. The reversal process proved to be the solution of that process.

It was also realized that in order to keep the expense down hand labor must be eliminated in favor of automatic machinery. At first the machinery was only semi-automatic, but as you will find in the following description, manual attention has been reduced to the extent that one person feeds the film into one end of the machine, and another person takes the finished positive from the other end. Two such persons can care for several machines as each machine takes a new film every five minutes.

Referring to the drawing, Fig. 1, you will see that the developing machine is made up of a number of glass tubes, each containing a chemical solution or clear water. There are eight groups of these tubes to each machine, the number of tubes in each group varying according to the amount of time the film is to be immersed in each solution. The film moves at a steady rate of speed you see, and the length of time required for the different chemicals to act, varies. The film is fed from the spool into the first group, which contain a developing solution, and the image on the film is developed to a negative. The film is then

it passed along and controlled the amount of light that was to "flash" it.

Recently, however, a piece of apparatus has been developed that depends on truly scientific principles for its operation. As you all know, photographic emulsions, with a few exceptions, are not sensitive to red light. Red light waves are close to the heat end of the spectrum and therefore affect heat registering instruments as heat waves do. This fact was taken advantage of in the construction of the timing apparatus. After the film leaves the bleaching bath, it passes beneath a red light. Below the film, that is, on the side of the film opposite the red light, is a thermopile, an instrument that is affected by delicate changes of heat. When the red heat rays fall on the thermopile, a minute electric current is set up in the thermopile. This current is conducted by wires to a galvanometer, a delicate electric instrument that is affected by minute currents such as those generated by the thermopile.

This galvanometer has a spade-shaped vane fastened to its needle. The vane is suspended below a white light. The white light is enclosed in a cabinet so that only a small amount is allowed to escape through an orifice covered by the galvanometer vane. The sketch shows this arrangement very clearly. Now when a piece of film passes

(Continued on page 854)

ENJOY THE THRILL OF ELECTRIFIED RADIO at SMALL COST

only \$6.85 complete
FREE TRIAL

Banish forever all the annoyance and expense of buying new "B" Batteries with a TOWNSEND "B" POWER UNIT. Hooked up in a few moments—and you have permanent power from your light socket from that time on. Use same tubes now in your set. No changes.

You'll be amazed at the way Townsends improve your reception and add to distance getting. More than 60,000 now in use. Send Coupon today for full information and free trial offer.



TOWNSEND LABORATORIES
Chicago Illinois

COUPON
TOWNSEND LABORATORIES 1-29
Dept. 35, 713 Townsend St., Chicago, Ill.
Please send me full information on the Townsend "B" Power and Free Trial Offer.

Name

Address



SQUAB BOOK FREE

Breed squabs and make money. Sold by millions. Write at once for free 48-page book beautifully printed in colors telling how to do it. You will be surprised. PLYMOUTH ROCK SQUAB CO. 606 H St., Melrose Highlands, Mass.

Make Yourself Fit For Successful Marriage

MARRIAGE always means misery to the unfit. What you are your children are bound to be, and your weaknesses will be increased as you pass them along to your children, who may live to curse you for their inheritance of woe. This is the inflexible law of heredity. You cannot avoid it. You dare not overlook it.

When love disappears, marriage becomes a tragedy that brings woe unto all concerned and visits wreckage upon the children. Love goes when physical weakness comes. To command love, admiration and respect you must be physically fit—a real 100 per cent man, with vigor and strength and stamina.

Don't Plunge

Don't plunge into marriage unless you know you are fit for it. Build up your body if you are weakened from excesses, neglect, stimulants or disease. Get rid of annoying ailments that disgust everybody with you—Catarrh, Constipation, Chronic Colds, Indigestion, Rheumatism, Rupture, Bad Blood, Nervousness, etc.

Make Yourself Fit

You are not fit if you are weak, sickly and under-developed. You dare not marry and ruin some trusting girl's life if dissipation and excesses have sapped your vitality and left you a mere apology for a real man. Don't think you can save yourself with dope and drugs. They can never remove the cause of your weaknesses and will surely harm you. The only way you can be restored is through Nature's basic laws. She will never fail you if you sit at her feet and learn her ways.

Don't Drag Through Life

How long, you weakling, are you going to drag through life in misery and shame and despair? How long are you going to put off being a man? How long do you think you can go on covering up the truth about your miserable physical condition, your unfit state, your drift towards complete collapse and mental disorder? You can't hope to go on as you are if you are one of those paying the price of the man guilty of neglect and waste and excesses that rob the body of every manly attribute and make marriage a thing to be dreaded. People spot such a man. There are tell-tale evidences that reveal to searching eyes the truth about your condition.

Snap Out Of It!

You can be vitalized. You can be made strong. You can be just as powerful, just as muscular, just as robust and healthy as you want to be. I know what I am talking about. I can show you piles of letters from young men and older ones telling of the miserable condition in which I found them—pitiful stories most of them—and then how I built them up into 100% men—strong, muscular, vital, energetic, magnetic men who could again look the world in the face, meet men with a hearty grip and mingle with women courageously.

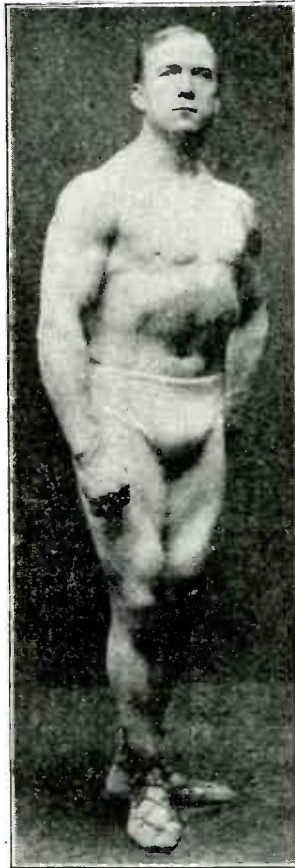

STRONGFORT

Dr. Sargent, of Harvard University, U. S. A., declared **Lionel Strongfort** to be unquestionably the finest specimen of physical development he had ever seen.

STRONGFORTISM

has helped thousands overcome the vitality-sapping disorders that afflict so many. It has, by natural methods, without the use of drugs or apparatus of any kind, enabled them to develop their muscular system internally and externally and banish Weakness, Constipation, Catarrh, Indigestion, Nervousness, Rupture and the result of abusing and neglecting the body, and to again feel the thrill of vigorous life, buoyant health and cheerful mentality. It will build you up speedily. There isn't any doubt about this. You will realize the truth almost from the moment you start my Course in

STRONGFORTISM

Science of Health and Strength

It was through the methods I used in developing my own body that I constructed the science of STRONGFORTISM. It is through it that I reclaim wrecked and weak men, make them into new beings and give them a body of which they can boast. I require you to use no apparatus. No drugs or medicines are prescribed. No inconvenient hours are required. Only a little of your time in the privacy of your own room is necessary to follow my easily understood instructions—and, oh man, how glad you'll be that you listened to me, once you've started on my Course. It means a new day for you, that's sure as you're alive. You can banish your weakness. There is no doubt about it. I can prove it if you'll just sit down and tell me frankly that you are willing to guide by what I tell you.

Send For My FREE BOOK

Send for your copy of my extraordinary book and you will learn facts that will astonish you and help you out of your sorry plight. The experience and research of a lifetime are contained in my wonderfully instructive book, "Life's Energy Through Strongfortism." It will tell you frankly how you can make yourself over into a vigorous specimen of vital manhood with 100% pep, power and personality. Just check the subjects on the consultation coupon on which you want special confidential information and send to me.

Clip and Send this Coupon
Send this FREE Consultation Coupon

ABSOLUTELY CONFIDENTIAL

Mr. Lionel Strongfort, Strongfort Institute, Dept 647, Newark, N. J.—Please send me absolutely free my copy of your book, "LIFE'S ENERGY THROUGH STRONGFORTISM." This does not place me under any obligation and no salesman is to call on me. I have marked (x) before the subjects in which I am most interested.

- | | | |
|-------------|----------------|------------------------|
| ..Catarrh | ..Overweight | ..Great Strength |
| ..Colds | ..Constipation | ..Vital Losses |
| ..Asthma | ..Weak Back | ..Lung Troubles |
| ..Headache | ..Weak Eyes | ..Round Shoulders |
| ..Rupture | ..Rheumatism | ..Youthful Errors |
| ..Thinness | ..Nervousness | ..Manhood Restored |
| ..Pimples | ..Night Losses | ..Stomach Disorders |
| ..Insomnia | ..Short Breath | ..Increased Height |
| ..Impotency | ..Weak Heart | ..Muscular Development |

Private Ailments

Name

Age Occupation

Street

City State

STRONGFORT INSTITUTE
LIONEL STRONGFORT, DIRECTOR.
PHYSICAL AND HEALTH SPECIALIST

FOR OVER 25 YEARS

DEPT. 647

NEWARK, NEW JERSEY, U.S.A.

What will you be doing one year from to-day?

Three hundred and sixty-five days from now—what?

Will you still be struggling along in the same old job at the same old salary—worried about the future—never quite able to make both ends meet—standing still while other men go ahead?

One year from today will you still be putting off your start toward success—thrilled with ambition one moment and then cold the next—delaying, waiting, fiddling away the precious hours that will never come again?

Don't do it, man—don't do it.

There is no greater tragedy in the world than that of a man who stays in the rut all his life, when with just a little effort he could bring large success within his grasp.

Make up your mind today that you're going to train yourself to do some one thing well. Choose the work you like best in the list below, mark an X beside it, mail the coupon to Scranton, and without cost or obligation, at least get the full story of what the I. C. S. can do for you.

INTERNATIONAL CORRESPONDENCE SCHOOLS "The Universal University"

Box 6173-F, Scranton, Penna.

Without cost or obligation, please send me a copy of your booklet, "Who Wins and Why," and full particulars about the subject before which I have marked X:

BUSINESS TRAINING COURSES

- | | |
|--|---|
| <input type="checkbox"/> Business Management | <input type="checkbox"/> Advertising |
| <input type="checkbox"/> Industrial Management | <input type="checkbox"/> English |
| <input type="checkbox"/> Personnel Management | <input type="checkbox"/> Business Correspondence |
| <input type="checkbox"/> Traffic Management | <input type="checkbox"/> Show Card and Sign |
| <input type="checkbox"/> Accounting and C. P. A. | <input type="checkbox"/> Lettering |
| <input type="checkbox"/> Coaching | <input type="checkbox"/> Stenography and Typing |
| <input type="checkbox"/> Cost Accounting | <input type="checkbox"/> Civil Service |
| <input type="checkbox"/> Bookkeeping | <input type="checkbox"/> Railway Mail Clerk |
| <input type="checkbox"/> Salesmanship | <input type="checkbox"/> Common School Subjects |
| <input type="checkbox"/> Secretarial Work | <input type="checkbox"/> High School Subjects |
| <input type="checkbox"/> Spanish <input type="checkbox"/> French | <input type="checkbox"/> Illustrating <input type="checkbox"/> Cartooning |

TECHNICAL AND INDUSTRIAL COURSES

- | | |
|---|--|
| <input type="checkbox"/> Electrical Engineer | <input type="checkbox"/> Architect |
| <input type="checkbox"/> Electric Lighting | <input type="checkbox"/> Architects' Blueprints |
| <input type="checkbox"/> Mechanical Engineer | <input type="checkbox"/> Contractor and Builder |
| <input type="checkbox"/> Mechanical Draftsman | <input type="checkbox"/> Architectural Draftsman |
| <input type="checkbox"/> Machine Shop Practice | <input type="checkbox"/> Concrete Builder |
| <input type="checkbox"/> Railroad Positions | <input type="checkbox"/> Structural Engineer |
| <input type="checkbox"/> Gas Engine Operating | <input type="checkbox"/> Chemistry <input type="checkbox"/> Pharmacy |
| <input type="checkbox"/> Civil Engineer <input type="checkbox"/> Mining | <input type="checkbox"/> Automobile Work |
| <input type="checkbox"/> Surveying and Mapping | <input type="checkbox"/> Airplane Engines |
| <input type="checkbox"/> Plumbing and Heating | <input type="checkbox"/> Agriculture and Poultry |
| <input type="checkbox"/> Steam Engineering <input type="checkbox"/> Radio | <input type="checkbox"/> Mathematics |

Name.....

Street Address.....

City..... State.....

If you reside in Canada, send this coupon to the International Correspondence Schools Canadian, Limited, Montreal

TYPEWRITERS
ALL STANDARD
10 days FREE Trial at 1/2 PRICE
Underwood, Remington, Royal, etc. ONLY 14¢
All late models, completely refinished brand new. GUARANTEED for ten years. Send no money—big free catalog shows actual machines in full colors. Get our direct-to-you easy payment plan and 10 days' trial offer. International Typewriter Ex., 186 W. Lake St., Dept. 117 Chicago, Ill.

LEARN TO PAINT STATIONS and SHOW CARDS
We quickly teach you by mail, or at school, in spare time. Enormous demand. Big future. Interesting work. Oldest and foremost school.
EARN \$50 TO \$200 WEEKLY
John Vassoe, N. Y., gets \$25 for single show card. Crawford, B. C., writes: "Earned \$200 while taking course." Don't delay. Send today for complete information, samples and guarantee.
DETROIT SCHOOL OF LETTERING
179 Stimson Ave. Est. 1899. DETROIT, MICH.

How a Negative Film Becomes Positive

(Continued from page 852)

under the red light, a small current is set up in the thermopile depending on the amount of heat waves that were permitted to pass through the film, this quantity being governed by the thickness of the emulsion. The current set up in the thermopile is conveyed to the galvanometer and deflects the vane a slight amount permitting a certain amount of white light to reach the emulsion of the film and affect the silver grains of the emulsion. We will say that this first piece of film has been under-exposed and therefore is thick.

Now let us watch the action when an over-exposed piece goes through. Due to the over-exposure, most of the emulsion has been bleached away in the negative, and in order to get a picture of satisfactory density on the screen, we must blacken the remaining emulsion as much as possible. Watch the thermopile; as this thin piece of film travels under the red light, almost the full force of the light is thrown into the thermopile. This sets up a large current in the thermopile, which when conducted to the galvanometer, deflects the vane almost its full extent, permitting the full force of the white light to fall on the film and affect the silver so that it will develop black. With the thick piece, you will remember, only a little of the white light came through, and consequently the emulsion was only slightly affected.

The film now goes into a fifth group of tubes which contain the second developer. Here the emulsion that has been affected by the white light in the last operation is developed. It becomes black. We then wash the film with water in a sixth group of tubes and fix the film in a seventh. The fixing is necessary so that the unexposed and undeveloped emulsion left after the second development will not remain in the film. The fixing agent is a solution containing a large proportion of sodium thiosulfate or hypo. This solution also contains various chemicals that will tend to harden the emulsion and render it less liable to scratching when it is projected. After the fixing bath comes another and final wash in clear running water. From this last wash the film goes to a drying cabinet where the water is dried off and the film is ready to be sent back to its owner.

From the time that the film was placed in the machine by an attendant until now, it has not been touched or observed by humans. At this point, where it leaves the drying cabinet it again goes through human hands, to be rolled on a spool and packed in its box for shipment.

You perhaps wonder why this process has

not been utilized by the professional. It is because the professional movie concerns need a large number of copies of each picture and a negative is the most desirable way to get a large number of prints. For the amateur who will probably not need more than the one copy, the process is ideal, and if he wants additional copies made of his reversed positives, he can have them made at any time. The process of copying is simply a repetition of the taking process. The film to be copied is placed in a machine with a piece of unexposed film and run past a white light. This impresses the images of the first film on the copying film, and when the copy is run through the developing machine, a true copy is delivered at the other end.

For the amateur who desires to experiment, film is available that can be developed to a negative, and positives made the same as the professional does. But the use of negative film is restricted almost entirely to scientific and experimental work, although some amateurs use it for their regular films. It is altogether a matter of personal preference and as such, it is up to the individual to decide whether he likes the one-film or the two-film method.

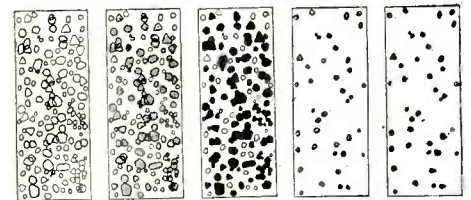

In Fig. 2B above we see how the metallic silver on the developed negative is bleached away. This leaves a balance of the emulsion to be developed as a positive. 1 at left, shows the grains unexposed to light; 2 shows the film after exposure, with the larger particles affected by the light. 3 shows the film after development—the negative stage. 4 shows the black metallic silver has been bleached out and the film has been exposed to light. In mathematical proportion to the lack of brilliance of any area of the subject, there is silver halide left on the film undisturbed by the bleaching. As soon as they have been developed out (Section 5) these remaining grains will determine the density of this area of film, and its consequent function in causing shading on the amateur movie screen.

Vegetable Oils Best for Hair Dressing

THERE are two kinds of oils used in hair dressings—mineral oils and vegetable oils. Many authorities on the care of the scalp and hair are outspoken in their opinion that vegetable oil is far better than mineral oil for the following reasons:

1. Mineral oils are solvents for the natural oils of the skin and scalp, hence they retard the natural functions of the skin.

2. Such oils are non-absorbable by the skin; thus they are accumulative. This is particularly true with the hair which receives so little attention and cleansing on the part of the average person.

3. Accumulation of mineral oils or waxes in the pores of the scalp retards its natural functioning and can create an unhealthy diseased condition.

4. Aggravation of the scalp thus brought

about readily transmits itself to the hair, producing unhealthy, lifeless brittle hair that readily splits, breaks off or falls out.

5. On the other hand certain vegetable oils act exactly the opposite.

(a) They are absorbable to a great degree.

(b) Are recognized as being stimulative to the productive glands of the skin.

(c) Are emollient in action.

(d) Furnish artificial food values and pliability as well to brittle, harsh or dry hair.

(e) Aid to maintain a naturally healthy condition to the scalp.

(f) Are greatly less accumulative than mineral oils and waxes.

(g) Are used by reputable physicians and authorities on scalp hygiene as a basis for scalp tonics and remedies.

There is No Substitute for Quality!

No amount of lurid claims by nimble-penned advertising writers will take the place of quality in the final analysis — the operation in your power supply.

Ever since the advent of Radio, Dubilier has been the manufacturers' standard—and the set-builders' stand-by.



Built in every Dubilier Condenser is a factor of safety which is *your* safeguard for years of service without failure.

Dubilier Light Socket Aerial —“A Moulded Bakelite Product”

Bring in programs with a minimum of interference. Do away with the un-

Type PL 1120 especially designed for the Thordarson types R-480 and R-280 Power Compacts, used with 171 type tubes and the 280 type tube Rectifier or the Elkon E-80 metallic Rectifier. Price \$15.50.

sightly and trouble causing outside aerial and *lightning* arrestor. Simply attach to the set and plug into the nearest light socket. Uses no current. Sold by all good dealers everywhere. Price \$1.50.



Address
Dept. 51

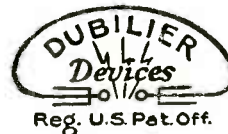

for free
catalog

Dubilier CONDENSER CORPORATION

10 East 43rd Street, New York City

“YOU CAN FORGET THE CONDENSERS, IF THEY ARE DUBILIER’S”

Please say you saw it in SCIENCE and INVENTION

BUILD... a Tri-Motored Model Airplane

BUILD with your own hands this model of the famous "Silver Wing" mail plane now in service between England and France! Model shows everything in exact miniature—the three great air-cooled engines, aileron and rudder control, wings, landing gear and huge fuselage. Or, if you prefer, make a real scale model of an automobile or of a high-speed ship coaler, both of which work just like real ones.

We will send you an easily understood instruction booklet for any one of these models you prefer, free. These booklets usually cost 10c each. If you want all three, send 20c. All you have to do is to send us your name and address and that of three of your friends, telling us which booklet you prefer. This is a wonderful chance. Act now!

MECCANO COMPANY, INC.

Div. J-3

Elizabeth, N. J.

Toronto, Can.

THIS OFFER WORTH 10¢

'The Wonder Hotel of New York' **HOTEL MANGER**

Heart of Times Sq. District
7th Ave. 50-51st Sts.
New York City

2000 Rooms

Rooms with running water . . . \$2.50

For two . . . 3.50

Rooms with shower or bath and shower . . . 3.00-5.00

For two 4.00-5.00-6.00

No Higher Rates

BE A RAPID-FIRE TRICK **CARTOONIST**

\$2 BUYS COMPLETE COURSE, including 40 Clever Cartoon Stunts, "How To Give Performance"; "How to Originate Ideas." Fun—Profit—Popularity! Send \$2 or pay C.O.D. EDUCATOR PRESS, 19 Park Row, N. Y., Dept. O-37

Learn To **Hypnotize!**

Complete course of Hypnotism, Mind Reading and Magnetic Healing 25 fascinating lessons. How to become an expert, hypnotize at a glance, make others obey your wishes, overcome bad habits and enemies, gain in power, wealth, love. Simple, easy system. Equals \$20 course; now only \$1. Send stamps, cash; no more to pay. EDUCATOR PRESS, 19 Park Row, New York, Dept. H-37

RESHAPE your NOSE

to beautiful proportions—while you sleep!

ANITA NOSE ADJUSTER is SAFE, painless, comfortable. Speedy, permanent results guaranteed. Doctors praise it. No metal to harm you. Small cost. Write for FREE BOOKLET BEFORE-AFTER ANITA INSTITUTE, A-73 Anita Bldg., Newark, N. J.

LAW STUDY AT HOME

Become a lawyer. Legally trained men win high positions and big success in business and public life. Be independent. Greater opportunities now than ever before. Big corporations are headed by men with legal training. Earn **\$5,000 to \$10,000 Annually**. We guide you step by step. You can train at home during spare time. Degree of LL.B. conferred. LaSalle students found among practicing attorneys of every state. We furnish all text material, including fourteen-volume Law Library. Low cost, easy terms. Get our valuable 64-page "Law Guide" and "Evidence" books FREE. Send for them NOW. LaSalle Extension University, Dept. 1384-L, Chicago. The World's Largest Business Training Institution

Insure your copy reaching you each month. Subscribe to SCIENCE AND INVENTION—\$2.50 a year. Experimenter Publishing Co., Inc., 230 Fifth Avenue, New York City.

Electrical Problems

By Ricarde Ludeke

(Continued from page 831)

say 200 turns, then you connect the lamp in series with these windings, to the 110-volt line; if the lamp gives any light you go on winding until there is no light at all. Supposing this happens with 300 turns, you need 5 times more on the secondary for 550 volts, that is, $5 \times 300 = 1,500$ turns.

Question Six

In the diagram shown previously, which of the ammeters will give the greater reading, and what reading will the voltmeter give?

Answer to Question

Neglecting the resistance of connecting wires and ammeters, ammeter 1 marks the current which flows through the high resistance plus the current which the voltmeter takes while ammeter 2 only indicates the current of the high resistance, hence ammeter 1 shows a greater reading. The voltmeter marks the voltage of both batteries, about 3 volts.

Question Seven

Suppose you oil or grease your antenna switch so much, that the direct electrical contact is interrupted, what will happen to your set when listening.

Answer to Question

If there is no direct contact the switch will act as a small condenser, in series with the antenna, therefore the natural wavelength will be reduced and you will have to retune your set.

Question Eight

Is it possible to charge completely a 180 volt "B" battery, connecting the same as shown, to the 200 volt line?

Answer to Question

No it is not, because each cell at full charge gives about $2\frac{1}{2}$ volts, needing therefore at least $90 \times 2\frac{1}{2} = 225$ volts. But you could charge the battery, putting 2 blocks of 90 volts each in parallel.

Red Buildings Floodlighted

That buildings need not be white or of light-colored material to be floodlighted has just been demonstrated by engineers of the General Electric Company in the illumination of a group of red brick factory buildings comprising the Johnson & Johnson plant at New Brunswick, N. J.

As red is a very poor reflector of white light, more than 100 floodlights equipped with red lenses were used. The effect is unusual and spectacular, attracting wide attention from persons traveling on nearby highways and on the main line of the Pennsylvania Railroad between New York and Washington, which passes near the plant.

When the matter of floodlighting this plant was first suggested by the General Electric Company, tests were made by W. D'A. Ryan in the illuminating engineering laboratory at Schenectady, with projectors using various colored lenses. White floodlights showed up the mortar between bricks and other defects prominently, but when the red was substituted, these facts were not emphasized and the effect was a smooth spread of light which could be seen at considerable distance. This is the first time that a group of red brick buildings has been floodlighted by the General Electric Company.



Build your Model Airplane the IDEAL way!

THE easiest, most practical way to build a strong, sturdy Model that will make wonderful flights. IDEAL Models are the most accurate copies of real Airplanes in appearance, proportions and constructional details, and have movable ailerons, elevators and rudder. All parts are realistic and completely finished. Build your Model the IDEAL way—and be sure of success!

"SPIRIT OF ST. LOUIS," shown above; 3-ft. Flying Model. Complete Construction Outfit.....\$7.50
Ask your Dealer for this Model, or Order Direct

Plans for Models, 25c each

Accurate, 1/2-size Plans, with Building-Flying Instructions for any one of the following: "Spirit of St. Louis"; FOKKER; DeHavilland; Curtiss; NC-4 Seaplane; Bleriot; Nieuport or Taube Monoplanes; Cecil Pooler Racer;—25c each postpaid. Catalog included free.



64-page Catalog, 5c

Biggest, best listing of everything for building all kinds of Models; also much other Aviation information. Send for yours now!

IDEAL AEROPLANE & SUPPLY COMPANY, Inc.
Largest Manufacturers of Model Airplanes
Established in 1911
22-24 West 19th Street New York City

HOW'D FREE LESSONS!

YOU LIKE to Play This Instrument?

YOU CAN PLAY THE KYLORIMBA

No reason why you shouldn't. Easy Lessons show you how. 5 days' free trial in your own home. A year to pay.

THE whole world seems different when you learn to play and now you can play the most spectacular of all instruments—the Deagan Xylorimba. No long waiting. No finger or lip exercises. No tiresome practice. Start to play very first day even if you can't read a note of music! Right now. Soon you'll be the "hit" of every party. Maybe, like the Musical Hallmans (Reading, Pa.) you'll make \$65 a week spare time.

Our Big FREE Book tells all about the free trial offer, the easy lessons, the wonderful payment plan. No cost or obligation—send in coupon today. J. C. Deagan, Inc., Dept. 1561, 1770 Berteau Ave., Chicago

Send me, without obligation, full details of Free Trial offer and easy-payment plan of the Deagan Xylorimba.

Name.....
Address.....

Electrical Engineering

Course for men of ambition and limited time. Over 5000 men trained. Condensed course in Theoretical and Practical Electrical Engineering including the closely related subjects of Mathematics and Mechanical Drawing. Students construct motors, install wiring, test electrical machinery. Course designed to be completed in one college year.

BLISS ELECTRICAL SCHOOL

Prepare for your profession in the most interesting city in the world. Catalog on request. 153 Takoma Ave., Washington, D. C.

THIS CLASS PIN 30c.

If you buy 13 or more, Silver plate, Singly 40c ea. choice of 2 colors enamel, 3 letters & date. Sterling Silver, 13 or more \$50 ea. Singly 60c ea. Big Free Cat. shows Emblems 95c to \$4 ea.

685 METAL ARTS CO., Inc., 863 Portland Ave., Rochester, N.Y.

The Most Thrill-Packed Western Story You'll Ever Be Likely To Read!

THEY called Steve Hewson the "Tornado"—and he was all of that and more when he strapped on his six-guns and swept down on a bitter range feud and rid the country of the worst rustlers in the west! Don't miss reading this high-speed action story of the old-time cow country. It's called—



The Tornado from Eagletail

By H. BEDFORD-JONES
in the JANUARY

At All
Newsstands.
PRICE
25c

AIR - WESTERN - WAR Triple-X Magazine

January
issue
now on
sale.

Also this thrilling epic of the sky:

Rivals Of
The Clouds
By RAOUL WHITFIELD

12 Other Top-Notch Stories
By Top-Notch Authors



TRIPLE-X MAGAZINE, Jan. Sci. & Inv.
Fawcett Publications, Inc.
Minneapolis, Minn.
Enclosed please find \$1 (bill or stamps), for which send me Triple-X for the next five months.
Name
Address
City State.....

Please say you saw it in SCIENCE and INVENTION



The funniest comic in America, 'Smatter Pop' will keep you in stitches from the moment you open it until you have read and reread every page time and time again. Fifty full-page comics in this edition of 'Smatter Pop'—Hundreds of real laughs. C. M. Payne sure knows how to get under your skin and bring out every laugh in your system.

Meet "Pop," "Desperate Ambrose," and Pop's little family. They can make you laugh when everything else has failed. Ask your newsdealer or, if he can't supply you, fill in the coupon and mail to us. The funniest comic ever written. Don't miss it! Get your copy now! Barrels of FUN!



APologies to C. M. PAYNE

EXPERIMENTER PUB. CO.
230 FIFTH AVE.
NEW YORK CITY

LISSEN---'SMATTER POP IS WHAT I'M
LOOKING FOR. 'SMATTER POP I SAY! SO
DON'T HOLD ME UP. DON'T HOLD ME UP
MAIL, MY COPY NOW---NOW I SAY---
HERE'S MY QUARTER---MY TWENTY-
FIVE CENTS-----SO RUSH.

NAME.....
ADDRESS.....
CITY..... STATE.....

Can You Sell Gas At 5c Per Gal.?

If so, write me quick. My distributors make as high as \$3,000.00 per month. Let me show you how.

SEND FOR FREE TRIAL

Proof of astounding success and my \$15.00 a day Guarantee to Distributors



Frank Andrews, Dept. 863-A-B., 154 E. Erie St. CHICAGO, ILL.



I'LL PAY YOU \$20 A DAY

To Show My Mystery Lighter to Men. What Makes It Light? All Guaranteed. Sample With Sales Plan 50c. Sample Gold or Silver Plated. \$1.00. Agents write for proposition. NEW METHOD MFG. CO., Desk S.I. 1, Bradford, Pa.

NO WIND CAN BLOW IT OUT



2966 Edgemont St.

STOP MOUTH BREATHING AND SNORING

with a PERFECT BREATHER. Assures perfect rest; heals inflamed nasal tissues; prevents flabby facial muscles, double chin, etc. Has helped thousands. Man's, woman's, child's sizes. PERFECT BREATHER, inhaler, inhaling balm, complete instructions and breathing exercises—\$3.00, cash or C.O.D. plus few cents postage. Satisfaction or refund. Booklet free.

PERFECT BREATHER CO. Dept. A Philadelphia, Pa.

Free Mailing Lists
Will help you increase sales Send for FREE catalog giving counts and prices on thousands of classified names of your best prospective customers—National, State and Local—Individuals, Professions, Business Concerns.
99% Guaranteed 5¢ each by refund of 5¢ each
ROSS-Gould Co. 515 N. 10th St. St. Louis

Artistic Letter Boxes

by Joseph H. Kraus

(Continued from page 821)

plastic compounds which adhere well to the metal, are used to produce base reliefs. Most of these metallic cements such as iron cement, used in furnace repairs, radiator repairs, and the like, can be easily molded with the fingers or with small wood or metal tools. These cements when they become hard can be painted like the rest of the letter box.

One of the most difficult things to do is to disguise the flag on the side of the box. In one of the illustrations this has been very effectively carried out by molding cement around the upright rod and shaping this in such a manner that it resembles a twig. When this twig is coupled with a bird illustration, it possesses the much desired harmonious relation with the rest of the box.

Another example of this harmony is shown in the letter box resembling a prairie schooner. Here the indicating flag is painted to resemble the material emblem. The wheels on the sides can be molded to the sides of the box or metallic wheels or half wheels from toys can be affixed thereto. In this instance the wheels were merely painted.

In the pirate's chest, two pieces of wood were fastened to the sides of the box, and these were bound with copper bands. Copper bands were also riveted and soldered to the box itself and an old lock was fastened to one of the wood strips. One can see that quite a change has been made with the exertion of but little energy and considerable ingenuity.

The effect of a yacht coming toward a person can be obtained in many ways. Such a scene can be painted on the side of the box or a yacht can be molded out of any of the innumerable plastic compounds. Another suggestion that lends itself to such a production is the building up of a small yacht of wood. After this has been completely formed, it is cut in half on the desired diagonal and one half is fastened to the side of the box so that it projects therefrom. The other half can then be fastened to the opposite side, or even to the same side for producing the illusion of two yachts passing each other.

And so in conclusion, it is to be hoped that the ideas presented here will impart a new theme for a letter box decoration. Perhaps long dreary days during the winter season will take on a new interest and those ordinarily unable to do any work because of inclement weather conditions will find that their hours will while away very pleasantly as they decorate their letter boxes. Some might even make this suggestion the basis of a business from which some lucrative return can be expected.

The plan of decoration is quite important. If the name of the person does not give a sufficient cue to form the basic idea around which the design is to weave, then perhaps the individual's habits or his hobbies may help. For example, sail boats might be suggested by the name Sales; logs or timber or a forest might be a fitting decoration for a name such as Woods.

In January RADIO NEWS

HUMAN RADIO REFLECTORS, OR EVERYONE HIS OWN AERIAL RADIO DOES NOT CHANGE THE WEATHER GIVING TELEVISION THE "EAST TOUCHES" "LAST TOUCHES" THE "BLOOPLESS" ONE-DIAL, TWO-TUBE RECEIVER THE "LAMP-SOCKET FIVE"—A SIMPLE A.C. SET RADIO WRINKLES ON THE SHORT WAVES THE CONSTRUCTOR'S OWN PAGE

\$62.50 Buys This MARVELOUS 8 TUBE ALL ELECTRIC

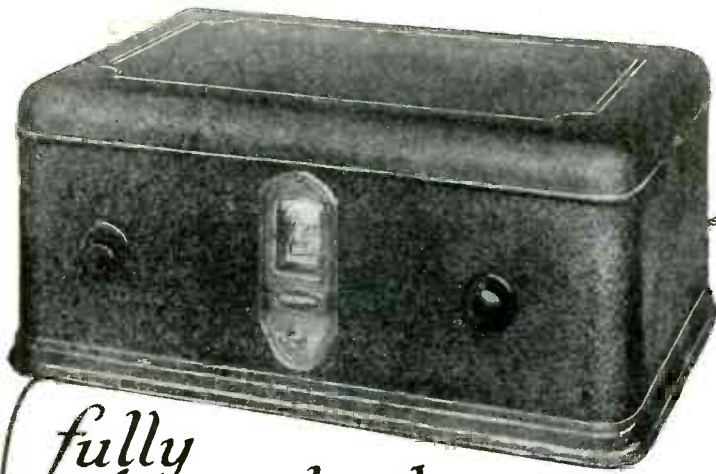

RADIO
Complete With
SPEAKER
and
8 TUBES

*fully
Guaranteed*

You Get the Dealer's Profit!

This is the MEL-O-RAD humanized tone, 19 inches high MAGNETIC CONE SPEAKER matched to every receiver.

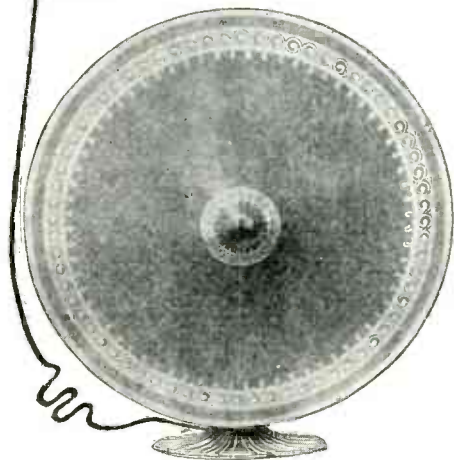

A radio set manufacturer, a tube maker, and a producer of cone speakers, all well and favorably known throughout the industry for the quality and efficiency of their products, have combined to make it possible for everyone everywhere to own an electric radio. They have organized their own selling agency, eliminating distributors, jobbers and dealers, and pass the savings along to the public.

The result is the most phenomenal offer ever made in the history of radio—an 8-tube all electric, one dial control radio with all necessary tubes and a lifelike reproducing magnetic cone speaker complete, with nothing else to buy, ready to plug in and operate, for only \$62.50, less than the regular retail dealer's price for a radio set alone, and—the entire outfit is absolutely guaranteed.

Set, Tubes and Speaker Matched for Perfect Performance

Before shipment, each and every tube is thoroughly tested and matched for the set in which they are to be used. The same test is given to the magnetic cone speaker, so that the complete outfit, the set, the tubes and the speaker are scientifically matched for the most perfect reproduction of voice and music.

The receiver itself is a thing of beauty, size 19½ by 12½ by 13½ inches, housed in a most attractive Aquatex metal cabinet which harmonizes with the furnishings of any home. One illuminated dial simplifies operation and brings in station after station, clearly, distinctly and with all the volume desired.

Satisfaction Guaranteed or Money Refunded

Take advantage of this unusual radio offer now. Send us your check or money order and complete outfit will be shipped to you ready for immediate operation. There is nothing else you need to buy. Everything you need is included at our more than 50% off list price offer. \$11-

ply plug into your electric light socket, turn on the switch and you will hear a most perfect radio performance. Order your Melorad Radio Outfit today, and if after two weeks you are not perfectly satisfied, just say so and your money will be cheerfully refunded.

Here's What You Get:

One Melorad 8-tube All Electric Radio Receiver with Phonograph Pick-up, Regular Retail Price	\$ 75.00
Eight Guaranteed Tubes as follows: Five 226 A-C, One 227 A-C, One 171-A and One 280, Regular Retail Price	24.50
One Magnetic Cone Speaker, Height 19 Inches, Regular Retail Price	25.00
One Complete Aerial Kit, including Approved Lightning Arrester	2.50
Total Regular Retail Selling Price	\$127.00
Our Direct from Factory to Public Price	\$ 62.50
You Save (MORE THAN 50 per cent)	\$ 64.50

Artee Radio Sales & Mfg. Corp.,

206 Broadway

New York, N. Y.

Mail This Coupon Order Now

ARTEE RADIO SALES & MFG. CORP.,
206 Broadway, New York City, N. Y.

Enclosed find money order for \$62.50, for which please ship me one 8-tube All Electric Melorad Radio Receiver complete, with all necessary tubes and magnetic cone speaker. It is understood that if after two weeks' trial I am not perfectly satisfied, I may return the outfit and my money will be refunded.

Name

Street No.

Town and State

If you desire further particulars check here

A \$100.00 SHIP MODEL \$4.98
FOR

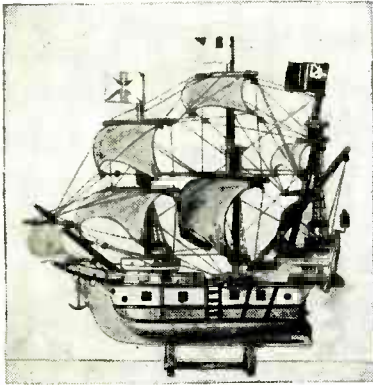

MAYFLOWER

SIZES: 25" High; 10" Wide;
26" Long

We will supply all the parts cut to fit and ready to assemble for the Santa Maria, Mayflower, or LaPinta, at \$4.98 each. Parts also may be had for the Constitution at \$6.98. Full instructions for assembling any of the above models are included with each kit. A diagram of parts showing the number of parts and just how to piece together the model make it impossible for you to go wrong. For very little money and a few hours of pleasant pastime you will have a beautiful ship model that will add a distinctive touch to your home.

Send for our beautiful illustrated free booklet containing photos and full information of all our models.

MINIATURE SHIP MODELS, Inc.
3818-24 Baring St., Philadelphia, Pa.

MINIATURE SHIP MODELS, Inc. S.S.2
3818-24 Baring Street
Philadelphia, Pa.

Please send me the complete parts cut to fit and ready to put together for the
I will pay the Postman \$.....
plus a few cents postage.

Name
Street or R. F. D.
City
State



High School Course in 2 Years

This simplified, complete High School Course—specially prepared for home study by leading professors—meets all requirements for entrance to college, business, and leading professions.

20 Other Courses

Over 200 noted Engineers, Business Men, and Educators helped prepare the special instruction which you need for success. No matter what your inclinations may be, you can't hope to succeed without specialized training. Let us give you the practical training you need.

American School
Drexel Ave. & 58th Street
Dept. H-1294 Chicago

Money Back When You Finish If Not Satisfied

American School, Dept. H-1294 Drexel Ave. and 58th St., Chicago
Send me full information on the subject checked and how you will help me win success in that line.

- | | |
|---------------------------|---------------------------|
|Architect |Electrical Engineer |
|Building Contractor |General Education |
|Automobile Engineer |Lawyer |
|Civil Engineer |Mach. Shop Practice |
|Structural Engineer |Mechanical Engineer |
|Business Manager |Steam Engineer |
|C. P. A. & Auditor |Sanitary & Heating |
|Bookkeeper |Surveyor & Mapping |
|Draftsman & Designer |High School Graduate |

Name
Address

5 EASY WAYS to Make Money IN RADIO

Reduce static—electrically old sets—improve tone—install 1-dial control radioify phonographs—make \$3.00 an hour spare time by joining the Radio Association. Our members cleaning up. Write today for No-Cost Membership and FREE RADIO HANDBOOK. RADIO ASSOCIATION OF AMERICA Dept. SNI, 4513 Ravenswood Av., Chicago, Ill.

The Graf Zeppelin Dissected

By Augustus Post

(Continued from page 803)

length of the longitudinal axis of the ship in a fore and aft direction, is a girder which acts as a support for all of the sixteen transverse bulkheads greatly contributing to the strength and safety of the ship. This girder affords an easy access to the gas cells and tends to add to the strength of their support, and also to the strength of the ship should one or more of the gas cells become damaged and partly or wholly deflated. This is a new improvement in the construction of the Zeppelin dirigibles.

The arrangement of the gas cells is different in the "Graf Zeppelin" from all her predecessors on account of the use of fuel gas (know as Blau gas) as well as gasoline in the engines. Blau gas is like the fuel gas used in gas ranges, but it is more efficient in an engine and heavier. Cells are provided for the storing of this fuel gas; the lifting gas cells in the twelve largest compartments of the seventeen do not fill the entire space, but they are made smaller so as to leave about one-third of the space for twelve other gas cells which hold the fuel gas, which is carried under normal atmospheric pressure. Many advantages are due to the use of this gas fuel, as it is practically the same weight as air, and, as the ship uses up this fuel, there is no great change of weight. In the case of the use of gasoline there is a continuous loss of weight due to its consumption during the flight, and upon the airship reaching its destination, in order to loose the excess lift, it is necessary to open the valves and loose part of the buoyant gas. In the case of helium, which is very expensive, this is a very important item. In the "Los Angeles" the loss of weight through using up of the gasoline fuel, is compensated for by the water recovery apparatus which recovers water from the exhaust gases of the motors to be used as ballast. This in a large measure, compensates for the loss of weight by using up the gasoline. Gasoline fuel tanks are installed in the "Graf Zeppelin" and the gasoline is used for ballast if necessary, as well as being a safety factor in the case of difficulty with the gas fuel. Another improvement which results directly from the use of gas as a fuel, is the reduction of the stresses and strains in the structure of the airship, on account of not being required to provide for the heavy loads of fuel which in the "Los Angeles" amounted to thirty tons, the weight of a small locomotive. This weight of gasoline in special tanks had to be distributed along the keel. They were strongly secured, so that they would not tear loose, if the airship were tossed about or hit by severe squalls, such as the "Graf Zeppelin" encountered on her trip in the middle of the Atlantic Ocean. The fuel gas having practically no weight at all, the required quantities can be carried in a much lighter structure. Another vital improvement is due to the fact that gas fuel reduces the danger of fire, for the fumes of gasoline are inflammable at a greater distance than fuel escaping into the air. A much greater range of flight is possible by the use of gas fuel than with liquid fuel. In order that an airship may lift her own weight with the exception of the fuel, the lifting gas cells may be between one-half and two-thirds full of hydrogen or helium. If gasoline fuel is added, the gas cells must be inflated to their full capacity, and the interior of the airship filled in order to lift this great weight. In the case of gas fuel which does not add weight, the fuel

(Continued on page 873)

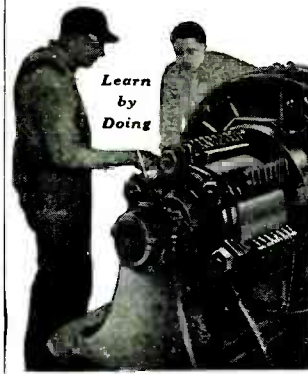

Learn by Doing

Earn \$50 to \$125 Weekly

Learn Easily in 90 Days on Real Equipment

ELECTRICITY

Begging for Trained Men

Do you know what it means to make real money—to hold down a big-paying job? Get into ELECTRICITY and step way ahead of the crowd. Old or young, educated or not, you can learn quickly, in my famous Electrical Schools, to get and keep the best electrical job in your town. 50,000 McSweeney Graduates prove success of my exclusive Shop-Training Plan. No books. No lectures. Not a correspondence course. You tackle real jobs on real equipment under direction of expert instructors. Electricity is making giant strides ahead. The field is short of trained men. Big money everywhere. Employment department helps you find spare time work and also job after you graduate.

FREE Learn what other men have done. Send name and address to-day for big, illustrated book on Electricity. Your copy is **FREE!**

McSweeney Electrical School
Dept. 73-W Cleveland, Ohio

450 Miles on a Gallon of Gas!

According to a recent article by the president of the world's largest motor research corporation, there is enough energy in a gallon of gasoline if converted 100% in mechanical energy to run a four cylinder car 450 miles.



NEW GAS SAVING INVENTION ASTONISHES CAR OWNERS

A marvelous device, already installed on thousands of cars, has accomplished wonders in utilizing a portion of this waste energy, and is producing mileage tests that seem unbelievable. Not only does it save gasoline, but it also creates more power, gives instant starting, quick pick-up, and eliminates carbon.

FREE SAMPLE and \$100 a Week

To obtain national distribution quickly, men are being appointed everywhere to help supply the tremendous demand. Free samples furnished to workers. Write today to E. Oliver, Pres., for this free sample and big money making offer.

WHIRLWIND MFG. CO.

999-394 E. Third St., Milwaukee, Wis.

CHEMICAL EXPERIMENTERS



100 Chemicals, Pure, with Apparatus to perform many experiments—\$4.00 Prepaid. 35 Pieces High-Grade Chemical Apparatus, suitable for the experimenter—\$5.00 Prepaid. Money Order or C. O. D.

PINES CHEMICAL COMPANY
1524 St. Marks Ave., Brooklyn, N. Y.

ILLINOIS COLLEGE of PHOTOGRAPHY

Earn \$200 to \$500 a month as photographer or photo-engraver. We prepare you in 6 to 8 months. Thorough practical training in making negatives, developing retouching, airbrush, printing. Photo-engraving in line, half-tone, and 3-color work. Individual instruction using latest equipment and methods. Big demand for our graduates. Diploma awarded. Nation-wide patronage. 36th year. Enroll now; Free catalog. Box 719, Effingham, Ill.

Insure your copy reaching you each month. Subscribe to SCIENCE AND INVENTION—\$2.50 a year. Experimenter Publishing Co., Inc., 230 Fifth Avenue, New York City.

THESE POPULAR BOOKS AT LOWEST PRICES EVER

NEVER BEFORE HAVE REAL BOOKS BEEN SOLD AT SUCH A PRICE!

Yes, REAL Books, not pamphlets, books well printed, well bound, averaging over 150 pages. Colored covers. Average size 4 1/2" x 6". Books to suit every taste. AND EVERY BOOK ONLY 10 CENTS! You can't go wrong at such a price.

Literally Hundreds of Thousands of these books have been sold. Try once—you'll come back for more. 200 titles listed here. Letter behind each book gives you its number of pages. A—300 pages, B—220, C—130, D—96, E—64, F—32 pages.



C247

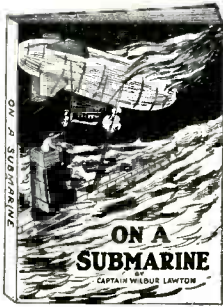

C223

Any Book listed here 10¢ only

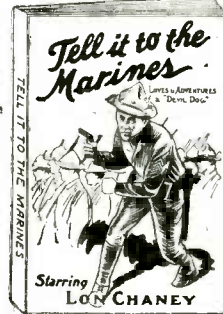

N84

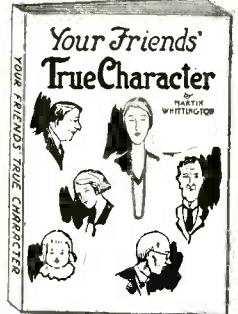

N215

Western Stories

- ..C275 The Shawnee's Poe. D
- ..C276 Wild Jim. D
- ..C277 Hawk-eye the Hunter. D
- ..C278 Iron Hand. D
- ..C279 Wapawkaneta. D
- ..C280 The Forest Avenger. D
- ..C281 Sharp Snout. D
- ..C282 Madman of the Colorado. D
- ..C283 The Panther Demon. D
- ..C284 A New York Boy Among the Indians. D
- ..C285 Deadwood Dick's Big Deal. D
- ..C286 Deadwood Dick's Dozen. D
- ..C287 The Woman Trapper. D
- ..C288 Brimstone Jake. D
- ..C289 The Shawnee Witch. D
- ..C290 Spider-Legs. D
- ..C291 Madman of the Oconto. D
- ..C292 Tiger Eye. D
- ..C293 Red Men of the Woods. D
- ..C302 Hunters and Redskins. D
- ..C303 The Panther Paleface. D
- ..C304 Bloody Brook. D
- ..C294 Red Rattlesnake. D
- ..C295 Roving Dick Hunter. D
- ..C296 Snake Eye. D
- ..C297 Bullet Head. D
- ..C300 The Silent Trapper. D
- ..C301 Marksman the Hunter. D
- ..C312 The Dagger Fate. D
- ..C298 Indian Spirit. D
- ..C299 The Twin Trappers. D
- ..C316 Three Fingered Jack. D
- ..C317 Pirates of the Prairies. D
- ..C318 White Falcon—The Renegade. D
- ..C319 Trail of Gold. D
- ..C320 The Red Haw's Nest. D

Boys' Detective

- ..N192 Kefton the Detective. D
- ..N197 The Twin Ventriloquists. D
- ..N199 Curisoo Harry. D
- ..N204 Lorie or the Phantom Ventriloquist. D
- ..N208 Life in New York. D

Care of Animals

- ..N321 Dogs, How to Keep. F
- ..N322 Song Birds, Rearing. F
- ..N323 Rabbits, Breeding. F
- ..N324 Pigeons, for profit. F

Mystery Stories

- ..C250 A Scandal in Bohemia. B
- ..C305 The Man They Could Not Hang. True Story. D
- ..C306 Mystery of Crimson Blind. White. B
- ..C307 Mr. Mark's Secret. Phillips Oppenheim. B
- ..C308 Mysterious M. Sabin. Oppenheim. B
- ..C309 Prince of Swindlers. Boothby. B
- ..C310 The Kidnapped President. Boothby. B
- ..C312 Dagger of Fate. Richard Marsh. B
- ..C313 Shadow on the Sea. M. Pemberton. B
- ..C314 The Darkest Hour. Louis Tracy. B
- ..C315 A Japanese Revenge. L. Tracy. B

Entertainment

- ..N1 How to Play Rhum. E
- ..N2 How to Play Poker. E
- ..N3 How to Play Euchre. E
- ..N1 How to Play Whist. E
- ..N5 How to Play Pinochle. E
- ..N6 How to Play Cribbage. E
- ..N7 How to Play Five-Hundred. E
- ..N8 How to Play Chess. E
- ..N10 Checkers and How to Play It. E
- ..N29 Book of Choice Riddles. E
- ..N29 153 Magic Tricks. E
- ..N32 84 New Card Tricks. E
- ..N34 700 New Toasts. E
- ..N35 Book of 145 Parlor Games. E
- ..N38 New Book of 200 Puzzles. E
- ..N42 Fun, Magic and Mystery. E
- ..N49 Book on Magic Made Easy. E
- ..N67 A Bunch of Limericks. E
- ..N90 Practical Mesmerism & Hypnotism
- ..C271 Book of 100 Games. D
- ..C272 Magicians' Book of Conjuring. D

Best Movie Sellers

- ..N72 The Divine Woman. C
- ..N73 Forbidden Hours. C
- ..N74 The Crimson City. C
- ..N75 Jazz Mad. C
- ..N77 Almost a Lady. C
- ..N78 Sensation Seekers. C
- ..N79 New York. C
- ..N80 Cohens & Kellys in Paris. C
- ..N81 Streets of Shanghai. C
- ..N82 You Can't Beat the Law. C
- ..N83 Tillie's Functured Romance. C
- ..N84 Tell It to the Marines. C
- ..N85 Tracked by the Police. C
- ..N87 Don't Tell the Wife. C
- ..N93 The Rambling Ranger. C

Travel Adventure

- ..C220 In South Seas. Capt. Roosevelt. A
- ..C221 World Cruise. Capt. Lawton. A
- ..C222 Iceberg Patrol. Capt. Lawton. A
- ..C223 On a Submarine. Capt. Lawton. A
- ..C224 Aboard a Destroyer. Capt. Lawton. A
- ..C225 On Battle Practice. Capt. Lawton. A
- ..C226 War Swept Seas. Capt. Lawton. A
- ..C227 Marooned in Tropics. Forrester. A
- ..C228 Boy Scouts in Great Flood. Shaler. A
- ..C229 On Aero Service. Capt. Lawton. A
- ..C230 Along the Yukon. Forrester. A
- ..C231 North of '53. J. Forrester. A
- ..C232 The Lost Liner. Capt. Lawton. A

Detective Stories

- ..C247 Sherlock Holmes. Conan Doyle. A
- ..C248 Beyond the City. Conan Doyle. A
- ..C249 Case of Identity. Conan Doyle. A
- ..C251 The Redheaded League. Doyle. A
- ..C252 The Sign of the Four. Doyle. A
- ..C253 Giant Detective. Old Sleuth. A
- ..C254 Surgeon of Gaster Fell. Doyle. A
- ..C255 Mill Street Mystery. Sargeant. A
- ..C256 The Bag of Diamonds. Fenn. A
- ..C257 The Red Lottery Ticket. Boisgoley. A
- ..C258 The Haunting Shadow. Old Sleuth. A
- ..C259 Joe Phoenix, Police Spy. Atkin. A
- ..C260 Joe Phoenix, Detective. Atkin. A
- ..C261 The Wolves of New York. Atkin. A
- ..C262 Chin Chin. Chinese Detective. By Albert W. Atkin. A
- ..C263 Electro Pete. Morris. A
- ..C264 West Shore Mystery. Old Sleuth. A
- ..C265 The Man Hunter. Dick Donovan. A
- ..C266 Mystery of Hanson Cab. Hume. A
- ..C267 The Abbey Murder. Jos. Patton. A
- ..C268 The Man Who Vanished. Hume. A
- ..C269 Piccadilly Puzzle. Hume. A

Instruction

- ..N66 Great Words of Great Men. E
- ..N212 Clog Dancing Made Easy. F
- ..N213 Athletic Exercises. F
- ..N214 How to Make Money in Wall St. F
- ..N215 Your Friend's True Character. C
- ..N216 Character in Handwriting. C
- ..N217 The Story in Your Hand. C
- ..C270 Lover's Casket. E
- ..C273 Gent's Letter Writer. D
- ..C274 Ladies' Letter Writer. D

Full Length Novels

- ..N12 Short Stories. Honore de Balzac. D
- ..N13 The Gold Bug. Edgar Allen Poe. D
- ..N16 My Double and How He Undid Me. D

Radio

- ..E600 How to Make Crystall Receiving Sets. E
- ..E601 How to Make a Neutrodyne Receiver. E
- ..E602 A Guide for the Radio Builder. E
- ..E603 The How and Why of Radio Parts. E
- ..E604 How to Build the Famous One Knob Set. E
- ..E605 How to Make a Resistance Coupled Amplifier. E

Love and Romance

- ..C233 Kidnapped at the Altar. Libbey. A
- ..C234 Gladiola's Two Lovers. Libbey. A
- ..C235 Lil the Dancing Girl. Hart. A
- ..C236 Aletta's Terrible Secret. Libbey. A
- ..C237 For Love or Honor. C. Hart. A
- ..C238 The Romance of Enola. Libbey. A
- ..C239 Little Princess. Caroline Hart. A
- ..C240 Sweetheart or Wife? Libbey. A
- ..C241 Love's Rugged Path. Hart. A
- ..C242 Married at Sight. C. Hart. A
- ..C243 Pretty Madcap Dorothy. Libbey. A
- ..C244 The Loan of a Lover. Libbey. A
- ..C245 Vendetta. Marie Corelli. A
- ..C246 The Girl He Forsook. Libbey. A

Humor

- ..N17 Irish Jokes. E
- ..N18 Hebrew Jokes. E
- ..N19 Dutch Jokes. E
- ..N21 After-Dinner Stories. E
- ..N23 Book of Vaudeville Jokes. E
- ..N24 Book of Funny Rhymes. E
- ..N25 Book of Flirtations. E
- ..N28 New Stage Jokes. E
- ..N30 Book of 1,000 Conundrums. E
- ..N33 Red-Hot Joker. E
- ..N36 Actors' Jokes. E
- ..N37 New Book of Monologues. E
- ..N41 Hebrew Yarns. E
- ..N44 Side-Splitting Jokes and Stories. E
- ..N45 Peachy Jokes. E
- ..N47 Snappy Jokes. E
- ..N48 Tramp Jokes, Monologues, Recitations. E
- ..N50 Komikal Joker. E
- ..N52 Book of Wit and Humor. E
- ..N54 Book of Roaring Jokes. E
- ..N55 Jingles, Jokes and Rhymes. E
- ..N56 Minstrel Jokes, Gags, Conundrums. E
- ..N59 Dorky Jokes and Funny Stories. E
- ..N60 Hoho Jokes. E
- ..N64 Boarding House Jokes. E
- ..N69 Coontown Comedy and Fun. E

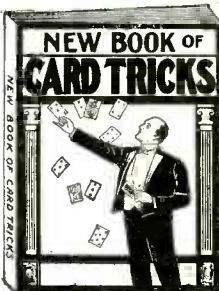

B118

HOW TO ORDER

Select book wanted by checking in front of number. Then list numbers on coupon or take a sheet of paper and list numbers only. Titles of books not necessary on your order.

We do not accept orders for less than \$0.50 (5 books.) No C. O. D.'s. Remit by Check, Money Order, Cash or Stamps. Add 2c postage for each book, otherwise we send by Express collect. (Foreign postage 4c each book.)

Mail This Coupon NOW

POPULAR BOOK CORPORATION, 102 Park Place, New York City, N. Y.

Gentlemen:—

I enclose..... for which kindly send me the books listed herewith (List number of books here).....

.....

Name

Address

City

State.....

POPULAR BOOK CORPORATION

102 PARK PLACE, NEW YORK

Please say you saw it in SCIENCE and INVENTION

PATENTS

TRADE-MARKS—DESIGNS
FOREIGN PATENTS

MUNN & CO. PATENT ATTORNEYS

Associated since 1846 with the
Scientific American

SCIENTIFIC AMERICAN
BUILDING

24 West 40th Street
New York City

SCIENTIFIC AMERICAN
BUILDING

Washington, D. C.

TOWER BUILDING
Chicago, Ill.

HOBART BUILDING
San Francisco, Cal.

VAN NUYS BUILDING
Los Angeles, Cal.

Books and Information on Patents and
Trade-Marks By Request

Associates in all Foreign Countries

INVENTORS

Protect Your Ideas

Send for our Guide Book, HOW TO GET A PATENT, and Evidence of Invention Blank, sent Free on request. Tells our terms, methods, etc. Send model or sketch and description of your invention for INSPECTION and INSTRUCTIONS FREE. TERMS REASONABLE. BEST REFERENCES.

RANDOLPH & CO.

Dept. 172, Washington, D. C.

Name.....

Street.....

City.....

PATENTS

WRITE FOR FREE INSTRUCTIONS
Send drawing or model for examination.
CARL MILLER, Patent Attorney
Former member Examining Corps, U. S.
Patent Office
261 McGill Building, Washington, D. C.

PATENTS

BOOKLET FREE HIGHEST REFERENCES
PROMPTNESS ASSURED BEST RESULTS

Send drawing or model for examination
and advice.

WATSON E. COLEMAN, Patent Lawyer
724 9th Street, N. W., Washington, D. C.

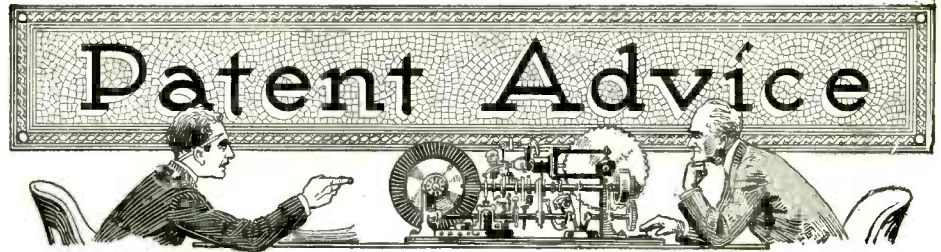

CONDUCTED BY JOSEPH H. KRAUS

In this Department we publish such matter as is of interest to inventors and particularly to those who are in doubt as to certain patent phases. Regular inquiries addressed to "Patent Advice" cannot be answered by mail free of charge. Such inquiries are published here for the benefit of all readers. If the idea is thought to be of importance, we make it a rule not to divulge all details, in order to protect the inventor as far as it is possible to do so.

Should advice be desired by mail, a nominal charge of \$1.00 is made for each question. Sketches, and descriptions must be clear and explicit. Only one side of sheet should be written on.

NOTE:—Before mailing your letter to this department, see to it that your name and address are upon the letter and envelope as well. Many letters are returned to us because either the name of the inquirer or his address is incorrectly given.

Bumper Signal, Spring Bicycle, and Hand Clapping Machine

(1143) J. B. Arnolfo, San Francisco, Calif., asks us about three plans, a signal operated by the rear bumper of an auto; a spring-operated bicycle, and a hand clapping system.

A. 1. We have considered your suggestions and our opinion is given below:

We are doubtful that placing an electrical contact on the rear bumper of an automobile is of any value whatsoever. If the bumper strikes the car immediately in back of it, it is too late to sound the horn. The impulse of the bump would be felt as rapidly as the noise of the horn would be heard, and at this particular instant it is usually too late. Inasmuch as man cannot act instantaneously and the brakes cannot be applied so suddenly as to prevent an accident, it follows that automobile damage would be greater than today. We advise no action along this particular line, nor do we see how you can possibly protect it in its entirety.

It is perfectly possible to propel a bicycle or even an automobile by means of a spring motor, but who would care to place a spring motor on a bicycle. It takes more energy to wind up a spring than you can possibly get out of the same. Quite a few years ago an automobile was tried out in which a series of springs served as the motor. These springs were previously wound by an electric motor applied to the automobile at night, making the power available on the following day. Nothing has since been done with the mechanism, to the best of our knowledge.

Your last idea would sound as foolish as a phoney invention if it were not so tragic. Unfortunately, the public is getting lazier and lazier, and eventually will have machinery to do everything for them. It is conceivable that they will have hand clapping machines in theaters to register their applause. Perhaps we will not need actors or actresses to amuse us; maybe the automaton will answer the purpose and, of course, machines need no response on the part of the audience. Perhaps theaters will be obsolete. We may have a television theater in our own home and then the actor or actress will get no applause whatever. We advise no action along this particular line.

Illuminated Hand Indicator

(1144) H. Feider, Los Angeles, Calif., believes he has discovered a system which will prevent auto accidents. Its nature is made clear in the answer.

A. 1. The suggestion for having a light attached to the wrist of an automobile user so that those in back of this automobile would know when he is making a turn is not new, and many different devices have been employed for that particular purpose. Some of them have automatic switches so that the instant the arm is extended, the switch closes the circuit and lights the lamp.

We doubt very much that you could secure a market on your system and advise no further action.

Good If It Works

(1145) A. Salkowe, Philadelphia, Pa., has designed a clear-view windshield which works by wind pressure.

A. 1. It is possible that your suggestion for the making of a clear vision windshield for automobiles could be patented. It is very unlikely that after you secure a patent you will be able to make this system work. Furthermore, if for any reason the wind stops blowing or the automobile stops, the glass will not be made to revolve at all, with the result that ice and sleet will form on the propeller and plate. Also, it is not at all likely that this propeller will drive the plate when put in the position you have indicated, because there is little relief for air pressure.

We advise experimental work along the line before you proceed further. If your experiments prove the system practical, by all means apply for a patent.

Atmospheric Engine

(1146) L. Marshall, Brooklyn, N. Y., asks if he should patent an idea of a means of securing power by atmospheric temperature changes. Air in a container expands and develops the power.

A. 1. The idea which you have advanced for securing power from atmospheric temperature changes is not new at all and much poorer than existing systems. If you will refer to back issues of SCIENCE AND INVENTION magazine you will find that this same suggestion was employed to operate a clock. The article is called, a Self-Winding Perpetual Clock. Instead of using air, which is quite compressible, as a source of energy, this clock uses a liquid such as xylene which does not freeze easily and is quite incompressible. This liquid, when it expands, due to heat, exerts a terrific pressure, and this pressure is used for winding the clock.

(Continued on page 864)

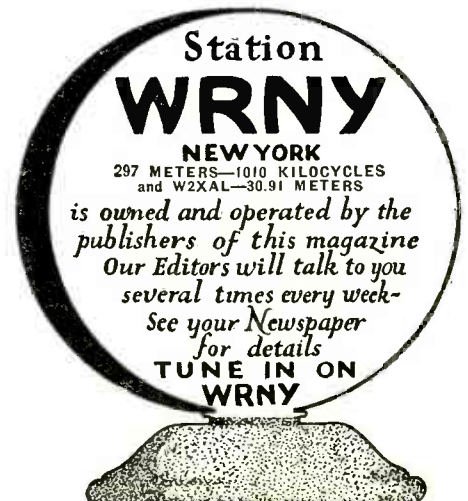

At the right is a view of my drafting and specification offices where a large staff of experienced experts are in my constant employ.



All drawings and specifications are prepared under my personal supervision.

PATENT ATTORNEYS

My Patent Law Offices
Just Across Street From U.S. Pat. Office



Protect Your Ideas

Take the First Step Today—Action Counts

If you have a useful, practical, novel idea for any new article or for an improvement on an old one, you should communicate with a competent Registered Patent Attorney AT ONCE. Every year thousands of applications for patents are filed in the U. S. Patent Office. Frequently two or more applications are made for the same or substantially the same idea (even though the inventors may live in different sections of the country and be entirely unknown to one another). In such a case, the burden of proof rests upon the last application filed. Delays of even a few days in filing the application sometimes mean the loss of a patent. So lose no time. Get in touch with me at once by mailing the coupon below.

Prompt, Careful, Efficient Service

This large, experienced organization devotes its entire time and attention to patent and trademark cases. Our offices are directly across the street from the U. S. Patent Office. We understand the technicalities of patent law. We know the rules and requirements of the Patent Office. We can proceed in the quickest, safest and best ways in preparing an application for a patent covering your idea. Our success has been built on the strength of careful, efficient, satisfactory service to inventors and trademark owners located in every state in the Union.

Strict Secrecy Preserved—Write Me in Confidence

All communications, sketches, drawings, etc., are held in strictest confidence in strong, steel, fireproof files, which are accessible only to authorized members of my staff. Feel free to write me fully and frankly. It is probable that I can help you. Highest references. But FIRST—clip the coupon and get my free book. Do THAT right now.

No Charge for Information On How to Proceed

The booklet shown here contains valuable information relating to patent procedure that every inventor should have. And with it I will send you my "Record of Invention" form, on which you can sketch your idea and establish its date before a witness. Such evidence may later prove valuable to you. Simply mail the coupon and I will send you the booklet, and the "Record of Invention" form, together with detailed information on how to proceed and the costs involved. Do this NOW. No need to lose a minute's time. The coupon will bring you complete information entirely without charge or obligation.

Clarence A. O'Brien

Registered Patent Attorney

Member of Bar of: Supreme Court of the United States; Court of Appeals, District of Columbia; Supreme Court, District of Columbia; United States Court of Claims.

PRACTICE CONFINED EXCLUSIVELY TO PATENTS, TRADEMARKS AND COPYRIGHTS

Inventors
Write for these
Free Books



Mail this Coupon Now

CLARENCE A. O'BRIEN

Registered Patent Attorney

53-J Security Savings & Commercial Bank Bldg.
WASHINGTON, D. C.

—or—
Suite 1106, Woolworth Bldg.
NEW YORK CITY

Please send me your free book, "How to Obtain a Patent," and your "Record of Invention" form without any cost or obligation on my part.

Name

Address

(Important! Write plainly and address office nearest you)



Washington Monument in the Nation's Capital

PATENTS DON'T LOSE YOUR RIGHTS TO PATENT PROTECTION

Before disclosing your invention to anyone send for blank form "EVIDENCE OF CONCEPTION" to be signed and witnessed. As registered patent attorneys we represent hundreds of inventors all over the United States and Canada in the advancement of inventions. The form "Evidence of Conception," sample, instructions relating to obtaining of patents and schedule of fees sent upon request.

LANCASTER & ALLWINE
255 Ouray Building
WASHINGTON, D. C.
Originators of forms "Evidence of Conception."

INVENTORS

Send details of your invention or patent at once, or write for information. In business 30 years.

Complete facilities. References

ADAM FISHER MANUFACTURING COMPANY
205D Enright, St. Louis, Mo.

NEW YEAR - NEW IDEA
PATENT YOUR IDEAS
Call or send me a sketch of your invention. Phone LONgacre 3088
FREE Inventors Recording Blank Confidential Advice
U. S. and Foreign Patents secured by
Z.H.POLACHEK Reg. Patent Attorney
Consult. Engineer
1234 Broadway, New York

BLUE BOOK ON PATENTS

and Priority Record blank gratis.

MONROE E. MILLER
PATENT LAWYER

411-6 Ouray Building, Washington, D. C.

Electrical and Mechanical Expert

PATENTS

As one of the oldest patent firms in America we give inventors at lowest consistent charge, a service noted for results, evidenced by many well-known Patents of extraordinary value. Book, Patent-Sense, free.

Lacey & Lacey, 644 F St., Washington, D. C. Estab. 1869

Mason, Fenwick & Lawrence

PATENT LAWYERS

600 F St., N.W., Washington, D.C.

Estb. over sixty years. Send sketches. Electrical and Chemical Inventions carefully handled. Practice before the U. S. Courts and the Patent Office. Prompt and careful service.

TRADE-MARKS REGISTERED

I can make a good penman of you at home during your spare time. Write for my **FREE BOOK**. "HOW TO BECOME A GOOD PENMAN." Your name elegantly written on a card if you enclose stamp. Write today. F.W.TAMBLYN, 424 Ridge Bldg., Kansas City, Mo.

Patent Advice

(Continued from page 862)

Electrical Railway

(1147) Carl Caspar, Chicago, Ill., submits a plan for an electro magnetically operated railway consisting of a metal tube in which the car moves. The magnetic coils or solenoids surround the tube and current is fed to them progressively.

A. 1. Your idea of a mechanism to travel very rapidly by means of electro-magnetic propulsion in the form of a magnetic railway is not new at all. You will find that the suggestion has already been worked up and also developed to a better extent by Bachelet. This magnetic railway was described in back issues of this magazine. It consisted of a series of electro-magnetic coils which pulled the car forward at lightning rapidity and alternating current electro-magnets at the base which held the car supported and away from the magnets.

In your system, the friction against the side walls would be terrific, it being practically impossible to support a mechanism midway between the circular electro-magnet. The traveling shell-like car is bound to scrape the sides of the tunnel and when it does so, the friction becomes so great that the shell will practically tear itself to pieces.

A Patent Suit

(1148) Amato N. Sammarone, Akron, Ohio, complains that another party has appropriated his patent and is manufacturing and selling the same. He wants to know what he can do without cash for lawyer's fees.

A. 1. We feel quite sure that if you have definite proof that your patent rights are being encroached upon, any attorney will gladly take up the case on a contingent basis. You, therefore, need pay nothing except the primary fees as a retainer, which are of little consequence, but indicate your sincerity. The attorney receives his fee from the case itself after he decides to take the same. This is a sort of percentage agreement reached between you and the attorney, but no attorney is going to fight your case if he knows definitely that you have not got actual proof.

We suggest that you communicate directly with either patent attorneys or lawyers in your home town who will be glad to take up this matter with you.

Radio Receivers

(1149) J. M. Williams, New York City, has designed a pair of radio receivers with electro-magnetic field pieces and he requests our advice.

A. 1. While it is perfectly true that you can probably increase the signal strength of a pair of receivers by winding an extra coil of wire upon the pole pieces of those receivers, and supplying this coil with a source of an electrical current, so as to increase the magnetic flux of the iron core, it is also true that the amount of current consumed will be as great, if not greater, than that employed by a vacuum tube. Furthermore, the amplification cannot possibly compare with the amplification produced by an extra stage of audio frequency, and the weight of the receivers is not at all a pleasant factor.

We believe that if you require more amplification, you can easily get it with our modern tube system of amplifiers, and the volume of the incoming signal can be increased to such an extent that it will operate a loud speaker. Why bother with a pair of phones, the sale for which is very limited, and the chances for possible future sales seem even less bright. In principle, your device is not at all new. We advise no action.

FREE TRIAL

on any Band Instrument



Saxophone, cornet, trumpet, trombone, clarinet, flute—choose any Conn instrument for band or orchestra; try it in your own home FREE. EASY PAYMENTS if you decide to buy.

With Conn's easy-playing features, you make quick progress. Take your place in a band or orchestra after a short period of pleasurable practice.

Send For Free Book, illustrating and describing instruments, and details of free trial offer. Mention instrument which interests you.

C. G. Conn, Ltd., 156 Conn Bldg. Elkhart, Ind.



This Needed Invention Paid \$135,000

A YEAR. Beverage manufacturers immediately adopted this simple crimped tin cap. This invention would have made you independently wealthy. Fortunes await inventors working along right lines. Concentrate on things that are NEEDED. Get Raymond Yates' new book.

right lines. Concentrate on things that are NEEDED. Get Raymond Yates' new book.

"1000 NEEDED INVENTIONS"

Costs only \$1.25 and may lead to a big idea. Find out what industry needs and the public wants. That's where the money is! Mr. Yates' book tells you what these things are. Send no money. Just write postal. Pay mailman \$1.25 plus postage when book arrives. Your money back if you want it. This offer limited. Write now and get on the right track. (Outside U. S. \$1.45 cash with order.)

BUREAU OF INVENTIVE SCIENCE

71 Wisner Building

Rochester, N. Y.

COMPLETE INFORMATION about the MOVIE EFFECT DEVICE

will gladly be forwarded on request. Also literature covering other special devices designed and manufactured by us for the Amateur Movie Maker.

Made by the Manufacturers of
GOERZ LENSES for
Still and Movie Cameras.

C. P. GOERZ AMERICAN OPTICAL CO.
317 E. 34th St. New York City

SPEEDSTER AIRPLANE

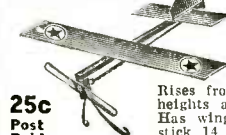

25c Post Paid

11-inch wing spread, 9 1/2 inches long, wood propeller accurately machined. A fast flyer that rises from the ground and speeds beautifully through the air. Comes to you all assembled. Only 25 cents postpaid. **SPEEDO-PLANE FLYER** Rises from the ground. Soars to great heights and glides perfectly to ground. Has wing spread of 16 inches. Motor stick 14 inches. 7-inch accurately machined wood propeller. Match its performance against your 35 plane. Fully assembled, 50 cents postpaid. **SPEEDO MANUFACTURING COMPANY** Dept. G 253 Albany Ave. Brooklyn, N. Y.

Foreign Work!

LIKE TO TRAVEL—Does Romantic, Wealthy South America call you? Unusual opportunities for young men. American employers. Fare and expenses furnished.

BIG PAY. Write for Free List.

SOUTH AMERICAN SERVICE BUREAU
14600 Alma Avenue Detroit, Mich.

Insure your copy reaching you each month. Subscribe to **SCIENCE AND INVENTION**—\$2.50 a year. Experimenter Publishing Co., Inc., 230 Fifth Avenue, New York City.

Earthquakes and Seismographs

By Father John W. Tynan, S. J.

(Continued from page 817)

attended by sound and tidal waves dependent upon the nature of the impulse and the circumstances of position on land or sea.

We see in this definition two distinct elements first from a center of impulse, a propagation of earth waves in all directions from this center.

Seismology, or rather the *new seismology*, created by the seismograph, is the study of the earthquake from the waves sent forth from the center of the impulse, rather than from the position at which the disturbance takes place and, hence, is sometimes called the *distant study of earthquakes*.

Earth Subject to Laws of Strain

OUR earth is a massive spheroid, solid unquestionably to certain depths, and like any other mass of matter is subject to

\$5,000 for Perpetual Motion

The editors have received thousands of different designs of perpetual motion devices, and have received hundreds of circular letters soliciting finances for the building of perpetual motion machines.

The editors know that if they receive these letters, there are thousands of others in this country who get similar letters and who fall for the claims made in the numerous prospectuses giving the earning capacities of the various machines.

Most of the shares of stocks for these perpetual motion machines are being sold at a rate of \$1.00 per share, although some inventors are trying to sell shares of stock at \$100.00 per share.

Therefore, the editors of this publication say, "Just come in and show us—merely SHOW us—a working model of a perpetual motion machine and we will give you \$5,000.00. But the machine must not be made to operate by tides, winds, waterpower, natural evaporation or humidity. It must be perpetual motion."

the laws of mechanics in general, and to the law of stress and strain in particular, and so when certain forces act on the surface of our globe, strains are set up in the crust. Such strains are sustained until the forces reach values that cause the elastic limit of the material of the earth to be overstepped and a fracture in the earth's surface is the result. Such a fracture is known as a fault, and these faults are generally admitted to be the proximate causes of earthquakes. In other words, the earth's surface gives way under a stress and the separation causing the fracture, which is considered the center of the impulse, and this disturbance travels out in the form of compressional and distortional waves that are commonly recognized as an earthquake.

What Theory of Isostasy Is

THE remote causes of the stresses on the earth's surface have been questioned. The best minds now agree that the theory of isostasy gives the most plausible explanation. According to the theory, the principal causes of earthquakes are the sinking

PATENTS TRADE-MARKS AND COPYRIGHTS



OUR OFFER: FOR THE PROTECTION OF YOUR INVENTION YOUR FIRST STEP. The inventor should write for our blank form—"RECORD OF INVENTION." This should be signed, witnessed, and returned to us, together with model or sketch and description of the invention for INSPECTION and ADVICE FREE!

Our FIVE Books Mailed Free to Inventors

Our Illustrated Guide Book

HOW TO OBTAIN A PATENT

Contains full instructions regarding U. S. Patents, Our Methods, Terms, and 100 Mechanical Movements illustrated and described.

OUR TRADE-MARK BOOK

Shows value and necessity of Trade-Mark Protection. Information regarding *Trade-Marks and unfair competition in trade*;

OUR FOREIGN BOOK

We have Direct Agencies in Foreign Countries and secure Foreign Patents in shortest time and at lowest cost.

PROGRESS OF INVENTION

Description of World's Most Pressing Problems by Leading Scientists and Inventors. All Communications and Data Strictly Confidential. Interference and Infringement Suits Prosecuted.

DELAYS ARE DANGEROUS IN PATENT MATTERS

IMPORTANT! To Avoid Delay!

YOU SHOULD HAVE YOUR CASE MADE SPECIAL IN OUR OFFICE to save correspondence, secure protection and early filing date in the Patent Office. To secure *special preparation* of your case send \$25.00 on account with model or sketch and description of invention.

Our Lawyers Practice in all U. S. Courts and defend Clients in Suits involving Patents, Trade-Marks and Copyrights

OUR ORGANIZATION OFFERS PERSONAL SERVICE

By Experienced Patent Lawyers, Solicitors and Draftsmen

We regard a satisfied client as our best advertisement, and furnish, upon request, lists of clients in any state for whom we have secured patents.

Highest References—Prompt Service—Reasonable Terms

—WRITE TODAY—

FREE COUPON

VICTOR J. EVANS & CO.

Registered Patent Attorneys

MAIN OFFICES: 715 Ninth St., Washington, D. C.

BRANCH OFFICES: 1007 Woolworth Bldg., New York City; 518-519 Liberty Bldg., Philadelphia, Pa.; 514 Empire Bldg., Pittsburgh, Pa.; 1114 Tacoma Bldg., Chicago, Ill.; 1010 Hobart Bldg., San Francisco, Calif.

Gentlemen: Please send me FREE OF CHARGE your books as described above.

Name.....

Address.....



Laycock Reports Another "Raise!"

"A LaSalle man should always be able to report progress," writes Harland C. Laycock, of Mishawaka, Indiana, "and my report this year shows a 20 per cent increase in salary."

"Always able to report progress"—that's the viewpoint of the man with training!

Quite a different viewpoint from that which Laycock had when, as street-car motorman for eight years in Toledo, he first enrolled with LaSalle for home-study business training.

But training brought him his opportunity. He gave up the job at which he had been working seven days a week, 365 days in the year, to become rate and claim clerk with the Mishawaka Rubber and Woolen Manufacturing Co. Better hours right at the start—and work that he liked!

Now he is Assistant Traffic Manager of this great and successful business institution, and every year he writes us to report how his increased ability is being reflected in a constantly increasing salary—already practically double what he was getting at the old job!

Send for Free Outline of LaSalle Salary-Increasing Plan

How much is it worth to you to gain, in a comparatively few months, substantial promotion—a new confidence and self-respect?

The way to all these things is outlined in a fascinating book, "Ten Years' Promotion in One"—a book which has set thousands and thousands of men on the path to real achievement. The coupon will bring it to you FREE.

In addition we will send you a 64-page book describing the unusual opportunities in any of the business fields listed below. If you want to look back a year from today and see a record of real progress, then—TODAY is the day to start—and the moment NOW!

— Find Yourself Through LaSalle! —

LaSalle Extension University

The World's Largest Business Training Institution
Dept. 1384-R Chicago

I should be glad to learn about your salary-increasing plan as applied to my advancement in the business field checked below. Send also copy of "Ten Years' Promotion in One," all without obligation.

- | | |
|---|---|
| <input type="checkbox"/> Business Management | <input type="checkbox"/> Stenography |
| <input type="checkbox"/> Modern Salesmanship | <input type="checkbox"/> Banking and Finance |
| <input type="checkbox"/> Higher Accountancy | <input type="checkbox"/> Expert Bookkeeping |
| <input type="checkbox"/> Traffic Management | <input type="checkbox"/> C. P. A. Coaching |
| <input type="checkbox"/> Railway Station Management | <input type="checkbox"/> Business English |
| <input type="checkbox"/> Law—Degree of LL.B. | <input type="checkbox"/> Commercial Spanish |
| <input type="checkbox"/> Commercial Law | <input type="checkbox"/> Effective Speaking |
| <input type="checkbox"/> Industrial Management | <input type="checkbox"/> Stenotypy |
| <input type="checkbox"/> Modern Foremanship | <input type="checkbox"/> Telegraphy |
| <input type="checkbox"/> Personnel Management | <input type="checkbox"/> Credit and Collection Correspondence |
| <input type="checkbox"/> Modern Business Correspondence | |

Name.....
Present Position.....
Address.....

Play the Hawaiian Guitar like the Hawaiians!

Only 4 Motions used in playing this fascinating instrument. Our native Hawaiian instructors teach you to master them quickly. Pictures show how. Everything explained clearly.

Play in Half Hour
After you get the four easy motions you play harmonious chords with very little practice. No previous musical knowledge needed.

Easy Lessons
Even if you don't know one note from another, the 62 printed lessons and clear pictures make it easy to learn quickly. Pay as you play.



GIVEN when you enroll
HAWAIIAN GUITAR, Carrying Case and Playing Outfit
Value \$18 to \$20
No extras—everything included

WRITE AT ONCE for attractive offer and easy terms. A postcard will do. **ACT!**
OTHER COURSES: Tenor Banjo, Violin, Triple, Tenor Guitar, Ukulele, Banjo Ukulele. Under well-known instructors.
FIRST HAWAIIAN CONSERVATORY OF MUSIC, Inc.
9th Floor, Woolworth Bldg., Dept. 240 New York, N. Y.
Approved as a Correspondence School Under the Laws of the State of New York—Member National Home Study Council.

of the earth's crust under the sediments, the rising of the crust under areas of erosion, and the expansion of the crust following great accumulations of sediments.

The operation of the seismograph is, of course, independent of any of these theories which we may evolve as the remote cause, and so we may discuss it from the point of view of the physicist, rather than that of the geologist, considering only the facts at hand, the mechanical phenomena of the quakes and the reactions of the seismological instruments to them.

The ordinary man in the street manifests interest when he hears that the seismograph registered a quake, say 6,500 miles away, and silently wonders how it is done—five minutes within earshot of an explanation, however—and he has more than begun to wish that he hadn't.

Such an attitude, however, is unnecessary, as we shall try to show, and while we will not expect you to read seismograms at the end of this article, at least we are sure that you will be able to tell your neighbor how a seismograph works—and be right.

Seismograph Based on Inertia

FIRST of all, they call it the seismograph—from the Greek, meaning to record a shaking. The principle underlying the action of almost every seismograph is the principle of inertia. But if you have never been exposed to a course in physics the only association that the word inertia engenders is that it is the stock in trade of the lazy man. But the lazy man is said to possess inertia because he hates to move, and the more he hates to move, the more inertia he is said to possess. So then, regardless of whether or not we have studied physics, we can leap at the definition of inertia as that quality by virtue of which a body resists being put in motion.

Relation Between Earthquakes and Inertia

BUT what has inertia to do with earthquakes? Well, if you were gauging the speed of a train, you would use as a point of reference an object outside the train which did not participate in the motion of the train. For example, the train is going 60 miles per hour, with reference to the ground. Suppose, however, the ground were moving, too, say at the same rate and in the same direction as the train—it would no longer be a reliable point of reference by which to calculate the train speed, for it is obvious that relatively to the ground the train would be standing still.

Now, an earthquake is an earth movement and the difficulty in measuring this motion lies in the fact that when the earth moves, everything on the earth participates in the movement so that relatively there is no motion. How then obtain a fixed or stationary mass which will not move when the earth does and so will serve as a point of reference by which to measure this motion? Here the principle of inertia enters the piece. Everyone is familiar with the fact that a coin placed on top of a card on the end of a cue will remain on the cue if the card is suddenly withdrawn. The coin remains behind by reason of its inertia by which it resists being put into motion.

How Seismograph Works

A CHINK of light appears now and we are beginning to see the connection between earthquakes and inertia; for if we can arrange a body so that its relation to the earth will be the same as that of the coin to the card, we will have found a means of measuring the amount which the earth moves. That is precisely what the essential part of a seismograph is—a mass which will remain steady when the earth moves under it.

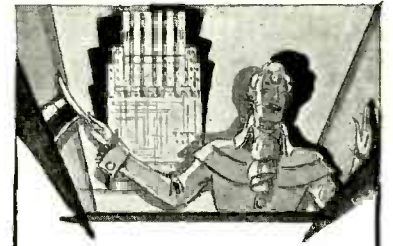

New York's
Newest Hotel

The Piccadilly

227 West 45th Street
At B'way-New York

Adjacent to Every
Activity

600 Bright Sunlit Rooms
Each with Bath, Electric Fan, Ice Water

Single Room & Bath, \$3.00
Double Room & Bath, \$4.50

Exceptional Restaurant
and Luncheonette

Wire at Our Expense
for Reservations

F. D. SOFIELD
Managing Director

Skin Troubles

CLEARED UP—OFTEN IN 24 HOURS

Pimples, Blackheads, Acne Eruptions on the Face or Body, Barbers Itch, Eczema, Enlarged Pores, Oily or Shiny Skin. "Clear-Tone" has been tried and tested in over 300,000 cases. Used like toilet water. Is simply magical in prompt results. At All Druggists—with Proven Directions.

Ask Your Druggist—You Can Rely on

Clear-Tone

FOR SKIN AND COMPLEXION

Insure your copy reaching you each month. Subscribe to **SCIENCE AND INVENTION**—\$2.50 a year. Experimenter Publishing Co., Inc., 230 Fifth Avenue, New York City.

In practice it consists of a pendulum whose bob is the steady mass and which may be set upright like the pendulum of a clock, or inverted, that is, with the mass uppermost or in any position not rigidly affixed to the earth. The pendulum bob has affixed to it a series of magnifying levers ending in pens which rest on the recording paper. Now, when the earth moves, everything on the earth moves too, so naturally, the recording paper will participate in this motion.

The revolving pen, however, is attached to the mass of the pendulum, and, since there is no motion of this bob there is no motion of the pens. The pens, although appearing to move over the paper, actually remain at rest, while the paper moves under them. The paper is formed into a ring and placed on a revolving drum immediately under the pens.

The Newest Style in Seismographs

THE newer types of seismographs have rejected the pen on paper method, and employ photographic paper encased in a light-tight box. A little point of light reflected by a mirror from the pendulum mass

\$31,000.00 FOR SPIRITS

\$1,000.00 was offered by this publication in the June, 1923, issue for spirit manifestations that could not be duplicated or explained by scientific means.

\$10,000.00 for spiritual phenomena was offered through SCIENCE AND INVENTION by Joseph F. Rinn in the August, 1923, issue.

\$10,000.00 was offered through SCIENCE AND INVENTION Magazine by Joseph Dunninger for spiritual manifestations which he could not explain or duplicate by scientific means under identical conditions.

\$10,000.00 is now offered through this publication by Mrs. Houdini for the ten-word message which Houdini promised to deliver.

TOTAL: \$31,000.00 for spirit manifestations.

falls on the photographic paper, exposing the part where it falls. This paper, too, is affixed to a drum, so that successive parts of the paper come under the beam; the result being a continuous line—straight when the earth is quiet, but following a wavy course when a quake is in progress.

Seismographs are divided into two classes, according as they are designed to record the up and down motion of a quake or the horizontal motion.

The present equipment at Fordham comprises three instruments for recording the horizontal motion of the earth. From Estonia came three more instruments, two for recording the horizontal motion of the earth and one for the vertical motion. These new instruments are the last work in seismological equipment, and are the gift of Mr. William J. Spain of New York City, in memory of his son, William Lavelle Spain, who died while a student at Fordham.

These instruments magnify the earth movement 1,000 times. The necessity of magnifying the receiver impulse will be obvious when we consider that the normal earthquake registered at Fordham consists of an earth motion that is exceedingly small. The most violent earthquake registered at Fordham showed a displacement on the rec-

(Continued on page 869)

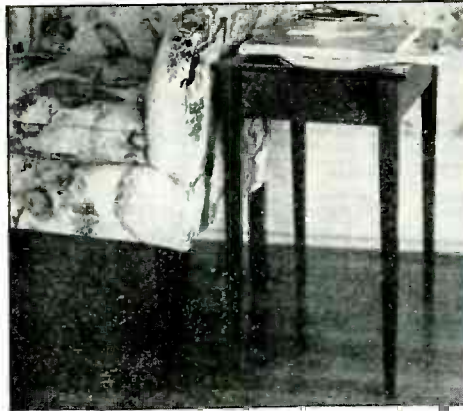

(Above) Smoking Table See LePage's Book, page 16

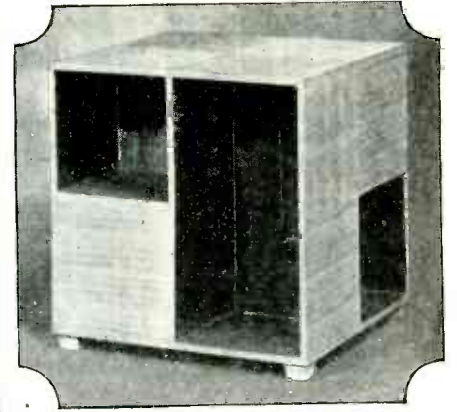

Modernistic Table See LePage's Book, page 11



Lady Washington Sewing Cabinet See LePage's Book, page 7

12 NEW Job Plans, Too!

There is, of course, a limit to what we can give in LePage's New Third Home Work Shop Book for only a dime. But we realize many men want additional projects. Hence our 12 new Job Plans. These also were made by Mr. Klenke. They are projects that require more elaborate presentation than we can give in our book. Each Job Plan presents one project on a single large sheet of paper. Each is well worth its price, one dime. Look over these projects and order those you want by number (see coupon), enclosing 10 cents for each.

- 16 Sheraton Writing Desk
- 17 Sheraton Desk Chair
- 18 Colonial Hanging Book Shelves
- 19 Smoking and Reading Cabinet
- 20 Colonial Mirror
- 21 Tea Wagon
- 22 Telephone Cabinet
- 23 Stool for Telephone Cabinet
- 24 Manual Training Work Bench
- 25 Home Worker's Tool Cabinet
- 26 Spanish Gal-leon
- 27 Vanity Table

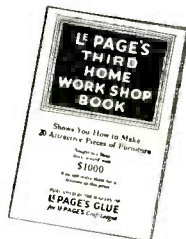

LE PAGE'S GLUE
HANDIEST TOOL IN YOUR WORK SHOP

LePage's latest book shows how to make \$1000 Worth of Fine Furniture at a Fraction of That Price

LePage's new "Third Home Work Shop Book" contains complete directions for making 20 pieces of household furniture. A careful check in retail shops showed them to be worth \$1,000. You can make them yourself for a fraction of that price.

For the first time, instructions are given for making modernistic furniture, so popular today. Or you can reproduce famous and handsome old Colonial pieces. If you are handy with tools, you can easily do it. Long winter evenings ought to give you plenty of time.

Expert Instruction

All the designs, dimension drawings, actual pieces of furniture, photographs and step-by-step directions how to make, were prepared by William W. Klenke, Instructor in Woodworking, Central Commercial and Manual Training High School, Newark, New Jersey. Also the designer of the first two LePage's Books. Each project and the directions for making it are perfectly practical.

Each project is presented in three parts—a photographic illustration of the finished article, a complete dimension drawing of its parts, and simple, easy-to-follow, step-by-step directions.

In addition to the three pieces shown above, the book includes the following: Cape Cod Chest of Drawers, Alexandria Nest of Tables, Old Salem Ship's Cupboard, Plymouth Built-in China Closet, Modernistic Book Shelves, Desk, Folding Screen, and Fire Screen, Chess and Checkers Table, Cane Side Chair, China or Book Cabinet, Book Trough and Magazine Stand, Magazine Carrier, Vanity Case, Book Stand, Fernery Stand, and Folding Sewing Screen. Where else could you get complete directions for making all these for only 10 cents?

Send 10 cents for this NEW LePage's Home Work Shop Book

Simply use the coupon below, sending it to us with 10 cents in coin or stamps, and we will at once send you a copy of this latest LePage's Book, postage paid.

MAIL THIS COUPON

LEPAGE'S CRAFT LEAGUE,
630 Essex Ave., Gloucester, Mass.

Gentlemen: Enclosed please find 10 cents (coin or stamps) in payment for LePage's New Third Home Work Shop Book. Please send a copy of this book to:

Name

Street

City

Please also send the following Job Plans..... (indicate by number those you want. See column at left), for each of which I enclose an additional 10 cents.

Please say you saw it in SCIENCE and INVENTION

WILBUR C. WHITEHEAD'S *new* "Picture Method" teaches **BRIDGE**

Drawing for partners.

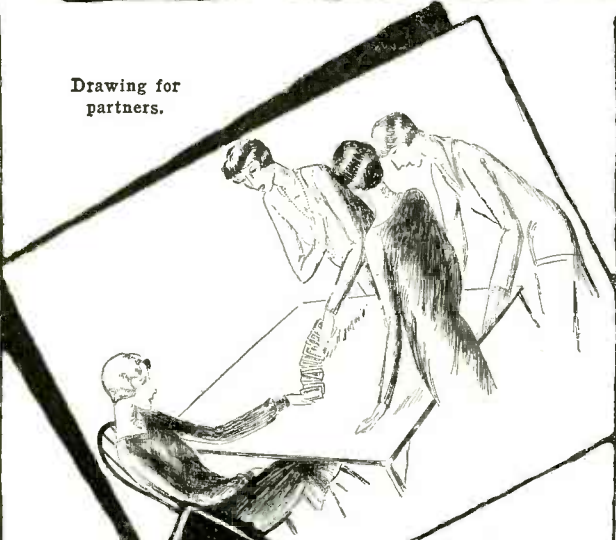

An example of the way in which each hand is illustrated.

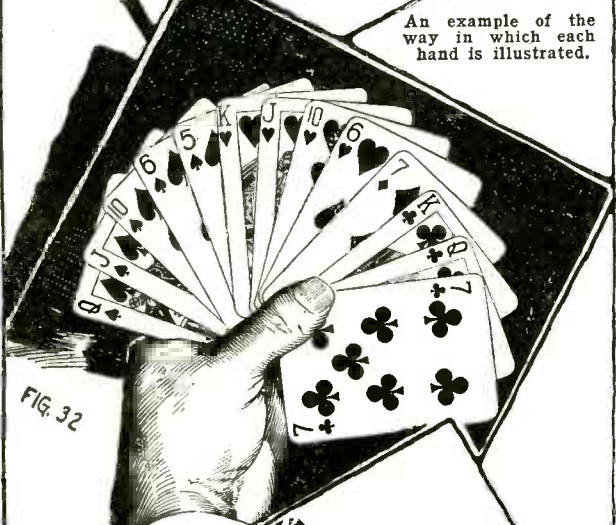

FIG. 32

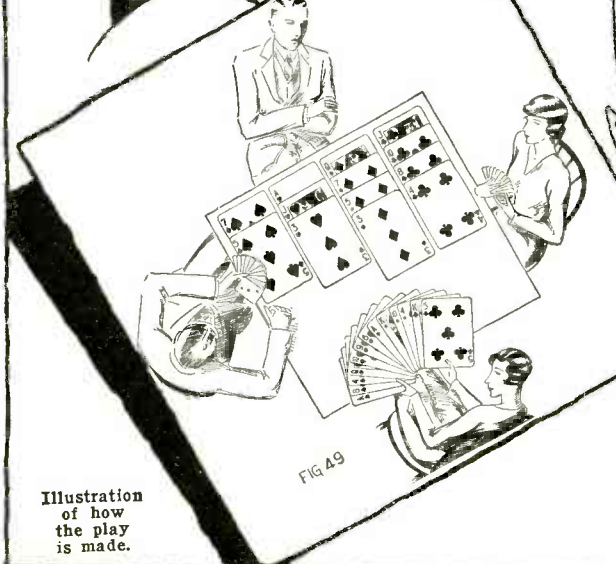

FIG. 49

Illustration of how the play is made.

easily and quickly.
Printed in **2 COLORS** Red and Black Cards

WILBUR C. WHITEHEAD, the world renowned bridge expert, has written this interesting instruction course for you. BRIDGE by Whitehead is unique in that it teaches the entire game of bridge by a new and original form of illustration known as Whitehead's "PICTURE METHOD." Every hand is illustrated, each card in its proper color, red or black as the case may be. Thus the beginner, or even the most seasoned player, has an actual illustration of the manner in which the play is made always before him.

Whitehead, whose reputation as the foremost authority, national or international, on the game of bridge, is one whose advice cannot be taken lightly; he knows the game as few others know it. In this book he passes on to his readers, in an easily understandable fashion, his picture method—that made him a success. Get your copy of BRIDGE by Whitehead today—100 pages—9" x 12" size. Beautiful colored cover. Each point illustrated.

50c
THE COPY

At All Newsstands or write direct
EXPERIMENTER PUBLISHING CO.
230 Fifth Ave., New York, N. Y.

MAIL THIS COUPON NOW

EXPERIMENTER PUBLISHING CO.
230 Fifth Avenue
New York, N. Y.

Gentlemen: Enclosed find 50c, for which please send me a copy of BRIDGE by Whitehead.

Name
Address
City..... State.....

Please say you saw it in SCIENCE and INVENTION

Earthquakes and Seismographs

(Continued from page 867)

cord of not more than two inches—when, however, we reduce this to actual ground movement we find that the earth actually moved about one-half millimeter or about 1/50th of an inch.

The principle upon which these instruments work is slightly different. Here we also have a weight, but the weight is relatively much lighter than those usually employed. To the end of the arm supporting the weight, there are four coils of wire, connected in series and held between permanent magnets. Any movement of the magnets thus induces a current in the coils, which causes the mirror of the galvanometer to deflect. This, in turn, makes the light quiver and a way line is produced on the photographic paper. The light itself is cut off for a second every sixty seconds. This

IMPORTANT

TO NEWSSTAND READERS

IN order to eliminate all waste and necessary to supply newsstand dealers with the actual number of copies for which they have orders. This makes it advisable to place an order with your newsdealer, asking him to reserve a copy for you every month. Otherwise he will not be able to supply your copy. For your convenience, we are appending herewith a blank which we ask you to be good enough to fill in and hand to your newsdealer. He will then be in a position to supply copies to you regularly every month. If you are interested in reserving your copy every month, do not fail to sign this blank. It costs you nothing to do so.

To Newsdealer
 Address

Please reserve for me copies of
SCIENCE AND INVENTION every month
 until I notify you otherwise, and greatly
 oblige,

Name

Address

leaves a small white spot in the record to serve as the time guide. This cut-off is accomplished by an electromagnetic shutter, operated by a master clock, which is tripped in front of the light beam. The room where these records are made is illuminated by red lights and is maintained at fairly constant temperature. The lights are red for the purpose of preventing possible fogging of the photographic paper on the recording drums.

The papers tell you at times that a seismograph registered a disturbance which lasted sometimes three or four hours—this does not mean that the earthquake continued for that length of time, but rather that the earth waves generated by the shock of the quake continued to arrive at the seismic station for that length of time. A pebble cast into a lake will cause wave to follow upon wave, but although they continue to lap the shore for an appreciable interval, it is not assumed that the pebble is still disturbing the surface of the water where it fell.

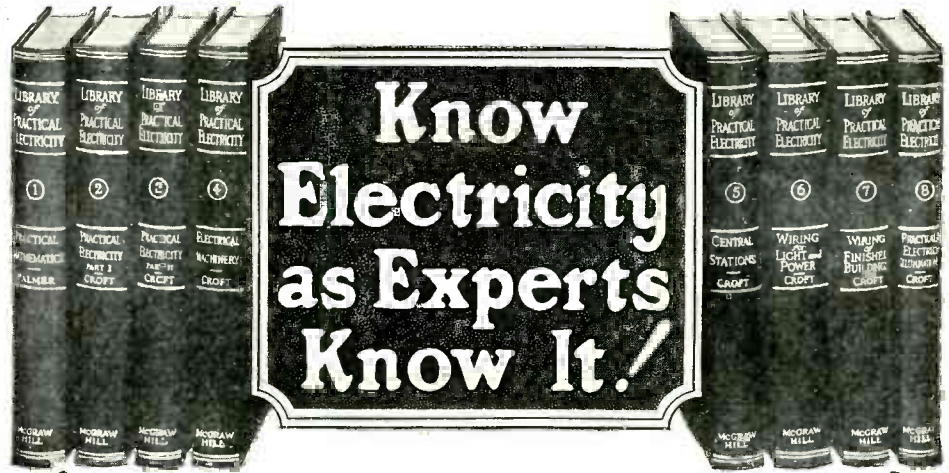

THIS is the electrical age, with unlimited opportunities for the man who has educated himself in the finer points of electrical practice.

Fit yourself for one of the really big jobs by knowing electrical practice complete, including inside and outside work, central stations, and the whole subject. With the aid of the Croft books you can know electricity as experts know it and put yourself in line for an expert's pay.

The Croft Library of Practical Electricity

A reference library and self-training course in eight volumes. 3000 pages—2100 illustrations



The Croft Library contains three thousand pages, with twenty-one hundred of the clearest illustrations ever put into book form. Each of the eight volumes is indexed so that everything you want to know about electricity is at the fingers' ends. And when you find what you want, there is not merely a short question and a short answer. You are told everything you want to know. The explanation is clear to you, regardless of whether you have had a previous knowledge of electricity or not.

Croft teaches you electrical practice complete. He takes you in quick, easy steps from the simplest principles to the complete and economical operation of a great central station.

He tells you the things you need to know about motors, generators, armatures, commutators, transformers, circuits, current, switchboards, distribution systems—electrical machinery—wiring for light and power—wiring of finished buildings—underwriters' and municipal requirements—how to do a complete job, from estimating it, to completion—illumination in its every phase—the latest and most improved methods of lighting—lamps and lighting effects, etc.

THE STANDARD IN PRACTICAL ELECTRICAL TRAINING



Everywhere the Croft Library is acknowledged as the standard—the leader—in practical electrical training. It is the daily guide of 59,000 highly-paid electrical workers and engineers. There is nothing like it in print today. It is the most complete, the best illustrated, the most carefully compiled, the most easily understood electrical library available. No matter how much or how little you know of electricity, you will find the Croft Library a sound, helpful guide to greater accomplishment.

Every day you use these great books you will learn something that will help to make you a better electrical worker. Every page is taken from every-day electrical practice. Croft deals only with the kind of problems you meet in daily work. Own a set and join the 59,000 men who have found the Croft Library to be a real working companion to bigger accomplishment in the electrical field. Keep these books handy in your room. Put one in your pocket when you take the car or train in the morning. Give them the odd hours. They are not tiresome treatises, but as interesting as any reading matter you ever owned. Consult your set regularly, acquire just one new fact a day, and in a few years you will be a broadly informed electrical man.

Easy Steps to Success in Electricity

Starting right in with the ABC's of modern electricity, Croft takes you through his books in easy steps. He gives you the boiled-down records of every-day electrical practice in plain words, figures, and illustrations. Nothing is left to the imagination—there is no guesswork. Croft has been through the mill. His knowledge of electricity has been gained by actual shirt-sleeve contact with electrical problems. He knows just

what is needed to get ahead. He has poured out all his knowledge—all his experience—in language that anyone can grasp. Yet the text is so scientifically correct that thousands of the highest-paid electrical engineers are using the books as a reference set.

The famous set is beyond a doubt the last word in practical electrical education. No one who wishes to get anywhere in the electrical field can afford to be without it.

Free Examination

No Money Down—
10 Months to Pay!

Fill in and mail the coupon attached and we will send you the entire set of eight volumes for ten days' Free Examination. We take all the risk—pay all charges. You assume no obligation—you pay nothing unless you decide to keep the books. Then \$1.50 in ten days and the balance at the rate of \$2 a month. Send the coupon NOW and see the books for yourself.

Free Examination Coupon

McGraw-Hill Book Co., Inc.,
370 Seventh Avenue, New York.

Gentlemen—Please send me the CROFT LIBRARY OF PRACTICAL ELECTRICITY (shipping charges prepaid), for 10 days' free examination. If satisfactory, I will send \$1.50 in ten days and \$2.00 per month until \$19.50 has been paid. If not wanted, I will return the books at your expense. (Write plainly and fill in all lines.)

Name.....
 Home Address.....
 City and State.....
 Employed by.....
 Occupation.....

Send the Coupon TODAY →

Magic



**Learn at Home
—by Mail!
Quickly! Easily!**

New! Different! Dr. Harlan Tarbell, Famous Magic Wizard, teaches you Big Tricks, Illusions, Stage Stunts, "Patter" and the Principles of Magic. You learn easily and quickly at home by mail. Earn \$250 to \$1000 a month. Write today for big free Magic Book.

Astonish Your Friends

Gain that magnetic popularity that makes you the center of any crowd. Business and social success is assured the man who can perform mystifying tricks. You can earn big money either on the side or as a professional, as well as being the most popular person in your crowd. Why envy others' skill? You can learn Magic yourself, quickly, easily—at home—by mail—during your spare time.

**Earn \$250
to \$1000 a Month**

Magic is now made simple to learn. For Dr. Harlan Tarbell, one of the really Great Magicians, has finally opened up the secrets of his profession in a completely illustrated course offered at a merely nominal cost. You will be able to mystify and entertain your friends with simple tricks taught in your very first lesson. Dr. Harlan Tarbell takes you through the entire maze of sleight-of-hand, card tricks and elaborate stage diversifications. The apparently superhuman doings of the accomplished magician become as simple as ABC when you just know how.

Write! Mail coupon now for big free Magic book telling all about the great Tarbell Course in Magic. Get Our Low Prices and Easy Payment Plan.

**Tarbell System, Inc., Studio 14-21
1920 Sunnyside Avenue, Chicago, Ill.**

Gentlemen: Without any obligation send me your free literature and information all about your wonderful "Tarbell Course in Magic." Also tell me about your Low Prices and Easy Payment Plan.

Name.....
Address.....
Age.....

The principal portion of an earthquake, that is the seat of waves of maximum amplitude, is preceded by two very definite groups of waves, called the First and Second preliminary groups. Then, a set of irregular waves of long period arrive, introducing the maxima and immediately preceding them. Then follow the maxima, which begin with their greatest amplitude and repeat themselves with decreasing amplitude until they have become imperceptible. There you have the personal autograph of the earthquake. These selfsame characteristics are common to all quakes within limits, and generally other wave forms, reflections of these, may be identified.

The first and second preliminary follow the shortest path through the earth and, hence, arrive first; the first preliminary is a longitudinal wave like a sound wave; the second is a transverse wave like the light wave.

The maxima arrive later because their initial velocity is less and because they travel along the surface of the earth. For this latter reason they are of much greater amplitude because they have lost less energy in passing through the surface which is less dense than the interior of the earth.

Intimate study of these waves has led to the discovery of their speed of travel and from a knowledge of their speed of travel we come to a knowledge of how far they have traveled. The first preliminary travels about eleven miles per second; the second preliminary about eight miles per second, and the surface waves have a constant velocity of six miles per second. Knowing these several velocities the elapsed time between the arrival of any two sets gives us the date required to calculate the distance from our observatory. The direction and the actual location can be accurately determined only by the collaboration of three or more stations. Father Sohon, a former director at Fordham, has evolved a method of determining the location from the data of one station—and while it is an accurate method, its use involves a long mathematical development.

I feel that this article would not be complete without reference to the probability of an earthquake occurring here in our midst.

Basing our argument upon what has happened and noting that where earthquakes have happened they have continued to do so with greater or less regularity, we may rest easy with the assurance that although it is possible that New York may some day experience an earthquake, it is not at all probable.

My predecessor at Fordham, Father John S. O'Connor, made a detailed study of the earthquake history of the New England and Middle-Atlantic states. His information included the period of 1727 down to about 1924. His conclusion may give us a great deal of comfort. He says: "No earthquake of destructive violence has ever been recorded as having taken place in New England. The Middle-Atlantic states are even relatively more immune from anything like a severe shock; at least as far as historical data goes."

The quake felt in New York on February 28, 1925, actually occurred in the St. Lawrence Valley.

Electricity Records Earthquakes

EARTHQUAKES are measured by the strength of electric current generated by vibrations of the earth's crust in an improved seismometer recently developed by Dr. F. Wenner, Bureau of Standards, Department of Commerce.

Instead of the usual mechanical method of a record traced by a huge balanced weight—17 tons, in one case—influenced as little as possible by the earth's motion, on a point rigidly connected with the earth mass, the improved seismometer records all motions
(Continued on page 872)

Did You Go to High School?

If not, here is your chance to get your education in spare time at home

It's EASY now to make up for the High School Education you missed. Fifteen wonderful books that you will enjoy reading in spare moments teach you every subject covered in the regular four-year course. Certificate awarded.

JUST READ FASCINATING QUESTIONS AND ANSWERS

It's fun getting your High School Education this way. You learn by the question and answer method—most interesting and effective teaching method known. All these subjects included: English, Latin, Ancient, Modern, and American History, Geography, Physiography, Literature, Biology, Physics, Arithmetic, Algebra, Spelling, Civics, and Economics.

SEND NO MONEY
Examine these fifteen books FREE. No money in advance. Pay nothing on delivery. Keep the books 5 days. Then decide. Return them if you choose. Otherwise send \$3.85 first payment and \$4 monthly for 4 months—total only \$19.85. Send name and address NOW.



High School Home Study Bureau
Dept. 241, 31 Union Square, New York, N. Y.

LEARN AUTOS IN LOS ANGELES

Auto Jobs Pay \$40 to \$100 a Week!

Trained auto repair men are needed to help repair the millions of autos in California and other states. The rapidly increasing number of cars means big pay for auto men—more garages, tire shops and battery stations are needed. You can be one of the highly paid men in this fast growing industry—if you get the right training. National Automotive special, practical Shop Training makes it easy for you to become an Auto Expert. In a quarter of a century this great institution has trained 16,000 men for Bigger Pay—it will help you earn more money by giving you individual instruction on repairing all makes of cars, all types of electrical equipment, machine shop equipment, etc. You learn everything Right at National.

Free Employment Service

Spare time jobs help pay expenses while training. All tools free. No extras. Send today for the big free illustrated catalog explaining how National trains you for bigger pay.

Learn about the opportunities awaiting you in California.
NATIONAL AUTOMOTIVE
Dept. 200R, 4006 S. Figueroa Street
Los Angeles California



1000 HOURS—of the Best Fun You Ever Had—Get Your Copy of SAM LOYD'S Tricks and Puzzles

The year's most unique book, contains 120 pages that are crammed full of all kinds of tricks, puzzles, games, conundrums, etc.

Size, 9 x 12 inches—illustrations on every page. Fun for every member of the family.

50c On All Newsstands

EXPERIMENTER PUBLISHING CO., Inc.
230 Fifth Avenue, New York, N. Y.

Insure your copy reaching you each month. Subscribe to SCIENCE AND INVENTION—\$2.50 a year. Experimenter Publishing Co., Inc., 230 Fifth Avenue, New York City.

DIRECTORY SECTION

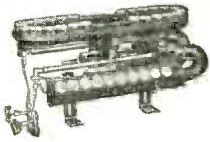

OXO GAS

Blue Flame Oil Burners for Cook Stoves, Heaters and many other purposes. The fastest growing industry of the times offers the opportunity to become branch manager; men of character and responsibility will be furnished with complete demonstrating outfits for themselves and sub-distributors.

DORAN OIL BURNER CO.
111-119 May Street Chicago, Ill.

HERE IT IS!

**SILVER MARSHALL
630 SHIELDED
GRID SIX**
The Radio Set with Distance and Tone to spare.
List \$99.00.

Your Cost while they last, \$36.95.

**RAWNER RADIO &
TELEVISION CO.**
142 Liberty Street
New York City

**LEARN
ELECTRICAL
TRADES**

Practical Training on Massive Lay-Out of Expensive Electrical Equipment.

Armature Winding, House Wiring, Electric Welding, Electric Refrigeration, Power Plants, Switchboards, Transformers, Motors, Generators, Radio, Batteries, Automobile Course included without extra cost. Write today for Free Catalog.

COLEMAN ELECTRICAL SCHOOL
1636 S. Main St., Kansas City, Missouri

Boice-Crane Bench Machines

FOR HOME SHOP OR FACTORY
8" Universal Handisaw
12" Band Saw, \$35.00
4" Joints, \$25
Jig Saw, \$12
Lathe, \$13.50

Send 10c for new 1929 catalog of 80 pages.

W. & J. BOICE
Dept. 201 E
Toledo, O.

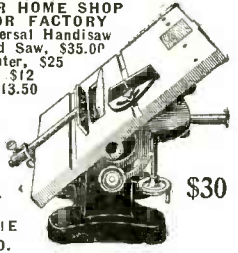

\$30

**STOP THAT LEAK
WITH
SMOOTH-ON No. 1**



Full or empty, hot or cold, on your car or detached, its one and the same with SMOOTH-ON. Instantly applied. Just press it into the leaks with your thumb. Write for complete data and the FREE SMOOTH-ON REPAIR BOOK!

SMOOTH-ON MFG. CO.
574 Communipaw Ave., Jersey City, N. J.

BE AN ARTIST

We can teach you drawing in your spare time and at your own home. Twenty five years of teaching others proves our ability. Write today for ART YEAR BOOK.



SCHOOL OF APPLIED ARTS
Battle Creek, Michigan.

\$15.00 Without Motor

No. 15 Motor Driven Scroll Saw for Home or Small Shop

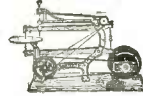

SCHROETERS

Saw is mounted on wood base and has 7 1/2 in. tilting table. Good for finest inlay or for sawing 3/8 in. pine. Efficient for radio panel work, etc. Write for catalog.

SCHROETER BROS. HARDWARE CO.
810 Washington Ave. St. Louis, Mo.

**PATENTS
TRADE-MARKS
REGISTERED**

Preliminary advice furnished FREE. Send for booklet and form for disclosing idea.

IRVING L. MCCATHRAN
Patent Lawyer
Formerly with and successor to
RICHARD B. OWEN
703 International Bldg., Wash., D.C.
41-T Park Row, New York

\$1.00

Brings This



A genuine leather 5 window, gold cornered, 2 1/2 x 3 1/2 case. Holds Railroad Passes, Auto License, Lodge cards, etc. Masonic or Shrine Emblem stamped in gold FREE. Mail your dollar NOW! We carry everything Masonic. Write for catalog.

REDDING MASONIC SUPPLY CO.
200 Fifth Ave., New York, N. Y.

150,000

Readers of SCIENCE AND INVENTION use this section as their buying guide. Your product here will reach them at the lowest cost ever.

RATE PER ISSUE, \$15.50

No order for less than 3 insertions accepted. Write for further information.

SCIENCE AND INVENTION
230 Fifth Avenue New York City

Silver Ace
Fly 800 Feet



Wings 30 in., weight 3 3/4 oz. Bright colors. Write today for circular and price list of models, sets and supplies, 10c.

AERO MODEL COMPANY
329 Plymouth Court, Chicago, Ill.



**CORNWELL
Expert
Mechanics
KIT**

Convenient kit of Cornwell chisels and punches of forged Chrome Molybdenum steel. Write today for catalog of other Cornwell Quality Tools.

The Cornwell Quality Tools Co.
Mogadore, Ohio
(Formerly Cuyahoga Falls, Ohio)

**BIG PROFITS
In KEY
Making**

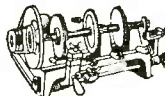

Don't be a slave. Be independent and make big money. The new Beisser Key Machine is the answer. Cuts all kind of keys. No hand-filing.

Write today for data.
BEISSER KEY MACHINE CO.
407 Fort St., East. Detroit, Mich.

**BUILDERS
of
GOOD LATHES**

Lathes, \$6.00 to \$75.00.

Large line. Send six cents for 32-page catalog of lathes, drill presses, bench saws, etc.

SYPPER MANUFACTURING CO.
Toledo, Ohio



FREE - BIG CATALOGUE
Hundreds of bargains in latest kits and parts at liberal discounts. See our new catalogue.

Write for Catalogue.
VAN-ASCHE RADIO COMPANY
206 N. 10 St., St. Louis, Mo.

GIVEN BIG MOVIE MACHINE

Large size Movie Machine. Operates on same principal as professional ones. Uses standard-size films. Imported special lenses. Complete outfit furnished. Tom Mix film—enough for a full hour's entertainment. Given for selling 12 bottles of Salut perfume. Only 25c a bottle. We furnish you 12 perfume novelties to give away with each sale. Easy plan for obtaining Movie Machine. Send no money. We trust you.



TREVAUX PERFUME CO., Chicago, Ill.



**ROYAL
Spray Attachment**

LACQUER YOUR FURNITURE
Use the power from your vacuum cleaner. Write for descriptive literature.
P. A. GEIER CO.
540 E. 105th St. Cleveland, Ohio

DRAKES
Practical Mechanical Books



They Will Raise Your Pay
Send today for catalogue which lists and describes over 200 Practical Mechanical Books for home study.

FREDERICK J. DRAKE & CO.
179 No. Michigan Ave., Chicago, Ill.

Six Tube Radio

30 DAYS FREE TRIAL ONLY \$25.00

Try it in your own home and be convinced. If not satisfied return it. Write today for booklet on this and our \$50.00 model—A.C. Operated Radio Receiver.

VIKING RADIO LABORATORIES
431 N. LaSalle St. Chicago, Ill.

GERSTNER Tool Chests



For Machinists and Tool-makers. Many sizes and a variety of styles shown in the New 1929 catalog. Send postal for free copy.

H. GERSTNER & SONS
661 Columbia Street, Dayton, Ohio.

BURN YOUR NAME ON TOOLS WITH THE ARKOGRAF



Protect your tools from theft. Make your mark with electricity on even the hardest steel or any other metal. Just like writing with a pencil. Complete Arkograp outfit \$3.50—Prepaid. Write today.

ARKOGRAF PEN CO.
1171 E. Stark St., Portland, Conn.

**USE ENGINITE
OR YOUR MOTOR COOLING SYSTEM**



Enginite prolongs the life of your motor. Assures free circulation of water. Prevents rust, scale and corrosion. Remedies overheated motors. Adds pep and power.
Dealers write.
INDUSTRIAL REFINING CO.
120 W. 42nd St., New York City

NEW AUTOMATIC WINDOW WASHER



Washes, Cleans, Dries, Polishes—in one quick operation.
Absolutely automatic. Agents make \$90.00 to \$150.00 a week. Write today for our big money making plan. No obligation.
NATIONAL INDUSTRIES
Wrigley Bldg., Chicago, Ill.

The DIRECTORY is your buying guide. Space permits display of only one product at a time. Write advertisers for complete catalog.

8 POPULAR MODERN MOVIE NOVELS \$1.00

GREATEST OFFER EVER MADE

Take Advantage of This Amazing Bargain

Eight full size books for one dollar. Never before has an offer of this kind been made. Only quantity production permits us to make this astounding offer now. Take advantage of it while you have the opportunity. Needless to say these modern up-to-date movie hits cannot last long at this tremendous bargain price. Each book contains at least two color "stills" of an actual scene from the photoplay. Don't hesitate. Mail this coupon now. Every story based on an actual moving picture triumph. The greatest book bargain of the age.

Titles of This Tremendous Bargain Offer

20. The Cohens and Kellys in Paris
21. The Divine Woman
22. Jazz Mad
23. The Crimson City
24. You Can't Beat the Law
25. Tillie's Punctured Romance
26. Forbidden Hours
27. The Cossacks
28. The Play Girl
29. The Man Who Laughs
30. The Hawk's Nest
31. Streets of Shanghai

8 BOOKS FOR \$1.00
Your Choice

An Addition To Your Library

These books will be a worthwhile addition to your library. You will find many hours of truly enjoyable reading in each beautiful volume. Printed on fine paper with large clear type. Beautiful colored covers of flexible durable material. These books are undoubtedly one of the greatest values ever offered at this amazingly low price.

Write Now! Don't Wait! This bargain cannot last long at this price.

CONSRAD COMPANY, INC.

230 FIFTH AVENUE

NEW YORK, N. Y.

CONSRAD COMPANY, INC., 230 Fifth Avenue, New York, N. Y.

Gentlemen: Enclosed find \$1.00. Kindly send me the books listed by number herewith:

Numbers.....

Name.....

Address.....

City..... State.....



CHEMISTS

Our new catalog, listing 5,000 Chemicals, 2,500 illustrations, Laboratory Apparatus and 1,000 books, sent on receipt of 50c.

LABORATORY MATERIALS CO.
635 East 71st St., Chicago, U.S.A.

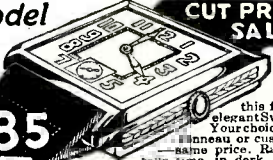

New Model Men's Strap Watch

CUT PRICE SALE

\$3.85

Two years written guarantee given with this full jeweled elegant Swiss watch. Your choice in square, binnacle or cushion shape—same price. Radium dial, toll time in dark. Accurate timekeeper, tested and adjusted. Rush your order. Quantity limited. Send no money, pay postman \$3.85. JENKINS, 621 Broadway, New York, Dept. 65 F-1



I Positively Guarantee

to increase your arms one-half inch in size, chest one full inch, strength 25%, health, 100% in one week's time, by following my instructions and using my exerciser 10 minutes mornings and at night. Send \$1 for complete course and exerciser. Satisfaction guaranteed or \$1 refunded.

PROF. J. A. DRYER
Box 1850-L Chicago, Ill.



HB PAINT SPRAY

DOES THE WORK OF FIVE MEN

Paint Spraying Brings Quick, Easy Profits—HB does work of 5 brush painters. Paints autos, furniture, houses, at lowest prices, with big profits for you. Pays for itself—only \$20 monthly. Easy payment terms brings it. Practically no investment. 30 days' trial. Write for valuable bulletins.

Hobart Brothers Co.,
Box 5191, Troy, Ohio.

EASY TERMS. 30 DAYS TRIAL. QUICKLY PAYS FOR ITSELF.

Earthquakes and Seismographs

(Continued from page 870)

of the earth's crust electrically and weighs no more than 15 pounds complete.

Instruments for recording earthquake shocks have been known for many years, and various methods have been employed for magnifying the vibrations, which are generally small at the receiving station, and for recording them in some permanent form. All seismometers employ some sort of a weight, the mass of which is considerable as compared with other parts of the instrument, and which tends to remain stationary while the earth and the point from which the weight is suspended move back and forth. This relative motion of the point of suspension and the weight is greatly magnified and operates a recording mechanism which traces a wavy line on a moving chart. In some cases a very heavy weight and a mechanical system of magnifying the vibrations are employed. Others use a small weight and an optical system. Both these schemes have disadvantages.

In the new seismometer the weight is small, the so-called steady mass being about one pound, and the whole instrument is enclosed in a case about a foot long. The base of the instrument rests on a heavy concrete pier imbedded in the ground. The weight is suspended in somewhat the same way as the bob of a pendulum laid on its side. In other words, motion is in a horizontal instead of a vertical plane. Attached to the pendulum arm is a coil of many turns of insulated copper wire located in the field of a permanent magnet attached to the support of the instrument, thus constituting a miniature dynamo. If any vibration occurs the coil moves back and forth in the field of the magnet and generates a weak electric current. This is carried by wires to the recording room and operates a galvanometer. As the galvanometer mirror moves it causes a greatly magnified motion of a spot of light which is recorded on a long strip of bromide paper carried by a revolving drum. This drum is driven at constant speed by a motor so that a permanent record is obtained.

The great advantages of the new instrument are its small size, sensitivity, and the fact that the recording can be done at any desired distance from the seismometer itself. As at present set up temporarily at the bureau, a magnification of 1,000 is easily obtained with an ordinary galvanometer. This could be increased to 20,000 if desired. The advantage of no mechanical multiplying system with its high friction losses is obvious.

To obtain a complete record three seismometers are necessary, the first for recording vibrations in a north and south direction, the second east and west, and the third up and down or vertical. Work on the development of a vertical component seismometer is in progress.

The instrument has been developed in the Bureau's electrical division, under the auspices of the Carnegie Institution, and with the co-operation of the Coast and Geodetic Survey. The Coast Survey is the government's authority on earthquakes, and the instrument will be turned over to that bureau shortly for an extended field test. If the instrument performs as expected, the Coast Survey plans to install it in the seismological station at Cheltenham, Maryland, about 17 miles east of Washington. Earthquake recording has been carried out for many years at this station and it is believed that the improved seismometer will greatly facilitate this important work.—S. R. Winters.

The Graf Zeppelin Dissected

(Continued from page 860)

can be stored in the empty space in the interior, and as the fuel gas is used up, there will be added space for the expansion of the lifting gas. In the case of helium, which is very expensive, this is a very important item. In addition, fuel gas has about one-third more potential power than a relatively equal amount of gasoline. One kilogram of gasoline contains 11,000 heat units, and it requires one cubic meter of hydrogen to lift one kilogram under average atmospheric conditions. A cubic meter of fuel gas contains from 14,000 to 15,000 heat units, and it has practically no weight to be lifted. Therefore, we have an advantage of about one-third in favor of fuel gas over gasoline.

The Engines

The engines of the "Graf Zeppelin" are five in number, arranged in the same way as the "Los Angeles," two pairs on each side of the hull, and one engine under the rear at the center line of the ship. Each one develops 550 horse-power and they have been tested up to 300 hours at full speed. They are made by the Maybach Motor Company, a subsidiary of the Zeppelin Company at Friedrichshafen. They are reversible and drive the airship at 82 miles an hour maximum, and 73 miles an hour cruising speed. They have been materially improved over the engines used in the "Los Angeles."

These five Maybach-Zeppelin VL-25, 12 cylinder 550 horse-power motors of the "Graf Zeppelin" are the most advanced type of internal combustion engine yet built. They are housed in individual power cars hung underneath the hull in such a position that the backwashes from the propellers do not interfere, and they are far enough outside of the frame work entirely clear of the airship hull. They weigh 2,450 pounds each, and give an aggregate of 2,750 horse-power. The VL-2 has slightly increased compression, aluminum pistons, and slight carburetor alterations, enabling it to develop 600 horse-power at sea level, at 1600 revolutions per minute, while weight is the primary consideration in an airplane engine, reliability is the most important requirement, the motors must run for a long period of time without stopping or without complete overhaul. If the motor is economical it can soon save a sufficient quantity of fuel to offset any greater weight that might be necessary to insure absolute reliability. The tests already made on these motors indicate that they will run at least 1,000 hours before requiring minor adjustments, and 2,000 hours before a general overhaul would be necessary. Roller bearings are used throughout the entire engine. The motors are directly reversible, which is a great advantage in landing. Reversing gears have been entirely eliminated. Simple shifting of the cam shaft changes the timing of the thirty-six overhead valves. A compressed air starter cranks the engine in either direction. The VL-2 is adapted to a gaseous fuel by hollowing the throttle valves of the fire-proof Maybach carburetors of which there are four, one to each three cylinders. An adjustment valve controls the flow of gas according to the throttle's position. Another valve inserted into the gas feed lines permits a change from gaseous to liquid fuel or vice versa, in a few seconds without interrupting the engine's operation, or impairing its power.

The blau gas is intentionally made a little heavier than air, so that it will drain by gravity from the storage bags into the carburetors, and also so that its consumption will tend to slightly lighten the ship and counteract any loss of buoyancy through the

(Continued on page 875)

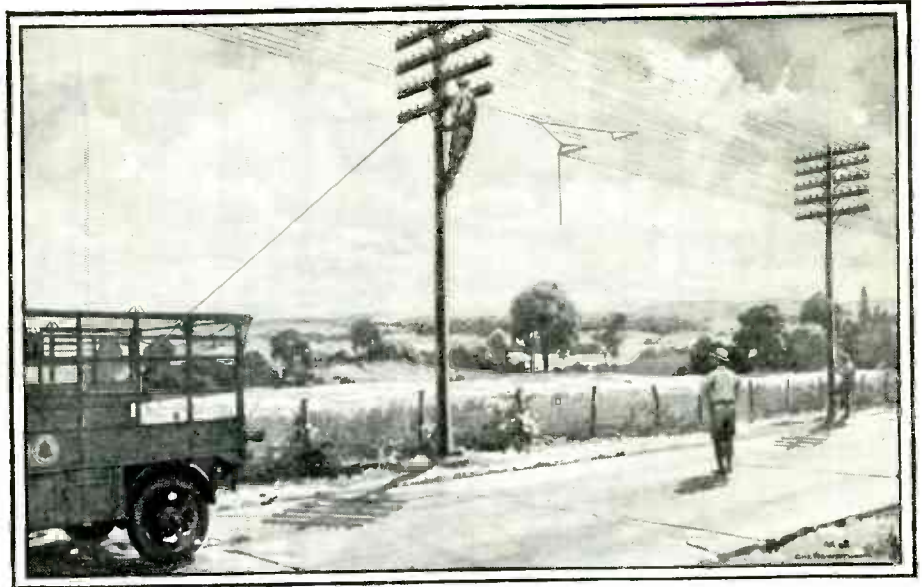

The U.S.A. is only a few minutes wide

An Advertisement of the
American Telephone and Telegraph Company



IN THE gold rush year of '49 a stagecoach succeeded in crossing the continent in about three months. Two decades later, for the first time, an unbroken stretch of railroad lay from New York Harbor to San Francisco Bay, and America was seven days wide. Today, by telephone, that entire width is only a matter of minutes. And these few minutes represent a round trip, taken in the ease of office or home.

The Bell System is ever busy reducing the width of America and the distance between cities. For example, during 1929 it will add to its lines nearly 2,000,000 of the new permalloy loading coils for correcting and maintaining the speeding voice currents.

Seven thousand miles of new inter-city cable, \$40,000,000 worth, will be added to the System to protect against storms and other slowing up influences.

In the last five years 350 major improvements, as well as thousands of others whose aggregate importance mounts high, have been made in telephone central office equipment.

Improved operating practices have eliminated the necessity of your "hanging up" and being called back in 95 per cent of toll and long distance calls, adding new speed and ease to out of town calling. You hold the wire and the operator does the rest.

Since New Year's Day, 1927, the average time for completing all out of town calls has been cut 35 per cent and at the same time the per cent of error has been further materially reduced.

There is no standing still in the Bell System. Better and better telephone service at the lowest cost is the goal. Present improvements constantly going into effect are but the foundation for the future's greater service.

"THE TELEPHONE BOOKS ARE THE DIRECTORY OF THE NATION"

Win a Nash Sedan

Or \$2,750.00 in Cash

Someone who answers this ad will receive, absolutely free, a fully equipped 7-Passenger, Advanced Six Nash Sedan, or its full value in cash (\$2,000.00). We are also giving away a Dodge Sedan, a Brunswick Phonograph and many other valuable prizes—besides Hundreds of Dollars in Cash. This offer is open to anyone living in the U. S. A. outside of Chicago.

Solve this Puzzle

There are 7 cars in the circle. By drawing 3 straight lines you can put each one in a space by itself. It may mean winning a prize if you send me your answer right away.

\$750.00 Extra for Promptness

In addition to the many valuable prizes and Hundreds of Dollars in Cash, we are also giving a Special Prize of \$750.00 in Cash for Promptness. First prize winner will receive \$2,750.00 in cash, or the Nash Sedan and \$750.00 in cash. In case of ties duplicate prizes will be awarded each one trying. Solve the puzzle right away and send me your answer together with your name and address plainly written. \$1,500.00 in prizes—EVERYBODY REWARDED.

John T. Adams, Mgr., Dept. 3791, 323 S. Peoria St., Chicago, Ill.

Clip This Ad

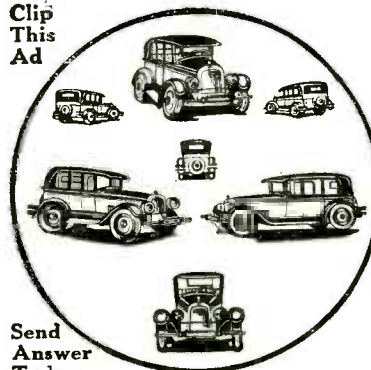

Send Answer Today

Please say you saw it in SCIENCE and INVENTION

Prices Slashed!

Order Today!

OFFER MAY BE WITHDRAWN
IN THIRTY DAYS



Your
Favorite Magazines
at
Record-Making Reductions.

No. 30

(THE GRADE 'A' SPECIAL)

AMAZING STORIES
RADIO NEWS
SCIENCE &
INVENTION

ALL 3
ONLY
\$5.75

YOUR CHOICE OF ANY ONE OF THE FOLLOWING:

RADIO NEWS1 Year
OR
SCIENCE & INVENTION.....1 Year
OR
AMAZING STORIES1 Year
AND

ANY ONE OF THE OFFERS LISTED BELOW:

OFFER 1		ALL 3
YOUTH'S COMPANION	1 yr.	ONLY
PICTORIAL REVIEW	1 yr.	\$5.25
OFFER 2		ALL 3
GOOD HOUSEKEEPING	1 yr.	ONLY
MODERN PRISCILLA	1 yr.	\$6.25
OFFER 3		ALL 3
COSMOPOLITAN	1 yr.	ONLY
MODERN PRISCILLA	1 yr.	\$6.25
OFFER 4		TTV 3
PICTORIAL REVIEW	1 yr.	ONLY
McCALL'S MAGAZINE	1 yr.	\$4.00
OFFER 5		ALL 3
PATHFINDER	1 yr.	ONLY
MODERN PRISCILLA	1 yr.	\$4.40
OFFER 6		ALL 3
AMERICAN MAGAZINE	1 yr.	ONLY
McCALL'S MAGAZINE	1 yr.	\$5.50
OFFER 7		ALL 3
DELINEATOR	1 yr.	ONLY
MODERN PRISCILLA	1 yr.	\$4.50
BIG FAMILY BARGAIN No. 29		
MOTHERS HOME LIFE	1 yr.	ALL 7 ONLY \$3.00
ILLUSTRATED MECHANICS	1 yr.	
TODAY'S WOMAN & HOME	1 yr.	
HOUSEHOLD GUEST	1 yr.	
POULTRY TRIBUNE	1 yr.	
AMERICAN FARMING	1 yr.	

Offer No.	Both for only
8—AMERICAN BOY	1 yr. \$4.00
9—AMERICAN MAGAZINE	1 yr. 4.50
10—BETTER HOMES & GARDENS	1 yr. 2.85
11—CHILD LIFE	1 yr. 5.60
12—COLLEGE HUMOR	1 yr. 4.00
13—COLLIER'S WEEKLY	1 yr. 3.75
14—COSMOPOLITAN	1 yr. 4.75
15—DELINEATOR	1 yr. 3.00
16—ETUDE (for music lovers)	1 yr. 4.00
17—EVERY CHILD'S MAGAZINE	1 yr. 3.50
18—FOREST & STREAM	1 yr. 4.00
19—GOOD HOUSEKEEPING	1 yr. 5.50
20—LITERARY DIGEST	1 yr. 6.50
21—McCALL'S MAGAZINE	1 yr. 3.00
22—McCLURE'S MAGAZINE	1 yr. 4.75
23—MODERN PRISCILLA	1 yr. 3.50
24—PATHFINDER	1 yr. 3.00
25—POPULAR SCIENCE MONTHLY	1 yr. 4.50
26—PICTORIAL REVIEW	1 yr. 3.00
27—SMART SET	1 yr. 5.25
28—YOUTH'S COMPANION	1 yr. 4.25

EXPERIMENTER PUBLISHING CO., Date.....
230 Fifth Ave., New York City.

Gentlemen: I am returning this coupon with \$.....
for which I am to receive your OFFER NO. and

PUT X IN BOX
OPPOSITE YOUR
CHOICE.

RADIO NEWS1 yr.
 SCIENCE & INVENTION .1 yr.
 AMAZING STORIES1 yr.

NAME
ADDRESS
CITY..... STATE.....

IF THE MAGAZINE YOU ARE INTERESTED IN IS NOT LISTED HERE, WRITE US FOR COMBINATION PRICE.

Please say you saw it in SCIENCE and INVENTION

The Graf Zeppelin Dissected

(Continued from page 873)

unavoidable seepage of hydrogen or helium gas. The motors used 38½ gallons of gasoline per hour. The crankshaft of the motor turns on seven roller bearings, it has a combined main and thrust bearing; lubrication is by spray, and there are one oil pressure pump and two scavenging pumps, one at each end of the crank case so that the drainage may be caught at whatever angle the ship may turn. The motors are V-type and water cooled. They have one intake and two exhaust valves for each cylinder. They are operated from a common cam shaft between the banks of cylinders.

The controls of the "Graf Zeppelin" are the same as those of the "Los Angeles," with telegraph visual signals from the control room to the engineers in the motor cars. The control room sometimes called

Trans - Atlantic Records Of Four Airships

Following are the times and distances traveled of the three dirigible airships which have crossed the Atlantic Ocean, and also the record of the airplane America, the first airship to carry mail across the sea. The time given in each case is New York time:

R-34, English, left East Fortune, Scotland, at 9:48 p.m., July 1, 1919, arrived at Mineola, L. I., in 108 hours 12 minutes. Distance traveled, 3,200 miles.

R-34 left Mineola on July 9, 1919, on return trip and sailed about 3,500 miles to England in seventy-five hours.

ZR-3, German, now the American dirigible Los Angeles, left Friedrichshafen on October 12, 1924, sailed 4,010 miles to Lakehurst, N. J., in 81 hours and 17 minutes.

Airplane America, first airship to carry mail across the Atlantic. Left Roosevelt Field, L. I., June 29, 1928, and landed at Ver-sur-Mer, France, forty hours later.

Graf Zeppelin, German. Left Friedrichshafen, Germany, at 2 a.m., Thursday, October 11; arrived at Lakehurst, N. J., at 5:39 p.m., Monday, October 15. Distance traveled, 5,978 miles. Time, 111 hours and 39 minutes. The second ship to carry mails and the first to carry paying passengers.

the bridge or the wheel house, contains navigating instruments, compass, inclinometers, drift indicators, valve levers giving control of the gas valves and ballast tanks, electric telegraph for communication with the engine cars, instruments which indicate the condition of the gas cells and telephones which connect to various parts of the ship.

The steering wheel operates the rudder and controls the direction in horizontal flight. In this room also is the wheel for the control of the elevators which govern the steering for ascending and descending. Immediately in the rear of the bridge is the chart house where the maps and weather charts can be studied just as on an ocean liner. In the rear of this chart house is the wireless room, containing radio compass as well as usual transmitting and receiving sets. The sets are of such power as to enable the ship to maintain communications with land from any point over mid-ocean. On the opposite side of the ship is the electric kitchen. Next



TRAVEL FOR "UNCLE SAM"

RAILWAY POSTAL CLERKS Commence \$1900 Year

Many other U. S. Government Jobs open to Men and Boys 18 up

POSTOFFICE CLERKS RURAL CARRIERS PROHIBITION AGENTS

CITY MAIL CARRIERS GENERAL CLERKS

These as steady positions. U. S. Government employees get their pay for full twelve months every year.

RAILWAY POSTAL CLERKS

Railway Postal Clerks now commence at \$1900 a year, being paid on the first and fifteenth of each month. \$79.16 each pay day. Their pay is quickly increased, the maximum being \$2700 a year. \$112.50 each pay day. They get extra allowance for hotel expenses when away from home.

PAID VACATIONS

Railway Postal Clerks, and all Government employees, get a yearly vacation of 15 working days (about 18 days). On runs they usually work 3 days and have 3 days off duty, or in the same proportion. During this off duty and vacation, their pay continues just as though they were working. When they grow old, they are retired with a pension.

CITY MAIL CARRIERS—POST OFFICE CLERKS

Clerks and Carriers get \$1700 the first year regular and automatically increase \$100 a year to \$2100 with further increase to \$2300. They also have 15 days' vacation. Many February examinations will be held. City residence is unnecessary.

GENERAL CLERKS

(Open to men or women 18 or over)

Salary \$1260 to \$2100 a year. Pleasant clerical work in the various departments and offices at Washington, D. C., and throughout the country.

Get Free List of Positions

FILL OUT THE COUPON. Tear it off and mail it TODAY—NOW.

FRANKLIN INSTITUTE
Dept. L178
ROCHESTER, N. Y.

Rush to me free of charge (1) a full description of the position checked below; (2) specimen coaching; (3) Free copy of 32-page illustrated book, "How to Get a U. S. Government Job"; (4) Full particulars regarding U. S. Government job now obtainable.

MAIL COUPON TODAY

- .. Railway Postal Clerk. (\$1900-\$2700)
- .. Post Office Clerk. (\$1700-\$2300)
- .. City Mail Carrier. (\$1700-\$2100)
- .. Rural Mail Carrier. (\$2100-\$3300)
- .. Bookkeeper. (\$1440-\$1920)
- .. General Clerk. (\$1260-\$2100)
- .. Prohibition Agent. (\$2300-\$3400)

Name

Address

Use this coupon before you mislay it—WRITE OR PRINT PLAINLY



The ANSONIA

BROADWAY AT 73 STREET, NEW YORK

Patrons of Prominence Choose The Ansonia
1400 HOME-LIKE ROOMS—Very spacious and sumptuous furnishings.

— Rates will surely please —
Room with Private Bath.\$3 per day up
For Two\$5 per day up
Parlor, Bedroom and Bath.\$6 per day up
RESTAURANTS OF EXCEPTIONAL MERIT!
Wire at our expense for reservations.

Insure your copy reaching you each month. Subscribe to Science and Invention—\$2.50 a year. Experimenter Publishing Co., 230 Fifth Avenue, N. Y. C.

Please say you saw it in SCIENCE and INVENTION

AMAZING STORIES

SCIENTIFCTION INTERPLANETARY COMMUNICATION

"A Magazine of Tomorrow"

THE future, mysterious, inviting, disturbing. Read tales of this wonderful future in the greatest magazine of *scientifiction* ever published. *Amazing Stories* will bring you, each month, the latest stories of other planets, of days-to-come, of weird happenings and strange people. To open this magazine is to immediately open the door to new adventure and excitement—to step from the commonplace of today into the mystical world of tomorrow.

Romances as thrilling as any of the day—adventure far more exciting than the wildest of western stories—mystery of a type that even the great Sherlock Holmes would be hard put to solve, more subtle, dealing with foreign elements of marvelous potency—tales of this nature you will find in abundance in each issue of *Amazing Stories*.

Go to your newsdealer now and obtain the latest copy of this remarkable magazine. Each issue over a hundred pages. Large magazine size.

**EXPERIMENTER
PUBLISHING
COMPANY, Inc.**
230 Fifth Ave., New York City

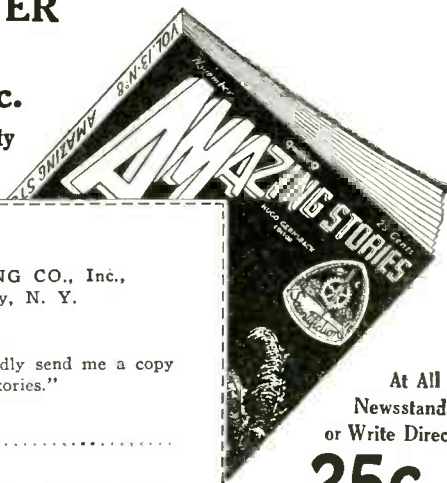

EXPERIMENTER PUBLISHING CO., Inc.,
230 Fifth Avenue, New York City, N. Y.

Gentlemen:

Enclosed find 25c for which kindly send me a copy of the latest issue of "Amazing Stories."

NAME

ADDRESS

CITY STATE

At All
Newsstands
or Write Direct
25c
The Copy

comes the salon extending entirely across the car, it is 16½ feet square, containing lounge, dining tables and beautifully decorated upholstered chairs that are as light as a feather. In the rear of the salon are accommodations for twenty passengers. Each stateroom has a large window, table and a clothes closet and comfortable berths. The bedding and all the linen of the dining room are marked with a large "Z," across which there is the outline of a zeppelin. Next to the staterooms are lavatories for men and women, and in the end of the main car is a stairway which leads to the walkway in the keel of the ship. The passenger space is so roomy that one will not feel cramped. There is no vibration and no noise of the engine is heard in the main car. There is no perceptible rolling or pitching, except in case of severe storms.

Some of the general dimensions of the ship are as follows:

Length over all	776.24 feet
Maximum diameter	98.44 feet
Maximum height	110.56 feet
Displacement	3,708,043 cu. ft.
Cruising speed	73 mi. per hr.
Maximum speed	80 mi. per hr.
Power Plant (5 Maybach engines)	2,750 H.P.
Cruising range	7,000 miles
Crew, normal	30
Passenger capacity	20
Gross lift	107 tons
Pay load	15 Tons

The "Graf Zeppelin" is the largest airship which has ever been flown. It is nearly one and one-half times as large as the "Los Angeles."

MODEL BLUEPRINTS Correct—Easy to Follow

- 1-2 Horizontal Steam Engine details set \$1.00
- 3-4 Boiler construction for above set \$1.00
- 5 880 Ton Bark 50c
- 6-7 Twin Cylinder Steam Engine and Boiler set \$1.00
- 8-9 Gasoline Fired Locomotive set \$2.00
- 10-11 U. S. S. Constitution, "Old Ironsides" set \$1.00
- 12 13th Century Man-of-War 50c
- 13-14 Chinese Junk set 50c
- 15-16 Electrically driven Automobile set \$1.00
- 17-18 How to Build a Reflecting Telescope .. \$1.00
- 19 Roman Ballista 50c
- 20-21 Simple Steam Engine, set 50c
- 22 "Santa Maria," complete 50c
- 23-24 Model U. S. S. Portsmouth set \$1.00
- 25 Building a Model Tug-boat 50c
- 26 Twin Cylinder Marine Engine 50c
- 27-31 U. S. S. Truxton \$2.00
- 32 Sopwith Biplane 50c
- 33 Speed Boat 50c
- 34 Airplane Engine 50c
- 35-36 Motor Winch 75c
- 37-38 Vertical Steam Engine \$1.00
- 39 Cannon 50c

Send Orders to
**MODEL DEPARTMENT
SCIENCE AND INVENTION**
230 Fifth Avenue
New York City

FOREST RANGERS
Men, get Forest Ranger job; \$125-\$200 month and home furnished; hunt, fish, trap, etc. For further details, write
NORTON INST. 1542 Temple Court
DENVER, COLORADO

**LEARN CARTOONING
At Home—In Your Spare Time**
The famous Picture Chart Method of teaching original drawing has opened the door of success for hundreds of beginners. Whether you think you have talent or not, send for sample chart to test your ability, and examples of the work of students earning from \$50 to \$300 per week. Please state your age.
THE LANDON SCHOOL
1460 National Bldg., Cleveland, O.



POPULAR CHEMISTRY
A Monthly Chemical Magazine
Latest chemical news, experiments, formulas, recent advancements in medicine, new uses for X-rays, ultra-violet light, radium, etc., every month.
Three trial copies (back issues) 30 cents. \$1.00 per year. Free solubility chart and book catalog to immediate yearly subscribers.
POPULAR CHEMISTRY CO.
Dept. JB Swedesboro, N. J.

Pathfinder TRIAL
EVERY WEEK 13 WEEKS
\$1 A YEAR. 15 CENTS
Your neighbors know the Pathfinder and you will like it—the every-week news digest from the Nation's Center. Bright, interesting, dependable, different—nothing else like it. Washington gossip, politics, science, travel, fun, lots of pictures, instruction, entertainment. Trial 13 weeks—13 big issues—only 15 Cents. or \$1 for full year. Send now. Address: Pathfinder, Dept. 16, Washington, D.C.

Home Movies in New Rôle

(Continued from page 829)

not be given, as the method of release on various cameras differ, but the same general idea can be carried out for all of them.

Deep Water and Night Photography

WHEN taking movies in deep water or at night, some means for lighting will

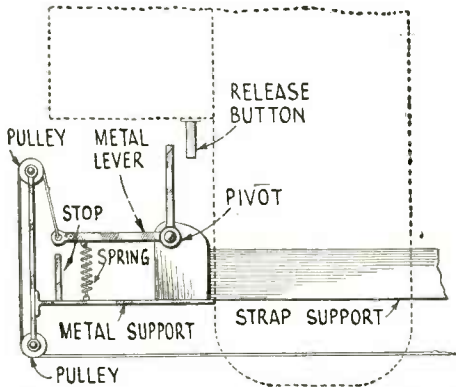

The above illustration shows an optional method of releasing the movie camera. In this case a manually operated device is used instead of the solenoid.

be necessary. Two floodlights arranged on sticks with a waterproof cable leading to the voltage supply are ideally suited for this work. These should be arranged on each side of the camera as illustrated. As a substitute, two automobile headlights thoroughly watertight may be used. It is essential that all lights and electrical leads be thoroughly impervious to water, otherwise short circuits will result.

Movie of Wild Life

FOR the amateur who wishes to take closeup shots of wild animals, birds, and the like, a method is here described whereby astonishing results are obtained. The camera is housed in a watertight box and rests

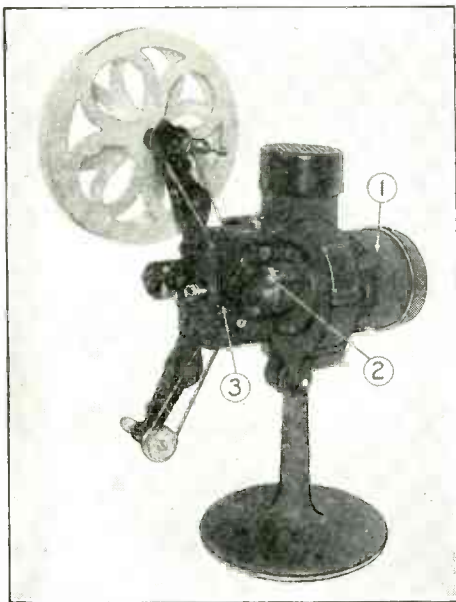

The photograph here shows a view of a movie projector which is finding favor with the amateurs. The electric motor is shown at 1, speed control at 2, and reverse lever for motor at 3.

FREE

for Copying This Jack

To All Men Who Want to Become Draftsmen

Draftsman's Pocket Rule

This Draftsman's Pocket Rule

← for Drawing This Jack →

Let me see what kind of a draftsman you will make. Draw this Jack, send it to me and right away I'll send you the draftsman's pocket rule shown at the left.

Copy me and get Pocket Rule Free. - Jack

Draftsmen Needed in

<p>Auto Work The automobile industry is one of the greatest in America. Thousands of draftsmen are needed. I'll train you for the work.</p>	<p>Electricity Electricity is the coming motive force of the world. Draftsmen are needed in every department of this fascinating work. I'll train you at home. Get a job here.</p>	<p>Aviation Aviation is just in its infancy. It is bound to expand to enormous proportions. Draftsmen are essential to it. I'll train you quick at home for drafting positions.</p>
--	---	--

Free My Pay-Raising Plan

Write to me. I will send you this new book. Not a catalog. My Pay Raising Plan and Money Making Advice. I can prove that John Savadge, trained by me, makes \$300 a month. Earl J. Dupree, trained by me, refused \$600 a month because he makes more in his own business. A. H. Bernier, trained by me, earns \$7000 to \$9000 a year. Arthur Dewalt, trained by me, makes more than \$400 a month. D. C. Stroop, trained by me, makes \$475 a month. L. V. Broughten, trained by me, makes \$300 a month.

Building Work
There will always be building. No structure can be erected without plans drawn by draftsmen. I'll make you an architectural draftsman at home.

Motor Bus Work
Motor bus building and motor bus transportation have become leading world industries. Hundreds of draftsmen are needed in this work. I'll show you the way.

I can give you many more names of Dobe trained draftsmen who are making big salaries. They wrote me just as I am asking you to write. They asked for my Free Book. They saw that opportunities in all of the great industries were tremendous for draftsmen. Through drafting you can get into almost any industry you want.

Money Back if Not Satisfied
What could be fairer than that? I don't ask you to take any chances, I train you under a positive Money Back Agreement. If my training does not satisfy you after you have finished you get every penny back.

Employment Service
After training you I help you to get a job without charging you a cent for this service. Employers of draftsmen come to me for men because they know that men I train make good.

Earn While You Learn
You can start earning extra money a few weeks after beginning my training. I give you special work and tell you how to make money.

Age or Lack of Education No Drawback
You do not need previous experience. You do not need to be a high school graduate. My practical, home study course gives you just the kind of training you need to become successful. Your spare time is all that is necessary.

If You Earn Less Than \$70 a Week - Write Me Today!

"I will train you at home."
Engineer Dobe

ACT NOW Before You Put this Magazine Down. Let me send you my books "Successful Draftsmanship" and "My Pay Raising Plan". Remember Draftsmen are needed everywhere. That's the kind of profession to get into. Get started now. Get into a better profession, paying a good straight salary the year around.

Engineer Dobe 1951 Lawrence Avenue Div. 14-21 Chicago, Ill.

FREE RULE COUPON!

ENGINEER DOBE

1951 Lawrence Ave., Div. 14-21 Chicago

Here's the sketch. Send me free rule; also send me free of all cost books "Successful Draftsmanship" and "My Pay-Raising Plan" - how to earn money while learning and proof of big money paying positions.

Name _____ Age _____

Address _____

Post Office _____ State _____

Magnified 225 Diameters

This is what the tip of a fly's leg is like when seen through the

Ultra Lens Microscope

At last a high powered microscope is within the means of all who wish to study, observe and experiment with the vast world of minute objects invisible to the naked eye. Such fun it is, as well as educational. No technical training required. Scientists and teachers are using this instrument. Gives enormous magnification and perfect definition. Send \$5.00 for complete outfit. Send for descriptive literature.

\$5.00 for Complete Outfit Prepaid

ROAT & LOHMAN, Dept. 203, Milton, Pennsylvania

ZIP-ZIP Shooter

We Believe that every boy ought to train the eye and mind. We Believe that every boy ought to be a good shot. We Believe that every boy ought to be happy. We Believe that every boy ought to own a Zip-Zip Shooter, which is scientifically and practically made. See your dealer, boys! If he happens not to have them, order from us. Zip-Zip Shooter, 35c, or 3 for \$1.00.

AUTOMATIC RUBBER CO., Columbia, S. C.

Agents Wanted Anti-Mist

Guarantees Clear Vision

You can quickly build a big money-making business of your own selling Anti-Mist. Sells to auto supply stores, opticians, druggists, cigar stores, garages, railroads and street car companies. Anti-Mist makes glass FROST-PROOF, STEAM-PROOF and WATER-PROOF. One application lasts 24 hours. Clear vision guaranteed in all weather; money back guarantee if it fails.

\$50 to \$100 WEEKLY

Others are doing it. Sells on sight. Anti-Mist retails at 35c for 3/4 oz. can - \$1.50 for 8 oz. can. Send 35c NOW for sample 3/4 oz. can and full particulars.

GASTON MFG. CO. Dept. 863-A, 4216 Lincoln Ave., Chicago, Ill.

THE MIDGET SLIDE RULE

Instantly adds, subtracts, multiplies, divides, solves proportion, gives all roots and powers. Logarithms, Sines, Cosines, Tangents, Cotangents, etc. Also gives decimal equivalents, lettered and numbered drill and tap sizes.

More than 110,000 sold, more than 2,000 unsolicited testimonials. The Englo-divided scales are on white finished aluminum and are grease and waterproof. Diameter 4". Price with Instruction Book, \$1.50. Pocket Carrying Case, 50c extra. Cash or C.O.D. Catalogue free. Your money back if you are not satisfied.

GILSON SLIDE RULE COMPANY. Stuart, Florida

New!

EDITION

TELEVISION

A Magazine for the Experimenting Fan

"TELEVISION" is a magazine pledged to further the art of the infant industry for which it is named, and to supply the "fans" with the latest information and developments in this fast-growing field. Television, as a science, occupies the same position today as radio did ten years ago. Like the radio fans of years back, enthusiasts of this new field have had to fight for whatever meager knowledge they have been able to obtain. This magazine, then, comes as manna to the information-hungry fan. It is our purpose to keep these enthusiasts constantly informed, through "TELEVISION," of each new development. The second issue of "TELEVISION" is now on the newsstands.



You will find below a partial list of its interesting contents

In the Television field there are all of the thrills that the radio fan knows so well. Get on the band wagon with your fellow enthusiasts. Be the first in your neighborhood to own a television set. Obtain a copy of "TELEVISION"; it will show you how to build a real Television receiver.

The first Television magazine was published by the EXPERIMENTER PUBLISHING COMPANY about a year ago. Over 50,000 copies of this magazine, "TELEVISION," have since been sold. This, alone, is sure proof of the popularity of this interesting new art.

Partial List of Contents

New Jenkins Radio Movies
New Belin Photo Transmitter
Vacuum Cameras to Speed Up Television
Infra-Red "Eye" Sees at Night
Valensi Television
Connection of Photo-Electric Cell

Practical Demonstrations Scheduled for Station WRNY
Campbell Swinton Television System
Quartz Crystals Synchronize Television Sets
Baird Optical Lever Increases Speed
Recording Pictures with Air Jet
How to Build a Radio Photo Recorder

and many other articles of equal interest

AT ALL NEWSSTANDS

THE **25c** COPY

OR WRITE DIRECT

EXPERIMENTER PUBLISHING CO., INC., 230 Fifth Ave., New York, N. Y.

EXPERIMENTER PUBLISHING COMPANY, INC.
230 Fifth Avenue, New York, N. Y.

Gentlemen: Please forward to me a copy of TELEVISION. Enclosed find 25 cents.

Name.....

Address..... City..... State.....

upon a felt or rubber pad, a glass window being provided for the lens. Two wires lead from the camera to the batteries and switch or, a cord leads out through the back of the box if manual release is employed. The operator then takes up his position in some concealed spot after having previously placed some "bait" in front of the camera. Excellent movies of birds, rabbits, squirrels, and a host of other small woodland creatures are obtainable in this manner. As the camera is placed within a watertight box and rests upon a resilient pad, all noise is properly muffled and the wild animals will not be frightened away.

Popular Camera and Projector

SEEN in the photographs appearing here are an excellent projector and movie camera especially suited for use in the manner outlined previously. An excellent fea-

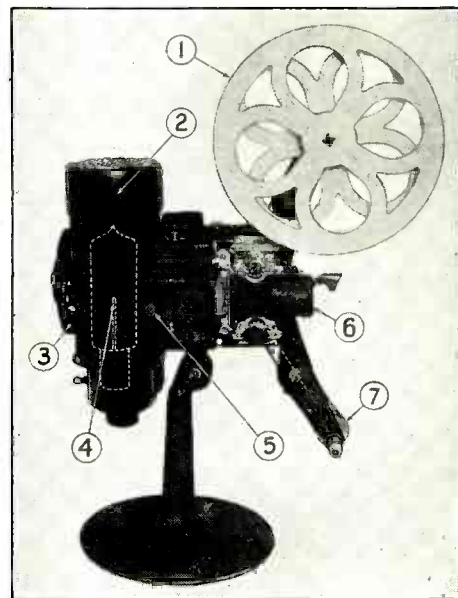

The above photo of home movie projector shows at 1, film reel, 2, lamp housing and resistance, 3, removable reflector, 4, concentrated filament tungsten lamp, 5, condensing lens, 6, projecting lens, and 7, take-up reel.

ture of the camera lies in the fact that any type of lens can be used, as provision is made for changing the view finder for other types of lenses. The lens openings are marked in triplicate upon the barrel, so that they can be quickly found. Other improvements are mentioned in the captions under the photos. A new feature of the projector is the powerful concentrated tungsten filament lamp above which is a resistance coil for the motor. These two portions of the apparatus become quite hot and are kept cool by a small blower which causes a constant blast of air to rush past them.—Name of manufacturer furnished upon request.

Correction Notice

In the article entitled, "Jupiter in a Stereoscope" on page 607 of the November issue of SCIENCE AND INVENTION, the statement was made that, "Jupiter is 1,000,000 times as big as the earth." This is a typographical error and should have been, "Jupiter is 1,000 times as large as the earth, volume for volume; its diameter is 10 times that of the earth," as pointed out by the author Prof. Donald H. Menzel.

Home Movies

By Don Bennett

(Continued from page 827)

possible, removing half the letters if necessary. Make this title several times and splice it into each of your films."

"That sounds like an awful lot of work, Mr. Jones."

"It is, Mr. Blake, but it also is lots of fun and you can spend a whole evening dopping out tricks with these movable letters."

(Next month Jones will explain the construction of an arc and incandescent lamp for illuminating interior scenes in "Without Benefit of Sunlight.")

New Equipment

Several combination cameras and projectors are soon to make their appearance in the home movie field. One, distributed by a well-known manufacturer of music rolls and radio tubes, has already been announced and delivery has started. Another, claimed by its makers to overcome some of the faults of a combination camera and projector, will make its appearance before the winter has passed. Both these outfits will surely attain great popularity, as they fall below the hundred dollar price mark, forty dollars less than the cheapest outfit heretofore.

All new outfits have adopted the 16mm film, which is standard for amateur usage, and this will enable the new amateur to purchase a low-priced outfit and still have available the films that have been produced in the last few years.

The Movie Question Box

(This department is conducted for the benefit of the readers of SCIENCE AND INVENTION and we will gladly answer any question relating to home movies except those that require a comparison of various products. Questions relating to the use of 9mm, 16mm or 35mm are all within the scope of this department. Address your questions to THE HOME MOVIES EDITOR, SCIENCE AND INVENTION, 230 Fifth Avenue, New York, N. Y.)

REDUCTION AND CONTACT PRINTING

A. L. Walsh asks:

Q. What is the difference between "reduction" and "contact" printing?

A. Reduction printing is an optical pro-

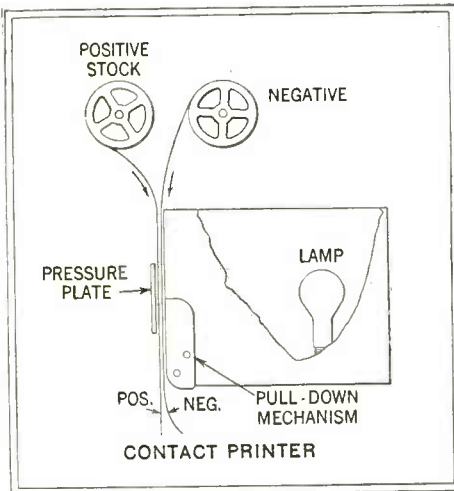

cess wherein a negative is placed in one side of the printing machine and a positive of a smaller size is produced from the other side of the machine. This printer is built on the camera principle, it has two "heads" one
(Continued on page 881)

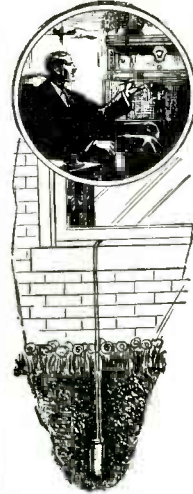

PROOF
Test after test has been made with SUB-AERIAL with amazing results. Radio engineers, magazines and fans heartily endorse SUB-AERIAL.
August 31, 1928.
"I received my Underground Aerial all O. K. It has my aerial beat I have ever seen. I have used every aerial on the market since I have been a radio fan. The first day I installed it I got distant stations that my set had never touched before. It wasn't good radio weather either. I got stations in the East that I never dreamed of getting and with absolute clearness and without static or interference. I heartily recommend your instrument to any lover of good radio reception."
A. N. Whitaua.
Box 565,
El Reno, Okla.

AVOID STATIC-DISTORTION-INTERFERENCE!

Now Make Your Radio Clear As a Bell with Marvelous New Underground Aerial!

Did you know that radio waves go through the ground just as they do through a building? If you had your set down in a deep mine, you'd get the program just as you do at home! In fact—and here's the surprising discovery that is revolutionizing radio reception—you'd probably get much better results. Scientists say that when the receiving antenna is below the surface of the ground, the earth absorbs practically all the static and other interference and allows practically only the clarified tone to reach the set. Starting from that important fact, radio engineers worked out the SUB-AERIAL. Set owners everywhere are now enjoying real radio pleasure with this marvelous new invention.

How SUB-AERIAL Works

Anyone can install the SUB-AERIAL in a few minutes. Simply bury it about two feet below the surface of the ground and bring the armored lead-in wire to your set. SUB-AERIAL then takes the radio waves from the ground and brings them to you sweet toned and clear as a bell. Howls and shrieks due to static-laden air conditions are reduced and your real radio enjoyment begins. SUB-AERIAL never needs to be touched again.

25 Year Guarantee

Any SUB-AERIAL installed that proves defective either in workmanship or materials or which deteriorates within 25 years will be replaced free of charge; also we will pay \$1.00 for any such new replacement.

TRY IT FREE

Don't hesitate to send for SUB-AERIAL on Free Trial. Test it against your overhead aerial and compare the two. If you are not astonished at the difference—if SUB-AERIAL does not bring in reception with marvelous tone value, if it doesn't give surprising volume and distance, if you are not more than satisfied you don't pay us a cent. Send coupon for the fascinating story of SUB-AERIAL. Do it NOW!

UNDERGROUND AERIAL SYSTEMS

St. Clair Bldg., Dept. 863-A.S.
Cor. St. Clair & Erie Sts., Chicago, Ill.



Mail This Coupon Today.



Underground Aerial Systems, Dept. 863-A.S., St. Clair Bldg., cor. St. Clair and Erie Sts., Chicago, Ill.

Send me complete information on Sub-Aerial and Free Trial Offer. No obligation.

Name
Address
City State.....

Enjoy Real Radio Pleasure with

SUB-AERIAL

LEARN TO FLY

WHERE LINDBERGH LEARNED!

GET the same complete, thorough, foundational training that Lindbergh received. Get it now—under greatly improved facilities at the Lincoln Airplane School. Much better than when Lindbergh learned here. Get the best training now available. Here, competent, experienced instructors teach you practical flying and ground work. You go right up into the sky in our famous Lincoln Page Government Licensed Planes—with transport pilots. Learn on actual planes and motors supplied by the Lincoln Aircraft Factory. Write for full information today!

LINCOLN AIRPLANE SCHOOL
220 Aircraft Bldg., LINCOLN, NEBR.

How To Secure A Government Position

Why worry about strikes, layoffs, hard times? Get a Government job! Increased salaries, steady work, travel, good pay. Till help you become a Forest Ranger, Custom House Clerk, Railway Postal Clerk, Post Office Clerk, City Mail Carrier, Rural Carrier—or any other Government job you want. I was a Secretary-Examiner of Civil Service Commission for 8 years. Have helped thousands.

Now FREE

My 32-page book tells about the jobs open—and how I can help you get one. Write TODAY, ARTHUR R. PATTERSON, Civil Service Expert, PATTERSON SCHOOL, 901 Wisner Building, Rochester, N. Y.

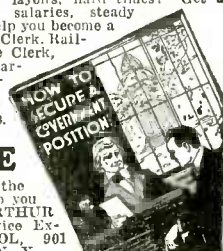

Insure your copy reaching you each month. Subscribe to Science and Invention—\$2.50 a year. Experimenter Publishing Co., 230 Fifth Avenue, N. Y. C.

Books no home should be without

HOUDINI'S SPIRIT EXPOSES and DUNNINGER'S PSYCHICAL INVESTIGATIONS

By JOSEPH DUNNINGER

In this remarkable new book the voice of Houdini has been resurrected, as though from the dead, and can be heard to echo again in sullen denunciation of the ever-increasing number of spiritualistic mediums who, since his decease, have been parasitically bleeding the innocent public of its choicest possessions whilst posing in the sacrilegious guise of the living dead.

Joseph Dunninger, famous magician, Chairman of the Science and Invention Investigating Committee for Psychical Research and the author of several notable works on magic, was a close personal friend of the late Harry Houdini. All the data appearing in this book was taken from the personal notes of the dead magician now in the possession of Dunninger. These and the accompanying remarkable conclusions drawn from the various successful exposés of Houdini, together with the tremendously interesting revelations contained in Dunninger's Psychical investigations, make this a book that all should read. Over 116 pages. Large 9x12-inch size.

Only
50c
Per Copy

At all newsstands
or write direct

BEAUTY SECRETS

By EVA NAGEL WOLF

This book, by Eva Nagel Wolf, prominent editor of the beauty column of one of the leading women's magazines and internationally known authority, divulges to seekers of beauty the true secrets of their type—just what is necessary to make themselves most attractive. "BEAUTY," says Miss Wolf, "is not difficult to obtain once you have learned the simple secrets of type." It is the purpose of this book to pass on to every woman these secrets—to show her the quickest and easiest way to genuine beauty and attractiveness.

There is nothing left unsaid—every phase of beauty culture is fully treated. The art of make-up, care of the hands,

the hair, the eyebrows and lashes; adding that extra pound or taking off excessive weight—all is covered.

BEAUTY SECRETS should be every woman's constant companion at the boudoir. Critics the country over have claimed that a fair price for a book of this kind would be from three to five dollars. However, due to our unique way of publishing, we are able to give this book to you at the phenomenally low price of—

50c
Per Copy

Sold at all newsstands or
write direct—112 pages—fully
illustrated—large magazine size

POPULAR CARD TRICKS

By WALTER B. GIBSON

Pleasant Entertainment for All

Walter B. Gibson has written what is conceded to be the most complete book of card tricks ever published. There are literally hundreds of these clever little tricks. You need not be a professional in order to work them out. There is no sleight-of-hand required. You can do any of them with little or no practice. Simple to perform—difficult to guess. Complete instructions—hundreds of illustrations.

Once you have mastered a few of the tricks that this book contains you will become extremely popular—always entertaining. Imagine the fun you can have at a party. Just nonchalantly pick up a deck of cards and inquire if anyone has "seen this one." Then, while all attention is focused on you do these tricks one after another to the admiration and wonderment of all.

This big book of entertain-
ment, fully illustrated—large
magazine size

Only
25c
Per Copy

At all newsstands
or write direct



EXPERIMENTER PUBLISHING CO., Inc.

230 Fifth Avenue
New York, N. Y.

EXPERIMENTER PUBLISHING COMPANY, Inc.
230 FIFTH AVE., NEW YORK, N. Y.

Gentlemen:
I desire the books checked below and am enclosing \$.....
in full payment of same.
 Houdini's Spirit Exposés
 Popular Card Tricks
 Beauty Secrets

Name
Address
City
State

Home Movies

(Continued from page 879)

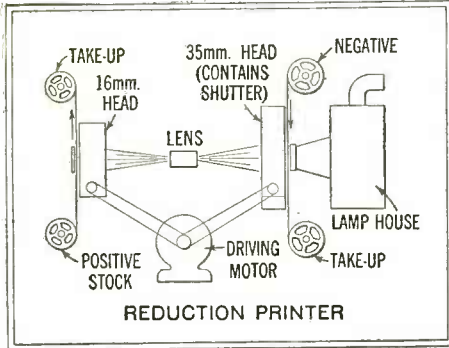

How reduction film printer is arranged.

taking the negative and the other the positive. A lens and shutter is placed between them and each has its own pull-down movement although both are driven in synchronism. The same process is used in enlarging from a small film to a large one, and in making duplicates on the same size film. In contact printing the negative and positive are placed together and run through a machine which permits light to go through the negative and affect the positive.

Calculating Exposure

V. Gabriel asks:

Q. How can I calculate the comparative exposure allowed by different stops?

A. Square both stops and the ratio of the squares is the inverse of ratio of the exposures. For example: Comparing F8 and F11. $8 \times 8 = 64$; $11 \times 11 = 121$. 64 is about half of 121 and therefore F8 gives twice the exposure of F11.

Filters

J. Clements asks:

Q. Is a filter necessary with panchromatic film?

A. No, but when a filter is used better tones result. A filter should not be used for the close-up of a person.

Color Movies

Harold Van Riper asks:

Q. Does panchromatic film reproduce pictures in natural colors?

A. No. Panchromatic film is sensitive to all colors but reproduces them in black and white. For practical uses a narrow band in the green part of the spectrum is left insensitive so that a green light may be used for developing. By the use of a K2 filter (amateur 2x) almost perfect rendition of natural colors in monochrome is secured. Red, instead of photographing black, becomes gray, and yellow is almost white, instead of being gray. The extra expense of panchromatic film is justified by the better results obtained with it, especially in scenic and travel photography. Practically all professional productions are now made with panchromatic negative. The 16mm amateur can obtain it either in reversal film or in negative-positive form.

If you like the "Home Movies" department each month—tell your friends about it. If you don't like it—tell the Editor.

WHOLESALE PRICES

New 1929 EDITION

75 LATEST RADIO CIRCUITS 750 ILLUSTRATIONS

FREE

This 200 Page RADIO CATALOG

FOR DEALERS, COMMUNITY SET BUILDERS GENERAL REPAIRMEN AND AGENTS.

BUY FROM RADIO'S OLDEST MAIL ORDER HOUSE

We are the oldest established, exclusive radio mail order house in the country. All orders are positively shipped within twenty-four hours; quick, prompt, courteous service. We carry a larger variety of radio parts, radio instruments, accessories and radio findings than any other radio house in the country.

You will find in Catalog No. 18 the largest assortment of radio merchandise in this country. Radio Specialty carries more radio parts and radio material than any other house in the country. You will find in this catalog positively the largest variety of radio merchandise.

If you are in need of certain small radio parts that other radio and mail order houses do not bother to carry get the Rasco Catalog and you will find the small parts there, anything from a screw to copper ribbon, telephone diaphragms, as well as thousands of the small radio findings.

We carry the Largest Variety of Small Radio Parts in the world, BUT we also carry All Standard Radio Merchandise.

RADIO SPECIALTY CO., 100 PARK PLACE, NEW YORK

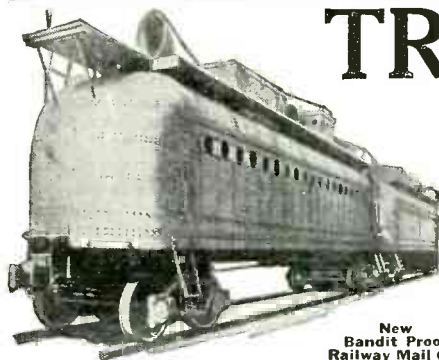

TRAVEL FOR "UNCLE SAM"

RAILWAY POSTAL CLERKS

\$1900 TO \$2700 A YEAR

Many Other Convenient Jobs Obtainable.

MEN—WOMEN—18 OR OVER

Short Hours. Steady Work—no "lay offs." Rapid Advancement. Permanent Employment, Long Vacation with Pay. MAIL COUPON—

DO IT TODAY SURE TOMORROW YOU MAY FORGET

VALUABLE COUPON

Name
Address
Use this coupon before you mislay it—Write or Print Plainly

FRANKLIN INSTITUTE
Dept. L183, Rochester, N.Y.

Rush to me free of charge (1) A full description of the position checked below; (2) Free copy of 32-page illustrated book "How to Get a U. S. Government Job"; (3) Send a list of U. S. Government Jobs now obtainable.

- RAILWAY MAIL CLERK (\$1900-\$2700)
- POST OFFICE CLERK (\$1700-\$2300)
- CITY MAIL CARRIER (\$1700-\$2100)
- RURAL MAIL CARRIER (\$2100-\$3300)
- GENERAL CLERKS (\$1240-\$2100)
- PROHIBITION AGENT—Investigator (\$2300-\$3400)

22 Cal. Blank Automatic

WITH BOX or permit to own this 6.2oz. Automatic. Use Required.

FREE! CART for fun or self-defense. Keeps away dogs—a real home protector. Fool your friends. Same as an expensive automatic in construction, finish, appearance, durability, automatic magazine loading and ejection of cartridges, instantly and powerful report. Guaranteed absolutely safe. Send no money. Fly expressman \$4.98 for automatic with box cartridges. JENKINS, 621 Broadway, N.Y., Dept. I 65 H I

GENUINE LEATHER HOLSTER FREE

A Real Gasoline Engine That Really Flies

Model planes: 1/2 h.p. in 3 lbs.; 1 h.p. in 6 lbs.

Descriptive bulletin 44, together with directions for making scale model planes, free.

DYNAMIC MFG. CO.
First National Bank Bldg. CHICAGO, ILL.

Learn Photography at HOME

Make money taking pictures. Prepare quickly during spare time. Also earn while you learn. No experience necessary. New easy method. Nothing else like it. Send at once for free book, Opportunities in Modern Photography, and full particulars.

AMERICAN SCHOOL OF PHOTOGRAPHY
Dept. 1421, 3601 Michigan Ave. Chicago, U. S. A.

SALESMEN! \$100 WEEKLY SELL COX HOLDFAST SCREWDRIVERS

Also made to use in Yankee or Ratchet Handle. Sells on sight to Garages, Radio Men, etc. Self Holding, Self Releasing. Sample and proposition, 50c. **S. J. COX, Dept. J, Franklin, Pa.**



“What would I do if I lost my job?”

SUPPOSE your employer notified you to-morrow that he didn't need you any longer? Have you any idea where you could get another position?

Don't have this spectre of unemployment hanging over your head forever. Train yourself to do some one thing so well that your services will be in demand. Employers don't discharge such men. They promote them!

Decide to-day that you are going to get the specialized training you must have if you are ever going to get—and keep—a real job at a real salary. It is easy if you really try.

Right at home, in the odds and ends of spare time that now go to waste, you can prepare for the position you want in the work you like best. For the International Correspondence Schools will train you just as they are training thousands of other men—no matter where you live—no matter what your circumstances.

At least find out how, by marking and mailing the coupon printed below. There's no cost or obligation, and it takes only a moment of your time, but it may be the means of changing your whole life.

Mail the Coupon To-day!

INTERNATIONAL CORRESPONDENCE SCHOOLS
“The Universal University”
Box 6176-F, Scranton, Penna.

Without cost or obligation, please send me a copy of your booklet, “Who Wins and Why,” and full particulars about the subject before which I have marked X:

BUSINESS TRAINING COURSES

- | | |
|--|---|
| <input type="checkbox"/> Business Management | <input type="checkbox"/> Advertising |
| <input type="checkbox"/> Industrial Management | <input type="checkbox"/> English |
| <input type="checkbox"/> Personnel Management | <input type="checkbox"/> Business Correspondence |
| <input type="checkbox"/> Traffic Management | <input type="checkbox"/> Show Card and Sign |
| <input type="checkbox"/> Accounting and C. P. A. | <input type="checkbox"/> Lettering |
| <input type="checkbox"/> Coaching | <input type="checkbox"/> Stenography and Typing |
| <input type="checkbox"/> Cost Accounting | <input type="checkbox"/> Civil Service |
| <input type="checkbox"/> Bookkeeping | <input type="checkbox"/> Railway Mail Clerk |
| <input type="checkbox"/> Salesmanship | <input type="checkbox"/> Common School Subjects |
| <input type="checkbox"/> Secretarial Work | <input type="checkbox"/> High School Subjects |
| <input type="checkbox"/> Spanish <input type="checkbox"/> French | <input type="checkbox"/> Illustrating <input type="checkbox"/> Cartooning |

TECHNICAL AND INDUSTRIAL COURSES

- | | |
|---|--|
| <input type="checkbox"/> Electrical Engineer | <input type="checkbox"/> Architect |
| <input type="checkbox"/> Electric Lighting | <input type="checkbox"/> Architects' Blueprints |
| <input type="checkbox"/> Mechanical Engineer | <input type="checkbox"/> Contractor and Builder |
| <input type="checkbox"/> Mechanical Draftsman | <input type="checkbox"/> Architectural Draftsman |
| <input type="checkbox"/> Machine Shop Practice | <input type="checkbox"/> Concrete Builder |
| <input type="checkbox"/> Railroad Positions | <input type="checkbox"/> Structural Engineer |
| <input type="checkbox"/> Gas Engine Operating | <input type="checkbox"/> Chemistry <input type="checkbox"/> Pharmacy |
| <input type="checkbox"/> Civil Engineer <input type="checkbox"/> Mining | <input type="checkbox"/> Automobile Work |
| <input type="checkbox"/> Surveying and Mapping | <input type="checkbox"/> Airplane Engines |
| <input type="checkbox"/> Plumbing and Heating | <input type="checkbox"/> Agriculture and Poultry |
| <input type="checkbox"/> Steam Engineering <input type="checkbox"/> Radio | <input type="checkbox"/> Mathematics |

Name..... State.....
Street Address.....
City..... State.....
If you reside in Canada, send this coupon to the International Correspondence Schools Canadian, Limited, Montreal

BIG VALUE for 10 Cts.



6 Songs, words and music; 25 Pictures Pretty Girls; 40 Ways to Make Money; 1 Joke Book; 1 Book on Love; 1 Magic Book; 1 Book Letter Writing; 1 Dream Book and Fortune Teller; 1 Cook Book; 1 Base Ball Book, gives rules for games; 1 Toy Maker Book; Language of Flowers; 1 Morse Telegraph Alphabet; 12 Chemical Experiments; Magic Age Table; Great North Pole Game; 100 Conundrums; 3 Puzzles; 12 Games; 30 Verses for Autograph Albums. All the above by mail for 10 cts. and 2 cts. postage. ROYAL SALES CO., Desk 377 Norwalk, Conn.



Wonderful, new device, guides your hand; corrects your writing in few days. Big improvement in three hours. No failures. Complete outline FREE. Perfect Penmanship Inst., Dept. 44, St. Louis, Mo.

Can We Control Sex?

By Professor Thomas H. Morgan,
B. S., M. S., LL. D., Ph. D.
(Continued from page 797)

inheritance is said to skip a generation, as a rule, and is more common in males than in females. If the gene for haemophilia is assumed to be carried by the X-chromosome, all the facts—and there are many pedigrees in the medical literature—can be satisfactorily explained. In the scheme (Fig. 6 and 10) the X-chromosomes, carrying the gene for haemophilia, are stippled, and the normal X's are represented by solid black lines. Here half the eggs carry the black X, half the stippled X. There are also two classes of sperms, half carry X, half carry Y. If any egg can be fertilized by any sperm there will result two kinds of females, one normal XX, the other carrying, as the mother did, one stippled X. The former has escaped and will have only normal descendants, the latter is affected, and, although she is not a bleeder (being saved by the normal X) she will transmit the malady to half her sons.

Turning now to the sons of the affected female (See diagram Fig. 6) it is apparent that half the sons will get the affected X-chromosomes. These are the bleeders. Half will get the normal X, and escape the fate of their brothers, and produce only normal descendants.

There are still other combinations, and all of these give results consistent with this interpretation based on the history of the sex chromosomes. In other animals also, where several sex linked characters are present at the same time, the explanation is placed beyond reasonable doubt. Thus genetics gives another proof that the chromosome mechanism is the sex-determining agent.

The Evidence from Identical Twins

IT has long been known that human twins are of two kinds. *Identical twins* are closely similar in all structural characters. They are always both males or both females. *Fraternal twins* are no more alike than any two children of the same parentage. They may be a male and a female, or both males, or both females. Identical twins are enclosed in a common *chorionic* envelope at birth, and this fact, combined with other information, makes it almost certain that they have come from a single egg. At some time in the early development of such an egg two embryos develop. Now if identical twins come from a single egg and if sex is determined at the time of fertilization, according to which kind of sperm enters the egg, an explanation of this identity in sex is found. The conclusion is further supported by the occurrence of double monsters—two embryos more or less united. Most of them perish before full-term and are aborted, but occasionally they survive. The Siamese and similar twins are identical twins. In all these cases the two individuals are of the same sex, and enclosed in a common chorion.

The Exceptions that Prove the Rule

THERE are two distinct groups of exceptions. One kind has been accounted for by the unusual distribution of the sex chromosomes; the other appears to come nearer to breaking the rule, yet, when fully understood, these cases serve to broaden our ideas concerning sex.

The life history of plant-lice, or aphids, offers an apparent exception to the ordinary sex mechanism. Throughout the summer these bugs breed by parthenogenesis, i.e., only females are present, and each brings forth young that have developed from unfertilized eggs. In the autumn the female

Read - - -



THESE SPECIAL SECTIONS FOR EVERY FAN

Besides the latest set construction articles and editorial matter covering each new development, there are many sections that make RADIO NEWS especially attractive to all radio enthusiasts.

THE LISTENER SPEAKS

This section belongs to the readers of RADIO NEWS. Its purpose is to provide a common “stamping ground” for the views of the radio public. Here the readers discuss among themselves all questions of interest to radio.

BROADCASTATICS

A page devoted to humor of purely radio interest. All contributions published are paid for at the rate of \$1.00. There is many a hearty laugh in each issue.

TELEVISION

A section in which the latest developments of television are reviewed each month. This comparatively new industry is fast gaining popularity. It opens a new field for experimenting to our friend, the “fan.”

WHAT'S NEW IN RADIO

Wherein all new radio apparatus is fully described and its use explained. This section is especially valuable to set builders.

THE RADIO BEGINNER

As its name signifies, this section is devoted to the radio beginner. All the elementary principles of radio are discussed and full constructional data for the simpler sets given. Full-sized blue prints of the circuits treated are FREE.

RADIO WRINKLES

This department contains many suggestions helpful to the radio enthusiasts. Each contribution published entitles the author to a year's subscription to RADIO NEWS or, in cases where he is already a subscriber, a year's subscription to either SCIENCE AND INVENTION or AMAZING STORIES.

RADIOTICS

A humorous page of misprints contributed by our readers. For each one published \$1.00 will be paid, provided that the actual article in which the misprint occurs is enclosed with a few humorous words from the reader.

RADIO NEWS LABORATORIES

In this section all apparatus awarded the RADIO NEWS LABORATORY CERTIFICATE OF MERIT in the month past is listed, and a technical description given of its purpose and characteristics.

I WANT TO KNOW

This department is conducted by Mr. C. W. Palmer. Its purpose is to answer the difficulties of our readers. The value in which the “fans” hold this section can be better realized when one considers that there are over 5,000 letters received from readers each month. Naturally only the more important ones are printed in RADIO NEWS.

Do not neglect to obtain your copy of RADIO NEWS. Each issue over 100 pages. Fully illustrated—large magazine size.

THE **25c** COPY

AT ALL NEWSSTANDS OR WRITE DIRECT
EXPERIMENTER PUBLISHING CO., INC.
230 FIFTH AVENUE - - NEW YORK, N. Y.

produces sexual eggs that must be fertilized. Males also appear at this time. When these eggs are fertilized, each produces a female. The result is due to the degeneration in the male of half the sperm cells—those that do not contain an X-chromosome. Thus, the exception proves the rule, for only the female producing sperms are functional, as microscopic study has shown.

Another group of exceptions includes those cases where an individual may be male on one side and female on the other—the so-called *gynandromorphs*. It has been shown that many of these are due to the dislocation of one of the X-chromosomes during development. Those cells that retain both X's produce female parts. Those that have lost one X produce male parts.

A third apparent exception includes *intersexes*, individuals that are, throughout, intermediate between males and females. Some of these are hybrids, whose chromosomes have come from two varieties of species in which the sex chromosomes may be assumed to have different values; others are due to multiple groups of chromosomes which bring about an intermediate balance between the X's and the other chromosomes. It has taken a great deal of work to straighten out these exceptional types, but when the solution has been found, it has in every case strengthened the explanation of the chromosomal mechanism.

The other group of exceptions includes a few cases in which, as it now appears, certain individuals that have the chromosome makeup of females have changed over into males, or at least have developed male-like parts. The classical case is that of a spider crab that becomes parasitized by another crustacean. When this happens to a male, the testes are absorbed and the secondary sexual characters of the female appear at the next molt, replacing those of the male.

Another case has been reported in frogs when, by certain treatment of the young tadpoles, the females become males. This case is especially interesting because the transformed individuals may function in their new rôle as males producing sperm. *But now the sperm are all female-producing, because every one has an X-chromosome.* The converse case is shown by toads. The young male toad has at the anterior end of the testis an ovary-like organ. If the testis is removed, the anterior organ becomes an ovary. The eggs are now female—and male-producing, because half of them contain an X-chromosome.

It has been demonstrated in certain fish that old females develop testes and function as males. When bred to young females all the offspring are females.

Finally it has been claimed that female fowls rarely change over into males. The evidence is not satisfactorily established, but a parallel case is beyond dispute. It has been shown that when the ovary has been removed from young chicks, a male-like organ develops. It is true that no functional sperms appear, but an unmistakable male organ takes the place of the ovary.

Lastly, the "reversal of sex," that has long been recognized in twin calves, has been shown to be due to an intimate union taking place between the embryonic envelopes. As a result, the two calves, *in utero*, come to have a common blood circulation. If, now, one twin has started as a male, and the other as a female, the latter fails to develop normal reproductive organs and a testis-like structure sometimes develops in place of an ovary. This calf, called a free-martin, never functions as a male, but it is certainly male-like in parts.

This second group of cases may appear to break the rule, and in a sense it does so, but only when the sex chromosome mechanism is given too narrow an interpretation. The chromosomal mechanism tells us no more than that under normal conditions the balance of the chromosomes is such that one X balanced against the other chromosomes

gives a male; and that two X's balanced against the others gives a female. This machinery is set to go under normal conditions. If the environment changes, something else may develop. It is to be kept in mind that both sexes have normally all the elements, and are therefore potentially alike. The difference between them is due to the presence of two X chromosomes in the female, and one of them only in the male.

Can Sex in Man be Profitably Altered or Controlled?

IN such knowledge as that just reviewed any technical discussion of the possibility of controlling sex must rest. Without the restrictions imposed by this information it would be futile to speculate on the subject. It is the complete lack of such information in the past that has made possible the fantastic guessing that has gone on concerning sex determination. From the evidence now at hand, can we hope to control sex in man in the sense of regulating the sex of the expected child? We may also ask whether it would be worth while doing so, even if we could; for who wants a son with the chromosome constitution of a daughter, or a daughter who has the make-up of a boy? *For the facts show that the moment the human egg is fertilized normal sex is settled.*

The one possibility of controlling sex in man would seem, then, to be by regulating the entrance of the male-producing or female-producing sperms into the egg. The differences in sizes between these two kinds of sperms is so small—the difference between one X and one Y—that it would scarcely seem possible to separate them by any mechanical device. Possibly chemical agents might make the discrimination, but this seems unlikely. Again, during the long passage up the oviduct of the female, it is conceivable that one kind of sperm might move faster than the other, and make more likely the fertilization of the egg by one kind of sperm rather than by the other. This, too, seems unlikely; for otherwise the sexes would appear more unequal in numbers. It may not seem improbable that the slight excess of boys at birth might, theoretically, be accounted for on such grounds, but even this is far from being known.

There are, it is true, certain hints furnished by exceptional cases in the animal kingdom that call for discussion, if for no other reason than the serious consequences that would be involved if applied without reservation to the human species. For example, if all the Y-bearing sperms of a male should fail to function, only daughters would be produced by such a male. As is well known, there are large families consisting only of daughters or of sons, but there is not the slightest reason for supposing that this is due to any such process; for, it has been shown that such families of all daughters, or all sons, occur no more frequently than expected on a run of luck, as we say. In other words, there would be as many runs of all heads or all tails if pennies were tossed.

The modern work on heredity has brought to light a widespread group of so-called lethal genes that are transmitted in the same way as other hereditary factors. In some plants, and possibly in some animals, they take part in the normal reproduction of the species. Sometimes these lethal genes destroy, or make non-functional, the germ-cells containing them; in other cases the embryos die after development has begun. Such a recessive lethal, if present in the X-chromosome of a female, would cause half of the male embryos to disappear with the result that twice as many daughters as sons would be born. The converse case in man would be more difficult to realize in the light of our present knowledge, yet a few special cases are known in other animals, where through lethal factors, more males than fe-

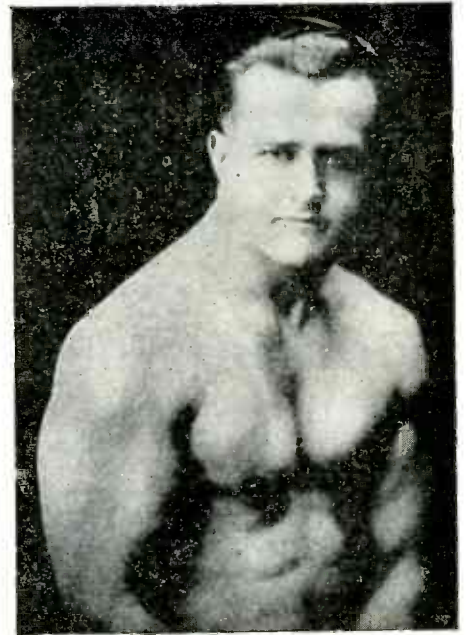

EARLE LIEDERMAN, the Muscle Builder
Author of "Muscle Building," "Science of Wrestling," "Secrets of Strength," "Here's Health," "Endurance," etc.

The Man I Pity Most

POOOR OLD JONES. No one had any use for him. No one respected him. Across his face I read one harsh word—FAILURE. He just lived on. A poor worn-out imitation of a man, doing his sorry best to get on in the world. If he had realized just one thing, he could have made good. He might have been a brilliant success.

There are thousands of men like Jones. They, too, could be happy, successful, respected and loved. But they can't seem to realize the one big fact—that practically everything worth while living for depends upon STRENGTH—upon live, red-blooded he-man muscle.

Everything you do depends upon strength. No matter what your occupation you need the health, vitality and clear thinking only big, strong virile muscles can give you. When you are ill the strength in these big muscles pulls you through. At the office, in the farm fields, or on the tennis courts, you'll find your success generally depends upon your muscular development.

Here's a Short Cut to Strength and Success
 "But," you say, "it takes years to build my body up to the point where it will equal those of athletic champions." It does if you go about it without any system, but there's a scientific short cut. And that's where I come in.

30 Days Is All I Need
 In just 30 days I can do things with your body you never thought possible. With just a few minutes' work every morning, I will add one full inch of real, live muscle to each of your arms, and two whole inches across your chest. Many of my pupils have gained more than that, but I GUARANTEE to do at least that much for you in one short month. Your neck will grow shapely, your shoulders begin to broaden. Before you know it, you'll find people turning around when you pass. Women will want to know you. Your boss will treat you with a new respect. Your friends will wonder what has come over you. You'll look ten years younger, and you'll feel like it, too.

I Strengthen Those Inner Organs Too
 But I'm not through with you. I want ninety days in all to do the job right and then all I ask is that you look yourself over.

What a marvelous change! Those great squared shoulders! That pair of huge, lithe arms! Those firm, shapely legs! You'll be just as fit inside as you are out, too, because I strengthen and exercising them. Yes indeed, life can give you a greater thrill than you ever dreamed. But, remember, the only sure road to health, strength and happiness always demands action. **Start now!**

Send for my New Book, 64 pages and—IT IS FREE

"MUSCULAR DEVELOPMENT"

It contains forty-eight full-page photographs of myself and some of the many prize-winning pupils I have trained. Some of these came to me as pitiful weaklings, imploring me to help them. Look them over now and you will marvel at their present physiques. This book will prove an impetus and a real inspiration to you. It will thrill you through and through. This will not obligate you at all, but for the sake of your future health and happiness do not put it off. Send today—right now before you turn this page.

EARLE LIEDERMAN
 Dept. 2701, 305 Broadway, New York City

It Is FREE	EARLE LIEDERMAN	
	Dept. 2701, 305 B'way, New York City	
	Dear Sir: Please send me, absolutely FREE and without any obligation on my part whatever, a copy of your latest book, "Muscular Development."	
	Name	AGE
	Street	State
City	(Please write or print plainly)	



Only 28 years old and earning \$15,000 a year

W. T. CARSON left school at an early age to take a "job" in a shoe factory in Huntington, W. Va., at \$12 a week.

He worked hard and long and he had greater handicaps than you will ever have. But he refused to quit. He made up his mind that he was going to get ahead in a big way and nothing could swerve him from that resolve.

Today W. T. Carson is owner and manager of one of the largest battery service stations in West Virginia with an income of \$15,000 a year.

He gives full credit for his success to the International Correspondence Schools and says he still refers to the I. C. S. text-books. Just a few months ago the faculty of a large college in West Virginia called him in to demonstrate the principles of battery construction to a class in electricity. That shows how thoroughly he understands his work.

If the I. C. S. can smooth the way to success for men like W. T. Carson, it can help you. If it can help other men to win promotion and larger salaries, it can help you.

At least find out by marking and mailing the coupon printed below. It won't cost you a penny or obligate you in any way to ask for particulars, but that one simple little act may be the means of changing your entire life.

Surely, W. T. Carson wouldn't be earning \$15,000 a year today if he hadn't found out about the I. C. S. when he did.

Mail the Coupon for Free Booklet

INTERNATIONAL CORRESPONDENCE SCHOOLS "The Universal University"

Box 6175-F, Scranton, Penna.

Without cost or obligation, please send me a copy of your booklet, "Who Wins and Why," and full particulars about the subject before which I have marked X:

BUSINESS TRAINING COURSES

- | | |
|--|--|
| <input type="checkbox"/> Business Management | <input type="checkbox"/> Advertising |
| <input type="checkbox"/> Industrial Management | <input type="checkbox"/> English |
| <input type="checkbox"/> Personnel Management | <input type="checkbox"/> Business Correspondence |
| <input type="checkbox"/> Traffic Management | <input type="checkbox"/> Show Card and Sign |
| <input type="checkbox"/> Accounting and C. P. A. | <input type="checkbox"/> Lettering |
| <input type="checkbox"/> Coaching | <input type="checkbox"/> Stenography and Typing |
| <input type="checkbox"/> Cost Accounting | <input type="checkbox"/> Civil Service |
| <input type="checkbox"/> Bookkeeping | <input type="checkbox"/> Railway Mail Clerk |
| <input type="checkbox"/> Salesmanship | <input type="checkbox"/> Common School Subjects |
| <input type="checkbox"/> Secretarial Work | <input type="checkbox"/> High School Subjects |
| <input type="checkbox"/> Spanish & French | <input type="checkbox"/> Illustrating |
| | <input type="checkbox"/> Cartooning |

TECHNICAL AND INDUSTRIAL COURSES

- | | |
|--|--|
| <input type="checkbox"/> Electrical Engineer | <input type="checkbox"/> Architect |
| <input type="checkbox"/> Electric Lighting | <input type="checkbox"/> Architects' Blueprints |
| <input type="checkbox"/> Mechanical Engineer | <input type="checkbox"/> Contractor and Builder |
| <input type="checkbox"/> Mechanical Draftsman | <input type="checkbox"/> Architectural Draftsman |
| <input type="checkbox"/> Machine Shop Practice | <input type="checkbox"/> Concrete Builder |
| <input type="checkbox"/> Railroad Positions | <input type="checkbox"/> Structural Engineer |
| <input type="checkbox"/> Gas Engine Operating | <input type="checkbox"/> Chemistry |
| <input type="checkbox"/> Civil Engineer | <input type="checkbox"/> Pharmacy |
| <input type="checkbox"/> Mining | <input type="checkbox"/> Automobile Work |
| <input type="checkbox"/> Surveying and Mapping | <input type="checkbox"/> Airplane Engines |
| <input type="checkbox"/> Plumbing and Heating | <input type="checkbox"/> Agriculture and Poultry |
| <input type="checkbox"/> Steam Engineering | <input type="checkbox"/> Radio |
| | <input type="checkbox"/> Mathematics |

Name.....

Street Address.....

City..... State.....

If you reside in Canada, send this coupon to the International Correspondence Schools Canadian, Limited, Montreal



Without any knowledge of Music or Notes you play in a few minutes, perfect like an artist, latest hits, songs and dances. No study or practice. Nobody can see the arrangement. Musical Entertainers wanted everywhere, making easy money. Three models. Every instrument guaranteed. Interesting circular No. 3 and roll list mailed free. Treasure Sales Co., 1690 Boston Road, New York, N. Y.

AVIATION FREE Information

Send us your name and address for full information regarding the Aviation and Airplane business. Find out about the many great opportunities now open and how we prepare you at home, during spare time, to qualify. Our new book "Opportunities in the Airplane Industry" is sent free if you answer at once.

AMERICAN SCHOOL OF AVIATION
Dept. 1421, 3601 Michigan Ave. CHICAGO

males are born. These and similar situations, which are of much technical interest, could scarcely ever be utilized to change the normal course of events in human propagation.

After all, it is not these alterations in the mechanism of sex production in man that are appealed to by the sensational writers who attract notice to their views by special pleading. They make use of the old procedure of an appeal to external agents. Fortunately the evidence that sex is normally determined by an automatic internal mechanism in man and in other animals and plants is now so well established and information concerning the mechanism is coming to be so widely diffused, that the exploitation of the ignorant by charlatans and cranks can only succeed with those who prefer the emotion of mysticism to knowledge, and fantasy to fact.

Scientists and Architects Build Latest Movie Palace

(Continued from page 805)

on rising lifts and can be raised independently. The echo organ chamber has its outlet on the sides of the theatre. Means have been provided for showing sound pictures with both the Vitaphone and Movietone systems, with the loud speakers upon a rising platform back of the screen. Several floors higher in the building is the broadcasting studio, with remote control panel, so that programs can be "tied-in" over land wires to any radio station. The amplifiers for loud speakers are also placed here.

Indirect lighting, striking statuary, and black marble streaked with white have been used skillfully by the designers to produce a movie palace which is undoubtedly one of the finest ever built.

FLYING THE ARCTIC, by Captain George H. Wilkins. Stiff cloth covers, 6" x 8 1/2", 335 pages, illustrated. Published by G. P. Putnam's Sons, New York and London. Price \$2.50.

Few people understand the scientific advances which can be made by aeroplane flights over the Arctic, Antarctic and other unexplored areas. By flying low over new country or over the ice, an experienced observer can tell the general aspects of the land or ice. The prevailing winds and currents mark the ice unmistakably and the condition of the ice near land is entirely different that that over deep water. Captain Wilkins was one of the first to realize the advantage of a fast mode of travel in exploring these ice wastes and at one time he unsuccessfully attempted to purchase a dirigible for this purpose. This book describes the three attempts that he made with heavier than air machines and the final success that he achieved when he flew from Point Barrow, Alaska to Green Harbor, Spitzbergen, a distance of over 2000 miles. The first attempt that he made was in 1926. He started with a large force of men and 3 planes. One by one they were wrecked and the attempts had to be given up for that year. In 1927 he tried again to explore the unknown area with 2 new planes but here again he failed although in both attempts he gained a host of useful information. In the last attempt, his force consisted of a pilot, Carl Ben Eielson, and himself as navigator and mechanic. The success of this trip over the ice is described in a thrilling and concise manner by the author Captain George H. Wilkins.—C. W. P.

Coming to NEW YORK ?

\$2,000,000

and how the Hotel McAlpin is spending it.

An improvement program that will make the McAlpin a NEW Hotel—inside and out

Luxurious NEW carpets, draperies and furniture throughout—bright, cheerful, interior decoration—spacious, IMMACULATE rooms, all with modern tiled baths—high-speed, electric, self-leveling elevators—and a NEW type of courteous, efficient hotel service that enthuses the most critical guests.

We invite you to visit the McAlpin and inspect the NEW rooms—several of which are already completed.

All improvements are being effected without the slightest interruption of service.

FRANK A. DUGGAN
President and Managing Director

HOTEL McALPIN

ONE BLOCK from PENNSYLVANIA STATION

B'WAY at 34th ST.

BIG NOVELTY BARGAIN! 10 Cts.

THROW YOUR VOICE

Into a trunk, under the bed or anywhere. Lots of Fun fooling the Teacher, Policeman, or Friends. Barrels of Fun.

THE VENTRILO.

A little instrument, fits in the mouth out of sight, used with above for Bird Calls, etc. Sent with full instructions; anyone can use it. NEVER FAILS. Also a 32 PAGE BOOK ON VENTRILOQUISM. Formulas for Secret Writing, 12 Money Making Secrets and the marvelous NOVELTY X-RAY WONDER.

With it you can apparently see the bones in your fingers, lead in pencil, etc. lots of fun with this outfit. Also 10 Big Magic Tricks Free with every order.

All the above Novelties by prepaid mail for **10¢**

VENTRILO COMPANY
Dept. 627, Norwalk, Conn.
LARGEST and OLDEST Mail Order House in Connecticut.

Wood Turning

By H. L. Weatherby

(Continued from page 835)

be glued together as indicated in the illustrations with a strip of good, strong wrapping paper in the joint. This and this alone is the whole secret of split turning. When

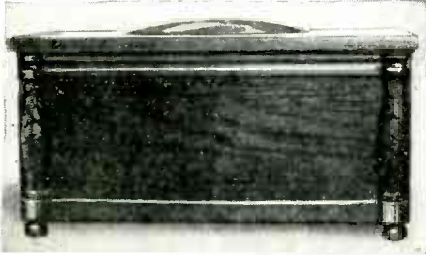

The above photograph shows a rear view of the finished treasure chest which can be easily made so as to resemble an antique in finish as well as in design. A coat of wax gives it a beautiful surface.

the work has been turned according to plan it is simply a matter of splitting the paper along the joint. But we are getting ahead of our directions.

Making the Box

WHILE the glue is setting on the column piece, assemble the sides, ends and bottom of the box, using mitre joints at the corners and fastening with nails and glue. All parts should be very carefully hand-planed and sanded, of course, before assembling.

The lid should be fitted next, allowing for proper projection in front. A sub-top may be attached also on the under side with glue and brads, as an added protection against warping, which may occur in thin wood. The lock and hinges can be fitted at this time also. The two strips of moulding can be made by hand by exercising a little patience; and with the aid of a hand gouge or a special plane for the top piece. These pieces of moulding should not be attached until the half columns are placed.

Turning the Columns

WHILE constructing the box the glue has been setting for the turning work, and by this time we are ready to begin making the half-round columns. There are only

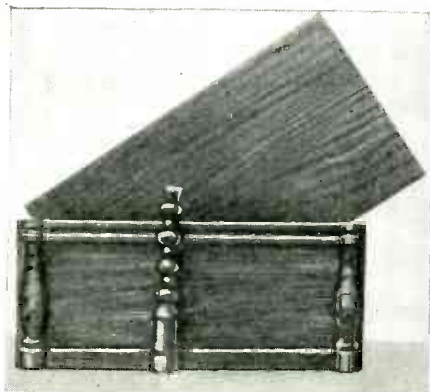

Above are the parts of the box ready for assembly, showing the feet before they are cut apart with a hacksaw. The columns and moulding have been tacked in place for a fitting.

two precautions to take; and they are to center the work very carefully on the joint and not to permit the spur of the live center falling along the line of the joint and thereby splitting the work in the lathe. Centering a little to one side will keep the work from being uniform after it has been split, and should be avoided.

The work itself calls for no detailed explanation. It is very simple spindle turning and calls for no new tool process.

When the turning of the columns is complete, and the piece has been very carefully sanded, take a wide chisel or a plane blade, as illustrated, and split the work along the joint. The paper along the joint will split very easily and must then be scraped off before the pieces are glued to the body of the chest. After these have been placed and the moulding very carefully fitted at the ends to the columns, and glued in place, we are ready to start on the feet.

Turning the Feet

THE feet are turned all in one piece and then cut into separate parts. A little review of the bead exercise in the second instalment of this series will give the method used in turning this part of the chest.

After they have been cut apart, a counter-sunk hole should be drilled in each one through which a screw passes to hold the foot in place to the bottom of the chest.



The finished chest as seen from the front appears above. If close grained wood is used, an on-rubbed finish is suggested and an oil finish with open grained wood.

Other Decorations

AS a final decoration for the top, a variety of suggestions is offered. The drawing illustrates a raised oval. This can be made by glueing a thin piece of the hard wood, of a variety that we have used for the other turnings, to a piece of scrap wood of large diameter, using the paper in glueing as in the columns. This large block is then turned to the shape desired in order to give a good outline for the part to be split off.

As a substitute for this, a small silver plate with the initials of the owner may be used, or an inlay design; or even a Decalcomania transfer pattern may prove to be desirable.

With reference to the hardware, it would be well to secure, if possible, small chest hinges, and a chest lock. A small wooden escutcheon may be cut from thin wood and used as an added decoration at the keyhole.

The Finish

IF a close grained wood is used, a filler will not be necessary. In order to bring

(Continued on page 888)

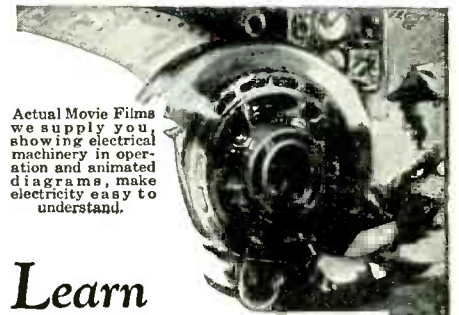

Actual Movie Films we supply you, showing electrical machinery in operation and animated diagrams, make electricity easy to understand.

Learn ELECTRICITY by Actual Movies

REAL moving pictures, in your own home, make the facts about electricity easy to grasp and fascinating as seeing a movie in your favorite theatre! You learn quickly, prepare for a big pay job in this ever-growing field.

Everything Supplied, No Extra Cost

Standard DeVry Movie Projector, so simple anyone can operate it immediately without experience. Used with regular light connection, farm lighting equipment, or auto battery. Thousands of feet of film—all supplied to every student at no extra cost.

Only School Using Real Movies

Nowhere else can you get real movie instruction in your home. Electricity, automotive electricity, and drafting all included in this wonderful course. Prepares you for all kinds of electrical work in aviation, radio, switch-board, power plant operation, contracting, etc.

A Better Job at Bigger Pay

We pledge to give you the training and employment service which helps you get a better job and more money or you need not pay a cent. The moment you enroll we begin helping you make your training count in more dollars. Employment service gets you in touch with employers who want Film-Way trained men.

Drafting Set Given

Complete professional outfit, including fine set of instruments, drawing board, rules, scales, etc., everything needed for drafting work included in this course given at no extra cost.



You Use This DeVry Projector

FREE THREE Lessons and our new book "The Film Way to Bigger Pay" Get in the big pay ranks. Send the coupon for information about this new, easier way to learn electricity.

The NATIONAL SCHOOL of VISUAL EDUCATION

"The Film Way to Bigger Pay"

537 S. Dearborn St., Chicago, Ill., Dept. 1-E

Without obligation, send three free lessons and your new book, "The Film Way to Bigger Pay"

Name.....

St. or R.F.D.....

City.....

State, County.....

FANS! third big edition

Don't
Miss
This
Big
Issue

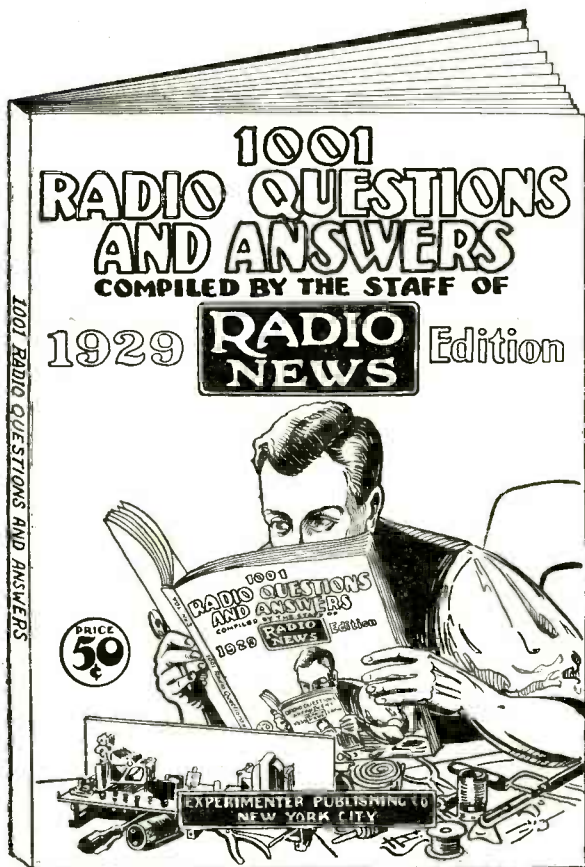

Over
150,000
Copies
Already
Sold



Compiled by the Staff of RADIO NEWS

Completely Revised-Up-to-the-Minute

1001 RADIO QUESTIONS AND ANSWERS, the most sensational seller in the radio field, is now in its third new and revised edition. No one interested in radio should be without a copy. The staff of RADIO NEWS, the leading fan magazine, has striven to make 1001 RADIO QUESTIONS AND ANSWERS the foremost work of its kind available. There is a full and complete explanation of every worthwhile circuit that has appeared since the beginning of radio, not only the explanation, but also complete diagrams from which the set can be con-

structed. Concise, authentic answers to every question that can possibly be asked concerning the many and varied branches of radio reception on both short-wave and broadcast bands.

FANS! Don't hesitate! Get your copy today! Over 112 pages — fully illustrated—large magazine size

50c

THE COPY

ASK YOUR NEWSDEALER
OR WRITE DIRECT

EXPERIMENTER PUBLISHING COMPANY, INC.

230 Fifth Avenue, New York, N. Y.

Mail This Coupon NOW!
EXPERIMENTER PUBLISHING CO., INC.
230 Fifth Avenue, New York, N. Y.
Gentlemen: Enclosed is 50c. Please forward
me a copy of 1001 RADIO QUESTIONS
AND ANSWERS.
Name
Address
City
State

Largest Vehicle Tunnel

By Harry Bercovich

(Continued from page 806)

tions needed 232 tons of reinforcing steel and stirrups. In all, 130,000 barrels of cement were used.

This tube has a greater diameter than any underwater subway in the world. The walls are two and one-half feet thick.

The next largest tube is the Rotherside tunnel under the Thames river, London. This has a thirty-foot outside diameter, with a 16.6-foot roadway. Although the Holland tunnel between New York and New Jersey is longer than the Posey tube, it is but 29 feet 6 inches in outside diameter.

In case of fire, engineers state, the blaze is not sucked diagonally, and poisonous gas from automobile exhausts or smoke from fires are eliminated from the tube without filling the entire tunnel.

The Posey tube is a model for safety. Thirty thousand vessels will sail uninterrupted over it and 4,500,000 automobiles will travel through it each year.

The comparative shortness of the tube makes it more safe from catastrophies caused by vehicular blockades and escaping gases than is the case with longer tubes.

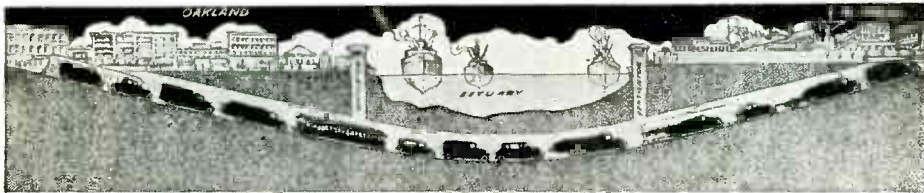

Sectional view of the new vehicular tunnel joining Oakland and Alameda, Calif.

At low tide the Holland tube is 60 feet below the surface; the Posey has an 85-foot clearance.

The ventilation systems of both tubes are identical. In place of the longitudinal system of ventilation used in many similar projects, the transverse system has been adopted. This method has two great advantages, engineers point out. Both fire and poison gas hazards are reduced.

Special ventilating features are used in the Posey tube. Above the roadway, which allows two vehicles to pass, are the elevated sidewalks; below is a great air vent, almost one-third of the tube's diameter, through which fresh air enters; and above are passages of almost equal size to serve as outlets for foul air. A battery of pumps is used to keep fresh air in circulation.

Waxes and Oils

By Dr. Ernest Bade

(Continued from page 830)

with two ounces of ether. Pour the ether into an evaporating dish and, after evaporating, extract the residue with alcohol, heating the mixture. Pour the alcohol into another evaporating dish and evaporate again. Dissolve the residue in ether and add twice the volume of acetone. The lecithin is precipitated as a yellow or dark brown waxy mass. Placed under the microscope, a small fragment begins to grow when water is added. This growth is called myelin formation.

The waxes resemble the fats in outward appearance but the glycerine of the fats is replaced by an alcohol in the waxes. The wax found in the head of the whale, spermaceti, also known as cetaceum, is primarily used for salves and pomades.

Bees wax is the most common of the waxes. Its natural color is yellow or yellowish red. When bleached it is white. It finds various uses, one of the most important being a constituent of floor wax. Almost all of the waxes melt under 100°C and are insoluble in water. They form creamy masses with turpentine, benzene and benzol. Bees wax melts between 63° and 69°C, Carnuba wax and palm wax melt at a higher temperature, the latter melting at 72°C.

The waxing of floors preserves the natural color of the wood and brings out the beauty of the grain. To make floor wax, waxes of different kinds are usually dissolved in turpentine. One pound of wax will coat about 250 square feet of surface. To make a floor wax, melt ¼ pound of bees wax

and one pound of paraffin. When melted, remove from the fire and stir in ¼ pint of raw linseed oil and 1¼ pints of turpentine.

The purity of bees wax may be ascertained by the melting point which should lie between 63° and 69° C. Dip the thermometer in the molten bees wax. Remove and let the wax adhering to the thermometer cool. When cold, place in cold water and heat gently and as soon as the wax becomes transparent, read the temperature. This is the melting point. A flocculent precipitate is obtained if stearic acid is present which is an adulterant, when 1 gram of the wax is dissolved in 10 cc. of 80% alcohol with boiling. After cooling and filtering, water is added. Only a slight milky appearance should be visible. If a flocculent precipitate is formed stearic acid is present.

TABLE OF COMMON ACIDS, THEIR ORIGIN AND PROPERTIES AND CHEMICAL FORMULA

Name of Acid	Found In	Properties	Formula
Oleic acid	Olive oil	Liquid, colorless, tasteless, solidifies +4 C.	C ₁₈ H ₃₄ O ₂
Palmitic acid	Palm oil	Melts at 62 C, crystallizes in needles	C ₁₆ H ₃₂ O ₂
Stearic acid	Lard	Melts at 70 C, crystallizes in plates	C ₁₈ H ₃₆ O ₂
Lauric acid	Cocoanut oil	Melts at 44 C, crystallizes in needles	C ₁₂ H ₂₄ O ₂
Linoleic acid	Linseed oil	Oily, yellowish in color, absorbs oxygen and become viscose	C ₁₈ H ₃₂ O ₂

Turpentine does not belong in this section. It belongs to a group known as terpenes.

In this . . . FREE BOOK a World-Famous Flier shows how YOU can get into AVIATION



WALTER HINTON]

Trail-blazer, pioneer, explorer, author, instructor. AVIATOR. The first man to pilot a plane across the Atlantic—the famous NC-4—and first to fly from North to South America. First, too, to explore the jungle fastnesses of the upper Amazon. The man who was a crack flying instructor for the Navy during the War; who today is training far-sighted men for Aviation. Hinton is ready to back YOU up to the limit. His Book is yours FREE for the coupon below.

HERE is the book that tells exactly what Aviation offers YOU. Walter Hinton—hero of history-making flights—gives you the brass tacks of Aviation Today. He shows you exactly where your opportunities lie—exactly how to fit yourself for them. Here is a book for men with too much backbone to stay chained to a small-pay job—too much adventure in their blood for a humdrum grind—too much good sound business sense to let this opportunity of a lifetime outgrow them!

THE RICHEST, FASTEST GROWING INDUSTRY THE WORLD HAS EVER KNOWN

Cities everywhere are building more airports; 24-hour shifts are racing construction on new plane and equipment plants. Air lines, air service of every kind is doubling and re-doubling itself almost while you watch! There's no doubt about there being BIG PAY plus a real future for YOU in Aviation. Your one sure move is to get the right training—QUICK!

AVIATION IS READY—HINTON IS READY NOW IT'S UP TO YOU

Hinton will train you for Aviation, right at home in spare-time. His proved course teaches all about plane construction, rigging, repairs, motors, instruments, theory of flight, navigation, commercial Aviation. Whether you plan to fly, or want one of the forty Big Pay ground jobs, you must have this ground work first. Hinton's Free Book tells you how to start. Clip the coupon and send it TODAY!

AVIATION INSTITUTE OF U. S. A.
WALTER HINTON, President
1115 Connecticut Avenue Washington, D. C.

Mail Now for Facts

Lieut. Walter Hinton, 4-N
 Aviation Institute of U. S. A.,
 1115 Connecticut Ave., Washington, D. C.
 Send me your FREE book, "Rich Rewards in Aviation," telling how you can give me my "ground work" right at home.

Name.....

Street..... Age.....

City..... State.....

The MOCAR

**Model Airplanes
THAT FLY**

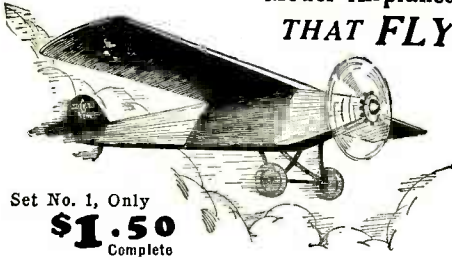

Set No. 1, Only
\$1.50
Complete

Aluminum Construction

BOYS—at last, here is a genuine aluminum model airplane that really flies. And at a small price. The "Mocar" monoplane—Set No. 1—is a copy of the famous Spirit of St. Louis. Wing spread 18 inches, fuselage 12 inches, powerful motor, ball-bearing propeller, rubber tired disc wheels. Weight complete only about 2½ oz. This is a practical, simple, real model plane that gives you a whole lot of fun for the moderate cost. The all metal construction makes a sturdy plane that will stand a lot of abuse. The outfit is mounted on cardboard with all parts plainly marked and full instruction for assembly. Pliers only tool necessary. Complete with rivets, bolts, nuts, wheels, wing and fuselage covering material, only \$1.50 postpaid (3 for \$4.00). Model L, made up ready to fly, \$2.25 (3 for \$6.30).

Great fun, learn how to make and fly airplanes. Order now. Jobbers, dealers and schools write for Discounts.



The Mount Carmel Mfg. Co.

Dept. W Mount Carmel, Conn.

PARKS
WOODWORKING MACHINES

Cabinet Shop Special No. 10

\$290

with Motor

You ought to have this handy Parks in your shop. Compact, complete machine designed like a big production outfit at one-fifth the cost. Iron outfit at one-fifth the cost. 42 x 72 inches. Does any kind of cabinet and joinery work. Write for circular.

THE PARKS WOODWORKING MACHINE CO.
1553 Knowlton Street, Cincinnati, Ohio
Canadian Factory: 338 Notre Dame East, Montreal

Art & Nature The PICTURE MAGAZINE

The MOST BEAUTIFULLY Designed and Illustrated magazine in the U. S.—we claim—Let us prove it to you!
For Students of Art, Nature-lovers, Hunters, Kodakers and Truth-seekers.
Lessons in Lettering, Designing, Illustrating, Poster work, Retouching, Cartoon and Comic drawing, Chalk-talking.
PRIZE Art and Photo Contests; Assignments, Criticisms, etc.
Amateur Writer's and Poet's corner.

THE BEST MAGAZINE

for Home, School and Correspondence Art Students, Teachers and Artists

CUT THIS OUT NOW

Send with \$1.00 for 4 Mo. Trial Subscription. O. K. or REFUND. Better send \$3.00 for Yearly Subscription.

ART AND NATURE, Dept. 2824 Kalamazoo, Mich., U. S. A.

Print Your Own

Cards, Stationery, Circulars, Paper, etc. Save money. Print for others, big profit. Complete outfits \$2.85. Job press \$11.32. Rotary \$149. All easy, rules sent. Write for catalog presses type etc. **THE KELSEY CO., P-47, Meriden, Conn.**

Wood Turning

(Continued from page 885)

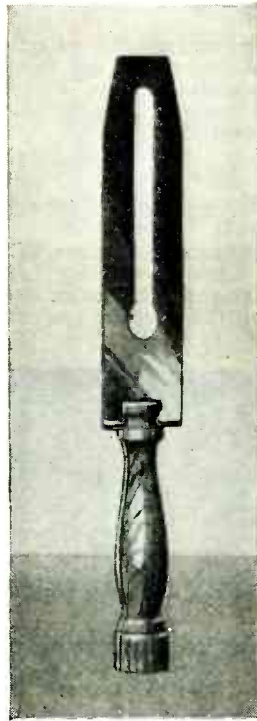

Above is a photograph showing the plane iron entering the joint and the split beginning to show.

out all of the beauty of the wood, an oil-rubbed finish is suggested. Where the wood is more or less open-grained, one or more coats of thinned white shellac, rubbed down after each coat, and followed by an oil finish will give equally as good results and the Treasure Chest will be a splendid replica of an antique; in finish as well as design.

The finish itself consists in taking boiled

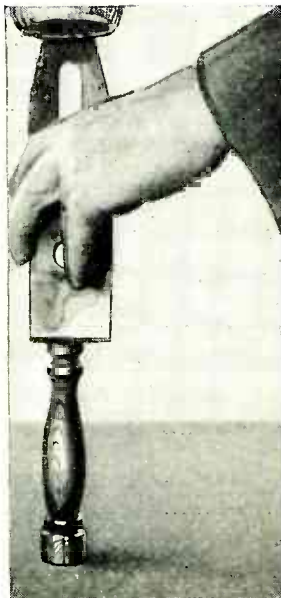

After the columns are turned they are split along the paper joint as shown.



**DIESEL & OIL
ENGINEERING
HAND BOOK**

(Rosbloom)

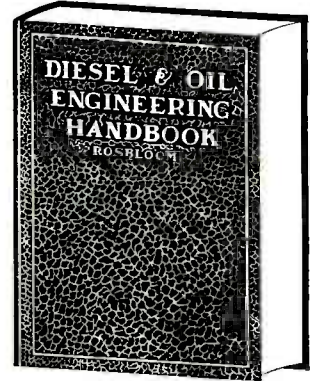

Fourth Enlarged Edition

**The World's Standard
Book on Diesel and
Other Classes of Oil
Engines**

A remarkable book of greatest value to all engineers, mechanics, and others interested in Diesel engines for land, marine, locomotive, automobile, and aircraft use. Over 300 tables, hundreds of formulae, profusely illustrated with color and plain views. Courses of instruction on all leading types. 830 pages. Size 5 x 7 inches. Bound in flexible, semi-flexible and stiff covers of very attractive imitation leather with reinforced back.

Price \$5.00 Prepaid

Order Direct from Book Department

EXPERIMENTER PUB. CO.

230 Fifth Avenue, New York



**BUILD AND FLY MODEL AIRPLANES
LEARNING**



**AVIATION
OUR MODEL**

of the *Bellanca* in flight

FOR PERFECT SCALE MODELS BUILD AND FLY THESE LISTED BELOW AND MANY OTHERS OF THE U. S. MODELS:

Lindbergh's "Spirit of St. Louis".....	\$8.50
Bellanca "Columbia".....	\$9.00
Junkers "Bremen".....	\$8.50
Fokker "Universal".....	\$8.50
Spad Biplane Scout.....	\$8.00
Nieuport Scout Biplane.....	\$8.00
Loening Monoplane.....	\$6.50
Curtiss J. H. 4 B.....	\$6.75
Dellavland Biplane.....	\$7.00
White Flyer.....	\$1.50

Our illustrated catalogue containing everything for the Model Builders. Sent postpaid for 10c.

DEALERS write for our discounts.

U. S. MODEL AIRCRAFT CORP.
341a Monroe St. Brooklyn, N. Y.

linseed oil, thinned with an equal part of turpentine, rubbed well into the wood. Two applications of this at forty-eight-hour intervals, followed by a wax coat will give a very beautiful finish.

Next month we hope to give you directions for turning long work in a short lathe, with drawings and photographs illustrating a floor or bridge lamp.

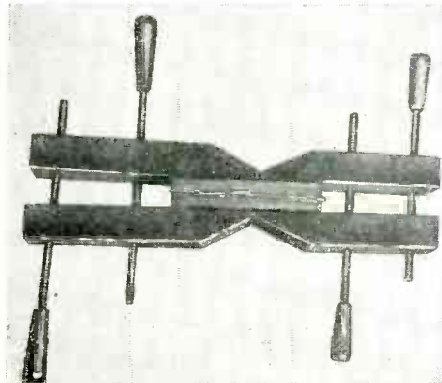

Glue two pieces together for the columns with paper between as illustrated above.



The scrap of wood to which the piece forming the oval has been glued.

Lining an Eight Inch Gun

By Edna MacDonald Serrem

(Continued from page 809)

must be used in the liner since it is the part above all other parts of a cannon that must undergo most of the wear of the passing projectile, and the erosion of the powder gases. The purpose of a liner in a big gun is, therefore, to increase the length of service it will give. It is the means of renewing the life of a gun by simple and inexpensive methods. When a liner is worn out, the gun need not be thrown away. It can be ready for service as soon as its new liner is inserted. But the big cannon would be useless after several hundred times or so of the firing they must do. The tremendous power and size of the shells would wear them out. But a practically new gun is ready with the slipping out and in of the liner.

The cooling system with the hydraulic press as described in this article are late improvements in the shrinking process, and were used for the first time on this type of gun. Various methods of discharging the water in the cooling process had been tried in the past, but never before had the flexible method of the series of valves that give control practically at will all the way down the liner, been used in the inner pipe as they were applied in the lining of this gun. Mr. Hugh Smith of the Watervliet Arsenal, a man who is rated as the greatest cannon-maker in the United States, is the inventor of the system of the series of valves used in the cooling process operated in the lining of this gun, and the particular application of the hydraulic press described is a method inaugurated by Hugh Smith. He has been making cannon at the Watervliet Arsenal for thirty-five years.



**Choose as Your Profession
Electrical
Engineering**

Electricity offers a brilliant future to the young man who is about to choose his career. Never before has there been such wonderful opportunity in this great field. Big paying positions in electrical work the world over are open to trained men — men who possess specialized, practical knowledge. Come to the School of Engineering of Milwaukee—the largest, the best equipped electrical school of its kind in America. Here you are trained in both theory and practice by a faculty of experts. You learn in large, finely equipped laboratories. If you have 14 high school credits or equivalent, you can become an Electrical Engineer with a Bachelor of Science degree in 3 years. If you have not finished high school you can make up the credits you lack in our short intensive Junior Electrical Engineering course.

Practical Electrical Education

Learn by the thorough, approved scientific methods which our twenty-four years of specializing enable us to give you. In addition to Electrical Engineering, the following complete courses are given: A.C. and D.C. Armature Winding—Wiring and Testing—Practical Electricity—Commercial Electrical Engineering—Junior Electrical Engineering and Automotive Electricity, Electrical Refrigeration, and Radio Sales, Service, and Broadcasting.

EARN LIVING EXPENSES

You can earn money to help defray your expenses while learning. Our wonderful co-operative plan brings an Electrical Career within the reach of every ambitious man. Our Free Employment Department secures positions for those students who wish to earn part of their expenses. In addition the Department will help you get a good position in the Electrical industry when your training is completed. Daily Broadcasting WISN.

New Term Opens Jan. 2nd

Write for FREE PHOTO STORY

Mail the coupon today for our big new Photo Story. Mention the course that interests you most and we will send you special illustrated bulletin. Read about the school that trains men for practical and quick success. See how easy it is for you to get the training that will enable you to step to a splendid position and a handsome income. Mail the coupon right NOW. No cost or obligation.

**SCHOOL of ENGINEERING
of Milwaukee**

Founded 1905

Dept. S.I.129

Jackson & E. Wells Sts.

Milwaukee, Wis.

SCHOOL OF ENGINEERING OF MILWAUKEE
Dept. S.I. 129 E. Wells and Jackson, Milwaukee, Wis.

Without obligating me in any way, please mail free Photo Story book, "Rise to Success Through Electricity" (just off the press) and your New Bulletin regarding the course I have marked with an X.

RESIDENT COURSES:

- ... Electrical Engineering, B. S. Degree. (3 years).
- ... Commercial Elec. Eng. (H. S. graduates 1 year —others 2 years).
- ... Armature Winding.
- ... Light, Motor Wiring and Testing.
- ... Electrical Refrigeration.
- ... Master Electrician.
- ... Automotive Electricity.
- ... Radio Sales Service and Broadcasting.
- ... Home Laboratory Service. (Home Study Course).
- ... I am interested in your "Earn While You Learn" plan.

Name.....Age.....

Address.....

City.....State.....

Education.....

AMAZE & MYSTIFY!

The BOOK of 1000 WONDERS

BIG MAGIC BOOK 10¢

"The Book of 1,000 Wonders" will be sent post-paid for 10c. Explains many mystifying tricks with coins, cards, handkerchiefs, etc., you can do. Also contains complete catalog of Magic Tricks, Jokes, Puzzles, Books, Escapes, Mind-reading Acts, Spiritualistic Effects, Illusion Plans, Curios and Imported Novelties from many foreign lands. Large assortment, lowest prices. You will amaze and mystify your friends! Send 10c today.

LYLE DOUGLAS Station A-3, Dallas, Texas

WANTED—MEN!

to Manufacture Metal Toys and Novelties

Big demand for 5 and 10c store Novelties, Ashtrays, Toy Soldiers, Animals, Auto Radiator Ornaments, etc. We co-operate in selling goods you make, also buy these from you. Small investment needed to start and we help you build up. We furnish COMPLETE OUTFITS and start you in well-paying business. Absolutely NO EXPERIENCE and no special place needed. A chance of a lifetime for man with small capital. Write AT ONCE if you mean strictly business and want to handle wholesale orders now being placed.

METAL CAST PRODUCTS COMPANY
Dept. E 1696 Boston Road New York City

Life's Secrets!

Amazing new book, "Safe Counsel," just out, tells you the things you want to know straight from the shoulder. Gives advice to newly married. Explains anatomy of reproductive organs, impotence, laws of Sex-Life, mistakes to avoid, diseases, pregnancy, etc. Contains 9 startling sections: 1—Science of Eugenics, 2—Love, 3—Marriage, 4—Child-Birth, 5—Family Life, 6—Sexual Science, 7—Diseases and Disorders, 8—Health and Hygiene, 9—Story of Life. In all, 104 chapters, 47 illustrations, 612 pages. Examine at our risk. Mailed in a plain wrapper.

Send No Money

Write for your copy today. Don't send a cent. Pay postman only \$1.38, plus postage, on arrival. Money refunded if not satisfactory.

FRANKLIN PUBLISHING CO.
Dept. 6107 800 N. Clark St., Chicago, Ill.

YOUR DIRECT MAIL SELLING
will be successful with carefully compiled

MAILING LISTS

AGENTS

BUYERS OF BOOKS AND MAGAZINES

SHOPPERS LIST

LIST OF WEALTHY SUBURBAN RESIDENTS

MAIL ORDER BUYERS

CYKO MAILING SERVICE
60 Elliott Avenue Yonkers, N. Y.

CAMPBELL'S INFRA-RED RAY LAMP



Have You Some Troublesome Ailment?

You will be greatly surprised when you learn how Infra-Red Rays relieve congestion or troubles causing aches and pains in the body. The Campbell Infra-Red Ray Lamp concentrates a mild beam of Infra-Red Rays upon any part of the body.

These rays penetrate deeply into the tissues. As they penetrate they create an active circulation of the blood. Most ailments are due to congestion—relieve the congestion and you relieve the ailment. Nature herself does the healing by active, normal blood circulation.

Why Suffer Needless Pain?

If you or some one in your home have a troublesome ailment, a lamp like this is a blessing. May be used safely by anyone. Entirely unlike ultra-violet or X-Ray. Positively cannot sunburn or blister.

Relieve bronchial trouble, Neuralgia, Neuritis, Sinus trouble, Catarrh, head noises, Asthma, Ear troubles, Rheumatism, Hemorrhoids, Prostatitis, Gall-Bladder, Tonsillitis, Lumbago and many other ailments with soothing Infra-Red Rays.

Let Us Send You Our Book on Infra-Red Rays

We have an interesting book on the use of Infra-Red Rays which we shall be glad to send free to any reader upon request. Our book quotes leading authorities as well as users of our lamp. Full directions for use, how to order, our home trial offer, etc., are also explained. Infra-Red Rays have brought such wonderful results for others you are sure to be interested. Write today for our book telling more about it.

THE WILLIAM CAMPBELL COMPANY
1050 Union Avenue • Alliance, Ohio

Mount Birds Learn at Home by Mail

Be a taxidermist. Learn to mount BIRDS, ANIMALS, GAME HEADS, FISH. Wonderful fascinating new art. All secrets revealed. Easily, quickly learned by men, women and boys. Decorate home and den with nature's finest art. SPORTSMEN save your trophies. BIG PROFITS for spare time. Sell your mounted specimens and mount for others. Have a business of your own. Big demand, high prices. Learn from old reliable school, 20 years' experience.

FREE! Beautiful illustrated book, "How to Learn to Mount Game", with dozens of photos of mounted specimens. Yours for the asking—FREE—Write Today. Taxidermy is a NECESSITY for sportsmen and nature lovers—INVESTIGATE. Get this wonderful FREE BOOK NOW—no obligations. Write! Don't delay. Send Coupon Today—NOW!

N. W. School of Taxidermy
3791 Elwood Bldg., Omaha, Neb.
Send me your free illustrated book "How to Mount Game." Also tell me how I may learn this fascinating art easily and quickly by mail. No obligation.

Name _____
Address _____

UX280 "B" Transformers, power tube taps, rectified output 180 volts, 80 milli. Complete, \$2.75. With shielded chokes one unit, complete, \$4.50.
J-71 or 210 Push-Pull Power Amplifier, plug in last stage, needs no filter or wiring changes, \$9.50.
B-Block Condensers, 600 V., 2-2-4-4-mfd., \$3.00 each. "A" chokes, \$3.00 each. "A" Eliminator, \$14.00 DIRECT RECTIFIER. Shield Grid tubes, \$3.50 each! Everything for the Set Builder. Catalog.

SOCKET POWER LABORATORIES
321 West 28th Street, Indianapolis

Motor Hints

Conducted by George A. Luers
(Continued from page 820)

The method, using a copper wire to wrap the break, is simple and readily applied. The surface at the break is cleaned, the copper wire is wrapped tight, that is, the coils are brought close and acid is applied to the joint. A small torch can then be used to melt solder around the wire. A similar method is to use a heavy piece of shim brass, tin one side, form this around the pipe and bind with wire. This patch is then sweated in place with the torch.

The pipe should be disconnected, each end should be blown out, and small wooden plugs should be placed in the tank openings to avoid fire.

The repair of leaking floats, from the carburetor or the vacuum tank, should be made with a soldering bit, as it is difficult to get the gasoline fumes out of the floats. A blow torch may ignite this gas and blow up the float. The method of repair is shown in the sketch, and consists in sweating small reinforcing pieces of brass at the holes. Float punctures are most frequently found at points where the float comes in contact with the carburetor or tank, as it swings.

Preventing Leakage at the Front Crankshaft Bearing

As a remedy for oil leakage at this location, one of the simplest repairs is that shown on the previous page.

A felt washer, of the type used on rear axles, is placed on the crankshaft, first removing the fan pulley. A section of light steel spring made so the ends can be hooked together, is used to retain this washer and force it in contact with the shaft.

A. C. Set Hints

By Paul L. Welker
(Continued from page 844)

is much less critical than either of these because it uses a separate heater element. The 227 is adopted for use as a detector because of freedom from ripple voltage with low plate currents. Usually greater audio amplification can also be employed with a 227 detector for this reason than with the direct heater types of tubes. The ripple voltage of a 226 is high with a low plate current and therefore it is not recommended for use as a detector, although several manufacturers have employed it in this position with fair results. The 227 is recommended as a detector to the constructor who builds his own A.C. set. Last but not least, it must be borne in mind that a noticeable hum will be experienced unless the proper filament, grid and plate voltages are used.

Usually positive, or occasionally negative bias of the 227 heater circuit is required. In the diagram the cathode return has been marked with an X. This has been so done because of the fact mentioned above. It may connect to the B— and C+, to the B+ 22½ V. or 45 V. or to the C+. Different positions should be tried until one is found which gives the least hum. A "C" battery of 4½ volts connected between the center tap of the filament potentiometer and the cathode terminal will in some cases eliminate the hum. The negative terminal of the battery should be connected to the center tap of the resistor.

The usual method of controlling volume by using filament rheostats or variable resistors in the plate circuit should not be



HAVE DAYS OF REAL FUN!

LEARN THE WONDERS OF CHEMISTRY

Anybody can master the science of chemistry with CHEMCRAFT. Work hundreds of amazing and useful chemical experiments: make soap, ink and dyes; test foods, water and soil; produce startling changes and perform wonderful tricks of chemical magic. CHEMCRAFT is the original and best chemical set, has more chemicals and experiments. Get CHEMCRAFT—then your fun begins!

Seven Dandy Outfits to Choose From:
No. 1—\$1.00 No. 2—\$3.50 No. 8—\$8.00
No. 2—\$2.25 No. 5—\$5.00 No. 12—\$12.00
Laboratory Work Bench \$35.00

SOLD WHEREVER GOOD TOYS ARE FOUND

Try Chemistry for 25c. Free Magazine for Boys
Get CHEMCRAFT Junior CHEMCRAFT Chemist
for, the set for boys who Club Magazine, full of fine
want to see if chemistry ideas, stories, chemical
interests them. Sent post- stunts and information.
paid for only 25 cents. Write for your free copy
Order it today! at once.

THE PORTER CHEMICAL COMPANY
105 Summit Ave., Hagerstown, Md.

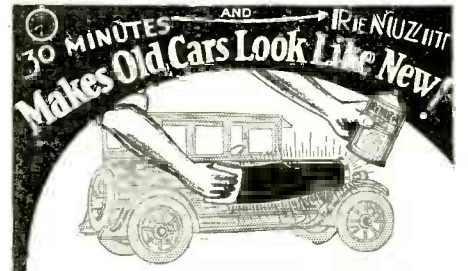

The Greatest Automotive Discovery of Scientists in Recent Years

You just flow ReNUZIT onto any automobile with a piece of cheesecloth, and instantly the ORIGINAL color and lustre of that car is like new again! NOT A POLISH, CLEANER, WAX, OR PAINT. No tiresome rubbing or polishing; harmless, lasting, sure. GUARANTEED NOT TO TURN WHITE.

AGENTS' NEW PLAN

ReNUZIT
Service Stations
Bring
\$1,000 a Month

It is easy to see why so many men can get into the big money class operating ReNUZIT Service Stations. Write for the thrilling story of ReNUZIT and your wonderful opportunity to make \$12,000.00 a year. Do it Now!

Make \$50.00 a Day

Millions are waiting to buy ReNUZIT. That is why ReNUZIT Agents all over the country can make almost unbelievable profits. And our PROPOSITION is so GOOD that you should have no trouble making \$50.00 a day and up.

Test ReNUZIT Free!

You have the privilege of trying ReNUZIT yourself right now without risk. Prove to yourself what miracles it accomplishes. Write TODAY for full details and Free Test Offer.

THE RENUZIT SYSTEM
154 E. ERIE ST. Dept. 863-A.R. CHICAGO, ILL.

AIRPLANE

12-inch scale model of Lindbergh's Spirit of St. Louis. Scientifically designed and very realistic. Rises from ground by own power and flies 30 ft. or more. Easily built without tools.

Construction set, with all parts and full directions, postpaid in U. S., only 50c. (no stamps). Satisfaction or money back. Send now.
MANN & BENTON, Box G, Chillicothe, Ohio.

HB O'BEDA BATTERY CHARGING

Only \$16 Monthly
Start your own big business now. Small payments brings complete outfit for recharging auto and radio batteries. Easy terms. Moneyback guarantee. Write to
HOBART BROS. CO.
Box 519, Troy, Ohio

EASILY CLEARS \$150 to \$300 MONTHLY PROFIT

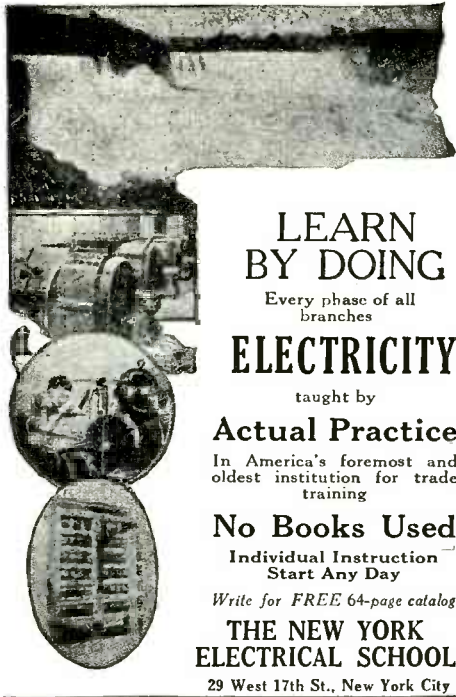

LEARN BY DOING
Every phase of all branches
ELECTRICITY
taught by
Actual Practice
In America's foremost and oldest institution for trade training
No Books Used
Individual Instruction Start Any Day
Write for FREE 64-page catalog
THE NEW YORK ELECTRICAL SCHOOL
29 West 17th St., New York City

\$75 to \$125 Weekly
Charging Batteries Starts You
Let meshow you how to make big money right from the start. I've prepared a FREE book explaining all details. First week's profit pays for all equipment. You can get all the battery charging business in your community with my Service Station Charger—it's years ahead of ordinary chargers—handles 50% to 70% more batteries. I explain everything—start you in a business of your own and put you on the way to big money. Write for FREE BOOK.
C. F. HOLMES, Chief Engineer, Dept. S1.
Independent Electric Works
5116 Ravenswood Ave. Chicago, Ill.
FREE BOOK—Just Out
Big Profits

PREPARE FOR AN ART CAREER
—thru the only art school operated as a department of a large art organization, who have actually produced over a quarter million drawings for leading advertisers. Where else can you get so wide an experience? Home study instruction. Write for illustrated book telling of our successful students.

MEYER BOTH COMPANY
Michigan Ave. at 20th St. Dept. 64 Chicago, Ill.

INKOGRAPH THE PENCIL POINTED PEN
10 DAY FREE TRIAL
Writes with ink smoothly, answering purpose of pen and pencil. Never blots, scratches, leaks or dries. Makes 3 carbon copies at one time with original in ink.
SEND NO MONEY. Pay postman \$1.00 plus postage. Sent prepaid if cash is sent with order. Money back if not satisfied within 10 days.
INKOGRAPH COMPANY, INC.
199-545 Centre St., New York
Send for Inkograph or write for Sales plan booklet. Big value. — sells on sight — no investment.

MUSIC LESSONS IN YOUR HOME
You can read music like this quickly
Write today for our FREE BOOKLET. It tells how to learn to play Piano, Organ, Violin, Mandolin, Guitar, Banjo, etc. Beginners or advanced players. Your only expense about 3c per day for music and postage used.
AMERICAN SCHOOL OF MUSIC, 57 Manhattan Bldg., Chicago

used with the A.C. tubes. Variable resistors for volume control should be connected across the primary or secondary of the radio frequency transformer. All leads carrying A.C. should be twisted together and kept away from the other parts of the circuit when possible.

Hum in "B" Eliminator

THE "B" eliminator if of poor design may be responsible for the hum in an A.C. set. This is usually due to improper filtering and can be cured by the use of additional bypass condensers, which should be placed across the output terminals of the eliminator, from the output or positive taps to the B—.

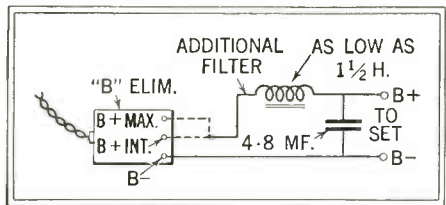

The above drawing shows how an additional filter is connected to the "B" eliminator.

Condensers having a capacity from 1 to 4 mf. are satisfactory. Sometimes in bad cases it is necessary to employ an additional filter system as illustrated here. A choke coil with a low D.C. resistance is used. In some cases this coil may have an inductance as low as 1 1/2 to 2 henries. A filter condenser of 4 to 8 mf. capacity completes the filter. This arrangement is connected successfully across the various output terminals of the eliminator until a position is reached where there is a noticeable decrease in hum.

Occasionally it happens that a hum is experienced only after the eliminator has been in operation for some time. Very often this is caused by a faulty buffer condenser or a broken down filter condenser. By replacing the offending component, this trouble can be cured. The method of testing condensers is illustrated. A sensitive voltmeter may be used or if such is not available, a lamp may be substituted as an indicator. A pair of phones and a battery connected in series can also be employed for testing condensers.

Sometimes a burnt-out resistor between the B— and low voltage tap will cause a hum, particularly when a potentiometer volt-

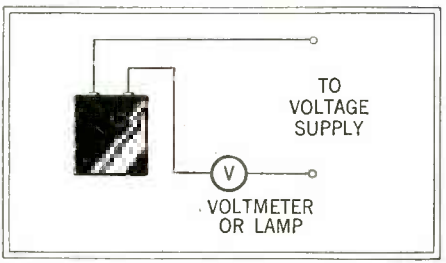

Condensers may be tested with a voltmeter or lamp in series with the voltage supply, as illustrated above.

age dividing system is used. Burnt-out or defective chokes can also be responsible for this annoyance.

Controlling Line Voltage

IT is a well-known fact that A.C. tubes must be prevented from being subjected to excessive line voltage which will damage them and materially lessen their life. The voltage reducer reduces abnormal line voltages to approximately 110 volts. However, as it is nothing more than a fixed resistor, the output of the regulator although lying within a safe value will fluctuate with the line voltage.

The voltage regulator, on the other hand, keeps the applied voltage constant, even though the supply may vary from 90 to 125 volts. This device delivers the proper voltage, regardless of the input voltage within a wide range.

SKINDERVIKEN Transmitter Units





Two for

\$ 1.75

Have hundreds of uses. Every amateur should have two or three of these amplifiers in his laboratory

A FEW USES FOR THESE UNITS

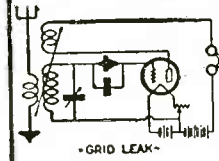
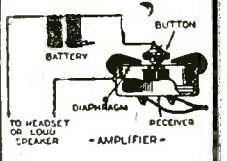
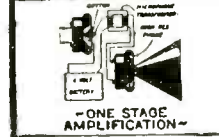
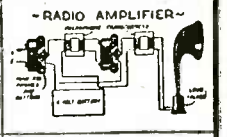
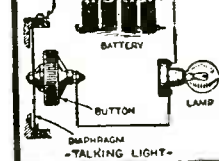
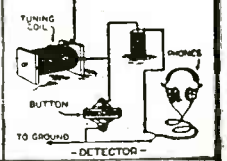
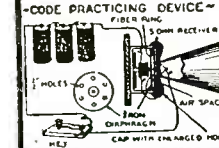
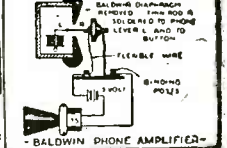
 -LOUD SPEAKER RETRANSMISSION-	 PHOTO-MICROPHONE MUSIC AT A DISTANCE
 -GRID LEAK-	 BATTERY DIAPHRAGM RECEIVER -AMPLIFIER-
 -ONE STAGE AMPLIFICATION-	 -RADIO AMPLIFIER-
 DIAPHRAGM -TALKING LIGHT-	 TUNING COIL TO GROUND -DETECTOR-
 -CODE PRACTICING DEVICE- FILE RING RECEIVER	 BALDWIN PHONE AMPLIFIER DIAPHRAGM FLEXIBLE WIRE BALDWIN PHONE AMPLIFIER

12 PAGE INSTRUCTION BOOKLET containing suggestions and diagrams for innumerable uses, furnished with each unit.

WE PAY \$5.00 IN CASH

for every new use developed for this unit and accepted and published by us.

P. G. MICROPHONE TRANSFORMER

A Modulation Transformer specially designed for use with the Skinderviken Transmitter Unit. Has many other uses. Primary resistance, 1/2 ohm; secondary, 55 ohms. **\$2**

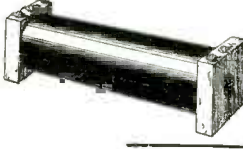

FOR SALE AT LEADING DEALERS
Or Order Direct, Using Coupon Below

SEND NO MONEY

When the postman delivers your order you pay him for whatever you have ordered, plus a few cents postage.

PRESS GUILD, INC. S.I.-1-29
16-18-D—East 30th St., New York, N. Y.

Please mail me at once as many of the following items as I have indicated.
... Skinderviken Transmitter Units at 95c. for 1; \$1.75 for 2; \$2.50 for 3; \$3.20 for 4.
... P. G. Microphone Transformers at \$2.
When delivered I will pay the postman the cost of the items specified plus postage.

Name.....
Address.....
City..... State.....

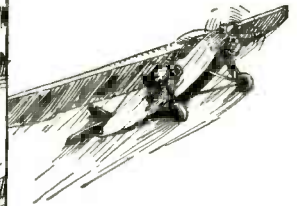
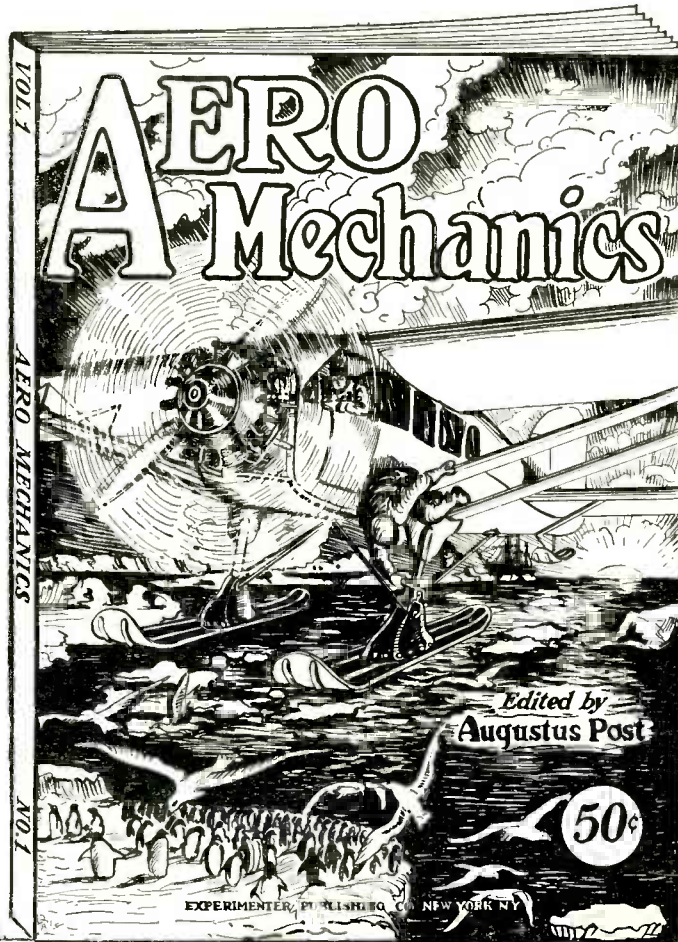

AERO MECHANICS-

The greatest magazine on modern aviation ever published. The many ramifications of the aeronautical field that it covers can be better appreciated by a glance at a synopsis of its contents.

CONTENTS IN BRIEF:

- Theory and Fundamental Principles of Flight.*
- Stability—How an Aeroplane Flies.*
- Complete Design, Construction and Assembly.*
- Scale Drawings—Names of Parts.*
- Flying Instructions—How to Become a Flyer.*
- Motors—Latest Inventions—Instruments, Use and Function.*
- Radio Installations.*
- Gliders.*
- Airports and Lighting.*
- Glossary of Aeronautical Terms.*
- The Aeroplane Mechanic.*
- Model Making.*
- Airplane Time Table.*



MR. AUGUSTUS POST
Editor of AERO MECHANICS

Mr. Augustus Post, editor of AERO MECHANICS, has been prominent in aeronautical circles throughout the country for over twenty years, his experience and adventures have made aviation history and placed him in a position to pass on to the readers of AERO MECHANICS honest, accurate and entirely dependable information on every phase of Aviation. Says the *North American Review* of Mr. Post: "No man in America has been more continuously at the centre of aeronautic activities in this country, and in touch with more history-making airmen here and abroad, than has Augustus Post who, besides having the "history of the air" in his head, has personally participated in some of the most thrilling adventures of aviation."

AERO MECHANICS, written by Augustus Post, is the most complete magazine of its kind ever published. It deals with every phase of aeronautical construction and operation, and its entire contents is edited by Mr. Post, who is one of the best known pioneers of aviation. Learn all about this great new field. Obtain your copy of AERO MECHANICS today. Over 112 pages. Fully illustrated. Large 9" x 12" size.

THE 50c COPY
At All Newsstands, or Write Direct
Experimenter Publishing Co., Inc.
230 Fifth Avenue, New York City

EXPERIMENTER PUBLISHING Co., INC.
230 Fifth Ave., New York City, N. Y.

Gentlemen:

Enclosed find 50c, for which please send me a copy of your remarkable new AERO MECHANICS.

Name

Address

City..... State.....

\$25.00 Drawing Course for \$2.98

Haven't you often wished that you could draw cartoons, illustrate some idea, sketch some pretty face, etc.? You can do all of these things. One of America's most famous Cartoonists and illustrators has developed a great, simple system for success in all branches of Commercial Art. This system has revolutionized the entire theory of drawing. It means that drawing can be as easy for you as writing—much simpler than learning short-hand, bookkeeping or typewriting. We are now placing this original system for learning Drawing, Art and Cartooning, consisting of 34 lessons with over 500 illustrations, within reach of every one. If you will devote a few hours each week to the Course WE ABSOLUTELY GUARANTEE that you will learn to draw and draw well before you have half finished the Course. If we fail to make this claim good we will refund every cent paid us. By eliminating a large office force for answering correspondence, expensive catalogs, etc., we are enabled to make a price of \$2.98 the cheapest price ever known for a high-grade home study course. Many have sent us letters similar to that of Rob't. P. Davis of Detroit, who wrote: "I can't see how you ask so little, when others with inferior Courses get from \$20 to \$60 for theirs. It is more than I expected." Learn to draw. It is a big asset, no matter what field you are in.

Send No Money

Just order the Course, and on arrival pay postman \$2.98 plus a few cents postage payment in full for the entire Course and Free Drawing Outfit. If not entirely satisfied, return within five days and we will REFUND MONEY. Address:

LEDERER SCHOOL OF DRAWING, Dept. 260-U
Chattanooga, Tenn.
Orders from outside the U. S. A. are payable \$3.28 cash with order.

FREE If you order the Course at once we will include a drawing outfit, consisting of artist's pencils, pens, paper, erasers, thumb tacks, etc., enabling you to go to work without any additional cost.

RULES FOR MODEL CONTEST

(Continued from page 825)

1. A handsome trophy cup engraved with your name, will be awarded as the prize for the best model submitted during the month. The decision of the judges will be final and will be based on: A—novelty of construction; B—workmanship; C—operating efficiency of the device which the model simulates, and D—the care exercised in design and in submitting to us sketches and other details covering the model.
2. Models of all kinds may be entered. They may be working models or not, according to the subject that is being handled.
3. Models may be made of any available material, preferably something that is cheap and easily obtainable.
4. Models must be submitted in all cases. Good photographs are also highly desirable, and where the maker does not desire the model to be taken apart, legible drawings with all dimensions covering parts that are not accessible must be submitted.
5. Models should be securely crated and protected against drainage in shipment and sent to us parcel post, express or freight prepaid. Models will be returned when requested.
6. Models for entry in any particular contest must reach this office on or before the 25th of the third month preceding date of publication. For instance, models for the December contest must reach us on or before the 25th of September.
7. Address all entries to Editor Model Department, c/o Science and Invention Magazine, 230 Fifth Avenue, New York City.



"Don't tell me you never had a chance!"

"Four years ago you and I worked at the same bench. I realized that to get ahead I needed special training, and decided to let the International Correspondence Schools help me. I wanted you to do the same, but you said, 'Aw, forget it!' You had the same chance I had, but you turned it down. No, Jim, you can't expect more money until you've trained yourself to handle bigger work."

There are lots of "Jims" in the world—in stores, factories, offices, everywhere. Are you one of them? Wake up! Every time you see an I. C. S. coupon your chance is staring you in the face. Don't turn it down.

Right now over 180,000 men and women are preparing themselves for bigger jobs and better pay through I. C. S. courses.

You can join them and get in line for promotion. Mark and mail this coupon, and find out how.

INTERNATIONAL CORRESPONDENCE SCHOOLS "The Universal University"

Box 6174-F, Scranton, Penna.
Without cost or obligation, please send me a copy of your booklet, "Who Wins and Why," and full particulars on the subject before which I have marked X:

- | | |
|--|--|
| <input type="checkbox"/> Architect | <input type="checkbox"/> Window Display |
| <input type="checkbox"/> Architectural Draftsman | <input type="checkbox"/> Plumber and Steam Fitter |
| <input type="checkbox"/> Architect's Blueprints | <input type="checkbox"/> Electrical Engineer |
| <input type="checkbox"/> Contractor and Builder | <input type="checkbox"/> Electric Lighting |
| <input type="checkbox"/> Building Foreman | <input type="checkbox"/> Mechanical Engineer |
| <input type="checkbox"/> Concrete Builder | <input type="checkbox"/> Show Card and Sign Lettering |
| <input type="checkbox"/> Structural Engineer | <input type="checkbox"/> Industrial Management |
| <input type="checkbox"/> Structural Draftsman | <input type="checkbox"/> Secretarial Work |
| <input type="checkbox"/> Heating and Ventilation | <input type="checkbox"/> Business Correspondence |
| <input type="checkbox"/> Plumbing Inspector | <input type="checkbox"/> Bookkeeper |
| <input type="checkbox"/> Foreman Plumber | <input type="checkbox"/> Stenographer and Typist |
| <input type="checkbox"/> Sheet Metal Worker | <input type="checkbox"/> Higher Accounting |
| <input type="checkbox"/> Surveying and Mapping | <input type="checkbox"/> Common School Subjects |
| <input type="checkbox"/> Civil Engineer | <input type="checkbox"/> Mathematics <input type="checkbox"/> English |
| <input type="checkbox"/> Electric Wiring | <input type="checkbox"/> Illustrating <input type="checkbox"/> Cartooning |
| <input type="checkbox"/> Telegraph Engineer | <input type="checkbox"/> Railway Mail Clerk |
| <input type="checkbox"/> Practical Telegraphy | <input type="checkbox"/> Civil Service |
| <input type="checkbox"/> Mechanical Draftsman | <input type="checkbox"/> Mining Engineer |
| <input type="checkbox"/> Toolmaker | <input type="checkbox"/> Gas Engine Operating |
| <input type="checkbox"/> Machine Shop Practice | <input type="checkbox"/> Textile Overseer or Supt. |
| <input type="checkbox"/> Chemist <input type="checkbox"/> Pharmacy | <input type="checkbox"/> Traffic Manager |
| <input type="checkbox"/> Navigation | <input type="checkbox"/> Automobiles |
| <input type="checkbox"/> Salesmanship | <input type="checkbox"/> Aviation <input type="checkbox"/> Marine Engines <input type="checkbox"/> Spanish |
| <input type="checkbox"/> Advertising | <input type="checkbox"/> Agriculture <input type="checkbox"/> French |
| <input type="checkbox"/> Business Management | <input type="checkbox"/> Poultry Raising <input type="checkbox"/> Radio |

Name.....

Street Address.....

City..... State.....

Occupation.....

If you reside in Canada, send this coupon to International Correspondence Schools Canadian, Limited, Montreal

New Karas Short-Wave Kit Reaches Around the World!

New radio thrills await you. Listen to Australia, Europe, Asia. Tune in on the world's airplane flyers, ships at sea; in fact, the whole world. You can do it easily with the remarkable Karas Short-Wave Receiver. You can't know the fascinations of radio until you experience this new sensation. Karas engineers have developed short wave to new peaks of perfection. Easy to build. Easy to tune with Karas Micrometric dials, 63 to 1 ratio. Uses famous Karas condensers, built like a fine watch. Karas coils and audios—the world's standard. Send now for full information and construction blueprint—Free.

KARAS ELECTRIC COMPANY
4049A N. Rockwell St., Chicago, U. S. A.

Name.....

St. and No.....

City and State..... 4049A

Insure your copy reaching you each month. Subscribe to SCIENCE AND INVENTION—\$2.50 a year. Experimenter Publishing Co., Inc., 230 Fifth Avenue, New York City.

Measuring the Speed of Atoms

By Donald H. Menzel, Ph. D.

(Continued from page 814)

axis of rotation, the vane being fastened thereto by a counterbalanced arm R. Unlike the windmill or weather-vane, however, complete rotation does not occur; when a stream of molecules from S2 impinges upon the vane, the latter is deflected until the torsion of the quartz thread balances the force. The number of atoms may be calculated from the measured torque upon the vane.

The results obtained from the machine are, within error of observation, quite in accord with Maxwell's theory and are of value in that they afford an experimental confirmation of the mathematical investigation. In still another way are the results of interest. Years ago, Maxwell speculated about what might occur if some being could separate molecules of various speeds, the creature who may possibly possess this faculty being called by common consent, a "Maxwell demon." The physicists, mentioned above, have fittingly christened their device a "mechanical Maxwell demon." Since this machine can be used to sort out the fast from the slow moving atoms, the temperature of the gas emergent from S2 will be higher, while that left behind will be cooler than the temperature of the original gas. One might speculate further upon the peculiar properties of the mechanism but, since the device is so new, such procedure would be of little value. In conclusion, it is interesting to find that such a cumbersome, relatively huge contrivance can be used to assort, count, and measure the speed of such small, delicate, and rapidly moving particles as atoms.

Orders - Inquiries

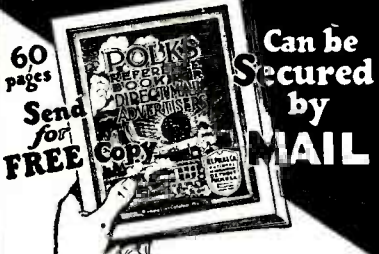

POLK'S REFERENCE BOOK and Mailing List Catalog

Gives counts and prices on over 8,000 different lines of business. No matter what your business, in this book you will find the number of your prospective customers listed. Valuable information is also given as to how you can use the mails to secure orders and inquiries for your products or services.

Write for Your FREE Copy
R. L. POLK & CO., Detroit, Mich.
Largest City Directory Publishers in the World
Mailing List Compilers—Business Statistics
Producers of Direct Mail Advertising



Working in spare time, J. H. Wade made \$200 in two weeks. A. G. Mason earned \$617 in a few days. You, too, can soon qualify for the wonderful opportunities in this big-pay profession. CAMERA FREE BOOK tells how famous GIVEN experts teach you money-making secrets of photography. In your spare time at home, or in our great New York Studios—how we help you get a fine position or start your own business—how we give you a professional camera. Write today for Book and Job Chart. N. Y. INSTITUTE OF PHOTOGRAPHY, 10 West 33rd St., New York, Dept. 82

Be a Movie Operator
We furnish projector and teach you at home. Get a good pay job with Movie or Vaudeville Theatre.
Write for folder

NEW SCIENTIFIC WONDER



10c 3-25c BIG FUN BOYS
You apparently see thru Clothes, Wool, Stone, any object. See Bones in Flesh. FREE—PKG. RADIO PICTURE FILMS. Takes pictures without camera. "You'll like 'em." 1 pkg. ea. 25c order. MARVEL MFG. CO., Dept. 83, NEW HAVEN, Conn.

OPPORTUNITY AD-LETS

YOU will find many remarkable opportunities and real bargains in these columns. It will pay you to read and investigate the offerings made every month by reliable firms, dealers and amateurs from all over the country. No matter what you may be seeking, whether supplies, automobile accessories, the opportunity to make money, or anything else, you will find listed here the best and most attractive specials of the month.

Advertisements in this section twelve cents a word for each insertion. Name and address must be included at the above rate. Cash should accompany all classified advertisements unless placed by an accredited advertising agency. No advertisement for less than 10 words accepted.

Objectionable or misleading advertisements not accepted. Advertisements for the March issue must reach us not later than January 5th. EXPERIMENTER PUBLISHING CO., INC., 230 Fifth Avenue, New York, N. Y.

Advertising

Get into Advertising. Learn quickly at home. Experience unnecessary. New, easy plan. No text books used. Practical work. Old established school. Send name and address for interesting free booklet. Page-Davis School of Advertising, Dept. 533-B, 3601 Michigan, Chicago.

Agents Wanted

Just Out—New Patented Apron. No strings or straps—\$20.00 a day every day; over 100% profit; commissions daily. Write for free offer. Sta-Put Co., Dept. 506, St. Louis, Mo.

Succeed With Your Own Products. Make them yourself. Formulas, Processes, Trade-Secrets. All lines. Catalog, Circulars free. D. Thaxly Co., Washington, D. C.

Don't sell for others. Employ agents yourself. Make your own products. Toilet Articles, Household Specialties, etc. 500% profit. Valuable booklet free. National Scientific Laboratories, 1975W Broad, Richmond, Va.

Agents—Make \$10-\$20 daily easy, selling men's silk and knit neckwear; wonderful proposition; samples on approval. Astor Neckwear Co., 318-K Broadway, New York.

Mirrors Resilvered at Home. Costs less than 5 cents per square foot; you charge 75 cents. Immense profits plating autotaps, reflectors, table ware, stoves, refinishing metalware, etc. Outfits furnished. Details Free. Write Sprinkle, Plater, 955, Marion, Indiana.

Wanted—District Purchasing Agents. No experience or money required. Write, Purchasing Manager, 5336 Berenice Ave., Chicago.

Strange Invention! Pays \$25 daily. Keeps telephone and iron cords from tangling and kinking. Prevents iron scorching. Saves electricity. Samples free. Neverknot, Dept. 13K, 4503 Ravenwood, Chicago.

\$60—\$200 a week. Genuine Gold Letters for store windows. Easily applied. Free samples. Liberal offer to general agents. Metallic Letter Co., 441 B, North Clark, Chicago.

\$50 to \$100 weekly. Men wanted to demonstrate the "fastest selling automobile accessory in the world"—Brite-Lite—the electro magnetic safety and emergency lamp. It's also a Perpetual Flashlight. No batteries to buy. It Sells Itself On Sight. County rights now being allotted to live salesmen. Write for demonstration and sales information to National Electric Corporation, 210 High Street, Newark, N. J.

New Invention—400% profit. Liquid quick mend for Fabrics and Hosiery. Stops runs. Every woman buys. Hundred other fast sellers. J. E. Johnson Co., Dept. 873, 6129 Wentworth, Chicago.

New household device washes, dries windows, sweeps, cleans walls, scrubs, mops. Costs less than brooms. Over half profit. Harper, 152 Third St., Fairfield, Iowa.

\$50 weekly placing boxed Neverun on store counters. Established steady income. Decatur district manager. Write today to Quincy Co., Dept. 892, 185 N. Wabash, Chicago.

\$10 daily silvering mirrors, plating and refinishing lamps, reflectors, autos, beds, chandeliers by new method. Outfits furnished. Write Gunmetal Co., Ave. D, Decatur, Ill.

Big money and fast sales. Every owner buys gold initials for his auto. You charge \$1.50; make \$1.35. Ten orders daily easy. Write for particulars and free samples, American Monogram Co., Dept. 71, East Orange, N. J.

Gold Leaf Window Letters and Script Signs; no experience; 500% profit; Samples free. Our Letters made Hazeltine \$200. week. Consolidated, 69-B, West Van Buren, Chicago.

Agents—Best seller; Jem Rubber Repair for tires and tubes; supersedes vulcanization at a saving of over 800 per cent; put it on cold. It vulcanizes itself in two minutes and is guaranteed to last the life of the tire or tube; sells to every auto owner and accessory dealer. For particulars how to make big money and free sample, address Amazon Rubber Co., Philadelphia, Pa., Dept. 601.

\$50.00 Weekly easy, applying Gold Initials on Automobiles. No experience needed. \$1.45 profit every \$1.50 job. Free Samples. "Ralco Monograms," R1043 Washington, Boston, Mass.

Sell our full line of store, office and garage brushes. All sizes and kinds. Cover regular route and make \$5 to \$15 on single call. Big sales easy. Line is flashy and prices well under competition. Write, The Brush Works, 852 Fourth St., Fairfield, Iowa.

66 Miles on 1 Gallon—Sensational New Moisture Gas Saver. All autos. One free to introduce. Critchlow, H-863, Wheaton, Illinois.

To Our Readers!

If you learned from a reliable source that gold lay beneath your very doorstep would you continue to live on ignoring this gift of the Gods? Of course not. You would make every effort to extract this vast wealth from the soils. And yet, here on these very pages your future may be sealed.

OPPORTUNITY AD-LETS may hold for you the opportunity of your lifetime. Read them carefully! Answer those that look interesting! Get the various propositions offered! One of them may insure your successful future.

Science and Invention

Airplanes, Aviation

Airplane Models, supplies. Send stamp for price list. Baby Bremen model, rises off ground, flies 200 feet—\$75. Hawthorne Model Aero Co., 161 Royal Ave., Hawthorne, N. J., Dept. O.

Biggest, Best Catalog Model Airplanes, Parts, Supplies; 5c postpaid. Ideal Company, 23 West 18th Street, New York.

Model Airplanes and Supplies—Send dime for circular. Star Model Shop, Vestaburg, Michigan.

Build your own single seater airplane. Booklet and blueprints \$1.00. Free literature. Russell Aero Co., Dept. 7, Ft. Wayne, Ind.

Various sizes of wood, reeds, extra prime stock, 26 inches long. Bamboo, rubber band, wheels, propeller, onion skin covering and other supplies. Big bundle for 25c, five for \$1.00. No stamps. Order yours today. Your friends will want one too. Will also send you circulars on free three foot model. Aero Shop, 3050 Hurbit Ave., Detroit, Michigan.

Antiques, War Relics and Indian Goods

For Dens, Relics and medals from Europe's battlefields. Illustrated catalog, 25c. International, 885 Flatbush Ave., Brooklyn, N. Y.

Books

Master Key 410 Pages Psychology—Inspiration—Success. Handsome binding, \$2.75. Phillips, 1014 Belmont, Chicago.

Fruit eating and fruit juice drinking. Most effective book printed, 50 cts. Free catalog. H. E. Wildman, 1733 Pine, Los Angeles, Calif.

Free—My illustrated Circulars on Newthought, Selfculture, Healing, Yogi Philosophy, Occult, Mystic and Scientific Books. Martens Publisher, Inc., Burlington, Iowa.

Books (Cont.)

Books, Magazines, Art Publications in French, English, Spanish. Photo novelties, etc. Samples, lists, 20 cents in stamps. Villaverde Co., Dept. 206, Box 1329, Havana, Cuba.

"Boycraft" 25 cents. New Testament 25 cents, 1929 Diary 20 cents. Bauer Company, 711 Ohio, Columbus, Ohio.

Midget Bible—12c. coin. Ma Jong game 50c. postpaid. John Kruse, 2308 N. Lawndale Avenue, Chicago.

Business Opportunities

Sell By Mail!—Books, Novelties, Bargains! Large Profits! Particulars FREE! E-Elco, 525 South Dearborn, Chicago.

Amateur Cartoonists: Sell Your Cartoons New Plan. Smith's Service EX191, Wenatchee, Washington.

Artists and Art Students are printing 250 signs and pictures an hour without machinery. Sample and particulars 10c. Straco—1015 Mulberry, Springfield, Ohio.

We Pay \$48.00 A Week, furnish auto and expenses to introduce our Soap and Washing Powder. Bus-Beach Company, Dept. A1N5, Chippewa Falls, Wis.

Free Book. Start little mail order business. Hadwil, 5A-74 Cortlandt Street, New York.

Toymakers—Make money at home. Be your own boss. Proposition and blueprints, 30c. Weesho-Uko, 31st Station, Detroit, Mich.

Good Positions are easy to get, anywhere. Write today for free advice. S34. A. Allard, 4724 Des Erables, Montreal, Canada.

Cameras and Photography Supplies

Make money in Photography. Learn quickly at home. Spare or full time. New plan. Nothing like it. Experience unnecessary. American School of Photography, Dept. 5333, 3601 Michigan Avenue, Chicago.

Chalk Talks

Laugh producing program. \$1.00. Catalog 10c. Balda Art Service, Dept. 4, Oshkosh, Wisconsin.

Chemistry

Chemist—Engineer, formulas developed, duplications, methods perfected and problems solved. H. W. Seigle, B. S. 418 W. Marion St., Elkhart, Indiana.

Chemical Lab. for sale cheap. E. Welsh, Fellsburg, Kansas.

100 Chemicals, pure, with apparatus to perform many experiments \$4.00, prepaid. Send Money order, or C.O.D. to Swimmer Chemical Co., 1500 St. Marks Ave., Brooklyn, New York.

Learn Chemistry at Home. Dr. T. O'Connor Sloane, noted educator and scientific authority, will teach you. Our home study correspondence course fits you to take a position as chemist. See our ad on page 790 of this issue. Chemical Institute of New York, 16 E. 30th St., New York City.

Your Chemical problems solved and working process furnished for Five Dollars. Write me, W. Stedman Richards, Consulting Chemist, Box 2402, Boston, Mass.

Biological and chemical analysis photomicrographs, formulas, consultations, rates reasonable. Hamilton Biochemical Laboratory, 7416 Colgate, Cleveland, Ohio.

10c. brings you Amateur Chemist Magazine. Everything in chemistry. Thompson-Allen Labs., Shamokin, Pa.

Correspondence Courses

Used correspondence school courses sold on repurchase basis. Also rented and exchanged. Money-back guarantee. Catalog free. (Courses bought). Lee Mountain, Pisgah, Alabama.

Detectives

Be A Detective. Make Secret Investigations. Experience unnecessary. Particulars free. Write George Wagner, 2190J Broadway, New York.

Please say you saw it in SCIENCE and INVENTION

Engines, Motors, Dynamos

Make Electric Motors—half and one horse-power. A. C. induction motor winding models show connections plain sight. Learn quick easy. Dept. C. Gaines Bros., Gainesville, Texas.

Esperanto

Send for free illustrated sample lesson of the international language, Esperanto. It immediately enables you to correspond with all nations of the world. Benson School of Esperanto, Inc., 518 Broad Street, Newark, N. J.

For Boys

Make and Sell Felt letters, emblems, armbands, etc. Outfit includes designs, alphabets and materials to make and stamp patterns. Felt included with outfit \$1.00. Ohmer D. Vance, 1218 1/2 Wabash Ave., Terre Haute, Indiana.

For Inventors

Inventors—You can protect and sell your own unpatented ideas without cost. Full directions, legal blanks and copy of Inventors handbook. Postpaid, \$1.00. N. H. Reynolds 2417 Edwards St., Berkeley, Calif.

Inventors. Use our special service for presenting your invention or patent to manufacturers. Adam Fisher Mfg. Co., 205-A Enright, St. Louis, Mo.

Unpatented Ideas Can Be Sold. I tell you how and help you make the sale. Free particulars (Copyrighted). Write W. T. Greene, 803 Baltic Bldg., Washington, D. C.

Free Book on Selling Unpatented Inventions. Sterling Buck, S-629 F, Washington, D. C.

Inventions Commercialized. Patented or Unpatented. Write Adam Fisher Mfg. Co., 205 Enright, St. Louis, Mo.

Help Wanted

Silvering Mirrors, French plate. Patented Process, easily learned. Immerse profits. Plans Free. Wear, Excelsior Springs, Mo.

Help Wanted—Instructions

Earn \$25 Weekly. Spare Time. Writing for Newspapers and Magazines. Experience unnecessary. Copyright Book, "How to Write for Pay." Free. Press Reporting Institute, 987, St. Louis, Mo.

How to Entertain

Plays, musical comedies and revues, minstrels, comedy and talking songs, blackface skits, vaudeville acts, monologs, dialogs, recitations, entertainments, juvenile plays and songs, musical readings, make-up goods. Catalog free. T. S. Denison Co., 623 So. Wabash, Dept. 99, Chicago.

Instructions

Learn Chemistry at Home. Dr. T. O'Connor Sloane, noted educator and scientific authority, will teach you. Our home study correspondence course fits you to take a position as chemist. See our full page ad on page 790 of this issue. Chemical Institute of New York, 16 E. 30th St., New York City.

Movie Writing Course 25c. Plays Bought, Sold; Films, etc. Wonder's, 207 Clifton Ave., Newark, N. J.

Inventions Wanted

Inventions Wanted—patented, unpatented. If you have an idea for sale, write Hartley, Box 928, Bangor, Me.

Inventions Commercialized. Patented or Unpatented. Write Adam Fisher Mfg. Co., 205 Enright, St. Louis, Mo.

Machinery & Tools

Concrete Building Block Machines and Molds. Catalogue free. Concrete Machine Co., 5 First St., St. Louis, Mo.

Magic and Games

Free with \$25 order our large die box. Send 20c for our large catalogue of tricks, puzzles, wigs, sensational escapes. Oaks Magical Co., Dept. 549, Oshkosh, Wis.

"The Book of 1000 Wonders" will be sent postpaid for 10c. Explains many mystifying tricks with Coins, Cards, Handkerchiefs, etc. you can do. Also, contains completed Catalog of Magic Tricks, Jokes, Puzzles, Books, Escapes, Mindreading Acts, Spiritualistic Effects, Illusion Plans, Curios and Imported Novelties from many foreign lands. Large assortment, lowest prices. You will amaze and mystify your friends! Send 10c today. Lyle Douglas, Station A-11, Dallas, Texas.

Male Help Wanted

Work For "Uncle Sam." Government Jobs. Men—women, 18 to 50, \$105.00 to \$283.00 month. Steady, pleasant work. Short hours. Paid vacation. No layoffs. Common education usually sufficient. Candidates coached without leaving home. Full particulars and 32 page book—Free. Write immediately. Today sure. Franklin Institute, Dept. L4, Rochester, N. Y.

Big Pay! South American Work, American firms pay fare, expenses. South American Service Bureau, 14,600 Alma, Detroit, Mich.

Firemen, Brakemen, Baggage men (white or colored), Sleeping Car, Train Porters (colored), \$150-\$250 monthly. Experience unnecessary. 897 Railway Bureau, East St. Louis, Ill.

Men, get Forest Ranger job; \$125-\$200 mo. and home furnished; hunt, fish, trap. For details, write Norton Inst. 1541 Temple Court, Denver, Colo.

Railway Postal Clerks. \$158.00 to \$225.00 month. Steady work. See your country. 25 men, 18 up coached free. Write immediately. Franklin Institute, Dept. L 15, Rochester, N. Y.

Miscellaneous

Forms to east Lead Soldiers, Indians, Marines, Trappers, Animals. 151 kinds. Send 10c for Illustrated Catalogue. H. C. Schlercke, 1037-2nd St., Brooklyn, N. Y.

Luminous Paint—Dozens of uses. Clocks, house-numbers, keyholes, light-switches, etc. Large bottle 25c. coin. Chemix Company, Box 1811, Denver, Colorado.

Trappers Pocket Gun 40c! Kills game! Illustrated literature for stamp. Grant Mfg., 31st Station, Detroit, Mich.

Mineral Products on positive all money-back guarantee if not satisfied. Write T. D. Robinson, Box 68F, Elgin, Texas.

Moulds

Moulds Making Toys. See ad on page 895. Miscellaneous. H. C. Schlercke.

Old Coins

California Gold, quarter size, 27c; half-dollar size, 53c Columbian nickel and catalogue, 10c. Norman Shultz, Box 746, Salt Lake City, Utah.

Old Money Wanted

\$2 to \$500 Each paid for hundreds of Old or Old Coins. Keep all old money, it may be very valuable. Send 10c for new illustrated coin value Book 4x6. Guaranteed Price. Get Posted, we pay Cash. Clarke Coin Company, 14 Street, LeRoy, N. Y.

Patent Attorneys

Patents. Time counts in applying for patents. Don't risk delay in protecting your ideas. Send sketch or model for instructions or write for Free book, "How to Obtain a Patent" and "Record of Invention" form. No charge for information on how to proceed. Communications strictly confidential. Prompt, careful, efficient service. Clarence A. O'Brien, Registered Patent Attorney, Security Bank Building (directly across street from patent office), Washington, D. C. See page 863.

Patents Procured at reasonable rates with time to pay. Sales negotiated. Staff of registered attorneys and engineers. A complete service for inventors. Write for particulars. Inventors Service Bureau, Union Trust Building, Washington, D. C.

Patent, Trade-Marks, Copyrights. Reliable services by an experienced practitioner devoting personal attention to each case. Inquiries invited. Reference furnished. B. P. Fishburne, Patent Lawyer, 525-D McGill Building, Washington, D. C.

Unpatented Ideas Can Be Sold. I tell you how and help you make the sale. Free particulars. (Copyrighted.) Write W. T. Greene, 803 Baltic Bldg., Washington, D. C.

ADAM E. FISHER, Registered Patent Attorney, in business 30 years; references; personal attention and promptness assured. Dept. E. 205 Enright, St. Louis, Mo.

Patents—Write for Free Instructions. Send drawing or Model for Examination. Carl Miller, Registered Patent Attorney (former Patent office examiner), 258 McGill Building, Washington, D. C.

Monroe E. Miller, Ouray Bldg., Washington, D. C. Patent Lawyer, Mechanical, Electrical Expert. Booklet and Priority Record blank gratis.

Patents Procured; Trade Marks Registered—A comprehensive experienced, prompt service for the protection and development of your ideas. Preliminary advice gladly furnished without charge. Booklet of information and form for disclosing idea free on request. Irving L. McCutran, 703 International Bldg., Washington, D.C., or 41-T Park Row, New York.

Inventors who derive largest profits know and heed certain simple but vital facts before applying for Patents. Our book Patent Sense gives those facts; free. Lacey & Lacey, 644 F. St., Washington, D. C. Established 1869.

Patents—Free instructions. Former Patent Office Examiner. Moderate terms. Booklet. Albert Jacobs, 708 Barrister Bldg., Washington, D.C.

Patent Attorneys (Cont.)

"**Inventors' Guide**" free on request; gives valuable information and advice for all who have original ideas or improvements. Frank Ledermann, Registered Attorney and Engineer, 15 Park Row, New York City.

"**Inventor's Adviser,**" Valuable Patentbook sent free. Labiner, 3 Park Row, New York.

Patents—Send for form "Evidence of Conception" to be signed and witnessed. Form, fee schedule information free. Lancaster and Allwine, Registered Patent Attorneys in United States and Canada, 242 Ouray Bldg., Washington, D. C.

Patents. Booklet free. Highest references. Best results. Promptness assured. Watson E. Coleman, Patent Attorney, Washington, D. C.

Patents

Inventions Commercialized. Patented or Unpatented. Write Adam Fisher Mfg. Co., 205 Enright, St. Louis, Mo.

Patents Wanted

Inventions Commercialized. Patented or Unpatented. Write Adam Fisher Mfg. Co., 205 Enright, St. Louis, Mo.

Photoplays Wanted

\$ \$ \$ For Photoplay Plots, Stories accepted any form, revised, criticised, copyrighted, marketed. Estab. 1917. Booklet free. Universal Scenario Co., 223 Western & Santa Monica Bldg., Hollywood, Calif.

Printing Outfits and Supplies

Print Your Own Cards, Stationery, Circulars, Advertising, etc. Complete outfits, \$8.85; Job Presses, \$11, \$29; Rotary, \$149. Print for others; big profit. Easy rules furnished. Write for catalog Presses, Type, Paper, etc. Kelsey Company, J-6, Meriden, Conn.

Printing, Engraving, Multigraphing

200 Letterheads and 100 Envelopes, \$1.10, postpaid. Oberman Company, Box 1042, Chicago.

Salesmen Wanted

"**Seven Eleven.**" Brand New. Punchboard—Sidelino Men \$200 Weekly. Free Catalog. Nothing to Carry. Rudy, 339 Madison, Chicago.

Punchboard Salesmen. 2 hours daily. \$100 every week. New line. Lowest prices. Full commission on repeat business. Catalog Free. Puritan Novelty Co., 1409 Jackson, Chicago.

Song Poems

Song Poem Writers, Write Sequoia Songwriters' Service, Sherman Branch, Los Angeles, Calif.

Song Writers

Song Poem or melody writers—Have "real" proposition. Hibber, D 24, 2104 N. Keystone, Chicago.

Free—"Song Writers Guide." Beaver D24-1257 Elm, Green Bay, Wis.

Songwriters Songs arranged for publication. Submit poems. Brennon, Musical Director, R1658 B'way, N. Y.

Stamps and Coins

Need Money? Cash for old gold, stamps, etc. Mail to Cleveland Salvage Company, 2533 St. Clair Ave., Cleveland, Ohio.

Stamps, 100, All Different, 3 cents. A. I. Quaker Stamp Company, Toledo, O.

Telegraphy

Telegraphy—Both Morse and Wireless—taught thoroughly and quickly. Tremendous demand. Big salaries. Wonderful opportunities. Expenses low; chance to earn part. School established fifty years. Catalog free. Dodge's Institute, Stone St., Valparaiso, Ind.

A Sky Ace Takes a Trick!

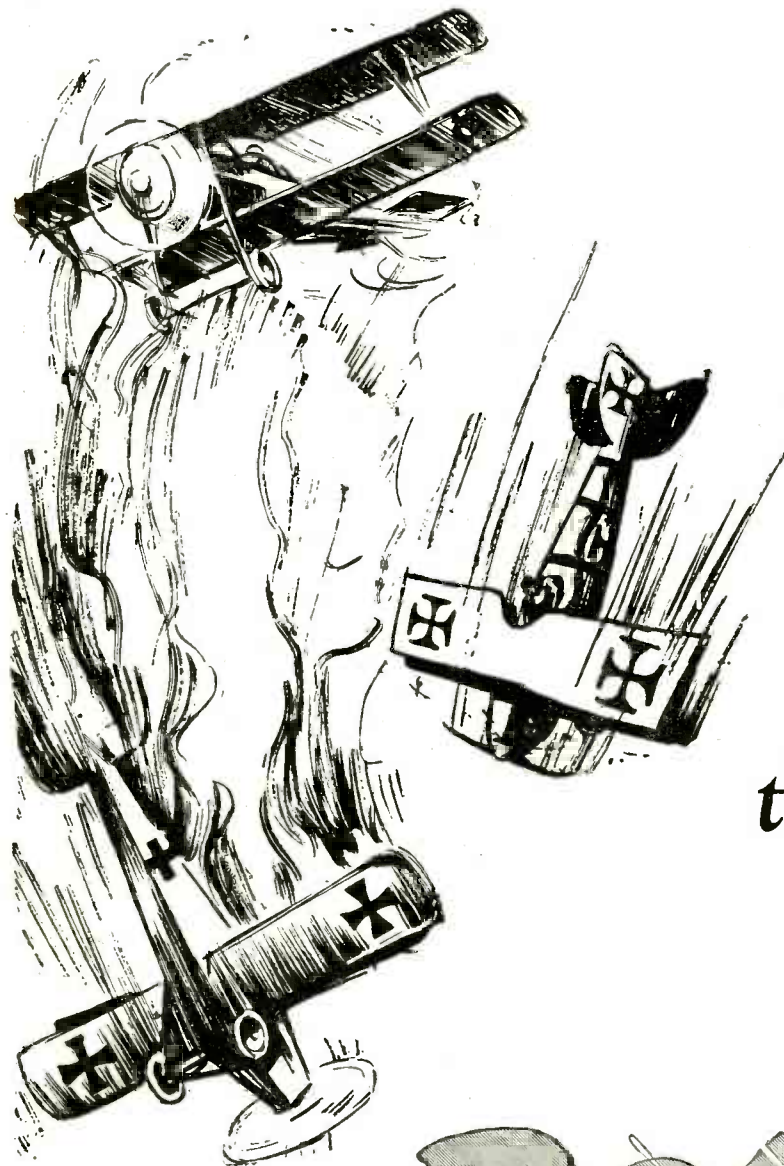

LIKE a pack of hungry wolves closing in for the kill, a flight of eager Fokkers swarmed around a lone American. And in the bitter fight that followed, this gallant ace played a daring trick — and won against overwhelming odds! Read how he did it in—

Lyons of the Cloud Patrol

By **RAOUL WHITFIELD**

in the

JANUARY

Battle Stories

Look for
This Cover,



The popular magazine of thrilling war tales of the
Army, Navy and Marines

January Issue

Now On Sale

25c

Jan. Sci & Inv.

BATTLE STORIES MAGAZINE,
Fawcett Publications, Inc.,
Minneapolis, Minn.

Enclosed find \$1 (bill or stamps), for which
send me BATTLE STORIES for the next five
months. Or, enclosed find 25c for copy of the
January issue.

Name

Address

Please say you saw it in **SCIENCE and INVENTION**

Let These Guides

Solve Your Problems

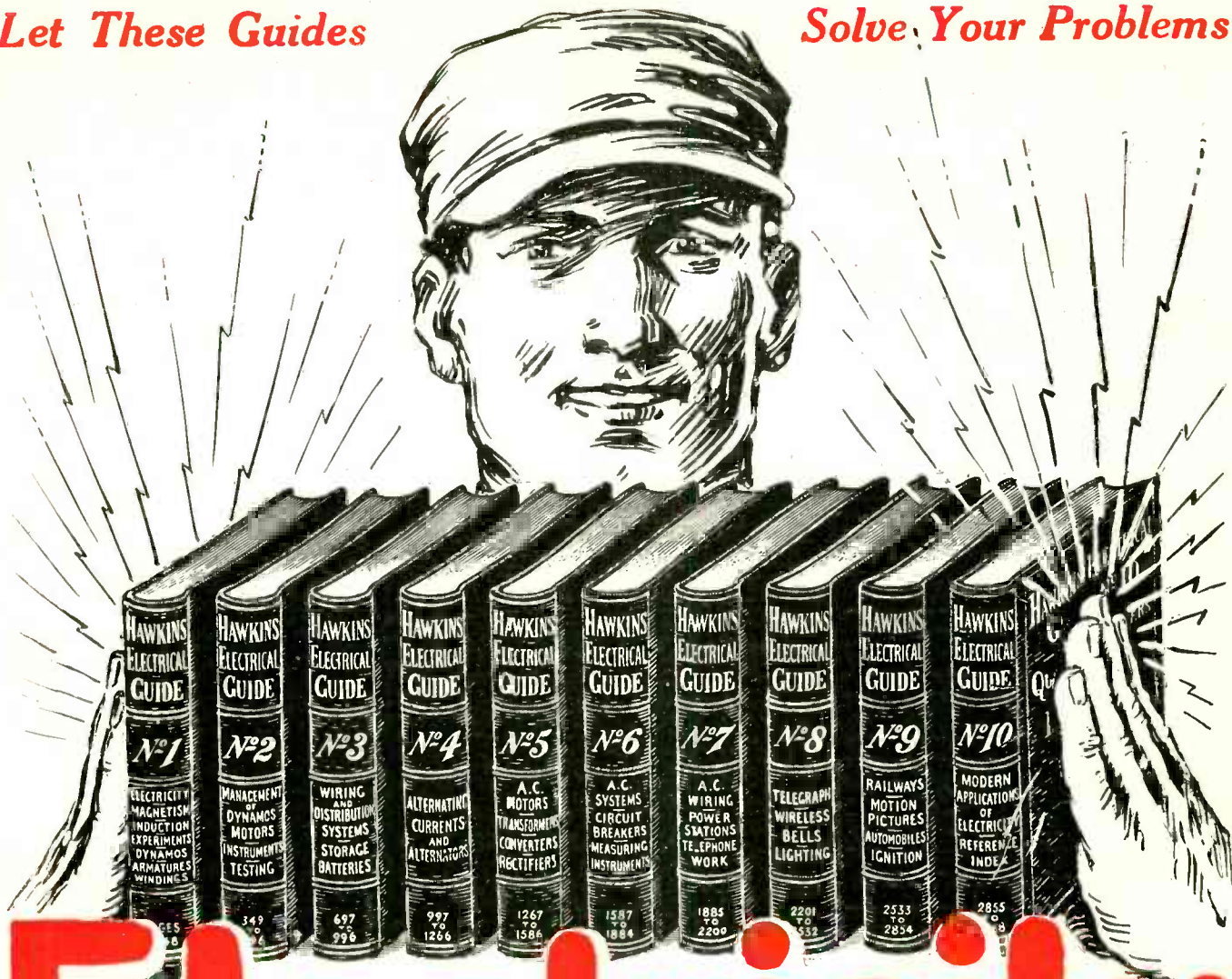

Electricity at your finger ends

HAWKINS ELECTRICAL GUIDES IN TEN VOLUMES

3500 PAGES
4700 PICTURES

\$1 A VOLUME
\$1 A MONTH

SEND NO MONEY—SEND ONLY THIS COUPON

Know the facts in Electricity. They mean more money and better position for you. Hawkins Guides tell you all you need to know about Electricity. Every important electrical subject covered so you can understand it. Easy to study and apply. A complete, practical working course, in 10 volumes. Books are pocket size; flexible covers. Order a set today to look over.

LEARN ALL ABOUT

Magnetism—Induction—Experiments—Dynamoes—Electric Machinery—Motors—Armatures—Armature Windings—Installing of Dynamoes—Electrical Instrument Testing—Practical Management of Dynamoes and Motors—Distribution Systems—Wiring—Wiring Diagrams—Sign Flashers—Storage Batteries—Principles of Alternating Currents and Alternators—Alternating Current Motors—Transformers—Converters—Rectifiers—Alternating Current Systems—Circuit Breakers—Measuring Instruments—Switchboards—Wiring—Power Stations—Installing—Telephone—Telegraph—Wireless—Bells—Lighting—Railways. Also many Modern Practical Applications of Electricity and Ready Reference Index of the ten numbers.

SHIPPED FREE

Not a cent to pay until you see the books. No obligation to buy unless you are satisfied. Send Coupon now—today—and get this great help library and see if it is not worth \$100 to you—you pay \$1.00 a month for ten months or return it.

THEO. AUDEL & CO.

65 West 23rd Street, New York City

Please submit me for free examination, HAWKINS ELECTRICAL GUIDE (Price \$1 a number). Ship at once prepaid, the 10 numbers. If satisfactory, I agree to send you \$1 within seven days and to further mail you \$1 each month until paid.

Name.....

Occupation.....

Employed by.....

Home Address.....

Reference.....

20 New Big Exclusive Features in the 1929 Model "Delta" Electric Handi-Shop

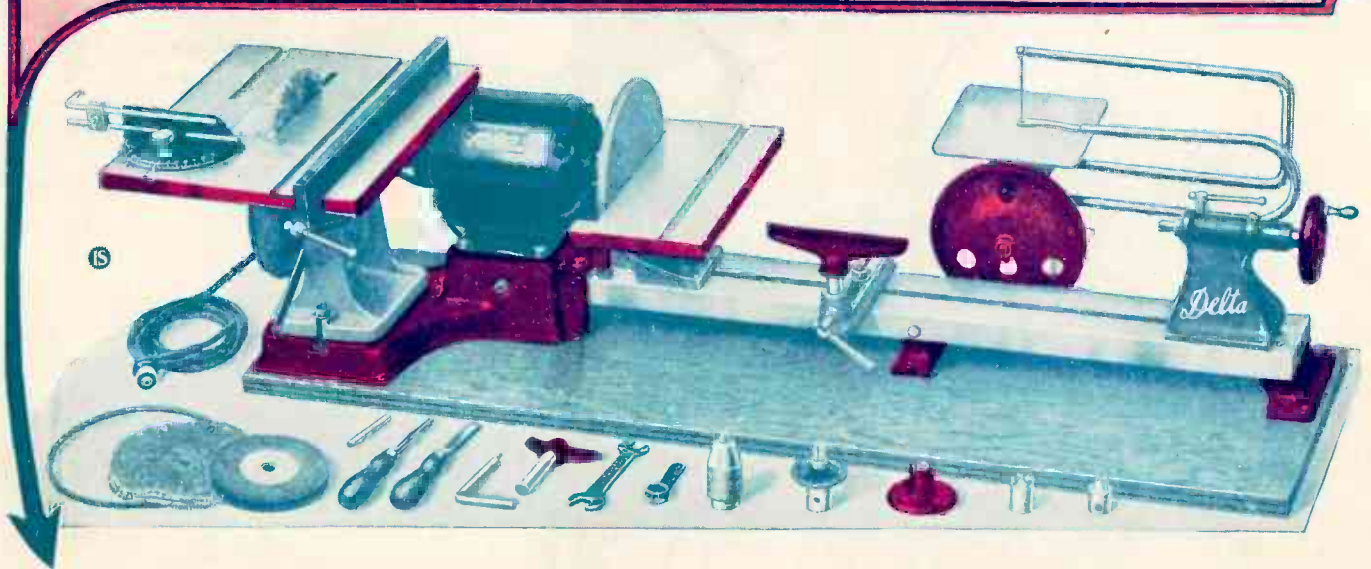

New Features of 1929 Model

found *exclusively* in the "Delta" Handi-Shop, in addition to the many regular exclusive advantages, make this shop one of the finest values in the workshop field. A few of the new improvements are:

- New Delta Miter-Gauge (with many new features).
- New Circular Saw Adjusting Lever.
- New Delta Adjustable Rip Gauge.
- Larger Circular Saw Table.
- 1/3 H. P. Motor.
- Larger Triple Foundation Lathe Bed.
- 1/2 inch capacity Drill Chuck.

For full details, send coupon below.

Make the Things You Have Always Wanted to Make

With this convenient, practical workshop. It's *so easy* and *so quick!* Save money on repair work. Earn money in your spare time. Complete instructions furnished. With each Handi-Shop is included, at no extra cost, complete set of working drawings. Below are a few of the hundreds of articles you can make in a jiffy with a Handi-Shop.

Blue Prints Included



Scores of Exclusive Advantages in this Big Husky Home Workshop

The DELTA Handi-Shop is a man-sized, motorized workshop, complete, efficient and **PRACTICAL IN DESIGN!** Does everything from building full-sized furniture, turning table legs, to finishing delicate detail work. Study the illustrations carefully. Note the two-shaft motor that permits two or three operations at one time—the heavy Triple Foundation U-Shaped Lathe Bed (no rods)—the *practical* arrangement of the Circular Saw that permits the cutting of large lumber without interference—the Improved Tilting Tables on the Circular Saw, Sanding Disc, and Jig Saw, with many exclusive features. Has automatically oiled bronze bearings and is completely assembled on heavy veneered wood base.

This combination of advantages, plus many more, IS FOUND **EXCLUSIVELY** in the DELTA HANDI-SHOP! No wonder even last year's Handi-Shop was an outstanding value. And now, with the many additional exclusive features of the new 1929 model, this shop is in a class by itself—above all comparison—at a new price that is **surprisingly low!**



This **TWO-SHAFT** motor is **THE** practical motor for the workshop. Permits you to carry on two or three important operations at one time—without continually dismantling the set-up.

ALL DELTA UNITS have 36 in. lathe capacity between centers



This Heavy Triple Foundation U-Shaped Lathe Bed (not rods or rails) is **GUARANTEED** not to spring or chatter.

10 DAY TRIAL in Your Own Home

without obligation. See how **PRACTICAL**, how **EFFICIENT** is this sturdy, full-sized machinery under actual working conditions. Study its many exclusive advantages. You will find the Handi-Shop complete with all necessary equipment for Circular Sawing, Woodturning, Jig Sawing, Sanding, Drilling, Grinding and Buffing.

Easy Terms

Then if you decide to keep the Handi-Shop, you can have your choice of three convenient methods of payment.

Send Coupon

at once for **Free** beautifully illustrated literature giving complete description of the New 1929 Model "Delta" Handi-Shop, with its many exclusive advantages and new features. Also full details of the 10 Day Trial Offer and Convenient Payment Plans.

DELTA SPECIALTY CO.
1661-67 Holton St. Milwaukee, Wis.
Dept. C-19

WRITE FOR THIS VALUABLE BOOK

cramped full of practical information on how to construct useful and decorative objects. Helpful whether you own workshop or not. Complete directions, illustrations, diagrams. Contains important information on "finishing." If you want this book, send 10c, which merely covers cost of mailing. See coupon below.



DELTA SPECIALTY CO. Dept. C-19
1661-67 Holton St., Milwaukee, Wis.

(Check material desired!)

Please send, without obligation, **FREE** illustrated literature describing new 1929 Model Delta Handi-Shop. Also full details of 10 Day Trial Offer and Easy Payment Plans.

Please send me copy of "How to Make Things with a Workshop." I enclose 10c to cover cost of mailing.

Name.....
Address.....