

Science and Invention

DO ANIMALS THINK?

See Page 302



WBERRY

A Yankee Ace Wins a Trick!



The Sky Gunner

By ALLEN HALEY BILL

BROUGHT down to earth by enemy bullets, this dare-devil American Ace and his buddy escape German capture and in enemy planes fight their way back to their own airdome. Here's a story of thrilling dog-fights, sky-high drama, and all capped by a climax that will set your scalp to tingling. **THE SKY GUNNER** appears in the

AUGUST

August Issue
Now
on Sale

Battle Stories

Price
25 cents
a Copy

The Big New Magazine of Thrilling Tales of War of the Army, Navy, and Marines

Included in a long list of smashing front-line war stories for August are:

Forty Fighting Thieves
By ARTHUR GUY EMPEY

Crash Dive
A Submarine Thriller
By J. J. KALEZ

War Wolves
A Novel of the Navy
By R. de S. HORN



(USE THE COUPON)

Aug. Se. & Inv.

Battle Stories, Fawcett Publications, Inc.,
Minneapolis, Minn.
Inclosed find \$1 (bill or stamps), for which send me BATTLE STORIES for the next 5 months.

Name.....

Address.....

City..... State.....

This \$10 Motor

One of the 8 outfits of standard tools and materials supplied without extra cost



ELECTRICITY

HOUSEHOLD APPLIANCES

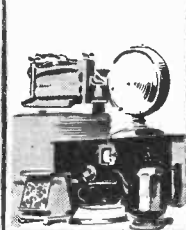

Plenty JOBS—\$40 to \$100 a Week!

This is the Electrical Age

Transportation, manufacturing, our homes, our work, our autos and airplanes are all electrified. 78% of the machinery of the U. S. is operated by electric power. More than half our homes, offices and farms are lighted by Electricity. Radio is Electricity, and so are telephone, telegraph, cable, elevators, street cars, refrigeration. It would take a big book just to mention the many uses and industries of Electricity. That's the kind of business to get into. Solid as the nation itself. Prosperous and busy whether times are good or bad.

AUTOMOTIVE ELECTRICITY



WORLD'S BIGGEST, FASTEST-GROWING BUSINESS

ELECTRIC POWER



HOUSE WIRING

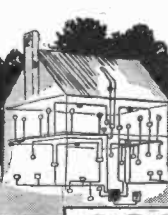

ELECTRICAL MACHINERY

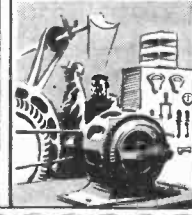

ELECTRIC RAILWAYS



This Contract assures you an Electrical JOB and 50% Raise

WE ARE looking for more ambitious men to place in well-paid Electrical positions. To qualify, you must have at least a grammar school education, you must be genuinely interested in Electricity and willing to devote a part of your spare time to getting ready. A two-million-dollar institution offers you this chance of a life-time to get into Electricity, the world's livest industry—without risk (as explained in our guarantee at the right).

We Say It With JOBS!

Instead of saying "learn Electricity and prepare for a good position"—we say LEARN ELECTRICITY AND WE'LL GET YOU A GOOD POSITION. At a cost and on easy terms you can afford, without risk of a penny, you can get a remarkable training built by 29 noted Electrical Engineers from America's greatest Corporations and Universities. Training simplified so you can understand and do it, at home, in spare time. A new, improved kind of preparation for a good job, which you learn by doing actual Electrical work with 8 outfits of standard tools and materials (supplied by us without extra charge).

There is no reason why YOU can't have a well-paid Electrical position. We can and will see that you get one. Mail the coupon and we'll send facts about the opportunities in Electricity that will astonish you, together with my sensational offer to prepare you, get you a job and raise your pay, or no cost!



Training built by CHIEF ENGINEER DUNLAP and 29 Noted Engineers from Westinghouse General Electric Western Electric Mass. Institute Cutler-Hammer Columbia Univ. Commonwealth Edison Am. Tel. & Tel. Armour Institute and other great Universities and Corporations



Dept. EC-294 Drexel Ave. and 58th St., Chicago, Ill.

American School
Contract
of Position and Increased Pay

to

- 1 WE GUARANTEE to find you a satisfactory position within 60 days after you finish our complete course of home-study training in Electricity; and, further,
- 2 WE GUARANTEE that said position will pay you a salary of at least 50% more than you are earning today, provided your present salary is less than \$40 per week;

OR, FAILING TO DO SO, we guarantee to refund to you immediately the entire amount that you paid for this training.

THIS GUARANTEE may be withdrawn without notice unless your enrollment application for the above training is sent to the AMERICAN SCHOOL promptly.

Given under the seal of the School by order of the Board of Trustees of the AMERICAN SCHOOL, this 16th day of June, A. D. 1928.

R. J. Muller, President

Figure this Guarantee in Dollars and Cents!

A little figuring will show you you can't afford to pass up this chance. Suppose you are earning \$30 a week now. Under this agreement you can actually buy a position paying \$45 a week (or more) or no cost. That means you pay \$1.50 a week for a short time, and it must raise your earning capacity at least \$15 a week, or the small cost will be refunded. We have made this agreement with 50,000 men in the past 4 years, and if you'll get in touch with me I'll be glad to tell you how you can qualify for the same opportunity.

Chief Engineer Dunlap, Electrical Division
AMERICAN SCHOOL, Dept. EC-294
Drexel Ave. & 58th St., Chicago, Ill.

Please send facts about the great Electrical industry, and tell me how I can get an Electrical Job and a 50% Raise—without risking a penny.

Name.....
Address.....
Age..... Occupation.....

Science and Invention

Formerly *ELECTRICAL EXPERIMENTER*
COMBINED WITH "THE EXPERIMENTER"

EDITORIAL, ADVERTISING AND GENERAL OFFICES:
230 Fifth Avenue, New York City

Published by Experimenter Publishing Company, Inc. (H. Gernsback, Pres.
S. Gernsback, Vice-Pres. and Treas.; C. E. Rosenfelt, Sec'y.)

Publishers of *SCIENCE AND INVENTION*, *RADIO NEWS*, *RADIO LISTENERS' GUIDE*, *AMAZING STORIES* and *TIDBITS*

Vol. XVI
Whole No.
184

AUGUST
1928
No. 4

Editorial Staff

HUGO GERNSBACK, *Editor-in-Chief*.
H. WINFIELD SECOR, *Managing Editor*.
T. O'CONNOR SLOANE, Ph.D.,
Associate Editor.
JOSEPH H. KRAUS, *Field Editor*.
PAUL WELKER, *Radio Editor*.
S. GERNSBACK, *Wrinkles Editor*.
W. J. ROMAINE, *Art Director*.

Contributing Editors

Astronomy—
Dr. Donald H. Menzel, Ph.D., Lick Observatory;
W. J. Luyten, of the Harvard College Observatory.
Entomology and Allied Subjects—
Dr. Ernest Bade, Ph.D.
Physics—
Dr. Harold F. Richards, Ph.D., Ernest K. Chaplin,
M.A., Dr. Donald H. Menzel, Ph.D.
Chemistry—
Raymond B. Walles, Dr. Ernest Bade, Ph.D.

Automotive Subjects— George A. Luers
Radio— A. P. Peck, Herbert Hayden.
Magic and Psychic Phenomena—
Joseph Dunninger, Joseph F. Rinn, Edward Merlin.
Foreign Correspondents—
Dr. Alfred Gradenwitz, Germany; Dr. H. Becher,
Germany; C. A. Gildroy, England; S. Leonard Has-
tin, England; Count A. N. Mirzaoff, France; Hubert
Slouka, Czechoslovakia; P. C. van Petegem, Hol-
land; Richard Neumann, Austria.

In SEPTEMBER Issue

Movies of Microscopic Life

A very interesting and brand new branch of amateur movie work will be described by an authority. Movie of invisible animal life presents a distinct novelty.

Thought Transference

Investigators in various parts of the world have been carrying on more intensely than ever various kinds of tests to determine whether thought transference is really possible. You cannot afford to miss it!

New Moon Rocket

The scientific and practical aspects of going to the moon via rocket are discussed pro and con. The tremendous power of the rocket as a propelling agent is brought out clearly and graphically.

Free Heat?

A French scientist has discovered how to heat a house with

CONTENTS OF THIS NUMBER

GENERAL SCIENCE		
Editorial	By Hugo Gernsback	295
Why Is a Skyscraper?	By H. Winfield Secor, E.E.	296
The Riddle of "Atlantis"	By Hanns Fischer	298
Electricity from the Sun		300
All-Metal Dirigibles		301
Do Animals Think?	By Raymond L. Ditmars	302
17-Year Locusts	By Dr. Ernest Bade	305
Advances in Aviation	By Joseph H. Kraus	306
Scientific Progress		308
New Dam Construction		310
The Month's Scientific News Illustrated		311
How Mediums Are Exposed in Germany		312
Curiosities of Plant Kingdom		315
A New "Wireless" Glow Lamp		316
The Movie Theater of the Future		317
The Cell—the Building Block of the Plant		318
Home Movies (a new Department)	By Don Bennett	320
The Metal Emperor—Concluding installment	By A. Merritt	322
Magic—A Monthly Feature	By Dunninger	325
Can You Answer These Questions?		326
New Devices of the Month		327
Readers Forum		337
Scientific Humor		344
Latest Patents		345
The Oracle		346
Patent Advice		360
CHEMISTRY		
Experimental Chemistry and Electrics	Edited by T. O'Connor Sloane, Ph.D.	328
Do You Eat the Right Food?	By William Lemkin, Ph.D.	329
RADIO		
Radio Beacon Guides Airplanes		333
New Radio Devices		339
Hints on Loud Speakers	By Paul L. Welker	340
New Summer Portables		342
Radio Oracle		343
AUTOMOTIVE		
Testing Auto Tires		314
Motor Hints	Conducted by George A. Luers	324
HOW-TO-MAKE-IT		
Model Department—Monthly Silver Cup Award		330
Constructor Department		332
Wood Turning	By H. L. Weatherby	334
How to Make It		335
Wrinkles, Recipes and Formulas	Edited by S. Gernsback	336

HOW TO SUBSCRIBE FOR "SCIENCE AND INVENTION." Send your name, address and remittance to Experimenter Publishing Co., 230 Fifth Ave., New York City. Checks and money orders should be made payable to Experimenter Publishing Co., Inc. Mention magazine desired, inasmuch as we also publish *RADIO NEWS*, *AMAZING STORIES*, *RADIO LISTENERS' GUIDE*, and *TIDBITS*, a bi-monthly. Subscriptions may be made in combination with the other publications just mentioned at special reduced club rates. Send postal for club rate card. Subscriptions start with the current issue unless otherwise ordered. ON EXPIRATION of your subscription we enclose a renewal blank in our last number to you, and notify you by mail. Then, unless we receive your order and remittance of a renewal, delivery of the magazine is stopped.

SCIENCE AND INVENTION is published on the 10th of each month. There are 12 numbers per year. Subscription price is \$2.50 a year in U. S. and possessions. Canada and foreign countries, \$3.00 a year. U. S. coin as well as U. S. stamps accepted (no foreign coin or stamps). Single copies, 25c each. All communications and contributions to this journal should be addressed to Editor, SCIENCE AND INVENTION, 230 Fifth Ave., New York City, N. Y. Unaccepted contributions cannot be returned unless full postage has been included. ALL accepted contributions are paid for on publication. SCIENCE AND INVENTION Monthly. Entered as second-class matter May 10, 1924, at the Post Office at New York, N. Y., under the act of March 3, 1879. Additional entry at Dunellen, N. J. and San Francisco, Calif. Title Registered at the Patent Office. Copyright, 1928, by E. P. Co., Inc., New York. The Contents of this Magazine are copyrighted and must not be reproduced without giving full credit to the publication. SCIENCE AND INVENTION is for sale at all newsstands in the United States and Canada. European Agents, S. J. Wise Et Cie, 40, Place Verte, Antwerp, Belgium.

ADVERTISING DEPARTMENT

New York Office:
Rhodes & Leisenring,
624 Graybar Building

Chicago Office:
Rhodes & Leisenring,
307 North Michigan Avenue

A HANDY RULE FOR YOU

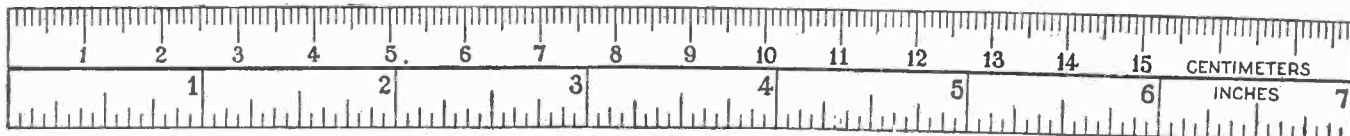

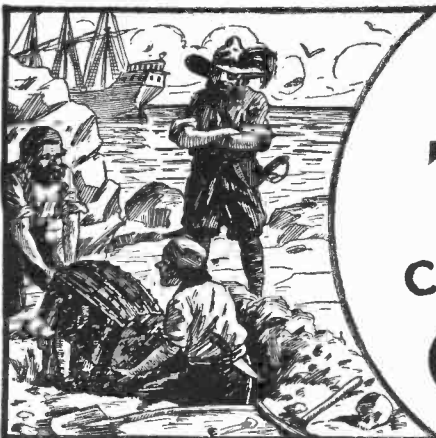

BURIED TREASURE can still be found in CHEMISTRY

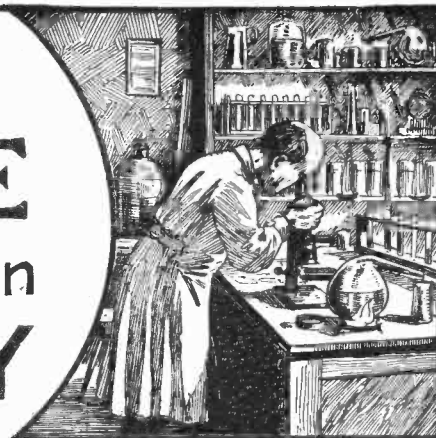

Good Chemists Command High Salaries

You can make yourself independent for life by unearthing one of chemistry's yet undiscovered secrets.



T. O'CONNOR SLOANE,
A.B., A.M., LL.D., Ph.D.
Noted Instructor, Lecturer and Author. Formerly Treasurer American Chemical Society and a practical chemist with many well-known achievements to his credit. Not only has Dr. Sloane taught chemistry for years, but he was for many years engaged in commercial chemistry work.

Do you remember how the tales of pirate gold used to fire your imagination and make you want to sail the uncharted seas in search of treasure and adventure? And then you would regret that such things were no longer done. But that is a mistake. They *are* done—today and everyday—not on desert islands, but in the chemical laboratories throughout your own country. Quietly, systematically, the chemist works. His work is difficult, but more adventurous than the blood-curdling deeds of the Spanish Main. Instead of meeting an early and violent death on some forgotten shore, he gathers wealth and honor through his invaluable contributions to humanity. Alfred Nobel, the Swedish chemist who invented dynamite, made so many millions that the income alone from his bequests provides five \$40,000 prizes every year for the advancement of science and peace. C. M. Hall, the chemist who discovered how to manufacture aluminum, made millions through this discovery. F. G. Cottrell, who devised a valuable process for recovering the waste from flue gases, James Gayley, who showed how to save enormous losses in steel manufacture, L. H. Baekeland, who invented Bakelite—these are only a few of the men to whom fortunes have come through their chemical achievements.

What Some of Our Students Say of This Course!

I have not written since I received the big set. I can still say that it far exceeded my anticipations. Since I have been studying with your school I have been appointed chemist for the Seranton Coal Co., testing all the coal and ash by proximate analysis. The lessons are helping me wonderfully, and the interesting way in which they are written makes me wait patiently for each lesson.—MORLAIS COUZENS.

I wish to express my appreciation of your prompt reply to my letter and to the recommendation to the General Electric Co. I intend to start the student engineering course at the works. This is somewhat along electrical lines, but the fact that I had a recommendation from a reliable school no doubt had considerable influence in helping me to secure the job. H. VAN BENTHUYSEN.

So far I've been more than pleased with your course and am still doing nicely. I hope to be your honor graduate this year.—J. M. NORKUS, JR.

I find your course excellent and your instruction, truthfully, the clearest and best assembled I have ever taken, and yours is the fifth one I've studied.—JAMES J. KELLY.

From the time I was having Chemistry it has never been thus explained to me as it is now. I am recommending you highly to my friends, and urging them to become members of such an organization.—CHARLES BENJAMIN.

I shall always recommend your school to my friends and let them know how simple your lessons are.—C. J. AMDAHL.

I am more than pleased. You dig right in from the start. I am going to get somewhere with this course. I am so glad that I found you.—A. A. CAMERON.

I use your lessons constantly as I find it more thorough than most text books I can secure.—W. H. TIBBS.

Thanking you for your lessons, which I find not only clear and concise, but wonderfully interesting. I am—ROBT. H. TRAYLOR.

I received employment in the Consolidated Gas Co. I appreciate very much the good service of the school when a recommendation was asked for.—JOS. DECKER.

Now Is the Time to Study Chemistry

Not only are there boundless opportunities for amassing wealth in Chemistry, but the profession affords congenial employment at good salaries to hundreds of thousands who merely follow out its present applications. These applications are innumerable, touching intimately every business and every product in the world. The work of the chemist can hardly be called work at all. It is the keenest and most enjoyable kind of pleasure. The days in a chemical laboratory are filled with thrilling and delightful experimentation, with the alluring prospect of a discovery that may spell Fortune always at hand to spur your enthusiasm.

You Can Learn at Home

To qualify for this remarkable calling requires elaborate specialized training. Formerly it was necessary to attend a university for several years to acquire that training, but thanks to our highly perfected and thorough system of instruction, you can now stay at home, keep your position, and let us educate you in Chemistry during your spare time. Even with only common schooling you can take our course and equip yourself for immediate practical work in a chemical laboratory. Dr. Sloane gives every one of his students the same careful, personal supervision that made him celebrated throughout his long career as a college professor. Your instruction from the very beginning is made interesting and practical, and we supply you with apparatus and chemicals for performing the fascinating analyses and experimental work that plays such a large part in our method of teaching, and you are awarded the Institute's official diploma after you have satisfactorily completed the course.

Easy Monthly Payments

You don't have to have even the small price of the course to start. You can pay for it in small monthly amounts—so small that you won't feel them. The cost of our course is very low, and includes everything, even the chemistry outfit—there are no extras to buy with our course. Our plan of monthly payments places a chemical education within the reach of everyone. Write us and let us explain our plan in full—give us the opportunity of showing you how you can qualify for a highly trained technical position without even giving up your present employment.

MAIL COUPON FOR FREE BOOK

Your name and address on the coupon will bring you by return mail our interesting free book, "OPPORTUNITIES FOR CHEMISTS," and full particulars about the course and what it will do for you. You owe it to yourself to get this book. Send the coupon right now while it is fresh in your mind. Or just write your name and address on postal and mail it to us. But whatever you do, act today.

DON'T WAIT—MAIL COUPON NOW!

NAME

ADDRESS

CITY

STATE

S.&I. AUG. '28.



Experimental Equipment Furnished to Every Student

We give to every student, without additional charge, this chemical equipment, including fifty-two pieces of laboratory apparatus and supplies, and fifty-two different chemicals and reagents. These comprise the apparatus and chemicals used for the experimental work of the course. The fitted heavy wooden box serves not only as a case for the outfit but also as a useful laboratory accessory for performing countless experiments.

CHEMICAL INSTITUTE OF NEW YORK, Inc.

Home Extension Division 8
16-18-S-E. 30th Street NEW YORK, N. Y.

CHEMICAL
OF NEW YORK
Home Extension
Division 8

16-18-S. -E. 30th St.
NEW YORK, N. Y.

Please send me at once, without any obligation on my part, your free Book "Opportunities for Chemists," and full particulars about the Experimental Equipment given to every student. Also please tell me about your plan of payment.

INDEX TO ADVERTISERS

A	PAGE	E	PAGE	Mc	PAGE	R	PAGE
A. H. S. Elec. Service Bureau, The	359	Elfco, F. A.	371	McCathran, Irving L.	360	Radio Association of America	357
American Chime Clock Co.	367	Electro Thermal Co., The..	348	McGraw-Hill Book Co., Inc.	349	Radio Institute of America	375
American Detective System	370	Evans & Co., Victor J.	363			Radio Specialty Co.	355
American Rabbit Association, Inc.	380	F		M		Randolph & Co.	362
American School	289, 378	Fawcett Publications, Inc., Inside Front Cover		Madison Shirt Manufacturers	353	Ross-Gould Co.	364
American School of Aviation	371	Fisher Mfg. Co., Adam	362	Mann & Benton	350		
American School of Cosmetic Manufacture	369	Franklin Institute	359, 376	Mega-Ear-Phone, The	376	S	
American School of Music	381	Franklin Publishing Co.	369, 381	Metal Cast Products Co.	365	School of Engineering of Milwaukee	354
American School of Photography	381	G		Miller, Monroe E.	360	Seaver-Williams Co.	370
American Telephone and Telegraph Co.	351	Gernsback, S.	366	Miniature Ship Models, Inc.	350	South American Service Bureau	378
Andrews, Frank	367	Gilson Slide Rule Co.	372	Model Aircraft Co.	366	South Bend Lathe Works	378
Anita Company	381	H		Movie Operators School....	365	Strongfort Institute	381
Apparatus Engineering Co.	367	Harper & Brothers.....	362	Munn & Co.	360		
Audel & Co., Theo., Inside Back Cover		Haywood Tire Equipment Co.	372	N		T	
Automatic Rubber Co.	355	High School Home Study Bureau	379	National Electrical School..	372	Tamblyn, F. W.	376
Aviation Institute of the U. S. A.	373	Hobart Bros.	358	National Radio Institute....	367	Tarbell System, Inc.	369
B		Hoernack, Paul	362	New Method Mig. Co.	357	Townsend Labs.	378
Bliss Electrical School	359	I		New Science Institute.....	357	Treasure Sales Co.	380
Broadfield Toy Co.	357	Ideal Aeroplane & Supply Co., Inc.	371	New Way Spray Gun Co. ..	381	Trilety, M.	364-371
Buescher Band Instrument Co.	369	International Correspondence Schools 353-366-370-377-380		New York Electrical School, The	365		
Bureau of Inventive Science	362	Inventors & Manufacturers Exhibit Co.	362	New York Institute of Photography	355		
C		J		North American Finance & Development Corp.	362	U	
California Laboratories	369	Jenkins Corp.	357	Norton Institute	372	Underground Aerial Systems	353
Chemical Institute of New York, Inc.	291	K		O		Universal Plumbing School	381
Coleman, Watson E.	362	Kitchin, Edgar M.	362	O'Brien, Clarence A.	361		
Conrad Co., Inc., 356, 364, 368, 372, 378		Koch Bros. Mfg. Co.	365	P		V	
Coyne Electrical Schools ..	293	L		Parks Woodworking Machine Co., The.....	371	Van Deventer, H. R.	362
Curtan Mfg. Company	355, 359	Lacey & Lacey.....	360	Perfect Penmanship Institute	380		
D		Lancaster & Allwine.....	360	Plymouth Rock Squab Co.	365	W	
Detroit School of Lettering	380	Landon School, The.....	350	Polachek, Z. H.	362	Wallace Co., J. D.	351
Douglas, Lyle	377	LaSalle Extension University	364	Polk & Co., R. L.	369	Whirlwind Mmg. Co.	367
Dryer, Prof. J. A.	350	Leonard, A. O.	367	Popular Book Corporation	347	Wilfred, L. E.	Back Cover
Du Maurier Co.	380	Le Page's Craft League....	359	Popular Chemistry Co.	358		
		Liederman, Earle E.	365	Press Guild, Inc.	368		
				Publishers' Classified Service	384		

Coyne Students Learning on Actual Machinery

electricity



It's
Easy
only 90 days

\$60 TO \$200 A WEEK

Is earned by Many in Electricity

**Railroad Fare
Allowed—**

I'll allow you railroad fare to Chicago and give you two Special Courses—Radio and Automotive—without extra charge.

See those fellows working away on real live electrical machinery? They're learning to earn \$60 to \$200 a week. In a short time their services will be in big demand. They'll step right out and get big jobs. Not one of them will have to worry about small pay checks—lay offs—or shudder at losing their jobs. They'll be in that great fascinating electrical profession of unlimited opportunity—where a wonderful future is assured.

You can do the same. It's the sure, quick, amazingly easy short cut to big salaries. You don't need advanced education or any previous experience. You learn by doing—not by correspondence. You can earn while you learn. My Employment Department will assist you in getting part-time work. FREE EMPLOYMENT SERVICE WHEN YOU GRADUATE—and from then on COYNE BACKS YOU FOR LIFE.

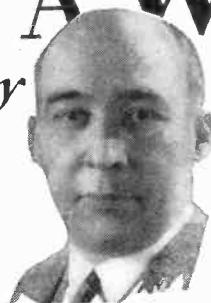

H. C. LEWIS, President

Send for Big Book

FREE I've got a big 66-page book, "THE BOOK OF BIG PAY FACTS." Get your copy NOW—fill in the coupon this minute. It's absolutely free—So act AT ONCE. DON'T WAIT!



My Course Includes **Aeroplane Electricity**
Training in

COYNE Electrical SCHOOL

H. C. LEWIS, President — Founded 1899
500 S. Paulina St., Dept. C-883 Chicago, Ill.

**Mr. H. C. Lewis, Pres., Coyne Electrical School,
Dept. C-883 500 So. Paulina St., Chicago, Ill.**

Dear Mr. Lewis: Without obligation send me your big free catalog and all details of Employment Service, Radio and Automotive Courses and how many "earn while learning." Also tell me about your railroad fare offer.

Name
Address
City State

Houdini's Spirit Exposés

and Dunninger's Psychological Investigations

Stilled by death but a short time ago,
the voice of Houdini lives again in this
book to carry on the work so prema-
turely cut short.

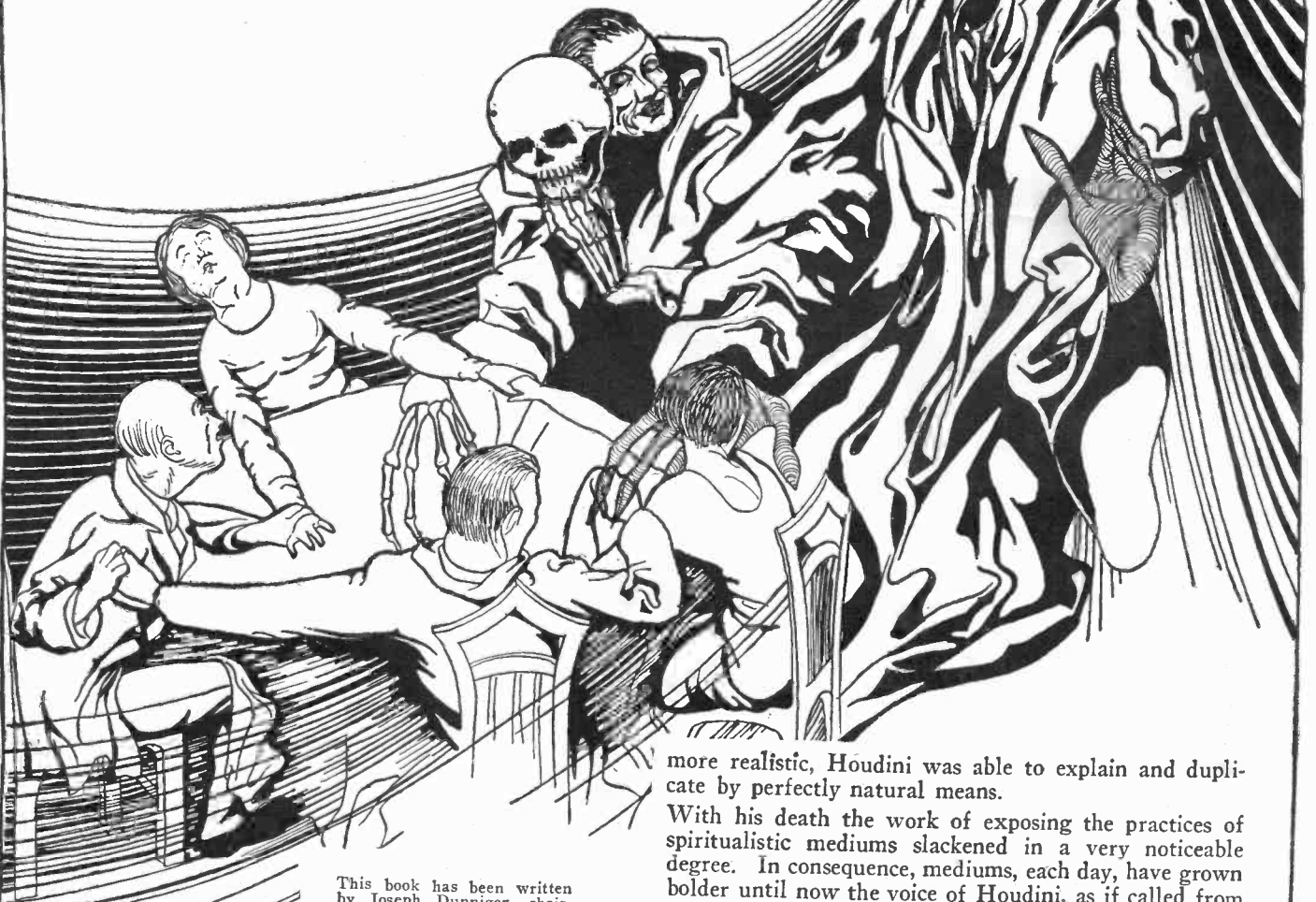

This book has been written
by Joseph Dunninger, chair-
man of the *Science and In-
vention* Investigating Com-
mittee for Psychological Re-
search.

H OUDINI was deeply interested in spiritualism. He spent years in the study of this fascinating subject. When he had fully mastered every angle, he turned his attention to exposing the fraudulent practices of mediums. Mysterious voices in the air, unearthly tappings on the table, wierdly moving furniture, floating figures, hands, lights—every trick employed by mediums in order to make their séances

more realistic, Houdini was able to explain and duplicate by perfectly natural means.

With his death the work of exposing the practices of spiritualistic mediums slackened in a very noticeable degree. In consequence, mediums, each day, have grown bolder until now the voice of Houdini, as if called from the grave, has returned and can be heard to echo throughout the pages of this amazing book, "HOU-DINI'S SPIRIT EXPOSÉS." Here Houdini lives again to crush the swelling number of mediums parasitically bleeding their victims of their most cherished possessions while posing in the guise of the living dead.

All should read this tremendously interesting book. The entire treatise has been written from the personal notes of Houdini—a startling exposé on one of the biggest frauds of the day. Do not fail to get your copy—112 pages—fully illustrated.

The 50c Copy

At all Newsstands or Write Direct

EXPERIMENTER PUBLISHING CO., 230 Fifth Ave., New York, N. Y.

Science and Invention

HUGO GERNSBACK, *Editor-in-Chief*

H. WINFIELD SECOR, *Managing Editor*

DR. T. O'CONNOR SLOANE, PH.D., *Associate Editor*

Editorial and General Offices 230 Fifth Avenue, New York

"Those Who Refuse to Go Beyond Fact Rarely Get as Far as Fact" HUXLEY

WHAT IS BEAUTY?

By HUGO GERNSBACK



SCIENTIFIC analysis of the term "beauty" reveals strange things in the make-up of the human being. In the first place, the dictionary tells us that beauty is a form of æstheticism. Beauty, in fact, is only a sensation as received by the human being through some of his senses. When we say a thing is beautiful, we actually see the particular object which we behold. It may be said that the greater proportion of the beauty impulses are perceived through the eye. Perhaps next on the list would be the sense of hearing. We hear a selection of music which pleases us, and we call it beautiful; or we listen to an actor reciting his verses and we term that beautiful. We can read, however, the same poem ourselves, without the actor reading it for us, and we will again give it the determination of beautiful, because it arouses certain emotions in our mind.

When it comes to the other senses, they do not seem to be well represented as far as the beauty impulses are concerned. By no stretch of imagination do we call a pleasing sensation to our bodies, as for instance, heat, or the wearing of fine cloth a beautiful sensation, as far as our sense of touch is concerned. With our sense of smell, however, we sometimes go as far and say that a certain thing, say, a flower, may smell beautiful, although we most often will call it really a pleasant odor, as opposed to, for instance, a vile odor, which we term unpleasant. We can taste the best food and imbibe the best drinks, but we very seldom call this beautiful, although the sensations may be pleasant, and may arouse the same mind pictures, as when we behold a beautiful work of art. Yet, there seems to be little æstheticism as far as that is concerned.

In going a little further into the subject, we find that our reactions to the beautiful things in general often take queer turns. We look at a magnificent sunset or we behold a mountain in all its majesty, and we exclaim, "what a beautiful scene." Just what we mean by that, would be difficult to explain in scientific terms. The human being is the only mammal that makes such distinctions. Evidently, animals have no æsthetic sense whatsoever, or if they have, we do not know it. Just why we do react as we do, is most difficult to understand. As a rule, it might be said that anything that is pleasant, and arouses our imagination and emotions, may fall under the classification of beauty, but again, there are many exceptions. Beauty, in other words, is simply a figment of the mind, and has very little scientific basis. Take the following case:

We go to a theater and we behold a beautiful actress. She looks quite radiant and we immediately are moved to say that she is a most beautiful creature. A few seconds afterwards, much to our dismay, she pulls off her wig and turns out to be a man. This has happened to many audiences. What happens? We start laughing, and not in our wildest dreams would we still call this man beautiful. Here, then, is a case where evidently beauty is not beauty, simply because the entire thing is mental, and has no real basis in fact.

Then, too, practically every human being has the most perverse notions of beauty. He will have his own ideas, which are shared by thousands of other human beings that this or that woman is beautiful, and at the same time, will also agree upon the fact that the bulldog she has on the leash is beautiful as well. Yet, we know that a bulldog is not a thing of beauty, but possibly, its very ugliness may become beautiful to

our eyes. This seems to be a clear case of perversion of our æsthetic sense.

And when it comes to beauty, who shall be the final arbiter? What is beautiful to a white man, is entirely opposite to the ideal of a Chinaman or of an African aborigine. Of course, these are extremes, and it may seem natural. But even to the same race, not the same objects or things register the same way. For instance, when it comes to colors, we find that color combinations which are beautiful and arouse one man or one woman, may not awaken the same impressions in another. The same is true of forms and lines, and practically everything you can think of. The Romans used to say there is no disputing about tastes. We might say in turn, that evidently there is no disputing about beauty, for the simple reason that no one seems to have any fixed ideas as to what it really is.

It is usually conceded that art, being æsthetic, should cover the whole range of beauty. This is the case, for instance, with paintings of all kinds, with sculptures, with pottery, and practically every object of art that you can think of. Most of these, in fact the majority, are linked with the word beauty. Yet, strangely enough, few people can agree upon a certain object as being more beautiful than another. Only when artists congregate, will there be any sort of an agreement, but even here, we have much discussion and much divergence. Furthermore, a thing that is beautiful today, may not be so tomorrow. This is well proven by the so-called Impressionistic school, who express their æsthetic feelings in the most unconventional manners. A painter will put a few smears of color on a canvas and call it "Nude Coming Downstairs." When the ordinary human being beholds this, it seems to him a confused maze of color, totally meaningless; whereas others, particularly artists, whose æsthetic sense is perhaps better developed, will wax rhapsodic in extolling the beauties of such a painting.

It is the same with music. What is beautiful music today, may not be beautiful music tomorrow, and when you at first listen to some strange concoction of some of our composers, we are, perhaps, not moved at all; it may take many years before you find anyone who will admit that such and such composition arouses his emotions at all.

Of course, all of this may only be the forerunner of something much greater in the future. It is, perhaps, a fact that as yet, our æsthetic sense has not been sufficiently developed, whereby it will be possible to investigate beauty by scientific means. Perhaps, in future generations, a new sense, or new senses will be developed, that will make it possible to put beauty on a basis where it will be an exact science. So far, we seem quite a distance away from that. One instance might be mentioned to explain what is meant.

A small number of people at this time can translate sounds into colors. To them, every note struck gives rise to a certain color. It would seem, that here is a blending of two senses, *i.e.*, sight and hearing. If it is carried still further, it may be possible, in the future, to hear a symphony, to see it, to smell it, to taste it, as well as to feel it physically. This may sound like an extravagant statement, but it is not. It is simply a matter of the development of the human race and a refinement of its senses, coupled with the emotional imagination; and as soon as all of them can be made to work harmoniously, then, perhaps, we shall be in a position to speak of the science of beauty which, today, does not exist.

WHY IS A

In the Accompanying Article the Various Factors
Details of Skyscrapers Are

By H. WINFIELD

tall buildings was in force, and the steel framework did not support the whole weight of the building, then it would be impossible, of course, to have the masons put stone or other masonry covering (not to mention the heavy fireproof floors) in place on ten, fifteen or twenty stories situated above the first few floors, which did not have any stone or other masonry work in place.

DO you know that it would be practically impossible to build 40- or 50-story skyscrapers, as the tall modern office buildings are called, if it were not for the fact that an enterprising engineer conceived the idea of placing a steel frame or skeleton inside the brick and stone structure? Without the steel skeleton the base walls of a skyscraper would be 30 to 40 feet thick.

In other words, each *window* or opening in the steel work measuring, say 12 feet by 20 feet, is, to all practical intents and purposes, a separate unit to be filled in with masonry and window frames where desired. This unit, when filled, so far as its weight is concerned, is carried by the steel beams and columns of the skyscraper skeleton.

MASONRY WALLS ALTERABLE AFTER COMPLETION

EACH *window* in the steel work is treated as a unit all the way through. At any



An unusual skyscraper photograph, the camera lens having been pointed skyward—showing the famous Woolworth Building on the right, and a new fifty story neighbor being erected next to it. This photo gives a good idea of the skyscraper's steel frame.

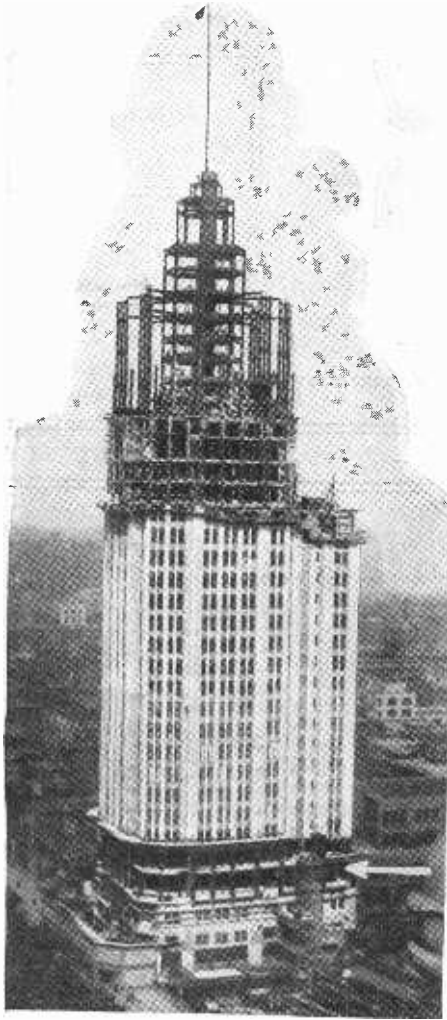

In this picture of the Tribune Tower during its construction in Chicago, one of the remarkable facts concerning skyscrapers is brought out vividly. The white arrow shows two lower floors on which the stone work has not been placed. With the old style masonry construction, where the walls support the weight above them, this would be impossible; here the steel frame supports all the weight.

SKYSCRAPERS mark one of the outstanding achievements of the present age of wonderful engineering and architectural development. The peculiar thing about these forty and fifty-story buildings that we find in such large cities as New York, Philadelphia, Chicago, not to mention many of the smaller cities, is that the average city dweller passes the building every day, perhaps, and never stops to think how these remarkable monuments to modern business and technical acumen have been made possible. Two generations ago city office or other buildings were limited to six stories or less, as no one would think of renting an office situated on a floor higher than six stories when there were no elevators and they had to walk upstairs to their place of business. A little later the first elevator was installed and this marked an epoch in tall building construction. Without our modern high-speed passenger elevators, the skyscraper would be useless. As soon as the elevators began to make their appearance, ten to twelve-story office buildings came into prominence in such cities as Chicago, where the first skyscrapers were built, as well as in New York and other cities.

THICK WALLS OF OLD TALL BUILDINGS

IT must be remembered that, thirty to forty years ago, when these buildings of six, eight and ten stories were erected, the use of steel or iron was practically unknown, and the upper floors were supported by the stone or brick masonry walls and columns.

As one of the accompanying pictures shows, a forty-story skyscraper erected by the old method, would be too ridiculous to even think about. To build a forty-story building would necessitate masonry walls about forty feet thick at the base, these huge walls being required to support the tremendous load of the floors above the street level. There are today some buildings to be found in many of our large cities, which show how the far thicker walls and consequent small windows, with poor lighting and ventilation arrangements were forced upon the architects of a generation or two ago.

In many examples of the older architecture as followed and required for buildings of ten to fourteen stories, huge columns occupied a goodly portion of the space on the lower floors, these columns, of course, becoming smaller as the upper floors were reached and the load became less. There was practically no basement space left by this older design before the age of steel construction, most all of the space being occupied by huge columns and foundation piers. As one of the accompanying diagrams shows graphically, the vast improvement in tall building construction has been brought about by the marvelous characteristics of steel as compared to stone, brick and cement. Using the old masonry wall construction to support the building load, each square inch could support only about two hundred pounds. Today the steel columns in a modern skyscraper support 18,000 pounds per square inch, or ninety times the old working pressure.

STEEL FRAME CARRIES THE WEIGHT

THE writer had a very interesting talk recently with one of the foremost architects and designers of skyscrapers in America, Mr. Harvey Wiley Corbett. From the windows of Mr. Corbett's office, situated in a breezy position atop the Bush Terminal Building in New York City, we could look at skyscrapers both completed and uncompleted, as they lay spread out on the scene.

One of the most interesting things that Mr. Corbett had to say was that the average person has a false conception of the skyscraper, when they think that the weight of the upper floors is carried, at least to quite a large extent, by the stone or masonry walls. Mr. Corbett drew a very interesting analogy at this point and stated that a skyscraper could be compared to the human body. "Did you ever stop to think," he said, "that it is not the muscles or flesh covering of the body which supports it; instead it is the bony structure." The writer said that he had never stopped to think about that particularly, but on second thought it brought out vividly the basic law regarding skyscrapers and how they carry the tremendous load of forty or fifty stories of cement and steel very beautifully.

In other words, the skyscraper is like the human body—the steel frame you see being rushed up so rapidly by the iron-workers, accompanied by the rat-tat-tat of the pneumatic riveting hammers, is to be eventually the hidden skeleton which supports the whole weight of the skyscraper. Remarkable as it may seem, the stone, brick or other masonry covering, which fills in the steel frame, does not support the weight of the great towering structure. One of the accompanying photographs will prove this to your satisfaction if you happen to be a "doubting Thomas." As this photograph shows, it frequently happens that the masonry work may be put in place on the upper stories, before it is erected on the lower floors. If the old method of constructing

SKYSCRAPER?

Regarding the Desirability as Well as the Constructional Explained in Everyday Terms

SECOR, E.E.

time one of these sections of stone or brick work can be removed without in any way endangering the building, or causing a collapse or sudden strain in the general building structure. This could not be done, of course, with the old method of construction before the era of steel. Changes in the walls of the building could be effected to a certain extent with the old style building

IF it were not for the modern high-speed passenger elevators, the skyscraper would be out of the question. For years the limit of office buildings was six floors—people would walk up no further than this. Did you know that the steel frame of a skyscraper carries the whole weight of the building, and that the masonry work is merely a filling or “dress” for the steel frame?

methods, by suitably shoring up the wall with a mass of heavy timbers, but operations of this kind were seldom carried on and only in a limited way. As Mr. Corbett pointed out, so long as the steel work is left intact and not interfered with, you can tear out as much masonry work as you care to, and on any floors desired. It seems almost impossible to a layman, perhaps, that the stone wall “filling” or “curtain” surround-

ing the first floors of the building, like the Woolworth Building, for example, could be torn away for the sake of a change in design or the addition of larger windows, with forty stories of stone, cement and brick above it, supported only by the relatively thin steel columns, which you would see exposed when the stone work was removed.

EXPANSION AND CONTRACTION CARED FOR

THERE are several very interesting aspects of the modern skyscraper design with regard to the outer (curtain) wall covering which the layman probably never thinks about. One of these factors is that with a large wall, such as that on the inside of a modern tall office building, there is a large amount of contraction and expansion due to temperature changes. In small buildings this expansion and contraction, continually taking place in summer and winter, is absorbed and distributed easily, owing to the small size of the walls.

Contraction and expansion in the outer masonry walls of the skyscraper is taken care of in two ways, as Mr. Corbett pointed out in a recent interview with the writer. In the first place, the brick or stone wall is divided up into a large number of sections, by virtue of the steel skeleton construction, each section measuring not far from 12 feet high by 20 feet long; and secondly, special flexible cement is used at each floor line, where the floor support girders join the upright steel columns. One of the accompanying sketches shows this feature and also how water-proofing, such as tar paper and tar, is used around the steel girders to prevent water reaching the steel work, becoming pocketed there and eventually weakening the steel frame. Although the casual passerby would probably never notice it,



Beautiful appearance of flood lighted modern design of skyscraper. This building was designed for the Pennsylvania Power and Light company, and was recently completed in Allentown, Penn. The architects were Helmie, Corbett and Harrison.

there is always more or less pointing up or filling in with cement required on skyscraper brick and stone work, caused primarily in most cases by the strains of contraction and expansion which result in cracks between sections of the wall.

FOUNDATIONS

PEOPLE who have stood and looked at a skyscraper for a time have frequently been puzzled as to how a sufficiently strong and permanent foundation for such a tremendous mass of steel and concrete could ever have been built. Some idea of the weight of a skyscraper, such as the Woolworth Building, will be obtained when it is considered that this magnificent structure of

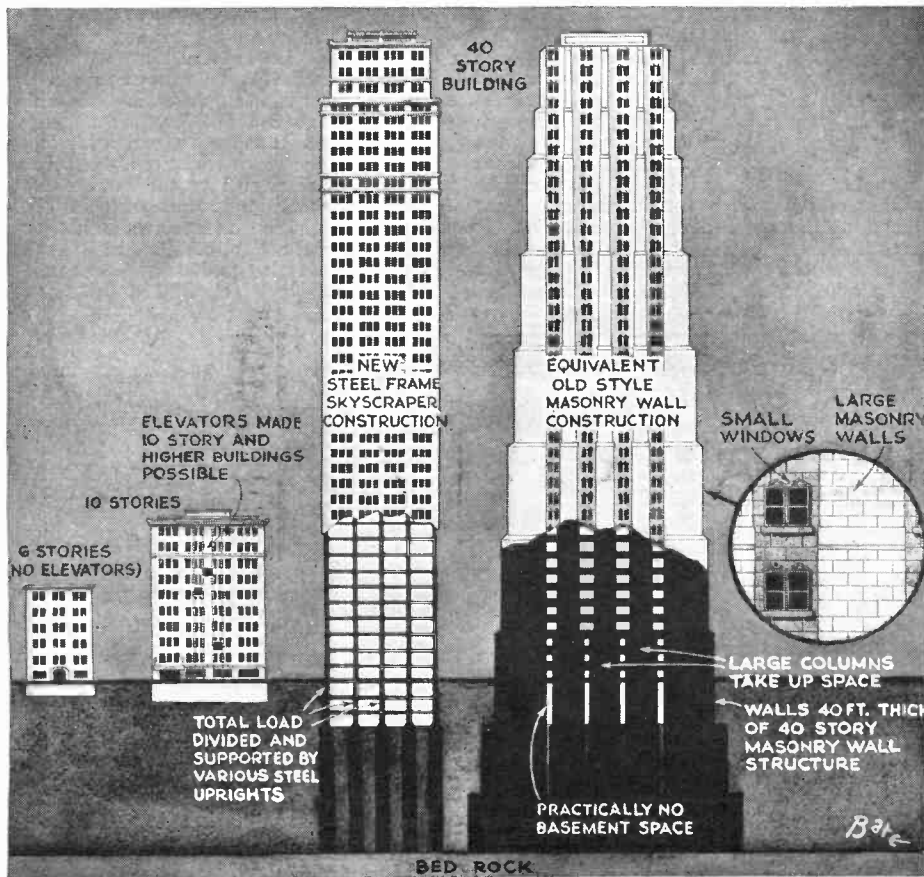

The illustration at the left shows vividly and graphically the evolution of the modern skyscraper from the six story elevator-less office building of forty years ago, to the modern steel frame, forty or more story structure of today. Note that if a forty story skyscraper had to be built with masonry walls, without the steel supporting frame that the walls, particularly at the base, would have to be so thick that the construction would be impracticable. There would be practically no basement space, the windows would be very small, and the huge masonry supporting columns on all the lower floors would occupy most of the floor space.

stone, concrete and steel weighs 100,000 tons, or 200,000,000 pounds; if you are familiar with ocean steamships to some extent, and are used to employing a ship like the *Leviathan* as your mental yardstick, it is interesting to remember that the weight of the Woolworth Building is equivalent to nearly twice the total displacement of a ship the size of the *Leviathan*, whose displacement is approximately 60,000 tons.

When the first tall buildings of ten to fourteen stories were built, the foundations represented one of the weakest points. In a great many cases the architects designed the buildings with the idea and provision in (Continued on page 348)

THE RIDDLE

Did the Earth's Capture of the Moon By HANNS



(Opinion of well-known Astronomical Authority)
HARVARD COLLEGE OBSERVATORY
CAMBRIDGE, MASSACHUSETTS

Dear Mr. Secor:

The article on Atlantis, by Hanns Fischer, which you sent me a few days ago, has interested me very much. The story of this lost continent, the sunken bridge between Europe, Africa, on the one hand and the American continent on the other, is one of the most fascinating subjects, upon which history, science, and imagination unite. Its study has occupied the minds of scientists, historians and linguists alike for centuries past, and will doubtless continue to do so for many centuries to come, particularly since such study will enable us to push back further the origin of man's civilization on earth.

Mr. Fischer has approached the subject in a novel way, and has proposed a theory which appeals to the imagination. As an astronomer, however, I am afraid that I cannot agree with him in some rather essential details.

For one thing, I do not think that astronomers in general are bold enough to try to guarantee perpetuity for the conditions at present existing on the earth, though some may have done so in the past.

Also, I take issue with him on the question of the origin of

The people of Atlantis were surprised by a huge tidal wave accompanied by earthquakes and electric storms, it is believed by the author of the present logical narrative.

their researches. Today we hardly credit the idea that Plato was romancing in his story.

ARGUMENT FOR LOST CONTINENT PLAUSIBLE

NOW if we can accept Plato's description as a depiction of facts, then we hear that once the highly cultivated and powerful inhabitants of Atlantis carried on strong attacks to the east in the Mediterranean Sea. If we believe in the truth of this narration, then it seems no longer wonderful when among one hundred similar words in American Indian language, the word "malko" means the prince; in Arabic "malka" has the same meaning, and in Hebrew "melek" means the king. We are no longer astonished if we can establish between middle American languages and the ancient Greek the closest relations, or if we find well-known myths from Grecian history repeated in American traditions. It seems to us that, with regard to the attacks of the Atlantis armies upon the Mediterranean coasts, and in the intercourse with the new world, these are almost to be taken for granted, that the famous step pyramid at Sakkara in Egypt, considered the most an-

SIX hundred years before Christ, Egyptian priests at Sais told the philosopher Solon that once upon a time, according to ancient traditions of the land of the Nile, beyond the pillars of Hercules, that is beyond the straits of Gibraltar, a great island kingdom, Atlantis lay; it not only had a large populace, but was also rich in gold, fruit trees and harvests, and was very highly cultivated, but was so extended that one could get at it readily from the nearest points of the European continent.

THE STORY OF ATLANTIS

ASTONISHING as it may seem, the old Egyptians seem to have known that on the other side of the straits of Gibraltar far to the west, there existed a continent that was known to the old ancient people long before it was discovered by Columbus; for-

merly, it was easy to reach because this island of Atlantis lay between Europe, Africa and America, and it was one of the greatest riddles of earthly history, and in an unhappy day and a frightful night, as these priests tell us, nine thousand years before the birth of Christ, it sank into the sea. This was the end of the Atlantis so rich in traditions; it became a troublesome question, that for centuries was investigated in vain for an answer by geologists and biologists, by sea navigators, ethnographers, geographers, antiquaries and astronomers. A few years ago the question came up whether the picturing of Atlantis in the works of Plato was a fable or actual history. Many have left the question to such authorities as illustrious linguists, who claim that there was no doubt that it was only a poetical invention, but others have gone further in

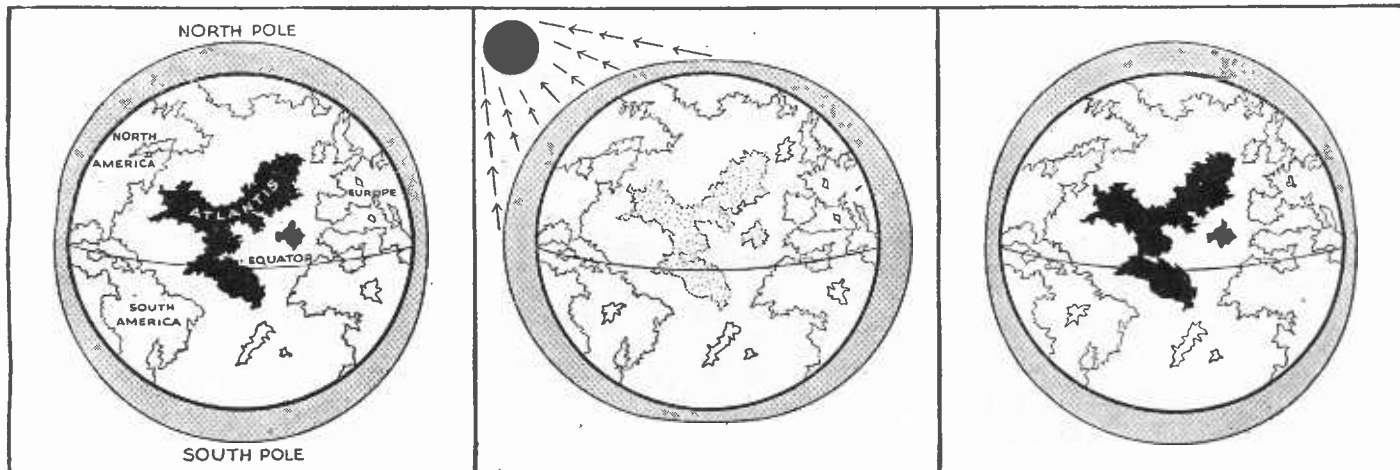

The picture above shows how Atlantis appeared before the earth captured the moon; the ocean water was shallow at the equator.

Here we see how Atlantis was covered by the ocean waters due to the moon's gravitational pull. The earth is here pictured with the moon (present condition).

The future—many scientists believe that when the earth loses the moon, the land comprising the lost continent of Atlantis will reappear.

OF ATLANTIS

Destroy Atlantis—the Lost Continent?

FISCHER

the moon, and its subsequent or rather ultimate return to the earth. The present day theory of the origin of the planetary system, the theory of dynamic encounter, made the earth come out of the sun, and, while the earth was still in a somewhat liquid state, made the moon come out of the earth as a result of the disruptive effect of the sun's tidal force. The moon originally revolved around the earth in a shorter time than it does now, and while it was wandering outward, along a spiral so to speak, and while it too, was still syrupy in consistency; the tremendous attraction of the earth raised huge tides on the moon, which ultimately succeeded in making the moon rotate on its axis in the same time that it revolves around the earth. Mr. Fischer, by his theory would have considerable difficulty explaining that on the capture theory. Finally, though it is not impossible that the earth may have had other moons in the past, it appears entirely impossible, from our present day knowledge of such processes, that an adjustment necessary for Mr. Fischer's theory should have completed itself in such an astronomical instant as 13,000 years. On the other hand, some astronomers now hold the view that the earth will slow down, due to the sun's disturbing tide, and this slowing down of the earth's rotation may eventually break up the moon, which will thus ultimately return to mother earth.

(Signed) W. J. LUYTEN.



cient building in the world, has its companion pieces in the ancient Mexican step pyramids. Also the discoveries of Frobenius on the African gold coast in Jorubaland in the neighborhood of the mouth of the Niger lose their mystery if we admit the former existence of Atlantis and keep before our eyes the connection of Atlantis with the west coast of Africa. Frobenius found here the bronze head of the God of the Sea, Neptune, the God, who, according to tradition, was the first governor of Atlantis. The same investigator could form similarities between the topography of the region of the lower Niger mentioned above, and the resemblances to each other, of the former inhabitants of Italy, the Etruscans, and of the Pueblo Indians in America, people who today are separated by thousands of years, by stretches of land, and by the ocean. Dr. Noetling shows that the pyramid of Cheops expresses in stone a reduced picture of the distance of the sun from the earth (the height of the pyramid), and the path of the earth around the sun (the ground circuit of the pyramid) in the proportion of one to one thousand millions, undoubtedly therefore representing the result of prehistoric ancient astronomy, whose development came a thousand years

One of the best maps showing how the islands comprising Atlantis are considered to have bridged the gap between Africa and the Americas. From—"The Problem of Atlantis" by Lewis Spence.

later. It appears also as self-understood why Paul Porchardt in North Africa found again the Atlantis name left us by Plato as the remains of the peaceful or warlike travels of the inhabitants of Atlantis. Also a further secret is explained: that of the Egyptians, whose culture seems without any root, who then without any development would have jumped into an astonishing development, out of primitive culture, which if an Atlantis colony existed would cease to be a mystery.

All this is in accord with Plato's story. Even the fantastic figure that Plato gives for the sudden sinking of Atlantis must part with its apparent incredibility. From calculations of the age of the wonderful culture on Crete investigations go back from ten or twelve thousand years. And Crete just as Jorubaland, as Egypt and Assyria, as the

northwest coast of Europe, were colonized by Atlantis. Also in the land of the Nile, investigations of the relics of ancient culture, which the Nile has given to us, indicate an age of at least twelve thousand years.

COINCIDENCE OF IMPORTANT DATES

Now let us take examples which can be grasped for a reliable estimation of the length of the period in question. If we compare for instance, a calendar of ancient inhabitants of the Euphrates and Tigris regions, and of the Egyptians, we find the Egyptian solar year and the Assyrian lunar year coincide, and if we go further back we find it surprisingly well established, that the two of them in the year eleven thousand, five hundred and forty-two B. C., came in accordance so that probably both had their

(Continued on page 375)



This profile of the Atlantic Ocean gives some idea of how, when the waters were more shallow before the earth had a moon, the fabled land of Atlantis could have readily been formed from the elevations observed rising from the ocean bed, above the present sea level, in some instances.

The shadowy outline of the larger peak in the background at the right, shows how the Azores are formed. If the waters should subside again, Atlantis would be exposed to view. Explorers may find evidence of the lost race before that time however.

Electricity from the Sun

"Light Energy Converters" Generate Electrical Energy

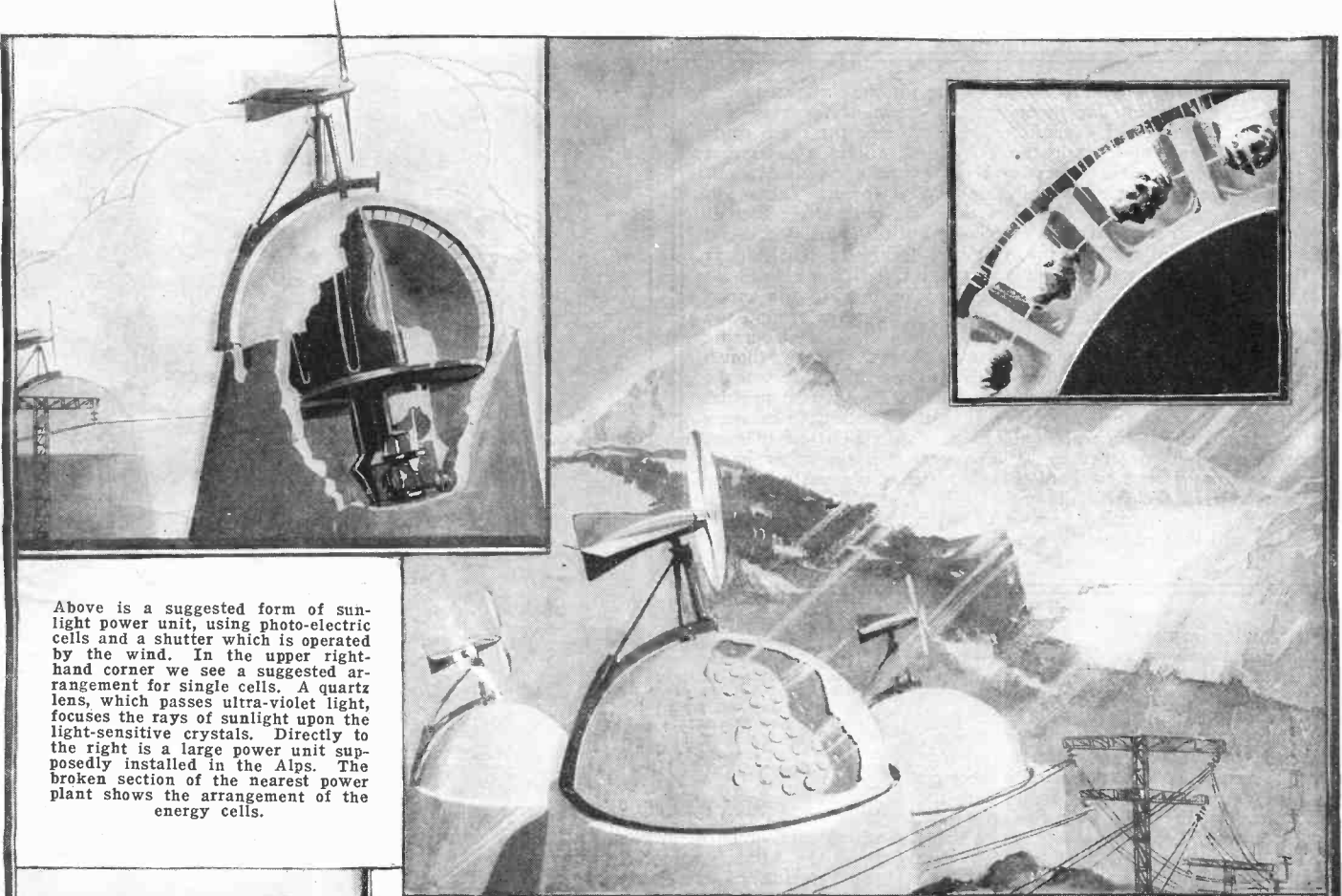

Above is a suggested form of sun-light power unit, using photo-electric cells and a shutter which is operated by the wind. In the upper right-hand corner we see a suggested arrangement for single cells. A quartz lens, which passes ultra-violet light, focuses the rays of sunlight upon the light-sensitive crystals. Directly to the right is a large power unit supposedly installed in the Alps. The broken section of the nearest power plant shows the arrangement of the energy cells.

Below we see how the light-sensitive cells may be used in the transit of the future. Each car or similar vehicle and airplane has its own generating station, as shown by the cutaway portion of airplane and train.

The central power station of the world could be established in the vicinity of the equator and change the energy immediately into high potential. The sunlight received is being constantly broken up by a shutter driven by wind power, thus producing an alternating current.

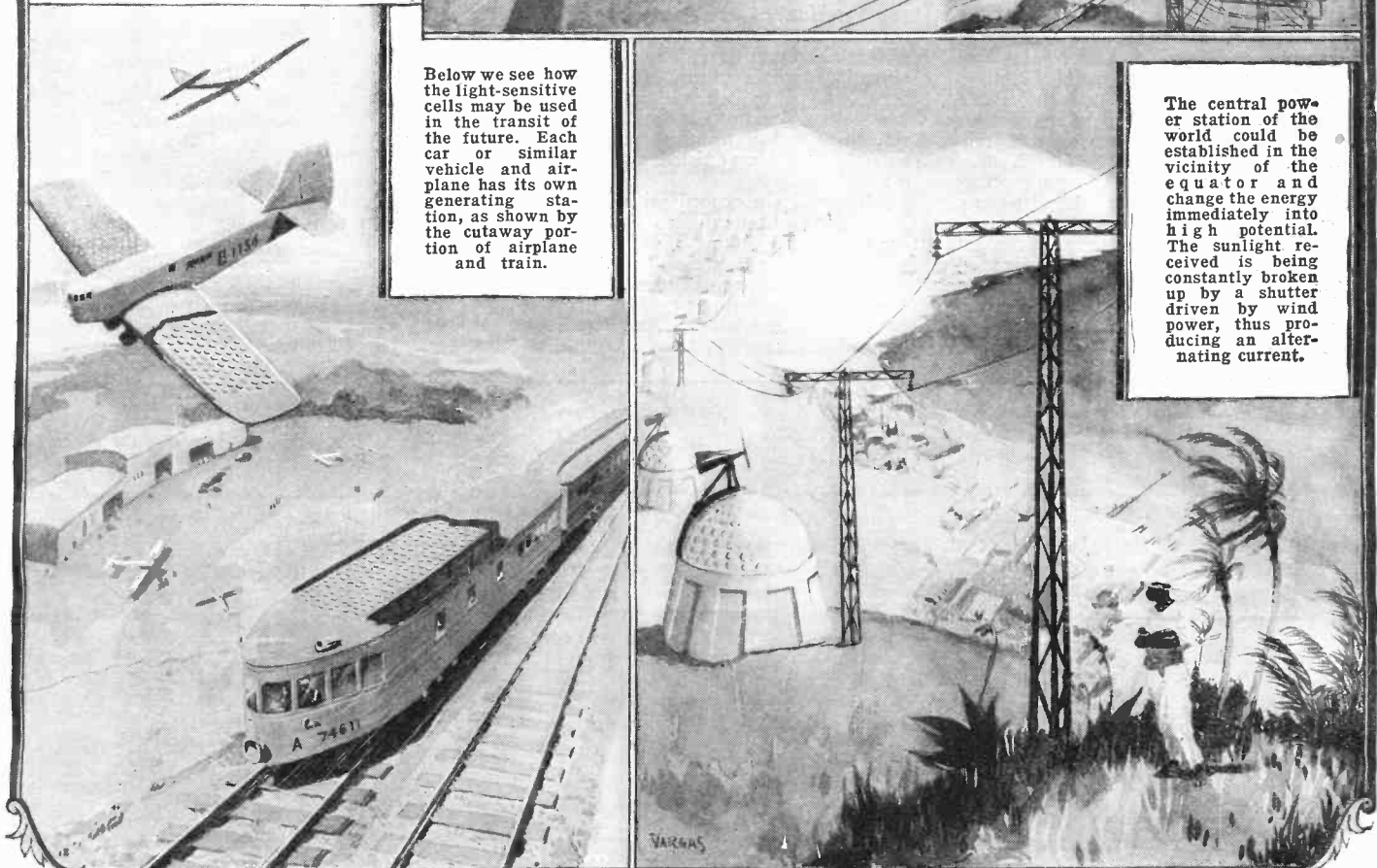

Suggestions for a sunlight-power generating system of the future are given in the above illustration, through the courtesy of *Die Woche*

ALL-METAL DIRIGIBLES

Metallic Ship Guided by Steering Fins

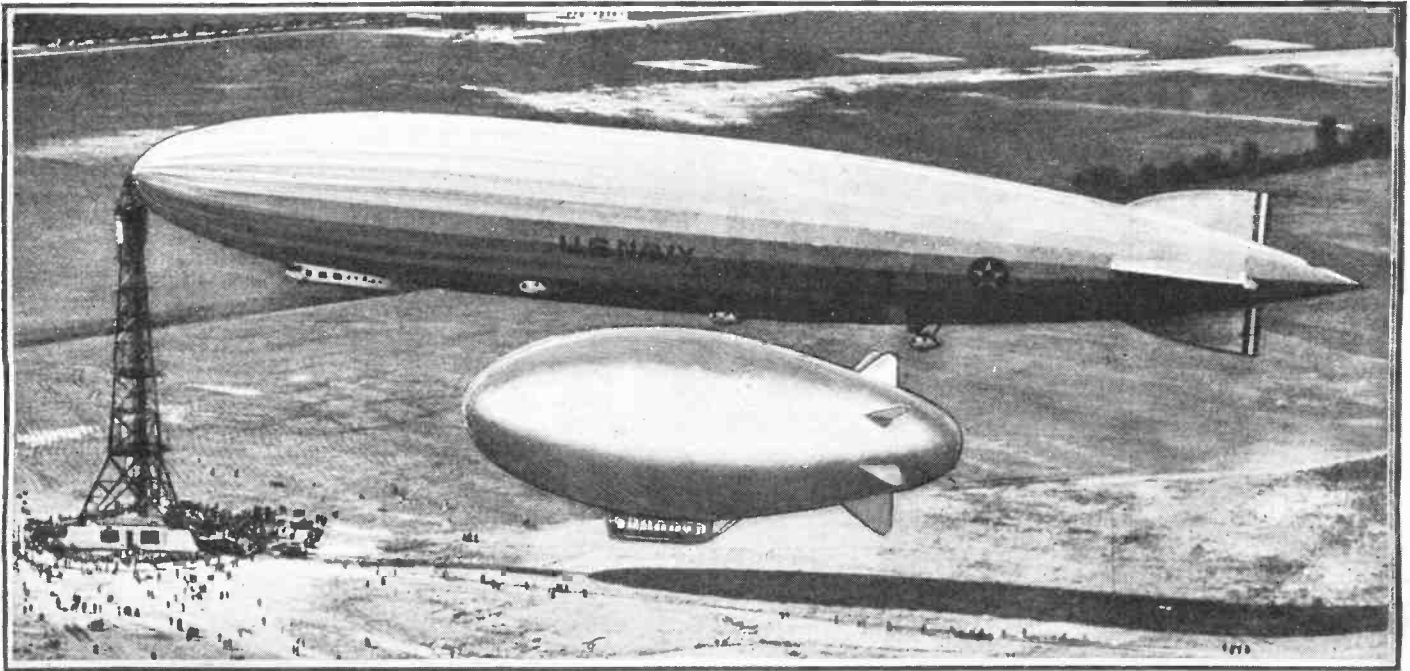

Above is a view of the U. S. Navy's huge dirigible "Los Angeles," tied up to the mooring mast, at the Ford Airport in Detroit.

A designer's visualization of the new all-metal airship has been superimposed below the "Los Angeles." The new ship is known as the MC-2.

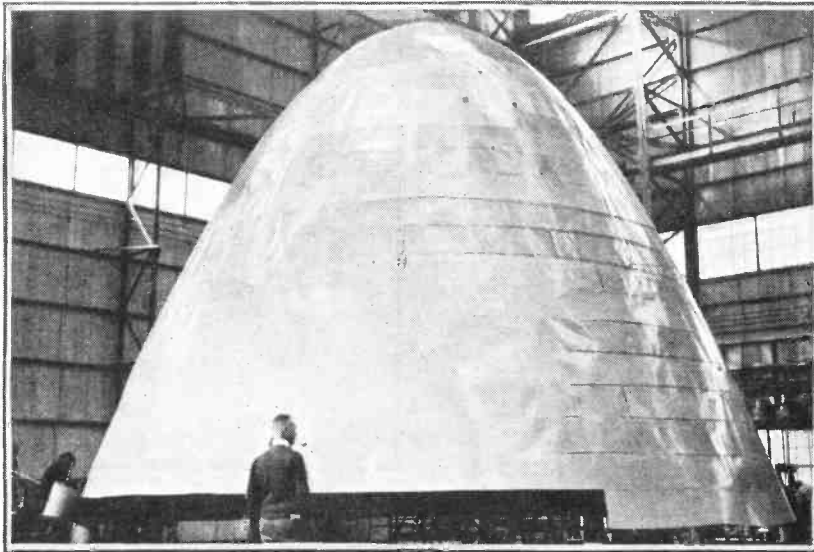

The above photo shows how the stern of the metal aircraft is fashioned out of light-weight metal ribbons, which are riveted together by a special process recently developed.

THE U. S. Navy is now building an all-metal dirigible, which will make it a pioneer of this type of craft and will open the way to the construction of huge air liners which might well exceed the size of the present-day Los Angeles, which is 656 ft. long. The new craft, which is known as the MC-2, will be 150 ft. long when completed and 50 ft. in diameter. Two 200-horsepower motors will furnish the motive power and give a speed of 70 miles per hour. In comparison with the fabric dirigibles of a similar class, the new metal ones are expected to have twice the stability and four times the durability, because they will have about half the air resistance and only about 5 per cent of the gas leakage of a blimp ship. The development of duralumin, an alloy of aluminum and copper, which is almost as strong as steel, has made the build-

ing of this type of aircraft possible. This same metal is used in all metal airplanes because of its lightness, uniformity of strength, and its high resistance to rust and corrosion of any kind. The gas cells will have a total capacity of 200,000 cu. ft. of gas and will give a total lift of 12,000 pounds. The design of the ship itself is the result of more than seven years of study, from the time of the Zeppelin to the present-day aircraft. The first step in the construction was to devise a method of building the ship in sections and then assembling them as they were completed. This method enabled the mechanics to fit every piece of frame into place while standing on the floor of the hangar and with the greatest ease. To build the metal "skin," the engineers in charge spent considerable time and money in

fashioning a riveting machine mounted on circular tracks, so that it could be wheeled around the sections of the airship while they were being built. This riveter carries a reel of duraluminum .008-inch in thickness, which is gradually unrolled and, at the same time, is riveted to the "skin," which has been previously attached to the frame. It is estimated that this machine will accomplish the work of more than forty men a day. The metal ship of the air will not be affected by weather changes and will last at least ten years.—Photos courtesy New York Sunday American.

HOME MOVIES!
A New Monthly Department
Don't Miss It!
See Page 320

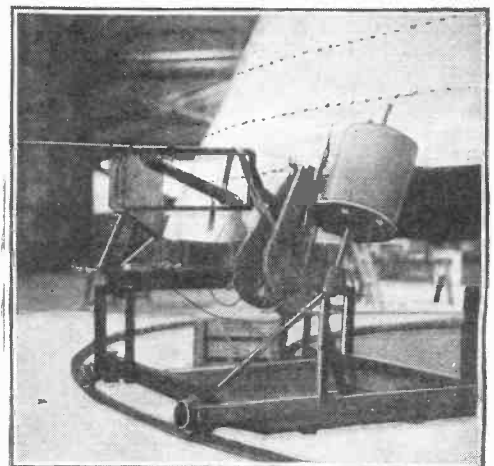

Above is a view of the special riveting machine which is being used in the construction of the MC-2. It cost \$30,000.00 to perfect and build this device.

DO ANIMALS

Are Snakes Useful? Could Monkeys be Trained as Servants? Can Horned Toad Live in Sealed Rock?



At the left we have a picture of a very intelligent chimpanzee, who is seen smoking a cigarette. This is one of the most humanlike of the animal family.

THIS talk may possibly be rated as a bit unkind—because the intention is to undermine and explode a series of pet theories regarding animals. This shattering of unnatural history, however, forms a clearing in the mind, in which to build a simple, practical knowledge of actual *natural* history.

Interest in animal life in this country is increasing. There is a developing, humane and sympathetic interest that is clearly indicated by the increasing mail received at the Zoological Park. It is the character of this correspondence that prompts the talk this evening—for we have to answer every kind of a query, from elephants being afraid of mice, through the mazes of hoop snake myths, to toads producing warts. Some day, I think, we will prepare a book citing the character of a generous part of our correspondence and illustrating the immense amount of unnatural history that exists in the minds of good Americans.

But in the meantime, let us consider a few of these superstitions:

DID YOU EVER SEE A HOOP SNAKE?

THE first to be cited is that of the hoop snake, alleged to take its tail in its mouth and roll downhill—or *propel* itself along a road. There is no serpent in the world that in its habits even indicates a basis for the story. When alarmed or excited, some snakes may thrash around, and it is quite possible that they might accidentally grasp their tail in their mouth, but never with an idea of rolling away to safer regions. Nor has any snake in the world a sting in the tail. When correspondents have become insistent about the hoop snake and the power to sting with its tail, we have offered to pay a thousand dollars for even a young specimen that would perform. Twenty-five years of repetition of this offer have produced no hoop snakes. In a similar fashion we dispose of the enthusiastic correspondent

The kangaroo is one of the most peculiar animals and it comes of a very hardy type, which breeds in captivity, according to Mr. Ditmars, the author of the present article.

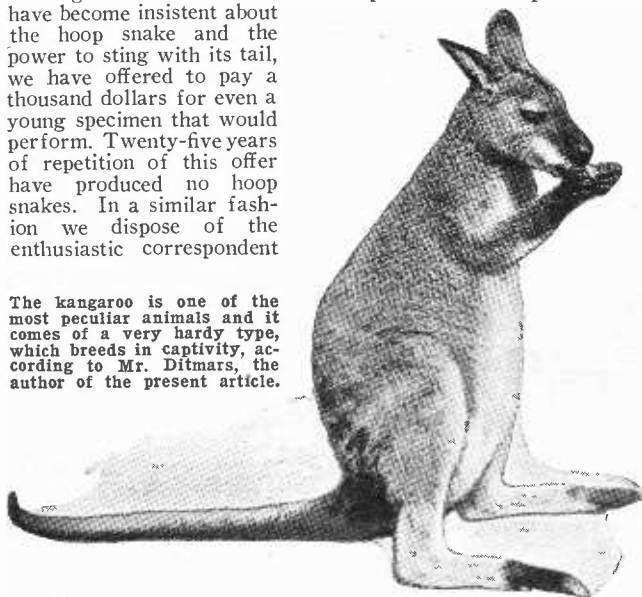

who insists he has records of 75-foot boa constrictors in the tropics. But in this instance the prize being of alleged noble size, we are willing to increase the offer—even offering a thousand dollars for a dried, rolled skin.

WELL! WELL! MEET THE MILK SNAKE?

NEXT in order of the snake myths, is that of the *milk snake*. Many farmers firmly believe there is a specific kind of snake that lurks around the barns and steals milk from the cows by actually milking the stock. Some blame the black snake for this pernicious habit. The allegation is that the cows are so robbed of milk there is a considerable loss to the farmer—hence the milk stealing snake is a distinct enemy.

Now to put a little truthful dynamite under the milk snake myth:—There is no doubt that certain snakes may warrant suspicion by their persistent lurking around barns and dairies. A knowledge of their habits, however, immediately explains their presence there. They are rodent-destroying species and gather near human habitations owing to the abundance of rats and mice around the farms. Thus they are friendly, or economic types. As to their stealing milk from the cows, let us clear up this foolish supposition with a few words of anatomical detail. A fair-sized serpent, if it were to crave milk, would be limited to contain not more than half a pint of fluid within its stomach. As serpents feed, it would not repeat the meal before a week. An amount like this would produce no effect upon even a scrawny cow. So you see, our milk snake is anatomically incapable of causing serious loss to the farmers.

HORSE HAIRS CHANGING INTO SNAKES

ANOTHER query we receive is about horse hairs falling into a well and turning into snakes. This is explained by a singularly slender aquatic worm, technically known as *Gordius*, quite active, sometimes over a foot long and appearing like an animated horse hair.

A common query is about rattlesnakes committing suicide when cornered. There is a story to the effect that if a horse-hair lariat is thrown in a circle and a rattler placed inside that it will not cross the rope, but, striking its fangs deeply into its body, quickly dies from the deadly venom. All venomous serpents are immune to

their respective poisons. In the excitement of capture they often strike this way and that, and wound themselves with the poisonous fangs, but there is no bad effect from such injuries.

I have tried the horse-hair lariat experiment a number of times and have seen rattlers calmly crawl over the rope—in fact have not noted that they even hesitated. This also eliminates the myth about the sleeping cowboy on the plains, seeking protection from prowling rattlers by sleeping within a large ring of his lariat.

THINGS MOTHER SNAKES DON'T DO

WE still have a few pet theories about snakes. One is that the mother serpent, accompanied by her litter of young, will “call” them and quickly swallow the litter when threatened with danger. I have

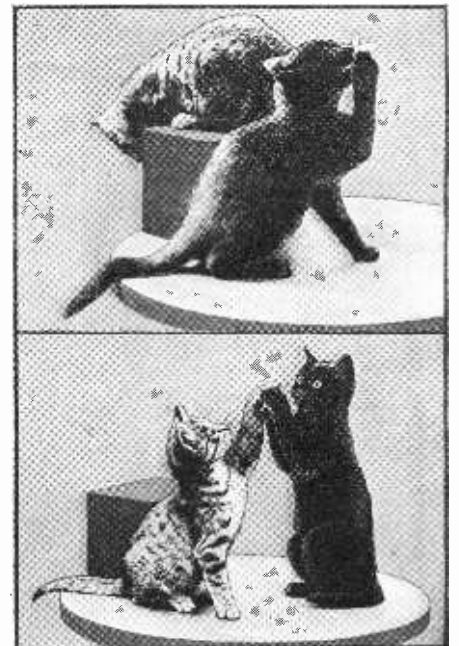

The household cat often shows very intelligent actions and reactions. Here we see two interesting pictures of cats playing with and capturing a butterfly.

not an atom of belief in this persistently alleged habit. In the first place the young serpents do not “accompany” the mother. They are fully provided to look out for themselves and immediately scatter into the world, each for itself. It happens sometimes that the mother serpent, lured from the rocks by a genial sun, may be incidentally surrounded by some of her offspring which have remained near the sheltering crevices. During many years of reconnoitering in wild places I have seen such serpent families, but as the observer approaches, in every instance I have ever noted, there is a general gliding of each member of the group for respective shelter—every reptile for itself, which is certainly the quickest way. If the mother were to hesitate and “call” her brood, the time consumed in getting a parade of snakelets down her throat would be fatal. Incidentally, snakes do not “call.” They

THINK?

Subject of a lecture given at WRNY in their "Home Science University" series.

BY RAYMOND L. DITMARS

Curator of Department of Mammals and Reptiles, at New York Zoological Park

have no power of hearing, as ordinary sounds go. I have never noted affection among parent serpents, either wild or in captivity, and am quite convinced that if young serpents ever reached the parent's stomach they

Here is an excellent picture of the famous horned toad (which is a lizard and not a toad, however), that was presumed to have been buried for thirty-one years in the cornerstone of a Texas courthouse. Read what Mr. Ditmars thinks of this stunt.

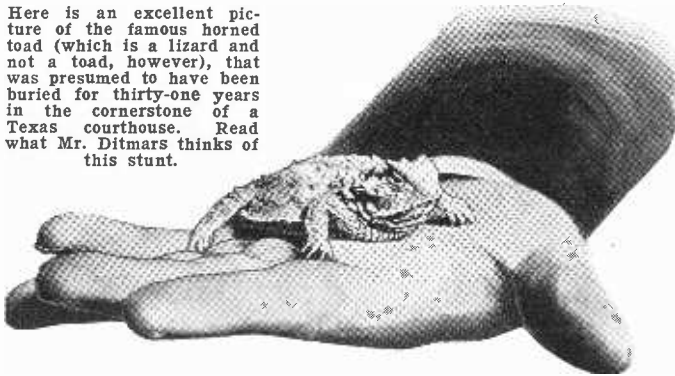

would be immediately smothered in the powerful gastric juices.

DO SERPENTS CHARM BIRDS?

EQUALLY fallacious is the idea that a serpent charms a bird. Observations of an apparently benumbed bird near a serpent relate merely to a keenly alert, parent bird luring a snake from the nest. Many of us have noted an apparently wounded bird in the grass, dragging a wing, keeping a short distance ahead. Try to pick her up and observe how alert and quick she is, but she has accomplished her object in trailing you away from a litter of helpless young—as she does the snake.

Another supposition is to the effect that if a snake is killed the mate will soon appear—and if it is poisonous, will seek vengeance upon the slayer. It seems a shame to explode this romantic theory and also to shatter the strength of a perfectly good poem which we hear recited nowadays, concerning the dreaded Dukite snake. The truth of the matter is that snakes do not travel in pairs, and where one is killed there is every indication that the victim has selected good ground to prowl for food and other serpents may have scented prey and are covering the same ground.

CONCERNING WARTS FROM TOADS

A VERY common belief is that toads, if handled, will produce warts. This is a myth. While there is an irritating poison in the skin of the toad which produces a burning pain in cuts and an inflammation that may last a few hours, no warts ever result from handling toads. This story probably originated in the warty appearance of the toad's skin.

ELEPHANT TALES

AND now for a few fallacies regarding the larger animals. There is the old-time story about the elephant's fear of a mouse. I have never noted any indication of this, but have, on the contrary seen mice and rats running through the hay in the elephant paddocks and the big animals paying no attention to them. I remember one illustration relating to a whole herd of elephants, when I was spending one vacation

traveling with a circus. A storm had damaged the animal tent and the whole troop of elephants—fifteen of them—was led across the fields to a big cattle shed and hastily staked in the usual row. They were uneasy, away from the canvas and the cars, so four of us, with equally spaced lanterns sat up with them all night to keep them company—and there were rats in that barn, lured out by the seeds in our sweet, fresh hay. So far as I could see, the human members of the group were the only ones that took exception to the rats—for we literally kicked them away from us.

THE HYDROPHOBIA SKUNK

FROM Arizona we have stories of a so-called hydrophobia skunk. The allegation is that if one of these animals bites you, rabies will positively result. This strange allegation cannot positively be de-



Bears are always interesting—here is "Ranjah," one of the trained bears owned by Mr. E. Pallenberg of California, riding on his hobby horse.

DON'T FAIL TO TURN THE PAGE AND READ THE OPINIONS OF EMINENT EXPERTS ON THE QUESTION DO ANIMALS THINK?



An interesting little animal—the Koala—formerly supposed to be very delicate in captivity, but which lives quite well as a captive, now that it is more thoroughly understood.

nied. The condition appears highly improbable, yet only recently the speaker talked with several men, one of them a bacteriologist, who declared it possible that several species of small mammals might harbor the organisms of the dreaded disease, yet themselves be immune to it. It is of course well known that the so-called virus (probably specific germs) of hydrophobia produce a deadly effect with most animals and that wounds produced by the teeth of such animals when developing the malady, pass the disease along to others. However, we should remember that the organism producing sleeping lives harmlessly in the blood of the crocodile.

ANENT SINGING MICE

THERE is a query that we get by phone sometimes that sounds weird and creepy. This relates to singing mice. I put the question just as we receive it: Can a mouse sing? Many claim they have heard them, set a trap, caught the mouse, and it sang while in the trap! Here is a myth that isn't a myth. A mouse cannot sing voluntarily, but certain mice become afflicted with a curious bronchial trouble that appears to become chronic, yet not serious enough to weaken the animal. The trouble in a way is similar to asthma, as it occurs at times—and during these periods the mouse wheezes, whistles, even appears to trill in a way that is quite musical.

TRUE ANIMAL STORIES STRANGER THAN FICTION

IF we go deeply into the records of remote places we will find many things that are far stranger than these myths about wild creatures. For instance—there is a Flying Snake in Java that makes long, floating journeys from tree to tree. In South America there is a beetle with lobes on the sides giving off a light so bright that one can read fine print in a dark room with a specimen held several feet away. Africa has a

(Continued on page 377)

Do Animals Think?

The Opinion of Authorities on This Subject

SCIENCE AND INVENTION, in an effort to get first-hand information and in this way obtain a consensus of opinion as to whether animals do or do not think, sent out hundreds of letters to various authorities. The questions asked are to be found in the box in the center of the page.

Some of the answers appear on this page. The editor will be glad to hear from readers, the question being still open for discussion both pro and con. Any of the readers who have carried on work along these lines, and who care to answer the questionnaire, may send the replies in to the editor. The answers below are numbered to correspond with the questions found in the center box copy.

FROM A SCIENTIST WHO TESTED ANIMALS

THE answer from Prof. O. G. Harne, Associate Professor of Pharmacology, University of Maryland Medical School, Baltimore, Md., reads as follows:

1. The term "animal" I construe to mean "Anything less than human." Ans. I do not think so.

3. It takes too long to teach animals complicated procedures. Until these movements become automatic with them they are very uncertain as to completion of an act.

Emergencies show only the responses of self-preservation, and its complexes.

4. (a) It is a result of repetition. Reflex. Automatic. I have tried the experiment in a different way. I have made noises that sound similar and had response. Also the reverse.

(b) Again it is a case of training. An incident may be connected with each sound.

(c) It had probably used both as protection many times before. It automatically responded to what experience taught was good in these emergencies.

5. No. There is something else which Nature has done. They have the power to react in emergencies in a most perfect way without any mentally conscious effort of the organized type. No premeditation.

6. When we sometimes contrive to outdo animals, and then scarcely succeed, we would be led to believe they reason, but I cannot credit them with even reason.

8. I have seen animals make no attempt to survive under quite similar conditions.

9. I have conducted many different types of animal experiments. None of the orthodox definitions for "thought," "reason," and

"intelligence" answer for that natural endowment which Nature has fortified her so-called "dumb animals" with.

Remarks: I had started out to try to settle this question once, but it became very involved. The methods for determining certain unknowns in animals are very poor and very expensive. I have never been able to quite make myself believe that the proper word has been coined which represents the actual cerebral physiology of animals.

In contrast to Prof. Harne's conclusions, we have the following observations:

(b) The dog thinks and also reasons from cause to effect, as do also the apes and the elephant.

(c) Rather difficult to explain. It is not instinct. It is an attempt to keep out of the way through the use of a protection (the fence).

5. Instinct is inherited experience memories. It is inherited knowledge.

6. Do not see how an animal can reason without thinking. Reason presupposes thinking and thinking presupposes memory, and memory presupposes recognized impressions

and the recalling of the impressions.

8. I am sure the animal would fare ill, and would have little chance to survive for any length of time. The senses named are the mainstay or main guide to the so-called lower animals.

9. Dogs, cats, white rats. Dogs certainly reason. Cats occasionally show evidence of reasoning. I am in doubts about the rat.

Remarks: I was much interested in an illustrated (cinema) lecture by Dr. Hermann Wolfgang, of the University of Berlin some five years ago, which showed so clearly the thinking and reasoning ability of the anthropoid apes (Chimpanzee), which, after all, is not unlike that of the lower human groups. I somehow feel that it is a waste of time to attempt to prove that many animals think and reason, for think and reason they certainly do, even though such thinking and reasoning may not be like that of a college professor or a clown. Furthermore, the ape, the dog, and also the elephant, feel certain emotions rather keenly and they express them clearly. To give examples of animal thinking and reasoning would be as profitable as to give examples of

like activities in the human. I would be more interested in arguing whether or not plants think and reason.

WHAT DR. FREDERIC A. LUCAS, FAMOUS SCIENTIST, THINKS

THE answer from Dr. Frederic A. Lucas, American Museum of Natural History, New York City, reads as follows:

1. Yes.
2. Various things that I have seen them do, especially a dog enjoying a joke, running off with my hat, and a dog trying to lie, to make you think it did not commit some fault.

4. (a) This is in response to some slight action on its owner's part—is not thought.

(Continued on page 378)

DO ANIMALS THINK? YES!

Say Majority of Scientists

To Whom Science and Invention sent Questionnaire given below

1. Do you believe that animals can think?
2. Name your reasons why you believe animals think.
3. Why do you hold that animals do not think?
4. (a) If animals do not think, in your opinion, how do you account for the circus horse that selects numbers called for by strangers in the audience?
(b) How do you account for the behavior of the German dog that recognizes any one of forty people, when they are mentioned by name?
(c) A hawk tried to get a rabbit; the rabbit ran for the protection of a barbed (single) wire fence and darted back and forth under the fence to a shed 50 feet away. Do you consider this action an example of reason, thinking or instinct?
5. Do you believe all the above reactions can be accounted for under the term "instinct"; and if so, define your opinion of "instinct."
6. Do you hold if animals do not "think," they may "reason?"
7. If so, where do you draw the line of demarcation?
8. If a wild animal were bereft of sight, smell and taste, do you think that animal would die of starvation? Or would the first law of nature (self-preservation) make the animal think or reason out a means of procuring food?
9. Have you conducted experiments along any of these lines? What were the conclusions?

REASON REQUIRES THINKING

Dr. Albert Schneider, North Pacific College, Portland, Ore., writes as follows:

1. I believe that every one having a knowledge of physiology and psychology admits that many different species of animals think and imply the thinking power instantly.

2. The deeds performed by such animals as the anthropoid apes, the dog, the elephant, and even the cat, the horse, the hen, the snake, the fish, indicate that they do think and think quickly and very clearly.

4. (a) These are mere memory tricks and in my estimation do not represent examples of thinking. The horse is, by the way, one of the stupidest animals, as far as evidence of reasoning power is concerned.

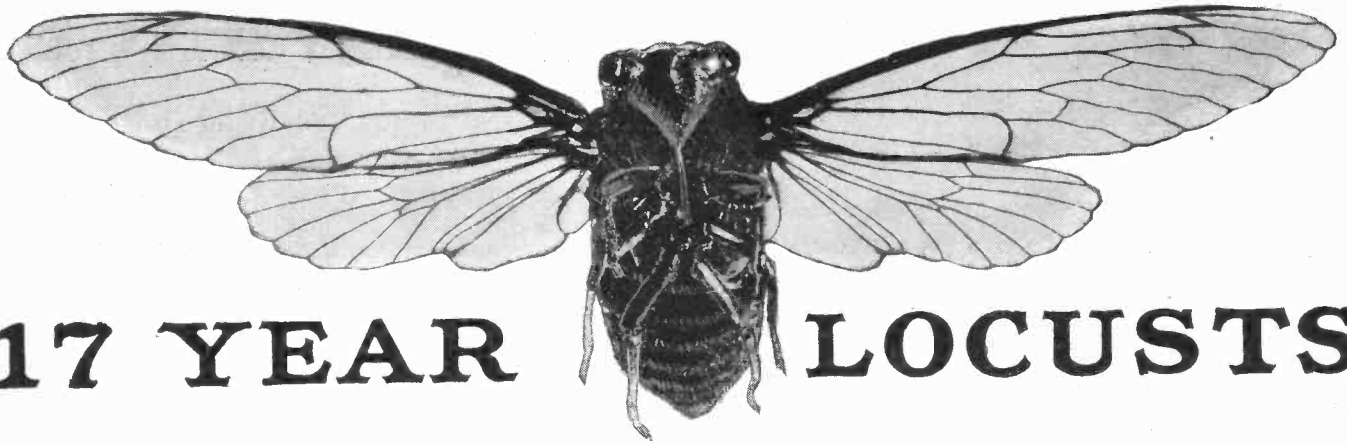

17 YEAR LOCUSTS

Some Pertinent Facts About the Cicada

By ERNEST BADE, Ph.D.

ONE of the most interesting insects, as well as the most remarkable, is about ready to emerge from the ground, where hordes of them have passed 17 years of their early life. This is the 17-year locust, a name absolutely wrong, although commonly accepted. In the first place it is not a locust, for locusts

finding entrance through the wounds caused by depositing the eggs.

A few weeks after the eggs have been deposited, the young larvae hatch from them. These resemble tiny ants and they leave the punctured twig and fall on the ground, where they begin to bury themselves, finding a final resting place near a root, where

17-year locust arises from the darkness of the ground and, after breaking through the outer shell the creatures cover, in the full sense of the word, the trees and shrubs of certain localities. The insects sit, one upon the other, covering every available space. New hordes come out of the ground, the nymphs slowly crawling upwards, anywhere, in any place, but always upward—on a fence, a stake, or a tree—the urge is upward after coming out of the ground. Here the shell is discarded and when the wings unfold in the air and are hardened, they fly away to those places where their kind have already found resting places. The branches bend under the unaccustomed weight of the creatures. They are everywhere and their presence is best compared to the tropical swarms of the locust, but the cicada does not do the damage that is inevitable with a grasshopper swarm.

Then the shrill and monotonous concert begins, the males break their 17-year silence and sing, the females remain silent. As is the case with many insects, the males die first, their life is short, the silent females being found long after the love song has died away.

In the breeding ground of the 17-year locust the ground is covered with holes like those of a sieve, where the nymphs have emerged. After the nymph shell has been discarded, many of the empty shells become detached from their support and several quarts of the shells can often be picked up beneath a single tree.

A few days after they have made their appearance the females begin to lay their eggs and the damage caused by these insects is a direct result of the method in which the eggs are deposited. The female, by means of its ovipositor, which is strong and saw-like, cuts a double row of slits in two-year-old twigs of many kinds of trees and shrubs. As many as 50 such slits may be cut in a row on a single twig. Each of these slits is an egg nest and contains from 15 to 20 eggs. These slits or punctures are very close together and the final result is that a long longitudinal scar is formed. This weakens the twig so that many break off and, in addition, the wounds result in the easy entrance of fungus diseases.

The damage produced is, in reality, an indirect one, being mainly a result of a weakening of the tree or bush, so that many branches are lost through breakage, due to wind or weight of these insects or to diseases

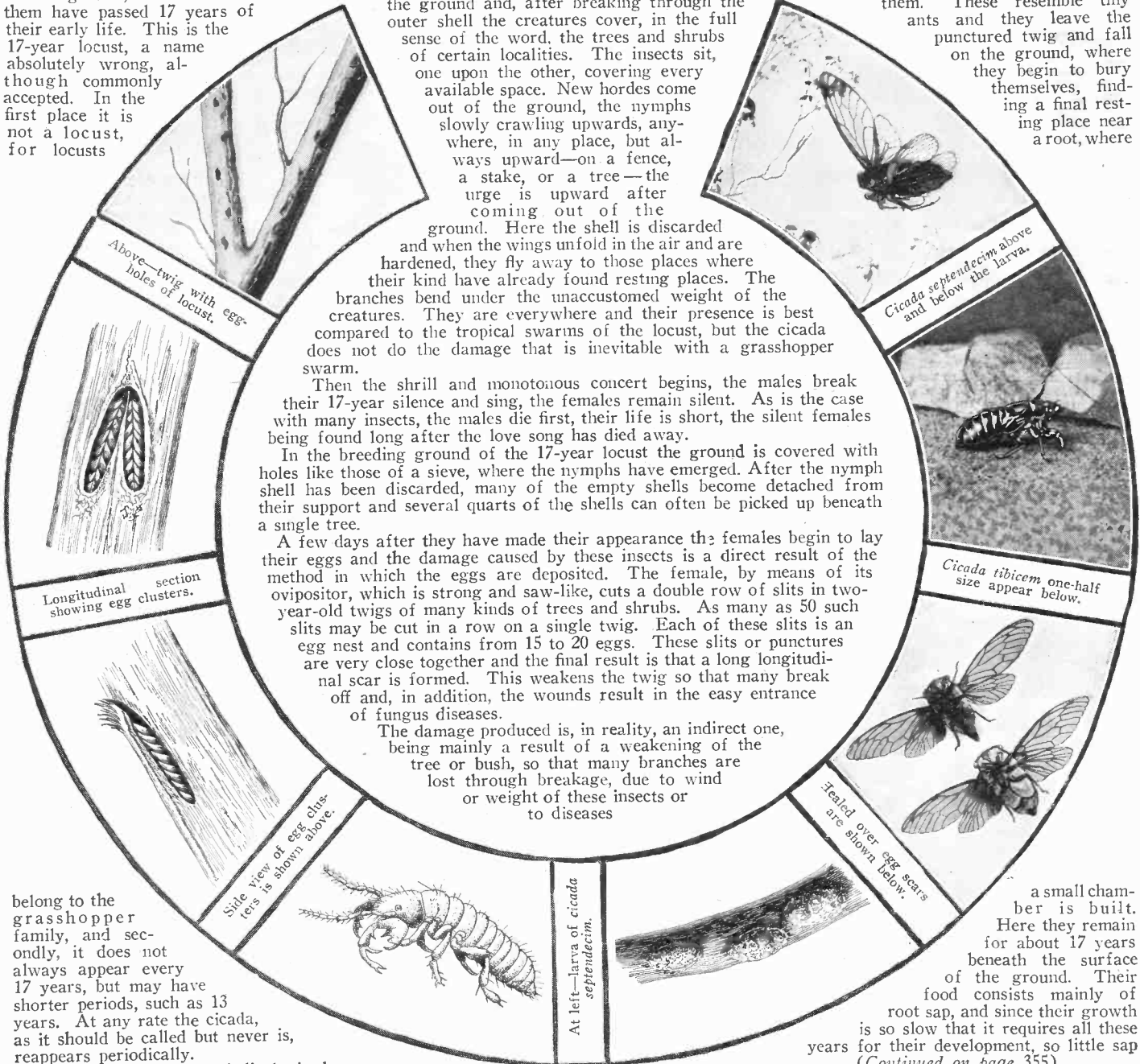

belong to the grasshopper family, and secondly, it does not always appear every 17 years, but may have shorter periods, such as 13 years. At any rate the cicada, as it should be called but never is, reappears periodically. The nymph of the periodical cicada or

a small chamber is built. Here they remain for about 17 years beneath the surface of the ground. Their food consists mainly of root sap, and since their growth is so slow that it requires all these years for their development, so little sap (Continued on page 355)

NEW ADVANCES

Steady and Rapid Progress Marks

By JOSEPH

THE airplane, invented in this country was frowned upon for years, by the American public in general, but since Colonel Lindbergh's epochal flight across the ocean, the advance in aviation is becoming far more rapid here than abroad where, by the way, the science has already been put on a commercial basis. Everything is now being done to further the knowledge of flight and to provide those safety appliances which will make aviation even more safe than automobiling, or any other mode of travel.

Among the many requisites for making flying safer, is a means for establishing radio beacons, light beacons, and signs, which can guide the aviator. Light beacons must of course be so arranged that they will penetrate fog; radio beacons should work under all conditions, and efforts must be provided to prevent radio sets on planes from going dead. Suitable safety equipment also has to be

arranged for trans-oceanic flight making it no more perilous to land in the middle of the ocean, than it is to land miles away from a suitable field. If possible some sort of a landing stage or stages will ultimately be arranged in mid-ocean for inter-continental fliers. The day will soon come when we will be able to get up out of bed at some hotel in London and arrange our affairs so that we can attend a banquet in New York the same evening.

BEACONS AND MARKERS

THE photographs at the top of this and the corresponding page show two of the world's greatest aerial beacons. The one on this page is now in the course of construction, on top of the 37-story Roanoke Tower on the corner of Madison and La-Salle Streets in the heart of Chicago's "loop." In point of power, it is proposed, that this light will be the greatest aerial beacon in the world. As can be seen from the small inset, it is composed of two parts, the first being a rotating and the other a stationary beacon, each with 8,000,000 candle power. These searchlights will be visible for more than 100 miles. One of the beams will constantly point to the new Lake Front Airport at Grant Park and the other beam will of course sweep the skies. As fog penetrators a group of U-shaped Neon tubes will be arranged beneath the searchlights and will serve as guides on foggy nights when the ordinary searchlight cannot penetrate through the obscured atmosphere.

In Los Angeles, California, the City Hall was lighted for ceremonies by President Coolidge, who pressed a button in the White House to accomplish this purpose. This is a new \$10,000,000.00 structure surmounted by the powerful Lindbergh "air beacon." As can be seen from the photograph on the right hand page the entire top of



How the Roanoke Tower in Chicago will appear when the aerial beacon is complete. One searchlight always points to the city's landing field.

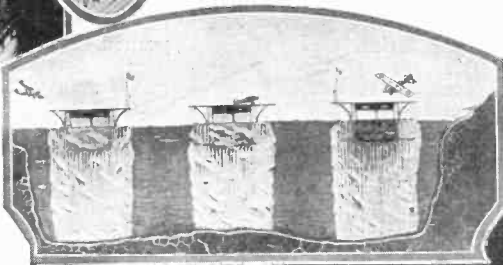

A proposed means for producing landing platforms in the middle of the ocean is here illustrated. Refrigerating machines build up an artificial iceberg on which inter-continental planes can land.

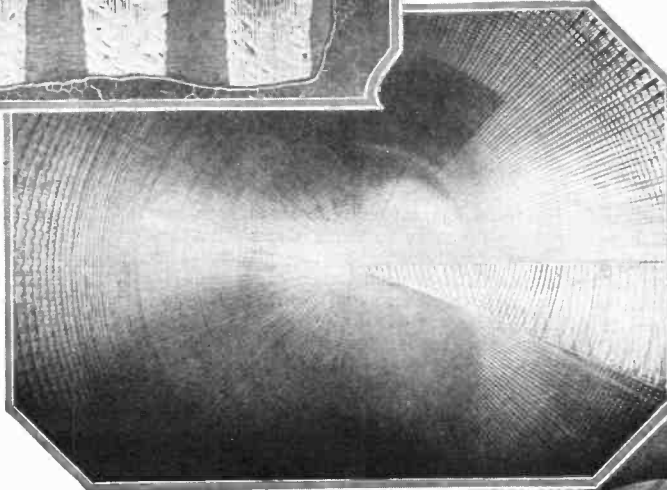

The photo at the right shows the interior of the all-metal dirigible now in the course of construction. Note that there are no struts crossing the interior of the structure, which when completed will be as rigid as any of the heavier-than-air types.

The all-metal dirigible, now nearing completion at Glendale, California, as seen from the outside. This photograph likewise shows the immense hangar that had to be built for this vessel.

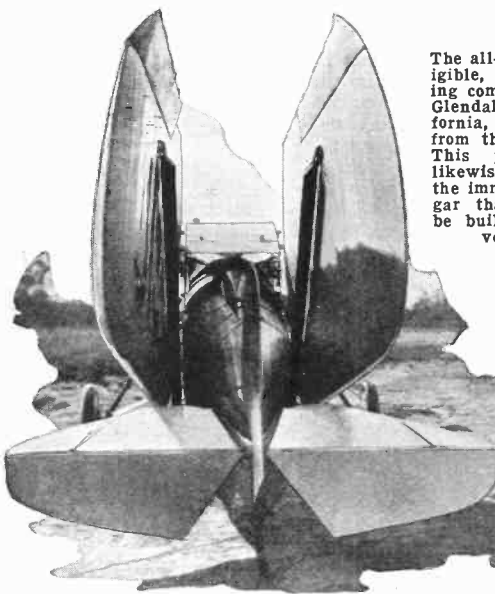
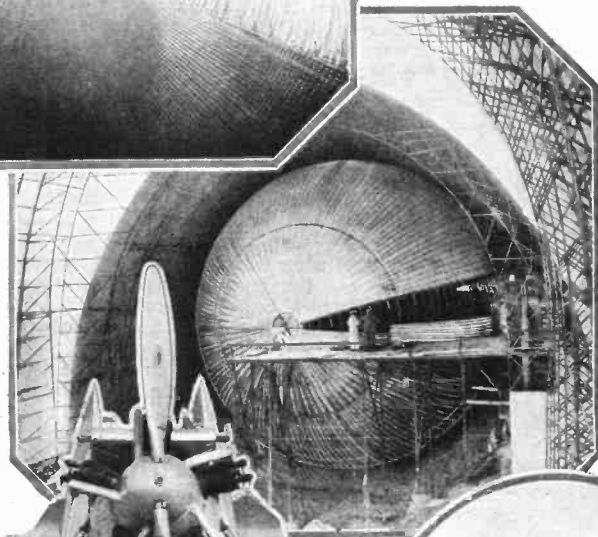

A rear view of the newest folding monoplane is illustrated here; it carries two passengers, weighs 900 pounds, and is capable of cruising at a speed of 120 miles an hour. When folded, the monoplane occupies a space of 8 feet x 0 feet x 25 feet.

This is a front view of the monoplane, also with the wings folded. It shows a new 5-cylinder radial type motor with which it is driven. When the wings are extended, they have a spread of 35 feet. Cruising radius is 800 miles.



Commander Byrd's plane, which he will take with him on his Antarctic expedition, is shown here in its first flying test, after being equipped with the new pontoons adapted to land in the water or on ice.

IN AVIATION

This Fastest Growing Industry

H. KRAUS

this tower is illuminated to such an extent that an aviator sixty miles away has no difficulty in spotting the guiding light. As an additional plan for assisting aviators to find the nearest airports and to tell them the direction while flying, a suggestion was made by the Bureau of Aeronautics of the Department of Commerce under Assistant Secretary, William P. MacCracken, Jr.

It was urged that every village display its name conspicuously on the top of any large depot, warehouse or other building. Flat topped roofs should preferably be selected. The name should be printed in block letters using a chrome yellow color on a black background. If the only large roof available in the town happens to have a pitch and this pitch is more than 30°, a sign should be painted on both sides. The width of letters such as "M" or "W" should equal two-thirds their height; and other letters should be in proportion. At the same time no letter should be smaller than six feet high, preferably even larger. An arrow should point to the city's nearest airport and indicate the mileage thereto. It is quite important that these letters be illuminated all night, and for this purpose ordinary flood lights may be employed. The Information Division of the Department of Commerce requests that those cities marking any buildings by signs in this fashion, send the location of such air marks to the Department for inclusion in its Airway Bulletins, or in other notices to pilots.

OCEAN LANDING FIELDS

THIS publication has already illustrated some of the various and novel means suggested for establishing aviation landing stages in mid-ocean. Some of these were in the

form of boats, others in the form of platforms, and still others in the shape of huge basins. A novel suggestion has just been advanced by a French engineer, Gaston Mourlaque. He proposes to establish a series of refrigerating mechanisms, arranged on suitable platforms with pipes running down into the water. These pipes will freeze quantities of water about them, making a body of ice to float the platform. The ice can be made to extend down to a foundation on the ocean bed in shallow places, or may remain afloat, held in position by suitable anchorages. The photograph on this page shows this plan in detail but, of course, the platforms will not be as close as here indicated. Radio installations will likewise be provided to serve both as beacons and to warn the aviators of inclement or unfavorable weather.

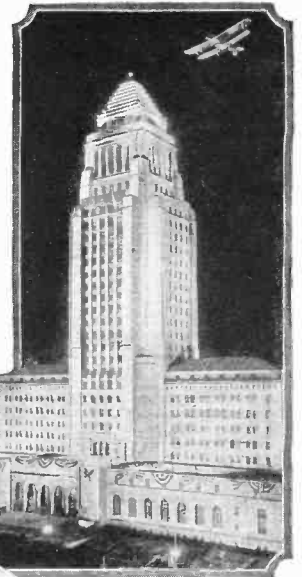

The new Lindbergh beacon, on Los Angeles' City Hall. Aviators can see it 50 to 60 miles away.



The first of a fleet of flying boats for Atlantic crossings is shown on left.



ALL METAL DIRIGIBLE

OUT at Glendale, California, an all metal dirigible is nearing its completion. This dirigible was described in detail in previous issues of this publication. Unfortunately, storms destroyed the previous constructions. One photograph shows that the interior of this vessel has no struts, cross bars, or other braces. While in this semi-completed form, the ship is not at all sturdy; but just as soon as the last sheet of metal is riveted in place, the airship becomes surpris-

(Continued on page 352)

The "Bonny Gull" after its unfortunate accident which proved fatal to the inventor. Note twisted mass of metal.

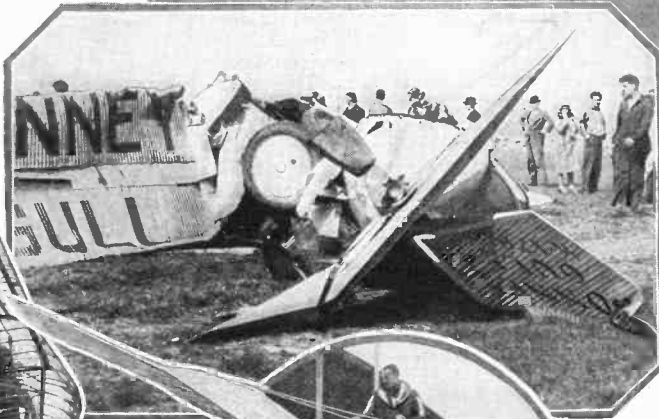

The above photograph shows the "Bonny Gull" poised for flight. The wing angle could be changed to permit of quicker take-off.

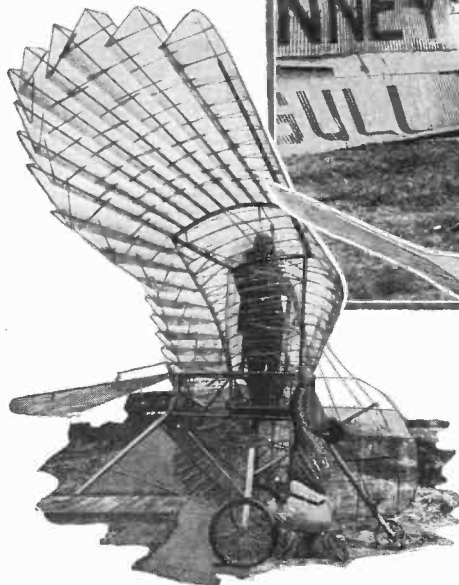

This is a view of what might be popularly called a "wing flapper" airplane. It is an ornithopter which its inventor holds will be made to rise from the ground purely by foot-power. It is not equipped with an engine or propeller.

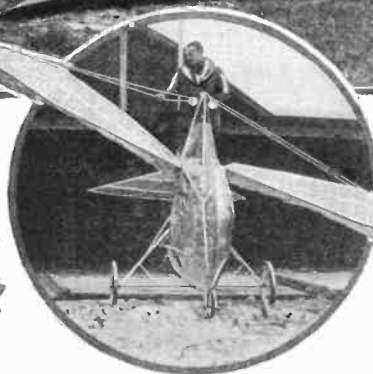

This view shows one of the wings raised and one lowered, and also shows the contour of these wings. Six years of study of bird flight by a Long Island inventor aided him in building this type of machine.



The wing spread of the ornithopter is 29½ feet. Note how bird-like the ends of the wings are, as tipped with feather-like constructions. Photo was taken on the beach at St. Augustine, Fla., where the first test is to be made.

Scientific

A Photographic Picturization

It is almost impossible to keep up with the rapid strides taken in the field of science. This is truly a scientific age.

NEW AIRPLANE MOTOR

IN the illustration below we find an interesting two-cylinder gasoline engine for airplanes which is of revolutionary design. This motor has no connecting rods, no lubricating system, nor any valves, and it delivers a power stroke on each down movement of the peculiarly-designed pistons, which are in the form of vanes. The fuel consumption on a motor of this type is very slight. No oil at all is required. The inventor, Harry A. Palmer, of Dorchester, Mass., an automobile mechanic, expects that he will be able to get more than 100 miles per gallon of fuel. Actual tests have indicated that his expectations may be realized. Small as this two-cylinder engine is, it has been able to turn a full-size airplane propeller at a speed of 1,100 revolutions per minute.

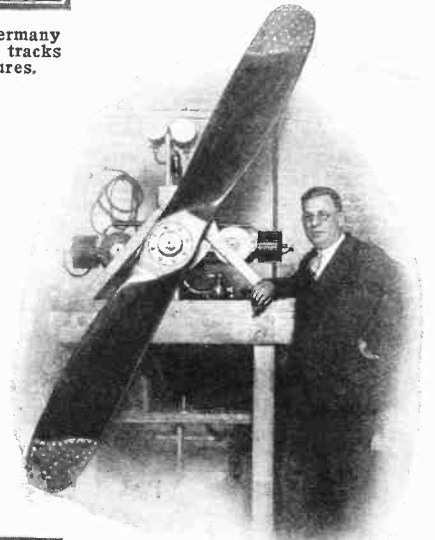

Mr. Palmer and his little two cylinder valveless engine.

LIGHT PRODUCES MUSIC

IN the photograph at the left, an apparatus is shown as set up for a demonstration at the Massachusetts Institute of Technology's Annual Demonstration. Specifically, it shows the production of music by the effect of light on a photo-electric cell. The photo-electric cell is the largest of the four tubes on the board. This cell controls the flow of current through the first of three vacuum tubes, the other two amplify the current, and then reproduce it in the loud speaker. Music is produced by waving the electrically-lighted baton and varying its distance from the cell.

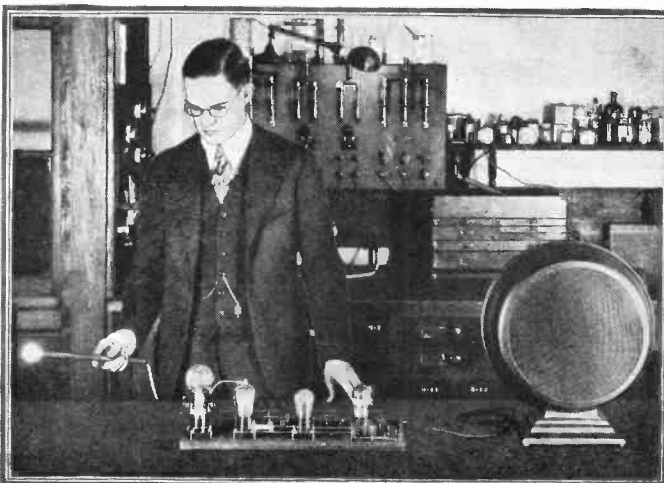

The photograph here shows a demonstration of how music can be produced by the effect of an electric light on a photoelectric cell. The electric light is on the end of a wand.



Powered only with a motorcycle engine and driven by an air screw, this hydro-glider was able to make a speed of 30 miles an hour on the river Severn in England. Photo shows glider running up stream.

HYDRO-GLIDER

MR. W. F. W. Davies, a young Dudley engineer, did not believe everything naval architects told him and it is for that reason that he was able to perfect a novel hydro-glider, powered only by a small motorcycle engine. Having been informed that his efforts would be futile, he set about designing a boat and mounting an air screw upon the shaft of a motorcycle engine, which in turn was supported by the glider structure. When tried out on the river Severn, at Stourport, England, a speed of 30 miles an hour was obtained with the inventor alone in the craft. With a passenger, the speed of the craft was 28 miles. Note combination air-water rudder.

SUSPENDED RAILWAY

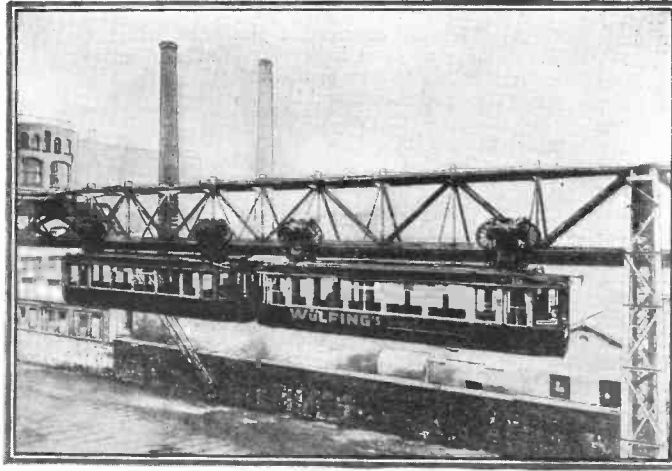

The photograph shows a new type of suspension railway in Germany which has proven a great success. The structure supporting the tracks is a mere phantom in comparison with our own elevated structures.

HERE is a new type of suspension railway seen in daily operation in the Rhineland. The trains operate between Vohwinkel and Elberfeld. It has been estimated that this suspension railroad has relieved heavy traffic in the busy industrial centers by at least 50 per cent. The trains operate on a regular schedule of a train every two minutes, and the average speed attained is 40 miles an hour. It will be observed that the cars hang from motor-driven trucks which rest upon a single rail. The superstructure supporting the rail is light and airy, hence, daylight is not interfered with, nor is the ground beneath as stuffy as it is under the average type of elevated trestle. Wherever possible the trains operate over the center of a stream of water, and the photograph here shows just such a position.

AIRPLANE WEATHER MAP

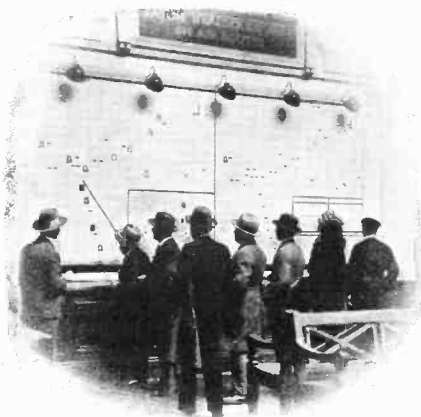

Upon this large map the weather reports of the world are plotted for aviators.

DUE to the rapid strides in commercial aviation it has been absolutely necessary that both passengers and aviators be told of the weather conditions in the various towns along the route of flight. Accordingly, at the Croydon Airport, the aviation center of London, England, a huge weather map has been erected which is captioned, "Latest Weather Reports on Air Routes." On this map every air-drome is marked accurately and relatively to others. Cards are hung up, indicating the latest climatic news from all districts, thus making it possible for both passengers and aviators to know what weather conditions to expect. Photograph shows man pointing to weather cards.

Progress

of Modern Scientific Advances

On these pages we can portray but a few of the advances made in many different fields.



In an effort to minimize the effect of casual collisions in heavy traffic, a German inventor has designed an automobile bumper made of rubber, shown here in contact with a tree.



The new tourist body for automobiles is shown in the photograph above. The back of the car represents an observation platform.

RUBBER AUTO BUMPER

IF your automobile is equipped with a rubber bumper, it will act in the manner illustrated in the photograph above, in event that the auto accidentally runs into a tree. This car, traveling at a speed of 25 miles an hour, was deliberately run into a tree. Note how the supports of the bumper on the car give to the impact, in this way greatly preventing a jarring of the car and its occupants. This bumper was invented by Harry Schief, a Berlin inventor, and was intended primarily to minimize the effects of casual collisions in heavy traffic when traveling at ordinary speeds.

LINDY FAN

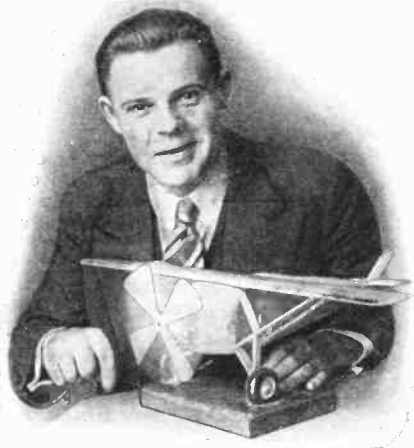

Photograph shows Judge Samuel Blake, of Los Angeles, and the "Spirit of St. Louis" fan which he has invented.

COMBINING a model of Lindy's airplane and an electric fan was a good idea, or so at least thought Judge Samuel Blake of Los Angeles. and accordingly he constructed the model shown in the photograph above. The airplane is firmly secured to a base, through which the cord leads to the outlet plug. Within the nose of the "Spirit of St. Louis" model, the electric motor has been mounted, and immediately in front of that is a two or four-bladed fan.

FLAMES FELL CHIMNEYS

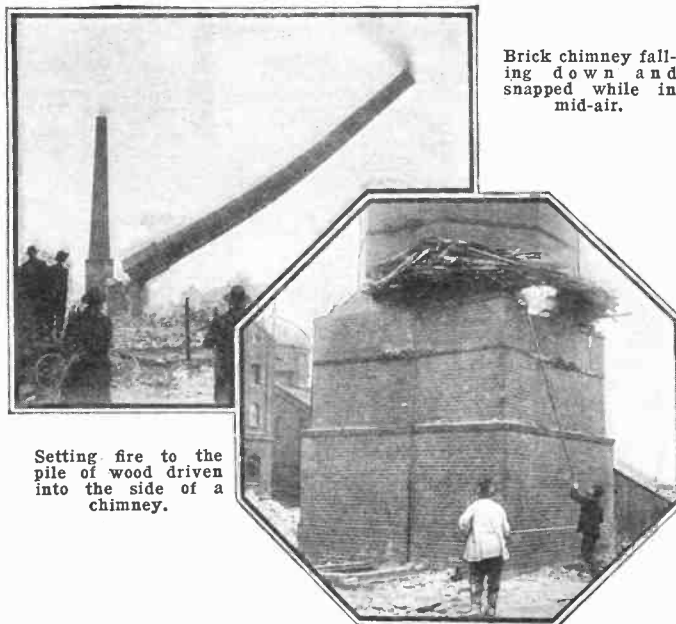

Brick chimney falling down and snapped while in mid-air.

Setting fire to the pile of wood driven into the side of a chimney.

HAVING stood idle for a decade and virtually becoming a menace, two great chimneys, each about 200 feet in height, which served the old gas works at Schmar-gendorfer, a suburb of Berlin, Germany, were razed by the fire method. This method consists in removing some of the bricks at the base of the chimney and then ramming timbers into the space, pouring gasoline over same and setting on fire.



These tiny locomotives show the developmental periods in railway engine construction during the past hundred years. Each is an exact replica and is capable of operating under its own power.

TOURIST AUTO BODY

THE body of the car shown above was built especially for E. Peter Jones, a wealthy Englishman. According to Mr. Jones it will eliminate back-seat driving, but this is by no means its most important asset. Entrance to the vehicle can be obtained either from the side or rear as is indicated. The seat can be shifted so that it either faces the rear of the car, as in this photograph, or faces forward. The construction is intended primarily for the tourist.

COLOR ORGAN

THE photograph below shows the new color organ of Thomas Wilfred who is here seen operating it. Mr. Wilfred's color organ was previously described in this publication. With his system, color takes the place of music, changing in hue and rising and falling in accordance with the moods and tempos.

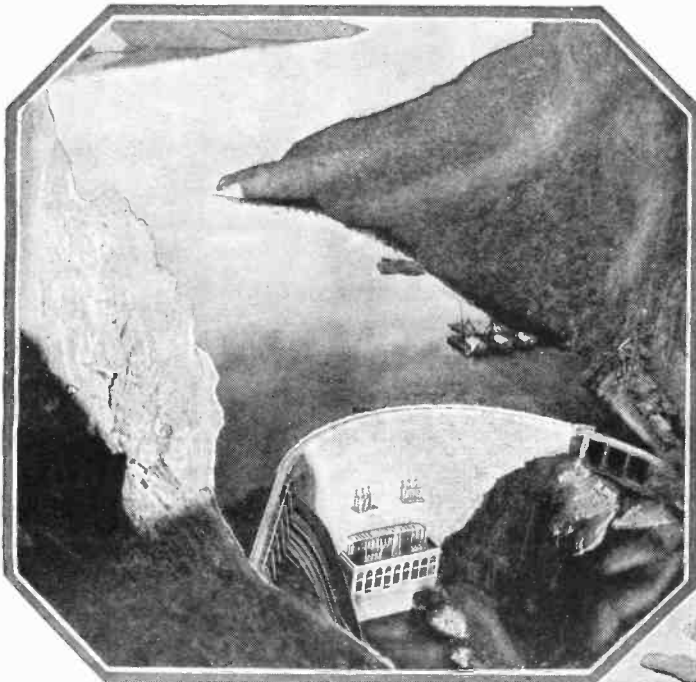

Photo shows Thomas Wilfred in the pit, operating his color organ.

MODEL LOCOMOTIVES

A SERIES of model locomotives has recently been completed by C. A. Leahmann, a school teacher, who is exhibiting them in the Pacific Southwest Exposition. The tiny locomotives, each exact replicas of engines used in the past century, are perfect in every detail, and are even able to operate under their own power. Photo shows Mr. Leahman in the midst of his collection of Lilliputian engines.

New Dam Construction



Above is a view of the newly completed Horse Mesa Dam in Arizona, which holds back a vast water storage for irrigation. It is tied to bedrock with structural steel.

THE completion of the Horse Mesa Dam, in Arizona, marks another engineering triumph. It is embedded in solid rock at both sides and tied to the bedrock with steel. From the bedrock to the crest it is 305 feet high and 784 feet across the crest. The novel feature, however, lies in its arched construction. The engineering foundation, after building many test models and studying dam disasters, such as the breaking of the St. Francis Dam, have found that a concrete dam 60 feet high and 140 feet long will only have to be 2 feet thick. In small models made of concrete or mortar, the deflections

and strains are very small and were measured with precision instruments. Engineering designs of dams using the arch were thus computed from models. As may be seen in the illustration, a thin board, when arched, shows the greatest strength. But if the same board is not arched, it will have to be thicker to support the same weight or withstand the same pressure. This is the secret of construction upon which the arch type of dam is based. Previously, it was necessary to employ a thick wall, which tapered upward from the base, where the point of greatest pressure lies. The bending or deflection and the stretching and compressing which is caused by the water retained in the reservoir by the dam, are very small in the arched dam because the material is absolutely stiff and rigid. Thousands of measurements of strain and temperature have been made with varying depths of water, in conjunction with the research work which is being carried on along this line. Until recently little was known about arch type dams.

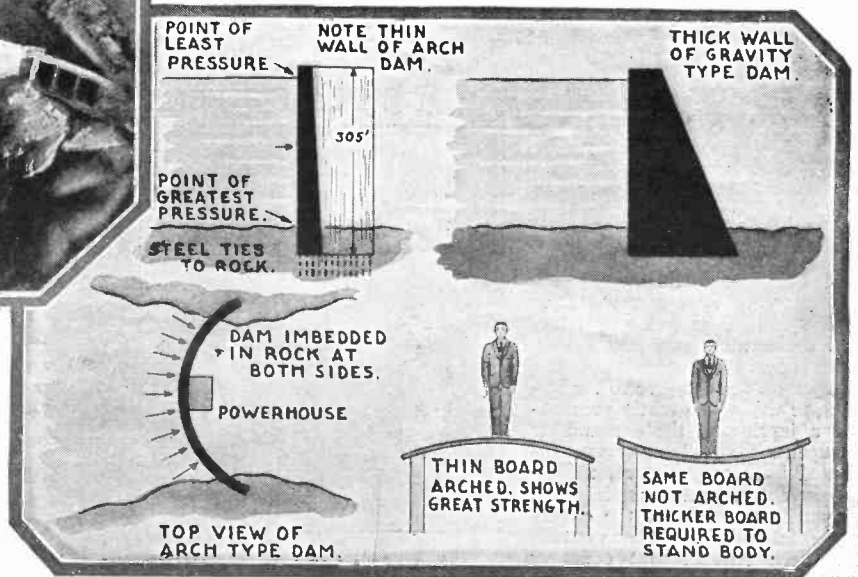

The above illustration shows some of the interesting points in the construction of the new type of dams. In building the Horse Mesa Dam, it was constructed in the form of an arch and embedded in rock at both sides. A gravity type of dam would require a thick wall. Advantages of the arched dam are apparent.

Newest Airplane Styles

WHAT the well-dressed airplane will wear in 1928. First, added visibility by the addition of windows, as illustrated here. New cabin monoplanes are equipped with windows of non-shatterable glass and may be raised or lowered. On the wings of the plane we have navigation lights and landing lights. A tail light has also been provided. The wheels are fitted with aluminum disc stream lining, and internal expanding mechanical brakes. Oil and air shock absorbers are used. A new tail skid is a special development and consists of a hard rubber wheel mounted upon a steel tube, so as to give the skid a caster-like action. The slightest movement of the

rudder is sufficient to swing the skid. This is also fitted with a shock absorber unit

which is a compression strut carrying eight rubber discs in compression. Each is one-half inch thick and alternate discs are drilled through or grooved around to obtain a cushion effect. Besides this, an emergency tail skid is built into the stern post. The newest design propellers are built from "micarta" and weigh only fifty pounds. The blades are interchangeable and the pitch may be adjusted. This propeller is quiet, vibrationless, and is not affected by acids, oil or salt water. Controls have been simplified by mounting the brake pedals alongside the rudder pedals, so the feet do not have to be lifted. Gasoline tanks are often placed in the wings.

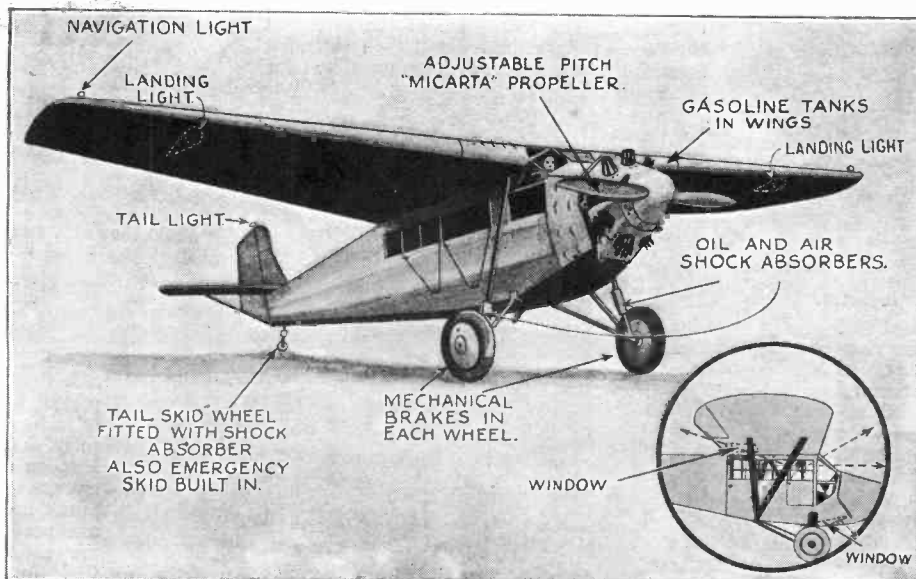

The illustration above shows an airplane equipped with the latest devices which have been developed in order to make flying safer, easier and more comfortable.

The Month's Scientific News Illustrated

By GEORGE WALL

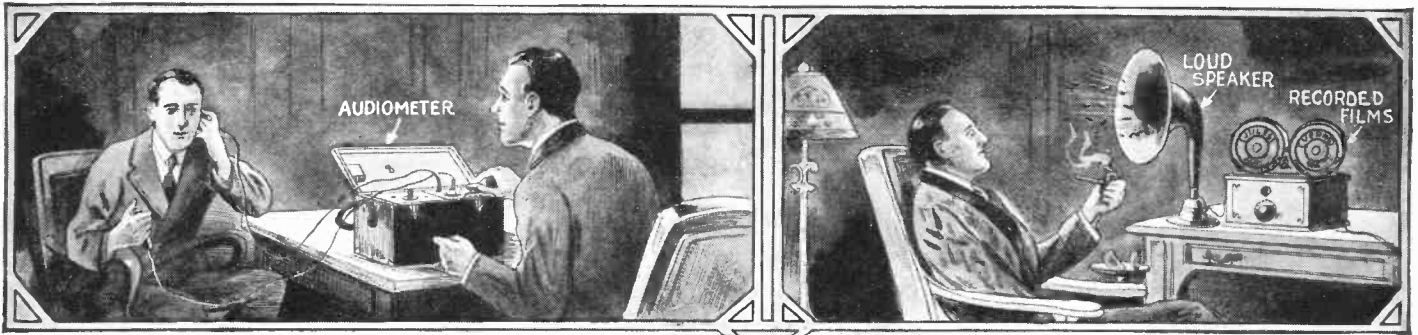

The Bell Telephone Labs. have found a new way to examine ears for deafness. Accurate instruments with psychological aids determine the exact degree of deafness. False claims of deafness or exceptional hearing powers are no longer of avail, for the truth can now easily be discovered. By using an audiometer, a certain tone is produced and a person with normal hearing will raise his voice each time he hears the sound, but one who is deaf will continue to read or talk without changing his voice. To detect false claims of deafness, the sound is switched repeatedly between the ears at varying intensity, and the patient is asked to signal each time that he hears the sound. These tests will prove valuable in compensation cases where the loss of hearing is involved.

Dr. Willis R. Whitney, director of the General Electric Co. Laboratory, at Schenectady, has perfected a talking book. The words are recorded on a long strip of film and by means of an amplifier issue from a loud speaker to be heard all over the room. Six or eight word "tracks" can be recorded on a single film, so that the booklover can relax and listen for two hours at a time. It is estimated that the films will cost about six dollars, eventually. If the device becomes popular, it will result in the resurrection of an old profession, that of story telling.

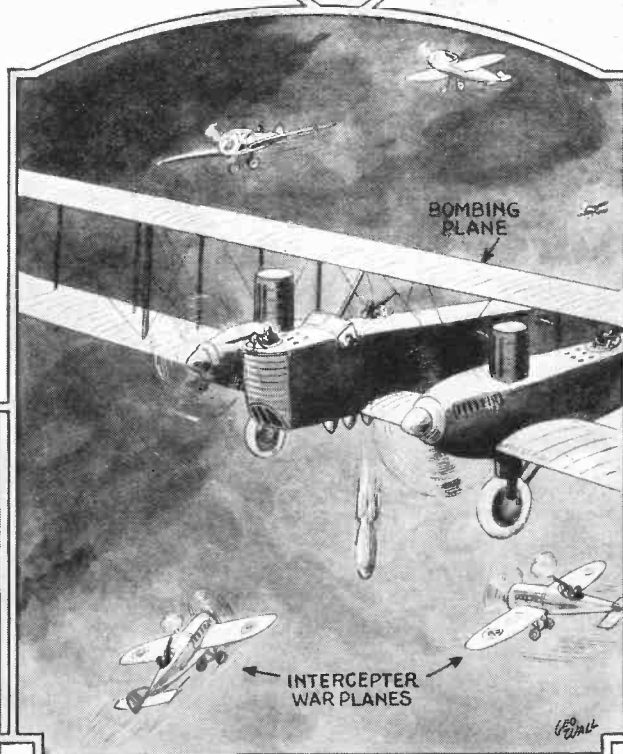

A single-seater fighting plane capable of climbing almost vertically, five miles in ten minutes, has passed successfully the tests given by the British Royal Air Force, in England. The new machine will be one of the deadliest weapons for short-range aerial attack, and is known as an "interceptor." As these planes are required only for flights of short duration, the weight has been reduced by cutting down the size of the gasoline and oil tanks, but it is estimated that their speed will enable them to patrol 500 miles along a limited frontage in two hours. The lightest types of machine guns, synchronized to fire through the propeller revolutions, will be carried as armament. A parachute will be carried, because it is planned that when other weapons fail, the pilot will drive his machine directly at the enemy plane, leaping to safety at the moment of impact.

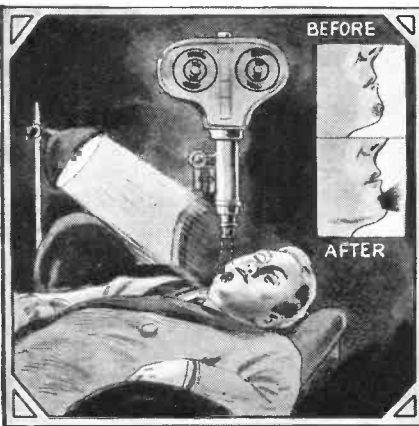

A photograph of a patch of whiskers was displayed recently at Ann Arbor, Michigan, before the meeting of the American Association of Anatomists, by Prof. R. J. Terry, Arthur C. Pillsbury and George A. Seib, of Washington University and the Missouri Botanical Gardens, of St. Louis, Mo. The picture was made with a movie camera "shooting" through a high-powered microscope. Three minutes after shaving, one of the subjects had a square centimeter, which is equal to about a sixth of a square inch, of his shaven face photographed. Thereafter, every two hours for four days and nights, the camera recorded the growth of his stubble. It was hoped that at the outset the experiment would make possible a motion-picture film of the growth of hair. The result, however, was disappointing, because the stretching of the subject's skin moved the hair about too much. As a long succession of "stills," the picture was a success and gave considerable interesting data on the rate of growth of human hair. Throughout the picture taking process, which lasted four days, the same section of skin was photographed.



An apparatus for relieving seasickness has been invented by a German physician. It consists of a tank of gas which is inhaled by the passenger. The anti-seasickness apparatus is to be installed on German steamship lines.

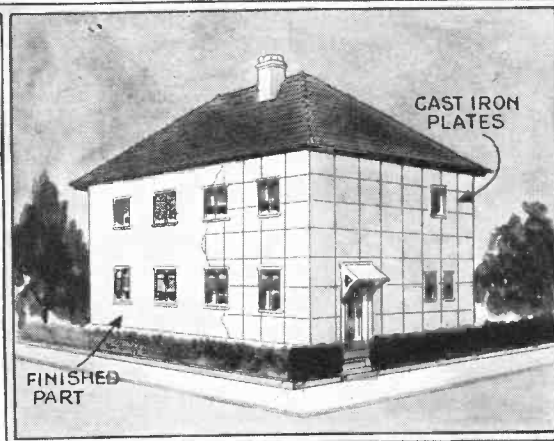

Cast-iron houses are being manufactured by a British iron concern, and two-story residences of this type may be purchased for \$2,125.00, and erected in thirty hours. They have been developed as a means for meeting the housing shortage and combating the high cost of building material. The town of Derby has erected five hundred such houses, which can be put up within a period of thirty hours to one week, depending upon the size. It is interesting to note that the moulds for the iron plates were made in this country in Cleveland, Ohio.

How Mediums in

Dr. Albert Moll, Berlin Authority, Demonstrates
Produces Them by Natural

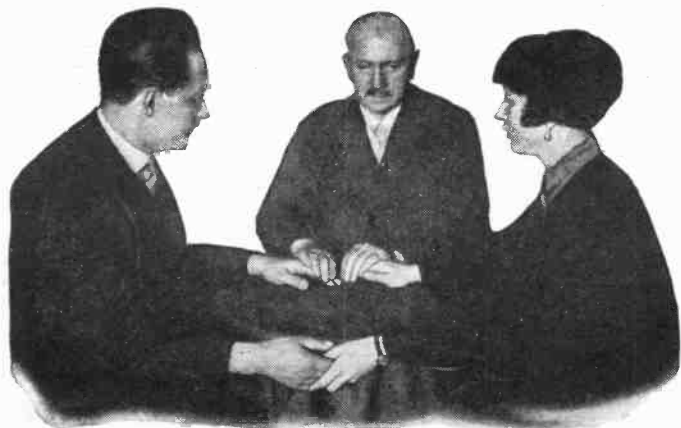

Fig. 1. This photograph shows Dr. Moll and two witnesses at the beginning of a séance. Note how hands are held. In spite of this, articles appear.

AMONG the various displays of modern occultism, teleplastic telekinetics, "apports," attraction and repulsion, as well as making matter do various things, play their parts. Twenty years ago, there were complete appearances of spirits (materializations), which, if it was nearly dark, were visible to the eye, or could be recorded on the photographic plate.

In more recent times, the fashion has changed on the part of the spirits. For instance; arms, fingers, faces, or formless masses show themselves. This is called ectoplasm. Under the term telekinetics, one classes movements (without any mechanical assistance) of an object at a distance; for instance, a table, or a handkerchief. Apport indicates the appearance of objects from the "other side"—that is to say—from the realm of spirits, or out of a completely sealed room. Contrariwise, vanishing indicates the disappearance of objects from the terrestrial zone, as for instance, from a room closed on all sides, the object going into another room. With apport and vanishing are closely connected the penetration of matter, just as objects come from the other world, or disappear into it. In other cases, a book, or a picture will come right through the wall from one room into another. It is imagined that the object is disintegrated into billions of atoms and that these pass through the wall and when they reach their destination, again build up their original mass.

A medium is requisite for all these phenomena. Formerly, and even today, he or she is frequently regarded as the connection between the spiritual world and this world of sorrow. In more recent times it is often accepted that the medium does not work on the spirits by being possessed by them, but that a special physical power is indicated. Sub-consciousness probably plays a material part in the discussion about movements in a distant place. While science has made the sub-conscious an important object of psychological investigation, the occultists

believe that sub-consciousness operates the occult phenomena when plants and flowers are brought from the other world, spirit pictures are produced, ectoplasm is made, tables move, or objects are reduced to atoms and brought through masonry walls. In a few words, sub-consciousness has become the servant for everything in occult literature. Most of the sittings of the occultists take place in the dark. A learned gentleman permitted darkness to be prescribed with the

the like, without regard to the fact that many mediums go into a trance, so that one could not attribute any deceit to them. It is also to be concluded that the outstanding person is often not the medium, but is the male, or female friend—the impressario—or else the experimenter. But I am by no means obliged to place confidence in every experimenter. In spite of the indignation affecting occultists, many have taken themselves out of the ranks of these. Charles Richet, the French pope of occultism, tells me, although in the form of a joke, that Ampère told him that once, at an electrical demonstration, that he had fooled people. We, therefore, must not leave out of considera-

Fig. 3. This photo demonstrates the beam of a scale rising and falling by psychical power. (That is a thread.)



assertion that it is a pre-requirement. If a Mecklenberg peasant was told that objects move themselves only in the darkness, he would answer: "Child's play. Give me a little light, so that I can see something."

DARKNESS OF SÉANCE ROOM DECEIVING

Opponents of occultism claim that the medium deceives the sitters by tricks and

tion that occultists help along the work themselves, perhaps, in the confident intention to complete imperfect phenomena, so that the others would be convinced of the reality.

In order to prevent the medium from artificially producing phenomena, he or she is often held firmly, or tied. Outside of the fact that even then a helper can take part, the medium can almost always free herself.

DECEPTION ALWAYS POSSIBLE

Let us assume that the medium has been tied with cord. It is well known that the medium can free herself from such fetters which seem perfectly secure to the layman. The average person then supposes that the medium cannot call forth any spirits or ectoplasm, because it is supposed to be ascertained that he believes that, after searching her person, the medium has nothing hidden about her. On the other hand, we must remember that often no examination is made, as in the case of the medium, Frau B., and that in many other cases, the examination is far from satisfactory. The Hungarian medium, Laszlo, who used to produce ectoplasm, was examined quite completely. Even Schrenck-Notzing's word was not accepted, although many occultists perhaps incorrectly

Fig. 5. In order to prove his capabilities of producing ectoplasm, Dr. Moll demonstrated this effect. One will find here a primitive production of a face. However, in this case the ectoplasm takes on no more concrete form than that produced by a piece of cheesecloth, attached to the drapery or curtain in the background by means of a pin. The ghosts were hidden behind the portières previous to the sitting.



Are Exposed Germany

Psychical Manifestations and Explains How He
Instead of Spiritual Means

attribute to him a good knowledge of magic. Schrenck-Notzing claimed that the possibility of deceiving manipulations in the case of Laszlo had to be excluded from consideration by the very nature of the search, and yet it was later proven that Laszlo had grossly deceived Schrenck-Notzing as well as other occultists.

The artificial ectoplasm, consisting of a piece of cheese cloth, or chiffon, can be so thin that it can be wrapped up into a very small package. It is stuck into a pocket of which none of the people know, but during a séance, it is fastened under the tabletop. The deception is very easy if the ectoplasm is concealed under an adjacent chair.

I have often made the same experiment and I have almost always succeeded in breaking the chain. I am convinced that the medium does not remain in any one position for a long time. Generally the sitters know nothing about how the hands have really been held. In a court process which the occultists carried on against me, and which ended in their utter prostration, two occultists argued over the manner in which the hands were held, holding a view opposite



Fig. 2. The above photograph shows some of the objects materialized after the chain had been broken and Dr. Moll was able to free one hand.

close together, as is shown in the picture. In the dark, the medium can make his spasmodic motions to bring the hands so close together, that it is never noticed. The medium now can very easily break the chain and free the left hand. While I in any way divert the attention of the sitters, I have placed my right hand, so that part of it covers the left hand of my right-hand neighbor and also a part of the right hand of my left-hand neighbor. The fact has to be remembered that the sense of touch is weaker in the dark than many, including a great many physicians, believe. After a short period, one cannot tell whether there are five fingers, or two, or three, resting on his own hand. Try this for yourself and see how easy is the self-deception. The longer the left or the right hand is kept on the right hand of the left-hand neighbor, the better will one be able to remove the left hand without any change being observed in the dark.

This trick I described as long ago as 1892. When the medium has freed the left hand, he takes the hoop, that is hidden under the table, under the clothing, or under the chair of the left-hand sitter, pushes it over his own left palm and again restores the chain by doing exactly the reverse of what was done to break it. Then, the hoop is pushed upon the right arm of the left-hand neighbor. To do this it is enough to raise the arm a little and make some spasmodic motion, even, if necessary, to rise a little from the chair. This brings the hoop very lightly over the arm of the left-hand sitter without his observing it. In this way, one can carry out the experiment by trickery, which is cited to show penetration of matter, or else apport. The credulous person, who knows nothing about how the chain was opened, comes to the conclusion that the hoop, of which nothing was known before, was dissolved into its atoms and now is brought together again by the medium. In

(Continued on page 372)



Fig. 4. Ectoplasm as produced by cheesecloth and the vanishing of a glass of coffee via a rubber tube "spirit."

It never occurs to the audience that this chair is purposely placed close to the medium during the preparations for the sitting. In the case of two well-known mediums, the ectoplasm was hidden within the person. Mediums are often very ingenious. One claims that she had put her false ectoplasm into the pocket of a well-known investigator, while he was searching her, and later took it out of the pocket, while the investigator was examining her more closely.

to that given in the published documents.

PENETRATION OF MATTER—HOAX

How the medium can free herself, I show in the photographs. A gentleman and a lady sit alongside me and we form a chain. I, myself, am supposed to represent the medium. During the sitting, the medium is restless and brings the hands of his two neighbors

CHAIN IS BROKEN WITH EASE

Chains are often made, that is to say, every one of the sitters clasps hands with his neighbors on right and left, or the hands are placed one on top of the other, or are hooked together. The making up of this chain is required by some mediums, who claim it creates a proper magnetic current. It apparently also makes it seem impossible for the medium to produce phenomena by other than psychical means. In the case of the Berlin medium, Frau B., appearances of plants seem to occur without any form of mechanical help, but by occult powers. Because all hands are held, it is apparently impossible for the medium to put the flowers on the table by trickery, or to put a complete hoop on the arm of her neighbor.

Fig. 6. Here a compass on the table could be made to move. Note the two spirits in back of the medium and one of the ladies staring at the ghost. Taken during the séance. The medium is under perfect control, his two hands being held at the time when the flash went off. After placing the ghosts in position, it is merely necessary to shift the curtain to bring them into view.



New Traveling Comforts

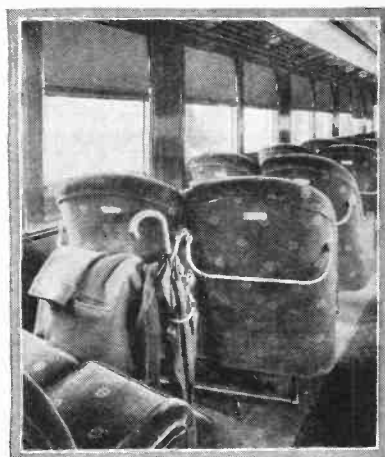

Above is an interior view of the new individual seat coach, showing the space provided for hanging coats, umbrella and canes. Hand baggage is placed overhead. Each seat is large and comfortable and the aisles are covered with carpet which matches the upholstery.

To the right is a view of one of the window ventilators employed on the new type of individual seat coaches. Four two-speed diffusion fans are also employed in each car.

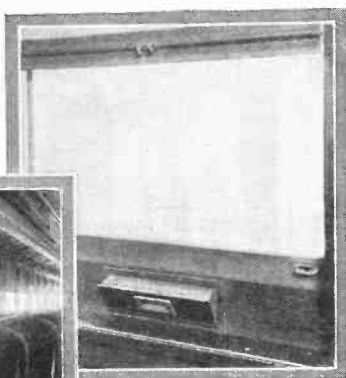

At the left is another view in one of the cars showing the front portion of the seats which are used in the day coaches. Each is deep cushioned and there is a drop arm between each pair. The seats are beautifully upholstered in a heavy quality of mohair plush.—Photographs courtesy B. & O. Railroad.

Placing in service on many of its main lines, coaches for day travel of a new and vastly improved type, the Baltimore & Ohio Railroad has given its patrons an added measure of travel comfort. These coaches are of all-steel construction, and are equipped with six-wheel trucks. The individual seat is the most novel feature of the new coach. These are built in pairs of two, as shown, with a drop arm between each pair. On the back of each seat, a coat hanger and umbrella or cane holder is provided for the convenience of the passenger. A wide, continuous overhead rack provides a place for the hand baggage. Fresh air can be enjoyed without discomfort, as each window is equipped with an individual ventilator which can be opened and closed as desired. The upper part of the car has been made unusually wide, to give full play to the twenty exhaust ventilators and the four two-speed diffusion fans which are suspended from the ceiling. An even temperature is maintained at all times by thermo-static control of a vapor-heat system. White enameled washrooms are provided at each end of the coach and are equipped with all conveniences. The aisles of the cars are laid with blue and grey carpets over rubber strips 5/16" thick.

Testing Auto Tires

MILLIONS of users of automobile tires will undoubtedly share the benefits of an invention of C. Francis Jenkins, whereby a high-speed camera is employed in taking motion pictures of tires. The camera is capable of taking 1,600 to 3,200 photos per second. When these are projected on the screen, the motion picture is slowed down, and reveals interesting exposures relating to different kinds of tires. The displacement

camera to the object. Some additional applications of this instrument are the study of gun recoil, shell trajectories, airplane propeller and landing gear action, the bursting of balloons and air hose, the propagation of flame, crankshaft whip, and in fact, anything which moves too fast for the eye to follow, can be optically slowed down and examined in detail and at leisure with the new camera."—S. R. Winters.

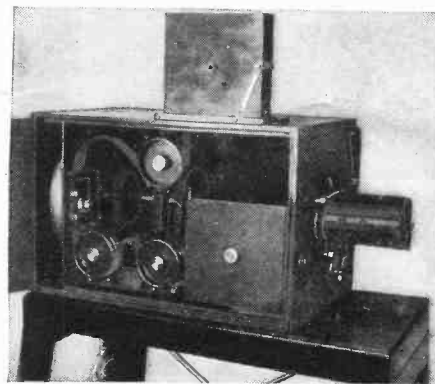

Above is a photo of the new high-speed camera which takes 1,600 to 3,200 photos per second. At the left are shown photos taken of a solid tire, a cushion tire, and pneumatic tire.

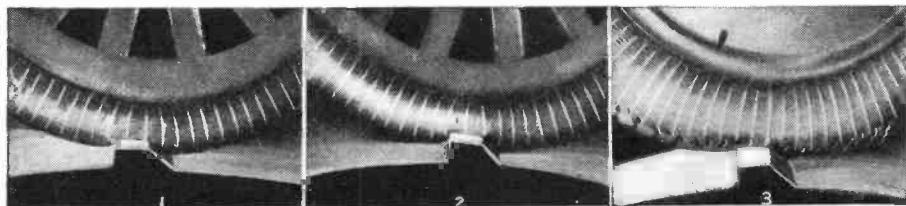

or "give" in the solid or cushion tires, for example, is longitudinally of the tires, as indicated by the widening of the radial lines which are drawn on the tires with chalk. The "give" of the rubber of the pneumatic tire is transverse to the tire, as shown by the fact that the radial lines do not widen perceptibly.

"The normal rate of exposures is 3,200 pictures per second on standard motion picture film negative," said Mr. Jenkins, the inventor of this high-speed camera. "Projection of these pictures at normal rate (16 per second) makes the action two hundred times slower than the original movement and twenty times slower than the slow motion films frequently shown in picture theaters. It photographs successfully objects which the intermittent film camera cannot photograph at all for purposes of study. The camera is built with a number of lenses moving exactly in synchronism with the film. These lenses pass in succession across the stationary shutter opening in the camera front. The lenses are carried in a disc about 13" in diameter which contains 48 matched lenses. The camera can be focused at short distances and the field of vision has a width equal to half the distance from the

Map Desks For Planes

SPECIAL two-seater observation planes have recently been built for official army use. These planes contain upholstered cock-pits, a special instrument board, an electric cigar lighter, and a folding desk, which holds the maps. The map desk is fitted with a glass top and can be folded up when not in use. The new planes are equipped with dual control, and are fitted with roomy baggage compartments.

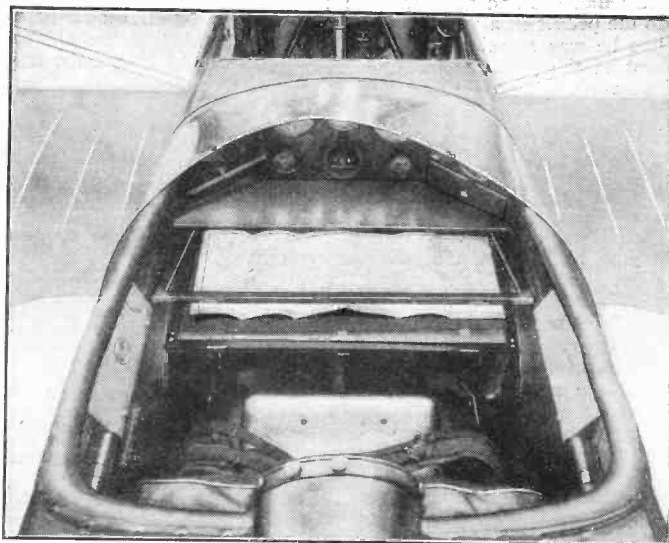

At the right is a photo showing the new map desk which is being built into airplanes for the convenience of the pilot.

Curiosities of Plant Kingdom

THERE exists a certain group of plants commonly known as sensitive plants, or Mimosa. This species obtains its common name because of the irritability of the leaves. Those kinds which are most irritable are herbaceous, or half-shrubby plants with beautifully divided pinnate leaves. The leaflets close upward in pairs when touched and, on repeated or rough touching, the leaflets of the neighboring leaves also close together, become depressed and, lastly, the whole leaf

hangs as if withered. The same phenomenon will be noted if the stem of the plant is shaken. After a short time, however, the leaf stalk rises, and the leaflets again ex-



Above we see Mimosa, the most sensitive plant known. A slight touch will cause it to shrivel up and close all of its leaves.



The electric plant which gives a painful sensation when touched, is shown above.



Above we have a photo of a species of plant known as Mimosa, or sensitive plant. These plants are so-called from the fact that they shrink when touched. This tendency is most marked in the *Mimosa pudica*.

pend. On account of this curious and interesting property, some of the species are often cultivated in hot houses. A plant which belongs to the same species, but has large leaves, is also shown upon this page. This plant, however, is equipped with a more deadly means of protection. It is commonly called the electric plant and, when touched by the back of the hand, will cause a pain to run slowly up the arm, and a lump to form under the arm. This painful sensation lasts for a few hours. Two or three species of sensitive briar and cacti exist in the southern United States, but these do not give pain when they are touched.

These so-called curiosities of the plant kingdom show one of the many ways in which Mother Nature guards her otherwise defenseless charges. The sensitive plant is only one of thousands of interesting plants.



This illustration shows the electric plant which causes pain for several hours after being touched.

Hot Air Engine Operates from Lamp Socket

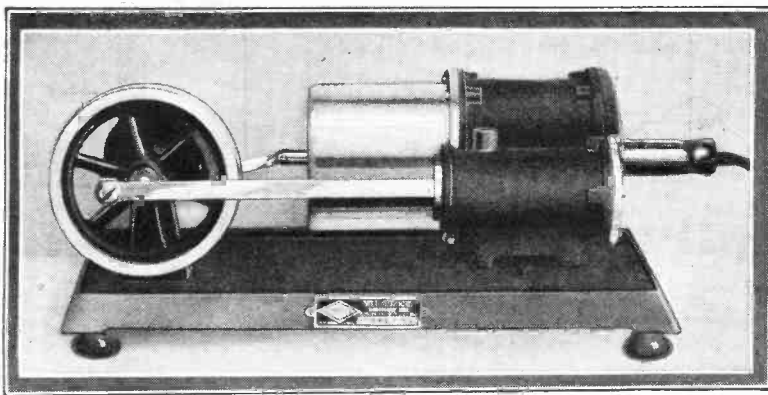

The photo at the left shows a front view of a new electrically heated hot air engine. The two air chambers may be seen, the larger one containing the heating element and metal sleeve.

successful engine was built in 1827, and one afterward was used in a foundry in Scotland. In this engine the same volume of air was alternately heated and cooled, producing a variation of pressure which actuated a working piston. The engine shown here belongs to the type of hot-air engines which utilize temperature changes at constant volumes. A hot-air engine in small size is more economical than a steam engine of the same capacity. It also has the advantage of avoiding the steam boiler and is safe and odorless.

The heater element in the engine shown here is designed to operate from the ordinary 110 volt light socket and will, in a short time, warm enough air for the starting of the engine. The metal sleeve which fits over this element must be accurately constructed. *Manufacturer's name on request.*

A NEW hot-air engine has recently appeared on the market. This device uses an electrical unit to heat the air. The air is heated in the larger chamber, shown in the photo, and then expands into the small one, driving the piston forward. A metal sleeve is then pushed over the heating element, the air contracts, and the piston is returned to its former position. The piston, which moves back and forth, transfers its motion to a revolving shaft. The engine itself is mounted upon a metal base and runs smoothly, with little mechanical losses. All parts have been made of good grade metal and are relatively few in number. The first hot-air engine was invented by Rev. Robert Stirling, an Englishman, in 1816. His first

At the right is a photograph showing the various parts used in the construction of this engine. Its simplicity is apparent and makes for a greater efficiency. Note the difference in size between the two air chambers.

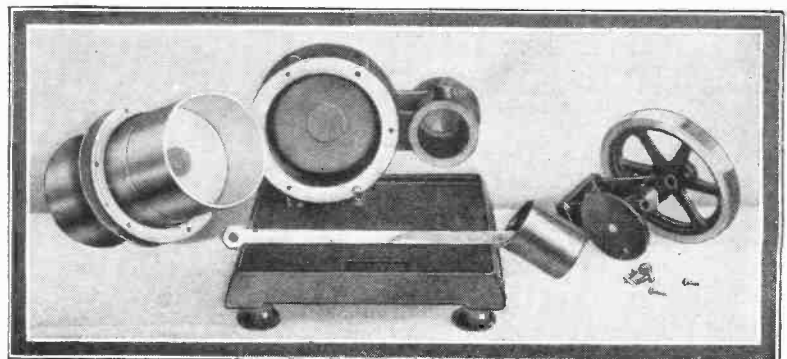

Reclaiming Metal Foil

This is not a pile of vegetables, but a table piled high with balls of metal in the form of crushed-up tinfoil.

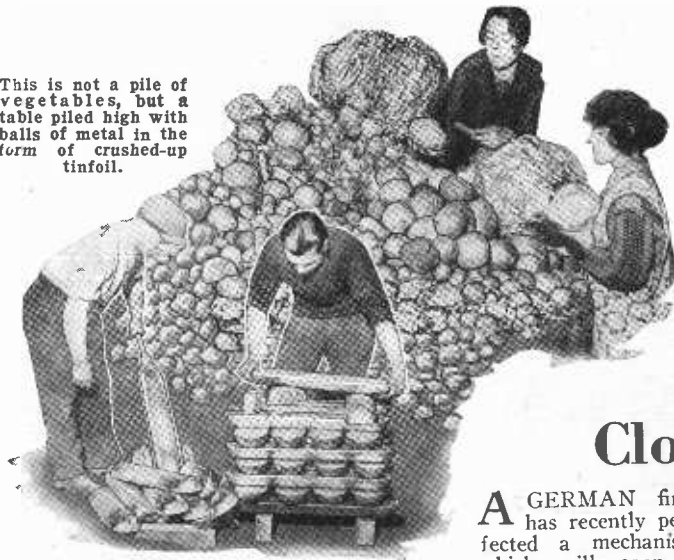

MOST of us have, at some time or other, collected and saved tinfoil, the source of supply being anything from the thin high aluminum-alloy foils, to the highly-prized thick sheets of nearly pure lead, such as are used for wrapping up tea. Practically all tinfoil is an alloy of lead, aluminum, and tin. The most valuable portion is, of course, the tin, which usually comprises less than half the alloy.

Thousands of people collect tinfoil and silver paper for various institutions, such as charity organizations and hospitals, but few have more than a vague idea of what happens to it after it is sold. In England, hundreds of tons of this foil is collected by the West London Metal Refining Co., of Bretford, from hospitals all over the kingdom. The foil is taken to their plant and is melted down to form ingots of lead, aluminum, and tin. Ordinary tinfoil is worth about twelve cents a pound, when sold in large quantities; a pound of this material is about the size of a tennis ball. Most tinfoil contains less than fifty per cent of tin; in fact, some so-called tinfoil is merely tin-plated sheets of thin lead.

Clever Cigar Lighter

This "wireless" cigar lighter is heated by pushing down the bakelite knob and holding

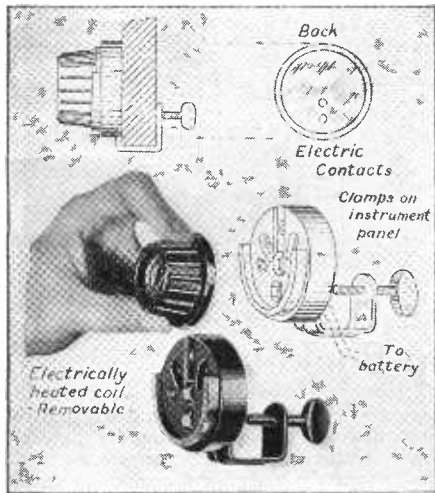

it down for about two or three seconds. Whereupon the heating element in the knob stays red hot for several seconds, after the knob is lifted out of the socket.

Clock Opened Parachutes

A GERMAN firm has recently perfected a mechanism which will open a parachute at any desired length of time after release. This device may be put to a number of uses, such as controlling airplane landing flares supported by parachutes, photographic illumination flares supported by parachutes, and it also makes possible the accurate delivery of air mail without the necessity of landing the mail plane. Fig. 1 shows the mechanism as used to open a small parachute and ignite a brilliant flare of short duration, when the apparatus has fallen to an elevation of about 200 yards above the earth. Fig. 2 shows the arrangement used to drop mail to within 100 feet of the ground before the parachute opens, which makes possible the quick and, therefore, accurate dropping of the mail

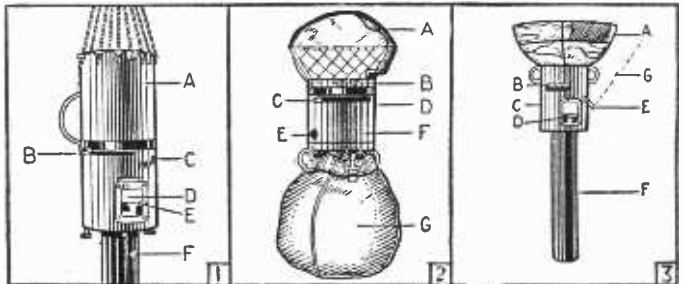
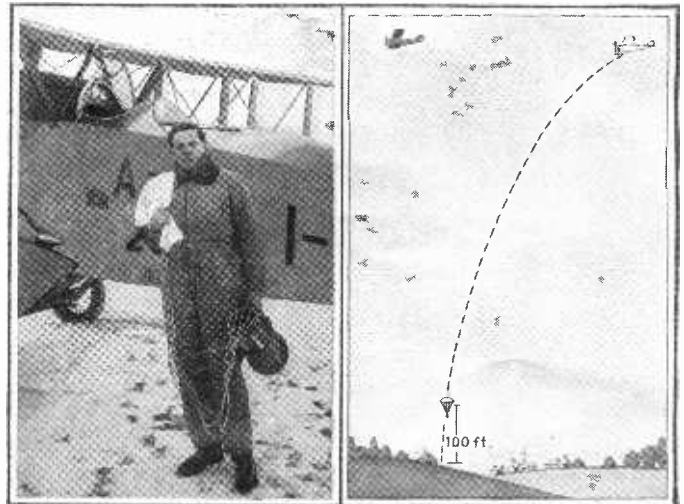

A New "Wireless" Glow Lamp

HIGHLY EVACUATED AND ALL OCCLUDED GASES DRIVEN OFF.



MOLYBDENUM DISK MOUNTED ON A TUNGSTEN ROD.

An examination of the above drawing reveals the fact that this lamp has no metallic connection with the power supply.

THIS lamp gives a convenient means of securing light or radiant heat for special purposes. After the disk has been heated to incandescence, it will stay hot ten minutes after the power has been shut off. This bulb was developed by Dr. Phillips Thomas, research engineer, of the famous Westinghouse company.

The tube contains a molybdenum disk, mounted at one end of a long tungsten rod, which is held in a blind press at the other



Dr. Thomas exhibiting the new glow lamp.

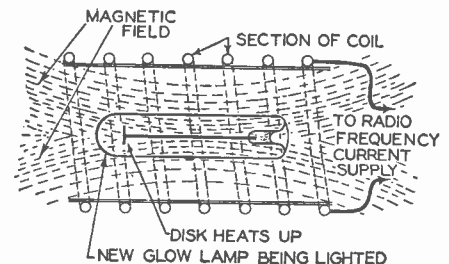

The lamp is placed in a helix supplied with a current alternating at radio frequency; the resulting field sets up eddy currents in the disk, which heat the disk to incandescence.

end. This tube is highly evacuated before sealing off, and when inserted in a single layer helix, through which a radio frequency current is passed, the circular disk becomes heated to a temperature limited by the power input and the fusing of the disk.

The Sun's Characteristics



The above drawing is a representation of the upper surface of the sun.

This is a reproduction of the original sketch of A. Zieberg, of Germany.

IF the upper surface of the sun were magnified or enlarged, it would look something like the illustration shown here, which was originally made by Prof. A. Zieberg, of Germany. A corona ray shot out by sun-matter at more than 375 miles per sec-

ond is shown at 1. The cloud protuberances, which reach a height of 1,500 to 2,000 miles, may also be seen at 7. The chromosphere of the sun is shown at 2. The photosphere, surface layer of cloudlike condensed vapors, is shown at 3. 4 indi-

cates an electrically charged gas cyclone which emits powerful cathode radiations. 5 indicates sunspots. A temperature of 5,900 degrees Centigrade exists at 6, and eruptive protuberances which reach a height of 248,000 miles are indicated at 8.—*Kosmos*,

The Movie Theater of the Future

THE theater of the future will be built in the form of a triangle, with the screen covering one whole side, as shown here. In a recent issue of the *Los Angeles Times*, Douglas Fairbanks predicts the advent of stereoscopic movies, possibly by using two synchronized projectors shooting upon a curved screen. Modern motion pictures are handicapped because they cannot bring the drama close enough to the spectator. How much more dramatic would be a cavalry charge, if it were shown in full panorama, keeping the close perspective. The screen of today is small and one has to look directly at it in order to see the action. The actors are jammed into the small frame, and it seems as though one were look-

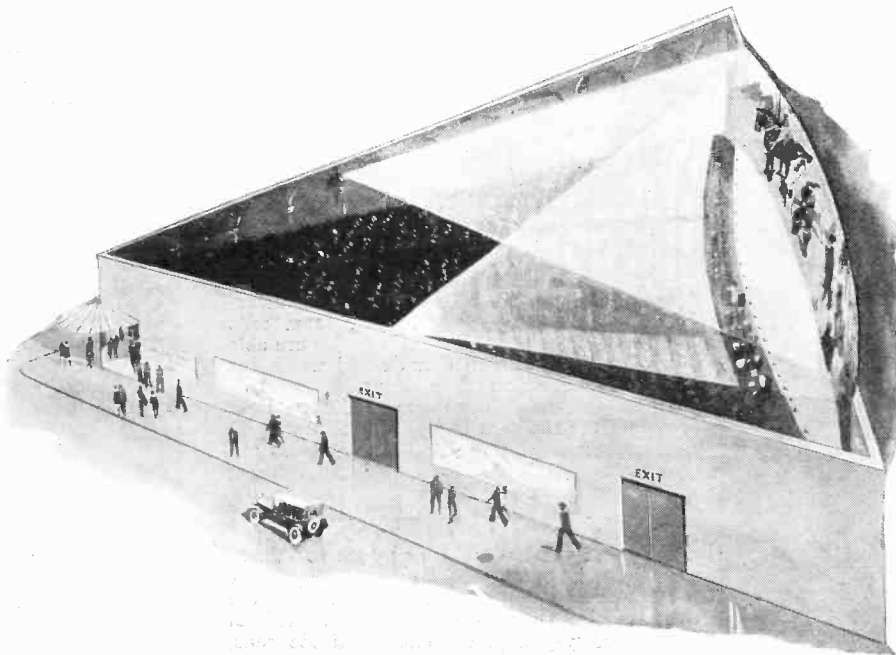

The theater of the future is envisioned above. It will use a large curved screen, big enough for the eye to rove about and come back to the main picture without distraction.

ing at a specimen viewed in a microscope. The future theater will have a curved screen large enough for the eye to rove about and then come back to the main action without being distracted. A member of the audience wouldn't know he was in a theater at all. With the music, voices and figures standing out lifelike, he would feel as if he were a part of the picture. Another change is also predicted in the studio regarding the camera. The camera of the future will reach out and bring action nearer to the eye. Reinhardt's Theater, in Berlin, is the reverse of the theater of tomorrow, shown here, as he puts the audience around the stage, instead of trying to put the stage around the audience.

The Cell, the Building Block of the Plant

How the Plant Grows, Feeds Itself and What
Makes the Colors

By DR. ERNEST BADE

EVERY living thing is under the influence of continual change and the mixtures and placement of organic substances, as well as the outward appearance, are never the same. The atoms which make up the body are only available



Section through the leaf of a water lily enlarged 30 diameters.

for a comparatively short time to the organism. They soon return to the place whence they came. And so life is always changing, always developing, always rejuvenating.

In an animal the individual cells have lost their identity and they do not act as a single cell. A group of them have come together in a unit to perform certain characteristic functions. In the plant, on the other hand, the cell has not been submerged to such an extent, it is still a more or less individual cell standing apart, although the community spirit is present and all work for the plant as a whole.

The cell is the foundation of the organic world. Under the microscope it is seen to be more or less irregular in form, and the cell of the plant is usually elongated and surrounded by a membrane. Its contents resembles a gelatinous mass and is known as protoplasm. Albumen is never absent, and therefore the elements carbon, oxygen, hydrogen, nitrogen and sulphur are present. In addition, organic compounds of phosphor-

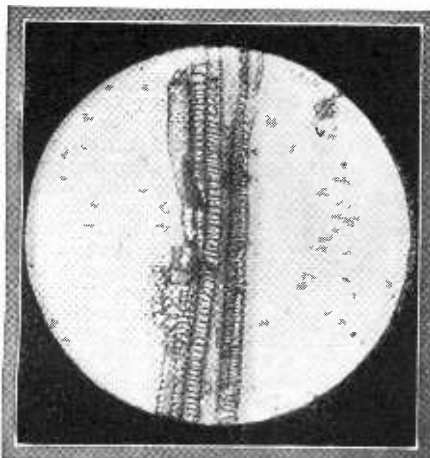

The spiral vessels of the bean enlarged 70 diameters.

ous, and also carbohydrates and fats may be found. Under such conditions it is natural that various types of protoplasm make up the contents of the different cells. In the protoplasm lifeless bodies are imbedded and these are food particles, fragments of excretory substances, minute droplets of oil, all forms and products which play their part in the life of the cell. The most important factor of the cell is not its membrane or outward shape, but its contents. The nucleus is never absent and this surrounds the nucleolus. The protoplasm follows the contour of the cell wall and sends threads toward the nucleus. At the same time the plasma is in continual motion. When cell division occurs then the division begins with the nucleus.

The walls of the individual cells are elastic and consist of cellulose, which permits the exchange of liquids but prevents the passage of solids. Another important constituent of the cell is chlorophyll, the green coloring matter of the leaves. This is not distributed throughout the cell, but consists of minute and more or less spherical bodies scattered throughout the protoplasm.

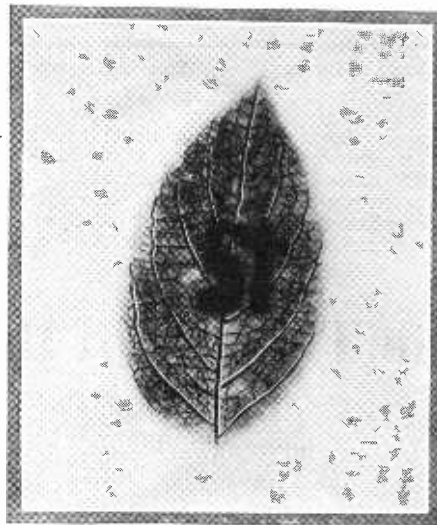

The effect of light on a leaf can be illustrated by covering a part with tinfoil and leaving a few days. If the leaf is then cut from the plant and boiled in alcohol to remove the green coloring matter and placed in a solution of iodine, the places exposed to the light turn dark blue showing that starch was made in the light.

The grain of chlorophyll is the device or organ used by the plant for the manufacture of raw products, and only those cells that contain these chlorophyll grains are able to decompose carbon dioxide and water for the making of starch and sugars, and this takes place only when daylight or other light rich in the red rays is playing on them.

By means of the cell division tissues are formed and these tissues combine, forming tissue systems which are necessary for the various functions in the different species of plants.

And so the leaf, which appears so thin to the eye, is composed of different layers of cells, and these cells, minute in size, are the chemical laboratory of the plant. Within the closely-packed columnar palisade cells, called the parenchyma tissue, the mysterious workers are the chlorophyll grains which act as catalysts in the manufacture of starch

or sugar. For raw materials, carbon dioxide from the air breathed in through the tiny leaf openings, the stomata, and water taken up through the roots, are used.

The process can most readily be illustrated in five steps:



Section through the bean stem enlarged 28 diameters.

- 1— H_2O (water) + CO_2 (Carbon dioxide) = H_2CO_3 (Carbonic acid)
- 2— $2\text{H}_2\text{CO}_3 = 2\text{CH}_2\text{O}_2$ (Formic Acid) + O_2 (Oxygen)
- 3— $2\text{CH}_2\text{O}_2 = 2\text{CH}_2\text{O}$ (Formaldehyde) + O_2
- 4— $6\text{CH}_2\text{O} = \text{C}_6\text{H}_{12}\text{O}_6$ (Grape sugar)
- 5— $\text{C}_6\text{H}_{12}\text{O}_6 = \text{C}_6\text{H}_{10}\text{O}_5$ (Starch) + H_2O (Water)

When the water and the carbon dioxide come together in the leaf, the green coloring matter, stimulated by the chemical influence of sunlight, begins to perform a series of chemical changes. Carbonic acid is produced first. This is changed to formic acid, and the latter to formaldehyde. Each of the last two chemical changes create a waste or by-product, oxygen, which is released and given back to the air. From formaldehyde a condensing process brings forth grape sugar; and finally, by a remarkable union of molecules, the grape sugar is turned into starch, together with the elimination of one molecule of water.

Starch is to be found within the chlorophyll grains and this substance may be considered the base of all other plant substances. With its aid, together with that of other



Stem of the elderberry showing lenticel, a place where respiration took place. Magnified 100 diameters.

substances, other products are made, of which the most important are the various sugars, cellulose, fats and the albumen.

The wanderings and travels of the manufactured substances from the place of origin to their destination, which may be for re-



Cells in the stem of the arrow weed enlarged 250 diameters. The green color of such a stem is due to the chlorophyll grains shown as black spots near the cell walls.

pair, new construction or even storage, is quite complicated, since an open circulatory system is absent. In addition, solids cannot be moved directly from cell to cell, especially not those which are insoluble in water. They must pass through the closed cell, some of which are short and others quite long, but at any rate millions of cell walls must be traversed. In the leaf the transportation of the starch may be observed with the microscope. In order to get from cell to cell, the starch grain is acted upon by an enzyme, which changes the starch to water-soluble dextrin and maltose. In this soluble state it passes to the next cell through its walls, and is again regenerated to starch. Here an unbalanced condition is produced, which causes more sugar to enter and be transformed to starch. Now it can be seen that the starch is not only transformed to sugars, but it is regenerated as starch in every cell that it must pass. The sending of albumen through the plant undoubtedly follows the same general rules, but its exact mechanism cannot be observed. It is thought possible that asparagin is formed, in some way or other, and that albumen is again regenerated as it passes from cell to cell.

The inorganic material necessary for plant life is not used directly as it enters, but the raw salts dissolved in water and taken up by the roots are first made into comparatively simple, though practically still un-

known products, a few of which can be made in the laboratory. The plant cannot produce albumen and proteins directly from starch or sugar, and nitrates or sulphates. Intermediate products must first be formed, but what these are and how they are made is still a mystery.

So that the leaf may work to the best advantage under all conditions of light, it has the power of movement. The light directs this motion. If it is strong and intense, then the leaf assumes a position almost vertical to the source of light; and as its intensity decreases, the leaf turns on its axis to a more horizontal position or, if the light comes at an angle, then it turns its flat side directly toward the light.

Under the palisade layers, which is made up of the starch manufacturing cells, is a network of spongy tissue which takes up the starch manufactured above them. At night, for work does not stop at dusk, more of the starch is accumulated and also gradually brought to other cells and into the conducting tissue, the veins of the leaves, and so into the plant, where it may be used for trunk, roots and twigs.

The rise of sap, that is the absorption of soil water with its soil salts, is brought upward into the leaves where the water, to a great extent, is evaporated and the salts remaining are used in building up its organic constituents. This rise of water takes place in certain well-defined regions, usually in the recent woody tissues; the manufactured products, on the other hand, are brought down in tissues near the bark. The manufactured material may be stored near buds and other growing twigs, seeds, or bulbs. This material also helps the plant pass its winter, so that it may begin growth as soon as warm weather sets in, without the necessity of first making all the material required for growth. In seeds, the foods so stored help the seedling to get its start, until its leaves are large enough to manufacture its food.

SEEDS A PUZZLE

THE length of time for the survival of seeds has been under investigation for quite a few years and it is definitely established by unquestionable authorities that some seeds can remain dormant for more than one hundred years, whereafter if planted, will produce plants that actually survive with only ordinary care. In most seeds that are capable of maintaining their vitality, a hard outer shell protects them

and prevents evaporation of the fluids within the covering. But the surprising feature of these investigations is that the germ of life continues to survive over that period of time. This statement does not necessarily imply that all seeds will remain active for such a

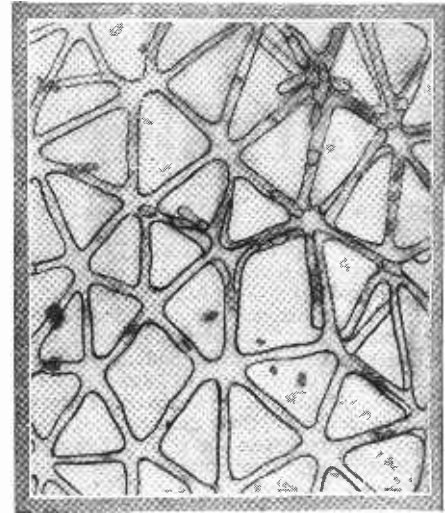

The individual cells in the stem of the Juncus form stars. This strengthens the central part of the stem with but little material. Enlarged 180 diameters.

long time. Some of them are very short-lived and unless planted every season, are practically worthless as far as their propensicity for developing into plants is concerned. It has also been found that the entire seed need not necessarily be planted. If the vital part is placed in soil conducive to its rapid development, the remainder of the seed can be discarded, but nature provides for emergencies, and it is for this reason that some seeds are filled with sufficient energy to give the seedling a good start in its battle with the elements. Experiments are likewise being carried on to determine whether a plant has any sort of feeling which can be likened to a conscious or sensory state in man. For this purpose, all sorts of appliances have been devised and all types of apparatus used. Plants are inoculated with germs and are treated with various remedies. Electricity is used to stimulate them, or to kill them, and the reactions are recorded and analyzed.

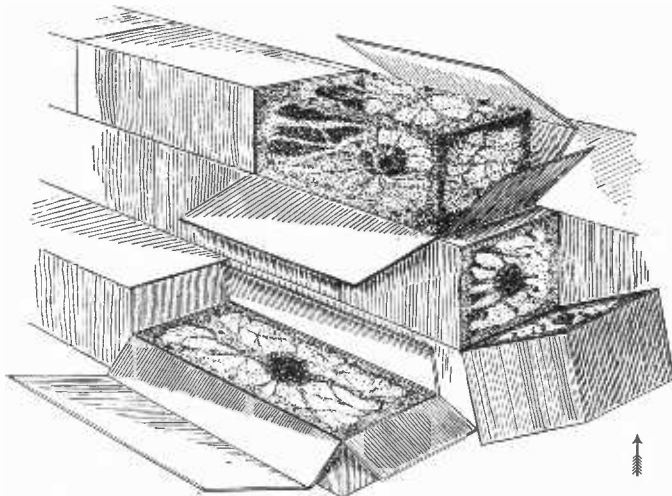

Above: Structure of the cell. The cells may be taken as boxes filled with living matter. The outer surface is the cell wall. In the center is the nucleolus within which the nucleolus is situated. The protoplasm is found near the outer cell walls with strands leading toward the nucleus; the remaining part of the cell consists of water.

At right: Section through the leaf. 1—Vein; a, cells which protect the vascular bundles; b, water-conducting tissues; c, food-conducting tissues. 2—Stomata or opening through which the exchange of gas takes place. 3—The upper epidermis. 4—Palisade cells, the factory of the leaf. 5—The spongy tissue. 6—Lower epidermis. 7—Air spaces within the leaf.

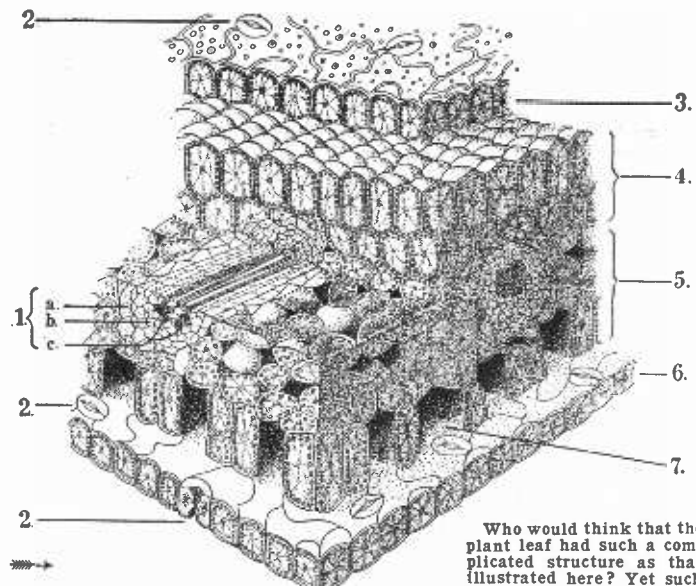

Who would think that the plant leaf had such a complicated structure as that illustrated here? Yet such is the case.



Hints on Exposure and Projection

No. 1

GEORGE SYLVESTER JONES was the motion picture expert of Rockland and his headquarters were at the amateur movie counter of the local camera store. His duties involved not only the sale of equipment and accessories but also, to his customers, the more important one of solving the problems that arose in the production of their animated albums. It was nearing noon on a Saturday and Jones knew from experience that he could

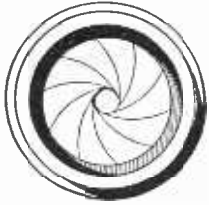

The light passed through the lens is controlled by the diaphragm. The iris diaphragm is regulated in size of opening by a lever which folds or unfolds the leaves.

expect a rush for the next several hours. He straightened up the piles of literature and ciné (movie) magazines on the display case, checked the quantity of film on hand, and saw that his sales book was ready for operation. The customers started drifting in for their supply of film for the week-end, one tried out several tripods and selected a neat, compact, folding affair. Another wanted a new exposure card to replace the one lost the previous Saturday.

As the rush hour drew to a close, a new customer drifted in, one who had bought a moderate priced outfit only the week before. "Mr. Jones, I have been reading my instruction book carefully and can thread up my camera like an expert. The only thing that confused me are these numbers on the front of the camera. The book says to set the pointer to a certain mark for a certain time of day and under different light conditions. But it doesn't mean a thing to me. What should I do if conditions are a little doubtful?"

MR. JONES EXPLAINS CAMERA ACTION

"**P**ERHAPS if I explain just what happens you can grasp the idea more readily," replied Jones. "The principle of taking any kind of pictures, either snapshots or movies, is that you have a piece of film that is coated with a chemical substance that is sensitive to light. This substance is called the *emulsion*. Emulsions vary in kind and speed but you need concern yourself only with one, the ciné (movie) film that you use in this camera.

"In front of the film is a lens, pieces of optical glass ground to a certain curvature in accordance with known laws. The lens gathers the rays of light, that are reflected from the object you want to photograph, concentrates them and passes them on to the sensitive emulsion I just spoke of. In passing the rays on, they are reduced in proportion so that a certain part of the field directly in front of the lens is transferred, in proportion, to the film, with faithful reproduction of all details.

HOW THE DIAPHRAGM WORKS

"**T**HE strength of the light varies; on bright cloudless days it is strongest, growing less as the clouds increase and

being weakest on days when the sky is completely overcast with clouds. Naturally, as the emulsion on your film has a constant sensitivity to these rays of light, some control is necessary, so that just the same amount will reach the film, no matter what the brilliancy of the sun. This control is centered in those little marks that have troubled you, and which are the indicators of the diaphragm (opening) setting. The diaphragm itself has several forms, the simplest of which is just a flat piece of metal

have controlled the composition of the emulsion, so that you have some latitude of exposure. Nevertheless, I would suggest that you bear in mind this rule, '*When in doubt, under-expose.*' The reason for this is, that when the films are processed in the finishing laboratory, an over-exposed film does not leave much emulsion for the print that will be returned to you, and as a result it will be very weak and without many details. An under-exposed film however, while a little dark, will have the details and sharpness that were in the original subject.

"The rule I just gave you does not mean that you should always "stop-down" (use a large number on the diaphragm indicator), a few points, it simply means that if you are in doubt about the brilliancy of the light, you should split the difference between the number on the card and the next higher number, setting the indicator halfway between the two numbers."

"Have you shot any film yet with your camera, Mr. Blake?"

"Yes, I used up this one roll I bought with the camera," replied the amateur, as he took a roll from his pocket and laid it on the counter.

"I'll have it processed for you and we can run it the end of this week, when it is returned from the finishing laboratory. By the way, have you used your projector yet?"

CAUSE OF FLICKER IN PROJECTING MOVIES

"**O**H yes. You know I bought some library films to show until I could have some of my own finished, but when I ran them they flickered so that they almost hurt our eyes. What causes that?"

"The projector was running too slow. Some machines have a little button in the base that you must turn to the proper mark, depending on whether your current is A.C. or D.C. On other machines you simply adjust the speed control until the flicker disappears from the screen. You see, the shutter goes in front of the light each time that the film is pulled down a *frame*. By *frame*, I mean *each separate picture on the film*. If your projector is running too slow, this means that the light is cut off from the screen long enough for the eye to realize it,

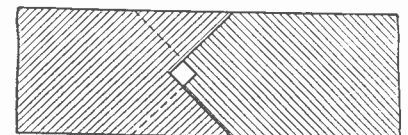

PARTLY CLOSED

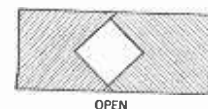

OPEN

Lens opening, adjustable type, of the form used on Ciné-Kodak. Two sliding metal leaves with V-slots provide openings of any desired size.

and you get that disagreeable sensation that *hurts the eyes.*"

"What kind of a screen did you use, Mr. Blake?"

"Why, first we just used the wall but the pictures were a little dim, and mother got out a freshly laundered sheet. That made quite an improvement and if it hadn't been

NEW! HOME MOVIES

is the newest craze sweeping the country. Don't miss the feature articles each month by

DON BENNETT

Well-known authority on movies
for the amateur

Mr. Bennett has had many years experience in the motion picture field, in all its branches.

or fibre with a hole through it. This is known as the *Waterhouse stop* and is found only in old professional still view cameras. The most common form is a ring, to which are attached odd-shaped leaves that overlap, and, as another ring is turned, these leaves spread, fan-like, and cover a greater area, thus changing the size of the hole left in the center. Like this—and Jones drew a sketch which is reproduced above at left).

"When the ring is at its highest number, the leaves are practically lying on each other and when the pointer is set at the lowest number, the leaves are extended to their full range—leaving just a pinhole. Some diaphragms are known as *full-closing* and their leaves close all the way, leaving no opening at all. These are usually found only in high-priced professional lense mounts but they are used in the *iris fade-out* attachments that fit the front of your camera.

"You can readily see that this diaphragm is like a valve, and it admits just as much light at each setting. There is a relation between the marks that you should bear in mind, each mark, starting at the highest number, admits just twice as much light as the next lowest. For example: f:11 lets twice as much light through as f:16; f:8 admits twice as much as f:11 or four times as much as f:16; and so on down the scale.

WHEN IN DOUBT—UNDER-EXPOSE

"**T**HERE would be serious danger in misjudging the strength of the light, were it not for the fact that the film makers

for the flicker we would have enjoyed the show. Do you think that a sheet is alright for a screen?"

GOOD SCREEN DESIRABLE FOR PROJECTION

"YES, it will do in an emergency, but a really good screen makes a world of difference in your pictures and your audience really appreciates the improved quality.

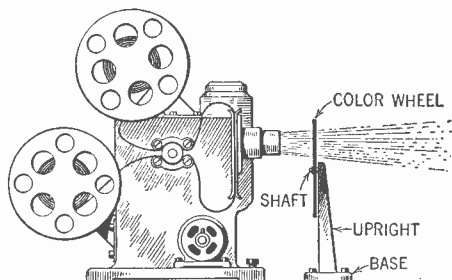

Color movies can be projected by placing color screen of desired tone in front of projector.

There are many kinds of screens made in a wide range of surfaces and prices, from the aluminum painted cardboard up to a screen made of small glass beads imbedded in a cementing material. A very good screen is one made from a sheet of aluminum that has been slightly roughened by sandblasting. This of course takes up quite some storage space and is not as convenient as the cloth screens that are mounted on a spring roller. "The glass bead screens are undoubtedly the best for home use as they have a wide angle of reflection and the image can be seen from almost any corner of the room. Their brilliancy is good too, and their color value is true."

COLORED MOVIES—HOW MADE

"SPEAKING of color," interrupted Blake, "is there any way I can color my pictures?"

"At present there is no way that you can color them exactly like the scene you photographed, but you can make them more attractive by tinting them, either the film itself or by slipping one of these attachments over the lens of your projector. Tinting the film is a job for an expert and can be done so cheaply that it is a waste of time for you to do it yourself. On the other hand, with one of these color filters you can tint the scenes when projecting and you can change the color at will, not being depending on the dye that you have put on the film."

"Why, I can make one of those. What do you use for the colors?"

"Tinted gelatin. I have some here that you can have for just a few cents a sheet, and you can combine them to make as many colors as you want. I would suggest that you have a six hole wheel, with these colors; one hole clear for black and white, one yellow, one amber, one blue, one pink and one green. You can make any other combinations you want by putting two pieces of gelatin over the same hole."

"How big would you make the wheel, Mr. Jones?"

"Well, your lens is about an inch in diameter, and you want the hole just a little larger, say an inch and one-quarter. Take the cardboard that you will use for a frame, and draw on it a circle three inches in diameter. Divide this into six equal parts, and at each division draw a circle one and one-quarter inches in diameter. Cut out these smaller circles and make another piece of cardboard to match. Then cut your gelatins and fasten them in a place and, last of all, cement the two pieces of cardboard together, being careful that none of the glue runs out into the openings. Put a small hole in the center of the wheel and make a pivot that will fit

Next Month!
Special Added Feature
"HOW TO TAKE MOVIES OF UNSEEN LIFE"
 The movie camera plus the microscope's eye, explained by
HERBERT C. MCKAY, A.R.P.S.

snugly and fasten the whole to a little stand. Then you can have the clear opening for black and white scenes. The yellow and amber will do for tinting or for disguising scenes, the blue for night scenes, and the pink for sunsets or fire scenes."

"I think I'll make one tonight. Give me a set of gelatins, Mr. Jones. By the way, when will my films be back from the laboratory?"

"They'll be here on Friday and if you want to drop in we'll run them and see how they turned out. If you have made any errors in them I can tell you so that you won't spoil any more."

"I'm sorry to have taken up so much of your time, Mr. Jones," said Mr. Blake, "it really seems an imposition."

"Not at all, Mr. Blake, drop in any time at all, I'm always glad to answer any questions you may have. It's part of our service."

(Next month Blake and Jones will criticize "the first film." Listen in on them and find out how to save your films, when you make a slight mistake in taking them.)

Movie Question Box

This department is open to all readers of SCIENCE AND INVENTION without charge. Any question relating to the taking of showing of motion pictures will be answered in this column. Questions involving extended research cannot be answered. Comparisons of manufactured products will not be made under any circumstances. Address all communications to: *Movie Question Box, care SCIENCE AND INVENTION, 230 Fifth Avenue, New York City.*

THEATRICAL STANDARD
35 mm.

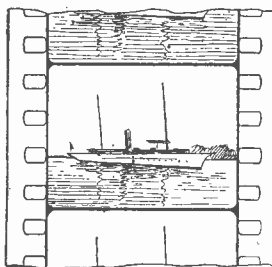

Use: Professional cameras and projectors, 35-mm. amateur cameras.

Emulsion: Regular; Super-speed; Panchromatic (color sensitive); hyper-sensitized (sensitive to all colors and to infra-red.)

AMATEUR STANDARD
16 mm.

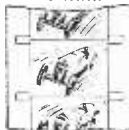

Use: Amateur cameras and projectors; industrial sales and educational.

Emulsion: Superspeed negative; Panchromatic negative; Reversal (direct positive); Reversal panchromatic.

PATHEX
9 mm.



Use: PatheX and some European cameras. House use only.

Emulsion: Reversal only. (Positive is negative film processed.)

E. A. Kenny writes:

Q. I am enclosing a strip of film made with my movie camera. You will notice that it is hazy. Please tell me how to overcome this.

A. The film you enclosed was of a distant object and a color filter should have been used. This filter cuts down the haze

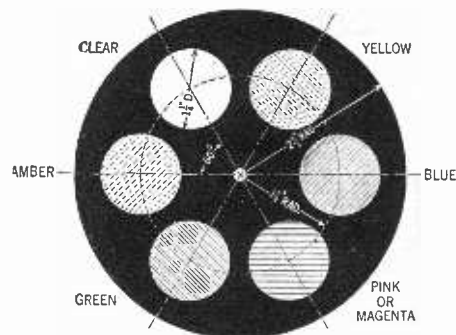

Home-made color screen to be mounted in front of movie projector. The cost is very slight.

and results in a much sharper picture that contains much of the detail of the object. When taking pictures of this type always consult the reverse side of your exposure card for supplementary instructions.

R. L. Vance asks:

Q. My pictures are not very clear on the screen. What causes this?

A. As your camera is a fixed-focus model, the fault may lie in a dirty lens, either on the camera or projector. Clean your projector lens first and see if this eliminates the trouble, if not, take a parlor match and wrap the head in a piece of lens tissue, obtainable from your movie or optical dealer. Wiping the lens with this tissue will clean it without smears or scratches. You should do this every few months to remove dust from the lens surface.

W. R. Turley inquires:

Q. When I project pictures they flicker badly. The motor is adjusted to run as fast as possible.

A. If your projector has an adjustment for A.C. or D.C. current, make sure that you have the switch turned to the proper point for the particular current you are using. Make sure that your projector is oiled at all points shown in your instruction book with the oil specified by the manufacturer. Lack of oil will cause a projector to run slow.

G. E. Spindler says:

Q. Will you tell me what different sizes of film there are, and the kind of emulsions available in each size?

A. The chart below shows clearly the different sizes and kinds of film now available.

TABLE OF EXPOSURES FOR 16MM. FILM

Month	Weather	11 am to 1 pm	10-11 am and 1-2 pm	9-10 am and 2-3 pm	8-9 am and 3-4 pm	7-8 am and 4-5 pm	6-7 am and 5-6 pm	5-6 am and 6-7 pm
Jan. Nov. Dec.	Bright Sun Hazy Sun Dull Very Dull	11 5.6 4.5	11 4.5 3.5	8 4.5 3.5	4.5 3.5 2.5	3.5 2.5 1.8	2.5
Feb. Oct.	Bright Sun Hazy Sun Dull Very Dull	16 11 8 4.5	11 8 5.6 4.5	8 5.6 4.5 3.5	5.6 4.5 3.5 2.5	4.5 3.5 2.5 ...	3.5 2.5
Mar. Apr. Sept.	Bright Sun Hazy Sun Dull Very Dull	16 11 8 4.5	16 11 8 4.5	11 8 5.6 4.5	8 5.6 4.5 3.5	5.6 4.5 3.5 2.5	4.5 3.5 2.5
May June July Aug.	Bright Sun Hazy Sun Dull Very Dull	16 11 8 5.6	16 11 8 5.6	11 8 5.6 4.5	8 5.6 4.5 3.5	5.6 4.5 3.5 2.5	4.5 3.5 2.5	...

The Metal EMPEROR

by A. Merritt
Author of "THE MOON POOL", "THE FACE IN THE ABYSS" etc.

Eleventh (Concluding) Installment

CHAPTER XXX "BURNED OUT!"

THE slender steeple of the cones drooped, sending its faceted coronet shattering to the floor. The mount melted. Beneath the flooding radiance sprawled the Cross, and the great Globe that was Norhala's sepulcher.

The crater filled with a pallid luminescence pouring fast and ever faster down into the Pit. From all the lesser craters of the smaller cones swept silent cataracts of that same pale radiance.

The City began to crumble.

Like pent waters rushing through a broken dam, the gleaming deluge swept over the valley; gushing in steady torrents from the breaking mass. Over the valley fell a vast silence. The lightnings ceased. The Horde stood rigid, the shining flood lapping about them and rising swiftly ever higher.

From the sinking City swarmed the multitudes of its weird luminaries. Out they trooped, swirling from every rent and gap— orbs scarlet and sapphire, ruby orbs, orbs tuliped and irised—the jocund suns of the birth chamber, and side by side with them hosts of the frozen, pale gilt, stiff rayed suns. Thousands upon thousands they

marched forth and poised themselves, solemnly, over all the Pit that now was a fast-rising lake of yellow sun froth.

They swept forth in squadrons, in companies, in regiments, those mysterious orbs. They floated over the valley. They separated, and swung motionless above it as though they were mysterious multiple souls of fire brooding over the dying shell that

had held them. Thrusting up from the lake of fire beneath them, like grotesque towers of some half drowned, fantastic metropolis, the great shapes stood black against its glowing.

What had been the City—that which had been the bulk of the Horde—was a vast and shapeless hill, streaming silent torrents of that released force which, concentrate and bound, had been the Cones. As though it was the Horde's shining life-blood it poured, raising ever higher the level of the radiant lake.

Lower and lower sank the City. It squattered and spread. About its helpless, patient crouching was something ineffably piteous, something cosmically tragic.

The watching orbs shook under a hail of sparkling atoms shooting down from the glittering sky, and raining upon the lambent lake. So thick they fell that quickly the brooding luminaries were dim aureoles within them. The veils in which we lay shook, and began to pulsate.

From the Pit came a blinding, insupportable brilliancy. From every rigid tower gleamed out jeweled fires—their clinging units opening into blazing star and disk and cross. The melting City was a hill of living gems over which flowed torrents of pale molten gold. The Pit blazed.



Synopsis

Dr. Louis Thornton is travelling through Tibet with his Chinese servant-cook, Chiu Ming, and two ponies that carried the impedimenta. They come upon a white man who introduces himself as Richard Keene Drake. Drake's father had been very friendly with Thornton. The three decide to carry on and come upon Martin Ventnor, a geologist, and Ruth, his sister. The latter are guarding themselves against hundreds of soldiers who belong to an age at least twenty centuries back. While escaping they are attacked and would have been exterminated, were it not for the timely intervention of Norhala, a tall, beautiful, metallic-haired woman, whose control over lightning and over heavy metallic blocks was phenomenal. These blocks, at her command, would make a bridge for her to walk on or form themselves into battling monsters to protect her or obey her every whim. Chiu Ming is killed in the battle, the survivors leaving with Norhala. Ruth and Norhala get on one of the blocks. The others stand upon a second composed of four smaller ones joined together by their own peculiar super-normal power. The platforms speed through space at a terrific rate, arriving eventually in the court of the Metal Emperor. Angered by the influence of Nor-

hala over Ruth, Ventnor raises his rifle and fires at the red, ruby-like object he believes to be the brain of the metal monster. He is struck down by a lance of green flame and rendered unconscious. The metal monster gives Norhala the entire company to serve as her toys. She takes them to her home, where she informs Yuruk, her ape-like eunuch attendant, they are not to be harmed. Ventnor talks, then lapses into unconsciousness again. Ruth, after telling about the strange power that holds her enslaved, goes to sleep. Drake and Thornton discourse on the metal intelligences, and come to the conclusion that they are guided by some sort of group consciousness, and that they move by super-rapid molecular "steps!" Yuruk, because of jealousy, informs Drake of the way back to the city, which Ventnor, in a semi-conscious state, told them was their only hope. Yuruk claims that though the inhabitants of the city were hostile, it is much safer to escape. Leaving Ruth with Ventnor, Thornton and Drake decided to skip away from Norhala. They informed Ruth that Yuruk has learned the meaning of the pistol. After rather spectacular adventures, they come upon the Metal City, where geometrical and intangible forms are seemingly endowed with super-intelligence. The city saw and was alive. Norhala appears unexpectedly and is just

as quickly blotted out from sight. They observe the metal hordes and make the acquaintance of the Metal Emperor, to be subsequently brushed out of his presence, after which they glide away rapidly.

Thornton and Drake finally come upon the birth chamber of the Metal Horde, a surprising sight. The corridor closed and pushed the adventurers off a precipitous cliff. Falling fast, they see Norhala appear. The metal cubes save the two men from destruction. Norhala tells Thornton and Drake that Ruth and Ventnor have been taken captive by Cherkis' men. Norhala causes the Horde to form a mighty metal dragon, which moves forward to Ruzark, the City of Cherkis. Norhala demands the surrender of the maid and the man.

By means of the long metal tentacles at Norhala's command, Ruth and Ventnor are snatched off the ground, after Cherkis had allowed them to appear. Kulun was also licked up by the tentacle, but he was killed a moment later. Norhala has her vengeance and destroys Ruzark and all its people. Later she destroys Cherkis—the scene closes with the dead body of Cherkis being consumed by birds of prey. The party returns to Norhala's home. The Metal Horde starts to fight against itself. In the mighty conflict between the two forces of the metal people—Norhala is snatched into oblivion.

There followed an appalling tensity, a prodigious gathering of force; a prodigious concentration of energy. And thicker fell the clouds of sparking atoms—and higher arose the yellow flood.

Ventnor cried out. I could not hear him, but I read his purpose—and so did Drake. Up on his broad shoulders he swung Ruth. Back through the throbbing veils we ran and passed out of them.

"Back!" shouted Ventnor. "Back as far as you can get!"

On we raced. We reached the gateway of the cliffs, ran on and on up the shining roadway toward the blue globe; ran sobbing, panting—ran, we knew, for our lives.

Out of the Pit came a sound—I cannot

describe it. A desolate, dreadful wail of despair. It shuddered past us like the groaning of a broken-hearted sun.

It died.

There rushed upon us a sea of that loneliness, that longing for extinction that had assailed us in the haunted hollow where first we had seen Norhala. We fell beneath it, torn by desire for swift death.

A dazzling brilliancy filled the sky. I heard with dying ears a chaotic, blasting roar. A wave of air thicker than water caught us up and hurled us hundreds of yards forward. It dropped us and in its wake rushed another wave, withering, scorching.

It raced over us. Scorching though it was, within its heat was energizing, revivifying force. Something that slew that deadly despair and fed the fading fires of life.

I staggered to my feet and looked back. The veils were gone. The precipice-walled gateway they had curtained was filled with a glare as though it opened into the heart of a volcano.

A hand clutched my shoulder and spun me around. It was Ventnor. He pointed to the sapphire house. Far ahead I saw Drake, the body of Ruth clasped to his breast. The heat became blasting, my laboring lungs seemed to shrivel in the air they breathed.

Over the sky above the canyon streaked a
(Continued on page 364)



Out of the Pit came a sound—I cannot describe it. A desolate, dreadful wail of despair. It shuddered past us like the groaning of a broken-hearted sun. It died.
There rushed upon us a sea of that loneliness, that longing for extinction that had assailed us in the haunted hollow where first we had seen Norhala.
A dazzling brilliancy filled the sky. I heard with dying ears a chaotic, blasting roar. A wave of air thicker than water caught us up and hurled us hundreds of yards forward. It dropped us and in its wake rushed another wave, withering, scorching.
It raced over us. . . .



Motor Hints

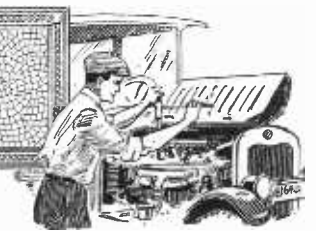

Conducted by **GEORGE A. LUERS**

DO YOU KNOW—

whites of eggs can be used for emergency repairs to a leaky radiator. Put in the whites of two eggs, while the engine is hot. While not permanent, this will bring the car back to the garage.

PADLOCKING GEAR SHIFT

If you value your car, do not carry extra insurance, and have every reason for wanting to keep it from being stolen, you cannot use too many locks.

An unusually simple and effective lock, which was made by one owner, is offered here for the owner readers' information and benefit.

A strap hinge is bent at one end to form a padlock eye, as shown in the drawing. This hinge is bolted to the dash of the car, and these bolts are riveted over, to prevent removal.

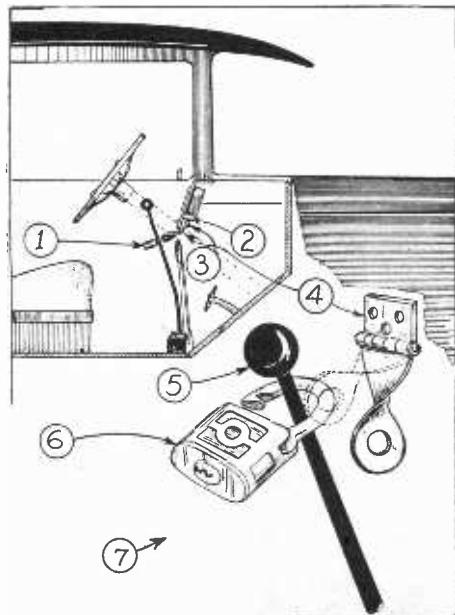

Above—1 indicates padlock; 2, padlock eye; 3, bolts; 4, strap hinge fastener; 5, gear shift lever; 6, padlock, and 7 indicates an enlarged view of the arrangement.

A padlock of the type with a hinged locking clasp is used with this padlock eye, to lock the gear-shift lever. The gear shift can be locked in any position, depending upon the length of hook made to secure it with. Reverse is a good position, and is given here for the additional reason that it serves as a brake on the car.

This hasp can be made up about as cheaply as any lock, and has the advantage of being cheap and dependable insurance against the operations of the average thief.

INDICATOR FOR RADIATOR WATER

The motorist who has to take off the radiator cap to determine the level of the water supply, will find the garage-made positive water level indicator, shown in the attached sketch, of more than passing interest.

This fixture can be made in the garage, from light metal parts, using only tin snips and a soldering iron.

A sheet-metal bracket is soldered to the radiator cap. Through it passes a brass rod about a sixteenth-inch in diameter. A small metal shaving stick tin is soldered to make it air tight and is soldered to the rod. The upper end of the rod is fitted with a small brass ball, such as are used on pull-chains of electric-light sockets.

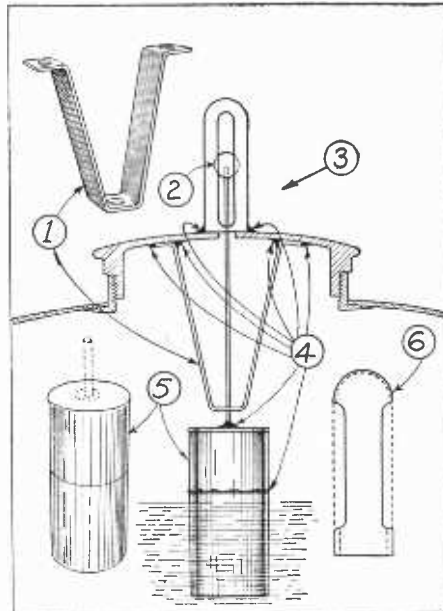

Above—1, bracket; 2, brass ball; 3 indicates sectional view; 4 shows soldered joints; 5, float, and 6, dome-shaped cover.

On top of the radiator cap, a dome end cover, with two opposite slots, is soldered.

The construction will be clear from the sketch. The use of this indicator will save the driver many anxious worries over the water content of the radiator. The top ball tells the story without even removing the radiator cap.

MIRROR SHOWS HIGH TRAFFIC LIGHTS

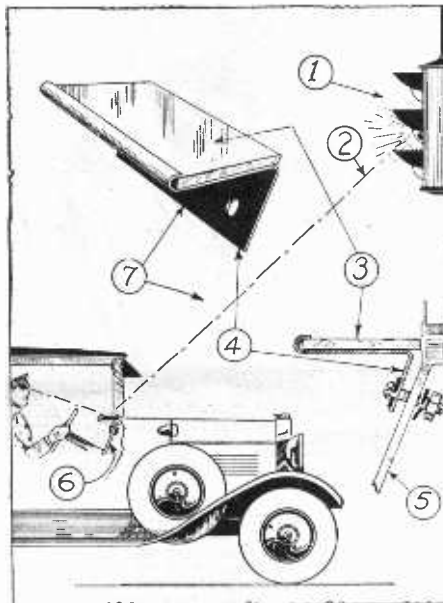

Above—1, traffic lights; 2, reflection; 3, mirror; 4, bracket; 5 and 6, dash, and 7 indicates enlarged view.

From a distance, traffic lights are readily seen by the driver. When close in and waiting for a turn to the green, the driver usually has to assume an uncomfortable position for watching.

The solution of one ingenious driver, as is shown by the attached sketch, will appeal to a large number of motorists, as being a simple solution for this trouble.

A small glass mirror, about one and a half inches by three or four, is mounted in a sheet-metal holder. This holder secures the mirror in place against the dash, so to reflect the traffic light direct to the driver, when in normal position.

A similar fixture can be provided by any car owner, with a half hour or so of spare time.

WHEN FORD RADIUS ROD SOCKET IS BENT

When a Ford takes a bump on the front axle, as when a curb is struck, and the front radius rod is crumpled, the socket for this

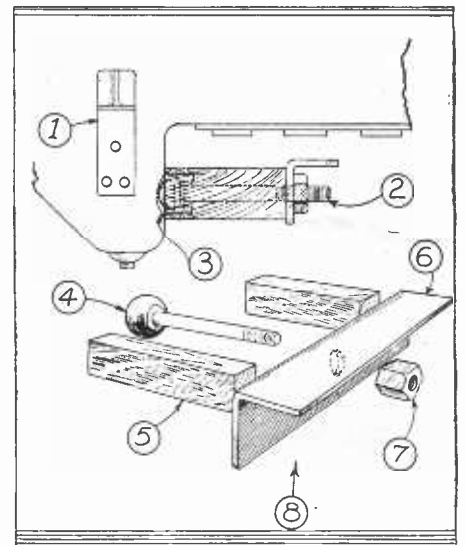

Above—1, flywheel housing; 2, straightening tool; 3, bent radius rod connection; 4, bolt; 5, wooden blocks; 6, angle iron; 7, nut, and 8 indicates detailed illustration of straightening tool.

rod in the flywheel housing is invariably dented back. The radius rod can frequently be straightened back with a hammer, but the wheels and axle will not be correctly tilted until this socket is put back into shape.

The tool shown in the attached sketch avoids tearing down the engine to do the job, saving much time and hard work.

A piece of angle-iron is drilled at the center for a 3/4-inch bolt, or one around this size. Two pieces of wood, about two by four inches in section, are sawed off of equal length to serve as props.

A long bolt is ground on the head, to approximately the size of the ball end of the radius rod.

This tool is set in place as shown, and a nut and wrench is used to straighten back the socket.

REFINISHING VALVES

To refinish valves in the overhaul of the engine, or when cleaning carbon and setting up the valves the owner-mechanic need not be handicapped through lack of adequate special tools, if a vise is available.

(Continued on page 354)

MAGIC By "DUNNINGER"

NO. 65 OF A SERIES

CIGAR CASE TRICK



A case full of cigars is made to mystically change into a cigar case full of colored handkerchiefs. The construction of the case is responsible for the change.

Magicians favor tricks with silk handkerchiefs of various colors because they are pleasing to the eye, and they carry with them a popular appeal. The color blend also seems to satisfy the audience to a greater extent than some of the even more spectacular effects. The modern showman requires variety and variation, so here is a variation which can be employed and which does not take up much room. A leather cigar case of apparently the ordinary type is seen lying on the table. The magician shows it, draws a cigar therefrom, closes it, and vanishes several handkerchiefs, which are later found in the case.

Explanation: The construction of the case is responsible for the strange transformation. In reality, the box has two covers, and by simply turning the case around either compartment is brought into view. Half cigars are found on one side with one whole cigar extending down into the bottom, if so desired. This trick can also be produced with a small cigar case, making it an admirable pocket magical apparatus.

NEW LEMON TRICK

There are many ways of producing the effect wherein a coin is vanished and afterwards discovered inside a lemon. This has always been a favorite among the professional magicians, and even various contrivances have been adapted so that the amateur will have no difficulty in mastering the moves necessary to bring about the effective termination of the trick. The present system described, enables this stunt to be performed without any practice whatever, and will permit one or more coins to be produced from inside of a lemon. The knife with which the lemons are divided, has a double blade which is hollow and which provides space sufficient to hold several coins. These coins drop out through a cavity as indicated. Ordinary lemons are passed out for thorough examination and any one of them can be selected and marked, and then presented to the performer. On cutting the lemon he, of course, starts to cut with the end of the knife nearer the handle, and by properly tilting the knife as the tip moves down into the citrous fruit, the coins can be made to drop into the lemon.

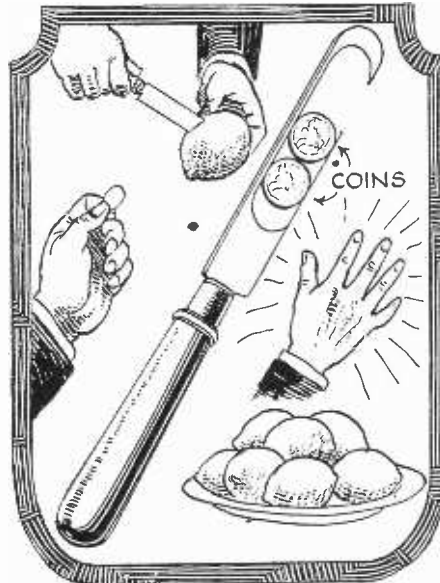

By the aid of the knife indicated in the above diagram, coins can be made to appear in a lemon, freely chosen by one of the spectators.

THE MYSTIC DECANTER

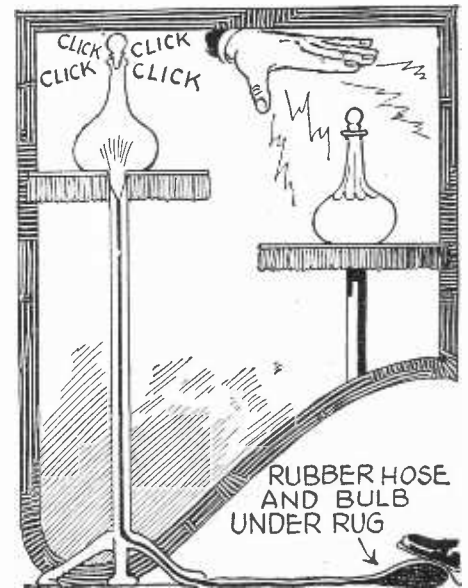

By the aid of a rubber hose and a bulb, the magician is able to control the movements of the glass stopper in the top of the decanter, and thus make it answer questions.

This effect is quite suitable for the stage or the drawing room. A seemingly ordinary decanter is exhibited, made entirely of glass. The mouth has the usual glass stopper, which is inserted by the wizard, who claims that the decanter is occasionally invaded by a spirit and this spirit causes the glass stopper to jump about, producing a series of clicks. Having made friends with the spirit, the magician has been able to get him to answer various questions, by the usual sign—one click meaning no, and two, yes. Questions are then asked of the audience and the answer is obtained from the jumping stopper.

Explanation: The diagram explains the system. A concealed assistant controls the action of this stopper through a long rubber tube, terminating in a rubber bulb. By pressing on the bulb, he is able to force air into the decanter, which causes the loose-fitting stopper to bounce up and down, in direct response to the puffs of air. The decanter being heavier and having a hole in the bottom, is not shifted by the air pressure. It can also be operated by the foot.

A CRYSTAL CASKET MYSTERY



An empty glass box is exhibited to the audience. Four tumblers are then placed on a table and the box is then placed on top of these tumblers. The magician explains that inasmuch as the casket and the tumblers are quite transparent, it is impossible for anything to enter the box, elevated above the table-top. Nevertheless, he produces in large numbers, flags, hundreds of ribbons, paper, handkerchiefs of different colors, etc. The effect is phenomenal, but easily explained. One of the glasses supporting

the box is bottomless and is what is technically known as a mirror glass. That is, a mirror is cut to fit the glass and placed within it. The glass thus appears entirely empty at all times, yet plenty of action can occur behind the mirror portion. All of the flags, ribbons, etc., being lightly fastened together, it becomes a simple matter to fill the box with the decorations from the false table-top in which they repose. The apparatus and the effect is illustrated in the diagrams above.

Can You Answer These Questions?

(Form your own answer before turning to page indicated)

1. Give your definition of the word "beauty" in not more than fifty words. (Now turn to page 295 and compare your opinion with Mr. H. Gernsback's.)
2. Does the steel frame of a skyscraper support the weight of the stone and brick work; or do you believe that the masonry walls help to support the weight of the building? (See page 296.)
3. How do you account for the fact that a bridge of land once joined the Americas with Africa and Europe, but at the present time you can see no evidence of it? (See page 298.)
4. What do you believe to be the simplest and most efficient means of utilizing the power in the sun's rays? (See page 300.)
5. Do animals think? Do you believe in hoop snakes? Do serpents charm birds? Do warts come from handling toads? Do mice sing? Are elephants afraid of mice? (See page 302.)
6. Do you believe that the 17 year locust is a figment of the imagination or real scientific fact? Why the 17 year cycle? (See page 305.)
7. Do you think it is feasible to freeze artificial icebergs and anchor them in a chain across the ocean, to be used as airplane landing stages? (See page 306.)
8. Which type of water impounding dam requires the most material: a gravity type or arched type? What are the advantages of the arched type? (See page 310.)
9. Spiritualistic mediums frequently fool their clients by freeing their hands, in the dark, after they have tightly clasped hands with the sitters on either side of them. How can you explain this? (See page 312.)
10. Do you know that there are some plants so sensitive that when you merely touch the leaves, they shrink from the hand and fold up? Also did you know that there are plants which can shock you severely? (See page 315.)
11. Are you familiar with the modern "home movie" camera and projector? How does the camera work? What frequently causes the projected pictures to flicker? (See page 320.)
12. How can ice be made directly from heat? Are you familiar with the method by which the newest home refrigerator makes ice from gas heat, without electricity or any moving machinery? (See page 327.)

Longest Railroad Tunnel in United States

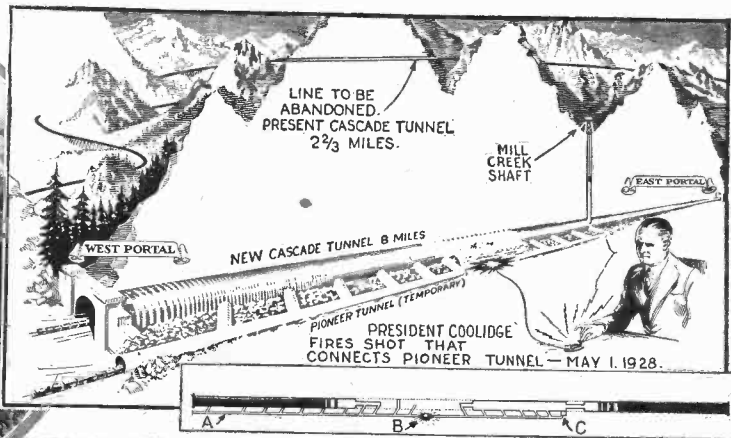

At the left is a progress chart showing the various stages in the construction of the new eight-mile tunnel which bores its way through the Cascade Mountains. Through the use of this tunnel 17 1/2 miles of the present trackage can be abandoned. It reduces the rise over the mountains by 505 feet. In the drawing at the left A is the pioneer tunnel, B shows where the tunnel was "holed through" and C is the Mill Creek shaft. The photograph at the extreme left shows the axis of the tunnel through the mountain.

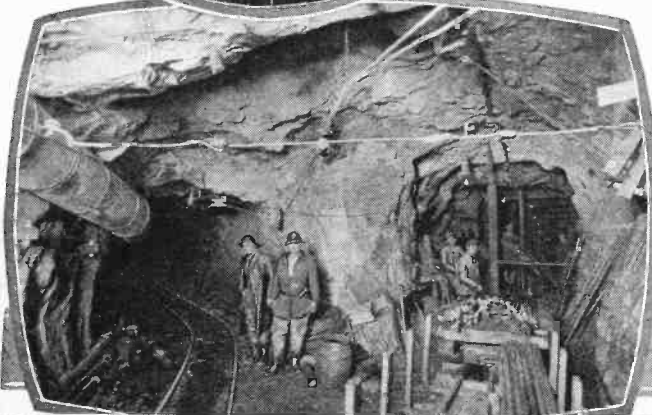

In the photograph at the left is a view of the pioneer tunnel. On the left hand side is the cross-cut to the main tunnel. The pioneer tunnel was a temporary means of communication and was kept well ahead of the main tunnel. The Mill Creek shaft, which reaches upward for 650 feet, was used to lower the shovels, rock trains, and the like into the tunnel. With the completion of the tunnel, the Atlantic is brought some fifty miles closer to the Pacific Ocean. It constitutes the largest engineering and rail project which was ever carried out in the United States. The completed tunnel is 24 ft. high and 16 ft. wide, and the total outlay amounted to \$25,000,000.00.

Illustrations courtesy Great Northern Railroad

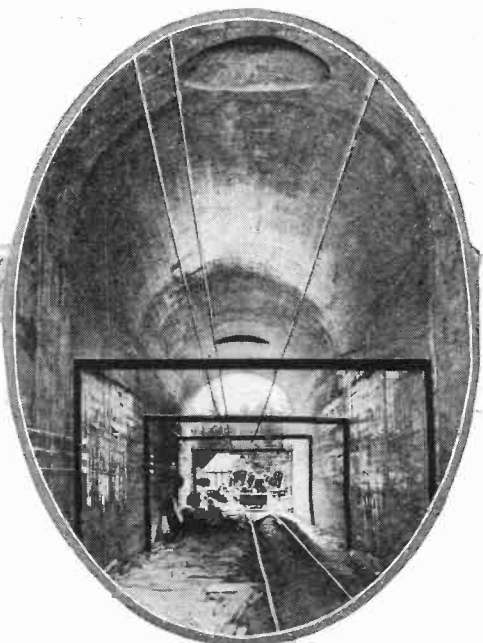
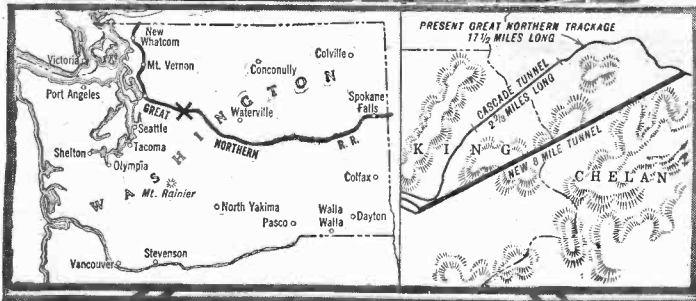

At the right is a view from the inside of the tunnel looking outward showing the concrete section. Huge steel forms, each housing a complete concrete plant, move along on rails, pouring the concrete into the arched ceiling under air pressure. At the left is a drawing showing the location of the tunnel.

LATEST

DEVICES

PAINTING WITH VACUUM CLEANER

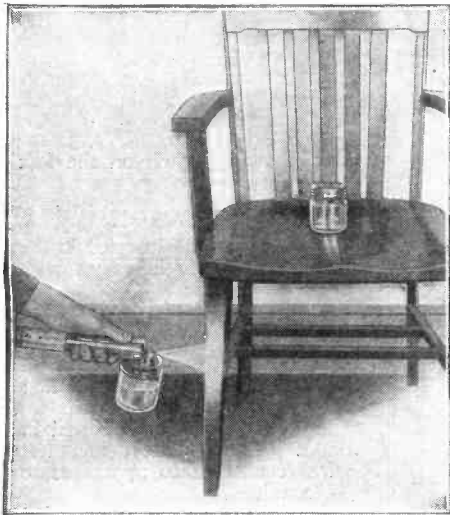

THE above photograph shows a new paint sprayer in use. This sprayer is so arranged that it can be directly attached to your vacuum cleaner; hence, the cost of a blower is eliminated, the blower of the vacuum cleaner serving the purpose admirably. Extra jars are used for different colors of paints and two spray nozzles are provided for using thin or heavy mixtures. The lever extending across the top either produces a narrow stream or a wide stream, depending on whether it is pressed all the way down or only halfway down. When half-way down, a portion of the air pressure is by-passed.

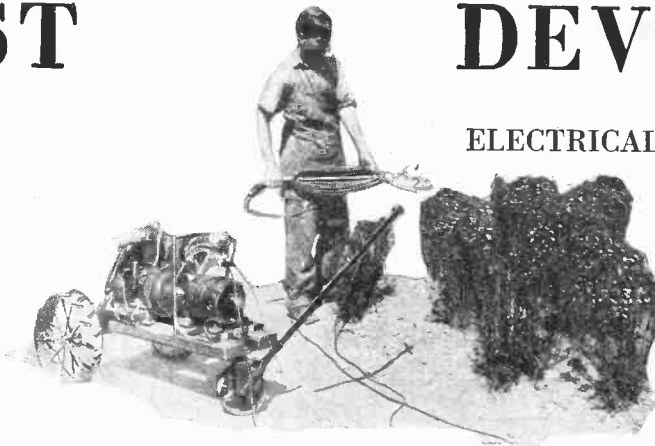

ELECTRICAL HEDGE TRIMMER

The photograph above shows an electrical hedge trimmer in actual use, combined here with a portable generator, driven by a gasoline engine. This same hedge trimmer can be attached to the ordinary house-lighting mains supplying either direct or alternating current.

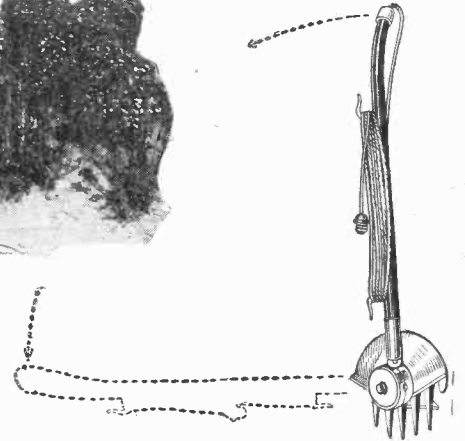

This diagram shows how the handle of the hedge trimmer can be shifted, so that it can be suited to the individual using the same, and also the type of trim desired. The hedge cutter consists of a two-bladed knife driven by an electric motor.

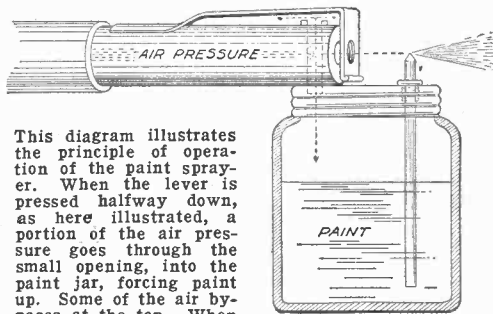

This diagram illustrates the principle of operation of the paint sprayer. When the lever is pressed halfway down, as here illustrated, a portion of the air pressure goes through the small opening, into the paint jar, forcing paint up. Some of the air bypasses at the top. When pressed all the way down, a broad spray is produced.

ICE FROM HEAT

HERE is a new refrigerator which has no moving parts whatever. It freezes trays of water and produces a refrigerating temperature by heat, which heat may be in the form of either an electrical heating coil or a gas flame. The photo at the left shows a combination electrical range with a refrigerator underneath. In this case the refrigerator is again either operated by electricity or gas. At the right there is a complete view of the refrigerating unit, and below, a diagram which explains how it operates.

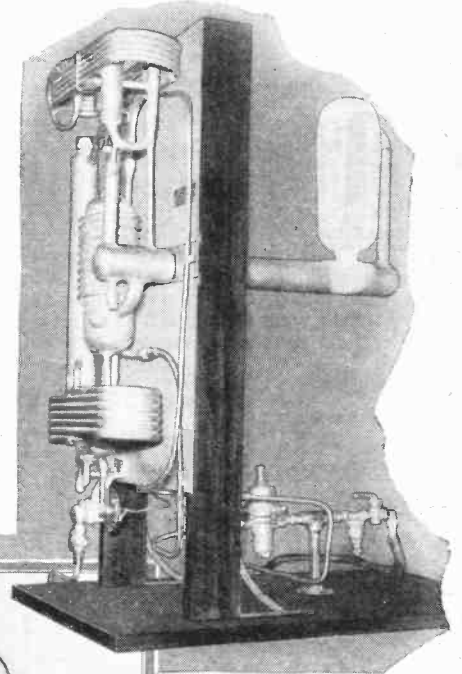
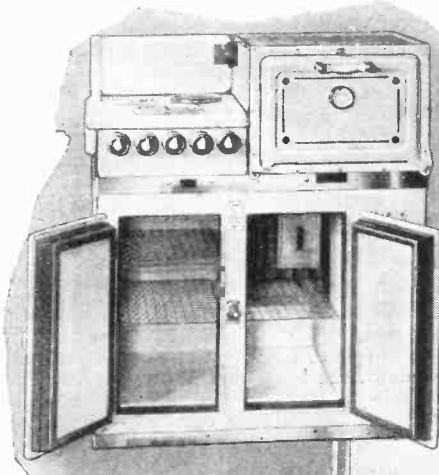

THE diagram at the right explains how this remarkable gas refrigerator operates. The gas flame heats what is called a strong liquid, consisting of ammonia dissolved in water. This ammonia and water go up through a tube in the generator, in much the same fashion as in a percolator. The water vapor and ammonia vapor now pass through a tube leading to the rectifier. In the rectifier, the water vapor is condensed, going back into the upper part of the generator as a weak liquid. The ammonia gas goes into a condenser, where it is condensed into liquid ammonia, and where it partly fills the U-shaped tube to such a height that it syphons over that in the evaporator. Here the liquid ammonia flows over a number of disks, evaporates, and mixes with hydrogen gas in the system constantly.

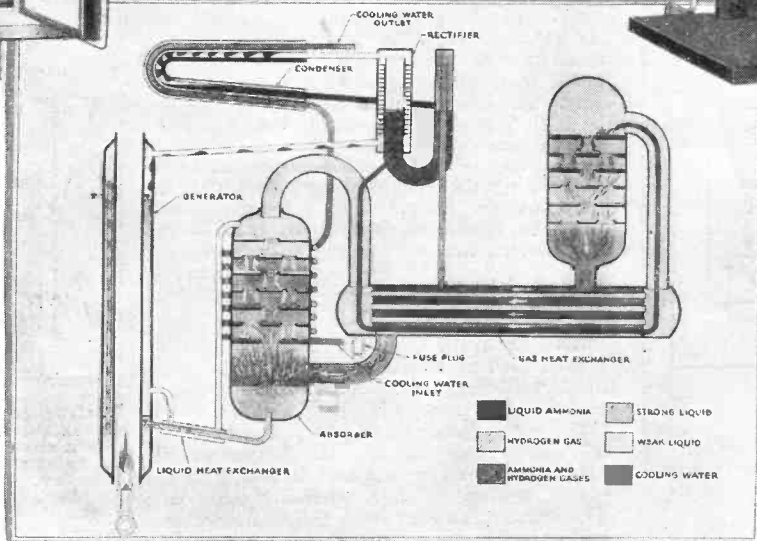

The gas mixture being of a higher specific gravity than pure hydrogen, sinks in the evaporator. During the evaporation of ammonia, heat is taken up through the walls of the evaporator, hence the freezing temperature is produced. From the bottom of the evaporator the gas mixture flows into the absorber, where it is met by a shower of water practically free of ammonia, which water reabsorbs the ammonia. The hydrogen thus freed of ammonia rises and finds its way back into the absorber again. The ammonia dissolved in water returns again to the generator, where the action is repeated. In the liquid heat exchanger, the hot weak liquid going from the generator into the absorber is pre-cooled by the cold strong liquid entering the generator.

(Names and addresses of manufacturers supplied on request)



A Switchboard for Experimenters

By BERNARD SUNSHINE

THE illustration shown is of a switchboard that will prove a boon to the experimenter in general. Although very elaborate in design and construction, it is very simple in operation.

When making tests of motors, faulty circuits, electro-chemical apparatus, and numerous other things electrical, this electrical control board will stand by itself for ease and rapidity of manipulation and effectiveness.

The instruments used on the board (usually to be found amongst the experimenter's supplies), are, a combination fuse block and DPST switch, two SPDT switches and either a SPDT switch or a switch arm with two contacts (such as illustrated), and of course two porcelain wall sockets with an outlet and plug.

The base of the switchboard is of hard wood with two Bakelite strips $\frac{1}{2}$ " thick underlying, so as to both insulate and raise the board from whatever it happens to rest on.

The controls on the board can be manipulated in such a way that experiments may be made, either with a "bulb in series" or the full 110 volts being used with a "bulb in parallel" as a current indicator. When in series, in place of a bulb, a plug connected to a rheostat or other electrical instrument, may be inserted

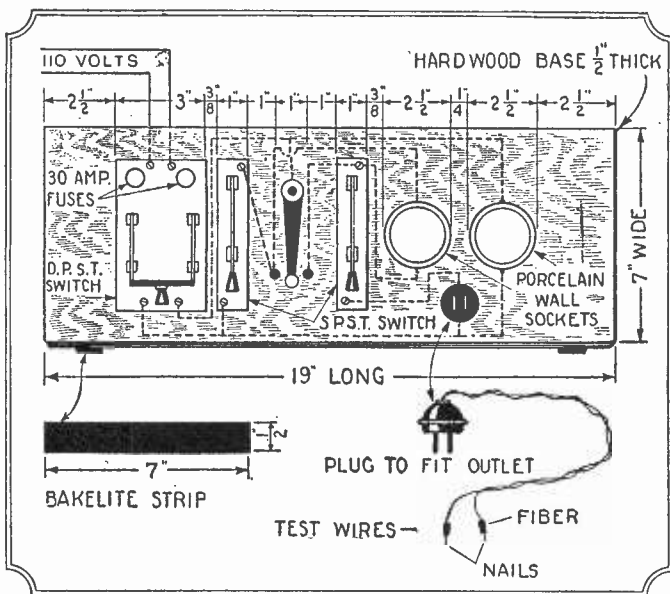

Above is shown a rather simple but very effectual type of switchboard for the use of experimenters in their laboratory. There is a great difference in the convenience of laboratory work, depending on whether one uses hit-or-miss connections, as it were, or has at hand a thoroughly reliable switchboard such as the above. The cut is almost self-explanatory, but the article will elucidate it all.

in the left hand porcelain socket and apparatus can be tested with great accuracy and precision. A bulb placed in the right hand porcelain socket is merely used as a current indicator for the entire circuit, when the

DPST main switch on the left is closed.

OPERATION

To use the bulb inserted in the left hand socket in series with other apparatus:

1. Close DPST main switch at left.
2. Place switch-arm shown in black, on left hand contact, and close switch on its left hand.
3. Plug should be inserted in outlet (black circle), and test wires connected to apparatus to be examined.
4. Care should be taken that the SPST switch on right of central switch (black) is not closed accidentally, or otherwise, as an occurrence of this sort will short-circuit and burn out the fuses.

To use a bulb in the left hand porcelain socket in parallel with other apparatus:

1. Open SPST switch on left of the socket and throw central switch (black) to right, closing SPST switch on left of latter.
2. Then close SPST switch on right of main switch (black) and 110 volts in full may be used from outlet.

By using a step down transformer, experiments can be made with a steady supply at low voltage.

The writer made the apparatus herein described, and found it very useful.

Two Electrical Kinks

A MYSTERIOUS BOAT

A mechanically operated boat designed as a window attraction is shown here. The boat contains a magnetized needle so as to have a north and south pole. Electromagnets

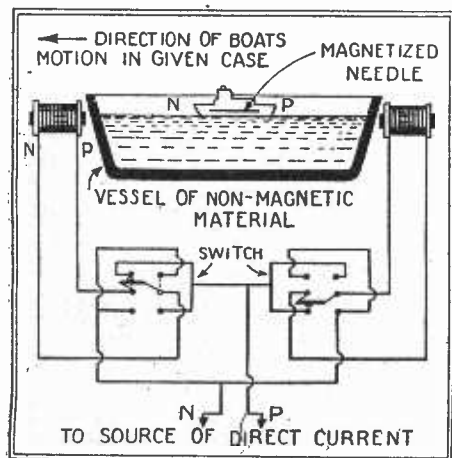

The above illustration shows the wiring diagram to be used with the magnetic boat which is controlled by passing a current through the electro-magnets.

are placed with poles facing the bowl containing the water on which the little boat floats. By passing currents through the electro-magnets the boat will be attracted and turned according to the respective polarities of the magnet in the boat and of the electromagnet. A momentary touch of a magnet switch sometimes jerks the boat about in the most amusing and mysterious way. An automatic make-and-break could be used instead of the hand, for changing the current in the magnet coils. All sorts and variety of effects could be produced by distributing the electromagnets in different parts of the basin. One very important thing to remember is that an iron basin must on no account be used.

—By Wayne Lees.

HOME MADE FAN

The illustration shows very clearly the construction of a home made fan to be run by a small independent motor. The dimensions are given so fully along with the captions that a long description is not needed. The shaft carrying the fan is supported near the top of a box and is belted to a motor resting on the bottom of the box. The current is taken from a lighting socket and goes through a resistance if needed. In

case of alternating current, a transformer may be used to cut down the voltage. The fan is made of heavy tin and the dimensions of one of the blades are given. By bending the wings on the dotted line an approximation of the helix is obtained.—Submitted by Frank Mackac, 1745 N. Hancock St., Chicago, Ill.

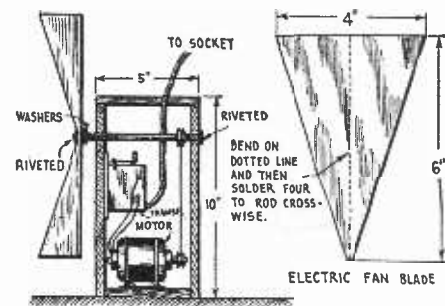

Details of the home-made electric fan are given above. The motive power is furnished by a small independent motor and the shaft carrying the fan is supported near the top of the box. The fan is made of heavy tin, the blades being six inches long and four inches wide at the ends. By bending each blade as shown on the dotted line, an approximation of the helix is obtained.

Do You Eat the Right Food?

Some Simple Food Tests for the Home Chemist

By WILLIAM LEMKIN, Ph.D.

WHAT is the most widely prevalent of all human habits? The habit of eating. What is the subject which is of primary concern to every living animal, human and otherwise? The subject of food. It is a topic which both literally and figuratively is on everyone's tongue. Most of us understand no

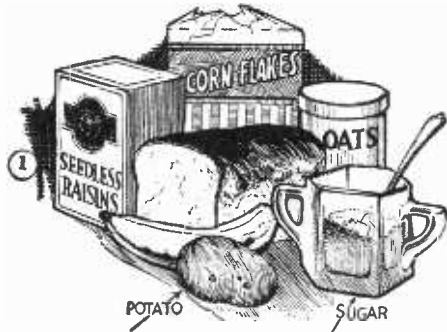

Above is a collection of some common carbohydrate foods. Note that this group embraces two classes of nutrients, starch and sugar.

more about food, than that it is something to fill an otherwise aching void, and that, in the process of thus filling the vacant space, we also obtain a considerable amount of sensory gratification.

WHAT DO YOU EAT?

WE know that if we go beyond our usual mealtime without partaking of food, we feel certain pangs, commonly known as hunger. We are aware, too, that if a person were to abstain from food for a long time, he would become weak. Should he continue to go without food, he will finally starve to death. We have acquired the habit of putting food into our mouth three times during the day—sometimes oftener—chewing it more or less thoroughly, and then swallowing it. But, what happens to it from that point, the changes which it undergoes, the final disposition of its various component portions is, to the majority of us, a profound mystery. With so meagre and shallow an understanding of the question of food, many of us lay ourselves open to serious errors in diet, which, if not properly checked, might lead to numerous grave consequences in ill-health and lowered vitality and bodily vigor.

The comparison is often drawn between the human body and a blacksmith's forge. The lungs are the bellows, and the food is the coal. The lungs provide the blood with air, which burns up the food (or fuel) that we eat and digest. The human engine has



Fatty foods make an excellent fuel for the body. Above are some of the well-known examples of food rich in this valuable nutrient.

frequently been compared also to a steam engine, in that we burn up our food to furnish heat and energy for the accomplishment of our daily work. The comparison is by no means complete, however, because our body is capable of utilizing its fuel in a manner entirely beyond the scope of the purely mechanical steam engine.

THE NUTRIENTS IN YOUR FOOD

STUDIES that have been made of foods show, that while we have a large variety of them, yet the kind of materials that really nourish the body may be divided into a few groups of nutrients, each having a definite function in our system. Most people know that there is much starch in bread and in potatoes. We may ask what purpose this nutrient has in the body. The food scientist informs us that starch burns in the human engine as the fuel burns in the furnace, yielding heat and energy. With starch, he tells us, is associated a partner, sugar, answering the same purpose as starch in our food. Third among the important nutrients is the familiar protein, found in all foods similar to lean meat and the curd of milk and cheese. The chief function of this vital nutrient is to build tissues, and repair the various cells in our body which are worn out in the daily work of the human engine. Butter is almost pure fat, the best fuel food, yielding about twice as much heat energy per pound as any of the other nutrients. In addition to these major elements found in our foods we have also the secondary ingredients, which, although not found in foods



A group of common protein or muscle-building foods are shown above.

to the same degree as those already mentioned, are of prime importance in our diet. These are mineral salts (sometimes called ash), water and the ever mysterious vitamins.

How can we recognize the presence of these nutrients in the foods of our daily diet? How can we measure the various proportions of starch, sugar, fat, protein, etc., in an egg, a sweet potato, a pork chop? The food chemist has evolved certain very simple qualitative tests which he employs to answer the question: "WHAT nutrients do foods contain?" By other tests that are not quite so simple, he is enabled to solve the problem: "HOW MUCH of each nutrient is found in the various foods?"

Would you desire to duplicate these food tests on some common articles of your daily diet? Are you anxious to steal a look into the vast mystery (at least to the layman) of what constituents are found in food? All you require is a superficial acquaintance with the reactions of these nutrients when treated with common test materials, ordinarily found in the household, or easily obtainable at your druggist. With a

collection of elementary chemical reagents, you can perform practically all of the qualitative experiments and, if you are so inclined, can even gain an insight into the highly fascinating field of food adulterations and the methods of detecting them.

WHAT FOODS CONTAIN STARCH?

HEAT some corn starch in water, and permit it to cool. Then add a drop or two of ordinary tincture of iodine (the kind

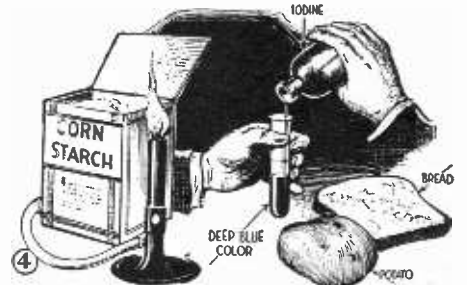

Iodine is used as a test for starch. A blue-black color shows the presence of this substance.

you have in your medicine cabinet). A deep, blue-black color shows the presence of starch. This test is extremely delicate, therefore only a minute quantity of iodine is required. Be sure to cool the solution well before adding the reagent, because heat causes the characteristic color to fade and disappear. Try a drop or two of iodine on bread, a raw potato, some cooked cereal. They all give the unmistakable deep blue color which indicates that starch is present. An accidental drop of iodine on a laundered article, such as a handkerchief, will reveal the same undeniable blue coloration.

TESTING FOR SUGAR

HEAT some ordinary cane sugar in a spoon and observe the formation of a brownish substance. This is caramel, a material used extensively in confectionery, and a harmless coloring-matter for liquors and extracts.

To test sugar chemically, we use Fehling's solution, prepared in the following way: Dissolve five full saltspoonfuls of copper sulphate (blue-stone), pour into the liquid, and add Rochelle salts water until there is a glassful. Stir well until all the copper-sulphate is dissolved. Add a saltspoonful of Babbitts' lye. This solution is a test for glucose or grape sugar, and the sugar found in fruits. It should be used as soon as made.

To make the test, place a thin slice of apple, pear, or other sweet fruit into a test tube, add enough Fehling's solution to cover it, and heat to boiling. The sugar in the fruit causes the liquid to turn green, then yellow, (Continued on page 358)



Fehling's solution is a delicate test for fruit sugar and will show the presence of a minute quantity of this nutrient by the formation of a brick-red precipitate.

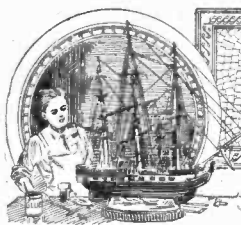

Model Department

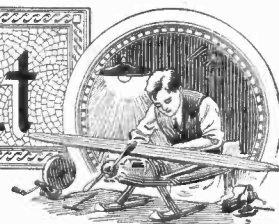

STEAM ENGINE Wins TROPHY CUP

Model Built by A. R. Cann of Victoria, B. C.

THE Trophy Contest is still operating in full force and soon twenty-four handsome loving cups will have been awarded to the model enthusiasts of this and foreign countries. In this contest, in which one of these trophies 18½ inches high and weighing nearly 5 pounds is awarded monthly, any type of model can be entered. Among those which have been awarded prizes, we find ships of all styles and types; steam engines, single-stroke, single-action, double-action and twin cylinder types; airplane models; a model of a Roman ballista; an electrically-driven miniature automobile; a mine hoist, and various other constructions.

A cup is awarded for the best model submitted during any month, and those who have interested themselves in the construction of models will find it to their advantage to compete for the prize. The rules call for the model and drawings of the same, the model being again returned to the owner. For further details of this cup contest, refer now to the contest rules on page 354.

The photograph shows the model and the cup which was awarded for it. The model itself is slightly less than 8 inches high over all, so the photograph presents a rather comprehensive comparative idea of the size of both objects. Full details for the construction of the model appear on the accompanying page.

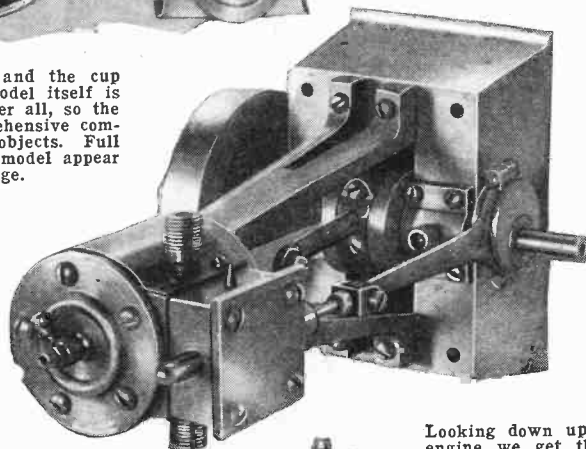

The photograph at the right gives us a view of the single cylinder, double-action steam engine and discloses the position of the steam port. It will be observed that oil cups are used on the top of the shaft bearings and recesses for oil are provided in the castings, for the purposes of properly lubricating the wearing parts. In this model, no rings are to be found on the piston, which fits the cylinder quite snugly.

Looking down upon the model engine we get the view here shown. Note how clean the entire construction appears. This is probably due to the fact that the model is cast almost in its entirety. The base is of cast iron, the shafts are steel and the balance of the construction, except where otherwise specified on the diagram accompanying, is brass casting. In duplicating the model, it is necessary to allow properly for shrinkage of the metal. The drawings indicate dimensions on the finished model.

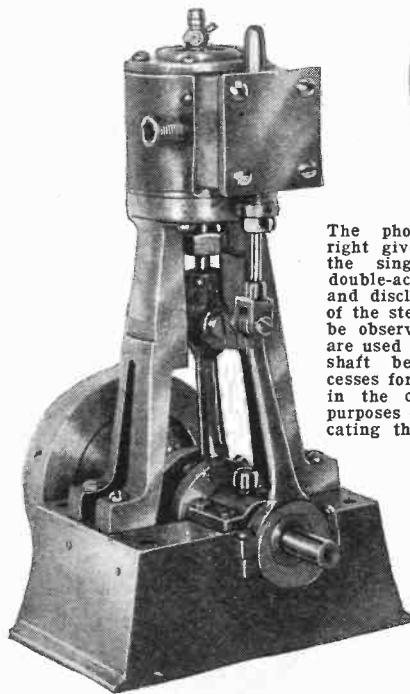

Another view of the steam engine taken from the side on which the eccentric is found. The slide valve is regulatable, being mounted on a threaded portion of the valve rod. There is thus very little difficulty in properly setting the valve over the parts in proper position in the steam chest.

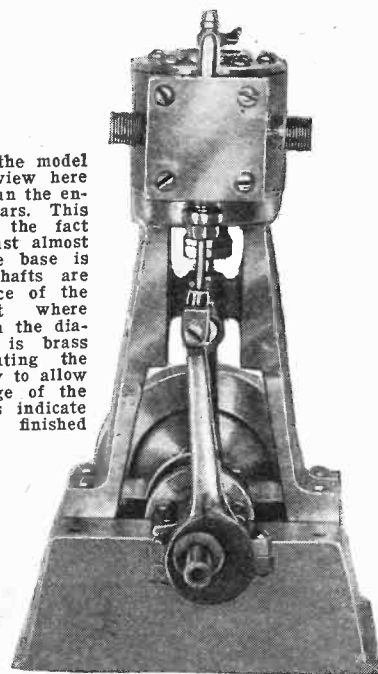
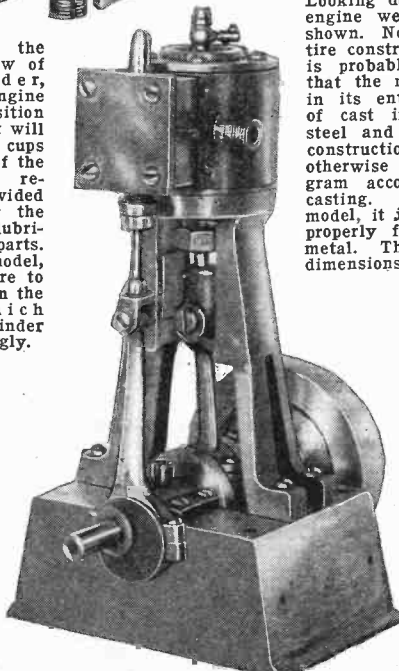

An end view from the eccentric side of the double-action steam engine. The opposite view can be obtained by referring to the photograph in the upper left-hand corner of this page. Those who are interested in duplicating the model will find the accompanying drawings complete in every detail.

IF YOU ARE A MODEL BUILDER, DON'T FAIL TO ENTER YOUR MODEL IN THIS CONTEST

Details of Steam Engine

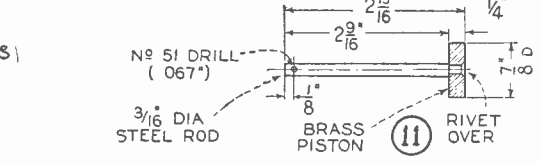
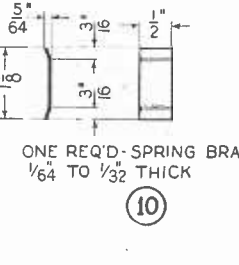
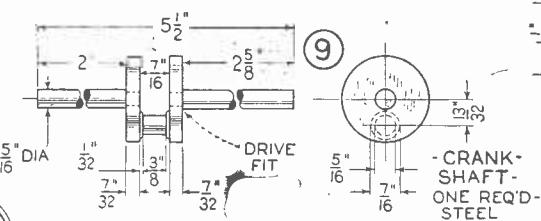
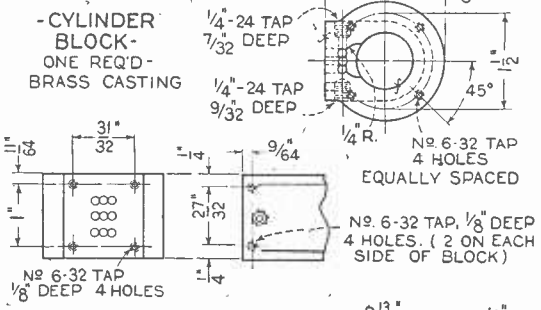
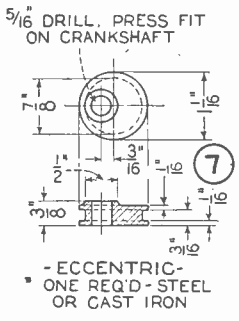
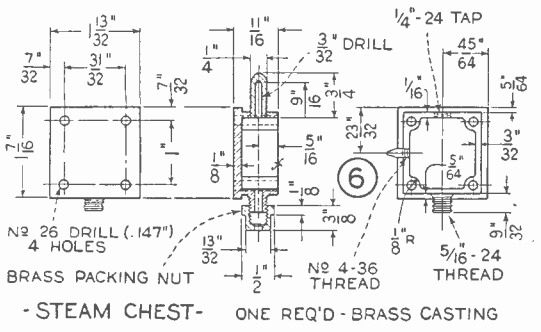
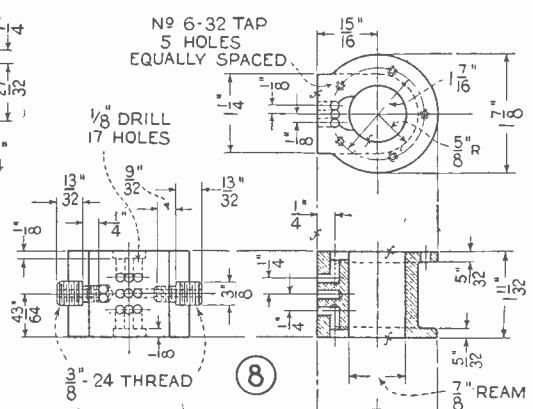
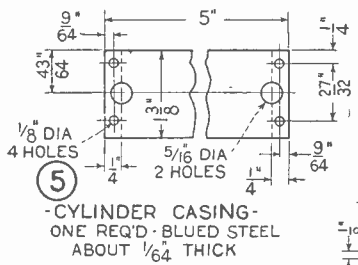
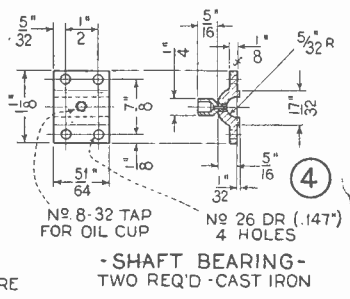
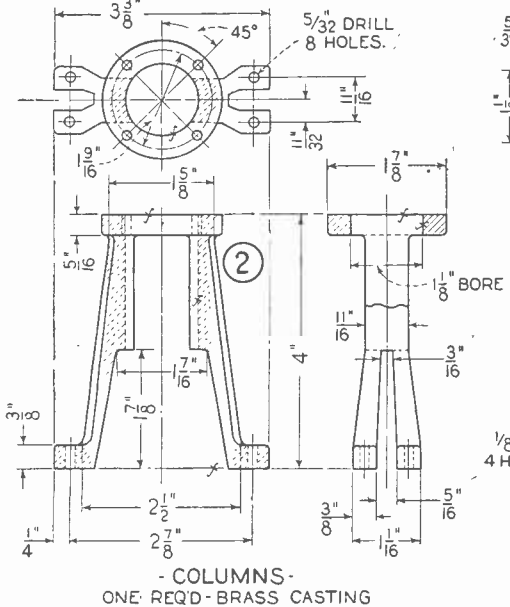
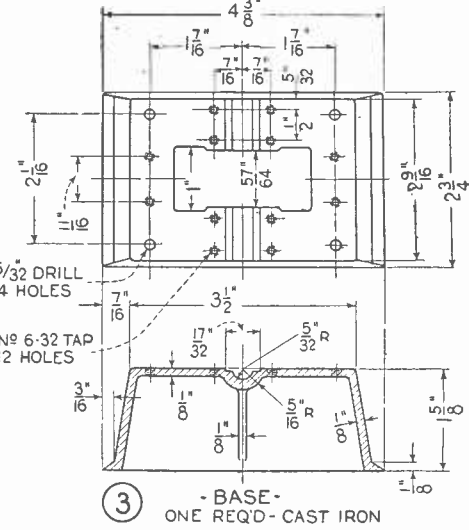
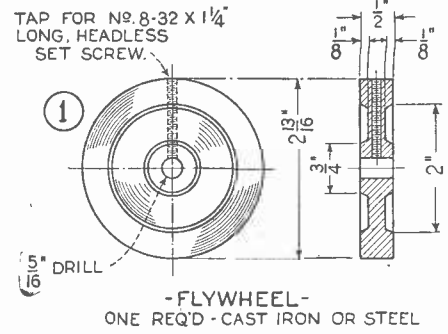
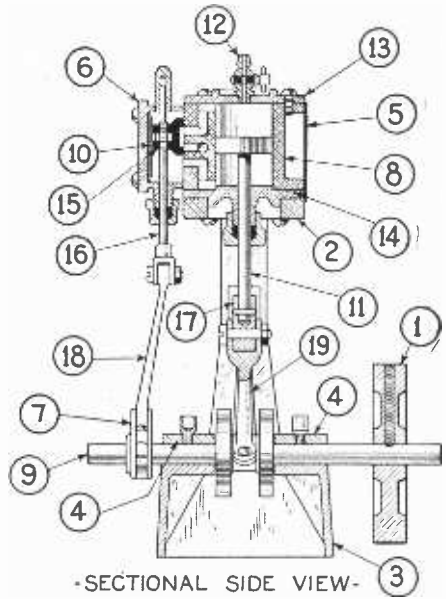
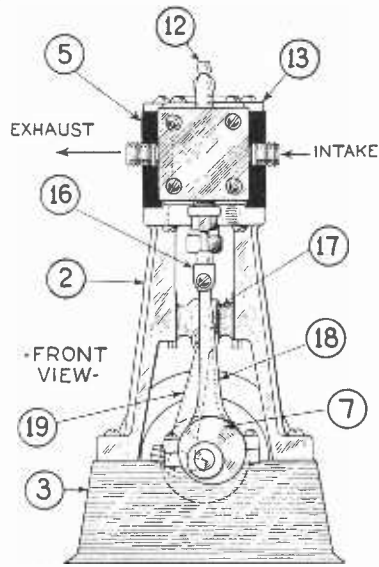

The above diagrams show the details of the steam engine which won the prize-winning trophy cup in this issue of SCIENCE AND INVENTION Magazine. Further details of this same engine will be given in the forth-

coming issue. As can be seen from the drawings, the engine is easy to duplicate and anyone desirous of a really powerful steam engine will find that this engine gives them what they desire.



Home-made Summer Amusements

How to Build Kiddie Railroads, Chute-the-Chutes, Carousels and Aerial Swings

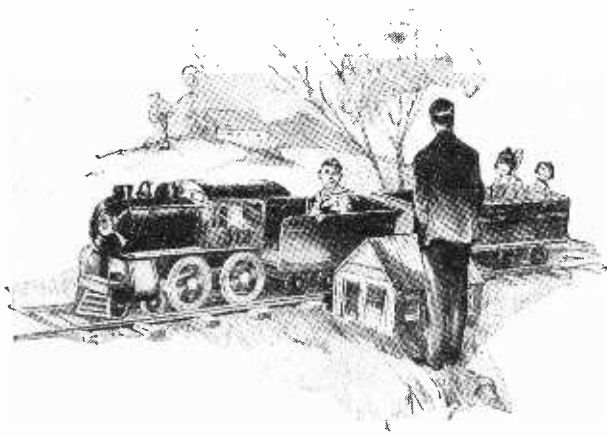

There is probably nothing more interesting and amusing to children than a miniature railway, and in the present article details for building them are given.

SUMMER amusements are not all to be found at seaside and mountain resorts, to which spots father often has to motor 30 to 50 miles or more in order to appease the appetite of the children for a good time. The accompanying illustrations show how the man a little handy with tools can build some home-made amusements which will afford a lot of fun and pleasure to the younger generation. If the devices shown are built sufficiently large and also quite substantial, then the older folks can share the amusements with the children.

KIDDIE RAILROADS

THERE are many different kinds and styles of miniature railroads which have been built. In England the great rage is to build small duplicates of the big locomotives which haul trains over the British railroad systems. Where the main object of the miniature railroad system is pleasure, however, then one does not have to be so fussy

about imitating the exact lines of the Pennsylvania or Southern Pacific "giant of the rails."

There are two principal sources of power which may be used for driving the locomotive of a small back-yard railroad. Either a gasoline engine of one or two horsepower may be used, or else an electric motor of one-quarter to one-half horsepower or more may be employed. A somewhat higher rating is necessary for the small size gasoline engine, owing to the peculiar way in which the power is here applied. Also, if the engine should happen to sputter, and miss now and then, the re-

serve horsepower is very desirable to prevent the engine being stalled.

There are many ways in which the builder may apply the power from the engine or electric motor. He may elect to use a belt drive with a flat or round leather belt, or else he might use a rope drive, with V pulleys, the rope having to be spliced in order to present a smooth surface as it rides over the pulleys. In the accompanying illustration a chain drive is suggested, the proper number of teeth in the gears and sprocket wheels being specified in the small drawing just under the locomotive. Some geniuses might like to build a subway style train of two or more cars and put a motor-drive on each car. A motorcycle chain is the best to use for the locomotive and if a real large engine is to be built, then a special heavy chain for the reduction gearing can be purchased.

The wheels for the locomotive and any

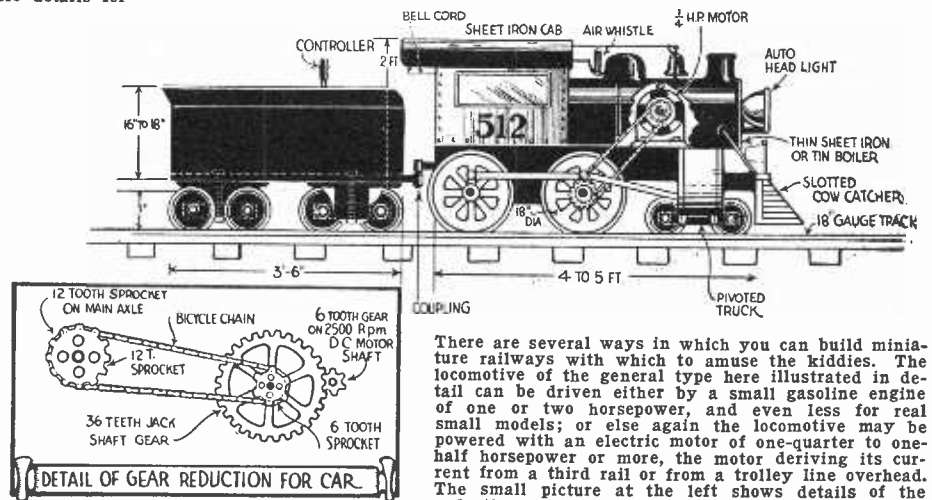

There are several ways in which you can build miniature railways with which to amuse the kiddies. The locomotive of the general type here illustrated in detail can be driven either by a small gasoline engine of one or two horsepower, and even less for real small models; or else again the locomotive may be powered with an electric motor of one-quarter to one-half horsepower or more, the motor deriving its current from a third rail or from a trolley line overhead. The small picture at the left shows details of the reduction gear and chain drive desirable for electric

motor propulsion. The rails may be made from wood and preferably they should be covered on top with iron hooping.

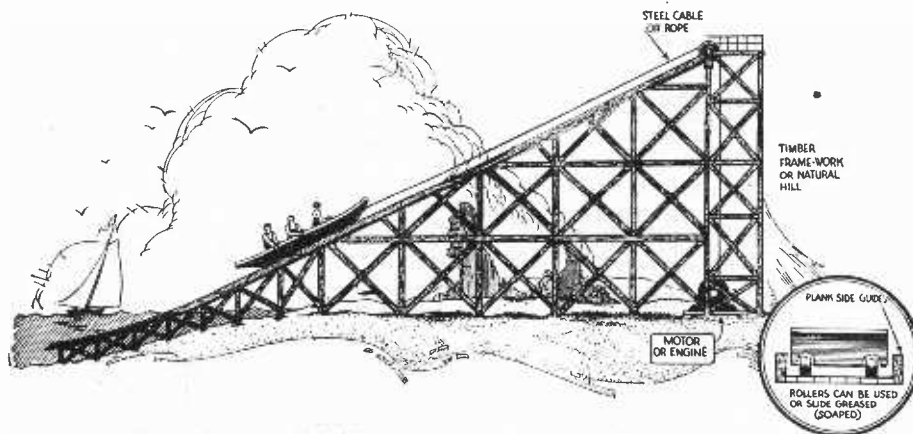

Home-made chute-the-chutes are illustrated here. An electric motor or gasoline engine serves to pull the boat up the slide. The boat may be fitted with rollers or else the slide may be well greased.

cars that may be built can be turned from wood, either by the home constructor, if he happens to be a lathe enthusiast, or they can be turned at small cost by any carpenter or cabinet shop. The wheels should have a flange formed by turning out two disks, one about one and one-half inches less in diameter than the other, and then nailing or screwing one disk against the other. Everyone will undoubtedly build such a locomotive out of tin, out of scraps of wood, etc., to suit themselves, and so no instructions are needed on this part of the job. For a small locomotive, eighteen inches between the rails is a good gauge to adopt. If you purchase a second-hand or even a new electric motor, you can procure a suitable speed control rheostat from the company supplying the motor. This rheostat should give at least three to four-speed variation. The connecting rod shown on the locomotive in the picture is merely a dummy and may be dispensed with. Suitable brake

shoes made of wood may be easily arranged by the ingenious home constructor.

CHUTE-THE-CHUTES

ONE of the greatest sports is diving down the chute-the-chutes in a boat which strikes the water with a great splash and everybody hollers their head off. One of the accompanying illustrations shows how a few young men, guided, perhaps, by their elders, may easily construct a small chute-the-chutes which will provide a barrel of fun. The boat may be picked up at small cost, or else it may be built especially for the purpose. It has two flat-bottom ends which taper toward the top, as shown in the picture. It must be quite a strong boat, especially if the slide is fairly long. Rollers may be fitted under the boat, or else the slide may be greased with soap or Albany grease. The boat is unhooked from the cable or rope which pulls it up to the top of the slide by any form of simple hook release which the builder may contrive. For that matter, the boat may be pulled up onto

men use an outfit such as this, the cost of operating the motor, which would not amount to very much in any case, could easily be defrayed by taxing each member of the "swimming club" a nominal amount.

MERRY-GO-ROUND

A HOME-MADE merry-go-round or carousel for the kiddies is shown here-with. There are many different ways in which this class of amusement device can be designed and built by the home constructor. If one cares to spend a little money

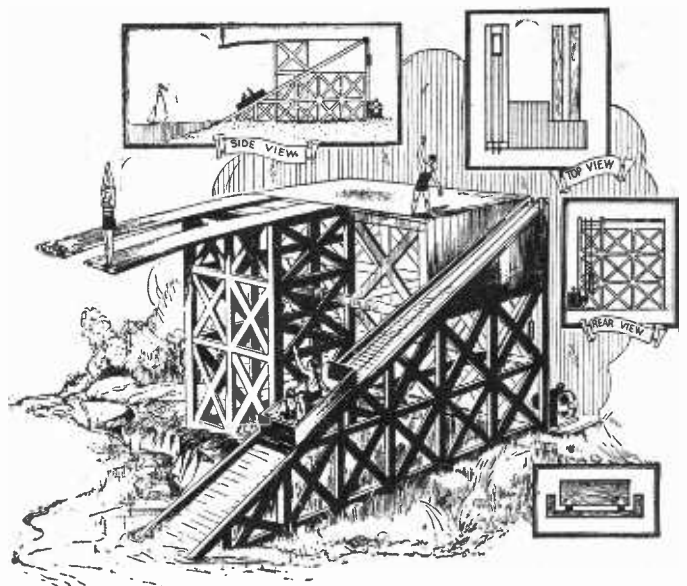

A motorized springboard—instead of having to climb up to a high springboard, the divers are here hoisted up an incline by means of a cable and motor or gasoline engine.

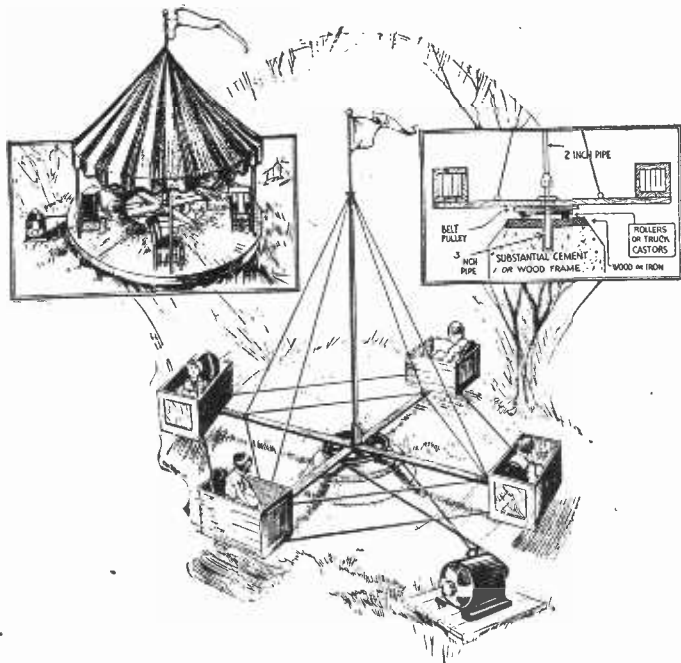

A merry-go-round or carousel of the home-made variety is here shown. The passengers are carried in soap box compartments.

on one of these home-made merry-go-rounds, he may build a circular wooden platform, as one of the pictures show, and provide a roof of red and white or green and white striped canvas. The carousel platform on which the chairs or boxes are mounted should be arranged to rotate on roller bearings or heavy truck casters. Your hardware dealer can procure these truck casters for you. If the device is to be built at a minimum cost, then a circular wooden block, say three feet in diameter and secured to the main platform of the

carousel, may rotate on a greased base structure. In any event, the center pipe or rod acts as a pivot for the carousel, and should be securely clamped by iron angle straps or otherwise to the rotating platform. A small gasoline engine or electric motor of one to two horsepower will rotate one of these kiddie carousels at fair speed. A suitable ratio in the diameters of the motor pulley and the pulley at the base of the carousel must be arranged for, so that a suitable speed reduction is obtained. The average electric motor runs at 1800 to 2000 R. P. M. Some form of gear reduction may be necessary in some instances unless a very large pulley is used on the bottom of the carousel platform. In figuring speed reduction, it is well to remember that the speed of the driven pulley will be to that of the driver as the diameter of the driven pulley is to the diameter of the driver. If the driven pulley has a diameter of 10 feet and the driver a diameter of 1 foot, then the speed of the driven pulley will be one-tenth that of the driver. It is probably the best (Continued on page 357)

the flat top of the platform, the passengers loaded in, the cable unhooked and the boat then given a push to start it on its downward journey down the slide. The size of the electric motor or engine required to pull the boat up the slide will vary according to whether children or adults are to be hauled upward in the boat, or whether just the empty boat is to be pulled up. An engine or motor of one or two horsepower will pull the boat up the greased slide with two or three children, whereas it would take at least a five horsepower motor on the average to haul the boat up the greased slide with two or three adults in it.

A MOTORIZED SPRINGBOARD

A LOT of the fun to be found around swimming holes provided with springboards is lost by the divers having to climb up the ladder or up through a tree to the springboard. A scheme for motorizing the springboard is shown in one of the accompanying illustrations. An electric motor or gasoline engine of two or five horsepower, as previously explained, is utilized to haul the car up the incline. The car may be fitted with rollers or wheels, or else the track may be greased with soap or Albany grease. A suitable brake should be worked out and applied to firmly hold the cable from slipping, once the car has been hauled to the top of the track. Where a group of young

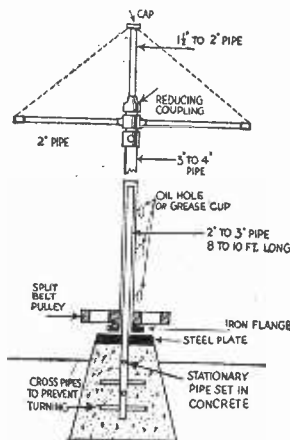

The illustrations above and at the right show how to make an airplane swing for the children. If made strong enough, grown-ups may ride in the compartments as well. It is driven by a small electric motor or gasoline engine of at least 2 to 3 h.p.

The boxes to carry the passengers should be reinforced and the speed controlled so that the boxes do not swing around too fast. Constructional details are given in the drawing above, iron pipe being the main element.

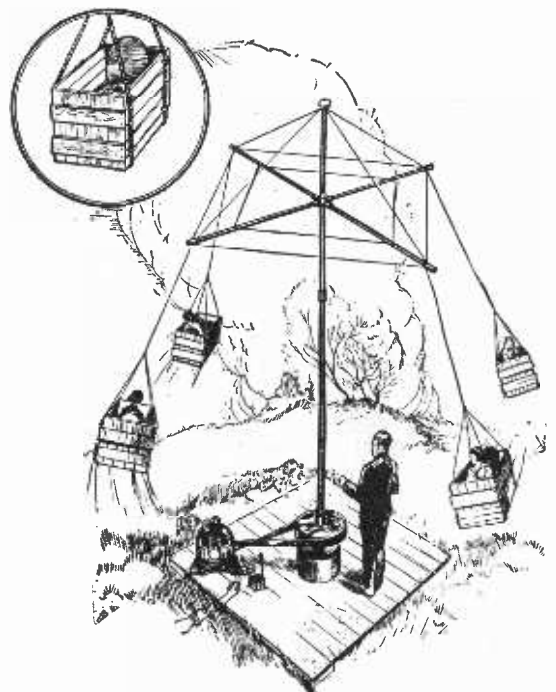

Wood Turning for the Amateur

No. 2 of a Series

By H. L. WEATHERBY

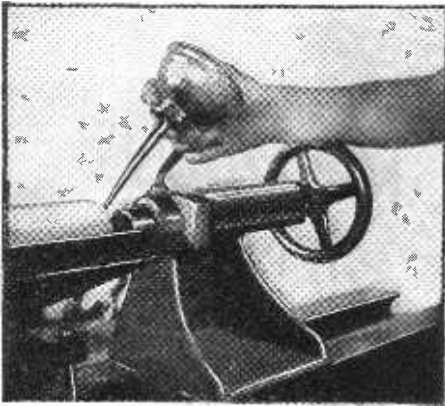

Place a drop of oil at dead center, before starting on old or new work.

CURVE CUTS

LAST month we told you about the simple straight cuts in turning; and this month we take up the more difficult convex and concave curve cuts, which will probably call for more practice, but when mastered will prove to be quite as simple as the beginning cuts.

All spindle-turned work is made up of fillets, coves, and beads, interspersed with plain areas, which are tapered or straight; oftentimes varied with square or octagonal-shaped sections. We must have in mind the different cuts and be able to vary them in such a manner that the design we may work

out will be pleasing. A series of any single cut, usually is uninteresting, but when a bead is followed by a fillet, and then by a cove, we have a pleasing application of these cuts.

TURNING THE COVE

BEGINNERS in turning will usually find that the concave cut, or the cove, is the least difficult to master of the curved cuts, and for that reason it is placed first in this series of exercises. It is formed with the gouge; and the secret of successful cutting out a perfect half circle, or irregular concave curve, lies in skillful tool manipulation, and a sharp gouge.

After the cylinder for this exercise has been turned to dimensions, as practice on previous exercises has taught, lay off the divisions for the coves. Now sharpen very carefully with grind rock and slip stone the small gouge. The gouge is hard to sharpen properly, and unless it has a very keen-cutting edge on it, the cut will prove more difficult than it need otherwise be.

With the lathe in high speed, cut in toward the center on each cut from the sides, practising a rolling motion with the tool. The handle is held high when starting, the tool is on edge in a vertical position, and as the operation is completed, the gouge is rolled into a horizontal position, with the handle lowered; cutting down the rounding sides and removing the wood in the cut. Do this from both sides toward the center until a perfect half circle is formed. A semi-circular templet cut-out of cardboard will prove an aid in checking the curves.

If skill is not acquired on the first attempt, and it is not at all likely to be, try

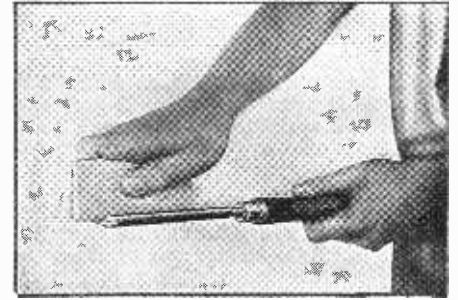

Sharpen tools frequently with slip stone.

again on another block, and yet another, until the gouge can be manipulated with ease. This will come when just the correct angle at which the tool must be held is discovered.

The convex cut or the bead, in the author's experience, has always been the most difficult to master. It is made with the heel of the small skew chisel which, of course, should have a very sharp edge.

After the lines on the cylinder have been marked for the second exercise, cut in on the right-angle shoulders with the point of the skew as in cutting off. Now, with the chisel on the rest, and the heel in contact with the cylinder, cut towards the right,

(Continued on page 362)

NO.1-CONCAVE OR COVE
NO.3-CONVEX OR BEAD
NO.5-CHISEL HANDLE
NO.7-MALLET

WOOD TURNING CURVE CUTS

NO.2-CONVEX - HALF BEAD
NO.4-COMBINATION CUTS
NO.6-HEAVY DUTY CHISEL HANDLE
NO.8-DARNING GOURD

Various examples of curve cuts in Wood Turning exercises are illustrated above. The work is very interesting.

How to make it

ARTICLES OF INTEREST TO EVERYONE

WIRE TIGHTENER

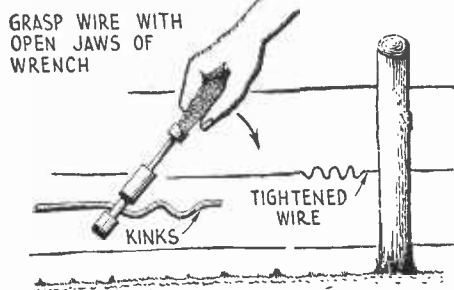

Fence wire may be tightened with a heavy monkey-wrench, as shown above. Several kinks help to remove the sag.

When a length of wire sags between two fence posts, it can be instantly tightened by the use of a heavy monkey-wrench. Hold the wrench vertically, open the jaws slightly and spread them over the wire. Then press the wrench downward. This operation will put a kink in the wire and should be repeated until the sag is removed. This is one of the simplest methods for stretching fence wire.—L. B. Robbins.

DRAWING SCALE

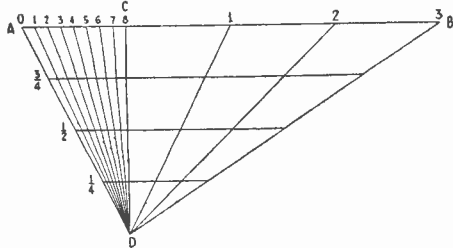

A scale for working drawings can be made as shown above. The line AB is marked off in inches, and at C, one inch from A, draw a line, CD, at right angles to AB. To make a scale of one-half inch, draw a line in the center of CD, parallel to AB. For one-quarter, one-eighth and one-sixteenth inch, a line is drawn parallel to CD.—I. E. Lovett.

HOME-MADE SMOKING STAND

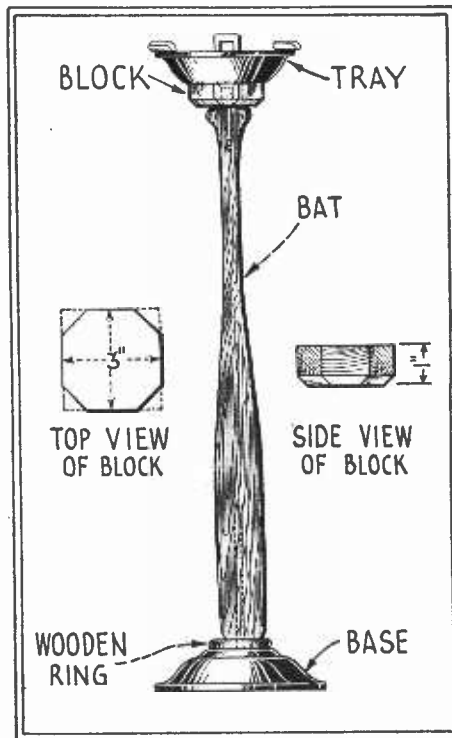

Details of the non-tippable smoking stand are given above.

A smoking stand which will not fall over easily can be made from a baseball bat about 22 inches long, and an iron base. The block of wood to hold the tray is about 3 1/2 inches square or octagon shape. The block is fastened to the bat with a long wood screw.—William Zoeller.

DOUBLE ACTION SEE-SAW

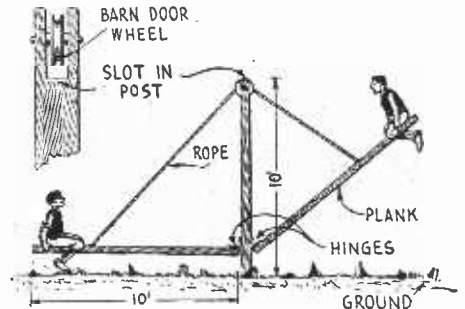

The see-saw built from two planks instead of one and fitted with a rope and pulley, as shown, is double-acting. The opposite plank is raised when one of the occupants leans backwards.—L. B. Robbins.

SPARK PLUG KINK

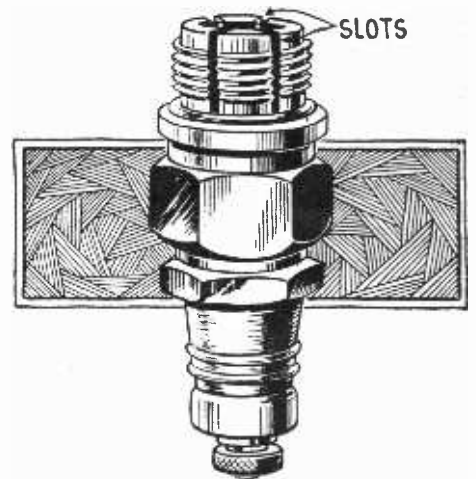

The bottom of a spark plug, if cut with slots as shown, will fit tightly into the spark plug hole, cutting out the carbon. The original plug can then be screwed tightly in place.—Robert Shupe.

MAKING A BIKANOE

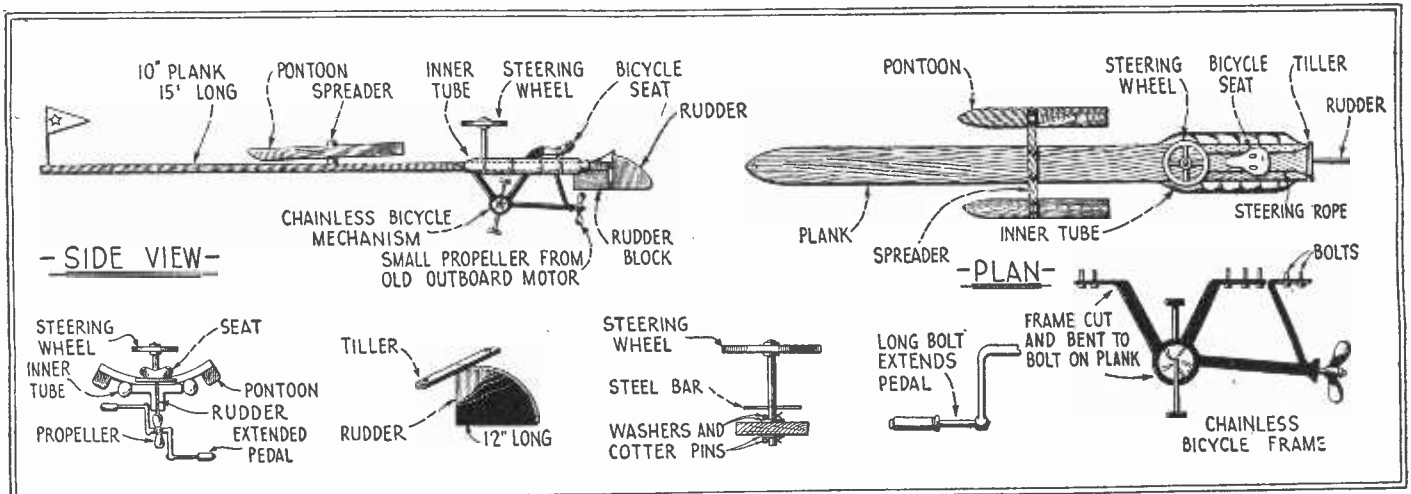

A simple bikanoe which will provide an endless amount of fun can be built from a long plank and the driving mechanism of a chainless bicycle. The plank is about 15 feet long and 10 inches wide. An automobile inner tube, placed as shown, provides added buoyancy. Two pontoons are fastened across the plank in the middle. They should be inclined slightly forward.

The detailed construction cannot be given here, but is made clear in the above illustrations. The chainless bicycle frame is bolted to the plank and a small screw propeller is fitted on the end of the drive shaft. Steering can be done by turning the wheel, which is taken from an automobile. The bikanoe cannot sink due to the addition of the pontoons.—L. B. Robbins.

Wrinkles

RECIPES & FORMULAS

Edited by S. Gernsback

POCKET CLIP

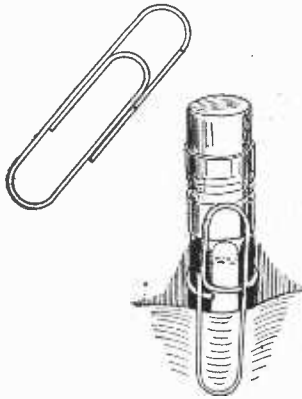

The illustration at the left shows how an ordinary paper clip can be used as a pencil pocket clip. One end of the clip is bent about the pencil, making a loop. The other half of the clip is bent down about the pen or pencil. In order to use, slip the pen or pencil into the pocket and press the outside of the clip down over the pocket edge.—Arthur A. Fabrizio.

PORCUPINE PENS

Excellent drawing pens can be made from porcupine quills. One end of the quill is cut on a slant as shown in the illustration. A handle is provided for the quill. For lettering they can be used in place of camel's hair brushes.—Leslie Carpenter.



LIGHT SUPPORT



A convenient method of fastening an electric light to the head of the bed or any tubular support, is shown at the left. A strong rubber band is looped over the socket. The light is easily adjusted to any position, yet the band holds it firmly in place.—J. A. Carithers.

BENCH LIGHT

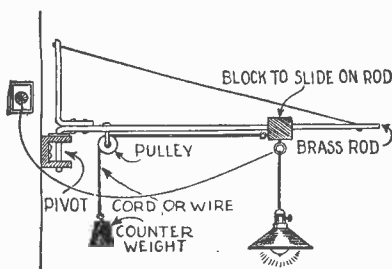

A handy light for use in the laboratory or workshop can be made as shown. It slides along a brass rod which is also pivoted, so that the light may be swung from side to side. A counter-weight and a pulley keep the light extended at the proper distance from the wall.—E. H. Fisel.

VEGETABLE HANDLER

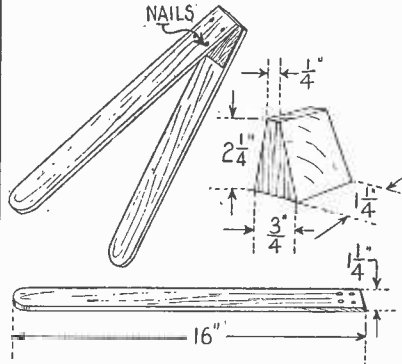

The above illustration gives the dimensions of a pair of wooden tongs which are used to handle pickled cucumbers, sour tomatoes and the like. It will reach down into the barrel, extracting the desired article.—Frank Schmulowitz.

TENT PEG HOLDER

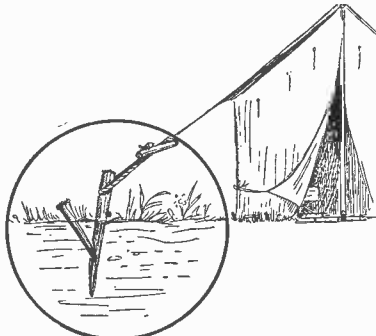

A good method of holding tent pegs securely in the ground is illustrated here. A notch is cut in the tent peg, and another peg driven in at an angle fits into this notch.—Thomas Upham.

NEWSPAPER VENDER

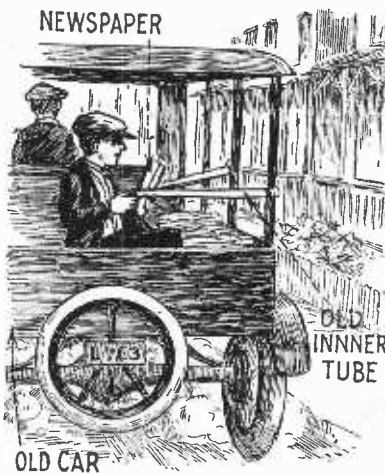

A large sling-shot made from an old inner tube provides a means for delivering papers quickly. The paper is simply rolled up, bent in the middle and shot onto the customer's porch.—Russel Raymond Voorhees.

PORTRAIT LIGHT DIFFUSER

The light diffuser for use in taking pictures, such as portraits that require a soft tone, can be adapted to any camera. The diffuser is merely a circular screen made of netting mounted on the sides of a round pill box. Since the screen is out of focus the netting will not show in the picture.—G. F. Stillwell.

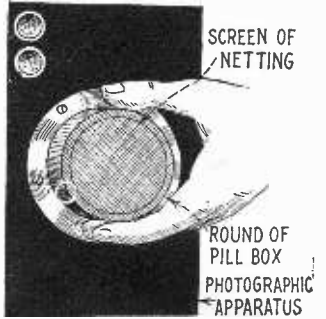

INSECT CASE

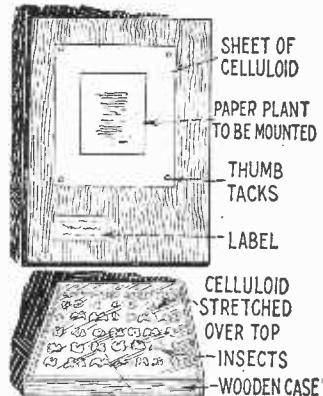

Celluloid can be used in the collectors' museum instead of glass in many cases. When mounting plants, it can be used to advantage, and also forms an admirable cover for the top of an insect case. The illustration here shows how it may be used.—Stephen R. Healey.

PULL SWITCH

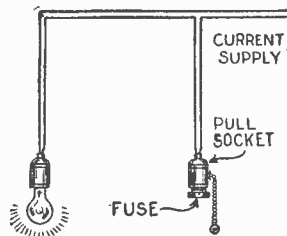

A very satisfactory pull switch can be made by screwing a fuse into a pull socket and connecting as shown. This provides a pull switch in series with the line.—Mortimer H. O'Connor.

IMITATING WOOD GRAIN

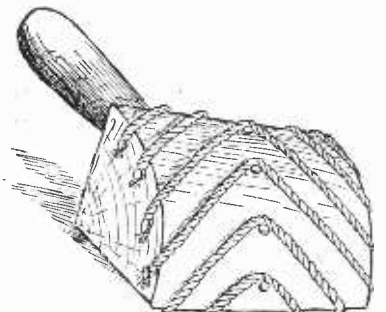

Good imitation wood grain may be made by tacking pieces of rope onto a curved block of wood as shown in the illustration. Soak the rope in water and then apply varnish freely. After the varnish has worked its way into the rope, good results can be obtained.—S. L. Bastin.

Readers Forum

SCIENCE AND INVENTION desires to hear from its readers. It solicits comments of general scientific interest, and will appreciate opinions on science subjects. The arguments pro and con will be aired on this page. This magazine also relishes criticisms, and will present them, whether

caustic or not. So if you have anything to say, this is the place to say it. Please limit your letters to 500 words or less, and address your letters to Editor—The Readers Forum, c/o Science and Invention Magazine, 230 Fifth Avenue, New York City.

NOISE CORRESPONDS TO DREAM

Editor, SCIENCE AND INVENTION:

There has been a question in my mind for some time that has been in need of an answer. Here is what I wish you would explain to me, if you can. Take the following instance:

"You are dreaming that around a certain table there are several men, either talking, playing cards or doing something like that. The game or conversation goes on for about ten or fifteen minutes. Suddenly, without reason, two of them rise and start a fight or an argument. One pulls a pistol and fires"—now what I wish you would explain is this:—Why is it that at the precise moment (in your dream) that the gun was fired there is some corresponding noise that happens in the immediate vicinity of your bed; for instance, a bell ringing, someone dropping a dish, or some similar noise. This has not only happened with me, but also with several friends of mine. First I thought it was just a coincidence, but now I have some serious doubts as to that.

Could that noise happen at some other time than at the exact instant that the gun was fired? The dream does not necessarily have to be like the one I described, but the part about the gun—why does this happen? Is there any explanation? I know there must be, and I sincerely hope that you can explain this to me.

I am exceedingly interested in a satisfactory answer to this incident.

SCIENCE AND INVENTION Magazine is a wonderful publication. I get it every month and it is one of my favorite pastimes. I always read your articles, as they are very instructive. AMAZING STORIES is also pretty good.

EDWARD REGALADO,
Ridgefield Park, N. J.

(Experiments have been conducted with people sleeping to find out just when a dream occurs. One of these experiments consisted in striking the sleeper with a rolled-up piece of paper. Invariably on awaking, the sleeper told about an accident, a fall, a gun-shot wound, or something of a similar nature, injuring the leg or other member struck by the newspaper. The conclusion has been reached that in dreams of this type, the dream is momentary, it is induced by the blow or excited by the noise, and between that stage of subconsciousness and the conscious state, the dream most probably occurs. This seems at first rather preposterous.

You might say, "Yes, but I have had dreams which have surely lasted more than fifteen minutes." Such is not necessarily the case. The dream may have seemed to have lasted fifteen minutes and yet took place in but a fraction of a second. This flash of events was vividly brought to the writer's mind some time ago when leaping from a pavilion over the rail to dive into the water 28 feet beneath. When he was in mid-air a log was sighted. During the time that it took to fall the distance of 28 feet, which is less than two seconds, the following events rapidly flashed through the mind, and so vividly that they seem real even to this day. The log was met head on, the body dragged out of the water, placed on the sands and resuscitation methods administered, the body was picked up, placed in an ambulance and taken to the morgue where it was identified by relatives, and every event occurring for the next three days until after the interment flashed through the mind. Here then was a day dream which could not have started before the log was sighted and which terminated when the log was struck a glancing blow, tearing the tissue, but in no way producing an injury great enough to produce unconsciousness. Here also was a dream which encompassed a period of three days, and which in spite of that was resplendent in every detail.—EDITOR.)

THE NERVOSAN

Editor, SCIENCE AND INVENTION:

I have with interest followed some of the items in your publication and have admired the frankness and thoroughness of going into details in exposing so-called scientific frauds. The exposure of the so-called "Concentrator" is no doubt of great advantage to the gullible public. No doubt you are interested in anything that is new, and there is a possibility that you have not seen or heard about a new device which is now sold to the public under the name of "Nervosan."

This machine sells for a considerable amount and if it is not what it is pretended to be, the purchasers would be at quite a loss if this instrument should prove to be of a fraudulent nature.

I am enclosing descriptive matter which explains the instrument more in detail and contains claims of the benefits derived from the use of the instrument.

One claim in particular is made for this instrument, that it will cure cancer in its various forms, diphtheria, etc. (It certainly will not—EDITOR.)

Personally I have many times investigated new matters put into the market in order to protect the members of our organization and for the sake of general knowledge, and as this instrument was demonstrated to me, I secured one at the regular price of \$100.00 to investigate this article further.

AMAZING STORIES

IN OUR
AUGUST ISSUE:

THE SKYLARK OF SPACE, by Edward Elmer Smith, in collaboration with Lee Hawkins Garby. (A Serial in Three Parts.) Part I. Much conjecturing has been done on the far-reaching effects and possibilities of the energy contained in an atom, if it ever could be released. If some method for liberation of intra-atomic energy is discovered, the discovery very probably will be accidental. The first instalment is chock-full of intense moments and thrilling detail.

ARMAGEDDON—2419 A.D., by Philip Francis Nowlan. While enormous strides were made during the World War, both in the type of mechanical warfare and in the uses of poisonous gases, the limit has not been reached by a far stretch. In this story, the author tells about some amazing things, which are scientifically correct. It certainly contains a number of interesting prophecies, many of which are sure to come true.

THE PERAMBULATING HOME, by Henry Hugh Simmons. This is the fourth of the series of "Hicks' Inventions with a Kick." It is funnier and more thrilling than the preceding amazing inventions of this inventive genius, and gives us some very startling new ideas.

THE HEAD, by Joe Kleier. Recent experiments in Germany have proved that it is possible to decapitate insects and transplant the heads from one insect to another, with no obvious harm to the insects, after the wounds are healed. If it can be done with insects, why not with animals, and perhaps with humans, sometime in the future?

And others.

However, I admit that I am not sufficiently advanced in the science of radio activity, electro-therapy, etc., therefore, I take the liberty to ask for your aid in the investigation.

Should the instrument prove only partly what it is claimed for, it certainly would be of the greatest benefit to suffering humanity.

The instrument bears the patent number 1,559,746, and has been patented in the United States about November, 1926. The trade-mark in the descriptive matter is "Nervosan," but I do not know if this name has been copyrighted.

There are various recommendations used in connection with the instrument which speak very highly of the results achieved by its use, and these recommendations bear the names of persons of very high standing and seem to be genuine.

Geo. Whigelt,

Inventors' League of the United States, Inc.
New York City

(We have carefully gone over the booklet on "Nervosan" and also examined thoroughly the "Nervosan" instrument which was left with us for the test purposes, with the slogan on the plate "Medico' Munchen 8.")

This apparatus consists essentially of a vi-

brator, condensers, and a high frequency Oudin type transformer, so arranged that the transformer itself rises on a pair of springs and when so doing, it opens the 110 volt circuit. A tap is provided for operation on 220 volts. A large metal electrode communicates with the high potential side of the Oudin, and in order to close the circuit, this metal electrode must be depressed.

Due to the fact that the contact between the skin and the large metal surface is quite perfect, little or no shock is felt. In order to produce the effect of something tangible occurring, additional electrodes in the form of glass applicators in various shapes are inserted into a holder and the wire to this holder is returned to one side of the 110 volt circuit.

Analyzing the system in its entirety, we have now an ordinary violet-ray machine such as those made in this country and sold at a cost of from approximately \$5.00 to \$35.00. The electrodes are practically identical, except that these in the foreign importation are probably filled with Neon gas. The only difference between the machine under investigation and the well-known violet-ray machines is that this particular device is non-adjustable; consequently, its intensity is constant and at no time can the intensity be increased; whereas in American styles, the intensity is variable as desired. Secondly, in this machine, contact with the electrode must positively be assured before the current can be turned on, and for that reason alone no shock is felt. Thirdly, a second electrode is applied to the body through a ground. Violet-ray machines built here can be used for the same purpose and an additional electrode can be connected directly to the ground for producing the identical effect.

In order to verify our statements, we then carefully went over patent No. 1,559,746, issued to E. Geissler, on November 3rd, 1926, who assigned it to the firm of Fabrik Chem. Gravuren, Luppe & Heilbronner, Gesellschaft, of Munich, Germany. The indication is clear that the machine differs in no way whatever from a violet-ray machine, as we know them today, and this is particularly exemplified in the two claims of the patent. The only thing which we can see covered in a device of this nature is a means for closing the circuit by pressing a plate which also serves as the electrode.

While the device cannot be considered to be a fraudulent medical treating system, it is by no means any better than those found on the American market and is more than three times as expensive.—EDITOR.)

DIDN'T SAY SPIRITS

Editor, SCIENCE AND INVENTION:

With SCIENCE AND INVENTION investigating "spirits," it will interest the readers of SCIENCE AND INVENTION to read this letter which was sent to Mr. Pecoraro, a medium for various spirits (of which only one showed up at the critical moment.) The letter read:—

"Having seen your name in the newspapers and the way it was connected with the spiritualistic research of the magazine SCIENCE AND INVENTION, I wish to ask if you are open to engagement to show spiritualistic phenomena, how you do it I care not, just entertainment.

A club I belong to intends to have an entertainment and we thought it would be a good idea to have you there. The entertainment will take place Saturday, June 2nd next, at 8 P. M., and there will be ample space and facilities.

If your price is reasonable, you are sure to be engaged.

Please let me know of your price for one hour entertainment and for two hours of entertainment." ISRAEL SALTZMAN, Secretary H. I. Club, New York City.

Now, to this letter, the first paragraph of which would easily tell him that I know, or am interested in spiritualism, the following reply was received:

"In answer to your letter of April 27th, with regard to giving a séance at your entertainment June 2nd, 1928, at 8 P. M., I wish to state that the date and time is quite convenient for me, and that my fee for the performance is \$100.00 for one hour entertainment and \$150.00 for two hours entertainment.

(Continued on page 381)

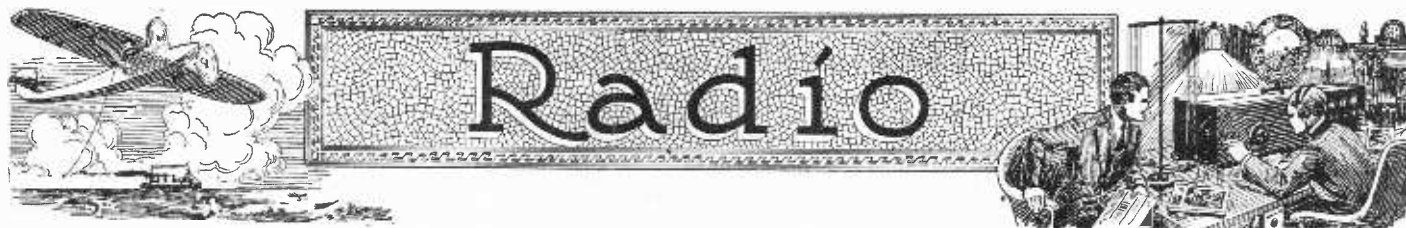

New Radio Beacon Guides Planes

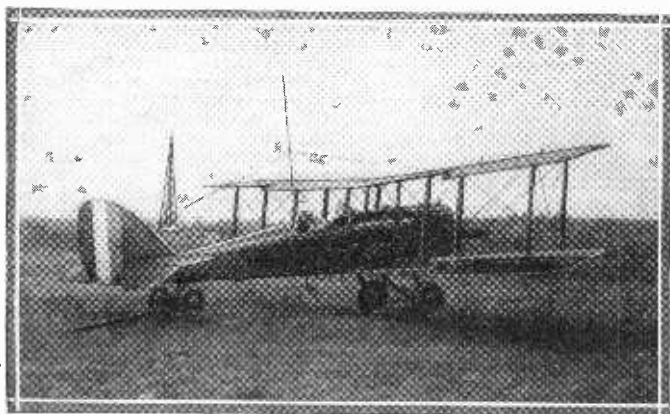

The above illustration clearly shows the 10 ft. metal rod which is now being used as an airplane antenna instead of the trailing wire.

AMONG the recent developments of the U. S. Bureau of Standards designed to lessen the risk of flying in the fog or during bad weather conditions, are the perfection of a ten-foot metal rod to be used in place of the conventional trailing wire antenna and a visual indicating device for marking the correct air route. A number of demonstrations have recently been given and it is now proved conclusively that the beacon system marks out an infallible course for the pilot at all times. To make use of this new development, the plane need only be provided with a small radio receiver and one of the new visual indicators, which will be described further on in the text. The troublesome trailing wire antenna and headphones which were used previously have been eliminated.

RADIO BEACONS

THE radio beacon system as used at the present time, employs double beam directive beacons and smaller stations known as "marker beacons," which are placed along a definite route. The directive radio beacon station employs two loop antennas placed at an angle of 90 degrees to each other. Each of these emits a signal which is at maximum in its plane and at right angles is at minimum. Both antennas transmit 290-kilocycle waves, but are modulated at two different frequencies. A master oscillator, producing 290-kilocycle oscillations, feeds two power amplifiers. These are then modulated by two different low frequencies and their outputs are fed separately to the two loops.

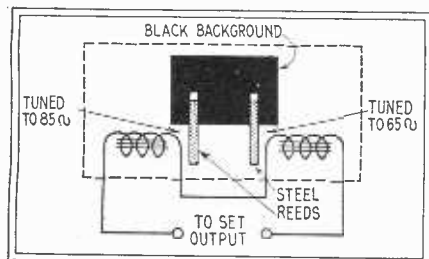

Details of the visual vibrating reed indicator which was developed by the U. S. Bureau of Standards, are shown in the above illustration.

Each power amplifier and, consequently, each loop passes radio-frequency current, each alternate half cycle, the frequency being either 85 or 65 kilocycles. When the beacon is to be used for air routes in several directions, a goniometer may be introduced. The beacon system can be used with any receiving set which operates at the frequencies used, by merely replacing the telephone headset with the reed indicator unit. The Bureau has developed special receivers in order to use

the beacons under the most advantageous conditions. One of the noteworthy achievements has been to do away with the trailing wire as an antenna, which has long been recognized as a source of difficulty. The trailing wire has been eliminated through the development of a set having the necessary sensitivity and capable of receiving through ignition interference. The antenna now used is a metal pole extending vertically from the cock-pit and has a total length of about ten feet. The receiver weighs less than fifteen pounds and has a receiving range from 285 to 350 kilocycles. It can be used to receive either the beacon signals or radio-telephonic and telegraph messages. The selectivity of the set design is supplemented by the added selectivity of the reed indicator, which will now be explained.

VISUAL REED INDICATOR

THE indicator for beacon signals is mounted on the instrument board in front of the pilot. Its function is much the same as a telephone receiver, except that its vibrating portions are tuned to certain frequencies. As shown in the illustration, the indicator consists of two coils through which passes the audio output current of the receiving set. Two steel reeds are placed adjacent to the two coils. These two reeds are tuned to the two frequencies of the beacon signals, in this case, 85 and 65 cycles, respectively.

When the two signals from the beacon are received with equal intensity and the pilot is directly on his course, the reeds will vibrate with an equal amplitude. The vibration is made visual by white tabs at their ends, behind which is placed a black background. These tabs are all that the pilot sees, and they apparently lengthen out into white lines when the indicator is in operation. By keeping the plane so that the two lines are always of equal length, the aviator remains on his course.

MARKER BEACONS

THE directive beacons at College Park, Maryland, and Bellefonte, Pa., operate on 1 kilowatt. Such beacons located about 200 miles apart would give satisfactory beacon service when the course was practically a straight line between them. Where the course varies in direction, low power beacons could be used at the turning points. The directive beacons successfully guide a pilot along the course, but give him no information as to the distance traversed. By the installation of non-directive "marker beacons" of a low power which emit a characteristic

(Continued on page 355)

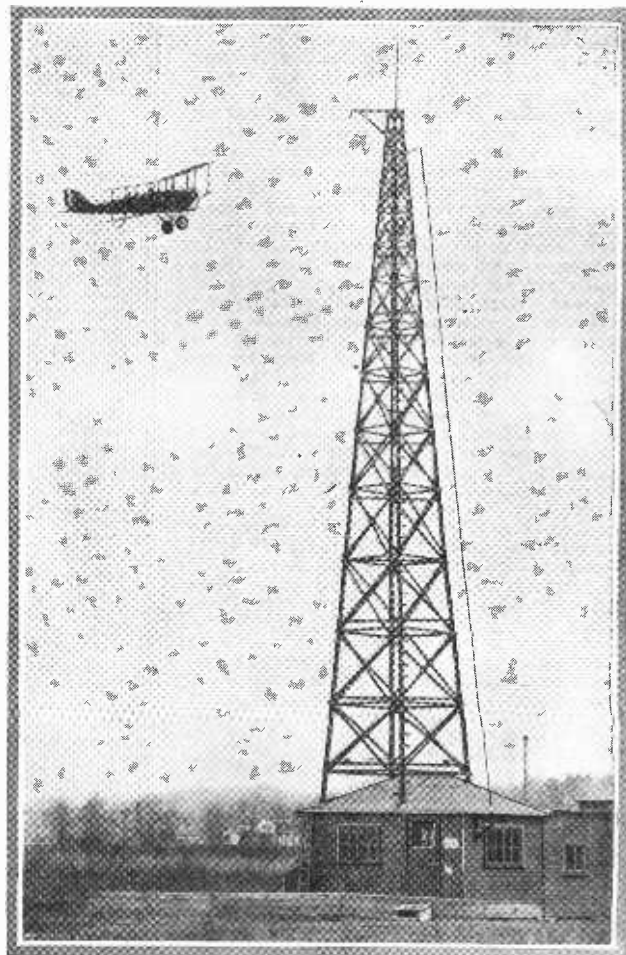

Above is a view of the new directive radio beacon situated at College Park, Maryland. One of the test planes may be seen flying past the beacon.

NEW RADIO DEVICES

Accessories Recently Developed Which Will Be of Value with Any Radio Set

SHORT-WAVE COILS

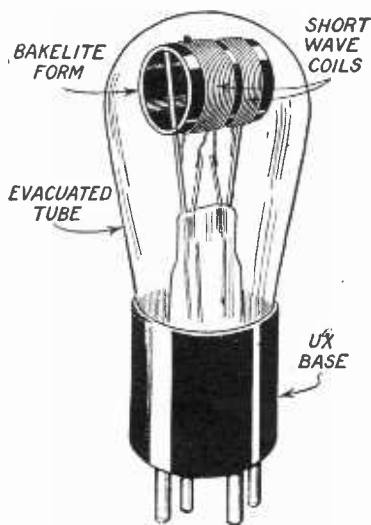

A view of one of the plug-in short-wave coils appears above. These coils are placed within vacuum tubes which are equipped with a standard UX base, enabling them to be quickly changed.

A SAN FRANCISCO radio concern is now placing on the market plug-in short-wave coils which are sealed in a vacuum, so that changes from one band to the other may be made without changing the calibration of the set. The coils are wound upon a bakelite form supported by four uprights and there is little chance of vibration, due to the solid construction. The evacuation of the glass bulb in which the coils are placed protects them from dirt and moisture and from handling, which sometimes changes the calibration. These coils are made in several different sizes which cover the amateur and broadcast short-wave bands. In size the novel inductances are about the same as an ordinary 201-A type tube and may be plugged in a standard UX socket, thus insuring firm contact at all times. Despite the distributed capacity of the leads and socket and losses due to the bakelite coil form, the short-wave coils shown here are very efficient and excellent results are obtained because of the concentrated field of the coil. A receiver using the coils is easily hooked up and is much neater in appearance than the usual short-wave set. The coils will retain their original features for an indefinite period. A receiver using them has two controls and any wavelength band can be covered by simply plugging in the correct short-wave coil.

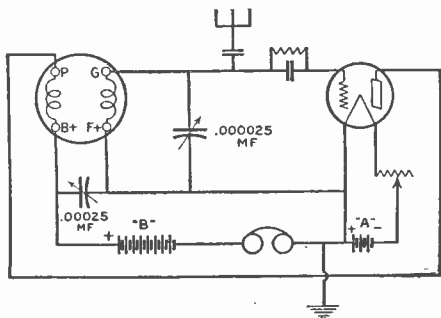

The above circuit diagram shows how the coils are hooked up for short-wave reception.

VACUUM CONDENSER

A FIXED condenser of efficient and compact design is now being made by a well-known Massachusetts manufacturer. The condenser itself is wound with mica and copper strips, is tightly bound together and placed within a small glass tube of about the same size as is used with the present-day grid leaks. The two leads from the condenser are securely attached to metal tips as shown, and the glass tube is evacuated so as to insure accurate and permanent rating of the condenser whose capacity would otherwise change if exposed to the atmosphere.

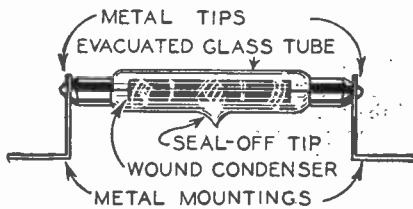

The new vacuum condenser is illustrated here. It is of about the size of a grid leak and is mounted in the same manner.

TUBE SHIELD

A CHICAGO radio company has developed a tube shield and shielded connector designed to be used with a screen grid tube of the 222-type. The shield, which is 5½ inches high and 2⅞ inches in diameter, completely covers the tube. The shield itself, which is of copper, is attached to the sub-panel by means of a bakelite base made in the form of a ring over which the shield is slipped. The top of the shield is remov-

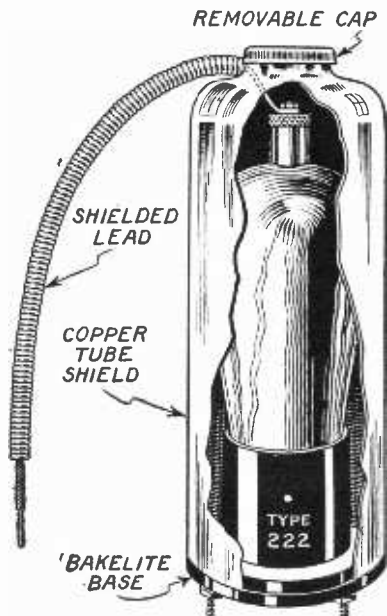

The copper tube shield and shielded lead to be used with 222-type tubes is shown here. The top of the shield is provided with a removable cap so that connection to the grid terminal on top of the tube is easily made.

able, so that connection can be made to the grid terminal of the tube as easily as possible. A shielded flexible lead, with a special terminal, is used for this top connection. The shielded lead is readily removable as is the shield itself.

Names of manufacturers supplied upon request.

CONVENIENCE OUTLET

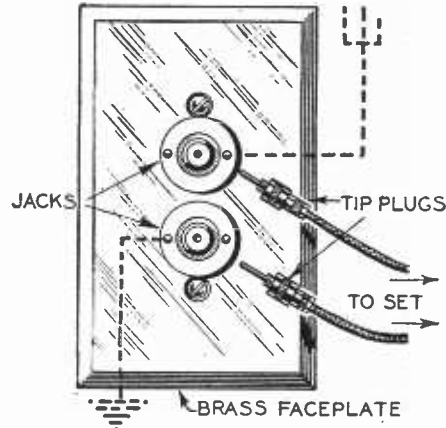

Above is a convenience outlet to be used for the aerial and ground. The antenna wire is brought to one of the jacks and the ground to the other. The upper jack is marked antenna and the lower ground, but were inadvertently left blank in this illustration.

A WELL-KNOWN radio manufacturer, located in Chicago, is now making radio convenience outlets which will fit any standard switch box and which are similar to the outlets used with the electric light house-wiring system. Probably the one most generally used is that which provides for aerial and ground connections. This is fitted with two small jacks for the aerial and ground wires and two tip plugs to which two leads for the set are attached. The jacks are mounted upon a standard size brass faceplate. The same manufacturer also makes outlets for the loud speaker and also gang-plates which contain jacks for speaker, aerial and ground, and battery connections. One of the single battery connection outlets is illustrated below. This is equipped with seven leads which will take care of the average requirements. The jack is insulated from the faceplate and the pin plug is connected to the wires for the receiver. The batteries, charging equipment and the like can be placed in an out-of-the-way place, in the basement or a closet, thus keeping this unsightly but necessary apparatus out of the way. When once properly installed it is impossible to make a wrong connection with this device, as the plug can only be inserted one way. As mentioned before, all the radio convenience outlets fit any standard switch box and they may be mounted directly on a switch box, thus making a more satisfactory job.

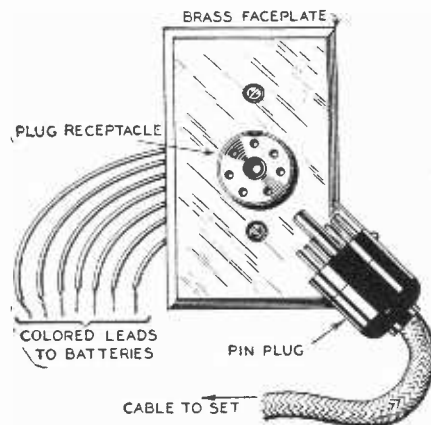

An outlet for the battery connections is illustrated above. Provision is made for seven leads.

Hints on Loud Speakers

Illustrations on opposite page

IN an effort to find a loud speaker which would respond to all frequencies equally well, the radio fan has been in a quandary. This is especially true at the present time, when there are so many types to choose from: horns, cones, electro-dynamic speakers and many combinations of designs, have all served to confuse and bewilder those engaged in the search for a good reproducer. It is the aim of this article to enumerate the faults and advantages of each, giving constructional hints and details, so that the reader can choose or build the speaker which appeals to him. There are undoubtedly many at the present time who have a horn stored away in some place, a relic of the pre-cone days. For those who have, the combination of horn and cone, as shown in Fig. 1, will be of advantage. A horn and cone connected in series aid materially in better reproduction, the horn favoring the higher register, and the cone the lower register.

CONE AND HORN COMBINATION

IN Fig. 2 is illustrated an exponential horn, which is energized by a small cone speaker, five or six inches in diameter. This should fit tightly into the horn, so that there is no space between the edge of the cone and the walls of the horn. One will have to go far to find a reproducer which sounds as lifelike as this. In a Western university, a large exponential horn, molded from concrete, was energized with a cone in the manner mentioned, and the results were very surprising. The construction of exponential horns will not be taken up here, as an article giving detailed information for building them appeared in the April 1928 issue of this magazine.

POINTS ABOUT CONE SPEAKERS

THE cone speaker increases the loudness of the sound by disturbing a large amount of air. The energy reaching the ear is thus increased. The higher the frequency of the sound, the smaller must be the diaphragm. A single cone cannot reproduce properly the higher frequencies and at the same time the bass note. This explains the advantage of the combination horn and cone mentioned above, and the double and multi-diaphragm speakers described here. The construction of a double cone was given in the June issue of this magazine. The off-center cone is a step toward better reproduction, and is shown in Fig. 4. It is claimed that the longer portion, from top to apex, reproduces the bass notes, and the shorter portion, from the bottom to the apex, amplifies the higher frequencies. Cones of elliptical shape, however, do not fall into this class. In practice, cones of the latter type, when properly designed, have proven to be quite satisfactory, the larger ones, 2½ to 3 feet in length, and 1 to 1½ feet wide, being the best.

CONE ANGLES

THE angle of the cone is also important, inasmuch as when the angle increases, the pitch also increases and the reproduction of the low or bass notes fall off. It is estimated that for cones about 1½ feet in diameter, the best angle varies from 90 or 100 to 130 degrees. The angle for other cones can be calculated from this.

In Fig. 3, various types of cones are illustrated, the movement of each when actuated by a unit is shown below in Fig. 5. The free-edge cone, as its name implies, is not fixed at the edge and consists of a single cone supported by the drive rod only. The main drawback to this type is the tendency to "blast." In an effort to relieve this, the other types were used. The "fixed"

edge cone is fastened about the periphery to a wooden ring. When excited by a signal, the movement of the diaphragm rises from zero at the edge to maximum at the apex, as shown by the dotted lines. The double fixed-edge cone has a supporting cone on the back, made as shown, and attached to a wooden or metal ring which holds the unit. When it is actuated, the sound-producing movements take place at the edge but are dampened, lying about midway between the fixed and free-edge cones. In this case also, maximum movement takes place at the apex. The moving coil type speaker is the only one of the diaphragm class which has an equal and free movement and it is now becoming justly popular. This last-named reproducer will be mentioned in the text later.

GRADUATING THE CONE PAPER

THE use of tapered cone paper has been advocated by at least one manufacturer and the constructor can, if he likes, build up his own paper as shown. Three to five strips are cemented together as shown, so as to taper from the circumference to the apex, that is, the thinnest part of the paper will be at the apex. This tends to equalize

This article, a summary of all that is good and bad in radio loud speakers, covers most of the important types and gives constructional hints, so that the fan can make his own if he so desires. In their desire to find a speaker which would respond to all frequencies equally well, the radio public has been at a loss as to what type they should use. This article will help you in the selection of a good reproducer. A very good construction article describing in detail the building of exponential horns appeared in the April 1928 issue of this magazine, and an article on making a double cone speaker was published in the June issue.

the radiated force of the cone and give a more pleasing response. The energy radiated at the low frequencies is constant, but as the frequency increases the power radiated falls off rapidly. In large cones this is usually more noticeable than in small ones. The tapered cone was developed to solve this problem and it helps to equalize the radiated energy, keeping it nearly constant for all frequencies as mentioned.

MULTIPLE CONES

INSTEAD of making one diaphragm reproduce all frequencies, a multi-diaphragmed cone, such as that shown in cross section in Fig. 7, can also be used. The drive rod of the unit actuates three cones of varying sizes, a large one for the low frequencies, a small cone for the high frequencies, and an intermediate size cone for the middle register. Good reproduction is obtained with this three-diaphragm speaker. The drive rod will have to be lengthened with enough jam nuts to take care of the three cones. The cones themselves can be of any type desired by the builder.

AIRPLANE CLOTH SPEAKERS

OF types of cone speakers there seems to be no end. A recent addition to this large family of reproducers is the linen-diaphragm or airplane cloth cone. This

speaker has veritably become popular overnight, as it is not at all difficult to construct. The first requirement is a wooden frame upon which the two linen diaphragms are stretched. Both of these may be of the same size or a small and a large one can be used, one for high and one for low notes. If both are of the same size, a double frame as shown in Fig. 8 is used. If of different sizes, a single frame will suffice. The linen is tacked to the frame and is stretched as tightly as possible. With two sizes of cones, the large one is fastened to the front and the small one to the back of the frame, the unit being mounted as shown in the side view. If both diaphragms are of the same size, the unit is placed between them as illustrated. The exact center of each diaphragm is located for attaching the drive rod of the unit. Each diaphragm must be given a coat or two of airplane "dope" before the unit is attached. This can be bought already prepared or collodion may be used. The diaphragms, when dry, are pulled inwardly, as shown, and the drive rod of the unit attached. An 8/32 bolt with washers will serve to hold the diaphragms together. A hole drilled lengthwise in the bolt will provide for the drive rod of the unit which can be held secure by a drop of solder.

DYNAMIC TYPE CONE SPEAKERS

ONE of the main drawbacks to the magnetic or iron armature type of speaker, into which class the cones mentioned above fall, is saturation. A strong signal may cause magnetic saturation of armature and so cause distortion. A lever system has been and still is used in order to hold the armature centered and also to give the cone less motion than that of the armature. These levers and the drive rod all cause resonant humps. Furthermore, the armature of this type of speaker moves with a pivotal motion, instead of having the more desirable reciprocating motion. In contrast to all these faults, the dynamic or moving coil type speaker has only a few disadvantages. The main ones are the cost and the fact that the field-winding must be excited from a separate battery or similar source of supply. This type of reproducer usually has a small plunger type cone and is used with a baffle as shown in Fig. 9. The cone is made with an angle of 90 degrees and is supported by a very flexible material at the apex and the front end. This cone is free to move in a horizontal direction, and with the small coil can move a long distance for low note reproduction. In order to match the impedance of the last audio tube to the moving coil, a step-down transformer is necessary and should have a ratio of 25 or 30 to 1. In order to prevent interference of sound waves from the rear surface, a baffle board will be necessary. The speaker is mounted in the center of a piece of heavy wall board, or wood may be used. This is the baffle and it lengthens the path of sound waves before they combine when coming from the front and rear sides of the cone. If a cabinet is used to house the speaker, it should have holes in the back to allow the pressure of sound waves to escape. The quality and pitch of the signal varies with the size of the baffle. With a large baffle low notes are reproduced better.

BALSA WOOD SPEAKERS

ONE of the best loud speakers has a large elliptical cone about four feet in diameter driven by a good unit. A balsa wood speaker, Fig. 10, if made properly, will give results comparable to such a cone. This wood is suitable for speaker construction.

(Continued on page 354)

ALL ABOUT LOUD SPEAKERS

By PAUL L. WELKER

Various types of reproducers have been illustrated below and are fully explained in the accompanying text. Constructional hints and the merits of each type are given.

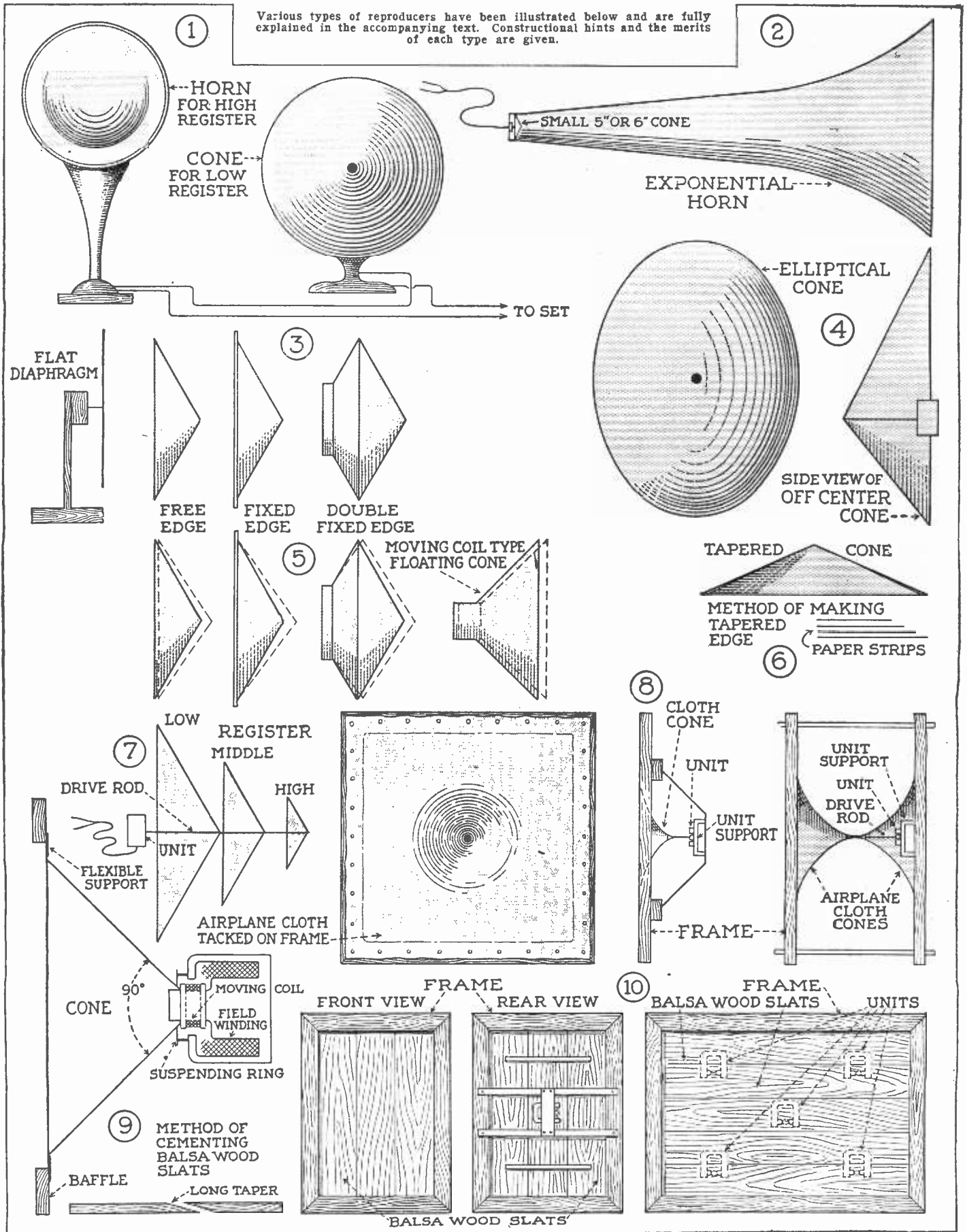

Above: 1, combination horn and cone; 2, exponential horn with cone; 3, diaphragm types; 4, elliptical and off-center cones.

5, Cone movements; 6, tapered cone; 7, multi-cone speaker; 8, linen diaphragm reproducer; 9, moving coil type, and 10, balsa wood speaker.

New Summer Portables

Compact Design and Better Quality Are Keynotes of Season

Below is a front view of the receiver, showing the loud speaker grill and neat panel arrangement. There are only two tuning controls using the illuminated dials and one other knob on the front panel which is a combined battery switch and volume control. The loop is wound within the front cover, but an aerial and ground may be used if desired through the provision of binding posts which have been mounted at the bottom of the cover. Two spring clasps hold the back and front covers of the portable securely closed when not in use. The receiver may be termed "an all purpose radio," as it can be used in the home, at the office, and on the vacation, wherever one chooses to go.



At the left is a photograph of the new portable radio receiver being used with a small portable phonograph. The phonograph employs an electric pick-up device and is especially designed to be used with a radio receiver. A length of flexible cable and a special plug is provided, so that one simply has to remove the detector tube, put the plug in place, start the phonograph going and sit back to enjoy the music.

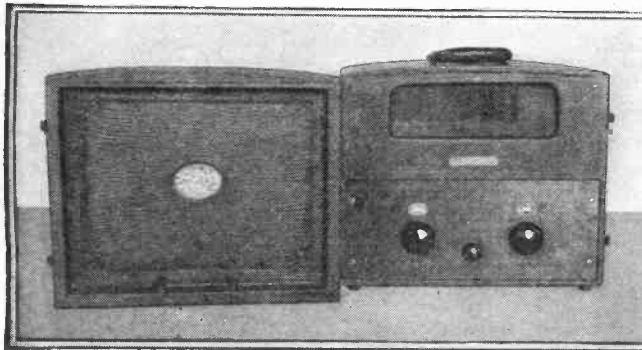

Below we see a rear view of the portable, showing the placement of A and B batteries, loud speaker and radio set. The shield-grid tube may be seen on the righthand side of the set. A battery cable has been provided for convenience when changing batteries and is plugged in on the sub-panel. The rear of the loud speaker and speaker unit are seen directly above the "A" batteries, with the "B" batteries placed in the compartment to the left. The four other small tubes are of the 199-type and are used throughout, except in the first radio-frequency stage.



The ideal combination and two of the best vacation companions may be seen in the center photo at the right. The enjoyment of a portable receiver can be doubled by using it to amplify phonograph programs. When radio programs are poor or do not suit, phonograph music can be had in a minute's time. Phonograph music reproduced in this way is heard from the radio loud speaker with an added volume and richness of tone which it is impossible to obtain otherwise. The portable phonograph shown here is equipped with a pick-up and single-spring motor. A volume control is conveniently located on the motor-board.

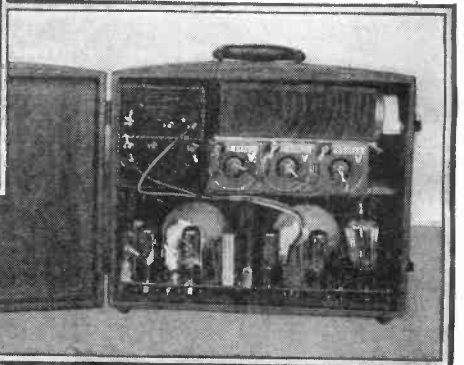

A RADIO receiver so compact that it can be taken anywhere as easily as one's luggage, is now being made by a Chicago radio manufacturer. Differing from other portables, the new set uses a shielded-grid tube, which provides very many times the amplification of that furnished by the ordinary tube. A special air-column type tone chamber provides clear, full, rich reproduction. The aerial is enclosed in a walnut frame in the cover, and the case is covered with shark grain, leather-like material. Two illuminated dials set into a golden-brown panel, furnish a most attractive appearance when the set is opened. There are two control knobs, which insure maximum selectivity to those who use it in metropolitan areas. A small knob placed in the center regulates the volume and serves also as a battery switch. Completely equipped, the receiver weighs but 26 pounds. When greater volume and distance are desired, an antenna and ground may be used, and are connected on the front cover to special binding posts. The dome top, with rounded corners, is individual in design and pleasing in appearance. In the above layout, the receiver is shown in conjunction with a small portable phonograph, making an ideal vacation combination. The phonograph is small in size and readily carried along with the radio set. A pick-up device and special

plug with a length of cable enable the vacationist to use the audio amplifier and loud speaker of the radio receiver for reproducing phonograph programs with added clarity and volume. By the use of a phonograph pick-up, any phonograph may be used with a radio receiver, but due to their compact size and efficiency, we are showing a new portable receiver and portable phonograph as a suggestion to those going away on their vacation.

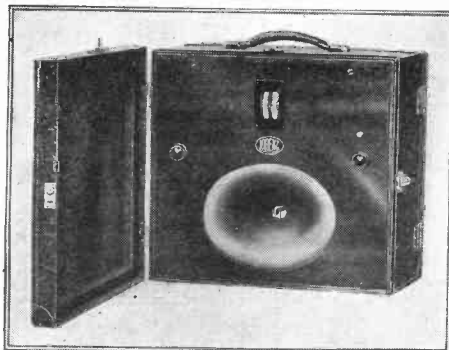

A portable receiver placed in a week-end travelling bag together with batteries and loud speaker is shown above. This model is of German design.

TRAVELING BAG SET

An attractive, small, leather handbag which differs in no way from the styles which are used at the present time by the ladies or for sleeping-car use, contains a complete radio receiver and is now being featured in Germany. The bag contains a complete superheterodyne receiver using six tubes and contains all the necessary batteries and an air-column loud speaker. The loop antenna is wound about the frame of the front cover or door, no separate antenna and ground being needed. When the front cover is open, it is ready for use and will cover a wavelength band from 200 to 2,000 meters. All that is necessary is to turn two knobs shown in the photograph and at once, whether in a forest or on the seashore, or out in the week-end cottage, one can listen to radio offerings, which are reproduced with plenty of volume. The portable is absolutely self-contained, no wires or straps being visible. The speaker, which has a funnel-shaped opening, is placed at the bottom of the set with a tuning control arranged on either side. A calibrated drum may be seen in the center of the panel, near the top. A leather carrying handle is placed on the top of the cabinet and the front and rear doors when the receiver is not in use.—Dr. A. Neuburger.

Names of manufacturers furnished upon request.

RADIO ORACLE

In this department we publish questions and answers which we feel are of interest to the novice and amateur. Letters addressed to this department cannot be answered free. A charge of 50c. is made for all questions where a personal answer is desired.

MEASURING DIELECTRIC STRENGTH

(634) Ralph Quinn, Cogswell, No. Dakota, writes:

Q. 1. Will you kindly give me a simple method of testing dielectric materials for breakdown value.

A. 1. One method which can be easily employed, is to machine two recesses, spherical segments, on opposite faces of a sheet of the dielectric. These two recesses should have the same radius of curvature as two spherical electrodes which will be used in the test. It is essential to eliminate the air film between the dielectric and the electrodes. The two spherical electrodes are supported from an insulated framework and clamped rigidly, so as to press tightly into the recesses on the sheet of dielectric material under test. The test itself may be carried out in air or in oil, and if the latter is used, the whole specimen, as well as the electrodes, should be submerged in good insulating oil. Without the oil, flashover on the surface of the dielectric frequently occurs, unless the specimen is rather large. In making the test, the two electrodes should be connected to the secondary of a step-up transformer which should have a rating of 1 KVA (1 KVA = 1 kilo-volt-ampere). A larger one can, of course, be used if available, but for stability, a rating of not less than 1 KVA is recommended. A resistance connected in the supply circuit will serve to regulate the voltage fed to the primary. In order to measure the voltage across the specimen under test, when breakdown occurs, it is preferable to connect a high voltage electrostatic voltmeter directly across the specimen. Another way is to connect an adjustable air gap across the specimen, making use of spark electrodes of known form, as needle points or spheres. The flashover voltages of spark gaps in air with electrodes of definite form are known, and a gap of this sort can be used in place of the voltmeter. With a calibrated spark gap, the gap is first set to a figure below the expected breakdown voltage and the transformer voltage raised until a spark jumps across the gap. The current is then turned off and the gap opened slightly and the test repeated. If this process is continued, a setting of the gap will be found where the discharge passes through the test piece instead of across the air. Another way in which the calibration spark gap can be used is with an ordinary A.C. voltmeter connected across the primary of the transformer. The test is made on the dielectric specimen without the spark gap connected, and the primary voltage is raised until breakdown occurs. At the moment of breakdown, a reading should be taken on the meter. The specimen may then be removed and replaced by the spark gap and a series of readings taken with different settings of the gap, until the high-tension voltage corresponds with the reading of the voltmeter. This gives the breakdown voltage of the dielectric. For most purposes the high-tension voltmeter and spark gap can be discarded and the primary voltmeter reading taken as the measure of secondary voltage when the ratio of the transformer is known. This method is of course subject to corrections, but for breakdown tests of this nature these corrections can be neglected. When testing thin materials, such as paper and mica, the spherical electrodes are not suitable and it is much better to employ flat-plate electrodes. A book containing further information on the testing of dielectrics and condensers is entitled "Electrical Condensers," and if you are at all interested in this subject, we would suggest that you obtain a copy.

PHILCO ELIMINATOR DIAGRAM.

(635) O. T. Griswald, Deerfield, Mass., writes: Q. 1. If possible, will you please publish a diagram showing the hook-up of the newest Philco "A" and "B" eliminator which delivers 180 volts and uses a dry rectifier for battery charging.

A. 1. On this page you will find the hook-up of the eliminator mentioned above. A transformer secondary is provided for sets using five to ten tubes. A relay switch turns on the battery charger when the radio receiver is turned off. Low, medium, high and boost charges may be given by varying a resistance called the "economizer" upon the diagram. Eight electrolytic rectifiers are used for the B supply and are followed by the usual filter system. A fuse is provided

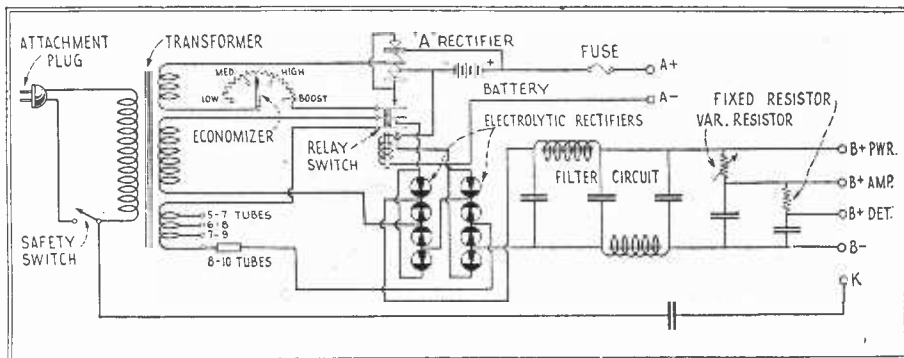

The wiring diagram of the Philco "A" and "B" eliminator appears above. A dry rectifier is used for charging the "A" battery, and eight electrolytic rectifiers are employed for rectifying the "B" voltage. A relay switch puts the battery in a "charge" position when the radio receiver is turned off. Low, medium, high and boost charges may be given.

in the A+ lead as shown. Three values of B voltage are obtainable from the device. If desired the ground connection from the receiver may be made to K, instead of to the water pipe.

Q. 2. A drawing of the rectifier used in this eliminator and something of its construction would also be appreciated.

A. 2. You will find illustrated here a cross-

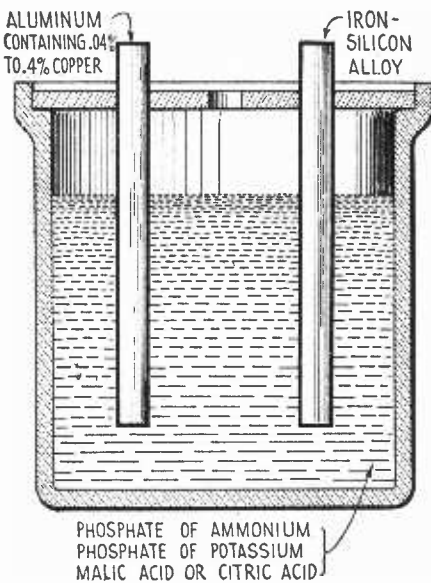

A cross-sectional view of the rectifier used with this eliminator. One of the rectifying electrodes is an iron-silicon alloy containing about 14% silicon, and the other is of aluminum, containing .04% to .4% of copper. An aluminum alloy electrode of this nature will deliver more rectified current and will operate at higher voltages without sparking and will show less wear than a similar electrode of pure aluminum. The electrolyte consists of a mixture of ammonium phosphate and potassium phosphate, with a mild organic acid such as citric or malic. Complete details of this rectifier will be found in U. S. Patent, No. 1,662,383.

sectional view of the electrolytic rectifier used with this eliminator. One of the rectifying electrodes is an iron-silicon alloy containing about 14% silicon, and the other is of aluminum, containing .04% to .4% of copper. An aluminum alloy electrode of this nature will deliver more rectified current and will operate at higher voltages without sparking and will show less wear than a similar electrode of pure aluminum. The electrolyte consists of a mixture of ammonium phosphate and potassium phosphate, with a mild organic acid such as citric or malic. Complete details of this rectifier will be found in U. S. Patent, No. 1,662,383.

INCREASING ELIMINATOR VOLTAGE

(636) Frank Souther, Lewiston, Maine, asks: Q. 1. How can I increase the voltage on the 90-volt tap of my 180-volt "B" eliminator?

A. 1. When it is desirable to increase the volt-

age from a given tap on the "B" eliminator, the following simple method may be employed. A resistance having a range of zero to 5,000,000 ohms, capable of handling at least 20 watts, is placed across the maximum voltage tap and the tap from which increased voltage is desired, in this case, the 90-volt tap. If it is desired to secure an added tap, one terminal of the resistor is connected to the "B" maximum, while the other is connected to a by-pass condenser, the other end of the condenser is connected to the "B" minus. This condenser should be 1 mf. or larger, and is connected in series with the lead of the resistor which goes to the "B-." The condenser thus by-passes any radio frequency energy which may exist in the circuit. The new tap, with a variable voltage from zero to maximum, is taken from the terminal of the resistor which leads to the "B-" of the eliminator. The condenser should be placed between this tap and the "B-."

RESISTANCE FEEDBACKS

(637) Philippe Sarrano, Westmount, Canada, asks:

Q. 1. What causes resistance feedbacks and how are they eliminated?

A. 1. Whenever two circuits come in contact at a resistance, there exists at that particular point a resistance feedback, due to resistance coupling. Connecting the plate circuits of two or more tubes to a common "B" battery, causes a coupling between these tubes which is provided by the resistance of the plate battery. If the grid returns of a number of turns are connected to the same "C" battery, a resistance coupling through the resistance of the battery will result. It will be seen therefore, that with these resistance couplings, energy from one stage or tube can be transferred to the preceding stage. These resistance feedbacks, of course, can be eliminated by using separate batteries for each tube. This, however, is not desirable from an economic standpoint and because of the space necessary. It is, however, possible to complete each grid and plate circuit without their going through the batteries. A large capacity condenser should be placed across the "B" battery, or between the tube filament and plate supply end of the coil or resistance. The current will then flow from the plate to the coupling coil or resistance, through the condenser to the filament. Radio-frequency energy is thus kept out of the "B" supply. When each tube is provided with a by-pass condenser, the resistance coupling will be practically eliminated. The capacity may vary between .006 to .01 mf. when used with radio-frequency tubes. In detector and audio circuits, the condenser capacity recommended is 1 mf. The coupling through "C" batteries is eliminated by connecting a condenser of 1/2 to 1 mf. capacity between the negative filament terminal of each audio-frequency tube and the filament terminal on the audio-frequency transformer which precedes the tube. The grid terminal of the transformer connects to the grid of the tube in question. In the radio-frequency stages where the grid returns are made to the battery side of a rheostat controlling these tubes, there will be a coupling through this rheostat, unless by-pass condensers are used between the grid return and filament.

Scientific Humor

WHERE THEY GROW

SHE: "You must be very fond of automobiles."
 HE: "What makes you think so?"
 SHE: "I heard you have a truck farm."
 —Walter M. Egel.

A WORSE CURSE

MODERN MISS TO HOMEY LITERARY LION:
 "How wonderful it would be to have a child with my face and your brain!"
 HOMEY LITERARY LION: "Suppose it should have my face and your brain?"
 —Lyn Blanning.



OR DROWN

DOCTOR: "Did you drink water one hour before eating, like I said?"
 PATIENT: "I started to, but had to give it up after fifteen minutes."
 —Leslie Carpenter.

FURIOUS SPIRITS

A man was bragging that he could name any brand of spirit, and an onlooker, taking a flask from his pocket, asked the connoisseur to taste that and tell him what it was. He did so and promptly spat it out, making horrible faces. "Good gracious, man!" he cried. "That's gasoline, that's what that is!" "Yes, I know that," came the quiet reply, "but what brand is it?"
 —T. B. Marsden, Jr., Rep. No. 16,872.



INVENTORS-GET BUSY

The patent cigar lighters won't replace the match entirely until they invent a toothpick attachment to go with them.
 —Henry A. Courtney.

LIGHT LIGHTLY PLEASE

FIRST LIGHTNING BUG: "So you think my candle-power is a bit below normal, eh?"
 SECOND LIGHTNING BUG: "Yes. What sort of shaving cream do you use? You don't seem to have that fine healthy glow."
 —Walter M. Egel.

AGAINST POTATO

CUSTOMER: "I would like to have my chops lean."
 WAITER: "Yes, sir. Which way, sir?"
 —Lyn Blanning.

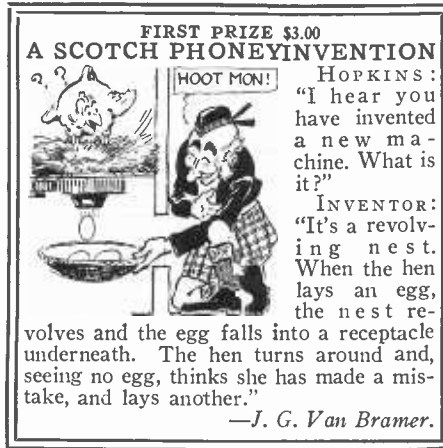

FIRST PRIZE \$3.00
A SCOTCH PONEY INVENTION
 HOPKINS: "I hear you have invented a new machine. What is it?"
 INVENTOR: "It's a revolving nest. When the hen lays an egg, the nest revolves and the egg falls into a receptacle underneath. The hen turns around and, seeing no egg, thinks she has made a mistake, and lays another."
 —J. G. Van Bramer.

HAIL—OH

FIRST ANGEL: "5984 kilowatt-hours for my halo this month. That seems like a good deal."
 SECOND ANGEL: "Yes, a fellow might make money at this job if it weren't for the overhead."
 —Gleason Pease.

ALL jokes published here are paid for at a rate of \$1.00 each; \$3.00 is paid for the best joke submitted each month. Jokes must have a scientific strain and should be original. Write each joke on a separate sheet of paper and add your name and address to each. Unavailable material cannot be returned.

UP-BRINGING

"This is your floor, daughter," announced the flip elevator boy.
 "How dare you call me daughter," stormed Aggie Riley.
 "Well, I brought you up, didn't I?" retaliated the lad.
 —Kenneth Purkes.

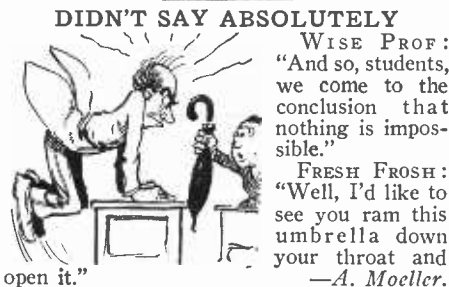

DIDN'T SAY ABSOLUTELY

WISE PROF: "And so, students, we come to the conclusion that nothing is impossible."
 FRESH FROSH: "Well, I'd like to see you ram this umbrella down your throat and open it."
 —A. Moeller.

SAY SICKNESS WITH FLOWERS

RASTUS: "I'se got catchy flowers."
 SAMBO: "Catchy flowers, what's dem?"
 RASTUS: "The doctor says I'se got contagious Daisies."
 —Leslie Carpenter.

AN ANSWER TO THE OLD GAG

RADIO FAN: "I got Hamburg and Java on the radio last night."
 HIS AUNT: "No, now, you can't make me believe they can deliver groceries with that contraption."
 —Edw. Weber.

EXPERIENCED

Rastus and Slim were stealing chickens when a farmer appeared on the scene. Both started running at a high rate of speed but Slim kept looking back. Finally he spoke up and said, "Rastus whaffo them flies follow us?"
 RASTUS: "Huh, jes' keep mov', nigger, jes' keep movin'. Dem ain't flies, dem's buck-shot."
 —L. Watson.



A FALL IN THE FALL

TOMMY: "Pa, why do they put salt on icy sidewalks in winter?"
 PA: "Same reason they put it in ice-cream freezers in summer."
 TOMMY: "But why?"
 PA: "To keep the dasher from falling down on the job!"
 —Henry A. Courtney.

BREATHING STOPPED

J. B. MCSNORTER: "I went home a bit under the weather last night, and my wife didn't suspect a thing."
 J. P. MCSNORLEY: "But couldn't she smell your breath?"
 J. B. MCSNORTER: "No. You see I ran the last block home and when I got there I was all out of breath."
 —Mrs. Z. B. Burris.

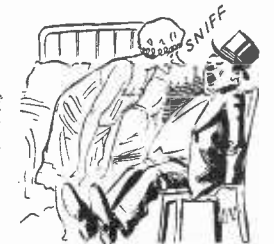

WHO'S BLACKEST

"Mandy, you say you done married a real black man; why, he ain't black nohow whatsoever. My husband am real black. I'se slept with him for five years and never seen him a-tall."
 "Mebbe so. But my man's so doggone black, the lightning bugs follow him around in the daytime."
 —Mrs. Z. B. Burris.

SCIENTY SIMON, Scientist

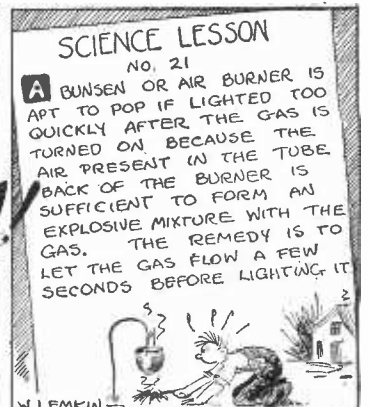
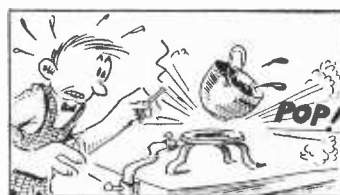



NON-INDUCTIVE RESISTANCE

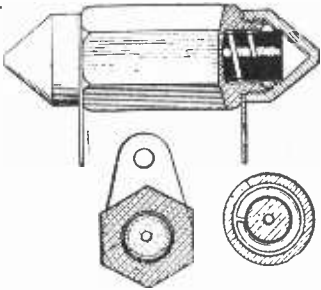

No. 1,635,184 issued to Lester L. Jones. The resistance element consists of a graphite impregnated base of high current carrying capacity. The resistance value is controlled by cutting a spiral groove with a large or small pitch, the value may also be controlled by varying the width of the cut. The resistance values may vary from 200 to about 200,000 ohms without changing the size of the unit. A perfectly water-tight electrical and mechanical joint is obtained without the use of solder, as illustrated. When the caps are screwed on the lead rings are forced into the triangular space and into intimate contact with the graphoidal surface of the base.

IMPROVED HARMONICA



No. 1,623,381 issued to Frederick C. Bender. This instrument is constructed in such a way that the necessity of sliding the lips has been eliminated, and besides this feature the operator can play a single tone easily, which cannot be done with the usual harmonica, as the openings to the air passages are very close together.

RADIO TELEGRAPH RELAY

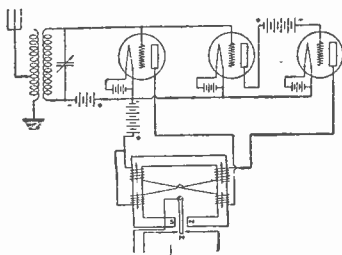

No. 1,649,341 issued to Walter N. Fanning. This invention provides a relaying system for radio signals in which but a single receiving circuit is used to affect alternately both coils of a differentially wound relay, as the signals stop and start. In this way the armature is positively moved from one extreme position to the other whenever a signaling impulse is received, as well as when the impulse ceases.

LIFE-SAVER AND SALVAGER

No. 1,663,412 issued to B. A. Mathews. This device is installed on ships, preferably one on the fore-deck and one aft. It not only provides means for locating the position of the sunken vessel, but also provides facilities for raising the vessel after it is sunk, and besides these features it constitutes a life-saving apparatus. This float contains a reel of strong cable (one end of which is fastened to the deck of the ship), a food and medicine chamber, and hand grips are placed around the body of the float.

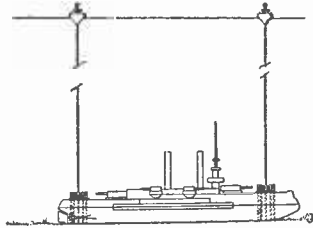

FOUNTAIN SHAVING BRUSH

No. 1,650,459 issued to Ralph J. Miele. The principal object of the invention is to provide a shaving brush having a magazine to hold the shaving cream and means to extrude the cream amongst the bristles. The brush includes a sliding plate which makes it possible to wash away all the lather after using the brush, without wasting any of the soap in the magazine. This sliding plate keeps the soap from getting hard near the opening when the brush is not in use.

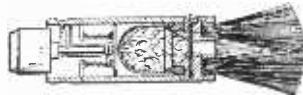

AIRCRAFT FIRE EXTINGUISHER

No. 1,660,992 issued to Orlando R. Erwin, shows an extinguisher for aircraft which is light and compact. This extinguisher uses foam as the extinguishing medium, consequently the engine must be provided with a casing as shown in the illustration, into which the fire-extinguishing medium is injected in time of fire, the purpose of the casing being, of course, to prevent the foam from being dispersed and blown away from the engine, by air currents.

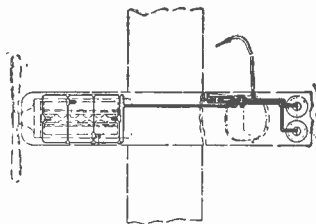

DIRIGIBLE MOORING

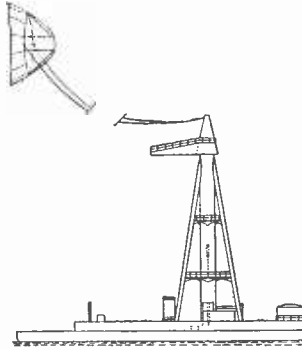

No. 1,664,188 issued to Barnes N. Wallis. This invention provides a means for drawing an airship to the mooring mast without causing the airship to kite or set up lateral hunting or over-rising forward movements. This action is obtained by using a number of anchoring cables or hauling down cables instead of the usual single hauling down cable. Anchor points are situated to leeward of the mast on laterally projecting members on the mooring mast.

AEROPLANE AMPLIFIER

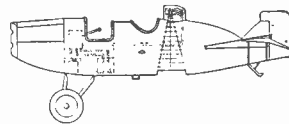

No. 1,667,300 issued to Samuel E. Adair. This invention relates to an amplifier system and sound-projecting horn of great capacity, to be carried by balloons, kites, dirigibles or aeroplanes. The outfit utilizes a dynamotor associated with a single set of comparatively lightweight low potential storage batteries for supplying the filament circuits.

MODULATING SYSTEM

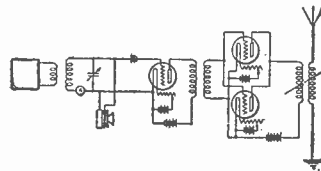

No. 1,650,934 issued to Lewis W. Chubb. This invention makes possible the modulating of radio frequency signaling energy at audio frequency without the use of electrical oscillations other than those of radio frequency. The illustration shows one form of the invention wherein a condenser type microphone is used to detune a highly selective tuned circuit, at audio frequency. The slightest variation of capacity in this circuit causes a large change in the voltage thereof.

COMB CLEANING DEVICE

No. 1,668,580 issued to Kazmer Wojttasiewicz. A rotatable brush is revolved for the purpose of cleaning the comb. A pair of strips are mounted in the wall of the device and spaced to form a slit, the size of the slit is adjustable so that the cleaner is easily adapted to different-sized combs. As the rotating brush strikes upon the comb and in between its teeth, dirt is driven from the comb and is deflected from a protective plate into a drawer, or is carried away by a pneumatic conveyor.

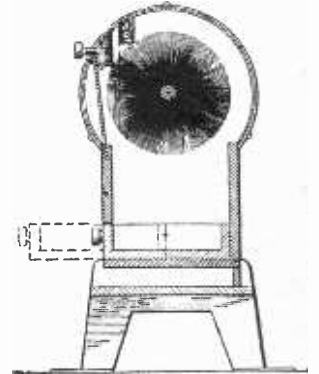

PHONOGRAPH PICK-UP

No. 1,593,690 issued to Theodore Willard Case. The form of the invention here illustrated is a new type of electric phonograph pick-up. It consists of a needle held lightly in the record groove, without intimate contact with the said groove.

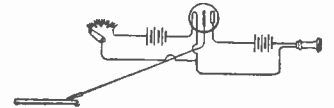

MAGNETIC KEY

No. 1,669,115 issued to Arthur E. Anakin. The key is made from hard steel and permanently magnetized, and is hinged to a soft steel or iron key blank which acts as a keeper for the permanent magnet when not in use. The lock contains one or more balls made of magnetic material which are lifted from their recesses by magnetic attraction when the key is inserted.

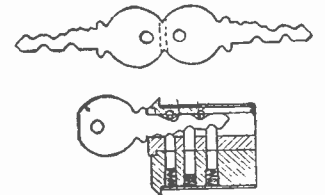

NOTICE TO READERS: The above illustrated and described devices have recently been issued patent protection, but are not as yet, to our knowledge, available on the market. We regret to advise that it is impossible to supply the names and addresses of inventors of the above devices to any of our readers. The only records available, and they are at

the Patent Office at Washington, D. C., give only the addresses of the inventors at the time of application for a patent. Many months have elapsed since that time, and those records are necessarily inaccurate. Therefore, kindly do not request such information, as it is practically impossible to obtain up-to-date addresses.

—EDITOR.



The "Oracle" is for the sole benefit of all scientific students. Questions will be answered here for the benefit of all, but only matter of sufficient interest will be published. Rules under which questions will be answered:

1. Only three questions can be submitted to be answered.
2. Only one side of sheet to be written on; matter must be typewritten or else written in ink; no penciled matter considered.

3. Sketches, diagrams, etc., must be on separate sheets. Questions addressed to this department cannot be answered by mail free of charge.

4. If a quick answer is desired by mail, a nominal charge of 50 cents is made for each question. If the questions entail considerable research work or intricate calculation, a special rate will be charged. Correspondents will be informed as to the fee before such questions are answered.

ELECTROLYTIC WATER-PROOFING

(2263) V. Orlando, Butte, Montana, writes:

Q. 1. Will you kindly give me an outline of the process used in the electrolytic method of water-proofing, and the method used in flame-proofing cotton fabrics.

A. 1. Probably the most successful method of water-proofing all kinds of fabrics by an electrolytic process consists in the electrolytic precipitation of an aluminum soap on the fibre. The fabric to be treated is first impregnated with a solution of sodium oleate, and is then passed through a bath of aluminum acetate, through which an electric current is passing. The electrolysis of the aluminum acetate solution in the presence of the fibre containing sodium oleate causes an electro-osmosis of the water-proofing agent which is supposed to penetrate the fibre rather than simply to furnish a coating on the outside. The method used successfully in this country on a large scale is known as the Tate process, and is used with wool, silk and cotton fabrics. The cloth is first passed through a very dilute bath of sodium oleate in two tanks with squeeze rolls between them. The fabric, thus impregnated with the soap solution, is then passed between the anode and cathode of the water-proofing section. The anode consists of laminated aluminum bars bolted together and covered with a heavy woolen pad. The cathode consists of eight graphite bars against which the cloth is pressed while moving through the apparatus. The solution of aluminum acetate is fed into the troughs between the graphite bars and continually trickles down through perforations, wetting the fabric thoroughly while the current is passing between the electrodes, and thus through the cloth. The electrolytic treatment requires a current of 30 to 60 amperes and a voltage of 50. The water-proofing compound that is formed is a basic oleate of aluminum, and this has the special advantage of permitting the cloth to be dry-cleaned without losing its water-resisting properties, which is not the case with the neutral oleate.

It has been found possible to reduce the inflammable nature of cotton by treating the fibre with various metallic salts, and compounds of ammonium have been largely employed for this purpose. A solution highly recommended for this purpose is composed of: 3 parts ammonium phosphate, 2 parts ammonium chloride, 2 parts ammonium sulfate, 40 parts water. The cloth may either be impregnated with this solution or the starch size may be made up with it. Alum mixed with the sizing of cotton goods also materially reduces their liability to catch fire. Borax and sodium tungstate have also been extensively employed for the same purpose. All of these salts, however, have the bad effect of being very soluble, consequently, the non-inflammable property they give to the cotton is removed when the material is washed.

REMOVING GREASE SPOTS

(2264) A. T. Ashton, Alton, Illinois, asks:

Q. 1. In removing grease spots from cloth with gasoline, a slight ring of grease is always left surrounding the spot. Is there any way in which this can be prevented?

A. 1. Surface tension is responsible for the above named trouble and is the name given to the tendency of a liquid surface to contract and become as small as possible. Adding to water, a drop of another liquid which will mix with it, usually reduces the surface tension of the water. The surface tension of gasoline is less than that of lubricating oil, or of a mixture of oil and gasoline. This fact is important when removing grease spots. The proper method is to pour the gasoline around the grease spot before pouring it directly on the spot. If the gasoline is poured onto the center of the spot, the greater surface tension of the mixture of grease and gasoline will cause the greasy gasoline to draw away from the pure gasoline at the center and a ring of

grease surrounding the original spot will be left on the cloth.

LIGHT BY INDUCTION

(2265) K. H. Gysel, Toledo, Ohio, asks:

Q. 1. Please give me information for lighting an electric lamp by induction, as shown in the May issue of SCIENCE AND INVENTION, on page 36.

A. 1. On this page you will find illustrated an A.C. magnet and a combination base and coil for performing this experiment. The A.C. magnet has a silicon steel core 3 in. square built from laminations 1/16 in. thick. The completed core is 18 in. long and should be wound with three 90 turn layers of No. 6 D.C.C. wire. The combination base and coil for the electric lamp is made as shown in the illustration. The coil is 6 in. in diameter and consists of 3,800 turns of No. 28 enameled wire. Each end of this coil is connected to the lamp. The A.C. magnet will draw a current of about 40 amperes. The coil base for the 25

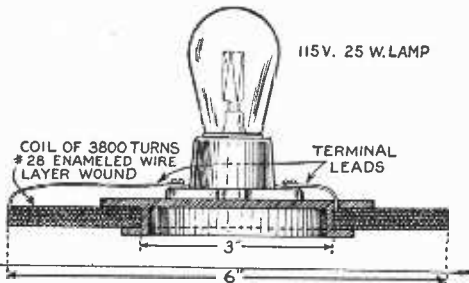

Details for the combination base and coil for the electric lamp are given above.

watt lamp should never be brought near the A.C. magnet while the power is on, unless a good lamp is in the socket, as the no-load voltage of this coil will reach as high as 1,000 volts.

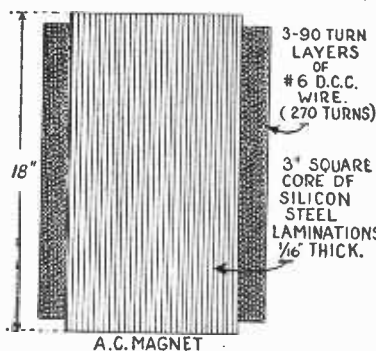

The A.C. magnet for performing the experiment mentioned here is shown in the above drawing.

ROTATING BEACON

(2266) B. Coinski, Brooklyn, N. Y., asks:

Q. 1. For some time I have noticed that several of the large buildings have installed rotating searchlights on their roofs. What is the purpose of these and are they used in connection with night flying or for an advertising medium?

A. 1. Often aerial beacons are given a rotating motion instead of pointing straight up toward the sky. The rotating beacon has a distinctive period or time of rotation, by means of which the air pilot can identify its location. These beacons are valuable guides to night fliers and are placed at suitable intervals to point out a definite course.

LIGHTNING ARRESTERS

(2267) R. Rabinov, Seattle, Wash., writes:

Q. 1. Please list the most common types of

lightning arresters used commercially and explain something of their construction and action.

A. 1. The function of the lightning arrester is to provide a spillway over which the momentary surge or wave may pass without reaching a sufficient height to cause punctures or flashovers at other points in the system. The auto valve arrester operates on the valve principle and consists of a stack of flat discs of resistance material separated by thin washers of insulating material. These are enclosed in a porcelain case and the disc area is large enough to make the total resistance quite low. In series with this stack is a spark gap which prevents leakage of current at normal line voltage. On voltages slightly in excess of the maximum line voltage, a discharge to the ground occurs, passing through the stack, but is quickly quenched when normal voltage is restored. This type of arrester is made in several forms and is often used on the cross arms of distribution lines operating at 2,500 to 15,000 volts.

To protect the motors of the electric equipment of locomotives and cars from damage by lightning, it is essential that lightning arresters be used. These arresters are connected in the circuit at a point ahead of a choke coil, so that the surge may be grounded. Several types, such as the spark gap, the magnetic blowout, and the like are used. On lines operating at voltages above 10,000, it is necessary to have an arrester which has a large discharge capacity. The electrolytic type is often used and consists of a stack of super-imposed aluminum cones containing an electrolyte, which allows the lightning to pass through the stack to the ground, but does not permit the wave of alternating current to follow. The film of oxide which produces the choking effect is maintained by momentarily closing the spark gap. This is called "charging" and is done every day or two. The expulsion type of lightning arrester has gases produced by the lightning discharge and these violently expelled, thus blowing out the arc formed. The gases produced develop a very high pressure in a special chamber. Arresters of this type are used on A.C. and D.C. lines and by connecting two or more in series they can be used on circuits up to 10,000 volts. Another arrester of the same type uses an electrolyte to generate the gas. Where arresters are installed on a pole, or where there is ample head room, the spark gap for the discharge is arranged in the form of a V, resembling a pair of horns, thus the name "horn gap." The bottom of the V is not closed and makes the spark gap. When an arc is formed, it is carried upward along the two horns until it is attenuated at the breaking point. This type is oftentimes used with other arresters, such as the electrolytic.

The necessity for frequently charging electrolytic arresters has led to the development of the oxide film type in which the electrolytic medium is replaced by a pressed powder (lead peroxide) which does not freeze and does not require charging. Devices for grounding lightning surges on telephone, telegraph and radio lines, usually provide an air gap between two carbon blocks, although metal is sometimes used. Some of these gaps contain a perforated sheet of thin mica, in some cases one of the blocks is recessed and filled with fusible metal, which melts and permanently grounds the line on a heavy discharge. A recent development has been a vacuum arrester which consists of a spark gap enclosed in a partial vacuum or vacuum tube. An arrester made of two or more metal plates, fitted with saw teeth is called a "saw tooth" arrester and is rather widely used. These various types and modifications and combinations of arresters are all used on radio antennas, fire alarm and other signalling circuits.

On D. C. lines, such as trolley circuits, the flow of power following a discharge of lightning may be stopped by the use of a solenoid so placed that the magnetic field is brought to bear on the arc, thus blowing it out.

EDGAR POE ALLAN POE THE FATHER OF SCIENTIFICATION

GREATEST OFFER EVER MADE

Never before has it been possible to obtain the complete works of America's greatest author and genius, Edgar Allan Poe, for the amazingly low price that we now offer them to you.

Edgar Allan Poe has come to be looked upon as the greatest literary genius that America has ever produced. He is the originator of the first "Scientification" stories—fiction with a plausible scientific background. Jules Verne and H. G. Wells freely acknowledge him as the originator of modern scientification.* In addition, there is little doubt but that the well known SHERLOCK HOLMES is the product of the inspiration that Sir Arthur Conan Doyle found in the works of Poe. Take advantage of this special introductory offer. There is just a limited number of copies in this edition.



.....Like a razor also, the pendulum was massy and heavy, it was appended to a weighty rod of brass, and the whole hissed as it swung through the air. I saw that the crescent was designed to cross the region of the heart. Down—steadily down it crept. The rats were wild, bold, ravenous, their red eyes glaring upon me. And then.....

From "The Pit and the Pendulum."

CONTENTS OF THE SET

*All Scientification Stories in list of contents are identified with a star and printed bold face.

VOLUME ONE

Memoir of Wm. H. Rogers.
Eulogy by James Russell Lowell.
Notes by N. P. Willis.
*Adventures of Hans Pfall
*The Gold Bug.
Four Beasts in One.

VOLUME TWO

Murders in Rue Morgue.

VOLUME THREE

Mystery of Marie Roget.
*The Balloon Hoax
*MS. Found in a Bottle.
*The Oval Portrait.
*The Purloined Letter.
*One Thousand and Second Tale of Scheherazade.
*A Descent into the Maelstrom.
*Von Kempelen and His Discovery.
*Mesmeric Revelation.
*Facts in Case M. Valdemar.
*The Black Cat.

Fall of the House of Usher.
Silence—A Fable.

VOLUME FOUR

The Masque of the Red Death.
The Cask of Amontillado.
*The Imp of the Perverse.
The Island of the Fay.
The Assumption.
*The Pit and the Pendulum.
*The Premature Burial.
The Domain of Arnheim.
Londor's Cottage.
William Wilson.

VOLUME FIVE

*The Tell-Tale Heart.
*Berenice. Ligeia.
Eleanora. Morella.
*A Tale of the Ragged Mountains.
*The Spectacles.
King Pest.
*Three Sundays in a Week.
The Devil in the Belfry.
Lionizing.
X-ing a Paragrab.

VOLUME SIX

*Narrative of A. Gordon Pym.

VOLUME SEVEN

Metzengerstein.
The System of Dr. Tarr and Prof. Fether.
The Literary Life of Thingumbob, Esq.
How to Write a Blackwood Article.
Predicament.
The Angel of the Odd.
Mystification.
Diddling.
*Mellonta Tauta.
The Duc de L'Omelette.

VOLUME EIGHT

The Oblong Box.
*Loss of Breath.
*The Man That Was Used Up.
The Business Man.
The Landscape Garden.
*Maelzel's Chess Player.
Poems of Words.
The Colloquy of Monas and Una.
The Conversation of Eros and Charman.
Shadow—A Parable.
Philosophy of Furniture.
A Tale of Jerusalem.
*The Sphinx.

VOLUME NINE

Hop Frog.
The Man of the Crowd.
Never Bet the Devil Your Head.
Thou Art the Man.
Why the Little Frenchman Wears His Hand in a Sling.
Bon Bon.
*Some Words with a Mummy.
The Poetic Principle.
The Philosophy of Composition.
Old English Poetry.

VOLUME TEN

Complete Poems.
The Raven.
The Bells.

*Sonnet to Science.
*Al Aaraaf.
Tamerlane.
Etc.

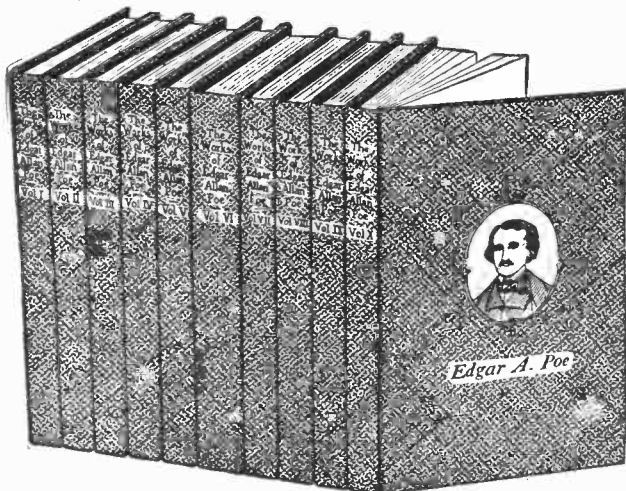

POPULAR BOOK CORPORATION, 102 PARK PLACE NEW YORK

**COMPLETE
WORKS
\$2.75**

**10 Volumes
Cloth Bound
OVER 2000 PAGES**

The complete works of Edgar Allan Poe are published in 10 beautiful volumes. Handsome red cloth cover. Special egg-shell paper, made to order for this set. Printed from plates made for the well-known Richmond Edition. Each volume contains an average of 200 pages. Size of type is long primer, which is easy reading and restful to the eyes. The volumes are handy in size, 4 x 6 1/4 inches. The greatest offer ever made. This is the chance of a lifetime. Take advantage of this astounding low price offer. Fill in the coupon now. Send no money—pay the postman \$2.75 on delivery. We pay the mailing charges in U. S.

SEND NO MONEY!

Popular Book Corporation,
102 Park Place, New York City.

Gentlemen:—

Please send me at once, the complete works of Edgar Allan Poe, comprising of 10 volumes, as per your advertisement. I will pay the postman \$2.75 upon arrival of the books. There are no extra charges of any kind, whatsoever. If the books are not as represented, I will return them to you within three days and you are then to return me my money.
(Free delivery only in U. S. Extra postage for foreign countries.)

Name
Address
City State



Are you aging too soon—getting up 5 to 10 times at night—is vitality ebbing steadily away—are you definitely on the down grade, half-living, blue, depressed—are you subject to chronic constipation, chronic fatigue, backache, foot and leg pains? Then look to the vital prostate gland!

New Facts About the PROSTATE GLAND

Do you think it is natural for a man to suffer after 40 or beyond a certain middle age? In men past 40, do you know that these symptoms are often the direct result of prostate gland failure? Are you aware that these symptoms frequently warn of the most critical period of a man's life, and that prostate trouble, unchecked, usually goes from bad to worse—that it frequently leads to months and even years of fruitless treatment and even surgery—that it even threatens life itself?

Free to Man Past 40

No man past 40 should go on blindly blaming old age for these distressing conditions. Know the true meaning of these symptoms. Send for a new illustrated and intensely interesting booklet, "Why Many Men Are Old at 40," written by a well-known American Scientist, and see if these facts apply to you.

Natural Method

There is little or nothing that medicine can do for the prostate gland. Massage is annoying, expensive and not always effective. Now this scientist has perfected a totally different kind of treatment that you can use in the privacy of your own home. It employs no drugs, medicine, violet rays, diets or exercises. It stimulates the vital prostate gland in a new natural way, and it is as harmless as brushing your hair. 40,000 men have used it with remarkable results.

Swift Natural Relief

Letters pour in from every state and from many foreign countries. Now physicians and surgeons in every part of the country are using and recommending this non-medical treatment. So directly does this new safe treatment go to the prostate gland that noticeable relief often follows overnight. So remarkable are the results that you can test it under a guarantee that unless you feel 10 years younger in 6 days you pay nothing.

Scientist's Book Free

Send now for this Scientist's free book and learn these new facts about the prostate gland and old age ailments. This book is sent without cost or obligation. Simply mail the coupon to The Electro Thermal Co., 4508 Morris Ave., Steubenville, Ohio.

(If you live West of the Rockies, mail your inquiry to The Electro Thermal Co., 303 Van Nuys Building, Dept. 45-H LOS ANGELES, CALIF.)

The Electro Thermal Co., 4508 Morris Ave. Steubenville, Ohio.
 Without obligation, kindly send me a free copy of "Why Many Men Are Old at 40."
 Name.....
 Address.....
 City.....State.....

WHY IS A SKYSCRAPER?

By H. WINFIELD SECOR
 (Continued from page 297)

mind that they would settle possibly a foot or more, in the course of a year. The sidewalks were built in place, low at the curb and high at the building side; so that as the building settled a foot or more, the sidewalks would eventually be level. Building engineers spent many years of study on foundations, before they finally arrived at the modern method of designing foundations for huge thirty and forty-story building structures, constituting masses which would have scared the earlier architects almost to death if they had been asked to design a foundation to hold them.

There are a number of large corporations today with staffs of engineers and construction experts who do nothing else but build foundations for new buildings; sometimes they undertake the construction of a new foundation under a building already erected, but whose underpinnings have become weak or faulty. How would you like to undertake the job of putting a new foundation under a forty-story skyscraper in crowded downtown Manhattan. This is an everyday job for the big foundation companies, and while the average person would turn ghastly pale when it came to undertaking such a proposition, the engineers behind this modern high-pressure building construction go to work with a slide rule and reference tables. They calculate the total weight they will have to support while the caissons are being sunk, and then proceed to carry on

HOW FOOT PRESSURE IS DIVIDED

ONE of the cleverest methods of reducing the pressure per square foot at the base of any one of the steel columns supporting the modern building structure, was worked out some years ago, by utilizing steel rails in the manner shown in one of the accompanying diagrams. A very pretty piece of

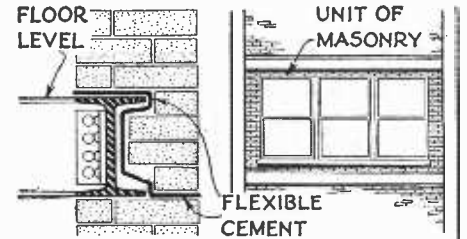

The illustration above shows unit of masonry in one of the "windows" formed by the steel framework of a modern skyscraper. Each unit of masonry can be removed and changes made in the building at any time, which could not be done with the old masonry wall structures. The picture at the left shows how flexible cement, plus some tar suitably placed, serves to protect the steel girders from rusting; also the flexible cement enables the masonry units to expand and contract without cracking the walls.

mechanical engineering indeed is the design of the footing for a steel column, which has a tremendous weight to support. Naturally, if the foot of the steel column was simply placed down on the rock, it would soon crush the rock, for the reason that

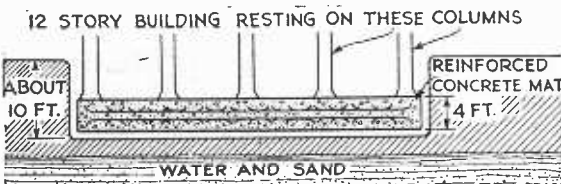

A twelve story building has just been completed by one prominent New York firm of architects, the building resting on steel columns which are supported by a re-enforced concrete mat, which had to be built in order to form a footing on the water and sand, as shown in the picture. The mat rests on the sand of course, there being no space between them, this space appearing here to make the drawing clearer.

the work in a methodical and systematic manner, while thousands of people occupy the offices in the building without one minute's interruption.

DOWN TO BED ROCK

WHEREVER possible, it is always the aim of the engineers to get down to bed rock for the foundation underpinnings. Holes are drilled through a stratum of dirt until bed rock is reached, and the steel caissons are sunk, which are afterward filled with concrete. The tops of these concrete-filled steel caissons project above the surface of the lowest sub-basement, and on to these are bolted the feet of the first steel columns, which are eventually to carry the weight of the building.

Another case which is interesting, is where a good quality of solid rock is available on a line with the basement or sub-basement floor level. Here holes are drilled into the solid rock, as shown in one of the accompanying pictures, the hole being drilled larger as it progresses into the rock, in the same way that a dentist enlarges the hole in a tooth which is to be filled. In this way the filling cannot pull out. In the case of the holes in the rock, steel rods with threaded upper ends are placed into the hole, and concrete is then poured in. When all of the concrete footings and steel rods with their threaded ends projecting are in place, the first sections of the steel columns are set in place, and by means of nuts turned home upon the bars projecting from the concrete, they are bolted firmly in place.

while steel can stand a working strain of 18,000 pounds per square inch, the rock can only stand about one-hundredth of this.

In other words, if the foot of the column had an area of one square foot, the rock on which it is to rest should have about 100 square feet in order to have the load suitably apportioned. As one of the drawings shows, the engineering trick in this case is to gradually spread out the load on a given column more and more by enlarging the foot area, taking care not to overload the respective area as each transition is made from steel to concrete, and from concrete to rock or hard pan.

BASE OF COLUMN BOLTED TO PLATE

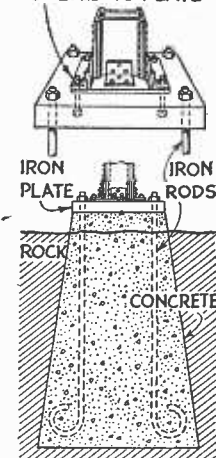

The drawing makes this quite clear as to how the architect or engineer places steel tee rails first in one position and then crosswise, etc., making these a little longer at each layer until a sufficiently enlarged area of steel is obtained, in order to safely transfer the

This picture shows how the feet of skyscraper columns are bolted to concrete footings placed in holes drilled in the rock. This is the practice where the rock is available without having to sink caissons.

load to a concrete foot or base. The concrete, let us say, is now carrying a safe working load per square inch on its top surface, and the side walls are tapered so as to give a greater area on the bottom surface which rests on the rock. Hence, if the area on the bottom face of the concrete foot was 100 square feet, while the top surface of

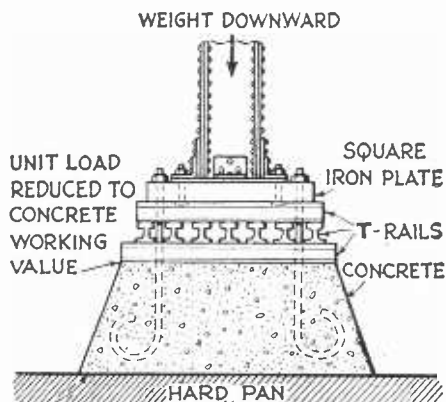

UNIT LOAD DIVIDED TO SOIL WORKING LIMIT
This drawing shows how the weight on the foot of a steel skyscraper column is distributed over a constantly larger area, until the stress in pounds per square foot, is spread out to the working value of the final material on which the footing rests.

the concrete had but 50 square feet area, the pressure in pounds per square inch on the bottom surface, where it is transferred to the rock, would be one-half what it is on the top. The column foot, which may be of cast iron or built up of steel plate, is bolted to a square iron plate, as the drawing shows; this iron plate in turn bolted to the concrete footing by means of the curled iron bars embedded in the concrete.

BUILDING ON WATER AND SAND

SO much for rock foundations. Here is a problem which recently confronted Mr. Corbett and his engineers where a building had to be erected in a small city near New York. There was water and quick-sand found about ten feet below the surface of the ground practically everywhere. A very clever piece of engineering was performed in designing the foundation for the twelve-story building, which is now rapidly nearing completion.

As one of the accompanying sketches show, a reinforced concrete mat measuring about four feet thick was built in the bottom of the cellar excavation. In other words, the cellar was excavated, and this four feet thick mat of concrete and steel reinforcing bars was constructed. Concrete feet were molded in place with suitable anchoring bolts, to which the steel columns were bolted.

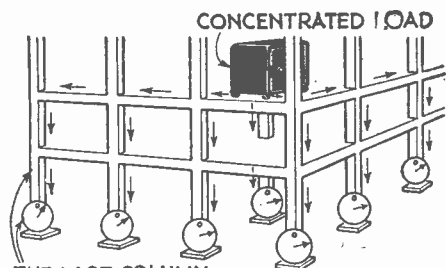

Here we see how the load at a given spot in a steel frame skyscraper is distributed proportionately, so that each column under the whole floor (or floors) carries its share of the weight. If we put a scale under a column anywhere under the loaded floor, a proportionate weight would be indicated.

One of the great troubles in the old days with tall buildings, was that the various columns supporting the structure were footed

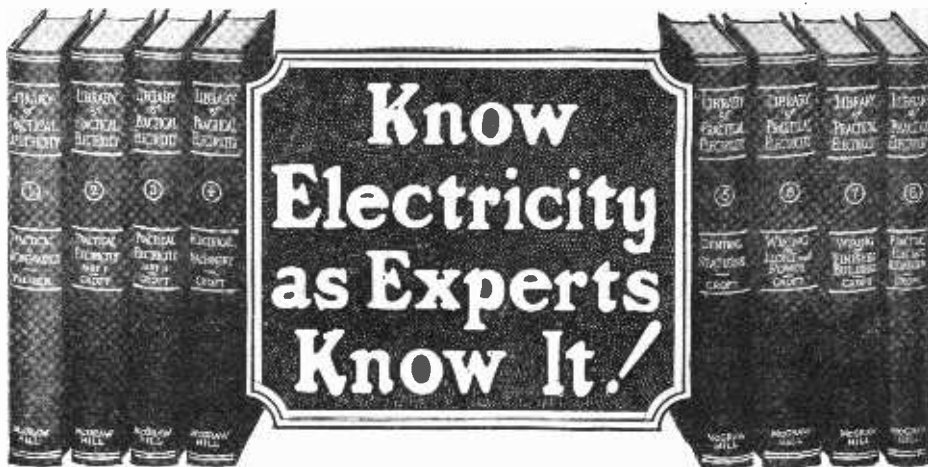

THIS is the electrical age, with unlimited opportunities for the man who has educated himself in the finer points of electrical practice.

Fit yourself for one of the really big jobs by knowing electrical practice complete, including inside and outside work, central stations, and the whole subject. With the aid of the Croft books you can know electricity as experts know it and put yourself in line for an expert's pay.

The Croft Library of Practical Electricity

A reference library and self-training course in eight volumes. 3000 pages—2100 illustrations



The Croft Library contains three thousand pages, with twenty-one hundred of the clearest illustrations ever put into book form. Each of the eight volumes is indexed so that everything you want to know about electricity is at the fingers' ends. And when you find what you want, there is not merely a short question and a short answer. You are told everything you want to know. The explanation is clear to you, regardless of whether you have had a previous knowledge of electricity or not.

Croft teaches you electrical practice complete. He takes you in quick, easy steps from the simplest principles to the complete and economical operation of a great central station.

He tells you the things you need to know about motors, generators, armatures, commutators transformers, circuits, current, switchboards, distribution systems—electrical machinery—wiring for light and power—wiring of finished buildings—underwriters' and municipal requirements—how to do a complete job, from estimating it, to completion—illumination in its every phase—the latest and most improved methods of lighting—lamps and lighting effects, etc.

THE STANDARD IN PRACTICAL ELECTRICAL TRAINING



Everywhere the Croft Library is acknowledged as the standard—the leader—in practical electrical training. It is the daily guide of 59,000 highly-paid electrical workers and engineers. There is nothing like it in print today. It is the most complete, the best illustrated, the most carefully compiled, the most easily understood electrical library available. No matter how much or how little you know about electricity, you will find the Croft Library a sound, helpful guide to greater accomplishment.

Every day you use these great books you will learn something that will help to make you a better electrical worker. Every page is taken from every-day electrical practice. Croft deals only with the kind of problems you meet in daily work. Own a set and join the 59,000 men who have found the Croft Library to be a real working companion to bigger accomplishment in the electrical field. Keep these books handy in your room. Put one in your pocket when you take the car or train in the morning. Give them the odd hours. They are not tiresome treatises, but as interesting as any reading matter you ever owned. Consult your set regularly, acquire just one new fact a day, and in a few years you will be a broadly informed electrical man.

Easy Steps to Success in Electricity

Starting right in with the ABC's of modern electricity, Croft takes you through his books in easy steps. He gives you the boiled-down records of every-day electrical practice in plain words, figures, and illustrations. Nothing is left to the imagination—there is no guesswork.

Croft has been through the mill. His knowledge of electricity has been gained by actual shirt-sleeve contact with electrical problems. He knows just

what is needed to get ahead. He has poured out all his knowledge—all his experience—in language that anyone can grasp. Yet the text is so scientifically correct that thousands of the highest-paid electrical engineers are using the books as a reference set.

The famous set is beyond a doubt the last word in practical electrical education. No one who wishes to get anywhere in the electrical field can afford to be without it.

Free Examination No Money Down—10 Months to Pay!

Fill in and mail the coupon attached and we will send you the entire set of eight volumes for ten days' Free Examination. We take all the risk—pay all charges. You assume no obligation—you pay nothing unless you decide to keep the books. Then \$1.50 in ten days and the balance at the rate of \$2 a month. Send the coupon NOW and see the books for yourself.

McGraw-Hill Book Co., Inc., 370 Seventh Avenue, New York.

Gentlemen—Please send me the CROFT LIBRARY OF PRACTICAL ELECTRICITY (shipping charges prepaid), for 10 days' free examination. If satisfactory, I will send \$1.50 in ten days and \$2.00 per month until \$19.50 has been paid. If not wanted, I will return the books at your expense. (Write plainly and fill in all lines.)

Name.....
Home Address.....
City and State.....
Employed by.....
Occupation.....SI-8-28

Send the Coupon TODAY →

When Caesar was a boy

THE Forum was the common market-place for all of ancient Rome. Today a few crumbling columns stand as mute reminders of its former grandeur.

In our present-day complex civilization, market-places have become scattered. It is no longer possible to visit them all in a morning—or even in a day.

Advertising, instead, has become the convenient Forum of modern buyers and sellers. If you are considering the purchase of a new car, you scrutinize the automobile advertising. Or if it's a razor or a talking machine that you want, you turn again to the advertising. Here is the national market-place for merchandise.

Furthermore, as you leaf over those same pages of products, your mind is storing away for tomorrow a compact and valuable fund of information. Instinctively, you will remember those facts when you make your future purchases. Increase your store of knowledge by reading the advertisements regularly.

* * *

Advertising has become the common market-place of this twentieth century

on different materials, such as sand, dirt, rock, etc. The usual consequence was that each column would settle a different amount as time went on, resulting in disastrous cracks in the masonry work, which endangered the building in some instances.

As will be seen in this case, all of the steel support columns rest on a strong, rigid, yet flexible concrete base. When the side walls for the basement were constructed, a suitable tar and tar paper water-proofing was placed between the concrete layers and also over the concrete floor of the basement.

THE STEEL FRAME

THE steel skeleton frame constituting the backbone of the modern skyscraper, as was carefully explained before, carries the whole load of the building, which term includes the live load, that is, the people, office desks and other furniture, besides the dead load of the steel work itself, plus all the outer and inner walls of brick, stone, etc., and the reinforced concrete floors. One of the good features of the steel skeleton frame designed and built as it is today to carry the whole weight of the building, lies in the fact that it is, as one architect put it, constantly in motion. In other words, due to wind stresses and the movement of various units of the live load in the building, the steel frame can move slightly in any direction as occasion demands. In the old form of masonry wall construction the limits of contraction, expansion and bending stresses

This diagram shows, in exaggerated fashion of course, the great flexibility feature of the steel frame building. The building can expand or contract in any direction without cracking the walls or causing the collapse of a section of the building. Mr. Harvey W. Corbett, well-known skyscraper architect, states that the top of the Woolworth Building may move $\frac{1}{2}$ to 2 inches maximum.

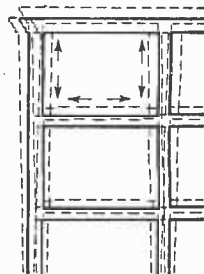

were soon reached, with the result that large cracks frequently developed. Such cracks were not only unsightly, but in many cases were a constant menace to the safety of the building, until that section of the wall had been replaced or repaired by masons. As the accompanying sketches show, the steel columns and cross girders of a skyscraper can move up, down or sidewise in any direction. Also when the steel frame moves, it does not cause the brick or stone outer walls to crack or disintegrate and fall in the street, due to strains or cracks set up in these masonry walls. This is so for the reason previously explained, that each section of the masonry wall acts, to a large extent, as an independent unit—due to the way the sections of masonry are joined by flexible cement, tar, etc.

HOW LOAD DIVIDES IN STEEL FRAME

AS one of the pictures herewith shows, if a series of pressure gauges calibrated to read the load at the base of each column in pounds, were placed between the foot of the column and its support, then if a concentrated load was placed on one corner of the second floor as shown, the weight and consequent downward strain on each column would be divided proportionally. In other words, as you went to the bottom of each column and read the pressure gauge, you would see a proportionate amount of pressure indicated. In a steel skeleton skyscraper each supporting column bears some portion of the weight placed upon any one of the floors, and on any part of a certain floor. Of course, if a concentrated load of several hundred or several thousand pounds is placed on one corner of the building on a certain floor, the support columns all the way down through that corner of the building will



AIRPLANE

12-inch scale model of Lindbergh's Spirit of St. Louis. Scientifically designed and very realistic. Rises from ground by own power and flies 30 ft. or more. Easily built without tools.

Construction set, with all parts and full directions, postpaid in U. S., only 50c. (no stamps). Satisfaction or money back. Send now. MANN & BENTON, Chillicothe, Ohio.

LEARN CARTOONING

At Home—In Your Spare Time. The famous Picture Chart Method of teaching original drawing has opened the door of success for hundreds of beginners. Whether you think you have talent or not, send for sample chart to test your ability, and examples of the work of students earning from \$50 to \$300 per week. Please state your age.

THE LANDON SCHOOL
1460 National Bldg., Cleveland, O.



I Positively Guarantee

to increase your arms one-half inch in size, chest one full inch, strength 25%, health, 100% in one week's time, by following my instructions and using my exerciser 10 minutes mornings and at night. Send \$1 for complete course and exerciser. Satisfaction guaranteed or \$1 refunded.

PROF. J. A. DRYER
Box 1850-L Chicago, Ill.

A SHIP MODEL FOR \$4.98



Build a ship for your home of the old antique type Santa Maria, Mayflower and La Pinta for \$4.98, and the Old Ironsides for \$6.98, plus postage, for which we furnish all parts, cut to fit and diagram telling you just how to assemble these ships. No tools necessary. We also have a complete line of assembled models. Write for our illustrated catalogue. MINIATURE SHIP MODELS, INC. Dept. S-9, 3818-24 Baring St., Phila., Pa.

have to bear the major part of the strain.

STEEL COLUMNS SMALLER IN UPPER STORIES

AS becomes evident after a little consideration, the steel supporting columns between each floor level, or between sections of floors, becomes smaller in size, as the building progresses skyward. For example, if twenty-four inch columns are used in the basement, and also the first, second and third floors, then we may use twenty-inch columns on the next three floors, eighteen-inch columns on the following three or four floors, and so forth. The steel columns are usually graduated so as to become smaller at each floor, thus keeping the cost down to a minimum.

THE ROLES OF ARCHITECT AND CONSULTING ENGINEER

WHEN it comes to erecting a thirty, forty or fifty-story skyscraper occupying a city square block, a huge structure weighing possibly a quarter of a million tons, and costing ten to twenty million dollars, a tremendous responsibility descends upon the architects and engineers who conceive and direct the erection of such an edifice. There has been much criticism of skyscrapers, as they have disadvan-

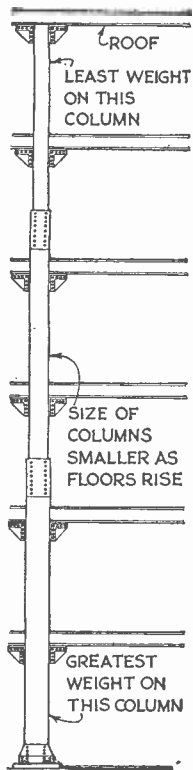

The size of the steel columns in a skyscraper becomes smaller and smaller as the building rises. It would be foolish of course to use the same size columns as those in the basement, to support the lesser weight of the upper floors.

tages as well as distinct advantages. Skyscrapers are liable to cause undue congestion in subways and surface traveling facilities, as they pour thousands of occupants all into a limited

section at say five o'clock in the evening. Until recent years the fire hazard was one of unknown magnitude, but this is now taken care of by the installation of stand pipes which carry the water up to the various floors, which invariably are supplied with sprinklers.

Architects are asked to draw plans for skyscrapers for the reason that in the business sections of large cities territory becomes more valuable each year. If you can erect a forty-story building in the place of a ten-story structure, and in this way increase the floor rental area four times on the same land area, it would generally pay to consider the huge initial investment necessary in order to obtain ownership of the land and erect the skyscrapers. Skyscrapers cost a lot of money and it is rare that one man or one concern can afford to erect one of these modern business monuments. Therefore, a group of financial men, which may include some real estate operators and others, get together, and this group, by pooling



What is due the public

An Advertisement of the American Telephone and Telegraph Company



THE Bell System recognizes the public requirement for a constantly extending and improving telephone service.

Last year 4 million telephones were either put in or moved. The number of local calls not completed on the first attempt was reduced by 5 per cent. The average time for handling toll and long distance calls was reduced from 2 minutes to 1½ minutes.

During the last 5 years the Bell System spent \$1,800,000,000 on additions, and improvements of its plant.

There is equally a public requirement for safety of principal and earnings of the stock of the American Telephone and Telegraph Company

— the parent company of the Bell System. Since its incorporation in 1885 it has never missed paying a regular dividend to its stockholders, who now number more than 420,000.

The very nature of the telephone business necessitates a single interconnected system. The American Telephone and Telegraph Company accepts its responsibility for a nationwide telephone service as a public trust. It is fundamental in the policy of the company that all earnings after regular dividends and a surplus for financial security be used to give more and better service to the public.

Portable Electric Planer for Woodworking

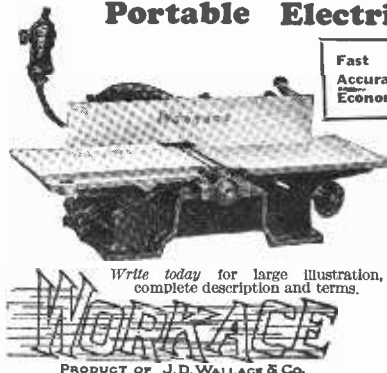

Fast Accurate Economical **\$25**

This Workace light-weight portable electric planer is specially built for amateur and professional woodworkers who want to do accurate work at the least cost and in the shortest time. It speeds up every planing operation.

Pulley drive or direct motor drive from any socket
Improved design includes many features. Steel cutterhead, three high speed steel knives, bronze bearings, rabbets 3/16" deep, planer takes any stock up to 4". Amazing low price of \$25 (with pulley drive) puts this money-saver and time-saver within anyone's means. With 1/4 H. P. G. E. motor (direct motor drive), with 10 ft. cord and plug providing instant power from any light socket, \$60 complete.

Better work done quicker
Tables raise and lower by hand wheels—quick and easy to operate. Makes possible better.

Easy terms—money back guarantee
We'll send you the "Workace" for a small down payment, the balance on easy terms. It pays for itself in better work done quicker and at less cost.
J. D. Wallace Co.
California Ave. & Wilcox St.
Chicago, Ill.

ALL ABOUT TELEVISION

INCLUDING EXPERIMENTS

BY H. Winfield Secor & Joseph H. Kraus

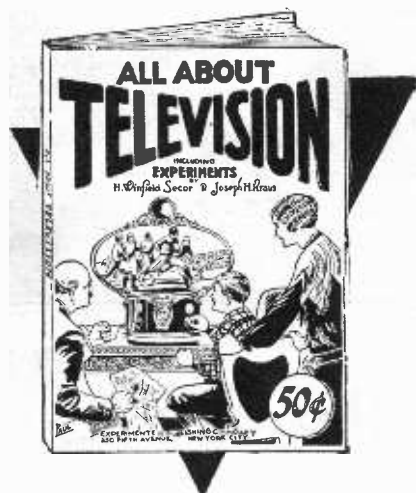

This book is one of the most complete treatises ever written on this all-engrossing subject. Its entire contents was prepared by the editor of SCIENCE AND INVENTION, Mr. H. W. Secor and the Field editor, Mr. Jos. Kraus. Many months of tireless research were spent in collecting the vast amount of information that it contains. Every known step in the development of Television has been fully and understandingly covered. All methods used to transmit and reproduce moving scenes are fully explained. But, TELEVISION gives you more than this. There are complete instructions for building an

EXPERIMENTAL TELEVISION OUTFIT

A modern method for constructing an experimental Television outfit is explained in detail in this remarkable discourse. With this set the "fan" can carry on his own experiments just as he did with radio a few short years ago. Do not fail to get a copy of this remarkable book.

Over 116 pages—Fully illustrated—Complete instructions for building an experimental set

THE **50c** COPY

AT ALL NEWSSTANDS OR WRITE DIRECT TO

Experimenter Publishing Co., Inc.
230 Fifth Ave., New York, N. Y.

EXPERIMENTER PUBLISHING CO., Inc.
230 Fifth Ave., New York, N. Y.

Gentlemen: Kindly send me a copy of TELEVISION. Enclosed find 50c.

Name.....

Address.....

City..... State.....

their financial resources, are then able to consider the erection of a ten-million dollar skyscraper.

The architect is the man to whom this business group or rather their committee come to talk over the matter and obtain some general information as to the probable cost of the structure, the size of which they have in mind. After talking the matter over with the architect for a while, or perhaps after several interviews are held, the architect has his staff consult on the design, and the draftsmen proceed to draw up a picture of the building as it will look when finished. These pictures of the finished building are often supplemented by a small model of the building, built from wood, together with a set of sectional drawings showing the floor arrangements, which are submitted to the owners. Once these drawings and general plans have been approved, or revised until they are approved, the next move is for the architect to hand the drawings over to the firm of consulting engineers with whom he does business.

This firm of consulting engineers then have a new set of drawings made in which the steel structure is all worked out, and the various sizes of the steel columns and floor girders evaluated and specified as to size. When these drawings have been completed, they are then checked with the representatives of the City Building Department, and every girder and column in the structure is checked and rechecked, in accordance with the city engineers' tables; so that a cheap builder cannot put too small a girder or column in the building, even though he would like to. If the city engineer objects to the size of a given column or girder, it has to be changed in accordance with the size he specifies.

In the meantime the architectural firm has other drawings out and is asking for bids on the electrical, plumbing, painting and

other work, all of which is sub-contracted. In general, one construction company may take over the erection of the whole building, and where the architect does not handle the construction directly, then the general contractor will usually place the sub-contracts.

Many people have often asked the question as to where the responsibility rests in case the building should collapse or fail in some other way. The answer is that the responsibility for the successful erection and stability of the building rests on the architects. In other words, if a forty-story skyscraper was being erected, and on the morning that it was to be turned over to its owners as being completed, it collapsed in the street, the architects would be held responsible. Of course, in turn they would get in touch with their consulting engineering concern and endeavor to find out just where the blame laid. In the event that there was a large loss, it would probably be divided between the architects, the consulting engineers, and the general contractor. If the loss was finally traced as being due to the failure of a sub-contractor, such as a mason, then he would probably be sued by the general contractor.

It is interesting, in passing, to note that while most American cities tolerate skyscrapers several hundred feet in height, coupled with proper zoning or setting back of the upper floors, to gradually decreasing widths on successive floors; in London buildings eighty feet high are the limit of vertical wall front, with two stories bordered by a sloping roof. In Paris low buildings are the rule also, as controlled by city ordinances, the limit being 60 feet and a mansard roof above, containing a story and a half, or two stories at the most. The newest recruit of engineering is the "zoning expert"; he specializes in interpreting the city laws in terms of properly "stepped" upper floors in skyscrapers.

ADVANCES IN AVIATION

By JOSEPH H. KRAUS

(Continued from page 307)

ingly resistant to disturbances. The mechanical explanation need not be here taken into consideration, we can merely visualize an egg shell and recall how thin yet how strong it is. This vessel the "City of Glendale" as it is called, will be steam-driven by an unique turbine-like propeller mounted in the nose, into which the air is sucked at the center and driven out sideways at the periphery action of the propeller. The gondola-like car is being constructed in another hangar and will be lowered into a pit, after which the dirigible will be floated over it and the connections will be finally made. By means of a steam turbine, passengers will be lowered from and raised to the dirigible via a cable elevator. It is predicted that the first voyage will be from Los Angeles to New York. It is likewise the contention of the designer, Capt. T. B. Slate, that the vessel will need no mooring mast and that this will be the first of a series of successful trans-continental and perhaps even inter-continental ocean liners. We refer those interested in further details about this particular vessel to the September 1927 issue of SCIENCE AND INVENTION in which the full details appeared.

EVERYMAN'S AIRPLANE

AMONG the smaller aircraft of radically new design is the one built by W. B. Kinner for Dr. T. C. Young. Dr. Young is Chairman of the 1928 National Air Race Committee. The photographs show both the front and the rear views of the plane, with wings folded up. A garage can easily be

provided for it. There is a 5-cylinder motor which develops a hundred horse-power, and which will give this plane a speed of 120 miles an hour and a cruising radius of 800 miles. The wingspread of the monoplane is 35 feet and when the plane is forwarded it takes up a space of 8 x 9 x 25 feet.

POLAR PLANE

THE new three-motor Fokker plane which Commander Byrd will take with him on his antarctic expedition was recently given its first flying tests since it was fitted with the new pontoons. These pontoons weigh 1,300 pounds and because of their weight the plane in order to have its due cruising radius, must carry 600 pounds more fuel than would be necessary if the lighter wheeled landing gear were used. The plane can take off from water and the pontoons are solid enough to permit of landing on ice where they will serve as skids.

VARIABLE PITCH AIRSCREW

FROM England comes a report that the Royal Aircraft establishment is testing out a new airscrew in which the pitch of the blades can be varied automatically by hydraulic control. Controlling the pitch of propeller blades is not a new idea. It has been demonstrated time and time again, but heretofore, little use of it has been made in actual practice. All of the work has been of experimental or test nature, and the same is to be said of the present variable pitch airscrew. Gears have been successfully employed for varying the pitch; the gears

being actuated directly through the propeller shaft. In the present style a small oil pump changes the propeller pitch in accordance with the speed of the engine, making the engine run at a constant predetermined rate. Whether or not this is an advance remains to be seen when the variable pitch propeller is given its first practical tests. Such a system would also give greater efficiency at climbing and the attainment of greater altitudes, where the rarefied atmosphere prevents purchase on the air by the fixed-pitch propeller.

FLYING BOAT

AT the Dornier Flying Boat Works at Friedrichshafen, Germany, much experimental work is being carried out with visions of regular flying boat service across the Atlantic daily. A photograph illustrating this article shows one of these flying boats in the air. This is a twenty passenger vessel fitted with two Packard engines developing over 900 horsepower. The tests were highly successful, so we may soon see thirty hour service between the continents in a perfectly safe vessel, which can either ride the waves, skim across the surface of the water on calm days, or even improve upon the speed by taking the air. This particular form of flying ship seems to be the solution to the heavier than air inter-continental vessel.

Along the lines of improvement for sustained flight, we might mention a new invention taken out by Anthony H. G. Fokker which is called Lateral Control for Airplanes. In the present means of effecting lateral control of flight, it is well known that the action of the ailerons causes the plane to deviate from a straight line of flight whenever the ailerons are shifted. This is due to a differential of resistance set-up. When one aileron is lowered and the other raised, and is generally compensated for by simultaneously operating the rudder. In the new invention the aileron is so arranged that this differential of resistance cannot be set-up. In other words, there is an equalization of resistance due to the fact that the aileron projects beneath the wing at the same time that it rises above the wing. In this way the tendency to turn from the straight line of flight is practically eliminated. This method would also be of value in teaching novices how to fly. The invention follows closely upon the tail spin preventer previously described in this publication and which is now the standard equipment on the Handley-Page plane.

GULL PLANE

A PIONEER birdman, Leonard W. Bonney, had for years been working on a plane modeled after sea gulls. His studies of slow motion pictures of gulls in flight helped him to design the wings of this plane, which were later tested in a wind tunnel and changed in order to make them conform with more desirable shapes. While the wings of this plane did not flap, their angle of incidence could be changed at the will of the operator, it being Mr. Bonney's contention (and this is the view held by leading airmen) that he could check flight much more rapidly and rise from a smaller field if this angle of incidence is increased. Unfortunately, for Mr. Bonney he did not prove his point. Powered with a special radial engine, his machine left Mitchell Field, Long Island, rose to a height of fifty feet, wobbled, and then crashed, burying its engine two feet into the ground. Mr. Bonney, tossed out of the plane, was instantly killed. The photograph shows the plane both before the flight and after the unfortunate crash. Mr. Bonney had flown as early as 1910 with Orville Wright.

FLAPPER PLANE

DIFFERING from the plane in which the angle of incidence can be changed by

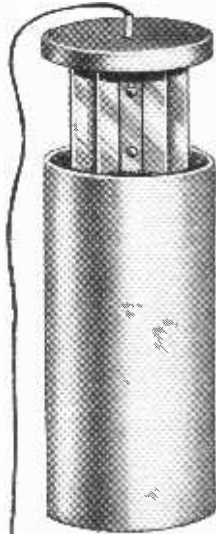

INSTALLED IN A FEW MINUTES

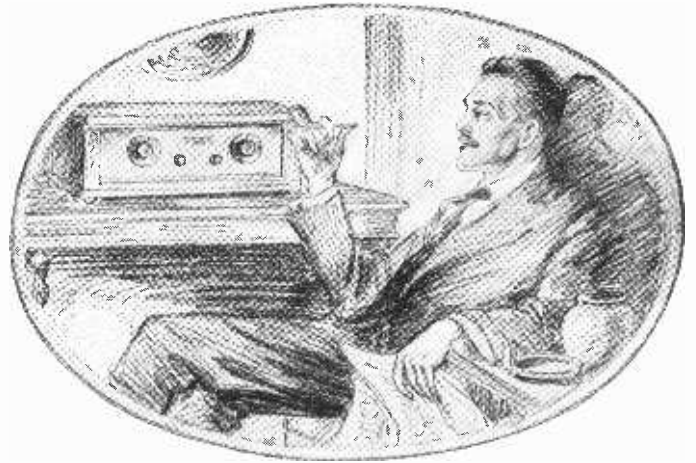

Ground Out Static with SUB-AERIAL

Let Ground Waves Bring You Amazing Distance, Crystal Clear Tone Quality, and Greater Volume and Selectivity without Distortion.

SUB-AERIAL has brought a new epoch in Radio. No need longer to bother with troublesome overhead Aerials. Why risk breaking your neck to put up roof aerials only to have the first storm blow them down? Forget your Aerial troubles. Why not use the whole earth as a static and noise filter with Sub-Aerial?

COSTS NO MORE THAN AN OVERHEAD OR LOOP AERIAL and less than many. Hook your set on to the newly discovered Ground Waves that bring practically static-free reception. Don't stand for the squawks and tin-pan reception you get from Air Waves when you can set right out and leave that stuff.

If you don't believe us, try it yourself. If you do not find we're right—absolutely right—you don't pay us a cent for the test.

TRY IT FREE! We know so well the surprising results you'll get that we'll let you put in a Sub-Aerial entirely at our Risk.

Don't take down your overhead Aerial. Pick a summer night when static and noise interference on your old Aerial are "Just Terrible." If Sub-Aerial doesn't Sell Itself to You Right Then on Performance—you needn't pay us a cent. Send for "all the Dope on Sub-Aerial." You'll be surprised. Do it NOW.

Underground Aerial Systems

St. Clair Bldg., Dept. 863-L.S.
Cor. St. Clair and Erie Sts.,
Chicago, Ill.

Mail Coupon NOW



UNDERGROUND AERIAL SYSTEMS, Dept. 863-L.S.,
St. Clair Bldg., cor. St. Clair and Erie Sts., Chicago, Ill.
Send me complete information on Sub-Aerial, Proof and Free Trial Offer. No obligation.
Name..... Address..... City..... State.....

Are You Ever Ashamed of Your English?

Do you say "who" when you should say "whom"? Do you say "between you and I" instead of "between you and me"? Do you mispronounce common words in your speech or use them incorrectly when you write? Many a man has been held down all his life and suffered untold embarrassment because of mistakes in English.

You do not need to make these mistakes any longer. Right at home, in the privacy of your own room, you can make up the education you missed in the days that you should have been at school.

The International School of English will teach you, just as it has taught thousands of other men and women, by a simple new method which shows you instinctively which word to use and how to use it.

Mail Coupon for Free Booklet

Name..... Address.....

INTERNATIONAL SCHOOL OF ENGLISH
Division of the International Correspondence Schools

Dept. 6245-E
Scranton, Penna.
Without cost or obligation, please send me full details of your home-study course in ENGLISH

Insure your copy reaching you each month. Subscribe to Science and Invention—\$2.50 a year. Experimenter Publishing Co., 230 Fifth Avenue, N. Y. C.



Choose as Your Profession Electrical Engineering

Electricity offers a brilliant future to the young man who is about to choose his career. Never before has there been such wonderful opportunity in this great field. Big paying positions in electrical work the world over are open to trained men — men who possess specialized, practical knowledge. Come to the School of Engineering of Milwaukee—the largest, the best equipped electrical school of its kind in America. Here you are trained in both theory and practice by a faculty of experts. You learn in large, finely equipped laboratories. If you have 14 high school credits or equivalent, you can become an Electrical Engineer with a Bachelor of Science degree in 3 years. If you have not finished high school you can make up the credits you lack in our short intensive Junior Electrical Engineering course.

Practical Electrical Education

Learn by the thorough, approved scientific methods which our twenty-three years of specializing enable us to give you. In addition to Electrical Engineering, the following complete courses are given: *A.C. and D.C. Armature Winding—Wiring and Testing—Practical Electricity—Commercial Electrical Engineering—Junior Electrical Engineering and Automotive Electricity—Electrical Refrigeration, and Radio Sales and Service.*

EARN WHILE YOU LEARN

You can earn money to help defray your expenses while learning. Our wonderful co-operative plan brings an Electrical Career within the reach of every ambitious man. Our Free Employment Department secures positions for those students who wish to earn part or all of their expenses. In addition the Department will help you get a good position in the Electrical industry when your training is completed. Daily Broadcasting, WISN.

New Term Opens NOW

Write for FREE CATALOG

Mail the coupon today for our big new illustrated catalog. Mention the course that interests you most and we will send you special information. Read about the school that trains men for practical and quick success. See how easy it is for you to get the training that will enable you to step to a splendid position and a handsome income. Mail the coupon right NOW No cost or obligation.



Dept. S.I.828

Jackson & E. Wells Sts. Milwaukee, Wis.

SCHOOL OF ENGINEERING OF MILWAUKEE
Dept. S.I. 828 E. Wells and Jackson, Milwaukee, Wis.

Without obligating me in any way, please mail free illustrated book, "Electricity and the One Best Way to Learn It," and particulars regarding the course I have marked with an X.

RESIDENT COURSES:

- ... Electrical Engineering, B. S. Degree. (3 years).
- ... Commercial Electrical Engineering. (H. S. graduates 1 year—others 2 years).
- ... Armature Winding.
- ... Light, Motor Wiring and Testing.
- ... Electrical Refrigeration.
- ... Master Electrician.
- ... Automotive Electricity.
- ... Radio Sales Service and Broadcasting.
- ... Home Laboratory Service. (Home Study Course).
- ... I am interested in your "Earn While You Learn" plan.

Name.....Age.....
Address.....
City.....State.....
Education.....

the operator, is the new ornithopter designed by George R. White of Stoneybrook, Long Island, who, after six years, completed a plane which he intends to operate by foot power. The wingspread of this heavier than air vessel is 29½ feet. The photographs show it in its various stages covered with a practically transparent material. The aviator sits within the body of the machine and by foot action causes the wings to beat up and down. It may be remembered by readers of SCIENCE AND INVENTION Magazine,

that arguments against the possibility of such a type of craft were advanced in this publication several years ago. Nevertheless, all eyes look forward to see what will happen when this plane is given its first experimental tryout. The inventor can be seen in the photographs with his plane, while one of the views shows the maximum movement of the wings, and the other shows the plane's structure. Observe how the wings of this plane are constructed to resemble the feathers of birds wings.

MOTOR HINTS CONDUCTED BY GEORGE A. LUERS (Continued from page 324)

Obtain a couple of nuts which will fit the valve stem and mount these in a vise, to form steady blocks for the valve, as shown by the attached illustration.

Use a file with one edge ground as a cutter and secured in place under one nut. The other nut is blocked out a corresponding amount. With valve grinder or a breast drill rotate the valve with slight pressure against the cutter. All pitting and rough spots can be quickly removed. Wrap a piece of emery cloth around the cutter for final finishing. With one set-up of the parts in the vise, all valves can be trued up and made ready with very little grinding in place required.

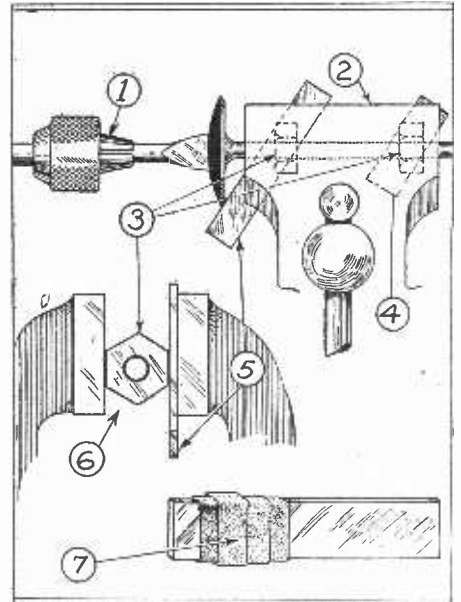

HAVE YOU A MOTOR HINT? If you have send it to the EDITOR, SCIENCE AND INVENTION, 230 Fifth Ave., New York City.

Right: 1 is a breast drill or valve-grinding tool; 2 is a vise; 3, nuts for valve stem; 4, block to even vise jaws; 5, file; 6, end view, and 7, emery cloth on cutter.

HINTS ON LOUD SPEAKERS By PAUL WELKER (Continued from page 340)

tion because of its lightness and also because the diaphragm can be made rigid. In the ordinary size balsa speaker, three slats of this wood are held together with smaller strips as shown. The long slats themselves should be cut on a taper and cemented together and the small strips then cemented in place. For home use a speaker two feet wide and about three feet long will be satisfactory. Ambroid cement is recommended

for holding the slats together, glue is hard and brittle and experience shows that it breaks loose after awhile. If a large speaker of this kind is desired for filling a large hall or theater with music, five or more strips may be cemented together and driven by a number of units as illustrated. Balsa wood kits and completely assembled speakers of the same material are now generally available.

RULES FOR MODEL CONTEST (Continued from page 330)

1. A handsome trophy cup engraved with your name, will be awarded as the prize for the best model submitted during the month. The decision of the judges will be final and will be based on: A—novelty of construction; B—workmanship; C—operating efficiency of the model as related to the efficiency of the device which the model simulates, and D—the care exercised in design and in submitting to us sketches and other details covering the model.
2. Models of all kinds may be entered. They may be working models or not, according to the subject that is being handled.
3. Models may be made of any available material, preferably something that is cheap and easily obtainable.
4. Models must be submitted in all cases. Good photographs are also

- highly desirable and where the maker does not desire the model to be taken apart, legible drawings with all dimensions covering parts that are not accessible must be submitted.
5. Models should be securely crated and protected against drainage in shipment and sent to us by parcel post, express or freight prepaid. Models will be returned when requested.
6. Models for entry in any particular contest must reach this office on or before the 25th of the third month preceding date of publication. For instance, models for the September contest must reach us on or before the 25th of June.
7. Address all entries to Editor Model Department, c/o Science and Invention Magazine, 230 Fifth Avenue, New York City.

17-Year Locusts

By DR. ERNEST BADE, Ph.D.
(Continued from page 305)

is taken that thousands of these larva may infest a single tree without causing any noticeable injury. The insects moult four times during their life under the ground; a resting stage does not take place.

Although this insect has been well studied, new facts, especially those relating to their distribution as well as to their emergence and final disappearance still require further study. In the Hudson Valley this periodical cicada has been studied for 12 generations at intervals of about 17 years, making a total recorded history which goes back 204 years.

Here it may be mentioned that the cicada is gradually disappearing in those regions which are undergoing rapid evolution, especially where rapid building and intensive farming is being carried on.

The life above ground is finished in a few weeks, and during this short time the shrill notes of their song is almost overpowering in the regions of their greatest distribution. At times it seems to fade away, only to increase in intensity again.

**New Radio Beacon Guides
Planes**

(Continued from page 338)

signal, the pilot will be helped on his course and informed when he is passing over a particular place. The marker beacons operate a 60-cycle reed vibrator mounted alongside the directive beacon indicator on the instrument board. Each marker beacon will send a characteristic signal assigned for its location. The reed indicator might also be used to transmit messages to the pilot when necessary, by interrupting the transmitting current at a slow rate in accordance with a code. Additional reeds tuned to other frequencies can be used to send special information.

*In the
September Issue
"ROCKET PLANES"*

**IMPORTANT
TO NEWSSTAND READERS**

IN order to eliminate all waste and unsold copies it has become necessary to supply newsstand dealers only with the actual number of copies for which they have orders. This makes it advisable to place an order with your newsdealer, asking him to reserve a copy for you every month. Otherwise he will not be able to supply your copy. For your convenience, we are appending herewith a blank which we ask you to be good enough to fill in and hand to your newsdealer. He will then be in a position to supply copies to you regularly every month. If you are interested in reserving your copy every month, do not fail to sign this blank. It costs you nothing to do so.

To Newsdealer

Address

Please reserve for me.....copies of SCIENCE AND INVENTION every month until I notify you otherwise, and greatly oblige,

Name

Address

WHOLESALE PRICES
New **1928 EDITION**
FREE
This **148 Page RADIO CATALOG**

75 LATEST RADIO CIRCUITS 500 ILLUSTRATIONS

BUY FROM RADIO'S OLDEST MAIL ORDER HOUSE

FOR DEALERS, COMMUNITY SET BUILDERS GENERAL REPAIRMEN AND AGENTS.

We are the oldest established, exclusive radio mail order house in the country. All orders are positively shipped within twenty-four hours; quick, prompt, courteous service. We carry a larger variety of radio parts, radio instruments, accessories and radio findings than any other radio house in the country.

You will find in Catalog No. 18 the largest assortment of radio merchandise in this country. Radio Specialty carries more radio parts and radio material than any other house in the country. You will find in this catalog positively the largest variety of radio merchandise.

If you are in need of certain small radio parts that other radio and mail order houses do not bother to carry get the Rasco Catalog and you will find the small parts there, anything from a screw to copper ribbon, telephone diaphragms, as well as thousands of the small radio findings.

We carry the Largest Variety of Small Radio Parts in the world, BUT we also carry All Standard Radio Merchandise.

RADIO SPECIALTY CO., 100 PARK PLACE, NEW YORK

Amazing New Ground Antenna

GETS FARAWAY STATIONS LOUD AND CLEAR REGARDLESS OF STATIC CONDITIONS

Radio Engineers and hundreds of users report that Aer-O-Liminator, the sensational new Ground Antenna, gets better long distance reception, almost unbelievable freedom from static and outside noises, far greater selectivity and marvelously clear and sweet tone quality.

R. Curtis, of Ill., says: "There's no such thing as static trouble since I got my Aer-O-Liminator. I get stations I never got before—so loud and clear I would almost swear they were in the next room." In addition you are free from troublesome overhead aerials that everyone now knows are static-gatherers. Aer-O-Liminator (Ground Antenna) is simple and easy to install. Takes but a few minutes.

Free Trial

Make this thrilling test at our risk! Install an Aer-O-Liminator (Ground Antenna). Leave your old overhead aerial up. Try out on a night when static is bad. If you do not get a wonderful improvement in freedom from static, greater selectivity and clear, sweet tone without interfering noises, if you can't get good reception on stations that are drowned by static on your old aerial, you need not pay us a red cent for this test. Send coupon today for scientific explanation of Aer-O-Liminator (Ground Antenna), proof of performance, and our conclusive iron-bound guarantee and remarkable Free Trial Offer. Send coupon today!

CURTAN MFG. CO.
154 E. Erie St., Dept. 863-L
Chicago, Ill.

Rush This Important Coupon

CURTAN MFG. CO.
154 E. Erie Street, Dept. 863-L,
Chicago, Ill.

Please send me at once complete description of Aer-O-Liminator with details of guarantee, Scientific Proof and FREE TRIAL OFFER.

Name

Address

City

State

\$100 a Week for Taking Pictures

We Furnish Camera and Teach You How

Men and Women Everywhere! Make Big Money!

Write for FREE BOOK Explains opportunities as Motion Picture Camera Man, Portrait, News or Commercial Photographer. You can learn at home or in our New York Studios. Same or full time.

N.Y. Institute of Photography, 10 W. 33rd St., N.Y. Dept. 2

ZIP-ZIP SHOOTER
LET'S GO, BOYS

Hunting, fishing, or camping, wherever you go you will need a Zip-Zip Shooter, elastic and lasting, with plenty of pep and force, scientifically and practically made. See your dealer—if he can't supply you order from us.

Zip-Zip Shooter, 35c., or three for \$1.00; send stamps, coin, or money order.

AUTOMATIC RUBBER CO., Dept. BB, Columbia, S. C.

Learn ALL ABOUT AVIATION

EVERYBODY'S AVIATION GUIDE is a complete discourse on practical aviation, by MAJOR VICTOR W. PAGE, one of the leading men in the field. Unlike most books of instruction, EVERYBODY'S AVIATION GUIDE is written in a unique question and answer fashion, which makes the subject far easier to study and a great deal more attractive as an instruction course.

This book was recently published and is absolutely up-to-date in every way. It has had very favorable criticism throughout country-wide aviation circles and has been highly recommended by all those in a position to pass judgment.

We list here the contents in order that you may see for yourself how completely the field of Aviation is covered.

Contents:

- Early Aeronautic History—First Flying Machines—The Atmosphere
- Forms of Aircraft—Airplanes and Airships
- Lighter-Than-Air Craft—Balloons and Dirigibles
- How An Airplane Flies—Elementary Aerodynamics
- Airplane Parts and Their Functions
- Fuselage Forms and Landing Gears
- Wing Arrangement and Construction
- Power Requirements, Engine Types and Engine Location
- Aircraft Propellers, Design and Application
- Airplane Equilibrium and Control
- Official World and American Air Records



Price **\$2.00**

Over 248 pages
Beautiful red cloth binding—Title in gold
Replete with illustrations
WRITE DIRECT TO
Consrad Company, Inc.
230 Fifth Ave., New York, N. Y.

CONSRAD COMPANY, Inc.,
230 Fifth Ave., New York, N. Y.
Gentlemen: Kindly send me one copy of your book, EVERYBODY'S AVIATION GUIDE. Enclosed find \$2.00.

Name

Address

City.....State.....

Hints for the Mechanic

Mechanics' needs have caused us to start this new department—"Hints for the Mechanic," in which we intend to publish wrinkles useful to mechanics in general. You can help us with this department by writing a brief description of your favorite shop wrinkle and sending this to the editor of this department, together with a pencil or pen and ink sketch of the wrinkle. The ideas published herewith will give you some idea of what we want. Our draughtsmen will make the necessary mechanical drawings, so you need not send us finished drawings. We will pay \$10.00 each month for the best Wrinkle or Hint sent in; others published will be paid for at space rates. Address all letters to Editor, Hints for the Mechanic Department, in care of this magazine.

FIRST PRIZE \$10.00 ADJUSTABLE SPANNER WRENCH

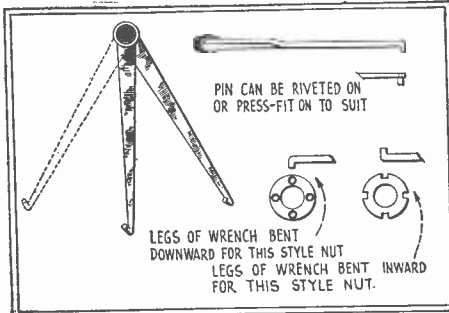

Details for making an adjustable spanner wrench will be found in the above illustration.

An adjustable spanner wrench which can be used with various types of nuts is shown here. The legs of the wrench are bent downward for one kind of nut and inward for another style. The pin can be riveted on or press-fit.—Contributor send name and address.

SUBSTITUTE FOR LATHE

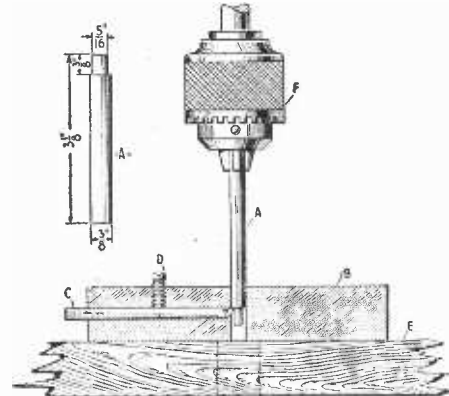

A drill press can be used for small lathe jobs, as shown above.

A small bench drill press can easily be rigged up as shown and used as a lathe. In the illustration A is the work, B, is a steel block, C, is the cutter, D, set screw, E, wood block and F, the chuck.—Frank N. Avakky.

IMPROVED TIN SHEARS

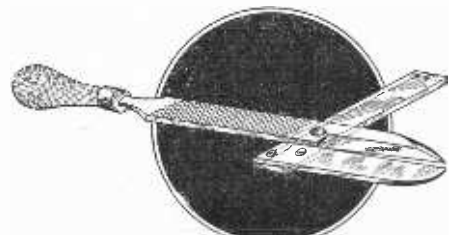

Good tin shears can be made from a pair of files as indicated above.

Tin shears may be made from an old file used as a stationary blade. The movable blade is made from a 14 to 16-inch file, with one end ground to a cutting edge. In order to provide a suitable hole for the shaft, the files will have to be heated and the holes punched through. The pivot should be about 4 inches from the end of the blade.—C. T. Schaefer.

REMOVING SAW STAINS

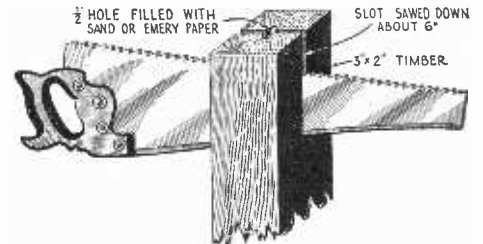

Details of a device for removing stains from a saw are given above.

In order to make a saw cleaner fasten a piece of 3-inch x 2-inch timber in the vise. Bore a 1/2-inch hole down the center. Saw down through the hole, then insert saw in cut upside down. Next, fill hole with sand or emery powder and water. To clean, move saw backwards and forwards.—I. E. Lovett.

BENCH CLAMP

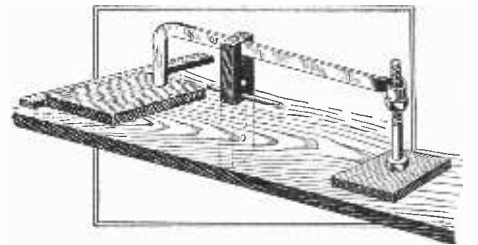

An adjustable bench clamp which will find many uses in the workshop can be made as shown.

The clamp shown in the above illustration consists of a 2-inch x 4-inch board drilled at one end and slotted at the other. A hole is cut in the bench so that the timber may be inserted. The lever is made from a piece of 1/4- x 1-inch flat steel. One end is bent in a circular form to provide for the insertion of a machine bolt. To use clamp, run a nut on the bolt and slip end of lever over the bolt.—C. T. Schaefer.

CHIP BLOWER

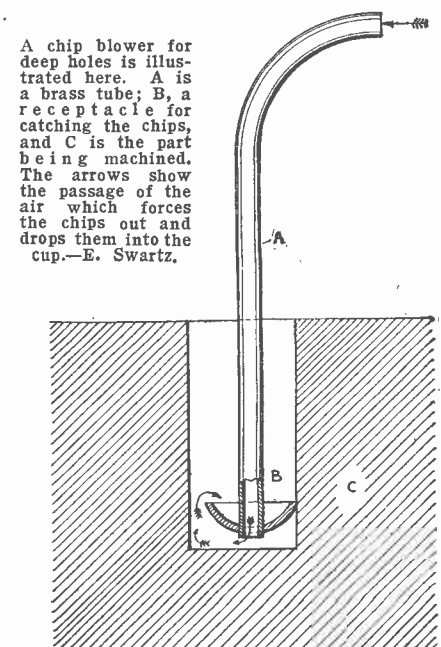

A chip blower for deep holes is illustrated here. A is a brass tube; B, a receptacle for catching the chips, and C is the part being machined. The arrows show the passage of the air which forces the chips out and drops them into the cup.—E. Swartz.

Home-Made Summer Amusements

(Continued from page 333)

idea to have an adult in attendance to supervise the running of these home-made merry-go-rounds, etc., as children are liable to start the machinery in motion before a passenger has become fully seated in the compartment.

MOTOR-DRIVEN AERIAL SWING

CCARE should be exercised in every detail of the aerial swing construction here suggested. You must remember that if one of the cables supporting a car or cab breaks that a child may be dashed to the ground and seriously injured. It is best to use steel cable at least a quarter of an inch in diameter, or preferably three-eighths of an inch in diameter, with which to support the passenger compartments. Suitable clamping devices can be purchased at hardware dealers for securing the ends of the cables after they have been passed through holes or otherwise made fast. As the detailed drawing herewith indicates, the aerial swing apparatus is built by having a large pipe rotate on a smaller size pipe. The base of the larger pipe is fitted with a heavy iron flange and just above this flange a split belt pulley may be bolted in place. These pulleys come split to the center and can be bolted on to any shaft, bushings being supplied so they will fit on different diameters of pipes or shafts.

There are a number of different ways in which the aerial swing may be driven by a motor or engine of one to two horsepower or more, a quarter turn flat leather belt being illustrated in the present instance. Rope drives are suitable for the purpose and a chain drive may also be used. A gear drive, using several gears in order to bring the speed ratio down to about one or two revolutions per second for the swing cabs may be worked out also.

One of the safest things to do with the aerial swing in particular, is to provide safety belts so as to strap the passenger in place. Also in building the cabs from reinforced wooden boxes or otherwise, the rope or wire cable should be carried around under the cab and held securely to the cab by iron staples or, better still, heavy pipe straps anchored in place by one-quarter inch stove bolts passing through holes drilled through the boards. Don't try to build such a device as this out of too lightweight pipe—a few dollars extra spent at the start for sufficiently strong pipe may mean the elimination of the chance of bad accidents later. Also, don't lose sight of the fact that a dollar or so spent for some red and blue paint will help to doll up the home-made amusement device and make it really attractive to the children.

Button Rupture Newest Way [Without Pressure]

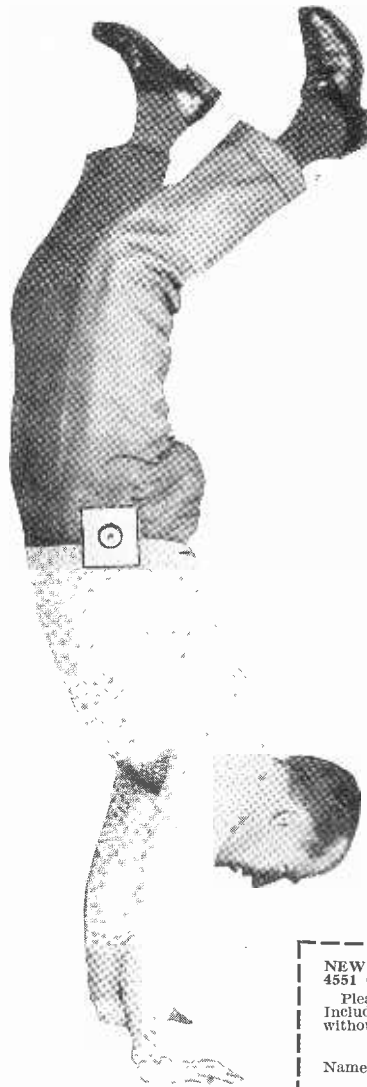

SCIENCE now advises discarding cruel steel springs, barbarous leg straps, and other harness that press against the rupture and thus prevent nature from healing it. A new sensible method has been perfected, after thousands of test cases, called Magic Dot—entirely different from any other way. Instead of "pressing" it "seals" rupture, and of course allows users to run, jump, bend and cough in perfect safety.

Breathes Air

With this 1-25th oz. device is a new kind of pad, air-porous and washable. It actually breathes air, and cannot slip off the rupture—a feature, you'll frankly admit, that is lacking in your present appliance. In fact, it is so superior and different that it is praised by physicians as "an entirely new departure." Users report they have forgotten they are wearing it. But don't buy it yet.

See It First

By a special arrangement you can now have it sent to your home without obligation to wear it. Don't send a penny or order it now. Just mail the coupon for full description of "Magic Dot" and details of this unusual offer. Act now for quick relief. Write your name and address on the coupon and mail it today!

NEW SCIENCE INSTITUTE

4551 Clay Street

Stuebenville, O.

NEW SCIENCE INSTITUTE
4551 Clay Street, Stuebenville, O.

Please send me free your illustrated book and sample of Airtex. Include also your offer which permits me to see the New Science System without cost or obligation.

Name.....
Address.....
City..... State.....

**EXPOSES of
SCIENTIFIC
SWINDLES**

appear often in

Science and Invention

If you know of some hocus-pocus scheme being used to swindle the public—write the Editor about it.

\$4.99 22 Cal. Blank Automatic
WITH 100 shot Automatic. Use for **Free!** No Permit Required. Fun or self-defence. Keeps away traps, frightens thieves, scares away dogs—a real home protector. Fool your friends. Same as an expensive automatic in construction, finish, appearance, durability; automatic magazine loading and ejection of cartridges. Instantly and powerful report. Guaranteed absolutely safe. Send no money. Pay expressman \$4.99 for automatic with 100 cartridges. **JENKINS, 621 Broadway, New York, Dept 65-J-8**

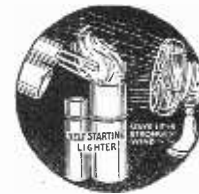

SCIENTIFIC MARVEL LIGHTER—WINDPROOF
What Makes It Light?

All guaranteed. Sample 25 cents. Sample Gold or Silver plated, \$1.00. Does the work of expensive lighters.

Agents Write for Prices

NEW METHOD MFG. CO.
Box S.1.8 Bradford, Pa.

Save \$75 Weekly Building Radio Sets
Join the Radio Association of America! We train you to build and repair radio sets—start you in business—enable you to earn \$3 an hour upwards. Free 5-Tube Radio Set to members.. Write for special limited-time plan whereby your membership need not cost you a cent. Write today!
RADIO ASSOCIATION OF AMERICA
Dept. SN-8 4513 Ravenswood Ave. Chicago, Ill.

MODEL AIRPLANES
25c to \$10 Complete
GLIDERS - TRACTORS - RACERS - CABIN MONOPLANES - CONSTRUCTION SETS
Raw materials, blueprints; everything needed to make your own models. Write for illustrated folder "I." Dealers inquiries invited.
Broadfield Toy Co. Est. 1919 **Hempstead, N. Y.**

Ring Up

\$150 to \$300

Monthly Profit With an

HB 8-Hour Battery Charger

Mechanics, garages, battery shops and filling stations are all adding tremendous profits this season with this new 8-Hour Battery Charging Business. Practically no expense or investment required. No special experience necessary. 8-Hour Service gives you a big advantage over other shops, saves 30% to 50% on electric bills over rectifiers. Find how easily you can have these profits by checking No. 1 below.

Only \$16 Monthly Easily Paid by Increased Profits

FREE AIR SERVICE

For only \$12 Monthly for a few months you can have the advantage of Automatic Air Service bringing customers to your door. Beltless, Silent, Ball Bearing. Lowest prices for such quality equipment. Get full details without obligation by checking No. 2 below.

HB TEST BENCH

Best paying equipment for auto motive electrical work. Tests starting, lighting, ignition systems. Brings you business from other shops. Priced \$100 to \$150 below similar quality outfits. Write today for full information without obligation. Check No. 3 below.

PAINT SPRAY

Does the work of five men with brushes. Paints cars, furniture, houses, barns, garages. You can do better, quicker work at lower prices, yet make far more money than old-time painters. No experience necessary. Investigate—Check No. 4 below.

HOBART BROTHERS

Successful manufacturers ~ since 1893 ~

BOX 588 TROY, OHIO

Tear Off Coupon and Mail Today

HOBART BROTHERS CO.
Box 588, Troy, Ohio.

Send me complete information on the items I've checked with your 30-day trial offer, easy payment terms, and information on how HB equipment will increase my earnings

1. One Day Battery Service Profits
2. Better Automatic Air Compressor
3. Electrical Test Bench Opportunities
4. Portable Paint Spray Business

Name.....

Address.....

We start you in business and help you succeed

New plan. No experience or capital needed. We furnish everything. Spare or full time. You can easily make

\$50-\$100 weekly

Write at once
Madison Shirt M'rs, 564 Broadway, N. Y.

POPULAR CHEMISTRY

POPULAR CHEMISTRY

A Monthly Chemical Magazine

Latest chemical news, experiments, formulas, recent advancements in medicine, vitamins, etc., new uses for X-rays, ultraviolet, light, radium, etc., every month. New feature articles that tell of the wonders of chemistry in a non-technical manner. Three trial copies (back issues), 30 cents. \$1.00 per year.

POPULAR CHEMISTRY CO.
Dept. GB Swedesboro, N. J.

Do You Eat the Right Food?

By WILLIAM LEMKIN, Ph.D
(Continued from page 329)

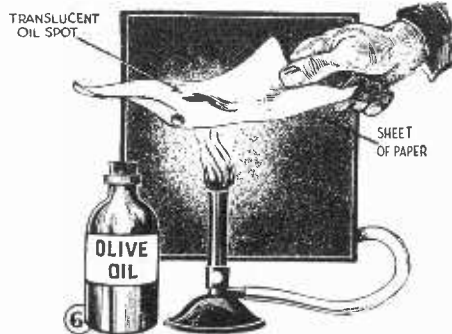

A simple test for fat can be made by placing a few drops of olive oil on a piece of paper. Hold over a flame and the paper becomes translucent.

and finally a red powder forms on the fruit. Cane sugar (the household granulated variety) does not give this test, but can be changed to a form which will give the same reaction. The process is called "invertin," and consists of warming the sugar for about five minutes with a few drops of vinegar or any dilute acid. Then repeat the test with Fehling's solution, and the same brick-red color as before will appear on boiling.

A SIMPLE TEST FOR FAT

AS a fuel, fat ranks first among our nutrients. The simplest test is the so-called "translucent" test. Place a few drops of olive oil on a piece of ordinary white writing paper. Allow it to spread a little. Hold high over the flame. The paper will become semi-transparent or translucent. Kerosene and other "hydrocarbon" oils will produce a similar "grease spot", which, however, rapidly disappears on warming the paper. Rubbing a Brazil nut on a paper will yield a translucent smear, indicating the presence of fat or oil.

Where the food being examined is dry, as is the case with corn meal, white flour, etc., the fat, if any is present, may be extracted with gasoline. In working with this highly inflammable liquid, be sure that there is no flame in the room. Place about a teaspoonful of the material to be tested in an evaporating dish near an open window. Pour on more than enough gasoline to cover the food, and stir thoroughly. Cover the dish, and allow to stand for ten or fifteen minutes. Pour the gasoline off into a beaker, and set the beaker outside the window until the gasoline has evaporated. If a residue remains after the gasoline has disappeared it must have been dissolved from the food. Place some of it on a piece of paper and warm it. The familiar translucent appearance of the paper will tell us that it is fat; if such appearance is produced.

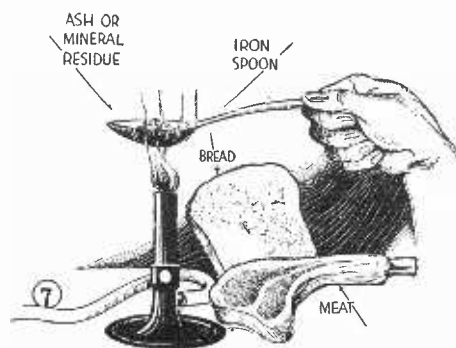

To separate materials in foods, heat in an iron spoon until there is no more burning. The light-colored ashes which remain are the non-burnable portion of mineral matter.

YOUR BODY

KNOW THYSELF
A Quarterly Magazine

NOT A "HEALTH" MAGAZINE

POPULAR PRACTICAL KNOWLEDGE ABOUT THE MECHANISM OF THE ORGANS OF THE HUMAN BODY

SEXOLOGY
PHYSIOLOGY
MEDICINE
ANATOMY

ON ALL NEWSSTANDS
50¢ A COPY

DEVOTED TO THE WELFARE OF THE HUMAN BODY

EXPERIMENTER PUBLISHING CO.
230 FIFTH AVE.
NEW YORK CITY

PROTEIN, THE MUSCLE BUILDER

WHEN burned, all substances containing protein will produce the characteristic disagreeable odor with which you are no doubt familiar in the burning of feathers, flesh and leather. The chemical test consists of boiling the food, such as a piece of meat or cheese, or some hardened egg white, with nitric acid (be careful not to get the acid on your hands or clothes!). The food will turn red, especially on its edges. Now pour off the acid, rinse with water, and add a little strong ammonia. The substance will turn a deep orange color, which proves the presence of protein.

Have you ever received a nitric acid stain on your finger?—not a severe burn, but a slight discoloration from an accidental drop. If you happen to touch the resulting yellow spot with ammonia, a bright orange tint is produced, which lasts for weeks, and disappears only with the gradual peeling away of the affected skin. Have you ever stopped to realize that you are inadvertently performing a protein test on the tissues of your own body?

MINERAL MATTER, THE ASHES IN YOUR FOOD

ALTHOUGH forming a very minute part of your diet, mineral salts are indispensable in the proper functioning of your body. They go to the forming of bones,



hair and teeth. They also aid in digestion and are found in the blood. To separate the materials in foods, it is only necessary to heat some of the material in an iron spoon over a strong flame. Do this where there is a good draft, so that no odors will penetrate the room. Hold in position until there is no more burning. You will find that all of the black residue is burnt out, leaving a deposit.

A test for protein consists of boiling with nitric acid. The food will turn red and should then be rinsed with water and dipped in ammonia. This remaining non-burnable portion is the mineral matter contained in the food.

These relatively simple tests will initiate the ambitious home experimenter into the interesting realm of food chemistry. He will find an absorbing interest in trying out these reactions on the host of food materials which enter into every household. He should derive genuine satisfaction in arranging a classification of the things he eats on the basis of the important nutrients which he discovers in each article of his diet. By observation and comparison of his results he will develop a real scientific understanding of the commonplace statements: "This is a good fuel food." "This is a muscle-building food." "Such-an-such is a valuable mineral food."

Radio Wrinkles Wanted!

The Radio Editor, Mr. Paul E. Welker, wants to hear from you, if you have a good idea or wrinkle. Make a pencil or pen and ink sketch of the contrivance, write 50 words or so of description, and mail to the Radio Editor, c/o this magazine.

**"Where'd You Get the New Car, Bob?"
"Say, Mac, You May Not Believe Me, But I Got It Out of This Can of ReNUZit!"**

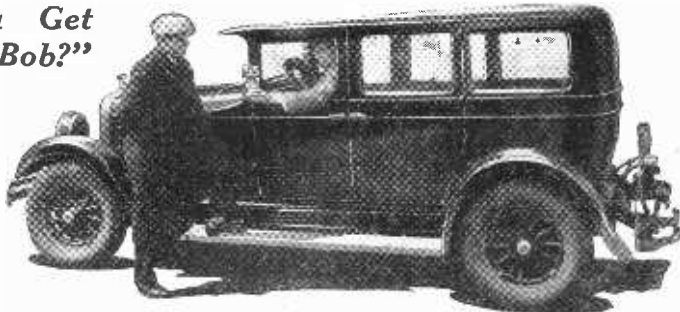

Miraculous Fluid Renews Original Finish of Old Cars in 30 Minutes!

Sounds like a Miracle! It IS a Miracle—a scientific Miracle that is astonishing the motor world! If YOU had seen Bob's car before he found out about ReNUZit, and could see it NOW—you'd hardly believe your eyes! It's as snappy looking as on the day he bought it. Yes, without doubt—ReNUZit is proving one of the great sensations of the motor age.

AGENTS—\$50.00 a Day

So like a Miracle is this wonderful Fluid that agents all over the country can make almost unbelievable profits. Full or spare time—ReNUZit sells like the wind. Car owners simply can't resist it! One glance at what it does—and they are more than eager to try it. And our reputation is so GOOD that no one could help making money with it. Live wires should make \$50.00 and up a day without any trouble. It costs nothing to investigate. You can't afford not to.

How This Astonishing Discovery Works

You just flow ReNUZit onto any automobile with a piece of cheesecloth, and immediately the ORIGINAL color and lustre of that car is like new again. It's not a polish, cleaner, wax or paint—but a marvelous chemical discovery that restores the original color and glowing lustre of any painted, enameled or lacquered surface. No tiresome polishing or rubbing. Harmless—Lasting—Sure.

Test ReNUZit Free!

You have the privilege of trying ReNUZit yourself right now without risk or obligation. Prove to yourself what miracles it accomplishes. See your own car being transformed to a thing of glistening beauty! Send coupon TODAY for full details and Free Test Offer.

CURTAN MFG. CO.
154 E. ERIE STREET
Dept. 863-L.R.
CHICAGO, ILL.



MAIL COUPON

CURTAN MFG. CO.,
154 E. Erie Street
Dept. 863-L.R. Chicago, Illinois

Rush full details of ReNUZit, with Free Trial Offer. No obligation.

Name.....
Address.....
City..... State.....

Not a Polish
Not a Paint
Not a Cleaner
Not a Wax

BLISS ELECTRICAL SCHOOL

A special technical school with concise but comprehensive course in Electrical Engineering designed to be completed in ONE COLLEGE YEAR. Non-essentials eliminated. Thorough knowledge of underlying principles emphasized. Theory and practice are closely interwoven in class-room and laboratory.

ELECTRICAL ENGINEERING

The course is designed for earnest, ambitious young men of limited time and means. Curriculum includes mathematics, mechanical drawing and intensive shop work. Students construct motors, install wiring, test electrical machines. Graduates are qualified to enter the electrical field at once.

Bliss men hold responsible positions throughout the world. Thoroughly equipped fire-proof dormitories, dining hall, laboratories and shops. Prepare for your profession in the most interesting city in the world. School established 1893. Catalog on request. Address Washington, D. C.

BLISS ELECTRICAL SCHOOL, 148 Takoma Avenue

WHY BE PERPLEXED? LET ME SHOW YOU HOW TO SOLVE THAT ELECTRICAL PROBLEM

My years of experience in APPLIED ELECTRICITY is here to serve for your accomplishments. Write me your problem now

THE A. H. S. ELECTRICAL SERVICE BUREAU
4735-159th Street Fushing, New York, N. Y.

LEPAGE'S Handiest Tool in Your Workshop
GLUE In bottles, tubes and cans

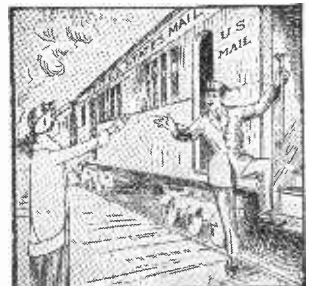

Travel—For "Uncle Sam"
RAILWAY POSTAL CLERKS—MEN—BOYS 18 UP
CARRIERS—POSTOFFICE CLERKS
PROHIBITION AGENTS
\$1700 to \$3000 YEAR
STEADY WORK NO LAYOFFS
Many Government Jobs Open to Women
Common Education Sufficient

FRANKLIN INSTITUTE, Dept. F184, Rochester, N. Y.

Sirs: Rush to me without charge, 32-page book with (1) Full information regarding Railway Postal Clerks; City Carriers; Postoffice Clerks; Prohibition Agents and sample coaching; (2) List of government jobs now open to men and women, 18 up; (3) Full particulars telling how to get a position.

MAIL COUPON IMMEDIATELY Name..... Address.....

PATENTS

TRADE-MARKS—DESIGNS
FOREIGN PATENTS

MUNN & CO. PATENT ATTORNEYS

Associated since 1846 with the
Scientific American

SCIENTIFIC AMERICAN
BUILDING

24½ West 40th Street
New York City

SCIENTIFIC AMERICAN
BUILDING

Washington, D. C.

TOWER BUILDING
Chicago, Ill.

MOBART BUILDING
San Francisco, Cal.

VAN NUYS BUILDING
Los Angeles, Cal.

Books and Information on Patents and
Trade-Marks By Request

Associates in all Foreign Countries

PATENTS

To The Man With An Idea

Patents Procured; Trade Marks Registered—A comprehensive, experienced, prompt service for the protection and development of your ideas. Preliminary advice gladly furnished without charge. Booklet of information and form for disclosing idea free on request.

IRVING L. McCATHRAN
Patent Lawyer
Formerly with and Successor to
Richard B. Owen

202 Owen Building, Washington, D. C.
41V Park Row, New York City

TRADE-MARKS

REGISTERED

PATENTS

DON'T LOSE YOUR RIGHTS TO PATENT PROTECTION

Before disclosing your invention to anyone send for blank form, "EVIDENCE OF CONCEPTION," to be signed and witnessed. As registered patent attorneys we represent hundreds of inventors all over the United States and Canada in the advancement of inventions. The form, "Evidence of Conception," sample, instructions relating to obtaining of patents, and schedule of fees sent upon request.

LANCASTER & ALLWINE
255 Ouray Bldg., Washington, D. C.
Originators of forms "Evidence of Conception"

INVENTORS

who derive largest profits know and heed certain simple but vital facts before applying for patents. Our book, Patent-Sense, gives these facts; sent free. Write

LACEY & LACEY

644 F STREET WASHINGTON, D. C.
Established 1869

BLUE BOOK ON PATENTS

and Priority Record blank gratis.

MONROE E. MILLER, PATENT LAWYER,
411-6 Ouray Building, WASHINGTON, D. C.
ELECTRICAL AND MECHANICAL EXPERT

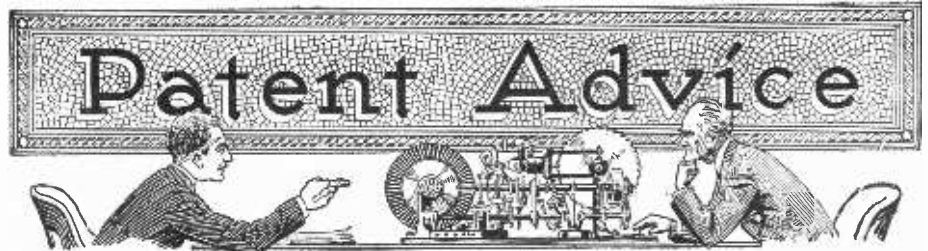

CONDUCTED BY JOSEPH H. KRAUS

In this Department we publish such matter as is of interest to inventors and particularly to those who are in doubt as to certain patent phases. Regular inquiries addressed to "Patent Advice" cannot be answered by mail free of charge. Such inquiries are published here for the benefit of all readers. If the idea is thought to be of importance, we make it a rule not to divulge all details, in order to protect the inventor as far as it is possible to do so.

Should advice be desired by mail, a nominal charge of \$1.00 is made for each question. Sketches, and descriptions must be clear and explicit. Only one side of sheet should be written on.

NOTE:—Before mailing your letter to this department, see to it that your name and address are upon the letter and envelope as well. Many letters are returned to us because either the name of the inquirer or his address is incorrectly given.

HOW TO MARKET

(1103) G. E. Conover, Newark, N. J., says he has a patent and wants to know who the likely manufacturers may be.

A. 1. It is quite impossible for us to advise what company would be interested in placing your product on the market, if you do not even suggest what the nature of that product may be.

It would not be advisable for us to suggest that you send the idea to a concern manufacturing rubber tires, if your invention is to be made of metal. On the other hand, we may not have the name of an organization desirous of undertaking the construction you have in mind.

If, therefore, you are in a position to send us a copy of the patent, we will be glad to do whatever is in our power to assist you in marketing the article.

WAVE POWER GENERATOR

(1104) Thomas W. Crocket, Santa Paula, Calif., has designed a wave power machine in which a series of abutments deflect the wave to cause it to act on spiral screws. These spirals in turn are geared to the generators. He asks our advice.

A. 1. While your suggestion for water power is conceivably possible, the idea is entirely impractical and we certainly do not advocate that you apply for a patent on this suggestion.

It is obvious that abutments of the nature described by you would be expensive to install, and in the course of one or two years at the most, would be completely destroyed by the hammering of the waves. It might also be mentioned that your device does not take into consideration what would happen in the event of stormy conditions or when heavy blocks of ice, litter, logs, etc., are hurled by the waves against the abutments and spirals. There are too many factors that must be taken into consideration in building systems of this nature which render the method entirely too far fetched.

WINDOW LATCH

(1105) Kenneth M. Dwyer, Durban, Natal, South Africa, submits a diagram of a safety window latch to prevent windows from being opened after they have been closed.

A. 1. We do not know of a safety window catch constructed as indicated by you, but in order to determine whether there is such a project, it would be necessary for you to first have a patent search made. This search can be made by any reliable patent attorney.

We are doubtful if a project of this nature would be of material advantage, because the desire today is to secure the windows, even though they may be partially opened. This your catch will not permit.

SCALP TREATING DEVICE

(1106) John Dregelies, Minneapolis, Minn., has submitted a system of scalp treatment consisting of a cap fitted with electrical flash boiler and other agencies. He requests our opinion.

A. 1. Probably you can patent your device for a beauty parlor appliance, and there is a possibility that if you marketed the same, you could develop a sale for an article of this nature.

The mounting designed by you is not as clever as it might be. It would be far more advisable to employ a mounting similar to the types used in the handling of large X-ray tubes at the various hospitals. There is, however, one more objectionable feature in your device that should be overcome, and that is the means of obtaining the

steam through a flash boiler system. Should anything go wrong with your method and should the water drip through without being converted into steam, the possibility of burning the scalp by means of this hot water is very great. We would suggest that a safety appliance be added or that another means of steam conversion be employed which will prevent the dripping of hot water over the head of the patron.

ANTI-SPLASH TIRES

(1107) Henry Dion, Detroit, Mich., asks whether he could secure a patent on an anti-splash tire device.

A. 1. We believe that it may be possible for you to patent some device for carrying out the idea, but you have not given us sufficient information to warrant a definite comment either one way or another.

There are many devices that will prevent a tire from splashing. There are many ways in which a tire could be designed so as to prevent this. Whether or not it will pay the manufacturer to make a tire of this type or pay the owner to use one, depends largely on its cost. The owner never need fear whether his automobile is splashing mud on the clothes or hosiery of a pedestrian because he can always get away by the time his victim recovers from the initial shock. Why then should he pay from \$10.00 to \$15.00 for something to prevent this splashing? Even those owners endowed with a feeling for the less fortunate pedestrians would not care to impair appearances by grotesque attachments.

WHY NO PATENT?

(1108) F. W. Weihe, Byron, Cal., asks why it should take several months to get a patent.

A. 1. Your attorney is quite correct when he makes the statement that it will take several months before you secure your patent. It may take as long as a year.

According to the Patent Office Bulletin, issued Tuesday, May the 22nd, of this year, there are 103,336 patents awaiting action, excluding those in the trade mark division. The oldest amended case is August 13, 1927 and the oldest new case July 14, 1927. You thus see that it may take approximately ten months on the average to secure a patent. Some of the department to which they are assigned are busier than others. The biggest department has over 2,600 applications on file awaiting action.

There is nothing you can do but wait patiently.

PARACHUTE

(1109) James M. Stont, El Paso, Texas, asks our opinion of a parachute for airplane pilots which will be opened by compressed air.

A. 1. There is nothing new in using compressed air for opening a parachute. Many attempts have been made to place an article of this nature on the market. The difficulty is that when agencies of this nature are employed, the pilot pays little attention to the way his parachute may be packed, assuming that the compressed air will overcome every defect. But sometimes the air fails and the next day they tell stories about how well versed in aeronautics the former pilot was. The same story was told about the aviator who designed a sort of a funnel arrangement which was to shoot the air into the interior of the parachute and thus open the parachute. It failed and the inventor never made another test.

Therefore, your method being old and quite impractical, we would certainly advise you not to proceed.

At the right is a view of my drafting and specification offices where a large staff of experienced experts are in my constant employ.



All drawings and specifications are prepared under my personal supervision.

PATENTS

My Patent Law Offices
Just Across Street From U.S. Pat. Office



Protect Your Ideas

Take the First Step Today—Action Counts

If you have a useful, practical, novel idea for any new article or for an improvement on an old one, you should communicate with a competent Registered Patent Attorney AT ONCE. Every year thousands of applications for patents are filed in the U. S. Patent Office. Frequently two or more applications are made for the same or substantially the same idea (even though the inventors may live in different sections of the country and be entirely unknown to one another). In such a case, the burden of proof rests upon the last application filed. Delays of even a few days in filing the application sometimes mean the loss of a patent. So lose no time. Get in touch with me at once by mailing the coupon below.

Prompt, Careful, Efficient Service

This large, experienced organization devotes its entire time and attention to patent and trademark cases. Our offices are directly across the street from the U. S. Patent Office. We understand the technicalities of patent law. We know the rules and requirements of the Patent Office. We can proceed in the quickest, safest and best ways in preparing an application for a patent covering your idea. Our success has been built on the strength of careful, efficient, satisfactory service to inventors and trademark owners located in every state in the Union.

Strict Secrecy Preserved—Write Me in Confidence

All communications, sketches, drawings, etc., are held in strictest confidence in strong, steel, fireproof files, which are accessible only to authorized members of my staff. Feel free to write me fully and frankly. Your case will have my personal attention. It is probable that I can help you. Highest references. But FIRST—clip the coupon and get my free book. Do THAT right now.

No Charge for Information On How to Proceed

The booklet shown here contains valuable information relating to patent procedure that every inventor should have. And with it I will send you my "Record of Invention" form, on which you can sketch your idea and establish its date before a witness. Such evidence may later prove valuable to you. Simply mail the coupon and I will send you the booklet, and the "Record of Invention" form, together with detailed information on how to proceed and the costs involved. Do this NOW. No need to lose a minute's time. The coupon will bring you complete information entirely without charge or obligation.

Clarence A. O'Brien

Registered Patent Attorney

Member of Bar of: Supreme Court of the United States; Court of Appeals, District of Columbia; Supreme Court, District of Columbia; United States Court of Claims.

PRACTICE CONFINED EXCLUSIVELY TO PATENTS, TRADEMARKS AND COPYRIGHTS

Inventors

Write for these

Free Books



Mail this Coupon Now

CLARENCE A. O'BRIEN
Registered Patent Attorney
53-D Security Savings & Commercial Bank Bldg.,
Washington, D. C.

Please send me your free book, "How to Obtain a Patent," and your "Record of Invention" form without any cost or obligation on my part.

Name _____

Address _____

(Important: Print or Write name clearly)

INVENTORS

Protect Your Ideas

Send for our Guide Book, HOW TO GET A PATENT, and Evidence of Invention Blank, sent Free on request. Tells our terms, methods, etc. Send model or sketch and description of your invention for INSPECTION and INSTRUCTIONS FREE. TERMS REASONABLE. BEST REFERENCES.

RANDOLPH & CO.
Dept. 172, Washington, D. C.

Name.....
Street.....
City.....



\$300,000
For This Invention

That's what Eastman Kodak paid for the Autographic idea. Thousands of other inventions are needed and offer enormous opportunities for earning fortunes. If you are of an inventive turn of mind why not concentrate on things that are really NEEDED. Get Raymond Yates's new book,

1,000 Needed Inventions
Costs only \$1.25 and may start you thinking along the right lines. You'll get nowhere just fussing around. Concentrate on what the industries need, and on what the public wants. Mr. Yates's book tells you what these things are. Send no money. Just write postal. Pay mail man \$1.25 plus postage when book arrives. Your money back if you want it. This offer limited. Write now and get on the right track. Outside U.S., \$1.45 cash with order. Address:
Bureau of Inventive Science 78 Wisner Bldg. Rochester, N. Y.

Your Invention
may be worth thousands.
Is \$4.00 too much to invest in protecting it? Send today for this complete authoritative volume by the famous patent attorney, H. A. Toulmin, Jr.
PATENT LAW for
The Inventor & Executive
HARPER & BROTHERS
49 East 33 Street New York

INVENTORS

WE ARE SEEKING INVENTIONS WHICH CAN BE MANUFACTURED OR MARKETED PROFITABLY.
CALL OR WRITE
INVENTORS & MANUFACTURERS EXHIBIT CO.
45 West 45th Street New York City

INVENTIONS Commercialized
ON A CASH OR ROYALTY BASIS
PATENTED or UNPATENTED

In Business 25 Years - Complete Facilities - Reference.
Write **ADAM FISHER MFG. CO.**
205D Enright Ave. St. Louis, Mo.

WOOD TURNING FOR THE AMATEUR

By H. L. WEATHERBY
(Continued from page 334)

continually revolving the chisel as the cut is made. This cut is continued until the bottom of the half bead is reached. After cutting the series at the left end of the exercise, practice on those at the right end, cutting in the opposite direction and finishing with the center bead.

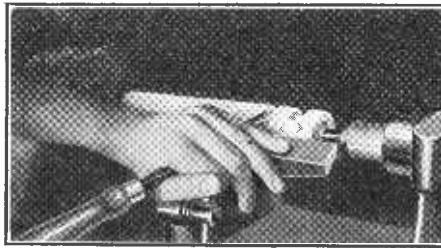

Position of gouge for concave cut.

The chief difficulty in this cut lies in the danger that comes from getting the chisel caught in the revolving wood and causing a "run."

INTERESTING BEAD EXERCISE

THE third exercise is a series of beads, separated by wide filets. After marking the cylinder off, rough the plain areas

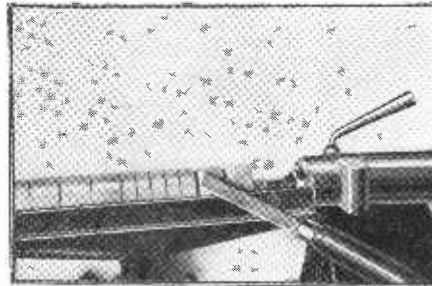

Position of skew, with hands removed, for convex cut.

down with parting tool; and smooth with small skew as in the shoulder cut exercise of last month. Now mark the center for each bead with a fine line, and proceeding as in the previous exercise, cut the right side of all the beads, then reversing the tool, cut the left side, completing the exercise.

The combination cut is an exercise involving all of the cuts practised on up to this time; and calls for good judgment, in order to secure well-proportioned curves.

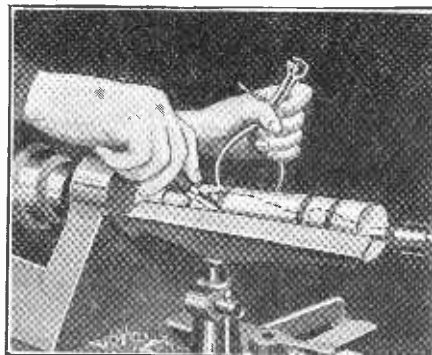

Depth gauge with the parting tool and callipers at several points for chisel handle before shaping.

A Personal Service for INVENTORS

I maintain an unexcelled organization and thoroughly equipped laboratories, to render the following services.

I PREPARE APPLICATIONS for patents for filing in the United States and foreign countries.

I PLACE INVENTIONS with responsible manufacturers, with whom I am acquainted, under arrangements that are made profitable to the inventor.

I SPECIALIZE in Electrical, Mechanical, Chemical, and Radio Devices.

I INVITE CORRESPONDENCE with reputable inventors, Scientists, Chemists and Physicists, regarding their inventions and uncompleted experiments.

H. R. VAN DEVENTER
Licensed Professional Engineer
Registered Patent Attorney
342 Madison Avenue, New York City

PATENTS

BOOKLET FREE HIGHEST REFERENCES PROMPTNESS ASSURED BEST RESULTS
Send drawing or model for examination and advice:

WATSON E. COLEMAN, Patent Lawyer
724 9th Street, N. W., Washington, D. C.

NEW YEAR - NEW IDEA
PATENT YOUR IDEAS
Call or send me a sketch of your invention. Phone LONGacre 3088
FREE Inventors Recording Blank Confidential Advice
U. S. and Foreign Patents secured by
Z. H. POLACHEK Reg. Patent Attorney Consult. Engineer
1234 Broadway, New York

MACHINE SHOP
FOR GENERAL AND EXPERIMENTAL WORK
Expert Mechanician in Electrical and Machine Work of all Kinds. Models, Light Manufacturing. Established since 1878. Paul Hoenaek, 108 Park Row, near Chambers Street, New York City. If it's mechanical, we make it.

WE COMMERCIALIZE INVENTIONS
Communicate with us if you have a patent to sell or wish to buy one.
North American Finance & Development Corp.
915-15th St., N. W., Washington, D. C.

EDGAR M. KITCHIN
Attorney and Counsellor at Law
Patent and Trade Mark Specialist
805 G. Street, N. W. Washington, D. C.

\$1.00 PER HOUR

Earned by our agents in spare time

You too can do it by soliciting subscriptions for two popular magazines. No trouble to sell. Beginners given help to get started.

If you want to add to your income, doing easy, pleasant work among friends and neighbors, if you are sincere,

send for full information right now. Address

AGENCY DEPT.
EXPERIMENTER PUBLISHING CO.
230 Fifth Ave., New York, N. Y.

With the next work we take up something that will be useful. Chisel handles are always needed, and two designs are shown, both to be used with the common woodworkers' socket firmer chisels; one for light work and the other for heavy duty.

There is nothing new to be learned in

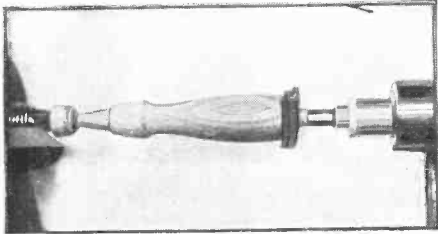

Leather tip on chisel handle glued in place and ready for final turning.

turning the chisel handles, but that the small end of the handle should be placed at the dead center end of the lathe.

In the case of the leather-tipped handle, take some scraps of leather or shoe soles; cut into squares as large as the end of the handle; bore 1/2" holes in these squares of leather with an ordinary auger bit; fit over the end that has been turned for this, and glue them in place with wood glue. After this has been allowed to set for twenty-four hours, the handle is ready for final turning.

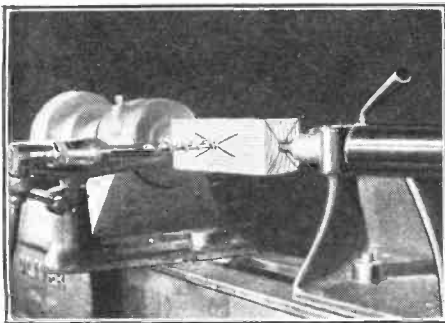

Bore hole in block for mallet head before turning.

This will prove to be a very efficient handle for heavy work and will stand a great deal of abuse without splitting.

The woodworker's mallet is turned in two pieces, and should be made of hickory or maple. The hole for the handle should be bored before the head is turned, great care being taken to bore at right angles. A saw cut should be made in the end of the handle and a wedge driven in as the handle is inserted into the head.

DARNING GOURD

THE last project in this group is the darning gourd. Make this of maple or

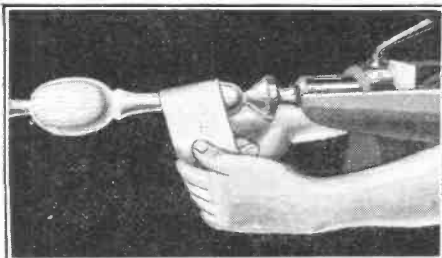

Sanding. Have rest out of the way and use narrow strips of fine sandpaper.

other close-grained hardwood, being careful to keep good curves and lines.

For the first time, on the darning gourd, the use of sandpaper on turning work is

(Continued on page 381)

PATENTS TRADE-MARKS AND COPYRIGHTS



OUR OFFER: FOR THE PROTECTION OF YOUR INVENTION YOUR FIRST STEP. The inventor should write for our blank form—"RECORD OF INVENTION." This should be signed, witnessed, and returned to us, together with model or sketch and description of the invention for INSPECTION and ADVICE FREE!

Our FIVE Books Mailed Free to Inventors

Our Illustrated Guide Book

HOW TO OBTAIN A PATENT

Contains full instructions regarding U. S. Patents, Our Methods, Terms, and 100 Mechanical Movements illustrated and described.

OUR TRADE-MARK BOOK

Shows value and necessity of Trade-Mark Protection. Information regarding Trade-Marks and unfair competition in trade;

OUR FOREIGN BOOK

We have Direct Agencies in Foreign Countries and secure Foreign Patents in shortest time and at lowest cost.

PROGRESS OF INVENTION

Description of World's Most Pressing Problems by Leading Scientists and Inventors. All Communications and Data Strictly Confidential. Interference and Infringement Suits Prosecuted.

DELAYS ARE DANGEROUS IN PATENT MATTERS

IMPORTANT! To Avoid Delay!

YOU SHOULD HAVE YOUR CASE MADE SPECIAL IN OUR OFFICE to save correspondence, secure protection and early filing date in the Patent Office. To secure special preparation of your case send \$25.00 on account with model or sketch and description of invention.

Our Lawyers Practice in all U. S. Courts and defend Clients in Suits involving Patents, Trade-Marks and Copyrights

OUR ORGANIZATION OFFERS PERSONAL SERVICE

By Experienced Patent Lawyers, Solicitors and Draftsmen

We regard a satisfied client as our best advertisement, and furnish, upon request, lists of clients in any state for whom we have secured patents.

Highest References—Prompt Service—Reasonable Terms

WRITE TODAY

FREE COUPON

VICTOR J. EVANS & CO.

Registered Patent Attorneys

MAIN OFFICES: 715 Ninth St., Washington, D. C.

BRANCH OFFICES: 1007 Woolworth Bldg., New York City; 518-519 Liberty Bldg., Philadelphia, Pa.; 514 Empire Bldg., Pittsburgh, Pa.; 1114 Tacoma Bldg., Chicago, Ill.; 1010 Hobart Bldg., San Francisco, Calif.

Gentlemen: Please send me FREE OF CHARGE your books as described above

Name.....

Address.....



Increase Your Pay Within the next few months!

Are you sacrificing the best years of your life to a routine job, in the thought that you must stand in line for promotion—that you can advance only at the shuffling pace of the rank and file? The man who depends on length of service for advancement rarely gets beyond the information desk.

Why throw away your future in a low-pay job, when you can qualify, in a comparatively few months, for a high-salaried position as a business specialist?

Thousands of men with no better start than you have doubled and tripled their incomes by home-study business training under the LaSalle Problem Method. During a period of only six months, 1,248 members of LaSalle Extension University reported definite salary-increases as a result of training under this remarkable method. *The average increase per man was 89 per cent.*

If "half as much again" would look good to you within the next twelve months, check the training that interests you, sign and mail the coupon NOW. It will bring you full particulars, together with details of our convenient-payment plan; also your free copy of "Ten Years' Promotion in One." "Get this book," said a prominent Chicago executive, "even if you have to pay five dollars for it." We will send it free.

Make your start toward that bigger job TODAY.

— Find Yourself Through LaSalle! —

LaSalle Extension University

The World's Largest Business Training Institution

Dept. 8384-R Chicago

Gentlemen: Send without obligation to me information regarding course indicated below:

- | | |
|---|---|
| <input type="checkbox"/> Business Management | <input type="checkbox"/> Modern Business Correspondence |
| <input type="checkbox"/> Modern Salesmanship | <input type="checkbox"/> Modern Foremanship |
| <input type="checkbox"/> Higher Accountancy | <input type="checkbox"/> Personnel Management |
| <input type="checkbox"/> Traffic Management | <input type="checkbox"/> Expert Bookkeeping |
| <input type="checkbox"/> Railway Station Management | <input type="checkbox"/> C. P. A. Coaching |
| <input type="checkbox"/> Law: Degree of LL. B. | <input type="checkbox"/> Business English |
| <input type="checkbox"/> Commercial Law | <input type="checkbox"/> Commercial Spanish |
| <input type="checkbox"/> Industrial Management | <input type="checkbox"/> Effective Speaking |
| <input type="checkbox"/> Factory Management | <input type="checkbox"/> Stenotypy—Stenography |
| <input type="checkbox"/> Banking and Finance | <input type="checkbox"/> Telegraphy |
| <input type="checkbox"/> Credit and Collection Correspondence | |

Name

Present Position

Address

HOW TO OBTAIN

A Perfect Looking Nose



My latest improved Model 25 corrects now ill-shaped noses quickly, painlessly, permanently and comfortably at home. It is the only nose-shaping appliance of precise adjustment and a safe and guaranteed patent device that will actually give you a perfect looking nose. Write for free booklet which tells you how to obtain a perfect looking nose. M. Trilety, Pioneer Nose-shaping Specialist, Dept. 3107, Binghamton, N. Y.

Free Mailing Lists

Will help you increase sales. Send for FREE catalog giving counts and prices on thousands of classified names of your best prospective customers—National, State and Local—Individuals, Professions, Business Concerns.

99% by refund of 5¢ each

ROSS-Gould Co. 315 N. 10th St. St. Louis

The Metal Emperor

By A. MERRITT

(Continued from page 323)

serpentine chain of lightnings. A sudden, cyclonic gust swept the cleft, whirling us like leaves back toward the Pit. I threw myself upon my face, clutching at the smooth rock. A volley of thunder burst—but not the thunder of the Metal Hordes. The bowing of the lightnings of our own earth.

And the wind was cold. It bathed the burning skin and cooled the fevered lungs.

Again the sky was split by the lightning. Then down roaring from it in solid sheets swept the rain.

From the Pit arose a hissing as though within it raged Babylonian Tiamat, Mother of Chaos, serpent dweller in the void.

Buffeted by the wind, beaten down by the rain, clinging to each other like drowning men, Ventnor and I pushed on to Norhala's house. The light was dying fast. The light became embers and died, blackness clasped us. Guided only by the lightnings, we beat our way to the door.

In the glare we saw Drake bending over Ruth. A slide began to slip over the open portal through which shrieked the wind and streamed the rain. As though its crystal panel was moved by some unseen, gentle hands, the portal was closed and the tempest shut out!

We dropped beside Ruth upon a pile of silken stuffs—marveling, trembling with a mingled agony of pity and thanksgiving.

For we knew—each of us knew with an absolute definiteness as we crouched there among the racing, dancing, black and silver shadows with which the lightnings filled the blue-globe—that the Metal Horde was dead.

With all its power, all its beauty and its terror, its colossal indifference to man and its colossal menace to him, its wisdom and its mysteries—the Thing was dead.

Slain by itself!

CHAPTER XXXI

RUTH'S AWAKENING

RUTH sighed and stirred. Her limbs relaxed and her skin faintly flushed, she lay in deep but natural slumber. Ventnor passed through the curtains of the central hall, returned with one of Norhala's cloaks, and covered the girl with it.

An overwhelming sleepiness took possession of me, a weariness ineffable. Nerve and brain and muscle went slack and numb. Without a struggle I surrendered to overpowering stupor and, cradled deep in its heart, ceased consciously to be.

When my eyes unclosed the chamber of the moon-stone walls was filled with a silvery, crepuscular light. I heard the murmuring and laughing of running water, the play of the fountained pool.

I lay for whole minutes luxuriating in the sense of tension gone, and of security. Memory spurred me. Quickly I sat up. Ruth still slept, breathing peacefully beneath the cloak, one white arm stretched over the shoulder of Drake—as though in her sleep she had drawn close to him.

At her feet lay Ventnor, as deep in slumber as they. I arose and tiptoed over to the closed door. Searching, I found its key, a cupped indentation, upon which I pressed.

The crystalline panel slipped back. It was moved, I suppose, by some mechanism of counterbalances responding to the weight of the hand. It must have been some vibration of the thunder which had loosed that



-in all its phases!

Complete instruction course in three volumes. Every point of aviation efficiently and thoroughly treated. Subjects covered in these volumes—



MODERN AIR CRAFT

700 Pages

500 Illustrations

Contents of each chapter— I. Aircraft Types. II. Lighter-than-Air Craft. III. Early Airplane Designs. General Design Considerations. IV. Design and Construction of Aerofolds. V. Arrange-

ment, Fabrication and Bracing of Airplane Wings. VI. Airplane Fuselage and Landing Gear Construction. VII. Airplane Power Plant Types and Installation. VIII. Aviation Engine Design and Construction. Air-Cooled Engines. IX. Aviation Engine Design and Construction. Water-Cooled Engines. X. Aviation Engine Auxiliaries. XI. Aircraft Propeller Construction and Action. XII. Airplane Equilibrium and Control Principles. XIII. Uncrating, Setting Up and Aligning Airplane. XIV. Inspection and Maintenance of Airplanes and Engines. XV. Details of Modern Airships and Airplanes. XVI. Seaplanes, Flying Boats, Amphibians and Other Aircraft. XVII. Some Aspects of Commercial Aviation. XVIII. Aircraft Instruments and Aerial Navigation. XIX. Standard Nomenclature for Aeronautics Report No. 240, Part I.

This book is written in simple, understandable language.

PRICE \$5.00

AVIATION ENGINES



This treatise, written by a recognized authority on all of the practical aspects of internal combustion engine construction, maintenance, and repair, fills the need as no other book does. The matter is logically arranged; all descriptive matter is simply expressed and copiously illustrated, so that anyone can understand airplane engine operation and repair even if without previous mechanical training. This work is invaluable for anyone desiring to become an aviator or aviator mechanic.

274 PAGES

PRICE \$1.25

A. B. C. OF AVIATION

This book describes the basic principles of aviation, tells how a balloon, or dirigible is made, and why it floats in the air. Describes how an airplane flies. It shows in detail the different parts of an airplane, what they are, and what they do. Describes all types of airplanes and how they differ in construction, as well as detailing the advantages and disadvantages of different types of aircraft. It includes a complete dictionary of aviation terms and clear drawings of leading airplanes.



PRICE \$1.25

Remit by cash, stamps, check, or money order. No C.O.D.'s

We Pay Postage On All Books

CONSRAD COMPANY, Inc.
230 FIFTH AVENUE NEW YORK



Paint by Air
NOW!
New, Quick,
Easy Way—No Brush

Now you can own a KB SPRAY GUN that makes painting a pleasure. Applies Lacquers, Varnishes, Paints, etc., leaving a smooth, glass-like finish. Ideal for Automobile painting, Furniture, Wickerware, Screens, and any odd job around the house.

MAKE \$50 TO \$100 A WEEK
On account of the unusual demand for this wonderful KB HAND-OPERATED SPRAY GUN big money-making possibilities are open in every locality. Thousands of homes are anxious to get it. Be the first in your locality.

Send No Money
Just order C.O.D. and pay special agent's price of \$9.75, plus transportation on arrival, or if you prefer, remit with order.

SPECIAL OFFER
Complete Outfit **\$9.75**

The Ideal Home Painting Outfit

Agents Wanted

Weights only 7 lbs.

Write for free circular

KOCH BROS. MFG. CO.
1515 Lawrence Ave., Dept. 21 Chicago, Ill.

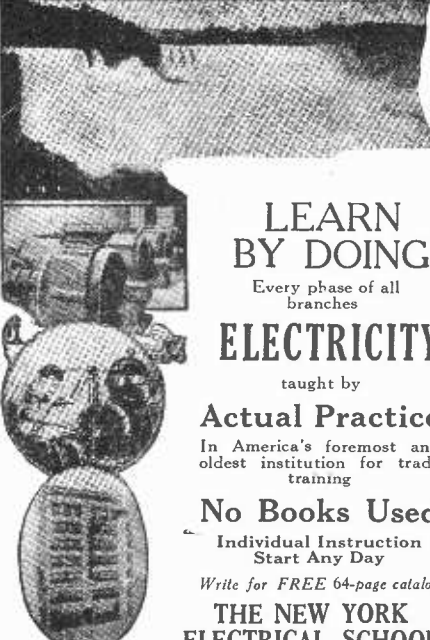

LEARN BY DOING
Every phase of all branches

ELECTRICITY
taught by

Actual Practice
In America's foremost and oldest institution for trade training

No Books Used
Individual Instruction Start Any Day

Write for FREE 64-page catalog

THE NEW YORK ELECTRICAL SCHOOL
29 West 17th St., New York City



A CHANCE TO START YOUR OWN BUSINESS
Either Full Time or Spare Time AS OUR REPRESENTATIVE Making Metal Toys and Novelties, a new industry in America, offers you great opportunity for Big Profits. Demand exceeds supply for Toy Soldiers, Animals, etc. and 10c Store Specialties, Ash Trays, Auto Radiator Ornaments, etc. We co-operate with you in selling goods you make, also buy them from you. Small investment puts you on Road to Success. WE FURNISH COMPLETE OUTFITS AND START YOU IN WELL-PAYING BUSINESS. Absolutely No experience necessary and no special place needed. A chance of a lifetime for man with small capital. ACT AT ONCE! If you want to handle Big Wholesale orders now being placed. Write for free catalog and full information.

METAL CAST PRODUCTS CO.
Dept. E, 1696 Boston Road New York

MEN TO LEARN
MOTION PICTURE PROJECTION
A BIG-MONEY PROFESSION—\$2,000 TO \$4,000
We Assist Students to Earn While Learning

MOVIE OPERATORS SCHOOL
61 Sprout Street Detroit, Michigan



SQUAB BOOK FREE
Breed squabs and make money. Sold by millions. Write at once for free 40-page book beautifully printed in colors telling how to do it. You will be surprised.

PLYMOUTH ROCK SQUAB CO.
506 H St., Melrose Highlands, Mass.

mechanism, and had closed the panel under the heels of our entrance—so I thought. Then seeing again in memory that uncanny, deliberate shutting I was not all convinced that it had been the thunder.

I looked out. How many hours the sun had been up there was no means of knowing. The sky was low and slaty grey. A fine rain was falling. The garden of Norhala was a wreckage of uprooted and splintered trees, and torn masses of what had been blossoming verdure.

The gateway of the precipices beyond which lay the Pit was hidden in webs of rain. Long I gazed down the canyon—and longingly, striving to picture what the Pit now held and eager to read the riddles of the night.

There came from the valley no sound, no movement, no light.

I re-entered the blue globe and paused on the threshold, looking into the wide wondering eyes of Ruth, bolt upright in her silken bed; Norhala's cloak clutched to her chin like a suddenly awakened and startled child. She stretched out her hand. Drake, wide awake on the instant, leaped to his feet, his hand jumping to his pistol.

"Dick," cried Ruth, her voice tremulous and sweet.

He swung about and looked deep into the brown eyes in which, with leaping heart I realized it, now was throned that spirit that was Ruth's, and Ruth's alone.

Ruth's clear, unshadowed eyes were glad and shy and soft with—love.

"Dick!" she whispered, and held soft arms out to him. The cloak fell from her. Their lips met.

Upon them, embraced, the wakening eyes of Ventnor dwelt, filled with a joyous relief.

Ruth drew herself from Drake's arms, pushed him from her and stood for a moment shakily, with covered eyes.

"Ruth!" called Ventnor softly.

"Oh!" she cried. "Oh, Martin—I forgot—" she ran to him, and held him tight, her face hidden in his breast. His hand rested on the clustering curls, tenderly.

"Martin." She raised her face to him. "Martin! it's gone! The taint, I mean. I'm—me again! All me! What happened? Where's Norhala?"

I started. Did she not know? Of course, lying bound as she had been in the vanished veils, she could have seen nothing of the tragedy enacted beyond them—but had not Ventnor said that, possessed by the inexplicable obsession evoked by the weird woman, Ruth had seen with her eyes, thought with her mind?

And had there not been evidence that in her body had been echoed the torments of Norhala's own death struggle?

Had she forgotten? I started to speak and was checked by Ventnor's swift warning glance.

"She's—over in the Pit," he answered her casually. "But do you remember nothing, little sister?"

"There's something in my mind that's been rubbed out," she replied. "I remember Ruzsark—and your torture, Martin—and mine—"

"Nothing else?" asked Ventnor.

Her face whitened, Ventnor's brow contracted, anxiously. I knew for what he watched—but Ruth's face was all human. On it was no shadow nor trace of that alien soul which so few hours since had threatened us.

"Yes," she nodded. "I remember. I remember how Norhala repaid them. I remember that I was glad, wickedly, fiercely glad, and then I was tired—so tired! And then—I come to the rubbed-out place," she ended, perplexedly.

Deliberately he changed the subject. He held her from him at arm's length.

"Ruth!" he exclaimed half mockingly, half reprovingly. "Don't you think your morn-

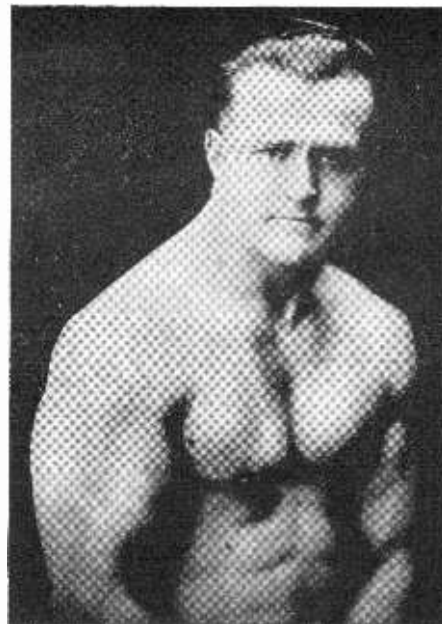

EARLE E. LIEDERMAN, the Muscle Builder
Author of "Muscle Building," "Science of Wrestling," "Secrets of Strength," "Here's Health," "Endurance," etc.

Now You Can Buy Strength!

How Much Do You Want?

Yes sir! Strength—that vital force and energy on which every man's health, happiness, success and very life itself depends—is now for sale.

Of course, I don't sell muscles at 10c each over the counter. You can't buy them like so many bars of soap. You've got to do your share, too. But it is simple if you will just follow my advice for 30 days. In one short month I can give you so much new strength that you'll have to pinch yourself to make sure you're the same man.

Over 100,000 Men Have Bought Strength from Me!

All over the world I am known as the "Muscle Builder." My scientific system of quick muscle building and method of developing new body energy by a few minutes work with you each morning is recognized everywhere as one of the few sure methods of correct scientific strength building.

Within three short months over 100,000 men have acquired more health, strength and energy from me than they ever thought possible.

Here's What I Do for You

In just 30 days I'll add one whole inch of real, live muscle to each of your arms. In those same 30 days I'll also put 2 full inches of health producing strength on your chest. Your legs will grow graceful and sturdy. You'll begin to acquire the light, fast foot work the professional fighter, or any man has when in the pink of health. Your shoulders will begin to broaden—your head snap back erect. You'll gain the confident sure stride of the man who feels sure he is on the road to success.

Then let me work on you a few minutes a day for 60 days more. It is in those final sixty days that the real fireworks occurs. What a change in you! You'll be a different man to your friends. A new, rejuvenated, husky, healthy he-man. A man they can count on in a pinch—a man that commands their respect and admiration. You'll be the sensation of your crowd. The women will all want to know you, and the men will envy you your health and strength.

Yes sir! Just reading this advertisement can be the turning point in your career. The difference between a happy success and a sorrowful failure. But you've got to do your part. You've got to act—and act at once! The first step is to fill out and mail the coupon to me today. It won't cost you a cent and it takes only a minute, so act now!

SEND FOR MY FREE BOOK

"MUSCULAR DEVELOPMENT" IT IS FREE!

It contains forty-eight full-page photographs of myself and some of the many prize-winning pupils I have trained. Some of these came to me as pitiful weaklings, imploring me to help them. Look them over now and you will marvel at their present physiques. This book will prove an impetus and a real inspiration to you. It will thrill you through and through. This will not obligate you at all, but for the sake of your future health and happiness do not put it off. Send today—right now before you turn this page.

EARLE E. LIEDERMAN

DEPT. 2708 305 BROADWAY, N. Y.

EARLE E. LIEDERMAN

Dept. 2708, 305 Broadway, New York City

Dear Sir: Please send me without any obligation on my part a copy of your book, "Muscular Development." (Please write or print plainly.)

Name.....
Address.....
City.....State.....



Only 28 years old and earning \$15,000 a year

W. T. CARSON left school at an early age to take a "job" in a shoe factory in Huntington, W. Va., at \$12 a week.

He worked hard and long and he had greater handicaps than you will ever have. But he refused to quit. He made up his mind that he was going to get ahead in a big way and nothing could swerve him from that resolve.

Today W. T. Carson is owner and manager of one of the largest battery service stations in West Virginia with an income of \$15,000 a year.

He gives full credit for his success to the International Correspondence Schools and says he still refers to the I. C. S. text-books. Just a few months ago the faculty of a large college in West Virginia called him in to demonstrate the principles of battery construction to a class in electricity. That shows how thoroughly he understands his work.

If the I. C. S. can smooth the way to success for men like W. T. Carson, it can help you. If it can help other men to win promotion and larger salaries, it can help you.

At least find out by marking and mailing the coupon printed below. It won't cost you a penny or obligate you in any way to ask for full particulars, but that one simple little act may be the means of changing your entire life.

Surely, W. T. Carson wouldn't be earning \$15,000 a year today if he hadn't found out about the I. C. S. when he did.

Mail the Coupon for Free Booklet

INTERNATIONAL CORRESPONDENCE SCHOOLS "The Universal University"

Box 6244-E, Scranton, Penna.

Without cost or obligation, please send me a copy of your booklet, "Who Wins and Why," and full particulars about the subject before which I have marked X:

BUSINESS TRAINING COURSES

- | | |
|--|---|
| <input type="checkbox"/> Business Management | <input type="checkbox"/> Advertising |
| <input type="checkbox"/> Industrial Management | <input type="checkbox"/> English |
| <input type="checkbox"/> Personnel Management | <input type="checkbox"/> Business Correspondence |
| <input type="checkbox"/> Traffic Management | <input type="checkbox"/> Show Card and Sign |
| <input type="checkbox"/> Accounting and C. P. A. | <input type="checkbox"/> Lettering |
| <input type="checkbox"/> Coaching | <input type="checkbox"/> Stenography and Typing |
| <input type="checkbox"/> Cost Accounting | <input type="checkbox"/> Civil Service |
| <input type="checkbox"/> Bookkeeping | <input type="checkbox"/> Railway Mail Clerk |
| <input type="checkbox"/> Salesmanship | <input type="checkbox"/> Common School Subjects |
| <input type="checkbox"/> Secretarial Work | <input type="checkbox"/> High School Subjects |
| <input type="checkbox"/> Spanish <input type="checkbox"/> French | <input type="checkbox"/> Illustrating <input type="checkbox"/> Cartooning |

TECHNICAL AND INDUSTRIAL COURSES

- | | |
|---|--|
| <input type="checkbox"/> Electrical Engineer | <input type="checkbox"/> Architect |
| <input type="checkbox"/> Electric Lighting | <input type="checkbox"/> Architects' Blueprints |
| <input type="checkbox"/> Mechanical Engineer | <input type="checkbox"/> Contractor and Builder |
| <input type="checkbox"/> Mechanical Draftsman | <input type="checkbox"/> Architectural Draftsman |
| <input type="checkbox"/> Machine Shop Practice | <input type="checkbox"/> Concrete Builder |
| <input type="checkbox"/> Railroad Positions | <input type="checkbox"/> Structural Engineer |
| <input type="checkbox"/> Gas Engine Operating | <input type="checkbox"/> Chemistry <input type="checkbox"/> Pharmacy |
| <input type="checkbox"/> Civil Engineer <input type="checkbox"/> Mining | <input type="checkbox"/> Automobile Work |
| <input type="checkbox"/> Surveying and Mapping | <input type="checkbox"/> Airplane Engines |
| <input type="checkbox"/> Plumbing and Heating | <input type="checkbox"/> Agriculture and Poultry |
| <input type="checkbox"/> Steam Engineering <input type="checkbox"/> Radio | <input type="checkbox"/> Mathematics |

Name.....

Street Address.....

City..... State.....

If you reside in Canada, send this coupon to the International Correspondence Schools Canadian, Limited, Montreal

LINDYTYPE AIRPLANE

New 1 1/2-ft. Cross-Atlantic Silver Sea Gull model Lindytype "Spirit of St. Louis" MONOPLANE \$1

Special introductory price. Rises from ground and flies 75 ft. or more by own power. Entire model finished in Brilliant Silver Lustre. Scientifically designed to last detail. Even the "Lone Eagle" himself is at the controls! Very educational! Decidedly realistic! Sensational performer! Thrilling fun as it zooms away through the air, banking, turning, soaring before gliding to earth. Easy construction set, put together in evening without tools, complete materials including six inch propeller, adjustable wings, full directions, postpaid U.S. \$1.00, Canada \$1.20. Satisfaction guaranteed or return outfit in five days and receive money back. Be the first to own one. Order yours NOW! MODEL AIRCRAFT CO., Box P, Chillicothe, Ohio

Guaranteed to Fly-or-Money Back

Insure your copy reaching you each month. Subscribe to SCIENCE AND INVENTION—\$2.50 a year. Experimenter Publishing Co., Inc., 230 Fifth Avenue, New York City.

ing negligee is just a little scanty even for this God-forsaken corner of the earth?"

Her eyes dropped to her bare feet, her dimpled knees. She clasped her arms across her breasts, and rosy red turned all her fair skin.

"Oh!" she gasped. "Oh!"

She hid from Drake and me behind the tall figure of her brother.

Laughing, I walked over to the pile of silken stuffs, took the cloak and tossed it to her. Ventnor pointed to the saddle-bags.

"You've another outfit there, Ruth," he said. "We'll take a turn through the place. Call us when you're ready. We'll get something to eat, and go see what's happening—out there."

She nodded. We passed through the curtains and out of the hall into the chamber that had been Norhala's. There we halted, Drake eyeing Martin with a certain embarrassment. The older man thrust out his hand to him.

"I knew it, Drake," he said. "Ruth told me all about it when Cherkis had us. And I'm glad, boy. I'm very glad. It's time she was having a home of her own, and not running around the lost places with me. This has taught me that. I'll miss her—miss her damnably, of course. But I'm glad."

There was a little silence while each looked deep into each other's hearts. Then Ventnor dropped Drake's hand.



Ventnor cried out. I could not hear him, but I read his purpose—and so did Drake. Up on his broad shoulders he swung Ruth. Back through the throbbing veils we ran and passed out of them.

"And that's all of that," he said. "The problem before us is—how are we going to get back home?"

"The—Horde—is dead!" I spoke from an absolute conviction that surprised me, based at it was upon no really tangible, known evidence.

"I think so," he said. "No—I know so, even as you do, Louis. Yet even if we can pass over its body, how can we climb out of its lair? That slide down which we rode with Norhala is unclimbable. The walls are unscalable. And there is the chasm she spanned for us. How can we cross that? And do you forget that the tunnel to the ruins was sealed? There remains, of possible roads, the way through the forest to what was the City of Cherkis. Frankly, I am loath to take it.

"I am not at all sure that all the armored men were slain—that some few may not have escaped and be lurking there. It would be short shift for us if we fell into their hands, now, Louis."

"And I'm not sure of that," objected Drake. "I think their pep and push must be pretty thoroughly knocked out—if any do remain. I think if they saw us coming they'd beat it so fast that they'd make smoke with the friction."

S. GERNSBACK'S RADIO ENCYCLOPEDIA

New limp Suede Edition



S. GERNSBACK'S RADIO ENCYCLOPEDIA is the first radio encyclopedia ever compiled. The many-sided labor of research involved in collecting the vast amount of information required to make this work a complete, dependable, and accurate guide, can best be realized from the fact that it took over two and one-half years to gather the material that it contains.

Every known circuit, each and every hook-up, every modern development in radio and electricity, every person of renown in the radio world, every word used in radio practice—this is what you will find in S. GERNSBACK'S RADIO ENCYCLOPEDIA.

But you will find it much more than just a dictionary of these terms. This pioneer radio encyclopedia is a manual of *applied* information, a working guide and instructor and an endlessly useful reference aid. There are 1,930 detailed definitions, 549 photographs, diagrams of circuits and drawings. A complete cross-index is just one of the many features of this remarkable book.

S. GERNSBACK'S RADIO ENCYCLOPEDIA can be had in either of two beautiful bindings.

The luxurious limp suede edition (\$5.00 a copy) was made to meet the demand for a more handsomely bound volume, after the usefulness of the book had been demonstrated by its extraordinary popular success in its plain first dress. This edition, designed for those connoisseurs who admit only choicely covered volumes to their libraries, is a masterpiece of *de luxe* binding.

The keratol-bound edition of this master Radio Encyclopedia can still be had for the original price of \$2.00. This is a neat, sturdy, workman-like book, offering precisely the same text, on equally attractive type pages.

Both editions are of the large 9" x 12" size, printed in clear, legible, large type. Both are adorned with gold-embossed cover titles.

More than 25,000 copies of the keratol-cover edition have already been sold, and are now being used, day in and day out, by that number of actual workers and students of radio, in colleges, schools, and public libraries, and special radio and other scientific institutions in every state in the country.

Mail this coupon now. No radio enthusiast can afford to be without this authentic guide, convenient and attractive in form, unfailingly serviceable in content—S. GERNSBACK'S RADIO ENCYCLOPEDIA.

S. GERNSBACK'S RADIO ENCYCLOPEDIA

Limp Suede Bound Edition.....\$5.00
Keratol Leather Stiff Binding..... 2.00

S. GERNSBACK

230 FIFTH AVE., NEW YORK, N. Y.

S. GERNSBACK,
230 Fifth Ave., New York, N. Y.

Kindly send me one copy of THE RADIO ENCYCLOPEDIA. I will pay postman.
Limp suede leather binding—\$5.00 plus postage.
Keratol leather binding—\$2.00 plus postage.
(check which binding you want)

Name.....

Address.....

City..... State.....

100 POWER MICROSCOPE
 Study wonders of insect, plant, other unseen worlds. Invaluable to Boy Scouts and experimenters. No toy, but a real instrument with imported lenses and mirror, complete in case.
\$4.50

250 POWER MICROSCOPE
 Laboratory type, for Physicians, Dentists, Doctors, and general professional work. Has quick adjustment by knurled nuts both sides of tube. Special device protects slides from breakage. Triple divisible objective gives different powers and large clear field of great depth. Square stage with Clips. Adjustable iris diaphragm, with plane and concave mirrors. Adjustable stand. A precision microscope complete with handsome case.
\$16.50

Catalog Free
 Apparatus Engineering Co.
 Dept. E, 342 Madison Ave.,
 New York City

450 Miles on a Gallon of Gas!

According to a recent article by the president of the world's largest motor research corporation, there is enough energy in a gallon of gasoline if converted 100% in mechanical energy to run a four cylinder car 450 miles.

NEW GAS SAVING INVENTION ASTONISHES CAR OWNERS

A marvelous device, already installed on thousands of cars, has accomplished wonders in utilizing a portion of this waste energy, and is producing mileage tests that seem unbelievable. Not only does it save gasoline, but it also creates more power, gives instant starting, quick pick-up, and eliminates carbon.



FREE SAMPLE and \$100 a Week

To obtain national distribution quickly, men are being appointed everywhere to help supply the tremendous demand. Free samples furnished to workers. Write today to E. Oliver, Pres., for this free sample and big money making offer.

WHIRLWIND MFG. CO.
 999-296 E. Third St., Milwaukee, Wis.

CAN YOU SELL GAS AT 5c PER GAL.?

Any man who can sell gas at 5c. per gallon should write at once to Frank Andrews, Dept. 863-L, 154 E. Erie St., Chicago, Ill. His agents make as high as \$3,000.00 a month. Send for free trial, proof, and \$15.00 a day guarantee to Distributors.

BUILD YOUR OWN CLOCK WITH OUR HELP
 Turn idle hours into welcome dollars building clocks. Very profitable spare time work. We furnish plans, instructions, works, dials, and all materials at low prices.
 Banjo Clocks, Mantel Clocks Works As Low As \$1.65
 Grandfather Clocks with Chimes
 Write for Catalog and FREE Blueprint Plan
AMERICAN CHIME CLOCK CO.
 1679-H RUFFNER ST., PHILADELPHIA, PA.

DEAFNESS IS MISERY

'Multitudes of persons with defective hearing and Head Noises enjoy conversation, go to Theatre and Church because they use Leonard Invisibile Antiseptic Ear Drums. Tiny Megaphones fitting in the Ear entirely out of sight. No wires, batteries or head piece. They are Unseen Comforts and inexpensive. Write for booklet and sworn statement of the inventor who was himself deaf.
A. O. LEONARD, Inc., Suite 785 70 5th Ave., N. Y.

"There's something to that," Ventnor said. "Still, I'm not keen on taking the chance. At any rate, the first thing to do is to see what happened down there in the Pit. Perhaps we'll have some other idea after that."

"I know what happened there," announced Drake surprisingly. "It was a short-circuit."

"A short-circuit?" asked Ventnor. "Burned out!" said Drake. "Every damned one of them—burned out. What were they, after all? A lot of living dynamos. Dynamotors—rather. And all of a sudden they had too much juice turned on. Bang! went their insulations—whatever they were."

"Bang! went they. Burned out—short-circuited. I don't pretend to know why or how. I can guess. The cones were some kind of immensely concentrated force—electric, magnetic, either or both, and more. I myself believe that they were probably solid—in a way of speaking—coronium."

"If about twenty of the greatest scientists the world has ever known are right, coronium is—well, call it curdled energy. The electric potentiality of Niagara in a pin-point of dust of yellow fire. All right—they or It lost control. Every pin-point swelled out into a Niagara. And as it did so, it expanded from a controlled dust dot to an uncontrolled cataract—in other words, its energy was unleashed and undammed."

"Very well—what followed? What had to follow? Every living battery of block and globe and spike was supercharged and went—blooey! That valley must have been some sweet little volcano while that short-circuiting was going on. All right—let's go down and see what it did to your unclimbable slide and unscalable walls, Ventnor. I'm not so sure we won't be able to get out that way."

"Come on, everything's ready." Ruth was calling. Her summoning blocked any objection we might have raised to Drake's argument.

It was no dryad, no distressed pagan maid we saw as we passed back into the room of the pool. In knickerbockers and short skirt, prim and self-possessed, rebellious curls held severely in place by close-fitting cap, slender feet stoutly shod, Ruth hovered over the steaming kettle swung above the spirit-lamp.

But she was very silent as we broke fast. Nor when we had finished did she go to Drake. She clung close to her brother, and beside him, with Dick striding at my elbow, we set forth at last down the roadway, through the rain, toward the ledge between the cliffs where the veils had shimmered.

Hotter and hotter it grew as we advanced. The air seemed like a Turkish bath. The mists clustered so thickly that at last we groped forward step by step, holding to each other. The wet heat became suffocating.

"No use," gasped Ventnor. "We couldn't see. We'll have to turn back."

"Burned out," said Dick. "Didn't I tell you? The whole valley must have been a volcano. And with that deluge of rain falling in it—why wouldn't there be a fog? It's why there is a fog. We'll have to wait until it clears."

We turned, stumbled back to visibility and trudged in retreat to the blue globe.

All that day the rain fell. Throughout the few remaining hours of daylight we wandered over the house of Norhala, examining its most interesting contents, or sat theorizing, discussing all phases of the phenomena we had witnessed; held back from definite conclusions as to their end, of course, by our uncertainty of what it was that actually lay within the Pit.

We told Ruth what had happened between that time she had thrown in her lot with Norhala until, with her in the arms of Drake, we had fled from the fiery opening of the Horde—that sunburst of jeweled in-

Make big money repairing, installing, servicing, Radio Sets
Openings Everywhere

Don't pass up this chance to have a profitable spare time or full time business of your own that the growth of Radio has made for you.

5375 in One Month Spare Time
 "Recently I made \$375 in one month in my spare time installing, servicing, selling Radio sets. Not long ago I earned enough in 'one week' to pay for my course."
 Earle Cummings, 18 Webster St., Haverhill, Mass.

\$1597 in Five Months
 "The N. R. I. is the best Radio school in the U. S. A. I have made \$1597 in five months. I owe my success to you."
 Henry J. Nicks, Jr., 302 Safford Ave., Tarpon Springs, Fla.

\$1164 Spare Time Profits
 "Look at what I made since I enrolled, \$1164—money I would not have had otherwise. I am certainly glad I took up Radio with N. R. I. I am more than satisfied."
 Henry R. Heikinen, 123 W. Erie St., Chicago, Ill.

So Many Opportunities You Can Make Money Almost at Once!
 Many students make \$10, \$20, \$30 a week extra while learning. I'll show you too how to begin shortly after you enroll. G. W. Page, 1807 21st Ave. S., Nashville, Tenn., made \$935 in his spare time while taking my course.

Your Money Back If Not Satisfied
 That's the agreement I make with you. You are the only judge. If my course and instruction service are not entirely satisfactory I will give your money back when you complete.

Find Out What Radio Offers You
 Get a copy of my book. It is free to any ambitious man or young man interested in getting ahead. Just tear out, sign and mail the coupon. No obligation.

You learn the "how" and "why" of Radio sets by building 100 circuits with the parts I give you. Here's one.

64 Page FREE Book
Mail this Coupon NOW

J. E. Smith, President, Dept. 87 National Radio Institute, Washington, D. C.
 Dear Mr. Smith: Send me your book. I want to know more about the opportunities in Radio and your practical method of teaching at home in spare time. This request does not obligate me to enroll and I understand no agent will call on me.
 Name _____ Age _____
 Address _____
 City _____ State _____

SKINDERVIKEN Transmitter Units

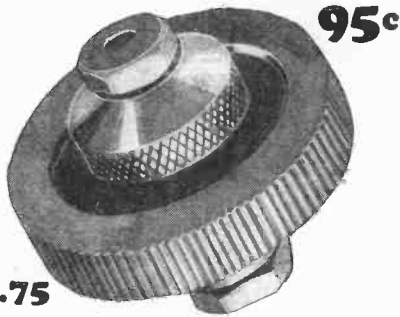

Two
for
\$ 1.75

Have hundreds of uses. Every amateur should have two or three of these amplifiers in his laboratory.

A FEW USES FOR THESE UNITS

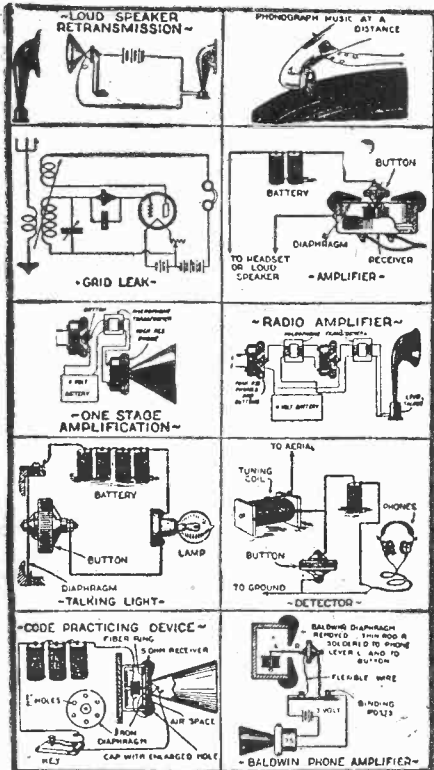

12 PAGE INSTRUCTION BOOKLET

containing suggestions and diagrams for innumerable uses, furnished with each unit.

WE PAY \$5.00 IN CASH

for every new use developed for this unit and accepted and published by us.

P. G. MICROPHONE TRANSFORMER

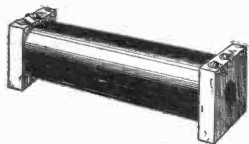

A Modulation Transformer specially designed for use with the Skinderviken Transmitter Unit. Has many other uses. Primary resistance 1 1/4 ohms. **\$2**

FOR SALE AT LEADING DEALERS

Or Order Direct, Using Coupon Below

SEND NO MONEY

When the postman delivers your order you pay him for whatever you have ordered, plus a few cents postage.

PRESS GUILD, INC. 16-18-S—East 30th St., New York, N. Y. S-8-28

Please mail me at once as many of the following items as I have indicated.
 Skinderviken Transmitter Units at 95c. for 1; \$1.75 for 2; \$2.50 for 3; \$3.20 for 4.
 P. G. Microphone Transformers at \$2.
 When delivered I will pay the postman the cost of the items specified plus postage.

Name.....
 Address.....
 City..... State.....

candescence between the downthrust of the flood of radiant corpuscles, the upthrust of the shining lake.

We told her of the enigmatic struggle between the Metal Emperor and the sullenly flaming Thing I have called the Keeper of the Cones.

We told her of the entombment of Norhala.

When she heard that she dropped her head upon her arms and wept.

"She was sweet!" she sobbed. "She was lovely, and she was beautiful. And dearly she loved me. I know she loved me! Oh, I know that we and ours and that which was hers could not share the world together. But it comes to me that Earth field would have been a garden more beautiful and far, far less poisonous with those that were Norhala's than it is with us and ours!"

Weeping, she went from us and passed through the curtains, into Norhala's chamber.

It was a strange thing indeed that she had said, I thought, watching her go. That the garden of the world would be far less poisonous blossoming with the Horde of wedded crystal and metal and magnetic fires than fertile, as now, with us of flesh and blood and bone. To me came appreciations of the harmonies of the Horde, their order—



It was afternoon of the second day that we found a rift in the wall of the valley. We decided to try it.

and like a black shadow, realization of struggling humanity. Drifted over my mind heterogeneous perceptions of the geometric energies, the miraculous co-ordination, whether united within the bulk of the monstrous City or activating apart from it either in units or in aggregations, and whether unit or aggregation still as much a part of the whole as those clustering to form the major mass.

Mingled with those perceptions were others of humanity—disharmonious, inco-ordinate, ever struggling, ever striving to destroy itself, unit against unit and government against government.

There was a plaintive whinnying at the door. A long and hairy face, a pair of patient, inquiring eyes looked in. It was the pony. For a moment it regarded us, and then trotted trustfully through, ambled up to us and poked its head against my side.

It had been ridden by one of the Persians whom Ruth had killed, for under it, with slipping girths, the saddle dangled. And its owner had been kind to it—we knew that from its lack of fear for us. Driven by the tempest of the night before, it had been led back by instinct to the protection of men.

"Some luck!" breathed Drake.

He busied himself with the whinnying little beast, stripping away the hanging saddle, grooming it.

THE NATIONAL SUCCESS COURSE

PRICE ~~\$24.60~~

Now **\$1.98**

24 Individual Lessons

A Necessary Guide to Business and Personal Efficiency

We have arranged to procure this valuable course for the readers of our magazine at the phenomenally low price of \$1.98. There are twenty-four full, complete lessons, treating all of the necessary points required for a successful business career and for personal efficiency—This course is an absolute requirement to any aspirant to business success.

The following are the subjects treated:

1. How to Get the Best Results
2. First Steps in Business Efficiency
3. How to do Business with Banks
4. The Principles of Business Achievement
5. How to Write Business Letters
6. How to Easily Develop Your Memory
7. How to Advertise Successfully
8. The Power of Right Thought
9. How to Make a Favorable Impression
10. How to Become a Successful Salesman
11. How to Prepare Sales Talks
12. How and Where to Find Customers
13. Your Health and How to Improve It
14. Psychology of Advertising and Salesmanship
15. Managing Men for More Profit
16. The Factors of Success in Business Building
17. The Money Value of System
18. How to Close Sales Successfully
19. How to Collect Money
20. How to Make Yourself Invaluable in Your Position
21. Premium and Sales Plans to Increase Business
22. A System of Accounts for Retail Merchants
23. Fundamentals of a Cost System for Manufacturers
24. Points of Law Everyone Should Know

SEND NO MONEY

Pay the Postman \$1.98 plus a few cents postage

CONSRAD CO.

230 Fifth Ave. New York, N. Y.

CONSRAD COMPANY
 230 Fifth Ave., New York, N. Y.
 Gentlemen: Send me your NATIONAL SUCCESS COURSE. I will pay the postman \$1.98 plus a few cents postage.

Name.....
 Address.....
 City..... State.....

CHAPTER XXXII

SLAG



Only a Buescher

Gives You All these Features

- Patented Snap-on Pads—the greatest improvement for beauty of tone—easy to replace, no more cementing. Found only on the Buescher.
- Patented Automatic Octave Key, always positive.
- Perfect Scale Accuracy; every tone always full, clear and true.
- 10 Evenings 1 Hour Each
- Quicker results are assured with a Buescher—you will be astonished at how easily it "comes" to you.
- Free Book** Illustrates all the various models, and contains pictures of many famous professionals—also first lesson chart. Send name for copy or ask for circular on any other instrument in which you are interested.

6 Days' Trial in your own home on any Buescher Saxophone, Cornet, Trumpet, Trombone or instrument.

Free with his Buescher

(471)

BUESCHER BAND INSTRUMENT CO., 2556 Buescher Block, Elkhart, Ind.

THAT night we slept well. Awakening, we found that the storm had grown violent again, the wind roaring and rain falling in such volume that it was impossible to make our way to the Pit. Twice, as a matter of fact, we tried, but the smooth roadway was a torrent, and drenched to the skin, even through our oils, we at last abandoned the attempt. Ruth and Drake drifted away among the other chambers. They were absorbed in themselves, and we did not thrust ourselves upon them. All that day the torrents fell.

We sat down that night to what was well-nigh the last of Ventnor's stores. Ruth's eyes were sparkling, she herself pulsing with life. Seemingly she had forgotten Norhala; she spoke no more of her, at least.

"Martin," she said, "can't we start home tomorrow? I want to get away. I want to get back to our own world."

"As soon as the storm ceases, Ruth," he answered, "we start. Little sister—I, too, want you to get back quickly."

The next morning the storm had gone. We wakened soon after dawn into clear and brilliant light. We had a silent and hurried breakfast. The saddle-bags were packed and strapped upon the pony. Within them were what we could carry of souvenirs, exhibits, from Norhala's home—a suit of lacquered armor, a pair of cloaks and sandals, the jeweled combs. Ruth and Drake at the side of the pony, Martin and I leading, we set forth toward the Pit.

"We'll probably have to come back, Louis," he said. "I don't believe the place is passable."

I pointed—we were then just over the threshold of the elfin globe. Where the veils had stretched between the perpendicular pillars of the cliffs was now a wide and ragged-edged opening.

The roadway which had run so smoothly through the scarp was blocked by a rocky barrier.

"We can climb it," said Ventnor.

We passed on. We reached the base of the barrier. An avalanche had dropped there. The barricade was the debris of the torn cliffs, their dust, their pebbles, and their boulders. We toiled up; we reached the crest; we looked down upon the valley.

When first we had seen it we had looked upon a sea of radiance pierced with lanced forests, swept with gigantic gonfalons of mists of flame. We had seen it emptied of its fiery mists—a vast slate covered with the chirography of a mathematical God. We had seen it as a radiant lake over which brooded weird suns, a lake of yellow sun froth upon which a sparkling hail fell, within which reared islanded towers and drowning mounts running with cataracts of sun fires. Here we had watched a Goddess woman, a being half of earth, half of the unknown, immured within a living tomb, a dying tomb, of flaming mysteries.

Where we had peered into the unfathomable, had glimpsed the infinite, had heard and had seen the inexplicable, was—Slag!

The amethystine ring from which had streamed the circling veils was cracked and blackened. Like a crown of mourning it stretched around the Pit. The veils were gone. The floor of the valley was fissured and blackened. Its patterns and its writings burned away. As far as we could see stretched a sea of slag—coal black, vitrified and dead.

Here and there black hillocks sprawled; huge pillars arose, bent and twisted as though they had been jettings of lava cooled into rigidity before they could sink back or break. They clustered most thickly around an immense calcified mound.

Somewhere within that mound rested the ashes of Norhala, sealed by fire in the urn

Magic

Learned Easily At Home



Dr. Harlan Tarbell, Master of Magic who has mystified magicians as well as laymen with his marvelous tricks.

Astonish Your Friends—

Gain that magnetic popularity that makes you the center of any crowd. Business and social success is assured the man who can perform mystifying tricks. You can earn big money either on the side or as a professional, as well as being the most popular person in your crowd. Why envy others' skill? You can learn Magic yourself, quick and easy.

Earn \$250 to \$1000 a Month

Even sleight-of-hand, generally supposed to require long practice, is NOW made simple to learn. For Dr. Harlan Tarbell, one of the really Great Magicians, has finally opened up the secrets of his profession in a completely illustrated course offered at a merely nominal cost. Through the wonderful Tarbell System you will be able to mystify and entertain your friends with simple tricks taught in your very first lesson. After that Dr. Harlan Tarbell takes you through the entire maze of sleight-of-hand, card tricks and elaborate stage diversions. The apparently superhuman doings of the accomplished magician becomes as simple as ABC when you just know how.

Mail Coupon for Free Magic Book

There is a tremendous demand for magic entertainment. Clubs, Lodges, Charity and Social affairs—all will pay high fees to the man who knows Magic. Dr. Harlan Tarbell really gets as high as \$250 for a half hour's work right now. Opportunity everywhere to make money aside from your regular occupation. Salesmen find it a tremendous asset. Write for free Magic Book telling all about amazing Tarbell course in Magic. Get our low prices and easy terms plan. Mail coupon NOW!

Tarbell System, Inc.
1926 Sunnyside Ave., Studio C 142 Chicago

Tarbell System, Inc.
1926 Sunnyside Ave., Studio C-142 Chicago
Tell me all about Dr. Tarbell's new and simple system by which I can learn the secrets of MAGIC. No obligation on my part.

Name.....
Address.....
Age.....

Orders - Inquiries

60 pages
Send for FREE Copy
Can be Secured by MAIL

POLK'S REFERENCE BOOK and Mailing List Catalog

Gives counts and prices on over 8,000 different lines of business. No matter what your business, in this book you will find the number of your prospective customers listed. Valuable information is also given as to how you can use the mails to secure orders and inquiries for your products or services.

Write for Your FREE Copy
R. L. POLK & CO., Detroit, Mich.
Largest City Directory Publishers in the World
Mailing List Compilers—Business Statistics
Producers of Direct Mail Advertising

Life's Secrets!

Amazing new book, "Safe Counsel," just out, tells you the things you want to know straight from the shoulder. Gives advice to newly married. Explains anatomy of reproductive organs, impotence, laws of Sex-Life, mistakes to avoid, diseases, pregnancy, etc. Contains 9 startling sections: 1—Science of Eugenics, 2—Love, 3—Marriage, 4—Child-birth, 5—Family Life, 6—Sexual Science, 7—Diseases and Disorders, 8—Health and Hygiene, 9—Story of Life. In all, 104 chapters, 77 illustrations, 612 pages. Examine at our risk. Mailed in a plain wrapper.

Send No Money

Write for your copy today. Don't send a cent. Pay postman only \$1.98, plus postage, on arrival. Money refunded if not satisfactory.

FRANKLIN PUBLISHING CO.
Dept. 6103, 800 N. Clark St., Chicago, Ill.

LEARN COSMETIC MANUFACTURE

AT HOME IN YOUR SPARE TIME

Easily learned. Experience unnecessary. Millions made manufacturing and selling Cosmetics. Taught you by the largest Cosmetic College in the world. We teach you at home in few weeks. Send for FREE Book today.

AMERICAN SCHOOL OF COSMETIC MANUFACTURE
743 So. Maple Ave. Dept. C Los Angeles, Calif.

Earn Money Gathering Butterflies—Insects

We require many kinds for scientific collections. Will pay \$25 to \$10 dollars each. Pleasant and profitable outdoor work under our instructions. Send 10c (coin) for Illustrated Prospectus.

CALIFORNIA LABORATORIES
Box 1771, Los Angeles, Cal.

SW

Don't Miss the Pleasures These BINOCULARS Bring

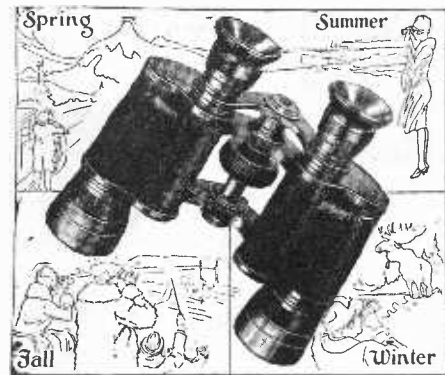

For Every Season of the Year!

PIERCE the Horizon! Bring people, scenes, ships, sports, wild game, to your feet! New worlds will open for you with these powerful Binoculars. All your life—they will be a prized possession.

Final Offering! FREE Trial!

GENUINE imported Binoculars, famous *Premiere Qualite* lenses—not six, not eight, but 10 *POWER* (10 times magnification). Exquisite illumination. Suited for long distance observation. Thousands sold to Army and Navy Officers, Commanders, Explorers, Big Game Hunters, Sportsmen. Indispensable for races, sports, hunting, vacation, motoring, voyaging, etc. Leather case, neck and shoulder straps. Usually sold for \$45.00 to \$55.00. Our final offering at **\$27.50**
Don't miss this great value!

Our Plan is Different!

It is arousing nation-wide comment. We ask for NO money in advance. NOTHING on Delivery. See, Try, Test, ENJOY Binoculars for 10 Days. ABSOLUTELY FREE!

If pleased, you may pay on Budget Plan: \$56.00 MONTHLY **\$25⁵⁰**
or if you prefer to pay cash at end of 10 DAYS, deduct \$2 and send check or Money Order for \$25.50 in FULL SETTLEMENT. Otherwise return them. Order NOW.

SEEVER-WILLIAMS CO.
Importers, Exporters, International Mail Order House
"2 Generations of Honorable Dealings"
365 Washington St., Boston, Mass.
Largest Retailers of Binoculars in the World
Gentlemen—Send me the 10-POWER BINOCULARS for 10 days FREE TRIAL on your "NO Money in Advance—NO Money on Delivery" Plan.
Name.....
Address.....
Clip and mail this Ad. NOW! If a new customer, please tell us something about yourself. We will appreciate and respect the information. THANK YOU. Sc.&Inv. 8-28

CHEMISTRY
Complete, practical home-study courses prepared by some of the best-known chemists in this country, including ALLEN ROGERS, B.S., M.S., Ph.D.—Head of Department of Industrial Chemistry, Pratt Institute; L. M. TOLMAN, Ph.D., Vice-president, United Chemical and Organic Products Co.; BRADLEY STOUGHTON, B.S.—Head of the Department of Metallurgy, Lehigh University, and OWEN L. SHINN, Ph.D.—Professor of Applied Chemistry, University of Pennsylvania.
Mail Coupon for Free Booklet

INTERNATIONAL SCHOOL OF CHEMISTRY
Division of the International Correspondence Schools
Box 6246-E, Scranton, Penna.
Without cost or obligation, please send me full details of your home-study course in
 Analytical Chemistry Metallurgical Chemistry
 Chemical Engineering Short Chemistry Course
 Industrial Chemistry Pharmacy
Name.....
Address.....

BE A DETECTIVE
Earn Big Money. Work home or travel. Make secret investigations. Experience unnecessary. Write Dept. S. A. American Detective System, 2190 Broadway, N. Y.

of the Metal Emperor!
From side to side, in broken beaches, in waves and hummocks, in blackened, distorted tusks and warped towerings, reaching with a hideous pathos in thousands of forms toward the charred mound was naught but—
Slag!

From rifts and hollows, still filled with water, little wreaths of steam drifted. In those futile wraiths of vapor was all that remained of the power of the Metal Horde.

Catastrophe I had expected, tragedy I knew we would find—but I had looked for nothing so filled with the abomination of desolation, so frightful as was this.

"Norhala!" sobbed Ruth.
"Burned out!" muttered Drake. "Short-circuited and burned out! Like a dynamo—like an electric light!"

"Destiny!" said Ventnor. "Destiny!"
We began, to pick our way down the heaped debris and out upon the plain. For all that day and part of another we searched for an opening out of the Pit.

Everywhere was the calcination. The surface that had been the smooth metallic carapaces with the tiny eyes deep within them, crumbled beneath the lightest blow. Not long would it be until they dissolved under rain and wind into mud and dust.

And it grew increasingly obvious that Drake's theory of the destruction was correct. The clustered Horde had been one prodigious magnet—or, rather a prodigious dynamo. By magnetism, by electricity, it had lived and had been activated. Whatever the force of which the cones were built, it was certainly akin to the electro-magnetic energies.

When, therefore, in the cataclysm, that force was diffused, it drew to itself the floods of atmospheric electricity that we had seen as a storm of sparkling corpuscles. There had been created a magnetic field of incredible intensity and there had been concentrated an electric charge of inconceivable magnitude.

Discharging, it had blasted the Horde—short-circuited it, burned it out, even, as Drake had said.

But what was it that had led up to the cataclysm? What was it that had turned the Horde upon itself? What disharmony had crept into that supernal order to set in motion the machinery of disintegration?

We could only conjecture. The cruciform Shape I have named the Keeper was the agent of the destruction—without a doubt.

In that enigmatic organism which when many still was one, and while one still was many, the Keeper had its place, its work, its duties.

So, too, had that wondrous Disc, whose visible power, whose manifest leadership had made us name it—Emperor.

And had not lost Norhala called it—Ruler?

What were the responsibilities of the twain to the mass of the organism of which they were such important units? What were the laws they administered, the laws they must obey? Certainly something of that mysterious law which Maeterlinck has called the spirit of the Hive—and something perhaps infinitely greater, like that which governs the swarming sun bees of Hercules' clustered orbs.

Had there evolved within the Keeper of the Cones—guardian and engineer as it was, of the power-hiving mechanisms—ambition? Had there risen within it determination to wrest to itself all power?

How else explain that conflict I had first sensed when Drake and I had been plucked from the Keeper's grip? How else explain that duel in the shattered hall of the cones whose end had been the signal for cataclysm? How else explain the alignment of the cubes behind the Keeper against the globes and pyramids loyal to the will of the Emperor?

Or had it envied the Disc the possession of—Norhala?
Enigma!



DIESEL & OIL ENGINEERING HAND BOOK

(Rosbloom)

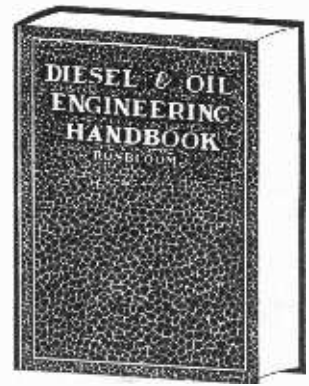

Fourth Enlarged Edition

The World's Standard Book on Diesel and Other Classes of Oil Engines

A remarkable book of greatest value to all engineers, mechanics, and others interested in Diesel engines for land, marine, locomotive, automobile, and aircraft use. Over 300 tables, hundreds of formulae, profusely illustrated with color and plain views. Courses of instruction on all leading types. 830 pages. Size 5 x 7 inches. Bound in flexible, semi-flexible and stiff covers of very attractive imitation leather with reinforced back.

Price \$5.00 Prepaid

Order Direct from Book
Department

EXPERIMENTER PUB. CO.
230 Fifth Avenue, New York



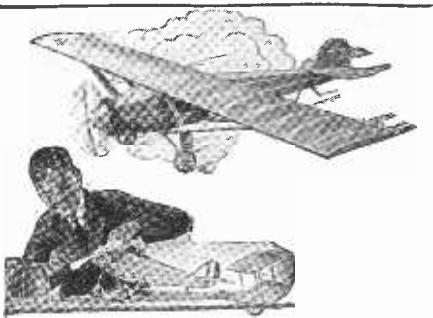

Build This IDEAL Flying Model of the "Spirit of St. Louis"

A PERFECT 3-ft. miniature of the most famous Airplane in the world; anybody can build and fly it. The IDEAL Complete Construction Outfit contains everything needed; all parts, fittings and materials, full plans, diagrams and instructions. The Model is guaranteed to fly when correctly built; **complete construction outfit (West of Denver, Colo., and in Canada, 8.00) \$7.50** Ask your Dealer, or Order Direct

Plans for Model Airplanes Complete, accurate, 1/8-size Plans, with building-dying instructions, for any one of the following: New York-Paris; FOKKER; Curtiss; DeHAVILLAND; NC-4 Seaplane; Bleriot; Faubert or Niépport; Codel; Peoli—Model Book Free with each plan **25c**

164-Page BOOK for MODEL BUILDERS Contains plans for building Gliders and Racers; full information about Scale Models and most complete catalog of Parts, Supplies, Materials and Fittings for all kinds of Models..... **Postpaid for 5c**

Ideal Aeroplane & Supply Co., Inc.
22-24 West 19th St., New York City

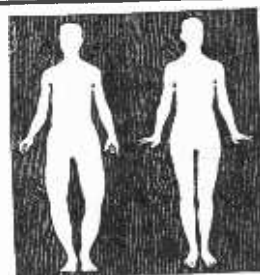

PERSONAL Appearance

is now more than ever the key note of success, both in social and business life. **Bow - Legged and Knock - Kneed men and women**, both young and old, will be glad to hear that my new appliance will successfully straighten, within a short time, bow-leggedness and knock-kneed legs, safely, quickly and

permanently, without pain, operation or discomfort. U. S. Patent, is easy to adjust; its results will soon save you from further humiliation, and improve your personal appearance 100 per cent. (Model 18 is not like old-fashioned splints or braces, with bothersome straps, hard to adjust, but a scientific, modern device of proven merit, used and recommended for the last 7 years by physicians everywhere.) Write today for particulars, testimonials, and my free copyrighted physiological and anatomical book, which tells you how to correct bow and knock-kneed legs without any obligation. Enclose a dime for postage.

M. TRILETY, Specialist 1656 L. W. U. Building, Binghamton, N. Y.

PARKS WOODWORKING MACHINES

Cabinet Shop Special No. 10

\$290 with Motor

You ought to have this handy Parks in your shop. Compact, complete machine designed like a big production outfit at one-fifth the cost. Fits in a corner of your basement. Does any kind of cabinet and joinery work. Write for circular

THE PARKS WOODWORKING MACHINE CO.
1553 Knowlton Street, Cincinnati, Ohio
Canadian Factory: 208 Notre Dame East, Montreal

LARGE 48 PAGE \$1.00 CIRCULAR SERVICE

Mail Dealers!—Sell Books, Formulas, Novelties, Bargains! Our Ready Made Circular Service Saves You Money. Large Profits! Thirty Attractive Propositions. Popular Sellers. Large Catalog "Sell by Mail" Free!

F. A. ELFCO
519 So. Dearborn St. Chicago, Illinois

And enigma, save for inconclusive theories, must remain the question of the Horde's origin. Whether the Horde had come from the geometric star or Ventnor's vision, or whether they were as his second vision seemed to hint, children of a secret caverned womb of earth, when they had come forth if the latter, how boarding this planet if from the star, why long ere this they had not swung out to conquer and to level to their will of metal and of crystal and of living fire, this world of ours—to all these questions we could find no answers.

If answers there were, they were lost forever in the slag we trod.

Of that slag we took no specimens—search as we might we could find no shape, great or small, that had not been fused by that enormous pulse of blasting, electrical energy beyond our strength to separate.

It was afternoon of the second day that we found a rift in the wall of the valley. We decided to try it.

We had not dared to take the road by which Norhala had led us. The giant slide was broken and climable, it was true. But even if we could have passed it safely through the tunnel of the abyss there was left the chasm over which we could have thrown no bridge, and if we could have bridged it, still at the end was the cliff whose shaft Norhala had sealed with her lightnings.

So we entered the rift.

Of our wanderings thereafter I need not write. From the rift we emerged into a maze of valleys, and after a month in that wilderness, living upon what game we could shoot, we found a road that led us into Gyantse.

In another eight weeks we were home. My story is finished.

There in the Asian wilderness is the blue bubble that was the home of the lightning witch, Norhala—and looking back I know now she could not have been all woman. There is the dead lair of the Metal Horde, with its coronet of fantastic peaks, its symbol, calcined floor and the crumbling body of the inexplicable Thing which, alive, was the very shadow of annihilation hovering over humanity.

That shadow is gone. Yet—in that vast crucible of life of whose ferment we are only a floating atom what other forms of life, what other atoms may even now be rising to push us down?

In that mystery-filled infinite through which we roll what other shadows may be speeding upon us?

Who knows?
Who knows!

THE END
(Second Serial Rights)

\$5,000 for Perpetual Motion

The editors have received thousands of different designs of perpetual motion devices, and have received hundreds of circular letters soliciting finances for the building of perpetual motion machines.

The editors know that if they receive these letters, there are thousands of others in this country who get similar letters and who fall for the claims made in the numerous prospectuses giving the earning capacities of the various machines.

Most of the shares of stocks for these perpetual motion machines are being sold at a rate of \$1.00 per share, although some inventors are trying to sell shares of stock at \$100.00 per share.

Therefore the editors of this publication say, "Just come in and show us—merely SHOW us—a working model of a perpetual motion machine and we will give you \$5,000.00. But the machine must not be made to operate by tides, winds, water-power, natural evaporation or humidity. It must be perpetual motion."



Aviation Brings Quick Success

TO young men of daring no other field of work offers such a fascination, such high pay, nor such opportunities for quick success as the field of Aviation. As yet, aviation is practically in its infancy. But now is the time to get in.

Amazing Opportunities in Airplane Industries

In the automobile industry and in the moving picture business hundreds of men got rich by getting in at the start. They made their success before others woke up. Today, these lines offer no greater opportunities than a hundred and one others. BUT AVIATION IS NEW. Get in while the opportunities are big. All over the country there will be a clamor for trained men. It will not be a question of pay but of getting capable men.

Easy to Get Into Aviation By this Home Study Method

The study of aviation is almost as fascinating as the actual work. Every lesson is full of interest. That is why it is easy to learn aviation. You do not have to make yourself study—it is like reading an interesting book that tells you things you have always wanted to know. Only one hour each evening will give you the basic training in a surprisingly short time.

One student, S. F. McNaughton, Chicago, says: "Your lessons are like a romance, and what is more, after one reading, the student gets a thorough understanding. One never tires of reading them." James Powers, Pa., another student, says, "I am indeed surprised that such a valuable course can be had from such practical men for so little cost."

PICK YOUR JOB!

Flying
Airplane Instructor
Airplane Engineer
Airplane Repairman
Airplane Assembler
Airplane Mechanician
Airplane Inspector
Airplane Builder
Airplane Salesman
Exhibition Manager
Airplane Contractor
Airplane Motor Expert
Airplane Designer

Personal Instruction by Experienced Men

Men who have had actual experience give you personal attention. They select the lessons, lectures, blueprints and bulletins. They tell you things that are essential in everyday practice. Each lesson is easy to read and understand.

Get Big FREE Book—Now

Send coupon below for New Book, just out, *Opportunities in the Airplane Industry*. It is interesting and instructive. It will show you many things you never knew before about aviation. We have but a limited supply of these books—send the coupon before they are all gone.

American School of Aviation
3601 Michigan Ave., Dept. 142-C
Chicago, Ill.

American School of Aviation
3601 Michigan Ave., Dept. 142-C
Chicago, Ill.

Without obligation, send me your Free Book, *Opportunities in the Airplane Industry*. Also information about your Home Study Course in Practical Aviation.

Name..... Age.....
Street.....
City..... State.....

8 POPULAR MODERN MOVIE NOVELS \$1.00

GREATEST OFFER EVER MADE

Take Advantage of This Amazing Bargain

Eight full size books for one dollar. Never before has an offer of this kind been made. Only quantity production permits us to make this astounding offer now. Take advantage of it while you have the opportunity. Needless to say these modern up-to-date movie hits cannot last long at this tremendous bargain price. Each book contains at least two color "stills" of an actual scene from the photoplay. Don't hesitate. Mail this coupon now. Every story based on an actual moving picture triumph. The greatest book bargain of the age.

Titles of This Tremendous Bargain Offer

1. New York
2. The Campus Flirt
3. Almost a Lady
10. Sensation Seekers
11. The Rambling Rangers
12. Don't Tell the Wife
14. Tracked by the Police
15. Tell It to the Marines
19. Irresistible Lovers
20. The Cohens and Kellys In Paris
21. The Divine Woman
22. Jazz Mad
23. The Crimson City
24. You Can't Beat the Law
25. Tillie's Punctured Romance
26. Forbidden Hours

8 BOOKS FOR \$1.00
Your Choice

An Addition To Your Library

These books will be a worthwhile addition to your library. You will find many hours of truly enjoyable reading in each beautiful volume. Printed on fine paper with large clear type. Beautiful colored covers of flexible durable material. These books are undoubtedly one of the greatest values ever offered at this amazingly low price.

Write Now! Don't Wait! This bargain cannot last long at this price.

CONSRAD COMPANY, INC.

230 FIFTH AVENUE

NEW YORK, N. Y.

CONSRAD COMPANY, INC., 230 Fifth Avenue, New York, N. Y.

Gentlemen: Enclosed find \$1.00. Kindly send me the books listed by number herewith:

Numbers.....

Name.....

Address.....

City..... State.....



THE MIDGET SLIDE RULE
Instantly adds, subtracts, multiplies, divides, solves proportions, gives all roots and powers. Logarithms, Sines, Cosines, Tangents, Cotangents, etc. Also gives decimal equivalents, lettered and numbered drill and tap sizes.

More than 110,000 sold, more than 2,000 unsolicited testimonials. The Engine-divided scales are on white-finished aluminum and are grease and waterproof. Diameter 4". Price with Instruction Book, \$1.50. Pocket Carrying Case, 50c extra. Cash or C.O.D. Catalogue free. Your money back if you are not satisfied.

GILSON SLIDE RULE COMPANY. Stuart, Florida

You and This New Machine Can Earn \$500 a Month

Operate a Tire Repair Shop
90,000,000 Tires in use. America's greatest opportunity for men with small capital. We furnish everything—\$100 and up. Easy payments. We train you FREE right at home. Start making money at once. Write today for **Free Book of Opportunity.**

HAYWOOD TIRE EQUIPMENT CO.
2337-L Ogden Ave. Chicago, Illinois

FORESTRANGERS

Men, get Forest Ranger job; \$125-\$200 month and home furnished; hunt, fish, trap, etc. For further details, write

NORTON INST.
1542 Temple Court, Denver, Colo.

Learn ELECTRICITY in Los Angeles

PRACTICAL training by National's tested job-experience method. All branches of electricity: radio, life scholarship. 17000 successful graduates. Million-dollar institution. 23rd year. Write for FREE illustrated catalog.

National Electrical School
Dept. 286 Figueroa & Santa Barbara Sts., Los Angeles, California

New Portable Phonograph

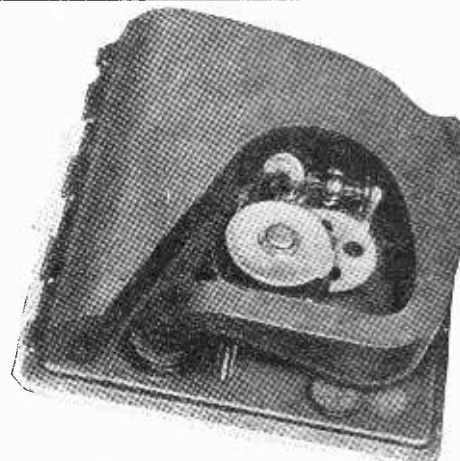

A photograph showing the exponential horn which is used appears above. Superior tone quality and greater volume have been obtained with this type of tone chamber. The horn is welded to the motor board, economizing weight and space and acting as a reinforcement.

Name of manufacturer furnished upon request.



Above is a view of the portable phonograph in use. With a drawn steel cabinet and long-run motor, this machine is an advance over the earlier portables. The winding handle is placed on an angle so that the instrument does not have to be moved to the corner of the table in order to be wound.

How Mediums Are Exposed in Germany

(Continued from page 313)

the case of a certain medium, one day, a hoop was brought upon the arms of both sitters. According to what the daughter of the medium asserted, these hoops had disappeared from her bedroom three days before. Unfortunately, this disappearance of the hoops was not called to the attention of the sitters. The apports can be made in a similar way. When the medium has prepared what is going to appear, he generally puts the articles under the table, or better yet, hides them under the chair of the adjacent sitter. This permits a search of his own pockets, or of his own chair.

I have in the course of time apported all sorts of things, such as beech-trees, just as the medium, Frau B., has done with plants, stones, etc. In one photograph, we see lying on the table a glass tube with a plaster of Paris cap, a stone which originated with the Resauer ghost and was, apparently, apported and never again taken away. This was the stone which fell at the feet of the policeman who was in search of the ghost. One sees flowers as well as a dead hand apported.

One can hardly imagine how easy it is to do the ghost business by trickery. In a similar way, and during the lawsuit men-

tioned before, I apportioned the beech-tree before the Berlin judge, Bornemann, without his seeing how it was done. When the judge thought that I was beginning, the whole thing was complete and finished. I can see, today, in front of me, the astonished face of the judge. Here the best way is to carry out the whole deceit the instant one begins to speak about the arrangements of the party. At this time the sitters are less observant, because they do not think that the preparations have anything to do with the sitting, preparations such as speaking about how the hands are to be held, or the playing of a harmonica. During this particular lawsuit, I started the apportion at the instant the eyes of the judge were being blindfolded. I assumed, naturally, that he regarded this as part of the preparations, so that when he believed that the sitting was just beginning, the trick had already been done.

The photographs, Figs. 1 and 2, show only the position of the hand at a special instant of the sitting. The sitting usually begins by the medium holding the hand of the neighbor, more or less enclosed. The hands of the medium will be far apart from each other. But this situation can be quickly changed, only one must not hurry the change. Everything is allowed to go along quietly for 15 minutes. In some cases—even an hour may pass—but then success is assured. The adjacent sitters will never hold the medium's hands for so long a period. Anybody who holds the opposite view has no conception of the effect of fatigue and the weakening of the powers of observation thereby. The pretense of the occultist that the way the hands are held in Fig. 2 is not the correct representation of how it is done, is quite false. But this picture shows only one short phase. The control of the hands changes every ten minutes, and in a longer sitting more often.

The larger the circle of participators is, the easier is the deceiving of the group. Some time ago I had a sitting composed of a number of people, of whom only a few were known to me, to carry out the artificial production of ectoplasm and telekinesis. I acted as the medium. In Fig. 3 I sit at the end of the table, but all you can see is the upper part of my head. The pictures were taken by flashlight. On the table there is a scale. In the picture everybody seems to be looking at the scale. Sitting in the dark, one had heard a constant noise coming from the scale, which was really due to the rising and falling of the beam. Noises of any kind play a great rôle in occult sittings.

The Berlin occultist, Schrenck-Notzing, once, with three other persons, was aware of very loud sounds which a blown-up balloon of at least three liters capacity had occasioned, and yet there was "no instrument present." Unfortunately, he had never told us how the person of the medium was searched, nor even once how he had calculated that it took three liters of air to fill the bag. Influencing the equilibrium of the scales by the medium was often upheld by spiritualists. Here, one sees how the beam has risen. The scales, which at first had no load on them, have now experienced a load. The occultists say that a great deal of force emanates from the medium which sometimes affects him. In reality, the suggestion of weight on the scales was carried out by means of a thread. Moreover, I had not touched the thread, but another of the sitters had done it, who, apparently, was an innocent participator in the performance. When I saw that my "fluid" had loaded the scales sufficiently, the thread was attached. Besides this, I had nothing whatever to do with the scales. No one suspected that the scales could have been prepared in any way. The thread was attached by the sitter as he seemed to be examining the scales in order to determine that no preparation had been applied to them.

Before this, an alarm clock that stood on

a chair which was outside of my reach began to ring. Some of the sitters knew my trick of extricating myself out of the chain so as to get both hands free, so they quarreled about this. The effect was thus made especially difficult. The method was worked by a thread, which, as we sat down, was thrown by me over the alarm handle of the clock, without anyone seeing it. Both ends of the thread were free and not knotted together. I first laid the ends over my knee. I could then bring them very easily between the thumb and forefinger of the right hand, without breaking the chain. All I had to do was to pull a little and that would move the alarm handle and the clock would begin to ring. After this, all present were convinced that I had freed myself from the chain, and had stood up and started the clock off. I had the bad luck that, when I started to pull the thread away and get rid of it, it fell from my hand. In order to excite no suspicion, I let it lie. No one saw it afterwards, although the clock was carefully examined. Subsequently, during the examination of the clock, I got rid of the thread in full light. The important consideration is always to lead the attention of the sitters to some definite place, while one is carrying on the trick at some other place.

CHEESECLOTH ECTOPLASM

But we have got to have ectoplasm also. What I have shown hitherto has only been telekinesis and penetration of matter. In Fig. 4 one sees the production of ectoplasm so characterized by Schrenck-Notzing. He declared seriously that it was a primitive production of a face with holes, wrinkles and contour made from the ectoplasm which underlay Willi Schneider, but I can give the assurance that the ectoplasm coming out of my body, as shown in Fig. 4, is not a primitive formation of a face of old times, or of the "Unknown," but a piece of cheesecloth. I had fastened it to my handkerchief, so that in searching me, they had never found it. Is it not very probable that we can settle in the case of Willi that he had prepared a piece of gauze, or other material, in advance, especially, as a former sitter declared that Willi's ectoplasm turned out to be chiffon, when he cut a piece off. My somewhat distorted face was due to the fact that it had to represent convinced astonishment. Schrenck-Notzing produced through his medium other ectoplasm exhibits. Schrenck-Notzing has in all earnestness labeled a photograph "ectoplasm napkin on the right shoulder and the right arm of the 16-year-old medium, Willi Schneider." We had better luck. As we, after forming the chain, carried on our sitting in the darkness and again a flashlight photograph was taken, they also saw an ectoplasm napkin on my right shoulder (Fig. 5) and also behind me a ghost of a form, such as often appears in spiritualistic séances. The continuation of the sitting, in which two ghosts appear behind me, succeeded still better. You will kindly excuse my startled face. Such ectoplasm exhibits are often, according to what the occultists say, accompanied by sensations of pain for the medium (they speak of the mediumistic pain). I cannot recall today, but it is possible that I had a mediumistic sorrow when the two ghosts appeared behind me. They were attached to the curtains, or portières. All these things belong to the "Unknown," if one will give any credence to the occultists. The explanation that one can make with the superstitious is very simple. One only needs to take one hand out of the chain, then to stand up and the ghost hidden in any way, as, for instance, behind the portières, can be brought out and pinned thereto. The position in which I find myself enables me, without going any further, to free the left hand and to produce the ghost. One sees, moreover, in Fig. 5, how one of the ladies stares at the ghost. The lady is an excellent observer, as I had

9 Years ago...
this Man Piloted
the First Plane
across the Atlantic



Today 400,000
Miles of Flight are
behind the Training
He offers YOU

WALTER HINTON—pilot of the NC-4, first plane to fly the Atlantic—expert flying instructor for the Navy during the War—the first and only world-famous flyer to give home-study students the benefit of his experience. Hinton will teach you the practical way.

Choose Your Job!

Estimates predict that over 5000 planes will be built in 1928. That demands 5000 pilots to fly them. Then realize that for each plane that flies, from 10 to 40 men are needed on the ground to build, inspect, service, and sell. Your job at your pay is waiting! Choose! Designer, Engineer, Pilot, Engine and Plane Mechanic, Rigger, Electrician, Welder, Instrument Maker, Wood, Metal Worker, Draughtsman, Plane and Motor Inspector, Airport Operator, Radio Expert, Assembler, Aerial Surveyor, Photographer, Aerial Transport Manager, Salesman.

YOU young men who are just starting your climb to success, and you older men who missed getting in "on the ground floor" of the Automobile and the Radio... start NOW with AVIATION! You mechanics, office workers, school and college graduates—who want to get into the richest, widest field where the odds are all in your favor... let Walter Hinton, the first Trans-Atlantic flyer of them all, train you right at home for an Aviation job you'll be proud of, plus a man-size salary!

Backed up by over 400,000 miles of history-making flying, Hinton teaches you plane design, construction, motors, rigging, instruments, theory of flight—every fundamental, every principle you need. He shows you how and where to get into Aviation.

Hinton's
FREE Book
Shows You How

Look what's happening in Aviation! The skies are humming—factories are teeming ahead—the world has discovered the Air! This book shows you how to learn the Industry—how to train yourself for its best jobs—how to cash-in on its success. Whether you want to fly, or want one of the more than 40 real-pay jobs on the ground, get all the Facts first. Hinton's book brings them. Mail the coupon NOW.

Aviation Institute of U.S.A.
WALTER HINTON, President
1115 Conn. Ave., Washington, D.C.



MAIL NOW!

WALTER HINTON, Pres., Aviation Institute of U. S. A., 1115 Conn. Ave., Washington, D. C. 4-H

Dear Lieut. Hinton: Rush me that Free Book on how I can train under you, right at home, for a real place in Aviation.

Name.....

Street..... Age.....

City..... State.....

HUMOR, COMIC ART, AMUSEMENT, PUZZLES, CONTESTS, ENTERTAINMENT, WIT.

TIDBITS

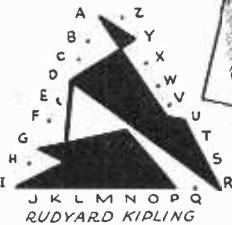
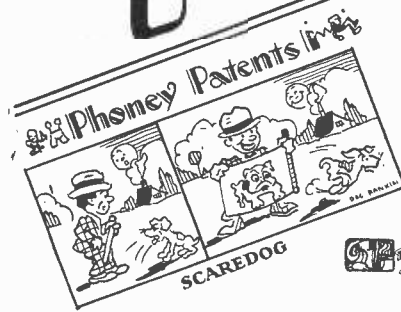

NEW ILLUSTRATED OVER \$150.00 IN PRIZES EACH ISSUE

In all the World THERE IS NO LOUD SPEAKER LIKE THIS
young married woman
POPULAR MECHANICS, FEB. ISSUE, OZARKA, ADV.
LIBERTY, MAR 3rd ISSUE ZONITE, ADV.
SUBMITTED BY ART HAMM, MILWAUKEE, WIS.

TIDBITS is new—is like no other magazine! A long procession of widely diversified topics created for your enjoyment parade before you thru its many pages. Namystics Phoney Patents, Right the Wrong, Advertwisters, Show Me, News Blunders, CookKoo Nuts, Radiocrostics—each of these is a new form of entertainment designed to help you while-away many pleasant hours. Pages of spicy illustrations all drawn by French artists. Zestful tales and jokes. There is a million dollars' worth of laughs in each issue of this fifteen-cent magazine. Go to your newsdealer now and obtain your copy of this new, different magazine of mirth.



PLANNING A TRIP TO EUROPE

My Maryland, my native home,
In Rain or Shine I'll ne'er forget,
Nor Lovely Lady Rosalie,
And Rio Rita—gay Coquette.

But now I must Keep Shufflin' on,
For soon I'll be for Paris Bound;
Parisiana I must see—
Artists and Models all around.

the **15c** copy

At all Newsstands, or Write Direct to
EXPERIMENTER PUBLISHING CO.
230 Fifth Ave., New York, N. Y.

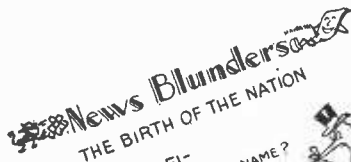

BIRTH CERTIFICATES ARE RECORDED IN THE CITY OR TOWN-CLERK'S OFFICE WHERE THE BIRTH OCCURS.—
WATERTOWN (N. Y.) PAPER.
SUBMITTED BY F. A. SMITH TROY, N. Y.

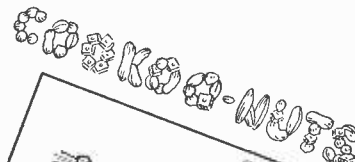

"THE MISSING LINK"
BY L. A. CLARK, OTTAWA, CAN.



THIS ISSUE'S \$5.00 PRIZE WINNER.
WEMC WE ELIMINATE MENTAL COBWEBS
SUBMITTED BY MRS. IRIS L. TOND, YONKERS, N. Y.

already found out. And as the ghosts were a little phosphorescent, she had already seen something in the darkness. After the sitting, the ghosts would naturally dematerialize. To me the situation was considerably more difficult than for that medium who works in a cabinet which is closed by curtains, because I sat right among the sitters, which, by professionals in occultism, is by no means usual.

I observed some other minor things that occurred on this evening. An empty tray, that one saw standing on the table, was seen from all sides to be empty and, although we again formed a chain, the tray in a few seconds was found at the other end of the table. It had to answer a question which had been audibly asked, and in answer there was found in a few seconds, after we turned up the light again, a joking, scolding word upon the tray. Such jokes ghosts often play upon occultists. I have taken a part in sittings where they told us that the spirits came by the street cars in order to be able to make an appearance. Another time a medium asked me to make my writing table quite warm, so that the spirits who were in it should not be cold. In Fig. 6 we see a compass on the table. One can move a compass needle very easily, if a little bit of iron is hidden near it. It is remarkable how even good observers, who have had many experiences in occultism, do not reach these simple conclusions. I carry out this trick often and there are always people to be found who could not be sufficiently astonished at my power of affecting the magnetic needle.

I have also carried on telepathic experiments which I have exercised with my assistant. Various figures were written on scraps of paper while my assistant, far away from me, sat quietly without being able to see it. Then I took the pieces of paper, all shuffled together, and anyone of the audience picked out one piece of paper after the other. We then asked out loud each time "what figure" so that the assistant sitting in another room, about 20 yards distant, could hear it. Almost immediately, the right number was then called out. I have in due time learned the possibility of doing that with the Zancigs, a well-known telepathic pair, who before the war carried out their art before the Kaiser. Here, the trick consists in this: The two performers count rhythmically, marking the beginning and the end of the count, which can be indicated by a light scratching of the finger nail, by a slight coughing, by a deep breath, or by a little scraping of the foot. One has only, then, to know the beginning and the end. For instance, both start on a cough, given by the medium, so that the other one can hear it, and then the two begin with the well-practiced rhythm of count, and when the second sign is given, a cough or other noise, the other knows what number is meant.

VANISHING LIQUIDS

Another small, but incomprehensible vanishing experiment I have also made. In Fig. 3 is shown a large weissbier glass. This was filled nearly full with coffee. Of course, so that all could see, the glass stood upon a piece of cardboard. The foot of the glass was traced out with a lead pencil, so as to make it impossible for the glass to be moved without its being known and then the room was darkened. In the darkness also, as in many of my other preceding workings, a piano was played, not, as occultists say in order to bring about the proper frame of mind, but in order to make suspicious sounds imperceptible. When, after a short period, the lights were turned on, the coffee had disappeared out of the glass. I could not have taken the glass in my hand, because, as one could tell by the pencil line around the foot, it was in exactly the same place as in the beginning of the sit-

ting. But the solution of all this is very simple. I had a little glass tube in my pocket that had a rubber tube drawn over it, so that when it is dropped into the glass, no sound is made. And then with my mouth, I took the glass tube out of my pocket, although my hands were both held, and stuck it into the glass without the least sound. I then drank up the coffee and got the glass tube into my side pocket the same way. Those who read the explanation will see how very simple the whole thing is, but one that does not know about it, is inclined to think a spirit power is at work.

40 YEARS' INVESTIGATION SHOWS NO SPIRITS

I have in this article tried to explain how one can produce phenomena artificially, such as those by mediums claiming to be occult. On account of my experience in occult circles, over 40 years, I must now assert the following: There may be occult phenomena,

I am willing to concede that, but up to the present no spiritualist has succeeded in having his attempts appear free of suspicion. I take the stand, therefore, that occultism in its present form not only is no branch of science, but is only a movement which, to express myself freely, is founded on the preconceived ideas of men. In the future, when one reads about the ectoplasm napkin and of the primitive formation of a face, a Homeric laughter will result. There is no question, here, of whether there are occult appearances, or not. I have never said that we uphold the impossibility of occult phenomena, but when one sees under what artificial means the modern occultists work, we can in all quietude say to these investigators: whatever you show us has nothing to do with science. The methods of investigation are so little related to those applied to real science, that one is prepared to draw a sharp distinction between modern spiritualists and unprejudiced seekers of the truth.

THE RIDDLE OF ATLANTIS

By HANNS FISCHER

(Continued from page 299)

origin in this year. Professor Dr. Posnansky in La Paz calculated from an astronomical position of the temple of the sun in Tihuanacu in Peru, that the year of its construction was 11,600 B. C. Its builders, the Urinkas, the ancient Incas, must then go further back as calculated today, than thirteen thousand five hundred years. This year, about which there is no room to doubt, must indicate some universally remarkable and overcoming event; for it would be more than strange, if it were longer ago than the estimated term of eleven thousand to twelve thousand years B. C., and if these determinations should accord with the coming together of the Assyrian moon year, and the Egyptian sun year, and with the building of the temple of the sun in Tihuanacu.

In the year thirteen thousand one hundred before the present era, no one had yet left us a known monument of this unknown great event which was of such importance for the inhabitants of America, Europe, Africa and Asia. It is then quite proper to consider the great earthquake, to which Plato refers, as having to do with this old event. And this earthquake it might have been which annihilated the continent of Atlantis. The great experiences of geologic history lead to the conviction that the annihilation of a continent could not take place in so short a time. The greatest catastrophe known to us annihilated hardly twelve square miles of land. This makes it easy to understand that all serious geographers and geologists, and all astronomers in spite of the impressive proofs for the former connection of a high cultivation in America in ancient times in touch with that of Europe—Africa, come to an impasse as regards the existence and sudden disappearance of Atlantis. Only the theory of Wegener that the continent was to a certain extent a floating island, appears to afford a solution, if we accept the view that America is further away meanwhile from Europe and Africa. Such a solution must lead to an impasse when it is shown that a perceptible movement of what are today solid continents took place in that distant age in which the earth had little or no ocean.

And now we say it in a few words. We have quite insufficient occurrences if we endeavor to find out the causes of the disappearance of Atlantis only from geographic and geologic points of view; because in the universe, the earth and life are involved in the event; so that no one branch of knowledge can solve the riddle, but we must have regard to the combination and interdependence of all things. This is the history of the world. We have to consider the cosmic dependence of things and their influence on our earth, on life and on their manifestations.

PHILOSOPHICAL REASONS FOR ATLANTIS

NO one can doubt that our life is related to the sun. No one contests the influence of gravity, between the members of our planetary universe. Everyone knows that the moon is the great cause of the tides. Everything shows us how we are affected by the forces of the universe. But we have neglected to value and investigate these facts; for otherwise we would have been forced to recognize both the geologic building up of the earth, the passing of the different geologic ages so that the progress of life and its fate, the development of civilization, the condition of climate, every earthly and cosmic influence must be considered, all appear to be relatives of each other. Everything stands in reciprocity with everything else. Our conclusions are incomplete if they appear to be based on only one division of knowledge, and we finally will come to the fixed conclusion that everything about us is in a state of flux.

Astronomy of our days would like to guarantee for us the present condition of our earth and sun for all eternity. A very impossible conclusion, contradicted by experiences of life, for the world is only the phase of a second as we see it. In the immediate future it will be something else. The fact that these little particles of the universe are to be disappointed in the idea of permanence, lies in the order of the cosmos.

The Bible wisely says that before God a thousand years is only a day. But today we only know with complete certainty that during the yesterdays of the world the heavens and the earth must have looked very different than as they appear today, and as a hundred thousand years from now they will appear to our remote descendants. In every one of its parts there is ceaseless movement and consequent change. It would be childish on our part if we wanted to reckon on the present state of things for all futurity, observing them as we see them today. The fate of the earth, of its life and of its culture in its real progress, can only be understood if we keep in mind the progress of things in the cosmic universe. He who does this sees that the environment of our home planet was not always as it is today.

We must then elevate ourselves to cosmic thoughts, and in the way of an example ask ourselves how the earth must have appeared if it had no moon. The ebb and the flow of the tide show us how great the power of the gravity of our satellite is in its effect upon the waters of the ocean.

Through its gravitational attraction the moon draws up the tropical seas that lie directly underneath it, acting as it were as a magnet, but in doing so it necessarily re-

Achieve SUCCESS in Radio

New course gives finest instruction obtainable

You Can Learn at Home!



R.L. DUNCAN, Director, Radio Institute of America and author of several volumes in radio.

Good pay from the start, rapid advancement, and phenomenal success—a life profession of fascinating brain-work—that is what Radio holds for the man who knows his subject thoroughly. Since 1909 Radio Institute of America has trained thousands to become successful in the many branches of Radio. Are you going to plod along at a thirty-five dollar a week job when REAL MONEY is waiting for you in radio?

New Course Finest Ever

Prominent radio men have enthusiastically greeted RIA's new course as the finest and most complete radio instruction offered today. It starts with the very fundamentals and takes you through every phase of radio—right through television, photoradiograms, and airplane radio equipment.

The instruction is the work of radio experts and its clearness and simplicity are such that you can master every point with ease. You take examinations and your papers are corrected by men with years of radio experience. All your questions are answered and you are in contact with the Institute at all times.

A-1 Equipment

Radio Institute of America's students must have the best. So we provide, without charge, all the first-quality material you need (except tubes) to make twelve different radio circuits—as well as the Peerless Signagraph and key and buzzer set for code instruction.

RIA Sponsored by RCA, G-E, and Westinghouse

You get all the benefits of instruction conducted by RCA and sponsored by RCA's associates, G-E and Westinghouse. Our employment department is at the service of graduates.

Study at Home!

Moreover you can STUDY AT HOME—when you please and as long as you please. This new booklet describing the course is just off the press. If you want to learn more about the well-paying positions in this fascinating profession send the coupon now for your copy.



RADIO INSTITUTE OF AMERICA
Dept. G-8 326 Broadway, New York City

RADIO INSTITUTE OF AMERICA, Dept. G-8
326 Broadway, New York City

Dear Mr. Duncan:
Please send me your new catalog. I want to know more about your new radio course.

Name.....
Address.....
.....

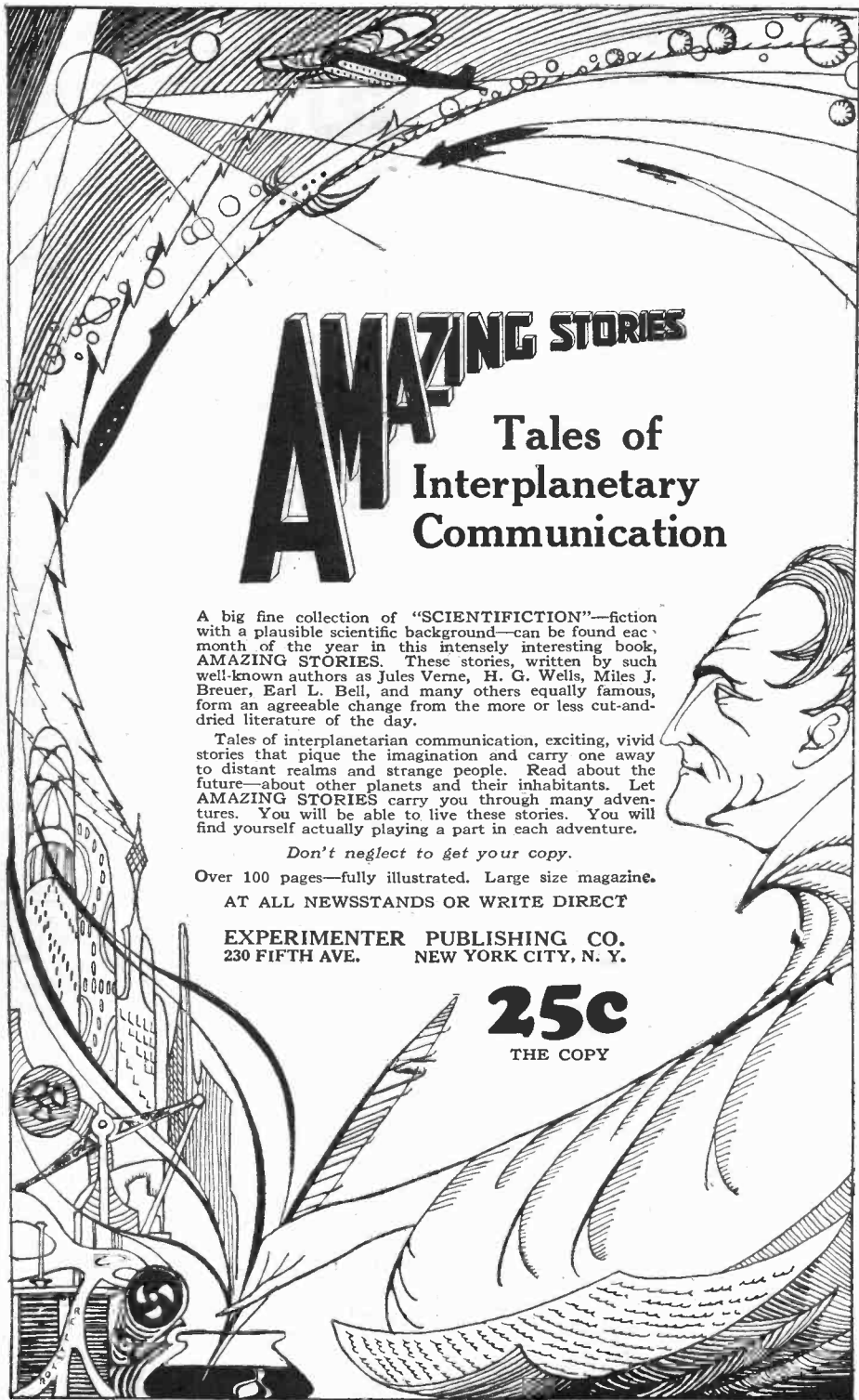

AMAZING STORIES

Tales of Interplanetary Communication

A big fine collection of "SCIENTIFICTION"—fiction with a plausible scientific background—can be found each month of the year in this intensely interesting book, **AMAZING STORIES**. These stories, written by such well-known authors as Jules Verne, H. G. Wells, Miles J. Breuer, Earl L. Bell, and many others equally famous, form an agreeable change from the more or less cut-and-dried literature of the day.

Tales of interplanetary communication, exciting, vivid stories that pique the imagination and carry one away to distant realms and strange people. Read about the future—about other planets and their inhabitants. Let **AMAZING STORIES** carry you through many adventures. You will be able to live these stories. You will find yourself actually playing a part in each adventure.

Don't neglect to get your copy.

Over 100 pages—fully illustrated. Large size magazine.

AT ALL NEWSSTANDS OR WRITE DIRECT

EXPERIMENTER PUBLISHING CO.
230 FIFTH AVE. NEW YORK CITY, N. Y.

25c
THE COPY

duces the water level of the polar seas, and makes them more shallow. If we had no moon, this suction so to speak, would be missing and the water would flow back from the tropics to the poles. But we do have a moon, and its influence determines the action of our seas. Was it always so and will it always remain so? This is a transcendently important question for the fate of the earth.

One thing we must not forget! Cosmic space is not empty! And the filling of this space whether it is due to the material of comets tails; to meteorites; to fragments of stars or to cosmic dust, perhaps also of hydrogen, brings us to the conclusion that all stars which move through space do experience a certain resistance to their motion. It follows from this that the moon with constant shortening of its period of rotation, that is to say the shortening of the length of its month, would have to approach the earth always closer and closer, as today the inner moon of Mars whirls around its planetary center. The way it travels will bring the moon of today after millions of years into union with the earth. Then the condition pictured above will exist. The earth will have no moon and the tidal waters of the equator, which as the moon approached were drawn up more and more, would flow back to their old level at the polar regions.

MOON CAPTURED BY EARTH

A STRANGE thought; certainly! *But today the view is taken by science* (see Professor Luyten's letter printed herewith) *that the moon is not a son of the earth, but once was an independent planet at some remote period captured by our earth.* And further: The earth in former times had several moons that had the same fate to be captured and to approach the earth in order to combine with it. Hundreds of so-called "sagas" tell of the experiences and fate of ancient mankind in the age of the ancient moons. And this precursor of our moon, after it had whirled around our planet for millions of years, approached so near that the gravity of the earth overcame its own forces and tore it to pieces. Within a few weeks these ruins of the moon would unite with the earth. The earth became moonless. The tropical seas sank, the polar seas rose. Land which in the equatorial regions were submerged, emerged and became habitable, and also was virginally fruitful, after incalculable immersion in the Atlantic Ocean. Today in a new moon age, it is again submerged under the water, and only shows at its highest elevations in the Azores, Canary Islands and others the back of Atlantis emerges into the light, from what in the future will be inhabitable land. The bridge between America and the east was broken down. Many hundred thousands of years that civilization developed which we are enjoying today, numerous colonies were founded, Egypt, Assyria, Crete and Jorubaland, northwest Europe, America, as far as China—we everywhere can find the traces of the culture of Atlantis.

The harmony of the world-history goes its way, even if the moonless age came to an end; for a star which in those days was far removed from the terrestrial orbit went around the sun as a planet in its own path, on account of its smallness, was brought in the course of cosmic time by the resistance of space so near the earth, that the tentacles of the earth's gravity could no longer be resisted, and they made it a terrestrial moon.

ATLANTIS DESTROYED BY DELUGE

THIS changed our earth; for this moon began to make its gravity act upon terrestrial waters. Like a magnet it drew water in great masses away from the polar regions down in great waves to the tropics,

DEAFNESS — THE MEGA-EAR-PHONE
"There are many good things to be heard"
A Comfortable, Invisible Ear Device (Not Rubber) relieves CATARRHAL DEAFNESS. Stops Head Noises. Makes words more plainly understood. An efficient substitute for Ruptured or Destroyed Ear Drums. **Immediate Results.**
Illustrated Booklet on Request
THE MEGA-EAR-PHONE, 407 Otis Bldg. Dept. S. I.-8, 16th & Samson Sts., Phila., Pa.

Learn to Write
I can make a good penman of you at home during your spare time. Write for my **FREE BOOK, "HOW TO BECOME A GOOD PENMAN."** Your name elegantly written on a card if you enclose stamp. **Write today.**
F.W. TAMBLYN, 424 Ridge Bldg., Kansas City, Mo.

Travel on "Uncle Sam's" Payroll RAILWAY POSTAL CLERKS MAIL CARRIERS \$1700 to \$3000 Year
Many U. S. Government Jobs Obtainable



COUPON →

FRANKLIN INSTITUTE
Dept. F179, Rochester, N. Y.
Sir: Rush to me, **WITHOUT CHARGE, FREE** 32-page book with list of U. S. Government positions open to men and women, sample coaching, and full particulars telling how to get them.

Name.....
Address.....

MEN—WOMEN, 17 UP SHOULD MAIL COUPON IMMEDIATELY
Steady Work No Layoffs Paid Vacations

burying all low-lying land beneath the waves, and one frightful night in the midst of earthquakes and tidal waves caused by the new satellite, Atlantis sank beneath the sea. There it lies, a goal for exploitation by science, reaching into the depths of the sea, buried since that day under the cold waters, while the moon gave a new datum for the reckoning of time to astronomers since about the year 11,500 B. C. The bridge to the west disappeared. But on both sides of the ocean lives today, speech, architecture, knowledge and men, as children of this

sunken continent. About the time when this sudden end brought about the new moon's influence, there lived a people Proselenites, in the south of Greece, whose long ridiculed mysterious name we now can correctly decipher, for it means: "Before the Moon"—*Courtesy "Das Buch für Alle."*

*It can also be translated as "Before Grecians." *Hellenes* meaning *Grecians*.—EDITOR.
 †Those interested in a complete story of "Atlantis" should read "The Problem of Atlantis" by Lewis Spence, which covers all the scientific aspects of this most enthralling subject.

DO ANIMALS THINK?

By RAYMOND L. DITMARS

(Continued from page 303)

frog so big that it can swallow a full-grown rat, and South America a medium-sized frog with jaws so sharp and strong it can nip off the end of your finger. In India there are fish that come out of the water and climb sloping trees, while in the shrew family are warm-blooded mammals no larger than a cricket—and there are many other wonders. The list is too long to continue this evening.

Questions Asked Mr. Ditmars by Hugo Gernsback, Editor-in-Chief of SCIENCE AND INVENTION Magazine, and the Answers

Q. 1. Mr. Ditmars, you have had such a wonderful opportunity of studying at close range so many different types of animals, that we are wondering if you believe that animals have merely instinct, or can actually think in a small way. In other words, is the intelligence of certain higher animals sufficient to classify it as thinking, rather than instinct?

A. 1. There is no doubt that animals think. To entirely credit their actions to instinct is a slight to the animals. I have noted many animals to escape from difficulties that required keen thought. Again, there is little doubt that instinctive inclination largely figures in the wonderful work of certain types like the beaver in building its houses and dams, and the construction of prairie dog burrows with their elaborate drainage provisions. With both of these types, however, actual thought again figures during emergencies when their homes are injured through storms, or attacked by enemies.

Q. 2. Snakes are usually believed by the public at large to be useless. What is the real function of snakes and what good do they do?

A. 2. If the average man realized that a large number of snakes feed upon rodents and other types of small animals extremely destructive to the agriculturists, he would know that certain serpents are of high economic value. From nature's point of view, the place of the snake thus appears to be in keeping the multiplication of certain forms of small animals in check.

Q. 3. Would you kindly tell us what sort of animals and what species in general cannot be taken from their natural surroundings and brought to a zoo? We understand that many animals cannot be kept in captivity.

A. 3. From years of observation of wild animals kept in captivity, I would say that such types as the moose, caribou and prong-horned antelope cannot be maintained in a zoo. One difficulty is to provide them with proper food. The caribou, for instance, feeds largely upon a moss that grows upon rocks, and when this is shipped long distances it either dries out, or, becoming moist; decomposes. Ordinary hay and grain form too rich a diet for such types. There are

also various types of monkeys too nervous to be kept in captivity. We have a list of such species and endeavor to induce animal dealers not to import them from their native homes.

Q. 4. Is it possible, through association with human beings, to tame wild animals so they can be trusted at any time in their intercourse with human beings?

A. 4. Generally speaking, I would say that the average type of wild animal cannot be tamed so as to be entirely trustworthy. This condition is very different from that of a domestic dog or cat or the larger types of domestic animals which, through hundreds of years of association with members of the human family, have inherited from their ancestors an actual sympathy and understanding. Even among these, however,

Station
WRNY
 NEW YORK
 326 METERS—920 KILOCYCLES
 and 2XAL—30.91 METERS

*is owned and operated by the
 publishers of this magazine
 Our Editors will talk to you
 several times every week—
 See your Newspaper
 for details*

**TUNE IN ON
 WRNY**

we often have reversion to the wild type in the so-called "bad-tempered" animal.

Q. 5. Do you believe it possible that the higher type of monkeys could be commercially reared to perform actual work, to lighten our labor?

A. 5. No. This is quite impossible, except for temporary show purposes, when the demonstration might be decidedly interesting. Left alone, the average type of anthropoid ape would be far more destructive than useful.

Q. 6. What chance would a lion whose past generations have been brought up in a zoo have, if any, if this lion was suddenly transposed into a regular jungle? Could he survive?

A. 6. I believe that a lion, released from captivity in a zoo into a jungle, would soon be living his normal life. Again bringing up the question of instinct, I think that this would guide the animal and help him to become at home and care for itself. No wild animal loses its instinctive traits in captivity and the forces would be quickly dominant if the animal were released.

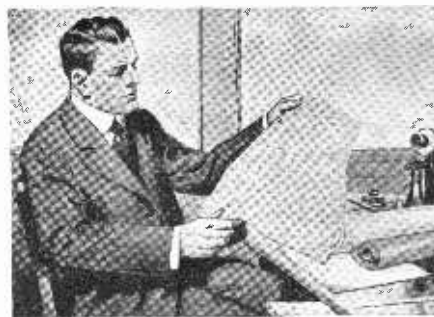

Mechanical Engineering

Learn at Home

MECHANICAL Engineering embraces the design, construction and operation of machines and machine tools.

It is a profession which offers almost unlimited opportunities to men who combine natural mechanical ability with technical training.

For this is The Age of Machinery. Almost every convenience, luxury or necessity which we enjoy depends on machinery for its production or adaptability to our needs. Every new invention multiplies the opportunities for competent designers, builders, erecting engineers, etc.

One of the best ways to train yourself to secure a position as a Mechanical Engineer is through the home-study courses of the International Correspondence Schools.

These courses are complete and up-to-date, and they are especially arranged to meet the needs of the student who studies at home.

They are particularly helpful because they are written by well-known mechanical engineers who have had years of practical experience in this field and who know the quickest, best way to solve every problem.

Just mark and mail the coupon and we'll gladly send you Free Booklets describing the I. C. S. courses in Mechanical Engineering or any other course in which you are interested.

Mail the Coupon for Free Booklet

INTERNATIONAL CORRESPONDENCE SCHOOLS

"The Universal University"

Box 6243-E, Scranton, Penna.

Without cost or obligation, please send me a copy of your booklet, "Who Wins and Why," and full particulars about the subject before which I have marked an X:

- | | |
|---|--|
| <input type="checkbox"/> Mechanical Engineering | <input type="checkbox"/> Toolmaking |
| <input type="checkbox"/> Mechanical Course | <input type="checkbox"/> Blacksmithing and Forging |
| <input type="checkbox"/> Drafting | <input type="checkbox"/> Patternmaking |
| <input type="checkbox"/> Mechanical Drawing | <input type="checkbox"/> Foundrywork |
| <input type="checkbox"/> Complete Shop Practice | <input type="checkbox"/> Machine Shop Practice |
| <input type="checkbox"/> Electrical Engineering | <input type="checkbox"/> Architects' Blueprints |
| <input type="checkbox"/> Electric Lighting | <input type="checkbox"/> Contractor and Builder |
| <input type="checkbox"/> Radio | <input type="checkbox"/> Architectural Draftsman |
| <input type="checkbox"/> Railroad Positions | <input type="checkbox"/> Concrete Builder |
| <input type="checkbox"/> Civil Engineer | <input type="checkbox"/> Structural Engineer |
| <input type="checkbox"/> Surveying and Mapping | <input type="checkbox"/> Chemistry <input type="checkbox"/> Pharmacy |
| <input type="checkbox"/> Mining | <input type="checkbox"/> Airplane Engines |
| <input type="checkbox"/> Steam Engineering | <input type="checkbox"/> Agriculture and Poultry |
| <input type="checkbox"/> Architect | <input type="checkbox"/> Mathematics |

BUSINESS TRAINING COURSES

- | | |
|--|---|
| <input type="checkbox"/> Business Management | <input type="checkbox"/> Advertising |
| <input type="checkbox"/> Industrial Management | <input type="checkbox"/> Business Correspondence |
| <input type="checkbox"/> Personnel Management | <input type="checkbox"/> Show Card and |
| <input type="checkbox"/> Traffic Management | <input type="checkbox"/> Sign Lettering |
| <input type="checkbox"/> Accounting and | <input type="checkbox"/> Stenography and Typing |
| <input type="checkbox"/> C. P. A. Coaching | <input type="checkbox"/> English |
| <input type="checkbox"/> Bookkeeping | <input type="checkbox"/> Civil Service |
| <input type="checkbox"/> Secretarial Work | <input type="checkbox"/> Railway Mail Clerk |
| <input type="checkbox"/> Salesmanship | <input type="checkbox"/> Common School Subjects |
| <input type="checkbox"/> Spanish <input type="checkbox"/> French | <input type="checkbox"/> High School Subjects |
| | <input type="checkbox"/> Illustrating <input type="checkbox"/> Cartooning |

Name.....

Street Address.....

City..... State.....

MAGIC

500 TRICKS—10C.

BE POPULAR—LEARN TO ENTERTAIN

Amaze and mystify your friends. Earn Money at Clubs and Parties. It's easy. No skill required. Our copyrighted book, "Fun—Magic—Mystery" tells how and explains many tricks you can do. Also catalogs over 500 Mystifying Tricks—Illusions—Jokes—Puzzles—Books—European Novelties, at Reduced Prices. New 1928 Edition, profusely illustrated, sent postpaid, only 10c.

LYLE DOUGLAS, Station A-3, DALLAS, TEX.

PROMPT SERVICE—LOW PRICES

Insure your copy reaching you each month. Subscribe to SCIENCE AND INVENTION—\$2.50 a year. Experimenter Publishing Co., Inc., 230 Fifth Avenue, New York City.

High School Course in 2 Years

This simplified, complete High School Course—specially prepared for home study by leading professors—meets all requirements for entrance to college, business, and leading professions.

20 Other Courses

Over 200 noted Engineers, Business Men, and Educators helped prepare the special instruction which you need for success. No matter what your inclinations may be, you can't hope to succeed without specialized training. Let us give you the practical training you need.

American School
Drexel Ave. & 58th Street
Dept. HC-294 Chicago

Money Back When You Finish If Not Satisfied

American School, Dept HC-294 Drexel Ave. and 58th St., Chicago
Send me full information on the subject checked and how you will help me win success in that line.

- | | |
|---------------------------|---------------------------|
|Architect |Electrical Engineer |
|Building Contractor |General Education |
|Automobile Engineer |Lawyer |
|Civil Engineer |Mach. Shop Practice |
|Structural Engineer |Mechanical Engineer |
|Business Manager |Steam Engineer |
|C. P. A. & Auditor |Sanitary & Heating |
|Bookkeeper |Surveyor & Mapping |
|Draftsman & Designer |High School Graduate |

Name.....
Address.....



Brings You 9" x 21" This

South Bend Jr. Back Geared Screw Cutting Precision Lathe. Set it up in your own shop and pay the balance of our low price of \$160 in 10 equal monthly payments. We ship at once on receipt of down payment.

No Extra Charge for Counter-shaft and Equipment

If you prefer, we can supply same Lathe equipped with 3/4 h. p. Electric Motor Drive for plugging in any light socket for power, for a down payment of only \$45.00. Costs less than 2c an hour to operate.

Lathe has power feed to carriage, compound rest, 3/4 in. hole through spindle and phosphor bronze spindle bearings. Also made with floor legs and with 3, 3 1/2, 4 and 4 1/2 ft. beds.

Free Catalog 89A shows 216 styles and types of Lathes. Write for it.

South Bend Lathe Works 463 E. Madison St. South Bend, Ind., U.S.A.
New York City: J. E. Boggs Co., 188 Centre Street

ENJOY THE THRILL OF ELECTRIFIED RADIO at SMALL COST

Banish forever all the annoyance and expense of buying new "B" Batteries with a TOWNSEND "B" POWER UNIT. Hooked up in a few moments—and you have permanent power from your light socket from that time on. Use same tubes now in your set. No changes.

You'll be amazed at the way Townsends improve your reception and add to distance getting. More than 50,000 now in use. Send Coupon today for full information and free trial offer.

TOWNSEND LABORATORIES
Chicago Illinois

COUPON
TOWNSEND LABORATORIES 8-28
Dept. 35, 713 Townsend St., Chicago, Ill.
Please send me full information on the Townsend "B" Power and Free Trial Offer.

Name.....
Address.....

Foreign Work!

Like to Travel—Does Romantic, Wealthy South America call you? Unusual opportunities for young men. American employers. Fare and expenses furnished. **BIG PAY.** Write for Free List. **SOUTH AMERICAN SERVICE BUREAU** 14600 Alma Avenue Detroit, Michigan

Q. 7. What is the reason for the great longevity of the turtle? Why do turtles live longer than other animals? Is there any scientific reason for this?

A. 7. The reason for longevity in turtles is the turtle's inclination to take everything easy. It is a slow going, leisurely type, and here we might find a moral that points to man's frenzied rush and comparatively short life.

Q. 8. Do animals of all kinds in captivity die sooner than if they were in their natural free surroundings?

A. 8. Generally speaking, animals in captivity do not die sooner than if they were in their natural free surroundings. We think there are types that actually live longer in captivity than if wild. Again, there are nervous kinds which may die sooner. Through our study of animals, we are seeking to eliminate the latter as exhibition specimens, in creating the most humane conditions possible in a zoological collection.

Q. 9. What is your opinion of a story appearing in the newspapers about a horned toad being sealed in cement for thirty years, and said to have been found alive?

A. 9. It is our belief that most of the "sealed" caves in which toads are found actually have long fissures running out from them to the surface of the ground. The horned "toad" said to have been sealed in cement for thirty years, in Texas, is actually a rather delicate lizard.

DO ANIMALS THINK?

The Opinions of the Authorities on the Subject
(Continued from page 304)

(b) never heard of him, but "Fellow" is adjudged to think; I saw him.

5. Instinct is generally thought to be inherited memory.

8. It would undoubtedly die.

Remarks: If the animal lived, it would be through sharpening of its senses and not through its reasoning powers. Some years ago, an albino fur seal (*Callochin Alascantus*) was observed on St. Paul Island (Pribilofs). The animal was blind, but was three years old and in good condition. Its hearing was acute and its response so quick that several times a camera failed to get a good photograph. Noted by H. D. Chichester.

I believe that the difference of mental powers between the other animals and man is a difference of degree and not of kind. The dog, for example, is as intelligent as an infant, but the dog stops and the child generally goes on.

Some dogs will knock off your hat and run away with it, letting you approach near enough to almost reach it, and then running away.

Dogs will often bring a stick or a stone for one to throw away, for the dog to chase and bring back. I have had this done by strange dogs which I had never seen before.

PHILADELPHIA EXPERT'S OPINION

THE answer from Dr. H. C. Wood, Jr., University of Pennsylvania, Philadelphia, Pa., follows:

1. Depends what you mean by "think." See remarks below.
4. (a) Probably collusion; that is, signals from trainer.
- (b) See no reason to doubt ability of dogs to learn names of objects or persons.
- (c) Probably instinct.
5. No. Instinct is inborn knowledge, emotion, or reaction; as contrasted to that acquired from experience or instruction.
6. See remarks below.
7. I did not start this. I see no reason to argue over meaning of words; look them up in dictionary.

SAVE YOUR MONEY! BE YOUR OWN SERVICE MAN

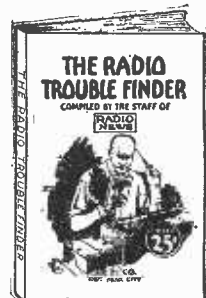

THE RADIO TROUBLE FINDER

Even the highest-priced radio set occasionally develops a fault and that at a time when you least expect it—maybe right in the middle of an interesting program. But, a handy copy of

The Radio Trouble Finder is the simple means for tracing every defect and remedying it in the easiest manner possible. There is no mishap that could befall a radio, but what is fully covered in this valuable book.

The Radio Trouble Finder is edited by men fully versed in the subject covered—men with years of actual experience behind them—and who have grown to prominence since the infancy of radio.

Don't wait till your set goes bad—get your copy of this remarkable guide to radio trouble now. Fill in the coupon and we will send you by return mail a copy of *The Radio Trouble Finder*, a money-saving investment. You can be your own service man.

The **25c** Copy

BUILD YOUR OWN RADIO SET

150 RADIO HOOK-UPS.



This is the latest issue of this remarkable book. Absolutely new and up-to-date. All the best circuits of the day. Full instructions on how to build. Make your own set from the diagrams shown in *150 Radio Hook-Ups*. Write today—pick the set you want to build and make it. Then you are sure to be satisfied with the results you get.

150 Radio Hook-Ups was prepared by the staff of *Radio News*. An accurate guide to better set construction for the radio "fans."

The **25c** Copy

MAIL THIS COUPON NOW

CONSRAD CO., INC.
230 FIFTH AVENUE NEW YORK, N. Y.

CONSRAD COMPANY, INC.
230 Fifth Avenue, New York, N. Y.
Gentlemen:
Kindly send me a copy of 150 RADIO HOOK-UPS... THE RADIO TROUBLE FINDER... (check which or both).
Enclosed find.....cents in full payment.
Name.....
Address.....
City.....State.....

8. Starve. I doubt if a man could "reason out a mode of procuring food" under analogous conditions.

9. No.

Remarks: The question of whether animals "think" is a mere matter of definition of the word and hence is not to be settled by scientific observations. If we define "think" as the ability to apply results of past experience to new situations, then animals do think. If you make some other definition of the word, my answer might be different.

UNIVERSITY OF CHICAGO PROFESSOR'S VIEWS

A LETTER from Professor W. C. Allee, University of Chicago, Chicago, Ill., reads as follows:

1. Yes.

9. Yes.

Remarks: I can draw no qualitative line between man and the other animals, but only quantitative ones. Man thinks more and more abstractly than other animals, but I see no good reason for believing that they do not think at all.

FROM PRINCETON UNIVERSITY

THE reply from Prof. Herbert S. Langfeld, Princeton University, Princeton, N. J., follows:

1. Yes.

5. No.

9. No.

Remarks: I cannot separate reason and thought into two distinct categories. Reasoning is a form of thought. Experiments in animal psychology seem to give ample evidence that animals can reason; also that they can think in the wider sense of the term. They are able to solve problems by the use of past experience, and to remember situations over a long period of time. Certainly one would be led to conclude from the actions of animals that they think.

BELIEVES ANIMALS THINK

A LETTER from C. F. Leavitt, 14 West Washington St., Chicago, Illinois, reads:

1. I believe they can use the power of thought to a degree, depending, like man, on their training and development.

2. A hundred reasons might be given to show they are able to select and differentiate which would require some thought.

5. No.

6. They possess a low grade of reasoning power. To reason is to consider, and I have seen dogs apparently consider before doing a certain thing. To think is to have an opinion, to feel, to imagine.

8. The more intelligent animals would find a way to procure food.

9. My opinion is based only on observation.

A WOMAN EXPERT'S IDEA

THE reply from Dr. Lilla Estelle Appleton, Oxford College for Women, Oxford, Ohio, follows:

1. In a small way.

2. They adapt their conduct frequently to changed conditions. (See below). Such conduct in human beings would be considered "thinking."

5. No, though instinct influences the thinking with the lower animals, just as it does with man.

8. The sense of touch would still procure food, provided the food were within touching distance. Otherwise he would probably starve.

9. No.

Remarks: Two robins (that ordinarily would have built their nest of mud) built a nest in front of my window of twigs. The season dry, no mud around. The female was already sitting upon the nest, when suddenly the weather turned very cold for the time of year. Next day I saw both birds standing on the edge of the nest peer-

ing down into the nest. Then both flew away. Presently both returned, one at a time, bringing bits of twigs in their bills. These they apparently rammed, with all their strength, into the crevices in the nest. The female had probably felt the cold coming through the sides of the make-shift nest.

FROM OHIO STATE UNIVERSITY

REPY from Prof. Herbert Osborn, Ohio State University, Columbus, Ohio, reads:

1. I think many animals have what may be called mental processes, but not necessarily of the same kind as man.

2. Many lines of behavior amongst higher vertebrates indicate a recognition of surrounding conditions and individual adaptations to such conditions.

3. That many animals do not "think" in the same manner as man is indicated by the different responses they make to changing surroundings or situations.

4. (a) I take it a horse might acquire ability to respond to certain numbers as it does to directing orders "Whoa," "Gee," or even when given by different individuals and in different voices.

(b) If such is the case, and I do not question the possibility, though I have never known of one, I should say it must have learned to associate such name with a certain individual.

(c) Might it not be a combination of instinctive effort to escape with some degree of appreciation of the means to successfully evade its pursuer.

5. I would not call all such responses pure instinct, which I understand to mean certainly more or less involuntary and invariable modes of behavior that have come to be linked with the survival of the species.

6. I should think reasoning dependent on ability to "think."

8. Not if food were available by contact or other means of perception.

9. None that I count conclusive.

Remarks: It seems to me more reasonable to admit certain forms of ability to "think" or to recognize changing environments and adapt responses to them among so-called "lower animals." These may vary greatly in degree, but should not be measured entirely from the standpoint of human intelligence. "Intelligence" or the ability to "think," has, I take it, been a gradual growth in the animal kingdom, although the gap between man and other animals may seem very great. That the gap is largely one of language or basis of mutual understanding, does not alter the importance of the separation.

WHAT A FAMOUS TRAVELER-LECTURER ON ANIMAL LIFE THINKS

A LETTER from Frederick H. Chase, 5 W. 101st St., New York City, reads as follows:

1. Yes—some more than others. Like humans, some are morons and merely function. Take dogs, no two of the same breed are alike. You read it in their eyes.

2. See letter.

6. I believe they do both.

8. I believe it would.

9. Contact with animals has made me believe they both "think" and "reason." "Glad to say a word for the animals. I'll never kill another if I can avoid it.

"Answering Question No. 2:

"The family dog is taking a nap. A little tot begins to annoy him. He growls ominously, with tail thumping the floor. He is thinking of two things. He tries to warn the child with a growl, but wags his tail to assure a nervous mother that he is bluffing—that he doesn't intend to bite. Looks to me like reasoning.

"Have had wolves in Alaska keep pace with me on the opposite side of a river. I stopped to wait for my partner to catch up with the dog team. Wolves likewise stopped and waited. The moment I reached for a

Would YOU Give \$19⁸⁵ to Gain a HIGH SCHOOL EDUCATION

HERE is the most sensational educational offer we have ever heard of! A High School education for only \$19.85. Think of it! And even this small amount is payable on such easy terms that you won't miss the money.

Moreover, you can gain this valuable training in your own home, in your spare time, through the most enjoyable method ever devised. You merely read interesting questions and their fascinating, enlightening answers, on every High School subject. You may examine the entire Course on approval without sending a penny in advance. See offer below.

These famous Question and Answer books are used and endorsed by thousands of students of all ages, as well as by over 12,000 High School Teachers and Principals throughout the country, because they *really teach*, in the most interesting way.

No one realizes better than you what it has cost you to have missed high school; and no one knows better than you what your lack of a high school education *will* cost you in the years to come—if you do not acquire it. Why not make up for lost time this easy, convenient, interesting and economical way?

How Are You Taught ?

Each book contains 200 to 300 questions and their boiled-down, simplified answers. You are taught one fact or law or principle at a time, in easily understood language, on fifteen high school subjects: *Ancient History, Biology, American History, Civics, Arithmetic, Elementary Algebra, Physics, Modern History, Literature, Economics, Geography, Latin, Physiography, English Grammar, and Spelling.*

The fifteen books contain the equivalent of all you can learn in a four-year High School Course of approximately 625 days' attendance, or 3,840 hours. Yet by spending only fifteen minutes a day with these Questions and Answers you can complete them in a few months.

FREE EXAMINATION— Send No Money

Before you pay a penny, see for yourself how easy it is to acquire high school training this new, easy way. The coupon will bring you the fifteen famous Blue Books to examine free. Keep them and enjoy them for 5 days. Then decide. You take absolutely no risk; you assume no obligation by mailing the coupon.

HIGH SCHOOL HOME STUDY BUREAU
Dept. X-248, 31 Union Sq., New York City



High School Home Study Bureau, Inc., Dept. X-248, 31 Union Square, New York City.

Gentlemen: You may send me, for FREE EXAMINATION, the 15 famous Blue Books, containing the equivalent of a four-year High School Education. Within 5 days I will either return the books or remit \$3.85 as first payment and then \$4 a month for four months, a total of \$19.85.

Name.....
Address.....
Town..... State.....



"There's One Man We're Going to Keep"

"Ed Wilson, there, is one of the most ambitious men in the plant. I notice that he never fools away his spare time. He studies his International Correspondence Schools course every chance he gets.

"It's been the making of him, too. He hasn't been here nearly so long as Tom Downey, who was laid off yesterday, but he knows ten times as much about this business.

"I'm going to give him Tom's job at a raise in salary. He's the kind of man we want around here."

HOW do you stand in your shop or office? Are you an Ed Wilson or a Tom Downey? Are you going up? Or down?

No matter where you live, the International Correspondence Schools will come to you. No matter what your handicaps or how small your means, we have a plan to meet your circumstances. No matter how limited your previous education, the simply-written, wonderfully-illustrated I. C. S. textbooks make it easy to learn.

This is all we ask: Without cost, without obligating yourself in any way, put it up to us to prove how we can help you. Just mark and mail this coupon.

INTERNATIONAL CORRESPONDENCE SCHOOLS "The Universal University" Box 6242-E, Scranton, Penna.

Without cost or obligation, please send me a copy of your booklet, "Who Wins and Why," and full particulars about the subject before which I have marked X in the list below:

- | | |
|--|--|
| <input type="checkbox"/> Electrical Engineer | <input type="checkbox"/> Advertising |
| <input type="checkbox"/> Electrician | <input type="checkbox"/> Window Display |
| <input type="checkbox"/> Electric Wiring | <input type="checkbox"/> Show Card and Sign |
| <input type="checkbox"/> Electric Lighting | <input type="checkbox"/> Lettering |
| <input type="checkbox"/> Telegraph Engineering | <input type="checkbox"/> Railroad Positions |
| <input type="checkbox"/> Practical Telephony | <input type="checkbox"/> Illustrating |
| <input type="checkbox"/> Mechanical Engineer | <input type="checkbox"/> Cartooning |
| <input type="checkbox"/> Mechanical Draftsman | <input type="checkbox"/> Industrial Management |
| <input type="checkbox"/> Machine Shop Practice | <input type="checkbox"/> Secretarial Work |
| <input type="checkbox"/> Toolmaker | <input type="checkbox"/> Business Correspondence |
| <input type="checkbox"/> Gas Engineer | <input type="checkbox"/> Bookkeeper |
| <input type="checkbox"/> Civil Engineer | <input type="checkbox"/> Stenographer and Typist |
| <input type="checkbox"/> Surveying and Mapping | <input type="checkbox"/> Accounting and C.P.A. |
| <input type="checkbox"/> Mining Engineer | <input type="checkbox"/> Coaching |
| <input type="checkbox"/> Architect | <input type="checkbox"/> Traffic Management |
| <input type="checkbox"/> Architectural Draftsman | <input type="checkbox"/> English |
| <input type="checkbox"/> Architects' Blueprints | <input type="checkbox"/> Civil Service |
| <input type="checkbox"/> Plumbing and Heating | <input type="checkbox"/> Railway Mail Clerk |
| <input type="checkbox"/> Sheet Metal Worker | <input type="checkbox"/> Textile Overseer or Supt. |
| <input type="checkbox"/> Navigator | <input type="checkbox"/> Agriculture |
| <input type="checkbox"/> Chemical Engineer | <input type="checkbox"/> Radio |
| <input type="checkbox"/> Pharmacy | <input type="checkbox"/> Automobiles |
| <input type="checkbox"/> Salesmanship | <input type="checkbox"/> Poultry Raising |
| | <input type="checkbox"/> French |
| | <input type="checkbox"/> Spanish |

Name.....

Street Address.....

City.....State.....

Canadians may send this coupon to International Correspondence Schools Canadian, Limited, Montreal, Canada.

Automatic Concertina

(Small Size Piano Accordion)
PLAYED WITH INTER-CHANGEABLE ROLLS

Without any faint idea of music or notes, without any study or practice, you can play perfectly, like an artist, any songs, dances, fox-trots, 'one-steps', operas, marches, etc. Nobody can see the mechanical arrangement, everybody must think you are an artist. Wonderful tone, playing complete with all bass and accompaniments. Music is wanted and welcomed everywhere. Biggest assortment of rolls, latest hits. Three models. College model, \$30.00; Home model, \$45.00; Concert model, \$60.00, and music rolls free. Descriptive circular No. 8 mailed free.

TREASURE SALES COMPANY, 1690 Boston Rd., NEW YORK, N. Y.



Wonderful, new device, guides your hand; corrects your writing in few days. Big improvement in three hours. No failures. Complete outline. PERFECT. Perfect Penmanship Inst. Dept. 44. St. Louis, Mo.

gun on the sled, they turned tail and lit out.

"A good lead dog in a dog team shows reasoning when he makes a wide turn where the trail bends. If he did not, the sled would be dragged through the deep snow and probably capsized. The dogs behind him in the team might be dumb heads, but a good leader leads them as they should go.

"I could go much deeper into this subject, but inasmuch as I am writing a series of animal stories, and largely make my living by writing and lecturing, I know you will not expect me to do so.

"On June 4th, I started to broadcast a series of 'Trail Tales' at your station WRNY."

ANIMALS THINK TO CERTAIN EXTENT
A LETTER from Prof. D. M. H. Yates, State Teachers College, San Jose, Calif., reads as follows:

1. Higher animals do.
2. Under given conditions animals draw conclusions and act on them.

(c) It seeks protection due to both instinct and reason.

5. Instinct is an action without thought.
8. This can only be done through evolution, a slow adaptation to environment.

9. Yes, with dogs and fish. Animals think up to a certain point, provided the thinking does not go too far.

FROM U. S. DEPT., AGRICULTURAL EXPERT
A LETTER from W. L. McAtee, U. S. Department of Agriculture, Washington, D. C., reads as follows:

1. Yes, some of them.
2. Observed cases; intellect, like other features of the animal world, is a product of evolution.

A letter from Dr. William T. Hornaday, Stanford, Conn., reads as follows:

Remarks: I am not well enough to answer categorically, but you will find what I know, and think, in my book, "The Minds and Manners of Wild Animals," Scribner's, 1922. I have nothing to add to it, or subtract from it.

MODEL DEPARTMENT BLUEPRINTS

Correct—Easy to Follow

- 1-2 Horizontal Steam Engine details set \$1.00
- 3-4 Boiler construction for above set \$1.00
- 5 880 Ton Bark 50c
- 6-7 Twin Cylinder Steam Engine and Boiler. set \$1.00
- 8-9 Gasoline Fired Locomotive set \$2.00
- 10-11 U. S. S. Constitution, "Old Ironsides" .. set \$1.00
- 12 13th Century Man-of-War 50c
- 13-14 Chinese Junk set 50c
- 15-16 Electrically driven Automobile set \$1.00
- 17-18 How to Build a Reflecting Telescope .. \$1.00
- 19 Roman Ballista 50c
- 20-21 Simple Steam Engine, set 50c
- 22 "Santa Maria," complete 50c
- 23-24 Model U. S. S. Portsmouth set \$1.00
- 25 Building a Model Tugboat 50c
- 26 Twin Cylinder Marine Engine 50c
- 27-31 U. S. S. Truxton..... \$2.00

Send Orders to
MODEL DEPARTMENT
SCIENCE AND INVENTION
230 Fifth Avenue
New York City

The FUTURE

by
Professor A. M. Low

"THE FUTURE" is one of the most remarkable books of the age. Professor Low, the author, is a scientist of international reputation, also an experimenter and inventor in the many branches of science. This book written by him has aroused wide-spread interest. It deals with the world of the future, certainly an unusually absorbing subject. Written in the popular, non-technical fashion, "The Future" reveals the many advances and changes that are in store for humanity in a new life to come.

This book has received favorable comment in book reviews the world over. Do not neglect to read this treatise on the future by Professor A. M. Low. It is a literary treat for everyone.

Mail your order now! Don't wait, everybody is reading this remarkable book.

Price—\$2.00

Experimenters Publishing Co.
230 Fifth Ave., New York, N. Y.
Gentlemen: Enclosed find check or money order (check which) for \$2.00. Kindly send me a copy of Prof. A. M. Low's new book "THE FUTURE."

Name.....
Address.....
City.....State.....

Magic Eyes \$7.95



8 Lenses Magic Eyes that will extend your vision over 15 to 25 square miles. See the multitude of things these powerful lenses will show you. They conquer distance and bring distant objects before your very eyes. Wonderful for hunters, naturalists, tourists, etc.

Only 8 Lens Galilean Binocular under \$30
Eight fine sparkling precision ground day and night lenses. No wonder they give crisp, clear-cut details, expansive field, and great range. Only 4 1/4" high. Fine compass on top. Graduated focusing scale 1 to 12 on middle bar. Case and straps free. Order one today while they last. Only \$7.95 C.O.D. Free Trial for Five Days. Money back if you want it.

15-25 Miles
FREE TRIAL

CATALOG Over 200 Glasses All Makes—\$1-\$110
Everything in binoculars, field glasses, telescopes and optical instruments. The finest and largest assortment in America. Catalog gives all information how to choose the best for your individual needs at the LOWEST PRICE.

Try America's Leading Binocular House First
DuMAURIER CO., Dept. 178, ELMIRA, N. Y.

YEAR BOOK of the Fur Rabbit INDUSTRY

128 Pages. Articles by Rabbitsmen of National Prominence. Directory of Clubs and Associations. Beautifully illustrated. Answers all questions on Rabbit-Keeping, hutching, breeding stock, feeding and management. How to market Furs and Meat. Now being completed. Send 30c (postage, etc.) today for your copy. "Should be in every Rabbit-Man's Library." Desk 31. AMERICAN RABBIT ASSOCIATION, Inc. 447 SOUTH HEWITT ST., LOS ANGELES, CALIF.

Learn to PAINT SIGNS and SHOW CARDS

We quickly teach you by mail or at school, in spare time. Enormous demand. Big future. Interesting work. Oldest and foremost school.

EARN \$50 TO \$200 WEEKLY

John Vassos, N. Y., gets \$25 for single show card. Crawford, B. C., writes: Earned \$200 while taking course. No delay. Send today for complete information, samples and guarantee.

DETROIT SCHOOL OF LETTERING
179 Stinson Ave. Est. 1899. DETROIT, MICH.

Insure your copy reaching you each month. Subscribe to SCIENCE AND INVENTION—\$2.50 a year. Experimenters Publishing Co., Inc., 230 Fifth Avenue, New York City.

NEWAY LACQUER SPRAY

Smoother and Swifter Than Brushing

For the easy and practical application of lacquer paints. A smooth, durable, glossy finish assured. Paint and refinish automobiles, furniture, screens, radiators, machinery, etc. Well designed and built, adjustable atomizing head affords a continuous spray. Useful for spraying oils, insecticides, etc.

Type "C-P"—as shown—complete with 1 1/4 in. heavy-duty pump, 8 ft. tubing, shut-off valve—New Way dual top for use on either metal or glass containers. Glass furnished as standard. \$4.45

Type "C-P"—less foot pump. For your pump or air supply. \$3.25

Type "A"—Attached hand pump. Dual top. Easy-clean glass container assures visibility. The sturdiest and finest hand spray. \$1.95

Type "C" DeLuxe. Complete with large auxiliary pressure tank and moisture trap. A professional outfit for shops. Heavy duty 1 1/4-in. pump, pressure gauge on tank, shut-off valve, 10 ft. hose, New Way dual top and glass container. \$7.95

Type "C"—Tank, pump and gauge only. \$4.75

Extra Glass or Metal Tanks with Air-Tight Tops for Keeping Lacquers and Liquids Handy for Use . . . 25c

We pay postage on all orders

end 10c. for 3,000-word booklet: "How To Do Lacquer"

NEW WAY SPRAY GUN COMPANY
Dept. T-8 - - 1983 East 57th Street - - Cleveland, Ohio
Headquarters for Lacquer Spraying Equipment



Wood Turning for the Amateur

(Continued from page 363)

recommended. One should work with sharp tools, and work so skillfully that sandpaper will not often be needed.

With narrow strips of fine sandpaper No. 1/2 or O, sand the darning gourd as illustrated, being very careful not to change the shape of the curves or to cut off the sharp corners. The lathe should be operating at high speed for this. After cutting off, sand the ends carefully and give the whole a coat of linseed oil, rubbing it dry. No other finish is necessary.

Next month we will take up face plate exercises, and give designs and instructions for the construction of a candle stick and a smoking stand.

Fit Yourself for Marriage



It is a crime to marry when you know that you are not physically fit. That pure girl is blinded by her love for you and does not realize your deficiencies. She thinks you are a prince among men—the ideal of vigorous manhood. She pictures you as her husband and father of her children. You know that you are not fit—you dare not marry in your present physical condition. The future looks dark and gloomy to you.

MAKE YOURSELF FIT

You are not fit if you are weak, sickly, and underdeveloped. You dare not marry and ruin some trusting girl's life if dissipation and excesses have sapped your vitality and left you a mere apology for a real man. Don't think you can save yourself with dope and drugs. Such unnatural stimulants can never remove the cause of your weaknesses and will surely harm you. The only way you can be restored is through Nature's basic law. She will never fail you if you sit at her feet and learn her ways.

STRONGFORT
Builder of Men

I MAKE WEAK MEN STRONG

My entire life has been dedicated to a study of Nature's Laws. I have applied her wonderfully effective principles to my own person and gained the world's award as the most perfect specimen of physical and health attainment. These are the same marvelous, restorative, uplifting elements that I want to apply in your case and fit you for the responsibilities of marriage and parenthood. I want to help you—I can help you with

STRONGFORTISM

SCIENCE OF HEALTH AND STRENGTH

STRONGFORTISM — Nature's first assistant — has lifted thousands of weak, ailing, discouraged men out of the bog of despair, and placed them on the straight road to health, vigorous strength, and happiness.

STRONGFORTISM has restored the manhood they thought lost forever and has given them renewed confidence, vitality, success, and fitted them for the joys of life. You can follow my instructions for repairing your health and strength in the privacy of your room, ridding yourself of weakness, nervousness, catarrh, constipation, indigestion, rheumatism and other ailments, and start a new lease of life.

SEND FOR MY FREE BOOK

The experience and research of a lifetime are contained in my wonderfully instructive book, "**PROMOTION AND CONSERVATION OF HEALTH, STRENGTH, AND MENTAL ENERGY.**" It will tell you frankly how you can make yourself over into a vigorous specimen of vital manhood. Just mark the subjects on the free consultation coupon on which you want special confidential information and send to me. Send for my free book—**RIGHT NOW—TODAY.**

STRONGFORT INSTITUTE
LIONEL STRONGFORT, DIRECTOR
PHYSICAL AND HEALTH SPECIALIST
DEPT. 498 NEWARK, NEW JERSEY, U.S.A.

FREE CONSULTATION

Clip and Send This Coupon
ABSOLUTELY CONFIDENTIAL

Mr. Lionel Strongfort
Strongfort Institute, Dept. 498, Newark, N. J.

Please send me absolutely free my copy of your book, "**PROMOTION AND CONSERVATION OF HEALTH, STRENGTH, AND MENTAL ENERGY.**" I have marked (x) before the subjects in which I am most interested.

.. Colds	.. Weak Eyes	.. Vital Losses
.. Catarhh	.. Flat Chest	.. Lung Troubles
.. Asthma	.. Dependancy	.. Poor Circulation
.. Headache	.. Emaciation	.. Round Shoulders
.. Rupture	.. Rheumatism	.. Youthful Errors
.. Thinness	.. Nervousness	.. Manhood Restored
.. Pimples	.. Constipation	.. Skin Troubles
.. Insomnia	.. Night Losses	.. Stomach Disorders
.. Impotency	.. Short Breath	.. Increased Height
.. Overweight	.. Weak Heart	.. Muscular
.. Weak Back	.. Great Strength	.. Development

Name.....
Age..... Occupation.....
Street.....
City..... State.....

Don't Envy the Plumber

BE ONE

\$11.00-\$16.00 PER DAY and work EVERY day, is the Plumber's wage.

Every skilled workman will tell you that Plumbers have the best of it. WINTER and SUMMER the Plumber is busy at top wages. No skilled Plumber is ever out of a job—compare his opportunities with any trade, plus the opportunities of having your own shop.

We teach you Plumbing with **TOOLS** (not books) under Licensed Master **PLUMBERS** in one of the finest equipped schools in America. We make you a Plumber, every branch is taught thoroughly—Lead Work—Blue Print for plan reading—all other tricks.

LEARN IN 8 TO 12 WEEKS without previous experience.

If you are making less than \$60.00 a week you owe it to yourself to investigate. Get **FREE** catalog that tells in pictures and words how we teach this trade. Special dates now.

UNIVERSAL PLUMBING SCHOOL
2057 Troost Ave. KANSAS CITY, MO.

IN "RADIO NEWS" FOR AUGUST, 1928

The Screen-Grid Short-Wave Receiver
A Booster Unit for the Browning-Drake
The Loffin-White Improved Direct-Coupled Amplifier
Radio Movies and Television for the Home —the Jenkins System
The Zero-Reactance Plate Circuit
A Two-Tube Reflex for the Beginner
The Influence of the Weather on Reception
Some Odd Uses for Vacuum Tubes
X-Raying the Radio Set

And many others

Learn to Dance

This New Easy Way

You can learn all the modern dances—Charleston, Black Bottom, Valencia, Casino, French Tango, St. Louis Hop, Latest Waltzes, Fox Tots, etc., at home easily and quickly. New chart method makes dancing as simple as A-B-C. No music or partner required. Learn anywhere, anytime. Win new popularity. Be in demand at parties. Same course of lessons would cost \$20 if taken privately.

Send No Money

Just send your name and address. We'll ship the complete course—328 pages, 49 illustrations—without one cent in advance. When package arrives, hand postman only \$1.50, plus delivery charges, and this wonderful course is yours. Try for 5 days. Money back if not delighted. Send your name NOW.

FRANKLIN PUB. CO. 800 N. Clark St. Dep. C-205 Chicago



Readers Forum

(Continued from page 337)

My performance is quite out of the ordinary and I can assure you an evening both instructive and entertaining.

Yours truly,
(Signed) NINO PECORARO."

Well, the letter said, "How you do it I care not," and the reply says it will be "quite out of the ordinary" (indeed).

Well, well, that's beyond me, but anyway I have his autograph among my assortment of magic, spiritualism, etc.

(By the way, the "H. I." is the first and last letters of Houdini. The whole club is a myth.)

ISRAEL SALTZMAN, Rep. No. 34,209.

(One hundred dollars is not too much to pay an entertainer. Mr. Pecoraro did not state that he was going to produce spirits, although he did promise them for the \$31,000 Prize. He claimed his performance to be quite out of the ordinary. This it undoubtedly is. A full report on the medium's demonstration at **SCIENCE AND INVENTION Magazine Offices** appeared in the July issue of **SCIENCE AND INVENTION Magazine** and it was out of the ordinary, but Mr. Dunningers was even more so without spirit aid.—EDITOR.)

FROM ANOTHER CUP WINNER

Editor, **SCIENCE AND INVENTION**:

Will write a few lines to let you know that I received the Model Trophy Cup which was awarded to me in the May issue of **SCIENCE AND INVENTION**. The cup is wonderful and is worth working for. I am taking this humble way to thank you for the beautiful trophy. I am always looking for the next issue of **SCIENCE AND INVENTION**.

CARL VON BARGEN,
Alliance, Nebraska.

(We are very glad indeed that you liked the cup and we trust that you will from now on consider model-making an interesting pastime, if not a lucrative one.—EDITOR.)

RESHAPE YOUR NOSE

to beautiful proportions—while you sleep!

ANITA NOSE ADJUSTER is SAFE, painless, comfortable. Speedy, permanent results guaranteed. Doctors praise it. No metal to harm you. Small cost.

Gold Medal Won 1928 Write for FREE BOOKLET

ANITA CO., 873 Anita Bldg., Newa. Nrk. J.



MUSIC LESSONS IN YOUR HOME

You can read music like this quickly

Write today for our **FREE BOOKLET**. It tells how to learn to play Piano, Organ, Violin, Mandolin, Guitar, Banjo, etc. Beginners or advanced players. Your only expense about 2c per day for music and postage used.

AMERICAN SCHOOL of MUSIC, 57 Manhattan Bldg., Chicago

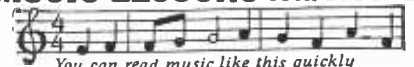

Learn Photography at HOME

Make money taking pictures. Prepare quickly during spare time. Also earn while you learn. No experience necessary. New easy method. Nothing else like it. Send at once for free book, **Opportunities in Modern Photography**, and full particulars.

AMERICAN SCHOOL of PHOTOGRAPHY
Dept. 142-C, 3601 Michigan Ave. Chicago, U. S. A.

Opportunity Ad-lets

YOU will find many remarkable opportunities and real bargains in these columns. It will pay you to read and investigate the offerings made every month by reliable firms, dealers and amateurs from all over the country. No matter what you may be seeking, whether supplies, automobile accessories, the opportunity to make money, or anything else, you will find listed here the best and most attractive specials of the month.

Advertisements in this section twelve cents a word for each insertion. Name and address must be included at the above rate. Cash should accompany all classified advertisements unless placed by an accredited advertising agency. No advertisement for less than 10 words accepted.

Ten per cent discount for 6 issues, 20 per cent discount for 12 issues. Objectionable or misleading advertisements not accepted. Advertisements for the October issue must reach us not later than August 5th.

EXPERIMENTER PUBLISHING CO., INC., 230 Fifth Avenue, New York, N. Y.

Advertising

Get into Advertising. Learn quickly at home. Experience unnecessary. New, easy plan. No text books used. Practical work. Old established school. Send name and address for interesting free booklet. Page-Davis School of Advertising, Dept. 533-B, 3601 Michigan, Chicago.

Advertising Agencies

24 Words—355 Rural Weeklies \$12.20. Ad-Meyer, 4112-SI Hartford, St. Louis, Mo.

Agents Wanted

\$20 Daily. New Auto Invention. Snappy metal initials installed on any car in 3 minutes. Low cost. 500% profit. Free particulars. Consolidated, 69-HQ—W. Van Buren, Chicago.

Can you sell house paint at \$1.98 per gallon and barn paint at \$1.30? Lowest prices in America. Beat all competition, dealers and mail order houses. Money back guarantee to every customer. Experience unnecessary, no delivering or collecting. Just talk to property owners about these low prices. \$50 to \$100 weekly easily made. Check mailed you each Friday. Write at once for Free Sales Outfit, with complete information. Farm & Home Paint Co., Dept. 127, Kansas City, Missouri.

66 Miles on 1 Gallon—Sensational New Moisture Gas Saver. All autos, 1 Free to Introduce. Critchlow, G-863, Wheaton, Ill.

Strange Invention! Pays \$25 Daily. Keeps telephone and iron cords from tangling and kinking. Prevents iron searching. Saves electricity. Samples free. Neverknot, Dept. 8-K, 4503 Ravenswood, Chicago.

Agents—Best seller; Jem Rubber Repair for tires and tubes; supersedes vulcanization at a saving of over 800 per cent; put it on cold. It vulcanizes itself in two minutes and is guaranteed to last the life of the tire or tube; sells to every auto owner and accessory dealer. For particulars how to make big money and free sample, address Amazon Rubber Co., Philadelphia, Pa., Dept. 601.

\$60—\$200 a week. Genuine Gold Letters for store windows. Easily applied. Free samples. Liberal offer to general agents. Metallic Letter Co., 441 B., North Clark, Chicago.

Big money and fast sales. Every owner buys gold initials for his auto. You charge \$1.50; you make \$1.35. Ten orders daily easy. Write for particulars and free samples, American Monogram Co., Dept. 71, East Orange, N. J.

Succeed With Your Own Products. Make them yourself. Formulas, Processes, Trade-Secrets. All lines. Catalog, Circulars free. D. Thaxly Co., Washington, D. C.

\$50.00 Weekly easy, applying Gold Initials on Automobiles. No experience needed. \$1.45 profit every \$1.50 job. Free Samples. "Ralco Monograms," P1043 Washington, Boston, Mass.

Agents Wanted to sell Men's Hats direct from factory. Write for catalog. Model Hat Mfg. Co., Dept. M-11, East Orange, N. J.

\$10 daily silvering mirrors, plating and refinishing lamps, reflectors, autos, beds, chandeliers by new method. Outfits furnished. Write Gunmetal Co., Ave. D, Decatur, Ill.

Men and Women Wanted to sell subscriptions in their own communities. Can make a dollar an hour in spare time. Two leading magazines. Help given to beginners. Write for information at once. Agency Dept., Experimenter Publishing Co., 230 Fifth Avenue, New York City.

Mirrors Resilvered at Home. Costs less than 5 cents per square foot; you charge 75 cents. Immense profits plating auto parts, reflectors, tableware, stoves, refinishing metalware, etc. Outfits furnished. Sprinkle, Plater, 955, Marion, Indiana.

Don't sell for others. Employ agents yourself. Make your own products. Toilet Articles, Household Specialties, etc. 500% profit. Valuable booklet free. National Scientific Laboratories, 1973W Broad, Richmond, Va.

Airplanes, Aviation

Biggest, Best Catalog Model Airplanes, Parts, Supplies; 5c Postpaid. Ideal Company, 23 West 18th Street, New York.

Model Airplane Engines: 1/2 h. p. in 3 lbs.; 1 h. p. in 5 lbs. We buy patentable improvements in engines. Circulars free. DYNAMIC MFG. CO., First Nat'l Bank Bldg., Chicago.

Send dime for 12-inch mounted propeller and circular on free three-foot model aeroplane. No selling. Aero Shop, 3050 Huribut Ave., Detroit, Mich.

Build your own single seater airplane. Book and blueprints on design, construction, and lessons in flying all for \$1.00. Chas. Russell, 545 Stadium Place, Ft. Wayne, Ind.

New! Three models in one. Perfect scientific reproductions. Catalog free. Stewart Marshall, Rome, Ga.

"The Story of Lindbergh," largest book published, his life, flight to Paris, Mexico, etc. 320 pages, 60 illustrations. Pay postman C.O.D. \$1.98. Reid Company, 440 Sansome St., San Francisco, Cal.

Books

Books, Magazines, Art Publications in French, English, Spanish. Photo novelties, etc. Samples, lists, 20 cents in stamps. Villaverde Co., Dept. 206, Box 1329, Havana, Cuba.

Free—My illustrated Circulars on Newthought, Selfculture, Healing, Yogi Philosophy, Occult, Mystic and Scientific Books. Martens Publisher, Inc., Burlington, Iowa.

Business Opportunities

Artists and Art Students are printing 250 signs and pictures an hour without machinery. Sample and particulars 10c. Straco—1015 Mulberry, Springfield, Ohio.

Want to make a dollar an hour in your spare time? Send for full information, Agency Dept. Experimenter Publishing Co., 230 Fifth Ave., N. Y. C.

Sell By Mail!—Books, novelties, bargains! Large profits! Particulars FREE! E-Elco, 525 South Dearborn, Chicago.

Sell by Mail. Wonderful opportunity. Particulars free. Mason, 3902 Broadway, Dept. 6, Chicago.

Free Book. Start Little Mail Order business, Hadwil, 5A-74 Cortlandt Street, N. Y.

Cameras and Photography Supplies

Make money in Photography. Learn quickly at home. Spare or full time. New plan. Nothing like it. Experience unnecessary. American School of Photography, Dept. 5333, 3601 Michigan Avenue, Chicago.

Chalk Talks

Laugh producing program, \$1.00. Catalog free. BALDA ART SERVICE, Dept. 4, Oshkosh, Wis.

Chemistry

Big Chemical Mail, 5c. Walker, 1514 Allison, Washington, D. C.

Catalogue listing 2500 illustrations laboratory apparatus 5,000 chemicals and 1,000 scientific books sent on receipt of 50c. Laboratory Materials Company, 635 E. 71st St., Chicago.

Attention Chemical Experimenters! 100 chemicals consisting of complete selection for the experimenter's laboratory. Chemicals of highest quality obtainable sufficient quantities for hundreds of experiments. Apparatus with this outfit to perform many experiments. Really ideal for any laboratory. Price \$4.00. 50 pieces high grade chemical apparatus containing most essential equipment for laboratory. Worth three times price asked. Our price \$7.00. Postage prepaid. Send money order or C. O. D. to Pines Chemical Co., 1524 St. Marks Ave., Brooklyn, New York.

(Chemistry continued)

Learn Chemistry at Home. Dr. T. O'Conor Sloane, noted educator and scientific authority, will teach you. Our home study correspondence course fits you to take a position as chemist. See our ad on page 291 of this issue. Chemical Institute of New York, 16 E. 30th St., New York City.

Your Chemical problems solved and working process furnished for Five Dollars. Write me. W. Stedman Richards, Consulting Chemist, Box 2402, Boston, Mass.

!!! 10c brings you "Amateur Chemist". Everyone likes it. Year, \$1.00. Thompson-Allen Laboratories, Shamokin, Pa.

Correspondence Courses

Used correspondence school courses sold on repurchase basis. Also rented and exchanged. Money-back guarantee. Catalog free. (Courses bought). Lee Mountain, Pisgah, Alabama.

Detectives

Detectives Earn Big Money. Travel. Excellent opportunity. Make secret investigations. Great demand everywhere. Experience unnecessary. Write American Detective System, 2190 Broadway, N. Y.

Engines, Motors, Dynamos

Make Electric Motors—half and one horse-power. A. C. induction motor winding models show connections plain sight. Learn quick easy. Dept. C, Gaines Bros., Gainesville, Texas.

For Boys

"The Boy Electrician," pocket size, 75 illustrations. 30c. J. Tillberg, Proctor, Vermont.

For Inventors

One hundred facts for inventors mailed to any address for one dollar. Donald L. Selman, Lincoln, Kansas.

Wanted to manufacture on royalty basis, appliances pertaining to health or surgery. Send full details, Cincinnati Automatic Machine Co., Cincinnati, Ohio.

Inventions Commercialized. Patented or Unpatented. Write Adam Fisher Mfg. Co., 205 Enright, St. Louis, Mo.

Inventors—We Build Models. Send us your rough idea. Our master mechanics will develop it for you into a practical working model. Thirty years successful experience doing this very thing. Best shop equipment. Expert advice. Confidential service guaranteed. Bank reference furnished. Send for free booklet, "The Road to Success." Crescent Tool Co., Dept. D, Cincinnati, Ohio.

Unpatented Ideas Can Be Sold. I tell you how and help you make the sale. Free particulars (Copyrighted). Write W. T. Greene, 808 Baltic Bldg., Washington, D. C.

Inventors. Use our special service for presenting your invention or patent to manufacturers. Adam Fisher Mfg. Co., 205-A Enright, St. Louis, Mo.

For Sale

Real Bargains in rebuild analytical balances and microscopes, also other laboratory equipment and some tools. Send stamp for list. A. L. Pouleur, Box 32, Norton, Massachusetts.

Health

Quit Tobacco! Tobacco or Snuff habit cured or no pay! \$1.50 if cured. Sent on trial! Write Frances Willard, Box 796, Los Angeles, Calif.

Help Wanted

Men—Experience unnecessary; travel; make secret investigations; reports; salaries; expenses. Write American Foreign Detective Institute, 304, St. Louis, Mo.

Help Wanted Instructions

Earn \$25 Weekly. Spare Time. Writing for Newspapers and Magazines. Experience unnecessary. Copy-right Book. "How to Write for Pay" Free. Press

Instructions

Wanted. Men, Qualify for Post-office Laborer Job. \$125-\$133 month. Write, Ozment Inst., 293 St. Louis, Missouri.

Men 18-45. \$1700-\$2700 year. Railway Postal Clerks. City Mail Carriers. Common education sufficient. Particulars with sample coaching—Free. Franklin Institute, Dept. F15, Rochester, N. Y.

Men, get Forest Ranger job: \$125-\$200 month and home furnished; hunt, fish, trap. For details, write Norton Inst., 1541 Temple Court, Denver, Colo.

Men—Women, 18 up. Get U. S. Government Life Jobs. \$1140 to \$3300 year. Steady work. Many Railway Mail Clerks—Carriers, appointed every year. Inside and outside work. Experience usually unnecessary. Common education sufficient with our coaching. List positions and full particulars—Free. Write today sure. Franklin Institute, Dept F4, Rochester, N. Y.

Learn Chemistry at Home. Dr. T. O'Connor Sloane, noted educator and scientific authority, will teach you. Our home study correspondence course fits you to take a position as chemist. See our ad on page 291 of this issue. Chemical Institute of New York, 16 E. 30th St., New York City.

Inventions Wanted

Inventions Commercialized. Patented or Unpatented. Write Adam Fisher Mfg. Co., 205 Enright, St. Louis, Mo.

Magic and Games

Free with \$25 order our large die box. Send 20c for our large catalogue of tricks, puzzles, wigs, sensational escapes. Oaks Magical Co., Dept. 549, Oshkosh, Wis.

Magical Goods

Magic—Big special offer, fine tricks valued at \$2.00 and big new catalogue all for \$1.00. Catalogue alone 15c. Sterling Magic Shop, Box 33, Danville, Va.

Card tricks, Coin tricks, Hypnotism, Ventriloquism. Instructive 64 page books, 10c each. G. Fenner, 2401 Jefferson, Louisville, Ky.

Male Help Wanted

Qualify for fireman, brakeman, baggageman, colored man for sleeping car, train porter, Standard roads. \$150-\$200. Experience unnecessary. 897 Railway Bureau, East St. Louis, Ill.

Men—Big Pay. South American work. Companies pay fare, expenses. South American Service Bureau, 14,600 Alma, Detroit, Mich.

Silk Cut Neckwear, \$3.50 dozen; \$39.00 gross. Samples, 3 Silk Ties \$1.00 Prepaid. Elite Sales, 1821 East 101st, Cleveland, Ohio.

Immense Profits making French plate mirrors; patented process; easily learned. Plans free. Wear, Excelsior Springs, Mo.

Miscellaneous

Beautiful Registered Bull Pups, \$15. Bulldogs, 501 Rockwood, Dallas, Texas.

Forms to cast Lead Soldiers, Indians, Marines, Trappers, Animals. 151 kinds. Send 10c for illustrated Catalogue. H. C. Schiercke, 1034-72nd St., Brooklyn, N. Y.

Expert watch repairing. Cleaning. Old watches made new, \$1.00—guaranteed. Send insured mail. Phillips Watch Repair, 5131 Kenmore, Chicago.

Historic Scenes World War. Genuine. 10c. Box 105, W. Scranton, Pa.

Moulds

Moulds Making Toys. See ad on page 383. Miscellaneous. H. C. Schiercke.

Musical Instruments

Violins—Deep, Mellow, Soulful—on easy credit terms. High grade, wonderful instruments of my own make. Development of many years' expertness. Write for book. Gustav A. Henning, 302 University Building, Seattle, Washington.

Old Coins

California Gold, quarter size, 27c; half-dollar size, 53c Columbian nickel and catalogue, 10c. Norman Shultz, Box 746, Salt Lake City, Utah.

Patent Attorneys

Patent Sense. As one of the oldest firms in America we give inventors, at lowest consistent charge, a service noted for results, evidenced by many well-known patents of extraordinary value. Book, Patent-Sense, free. Lacey & Lacey, 644 F Street, Washington, D. C. Estab. 1869.

Patents—Write for Instructions. Carl Miller, Registered Patent Attorney (former Patent Office examiner). 211-E McGill Building, Washington, D. C.

Patents—Free advice. Confidential, prompt personal service of Registered Patent Attorney, former Patent Office Examiner. Booklet. Albert Jacobs, 728 Barrister Bldg., Washington, D. C.

Patents procured at reasonable rates with time to pay. Sales re-estimated. Staff of registered attorneys and engineers. A complete service for inventors. Write for particulars. Inventors Service Bureau, Box 1648, Washington, D. C.

Patents. Booklet free. Highest references. Best results. Promptness assured, Watson E. Coleman, Patent Attorney, Washington, D. C.

Richard E. Babcock, Patent Lawyer, Washington Lo- & Trust Bldg., Washington, D. C., Booklet.

Monroe E. Miller, Ouray Bldg., Washington, D. C. Patent Lawyer, Mechanical, Electrical Expert. Booklet and Priority Record blank gratis.

Patents—Send for form "Evidence of Conception" to be signed and witnessed. Form, fee schedule information free. Lancaster and Allwine. Registered Patent Attorneys in United States and Canada, 242 Ouray Bldg., Washington, D. C.

Unpatented Ideas Can Be Sold. I tell you how and help you make the sale. Free particulars. (Copyrighted). Write W. T. Greene, 809 Baltic Bldg., Washington, D. C.

Patents. Time counts in applying for patents. Don't risk delay in protecting your ideas. Send sketch or model for instructions or write for Free book, "How to Obtain a Patent" and "Record of Invention" form. No charge for information on how to proceed. Communications strictly confidential. Prompt, careful, efficient service. Clarence A. O'Brien, Registered Patent Attorney, Security Bank Building (directly across street from patent office), Washington, D. C. See page 361.

"Inventor's Advisor," Valuable Patentbook sent free. Labiner, 3 Park Row, New York.

ADAM E. FISHER, Registered Patent Attorney, in business 25 years; references; personal attention and promptness assured; Dept. E. 205 Enright, St. Louis, Mo.

Patent, Trade-Marks, Copyrights. Reliable services by an experienced practitioner devoting personal attention to each case. Inquiries invited. Reference furnished. B. P. Fishburne, Patent Lawyer, 525-D McGill Building, Washington, D. C.

Patents Procured; Trade Marks Registered—A comprehensive experienced, prompt service for the protection and development of your ideas. Preliminary advice gladly furnished without charge. Booklet of information and form for disclosing idea free on request. Irving L. McCathran, 202 Owen Bldg., Washington, D. C., or 41-T Park Row, New York.

Patents

Inventions Commercialized. Patented or Unpatented. Write Adam Fisher Mfg. Co., 205 Enright, St. Louis, Mo.

Patents for Sale

Canadian Patent No. 279,764 "Process of Producing Combination Ice Cream." C. March, 2339 N. Ashland Ave., Chicago.

Patents Wanted

Inventions Commercialized. Patented or Unpatented. Write Adam Fisher Mfg. Co., 205 Enright, St. Louis, Mo.

Mr. Inventor—If you have a patent or invention for sale, write Hartley, 38 Court St., Bangor, Me.

Photography

Have you a Camera? Write for free sample of our big magazine, showing how to make better pictures and earn money. American Photography, 118 Camera House, Boston, 17, Mass.

Big Opportunities! Learn at home; Motion Picture Photography, portrait. Commercial or news photography; write for catalog. New York Institute of Photography, Dept. 82A, 10 W. 33d St., N. Y.

Photoplays Wanted

\$\$\$ For Photoplay Plots, Stories accepted any form, revised, criticized, copyrighted, marketed. Estab. 1917. Booklet free. Universal Scenario Co., 223 Western & Santa Monica Bldg., Hollywood, Calif.

Printing Outfits and Supplies

Print your own cards, stationery, circulars, paper, etc. Complete outfits \$3.85; Job Presses \$11, \$29; Rotary \$149. Print for others, big profit. All easy, rules sent. Write for catalog presses, type, paper, etc. Kelsey Company, F-6 Meriden, Conn.

Something Nifty—200 Ripple Finished Monarch Letterheads and 100 Envelopes to match, printed and process embossed. \$1.50 postpaid. Herman Pogue, Box 96, Greenville, Mississippi.

200 Letterheads and 100 Envelopes, \$1.10, postpaid. Oberman Company, Box 1268, Chicago.

Radio

Tube type chargers. Easily built. No transformers. No noise. Efficient. Any rate complete \$5 to \$10. Blueprints, 50c. Universal Rectifier Co., 106—2nd St., N. E., Charlottesville, Va.

Buy Your B Power Devices direct from Factory. Send for particulars. D. L. & G. Mfg. Co., 2941 W. Lake, Dept. 10, Chicago.

Salesmen Wanted

A Paying Position Open to representative of character. Take orders shoes—hosiery direct to wearer. Good income. "Permanent. Write now for free book, "Getting Ahead." Tanners Shoe Mfg. Co., 6603 C St., Boston, Mass.

Punchboard Salesmen. 2 hours daily. \$100 every week. New line. Lowest prices. Full commission on repeat business. Catalog Free. Puritan Novelty Co., 1409 Jackson, Chicago.

Sell us your spare time. Solicit subscriptions for two leading magazines in your city. You can make a dollar an hour easy. Write for full information. Agency Dept., Experimenter Publishing Co., 230 Fifth Ave., N. Y.

Song Poems

Song-poem Writers. Address Monarch, 236 West 55th, Dept. 133, New York.

Song Poem Writers—Send for proposition. Ray Hibeler, D24, 2104 N. Keystone Ave., Chicago.

Song Poem Writers, Write Sequoia Songwriters' Service, Sherman Branch, Los Angeles, Calif.

Stamps and Coins

Stamps, 100, All Different, 3 cents. S. I. Quaker Stamp Company, Toledo, O.

Typewriters

Typewriters, all standard makers. \$10 up. Fully guaranteed. Free trial. Write for complete illustrated lists. Northwestern Exchange, 121 N. Francisco Ave., Chicago.

HOW TO ELECTRIFY YOUR RADIO SET

By Victor L. Osgood

The Conrad Company has published this book so that all may own a modern radio set—no more batteries. In good, simple English, this book goes thoroughly over the subject and shows you exactly how to build an Eliminator, and all parts necessary.

"How To Electrify Your Set"
25c.

6 x 9 inches, illustrated

On all newsstands, or direct

The CONRAD CO., Inc., 230 Fifth Ave., N. Y. C.

DEPARTMENT

Sell from Actual Sample Garments. Finest lingerie, shirts, collars, underwear, etc. Million-dollar factory furnishes complete equipment worth \$53.00. Make \$47 to \$115 weekly. Commissions advanced daily. Write Teilson Mills, Inc., Suite G, 1107 Broadway, New York.

Sell your spare time to us for \$3.50 an hour. Show quality dresses, coats and lingerie. America's greatest values. No experience needed. Liberal advance commissions. Selling equipment free. Write Bartlett Brooks, 815 Walnut St., Indianapolis, Ind. (Subsidiary of Famous Real Silk Hosiery Mills.)

Big Money. Full or Spare Time. Take orders direct for guaranteed Boys' and Youths' Clothing. Cash commissions and bonuses. Experience unnecessary. Sample outfit free. Write Kraige-Wilson, 719 Broadway, N. Y.

New Invention prevents shoulder straps slipping. Earn \$60 up weekly. Selling experience unnecessary. Women adore this amazing comfort chain. Free sample offer. Lingerie "V" Co., 98 Oak St., North Windham, Conn.

Agents—New Lines Just Out. Everything in hosiery, lingerie and underwear for men, women and children. Beautiful illustrated Catalog and Samples now ready. Two new special big-money plans. Cash bonus, service awards. No capital needed. Choice territories going. Write quick. World's Star Knitting Company, 2510 Oak St., Bay City, Mich.

High Grade Specialty Salesmen. To call on beauty shops, druggists, etc. \$50 to \$125 commission weekly. Side line or full time. L. Bielbo, B. J. Wheaton, 1107 Broadway, New York.

America's Greatest Tailoring Line Free! 130 large Swatch Samples—All Wool—Tailored to Order—Union Made—Sensational low price. Get outfit at once. Address Dept. 601, Goodwear, 344 W. Adams, Chicago.

Make \$85 weekly, taking orders for finest-tailored shirts and ties. Free Outfit. Dan Reilly, 1237 Broadway, New York.

If I show you an all Virgin Wool Suit, tailored-to-order, priced at \$32.50, you can sell for \$22.50, make \$4.00 yourself, give you absolutely free. Complete selling outfit, will you give me proposition a trial? P. C. Kink, 2238 South La Salle, Chicago, Ill.

In Lunch hours selling Christmas Cards. Full or spare time. Weekly pay, \$10. Sample Book Free. Exper. unrec. Get details. John Hertel Co., 320 Washington, Chicago.

Make \$12 a day and great bonus selling Pioneer \$23.50 and \$33.50 all-wool tailoring. Commissions paid daily. 100 extra large cloth samples furnished. We train the inexperienced. Write Pioneer Tailoring Co., Congress & Throop, Dept. V12, Chicago, Ill.

Own a roadside Bar-B-Q. We start you in this profitable business with small investment. Peerless Stove Company, Scott and Darby Sts., Columbus, Ohio.

Sensational tailoring offer. \$100 weekly, \$5 commission on \$23.50 suits or coats. Tailored to measure. Materials, style, fit, guaranteed. Big selling outfit free. Oliver D. Woods, 515 S. Franklin, Chicago.

\$10.00 Daily Easy! We start you in auto accessory business. Exclusive Territory. Motor Products, MC, 1760 Lunt, Chicago.

Nimrod's All Year Sellers Pay Agents \$10-\$25 daily. Guaranteed best values—Dress Shirts, Work Shirts, Overalls, Pants, Sweaters, Underwear, Leather Coats, Lumberjacks, Playsuits. Experience unnecessary. Big Outfit Free! Nimrod Co., Dept. 58, 4922-28 Lincoln Ave., Chicago.

Salesmen to sell Roberts' Clothes; virgin wool of blue serge and chevvy worsted casimers and all wool top coats and overcoats at \$16.75; commission \$3.50 plus liberal bonus; send for Free outfit. Roberts Tailoring, 752 Broadway, New York.

Agents—\$240 Month. Sell Silk Hosiery. Guaranteed 7 months. We furnish outfit. Samples furnished. Free silk hosiery for your own use. Write today, state size of hose worn. Better Textile Co., Silk 1635, Greenfield, O.

Story-writer, Poet and Song Composer. Make real money. My Free book shows you how. Write at once. Richard D. Abbott, 22 E. 12th St., Cincinnati, Ohio.

Big Income. Sell Longwear Trousers wherever men wear. One pair \$1.95, 3 for \$5.50. Outlast two ordinary trousers. Big commissions. Sales outfit free. Dept. L-8, Longwear, 489 Broome Street, New York.

Don't Sell for Others. Employ Agents Yourself. Make your own products. Toilet Articles, Household Specialties, etc. 60% profit. Valuable booklet free. National Scientific Labs., 1929 W. Broad, Richmond, Va.

Brand New Plan—Free Suit to Each Agent—\$45 up and weekly, paid in advance. Take orders for our high-grade tailoring. Handsome carrying case outfit of large real cloth samples—furnished free. Spencer Meach Company—Harrison and Throop, Dept. V-12, Chicago, Illinois.

Make Money Every Day Selling All manufacturing, business, professional, society people and individuals everywhere our nation ally known Starline Announcements, etc. Also America's finest Monogrammed Personal and Business Christmas Greeting Cards. Large commission paid daily and liberal monthly bonus. For beautiful free sample equipment write Manager, process of engraving Company, Troy at 21st Street, Chicago.

Man Wanted Quick—Big Pay as Local representative for 500,000 Kriss-Kross Strop Corp. \$75 a week and up! Our Florida man makes \$500 a month. Just demonstrating this amazing shave invention. Get details now! Write M. H. Rhodes, Dept. K-3252, 1418 Pendleton Ave., St. Louis, Mo.

M. H. Rhodes, Dept. K-3252, 1418 Pendleton St. Louis, Mo.

Am interested in your proposition. Rush Details.

Name.....
Address.....

Write for Big Free Outfit showing men's made-to-measure rainproof caps. Also men's hats, mufflers and charming Lovette Hats for women. Show line—take orders everywhere—\$15.00 a day easy. Experience unnecessary. Free Caps given. Fitts-U Cap Co., Dept. J-105, Cincinnati, Ohio.

World's leading manufacturer of Fire Extinguishers has positions open for salesmen in direct selling, capable of earning \$3,000 to \$6,000 yearly. Prospects everywhere—cash sales. We train you. Rapid promotions to producers. Fyr-Fyter Co., 1720 Fyr-Fyter Bldg., Dayton, Ohio.

\$100 weekly selling better-quality, all- wool, made-to-measure suits and overcoats at \$23.50. Highest commissions. Extra bonus for producers. Large swatch samples free. W. Z. Gibson, Inc., 500 Throop St., Dept. V-672, Chicago, Illinois.

Polishing Cloth—Cleans all metals, gets enthusiastic attention, sells fast at 25c; sample free. F. C. Gale Co., 99 Edinboro St., Boston, Mass.

Great neckwear line now free! Features finest quality, pressed at factory prices. Collect big commissions daily. Write for FREE tie offer and FREE outfit. Nawco Neckwear, H-125, Covington, Ky.

Selling Simpson's All-Wool, Made-to- measure suits. Make \$90 weekly. Make \$100 a week. Big season starting. Write for exclusive territory; complete equipment, 175 samples free. J. B. Simpson, 843 Adams, Dept. 1501, Chicago, Illinois.

Now! \$5,000 year easy! Sell Gibraltar Shirts! Finest quality. Lowest prices. Defy competition! Liberal daily commissions. Send outfit for free outfit containing large assortment shirt samples. Gibraltar Shirt Co., Dept. W-7, 20 West 22nd Street, New York.

Punchboard Salesmen. New fascinating game. Excitement! legal all states; \$200 weekly easy. 15 minute sales talk; pay daily. Cigar Stores Nov. 17, Dept. E. Peoria, Ill.

\$14.85 men's suits or coats! Amazing value. 2 for \$27.85—Commissions \$6.50. Easy sales, quick profits. Large sample outfit free. Wholesale Tailors, 306 W. 14th, New York.

Something New! Latest Craze—Hand- some Colorful Rubber Art Rugs in attractive patterns and colors. Practical, serviceable, economical. Soft, easy on feet. Most women buy 3 rugs, cleaning up. Make \$90 weekly. Also 47 other fast-selling rubber specialties. Free Outfit. Write quick. Kristie Mfg. Co., 85 Bar Street, Akron, Ohio.

Bankrupt and Rummage Sales. Make \$50 daily. We start you, furnishing everything. Permanent business. Write for samples. Distributors, Dept. 279, 429 W. Superior, Chicago.

Ties Pay Big! Write for my big Free outfit showing ties styled on Fifth Avenue, 860 W. 14th St., Dept. 4943-X, Hudson Boulevard, North Bergen, N. J.

\$40.00 Suits for \$23.00—All One Price. Union-made of finest quality virgin wool. You don't have to know anything about selling clothing. We guarantee your success if you are honest and will try to sell. Write at once. William C. Bartlett, 850 Adams St., Dept. 101, Chicago, Ill.

Business Success: Complete National Success Course we offer to you at the amazingly low price of \$1.98. Previously sold for \$24.00. Every subject on business and personal efficiency treated. Pay postman \$1.98 plus a few cents postage on delivery. Conrad Co., 230 Fifth Avenue, New York City, N.Y. Desk B.

Men—La Salle can use a limited number of producers to sell Quality Suits, Topcoats and Overcoats, any two for \$27.95 with \$6.00 for you on each sale. Free Outfit. La Salle Department, P. O. 527 Broadway, New York. Get Our Free Sample Case Toilet Articles, Perfumes and Specialties. Wonderfully profitable. La Derma Co., Dept. RC, St. Louis, Missouri.

Agents—District Manager \$8.88 for me to sell my best-selling sparkling water. No competition. Kit furnished. 888 Company, Dept. H-15, Fort Wayne, Indiana.

\$5.00 to \$15.00 daily selling Parmede Wash Dresses and Men's Shirts. Best values—highest commissions. Write Parmede Co., 704 N. 9th St., St. Louis.

\$12.00 daily easily earned—no experi- ence necessary, selling overcoats. Price \$17.50, Commission \$4.00. Sample line free. Write 101 E. Kay Co., 21 W. 3rd St., New York.

Write for Free Soap Sample & Agents terms on Face Creams, Extracts, etc. Make Extra Money during your spare time. Lacassian Co., Dept. 90, St. Louis, Mo.

Men and women wanted. Become Suc- cessful. Be independent. My three books explain plain secrets of successful business men. 750 rare opportunities and money-making plans sent for only 10c. Money back if not satisfied. Frasier, Bernard, 22 East 12th Street, Cincinnati, Ohio.

Every headache pays you profit. Mil- lions use Aspirin. Agents can make \$500 month on new 5 cent Aspirin Plan. Write Chas. M. Hiek, 1018 S. Broadway, Chicago.

We Start You Without A Dollar. Soaps, Extracts, Perfumes—Toilet Goods, experience unnecessary. Carnation Co Dept. 593, St. Louis, Mo.

Agents—Start you in business and help you succeed. No capital or experience needed. Spare or full time. You can earn \$50-\$100 weekly. Write Madison Products, 566 Broadway, New York, N. Y.

Business of your own! Make \$68.00 a week and up. We furnish everything. Sell on wool made-to-measure suits direct from factory \$23.75. It's easy—real \$45.00 values. No experience needed. Advertising and sales training course furnished. Write Airbanks Tailoring Co., 2304 Wabansia Ave., Chicago, Ill.

Agents earn big money taking orders for our beautiful Dress Goods, Silks, Wash Fabrics, Hosiery, Fan Goods, 1000 Samples furnished. The National Importing Co., Dept. 850, 573 Broadway, New York City.



SQUARE DEAL ADVERTISERS ONLY

If you do business on the basis of "satisfaction or money back" write us for rates in this and other magazines.

Publishers Classified Service, 9 East 46th St., New York

I pay my agents \$90 a week just to wear and show beautiful New Free Raincoat and give away Free Hats. Write for yours. R. F. King, 230 So. Wells, Chicago.

Marcelwaver is Taking American Women by storm. Men and women representatives everywhere making biggest profits of years. \$279 a week—\$57 a day—17 an hour—spare or full time workers earn such amounts easily. Territories now being allotted. Full information free. Marcelwaver, Dept. 98K, Cincinnati, Ohio.

No Canvassing from House-to-House—Make \$10 daily, full or spare time, acting as our District Sales Manager. A dignified, respectable, good-paying position open to honest, reliable men and women. Write for details. No obligation. Badger Company, Fort Atkinson, Wisconsin.

Agents—90c an hour to advertise our goods and distribute Free samples to consumers. Write quick for territory and particulars. American Products Co., 1923, Monmouth, Cincinnati, Ohio.

Men! Here's Biggest Seller of 1928—Boots and distribute Free samples to outdoor workers and sportsmen. \$2.00 on every three pair sale. Business getting Sales Outfit Free. Dept. B-8, Big Bob, 491 Broome Street, New York, N. Y.

New and Going Big—Two Amazing New patented household items. Year around sellers. Big profits every sale. Write for unique selling plans and outfit offer. Central States Mfg. Co., Dept. K-2011, 4500 Mary Avenue, St. Louis, Missouri.

Free Pants: Finest All-Wool, Made-to-measure pants offered free to first man in each community to write us. Agents given all their clothes free. Chicago Tailors Ass'n, Dept. 837, State Street, Chicago, Ill.

Make \$1,000 before Xmas selling exclusive personal Xmas Cards in distinctive steel engraved designs. Expensive sample book free. Westmore, Jane & Sugden, Dept. PCS, Rochester, N.Y.

Agents \$300 Month and New Ford Car. Bonus besides. Sell new line guaranteed hosiery. 126 styles, colors. Beats store prices. Guaranteed 6 months or new hose free. Finest line Silk Hosiery you ever saw. Credit given. 10 day's trial. Write for samples to Wilkint Hosiery Co., Dept. 2035, Greenfield, Ohio.

The National Home Study Council of Washington, D. C. has investigated the Home Study Schools whose ads, marked with a star (*) appear in this column. These schools are recommended on the following grounds:

Truthful promises, thoroughness of courses, capable instructors, and reasonable instruction fees. These institutions are worthy of your confidence.

Hotels Need Trained Executives. Nationwide demand for trained men and women; past experience unnecessary. We train you by mail and put you in touch with big opportunities. Write at once for particulars. Lewis Hotel Training Schools, Suite A-V-637, Washington, D. C.

Send for Free Catalog describing Music Courses by noted teachers. Diplomas and 10 Degrees awarded by authority State of Illinois. Instruction for Beginners or Advanced Students. University Extension Conservatory 706 E. 41st St., Chicago.

Factories Demanding Thousands of Trained shop executives. Big Pay. Train at home in spare time. Employment assistance. Write at once for details. Lincoln Extension University, Inc. Dept. E-1, Cleveland, Ohio.

Men quality Forest Ranger Position: start \$125 monthly, cabin and vacation. Patrol the forests; protect the game. Write Mokane Institute, Dept. M-44, Denver, Colo.

Test Your Art Ability Free. Send now for Art Questionnaire which tests your drawing ability, sense of color, etc. Learn Commercial Art at home in spare time. Federal students making \$2,000-\$6,000 yearly. Live age, occupation. Federal Schools, Inc., 61 Federal Schools Bldg., Minneapolis, Minn. (Member National Home Study Council.)

LEARN WHILE YOU EARN

Foreign Positions—Men interested going romantic South America write us. Good pay. Expenses paid. South America Service Bureau, 14,600 Alma, Detroit, Mich.

Learn innermost secrets of Magic quickly at home and earn big money as a Magician, or make yourself a business and social success with Magic as your hobby. Full details free. Write Tarbol Systems, Inc., 1926 Sunnyside Avenue, Dept. C-260, Chicago, Illinois.

Men, get Forest Ranger job; \$125-\$200 month and home furnished; hunt, fish, trap. For details, write Norton Institute, 1523 Temple Court, Denver, Colo.

Want U. S. Gov't Position: commence \$115-\$250 month? Men-women 18-55, trained at home in three weeks. Write Ozment's Instruction Bureau, 137, St. Louis, Mo.

BIG BARGAIN SALE



Send NO money

CHAIN AND KNIFE GIVEN GOLD BOND GUARANTEE

SOLID Gold effect case, guaranteed 25 years. Accuracy guaranteed by 100-year old Million Dollar factory. Richly engraved. Locomotive crown, timekeeper dial, railroad back. Why pay \$20 or \$30 for your next watch? Order NOW. Knife and chain GIVEN during Bargain Sale. Only \$3.87 and Postage. SEND NO MONEY. Send postal or coupon below and pay when your watch arrives. FREE TRIAL. Wear 10 days at our expense. Money back if not delighted. Use coupon below. Order by No. A.

Ladies Jewelled WRIST WATCH



Dainty, accurate, beautiful. Society model. Richly carved. Platinum effect. Sapphire crown jewel. Compare with \$12.00 watches. Pay Bargain Sale \$3.98 and postage on arrival.

RING WATCH

Solid white gold effect richly engraved. Set with 10 brilliant diamond cut gems. Gorgeous beauty! Fine mirror and four compact hidden under clever dial. Blue synthetic sapphire crown jewel.

SEND NO MONEY. Pay postman and postage on arrival. Money back guarantee. Use coupon below. Order by No. C

Dinner Ring

Gorgeous platinum effect. Fine brilliant reproduction diamonds and sapphires. Richly carved. Hand engraved. Fifth Avenue model—first time offered at this Sale price and postage on arrival.

Use coupon below. Order by No. D

Rich Folks

Wear Bradley Reproduction Diamonds—Friends cannot tell difference. These gorgeous new gems have 32 facets—diamond cut—guaranteed for 20 years. Richly engraved. Write for Reproduction Diamonds—each one-half karat of leaping rubies—how free. SEND NO MONEY. Pay SALE Price and \$3.77 Postage on arrival. Use coupon below. Order by No. E

BRADLEY, Wholesale Jewelers, Dept. P-1 NEWTON, MASS.

Ship at once to address below the following bargains: Offer No. A []; No. B []; No. C []; No. D []; No. E []. (Place X in box to show your selections.) Will pay on arrival. Money back if I want it, risk nothing.

Name.....
Street.....
City..... State.....

Let These Guides

Solve Your Problems

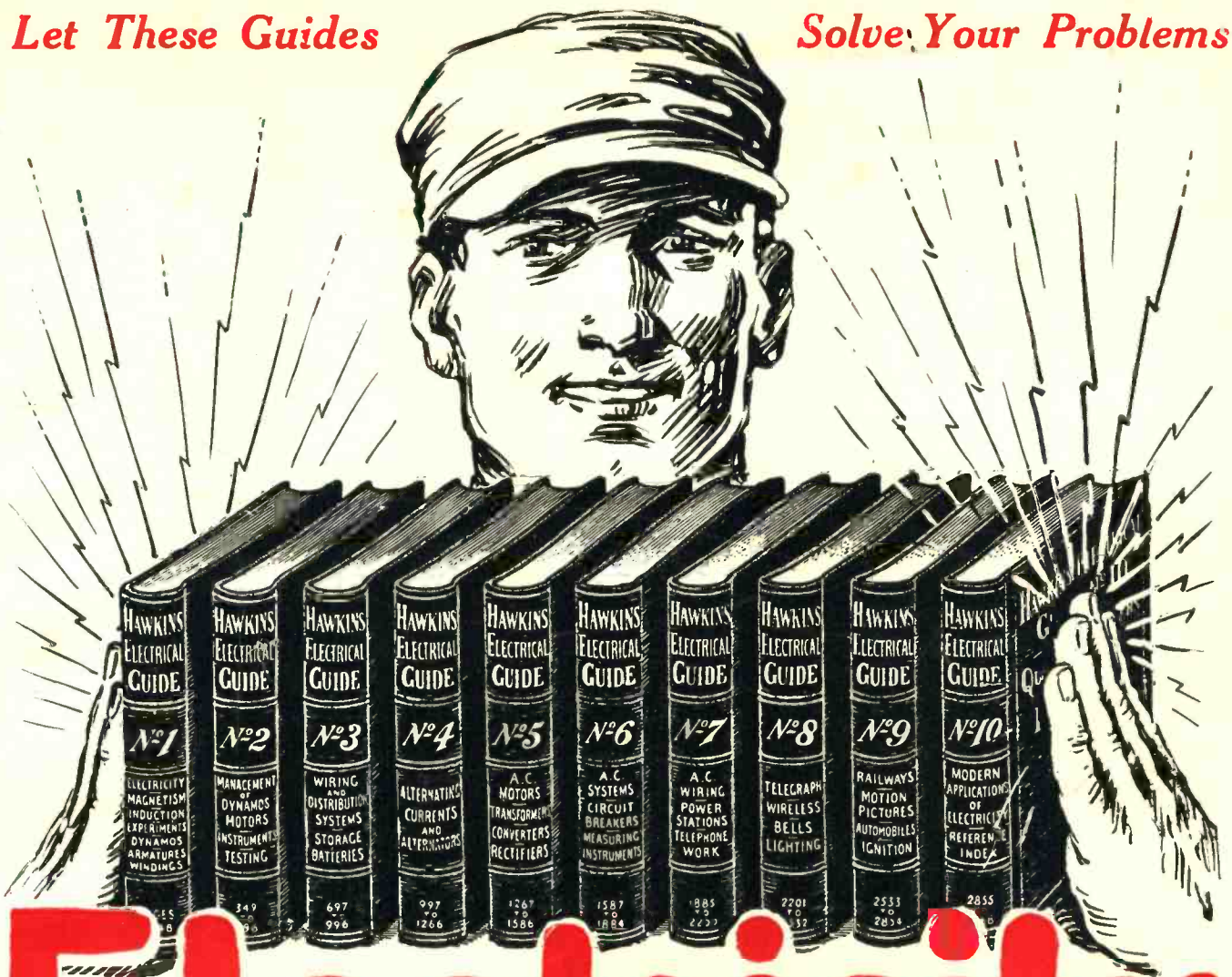

Electricity at your finger ends

HAWKINS ELECTRICAL GUIDES IN TEN VOLUMES

3500 PAGES
4700 PICTURES

\$1 A VOLUME
\$1 A MONTH

SEND NO MONEY—SEND ONLY THIS COUPON

Know the facts in Electricity. They mean more money and better position for you. Hawkins Guides tell you all you need to know about Electricity. Every important electrical subject covered so you can understand it. Easy to study and apply. A complete, practical working course, in 10 volumes. Books are pocket size; flexible covers. Order a set today to look over.

LEARN ALL ABOUT

Magnetism—Induction — Experiments — Dynamos — Electric Machinery—Motors—Armatures—Armature Windings—Installing of Dynamos—Electrical Instrument Testing—Practical Management of Dynamos and Motors—Distribution Systems—Wiring—Wiring Diagrams — Sign Flashers — Storage Batteries — Principles of Alternating Currents and Alternators — Alternating Current Motors — Transformers — Converters—Rectifiers—Alternating Current Systems—Circuit Breakers—Measuring Instruments—Switchboards—Wiring—Power Stations—Installing —Telephone—Telegraph—Wireless—Bells—Lighting—Railways. Also many Modern Practical Applications of Electricity and Ready Reference Index of the ten numbers.

SHIPPED FREE

Not a cent to pay until you see the books. No obligation to buy unless you are satisfied. Send Coupon now—today—and get this great help library and see if it is not worth \$100 to you—you pay \$1.00 a month for ten months or return it.

THEO. AUDEL & CO.

65 West 23rd Street, New York City

Please submit me for free examination, HAWKINS ELECTRICAL GUIDE (Price \$1 a number). Ship at once prepaid, the 10 numbers. If satisfactory, I agree to send you \$1 within seven days and to further mail you \$1 each month until paid.

Name.....
 Occupation.....
 Employed by.....
 Home Address.....
 Reference.....

S. I. AUG

Win An 8 Cyl. Studebaker

or **\$2,800⁰⁰** In Cash

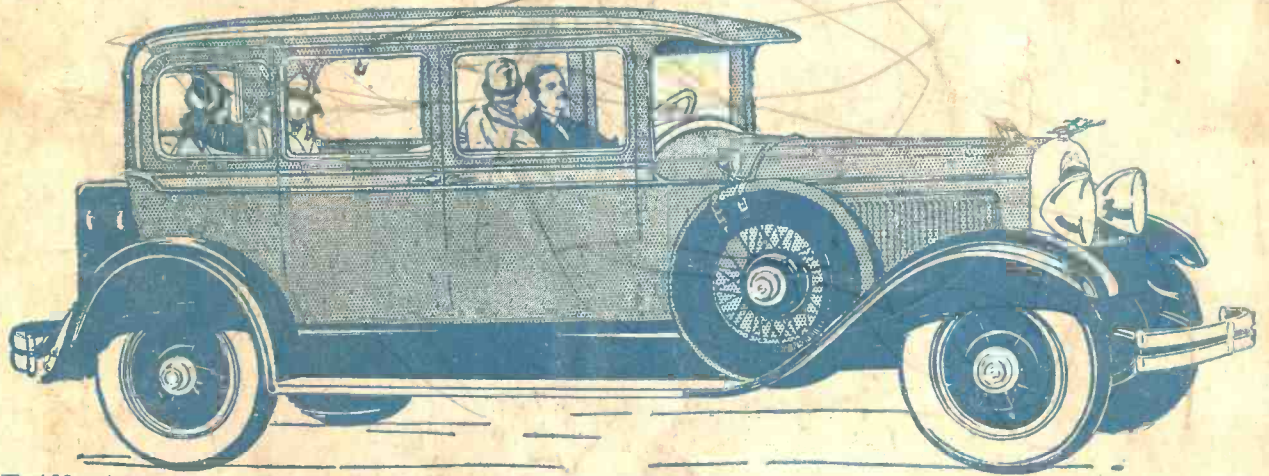

I AM going to give away, absolutely free, an 8-Cylinder, 100 Horsepower, Custom-Built Studebaker Sedan to someone who answers this ad. We have already given away many automobiles and thousands of dollars in cash and prizes to advertise our business, but this is the most liberal offer we have ever made. It is your chance to get a wonderful car for your very own. It will be delivered through the nearest Studebaker dealer or winner may have its full value in cash (\$2,250.00). This offer is open to anyone living in the United States, outside of Chicago, and is backed by a Big Reliable Company of many years' standing.

Solve This Puzzle

25	15	21	3	1	14	23	9	14
----	----	----	---	---	----	----	---	----

The numbers in the squares above spell three words. A is 1, B is 2, C is 3, etc. Can you make out what they are? Write your answer in the coupon below together with your name and address and send it to me right away. This is your opportunity to win both a Studebaker Sedan and \$550.00 in cash—or a total of \$2,800.00 in cash—if you act promptly.

\$550.00 GIVEN FOR PROMPTNESS

In addition to the Studebaker Sedan, I am also giving away a latest model Chevrolet Sedan; a Victor Orthophonic Victrola; a Shetland Pony, Bridle, Saddle and Halter; a Seven Tube, Single Dial Metrodyne Radio and many other valuable prizes—besides Hundreds of Dollars in Cash—including a Special Cash Prize of \$550.00 for acting promptly. Any winner may have cash instead of the prize won. First prize winner will receive the 8 Cylinder, Custom Built Studebaker Sedan and \$550.00 in cash, or a total of \$2,800.00 in cash. In case of ties duplicate prizes will be awarded. Solve the puzzle and send me your answer right away together with your name and address plainly written. \$5,000.00 worth of prizes in all. EVERYBODY REWARDED. Address L. E. WILFERD, Dept. C379; 315 S. Peoria St., Chicago, Ill.

MAIL THIS COUPON TODAY!

L. E. Wilferd, Mgr., Dept. C379,
315 So. Peoria St., Chicago, Ill.

The answer to the puzzle is _____

My Name _____

Address _____