

Dec.

BROADCAST  
**WRNY**  
STATION

25 Cents

# Science and Invention

OVER 300 ILLUSTRATIONS

## WIREKRAFT

### A NEW ART

See Page 686

**\$3,000.<sup>00</sup>**  
**IN PRIZES**  
 What Can YOU Do  
 With Wire?



OVER 200,000 COPIES OF THIS ISSUE

EXPERIMENTER PUBLISHING COMPANY, NEW YORK, PUBLISHERS OF  
 RADIO NEWS - SCIENCE & INVENTION - RADIO REVIEW - AMAZING STORIES - MONEY MAKING - RADIO INTERNACIONAL

[www.americanradiohistory.com](http://www.americanradiohistory.com)

**30  
DAYS  
FREE  
TRIAL**

# 7 Tube Set Single Dial Radio



## The Metrodyne

**ONLY ONE DIAL TO TUNE**

**Retail Price**

**\$75**

**Completely Assembled**

**Big Discounts  
to Agents and Dealers**

**Wonderful offer direct from the factory! The world's greatest radio.** A perfect working, single dial control, 7 tube receiver. And just to prove our claims, we will ship it to your home for **30 days' free trial**. Test it under all conditions. Test it for distance, volume and tonal quality — and if you are not convinced that it is the best single dial set you ever heard, return it to the factory. We don't want your money unless you are completely satisfied.

**BIG PROFITS  
TO AGENTS AND DEALERS**

Our Agents and Dealers make big money selling Metrodyne Sets. You can work all or part time. Demonstrate the superiority of Metrodynes right in your home. Metrodyne Radios have no competition. Lowest wholesale prices. Demonstrating set on 30 days' free trial. Greatest money-making opportunity. Send coupon below — or a letter — for our agent's proposition.

## Metrodyne Super-Seven Radio

A single dial control, 7 tube, tuned radio frequency set. Approved by America's leading radio engineers. Designed and built by radio experts. Only the highest quality low loss parts are used. Magnificent, two-tone walnut cabinet. Artistically gilded genuine Bakelite panel, nicked piano hinge and cover support. All exposed metal parts are beautifully finished in 24-k gold.

Easiest set to operate. Only one small knob tunes in all stations. The dial is electrically lighted so that you can log stations in the dark. The volume control regulates the reception from a faint whisper to thunderous volume, 1,000 to 3,000 miles on loud speaker! The Metrodyne Super-Seven is a beautiful and efficient receiver, and we are so sure that you will be delighted with it, that we make this liberal **30 days' free trial offer**. You to be the judge.



**30  
Days' FREE Trial**

**6  
Tube Set  
\$48.50**  
**RETAIL PRICE**  
**Completely  
Assembled**

## Metrodyne Super-Six

Another triumph in radio. Here's the new 1927 model Metrodyne 6 tube long distance tuned radio frequency receiving set. Approved by leading radio engineers of America. Highest grade low loss parts, completely assembled in a beautiful walnut cabinet. Easy to operate. Dials easily logged. Tune in your favorite station instantly on same dial readings every time. No guessing.

Mr. Howard, of Chicago, said: "While five Chicago broadcasting stations were on the air I tuned in seventeen out-of-town stations, including New York and San Francisco, on my loud speaker horn, very loud and clear, as though they were all in Chicago."

We are one of the pioneers of radio. The success of Metrodyne sets is due to our liberal **30 days' free trial offer**, which gives you the opportunity of trying before buying.

**MAIL THIS  
COUPON**  
or send a postal or letter. Get our  
proposition before buying a radio.  
Deal direct with manufacturer —  
**Save Money.**

## Mail COUPON Below!

**Let us send you proof of  
Metrodyne quality**

F. L. Warnock, Greentown, Ind., writes: "I received the Metrodyne in good shape and am more than pleased with it. Got stations 2,000 miles away."

C. J. Walker, Mariposa, Calif., writes: "Received my Metrodyne Single Dial set O. K. I believe that these one-dial sets are going to be excellent sellers. I had no trouble in tuning in stations enough to satisfy anyone, so you will please send me another set."

Roy Bloch, San Francisco, Calif., writes: "Very often we travel from New York to the Hawaiian Islands quickly — from station to station — by means of the little tuning-knob which operates the electrically-lighted dial. The Metrodyne Single Dial Set is much easier to operate than any radio set I've ever seen."

We will send you hundreds of similar letters from owners who acclaim the Metrodyne as the greatest radio set in the world. A postal, letter or the coupon brings complete information, testimonials, wholesale prices, and our liberal **30 days' free trial offer**.

**METRO ELECTRIC COMPANY**  
2161-71 N. California Ave., Dept. 169  
Chicago, Illinois

Gentlemen:

Send me full particulars about Metrodyne 6 tube and 7 tube sets and your **30 days' free trial offer**

Name \_\_\_\_\_

Address \_\_\_\_\_

If you are interested in AGENT'S proposition, place an "X" in the square

**METRO ELECTRIC COMPANY**  
2161-71 N. California Ave. • Dept. 169 • Chicago, Illinois



### Jumps From \$3 to \$26 a Day

Mr. Cooke: If it had not been for your Course I would still be plugging away for \$3 a day. Instead I have all the work I can do and my earnings run as high as \$23 to \$26 a day. I owe all my success to your training.—Edward A. Lehmann, 1521 Market St., Oakland, California.

# They Know How to Get the Big Pay

**Will You Learn the Secret of Lehmann's and Hines' Success? Mail Coupon for Free Book That Tells All**



**L. L. COOKE**

He is Chief Engineer of the Chicago Engineering Works, Inc., and has trained and helped hundreds of men into big-pay Electrical Jobs.

## \$85 a Week — and Going Up!

Dear Chief: With your Course and your great help and encouragement, I am going right over the top. I am making \$85 a week now and still going up. I had only a common school education when I started with you and no electrical experience. Your lessons were easy and clear and I owe my success to you.—R. M. Hines, 1654 Aberdeen St., Chicago Heights, Ill.

IT sounds too good to be true—it's hard to believe—that thousands of men like the two pictured here could step out of small pay, no future jobs and earn \$3500 to \$10,000 a year in Electricity. Yet that's just what many hundreds of men have done. Most of them had no previous experience—all of them kept right on with their regular jobs and used spare time only, to prepare for the big-pay jobs they hold.

What was "the something" that brought these men big-pay and quick success? What makes it possible for them to earn from two to four times more than you are able to earn working hard every day? They couldn't have used ordinary methods because other men who tried them have failed. They must have gotten hold of something new—something different—something that matches electricity itself. And electricity, you know, is the world's greatest business, growing with leaps and bounds every year and continually demanding more and more trained men.

No matter what you may have heard about home-training—no matter what kind of work you are doing now—you owe it to yourself to find out the secret of these men's success—to find out about Cooke Training which has already lifted hundreds of other men into the big-pay class, and which today offers you one of the world's greatest opportunities.

Chief Engineer Cooke has prepared a wonderfully interesting book printed in colors with 64 pages and over 100 pictures, telling all about electricity, the opportunities it offers young men and what these opportunities mean to you. This is the same book that started so many other men on the road to big pay. It's free and it may help you like it helped them. Anyway send for the book and decide for yourself. There is no obligation on your part and no agent will call on you. Mail the Coupon Now, to—

**L. L. Cooke, Chief Engineer**

## L. L. Cooke School of Electricity

Owned and Operated by

**Chicago Engineering Works**  
INCORPORATED  
2150 Lawrence Ave. Chicago, Illinois

**L. L. Cooke, Chief Engineer**  
Dept. 29, 2150 Lawrence Ave.,  
Chicago, Illinois

Send me your free book about Electricity and proof that the men you have trained are holding big pay jobs. I understand no agent will call on me and I won't be obligated to take your Course.

Name .....

Address .....

City..... State.....



Vol. XIV.  
Whole No. 164

# Science and Invention

December, 1926  
No. 8

## FORMERLY ELECTRICAL EXPERIMENTER

COMBINED WITH "THE EXPERIMENTER"

Member Audit Bureau of Circulations

EDITORIAL & GENERAL OFFICES: 53 Park Place, New York City  
GENERAL ADVERTISING DEPT.: 53 Park Place, New York City

Published by Experimenter Publishing Company, Inc.  
(H. Gernsback, Pres.; S. Gernsback, Treas.; R. W. DeMott, Sec'y.)

Publishers of SCIENCE & INVENTION, RADIO NEWS,  
RADIO INTERNACIONAL, RADIO REVIEW and AMAZING STORIES

### EDITORIAL STAFF

HUGO GERNSBACK, *Editor-in-Chief.*  
H. WINFIELD SECOR, *Managing Editor.*  
T. O'CONNOR SLOANE, Ph.D., *Associate Editor.*  
JOSEPH H. KRAUS, *Field Editor.*  
JAMES FRANCIS CLEMENGER, *Radio Editor.*  
S. GERNSBACK, *Wrinkles Editor.*  
M. ESSMAN, *Art Director.*

### CONTRIBUTING EDITORS

**Astronomy—**  
Dr. Donald H. Menzel, Ph.D.  
Isabel M. Lewis, M.A., of the U. S. Naval Observatory.  
**Entomology and Allied Subjects—**  
Dr. Ernest Bade, Ph.D.  
**Physics—**  
Dr. Harold F. Richards, Ph.D.  
Ernest K. Chappin, M. A.  
Dr. Donald H. Menzel, Ph.D.  
**Automotive Subjects—**  
George A. Luers  
**Chemistry—**  
Raymond B. Wailes.  
Dr. Ernest Bade, Ph.D.  
**Radio—**  
A. P. Peck.  
Herbert Hayden.  
**Magic and Psychic Phenomena—**  
Joseph Dunninger.  
Joseph F. Rinn.  
Edward Merlin.  
**Foreign Correspondents—**  
Dr. Alfred Gradenwitz, Germany.  
Dr. H. Becher, Germany.  
C. A. Oldroyd, England.  
S. Leonard Bastin, England.  
Count A. N. Mirzaoff, France.  
Hubert Slouka, Czechoslovakia.  
P. C. van Petegem, Holland.  
Richard Neumann, Austria.

### IN JANUARY ISSUE

#### Fake Radio Doctors

Thousands of dollars are paid annually for home treatment machines advertised as employing radio for the curing of diseases. Read why they are fakes.

#### Card Tricks

Nothing seems to interest people quite as much as card tricks and magic. Some simple card tricks will be described in January issue.

#### Foiling the Yeggmen

Several new scientific tricks to foil the attempt of safebreakers; you will find the illustrated article in the next issue very interesting.

#### Blueprint Reading

Another article showing in simple fashion how to read shop blueprints.

#### What is the Shape of the Moon?

One of the foremost astronomers in America answers this popular question.

#### How to Build a Good "B" Eliminator

Full details and construction diagrams will be given.

### Contents for December

Editorial .....	681	Science Moves On .....	701
By Hugo Gernsback .....		Aviation News .....	702
Why Florida Hurricane Occurred .....	682	Matchcraft—Monthly Prize Awards .....	703
By E. B. "Farmer" Dunn, Former Chief U. S. Weather Bureau at N. Y. ....		Motor Hints .....	706
Magic Tables and Floor in New Restaurant .....	684	Conducted by George A. Luers .....	
By H. Winfield Secor .....		Home-Made Animal Toys .....	707
Paper Actors Movies' Latest .....	685	By Wm. M. Butterfield .....	
\$3,000.00 Wirecraft Contest .....	686	Experimental Chemistry Depart- ment .....	708
By Hugo Gernsback, Member of the American Physical Society. ....		Experimental Electricians .....	710
Now the Flying Flivver .....	689	Laboratory Apparatus From Toy Constructor Parts .....	712
Bicycle Propelled by Arms .....	689	By Dr. Ernest Bade .....	
Free Cathode Rays .....	690	How-to-Make-It Department .....	714
By G. C. B. Rowe .....		Wrinkles, Recipes and Formulas .....	715
The Astrology Humbug .....	692	Edited by S. Gernsback .....	
By Joseph H. Kraus .....		Readers Forum .....	716
Our Spiritualistic Investigations .....	693	WRNY Changes Transmitter Location .....	717
By "Dunninger" .....		Six Tube Shielded T.R.F. Set .....	718
Why the Sikorsky Trans-Atlantic Plane Failed to Cross Ocean .....	694	By A. P. Peck .....	
\$41,000.00 in Contests and Chal- lenges .....	695	Sir Oliver Lodge's "N" Circuit .....	720
Into the Fourth Dimension— Fourth Installment .....	696	By James Francis Clemenger .....	
By Ray Cummings .....		Radio Oracle .....	722
Santa Goes in For Science .....	698	Scientific Humor .....	723
Model Department .....	700	Latest Patents .....	724
		Oracle .....	725
		"Magic" .....	726
		By Dunninger .....	
		Patent Advice .....	732

HOW TO SUBSCRIBE FOR "SCIENCE AND INVENTION." Send your name, address and remittance to Experimenter Publishing Co., 53 Park Place, New York City. Checks and money orders should be made payable to Experimenter Publishing Co., Inc. Mention the name of the magazine you are ordering inasmuch as we also publish RADIO NEWS, RADIO INTERNACIONAL, RADIO RE-

SCIENCE AND INVENTION is published on the 10th of each month. There are 12 numbers per year. Subscription price is \$2.50 a year in U. S. and possessions. Canada and foreign countries \$3.00 a year. U. S. coin or stamps. Single copies, 25 cents each. A sample copy will be sent gratis on request. All communications and contributions to this journal should be addressed to Editor, SCIENCE AND

VIEW and AMAZING STORIES. Subscriptions may be made in combination with the other publications just mentioned at special reduced club rates. Send postal for club rate card. Subscriptions start with the current issue unless otherwise ordered. ON EXPIRATION of your subscription we enclose a renewal blank in our last number to you, and notify you by mail. Then unless we receive your

INVENTION, 53 Park Place, New York City, N. Y. Unaccepted contributions cannot be returned unless full postage has been included. ALL accepted contributions are paid for on publication.

SCIENCE AND INVENTION, Monthly, Entered as second class matter May 10, 1924, at the Post Office at New York, N. Y., under the act of March 3, 1879. Additional entry at Long Island City, N. Y., and

order and remittance for a renewal, delivery of the magazine is stopped. CHANGE OF ADDRESS: Notify us as far in advance as possible, giving your old address as well as the new one to which future magazines are to go. It takes several weeks to make an address change on our records.

San Francisco, Calif. Title Registered at the Patent Office. Copyright, 1926, by E. P. Co., Inc., New York. The Contents of this Magazine are copyrighted and must not be reproduced without giving full credit to the publication. SCIENCE AND INVENTION is for sale at all newsstands in the United States and Canada. European Agents, S. J. Wise & Co., 40 Place Verte, Antwerp, Belgium.

FINTICAN & McCLURE, 720 Cass Street, Chicago, Ill.  
DAVIES, DILLON & KELLY, 15 West 10th St., Kansas City, Mo.  
T. F. MAGRANE, Park Square Bldg., Boston, Mass.

ROY BUELL, Donovan Building, Detroit, Mich.  
HARRY E. HYDE, 548 Drexel Building, Philadelphia, Pa.  
A. J. NORRIS HILL CO., 5 Third St., San Francisco, Calif.  
412 West 6th St., Los Angeles, Calif.



Eveready's exclusive Layerbilt construction makes this the most economical of "B" batteries

IMPROVEMENT on top of improvement has been the history of Eveready Radio Batteries. Here, in the radically different Eveready Layerbilt, is the "B" battery which tops them all. The ability of this battery to give you unrivaled service and economy is due to its unique internal design. Instead of the usual assembly of round cells, it is built of flat layers of current-producing materials pressed firmly together. This construction makes use of the spaces now wasted between the round-type cells and avoids the usual soldered wire connections. Eveready Layerbilt is every inch a

battery. This exclusive Eveready Battery development packs more active chemicals in a given space and enables them to produce more current and give longer life.

This HEAVY-DUTY EVEREADY LAYERBILT BATTERY gives twice the service of the smaller Light-Duty batteries and greatly reduces your "B" battery operating cost.

Use Eveready Layerbilts on any set, and get not only this extra service, but also—the greatest "B" power operating economy—the utmost in "B" power dependability—D. C. (direct current) in its purest form, so necessary for pure tone quality. There is an Eveready dealer nearby.

Manufactured and guaranteed by  
 NATIONAL CARBON CO., Inc.  
 New York San Francisco  
 Canadian National Carbon Co., Limited  
 Toronto, Ontario

Tuesday night means Eveready Hour—9 P. M., Eastern Standard Time, through the following stations:

WEAF—New York	WTAM—Cleveland
WJAR—Providence	WWJ—Detroit
WEEI—Boston	WGN—Chicago
WTAG—Worcester	WOO—Davenport
WFI—Philadelphia	WCCO { Minneapolis
WGR—Buffalo	{ St. Paul
WCAE—Pittsburgh	KSD—St. Louis
WSAI—Cincinnati	WRC—Washington

**EVEREADY**  
**Radio Batteries**  
*—they last longer*

INDEX TO ADVERTISERS

# INDEX TO ADVERTISERS

<p><b>A</b></p> <p>Airway School .....764</p> <p>American Bazaar, Inc., 742, 751, 755</p> <p>American Correspondence School of Law .....734</p> <p>American School of Aviation .....728</p> <p>American School of Correspondence .....741</p> <p>American School of Music .....752</p> <p>American Telephone &amp; Telegraph Co. ....747</p> <p>Anita Co., Inc., .....752</p> <p>Arnold Checkwriter Co., Inc. The .....758</p> <p>Audel &amp; Co., Theo. Inside back Cover</p> <p>AutoStrop Safety Razor Co. ....745</p> <p><b>B</b></p> <p>Baby Calculator Sales Co. ....754</p> <p>Balda Art Service .....761</p> <p>Barawick Co. ....765</p> <p>Bathe Mfg. Co. ....754</p> <p>Bliss Electrical School .....761</p> <p>Rogue Institute for Stammerers 744</p> <p>Buescher Band Inst. Co. ....740</p> <p>Bureau of Inventive Science .....734</p> <p>Burns School of Wrestling .....734</p> <p><b>C</b></p> <p>Carlton Mills .....752</p> <p>Central Novelty Co. ....744, 759</p> <p>Chemical Institute .....679</p> <p>Chicago Engineering Works .....673</p> <p>Chicago Solder Company .....753</p> <p>Chicago Tenor Banjo Institute. 754</p> <p>Clock Co. ....755</p> <p>Coleman, Watson E. ....734</p> <p>Conn. C. G., Ltd. ....758</p> <p>Conrad Co., Inc. ....756, 764</p> <p>Coyne Electrical School .....677</p> <p>Critchlow, Walter .....754</p> <p><b>D</b></p> <p>DeForest, Jimmy .....757</p> <p>Douglas, Lyle .....750</p>	<p><b>E</b></p> <p>Electro Magnetic Tool Co. ....763</p> <p>Evans, Victor J. ....735</p> <p><b>F</b></p> <p>Fawcett Publications, Inc. ....678</p> <p>Federal Mail Order Corp., 744, 750, 754, 761</p> <p>First Hawaiian Conservatory of Music .....756</p> <p>Fischer, A. C. ....730</p> <p>Fisher, Adam, Mfg. Co. ....734</p> <p>Franklin Institute .....749, 755</p> <p>Furness Bermuda Line .....738</p> <p><b>G</b></p> <p>Gaston Mfg. Co. ....756</p> <p>General Electric Co. ....749</p> <p>Gerold Company, The .....744</p> <p>Gilbert, A. C., Co., The .....743</p> <p>Gilson Slide Rule Company .....748</p> <p>Givens Chemical Co. ....744</p> <p><b>H</b></p> <p>Hansen, Vic. Co. ....742</p> <p>Hardin-Lavin Co. ....761</p> <p>High School Study Bureau .....763</p> <p>Hobart Bros. ....751</p> <p>Hotel Touraine .....750</p> <p><b>I</b></p> <p>Ideal Aeroplane &amp; Supply Co. .738</p> <p>Inkograph Co., Inc. ....Back Cover</p> <p>International Correspondence Schools .....744, 748, 754</p> <p><b>J</b></p> <p>Johnson Smith Co. ....729</p> <p><b>K</b></p> <p>Kelsey Co., The .....749</p> <p><b>L</b></p> <p>Lacey &amp; Lacey .....732</p> <p>Lancaster &amp; Allwine .....732</p> <p>Leonard, A. O. ....757</p> <p>Le Page's Craft League .....739</p>	<p><b>L</b></p> <p>Liggett &amp; Myers Tobacco Co. ....753</p> <p>Loftis Bros. ....738</p> <p>Long Eakins Co., The .....748</p> <p><b>Mc</b></p> <p>McGraw-Hill Book Company ..737</p> <p><b>M</b></p> <p>M. M. Laboratories .....750</p> <p>Maxon, F. P. ....763</p> <p>Meccano Co. ....751</p> <p>Metal Arts Co., Inc. ....761</p> <p>Metal Cast Products Co. ....759</p> <p>Metro Electric Co. Inside Front Cover</p> <p>Midwest Radio Corp. ....755</p> <p>Miller, Monroe .....734</p> <p>Miller System of Correct English .....757</p> <p>Mokane Institute .....734</p> <p>Motion Picture Operators School .....746</p> <p>Munn &amp; Company .....734</p> <p>Mussehl &amp; Westphal .....761</p> <p><b>N</b></p> <p>National Carbon Co. ....675</p> <p>National Radio Institute .....680</p> <p>Newark Pen Co. ....752</p> <p>Newell Pharmacal Co. ....752</p> <p>Newspaper Institute of America 759</p> <p>New York Electrical School ....736</p> <p><b>O</b></p> <p>O'Brien, Clarence A. ....733</p> <p>Occult Science .....744</p> <p>Ogilvie Publishing Co. ....750, 759</p> <p>Owen, Richard B. ....732</p> <p>Ozment, C. J. ....748</p> <p><b>P</b></p> <p>Parker, C. L. ....734</p> <p>Parks Ball Bearing Machine Co. 746</p> <p>Pathfinder Publishing Co. ....754</p> <p>Perfect Sales Co. ....761</p> <p>Physical Culture Magazine, 735, 760</p> <p>Papao Company .....748</p>	<p><b>P</b></p> <p>Plymouth Rock Squab Co. ....761</p> <p>Polachek, Z. H. ....734</p> <p>Polk, R. L. &amp; Co. ....730</p> <p>Porter Chemical Co. ....746</p> <p>Practical Mechanic .....761</p> <p>Premier Electric Co. ....754</p> <p>Press Guild, Inc. ....728</p> <p><b>R</b></p> <p>Radio Association of America 761</p> <p>Radio Specialty Co. ....731</p> <p>Randolph &amp; Co. ....732</p> <p>Randolph Radio Corp. ....758</p> <p>Reliable Typewriter &amp; Adding Machine Corp. ....747</p> <p>Roll-O Radio Corp. ....748</p> <p><b>S</b></p> <p>School of Engineering, 742, 750, 759</p> <p>Sea Arts Guild .....751</p> <p>Seaver Williams Co. ....730</p> <p>Sedgley, R. F., Inc. ....740</p> <p>Shipman Ward Mfg. Co. ....742</p> <p>Sincere Co. ....752</p> <p>Standard Radio Co. ....754</p> <p>Strongfort, Lionel .....757</p> <p>Swift &amp; Anderson, Inc. ....740</p> <p><b>T</b></p> <p>T. Garter Co. ....750</p> <p>Tamblyn School .....752</p> <p>Tarbell System, Inc. ....727</p> <p>Tri-Una Co. ....740</p> <p><b>U</b></p> <p>United States Pencil Co. ....747</p> <p>Universal Plumbing School ....763</p> <p><b>W</b></p> <p>Wagner, George .....761</p> <p>Washington School of Art .....740</p> <p>Washington School of Cartooning .....730</p> <p>Washington Show-Card School. 734</p> <p>Westingale Electric Co. ....738</p> <p>Witte Engine Works .....742</p> <p>World Battery Co. ....744, 753</p>
---	---	---	---

## SCIENCE and INVENTION READERS' BUREAU

TEAR ALONG THIS LINE

### Time and Postage Saver

IN every issue of SCIENCE AND INVENTION you undoubtedly see numerous articles advertised about which you would like to have further information. To sit down and write an individual letter to each of these respective concerns, regarding the article on which you desire information, would be quite a task. As a special service to our readers, we will write the letters for you, thus saving your time and money. Just write the names of the products about which you want

information, and to avoid error the addresses of the manufacturers, on the coupon below and mail it to us. If the advertiser requires any money or stamps to be sent to pay the mailing charges on his catalog or descriptive literature, please be sure to enclose the correct amount with the coupon. We will transmit to the various advertisers your request for information on their products. This service will appear regularly every month on this same page in SCIENCE AND INVENTION.

**TO: READERS' SERVICE BUREAU,**  
**EXPERIMENTER PUBLISHING CO., Inc., 53 Park Place, New York, N. Y.**

**FROM** WRITE YOUR NAME and ADDRESS HERE:  
 NAME .....  
 ADDRESS ..... CITY, STATE .....

Gentlemen: Please advise the firms listed below that I would like to receive detailed information on their product as advertised in the ..... issue of SCIENCE AND INVENTION.

<p><b>This form should not be used for technical questions.</b></p>		<p>List here specific article on which you wish literature.</p>	<p>If Catalogue of complete line is wanted check in this column.</p>
<p>NAME</p>	<p>ADDRESS (Street—City—State)</p>		
.....	.....	.....	.....
.....	.....	.....	.....

Check here if you are a dealer

Your Dealer's Name .....

Address .....

S & I 12-26

# We Will Make You An Electrical Expert In 12 Weeks At Coyne

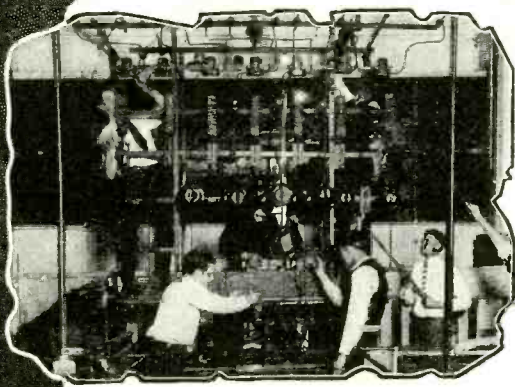

Students Doing Actual Work On Power Transmission Apparatus.

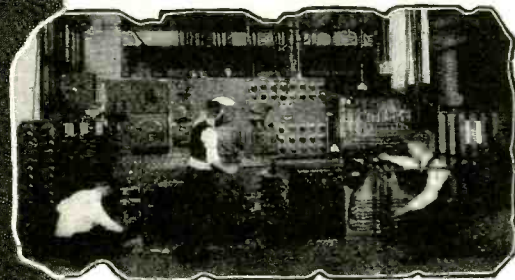

Students Working on Massive A. C. Control Equipment.



Students Practicing House-wiring In Skeleton Houses.

## Send For Free Book

Send for the Big Free Book which shows the Great School of Coyne and a great part of our massive electrical equipment. You will be convinced that the only place to get a practical electrical training is in the Great School of Coyne. Get the details of our Free Railroad Fare Offer.

H. C. Lewis,  
Pres.



Founded  
1899

Endorsed by Electrical Industry

1306-1310 W. Harrison St., Dept. 96-83

Chicago, Ill.

## EARN BIG PAY

**Many Make \$200 to \$800 a Month**

Why work for a small pay. Why make \$25.00 or \$30.00 or even \$40.00 a week in a hard job doing dirty disagreeable work, and never sure of your job. As a Coyne TRAINED ELECTRICAL EXPERT you can make \$200 to \$800 a month. You will do pleasant work, with chance to travel, and advancement will be quick. Steady work the year around. YOUR SERVICES WILL ALWAYS BE IN DEMAND ANY PLACE, or you can own your own business and make up to \$15000 a year.

## No Books—No Lessons— You Do Actual Work

I don't teach you a lot of useless theory. I give you a useable knowledge on the same kind of Electrical Machinery used in Power Houses, plants and big industrial businesses and give you this complete training in 12 weeks.

## 12 Weeks at Coyne You Don't Need Education

I don't require that you have a lot of book learning. You don't need advanced education or any previous education to master my course. Put your faith in me and I'll make you independent and happy.

## Free Railroad Fare and Two Big Courses—When You Enroll

For a short time I will pay YOUR RAILROAD FARE TO CHICAGO from any part of the United States, and besides, I'll include my RADIO and Automotive Electrical Course. All given Free with my big NEWLY ENLARGED ELECTRICAL COURSE for a short time only.

## Earn While You Learn!

My Employment Department will assist you in securing a part time job to earn living expenses while training, and will assist you to a big pay job on graduation and any time thereafter for life.

## My Big FREE Book Tells Complete Story

I haven't space here to tell you all the advantages of my training but I'll send absolutely Free my big book with over 150 actual photographs and success stories of my graduates. It tells you facts that will amaze you. You owe it to yourself to get these facts. Fill in this coupon and mail it today.

## Fill in-MAIL TODAY

H. C. Lewis, President  
Coyne Electrical School, Dept. 96-83  
1306-1310 W. Harrison St., Chicago, Ill.

Dear H. C.: I sure want one of those big handsome books absolutely free, so I can get all the facts and it is understood this places me under no obligation.

Name.....

Address.....

Town..... State.....

# Love Goes *with* Adventure in **Triple-X** MAGAZINE

Read  
how a  
pretty  
Mexican girl  
sought to trap  
a rich American

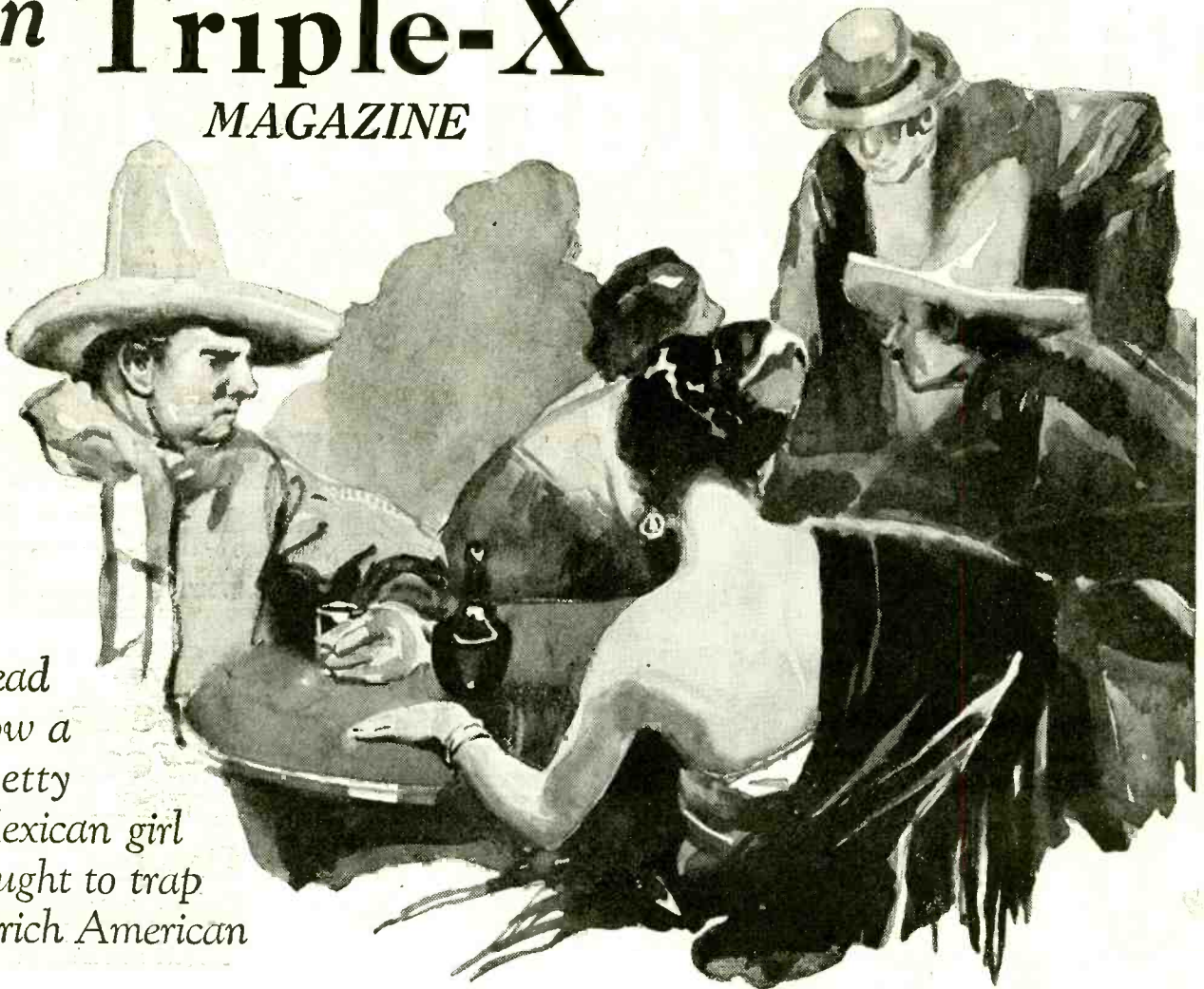

**What you'll find in the December Triple-X:**

A New Romantic-Adventure Novel

By H. BEDFORD-JONES

A Girl Disguised as a Lumberjack!

By WILLIAM M. ROUSE

DECEMBER

On  
Sale  
NOW

25¢

A Copy

A Cowboy rides for Cupid  
in a new story by  
Jay Lucas

and other tales by Arthur  
Guy Empey, L. Paul and  
many noted writers

Fawcett's  
**Triple-X**  
Western-Adventure  
MAGAZINE



# Chemistry paves the road to Success!

Some people measure success in terms of money and others in degree of knowledge and culture. Chemistry is the one uncrowded profession today that offers both. America, always a land of amazing opportunities, is especially so now in the field of applied Chemistry. Industries have developed within eight years more rapidly than the output of trained men to conduct them. Every big industry needs chemists and there is a real demand for them immediately.

## Earn a Bigger Salary from now on—

**Good Chemists Command High Salaries; you can make yourself independent for life by unearthing one of Chemistry's Undiscovered Secrets!**

Do you remember how the tales of pirate gold used to fire your imagination and make you want to sail the uncharted seas in search of treasure and adventure? And then you would regret that such things were no longer done. But that is a mistake. They *are* done—today and everyday—not on desert islands, but in the chemical laboratories throughout your own country. Quietly, systematically, the chemist works. His work is difficult, but more adventurous than the blood-curdling deeds of the Spanish Main. Instead of meeting an early and violent death on some forgotten shore, he gathers wealth and honor through his invaluable contributions to humanity. Alfred Nobel, the Swedish chemist who invented dynamite, made so many millions that the income alone from his bequests provides five \$40,000 prizes every year for the advancement of science and peace. Herman Frasch, who showed how to extract sulphur built up a huge fortune. C. M. Hall, the chemist who discovered how to manufacture aluminum made millions through this discovery. F. G. Cottrell, who devised a valuable process for recovering the waste from flue gases, James Gayley, who showed how to save enormous losses in steel manufacture, L. H. Baekeland, who invented Bakelite—these are only a few of the men to whom fortunes have come through their chemical achievements.

### NOW IS THE TIME TO STUDY CHEMISTRY

Not only are there boundless opportunities for amassing wealth in Chemistry, but the profession affords congenial employment at good salaries to hundreds of thousands who merely follow out its present applications. These applications are innumerable, touching intimately every business and every product in the world. The work of the chemist can hardly be called work at all. It is the keenest and most enjoyable kind of pleasure. The days in a chemical laboratory are filled with thrilling and delightful experimentation, with the alluring prospect of a discovery that may spell fortune always at hand to spur your enthusiasm.

### YOU CAN LEARN AT HOME

To qualify for this remarkable calling requires elaborate specialized training. Formerly it was necessary to attend a university for several years to acquire that training, but thanks to our highly perfected and thorough system of instruction, you can now stay at home, keep your position, and let us educate you in Chemistry during your spare time. Even with only common schooling you can take our course and equip yourself for immediate practical work in a chemical laboratory.

### EASY MONTHLY PAYMENTS

You don't have to have even the small price of the course to start. You can pay for it in small monthly amounts—so small that you won't feel them. The cost of our course is very low, and includes everything, even the chemistry outfit—there are no extras to buy with our course. Our plan of monthly payments places a chemical education within the reach of everyone.

### SPECIAL 30 DAY OFFER

Besides furnishing the student with his Experimental Equipment, we are making an additional special offer for a short while only. You owe it to yourself to find out about it. Write today for full information and free book "Opportunities for Chemists." Send the coupon right now while it is fresh in your mind. Or just write your name and address on a postal and mail it to us. But whatever you do, act today before this offer is withdrawn.

### DON'T WAIT—MAIL COUPON NOW!

**CHEMICAL INSTITUTE OF NEW YORK, Inc.**

Home Extension Division 12

66-Z West Broadway

New York City



**Our Course Will Fit You For a Position of Authority**

### LETTERS From Students Who Have Taken This Course

You will probably be pleased to learn one of the lessons gave me an idea to turn my chemical knowledge to profitable account. I am now making a varnish and paint which undersells the other type products by \$2.60 a gallon. In some cases more. Have been receiving gallon orders from painters during past week which has netted me a profit of \$12.50 for my "spare-time chemical industry." Many thanks for your training thus far.

J. J. KELLY.

I am but half way through your course and am certain that I have saved my Company many times the cost of the course and raised myself in the Share Holders estimation. The knowledge obtained has its immediate practical application and I do not hesitate in saying your course and the personal attention you give is invaluable to the practical man in any business where chemistry plays a part. You may use this letter and my name and address to the furtherance of your good work.

JOHN WALTER.

I have not written since I received the big set. I can still say that it far exceeded my anticipations. Since I have been studying with your school I have been appointed chemist for the Seranton Coal Co., testing all the coal ash by proximate analysis. The lessons are helping me wonderfully, and the interesting way in which they are written makes me wait patiently for each lesson.

MORLAIS COUZENS.



**T. O'CONOR SLOANE.**  
A.B., A.M., LL.D., Ph.D.

Noted Instructor, Lecturer and Author. Formerly Treasurer American Chemical Society and a practical chemist with many well known achievements to his credit. Not only has Dr. Sloane taught chemistry for years but he was for many years engaged in commercial chemistry work.

### EXPERIMENTAL EQUIPMENT FURNISHED TO EVERY STUDENT

We give to every student without additional charge this chemical equipment, including forty-nine pieces of laboratory apparatus and supplies, and forty different chemicals and reagents. These comprise the apparatus and chemicals used for the experimental work of the course. The fitted heavy wooden box serves not only as a case for the outfit but also as a useful laboratory accessory for performing countless experiments.

**CHEMICAL INSTITUTE OF NEW YORK**  
Home Extension Division 12  
66-Z West Broadway, New York City

Please send me at once, without any obligation on my part, your free Book "Opportunities for Chemists," and full particulars about the Experimental Equipment given to every student. Also please tell me about your plan of payment and your special 30 day offer.

NAME .....  
ADDRESS .....  
CITY ..... STATE.....

S.I. Dec



# I Will Train You At Home To Fill a Big Pay Radio Job



"I give you all this apparatus so you can learn quickly at home the *Practical Way*"



J.E.S.

FREE OF EXTRA COST

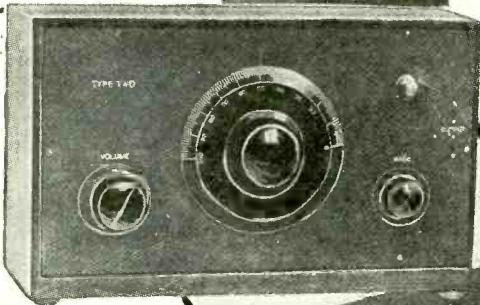

## You Get All of This

All instruments shown here and others sent to all my students free of extra cost under short time special offer. Clip coupon now—find out all about this big unequalled offer while you still have time to take advantage of it. This training is intensely practical—these instruments help you do the practical work. You learn workmanship and get added confidence in your ability.



\$70 In One Day For T. M. Wilcox

"I am in business for myself and RECENTLY MADE \$70 in ONE DAY. I was an electrician of rich experience, occupying a splendid position as telephone superintendent when I enrolled with you believing it would open up greater opportunities—haven't been disappointed. Estimate Radio will be worth tens of thousands of dollars to me in next few years." T. M. Wilcox, Belle Island, Newfoundland.

### World Famous Training That "Pays for Itself"

My Radio course World-Famous as the training that "pays for itself." Make more money QUICK when you take up this practical course. Work on millions of antennae, receiving sets, offers you big chance to make spare time cash while you're learning. I'll show you how—teach you the latest "dope," furnish you with business cards, show you how to get the business and make it pay. My students don't wait a year to increase their income—they report QUICK INCREASES as a result of this course—often two or three weeks after starting. Howard Luce, Friedens, Pa., made \$320 in 7 weeks during spare time. D. H. Sutt, Newport, Ark., writes, "While taking the course I earned in spare time work about \$900." Earl Wright, Omaha, reports making \$400 in a short time while taking course—working at Radio in spare time! Sylvester Senso, Kaukauna, Wis., made \$500. These records not unusual—these men a few of hundreds.

### Your Satisfaction Guaranteed

We who know the results this practical tested training gets—the increased earnings it has brought to men everywhere—stand behind it all the way with a signed guarantee bond that we give you when you enroll. On completion if you're not entirely satisfied in every way, you get back every cent you've paid us. No strings to this offer—you yourself are the only judge. Get started today! It's your big chance for one of the bigger Radio jobs—mail coupon NOW for my Big FREE BOOK and proof! No obligation.

EMPLOYMENT SERVICE TO ALL GRADUATES

Originators of Radio Home-Study Training

If you're earning a penny less than \$50 a week, clip coupon now. Send for AMAZING FREE BOOK, "Rich Rewards in Radio." Why go along at \$25 or \$35 or \$45 a week, when you could earn \$50 to \$250 in the same six days, as a Radio Expert? Hundreds of N. R. I. trained men are doing it—why can't you?

## Earn \$50 to \$250 a Week—

### RADIO EXPERTS IN BIG DEMAND

Radio needs trained men. Get into this new live-wire profession of quick success. It's the trained man, the Radio Expert, who gets the big jobs of this profession—paying \$75, \$100, \$200 a week and up. Every day N. R. I. trained men are taking good places in the Radio field—men just like you—their only advantage is TRAINING. You can prepare just as they did, by new practical methods. Our tested clear training makes it easy for you. Big Free Book contains all the proof.

## You Learn Quickly In Spare Time

So sure am I that I can train you successfully for a better future in this new Big-Pay profession, that I guarantee your training with a money-back bond. Lack of experience or education won't hold you back—common schooling all you need to start. You can stay home, hold your job, and learn quickly and pleasantly in your spare time. My practical, helpful methods enable you to start RIGHT AWAY toward one of the bigger Radio jobs paying \$50 to \$250 a week. No delay, no losing time from work—no scrimping or scraping to get your training.



### Operates WMAQ

"Accepted a position with the Chicago Daily News Station WMAQ. MY INCOME PRACTICALLY DOUBLED, thanks to you. I handle all consultation, also do operating. Your course taught me not only the theoretical but also the practical knowledge that makes my work easy for me." Keith Kimball, Station WMAQ, Chicago, Ill.

## Get This FREE BOOK

Most amazing book on Radio ever written—full of facts and pictures—tells all about the great new Radio field, how we prepare you and help you start. You can do what others have done—GET THIS BOOK. Send coupon today—no obligation.

J. E. SMITH, President  
NATIONAL RADIO INSTITUTE  
Dept. PX5, Washington, D. C.



J. E. SMITH, President  
NATIONAL RADIO INSTITUTE  
Dept. PX5, Washington, D. C.

Dear Mr. Smith—without obligating me in any way, send me your free book "Rich Rewards in Radio" and all information about your practical, home-study Radio Course.

Name..... Age.....  
Street Address.....  
Town..... State.....

# Science and Invention

HUGO GERNSBACK, *Editor-in-Chief*

H. WINFIELD SECOR, *Managing Editor*

DR. T. O'CONNOR SLOANE, Ph.D., *Associate Editor*

Editorial and General Offices, - - - 53 Park Place, New York

*"Those Who Refuse to Go Beyond Fact Rarely Get As Far As Fact" - - - HUXLEY*

## SCIENCE MEETS THE IMPOSSIBLE

By HUGO GERNSBACK

**H**UMANITY has become so immune to the marvels of science that we no longer are astonished at anything. We have become so used to the "impossible" that we have actually come to accept it without question.

But every once in a while science discovers something that really makes us sit up and take notice, on account of its tremendous importance, and even the word "impossible" fades into nothingness.

Suppose someone stepped up to you and handed you a small ball. If you clutched at it with sufficient force, either one of two things might happen. The weight of this seemingly innocent article would probably either tear out your fingers, or, if you grasped the ball tightly enough, your arm would be torn from its socket. The little sphere would strike the floor, and even if the floor were made of cement or concrete, it would go right through it as if it had been fired from a cannon. It would probably go in succession through all the floors of a skyscraper and bury itself in the ground for many feet. You see, the little sphere, the size of a baseball, actually weighs a little over 14 tons, or approximately, one ton per cubic inch.

Of course there would not be anybody strong enough to hand you the ball in the first place, because nothing but a power derrick could lift it. And, furthermore, it is to be doubted whether it will be within any conceivable time that some one will be able to make a sphere as just described. Nevertheless, the material exists. This substance, for which we have no name, actually is in existence today and is contained in the densest star we know, which is the small satellite of Sirius; it is a star not much larger than our own earth, but weighing almost as much as our sun. For a long time scientists could not believe that such an aggregation of matter could be contained in such a small space, but we know today that such is the case, and we have to accept the facts, staggering and quite impossible to the human mind as they are.

We know that matter under tremendous and unthinkable pressure will shrink just like a sponge, and this apparently can be carried on almost indefinitely, as far as we know. This happens to be the case with all the heavy stars which have been investigated. It is even possible that such fluid substance exists in the inside of the earth, where the pressure is so great that everything must be in a molten state. Science, for instance, today believes that the core of the earth is of iron—as we may put it—a solid iron, and yet liquid. Conflicting as this statement sounds, the tremendous pressure liquefies the metals, of whatever nature they may be, and at the same time such materials may be far more solid than wrought iron.

Staggering as is the example of the material weighing one ton per cubic inch just mentioned, it fades to the vanishing point when we come to the substance called Neutronium, which scientists know today also exists. Neutronium, if you please, weighs 60,000,000 tons per cubic inch. The whole of the Woolworth Building weighs only 100,000 tons, and it is a building some 200 feet square and almost 1,000 feet high. *It would take 600 Woolworth Buildings, if placed in a scale, to balance one cubic inch of Neutronium.*

These are staggering facts, but are facts nevertheless. The Neutron is the name given to the combination Proton-Electron. The electron itself is only one ten-trillionth of an inch in diameter, and when such combine by colliding with a Proton, a Neutron is formed.

To understand this, it should be noted that in hydrogen gas the nucleus of the atom is composed of only one particle, which we call the Proton. Around the Proton a single Electron circulates in the path of a perfect circle. The Proton and Electron

attract each other with a tremendous force, and the only way the Electron can keep from plunging into the central nucleus is by circling around it, just as our own earth circles around the sun. But the Proton is about 1,800 times heavier than the Electron. On the other hand, a hydrogen Proton is no more than one ten-quadrillionth of an inch in diameter, and it does not often happen that the Electron and Proton collide with each other; it happens only when some outside force disturbs the combination. When this occurs, and the two collide, they merge into one and disappear from sight completely. The combination produces the Neutron, which has as yet never been isolated, but science knows that it exists. It is not affected chemically. It can not be seen, and we have as yet no means of getting at it at all. This is on account of its extremely small size, so small that it immediately falls, passing through every material on its way. It passes through glass walls, metal buildings, the earth itself, and continues falling right through the earth, passing through the center and emerging on the other side, only to fall back. It then keeps up a pendulum-like motion, its speed decreasing after it emerges on the other side of the earth, until finally, due to friction, it locates at the center of the earth, where it comes to a stop.

Scientists have calculated that the minimum density of solid Neutronium is 4 trillion times that of water. This makes the stupendous weight of about 60 million tons per cubic inch. It should be noted, at this point, that the Electron and the Proton at first were nothing but electrical charges, but on uniting they became a solid particle, the Neutron, or Neutronium. Thus science today believes that all matter in its final stage is electrical, while the Neutron itself, made up of electrical charges, is a substance, in other words, of the materials of an atom.

Just what these discoveries may mean to humanity, no one can foresee today, or even calculate. One wild guess is as good as another. Even if we should be able to isolate a small particle of Neutronium, we would have nothing to keep it in captivity, as it would go through everything just as water falls through a sieve. We would have no means of retaining it unless it were by electrical means, and this, of course, is quite possible. The quantity of isolated Neutronium, however, would of necessity be microscopically small, because even the smallest quantity visible to the naked eye would be of such great weight that it would be impossible for anything to hold it captive.

What benefits the human race may derive from this knowledge or the isolation of Neutronium, it is impossible to predict. It is fair to say, however, that in years to come, not only our entire conception of matter will be revolutionized, but our entire mode of living, and, indeed, our entire lives, will no doubt be affected by these discoveries, mysterious as they may seem today.

Matter under great compression seems to be something totally different from matter not compressed. Only during the past 100 years have we found out this important fact, and already industry is beginning to make use of this discovery. For instance, liquid air is a product due to compression as also is refrigeration. The chemical

industry is possibly the biggest where compression of gases, as in the fixation of nitrogen of the air and of solids is constantly coming into greater use. But of course the pressures that we have been working with so far, are really infinitesimal compared to those that we shall use in years to come. We may never be able to produce pressures that will give us a solid weighing 14 tons per cubic inch, not to mention 60 million tons per cubic inch.

### THE GOLDEN AGE OF SCIENCE

is symbolized by the golden cover  
OF SCIENCE & INVENTION  
LOOK FOR THE GOLD COVER  
every month!

Mr. Hugo Gernsback speaks every Monday at 9 P. M. from Station WRNY on various scientific and radio subjects.

# WHY FLORIDA HURRICANE

Popular Explanation of Florida Hurricane by Well-K New York

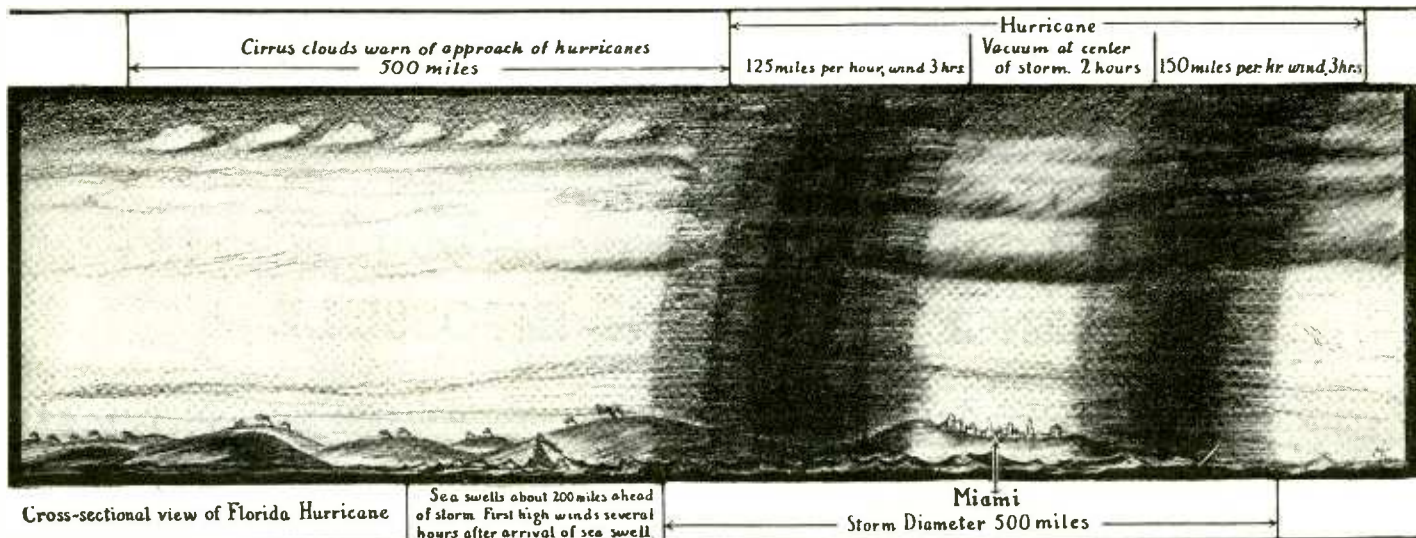

A remarkable cross-section view of the Florida hurricane which gives a clear idea of how the two "blows," with an intervening quiet spell of about two hours took place. The top view of this hurricane shown on the opposite page will help the reader to gain a clear idea of the physical make-up of this and all other hurricanes. E. B. "Farmer" Dunn, well-known weather expert,

prepared the accompanying article and he blames much of the property loss and deaths on the Weather Bureau, who did not display storm warnings far enough in advance. Experts can tell many hours ahead when a hurricane is approaching, as drawing above shows. Storm above is moving from right to left across the page.

THE most disastrous hurricane that ever visited the South Atlantic coast struck the southern end of Florida at Miami about midnight of Friday, September 17th, and by 3:15 A. M. of Saturday, the 18th, the storm raged with great violence. Its severity lasted until 6 A. M., then an abatement came in the passing of the storm centre. For a period of two hours, during which the sky cleared, the wind ceased and a comparative calm prevailed. The lull in the storm was in reality the most treacherous period. It led the people into a sense of false security in thinking that the storm had passed. Many left their homes and were exposed to the fury of the afterblow, which is always of greater violence than that before the passing of the storm centre. The wind at each period of the storm had an approximate maximum velocity ranging from 100 to 150 miles an hour. The lowest barometer record was 27.62.

### HURRICANE WITHOUT PROPER WARNING

As early as Thursday, the 16th, the Weather Bureau had knowledge of the approaching hurricane. The 8 A. M. map of Friday the 17th, showed the storm to be moving nearer Florida, with increasing intensity; the advance heavy rainfall then reached as far north as Jacksonville. No heed was paid to these facts and no warning given. The weather summary on the same map read as follows:—"Hurricane in the vicinity of Southern Florida and evidently of minor intensity." No one with a knowledge of hurricanes would have made such a statement. Early Saturday morning, the 18th, the storm was sweeping with great force across the southern end of Florida, having before 6 A. M. caused the loss of hundreds of lives and millions of dollars of property. Two hours after the storm had passed Miami, the weather map appeared with the statement as follows:—"The southern storm is apparently central, east of and near Southern Florida and probably still advancing northwestward." Timely and accurate warning would undoubtedly have saved many lives.

The hurricane on reaching the west coast did considerable damage, although it had

lost some of its force and deposited the greatest volume of rainfall on the east coast. Between Sunday and Tuesday it moved very slowly and was practically stationary between Pensacola and New Orleans; the rotary force diminished to light winds and the storm dissipated.

### CHARACTERISTICS OF STORMS

There are elements of regularity in the history of hurricanes which are quite distinctive, their place of birth, the season of the year and their serpentine course. They are the only storms taking a westward course, before they recur to the north-east. They are in all features similar to the "Typhoon," except that the latter has its birth south of the equator and travels directly opposite.

Knowledge of hurricanes is based upon a firm foundation of observed facts. It is on such a foundation that the "law of storms" is formulated. A forecaster possessed of these facts should make most accurate predictions of these storms.

### WHAT A HURRICANE IS

Hurricanes of the West Indies and Typhoons of the East Indies are what are termed cyclones in the temperate zones, but owing to their greater development, magnitude and power, which they attain in the torrid zone they have been given the more terrifying titles of "Hurricanes" and "Typhoons." The hurricane season is from July to October inclusive, although these storms have infrequently occurred in other months.



Many people wonder where the Florida hurricane started and what became of it after it had caused so much damage in the state of Florida. The map above prepared by Mr. Dunn shows where hurricane started, its path northward and point where it died out between New Orleans and Pensacola.

# OCCURRED

By E. B.  
"FARMER"  
DUNN

nown Expert, Former Chief U. S. Weather Bureau at  
City.



The two photographs herewith give a very good idea of the terrific power of the wind and waves as they swept over Miami and other Florida resorts. Newspapers mentioned winds of 125 miles per hour velocity; Mr. Dunn stated that from the barometer readings, he knew that the wind reached 175 miles per hour and upward.

The hurricane has its birth in the southern region or zone of easterly trade winds and generally east of the Windward Islands or on the border of the Torrid zone of the equatorial belt of calms, which ranges close to latitude 10 degrees north. At the hurricane season, extensive areas of calm, sultry and rainy weather stretch

may reach from fifty to two or three hundred miles an hour.

### DETECTING APPROACH OF HURRICANE

There is an outward flow of air at the top of the storm center, which spreads far in advance, producing cirrus (feathery) clouds which are the forerunners of the approaching storm. These clouds precede the storm some four or five hundred miles. Another pronounced indication of an approaching storm is the sea swell, which also precedes the storm by several hundred miles. Before the approach of these storms the barometer shows an unusually high reading for the latitude and season, and almost always a dead calm exists for some time and the weather is such as would indicate to the layman no cause for alarm. Such is Nature's camouflage to deceive the unwary. It is

not long after the motion of the central column sets in, that the storm moves from the place of its formation in a westerly course, contrary to the general movement of storms in more northerly latitudes. The westerly movement terminates when the storm center reaches the neighborhood of 25 or 30 degrees north latitude and comes within the influence of the prevailing south and west winds. Then it recurves to the northeast. The point of recurve may bring the centre of the storm to the vicinity of the west Gulf coast or the east of Florida.

On the close approach of these storms the weather which has been balmy and calm, becomes hazy; a surface breeze springs up, coming from the opposite direction to the flow of the clouds. The breeze blowing toward the centre of the impending storm, and  
(Continued on page 765)

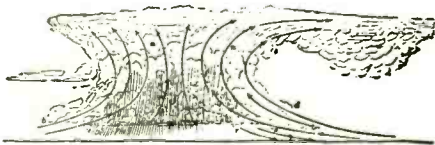

The drawing above shows general storm formation, such as occurs in the case of a hurricane. the arrows indicating the ascending column of warm moist air, this warm air rushing in from areas extending for many miles.

from the west coast of Africa to the north coast of South America. As these great storms move northward their progress is slow at first. They gather in moisture until the excessively heated and widely expanded atmosphere is thoroughly saturated, thus greatly reducing the atmospheric pressure for miles around the embryo centre, which creates a low pressure area deeper than is usual in the ordinary cyclone. The barometer continues to fall and the inrushing air starts a whirl as the over-heated air ascends higher and higher, and the storm moves over the central region of abnormal heat, being carried forward by the movement of the upper atmosphere. The lower strata of hot, moist air continue their rush toward the storm centre, feeding the central column and giving greater progressive and rotary motion.

Clouds are formed and spread far in advance of the body of the storm; as soon as the colder strata of air in the north is reached, the moisture is condensed; rain falls in torrents or cloudbursts, liberating the great amount of latent heat absorbed in the process of evaporation, thus giving greater impetus to the storm's progress. The inflowing air at the surface blows horizontally and with increasing force as it approaches the centre, where it joins the upward spiral or rotary motion. The progressive motion may not be more than twenty-five miles an hour, but the rotary or destructive force

The drawing to the right shows a top view of a tropical hurricane, such as that which destroyed millions of dollars worth of property and hundreds of lives in Florida a few weeks ago. This top sectional view of a tropical hurricane is that of a storm which occurred quite a few years ago. Note the general circular motion of the air currents, these currents coming in from the upper right hand corner and swirling around in vortex fashion, forming a vacuum at the center. The radius of such a storm is about 250 miles and the diameter is about 500 miles. Referring to the cross sectional view on the opposite page, one now sees that with every hurricane there are two "blows" felt, and not three as some of the newspapers reported. The first blow at about 125 miles per hour velocity lasted about three hours; then came a period of two hours while the vacuum center of the storm passed and fooled many people into thinking that the end of the storm had come; finally came the second and hardest blow, as the rear section of the storm passed over, with the wind blowing at a velocity of 150 to 175 miles per hour. This second blow lasted about three hours, the terrific wind ending abruptly. At the start of the hurricane the wind comes on more gradually, and to the trained weather observer or sea-faring man, Cirrus clouds about 500 miles ahead of the storm warn of its approach, followed by the sea swell about 200 miles ahead of the storm. The average forward velocity of the storm center is 25 miles per hour.

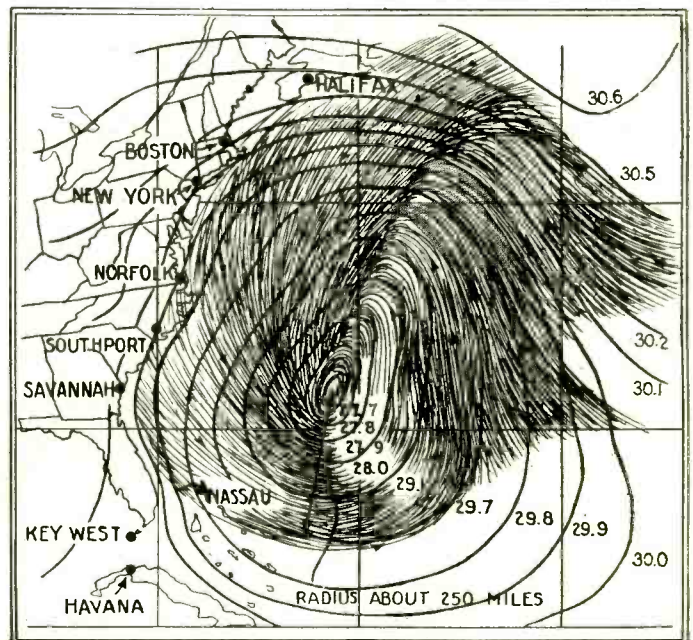

# Magic Tables and Floor In New Restaurant

By H. WINFIELD SECOR

New York City's newest night club, Le Perroquet de Paris, will boast of some of the greatest novelties imaginable. The glass covered tables, when lit, will expose live gold fish swimming about.

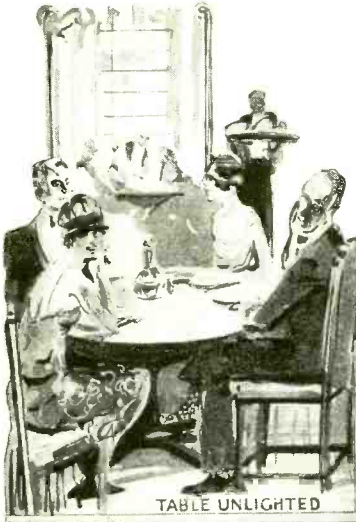

TABLE UNLIGHTED

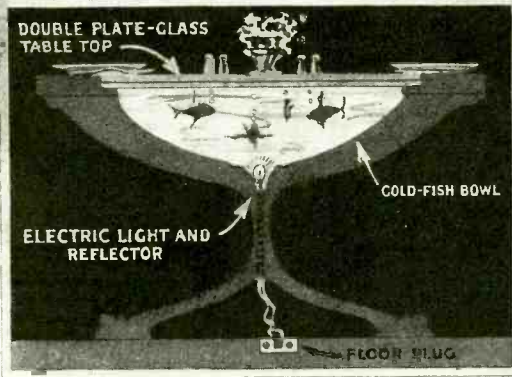

TABLE LIGHTED - FISH VISIBLE

Glass dance floor, under which electric lights will glow; with lights out floor becomes mirror.



FLOOR IS 22 X 28 FEET - DOUBLE PLATE GLASS

TO CONTROL SWITCH-BOARD

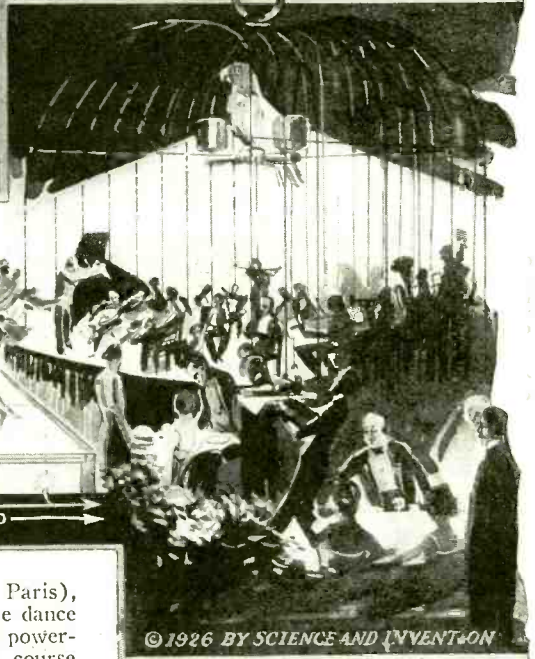

© 1926 BY SCIENCE AND INVENTION

NEW YORK CITY'S newest night club, Le Perroquet de Paris (the Parrot of Paris), will provide many new surprises. Among other features is the most remarkable dance floor ever seen in America. It will be made of double thick plate glass, under which powerful electric lights will blaze upward. The other lights in the restaurant will be of course carefully toned down, so as to emphasize this dance floor feature. At frequent intervals the dance floor lights will be switched off, and the table lights switched on. When this happens the glass floor becomes a mirror, and the guests seated at the tables experience the startling novelty of seeing real live gold fish swimming about under their plates. When the table lights are switched off, the glass top becomes a mirror. The lights for the orchestra in the gold cage flash out from under the stuffed parrot. Roger Wolfe Kahn, a leading director of jazz orchestras, is sponsor of this newest idea in night clubs. Mr. Kahn's associate in this enterprise is Rene Racover, famous French flier and formerly director of the Café de Paris in New York City.



FLOOR BECOMES MIRROR WHEN LIGHTS ARE FLASHED OFF

When lights under glass dancing floor are extinguished, the floor becomes a mirror, and the lights under the tables having been switched on, swim-

ming gold fish become visible to the guests seated about the tables. Orchestra plays inside giant parrot cage symbolizing restaurant's name.

# Paper Actors Movies' Latest

Latest "Shadow Film" Novelty Presents "The Story of Prince Achmed."

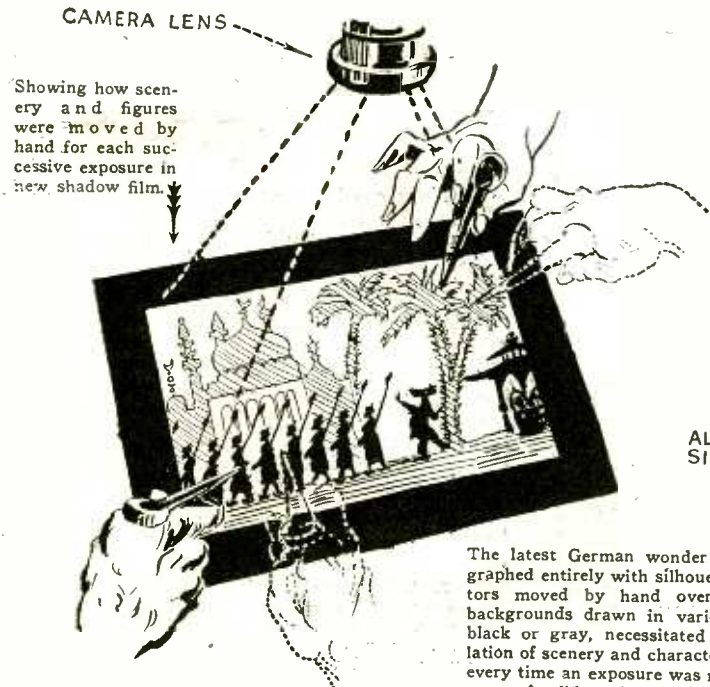

Showing how scenery and figures were moved by hand for each successive exposure in new shadow film.

In the drawing above one will perceive how many figures were moved simultaneously by being joined together.

The latest German wonder film, photographed entirely with silhouette paper actors moved by hand over translucent backgrounds drawn in various tones of black or gray, necessitated the manipulation of scenery and character silhouettes every time an exposure was made. Three years of solid work were required to film "The Story of Prince Achmed," 250,000 pictures being taken, 100,000 of which were finally used.



Beautiful scene from the new German photoplay "The Story of Prince Achmed." The moving figures and trees were hand manipulated. Beautiful rippling water effects were obtained by means of cut paper and sand moved over glass.

SCENES PAINTED OR DRAWN IN VARIOUS TONES OF BLACK OR GRAY.

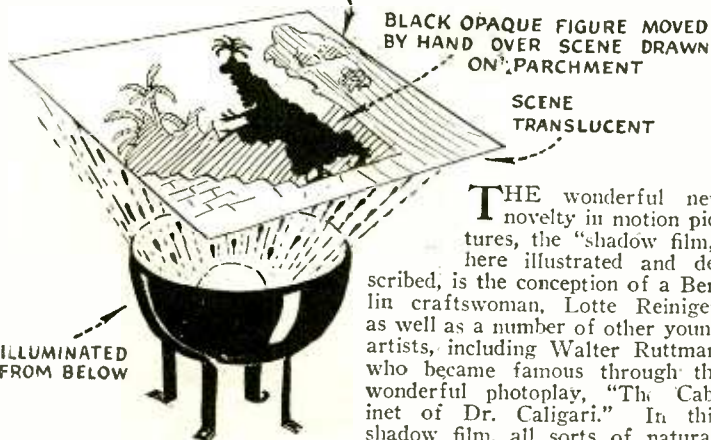

ILLUMINATED FROM BELOW

The reflector and lamp below the scene were in light-tight box.

THE wonderful new novelty in motion pictures, the "shadow film," here illustrated and described, is the conception of a Berlin craftswoman, Lotte Reiniger, as well as a number of other young artists, including Walter Ruttmann, who became famous through the wonderful photoplay, "The Cabinet of Dr. Caligari." In this shadow film, all sorts of natural, yet startling effects are produced, such as fairy scenes.

Figure below shows how all the various parts of the body representing one of the characters was jointed, so that the figure could be manipulated, to properly assume hundreds of different poses. The actions of the figures are extremely realistic.

ALL BLACK SILHOUETTE

SHOULDERS MOVABLE, ALSO ABDOMEN AND HIPS

CARD BOARD FIGURE WITH JOINTED LIMBS, WEIGHTED WITH SHEET LEAD

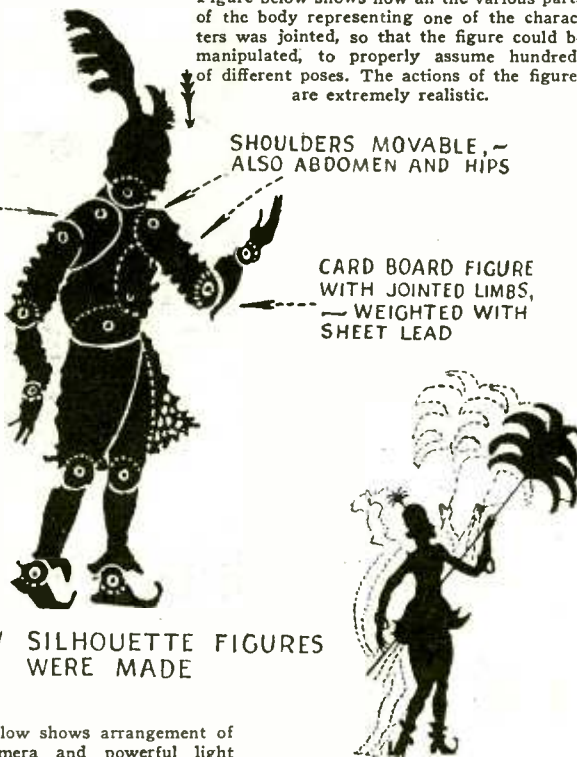

HOW SILHOUETTE FIGURES WERE MADE

Picture below shows arrangement of movie camera and powerful light placed below translucent scene drawn on parchment, and over which opaque figures were moved by hand.

FIGURE MOVED BY HAND TO TAKE PROGRESSIVE POSITIONS, EACH BEING PHOTOGRAPHED

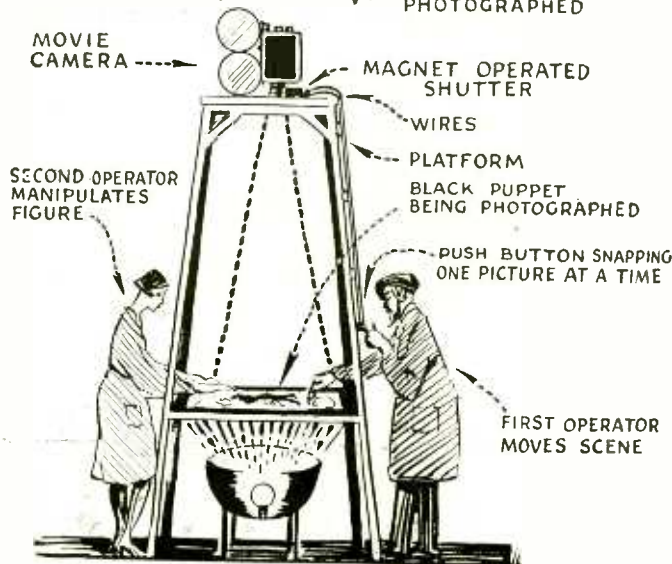

IN THREE YEARS' TIME OVER 250,000 SEPARATE PICTURES WERE TAKEN, 100,000 OF WHICH WERE USED IN MOVIE

IN the new photoplay described herewith and in which no living characters appear whatever, infinite patience as well as artistic skill of the highest degree was required. The backgrounds were so cleverly handled with regard to the different depths of tone, that the buildings and other objects seemed to actually exist in the solid form. Likewise the figures were so cleverly constructed and manipulated, that one can hardly believe that he is looking at a scene filmed from a mere piece of parchment, on top of which a series of cardboard people are moved around by hand. The presentation of this new shadow photoplay has been much enhanced by the creation of special music to accompany it, which music was prepared by Wolfgang Zeller. Imagine the clever work involved in moving as many as sixty figures simultaneously in some of the mob scenes.

**A New and  
Important  
Prize  
Contest**

# WIREKRAFT

## \$3,000.00

BY HUGO  
Member American

things can be constructed from wire by any intelligent builder handy with a few elementary tools. Anything from a floor lamp to a replica of the Woolworth Building can be built from wire. Any number of useful things also can be made for use in the home, the office, the factory, or the automobile, and even for your radio. The possibilities are endless and we know that the contest will no doubt be one of the greatest that has ever been staged anywhere. We know it will bring out the latent ingenuity of almost any one who comes in contact with Wirekraft, and it is hoped that an entirely new art may be developed.

Unlike the Matchcraft Contest, Wirekraft

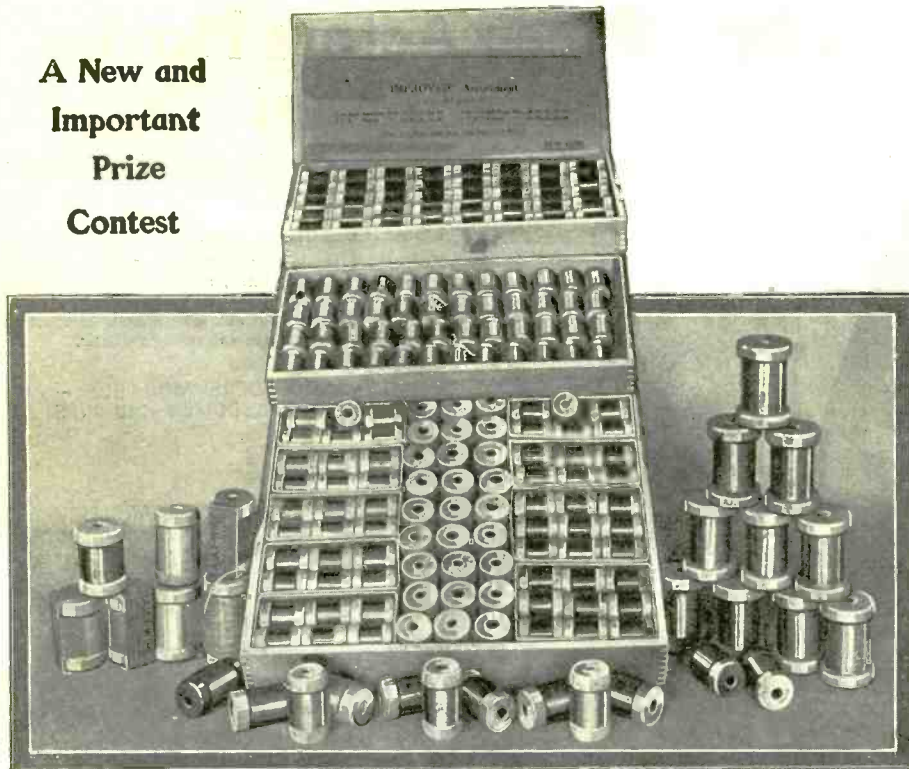

Fig. 1. Above we see an assortment of wire of various sizes which can be conveniently purchased on spools as this illustration shows. Wire of this nature can be used for the making of models for the Wirekraft Contest and those particular types of wire represented in the illustration were furnished through the courtesy of E. H. Tate Mop & Cordage Co.; The Malin & Co.; The Cornish Wire Co.; U. T. Hungerford Brass and Copper Co., and the Russell Fraser Wire Co.

**O**UR Matchcraft Contest, one of the most unique handicraft contests ever staged anywhere, has proved a great surprise to many people for the astonishing variety of models and things that can be fashioned out of matches. We are now about to begin another contest termed "Wirekraft", which, in our opinion, will far surpass even the popular Matchcraft

Contest. The difference between the two contests is obvious. With matches only models can be built that in the very nature of the material can not be used for utilitarian purposes.

Wirekraft is a new art which simply means "What can you do with wire?" At once you will perceive that there are really no limits to this new handicraft, which should become popular over night. Myriads of

is of a much more substantial nature. The models and articles will keep indefinitely, and furthermore the builders will have something for their pains when they have finished building their Wirekraft Models or appliances. In these pages we have just shown a few illustrations of what can be done. Before going further, be sure that you do not duplicate any of the things shown in these pages, because such articles will positively NOT

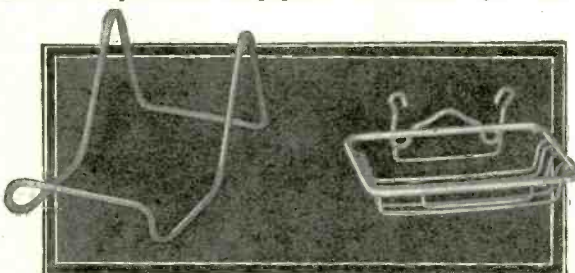

Fig. 2. The photo at the left shows a wirekraft novelty in the form of a picture frame stand. The wire is completely covered with rubber tubing to prevent marring of furniture or frame. The illustration at the right is a wirekraft soap dish, white enameled. These two articles constitute utilitarian suggestions.

Fig. 4. There are many methods of soldering or welding wires together. The spot welding system is applicable to wirekraft models. In the particular photo below, soldering of a bed lamp frame is being accomplished by the aid of a clutch pencil and a storage battery. One lead from the storage battery is grounded to the frame and the other to the metal pencil.

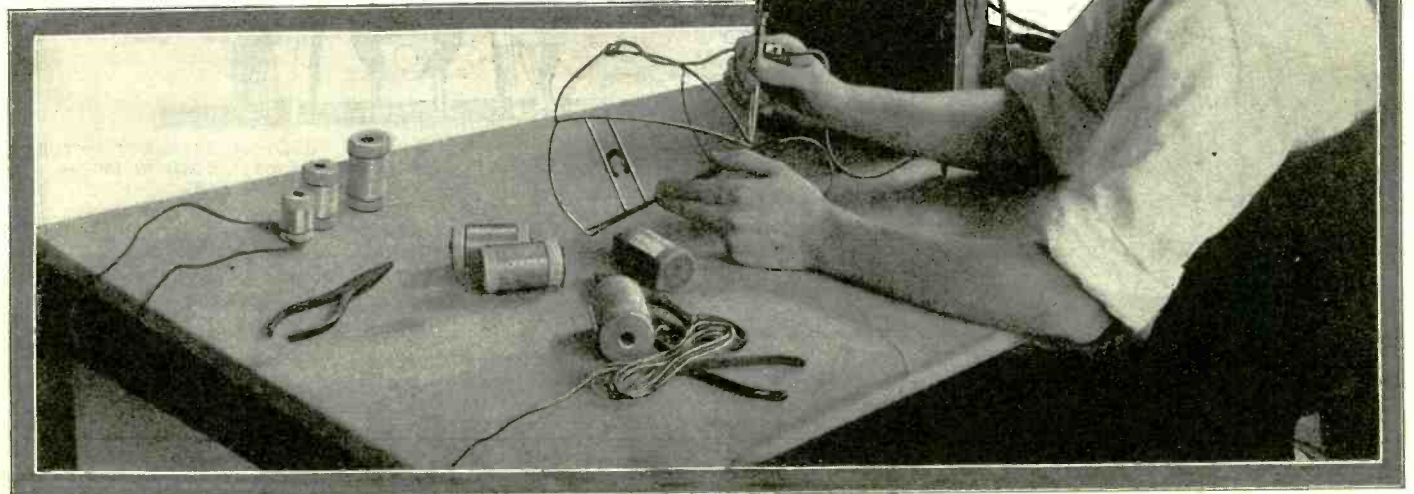
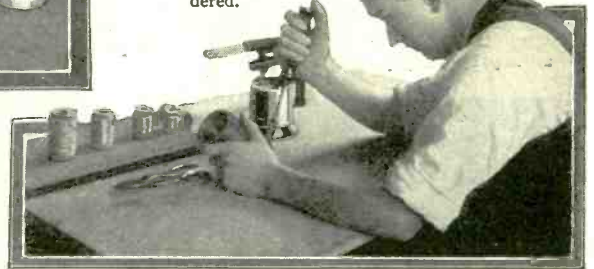

Fig. 3. This photo shows the construction of a tube of wire. The wire is wound on a cylindrical form, removed and soldered.



The point of the pencil is turned out to a distance of approximately 3/8ths of an inch. When it touches the grounded frame, intense heat is set up at the point of contact. a tiny bit of solder forms the joint.



# -A NEW ART Prize Contest

**GERNSBACK**  
Physical Society

be awarded prizes. The editors want new and novel things, not articles that can be bought in the open market now. Furthermore there are a number of large manufacturing concerns making a specialty of manufacturing wire appliances. Articles of this kind obviously can not be admitted to the prize contest as only novel things are wanted. The rules are clearly stated elsewhere on this page, and should be carefully read for full details.

In the very nature of the contest it should be obvious that wire must form the largest proportion of the article or model submitted. The more wire that is used in the model, the better its chances for a high prize because the prize is awarded only for the wire construction. Models and articles may be decorated to suit. They may be cov-

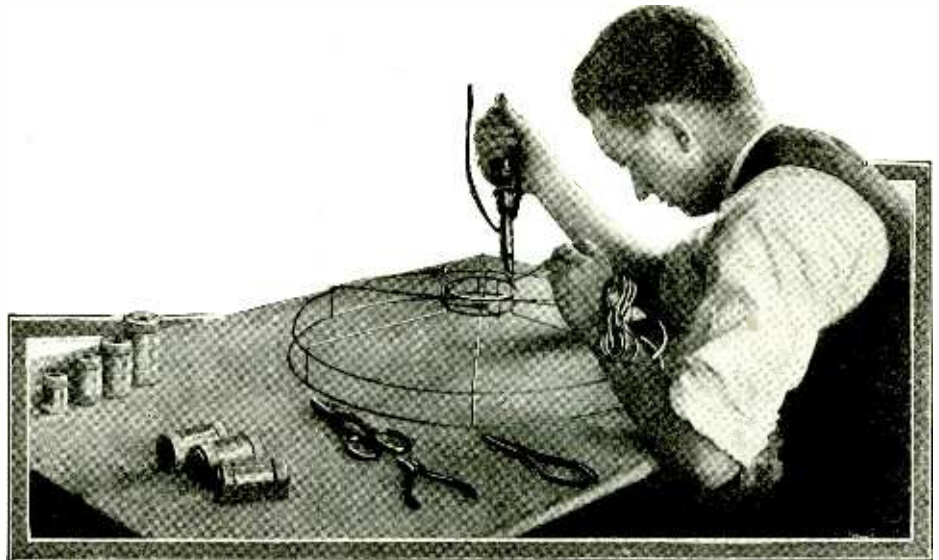

Fig. 5. In the photograph above an electric soldering iron is being employed to solder the wires forming a lamp shade frame together. Wirecraft is a fascinating art.

## Rules of Wirecraft Contest

**T**HIS is a wirecraft contest. Hence wire is to be used in the construction of all of the models entered in this contest.

The size of the wire to be employed is limited. The heaviest wire must not be larger than No. 8 American or B and S gauge, and the smallest no smaller than No. 30 B and S gauge—or (for foreign countries not having these exact sizes), the nearest available equivalent. (No. 8 B and S gauge is .12849 inches in diameter or 3.264 millimeters. Its nearest equivalent in the Birmingham or Stubs iron wire gauge is No. 18. In the Stubs steel wire gauge it is No. 30; in the British Imperial Standard it is No. 10. The nearest wire to No. 30 B and S gauge which is .01002 inches or .2546 millimeters in diameter is No. 31 in the Birmingham or Stubs iron wire gauge. In the Stubs steel wire gauge it is No. 80; in the British Standard it is No. 33.)

The builder may avail himself of the opportunity of using any intermediate sizes of wires between No. 8 and No. 30. B and S gauge.

The wire may be copper, brass, iron, steel, or these materials coppered, tinned, nickel-plated, or galvanized, or the wire may consist of an alloy. Any kind of wire available on the market may be employed.

It is preferable to use non-rusting wires. The publishers will not be responsible for the rusting of any model. To protect wire which rusts easily or for color effects, the models may be painted, lacquered, varnished or otherwise covered.

Any additional decorations or accessories may be employed to enhance the effect. (Example: Silk on a lamp shade; glass in decorative fixtures; electric motors for operating mechanisms, etc.)

Only those portions actually constructed of wire will be judged.

**Address All Entries to Editor Wirecraft SCIENCE & INVENTION MAGAZINE, 53 Park Place, New York City**

(Example: A reed basket is suspended from a wire chain. The basket not being made of wire is NOT considered. On the merits of the chain only will the prize be awarded.)

Wires may be twisted, spliced, soldered, welded or bound together. Wire may be used to bind other wires together. If soldered a non-corrosive soldering flux should be employed.

There is no limit to the size of the models which may be entered nor to the number of entries which any maker may submit during any calendar month.

In every case the model must be forwarded express prepaid to SCIENCE AND INVENTION Magazine. It should be tagged with name and address of the maker, who will prepay charges if model is to be returned.

The first prize will always be awarded to a model possessing the greatest utilitarian merits. This must be an object NOT found on the market today.

The second prize will always be awarded to an object possessing the best decorative artistic or constructive effect. It may be a replica of an existing object or a model of an imaginative object or effect.

All models may remain at the office of this publication until the close of the contest at the discretion of the editors.

This contest starts January 1st, 1927, and will terminate January 1st, 1928.

The remaining prizes will be judged from either one or the other viewpoints at the discretion of the judges.

This is a monthly contest lasting for twelve months, each monthly contest closing on the first of the month following dates of issue. Thus the contest for the month of January, 1927, will close Feb. 1st, 1927. Winners for January will be announced in the April issue.

### \$3,000.00 In Prizes Arranged in Monthly Awards

First Prize .....	\$100.00
For Utility Only	
Second Prize .....	50.00
For Artistic, Decorative or Constructive Effect—may be a replica or model of some imaginative or existing object.	
Third Prize .....	25.00
Fourth Prize .....	20.00
Fifth Prize .....	15.00
Sixth Prize .....	10.00
Seventh Prize .....	7.50
Eighth Prize .....	5.00
Ninth Prize .....	3.50
10th to 16th Prizes of \$2.00 each ...	14.00
<b>Total .....</b>	<b>\$250.00</b>

Fig. 6. Where a great many pieces of the same general contour must be made, it is advisable to drive nails into a piece of wood and thus form a pattern. The wire is then twisted around the nails as indicated in this action photo.

Fig. 7. Three nails driven along a straight line into a piece of board will facilitate the straightening of wire. Note S twist around the nails.

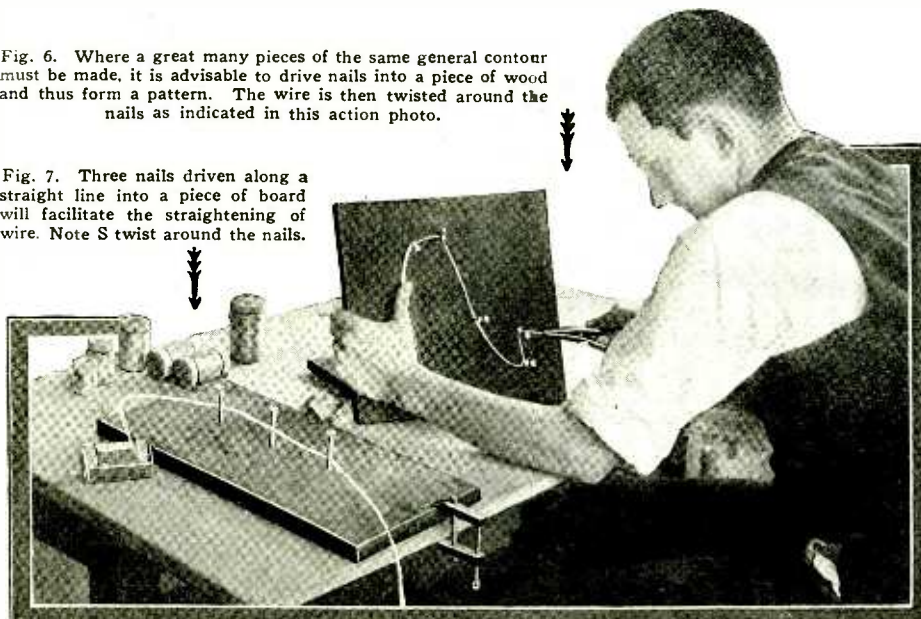

ered with silk, paper,—the finished model can be painted, gilded or silvered,—the wire may be covered with rubber tubing, or with cord or twine, if the builder so elects. Any of thousands of other ways to finish it up and make it look presentable may be employed. Some articles require a substantial base, as, for instance, that shown under Fig. 16. Such articles are, of course, admissible, but it will be seen that in a model of this kind there is, roughly, 50 per cent. wire and 50 per cent. wood. Consequently a similar article would not win a high prize, because in this particular article the wire would be of no use without the wooden base. Remember that on the wire portions of the model the contest will be judged, but don't make the mistake of using wire where some other substance might be much better. In this case wire could be used as an inferior base material.

We have said before that we wanted novelty, and we mean just that. There is also the possibility, when producing a novel thing in wire, that it is so novel that it can be patented. In this case it should be remembered that publication in any magazine of a national character is a *prima facie* evidence of conception and a patent can be se-

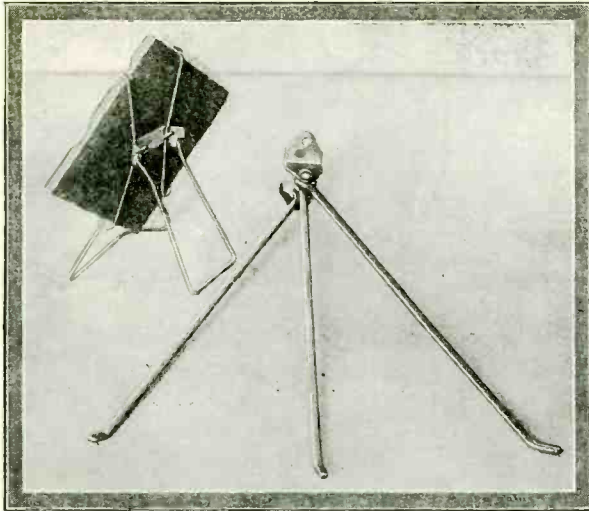

Fig. 8. Above and to the left the photograph shows a simple stand made of wire which is used to hold a square mirror. The other photo shows how wire can be employed to make a clothes drier. The wires in the latter case are preferably heavily nickel-plated.

cured by the builder or constructor within two years after publication in SCIENCE AND INVENTION.

This Wirekraft Contest will naturally be watched with great interest by all manufacturers of such articles in the United States, and the chances are that if an idea is presented of great utilitarian value, the manu-

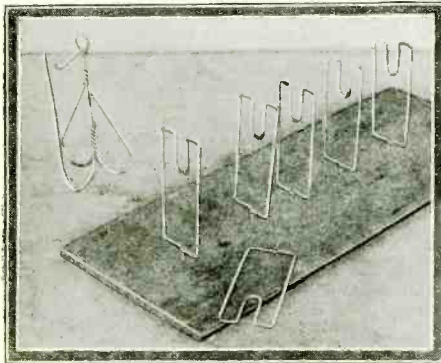

Fig. 9. Two unique wirekraft ideas. One represents a bill file and the other shows a twisted wire form which may be inserted in the drawers of a desk in order to hold letters in place. The system is also suitable for a letter file.

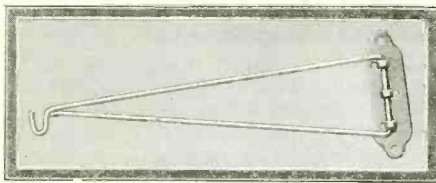

Fig. 10. A rather simple yet unique bird-cage hook is depicted in the photo above. The bracket is not made of wire, therefore would not be considered by the judges.

Fig. 11. The photo at the right shows a cloth covered coat hanger made of wire.

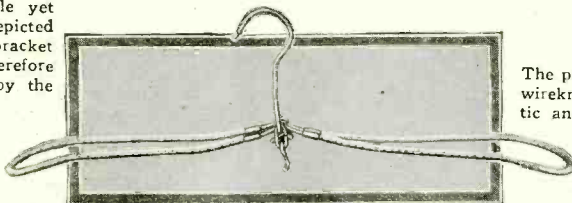
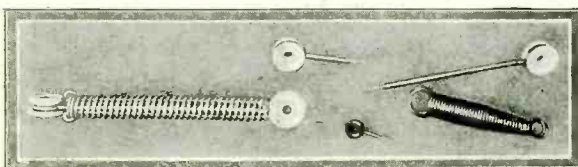

Fig. 12. Spring wire is of course permissible in a contest of this nature. The photo below shows two types of springs for radio antennas and three eyelets also made of wire, the ends of which are provided with threads.—Courtesy Parker Metal Goods Co.



# "WIRE-KRAFT"

\$3000.00

In Prizes to be Awarded in this Contest

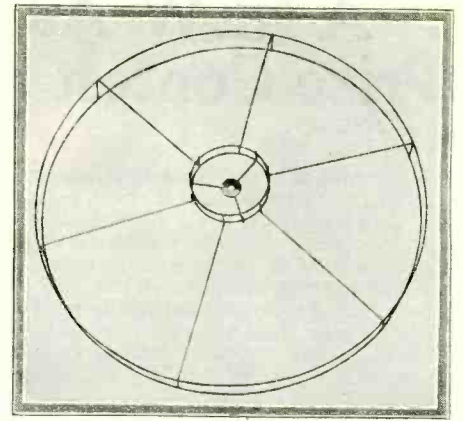

Fig. 15. A simple large shade for a piano lamp is indicated above. The small metal circllet in the center fits over the top of the piano lamp stand and is there locked in place by a nut.

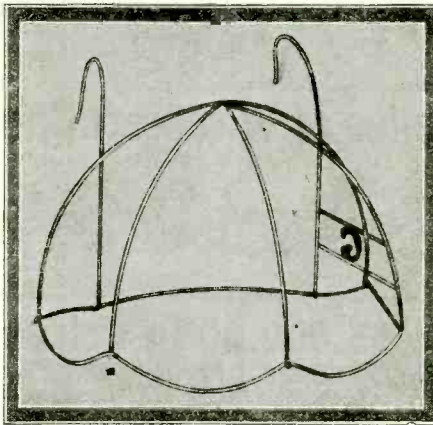

Fig. 13. This photo shows another of the possibilities of wirekraft. The frame is intended for a boudoir or bed lamp which may be covered with silk if the builder so desires. The wire portion of the model only will be judged.

factors would wish to get in touch with the inventor with a view to manufacturing such an article. Publication of such an article in SCIENCE AND INVENTION is therefore an actual protection to the inventor. This should not be overlooked.

The first prize in the Wirekraft Contest will always be awarded to the model possessing the greatest practical and utilitarian merit. It must be an object not found on the market today. The second prize will always be awarded to an object possessing great decorative or artistic or constructive effect.

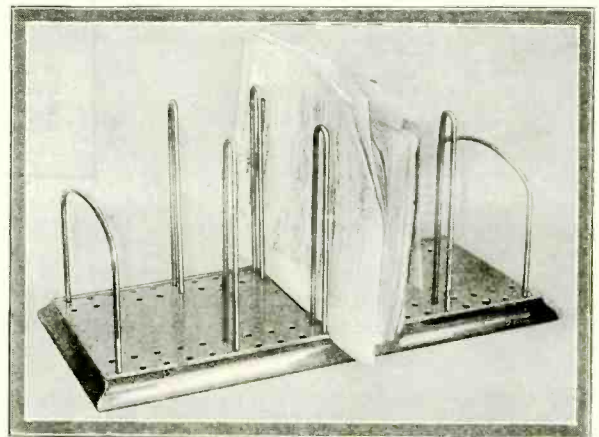

Fig. 16. Here is a unique letter file also made of wire, but in this photo the baseboard is of wood. The same base could also have been composed of wire but the device would then be not quite as practical and infinitely more difficult to construct.

The photos on this page show wirekraft ideas of both artistic and utilitarian properties.

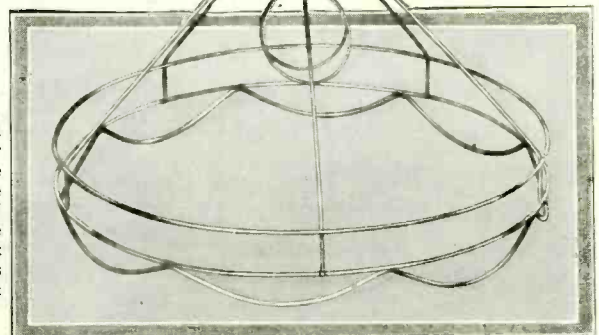
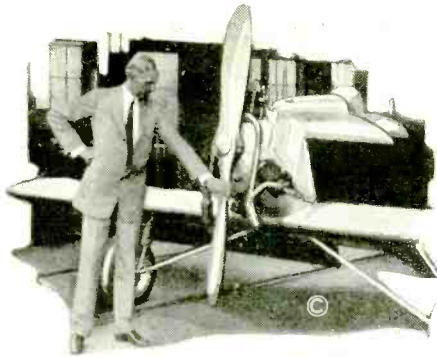

Fig. 14. Here is a unique wire frame also intended for a boudoir lamp or wherever a small size lamp is indicated. Note the scalloped bottom of the frame and also the double circllet of wire at the top which clamps around the incandescent globe.

# Now the Flying Flivver



Henry Ford and his flying flivver.

**H**ENRY FORD, world-famous as the manufacturer of the well-known "flivver", recently announced the perfection of a small, easily housed airplane which is expected to be the first of a series of developments in popular aviation. The "flying flivver" has a wing spread of 18 feet, it is 12 feet from propeller to rudder, and weighs only 300 pounds. Powered with a 3-cylinder Anzani motor, it is capable of a speed of over 100 miles an hour. Mr. Ford is shown at the left explaining the operation of the "baby plane" to visitors at the Dearborn plant, while below the plane is seen in comparison with the ill-fated Sikorsky bi-plane in which Fonck had intended to fly from New York to Paris.

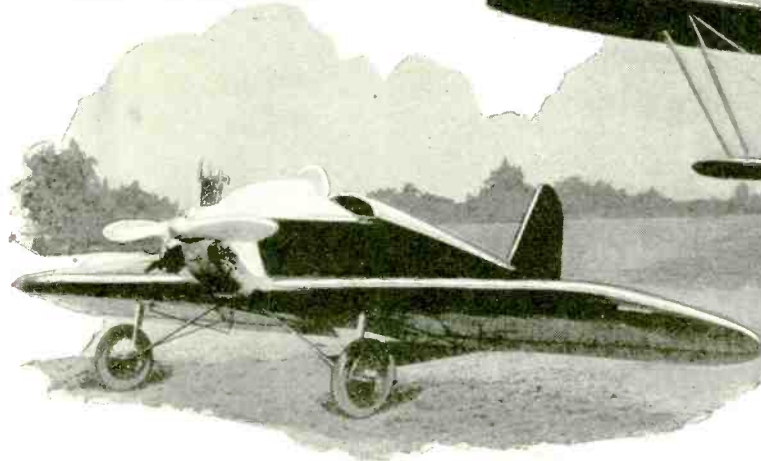

The Sikorsky plane "New York-Paris" is shown above as it appeared just before first test flight. Due to an error in judgment, the pilot lost control as he was taking off for the Trans-Atlantic flight, and two of the crew died in the crash. The flying flivver is also shown as it appeared at Curtiss Field near the larger plane.

## Bicycle Propelled by Arms

**G**ERMAN inventors seem to be concentrating upon hybridizing rowboats and land-vehicles. A few months ago we published the photos of the four-wheeled "Rowmobile", which seemed to interest our readers, and now we present a bicycle which is propelled through a series of gears by a rowing action of the arms. We are unable to obtain the name of the inventor of this machine and its manufacturer is also unknown.



Above the "Row-cycle," as it appears in the operating position. The steering is controlled by means of pedals, and the seat slides in a fashion exactly like that of a racing boat. At left, the method of propulsion is seen to consist of a series of belts connected so as to transmit a continuous forward motion through a chain to the rear wheel.



## Water Shoes Offer New Sport

**S**teuerlein, an engineer of Schweinfurth, Germany, has invented a new "water shoe," intended for sport purposes. The photo at the right shows the inventor demonstrating his device. The apparatus is controlled by the levers which he is holding, and is actuated by leg power. Every step made throws the paddles into action with an oar-like motion.



# Free Cathode Rays\*

## Dr. W. D. Coolidge, of the General Electric Company, Makes Remarkable New Discoveries with Free Cathode Rays in Air

By G. C. B. ROWE



Dr. W. D. Coolidge, the physicist, who has developed a vacuum tube through the end of which cathode rays pass into the open air.

Fig. 8A. This block of Iceland spar (calcite) was exposed to the influence of cathode rays and retained its orange glow for several hours. Also there were minute bluish sparks, which after the first flash showed black against the orange glow. (See Fig. 8B.) These black spots proved under microscopic examination to be minute craters, connected by canals running at right angles to each other and parallel to the surface of the crystal. An enlarged photograph of one of these craters is reproduced in Fig. 8C. Fig. 8D is a microphotograph of the sparks occurring under the influence of the cathode rays.

In Fig. 10 (left) is shown the ear of the rabbit with the round scab, which formed a few days after the ear was rayed. Fig. 11 shows this same ear after two weeks. In that time the scab came off and white hair grew in place of the ordinary gray hair.

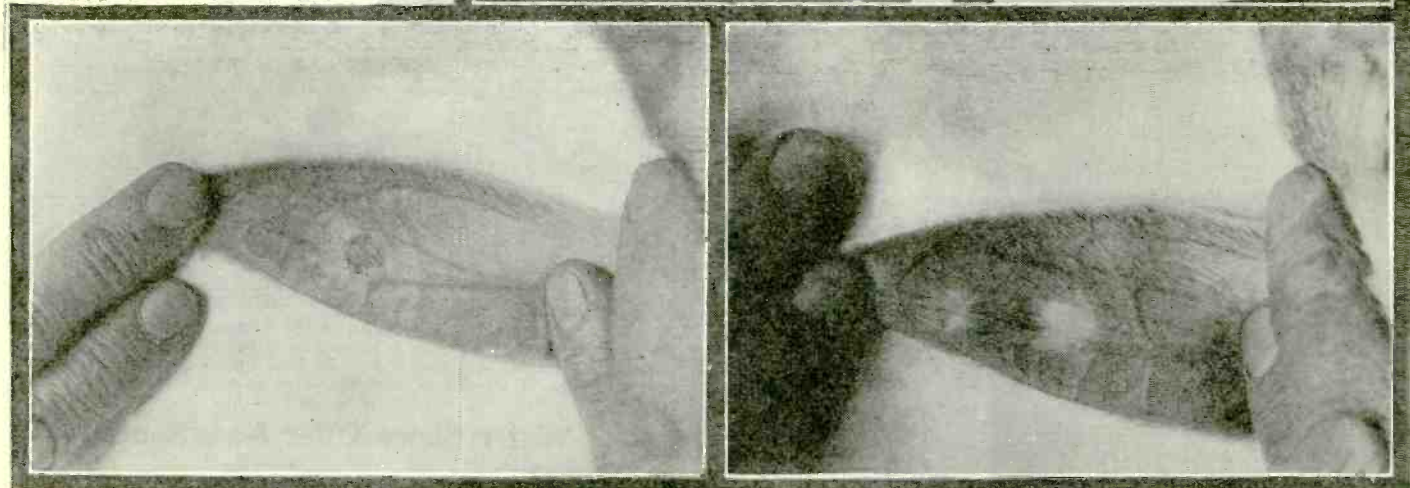
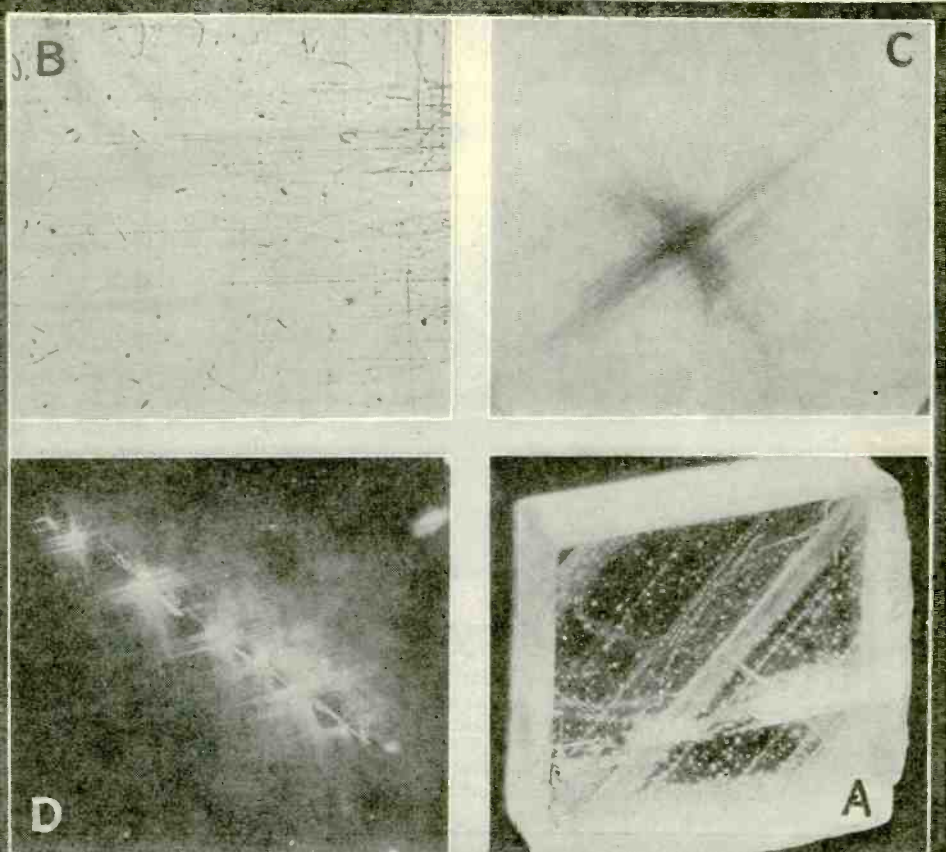

FIG. 1

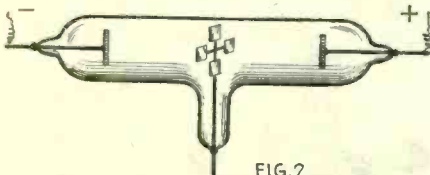

FIG. 2

Fig. 1 is a sketch of a cathode tube, which is the simple form used by Crookes in his early experiments. The negative terminal is the cathode and the positive one the anode. In Fig. 2 a small easily-turned windmill was inserted in the path of the cathode rays, the speeding electrons of which caused the mill to revolve.

CATHODE rays have been the subject of a vast amount of research for scientists ever since Sir William Crookes discovered their presence in a glass tube from which most of the air had been removed, and through which he passed a high voltage electric discharge. Their characteristics and behavior within the evacuated tube were studied by Crookes and others but the Hungarian physicist, Philipp Lenard, succeeded in making them flow through a small, thin metal window into the surrounding air where they could be more conveniently utilized. Until recently, the output of such tubes has been very

\* The material for this article was taken from a paper read before The Franklin Institute, on October 20th, 1926, by Dr. W. D. Coolidge, of the Research Laboratory of the General Electric Company. Acknowledgement is hereby made to The Franklin Institute for the use of the various illustrations.

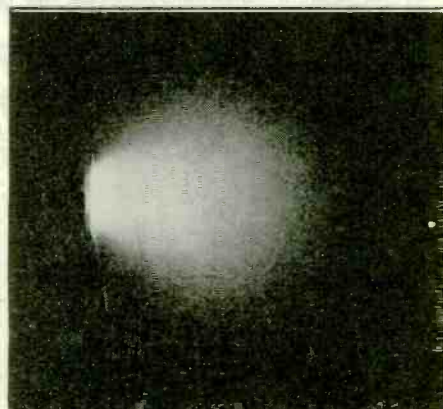

Fig. 4 shows the purple glow of the rays beyond the tube's end.

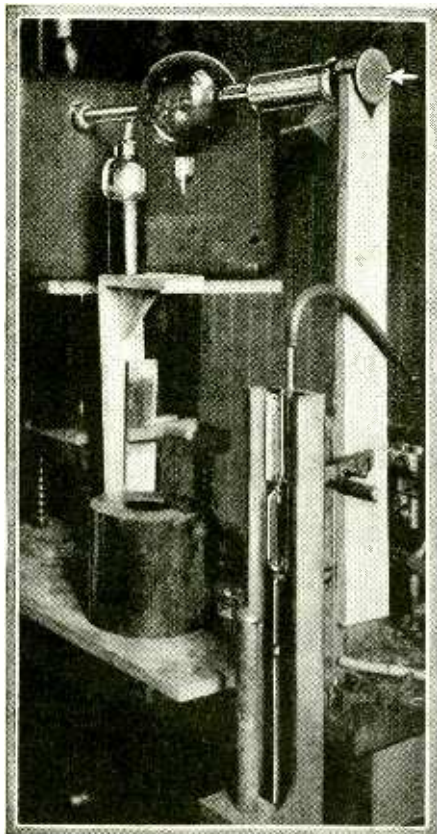

Fig. 6 at right shows the remarkable new tube developed by Dr. W. D. Coolidge in the General Electric Co.'s research laboratories, which tube is capable of producing powerful cathode rays outside the tube.

Fig. 7 at left shows close-up view of new cathode ray tube, the arrow pointing to the window at end of tube, through which window the free cathode rays are projected outside the tube in considerable quantity.

that a discharge from the cathode or negative terminal still continued. He gave this radiation the name of "cathode rays." He discovered that metallic plates placed within the vacuum tube (see Fig. 2) intercepted the cathode rays, and that the impact of the rays against the glass walls of the tube produced a greenish fluorescence and phosphorescence, accompanied by an increase in temperature. Various substances placed in the path of the ray fluoresced brilliantly. He also noted that the cathode rays were deflected by a magnet. Crookes spoke of this gaseous discharge as the "fourth or radiant state of matter." Later investigations have shown it to be composed simply of a stream of electrons or minute particles of negative

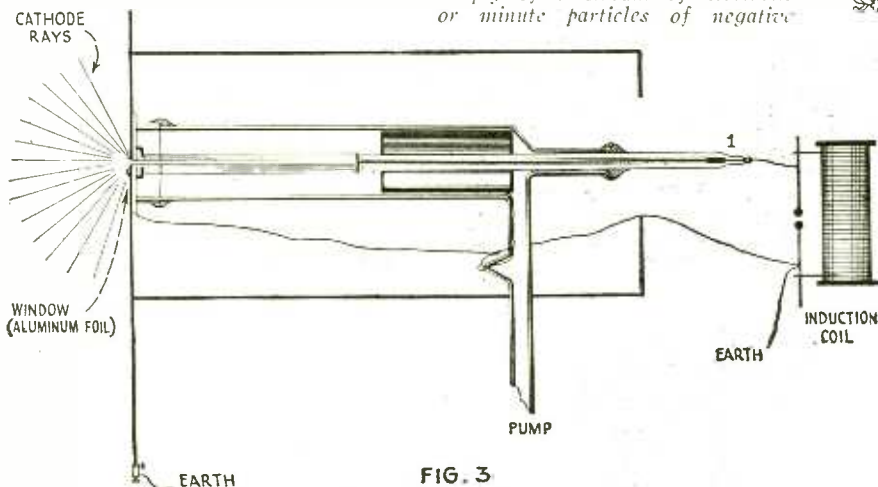
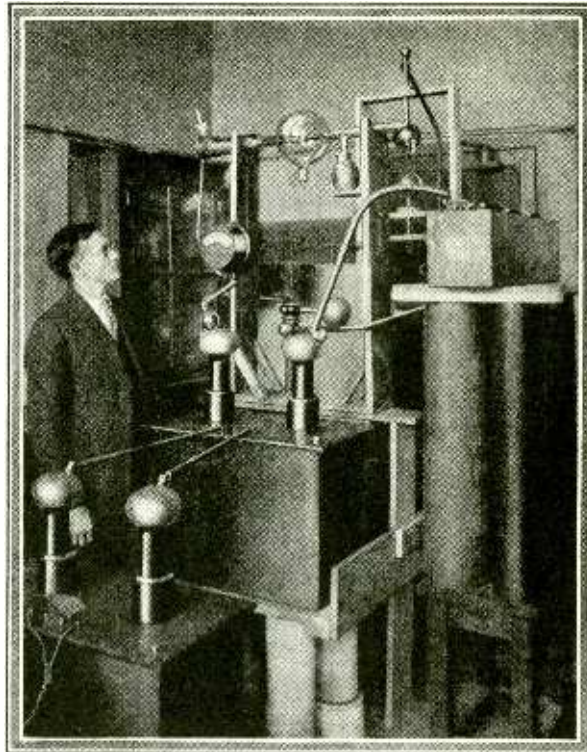

FIG. 3

Fig. 3 above shows the arrangement of vacuum tube devised by the Hungarian physicist, Philipp Lenard, for the purpose of producing free cathode rays outside the tube. Lenard was handicapped in many ways and Dr. Coolidge has, with the aid of modern apparatus, built a powerful cathode ray generator.

limited, due to the relatively low voltages and currents at which the tubes could be operated and to the window structure employed. Due, however, to the efforts of Dr. W. D. Coolidge, well known for his work on various types of vacuum tubes, the scientific world today has a cathode ray tube capable of delivering through its window a much greater quantity of electrons at velocities which are producing new and startling results.

Let us consider for a moment the nature of cathode rays. Professor Crookes found that, in a tube, such as is shown in Fig. 1, containing two metal electrodes connected to a source of high voltage current, the luminous Geissler glow disappeared if a sufficiently high vacuum was obtained, but

electricity.

Hertz announced in 1892 that cathode rays would penetrate gold leaf and other thin sheets of metal when placed within the tube and, as has been mentioned previously, Philipp Lenard was later successful in getting them to come through the end of the tube in which they were generated. A sketch of the tube which he used is shown in Fig. 3. On the right is in-

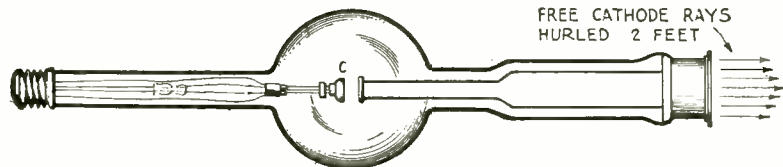

dicated an induction coil. The negative side of this coil is connected to the terminal, 1, which is the end of the cathode, or negative electrode, and the other side is connected to the window. This window is the interesting part of the tube, for it is through it that the ray travels into the open air. Lenard used aluminum foil as a window. The foil, about an eighth of an inch in diameter, and one ten-thousandth of an inch thick, was cemented to a perforated brass plate attached to the end of the glass tube. The foil was selected by microscopic examination to obtain an area free from minute holes.

Lenard was handicapped by the melting point of the wax joint between window and tube, by the smallness of the window and the comparatively low voltages employed.

Other investigators have worked with and further developed the Lenard tube and have somewhat increased its output. In all of their work, however, it has been necessary to have the tube during its operation connected to the exhausting system. Dr. Coolidge's contribution to the art has been

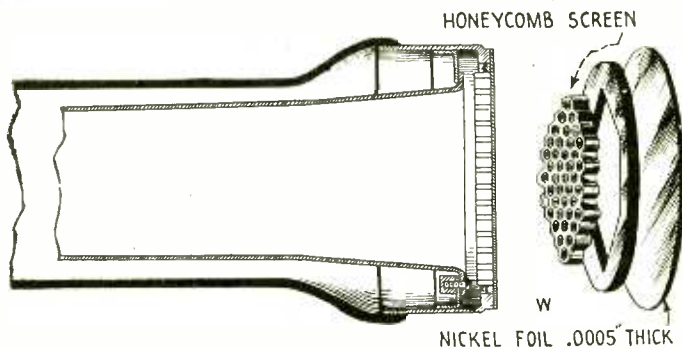

FIG. 5-B

Fig. 5-B above shows a close-up sectional view of the window in the Coolidge cathode ray tube. The thin nickel foil permits a vacuum to be established, thanks to the support of the honeycomb screen.

the development of a tube capable of being sealed off from the pump and of being operated at voltages as high as 350,000 and delivering a greatly increased quantity of energy through the window.

**THE CONSTRUCTION OF THE NEW TUBE**

In Fig. 5 will be found a sketch showing the main parts of this tube. At the left in Fig. 5A is an ordinary lamp screw plug, through which is supplied the current, which  
(Continued on page 728)

# The Fastest Boat In the World?

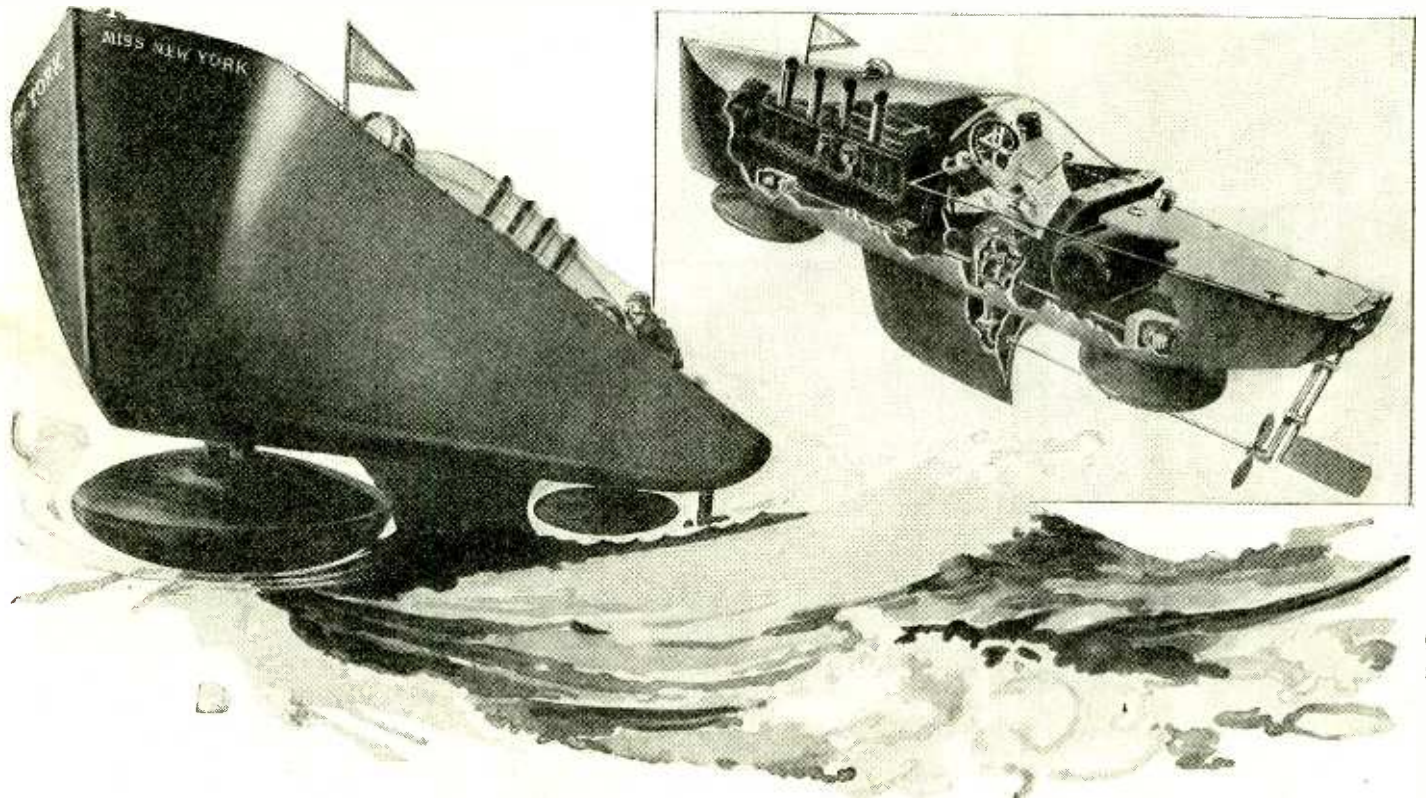

Our illustration shows a new construction of a boat patented by Hans Becham. The design is based upon the fact that hollow lenticular bodies convex on the bottom, immersed in water, lift themselves out of the water as soon as they are set in rotary motion. The drawing shows a vessel with two such lenticular bodies susceptible of rotation about the vertical axis. As soon as these floats are set into rotation, the hull of the boat rises from

the water. Inasmuch as the drag of the water at full speed is extremely small, the resistance to the motion of the boat is very slight, so that with a proportionately small development of power, a very high speed can be obtained. The phantom diagram shows the mechanism of the vessel. Note that the propeller extends from a shaft passing through the keel of the vessel. The keel, propeller and a rudder only are submerged.

## The Astrology Humbug

By JOSEPH H. KRAUS

SINCE the last two articles on Astrology were written, the editors have received a great many letters from astrologers and astrological students. Regardless of what we may say about astrology, we must certainly admit that the students of astrology at least rally to the standard of their favorite subject while it is being battered and torn. This same statement does not hold for most of the astrologers who are looked up to as leaders in the field. While we have received many communications from students of astrology as well as from a few astrologers, those who are well known in the field have not requested the data on the birth dates and locations of several of the test cases which we have on hand and upon which \$1,000.00 is being placed.

Judging from the letters, it is plain to be seen that even the astrologers themselves do not know their subjects. One astrologer will state that it is impossible to forecast events or calamities over which the astrologer has no control and another group of astrologers will then analyze the events likely to occur in a day, week, month or year. We have all seen forecasts for the month and we have all seen the astrological forecasts for a year. These find space in our daily newspapers and in our Sunday feature editions just before the new year comes into being.

There is one group of astrologers that desires the date of birth. There is another group of astrologers that request the time of conception and that disregard entirely the dates of birth. How this latter factor can possibly be given is difficult for us to ascertain because the exact moment of conception cannot possibly be known by even surgical

### \$6,000.00 For Proofs of Astrology

SCIENCE AND INVENTION Magazine holds that there is nothing scientific in Astrology, that Astrology is not a science and that statements made by astrologers unless very general cannot be entertained seriously.

Accordingly, this publication has decided to award an Astrology Prize of \$6,000 for the following:

\$5,000 will be paid to the astrologer or forecaster who will foretell three major events of such a nature that he will have no control over the outcome of the same. He must describe in advance each event in detail, giving the location and result or the casualties if the event is an accident.

\$1,000 will be paid to the astrologer or forecaster who will produce three accurate, detailed and perfect horoscopes, free of contradictions on the lives of three people whose initials will be given him when he requests the same and the birth dates and place of birth will also be supplied by this office.

This contest closes October 1st, 1927, and all entries must reach us by that time. In event of a tie, prizes of an identical nature will be given those so tying.

Address all entries to Editor, Astrology, care of SCIENCE AND INVENTION Magazine, 53 Park Place, New York, N. Y.

methods. The most that a physician can do is to approximate this time. Under the circumstances it would appear that the latter group of astrologers could not develop an accurate horoscope yet this remains to be seen.

In a clipping before us we find according to a horoscope that "President Coolidge is now entering one of the most evil cycles of his career. There is much sorrow for both our President and our Government, as well as for most all high governmental officials."

In another horoscope also before us we find "The good influence of Venus favors the popularity of the President and his cabinet and brings social activity and merry-making into this department of the National life."

Both horoscopes were cast by different astrologers. Can it be that even they do not know how to read the signs of the planets? Of course, it can be easily argued that there may be good leaders as well as incapable workers in the field. How are we to know unless some of the astrologers who are looked up to by the students take advantage of the awards which we offer.

One group of astrologers will tell us that the lower animals are not affected by planetary influences, but only thinking individuals are affected. Another group state that animals are affected, but their reactions are different and consequently we cannot observe the difference.

To emphasize the fact that only thinking individuals are affected by the planets, some astrologers say "that the stars incline but cannot compel" and that "a wise man rules the stars, while a fool obeys." Now if a thinking individual is affected by planetary influence,

(Continued on page 747)

# Our Spiritualistic Investigations

By

*Dunninger.*

NO. 5 OF A SERIES

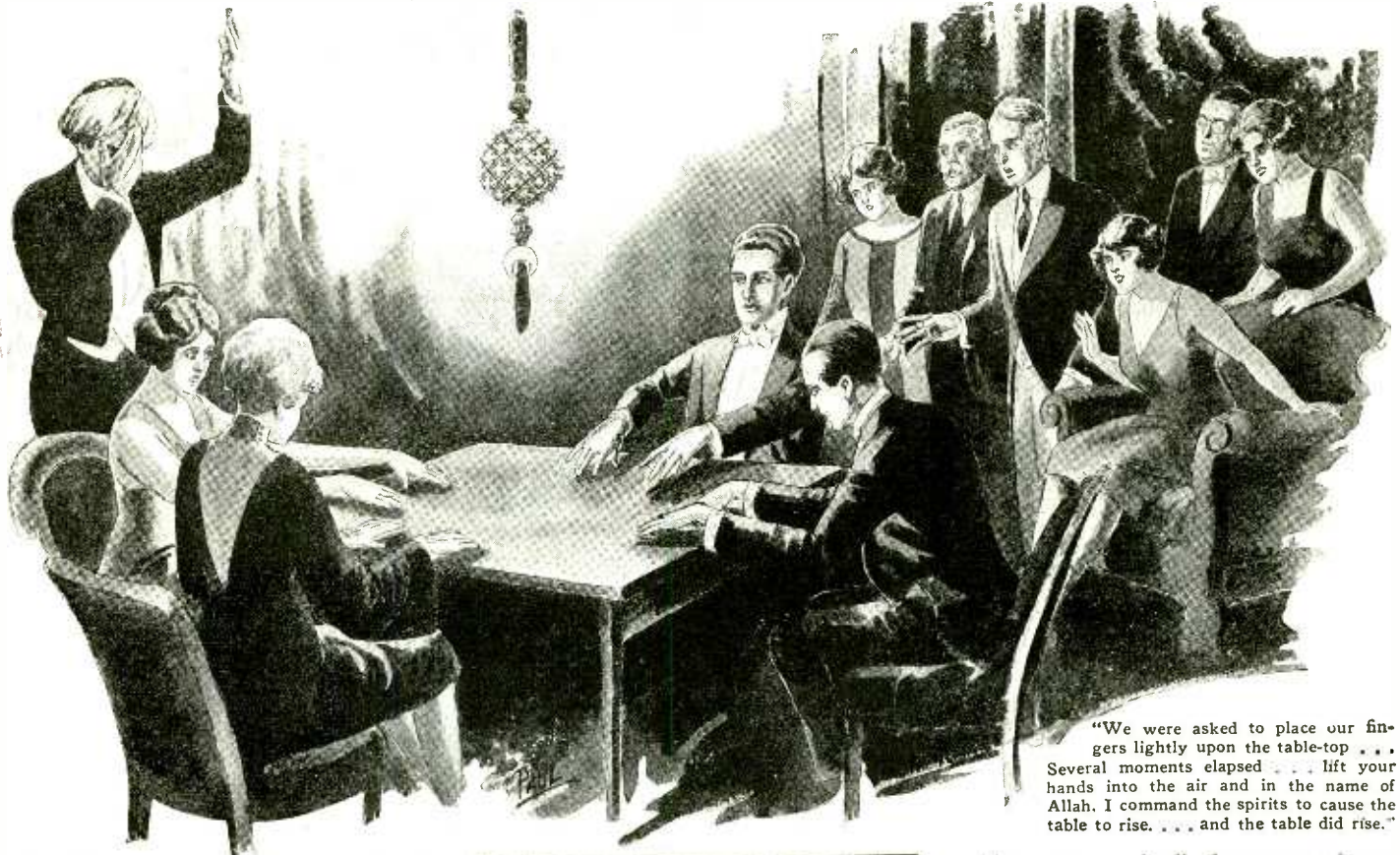

"We were asked to place our fingers lightly upon the table-top . . . Several moments elapsed . . . lift your hands into the air and in the name of Allah, I command the spirits to cause the table to rise. . . . and the table did rise."

**I**NDIA is the home of mystery. Ghostly things and creepy experiments galore have been unfolded from the shadows of the East. Hindu fakirs have startled civilization. Yogis have mystified the natives, from the land of the turbaned-worshippers come beliefs of ancient products, such as East Indianism, Occultism, Yogism, East Indian psychology, and other titles enwrapped in mystery. Yet strange as it may seem, Hindu spiritualists are rare. One, however, I have recently unearthed . . . Rajah Hassid, "The Spirit Force, from the East," as he terms himself. A suave, well mannered fellow . . . short in stature, characteristic in appearance. Always seen in the dress attire of the European, yet his dark skin, piercing eyes, lacquered black hair, and large Oriental jewelry, leave nothing to the imagination. He is a Hindu, and almost abuses his mystic privileges, as the many powers he admits possessing, would almost credit him with being a reincarnated subject, referred to in the ancient days of Biblical history. Rajah Hassid mingles in high society, and has upon his mailing list, names of persons prominent, as well as those of quite a number of celebrities. Conversing, as he does, in several languages, and pleasing to the studios, thanks to his ability as a conversationalist upon mystic topics in general, he has many followers. His work is mostly readings from the gardens of the dead, and although an Orientalist, his spirit guide seems to have a key into the land where the souls of European races dwell, as he can call forth spirit messages, for any and all. Of course, the Rajah gives seances as well, but only to those recommended to him. During the summer months, the limousines of many leaders of society can be found parked in front of his abode in Newport. Tea is served in the

## \$21,000.00 for Spirits

Dunninger, who writes exclusively for SCIENCE AND INVENTION Magazine and who is the Chairman of our PSYCHICAL INVESTIGATION Committee will personally pay \$10,000.00 to any medium or spiritualist who can present any psychical manifestation in so-called spiritualism, that he will not explain or that he cannot reproduce by natural means.

More than two years ago SCIENCE AND INVENTION Magazine offered a prize of \$11,000.00 to anyone who could demonstrate his or her ability to communicate with the spirits or to give some definite form of a psychical demonstration which in itself was not trickery.

The result has been that mediums and spiritual organizations have been afraid to place proofs before us. Those weak attempts which have been made to demonstrate psychical phenomena were almost instantly proven fraudulent, and no medium has dared to contradict our findings.

In view of these facts, should we not consider all mediums fraudulent? Should we not consider every psychical manifestation as being trickery pure and simple, intended primarily to fleece those who visit the circle and who find solace in the words from the worst forms of charlatans, namely those who are being permitted to practise upon the poor, seeking words from loved ones?

To the \$10,000.00 which has been offered by Joseph F. Rinn through this publication for Spiritual proofs and the \$1,000.00 in addition offered by SCIENCE AND INVENTION Magazine we now add Dunninger's \$10,000.00.

So now we have a total of \$21,000.00 offered for proofs of Psychical Manifestations. Spiritualists—get busy.

waiting room, and all those conveniences, to which his clients are accustomed have been well considered. These spirit meetings are conducted only for these invited guests, and there is no charge, as it is his form of advertising. Astounded at his demonstrations, new clients are easily made, and private readings for these proved sufficiently profitable to well afford his apparent generosity at his occasional exhibitions. It was one of these meetings that I was invited to attend. My host at this occasion therefore presented me in person to the Rajah, and although using a fictitious name so as not to disclose my identity, unfortunately described me as a fellow student of the spiritual. This introduction caused me quite a bit of uneasiness, as the medium at once opened conversation upon general spiritual topics, which it seemed was done particularly for the benefit of the bystanders. This was rather embarrassing to me, as I could not very well analyze my view points, without disclosing the fact that I was a disbeliever, and present at the meeting, only to discover the *modus operandi* of his methods. I therefore posed as a rather gullible subject, and was obliged to accept an array of unusually well rendered conversation, which he gladly volunteered. An Oriental attendant relieved my agony, after but a few moments of controversy, as he interrupted, asking the Rajah's permission to usher the guests into the seance room. The mystic excused himself, and offering me an invitation to continue our conversation after the seance, he left me, and quickly vanished behind a set of deep colored, thickly woven, Indian portiers. Several moments later, the gathering was ushered into another room, which was furnished in exceptionally good taste, with slight sugges-

(Continued on page 752)

# WHY THE SIKORSKY TRANS-ATLANTIC

## "Movie" camera reveals details of accident which destroyed Fonck's hopes of New York-Paris flight

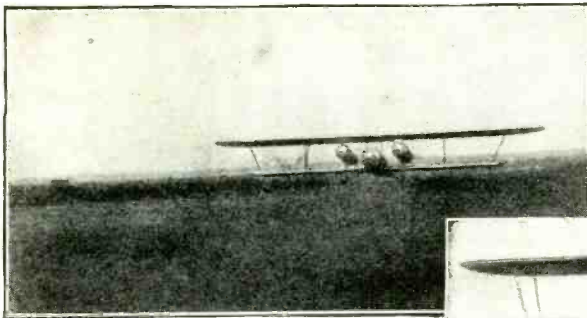

The plane appears to move somewhat sluggishly as it comes down the runway, due no doubt to the fact that it is loaded far in excess of its normal capacity. This photograph shows the plane at about the middle of its one-mile dash from the hangar to the edge of Curtiss Field.

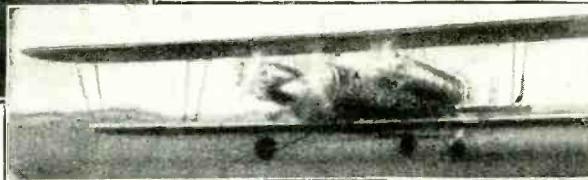

The plane wobbles a bit as it roars past the photographer stationed at the brink of the embankment on the edge of Curtiss Field. It appears certain that the plane cannot rise.

At 6.32 A. M., Tuesday, September 21, 1926, a giant Sikorsky biplane designed to be the first to fly from New York to Paris stood with motors roaring, ready to begin the great adventure. The plane had been carefully loaded with a tremendous cargo of gasoline and oil, sufficient to fuel it for the trans-oceanic flight, and the motors were tuned up in anticipation of the arrival of the crew of four who were risking their lives for the thrill of being the first to get across. Just as the rising sun began to brighten the horizon, Charles Clavier, radio operator, and Jacob Islamoff, mechanic, entered the cabin of the great silver bird.

There was delay. The hum of the engines died. Then an automobile drove up and stopped with a screech of brakes. Rene Fonck and Lieut. John Curtin jumped from the tonneau and hurried to the plane.

The engines roared in a crescendo of impatience. With a gay flip of his hand and a smile toward

The plane shoots down the embankment and the right wing-tip grounds as it bumps across the rough field. The roar of the motors ceases as Fonck throttles down in an attempt to stop.

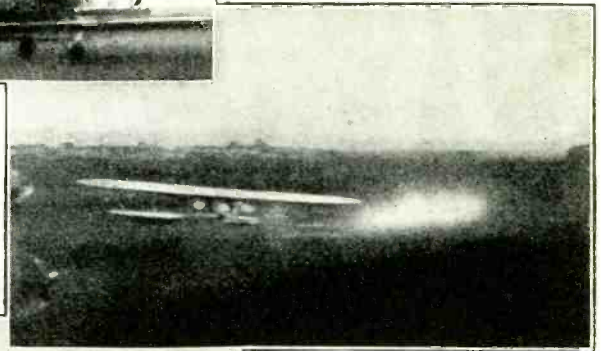

A cloud of dust arises as the right wheel drops off and the lower wing begins to crumble. The machine skids along at fifty miles an hour and begins to swing around to the right. The cameraman continues to grind as the wreck seems inevitable.

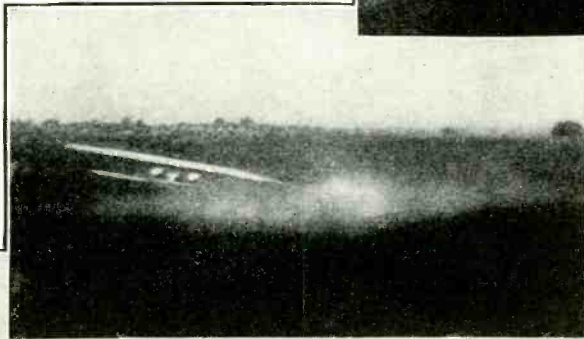

The tail of the plane rises and the nose goes down as it spins around on the crushed wing-tip. The entire incident covered a period of only a few seconds, hardly giving the spectators time to realize what was happening.

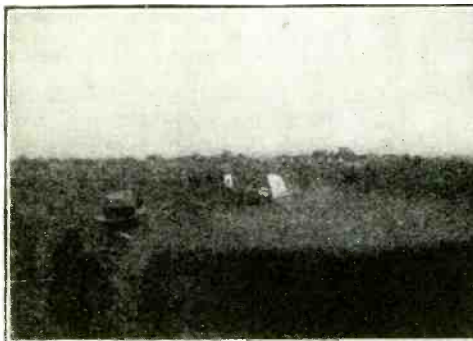

Sikorsky and his workers, Fonck opened the throttle and was off.

Lightly the plane darted down the runway. There was a great cheer. In a moment the crowd became silent with wonder and pride.

Then there was a gasp. Halfway down the long runway the plane paused for a moment in its swift, sure glide. It leaped sideways, hovered for a moment, and bounded with a sudden increase in speed to the end of the take-off.

Transfixed with the uncertainty of a dawning fear, the crowd stood still as the plane lifted itself into the air. It plunged and lurched for a terrible second.

Nose down, the plane dove thirty feet off the end of the runway. A puff of smoke whirled from the plane as it plowed crazily for 300 feet across the rough ground.

Then, suddenly, the plane tilted and the right wing-tip struck the ground. The machine swirled around in a cloud of dust and crashed over backwards. Fonck and Curtin were thrown from the cockpit as the plane settled in a mass of tangled wreckage.

Nine seconds of deathly silence, then a blinding flash of white flame as the fuel from the broken tanks ignited on the red-hot manifold. Five minutes later, the framework and motors were welded to a mass of shapeless steel, and the wreck blazed as a funeral fire to the two unfortunate aviators who were trapped in the crushed fuselage.

That is the story of the failure of one of the most ambitious plans conceived by any man in this age. Many reasons have been assigned as a cause for the accident. Some said that Captain Fonck was too eager to soar on his greatest flight when

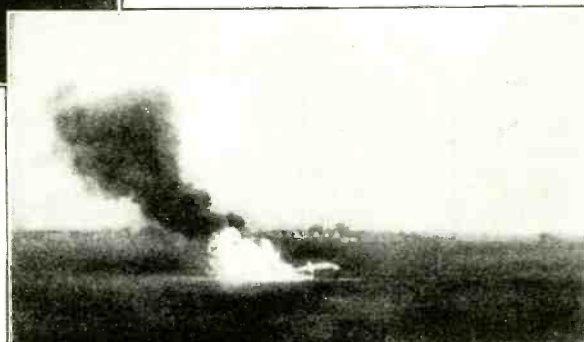

The wing folds up and the plane crashes over on its back. Fonck and Curtin, who were in the control cockpit, were thrown clear, but the blaze which followed a few seconds later caught the radio operator and mechanic, who were instantly killed by the shock of the crash.

The gasoline soaked fabric disappeared instantly, but the fuel continued to blaze for fifteen minutes. The tremendous heat created caused the motors and frame to be welded together, and the molten aluminum flowed along the ground like lava.

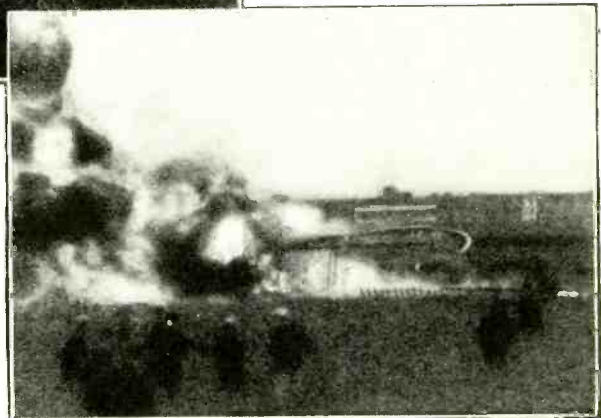

he manipulated the controls. Others said there was a mechanical defect in the plane or undercarriage. Still others said the giant bird was overloaded; we, forced to form our opinion at second hand, reserve decision, but we are able here to present the entire incident in pictures so that perhaps you may be enabled to pass judgment.

The series of photographs on this page, which by the way you will not find published anywhere else, are a tribute to the presence of mind of Herman Stockhoff, International News Reel photographer, who kept on cranking his camera when the other photographers were too amazed to do anything but gasp. These photographs were enlarged especially for us from his news reel strip.

The editors attended several showings of the various news reels covering the accident and consulted with the staff of the *Daily News*, with a view to discovering, if possible, the cause. Some of the details are rather obscured in these photographs, due to unfavorable light, so the sketches on the opposite page may make the events a little clearer.



# PLANE FAILED TO CROSS OCEAN

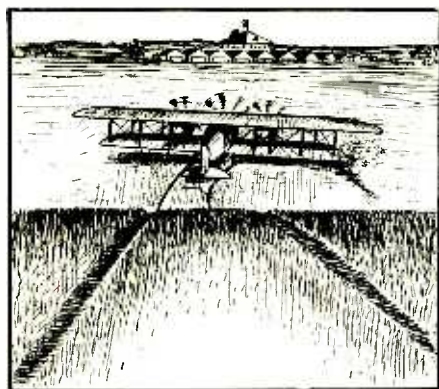

The drawings reproduced here were made by our artist to illustrate more clearly the details of the accident. This sketch corresponds approximately to the third photo opposite.

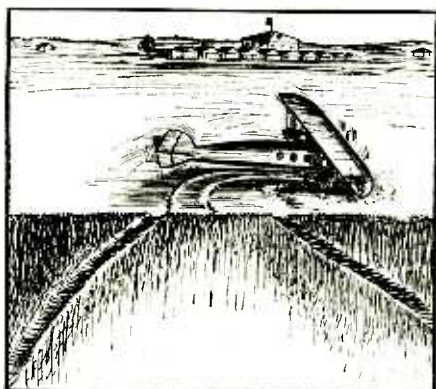

Fonck claimed that the right wheel dropped off, causing him to lose control. This wheel was found in the same place as the rest of the wreckage. See the fifth photograph.

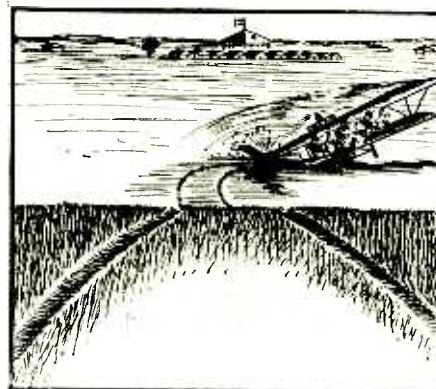

The plane spins about as its momentum causes it to skid backwards in the line of its original direction. Dust clouds rise, hiding the details from most of the observers present.

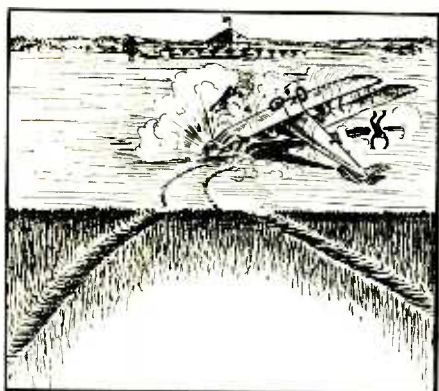

The momentum causes the nose of the plane to rise and it crashes over backwards, throwing the pilot and navigator to some distance and completely crushing the fuselage.

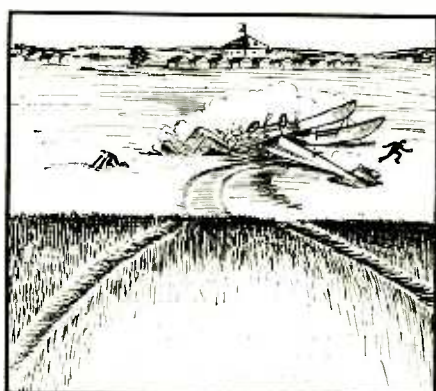

When the wreck had ceased crumpling, it lay still for several seconds as the two dazed men rose to their feet and looked back at the destruction they had escaped.

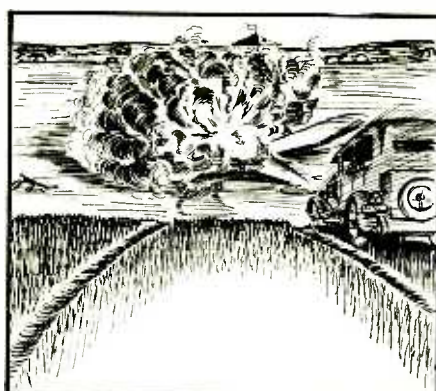

The ruptured tanks spilled their contents on the hot motors and manifold pipes and the wreck burst into rocketing sheets of flame as the observers raced toward it.

## \$41,000.00 IN PRIZES Offered by Science and Invention Magazine

\$21,000.00 is offered by this publication for proofs of spiritualism. The editors of **SCIENCE AND INVENTION Magazine** do not believe that any authenticated cases of spirit manifestations or phenomena have ever been produced. They hold that all spirit phenomena are fraudulent in nature and that those organizations which try to entice people into their circles to ostensibly listen to messages from beloved ones who have passed from this world into the next are carrying on a fraudulent game which is more harmful than good. This publication does not mean to infer that legitimate forms of religion are harmful. Its fault is only with that form masquerading under the guise of "spiritualism" and purporting to give messages from the spirit world. See page 693.

\$6,000.00 will be given by this publication for proofs of "astrology." **SCIENCE AND INVENTION Magazine** holds that there is no truth in astrology, and that it is not a science and that statements made by astrologers, unless they are very general, cannot be seriously entertained. This publication will, therefore, pay \$5,000.00 to the astrologer or forecaster who will foretell three major events of such a nature that he will have no control over the outcome of the same, and who will describe in advance each event in detail, giving the location and the result or the casualties if the event is an accident. This journal will also pay \$1,000.00 to the astrologer who will produce three accurate and perfect horoscopes of individuals whose initials and dates of births will be supplied to him. For further details, see page 692.

\$5,000.00 will be paid by this publication during the fiscal year for models built entirely of matches. The entire construction of these models must be of the wood of matches, the heads of which should preferably be cut from the wooden sticks. Although this contest was primarily in-

tended for shut-ins, it is not limited to those unable to get about other businesses. Full details of the contest as well as this month's prize winning contestants and the models which they built are to be found in this issue on page 703.

\$5,000.00 will be paid by **SCIENCE AND INVENTION Magazine** to the individual or individuals who will demonstrate a working model of a perpetual motion machine at the offices of this publication. This magazine does not believe that perpetual motion is possible, and this award is primarily made as a protection for those who would invest in constructions of this nature. Many times a would-be perpetual motion inventor will tell prospective investors that he needs just a few more dollars to patent his invention, that his machine is the only one which will operate, and that it has received recognition in the scientific world. The story told in present-day circles is that the inventor has collected millions of dollars for his system from any one of the large automobile manufacturing concerns. Under the latter circumstances, the inventors claim to do investors a favor by permitting them to invest. Those telling the first story will patent the invention as soon as they get the additional funds. To both of them the editors say that they will pay them \$5,000.00 when they merely exhibit a working model of the device. We desire no rights to the invention whatsoever.

\$1,000.00 and more is being paid every month by **SCIENCE AND INVENTION Magazine** to its authors. Articles are all paid for, except those written by our staff.

\$3,000.00 will be paid during the fiscal year for "Wire-kraft" models. This is a new contest inaugurated by **SCIENCE & INVENTION Magazine**, and the conditions of the contest will be found on page 686 of this issue. Get busy!

# Into the Fourth Dimension

FOURTH INSTALLMENT  
First American and Canadian Serial Rights  
By RAY CUMMINGS

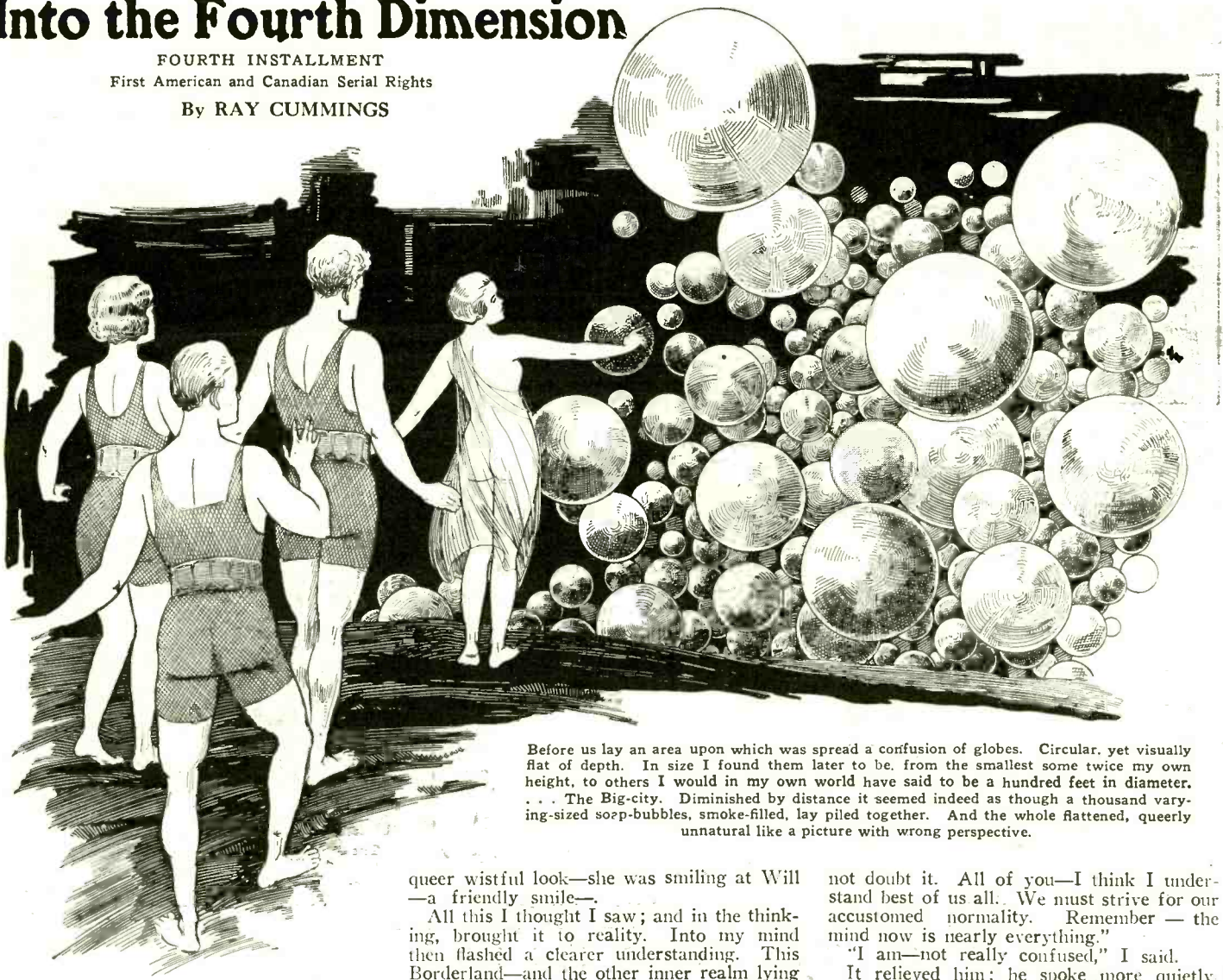

Before us lay an area upon which was spread a confusion of globes. Circular, yet visually flat of depth. In size I found them later to be, from the smallest some twice my own height, to others I would in my own world have said to be a hundred feet in diameter. . . . The Big-city. Diminished by distance it seemed indeed as though a thousand varying-sized soap-bubbles, smoke-filled, lay piled together. And the whole flattened, queerly unnatural like a picture with wrong perspective.

## CHAPTER VII

### THE STRUGGLE AT THE BORDERLAND

THE thing stood waiting as Will drew us toward it. Fear swept over me. Yet the very sense of fear brought with it a reassurance, for it was the physical I feared; the vanished sense of my body was not entirely gone, for now I was fearing its welfare.

My voice protested, "Will. Wait. That thing there—"

"It is friendly, Rob."

The fear died. I remembered what now seemed obvious; Will had been leading us somewhere with a set purpose. To meet this friendly thing, of course; this thing which doubtless he had met before. I stared at it as we approached. A dim, opaque grey shape like ourselves; but it seemed formless, sexless; neither human nor un-human—a shape merely—a something poised there of which my mind seemed able to form no conception. Then I heard Will say to Bee.

"A girl, Bee—you understand—Rob, listen. We must cling to the realities of our world. There are no other words—no other conceptions—with which we can think these unthought things. This is a girl—"

I thought it was a girl; and at once I fancied that I could distinguish her. Standing there with a phantom barn and haystack of our own world above and behind her. A girl like Bee. I could see the grey-formed outlines of her; vaguely flowing draperies; long hair; a face of human beauty with a

queer wistful look—she was smiling at Will—a friendly smile—

All this I thought I saw; and in the thinking, brought it to reality. Into my mind then flashed a clearer understanding. This Borderland—and the other inner realm lying beyond it which soon we were to enter—could no more be compared to the world we had left than an apple can be added to an orange. The very essence of every thought we now were thinking was different—incomparable. Yet within our minds was some lingering, unchangeable quality—call it Ego—or a mere limitation, a lack of versatility; so that these new things must be clothed in the fashion of the old.

My words grow futile? I can only say then that this first encountered being seemed like a girl, wistful of face; grey, colorless of aspect; yet solid—as solid as ourselves which every moment was seeming a more normal solidity. But what to a mind Omniscient she would have been, again I do not know.

Will touched her. "Rob—Bee—this is Ahla—she has been waiting for us."

Her voice said, "I am Ahla who will do what I can to help you."

The tone seemed soft, liquid, musical and wholly feminine. Soundless words but clearly intoned as though I had heard them with a physical ear.

Bee said, "Why she speaks English."

It struck a note of whimsicality; the thought momentarily relieved the tension under which I was laboring. And so I think it was with the others; they were smiling; but Will's smile faded as he turned to us.

"You must keep on thinking things like that. Cling always to normality." His voice was earnest. "You also, Ahla—English you see, is our language."

"But you are speaking my language," she said gravely.

"Of course," he agreed hurriedly. "Do

not doubt it. All of you—I think I understand best of us all. We must strive for our accustomed normality. Remember—the mind now is nearly everything."

"I am—not really confused," I said.

It relieved him; he spoke more quietly. "This girl, Ahla, came from her own realm—wandered out here to see and feel for herself what madness was possessing her people."

"It is strange," Ahla said abruptly. "I am frightened—" Sudden terror marked her features. I was standing nearest to her and her hand gripped me. Again I felt that blessed solidity. Normality. I was real; I laughed contemptuously at all these shadows. The girl added anxiously.

"Cannot we go back? Now—where all is real—not like this. I—cannot stay here much longer."

"We will go," said Will. "Bee—and you Rob—listen carefully. From now on it is a question of the power of our minds—our will-power. If you wander—weaken for a moment—we are lost. Keep thinking, I am here with my friends. We are going together—going into the other realm." He swung to the girl. "You, Ahla—for you it is easier. But yield yourself slowly. If you withdraw resistance you will rush beyond us. You understand? Above everything else we must keep together."

She nodded. "Oh—yes, we must keep together."

We clung to each other. Ahla began moving forward, drawing us onward up that empty Borderland slope which now was steeply inclined. We passed through the haystack—a mere shadow; passed upward through a corner of the barn roof.

Beneath us now spread the phantom world we had left. But as my thoughts dwelt on what we were going to do, the shadows of our earthly realm seemed fading; growing dimmer, blurring as though about to vanish.

I watched them fearfully; when they were gone I would be in darkness—pregnant darkness thronged with things unseeable. I thought vehemently.

"We must keep together—we are going on into that other realm, Will says we are—Will says we must keep together."

But my thoughts strayed, I remembered Will's house; the room we had left—the little clock— Why, I fancied I almost saw it. Was I there, back in that room? — Where was Bee?— Bee?—

I must have called her name in my thoughts, and at once she answered.

"Here Rob. Right here." And I felt the pressure of her hand.

A struggle of the mind. I knew then that every quality of mind inherent to me was winging backward; tugging, pulling, but I fought against it. And I became aware too of a different struggle within me. I had sensed it for some time past but now it sprang into keen intensity. A struggle of the physical. A vague racking pain possessed me. Dull, detached seemingly from my consciousness, yet I knew it was the pain of my body. It grew sharper. Not intolerable; but frightening with a sense of horror. It permeated my every fiber; tingling with infinitely tiny needles; and tugging, physically as my mind was tugging, to resume its original state. Like a chip in an undertow I was being drawn backward . . .

"Now." I felt Will's tense voice. And Ahla's soft words.

"We—are—passed. Hold me—now."

Someone was clutching my arm. I seemed floating, storm-tossed—a feather blown in a wind I could not feel. But abruptly the struggle ceased; vaguely I was conscious that my feet were standing upon something solid—Will and Bee were here—Ahla was here—I was a reality once more, and there were rational thoughts to think and real things to see. .

CHAPTER VIII  
THE REALM OF NEW  
DIMENSIONS

THE shadows of our world were vanished. The Borderland, with its darkness, its drab empty slope, was gone. A new world lay spread about

me; new companions. And I was conscious of a new entity—a new Robert Manse, who was myself.

I remember now that my first thought was surprise that I should be able to visualize things of strangeness. But now I know that

Synopsis

Robert Manse, a correspondent in the New York Office of a Latin-American export house, in company with Wilton Grant and his sister Beatrice, saw the first of the ghosts in February, 1946, a few miles from Rutland, Vermont. These ghosts were semi-transparent, glowing figures much resembling human beings. Attempts to destroy them with bullets or clubs had no effect on the shadows. Passing the hand through the space occupied by one of these ghosts produced no tangible sensation. Later, the ghosts became more bold and more numerous, even molesting human beings and causing at least one death in Kansas, the result of heart failure induced by the fright of encounter.

Some time later, Will calls Rob on the telephone, saying that his sister Bee is quite ill and asking Will to pay them a visit. During the visit Will mentions that the ghosts have already arrived in the Borderland lying between their world and ours, and that they were on the point of coming into our world. Rob himself has discovered a means of entering into this borderland, and declares that even though he is being watched by many of the ghosts he will make an attempt to-night to enter their realm and turn the spirit-like creatures back into their former paths. While he makes the journey, Rob is to stay behind with Will's sister, Beatrice.

The preparations for the experiment are made, and Will clasps upon his arm a connection to the vibration-transformer which, by altering the vibrations of his body, is to transform it from normal substance to the wreath-like material of the other world. They see a ghostly form watching them as Will's body becomes transparent, but finally the apparatus is disconnected and they wait for his return. Five hours later, Will returns saying that they must go back with him to save the world from an invasion of the ghostly hordes.

Robert and Beatrice, though face-to-face with the unknown, succeed in suppressing their fear, and agree to accompany Will across the border. The three adventurers don their metallic garments, attach the batteries, and swallow the acid compound which is to transform their tissues. In a few minutes they find themselves transposed into the Borderland, and they alertly wait for what may come.

Now continue with the story.

once over the Borderland my mind itself had changed, yet retaining of its old self just enough, so that I might be conscious of the strangeness. In a grey half-light of luminosity seemingly inherent to everything, I found myself standing upon a hillside, gazing down an empty slope of greyness. Was it land? I can only say that it seemed solid beneath me; solid, quivering with a tiny tremble: vibrating, and within itself vaguely luminous.

Overhead was darkness. Yet hardly that, for the same luminosity was there; and I felt that I was gazing, not through emptiness but rather through some tenuous fluid illimitable to my vision, with things there to see, as yet—for me—unseeable.

The slope before me was empty. But shapes were materializing; it was as though I had come out of the darkness, with eyes not yet accustomed to the light. I fancied I saw water in the distance. A white lake; but when I stared, it seemed more like a grey rolling cloud. Was it liquid? . . .

The mind receives a multitude of impressions in an instant. I was conscious of myself. My body was an entity wholly vague—yet there seemed a tingling in it; a weight to it, for I was standing upright. Will and Bee—and the girl Ahla—were beside me. I saw them now in their old familiar form, but with a queer sense of flatness to them. Flat; unnatural of outline; not grotesque, merely strange, unreal. Almost indescribable; and though distinctly it was not a two-dimensional aspect, I think that flatness best describes it. A something about them which was lacking; or perhaps a something added—I do not know.

And inherent to this whole realm as soon I was to see it, was this same queer flatness. Things without depth; yet to view them side-wise, the depth was there, with the flatness still persisting.

And I saw color; nameless colors which I might call blue, or red, or green and the words would have no meaning. Men, women—houses, or at least habitations; the words are all I can command, but they are grotesquely meaningless. It was all so incomparably strange; and paradoxically, the strangest of it all was the fashion in which my mind began to accept it. I could think of Ahla as nothing but a girl. A frightened, likable girl—with thoughts and feelings similar to my own. This realm was real—a new country; with friends, enemies—a struggle going on within it in

(Continued on page 734)

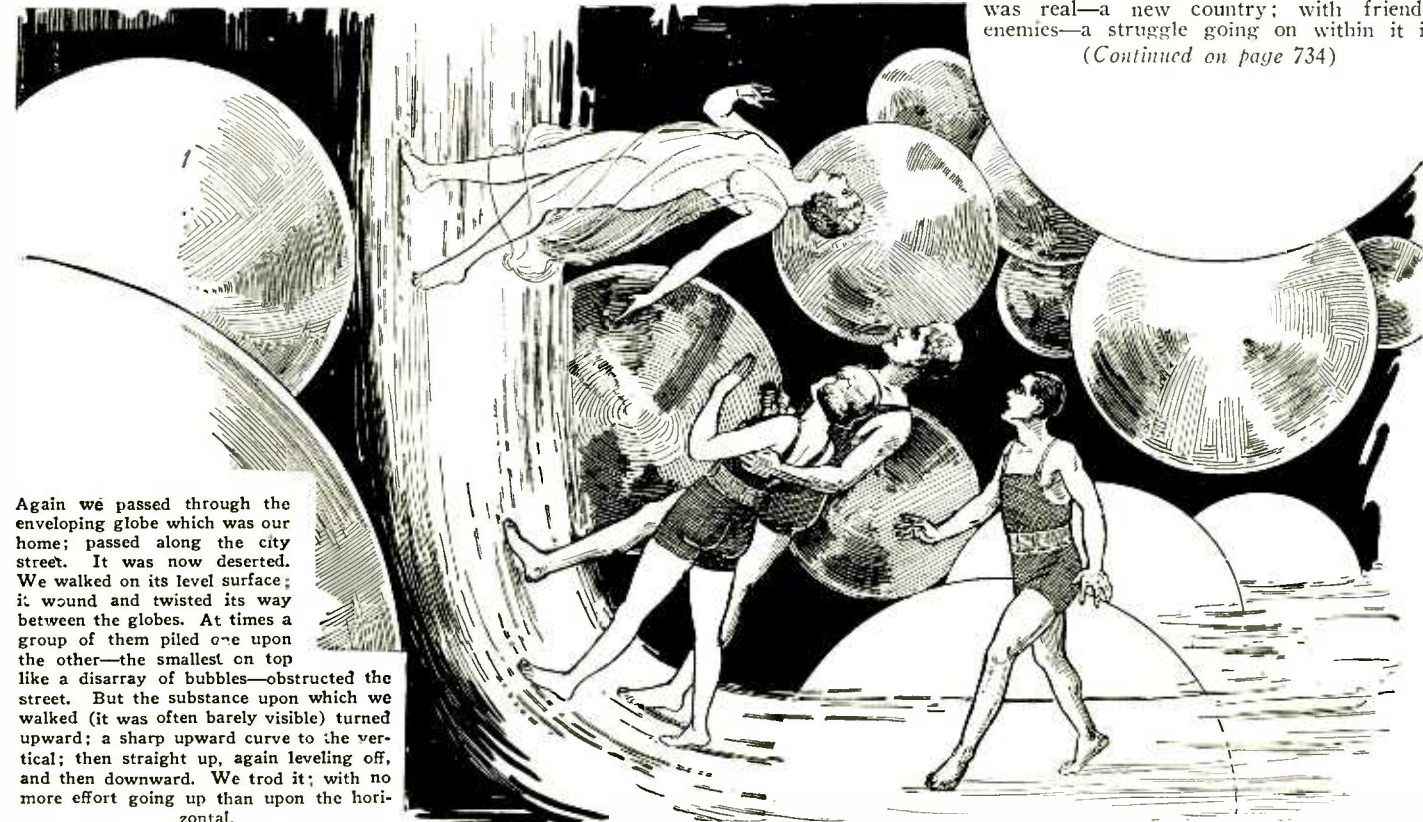

Again we passed through the enveloping globe which was our home; passed along the city street. It was now deserted. We walked on its level surface; it wound and twisted its way between the globes. At times a group of them piled one upon the other—the smallest on top like a disarray of bubbles—obstructed the street. But the substance upon which we walked (it was often barely visible) turned upward; a sharp upward curve to the vertical; then straight up, again leveling off, and then downward. We trod it; with no more effort going up than upon the horizontal.

FLOATING DICE



The above photograph shows a cylindrical celluloid container filled with water and holding two dice which float to the surface when the container is inverted. The system is fraud-proof and ideal for operating toy games.—Hydro Novelty Co.

TUMBLING CLOWN

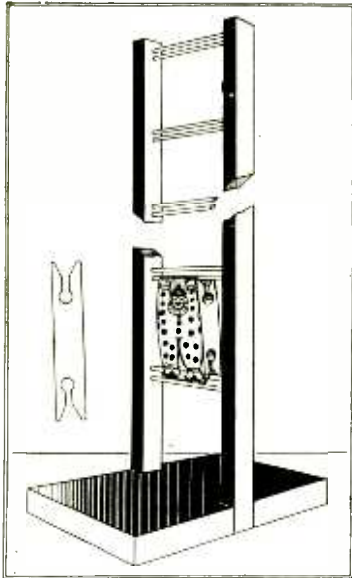

The above diagram in the accompanying photograph shows a very interesting clown. The wooden clown tumbles from rung to rung of the ladder until he reaches the bottom. It will be observed that there are two uprights secured to a base and that the rungs of the ladder are made of double bars of heavy wire. Due to the peculiar construction of the slots in the hands and feet of the clown, it is apparent that the wood figure will drop to the rung below and then turn on the rung through an arc of 180 degrees until ready to drop to the next rung.—Miami Wood Specialty Co.



The photograph and diagram at the right illustrates a unique racing game in which pressure on the button at the top causes the horses to run around very rapidly. The game is approximately the size of a watch and is provided with a very interesting mechanism for spinning the disk, as well as quite a clever brake. When the stem is pressed down, a metal catch moves over to the right, grips one of the prongs of a ten toothed gear, and imparts momentum to the gear. This causes the dial to which the gear is connected to spin.

Quack medical men sensing the possibilities of fooling the public by using radio apparatus in ridiculous combinations and hook-ups, are selling all sorts of machines for home medical treatments. See the January issue for an expose of some of these devices.

Santa Goes in

Christmas Gifts From a

RACING GAME



If the stem of the game above described is released the brake moves toward the center stopping the race so that one of horses is always immediately above the winner designation.

A VACUUM ENGINE

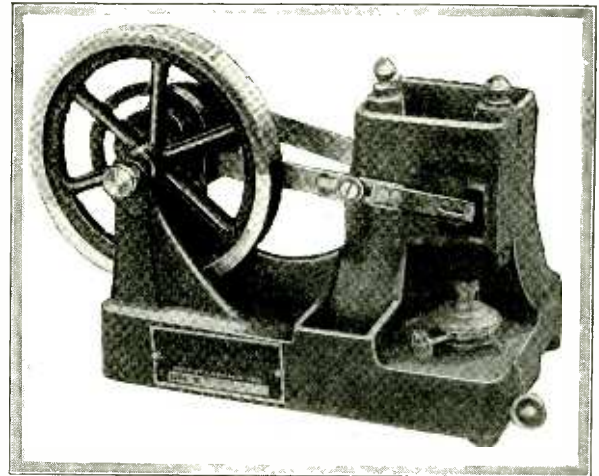

The photograph above shows a very unique innovation in toy engine designs. This engine works by atmospheric pressure. It is not a hot air engine. The alcohol lamp is lit and the engine turned over a few times. It will be found that the flame is sucked into the chamber of the engine where it expands the gases. A slide shuts the port and the gases on cooling contract, the atmospheric pressure pushing the piston in and thus causing rotation.—Modern Engine and Supply Co.

SAFE ACCURATE MAGAZINE PISTOL

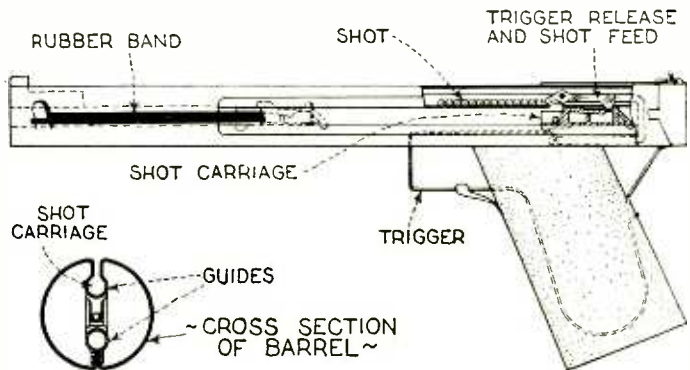

The photograph at the left shows a magazine pistol operated by rubber bands. The force of the shot can of course be varied by using two or more rubber bands to operate the shot expelling mechanism. The pistol is being held in the hand to show the comparative size. It will be observed from the drawing above that the top of the pistol provides a magazine for the shot. One of these shots is released each time that the shot carriage is pulled to the back end of the pistol. When the trigger is pulled, the entire carriage moves forward and the shot is catapulted out of the end. So remarkably accurate is this pistol that a trained shooter can place a shot on a piece of paper and hit it with a similar shot expelled by the gun. The shot carriage rides on two guides, the upper one of which also serves as the magazine.—Bulls Eye Pistol Co.

# for Science

Scientific Standpoint

## POWERFUL TARGET AIR PISTOL



The above photograph shows a remarkably powerful air pistol intended for target practice. Its weight is practically the same as an automatic and it balances in the hand in the same fashion. It is absolutely accurate at short ranges. The diagram of construction is shown at the right.

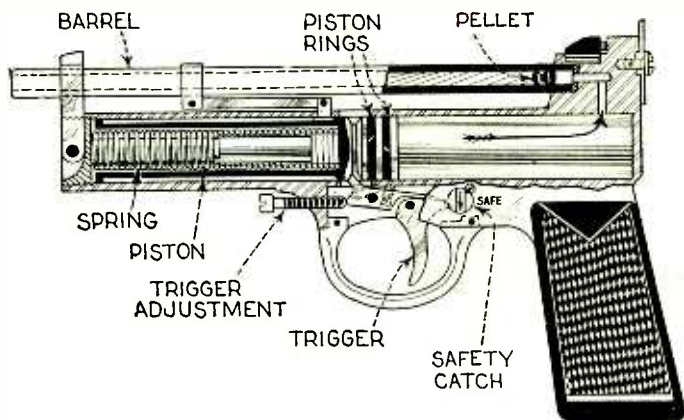

The above diagram shows the construction of the air pistol. Near the back end and immediately above the barrel a catch will be found which is pressed backward and the barrel is then raised to compress the spring. In the diagram the spring is shown in the compressed position. A .22 calibre pellet is then inserted in the barrel and the same locked in the position indicated. When the trigger is pressed, the spring is released and the air is transmitted into the barrel chamber. Notice the piston rings on the piston.—Wembley & Scott Arms Co.

## DIZZY LIZZIE—A UNIQUE TOY

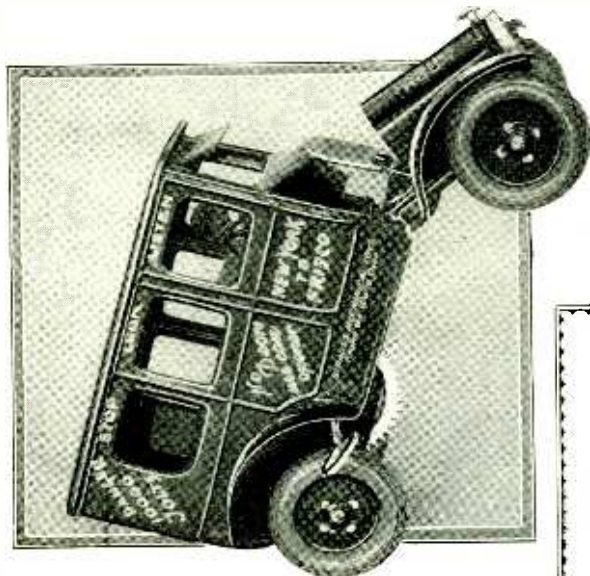

The diagram at the right shows the mechanism for operating the toy illustrated in a photograph at the left. The entire body of this automobile is mounted on a carriage by two pins located at the front and back of the auto. A trammel directly connected to one of the gears communicating with the spring, causes the auto to bump up and down and this motion in turn imparts a sideways or rocking motion to the body of the car.—Ferdinand Strauss Corp.

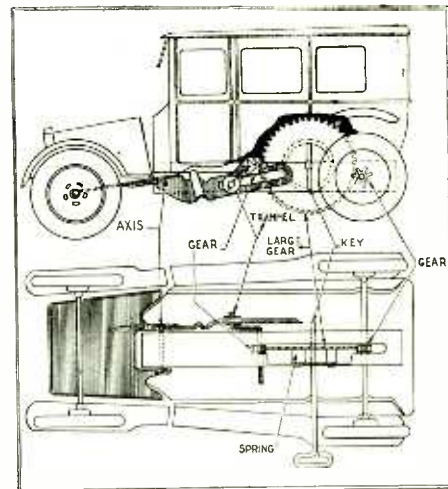

In the photograph above the automobile is seen standing on end. In this position the auto bucks like a typical bronco. This procedure continues until, because of a violence of one of the bucks, the equilibrium of the mechanism is upset and the auto falls down on all four wheels and proceeds to run away with its continued bucking movement.

Due to lack of space the publishers were forced to omit the article on Muscle Reading with illustrations showing the incomparable "Dunninger" demonstrating this system. Look for the article in the January issue.

The articles on this page will make ideal Christmas gifts for men and boys. There is no doubt but that members of the fairer sex get quite a kick out of most of them. Perhaps the suggestions on these pages will aid someone in picking out an unusual gift.

A postal card of inquiry concerning the names and addresses of any of the manufacturers of devices found in SCIENCE AND INVENTION Magazine will bring the desired information.

## TOY AIRPLANE

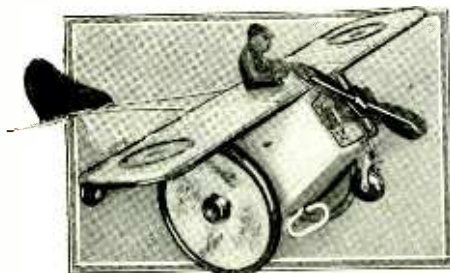

The photograph above shows the toy airplane which performs on the ground or floor in much the same manner as an expert aviator. It nose dives, tail spins and never repeats the same effect all because its designer foresaw the possibility of employing a fairly well balanced toy and equipping it with one wheel, which is free, and the other one which moves forward and backward alternately.

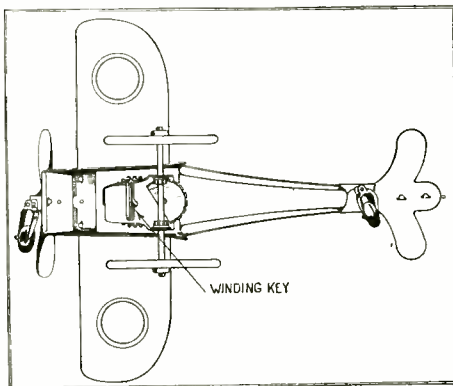

The above illustration shows the mechanism of the airplane, one wheel of the plane is free and the other is connected with the shaft and gears.—Ferdinand Strauss Corp.

## AN ODD TOY

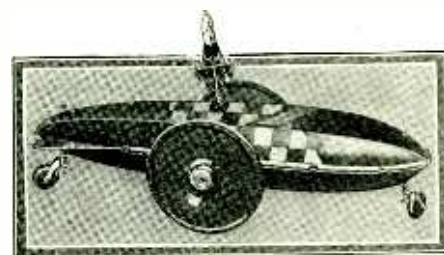

The toy of peculiar shape illustrated in the photograph above is operated by a mechanism identical with that shown in the drawing of the airplane at the left. It will be observed that one of the wheels is lashed back and forward, while the other wheel remains free. The capers cut by the toy are never the same.

# MODEL DEPARTMENT

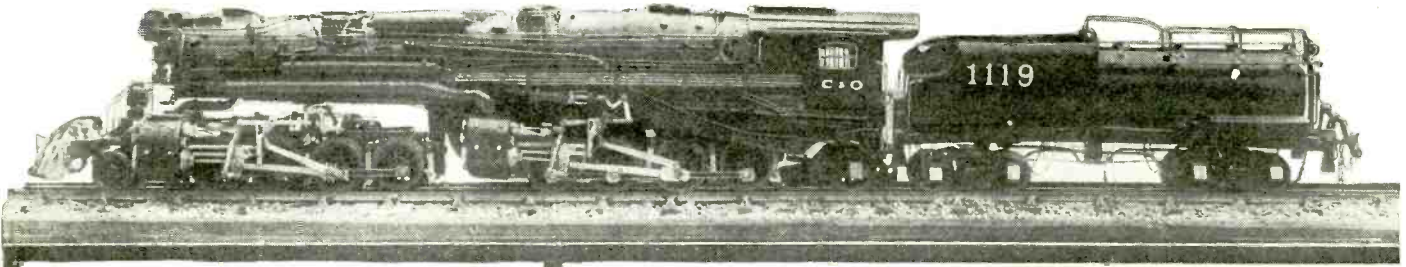

THE statement has often been made that our English cousins are far advanced in the art of building models over the American youth. Of course it is perfectly natural for the American lad to dispute this fact and state that he has seen as fine models built in this country as any of foreign make. The fact of the matter is that the art of model building is much more popular in England than in America just as radio in America is much more popular than model making. The American boy has not yet arisen to the point of seeing the possibilities which model engineering holds in store for him. On this page we are showing a group of photographs of models from an engineering exhibit in England. We do not doubt but that the constructions are very remarkable and we also wish to advise those of our readers in foreign countries that the SCIENCE AND INVENTION Magazine trophy contest is open to them as well as to those in America. Every month this publication offers a handsome trophy cup for the best model submitted during any one fiscal month. The conditions of the cup contest will be found on page 746 of this issue.

The photograph immediately above is a 7 mm. scale model of a 2-8-8-2 compound locomotive, a duplicate of the Chesapeake and Ohio Railroad. The model is electrically driven, and was built by Mr. A. Knock.

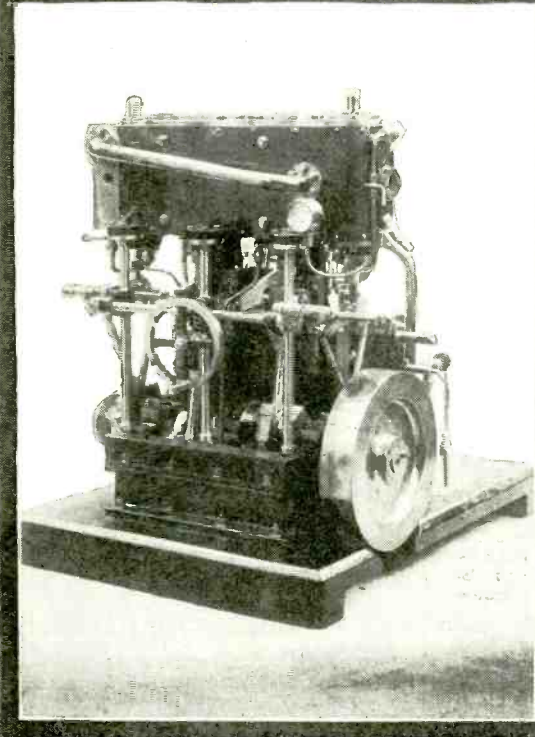

The photograph of the model above is that of a compound condensing steam engine built by G. T. Williams, and the one below is a model of a steam tractor constructed and exhibited by H. Smallbones. This particular model won a silver medal at the exhibition at Horticultural Hall, Westminster.

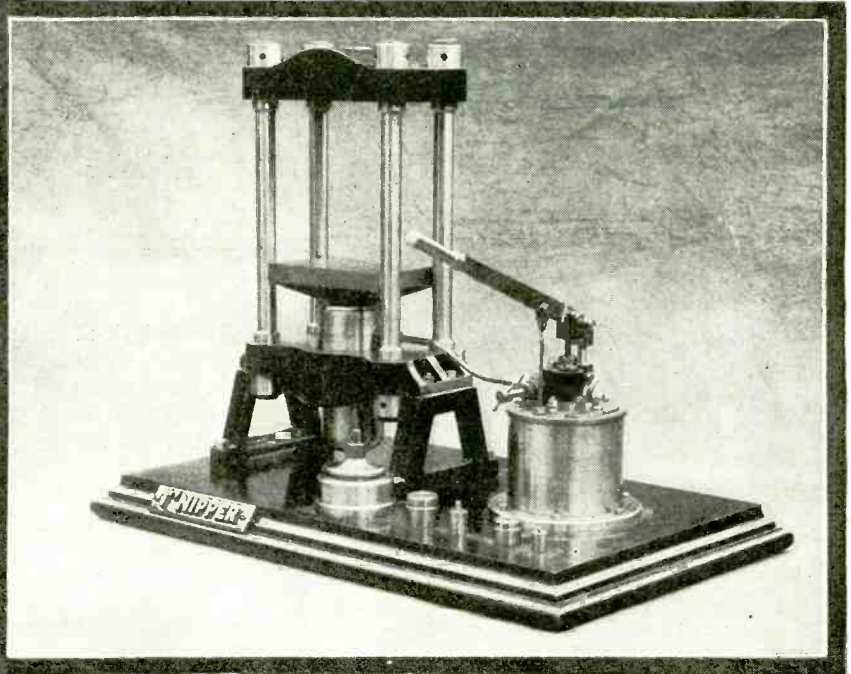

The model above was made by F. C. Hill and represents a hydraulic press.

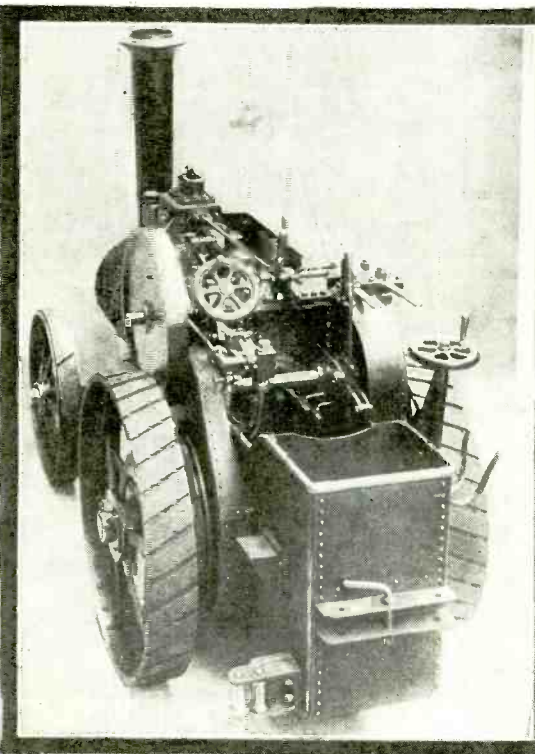

At the right is illustrated the handsome trophy awarded monthly by SCIENCE AND INVENTION Magazine for the best model entered during any fiscal month. The conditions of the model contest will be found on page 746 of this issue. One of these cups is awarded every month, so the model engineers of this country, and also of foreign countries will not have very great difficulty in carrying off an award. This cup stands nearly 18 inches high. On the front there is a shield representing model engineering. In addition to the cup, a certificate award of merit is awarded to the model engineer winning the trophy. Anyone can enter this contest.

America at the present time is busy building model ships. Many of these do not compare with foreign models. Most of the fine details are slid over and no effort is made to make the model look like the original. Even most of our engineering replicas are carelessly constructed. Here's hoping that some of our model engineering societies will wake up and that others will be formed to encourage the interesting pastime.



RULES FOR MODEL CONTEST APPEAR ON PAGE 746.

# Science Moves On



The latest thing from Paris this time does not happen to be a new style of short skirt, reports to the contrary notwithstanding. Look at the new cigarette box which the young lady at the left is operating. A match box lies on top of the cigarette compartment, over a tiny trigger. Lift the matches and the latest jazz from Montmartre, comes floating ut of the cigarette case to chase away your sorrows.



Col. B. C. Goss has developed the latest in protective devices for the flapper in this miniature gas pistol.

**SCIENTISTS** at the Paris Laboratory of Toxicology have been working for some time on the problem of rendering the exhaust gases of automobiles less dangerous. Due to the high percentage of carbon monoxide present in exhaust-polluted air, the danger to pedestrians becomes more serious each day, as the number of automobiles in the large cities increases. The newspapers almost daily print stories of prostrations and deaths due to the inhalation of these gases, usually because the doors of garages are left closed, while the engine of a car inside is turning out carbon monoxide at full blast. After considering the possibilities of minimizing this peril, M. Eugene Royer developed the new type of muffler which is illustrated in the photo at the right. It is so arranged inside that it effectively damps the noises of the motor exhaust, and at the same time chemically converts the carbon monoxide gases into carbon dioxide or carbonic acid gas. This gas, while it will not support life, is much less toxic than carbon monoxide, and is at all times present in normal air.

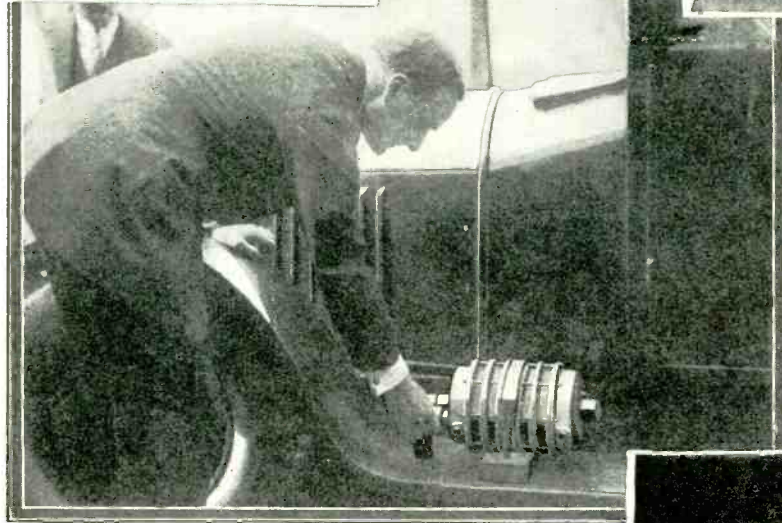

No more trembling moments for unescorted women now that milady has this sort of moral support. With the males completely at the mercy of her charms and her fountain-pen gas pistol, she need have no fear. The device was originally developed to aid policemen in case of attack by thugs, and it contains enough powerful gas to knock a man completely out for thirty minutes. Something tells us that this is the ideal instrument for poison-pen letter fiends.

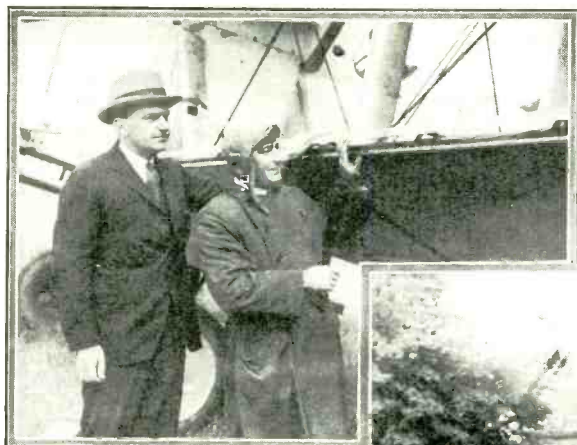

A demonstration was recently given at Cricklewood before a group of aviation experts of the Handley Page-Napier deck-landing torpedo plane. This plane, which the makers claim will fly backwards, is fitted with a slotted wing which opens and shuts like a Venetian blind, enabling the machine to hover and alight or get off at low speed in a restricted area. Mr. Handley Page and Capt. A. F. Wilkinson, pilot, are shown above.

A valuable collection of fossilized trees, ferns and rootlets that flourished one hundred million years ago was uncovered in the construction of a dam at Gilboa, N. Y., and forwarded to the Field Museum at Chicago. At the right is a fossil tree stump.

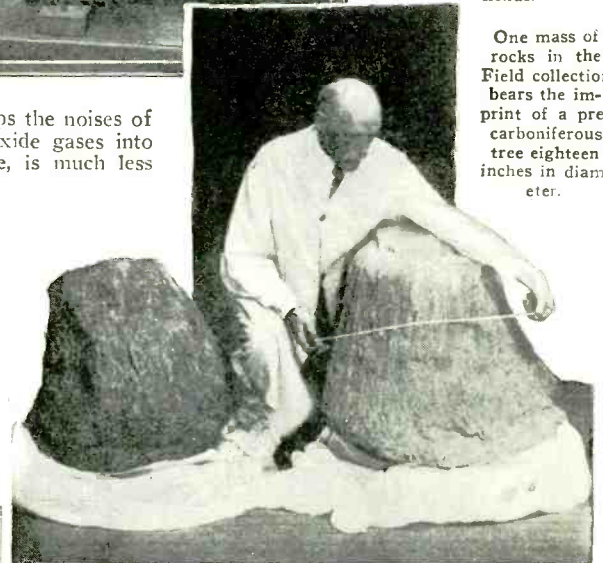

One mass of rocks in the Field collection bears the imprint of a pre-carboniferous tree eighteen inches in diameter.

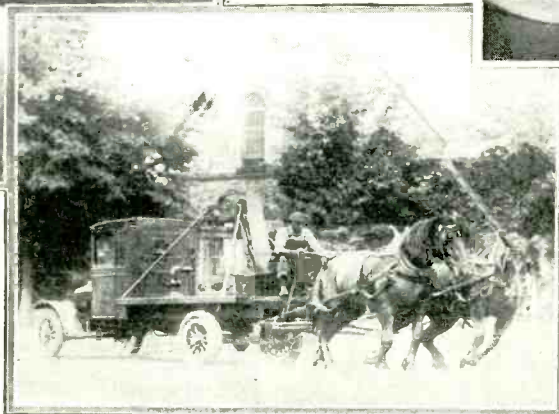

Amherst, Massachusetts, was the scene of a recent test with the portable dynamometer laboratory.

**THE** unit of work known as the "horse-power" was originally developed by actually testing the pulling power of a number of London dray horses and finding their average strength, but the unit has since applied exclusively to mechanical sources of power. It is of considerable interest to learn that through the efforts of Prof. E. V. Colins of the Iowa State College of Agriculture, we are about to learn just how much horsepower a horse develops. Prof. Colins has been experimenting with the dynamometer system of power measurement, and he has finally evolved a portable testing laboratory which he used at Amherst, Mass., to test the pulling power of horses and oxen. A light motor truck chassis is used as a mounting for the apparatus.

# Aviation News

## U. S. Submarine Carries Peanut Plane

**T**HE new submarine S-1 carries a small "peanut plane" in a cylinder on its deck. The plane weighs 1000 pounds and has a three cylinder motor. In tests conducted at New London, Conn., it was found that the plane could be taken out and assembled, ready to fly, in nine minutes. It is flown by the first submarine airplane pilot in the world, Lieut. Adolph C. Allen.

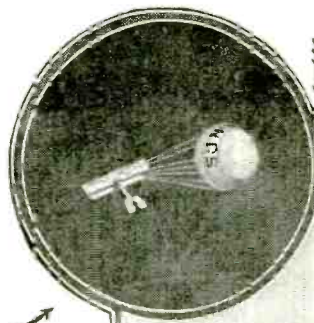
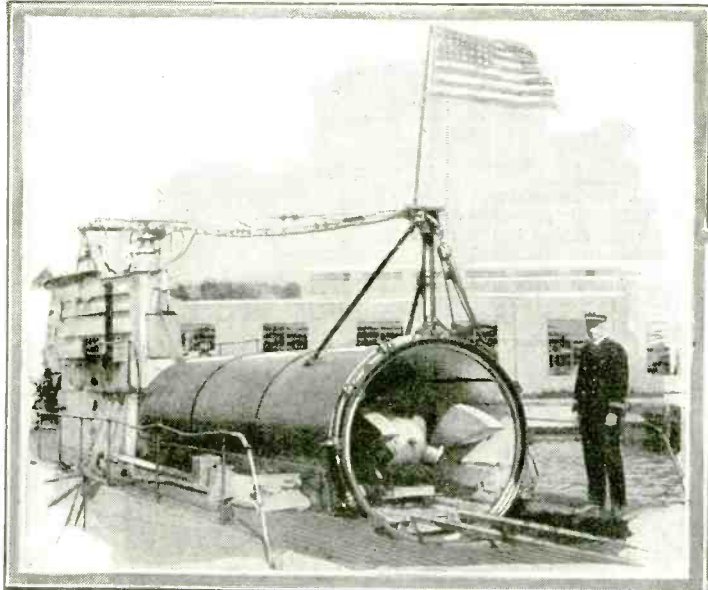

The movies added another chapter to science when the Paramount feature picture "Wings" made it necessary to perfect a new parachute for lowering plane.

The new parachute permits an 1800-pound plane to be lowered in perfect safety from 2500 feet.

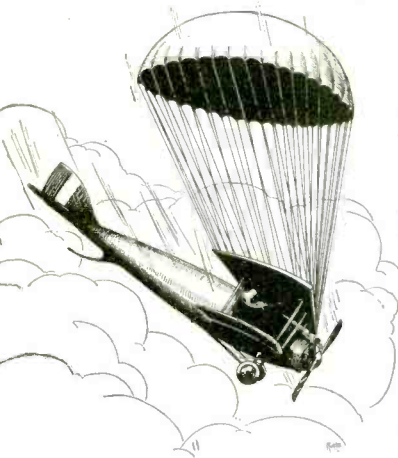
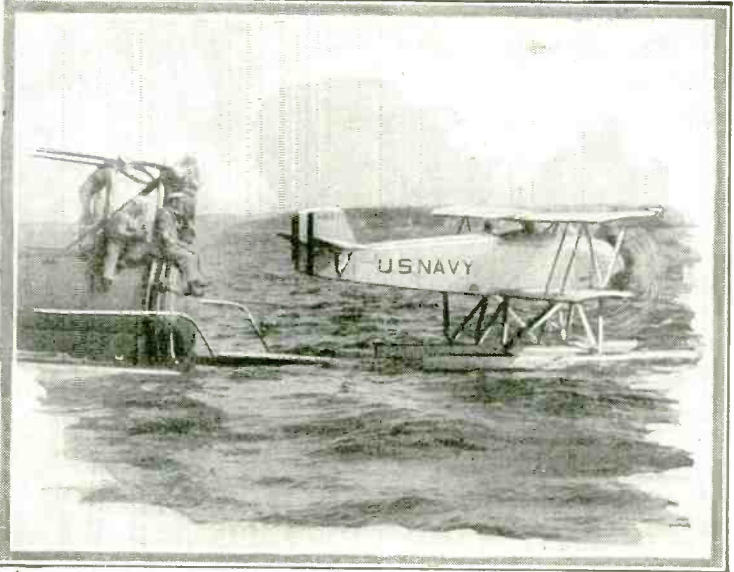
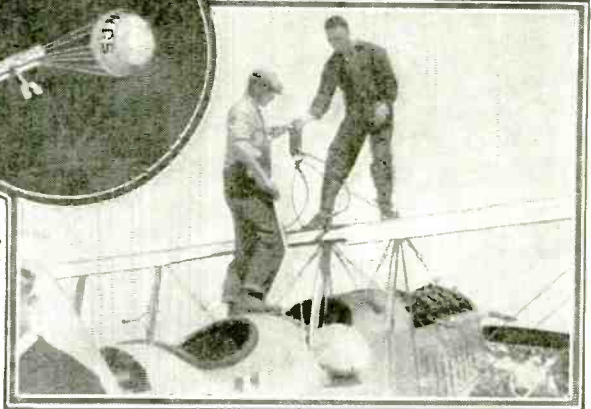

Florence Doty, one of America's few women aviators, invented the parachute illustrated at the left. When not in use, the parachute is folded and lashed tightly to the top of the upper wing. Aviation experts approve it.

Here is the way the "Peanut Plane" looks when it is assembled and ready to fly. It is launched by partially submerging the submarine.

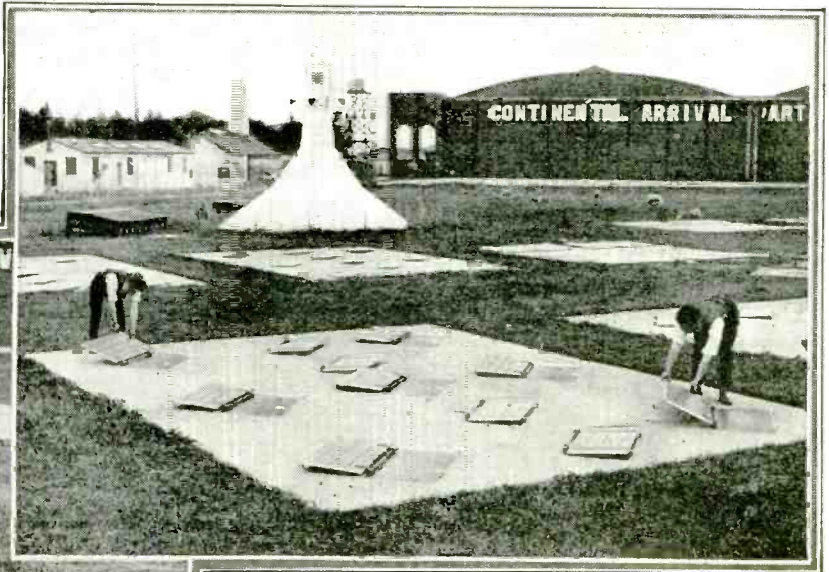
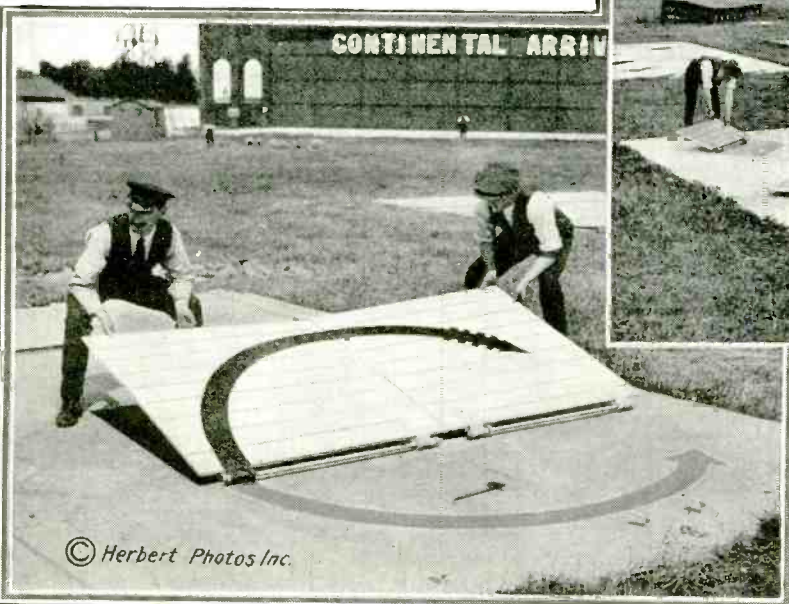

**T**HE two photographs, above and at left, show an ingenious device used by a large commercial aircraft company as a means of communicating with their pilots while in the air. The design at the left is a gale warning, and it is erased by simply folding back the hinged flap. As in the photo above, varying patterns of dots, each carrying a different meaning, may be formed very quickly by folding back the covers which hide them. In the background may be seen one of the concrete pylons, illuminated from above by high-power lights at night.

© Herbert Photos Inc.



# \$5,000.00 Matchcraft Contest Awards

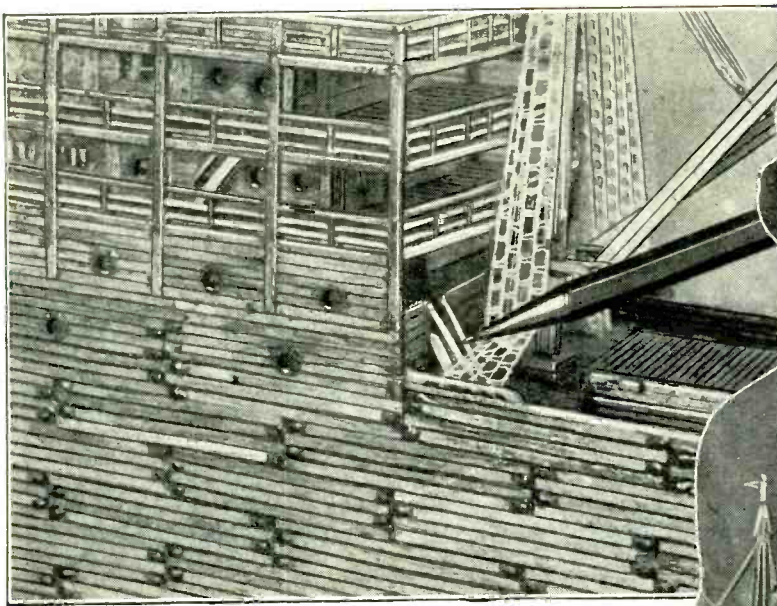

**MATCHCRAFTERS** note—many of you will be unable to complete your models before December 1st, when the Matchcraft Contest officially expires. But don't worry about this. The contest will continue until further notice in accordance with a new list of prizes indicated on this page.

This model resembles the unsinkable ship illustrated in **SCIENCE & INVENTION** Magazine, the rigging is of cotton, the stern unclaps to show construction.

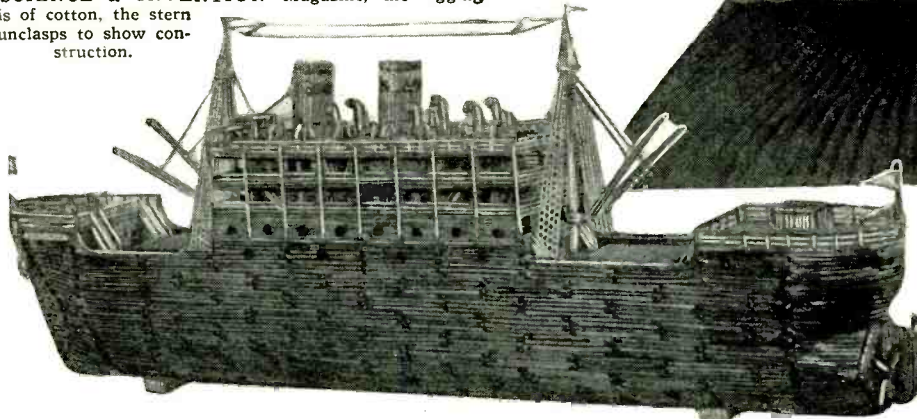

**FIRST PRIZE, \$100.00**, is awarded in this month's matchcraft contest to Walter J. Atkins, of Sault-Ste. Marie, Ont., Canada, for his model of a ship illustrated in the photographs above. In the upper left-hand corner the point of a pencil is pointing to a stairway constructed on this model.



This ship is 23 inches long, 8½ inches high and contains about 10,000 matches.

This photo shows Miss Sadie Bernstein holding the prize winning model in this month's contest.

## 16 Monthly Prizes

First Prize .....	\$100.00
Second Prize .....	75.00
Third Prize .....	50.00
Fourth Prize .....	35.00
Fifth Prize .....	25.00
Sixth Prize .....	20.00
Seventh Prize .....	15.00
Eighth Prize .....	12.50
9th to 16th Prizes of \$10.00 each .....	80.00

## \$5,000.00 Prize "Matchcraft" Contest

THIS CONTEST EXPIRES DECEMBER 1, 1926 AND A NEW ONE STARTS.

**F**OR the present year, **SCIENCE AND INVENTION** magazine will award a total of \$5,000 in prizes, in a new contest. You are asked to make models, fashioning the same entirely from safety matches. Please observe the following simple rules:

- (1) Models submitted must contain at least 90 per cent. safety matches in their construction.
- (2) Models made of toothpicks, paper matches, or non-safety matches, are not eligible in this contest.
- (3) Models can not be built around boxes or other supporting articles. Walls, roofs, etc., must all be self-supporting and made of matches.
- (4) All liquid adhesives, such as glue, shellac, cements, etc., are permissible.
- (5) Models may be painted, gilded or silvered.
- (6) Models may be of any size.
- (7) In order to win a prize, it is necessary that either models be submitted, or, if this is not practical, owing to their size, a 5"x7" photograph of the model may be sent in lieu of the model itself. The best models submitted each month will be awarded the prizes scheduled herewith.
- (8) All models submitted to **SCIENCE**

AND **INVENTION** Magazine will be promptly returned to the builder, who will prepay all charges.

(9) Where **SCIENCE AND INVENTION** has any doubts as to the model (where photos

only are submitted) complying with all the regulations, the judges may, at their discretion, request that the actual model be sent in for inspection, paying transportation charges both ways.

(10) This is a monthly contest, lasting for twelve months, each monthly contest closing on the first of the month following date of issue. Thus the contest for the month of December will close January 1, 1927, and prize winning announcements will be made in the March, 1927, issue. The January issue will contain October prize winning entries.

Note that beginning with December, 1st, 1926, \$100 in prizes will be paid monthly.

(11) Models must be shipped in a strong wooden box, never in a cardboard box, as **SCIENCE AND INVENTION** can not be held responsible for breakage in transit due to models having been improperly packed.

(12) When models are sent, be sure to affix tag, giving your name and address, to the model itself. In addition, put name and address on outside wrapper of package.

(13) Address all letters, packages, etc., to Editor, "Matchcraft" Contest, care **SCIENCE AND INVENTION** Magazine, 53 Park Place, New York.

### IMPORTANT

**O**N December 1st, 1926, the \$5,000.00 Matchcraft Contest officially expires. Any entries arriving after that date will be entered in a \$100.00 monthly Matchcraft Prize Contest which will continue until further notice offering the following prizes:

First Prize .....	\$50.00
Second Prize .....	20.00
Third Prize .....	15.00
Fourth Prize .....	10.00
Fifth Prize .....	5.00
<b>Total .....</b>	<b>\$100.00</b>

**Caution—Soak or cut heads from matches before building your model so that the models may be expressed or mailed. The strike-everywhere square cut Liberty matches can be used if the heads are cut off.**

This contest started Dec. 1, 1925, and will terminate Dec. 1, 1926.

# Matchcraft Awards (Continued)

Third Prize—\$50.00, is awarded in this month's contest to Carl Fichtner of Phila., Pa., for his model of a ladder truck illustrated in the photo below. Mr. Fichtner built two other ladder trucks, each of which arrived in a broken condition, before he finally succeeded in making one strong enough to withstand shipping difficulties. The extent of ladder is 24 in. long and is operated by a windlass, the rear wheels and shafts disconnecting thru a match coupling.



**Milk Wagon Wins**  
**Second Prize - \$75.00**  
**Ladder Truck**  
**Third Prize - - \$50.00**  
**Saxophone**  
**Fourth Prize - \$35.00**

Second Prize—\$75.00 is issued this month to Fred Spinden, of Abingdon, Illinois, for the milk wagon illustrated above and in the photograph at the right, the model being examined by Miss Mae Quellman. The wheels of this wagon are bound with brass strips; the window opens, the door slides back and forth, and as will be observed, even match springs are found on the model. The construction is 19 in. long, including the shafts, and 8½ in. high. This is not Mr. Spinden's first prize winning model.

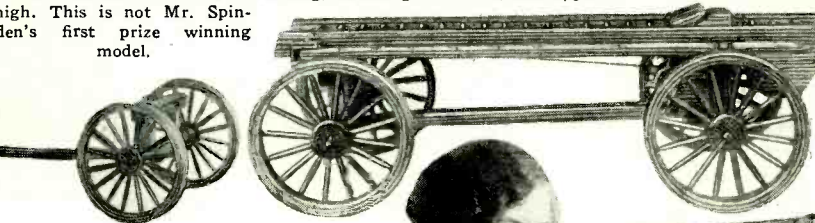

**A**LL matchcrafters should refer to the new schedule of prizes which will go into effect after December 1st, 1926. These are published on the preceding page.

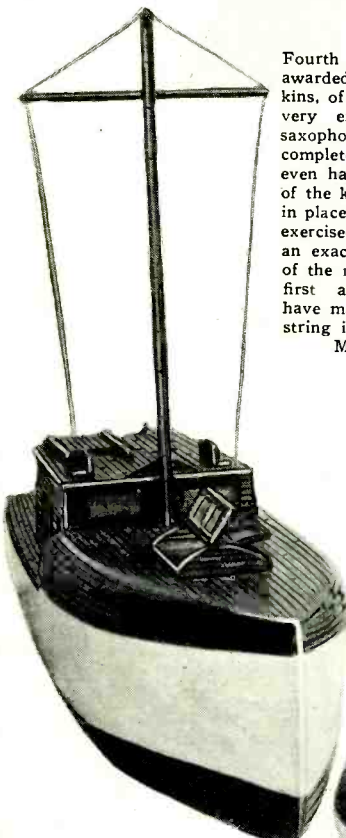

Sixth Prize—\$20.00 was won by J. J. Quinn, of New York City, for his splendid example of a motor boat here shown. The boat itself is 21 in. long, and the deck is carefully ribbed, varnished and then shellacked. Note the curtains in the windows. The only thing required to make this a working model is to install a motor to drive the propeller. Mr. Quinn won a prize before which acted as an incentive for building another model.

Fourth Prize—\$35.00 is awarded to Ralph H. Hopkins, of Castle, N. Y., for his very excellent model of a saxophone. This saxophone is complete to every key and even has the rollers on some of the keys. The stops are all in place and extreme care was exercised in making the device an exact non-working replica of the real thing. This is the first attempt Matchcrafters have made to get away from string instruments. Posed by Miss Ruth Olsen.



Fifth Prize—\$25.00 was won by Larry McCarty of Los Angeles, Calif., for his match construction of a castle. The two photographs below give two different views of this interesting bit of work. It will be noted that the draw bridge is down in both photos. The model measures 16 in. wide, 12 in. deep and 14 in. high over all. The base is constructed of plaster of Paris and marked to represent masonry.

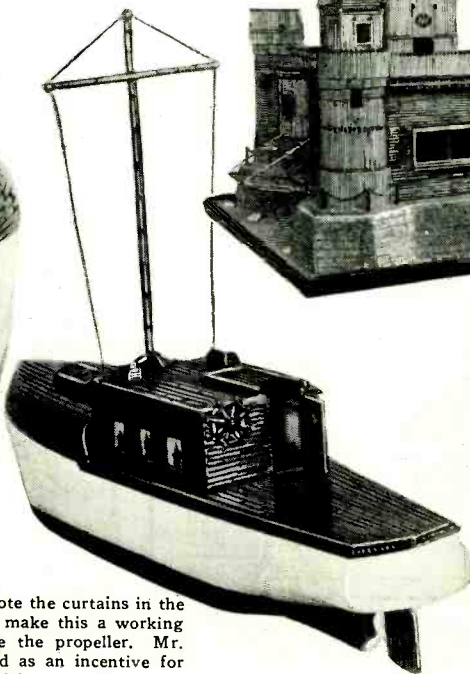
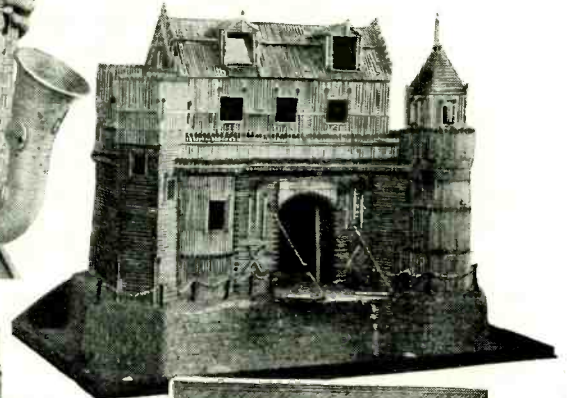
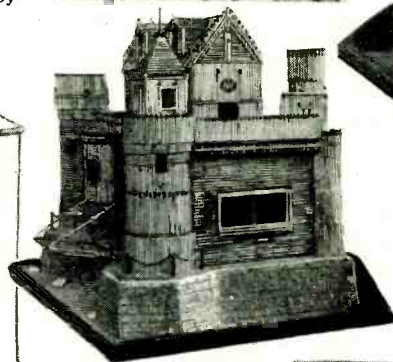

Seventh Prize—\$15.00 is the amount awarded to Edward Raible, of Louisville, Ky., for the inlaid checkerboard, checkers and box here illustrated. Note that the matches for alternate squares of the checkerboard are stained to give the contrast between the squares.

# Further Matchcraft Awards



**NINTH PRIZE—\$10.00.** This very wonderful parrot and stand was built by Alexander E. Paluck, of Belfield, N. Dak. Had it not been for the number of truly excellent models in this month's contest, this would undoubtedly have won a higher prize. →

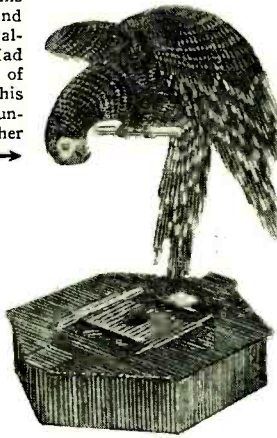

**TENTH PRIZE - \$10.00** was won by Herman W. Gerdts, of Brooklyn, N. Y., who in a previous contest won the first prize.

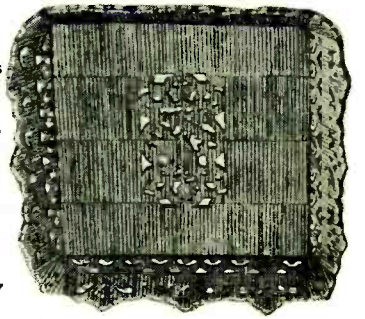

↑ A top view of the card tray is illustrated in the photograph above. Note scroll saw pattern.

**EIGHTH PRIZE — \$12.50** is awarded to L. J. Schumacher of Bronx, N. Y., for the wonderful cathedral shown in the photograph above. It took a hundred and forty-five days to make this model. There are nine thousand match tips in the construction and twenty-one thousand pieces of matches. If all the matches which entered in the construction of this model were placed end to end, they would reach fifty stories higher than the Woolworth Building, and be twice the length of the S. S. Homeric. Nail polish rolled out and painted forms the windows.



← This photo shows Miss Ruth Olsen holding the ninth prize winning model. The model itself in knock-down form is shown above.

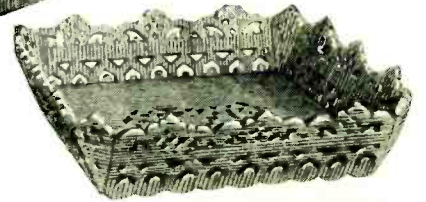

↑ A perspective view of the card tray showing the pattern along the side is seen in the photograph above.

← Eleventh Prize — \$10.00 is awarded to Dr. A. A. Hansen of Virginia, Minn., for his model of a safety razor, razor blades, blade case and box. Would anyone believe that such things could possibly be made of matches?

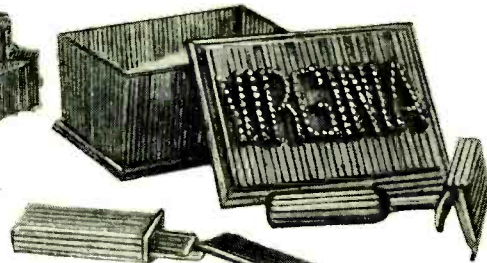

**Sixteenth Prize—\$10.00** was awarded to Edward Mazone, of Wilmerding, Penn., for a rather ancient-looking grindstone which one would expect to find on a farm. →

Sandstones such as this are usually employed for grinding axes. Of course they cannot be made of matches.

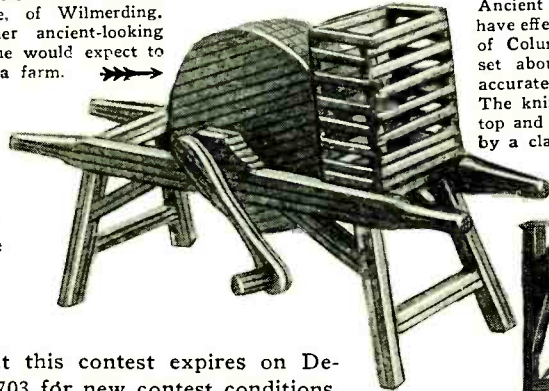

**TWELFTH PRIZE — \$10.00.** Ancient torture methods must have effected Mr. E. Don Bailey, of Columbus, Ind., because he set about constructing a very accurate replica of a guillotine. The knife may be raised to the top and is there hooked in place by a clamp controlled from the platform.

→ **Thirteenth Prize—\$10.00** was awarded to Irving Klein, of Brooklyn, N. Y., for the Spanish comb illustrated in the photograph at the right. Several layers of matches were glued together and then the entire device was shaped by the aid of a scroll saw.

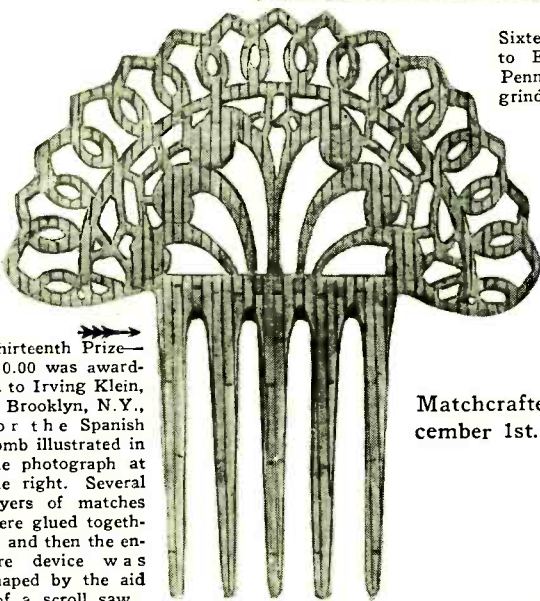

Matchcrafters note that this contest expires on December 1st. See page 703 for new contest conditions.

→ **Fifteenth Prize — \$10.00** was won by Charles W. Reese for his samples of household appliances. We find a wash tub, a washboard, a pail, a broom, a bench and an ironing board all made of matches. Will Mr. Reese please send us his address?

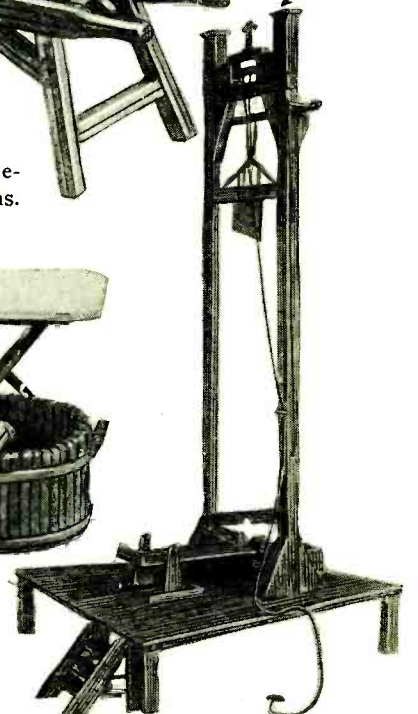

↑ **Fourteenth Prize—\$10.00** is awarded to William E. Lee of Richmond Hill, L. I., for the shapely pipe here illustrated.

# MOTOR HINTS

Conducted by **GEORGE A. LUERS**

A New Monthly Department Prepared by a Well-Known Automotive Engineer

### PLANNING THE GARAGE LOCATION TO AID IN REPAIRS

A garage pit has little to recommend it and much to condemn it. It is usually a wet greasy hole to work in, the gasoline

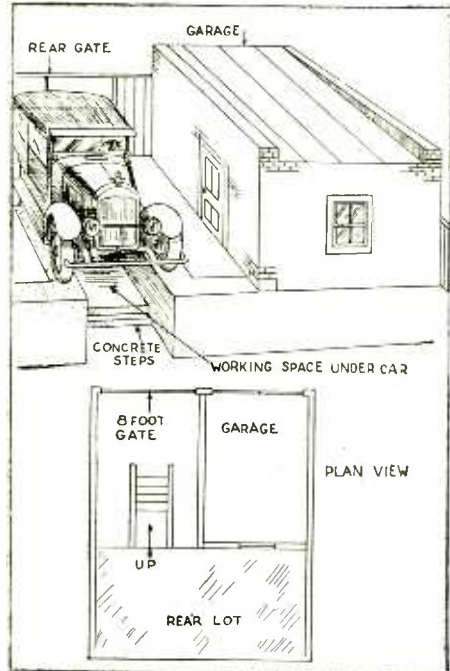

Simple yet very effective way in which to arrange an open pit from which the bottom of an automobile engine becomes instantly accessible.

which collects there is bad on the health and monoxide gas, which is heavy, is more likely to settle in this pit.

It is possible to plan a garage on the rear lot, accessible from the alley which will provide facilities for maintenance of the repairs to the car. A brief outline of a planned garage on an eighteen foot or wider lot, is shown in the accompanying sketch.

The garage occupies one half or less of the lot, while the adjacent open space is provided with an eight foot gate made for

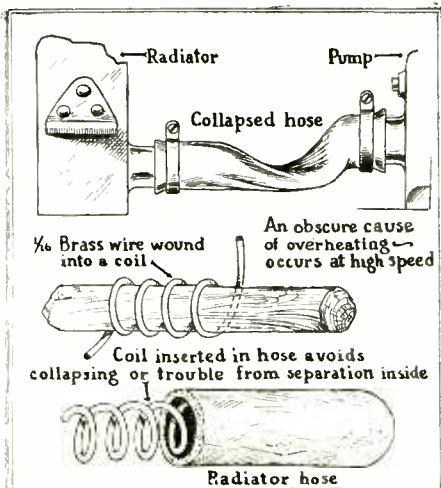

Clever method of reinforcing rubber water hose on engine, so that it cannot collapse as pictured above.

entering the car. Service steps will be required from the rear of the lot to the alley, so these should be located in the center of the space, permitting the car to be driven into the space and over these steps. This makes it comfortable and convenient for the owner, to handle spring lubrication, brake adjustment, replenish the lubricant in the grease cups and attend the other details.

In the event the lot is level with the alley, then concrete runways can be used. These runways can be inclined so that the high ends are about three feet high and the intervening space is concreted.

The car is driven in either backwards or forwards, permitting access to all parts and in fair weather the owner enjoys the advantage of working safely with plenty of light and ventilation.

### HOSE CONNECTIONS MAY CAUSE OVERHEATING

If the car owner will change radiator hose connections each year, it is not probable that he will have trouble from this source. If on the other hand the hose connection becomes flabby and the inside rubber separates, as it will after a year or more of use, trouble will result.

The loose inner rubber will close an inlet or outlet passage, acting as a sort of check valve, with the result that a very obscure cause of overheating is evident in the engine. If the hose becomes flabby, it is quite often that the suction of the circulating pump will cause it to collapse and shut off the circulation of the cooling water.

To forestall trouble from hose connections, a commendable means is that shown in the attached sketch. This consists of coiling a piece of one sixteenth inch brass wire, over a brush or broom handle and inserting this in the hose before connecting it up. This is an assurance that the hose will stay extended and that the inside rubber will not obstruct the water passage. This expedient is readily adopted and the owner is saved from further trouble with the hose connections.

### CAR FITTINGS VERSUS WINTER MUD

The driver will appreciate the advantage of the foot scraper shown in the attached sketch, especially the Ford driver who knows the difficulty of operating the foot pedals, when the frost has stirred up a sticky mud that causes the feet to slip.

This attachment can be made from a strip of iron, about a foot and a half in length, three sixteenths inch thick and one and a quarter inches wide. This is secured with a couple of quarter inch wagon bolts under the right running board at the driver's entrance.

The second fitting shown in the sketch, is a means for clearing tire chains of the mud and moisture, before stowing these chains under the rear deck or under the seat.

Four hook bolts are attached to the left running board, to which the chains are hooked on when these are first removed from the tires.

The movement of the car and the air will shake off the mud and dry them nicely, that

they can be stored, without messing up the other tools with dirt and causing the chains to be rusted and hard to handle. These attachments contribute somewhat to keeping the inside of the car clean, which is especially desired in the closed type of car.

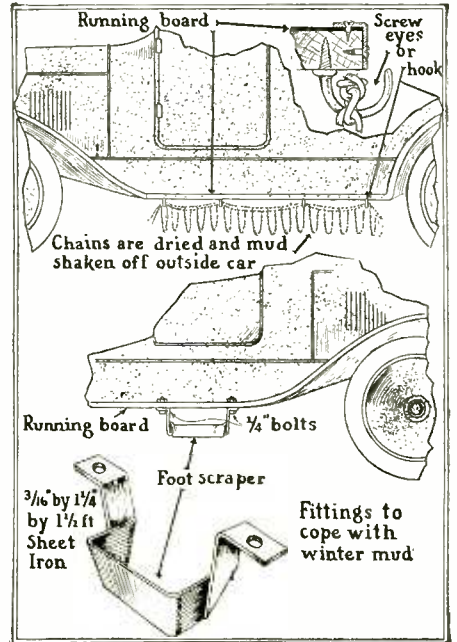

The two illustrations above show how to make a simple foot scraper useful in winter weather, and also how to dry and shake the mud from non-skid chains by suspending them along the running board.

### BIT BRACE SPEEDS UP SOCKET WRENCH

There are sixteen cylinder-head bolts in the joint of a Ford engine, each of which requires time and patience to remove with the usual wrench equipment. Other engines have frequently more than this and require still more patience, when it becomes necessary to remove the cylinder head.

(Continued on page 741)

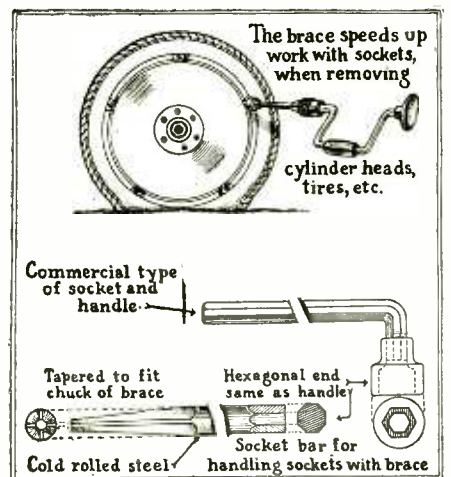

To speed up the removal of hexagon nuts on engines and tire rims, Mr. Luers here suggests the use of a carpenter's brace with the fittings described.

# Home Mechanics

## Home-Made Animal Toys

By W. M. BUTTERFIELD

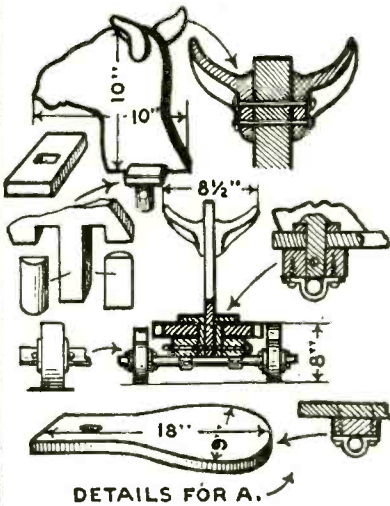
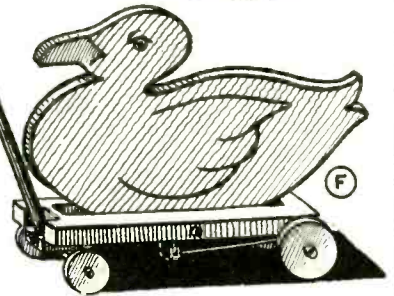
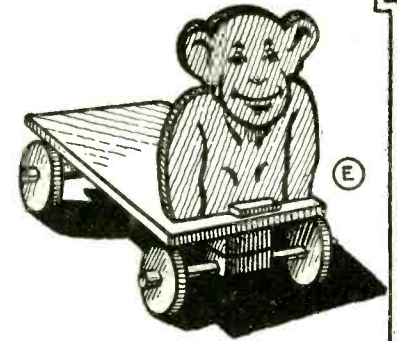
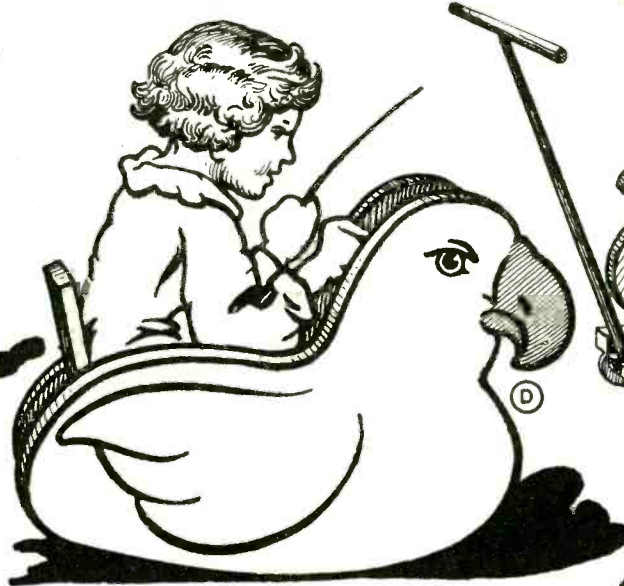
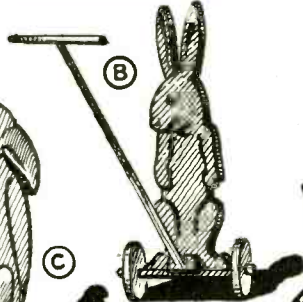
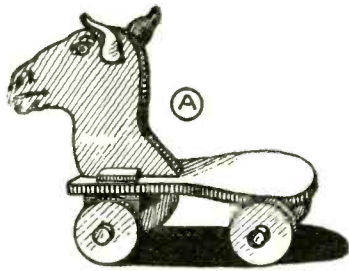

DETAILS FOR A.

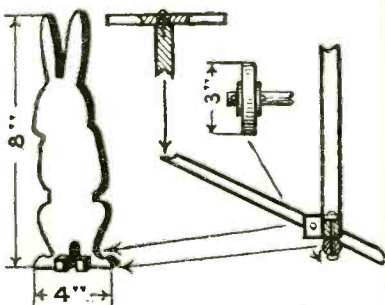

DETAILS FOR B.

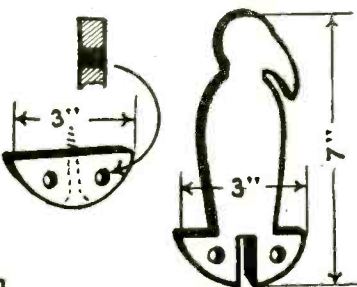

DETAILS FOR C.

PERHAPS one of the most popular things of the day is the animal toy. It would seem, from its popularity, to be the fascinating one to make. For this reason we have laid out a page illustrating six toys that may serve as suggestions to the home-mechanic. Native inventive propensities and caricaturing ability can increase the number indefinitely, for the styles now shown on the market are beyond number with very good possibility of others yet to come.

Not only is the making of the toy fascinating, but the artistic ingenuity involved in choosing colors and the "motif" of treatment is more than fascinating. The most successful treatment for painting is that of broad flat tints, where no attempt is made at blending the different colors employed. Enamel paint is used over a priming coat. The colors are white, black, brick red, lemon yellow, grass green and new blue.

It would seem advisable before painting a toy to sketch out on paper rough outlines in contour, and color the sketches either with colored chalks or with water colors. Several attempts may be made in this way until a pleasing combination is obtained—comparison of the various sketches thus colored will aid in making a final choice.

Details sections and dimensions are given for each example on the lower portion of the page.

The first sketch (A) shows a kiddy car. The car is made of  $\frac{5}{8}$ " and of  $\frac{1}{2}$ " plywood lumber— $\frac{5}{8}$ " for the wheels and seat and  $\frac{1}{2}$ " for the head, which is that of a young goat or kid. The ears, serving as handle bars, are made of hard wood, as are also the brackets holding the wheel. The car may be painted with red seat and under-parts, yellow wheels, and head slate gray with nose, eyes and mouth outlined in black.

The next is (B) a rabbit toy. It is made of  $\frac{3}{8}$ " plywood, has a metal shaft and hard wood handle. It is painted white with black eye, nose, mouth and other outlines for the rab-

(Continued on page 742)

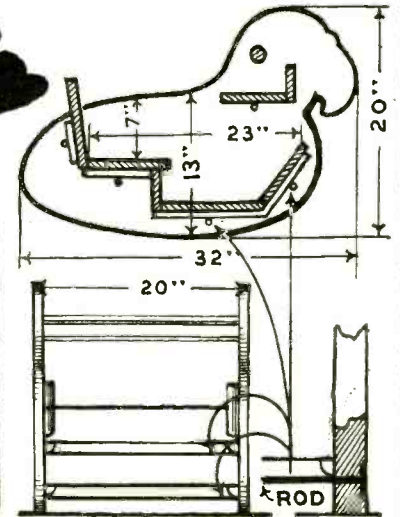

DETAILS FOR D.

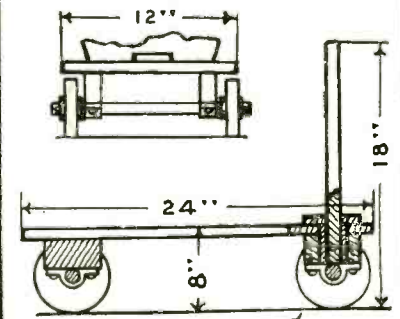

DETAILS FOR E.

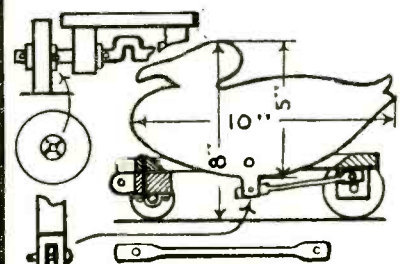

DETAILS FOR F.

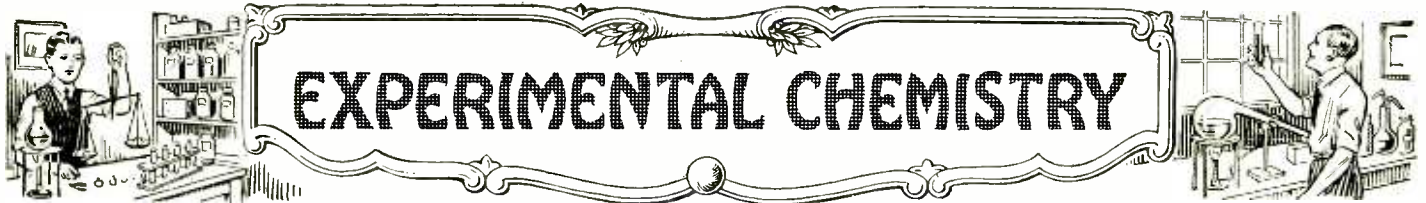

# EXPERIMENTAL CHEMISTRY

## Applying the Bunsen Burner

By J. M. BYERS

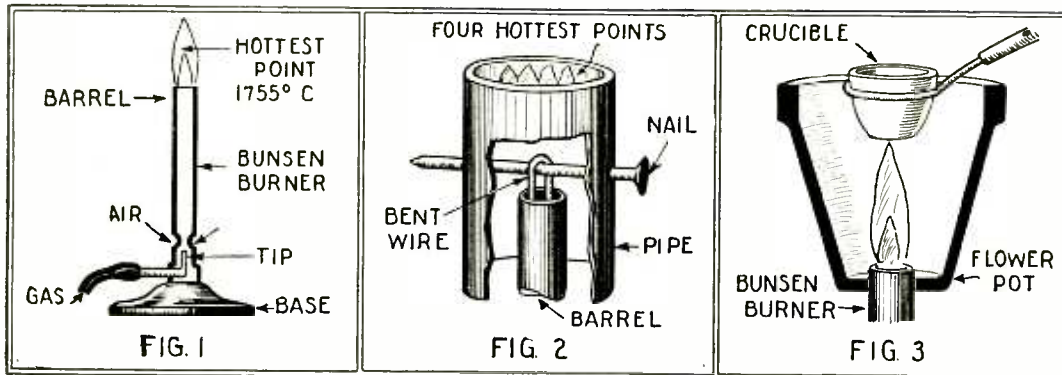

The five illustrations give what may be called a sort of treatise on the Bunsen burner. Different ways of using it are shown, which are explained in the text on the illustrations, and these are only suggestions for the burner can be used in many other ways. Referring to Fig. 6, there is one thing to be remembered about the Bunsen burner, that if it does burn at the base, it gets very hot; it may melt the tube and light the gas and cause a conflagration.

1. The best known of laboratory heating apparatus is the Bunsen burner. This simple, yet ingenious contrivance is capable of reaching a temperature of 1755 degrees centigrade, the melting point of platinum and of rocks. You can prove that the Bunsen flame reaches this temperature by fusing a fine platinum wire in it. This high temperature is confined to an area so limited that for practical purposes 600 degrees is reached with difficulty.

2. Several methods of obtaining more heat with the Bunsen burner are in use. One employs a device shown in the picture. This piece of apparatus constructed from a section of one-inch pipe, a nail and a bent wire, splits the flame in four parts giving four hottest points instead of one. The results are quite satisfactory for fusions and ignitions and ordinary laboratory use. Experiment will show you the height at which the flame splitter should be fixed for most heat.

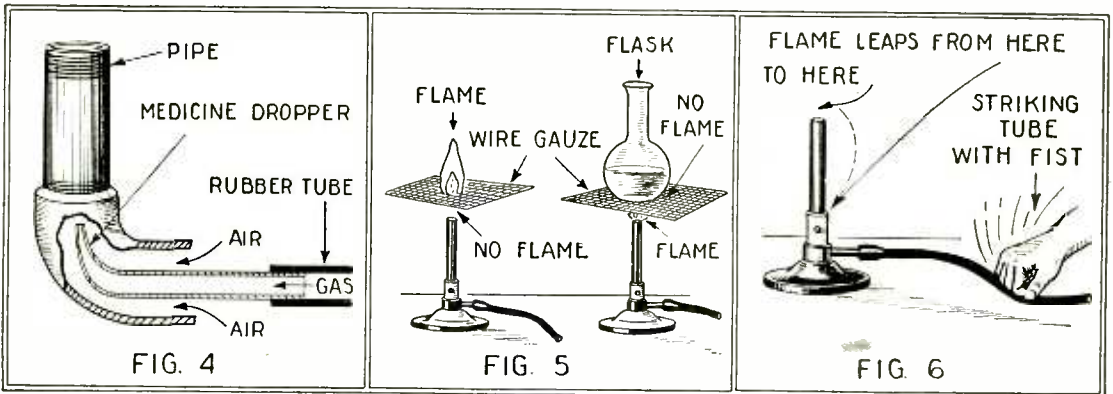

part or controlling the air inlet with a slip of paper.

5. In many instances high temperatures are to be avoided as for instance in the heating of glassware. A piece of wire gauze prevents the flame from direct contact with the glass.

To show the action of a wire gauze screen support a six inch square piece over a Bunsen burner, turn on the gas, and light above the gauze. The flame will burn above only, being unable to get through the meshes and burn below.

6. "Striking back" is an annoyance caused by too rapid combustion. This may be remedied by cutting down the supply of air. When a "strike back" occurs hit the rubber gas tube where it lies on the desk. The sudden compression often sends the flame up to its proper position.

### PHOSPHONIUM IODIDE

By CHARLES C. ABBATE

This beautiful compound, which crystallizes in large transparent glittering quadratic prisms, can easily be obtained by placing in a retort, A, of a liter capacity, 400 grams of common phosphorus, allowing an equal weight of carbon bisulphide to run in, and gradually adding 680 grams of pure iodine, care being taken to keep the retort well cooled. The carbon bisulphide is next completely removed by distillation in a water bath, and the retort, A, is connected with a long wide tube, C, placed in a slightly slanting position, and furnished on the lower end with a 250 cc. flask, D, equipped with a two-hole rubber stopper. This is connected to a 150 cc. flask, E, which contains a dilute solution of hydriodic acid. To this is connected another 150 cc. flask, F, containing water.

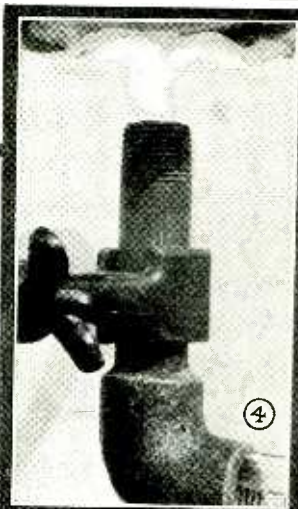
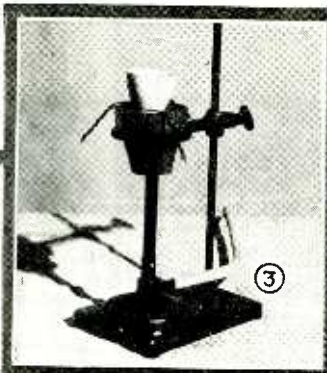
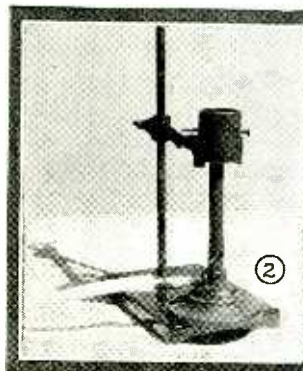

These are repetitions of photographs from apparatus set up in accordance with five of the illustrations given above. In connection with diagrams above, they give a perfect idea of the work.

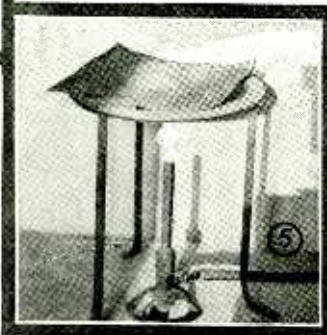

3. Another method of securing greater heat is the use of the "flower pot" furnace. The flame is protected from draughts, the heat accumulates and work may be done for which a blast lamp is usually necessary.

4. "Where the Sam Hill's that Bunsen

burner?" Like the collar button of which we always need several and have but one it turns up missing at just the wrong time. No need to despair, however, when a temporary burner can be rigged from a piece of pipe and a medicine dropper. A hot blue flame can be obtained by adjusting the position of the medicine dropper

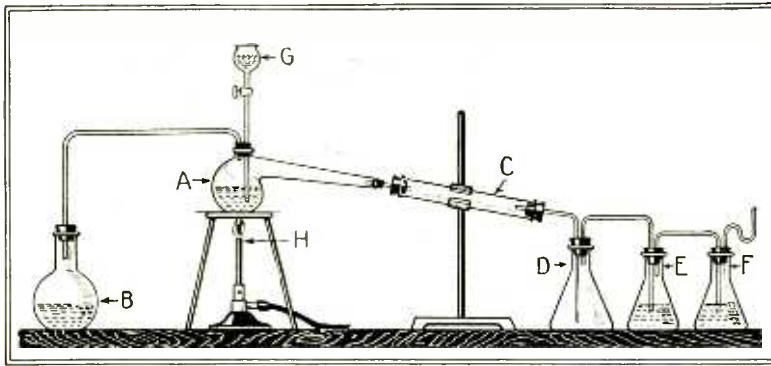

An interesting experiment in the production of phosphorus iodide is carried out by this apparatus. The reaction occurs in the retort A, the flask B serving to generate carbon dioxide gas to prevent the phosphorus or any of its compounds from entering into combustion.

The object of this arrangement is to absorb the hydriodic acid formed during the reaction, and at the same time to prevent the liquid from entering the wide tube into which the phosphonium iodide is sublimed. The apparatus is then filled with carbon dioxide, which is generated in the generator, B, by the action of hydrochloric acid on calcium carbonate, forming carbon dioxide calcium chloride and water.

Note, however that a current of the carbon dioxide gas is passed through the apparatus throughout the operation. The experiment being thus far arranged, 340 cc. of water are allowed to drop slowly by means of a stoppered tube-funnel, G, into the retort, A, which is slightly warmed.

The heat evolved from the action then taking place is sufficient to sublime the greater part of the phosphonium iodide into

the long, wide tube, C. Towards the end of the operation, which usually requires about eight hours for its completion, the retort, A, is heated somewhat more strongly by the Bunsen burner flame, H. When no further increase in the amount of sublimate takes place, the apparatus is dismantled, the end of the long tube, C, is closed with corks, and the thick crust of phosphonium iodide is loosened by means of a stout iron wire and preserved in stoppered bottles. The formation of the phosphonium iodide is represented by the following equation:



An excess of phosphorous is, in practice, employed because a part of this substance is converted, during the reaction, into the red modification. The formation of the hydriodic acid which escapes is due to the decomposition of the phosphonium iodide in the presence of warm water. Phosphonium iodide boils at about eighty degrees Fahrenheit, but easily vaporizes at a lower temperature. It is used in the laboratory as a powerful reducing agent, as well as for the preparation of many organic compounds.

### An Interesting Experiment

By S. WOODALL

THE production of silica by the action of a gas called silicon tetrafluoride on water, is a peculiar and interesting experiment.

To prepare it by this method, set up the apparatus as shown in the figure. Into a

form hydrogen fluoride, which immediately reacts upon the silicon dioxide or silica of the powdered glass, to form silicon tetrafluoride as can be seen in the following equation:

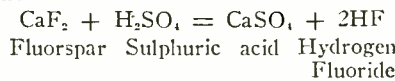

The silicon tetrafluoride is a colorless, invisible gas, as may be observed in the upper part of the test tube. When this body meets the water, it decomposes it, with the formation of silica and an acid containing fluorine, silicon, and hydrogen called hydrofluosilicic acid.

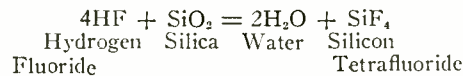

The production of silica in this process allows a very pretty phenomenon to be witnessed. Each bubble of silicon tetrafluoride, as soon as it rises out of the mercury into the water, is converted into a little sack or bladder of silica. When these bubbles are broken, the silica exactly resembles in appearance gelatinous starch as it is used in the laundry. If the bubbles of gas succeed each other slowly, they produce a tube of silica closely resembling one of animal membrane, and extending from the surface of the mercury to the surface of the water.

This appearance, however, cannot be produced at will. The hydrofluosilicic acid in the solution should be separated by filtration from the silica, and saved as a valuable reagent for potassium. The potassium, and barium salts of this acid are insoluble in water and alcohol. The silica left on the filter is exceedingly pure, and when dried, presents itself in a state of very fine division. This process of making silica from hydrofluosilicic acid, supplies us with one of the most convenient methods known of obtaining pure silica.

The object of the mercury in the bottom of the beaker, is to prevent the silicon tetrafluoride meeting moisture till it has issued from the tube. If the latter is dipped directly into the water, it would soon become plugged up by the silica produced and the gas, unable to escape, might burst the test tube or blow out the cork and occasion dangerous accidents.

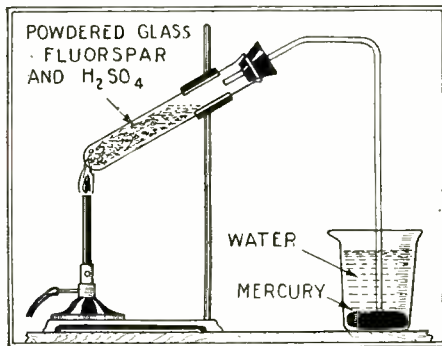

A colorless gas is produced by the reaction of hydrofluoric acid upon a silicate. If this gas is passed through water it is decomposed precipitating silica. A mercury seal is used for the end of the tube as shown to prevent its choking with the silica.

moderately large test tube put a mixture of equal parts of powdered glass and fluorspar with twice the weight of strong sulphuric acid. The test tube is fitted with a one-hole rubber stopper. A glass delivery tube carries the gas down from the test tube to the bottom of a narrow beaker where it is



As the bubbles rise from the mercury, they form curiously shaped tubes, of which one is shown above. Quite a forest of tubes can be produced.

made to dip below the surface of a small pool of mercury. Water is then poured over the mercury so as to form a column of some inches in height above it, and heat is then applied to the bottom of the test tube. The heat causes the sulphuric acid to react with the calcium fluoride (fluorspar) to

A simple method of "re-footing" graduates is shown in the illustration.

The graduate is placed in a shallow tin lid or tin ointment box of the correct size and the lid is then filled with a thick paste of plaster of Paris or melted sealing wax. The graduate should be supported in an

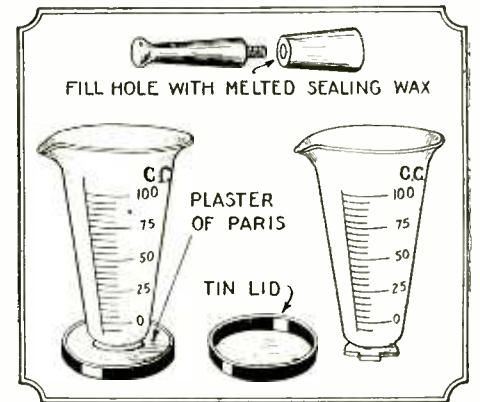

upright position until the material "sets." It will then "stand on its own feet."

The wooden handles on wedge wood pestles often pull out. They are easily repaired by filling the hole in the "butt" end of pestle with melted sealing wax and replacing handle.

Contributed by Forrest K. Green.

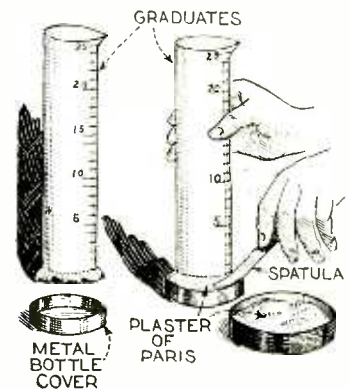

Simple mending operations for the laboratory. With plaster of Paris all sorts of things can be repaired, and it will be found of great use in making up special apparatus. The drawings are self-explanatory. The pestle is mended with sealing wax however. There is one thing to be kept in mind when using plaster of Paris, that it expands on solidifying, and will break a glass vessel if within it. For the outside application it is perfectly safe.

### MENDING BROKEN GRADUATES REPAIRING PESTLES

Quite often the foot on a graduate is broken off, rendering an otherwise good graduate practically useless.



# A Sensitive Bridge Galvanometer

By ERNEST F. SHAWVER

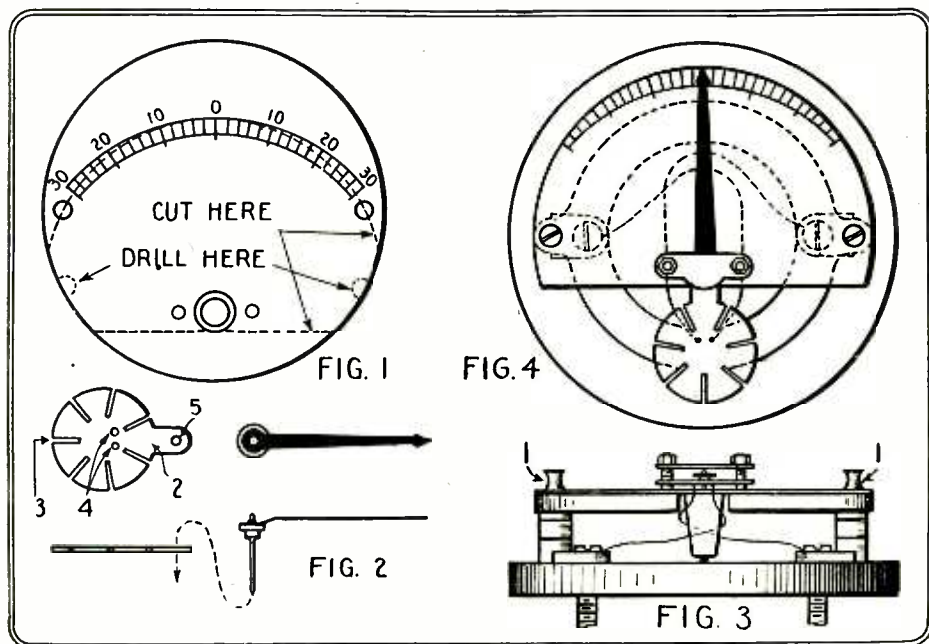

A galvanometer made from a discarded automobile dashboard ammeter; as reconstructed, it is of great sensitiveness and it is designed to be used as the indicating instrument on a Wheatstone bridge.

A GALVANOMETER is an essential part of the apparatus for bridge-testing work, but because of the high cost of this instrument few amateur experimenters can afford a bridge for testing resistances, capacitances, inductances, etc.

A galvanometer that is sensitive to very small currents may be constructed as detailed in this article. This instrument is built from an old Weston automobile dashboard ammeter, that has the zero position in the center of the scale.

Remove the case from the old ammeter and take it apart very carefully. The scale plate and the indicator needle arrangement will come off together when the two screws marked 1, and 1, are removed. Lay this part aside to be worked on later. Remove the permanent magnet from its place by prying under it near the supports—pry a little on each side at a time to prevent bending the supports. Now remove the electro-magnet arrangement by filing the rivet head off

from the back of the base plate of the instrument and discard it with the inside wiring of the meter. Remove the needle and damping device from the scale plate and cut the scale plate as indicated in Fig. 1, in the sketch. The radius for marking the arc over the top of the scale is just a little longer than the length of the needle and the center is a point  $\frac{1}{8}$  of an inch above the needle pivot hole. Cut the bottom of the scale plate off straight as is indicated in the sketch. Great care must be taken when handling the delicate needle indicator as it is easily broken off. Cut the part of the damping device, that is fixed to the shaft, off close to the shaft and remove all the little pieces of iron from the lower end of the shaft. This leaves the indicator needle and shaft ready for the mounting of the coil upon it. It will appear as shown in Fig. II.

The turning element of the instrument is a tiny spider-web coil fixed to the shaft of the indicator needle as shown in the sketch.

The spider-web form or core is of thin celluloid and the outside diameter is approximately  $\frac{1}{2}$  of an inch. Lay the whole thing out on a sheet of celluloid before cutting it out. One segment is left longer than the rest and is shaped as indicated by 2, to fit upon the shaft, and this segment is made narrower than the rest. Set the dividers slightly less than the radius of the form and lay off the segments around the circle, starting at the point 3, and working around the circumference from either side of this point. This will leave the last segment narrower than the rest and that is what is desired. When the form is completed and cut out as shown in the sketch it is ready for the windings.

Wind it full of very fine wire from the secondary of a Ford spark coil making about 50 turns in all. Two holes are then punched in the form as indicated at the points marked 4, and the ends of the winding pulled through them. These ends should be left about four inches long for connecting to the terminals. Punch a small hole at 5, to fit over the shaft. The ends of the winding should be put through their holes in the form and allowed to dangle below. Now the shaft of the needle is slipped into the hole 5, which should grip the shaft tightly. Reassemble the scale plate and the needle with the spider-web coil in place. The whole thing is then put together as before except that the magnet is turned over in order to fit as closely to the coil as possible. Loop the free ends of the winding around to the terminals as shown. Set the center of the coil midway between the poles of magnet and the needle at the zero position. The coil turns against the torsion of the loops of wire which are bent around until the torsion is equal from both sides. Be sure to make this adjustment carefully so that the deflection either side of zero will be the same for the same current.

Replace the case and the galvanometer is completed. It should give good results in any kind of a Wheatstone bridge arrangement in which a galvanometer is used.

### TOOL LIST FOR BUILDING SENSITIVE BRIDGE GALVANOMETER

Tools required for building this Galvanometer embrace pliers, tweezers, hand drill, files, twist drills, screw driver, tinners' snips, hack saw, hammer and center punch.

## Home Made Storage Battery

THE following simple "B" battery has been described by Hans Vatter in a recent German Publication. The example given describes a 60-volt "B" battery requiring thirty cells. The author uses test tubes one inch in diameter and five inches long, and his lead plates are made of sheet lead  $\frac{1}{12}$ th of an inch thick. The lead is cut in strips a little less than one inch wide (2.3cm) and each plate has a lug or ear for the connection. The drawing shows everything. The plates now have to be roughened. They are placed on a flat surface and fine lines are drawn across them using a ruler and a nail and the lines should be close together, sharp on the edges and rather deep. Care must be taken not to go through the plate. By two sets of these scratchings the plate is

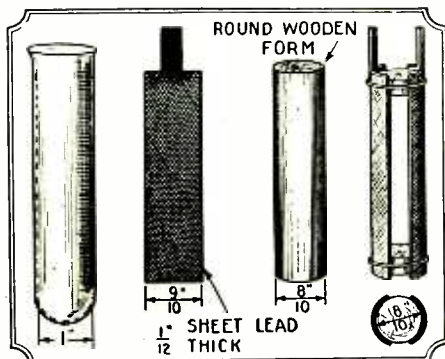

divided up into a sort of little diamonds or dots. The closer these scratches can be given the better, and they must be given with a sharp pointed nail or steel wire. Each plate now has to be bent into a section

This is a plan of construction for a "B" battery, using test tube as the battery jars, as practically only voltage is required with a very slight current.

of a cylinder, and to do this a wooden mandrel eight-tenths of an inch in diameter is used around which to bend the plates one by one or two by two. This can all be done by hand. Next sixty pieces of the same wood, are needed, doweling may be used, each piece to be  $\frac{1}{4}$  inch long, and these



are to be boiled in melted paraffin, or at least heated to a high temperature therein. When thoroughly saturated, they are fished out of the paraffin and "dried" on a piece of paper. Thirty India rubber bands are required to grip the little plates, and as these must be only about .4 of an inch in diameter, they must be made by cutting sections from a piece of India rubber tubing. Two of the little disks of wood, one for the

top and the other for the bottom, hold two of the curved plates apart, and two India rubber bands are sprung around them, and we have our element. A stopper is made for each tube out of two pieces of wood put together with holes for the connecting strips to go through, two for each stopper, and the piece must be also heated in paraffin. As the connecting strips will not fit tightly, there is plenty of chance for the hydrogen

to escape. They are filled with battery acid and the plates are formed in the regular way by successive charging and discharging giving what may be termed a little Plante battery.

**TOOL LIST FOR BUILDING HOME-MADE STORAGE BATTERY**

Tools required for building this storage battery are tinners' snips, scriber, ruler, pan and Bunsen burner, jack-knife, and pliers.

## What Happens in a Condenser

By DONALD H. MENZEL and WINFIELD W. SALISBURY

**T**HE condenser is a very simple and widely used piece of laboratory apparatus yet the theory of its action, as explained in most text-books of physics, is highly complex. In its simplest form it consists of two conducting plates separated by a layer of some insulating substance—glass, paraffin, oil, or air. The so-called Leyden jar, shown in Fig. 1, was one of the earlier methods of constructing a condenser.

Of the various parts of a condenser, the function of the dielectric is the most obscure. When the inside coating of the jar is charged, an opposite charge is induced in the outside coating. The two may be discharged by connecting them. Benjamin Franklin, in 1748, performed a very interesting but puzzling experiment, using the glass jar of Fig. 1. If the conditions are just right, the metal coatings may be removed and found to have little or no charge. They may even be completely discharged by touching, as shown in Fig. 2, put back in place and the jar will be found to have retained almost all of its original charge, giving a considerable spark as shown in Fig. 3.

Franklin explained this by saying that the charge was held in the dielectric of any condenser, as some sort of a strain, and hence remained with the glass when the metallic coatings were removed. In spite of the fact that this explanation cannot be made to agree either with Maxwell's electro magnetic theory, or with Faraday's tubes of force, it has stood for over a hundred and fifty years. It is time that attention be called to the work of G. L. Addenbrooke, M.I.E.E., who has apparently solved the problem completely.

In Mr. Addenbrooke's experiments, the operations described above were repeated with a jar of paraffin instead of glass, as shown in Figs. 4, 5, and 6. The results were exactly those expected from Maxwell's theory. The charge remained entirely on the metal plates and no charge remained after they had been touched. This

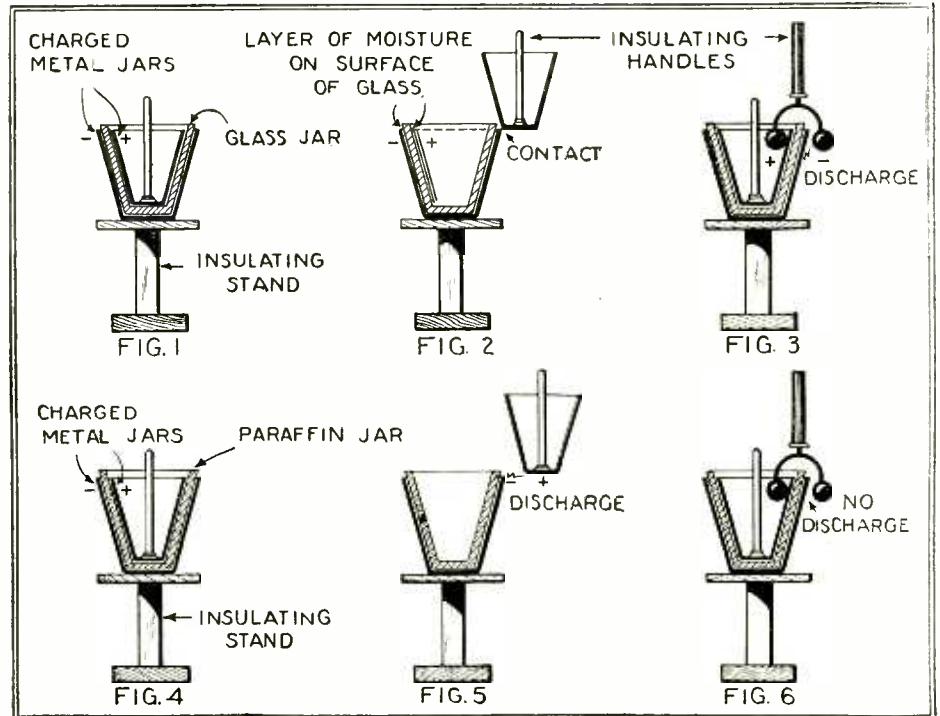

A very interesting set of illustrations of the action of a condenser, bringing out the last theories on the dielectric constant of different substances and the reason for the variations.

led to speculation as to where the difficulty lay with the glass jar. Further experiments, under different conditions, disclosed that when the glass had been thoroughly dried and when the experiment was performed in dry air, it behaved exactly like the paraffin jar.

This, and still further experimentation led to the conclusion that, due to the hygroscopic (water absorbing ability) nature of the glass usually employed in Leyden jars, there exists a conducting film of moisture on the surface which is the actual plate of

such a condenser, and on which the charge remains when the metal plates, which are only as connectors, are removed.

The charge in a condenser is, therefore, due to the presence of electrons on the surface of the conducting plates. This is consistent with Maxwell, Faraday, and the modern electron theory. It is hoped that authorities will soon correct text-books with their misleading impressions of the past, and add this evidence to the consistency of science.

## Arresting the Deflections of a Galvanometer

By SAM FISHMAN

**I**N a laboratory in which many galvanometer deflections had to be read in rapid succession, a novel method was used to bring the under-damped or over-damped galvanometer back to zero. A Faraday's disk was built and placed across the galvanometer terminals and was left in open circuit. After the deflection was read, the disk was put into the circuit and by a slight rotation the galvanometer was brought to zero.

A Faraday disk is used to give a minute current to bring a galvanometer to the zero point after it has been deflected. A very interesting application of this classic instrument.

The Faraday's disk consists of a copper disk mounted on an axis, so that it rotates between the poles of a horseshoe magnet. The edge of the disk dips into a mercury trough. Rotating the disk sets up an induced voltage, and by closing the circuit a small current is obtained.

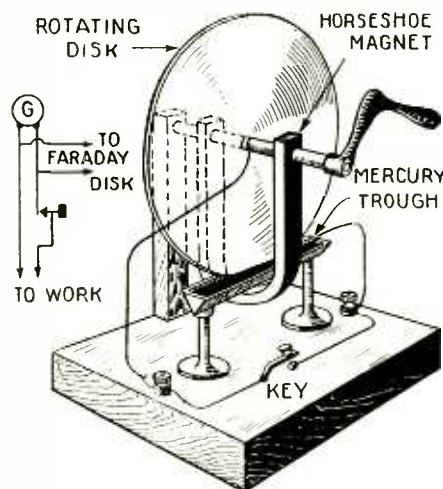

Faraday's Disk is a classic in the history of electricity. Its principal and practically its only use in the past, has been to serve as an experimental demonstration of induced currents. It is reversible, that is to say, it can be used as a generator or as a motor. It is as reversible as the regular wound type of motor operated by the electric current.

The fact that it is weak protects the galvanometer from harm as its incapacity for giving a strong current as well as the lowness of the potential which it generates enables it to serve its purpose—the very features which seem to be its defects telling in its favor. There is very little strain involved in its manipulation.

**TOOL LIST FOR BUILDING FARADAY DISK**

Tools required for building the Faraday Disk embrace hack saw, hand drill and twist drills, files, hammer, center punch, circle cutter or pair of dividers.



# THE CONSTRUCTOR



## “LAB” Apparatus From Toy Girders---

Using Toy Construction Parts for Useful Laboratory Apparatus

By DR. ERNEST BADE

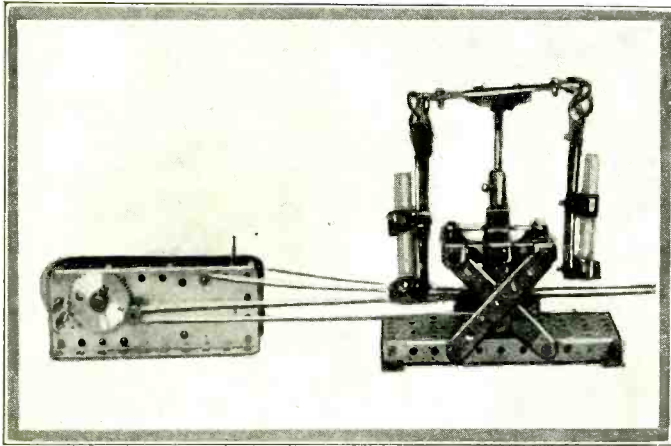

General view of centrifuge and electric motor for rotating it as built by Dr. Bade from toy constructor parts. If good parts are used and properly arranged, the device makes a practical addition to the chemist's laboratory.

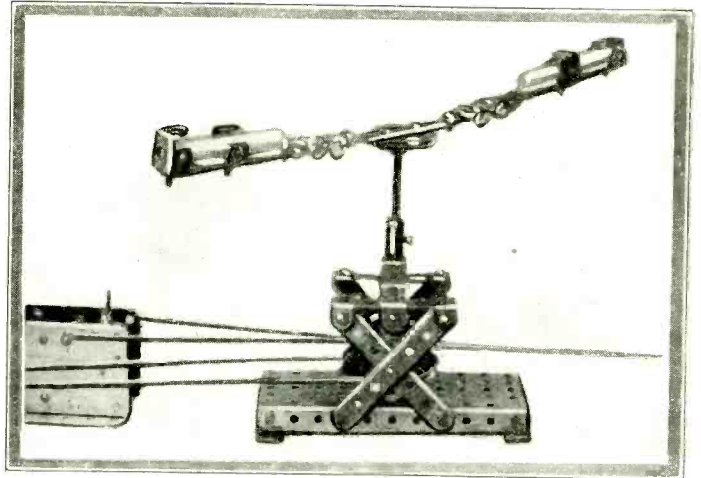

Close-up view of the centrifuge in action, the two test tubes and their contents being rapidly whirled around by the motor seen at the left. The motor may be run by dry cells.

**T**HE better grades of toy construction sets on the market today which are made with precision instruments and incorporate all of the important mechanical devices for reproducing movements can be used for the building of the most complicated structures. Since all of the parts are standards in miniature, they are all interchangeable among themselves and thus make possible the reproduction of model machines, with all the complexity of the original as well as the new devices and new movements.

The child may play with such construction sets and he may even build the most elaborate mechanical devices with all their intricate movements but still it is only a toy. But when he is older and begins to experiment on a more serious scale, these same con-

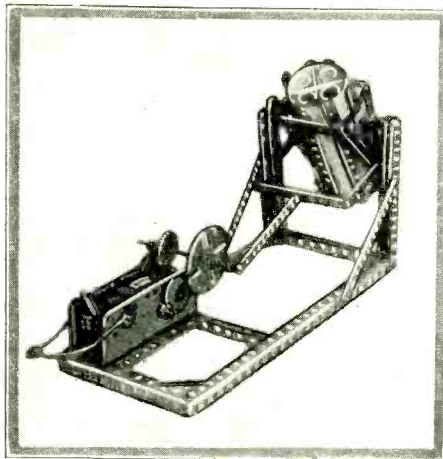
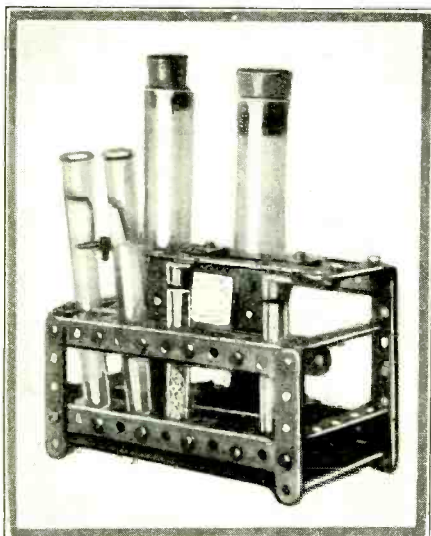

Photo above shows a test tube shaker comprising an oscillating carrier which is moved back and forth by crank connected to a disk on the electric motor.

building what were virtually toys, in constructing instruments and devices which he expects to use in his laboratory.

In the electric motor he has a device that saves him much labor and time in carrying out his experiments and since a powerful motor usually accompanies a toy construction set and since it may be attached in any desired position, he is enabled to build an apparatus which, if he bought it, would cost him so much money, especially if his means are limited, that he would far rather do without it. But still, if he is fortunate enough to have one of these construction sets, he can build the machine or device that he needs most at any given time and, when the need for it has passed, he can take it apart and build an entirely different device. This is a thing impossible with a bought machine. When the use for it has passed,



Toy constructor parts are useful in making test tube rack at left

struction toys are of inestimable value for him. By childhood experience he has realized that all possible mechanical movements may be made with them, that any structure may be made exceedingly strong by the application of sound engineering principles and he will carry out the things he has learned while

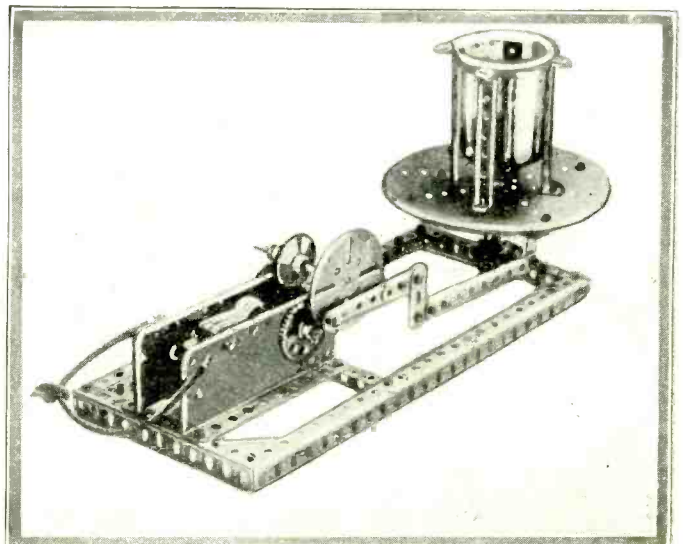

Rotary motion is given beaker by motor-driven device shown.

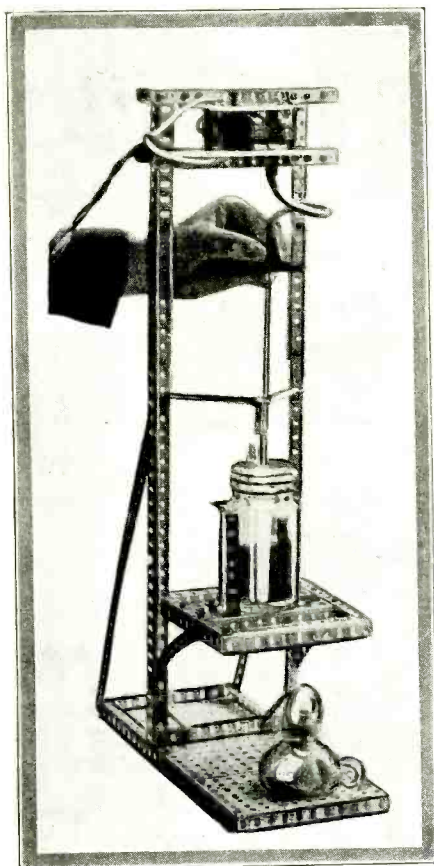

One of the most useful apparatus for the chemical laboratory and also the home is the motor-driven stirrer shown above.

the machine becomes a dust collector of the first order, until it is again pressed into service many weeks and often months later.

One of the simplest devices to make from a toy construction set is a centrifuge and when made with a Meccano set, which contains strong steel strips and brass machine-cut, not stamped, gears which mesh accurately, little vibration is produced. Since the electric motor can be used for many devices, it is mounted to one side so that it may be removed easily and used for other purposes. For ordinary work two test tube holders are usually sufficient although more may be provided. Some of the many uses to which it can be put are rapid settling of fine precipitates, the separation of oils from water and, at times, the breaking up of emulsions.

The construction is very simple. It consists of a base and a pair of uprights, supporting a comparatively long shaft, near the lower end of which there is a pulley wheel, while the upper end carries hinged test tube holders, the hinges being made with bent wires.

Slightly more difficult is the bottle churn for the violent agitation of liquids and the

production of emulsions. This device is nothing more than a small wagon running on a track. The wagon, which must be of sufficient size to hold the bottle firmly, is directly connected to an eccentric or the outer rim of a large wheel by means of a strip or shaft. Then, when this wheel is turned, the shaft is carried back and forth, rapidly throwing the wagon with the bottle first in one direction and then in the other. This keeps the contents of the bottle violently agitated. An electric motor is, naturally, the motive power.

A similar principle is employed for a test tube shaker. Here the test tube can be left open if the contents do not rise more than 2/3rds above the bottom. This keeps the tubes gently agitated. The principle employed is that of the swing, and the gentle sway, although quite fast will prevent the settling of even the heavier precipitates. This shaker is especially adapted for some organic work.

An oscillating rotary movement to a beaker to keep its contents stirred up without spilling is obtained by attaching an arm to a large rotating wheel, an eccentric, and fastening the other end to the outer rim of a horizontal plate. Then, when the motor is running, the arm oscillates back and forth, pull-

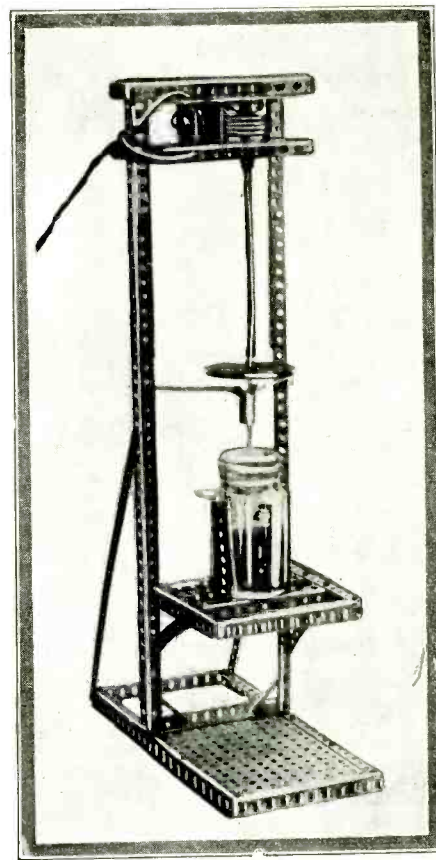

Another view of the motor driven stirrer in operation. Toy constructor parts only are used.

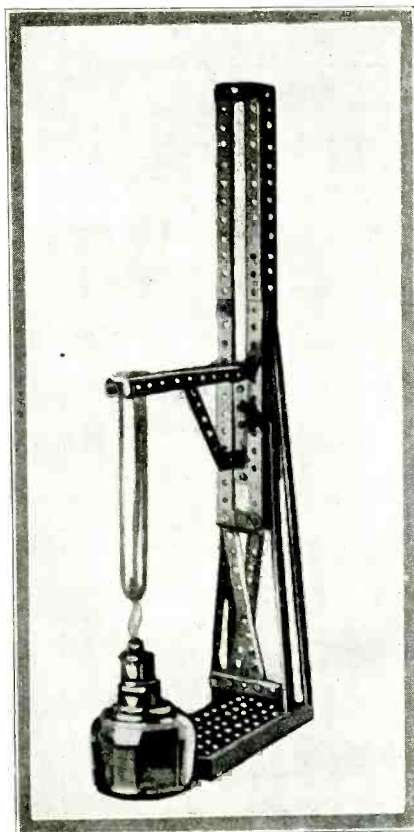

Test tube holder made from toy constructor parts, alcohol flame being used to heat contents of tube.

ing and pushing the plate for a distance of about 1/3 of its circumference about its axis. If now a beaker is placed in a holder attached to the plate the contents of the vessel will be thrown first in one direction and then in the other.

Probably one of the simplest of all devices used in the chemical laboratory is the stirrer. The stirrer itself is a closed glass tube or solid glass rod, bent on its lower back upon itself a number of times. The upper end of the tube or rod is provided with a fly-wheel to make its rotation smoother and it is attached to the motor by means of a piece of heavy rubber tubing extending between glass rod and the hub of the wheel. The rubber permits the stirrer to be lifted up out of the vessel. If desired, the vessel may be placed on a shelf and below it a small flame may be placed to give the contents of the container the benefit of a hot air bath whenever heat becomes a necessity.

**TOOL LIST**

The tools desirable for building the apparatus described here comprise: pliers of different types, several sizes of screwdrivers, back-saw and blades, hammer, hand-drill and twist drills, rule and scriber.

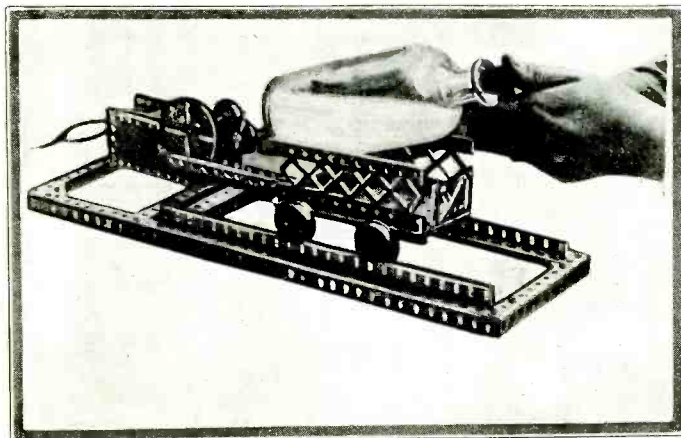

A very useful bottle churn which the amateur chemist can make with little trouble from toy constructor parts, plus electric motor.

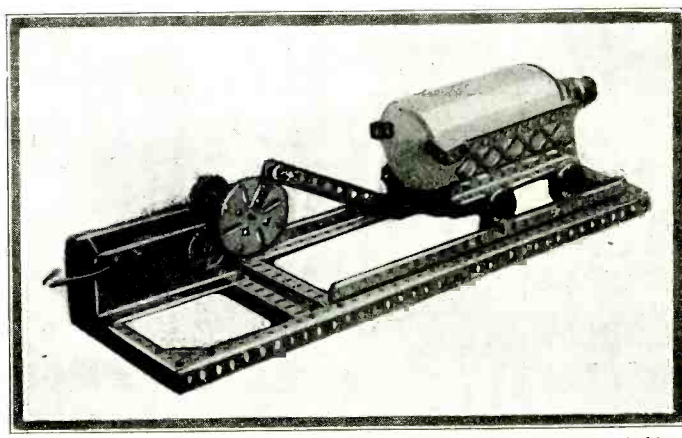

Another view of the electric motor-driven bottle churn, the bottle holder moving back and forth rapidly as the motor turns the crank.



# HOW TO MAKE IT



## CONVENIENT MILKING BENCH

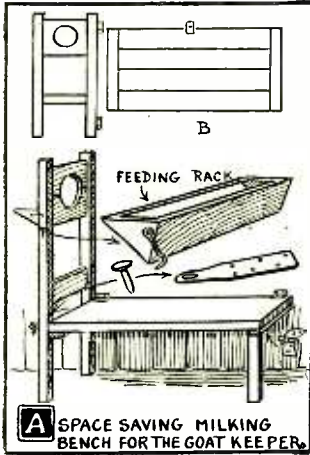

The milking bench illustrated here is very useful where space is limited, as it can be folded up out of the way. It is made from scantling and 1-inch lumber. The leg is hinged so that it can be folded up, and the feed-rack is hung with hooks, to be easily removed when not in use. The device is inexpensive and easily made.—T. Sheward.

## HOME-MADE WATER BOILER

A very good boiler for heating water can be made from an old gasoline drum set in concrete as shown. A hole is made in the top for filling the tank, and a cap placed in one end for drawing off the water. The base is made of cement in which may be inserted a stove pipe chimney and iron door.

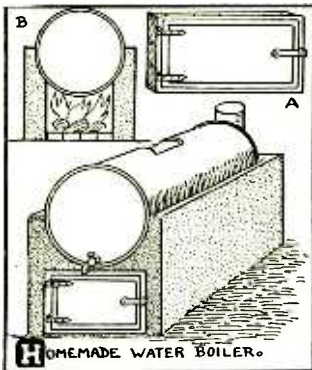

—T. Sheward.

## WOODPECKER'S HOUSE

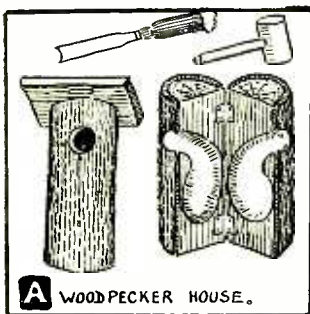

The woodpecker house illustrated is made by splitting a log, gouging it out, and hinging the two parts together. A flat piece of wood or zinc nailed on top makes the roof. It can be fastened up in a tree in the garden.—T. Sheward.

## ROAD SURFACE SIGNS

The ordinary style of lettering is highly distorted when viewed from an angle, so highway engineers have developed a system of perspective lettering, which gives a much greater visibility and readability, for use in road surface signs.

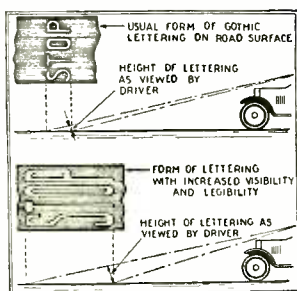

—G. A. Luers.

## CEMENT HANGING BASKET

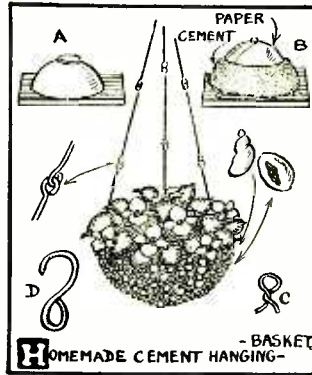

HOME-MADE CEMENT HANGING-BASKET

The hanging basket shown here is made by placing a bowl, A, on a piece of wood, covering it with paper, building cement over this and allowing it to dry for a few days. Three parts sand and 1 part Portland cement are mixed to a thick mortar and later decorated with shells and colored stones. C and D show wire fittings used.

—T. Sheward.

## DRILL AND CULTIVATOR

Another seeder which may be adapted for use as a cultivator can be constructed by following the design given at the right. The details of construction are also given. The seeder may be used as a cultivator if an old buggy tire is shaped as at C and fastened in place of the seed-tube.—T. Sheward.

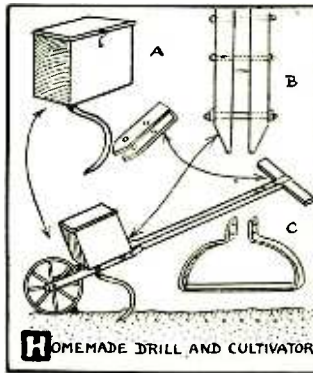

HOME-MADE DRILL AND CULTIVATOR

## RABBIT HUTCHES

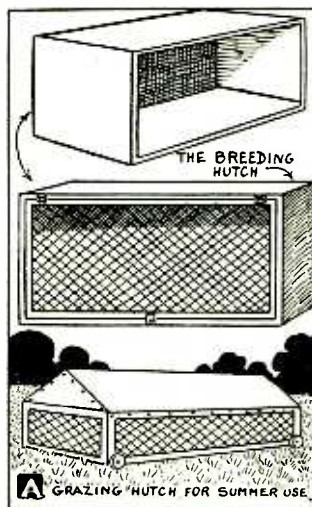

The drawings at the left show inexpensive breeding and grazing hutches for the rabbit fancier. They are constructed from light packing cases and enclosed at the sides and bottom with strong wire screen. It is well to keep in mind that rabbits can burrow out of an enclosure in a very few minutes, which makes it necessary to take unusual precautions against escape.—T. Sheward.

## CHEAP EXERCISING MACHINE

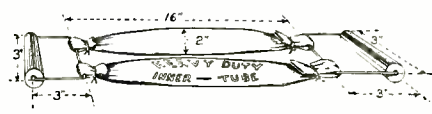

Two heavy inner tubes connecting strong pail-handles make a very useful "muscle stretcher" for the amateur gymnast.—Einer Lehti.

## HOME-MADE SEED DRILL

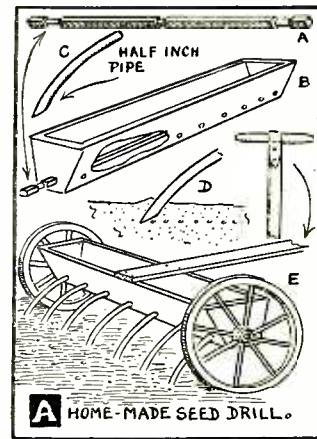

HOME-MADE SEED DRILL

A very useful seed drill can be made from two old wheels, a box, and some pieces of scantling. The seed trough is made from light lumber, short pieces of half-inch pipe are bent and sharpened to cut into the soil, and are placed in holes in the seed box. The square axle runs through the seed box and agitates the seeds as the seeder is pushed along.

—T. Sheward.

## HOME-MADE HOT WATER FURNACE

A good hot water furnace for heating green houses can be made of concrete at a very low cost. A coil of pipes A, supported as at B on iron bars over the fire, E is the flow, D the return, and C the cold water inlet. The rise in the flow pipe will reach a maximum, some 20 feet.

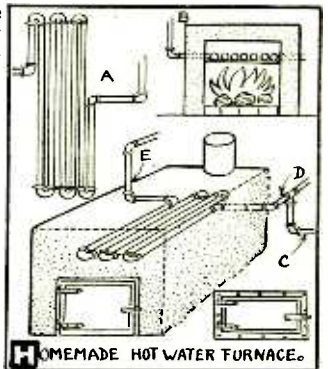

HOME-MADE HOT WATER FURNACE

—T. Sheward.

## SODIUM FLAME GENERATOR

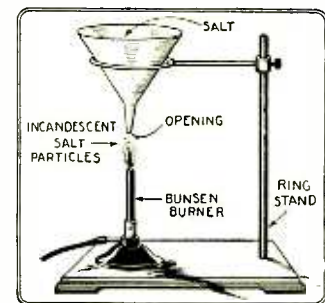

The chemical experimenter often finds it necessary to produce a yellow sodium flame for study with a spectroscope, but is handicapped by lack of apparatus. A very good bright yellow flame will be produced by the device shown here.—F. Ebel.

## RUSTIC BIRD HOUSE

This rustic bird house is made of nine-inch cedar slabs nailed to two pieces of half-inch dressed lumber six inches in diameter. When finished it is hung in a tree in the garden and is a suitable home for wrens.

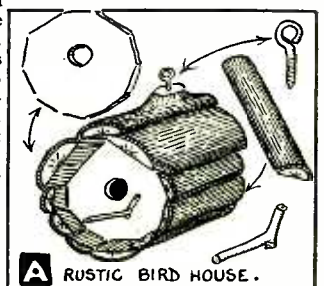

RUSTIC BIRD HOUSE

—T. Sheward.



# WRINKLES

## RECIPES & FORMULAS



Edited by S. Gernsback

### Repairing Leaky Carburetor Float

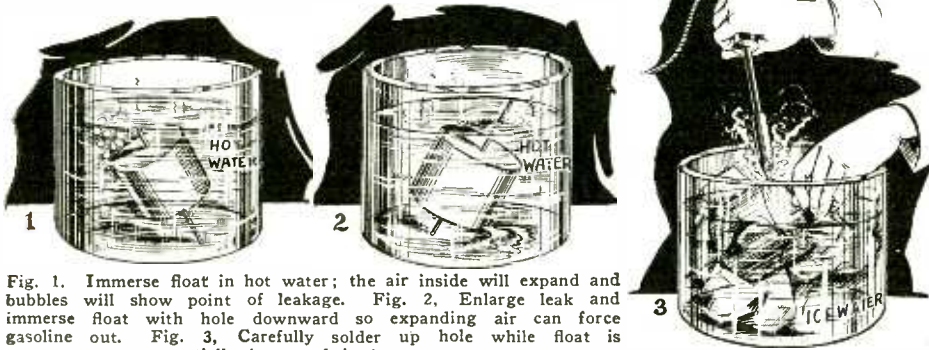

Fig. 1. Immerse float in hot water; the air inside will expand and bubbles will show point of leakage. Fig. 2. Enlarge leak and immerse float with hole downward so expanding air can force gasoline out. Fig. 3. Carefully solder up hole while float is partially immersed in ice water.

### Keeping Salt Dry



A tumbler placed over the salt shaker during the period of rainy weather will prevent the moisture in the atmosphere from causing the salt to cake. Another method is to mix a small amount of cornstarch with the salt to prevent it from absorbing moisture.

### Poison Bottle Marker



A rubber band  $\frac{1}{4}$  to  $\frac{1}{2}$  inch wide has a number of carpet tacks shoved through it from the inner side. The tacks are spaced about  $\frac{1}{2}$  inch apart and afford an excellent protection, by serving for warning as to the contents of the bottle.

### Easily Made Hat Rack

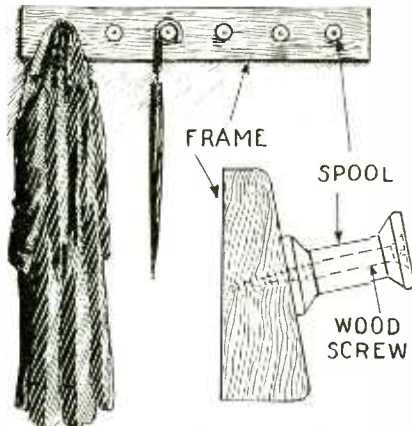

A very effective rack for hats, umbrellas, coats, etc., may be made from thread spools fastened with long woodscrews to a narrow board. The heads of the screws may be countersunk, and a sloping front to the board will improve the appearance.

### Oiling Aerial Pulleys

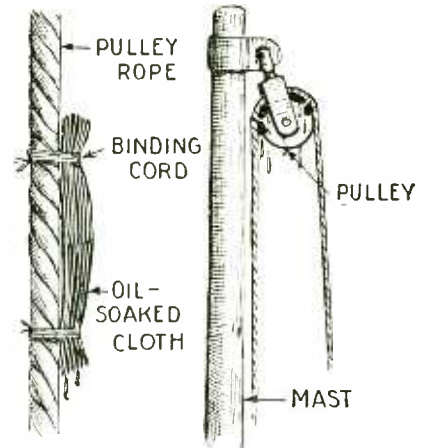

Pulleys which are hard to reach from the ground may be easily oiled by binding a small piece of oil-soaked cloth to the rope and pulling it through the pulley.

### Razor Blade Knife

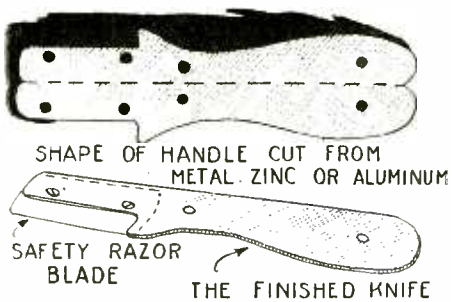

A piece of thin metal may be cut and bent as shown above to form a handle for discarded safety razor blades, which will permit them to be used for numerous small jobs about the house.

### Improvised Bunsen Burner

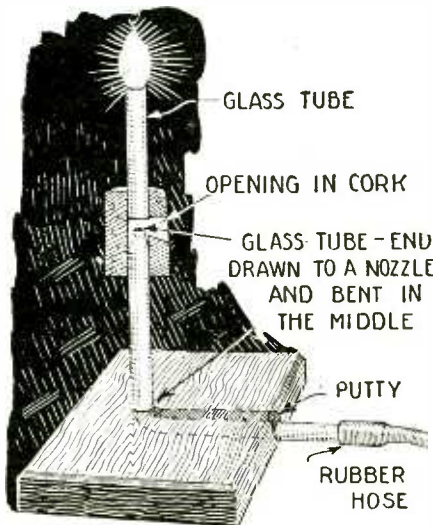

Where a small hot flame is required, the Bunsen burner illustrated above may be quickly improvised. A piece of  $\frac{1}{4}$ -inch glass tubing is bent at right-angles and one end is drawn to a fine nozzle. Another short piece of straight tubing is inserted into a cork cut as shown, to admit air for a proper burning mixture. The assembly is mounted in putty on a wooden baseboard for stability.

### Reducing Motor Carbon

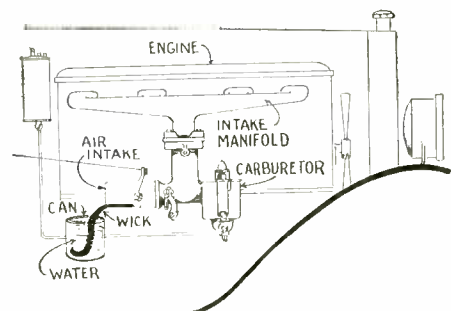

An ordinary lamp-wick, one end of which is inserted into the intake manifold of the automobile carburetor, is placed in a can of water anchored securely to the cowl. Moistening the air supply reduces carbon and improves general efficiency.

### Small Parts Vise

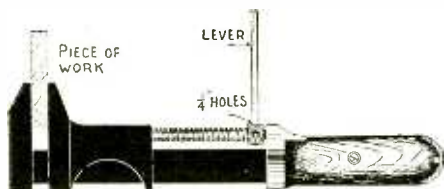

Four holes drilled into the adjusting screw of a large monkey wrench will permit the use of a lever for gripping small parts.

### Emergency Terminal

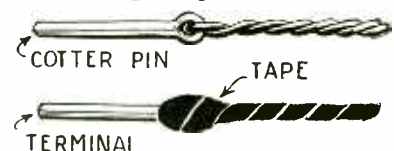

A large cotter-pin may be used as above to furnish an emergency terminal tip.

## NOAH'S ARK.

Editor, SCIENCE AND INVENTION:

In the October issue of SCIENCE AND INVENTION Magazine, I notice that the Ark story takes an important place. The article takes up the question as to whether the Ark was large enough to hold all of the animals. The article seemed to sustain its point; the possibility of Noah's Ark. How about its probability?

According to the Bible story, the descendants of Adam had just become too wicked for any use at all, so God decided that he would have to drown all of them except Noah and his family, who alone deserved to be saved. Noah, it seems had been a bachelor for five hundred years, but he finally decided to marry and raise a family. So it was in his six hundredth year that he completed the Ark and fitted it for a most momentous voyage. The Ark was five hundred feet long, eighty or ninety feet wide and fifty-five feet high. There was one door on the outside and one window twenty-two inches square. This establishes Noah as the world's foremost authority on ventilation. Into this Ark Noah ushered two of each kind of animal on the face of the globe. (The earth wasn't exactly a globe then, according to the Bible. It had four corners, and was flat. Copernicus started the movement to change the shape from flat to round.) There were no plants saved; evidently there were no xerophytes or mesophytes in those days. Beyond all doubt, Noah had quite a task counting out the thousands of mammalia, reptilia, and insecta, but the separation, two by two, of the tiny protozoa, without even a semblance of a microscope, puts Noah far above our best protozoologists. As a man of keen sight and meticulous observation and perseverance, Noah deserves our everlasting homage.

It must have indeed been an unforgettable sight to see all of those animals gather, prior to entering the ark. The polar bears probably came all the way from Greenland. Friendly animals probably informed them of the exact whereabouts of Noah. The kangaroo probably hopped all the way from Australia. The American animals had to swim across the Atlantic, a feat that puts all channel swimmers in the shade. When the animals were all safely aboard the ark, and the door and window were shut, then the rain began. Forty days it rained until the water covered the highest mountains. On the average, the water was about five and a half miles deep. It had come down at the rate of over eight hundred feet per day, which is going some for dampness. The story says that the windows of heaven were open. It looks as though a couple of doors were also open. After cruising around for one hundred and ten days the good ship ark finally came to rest on top of Mount Ararat, a peak seventeen thousand feet above the sea, crowned with three thousand feet of snow. We imagine that the tropical animals enjoyed coming out of the ark in a climate so different from their native habitat. The American mammals probably had to borrow the ark to go back home in. That would have been lots better than swimming back.

Further on the story says that God put a rainbow in the sky, saying: "When I see that I will recollect that I have promised not to drown you." There are other rainbow theories, but you can readily see that this is the only true one. Scientists can say what they please, but the meaning and cause of rainbows needs no study. The question has already been settled.

Perhaps other readers have probed the Ark story with deeper insight. Their opinions of this marvelous narrative ought to be highly interesting and instructive to every intelligent man, especially those very numerous readers of SCIENCE AND INVENTION Magazine. JOHN G. JACKSON, JR.,  
New York City

(Your letter of September 24th to hand, and we would make the following reply in regard to your questions concerning Noah's Ark, the article on which appeared in the October issue of SCIENCE AND INVENTION Magazine.

Most of your questions concern of course the possibility that Noah's Ark was actually built, and how Noah, even with considerable help perhaps managed to gather all the animals from the far ends of the earth.

This is a very large subject, and as you will remember in reading our article we did not take up any such issue as the possibility or impossibility of Noah having constructed the Ark, and having gathered animals from various parts of the earth in accordance with the Biblical tale. We wish to preserve our absolute neutrality on this point, as it seems to us from our extensive experience with subjects of this nature, that it is up to the individual in every case, and it really amounts to a question of personal religion as to whether the individual cares to accept or reject the story of Noah and his Ark.

There are many devout students of the Bible, referring for the moment to the so-called modernists, who do not believe in all the Bible tales, such as Noah's Ark, the virgin birth of Jesus Christ, and many other narratives which appear in that venerable book. The fundamentalist, on the other hand, would have everyone swallow every tale in the Bible just as it is written. Our viewpoint is that the fundamentalists are partly right and so are the modernists, and as you will at once see, it is splitting hairs pretty fine and treading on



SCIENCE AND INVENTION desires to hear from its readers. It solicits comments of general scientific interest, and will appreciate opinions on science subjects. The arguments pro and con will be aired on this page. This magazine also relishes criticisms, and will present them in both palatable and unpalatable forms. So if you have anything to say, this is the place to say it. Please limit your letters to 500 words and address your letters to Editor—The Readers Forum, c/o Science and Invention Magazine, 53 Park Place, New York City.

dangerous ground indeed for anyone to take a given stand and say he believes this and does not believe that, et cetera.

Many of the questions raised in your letter are answered from a scientific point of view in a very excellent article which contains the transcription of a very ancient stone tablet just deciphered by the archeologists of the University of Pennsylvania, this article having appeared in the Sunday American Magazine for Sept. 12th, 1926, copy of

**AMAZING STORIES** IN THE DECEMBER NUMBER:

"THROUGH THE CRATER'S RIM," by A. Hyatt Verrill. A brave explorer sets out to find an entrance into "The Lost City" and the story tells of his exciting and dangerous adventures, his experiences in the lost city and his timely rescue from these strange people.

"THE FIRST MEN IN THE MOON," by H. G. Wells. This is undoubtedly one of the greatest moon stories ever written. It is safe to say that only a Wells could think of the most amazing creatures that he describes so vividly. Don't fail to read this amazing story.

"THE TIME ELIMINATOR," by Kaw. This is a scientific love story. By utilizing light waves produced in the remote past, the events of preceding centuries and years are thrown upon a screen and a bride is won thereby; but how?

"THE SECOND DELUGE," by Professor Garrett P. Serviss. The second installment of this engrossing story. Read about the Noah of the future, who built his ark out of a marvelous light metal of the coming ages.

"THE DIAMOND LENS," by Fitz-James O'Brien. This is one of the world's classics in the realm of scientific fiction.

PRICE 25c PER COPY  
AT ALL NEWSSTANDS

which you can obtain through your news dealer. According to the translation of the characters on this most interesting tablet, the ark as built by Noah, was about twice the length of the ark mentioned in the Bible narrative. This of course simplifies the matter of taking care of all animals that existed in Noah's time and the necessary food.

There are a number of other very interesting scientific points brought out in this article as follows. Drinking water for the animals could have been obtained by gathering rainwater from the upper deck and cabin roofs of the ark. Noah probably did not select two of the largest specimens of each species, but picked out young animals which would occupy far less space than full sized adults. Another important point is that these small animals would eat much less food, and during the year's sojourn on the ark they would also hibernate and sleep for many months no doubt. Plant life would not be destroyed by the flood, at least the roots and seeds, and these would take care of themselves when the waters receded. It is also interesting to consider that after thinking over the above statements, that as the small animals grew larger during their sojourn on the ark, and the food took up less and less space, this automatically provided more space for the growing animals.

If you have talked to many Bible students and preachers of the Gospel of the present day, you will no doubt obtain a much wider viewpoint of all things pertaining to the Biblical tales, chief among these being the fact that many of the passages in the Bible were no doubt written many years or centuries after they oc-

curred, and those who wrote them finally did so from memory and from tales handed down through generation after generation of people. Another salient point to be remembered, as many modern preachers of the gospel have rightly stated, is that a great many of the tales which we read today in the good book were written in a time far different from ours, and for an oriental people who had to have stories told or written in a big way to stir them. As one eminent preacher put it, there is probably a gist of truth behind each of the Biblical wonder stories, such as Jonah and the Whale and Noah's Ark, but the actual facts in the case have probably been changed somewhat as they were handed down generation after generation, and finally recorded for posterity by some scribe, who decided to write it in a clay tablet or in some other form, years after the actual occurrence of the event.

The trouble with many students of the Biblical tales of miracles or near miracles is that they fail to think for a moment that the earth was probably far different in its land and water make-up than it is at present. In a very interesting article which appeared in "The Scientific Monthly" for July, 1925, you will find some wonderful food for thought, and some scientific data which will no doubt change your opinion as to how Noah might have gathered the animals to the ark and also, which is just as important, how the animals were probably distributed after the Noachian Deluge. One scientist's belief is that North and South America were once joined to Europe by a land bridge, or in fact constituted an actual part of Europe and Africa. Unless we find some much older records than have so far been unearthed by our archeologists, we will probably never know just exactly the arrangement of the continents and seas on the earth thousands of years ago. Some letters we have received talked in terms of 4,000 years B. C., or a total of 6,000 years since the beginning of the earth, according to the Bible. People who mention such facts as these are not thorough students of the Bible and apparently do not know that the dates given beside the various passages in the Bible are those suggested by Bishop Ussher quite some years ago. The Bishop was an excellent student of the Bible, but in many ways the dates as suggested by him have caused more trouble than they have good. The date of the Noachian Deluge is probably far earlier than we at present suspect. We shall probably never know from what year or century the early facts stated in Genesis were handed down though hundreds and perhaps thousands of generations before they were recorded for posterity.

Great earthquakes, the close approach of heavenly bodies and other vast and titanic astronomical events could and no doubt did occur, which caused mountains to be thrown up, and even continents and seas to be changed, as the centuries went by.

Another view often taken of such Bible narratives as that of Noah and his Ark, is that it is quite conceivable that the civilized world as Noah knew it was a very small section, probably as big as Europe today. This would make it comparatively easy to gather the various specimens of animals, insects and reptiles. Another important scientific consideration, based upon evolution, is that Noah need not necessarily have had to gather two or more of all the mammals, insects and reptiles we know today. On the theory of evolution, it is at once conceivable that with a relatively small number of mammals and other forms of life, the world could easily have been repopulated by the production of new species as the years went by. This could not have occurred in 4,000 years to any great extent perhaps, but no one has proved or probably ever will prove that Bishop Ussher's 4,000 B. C. marks the beginning of the world. This figure is purely arbitrary. According to our geologists, the Noachian Deluge and repopulation of the earth may have occurred a million years ago or fifty million. No one will ever know.

We have received hundreds of letters about the Noah's Ark story, but most of them deal with, we might say, almost a personal aspect of the narrative as we mentioned previously, i. e., it really depends in the final analysis, on the individual viewpoint in every case. We note from many of the letters that the writers apparently did not accept the Noah's Ark story at all, and we have nothing to say of course in that respect, and could not if we cared to, if we follow the ethics of the editorial profession in getting out a non-sectarian magazine such as SCIENCE AND INVENTION. It is well to remember, if you have any religious faith at all, that many things could happen under the Divine influence that simply could not occur or happen from the cold scientific point of view, as entertained by some of our modern students on such matters as these.

It is well we think, to take a broad general view of the whole situation, and not try to consider a subject like Noah's Ark, or any of the other Biblical tales from a cold scientific point of view, which is quite likely to be too materialistic. In other words, such an investigator will tell you that what he cannot see logically or otherwise could never happen. Miracles are happening today just as they did thousands of years ago, and just because we know a good deal more of science in all its branches today than our forebears, is no reason why at all that we should sit on a throne and condemn everybody else's opinion, even if it was expressed in writing centuries ago.—Editor.)

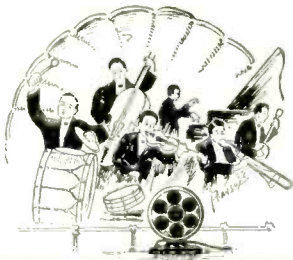

# RADIO

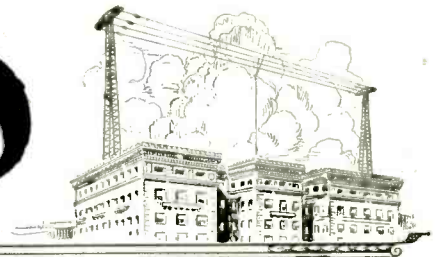

## WRNY Changes Transmitter Location

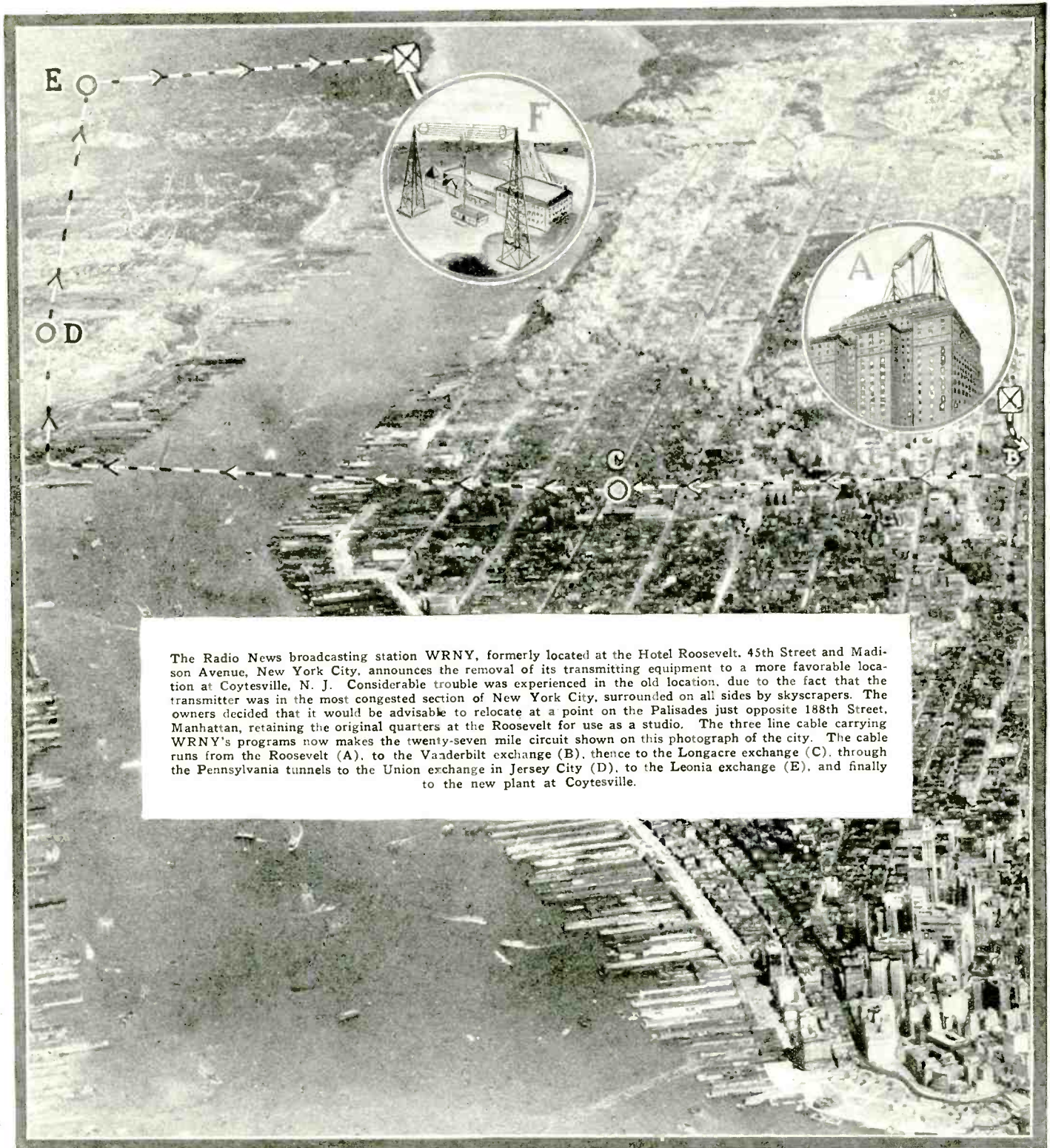

The Radio News broadcasting station WRNY, formerly located at the Hotel Roosevelt, 45th Street and Madison Avenue, New York City, announces the removal of its transmitting equipment to a more favorable location at Coytesville, N. J. Considerable trouble was experienced in the old location, due to the fact that the transmitter was in the most congested section of New York City, surrounded on all sides by skyscrapers. The owners decided that it would be advisable to relocate at a point on the Palisades just opposite 188th Street, Manhattan, retaining the original quarters at the Roosevelt for use as a studio. The three line cable carrying WRNY's programs now makes the twenty-seven mile circuit shown on this photograph of the city. The cable runs from the Roosevelt (A), to the Vanderbilt exchange (B), thence to the Longacre exchange (C), through the Pennsylvania tunnels to the Union exchange in Jersey City (D), to the Leonia exchange (E), and finally to the new plant at Coytesville.

The next time you hear the voices of SCIENCE & INVENTION Magazine's editors, you will be listening to WRNY from its new location to which it was recently transferred at a cost of \$15,000.00. The antenna,

527.5 feet above the Hudson River, points directly across the Metropolitan district, and assures our listeners of a more satisfactory reception with less interference and, we hope, greater DX.

# Six Tube-Shielded T.R.F. Set

Three Stages of Shielded Radio-Frequency Amplification, a Shielded Detector Circuit, But Only Two Controls Are Features of This Exceptional Broadcast Receiver.

By A. P. PECK, Assoc. I.R.E.

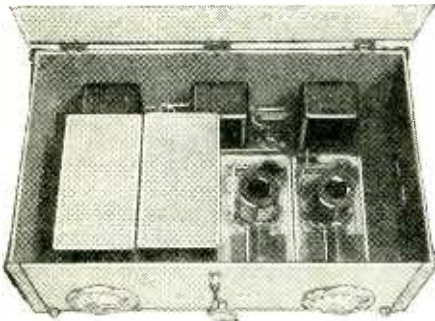

Fig. 5. One of the features of the World's Radio Fair was this two-control shielded set in its beautiful mottled green cabinet made of milk.

At the recent World's Radio Fair at the New Madison Square Garden, New York City, one of the radio receiving sets which attracted wide interest made use of a novel circuit and a very unusual assembly of apparatus. Furthermore, the cabinet and dials were of such a distinctive appearance that they caused extensive comment. Probably very few of the people viewing the exhibit realized that the material used for both the cabinet and dials was *milk*. This material, with its mottled surface is made by a special process from the casein contained in milk. The set under discussion was constructed by Mr. L. A. Brams of Brooklyn, N. Y., and uses a 6-tube circuit having several novel features.

The illustration, Fig. 1, shows the outward appearance of Mr. Brams' set. Probably the average radio constructor will not want to go to all the trouble of making a special cabinet and dials such as were used in this receiver, so it may be said here that these materials have no effect on the set itself. Therefore, we will forget that this unusual receiver was housed in an unusual cabinet, and will consider the other mechanical and the electrical details.

Possibly the very best panel to use for this particular receiver is that recommended by the manufacturer of the parts, namely a copper, brass or aluminum panel suitably

drilled. A standard wooden cabinet of any desired design may be employed.

Reference to the complete circuit diagram in Fig. 2 will make plain most of the details of the receiver. Specially designed and constructed plug-in coils are used. The antenna coil used for tuning the first stage of radio frequency amplification has a tapped primary. This is connected to a two point switch, the blade of which is connected to the antenna. By means of this switch, the set can be adapted to use with a long or short antenna. Nor is the manipulation of this particular part confined only to this purpose. It is often found, in tuning, that selectivity can be sharpened and volume improved by throwing the switch from one point to the other. This particular unit is the one seen in the lower left hand corner of the panel in Fig. 1.



Fig. 1. This photo shows the fine appearance of the panel and hand-carved dials which attracted a great deal of attention at the show.

Due to the necessity of very careful design and construction of the coils used in this set, no winding data is given. Because three of the variable condensers are actuated by one control, a slight variation of the characteristics of one of the coils will mean that the tuning will not be right. Therefore, machine-made manufactured coils are to be preferred and recommended. For the benefit

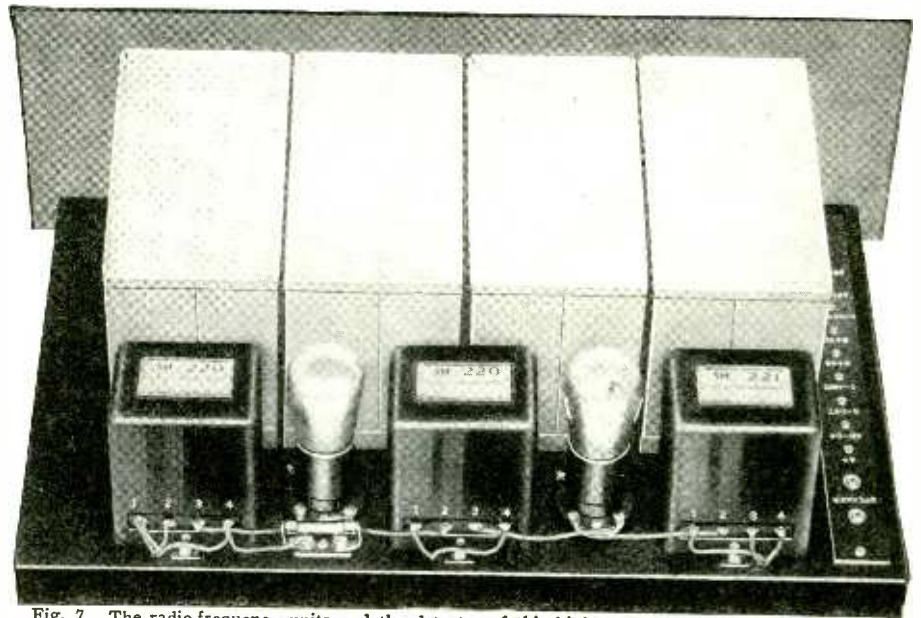

Fig. 7. The radio-frequency units and the detector of this highly efficient set are completely encased in heavy aluminum shields. The shields are made sufficiently large so that they do not broaden tuning by altering the fields of the radio-frequency coils.

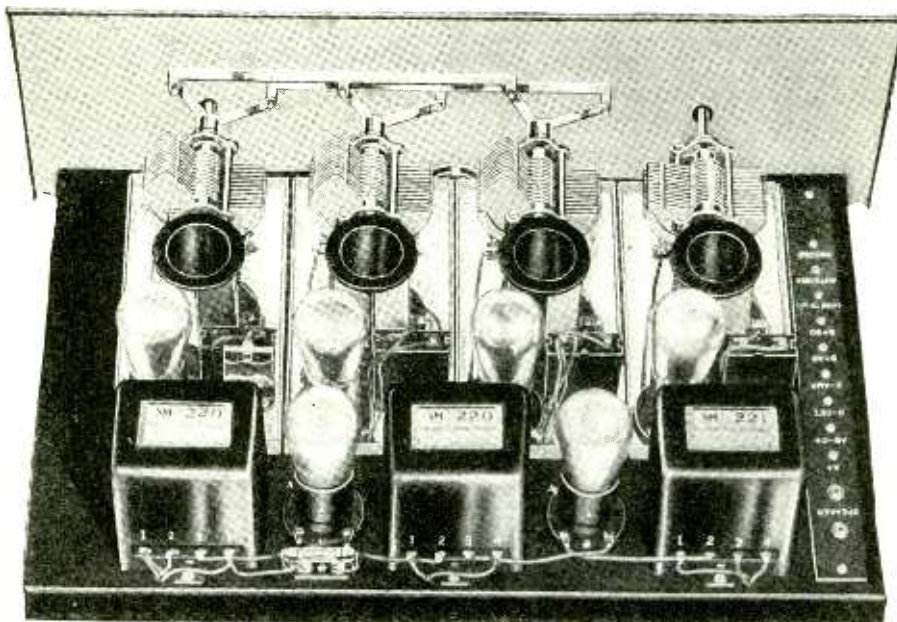

Fig. 6. When the shields are removed, it is seen that the units are neatly and efficiently arranged. The yoke coupling three of the tuning condensers may be easily discerned in this photo.

of the readers who are not sure as to where the coils and other parts can be bought, we will mail a complete list of parts on request by letter to the Radio Editor.

Referring again to the circuit given in Fig. 2, we note that the shields which completely enclose the various stages of radio frequency amplification and the detector are indicated by dotted lines. Also be very careful to note that certain connections terminate at the shields. These shields are furthermore all connected together, and therefore may be considered as a continuous conductor. The negative filament circuits are grounded at various points, in this way continuous connection being made between the negative "A" battery and the ground. Note that the connection from the ground binding post is merely made to the shield. The other shield connections complete the circuit.

All of the coils employed in this receiver have three windings. In the case of the detector circuit, one of these windings is not employed. There is, on the other hand, a small radio frequency choke coil of standard construction connected in the plate circuit of the detector tube.

In the three radio frequency amplifiers, a coil closely coupled to the grid circuit is connected in series with the plate circuit.



This is used to obtain an additional amplifying value, and when the coils are properly designed and connected, exceptional results are noted with this form of apparatus. It will be noted that the radio frequency amplifiers are stabilized by means of grid resistances and further by means of a 25,000-ohm potentiometer connected in the plate circuit of the first radio-frequency tube. Also, rather large by-pass condensers are connected from the shields to the positive "B" battery terminals. These are of great value in stabilizing the set and keeping it in a stable operating condition. Failure to include these condensers will result in poor reception.

Without a doubt, today is the era of standardization in radio material. There is no longer any need of searching from store to store in order to find certain parts. Kits supply everything. All of the parts for this particular receiver under discussion can be obtained very readily. Furthermore, it is no longer necessary for you to construct a base board and fasten all the parts to it. A complete metal chassis can be obtained and all of the instruments bolted thereto. This metal chassis simplifies construction to an enormous degree, and enables even the veriest tyro to turn out a receiver which will compare favorably with the very best of manufactured sets.

The simplicity of the entire lay-out will become noticeable at once by reference to the various photographs in Figs. 3 to 7, in-

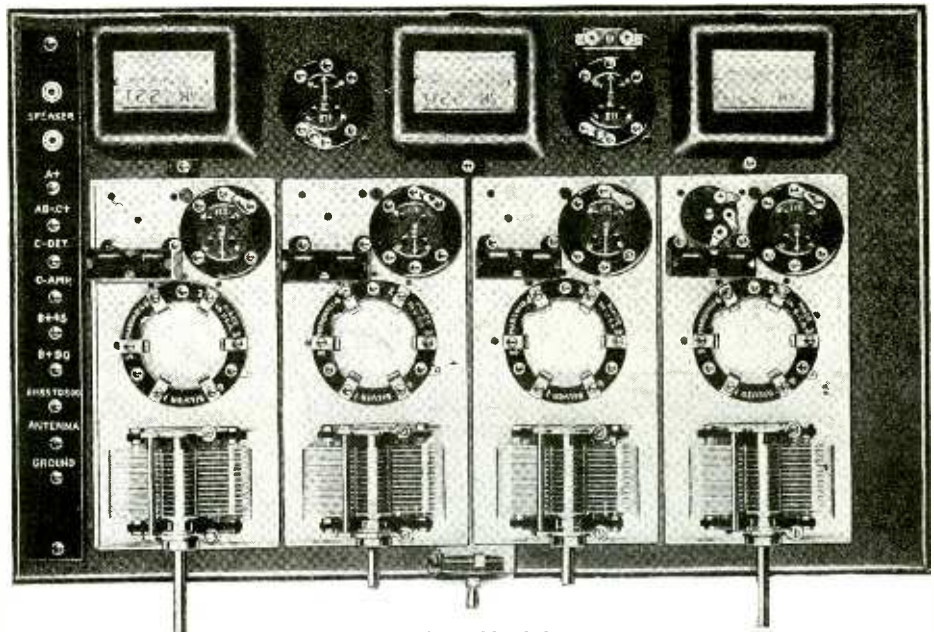

Photos courtesy Silver-Marshall, Inc.  
 Fig. 4. A bird's-eye view of the baseboard with tuning coils and tubes removed from their sockets. The wiring is carefully placed out of the way under the base. Panel and cabinet are not essential.

Fig. 3. A close-up of one of the radio-frequency units. The mounting of the variable condenser, coil-socket, tube-socket, grid-resistance and by-pass

condenser is so arranged that there is no appreciable coupling or capacity effect between the elements in the unit. Several stages of R.F. may be used.

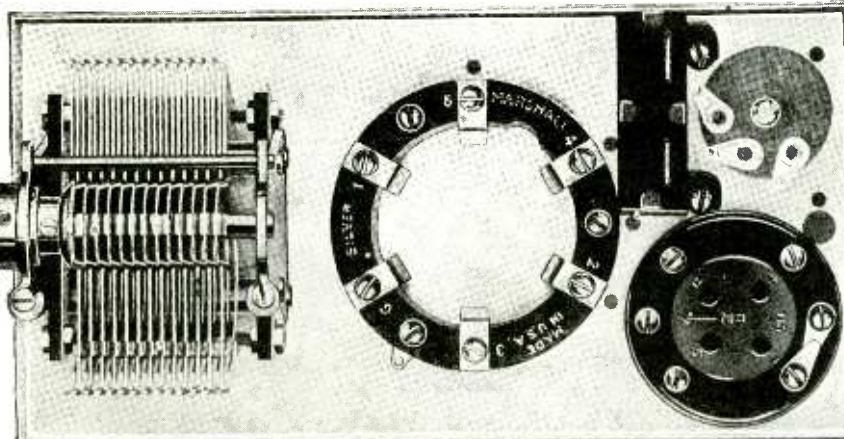

and strong both mechanically and electrically. Fig. 3 shows a single one of the shielded units with the outside "can" or over-all

is the special socket designed for receiving the plug-in coil. At the extreme end of the metal base is mounted the variable condenser.

Referring to the photograph shown in Fig. 4, we find a view of all of the parts. They are laid out on the metal chassis and are bolted down, but have not yet been wired. A special terminal strip mounted at the left end of the chassis provides for all terminals. Two cord-tip jacks are included for loud speaker.

Fig. 6 shows yoke making it possible to operate three of the four variable condensers with a single control. As will be seen, this yoke is fastened to the shafts of three of the condensers. Two of these have short shafts which do not project through the panel. The third one, on the extreme left in the photograph, has a long shaft which projects through a collar in the yoke and through the panel.

One of the tuning dials is fastened to the outer end of this shaft. The other is mounted on the right hand condenser which also has a long shaft, but which is not fastened to  
 (Continued on page 743)

clusive. Fig. 5 again shows the novel cabinet employed by Mr. Brams in the construction of the original receiver, and shows how the complete set, assembled on the metal chassis, fits within the cabinet. It will be noted that everything is extremely compact

shield removed. The particular unit illustrated is that used for the detector. The circular object in the corner nearest to the vacuum tube socket is the choke coil, mounted on end. Next to it is a fixed condenser of 1-mf capacity, and next to this

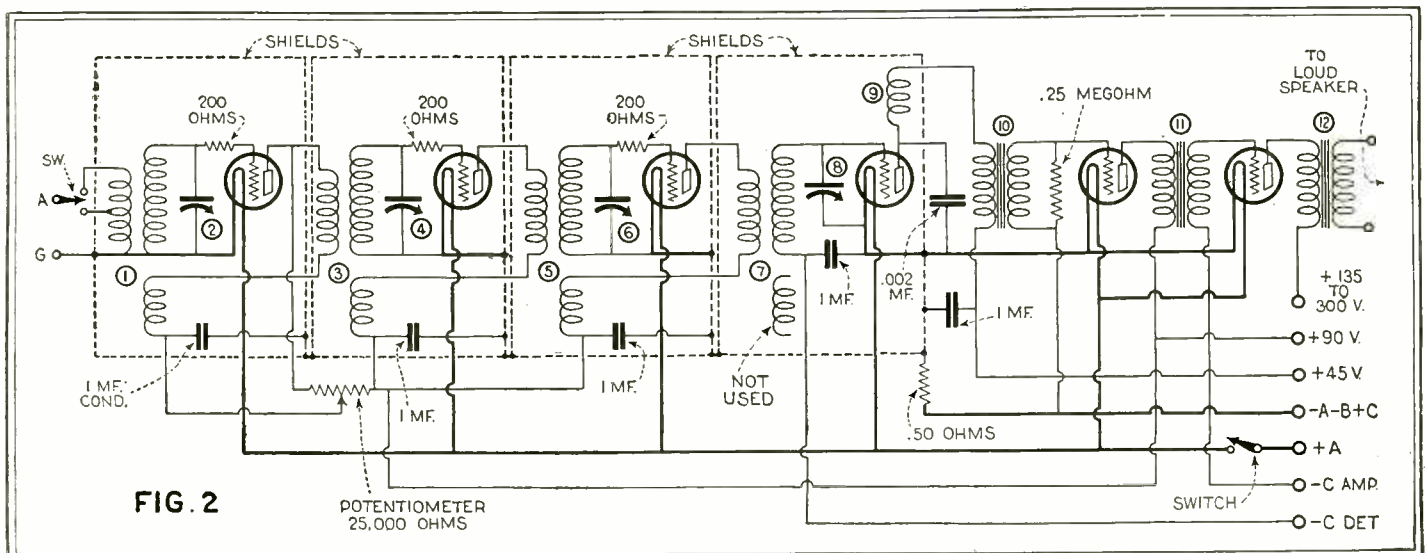

Fig. 2. The diagram above contains all the details of the circuit using the set described in these columns. Three stages of tuned-radio-frequency,

detector and 2 stages of audio-frequency amplification are employed. The set is remarkable for its sensitivity, selectivity and tone quality.

# Sir Oliver Lodge's "N" Circuit

Latest Circuit Gives Extreme Selectivity, Sensitivity and Volume

By JAMES FRANCIS CLEMENGER

CONSIDERABLE interest has been aroused in all classes of British amateurs by the announcement of a new invention by the oldest and most famous of British radio pioneers, Sir Oliver Lodge, F.R.S. Sir Oliver's invention, which has been temporarily named the "N" Circuit, has now been taken up for

of one definite frequency into great amplitude by sympathetic tuning, and to transmit these enhanced oscillations of potential, and no others, to another circuit in which they are utilized; for example, a three-electrode tube or a crystal detector.

According to the patent taken out by Sir Oliver Lodge, an important application of

the invention is to receiving apparatus for radio work where it is claimed its use secures high selectivity combined with strong and clear signals, without the use of regeneration and with the exclusion of extraneous noises. The transmission of the enhanced oscillations, continues the patent specification, may be effected by direct connection or

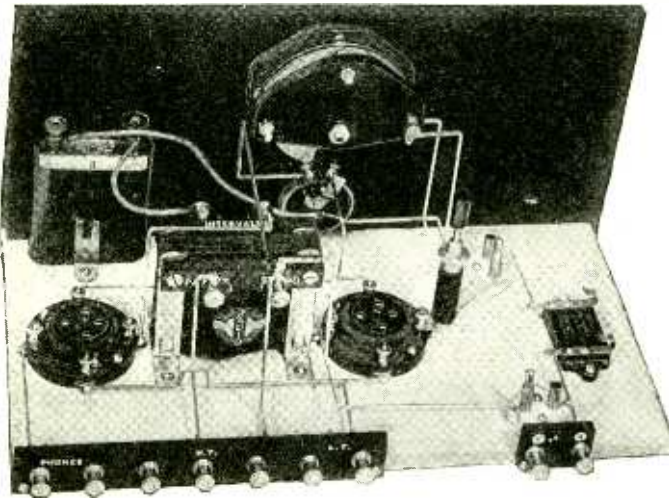

Fig. 5. This photo shows the rear of one of the commercial "QN" circuit sets recently placed on the market by an English firm.

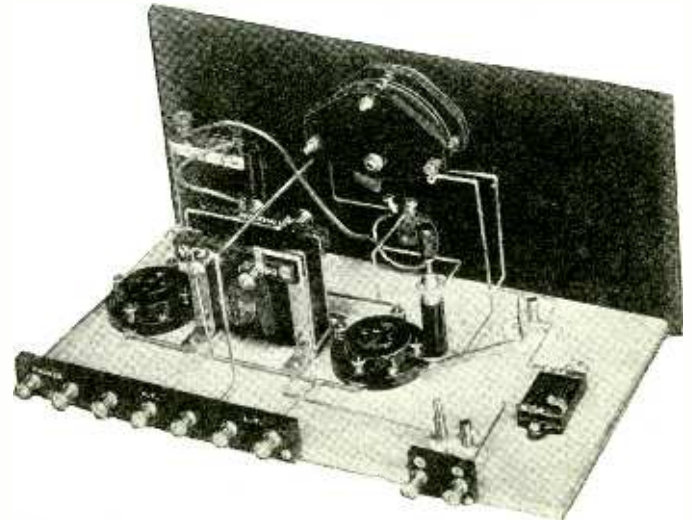

Fig. 6. Another view of the same set showing its extreme simplicity. In both these photos the coils are omitted for clearness.

commercialization by a well-known British radio firm, and a few weeks ago the first commercial models of two-valve and three-valve "N" circuit receivers were on view to the public at the British Radio Exhibition at Olympia. Public demonstrations have been given and the press have been invited to attend demonstrations, and all the newspapers in the country have remarked in highly favorable terms on the "N" circuit. So much so, in fact, that I understand that large orders have already been placed by dealers "on the other side" who realize that the "N" circuit is a type of receiver which will make a tremendous appeal to the ordinary listener. And the reason for all this great interest is that Sir Oliver Lodge has devised a circuit which does away with the bugbear of oscillation.

My American readers do not need telling that there is nothing new in doing away with oscillation and howling in a receiving set, but I think they will agree with me that such sets, which do away with these bugbears, are generally multi-tube receivers, and that when regeneration is cut out of a tube set the loss in volume has to be made up in extra tubes for amplification.

And furthermore, such receivers are, as a rule, not exactly easy for the absolute novice to control. One of the great points about the Lodge "N" circuit receiver is its simplicity. On the commercial sets which I have inspected there is one tuning condenser and one switch for turning on the filament. That is all. And this simplified receiver will undoubtedly make a very great appeal to listeners, not only in this country, but in other countries, who do not like complicated switches and knobs on their radio sets.

Sir Oliver Lodge's invention may be described briefly for the benefit of the technical reader as follows: The invention consists in the use of a free, uncoupled low-resistance oscillatory circuit, capable of very exact tuning, to be stimulated by oscillations from any place where oscillating currents are passing, or where there is an oscillating potential, to work up oscillations

Through the efforts of our London correspondent, who is in contact with Sir Oliver Lodge, we are enabled to present to our readers the first authorized, accurate description of the famous Lodge "N" circuit to be published in this country. The set illustrated and described here is designed for British conditions, but the information given will be sufficient to give the experimenter a start.

In the January issue of **SCIENCE AND INVENTION** Mr. Clemenger will present a complete constructional article upon a highly efficient American adaptation of this revolutionary circuit. The most important highlights of this set are:

1. Simplicity
2. Selectivity
3. Sensitivity
4. Superior signal strength.

**DON'T FORGET: A FULL CONSTRUCTIONAL ARTICLE IN THE JANUARY ISSUE.—**  
The Editor.

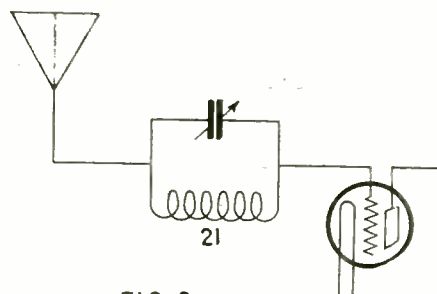

~ FIG. 3 ~

Fig. 3. This diagram illustrates the essential principle of the new circuit, and is taken directly from the letters patent issued to Sir Oliver Lodge. See text for a thorough explanation of the theory.

by coupling, provided the oscillator is only coupled to a detector which takes so small a current as not to interfere with its free oscillation. It is a transmitter of *alternating potential* rather than of alternating current.

In Fig. 1 the aerial (1) and inductance (2), condenser (3) and ground (4) represent any ordinary aerial circuit while (5) is the filament, (6) the grid and (7) the plate of any ordinary tube. The filament of the tube is supplied with current from a battery (8) through a resistance (9), while a pair of telephones (10) shunted to a condenser and "B" battery (11) complete the plate circuit. In this diagram a connection is made from the aerial circuit to the grid of the tube and in the usual way through a grid leak and condenser, and in the connection between the aerial circuit and the filament there is inserted the oscillatory circuit "N," which consists of a condenser (12) and inductance (13), one or both of which may be variable. The chief point of the invention lies in the provision of the oscillatory "N," and here it may be stated that it is also possible to insert the oscillatory "N" in the connection to the grid of the tube instead of in the connection to the filament.

But Sir Oliver Lodge points out that this form of the invention must not be confused with the well-known use of so-called rejector circuits.

Fig. 2 shows another well-known form of receiving circuit consisting of a closed oscillatory circuit (15) tuned and coupled to the open aerial circuit. (In the patent it is emphasized that the invention is entirely independent of this part of the system, since it may be supplied to any usual receiving system such as a frame aerial, and even allows the use of an untuned aerial without earth connection).

Fig. 2 shows a diagram with a tube (16) used for high frequency amplification. Its grid and filament are joined across the oscillator (17) which corresponds with the "N" in Fig. 1. One point in this oscillator is joined to a point in the stimulating circuit and the connector used for this purpose may

be quite long provided the capacity between it and neighboring bodies is kept small. This single connection is enough to set up oscillations which build up by resonance, and they must not be disturbed by any other association with the stimulating circuit, as any accidental coupling of the oscillator with the stimulating circuit tends to nullify the effect.

Fig. 2 also illustrates the manner whereby it is possible in this invention to convey impulses from one tube circuit to another. The oscillator (18) which again corresponds with "N" in Fig. 1 has a single connection to the plate circuit of the tube (16). This circuit is shown as including besides a "B" battery an oscillator circuit (19), but other usual methods of plate circuits will do. In order to illustrate the different methods of connecting the oscillator "N," the second tube (20) is shown not connected directly across the oscillator (18) but magnetically coupled with it, the inductance of the oscillator forming one winding of a transformer which may, if it is desired, step up the voltage.

The aerial circuit is merely a means of collecting an alternating potential and conveying it to the oscillator, and it is not

To have an oscillator of low resistance accurately coupled; (2) to excite oscillations in this by a

The coils and tubes are shown in place at right. The simplicity of this set is really amazing when its results are considered.

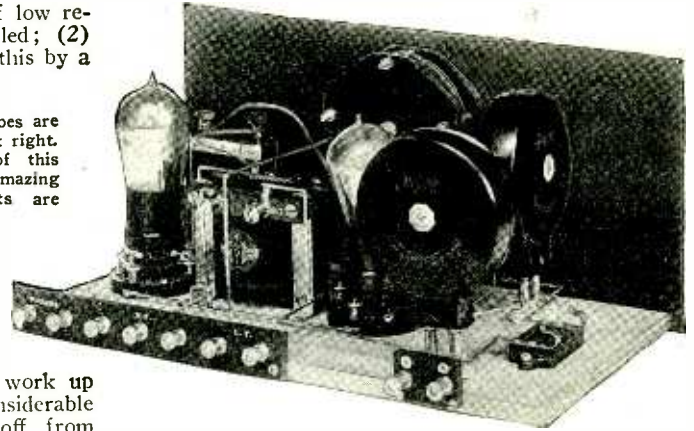

"collector" or aerial or by a single connection to a stimulating circuit, so as to leave the oscillations free to work up by resonance to a considerable strength; (3) to tap off from this resonance-amplifier the alternating potentials desired for any purpose, such as the working of a crystal or a tube. Furthermore, the working up of a feeble alternating potential to a stronger alternating potential of a constant frequency by the use of a low resistance resonating circuit capable of precise tuning, having only a single connection with the conductor in which the feeble

The third claim—a method of supplying voltage-impulses from a circuit in which oscillations occur to a vacuum tube or to the high resistance detector which consists in placing in the connection between the said circuit and one terminal of the detector, an oscillatory circuit tuned to the frequency of the incoming signal, and not otherwise coupled to the circuit in which the oscillations occur.

And, finally, a method of supplying impulses of a particular frequency collected from space to a vacuum tube which consists in joining to the grid of the tube a low resistance freely oscillating circuit tuned to the incoming frequency, and joining an opposite point of the said oscillatory circuit to a collector or aerial with no ground.

While I have not given the precise constants for the construction of any of the circuits involving the new invention, the experimenter will find it easy to try the circuit out by using standard values of inductance and capacity, as each oscillatory circuit has approximately the same constants as those of the secondary circuit of the usual regenerative receiver.

Fig. 4 shows the hook-up of a British-made two-valve "N" circuit receiver. This receiver has only one main control for tuning, and that is the variable condenser shown in the actual "N" circuit. The coil "A" is wound with fifty-five turns of insulated wire, this being sufficient to cover the British broadcast wavelength band of 300 to 500 meters, while the "N" circuit coil has one hundred and twenty-five turns. The latter coil is tuned by a parallel variable condenser with a capacity of .0001-mfd., and I have found in actual test with this receiver that extraordinarily selective tuning can be obtained. The fixed condensers shown across the primary of the audio-frequency transformer winding have been specially fitted to the commercial Lodge "N" sets in order to switch from the ordinary British broadcast wavelength bands of 300 to 500 meters to the 1,600-meter wavelength of the high-power station.  
(Continued on page 745)

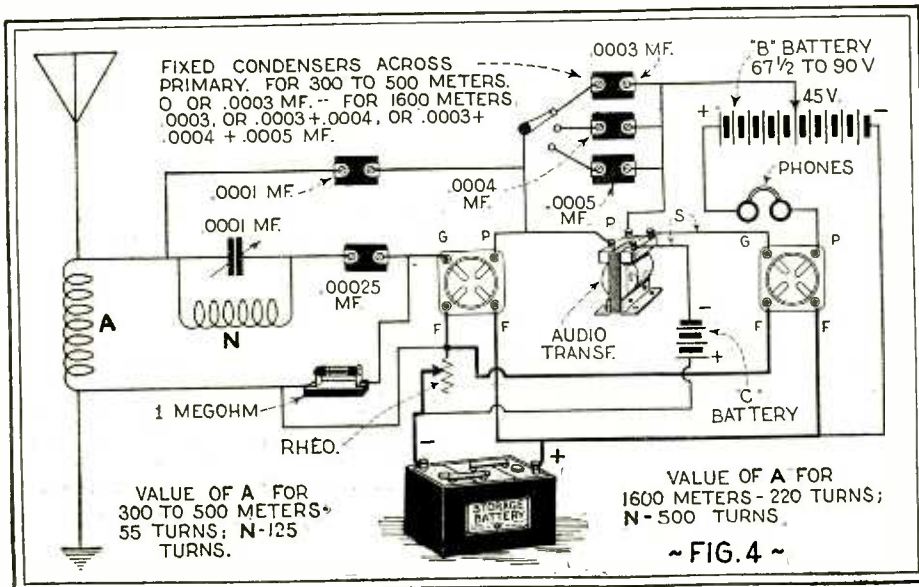

Fig. 4. The circuit used by the manufacturer of the set illustrated in this article is shown above. The circuit may be easily adapted for use on the American wavelengths.

necessary to have an accurately tuned aerial circuit nor is it necessary to have a ground connection to any part of the apparatus.

Fig. 3 shows the oscillator (21) connected on the one hand to a single aerial wire which is termed in the Patent Specification a "collector," and on the other hand to the grid of a tube, the plate and filament circuit of which can be wired up in the usual way.

In his final patent, Sir Oliver Lodge sums up the essence of his invention as follows:

alternations of potential occur. That is the first claim.

The second claim is: In radio receiving apparatus the combination with a tube or crystal detector of a low resistance oscillator circuit, connecting across the grid and filament of the valve or across the detector tuned to the frequency of the oscillations to be amplified or rectified and joined by a single connection to the aerial circuit from which the oscillations are derived.

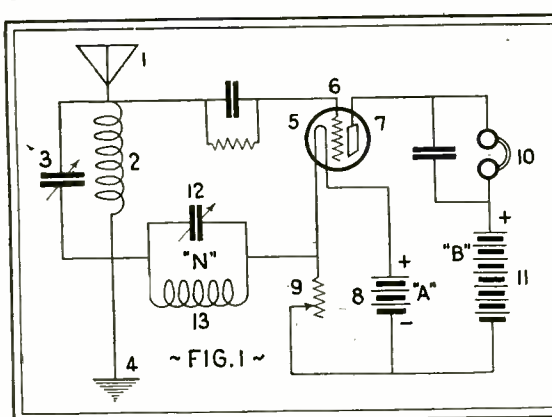

Fig. 1. One of the simplest circuits using the new principle is shown by the diagram of the 1-tube set shown above and explained in the article.

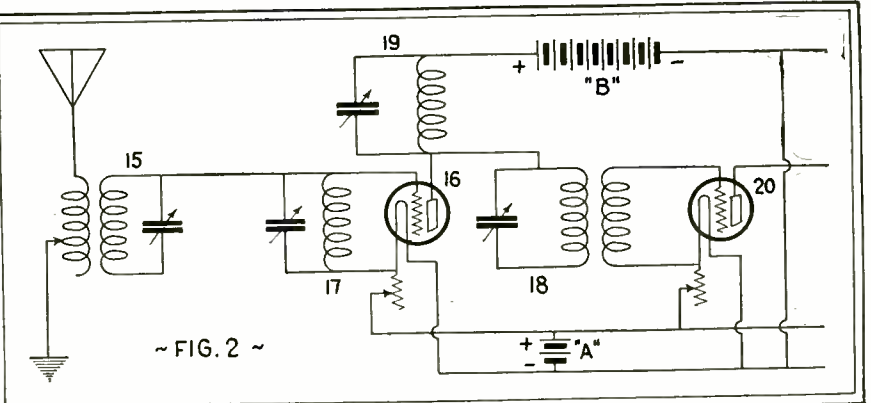

Fig. 2. The "N" circuit may also be adapted to radio-frequency amplification. The various types of coupling are illustrated here.

# RADIO ORACLE

In this Department we publish questions and answers which we feel are of interest to the novice and amateur. Letters addressed to this department cannot be answered free. A charge of 50c. is made for all questions where a personal answer is desired.

## EFFICIENT VOICE AMPLIFIER

(513) Q. 1. G. Dussan, Cincinnati, Ohio, wants to know how to amplify the sound picked up by a Skinderviken or similar microphone transmitter button.

A. 1. The following dimensions are furnished by the manufacturers of the Raytheon tube. Transformer core 7/8 square, as shown here. Primary 1140 turns No. 28 enamelled copper wire. Tap at 910 turns.

Two halves of secondary should be balanced for voltage output at full load output within two per cent.  
Choke Coils—Core 7/8" square, same design. 5800 turns No. 28 enamelled copper wire on each coil.  
D.C. resistance of each coil is approximately 190 ohms.  
Laminations are assembled to form a butt joint, with .003" insulated air gap.

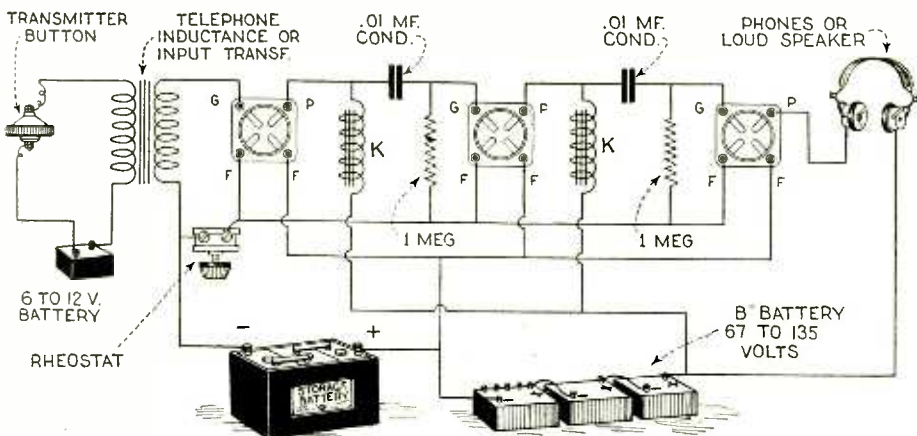

The amplifier shown here is designed to build up the sound picked up by a microphone so that it will operate a loud speaker. Impedance coupling is used to reduce distortion, and the amplification obtained is about equivalent to two stages of transformer-coupled amplification.

A. 1. The diagram given here has been found very effective for all types of amplification at voice frequencies, particularly in the case being considered, where the current to be amplified originates in a microphone circuit. The amplification is sufficiently great to make it possible to use the apparatus in many interesting experiments.

Secondary 4200 turns No. 31 enamelled copper wire. Tap at center.  
Wound in layers with .0015" paper between layers.  
Electrostatic shield between primary and secondary (.005" copper).

## MULTI-TUBE NEUTRODYNES

(514) Q. 1. John C. Hays, Indianapolis, Ind., asks: Why is it that a neutrodyne with five stages of radio-frequency amplification has not been put on the market? Would such a set be a success?

A. 1. We consider your inquiry very interesting. Sets having more than four stages of radio-frequency amplification are available, but there are no neutrodynes among the lot. Some of the points are:

1. Two stages require three dials; five stages, at that rate, would necessitate six dials! Take too much time to tune. One-dial controls are easy, in the laboratory. When it comes to commercial production, we have "an equine of a differing hue." A two-dial arrangement might prove practical, after a great deal of experimentation, but there would be plenty of work before the set was ready for the public. It takes a mighty good one-dial set, where the one dial operates two controls, to equal a 2-dial set where each dial has but one control.

2. Some current supply units will work well with five tubes but poorly with eight. The eighth tube also means added expense (the tube price) and battery consumption (if batteries are used) would be more.

3. Tube noises would be more pronounced. Detector tube would often be overloaded, resulting in distortion. Audio amplifier would have to be a wonder to be really efficient, if the set were to include two stages of audio, for both tubes and transformers would have a terrific load when locals were operating.

4. If set is made on low-loss lines, one would have to put a "ring door-bell" sign out, and hope the signals could read, for the selectivity would be so high that it would take considerable time to tune in wanted signals originating at a distance of more than, say, 150 miles. Anyone who has tuned a neutrodyne can appreciate this.

5. Every stage requires neutralization. This is more or less easy to do at home, given all the time, knowledge and patience necessary for success. But to do this rapidly and certainly in production is an entirely different matter. Then again, a set balanced in the factory test-rooms would not necessarily be balanced (neutralized) when entirely different tubes and batteries are used by the broadcast listener.

6. There is the amount to be added to the purchase price of the set, due to several additional production costs. Considering everything, there would probably be a sale for a set having five stages of radio-frequency amplification, neutralized, if the above stated objections were overcome. The most important points we should say, would be (a) to keep down the number of tuning controls and (b) to have a resulting efficiency greater than could be secured by the use of a lesser number of tubes.

## TRANSFORMER AND CHOKE DESIGN

(515) Q. 1. Mr. Edwin Thompson of Wichita, Kansas, asks for the dimensions of form and winding required for B-battery eliminator, transformers and filter chokes.

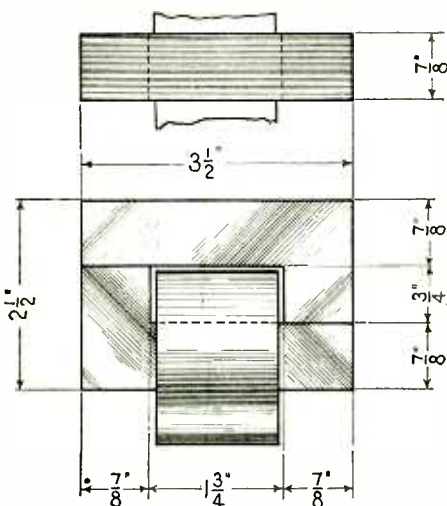

The form above is that recommended by the manufacturers of the Raytheon tube for chokes and transformers in their "B" eliminator circuit.

Core material is Apollo special electrical steel No. 29 gauge. Laminations are assembled to give staggered air gaps.  
Primary d.c. resistance is approximately 25 ohms.  
Secondary d.c. resistance is approximately 300 ohms, total.

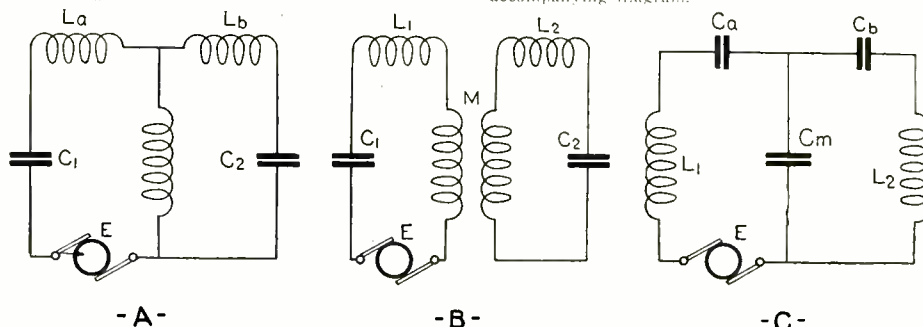

The three types of coupling used in transferring energy from one circuit to another are shown above. A indicates the type known as direct coupling, where the circuits are connected together by conductors. B illustrates inductive coupling, while C represents capacitive coupling.

## BROADCASTING STUDIOS

(516) Q. 1. Fred T. Barton of Chillicothe, Ohio, asks: Please describe the construction of a modern broadcast station studio.

A. 1. The walls may be constructed of gypsum block. Over this is placed a layer of lith. This is a sound absorbing material. It is also applied to the ceiling. A triple wall construction should be used. Between the walls a thick layer of sound-deadening material is laid. The furniture should be wood-doweled, not nailed.

Q. 2. Should draperies be used to prevent echoes?

A. 2. A certain amount of reverberation is required. By use of a partial drapery, the correct balance between reverberation and a total absence of echo may be easily obtained. If the special wall construction described above is used, no drapery is required.

Q. 3. What is the difference between reverberation and echo?

A. 3. Reverberation is a type of echo so closely spaced to the original sound that the separation cannot be detected by the ear. An echo is so timed that the separation can be readily detected.

## DIFFICULTIES IN TRANSMISSION

(517) Q. 1. Miss Nancy MacDonald, New York, N. Y., asks: What are the difficulties in transmission of radio signals which cause varying ranges of reception, etc.?

A. 1. There are three principal sources of trouble encountered in practice which make it difficult to receive readable radio signals: (1) Interference from transmitting stations whose signals it is not desired to receive. (2) strays or static, and (3) the "fading" of the strength of the received signal.

Interference from other transmitting stations can to a large extent be eliminated by selection of frequency (wavelength), particularly by the use of transmitting apparatus which will radiate only a single wavelength or a narrow band of wavelengths. Laws have been enacted which are designed to minimize interference from other stations.

Strays are electrical disturbances giving rise to irregular interfering noises heard in the telephone receivers. They are also called "static," "atmospherics," "X's," and other names. In any particular case the possibility of getting a readable signal depends on the ratio of the strength of the signal to the strength of the static at that time. Experienced operators have stated that it is possible to copy messages when the strays were four times as strong as the signals but much difficulty is often experienced even when the strays are much weaker than this. The most common type of stray produces a grinding noise in the telephones; this type causes the most serious trouble. Another type, which produces a hissing noise, is usually associated with snow or rain. Near-by lightning produces a sharp snap.

## TYPES OF COUPLING

(518) Q. 1. F. White, Baltimore, Md., asks how the current in the primary circuit of a radio set gets to the secondary circuit.

A. 1. There are three methods by which a change in voltage in one circuit may be made to cause a corresponding change in another circuit coupled to it. The three methods are shown in the accompanying diagram.

# Scientific Humor

## AN ESSENTIAL COMPOUND

"Why," said the philosopher, "is chemistry necessary in your joke-writing profession?"

"Because," answered the humorist, "it is necessary that I study the silicide of life."—*E. A. Daansen.*

(And some think Petruchio's wife was a silicate (Silly Kate).)

## PERHAPS A YOUNG EINSTEIN

"I understand your boy Josh, is interested in perpetual motion."

"Yes," replied Farmer Sawbuck, "and I'm kinder encouraged by it. I thought for a while that the only thing he was interested in was perpetual rest."—*L. J. Schario.*

## A (C)RUSTY TRICK

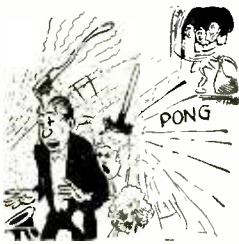

Hammers and hatchets will never rust if kept covered in rice. Care must be taken, of course, to remove the tools if the rice is to be used for wedding purposes. — *Jos. Malnikof.*

## WE NEVER THOUGHT OF IT THAT WAY

Professor in physics class: "Johnny, why is it that everything that I tell you goes in one ear and out the other?"

"I didn't know it did, sir."

Voice in back of room: "That's right; it doesn't. Sound can't pass through a vacuum!"—*Earl Floathe.*

## GASOLINE VS. GAS

GASOLINE VENDER (to dissatisfied customer): "This gasoline is of the highest quality. It is made by the cracking of hydrocarbons."

CUSTOMER: "I can't help it if it is. It isn't what it's cracked up to be."—*Donald A. Cuthbert.*

## YES, HE DID!



A spinster living in a growing suburb was shocked at the language used by workmen repairing telegraph wires close to her house. She wrote to the company, and the

foreman was asked to report. This he did in the following way:

"Me and Bill Fairweather were on this job. I was up the telegraph pole and accidentally let the hot lead fall upon Bill. It went down his neck. Then he said: 'You really must be more careful, Harry.'"—*Leonard Keiser, Jr., Rep. No. 27612.*

**First Prize \$3.00**  
**THE FOURTH DIMENSION**

Science points out that the lesser cannot contain the greater, but science evidently knows little about a woman's shoe. — *Louise Krauss.*

## WHAT IT IS (OR WHAT IT ISN'T)

One day in school the teacher said: "Mickey," give me a definition of salt." "Shure," Mickey responded. "It's the stuff that makes potatoes taste bad when you boil 'em and don't put any in."—*Carl C. Slaybough.*

**WE** receive daily from one to two hundred contributions to this department. Of these only one or two are available. We desire to publish only scientific humor and all contributions should be original if possible. Do not copy jokes from old books or other publications as they have little or no chance here. By scientific humor we mean only such jokes as contain something of a scientific nature. Note our prize winners. Write each joke on a separate sheet and sign your name and address to it. Write only on one side of sheet. We cannot return unaccepted jokes. Please do not enclose return postage. All jokes published here are paid for at the rate of one dollar each, besides the first prize of three dollars for the best joke submitted each month. In the event that two people send in the same joke so as to tie for the prize, then the sum of three dollars in cash will be paid to each one.

## DOUGH! DOUGH!



FATHER: "Your talk is just like the musical scale."

DAUGHTER: "Musical scale?"

FATHER: "Yes, you begin with dough, and you end with dough." — *Booth Mooney.*

## THE LUNACY OF LOVERS

TEACHER (in science class): Can anyone of you tell me how the moon affects the tide?"

A girl in back part of the room raised her hand and said, "No, it doesn't affect the tied much, but it affects the untied a great deal."—*John Kosik.*

## INDEED IGNORANT!

"We are getting wiser each generation. I am wiser than my father was and he was wiser than his father."

"I dare say your grandfather must have been ignorant!"—*Adela Tomfohr.*

## A SIGHT TO BEHOLD

PROF: "Why are you standing before the mirror with your eyes closed?"

GIRL STUDENT: "To see how I look when I'm asleep." — *Wilbur Gager.*



## NOT THEIR DIET!

SUNDAY SCHOOL TEACHER: "Tommy can you tell me why it was that the lions didn't eat Daniel?"

TOMMY: "Cause most of him was grit and the rest backbone!"—*Henry A. Courtney.*

## AN IMPROVEMENT ON RADIO

"You should come over to our house, Ed. Our new howler runs without batteries, neither has it aerial or ground. The mere point of a pin will start it. If you want to hear howly music some night, bring your wife."

"Wonderful . . . I will. But where do you get a radio of that sort?"

"Radio be d—! It's a boy."—*J. Leo Vanderheyden.*

## A DIZZY JOB

FIRST RADIO FAX: "Come on and tune in this set."

SECOND DITTO: "Can't. I'm too dizzy from reading a circular letter." — *Clifton Ask, Lanesboro, Minn.*



## HELLO!

Perhaps the reason why radio listeners in the United States have difficulty in hearing the principal broadcast station in London, England, is because it is 2 L. O. (too low). — *W. L. Cbb Buckley.*

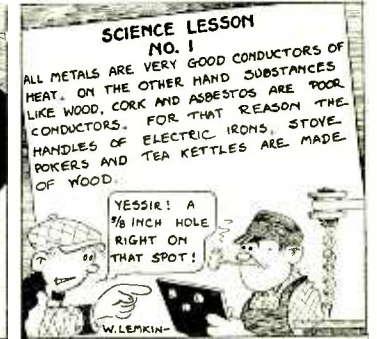
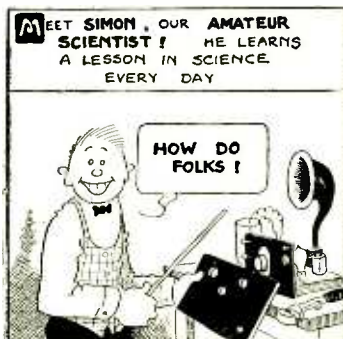



# LATEST PATENTS

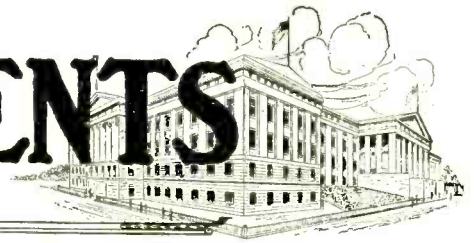

**WHIP MOTOR**

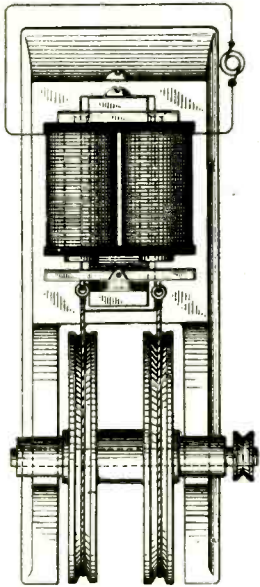

No. 1,587,665 issued to Fritz P. Mansbendel. This patent covers an improvement on a very interesting but little known machine. It is an alternating current motor operating on the principle of the whip top. The power developed is much greater than that of the usual type of small motor.

**TRANSOM LOCK**

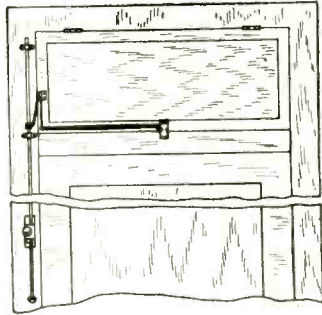

Issued to Jos. S. Hayworth. A useful improvement in door-fittings, which is designed to cause the transom to be firmly locked against entry when it is closed, and to be automatically released when it is desired to be opened.

**EXTINGUISHES FILM FIRE**

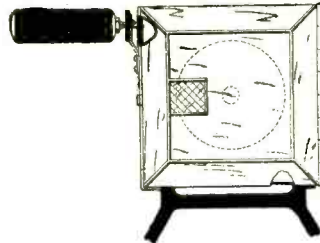

No. 1,589,514 issued to Walter S. Josephson. Practically all the destructive fires in motion-picture theatres occur as the result of the ignition of highly inflammable celluloid film contained in the projector magazines. In this case a fire extinguisher containing a non-combustible gas at high pressure is attached to the magazine so that it may release the gas, thus extinguishing the fire at the first sign of danger.

**PHOTOGRAPHIC SOUND RECORDER**

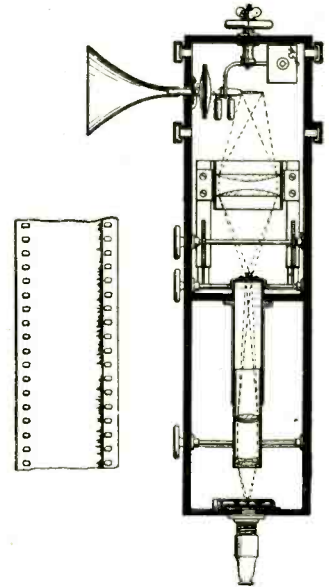

No. 1,588,884 issued to Russel Hart. A method of recording sound upon a motion picture film which employs the well-known principle of the manometric flame. The flame is controlled by the sound waves, and its image is recorded at the edge of a standard cinema film. The reproducing device is essentially similar, using the light-sensitive cell to change the record back into sound-waves.

**AMUSING TOY**

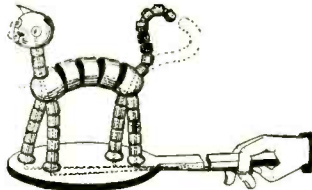

No. 1,601,983 issued to Edward S. Savage. Flexible cords running through the blocks forming this toy permit amusing gyrations to be performed. The toy is operated as seen above.

**STORAGE BATTERY IMPROVEMENT**

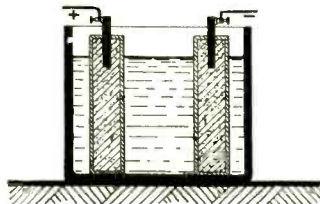

No. 1,588,608 issued to Rene Oppenheim. An improvement in storage battery design, in which the electrodes are suspended in a solution of ammonium chloride in porous cups.

**TRANSPOSITION CHART**

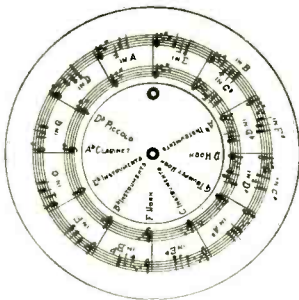

No. 1,692,204 issued to Aime Pollefeyt. Arrangers are constantly faced with difficulty in making orchestrations, arising from the fact that practically every instrument requires music written in a different key. This device is designed to eliminate much of the labor involved by providing a direct reading method of transposition. The chart may be adjusted to transpose from any key into any other. The device should also be useful in arranging vocal scores, where different parts must be combined.

**MILK BOTTLE PROTECTOR**

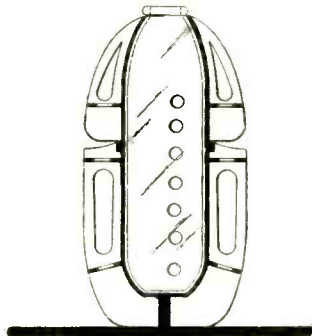

No. 1,601,888 issued to Americo Sico. This patent covers a protective envelope, made of sponge rubber, which is to be used as a cover for baby's milk bottle. The sponge rubber is very resilient and should prevent breakage due to the bottle dropping to the floor. The same principle may be applied to any other type of glass container.

**SELF CLEANING RAKE**

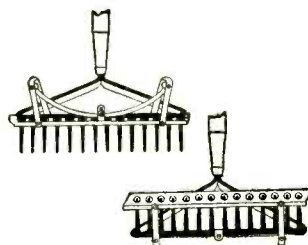

No. 1,595,556 issued to Edmond Laurencelle. A simple and extremely ingenious attachment for the usual garden rake, which makes it possible to remove debris adhering thereto by reversing the teeth and pressing the back of the rake to the ground.

**COMPLETE VANITY CASE**

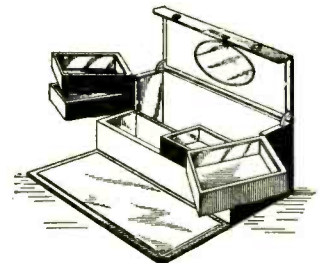

No. 1,600,830 issued to Florence N. Lewis. Vanity cases seem to be approaching more and more the size and completeness of professional make-up boxes. This one contains a space for everything, but is still small enough to be easily portable. The swinging drawer arrangement permits a large variety of contents without causing them to be badly mixed together. A mirror is of course provided, also a space for change, stamps, etc.

**NOTICE TO READERS.** The above illustrated and described devices have recently been issued patent protection but are not as yet to our knowledge available on the market. We regret to advise that it is impossible to supply the names and addresses of inventors of the above devices to any of our readers. The only records available, and they are at

the Patent Office at Washington, D. C., give only the addresses of the inventors at the time of application for a patent. Many months have elapsed since that time, and those records are necessarily inaccurate. Therefore, kindly do not request such information. —EDITOR.



# THE ORACLE



The "Oracle" is for the sole benefit of all scientific students. Questions will be answered here for the benefit of all but only matter of sufficient interest will be published. Rules under which questions will be answered:

1. Only three questions can be submitted to be answered.
2. Only one side of sheet to be written on; matter must be typewritten or else written in ink; no penciled matter considered.

3. Sketches, diagrams, etc., must be on separate sheets. Questions addressed to this department cannot be answered by mail free of charge.

4. If a quick answer is desired by mail, a nominal charge of 50 cents is made for each question. If the questions entail considerable research work or intricate calculations, a special rate will be charged. Correspondents will be informed as to the fee before such questions are answered.

## TYPES OF REAR AXLES

(2143) Q. 1. Mr. Edward Tyson, Birmingham, Ala., asks us to differentiate between the types of automobile rear axles.

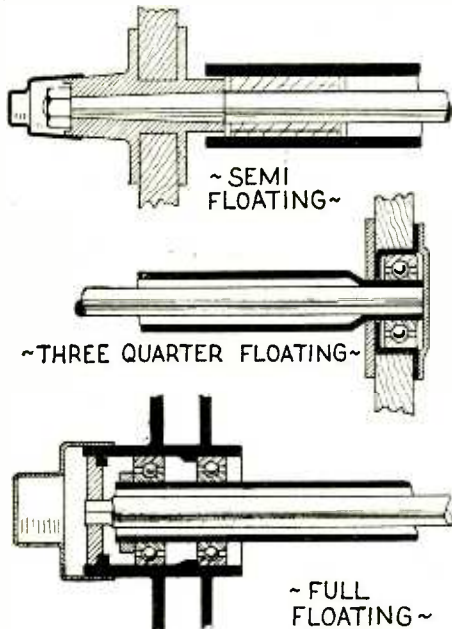

The three most-used types of rear axle design used in motor car construction are illustrated in these three cross-sections.

A. 1. Referring to the accompanying descriptions, you will see the three common types of rear axles illustrated. The difference between the "full-floating," "semi-floating," and "Three-quarter floating" axle is given by The Timken-Detroit Axle Co., as follows:

In the "full-floating" type of axle, all the bending stress due to static force and skidding force is carried by the housing. The driving shafts turn freely within the housing and bear only the "torque" or stress of turning the wheels. The shafts are said to "float" within the housing. The axle is not a full-floating type if the wheel is keyed to the shaft.

In the full-floating axle the shafts can be more easily removed for repairs. This is an advantage. It is necessary to make the full-floating somewhat heavier than the fixed-hub type for the same capacity.

In the "semi-floating" type, more properly called the "fixed-hub" type, the driving shafts turn freely within the housing. At their outer ends they are fixed in the hubs of the wheels and carry the bending stresses as well as the torque. The hub of the wheel is fitted to the shaft with Woodruff keys and a nut which serve to secure the wheel to the shaft. The hub cap is merely a protection to the end of the hub.

In the "three-quarter floating" type or, better, the "flanged-shaft" type, the housing extends into the hubs of the wheels as in the "full-floating" type, but the ends of the driving shafts are connected rigidly by flanges with the wheels so that the shafts take almost all the bending stresses and all the torque. In the flanged-shaft axle, especially when only one bearing is used under the center of the wheel, the stresses are quite similar to those in the fixed-hub type.

## ARC WELDING TRANSFORMER

(2144) Q. I. W. D. Bohon, Rupert, Idaho, asks for data on the standard type of arc welding transformer and on the best type of torch to use with the transformer.

A. 1. The data for the construction of an arc welding transformer is as follows: The core is built up of strips of silicon steel, .014 inches thick into the form of a rectangular frame, 15 inches long by 7 1/2 inches wide in outside dimensions. The legs are to be 2 inches square. The

**Science and Invention**

CORRESPONDENT REPORTER'S IDENTIFICATION NO. 1000

THE BEARER OF THIS CARD IS AN AUTHORIZED CORRESPONDENT REPORTER OF SCIENCE AND INVENTION MAGAZINE. THE PUBLISHERS OF SCIENCE AND INVENTION WILL APPRECIATE ANY COURTESY EXTENDED THEIR REPRESENTATIVE.

EXPERIMENTER PUBLISHING CO.

(Cover)

IN ORDER to present to the public the very latest scientific details, SCIENCE AND INVENTION maintains a large staff of field reporters. Any one of our readers is eligible to join this staff and, upon request, a reporter's card will be forwarded, together with complete instructions for gathering material. The reporter's card is illustrated above, and its use will gain admittance to many places that would otherwise be closed to the ordinary person. You need not have any special ability to obtain one of these cards other than a desire to help others to gain knowledge.

Address Field Editor, SCIENCE AND INVENTION. Submitted manuscripts cannot be returned unless accompanied by postage.

primary is wound with 13 1/2 pounds or 344 turns of No. 10 D.C.C. wire. The secondary consists of 31 turns of No 0 D.C.C. wire. Carbon electrodes are to be used with this transformer.

## FINDING BURIED TREASURE

(2145) Q. 1. Bill Cothrum, Dallas, Texas, asks if we know of any system of locating buried metals by electricity or radio.

A. 1. In our issue of March, 1926, we described all the common methods used for the purpose you specify in your question. More or less success has been obtained in the location of ore bodies by these methods, but the detection of buried treasure is very much like looking for a needle in the haystack, as the old saying has it. In our issue for August, 1921, the Hughes Induction Balance is described. Both of these issues may interest you.

## UNINFLAMMABLE CELLULOID

(2146) Q. 1. Mr. Jos. Leland, Wilmington, Ohio, desires a method for the preparation of uninflammable celluloid.

A. 1. The operation of this process as prescribed by Woodward is the following: In a receiver of glass or porcelain, liquefied fish glue and gum arabic are introduced and allowed to swell for 24 hours in a very dry position, allowing the air to circulate freely. The receiver is not covered. Afterwards it is heated on a water bath, and the contents stirred (for example, by means of a porcelain spatula) until the gum is completely liquefied. The heating of the mass should not exceed 77°F. Then the gelatin is added in such a way that there are no solid pieces. The receiver is removed from the water bath and colza oil added, while agitating anew. When the mixture is complete it is left to repose for 24 hours. Before cooling, the mixture is passed through a sieve in order to retain the pieces which may not have been dissolved. After swelling, and the dissolution and purification by means of the sieve, it is allowed to rest still in the same position, with access of air. The films formed while cooling may be removed. The treatment of celluloid necessitates employing a solution completely colorless and clear. The celluloid to be treated while it is still in the pasty state should be in a receiver of glass, porcelain, or similar material. The mass containing the fish glue is poured in, drop by drop, while stirring carefully, taking care to pour it in the middle of the celluloid and to increase the surface of contact. When the mixture is complete, the celluloid is ready to be employed and does not produce flame when ignited. The solution of fish glue may be prepared by dissolving in 200 parts of cold distilled water. It is then passed through the sieve, and the pieces which may remain are broken up, in order to mingle them thoroughly

with the water. Ten parts of kitchen salt are then added, and the whole mass passed through the sieve. This product may be utilized for the preparation of photographic films or for those used for cinematographs, or for replacing hard caoutchouc for the insulation of electric conductors, and for the preparation of plastic objects.

## THE MAKING OF MAGNETS

(2147) Q. 1. Everett Robertson, Tucson, Arizona, asks how magnets are made.

A. 1. To answer this question intelligently, it is necessary to take up something of the theory of magnetism. The facts of magnetism are most easily accounted for by assuming two things:



-A-



-B-

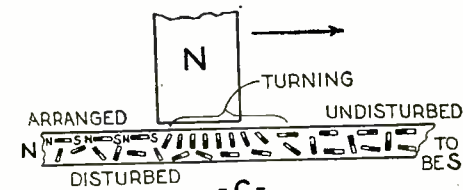

-C-

When steel is magnetized, the molecules, which are normally disarranged and scattered throughout the substance, are caused to "line up."

First, every molecule of a magnetic substance is itself a magnet; second, in an unmagnetized substance, these molecular magnets are pointing in many directions on account of the mutual attraction between their poles (Fig. A.) When the north pole of a magnet is brought near a piece of iron, the molecules swing around, so that their south poles are pointing toward the north pole of the magnet. Magnetizing a body, then, consists in turning the molecular magnets so that similar poles all point in the same direction and remain so. (Fig. B.) At one end of a magnet, north molecular poles will make the outside layer, and this will be a north pole; at the other end, there will be a south pole for a corresponding reason. Throughout the body of the magnet, the attraction for each other between these unlike molecular poles, tends to neutralize the magnetism; in the center portions of the bar it practically is not noticeable. All magnets are made by induction. Two different methods of induction are illustrated in following experiments. Rubbing the N pole of a magnet along a steel bar brings the magnetizing force so close to the molecules in the bar that these molecules turn their S poles in one direction to face the moving N pole of the magnet (Fig. C.) Thus these molecules are left so that the end of the bar last touched by the magnet pole will be a pole opposite in sign to the magnetizing pole. This method, while simple, does not make very strong magnets. The best way of making a magnet is to use an electric current. The steel to be magnetized is placed within a coil of insulated wire and an electric current is passed through the coil. Tapping the steel while the current is passing, aids the molecules to rearrange themselves and results in a stronger magnet. A powerful electromagnet can also be employed. This is the method used in making magnets commercially.

## DAMP-PROOFING HOUSE

(2148) Q. 1. Thos. C. Henry of Henderson, Ky., would like to know a good, cheap filling to check drafts and keep out dampness in wainscoting his new home.

A. 1. Concerning damp-proofing of walls which are to be wainscoted, would say that about the only thing to do is to use tar paper over the studding first, and to follow this with newspaper.



# MAGIC "DUNNINGER" By



**THE MAN WHO MYSTIFIED**  
 Pres. Coolidge  
 Prince of Wales, Ex-President  
 Harding, Tatt, Roosevelt,  
 and other celebrities  
 Writes Exclusively for  
**SCIENCE AND INVENTION**



NO. 45 OF A SERIES

## Chinese Lantern

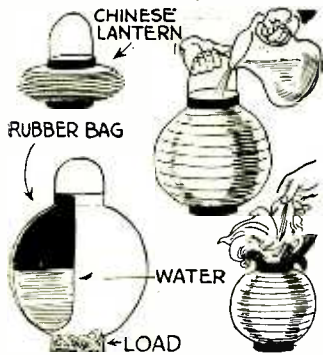

A folded Chinese lantern is filled with water after being opened. The magician then plunges his hand into the interior of the lantern and withdraws large quantities of silks, pours out the water and collapses the lantern.

## Sawed and Restored Match Box

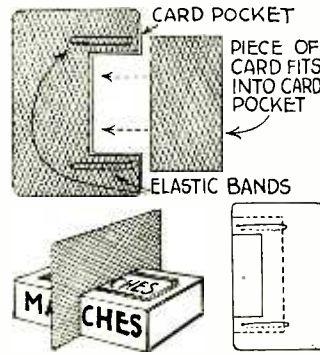

This is an excellent pocket trick. The performer apparently saws a match box in half with a playing card. Upon removing the playing card, the match box is found whole. The match box is unprepared, but the card is not innocent.

## Improved Swallowing Wand

The necessity of holding the hand over the nickel-plated tip of the wand while performing the swallowing wand and kindred stunts is eliminated by the use of this type of construction which uses a sliding black tube.

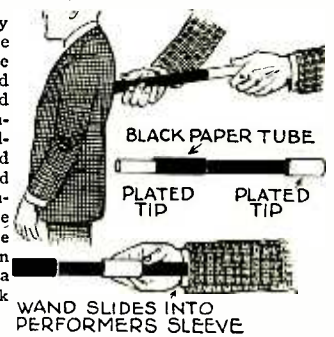

The first movement of pushing the wand through a spectator's back consists in sliding the black paper tube over the plated tip. From this point only one hand need be used.

It is apparent from the drawings above that the telescopic Chinese lantern contains a rubber bag affixed to half of the lantern and extending halfway across the top. This serves as the container for the water.

It will be observed that the playing card is really made of two cards, partially glued together and so arranged that a pocket is formed between them. Another piece of card fits into the pocket thus formed.

## Dunninger Versus Science

**DUNNINGER**, the Master Mind of Modern Mystery, as he is termed, is known to thousands of our readers throughout the nation. Dunninger has for years been our chief magical authority, and Chairman of our Scientific Investigation Committee on Spiritualism. He is perhaps the best known society entertainer in the world, and has mystified hundreds of prominent persons.

Dunninger presents an offering in so-called mind-reading, in which he offers a reward of \$10,000.00 to anyone who can prove that he employs assistants or confederates in his work, in any manner or fashion. The editor is frank to admit that he attended one of Dunninger's recent performances, with a view toward discovering the modus operandi employed in Dunninger's work, possibly to collect the \$10,000.00 offered. The writer has failed in both attempts. Dunninger tells his

audience he is not supernatural, and yet he presents things that are little short of miraculous. At least there seems no scientific explanation for his work. I viewed his act at the B. F. Keith theatre, Boston, one of the theatres in which he was recently a headliner. Ushers legitimately connected with the theatre, passed small slips of paper among the audience. The spectators were requested to write names and questions upon these slips, which they retained in their possession. They were positively not collected. Dunninger, seated upon the stage, in full and brilliant light, called aloud dozens of these names, many of the questions, called telephone numbers correctly, told people the day, month, and year of their birth, and yet we know there is no such thing as the supernatural... and what is more, he admits it... yet, how does he do it? We cannot say, and he will not tell.—*The Editor*.

## A Temple Buddha Mystery

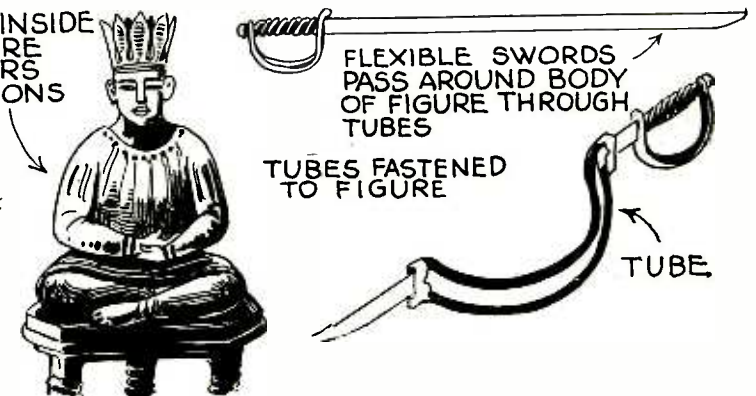

Here is an original illusion, inexpensive to construct and mystifying to the extreme. An East Indian Buddha is seen sitting on a platform. The figure on the magician's command sings, whistles, speaks and answers whatever question the wizard asks. In order to illustrate that the figure is simply mechanical, the wonder worker proceeds to run a number of sharp edged swords through the body of the Buddha. One of these passes through the

neck, two through the chest, one through each leg and one through the stomach. In spite of these the automaton continues his conversation. The secret lies in the fact that a small midget is concealed in the figure which is made of metal. The figure has a mechanical moving face, operated from strings on the inside, similar to that of the ventriloquist figures. Tubes leading around the body, legs and neck permit the swords to pass.



# Magic

## Learned Easily at Home



Dr. Harlan Tarbell  
Master of Magic  
who has mystified magicians as well as laymen  
with his marvelous magic

## Astonish Your Friends!

Gain the magnetic popularity that makes you the center of any crowd. Business and social success is assured the man who can perform mystifying tricks. You can earn big money on the side or as a professional, as well as being the most popular person in your crowd. Why envy others' skill? You can learn Magic yourself, quickly and easily.

**The First and Only Course in Magic**  
ever offered to the public teaching **Real Professional MAGIC**

## Earn \$250 to \$1000 a Month

even sleight of hand, generally supposed to require long practice, is NOW made simple to learn. For Dr. Harlan Tarbell, one of the really Great Magicians, has finally opened up the secrets of his profession in a completely illustrated course offered at a merely nominal cost. Through the wonderful Tar-

bell system you will be able to mystify and entertain your friends. After that Dr. Harlan Tarbell takes you through the entire maze of sleight of hand, card tricks and elaborate state divertissements. The apparently superhuman doings of the accomplished magician becomes as simple as ABC.

read what the Great Madame Hermann says:  
My Dear Dr. Tarbell: I have read with interest your course in Magic. It is the most original and perfect work of its kind I have seen. I highly recommend it.  
—A. Hermann

## Great Special Offer!

There is a tremendous demand for magic entertainment. Clubs, Lodges, Charity and Social affairs—all will pay high fees to the man who knows Magic. Dr. Harlan Tarbell really gets as high as \$250 for a half hour's work right now. Opportunity everywhere to make money aside from your regular occupation. Salesman find it a tremendous asset. Find out all about this unprecedented opportunity to learn Magic. Learn about the great Special Price and Easy Payment Offer we are making Now, for a limited time only. The coupon brings full details without any obligation. Mail it TODAY.

Tarbell System, Inc., Studio 14-29  
1920 Sunnyside Avenue  
CHICAGO, ILLINOIS

## Mail This Coupon NOW!

Tarbell System, Inc., Studio 14-29  
1920 Sunnyside Avenue, Chicago, Illinois  
Gentlemen: Without any obligation send me your free literature and information all about your wonderful "Tarbell Course in Magic." Also tell me about your great Special Price Offer and Easy Payment Plan—offered NOW for limited time only.

Name .....

Address .....

Age .....



# Aviation Brings Quick Success

**T**O young men of daring no other field of work offers such a fascination, such high pay, nor such opportunities for quick success as the field of Aviation. As yet, aviation is practically in its infancy. But now is the time to get in.

## Amazing Opportunities in Airplane Industries

In the automobile industry and in the moving picture business hundreds of men got rich by getting in at the start. They made their success before others woke up. Today, these lines offer no greater opportunities than a hundred and one others. **BUT AVIATION IS NEW.** Get in while the opportunities are big. All over the country there will be a clamor for trained men. It will not be a question of pay but of getting capable men.

## Become an Aviation Expert \$50 to \$100 per Week

The study of aviation is almost as fascinating as the actual work. Every lesson is full of interest. That is why it is easy to learn aviation. You do not have to make yourself study—it is like reading an interesting book that tells you things you have always wanted to know. Only one hour each evening will give you the basic training in a surprisingly short time.

One student, S. F. McNaughton, Chicago, says: "Your lessons are like a romance, and what is more, after one reading, the student gets a thorough understanding. One never tires of reading them." James Powers, Pa., another student, says, "I am indeed surprised that such a valuable course can be had from such practical men for so little cost."

### Fascinating—Daring—Big Paying Prepare Now for One of These Positions

- Aeronautical Instructor \$60 to \$150 per week
- Aeronautical Engineer \$100 to \$300 per week
- Aeronautical Contractor
- Enormous profits
- Aeroplane Repairman \$60 to \$75 per week
- Aeroplane Mechanician \$40 to \$60 per week
- Aeroplane Inspector \$50 to \$75 per week
- Aeroplane Salesman \$5000 per year and up
- Aeroplane Assembler \$40 to \$65 per week
- Aeroplane Builder \$75 to \$200 per week

### Personal Instruction by Experienced Men

Men who have had actual experience give you personal attention. They select the lessons, lectures, blueprints and bulletins. They tell you things that are essential in everyday practice. Each lesson is easy to read and understand.

## Get Big FREE Book—Now

Send coupon below for New Book, just out, "Opportunities in the Airplane Industry." It is interesting and instructive. It will show you many things you never knew before about aviation. We have but a limited supply of these books—send the coupon before they are all gone.

**American School of Aviation**  
3601 Michigan Ave., Dept. 1429 Chicago, Ill.

**American School of Aviation**  
3601 Michigan Ave., Dept. 1429 Chicago, Ill.  
Without any obligation, send me your Free Book, "Opportunities in the Airplane Industry", also information about your course in Practical Aeronautics.

Name.....  
Street.....  
City..... State.....

## Free Cathode Rays

By G. C. B. ROWE  
(Continued from page 691)

heats the filament in the cup-shaped cathode, C. The long tube on the right in which there is an enlargement, is of copper and goes just up to the window, W, as seen in Fig. 5B. This tube serves as a shield to prevent the electrons from striking the glass walls of the anode arm.

The construction of the window is extremely interesting, as it is here that the majority of the difficulties have been encountered. The window itself, i.e., the foil used, must be strong enough to withstand the 15 pounds per square inch pressure of the atmosphere; the smaller the atomic number of the window material, the less will be the hindrance offered to the electrons in

## \$5,000 for Perpetual Motion

When SCIENCE AND INVENTION Magazine was still in its infancy, the editors denied the possibility of constructing a perpetual motion machine using those forces of nature as we now know them.

Since that time the editors have received thousands of different designs for perpetual motion devices, and have received hundreds of circular letters soliciting finances for the building of perpetual motion machines.

The editors know that if they receive these letters, there are thousands of others in this country who get similar letters and who fall for the claims made in the numerous prospectuses giving the earning capacities of the various machines.

Most of the shares of stock for these perpetual motion machines are being sold at a rate of \$1.00 per share, although some inventors are trying to sell shares of stock at \$100.00 per share.

Therefore the editors of this publication say, "Just come in and show us—merely SHOW us—a working model of a perpetual motion machine and we will give you \$5,000.00. But the machine must not be made to operate by tides, winds, waterpower, natural evaporation or humidity. It must be perpetual motion."

their passage through the foil; also it must be possible to make a vacuum-tight joint between it and the glass. The metal which most nearly met all these requirements was nickel. A sheet of this 0.0005 of an inch thick and about 3 inches in diameter, was soldered to a ring of invar, which is an alloy of nickel and steel. Invar was used, because it has approximately the same coefficient of expansion as glass and therefore will expand and contract with the glass of the vacuum tube as it becomes hot and cold. Behind this ring of invar is a honeycomb screen of molybdenum, to support the foil against the atmospheric pressure.

It is necessary to have as high a vacuum within the tube as possible and three vacuum pumps in series are used to exhaust it. From a close inspection of the end of the tube in Fig. 7 the foil window may be seen to be pressed so tightly against the molybdenum honeycomb that there are indentations in the foil. This is entirely due to the pressure of the air outside the tube and the very high vacuum within it.

To eliminate from the tube any gases that might remain in the metal parts of the tube during exhaustion and subsequently escape when the tube is in operation, there is

(Continued on page 730)

## Thousands Use These Ingenious TRANSMITTER UNITS

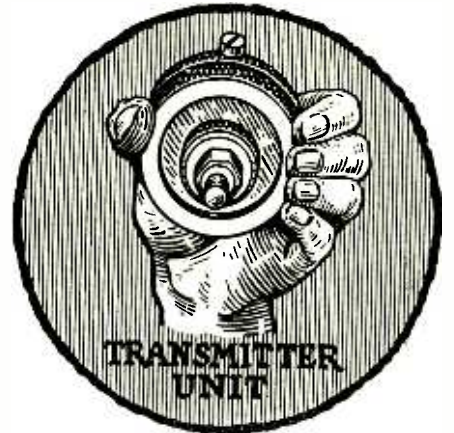

Here's a marvel of Engineering design—a practical miniature transmitter, used by thousands of radio fans and experimenters for amplification purposes. It is a most novel unit, having hundreds of uses. Every amateur should have two or three of these amplifiers in his laboratory.

### A FEW USES FOR THESE UNITS

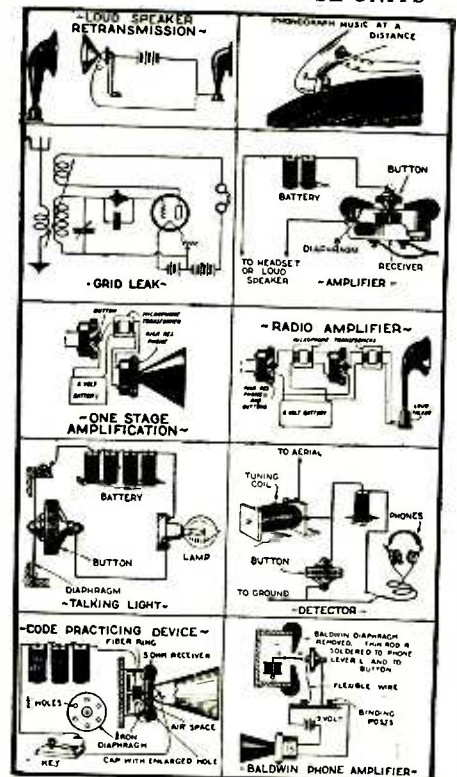

With each unit is mailed an eight-page instruction pamphlet containing suggestions for innumerable uses. Our supply is limited; avoid disappointment by ordering today. The coupon below is for your special convenience.

**SPECIALLY PRICED**  
While they last— **95c**  
(or Two for \$1.75) per unit

THE PRESS GUILD,  
66-S West Broadway, New York, N. Y.  
Enclosed find 95c/\$1.75 for which send me postpaid one/two amplifier units as advertised.  
Name.....  
Address.....  
City, State.....

# LUMINOUS PAINT

### Make Your Watches, Clocks, Etc., Visible by Night

The very latest discovery in the scientific world. Hitherto, practically unobtainable except at an exorbitant price, we have at last succeeded in producing this remarkable LUMINOUS PAINT, which, when applied to the surface of the DARKER NIGHT, the MORE BRILLIANT IT SHINES. Quite simple to use. Anyone—you can do it. A little applied to the dial of your watch or clock will enable you to tell the time by night. You can coat the push buttons or switch plates of your electric lights, match boxes, and innumerable other articles; make your own Luminous Crucifixes, Luminous Rosaries, etc. Bottle containing sufficient to coat several small articles. Price 25c. Larger sizes 50c and \$1 postpaid. Johnson Smith & Co., Dept. 367 Racine, Wis.

# The "Little Giant" Typewriter

### A First Class Writing Machine For \$1.50

A perfect little typewriter for \$1.50. There are the thousands of persons who would like to use a typewriter but whose needs and business do not warrant the expense attached to the purchase and use of a fifty or seventy-dollar machine. To such persons we confidently recommend our Little Giant. It is strongly recommended, but simple in construction, so that anyone can quickly learn to operate it, and write as rapidly as they would with pen and ink. The letters of the alphabet most frequently used are so grouped as to enable one to write rapidly, the numerals 1 to 10, and the punctuation marks being together. With your best kind typewriter, the letters, address envelopes, make out bills, and do almost any kind of work not requiring a large, expensive machine. With each typewriter we send a tube of ink and full printed instructions for using the machine. Price complete \$1.50 by mail postpaid to any address in the world.

### Every Boy His Own Toy Maker

Greatest boys' book written. Tells how to make a Pinhole Camera, a Cannon, model Railroad, a Telephone, Boomerang, Telegraph Instrument, Box Kite, Talking Machine, Microscope, Electric Motor, Electric Door Bell, Water Wheel, Paddle Boat, pair of Skis, a Dog Sled, Bird House, Rabbit Yard, etc. 64 pages, 150 illustrations. PRICE, 10c postpaid; 3 for 25c.

### JOHNSON SMITH & CO., Dept. 367 Racine, Wis.

# REAL PISTOL

### Miniature Watch Charm Pistol

Exact reproduction of a real pistol; actually fires REAL BLANK CARTRIDGES. Illustration is actual size. 1 1/2 inches long, with ring at end for attaching to watch chain. Loads like a regular pistol. Pistol is break-open type; illustration shows position for loading. Made entirely of high grade steel, nickel plated, octagon barrel, furnished with pearl handles, \$2.50. BLANK CARTRIDGES, 50c per box of 25.

# BOYS! BOYS! BOYS! THROW YOUR VOICE

Into a trunk, under the bed or anywhere. Lots of fun fooling the teacher, policeman or friends.

## THE VENTRILO

a little instrument, fits in the mouth out of sight, used with above for Bird Calls, etc. Anyone can use it.

Never Fails. A 16-page Course on ventriloquism, and the Ventrilo, ALL FOR 10c postpaid.

### MIDGET BIBLE GREAT CURIOSITY

Smallest Bible in the world. Size of a postage stamp. 200 Pages. Said to bring good luck to the owner. A genuine work of art. Must be seen to be appreciated. Make good money selling them to friends, church acquaintances, etc. PRICE 15c each, 3 for 40c, 12 for \$1.35, 100 for \$7.50. Also obtainable in Leather Binding, with gold edges. Price 50c each, 3 for \$1.25, \$4.50 per doz. Magnifying Glass for use with Midget Bible. 15c

### EXPLOSION

Everything about the Ku Klux Klan told in a clear, fearless manner. Book tells all: How it started and was suppressed in 1871—The New Ku Klux Klan—How organized—How members are enrolled—Oath of the Klan—Questions for Candidates—Creed—Objects of the Order—Obedience to the Klan—The Jews—Ku Klux Klan—Fidelity—Pledge of Loyalty—The Masons—Real and the Masons—The Negro Ku Klux Klan, etc., etc. Latest and most complete book on the Klan published. Price, 35c, postpaid.

### Female SEX INDICATOR

Hold the MAGIC INDICATOR over a man's hand—instantly it will indicate sex. Hold it over a woman's hand and it describes a complete and continuous circle. The same action can be obtained over a letter written by a man or woman, etc. It is fascinating; baffling. We have never been able to figure out how it's done—but we've never been it fail. Many novel and entertaining feats may be performed with the Sex Indicator. For example, similar results can be obtained with animals, cats, dogs, rabbits, over birds, chickens, canaries, etc. Also used to predetermine the sex of chickens and birds, etc., in fact it is sold as a patented egg tester in Europe. Price 25c, or 3 for 65c, postpaid.

A DeLuxe Edition of our new 1927 CATALOG mailed on receipt of 25c. Handsome cloth binding. Only book of the kind. 150 pages of all the latest tricks in magic, the newest novelties, puzzles, games, sporting goods, interesting books, curiosities in seeds and plants, etc.

# STAGE MONEY

With a bunch of these bills, it is easy for each person to mean to appear prosperous by flashing a roll of these bills. The proper time and peeling off a genuine bill or two from the outside of the roll, the effect created will be found to be all that can be desired. Prices, postpaid: 40 Bills 20c, 120 for 50c, or \$3.50 thousand postpaid.

# Wonderful X-Ray Tube

A wonderful little instrument producing optical illusions both surprising and startling. With it you can see what is apparently the bones of your fingers, the lead in a lead pencil, the interior opening in a pipe stem, and many other similar illusions. A mystery that no one has been able to satisfactorily explain. Price 10c, 3 for 25c, 1 dozen 75c. Johnson Smith & Co.

# Good Luck Ring

A VERY striking and uncommon ring. Silver finish, skull and crossbones design, with the brilliant, flashing gem sparkling out of the eyes. Fitted with many to bring Good Luck to the wearer, hence its name, Good Luck Ring. Very unique ring that you will take a pride in wearing. ONLY 25 CENTS.

# Exploding Cigarettes

JUST LIKE ORDINARY CIGARETTES. BUT SUCH REAL STARTLERS! The box contains ten genuine cigarettes of excellent quality. They appear so real, but when each cigarette is about one-third smoked, the victim gets a very great surprise as a loud BANG! is sent harmlessly. Price 25c per box.

# Popular Watch Charms

Very pretty little curiosities and decidedly novel. Fitted with Magnifying Lenses that enlarge the pictures to a very surprising degree; in fact, it seems almost incredible that the picture could be possible in such a small compass, and how sharp and distinct they show up when you look through. Come in assorted views—Actress, View of Panama Canal, Lord's Prayer in type, etc.

# CIGARETTE MAKER

Roll your own and save money. Makes them better and quicker besides saving more than half the cost of your favorite brand of tobacco. Neat, useful and handy. Metal, size, weight 5 oz. Made entirely of nickel, nickel-plated. Price 25c postpaid.

# MAGIC FLUTE

Wonderfully Sweet Toned and Musical. The Magic Flute, or Humantone, is a unique and novel musical instrument that is played with nose and mouth combined. There is just a little knack in playing which, when once acquired after a little practice will enable you to produce very sweet music that somewhat resembles a flute. There is no fingering, and once you have mastered it you can play all kinds of music in clear, to a piano or any other musical instrument, the effect is as charming as it is surprising.

# Novelty Badges

Kissing Permit 10c. Garter Inspector 10c. Two very novel metal badges, nickel plated, that you can wear, giving you fun out of all proportion to their trifling cost. doz. p.p.d.

# BLANK CARTRIDGE PISTOL

This well made and effective Pistol is modelled on the pattern of the latest type of Revolver, the appearance of which is so convincing as to be enough to scare a burglar whilst, when loaded, it will probably prove just as effective as a revolver with real bullets, without the danger to life. It takes the standard .22 Calibre Blank Cartridges, that are obtainable most everywhere. Even the most timid women can use it with perfect safety and frighten a thief with out risk to herself or anyone else. A Great Protection Against Burglars, Tramps and Dogs. You can have it linked about with the danger attached to other revolvers. We sell large numbers around the 4th of July. Well made of solid Metal. PRICE ONLY \$1.00 Postpaid. Blank Cartridges 22-cal. shipped by express only, 50c per 100. Johnson Smith & Co., Dept. 367 Racine, Wis.

# Sneezing Powder

Place a very small amount of this powder on the back of your hand and blow it into the room or car will begin to sneeze without knowing the reason why. It's most amusing to hear their remarks, as they never suspect the source, but think they have caught it one from the other. Between the laughing and sneezing you yourself will be the cause of your own sneezing. For parties, political meetings, car rides, or any place at all where there is a gathering of people. It is the greatest joke out. Price 10c or 3 for 25c.

# Mystic Skeleton

A jointed figure of a skeleton in its height, will dance to music and perform various gyrations and movements while the operator may be some distance from it.

# Serpent's Eggs

Box contains 12 eggs. When lit with a match, each one gradually hatches itself into a snake or other reptile. It is ultra-sensitive, feet long, white and twists about in a most lifelike manner. Price per box 10c p.p.d.

# Microphone Transmitter Button

You can easily make a highly sensitive telephone by using this Transmitter Button to collect the sound waves. You can build your own outfit without buying expensive equipment. It is simple and inexpensive. You can install an outfit in your home and hear conversations being held all over the house. You can connect up different rooms of a hotel. This outfit was used by secret service operatives during the war. It is being used on the streets. You can live and die in the greatest invention in microphones. You can mount the button almost anywhere—card board boxes, stove pipes, staff calendars, and all the while a picture frame, etc. Button is so light and small it cannot be detected. Persons can be heard without suspecting it. You can listen in on other mutual instrument, music can be heard hundreds of feet away. Button may be used to renew telephons transmitters; often makes an old line "pick-up" when nothing else will. The ideal microphone for radio use; carries heavy current and is extremely sensitive. Amplifies radio signals. Countless other similar uses will suggest themselves. Experimenters find the button useful in hundreds of experiments along the lines of telephones, amplifiers, loud speakers, etc. Many fascinating stunts may be devised, such as holding the button against the throat or chest to reproduce speech without sound waves. \$5.00 is given to anyone who sends in a new suggestion for the use of the Button providing the manufacturer find it suitable for use in their literature. PRICE \$1.00 POSTPAID ANYWHERE.

# ANARCHIST BOMBS

One of these glass vials dropped in a room full of people will cause more consternation than a limburger cheese. The smell entirely disappears in a short time. 10c a Box, 3 Boxes for 25c.

# INVISIBLE INK

The most confidential messages can be written with this invisible writing. MAKES NO MARK. Cannot be seen unless you know the secret. Invaluable for many reasons. Keep your postcards and other private correspondence safe from prying eyes. Great fun for playing practical jokes. Only 15c Bottle.

# ITCHING POWDER

This is another good practical joke; the intense discomfort of your victims to everyone but themselves is thoroughly enjoyable. All that is necessary to start the ball rolling is to deposit a little of the powder on a person's hand and the powder can be relied upon to do the rest. The result is a vigorous scratch, then some more scratch, and still some more.

# LOOK 35c Look

Wonderful Instrument. Greatest thing yet. Nine separate articles in one. Everybody delighted with it. Odd, curious and interesting. Lots of pleasure as well as very useful. It is a double microscope for examining the wonders of nature. It is also an Opera Glass, a Stereoscope, a Burning Lens, a Reading Glass, a Telescope, a Compass, a Pocket Mirror, and a Laryngoscope. It is worth all the cost to locate even one painful cinder in the eye. Folds flat and fits the pocket. Something great—you need one. Don't miss it. Sent by mail, postpaid. Price, only 35c or 3 for \$1.00 postpaid.

ADDRESS ORDERS FOR ALL GOODS ON THIS PAGE TO JOHNSON SMITH & CO. DEPT. 367, RACINE, WIS.

Postage Accepted

# CARTOONING EASY TO LEARN AT HOME



## "Student Receives \$250 For a Few Cartoons"

THE Washington School of Cartooning quickly prepares you for the highly paid field of cartooning. And when we say "highly paid" we mean just that! Facts are facts. Money talks. And here's proof! Just read this "straight from the shoulder" letter.

"The enclosed cartoons," says O. A. Pokrandt, a Wisconsin student, "are samples of my progress in drawing. I have received \$250 for these and the enclosed letter will show that I have a ready market for my work in the future. The making of cartoons has been one round of pleasure and enjoyment as well as profitable to me."

### Cartooning Pays Big

There's no more attractive or highly paid profession today than Cartooning. Millions of dollars are spent every year on cartoons. Capable cartoonists earn from \$50 to \$250 a week. And now you, too, can learn to draw side-splitting comedies—right at home in spare time through this method that has already been tested and proved by many Washington School Graduates. No talent or training needed. No drudgery. And in a very short time you should be ready for one of these pleasant, big-money cartoonist's jobs!

### Send For FREE Book

A new handsomely illustrated book has just been printed, which gives all the most up-to-date information on the thousands of wonderful opportunities in Commercial Art, and shows how this startling method easily enables you to enter this field. It tells all about our students—their success—what they say—actual reproductions of their work—how they made quick profits while studying. This attractive book will be sent without cost or obligation. Send for it. Mail coupon NOW. Washington School of Cartooning, Room 2612-D, 113-15th St., N. W., Washington D. C.

Washington School of Cartooning,  
Room 2612-D, 113-15th St., N. W., Washington, D.C.

Please send me without obligation, your illustrated FREE BOOKLET on Cartooning.

Name \_\_\_\_\_  
(Write Name Plainly) State whether Mr. Miss or Mrs.

Address \_\_\_\_\_

City \_\_\_\_\_

If under 16 years, please state age.

## Free Cathode Rays

(Continued from page 728)

a calcium "getter" tube attached to the cathode arm of the tube. When any gas such as oxygen is detected in the main tube, the filament of the "getter" tube is lighted and chemical combination takes place in the smaller tube between the calcium and the gas, thus removing the gas from the main tube.

The electrons are generated at the cup-shaped cathode and as the end of the copper tube is at the same positive potential as the window is, the electrons gain their tremendous velocity (about 0.8 that of light, or approximately 150,000 miles per second) in the short space between the cathode and the end of the copper tube, this space being about one inch. From this point on, the electrons continue with undiminished velocity, until they reach the window. Most of them pass through the window and at a voltage of 350,000 are hurled through the air more than two feet beyond the end of the tube.

The bombardment of the air in front of the window, by the escaping electrons, produces a beautiful purple glow. Due to the collisions of the electrons with the atoms of the air the electrons are scattered and the beam spreads out and bends around until it extends perhaps half as far behind the window as it does in front. This bending of the ray is not clearly shown in Fig. 4, but some idea of the scattering effect may be seen.

### To Readers of "THE EXPERIMENTER"

You will find the best features of THE EXPERIMENTER preserved in SCIENCE & INVENTION, besides a brand new "Model Department". See the beautiful Silver Trophy cup for best model each month described elsewhere in this issue.

### EFFECTS OF THE CATHODE RAY

Although as yet there have been found no practical applications for these rays that come through the end of the generating tube, there have been some most interesting results obtained from the experiments which are being conducted.

Before the advent of the Lenard tube, it had been impossible to ascertain the effect of cathode rays on different substances without considerable trouble, due to the fact that whatever was to be studied had to be sealed within the tube. Now thanks to the fact that the rays can be brought out through the window, a vast number of experiments can be performed, with no more trouble than placing the substance in the path which the rays follow at the end of the tube.

A few interesting experiments will now be described.

It is a well-known fact that under cathode ray bombardment, lime becomes luminous and glows with a bright orange color, the glow ceasing immediately when the bombardment stops.

Use is made of this property of lime in an experiment to show the range of the cathode rays in the air in front of the window. A block of lime is moved back and forth in the path of the rays until the point is found at which the orange glow just begins. The distance from this point to the window may be taken as a measure of the range of the electrons at the particular voltage at which the tube is being operated.

Previous experimenters have shown that, while lime is luminous only while it is being rayed, calcite (Iceland spar, noted chiefly for

(Continued on page 740)



## Binoculars!

Christmas Gift  
for  
Husband, Son,  
Dad, Brother!

### SPECIAL PRICE!

HERE'S a Gift that's Different, Useful, Instructive, Entertaining, Pleasure-giving all year round! 8-POWER BINOCULARS—magnify eyesight 8-times! Brings people, objects, sports, glorious vistas—right to one's feet! See miles away! Fine for football, hunting, hiking, yachting, races, baseball and football games; shuttles; bird and nature study, etc. Any man or woman will welcome and treasure a pair.

### 10-DAYS TRIAL ABSOLUTELY FREE!

THESE are Genuine Imported Famous French and German 8-POWER Prism Binoculars, same as used by Army and Navy Officers, European Commanders, etc. Superb lenses, exquisite definition, wide view of vision. Adjustable to eye-strength and eye-shoulder straps. List Price, \$42. Advantageous foreign exchange rates make possible Bargain price \$23.50

Our Plan  
is Different!

Send NO Money now! Pay NOTHING on delivery. We send Binoculars for 10 Days! Absolutely FREE TRIAL to responsible persons.

If pleased you may pay on Budget Plan:

\$5.00 MONTHLY

\$21.75

or, if you wish to pay cash at end of 10 DAYS, deduct \$1.75 and send Check or Money Order for \$21.75 in FULL SETTLEMENT. Otherwise, return them. Order NOW! Limited Quantity! Rare Value! Send NO Money! Pay NOTHING on delivery.

### SEEVER-WILLIAMS CO.

Importers, Exporters, National Mail-Order House

"2 Generations of Honorable Dealings"

365 WASHINGTON ST., BOSTON, MASS.

Largest Retailers of Binoculars in America.

Gentlemen—Send me \$23.50 8-POWER BINOCULARS for 10 days' FREE Trial on the above plan.

Name \_\_\_\_\_

Address \_\_\_\_\_

City and mail this Adv. NOW to insure Xmas delivery! Please tell us something about yourself. Trade references preferred. We will appreciate and respect the information. THANK YOU!

S.I. 12-26



Mailing List Catalog No. 55

### Get Business by Mail

60 pages of vital business facts and figures. Who, where and how many your prospects are.

5,000 lines of business covered. Compiled by the Largest Directory Publishers in the world, thru information obtained by actual door-to-door canvass.

Write for your FREE copy.

R. L. POLK & CO., Detroit, Mich.

600 POLK DIRECTORY BLDG. Branches in principal cities of U. S.

## MAKE MONEY EVENINGS

Let me show you how 4364 men, without experience add \$25 to \$75 weekly to their income without giving up their present position. A. C. FISCHER, 122 W. Austin Ave., Chicago, Ill.

# Largest variety of Radio Parts!

**1926  
EDITION  
No. 16**

**300  
Illustrations**

**8-Page  
log book of  
all U. S.  
Broadcast  
Stations**

# RASCO RADIO PARTS CATALOG No 16

**RASCO  
HAS  
IT**

## THIS 68 PAGE RADIO CATALOGUE FREE

### 75 HOOKUPS

*Radio Specialty Co.*  
96-98 Park Place  
New York  
**"ALL GOODS SENT PREPAID IN U.S.A."**

## BUY FROM RADIO'S OLDEST MAIL ORDER HOUSE

WE are the oldest established, exclusive radio mail order house in the country. Our motto is "Quick Shipment." All orders are shipped within 24 hours. Quick, prompt, courteous service. We carry a larger variety of radio parts and findings than any other radio house in the country.

### "RASCO HAS IT"

If you are in need of certain small radio parts that other radio and mail order houses do not bother to carry, get the Rasco parts catalog, and you will find them there, anything from a screw to copper ribbon and telephone diaphragms, as well as thousands of other small radio findings. Just to mention a few:

Lugs, nuts, dials, vernier dial, jacks, plugs, every kind of knob, cords, panels, screws, sliders, washers, selenium, tinfoil, switches, crystals, cap nuts, Litz wire, cord tips, brass rods, resistances, name plates, spring binding posts, switch parts, metal ribbon, carbon balls, binding posts, all types, switch points, switch levers, lock washers, carbon grains, ground clamps, metal pointers, insulated tubing, low melting metal, antenna connectors, bus bar wire, as well as thousands of other articles.

*We carry the Largest Variety of Small Radio Parts in the World.*



### THE NEW RASCO CATALOG No. 16

Contains the Following Hookups  
All Armstrong Circuits: These important circuits are explained clearly, all values having been given. Just to name a few of the Vacuum Tube circuits: The V.T. as a detector and one-step amplifier; Super Regenerator; one-step radio frequency amplifier and detector; three-stage audio frequency amplifier; short wave regenerative circuits; 4-stage radio frequency amplifier; radio and audio frequency amplifier; inductively coupled amplifier; all Reflex Circuits. This catalog is crammed full of small parts and radio findings, literally thousands of them. In addition there is much useful information contained herein.

**If you will paste this coupon on a post card and mail today, we will be pleased to send you our new Catalog at once.**

**RADIO SPECIALTY CO.,** 98 Park Place, New York  
S.I. 12-'26  
You may send me, without charge or obligation, your **NEW CATALOG No. 16.** (Write on margin if you desire.)  
Name \_\_\_\_\_  
Street \_\_\_\_\_  
P. O. \_\_\_\_\_ State \_\_\_\_\_

**RADIO SPECIALTY CO.**  
98 Park Place New York, N. Y.

# U.S. PATENTS



**SEND FOR THIS FORM**

## Don't Lose Your Rights

Before disclosing your invention to anyone send for blank form "Evidence of Conception" to be signed and witnessed. A sample form together with printed instructions will show you just how to work up your evidence and establish your rights before filing application for patent. As registered patent attorneys we represent hundreds of inventors all over the U. S. and Canada in the advancement of inventions. Our schedule of fees will be found reasonable. The form "Evidence of Conception" sample, instructions relating to obtaining of patent and schedule of fees sent upon request. Ask for them,—a post card will do.



Registered Patent Attorneys in U.S. and Canada  
255 Ouray Bldg., Washington, D. C.  
"Originators of form Evidence of Conception"

# PATENTS

## TO THE MAN WITH AN IDEA

I offer a comprehensive, experienced, efficient service for his prompt, legal protection and the development of his proposition.

Send sketch, or model and description, for advice as to cost, search through prior United States patents, etc. Preliminary advice gladly furnished without charge.

My experience and familiarity with various arts frequently enable me to accurately advise clients as to probable patentability before they go to any expense.

Booklet of valuable information and form for properly disclosing your idea, free on request. Write today.

**RICHARD B. OWEN, Patent Lawyer**  
164 Owen Building, Washington, D. C.  
41V Park Row, New York City

**TRADE-MARKS REGISTERED**

# INVENTORS

who derive largest profits know and heed certain simple but vital facts before applying for Patents. Our book Patent-Sense gives those facts; sent free. Write

## LACEY & LACEY

644 F STREET, WASHINGTON, D. C.  
Established 1869

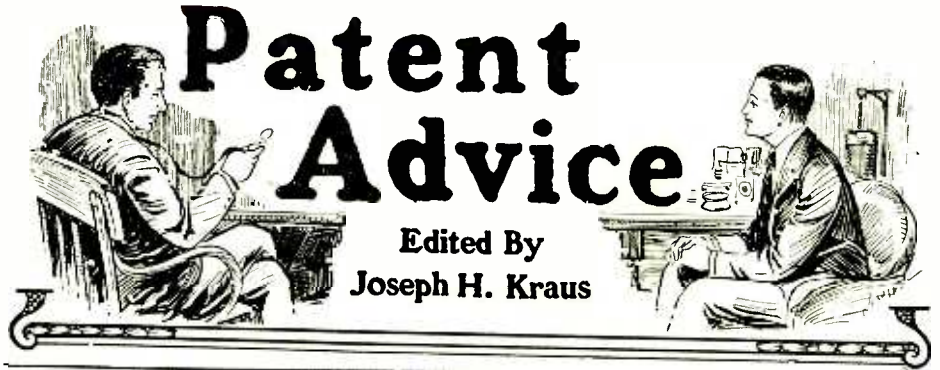

# Patent Advice

Edited By  
**Joseph H. Kraus**

In this Department we publish such matter as is of interest to inventors and particularly to those who are in doubt as to certain patent phases. Regular inquiries addressed to "Patent Advice" cannot be answered by mail free of charge. Such inquiries are published here for the benefit of all readers. If the idea is thought to be of importance, we make it a rule not to divulge all details, in order to protect the inventor as far as it is possible to do so.

Should advice be desired by mail a nominal charge of \$1.00 is made for each question. Sketches and descriptions must be clear and explicit. Only one side of sheet should be written on.

**NOTE:**—Before mailing your letter to this department, see to it that your name and address are upon the letter and envelope as well. Many letters are returned to us because either the name of the inquirer or his address is incorrectly given.

### FOUR ELECTRODE VACUUM TUBES

(978) Thos. Denike, Caldwell, N. J., has submitted idea for a fourth electrode in a vacuum tube and reasons that the tube should work more satisfactorily with the fourth electrode inserted. He asks whether he should secure a patent on the idea or continue his experiments along that line.

A. After having considered your proposed type of electron tube very carefully, we have arrived at the opinion that we do not believe that such a tube presents any advantages over the present type. It is more complicated in construction and obviously would have to sell at a higher price than the present-day tubes. Furthermore, we do not see any reason why the introduction of the fourth electrode in the position you mention and for the purpose you design it should increase the efficiency of the tube. We do not believe that it would pay you to prosecute this idea as we are very much of the opinion that you could never make a commercial success of it. As witness to this fact, note the Solodyne tube which was recently placed on the market and given quite some publicity. In a short space of time, the manufacturers had to go out of business as they could not compete with the standard three-electrode tube which is on the market today.

### GASOLINE TURBINE

(979) Irven Culver, Riverside, Calif., submits an idea for a gasoline turbine having a rotor eccentrically located, said rotor being provided with a series of sliding baffle plates. At the position of maximum compression an explosion is to take place between two adjacent baffle plates and the compressed gases are to drive the rotor around.

A. We do not see that your idea for a gas turbine is practical at all, and we even doubt that you can secure a patent on the system.

The method for compressing gas and also for causing the explosions to occur on the far side of the rotor or in other words under full compression has been employed before. The difficulty of all mechanisms of this nature is that the valves slide, as they enter the center shaft or rotor and the slide is rarely, if ever, gas-tight. The mechanism carbonizes easily and does not give a full-power stroke.

You must also remember that when gas explodes, it acts quickly in all directions. Consequently, there is no reason why your system should move, because the force exerted by the gas will act against the casing as well as against the center drum, and also against both sides of the moving vanes or valves.

We do not advise applying for a patent on the idea.

### PUNCTURE-PROOF TIRE

(980) Edward G. Crookes, East Hartford, Conn., asks for patent advice on a puncture-proof tire the nature of which is not described.

There are a great many puncture-proof tires on the market, and we would suggest that you secure a complete group of patents on this same subject from the Patent Office at Washington. These patents will cost you 10c each.

There are puncture-proof tires using air; there are others containing balls of soft rubber; still others which are filled with rubber sponge or other composition, and another group which contains a rubber cement in the center, so that when punctured the tire becomes self-repairing.

We do not suggest a patent on a puncture-proof tire unless it will give the identical riding qualities of the air tire and unless it is absolutely puncture-proof.

### REMOVABLE RING STONES

(981) Geo. B. Hess, Jr., North Lake, Wis., requests our opinion of a ring with removable stones and also a cakeless salt shaker, the top of which is to close automatically.

A. The same objections that apply for removable stones for tie-pins apply also for finger rings. Furthermore, in the case of rings, the stones would be subjected to a much greater vibration and amounts of mechanical movements than would be found in a tie-pin. Therefore, unless the lock for holding the gems in position was very strongly constructed, frequent losses would occur. We are of the opinion that such a device is not to be desired and would therefore not advise you to attempt to prosecute the same.

It is all very well to say that a salt shaker with a closing top will keep the salt from caking, but it is quite another matter to design such a closure that will be practical in all ways. You have not explained how the salt shaker top is to be closed and therefore we cannot advise you more fully.

### DINNER PAIL

(982) Chas. Coleman, Jr., Mildred, Pa., has designed a dinner pail and requests advice.

A. We do not see anything at all new in your proposed combination dinner pail. However, you do not give any details on the construction of the compartment for containing liquids. This compartment would have to be tightly sealed in order to prevent the liquids from leaking out. However, the basic principle of your whole idea is so old that we are sure a patent on the same would be of no value.

### TIMING EXHAUST VALVES

(983) H. Skan, San Pedro, Calif., submits an idea for timing the exhaust valves of a gasoline engine and requests information on its patentability.

A. We certainly do not believe that your proposed automobile device should be patented. We are very much of the opinion that it would not be at all practical and that if ever adopted, it would cause more trouble than it would ever be worth. A system of this nature would be prone to every trouble that is ever found in any mechanical device and probably would have a few that would be peculiar to itself.

Furthermore, we do not believe that the advantages you mention in your letter would be of sufficient value to overcome the complicated mechanism that would naturally have to be used for a system of this nature. Also, the retarding or advancing of the action of the exhaust valve would undoubtedly have a detrimental effect upon those valves which would not be at all desirable.

It is our frank opinion that you should certainly not attempt to proceed further with this system as we do not consider it at all practical.

# INVENTORS PROTECT YOUR IDEAS

Send for our Guide Book, HOW TO GET A PATENT, and Evidence of Invention Blank, sent Free on request. Tells our terms, methods, etc. Send model or sketch and description of your invention for **INSPECTION AND INSTRUCTIONS FREE. TERMS REASONABLE. BEST REFERENCES.**

Name .....

Street .....

City .....

**RANDOLPH & CO.**  
Dept. 172, WASHINGTON, D. C.



**MY PATENT  
LAW OFFICES**

**JUST ACROSS  
STREET FROM  
U.S. PAT. OFF.**

# PATENTS

**INVENTORS**  
Write for these  
**FREE BOOKS!**



At the left is a view of my drafting and specification offices where a large staff of experienced experts are in my constant employ. All drawings and specifications are prepared under my personal supervision.

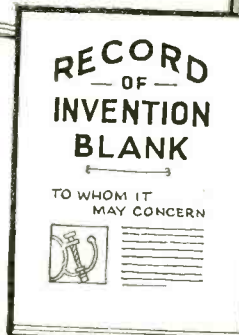
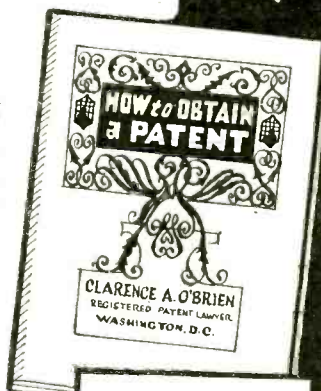

## PROTECT YOUR IDEAS

### Take the First Step Today—Action Counts

If you have a useful, practical, novel idea for any new article or for an improvement on an old one, you should communicate with a competent Registered Patent Attorney AT ONCE. Every year thousands of applications for patents are filed in the U. S. Patent Office. Frequently two or more applications are made for the same or substantially the same idea (even though the inventors may live in different sections of the country and be entirely unknown to one another). In such a case, the burden of proof rests upon the last application filed. Delays of even a few days in filing the application sometimes mean the loss of a patent. So lose no time. Get in touch with me at once by mailing the coupon below.

#### No Charge for Information on How to Proceed

The booklet shown here contains valuable information relating to patent procedure that every inventor should have. And with it I will also send you my "Record of Invention" form, on which you can sketch your idea and establish its date before a witness. Such evidence may later prove valuable to you. Simply mail the coupon and I will send you the booklet, and the "Record of Invention" form, together with detailed information on how to proceed and the costs involved. Do this NOW. No need to lose a minute's time. The coupon will bring you complete information entirely without charge or obligation.

#### Prompt—Careful Efficient Service

This large, experienced organization devotes its entire time and attention to patent and trademark cases. Our offices are directly across the street from the U. S. Patent Office. We understand the technicalities of patent law. We know the rules and requirements of the Patent Office. We can proceed in the quickest, safest and best ways in preparing an application for a patent covering your idea. Our success has been built on the strength of careful, efficient, satisfactory service to inventors and trademark owners located in every state in the Union.

## Clarence A. O'Brien

Registered Patent Attorney  
Member of Bar of: Supreme Court of the United States; Court of Appeals, District of Columbia; Supreme Court, District of Columbia; United States Court of Claims

Practice confined exclusively to Patents, Trademarks, and Copyrights

#### Strict Secrecy Preserved—Write Me in Confidence

All communications, sketches, drawings, etc., are held in strictest confidence in strong, steel, fireproof files, which are accessible only to authorized members of my staff. Feel free to write me fully and frankly. Your case will have my personal attention. It is probable that I can help you. Highest references. But FIRST—clip the coupon and get my free book. Do THAT right now.

## Mail this Coupon NOW.

**CLARENCE A. O'BRIEN**  
Registered Patent Attorney,  
53-R Security Savings & Commercial Bank Bldg.,  
Washington, D. C.

Please send me your free book, "How to Obtain a Patent," and your "Record of Invention" form without any cost or obligation on my part.

Name .....

Address .....

(Important: Print or Write name clearly)



# Learn at Home to Make Clever SHOW CARDS

A Profitable Business of Your Own for full or spare time. Earn \$25 to \$50 a week in spare time. Double your pay. Practical method of home instruction makes learning easy.

Why work for low-pay? Clever "sales-increasing" display material is always needed by progressive business enterprises of every description. \$10 to \$20 is often paid for a single attractive show card. Skilled Show Card Writers command high salaries—right from the start.

Prepare now. No special ability needed. Learn at home in your spare time through a most complete and practical method. We develop your originality and teach you how to make attractive show cards, just like a professional. We give all of your work personal attention through the mail. Scores have learned Show Card Writing this quick, easy way and are now making more and more money each week. **SO CAN YOU.**

Take advantage of the wide range of money-making opportunities always open in the Show Card field. Make original Show Cards for your own employer or work for several merchants at the same time. Establish a profitable business of your own. Show Card experts earn up to \$110 a week—and more if you're ambitious.

### Send for FREE Book

Get busy. Boost your pay. Don't delay your preparation for this uncrowded, lucrative profession. Write today for our big Free Book, full of illustrations. Gives complete details of our practical home-study course. Mail coupon now!  
**Washington Show Card School Dept. 2612-D**  
 1117-15th Street, N. W., Washington, D. C.

**Washington Show Card School Dept. 2612-D**  
 1117-15th Street, N. W., Washington, D. C.

Please send me FREE and without obligation, a copy of the new 32-page book, "Quick Success in Show Card Making."

Name .....

Address .....

City ..... State.....

## 1000 NEEDED INVENTIONS!

Here is the most remarkable book ever offered to inventors. One Thousand needed inventions listed and described. Arranged as follows: General Problems; Automotive; Mechanical; Electrical; Chemical; Radio; Marine. Separate chapter on the Ten Most Needed Inventions. This book may give you one idea that can win you a fortune. Nothing else like it has ever been published. Compiled at enormous expense. Edited by Raymond Francis Yates, formerly Managing Editor of a leading scientific magazine. Over 100 pages, durably bound. Send no money. Pay postman only \$1.00 plus postage on arrival. Money back after 10 days' examination if desired. Limited edition. Write NOW.

**BUREAU OF INVENTIVE SCIENCE**  
 DEPT. 712 ROCHESTER, NEW YORK

Insure your copy reaching you each month. Subscribe to Science and Invention—\$2.50 a year. Experimenter Publishing Co., 53 Park Pl., N. Y. C.

## Into the Fourth Dimension

By RAY CUMMINGS  
 (Continued from page 697)

which I must play a part. The whole seen and thought of in terms of my own world. And I realized that I—to these others of this other realm—must have seemed a stranger, but not so very strange. Thought of by them in their own terms—each of us upon a common ground, an equality of material state, to visualize the other in terms of ourselves.

### CHAPTER IX

#### THE ATTACK ON THE MEETING HOUSE

AHLA was saying, "At last—it is so good to be back." For her the struggle was wholly past; she was smiling, relieved, and upon her face there was solicitude for us. "You are not injured? At rest—now?"  
 "Yes," said Will. "It is over." His hand touched Bee affectionately. "The strangeness will soon be gone, I think. You all right, Rob?"



The people we passed did not heed us; the globes, from whatever angle we viewed them, were circular, seemingly flat, but always flat in the unseen dimensions. We passed close to one. It appeared solid. It had no apertures—no doors nor windows. A man went by us—a shape in the guise of a man; and he entered the globe by passing through it. It yielded to his passage; its substance closed after him, opaque, sleek, glistening as before.

"Yes," I said. In truth every moment a rationality of being was coming to me. And curiosity, of itself evidence of normality, made me ask, "Where are we going? What are we going to do?"

"Going with Ahla," said Will briefly. Her people are friendly to us—deploring the threatened invasion of our world."

I realized that he and Ahla at their first meeting must have exchanged knowledge, and planned what we now were to do.

Bee asked, "Are we going far? Will it take long?"

Ahla seemed puzzled. "Far"—"long." The words involved Space and Time. I saw that at first they had no meaning to her.

"We are going there," she answered. Her gesture was vaguely downward ahead of us. "Come," she added.

We started. My impression now is that we were walking. I could feel a part of my body in movement, quite as though of my volition I were moving my legs. A sense of lightness again possessed me; a lack of

## PATENTS

TRADE MARKS DESIGNS  
 FOREIGN PATENTS

## MUNN & Co.

PATENT ATTORNEYS

Associated since 1846 with the Scientific American  
 1518 Scientific American Bldg., 24 West 40th St.  
 New York City  
 525 Scientific American Bldg., Washington, D. C.  
 1311 Tower Building, Chicago, Ill.  
 667 Hohart Building, San Francisco, Cal.  
 522 Van Nuys Building, Los Angeles, Cal.  
 Books and Information on Patents and Trade Marks by Request.

## PATENT YOUR IDEAS

Inventions developed. Patents secured in the U. S. & Foreign countries. Satisfactory Terms. Write, call or phone HANOVER 3662 for confidential advice and Invention Recording Blank.



## INVENTIONS Commercialized

ON A CASH OR ROYALTY BASIS  
 PATENTED or UNPATENTED

In Business 25 Years - Complete Facilities - References.

Write **ADAM FISHER MFG. Co.**  
 205D Enright Ave. St. Louis, Mo.

## PATENTS

BOOKLET FREE HIGHEST REFERENCES  
 PROMPTNESS ASSURED BEST RESULTS

Send drawing or model for examination and report as to patentability

**WATSON E. COLEMAN, Patent Lawyer**  
 644 G Street, N. W., Washington, D. C.

## C. L. PARKER

Ex-Examiner U. S. Patent Office  
 Attorney-at-Law and Solicitor of Patents

McGill Building, Washington, D. C.  
 Patent, Trade Mark and Copyright Law

## Book on Law Free

Write today for this new book. It tells you how a law training will shorten your road to success. It also carries a vital and inspiring message to every ambitious man. Find out about the opportunities that the law trained man. Find out how you can learn law right in your own home. No obligations. The book is absolutely FREE. Write Today—special reduced tuition offer.  
 American Correspondence School of Law,  
 3601 Michigan Ave., Dept. 1429, Chicago, Ill.

## GOV'T POSITIONS

Men wanting forest ranger, railway mail clerk, internal revenue agent, postoffice clerk, carrier and field clerk positions. \$1,500 to \$2,700 a year. Write for free particulars. **MOKANE, Dept. 245, Denver, Colo.**

## BLUE BOOK ON PATENTS

and Priority Record blank gratis.  
**MONROE E. MILLER, PATENT LAWYER,**  
 411-6 Ouray Building, WASHINGTON, D. C.  
 ELECTRICAL AND MECHANICAL EXPERT

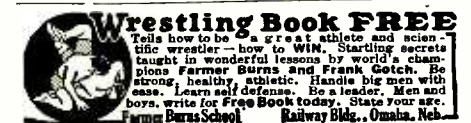

**Wrestling Book FREE**  
 Tells how to be a great athlete and scientific wrestler—how to WIN. Startling secrets taught in wonderful lessons by world champions Farmer Burns and Frank Gotch. Be strong, healthy, athletic. Handle big men with ease. Learn self defense. Be a leader. Men and boys, write for Free Book today. State your age.  
 Farmer Burns School Railway Bldg., Omaha, Neb.

Insure your copy reaching you each month. Subscribe to Science and Invention—\$2.50 a year. Experimenter Publishing Co., 53 Park Pl., N. Y. C.



stability. But I could feel solidity beneath me, and I was moving upon it.

We walked then, down the hill. There was vegetation; things, let me say, seemed rooted within the ground. But they bent from our advance as though with a knowledge and a fear that we might tread upon them.

The scene was no longer empty. A rolling land, with what might have been a mountain range rising in the distance. All in that half-light of seeming phosphorescence. I noticed now that the familiar convexity of earth was gone. The scene had a queer concavity; to the limit of my vision it stretched upward, as though we were upon the inner surface of some vast hollow globe with the concave darkness overhead coming down to meet it. A hollow globe within which we were standing; but it seemed of infinite size.

Not far away now was that region which first I thought was water. We passed over it—partly through it. I felt the resistance against me. Like water with no wetness; but to my sight it was a heavy fog lying upon the land. Its breath was oppressive; I was glad when we were past it, emerging again into the twilight with a city before us.

**Station  
WRNY  
NEW YORK**  
373.8 Meters - 802 kilocycles  
is owned and operated by the  
publishers of this magazine  
Our Editors will talk to you  
several times every week -  
See your Newspaper  
for details  
**TUNE IN ON  
WRNY**

A city! Houses—human habitations! I knew it—divined it with a new mental alertness; and Ahla's words presently confirmed my thoughts.

"Our Big-city," she said.

Before us lay an area upon which was spread a confusion of globes. Circular, yet visually flat of depth. In size I found them later to be, from the smallest some twice my own height, to others I would in my own world have said to be a hundred feet in diameter. Opaque grey globes, of a material unnameable. Of every size they lay seemingly strewn about; and in places piled one upon the other. All of grey color that glistened with a sheen of iridescence.

The Big-city. Diminished by distance it seemed indeed as though a thousand varying-sized soap-bubbles, smoke-filled, lay piled together. And the whole flattened, queerly unnatural like a picture with wrong perspective.

The globes were scattered about; but as we approached I saw open spaces twisting among them like tortuous streets. Horizontal streets; and vertical streets as well. Abruptly I realized that this realm was not cast like my own upon a single plane. On earth we move chiefly in a world of two dimensions—only in the air or water do we have the freedom of three. Here, the vertical and the horizontal seemed no different.

Bee said. "The Big-city. Houses—" Her voice trailed away into wonderment. From our presently nearer viewpoint, movement

# Why Wear Glasses?

## Thousands Are Throwing Them Away

Upon startling revolutionary facts has been based a remarkable new scientific system of eye-training, which quickly enables you to train the muscles of the eye so you can make them work properly at all times, and without effort or strain. This new system has been prepared by Bernarr Macfadden, in collaboration with the eminent ophthalmologist who discovered the real truth about eyes.

Remarkable tests were made in the N.Y. City Public Schools from 1903 to 1911. 2,000 children who had defective eyesight were instructed in a few of the simple exercises and in a short time their vision was radically improved. In one school, several children who had been compelled to wear glasses were enabled to discard them altogether.

No claim is made that this course is a cure-all. In many cases glasses are essential. But

if you are wearing glasses because of faulty refraction—far or near sightedness—astigmatism—cross eyes—squint eyes—weak, watering eyes—eye headaches or strain—you owe it to yourself to try this course without delay.

Cross section drawings show plainly the whole mechanism of the eye—muscles and nerves. Photographs of defective eyes make clear the real reasons for poor sight. Your own trouble is clearly illustrated. With this knowledge in mind, it becomes easy for you to correct your defective muscles and gain strong sight.

We are willing to send the entire course on approval giving you the privilege of returning it within five days after receipt if not satisfactory. The price of the course is only \$3.00, plus delivery charges.

MACFADDEN PUBLICATIONS, Inc., Dept. Sc-12, 1926 Broadway, New York City

## Are You Fair to Your Son?—Your Daughter?

There are dangers lurking just around the corner for every young man or woman. It is a parent's first duty to advise and guide them—keep them morally straight and physically strong and healthy.

If you want to be fair to them be sure to see Page 760.

Turn to Page 760 Now

# PATENTS TRADE-MARKS AND COPYRIGHTS

## OUR OFFER: FOR THE PROTECTION OF YOUR INVENTION

**YOUR FIRST STEP** before disclosing an invention. The inventor should write for our blank form—"RECORD OF INVENTION." This should be signed, witnessed and returned to us together with model or sketch and description of the invention for INSPECTION and INSTRUCTIONS.

**NO CHARGE FOR THE ABOVE INFORMATION**

**Our Four Books Mailed Free to Inventors**

Our Illustrated Guide Book

### HOW TO OBTAIN A PATENT

Contains full instructions regarding U. S. Patents. Our Methods, Terms, and 100 Mechanical Movements illustrated and described.

### OUR TRADE-MARK BOOK

Shows value and necessity of Trade-Mark Protection. Information regarding Trade-Marks and unfair competition in trade.

### OUR FOREIGN BOOK

We have Direct Agencies in Foreign Countries and secure Foreign Patents in shortest time and lowest cost.

### PROGRESS OF INVENTION

Description of World's Most Pressing Problems by Leading Scientists and Inventors  
All Communications and Data Strictly Confidential.  
Interference and Infringement Suits Prosecuted.

### IMPORTANT

**TO MAKE YOUR CASE SPECIAL AND AVOID DELAY YOU SHOULD HAVE YOUR CASE MADE SPECIAL IN OUR OFFICE** to secure protection, save correspondence and obtain early filing date in Patent Office. To secure special preparation of your case send \$25.00 on account with model or sketch and description of your invention.

Highest References—Prompt Attention—Reasonable Terms

WRITE TODAY

**FREE COUPON** VICTOR J. EVANS & CO., Patent Attorneys  
Main Offices, 779 Ninth Street, Washington, D. C.  
New York Offices, 1007 Woolworth Bldg.; Philadelphia Offices, 518-519 Liberty Bldg.;  
Pittsburgh Offices, 514 Empire Bldg.; Chicago Offices, 1114 Tacoma Bldg.; San Francisco  
Offices, Hobart Bldg.

Gentlemen: Please send me FREE OF CHARGE your books as described above.

Name .....  
Address .....

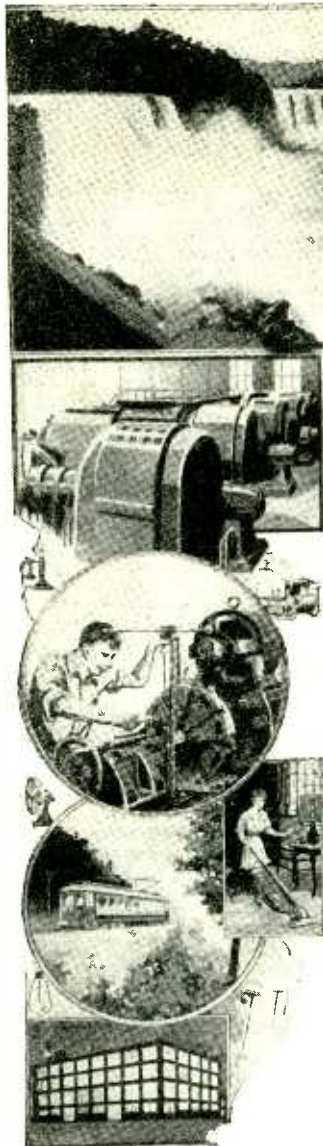

## Master Electricity By Actual Practice

The only way you can become an expert is by doing the very work under competent instructors, which you will be called upon to do later on. In other words, *learn by doing*. That is the method of the New York Electrical School.

Five minutes of actual practice properly directed is worth more to a man than years and years of book study. Indeed, Actual Practice is the only training of value, and graduates of New York Electrical School have proved themselves to be the only men that are fully qualified to satisfy EVERY demand of the Electrical Profession.

### The Only Institution of the Kind in America

At this "Learn by Doing" School a man acquires the art of Electrical Drafting; the best business methods and experience in Electrical Contracting, together with the skill to install, operate and maintain all systems for producing, transmitting and using electricity. A school for Old and Young. Individual instruction.

### Over 10,000 Graduates are Successful Men in the Electrical World

No previous knowledge of electricity, mechanics or mathematics is necessary to take this electrical course. You can begin the course now and by steady application prepare yourself in a short time. You will be taught by practical electrical experts with actual apparatus, under actual conditions.

The N. Y. E. S. gives a special course in Automotive Electricity. The course covers completely all systems of Ignition, Starters, Lighting, Storage Batteries and other electrical equipment on automobiles, motor-boats and aeroplanes, etc.

Let us explain our complete course to you in person. If you can't call, send now for 64-page book—it's FREE to you.

**New York Electrical School**  
29 West 17th Street, New York

New York Electrical School  
29 W. 17th St.,  
New York, N. Y.

Please send FREE and  
without obligation to me  
your 64-page book.

..... Name  
..... Street  
..... City

showed in the city; beings—people like our selves—moving about the streets. And soon we were among the globes—within the city.

I say "soon." I can remember no conception of time, save in terms of the events within my ken. How long it was from our crossing the borderline until we reached the city I do not know—we moved, walked and entered the city. How far we walked—that too I do not know.

The people we passed did not heed us; the globes, from whatever angle we viewed them, were circular, seemingly flat, but always flat in the unseen dimension. We passed close to one. It appeared solid. It had no apertures—no doors nor windows. A man went by us—a shape in the guise of a man; and he entered the globe by passing through it. It yielded to his passage; its substance closed after him, opaque, sleek, glistening as before.

We stopped at a globe of larger size. Ahla said, "I will leave you here. And when I come back—we will go together to the meeting place. They are waiting for you."

Will nodded. "Very well, Ahla. How long before you come?"

Again she was puzzled. "How long? Why I will come."

### Articles In December "Radio News"

- The Loud-Speaking Christmas Tree,  
By Hugo Gernsback.
- The New Hammarlund-Roberts 5-Tube  
Receiver, By V. T. Baird.
- Electrifying Your Phonograph,  
By H. B. Whiffen.
- All About Loud Speakers,  
By M. L. Muhleman.
- Home-made Coils for the Browning-Drake,  
By C. A. Oldroyd.
- Magnetic Fields in Vacuum Tubes,  
By Robert Serrell.
- The Improved "Bass Note" Circuit,  
By George V. Rockey.
- An Infradyne Combination Set,  
By Clyde J. Fitch.

She left us; I did not see how or where she went.

Will said, "Come on. This is our house they have given us."

Together we passed through the side of the globe. I felt almost nothing—as though I had brushed against something, no more. Were the globes of a material solidity? I do not know.

Within the globe was a hollow interior. Call it a room. The same luminous twilight illumined it. A room of circular concavity. No walls, no ceiling; it was all floor. We walked upon it and though we had passed through it, nevertheless it sustained us; and in every position beneath us seemed the floor, above us the ceiling. A memory of the vanished gravity of our earth came to me. The word—the conception—had no meaning here. Yet we had weight; the substance upon which we rested attracted us perhaps. I cannot say.

We gazed around us. There were places of rest—rectangles of a misty white into one of which I found myself instinctively reclining as though with a need of physical quiet. A sense of ease came to me; but it was only vaguely of the physical. I was indeed now barely conscious of a body; but of my mind I was increasingly aware. I could be tired in mind. I was, and I was resting.

Will and Bee were resting also. I saw upon Bee's face that same queer, wistful expression which had marked Ahla's; I

## Novelties—How to Make Them

Make Hundreds of Remarkable Things at Home

Almost every home has an old clock around—Do you know that a great many surprising, fun making and useful novelties can be made just from the old springs, the gears, etc.

NOVELTIES, the new book, compiled by the staff of SCIENCE & INVENTION, shows you how to make hundreds of wonderful Novelties, mostly out of old scrap things laying around the house. 116 Pages, in this book, show pictures, diagrams and explanations of remarkable, interesting things to make in your spare time.

**PRICE**  
**50¢**

116 Pages, 300 Illustrations,  
Size 9 x 12 inches

Sold on all newsstands. If your newsdealer cannot supply you, order direct. We pay postage charges.

**EXPERIMENTER PUBLISHING CO., INC.**  
53 PARK PLACE :: NEW YORK CITY, N. Y.

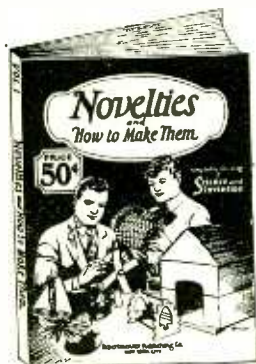

saw her regarding me intently; and I answered her affectionate smile.

Will said, "The strangeness is leaving us. I'm tired—I wish I did not have to talk, but I feel that I should."

He told us then what he had learned from Ahla. This Big-city was the most populous place of the realm. Ahla's parent—I might say her father, to make the term more specific—was leader of the Big-city people. One among them—one whom they called Brutar—had found a way to get into the Borderland. He had gone there—and I think that it was he whom we termed the first of the ghosts—whom we had seen that night on the little Vermont farm. He had returned, with tales of an outer world. . . . tales of the consciousness of a different body . . . a physical being with pleasures unimagined. . . .

The craze to follow him spread. An element undesirable among the people seemed most inspired to join him.

"Ahla told me little more than that," Will went on. "The method they are using to get to the Borderland—I do not yet know. But I know that this Brutar—he would sweep with his followers into our world. Physically possessed, in a fashion they could not understand. . . ."

He stopped with the sentence unfinished;



**FREE** if you order now

To all who subscribe to this pay raising set now we will give a copy of Bishop's Electrical Drafting and design, a great book that tells you everything you want to know about the preparation, reading and use of all kinds of electrical diagrams and drawings. It tells you how to handle electrical plans and blueprints. It shows you how to put your own ideas into correct drawing form. It is a book no man would expect to get free — it comes to you with the Croft Library as a premium for promptness.

## Raise your pay with these books

**B**IG salaries are paid in the electrical field for expert knowledge. The man who knows electricity in all its many phases—the man who has completely mastered the subject from A to Z—can pick his own job and name his own salary. The only way you can earn more is to learn more. Small knowledge means small pay. Learn the way to bigger pay. Become an expert. Croft will show you how.

### Croft Library of Practical Electricity

8 volumes—3000 pages—2100 illustrations—flexible keratol—small monthly payments

Everywhere the Croft Library is acknowledged as the standard—the leader—in practical electrical training. In the Croft books you will find complete, detailed and up-to-the-minute information on all phases of electricity, motors, generators, armatures, commutators, transformers, circuits, currents, switchboards, distribution systems—electrical machinery of every type—wiring for light and power—how to do it mechanically perfect, in accordance with the National Electrical Code—wiring of finished buildings—underwriters' and municipal requirements—how to do a complete wiring job, from estimating it to completion—illumination in its every phase—the latest and most improved methods of lighting—lamps and lighting effects, etc.

### Know electricity as experts know it and get an expert's pay

Fit yourself for a bigger position by knowing electrical practice complete—inside and outside work—central stations and the whole subject. Croft will teach you. He will take you in quick, easy steps from the simplest principles to the complete and economical operation of a great central station. The Croft-trained man wins because he knows the "why" and the "how" of modern electrical practice. Croft has been through the mill. His knowledge has been gained by shirt-sleeves contact with electrical problems. He has worked his way up from the bottom to the top—from apprentice lineman to electrical engineer for one of the great electrical manufacturing companies. Now he heads his own consulting company, and his name is known in every corner of the electrical world. He is the one man above all others who can show you the way to permanent success.

### Examine these pay-raising books free

We want you to test our statement—we want you to compare Croft books with others. Fill in and mail the coupon attached and we will send you the entire set of eight volumes for ten days' Free Examination. We take all the risk—pay all charges. You assume no obligation—you pay nothing unless you decide to keep the books. Then \$1.50 in ten days and the balance at the rate of \$2 a month. Send the coupon NOW and see the books for yourself. When your first payment of \$1.50 is received we will send you your free copy of Bishop's Electrical Drafting and Design.

McGraw-Hill Book Co., Inc.,  
370 Seventh Avenue  
New York.

Gentlemen—Please send me the CROFT LIBRARY OF PRACTICAL ELECTRICITY (shipping charges pre-paid), for 10 days' free examination. If satisfactory, I will send \$1.50 in ten days and \$2 per month until \$19.50 has been paid. If not wanted I will write you for return shipping instructions. Upon receipt of my first payment of \$1.50 I am to receive a copy of Bishop's Electrical Drafting and Design without additional charge. (Write plainly and fill in all lines.)

Name .....

Home Address .....

City and State .....

Employed by .....

Occupation ..... S.I.-12-1 '26

**Send no money -- just the coupon**

#### IMPORTANT

#### TO NEWSSTAND READERS

**I**N order to eliminate all waste and unsold copies it has become necessary to supply newsstand dealers only with the actual number of copies for which they have orders. This makes it advisable to place an order with your newsdealer, asking him to reserve a copy for you every month. Otherwise he will not be able to supply your copy. For your convenience, we are appending herewith a blank which we ask you to be good enough to fill in and hand to your newsdealer. He will then be in a position to supply copies to you regularly every month. If you are interested in receiving your copy every month, do not fail to sign this blank. It costs you nothing to do so.

To ..... Newsdealer:

Address .....

Please reserve for me ..... copies of SCIENCE & INVENTION every month until I notify you otherwise, and greatly oblige,

Name .....

Address .....

it left me with a memory of that Kansas farm-house, and of the young girl who had died of fright.

Bee asked, "What do they call themselves—these people? This race—beings—" She floundered. "There are no words, yet I have so much to ask."

He shook his head. "All that we have to learn. There is a civilization here—a mental existence in which we'll soon be taking a rational part. For myself, it is less strange every moment."

I nodded. "And Ahla's people—they refuse to join in this invasion of our world?"

"Yes," he said. "They deplore it—they're trying to stop it. A meeting is to be held—Ahla is coming to take us to it."

I drifted off into a reverie; and Ahla came. I glanced up to see her beside us.

"If you are ready," she said, "we will go."

Again we passed through the enveloping globe which was our home; passed along the city street. It was now deserted. We walked on its level surface; it wound and twisted its way between the globes. At times a group of them piled one upon the other—the smallest on top like a disarray of bubbles—obstructed the street. But the substance upon which we walked (it was often barely visible) turned upward; a sharp upward curve to the vertical; then straight

# 30 Days Free Trial

Just Out-  
1927  
Model

Yes Sir!  
You can put a new 1927 Westingale Radio in your home and use it to your heart's content on 30 Days' Trial. Listen to music, concerts, news, sports, market reports from stations all over the country. Compare it with old style 3 or 4 dial sets costing more, then if not convinced that Westingale gives you the greatest Radio satisfaction and the best value for your money, you don't have to keep it.

New ONE  
Dial Radio  
\$57<sup>00</sup>  
Retail Price

NOW! Westingale offers the last word in Radio. Either 1 or 2-Dial Control — easiest to tune and years ahead in powerful reception and tone. Newest period type cabinets, two-tone walnut finish. The front panel embossed in dull gold with artistic Spanish Galleon design. Unbeatable for performance, appearance or price.

2-Dial, 5 tubes \$47<sup>00</sup>  
1-Dial, 5 tubes \$57<sup>00</sup>

Where else can you get so much for the money on 30 days' trial? Why pay more? Why take chances? Why not have the NEWEST Radio when you can try them at our risk. Before you buy get our Free Catalog and 30 Day Trial Offer.

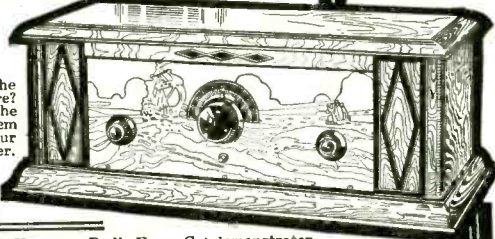

Westingale Electric Co.  
Department 53  
1751 Belmont Av., Chicago, Ill.

**AGENTS WANTED BUY at COST** Your own Radio Free. Get demonstrator set on 30 Days' Trial—make \$100 a week easy. Full or spare time. Big discount on first set placed in each locality. Be first—write today for dealers' discount and full details.

up, again leveling off, and then downward. We trod it; with no more effort going up than upon the horizontal. It seemed, indeed, only as though the scene about us had shifted its plane.

In silence we proceeded. I wondered where the inhabitants of the place might be. Then I saw a few. Not walking openly, these few we now encountered; one I saw lurking in the curve between two adjacent globes. A man . . . robed darkly . . . a dark hood seemingly over his head . . . like a shroud enveloping him to mingle his outline with the darkness . . . Darkness? Had the twilight turned to night? . . . Was this the Borderland again? . . . I seemed to see its darkness . . . I strained my vision for the familiar shadows of our own world . . . Was that a tree? . . . A street? . . . Was that Will's house over there? . . . Bee's agonized voice reached my consciousness. "Rob! Rob dear, come back to us!" My mind had wandered, and had drawn with it the tenuous wraith of a body it so easily dominated. I fought myself back.



We passed through one of the bands of the gigantic globe, and found ourselves in a single great room. A globular amphitheatre; to use earthly measurements it had perhaps a thousand feet of interior diameter. Its entire inner surface was thronged with grey-white shapes of people. . . .

Told myself vehemently I was *not* in the Borderland; I was with my friends. With Will—Bee; with Ahla.

I saw them, distantly; with Space I know not how much, nor Time, how long—between us. Saw them; saw Bee with horrified arms held out as though to bring me back. And felt myself whirling in Nothingness.

"Rob! Rob!"  
"Yes," I called. "I'm here—coming."  
And at last again I was with them.

"You're careless, Rob." Concern mingled with the relief in Will's tone. "Careless—you must not wander that way."

Ahla said quietly. "There are many like that. A wandering mind brings evil to the body it tosses about."

"But with us now, it is additionally hard" Will said. "Every instinct within us draws us away—as it was with you, Ahla, in the Borderland."

"Yes," she agreed. "I know that."

We continued our passage toward the meetinghouse. That shrouded shape I had seen was not of my wandering fancy, for now I saw others. Peering at us from dark spaces; eyes that glowed unblinking; or shapes of mantled black skulking furtively along the streets. Avoiding us, yet always watching as we boldly passed.

"Brutars," Ahla said. "Those who with Brutar would attack your world. They are

DIAMONDS

The Old Reliable Credit Jewelers

## LOFTIS BROS. & CO.

125 S. State St. Chicago, Ill.

**Genuine Diamonds Guaranteed — Cash or Credit**

Give a Diamond for Christmas! Buy from Loftis, the Direct Importer, and be sure of highest quality and most value for your money. Our ring and mounting are the latest creations in 18-k white gold, elaborately carved and pierced. Satisfaction guaranteed, or money back. Goods sent for your free examination on request. Credit Terms: Pay one-tenth down, balance weekly, semi-monthly, or monthly at your convenience. All goods delivered on first payment.

**Christmas Catalog Free!** Big 132-page book, illustrating our Diamonds, Watches, Jewelry, Silverware, and gift articles for all occasions, sent absolutely free. Write today.

19-Jewel Adjusted Waltham No. 846—14-k white gold filled; assorted pattern, \$42.50 \$4.25 down and \$1.00 a week

We carry all standard makes of Railroad Watches—guaranteed to pass inspection.

**Credit at Cash Prices**

Our References: Any Bank or Banker in U. S. A.

WATCHES

No. 843 \$1.00 \$2.50 a wk.

No. 851 \$1.00 \$1.25 a wk.

No. 857—Ladies' Wrist Watch, solid 14-k white gold, 15 Jewels. \$27.50—\$2.75 a wk. \$2.75 down \$2.75 month

No. 847 \$3.75 a wk.

No. 1

No. 2

Solid 18-k white gold Wedding Rings. Beautifully engraved and carved in floral patterns of the newest design.

No. 1—Four-leaf clover \$4.50  
No. 2—Mignonette . . . \$4.50

Accurate 3 ft. Scale Model

Build a Model of This Famous

## FOKKER

### NORTH POLE AIRPLANE!

It's the most interesting thing you ever did; shows you the parts of the real machine, how it is constructed, what makes it fly. Anyone can do it; the Ideal Construction Outfit contains all parts, materials and supplies required, including Drawn-to-Scale Plans, Forming-Assembling Layout and Building-Flying Instructions. The Model is wonderful; a perfect duplicate of the original; 3 ft. wing-spread size; weighs only 11½ oz. when completed and is guaranteed to fly under its own power when correctly constructed.

Complete Ideal FOKKER Construction Outfit \$8.00

Ask Your Dealer or order direct.  
(West of Denver, Colo., price is \$8.50)

48-PAGE AIRPLANE CATALOG

Gives full information about many wonderful Models of well-known Airplanes; also biggest assortment of parts and supplies for Model builders. Send for a copy now.

5c

IDEAL AEROPLANE & SUPPLY CO.  
165-169 SPRING STREET NEW YORK CITY

## FURNESS BERMUDA LINE

(Bermuda Government's Official Contract Steamers)

### BERMUDA

Fairlyland for Rest or Play

(Average Yearly Temperature of 70°)  
Only 2 Days From New York

Sailings Twice Weekly  
From New York  
Wednesday and Saturday

Tickets good on either Steamer, insuring unequalled express service via Palatial New Twin-Screw Oil-Burning Transatlantic Liners.

S.S. "FORT VICTORIA"  
S.S. "FORT ST. GEORGE"

No Passports Modern Hotels All Sports  
including Golf, Tennis, Sailing, Bathing, Horse Racing, Fishing, Riding, Driving, Cycling, etc.

ST. GEORGE HOTEL, BERMUDA—Unsurpassed location overlooking ocean, harbor and surrounding islands. Finest cuisine and service, magnificent tiled, covered and heated swimming pool.

For Illustrated Booklet on Bermuda or St. George Hotel or West Indies, write

FURNESS BERMUDA LINE  
34 Whitehall Street New York  
or Any Local Tourist Agent

everywhere now about the city. I am afraid of them."

We came upon the meetinghouse. It was a tremendous globe, in outward aspect no different from the others save that its size was gigantic. As we neared it I saw that upon its luminous grey surface were narrow circular bands of a lighter color—bands both vertical and horizontal. These also I had noticed on most of the other globes; a lighter color in bands, or sometimes in small patches. I questioned Ahla; the lighter-colored parts were where one might safely enter, thus not to encounter the occupants, or the furnishings within.

We passed through one of the bands of the gigantic globe, and found ourselves in a single great room. A globular amphitheatre; to use earthly measurements it had perhaps a thousand feet of interior diameter. Its entire inner surface was thronged with grey-white shapes of people, save where, like aisles, the space of the outer bands divided them into segments.

The segments were jammed; the people seemed crouching upon low pedestals one close against the other. A few of the pedestals were vacant. None where we entered, and the nearest I saw were almost above us. We passed along an aisle to reach them. The globe and everyone in it appeared slowly turning over, so that always we seemed to be at its bottom with those opposite to us over our heads.

At last we were seated. In the center of the globe, suspended there in space by what means I could not know, was a ball some fifty feet in diameter. Upon it men were sitting. Dignitaries; leaders of the people facing from every angle the waiting throng. And one—a man of great stature—Ahla's father, walking around the ball restlessly, awaiting the moment when he would begin his address.

A silence hung over everything. Again I was reminded of the utter soundlessness of this realm. I felt the suppressed murmurs of the people—but I know no physical sounds were audible. Nor indeed, had I ear-drums with which to hear them had such sounds existed.

Time passed as we found our seats. Immobile we sat; and for me at least, time ceased to exist.

Then Ahla's father spoke. "My people—danger has come to a strange race of friendly neighboring beings. And it brings a danger also to us all—to you, to me—"

He stopped abruptly. I felt a sound; a myriad sounds everywhere about us. Shouts of menace; a swishing, queerly aerial sound as of many rapidly moving bodies.

Through all the aisles of the globe, from outside, the shapes of men were bursting. Swishing through the opaque surface of the globe, entering among us, whirling inward. Like storm tossed feathers they whirled, end over end, uncontrolled with the power of their rush. A cloud of hostile grey shapes in the fashion of menacing men come to attack us!

—END OF PART 4—

## Radio Wrinkles Wanted!

The Radio Editor, Mr. J. Francis Clemenger, wants to hear from you, if you have a good idea or wrinkle. Make a pencil or pen and ink sketch of the contrivance, write 50 words or so of description, and mail to the Radio Editor, c/o this magazine.



### Handiest Tool in Your Work Shop

PERHAPS you have never thought of the special advantages of using LePage's Liquid Glue. It is always ready for immediate use. No weighing, soaking or heating is required. Its quality is always the same. It "sets" slowly enough so that you have plenty of time to place the joints together exactly as they should go. Slow setting also allows LePage's to penetrate the wood, increasing the strength of the joint. LePage's Liquid Glue is equal in strength to any animal glue. Buy a can for your workshop. It is the easiest, quickest, handiest form of Glue. Insist on LePage's.

#### Recipe for Making LePage's Gesso

To MAKE one cup of LePage's Gesso, you need 1 gill can of LEPAGE'S GLUE, 1/4 cups whiting, 3 teaspoons linseed oil and 3 teaspoons varnish. Place whiting in mixing bowl and pour in slowly in this order, LEPAGE'S GLUE, linseed oil, and varnish. Mix until smooth. All ingredients obtainable at nearest hardware store.



# LE PAGE'S GLUE

Bottles, Tubes, Cans

## Try this NEW way to improve your craftsmanship

### LePage's New Books Will Show You How

WITH the coming of the long winter evenings, the best time of the year is here for the man with the Home Work Shop Hobby. What articles of furniture are you planning to make this winter? Whether it is a radio cabinet, end table, book case, cedar chest, or any other piece of household furniture, LePage's New Books can be of practical help to you.

"LePage's Practical Suggestions for the Home Work Shop", and "LePage's Gesso-Craft Book", will help you come closer to equalling the skill of the trained cabinet maker, turning your evenings spent on this hobby to better account. They tell you how to make strong joints with glue, and not only with glue, but with glue in its most convenient form—LePage's Liquid Glue.

These books also show you how to cover up small defects in your craftsmanship. Now and then a tool will slip and an error is made. Or there are holes to be filled where nails or screws have been countersunk. Or the edges of a joint are not exactly even. A simple new way to repair these defects is with the use of LePage's Gesso instead of putty. LePage's Gesso will stick to any surface—wood, metal, glass, etc. It can be sandpapered, planed and painted or stained, just like wood. We give you in the small panel below a simple formula for making LePage's Gesso, but of course we tell you more about it in the books themselves, together with practical information on decorating your finished articles with Gesso.

#### Send 10 cents for these NEW LePage's Books

THE practical and useful help of these two books is yours for only 10 cents. Just write your name and address on the coupon below, tear the coupon out and mail it to us today with 10 cents in coin or stamps, and we will at once send you a copy of these two LePage's Books, postage paid. Address LePage's Craft League, Dept. NN-6, Gloucester, Mass. Tear out the coupon now so you will not forget it.

LEPAGE'S CRAFT LEAGUE,  
Dept. NN-6, Gloucester, Mass.  
Gentlemen: Enclosed you will find 10 cents (coin or stamps) in payment for "LePage's Practical Suggestions for the Home Work Shop," and "LePage's Gesso-Craft Book." Please send a copy of each to:

Name .....

Street .....

City..... State.....



## Show them what you can do

Wouldn't it be fun to astonish your friends some evening real soon by playing the latest popular tunes on your new

# BUESCHER

## True Tone Saxophone

Popularity; good times; the smiles of those whose smiles you most desire; these will be yours. And you can learn so easily.

### You Can Teach Yourself

If you can whistle a tune, if you can beat time, you can learn to play the Buescher Saxophone, Easily! You can teach yourself, at home, in a few evenings. Three simple lessons given on request with each new Saxophone start you. You learn scales in an hour and start playing tunes in a week. Your progress will astonish and delight you and surprise your friends.

### Try Before Buying. Easy Terms

Take home with you any Buescher instrument, Trombone, Cornet, Trumpet, Saxophone for six days' trial. Test it. See what you can do with it. If you like it, pay a little each month. Satisfaction guaranteed. Send for beautiful free catalog of any instrument and details of trial and payment plans. No obligation. Do this today.

**BUESCHER BAND INSTRUMENT CO.**  
Everything in Band and Orchestra Instruments  
1741 Buescher Block Elkhart, Indiana



### The Story of the SAXOPHONE

Gives complete history and tells why the Buescher is so easy to learn to play. In it you will find the first lesson chart. You must have this fine book.

Free BOOK

### Clip the Coupon NOW!

**BUESCHER BAND INSTRUMENT CO.** 303B  
1741 Buescher Block, Elkhart, Indiana.  
Gentlemen: Without obligating me in any way please send me your free literature. I am interested in the instrument checked below.  
Saxophone  Cornet  Trumpet  Trombone  Tuba   
Mention any other.....  
Name.....  
Address.....

## Free Cathode Rays

(Continued from page 730)

its property of double refraction) retains its luminosity for several hours after being subjected to the cathode rays.

When subjected to the powerful radiation from the new tube, calcite shows, in addition to the orange glow, bright bluish scintillations or sparks. These continue to occur after the raying even for as long as a minute. The area in the neighborhood of these scintillations loses all luminosity as the scintillations occur and then appears black against the orange of the glow. When these spots are subsequently observed under a microscope they are marked by a minute crater with tiny straight canals running at right angles to one another and parallel to and about 0.01 of an inch beneath the surface. From the microphotographs in Fig. 8 it will be seen that the canals are not continuous channels; but appear to be frequently interrupted, looking like dotted lines in the crystal.

When a thin sheet of celluloid is rayed at a very low temperature, craters are formed as in the case of calcite, but the canals leading to them are curved and of no regular formation. Although the causes of some of the peculiarities of these craters and canals is not yet fully understood, the difference in the form of the canals in these two substances is due most likely to the fact that calcite has a crystalline and celluloid a non-crystalline structure.

The effect of the cathode rays upon such an organic substance as glue is very remarkable. Two small circular areas on the piece of glue have been exposed to the rays, but not visible effect is produced until the sample was subsequently gently heated. Then the exposed areas lose their brown color and become white. Examination under the microscope shows the exposed areas to be full of minute gas bubbles.

Another interesting effect to be observed is the action of the rays upon acetylene gas (C<sub>2</sub>H<sub>2</sub>). Several grams of a yellowish-brown powder have been formed and this material has been found insoluble in all of the many different chemical agents which have been tried. Also under the influence of cathode rays, castor oil rapidly changes into a solid material; crystals of cane sugar turn white in color and upon heating, give off quite a bit of gas, and an aqueous solution of cane sugar becomes acid to litmus upon being rayed.

That temperature in some cases has a marked effect upon results produced by the cathode rays is shown by an experiment performed on a card coated with cadmium tungstate. At room temperature the cadmium tungstate glows with a brilliant bluish light, and as soon as the ray is turned off, the material is no longer luminous. However, after allowing the card to remain in liquid air for about 30 seconds and then placing it in the rays for an instant, the bluish glow quickly fades out and as the card warms up from -180 degrees Centigrade to room temperature, it undergoes a series of brilliant color changes.

### EFFECT OF CATHODE RAYS ON PLANT AND ANIMAL TISSUES

A portion of the leaf of a rubber plant, when rayed with one milliamper for about 20 seconds, was immediately covered with white latex, as though the walls of the cells of the leaf had become ruptured. This same effect could be produced by pricking the leaf of this plant at a great many places with a sharp point. Even though the exposure was reduced to 1 second and the current to 0.1 milliamper, there was a color change with a subsequent drying-out of the



## This Remarkable Clock Does the Work of \$375 12 Clocks . . . Postpaid

This new time device is being used by DX fans everywhere—Frame may be removed and clock inserted in panel of your receiver. This radio clock girdles the globe—overcomes confusion in bringing in distant stations. A glance tells you the time anywhere.

Most essential to the traveler in foreign countries or those motoring 'cross country. Guaranteed mechanically perfect. Shipped promptly, postpaid, on receipt of check or money order for \$3.75. State time zone wanted.

**SWIFT & ANDERSON, INC.**

Successor to Henderson Brothers

Largest Importers of Field Glasses in America

97 FEDERAL STREET BOSTON, MASS.



## Learn to Draw at Home

**Simple Method Makes It Amazingly Easy**  
Trained artists earn from \$50 to over \$250 a week. Tremendous demand right now for good art work. Magazines, newspapers, advertisers, printing houses, etc.

Become an artist through this quick, easy method—right at home in spare time. Learn Illustrating, Designing and Cartooning. Actual fun learning this way. Individual attention by mail from successful commercial art instructors. Learn to draw and earn big money.

### Send for FREE BOOK

Just printed—a new book which describes the latest developments and wonderful opportunities in Commercial Art, and gives full details of this quick, easy method of learning to draw. Tells all about our students—their successes—what they say—actual reproductions of their work—and how many earned big money even while learning. Write for this Free Book and details of attractive offer. Mail postcard or letter now.

**WASHINGTON SCHOOL OF ART**  
Room 2612-D 1115-15th St., N. W., Washington, D. C.

**"BABY" HAMMERLESS**  
EJECTOR REVOLVER **6.00**  
6 Long, 22 Cal  
VERY COMPACT  
4" OVERALL  
WT 6 OZ

Made in U.S.A. and Guaranteed  
Wonderful protector to meet any emergency. Always ready, so small and compact that it can be carried in your vest pocket. Not a toy. Nickel or Blue finish. Leather holster 75c extra.  
R.F. SEDGLEY, Inc., Mfrs., 2330 N. 16th St., Phila., Pa.

rayed area to a depth corresponding to the penetration of the rays.

A portion of the ear of a rabbit was rayed with 1 milliampere of current for 1 second. After a few days a scab formed over the rayed portion of the ear (Fig. 10, right) and in another few days the scab came off, taking the hair within that area with it. In about two weeks after this, (Fig. 11, left) snow white hair started growing on this spot and soon became longer than the original gray hair. Another area was rayed with 0.1 milliampere for 0.1 of a second. The effect was much less marked, as is shown by the upper part of Fig. 10, and when the hair came back again it was partly gray and partly white.

**HOME SHOP TOOLS**

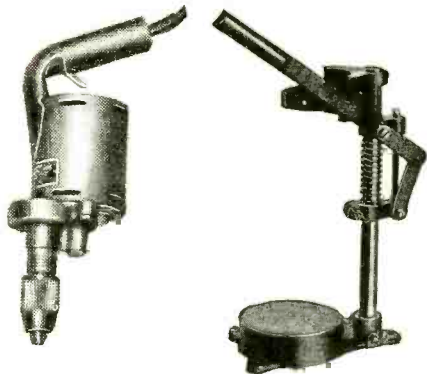

Indispensable electric hand drill. Home mechanic's drill stand to fit hand drill.

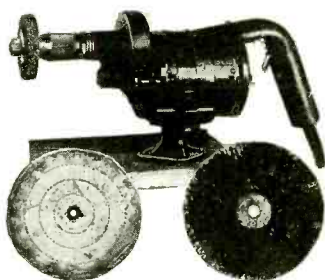

Electric hand drill mounted on base to accommodate emery wheel or buffer, etc.

Photos courtesy Electro-Magnetic Tool Co.

**F**OR drilling radio panels and dozens of other purposes, the electric hand drill shown above will prove indispensable. The ordinary hand drills and breast drills, do the work very well, but the average home mechanic and radio set builder today finds the common hand drill far too slow. This electric motor-driven hand drill illustrated above is a universal tool, the makers supplying it also furnishing drill press stand and the grinding wheel support shown in the lower picture.

**Motor Hints**

(Continued from page 706)

To use this means, either convert one of the socket handles to fit the jaws of the brace or make up a part from cold rolled steel that will allow of rotating the socket with the brace.

A single socket bar or handle, will permit of use of all the sockets in the set, in the same brace.

Naturally, the use of the brace is not confined to cylinder head bolts alone, as the same brace means of turning the socket is applicable to removing tires, transmission bolts or for work on any of the bolted members in the car. This simple means makes overhaul and adjustment work far less tedious.

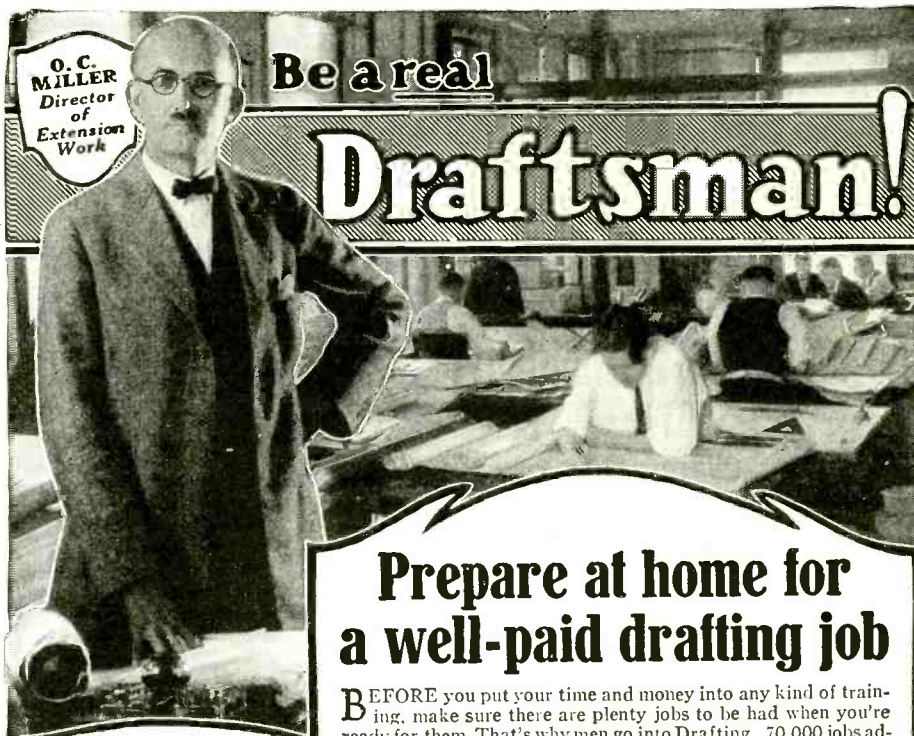

**Prepare at home for a well-paid drafting job**

**B**EFORE you put your time and money into any kind of training, make sure there are plenty jobs to be had when you're ready for them. That's why men go into Drafting. 70,000 jobs advertised in 12 months. Big salaries. Fascinating, easy work, short hours and unlimited opportunities for advancement to executive positions. Here's "white collar work" that controls all building, manufacturing, public works. Called the Ideal Profession for Men because it offers the greatest opportunities for success.

**Drafting Made Easy for You Real Draftsmen SPECIALIZE**

We have developed a new, one-step-at-a-time method which makes Drafting principles easy to understand. Even men with only common schooling make rapid progress with this instruction. Right from the very beginning you do actual Drafting room jobs. And by a wonderful new system you learn *without* copying, you see *why* every step is done, and so you become a *Draftsman*, not a *tracer*.

The big money in Drafting goes to men who specialize in Machine Design, or Electrical Drafting, or Architectural Drafting, or Structural, or Automotive. It isn't enough merely to know general Drafting practice. You must know how to calculate and design and plan original work to fill the kind of Drafting position that pays \$60 to \$125 a week. The American School, for 29 years a leading institution teaching Engineering by home-study methods, now includes this specialized training in the complete Drafting course.

**Training Backed With Nation-wide Free Job Service**

The American School now offers its students and graduates, without cost, the services of an efficient Employment Department which keeps in touch with the employers of Draftsmen all over the United States. *We have placed hundreds of men in good Drafting positions.* The demand for Draftsmen in all lines at all times exceeds the supply. This is the work to get into. I will show you how, and help you make a success of it. Real Draftsmen go quickly to the top with the backing of this million-dollar Institution.

**No-Profit Price Easy Terms**

This wonderful, more complete, simplified, rapid, up-to-date instruction in Drafting offered at very low tuition, easily within reach of the untrained man who needs it. Small monthly payments make it easy for you to prepare for a fine Drafting position at a big increase over your present salary.

**Look into this opportunity. Get my free book, Job and Raise offer quick! Let me show you how to turn part of your spare time into real training and for a real job**

*Mail this coupon for my amazing offer!*

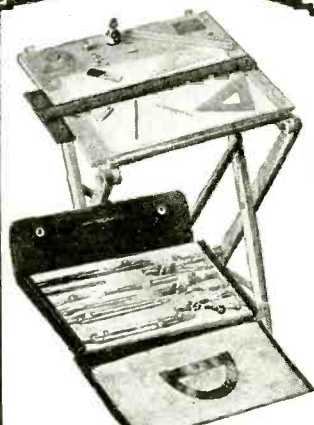

Complete Professional Outfit Given. These standard instruments, board, table, triangles, T Square, ink, protractor, etc., given without charge.

**will make this contract with you**

**W**HEN you enroll for my home-training in **DRAFTING**, I agree to give you:

1. Complete instruction by my new practice method.
2. Mostly professional outfit shown above.
3. I WILL HELP YOU GET A GOOD JOB AND A RAISE IN PAY—
4. Or I'll refund every cent of your money.



O. C. MILLER

O. C. MILLER  
Director of Extension Work

**American School**  
Dept. D926  
Drexel Ave. and 58th St.  
CHICAGO

O. C. MILLER, Director of Extension Work  
American School, Dept. D926 Drexel Ave.  
and 58th Street, Chicago

Please send me Free Drafting Book, Job and Raise offer and complete information about preparing for a fine Drafting Job at home in spare time.

Name.....  
St. No.....  
City.....State.....



Corner of One of the Seven S. of E. Laboratories

## Take This Short Cut to Accomplish Your Ambition

The field of electrical engineering offers wonderful opportunities for trained men to direct and carry out great industrial and commercial projects. Get a thorough and practical training here in our course of

### ELECTRICAL ENGINEERING with B. S. Degree in 3 Years

A faculty of specialists is leading hundreds of ambitious young men to sure success. Why not you?

If you are lacking some preparatory studies you can make them up here. This is an exceptional opportunity to become an Electrical Engineer in the shortest possible time.

### JUNIOR ELECTRICAL ENGINEERING

From 1 to 2 Years in this course makes you a completely trained Junior Electrical Engineer—prepared to fill such positions as general plant superintendent, director of construction, superintendent of maintenance, chief draftsman, etc. The Junior Electrical Engineer is the man between the Electrical Engineer and the Electro-technician—a well paid position and a stepping stone to higher executive work. A grade school diploma or equivalent admits you without examination. New term opens every 6 weeks.

### COMMERCIAL ELECTRICAL ENGINEERING in 1 Year

Unparalleled opportunities for brilliant, successful careers in the new field of Commercial Electrical Engineering. To meet the extraordinary present-day demands for trained electrical business men, consulting and efficiency engineers, we offer this thorough, condensed and very practical training, especially adapted to high school graduates.

### ELECTROTECHNICS

In this complete 6 months' Electrical Course—8 hours daily—you can learn house, factory and theatre wiring, testing and meter work, A.C. and D.C. Armature Winding and all necessary mathematics.

A 3 months' course in A.C. and D.C. Armature Winding, or a 3 months' Course in Light and Motor Wiring and Testing is offered to those with limited time and means.

### AUTOMOTIVE ELECTRICITY

Electrical specialists who instinctively diagnose and locate automotive electrical troubles command high positions and are well paid. Specialize in starting, lighting, ignition and storage batteries and command a big job at a big salary.

### "EARN WHILE YOU LEARN"

We agree to provide for a limited number of worthy young men, part-time jobs at good wages, and permanent positions with unlimited prospects to all duly qualified graduates. Here is the opportunity of your life to acquire a thorough, practical training for big-paying profession that is in urgent need for trained men.

### ESTABLISHED 22 YEARS AGO

The S. of E. stands absolutely alone in the field of thorough, practical electrical education and in commercial and electrical engineering.

### NO NEED OF YOUR BEING WITHOUT AN S. OF E. TRAINING

It does not matter how old you are or what schooling you have had. Students from 16 years up to 50 are in attendance here.

Fill out the following coupon and mail it to-day.

## SCHOOL of ENGINEERING of Milwaukee

FOUNDED 1905

SCHOOL OF ENGINEERING OF MILWAUKEE  
S. I., R696—Oneida at Jackson Street, Milwaukee, Wis.

Without obligating me in any way, please mail free 61 page illustrated book, "Electricity and the One Best Way to Learn It," and particulars regarding the course I have marked with an X.

- ....Electrical Engineering.
- ....Commercial Electrical Engineering.
- ....Junior Electrical Engineering.
- ....Electrotechnics.
- ....Armature Winding.
- ....Light, Motor Wiring and Testing.
- ....Automotive Electricity.
- ....Radio Sales Service
- ....Home Laboratory Service

I am interested in your "Earn While You Learn" Plan.

Name ..... Age.....

Address .....

City ..... State.....

Education .....

## Home Mechanics

By W. M. BUTTERFIELD  
(Continued from page 707)

bit and with yellow for wheels, shaft and handle.

Following this is a bird toy (C) with weighted rockers. It is made of 3/8" plywood. The rockers are weighted by boring 1/2" holes and filling with bar lead slightly riveted into the wood at each end. If a small, flat spot is made about the screw head on the bottom of the rockers, the toy will come to a stop, when rocked, in an upright position, otherwise it may end its rocking and come to rest in an inclined position. The toy is painted with red beak, green body with black outlines, black wings, yellow legs and black rockers.

The rocking bird shown at (D) is made of 5/8" plywood and is a roomy, unbreakable and safe toy. Five 1/4" iron rods are riveted in the positions shown to hold the sides firmly in place. Washers are provided and put over the ends before riveting. The washers lie flush with the surface of the wood. The shallow holes for the washers are counter-bored by using a bit of the diameter of the washers first, then a smaller one for the rods afterwards. The holes can then be filled, when the rods have been riveted in place over the washers, with putty, giving a smooth painting surface for the outside parts. The rocker is painted white with black markings as shown. The beak of the bird is yellow and the inside of the seat, the handle bar, shelf, foot rest and floor is blue. All the other inside parts are painted white.

A small variety of kiddy-car, or a coasting or push car is shown at (E). This car is made of 5/8" plywood and is constructed in exactly the same way as the kiddy car already described (A). Cord attached to the front shaft can be used to pull the car. It is painted with yellow platform, red wheels and under-parts and brownish red for the monkey figure. Black is used for outlining the figure—that is drawing the arms, ears, eyes, etc. The ears are used as handle bars as on the kiddy car (A).

An automatic toy is shown at (F). It is made of 3/8" plywood and represents a swan that rocks backward and forward as the toy is drawn over the floor. The crank shaft is made by bending a brass rod of the desired size, (say 1/8") as shown. The wooden wheels are secured to the shaft by means of washers that are first screwed to the wheels, then deeply grooved with a round file (see detail).

The groove fits over a pin in the shaft and is held against the pin by another washer on the opposite side of the wheel, also held in place by a pin driven through the shaft. A third washer holds the shaft, wheel and crank in place on this side. It is placed as shown on the inside of the hanger-post. This washer is also held in place with a pin in the shaft. The connecting rod is made of a brass rod with flattened ends (made flat with a hammer). The holes are large enough to slip over the crank shaft, then over the bent parts of the crank and thus into place. The bar is held in position, when the toy is fully assembled, attached to the slotted projection on the swan's body, by a pin passing through it and through this slotted part. The toy is painted with a white swan having a yellow bill and black markings, a green wagon body and under-parts and with red wheels and handle.

## HOW TO BUILD A GOOD "B" ELIMINATOR

In the January Number  
Don't Miss It!



## WITTE ENGINE

150,000 WITTE Engines in daily use. Sold all over the world, but to the honest American farmer I sell at Wholesale, DIRECT Factory Price, Special Easy Terms and No Interest.

Develops more than rated power from almost ANY FUEL, THROTTLING GOVERNOR enables use of cheap distillate. Valve-in-head motor. Semi-steel construction. Fewer parts. Free from usual engine trouble. LIFETIME GUARANTEE. Many NEW REFINEMENTS and LOWER PRICES.

Get my NEW COMBINATION OFFERS ON SAWING and PUMPING OUTFITS.



**FREE** Big illustrated Catalog just out shows latest improvements. New LONG TERM PAYMENTS. Solves all farm power problems. 67 years practical experience. Send name—no cost—no obligation. **3 Hour Shipping Service.**

**WITTE ENGINE WORKS**  
3753 Witte Building, KANSAS CITY, MO.  
3753 Empire Bldg., PITTSBURGH, PA.  
3753 Witte Bldg., SAN FRANCISCO, CAL.



**CLIP THIS NOW!** It's your own fault if you go without a typewriter now. There is a bargain price on this Underwood! Totally rebuilt; new type; new platen; new finish; and a 100-year guarantee. Easiest terms ever—\$3 and it's yours.

**FREE BOOK!** Typist Manual and complete catalog explains whole plan. To first fifty who answer, instructions free in tough typewriting. Mail now to the Shipman-Ward Mfg. Co., 2169 Shipman Bldg., CHICAGO.

Name.....  
Address.....

### Mind Reading Mystery!

A great trick that is different from any one you have ever seen. Real fun! Don't miss it!

**Price 10c**

### OUR BIG CATALOG

Over 161 pages of laugh-producing tricks, magic novelties and jewelry are contained in this big book. See our ad in this issue on page 733 which tells how you can obtain it for only 10c in stamps. AGENTS WANTED.

American Bazaar, Inc., 640B Broadway, New York City

### BETTER HANDWRITING

Quickly and easily learned by children and adults. Perfect penmanship assured. Write for information, or send price, 98c, today.

VIC. HANSEN, WALLACE, IDAHO



**Six Tube-Shielded  
T.R.F. Set**  
By A. P. PECK  
(Continued from page 719)

the yoke. This provides a two control receiver which is far more selective and flexible in tuning than any single control receiver, yet that will give many of the advantages of three, or four-control sets. In Fig. 7, the "cans" have been replaced over the various units. Note that everything is enclosed, and there is no possible chance of stray currents from the radio frequency amplifiers interfering with each other or with the audio-frequency amplifying parts of the receiver.

It will be seen in the diagram that the negative filaments of all the tubes are grounded to the chassis. This is most easily accomplished by means of the little stunt shown in the various photographs and in particular in Fig. 3. Two soldering lugs are employed for this purpose. One of them is placed under the set screw which makes connection to the negative prong of the tube through the socket. The other one is placed under the head of the mounting bolt adjacent to the set screw. The two lugs are turned to overlap and then soldered together. This makes a very neat connection between the metal base and the negative lead, and eliminates the necessity of making a wire connection between these two points. This stunt may be carried through, and in fact should be carried through, on all six of the sockets. Failure to do this will result in an open filament circuit at some point throughout the set.

Some of the readers may be puzzled to account for the placement of certain of the fixed condensers used in this particular receiver. Some of them are visible in the circuit diagram in Fig. 2, but not in the various photographs. This is because of the fact that they are mounted underneath the metal chassis. Reference to Figs. 6 and 7 will show that the chassis is in a pressed form and has a raised edge. This allows ample room under the base for wiring and for the placement of certain of the fixed condensers. It is also usual to place a 1/2-ohm filament resistance, the two small switches and the special 25,000-ohm potentiometer in this position. This puts them out of the way and still in a convenient location for wiring.

When assembling a receiver of this nature, and before attaching the panel, be sure the three yoked variable condensers are placed correctly in position. Possibly the best way to do this is to slip the three collars on the three shafts and then turn the condensers to minimum capacity. This point can be held by cutting three short strips of rather thick cardboard and placing them before the ends of the rotor plates and the ends of the stator plates on the side where the two will start to mesh. Closing the rotor plates over this strip will hold it in position and will cause the strip to serve as a guide and to keep all three of the condensers at the same capacity while the yoke is being placed in position and fastened. When this operation is accomplished, a 180 degree rotation of the controlling shaft will cause a like rotation of the other two variable condensers. This adjustment cannot be carried on quickly and must not be slighted as the receiver will not operate properly if the three condensers do not travel in perfect unison with each other. If, after the set is assembled and placed for operation, stations will come in at two points on the dial that controls the single condenser, this indicates that the yoke mechanism is not set correctly. Therefore, the adjustment method described above should be carried through again until proper results are obtained. When

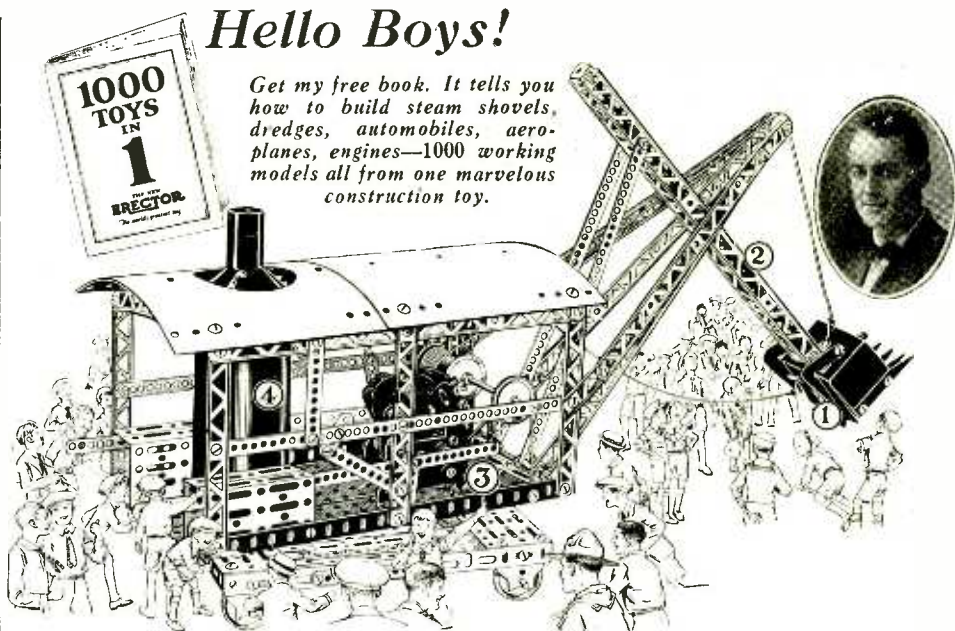

**Hello Boys!**

Get my free book. It tells you how to build steam shovels, dredges, automobiles, aeroplanes, engines—1000 working models all from one marvelous construction toy.

**ERECTOR SETS**

- No. 1 contains 104 parts. Builds 278 models. . . \$1.00
- No. 3 contains 169 parts. Builds 381 models . . . \$3.00
- No. 4 contains 235 parts. Builds 500 models; with powerful electric motor . . . \$5.00
- No. 7 contains 473 parts. Builds 533 models; the Super-Erector with motor . . . \$10.00
- No. 7 1/2 contains 860 parts. Builds 539 models. The set with the Chassis \$15.00
- No. 8 contains 1226 parts, with motor and dredge . . . \$25.00
- No. 10 contains 2469 parts with motor, dredge and giant fly-wheel . . . \$50.00

**J**UST think of the fun that is waiting for you when you read about these marvelous working models of the greatest engineering feats—trains, draw-bridges, steam shovels, concrete mixers, diggers, lighthouses, engines, motors, dynamos, railroad signals. And when you actually own a new Erector Set and make these wonderful models, the best fun is yet to come because the powerful Erector electric motor makes them whiz and spin just like real ones. You'll get the thrill of your life when the motor starts to purr and the model which you have built with your own hands starts working—oh, boy!—how you will shout. My free book tells how the 473 parts make the 533 models. But there is no end to the things you can build. Send for my book this very day. Then you can show him the pictures of these dandy Erector Models. He will understand why boys call the new Erector the world's greatest toy.

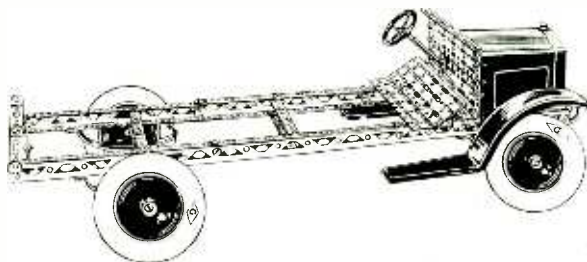

**New Erector No. 7 1/2 With Automobile Chassis \$15.00**

This brand new 1927 addition to the line of Erector Sets is a dandy. It contains, in addition to this chassis, parts to make hook and ladder, trolley repair trucks with elevated tower, dump truck, 5th Avenue bus, oil truck, moving van, coal wagon, delivery truck, fire engine, dozens of models.

**The Super-Erector Set, No. 7, \$10**

The most popular Erector set. Contains powerful Erector electric motor, new Erector boilers and sand shovel, base plates, curved girders, perforated strips, die-cast gears, beveled gears, solid brass gears. 473 parts—builds 533 models.

you will also get an amazing present; the mysterious Erectorscope. It will fool the smartest boy. You've never seen anything like it. Just look through the Rectorscope! You won't believe your eyes. Everybody will want to look through it, too. Send the coupon now and get the book and the Erectorscope absolutely free.

Sent FREE with this book—  
The Mysterious Erectorscope  
When you send the coupon for my free book.

**THE NEW  
ERECTOR**  
"The world's greatest toy"

A. C. GILBERT CO.,  
163 Blatchley Ave., New Haven, Conn.

Please send me FREE my copy of the book, "1000 Toys in 1." and the mysterious Erectorscope.

Name .....

Street .....

City ..... State .....

**Buy an Erector Today—At all stores where toys are shown**



## His Salary Was Raised while others were reduced

"Up to the time I enrolled for a course with the International Correspondence Schools, I had only a grade-school education. Since enrolling, I have advanced to a much better position, where my salary is nearly four times as much as I was making previously. I would not be able to hold my present position had I not taken your Course. Recently I received a nice increase in salary, while other men were being reduced."

Read that last sentence again—"Recently I received a nice increase in salary, while other men were being reduced."

There could be no better proof of the value of an I. C. S. course than that. It shows that the trained man is given preference over all others and paid more money, even in slack times, if his work deserves it. It shows that there are always bigger, better jobs open for men who have the foresight to prepare for them in spare time.

Why don't you study and get ready too? We'll be glad to help you if you will only make the start.

Choose the work you like best in the coupon below; then mark and mail it to the I. C. S. today. This doesn't obligate you in the least, but it will bring you information that will start you on a successful career. This is your opportunity.

### Mail the Coupon for Free Booklet

**INTERNATIONAL CORRESPONDENCE SCHOOLS**  
Box 6173-E, Scranton, Penna.  
Oldest and largest correspondence schools in the world  
Without cost, please tell me how I can qualify for the position or in the subject before which I have marked an X:

#### BUSINESS TRAINING COURSES

- |  |   |
|--|---|
| <input type="checkbox"/> Business Management                     | <input type="checkbox"/> Salesmanship           |
| <input type="checkbox"/> Industrial Management                   | <input type="checkbox"/> Advertising            |
| <input type="checkbox"/> Personnel Organization                  | <input type="checkbox"/> Better Letters         |
| <input type="checkbox"/> Traffic Management                      | <input type="checkbox"/> Show Card Lettering    |
| <input type="checkbox"/> Business Law                            | <input type="checkbox"/> Stenography and Typing |
| <input type="checkbox"/> Banking and Banking Law                 | <input type="checkbox"/> Business English       |
| <input type="checkbox"/> Accountancy (Including C.P.A.)          | <input type="checkbox"/> Civil Service          |
| <input type="checkbox"/> Nicholson Cost Accounting               | <input type="checkbox"/> Railway Mail Clerk     |
| <input type="checkbox"/> Bookkeeping                             | <input type="checkbox"/> Common School Subjects |
| <input type="checkbox"/> Private Secretary                       | <input type="checkbox"/> High School Subjects   |
| <input type="checkbox"/> Spanish <input type="checkbox"/> French | <input type="checkbox"/> Illustrating           |

#### TECHNICAL AND INDUSTRIAL COURSES

- |   |  |
|---|--|
| <input type="checkbox"/> Electrical Engineering                           | <input type="checkbox"/> Architect                                   |
| <input type="checkbox"/> Electric Lighting                                | <input type="checkbox"/> Architects' Blueprints                      |
| <input type="checkbox"/> Mechanical Engineer                              | <input type="checkbox"/> Contractor and Builder                      |
| <input type="checkbox"/> Mechanical Draftsman                             | <input type="checkbox"/> Architectural Draftsman                     |
| <input type="checkbox"/> Machine Shop Practice                            | <input type="checkbox"/> Concrete Builder                            |
| <input type="checkbox"/> Railroad Positions                               | <input type="checkbox"/> Structural Engineer                         |
| <input type="checkbox"/> Gas Engine Operating                             | <input type="checkbox"/> Chemistry <input type="checkbox"/> Pharmacy |
| <input type="checkbox"/> Civil Engineer                                   | <input type="checkbox"/> Automobile Work                             |
| <input type="checkbox"/> Surveying and Mapping                            | <input type="checkbox"/> Airplane Engines                            |
| <input type="checkbox"/> Metallurgy <input type="checkbox"/> Mining       | <input type="checkbox"/> Agriculture and Poultry                     |
| <input type="checkbox"/> Steam Engineering <input type="checkbox"/> Radio | <input type="checkbox"/> Mathematics                                 |

Name..... 6-26-25  
Street.....  
Address.....  
City..... State.....

Occupation.....  
If you reside in Canada, send this coupon to the International Correspondence Schools Canadian Limited, Montreal

**Absolutely Guaranteed**

## WADE BENCH LATHE

For Repair Shops, Amateur Mechanics, Model Makers, Inventors

who want a real, accurate machine tool at a price within easy reach. A complete shop in itself. Capacity 4 in diam. x 12 in. length. Handles metal, wood, and other materials. Turning—facing—boring—drilling—winding—thread cutting. Guaranteed accuracy, quality of materials, workmanship. The slider rest has travel entire length of bed. Leadscrew inside bed. Hollow spindle.

No. 1 Lathe, plain headstock - - - \$28.00  
No. 2 Lathe, back-geared - - - \$8.00

Either lathe with 19 in. length between centers, \$7.00 extra. Complete line of accessories. By all means write for this free book.

**THE GEROLD COMPANY**  
Dept. S-19 120 Liberty St., New York

Insure your copy reaching you each month. Subscribe to Science and Invention—\$2.50 a year. Experimenter Publishing Co., 53 Park Pl., N. Y. C.

the condensers are adjusted correctly, stations come in only at one point on either dial.

The audio frequency amplifying end of this receiver is of the standard two stage transformer-coupled type having a special output transformer which is employed to prevent the high voltage DC from reaching the talker. This is all indicated in the circuit diagram in Fig. 2. One point that must be impressed is the connection of a .25 megohm (250,000 ohm) resistance across the secondary of the first audio amplifying transformer. This will assist materially in providing good reproduction of the received signals.

In the receiver as designed, no provision is made for using less than the two stages of audio-frequency amplification. To do this would only cause further complications, and the average radio user today desires quite a bit of volume. However, the stabilizing potentiometer will also be found to operate as an excellent volume control. It may be used for this purpose as well as for preventing oscillation. It will be found that as this control is turned toward the left, the signal strength will decrease gradually until it reaches practically zero. When the direction is reversed, the volume will increase up to a certain point and beyond that point a squeal will develop. This indicates that the circuit is in a condition of oscillation and should not be allowed to continue thus. Always keep the knob just to the left of the point where a squeal or click is heard.

After setting up a receiver of this nature and checking over the various connections for continuity, the "A" battery circuit should be tested. To do this, leave one terminal connected to the negative "A" post and touch the other wire to each of the other binding posts in succession. This should be done with a tube and one of the sockets. If the tube lights when connected to any terminal other than the positive "A" post, there is a wrong connection and it must be found before the "B" battery is hooked up.

After everything is correct, the shield should be placed over the three radio-frequency stages, and the set should be placed in its cabinet. It is important that an overall cabinet be used for housing this receiver. This serves to deaden mechanical vibrations from the loud-speaker which might otherwise set up an unpleasant noise in the set. This is evidenced by a hum caused by feedback from the loud-speaker, or a "drum" effect when low notes are reproduced. Removing the loud-speaker from the vicinity of the set and placing the set in the cabinet tends to reduce mechanical vibrations and vibrations due to sound waves to a minimum.

With a sensitive receiver of this nature, the "A", "B" and "C" batteries should always be of the best. A run down battery will change the operation of the set considerably. If the "A" battery becomes weak, an occasional high pitched squeal will often be evidenced. Depleted "B" or "C" batteries will cause the reproduced signals to sound unnatural, particularly on the low notes.

Furthermore, a sensitive three-stage radio frequency amplifying set of this nature should not be operated without the shields for which it is designed. Here again unpleasant and unsatisfactory results will be found if this warning is ignored.

As indicated in Fig. 2, the first five tubes are of the UX 201A type, while the sixth tube should be of a power type such as the UX 171. If this is carried through, the receiver here described will give maximum all around results.

A complete list of parts required for this set will be forwarded upon receipt of a stamped, self-addressed envelope mailed with your request to the Radio Editor.

—Photos courtesy Silver-Marshall.

# DESIGNED to OUTLAST

## World Storage "A" Battery

**Two-Year Guarantee Bond in Writing**      **NEW LOW PRICES**

Famous the world over for reliable, enduring performance. Solid Rubber Case lasting protection against acid or leakage.

**Approved and Listed as Standard by Leading Authorities**

including Radio News Laboratories, Popular Sci. Inst. Standards, Pop. Radio Laboratories, Radio Broadcast Laboratories, Radio in the Home and Lefax, Inc.

**Send No Money**

Just state number wanted and we will ship same day order is received, by express C. O. D. Pay expressman after examining batteries. 5% discount for cash with order. Remember, you save 50% on World Batteries—so send your order today.

**WORLD BATTERY COMPANY**  
Dept. 19  
1219 S. Wabash Ave., Chicago, Ill.

KDKA    WSBC    WEAF    KYW

# FREE!

## WONDER OF THE 20th CENTURY

The rare, valuable secret book, as foretold by the seers of hypnotism, telepathy, personal magnetism, mesmerism, clairvoyance, mind-reading, etc. This book—the wonder of the 20th Century—worth \$1.00, but sent FREE to you if you order our remarkable course in Practical Hypnotism—teaches you how to control others—make everybody obey your every wish and desire—conquer bad habits, enemies, win success in life and LOVE, obtain power, wealth, social position. Explains the greatest force in the history of man. The most perfect, complete and easily learned system. Pay only \$2.49 on arrival. Money postage.

Occult Science Ass'n., 132 Nassau St., Dpt. 65, New York

# PIMPLES

Cleared Up—often in 24 hours. To prove you can be rid of Pimples, Blackheads, Acne Eruptions on the face or body, Barbers' Itch, Eczema, Enlarged Pores, Oily or Shiny Skin, simply send me your name and address today—no cost—no obligation. CLEAR-TONE tried and tested in over 100,000 cases—used like toilet water—is simply magical in prompt results. You can repay the favor by telling your friends; if not, the loss is mine. WRITE TODAY.

E. S. GIVENS, 468 Chemical Bldg., Kansas City, Mo.

**FINAL SALE**      **CUT TO \$8.99**

## KING OF REVOLVERS

Has all improvements of latest guns, \$35 value, left wheeler, safety hand ejector, guaranteed never out of order, 6-shot, 32-20 or 38 cal. Send No Money. Pay on delivery \$3.99 plus postage. Satisfaction or money back. FEDERAL MAIL ORDER, 561 Broadway, New York Dept E80

You can be quickly cured, if you

# STAMMER

Send 10 cents for 288-page book on Stammering and Stuttering, "Its Cause and Cure." It tells how I cured myself after stammering 20 yrs. B. N. Bogue, 8135 Bogue Bldg., 1147 N. III. St., Indianapolis

MAGIC Dice, \$5.00; Cards, \$1.25; Inks, \$1.50; Magic Fluid for Transparencys, \$3.00. Slick Ace Cards, \$1.25; Factory Readers, \$1.00. Sales Boards, etc.

**CENTRAL NOVELTY COMPANY**  
112 N. La Salle Street, Chicago, Ill.

Insure your copy reaching you each month. Subscribe to Science and Invention—\$2.50 a year. Experimenter Publishing Co., 53 Park Pl., N. Y. C.

**Sir Oliver Lodge's "N" Circuit**

By JAMES FRANCIS CLEMINGER

(Continued from page 721)

tion, 5XX, at Daventry, England. This switch is fitted inside the receiver and, the switch is moved so that for the 300- to 500-meter wavelength band a condenser of .0003-mfd. can be inserted if necessary, while for the 1,600 meters one of .0003 or .0003 + .0004, or .0003 + .0004 + .0005 can be inserted if necessary.

For the broadcast wavelength of 1,600 meters both the "A" and "N" coil have to be substituted for by another "A" and "N" coil respectively. For 1,600 meters the "A" coil has 220 turns, while the "N" coil has 500 turns. The rest of the circuit needs very little explanation.

It will be seen in this case that the filament is grounded and this was found to give the circuit much greater stability. Only one filament rheostat is included in the set and this is found to be quite sufficient for adequate control of filament supply. The "B" battery voltages vary according to the type of tube used.

The photographs which illustrate this article show the back of panel layout and wiring of some of the first two-valve Lodge "N" set receivers. So far Lodge "N" sets using radio-frequency amplification have not been put on the market, and I understand that there is still some experimental work to be done before really satisfactory R.F. amplification can be obtained. But from the tests I have made and from advices received from those in personal contact with Sir Oliver, I have satisfied myself that a two-valve Lodge "N" set as illustrated in Fig. 4 gives better volume than an ordinary straight two-tube set with regenerative detector; and furthermore its selectivity is considerably greater.

It must be remembered that one of the fundamental principles of the Lodge "N" circuit is the employment of a single connection between the aerial system and the detector tube. The "N" circuit principle is included between the aerial and the detector tube and, as will be seen from the diagram, this circuit consists of a variable condenser in parallel with an inductance and it is therefore a resonant circuit. The aerial itself, including the "A" coil, is, however, a non-resonant circuit and is heavily damped. Therefore the resistance in the resonant circuit being very low, high voltages may be generated by comparatively small voltage impulses.

Sir Oliver Lodge maintains that for good quality of reproduction there should not be more than one tuned circuit, as if two tuned circuits be employed there is great liability to distortion due to heterodyning between the circuits. So you will see that in the "N" circuit, the coil is made of a very high inductance value while the capacity of the condenser is small and, owing to the much greater wavelength of the aerial system and to its damping, radiation from the aerial is practically impossible. This has been proved by the fact that, in recent dual broadcasts from the London broadcasting station, the wavelengths were separated with the greatest ease, and it will also be found that static is reduced very considerably and that for short-wave work the circuit has many advantages.

Although in operation the set can be made to oscillate itself, the radiation from it is entirely negligible and extensive tests have shown that it is practically impossible to cause interference with neighboring sets.

In a recent talk by our London representative with Sir Oliver Lodge, he pointed out



**A Gift for Any Man**

Valet AutoStrop Razor is the Ideal Xmas gift. For the young man beginning to shave—or for the older man, who, thru habit, daily pursues, old unsatisfactory shaving methods.

Valet AutoStrop Razor is the only razor in the world that sharpens its own blades, thus ensuring a new, keen edge for every shave. Each set is complete with Case, Razor, Strop and Blades.

PRICES \$5.00 TO \$25.00

**Valet Auto-Strop Razor**

REG. U. S. PAT. OFF.

AUTO STROP SAFETY RAZOR CO.,

656 First Avenue,

NEW YORK CITY

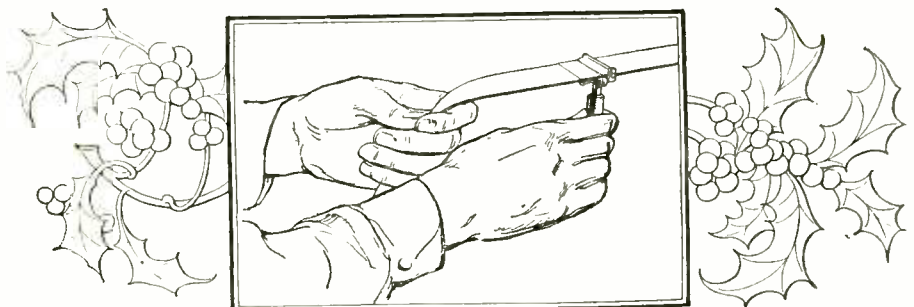

*The Razor That Sharpens Itself.*



# Be a Boy Chemist!

Have Days of Real Fun and Learn the Wonders of Chemistry

HAVE more fun than you ever had before! Make soap, inks, dyes and paints; test water, food, soil and metals; do lots of other wonderful chemical experiments and learn the principles of chemical science. Perform mystifying tricks of chemical magic and astonish your friends; experiment with chemical sorcery and produce many magical changes. It's fine fun for any boy; keeps you interested and teaches you facts about the wonders of chemistry. You can do it all

with



The Boy's Own Laboratory!

Get Chemcraft for Christmas! The original of all chemistry sets, and the most scientific set on the market. Contains more and better experiments, more chemicals and apparatus. Teaches reliable chemical science; anybody who experiments with Chemcraft knows more about Chemistry than most people. Each outfit is complete and contains safe chemicals, all necessary apparatus and a big Manual of Instruction and Experiments.

Sold in all good toy stores

No. 0—75c; No. 1—\$1.50  
No. 2—\$2.50 No. 3—\$5.00 and  
No. 4—\$10.00

(West of Denver, Colo. and in Canada, add 10 per cent)

Don't accept anything but Chemcraft; insist upon having the best outfit. If more convenient, we will send your set prepaid, upon receipt of price.

## BIG FREE BOOK

The Chemcraft Chemist Club Magazine; prepaid specially for boys who want to know more about chemistry. Full of stories, fine experiments and club news. It's free—just write for it.



A fine set for boys who want to try chemistry. You can make ink, dye cloth, test water and do lots of magical tricks. Always sold for fifty cents, but if you send us the names and addresses of five boys who haven't Chemcraft, we will send you Chemcraft Junior for only 25c.



The Porter Chemical Co.  
105 Summit Ave.  
Hagerstown, Md.



that in designing the "N" circuit his object was first to provide a radio set that would not oscillate or cause interference with another neighboring set (and in Great Britain this is very necessary, for the bug-bear of howling is very bad indeed), and secondly to provide a set which would be perfectly simple to operate and yet would give all the programs from the local station and from the special station at Daventry without the use of regeneration and without increasing the number of tubes as would be necessary after to bring up the volume upon the elimination of regeneration.

"If," said Sir Oliver Lodge, "the 'N' circuit be universally adopted there would not, in my opinion, be any further oscillation nuisance. Moreover, the set is simple and efficient; it involves no complications and it is essentially a family wireless set. My hope is that it will make possible the enjoyment of wireless reception by the vast section of the public who have hitherto felt afraid of its technicalities. With the 'N' set there are practically no technicalities; the tuning is very simple and the set should thus make in the widest sense a popular appeal; I hope it may solve a problem and supply a want."

This article, while theoretical, should furnish considerable food for thought to the experimentally inclined of our readers. The circuit has been redesigned and adapted in our laboratories to meet American conditions, and you will find a complete constructional article of a particularly excellent 4-tube receiver, using the "N" circuit, in an early issue of this magazine.

## Model Department

(Continued from page 700)

### Rules for Model Contest

1. A handsome trophy cup engraved with your name, will be awarded as the prize for the best model submitted during the month. The decision of the judges will be final and will be based upon, A—novelty of construction; B—workmanship; C—operating efficiency of the model as related to the efficiency of the device which the model simulates, and D—the care exercised in design and in submitting to us sketches and other details covering the model.
2. Models of all kinds may be entered. They may be working models or not, according to the subject that is being handled.
3. Models may be made of any available material, preferably something that is cheap and easily obtainable. Models made of matches should not be submitted to this department but should go to our Matchcraft Contest Editor.
4. Models must be submitted in all cases. Good photographs are also highly desirable and where the maker does not desire the model to be taken apart, legible drawings with all dimensions covering parts that are not accessible must be submitted.
5. Models should be securely crated and protected against damage in shipment and sent to us by parcel post, express or freight, prepaid. Models will be returned when requested.
6. Models for entry in any particular contest must reach this office on or before the 25th of the third month preceding date of publication. For instance, models for the November contest must reach us on or before the 25th of August.
7. Address all entries to Editor Model Department, c/o Science and Invention Magazine, 53 Park Place, New York City.

MORE "BOARD" CONTEST AWARDS IN JANUARY ISSUE.

## Make Money Taking PICTURES



Tremendous, big-paying opportunities are open for ambitious men in Modern Photography. This is the picture age. Magazine and newspaper publishers buy thousands of photographs each year. Every manufacturer sends out high priced pictures of his products. Every home wants portraits. Photography is a business running into millions of dollars each year. And there is a great shortage of trained photographers.

Got \$100 for Flood Pictures  
"I took pictures of a flood and sold them for \$100. I have been able to buy my house and lot from the sale of pictures."  
C. M. Cole.  
Washington.

\$97 in 2 Days!  
"I made \$285 in December. Went out two days last week on home portrait work and made \$97."  
A. G. Hughes, Kentucky.

### Earn \$3,000 to \$10,000 a Year

Hundreds of men are earning big money and establishing their own businesses. Even during spare time, while training, you can make \$75 a week easily—no matter where you live!

### Amazing New Easy Method

I show you at home, how to do the kind of work turned out by the big studios in New York and Chicago! I show you how to make big money within 30 days! C. M. Cole bought a home with money he had made when only half way through his training. So well do I know what I can do for you that I guarantee

under bond to return every cent of your tuition if you are not thoroughly satisfied.

### Professional View Camera FREE!



Write at once for Free Camera Offer—I give you, free, a splendid professional view camera. You will be astonished and delighted. This offer open for short time only—so act quick! No obligation.

INTERNATIONAL STUDIOS, Inc.  
Dept. 1429  
3601 Michigan Ave., Chicago, Ill.

## PARKS

WOODWORKING MACHINES

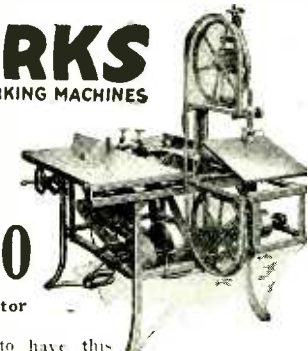

Cabinet Shop Special No. 10

\$290

with Motor

You ought to have this handy Parks in your shop. It is a compact, complete machine designed just like a big production outfit at one-fifth the cost. Includes 8-in. circular rip and cross cut saw with polished cast-steel saw table, 16-in. band saw with tilting table for bevel-sawing, 6-in. jointer, and motor operating from any light socket. Just plug in and go to work! Fits in a corner of your basement. Does any kind of cabinet and joinery work. Add lathe, shaper and other attachments any time at small cost. For the man who does "odd jobs" in his off time this Parks is a big money maker. Turn out as much as a four-man shop working by yourself.

Write for circular and Parks complete catalog of handy woodworking machinery.

The Parks Ball Bearing Machine Co.  
1553 Knowlton Street Cincinnati, Ohio

## MEN WANTED

TO LEARN

### Motion Picture Projection

\$2,000 to \$4,000 a Year

Quickly learned. Short hours, big pay. Best equipped school in Michigan. Projectionists for Movie Houses and Road Shows.

MOVIE OPERATORS SCHOOL  
61 Sprout Street DETROIT, MICHIGAN

### GAS BLOW TORCH and SOLDER IRON HEATER

Connects to any gas jet or gas connection. No air attachment necessary. Heats solder iron in less than a minute. For home use, repair shops, electricians, plumbers, laboratories, manufacturing plants, foundries, etc. A wonder for the mechanic's work bench and radio builders. A Blast 8" Long, 1" in Diam.—Intense Heat. Postpaid \$1. Can. \$1.40. TRI-UNE CO., Dept. 804-C, 215 S. 15th Ave., Maywood, Ill.

Insure your copy reaching you each month. Subscribe to Science & Invention—\$2.50 a year. Experimenter Publishing Co., 53 Park Pl., N. Y. C.

**The Astrology Humbug**

By JOSEPH H. KRAUS

(Continued from page 692)

and the wise man can control the stars, would not the phrase, "a fool obeys," contradict the statement that "only thinking individuals are influenced by the stars?"

Here are but a few letters from those who are either student astrologers, astrologers or those interested in the subject and our answers thereto.

**THE ASTROLOGY HUMBUG—SOME LETTERS FROM ASTROLOGERS AND ANSWERS**

Editor, SCIENCE AND INVENTION:

I have read your article in the October number of SCIENCE AND INVENTION assailing the truths of Astrology, and I note your offer of \$6,000.00 for proofs of the science, but inasmuch as you yourself are to be the judge, jury and prosecuting attorney of the case, and your article discloses abundant evidence that you are innocent of any proper knowledge of the science, I do not propose to accept your offer and enter the contest.

However, if you are still anxious to get the truth, and are willing to publish it, I am ready to write you an article in refutation of your unsound statements regarding astrology. This article will be supplied to you at the usual magazine terms for scientific papers. (Our rates are higher.—Ed.)

In addition I should like to state that in the article by Mr. J. H. Kraus termed "The Truth About Astrology," wherein he states that he sent Prof. Gustave Meyer, an astrologer, the data of a person requesting the horoscope of the same, Mr. Kraus admits that he supplied the wrong sex, stating that it was a Miss instead of a Mr. Had he known the very simplest elements of the science of astrology, he would have known that the sex is always required for a correct judgment; hence the mistakes in the horoscope. The entire article discloses the fact that Mr. Kraus' knowledge of the science is not even elementary.

Should you still be anxious for the truth the article mentioned will be supplied you at the terms quoted; and the difficulties of the twins which seem to disturb your mind will be set at rest.

ALEXANDER ELLIOTT,

Analytical and Consulting Chemist.  
Los Angeles, Calif.

You have evidently not read the article on astrology correctly. You will note that the writer gave his own address as being that of Miss Florence B. and impersonated her. Please read the writer's letter to the astrologer again and again. The facts in the case are that Florence B. was a Miss, that she was born on the date and at the time specified in the article, and also that she died at the time and date likewise specified. It may also be interesting to you to know that this same astrologer, Prof. Gustave Meyer, stated that Jack Dempsey must win his fight against Gene Tunney. He cast the horoscope for both of these individuals. According to the horoscope, Gene Tunney could not possibly win. He was entering the fight on a particularly unlucky day, with the stars very unfavorably set against him. Jack Dempsey, on the other hand, according to his horoscope, would have things his own way.

Had the astrologer "guessed" correctly, it would not have been anything wonderful, inasmuch as the betting odds were in favor of Dempsey to win at 7 to 1 before the prizefight started. The results not only astonished fighting habitues, bettors and promoters, but it also gave the subject of astrology a 1-2 blow, knocking it out completely as far, at least, as this example was concerned. Is this not another sample of the horoscope humbug?

If you can give an astrological reason why the two Blazack twins had different lives, why one married and had a child and the other did not, and if you can eliminate from this reasoning, natural causes, such as environment and associations, basing your reasoning purely on planetary configurations, we shall certainly be glad to read it with a view toward determining its availability for publication. The writer will admit that he knows very little about astrology. He merely knows enough not to be fooled by those professing to be able to cast horoscopes.

Our judgment in awarding prizes of any nature has never been questioned heretofore. We believe we are just as able to judge an astrology contest as we are able to judge a \$5,000.00 Matchcraft Contest, a \$5,000.00 Perpetual Motion Contest, a \$21,000 Spiritualism Contest, a \$3,000.00 Wirecraft Contest and kindred others. What we desire is evidence, and if the evidence is accurate we shall pay the prize monies. If it is not accurate, naturally the prizes will not be paid. We shall mention now, that at the close of this contest we shall publish the complete details of the lives of the individuals upon whom horoscopes are now to be cast, and we are confident that the prize winners, (if there are any) will have made correct statements, whereas all of the others, who fail, will know just in what particular points they failed.—Editor.)



*Rain and Telephone Calls*

THE annual rain fall in the United States would weigh over three and one-half trillions of tons.

This vast weight is drawn up to the clouds by the unseen but effective power of the sun; representing energy equivalent to three hundred billion horsepower.

The annual telephone conversations total over twenty-five billion a year. As silently as sunlight, electricity, mastered by the human mind, carries the voices of the nation.

There must be the man-power of 300,000 individuals to build, maintain and operate the telephone system.

There must be the money-power of over seven hundred million dollars a year to pay for operating the plant, in addition to three billion dollars invested in the plant.

The rain sustains life; the telephone furnishes swift communication for the nation, and they are alike in requiring a vast amount of unseen energy.

**AMERICAN TELEPHONE AND TELEGRAPH COMPANY AND ASSOCIATED COMPANIES**



IN ITS SEMI-CENTENNIAL YEAR THE BELL SYSTEM LOOKS FORWARD TO CONTINUED PROGRESS IN TELEPHONE COMMUNICATION

**ADDING MACHINE**

**Fits Vest Pocket**

**SEND NO MONEY**  
A marvelous calculator. Does the work accurately and quickly as a \$300 machine. Invaluable to anyone who uses figures. Don't carry pad and pencil. This startling invention will solve all problems in a minute. Business men, students, professional people, all need this **HANDY HELPER**.

**Counts 1 Billion**  
To  
Results in plain sight **PRICE** all the time -- clear **\$2.95** instantly. Made of steel and brass, in handsome case, fits vest pocket; weight only 3 oz. Send for yours now -- you'll save time and money.

Reliable Adding Machine Corp., Dept 169  
184 W. Washington St., Chicago, Ill.  
Here's a dandy chance to make money. Everybody wants one. Fine profit. Write for new offer.

**AGENTS**

**The Write Gift for Children**

Individual Names **\$1.00** post paid  
**PENCIL SETS**  
De Luxe Set: **1.00**

Finest genuine sheepskin leather case with coin pocket, richly embossed. Any name engraved in 18 kt. gold. Contains pencils and penholder in assorted colors, point protector, ruler, sharpener. Absolutely supreme in its class.

Send Check, Money Order or U. S. Postage.  
**U. S. PENCIL CO., Inc.**  
487 Broadway Dept. L New York



## SHOW CARD LETTERING

### Learn at Home

HERE is the very course you need if you want to get a good paying position as a Show Card Letterer or Sign Letterer, or have a business of your own. This course is complete and practical and especially arranged to meet the needs of the student who studies at home. It was written by E. L. Koller, Principal of the School of Art of the International Correspondence Schools, member of the American Federation of Arts, and The National Society of Craftsmen.

Mr. Koller has had twenty years' teaching experience, and his success in helping other men and women is an indication of what he can do for you.

H. L. Wood, a clerk, made more than \$700 "on the side" before he had completed his course and also won \$125 in prizes. Harry William Lord writes that he has more than doubled his salary as a result of studying this I. C. S. course in spare time. William Whitman, a former wagon builder, now has a sign painting business of his own and is earning nearly three times as much as he did before enrolling with the International Correspondence Schools.

There is no doubt that Show Card Lettering and Sign Lettering offer a real opportunity to ambitious men and women. Just mark and mail the coupon and we'll gladly send you a booklet telling all about the I. C. S. course in Show Card Lettering, or any other subject in which you are interested.

#### INTERNATIONAL CORRESPONDENCE SCHOOLS

Box 6174-E, Scranton, Penna.

The oldest and largest correspondence schools in the world. Without cost or obligation on my part, please tell me how I can qualify for the position or in the subject before which I have marked an X:

- |   |  |
|---|--|
| <input type="checkbox"/> <b>SHOW CARD LETTERING</b>                       |  |
| <input type="checkbox"/> <b>ILLUSTRATING</b>                              | <input type="checkbox"/> <b>CARTOONING</b>                           |
| <input type="checkbox"/> Business Management                              | <input type="checkbox"/> Advertising                                 |
| <input type="checkbox"/> Business Law                                     | <input type="checkbox"/> Better Letters                              |
| <input type="checkbox"/> Banking and Banking Law                          | <input type="checkbox"/> Stenography and Typing                      |
| <input type="checkbox"/> Accountancy (including C.F.A.)                   | <input type="checkbox"/> Business English                            |
| <input type="checkbox"/> Nicholson Cost Accounting                        | <input type="checkbox"/> Civil Service                               |
| <input type="checkbox"/> Bookkeeping                                      | <input type="checkbox"/> Railway Mail Clerk                          |
| <input type="checkbox"/> Private Secretary                                | <input type="checkbox"/> Common School Subjects                      |
| <input type="checkbox"/> Salesmanship                                     | <input type="checkbox"/> High School Subjects                        |
| <input type="checkbox"/> <b>TECHNICAL AND INDUSTRIAL COURSES</b>          |  |
| <input type="checkbox"/> Electrical Engineering                           | <input type="checkbox"/> Surveying and Mapping                       |
| <input type="checkbox"/> Electric Lighting                                | <input type="checkbox"/> Architect                                   |
| <input type="checkbox"/> Mechanical Engineer                              | <input type="checkbox"/> Architect's Blueprints                      |
| <input type="checkbox"/> Mechanical Draftsman                             | <input type="checkbox"/> Contractor and Builder                      |
| <input type="checkbox"/> Machine Shop Practice                            | <input type="checkbox"/> Architectural Draftsman                     |
| <input type="checkbox"/> Railroad Positions                               | <input type="checkbox"/> Structural Engineer                         |
| <input type="checkbox"/> Gas Engine Operating                             | <input type="checkbox"/> Chemistry <input type="checkbox"/> Pharmacy |
| <input type="checkbox"/> Civil Engineer                                   | <input type="checkbox"/> Automobiles                                 |
| <input type="checkbox"/> Steam Engineering <input type="checkbox"/> Radio | <input type="checkbox"/> Mathematics                                 |

Name.....

Street Address.....

City..... State.....

## Stop Using a Truss



**STUART'S PLAPAO-PADS** are different from the truss, being mechanico-chemico applicators made self-adhesive purposely to hold the distended muscles securely in place. No straps, buckles or spring attached—cannot slip, so cannot chafe or press against the pubic bone. Thousands have successfully treated themselves at home without hindrance from work—most obstinate cases conquered.

Reduced Fac-Simile Gold Medal  
Soft as velvet—easy to apply—Inexpensive. Awarded Gold Medal and Grand Prix. Process of recovery is natural, so afterwards no further use for trusses. We prove it by sending Trial of Plapao absolutely FREE.

Write name on Coupon and send TODAY.  
**Plapao Co., 924 Stuart Bldg., St. Louis Mo.**



Name.....

Address.....

Return mail will bring Free Trial Plapao

#### Editor, SCIENCE AND INVENTION:

For the past six years I have been reading your articles with a great deal of interest, especially as you have shown yourself to be a man of wonderful vision and far in advance of your times. This being the case, I was surprised and disappointed by your editorial in the current issue of SCIENCE AND INVENTION.

Frankly, I am favorable to the claims of astrology, and this fact you may attribute to my ignorance if you please to do so, for I was reared in the backwoods of Florida and have never attended school or any other "institution of learning." My protest against your editorial is not, however, intended to prove the truth of this science, for my knowledge of it is too small to warrant me in such an undertaking. All I wish to do is to point out that some of your assumptions are not in harmony with the facts of the case. I am certain that you had no intention of being unfair, and you can easily verify the statements I am going to make.

In the fourth paragraph you ask why a planet should be supposed to influence a person "exactly at birth," and not before or after. Some astrologers count the life of the subject from the moment of conception, while all teach that he is influenced by the planets during the whole course of his life.

In the fifth paragraph you ask why the lower animals should not be affected by planetary influences as well as human beings. Astrology teaches that they are; but naturally not many people care to have a horoscope cast for a dog or a cat.

In the sixth paragraph you say: "Furthermore, if the astrologers are right, then every human being born at the same instant all over the earth should have exactly the same horoscope and the destiny of each should be exactly alike." But astrologers who are thorough in their work require you to give the place as well as the date of nativity. (Correct, this was inferred. See contest conditions; location of birthplace is gladly given.—Ed.) You can readily see that a planet rising in one part of the earth is setting in another, for instance. Again, you call attention to the indisputable fact that sometimes twins born at the same time "have entirely different careers and destinies." Allow me to remind you of a favorite motto of astrologers: "The wise man rules his stars, the fool obeys them." Astrology merely reveals the influences to which you will be subject, while your destiny depends on the manner in which you react to them. Again: there are characteristics which in themselves are neither good nor bad, but which are capable of being directed into channels either extremely good or extremely bad. Take twin boys born with a keen curiosity concerning sexual matters: One may grow up a "peeping Tom," the detestation of the community, while the other develops into a famous gynecologist. Again: if you regard the opposite careers of twins as arguments against astrology, why should you not consider them as proof that the kind of training a child has is unimportant, inasmuch as two children brought up in the same home often turn out very differently, one being the pride and the other the shame of his parents?

In paragraph thirteen, you argue that if it were forecast that you would die in a railroad wreck on a certain day, you simply would not board a train at that time, and so would prove the fallacy of the prediction by not fulfilling it! The fact is that you would merely prove the truth of another favorite motto of the astrologers:—"The stars incline, they do not compell."

It is undeniable that horoscopes are often unsatisfactory, but this may be explained without reflecting in any way on the scientific nature of astrology. Some are intended only to apply in a general way to those born under a certain sign, and no one with even a rudimentary knowledge of the subject expects them to fit in detail all born under that sign, for the reason that there are many astrological influences besides that of the birth sign that go to the shaping of one's life. Such horoscopes may be compared to a summary of February weather as being cold and stormy, when we all know that it varies greatly according to location, and varies in the same place in different years. Other horoscopes, based on data regarding sex, and date and place of birth, and written by painstaking and conscientious astrologers—note this qualification—contain a great deal of truth. If they also include mistakes, it is not fair to assume that the astrologer is to blame, for they may well arise from inaccuracy in the basic data. If everybody believed in astrology, care would always be taken to ascertain the exact time of a child's birth, but as a matter of fact, the chances are great against one's determining his precise birthdate. You may have been told that you were born "about" three in the morning, but that "about" may allow for some very important change in planetary relationships. Even if you know you were born at just three by the clock, can you be sure that that clock was right? Two clocks in the same house may vary as much as half an hour.

Even correct data would not insure an absolutely infallible horoscope, because astrologers—like all other scientists—continually find they have something yet to learn. Science as a whole is just in the making, and if its usefulness were to

## \$351.00 CLEARED IN ONE DAY

So writes W. H. Adams of Ohio. Letter from V. A. Marin of California reports \$11275 sales in three months. Jacob Gordon of New Jersey \$4000 profits in two months." Alexander of Pennsylvania \$3000 profits in four months." Ira Shook \$365 sales in one day. Bram bought one outfit April 5 and 7 more by August 28. Iwata, bought one outfit and 10 more within a year. Mrs. Lane of Pittsburg says "sold 4000 packages in one day. J. R. Bert says "only thing I ever bought that equaled advertisement." John Culp says:



#### WE START YOU IN BUSINESS

Furnish secret formulas, raw material, and equipment. Little capital required; no experience needed.

#### Build a Business of Your Own

No limit to the sale of Crispettes. Everybody likes them. It's a delicious food confection. Write for facts about a business that will make you independent. Start now, in your own town.

#### Profits \$1000 a Month Easily Possible

Send postal for illustrated book of facts. It contains enthusiastic letters from others—shows their places of business, tells how and when to start, and all information needed. Free. Write now!

#### LONG-EAKINS COMPANY

1253 High Street Springfield, Ohio

## 'B' BATTERY ELIMINATOR



Only \$7.95

**MONEY-BACK GUARANTEE**  
No more worry with "B" Batteries! Hook up a Roll-O "B" Battery Eliminator and forget battery troubles forever. This wonderful new invention means better reception, sharper tuning. Gives you more real pleasure from your set.

**Completely Equipped—No "Extras" to Buy**  
Operates perfectly on direct or alternating current, giving up to 90 volts current, and using the full wave of the power supply. Simple directions enclosed—anyone can plug it in to any kind of set up to six tubes. Constant voltage gives set more power. Costs no more than set of good "B" Batteries. Solidly built in beautifully finished metal case, with genuine Bakelite top.

**SEND YOUR ORDER NOW**  
Don't blame your set because run down "B" Batteries won't let it work right. Order your Eliminator NOW. Write name and address on a piece of paper, pin a dollar bill to it, and mail it TODAY. Pay postman balance (\$6.95 plus a few cents postage) when he delivers your Eliminator. Use it ten days. If not more than satisfied, return it and get your money back.

**THE ROLL-O DIAL CO.**  
Dept. Q 4 3d & Sycamore, Cincinnati, O.



**THE MIDGET SLIDE RULE**  
Instantly adds, subtracts, multiplies, divides, solves proportion, gives all roots and powers. Logarithms, Sines, Cosines, Tangents, Cotangents, Etc. Also gives decimal equivalents, lettered and numbered drill and tap sizes.

More than 110,000 sold, more than 2000 unsold patented testimonials. The Engine-divided scales are on white finished aluminum and are grease and waterproof. Diameter 4". Price with Instruction Book, \$1.50. Pocket Carrying Case, 50c extra. Cash or C. O. D. Catalogue free. Your money back if you are not satisfied.  
**GILSON SLIDE RULE COMPANY, - NILES, MICH.**



Wonderful, new device, guides your hand; corrects your writing in few days. Big improvement in three hours. - No failures. Complete outline FREE. Write C. J. Ozment, Dept. 43 St. Louis, Mo.

Insure your copy reaching you each month. Subscribe to SCIENCE & INVENTION—\$2.50 a year. Experimenter Publishing Co., 53 Park Pl., New York City.

be gauged by its utter freedom from all error, how little of it would escape the junk heap!

MARIE SNOW,  
Tampa, Fla.

(Concerning your statements on Astrology, you have made the assertion that some astrologers count the life of the subject from the moment of conception. How can any astrologer count the influence of the planets from that instant when medical men themselves do not know when conception actually occurs?)

You make the assertion that the "wise man rules the stars and the fool obeys them." How can the fool obey anything which does not give him audible commands? How can he obey the stars when he does not know what their influences are, if there are any? We deny the presence of such influences.

We do consider the kind of training that an individual has as being very important in its bearing upon the future life of the child. Two children brought up in the same home turn out differently, not because one is influenced differently by the stars, but because the environment of one of the children is markedly different from that of the other. This will take place even if a family has as many as seven or eight children.

If you have a brother or a sister, you will remember that many times he or she was able to do things which, if you attempted to do as well, would have brought upon you the censure of your folks. You will undoubtedly recall that many times your people showed favoritism toward one of the children in the family. Consequently, the training and environmental stimuli were entirely different in each case.

If the stars rule or control the life of any individual, they must control it in the face of all odds. Your statement that the "stars incline and do not compel" is very much like that famous cross-examination answer, "I don't remember." Neither of these statements mean anything. It is just a way astrologers have of trying to "pass the buck."

You assert that "horoscopes are very often unsatisfactory." Why use the term "very often?" We make the statement that horoscopes are always unsatisfactory, that they are never accurate, and we stand ready to prove this statement. Even those horoscopes written by a college of painstaking and conscientious astrologers and then averaged can not be any more than fifty percent correct. The average number of guesses to a given question will always result in approximately the same percentage of accuracy.

Astrology is a very old science. It is older than astronomy, but instead of improving with age, it is becoming worse as the years go along, because now we know which things do influence our lives and we do not follow the sheep at the head of the herd.

Your statement as to whether or not the clock was right when a child was born, may, of course, carry some weight. As far as a difference in clocks of half an hour is concerned, we doubt that such a difference always takes place. It is known that Kaiser Wilhelm II was born at 3 P. M. You don't mean to infer that the half dozen or more physicians who were at the bedside at the time of birth all had clocks or watches with them which varied as to the exact time of birth?

Also, please remember that even though the planets still hurtle through space at a terrific speed their positions do not vary to such an extent that a difference of a few minutes would be apparent. The exact positions in the heavens could only be calculated, and then the possibility that the planets were miles from this position, due to the length of time which it takes for a light beam to reach this earth from the planets, and also due to possible refraction or bending makes it ridiculous for any astrologer to insist on the time correct to the second.—Editor.)

Editor, SCIENCE AND INVENTION:

The article on "Astrology" in the current issue of SCIENCE AND INVENTION is highly interesting. The following four hundred year old quotation from Luther, in which the Reformer uses very similar arguments against this fake, may or may not be new to you. With characteristic distaste for anything that savored of superstition or trickery, Dr. Luther expressed himself rather feelingly about astrology:

"I praise astronomy and mathematics, which have to do with demonstrations. For astrology I have no respect. I have no patience with such stuff. Let any man answer this argument. Esau and Jacob were born of the same father and mother at the same time and under the same planets, but their natures were wholly different. I caught the Pope by his hair, and he caught me by mine. I married a runaway nun and begat children with her. Who saw that in the stars. Astronomy is very well, astrology is naught. The example of Esau and Jacob proves it."

Such statements of course scandalized Melancthon, to whom astrology was almost an article of faith.

The translation given is that of Dr. Wm. Dallmann, on page 277 of his Luther (Concordia Publ. House, St. Louis, 1917).

ARTHUR PIEPKORN,  
Concordia Theological Seminary,  
St. Louis, Mo.

(This letter speaks for itself. Need we say more?—Editor.)

(Continued on page 751)



## Man-power

Four millions of the best man-power of Europe perished in the Napoleonic conquests. Military conquest is non-creative, while industry is always creative.

In the last ten years one American manufacturer—the General Electric Company—has created machines having a man-power forty times as great as that of all the lives lost in the Napoleonic wars.



The laboratories and shops of industry are the sources of many of the enduring attainments of our times. In the General Electric organization is an army of 75,000 persons, co-operating to make electricity do more and better work for you.

# GENERAL ELECTRIC

Travel on "Uncle Sam's" Pay-Roll  
RAILWAY POSTAL CLERKS  
MAIL CARRIERS

\$1700 to \$3000 a Year

TRAVEL—See your country on government pay

Many U. S. Government Jobs obtainable  
MEN—BOYS, 17 UP SHOULD MAIL COUPON IMMEDIATELY  
Steady Work. No Layoffs. Paid Vacations.



COUPON  
FRANKLIN INSTITUTE,  
Dept. D-180, Rochester, N. Y.  
Sirs: Rush to me without charge: (1) Specimen Railway Postal Clerk coaching lessons; (2) FREE 32-page book describing U. S. government positions open to men and women and full particulars telling how to get them.  
Name.....  
Address.....

Insure your copy reaching you each month. Subscribe to SCIENCE AND INVENTION—\$2.50 a year. Experimenter Publishing Co., 53 Park Pl., N. Y. C.



Print Your Own  
Cards, Stationery, Circulars, Paper, etc. Save money. Print for others, big profit. Complete outfits \$8.85. Job press \$11.29. Rotary \$149. All easy, rules sent. Write for catalog presses type etc. THE KELSEY CO., P-47, Meriden, Conn.



# Choose as Your Profession Electrical Engineering

Electricity offers a brilliant future to the young man who is about to choose his career. Never before has there been such wonderful opportunity in this great field. Big paying positions in electrical work the world over are open to trained men — men who possess specialized, practical knowledge. Come to the School of Engineering of Milwaukee—the largest the best equipped electrical school of its kind in America. Here you are trained in both theory and practice by a faculty of experts. You learn in large, finely equipped laboratories. If you have 14 high school credits or equivalent, you can become an Electrical Engineer with a Bachelor of Science degree in 3 years. If you have not finished high school you can make up the credits you lack in our short intensive Junior Electrical Engineering course.

**Practical Electrical Education**  
Learn by the thorough approved scientific methods which our twenty-two years of specializing enable us to give you. In addition to Electrical Engineering, the following complete courses are given: *A.C. and D.C. Armature Winding—Wiring and Testing—Practical Electricity—Electrotechnics—Commercial Electrical Engineering—Junior Electrical Engineering and Automotive Electricity, and Radio Sales and Service.*

**EARN WHILE YOU LEARN**  
You can earn money to help defray your expenses while learning. Our wonderful co-operative plan brings an Electrical Career within the reach of every ambitious man. Our Free Employment Department secures positions for those students who wish to earn part or all of their expenses. In addition, the Department will help you get a good position in the Electrical industry when your training is completed. Daily Broadcasting W.S.O.E.

**New Term Opens January 3rd, 1927**  
**Big Book FREE**  
Mail the coupon today for our big new illustrated catalog. Mention the course that interests you most and we will send you special information. Read about the school that trains men for practical and quick success. See how easy it is for you to get the training that will enable you to step to a splendid position and a handsome income. Mail the coupon right NOW. No cost or obligation.

**SCHOOL of ENGINEERING of Milwaukee**  
FOUNDED 1905  
Dept. S.I.-696A  
Jackson & Oneida Sts., Milwaukee, Wis.

SCHOOL OF ENGINEERING OF MILWAUKEE  
Dept. S.I.-696A—Jackson & Oneida Sts.  
Milwaukee, Wis.  
Without obligating me in any way, please mail free 64-page illustrated book, "Electricity and the One Best Way to Learn It," and particulars regarding the course I have marked with an X.  
... Electrical Engineering.  
... Commercial Electrical Engineering.  
... Junior Electrical Engineering  
... Electrotechnics.  
... A.C. and D.C. Armature Winding.  
... Light, Motor Wiring and Testing.  
... Automotive Electricity.  
... Radio Sales and Service.  
... Home Laboratory Service  
... I am interested in your "Earn While You Learn" Plan.

Name ..... Age .....  
Address .....  
City ..... State .....  
Education .....

### RADIO WRINKLES

#### Variable Grid Leak

By mounting two sets of grid leak clips as above, and placing two different values of leaks in them, four values may be obtained. Either one of the leaks may be used separately or they may be connected in series or in parallel. With values shown, resistances of 1 1/6th, 2, 3 and 5 megohms may be had.  
—Herbert Claybaugh.

### Invisible Loud Talker Leads

Get rid of the unsightly lead wires from your loud talker to the receiving set. This is the only kind you can't trip over.—J. C. Foreman.  
Rep. No. 20.385.

Get rid of the unsightly lead wires from your loud talker to the receiving set. This is the only kind you can't trip over.—J. C. Foreman.  
Rep. No. 20.385.

### Easily Adjusted Grid Leak

Plunger-type variable grid leak may be mounted as shown to permit adjustment from in front of panel.—Masichi Hori.

Plunger-type variable grid leak may be mounted as shown to permit adjustment from in front of panel.—Masichi Hori.

### Socket for UX Tubes

A neat socket for UX-type tubes may be made by mounting a bakelite tube base as illustrated above.—R. A. Marks, Jr.

A neat socket for UX-type tubes may be made by mounting a bakelite tube base as illustrated above.—R. A. Marks, Jr.

A HOTEL OF DISTINCTION CATERING TO AN EXCLUSIVE PATRONAGE

The **TOURNAINE**  
9-11 EAST 39<sup>TH</sup> ST.  
NEW YORK CITY  
Near Fifth Ave.  
Within walking distance of shops and theaters

PARLOR, BEDROOM & BATH \$ 8 & \$ 10 per day  
PARLOR, 2 BEDROOMS & BATH \$ 14 AND UP

Restaurant a la carte  
A. R. SMITH  
formerly of  
HOTEL ST. REGIS

### Chicago Man Discovers Gasoline Miracle!

What is this strange new miracle guaranteed to give 500 gal. of gas at only four-fifths cent a gal., instantly remove all carbon, increase power, speed, pep? Sworn proof backs our guarantee. Nothing ever like it! A mechanical device or gas dope. Use it only every 10,000 miles. Costs practically nothing. It is called MOT-O-METER, discovered by the eminent scientist, L. Forgrave. Starting in action. Thousands of users. **TRY IT FREE** We trust you. Write quick for FREE TRIAL, \$100 WEEK SALARY GUARANTEE to practicing Agents, M-M LABORATORIES, 6935 A21 N. Clark St., Chicago, Illinois.

Agents \$100.00 A Week Salary Guaranteed

### Anyone CAN LEARN!

No talent or experience necessary. Fascinating work. Pays big money. Complete instruction book TELLS ABOUT: Alphabets, Colors, HOW TO MIX PAINTS, Show Cards, Window Board and Wall Signs, Ready-made letters, Gliding, TRICKS OF THE TRADE, also gives 100 Alphabets and Designs. Book bound in flexible int. leather, gold edges, and four ball bearing Show Card Pens. Book and Pens sent postpaid for \$3.00. (C. O. D. 10c extra.)  
Oxide Pub. Co., 37 Rose St., Dept. 1109 New York

**EARN MONEY IMMEDIATELY—WE FURNISH EQUIPMENT TO START**

### BOW LEGS?

This Garter (pat'd) Makes Trousers Hang Straight If Legs Bend In or Out Self Adjustable It Holds Sox Up—Shirt Down Not a "Form" or "Harness" No Metal Springs  
Free Booklet—Plain Sealed Envelope  
**THE T. GARTER CO.**  
Dept. 10 NEW LONDON, NEW HAMPSHIRE

### 500 Tricks

**BIG BOOK 10c!**  
Be a Man of Mystery! Amaze and Mystify your friends. Easy to learn. This New 80-page Copy-righted Book tells how. Large Catalog of Magic Tricks, Jokes, Puzzles and Imported Novelties included. Send 10c today!  
LYLE DOUGLAS  
Station A-3, Dallas, Texas

4 or 6" Barrel  
6-Shot Finest Long Range Revolver  
This gun "free" if you can beat our price anywhere—4 or 6 in. barrel, blue or nickel—32, 38 or 22 caliber. Powerful accurate, hard hitting. Money back guarantee.  
Pay on delivery \$6.25. Federal Mail Order.  
561 Broadway, New York, Dept. X80

Cut to \$6.25

Insure your copy reaching you each month. Subscribe to Science and Invention—\$2.50 a year. Experimenter Publishing Co., 53 Park Pl., N. Y. C.



## The Astrology Humbug

(Continued from page 749)

Editor, SCIENCE AND INVENTION:

I have just read your challenge to astrologers in your October issue, and wish to be sent the data for the three horoscopes. However, in order to cast a horoscope not only the exact moment of birth is necessary, but also the exact place so that one may use the correct latitude and longitude. It is also necessary to know the sex, for the masculine and feminine principal has different rulership. (This was sent.—Ed.)

From your experience with so-called professional astrologers, I do not wonder that you are thoroughly disgusted. The sort of astrologers who do not work from an accurate horoscope and who merely tabulate consecutively a series of influences are indeed pseudo-scientists who obviously are preying upon the ignorant public to extract all the money they can. The trouble is not with the science of astrology, but with the interpretation. Since a horoscope is a "map" of a life in all its almost infinite complexity and inconsistency, it is evident that the wisest, most competent astrologer must weigh and balance with utmost care in order to render a judgment which approximates the truth.

Therefore, I am glad to see your offer, for I believe it will bring a response from sincere and competent astrologers who will prove to you and through you to your readers that astrology is a true science.

After completing a scientific college course I looked upon astrology and all kindred subjects with great contempt. So bitter was my prejudice that it required the most overwhelming, repeated, and conclusive evidence to convince me of astrology's truth. Now I know that the astrological influences, that seem so very impossible and absurd can be explained as logically and reasonably as any other of the laws of nature.

Pardon me for saying this, but your discussion of the law of gravitation in connection with astrology exposes your total ignorance of the subject and palpable unfitnes to set rules for a contest of its truth. If you, as editor of this contest, are really sincere enough in desiring to find an explanation of the natural law involved to read a short series of manuscripts which will make the principles clear to you, I shall take pleasure in informing you as to where you may secure them at trifling expense.

And don't you think for the sake of fairness you should acquaint yourself with just what astrologers claim to be able to do before establishing rules for your contest? As now stated your demands are unreasonable, particularly those relating to some public event.

A horoscope of an individual merely maps the organization of his sub-conscious mind at the time of birth. Then by progression the major influences that play upon the sub-conscious mind from time to time are shown. These influences set up sub-conscious desires and trains of thought that cause the person to react in certain ways, just as the degree of heat causes us to act in a certain manner. The weather predictions tell us when the day will be hot, but, while, from that one could judge that each person will act correspondingly, could one judge the exact detail of the individual's reaction to the hot day? Will he drink ice-water, seek shade, go to the shore, swim, or what? The horoscope shows the sub-conscious urges stimulated, their combinations, the intensity, and the harmony or inharmony and the departments of life concerned. But it is outside the province of astrology to indicate the exact details in which these definite influences will externalize. The same law holds for public events—the sort of influences operating at a given time are predicted, but to picture the details through which they will work out is impossible, at least to astrologers of this age.

If you wish an example of the practical application of the value of fact obtainable through astrology, you will find it in a very interesting series of articles published in Collier's May 15, 33, 39, 1926. I believe Evangeline Adams, the astrologer who furnished the information, is reliable. Two other New York astrologers whom I believe to be reliable are Kevah Deo Griffis, 45 E. 58th St., and Miss Elizabeth Aldrich, 535 W. 160th St. May I suggest that a personal interview with one of these persons might prove illuminating?—(It did—see November issue.—Ed.)

If you and the other editors of SCIENCE AND INVENTION sincerely desire to discover and present the truth instead of attempting to verify your preconceived opinions, I have in this letter indicated the sources through which you may do so.

Whether or not you avail yourself of the opportunity to acquaint yourself with the principles of astrology in a scientific way by securing the brief manuscripts I mentioned will reveal to me and to my astrological associates your sincerity or lack of it.

Believing that you are desirous of presenting the truth, whatever it may be, I look forward with interest to your reply.

Mrs. IONE G. WILLIAMS,  
San Francisco, Calif.

(Continued on page 754)

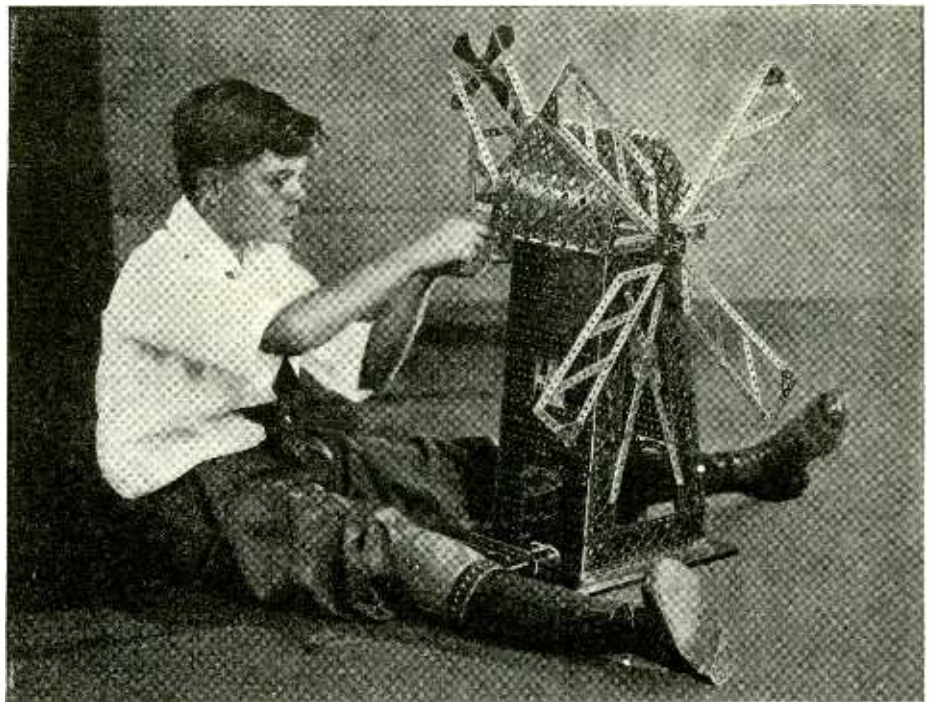

# Now you can build models in color!

You've never seen anything like it, fellows—this new Multicolor Meccano. Part after part gleams with brilliant colors, that's why the models you build are so realistic. And all of Meccano's famous engineering quality is still there.

We wanted the best colors, so we selected Duco, the same that is used on the finest automobiles. This will not crack or peel, and Duco-finished parts cannot rust.

Building with Meccano is dead easy. No study required. Build your models in bright colors—only Multicolor Meccano gives you this, yet it costs no more.

You'll give the gang a surprise with your up-to-the-minute Multicolor outfit. No more colorless, dull models for you. This is the day of the new Multicolor Meccano.

### Send For This Book

An interesting story, "How Jack Discovered the Perfect Toy." It tells you all about the new Multicolor Meccano. Sent free for your name and address and those of three of your chums. Put No. J-2 after your own name for reference.

MECCANO COMPANY, INC.

Div. J-3 Elizabeth, N. J.

In Canada:

Meccano, Ltd., 45 Colburne St., Toronto

New! the  
**MULTICOLOR  
MECCANO**  
The last word  
in Construction Toys

## THE QUALITY TOY



**\$150 to \$300 MONTHLY PROFIT—30 DAYS' TRIAL**  
Charges batteries in 1/3 the time required by others and get the business. **HIG YEAR ROUND PROFITS.** Best paying business in automotive field. Requires no special experience, uses small space. **30 DAYS' FREE TRIAL** at our risk under absolute money back guarantee. Write today for Bulletin X, giving full particulars.  
**HOBART BROS. CO., Box 8-12 TROY, OHIO**



### 100 SCALE PLANS OF OLD and MODERN SHIPS



Easy to build and sell ship models. Send for catalog of over 100 plans, books, prints, maps and other things that smack of the sea.

SEA ARTS GUILD

405X ELEVENTH AVE. MILWAUKEE, WIS.

### BIG BARGAINS!

The biggest novelty, magic and jewelry bargains in the country are all listed in our new 164-page catalog. A wonderful informative book for fun-lovers. See our "ad" in this issue on page 755. Tells how this book can be sent to you for 8c in stamps. **AGENTS WANTED.**

AMERICAN BAZAAR, Inc.

640A Broadway New York City

**A Christmas Gift that will last forever**

**Only \$2.50**

for this handsome pen—positively the equal of any at \$8.50.

**Unconditionally Guaranteed**

First cost is last cost. Never will you be charged for any repairs, regardless if the Newark Pen is broken through accident or misuse. Never another cent of cost.

**Lasts a Lifetime**

The nib is made of 14-kt. gold, tipped with the best grade of hard iridium which can't wear out. Nothing can affect the super-smooth writing point. Glides over the roughest paper—yet can make 4 carbon copies. Truly a manifold pen!

Has a hand-turned barrel, cardinal red or flashing black, artistically chased. Heavy, 14-kt. gold filled mountings. A pure gum sack of large ink capacity. Never-clogging; never-leaking. In every sense the equal of any \$8.50 pen at a price which is less than a storekeeper's profit on such a pen. Made by experts with 25 years' experience and sold O. N. L. Y. by mail—from Maker to You.

**FREE Premium**

Send no money. Just mail the coupon below. You will receive a Newark Pen and 5 premium cards, each worth 50c on the purchase of another pen. You can give them away if you wish. But you can easily dispose of these cards at 50c each. **YOUR PEN WILL THEN COST YOU NOTHING.**

Your choice of men's or women's models. They make ideal and useful gifts—that compliment both the giver and the recipient. Show it to friends—write with it for 5 days—you'll be surprised and delighted, or we'll refund your money.

**Send No Money—Mail This! 5 Days Free Trial**

Newark Pen Co.,  
276 N. J. R. R. Ave., Newark, N. J.

Please send me via Parcel Post collect, a Newark Pen and five premium cards which I may dispose of at 50c each. I will pay the postman \$2.50 plus postage, and if I am not satisfied after five days use, you guarantee to refund my money

X indicates my choice: Men's.... Women's.... Red....  
Black..... Medium Nib..... Fine Nib.....  
Coarse Nib.....

Name .....

Address .....

Town .....

PEN ACTUAL SIZE



**Our Spiritualistic Investigations**  
By DUNNINGER  
(Continued from page 693)

tions of the Orient, reflected in bits of ornaments that were scattered artistically about. Upon a slightly elevated platform the Rajah stood, and after inviting all to be seated, the lights were dimmed, save for two lamps in opposite corners of the room.

The subjects of his speech were well chosen, well rendered, and seemed to come from the lips of one entirely sincere. Perhaps this was a complex with our mystic, as his talk was truly convincing. He took pains to explain that delicate subjects were often discussed through the mouths of the dead, and in consideration of the privacy his believers demanded, he did not think it policy to deliver messages in public form. This was his excuse for giving these private seances in individual form. Expecting to see a psychical manifestation, and believing to be in for nothing more than a lecture, I felt a keen disappointment, but this was soon relieved, as the spiritualist announced, that in consideration of the many new faces present that night, he was about to offer a most unusual demonstration in spirit force, by causing a table to levitate in mid-air, by psychic control. I was now all ears and

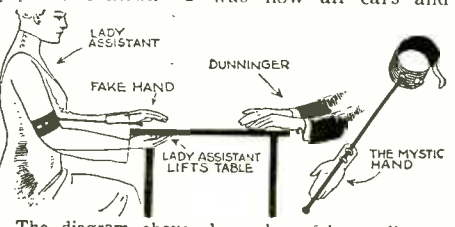

The diagram above shows how fake medium causes table to rise by showing artificial hand, secured to her right arm by means of the attachment illustrated.

eyes. The attendant brought forth a small bridge table, the folded legs of which were quickly opened, and the table placed in the center of the room. Whether the Rajah was also a student of mind-reading or not, I cannot say, but looking directly at me, he quickly said, "If you are skeptical, you might inspect the table. I would, in fact, appreciate your assistance in this matter if you will." Thanks to this invitation, I at once proceeded to do as he requested, secretly pleased that I had been chosen.

It was plain to see, however, that the table was unprepared, so I pronounced the examination satisfactory, and slowly returned to my seat. "I'd rather you would help me," said the wizard, quickly. "Please bring your chair closer, and seat yourself to the side of the table." I obeyed. "Will two or three other subjects accommodate, and do likewise," came a further request. With little coaxing, another gentleman and two ladies stepped forth. They were seated about the table in a circle, and we were all asked to place our fingers lightly upon the table top. The Hindu placed his hands, to his head, and entered deep concentration. Several moments elapsed. In a soft, distinct tone, and with slow, drawn words, he commanded . . . lift your hands into the air, and in the name of Allah, I command the spirits to use their unearthly influence to cause the table to rise. Slowly the quartette lifted their hands, and the table did rise. Amazement came over the faces of the spectators. Sounds of surprise were murmured, and in dramatic fashion, the medium maintained his pose, as he uttered words in his native language. Lower your hands . . . came the sharp command. We did, and the table slowly followed to the ground. Raise them again . . . he shouted, and once more



**Tobacco Habit BANISHED**  
Let Us Help You

No craving for tobacco in any form after you begin taking Tobacco Redeemer. Don't try to quit the tobacco habit unaided. It's often a losing fight against heavy odds and may mean a serious shock to the nervous system. Let us help the tobacco habit to quit YOU. It will quit you, if you will just take Tobacco Redeemer according to directions. It is marvelously quick; thoroughly reliable.

**Not a Substitute**

Tobacco Redeemer contains no habit-forming drugs of any kind. It is in no sense a substitute for tobacco. After finishing the treatment you have absolutely no desire to use tobacco again or to continue the use of the remedy. It makes not a particle of difference how long you have been using tobacco, how much you use or in what form you use it—whether you smoke cigars, cigarettes, pipe, chew plug or fine cut or use snuff, Tobacco Redeemer will positively remove all craving for tobacco in any form in a very few days. This we absolutely guarantee in every case or money refunded.

Write today for our free booklet showing the deadly effect of tobacco upon the human system and positive proof that Tobacco Redeemer will quickly free you of the habit.  
**Newell Pharmacal Company.**  
Dpt. 788 Clayton Station, St. Louis, Mo.

**Thrill Your Friends! Like a real Automatic \$1.79**

Be on your Guard! Beware of holdup men and toughs. Carry a "Pioneer Automatic," and protect yourself. Looks just like a real Automatic. Lots of fun scaring your friends. Made of light weight metal. Pull the trigger—and Zip!—it's a cigarette case.

**SEND NO MONEY!** For postman only \$1.79 plus postage on delivery. Satisfaction guaranteed.

**SINCERE COMPANY**  
24 East 21st St., N.Y. Dep. G103

**MUSIC LESSONS FREE**

You can read music like this quickly

**IN YOUR HOME.** Write today for our FREE booklet. It tells how to learn to play Piano, Organ, Violin, Mandolin, Guitar, Banjo, etc. Beginners or advanced players. Your only expense about 2c per day for music and postage used.

**AMERICAN SCHOOL OF MUSIC, 57 Lakeside Bldg., CHICAGO**

**\$100 a week Selling Shirts**

Fred Frankel, Ill., writes: "I earned \$110 first week selling Carlton Shirts direct to consumer." You can too. No capital or experience required. We pay 25 per cent. cash commissions daily and big extra bonuses.

**WRITE FOR FREE SAMPLES**  
CARLTON MILLS, Inc., Shirt Mfrs.  
114 Fifth Ave., Dept. 166, New York

**Learn to Write**

Begin Today—Write for My FREE BOOK. I can make a good penman of you at home during spare time. Write for my FREE BOOK, "How To Become a Good Penman." It contains specimens and tells how others mastered penmanship by the Tamblin System. Your name will be elegantly written on a card if you enclose stamp to pay postage. Write today for book.

**F. W. TAMBLIN, 224 Ridge Bldg. Kansas City, U.S.A.**

**RESHAPE YOUR NOSE!**

You can safely reshape your nose to beautiful proportions with

**ANITA NOSE ADJUSTER**

—painlessly, comfortably. Results speedy and guaranteed. Physicians praise it highly. No metal to harm you. Winner of Gold Medal, 1923.

**FREE BOOKLET**  
Write for it today.

**THE ANITA CO., Dept. 1273 ANITA Building Newark, N. J.**

the table clung to our finger tips, as if some magnetic power had suddenly settled within us, and radiated its force of attraction into this piece of furniture. While all this was going on, I tried to observe things as rapidly as the time would permit. There was nothing beneath the table that would cause this levitation. The knees and feet of the strangers about it were not touching it in any way. There was no evident explanation as to how it might have been accomplished. Silence again prevailed. Slowly the Hindu removed his hands from his face, and with a much exhausted expression, sighed deeply. As if in great effort, he quietly asked us back to our seats, and then uttered another short address, which resembled a good spokesman selling some product or other. We were presently informed that the meeting was over. The spectators quietly arose and many of the newcomers rushed to the Hindu, to shake him by the hand, and congratulate him upon his marvelous powers. There seemed no great haste for anyone to leave, as they all stood about in small groups, exchanging views with one another still apparently impressed with the mysterious spectacle they had witnessed. Observing that Rajah Hassid was busily engaged in controversy, I took this occasion to make my exit, and was helped by the attendant, who politely ushered me to the door. My host left with me.

"Well, Dunninger, what say you now?" he asked of me when we were some twenty feet away from the threshold. An expression of victory o'ercame his countenance. He evidently felt I had been mystified. Such was not the case, however, dear reader, as I at once proceeded to explain to my gullible friend.

The Hindu used a confederate in his work. She was none other than the lady who sat directly opposite me, at the table. I had observed that throughout the evening, she wore gloves upon her hands, which reason is quite apparent. The gloves concealed two artificial hands, which were placed upon the table, and remained in full view of the audience, while her natural hands stationed themselves in firm grip upon the surface below table top, and raised the light piece of furniture into the air, as the Hindu dictated. A smartly tailored dress, with flowing sleeves, was not alone becoming to the charming Miss, but helped well to conceal this action from the spectators, as the flowing sleeve effect covered well the action of her double hands. The angle at which she sat, well away from the spectators, made it quite impossible for all others about to see this, with the probable exception of Rajah Hassid, who stood directly in back of the lady, but knowing well what was taking place had no particular interest in watching the lady's actions. This charming creature must have been the "Spirit Force from the East" referred to so proudly in the medium's slogan.

A "REEL" AERIAL



A portable 100-foot antenna which looks like a very handy device. Hard drawn flat copper wire reels up inside a pocket size metal case. Cord and plug is provided to connect aerial with set. Case is 4 1/4" diameter. Weight is 20 ounces.

Isn't it natural?

A EUROPEAN WIT says, "Americans not only want the best of everything — but spare nothing to get the best of everything."

A characteristic that explains, perhaps, why American cigarette smokers so willingly pay a few cents more to get Fatimas

F A T I M A



"What a whale of a difference just a few cents make"

LIGGETT & MYERS TOBACCO CO.

fix it yourself

Cheer up—now you can mend metalware as easily and perfectly as a mechanic! All you need is a touch of heat and Kester Metal Mender.

The pleasure of watching the bright, flowing solder, plug a hole or mend a break is only exceeded by the satisfaction of knowing you have done something useful.

Your hardware dealer can supply you with a can of this household solder.



Free sample upon request



KESTER METAL MENDER

CHICAGO SOLDER COMPANY  
4201-349 Wrightwood Ave., Chicago, U.S.A.  
Est. 1899

Insure your copy reaching you each month. Subscribe to Science and Invention — \$2.50 a year. Experimenter Publishing Co., 53 Park Pl., N. Y. C.

Choose with Confidence



World Radio Storage "B" Battery  
12 Cell—24 Volt

275

Proved value. Thousands of users find reception almost magical. Clear, true power—instantly and unendingly. Wise economy. Sturdy construction—Solid Rubber Case protection. Recharged for almost nothing. Endorsed and listed as standard by famous Radio institutions including Pop. Radio Laboratories, Pop. Sci. Inst. Standards, Radio News Lab., Lefax, Inc., and other Radio authorities. What more need be said? Extra Offer: 4 Batteries in series (96 volts) \$10.50.

Send No Money Just state number wanted and we will ship same day order is received, by express C. O. D. Pay expressman after examining batteries. 5% discount for cash with order. Remember—you save 50% on World Batteries.

WORLD BATTERY COMPANY

1219 So. Wabash Ave. Dept. 83 Chicago, Ill.  
Makers of the Famous World Radio "A" Storage Battery  
Prices: 6-volt, 100 Amp. \$10.00; 120 Amp. \$12.00; 140 Amp. \$15.00.  
All equipped with Solid Rubber Case.

Set your radio dials at 288.5 meters for the World Storage Battery Station W5IC. Variety—New Talent—Always Interesting. JERRY SULLIVAN—Director and Announcer—Chi-CAW-go



### The Astrology Humbug

(Continued from page 751)

(As in the other letters requesting astrological data on the lives of three individuals, we would advise that we have also forwarded the data to Mrs. Williams.)

We do not claim that every astrologer is knowingly humbugging the public. As a matter of fact, many of them believe in astrology and they are absolutely sincere in their beliefs.

You mention in your communication that horoscopes cannot be cast on matters relating to public events. This being the case, your opinion is not in accord with that of other astrologers and certainly does not jibe with published articles in which the astrologers not only forecast the day's lucky hour and the events that will probably happen during the day, but also give forecasts for the week, month and year. Can it be that the astrologers themselves do not know their capabilities?

We thank you for the reference to Mrs. Doris K. Griffis or Kekah Deo Griffis about whom you write that "an interview might prove illuminating." It did. As a matter of fact, it was so illuminating that it was made the subject of an article in the November issue of this publication. You may recall that we sent the birth date of Kaiser Wilhelm to Mrs. Griffis. We also sent her a money order for \$25.00, and we received a horoscope which told us that we were the Kaiser's double and told all sorts of remarkable things that were never true. The text of this horoscope is given in the aforementioned article. Possibly after reading this article you will change your opinion as to the reliability of horoscopes as cast by Mrs. Griffis. Whether Evangeline Adams or Miss Aldrich are in the same class probably remains to be seen.—Editor.)

Editor, SCIENCE AND INVENTION:

The attention of the writer has been directed to the editorial entitled, "The Astrological Humbug," and the article "The Truth About Astrology" circulated in the October issue of SCIENCE AND INVENTION.

Enclosed, you will find four blank applications for Astrological analysis, which we ask you to fill out carefully and honestly. I care nothing about the names of your subjects, merely give the initials in the place allotted to names, but be careful to fill in the remainder under the caption "Information," except that if the minute of birth is in each case known, the personal description may be omitted. Be certain to give the sex of your subjects and incidentally, the dates of death.

You will find enclosed a self-addressed envelope for the return of these blanks, properly filled out. In addition to your three test cases, kindly give the following, in regard to your subject, Florence B., born January 1st, 1889, died January 2nd, 1919, and on which you dishonestly trapped some practitioners, whether they were honest or otherwise is beside the question (sic.) The point that I am raising here is that in your zeal to discredit something of which you are evidently ignorant, you resorted to and employed dishonest and dishonorable methods.

Kindly fill out one of these blanks for Florence B. in full, being careful to give me the residence of the Mother nine months previous to birth. I would like you to interview that Mother, as also the Mothers of all your subjects, and ascertain whether the periods of gestation were normal, long or short, whether the deliveries were natural or forced, or delayed, as this information is necessary to the work before us.

I note that in your copyright announcement your rights are not reserved, that articles may be reproduced by giving credit to your magazine. However, as the work before us necessitates the reproduction of these articles, either in part or in whole, we would appreciate your written permission.

Congratulating you on your very able efforts in eliminating the frauds and charlatans from (we hope) all departments of science, and thanking you for your kindly attention to the requests herein made, I remain

DR. CHAS. A. LOGAN,  
Fairhope, Alabama.

(This is the information we are requested to give.)

Name in full ..... Race .....  
Date of birth ..... Place of birth .....  
Time of birth—hour ..... Minute ..... A.M. or P.M. ....  
Type of birth—normal ..... Surgical .....  
Prenatal term—normal ..... Short ..... Long .....  
Mother's residence at time of conception .....  
Personal description—Photographs are helpful where they can be lent.  
Height ..... Weight ..... Built—Slight .....  
Medium ..... Heavy Flesh—Firm ..... Soft .....  
Muscular ..... Wiry .....  
Complexion Ruddy ..... Pale ..... Dark ..... Freckled .....  
Arms and legs—Long ..... Short (in proportion to body) .....  
Eyes—Color ..... Shape—Round ..... Oval .....  
Small ..... Large .....  
Set straight ..... slant ..... Close together .....  
(Continued on page 758)

## Mechanical Engineering

### Learn at Home

MECHANICAL ENGINEERING embraces the design, construction and operation of machines and machine tools.

It is a profession which offers almost unlimited opportunities to men who combine natural mechanical ability with technical training.

For this is The Age of Machinery. Almost every convenience, luxury or necessity which we enjoy depends on machinery for its production or adaptability to our needs. Every new invention multiplies the opportunities for competent designers, builders, erecting engineers, etc.

One of the best ways to train yourself to secure a position as a Mechanical Engineer is through the home-study courses of the International Correspondence Schools.

These courses are complete and up-to-date, and they are especially arranged to meet the needs of the student who studies at home.

They are particularly helpful because they are written by well-known mechanical engineers who have had years of practical experience in this field and who know the quickest, best way to solve every problem.

Just mark and mail the coupon and we'll gladly send you Free Booklets describing the I. C. S. courses in Mechanical Engineering or any other course in which you are interested.

#### Mail the Coupon for Free Booklet

INTERNATIONAL CORRESPONDENCE SCHOOLS  
Box 6175-E, Scranton, Penna.

Without cost or obligation, please send me one of your booklets and tell me how I can qualify for the position or in the subject before which I have marked an X:

- |   |  |
|---|--|
| <input type="checkbox"/> Mechanical Engineering                     | <input type="checkbox"/> Toolmaking                                  |
| <input type="checkbox"/> Mechanical Course                          | <input type="checkbox"/> Blacksmithing and Forging                   |
| <input type="checkbox"/> Drafting                                   | <input type="checkbox"/> Patternmaking                               |
| <input type="checkbox"/> Mechanical Drawing                         | <input type="checkbox"/> Foundrywork                                 |
| <input type="checkbox"/> Complete Shop Practice                     | <input type="checkbox"/> Machine Shop Practice                       |
| <input type="checkbox"/> Electrical Engineering                     | <input type="checkbox"/> Architects' Blueprints                      |
| <input type="checkbox"/> Electric Lighting                          | <input type="checkbox"/> Contractor and Builder                      |
| <input type="checkbox"/> Radio                                      | <input type="checkbox"/> Architectural Draftsman                     |
| <input type="checkbox"/> Railroad Positions                         | <input type="checkbox"/> Concrete Builder                            |
| <input type="checkbox"/> Civil Engineer                             | <input type="checkbox"/> Structural Engineer                         |
| <input type="checkbox"/> Surveying and Mapping                      | <input type="checkbox"/> Chemistry <input type="checkbox"/> Pharmacy |
| <input type="checkbox"/> Metallurgy <input type="checkbox"/> Mining | <input type="checkbox"/> Airplane Engines                            |
| <input type="checkbox"/> Steam Engineering                          | <input type="checkbox"/> Agriculture and Poultry                     |
| <input type="checkbox"/> Architect                                  | <input type="checkbox"/> Mathematics                                 |
- BUSINESS TRAINING COURSES**
- |   |   |
|---|---|
| <input type="checkbox"/> Business Management              | <input type="checkbox"/> Spanish                |
| <input type="checkbox"/> Industrial Management            | <input type="checkbox"/> French                 |
| <input type="checkbox"/> Personnel Organization           | <input type="checkbox"/> Advertising            |
| <input type="checkbox"/> Traffic Management               | <input type="checkbox"/> Better Letters         |
| <input type="checkbox"/> Business Law                     | <input type="checkbox"/> Show Card Lettering    |
| <input type="checkbox"/> Banking and Banking Law          | <input type="checkbox"/> Stenography and Typing |
| <input type="checkbox"/> Accountancy (including C. P. A.) | <input type="checkbox"/> Business English       |
| <input type="checkbox"/> Nicholson Cost Accounting        | <input type="checkbox"/> Civil Service          |
| <input type="checkbox"/> Bookkeeping                      | <input type="checkbox"/> Railway Mail Clerk     |
| <input type="checkbox"/> Private Secretary                | <input type="checkbox"/> Common School Subjects |
| <input type="checkbox"/> Salesmanship                     | <input type="checkbox"/> High School Subjects   |
|   | <input type="checkbox"/> Illustrating           |

Name.....  
Street Address.....  
City..... State.....

**ADDING MACHINE**

NEW POCKET SIZE—Does work of \$300 machine. Guaranteed 5 yrs. Made of Steel—not a Toy.

FREE TRIAL SEND NO MONEY

**\$2.50** Total Cost

Just name and address. We will ship immediately. Pay postman \$2.50 plus postage on delivery. If not satisfied after 10 day trial money refunded. Agents Wanted. Baby Calculator Sales Co., Dept. 14 P.O. Box No. 1118 Chicago, Ill.

**\$7.98** .32 CAL. MILITARY AUTOMATIC

Biggest bargain. Flash-like, accurate, hard hitting. Blue steel, checkered grip. A real he-man's gun. With extra magazine. 20 quick, hard and straight shots. Send no money. Pay postman our price, plus postage. Money refunded if you are not satisfied. Federal Mail Order Corp., 551 Broadway, New York City. Dept. No. T80

**20 SHOTS**

# TOM SAWYER'S COMING BACK

Yes, right into your own home, in the Pathfinder. Tom is alive again with all his impishness, his hair-raising experiences, his escapades, his thrilling rescues, his quest for adventure—the very same Tom Sawyer who made Mark Twain famous—and he's coming to you in the Pathfinder. The Pathfinder editor is spending a lot of money so that everybody may have a chance to read this most popular of all American stories. The only way to secure this story except in costly book form is to read the Pathfinder. Every week the Pathfinder is loaded down with just the things you want to read—world news and pictures, brilliant editorials, stories, travel articles, puzzles, humor and miscellany. The Pathfinder is the nation's most helpful and entertaining weekly magazine with nearly five million readers—and it comes to you direct from the seat of government. Not sold on newsstands or streets. Mark Twain's masterpiece, Tom Sawyer, will begin in the Pathfinder early in 1927. Why not use a Pathfinder subscription, including Tom Sawyer, for Xmas gifts? You can get the Pathfinder every week for one year, 52 issues, for only \$3. 3 subscriptions, \$2. Gift announcement cards, giving your name as donor, mailed if desired. If you do not know the Pathfinder and wish to see it, we will send it on trial for 3 months, 13 issues for 15c, coin or stamps. PATHFINDER, 341 Langdon Sta., Washington, D. C.

**RADIO on FREE TRIAL**

SURE you can sell Radios when you can put them in on Free Trial and back them with a money-back guarantee. No salesmanship or experience necessary. Here is a line good for \$50 a month, \$50 a year!

**We Trade in Old Sets!**

Another knock-out feature. We pay cash for old squealers! Bring 'em in to sell EVERYBODY!

**5-Tube Console**

Tuned Radio Frequency circuit licensed by U. S. Navy Dept., two-tone cabinet built in loud speaker. List, \$117.00 Agent's Cost after trade-in only \$45.20

**5-TUBE TABLE MODEL**

Tuned Radio Frequency Circuit, Walnut finish cabinet. List Price, \$50.00 Agent's Cost Special Price \$24.50

**AGENTS WANTED EVERYWHERE**

Agents to take orders for famous Premier radios. Made COMPLETE IN our factory from Premier parts exclusively, priced at one small profit direct from factory to user. But big commissions for you. Write for amazing new plan and make money quick this season. **Big Discount to Agents!** Get into the radio business with our enormous stock and big factory-back of you. Write Today for complete details of sensational offer to agents. **PREMIER ELECTRIC CO.** Dept. 119 Grace Street at Ravenswood, CHICAGO

**RADIO BOOK FREE**

Tells how you can make big money in world's newest and greatest field. Presents lifetime opportunity in Radio. Right now we want live agents and dealers in every locality. \$60 to \$100 a week easy.

40% to 60% Profit Simply send name for this big illustrated book explaining liberal profit proposition and how to get latest radio goods at wholesale. Also prices on parts, sets and accessories and amazing special offers—all FREE. Write today.

**5-Tube Set only \$39.50 RETAIL**

Standard Radio Co. 1412 Walnut St. Kansas City, Mo.

**MODEL MAKING**

When you have made your Model Boiler, you will naturally wish to mount it with the best Steam Fittings obtainable. We can supply accurately made miniature Steam and Water Gauges, Steam Valves, Pumps, etc., also finished Engines and Boilers suitable for Model boats and stationary. Purpose Special work to order. Large Illustrated catalog 20c (refunded on first order). **BATHE MFG. CO.** Dent. 2, 5214 Woodland Ave., Phila., Pa.

**66 Miles on 1 Gallon**

Amazing New Auto Gas Saver

All Make Cars. Spare or Full Time Agencies Wanted Everywhere

**1 FREE TO ADVERTISE**

**BIG PROFITS TO any MAN WITH CAR**

CRITCHLOW, Inventor, T-863, Wheaton, Ill.

**Wanta Play Banjo?**

C. McNeil—Earn money thru famous McNeil Banjo Course. Easy as A B C with CHORD-CHART SYSTEM and phonograph record by Chas. McNeil, 5 years with Hetaswick. Easy playing method. Free Book and Banjo offer! **CHICAGO TENOR BANJO INSTITUTE** Dept. 1959 1621 N. Lincoln St., Chicago

### BUILD YOUR OWN GRAND-FATHER'S CLOCK

By LOUIS A. BREITINGER

UNTIL recently many homes in which a Grandfather's Clock would be warmly welcomed, were necessarily deprived of having one by reason of their prohibitive cost; but to those who have the knack of building things and the patience and skill to stick to a job until it is finished, the opportunity of building a Grandfather's Clock is hereby presented. Many handy men will not merely build a clock for their own use, but build others for profit.

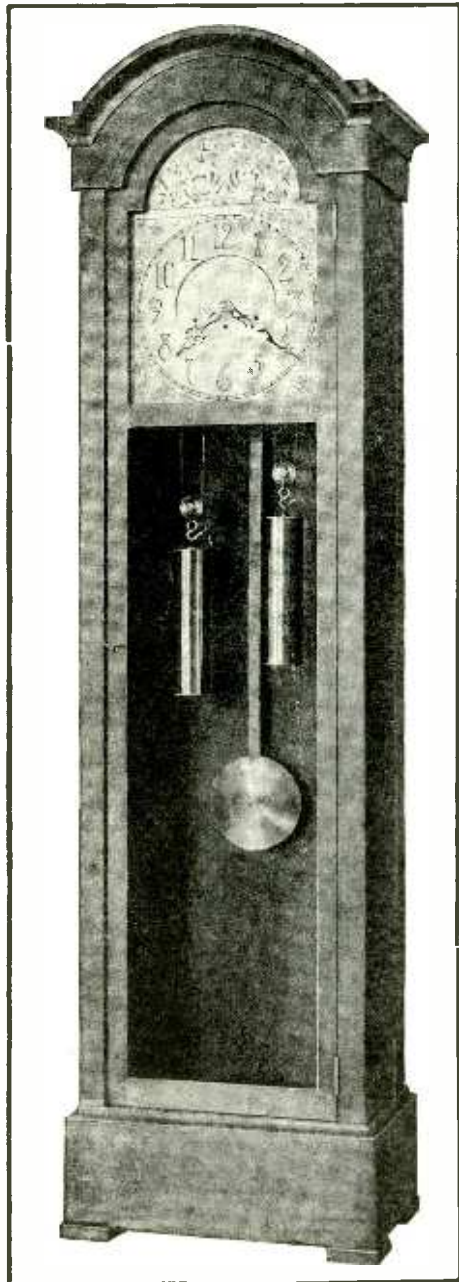

You will be proud to have this stately Grandfather's clock in your home.

The drawings and explanations given should be gone over very carefully before starting the work. The sizes given in the stock schedule are nearly all finished sizes.

Waist sides should be planed straight and square to a length of 68 inches and width of 10½ inches.

Pilasters are 68 inches by 1¾ inches, planed straight and square, glued to the waist sides as seen in sections AA and BB; use lots of clamps, and see that the joints are up good and tight before gluing. Rabbit out the back edge of each side to allow the back to be set in.

## Turn Dial-get stations everywhere:-30 Days Free!



SEND COUPON FOR AMAZING SPECIAL OFFER!  
NOTE: This offer is made to prospective buyers by famous Big Radio Corporation, one of America's oldest reliable manufacturers of fine sets—seventh successful year. Many satisfied users in every state. Postal or coupon brings testimony of nearby users and proof Miraco's output form sets costing up to 4 times as much. Very easy to operate.

### BEAUTIFUL-BIG-POWERFUL Ultra-MIRACO Selective

Build to look like and perform like a \$200 set. Users report!

**MIRACO RADIO GETS 'EM COAST TO COAST**

**ONE DIAL CONTROL**  
Only one dial to turn for all programs.

Beautiful Walnut Cabinet  
28 inch Long  
Special Wholesale Prices to user-agents who show the set to friends. DEALERS WRITE!

Users report Miraco Radios get programs Coast to Coast, also Canada, Cuba and Mexico, loud and clear on speaker; output from \$100 to \$200 sets. Some have heard Europe, H. America. Don't count on Miraco's small cheap sets. Unless trial proves it's **SELECTIVE, WEAK, AND NOISEY**. **POWERFUL DISTANCE-GETTER** among beautiful big 5-tube sets, don't buy it. Every Miraco comes completely assembled, rigidly tested and fully guaranteed.

Our Factory Prices Save You Up to 1/2!  
**SEND NO MONEY!** Much more Ultra-5 on sets, speakers, tubes, batteries—write for AMAZING OFFER. Ultra-5 (not illus.) is marvelous value in a big guaranteed 5-tube, 5-dial set. Retail List \$49.75

**COAST TO COAST RECEPTION**  
verified by Miraco users

Reports from users everywhere leave little for us to add. These are only a few of the many in our files and which we receive daily. Send coupon for plenty of additional proof, testimony of nearby users and SPECIAL OFFER

"UNITUNE" SEPARATES CHICAGO LOCALS. Chicago. With 4 stations broadcasting less than a mile away, one after another I cantine and keep separated as high as 15 Chicago stations on your "Unitune-5". Even during the summer I frequently get stations clear and loud on speaker as far away as Colo., New Jersey, New Orleans and many others. With the single dial I switch from one to another station in an instant. The selectivity is amazing, the set is a beauty and the tone is perfect. W. H. Schaeffer, COAST TO COAST THROUGH LOCALS Omaha, Nebraska. Min. scotis a wonder for distance, volume, tone. We have 5 local broadcasting stations here and she goes right thru and brings them from coast to coast. No trouble at all. H. N. Eller. BEATS OTHERS FOR SELECTIVITY. Cleveland, O. Have been up against some pretty good radio men with other sets and this receiver has them guessing. In selectivity, volume and range it has outdone several. We were able to cut out WTAM (powerful local station) in points, to bring in other stations W. C. Pike. HONOLULU TO LONDON FROM IOWA. Anthon, Iowa. Here are some of the stations we picked up on the Miraco 5 Sunday Jan. 24 between 10 and 11 P. M.: 2LO London, KYO Honolulu, Hawaii; WKAQ San Juan, P. R. and a station in Ireland; could not get call letter. John Kuhn.

NEW YORK LOGS 163 STATIONS Buffalo, N. Y. I received 2LO London, 11:05 on Monday night but there was so much interference it was not very plain. I also logged 163 stations in U. S. and Canada. Satisfied user of Miraco. Mrs. E. A. Resier. NEBRASKA HEARS PORTO RICO ON SPEAKER. Spencer, Nebraska. Using the Miraco we have heard Mexico City, Porto Rico, Miami, Florida, Ottawa, Canada and Vancouver, B. C., Canada and all along the Pacific Coast. All the above stations on the speaker. Have also heard Lima, Peru, South America, H. J. Schmidt. TONE, VOLUME, DISTANCE, Elbing, Kans. Well like our Miraco fine especially because of its volume, tone and its freedom from howling. Although I do not try much for distance we received programs from Oakland, Cal.; Los Angeles, New York, Miami and Havana. In my opinion it's the best ever. Mrs. E. A. Resier. MIRACO EQUALS \$240 SET. Onaka, S. D. Miraco works fine. Selective and plenty of volume. Stations logged include Winnipeg, Canada; P.W.K. Havana, Cuba; and CYL, Mexico City, Mexico. Have heard quite a few sets, one costing as much as \$240, but can't see where it is any better. Clarence Rich. NO HOWLS... SUPERIOR TO COSTLY SETS. Modoc, Ind. We certainly enjoy our Miraco-5. Results equal to any radio I ever heard and

far superior to most radios costing a great deal more. All stations come in loud and clear on the loud speaker. James Tullis. OUTPERFORMS 6 AND 8 TUBE SETS. Duncanville, Pa. I don't think there is a better receiving set made than a Miraco-5. Stations received—all on the loud speaker—include KFI, Los Angeles, California—distance, 2,250 miles. I got this on loud speaker plain, when others couldn't get it with 6 and 8 tube sets. Also have heard Can., Colo., Fla., Cuba, Neb. and many other states. S. D. Fowkes. CALIFORNIA HEARS PENNA. ON THE SPEAKER. San Rafael, Calif. I have purchased three of your sets and will give you an idea of what the Miraco-5 does out here. I have logged 86 stations, which I can get nearly any time I try, Mexico City on the squib to CPN, Calif. gary, Canada, on the North, with Honolulu to the West and E. Pitts., Pa., to the East. All on loud speaker, clear and Roy L. Sharer. WEST RADIO CORPORATION, Pioneer Builders of Sets 409 - Miraco Bldg., Cincinnati, Ohio WRITE OBLIGATION, send for literature, AMAZING SPECIAL OFFER, testimony of users, etc. NAME: ADDRESS:

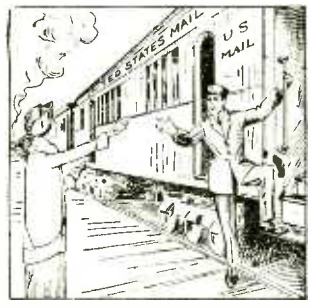

## TRAVEL for "UNCLE SAM"

RAILWAY POSTAL CLERKS—\$1900 TO \$2700 YEAR

Mail Carriers --- Post Office Clerks  
MEN—BOYS 18 UP  
Steady Work. No Layoffs  
Paid Vacations.  
Common Education Sufficient  
Travel—See Your Country  
Many U. S. Govt. Jobs open to women  
MAIL COUPON IMMEDIATELY

FRANKLIN INSTITUTE, Dept. D-184, Rochester, N. Y.  
Sirs: Rush to me, without charge, (1) Sample Railway Postal Clerk coaching lessons; (2) List of U. S. Government jobs now open to men and women; (3) send 32-page book, "Government Jobs."

COUPON  
Name: \_\_\_\_\_  
Address: \_\_\_\_\_

### Build Your Own Grandfather's Clock with our help



We furnish blue prints, finishing material and instructions. Buy the works, dial, weights and pendulum from us at surprisingly low prices. You make a fine profit building artistic clocks for your friends.

**COMPLETE WORKS \$5.00**  
Others with chimes at all prices  
Ask for attractive Free Offer  
L. A. BREITINGER, Pres.  
**CLOCK COMPANY**  
1679 Ruffner St. Philadelphia, Pa.

## Novelties!

The Ross Radio ring is a miniature crystal radio receiving set. Wear it as a ring—use it as a radio. With a phone and aerial brings in local stations clearly and distinctly. Results guaranteed or money refunded.

PRICE 50c. POSTPAID

The Jewish Nickel  
Fun with these never ends, try them on the grocer, the street car conductor, your friends and watch their faces—keep a few on hand always.

No. 1195 10c each 3 for 25c 75c a Doz.

Pull the trigger of this Pistol Cigarette Case!  
But only cigarettes are fired. Looks like deadly weapon. Fools everyone—protective as well as amusing.

No. 1428 ..... Postpaid \$1.59

OUR 164 PAGE CATALOG  
Our huge, new catalog is ready for fun-lovers. Contains actual reproductions of all the laugh-producers on the market. For only 8c in stamps to cover postage we will send it to you. Mailed FREE with all \$2.50 orders. AGENTS WANTED.  
**AMERICAN BAZAAR, Inc.**  
Dept. S12, 640 Broadway, New York City

# A BIG, HANDY FRIEND

## for Winter Reception

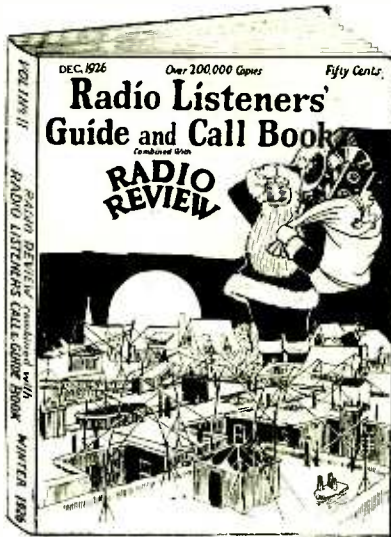

Winter brings Radio Magic, Distance, volume, clarity—all those things you may have striven for all summer without success.

Enjoy good reception to its fullest — Radio Listeners' Guide and Call Book (WINTER EDITION) gives you the latest list of every Broadcast station in the United States, Canada and Foreign countries, gives wavelength, power, location and even the hours of operation.

Also this book has a whole section of illustrated articles on how to build sets and accessories.

And the final supplement of S. Gernsback's famous Radio Encyclopedia.

More data in one book than you have ever before encountered.

**BUY YOUR COPY  
NOW**

Published by  
**The CONSRAD CO., Inc.**  
53 Park Place, New York

If your dealer cannot supply you  
write direct

## RADIO'S FOREMOST CALL BOOK

Completely Revised  
and brought up-to-  
date for Winter use

196 PAGES

Photos of Broadcast Stars  
and Stations  
SIZE 9 x 12

50c the Copy

ON ALL NEWSSTANDS

The lower front rail is 16 inches by 6 3/4 inches. This is made of poplar with the top edge of mahogany. Dowel the rail to the sides with two dowels in each end. Use a screw between the dowels to draw the rail up to the pilaster.

The base may now be moulded on the upper edge and scalloped on the lower. Glue and screw around the waist sides. Miter the front piece first, glue that in place and fit the side returns to it. Size the miter joints before gluing to prevent the glue working away from the joints. The bottom, made of poplar, should now be screwed in place, as it will help to strengthen the base. See that everything is straight, plumb and square. Screw a strip across the top on the inside of the pilasters to hold the sides temporarily until the hood is fastened.

The hood-front should be made up of two pieces, the front of mahogany 20 1/2 inches by 10 1/2 inches by 1 5/16 inches; the second of poplar. This piece should be as long as the distance between the waist sides on the inside, 10 1/2 inches wide, 13/16 inch thick, and must be square on the end, not mitered. Miter the front piece and glue on the second. Miter and fit the hood returns, which are 11 7/8 inches by 6 inches by 1 5/16 inches. Rabbet out the top and back edges for the top and back to set in. Lay off the 6 3/4 and 11 3/4 circles, bandsaw to the line and smooth up with a sharp spokeshave.

Care should be taken in clamping the hood returns to the front, not to draw too hard on the clamps, as the circle may be contracted and held there after the glue has hardened. Size all miter joints before gluing. The hood and arch moulding is to be laid out on a piece 24 inches by 8 inches by 1 1/2 inches, and moulded at the mill. The returns may be worked in one piece 28 inches by 2 inches by 1 1/2 inches.

The front moulding should be mitered and glued in place.

Care should be taken to have everything square and all joints tight, as any imperfection will show up badly.

Dowel the hood to the waist sides and fasten with hooks, so that the hood may be removed to place the works in position. The door is to have all joints strongly mortised. The tenons should not go all the way through the stiles, as they would not look well if exposed.

Rabbet the inside edge of the door for the glass. The arch rail should be cut at the mill.

In gluing and clamping the door, have it on a level surface to avoid having a twist in it, and be sure that it is square. The door sits back from the pilasters 3/8 of an inch, and three extra wide hinges should be used to swing it clear of the hood and pilasters.

Rabbet strips should be screwed on the inside of the pilasters to allow the door to shut against—two on the sides from the middle rail down (see sec. BB), and one across the bottom; two on the sides from the middle rail up for the dial frame to rest against (see AA); the arch circle furnishing around the arch.

The dial frame is intended to hold the dial and should fit the hood and sides neatly. The joints should be strongly mortised. The back may be made of poplar and either paneled or in one piece. Panelling is to be preferred as it takes care of the expansion and contraction. In panelling make the lower panel extend to the middle rail of the door. The top and back should be screwed in, not glued.

Finishing—Scrape well with a sharp cabinet scraper and sandpaper with the grain, using No. 1 and 0 sandpaper. Be careful to select a good mahogany stain, only a penetrating or water stain should be used. Do not use stain that contains varnish. After scraping and sandpapering, sponge the wood lightly with clean, hot water containing about a tablespoonful of glue. Allow this to dry.

**Play the HAWAIIAN GUITAR**  
Just as the Natives Do

**FREE \$15 HAWAIIAN GUITAR and Case** when you enroll

Only 4 Motions used in playing this fascinating instrument. Our native Hawaiian instructors teach you to master them quickly. Pictures show how. Everything explained clearly.

**Play in Half Hour** Even if you don't know one note from another, the 52 printed lessons and the clear pictures make it easy to learn quickly. Pays you play.

**Easy Lessons** Write at Once You'll never be lonesome with this beautiful Hawaiian Guitarr. Write for Special Offer and easy terms. A postcard will do. ACT!

**Free Guitarr and Outfit in Genuine Seal Grain** Case as soon as you enroll. Nothing to buy—everything furnished. No delay.

**FIRST HAWAIIAN CONSERVATORY OF MUSIC, Inc.**  
9th Floor, Woolworth Bldg., Dept. 140 New York, N. Y.  
Approved as a Correspondence School Under the Laws of the State of New York

**Agents Wanted**

**Anti-Mist**  
Guarantees Clear Vision

You can quickly build a big money-making business of your own selling Anti-Mist. Sells to auto supply stores, opticians, druggists, clear stores, garages, railroads and street car companies. Anti-Mist makes glass FROST-PROOF, STEAM-PROOF and WATER-PROOF. One application lasts 24 hours. Clear vision guaranteed in all weather; money back guarantee if it fails.

**\$50 to \$100 WEEKLY** Others are doing it. Sells on sight. Anti-Mist retails at 35c for 3/4 oz. can—\$1.50 for 8 oz. can. Send 35c NOW for sample 3/4 oz. can and full particulars.

Gaston Mfg. Co., Dept. 5, 4216, Lincoln Ave., Chicago, Ill.

Insure your copy reaching you each month. Subscribe to Science & Invention—\$2.50 a year. Experimenters Publishing Co., 53 Park Place, N. Y. C.

# Do You Speak Correct English?

Or do you only think you do?

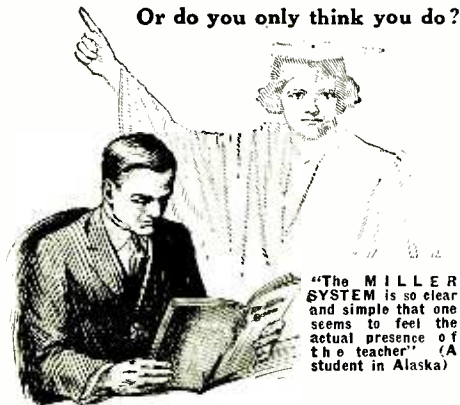

"The MILLER SYSTEM is so clear and simple that one seems to feel the actual presence of the teacher" (A student in Alaska)

You owe yourself time for self-culture. Study the MILLER SYSTEM OF CORRECT ENGLISH as a basis. You can never rise to the top in business or society, in club, church or lodge unless you speak and write correct English. The MILLER SYSTEM is bright, brief and practical with entertainment and variety that will hold your attention. Look it over without obligation and BE YOUR OWN JUDGE.

## Does Your English Embarrass or Betray You?

Do you know when you make mistakes? You cannot afford not to know your own language. DO YOU SAY—in'kwirry for in'qu'ry; ad'dress for ad'dress'; cu'pon for cou'bon; press'dence for pree'dence; hydth for heighth; con'versant for con'versant? DO YOU SAY—between you and I, a raise in salary; a long ways off; a setting hen; let's you and I go somewheres; those kind of men; that coat sets good; he don't know as he can; a mutual friend; refer back? DO YOU KNOW WHEN TO USE—sits or sets, laying or lying, farther or further, drank or drunk, who or whom, I or me, lunch or luncheon, affect or effect, council, counsel or consul, practical or practicable, admittance or admission, shall or will?

## MILLER SYSTEM OF CORRECT ENGLISH

Room 106 1341 Beacon St., Boston, Mass.

Improve your conversation, letters and position. A practical, intensive, entertaining, home study course in the essentials of grammar, rhetoric, letter-writing, pronunciation of 525 misused English words. Good Speech for Cultured Conversation, Poise and Personality.

### Miller System of Correct English.

Room 106, 1341 Beacon St., Boston, Mass.

Please send, for my inspection, parts 1 and 2 of your 15 lesson COURSE IN CORRECT ENGLISH. I enclose \$1 down. If I decide to keep the course, I will send the balance of \$4, and receive Parts 3, 4, 5, and the SELF-CORRECTING KEY. Otherwise I will return the lessons within one week, and you will refund my \$1 deposit. (Ref. U. S. Trust Co., Boston.)

Name .....

Address .....

**WANTED** Agents everywhere to organize classes in clubs, stores, factories and independently. Teachers and clubs should ask for circular, "How to Conduct a Money-Making Study Class." Club Rates.

## Learn How to BOX

In 20 weeks, the System of Jimmy DeForest, World's Greatest Trainer and Maker of Champions, teaches you all there is to learn about boxing. Every 0 month, 20 are selected from all classes and recommended to leading promoters or encouragement. Send for famous book, "The Golden Age of Boxing," full of valuable information, photos of great fighters and pupils who became successes overnight. Enclose 10c to cover cost of mailing, etc. Jimmy DeForest Boxing Course, 347 Madison Avenue, Box 3012, New York City.



## DEAFNESS IS MISERY GOOD HEARING A JOY

Millions of people know that, but Multitudes of persons with defective hearing and Head Noises are again enjoying conversation, go to Theatre and Church because they use Leonard Invisible Anti-septic Ear Drums, which are Tiny Megaphones fitting in the Ear entirely out of sight. No wires, no batteries, no head piece. They are Unseen Comforts and inexpensive. Write for booklet and sworn statement of the inventor who was himself deaf.

A. O. LEONARD, Inc., Suite 369 70 5th Ave., New York

Insure your copy reaching you each month. Subscribe to SCIENCE & INVENTION—\$2.50 a year. Experimenter Publishing Co., 53 Park Pl., N. Y. C.

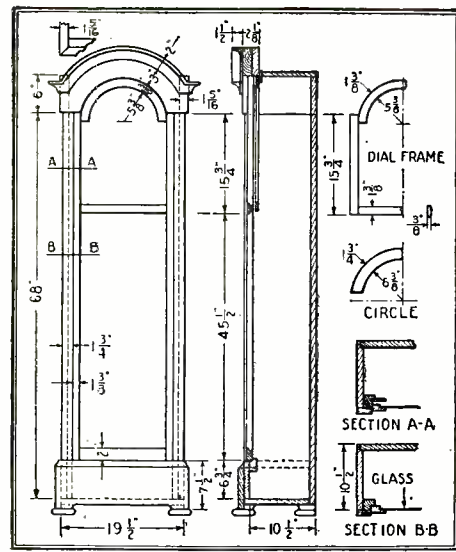

The drawing above shows the complete wood frame of the grandfather's clock here described.

about 24 hours, and sandpaper with the grain, using No. 00 sandpaper. This will keep the grain from rising after staining.

Try staining and filling a piece of mahogany before attempting the clock case, so as to get the desired shade. After the stain is applied and given 24 hours to dry, sandpaper lightly with No. 000 sandpaper, taking care not to cut the stain, after which give a coat of filler. This should be well rubbed off after setting a few minutes. Use a piece of burlap, rubbing across the grain.

Allow the filler to dry for about two days, then sandpaper lightly with 000 sandpaper, clean off with a woolen rag and give a thin coat of orange shellac. This will dry within 24 hours, when it should be sanded with a fine paper and given a coat of the very best cabinet varnish. This should be flowed on with a fine brush and allow to dry from 4 to 5 days. It may now be rubbed down with fine pumice stone and water; care should be taken not to cut through the varnish into the bare wood. Clean off the water and after the work is thoroughly dried, give another coat of varnish. Let this dry as before and rub with rottenstone and oil, cleaning and finishing with a soft woolen cloth.

An enterprising clock manufacturing concern has for some years been specializing in the business of furnishing clock movements, dials, chimes, gongs and parts for amateur clock builders, also some of the more difficult parts of the cases as well, the special hardware and the finishing material needed. The name of this concern may be obtained from publisher or advertising columns.

### STOCK SCHEDULE

- 2 Waistsides, 68 by 10 1/2 by 13/16.
- 2 Pilasters, 68 by 1 3/4 by 13/16.
- 1 Bottom Rail, 16 by 6 3/4 by 13/16.
- 2 Door stiles, 64 by 1 3/4 by 13/16.
- 1 Head rail, 15 by 7 by 13/16.
- 1 Middle rail, 15 by 1 1/2 by 13/16.
- 1 Bottom rail, 16 by 2 by 13/16.
- 1 Base, 47 by 7 1/2 by 13/16.
- 1 Hood front, 20 1/2 by 10 1/2 by 1 5/16.
- 1 Hood front, 17 1/2 by 10 1/2 by 13/16, poplar.
- 2 Hood returns, 11 3/4 by 60 by 1 5/16.
- 1 Arch moulding, 24 by 8 by 1 1/2.
- 2 Arch moulding returns, 14 by 2 by 1 1/2.
- 1 Dial frame (see drawing).
- 2 Rabbit strips, 15 3/4 by 1 1/4 by 1 1/4.
- 2 Rabbit strips, 47 by 1 1/4 by 13/16.
- 1 Rabbit strip, 20 by 1 1/4 by 13/16.
- 1 Dial circle (see detail).
- 1 Back, 75 by 19 by 3/4, poplar.
- 1 Bottom, 18 1/2 by 10 1/2, poplar.
- 1 Top, 18 1/2 by 9 3/4 by 3/4, poplar.
- 3 special hinges.
- 1 mortise lock.

### TOOL LIST.

The tools required in building this grandfather's clock include hammer, coarse and fine carpenter saws, hand drills, files, rasp, rabbit planes, wood chisels, gouges, carpenter's finishing plane, screw drivers and twist drills, and scriber.

# Now You Smarty You Are Paying the Penalty!



YOU were a wise guy. You were young, you were vigorous and peppy. Bating around nights until all hours of the morning didn't phase you in the least. Four hours sleep—three hours sleep—that made no difference. Oh, you were smart—and you did love those wild parties with the boys and girls—the wilder the better. You were always set—the sky was the limit. "Where will we go from here, boys?" "Go! Go! Go!" It was a great life! Nothing like it—"Wine, women, and song!" Pshaw! you didn't feel any bad effects of the high speed at which you were going. You felt fine. You were strong and you loved to brag to your friends about the many "big times" you had. If you stayed up all night, so much colder the boast. Oh! you were very smart! But now—

## You're Worried—Your Pep Is Gone!

You awaken in the morning all tired out, sluggish, nervous, constipated, dizzy, with headaches and a nasty taste in your mouth. Your cheeks are sallow or sunken. Your eyes—black rings under them, bloodshot, and burning—in other words, you are bleary-eyed. You go to your work, not with energy and ambition, but with a slouch and a groan. Work drags. Your head is befogged—you can't think straight. You feel miserable. You are wretched. Why is it? Ah—you are paying the penalty for those wild days of youth. The terrible mistakes you then made, the terrific pace at which you traveled, the awful abuse of your body, have come in for a reckoning.

## STRONGFORT Builder of Men

I Restore Your Health, Your Strength! No matter how far down you have gone, I can and will help you. Only give me the chance. I am your friend, holding out my helping hand to you. I don't care how serious your mistakes of youth were, how much you dissipated, or how badly you abused your body. I don't care how miserable and wretched you are now—how weak and sickly—how wasted—I can and I will help you. I will build you up inch by inch—internally and externally—until you are a robust powerful fellow—a real He-man who will command respect and admiration wherever you go. I have done this for thousands of others and I will do it for you through my original and unfailling methods of

# STRONGFORTISM

## Science of Health and Strength

A new life will dawn for you. A new energy will grip you. You will be chock full of ambition. Your head will be high, your shoulders erect, your eyes bright, your cheeks radiant with color. STRONGFORTISM has lifted thousands of weak, ailing, discouraged men such as you are out of the bog of hopelessness and despair and placed them on the straight road to health, happiness and prosperity. STRONGFORTISM has aided Nature in overcoming such ailments as Constipation, Nervousness, Rheumatism, Catarrh, Bad Blood, Poor Memory, etc., as well as the ruinous results of neglecting and abusing the body. STRONGFORTISM gave these men renewed confidence, vitality, ambition, success, and fitted them for the joys of a healthy, happy life. STRONGFORTISM will do the same for you, no matter what your occupation or surroundings.

### SEND FOR MY FREE BOOK

"PROMOTION AND CONSERVATION OF HEALTH, STRENGTH, AND MENTAL ENERGY." It will tell you frankly how I can make you over into a vigorous specimen of vital manhood. It is filled with astonishing facts about the body that will prove a revelation and give you new hope for a future joyous life. It is worth its weight in gold. Send for my book RIGHT NOW.

## LIONEL STRONGFORT

Physical and Health Specialist for over 25 Years

DEPT. 274, NEWARK, NEW JERSEY, U. S. A.

CLIP AND SEND THIS COUPON

### FREE CONSULTATION

#### ABSOLUTELY CONFIDENTIAL

### MR. LIONEL STRONGFORT,

Strongfort Institute, Dept. 274, Newark, N. J. Please send me absolutely free my copy of your book, "Promotion and Conservation of Health, Strength and Mental Energy." I have marked (x) before the subjects in which I am most interested.

- Colds
- Catarrh
- Asthma
- Headache
- Rupture
- Thinness
- Pimples
- Insomnia
- Impotency
- Overweight
- Weak Back
- Weak Eyes
- Flat Chest
- Despondency
- Emaciation
- Rheumatism
- Nervousness
- Constipation
- Night Losses
- Short Breath
- Weak Heart
- Great Strength
- Vital Losses
- Lung Trouble
- Poor Circulation
- Round Shoulders
- Youthful Errors
- Manhood Restored
- Skin Trouble
- Stomach Disorders
- Increased Height
- Muscular Development

Name .....

Age ..... Occupation .....

Street .....

City ..... State .....

# FREE! This 84 Page RADIO BOOK

The Guide to Radio prices and Radio Quality. Our vast resources and radio experience have been utilized to assemble in one gigantic institution, the best and newest things in radio. The Randolph catalog is the great radio market place—a masterpiece of merchandising that befits our house—

**The World's Largest Exclusive Radio Mail Order House**

**CATALOG CONTAINS OVER 2000 ITEMS**, from the most beautiful, fully equipped console radio set, down to the smallest part or tool for the set builder—kits, parts and supplies of every type and style. All beautifully illustrated and interestingly described. Also valuable data of today's most fascinating and most wonderful achievement—**RADIO**.

**5-TUBE SETS AS LOW AS \$24.90**  
**LATEST 1927 MODELS**

All Randolph sets are sold at amazingly low prices. No matter what kind of set you want—no matter how little you want to pay—you can select **YOUR SET AT YOUR PRICE** from the Randolph catalog.

**WE SAVE YOU MONEY** Because we handle radio exclusively and sell a tremendous volume of everything in Radio, we can concentrate our buying power for the benefit of our customers.

**SEND FOR BOOK TODAY** We cannot begin to tell all about this wonderful Radio Book. Simply send letter or postal and this bargain catalog of guaranteed radio sets and supplies will come to you **absolutely FREE**.

**RANDOLPH RADIO CORP.**  
180 N. Union Ave., Dept. 192 Chicago, Ill.



**RANDOLPH RADIO CORPORATION**  
180 N. Union Ave., Dept. 192 Chicago, Ill.  
Send me—free—your 84-page, 1927 Radio Book.

Name.....  
Street and No.....  
R. F. D..... Box.....  
City..... State.....

## The Astrology Humbug

(Continued from page 754)

- Far apart ..... Sight—normal... Defective....
- Hair—Color ..... Fine ..... Medium ..... Course
- ..... Thick ..... Thin ..... Curly
- Wavy ..... Straight ..... Early baldness in men?
- Teeth—Regular ..... Irregular ..... Pointed cusp teeth ..... Front teeth separated?.....
- Sound ..... Subject to decay .....
- Nose—Large ..... Medium ..... Small .....
- Straight ..... Aquiline ..... Hump .....
- Irregular .....
- Ears—Hearing good ..... Poor ..... Deaf .....
- Throat—Long ..... Medium ..... Short .....
- Any goitre trouble? ..... Give date .....
- Size of shoe..... Size of glove.....
- Birth marks—Color ..... Size ..... Location.....
- Sex ..... Occupation .....
- Dates—Marriage .....
- Children .....
- Important journeys.....
- Illness or operation (please describe).....
- Emotional or psychic crises.....
- Please give date of death or fatal disease.....

In filling out this blank, the dates of events are not so necessary if you have a correct birth time. If it is not certainly known, then all the items you care to give are needed to arrive at your correct time.

Please indicate carefully just the sort of work you want done, fill out the blanks, and return with check. You will probably have your work within two weeks, unless some condition exists which makes for delay—in which case you will be notified.

If the delay interferes with your plans, your money will be promptly returned. Address all inquiries to

DR. CHAS. A. LOGAN,  
Drawer F,  
Fairhope, Alabama.

(We shall be glad to give you permission to republish the article on astrology in SCIENCE AND INVENTION Magazine and make any comments thereto that you care to, provided that you give this publication credit and also with the hope that you will send us a marked copy of the magazine or pamphlet in which this is reproduced. Inasmuch as the writer was intimately acquainted with Florence B. for many years, he is able to state with a fair degree of accuracy that there was absolutely nothing abnormal in either the period of gestation or the delivery.

What is there that is dishonest and dishonorable in sending for a horoscope of a departed friend to see if an astrologer knows his business? If the astrologer had sent us an accurate horoscope would it have been honest? Was the forecast of the Dempsey-Tunney bout dishonest because it proved a fizzle and resulted in a negation of the astrology, Prof. Gustave Meyers' calculations? Was the analysis by Dr. Lillian L. Houghtaling on the Willis-Sharkey prize-fight obtained dishonestly? Why should both winners have held the worse horoscopes? Why should horoscopes favor the same individual upon whom betting money is placed, at odds in the first case of as much as 6 to 1 just before the fight and in the second at 3 to 1. Why should the astrologer's honesty be "beside the question?"

Code initials of three men and birth places as well as dates and times were then given. Dr. Logan did not request a check for drawing up an astrological chart. We merely republished his printed form above.

Inasmuch as the questions concerning life or death, the nature of the teeth, the height, weight and build of the individual or the complexion of the person are supposed to be ruled by the planets, we are omitting this information for the present. The individual's occupation is also not given.—Editor.)

## FURNITURE, RADIO CABINETS, LATHES, SPORT DEVICES, Etc.—(Can be made at home)

HERE'S THE BOOK THAT TELLS YOU HOW

Building your own home furniture, cameras, radio cabinets, sport devices, etc., is easy if you know what materials you need, and have an illustrated explanation on how to proceed. Then, too, you can save a good deal of money by making these valuable things yourself.

"How to make it" a big book compiled from the great magazine "Science and Invention," is full to the brim with hundreds of up-to-date things to make at home. Things that can be made by any man with only a few simple tools.

Published by  
**EXPERIMENTER PUBLISHING CO., Inc.**  
53 PARK PLACE NEW YORK, N. Y.  
If your dealer cannot supply you order direct.

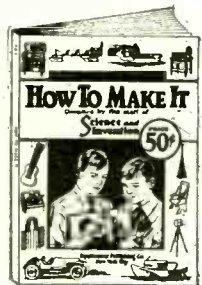

116 PAGES - 300 ILLUSTRATIONS - LARGE  
SIZE 9x12 INCHES - PRICE 50c

**SOLD ON ALL NEWSSTANDS**

**NEW! A BIG HIT!**  
**The Little Checkwriter with the Big Protection**

from October 10 to 6 at 75¢

**Salesmen!**  
At least a checkwriter at everybody's price! Sells for \$12.50. Does more than larger machines costing hundreds! Our salesmen cleaning up!

**The Arnold Features**

1. Pocket size convenience.
2. Handsome nickel plated aluminum.
3. Light weight. Easy to operate.
4. Prints and cuts characters in acid proof ink.
5. Unlimited capacity. Low cost. Easy to ink.
6. Guaranteed for 5 years. Nothing to get out of order.

**FREE SAMPLE OFFER!** Salesmen! Here's the biggest selling proposition of the year for you. Wonderful opportunity with very liberal commissions to district managers and salesmen.

**THE ARNOLD CHECKWRITER CO., Inc., Dept. 14**  
FLINT, MICHIGAN

*Your Musical Bump will pay You well*

START now to develop your talent with a Conn easy-to-play hand or orchestra instrument. Demand for players exceeds supply. Free Trial; Easy Payments on any Conn. Send for free literature and details; mention instrument.

**C. G. CONN, LTD.**  
1250 Conn Bldg. Elkhart, Ind.

**CONN BAND INSTRUMENTS**

Insure your copy reaching you each month. Subscribe to SCIENCE AND INVENTION—\$2.50 a year. Experimenter Publishing Co., 53 Park Place, New York City.

## DIVING SCHOOL

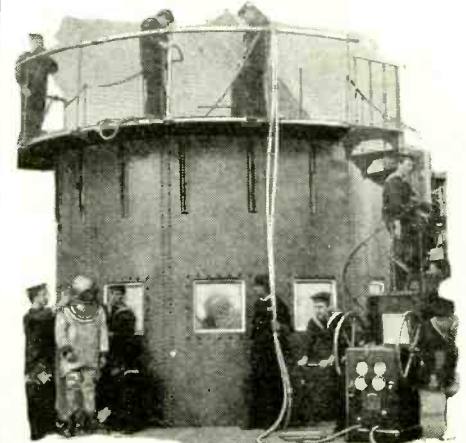

English divers learning to use apparatus and suits in water filled tank.





## Learning to Write Now Amazingly Easy Through New Method

THINK of the joy of opening a magazine or newspaper and seeing your story or article in print! Could anything be more gratifying, more thrilling than that?

### A Remarkable New Method of Training

Whether you have ever written a line for publication or not, if you believe in yourself—if you really want to write—there is no longer any reason why you should not realize your ambitions. For under our new method of training anyone can learn to write for newspapers and magazines—and start to carve out a real career.

This new method of instruction—known as the "Copy Desk" method—was originated by a group of practical New York newspaper men who have learned by personal experience the things they teach you how to do.

Step by step, under their expert guidance, you are given a thorough, all-round training in every kind of profitable writing for newspapers and magazines. You are taught not only how to write, but what to write—the kind of material that editors are glad to pay real money for. There is no other course like it, either in character or extent—no other course that will prepare you for success so quickly and easily—right in your own home.

### Your Writing Ability Tested—FREE

Send at once for our FREE Writing Ability Test which will enable us to judge your writing ability quickly and fairly. No obligation. Simply mail the coupon NOW!

NEWSPAPER INSTITUTE OF AMERICA,  
Dept. 1912, 25 West 45th St., New York City.

Please send me your free writing ability test and free information on opportunities for profit in writing.

NAME .....  
(Please state whether Mr., Mrs. or Miss)

ADDRESS .....

CITY ..... STATE .....

### Men wanted to manufacture Metal Toys and Novelties

NO SALESMANSHIP NECESSARY  
Don't let crowds supply and we co-operate with you in selling goods, also buy them from you. We put you in touch with the buyers. Guaranteed casting forms with complete outfit furnished for speedy production of Toys, Novelties, Ash Trays, Bookends, and other big all-year sellers. Absolutely no experience or machinery necessary. No special place needed. Small investment puts you on road to success. You do the manufacturing and we take care of the selling. Act immediately if you want to handle big 1926 wholesale orders now being placed. Strictly a business proposition. Catalog and information mailed on request.

METAL CAST PRODUCTS COMPANY  
1596 Boston Road New York

**LEARN TO DRAW!**  
Remarkable book—"COMMERCIAL ART AND CARTOONING." Explains how to make illustrations for books, advertisements, etc. Also how to become a Cartoonist. NO CORRESPONDENCE COURSE—Book tells all—14 chapters—125 illustrations. Explains Elementary Drawing—Still Life, Pen, Ink, Charcoal and Crayon Work; Cartooning, etc. Bound Flexible, Im. Leather. Postpaid for \$2.00 C. O. D. The Central O'GILVIE PUBLISHING CO., 57 Rose Street, New York. Dept. 139

**POSTALS** 20 samples, 25c; 10 hold to mirror, 25c; 10 transparents 25c; 5 bathers, 25c; all, 75c. Photos. Set of 20, \$1.00; 4 samples, 25c.  
CENTRAL NOVELTY CO.,  
112 N. LaSalle St., Chicago, Ill

## Wirecraft—A New Art

By HUGO GERNSBACK  
(Continued from page 688)

wire for the purpose may be bought at most hardware, radio and electrical stores, but if you can not secure the right size of wire, a stamped addressed envelope sent to the Editor of Wirecraft Contest will bring you the information where this wire can be secured in your vicinity.

### TECHNICAL DATA ON WIRECRAFT

Wirecraft is a simple craft and requires no great amount of skill. Any one handy with a pair of pliers and a soldering iron can build Wirecraft articles. Here are a few simple rules that should be observed in Wirecraft building:

#### STRAIGHTENING OF WIRE.

Most wire comes in spool form. Wire as wound on spools usually does not come off straight. In Fig. 7 is shown one simple way to straighten the wire. Simply drive three nails along a straight line into a piece of board. Run the wire in and out between the nails, and now when you pull you will find that the wire comes off straight. By placing the nails in correct position, best results are obtained.

After being straightened, the wire can then be cut into the required lengths, all depending upon what lengths are needed. In Fig. 6 is shown a form for bending the wire after it has been straightened, where a great

(Continued on page 761)

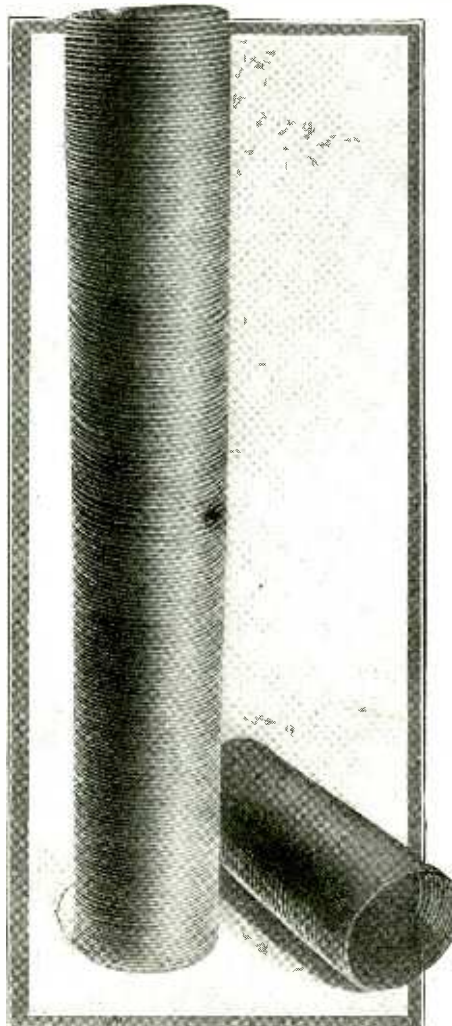

Fig. 17. Here are two cylinders made of wire and then soldered. The one at the left is 3 feet long. It is obvious that the diameter could have been much narrower and that a tube of this nature can be employed in a variety of different ways.

## Jobs for Home Trained Men in ELECTRICITY

### \$65 a WEEK AND UP!

Get into a field that's not crowded. Draw real pay! If you can be reached by mail, we can train you for success in electricity.

A few Happy Hours a week in work with a kick in it.

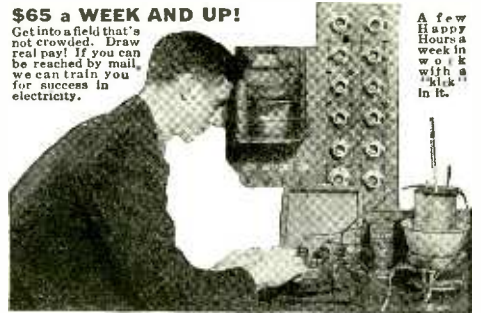

**ELECTRICAL EXPERTS** are needed now as never before. Even electrical trades are making record money. But men with expert electrical training such as we give you, are earning \$3250 a year and up by the thousands. And the big

modern electrical "boom" has only started. Jobs by the hundreds are opening up. Electrical refrigeration, power plants, battery stations. A profitable business for yourself. The kind of job you've always wanted. Where you do the bossing and let the other fellow do the \$25 a week hard work.

**FREE EMPLOYMENT SERVICE** and it doesn't cost you a penny. Thousands of firms look to us for men. Nordberg, Harnischfeger Corp'n., Commonwealth Edison are only a few places where S. of E. men get rapid advancement. Hundreds have been helped by us in selecting the right place to go into business for themselves. Coupon brings you big FREE book with all details.

**WHATEVER YOUR AGE OR EXPERIENCE** we can train you for success and big pay in electrical work. Hundreds of our most successful students are not even high school graduates. You don't need to know a single fact about electricity. In 22 years of teaching men to be successful we have found just what you should know and how to teach it to you to insure the quickest success when you go on the job. Earn \$65 a week and up. It's "in the cards" for you if you act and send the coupon.

**IN BUSINESS FOR YOURSELF**



Hundreds of S. of E. men locate in business for themselves. With our help it's easy to get started.

**SATISFACTION GUARANTEED OR MONEY BACK** is the way we stand behind S. of E. training. We can afford to because S. of E. men make good. They have the prestige for some of the biggest electrical men in America are S. of E. men. A signed money-back guarantee bond is yours the minute you enroll. Your training must satisfy you or every penny is returned.

**GET STARTED—MAIL THE COUPON NOW.** A big 64 page book in colors and illustrated with pictures of successful S. of E. men and their jobs will be rushed postpaid. Full details on S. of E. home training and the big opportunities that await you. **Mail Coupon Right Now.**

## \$50 Outfit FREE

An electrical expert's outfit complete, of finest materials when you enroll



SCHOOL OF ENGINEERING OF MILWAUKEE  
Dept. H69E, Box 572, Milwaukee, Wisconsin

Send me FREE and postpaid without obligation your big 64-page book telling about S. of E. training and opportunities for me in electrical work. Also details of your employment service and money back guaranty.

Name..... Age.....

Address.....

City..... State.....

Here are a few of the important subjects covered in this valuable book

SEX EDUCATION AND CHARACTER EDUCATION

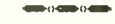

COLD IN THE HEAD



SEX IN ANCIENT RELIGION



APPENDICITIS



PRENATAL INFLUENCE



COSMETICS



WHAT EVERY YOUNG WOMAN SHOULD KNOW



CLOTHES, NAKEDNESS AND SHAME



WHAT WE DIE OF



PHYSICAL AND MENTAL BARS TO MARRIAGE



WHAT EVERY YOUNG MAN SHOULD KNOW

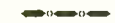

ACNE, BLACKHEADS, PIMPLES

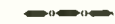

MEDICAL MISCONCEPTIONS

# YOUR BODY

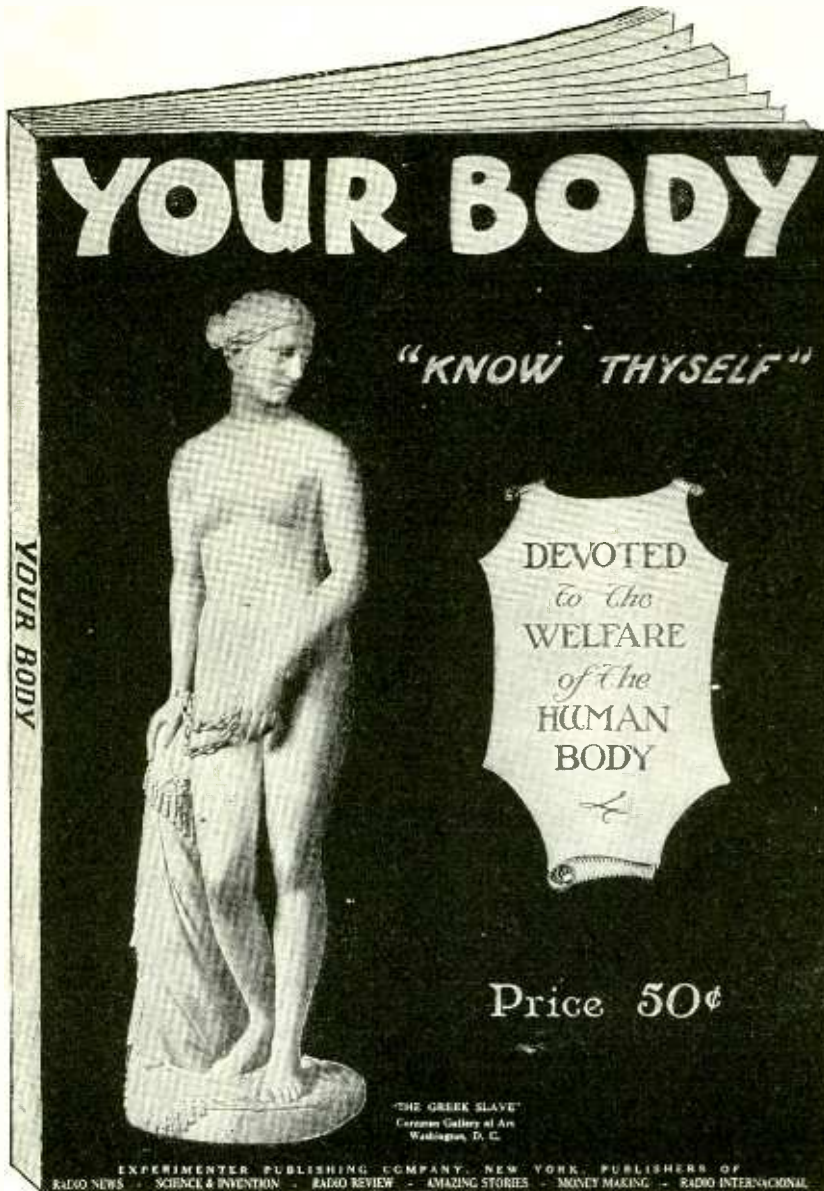

THE BOOK OF GOOD ADVICE FOR EVERY FAMILY



SOLD EVERYWHERE

50c



On All Newsstands

By B. M. BOLTON, M.D.

*The first and most important new book for everyones' home!*

Are you enough of a father or mother to tell your sons or daughters those things they should know? Do you know who they should not marry? Do you still believe in Prenatal influence? Do you know how to guard against illnesses? How to treat illnesses or what to do in case of accidental injury? Why not keep around this new book to use as a guide and authority? It is written by a competent, well known physician who tells the frank, open facts on vital things.

"Your Body" is a large size book, 9 x 12 inches, with illustrations and handsome colored cover.

Published and Distributed by

The Experimenter Pub. Co., Inc., 53 Park Pl., New York

If your dealer cannot supply you write direct

50c THE COPY ON ALL NEWSSTANDS

**BUY DIRECT**  
**SAVE HALF**

GRADE A QUALITY GOODS at WHOLESALE

Any handy man can install his own plumbing and heating by our new, easy method. FREE installing plans show you how. You save waste and high labor cost with our cut-to-fit system. Fifty years of economy service to home owners, farmers, builders and mechanics. Million dollar plants behind our guarantee. Free Book shows everything in plumbing and heating fixtures and supplies. Write today. **HARDIN-LAVIN COMPANY,** 194-14 West Pershing Road, Chicago, Ill. ESTABLISHED 1876

**SEND UP FREE BOOK**



**Electrical Engineering**

Course for men of ambition and limited time. Over 4000 men trained. Condensed course in Theoretical and Practical Electrical Engineering. Including the close-related subjects of Mathematics and Mechanical Drawing taught by experts. Students construct motors, install wiring, test electrical machinery. Complete course **In One Year**

Prepare for your profession in the most interesting city in the world. School established 1893. Send for catalog. **BLISS ELECTRICAL SCHOOL** 132 Takoma Ave., Washington, D. C.

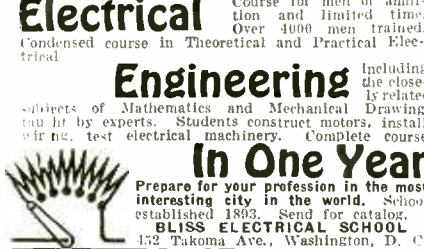

**LEARN DRAFTING**  
AT HOME IN SPARE TIME

**BECOME AN EXPERT DRAFTSMAN.** Earn \$200 to \$350 per month. Learn Machine, Architectural, Structural Drafting, and Shop Mathematics in your spare time. Personal instruction. Drafting outfit given. Write for trial lesson and 56 page book. Both are free. **THE PRACTICAL MECHANIC** Dept. 105, SOUTH HAVEN, MICH.



**\$75 WEEKLY BUILDING RADIO SETS**

Join the Association! We train you to build and repair radio sets—start you in business—enable you to earn \$3 an hour upwards. Free 5-Tube Radio Set to members. Write for special limited-time plan whereby your membership need not cost you a cent. Write today. **RADIO ASSOCIATION OF AMERICA** Dept. 612 4513 Ravenswood Ave. Chicago, Ill.

**TEXAS 38 CAL. RANGER**

ALL Prices Smashed!! Buy now and save 50 percent. Newest model, case hardened frame, blue, 6-inch barrel, with side rod ejector, with special handles, used by every cow-puncher because of accuracy, dependability. **SEND NO MONEY.** Pay postman on delivery \$9.25, plus postage. Money back guarantee. **Federal Mail Order Corp.** 661 Broadway, New York. Dept. S-30



**"BOW LEGS and KNOCK-KNEES" UNSIGHTLY**

Send for booklet showing photos of men with and without THE PERFECT LEG FORMS. **PERFECT SALES CO.** 140 N. Mayfield Ave., Dept. 50, Chicago, Ill.



**BE A DETECTIVE**

Earn Big Money. Work home or travel. Make secret investigations. Fascinating work. Excellent opportunity. Experience unnecessary. Particulars free. Write **GEORGE WAGNER,** former Government Detective, 1968-J Broadway, New York.

**"BECOME A LIGHTNING TRICK CARTOONIST"**

Send \$1.00 for Beginners Instructions with Laugh Producing Program of 23 Comic Trick drawings. Catalog of Chalk Talk Supplies Free. **BALDA ART SERVICE,** Dept. 4, Oshkosh, Wisconsin.



**THIS CLASS PIN 25c.**

12 or more, Silver plate, Single pins 35c ea. choice 2 colors enamel, 3 letters, date, Sterling Silver, 12 or more 45c ea. Single pins 55c ea. Free Cat. shows Pins, Rings, Emblems 20c to \$1.00. **Metal Arts Co., Inc.,** 7723 South Ave., Rochester, N.Y.



**SQUAB BOOK FREE**

Breed squabs and make money. Sold by millions. Write at once for free 40-page book beautifully printed in colors telling how to do it. You will be surprised. **PLYMOUTH ROCK SQUAB CO.** 506 H St., Melrose Highlands, Mass.



**Wirecraft.— A New Art**  
(Continued from page 759)

number of wires have to be bent in a certain shape. Wire can also be bent and shaped by means of round-nosed pliers of small circumference, or else it can be shaped by wrapping the wire around drums or prepared wooden or metal forms. Heavy wire can be hammered into shape by using a vise, which can be fitted with extension blocks of suitable shape, if many heavy wires are to be thus bent.



Fig. 18. A convenient form of wire can be obtained on the market in spools which are provided with metal stops and which hold the wire in place on the spool after it is cut. With this type of spool it is quite impossible for spring wire to slide off its holder.

The method of straightening wires shown in Fig. 7 is not advisable when the wire is thicker than No. 12 B. & S. gauge. In that case it is best to cut the wire to size and use a hammer or a piece of wood to straighten the wire, first giving it rough straightening. Then it can be made absolutely straight by placing the wire between two pieces of thick board and rolling the cut wire between the two boards, applying pressure to the top board. It will be found that the wire rolls easily back and forth until a perfectly straight piece of wire results. If a great number of heavy wires are to be straightened in this manner it is advisable to use iron plates, as the wood will not stand up for any great number of wires and will become badly dented and broken up.

**FASTENING WIRES TOGETHER**

Various methods can be used in Wirecraft to join wires together. This may be done either by soldering, spot welding or wrapping thinner wires tightly around two adjoining wires. The mechanical joint can be held together simply by the wrapping, or, to make it stronger, by soldering the wrapped wire. Adjoining wires may also be twisted together, or spliced, or held together by some sort of metal fastener. Any and all of these methods may be used, whichever is the most practical and suitable for the purpose. In most cases, however, ordinary soldering may be used.

At this point we wish to state that whenever soldering is done, flux solder should be used. Never use acid, as sooner or later the joint will corrode. Soldered connections with flux can be wiped clean and will last for years.

Be sure, when soldering, that you have a good iron, and be doubly sure that the point is nice and clean, because you can not make

(Continued on page 763)

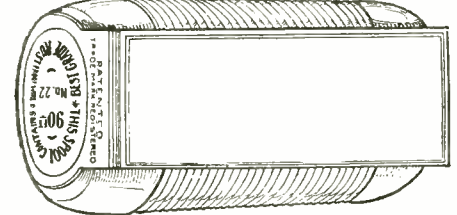

Fig. 19. This illustration shows a top view of the patented wire holder found on some of the wire spools.

**Play a Saw**

**O. J. MUSSEHL**, Pioneer Musical Saw Artist has taught thousands to become Experts, Vaudeville stars and high priced entertainers.

**I'll Teach You In 24 Hours**

**FREE! 5-Day-Trial to Prove It**



**JUST to prove how quick and easy you can learn to play a saw, I'll send you a genuine, specially tempered Musical Saw for 5 days' trial. I guarantee that in 24 hours you can play tunes like "Old Black Joe" and "Home Sweet Home". Then you quickly learn latest jazz and song hits, operatic and classical music. Amazingly simple—no notes to read, no dreary practice. You don't need to know a thing about music.**

**Play for Money or Fun**

The Musical Saw's only rival is the violin for sweetness and expression. Tone effects are positively startling and so unexpected that nothing compares to it in winning instant popularity or becoming a salaried entertainer. Its novelty gains headline position for you. You are always in demand.

**Success Guaranteed**

I have taught thousands to play the Musical Saw. Just three short simple lessons reveal every secret of my 12 years' success as a professional saw musician. Scores of others have won fame and fortune like the three pupils shown here. Let me prove that you, too, can quickly play like a professional.

**Phonograph Record FREE!**



Double-disc, demonstration-size Phonograph Record of beautiful saw solo and duet. Two beautiful selections, positively amazing to anyone who has never heard the Musical Saw and its sweet tone. Send 10c (stamps or coin) to cover handling and postage.

However, if you have already heard the Saw, and do not want the record, ask only for my big FREE TRIAL OFFER with which all my pupils have made their start to fame and money. No charge; sent post-paid. Simply mail me this ad with your name and address printed along the margin.

**MUSSEHL & WESTPHAL**  
West Water St. Fort Atkinson, Wis.

# A Christmas gift that lasts the whole year through

Choose from this list. Use coupon below and order by Group Number. Subscriptions sold only in groups shown.

- A  
1 Money Making } \$4.25  
2 Radio News }
- B  
1 Science & Invention } 3.75  
2 Boy's Life }
- C  
1 Amazing Stories } 4.25  
2 Science & Invention }
- D  
1 Radio News } 3.75  
2 Collier's Weekly }
- E  
1 Science & Invention } 5.50  
2 World's Work }
- F  
1 Amazing Stories } 5.00  
2 American Magazine }  
3 Woman's Home Companion }
- G  
1 Money Making } 2.75  
2 Pathfinder }
- H  
1 Radio News } 2.75  
2 Pathfinder }
- I  
1 McCalls } 3.00  
2 Science & Invention }  
or  
3 Money Making }
- J  
1 Radio News } 6.00  
2 Science & Invention }  
3 Amazing Stories }
- K  
1 Amazing Stories } 4.25  
2 Money Making }
- L  
1 Cosmopolitan } 6.25  
2 Good Housekeeping }  
3 Radio News }  
or  
4 Science & Invention }
- M  
1 Pictorial Review } 4.00  
2 McCalls }  
3 Money Making }  
or  
4 Amazing Stories }
- N  
1 Radio News } 8.00  
2 Science & Invention }  
3 Amazing Stories }  
4 Money Making }
- O  
1 Radio News } 3.50  
2 Radio Review }  
(quarterly) }



and it's inexpensive too!

Here's a happy solution to your gift problem. Use the coupon below. We take care of the rest.

Not every day in the year can you offer such a genuine, agreeable surprise to your friend or friends.

As a special Christmas opportunity you can obtain a 12 months subscription to any of the magazines shown on this page at greatly reduced rates.

In order to make possible this reduction it has been necessary to combine these magazines into groups of 2 or more. If you prefer, we will send one to you, the other to your friend together with Christmas card to reach him on Christmas morning.

Just fill out the coupon—we take care of the rest.

**EXPERIMENTER PUBLISHING CO., Inc.**  
53 PARK PLACE :: :: NEW YORK, N. Y.

**SPECIAL**

Your own subscription to either Science & Invention, Amazing Stories, Radio News or Money Making and a year of either of these magazines for your friend with a Christmas Card to reach him on Christmas Day, all for \$4.00.

EXPERIMENTER PUBLISHING COMPANY, Inc.,  
53 Park Place, New York, N. Y. S & I 12

Gentlemen:—I enclose \$..... for 12 months subscription to magazines in Group .....  
Kindly send magazine Number ..... in this group to my friend and magazine Number ..... to myself.

YOUR FRIENDS NAME .....

ADDRESS .....

CITY, STATE .....

YOUR NAME .....

ADDRESS .....

CITY, STATE .....

NOTICE.—Be sure to mention group letter, and the number of each magazine desired. Enclose money order for full amount. Do not forget to write your friend's name and address.

# CASH PRIZES

## Easy to Win

### WRITE

At once for complete details of this new contest for cash prizes. Anyone can enter and anyone can win a very much worthwhile cash prize without a bit of trouble. Entries must be postmarked before midnight, December 30, 1926. Prizes awarded to most novel and ingenious model of wood, made by using F. P. M. coping saw.

First prize \$25; second \$10; third \$5; next ten \$1 each. In case of tie, equal prize to each contestant whose article is of equal merit. Judges—F. P. Maxson; a teacher from Gary Public Schools; a teacher from Lane Technical Public High School.

## A Real Contest!

Maxson's Contest Manager guarantees that this will be a real contest, in which everyone has an equal chance to win. Be sure to write us today, saying that you would like to know all about Maxson's Cash Prize Contest.

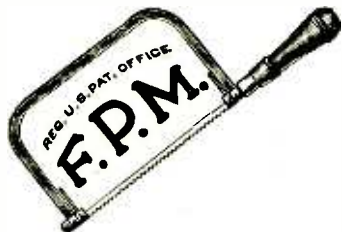

## Coping Saws

For WORK on WOOD or METAL  
AT HOME :: AT SCHOOL  
OR IN THE SHOP

The F. P. M. Saw is the ideal tool for use at home, at school or in the shop. A handy saw of a thousand and one uses for work on wood or metal. Excellent for Radio work on panels, shafts and shielding. Manual Training Students prefer the F.P.M. for its easy adjustment—unbreakable blades and perfect performance in scroll saw work. The F.P.M. Kit includes Saw—7 Blades, \$1.00. Enclose remittance with order or we will ship C.O.D.

REMEMBER—The Cash Prizes!  
WRITE TODAY

## F. P. MAXON

Sole Manufacturer  
1031 Newport Ave., Chicago

### Don't Envy The Plumber BE ONE!

\$11.00-\$16.00 PER DAY and work EVERY day,  
is the Plumber's wage.

Every skilled workman will tell you that Plumbers have the best of it. WINTER and SUMMER the Plumber is busy at top wages. No skilled Plumber is ever out of a job—compare his opportunities with any trade, plus the opportunities of having your own shop.

We teach you Plumbing with TOOLS (not books) under Licensed Master PLUMBERS in one of the finest equipped schools in America. We make you a Plumber, every branch is taught thoroughly—Lead Work—Pipe Fitting for pipe reading—all other tricks.

LEARN IN 8 to 12 WEEKS without previous experience.  
If you are making less than \$50.00 a week you owe it to yourself to investigate. Get FREE catalog that tells in pictures and words how we teach this trade. Special rates now.

UNIVERSAL PLUMBING SCHOOL  
2057 Troost Ave. KANSAS CITY, MO.

Insure your copy reaching you each month. Subscribe to SCIENCE & INVENTION—\$2.50 a year. Experimenter Publishing Co., 53 Park Pl., New York City.

## Wirecraft—A New Art

(Continued from page 761)

a perfect joint with a dirty iron. If you have had no experience in soldering, any tinsmith will show you how to do it, or you might experiment a little yourself. You should be able to master the art of soldering within an hour by trying different materials. Always remember, when soldering, that no good joint can be made unless the articles to be joined are clean and tinned first. For instance, iron wire will not solder unless the wire is first tinned. The tinning is done by running the solder with the hot soldering iron, using a good flux, around the clean iron wire, and then letting the wire and solder cool. Two articles thus treated can easily be soldered afterwards.

Remember that in soldering, success can only be had when the articles to be joined are perfectly clean. Copper, brass, and iron wires can not be soldered well unless they are scraped metallicaally clean. Wires can also be spot welded. This spot welding requires electricity—a storage battery or transformer is preferred.

A small alcohol or gasoline blow torch can also be used in lieu of a soldering iron, but the danger here is that the whole contrivance will get so hot that other joints already soldered may become unsoldered, due to the heat. With the soldering iron there is no such danger unless the wires are very closely adjacent, in which case they should be cooled by a wet rag or water so they do not come unsoldered.

Cylinders of any size and very solid can be fashioned by winding the wire on either cardboard, wooden or iron cores, or even bottles. While still on the form, a straight line is scraped or sandpapered up and down the entire cylinder, when the various wire convolutions can then be soldered together. If soldered at four points around the circumference, you will have a very solid cylinder after you take it off the form. Such a cylinder can even be made waterproof by soldering every point of contacting wire. Usually tacking a straight strip of solder straight up and down the cylinder will hold it together and make it a workmanlike job. Cylinders thus formed in our Laboratory are shown in Fig. 17. After sandpapering the soldered joint smoothly, and after the article has been painted, it is quite impossible to detect the soldered joint.

### TOOLS

Wirecraft does not necessitate expensive tools. A pair of good shears, several pairs of pliers—round nose, flat nose, and side cutters—a good soldering iron, solder, flux, a good vise, small hammer, a few boards, and maybe a steel plate or two (the latter to be used in straightening out wires) are all that is needed. You will be surprised to see what wonderful models and articles you can build with just these few tools and a few spools of wire. Nor is the work very intricate or hard. The more Wirecraft models you build the more interested you will become in this new art, which should prove of great interest to all those handy with their hands and those who wish to fashion things themselves for the pleasure and instruction gained thereby.

During the coming months you will be astonished at the tremendous variety of articles that can be fashioned from wire. Thousands of dollars in prizes will be awarded, and the sooner you start, the quicker you will win a prize.

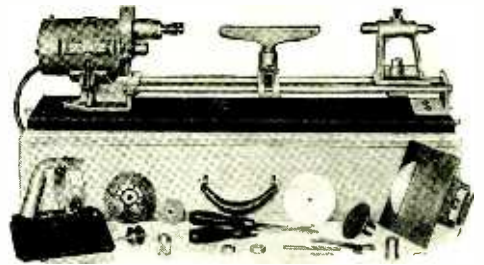

## NEW ELECTRIC SpeedWay Shop & Tools

A compact and efficient electric work shop driven by the famous SpeedWay motor. Equipped with

### Eight Motor Driven Tools

Gives you a complete Lathe, Bench Saw, Jig Saw, Portable Electric Hand Saw. A portable or stationary power drill, equipped for buffing, grinding and cleaning. Attach the SpeedWay Shop to any light socket and you have a completely equipped tool and machine shop.

### Only \$10.00 Down

A small down payment, balance in easy monthly payments, puts one of these efficient machine shops in your own home.

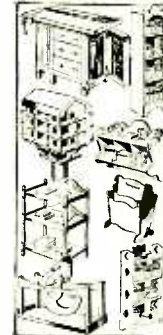

### 10 Days' Free Trial

Our free trial plan enables you to test out this shop in your own home. If it does less than we claim for it send it back.

### Make Things at Home

with this shop—you can make attractive furniture, novelties, toys, radio work, bric-a-brac—countless other useful pieces.

### Don't Delay—Write Today

Write for full information on the SpeedWay Shop. The shop is a money maker for the small job man and fun for the man who makes things at home. Write today

Free Blue Prints  
Write for list of working blue-prints that we furnish free with each SpeedWay shop.

Electro-Magnetic Tool Company  
1830 S. 52d Av., Cicero, Ill. (Adjoining Chicago)

Manager, Dept. 312: Please send me particulars about 10-day free trial, free blue-prints and \$10 down payment

NAME .....

ADDRESS .....

## HIGH SCHOOL BROUGHT TO YOUR HOME

Post Card Brings Information

It is not too late to acquire High School Training! Learn by Question and Answer method, at home in spare time, at astonishingly low cost. Everything boiled down, no long dry essays, no lessons to prepare. Subjects include: History—Language—Sciences—Algebra—English—Economics. In use in thousands of High Schools. Gov't figures show High School Training increases earnings. Write for particulars.

HIGH SCHOOL HOME STUDY BUREAU  
31 Union Square, Dept. 212 New York

## READ AMAZING STORIES

The Greatest Story Magazine in Years  
25c--ON ALL NEWSSTANDS

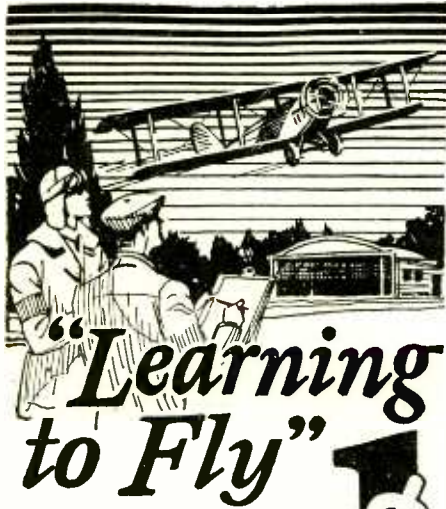

# “Learning to Fly”

Send Dollar Bill for “Learning to Fly” course complete, prepared by Murphy McHenry. Direct — simple — practical — non-technical explanation of beginners’ aviation training, with accurate description of actual experiences in an airplane. If you plan to take flying lessons, be sure to get this important information first. “Learning to Fly” is written by a recognized, licensed pilot. Course is sent complete — postpaid — for \$1 bill. Start now to prepare for future developments of civil aviation. Send coupon today.



**AIRWAY SCHOOL**  
San Mateo, Calif.

○ Pin ○

**AIRWAY SCHOOL**  
Dept. 2, San Mateo, Calif.

Gentlemen:

Enclosed find One Dollar for which please send me, postpaid, Murphy McHenry’s course, “Learning to Fly”, complete.

Name.....

Street, Number,.....

City.....

State.....

## CARBON IN AUTOMOBILE CYLINDERS

Some very exhaustive tests have been made to determine the causes of the deposition of carbon in automobile engines and to ascertain or discover the means of preventing it. It might be attributed largely to a deficiency of air, but this is a minor trouble, as is also the cooling effect of the mass of iron in the cylinder and cylinder heads. These causes operate to prevent complete combustion. It is quite possible that sufficient air to burn the gasoline completely and perfectly may be in the mixture, and yet the cooling effect of the cylinders acts to impair the combustion. It has been found that various substances can act as catalyzers and separate the undesirable carbon, but to determine the definite cause of the deposition has not been so easy. The Bureau of Standards and the Bureau of Mines, both federal organizations, have found that it is very difficult to draw reliable conclusions. With the utmost care they were unable to get two runs of an engine apparently under similar conditions to show the identical or relative deposition of carbon. This is laboratory work, and on the road no such identical conditions can be established, and the problem is much more complicated. However, it was tried on the road with changing about of chauffeurs to eliminate the personal factor. Four new automobiles were driven twelve thousand miles without any consistent results, but at last by applying refinements to the test some very tangible results were obtained.

Whenever oil appeared on the heads or on the pistons, carbon was formed, as might have been expected. Variations in the kind of oil used in the gasoline and the temperature of the cooling jacket and other factors influenced the depositon. Eventually a more or less definite conclusion was reached that carbon deposition was intimately connected with the amount of oil that found its way in above the pistons into the combustion chamber. With bad or broken piston rings gasoline would find its way into the crank case, and oil on the intake stroke would be drawn up above into the combustion chamber and would spray all over the walls. The vacuum on this stroke may amount to as much as twenty-five inches of mercury. It follows that the piston rings should fit very well, but this is not all. They do not act only by their fitting, but oil accumulates around the back of them, so that what is known as an oil-seal is formed, and this is a very critical thing, and its maintenance has a great effect in preventing the deposition of carbon.

Tests were made under conditions which practically prevented oil getting into the combustion chamber. Analysis of the exhaust gases showed imperfect combustion, but with a very rich mixture, there was very little carbon deposited after the first twelve hours. Economy dictates the importance of perfect combustion, but oil seems to be the criminal when it comes to the deposition of carbon. Without giving the exact figures reached, it was found that the major factors of carbon deposition in an automobile engine are: (1) The amount of lubricating oil projected into the combustion chamber. This is by far the greatest factor. (2) The kind of oil used. (3) The temperature of the combustion chamber. (4) The extent of time the preceding factors have been in effect. The general result is that in practice, which means on the road, oil cannot be kept out of the combustion chamber and carbon will be deposited. The data are taken from a paper by J. W. Orelup and O. Ivan Lee, the latter a familiar name to our readers. (Reprinted from *Industrial and Engineering Chemistry*, Vol. 17, No. 7, page 731.)

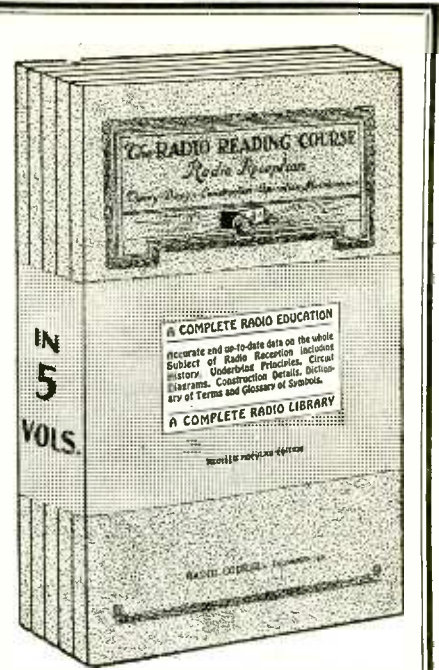

Price \$1.97

# A RADIO EDUCATION

IN 5 VOLUMES

Theory, Design, Construction, Operation and Maintenance

LEARN AT HOME

These five component parts of a complete Radio Instruction Course are outlined in five volumes that contain not merely the essentials as so many books do, but more, they contain all that any modern up-to-the-minute textbook on any subject would cover. They are in themselves a COMPLETE radio education teaching every possible portion of Radio science.

Size of each book 6 by 9 inches, handsomely bound and illustrated with charts, diagrams, descriptions of equipment, etc.

SEND NO MONEY for these books. Just forward your name and address. We send you the books at once. On receipt of same you pay the postman \$1.97 plus a few cents postage and then they are yours.

Distributed by

**The Consrad Co.**

64 Church St., New York, N. Y.

### Why Florida Hurricane Occurred

By E. B. "FARMER" DUNN.  
(Continued from page 683.)

it steadily increases and becomes brisk. The barometer begins to fall, while black, threatening clouds darken the horizon and rapidly cover the upper sky. Rain suddenly falls in torrents, the wind screeches and howls, lashing the waves of the ocean into a menacing sea. On land there is a weird and torn mass of wreckage. The hurricane has arrived in full force. The more furious the storm the quicker it passes, and the more rapid the rise in the barometer the harder the wind blows after the center has passed.

Hurricanes have been more numerous this season than for many years. No less than three have been in operation at one and the same time during the past month.

#### STATEMENT OF THE OWNERSHIP, MANAGEMENT, CIRCULATION, ETC., REQUIRED BY THE ACT OF CONGRESS OF AUGUST 24, 1912,

OF SCIENCE AND INVENTION, published monthly, at New York, N. Y., for Oct. 1, 1926. State of New York )  
County of New York ) ss.

Before me, a NOTARY PUBLIC, in and for the State and county aforesaid, personally appeared HUGO GERNSBACK, who, having been duly sworn according to law, deposes and says that he is the EDITOR OF SCIENCE AND INVENTION, and that the following is, to the best of his knowledge and belief, a true statement of the ownership, management (and if a daily paper, the circulation), etc., of the aforesaid publication for the date shown in the above caption, required by the Act of August 24, 1912, embodied in section 411. Postal Laws and Regulations, printed on the reverse of this form, to wit:

1. That the names and addresses of the publisher, editor, managing editor, and business managers are:

Publisher, EXPERIMENTER PUBLISHING CO., INC., 53 Park Place, New York, N. Y.  
Editor, HUGO GERNSBACK, 53 Park Place, New York, N. Y.

Managing Editor, H. WINFIELD SECOR, 53 Park Place, New York, N. Y.

Business Manager, R. W. DEMOTT, 53 Park Place, New York, N. Y.

2. That the owner is: (If owned by a corporation, its name and address must be stated and also immediately thereunder the names and addresses of stockholders owning or holding one per cent. or more of total amount of stock. If not owned by a corporation, the names and addresses of the individual owners must be given. If owned by a firm, company, or other unincorporated concern, its name and address, as well as those of each individual member, must be given.)

THE EXPERIMENTER PUBLISHING CO., INC., HUGO GERNSBACK, SIDNEY GERNSBACK, R. W. DE MOTT, H. W. SECOR, DR. T. O'CONNOR SLOANE—all of 53 Park Place, New York, N. Y.; MRS. CATHERINE MAJOR, 545 West 158th St., New York City; M. M. FINUCAN, 720 Cass St., Chicago, Ill.

3. That the known bondholders, mortgagees, and other security holders owning or holding 1 per cent. or more of total amount of bonds, mortgages, or other securities are: (If there are none, so state.) NONE.

4. That the two paragraphs next above, giving the names of the owners, stockholders, and security holders, if any, contain not only the list of stockholders and security holders as they appear upon the books of the company but also, in cases where the stockholder or security holder appears upon the books of the company as trustee or in any other fiduciary relation, the name of the person or corporation for whom such trustee is acting, is given; also that the said two paragraphs contain statement embracing affiant's full knowledge and belief as to the circumstances and conditions under which stockholders and security holders who do not appear upon the books of the company as trustees, hold stock and securities in a capacity other than that of a bona fide owner; and this affiant has no reason to believe that any other person, association, or corporation has any interest direct or indirect in the said stock, bonds, or other securities than as so stated by him.

5. That the average number of copies of each issue of this publication sold or distributed, through the mails or otherwise, to paid subscribers during the six months preceding the date shown above is..... (This information is required from daily publications only.)

(Seal) HUGO GERNSBACK.  
Sworn to and subscribed before me this 24th day of Sept., 1926.

JOSEPH H. KRAUS, Notary Public.  
My commission expires March 30, 1927.

# SPECIAL HOLIDAY OFFER

→ \$24.<sup>95</sup> ←

## Wonderful Five-Tube Set

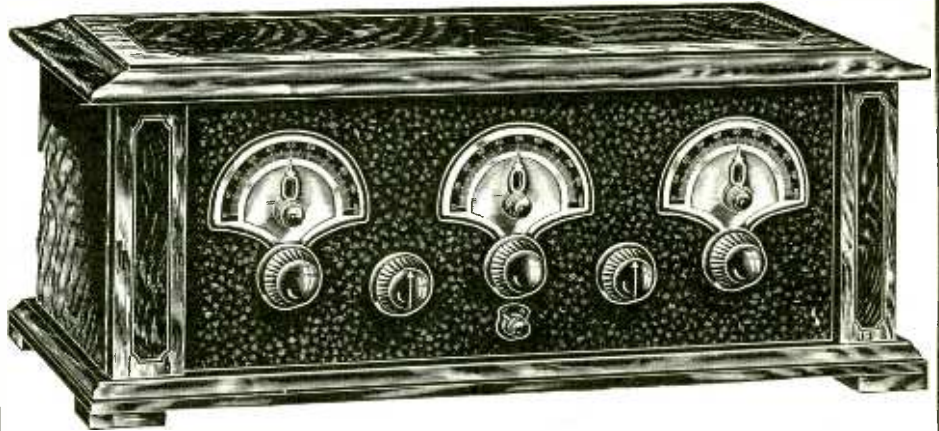

Quick Delivery Direct From Factory to Your Home

### The Radio Set You Want at the Price You Want to Pay

A 5-Tube Set Superior to Most 6- and 7-Tube Sets in Tone Quality, Volume and Distance Getting

Take advantage of this unusual opportunity and special Holiday Offer

Nowhere will you find a value to compare with this remarkable new 1927 design 5-tube radio set. DIRECT FROM FACTORY to you at a tremendous saving. Embodies the newest forward steps in radio, such as U. S. Standard low loss coils, straight line frequency condensers, handy Vernier dials with etched metal plates. Gives you the best radio reception at low cost. A set you can buy complete cheaper than you can build. Direct from our own factory. The Barawik Company is one of the oldest radio specialty institutions in America, numbering 200,000 customers. Every item sold is of high standard. Buy from radio experts and save money. A remarkable 5-tube radio set—super, better built and producing superior results. It is both rich and attractive looking and for easy tuning, clear, sweet, natural tones, and distant reception. It is everything you will expect. Takes all tubes including the new power tubes.

**Perfect Reproduction** It stands alone in tone quality, as comparison with any set at any price will reveal. In the choice of expert musicians who recognize these distinctions of harmony and tone. Its beautiful, natural, well-rounded tones reproduce the human voice, whether in song or speech, as clear as a bell. Musical programs are reproduced in a sweet, perfect tone, delightfully and harmoniously.

**Artistic Cabinet** Exceptionally fine hand-rubbed mahogany walnut finish cabinet. An ornamental addition to any room. A truly distinctive, dignified cabinet in keeping with other Barawik qualities.

**The Greatest Value Today—Look at These Prices!** Quality considered our price is low—est. Nowhere is there value to equal **\$24.95** for these prices.

103 S 15893—Set only, no accessories.....  
**Complete with All Accessories** For Storage Battery 5 201A type tubes, 2 45 Volt "B" Batteries, 1 Fine Loud Speaker, 1 5 Volt Storage Battery, 1 Complete Antenna Equipment, 1 "C" Battery, 1 Fine Head Set, Complete. **\$50.95**  
201 S 15901—Shipping weight, 120 lbs. **\$50.95**  
201 S 15902—For Dry Cell Operation including: 5 190 Type Tubes, 2 45-Volt "B" Batteries, 1 Fine Loud Speaker, 3 Dry Cell "A" Batteries. **\$51.50**  
1 "C" Battery, 1 Fine Head Set, Complete. **\$51.50**  
Mail your order today direct from this ad and get your set before the holidays. Anyone can set up this outfit in an hour or so. Transportation charges extra.

**Genuine Raytheon "B" Eliminator Delivers Up to 180 Volts. 50 Millamp Capacity at 150 Volts.**

**One of the leading "B" eliminators of highest quality maintains 1700 v. exp.ensive finish of real green Duco on case to genuine Raytheon tube. Filtering system of 1000 volt high-test condensers and extra capacity choke coils completely remove all hum out of the alternating current. Connect to your light socket, 110-volt 60-cycle A. C. current; uses few cents of current a week; easy for use in replacing "B" batteries. Reception is clear, long distance easy to get due to constant output. Furnished completely assembled, ready to use, and fully guaranteed. Send your check or money order today. C. O. D. orders accepted with 25% deposit.**

**103 S 15175**

### Get Your Free Copy Today—NOW!

Mail your order for the Barawik Special 5-tube set and eliminator today and insure delivery to your home before the holidays. Also mail the coupon or write us a letter or postcard and we will immediately mail you free the new 1927 Barawik Radio Guide, with its 164 pages of everything interesting for the Radio fan. This will give you plenty of time to do your holiday shopping and get back your orders in time. Never in the history of radio has such a tremendous collection of radio and electrical supplies been presented to the public. Build the set of your dreams now. Get the set or parts and accessories you have always longed for. You can do it, for our low prices will make the most expensive articles reasonable in price. A New Feature—A new special Amateur section under the direction of F. J. MARCO, 92A. Ask about it.

**\$26.<sup>95</sup>**

Postage 30c extra

### FREE RADIO GUIDE

Mail Coupon Now. Get this Guide into your hands before you buy another part. It will mean money in your pocket. Write today; also please send names of other radio fans.

**MAIL TODAY**  
Barawik Co., 540-557A Monroe Street, Chicago, Ill.  
Send me the free copy of your new 1927 Radio Guide for 1927. FREE.

Name.....  
Address.....  
Friend.....  
Address.....

# The Barawik Co.

540-557A Monroe St., Chicago, Ill.

# Opportunity Ad-lets

**YOU** will find many remarkable opportunities and real bargains in these columns. It will pay you to read and investigate the offerings made every month by reliable firms, dealers and amateurs from all over the country. No matter what you may be seeking, whether supplies, automobile accessories, the opportunity to make money, or anything else, you will find listed here the best and most attractive specials of the month.

Advertisements in this section twelve cents a word for each insertion. Name and address must be included at the above rate. Cash should accompany all classified advertisements unless placed by an accredited advertising agency. No advertisement for less than 10 words accepted.

Ten per cent discount for 6 issues, 20 per cent discount for 12 issues. Objectionable or misleading advertisements not accepted. Advertisements for the February issue must reach us not later than December 10th.

## The Circulation of Science and Invention is over 200,000 and climbing every month

EXPERIMENTER PUBLISHING CO., INC., 53 Park Place, New York City, N. Y.

### Adding Machines

**Free Trial.** Marvelous Calculator. Adds, Subtracts, Multiplies, Divides automatically. Work equals \$300.00 machines. Five year guarantee. Price only \$15.00. Write today for free trial offer. Special: \$3.00 Pocket Calculator, only \$2.00 cash. Lighting Calculator Co., Dept. K, Grand Rapids, Mich.

### Advertising Agencies

**24 Words—335 Rural Weeklies \$14.20.** Ad-Meyer, 4112-SI Hartford, St. Louis, Mo.

Advertising in all magazines and newspapers at publishers' lowest rates. Write for Rate Book. Taylor's Advertising Service, 315 Brown Bldg., Rockford, Illinois.

**Advertisers' International Manual,** new edition. Inside information for advertisers & Publishers' Rates. 50c postpaid. Economics Publishing Co., Dept. 55, 1475 Broadway, New York.

### Advertisers and Distributors

**Earn \$4 advertising stop-leak Rivets.** Distribute 100 packages and free samples. Send 10c for sample instructions. Rivette Cos., Cohoes, N. Y.

### Agents Wanted

**Agents—Best seller;** Jen Rubber Repair for tires and tubes; supercedes vulcanization at a saving of over 800 per cent; put it on cold. It vulcanizes itself in two minutes and is guaranteed to last the life of the tire or tube; sells to every auto owner and accessory dealer. For particulars how to make big money and free sample, address Amazon Rubber Co., Philadelphia, Pa., Dept. 601.

**\$60—\$200 a week.** Genuine Gold Letters for store windows. Easily applied. Free samples. Liberal offer to general agents. Metallic Letter Co., 441 B., North Clark, Chicago.

**\$10 daily silvering mirrors,** plating and refinishing lamps, reflectors, autos, beds, chandeliers by new method. Outfits furnished. Write Gunmetal Co., Ave. D, Decatur, Ill.

**Bankrupt and Rummage Sales.** Make \$50.00 daily. We start you, furnishing everything. Distributors, Dept. 171, 609 Division, Chicago.

**Make Money Silvering Mirrors,** refinishing auto headlights, tableware, metal plating, bedsteads, chandeliers. Outfits furnished. International Laboratories, Dept. 69, 309 Fifth Ave., New York.

**Agents—New Plan,** makes it easy to earn \$50.00 to \$100.00 weekly, selling shirts direct to wearer. No capital or experience needed. Represent a real manufacturer. Write now for FREE SAMPLES. Madison Company, 566 Broadway, New York.

**Gold Initials, easily applied on Automobiles.** Biggest moneymaker today. Cost 5c, you get \$1.50. No experience needed. Free Samples. "Ralco" Monograms, 1043 Washington, Boston, Mass.

**To sell Ray-O-Lite cigar and gas lighters.** Big earnings. Sample 50c. Rapid Mfg. Co., 799-L Broadway, New York.

**Sell by Mail! Big Profits!** Books, Formulas, Novelties, Bargains, Particulars Free. Ethco., B-523 S. Dearborn St., Chicago, Illinois.

**Big money and fast sales.** Every owner buys gold initials for his auto. You charge \$1.50, make \$1.35. Ten orders daily easy. Write for particulars and free samples. American Monogram Co., Dept. 71, East Orange, N. J.

**Earn \$10 daily silvering mirrors,** plating, refinishing tableware, chandeliers, headlights, bedsteads. Outfits furnished. N. Decio Laboratories, 1133 Broadway, New York.

**66 Miles on 1 Gallon—Amazing New Auto Gas Saver.** All makes. 1 Free. Critchlow, C-87, Wheaton, Ill.

**Agents: Make \$500.00 before Xmas.** Pay daily. No investment. Rhinestone initial buckles and novelties. Big Xmas and all year sellers, exclusive territory. Chaton Novelty Co., 606 Blue Island, Chicago.

**Auto Owners, Agents \$50** if "Clear-Vu" fails to produce results. A single application on your windshield enables you to drive in safety for months. Conveniently carried in auto pocket. Easily applied. Leaves no stains. Enjoy your "Clear-Vu" each time it rains. Will not wear or wash off. Wonderful money making opportunity for agents. 50c postpaid. For wholesale prices write P. Jones Specialties, 2133 N. 12th St., Philadelphia, Pa.

**Make Much Money—Making and Selling Your Own Goods.** Formulas by experts. Manufacturing processes. Trade-Secrets. All lines. All kinds. Catalog, special circulars free. D. Thaxly Co., Washington, D. C.

**Mirrors Resilvered At Home.** Costs Less Than 5 cents per square foot; you charge 75 cents. Immense profits, plating like new, brassy worn-off autoprotrags, reflectors, tableware, stores, etc. Outfits furnished. Details free. Sprinkle, Plater, 955, Marion, Indiana.

**Agent Makes \$57 a day driving nails in tire!** Amazing discovery heals all punctures. One tire was punctured 85 times without a leak. Send for Free Sample Offer. O. S. Nelson, T-3215 Logan Bldg., Mitchell, S. Dak.

**Easy Sales—Quick Profits!** Dilute our concentrated materials for making high quality foods, beverages, extracts, toilet and auto specialties. Market under your brand or ours. Labels and containers furnished. Permanent profitable, exclusive. D-B Concentrating Co., Station E-12, Kansas City, Mo.

### Agents Wanted (Continued)

**Agents—Biggest money makers ever offered.** Sell offices, homes, Bestulone, which makes both hands free while telephoning; Midget Collapsible Garment Hangers. Wonderful Holiday Sellers and Everin Keyruse to hold change and keys. P. Kalina Company, 1308 Avenue N, Brooklyn, N. Y.

**Agents \$240 month and new Essex automobile.** Introduce finest line latest style silk hosiery. Your pay daily in advance. Extra bonus besides. No experience needed. Samples furnished. Silk hose free. We give you extra fine silk hose for your own use. Write for special offer, Jennings Hosiery Co., Dept. 855, Dayton, Ohio.

**Fire Salvage Rummage Sales, \$50.00 Daily.** We start you furnishing everything. Jobbers, Desk M17, 1608 So. Halsted, Chicago.

**Agents: Eze-Sharp Knife Sharpeners** sell like hot cakes. Sample and particulars 25 cents. The Eze-Sharp Products, 810 Third Ave., N. Y. C.

**Selling Like Blazes!** Eleven piece toilet goods assortment at \$2.25 with two piece shaving set. Free to your customers. 100% profit. Davis Products Co., Dept. 67, 1421 Carroll, Chicago.

**Agents: 90c an hour to advertise and distribute samples to consumers.** Write quick for territory and particulars. American Products Company, 6339 Monmouth, Cincinnati, Ohio.

**300% Profit.** Goods from all parts of the World. Repeat orders. Pocket samples. H. B. Lucas Co., 731 East 15th Street, Minneapolis, Minn.

**A Permanent Position and Good Income** is open to men or women handling our goods in your locality. Established 35 years. No experience or capital. Full or part time. Dignified work. Write Employment Dept. Winter Company, 20 Winter Bldg., Washington, D. C.

**Open a Rummage Store.** We furnish everything. \$75.00 daily. Write for free particulars. Young, R2549 South Halsted, Chicago.

**Real Selling Sensation!** Tremendous earnings whole or part time! Patented Hot Water Bottle Combination invention needed everywhere. Big commissions. Extra bonus. We deliver. Write C/O 16 Lobl Corp. Middleboro, Mass.

**Agents: Our new household cleaning device** washes and dries windows, sweeps, cleans walls, scrubs mops. Costs less than brooms. Over half profit. Write Harper Brush Works, 152-3rd St., Fairfield, Iowa.

### Airplanes, Aviation

**Three foot flying model aeroplanes,** 12 inch mounted propeller for 25c. Aero Shop, 3030 Hurlbut Ave., Detroit, Mich.

**Curtiss Pultizer Racer Construction Set,** including plans and genuine Curtiss Reed Propeller \$1.25 postpaid. Special offer: Scientific AirGlider with Ground Launching Device 50c postpaid. Big Catalog 5c listing latest types Model Airplanes, Boats & Supplies. Phipps Company, 367 Wilson Ave., Brooklyn, N. Y.

**Airplanes. How to build them and be sure they will fly.** Learn the two most powerful influences on the stability and operation of an airplane. Get our free information. Blue Prints and Propeller literature. Crawford Airplane Manufacturer, 2225 American Ave., Long Beach, Calif.

### Art

**Imported French Art Pictures,** five for 25c, small supply. Edelman, 2120-B Surf Ave., Brooklyn, N. Y.

### Battle Photos and War Relics

**For Dens: Relics from Europe's battlefields** (also medals) illustrated catalogue with sample war photos 25c. International, 1839 Albany Ave., Brooklyn, N. Y.

### Books

**Books, Radio Apparatus.** Send for list. V. Winters, Tuskegee Inst., Ala.

**Hypnotism Wins! 25 easy lessons and 248 page illustrated reference guide \$2.00.** "Mindreading" (any distance). Wonderful, \$2.00. Science Institute, S430 Milwaukee Ave., Chicago.

### Business Opportunities

**Free Book.** Start little Mail Order Business. Pier Company, 72AF Cortland Street, N. Y.

**You can have a business-profession of your own and earn big income in service fees.** A new system of font correction; readily learned by anyone at home in a few weeks. Easy terms for training, openings everywhere with all the trade you can attend to. No capital required or goods to buy, no agency or soliciting. Address Stephenson Laboratory, 18 Back Bay, Boston, Mass.

**Stop Plodding! Be Successful.** Operate a Tire Repair Shop. Make big profits in any locality. We teach you and furnish complete equipments \$100 up. Book of Opportunity free. Haywood's, 1312 South Oakley Avenue, Chicago.

### Business Opportunities (Continued)

**Stocks—Bonds, Domestic-Foreign,** bought-sold. Dealers in all marketable securities. Frank X. Everett & Co., 20 Broad St., New York.

**We Start You in Business,** furnishing everything. Men and women, opportunity to earn \$10.00 to \$100.00 weekly operating Ragsdale's Original "New System Specialty Candy Factories" anywhere; wholesale or retail. Valuable commercial candy book free. W. Hillyer Ragsdale, Drawer 129, East Orange, N. J.

**New complete International Advertising catalogue.** Publishers rates. Postpaid 25c. Owl Agency, Times Bldg., New York.

**Manufacture New Fast Selling Novelties.** Toys, Preparations, Agents' Goods. Free list reliable plans, Patterns, processes, commercial information. Manufacturer's Bureau, 1129D East 31st, Kansas City, Mo.

**Toymakers—Make money at home.** Proposition and blue-prints 30c. Weeshor'oko, 31st Office, Detroit, Mich.

**Publish a magazine of your own and start a mail order business on \$1.00 capital.** Sample magazine and details 25c (coin). E. D. Tipper, P.O. Box 181, Los Gatos, Calif.

**Be a Laboratory expert.** Earn from \$300 to \$500 monthly. Study Microbiology, Sanitation, Dis. Evening classes, Diplomas, Degrees. Granted 71 Piece outfit free to students. Write for our Free Prospectus to-day. International College of Microbiology, 7202 W. Grand Ave., Chicago, Ill.

### Chemistry

**Experimenters, Students, Amateur Chemists!** Read "Popular Chemistry" for experiments, chemical news; any formula you want printed; Question-answer department, book list, every month. Subscription, \$1.00 year. Special three month trial including Radium number, 25c. Popular Chemistry Company, Caldwell, New Jersey.

**Learn Chemistry at Home.** Dr. T. O'Connor Sloane, noted educator and scientific authority, will teach you. Our home study correspondence course fits you to take a position as chemist. See our ad on page 679 of this issue. Chemical Institute of New York, 66 W. Broadway, New York City.

**Experimenters—Chemicals and Apparatus Catalog—1000 illustrations.** Price 25c refunded on \$5.00 order. Radio catalog 10c, 80 pages. Liberal discounts. Laboratory Materials Company, 635 East 71st., Chicago.

**Extraordinary offer to introduce our high grade chemicals for the experimenter.** Complete outfit containing 108 different reactive chemicals and apparatus. Generous quantities of each. Price complete \$7.00 express prepaid. Money order, cash or C. O. D. One outfit only to each purchaser. Send for yours now to Pines Chemical Co., 1524-St. Marks Ave., Brooklyn, N. Y.

### Correspondence Courses

**Used correspondence school courses.** All kinds. Sold on repurchase basis. Big saving. Money back guarantee. Lists free. (Courses bought). Lee Mountain, Pisgah, Alabama.

**Used Correspondence School Courses and Educational Books** bought, sold, exchanged; Bargain Catalogue Free. Mantling, 799-A Broadway, New York.

### Educational

**Correspondence courses.** All schools. Lowest prices. Terms, Catalog Free. Mention Subject. Fred. Goetz, 440-H Sansome, San Francisco.

### For Advertisers

**I write letters, folders, booklets, complete followup for manufacturers, mail order dealers.** Long Experience. Write for details. L. Taylor, 315 Brown Bldg., Rockford, Ill.

### For Inventors

**Inventors—Get this pamphlet, "What to Invent."** No theory or guess work, but things actually asked for by manufacturers. Sent prepaid for only \$1.00. Inventor's Syndicate, 22 Paladium Bldg., St. Louis, Mo.

**U. S. and foreign patents, trademarks, moderate rates.** 22 years experience. George C. Heinicke, 32 Union Square, New York, registered in U. S. and Canada.

**Unpatented Ideas Can Be Sold.** I tell you how and help you make the sale. Free particulars (Copyrighted). Write W. T. Greene, 808 Jenifer Bldg., Washington, D. C.

**Inventors! Use our special service for presenting your invention or patent to manufacturers.** Adam Fishler Mfg. Co., 205-A Brough, St. Louis, Mo.

**Your Chemical problems solved and working process furnished for Five Dollars.** Write me, W. Stedman Richards, Consulting Chemist, Box 2402, Boston, Mass.

**Inventions developed to commercial basis—Non infringing devices designed—Basic claims suggested.** A. Pabini, Leonia, N. J.



**For Inventors (Continued)**

Ideas for ten inventions. Inquiries answered. Mrs. R. HARRY, 2734 Rose St., Victoria, B. C.  
**Inventions bring millions!** Have you an idea? We will help you to get a patent. Equitable Investment Company, Union Trust Bldg., Washington, D. C.  
**Mail copy of patent or description of invention.** Central Sales Agency, Independence, Mo.

**Formulas**

500 Formulas 20c, Catalog FREE. Ideal Book Shop Park Ridge, Illinois.

**Help Wanted**

**Silvering Mirrors, French plate.** Easily learned, immediate profits. Plans free. Wear Mirror Works, 14 W, Excelsior Springs, Mo.  
**All men-women, 18 to 60,** wanting to qualify for Government Positions, \$110-\$250 monthly. Local or traveling, write. Mr. Ozment, 293, St. Louis, Mo.  
**U. S. Government Jobs.** \$1140 to \$3000 year. Men-women, 18 up. Steady work. Paid vacation. Short hours. Life positions. Common education sufficient with our coaching. Full particulars with list positions—Free. Write today sure. Franklin Institute, Dept. 1919, Rochester, New York.  
**Firemen, Brakemen, Engagemens,** (white or colored), sleeping car, train porters (colored), \$150-\$250 monthly. Experience unnecessary. 897 Railway Bureau, East St. Louis, Ill.

**How to Entertain**

Plays, musical comedies and revues, minstrel music, blackface skits, vaudeville acts, monologs, dialogs, recitations, entertainments, musical readings, stage handbooks, makeup sounds. Big catalog free. T. S. Denison & Co., 623 So. Wabash, Dept. 99, Chicago.

**Instruction**

**Learn Chemistry at Home.** Dr. T. O'Connor Sloane, noted educator and scientific authority, will teach you. Our home study correspondence course fits you to take a position as chemist. See our ad on page 679 of this issue. Chemical Institute of New York, 66 W. Broadway, New York City.

**Inventions Wanted**

Will buy approved invention. Write W. L. Kendig, 416 N. Duke Street, Lancaster, Pa.

**Machinery and Tools**

**Concrete Building Block Machines and Molds.** Catalogue free. Concrete Machine Co., 5 N. First St., St. Louis, Mo.  
**Moler Millwright Units are Built Like a Skyscraper.** The new way to install machinery in Garages, Factories, Laboratories. Portable or stationary. Write for circular. 12 Bridge St., New Rochelle, N. Y.

**Magic and Games**

Free with \$25 order our large die box. Send 20c for our large catalogue of tricks, puzzles, wigs, sensational escapes. Oaks Magical Co., Dept. 549, Oshkosh, Wis.  
**Books—Magic, Mysteries, Magic Tricks, Novelties,** Catalogue Free. Singer, 200, Hancock, Wis.  
**Card tricks, Coin tricks, Hypnotism, Ventrioloquism,** 61 page books. Complete guides, 10c each. G. Penner, 2101 Jefferson, Louisville, Ky.  
**Book of Magic, Set Trick Cards,** and price list, 10c. Planchon Novelty Shop, Box 631, Danville, Va.

**Manufacturing**

**To Order—Mechanical work,** all branches. Models, Experimenting. Quantity production. Parina Engineering Works, Brooklyn Station, Cleveland, Ohio.  
**Models made to order. Estimates free.** Bennie Nortwed, Ethan, S. D.

**Manuscripts Wanted**

Earn \$25 weekly. Spare time, writing for newspapers, magazines. Experience unnecessary. Details Free. Press Syndicate, 987, St. Louis, Mo.

**Miscellaneous**

**Beautiful registered bull pups \$15.** Bulldogs, 501 Rockwood, Dallas, Texas.  
**I Catch From 45 to 60 foxes in from 4 to 5 weeks' time;** can reach any reader of this magazine how to get them. Just drop me a card for particulars. W. A. Hadley, Stanstead, Quebec, Canada.  
**Underground Treasures.** Simple scientific method for locating. Free booklet explains. T. Santsehl, Glen Ellyn, Ill.  
**Lightning Electrolyte.** Charges storage batteries instantly. Gallon costs 50c, sells \$10.00. Make it yourself. Guaranteed formula \$5.00. Write for free circulars. Murphy, Chemist, Tujunga, Calif. Box-C.  
**What Work is best for You?** Careful character analysis helps you select intelligently. Send sample handwriting and \$1. Box 1, 139 Western Ave., Waterville, Maine.  
**Manuscript typing, 50c per thousand words** or fraction thereof. M. L. Blanchard, 3120 Lafayette St., Denver, Colorado.  
**Chemical Questions Answered.** Accurate information \$5.00. Snover, 80 Wall Street, New York.

**Motorcycles—Bicycles**

**Don't buy a Bicycle Motor Attachment until you get** our catalogue and prices. Shaw Mfg. Co., Dept. 6, Galesburg, Kansas.

**Musical Instruments**

**Violins—Deep, Mellow, Soulful—on easy credit terms.** High grade, wonderful instruments of my own make. Development of many years' experience. Write for book. Gustav A. Henning, 2124 Gaylord St., Denver, Colo.

**Old Coins**

**German Govt. Bond, 100,000 Mk. 1923 \$1.40, 5,000,000 Mk. bond 1921, \$1.50, 100,000 Mk. bill and catalogue 10c.** Norman Shultz, Box 716, Salt Lake City, Utah.  
**California Gold, quarter size, 27c; half-dollar size, 53c.** Columbian nickel and catalogue, 10c. Norman Shultz, Box 716, Salt Lake City, Utah.

**Old Money Wanted**

**\$2 to \$500 Each** paid for hundreds of Old or Odd Coins. Keep all old money, it may be very valuable. Send 10c for new illustrated Coin Value Book, 48c. Guaranteed Prices. Get Posted. We pay Cash. Clarke Coin Company, 14 Street, LeRoy, N. Y.

**Patent Attorneys**

**Millions spent annually for ideas!** Hundreds now wanted! Patent yours and profit! Write today for free book—tells how to protect yourself, how to invent, ideas wanted, how we help you sell, etc. American Industries, Inc., 212 Victor Bldg., Washington, D. C.  
**Richard E. Babcock, Patent Lawyer,** Washington Loan & Trust Bldg., Washington, D. C. Booklet.  
**Monroe E. Miller, Ouray Bldg.,** Washington, D. C. Patent Lawyer; Mechanical, Electrical Expert. Booklet and Priority Record blank gratis.  
**Patents—Send for form "Evidence of Conception"** to be signed and witnessed. Form, fee schedule, information free. Lancaster and Allwine, Registered Patent Attorney in United States and Canada, 212 Ouray Bldg., Washington, D. C.  
**Patents Procured; Trade Marks Registered—A comprehensive,** experienced, prompt service for the protection and development of your ideas. Preliminary advice gladly furnished without charge. Booklet of information and form for disclosing idea free on request. Richard B. Owen, 139 Owen Bldg., Washington, D. C., or 41-T Park Row, New York.  
**Patents.** Send for free booklet. Highest references. Best results. Promptness assured. Send model or drawing for examination and opinion. Watson E. Coleman, Patent Attorney, 611 G Street, N. W., Washington, D. C.  
**Cooperative Plan for safe-guarding and commercializing** inventions before patenting. Write for free booklet, Ralph Burrell, Patent Lawyer, 501 Jenifer Building, Washington, D. C.  
**Unpatented Ideas Can Be Sold.** I tell you how and help you to make the sale. Free particulars (Copyrighted). Write W. H. Greene, 809 Jenifer Bldg., Washington, D. C.  
**Get your own patents.** Application blanks, complete instructions \$1. Cutting Bros., Campbell, Calif.  
**Patents.** Time counts in applying for patents. Don't risk delay in protecting your ideas. Send sketch or model for instructions or write for Free book, "How to Obtain a Patent" and "Record of Invention". No charge for information on how to proceed. Communications strictly confidential. Prompt, careful, efficient service. Clarence A. O'Brien, Registered Patent Attorney, Security Bank Building (directly across street from patent office), Washington, D. C. See page 723.  
**Patents: Trade-Marks.** Ten years experience in Patent Office. Consultation invited. Booklet. Geo. Heeler, 2001, 150 Nassau St., New York.  
**"Inventor's Advisor"** the valuable Patentbook with 129 Mechanical movements and illustrations, sent free upon request. M. I. Labiner, Patent Attorney, 3 Park Row, New York.  
**Patent-Sense—As one of the oldest firms in America** we give inventors, at lowest consistent charge, a service noted for results evidenced by many well-known Patents of extraordinary value. Book, Patent-Sense, free. Lacey & Lacey, 614 F St., Washington, D. C. Estab. 1869.  
**"Inventors' Guide"** free on request; gives valuable information and advice for all who have original ideas or improvements. Frank Ledermann, Registered Attorney and Engineer, 17th Floor, Woolworth Bldg., New York.

**Patents**

**Inventions commercialized.** Patented or unpatented. Write Adam Elsher Mfg. Co., 205 E. Bright, St. Louis, Mo.  
**Two Inventions—Two automatic inventions** and a plaster Paris process. Beware inventors' rights. William Haines, Habana, Cuba.

**Patents Wanted**

**Mr. Inventor.** If you have a patent or invention for sale write Hartley, 38 Court St., Bangor, Me.

**Photography**

**Have you a Camera?** Write for free sample of our big magazine, showing how to make better pictures and earn money. American Photography, 118 Camera House, Boston, 17, Mass.

**Photoplays Wanted**

**\$55 For Ideas.** Photoplay Plots revised, criticized, copyrighted, marketed. Send for free booklet. Universal Scenario Company, 210 Security Bldg., Santa Monica & Western Ave., Hollywood, Calif.

**Postcards and Pictures**

20 pictures of scenic Wisconsin \$1.00. George Contoy, Lake Geneva, Wis.

**Printing Outfits and Supplies**

Print your own cards, stationery, circulars, paper, etc. Complete outfits \$8.85; Job Presses \$11, \$29; Rotary \$19. Print for others, big profit. All easy, ruins set. Write for catalog presses, type, paper, etc. Kelsey Company, F-6 Meriden, Conn.

**Radio**

**Boys! Don't overlook this.** The "Itascó" Baby Detector. Greatest detector ever brought out with molded base. Fully adjustable. See former advertisements in this publication, or our catalogue. Detector with Galena Crystal complete 50c, the same detector with Radioite Crystal 75c prepaid. Send for yours today. Radio Specialty Company, 100 Park Place, New York City.

**Trouble-Shooting.** Do you know the key to the knowledge of any electrical circuit? You can find correct answer in a booklet written by nationally known authorities on Radio and Electricity. Ask your radio dealer for "Practical Guide for Every Radio Owner and Builder", or send 10c today to Universal Test Equipment Co., 2939 N. Oakley Ave., Chicago, Ill. Sold at all newsstands in the city of Chicago.

**Selenium or Photo-Electric Cells.** For all purposes very sensitive, quick, and permanent in action, three years' guarantee. Send 10c stamps for catalog. Selenium Laboratories, Hampton Bays, Long Island, N. Y.

**A & B Trickle Chargers \$1.95.** 2 1/2 Volt alkaline Storage B Batteries \$1.95. Other bargains 10c. Chemicals, 1157 So. Selenee Specialties, 620 Fayette, Indianapolis.

**Rubber Stamps**

Your name handsomely moulded in fancy letters upon a rubber stamp \$1.00 plus 10c for postage. Please print name. R. Skeffington, 18 Bulfinch St., Boston, Mass.

**Salesmen Wanted**

**Minutes Pay Dollars** demonstrating wonderful three pound calculator. Retail \$15.00. Work equals \$300 machines. Adds, subtracts, multiplies, divides automatically. Five year guarantee. Big demand; large profits, experience unnecessary. Write quick for liberal trial offer and protected territory. Lightning Calculator Co., Dept. W, Grand Rapids, Mich.

**\$100-\$200 weekly.** Retailers live wire specialty. \$10 weekly guaranteed against com. Reliable house. Guarantee dealers turnover or money back. Pay you to investigate. Appleton Novelty Co., Cedar Rapids, Iowa.

**Make \$100 Weekly** in spare time. Sell what the public wants—long distance radio recording sets. Two sales weekly pays \$100 profit. No big investment, no canvassing. Share of Colorado made \$95 in one month. Representatives wanted at once. This plan is sweeping the country—write today before your county is gone. Ozarka, Inc., 431 N. LaSalle, Ave A, Chicago.

**Discovered! Diamond Rival—Rajah Gems** astound Jewelry world and defy detection. Set in artistic Sterling Silver mountings copies of higher priced platinum designs. Sell like wildfire at popular prices. Salesmen and Agents unique selling plan means enormous profits for you. Write immediately for details. Rajah Company, Dept. Y-12, Salisbury, N. C.

**Great neckwear line now free!** Features finest quality neckwear at factory prices. Collect big commissions daily. Write for Free tie offer and Free outfit. Newco Neckwear, Desk 12-D, Covington, Ky.

**Auto Radiator Shutter just out.** \$20.00 daily easy. Big winter seller. Retail \$1.50. Jones, 802 N. Clark, Chicago.

**Schools**

**Make \$75 to \$250 weekly:** Motion Picture, Portrait and Commercial Photography. Camera Free—For Special offer write New York Institute of Photography, Dept. 82A, 10 W. 33d St., New York.

**Song Poems**

**Song Poem Writers—Send for proposition.** Ray Hibbler, D-21, 2101 N. Keystone Ave., Chicago.  
**Free "Song Writers Guide".** B24-1230 Elm, Green Bay, Wis.

**Song Writers**

**Song—poem writers.** Address Monarch, 1472 Broadway, Dept. 133, New York.

**Stammering**

**ST-STU-T-T-TERING and Stammering Cured at Home.** Instructive booklet free. Walter McDonnell, 105 Arcade, 1126 Granville Ave., Chicago, Ill.

**Stop Stammering.** All speech defects successfully corrected. Samuel Robbins, 399 Boylston St., Boston.

**Stamps and Coins**

**Stamps 100 All Different 3 cents.** S. I. Quaker Stamp Company, Toledo, O.

**Typewriters**

**Typewriters, all standard makes.** \$10 up. Fully guaranteed. Free trial. Write for complete illustrated lists. Northwestern Exchange, 121 N. Francisco Ave., Chicago.

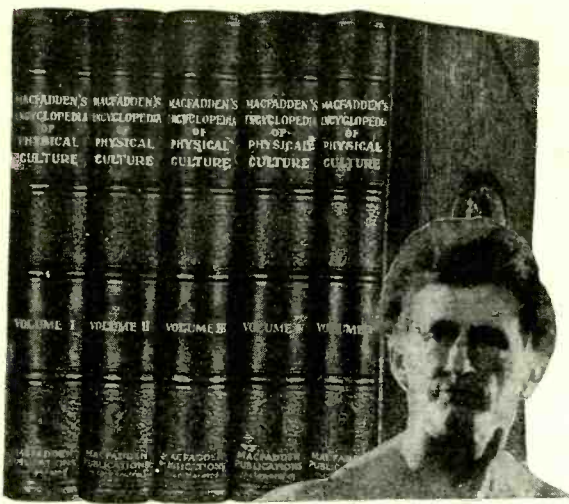

# Will you be one of the 800,000 who will die this year of preventable disease?

OF the hundreds of thousands who die from respiratory diseases, bronchitis, pneumonia, kidney diseases, tuberculosis, influenza, and intestinal disorders, a large proportion would not have died if they had been able to recognize early symptoms and had known how to treat themselves.

Nature always warns of impending sickness. The occasional headache, that tired, exhausted feeling, loss of appetite, a casual cold and other slight disarrangements are Nature's warnings to you that your body isn't functioning properly or that you are not living and eating correctly.

You can rule your health just as surely as you can rule your actions.

If you are not enjoying perfect health today it is because you haven't employed the method provided by Nature to keep you well. If you don't know what her requirements are, you are sure to blunder into some kind of sickness—perhaps fatal disease.

## ENCYCLOPEDIA of PHYSICAL CULTURE New 6th Edition ~ Completely Revised

EVERY year more than ten thousand people die of bronchitis, sixty-four thousand die of pneumonia, seventy-five thousand die of kidney trouble, fifty thousand die of respiratory disease, one hundred and six thousand die of tuberculosis, approximately eighty-five thousand die of influenza, and more than ten thousand die of intestinal trouble.

Barring accidents and suicides, only a small percentage of these thousands should die.

It is a fact that only about one person out of three enjoys good health. And those who are physically a little "off" right now will more than likely be the ones to succumb to preventable diseases this year. And they are the ones who should not die.

Nature is constantly warning you of impending sickness. Seemingly trivial symptoms tell of serious trouble taking root in your body. And yet, ninety-nine people out of every hundred will absolutely ignore these danger signals. As long as they are not flat on their backs, they will fool themselves into believing that they are all right.

Nature is merciful. If you do not understand her laws and her methods of preventing and curing sickness, you suffer. She knows no excuse—she accepts no apologies.

### The Average Person Pays Thousands of Dollars in Doctor's Bills

Those who do not know Nature's methods of preventing and curing sickness are ill an average of 21½ days each year. In fact, it is estimated that the average person in a lifetime spends \$4,100 on doctor and hospital bills, loss of time from business, medicine and other expenses due to illness. Thousands of people are living half-powered lives because they are ignorant of the laws of Nature. Many of these people will fill an early grave, when they might easily have lived to enjoy a ripe old age.

What would it be worth to you to be able to in-

stantly identify in its earliest stages any sickness or disease that might overtake you or any member of your family? To enjoy perfect health, almost complete freedom from sickness, doctor and hospital bills, and no days of suffering and worry, or salary lost through sickness?

### How to —

- possess exhilarating health every day in the year
- know your own body
- eat for health
- diet for the cure of disease
- apply all methods of drugless healing
- build a powerful physique
- correct physical imperfections
- become a physical director
- avoid unhappy marriages
- avoid disease
- fast as a curative measure
- cure by hydropathy (heal by the use of water)
- apply all methods of drugless healing
- give first aid in emergencies
- apply home treatment for disease
- recognize diseases by manifestations
- build nervous energy
- treat the common form of disease
- understand the process of reproduction
- benefit by laws of sex and marriage
- treat diseases of women
- diagnose diseases
- have healthy and vigorous children
- treat female disorders
- treat male disorders
- obtain virility and manhood
- care for the complexion
- manicure; care for the hair and feet
- cultivate the mind
- These are only a few of the matters explained in the Encyclopedia.

### The Encyclopedia of Physical Culture (6th Edition—Greater Than Ever Before)

This marvelous 5-volume work gives you the information you need to build up rugged strength, health and vitality. It is for every member of the family—it covers every phase of strength and body building for adults, children and babies. It gives invaluable information on fasting, dieting and exercise. A thorough and extensive treatment

is given of the laws of sex, the attainment of virile manhood and womanhood, and happy, successful parenthood, together with details for diagnosis and treatment of all sexual diseases. Handsomely illustrated charts on anatomy and physiology are scattered throughout the book.

It is neither dull nor technical, but is simple, comprehensive and complete in every sense. It is the crowning effort of Bernard Macfadden's rich, full experience in the science of health and physical culture. He has had more than thirty years' experience in guiding thousands of physical wrecks to glorious health and vigor. Out of that experience he built his Encyclopedia of Physical Culture.

Five big editions of this popular work have been exhausted. And now the sixth edition—greatest of all—has just come off the press. This edition has been completely revised at great expense. Scores of new illustrations have been inserted. The binding has been changed to a beautiful all Fabricoid, more durable than leather. Altogether it is the finest edition of the Encyclopedia ever issued.

### 10 Days' Free Examination of Entire Set—No Money Needed

This is the most liberal offer we have ever made on the Encyclopedia—10 days' examination of the entire set at no expense to you. There is no money needed—no deposit to pay. Just fill in the coupon and we will send the five volumes to you, all shipping charges prepaid, for your inspection.

Take ten days to examine the set. Then, if you decide to purchase, send us only \$2.00 as your first payment. Additional payments may be made at the rate of only \$3.00 a month until the total cost of \$35.00 has been paid.

If you care to pay cash you may do so by sending us only \$31.50. This represents a 10 per cent discount.

If you purchase the set we will include with it special membership in our Advice Department, maintained and equipped to serve you. This service alone may be worth many times the cost of the books.

Remember, no money now, and no obligation to purchase. You simply agree to return the books at the end of ten days in case you decide not to keep them.

MACFADDEN PUBLICATIONS, Inc.  
Dept. SC-12, Macfadden Building,  
1926 Broadway, New York City.

**SPECIAL**

Send me on 10 days' inspection the five volumes of the Encyclopedia of Physical Culture. If I find the set satisfactory I will either send \$2.00 in ten days and \$3.00 a month until \$35.00 has been paid, or \$31.50 cash. If I decide not to keep the books I will return them in 10 days postpaid.

Foreign orders—cash in advance.

Name .....

Occupation .....

Residence .....

Employed at .....

Business Address .....

I understand that this price includes Special Membership in your Advice Department.

**MACFADDEN PUBLICATIONS, Inc.**  
Dept. SC-12 1926 Broadway, New York City, N. Y.

Let These Guides

Solve Your Problems

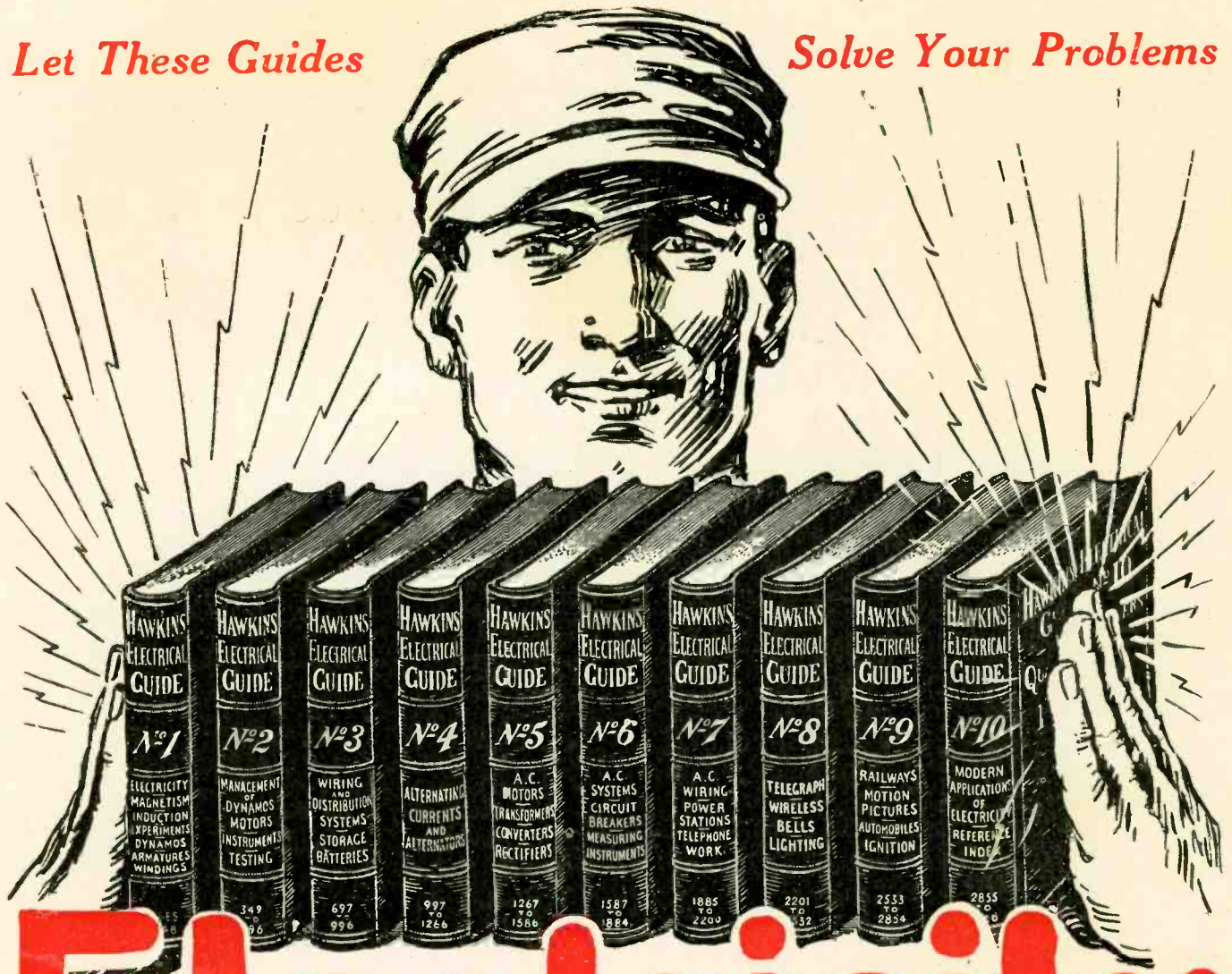

# Electricity at your finger ends

## HAWKINS ELECTRICAL GUIDES IN TEN VOLUMES

3500 PAGES  
4700 PICTURES

\$1 A VOLUME  
\$1 A MONTH

SEND NO MONEY—SEND ONLY THIS COUPON

Know the facts in Electricity. They mean more money and better position for you. Hawkins Guides tell you all you need to know about Electricity. Every important electrical subject covered so you can understand it. Easy to study and apply. A complete, practical working course, in 10 volumes. Books are pocket size; flexible covers. Order a set today to look over.

### LEARN ALL ABOUT

Magnetism—Induction—Experiments—Dynamometers—Electric Machinery—Motors—Armatures—Armature Windings—Installing of Dynamometers—Electrical Instrument Testing—Practical Management of Dynamometers and Motors—Distribution Systems—Wiring—Wiring Diagrams—Sign Flashers—Storage Batteries—Principles of Alternating Currents and Alternators—Alternating Current Motors—Transformers—Converters—Rectifiers—Alternating Current Systems—Circuit Breakers—Measuring Instruments—Switchboards—Wiring—Power Stations—Installing—Telephone—Telegraph—Wireless—Bells—Lighting—Railways. Also many Modern Practical Applications of Electricity and Ready Reference Index of the ten numbers.

### SHIPPED FREE

Not a cent to pay until you see the books. No obligation to buy unless you are satisfied. Send Coupon now—today—and get this great help library and see if it is not worth \$100 to you—you pay \$1.00 a month for ten months or return it.

THEO. AUDEL & CO.

65 West 23rd Street, New York City.

Please submit me for free examination, HAWKINS ELECTRICAL GUIDE (Price \$1 a number). Ship at once prepaid, the 10 numbers. If satisfactory, I agree to send you \$1 within seven days and to further mail you \$1 each month until paid.

Name .....

Occupation .....

Employed by .....

Home Address .....

Reference .....

S. I., Dec.

**FREE  
10 DAYS  
TRIAL**

**GREATEST VALUE EVER OFFERED**

**\$2.98**

**THE NEW IMPROVED INKOGRAPH**  
*The Perfect Writing Instrument*

**A**NSWERS the purpose of both pen and pencil combined. Its point is shaped like a fine lead pencil point and writes with ink free and easy without a miss, skip or blur.

The steady uniform flow of ink actually improves your handwriting. Won't blot, scratch, leak or soil hands.

**Combines the Best Features of Pen and Pencil**

minus the weak points of both, plus improvements not found in either. The lead pencil smudges, the point breaks and its writing soon is obliterated. Most fountain pens skip, scratch, flood, clog, leak, blot, soil hands and clothing. The old stylographic ink pencil dries up, balks, blots, writes heavy, flows unevenly and is never reliable. The Inkograph feeds as fast and uniform on the 20th page as it did on the first.

**Cannot Leak**

Not the tiniest drop of ink will spill although one filling is sufficient to write thousands of words.

**Makes 3 to 4 Carbon Copies**

at one time with original copy in ink. Bear down as hard as you like, without fear of bending, spreading, injuring or distorting its 14Kt solid gold point.

**Draws Lines to a Ruler**

without smearing, smudging or blurring the paper. Writes with any color of ink.

**Requires No Blotter**

The ink dries as fast as you write, because the flow is fine, even and uniform.

**Patent Automatic Feed**

Prevents clogging. No complicated mechanism to clean or get out of order. A year's guarantee certificate with full directions accompanies each Inkograph and is your absolute protection.

**An Instrument of Refinement**

In appearance it is extremely attractive. Its beautifully highly polished finest quality of hard rubber, its **14Kt solid gold point and feed, gold band on safety screw cap, gold self filling lever and gold clip** makes it an instrument of distinctive elegance and refinement. The equal in size, workmanship and material of any \$7, \$8 or \$9 fountain pen. Also made in ladies' size.

**INKOGRAPH CO., INC., 185-59 Centre St., New York City**



**STYLE No. 47 DG**  
The Executive, an ebony black rubber, highly polished Inkograph of superb refinement, the choice of men of affairs.

Illustrations Actual Size

**STYLE No. 6 DG**  
The X Ray Inkograph barrel made of transparent amber material which makes it possible to see how much ink it contains. Has large ink capacity. Filled with ink dropper, not a self filler.



**STYLE No. 20 DG**  
The Big Chief, made of highest quality red rubber, a large sturdy attractive Inkograph.

Illustrations Actual Size

**STYLE No. 19 DG**  
The Big Chief, made of mottled rubber which is black and red rubber artistically blended producing an effect of extreme beauty and refinement.

**DEALERS:** Send for Our Catalog and Trade Prices

**INKOGRAPH CO., Inc.** 185-59 Centre St., New York City

Gentlemen: You may send me your Inkograph Style No. \_\_\_\_\_  
I will pay postman \$2.98 plus postage on delivery.

Name \_\_\_\_\_

Address \_\_\_\_\_

City \_\_\_\_\_ State \_\_\_\_\_

**SEND NO MONEY**

Your name and address and the style number of the Inkograph of your choice are sufficient. Pay the postman \$2.98 plus postage on delivery. Specify if you want ladies' size. When cash accompanies order Inkograph will be sent postage prepaid. If within ten days the Inkograph does not prove satisfactory return it and we'll refund your money.

**The Writing HEMISPHERE**



**The INKOGRAPH ACCOMPLISHMENT**

That 14kt solid gold ball like point which is hard, round and smooth slides with ease over the coarsest paper and makes it possible to write in ink as rapidly as with the softest lead pencil.

**AGENTS** Sell Inkographs, make bigger profits, more sales, without investment. Quicker commissions, popular prices, no competition. Send for an Inkograph or write for special sales plan booklet.