

August

25 Cents

# Science and Invention

IN PICTURES

THE LATEST  
THRILLER

See Page 310



40  
NON-TECHNICAL  
RADIO  
ARTICLES

# Pacent

## Engineering Achievements

*The last word in Condenser design*

### PACENT TRUE STRAIGHT LINE FREQUENCY CONDENSER

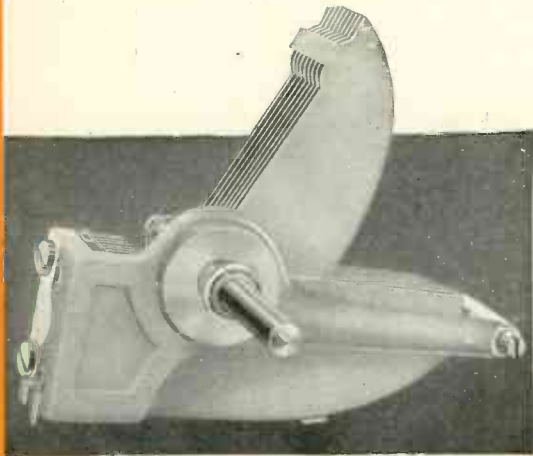

First there was the "Straight-Line" Capacity Condenser. Then the "Straight-Line" Wave Length Condenser was produced. Neither of them satisfactorily divided the stations on your dial. Now we announce the Pacent True "Straight-Line" Frequency Condenser. It makes possible the equi-spacing of stations—because stations are spaced according to Frequencies.

A Real Engineering Feat, both Electrically and Mechanically, low loss design. Isolantite—highest grade dielectric—used, placed so that absorption losses are negligible. Plates permanently spaced and joined together with metal tie bars—riveted and soldered joints. Simple and Practical one-hole mounting. Two or three of these condensers can be mounted in tandem for monocontrol.

*Manufacturers, Dealers and Jobbers, write or wire for particulars.*



*The last word in Vernier Dials*

### PACENT MICROVERN A SUPER TUNING DEVICE

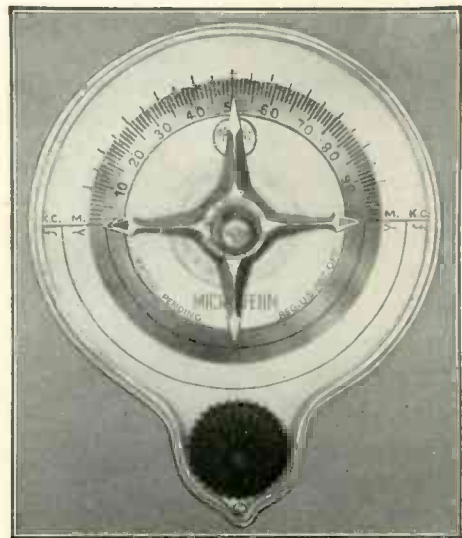

Designed for real sharp tuning, the Pacent Microvern is distinctive—totally different from any other vernier control in appearance and mechanical design. No gears are used. No backlash. Mechanism is radically new. Unique triple tuning obtained through exclusive radio-file feature.

*Manufacturers, Dealers and Jobbers, write or wire for particulars.*

## COMING — New Pacent Features — Watch for Announcements

**Pacent Electric Company, 91 Seventh Ave., New York City**

SALES OFFICES: Chicago, Minneapolis, Buffalo, Boston, Philadelphia, Washington, D. C., Pittsburgh, San Francisco, St. Louis, Jacksonville, Detroit  
Canadian Licensee: R. H. White Radio Co., Hamilton, Ontario

**"DON'T IMPROVISE — PACENTIZE"**

# "Electricity Has Paid Me \$301 for Every Dollar My Training Cost"

## The Amazing Story of a Young Man Who Built a \$10,000 a Year Income—and How He Did It

By ROBERT TODD

**A**MONG the many young men who have won big success in Electricity, few have had a more interesting career than Harold H. Hastings, President of the Hastings Electric Company, 312 Pine St., Bradentown, Fla.

In the fall of 1919 Hastings, just entering his fourth year at high school, decided he wanted to be an electrical man. He knew nothing about Electricity, being a farmer boy with no opportunities to study it. But he resolved to train himself, by spare-time study in his own home, for a place in the great and growing field of Electricity.

Through a friend he learned of the Chicago Engineering Works and of the home-study training in Practical Electricity conducted by its Chief Engineer, L. L. Cooke, a college-trained engineer of worldwide experience. Convinced that this was his one best means of securing the training he needed, Hastings enrolled for the Cooke Course.

His progress was astonishing. One month after he received his first lessons, he was doing Electrical jobs in his neighborhood, repairing doorbells and call systems, and earning about \$10 a week after school hours.



L. L. COOKE, Chief Engineer, Chicago Engineering Works, who has trained Harold Hastings and thousands of others for big success in Electricity.

Two months later he did his first job of house wiring.

Two months after that, he was appointed School Electrician for the high school he was still attending, and for spending an hour or two a day tak-

ing care of the 20 call bells, the call system, and the 70 or more electric lights in the building, he was given a regular salary of \$75 a month.

Eight months after he enrolled, Hastings received his L. L. Cooke Diploma, having completed the entire Course. The same month he gradu-

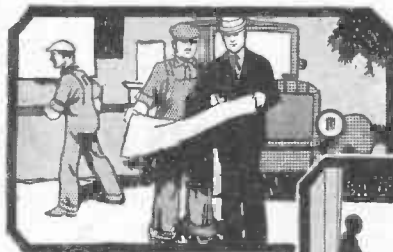

Left, below—Harold Hastings on the job as an Electrical Contractor supervising the wiring of a new house for electric lights.

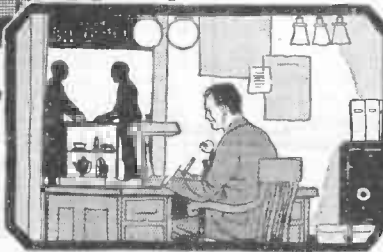

Above — The Electrical Contractor in the office of his big Supply Store. Left — A "close-up" of Harold Hastings.



ated from High School. Then he started in business for himself as a Licensed Electrical Contractor.

Inside of a year he was making from \$12 to \$20 a day and his reputation as a successful Electrical man had spread far and wide.

Today he owns one of the finest Electrical Supply Stores in the State of Florida, doing a monthly business of \$3,000, with a stock valued at \$12,000 and 10 men on his payroll. His concern, as he says, "does everything from wiring up a lamp to installing a power plant." In two weeks he supervised 32 wiring jobs and in the busy season he often outfits 20 houses in one day with electric fixtures. As Hastings says—"In the five years I have been in the Electrical game, I have made \$24,000—over \$301 for every dollar my electrical training cost me."

### How Hastings Did It

I asked Hastings how he achieved such a big success—an income so far beyond what the average man ever hopes to earn—in such a short time. His face lit up with a smile as he replied, "I had no other training than what Mr. Cooke gave me. His Course made everything in electrical work plain and easy to understand. Mr. Cooke kept close tab on my progress, encouraged me along, and boosted me in my work even long after I had finished the Course and paid for it in full.

"Since becoming an Electrical Contractor I have employed many other Cooke-Trained Men, and I find they are all strong for the Chicago Engineering Works and L. L. Cooke.

"With Mr. Cooke's Course and advice, and a little pep of his own, any man cannot help but become a Big Pay Man in Electricity."

### Do You Want To Succeed Like Hastings?

L. L. Cooke has become famous as a maker of Big-Pay Electrical Experts. Hundreds and hundreds of men trained by him now earn \$3,500 to \$10,000 a year—men with little or no knowledge of Electricity to begin with. If you are interested in Big Pay, send the coupon below to L. L. Cooke, Chief Engineer, Chicago Engineering Works, Dept. 2-C, 2150 Lawrence Avenue, Chicago, Illinois, for a copy of his big Electrical book and latest offer. Do this today and learn the way to big money in Electricity.

L. L. COOKE, Chief Engineer,  
Chicago Engineering Works,  
Dept. 2-C, 2150 Lawrence Ave., Chicago, Illinois.

Without obligating me in any way, please send me your big illustrated book on Electricity and tell me how I can be a Big-Pay Electrical Expert.

Name .....

Address .....

City .....

State ..... Age.....

Vol. XIII.  
Whole No. 148

August, 1925  
No. 4

# Science and Invention

FORMERLY  
ELECTRICAL EXPERIMENTER

Member Audit Bureau of Circulations

EDITORIAL & GENERAL OFFICES: 53 Park Place, New York City

GENERAL ADVERTISING DEPT.: 53 Park Place, New York City

Published by Experimenter Publishing Company, Inc.

(H. Gernsback, Pres.; S. Gernsback, Treas.; R. W. DeMott, Sec'y.)

Publishers of SCIENCE & INVENTION, RADIO NEWS, THE EXPERIMENTER  
and MOTOR CAMPER & TOURIST.

## EDITORIAL STAFF

HUGO GERNSBACK, *Editor-in-Chief.*

H. WINFIELD SECOR, E. E.,

*Managing Editor.*

DR. T. O'CONNOR SLOANE, Ph.D., M. A.,

*Associate Editor.*

JOSEPH H. KRAUS, *Field Editor.*

A. P. PECK, Assoc. I. R. E.,

*Radio Editor.*

S. GERNSBACK, *Wrinkles Editor.*

J. KELLY BURLEIGH, *Art Director.*

## CONTRIBUTING EDITORS

*Astronomy—*

Dr. Donald H. Menzel, Ph.D., Uni-  
versity of Iowa.

Isabel M. Lewis, M.A., of the U. S.  
Naval Observatory.

*Entomology and Allied Subjects—*

Dr. Ernest Bade, Ph.D.

*Physics—*

Dr. Harold F. Richards, Ph.D.

Ernest K. Chapin, M. A.

*Automotive Subjects—*

Tom C. Plumridge.

George A. Luers.

*Chemistry—*

Raymond B. Wailes.

Dr. Ernest Bade, Ph.D.

*Radio—*

Sylvan Harris.

Leon L. Adelman.

*Magic and Psychic Phenomena—*

Joseph Dunninger.

Joseph F. Rinn.

Edward Merlin.

*Foreign Correspondents—*

Dr. Alfred Gradenwitz, Germany.

Dr. H. Becher, Germany.

C. A. Oldroyd, England.

S. Leonard Bastin, England.

A. N. Mirzaoff, France.

Hubert Slouka, Czecho-Slovakia.

P. C. van Petegem, Holland.

Richard Neumann, Austria.

## IN OUR NEXT ISSUE

### *Have You a Radio Set and House Current?*

If you have, then you will be interested in the exhaustive article on the subject of "B" battery eliminators which will appear in the next issue. We have selected the best types from those that have been designed up to the present time and will give full constructional details.

### *Can Rain Be Produced Artificially By Electricity?*

It is claimed that in a certain western state a high frequency electrical installation has produced rain. We will give details on the instruments.

### *Topographical Maps Now Made From the Air*

Photographs can be taken from air-planes and heights of mountains measured directly from them. An authority on aerial mapping will give full information on the subject.

### *Is the Einstein Theory Sound?*

A prominent authority on astronomy and the Einstein theory of relativity has recently completed a lengthy series of tests based on the Michelson-Morley experiment and has proven quite conclusively that, contrary to Einstein, there is ether and an ether drift.

## Contents for August

Editorial	303	Oddities in the News	330
<i>By Hugo Gernsback.</i>		Colloids—What They Are	331
How Spurious Gems May Be De-		<i>By Raymond B. Wailes.</i>	
tected	304	Dr. Hackensaw's Secrets	332
<i>By A. N. Mirzaoff and A. P. Peck.</i>		<i>By Clement Fezandie.</i>	
Ancient Burials	306	Prizes for Uses for Clock Springs	334
How Bees Talk	307	Scientific Problems and Puzzles	336
Hero's Magic Horse	309	<i>By Ernest K. Chapin.</i>	
<i>By Charles Beecher Bunnell.</i>		Experiments With A. C.	337
Dashing Through Brick Wall—King		<i>By Raymond B. Wailes.</i>	
of Thrillers	310	A Swimmer's Sail Boat	338
Attaining World's Speed Records	311	Experimenting With Color Screens	339
<i>By William P. Sullivan.</i>		Fire Extinguishers	340
What to Do in Thunder Storms	312	Shellac and Shellac Varnishes	341
<i>By H. Winfield Secor, E. E.</i>		<i>By Dr. Ernest Bade.</i>	
Rose Arbors	313	How-to-Make-It Department	342
<i>By William Butterfield.</i>		Wrinkles, Recipes and Formulas	343
Airplane Bombs vs. Anti-Aircraft		<i>Edited by S. Gernsback.</i>	
Defence	315	Readers' Forum	344
<i>By Major H. H. Arnold.</i>		Radio in Odd Places	345
Are You Fit?	316	WRNY—The Science Station	346
<i>By Sam Brown.</i>		Hunting Interference	348
Cheating Cheaters	317	Artists Forty Miles Apart Broadcast	349
<i>By John J. Birch.</i>		Radio Aerials	350
Dynamiting Oil Fires	318	<i>By Leon L. Adelman, Assoc. I. R. E.</i>	
Portable Pneumatic Boat	319	Freak Radio Sets	352
Basket of Many Forms	320	A Page for the Novice—Part 6	353
<i>By Dale R. Van Horn.</i>		Radio Constructor	354
An Aid to Drawing Students	321	<i>By A. P. Peck, Assoc. I. R. E.</i>	
Man is Mostly Empty Space	322	Static Reducers	356
<i>By Dr. Russell G. Harris.</i>		<i>By Moe Joffe.</i>	
Corn and Its By-Products	323	Radio Oracle	357
<i>By P. A. Judd.</i>		Scientific Humor	359
This Month's New Devices	224	Latest Patents	360
Magic For Everybody	325	Non-Sc(i)ence	361
<i>By Prof. Joseph Dunninger.</i>		Oracle	362
Odds and Ends of Physics	326	Awards in \$1,000 Monthly Contest	364
<i>By Dr. T. O'Connor Sloane, Ph.D.</i>		Patent Advice	368
Chemical Magic	327	<i>Edited by A. P. Peck.</i>	
<i>By Nicholas Klein.</i>		Motor Hints	384
Tarrano the Conqueror—Part 2	328	Radio Wrinkles	390
<i>By Ray Cummings.</i>			

HOW TO SUBSCRIBE FOR "SCIENCE AND INVENTION." Send your name, address and remittance to Experimenter Publishing Co., 53 Park Place, New York City. Checks and money orders should be made payable to Experimenter Publishing Co., Inc. Mention the name of the magazine you are ordering inasmuch as we also publish RADIO NEWS, THE EXPERIMENTER and MOTOR

CAMPER & TOURIST. Subscriptions may be made in combination with the other publications just mentioned at special reduced club rates. Send postal for club rate card. Subscriptions start with the current issue unless otherwise ordered. ON EXPIRATION of your subscription we enclose a renewal blank in our last number to you, and notify you by mail. Then unless we receive your

order and remittance for a renewal, delivery of the magazine is stopped. CHANGE OF ADDRESS: Notify us as far in advance as possible, giving your old address as well as the new one to which future magazines are to go. It takes several weeks to make an address change on our records.

SCIENCE AND INVENTION is published on the 10th of each month. There are 12 numbers per year. Subscription price is \$2.50 a year in U. S. and possessions. Canada and foreign countries \$3.00 a year. U. S. coin as well as U. S. stamps accepted (no foreign coin or stamps). Single copies, 25 cents each. A sample copy will be sent gratis on request. All communications and contributions to this journal should be addressed to Editor, SCIENCE AND

INVENTION, 53 Park Place, New York City, N. Y. Unaccepted contributions cannot be returned unless full postage has been included. ALL accepted contributions are paid for on publication.

SCIENCE AND INVENTION. Monthly. Entered as second class matter May 10, 1924, at the Post Office at New York, N. Y., under the act of March 3, 1879. Additional entry at Long Island City, N. Y., and

San Francisco, Calif. Title Registered at the Patent Office. Copyright, 1925, by E. P. Co., Inc., New York. The Contents of this Magazine are copyrighted and must not be reproduced without giving full credit to the publication. SCIENCE AND INVENTION is for sale at all newsstands in the United States and Canada; also at Bretano's, 37 Avenue de l'Opera, Paris. Member of the Audit Bureau of Circulations.

New England Advertising Representative Western Advertising Representatives Pacific Coast Advertising Representatives Kansas City Advertising Representatives  
T. F. Magrane Finucan & McClure A. J. Norris Hill Co. George F. Dillon  
Park Square Bldg., Boston, Mass. 720 Cass St., Chicago, Ill. Hearst Bldg., San Francisco, Cal. 707 Lans. Bank Bldg., Kansas City, Mo.

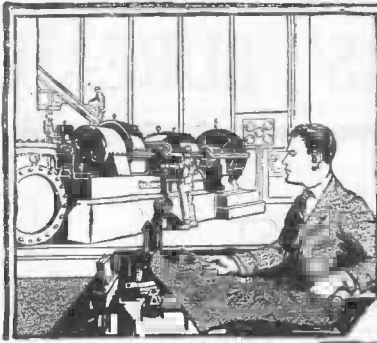

Be Superintendent of an Electrical POWER PLANT



Own Your Own Electrical REPAIR SHOP

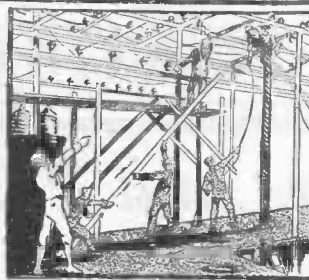

Boss Electrical Construction Jobs

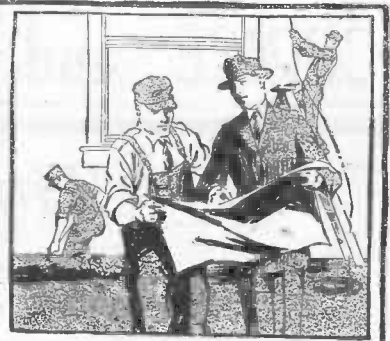

Be an Electrical CONTRACTOR

# Train AT HOME for a fine Electrical Job and a Big Raise Get my Amazing GUARANTEE!

If you are now earning less than \$40 a week, if you want to be an ELECTRICAL EXPERT, if you want to step quickly into the class of men who earn \$60 to \$250 a week—write me at once! This million-dollar training school guarantees you COMPLETE, thorough training, guarantees to back you from one position to another until you are a success! My training easy to understand, rapid, practical, because you learn by doing actual Electrical jobs!

\$10 Motor - 4 Big Outfits Given to every Student Not a Penny Extra Cost

When you put your time and money into home-training you want to know in advance which training is best. AND WHETHER IT WILL EQUIP YOU TO FILL A BETTER JOB AT BIGGER PAY. The AMERICAN SCHOOL answers these questions in plain English. With an astonishing new money-back guarantee. You owe it to yourself to get this guarantee. Coupon brings it.

## Go into ELECTRICITY

—the business of a million opportunities

Be an Electrical Expert. Go into the one great Industry where it's easy to get to the top, to make money, to make a real success. You don't need money in the bank or "pull" to get ahead in Electricity—all you need is TRAINING, honest, complete training, such as I guarantee you. Whether you want a good job or want to go into business with small capital, choose ELECTRICITY, the billion-dollar industry of a million opportunities.

Many graduates report pay increases of 50% all the way up to 500%

I have hundreds of letters which prove my training has doubled and trebled the pay of my students and graduates. So unless my training increases your pay at least 50%, I promise to refund every cent you have paid for it. My training includes Radio, Auto Electricity, Electrical Drafting, Business Training, and Electrical Engineering subjects, all for one small price and on terms within reach of all.

### I will send you these 4 big outfits!

Nearly 100 items included in Motor, Radio, and Electrical outfits, given to you without one penny of extra charge. The man-size motor of the same type as the big fellows in a power plant. Not a toy, but a regular power-motor. It comes to you knock-down. It's part of your job to wind the armature and assemble it.

### Write Me At Once!

Get my catalog, my wonderful new guarantee, my sensational offers—quick! Get the facts about your opportunities in Electricity when you are Dunlap-trained and when you have the backing of the American school. Get the facts about my training, so you can compare it intelligently with others.

Chief Engineer Dunlap  
**American School**  
Dept. E.C.26  
Drexel Ave. & 58th St.  
CHICAGO

## FREE JOB SERVICE for Students and Graduates!

We have supplied thousands of jobs FREE, not only to graduates, but to STUDENTS also. This JOB-SERVICE keeps in touch with great Electrical employers all over America. The day you enroll, this Job-Service department registers you, finds out what kind of job you want, where you want to work, etc. When the AMERICAN SCHOOL backs you for a fine BIG-PAY job, you are pretty sure to get it and make good in it.

## Training by 23 Engineers!

This is no one-man, one-idea school. 22 famous engineers and executives of the world's greatest Electrical corporations and leading Universities helped Chief Engineer Dunlap make this training complete and up-to-date.

- |                    |                   |
|--------------------|-------------------|
| Gen'l Electric Co. | Underwriters Lab- |
| Commonwealth       | oratories         |
| Edison Co.         | Columbia Uni.     |
| Crocker-Wheeler    | Dartmouth College |
| Cutler-Hammer      | Mass. Inst. of    |
| Amer. Telephone    | Technology        |
| & Telegraph Co.    | Lehigh Uni.       |
| Westinghouse       | Unl. of Vermont   |
| Elec. & Mfg. Co.   | Armour Inst. of   |
| Western Electric   | Technology        |
|                    | Unl. of Kansas    |
- AND MANY OTHERS

## I WANT TO BE AN ELECTRICAL EXPERT

Chief Engineer Dunlap  
AMERICAN SCHOOL, Dept. E.C.26  
Drexel Ave. & 58th St., Chicago

I want to be an Electrical Expert. Please rush guarantee, job-service facts, complete information, and money-saving offers.

Name.....

St. No.....

City..... State.....

MAIL COUPON TO DAY



Chief Engineer Dunlap

My Job-Method Home-Training is divided in two parts. The first, "Applied Electricity," 53 lessons and "jobs," covers all the ground usually found in Electrical home-training. In the second part, containing 51 lessons and jobs, you get Electrical Engineering subjects. It is this second part which raises you out of the mechanics class into the big-pay expert class.

# SCIENCE and INVENTION READERS' BUREAU

## Time and Postage Saver

**I**N every issue of SCIENCE and INVENTION you undoubtedly see numerous articles advertised about which you would like to have further information.

To sit down and write an individual letter to each of these respective concerns, regarding the article on which you desire information, would be quite a task.

As a special service to our readers, we will write the letters for you, thus saving your time and money.

Just write the names of the products about which you want information, and to avoid error the addresses of the manufacturers, on the coupon below and mail it to us.

If the advertiser requires any money or stamps to be sent to pay the mailing charges on his catalogue or descriptive literature, please be sure to enclose the correct amount with the coupon.

We will transmit to the various advertisers your request for information on their products.

This service will appear regularly every month on this same page in SCIENCE and INVENTION.

If there is any Manufacturer not advertising in this month's issue of SCIENCE and INVENTION from whom you would like to receive literature, write his name, address and the product in the special section of the coupon below.

TEAR ALONG THIS LINE

**READERS' SERVICE BUREAU,**  
Experimenter Publishing Co., Inc., 53 Park Place, New York, N. Y.

S. & I. 8-25

Please advise the firms listed below that I would like to receive detailed information on their product as advertised in the \_\_\_\_\_ issue of SCIENCE and INVENTION.

**THIS FORM SHOULD NOT BE USED FOR TECHNICAL QUESTIONS**

NAME	ADDRESS (Street—City—State)	List here specific article on which you wish literature.	If Catalogue of complete line is wanted, check in this column.
.....	.....	.....	.....
.....	.....	.....	.....
.....	.....	.....	.....
.....	.....	.....	.....
.....	.....	.....	.....
.....	.....	.....	.....
.....	.....	.....	.....
.....	.....	.....	.....
.....	.....	.....	.....
.....	.....	.....	.....

**THIS FORM SHOULD NOT BE USED FOR TECHNICAL QUESTIONS**

If you desire information from a manufacturer whose advertisement does not appear in this month's issue, use this space.

NAME	ADDRESS
.....	.....
.....	.....
.....	.....

Your local dealer's name here.....

Your own name here.....

If you are a dealer check here.

Address.....

City..... State.....

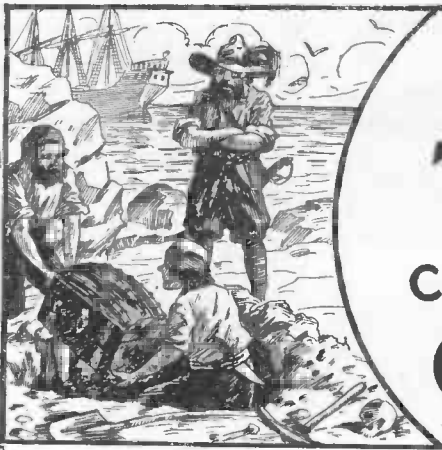

# BURIED TREASURE

can still be found in

# CHEMISTRY



## Good Chemists Command High Salaries

and you can make yourself independent for life by unearthing one of chemistry's yet undiscovered secrets.



**T. O'CONOR SLOANE,**  
A.B., A.M., LL.D., Ph.D.  
Noted Instructor, Lecturer and Author. Formerly Treasurer American Chemical Society and a practical chemist with many well known achievements to his credit. Not only has Dr. Sloane taught chemistry for years but he was for many years engaged in commercial chemistry work.

Do you remember how the tales of pirate gold used to fire your imagination and make you want to sail the uncharted seas in search of treasure and adventure? And then you would regret that such things were no longer done. But that is a mistake. They are done—today and everyday—not on desert islands, but in the chemical laboratories throughout your own country. Quietly, systematically, the chemist works. His work is difficult, but more adventurous than the blood-curdling deeds of the Spanish Main. Instead of meeting an early and violent death on some forgotten shore, he gathers wealth and honor through his invaluable contributions to humanity. Alfred Nobel, the Swedish chemist who invented dynamite, made so many millions that the income alone from his bequests provides five \$40,000 prizes every year for the advancement of science and peace. C. M. Hall, the chemist who discovered how to manufacture aluminum made millions through this discovery. F. G. Cottrell, who devised a valuable process for recovering the waste from flue gases, James Gayley, who showed how to save enormous losses in steel manufacture, L. H. Baekeland, who invented Bakelite—these are only a few of the men to whom fortunes have come through their chemical achievements.

### What Some of Our Students Say of This Course:

I have not written since I received the big set. I can still say that it far exceeded my anticipations. Since I have been studying with your school I have been appointed chemist for the Scranton Coal Co. testing all the coal and ash by proximate analysis. The lessons are helping me wonderfully, and the interesting way in which they are written makes me wait patiently for each lesson.—**MORLAIS COUZENS.**

I wish to express my appreciation of your prompt reply to my letter and to the recommendation to the General Electric Co. I intend to start the student engineering course at the works. This is somewhat along electrical lines, but the fact that I had a recommendation from a reliable school no doubt had considerable influence in helping me to secure the job.—**H. VAN BENTHUYSEN.**

So far I've been more than pleased with your course and am still doing nicely. I hope to be your honor graduate this year.—**J. M. NORRUS, JR.**

I find your course excellent and your instruction, truthfully, the clearest and best assembled I have ever taken, and yours is the fifth one I've studied.—**JAMES J. KELLY.**

From the time I was having Chemistry it has never been thus explained to me as it is now. I am recommending you highly to my friends, and urging them to become members of such an organization.—**CHARLES BENJAMIN.**

I shall always recommend your school to my friends and let them know how simple your lessons are.—**C. J. AMDAHL.**

I am more than pleased. You dig right in from the start. I am going to get somewhere with this course. I am so glad that I found you.—**A. A. CAMERON.**

I use your lessons constantly as I find it more thorough than most text books I can secure.—**WM. H. TIBBS.**

Thanking you for your lessons, which I find not only clear and concise, but wonderfully interesting. I am—**ROBT. H. TRAYLOR.**

I received employment in the Consolidated Gas Co. I appreciate very much the good service of the school when a recommendation was asked for.—**JOS. DECKER.**

## Now Is the Time to Study Chemistry



Not only are there boundless opportunities for amassing wealth in Chemistry, but the profession affords congenial employment at good salaries to hundreds of thousands who merely follow out its present applications. These applications are innumerable, touching intimately every business and every product in the world. The work of the chemist can hardly be called work at all. It is the keenest and most enjoyable kind of pleasure. The days in a chemical laboratory are filled with thrilling and delightful experimentation, with the alluring prospect of a discovery that may spell Fortune always at hand to spur your enthusiasm.

### You Can Learn at Home

To qualify for this remarkable calling requires elaborate specialized training. Formerly it was necessary to attend a university for several years to acquire that training, but thanks to our highly perfected and thorough system of instruction, you can now stay at home, keep your position, and let us educate you in Chemistry during your spare time. Even with only common schooling you can take our course and equip yourself for immediate practical work in a chemical laboratory. Dr. Sloane gives every one of his students the same careful, personal supervision that made him celebrated throughout his long career as a college professor. Your instruction from the very beginning is made interesting and practical, and we supply you with apparatus and chemicals for performing the fascinating analyses and experimental work that plays such a large part in our method of teaching, and you are awarded the Institute's official diploma after you have satisfactorily completed the course.

### Easy Monthly Payments

You don't have to have even the small price of the course to start. You can pay for it in small monthly amounts—so small that you won't feel them. The cost of our course is very low, and includes everything, even the chemistry outfit—there are no extras to buy with our course. Our plan of monthly payments places a chemical education within the reach of everyone. Write us and let us explain our plan in full—give us the opportunity of showing you how you can qualify for a highly trained technical position without even giving up your present employment.

### Special 30 Day Offer

Besides furnishing the student with his Experimental Equipment, we are making an additional special offer for a short while only. You owe it to yourself to find out about it. Write today for full information and free book "Opportunities for Chemists." Send the coupon right now while it is fresh in your mind. Or just write your name and address on a postal and mail it to us. But whatever you do, act today before this offer is withdrawn.

**CHEMICAL INSTITUTE OF NEW YORK**  
Home Extension Division 8  
66-S—West Broadway  
New York City

Please send me at once, without any obligation on my part, your free Book "Opportunities for Chemists," and full particulars about the Experimental Equipment given to every student. Also please tell me about your plan of payment and your special 30 day offer.

### Experimental Equipment Furnished to Every Student

We give to every student without additional charge this chemical equipment, including forty-nine pieces of laboratory apparatus and supplies, and forty different chemicals and reagents. These comprise the apparatus and chemicals used for the experimental work of the course. The fitted heavy wooden box serves not only as a case for the outfit but also as a useful laboratory accessory for performing countless experiments.

## CHEMICAL INSTITUTE OF NEW YORK, Inc.

Home Extension Division 8

66-S—WEST BROADWAY

NEW YORK CITY

DON'T WAIT—MAIL COUPON NOW!

NAME .....

ADDRESS .....

CITY..... STATE.....

S.I. Aug. 25



# Master Electricity By Actual Practice

The only way you can become an expert is by doing the very work under competent instructors, which you will be called upon to do later on. In other words, *learn by doing*. That is the method of the New York Electrical School.

Five minutes of actual practice properly directed is worth more to a man than years and years of book study. Indeed, Actual Practice is the only training of value, and graduates of New York Electrical School have proved themselves to be the only men that are fully qualified to satisfy EVERY demand of the Electrical Profession.

## The Only Institution of the Kind in America

At this "Learn by Doing" School a man acquires the art of Electrical Drafting; the best business methods and experience in Electrical Contracting, together with the skill to install, operate and maintain all systems for producing, transmitting and using electricity. A school for Old and Young. Individual instruction.

### Over 9,500 Graduates are Successful Men in the Electrical World

No previous knowledge of electricity, mechanics or mathematics is necessary to take this electrical course. You can begin the course now and by steady application prepare yourself in a short time. You will be taught by practical electrical experts with actual apparatus, under actual conditions.

The N. Y. E. S. gives a special Automobile Ignition Course as an advanced training for Auto Mechanics, Garage Men and Car Owners. The course covers completely all Systems of Ignition, Starters, Lighting and other electrical equipment on automobiles, motor boats, airplanes, etc.

*Let us explain our complete courses to you in person. If you can't call, send now for 64-page book—it's FREE to you.*

# New York Electrical School

29 West 17th Street, New York

New York Electrical School  
29 W. 17th St., New York, N. Y.

Please send FREE and without obligation to me your 64-page book.

..... NAME  
 ..... STREET  
 .....CITY .....STATE



# Science and Invention

Editorial and General Offices, - - - 53 Park Place, New York

*"Those Who Refuse to Go Beyond Fact Rarely Get As Far As Fact" - - - HUXLEY*

## Nothing Lasts

By HUGO GERNSBACK

**W**HEN wandering through one of our modern cities, the studious man must often be struck by the thought, "How long will it all last?" We look at our modern skyscrapers, our titanic bridges, our monuments, our subways, our elevated roads, and we begin to ponder. To the man in the street, it matters not if the Brooklyn Bridge or the Woolworth Building lasts seventy-five or one hundred years, because he cannot expect to live that long. He is to be compared to the ephemeral, the one-day fly, which cares naught about the winter, because it never knew more than the weather of the single day—his span of life.

### I BELIEVE THAT:

our present unknown senses will be developed as the race advances.

But to the scientist who realizes the short period of elapsed time as figured by the life of the average human being, a totally different picture presents itself. He knows

that none of man's handiwork, no matter how constructed, can possibly last for more than five or ten thousand years, which in itself is a ridiculously small lapse of time compared to the age of this planet itself. Having in mind the fact that the human race has been on this planet for 500,000 years, and that the age of the earth is figured, not in millions, but probably billions of years, we begin to feel quite humble when we contemplate man's handiwork.

How long do things last? As figured in geological time, they do not last at all, but vanish almost immediately. Take such an imposing looking structure as the Brooklyn Bridge. If this bridge were left to its own devices, it probably would not last one hundred years. Long before that time it would have crumbled into rust. Salt air, wind, heat, and ice are the constant enemies of man's handiwork. If the Brooklyn Bridge were not constantly repainted and new cables constantly strung, it would not even last 100 years. Possibly fifty years would be the limit. The reason is that the metal of the cables not only rusts, but crystallizes under the load and must be replaced ever so often.

How long would the Woolworth Building last if left without attention? Possibly one hundred years. Surely not more than two hundred years. This may sound like a rash statement, but it is not. In the first place, during severe storms, windows are shattered and broken. After that it does not take long for rain, snow, and the wind and storm to peel off the covering of the walls inside the building, and the minute a small inroad is made here, the decay follows with astonishing rapidity. As soon as a small portion of this steel skeleton work is exposed, the rusting process starts in at once, while seeping water

coming afterwards quickly flows from floor to floor. Finally a few girders will start to give, and soon we have parts of the building crashing. Some of the outside walls will begin to cave in under such influence, and it will not be many generations before the entire building will become a heap of dust. In two hundred years, the building would probably be leveled to the ground.

How about the Pyramids, some of which have already lasted five thousand years? Here it must not be forgotten that we have an ideal dry climate, no salt air, and no ice, rain or sleet to do effective damage. Nevertheless the Pyramids once had absolutely smooth sides, and were covered from top to bottom with a sort of cement. During the five thousand years this cement has been eaten away, only the original stones remaining, and these stone blocks now show signs of wear. Even under these ideal conditions the Pyramids, if left without attention, cannot possibly last another ten thousand years.

Suppose that by some mysterious disease, the entire population of the world were to vanish. Left thus to the elements, our cities and all other man's handiwork would probably be totally razed within one thousand years, with very few exceptions. A new race springing up on the planet ten or fifteen thousand years hence, would find very little evidence that the earth had ever been inhabited before. To be sure, some of their archeologists would dig out some remains of our culture, but not much of it would remain. This is particularly true in the northern climate, where temperature changes, frequent rains, snow, and storms quickly obliterate practically everything. Such a thing as our best constructed railroads would be entirely annihilated, as the rails would not last one hundred years, crumbling to rust long before that. The wooden ties would have gone, while climatic changes, frost, rain and the like would have eliminated the roadbed completely, so there would be no remains. In some of the dry parts of the various countries, future archeologists would find some of our present cities underground, but the most they would find would be the stone work.

Such structures as subways and underground tunnels, unless dug into the rock, would probably have been obliterated entirely by new water streams that would find their way into them, eating out all of the steel work. The walls would then collapse, leaving little to show that there was an underground railroad at one time.

### I BELIEVE THAT:

the present generation will witness the transmutation of several elements into other ones.

### THE GOLDEN AGE OF SCIENCE

is symbolized by the golden cover OF SCIENCE & INVENTION, LOOK FOR THE GOLD COVER every month!

# How Spurious Gems

Some Professional and  
By A. N. MIRZAOFF

**T**HIRTY years or more ago, a Japanese, Kokichi Mikimoto, began his first investigations into the experimental production of fine pearls, but the results he obtained were imperfect for a long time. Meleagrine oysters gave "half pearls," having a beautiful luster, but only on a restricted area of their surface.

Later on the tenacious Japanese investigator managed to solve the mystery of the formation of pearls. He saw that the real fine pearl, independent of the shell, was imbedded in the depth of the tissues of the mollusk, in an epithelial sack. Basing his work on these facts, Mikimoto imbedded in the tissues of his "marine co-worker" pearl-sacks already made and on opening the oysters, after the expiration of some years, he found nacreous cores uniformly covered with an opalescent substance. And now the pearls, coming from his beds installed in the Bays of Ago and of Bokasho, district of Shima, Japan, seriously compete with true natural pearls of Ceylon, because experienced jewelers have often great difficulty in distinguishing one from the other with the naked eye. A method of detecting these man-made gems has recently been proposed by M. Szilard, a French physicist, and is outlined on these pages.

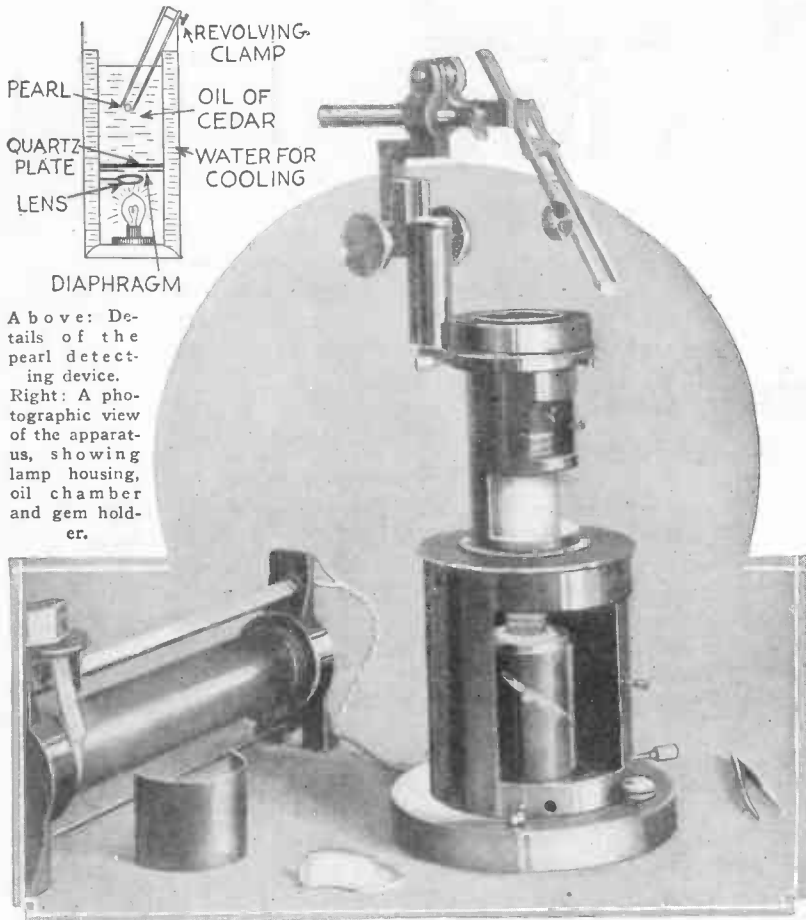

Above: Details of the pearl detecting device.  
Right: A photographic view of the apparatus, showing lamp housing, oil chamber and gem holder.

The diagrammatic view in the upper left hand corner shows the principle upon which the Rosenthal lucidoscope operates after it has been adapted to the detection of cultivated pearls.



Above: Operating the modified Rosenthal lucidoscope used in detecting the genuineness of pearls.

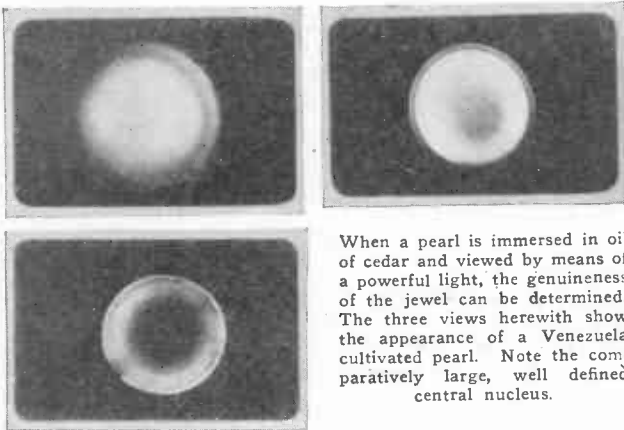

When a pearl is immersed in oil of cedar and viewed by means of a powerful light, the genuineness of the jewel can be determined. The three views herewith show the appearance of a Venezuela cultivated pearl. Note the comparatively large, well defined central nucleus.

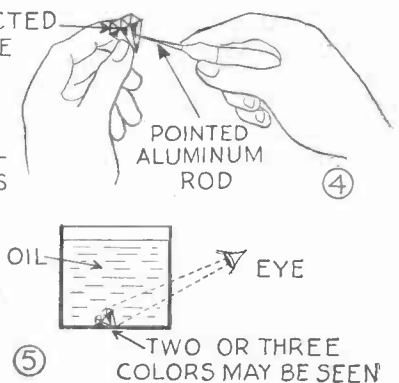
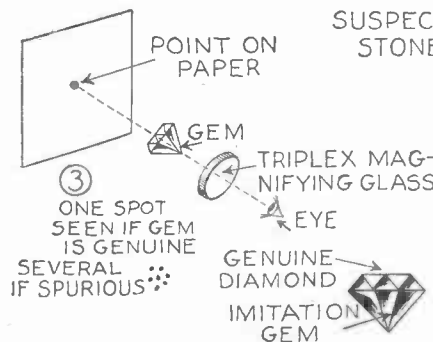
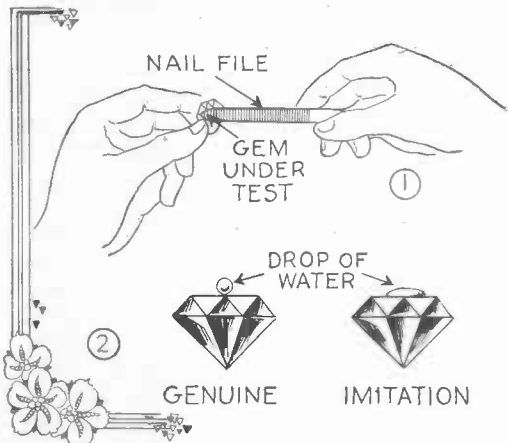

# May Be Detected

Amateur Methods Outlined

and A. P. PECK

AFTER having dissected thousands of genuine and imitation pearls, M. Szilard found certain differences in them which could be detected by means of an optical effect. He modified the Rosenthal lucidiscscope so that when the little vessel shown in the detail on the opposite page was filled with oil of cedar, a suspected pearl could be placed therein and viewed by means of a powerful light. In this way, the striations and nucleus in a pearl could be seen and after months of experimental work, the effects thus made visible were classified so that the genuineness of the gem could be immediately determined by sight. When desired, a camera as shown at the right could be placed in position to permanently record the appearance of the gems.

Some of the observations made with the lucidiscscope were as follows: A genuine pearl showed a very small translucent nucleus and viewed from different angles, the pearl changed neither in color or outline. A Venezuela pearl shows a more sharply defined nucleus, larger than that of the Oriental pearl. A Japanese cultivated pearl shows a dark central nucleus and when it is turned, while being viewed in the oil of cedar, distinct striations become visible.

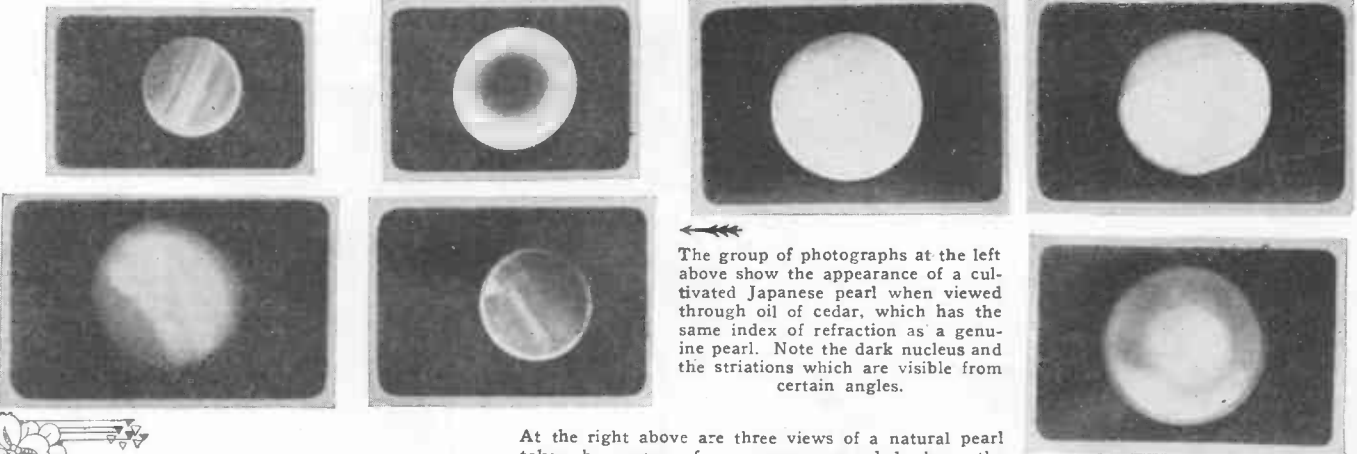
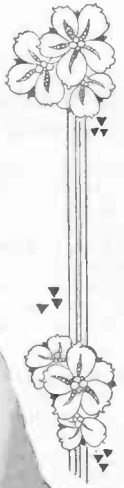

The group of photographs at the left above show the appearance of a cultivated Japanese pearl when viewed through oil of cedar, which has the same index of refraction as a genuine pearl. Note the dark nucleus and the striations which are visible from certain angles.

At the right above are three views of a natural pearl taken by means of a camera suspended above the lucidiscscope as in the upper righthand corner. Note the uniformity of the gem when viewed from various angles.

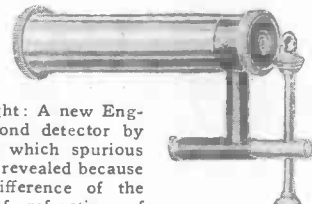
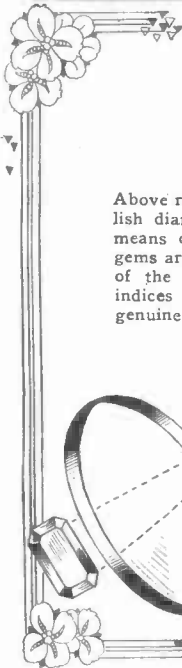

Above right: A new English diamond detector by means of which spurious gems are revealed because of the difference of the indices of refraction of genuine and imitation gems.

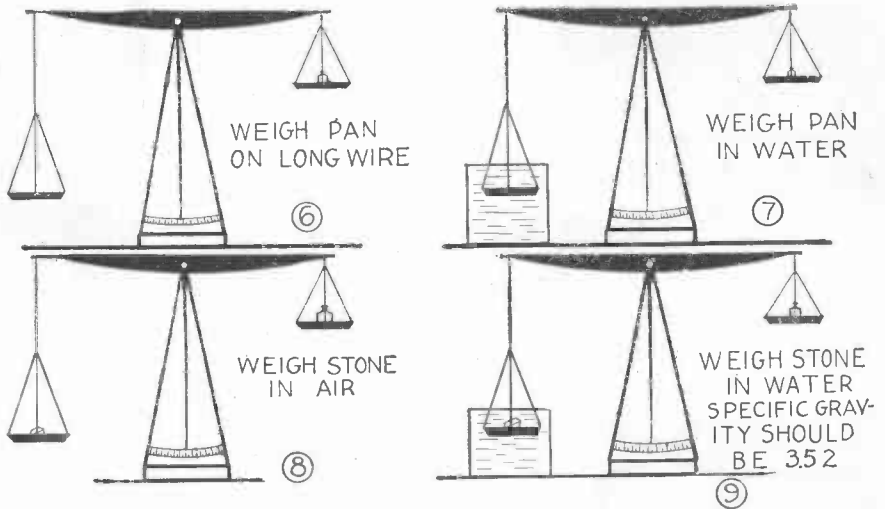
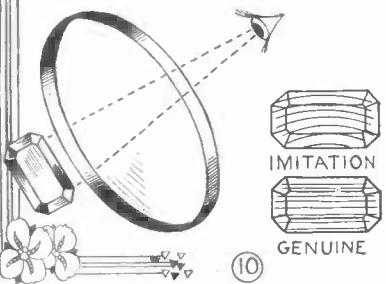

On this and the opposite pages are outlined various tests for determining the genuineness of gems. 1. A nail file will scratch an imitation diamond, but will not harm the surface of a genuine stone. 2. A drop of water will keep its spherical shape on the "table" of a genuine diamond, but will spread out on an imitation. As in 3, a point on a piece of paper viewed through a suspected stone will be seen as shown if gem is genuine. Several spots will be seen if it is an imitation. A mark on a clean genuine diamond with a pointed aluminum rod can be easily erased, whereas on a clean imitation it is hard to remove. Doublets or

triplets, as in 5, may be detected by viewing through oil as shown. The specific gravity of a gem may be determined as in 6 to 9. The formula for determining the specific gravity is Specific Gravity = Weight in air ÷ Loss of weight in water. These figures are obtained as shown. The weight of the pan in 6 and 7 is deducted from the total weights in 8 and 9, respectively. If an imitation ruby is viewed through a magnifying glass, curved striations will be seen as in 10. The striations are straight in a genuine ruby.

# Ancient Burials

## Recent Discovery of Deepest Tomb Supposed To Be King Sneferu's

From time to time, Egyptologists have made remarkable discoveries in their explorations in various parts of Egypt. Many interesting facts have been unearthed by these untiring workers and much has been added to the knowledge that is available of the ancient Pharaohs, their customs and the ways in which they were buried. The latest discovery is of an extremely deep tomb and it is reported that the remains contained therein are those of King Sneferu.

The photograph at the right shows the arid country in which recent discoveries have been made. The arrow indicates the spot where Egyptologists of Harvard University and of the Boston Museum of Fine Arts in charge of Prof. George A. Reisner started excavations which eventually resulted in the discovery of one of the most remarkable tombs yet viewed by modern man.

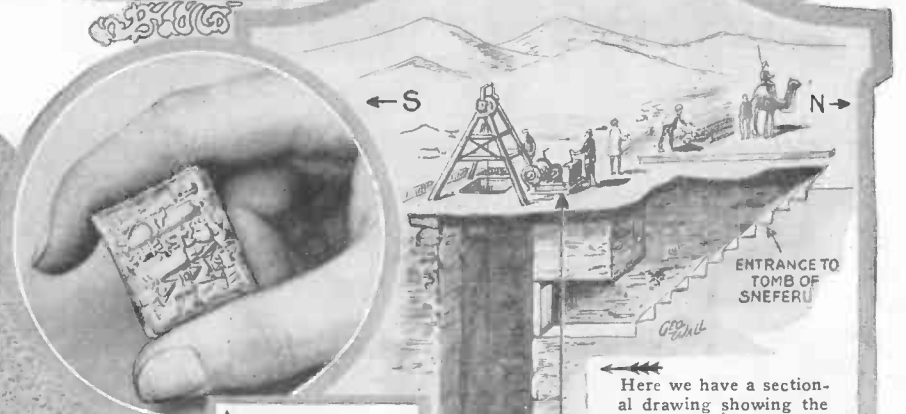
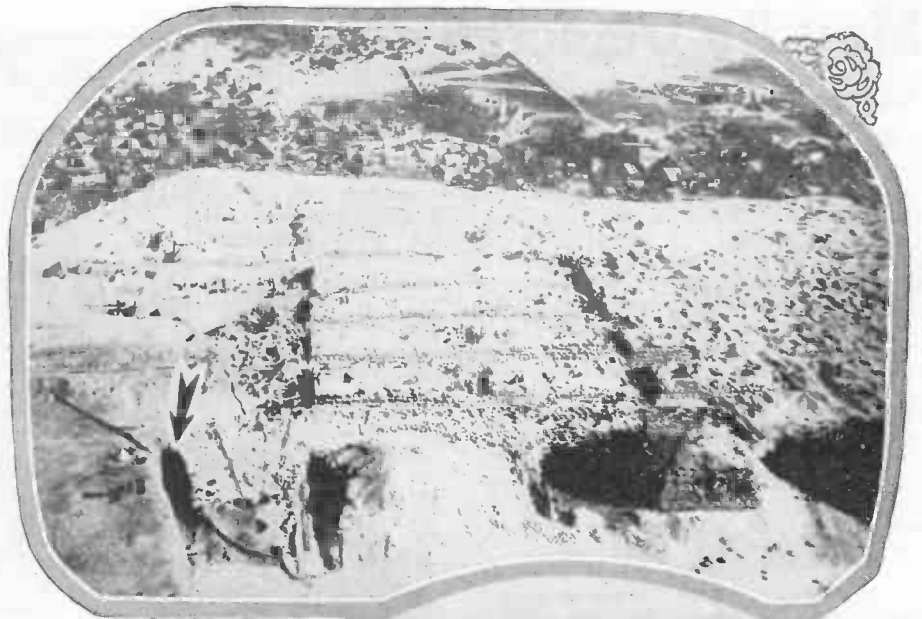

An interesting bit of ancient writing. The stone tablet shown is a butcher's bill for the delivery of three lambs.

Here we have a sectional drawing showing the unusual and interesting constructional details of the burial chamber which is supposed to be that of King Sneferu, an ancient Pharaoh of Egypt, who lived about 3000 B. C. or nearly 5000 years ago. If this tomb is not that of the King, it has been definitely ascertained that it is at least the final resting place of one of his immediate family. To gain access to this tomb it is necessary to be lowered by means of a rope down into a shaft 90 feet deep and 10 feet square. Part way down an observer will notice a niche cut in the side of the shaft where relics, offerings and personal belongings of the deceased are placed. Communicating with the shaft by a small door is the burial chamber about 18 feet square and 12 feet high.

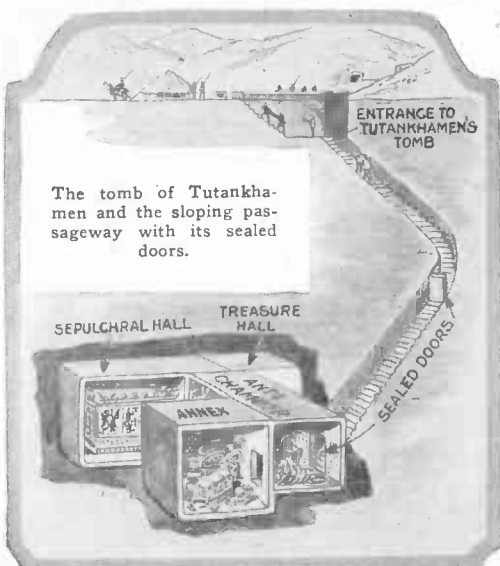

The tomb of Tutankhamen and the sloping passageway with its sealed doors.

The photo directly above shows the Great Pyramid of Giza near which the entrance to King Sneferu's tomb was discovered. If the excavations in this vicinity yield the material that it is hoped they will, the relics found will be even greater in historical value than those found in the famous tomb of Tutankhamen illustrated at the left. Another type of burial tomb found in Egypt is shown at the right. Here a tunnel 300 feet long has been dug into the side of a mountain, and various intercommunicating chambers built, ending in the burial tomb.

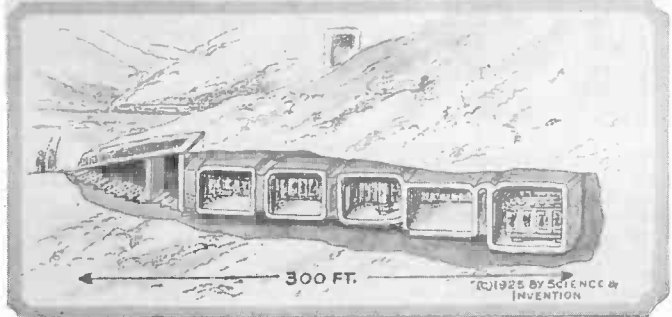

# How Bees Talk

Some Wonderful New Discoveries About Our Friends the Bees



Left: The specially constructed bee hive used in studying the methods employed by bees for communication among themselves.

Left: A maze through which a bee, marked as below, slowly found his way from the hives to the flowers. He then returned, told of his find and lead the entire colony to the flowers. The experimenter studied the actions of the marked bee and learned many things. This work was done by Dr. von Frisch, German entomologist.



SLIDING SCREEN DOORS TO CONTROL THE BEES

SWARM OF BEES LED BY MARKED BEE

HIVES



One bee makes on an average 32 honey-gathering trips during his lifetime. He collects approximately .8 gram of nectar. One pound of honey represents the entire life-work of 567 bees. Bees are partially color blind as shown at the right.

.8 GRAM NECTAR DURING ENTIRE LIFE

1 LB. HONEY—ENTIRE LIFE WORK OF 567 BEES

		ACTUAL COLORS
RED	GREEN	
		AS THE BEE SEES THEM
BLACK	YELLOW	
		THE BEE SEES TRUE BLUE AND TRUE YELLOW BEST
BLUE	BLUE (AS EITHER)	

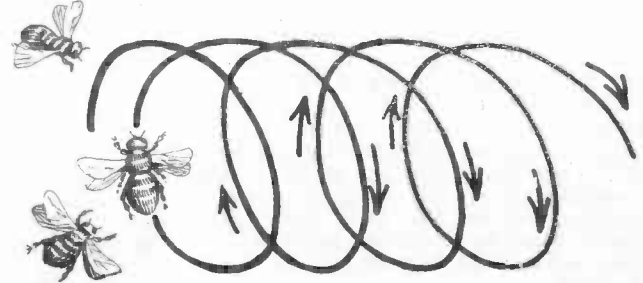
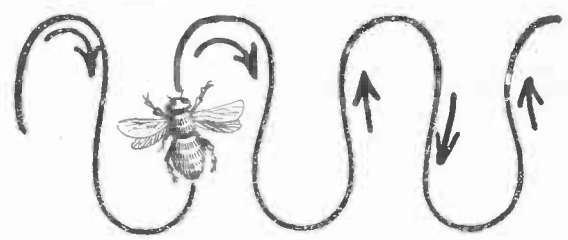
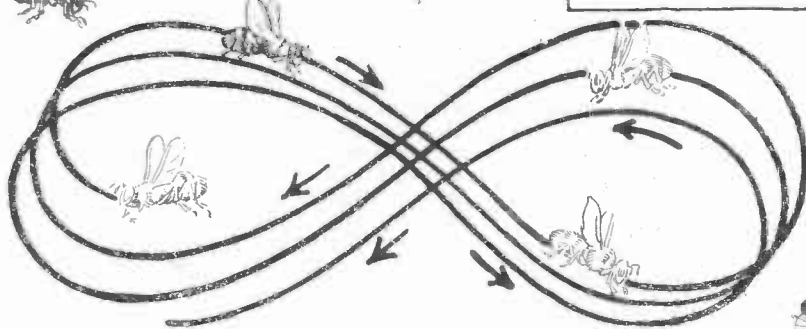

Assisted by the maze and the special hive shown above, Dr. von Frisch discovered that bees communicate with each other by means of dancing and not by smell or vibration, as many authorities have attempted to show. A bee denotes confusion or doubt by means of the figure 8 dance shown above. When a bee is going to start to search for pollen he performs a graceful undulating figure as at the right above. When a source of food or honey has been found he communicates this fact to his swarm by flying in a series of helical spirals as shown at the direct right.

# Hero's Magic Horse

By CHARLES BEECHER BUNNELL

Detailed drawings D1 and D2 below show how the horse's head remains attached to the body after the sword has passed through and also shows how the drinking tube opens and closes, first making way for the sword and then closing so as to allow the horse to "drink" by means of the partial vacuum formed in the chamber shown on the opposite page. The sword first revolves a wheel, M, which allows the sword to pass but still holds the horse's neck to the body by locking in the grooves. The sword then proceeds to first open and close the drinking tubes by means of segments, K and L.

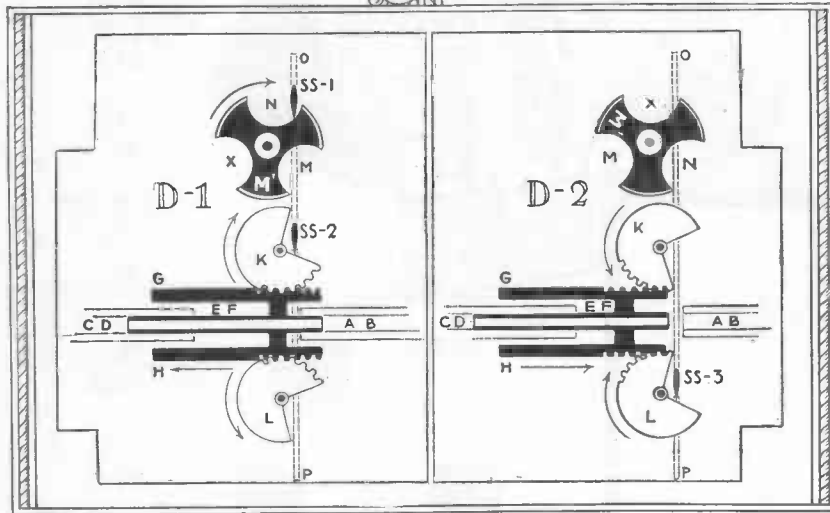
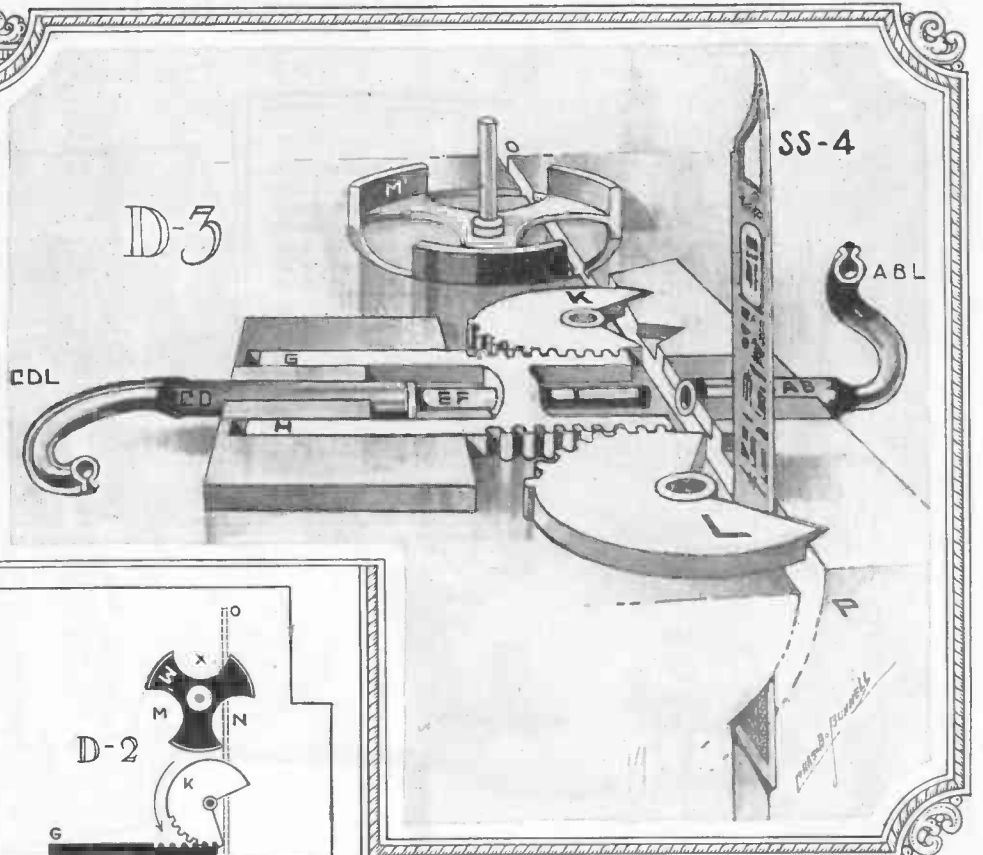

Above is shown a cross-section perspective illustration of Hero's magic horse's neck. The sword has nearly finished its passage through the neck and is about to actuate segment L, which, when rotated slightly, will close the drinking tube, telescoping section EF into section AB. The upper point of segment K will at the same time recede from its notch and that of L will lock into a similar notch.

**H**ERO'S horse is an animal which submits to having a sword passed through its neck from top to bottom, yet the head never falls. After the sword is passed through the neck and emerges therefrom, a cup of beer or other liquid is presented to the animal who coolly imbibes it, although the sword cut, it would seem should prevent it from drinking. If the reader will follow through the construction, he will see that the interlocking mechanism is such that the head is never released from the body, and that when the sword emerges, the head is locked fast just as it was before; he will also see that the tube through which the animal drinks is drawn out of the way of the sword by the cams, and reinstated after the sword has passed by it. And now we leave the further elucidation to the drawings and description. Hero's horse is absolutely authentic. It will be remembered that Hero was the inventor of the first reaction steam engine, and now after two thousand years, we are coming back to the reaction engine in the shape of a steam turbine and in a fair way to forget the work of Newcomen and Watt.

Don't decapitate, Mahh-Mood would have said. Long ago at the Gate of Mecca, the prominence of two bow-string executioners, reminded one that life there entirely depended upon one's ability to pronounce Mohammed's name, according to the school of Islam.

Our illustration shows Hero's 78th Propo-

sition before Ptolemy Euergetes. The chief Executioner has put his sword through the horse's neck several times—so he is now trying to saw his way down through it—without result. Then he silently wishes his own head was fastened as securely upon his own shoulders—for the Pharaoh might say something, you know. But he didn't. The ordinary Egyptians were apt to believe the horse was a son of Isis—for superstition was the rule of Egypt—as in no other way could the common people be held in control by the ruling classes. Still Ptolemy was surprised himself to see that *decapitation didn't decapitate*.

### "THE REVOLVING LOCK"

"D-1" shows the sword in its operation as follows: A cross section of the sword blade, shown in cross-section at "SS-1," has entered the slot at "O" and striking in the cleft "N" of the wheel "M" turns it exactly 120 degrees; this leaves it in the same relative position shown in "D-2"; thence the sword strikes the cam gear wheel "K" at "SS-2" in "D-1" which pushes the frame "GH" which holds the male cylinder "EF" to the left and out of the female cylinder "AB," whence the sword blade goes to "SS-3" in "D-2" where it strikes the cam gear wheel "L" which reverses the whole motion and reinserts the male cylinder "EF" into the female cylinder "AB," making an airtight joint; then the sword blade passes out of the slot at "P"—which completes the sword operation.

The third figure, "D-3," shows the sword "SS-4" striking the last geared cam "L"—and also the wheels "K" and "L" each in the notch lock—which could not be moved under pressure. Figures "CDL" and "ABL" are lead pipes soldered to the cylinders "CD" and "AB" to merely show how lead piping was made. The turning and boring of cylinders is described in Hero's *Pneumatika* in detail, and it may be found in all the manuscripts in Arabic, Greek and Latin. The casing which covers this mechanism fits like a mould, and if all the pivots were removed the wheels would perform accurately. Note that the rim on wheel "M" is not centered upon its spokes—but  $\frac{1}{4}$  of the rim is on one side and  $\frac{3}{4}$  on the other—so that while it is in its circular slot the exact center of the rim rests upon a slight ridge in its groove. Mechanically this quadruple lock of Hero's is equal to any modern gun lock so far devised.

### THE HORSE DRINKS

The bronze horse shown drinking his beer—operates as follows: "AB" and "CD" now being a siphon, its operation is started by the turning of the valve "S," whose handle is a soothsayer. That lets the water out of the airtight chamber "C-1"; this creates a vacuum whose suction starts the siphon "AB" and "CD" that runs through the horse's leg to its mouth—consequently the brassy animal can drink as long as supplied with any kind of liquid; in fact, he could drink more beer than an entire army.



Above we see the famous historical horse of Hero being demonstrated before Ptolemy Euergetes with astonishing results. His Royal Highness is surprised and amazed in the extreme to see that the bronze horse's head does not fall off after the wielder of the sword has passed his implement through it. This surprise is further heightened when a bowl of liquid is presented to the horse's mouth and immediately disposed of via the usual path of liquids, i.e., through the mouth.

Below we see the mechanism of the famous magic horse of Hero. A detail of the wheel M is shown and its position indicated in the horse. Further explanation is given on the opposite page. The action of the liquid reservoir W and the valve actuated by the statue S is plainly shown.

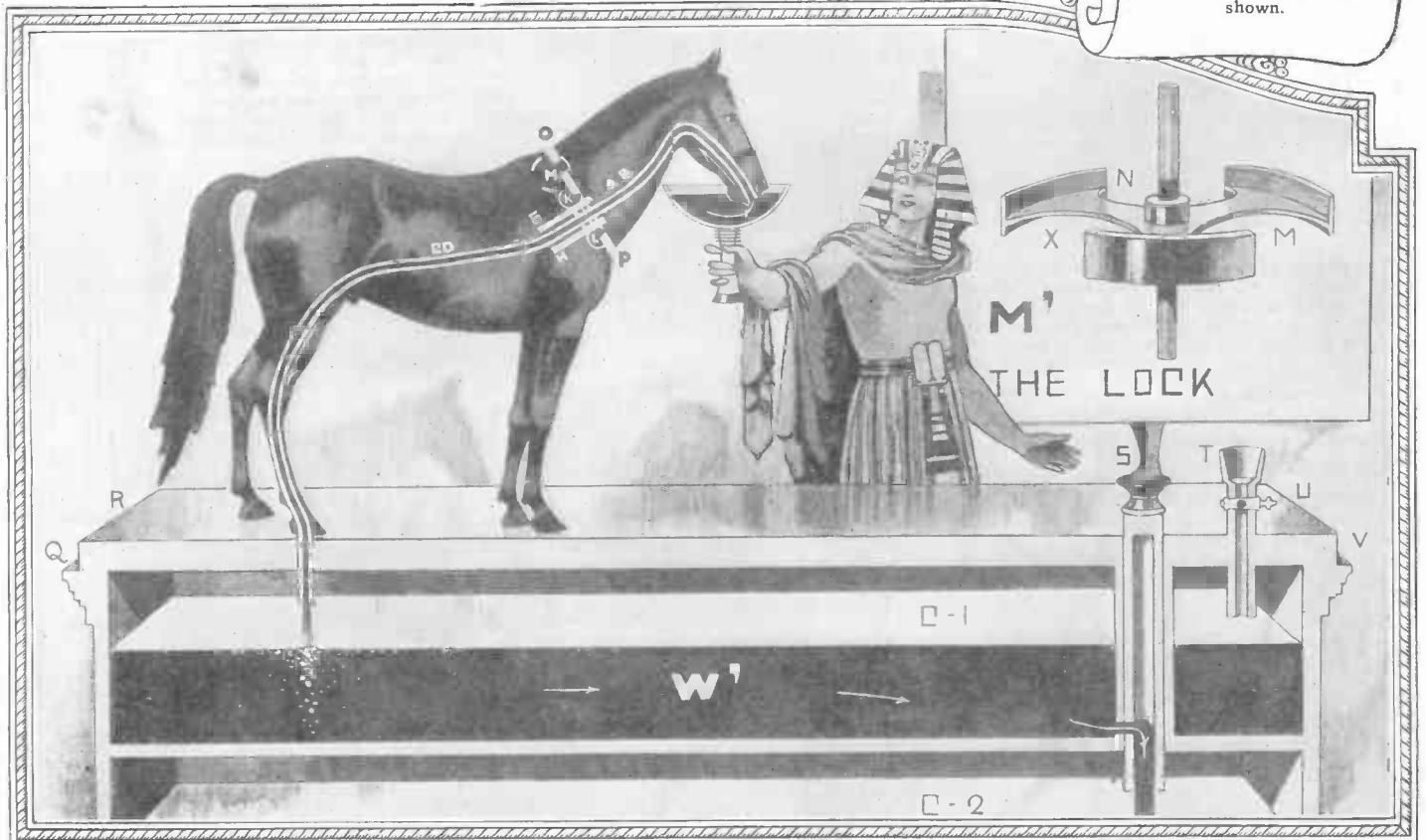

# Dashing Through Brick Wall, King of Thrillers

By JOSEPH H. KRAUS

THE ultimate in thrills illustrated on this page was designed for the Wembley Exposition in England. It resembles to a great extent the American scenic railways or switchbacks, as they are sometimes popularly called. The passengers are seated in cars coupled together in a train of threes. The cars are then drawn upward to a considerable height and are allowed to continue on the rest of their journey actuated by gravity alone. On descending one of the crests the passengers find their way blocked by what seems to be a solid brick wall. A crash seems inevitable. A moment later, however, the wall opens and the car dives through the opening thus formed. Several bricks secured to cables dangle perilously over the heads of the passengers. A few seconds later the car seems to be ready to plunge into a lake of water, but as it approaches the lake the water recedes, only to rush back again after the car has passed.

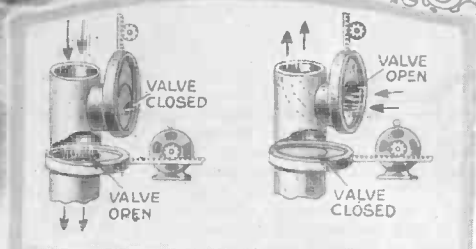
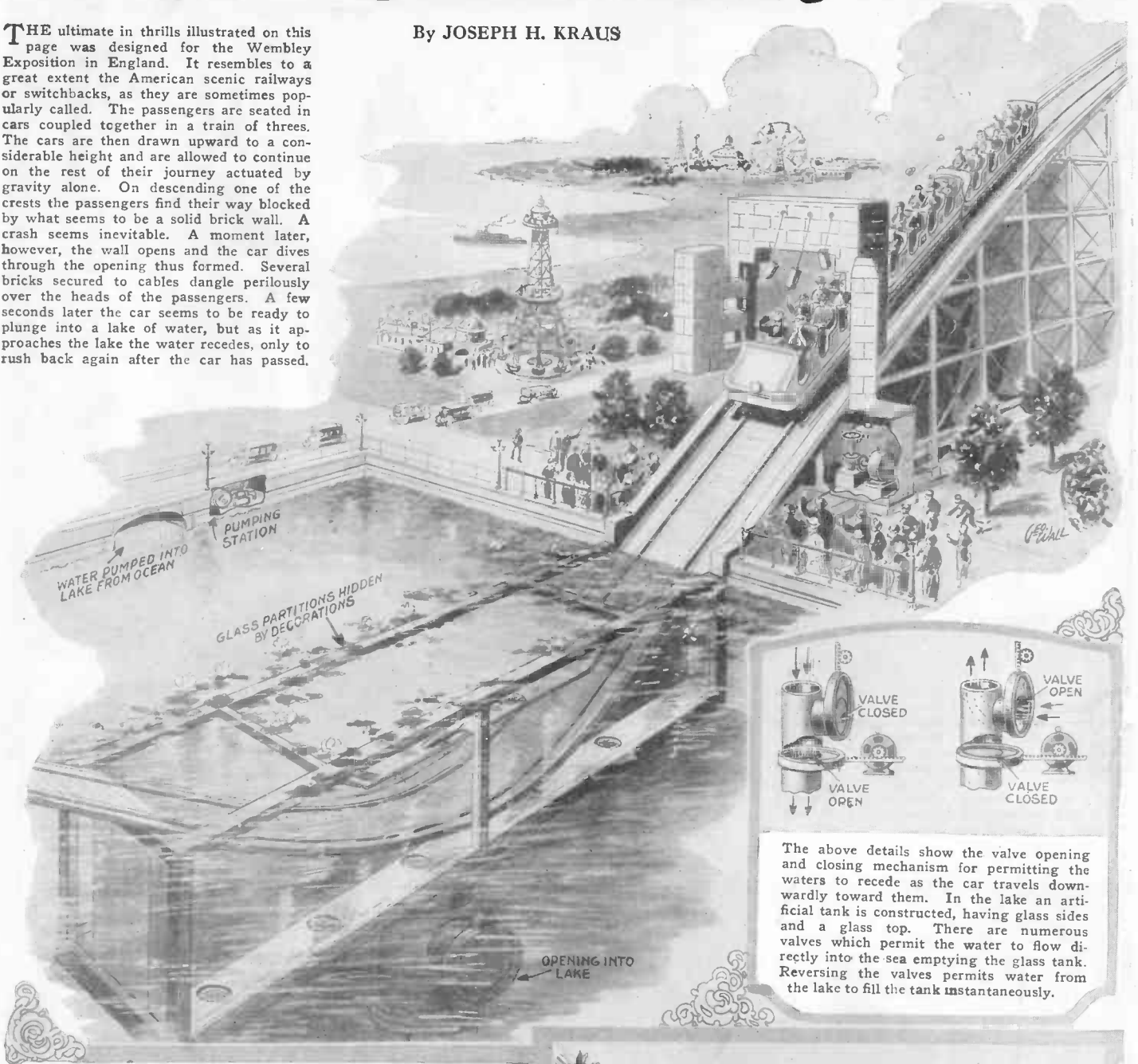

The above details show the valve opening and closing mechanism for permitting the waters to recede as the car travels downwardly toward them. In the lake an artificial tank is constructed, having glass sides and a glass top. There are numerous valves which permit the water to flow directly into the sea emptying the glass tank. Reversing the valves permits water from the lake to fill the tank instantaneously.

The system at the right shows the brick door opening mechanism. As the car travels downward, it closes the circuit to a motor through the agency of a shoe and an extra contact rail. The doors swing open, the bricks are lowered and the doors close again as the car closes the circuit to the motor after it passes through the opening in the wall.

The mechanism below shows in detail the circuit to the motor for operating the gates in the brick wall and similarly the water illusion.

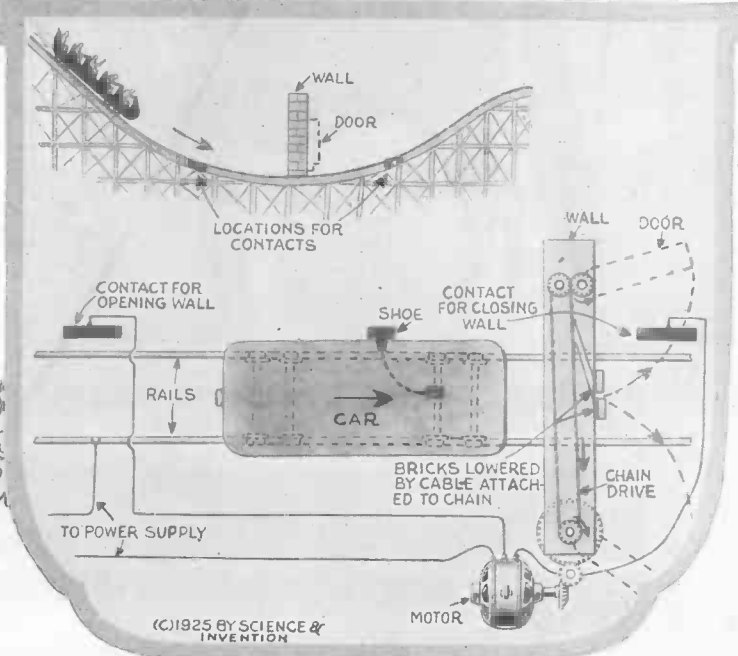
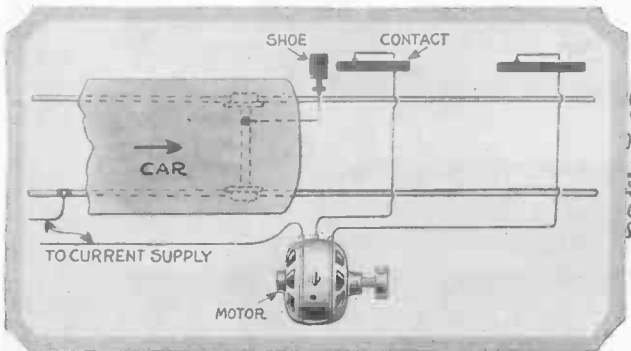

(C) 1925 BY SCIENCE & INVENTION



# Attaining World's Speed Records

By WILLIAM P. SULLIVAN  
AERONAUTICAL ENGINEER

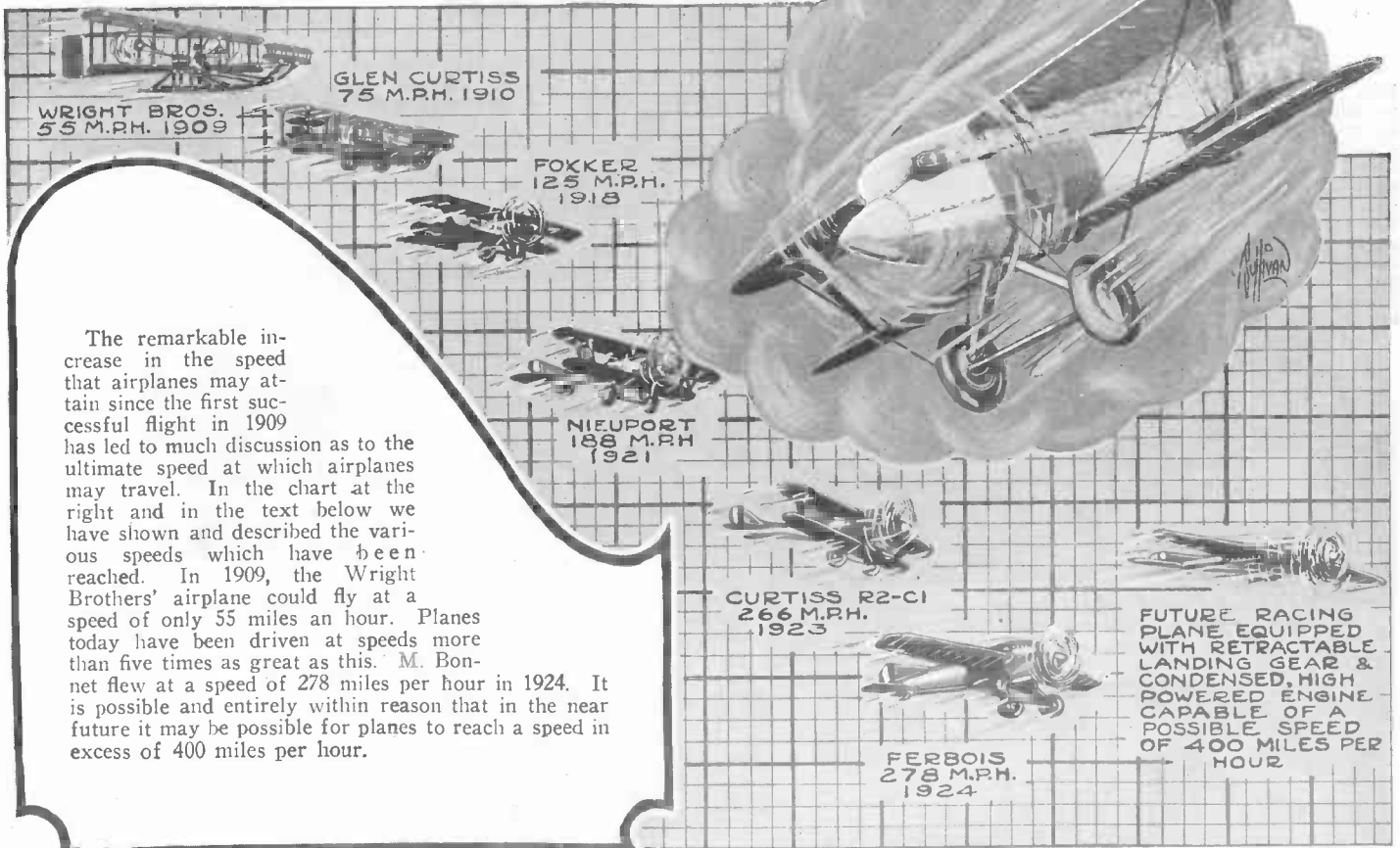

The remarkable increase in the speed that airplanes may attain since the first successful flight in 1909 has led to much discussion as to the ultimate speed at which airplanes may travel. In the chart at the right and in the text below we have shown and described the various speeds which have been reached. In 1909, the Wright Brothers' airplane could fly at a speed of only 55 miles an hour. Planes today have been driven at speeds more than five times as great as this. M. Bonnet flew at a speed of 278 miles per hour in 1924. It is possible and entirely within reason that in the near future it may be possible for planes to reach a speed in excess of 400 miles per hour.

**W**HAT will be the limit of man's speed through the air? Experts and engineers have tried to estimate this limit since the Wright Brothers made their first successful flight in a power-driven airplane. One hundred miles per hour was once considered an amazing speed limit for airplanes. This, with many estimates that followed, has been surpassed by the rapid advance of aircraft and motor designs, until up to the present time it is difficult to estimate what the maximum speed of future airplanes will be.

There are, however, two conditions to be considered, namely the mechanical limit and the physical limit. The latter has already shown itself in closed circuit speed trials, when making turns, due to the fact that centrifugal force begins acting on the blood,

forcing it away from the pilot's head and rendering him temporarily unconscious. While there are practically no physical defects noted in flying a straight course, outside of nerve strain, the mechanical limits are present. This is known as an airplane's speed range which is the difference between the low landing speed and the highest level flying speed, the definite landing speed desired becoming the point of departure in the design.

At the annual International Air Races a landing speed not to exceed seventy-five miles per hour is fixed, so that safety is not sacrificed in the work of science to advance the world's speed records.

As the airplane at present is the most effective weapon of war, due to its speed and maneuverability and with the leading

countries of the world striving to attain constantly increasing speeds, it is safe to estimate velocities in excess of 400 miles per hour in the near future.

The chart shows a few of the progressive speed records from the first flight of the Wright Brothers up to the present time. The photo insert shows the Curtiss R2-C1 diving to attain its maximum speed at the start of a speed trial just before leveling off at a point one kilometer from the starting line of the standard three-kilometer straight-away course. At this point these planes have attained a speed in excess of 350 miles per hour which leads us to believe that a prophecy of 400 miles per hour is not far off.

## Safety Auto Fender

The many accidents along public highways due to automobiles running into pedestrians have led many inventors to work on the problem of making automobile roads safe for those who are compelled to travel on foot. Many automatic fenders and devices of a similar nature have been brought out in the past, but most of them found to be entirely too complicated or so fragile in construction that they will not operate properly at all times. The one illustrated herewith is probably the most successful of any so far proposed.

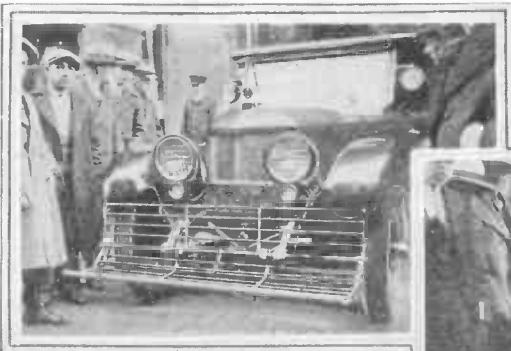

The new automobile fender in operating position ready to prevent the vehicle to which it is attached from running over any pedestrian.

When a pedestrian is run into as below, he falls upon the automobile fender and through a series of links, the rear wheel brakes are automatically set.

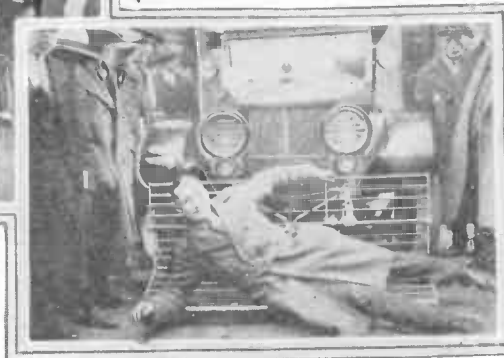

Many automobile fenders of a type similar to that shown herewith which have been proposed in the past only serve to pick up the person who is struck. In this device, the inventor goes a step further and connects the fender with the brakes so that when a person is hit, the brakes will be applied. This feature has other uses in that when the car equipped with this safety device strikes any object at all, the brakes will be applied and the likelihood of damage reduced. The device has been demonstrated.—Miss Marion E. Parsons.

# What To Do In Thunder Storms

By H. WINFIELD SECOR, E. E.

Keep away from isolated trees. A forest is a safe place, but single trees as at the right act as lightning collectors. The center insert shows the clothing of a man who was struck by lightning while taking shelter under a tree.

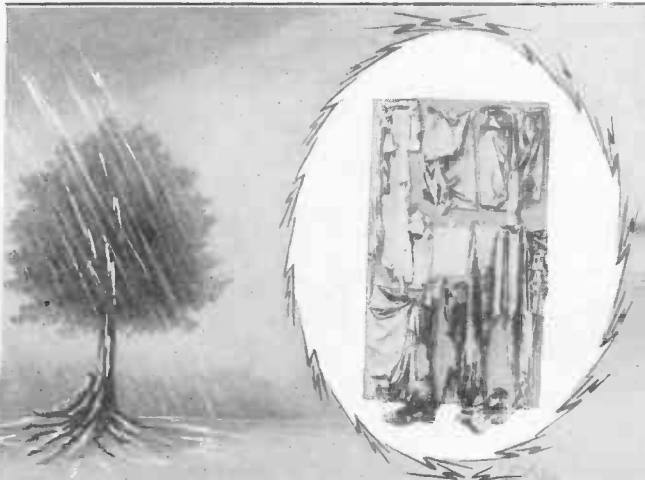

Keep away from wire fences and all outdoor wires. They also serve as lightning collectors. A metal bed is a safe place in a thunder storm, if you are well insulated from the frame by a mattress. Never touch the frame. Best of all, ground the frame.

ANIMALS BEING SHOCKED

INDUCED CHARGE JUMPING TO TREE (UNDER CLEAR SKY)

MAN BEING SHOCKED

All grounded metal objects act as atmospheric electricity collectors and reduce the possibility of lightning damage.

When indoors during a thunder storm, observe the rules illustrated below.

WET ROOF HELPS DISSIPATE ELECTRIC CHARGE

AERIAL LIGHTNING (GROUND) SWITCH OR ARRESTER

GOOD TO CONNECT RAIN LEADERS TO GROUND

DONT USE TELEPHONE

DONT SIT UNDER CHANDELIER

DONT PUT FEET ON HOT AIR REGISTER

DONT TOUCH STOVE OR KITCHEN SINK OR SPIGOT

## Lightning Rods Demonstrate Their Efficiency

By S. R. Winters

AN animated model which was designed to demonstrate the efficiency of lightning rods for the protection of buildings was recently designed and constructed by the United States Department of Agriculture. This demonstration illustrates statistics which show that of every 100 houses struck by lightning, 98 of them are not equipped with lightning rods. The visible portion of this exhibit is shown in the upper part of the illustration at the left. It represents a window covered with screen through which two houses may be seen, one equipped with a lightning rod and the other without this form of protection. At intervals of 7 seconds, flashes of lightning strike first one house and then the other. The one safeguarded by the rod is immune from the stroke while the unprotected house is set afire. The lightning flash is one second in duration, while the unequipped house apparently burns for a period of 14 seconds.

The operating mechanism for this ingenious display is concealed from the view of the spectators and is placed in the rear of the exhibit booth. The mechanism is shown in the insert at the left. There is a motor-driven "thunder" machine and a flasher which controls the "lightning." The thunder producer is a thin sheet of galvanized iron which is shaken mechanically. The lightning effect is caused by a spark with a make-and-break contact. The background of the exhibit is made up of galvanized iron covered with non-inflammable celluloid. Across this, the lightning is seen to flash. There are separate compartments back of the screen of this exhibit, one for each of the artificial lightning strokes. Some of the channels end at one house and some at the other. It is possible to thus control the respective flashes to obtain any desired effect. The burning effect is produced by colored lights.



The illustration above shows a new exhibition device which demonstrates the effectiveness of lightning rods. The operating mechanism is shown at the right.

# Rose Arbors

By WILLIAM BUTTERFIELD

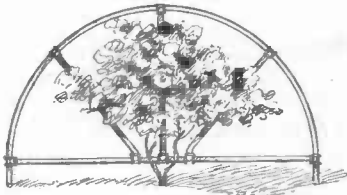

Above and left: Bow type of rose arbors.

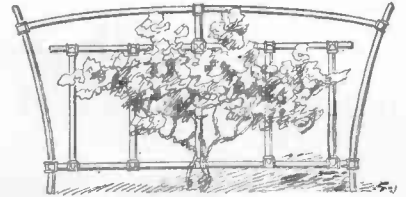
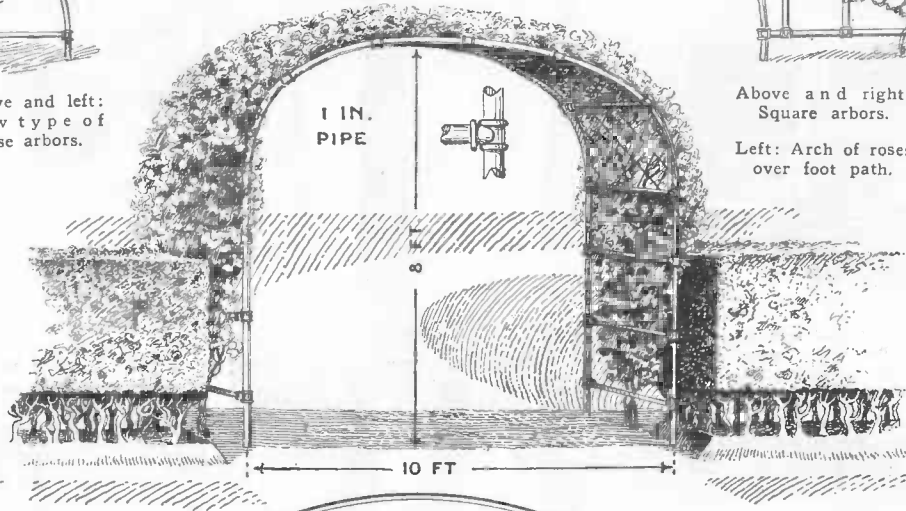
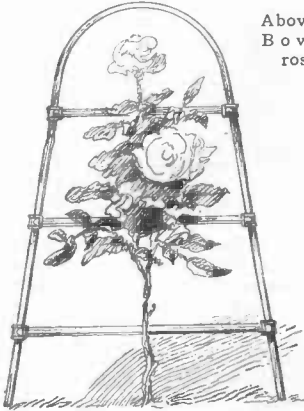

Above and right: Square arbors.

Left: Arch of roses over foot path.

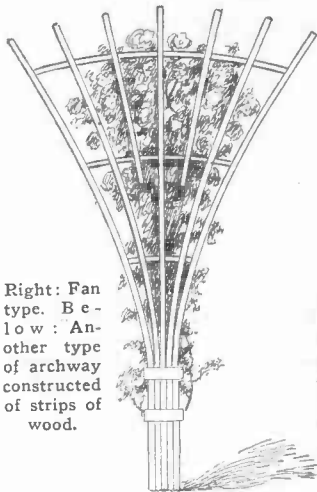
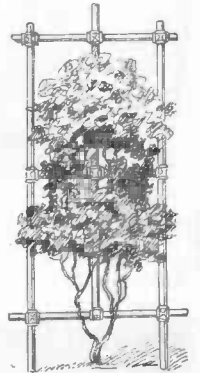

Right: Fan type. Below: Another type of archway constructed of strips of wood.

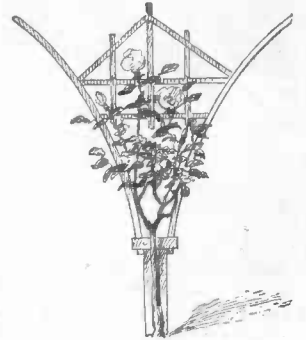
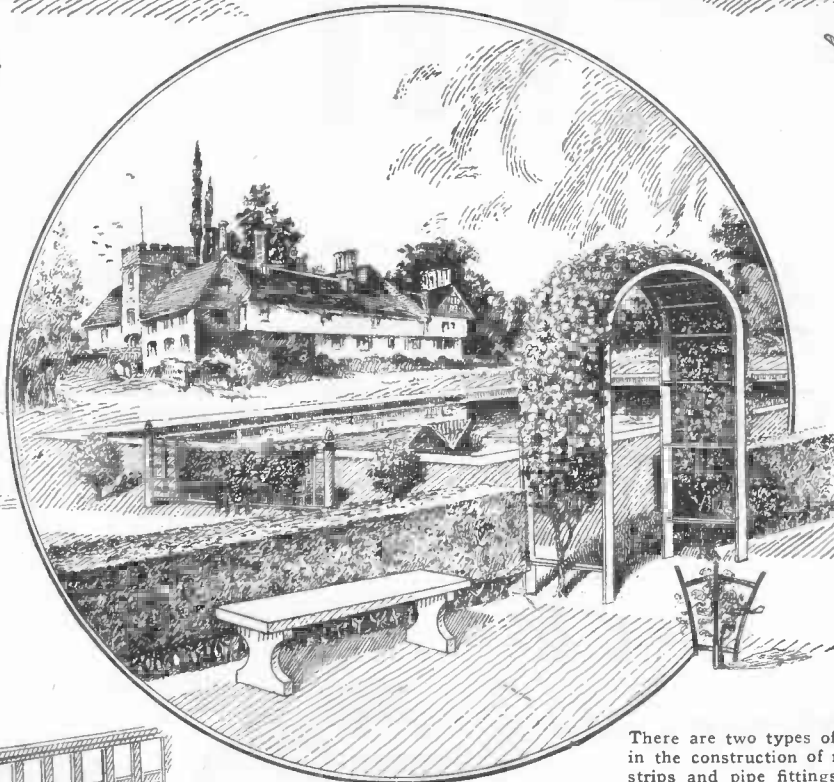

Above: Another type of fan-shaped trellis.

There are two types of materials which may be used in the construction of rose arbors. These are wooden strips and pipe fittings. Various details of different types are shown on this page. A very pretty arbor, the frame of which is made from pipe fittings, is shown at top center. A similar type, but of wooden construction, is shown in the center.

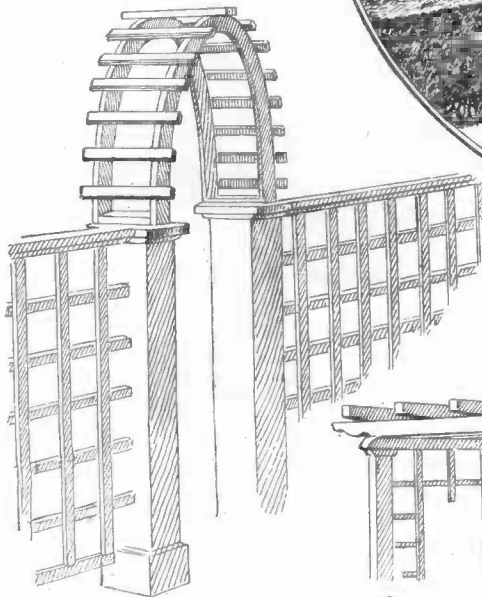

Left: A pretty decorative effect.

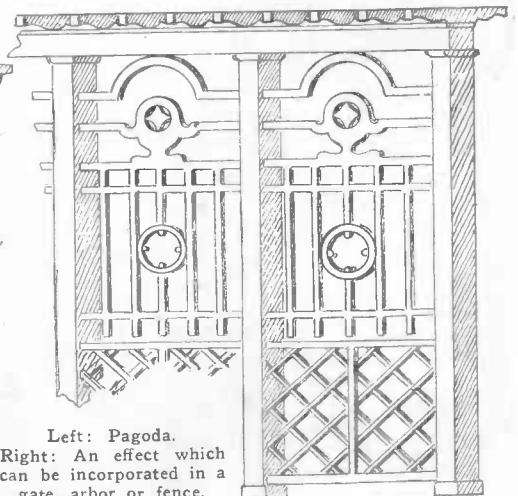
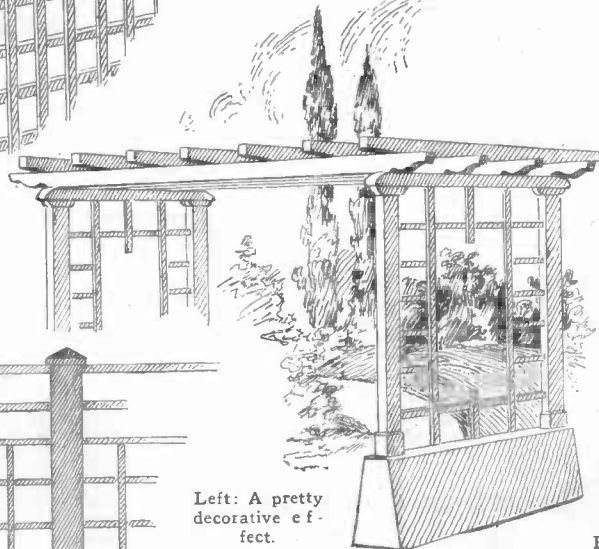

Left: Pagoda. Right: An effect which can be incorporated in a gate, arbor or fence.



One of the first aerial bombs that was ever used. It weighed ten pounds and was first dropped from a plane in 1910. It could do little damage and was hardly worth the trouble necessary to drop it.



The illustration above shows one of the present-day type of bombs carried by airplanes. Compare it with the one shown at the extreme left. The advance in aircraft warfare is obvious.

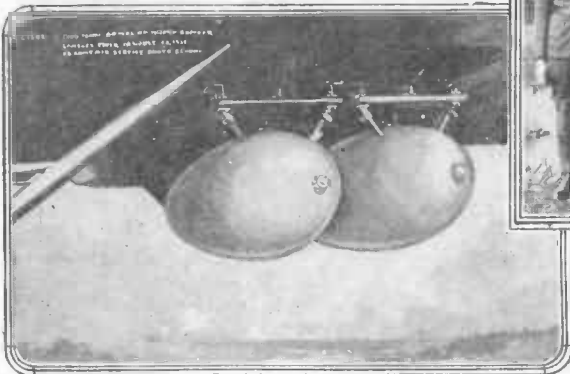

One of the methods used for carrying aircraft bombs under the wings of a plane, ready for instant release.

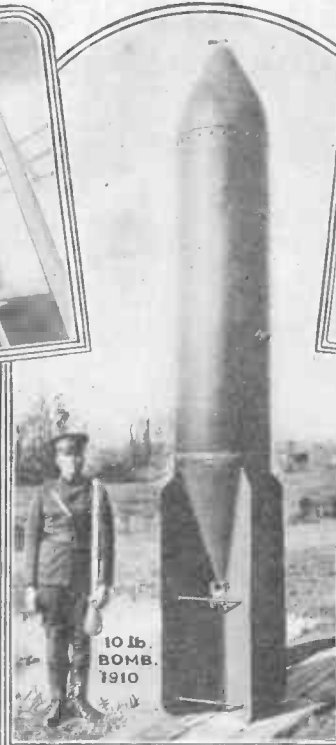

A 4000-pound aerial bomb compared with a man and with the 10-pound bomb of 1910.



A crater formed by the explosion of a 4000-pound bomb. The crater is 65.5 feet in diameter and 19 feet deep.

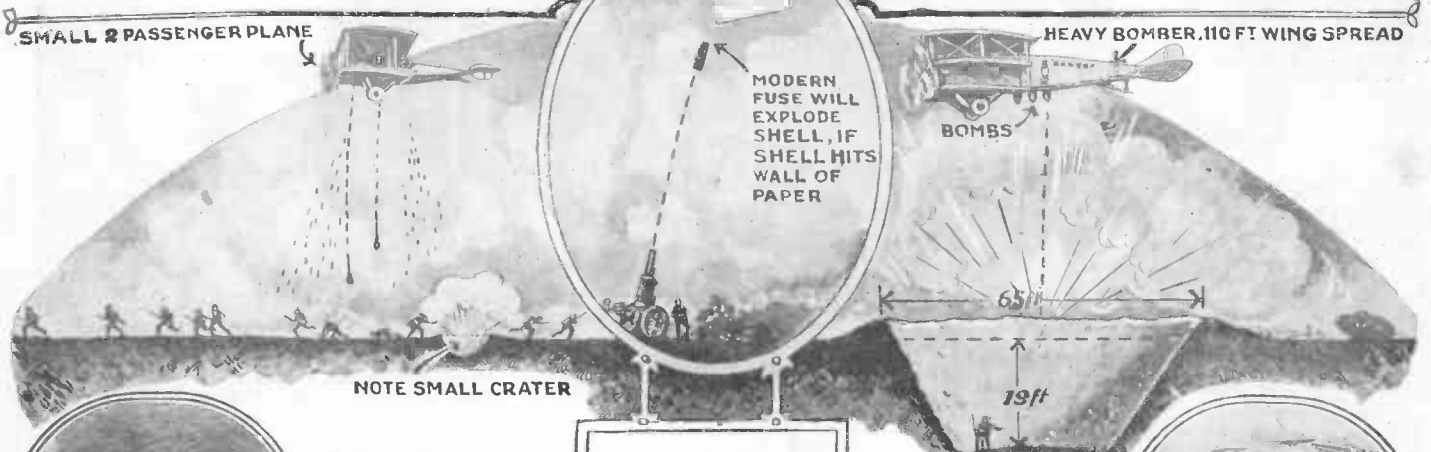

Left: The explosion of an aerial bomb near the bow of a battleship. In this particular case, the entire superstructure of the ship was demolished.

Anti-aircraft shells will explode upon contact as light as with a sheet of paper.

Right: The result of the explosion of a 25-pound bomb dropped from 500 feet. Above and left: Comparative results of old and new bombs.

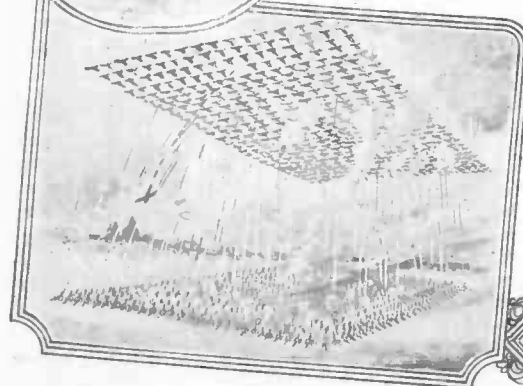

During the recent World War statistics show that for every thousand shots fired at airplanes, only one plane was brought down. Right: The device shown is for the release of aerial bombs at the proper moment. It allows for wind drift and for the speed of the plane.

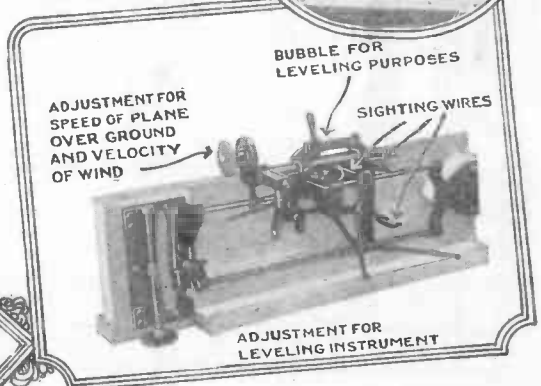

Official Army Air Service Photos.

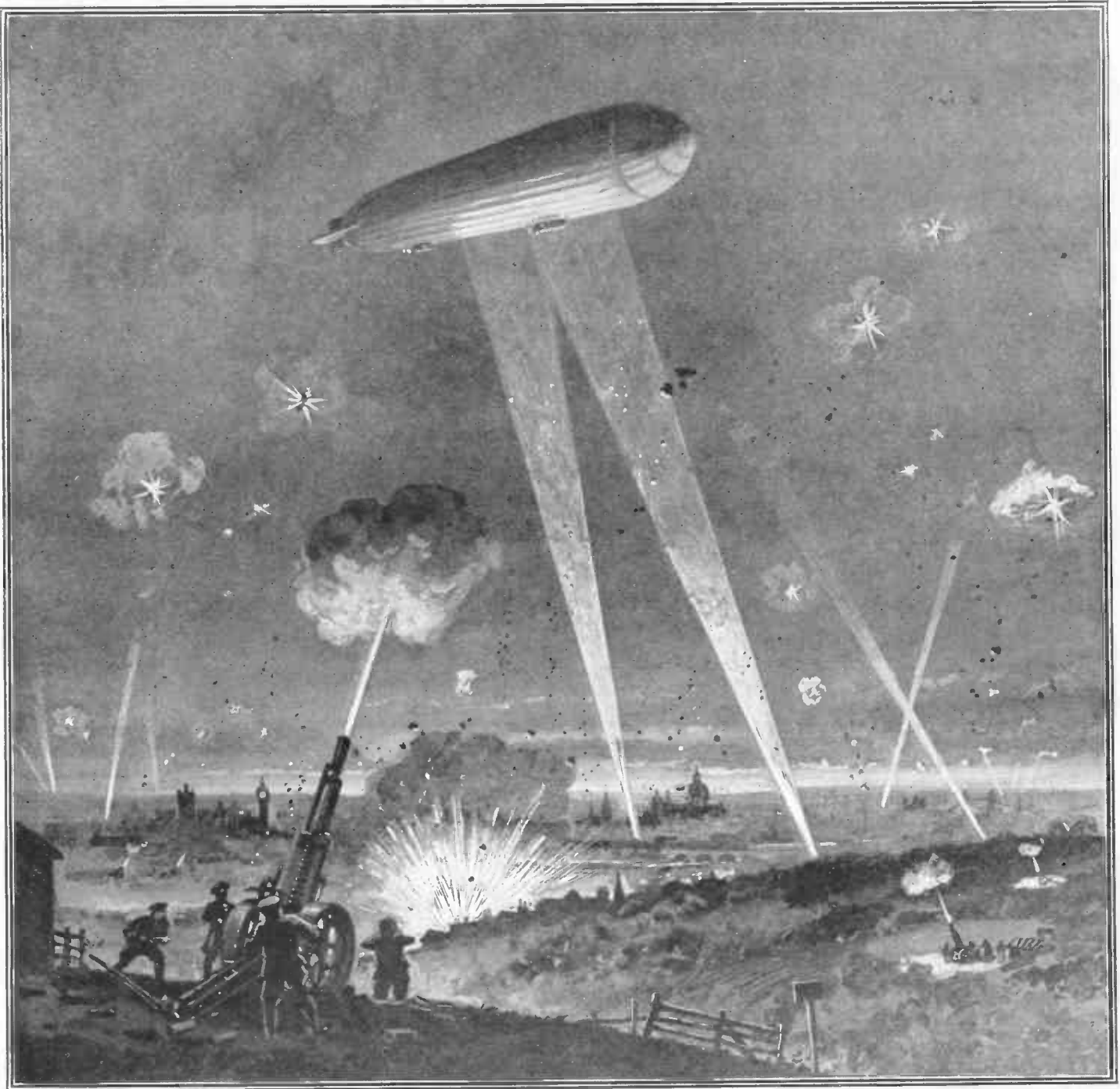

It was often said during the recent war that the anti-aircraft guns mounted around cities were so regulated that the shrapnel and shell fragments would fall within a certain deserted area. This has been

proven false and it has been shown that in the case of London many casualties resulted in the city due to shrapnel from the guns protecting the city falling in an occupied section.

## Aircraft Bombs Versus Anti-Aircraft Defense

By MAJOR H. H. ARNOLD, U. S. Army Air Service

**D**URING the period from the time that the Wright Brothers made their first flight until 1910 the airplane was accepted as a possible advancement in the army Courier Service and also as having certain unknown possibilities in making reconnaissances, but otherwise it was not considered seriously as a war machine. The military minds of the world were given a serious jolt, however, when at San Francisco, Cal., in 1910, Lieutenant Myron Crissy brought home to the thinking people the offensive possibilities of the airplane by dropping the first bomb ever released from an airplane. Although the bomb was dropped by hand, the feat was a decided step toward making aircraft the powerful offensive weapon that they are today.

The plane that he went up in could carry only a few pounds in addition to the pilot and the passenger. It was therefore very remarkable that the bomb was dropped at all. The bomb weighed only about ten pounds, was made of cast iron and had a long stick inserted in its tail to keep it in a straight line of flight.

### FIRST AIRPLANE BOMBING

No further developments were made until the Italians landed an expedition, in 1912, at Tripoli for operations against the Turks. The troops making up this expedition were accompanied by two planes but no one, not even the aviators themselves, would venture to predict what value, if any, the planes would be to the army. These planes made

reconnaissance of great value, by their presence alone caused much consternation among the Arabs and dropped bombs whenever they had the opportunity and could get the bombs. In some instances they dropped these bombs upon enemy encampments or masses of troops causing great havoc and many casualties. They used small fragmentation bombs which were dropped by hand but they had no means of determining the proper time to project them from the plane other than the judgment of the bomber. Accordingly they made more misses than hits.

Later in the same year, the Bulgarians in their war against the Turks made a rather important development, when they

*(Continued on page 370)*

# Are You Fit?

## Seven Health Tests For the Busy Man

By SAM BROWN

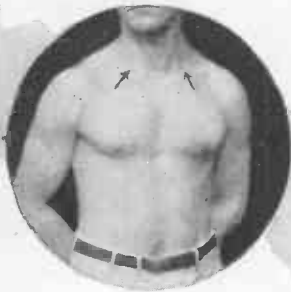

Have you hollows in your chest at the points indicated by the arrows deep enough to hold half a teaspoonful of liquid? If so you are not using your lungs to full capacity.



If you cannot lock your hands behind your back as illustrated at the left, your shoulder muscles are becoming stiff. Exercise daily to rectify the condition.



Do you lean your hands wearily on the arms of the chair to assist yourself to rise? If so, your abdominal muscles are not strong enough for the task.



Stand with your left side toward the wall in your room. Place the right foot on the wall seven inches from the floor. Then jump through the angle just formed. Failure indicates lack of coordination between mind and muscles.

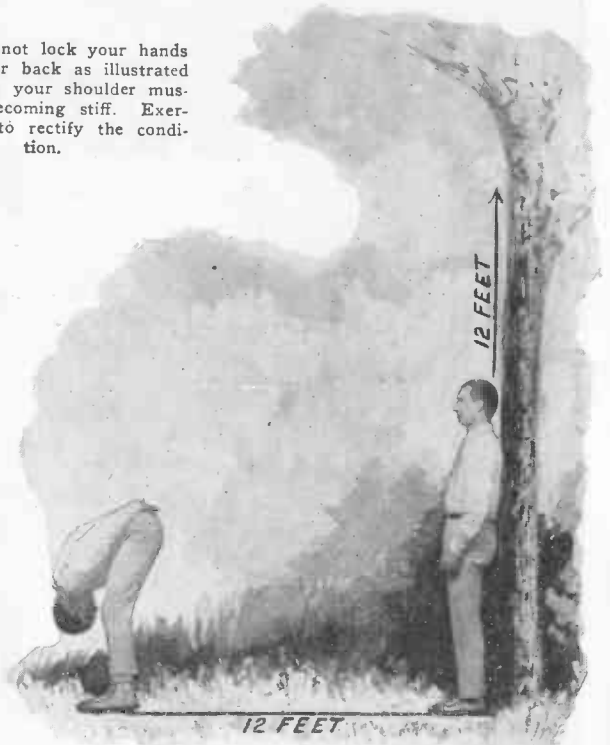

Can you tuck your head between your legs and sight the top of a tree 12 feet high when standing 12 feet from that tree? If not, abdominal muscles and muscles at the back of the neck need developing.



Place a match between the fingers of the left hand, and assume position shown in top photo above. Now let down, take the match from the hand with your teeth, and assume original position.

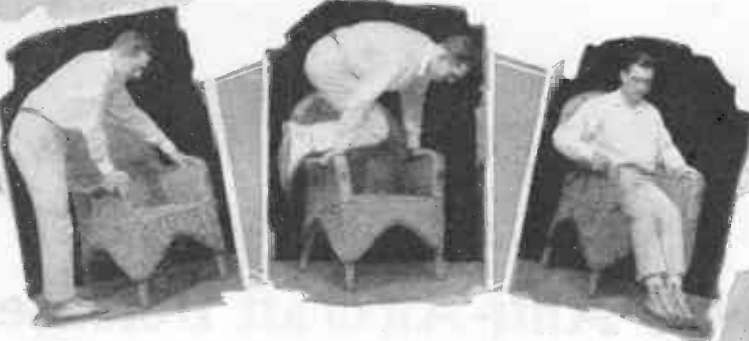

Stand beside a chair with arms as indicated above and then leap into it as illustrated. Reverse the action beginning at the position indicated, and wind up as illustrated in the photo at the left. If you cannot do this your sense of balance is warped, or you are lacking in muscular strength.

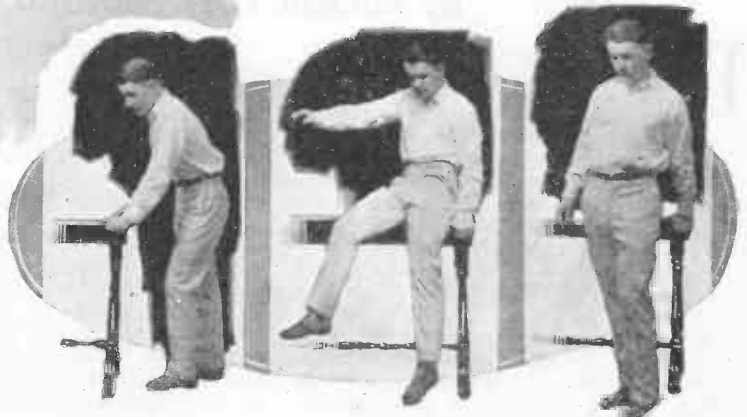

Can you vault over the library table, as indicated in the three photos at the right? If not, try to vault over the rail of a bed. Exercise and perseverance will make each of the simple health tests indicated on this page, easy. Try all the tests, credit yourself with ten points for each test thoroughly satisfactory. Fifty points is average, but not good. Forty points or under is bad.

Perhaps the most common of all gambling devices are the roulette wheels and other revolving devices. The manufacturers state that these machines require no attention, and percentages can be changed instantly. "It is just the machine to get the boys started, then keep them coming and the dollars simply roll into your till," reads one of the advertisements describing the revolving wheel here illustrated.

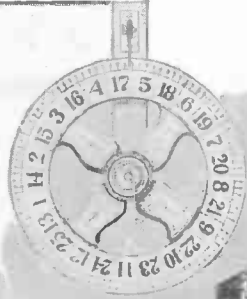

Dice dropped into a revolving tub as illustrated above are supposedly straight. However, it is a simple matter to drop loaded dice into the tub, or to place a large magnet beneath the device to control dice made for this purpose. The man who tries to beat the game never succeeds, and the house always wins.

# Cheating Cheaters

By JOHN J. BIRCH

THE traveling carnivals in their migration from city to city bring with them gambling devices, nearly all of which not only violate the laws of the various states, but are also "gimmicked" or controlled by the operator. The fact that these devices are adjusted so as to play unfair is best shown by the advertisements of the manufacturers themselves in their catalogs which they send only to men in the show business, or to others whom they can trust. Most of the carnivals open on Monday with all of the concessions operating on the square. Frequently carnival managers invite the officers of the law and reporters of newspapers to inspect their shows and games on the opening night, so as to secure their approval and get a good write-up in the local papers. The following night the "grifting" schemes start, and they increase from night to night until the entire show has been changed to an orgy of gambling, cheating and swindling. Games that were on the level are fixed. Many of them are instantly alterable, and none but the most experienced can detect the change. Should an enraged citizen who has been swindled lodge a complaint with the officers of the law and a raid be ordered, the carnival managers would be apprised of the facts beforehand, and when the city officials arrive on the lot, they find everything O. K. again. If any concessionaire should recognize an officer of the law, he warns his confederates by a peculiar intonation of his spiel.

Punch boards are gaining in popularity. The latest sensation is illustrated above. This is advertised for closed territory. It is a board arranged in the inside of a cigar box, so that when closed and placed among other boxes of cigars, it is incapable of easy detection. Aside from being safe, these boards often doubly protect by giving small returns for still smaller prizes. Punching the paper with a round stick gives prize number.



The device illustrated above shows a new kind of dice. These dice can be altered by simply tapping them on the table, or on some other hard surface, which automatically converts them into percentage dice. One manufacturer advertises, "This is the most mystifying dice ever produced, and represents a class of dice work that no one has yet been successful in duplicating."



If the device above is set level, the house gets a good percentage. If the house desires an extra percentage, the board is slanted a trifle. Some people are of the opinion that the Derby horse-racing game, the airplane flyer, the balloon game, etc., must be fair. The manufacturer says, "These outfits are under perfect control at all times."

This is an old game of throwing rings over small pegs. The distance seems so short, and the hoops so much larger than the pegs, and the prizes so large, that one is tempted to try the device. The person who tries his skill seldom succeeds, because there is a weight in one side of the ring which causes the ring to fall between the pegs rather than over them.



"Pop in the bucket" is a bucket mounted on a cord network. The manufacturer advises "the bucket is adjusted before being sent out, but always try it and see if the set-screw on the bottom of the bucket is properly set, so it will throw out the balls. The lower part of the bucket is so constructed that the balls will bounce out all the time."

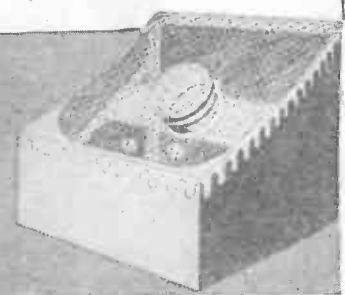

# Dynamiting Oil Fires

Oil well fires are very difficult to put out and all sorts of systems have been devised for extinguishing these blazes which annually cost millions of dollars. In one recent case, such a fire was extinguished in a novel manner by means of dynamite. The oil well fire continued to rage with undying fury in spite of the fact that sand, mud, live steam and carbon tetrachloride were being used singly and in combination to put out the conflagration. Then dynamite was decided on. One of the engineers threw a charge of dynamite into the midst of the flame. There was a terrific explosion, and the flames were seen to part. The upper part of the flames shot skyward, and the middle was violently thrown out horizontally; the bottom portion of the fire was snuffed out by the explosion of the dynamite. The fire ceased.

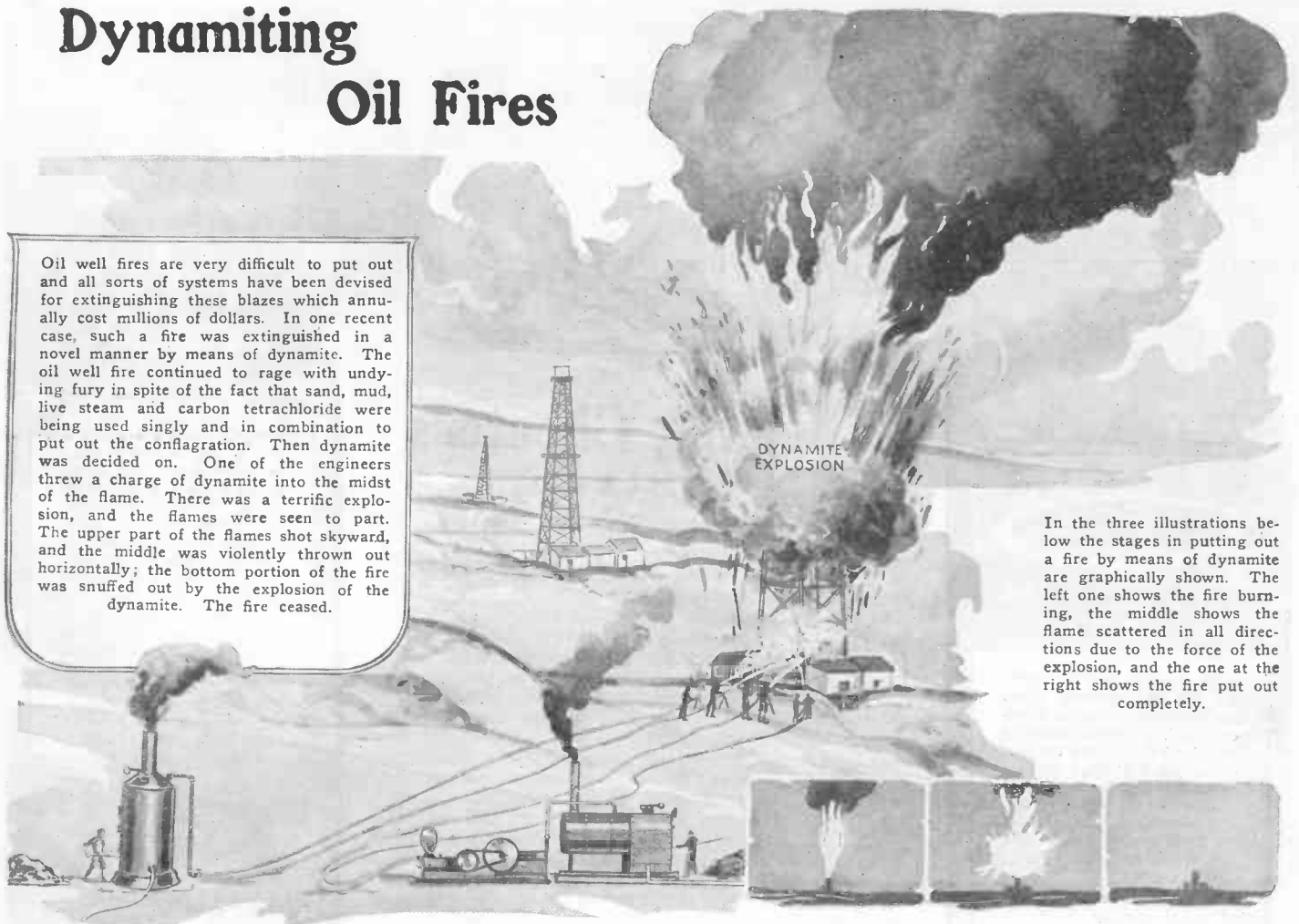

In the three illustrations below the stages in putting out a fire by means of dynamite are graphically shown. The left one shows the fire burning, the middle shows the flame scattered in all directions due to the force of the explosion, and the one at the right shows the fire put out completely.

# Hindu Rope Trick Exposed

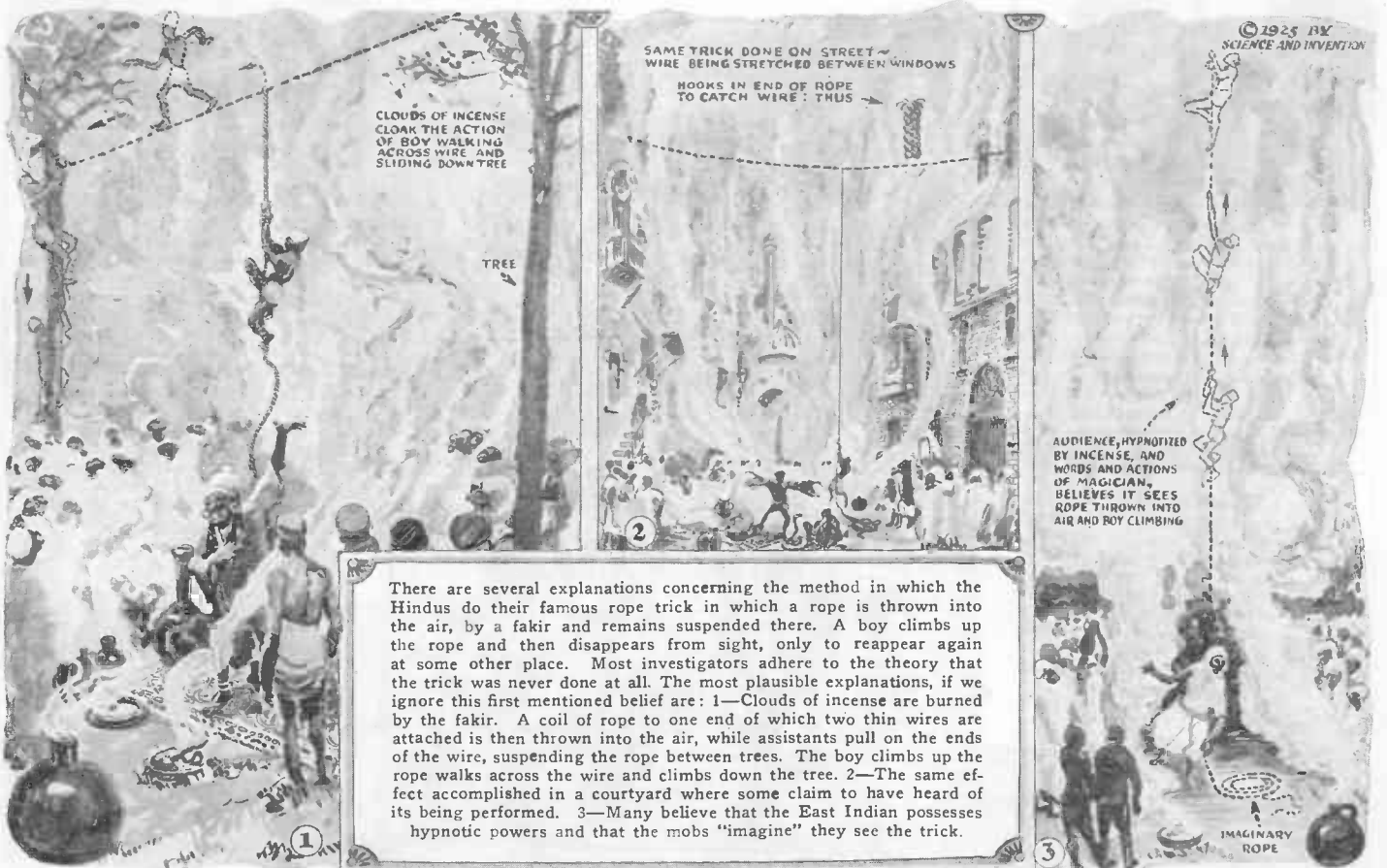

There are several explanations concerning the method in which the Hindus do their famous rope trick in which a rope is thrown into the air, by a fakir and remains suspended there. A boy climbs up the rope and then disappears from sight, only to reappear again at some other place. Most investigators adhere to the theory that the trick was never done at all. The most plausible explanations, if we ignore this first mentioned belief are: 1—Clouds of incense are burned by the fakir. A coil of rope to one end of which two thin wires are attached is then thrown into the air, while assistants pull on the ends of the wire, suspending the rope between trees. The boy climbs up the rope walks across the wire and climbs down the tree. 2—The same effect accomplished in a courtyard where some claim to have heard of its being performed. 3—Many believe that the East Indian possesses hypnotic powers and that the mobs "imagine" they see the trick.





One of the smaller boats in use for a day's outing. It can be inflated in 10 minutes and, equipped with a sail, makes a perfect camper's boat.

# Portable Pneumatic Boat

By G. H. WAETJEN

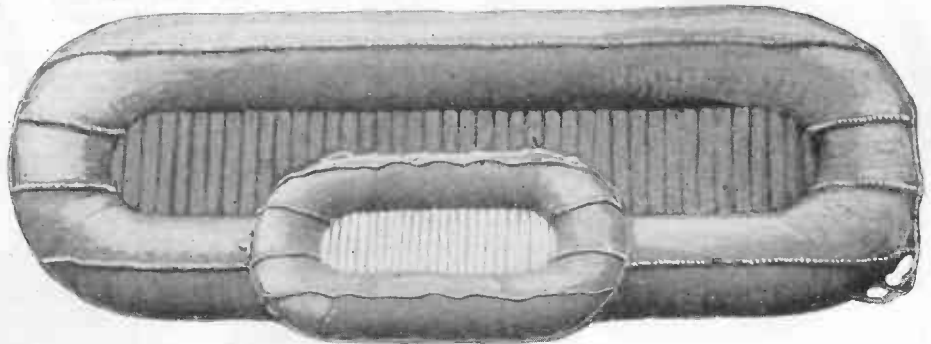

The largest and smallest sizes of collapsible portable boats capable of supporting 50 and 2 people respectively. These boats, manufactured by a German concern, consist of a central portion of wooden slats and a rim made in the form of an oval tube which is to be inflated by means of specially constructed pumps.



A pneumatic life boat used by Argentine Army. A corps of soldiers from the Buenos Aires Rifle School crossing a stream.

The pneumatic boat as a life saver for airships. Due to its extremely light weight, its compactness and the rapidity with which it can be launched, this boat is ideal for work of this nature. After inflation, the boat need merely be thrown overboard. No launching is necessary since either side is the right side and the boat is equally serviceable, regardless of how it lands in the water.

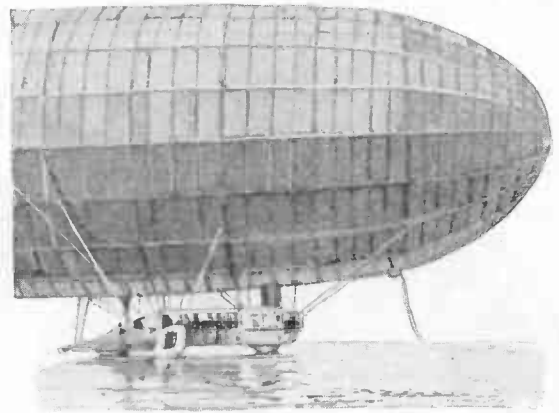

## Strange Photographs

The boat in transportation. A small light weight hand truck may be used for taking the boat from one place to another, or where such a procedure is undesirable, the boat may be carried on the back.



A small foot pump of the bellows type may be used for inflating the tube portion of this boat. Such a pump is illustrated in action at the left below.



The pneumatic boat described on this page is practically fool-proof. A strong outer covering of sail cloth prevents damage from stones and branches in the water and even if the air-retaining compartment is punctured, it can be quickly and easily patched.

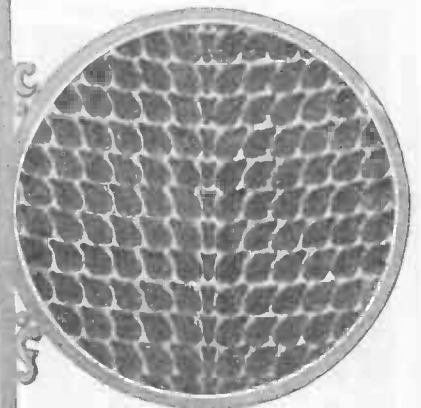
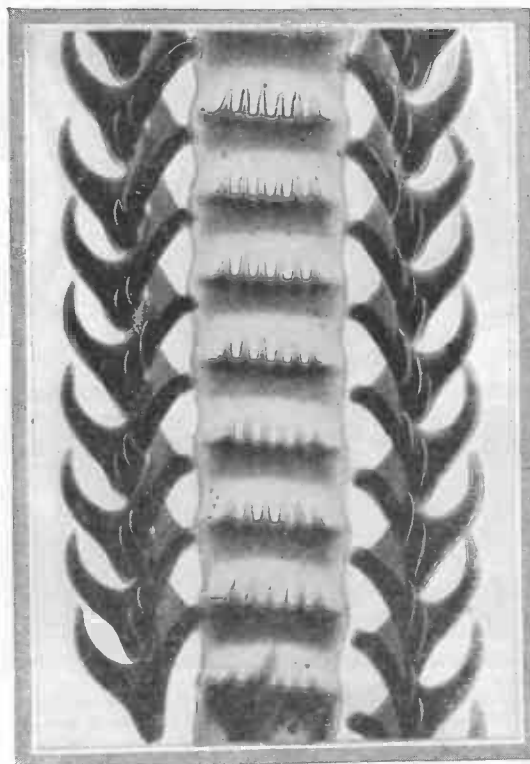

The micro-photographs shown are not new patterns in wire-work or skid-chains. Far from it! They are the greatly enlarged hair-teeth from the tongues of snails. These animals have innumerable microscopic teeth, which are characteristic of the various sub-species. Herbivorous snails have very small teeth, but many of the carnivorous kinds have larger ones, fewer in number. The difference between the two groups is clearly visible in the pictures. The carnivorous type is at the left.

# A Creature Without Blood Vessels

By DR. ERNEST BADE

Below The female of the Cyclops, showing the eggs carried in sacks, two of which are found on either side of the abdomen. The eggs are embedded in a gelatinous mass and hatch a larva which grows into the adult form. E<sub>1</sub> and E<sub>2</sub> represent eggs while D indicates the digestive organ. This creature has no blood vessels.

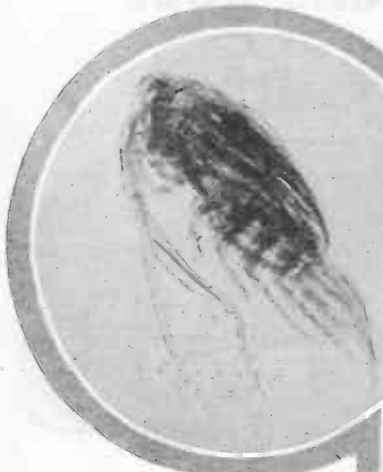

Above: The male of the Cyclops. These creatures belong to the lobster family and compose the food of young fish. They can be found at all times of the year in both fresh and salt water and their structure is so delicate that they breathe through the skin.

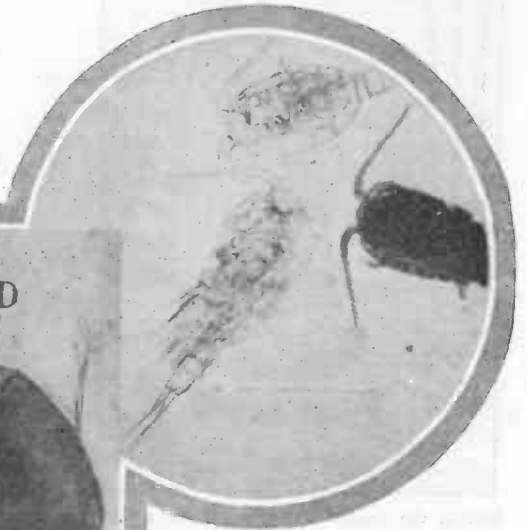
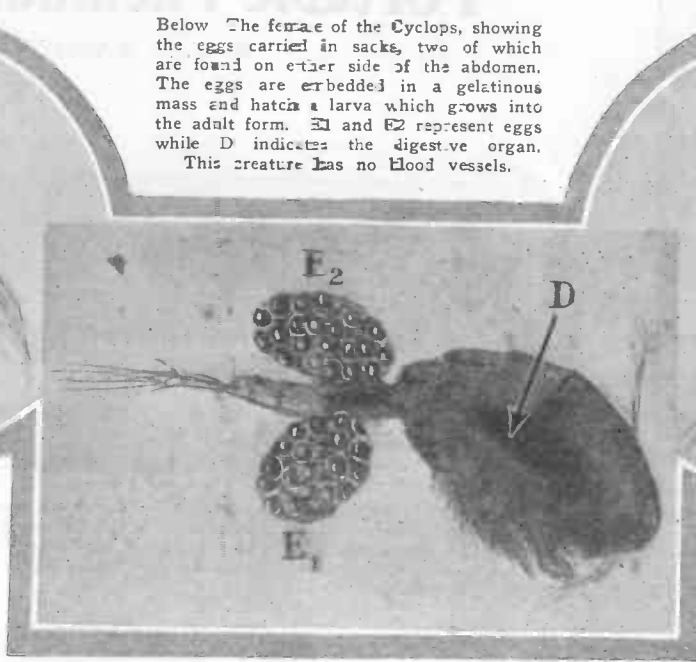

Above: Examples of two branches of the Cyclops family, one equipped with a heart while the two of the other family have no hearts. Members of both branches have only one eye.

# A Basket of Many Forms

The photographs below and at the left show various formations into which this trickiest of trick baskets can be formed with a single flip of the fingers. It is quite useful as a darning basket, toaster or hot plate support. Other uses will suggest themselves.

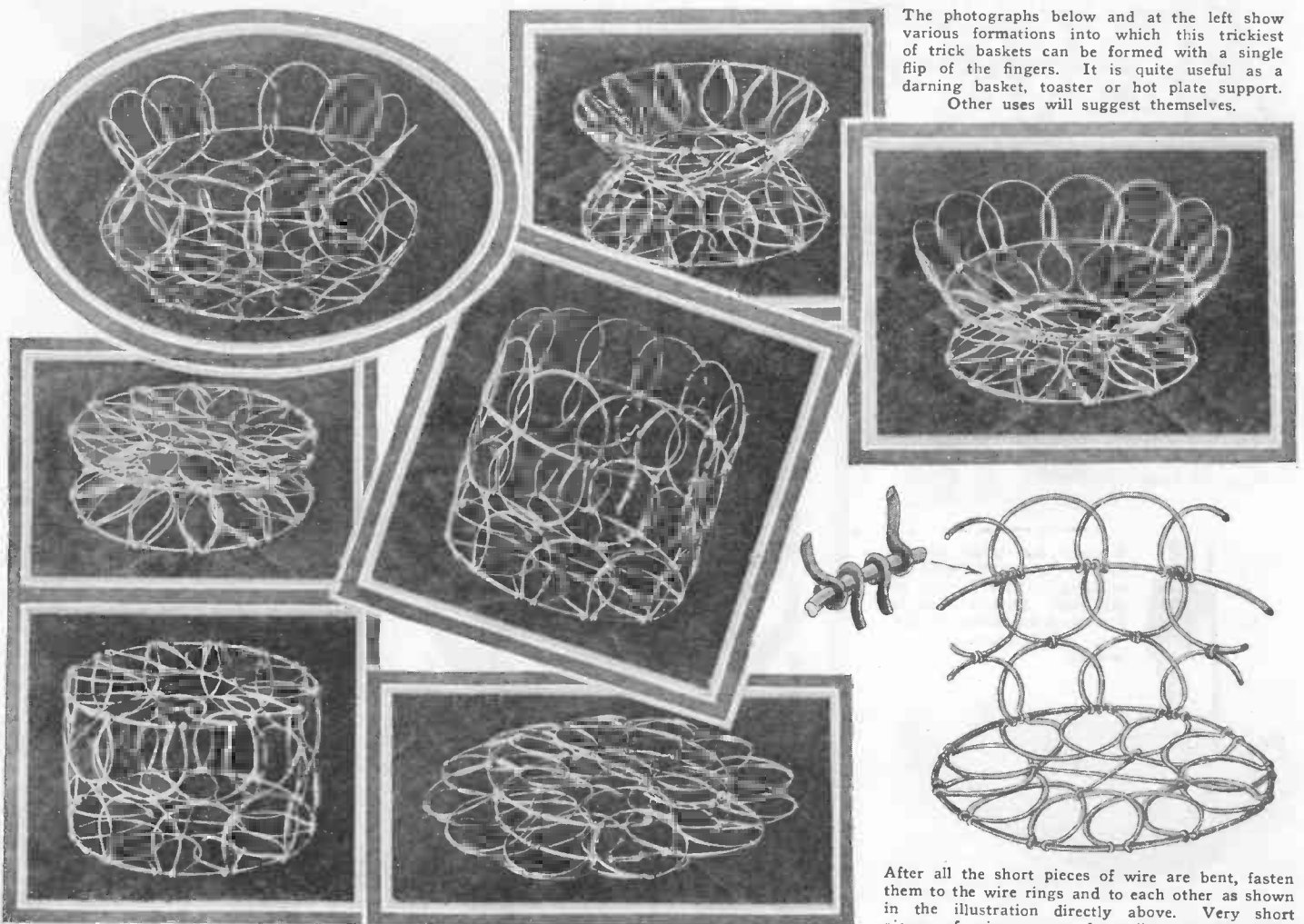

The tools and materials needed for making this basket are a pair of pliers and some smooth galvanized iron or stiff copper wire. You will also need sufficient heavier wire to make two 8-inch rings. Cut 48 pieces of the first mentioned wire, 4 1/4 inches long and bend them in a half circle. A milk bottle may be used as a form for this work.

After all the short pieces of wire are bent, fasten them to the wire rings and to each other as shown in the illustration directly above. Very short pieces of wire are used to link the loops together. Be sure to follow the diagram so that in the half circular rings, one side will go over and the other under each adjacent wire as shown.

—Dale R. Van Horn.

# An Aid To Drawing Students



A new aid to drawing students has been developed by Anson K. Cross of Boston, Mass. It is illustrated in use herewith. In operation, the student first takes a specially prepared frame equipped with a glass panel and holds it up in front of him, viewing the subject to be drawn through the glass. With pencil or paint the subject is then reproduced directly on the glass while it is held in this position. The student then places a previously completed drawing of the subject made without frame in a specially prepared slot directly in back of the glass. By lining up the finished drawing with the sketch on the glass, any mistakes that have been made can be quickly noted. The student's sense of proportion is thus corrected. The two lenses in base of frame are used to view subject when painting in colors. They give the color key quickly.



The subject is viewed through a sheet of glass.



The student sketches the subject on the glass.



A finished drawing shows up mistakes.

## Excess Weight In Passenger Vehicles

By F. W. HORTON

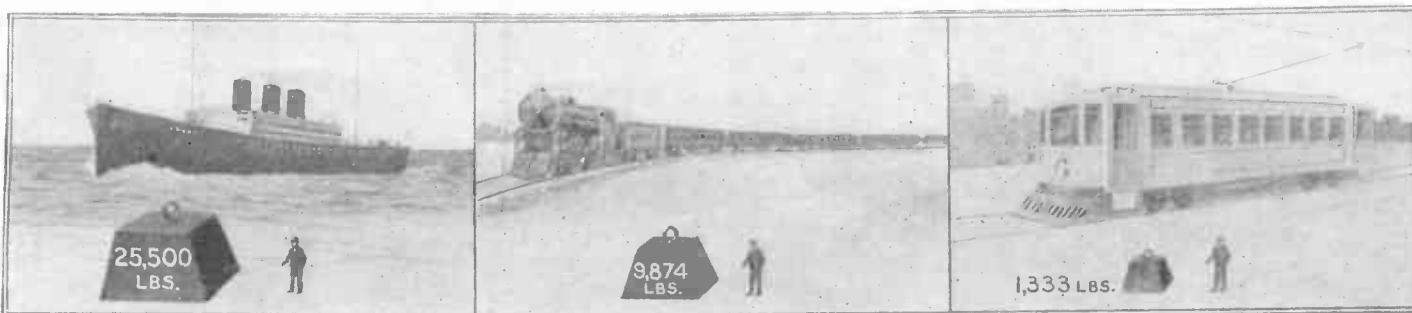

Although our modern methods of transportation are thought to be efficient, still when we consider the excess weight that is moved when we travel, we are prone to think otherwise.

On an ocean-going steamship the size of the Leviathan, 25,500 pounds are moved for every person carried. On the Twentieth Century Limited, 9,874 pounds per person are carried.

An ordinary sized trolley car weighs 40 tons and carries 60 people. Thus we see that a dead weight of two-thirds of a ton is carried for every person transported on this vehicle.

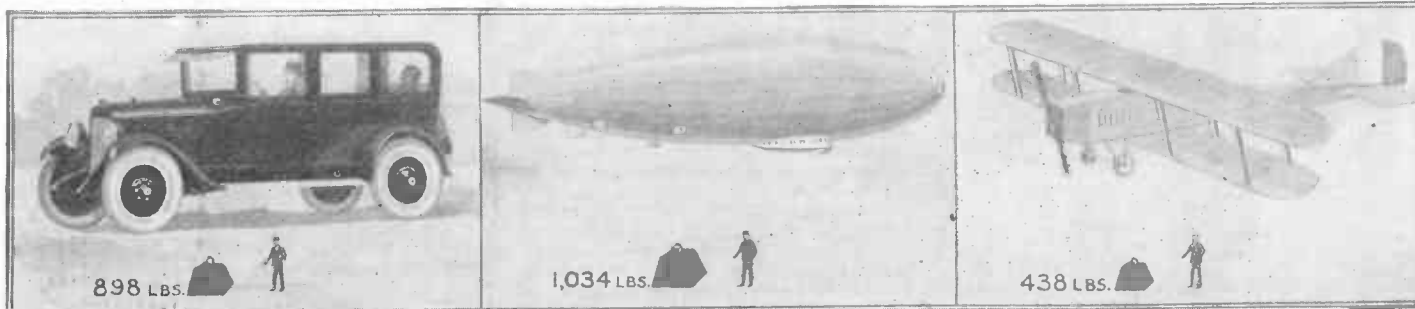

Consider a high-powered automobile weighing in the neighborhood of 4,490 pounds. With five people in it, an excess weight of 898 pounds per person is carried.

Travel in a dirigible such as the Shenandoah with a gross lift of 177,630 pounds means that a dead weight of 1,034 pounds per person is carried. The Shenandoah can carry 150 persons.

An airplane such as the all-metal type designed by Edsel Ford carries 2 pilots and 6 passengers. It weighs 3,500 pounds. The dead weight per person is 438 pounds.

# Man is Mostly Empty Space

By DR. RUSSELL G. HARRIS

Of the Jefferson Physical Laboratory, Harvard University

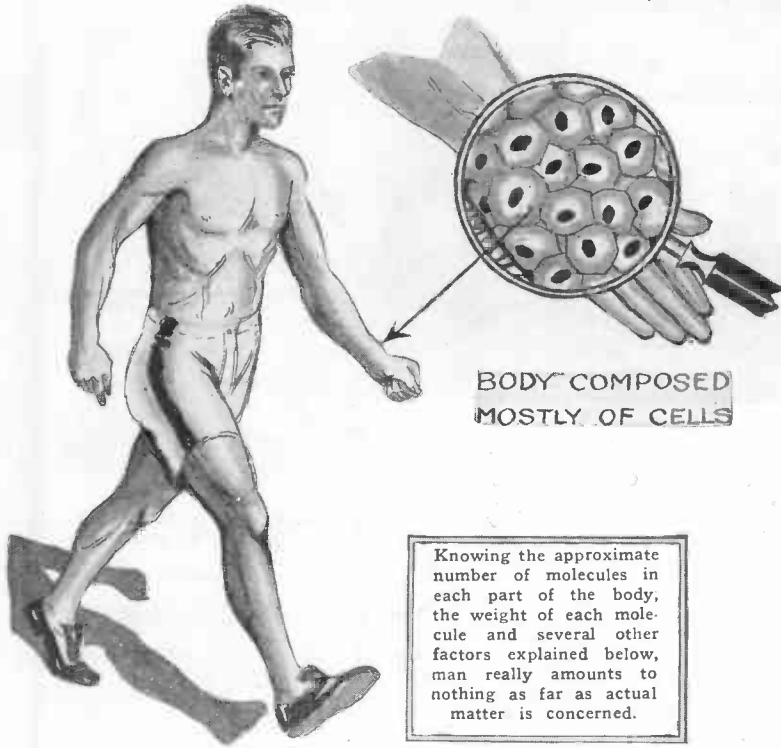

The human body is composed of cells which are groups of molecules made of atoms which in turn consist of a nucleus surrounded by electrons. Neglecting the fact that certain organs in the body are hollow we can show that man is mostly empty space anyway.



Knowing the approximate number of molecules in each part of the body, the weight of each molecule and several other factors explained below, man really amounts to nothing as far as actual matter is concerned.



**DENSITY OF BODY ALMOST THE SAME AS WATER**

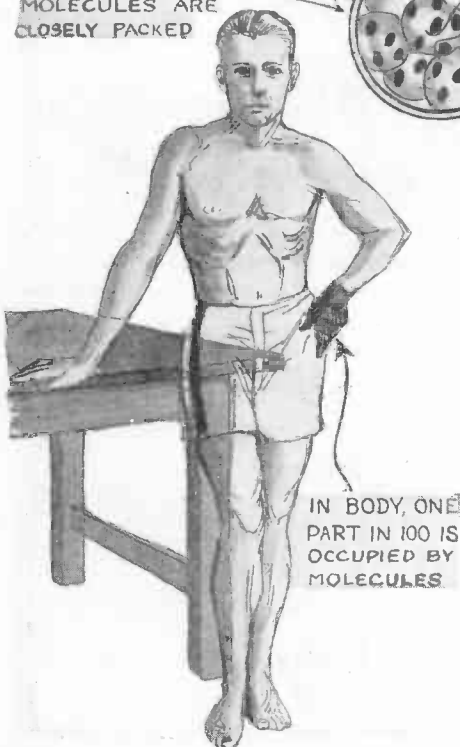
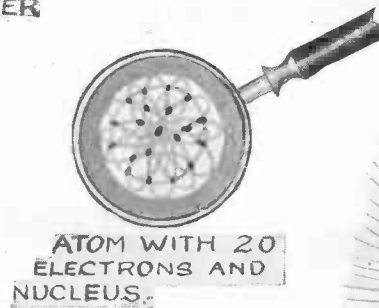
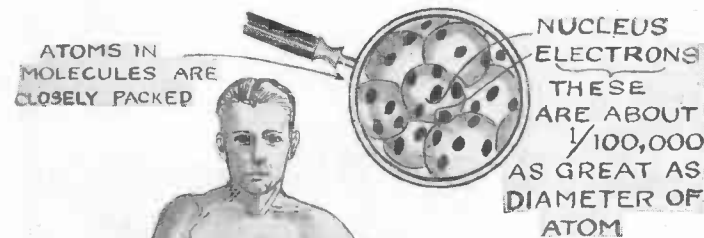

Knowing the approximate number of molecules in each part of the body, the weight of each molecule, the fact that the body is composed largely of carbon, hydrogen and oxygen and that the average density of the body is the same as that of water, we can show that only one part of the volume of the body is occupied by molecules, the remainder being empty space. Atoms in the molecule are closely packed and need not be taken into consideration. But each atom is composed of a nucleus and from one to one hundred electrons, all about 1/100,000 as great in diameter as the atom. If we take an atom with an average of twenty electrons and a nucleus, we find that one part in 50,000,000,000,000 of the volume of the atom is occupied. The human being, therefore, consists of one part of matter in 5,000,000,000,000,000. Should the forces exerted by the electrons and nuclei collapse suddenly, a six-foot man would be converted into a tiny heap of electrons less than one-thousandth of an inch high.

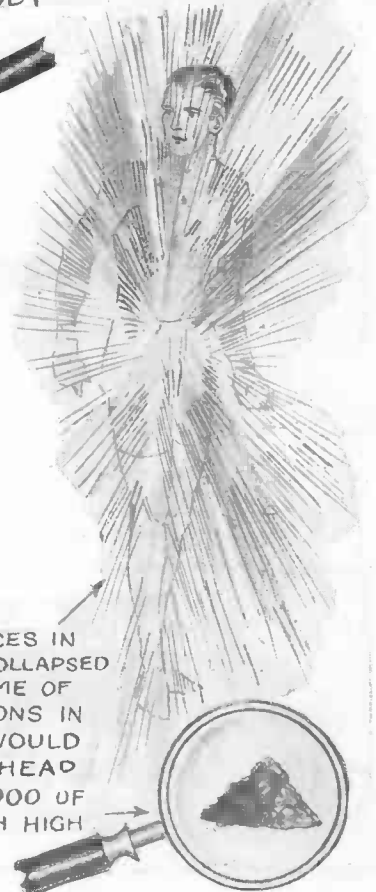

In the illustration above the shaded hand indicates the actual proportion of the body occupied by molecules.

The human body consists of one part in five quadrillion (5,000,000,000,000,000.) of what we consider matter.

# Corn and Its By-Products

By P. A. JUDD

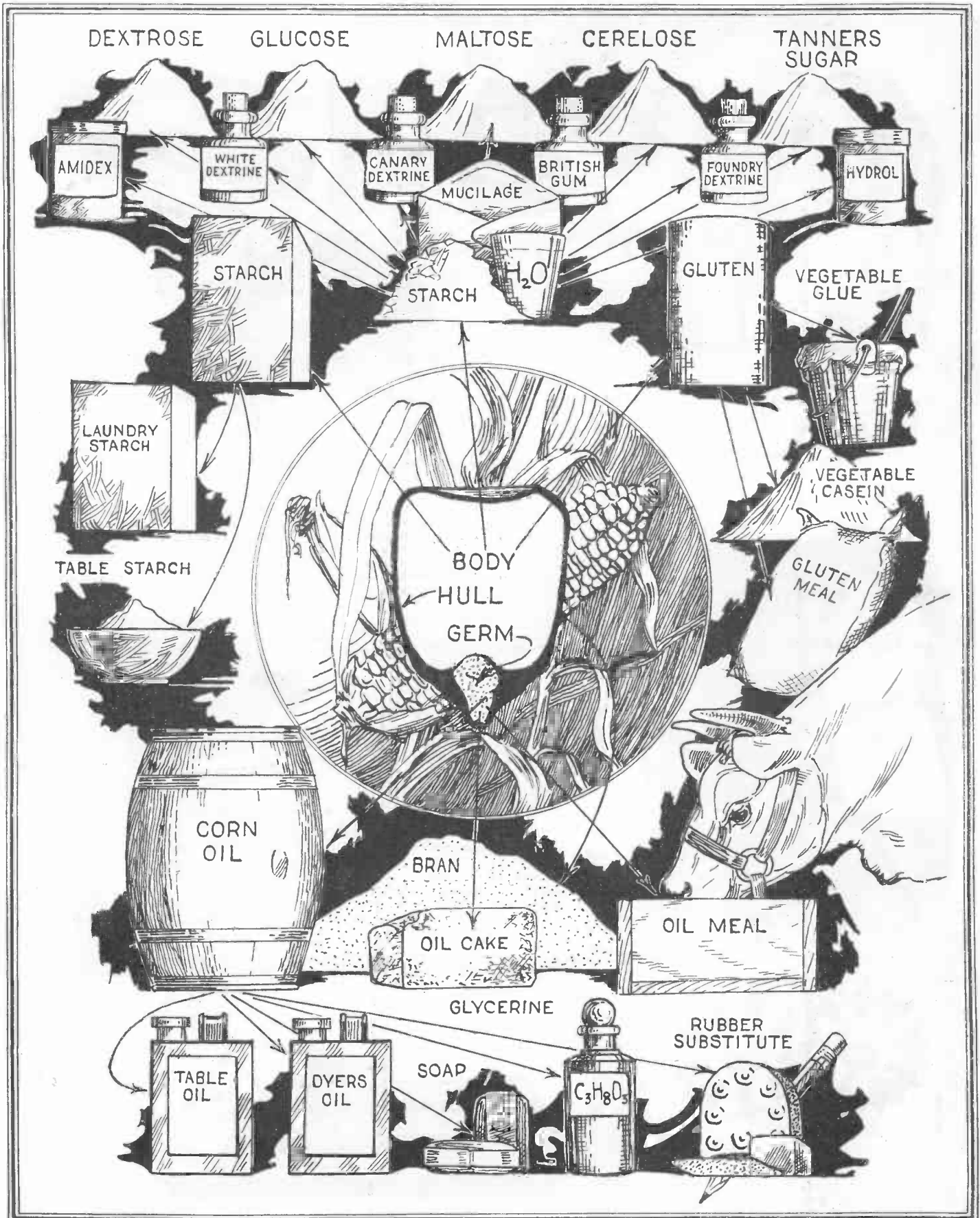

Each grain on an ear of corn is capable of producing many different products in daily use by man. The grain of corn may be roughly divided into three parts, namely, the body, the hull and the germ. Arrows leading from the body, hull and germ show what products are obtained

from each of these parts of the grain. Nearly every one of these products again forms the base for other products also indicated by the arrows. Thus from corn oil, we obtain table oil for salad dressings, dyer's oil, soap, glycerine and substitutes for rubber for either erasers or rubber heels.

# This Month's New Devices

## Electric Razor



The electric shaving device illustrated above is so constructed that it will hold a safety razor or a straight blade. When the current is turned on, the blade vibrates rapidly, making shaving easier and giving the effect of a massage at the same time. By substituting a rubber applicator for the razor, a perfect massaging machine results.

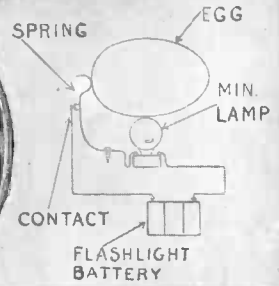
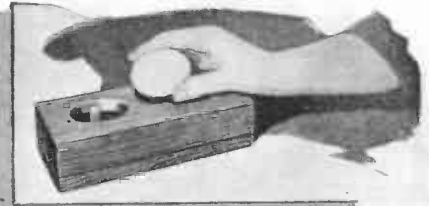

The egg tester illustrated above is an English product. The case is made of wood and houses the flashlight battery and a miniature lamp. The lamp lights up automatically as soon as an egg is placed over the hole provided for it, and naturally when the egg is removed, the circuit is broken and the light switched off again, preventing in this manner any waste of current. The circuit diagram for the device is illustrated above. —C. A. Oldroyd, Reporter No. 4433.

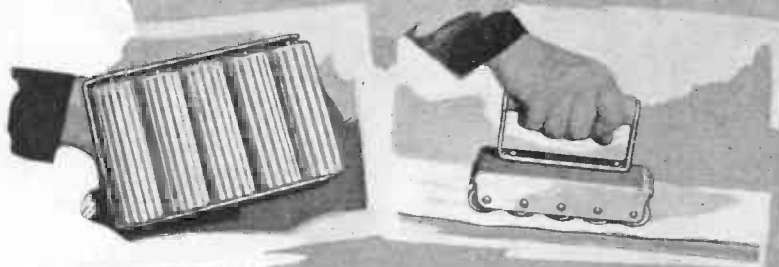

A new hand washing machine which eliminates tiresome rubbing is illustrated here. After the material to be washed has been soaped and soaked, it is placed upon a table, and the washer run over the whole. A gentle pressure is exerted. Due to the action of the rollers, the dirt is easily removed and even laces and silks suffer no damage when using this device. Photos show the under side of the washer with grooved roller, and the washer in use.—C. A. Oldroyd, Rep. No. 4433.

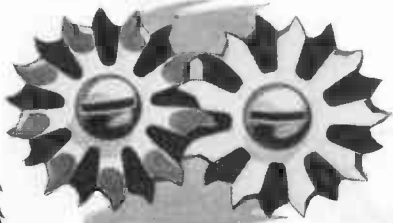

The lawn mower illustrated above is of unique design and construction. In more respects than one it differs from the ordinary type of lawn mower but chiefly in the fact that a child can actually operate it. The cutting wheels rotate as the mower is pushed forward. Photos show lawn mower in use and close-up of the cutting wheels. —J. B. Roswick.

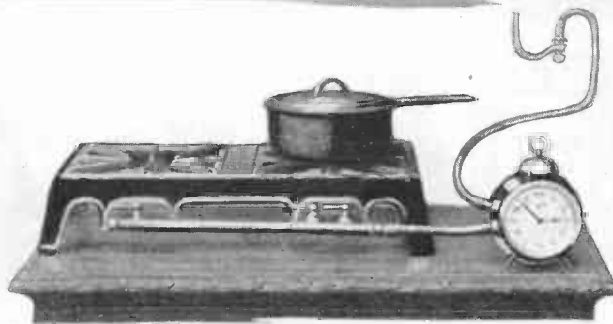

The French device illustrated above automatically turns off the gas at a predetermined hour. The alarm clock is set for the desired time, the gas is turned on and then lit. Twenty minutes or a half hour later when the alarm goes off, the valve inside the clock mechanism turns off the gas. Notice that the hose connecting with the gas stove leads first to the clock, and from it a second hose connects with the gas jet.



# MAGIC "DUNNINGER"

**THE MAN WHO MYSTIFIED**  
Prince of Wales, Ex-President Harding, Taft, Roosevelt, Pres. Coolidge and other celebrities  
Writes Exclusively for **SCIENCE AND INVENTION**



NO. 29 OF A SERIES

**BORROWED HAT**  
PERFORMER CUTS CROWN OF HAT.

**NICKLED STAND**

**YARDS OF RIBBONS FROM HAT.**

**BORROWED HAT**

**DUPLICATE CROWN CUT FROM OLD HAT**

**ROLL OF PAPER RIBBONS**

**STAND**

**CATCH**

**LEAD CONTAINER HOLDING DUPLICATE SILKS - ENDS KNOTTED**

**GLASS CYLINDER**

**ORIGINAL SILKS**

**EMPTY LIQUOR**

**TUBE TO RING**

**PRESSURE PRODUCES LIQUID**

**RUBBER TUBE**

**FINGER RING**

**METAL TUBE**

**RUBBER BAG**

**WIRE ROD THROUGH UNPREPARED ENVELOPE**

**ENVELOPE WITH BOTTOM CUT OPEN**

**STRING OFF STAGE**

**SPRING WIRE**

**WIRES HOLD IN CATCHES**

Three separate handkerchiefs are placed in a glass cylinder. The top is covered with a metal cover and then a silk cloth is spread over all. On withdrawing the kerchiefs they are found knotted together. A lead container slides down, hides original silks and releases the knotted ones.

Cut and destroyed derby hat is illustrated at the left. A borrowed hat is placed in a nickled stand, then removed and yards of ribbon pulled from a cut in the crown. A duplicate crown containing the ribbon is concealed in the stand and is the one cut. The duplicate is returned to the stand.

An unprepared glass is made to fill itself mysteriously with the forbidden liquid several times. The secret is made clear in the illustrations at the right.

A bank-note is placed in an envelope which, without exchanging, is put into a framework and the contents burned. Really there are two envelopes, one prepared with a piece of wire. Into this the bank-note is put. An assistant withdraws the envelope containing the money.

# Odds and Ends of Physics

By T. O'CONNOR SLOANE, Ph.D.

### Surface Tension and Capillarity

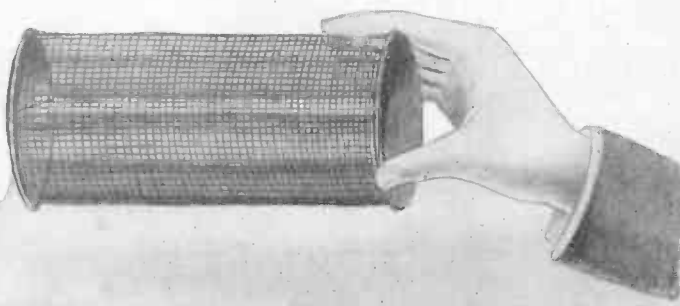

The above is a cylinder made of wire gauze of about one hundred meshes to the inch. It is soaked in water over night. Then it will hold water as if it were of solid sheet metal. The film of water in the upper meshes excludes the air. If the meshes are blown against so as to expel the water therefrom, the water will instantly run out. While it is running out, a shake will close them and the water will cease escaping. Water can be poured through it as shown at the right.

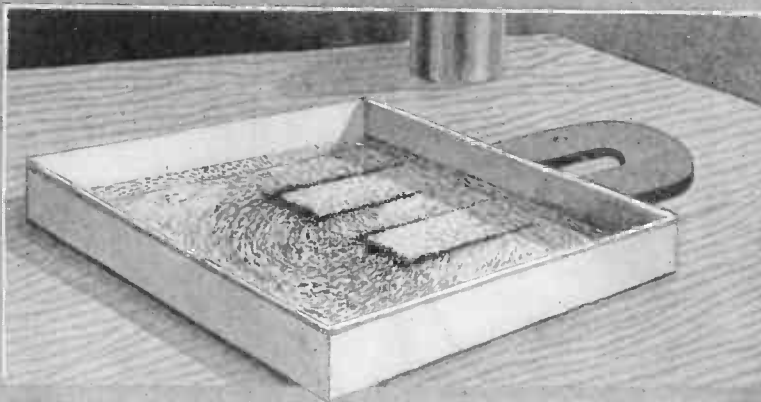
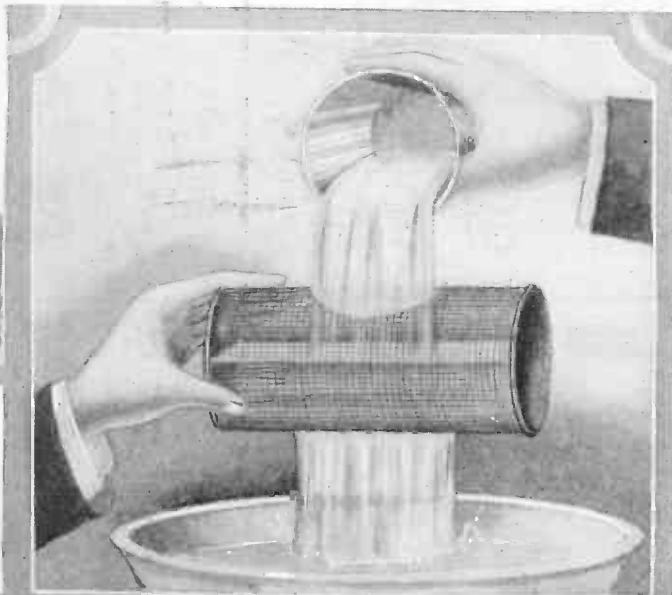

These two pictures represent lycopodium floating on water. In the left the finger is inserted in the water, and can be withdrawn dry, the lycopodium preventing the water from touching it. Pens and other relatively heavy objects can be floated on it. Above iron filings have been dusted over water covered with lycopodium and a magnet below produces magnetic curves. It can be procured at any drug store.

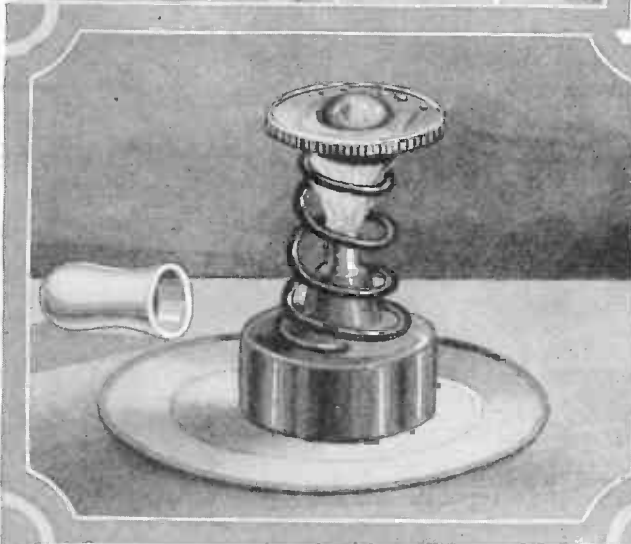

A piece of metal, the size of a quarter, forms a cup, is supported as shown and heated to redness. It will then hold water which will not boil, and which by the same film action is drawn into a spheroid. The water does not touch the metal but rests upon a cushion of steam. If the metal cools the water will boil.

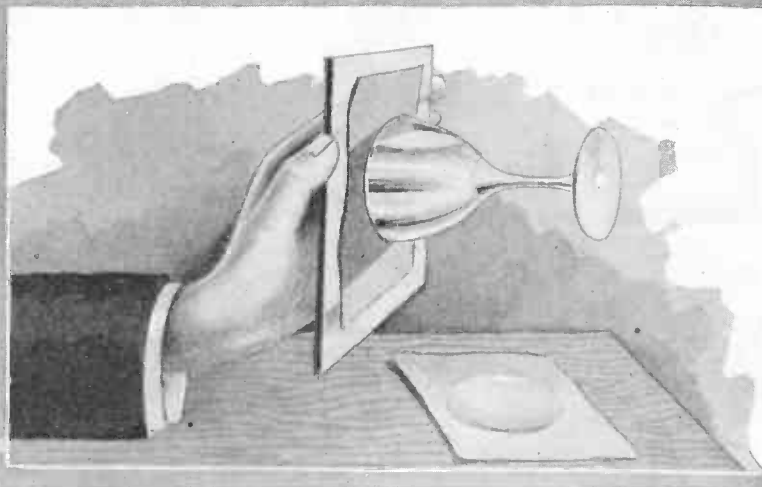

A piece of dry blotting paper is laid over a pane of glass. The paper is below the glass pane and both are placed on top of a wine glass of water, and by tipping the glass the water is brought in contact with the blotting paper. It is absorbed by surface tension or capillarity, a partial vacuum is created, and glass and paper adhere.



# Chemical Magic

By NICHOLAS KLEIN

On this page we show a few chemical tricks easily performed by anybody having access to the medicine chest or the corner drugstore. The experiments themselves are very interesting. At the right is Ponce de Leon's sprinkler. White cloth roses and leaves take on natural colors when water is poured over them. The water in the can contains a little household ammonia. The roses are dipped in phenolphthalein solution. The leaves and stalks are sprinkled with malachite green. The cloth flower is then put in a pot which should not be placed on the table as ammonia water does not polish the varnish of the table.

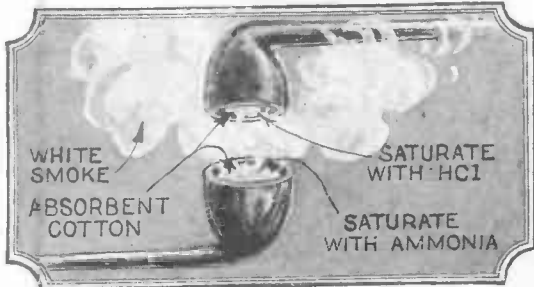

Even after the inveterate smoker died, his pipes continued to smoke when brought together. The experiment is performed as shown above. Dense clouds of smoke appear when the mouths of the pipes are held close to each other.

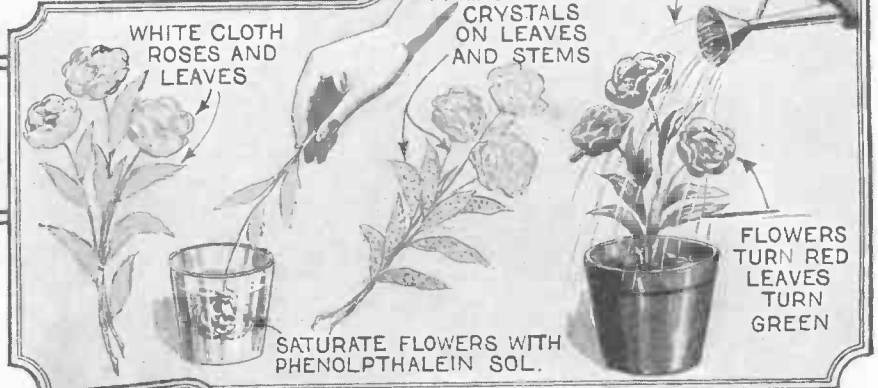

SATURATE FLOWERS WITH PHENOLPHTHALEIN SOL.

FLOWERS TURN RED  
LEAVES TURN GREEN

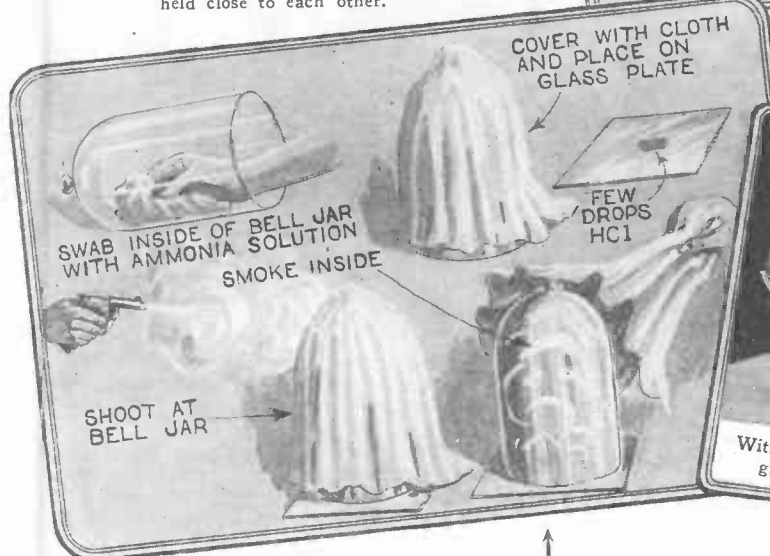

A glass bell jar is swabbed inside with ammonia water. A cloth cover is then placed over the bell jar and the whole put on a glass plate upon which several drops of hydrochloric acid have been put. Smoke seemingly enters the jar.

To prove that your friend is full of "hot air," prepare an enameled basin as indicated at the right. Ask him to blow up the crumpled paper in the basin while you simultaneously tip it. The paper will be ignited. Use caution as the experiment is dangerous.

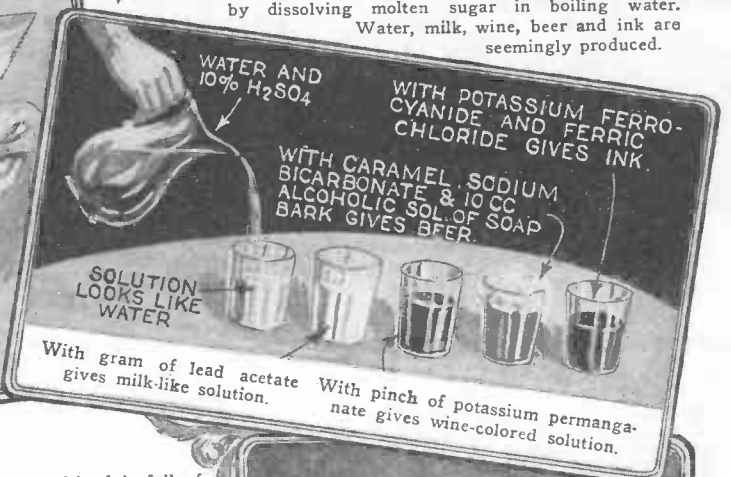

The magic pitcher shown below contains water and about ten per cent. sulphuric acid. When this is poured into the glasses containing the various solutions indicated, different drinks are seemingly produced. Caramel solution is made by dissolving molten sugar in boiling water. Water, milk, wine, beer and ink are seemingly produced.

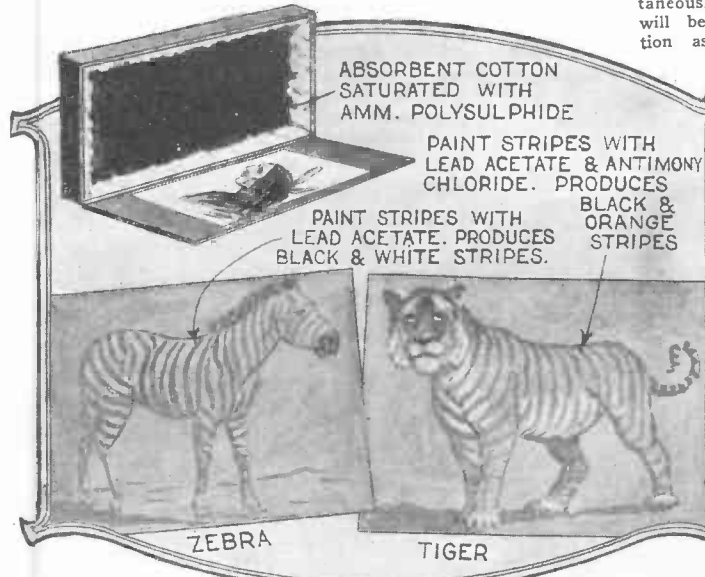

Above is illustrated the magic picture frame. This picture frame is made of wood in the form of a hinged box about 1/2-inch deep, and has a piece of ordinary glass as a frontface. Strips of absorbent cotton are tacked inside of the wooden frame and saturated with ammonium polysulphide.

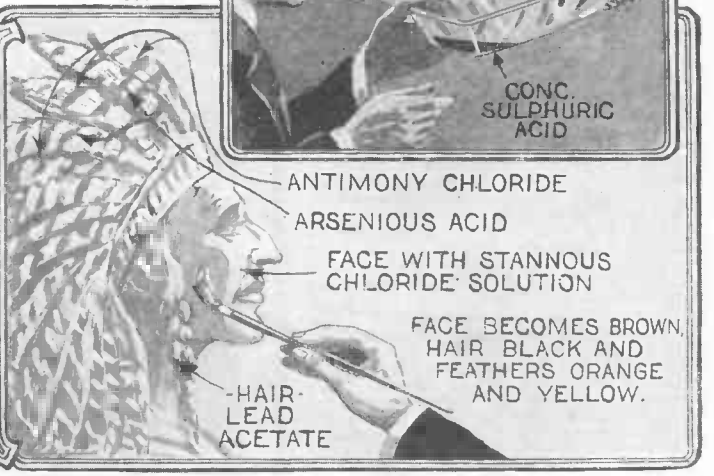

On strips of paper slightly smaller than the box faint outlines of a zebra, a tiger and an Indian are drawn, and then painted with solutions of the various salts indicated in the drawings above. These solutions are invisible until developed by putting them in the frame in which they gradually color.

# Tarrano the Conqueror

SECOND INSTALLMENT

By RAY CUMMINGS

First American and Canadian Serial Rights

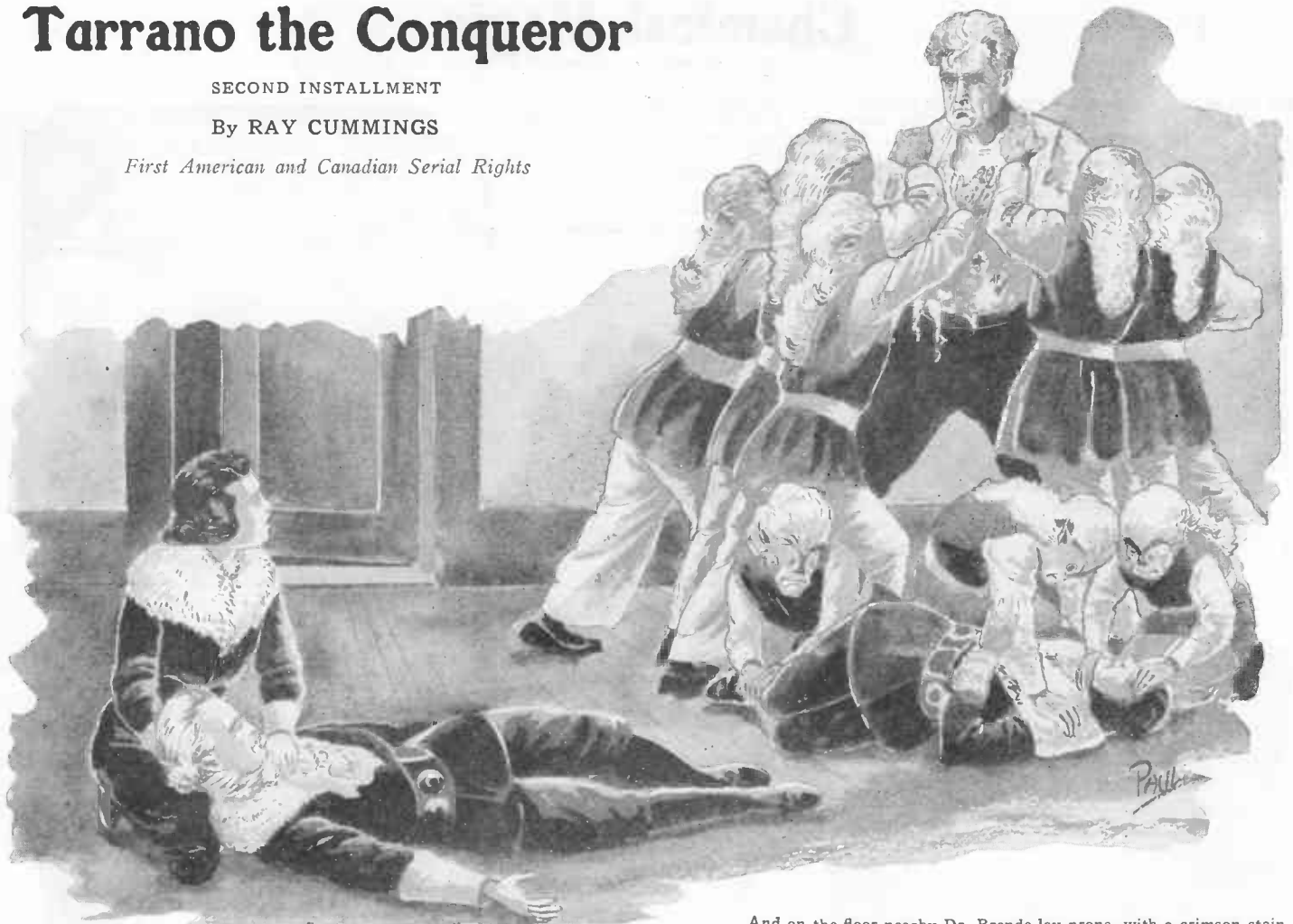

And on the floor nearby Dr. Brende lay prone, with a crimson stain spreading on his white ruffled shirt, and Elza sobbing over him.

## SYNOPSIS

**T**HE story opens in the year 2325 and is related by Jac, a writer of that time, employed by a large news organization of Great New York. On the afternoon of May 12 of that year, the President of the Anglo-Saxon republic is murdered in the midst of a speech. In his talk, just before the murder, the President had stated that the Anglo-Saxon public must remain friendly with Venus and that all controversies must be settled by arbitration.

Immediately after the murder, the narrator of this story, together with the thousands of other listeners, were hurried away from the spot on the moving sidewalks that were in general use. This happened at 5:10 P. M. At 6:15 of the same day the ruler of Allied Mongolia was murdered. Ten minutes later the leader of the negroes of Africa was killed while asleep. This left the earth without leadership. Jac and Grayson, a co-worker of his, suspect that the murders are the result of a plot on the part of the inhabitants of Venus. At 8:26 the mail from Venus landed. At 8:44 a message by helio from that planet announced the murder of the ruler of the Venus Central State. A warning came with the same message and read in part, "City being attacked . . . Tarrano, beware . . . you are in danger of . . ." The message broke at this point and further communication was impossible.

At 9 P. M. Jac was summoned to North-east Island, off the coast of Maine, by a Dr. Brende. He goes and is welcomed by the Doctor and informed that the Martian ruler of the Little People had also been assassinated and at the same time communication had become impossible with Mars. A few moments later Venus re-establishes helio communication and sends in part: ". . . Beware Tarrano! Notify your Dr. Brende, danger." Another message from Venus says, "Smashing apparatus." At that moment the maid of Elza, Dr. Brende's daughter, appears on the scene and Jac notices to his astonishment that she is a Venus-girl.

## CHAPTER III

### THE SPY IN THE HOUSE

**T**HE insulated room was small, with a dome-shaped ceiling; no windows, and but one small, heavy door through which we entered, closing it carefully behind us.

"At last," Dr. Brende exclaimed. "Now we can talk freely."

But I was not satisfied. "That girl, Ahla—can you trust her?"

They all looked at me in surprise. When one is close to danger, sometimes one recognizes it least; with Ahla in this household for over a year now, they could not imagine her an enemy.

"I saw her looking up at the insulator," I added swiftly. "Out there in the corridor. Am I talking wild? Perhaps I am. But she seemed startled; and she was standing just under the insulator, wasn't she?"

"But—" began Elza.

"Wait," I exclaimed. "When I first saw the President fall, at Park Sixty, I felt that a Venus-man had done it. These other murders—they're all the same. Done by Venus-men of the Cold Country."

"Ahla's country," Elza murmured.

"Yes. Exactly. And the Venus Central State has been attacked and has fallen. An assassination on Mars, and three here on Earth—all simultaneously. It's one gigantic

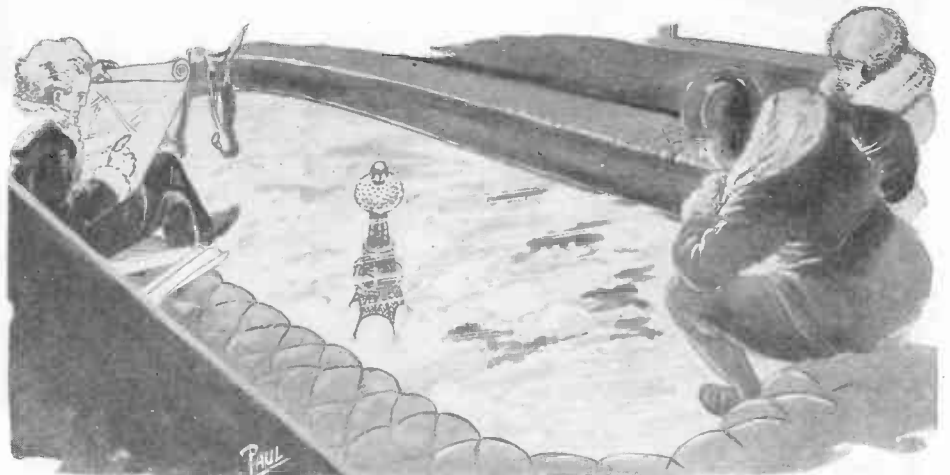

At eight o'clock, flying low—no more than a thousand feet—we sighted the steel tower with foundations sunk into the ocean's depths which marks the top of our little Earth.



The buildings stood silent, without sign of life. There was no one in sight anywhere. No one out to greet us; I thought it a little strange but I said nothing.

plot, I tell you—and the Cold Country of Venus is at the bottom of it.”

Georg jumped to his feet. “I’ll see if the room has been tampered with.”

He was back presently. “The insulator is intact. I set the alarm bell. If she touches it—”

“Where is she?”

“In the cookery, where she should be. I told her we would eat in an hour. That ought to keep her busy.”

Dr. Brende made an attempt at a smile. “I think we are all a little overwrought—though with reason, no doubt. Sit down, Jac. Elza, come here by me. Don’t look so solemn, child.”

He drew Elza to him, with his arm about her. I would have spoken, but his gesture checked me. “I have much to say, Jac. I think I understand these events, perhaps better than any of you. Let me go back two years—I was in the Venus Central State two years ago.

I nodded my remembrance; and he went on:

“At that time the authorities there were greatly perturbed. They were menaced by rebellion in the Cold Country. They would not let the Cold Country people into the Central State, for it is already overcrowded. You did not know that, did you?”

“You mean the threatened rebellion?” I asked. “They were trying to keep it secret, but we heard rumors.”

“Just so. And Jac, I will tell you why they kept it secret. The Central State was encouraging emigration to the Earth. The Venus Cold Country is a poor place to live in—and on a whole its inhabitants are miserable people. Villianous, too, I should say. The Central State did not want them within its borders; and so it kept secret its troubles with them—and encouraged emigration to the Earth.

“We—as you know—make no distinction between Venus-people. We are friendly with the Central State, and the Cold Country is governed by it—or was until tonight. Thus, you see, we have been in the position of having to receive these renegade immigrants. Shut out from all the good land and decent climate of Venus, they began coming here.

“But we did not want them, and of late we have been holding them off, cutting the quota allowed very materially. Last week, as you also know, in Triple Conference, our three races decided to allow at each Inferior

Conjunction of the Earth and Venus, so small a quota that the Central State protested vigorously.

“The controversy has been hot; but the Central State—trying to foist off its undesirables on us—knows it is in the wrong. And fundamentally, it is friendly to us—I think it has proven that in the last two hours.”

Again I would have spoken, but he went on at once.

“I know you’re familiar with most of this, Jac. But you news-gatherers sometimes reason in too lurid a fashion. Let me go on. Mars was drawn into the affair. To extricate ourselves, we offered to admit—under temporary guard—all Venus immigrants who would pass on at once—at the first astronomical opportunity—to Mars. This would

have been very nice for us—but not for Mars.”

“They are hot-headed, in Mars,” Georg commented.

“Quite so,” said the doctor. “But very direct and forceful, nevertheless. They met our suggestion with a law excluding Venus immigrants entirely. It was this, I think, that precipitated tonight’s events—though of course they must have been brewing for a long time.”

“This Tarrano—” I began.

“I heard of him when I was in Venus,” said Dr. Brende. “He was at that time a lower official in the Cold Country. Evidently he has risen in his world.

“I come now to conjecture—but I think it must be fairly close to truth. Tarrano, leading the Cold Country, has risen to open rebellion. His attack upon the Central State must have come suddenly—”

“You mean, just this evening?” Elza asked.

“No, of course not. But hoping to quell  
(Continued on page 372)

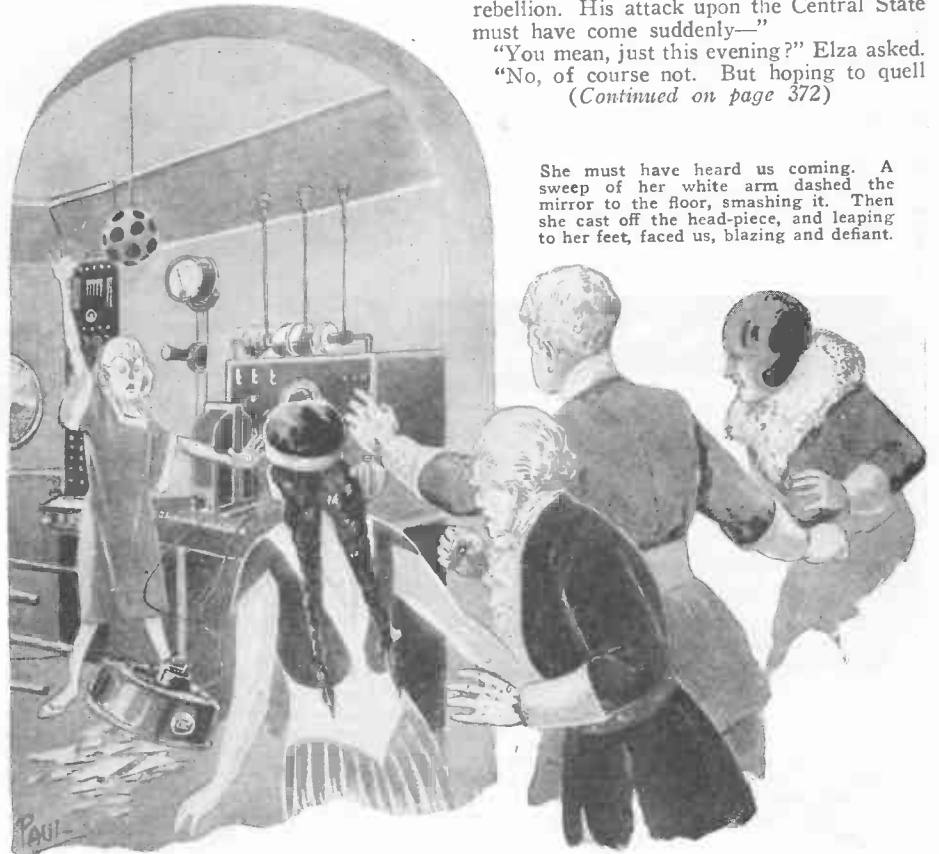

She must have heard us coming. A sweep of her white arm dashed the mirror to the floor, smashing it. Then she cast off the head-piece, and leaping to her feet, faced us, blazing and defiant.

# Oddities in the News

Newsie Items in Various Walks of Life

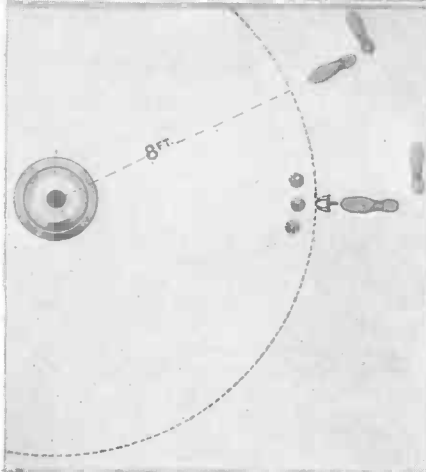

A new indoor game called "Shovelball" is being demonstrated by Miss Shirely Hecht in the photo above. This game combines exercise with skill and may be played on the deck of a ship, in the parlor, or on any smooth surface. The game comprises a pair of shovels, three rubber balls heavily weighted with lead and a corrugated aluminum disk. The player stands eight feet from the disk and pushes the balls toward it. The game looks a good deal easier than it is and the exercise one gets after playing a round is truly surprising.

—F. L. Kelsey

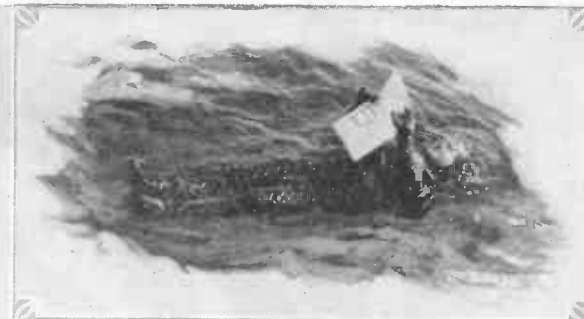

Mr. Jenkins and Mr. Robertson demonstrating a machine for transmitting and receiving sketches, drawings or written messages via radio or wire. Messages are written with a graphite pencil and wrapped around the cylinder. A contact is closed when a pencil mark passes.



One of Germany's best swimmers, Otto Kemmerich, is shown in the photos above in a new type of swimming suit. In this suit he remained afloat in the icy waters for more than a half hour. The suit is really a life preserver as the person wearing it need not know how to swim in order to remain afloat in it. It is well padded and will keep the swimmer warm regardless of conditions or circumstances.



At the SCIENCE AND INVENTION booth at the New York Inventors' Exhibition an interesting model of a "perpetual motion" (?) machine was exhibited. This model kept the crowds guessing and few, if any, knew exactly how it worked. In the booth a sign appeared reading "Perpetual Motion? How Does It Work?" All the visitors were permitted to guess. The model was later shown in the city. The theory of its operation is, of course, simple. The weights on one side of the wheel are further from the center than those on the other, consequently it rotates—provided the secret gimmick is employed.



Mounted on glass pillars with no visible connection, the wheel continues to rotate.

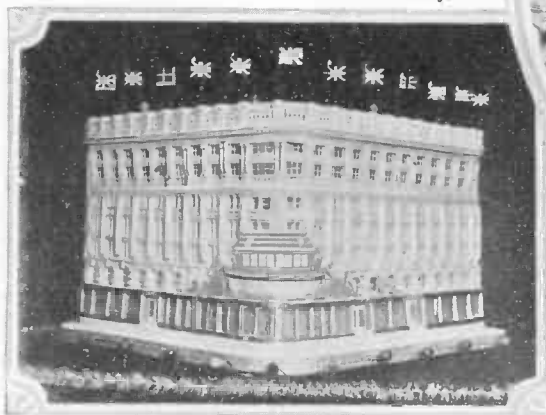

Cake making is not considered an art by most of us, yet there are but few who could look at the photo above without remarking its real beauty; nevertheless, this representation is made entirely of cake. The object is an exact reproduction of the premises of a well known English firm who gave the cake to their two thousand employees.

—C. A. Oldroyd, Rep. No. 4433.

# Colloids---What They Are

By RAYMOND B. WAILES

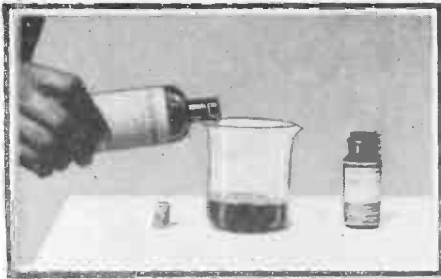

Ruby glass, milk, glue, coffee and hundreds of other substances found in our everyday life are typical forms of colloids. By colloidal is meant the property of not being able to crystallize or settle out of solution. Colloids are usually opaque, coffee is an example. A weak solution of potassium permanganate mixed with hydrogen peroxide, left, produces a brown precipitate of colloidal manganese dioxide, which cannot be filtered out of the water present.



Colloids are so finely divided that they cannot be filtered out of solution. They are able to pass through the finest filter paper obtainable. An excellent laboratory demonstration of this peculiar property is illustrated at the right. The procedure is as follows. Add a drop or two of sulphuric acid to a standard photographer's solution of hypo—sodium hyposulphite. This procedure will produce colloidal sulphur in the form of a white powder which as our photograph shows, cannot be filtered off. Furthermore, a colloid will not settle out of solution even after being left to stand for some time. Try this with coffee. The solution will remain the same color regardless of the length of time it is allowed to stand.



Colloidal solutions produce the phenomena known as the Tyndal effect. A colloidal solution viewed by a strong light passing through a pin hole in a card, above, will show a small cone of light passing through the solution. The particles are too small to be seen but their effects can be visualized by the reflection and diffraction of light.

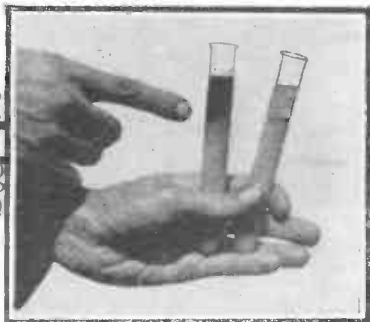

Soluble substances which are not colloidal in property are called crystalloids. These latter substances diffuse or penetrate into and through substances much quicker than do colloids. An effective laboratory demonstration of this difference of penetration may be performed with simple apparatus. The effect is illustrated at the left. The procedure is as follows. Prepare sufficient gelatin to fill two test tubes two-thirds full. Place in the tubes and allow the mixture to set. Cover one tube of gelatin with about one inch of copper sulphate solution (copper sulphate is a crystalloid) and the other with about the same quantity of coffee, a colloid. The copper sulphate solution colors the gelatin in the tube below it much faster than does the coffee in its tube.



Colloidal metals such as copper, platinum, nickel, etc., can be made by sparking the metals under water. Two wires of the material desired or copper wires tipped with that metal which is to be made into a colloidal form, are connected to a current source capable of supplying about ten amperes. An arc is struck and drawn out under the water with the ends of the wire as electrodes, whereupon the colloidal metal will be formed by the rapid disintegration of the wires by the current. Different metals when treated as above give different colored colloidal solutions.

Another method of making a certain metallic colloid, gold, is illustrated above. Such a solution is purple in color and consists of ultra-microscopic particles of gold metal in solution. You can easily make this substance as follows. Mix a weak solution of a gold salt, gold chloride for example, and to this solution add a small quantity of tannic acid as above. Gold in this fine state of sub-division will impart a red color to glass when melted with it.

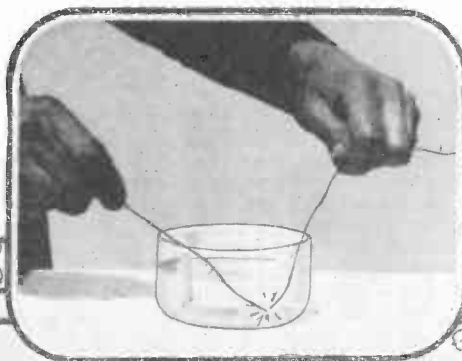

Some colloids have positive charges of electricity whereas others have negative charges. Therefore, referring to the well known laws of electrical charges, we should expect them to be attracted or repelled by a positive or a negative charge of electricity according to that residing on their surface. Colloidal iron hydroxide can be made by pouring a bit of a strong solution of ferric chloride into half a liter of hot water. When a current is passed through the solution as at the right, the iron hydroxide will move to the cathode, negative pole, showing that the iron hydroxide is positively charged.

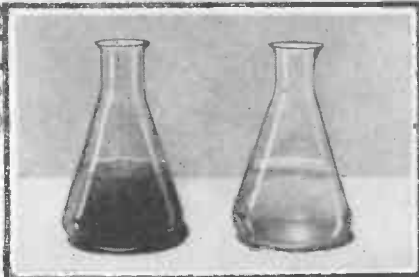
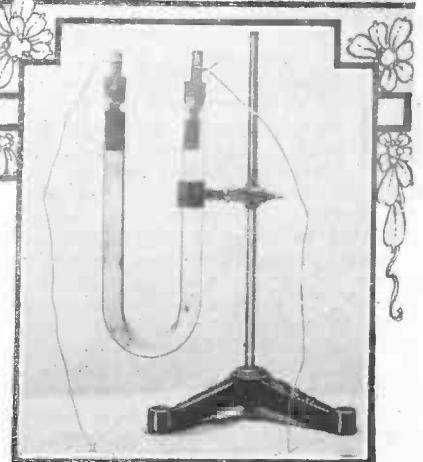

The reason river water is muddy is because it is colloidal. When muddy rivers meet sea water which contains an electrolyte—salt, the mud is dropped, the water becomes clear, and a mud bar is formed. As above, several drops of salt water added to muddy water will clear it.

# Doctor Hackensaw's Secrets

By CLEMENT FEZANDIÉ

No. 42—A Journey to the Center of the Earth. (Part III.)

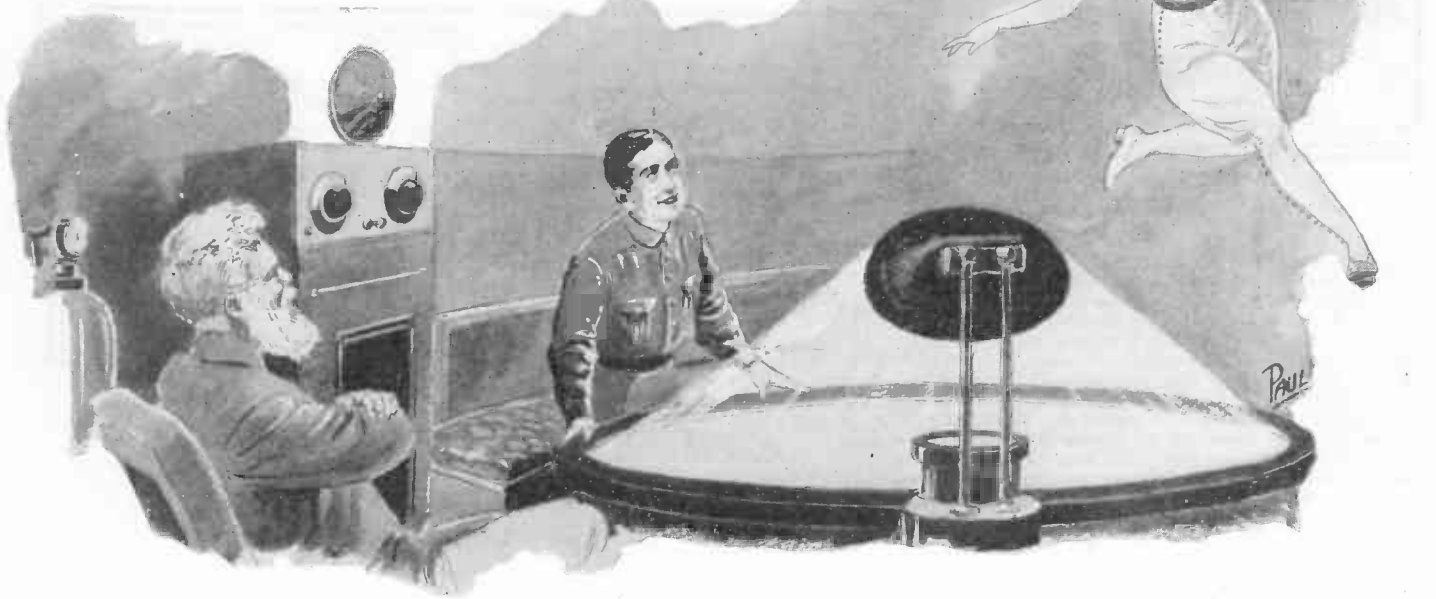

## SYNOPSIS OF PART I.

**D**R. HACKENSAW, after having determined to explore the center of the earth and having made preliminary observations, asks his very good friend Pepita Perkins, a newspaper reporter, to accompany him on a trip to the South Pole where the excavation was to be started for the trip to the center of the earth. They arrive at Dr. Hackensaw's village at the South Pole where a crevice in the earth five miles deep has been discovered. Working first with a diamond drill and then with an "atomic force drill," one of Dr. Hackensaw's inventions, they start work on the bottom of the pit. After some hours of drilling, observations made by means of a special microphone show that they are nearing another natural cavern in the interior of the earth. The diamond drill is once more brought into play and soon pierces the remaining shell of the rock into the lower cavity in which a partial vacuum is found to exist. A concussion bomb dropped into this cavity proves, by measuring the time it takes for the sound of explosion to reach the observers, that the cavern is over 100 miles deep.

In the Dart, which has been reconstructed for the special work at hand, Dr. Hackensaw, Pep and Miggs start on their journey toward the center of the earth. Their machine is provided with brakes and automatic speed devices which allow them to travel at an even rate of 100 miles per hour. Soon they find that their weight is greatly reduced. At 1,200 miles below the surface of the earth calculations show that something has gone wrong. Suddenly Dr. Hackensaw exclaims:

"If my hypothesis is correct, the center of the earth may be an even more marvelous place than anyone has ever suspected it to be."

## CHAPTER 9.

**D**OWN, down, went the car on its journey toward the center of the earth. And now the automatic brakes no longer pressed against the sides of the well to check the speed of their descent. Instead of this, the doctor had started the propeller working backwards, for the air in the pit had now reached more than normal density and the propeller was easily able to check any increase in speed, or even to stop the car completely. Doctor Hackensaw assured himself by a test that such was the fact, and was overjoyed to find that the propeller could now even pull the car upwards. Consequently, the tentacular brakes became useless, and were withdrawn until they should be needed again.

... she performed a series of the most graceful evolutions, slowly gyrating as her hands and feet went through the motions of an oriental dance.

Miggs was very much interested in the engine, which was electrical in the sense that it made use of atomic energy as a motor-power. The mechanism was as simple as it was efficient. The power was obtained by disintegrating molecules of sand. The sand was first pulverized to an incredible fineness. As this fine dust hung suspended in the air, a sticky thread, whose composition Doctor Hackensaw kept a profound secret, was drawn rapidly through a room filled with it and passed over heating surfaces which dried it and the dried thread was wound on spools like ordinary sewing-cotton.

Doctor Hackensaw had made all these preparations in New York, and had brought with him a number of spools of this prepared thread, which was to serve as motive-power as well as for producing heat, cold, light, etc.

The disintegration of the dust particles imprisoned in the thread was started by an electric current at an undreamt-of potential. Once started, the disintegration proceeded automatically from one dust particle to the next, the thread being fed forward as fast as consumed. In principle it was like a gas-jet, which requires to be lighted at the start; but, once started, the flame keeps igniting the new gas as it streams forth from the burner.

The doctor had started the disintegration-process before leaving the surface of the earth where he had facilities for producing the high potential required. This greatly simplified the equipment in the car, which consisted merely of the connections required for turning the propeller.

Doctor Hackensaw kept an eye on the odometer, and also on a weight suspended to the spring-scale. Finally he uttered an ejaculation and cried out:

"Pep, do you want to see what it feels like to have no weight at all?"

"Shure, Pop," replied the young girl, and Miggs echoed her wish.

"Very well, then I shall stop the car here, for unless I am greatly mistaken, we have reached a spot where we shall have no weight at all."

"Why, how can that be?" asked Pep. "The odometer says we have only gone fifteen hundred miles, and you told me that the center of the earth was four thousand miles from the surface. We can't be anywhere near it, yet!"



... the car emerged from the pit into an enormous cavern lit up with a sort of diffused phosphorescent light.

"True," assented Doctor Hackensaw, "that's a puzzle, the solution of which you will soon learn for yourself. In the meantime we shall make a short halt for amusement."

The car, which had been descending at a uniform speed of one hundred miles per hour, was now gradually slowed up until it came to a complete stop.

Long before this point had been reached, the three friends had found their weight gradually diminishing and they were obliged to hold on to specially prepared handles arranged in the car, in order that a slight movement might not send them spinning in all directions.

The lightness was especially emphasized by the rapidity of their motions. Their muscular force being unimpaired, and their arms and legs having lost all weight, any exertion would move an arm or leg sixteen times as fast as when opposed by gravity on the surface of the earth. The result was comical in the extreme.

As soon as the car stopped, Miggs, anxious to convince himself that he had indeed lost all weight, made a jump for the ceiling. The result was a complete surprise to him. Instead of going straight up, he began turning a rapid series of somersaults in the air and was shot up against the ceiling with a bump, and then bounced up and down again until Pep, clinging with one hand to a couch securely fastened to the frame of the car (as was every other object in it), caught him with the other hand.

A book that Pep had been reading and had been carelessly laid down on the table was started off by the slight shock when the car stopped, or perhaps by a slight breeze made by the motions of the passengers, and ascended slowly to the ceiling. To catch the book Pep swam slowly upward through the air. Although she tried to make her movements very deliberate, her arms worked faster than if she were swimming in water. After she caught the book, she thoughtlessly put out her hand to keep her head from striking the top of the car, but she pushed too hard and she too went somersaulting around the room, though more slowly. Her push being diagonal, she found that instead of going straight up and down she bounced from the ceiling to the wall on one side, then to the floor, then to the opposite wall and then to the ceiling again, traveling around in a sort of circle and all the while spinning somersaults in a graceful but most unladylike manner.

Doctor Hackensaw, laughing as he watched her, in an unguarded moment released his hold and he too performed a series of grotesque acrobatic contortions as he circled through the air.

Finally Pep caught the doctor on the fly and holding him by one leg finally managed to catch hold of a couch and so checked their breathless flight.

"It's lucky we didn't break any of the glass instruments in our gymnastics," panted Doctor Hackensaw.

"Why, how could we break them?" asked Miggs. "As we have no weight, we couldn't break them no matter how hard we hit them! It would be like trying to break them by throwing a feather at them."

"Don't you believe it, Miggs," replied Doctor Hackensaw. "If you had hit one of these instruments it would have smashed into little pieces. Momentum is a question of mass and velocity. A feather has very little weight and very little mass and hence cannot acquire much momentum; but you, although you have no weight, have just as much mass as you had on the surface of the earth and I tremble to think what would have happened if one of us had hit those instruments—I see you're rubbing your head, so you have had a practical proof that even though you have no weight, you can give and re-

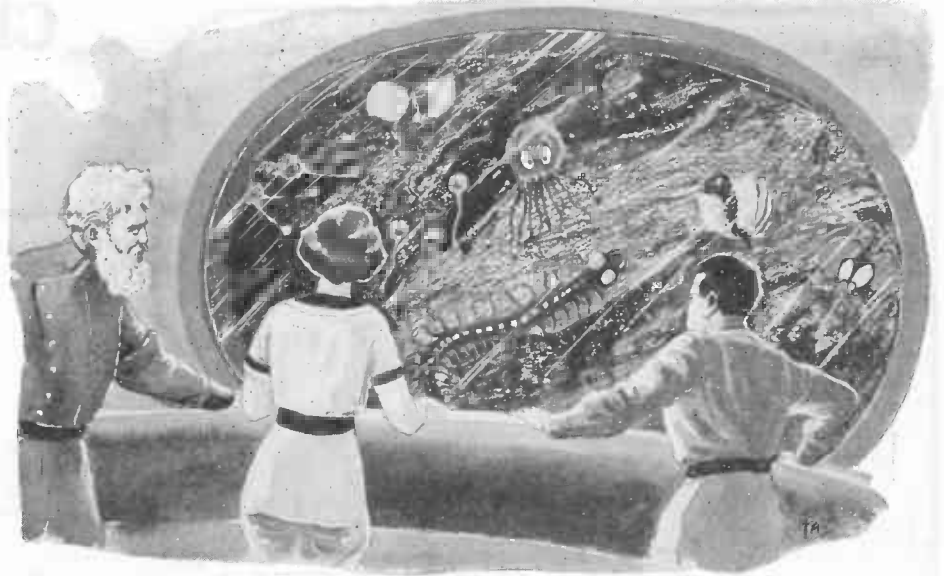

... But see, even here there are animals and plants of some kind, though like nothing with which we are familiar. Everything seems phosphorescent.

ceive hard bumps when you butt into an object."

### CHAPTER 10

"Ladies and gentlemen," cried Pep, "just keep your eyes on me for a minute, and I'll give you a sample of the latest dance, the 'Aerial Whirl.'" With these words she swam slowly and carefully to a point in the center

of the car, midway between floor and ceiling, and after having carefully checked her impetus, she performed a series of the most graceful evolutions, slowly gyrating as her hands and feet went through the motions of an oriental dance. A moment she would be upright, a moment later she would be horizontal, then head downwards, but her feet and hands kept going as she imitated the poses of the ancient Egyptian and other oriental dancers, while she accompanied herself with a song. Gradually her motions became more rapid; faster and faster she spun around, until she was whirling around with terrific speed like a windmill. Finally she stopped, breathless, but even then the gyrations continued until she checked them by motions in the opposite direction.

"Gee! That was great!" she cried joyfully. "It's a dance of my own invention, but it beats anything I've ever seen!"

As soon as the dance ended, Doctor Hackensaw made a few observations to convince himself that the car was now really at the center of attraction. Then he started the propeller going again and continued the journey.

No longer were the brakes needed—on the contrary, the propeller had to do all the work, for the car was no longer falling, and as mile succeeded mile, the propeller had to work faster to keep the speed unchecked, for the car was now being pulled backwards by the attraction of gravitation.

The weight of bodies was still so slight that Pep and Miggs amused themselves with all kinds of queer antics. Once Miggs knocked Pep down, and in retaliation she seized him by one foot, swung him around her head and hurled him at the roof of the car. He bumped against the ceiling and bounced around the car several times before he could stop himself.

Doctor Hackensaw then explained that if there were no air in the car, and the car were stationary at the center of the earth, no exertion made by a passenger suspended in mid-air would enable him to reach the top, bottom, or sides of the car. He could spin around at will, but could not displace his center of gravity in any way as there was nothing against which he could push. Action is impossible unless there is equal reaction.

"If Miggs were up in the air with you," explained the doctor, "you could push him and the push would send him to one side of the car and you to the other. Otherwise you would die of starvation even if food were plentiful in the cupboard here. You

(Continued on page 380)



... he was perched upright on Miggs' hand while Miggs in turn stood on Pep's open palm.

# Clock Spring Contest

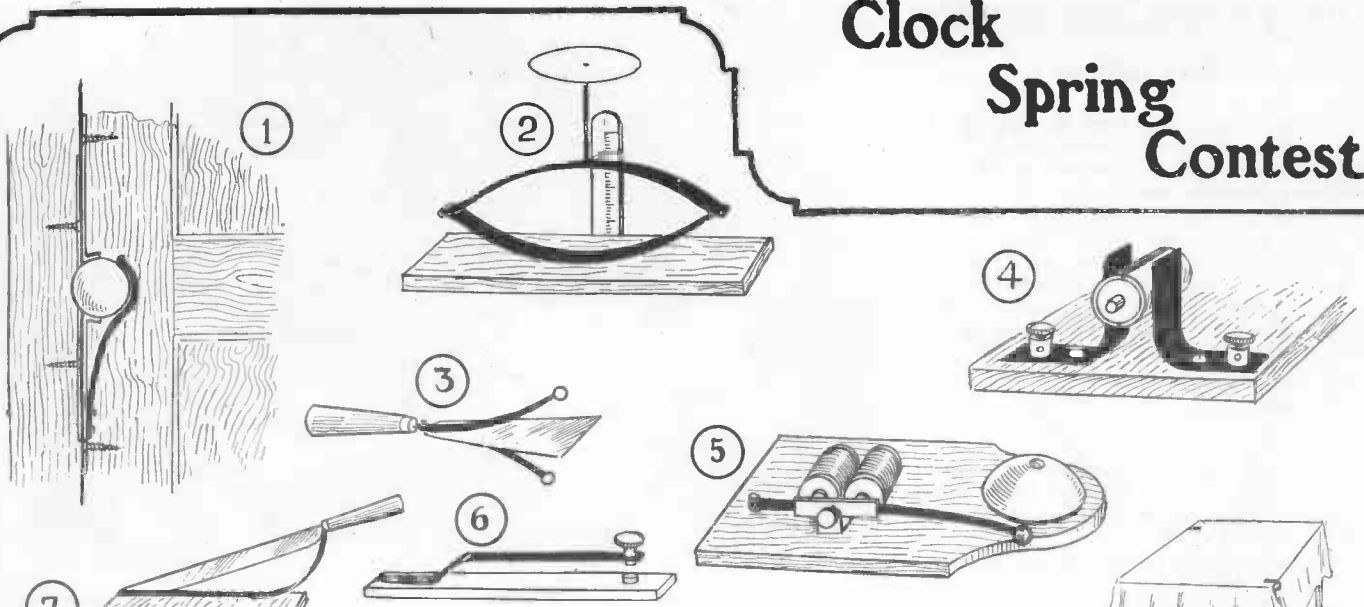

### Thirty Combination Pen-Pencils In Awards

A BEAUTIFUL combination of pen and pencil in one unit will be awarded to those submitting the thirty best suggestions for uses of old clock springs. The point is solid fourteen karat gold. The pen barrel is of hard rubber and of the self-filling type. The pencil at the opposite end propels, repels and expels the lead. The combination also contains an eraser and extra refill leads and is engraved with the words "Awarded by Science and Invention Magazine." The thirty suggestions thought best by the judges will receive the awards. In event of ties for any of the awards, contestants so tying will also receive the combination pen-pencils. Contest closes in New York City, Thursday, October 1, 1925. All entries must be in our hands at that time. Further details on next page.

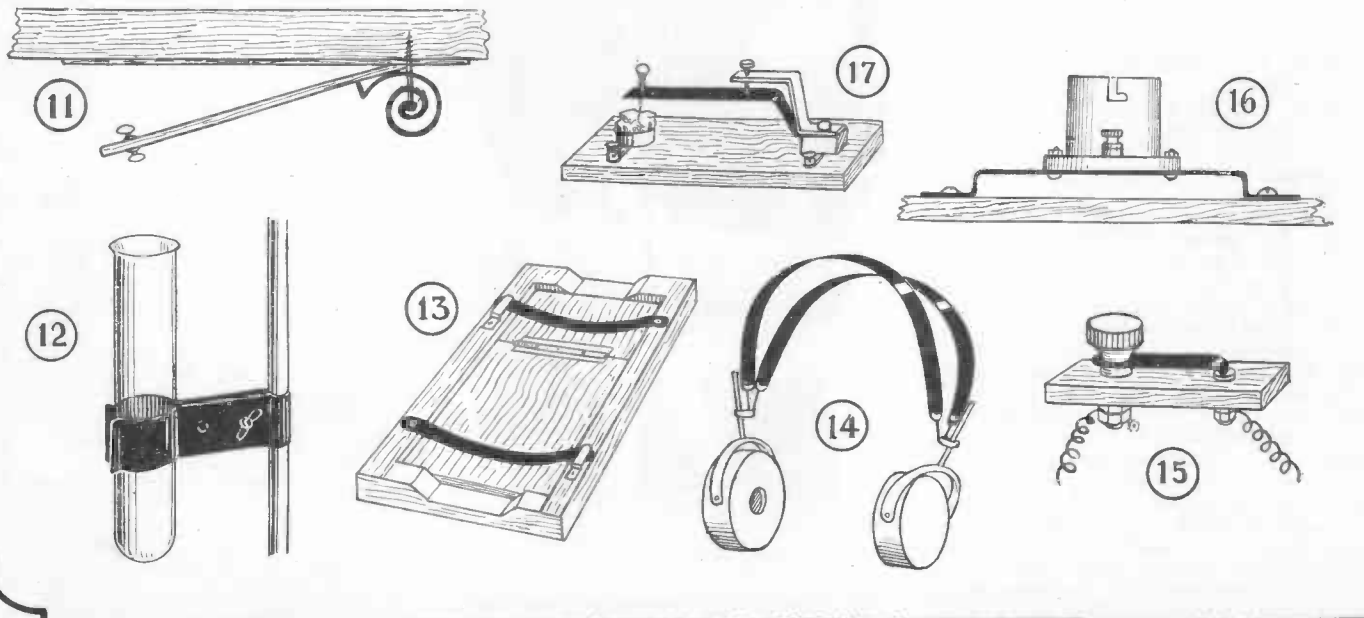
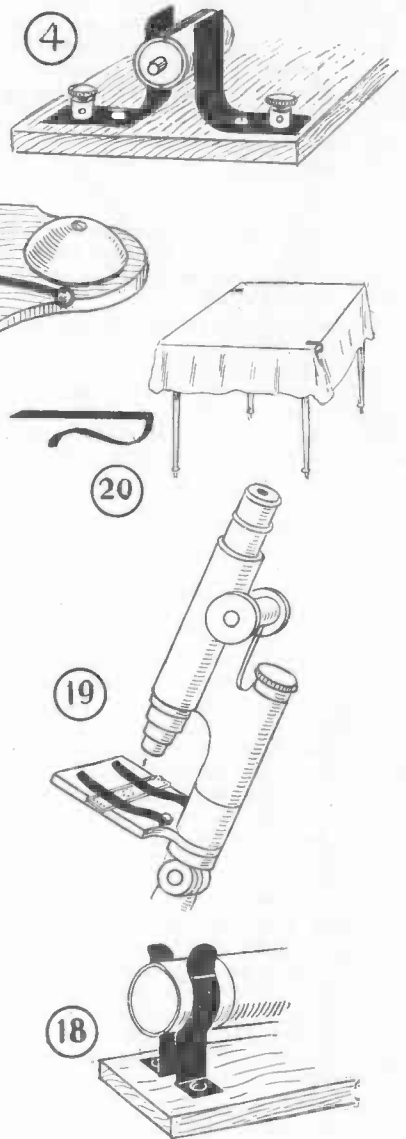



# Thirty Combination Pen-Pencils to Be Awarded

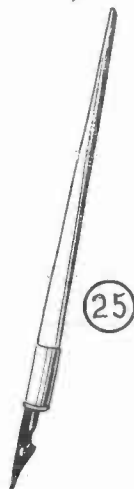
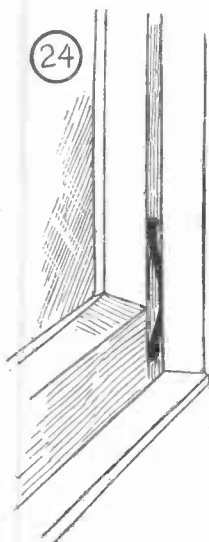
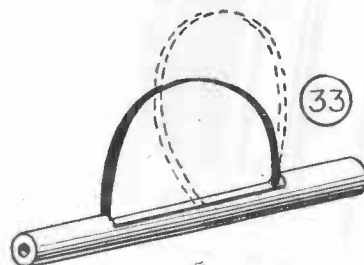
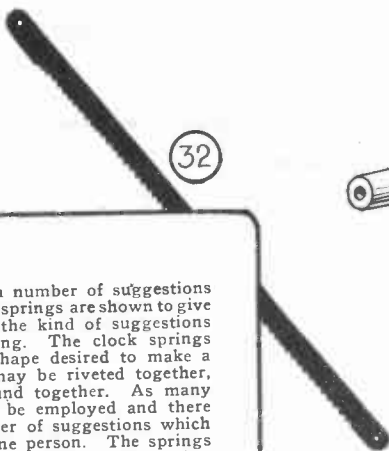
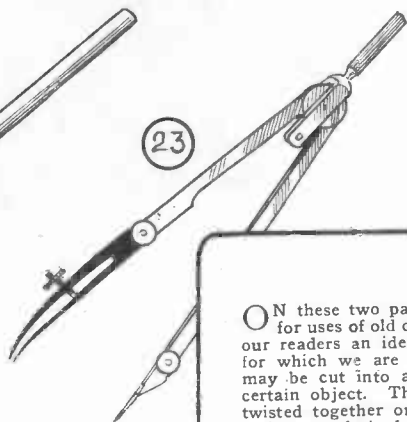
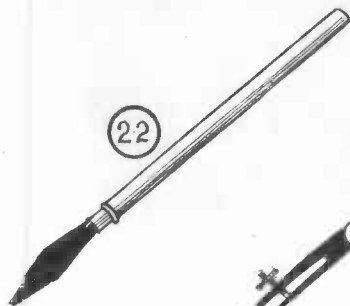
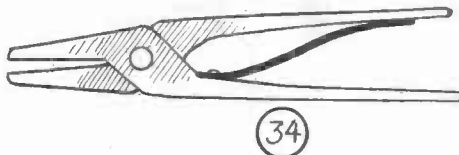

ON these two pages a number of suggestions for uses of old clock springs are shown to give our readers an idea of the kind of suggestions for which we are looking. The clock springs may be cut into any shape desired to make a certain object. They may be riveted together, twisted together or bound together. As many springs as desired may be employed and there is no limit to the number of suggestions which may be submitted by one person. The springs may be fitted into any sort of a suitable holder. A model of the device should preferably be submitted, although this is not essential. A small sketch and a short description of about twenty-five words for each item are the only requirements. None of the suggestions on these two pages will be awarded prizes.

The suggestions in their numerical order are: 1, door latch; 2, scale; 3, noise maker; 4, motor brushes; 5, armature spring; 6, test key; 7, photo trimmer spring; 8, tweezers; 9, switch jaws; 10, phone jack; 11, door spring; 12, test tube clamp; 13, springs for photo printer; 14, phone headband; 15, switch blade; 16, socket mounting; 17, crystal detector spring; 18, fuse clips; 19, slide clips; 20, table cloth clips; 21, screw holder; 22, lettering pen; 23, compass pens and points; 24, anti-rattler; 25, pen; 26, motor for models; 27, rat trap; 28 and 29, repairs for locks and latches; 30, vibrator spring; 31, governor; 32, hacksaw; 33, match gun; 34, 35, springs for pliers and shears.

Address Clock Spring Contest Editor, c/o Science and Invention Magazine, 53 Park Place, New York City.

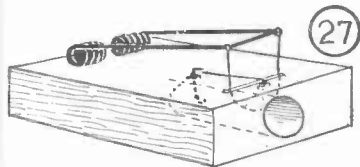
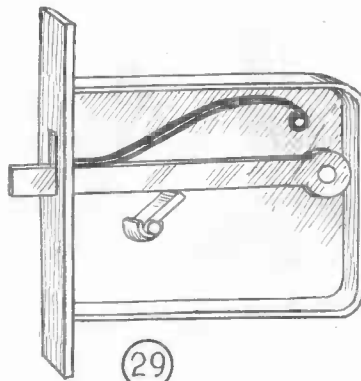
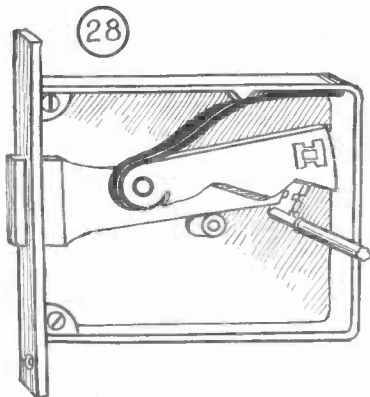
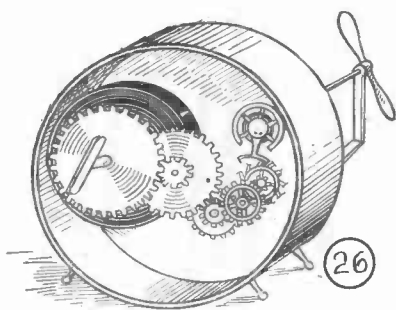
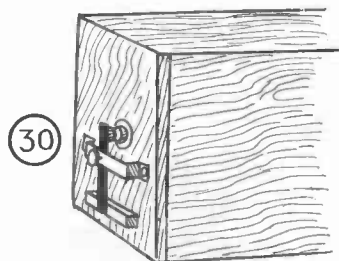
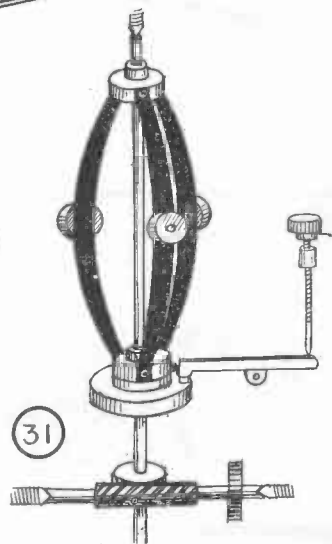

# Scientific Problems and Puzzles

By ERNEST K. CHAPIN

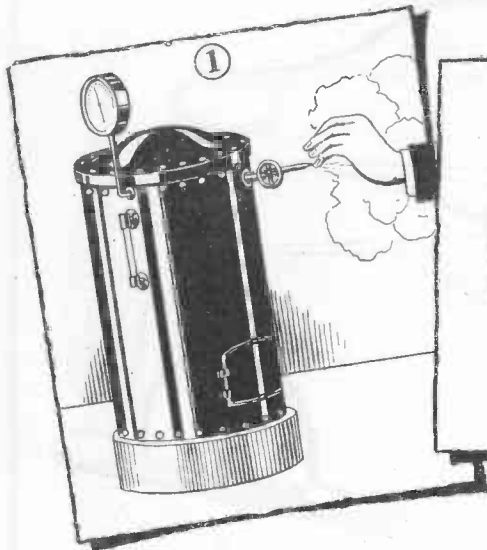

Considering that both issue from a small opening, will steam at high temperature and high pressure or that at low temperature and low pressure cause the worst burn?

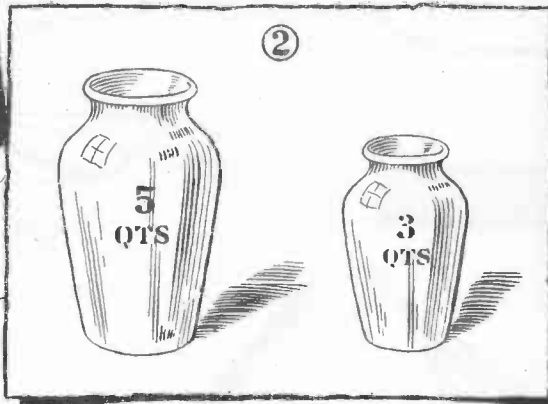

A man has a 5-quart and a 3-quart jar and has to make up a solution equivalent in strength to two tablets dissolved in 15 quarts of water. He has only one tablet and the two jars and must have 5 quarts of solution. How can he do it?

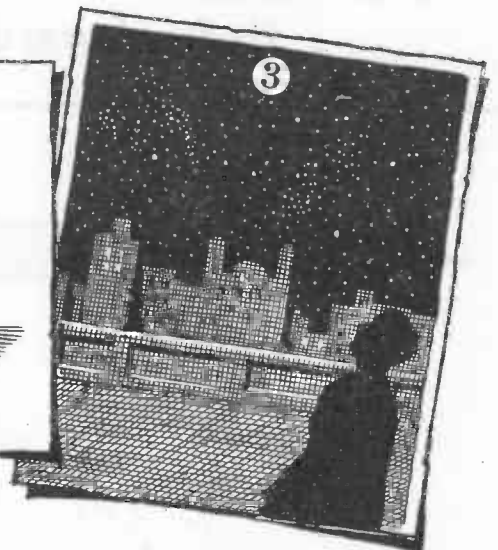

Have you ever noticed that faint stars can often be more readily seen if one does not look directly at them? Why is this so?

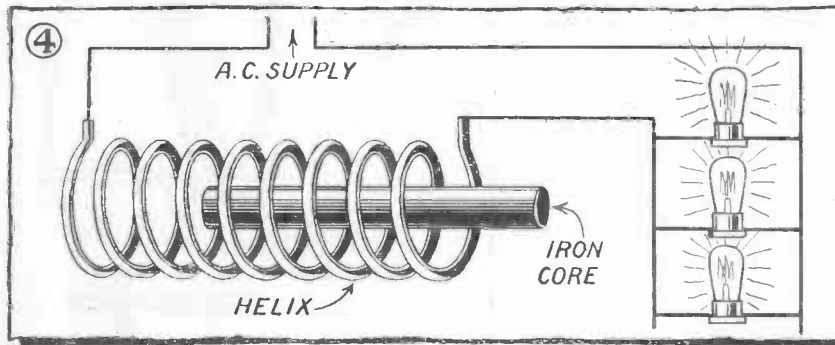

In an A.C. circuit such as shown above, the lamps may change in brilliancy quite visibly if the iron core is moved in and out of the helix. At what position of the core will the lamps be brightest?

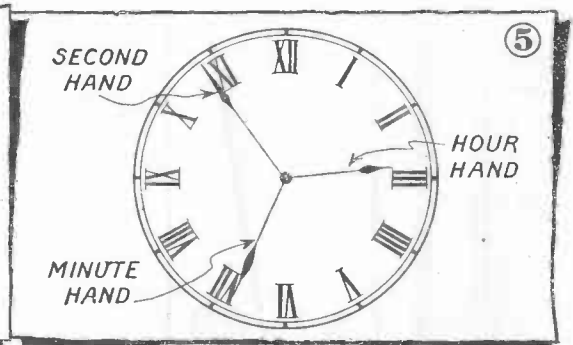

In a clock having three hands, is it possible for all three to be equidistant from each other, providing that all three start from 12 at the same time and keep perfect time?

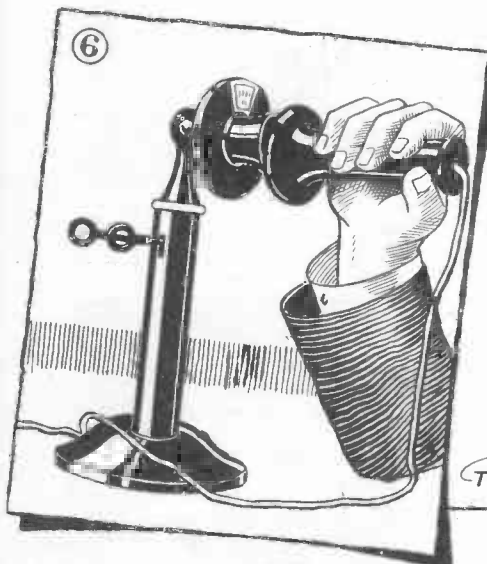

If the receiver of an ordinary telephone is brought close to the transmitter mouthpiece as shown above, a loud howling sound will be heard. What causes this noise? Do not try this experiment when somebody is listening on the other end of the line.

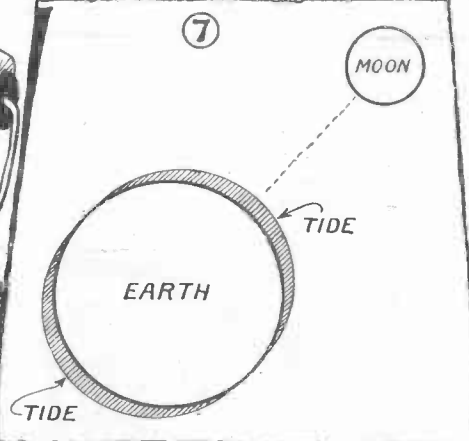

It is easy to explain a high tide on the side of the earth that is nearest to the moon, but can you explain why there should be another high tide on the opposite side of the earth at exactly the same time? This in reality is what happens every day.

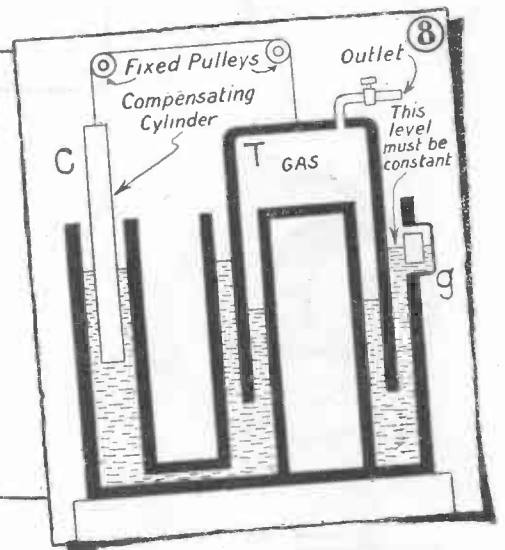

In the gasometer above, the level in the glass "g" must be kept constant. For this reason the compensating cylinder C is used. If this cylinder is not of the right size, should it be enlarged or diminished if the pressure in the tank T rises as the gas is drawn from the tank?

Answers to these Problems on page 374

# Simple Experiments with Alternating Current

Only An Electric Pressing Iron and An Electro-Magnet  
Are Necessary For This Work

By RAYMOND B. WAILES

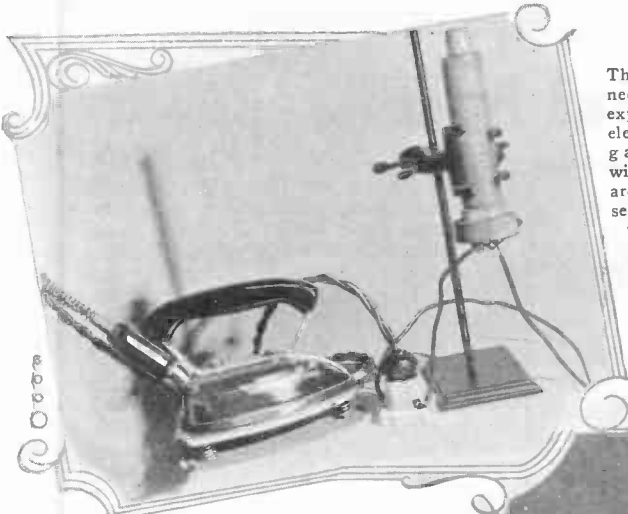

The apparatus needed for these experiments: An electric iron and a gas lighting coil with an iron core are connected in series with a 110-volt A.C. line.

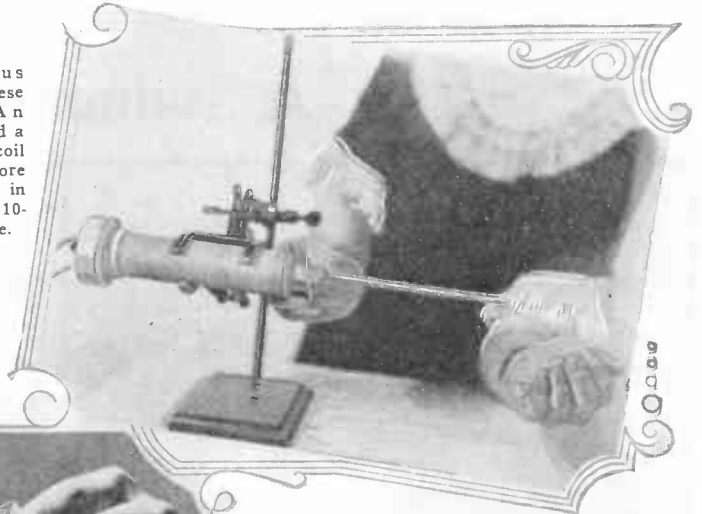

Above: An aluminum ring is repelled from the core. It will jump over an iron rod or nail and the ring gets hot. Below: Hearing the effect on a coil. The phones are connected across a honeycomb coil.

Below: Stretch a piece of thin rubber across the mouth of a cardboard tube and glue an iron washer to the center as shown. Place your ear to the open end and hold the other end near the excited core of the coil. A buzz will be heard.

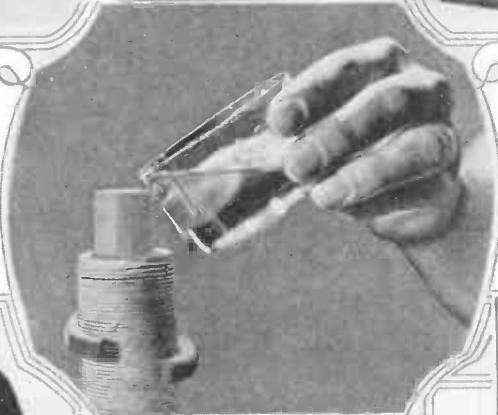

↑ To remove a steel ball from a glass of water without pouring out the liquid or putting anything into it, allow the excited iron core to attract the steel ball to the side of the glass. Lower the glass and the ball will follow the core.

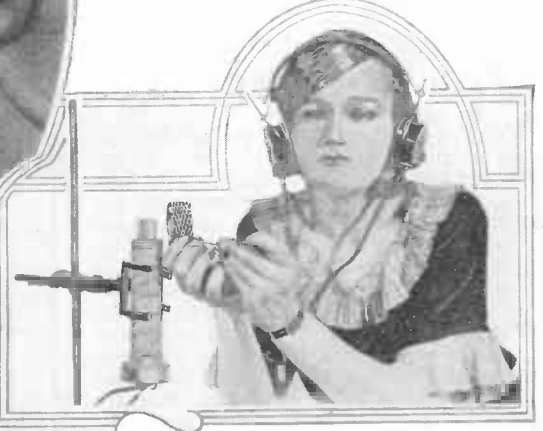

Below: Lighting a lamp by induction. Connect a flashlight lamp across a honeycomb coil and hold the coil over the iron core. The lamp will light.

Many fantastic shapes and lines are assumed by iron filings when sprinkled over the excited core of the coil as below.

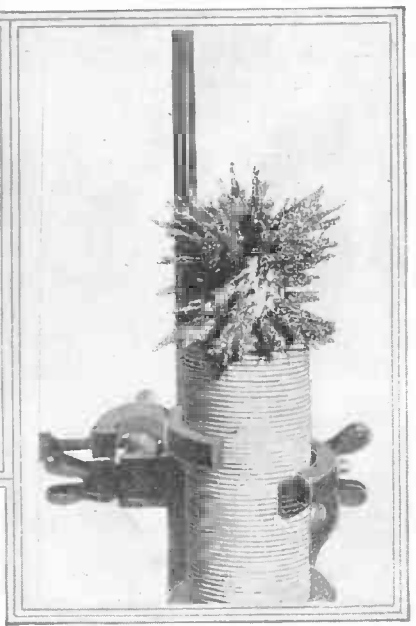
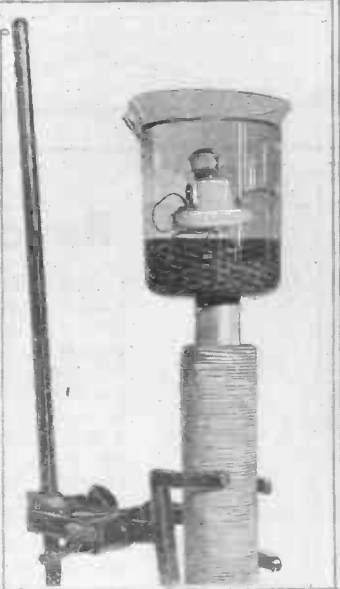
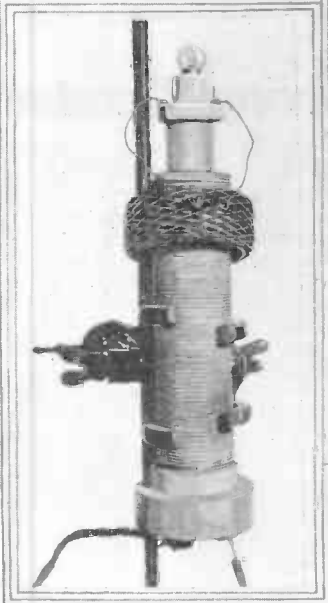

The inductive effect can be shown in a startling manner by placing the honeycomb coil and the lamp in a beaker of water as at left above. You can ring a bell or buzzer by connecting it to the honeycomb or other coil as shown above at the right.



# THE CONSTRUCTOR



## A Swimmer's Sail Boat

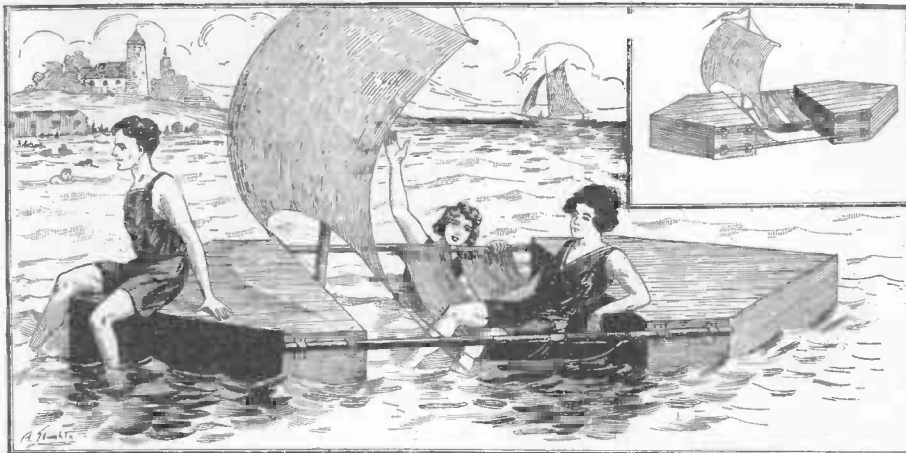

THE contrivance illustrated at the left will afford great pleasure to swimmers at resorts near large bodies of water. It is readily constructed from scrap material and consists of two wedge-shaped water-tight sections, one for the bow and one for the stern. These sections are connected together by means of four rods. The top and bottom of the sections should consist of boards  $\frac{3}{8}$ -inch thick, while the sides should be made of 1-inch lumber. Assemble the sides and bottom and give the inside several coats of tar. Then nail the top on, calk all the joints and paint the outside with several coats of water-proof paint. If you want to be sure of having an unsinkable boat, fill the end sections with cork. Fasten the side rods in place as shown and provide a seat and sail. In lieu of a sail, an ordinary canoe paddle may be used to propel the boat.

## The Dodging Bag

Very good practice for the amateur or even for the professional boxer may be had with the dodging bag illustrated at the left. This consists of an ordinary punching bag mounted in the rather unusual manner illustrated. A spring constitutes the top supporting member and the bottom rope, instead of being rigidly fastened as is the usual practice, passes through a pulley which in turn is fastened to the floor by a heavy screw eye. A second party holds the end of this rope in his hand as illustrated and as the boxer is practising, he pulls or releases this rope somewhat, causing the punching bag to go up or down. The boxer can thus develop quickness of eye and co-ordination between sight and muscles that cannot be obtained with the ordinary bag.

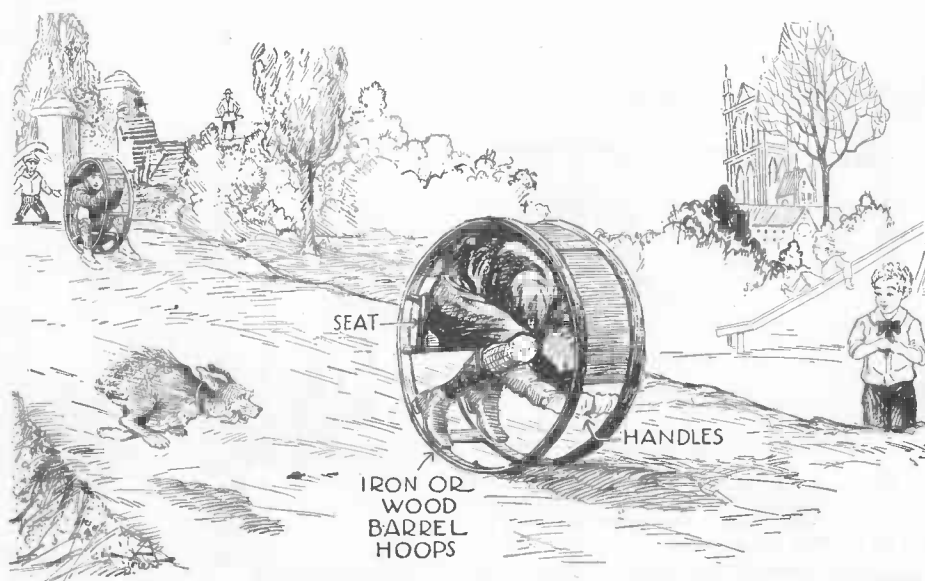
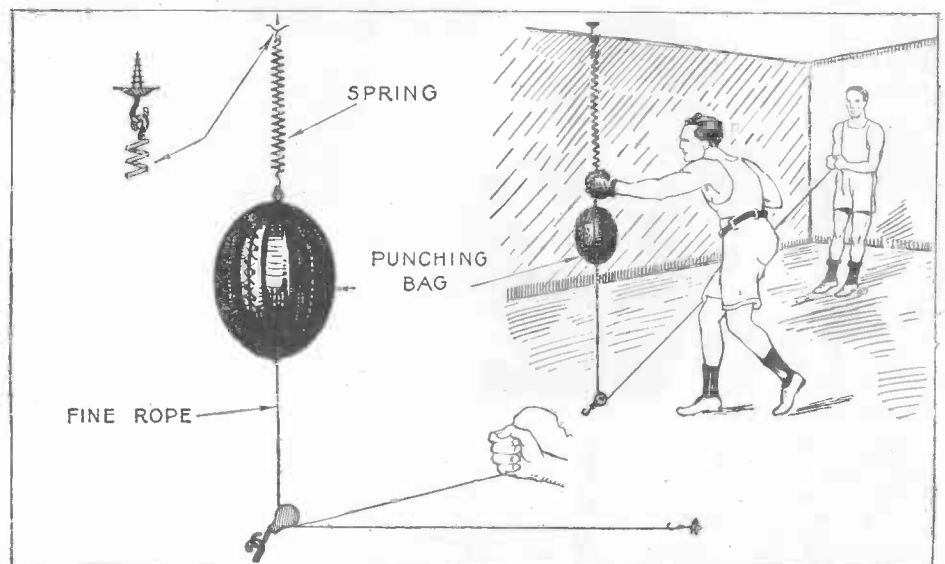

## Revolving Coaster

Great fun may be had by the youngsters with the revolving coaster illustrated at the left. The construction of the device is clearly shown. Two large hoops are used for the main framework and are connected together by means of cross strips. A handle is provided which is set back from the frame a few inches toward the center. Thus the operator's hands are protected from the ground. Almost opposite the handle, a seat is fastened as shown. Part of the framework may be covered with canvas or a very thin strip of wood curved to the shape required. In starting, the user assumes his position at the top of a slight grade as shown at the extreme left. Then with a slight push of his feet and at the same time drawing them in, and resting them on the hoops, he rolls down the embankment at an exhilarating speed.

# Decorating Windows With Leaves

An attractive method of decorating windows in the home is by means of real foliage from various species of trees. The procedure is simple in the extreme and is completely outlined below. Some examples of the beautiful work produced in this way are also shown. Even ferns may be used with a delicate effect.

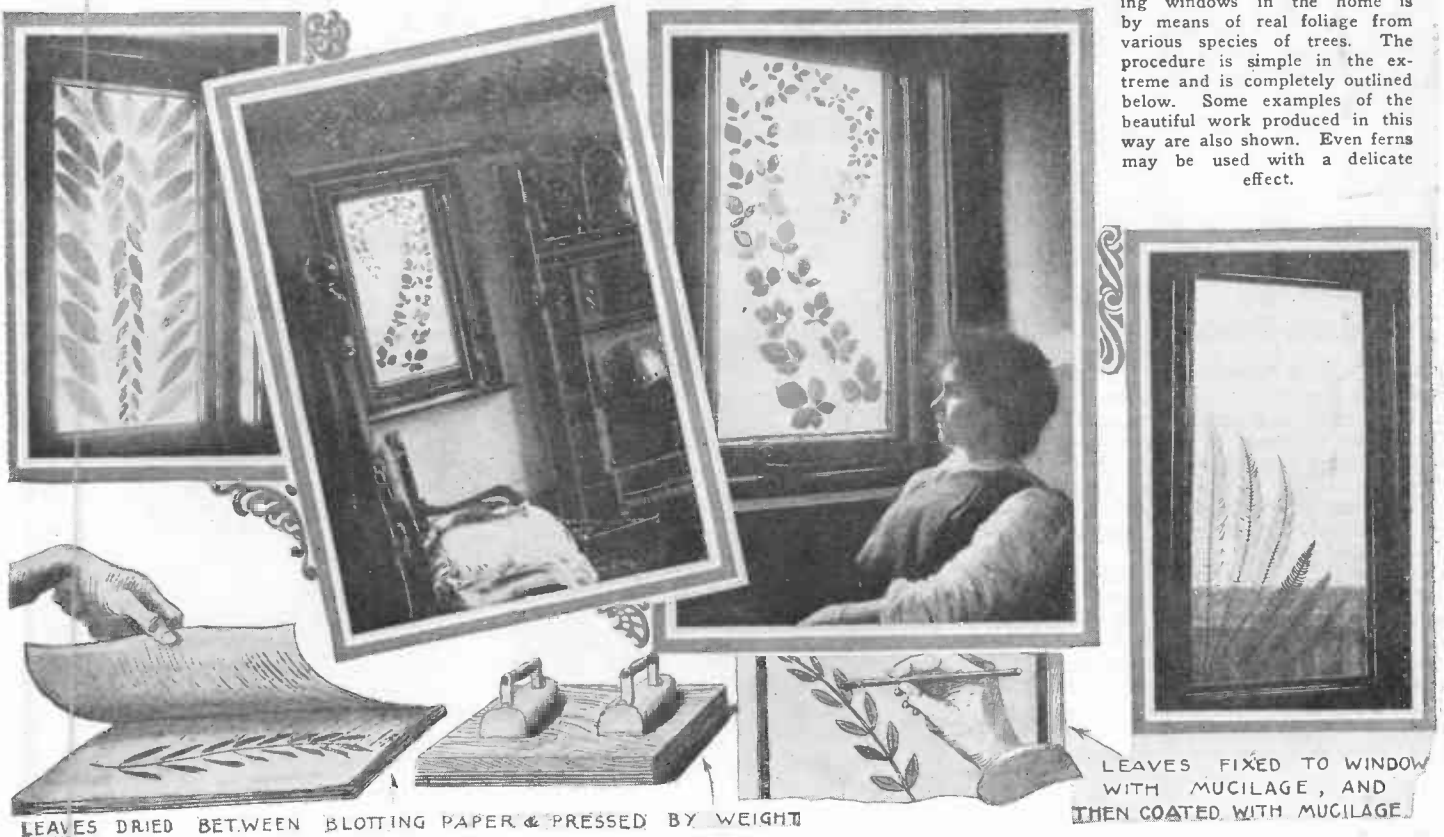

LEAVES DRIED BETWEEN BLOTTER PAPER & PRESSED BY WEIGHT

LEAVES FIXED TO WINDOW WITH MUCILAGE, AND THEN COATED WITH MUCILAGE

To use leaves for decorations, they must first be pressed and dried between sheets of blotting paper. When perfectly dry, they still maintain their natural color and may be fastened to the glass with a thin,

clear mucilage or newly made gum tragacanth solution. A coating of mucilage is also given to the other side of the leaf. The light shows up the veins in a very striking manner. —S. Leonard Bastin.

# Experimenting With Color Screens



Some novel effects with an ordinary hand-camera may be obtained by using sheets of various colored gelatin or glass (color screens) between the camera lens and the object to be photographed. Panchromatic plates or films must be used.

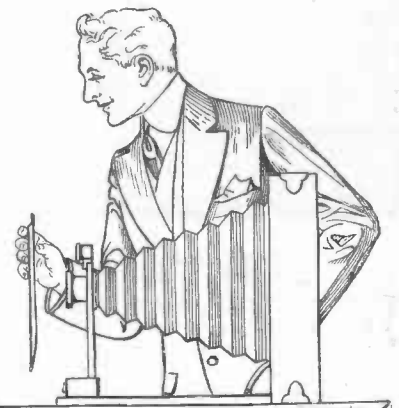

Figs. 4 and 5 above show a white china pitcher with a bright blue design painted upon it. Fig. 4 was taken without any filter or screen, while a strong yellow contrast filter produced the picture shown in Fig. 5. This filter is known to the trade as a G type.



Figs. 1, 2 and 3 are other examples of photography through filters. Fig. 1 was taken without any screen and seems to be lacking in many respects. Fig. 2 was taken through a yellow filter known as K3, and Fig. 3 through a red filter known as A. —Herbert E. Hayden.

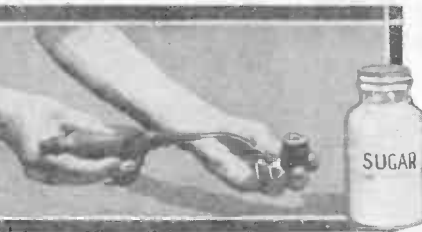

↑↑↑ To break in a pipe, first put in a pinch of tobacco, then a mixture of sugar and tobacco. "Puff" with a rubber bulb pump as shown above.  
—Raymond B. Wailes.

### Fire Extinguishers

#### ←←← Pipe Aging

At the extreme left is shown a "Blanket of Foam" fire extinguisher. In the center compartment of a double bucket is placed a strong solution of aluminum sulphate. In the outside compartment is a solution of 8 parts of baking soda, two parts of casein and 92 parts of water, or a strong solution of baking soda and the contents of 1 bottle of glue. The two solutions mix on being poured over a fire and form a thick foam of carbon dioxide bubbles which smothers oil and other fires.

—Raymond B. Wailes.

### Dust-Proof Floors

CONCRETE floors are often most troublesome because of the fact that they become so dusty in a very short space of time. They can, however, be made dust-proof in the following manner which is illustrated at the right. First mix together 1 part of a thick syrup of water glass with 5 parts of water. Apply this solution liberally to the floor, using a broom as shown. After this coat has thoroughly dried, repeat the performance with a solution of 1 part of water glass of the consistency of syrup and 3 parts of water. This surfacing effectively fills the pores of the concrete and keeps down the dust by forming an insoluble compound. Floors that have been treated in this manner can afterwards be painted in any desired color to match surrounding objects.

—Raymond B. Wailes.

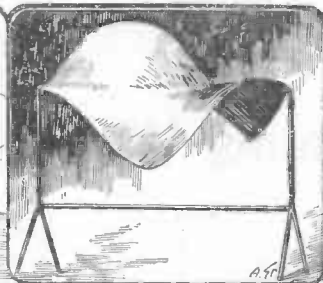
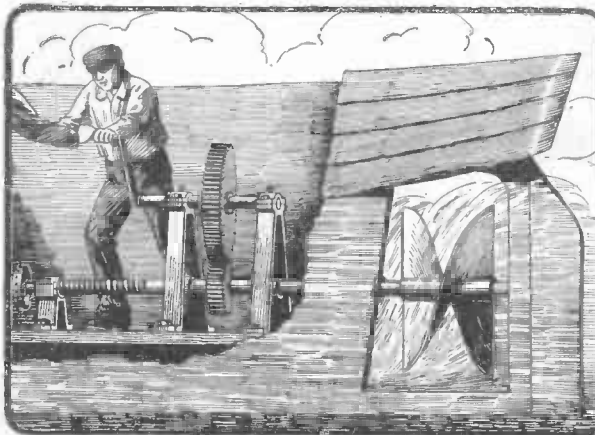

↑↑↑ Ressel's propeller as it appears today, well preserved through the years.

### Original Propeller

THE small illustration at the left shows an original model of a screw propeller made from one piece of copper and patented by J. Ressel. This model now reposes in the Technical Museum in Prague. In the application for the patent on this device in 1826, Ressel also requested protection on a device for driving a screw of this nature such as illustrated in the large drawing at the left. In this application, the propeller took a slightly different form as is shown and was designed to be driven by hand through two gears. Ressel's screw was the forerunner of present day propellers.

—H. Slouka, Rep. No. 7110.

### Filter System

WHEN drinking water is obtained from a natural source, it should be well filtered. The system shown at the right is simple, easily constructed yet thoroughly efficient. In this system, little water is lost in spite of the inability of the filter to take care of it all. Two well cleaned barrels are placed on a strong level platform and equipped with drain pipes as shown. The ends of each outlet should be screened with fine copper gauze to prevent the flow of sediment through the pipes. In the bottom of each barrel place a layer of clean stones about 3 inches thick. Over these place a layer of fine gravel and then a deep layer of powdered charcoal. Arrange the supply pipe with a pivoted rocker and two floats as shown. Two loops should be soldered to the rocker at each end in order to guide the float rods. These rods are forked, and when one barrel is nearly full, the pivoted arm is swung so as to fill the opposite barrel while the full one is draining off. The floats may consist of two large tin cans soldered so as to be water-tight.

—L. B. Robbins.

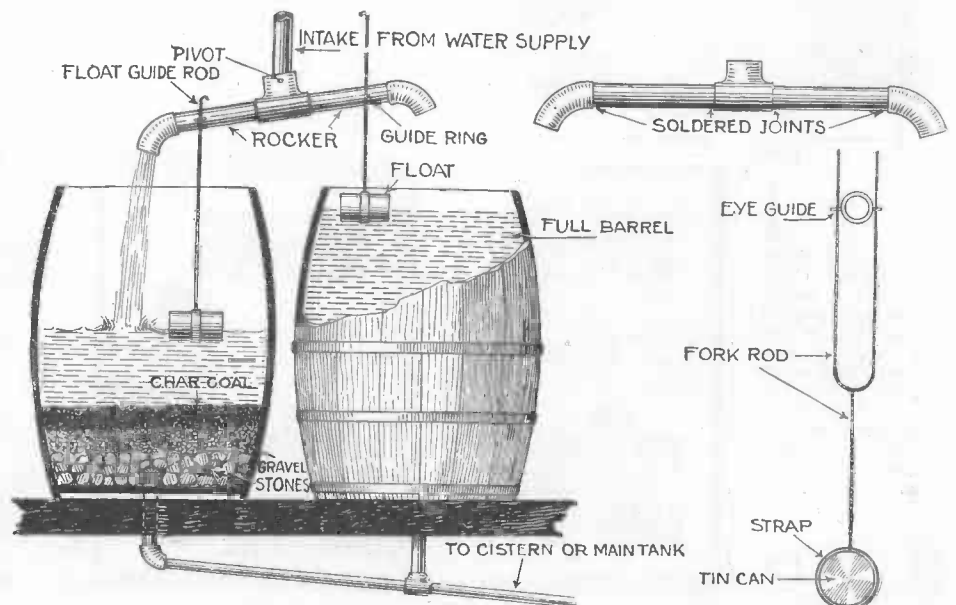

# Shellac and Shellac Varnishes

## How Shellac May Be Purified

By DR. ERNEST BADE

3/4 LB. MANILA COPAL  
4 LB. PURE SHELLAC  
3/4 LB. VENETIAN  
TURPENTINE  
1 3/4 GAL. ALCOHOL



Contrary to general opinion, shellac will make an excellent varnish for floors and other uses if properly purified as described below.



Above: Dissolving shellac with the aid of heat preparatory to purifying.



Above: Preparing the filter to be used in the process of purifying shellac. Either ordinary folded filter paper or the type shown may be used.

**S**HELLAC, one of the most common finishing varnishes employed at home, is a vegetable product indirectly produced by an East Indian scale insect. The creature, depositing its eggs on the twigs of certain trees, injures them which causes a flow of sap. On hardening, this solidified sap is collected, melted, poured on flat trays where it again hardens and is then sold as purified or orange shellac.

In order to remove the wax which makes the shellac milky, 100 parts (3 oz.) of shellac are boiled with 50 parts (1 1/2 oz.) of sodium carbonate dissolved in 2,000 parts (2 qts.) of water until the melted wax collects on the surface of the water. Then the solution is cooled, and when cold, the solidified wax is removed by filtration which also removes any foreign substance which may be present. The dark brown liquid is then very carefully acidified with hydrochloric acid under constant stirring, the operation being, of course, conducted in glass or porcelain ware. The granular light brown or yellow precipitate thus obtained is collected on a filter and is melted in boiling water. The shellac thus purified has the hardness of the raw product and softens in boiling water without melting. It is only that particular shellac which has been purified by the removal of its wax which will give a perfectly clear solution in alcohol.

For varnishing radio coils and other electrical devices, one ounce of shellac is dissolved in 8 ounces of alcohol to which 3 ounces of sealing wax have been added.

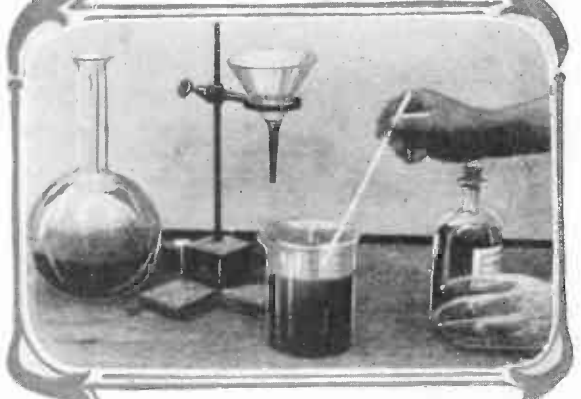

Above: Precipitating the shellac with acid in order to coagulate it.



The granular precipitate obtained by the use of acid is collected and melted in boiling water.

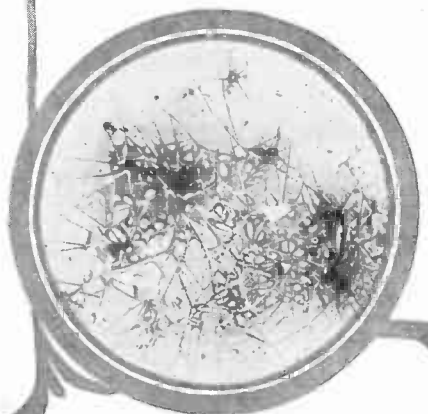

Micro-photo of impure shellac varnish fifty times enlarged showing imperfections.



# HOW TO MAKE IT



## Heater

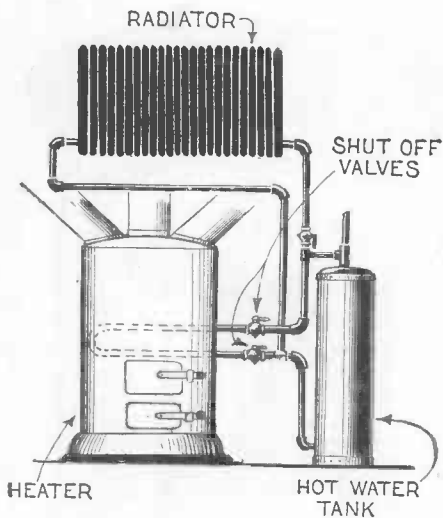

An old hot-water radiator may be used to warm some part of a house, equipped with a hot-air furnace, which part may be ordinarily rather cool in winter. A loop of pipe and its attendant fittings as shown above are all that is required.

—H. T. Schuesen.

## Luminous Objects

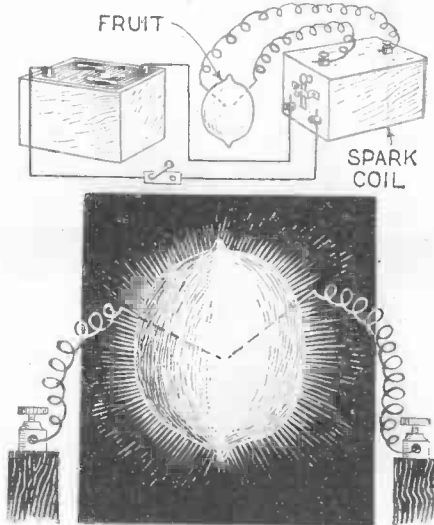

If two heavy wires are pushed into an orange or lemon as shown above and hooked up to the secondary of a spark coil, a pretty luminous effect will be obtained. A gap should be left between the ends of the two wires. A cake of soap will exhibit the same effect.

—Joseph Mersand.

## Boiling Eggs

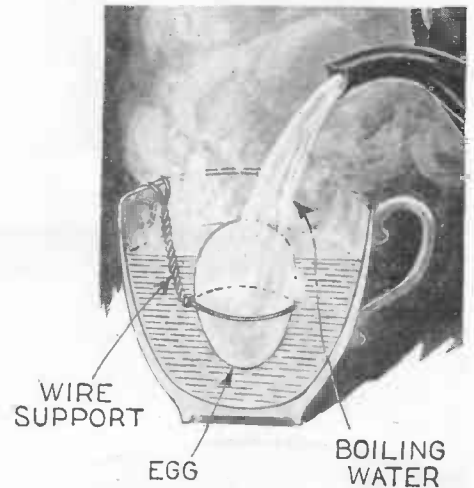

A safe way of cooking medium hard eggs is shown above. In this way, the egg cannot be overdone. Make a wire frame as shown, place the egg in position and cover with boiling water. At any time after 5 minutes, remove the egg and it will be done.—C. A. Oldroyd.

## Coin Record

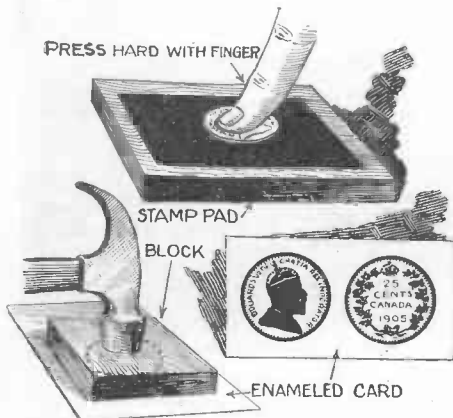

A coin collector may record his coins for filing purposes as above. Press coin on stamp pad, remove and lay it on a finely finished sheet of cardboard and tap as shown. The result is illustrated.

—Wilbert Whitfield.

## Funnel

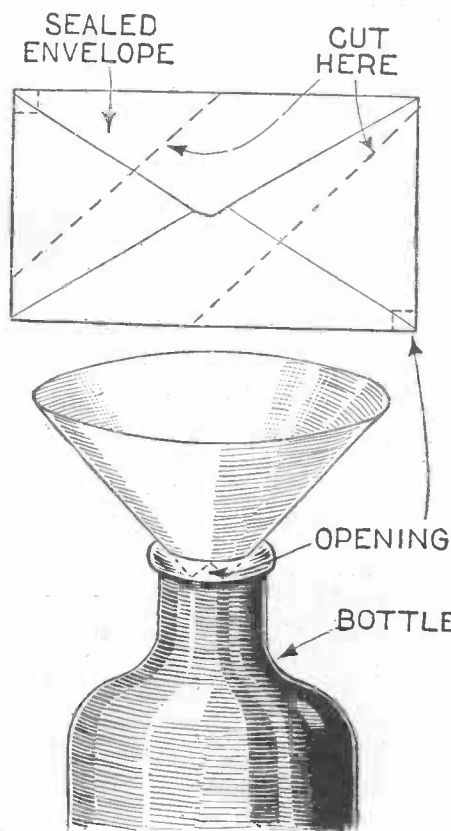

Where powdered chemicals are to be placed in a comparatively narrow mouthed bottle, a simple funnel cut from an envelope as shown above comes in handy. Two may be obtained from one envelope.

—C. A. Oldroyd.

## Nut Holder

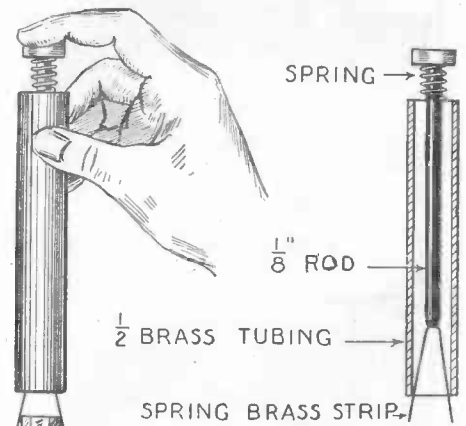

With the device shown above, nuts may be started in places which the fingers cannot reach.

## Collar Button

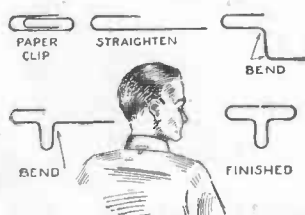

An ordinary paper clip of the type shown when bent as illustrated makes an excellent collar button. A fastener of this nature cannot cause a bulge in the back of the collar.

—H. C. Frante, Jr.

## Iron Test

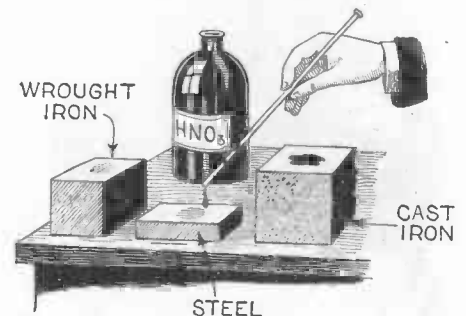

Nitric acid on cast iron yields a deep blue color; on steel, a brownish black or dark gray, while on wrought iron it gives a pale gray.

—E. R. Caley.





# WRINKLES

## RECIPES & FORMULAS



Edited by S. Gernsback

### Pen Rack

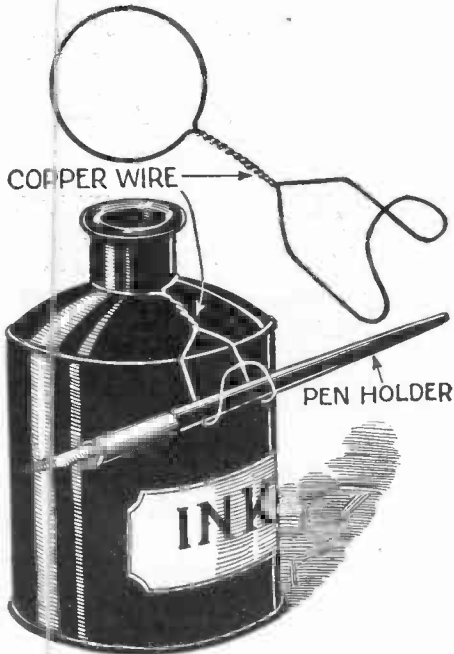

A rack for holding a pen right on the ink bottle just where it is always needed may be quickly and easily made from twisted wire as is clearly shown above. —L. J. Gauvin.

### Two Hints

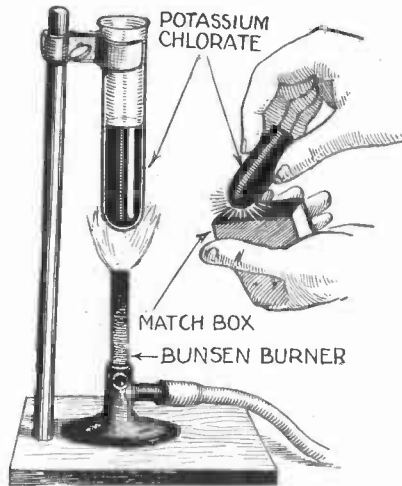

Potassium chlorate melted and allowed to harden will present a curious sparkling appearance when rubbed on the side of an ordinary safety match box as above.

### Substitute Funnel

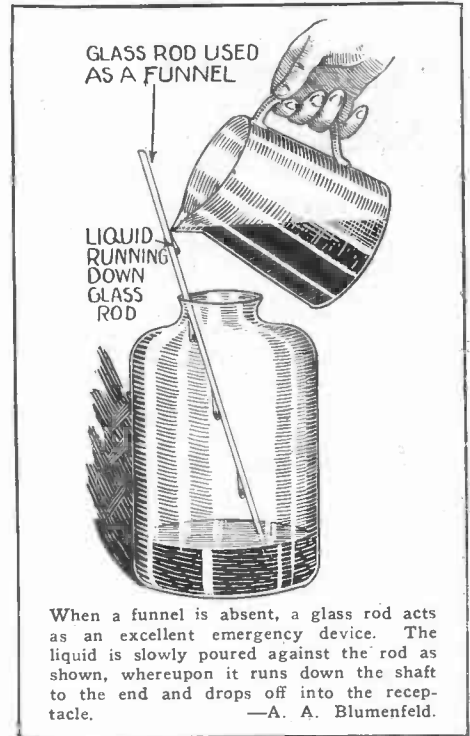

When a funnel is absent, a glass rod acts as an excellent emergency device. The liquid is slowly poured against the rod as shown, whereupon it runs down the shaft to the end and drops off into the receptacle. —A. A. Blumenfeld.

### Ink Cleaner

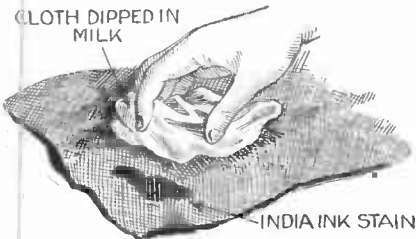

If a cloth has been stained with India ink, the stain can be quickly removed if it is sponged with milk. Apply liberally as shown, as soon as possible after the ink has been spilled. —A. A. Blumenfeld.

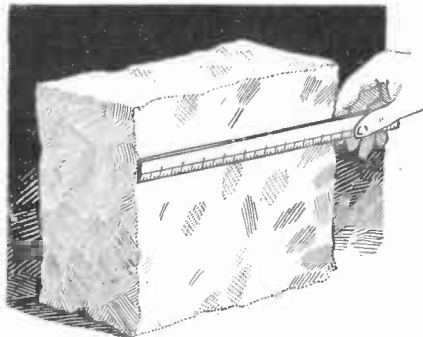

The weight of a cake of ice in pounds is equal to its volume in cubic inches divided by 30. Measure the three sides of the block, multiply these figures together and divided by 30. —A. A. Blumenfeld.

### Bezels



Old ink bottles may be used as bezels in a radio set by mounting them directly over the tubes as shown in the above illustration. The tubes may be viewed through the glass. —Paul Saffron, Rep. No. 4664.

### Berry Squeezer

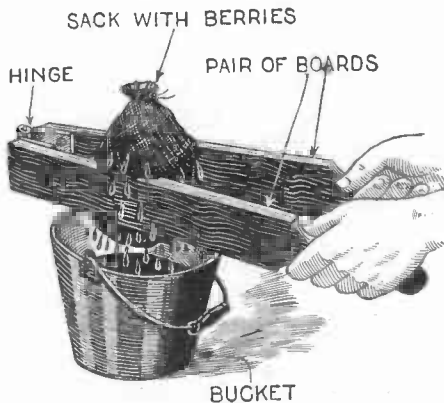

Two boards shaped as shown above and provided with a hinge make an excellent berry squeezer. Place a cloth sack of berries between them and press. The juice will be quickly extracted. —Andrew M. Shandor.

### Bottle Kink



An ink bottle on a sloping drawing board or table tends to slide and fall off. A square of sandpaper or rubber glued to the bottom prevents this. —C. G. Lisman, Rep. No. 15,446.

### Small Parts

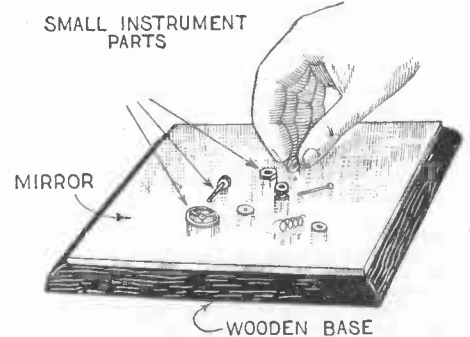

Small parts placed on a mirror are easy to find when wanted. —C. A. Oldroyd.

## QUADRATURE OF THE CIRCLE

Editor, SCIENCE AND INVENTION:

I have been a steady and really very satisfied reader of SCIENCE AND INVENTION Magazine for the past two years, during which time I have read some very interesting articles, and being a music teacher I have occasionally found articles in your paper about musical instruments which interested me greatly. Besides my profession I have another great passion, i. e., the study of geometrical problems.

In one of your recent issues you threw light on the mysteries of "perpetuum mobile" or perpetual motion. I would like you to give some information concerning the quadrature of a circle. I understand it is impossible to solve this geometrical problem as the Ludolph number 3.1415926 is endless, and consequently no drawing can possibly be correct. There surely must be some nearly correct solution, and no doubt many readers would be pleased to get an article about the "quadratura circuli," which in itself is a problem as old as the philosopher's stone and perpetual motion.

LEON BARTOSH, Music-Teacher,  
Roebling, N. J.

(Many people have a mistaken impression concerning what is meant by the terms "quadrature of a circle," or "squaring the circle," as it is popularly called. Many have supposed that there was a large reward offered for the success of the calculations or that the longitude problem depends upon the solution, or that the solution is one of the great ends or objects of geometry. The fact of the matter remains that there is no reward being offered by any government of any country for the solution, and that the longitude problem in no way depends upon the perfect solution. In 1775 the Royal Academy of Sciences of Paris passed a resolution not to entertain communications claiming to give solutions to the duplication of the cube, the tri-section of an angle, the quadrature of the circle, or any perpetual motion machine.

Attempts to square the circle are very old. The objects of the many attempts to solve this problem fall into two classes; first the arithmetical method, by which the area of the circle is found, and then expressed numerically in square measure, and secondly the geometrical quadrature, which attempts to produce a square equal in area to a given circle. But the ascertaining of the area of the circle is the difficult part. The problem really resolves itself into finding the area of the circle when the radius or diameter is known. The ratio between the diameter and circumference of the circle was expressed as being 3 to 1 in ancient Jewish times, as may be noted in the First Book of Kings. The ancient Egyptians reached the closer approximation of 3.16 to 1, and Archimedes attempting to solve it in a more scientific manner, arrived at the conclusion that the ratio lay between 3.1428 and 3.1408. At the present time 3.141592, known by the Greek letter  $\pi$  is now adopted all over the world. In 1873 the figure was carried out to 707 decimal places.

## \$250.00 in Prizes RAT CONTEST

The Federal Government and State Departments are doing all they can to exterminate the rats. SCIENCE AND INVENTION MAGAZINE now offers prizes for the best new methods for exterminating rats. See July issue of this magazine for full details.

The prizes to be awarded are as follows:

First Prize	\$100.00
Second Prize	50.00
Third Prize	30.00
Fourth Prize	25.00
Fifth Prize	20.00
Sixth Prize	15.00
Seventh Prize	10.00

Suggestions must be accompanied with photographs or affidavits sworn to before a Notary, or if a trap is entered, a model must be submitted.

Contest closes at noon in New York on October 15th. All suggestions must be in our hands at the time.

The number of entries per person is not limited.

In event of a tie for any of the awards, an identical prize will be paid to the contestants so tying.

Address entries to Editor, Rat Contest, c/o Science and Invention, 53 Park Place, New York City.

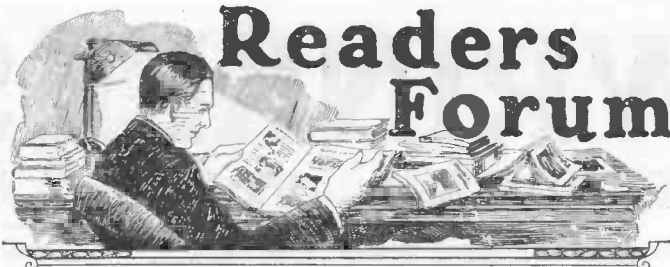

SCIENCE AND INVENTION desires to hear from its readers. It solicits comments of general scientific interest, and will appreciate opinions on science subjects. The arguments pro and con will be aired on this page. This magazine also relishes criticisms, and will present them in both palatable and unpalatable forms. So if you have anything to say, this is the place to say it. Please limit your letters to 500 words and address your letters to Editor—The Readers Forum, c/o Science and Invention Magazine, 53 Park Place, New York City.

Making a square of a size equal in area to that of a circle and using 707 places to calculate the size of the square, we would arrive at such accuracy that the error could not be visible under the most powerful microscope now made. As a matter of fact if we could produce a perfect circle having the diameter of the orbit of this earth, namely 185,000 miles, and having a thickness of 8,000 miles, and then by means of the 707 places, calculate a square of the same material and thickness, and then were we able to weigh both of these pieces of metal on a beam balance, the difference in weight between the circle and the square would not be sufficient to be indicated by the most delicate balance ever constructed. It consequently makes very little difference whether the ratio between circumference and diameter ever reaches a definite conclusion or not. Geometrically, it would have but little bearing on any of our present day calculations or figures.

A very interesting treatise on the quadrature of the circle is given in the excellent work of Joseph Phin called, "The Seven Follies of Science."—EDITOR.)

## BOOKS ON THE MOON

Editor, SCIENCE AND INVENTION:

I guess the best way to start would be to explain myself. I am a "nut" on the subject of pseudo-scientific fiction. That should be sufficient.

In your magazine many interesting stories have appeared, such as the one about the girl on Venus, stealing the earth's air for the moon, going into the future, etc., and I would like to know where or if I could buy a book having any or all these yarns.

Now, for some reason or another I have specialized in digging up books on the moon. The sum and total of my work is eighteen titles, so far, and I would like to have you print them, so that any of your readers could write either to you or to myself and name others. I would like to have more. The ones I know of are:

- 1—"The Moon Hoax," by Locks (Ran in New York Sun.)
- 2—"Adventure of One Hans Pfall," by Poe. (Among short stories.)
- 3—Third volume of American Quarterly Review has a discussion of a journey to the moon.
- 4—"Flight of Thomas O'Rourke." (Author unknown as yet.)
- 5—"Journey Performed from the Earth to the Moon," by Domingo Gonzalez, Spanish Adventurer," by Jean Bauloin. (In French.)
- 6—"Journeys in the Moon," by Cyrano de Bergerac.
- 7—"The Plurality of Worlds," by Fontenelle.
- 8—"From the Earth to the Moon," by Jules Verne.
- 9—"Round the Moon," by Jules Verne.
- 10—"The First Men in the Moon," by H. G. Wells.
- 11—"The Moon Metal," by G. P. Serviss.
- 12—"The Moon Maiden," by Serviss. (In magazine in 1915.)
- 13—"Out of the Moon," by Flint. (In magazine year or so ago.)
- 14—"The Man in the Moon," by Flint. (In same magazine earlier.)
- 15—"The Moon Maid," by E. R. Burroughs. (Not yet in book form.)
- 16—"The Moon Men," by E. R. Burroughs. (In a magazine this year.)
- 17—"Lost on the Moon," by Rockwood. (Not so good.)
- 18—"Dr. Hackensaw's Trip to the Moon," by C. Fezandé. (This ran in SCIENCE AND INVENTION last year.)

That is all, but I hope to see it grow.

DONOVAN HELMUTH,  
Cleveland, Ohio.

(Undoubtedly some of our readers have read other books not listed by Mr. Helmuth. If so, Mr. Helmuth would like to have the names of the works and any comments on the same that may be deemed advisable.—EDITOR.)

## THE DEATH RAY

Editor, SCIENCE AND INVENTION:

Will you please explain through the "Readers Forum" whether the recent moving picture of "The Death Ray" was real or a fake? I can

duplicate two of the experiments. In the case where two men held a Geissler tube between them and it was lighted, there need not be any electrical connection, inasmuch as the current could pass through the men's bodies. My friend and I are greatly interested in this, and my ray is on the principle of directed radio beams carrying the actual ray. If I have any success, I will call it "The Radio Ray."

L. CARPENTER,  
Burlington, Vt.

(It is very difficult to state whether the motion pictures of "The Death Ray" were fraudulent or not. SCIENCE AND INVENTION Magazine does not believe that a real death ray has been discovered. Our own experiments along this line do not justify the claims as given by the inventor of the so-called "Death Ray." If you have any success with your experiments, we would like to have you forward photographs of the same and explain the results you may have obtained along this line of research.—EDITOR.)

## S. &amp; I. UP-TO-DATE

Editor, SCIENCE AND INVENTION:

I am going to try and express in words my opinion of SCIENCE AND INVENTION. It is unquestionably the most complete, up-to-date scientific magazine ever published. I am an old reader of your magazine, and get all your publications every month.

All the departments are interesting, especially the Scientific Humor department, because it conveys fun to you in a remarkably interesting and droll way.

In regard to a letter from C. E. Payne, appearing in the November, 1924 issue, he says that the covers should have pictures of pre-historic mammals, epics in the ice age, the heads of insects, etc. I am afraid that in this matter I cannot side with him. Your magazine doubtlessly needs a little improvement, but to my eye it is all right as it is. I am sure you could find many people of the same opinion.

WILLIAM S. HOOD,  
Fairmont, West Va.

(We are glad that you like SCIENCE AND INVENTION the way it is, but at any time the publication does not please you, write and tell us about it. We are out to please you.)

## PERPETUAL BATTERY

Editor, SCIENCE AND INVENTION:

I noticed your offer for a perpetual motion machine. My idea is a battery that obtains its power from the air. It comprises two elements, Lead-stone and Brimstone, ground fine and mixed together, using the same amount of each. Different voltages would be obtained by use of more or less of the two minerals.

ROY L. RENO,  
Grant County, Ind.

(Such a battery as you described would be remarkable if it worked. The difficulty is that the system does not and will not operate at all.—EDITOR.)

## WRNY Is on the Air

Listen in to New York City's newest radio broadcasting station—WRNY. This station is operated by the Experimenter Publishing Co., who publish this magazine.

Our editors will speak on timely subjects every week from this station on the following days:

Monday, 9 P. M.  
Tuesday, 8:30 P. M.  
Wednesday, 9 P. M.  
Thursday, 9:30 P. M.  
Friday, 8:30 P. M.

(New York Daylight Saving Time)  
Our call after 12 o'clock midnight is

2XAL

Address letters to

### Station WRNY

Hotel Roosevelt 45th St. and Madison Ave.  
New York City, N. Y.

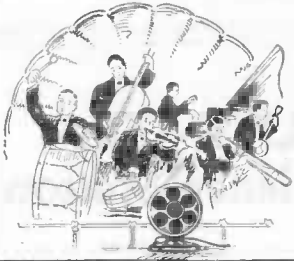

# RADIO

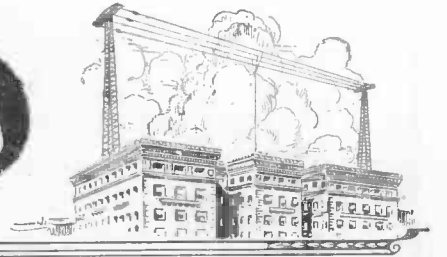

## Radio In Odd Places

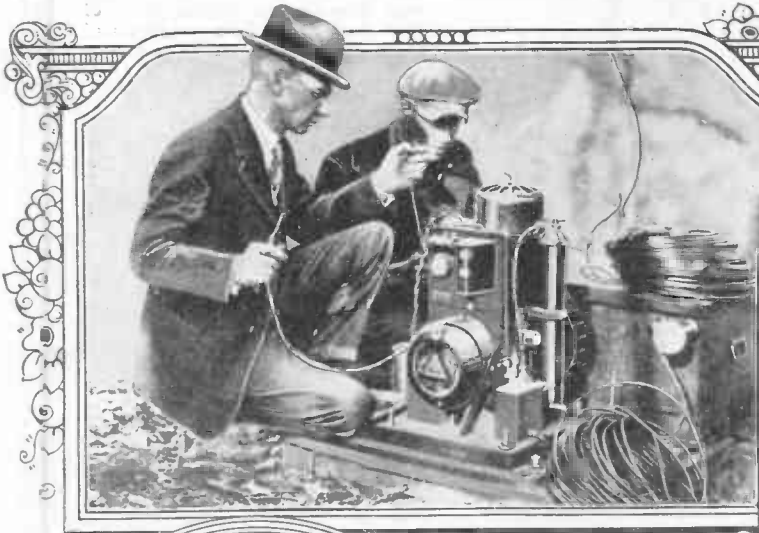

The power plant that furnished light in the cave and power for the radio transmitter during the agonizing days of digging for Floyd Collins, who was entombed in Sand Cave, Ky.

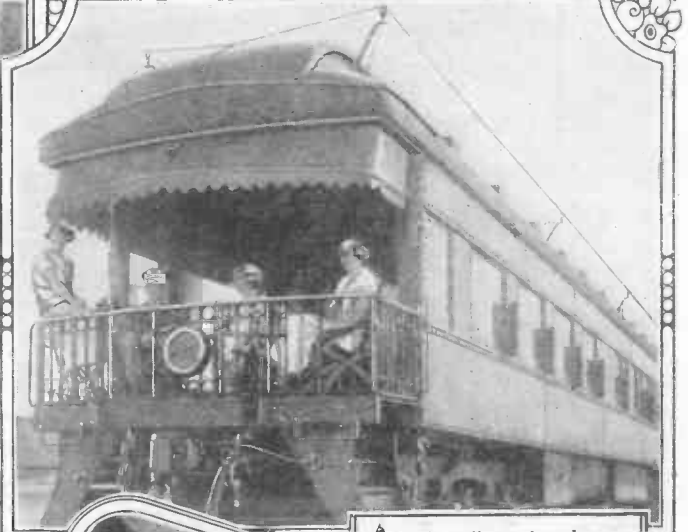

Radio relieves boredom of train travel. Loud speaker or headphones may be used as desired.



Left: A Zulu workman near the Drakensberg Mountains in Natal, South Africa, listens in to his first radio program on a one-tube reflex circuit of English manufacture. Evidently his experience is a most pleasing one, judging by the expression on his face.—T. Spence.



Below: Dr. L. W. Austin is shown with a loop antenna which will be used in studying atmospheric disturbances in the Panama Canal Zone.

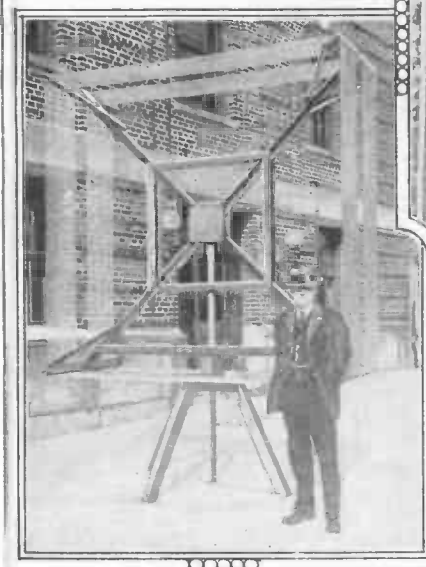

Radio receivers have been taken into the subways, on railroad trains, on speed boats and almost every other imaginable place. Recently the crater of Mt. Vesuvius has been made the scene of radio activities as shown above and at the right. Reception on either loop or standard antenna was comparatively poor and at times impossible.



# WRNY—The Science Station

The details of Station WRNY, located in the Roosevelt Hotel, New York City, are given on this page. Besides being able to broadcast from the ball room and the grill room of the hotel, there are many private telephone trunk lines extending to various parts of New York and vicinity by means of which various items can be picked up and broadcast.

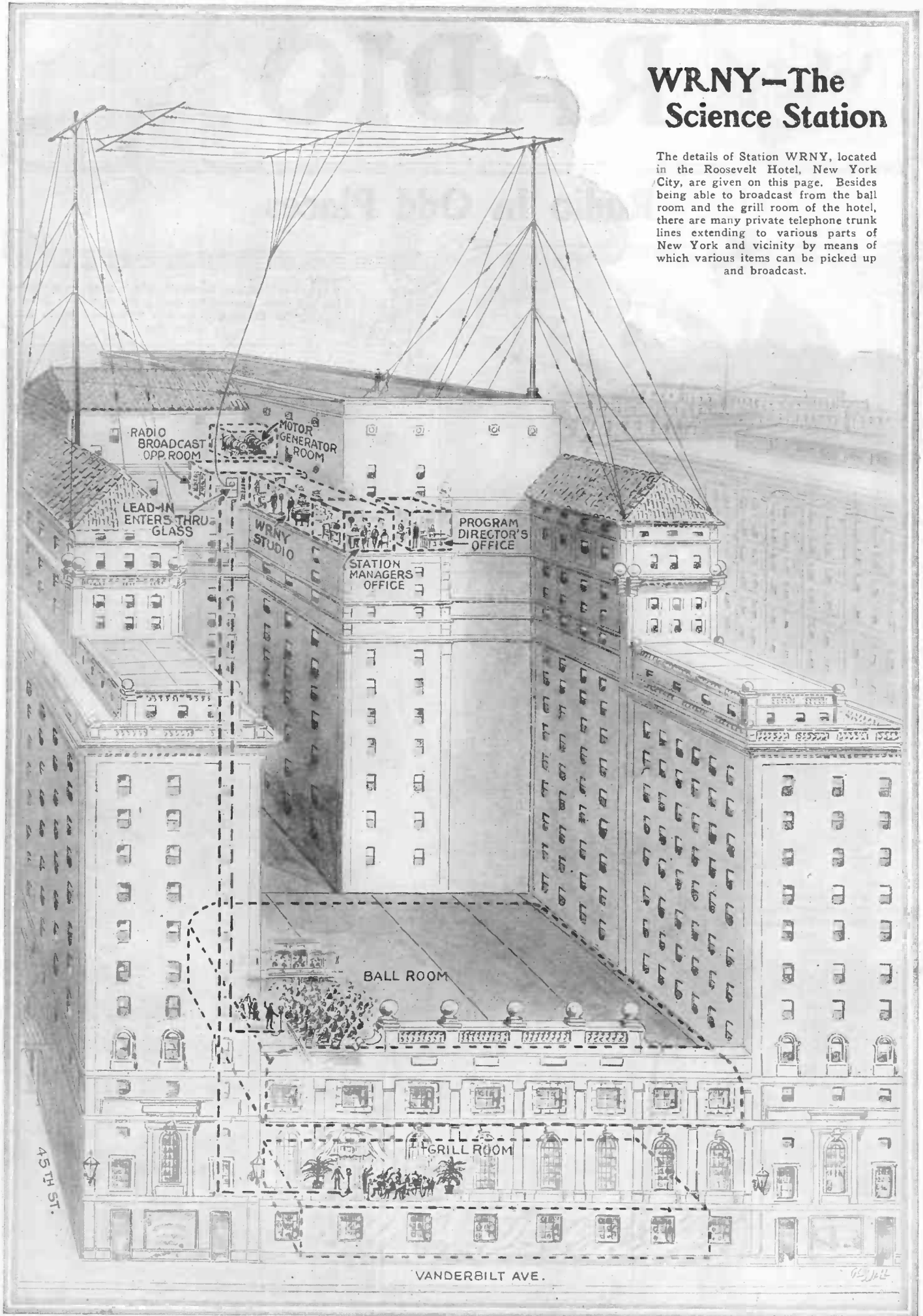

This station is owned and operated by the publishers of this magazine.



ONE of the main objects that The Experimenter Publishing Co. had in mind when opening station WRNY was the dissemination of knowledge intermixed with entertainment of the highest possible class. To fulfill the first part of this object, the editors of SCIENCE AND INVENTION, RADIO NEWS, THE EXPERIMENTER and MOTOR CAMPER & TOURIST will each give a weekly talk on some phase upon which each is an authority. The entertainment will be widely diversified and will include RADIO NEWS Orchestra, conducted by Joseph H. Kraus, Field Editor of SCIENCE AND INVENTION Magazine, and illustrated at the right. Aside from this group of entertainers, other talent will be continuously employed and either brought to the studio of WRNY for the benefit of the listeners-in, or else connected to that point by one of the many private telephone lines which have been provided for the broadcasting of events which happen outside of the studio. Taken as a whole, the programs furnished from this station will undoubtedly be the most diversified offered anywhere.



Right: Hugo Gernsback, Editor-in-Chief of SCIENCE AND INVENTION. Mr. Gernsback will speak to the radio audience every Monday evening on various scientific subjects. Mr. Gernsback is the designer of the "circuit-grams" described in the last issue of this magazine and will broadcast directions for the hooking up of various circuits each week.



Below: H. Winfield Secor, Managing Editor of SCIENCE AND INVENTION, who will talk every Tuesday night on subjects that we are sure will be of interest to all of the listeners-in. Mr. Secor will deliver some interesting essays, covering aircraft evolution and the uses of aircraft in warfare, and modern scientific inventions of everyday interest.



**WR NY**



Above: A. P. Peck, Radio Editor of SCIENCE AND INVENTION, who will address the radio audience on the subject of radio in a non-technical manner. Mr. Peck's articles in this magazine and RADIO NEWS on radio for the beginner have been cordially received. We are sure that all of the radio audience will appreciate the method in which obscure phases of the subject are explained.



Left: Joseph H. Kraus, Field Editor of SCIENCE AND INVENTION. Besides leading the official RADIO NEWS Orchestra, Mr. Kraus will speak to the listeners-in on various phases of scientific subjects. An authority on perpetual motion, spiritualism, medicine and allied subjects, Mr. Kraus' talks will undoubtedly be of vast interest to anyone listening in.

# Hunting Interference

The photographs herewith show the arrangement of a portable receiving set and a rotatable loop aerial placed in and on an automobile so that the entire outfit can be quickly and easily moved around a town in a hunt for power leaks and other sources of radio interference.

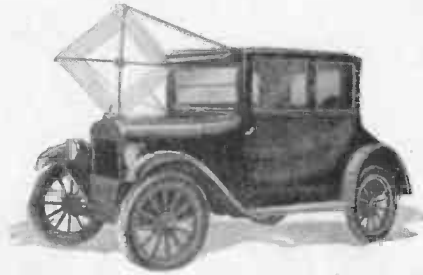

The author resides in a small city where radio enthusiasts have had considerable interference from power leaks on electric lighting lines. With the outfit illustrated herewith and with the assistance of an electrician from the local power company, it was possible to locate most of the interference sources. The electric light company then repaired the leaks and the interference affecting radio sets was greatly reduced. The method used was as follows: Listening in on the headphones, the worst noise or buzz was tuned in and the direction of its source obtained. Moving on to a second position, another bearing was taken and the two locations thus obtained plotted on a map. The spot where the trouble was located could in almost all cases be immediately located.

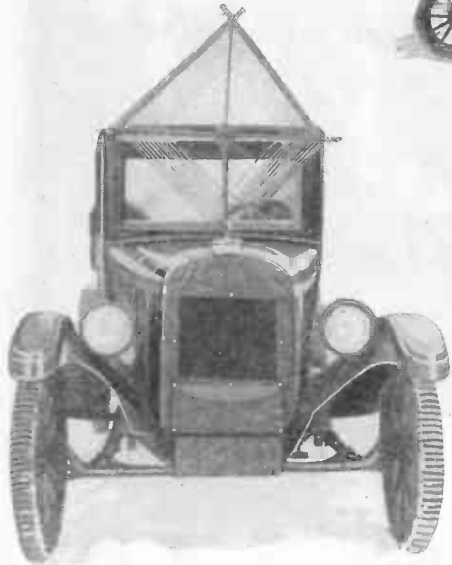

The loop used in this trouble finder was an ordinary home-made affair, supported in a socket on the hood of the car and controlled by means of two ropes running through a board placed in the windshield frame. The two leads from the loop were also led into the interior of the car, where they were connected to the portable receiver.

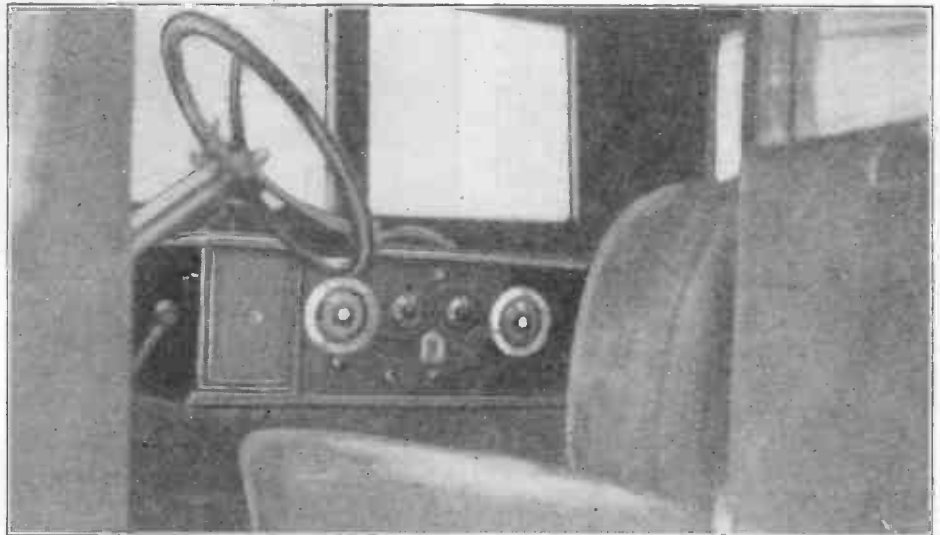

The view directly above shows the portable super-heterodyne receiver and its location in the interior of the trouble hunting automobile. Headphones were used to make the tests more accurate. Swinging the loop gave a directional effect. —R. M. Lapham.

## Largest Rectifier

The Marconi firm of London has recently designed and constructed the largest rectifying tube ever made. It is illustrated below. This tube is to be used for radio, X-ray or cable testing work and will work on plate voltages up to 150,000 volts on a resistance load or 75,000 volts on a capacity load.



## Britain to Brazil

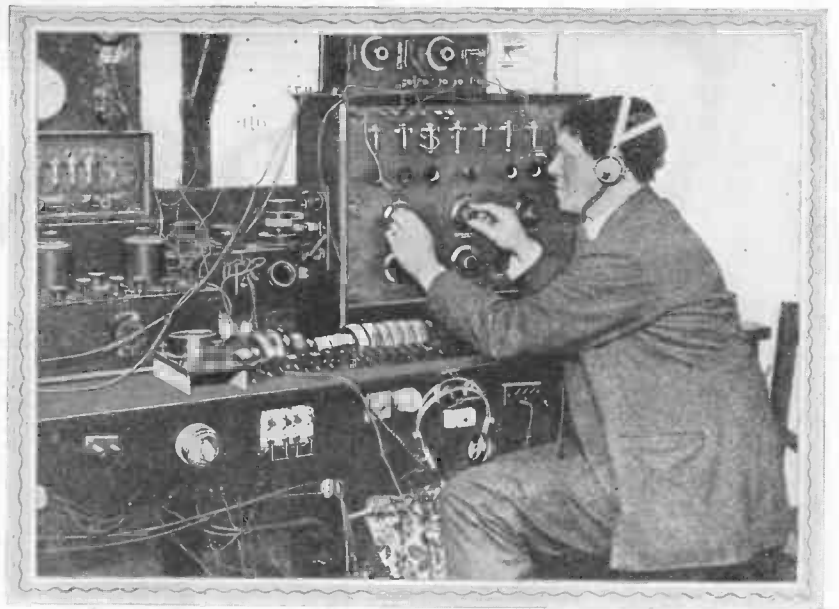

The illustration above shows Gerald Marcuse, a British amateur, at work in his laboratory at Caterham, England. Mr. Marcuse, British representative of the International Amateur Radio Union, has succeeded in communicating with the Rice Expedition in Brazil, a distance of 7,000 miles. The apparatus used is almost entirely home-made, and the appearance of the station reflects a great amount of credit to Mr. Marcuse.

# Artists Forty Miles Apart Broadcast

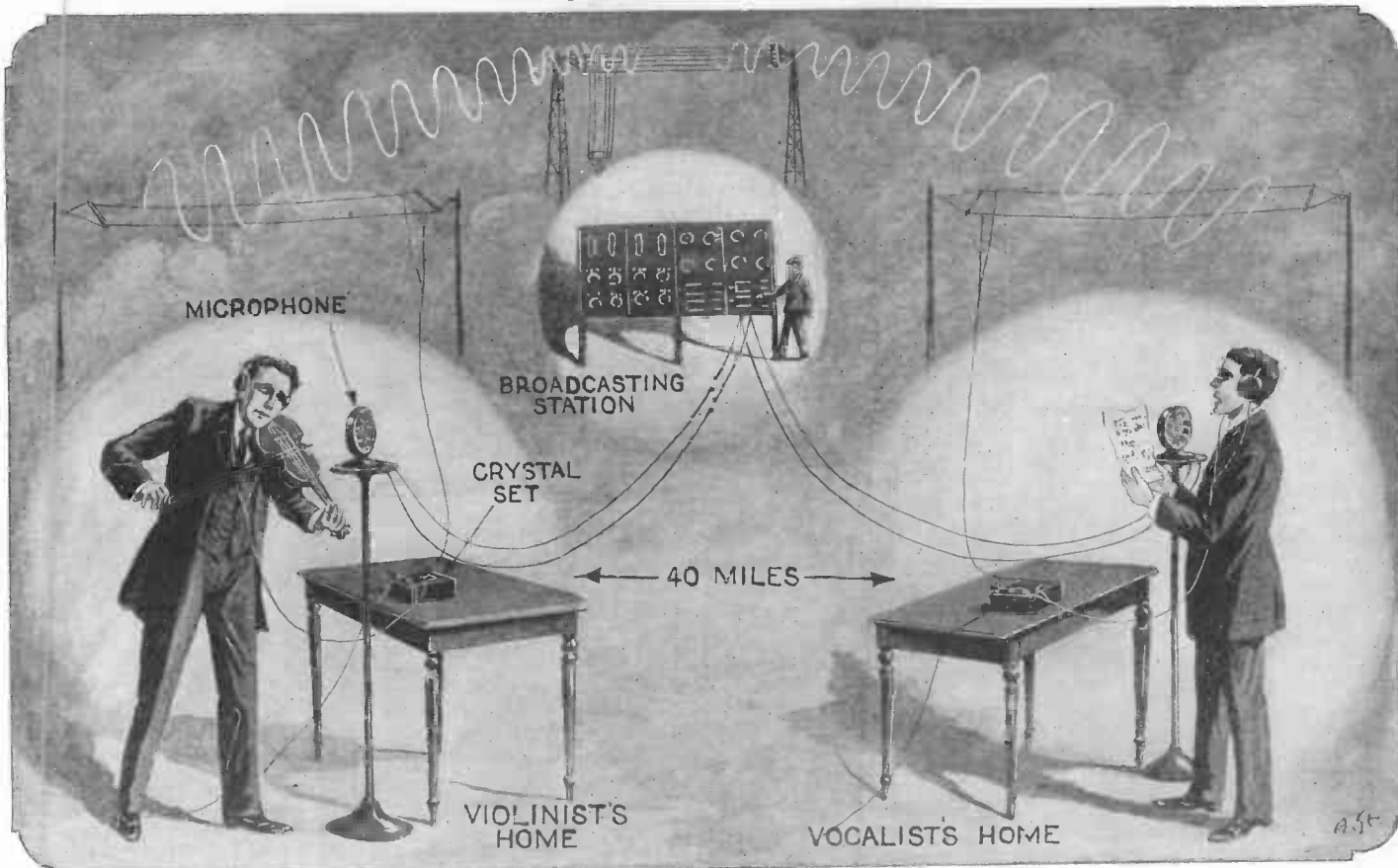

In a recent novel test, illustrated above, a violinist and a vocalist in their respective homes broadcast in perfect synchronism from a distant station. Their microphones as shown were connected to the broadcasting

stations and they listened in on each other and checked their synchronism by means of two small crystal sets, each connected to an antenna as shown. "Listeners-in" stated that the accompaniment was perfect.

## A New Use For The Radio

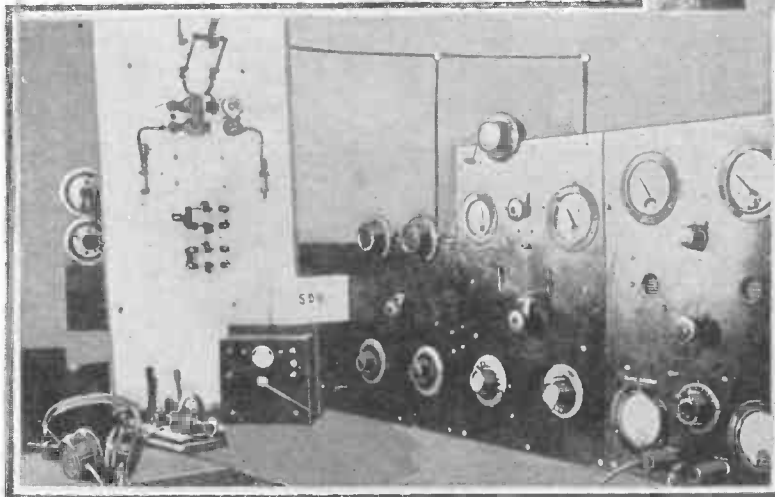
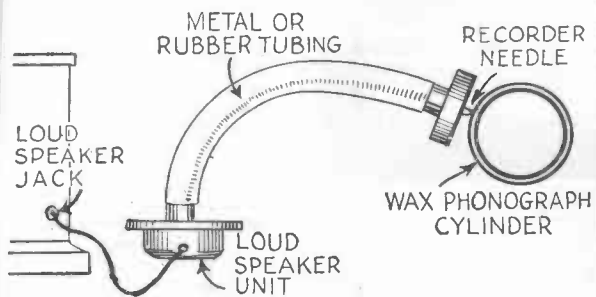

Quite a few radio fans wire to broadcasting stations at different times, asking for favorite selections to be played. On account of the pre-arranged programs these requests are sometimes refused. A San Francisco man solved this problem by attaching one of the earphones of his head set to the speaking tube of his stenographer's dictaphone, with the result that he no longer has to call up the studio of the broadcasting station for his favorite selection, to be refused on account of lack of time. The selection when it comes over is recorded on his own record and can be played at any time desired.

The photo to the left shows the radio station of Dave Ablowich, Jr., call 5DW, at Greenville, Texas, with which he reached New Zealand, 3,500 miles away. We see the marble power panel, a wavemeter; the small panel with the 50-watt transmitter tuned to 78 meters for New Zealand. Next is a 15-watt telegraph set for 176 meters, its record is 3,500 miles. A 10-watt radio-telephone set broadcasts under the call KFPM.

# Radio Aerials—

By LEON L.

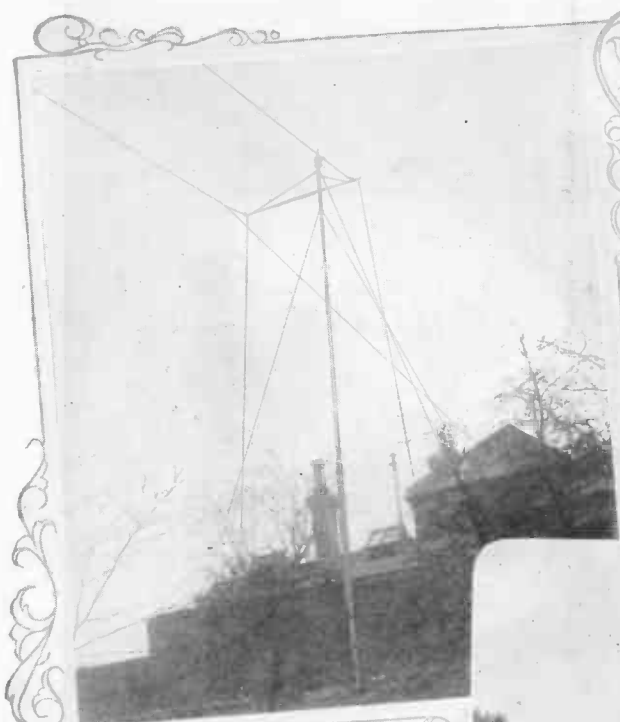

↑ A typical type of amateur transmission and reception antenna. One or two wires are usually sufficient for this work, particularly on the new short wave bands that have just been opened to the amateur.

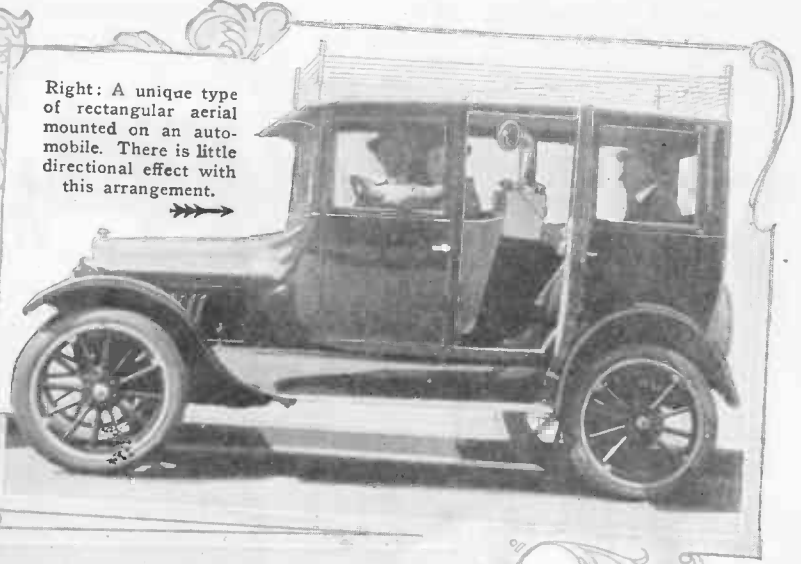

Right: A unique type of rectangular aerial mounted on an automobile. There is little directional effect with this arrangement. → →

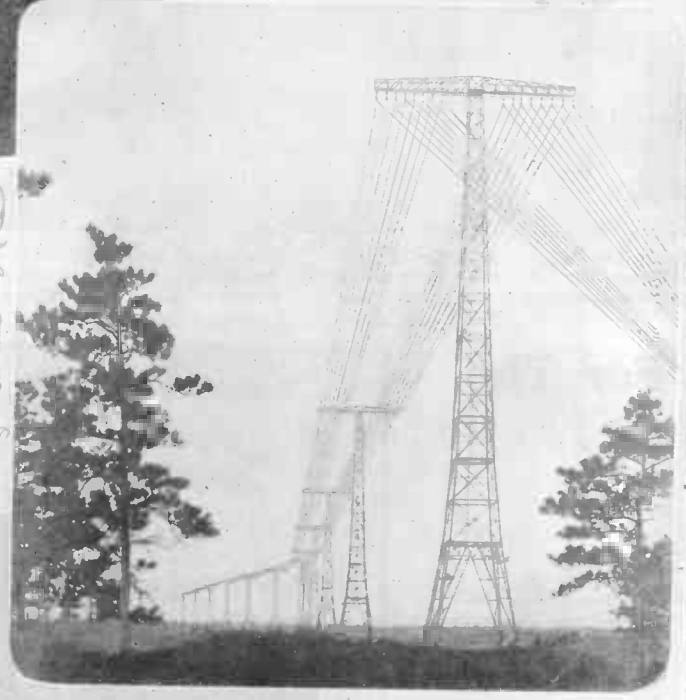

← ← An enormous commercial antenna system is shown at the left. Often in installations of this nature many miles of wire are used and the power output of the transmitter is rated in hundreds of kilowatts. Structural steel towers support cross-arms of the same material from which the antenna wires are suspended by means of large, strong insulators. The particular type of tower shown is self-supporting.

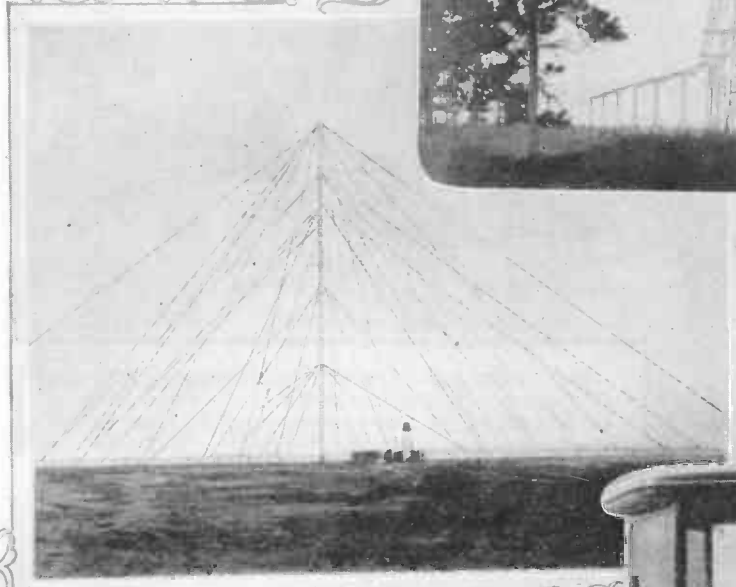

↑ Another commercial installation is shown directly above. Here it is hard to differentiate between the guy wires and the antenna, but they are all shown.

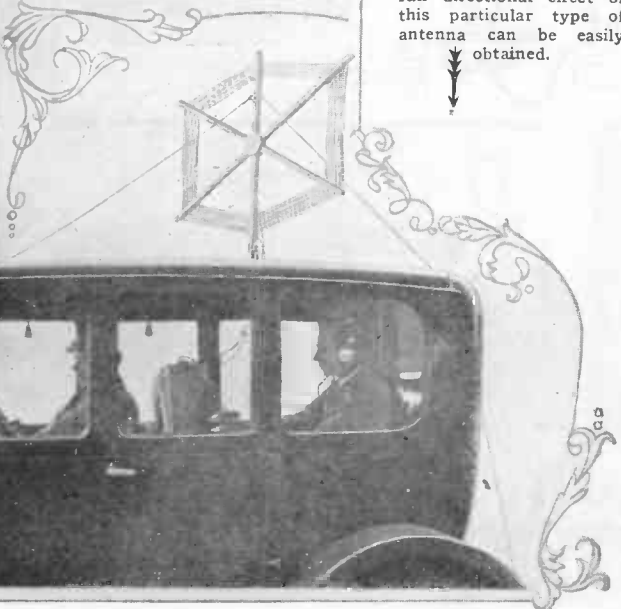

Another type of automobile antenna is shown at the left below. Here a hexagonal loop is mounted in a socket on the top of the car and braced by means of two guy wires. This loop can be rotated by the operator seated in the interior and thus the full directional effect of this particular type of antenna can be easily obtained. ↓



# Their Design and Use

ADELMAN, Assoc. I. R. E.

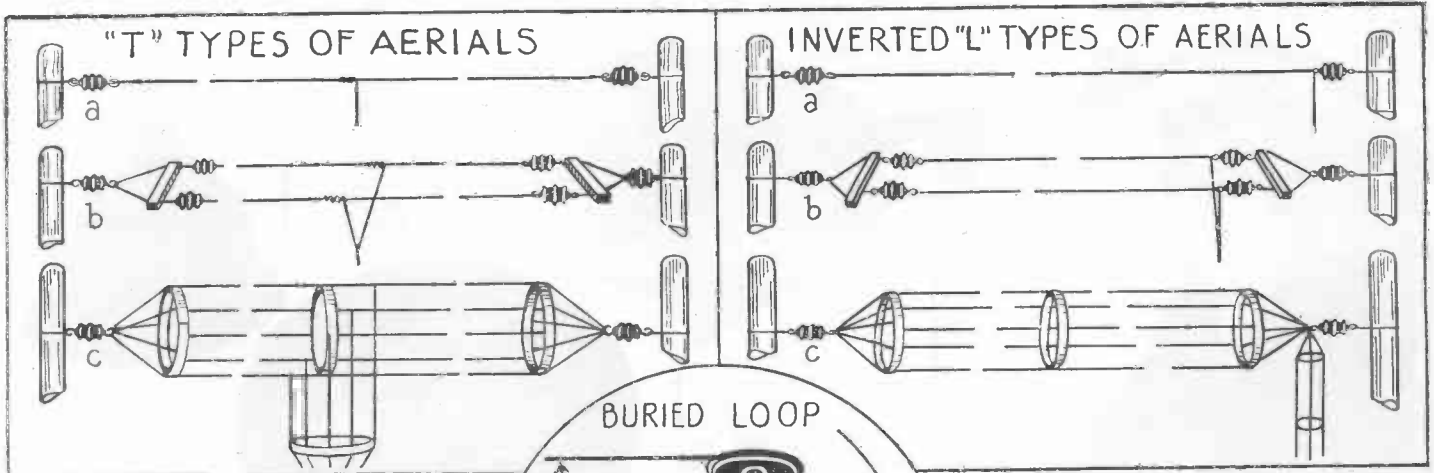

A T type aerial has little directional effect and is effective for transmission or reception in both directions in which the antenna points. This antenna, of course, also works in other directions.

The L type aerial is most effective in the direction toward which the knee points. It also gives results in other directions, but not with as great efficiency. Keep this in mind when designing your aerial.

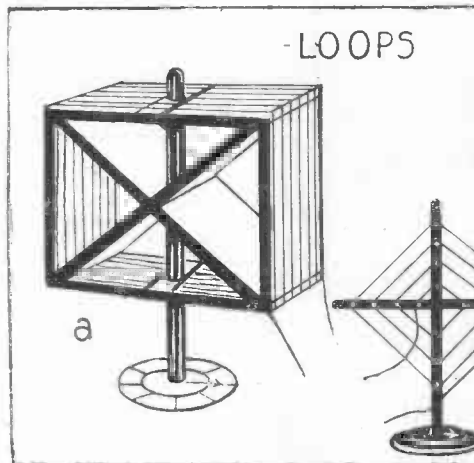

-LOOPS

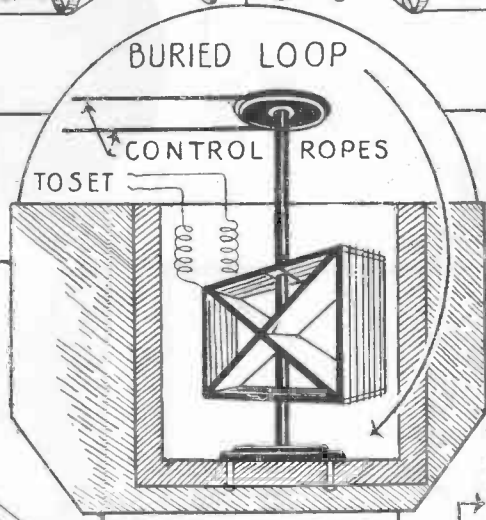

The buried loop shown above is very directional and reduces static.

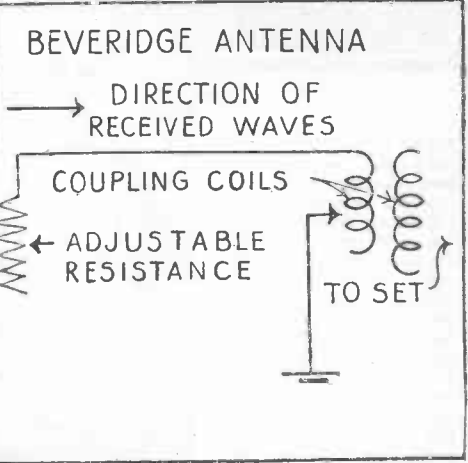

BEVERIDGE ANTENNA

Loop aerials are usually in one of the two forms shown above at A and B. A is known as the solenoid type and B as the pancake type. Both are equally effective and B has the advantage of being more compact. In making any loop, have the supports rigid and preferably supply a pointer for indicating the direction of the station which is being received.

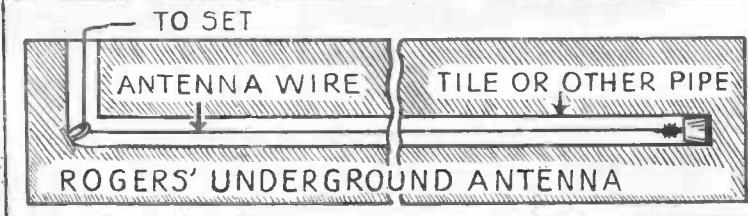

ROGERS' UNDERGROUND ANTENNA

The Beveridge antenna is one which has attained considerable prominence in the reception of messages from a certain distant point. The directional effects of this aerial are marked in character and when a station from the direction indicated is being received, the best results are obtained. The resistance is adjusted to greatest efficiency.

The Rogers underground aerial, detailed above, consists of a length of ordinary wire, either bare or insulated, contained in a long pipe buried a few feet below the surface of the earth. The wire is insulated from the pipe. With only a 100-foot aerial, excellent results have been obtained with this arrangement, both for transmission and reception.

Probably the most efficient of all aerials with the exception of the Beveridge type, the utility of which is limited, is the vertical aerial. Three types are illustrated at the right. A is practical for amateur and broadcast reception work, whereas B and C are quite extensively used commercially. If you have room for type A, you will undoubtedly obtain good results from it.

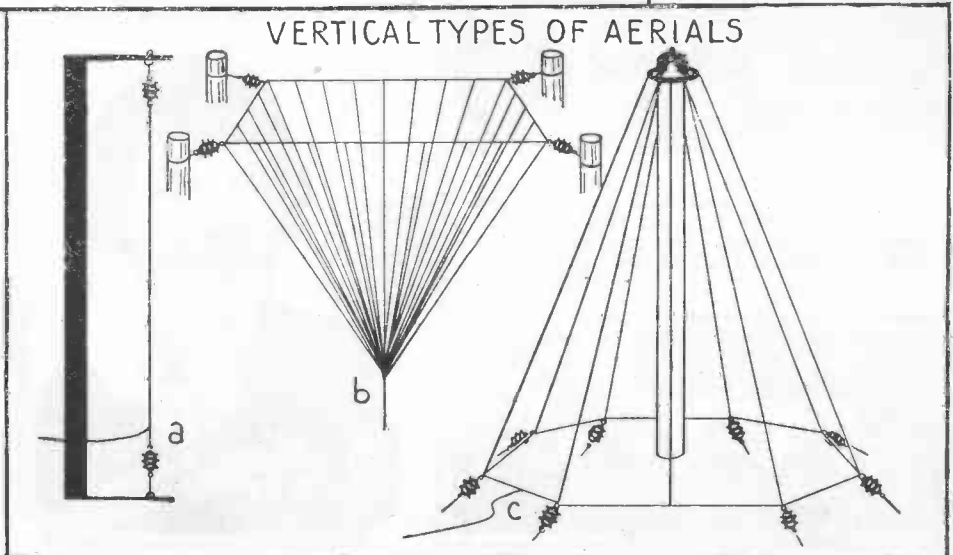

VERTICAL TYPES OF AERIALS

# Freak Radio Sets



A radio set built in a derby hat. The tuning instruments are within the hat as below and the tube controls are mounted on the outside as at the right. —Karl Stefan.



A complete radio receiver built in a finger ring. The detector and capacity and inductance are enclosed. Four binding posts provide connection to aerial, ground and phones. —Carl G. Peterson.

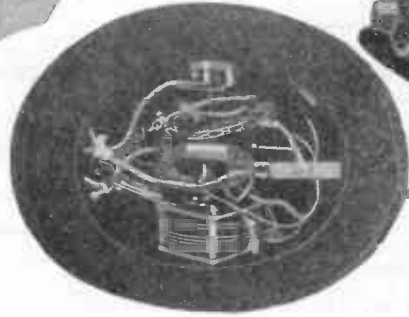

Many things have been done with bottles since their use for certain liquids has supposedly been prohibited, but probably the most unique is that shown above and to the right. Here we find a complete radio set enclosed within the bottle and provided with connections mounted on the bottle itself. An inductance, condenser and detector are all placed within the bottle and binding posts mounted on the outside for aerial, ground and phone.

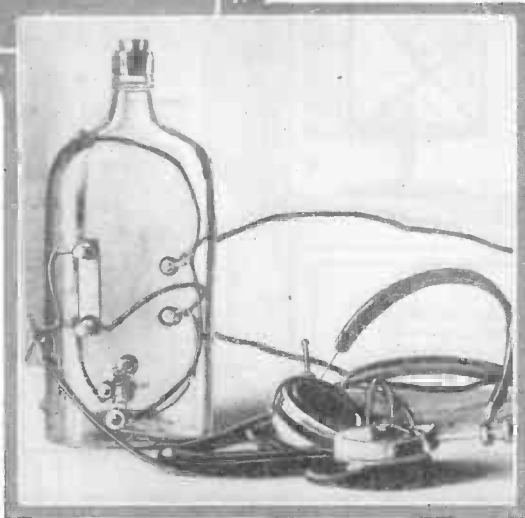

An Easter basket radio set is illustrated at the left and above. A crystal detector is used and may be seen directly below the chicken's head. The usual accessory instruments are enclosed in the basket and connections thereto are provided.

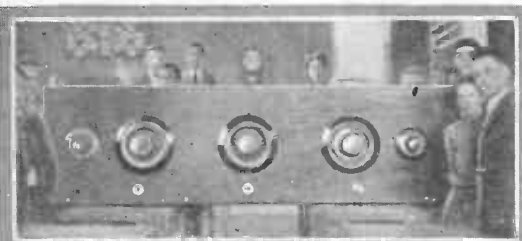

And now we go to the other extreme. Above and below are front and back views of an enormous radio set built in a Cleveland High School for demonstration purposes. This set is a model, and does not operate as do all the others on this page. —Horace Evans.

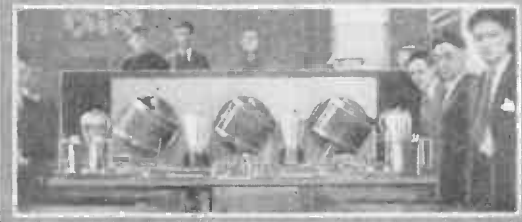

Another set pertaining to chickens and eggs is shown below. A crystal detector is mounted on the top of the small imitation chicken, the cat-whisker extending from the head back toward the galena. The set is tuned by revolving the egg.

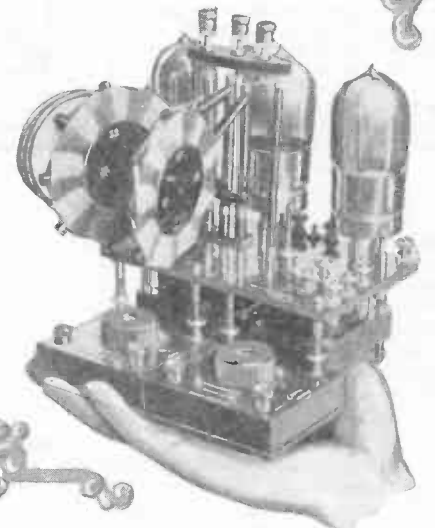

Above is shown a most compact three-tube radio receiving set of French design and manufacture. The entire set, which consists of tuning inductances and condensers, tubes and transformers, is so small that it can be readily held on the palm of the hand as shown above. The set is highly efficient in operation, despite its small size. —Pierre Dahan.

# A Page for the Novice

## Part VI.

This month we are going to illustrate and discuss various types of radio frequency amplification. The circuit shown at the right is of the Neutrodyne type employing two stages of tuned radio frequency amplification with two small neutralizing condensers,  $C_2$ , connected in the circuit so that the tubes cannot set up oscillations within themselves and thus cause squealing and distortion. Specially designed neutroformers, as the radio frequency transformers are called, are employed. For experimental work, the primaries may consist of 10 turns of No. 20 D.C.C. wire, wound over the secondary of 60 turns of No. 22 D.C.C. wire. Where a tap is necessary it is taken at the fifteenth turn.

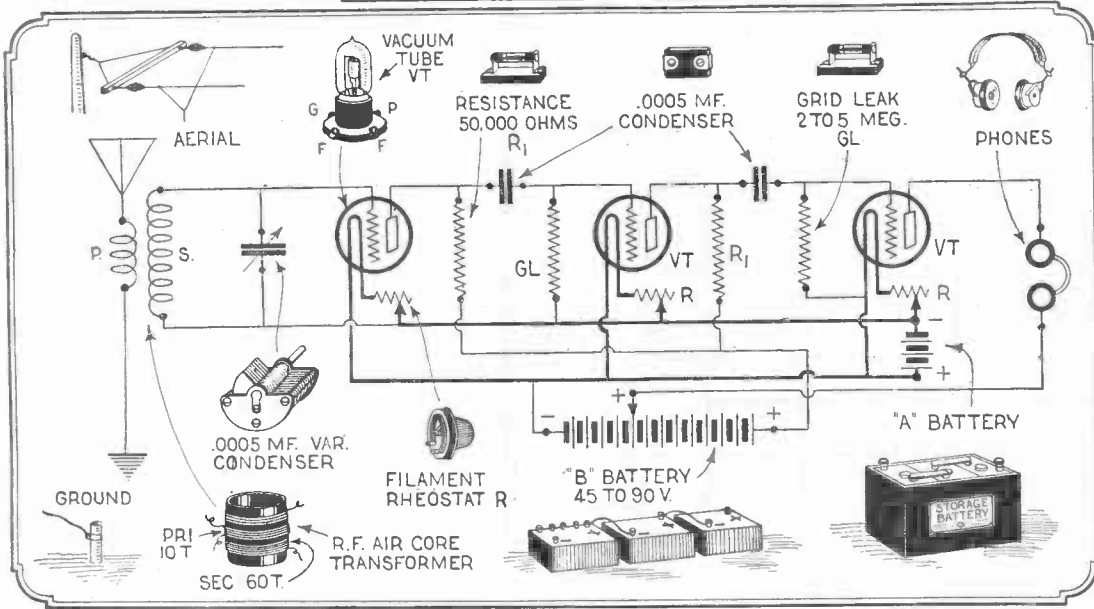
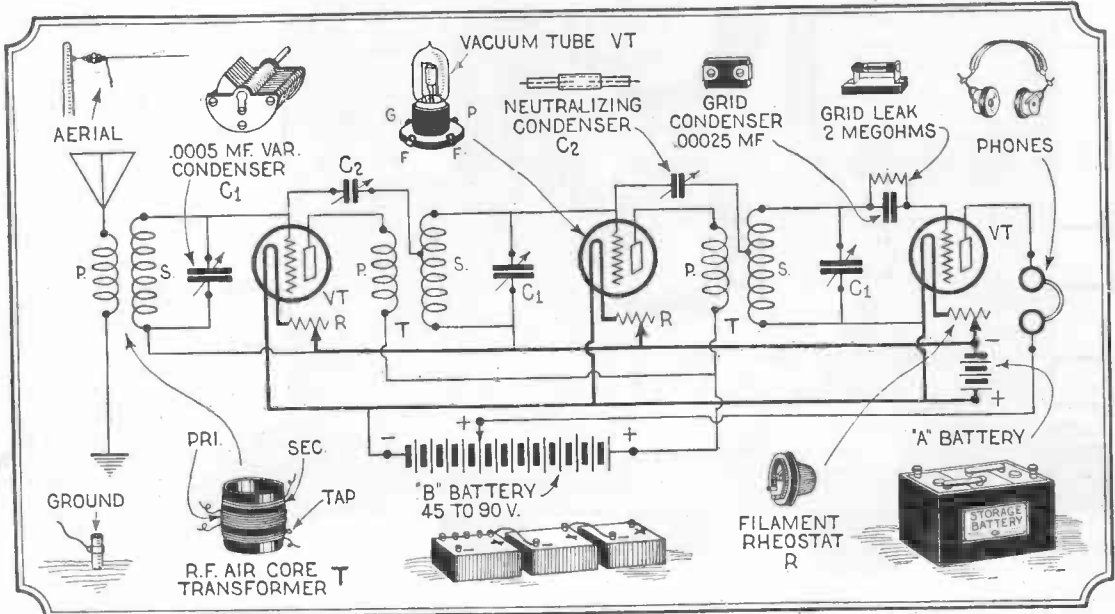

Many experimenters like to work with circuits coupled by means of resistances instead of by the usual transformer. This system, while it works on broadcast waves, is not very efficient until a wave-length of around 2,000 meters is reached. The effects noticed through the use of this circuit, however, are very interesting and since the apparatus used is comparatively inexpensive, the experimenter will be repaid in knowledge obtained by setting up and trying out a circuit of this nature. By placing a grid condenser and leak in the circuit of the first tube, this set will become an audio frequency amplifier. "B" battery connections must be changed to suit.

The third important type of radio frequency amplification is transformer coupled, using either air core or iron core radio frequency transformers, untuned. Our illustration herewith shows the iron core type of transformer. The antenna system of course, is tuned by an air core transformer or by a variocoupler as the constructor may desire. A standard three-circuit coupler may be used at this point, by disregarding the tickler or rotor and not connecting it in the circuit at all. If the reader desires to make his own coil especially for this set, the details are given in the illustration. Furthermore, if desired or convenient, a neutroformer may be used in the antenna circuit.

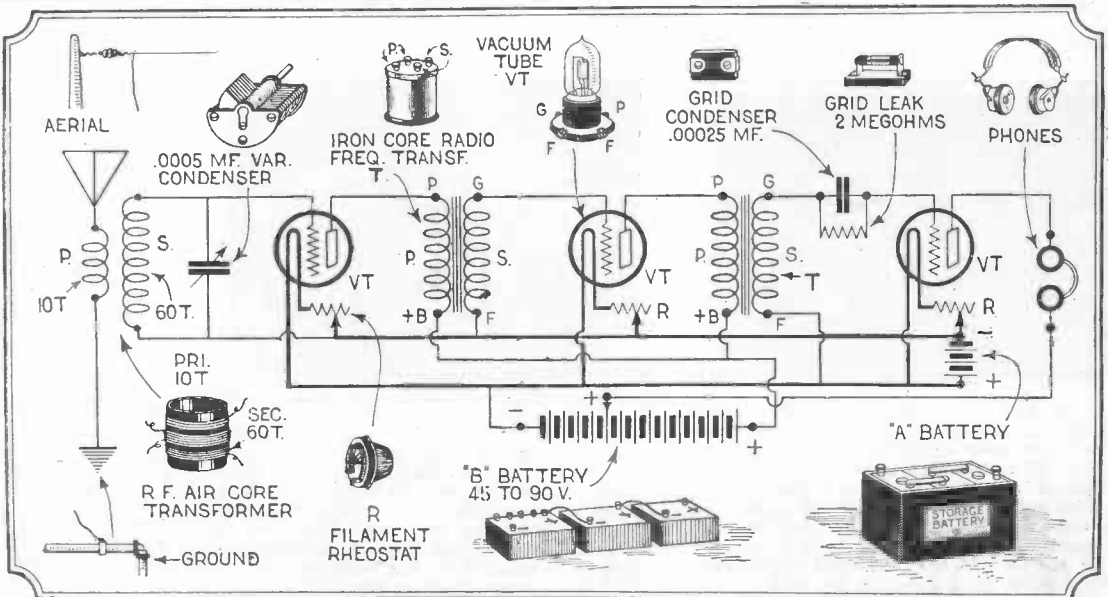

# The Radio

All the Details for the Efficient Two To Be Used

By A. P. PECK,

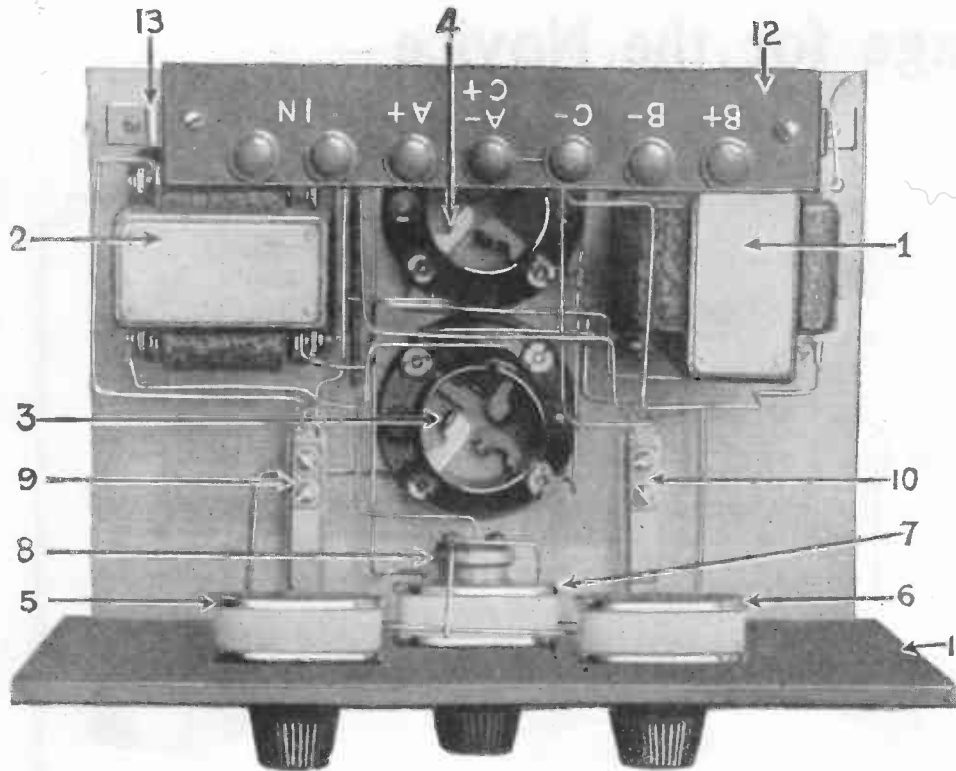

Fig. 1. The illustration directly above is a top view of this two-stage amplifier which was designed by the writer to give the very best possible results and to be so arranged that it can be connected to any set from which it is desired to obtain more volume. The numbers on the photograph above correspond to those on the drawings. Photographs courtesy of Allen-Bradley Co., Alden Mfg. Co., All American Radio Corp'n, and Radio Specialty Co.

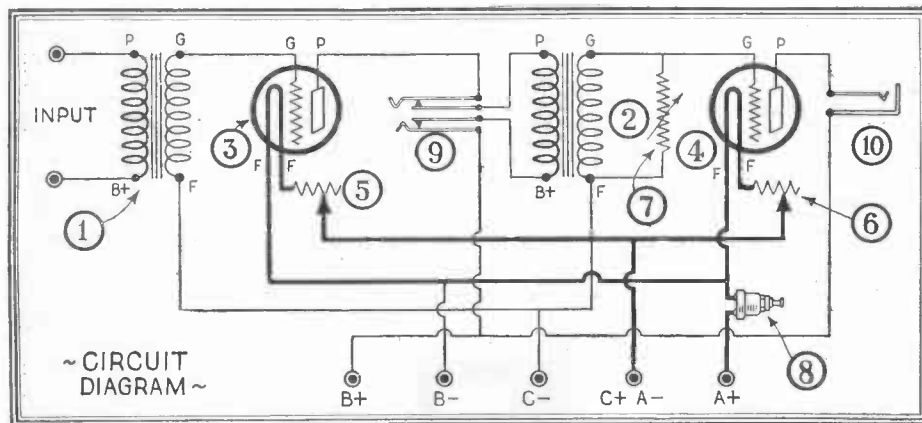

Fig. 2. The circuit diagram of this efficient two-stage amplifier in schematic form is shown directly above. No jack has been provided in the input circuit as this causes a detuning effect when the plug is removed therefrom and placed in the first or second stage of audio frequency amplification. The variable resistance 7 controls volume.

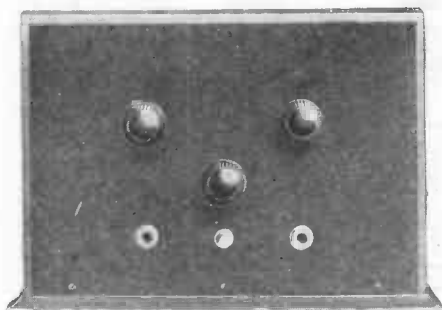

Fig. 3. The simple yet symmetrical panel of this two-stage amplifier is shown above. The two upper knobs control the filaments of the tubes. Of course, these controls could be incorporated in one rheostat, but in the writer's opinion greater flexibility and better results are obtained if each filament in a set has its own separate control. The center knob is the volume control and the jacks and switch are placed in a line near the base.

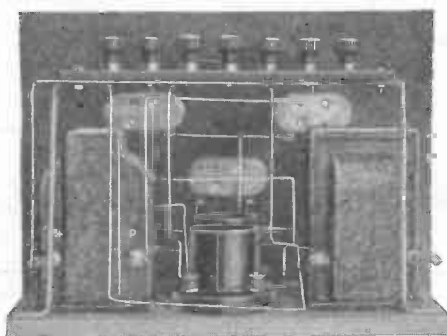

Fig. 4. A rear view of this two-stage amplifier showing the transformers mounted near the back at right-angles to each other. Note how the terminal strip is mounted on long brackets so that they are in a handy position for the connection of wires. This strip is very close to the back of the cabinet and unless it is mounted in this way, the binding posts cannot be reached.

WHEN the design of this two-stage amplifier was first undertaken, the writer took into consideration just what the various readers would desire in an amplifier. Many are equipped with one- and two-tube sets of different designs and desire to have greater volume produced by their sets. The obvious solution to this problem is the installation of an audio frequency amplifier. Since the sets throughout the country differ so greatly in construction, the amplifier was designed so that it could be used with practically any existing type of set with few, if any, changes on the present one. Therefore, the circuit of this amplifier starts at the output of the detector on any set. If a jack is incorporated in the existing receiver, it may be left in the circuit, but should not be used. Do all your tuning with the phone plug in the jack, 9, shown in Figs. 1 and 2. When the station is tuned in on its best, plug the loud speaker into jack, 10, and remove plug from jack 9. The reason for not using the detector jack is because when the plug is removed therefrom, there will be a slight change in tuning and when you plug in on the second stage it will be necessary to slightly retune. This will not happen if the procedure outlined above is followed.

In future articles under the head of The Radio Constructor, various types of tuners using only a vacuum tube detector or a detector and one or two stages of radio frequency amplification will be described. These will be designed to be used in connection with this audio frequency amplifier. Thus two purposes will be served by this present article. You can build the amplifier and use it with your present set. Then when future articles appear, if you are of an experimental turn of mind, you can try out the tuners and radio frequency amplifiers and obtain good volume by connecting this audio frequency amplifier in the circuit.

The main consideration in the construction of an audio frequency amplifier is the selection of the transformers. Those shown herewith are one of the best types obtainable on the market today and give excellent volume with are of one of the best types sold on rather large in size and, therefore, a little difficulty may be encountered when attempting to mount them on a baseboard cut to fit a 7x10" panel and cabinet. However, a little judicious care at this point will produce the desired results. The layout shown in Fig. 1 is rather unusual for this type of unit, but by placing the instruments as shown, the best arrangement of various leads could be obtained. It may seem from the photograph in Fig. 1 that the socket, 4, is inaccessible. This, however, is not true as there is just room to slide a standard UV-201A into the socket comfortably. A little care must be exercised in wiring this unit to make sure that none of the wires touch each other. Little, if any, spaghetti need be employed if the wiring is carefully laid out. In the set illustrated, only one short piece was necessary to separate one "A" and one "B" battery connection.

Many constructors are in the habit of using square bus wire for the connections of a radio set. This material is always tedious to work with and often does not produce the results desired. No. 14 bare copper wire will give as good results and is easier to use. The soft drawn material is to be preferred.

# Constructor

## Construction of a Highly Stage Amplifier With Any Set

Assoc. I. R. E.

THE constructional details of the various parts of this two-stage amplifier are given on this page. The progressive wiring diagrams introduced by the writer in the July issue of this magazine are given in Figs. 7 and 8. Working from these diagrams you can quickly and easily wire the set absolutely correct. In the diagrams we have shown the wires running over the sockets. This was done for the sake of clarity and the correct way in which to run the wires may be easily seen in Fig. 1 on the opposite page.

Binding posts have been provided for the connection of a "C" battery. The use of this unit reduces the drain on the "B" battery and lengthens its life. A voltage of 3 to 4½ volts should be employed. Try various voltages until the best is obtained. If a "C" battery is not used, or if at some time your "C" battery gives out and you cannot obtain another at once, connect a short length of wire between the two "C" battery binding posts. This will complete the circuit and allow operation without the battery.

The variable resistance, 7, shown in Fig. 2 and in the photographs on the opposite page is a volume control and aids in eliminating tube noises and distortion. When putting the set into operation, turn the volume control knob to the left until it comes out of the threaded sleeve. Then start turning it in to the right and with the set in operation, continue until the best results are obtained. On very loud signals the knob should be turned quite far in.

After a signal is tuned in, adjust the rheostats to the best operating position.

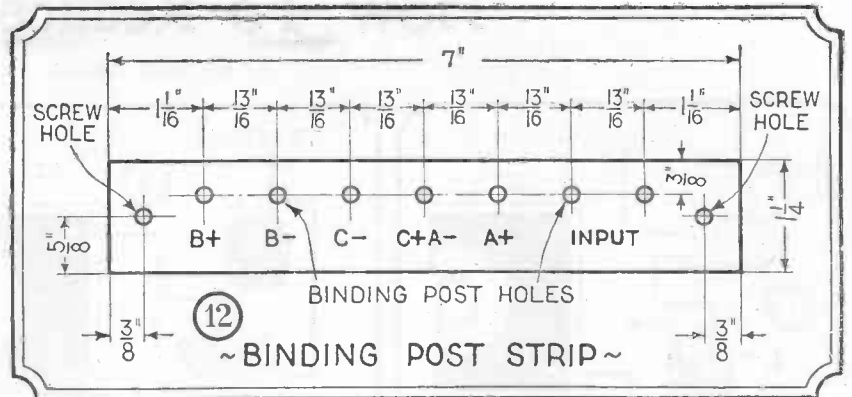

Fig. 5. The binding post strip to be mounted on the brackets, 13, is shown in detail above. This may be made of hard rubber, radion, bakelite or celeron.

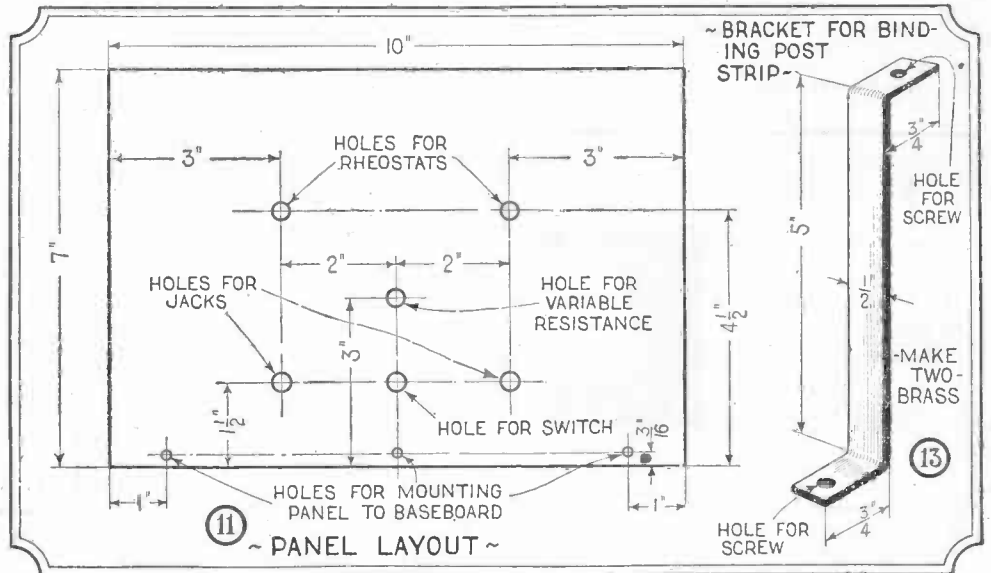

Fig. 6. The panel layout for the two-stage amplifier is given above at 11. The panel may be of hard rubber, radion, bakelite or celeron. The terminal strip bracket is shown at 13.

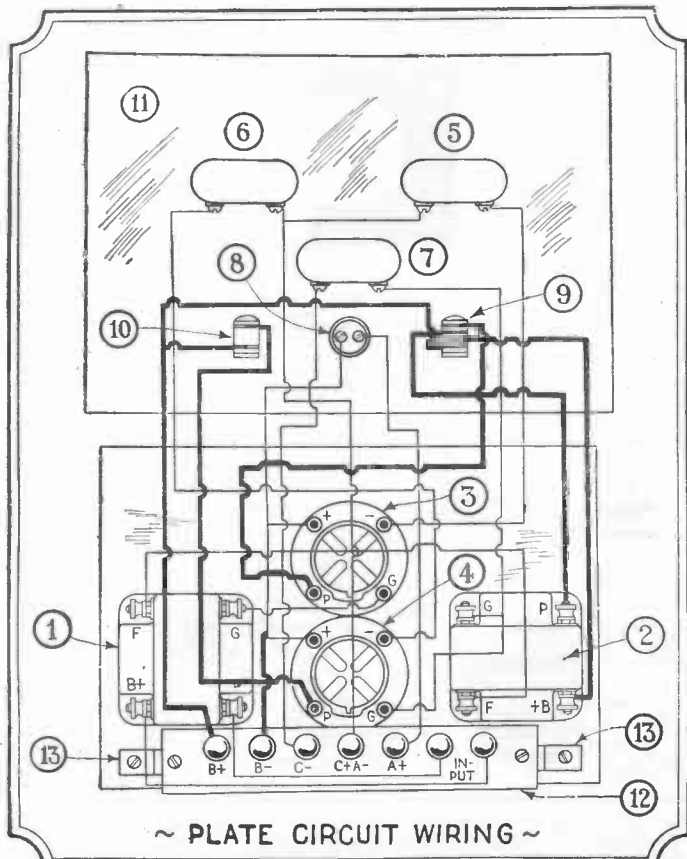

Fig. 7. The filament and grid circuit wiring is shown above. The input connections to the first transformer are also indicated.

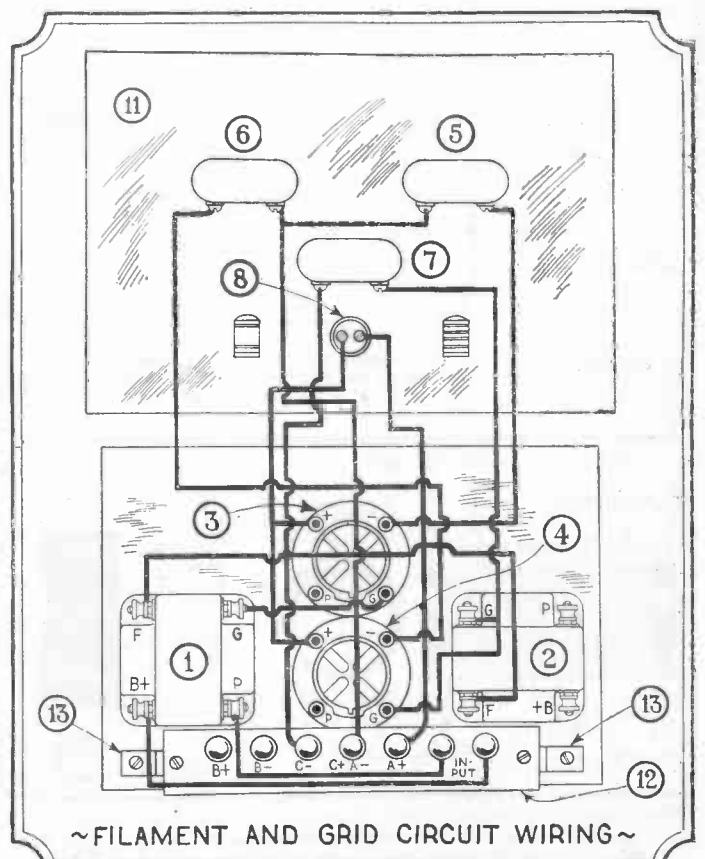
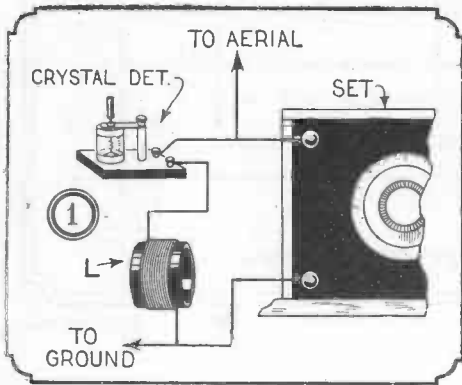

Fig. 8. All of the connections in the various plate circuits are shown above. The grid wiring is indicated in light lines.

# How To Reduce Static

By MOE JOFFE



In the circuit above a crystal detector and a coil, L, are connected as shown. L should have about 10 turns of wire on a 3-inch tube, although a variable coil is preferable.

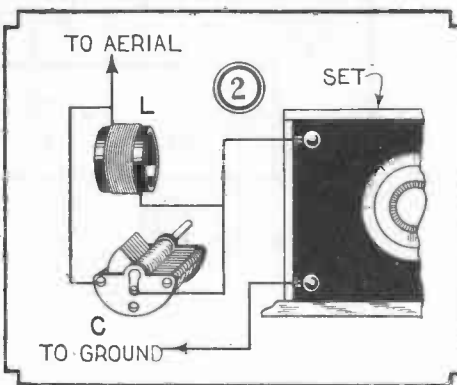

Wave-traps are of great assistance in reducing static. In the series type above a 50-turn coil on a 3-inch tube is shunted by a .0005 mfd. variable condenser.

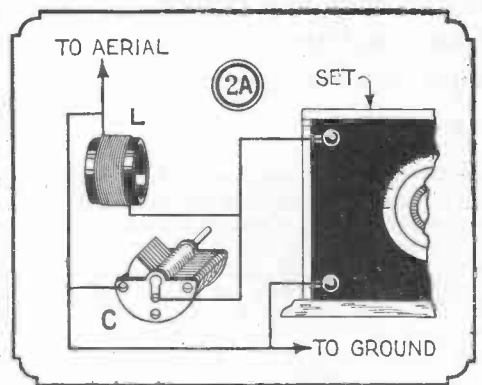

In the circuit above, a parallel wave-trap is used. The constants here are the same as for the circuit in Fig. 2. Both of these give very sharp tuning.

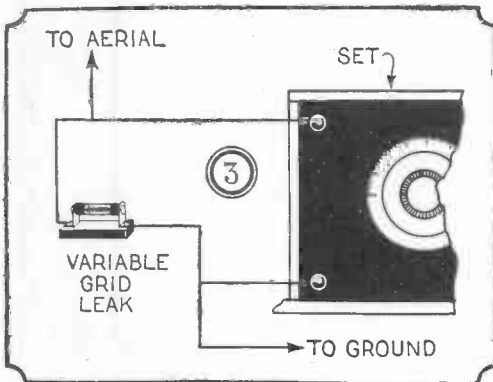

A variable grid leak connected across the aerial and ground posts of a receiving set and properly adjusted will reduce static.

BY means of various simple devices the interference from static can be considerably reduced, although as yet it cannot be successfully eliminated in the ordinary receiving set. On this page, the outline of several methods of static reduction is given. All of these will at the same time reduce signal strength somewhat, but when properly adjusted will reduce the static in a greater proportion than the real signal. Experimenting will reveal the proper settings. In some of the circuits shown, only those parts which differ from standard practice are detailed. For instance, the principles shown in Figs. 4 and 5 may be applied to any type of set which does not use radio frequency amplification.

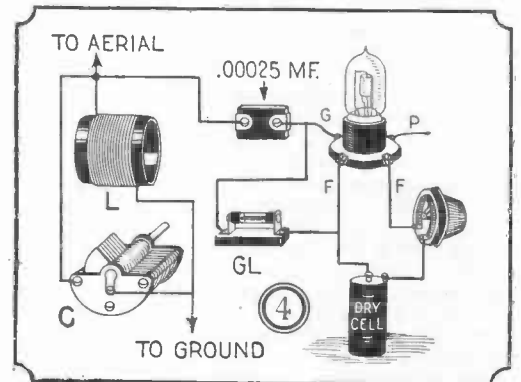

Here no grid return connection is used and the result is that tuning is sharpened and static reduced considerably.

In the reduction of static, the use of a loop aerial with two or three stages of radio frequency amplification is of great assistance. This is not due to the fact that radio frequency amplifiers will not amplify static, but is because the loop does not pick up as much atmospheric electricity as an outside aerial. On smaller sets, however, the static reduction methods shown are quite effective.

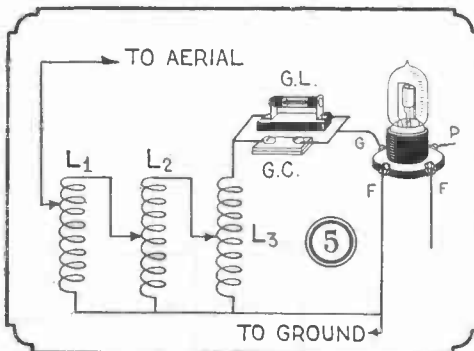

A filter tuning system is shown above. The inductances may be standard coupler secondaries or the equivalent. They should be variable by steps of two turns.

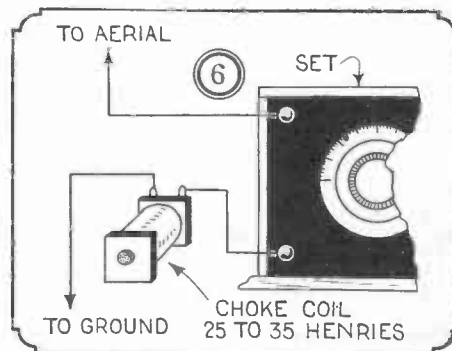

A choke coil when connected in series with the ground lead as above will aid materially in reducing static as well as induction from nearby power lines.

One of the most effective methods of reducing static is the resonant coil system shown in Figs. 7 and 7A. The coil consists of a single layer of No. 30 wire, wound on a tube 4 inches in diameter by 18 inches long. The slider consists of a strip of brass bent in the arc of a circle of the same diameter as the coil, and so arranged on a slider so as to be held about one-eighth of an inch away from the coil as shown.

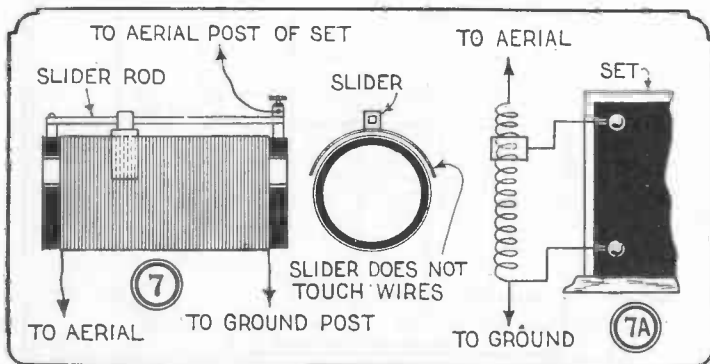

The details of the resonant wave coil are shown in Fig. 7 and the circuit of the same in Fig. 7A. The slider is connected to the aerial post of the set. The curved brass strip is wide enough to cover 8 or 9 turns of the coil.

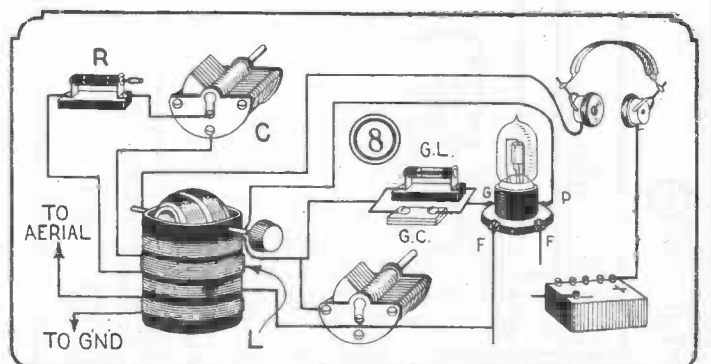

Wind 15 turns of No. 20 D.C.C. wire over the secondary of the coupler and connect to a variable grid leak and condenser. Tune this circuit to the point of least static. Complete filament circuit is not shown.

(Radio Department Continued on page 390)

# RADIO ORACLE

In this Department we publish questions and answers which we feel are of interest to the novice and amateur. Letters addressed to this Department cannot be answered free. A charge of 50c. is made for all questions where a personal answer is desired.

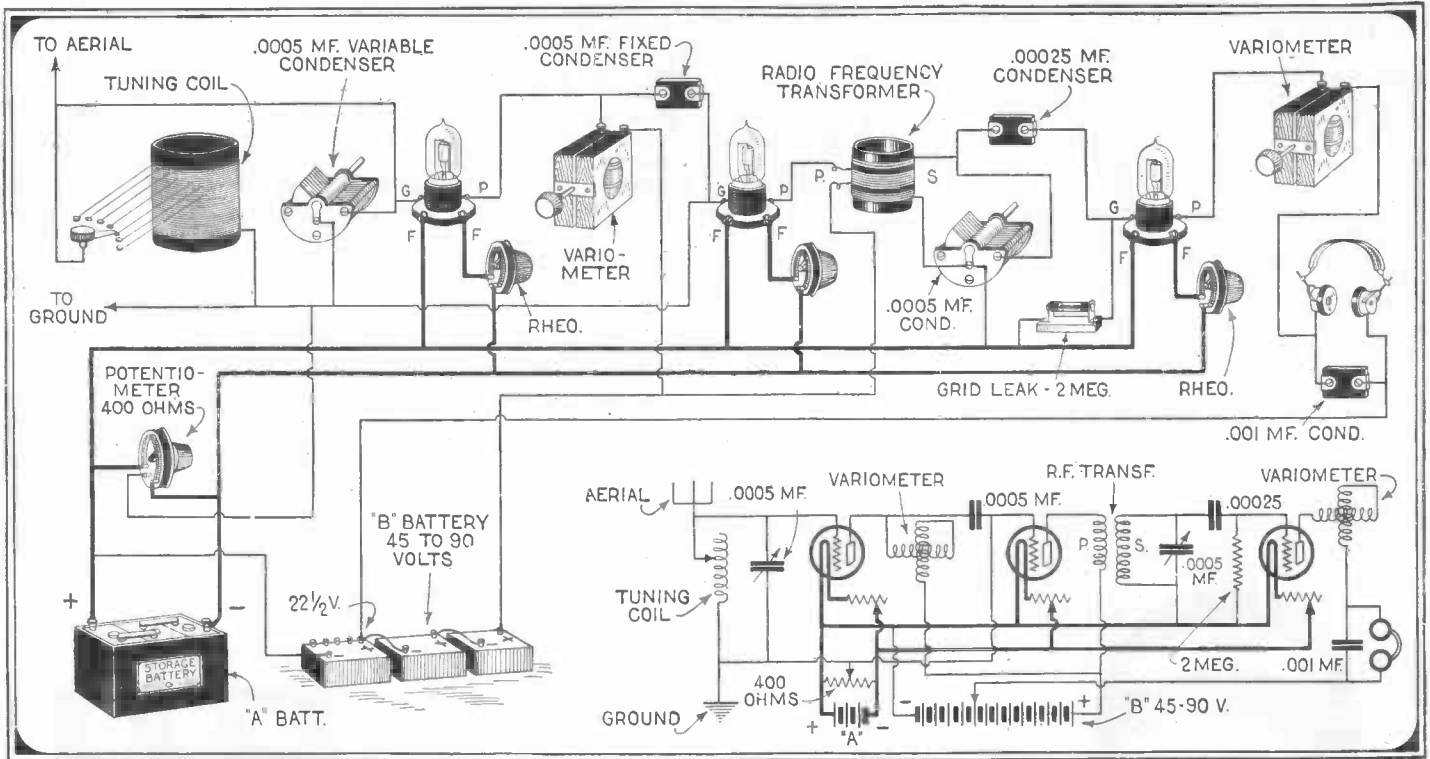

A circuit diagram of two stages of tuned radio frequency amplification with a vacuum tube detector. The correct constants are given on the diagram. This circuit is quite selective and is an excellent one for the "DX hound" who does not care for ear-splitting volume.

### TUNED R.F.

(363) Q. 1. K. Edler, Washington, D. C., sends us a circuit of a two-stage radio frequency and detector set wherein the first stage of R.F. is tuned by means of a variometer and the second by means of the coupling coil and condenser. He has been unable to accomplish satisfactory reception with this circuit. He requests us to check over the circuit and let him know what is wrong.

A. 1. We reproduce the circuit herewith with the necessary additions and changes. You did not have any grid or blocking condenser in the grid circuit of the second radio frequency amplifying tube nor grid leak in the detector circuit. Neither was there a fixed phone condenser. We have made these corrections on the drawing herewith.

### A CAUTION TO AMATEURS

(364) Q. 1. Jerome Russell, Jr., Deep River, Conn., says that he has repeatedly heard a short wave radiophone station signing the call letters APRC on phone. He asks: Can you tell me who gives this station call?

A. 1. There is a possibility that the person signing these call letters is some unlicensed experimenter, as we have no record of any such call ever having been assigned by the United States Government. Let us sound a warning here to all experimenters interested in radio transmission. It is posi-

tive against the laws of this country to operate any type of radio transmitter without first obtaining government license for that station and a second license for the operator thereof. There is no charge for such licenses, but an examination must be passed by the applicant for the operator's license. Experimenters living at too great a distance from examining centers to warrant their personal appearance can obtain a second grade license upon filling out the required blanks. These may be had from the Radio Inspector who is located at the nearest Custom House.

### LEAD-IN

(365) Q. 1. Y. Sagnotty, Toronto, Canada, wants to know if it makes any difference where the lead-in is connected to the aerial.

A. 1. If you make the inverted L type aerial bring your lead-in off the very end of the flat top. If you make the T type, connect the lead-in exactly in the middle. Otherwise, you have an unbalanced condition, with currents bucking each other at one point or another. Surface is what you want in an antenna; therefore, we recommend that you use enameled stranded wire. If you point the lead-in end of the aerial toward the transmitter you will have more of a chance of getting the station, while in a T type antenna, the directional effect is not so noticeable.

### NOISE

(366) Q. 1. J. B. Petrus, Mount, La., says that when he taps the table upon which his radio set is resting or taps the cabinet, a loud noise is heard in the receivers or loud speaker. He asks what produces this and how it can be eliminated.

A. 1. Regarding the noise which is heard when your set is tapped, we would advise that the same is caused by the vibration of the elements contained within the tubes. This can be eliminated or at least reduced to a considerable extent by suspending the sockets of the tubes on springs or rubber bands so that they will not vibrate excessively. This can be done in the manner illustrated many times in the "Radio Wrinkle" section of this magazine.

Q. 2. He also says that he occasionally experiences trouble in tuning out wireless stations and asks us how such trouble can be eliminated.

A. 2. Regarding the tuning out of radio telegraph transmitting stations, which we presume you mean by wireless stations, we would advise the addition of a series, inductively coupled wave-trap. We do not believe that this trouble could be eliminated by the purchase of a better variocoupler and variable condenser. However, if the primary and secondary coupler are wound with wire any smaller than No. 20, we would advise you to rewind them with that size wire, placing thereon the same number of turns as is removed. This will make your tuning considerably sharper.

### WANTED!!! RADIO ARTICLES

WE want descriptions of new radio ideas which you have worked out in practice. Take photographs of the important parts and make pencil or pen and ink sketches of the hook-ups or mechanical details, et cetera. We are particularly

desirous of obtaining new hook-ups and descriptions of single tube sets, reflex and other types which have proven satisfactory. We like articles on new single tube receptors. We will pay good prices for your ideas. —Editor.

**RADIO AMMETERS**

(367) Q. 1. Mr. Jack Finke, Los Angeles, Calif. Will you kindly explain the differences in operation between a hot-wire ammeter and a thermocouple ammeter?

A. 1. It will be noticed that the operating element in the hot-wire ammeter shown in Fig. 1 of the accompanying diagram consists of a length of expansible metal such as a thin piece of resistance wire or a length of platinum strip. One turn of thin silk thread is wound around the bearing rod and is held taut by a small spring. When an E.M.F. is applied to the binding posts, the wire becomes heated, thereby expanding and allowing the spring to take up on the thread, which sends the pointer over a graduated scale. The hot-wire ammeter operates on the principle of the expansion of metals when heated.

In Fig. 2 may be seen the diagram of a thermo-coupled ammeter. This instrument operates on the principle of the generation of an E.M.F. at the junction of two unlike metals which are being heated by another E.M.F. The metals most commonly used in thermo-couple elements are constantan and steel, or constantan and manganin, of about .02 millimeter in diameter and four millimeters long. When the two ends of

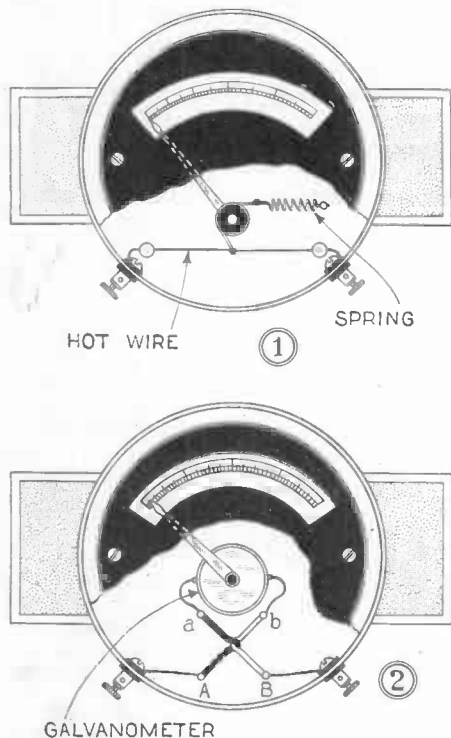

A hot wire and a thermo-couple ammeter are shown above in Figs. 1 and 2 respectively.

the thermo-element, A and B, are connected to an E.M.F., the heat generated at the junction of the two elements induces another E.M.F. across a and b, which acts upon a sensitive galvanometer.

**INCREASING SELECTIVITY**

(368) Q. 1. Robert Smith, Detroit, Mich., desires to obtain better selectivity with a standard type of receiving set employing a three-circuit coupler. The set is connected to an antenna system, having a total over-all length of 140 feet.

A. 1. Since you desire to leave your set in its present form, the only way you can materially increase your selectivity is by sacrificing some volume. The method to use is to cut down your antenna so that the over-all length including the lead-in is not more than 75 feet. You should then be able to cut out the undesired local stations and tune in "DX" without much trouble.

**AIR HOGS?**

(369) Q. 1. Clair Dale Cable, Minneapolis, Minn., asks: What does air hog mean when used in connection with radio? We take it to mean a person who would like to have the use of the air all of the time and not give anyone else a chance to use it. We have a great many of these so-called air hogs in Minneapolis who are amateurs. They commence sending code about 6:30 or 7 P. M. and keep it up until 12:30 or 1 A. M. It may be great sport for them but what about other people who have receiving sets and would like to listen to distant concerts? They may be able to get distance stations, but the concerts are always broken up by a lot of God-forsaken code.

Large broadcasting stations have certain times at which they broadcast; why should not amateurs be restricted, and not be allowed to transmit between the hours of 6 o'clock P. M. and 12:30 P.M. These are the hours during which almost all large stations are broadcasting their best programs. These programs are broadcast for the enjoyment of people who wish to listen in. They can't enjoy these programs when amateurs are always sawing and chopping them to pieces. Don't think this is meant only for Minneapolis amateurs. It is meant for amateurs from coast to coast.

A. 1. In answer to your communication regarding "amateur air hogs," we would advise you as follows. The amateur who sends "God-forsaken code" is the person that made possible your broadcast reception. If it were not for the amateurs and their work in developing radio communication to its present point, you would doubtless still be listening to your phonograph when you desired musical entertainment. There would be as yet no broadcasting stations and, therefore, of course no musical programs for you to receive.

In the majority of cases the fault of interference lies not with the amateur, but with the broadcast listener himself whose set is not selective enough to tune out the amateurs who are on a wave-length of 200 meters or less. Many of the radio receiving sets which are in use today cannot differentiate between wave-lengths 200 meters apart and everything comes through as through a sieve. This fault gives rise to many unjust complaints against the amateurs who, by the way, are barred from the air during certain hours. On the 150- to 200-meter band these hours are 7:30 to 10:30 p.m., local standard time. Possibly the interference you mention is caused by Army and Navy stations transmitting official government business. Since many receivers are not selective, it is impossible for them to separate the radio telegraph transmitting stations from the broadcasting stations.

In discussing this matter we must remember that every question has two sides and that in respect to the broadcast listener, the amateur has been limited in his hours. If you can positively ascertain that it is an amateur who is breaking up your broadcast reception, we would advise you to inform your nearest radio inspector so that steps may be taken in the matter to remove the trouble.

Every transmitting amateur is a gentleman at heart and only too glad to regulate his experiments so as not to interfere with other people's enjoyment. We are sure if you will find out who is causing the interference and approach him in the proper manner that no more trouble will be experienced. Furthermore, there have recently been formed throughout this country vigilance committees under the auspices of a nation-wide amateur organization. If you will inquire as to the members of this committee in your home town and communicate with them, they will be only too glad to investigate all your troubles.

**RHEOSTAT CONNECTION**

(370) Q. 1. J. C. Porter, Habana, Cuba, says that he has noticed that in different circuits the rheostats are sometimes shown in the positive filament lead, while in others these instruments are indicated as being connected in the negative lead. He asks which connection is correct.

A. 1. The exact connection of the rheostat which you inquire about causes very little difference. Usually, however, it is advised that they be placed in the negative lead of the "A" battery.

Q. 2. Are "C" batteries needed in a two-stage amplifier, and if so how should they be connected?

A. 2. In two-stage amplifiers, "C" batteries are usually desirable. To use them, connect the grid return binding posts of the audio frequency transformers together and connect the common wire to the negative of the "C" battery. Connect the positive side of the "C" battery to the negative "A."

**WIRED WIRELESS**

(371) Q. 1. Mr. Paul Davis, Denver, Colo., inquires about *wired wireless* and asks for a circuit for experimentation with it.

A. 1. Wired wireless is the transmission of radio-telephone messages over power lines. The ordinary transmitting and receiving set may be made use of in connection with this

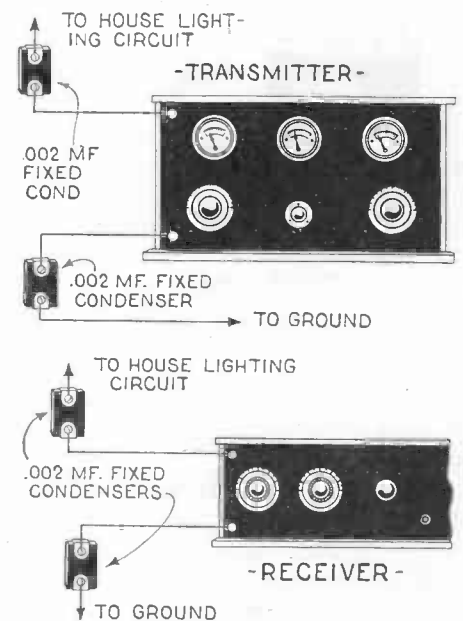

Two circuit diagrams for experimental wired wireless, both transmitting and receiving, are given above.

method of transmission and reception. The circuit used with wired wireless is given in the accompanying cut. Condensers are placed in the aerial and ground leads of both the transmitter and receiver in order to prevent any catastrophe to the tubes or power lines.

**TROUBLE**

(372) Q. 1. Wm. N. Keech, York City, Pa., says that he has built a radio receiving set following the directions given in this magazine, has used all good parts and wired the set carefully. Says he cannot get any results worth while, and that the volume delivered is very small. He asks our opinion as to his trouble.

A. 1. Inasmuch as you state that you have followed directions very carefully and are unable to get results from your set, we would suggest that the trouble lies in the fact that the tickler connections are reversed. This of course will prevent regeneration, and naturally you will be unable to produce volume. The problem resolves itself simply into reversing the terminal connections to the tickler coil.



# Scientific Humor

## THE COUNTRY OF ORIGIN

SHE: "How is it that this country is dry, and I'm told that you are an excessive drinker of gin?"

HE: "Yes, I drink two kinds of gin—and you do too."

SHE: "What!—You'll have to prove!"

HE: "Don't you drink water?—Well, isn't that Hydro-gin, and Oxy-gin?"—*Alexander Seymour.*

## WHERE'S THE RUB?



A lady visitor and a professor were standing outside a country church, while the rural choir were lustily singing.

"How beautifully they sing," said the lady.

"Yes," murmured the professor, who was studying a cricket. "They produce that noise by rubbing their hind legs together."—*Stanley R. Russell.*

## MUST GO DEAD!

ANGRY MOTORIST: "Look here, my man, this car belongs to me, and what I say goes, get me?"

GARAGE MECHANIC (meekly): "Please, sir, say engine."—*P. J. Colohan, Rep. No. 21504.*

## ZERO HOUR

BRIGHT STUDENT (after working half an hour on an algebraic equation): "Doggone it! All this work, and the answer's nothing! —*E. M. Newbold.*

## HE AUTO-METER HUSBAND

OFFICER: (To motorist) "Did you hit this woman?"

MOTORIST: "No I just made her acquainted with some of the accessories."

OFFICER: "What do you mean?"

MOTORIST: "I let my motor-meter." (motor meet her)—*Orin C. Watkins.*

## A KICK-TRICK CAR



MR. DONOR (to a neighbor whose stolen car has been returned): "I see you have trained your car to come home."

MR. SPICER: "Yes, indeed! And I am going to teach it to

kick any stranger who tampers with it."—*Clara E. Smith.*

## THIS IS THE LIMIT

There was once a widow who had seven sons. They bought a ranch and stocked it with cattle. One day, at the dinner table, they were discussing a name for the place, but no name suggested seem to fit.

"I guess we had better call it 'Focus,'" said one finally.

"Why?" asked his mother.

"Well, you see," he replied, "A focus is a place where the sun's rays meet (son's raise meat)"—*Richard W. Stasch.*

## AND KEEP IT OHM!

1ST RADIO BUG: "How can I cut down the resistance in my set?"

2ND RADIO BUG: "Put an Ohm Eater (ohmmeter) in the circuit."—*Charles Carter.*

## First Prize \$3.00 CURRENT EVENTS

TEACHER: "Johnny, explain to the class what currents are."

JOHNNY: "Currents are the fruit of Electric Plants which grow from Radio Bulbs."—*Gilbert Swift.*



## MOST SETS DO!

VOICE OVER PHONE: "I think my radio set needs a plumber."

RADIO EDITOR: "Why! What's the trouble?"

VOICE: "It has a grid leak."—*Daniel W. Farnsworth.*

**W**E receive daily from one to two hundred contributions to this department. Of these only one or two are available. We desire to publish only scientific humor and all contributions should be original if possible. Do not copy jokes from old books or other publications as they have little or no chance here. By scientific humor we mean only such jokes as contain something of a scientific nature. Note our prize winners. Write each joke on a separate sheet and sign your name and address to it. Write only on one side of sheet. We cannot return unaccepted jokes. Please do not enclose return postage.

All jokes published here are paid for at the rate of one dollar each, besides the first prize of three dollars for the best jokes submitted each month. In the event that two people send in the same joke so as to tie for the prize, then the sum of three dollars in cash will be paid to each one.

## BORROWING TROUBLE

TED: "How is it the old professor is afraid of being caught in a shower, when he has an umbrella?"

NED: "He forgot he brought it."—*Jas. J. O'Connell.*

## FOLLOWING HIS TRADE

JUDGE SCAREM: "What is your trade?"

PRISONER (who was caught in a gambling house raid): "I'm a locksmith."

JUDGE: "What were you doing in there when the police entered?"

PRISONER: "I was making a bolt for the door."—*Herman L. Gottlieb.*

## MAYBE HE ATE GRASSHOPPERS TOO



CANNIBAL DOC: "Your chief has hay fever."

CANNIBAL: "What brought it on?"

CANNIBAL DOC: "He ate a grass widow."—*Charles A. N. Hall.*

## ARE YOU STRINGING US?

The following is a copy of an order mailed to a prominent piano company:

Dear Sir:—

Please send me by mail a string for my piano. Have the string tuned to G, before you send it, as my husband can put it in, but he can't tune it.

P. S.—It's the G on the right side of the piano.

Mrs. X.....

—*Chas. C. Zimmerman, Rep. No. 21608.*

## ONE FOR DUNNINGER

EAST: "Did you know that Jones had an automobile accident? He's in the aquarium now."

WEST: "You mean sanatarium, don't you?"

EAST: "No, aquarium. He turned turtle!"—*Clifton Ask.*



## INDEED!

TEACHER: "Do you know anything about the moon?"

STUDENT: "Yes sir, I know its weight."

TEACHER: "What does the moon weigh?"

STUDENT: "Well sir, the moon consists of four quarters, four quarters make one hundred-weight, therefore the moon weighs one-twentieth of a ton."—*G. H. Varley, Rep. No. 19629.*

## A CONCRETE EXAMPLE

TEACHER (in grammar class): "Give me an example of a concrete noun."

BRIGHT PUPIL: "Dam."—*Stanley Stanbery.*

## MOST JOKES ARE TOO

TEACHER (to class in physics): "Transparent objects are those which can be seen through. Name such an object!"

STUDENT: "A ladder, sir."—*Hubert Slouka.*

## A KEY TO BALDPATE

AUTHOR: "I have here a hair rising story."

PROFESSOR: "Tell it to some bald-headed man."—*Leon Burlandt.*



## SIZED UP

MADGE: I suppose there's no chance of the slim silhouette going out of style.

MARJOIRE: Doesn't look so. I see the air liners are going to charge the passengers by weight."—*Jas. J. O'Connell.*

## A SPRINGY FALL

SOPH: Nature cannot jump from winter to summer without a spring, or from summer to winter without a fall.—*Charles A. N. Hall.*

## WHY NOT USE A CHISEL?

FRIVOLOUS STUDENT (after half-hearted recitation in a nutrition class): "Something's preying on my mind."

EXASPERATED TEACHER: "Leave it alone and it will die of starvation."—*E. M. Newbold.*



# LATEST PATENTS

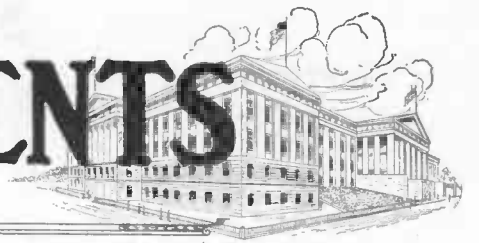

## Alarm Clock

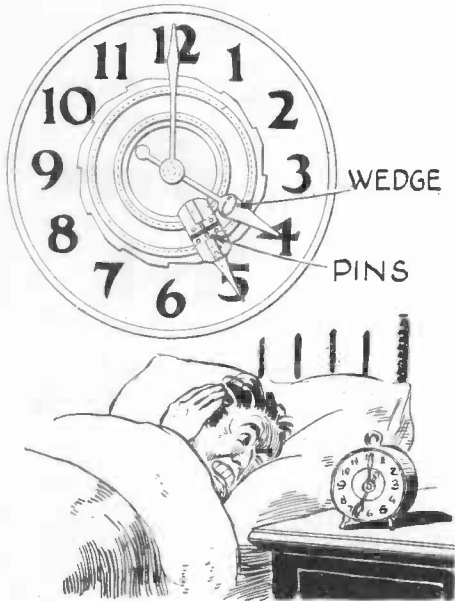

No. 1,521,600, issued to F. P. Crowe, protects a novel electric alarm device which operates until the circuit is opened by means of a switch or until a certain time limit has been passed. Two pins separated by a small space are connected in the alarm circuit. A metal wedge on the hour hand passes between these pins and closes the circuit. The pins are furnished with springs so as to make good contact.

## Ship Raising

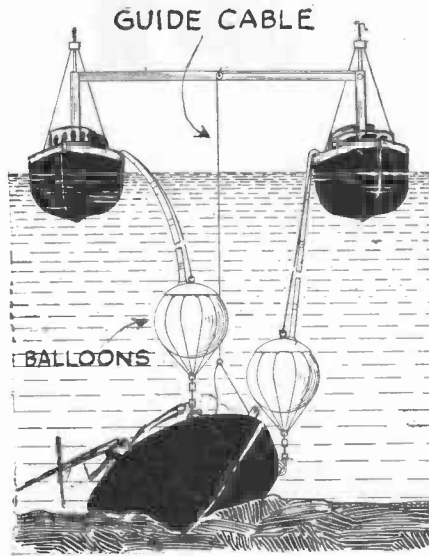

No. 1,531,433, issued to U. A. Carr, covers a proposed method for raising sunken vessels in order to reclaim them from a watery grave. The device uses two large ships which are held apart by the brace shown. Divers fasten balloons to the sunken ship by means of hooks which are attached to some part of the vessel. These balloons when first lowered are deflated. By inflating them with pumps placed on board the two rescue vessels, the buoyancy is so increased that the balloons are supposed to raise the ship.

## Wrench

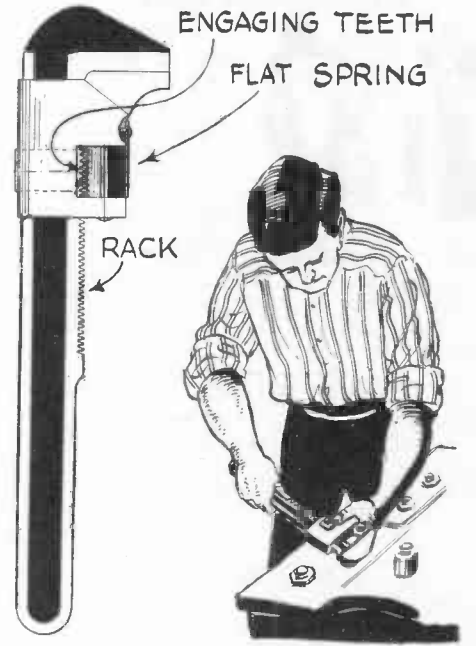

No. 1,532,174, issued to J. M. Crocker, presents a novel type of machinist's wrench. To adjust this wrench it is not necessary to turn a knurled nut until the jaws are the desired distance apart. The engaging teeth are merely pulled out of mesh with the rack, and the lower jaw moved on the handle to the required position. The spring holds the teeth in mesh.

## Speed Signal Light

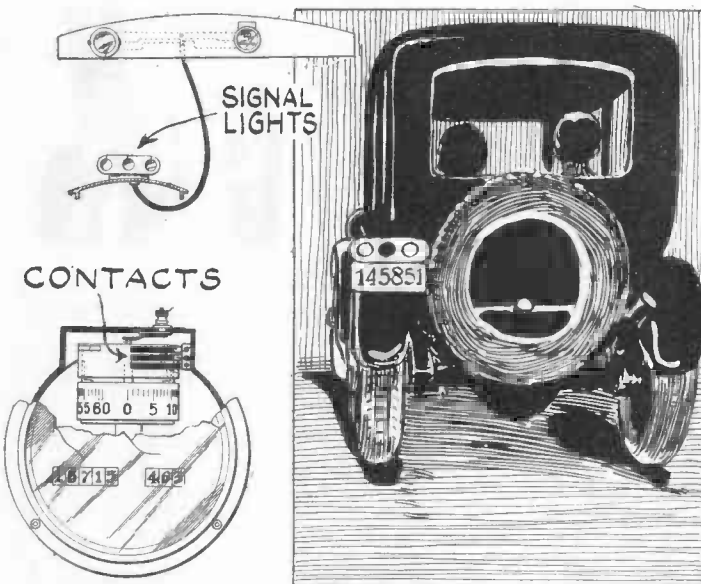

No. 1,527,279, issued to L. H. Smiley, provides protection for another new type of automobile signal lamp. This device is intended to show just how fast an automobile is traveling. Three contacts arranged on the speedometer, as shown, cause certain colored lights to light when a predetermined speed is reached. A warning light on the dashboard informs the driver that he is going too fast. Rear lights inform the authorities.

## Power Hand Saw

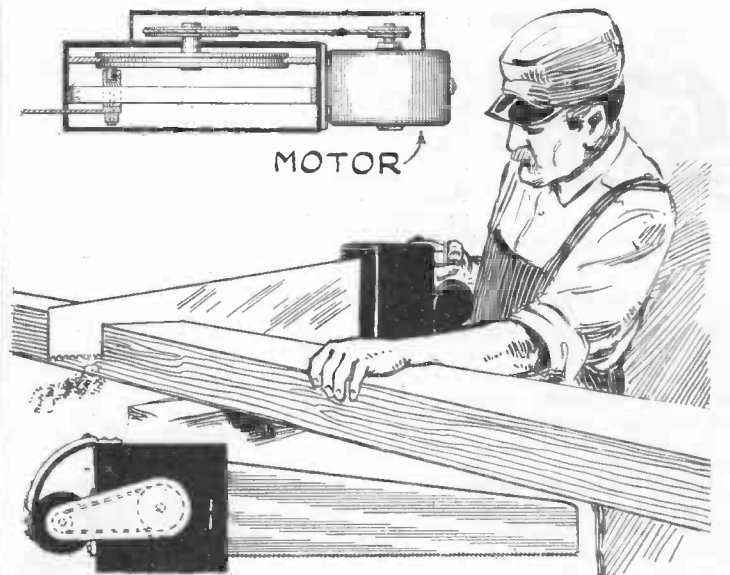

No. 1,521,692, issued to H. Lustig, describes the electrically driven motor hand saw illustrated above. A small motor within the case as shown is connected through a belt or other power transmitting method to a large pulley which in turn is connected to a wheel, near the periphery of which the end of the saw blade is pivoted. Thus, when the motor is running, the blade is given a reciprocating motion. Power is obtained from any source.

# Non-Science

## TWO FACED

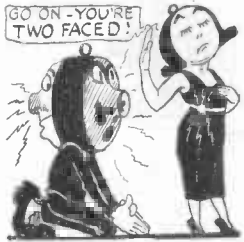

The Birmingham Post of Feb. 11th contains the following item in the advertising pages: "Wanted, Single-faced Electric Motor, 5 to 10 H.P.; or will exchange 8 H.P. Double-Faced Motor." Now here is something remarkable. Just think of exchanging a single-faced motor for a double-faced one. If you were able to make the exchange you would then have one face more than you bargained for, and having one more face, could you not be called two faced?—Sadie Liebling.

## STILL SHAPING

The Anita Co. advertising in SCIENCE & INVENTION Magazine, June issue, state that their nose adjuster shapes while you sleep. Wouldn't it be better to purchase a nose adjuster already shaped? Perhaps the nose adjuster is liable to depress a pug nose, making it look more puggy, or vice versa?—Joseph Allison, Jr.



## MOTOR-LESS FLIES



The January issue of Popular Science advertises the "Gettins Octoplane" as follows: "Flies Without Motor."

Now the writer wishes to say that even though he has seen a great many flies, he has not as yet known of any with motors, so there is absolutely nothing unusual about the statement "flies without motor."—M. Bercovitch.

## AU—TO BE DEAD

The Green Bay Press-Gazette of May 30th contains the following headline: "Auto Overturns, Dies."

The auto probably died from heart failure. My engine has a peculiar habit of "dying" at busy street crossings and on railroad tracks, but I never supposed this condition was likely to effect the whole car. Wonder what a dead auto looks like.—Mrs. L. G. Derrick.

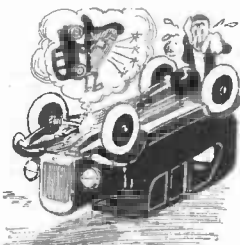

## COUNTERFEITING



In an ad in SCIENCE & INVENTION for June, a headline reads: "Make Money at Home."

There have been a great many people who have tried making money at home, but as soon as they were discovered they were given striped suits.—K. F. Rudolph.

## Money for Mistakes

The newspapers throughout the country, as well as the magazines, occasionally err. Sometimes these errors are misprints. At other times they are pure scientific misstatements. If you happen to see any of these humorous mistakes in the press, we will be glad to have you clip them out and send them to us. Give the name of the newspaper or magazine in which the error appeared and accompany the inclosure with a few humorous lines. The most humorous ones will be printed in this department, and for each one accepted and printed we will pay \$1.00. No NON-SC(i)ENCE entry will be accepted, unless the printed original accompanies the same. Address all NON-SC(i)ENCE entries to:

Editor, NON-SC(i)ENCE Dept., c/o Science & Invention Magazine, 53 Park Place, New York City.

## CATTY OATS



The Department of Agriculture has prepared a printed bulletin saying: "The cat crop ranks third in importance. Cats traditionally constitute the banner horse feed of the world, and 3 per cent. is used for human consumption. The cat crop is subject to several diseases, chief of which are loose and covered smuts, stem rust and crown rust."

Then the pamphlet contains a discourse on the main varieties in the U. S. which are given as being Swedish select, silver mines and white tartar. There are wild cats, broken cats, wilted cats and tame cats." Now isn't that remarkable? What more can we say? We have often heard of people using cats instead of rabbits, but we have never seen cats covered with stem rust or crown rust. They must be iron cats. When it comes to horses feeding on these animals, there is nothing left to say. Of course, the difficulty occurred when a linotype operator insisted on hitting a "c" instead of an "o." The treatise was intended to cover the subject of oats. The savant who composed this treatise probably selected the menus on British transports during the war.—H. W. S.

## MURDEROUS CITATIONS



The New York Herald-Tribune of May 16th, 1925, in an article on the death of General Miles, contains the following headline: "Won Fame in Civil War, Receiving Four Wounds and Praise From Grant." Now isn't General Grant the nicest kind of a gentlemen. With a revolver in one hand and a medal in the other, he must have been an imposing figure. And as General Miles stepped forward, Grant's left hand pinned the medal on his chest, and the gat in his right hand administered the four tokens.

## SMALL GIANT

The Muskegee Daily News of Sunday, June 7th, 1925, contains the following headline:

"Giant Locomotive For Railway But 20 Miles in Length."

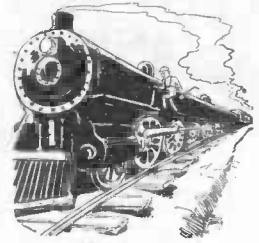

Well, now, we citizens of Oklahoma are "oil right." According to the news we can boast of the largest locomotive in the world. Of course it is only twenty miles long, but at that it must be the eighth wonder of the world. If the smoker is in the rear car of the train, and each car were as long as the locomotive, we could walk for several days to reach the end of the smoker.—Ray Wilson.

## YACHTING IN-DOORS



toilet and boat."

The inside boat must be something new in the line of modern improvements. Perhaps they keep them in the bathtub, but no mention of a bathtub was made.—Hugh Jewell.

In the Want Ad Department of the Lansing State Journal in the June 8th issue, this ad appeared: "Pine Lake — Cottage for rent for the season. Electric lights, inside

## MAKE YOUR OWN

The following advertisement recently appeared in an issue of Rich Puzzler, a booklet issued to his patrons about the delicious fruit flavored sodas he serves. "Fresh fruits used are made right on the premises."



Truly a new discovery. We would appreciate it greatly I am sure if this second Burbank would disclose to us his method of manufacturing fruits. He doesn't advise from what substance he compounds them.—Arthur Thurn.

## SECRETS OF WEDDED BLISS



covered."

In the May 19th issue of the Holyoke Evening Transcript the following item appeared: "A wife of about 24 gauge will make a compact unit. Use either double silk or cotton covered." Is it any wonder that a lot of these single young fellows get such poor results from their home-made apparatus, when the first requisite towards success is to have a wife of about 24 gauge. Even those of us who are fortunate enough to have such a "compact unit" are not getting full efficiency, due to inclination toward abbreviated attire, when the instructions say it should be double silk or cotton covered.—Harold E. Bentley.



# THE ORACLE



The "Oracle" is for the sole benefit of all scientific students. Questions will be answered here for the benefit of all but only matter of sufficient interest will be published. Rules under which questions will be answered:

1. Only three questions can be submitted to be answered.
2. Only one side of sheet to be written on; matter must be typewritten or else written in ink, no penciled matter considered.

3. Sketches, diagrams, etc., must be on separate sheets. Questions addressed to this department cannot be answered by mail free of charge.

4. If a quick answer is desired by mail, a nominal charge of 50 cents is made for each question. If the questions entail considerable research work or intricate calculations, a special rate will be charged. Correspondents will be informed as to the fee before such questions are answered.

## FIRE EXTINGUISHER

(1870) Q. 1. J. K. Martin, New Boston, Ill., asks how a standard fire extinguisher operates in which it is only necessary to invert the instrument in order to start a stream flowing from the nozzle.

A. 1. Our diagram illustrates a sectional view of such an extinguisher. In an upright position, the sulphuric acid in the container does not mix with the baking soda solution. If, however, the

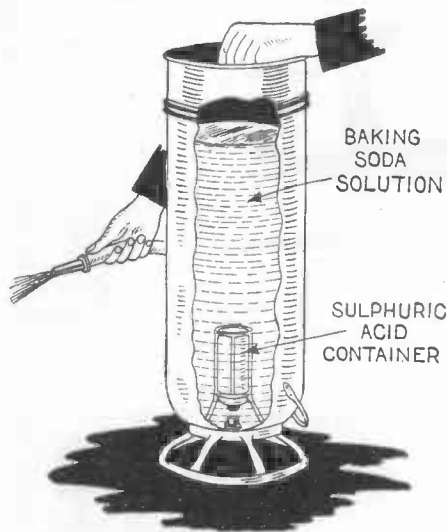

In the above illustration, a section of a fire extinguisher has been cut away to show the interior.

apparatus is inverted, the two liquids mix and gas is evolved which rises through the liquid, collects at what is now the top of the container, creates pressure and forces the solution out through the nozzle at high pressure.

## TIN CEMENT

(1871) Q. 1. I. Rubin, Chicago, Ill., asks for a formula for securing a sheet of tin to lumber.

A. 1. We do not have any formula covering a glue or cement which will permanently fasten tin to lumber. Probably the best method to use would be several tacks or very fine wire nails. Varnish or shellac solution might answer if the tin was very thin.

## METALLIC SODIUM

(1872) Q. 1. Herman Kunschman, New York City, asks what precautions should be taken when using metallic sodium in the laboratory.

A. 1. Metallic sodium should be kept absolutely away from water and moisture and in all cases when it is to be kept for any length of time it must be kept under oil of some kind such as any mineral oil.

## NITRO-GLYCERINE

(1873) Q. 1. G. P. Harl, Columbia, Mo., says that he has in his possession a box which is used to keep dynamite in during the summer months, and that some of the nitro-glycerine has seeped out of the dynamite and collected in the bottom of the box. About a tablespoonful of nitro-glycerine is present. He asks how he can dispose of this nitro-glycerine in a safe manner.

A. 1. Probably the best thing for you to do in connection with the nitro-glycerine is to fill the box with sawdust and allow it to soak up the explosive. Another method would be to cover the nitro-glycerine with castor oil, allow it to dissolve by standing for a day or so and then allow it to soak into the ground in some secluded spot. Also in place of sawdust, any form of infusorial material could be used.

## TALKING MOVIES

(1874) Q. 1. Rufus Harmon, Providence, Ky., asks what is the greatest obstacle which prevents talking movies from becoming commercially practical.

A. 1. There are several types of very practical talking movies on the market today, the DeForest Phonofilm being one of the best. The problem of synchronizing the voice and the actor's motions has been solved and no longer gives any trouble. One of the greatest drawbacks is the production of sounds which do not seem mechanical and which very nearly represent that of the human voice.

Articles in the pages of SCIENCE AND INVENTION have put forth the latest developments in talking movies which show them to be entirely practical, although much more expensive to produce than the standard motion pictures.

## TRI-SECTING AN ANGLE

(1875) Q. 1. N. Hannula, Virginia, Minn., asks whether or not any financial benefit would revert to the person who solves the problem of directly tri-secting an angle by means of geometry.

A. 1. We do not believe that there would be financial benefit to the person who solved the tri-secting of an angle by geometry. The only thing that you might possibly gain would be some publicity. In all practical work, an angle can be tri-sected by measurement. No geometrical construction is known.

## STORAGE BATTERY ELECTROLYTE

(1876) Q. 1. Henry G. Garary, Brooklyn, N. Y., asks how the amount of water to be added to sulphuric acid for an electrolyte of certain specific gravity in a storage battery may be determined.

A. 1. We give herewith a chart which shows how much water either by volume or by weight must be added to one part of concentrated sulphuric acid with a specific gravity of 1.835 in order to obtain any desired specific gravity. Furthermore, this chart shows the percentage of acid in solution for any given specific gravity of the mixture. To use this chart, let us presume that we want to have a mixture with a specific gravity of 1.300. We have one part of concentrated sulphuric acid on hand. Tracing the line indicated by the desired specific gravity upward to where it joins the curve labeled "by weight" and then going over to the left-hand margin we find that approximately 1.4 parts of water to 1 part of acid will give the required specific gravity. This is by weight. If we desire to measure by volume, we will continue following the line marked "1.300"

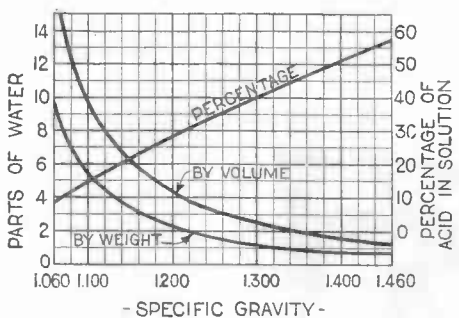

A percentage, volume and weight chart for mixing the electrolyte used in a lead plate storage battery.

to the curve marked "by volume," whereupon we find that 2.5 parts of water by volume must be added to 1 part of acid by volume to produce the required specific gravity. The percentage of solution is determined by following the specific gravity line up to the percentage curve and over to the right. We will then find that the desired specific gravity 1.300 is approximately a 40% solution.

## TRANSFORMER DESIGN

(1877) Q. 1. William B. Marks, Jersey City, N. J., asks how the number of turns to be placed on the primary of a small 60-cycle transformer is to be determined.

A. 1. The exact number of turns on the primary of a transformer depends directly upon the cross-sectional area of the core in square inches. We give in these columns a chart showing the number of turns of windings per volt for any given cross-sectional area of core in square inches up

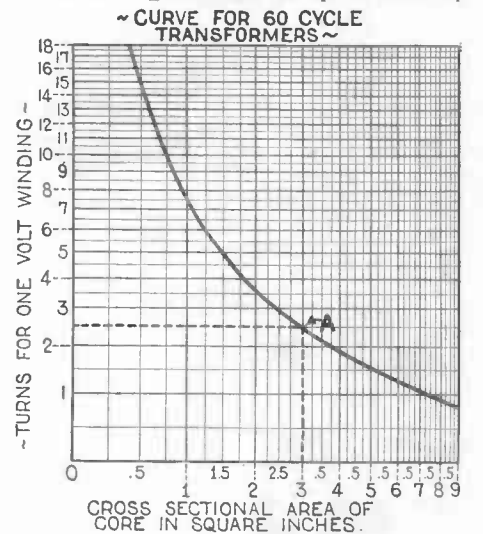

A chart for determining the number of turns on transformer windings.

to 9 square inches. This is considering the use of silicon steel for the laminations of the core. The figure obtained from this chart, that is, the number of turns of winding per volt may be applied to the calculation of both the primary and the secondary.

Let us consider as an example a core with a cross-sectional area of 3 square inches. Following the line 3 upward on the chart to the curved line and over to the left-hand edge, we find that 2½ turns of wire per volt are required. Multiply this by the voltage in the primary and you will have the number of primary turns. Multiply it by the number of volts desired on the secondary and the result will be the number of turns necessary to produce that voltage. The size of the wire in the windings will depend upon the amount of current to be used and may be determined from any standard wire table, giving the carrying capacity of wire in amperes.

## ELECTRIC RIFLE

(1878) Q. 1. D. M. Thompson, Park City, Utah, says that he has witnessed a demonstration of an electric rifle, describes the device in general and asks our opinion as to how this rifle was constructed and operated.

A. 1. We regret to say that we have no actual constructional data on an electric rifle of the type you mention, but would say that it undoubtedly operated on the principle of the solenoid. Steel bullets were probably placed to the rear of the solenoid and the current turned on. The bullet would then, of course, start to move toward the center of the coil and at a certain distance therefrom the current would be turned off. The bullet would then continue to travel onward because of its momentum.

Usually there are several solenoids located along the barrel at various points, which by the passage of the bullet are automatically switched into the circuit. Thus there is a pull exerted on the bullet over a considerable distance and just before it reaches the last solenoid, all the current is cut off and the bullet travels on through space.

Back as far as 1915 a description was published of a weapon very similar to this. This appeared in this magazine, which was then known as the ELECTRICAL EXPERIMENTER.

**SODIUM CHLORIDE**

(1879) Q. 1. James W. Koehler, Miami, Fla., asks how to prepare chemically pure sodium chloride in the laboratory.

A. 1. In a 500 cc. beaker place 150 grams of ordinary table salt. Add 360 cc. of distilled water and stir vigorously until no more will go into solution and the water is saturated. Then filter into a clean beaker and add concentrated hydrochloric acid until the salt just begins to separate from solution. Now set up a hydrochloric acid generator, as shown, connecting it with a wash bottle containing concentrated hydrochloric acid solution. With the wash bottle connect a delivery tube terminating in a 2-inch funnel and allow the latter to dip beneath the surface of the saturated salt solution.

Place in the generator a quantity of rock salt and cover it well with concentrated sulphuric acid and heat very gently. This generates hydrochloric

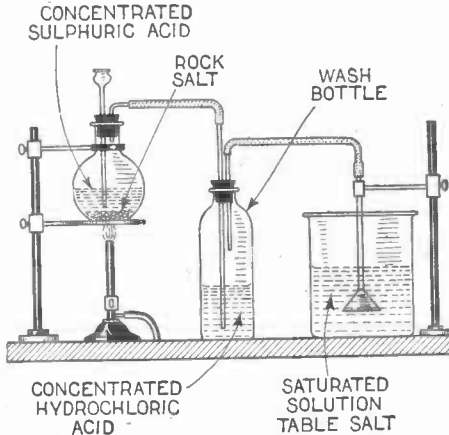

The necessary apparatus for the production of chemically pure sodium chloride in the laboratory. The complete process is described in the text.

acid gas which on passing into the salt solution drives chemically pure sodium chloride out of solution and precipitates it in crystal form. This results from the fact that sodium chloride is less soluble in hydrochloric acid than in water, and, therefore, the sodium chloride is thrown out of solution. Allow the salt to settle and pour off the clear liquid leaving the salt in the beaker. Cover it with pure dilute hydrochloric acid, agitate the contents of the beaker with a rotary motion, allow to settle and pour off the clear liquid. Repeat this several times. Then filter through a filter paper and allow to dry. The product is chemically pure sodium chloride.

**LIQUID AIR**

(1880) Q. 1. Fritz Kummer, Chicago, Ill., asks an unusual number of queries which, however, are answered herewith as we believe that they are of interest to many of our readers. The queries are all relative to liquid air and are listed in rotation herewith. A composite answer to all of them is given below.

Q. 1. Ten pounds of air are cooled off to 180° C. and then compressed until liquefied. How many foot pounds of energy have to be applied? And how many, if cooled off to 185° C.? And how many if cooled off to 190° C.?

Q. 2. Ten pounds of air at a temperature of 10° C. are to be compressed to the density of liquefied air and the temperature kept constant. How many foot pounds of energy will it take?

Q. 3. How many foot pounds are lost in Q. 2 due to radiation of heat from the compressed gas and how much due to friction?

Q. 4. How low will the air have to be cooled off to completely liquefy under pressure as in Q. 2?

Q. 5. To what temperature will liquefied air at 194.4° C. drop, if the pressure is lowered to 10 mm. mercury with a vacuum pump?

Q. 6. How much of 10 lbs. of liquefied air will evaporate under the conditions mentioned in Q. 5 in order to liquefy 10 lbs. of air at a temperature of 180° C. and under pressure as in Q. 2?

Q. 7. In a past issue of SCIENCE AND INVENTION you state that an air compressor is only 54 per cent. efficient and a turbine 80 per cent. Would this hold good in the above-mentioned cases where very high pressures are used?

Q. 8. Will air compressed to the density of liquefied air and both at the same temperature contain the same amount of energy? If any difference, explain why and how much.

Q. 9. In a book published in 1920 by T. O'Connor Sloane, Ph.D., I read that in 1 lb. of liquefied air are stored 139,100 pounds of energy. (No temperature was given.) Is this correct, and how much actual mechanical power could we get out of it? Would we have to consider the efficiency of a turbine in this question?

A. We will start by answering your ninth question. While 139,100 foot pounds of energy are stored in one pound of liquefied air, still this figure represents only a small fraction of a horse-

power which would be exerted per hour of expansion. If it were allowed to operate an 80 per cent. efficient motor, only about 1/30th of a horse-power for perhaps a single hour would be obtained. This is because of the fact that the chill due to the evaporation of the liquid air would waste a lot of power.

Now to go back to Q. 1, we find that 10 pounds of liquefied air would contain approximately 139,100 foot pounds of energy. Therefore, somewhat more than this same amount of energy would have to be used in compressing the air to the necessary point.

In regard to your second question. If 10 pounds of air at a temperature of 10° C. are to be compressed to the density of liquid air at a temperature kept constant, the air will not be liquefied.

In regard to Q. 3, it is impossible to answer the query as stated with any accuracy as everything depends upon the machinery used. The same applies to Questions 4, 5, 6 and 7 wherein the answers will depend on the containers and their conductivity of heat. It is futile to assume that you will get a definite efficiency from an air compressor or from an air turbine operating in liquid air, because different machines will give different results.

Air which is compressed as mentioned in your Q. 8, but not liquefied, will, from a practical standpoint, contain the most energy because in its expansion it will not absorb as much heat as would liquefied air. Figuring from a practical standpoint, everything will depend on the machinery used and the heat insulation. When expanding, liquid air produces great cold which of course prevents us from extracting the total mechanical energy contained therein. If the walls of the vessel are good conductors, the liquid air will absorb heat from the atmosphere and practically will evolve more energy. This energy, however, will really be derived from the heat of the apparatus and the atmosphere rather than from the liquid air itself.

**MIRROR IN PHOTOGRAPHY**

(1881) Q. 1. Jas. J. Thomas, Long Branch, Ont., Canada, asks if it would be possible to photograph objects which are placed in an inaccessible location by means of a light-proof box and a mirror. He sends us a sketch of his arrangement.

A. 1. You could very readily do the work you

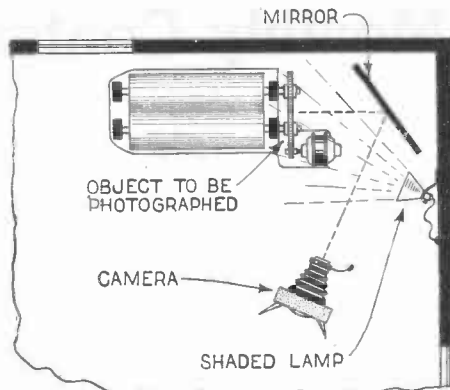

How objects in obscure corners may be photographed.

mention by the use of a mirror. It would not even be necessary to use a light-proof box. The object, however, should be brilliantly illuminated so as to get the best possible photograph of it. The mirror used should be practically flawless. It could be set up so as to reflect the image toward the camera with the camera focused on the mirror in the usual manner. This system of photographing objects in difficult places is well known and in fact used quite frequently. The writer used it at one time in photographing a particularly intricate device for publication in the pages of this magazine. Very good results were obtained by the use of a mirror. We illustrate in these columns a method very often used where there is not room for the camera to be set up between the object and a nearby wall or other obstructing object.

**D. C. GENERATOR**

(1882) Q. 1. Joseph Thome, Chicago, Ill., says that he has a direct current motor rated at 1/8 horse-power and wants to know if it can be used as a generator to deliver direct current. He also asks how many 110-volt lamps the generator would light.

A. 1. In order to use your 1/8 horse-power direct current electric motor as a generator, you will have to drive it at a slightly higher speed than it runs as a motor in order to produce 110 volts; that is, taking for granted that the motor is a 110-volt motor. Of course, being of 1/8 horse-power capacity, it will furnish somewhat less than 100 watts when running at full speed. The average lamp is 40 watts, therefore, two such lamps in parallel will be the greatest number you will be able to light with this generator without any strain on the machine.

**MOLDING**

(1883) Q. 1. Joseph B. Lombardo, Phillipsburg, N. J., says that he is making a plaster of Paris matrix, but has had considerable trouble with the wooden pattern. He states that when the mold has been made, the wooden pattern sticks to the plaster so that it is impossible to remove the same. He asks us if we can tell him how to eliminate this trouble.

A. 1. Of course, we presume that in the making of your plaster of Paris molds that the wooden form is of a correct shape to enable it to be drawn from the mold providing it does not stick. We would then suggest that you try coating the wood with thin shellac and allowing it to harden before placing the plaster of Paris around it. If this does not work, talcum powder can very often be used and wax-coated forms have been found to give good results. Oil will prevent adherence.

**VEHICLE**

(1884) Q. 1. Wilfrid D. Leslie, Ontario, Canada, says that he has an 8-foot airplane propeller and a 4-cylinder gasoline engine. He says that he is going to build a light four-wheel car which is to be propelled by means of this engine and the propeller. He asks our advice as to whether such a vehicle would be practical.

A. 1. You could build a vehicle of the type you mention which would give you fairly good results, but you would undoubtedly obtain greater efficiency by gearing the motor to the rear wheels of the vehicle. We cannot tell just exactly what speed or power you would get from wind-driven car using your propeller, as many factors which could best be determined by experiment enter into the calculation.

**LOSS OF WEIGHT**

(1885) Q. 1. Esten Moen, Fosston, Minn., refers to an article published in the February, 1924, issue of this magazine entitled "Eastbound Steamship Loses Weight." He asks if the phenomenon described therein is authentic.

A. 1. In order to have an unbiased opinion on this question, we have referred it to Ernest K. Chapin for answer. His reply appears below.

"In regard to the question loss of weight of an eastward bound ship, I would say that the author of the article was technically right. At least I see no reason to doubt it though, of course, the effect would be slight. By applying the familiar formula for centrifugal force it can be shown that a ship moving eastward at the equator at the rate of 10 miles per hour would lose about 3 millionths of the weight which it would have when standing still, and would gain the same amount when moving westward at the same rate."

**FREQUENCY DOUBLER**

(1886) Q. 1. Lewis R. Gould, Kansas City, Mo., asks how the frequency of an alternating current may be doubled.

A. 1. This is accomplished by using two 3-winding transformers connected as shown in the diagram. The alternating current generator or alternator energizes the two primary coils which are wound in opposite directions to each other. A source of direct current as indicated energizes the two auxiliary coils which are also bucking or wound in opposite directions. The secondaries are wound in the same direction. By calculating the iron cores so that they will be of the correct value, they will be operated on the upper bend of their magnetization curves and in the secondary windings there will be set up a powerful second harmonic. By tuning the secondary circuit by means of the variable condenser so

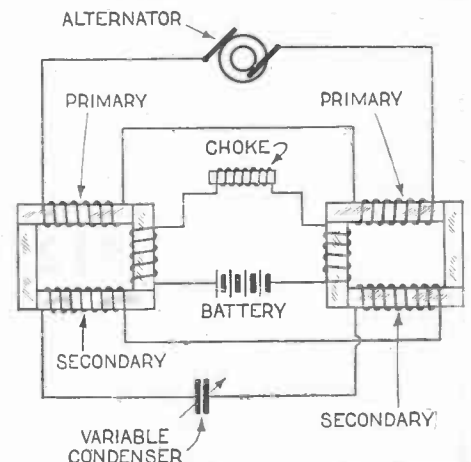

A circuit diagram of a frequency doubler such as is fully described in the accompanying text.

that the frequency of this circuit is also the second harmonic, the efficiency is improved and powerful currents will flow in the secondary circuit and will be double the frequency of the original current. In the circuit diagram which we show an iron core choke coil is inserted in the D. C. circuit to prevent alternating currents from flowing in that circuit.

# Prizes of More Than \$28,000.00 Offered by Science and Invention Magazine

## \$5,000.00 in Prizes For Perpetual Motion

HAS anyone requested you to purchase stock in a perpetual motion machine which is to be submitted for the prize offered by SCIENCE AND INVENTION MAGAZINE? Have you heard anyone tell that they have a working perpetual motion machine?

Up to the present time no working perpetual motion machine has been invented. We have received dozens of drawings of prospective working models which are all fallacious in design or theory. We have not seen one design which would work, and accordingly advise all of our readers not to invest in any perpetual motion machine stock regardless of how laudable the claims may be.

SCIENCE AND INVENTION has offered \$5,000.00 to any inventor who can demonstrate a working model of a perpetual motion machine. We refer the reader to the March, 1925, issue for details. This publication does not desire the rights to the invention. It merely wants to see the machine in operation. This publication brands as imposters all who have claimed to have developed a working model of a perpetual motion machine but who have "destroyed the model because they feared that the idea would be stolen." \$5,000.00 is amply sufficient to protect the idea by patenting it in U. S. and foreign countries.

## \$11,000.00 in Prizes For Psychical Phenomena

A SHORT time ago a medium told us that she would not care to sit before our investigating committee because of the indignities she would have to suffer at the hands of the committee investigating psychical phenomena.

This statement is absolutely ridiculous and an out and out lie. Any medium desiring to sit before our committee to demonstrate her capability as a medium, will have no restrictions imposed upon her except those specified in the contest rules and regulations.

These restrictions are not impositions as our readers can easily determine by referring respectively to the August, 1923 issue or the October, 1924 issue in which we mention the conditions for the awarding of the prizes, totaling \$11,000.00. These are offered by SCIENCE AND INVENTION MAGAZINE and Mr. Joseph F. Rinn through this publication.

The above statements imply that psychical phenomena do not occur and cannot occur when the medium is carefully guarded or watched. Whenever trickery is prevented, there are no trumpet voices, there are no raps, there is no table levitation, and this publication has \$11,000.00 which says these things do not occur.

### Other Pending Contests

Twenty Combination Pen-Pencils Awarded as Prizes in the Cut Flower Contest Announced in the June issue of this publication. Contest Closes July 30, 1925.

Thirty Combination Pen-Pencils Awarded as Prizes in the Clock Spring Contest. Contest announced in this issue and closes October 1, 1925.

\$250.00 in Prizes Awarded for the Best Methods for Exterminating Rats. Contest Announced in the July Issue and Closes Noon, October 15, 1925.

## \$1000.00 Monthly Contest Awards

FIRST PRIZE \$100.00	
Airplane Bombs vs. Anti-Aircraft Defense, by Major H. H. Arnold...	314-315
SECOND PRIZE \$75.00	
Cheating Cheaters, by John J. Birch.....	317
TWO PRIZES OF \$50.00 EACH	
Hero's Magic Horse, by Charles Beecher Bunnell.....	308-309
Man Is Mostly Empty Space, by Dr. Russell G. Harris.....	322
THREE PRIZES OF \$35.00 EACH	
How Spurious Gems May Be Detected, by A. N. Mirzaoff.....	304
Corn and Its By-Products, by P. A. Judd.....	323
Static Reducers, by Moe Joffe.....	356
FIVE PRIZES OF \$25.00 EACH	
Are You Fit? by Sam Brown.....	315
Portable Pneumatic Boat, by G. H. Waetjen.....	319
Chemical Magic, by Nicholas Klein.....	327
Experiments with A.C., by Raymond B. Wailes.....	337
Radio Aerials—Their Design and Use, by Leon L. Adelman.....	350
FIVE PRIZES OF \$20.00 EACH	
Attaining World's Speed Records, by William P. Sullivan.....	311
Basket of Many Forms, by Dale R. Van Horn.....	320
Excess Weight in Passenger Vehicles, by F. W. Horton.....	321
Colloids—What They Are, by Raymond B. Wailes.....	331
Shellac and Shellac Varnishes, by Dr. Ernest Bade.....	341
TEN PRIZES OF \$15.00 EACH	
Safety Auto Fender, by Miss Marion E. Parsons.....	311
Lightning Rod Demonstration, by S. R. Winters.....	312
Creature Without Blood Vessels, by Dr. Ernest Bade.....	320
An Aid to Drawing Students, by Anson K. Cross.....	321
Egg Tester, by C. A. Oldroyd, Rep. No. 4433.....	324
Lawn Mower, by J. B. Roswick.....	324
Shovel Ball, by F. L. Kelsey.....	330
Decorating Windows with Leaves, by S. Leonard Bastin.....	339

Coin Record, by Wilbert Whitfield.....	342
Hunting Interference, by R. M. Lapham.....	348
FIFTEEN PRIZES OF \$10.00 EACH	
Hand Washing Machine, by C. A. Oldroyd, Rep. No. 4433.....	324
Cake, by C. A. Oldroyd, Rep. No. 4433.....	330
Dodging Bag, by Gerald Enright.....	338
Fire Extinguishers, by Raymond B. Wailes.....	340
Pipe Aging, by Raymond B. Wailes.....	340
Dust-Proof Floors, by Raymond B. Wailes.....	340
Original Propeller, by H. Slouka.....	340
Filter System, by L. B. Robbins.....	340
Heater, by H. T. Schuesen.....	342
Luminous Objects, by Joseph Mersand.....	342
Boiling Eggs, by C. A. Oldroyd, Rep. No. 4433.....	342
Collar Button, by H. C. Frante, Jr.....	342
Funnel, by C. A. Oldroyd, Rep. No. 4433.....	342
Ink Cleaner, by A. A. Blumenfeld.....	343
Berry Squeezer, by Andrew M. Shandor.....	343
TEN PRIZES OF \$5.00 EACH	
Strange Photographs, by G. H. Waetjen.....	319
Swimmer's Sail Boat, by G. H. Waetjen.....	338
Nut Holder (Author please send address).....	342
Iron Test, by E. R. Caley.....	342
Sparkler, by A. A. Blumenfeld.....	343
Bottle Kink, by C. G. Lisman, Rep. No. 15,446.....	343
Substitute Funnel, by A. A. Blumenfeld.....	343
Small Parts, by C. A. Oldroyd, Rep. No. 4433.....	343
Rheostat, by Charles D. Savage.....	390
Aerial Mast, by Allen Cunningham.....	390
FIFTEEN PRIZES OF \$2.00 EACH	
Weight of Ice, by A. A. Blumenfeld.....	343
Bezels, by Paul Saffron, Rep. No. 4664.....	343
Pen Rack, by L. J. Gauvin.....	343

No further entries.

## \$12,000.00 in Prizes for Articles

82 monthly prizes will be given as follows:

FIRST PRIZE \$100.00	
SECOND PRIZE \$75.00	
2 PRIZES OF \$50.00 each	
3	" " 35.00 "
5	" " 25.00 "
5	" " 20.00 "
10	" " 15.00 "
15	" " 10.00 "
10	" " 5.00 "
15	" " 2.00 "
15	" " 1.00 "

Last year SCIENCE AND INVENTION Magazine paid for articles \$13,320.00 to 1,112 prize winners. Hundreds of SCIENCE AND INVENTION reporters won prizes, and up to the time of going to press there were more than 22,000 reporters in the field.

Every month this publication pays \$1,000.00 or more in prizes, exclusive of money paid to those authors who are on contract, and who receive their own rates. At the left the list of prizes issued monthly is itemized, and above are the names of the prize winners for this issue. In order to assist our reporter correspondents in securing available material for publication, we issue without charge the reporter's card, a sample of which is illustrated at the right. Send a postal card for one. It will act as an open sesame in securing news. Address Field Editor, SCIENCE AND INVENTION, 53 Park Place, New York City.

(Note—Unavailable material not accompanied by postage will not be returned.)

REPORTER

### Science and Invention

CORRESPONDENT REPORTER'S IDENTIFICATION

NO. 10000

*L. N. Shadner*

THE BEARER OF THIS CARD IS AN AUTHORIZED CORRESPONDENT-REPORTER OF SCIENCE AND INVENTION MAGAZINE. THE PUBLISHERS OF SCIENCE AND INVENTION WILL APPRECIATE ANY COURTESY EXTENDED THEIR REPRESENTATIVE.

EXPERIMENTER PUBLISHING CO.

*Alfred G. Bell*  
PRESIDENT

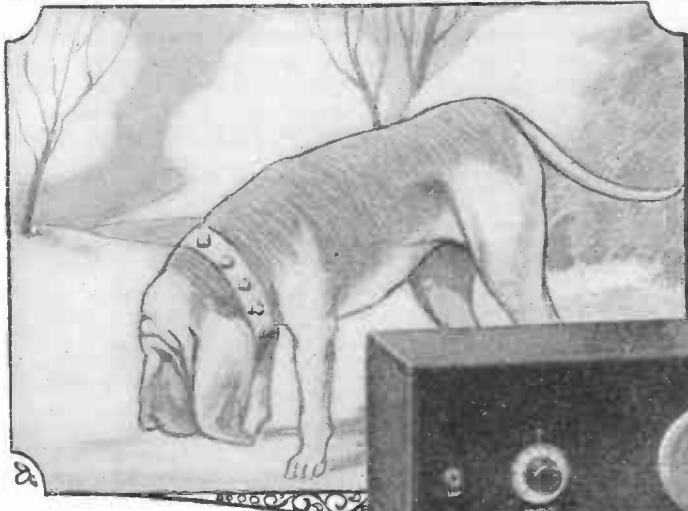

# Sensitivity

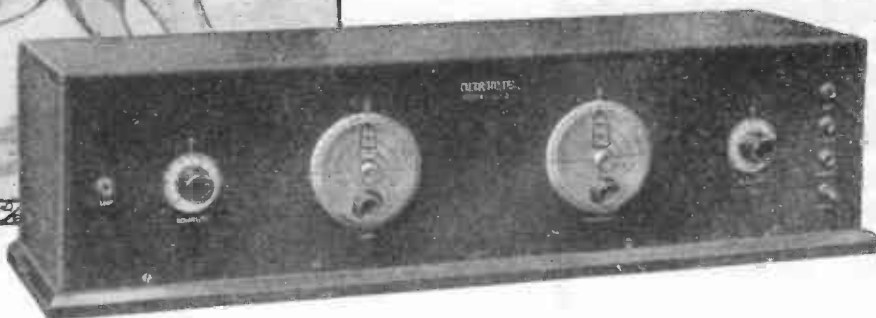

The bloodhound, remarkable for the acuteness of its smell, can pick up a scent and follow a trail when all else fails.

*-never before thought possible!*

With the extreme acuteness of the bloodhound's scent, the Model L-2 Ultradyne detects the faintest broadcast signals—signals that are "dead" to other receivers—regenerates and makes them audible on the loud speaker.

It's here, where the development of other super-radio receivers has halted; the Ultradyne forges ahead.

The unusual sensitivity of the Model L-2 Ultradyne is due to the successful application of regeneration, to the famous Modulation System of radio reception, recently perfected by R. E. Lacault, R.E.,A.M.I.R.E. Chief Engineer of this Company and formerly Radio Research Engineer with the French Signal Corps Research Laboratories.

It's this development, an exclusive feature of the Model L-2 Ultradyne, that makes it possible to receive great distance on the loud speaker.

Everything that the Model L-2 Ultradyne means in actual results and genuine satisfaction, you will appreciate the first evening you operate it.



**THE ULTRADYNE KIT**

Consists of 1 Low Loss Tuning Coil, 1 Special Low Loss Coupler, 1 Type "A" Ultraformer, 3 Type "B" Ultraformers, 4 Matched Fixed Condensers.

To protect the public, Mr. Lacault's personal monogram seal (R. E. L.) is placed on all genuine Ultraformers. All Ultraformers are guaranteed so long as this seal remains un-**\$30.00** broken .....

*Write for descriptive folder.*

# ULTRADYNE MODEL L-2

**PHENIX RADIO CORPORATION**  
114-116 East 25th St. New York City

**25¢ This Coupon is Worth 25¢**

PHENIX RADIO CORPORATION, S&I  
114 East 25th St., New York City.

Gentlemen: Enclosed find 25c in stamps, together with coupon valued at 25c, for which please send me your regularly 50 cent priced Book of Instructions on "How to Build and Operate Ultradyne Model L-2."

Name .....

Address .....



## HIGH SCHOOL COURSE IN TWO YEARS

**YOU ARE BADLY HANDICAPPED** if you lack High School training.

You cannot attain business or social prominence. You are barred from a successful business career, from the leading professions, from well-paid civil service jobs, from teaching and college entrance. In fact, employers of practically all worth-while positions demand High School training. You can't hope to succeed in the face of this handicap. But you can remove it. Let the American School help you.

### FIT YOURSELF FOR A BIG FUTURE

This course, which has been prepared by some of America's leading professors, will broaden your mind, and make you keen, alert and capable. It is complete, simplified and up-to-date. It covers all subjects given in a resident school and meets all requirements of a High School training. From the first lesson to the last you are carefully examined and coached.

### USE SPARE TIME ONLY

Most people *idle* away fifty hours a week. Probably you do. Use only one-fifth of your wasted hours for study and you can remove your present handicap within two years. You will enjoy the lessons and the knowledge you will gain will well repay the time spent in study.

Check and mail the coupon NOW for full particulars and Free Bulletin.

### American School

Dept. H.C.26  
Drexel Ave. and 58th St., Chicago

#### American School

Dept. H.C.26 Drexel Ave. & 58th St., Chicago  
Send me full information on the subject checked and how you will help me win success.

- |                              |                            |
|------------------------------|----------------------------|
| .....Architect               | .....Lawyer                |
| .....Building Contractor     | .....Machine Shop Practice |
| .....Automobile Engineer     | .....Photoplay Writer      |
| .....Automobile Repairman    | .....Mechanical Engineer   |
| .....Civil Engineer          | .....Shop Superintendent   |
| .....Structural Engineer     | .....Employment Manager    |
| .....Business Manager        | .....Steam Engineer        |
| .....Cert. Public Accountant | .....Foremanship           |
| .....Accountant and Auditor  | .....Sanitary Engineer     |
| .....Bookkeeper              | .....Surveyor (& Mapping)  |
| .....Draftsman and Designer  | .....Telephone Engineer    |
| .....Electrical Engineer     | .....Telegraph Engineer    |
| .....Electric Light & Power  | .....High School Graduate  |
| .....General Education       | .....Fire Insurance Expert |
| .....Vocational Guidance     | .....Wireless Radio        |
| .....Business Law            | .....Undecided             |

Name.....

Address.....

## Book Review

**PRINCIPLES AND PRACTICES OF UPKEEP PAINTING.** Hard covers, 5 3/4" x 9", illustrated, 200 pages. Published by E. I. du Pont de Nemours & Co., Philadelphia, Pa. \$2.00.

We have recently had occasion to review a couple of textbooks published by the Starrett Tool Co., and here we have another of that class of books published by the E. I. du Pont de Nemours & Co., which while unhesitatingly figuring as an advertisement, contains an immense amount of valuable information for the painter. We note with special interest the twenty-fourth chapter on spray painting, which is now fast superseding the bristle brush where large areas are to be covered. An interesting figure is that spraying which is used with the air brush requires about ten per cent. more paint than brushing, while brushing requires about two hundred per cent. more labor. The book is certainly to be recommended.

**LECCIONES DE COSAS, Libro Tercero.** Hard covers, 5 1/2" x 7 1/2", illustrated, 290 pages. Published by I. G. Seix & Barral Herms, Barcelona, S. A. \$1.25.

This little work certainly covers a very extensive field. We find on one page the famous group of the Laocoon from the Vatican; on another page pictures of the equipment of a submarine diver are given; a treatise on photography, fishing, a visit to the Alhambra, and the life of ants are included. It is evident that it is a considerable mixture. It ends up very properly we may presume, with a treatise on the history of the earth. It forms the third book of a series.

**ROMANCE IN SCIENCE,** by Prof. Bessie I. Miller. Hard covers, 5" x 7 1/2", 87 pages. Published by the Stratford Co., Boston, Mass. \$1.00.

These are lectures from a course given by Bessie Irving Miller in Rockford College. People who are not addicted to mathematics will not find the full amount of romance which the title would seem to indicate. However, the author does very well in giving mathematical formulas a meaning. There are two chapters which form a sort of introduction, and then the book goes on with its romance. In looking it over, one feels tempted to take it home and read it, and perhaps that is the best compliment we can give it.

**BILDTELEGRAPHIE,** by Prof. Dr. Arthur Korn. Hard covers, 4" x 6 1/4", 146 pages. Published by Walter de Gruyter & Co., Berlin, Germany.

Recently there have been published wonderful examples of portraits sent across the ocean by wireless. The transmission of pictures by telegraphy is an accomplished fact, and among all the inventors and scientists who devoted themselves thereto, none stand higher than Prof. Korn, and all we can say is that these little books most interestingly and in very short space cover the subject and give numerous examples of pictures which have been transmitted, and unhesitatingly difficulties are spoken of. Both transmission by wire and wireless are given, and the illustrations are by no means the least interesting part of the book. A valuable feature is that for several illustrations, the time required for their transmission is given. One picture of a woman's face was transmitted from Italy to an Italian ship on the high seas.

**CHARLES PROTEUS STEINMETZ—A BIOGRAPHY,** by John Winthrop Hammond. Hard covers, 5 1/4" x 8 1/4" illustrated, 489 pages. Published by The Century Co., New York City. \$4.00.

Prof. Steinmetz's middle name of "Proteus" gives a certain clue to his character, for Prof. Steinmetz, despite his exhaustive researches into electricity and his expertness with the higher mathematics, had a protean character and was devoted to children and was a great favorite with them. He loved the simple life and in his own way was exceedingly popular. His life was a strange one; he began comparatively poor and quite unknown, and was "discovered" after his coming to this country, driven away a political fugitive in the Bismarckian days. The famous inventor, Rudolf Eickemeyer of Yonkers gave him his first job in America. It is interesting to see how the author of this work dilates on Eickemeyer's achievements. The book will be found to be admirable reading, for it tells so much of the personality of the man, his traits, his fondness for pets, alligators and kittens. He said that one of them, the Gila monster died because he was too lazy to eat.

We certainly recommend the book to our readers. We need not tell of his scientific achievements, for these are known to every electrician.

**THE STARRETT DATA BOOK FOR MACHINISTS' APPRENTICES.** Hard covers, 4 1/2" x 7", 179 pages. Published by The L. S. Starrett Co., Athol, Mass. \$75.

The Starrett firm are publishing a series of manuals for the use of machinists, and this is the first volume. It is modestly said to be for the use of apprentices, but looking into its rather admirable arrangement and data, we are inclined to believe that very many machinists will be benefited by its perusal.

The second volume contains a great quantity of tables, and the two are an admirable example of the type of publication now being issued by some of our great manufacturing firms. The manuals are small, but it is refreshing to see a thoroughly good index in both of them, followed by a digest of the contents.

**DAEDALUS OR SCIENCE AND THE FUTURE,** by J. B. S. Haldane. Hard covers, 4 1/2" x 6 1/2", 93 pages. Published by E. P. Dutton & Co., New York City. \$1.00.

This is a paper which was read before the Heretics, whoever they are. It speaks about Kant, Chesterton and Einstein. It gives a rather saturnine view of Christianity, saying that the moral precepts of its founder are such that no society has ever made any serious attempt to carry them out. However, all we can say to that is that if modern society had the decency to carry them out, there would have been no World War.

Station  
**WRNY**  
NEW YORK

258.5 Meters - 1160 kilocycles  
*is owned and operated by the publishers of this magazine*

*Our editors will talk to you on —*  
Monday 9:00 P.M. - Tuesday 8:30 P.M.  
Wednesday 9:00 P.M. - Friday 8:30 P.M.  
*of each week.*

**TUNE IN ON WRNY**

**CHATS ON SCIENCE,** by Edwin E Slosson, Ph.D. Hard covers, 5" x 7 1/2", illustrated, 273 pages. Published by The Century Co., New York City. \$2.00.

It is fair to call Dr. Slosson one of the most popular scientific writers. All through his books, which are now quite numerous, a thread of delightful humor passes. Readers of "Creative Chemistry" must have been impressed by this feature, and here we have the same sort of writing—very accurate, very much to the purpose, contained in eighty-five chapters—and covering so extensive a range that it is impossible to give it an adequate review. As an example of the strictly scientific part of it, we would refer to the illustration and description of Michelson's interferometer as used for measuring the diameter of Betelgeuse. We find two references to Einstein in the index, one chapter being entitled, "An Einstein Primer."

**THE KINETIC THEORY OF GASES,** by Eugene Bloch. Hard covers, 5" x 7 3/4", 178 pages. Published by E. P. Dutton & Co., New York City. \$3.00.

It is in less than 200 pages of very comprehensive mathematical treatment that the titular subject of this book is given, and the treatment is to a degree mathematical, running up into the calculus. The Brownian movement of particles observable by the ultra-microscope is briefly treated, and Einstein is referred to. The book is closed by a brief biography, and one of the surprises we encounter in examining it is that it has no index and only a short table of contents.

(Continued on page 380)





The Simplest Practical Radio Set Made

\$1.00

# The RADIOGEM

The simplest radio outfit made—yet as practical as the most expensive. A crystal receiving set that you can operate and enjoy even though you know absolutely nothing about radio. You receive the RADIOGEM unassembled, together with a clearly written instruction book, which shows you how to quickly and easily construct the set, using only your hands and a scissors. The outfit comprises all the necessary wire, contact points, detector mineral, tube on which to wind the coil, etc., etc. The instruction book explains simply and completely the principles of radio and its graphic illustrations make the assembling of the RADIOGEM real fun.

## AERIAL OUTFIT

Complete aerial outfit for the RADIOGEM, consisting of 100 ft. of standard copper aerial wire and two special porcelain insulators. Price 50c.

- Radiogem - - - \$1.00
- Aerial Outfit - - - .50
- Radiogem and Aerial Outfit - - - 2.50

# RAGEMCO

Radio Headquarters for the Finest and BEST Radio Tools

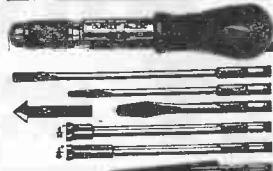

## RADIO TOOLSET

This is the handiest set of tools ever made for Radio Work by the makers of the famous "YANKEE" Tools. It contains the following: 1 Ratchet Screw-driver, 6 1/2 in. long holding all attachments; 1 Blade, 5 1/2 x 3-16; 1 Blade, 3 1/2 x 1/4; 1 Blade 2 1/2 x 1/4; 1 Countersink; 2 Socket Wrenches for all small nuts; 1 Reamer to enlarge holes in panel from 1/8 x 1/8; 1 Wrench, one end 5-16" square or hex. for jack, other 1/2" hex., etc.  
PRICE per set—No. 701.....\$3.00

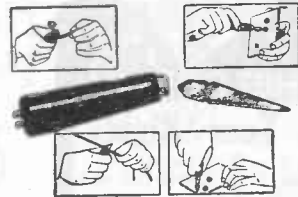

## RADIO HANDI-TOOL

Bends Bus Bar or wire strips and scrapes wire e. bores and reams holes, etc. Tool consists of 4 in. black japanned handle, to which is attached wire bending device, with nickeled ferrule and 3 in. long two sided reamer.  
PRICE—No. 702 .....50c



## HAND DRILL

The hardwood handle is hollow to store drills. Iron frame, nickeled parts, ball bearing three jawed chuck holding and centering accurately round shank drills from 0 to 3-16. Length of drill, 12 inches.  
PRICE—No. 303 .....\$2.25



## WIRE BENDING TOOL

For making eyes, loops, bends, and offsets on Bus Bar wire. With this device any Radio Constructor can wire his set to compare favorably with any factory made set. Easier to use and more accurate than pliers. Full directions in box. Made of heavy steel, blued and finished.  
PRICE—No. 203 .....\$1.00



## TOOL CHEST

Set consists of "LOCK-GRIP" master handle, 5" long, black Rubberoid finish with steel chuck, nickeled, buffed and with the following 9 tools: Saw, bradawl, large screwdriver, file, scratch awl, gimlet, reamer, chisel, small screwdriver. Each tool of fine steel, drop forged tempered, hardened, and nicely finished. Set comes in leatheroid box with tray.  
PRICE—No. 703 .....\$1.85

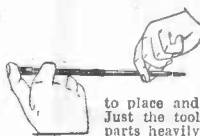

## SCREW STARTER and DRIVER

Holds any screw by its slot with a firm grip, makes it easy to place and start screws in difficult places. Just the tool for the Radio Constructor. All parts heavily nickeled and polished.  
PRICE—No. 304 .....\$1.00



## CIRCLE CUTTER

Especially designed for the Radio Constructor. Made of the finest material and equipped with the highest grade high steel cutting bits. It does three things at once. It drills its own pilot, cuts out plug and puts bead or scroll around the hole in one operation. Cuts holes 3/4 to 4 in. in diam.  
PRICE—No. 402 .....\$3.00  
401. Same tool but smaller and not fitted with bead or scroll in one operation.  
PRICE—No. 401 .....\$2.00

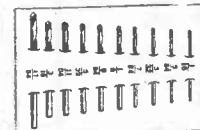

## RADIO DRILL SET

Composed of 10 straight shank twist drills, fitting all hand and breast drills. The selection of these drills has been especially made for Radio Constructors and consists of the following sizes: 1-16, 5-64, 3-32, 7-64, 1/8, 9-64, 5-32, 11-64, 3-16, 17-64. Drills are mounted on white Holland Linen with sizes clearly marked.  
PRICE—No. 305 .....\$1.25



## HAND DRILL

Especially designed for Radio Work by the makers of the famous "Yankee" Tools. A beautiful balanced, small, powerful drill with 4 to 1 ratio of gears for speed. Special chuck 9-32" capacity, to take largest drill, mostly furnished with drill or tool sets. Length over all, 9 1/2 in. Weight 1 1/2 lbs.  
PRICE—No. 302 .....\$2.75



Three-in-One Nut Wrench. Consists of handle with hollow stem 6 inches in length and three interchangeable sockets fitting popular sizes of nuts. The hexagon sockets grip the nut solidly.  
PRICE per set—No. 301.....65c



## ELECTRIC SOLDERING IRON

A perfect tool for Radio Work. Operates either on 110-volt A.C. or D.C. The heat element is of Nichrome, which prevents overheating and assures the desired even temperature. Size of Iron, 10 1/2 in. long. A 4-ft. cord and plug is furnished.  
PRICE—No. 800 .....\$2.00

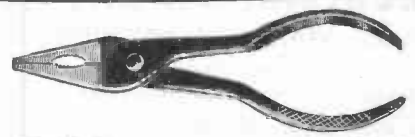

Combination Plier, Wire Cutter, Wire Former and Wrench. Drop forged, slender but exceptionally strong. 6 in. long.  
PRICE—No. 202 .....75c

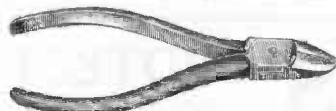

Side Cutting Nipper, Lap Joint. For cutting all kinds of wire. Jaws hardened and oil tempered. Natural steel finish with polished jaws. Length 6 inches.  
PRICE—No. 201 .....75c

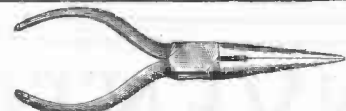

Long Sharp Nose, Side Cutting Pliers. Just the pliers for the radio constructor. Bends and cuts all kinds of soft wire. Nose 1 1/2 inches long, black body, polished jaws. Length 5 1/2 inches.  
PRICE—No. 200 .....75c

Order all tools by order number. All goods are shipped free of transportation charges to all parts of the United States and possessions the same day as the order is received.

### MONEY REFUND GUARANTEE

If you are not satisfied money will be refunded on return of goods.

The RADIOGEM CORP., 66-S W. Broadway, New York

# U.S. PATENTS



**SEND FOR THIS FORM**

## Don't Lose Your Rights

Before disclosing your invention to anyone send for blank form "Evidence of Conception" to be signed and witnessed. A sample form together with printed instructions will show you just how to work up your evidence and establish your rights before filing application for patent. As registered patent attorneys we represent hundreds of inventors all over the U. S. and Canada in the advancement of inventions. Our schedule of fees will be found reasonable. The form "Evidence of Conception" sample, instructions relating to obtaining of patent and schedule of fees sent upon request. Ask for them,—a post card will do.



Registered Patent Attorneys in U.S. and Canada  
255 Ouray Bldg., Washington, D. C.  
"Originators of form Evidence of Conception"

# PATENTS

TRADE MARKS · DESIGNS  
FOREIGN PATENTS

## MUNN & Co.

PATENT ATTORNEYS

Associated since 1846 with the Scientific American  
618 Woolworth Building, New York City  
325 Scientific American Bldg., Washington, D.C.  
414 Tower Building, Chicago, Ill.  
367 Hobart Building, San Francisco, Cal.  
222 Van Nuys Building, Los Angeles, Cal.  
Books and Information on Patents and Trade Marks  
by Request.

# AMERICAN PATENTS

Trade Marks, Copyrights

Foreign and Domestic

All patent and trade-mark applications are prepared and prosecuted by patent experts of many years' experience. Send us a sketch and description of your invention for our free and expert advice.

We have associate Patent Lawyers in all foreign countries.

**F. V. WINTERS, M. E.**

Registered Patent Lawyer

1133 Broadway, N. Y., Tel. Watkins 4748

# INVENTORS PROTECT YOUR IDEAS

Send for our Guide Book, HOW TO GET A PATENT, and Evidence of Invention Blank, sent Free on request. Tells our terms, model or sketch and description of your invention for INSPECTION and INSTRUCTIONS FREE. TERMS REASONABLE. BEST REFERENCES.

Name .....

Street .....

City .....

**RANDOLPH & CO.**  
Dept. 172, WASHINGTON, D. C.

# Patent Advice

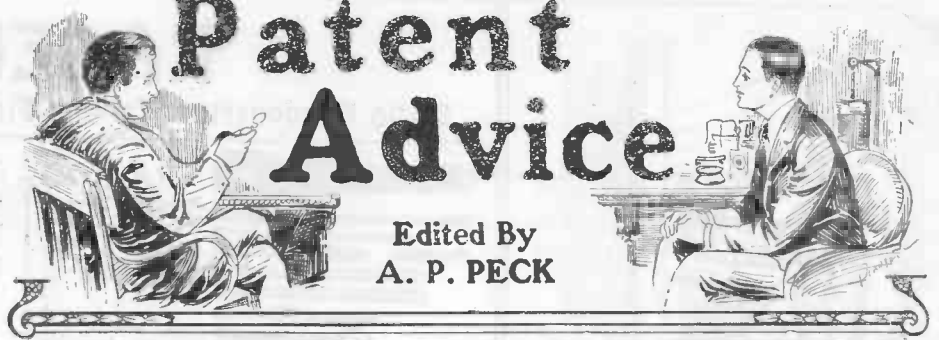

Edited By  
**A. P. PECK**

In this Department we publish such matter as is of interest to inventors and particularly to those who are in doubt as to certain patent phases. Regular inquiries addressed to "Patent Advice" cannot be answered by mail free of charge. Such inquiries are published here for the benefit of all readers. If the idea is thought to be of importance, we make it a rule not to divulge all details, in order to protect the inventor as far as it is possible to do so.

Should advice be desired by mail a nominal charge of \$1.00 is made for each question. Sketches and descriptions must be clear and explicit. Only one side of sheet should be written on.

NOTE:—Before mailing your letter to this department, see to it that your name and address are upon the letter and envelope as well. Many letters are returned to us because either the name of the inquirer or his address is incorrectly given.

### COLLAR BUTTON

(901) B. Parmenter, Birmingham, Ala., submits a design of a "No Bounce" collar button and also a patent upon another similar button which patent was issued over seventeen years ago. He asks our advice.

A. I. The patent which you refer to in your letter of recent date would not of course prevent you from working on your new type of collar button. After a patent expires, which happens at the end of seventeen years after issuance, said patent cannot be renewed except by a special act of Congress. Therefore, you may expect no opposition from the patentee of the swivel button. However, we see very little to recommend your "No Bounce" collar button, but we do see several features that would not be desirable. Of course, the button as you have designed it does not bounce very much and would therefore not be lost quite as readily or frequently as the common type. However, in our opinion this button would be rather awkward to use. When placed in the collar, the swivel part of it would undoubtedly cause the wearer considerable trouble when trying to fasten the collar over the tip of the button. Such a feature would be particularly noticeable when the button is used with starched collars.

We do not consider that the "No Bounce" feature of your button is of sufficient importance to offset its undesirable features and would, therefore, not advise you to invest any money either in the patenting or financing of the sale of such a device.

### VACUUM TUBE SOCKETS

(902) Fred Bauer, Omaha, Nebraska, has designed a radio vacuum tube socket, into which is built a neutralizing condenser so that the unit may be used in the well known Neutrodyne circuit. He asks our advice as to patenting and promoting this scheme.

A. I. There are two objections to your proposed combination socket and neutralizing condenser.

The first is that it would be much more expensive to manufacture than a single socket and a single neutralizing condenser, and the second is that it would have a limited sale. Ordinarily sockets can be used in any type of set and are, therefore, so purchased. In the case of your proposed combination, only those desiring to build Neutrodyne sets would purchase one of the instruments.

We do not believe that your device is worthy of a patent, because of the fact that the financial returns would be very small in comparison with the cost of manufacture.

### RAILROAD CROSSING GATE

(903) B. Y. Smith, Dallas, Texas, has designed a railroad crossing gate which slips down into a sort of trap in the road bed on either side of the tracks. When the train enters a block the gates come up from the bottom and stop traffic going in both directions. He asks whether he should patent the idea.

A. Your road crossing for railroads is no better than any of the other protective gates for grade crossings, which we have looked at during the past few months, for the following reasons.

Supposing that a vehicle were half way across the road-bed when a train in the distance operated the gates. Naturally the road crossing gate would rise up and cause the rear wheels to be impaled on the gate, bring the automobile, or horse and wagon, directly in line with the oncoming train. The result would be the placing of occupants of the vehicle in such precarious position that death would possibly follow. If the gate did not work they might have safely crossed before the train came. These gates, furthermore, cause a long trough to open in the roadway, which is a danger to vehicle and pedestrian traffic.

Your device does not prevent pedestrians from crossing the tracks. In the winter time when snow, ice and sleet cover the road-beds, this system which you have designed becomes entirely inoperative. If the gates were left open at the time freezing occurred, they would not close. If they were closed, they would not open. Many other failures can be ascribed to such a design, although it is far better than a great many devices for similar purpose. The original expense of installation and maintenance of a trap gate is considerable and its efficiency questionable. We do not advise application for a patent.

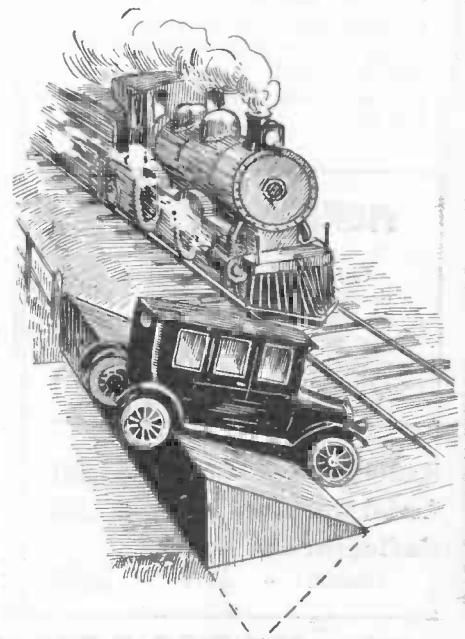

Above: A railroad crossing gate that would probably damage more cars than it would ever save.

# PATENTS INVENTORS -write for these FREE BOOKS

MY PATENT LAW OFFICES



Just across street from U.S. PAT. OFF.

At the right is a view of my drafting and specification offices, where a large staff of experienced experts are in my constant employ. All drawings and specifications are prepared under my personal supervision.

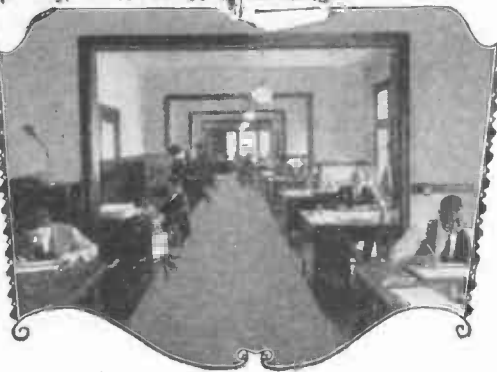

If you have a useful, practical, novel idea for any new article or for an improvement on an old one, you should communicate with a competent Registered Patent Attorney AT ONCE.

Every year thousands of applications for patents are filed in the U. S. Patent Office. Frequently two or more applications are made for the same or substantially the same idea (even though the inventors may live in different sections of the country and be entirely unknown to one another). In such a case, the burden of proof rests upon the last application filed. Delays of even a few days in filing the application sometimes mean the loss of a patent. So lose no time. Get in touch with me at once by mailing the coupon below.

## Prompt, Careful Efficient Service

This large, experienced organization devotes its entire time and attention to patent and trademark cases. Our offices are directly across the street from the U. S. Patent Office. We understand the technicalities of patent law. We know the rules and requirements of the Patent Office. We can proceed in the quickest, safest and best ways in preparing an application for a patent covering your idea. Our success has been built on the strength of careful, efficient, satisfactory service to inventors and trademark owners located in every state in the Union.

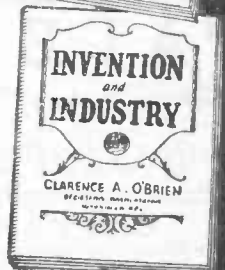

## No Charge for Information on How to Proceed

The books shown here contain valuable information relating to patent procedure that every inventor should have. And with them I will also send you my "Record of Invention" form, on which you can sketch your idea and establish its date before a witness. Such evidence may later prove valuable to you. Simply mail the coupon and I will send you the books, and the "Record of Invention" form, together with detailed information on how to proceed and the costs involved. Do this NOW. No need to lose a minute's time. The coupon will bring you complete information entirely without charge or obligation.

### Strict Secrecy Preserved

All communications, sketches, drawings, etc., are held in strictest confidence in strong, steel, fireproof files, which are accessible only to authorized members of my staff. Feel free to write me fully and frankly. Your case will have my personal attention. It is probable that I can help you. Highest references. But FIRST—clip the coupon and get my free books. Do THAT right now.

# Clarence A. O'Brien

Registered Patent Attorney

Member of Bar of { Supreme Court of the United States; Court of Appeals, District of Columbia; Supreme Court, District of Columbia; United States Court of Claims.  
Practice confined exclusively to Patents, Trademarks and Copyrights.

## Mail this Coupon now!

CLARENCE A. O'BRIEN,  
Registered Patent Attorney,  
5394 Security Savings & Commercial Bank Bldg.,  
Washington, D. C.

Please send me your free books, "How to Obtain a Patent," and "Invention and Industry," together with your "Record of Invention" form, without any cost or obligation on my part.

Name .....

Address .....

(Important: Write or print name clearly)

# PATENTS

**TO THE MAN WITH AN IDEA**

I offer a comprehensive, experienced, efficient service for his prompt, legal protection and the development of his proposition.

Send sketch, or model and description, for advice as to cost, search through prior United States' patents, etc. Preliminary advice gladly furnished without charge.

My experience and familiarity with various arts frequently enable me to accurately advise clients as to probable patentability before they go to any expense.

Booklet of valuable information and form for properly disclosing your idea, free on request. Write today.

**RICHARD B. OWEN, Patent Lawyer**  
164 Owen Building, Washington, D. C.  
41V Park Row Bldg., New York City

## INVENTIONS Commercialized

ON A CASH OR ROYALTY BASIS  
PATENTED or UNPATENTED

In Business 25 Years - Complete Facilities - References.  
Write **ADAM FISHER MFG. CO.**  
205D Enright Ave. St. Louis, Mo.

# PATENTS

BOOKLET FREE HIGHEST REFERENCES PROMPTNESS ASSURED BEST RESULTS

Send drawing or model for examination and report as to patentability

**WATSON E. COLEMAN, Patent Lawyer**  
644 G Street, N. W., Washington, D. C.

**C. L. PARKER**  
Ex-Member Examining Corps, U. S. Patent Office  
**Attorney-at-Law and Solicitor of Patents**

American and Foreign Patents secured. Searches made to determine patentability, validity and infringement. Pamphlet of Instructions sent upon request

**MCGILL BUILDING WASHINGTON, D. C.**

**FREE BOOKLET FOR INVENTORS**

If your invention is new and useful it is patentable—send me your sketch. Inventions developed, patented. Trade marks and copyrights obtained in the U. S. and Foreign countries.

**Z. H. POLACHEK**  
Reg. Patent Attorney  
Professional Engineer  
**70 Wall Street New York**

## INVENTORS

who derive largest profits know and heed certain simple but vital facts before applying for Patents. Our book *Patent-Sense* gives those facts; sent free. Write **LACEY & LACEY, 644 F St., Washington, D. C. Established 1869.**

**INVENTORS**

Prompt, Conscientious service, at fair rates, for your PATENT protection.

**M. P. LAUGHLIN, Engineer Patent Attorney**  
47 West 42nd St. New York City

**INVENTORS**

Have your invention patented. Complete information in my booklet "Patents." Copy free.

**AMBROSE T. BUCKLEY — Patent Attorney**  
30 Church Street New York City

**\$1 DOWN PER MONTH ELECTRICAL EXPERT Home Training**

New Manual Plan on one of oldest, best, courses. Easy, Practical, Thorough. Brings success and money. For beginners or experienced men. **FREE 5 Days Trial.** Send for Free Catalog. Burgess Electrical School, 324-127 N. Dearborn St., Chicago

## Aircraft Bombs Versus Anti-Aircraft Defense

By MAJOR H. H. ARNOLD  
(Continued from page 315)

found out that by adding flanges to the tail of the bomb, it would keep the bomb steady in flight and eliminate the tumbling in its descent through the air.

### FIRST BOMBING SIGHT

In 1911 Lieutenant R. E. Scott, an American army officer, exhibited the first practical mechanical bomb dropping device. He computed mathematically the trajectory of the bomb falling from the plane and, after determining the variations in this trajectory due to the speed of the plane through the air, to the distance of the plane above the ground and to the direction and velocity of the wind, he developed a combination bomb rack and sighting device which would correct for these variables. His device was, in fact, so complete that he could make readings in the air to get these unknown quantities and set his sight accordingly. After setting the instrument, the bombs were released when the target cut the cross hairs in the telescope of the bomb sight.

For bombs, Lieutenant Scott used regular three-inch shells, with vanes on the rear ends. These shells weighed about 18 pounds apiece and his device was arranged to carry and release two of them at the same time. It is interesting to note that the additional weight of the sighting apparatus, the rack and the two bombs was about all that the planes of that day could take up to the three thousand foot level.

### FIRST ANTI-AIRCRAFT GUN

After it had been demonstrated that targets could be actually hit from planes, the various governments began to develop means for combatting the planes. The Germans brought out the first anti-aircraft gun. It was the ordinary field piece of about 75 mm. cal. mounted on a pedestal in such a way that they could get an almost vertical firing angle. The prevailing idea seemed to be that the gun should be a movable one so that it could be used as an ordinary field piece and also against aircraft. Accordingly it was mounted on an automobile truck. Although it was used extensively in maneuvers, no actual firing was done against targets moving through the air and no real improvements were made on the first model until after the start of the World War.

By the time the World War started all of the belligerent nations realized that there was an actual menace in aircraft offensive, so that they had a certain number of these guns in their equipment and had also adapted search lights for protection against night attacks. The methods of employing these anti-aircraft defenses were varied and lacked the uniform system later adopted as a result of their experience in combatting the aerial raids made upon certain well-known points of importance.

The bombs carried during the early stage of the World War were small, weighing only about 10 to 25 lbs. They were all of the same type, fragmentation bombs, and were dropped indiscriminately upon hostile aircraft, massed troops and important structures. Another missile, used at first but later abandoned, was the steel dart. The dart was about six inches long, pointed at one end and fluted on the other. The flutes were intended to keep the dart falling with its point downward. The idea prevailing seemed to be that if these darts were dropped upon troops in large quantities some of them would be sure to make hits.

### DANGER FROM ANTI-AIRCRAFT GUNS

The number of anti-aircraft guns and

searchlights was increased and they were located in definite areas with a uniform method prescribed for their use. Although it would have been impossible for the military authorities to supply the guns in the numbers which the civilians would like to have had them, the number increased in some places, for instance around London, until it seemed as if the entire country was covered with them, when they were firing during a bombing raid. The inhabitants of these cities were satisfied that they were properly protected when they heard the guns booming, although it is almost certain that there were nearly as many casualties from fragments of anti-aircraft shells in and around London, as resulted from the bombs dropped by the Germans.

There was considerable improvement made in these guns during the war. The vertical range and the rapidity of fire were materially increased, thereby forcing the raiding planes to fly at higher altitudes, but they were held in absolute contempt by the aviators in spite of their increased efficiency and rapidity of fire. It was an almost common occurrence for some of the old seasoned squadron commanders to lead their formations over areas known to be heavily defended by archies just to give to their rookie pilots a taste of actual service that would assist in overcoming the initial fear of the guns. It was well known that, even after the gun crews had been seasoned by long service, well over a thousand shells were fired at planes for every one that was brought down.

### 4,000 LB. BOMB CAUSES 100 FT. CRATER

The post-war development of bombs was accelerated by the airplane-battleship controversy. The size of bombs was increased from 600 lbs. to 1,100, to 2,000 and finally to 4,000 lbs. Actual tests on the German battleship *Ostfriesland* and the United States battleships *Virginia* and *New Jersey* demonstrated that such ships could be sunk with 1,100 and 2,000 lb. bombs. One of these bombs exploding within 40 ft. of the side of a ship will sink it more quickly from its mining effect than will one making a direct hit. One hit was made with a 1,100 lb. bomb on the deck near the stern and the masts were blown down and the deck rolled forward over the wreckage. There was no doubt as to the destructive effect of that bomb. Only two 4,000 lb. bombs have been made. One of these was exploded at Aberdeen by dropping it from an airplane and it made a crater large enough to conceal the average bungalow. This crater was 100 feet wide at the top, and 19 feet deep.

The development of the bomb-sight has kept pace with that of the bomb and the sight of today almost entirely eliminates the possibility of human error. In fact bombing operations are almost reduced to mathematical certainty. The bomber, after the planes reach a point near the target, reads the altitude from his altimeter, measures the velocity and direction of the wind with his bomb-sight. If the target is moving, he also measures its speed and direction of motion. Proper allowance is made for all of these variables by proper settings made on the instrument. Formerly the plane had to approach the target either up- or down-wind to be sure of making hits. Now the plane approaches the target from any direction and, when the image of the target moves across the intersection of the cross-hairs in the telescope, the bomb release is pulled. Experience has shown that the sight is most accurate.

(Continued on page 372)

# PATENTS TRADE MARKS AND COPYRIGHTS

## OUR OFFER:

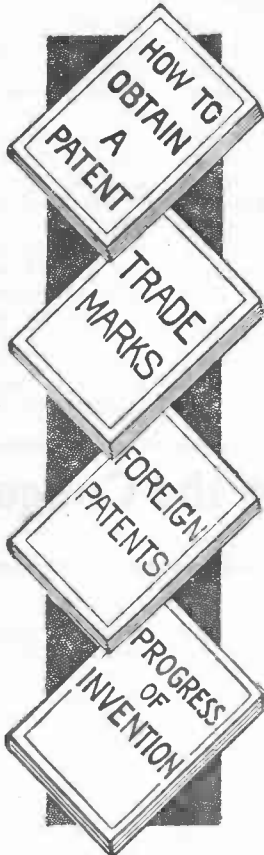

### Your first step

Before disclosing an invention the inventor should write for our blank form "RECORD OF INVENTION." This should be signed, witnessed and returned to us together with model or sketch and description of the invention for INSPECTION and INSTRUCTIONS.

NO CHARGE FOR THE ABOVE INFORMATION

## Our Four Books Mailed Free to Inventors

*Our Illustrated Guide Book*

### HOW TO OBTAIN A PATENT

Full instructions regarding U. S. Patents. Our Methods, Terms, and 100 Mechanical Movements illustrated and described.

### OUR TRADE MARK BOOK

Shows value and necessity of Trade Mark Protection. Information regarding Trade Marks and unfair competition in trade.

### OUR FOREIGN BOOK

We have Direct Agencies in Foreign Countries, and secure Foreign Patents in shortest time and at lowest cost.

### Progress of Invention

Description of World's Most Pressing Problems by Leading Scientists and Inventors

ALL COMMUNICATIONS AND DATA STRICTLY CONFIDENTIAL  
INTERFERENCE AND INFRINGEMENT SUITS PROSECUTED



Private Office, Victor J. Evans, with View of Patent Office Through Window

Highest References Prompt Attention Reasonable Terms

## VICTOR J. EVANS & CO., Patent Attorneys

Main Offices: 779-9th Street, N. W., Washington, D. C.  
Gentlemen: Please send me FREE OF CHARGE your books as described above.

**FREE  
COUPON**

Name.....  
Address.....

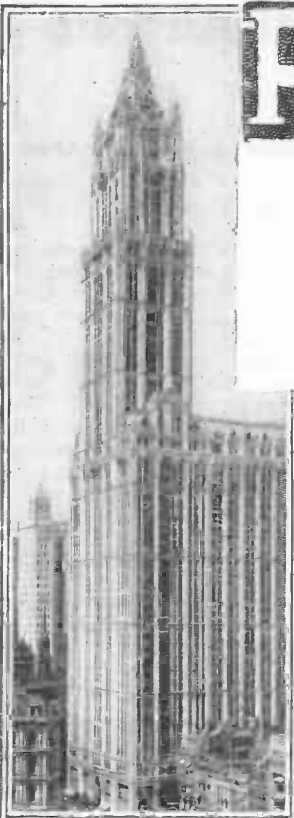

New York Office  
Suite 1007 Woolworth Bldg.



Philadelphia, Pa., Office  
Suite 714-715 Liberty Bldg.



Washington, D. C., Office  
Victor Bldg.

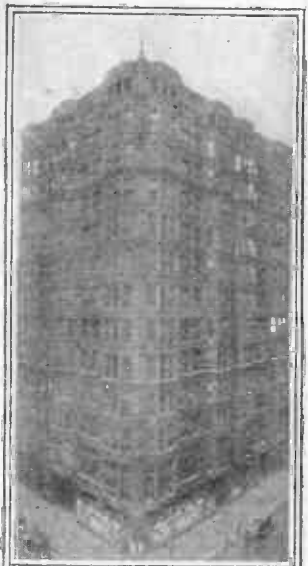

Chicago, Ill., Office  
Suite 1114 Tacoma Bldg.



Pittsburgh, Pa., Office  
Suite 514, Empire Bldg.



San Francisco, Cal., Office  
Suite 1010 Hobart Bldg.



**Ernest Pechin**  
Cornet Virtuoso  
Uses a Conn

## How to Win Success in Music

Begin with the right instrument. This is the advice of the world's foremost artists. Conn instruments, used and endorsed by the most successful players, are easier to play, most beautiful in tone, perfect in scale; reliable in action—possess many exclusive features, yet cost no more than others.

Free Book by Sousa and nine other famous artists on "Success in Music," helps you choose the instrument for your talent. Send now for your copy and details of Free Trial, Easy Payments on any Conn instrument.

C. G. CONN, LTD.  
856 Conn Bldg. Elkhart, Ind.



# CONN

BAND INSTRUMENTS  
WORLD'S LARGEST MANUFACTURERS

## Aircraft Bombs Versus Anti-Aircraft Defense

(Continued from page 370)

When shooting at targets moving through the air, the operation of anti-aircraft gun is still a question of *hunt and find*. The advocates of this defense still give various reasons for not making hits at moving targets, but the fact remains that it is still very seldom that the target is hit, even though the plane pulling it usually flies in a straight line, on a predetermined course. There is no doubt that the development of new sighting devices and systems, with increased rapidity of fire and more sensitive fuses, will greatly increase the efficiency of these weapons. The greatest development up to date is the super-sensitive fuse that explodes the shell upon contact with any material no matter how thin. This fuse will act if it pierces a piece of writing paper. Thus the

destruction of the plane is assured no matter where it may be hit, *but a hit must first be made.*

The problem of anti-aircraft guns *versus* aircraft is very similar to one of determining the best method of hitting one projectile traveling through the air with another one. A plane traveling along at a speed of 150 to 200 miles an hour resembles, in a great many ways, a projectile, but unlike a projectile it can change its course at will. The gun crews have a very complex problem to solve in endeavoring to hit a target moving at unknown speed, one that can change its altitude and course almost instantaneously, and which is a menace in itself for there is always the possibility of its opening up with machine gun fire or dropping a few bombs.

## Tarrano the Conqueror

(Continued from page 329)

the rebellion, the Central State has suppressed news of it. At such a time—with this controversy going on—such reports would only injure the Central State's Inter-planetary position. That's obvious, isn't it? Then tonight, when things were desperate, the Central State give out its call. Tarrano has conquered Venus, I'm sure. And at the last, before destroying its helio, the Central State tried to warn us."

"Of what?" I demanded. "And what about these murders?"

"Done by emissaries of Tarrano, no doubt. For revenge, because of the Martian and Earth legislation—or for—"

"I think we should not speculate too much," said Georg. "At least, not on that line. They warned you personally, father. We were so careful to keep everything secret—"

Dr. Brende mopped his forehead. He was trying to appear calm—I knew he did not want unduly to alarm Elza; but I could see that he was laboring under great emotion nevertheless.

"Things get out, Georg," he said. "We have been careful—yes. But two years ago, when I visited the Central State, I told them there what I hoped to accomplish. There were no grave Inter-Planetary problems then—I thought I had no need of great secrecy. And since then, though, we have been very careful—"

Careful! With a Venus-girl from the Cold Country living in their household! Truly, humans are a strange mixture of sagacity and folly!

"The Central State has heard something concerning you," George said. "That could easily happen—prisoners captured from Tarrano's forces, for instance. With dispatches—or perhaps some intercepted aerial message."

What was this secret they were discussing? I was the only one in the room who did not know it. And why had Dr. Brende sent for me tonight?

I asked him both questions. His face went even more solemn than it had been before.

"I sent for you, Jac, because in a measure I anticipated what has now befallen. Danger specifically to us Brendes, I mean. We count you as our friend—"

How it warmed my heart to hear him say that; and to see the glance that Elza cast me!

"—Our friend. I am an old man—you are young. Yet you are wise, too. We need you tonight."

He raised his hand when I would have told him how glad I was to be with them.

"You know something of my work," he said, as a statement, rather than a question. "I should say, mine and Georg's and Elza's, for they have both helped me materially."

I knew that Dr. Brende had for years been one of the Earth's most eminent research physicians. It was he who discovered the light vibrations which had banished forever the dread germs of several of the major diseases. He did not practice; his work was research only.

He went on: "Jac, I have found what for years I have been striving to find—a vibration of light, though it is invisible—which

(Continued on page 376)

## WANTED-MEN TO LEARN RADIO



**\$75 to \$200 a Week**  
Right now, everywhere, big, easy money is being made in Radio. Field unlimited. You can master radio quickly at home in spare time. No previous experience necessary. Now is the time to enter this new, uncrowded field.

**1,000 Mile Receiving Set—FREE**  
Our new home-study methods make everything about radio amazingly simple. No other course like it. Makes you expert on radio operation, repairs and installations of all kinds. Send for literature telling all about opportunities and how we give 1,000 mile receiving set FREE. Don't miss this big offer—ACT. Write now for big free book.

**Radio Association of America**  
4513 Ravenswood Ave., Dept. 68 Chicago

## WANTED

Men to manufacture Metal Toys and Novelties. Good chance to start your own well-paying business producing such big sellers as Toys, Novelties, Ash Trays, Book-blocks, Souvenirs, Advertising Specialties, Paper Weights etc. We furnish forms with complete outfit for speedy production. Absolutely no experience or tools necessary; no special place needed. Small investment puts you on road to success. Demand exceeds supply and we assist and co-operate with our manufacturers in selling their products. We put you in touch with the buyers and assure an outlet for your goods. Strictly a business proposition and thorough investigation invited. A splendid opportunity for an enormous and profitable business for ambitious men. No others need apply.

Catalog and information mailed on request.

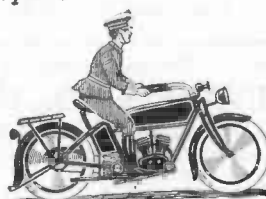

**Metal Products Co., 1696 Boston Rd., New York, N. Y.**

### LUMINOUS PAINT

**Make Your Watches, Clocks, Etc., Visible by Night**

The very latest discovery in the scientific world. Hitherto, practically unobtainable except at an exorbitant price, we have at last succeeded in producing this remarkable LUMINOUS PAINT, which, applied to the surface of any article, emits rays of white light, rendering it perfectly visible in the dark. **THE DARKER THE NIGHT, THE MORE BRILLIANT IT SHINES.** Quite simple to use. Anyone—you can do it. A little applied to the dial of your watch or clock will enable you to tell the time by night. You can coat the punch buttons or switch plates of your electric lights, boxes, and innumerable other articles; make your own Luminous Crucifixes, Luminous Rosaries, etc. Bottle containing sufficient to coat several small articles. Price 25c. Larger sizes 50c and \$1 postpaid. Johnson Smith & Co., Dept. 407, Racine, Wis.

### THE EXPO WATCH CAMERA

The most wonderful and ingenious camera made. It is but little larger than a watch, which it closely resembles. You can carry the Expo about in your pocket and take pictures without any one being the wiser. **Less Than 2 Cents a Picture.** The Expo loads in daylight with 10 or 20 Exposure Films, costing 25c and 35c respectively, and thus the picture taking part of a whole day's outing may be had for a very nominal sum—Little more than one cent a picture. **Easy to Manipulate.** Takes pictures through the stem, where the Rapid Fire Lens is located. The photos (3-8x7-8) may be enlarged to any size. Operated as quick as a flash. Time and instantaneous shutters, weighs but 3 ounces, nickel plated. Endorsed by amateurs and professionals the world over. Thoroughly practical—printing and developing of films just the same as ordinary cameras—in daily use by the police, newspaper reporters, detectives, and the general public. Important beats have been secured with the Watch Camera by enterprising reporters. Produces clear, sharp negatives indoors or outdoors equal to any camera on the market, size or price notwithstanding. Sold Under a Positive Patent.

Expo Watch Camera \$3.60 FILMS, 10 Exposures 25c, 20 Exposures 35c  
Price Post Paid Leather Pocket Carrying Case, 35c

**JOHNSON SMITH & CO., Dept. 407, Racine, Wis.**

### U. S. BABY TANK

It goes with real Yankee Pep—by its own power. Most remarkable Toy ever invented. By drawing the Tank backward, over the hand or over the floor or table and then placing it down, it will crawl along, over all obstacles, in the same life-like manner as the larger tanks that proved so deadly in the great war. What makes it go is somewhat of a mystery, for there is no mechanism to wind up as is usually understood with mechanical toys. It is a great surprise to eyes. Great fun for playing practical jokes. Only 15c Bottle.

Price 15c Bottle

### ANARCHIST BOMBS

One of these glass vials dropped in a room full of people will cause more consternation than a limburger cheese. The small contents entirely disappears in a short time. **10c a Box, 3 Boxes for 25c.**

### MIDSET BIBLE

GREAT CURIOSITY. Smallest Bible in the world. Size of a postage stamp. 200 Pages. Said to bring good luck to the owner. A genuine work of art. Must be seen to be appreciated. Make good money selling them to friends, church acquaintances, etc. **PRICE 15c each, 3 for 40c, 12 for \$1.35, 100 for \$7.50.** Also obtainable in Leather Binding, with gold edges. **Price 50c each, 3 for \$1.50, 12 for \$4.50 per doz.** Magnifying Glass for use with Midget Bible, 15c.

### SEX INDICATOR

Hold the MAGIC INDICATOR over a man's hand—instantly it moves in a straight line, backward and forward. Hold it over a woman's hand and it describes a complete and continuous circle. The same action can be obtained over a letter written by a man or woman, etc. It is fascinating; baffling. We have never been able to figure out how it's done—but we've never seen it fail. Many novel and entertaining feats may be performed with the Sex Indicator. For example, similar results can be obtained with animals, cats, dogs, rabbits, over birds, chickens, canaries, etc. Also used to predetermine the sex of chickens and birds, etc., in fact it is sold as a patented egg tester in Europe. **Price 25c, 3 for 65c, postpaid.**

### Female SEX INDICATOR

Everything about the Ku Klux Klan told in a clear, fearless manner. Book tells all—How it started and was suppressed in 1871—The New Ku Klux Klan—How organized—How members are enrolled—Oath of the Klan—Questions for Candidates—Creed—Objects of the Order—Obedience—Fidelity—Pledge of Loyalty—Ku Klux Klan and the Masons—The Jews—The Masons—Real K. of C. Oath—The Negro Ku Klux Klan, etc., etc. Latest and most complete book on the Klan published. **Price, 35c, postpaid.**

### All the Latest Surprising and Joke Novelties

Miniature Water Pistol	10c
Cigarette Snake (every 10 minutes)	10c
False Mustache	10c
Pocket Detective (see behind you)	15c
Break Mind Reading	10c
Thurston's Mysterious Trick Cards	10c
Fighting Roosters, pair	10c
Genius Ring	20c
Rubber Tacks (a good joke)	10c
Memorized Penny	20c
Cachool Sneezing Powder	10c
Magic Plate Lifter	25c
Imitation Gold Teeth	3 for 50c
Barking Dog (imitates dog bark)	20c
Exploding Cigarettes, per box	25c
26-piece Set Silveroid Tableware	\$1.98

### JOHNSON SMITH & CO. CATALOG

A Deluxe Edition of our new 1925 CATALOG mailed on receipt of 5c. 480 pages of binding. Only book of its kind. 480 pages of all the latest tricks in magic, the newest novelties, puzzles, games, sporting goods, interesting books, curiosities in woods and plants, etc., unobtainable elsewhere.

### STAGE MONEY

With a bunch of these bills, it is easy for each person of limited means to appear prosperous by flashing a roll of these bills at the proper time and peeling off genuine bill or two from the outside of the roll, the effect created will be found to be all that can be desired. Prices, postpaid: 40 Bills 20c, 125 for 50c, or \$3.50 thousand postpaid.

### Wonderful X-Ray Tube

A wonderful little instrument producing optical illusions both surprising and startling. With it you can see what is apparently the bones of your fingers, the lead in a lead pencil, the interior opening in a pipe stem, and many other similar illusions. A mystery that has been able to astound anyone explain. Price 10c, 3 for 25c, 1 dozen 75c. Johnson Smith & Co.

### Good Luck Ring

Qualit and Novel Design. A VERY striking and uncommon ring. Silver finish, skull and crossbone design, with four brilliant, flashing gems sparkling out of the eyes. Said by many to bring good luck and warder, hence its name, Good Luck Ring. Very unique ring that you will take a pride in wearing. **ONLY 25 CENTS.**

### Exploding Cigarettes

JUST LIKE ORDINARY CIGARETTES. BUT SUCH REAL STARTLERS! The box contains ten genuine cigarettes of excellent quality. They appear so real, but when each cigarette is about one-third smoked, the victim gets a very great surprise as it goes off with a loud BANG! A great mirth provoker yet entirely harmless. Price 25c per box.

### Popular Watch Charms

Very pretty little curiosities and decidedly novel. Fitted with Magnifying Lenses that enlarge the pictures to a very surprising degree; in fact, it seems almost incredible that a clear picture could be possible in such a small compass, and how sharp and distinct they show up when you look through. Come in assorted views—Admirer, views of Panama Canal, Lord's Prayer in type, etc.

Price 15c  
ONLY 3 for 40c; \$1.35 doz.

### CIGARETTE MAKER

Roll your own and save money. Makes them better and quicker besides saving more than half. Use your favorite brand of tobacco. Neat, useful and handy. Pocket size, weighs 1/2 oz. Made entirely of metal, nickel-plated. **Price 25c postpaid.**

### MAGIC FLUTE

Wonderfully Sweet Toned and Musical. The Magic Flute, or Human-toned, is a unique and novel musical instrument that is played with nose and mouth combined. There is just a little knack in playing it which, when once acquired after a little practice, will enable you to produce very sweet music that somewhat resembles a flute. If you have mastered it you can play all kinds of music with facility and ease. When played as an accompaniment to a piano or any other musical instrument, the effect is so charming as it is surprising.

### NEW BOOK ON ROPE SPLICING

Useful Knots, Hitches, Splices, etc. A most practical handbook giving complete and simple directions for making all the most useful knots, hitches, rigging, splices, etc. Over 100 illustrations. All about wire rope attachments, lashing, blocks, tackles, etc. 37 Heads of knots illustrated. Of great value to mechanics, riggers, carpenters, boatmen. Price 20c ppd.

### RESURRECTION PLANT

One of the most wonderful plants known. Possesses the strange power of turning in a few minutes from an apparently lifeless, dry herb to a BEAUTIFUL LIVING FERN-LIKE PLANT of a dark green color. Simply place the plant in saucer of water, it will open up and start to grow in 20 minutes. When taken out it will dry up and go to sleep until placed in water again. Fine house plant—summer or winter. **10 cents each or 3 for 25c.** Agents Wanted postpaid.

### ADDRESS ORDERS FOR ALL GOODS ON THIS PAGE TO

## JOHNSON SMITH & CO. DEPT. 407, RACINE, WIS.

Postage Stamps Accepted

### BLANK CARTRIDGE PISTOL

This well made and effective Pistol is modeled on the pattern of the latest type of Revolver, the appearance of which alone is enough to scare a burglar, whilst, when loaded, it will probably prove just as effective as a revolver with real bullets, without the danger to life. It takes the standard .22 Calibre Blank Cartridges, that are obtainable most everywhere. Even the most timid women can use it with perfect safety and frighten a thief without the danger attached to other revolvers. We sell large numbers of these pistols. **PRICE ONLY \$1.00 Postpaid.** Blank Cartridges 22-cal., shipped by express only, 50c per 100. Johnson Smith & Co., Dept. 407, Racine, Wis.

### Sneezing Powder

Place a very small amount of this powder on the back of your hand and blow it into the air, and everyone in the room or car will begin to sneeze without knowing the reason why. It is most amusing to hear their remarks, as they never suspect the real source, but think they have caught it one from the other. Between the laughing and sneezing you yourself will be having the best use of your life. For parties, political meetings, car rides, or any place at all where there is a gathering of people, it is the greatest joke out. **Price 10c or 3 for 25c.**

### Mystic Skeleton

A jointed figure of a skeleton 14 in. in height, will dance to music and perform various gyrations and movements while the operator may be some distance from it.

### Serpent's Eggs

Box contains 12 eggs. When lit with a match, each one gradually hatches itself into a snake several feet long, which curls and twists about in a most life-like manner. **Price per box 10c ppd.**

### BOYS! BOYS! BOYS! THROW YOUR VOICE

Into a trunk, under the bed or anywhere. Lots of fun fooling the teacher, policeman or friends.

### THE VENTRILO

a little instrument, fits in the mouth out of sight, used with above for Bird Calls, etc. Anyone can use it.

Never Fails. A 32-page book on ventriloquism, and the Ventrilo, ALL FOR 10c postpaid.

### ITCHING POWDER

This is another good practical joke; the intense discomfiture of your victim to everyone but themselves is thoroughly enjoyable. All that is necessary to start the ball rolling is to deposit a little of the powder on a person's hand and the powder can be relied upon to do the rest. The result is a vigorous scratch, then some more scratch, and still some more.

10c box, 3 boxes for 25c or 75c per doz boxes postpaid.

### DANCING BEAUTIES

Get a Kinemetograph and see the picture move. France's latest sensation. A great surprise is worth twice what they cost. Are made of solid brass highly nicked and very durable. Satisfactory, or your money back. **Price 50c.**

### SILK REMNANTS

For patching Crazy Quilts, Sofa Cushions, Head Rests, Pin Pads, etc. Large pieces, all colors and shades. Sure to delight you.

For 25 Cents stamps or coin we send a large package and book of quilt designs. 1 pound makes a lovely large quilt. **Price, 75c postpaid.** Our silk is the best.

### LOOK 35c LOOK

Wonderful Instrument. Greatest thing yet. Nine separate articles in one. Everybody delighted with it. Odd, curious and interesting. Lots of pleasure as well as very useful. It is a double microscope for examining the wonders of nature. It is also an Opera Glass, a Telescope, a Compass, a Pocket Mirror, and a Laryngoscope for examining eye, ear, nose and throat. It is worth all the cost to locate even one painful cinder in the eye. Folds flat and fits the pocket. Something great—you need one. Don't miss it. Sent by mail, postpaid. **Price, only 35c or 3 for \$1.00 postpaid.**

### RESURRECTION PLANT

One of the most wonderful plants known. Possesses the strange power of turning in a few minutes from an apparently lifeless, dry herb to a BEAUTIFUL LIVING FERN-LIKE PLANT of a dark green color. Simply place the plant in saucer of water, it will open up and start to grow in 20 minutes. When taken out it will dry up and go to sleep until placed in water again. Fine house plant—summer or winter. **10 cents each or 3 for 25c.** Agents Wanted postpaid.

### ADDRESS ORDERS FOR ALL GOODS ON THIS PAGE TO

## JOHNSON SMITH & CO. DEPT. 407, RACINE, WIS.

Postage Stamps Accepted

Answers to Scientific Problems and Puzzles

(Continued from page 336)

HIGH AND LOW PRESSURE STEAM

It is a curious fact that high pressure steam is less apt to produce serious burns than steam at low pressure, provided it issues from a small opening. This is because steam at high pressure and temperature is less apt to be cooled to the temperature of condensation when it comes in contact with the skin than steam which is already near the condensation point. For each gram of steam that condenses about 540 calories of heat are liberated. Hence, if any steam is converted to water, it gives up many times as much heat as steam which is cooled considerably without condensation.

MIXING A SOLUTION

To obtain a solution equivalent in strength to two tablets dissolved in fifteen quarts of water one could fill the 5-quart jar by filling the 3-quart jar twice with water and emptying the contents into the 5-quart jar. When the latter is thus filled, there would remain 1 quart of water in the 3-quart jar in which the tablet could be dissolved. Then pour back into the 3-quart jar enough water from the 5-quart jar to just fill the former which would now contain a solution of one tablet dissolved in 3 quarts of water. By now pouring 2 quarts of this solution into the 5-quart jar (enough to just fill it), one would have  $\frac{2}{3}$  of a tablet dissolved in 5 quarts of water which is equivalent in strength to 2 tablets dissolved in 15 quarts.

SEEING FAINT STARS

Physiologists have shown that there are two types of sensitive cells in the eye which, because of their respective shapes, are called rods and cones. The former are very sensitive to faint light, the latter much less sensitive.

In the central portion of the retina, called the fovea, there is an abundance of cones, but an absence of rods; whereas in neighboring regions there are plenty of rods but relatively few cones. Hence, if one looks directly at a faint star the object is focused on the fovea in which are the less sensitive cones, while if he looks a little to one side of the star the more sensitive rods are affected. It should be noted, however, that in ordinary daylight vision, in which there is sufficient light to affect the cones, the fovea becomes the most, instead of the least, sensitive portion of the eye since within it the cones are closely concentrated and lie close to the surface of the retina, or lining of the eye, in which they are located.

MAGNETIC DIMMER

When electric lamps are placed in series with a helix or coil of wire and operated on an alternating current, the coil offers a certain opposition to the flow of current through it, which is not present when the wire is straight. Introducing a bar of iron within the helix greatly increases this opposition to an A.C. current, hence the current may be so greatly reduced by the presence of the iron as to cause the lamps to burn dimly when the iron is introduced into the coil.

CLOCK HANDS EQUIDISTANT

Assume that in a time (??) minutes after 12 o'clock all three hands will be equidistant, i. e., 20-minute spaces apart. This time must be less than 720 minutes, for in that time all hands would be back to 12, the starting point. Now the hour hand moves  $\frac{1}{2}$  of a minute space per minute, the minute hand 1 space per minute and the second hand 60 spaces per minute. Hence, the minute hand will gain  $1-\frac{1}{12}$  or  $\frac{11}{12}$  spaces per minute on the hour hand, and

the second hand will gain  $60-\frac{1}{12}$  or  $\frac{719}{12}$  spaces per minute on the hour hand. The second hand will then gain  $\frac{719}{12} \div \frac{11}{12}$  or  $\frac{719}{11}$  times as many spaces as the minute hand gains. But the number of spaces (n) gained by the minute hand must be 20, 40, 80, etc., i. e., exactly divisible by 20. It must also be such a number that  $\frac{719}{11}$  (n) is an integer, since the second hand must also gain an integral number of spaces on the hour hand. The only numbers below 720 that satisfy these conditions are 220, 440 and 660. For the minute hand to gain 220 spaces it would take  $220 \div \frac{11}{12}$  or 240 minutes. This would be 4 o'clock. It would gain 440 spaces in 480 minutes or by 8 o'clock, and 660 minutes in 12 hours, or by 12 o'clock. Since at none of these times are the hands equidistant, it is evident that such a condition is impossible.

TELEPHONE HOWLING

When a receiver of a telephone is placed near the transmitter, any sound reaching the latter will not only affect the receiver at the far end of the line, but also the one near by, since both receivers are magnetically coupled to the transmitter circuit through the medium of a transformer. The adjacent receiver will then impulse the transmitter and the latter will, in effect, return the sound to its source to be repeated again and again as rapidly as the electric current can cause the diaphragms of the instruments to vibrate.

TWO TIDES

In considering the motion of the moon about the earth we are in the habit of thinking of the earth as fixed and the moon alone as revolving. The fact is, however, that both moon and earth revolve about their common center of gravity—a point about three thousand miles from the center of the earth and on a line joining the centers of both bodies. The greater attraction of the moon for the water nearest it tends to raise the water into a hump or high tide on the side facing the moon, while the centrifugal force of the earth's revolution about the common center of gravity throws the water up into a high tide on the opposite side as well.

THE COMPENSATOR

If the compensating cylinder is too large, it will reduce the displacement of the system faster than the lowering gas tank increases it. The water level will then fall and diminish the pressure on the gas. On the other hand, if the compensator is too small, it will fail to reduce the displacement of the system as fast as the lowering gas tank increases it. The water level will consequently rise and increase the pressure on the gas. The remedy for this is to enlarge the cylinder somewhat by coating it with one or more coats of paint until it is just large enough to keep the water level constant.

CORRECTION NOTICE

We have received a letter from Dr. W. D. Chesney, which we acknowledge with thanks, calling our attention to the statement on page 241 in the July issue describing caps for toy pistols. The statement says, "Powder together potassium chlorine, sulphur and black antimony sulphide."

He calls our attention to the fact that, "This is an extremely dangerous and explosive mixture and if powdered together will explode with great violence. This mixture has caused many deaths in the past. The writer knows of three deaths at one time from this very mixture. No amateur should ever rub or powder any substance giving off so much O as KClO3, and especially with chemicals having the affinity for O possessed by sulphur, carbon, etc."



**FREE!**

12-Cell — 24-Volt Storage 'B' Battery

Positively given free with each purchase of a WORLD "A" Storage Battery. You must send this ad with your order. WORLD Batteries are famous for their guaranteed quality and service. Backed by years of successful manufacture and thousands of satisfied users. Equipped with Solid Rubber Case, an insurance against acid and leakage. You save 50 per cent and get a 2-Year Guarantee

**Bond in Writing** "tell their friends." That's our best proof of performance. Send your order in today.

**Solid Rubber Case Radio Batteries**  
 6-Volt, 100-Amperes . . . . . \$12.25  
 6-Volt, 120-Amperes . . . . . 13.25  
 6-Volt, 140-Amperes . . . . . 14.00

**Solid Rubber Case Auto Batteries**  
 6-Volt, 11-Plate . . . . . \$12.25  
 6-Volt, 15-Plate . . . . . 13.25  
 12-Volt, 7-Plate . . . . . 16.00

**Send No Money** Just state battery wanted and we will ship day order is received, by Express C. O. D. subject to your examination on arrival. FREE "B" Battery included. Extra Offer: 5 per cent discount for cash in full with order. Buy now and get a guaranteed battery at 50 per cent saving to you.

**WORLD BATTERY COMPANY**  
 1219 So. Wabash Ave., Dept. 19 CHICAGO, ILL.

**World** For AUTO and STORAGE BATTERIES RADIO

KDKA - WEAZ - WGN - WJS - KHJ - KGO - KFEE - WJY - KOP



**McWilliams Selenium Cells**

McWilliams selenium cells with a ratio of 50 to 1 for voice modulation and experiments with the amplification of Radio by light rays. Complete instructions and diagrams for simple experiments with the amplification of Radio by light rays free with each cell, or sent prepaid on receipt of 50c.

**Micro-amp Relay**

Works with a current of 10 Micro-amperes. Contact points will not stick. Works in any position. Not influenced by shocks or jars. Double relay action. The most reliable instrument for relay work.

Prices and descriptive matter mailed on request.

**Electric B. G. Products Co.**  
 ITHACA, MICHIGAN

You can be quickly cured, if you

**STAMMER**

Send 10 cents for 288-page book on Stammering and Stuttering, "Its Cause and Cure." It tells how I cured myself after stammering 20 yrs. B. N. Bogue, 8118 Bogue Bldg., 1147 N. Ill. St., Indianapolis

**"BECOME A LIGHTNING TRICK CARTOONIST"**

Make money chalk talking. Send \$1 for snappy program of trick drawings, with instructions by a professional cartoonist. Satisfaction guaranteed. Circular free. Balda Art Service, Dept. 4, Oshkosh, Wis.



# "BUILD YOUR OWN" WITH "RASCO" PARTS!

## Buy from the Oldest and Original Exclusive Radio Parts House in the United States

We pay ALL transportation charges in U. S. ALL GOODS SENT PREPAID IN 24 HOURS

Order direct from this page.

### SPECIAL PRICES FOR AUGUST

Money refunded if goods do not satisfy



**Dial Marker**  
The big little thing you have been waiting for. Just drill a hole in the panel and mount the marker above the dial. Nickel plated and polished. G2788 Dial Marker, three for .....\$1.10

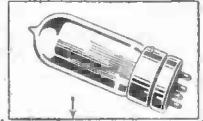

**Vacuum Tubes Specially Priced**  
Only best make tubes carried in stock. Any tube replaced if defective, providing filament lights. G701A 5 v., .25 amp. \$1.65 G799 3 v., .06 amp. 1.65 G672 1 1/2 v., .25 amp. 1.65

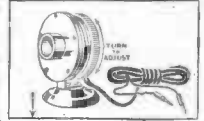

**Melotone Loud Speaker**  
The greatest and most powerful loud speaker phonograph attachment made. If, after five days trial, you do not proclaim it the best and most powerful speaker return it for refund. G6699 Melotone...\$6.90

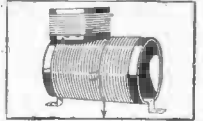

**Cockaday Coil**  
Guaranteed best make. Three windings of No. 18 Magnet wire. Has brass brackets for panel or base mounting. Satisfaction guaranteed or money back. G2750 Cockaday coil \$1.50

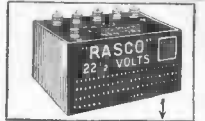

**Tapped "B" Batteries**  
We positively guarantee these batteries to be of long life. We carry only fresh stocks. All with taps. G2250 Sm. 22 1/2 v. ....\$ .85 G2251 Medium Navy size, 22 1/2 volt. ....1.20 G4500 Medium large size, 45 volt ..... 2.30

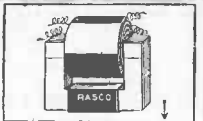

**Audio Frequency Transformer**  
No Better Transformer made. Highest class materials. Impregnated coils. Silicon steel stampings used. Save 50 per cent by assembling it yourself. G1100 Ratio 4 1/2-1. \$1.85 G1150 Ratio 6 1/2-1. 1.85

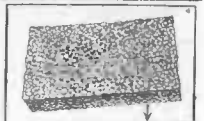

**Sponge-Rubber Cushions**  
Get rid of tube noises due to vibration. Softest sponge rubber made. Size 2 1/2"x3", 3/8" thick. G8989 Sponge-rubber cushions, each .....\$ .12 Six for ..... .60

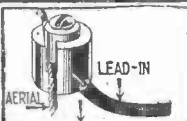

**Antenna Connector**  
At last the solderless antenna connector, made entirely of brass in three pieces; clamps aerial and lead-in with vise-like grip, keeping perfect contact at all times. Dia. 3/4", height 1/2". G4244 Connector .....\$0.20

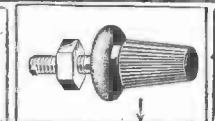

**Rasco Vernier**  
Why use a vernier condenser when a vernier attachment will do anything and everything a vernier condenser accomplishes? Cleverest vernier made. Can be used with any dial. Soft rubber ring engages dial. Nothing to come apart. G1450 Vernier .....\$ .18

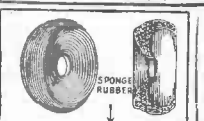

**FONEKUSHIONS**  
Made of sponge rubber. Made wearing your receivers a pleasure. Positively exclude all noises and make reception a pleasure. Sponge rubber will last for years. Light as a feather. Sanitary. G3550 Fonekushions, set of two .....\$ .35



**Dial Button**  
Made in blue enamel and gold, to be worn in button hole. Every radio fan wants one. 3/4" diameter. Best gold plate. Perfect reproduction of radio dial. G7799 Dial Button, Each .....\$0.25

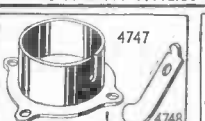

**Vacuum Tube Shell**  
Nickel plated shell for the man who builds his own. 4 holes to attach to sub-base. Each shell comes complete with 4 phosphor bronze socket contacts. See illus. 4748. G4747 Vacuum Tube Shell and Contacts .....\$0.16

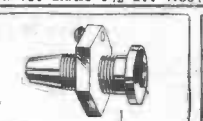

**Cord Tip Jack**  
Takes place of binding posts. Cord tip firmly gripped by jack. Made of brass, nickel plated. Screw to attach lead wire. No soldering necessary. G1500 Cord tip jack. Each .....\$ .15

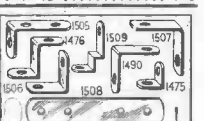

**Brass Nickel Brackets**  
All illustrations 3/4 size. G1505 Bracket, each \$ .05 G1507 Bracket, each .05 G1509 Bracket, each .04 G1476 Bracket, each .05 G1506 Bracket, each .05 G1490 Bracket, each .04 G1475 Bracket, each .03 G1508 Bracket, each .05

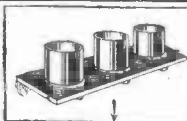

**Three-Gang Socket**  
Aluminum shells, genuine heavy bakelite base, 3 brackets for mounting, 12 nickel binding posts. Length 7 1/4". G5995 3 gang socket \$1.50

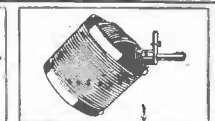

**Rasco 180° Variocoupler**  
Silk wire wound on bakelite tubes. Six taps. Wave length, 150 to 600 meters. For panel mounting. 3/4" shaft. Your money refunded if it is not all we claim. G3100 Variocoupler prepaid .....\$1.50

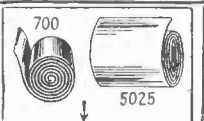

**Copper Ribbon**  
.005" thick. G700 3/4" wide; G701 1/2" wide; G702 3-16" wide. All sizes per foot. ....\$ .01 .001" thick. 4" wide. G5025 Copper Foil, per foot .....\$ .16 10-foot length ..... .80

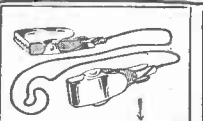

**Rasco Clip Leads**  
Invaluable for experimental work. Clip lead hooks in a jiffy onto any wire, binding post or conductor. Safest experimental connection. Brass clips, 1 foot silk wire, green or red. G7887 Clip Leads, ea. \$1.20 Dozen lot .....\$1.35



**Radio Frequency Transformers**  
Best Radio Frequency Transformer developed so far. Designed by R. E. Lacault, Inventor of Ultra-adyne. Air core type. 200-600 meters. G2800 Transformer, size 1 1/2"x2 1/2" .....\$1.35

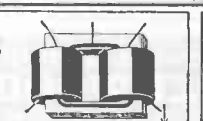

**PUSH-PULL Transformer**  
Push Pull Transformer for many new circuits. See any radio magazine. Made of best materials. Coils impregnated. Silicon steel laminations. Save 50 per cent by assembling yourself. Simple instructions furnished. G1159 Push-Pull Transformer, ratio 6 1/2 to 1 \$3.40



**Electrolyte Panels**  
Highest dielectric strength as per Bureau of Standards. Beautiful high finish. G7100 7x10x3-16" ..\$.70 G7120 7x12x3-16" ..\$.85 G7140 7x14x3-16" ..\$.95 G7180 7x18x3-16" ..1.25 G7210 7x21x3-16" ..1.45 G7240 7x24x3-16" ..1.65



**Low Loss Tuner**  
Some type as used in our L O L O S EXPLORE! Tuner from 200 to 600 meters. Hard rubber insulation throughout. Silicon plated primary. Secondary D. C. C. Ticker silk insulated wire. G2690 Tuner .....\$5.00



**"T" Wire Connectors**  
This big little article solves all troubles when making "T" wire connections. Made to take 1/16" square or round bus-bar wire. Can be attached with a pair of pliers. G2975 "T" Wire Connectors, 12 for .....\$0.05

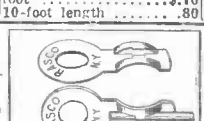

**Nosolder Lugs**  
Finally, a real solderless lug is here. Soldering positively done away with. Takes square or round bus-bar, which it holds with a vise-like grip. Perfect connection. Just slide bus-bar into slip-grip. G3727 Lug, 25 for .....\$1.15



**Low Loss Coil**  
Same type coil as used in Freshman and other Tuned Radio Frequency sets. D. C. wire, 200-350 wave-length, 3" diameter, 1" wide, 5-16" thick. 4 secondary, 2 primary, 2 secondary. G2629 Low Loss Coil \$7.75



**Storage "B" Battery**  
48 volts, 4 1/2 amp. hours. Buy storage "B" batteries by capacity, not by looks. Charge lasts one month. Rubber tops and vents, wooden tray. Sent Express Collect. G9848 Storage "B" Battery .....\$14.00



**Tinned Nickel Lugs**  
All our lugs are tinned. G310 Brass Lugs for No. 8 screw, doz. ....\$1.10 G311 Copper Lugs for Nos. 6 and 8 screws, doz. \$1.10 G309 Copper Lugs for Nos. 4, 6 and 8 screws, doz. \$1.10 G308 Copper Lugs for 6-32 screw, doz. ....\$1.10



**Formica Panels Clearance Sale**  
As we are discontinuing these particular sizes, this material is now offered at cost. All 3-16" thick. G352 8x12" each .....\$1.25 G354 8 1/2x12" ea. ....1.60 G356 6x14" each .....1.20 G357 6x4" each ..... .45

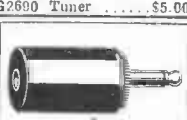

**Phone Plugs**  
Sold from 50c to 75c everywhere. Hard rubber composition shell and patented cord tip holder. Finest workmanship throughout. G1030 Rasco Telephone Plug, Each .....\$ .35



**Bakelite Socket**  
Octagon shape. Four nickel binding posts, phosphor bronze contact springs. Best brown bakelite. G6510 Bakelite socket \$ .40 G6500 Tube Socket, Made entirely of composition. Best made. Each .....\$ .35



**Binding Post Name Plates**  
Dia. 3/4". These styles: Phones, Ground, Output, "A" Bat., "B" Bat., Loud Speaker, Input, "A" Bat., "B" Bat., Loop, "C" Bat., New! "A" Bat., "B" Bat. G6000 Name Plates, Dozen .....\$ .25



**"Rasco" Posts**  
Made of black composition. G650-51 Each .....\$ .08 G202 Has nickel-plated bottom, each .....\$ .08 Dozen, each style. ....\$ .90 G122 Initialed Binding Posts. Six popular styles. Each .....\$ .06

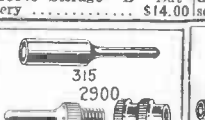

**Cord Tips**  
Standard phone cord tips, nickel. G315 Each .....\$ .03 Separable Cord Tips No solder required. Wire goes in ferrule. Shank holds it tight. Nickel plated. G2900 Each .....\$ .06



**"Perfect" Lugs**  
These new and improved lugs are brass, nickel plated, flattened on top as shown. Made of a single piece of metal. Lead wire goes into tube. G3110, G3080 "Perfect" Lugs, Each .....\$0.02 Dozen lots ..... .20

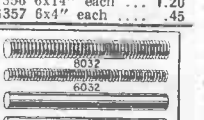

**Brass Rods**  
Sold in 6" lengths only. G8032 Rod 8-32" thread length .....\$ .08 G6032 Rod, 6-32" thread length .....\$ .06 G1425 Rod, plain, 1/4" round, length .....\$1.10 G3616 Rod, plain 3-16" round, length .....\$ .06



**Panel Mounting Grounded Rotor Condensers**  
Positively no better condenser made. Lowest losses, all insulation hard rubber. Have binding posts, aluminum plates, rugged construction. Used by 9 big set manufacturers. G5113 13-plate .....\$1.10 G5123 25-plate .....1.20 G5143 43-plate .....1.30

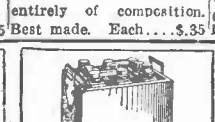

**Storage Batteries**  
Guaranteed for two years. Only NEW material used. Acid proof terminals. Patent vents. G2400 Two volt, 40 amp. hours .....\$3.90 G640 Six volt, 40 amp. hours ..... 7.25 G666 Six volt, 60 amp. hours ..... 8.90 Shipped express collect.

**New 1925 "Rasco" Catalog No. 12**  
CONTAINS 75 VACUUM TUBE HOOK-UPS, 300 ILLUSTRATIONS, 500 ARTICLES, NOW 100 PAGES

All Armstrong Circuits are explained clearly, all values having been given, leaving out nothing that could puzzle you.

Just to name a few of the circuits: The V.T. as a detector and one-step amplifier; all Armstrong circuits; one-step radio frequency amplifier and detector; three stage audio frequency amplifier; short wave regenerative circuits; 4-stage radio frequency amplifiers; radio and audio frequency amplifier; inductively coupled amplifier; all Reflex Circuits.

**FREE**

A POSTAL CARD BRINGS IT



**Battery Lead Tags**  
Latest wrinkle, made in metal, nickel-plated, polished. Clamp tag on battery wire and it won't come off. These five styles: "B", "A", "B + Det.", "B -", "A +", and "A". G8030 Tags, set of 10 \$1.15

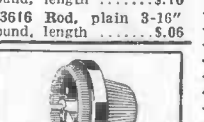

**Rheostats and Potentiometers**  
High heat dielectric base. Come with tapered, knurled knob, 2 1/2" dia. Complete with pointer. G4310 6 ohm .....\$ .38 G4311 30 ohm ..... .44 G4312 Potentiometer 200 ohms ..... .65

**RADIO SPECIALTY COMPANY, 100 Park Place, New York City**

Factories: Brooklyn, N. Y. Elkridge, Md.

# Make Money Taking PICTURES



Tremendous, big-paying opportunities are open for ambitious men in Modern Photography. This is the picture age. Magazine and newspaper publishers buy thousands of photographs each year. Every manufacturer sends out high priced pictures of his products. Every home wants portraits. Photography is a business running into millions of dollars each year. And there is a great shortage of trained photographers.

### Earn \$3,000 to \$10,000 a Year

Hundreds of men are earning big money and establishing their own businesses. Even during spare time, while training, you can make \$75 a week easily—no matter where you live!

### Amazing New Easy Method

I show you at home, how to do the kind of work turned out by the big studios in New York and Chicago! I show you how to make big money within 30 days! C. M. Cole bought a home with money he had made when only half way through his training. So well do I know what I can do for you that I guarantee

Got \$100 for Flood Pictures  
"I took pictures of a flood and sold them for \$100. I have been able to buy my house and lot from the sale of pictures."  
C. M. Cole, Washington, \$97 in 2 Days!  
"I made \$285 in December. Went out two days last week on home portrait work and made \$97."  
A. G. Hughes, Kentucky.

under bond to return every cent of your tuition if you are not thoroughly satisfied.

### Professional View Camera FREE!

Write at once for Free Camera Offer—I give you, free, a splendid professional view camera. You will be astonished and delighted. This offer open for short time only—so act quick! No obligation.



INTERNATIONAL STUDIOS, Inc.  
Dept. 142C  
3601 Michigan Ave., Chicago, U.S.A.

## \$3 Brings you a Genuine UNDERWOOD TYPEWRITER

10 DAYS FREE TRIAL. Your \$3.00 unconditionally returned if at end of 10 days you are not satisfied with this late model UNDERWOOD typewriter rebuilt by the famous Shipman Ward process.

GREAT PRICE SAVING. Direct to you from the largest typewriter factory of its kind in the world by our money saving methods.

EASY MONTHLY PAYMENTS. So small that you will not notice it while you enjoy the use of this wonderful machine.

FREE BOOK OF FACTS. Explaining Shipman Ward's wonderful system of rebuilding typewriters and also valuable information about the typewriter industry both instructive and entertaining.

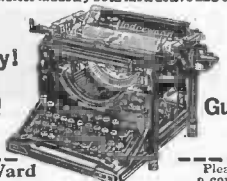

Act Today! Mail Coupon 5 Year Guarantee

Shipman Ward Mfg. Company  
C216 Shipman Building  
Montrose & Ravenswood Aves., Chicago  
Name.....  
St. and No.....  
City..... State.....

## For Your Boat

**Elto**  
Ole Evinrude's New Quick Detachable ROWBOAT MOTOR  
Easily carried. Quickly attached to any boat (without tools). Drives boat any speed, 2 to 10 miles per hour. No rowing, no work, no bother.  
Fast—Light—Powerful Easy to Carry  
Has 12 exclusive features, all described in our new Free Catalog. Write for it today.  
Elto Outboard Motor Co.  
Manufacturer's Home Bldg.  
Dept. 46  
Milwaukee, Wis.

The Motor that Starts with a Touch

SEND FOR THE INTERNATIONAL CATALOG



FOR FORD—Prices from \$27.85 up. Factory to consumer direct—Pay only One Profit  
International Body Wks, 914 W. Ohio St., Dept. 4, Chicago, Ill.

# Tarrano the Conqueror

(Continued from page 372)

so far as I can determine, kills every bacillus harmful to man. There is nothing new in the idea—I have been working at it all my life. Sunlight! Altered and modified in several particulars, yet sunlight nevertheless. How strange! that for countless centuries, man never realized the blessed boon of sunlight—the greatest enemy of all disease!

"Each year, as you know, I have conquered some of what we call the major diseases. A few of them—cancer\*, for instance—persisted in eluding me. Its bacilli—you can easily recognize the tiny purplish, horned rods which cause what we popularly call cancer—just would not die. No form of light or other vibration I could devise, seemed to hurt them—unless I used a vibration harmful, even fatal, to the blood-contents itself: I killed the cancer—in the words of you news-gatherers—but I also killed the patient."

His eyes smiled at the jest, but his face remained intensely serious.

"Then, Jac, I solved that problem—just a few months ago. And upon the heels of it I solved another, of infinitely more importance." He paused slightly. "I have learned how to kill, or at least arrest, the bacillus of old age. It is a bacillus, you know. We grow old because every day we live beyond the age of thirty—the bacillus of old age is attacking us. I call them the Brende-abcilli—these tiny, frayed discs that make us grow old. I have seen them—and killed them!"

It dawned on me slowly, the import of what he was saying.

"You mean—"  
"He means," said Georg, "that at present we cannot only banish disease—all disease—but we can keep your body from aging. Not permanently, doubtless—but with the span of life lengthened threefold at least. Only by violence now need you die prematurely."

This then was the secret the existence of which Tarrano had learned. He had . . .

But Dr. Brende was quietly voicing my thoughts.

"It seems obvious, Jac, that this Tarrano at least suspects that I have made some such discovery as this. That he would withhold it from mankind, for the benefit of his own race, seems also obvious. That he is about to make an attempt to get it from me, I am convinced."

I remembered the wording of the message of warning from the Central State. "Your Dr. Brende, in Eurasia." I mentioned it.

"Our main laboratory is there," Georg said. "In Northern Siberia—isolated from people so far as possible, and in a climate advantageous for the work."

Elza spoke for the first time in many minutes.

"We have guards there, Jac—eight of our assistants. . . . Father, I called Robbins a while ago. He said everything was all right. But don't you think we should call him again?"

The doctor had drifted into deep thought. "What? Oh, yes, Elza. I was thinking—we should go there. My notes—descriptions of how to build a larger apparatus—larger than the small model I have installed there—my notes are all there, and I want them. And I don't think, at such a time, I should trust Robbins to bring them."

"What shall I send to Headquarters?" Georg asked. "They wanted an answer, you remember."

"I'm going there to the Potomac—tell them

that. Tell them we will come there for safety. But first I must get my notes, and the model."

As Georg went to the door, something in his attitude made us all start to our feet and follow him. No alarm from the insulator had come, yet for myself I had not forgotten that Venus-girl outside.

Georg was at the door, tense as though to spring forward as soon as he opened it. I was close behind him.

"What—"  
"Wait, Jac! Quiet! I just want to see—in case she is doing something."

He jerked open the door suddenly and bounded through, with me after him.

The corridor was empty. But there was a whirring coming from the instrument room.

We leaped across the padded corridor. In the instrument room, Ahla the maid sat at the table with a head-piece clasped to her ears. She was talking softly but swiftly into the transmitter. In the mirror beside her I caught a glimpse of the place to which she was talking. A sort of cave-flickering lights—a crowd of dark figures of Venus-men, seemingly armed.

She must have heard us coming. A sweep of her white arm dashed the mirror to the floor, smashing it. Then she cast off the head-piece, and leaping to her feet, faced us, blazing and defiant.

### CHAPTER IV.

#### TO THE NORTH POLE, AND BEYOND

"You stand back! You do not touch me!" The Venus-girl fairly hissed the words. Her eyes were dilated; her white hair hung in a tumbling, wavy mass over her shoulders. She stood tense—a frail, girlish figure in a short, grey-cloth mantle, with long grey stockings beneath.

We were startled. Georg stopped momentarily; then he jumped at her. It was a false move, for before we could reach her, with a piercing cry, she was tearing at the instruments on the table; her fingers, with burns unheeded, ripping the delicate wires, smashing the small mirrors, flinging everything to the floor.

A few seconds only, but it was enough. She was panting when Georg caught her by the wrists, and we others gathered around them.

"Ahla!" Elza cried in horror. I can appreciate the shock to Elza, who had trusted, even loved this girl.

Dr. Brende stood in confused astonishment, staring at the wreck of the instrument table. From a naked wire a little black coil of smoke was coming up. I fumbled about and switched the current out of everything.

We were cut off from all communication with the world. It gave me a queer feeling—made the small island we were on seem so remote.

Georg was shaking the girl, demanding with whom she had been talking and why. But she fell into sullen silence, and nothing we could do would make her break it. It infuriated me, that stubbornness; it was all I could do to keep from harming her in my efforts to make her talk.

Georg, at last, pulled me away; he led the girl to a couch and sternly bade her sit there without moving. She seemed willing enough to do that; she still had not spoken, but her eyes were watching us closely.

Dr. Brende was examining the smashed instruments. "Ruined. We cannot use them. Those messages—we must send them. I must talk to Robbins—"

\*A medical word, translated here as Cancer, though possibly not that.

We went into the corridor, out of earshot of the girl, but where we could watch her. That we were in immediate danger was obvious, and we all realized it. Ahla had told some of her people that we were here on the island; doubtless was planning to have them come here at once and seize us.

How far away from us were they? I had seen in the mirror the interior of a cave-like room. Where was it? Might it not be near at hand—over on the mainland? Might not these enemies arrive on the island at any moment?

Georg suggested that we send our messages from the aeros. We had my own car—and a larger car of the Brendes. More than ever now, Dr. Brende was worried over the safety of his Siberian laboratory; but from the aero we could talk to Robinss.

We went to the landing stage. I wanted to tie up Ahla, but as George said, she could do nothing now that the instrument room was out of commission. We admonished her sternly to stay where she was, and left the house.

On the open landing stage my small aero was lying where I had left it; but a moment's glance showed us it was wrecked—its instruments and its driving mechanism demolished!

There was no doubt about it now; Ahla had planned to keep us on the island while her people came and seized us. Fortunately the Brende car was well housed and barred. We saw that the gates had been tampered with, but with the limited time Ahla had to work in, she had been unable to force them. We swung them wide, and to our infinite relief found the car unharmed.

At once Dr. Brende called Robinss. But the laboratory did not answer!

"It may be your sending apparatus," I suggested. "Send your message down to Headquarters—with their high power they'll get Robinss quickly enough."

He tried that—sending also his answer to the previous coded message Headquarters had sent him. It was now 11:45. We waited some eight minutes, during which time I rushed back to the house. Ahla was sitting obediently where I had left her.

"You stay there," I told her. "If you move, I'll break every bone in your rotten little body."

Back at the landing stage I found Dr. Brende in despair. Headquarters could not raise Robinss. They had relayed the message to Wrangel and Spitzbergen Islands—but the stations there reported similarly. Dr. Brende's laboratory did not answer its call.

This decided us. We had no wish to remain where we were. The Brende car, far larger than the small one of mine, was fully equipped and provisioned. We rolled it out, and in a moment were in the air.

Dr. Brende's car was large, commodious, and smooth-riding. A pleasure to fly in such a car! Georg was at the controls. I sat close beside Elza in the semi-darkness, gazing down through the pit-rail window to where the island was dropping away beneath us. It was a perfect night; the moon had set; the stars and planets gleamed in an almost cloudless sky. Red Mars, I saw, very nearly over our heads.

It was now midnight, and for the moment we chanced to have the air to ourselves. We rose to the 10,000-foot level, then headed directly North. It carried us inland; soon the sea was out of sight behind. Lights dotted the landscape—a town or city here and there, and occasionally a tower.

Dr. Brende was poring over charts, illumined by a dim glow-light beside him. "Can we get power all the way, George? Elza child, hadn't you better lie down? A long trip—you'll be tired out."

"Call Royal Mountain,"\* Georg suggested.

\*Now Montreal.



# Go after the Big-pay Job!

**"Know electricity as experts know it and get an expert's Pay!"**

**D**ON'T be satisfied to worry along in little jobs with little pay. Master the finer points of electrical practice and bring the big pay job within your reach. Croft will show you how. Through his famous books he will teach you electricity as experts know it and put you in line for an expert's pay. Forty thousand men are using these books to step ahead—WHY NOT YOU?

**A great book on Transformer practice—free if you order now!**

## The Croft Library of Practical Electricity

**A Combined Home Study Course and Reference Library**  
8 volumes—3000 pages—2100 illustrations—flexible Keratol binding  
Was \$27.00—Now \$19.50

**FREE**  
with the  
**LIBRARY**  
**Taylor's**  
**Transformer**  
**Practice**

**IF YOU ORDER NOW!**

**YOU SAVE \$10.50 AND HAVE 10 MONTHS TO PAY**

**FREE EXAMINATION**

**NO MONEY IN ADVANCE**

**SEND YOUR COUPON NOW**

**McGraw-Hill Book Company, INC.**  
370 Seventh Avenue  
**New York**

No method of teaching electricity offers a quicker, surer way to success than the Croft books.  
Starting right in with the ARC's of modern electrical practice, Croft takes you through his books in easy steps. He gives you the secrets of success in electricity in plain words, figures and illustrations.  
Croft teaches you electrical practice complete—inside and outside work—central stations and the whole subject. He takes you in quick, easy steps from the simplest principles to the complete and economical operation of a great central station.

He tells you things you need to know about motors, generators, armatures, commutators, transformers, circuits, currents, switchboards, distribution systems—electrical machinery of every type, installation, operation and repair—wiring for light and power—how to do it mechanically perfect, in accordance with the National Electrical Code—wiring of finished buildings—Underwriters' and municipal requirements—how to do a complete job, from estimating it, to completion—illumination in its every phase—the latest and most improved methods of lighting—lamps and lighting effects, etc.

### The Sure Way to Bigger Pay

Big salaries are paid in the electrical field for expert knowledge. The man who knows electricity in all its many phases—the man who has completely mastered the subject from A to Z—can pick his own job and name his own salary. The only way you can earn more is to learn more. Small knowledge means small pay. Learn the way to bigger pay. Become an expert.

#### FREE TRIAL

The proof of all we have said is in the books themselves, and it costs you N-O-T-H-I-N-G to examine them. There are no charges of any kind to pay. We pay everything. We send the books to you for 10 days' examination and let you be the sole judge as to their value.

#### EASY PAYMENTS

If you decide to take this sure road to promotion, you need send only \$1.50 in ten days and pay the balance at the rate of \$2 a month. You do not have to send any money to see the books. On receipt of your first payment of \$1.50 we will send you your free copy of Taylor's Transformer Practice.

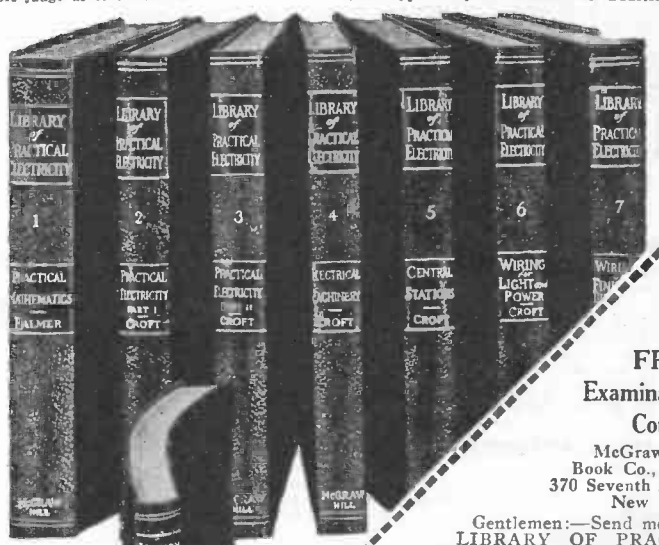

**FREE Examination Coupon**  
McGraw-Hill Book Co., Inc.,  
370 Seventh Ave.,  
New York

Gentlemen:—Send me the LIBRARY OF PRACTICAL ELECTRICITY (shipping charges prepaid), for 10 days' free examination. If satisfactory, I will send \$1.50 in ten days and \$2 per month until the special price of \$19.50 has been paid. If not wanted, I will write you for return shipping instructions. Upon receipt of my first payment of \$1.50 I am to receive a free copy of Taylor's Transformer Practice.

Name .....

Home Address .....

City and State .....

Employed by .....

Occupation .....S.I. 8-1-25

**SOUTH BEND** **Lead the World in LATHE Value**

Quality LATHES \$197<sup>UP</sup>

Quantity Production reduces our costs. We pass the saving on to you.

Prices Quick Change Gear Lathes

9" x 3'.....	\$241.00
11" x 4'.....	288.00
13" x 6'.....	366.00
16" x 8'.....	498.00

Easy Payments if desired. Write for Catalog No. 84.

**SOUTH BEND LATHE WORKS**  
502 E. Madison St., SOUTH BEND, IND.



15" x 6' Quick Change Gear Lathe, Price \$431.00.

**VESCO SMILES AT MILES**



**ON ONE TUBE**

BIG FREE BOOKLET tells the story. California users of CROSS COUNTRY CIRCUIT hear Atlantic Coast, Canada, Cuba, Mexico and Hawaii. Atlantic Coast users hear England to California. Our new plan makes this set easiest and cheapest to build. One hour puts in operation. One tuning control. No soldering. Any novice can do it. BIG BOOKLET FREE or complete instructions for 25c stamps or coin.

**VESCO RADIO CO.,** Box 51-117 Oakland, Calif.

**PERSONAL STATIONERY**  
200 SHEETS and 100 ENVELOPES **\$1.00**

Printed with your Name and Address

Clear, white bond paper, with envelopes to match. Your name and address printed in beautiful, rich blue ink, on both paper and envelopes, and sent to you postpaid for only \$1.00. (West of Mississippi river and outside of U. S. \$1.10.) If inconvenient to send the money, we will ship C.O.D. Money returned if you are not more than satisfied. Order today. Write name and address plainly.

AGENTS MAKE BIG MONEY taking orders for us. Write us today for our agent's proposition.

**ELITE STATIONERY COMPANY**  
5030 Main Street Smethport, Pa.

The Famous **KON-VER-TER** Slide Rule

Instantly adds, subtracts, divides, multiplies, converts fractions or decimals of an inch. Gives sines, co-sines, versed sines, co-versed sines, tangents, co-tangents, secants co-secants of angles directly. Gives square roots, squares, cube roots, cubes and fifth roots and powers of all numbers. Logarithms, co-logarithms, anti-logarithms. Instructions with rule.

DeLuxe Model \$3. Cash or C.O.D. New England Novelty Company Wakefield, Mass.



**Straightens Shoulders**  
—Increases Spine

**THE NATURAL BODY BRACE**—Corrects stooping shoulders, straightens the back, gives the lungs chance for normal expansion, induces proper breathing. Brings restful relief, comfort, energy, and pep. For men and women.

Costs nothing to try it

Write for 30 days free trial offer and free book.

**NATURAL BODY BRACE CO.**  
Howard C. Rash, Ft. 286 Rash Bldg., Salina, Kansas



"Ask them about serving us power; I'll stay 10,000 or below. Under one thousand, when we get further North. Ask them if they can guarantee us power all the way."

The station at Royal Mountain would guarantee us nothing on this night; they advised us to keep low. Their own power-sending station was working as usual. But this night—who could tell what General Orders might come? Everyone's nerves were frayed; this Director demanded gruffly to know who we were.

"Tell him none of his business," I put in. My own nerves were frayed, too.

"Quiet!" warned Georg. "He'll hear you—and it is his business if he wants to make it so. Tell him we are the Inter-Allied News, father. That is true enough, and no use putting into the air that Dr. Brende is flying North."

Mountain Royal let us through. We passed well to the east of it about 12:45—too far away to sight its lights. The cross-traffic was somewhat heavier here. Beneath it, at 5,000 and 6,000 feet, a steady stream of cars was passing east and west.

We were riding easily—little wind, almost none—and were doing 390. You cannot bank or turn very well at such a speed; it is injurious to the human body. But our course was straight North. Dr. Brende showed it to me on his chart—North, following the 70th West Meridian. Compass corrections as we got further North—and astronomical readings, these would take us direct to the Pole. I could never fathom this air navigation; I flew by tower lights, and landmarks—but to Dr. Brende and Georg, the mathematics of it were simple.

At two o'clock we had crossed the route of the Chicago-Great London Mail flyer. But we did not see the vessel. The temperature was growing steadily colder. The pit was inclosed, and I switched on the heaters. Elza had fallen asleep on the side couch, with my promise to awaken her at the first sign of the Arctic dawn.

At two-thirty, the Great New York-East Indian Express overhauled us and passed overhead. It was flying almost North, bound for Bombay and Ceylon via Novaya Zemlya. It was in the 18,000-foot lane. The air up there was clear, but beneath us a fog obscured the land.

At intervals all this time Dr. Brende had been trying to raise Robins—but there was still no answer. We did not discuss what might be the trouble. Of what use could such talk be?

But it perturbed us, for imagination can picture almost anything. Georg even felt the strain of it, for he said almost gruffly:

"Stop it, father. I don't think you should call attention to us so much. Get the meteorological reports from the Pole—we need them. If they tell us this weather will hold at 10,000 and below, we'll make good time."

Soon after three o'clock we swept over Hudson Strait into Baffinland. We were down to 4,000 feet, but the fog still lay under us like a blanket. It clung low; we were well above it, in a cloudless night, with no wind save the rush of our forward flight.

Then came the pink flush of dawn. True to my promise I awakened Elza. But there was nothing for her to see; the stars growing pale, pink spreading into orange, and then the sun. But the fog under us still lay thick.

We were holding our speed very nearly at 380 an hour. By daylight—about five o'clock, after a light meal—we were over Baffin Bay. I had relieved Georg at the controls. The headlands of North Greenland lay before us. Then the fog lifted a little, broke away in places. The water became visible—drift and slush-ice of the spring, with lines of open water here and there.

And then the fog closed down again, lifting momentarily at six o'clock when we passed over the Northwestern tip of Green-

land. The tower there gave us its routine signal, which we answered in kind. There was little traffic along here; a few local cars in the lowest lanes.

Shortly after six, when we were above Grantland, another of the great trans-Arctic passenger liners went over us. The San Francisco Night Line, for Mid-Eurasia and points South. It was crossing Greenland, from San Francisco, Vancouver, Edmonton, to the North Cape, the Russias, and African points South of Suez.

At seven o'clock, with the sun circling the lower sky, the fog under us suddenly dissipated completely. We were over the Polar ocean. Masses of drift ice and slush, but for the most part surprisingly clear. At eight o'clock, flying low—no more than a thousand feet—we sighted the steel tower with foundations sunk into the ocean's depths which marks the top of our little Earth.

We flashed by the tower in a moment, answering the director's signal perfunctorily. Southward now, on the 110 E. Meridian, without deviating from the straight course we had held.

It was truly a beautiful sight, this Polar ocean. Masses of ice, glittering in the morning sunlight. A fog-bank to the left; but everywhere else patches of green water and floes that gleamed like millions of precious stones as they flung back the light to us. Or again, a mass of low, solid ice, flushed

**Important Articles to Appear In August Issue of "The Experimenter"**

- The Tungsten Arc Lamp. By Dr. Franz Skaupy.
- Disrupting the Atom with Intense Magnetic Fields. By Prof. T. F. Wall.
- The Mutochrome—A New Color Machine. How to Make the Radio-Tonoscope. By William Grunstein, E. E.
- Repairing Electric Fans (Continued from July issue). By H. Winfield Secor, Assoc. Member A.I.E.E.
- An Ideal "A" and "B" Battery Charging Panel.

pink in the morning light. And behind us, just above the horizon, a segment of purple sky where a storm was gathering—a deep purple which was mirrored in the placid patches of open water, and darkened the ice-floes to a solemn, sombre hue.

Elza was entranced, though she had made many trans-Polar trips. But Georg, now again at the controls, kept his eyes on the instruments; and the doctor, trying vainly once more to talk with his laboratory, now so close ahead of us, sat in moody silence.

It was 9:38 when we sighted, well off to the right, the rocky headland of Cape-Chelusin\*—the most northerly point of Eurasia. A long, low cliff of grey rock, ridged white with snow in its clefts. We swung toward it, at greatly decreased speed, and at an altitude of only a few hundred feet.

This was all a bleak, desolate region—curiously so—and I think, one of the very few so desolate on Earth. As we advanced, the Siberian coast spread out before us. Mountains behind, and a strip of rocky lowland along the sea. There were patches of snow—the mountains were white with it; but on the lowlands, for the most part the Spring sun had already melted it. The Spring was well advanced; there were many open channels in the water over which we were skimming—drift-ice, and slush-ice which soon would be gone.

\*Now Cape Chelyuskin, Taimur Peninsula, Siberia.

Cape-Chelusin! It was here that Dr. Brende had placed his Arctic laboratory—as far from the haunts of man as he could find—a hundred miles from the nearest person, so he told me. And as I gazed about me I realized how isolated we were. Not a car in the whole circular panorama of sky; no sign of vessel on the water; no towns on the land.

It was just after ten in the morning when we dropped silently to the small landing stage a hundred yards or so from the shore. We disembarked in the sunlight of what would have been a pleasant December morning in Great New York; and I gazed about me curiously. A level lowland of crags with the white of snow in their hollows; a collection of broad, low buildings nearby, with a narrow steel viaduct running down to them from the landing stage. And behind everything, the frowning headland of the Cape.

The buildings stood silent, without sign of life. There was no one in sight anywhere. No one out to greet us; I thought it a little strange but I said nothing.

We started down the viaduct. Under us, in patches of soil, I could see the vivid colors of the little Arctic flowers already rearing their heads to the Spring sunlight. I called Elza's attention to them. A vague apprehension was within me; my heart was pounding unreasonably. But this was Dr. Brende's affair, not mine; and I wanted to hide my perturbation from Elza.

The viaduct reached the ground; a path led on to the houses.

Suddenly Dr. Brende called out: "Robins! Robins! Grantley! Where are you!"

The words seemed to echo back faintly to us; but the buildings remained silent.

"You'd better wait here with Elza," Georg said. "I'll go on—see what—"

He checked his words, and started forward. But Dr. Brende was with him, and in doubt what to do I followed with Elza.

We entered the nearest building, into a low, dim room, with doors on the sides. In the silence I seemed to hear my heart pounding my ribs. Elza's face was pale and perturbed, but she smiled at me.

"Wait!" said Georg. "You wait here."

He turned into a side door leading to another room, and in an instant was back with a face from which the color had departed.

"They're not in there," he said unsteadily. "Elza—you go outside with father. They must be around somewhere, Jac. Come, look."

There was a rustle behind us. Arms came around me, pinning me. I heard Elza scream, saw Georg fighting two dark forms which had leaped upon him.

I was flung to the ground, but I fought—three men, it seemed to be, who were upon me. Then Georg's voice:

"Jac! Stop—they'll kill you."

I yielded suddenly, and my assailants jerked me to my feet. A group of Venus-men were surrounding us. Georg, his jacket torn to ribbons, was backed up against the wall with three or four Venus-men holding him.

And on the floor nearby Dr. Brende lay prone, with a crimson stain spreading on his white ruffled shirt, and Elza sobbing over him.

(End of Part II)

**CORRECTION NOTICE**

In the article entitled "Model Demonstrates Eclipses" by Dr. Ernest Bade, published in the May issue, and also the article "Glass Panels and Cabinets," by the same author, published in the June issue, the fact was mentioned that the parts necessary for building this apparatus were those bearing the name of "Erector," whereas they were built with "Meccano" parts. We are glad to make this correction, as these particular parts were chosen by the author in each case for various mechanical reasons.



## Within the means of all

Visitors from foreign countries invariably wonder at the number of telephones in America. "Why is it," they ask, "that nearly everybody in America has a telephone, while in Europe telephone service is found only in a limited number of offices and homes?"

First of all, telephone rates in the United States are the lowest in the world for the service given. Here, since the beginning, the best service for the greatest number of people has been the ideal. By constant improvement in efficiency and economy the Bell System has brought telephone service within the means of all. From the start, its rate policy has been to ask only enough to pay fair wages and a fair return on investment.

The American people are eager to adopt whatever is useful. They have found that Bell telephone service, comprehensive, prompt and reliable, connecting them with the people they wish to reach, is worth far more to them than the price charged for it.



**AMERICAN TELEPHONE AND TELEGRAPH COMPANY  
AND ASSOCIATED COMPANIES**

**BELL SYSTEM**

*One Policy, One System, Universal Service*

**WANTED**  
**RAILWAY POSTAL CLERKS**  
**\$1900 to \$2700 Year**  
(Postal Pay Just Raised)

Many Government Jobs open to women -  
**MEN—WOMEN, 18 UP** SHOULD MAIL COUPON  
Steady Work. No Layoffs. Paid Vacations  
**TRAVEL—See Your Country**



FRANKLIN INSTITUTE,  
Dept. F182, Rochester, N. Y.

Sirs: Send me without charge: (1) Specimen Railway Postal Clerk Examination questions; (2) Schedule showing places of coming U. S. Government examinations; (3) Free sample examination coaching.

Name.....  
Address.....



**AGENTS WANTED SALESMEN DISTRIBUTORS**  
To sell Blancke Thermostatic Carburetor Control. Makes Fords run on 94 per cent air. Doubles gas mileage. Sells on sight. Cadillac now uses thermostatic control under Blancke license. No experience needed. \$250. to \$2,000. a month profit. Write today.  
**A. C. BLANCKE & CO.,** Dept. 863 L 602 W. Lake St., CHICAGO



**Print Your Own**  
Cards, Stationery, Circulars, Paper, etc. Save money. Print for others, big profit. Complete outfits \$8.85. Job press \$12. \$35. Rotary \$150. All easy, rules sent. Write for catalog presses type etc. **THE PRESS CO.,** Y 47, Meriden, Conn.

**YOU TOO CAN PLAY THE HAWAIIAN GUITAR**  
 JUST AS THE HAWAIIANS DO  
 PLAY ALL THE LATEST HITS

**FREE! THIS \$15. HAWAIIAN GUITAR**

**ONLY 4 MOTIONS** used in playing the fascinating Hawaiian Guitar. Our native Hawaiian instructors teach you to master them quickly. Pictures show how. Everything explained clearly. **PLAY IN HALF HOUR** After you get the 4 easy motions, you can play harmonious chords with very little practice. 40,000 students have learned to play in this easy, pleasant way.

**EASY LESSONS**  
 The 52 printed lessons with a great many pictures make it easy to learn quickly. You don't have to know how to read notes. No previous musical knowledge necessary. You learn to play any kind of music, and pay as you play.

**FREE GUITAR**  
 As a special offer to new students we give this full size, high grade instrument free of charge. It is sent at once without red tape or delay.

**WRITE AT ONCE**  
 Send your name at once and let us tell you all about the 52 easy lessons and the free guitar. You have everything to gain. Don't put it off. A post card will do. Ask for new special offer and easy terms.

**First Hawaiian Conservatory of Music, Inc.**  
 233 Broadway (Woolworth Bldg.) Dept. 40, New York, N. Y.

Special courses on Violin, Tenor-Banjo, Banjo-Ukuleles and Ukulele

**Doctor Hackensaw's Secrets**  
 By CLEMENT FEZANDIE  
 (Continued from page 333)

couldn't reach it. Of course, air in the car offers a certain amount of resistance and so enables you to swim easily from one point to another as the acquired speed keeps your velocity increasing until the resistance of the air equals the acceleration."

"I bet I could reach the side of the car!" said Miggs.

"How would you do it?"

"I'd take off my jacket and throw it in the direction opposite to the one I wanted to go. The jacket would reach one wall and I would be pushed backward and reach the other."

"Bravo, Miggs!" cried the doctor. "That's a very clever idea and would certainly succeed. If your jacket weighs five pounds and you weigh one hundred pounds, the jacket would travel twenty times as fast as you would, but you would eventually reach the other side unless the resistance of the air stopped you."

"If it did, I'd shoot off my pants the same way!" exclaimed Miggs, and at this heroic measure both the doctor and Pep laughed heartily.

**Book Review**  
 (Continued from page 366)

**ELEMENTS OF STORAGE BATTERIES.** By Cyril M. Jansky, B.S., B.A., hard covers 5 3/4" x 9 1/4", 241 pages, published by McGraw-Hill Book Co., Inc., New York City. \$2.50.

Storage batteries for only too many years have been treated from a rather elemental standpoint, but in this book we find that the subject is taken up in the broader and more scientific aspect. It is interesting to find a full chapter devoted to the chemistry of the lead plate storage battery. But now there are other storage batteries on the market besides the lead plate one, notably the nickel-iron-alkaline cell which has been developed by Mr. Edison. The subjects of testing, maintenance and diseases of batteries give typical chapter headings; and in each chapter the subject is treated in very detailed presentation. We note with special interest that considerable is said about the Planté battery. To the writer it always seems that this plate has not received adequate exploitation, and this book enlightens us when we find that the Gould Battery and National Storage Battery Co.'s are among those using the Planté system. There is this to be said about the care of batteries. What we find in this book applies almost entirely to the lead plate battery, because the Edison battery is almost undamageable.

**DYNAMO ELECTRIC MACHINERY,** by Erich Hausmann, E.E., Sc.D. Hard covers, 5 1/2" x 8 3/4", 645 pages. Published by D. Van Nostrand Co., New York City. \$4.50.

Over six hundred pages of this rather exhaustive work are followed by a ten page index, an example which should be followed by all publishers and authors. The title tells about what the book is composed of. It is meant for study as well as reading, chapters being followed by problems on the topics treated in each. A person who felt himself to be an advanced student might very well go through this book and work out the problems, and we believe that the majority of engineers would acquire great benefits from so doing. It is very profusely illustrated, and mathematics are used without hesitation, calculus and vector calculations being used throughout. Complex numbers and the so-called complex variable are treated, and in addition to very lucid diagrams, a number of half-tone illustrations from photographs are given and add greatly to the interest of the work.

**PRINCIPLES OF ELECTRIC MOTORS AND CONTROL,** by Gordon Fox. Hard covers, 5 1/4" x 8 3/4", 499 pages. Published by McGraw-Hill Publishing Co., New York City. \$3.50.

Departing from electric generators, we here have a book devoted to motors and their control. There are comparatively few books restricted to this subject, the present one includes all kinds of controllers, switchboards and such details as starting boxes, and even the use of fly wheels in the application of electric power. Another interesting topic is electric motor braking, in which a motor is used to retard machinery, to give it what is known as negative acceleration or "to put on the brake." This one topic fills a very interesting chapter and it is cited as typical of the treatment. Another very valuable feature of the book is the giving of short bibliographies instead of accumulating all the references in one place. Not every chapter has a bibliography, but there are a number of them scattered throughout the book. Polyphase motors are treated in considerable detail, taking up a large section of the work. The direct current motor naturally receives less attention.

**MEN OF THE OLD STONE AGE,** by Henry Fairfield Osborn. Hard covers, 6" x 9", illustrated, 559 pages. Published by Charles Scribner's Sons, New York City. \$5.00.

This book on pre-historic man has much interest added to it by its treatment not only of what man was like, but it even treats of the animals which he hunted in ancient times. Considering the small amount of information accessible, it sometimes seems as if the writers on this subject went too much into detail. Very interesting illustrations show examples of sculpture, pictures and graffiti done by the early races, their tools with decorations and their drawing of a horse's head, for example, and of animals, show a considerable development of the art idea. We have not spoken too much in favor of the book, as is evidenced by the fact that after ten printings, this edition comes out as the popular one. Personally we do not advocate too much certainty and fixity of view on these matters, as there is very little to expatiate upon. A very excellent bibliography and a good index end the book, which also has maps covering the subject.

**ARROW BATTERY**

**Battery Prices SMASHED!**

**To Consumers Only**  
 Here is a real battery quality, guaranteed to you at prices that will astound the entire battery-buying public. Order Direct From Factory. Put the Dealer's Profit in your own pocket. You actually save much more than half, and so that you can be convinced of true quality and performance, we give a **Written 2-Year Guarantee**. Here is your protection! No need to take a chance. Our battery is right—and the price is lowest ever made. Convince yourself. Read the prices!

<b>Auto Batteries</b>	<b>Radio Batteries</b>
6 Volt, 11 Plate, \$9.50	6 Volt, 100 Amp, \$9.50
6 Volt, 13 Plate, 11.50	6 Volt, 120 Amp, 11.50
12 Volt, 7 Plate, 13.00	6 Volt, 140 Amp, 13.00

**Buy Direct—Send No Money**  
 We ask no deposit. Simply send name and address and style wanted. Battery will be shipped same day we receive your order Express C.O.D. subject to your examination on arrival. Our guarantee accompanies each battery. We allow 5% discount for cash in full with order. You cannot lose! Send your order today—NOW!

**ARROW BATTERY CO.**  
 Dept. 9 1215 So. Wabash Ave., Chicago

**Learn Electricity**  
 —the Big-Pay Profession!

... Big opportunities for men with limited time and money. We train you by actual practice on quarter-million dollars worth of new electrical equipment. Expert instructors. Short easy courses. Low tuition rates. No previous education required. 14,000 successful graduates.

**—FREE HANDBOOK—**  
 Big illustrated book shows you how to become an Electrical Expert and earn while learning. Write Dept. 569

**NATIONAL Electrical School**  
 Los Angeles

Insure your copy reaching you each month. Subscribe to **SCIENCE & INVENTION**—\$2.50 a year. Experimenter Publishing Co., 53 Park Pl., N. Y. C.

And now the weight of bodies in the car kept getting heavier and heavier. The speed of the car had been gradually increased until the speedometer indicated one hundred miles per hour. The air pressure in the pit at the center of attraction had been over fifty pounds to the square—more than triple the normal atmospheric pressure—but now the air-gauge showed that the pressure was diminishing again.

Doctor Hackensaw called Pep's attention to this matter, and showed her how it confirmed the indications of the spring-balance.

"Everything goes to show," said he, "that we reached the center of attraction when we were only fifteen hundred miles below the surface of the earth. There bodies lost all their weight and the air was densest because under greater pressure, the air above and below both pressing toward the center of attraction."

"In that case," said Pep, "the earth can be only three thousand miles in diameter from pole to pole!"

"No, the earth is eight thousand miles in diameter. There is no possible question about that. Men have circumnavigated the earth, and scientists have accurately measured the length of a degree of longitude. Other observations confirm these results. There is no doubt of the accuracy of the figure 'eight thousand miles' as the diameter of the earth."

"Then how do you explain that bodies fifteen hundred miles down had lost all weight?"

"I see only one explanation. The center of the earth must be hollow. The earth must be a hollow sphere within a crust or shell three thousand miles thick. This would explain everything and tallies with the radio-observations that I had made before starting. As I told you I sent ships to circumnavigate the globe, one ship in each pair following the other around on a great circle, always keeping exactly opposite to its twin, that is to say, one hundred and eighty degrees from its companion ship. These ships sent directed radio waves straight through the center of the earth to each other. The result of these observations when summed up convinced me that there must exist an enormous hollow at the center of the earth, filled possibly with air or gas. I am now more than ever confirmed in this belief, but if the pit we are in extends to the central hollow, as it seems to, we shall in the course of a day or so know the truth."

"But," objected Pep, "even if the earth is hollow at the center, it seems to me that bodies ought to keep weighing more and more as we go down."

"Not at all," replied the doctor. Then with some difficulty he took his note-book from his pocket and drew the following rough diagram:

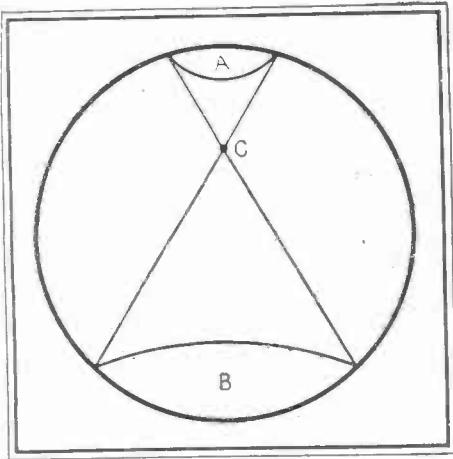

Diagram of Sir Isaac Newton's proof. C = an object at any point inside of a hollow sphere. A and B are the two opposing portions of the shell of the sphere that attract the object in opposite directions. These two attractions are always equal.

"Here is the gist of the proof given by Sir Isaac Newton in his 'Principia' to show that a body situated at any point within a hollow sphere will not be attracted in any direction by the shell, or rather that the opposing attractions will neutralize each other. Let C be the body inside of the shallow sphere and consider the piece of the shell A that attracts the body in one direction. There will be opposed to this force a pull from the portion B of the shell opposite to A. The attractions A and B are proportional to the areas A and B and inversely proportional to the squares of their distances from the object C. But the areas A and B are to each other as the squares of any homologous lines—hence they are to each other as the squares of their distances from C. Hence the two opposite pulls are exactly equal and neutralize each other. If my supposition is correct and if the earth is really a hollow shell, we shall find when we reach this hollow space that no matter what the position of the car in the central hollow, we shall have no weight. You will there be able to dance your 'aerial whirl' as easily as you did just now. But enough of this lecture. I wish now to send a radio message to Mr. Sam telling him all that has happened to us so far. When I have finished we can listen in and receive the latest broadcast news and hear a little jazz music to liven us up."



## Men Needed in Electricity

Good salaries and rapid advancement await trained men

**N**O PROFESSION offers greater opportunity to-day than Electricity. Salaries of \$12 to \$30 a day are not uncommon and the opportunity for advancement is unlimited.

For this is the Electrical Age. New uses for electricity are being discovered every year. The growth of Radio is simply one illustration of the progress that is yet to be made.

As Forrest Crissey said recently in *The Saturday Evening Post*—"The demand for electrical work is increasing immensely and electrical contractors assert that the supply of electrical workers cannot overtake the demand for several years to come."

Now is the time to prepare for a good position in this profitable, interesting profession.

Best of all, you can study right at home in spare time through the International Correspondence Schools—just as so many other men have done. These courses are the most authoritative courses ever offered, and have been endorsed by both Thomas A. Edison and the late Dr. Charles P. Steinmetz.

Just mark and mail the coupon printed below and full information about Electrical Engineering, Electric Lighting, Electric Wiring, Electric Railways, Radio or any other work of your choice will come to you by return mail. To-day—not To-morrow—is the day to make that all-important start toward success.

Mail the Coupon To-day for Free Booklet

TEAR OUT HERE

**INTERNATIONAL CORRESPONDENCE SCHOOLS**  
Box 6217-D, Scranton, Penna.

Explain, without obligating me, how I can qualify for the position, or in the subject, before which I mark X.

<input type="checkbox"/> ELECTRICAL ENGINEER	<input type="checkbox"/> CHEMICAL ENGINEER
<input type="checkbox"/> Electrician	<input type="checkbox"/> Pharmacy
<input type="checkbox"/> Electric Wiring	<input type="checkbox"/> SALESMANSHIP
<input type="checkbox"/> Electric Lighting	<input type="checkbox"/> ADVERTISING MAN
<input type="checkbox"/> Electric Car Running	<input type="checkbox"/> Window Trimmer
<input type="checkbox"/> Heavy Electric Traction	<input type="checkbox"/> Show Card and Sign Painter
<input type="checkbox"/> Electrical Draftsman	<input type="checkbox"/> RAILROAD POSITIONS
<input type="checkbox"/> Electric Machine Designer	<input type="checkbox"/> ILLUSTRATOR
<input type="checkbox"/> Telegraph Expert	<input type="checkbox"/> DESIGNER
<input type="checkbox"/> Practical Telephony	<input type="checkbox"/> BUSINESS MANAGEMENT
<input type="checkbox"/> MECHANICAL ENGINEER	<input type="checkbox"/> Private Secretary
<input type="checkbox"/> Mechanical Draftsman	<input type="checkbox"/> Business Correspondent
<input type="checkbox"/> Machine Shop Practice	<input type="checkbox"/> BOOKKEEPER
<input type="checkbox"/> Toolmaker	<input type="checkbox"/> Stenographer and Typist
<input type="checkbox"/> Gas Engineer	<input type="checkbox"/> Cert. Pub. Accountant
<input type="checkbox"/> CIVIL ENGINEER	<input type="checkbox"/> Traffic Management
<input type="checkbox"/> Surveying and Mapping	<input type="checkbox"/> Commercial Law
<input type="checkbox"/> Mining Engineer	<input type="checkbox"/> GOOD ENGLISH
<input type="checkbox"/> ARCHITECT	<input type="checkbox"/> STATIONARY ENGINEER
<input type="checkbox"/> Architectural Draftsman	<input type="checkbox"/> CIVIL SERVICE
<input type="checkbox"/> Architects' Blue Prints	<input type="checkbox"/> Railway Mail Clerk
<input type="checkbox"/> PLUMBING AND HEATING	<input type="checkbox"/> Textile Overseer or Supt.
<input type="checkbox"/> Sheet Metal Worker	<input type="checkbox"/> AGRICULTURE
<input type="checkbox"/> Navigator	<input type="checkbox"/> Penmanship <input type="checkbox"/> Spanish
	<input type="checkbox"/> Automobiles <input type="checkbox"/> RADIO

Name \_\_\_\_\_

Present Occupation \_\_\_\_\_ Business Address \_\_\_\_\_ 3-6-24

Street and No. \_\_\_\_\_

City \_\_\_\_\_ State \_\_\_\_\_

**Interesting Articles in August "Radio News"**

The Piezo Electric Oscillograph.  
By Prof. C. B. Bazzoni.

Straight-Line Frequency Condensers.  
By Sylvan Harris.

Radio Shower—\$20,000 worth of radio apparatus given away.

Portable Set Directory.

Push Button Radio.  
By Brainard Foote.

A Ten-Cent Store Cone Speaker.  
By Jay Hollander.



### AUTO RUNS 57 MILES ON GAL. of "GAS"

A new automatic and self-regulating device has been invented by John A. Stransky, 471 Fourth st., Pukwana, South Dakota, with which automobiles have made from 35 to 57 miles on a gallon of gasoline. It removes carbon and reduces spark plug trouble and overheating. It can be installed by any one in five minutes. Mr. Stransky wants distributors and is willing to send a sample at his own risk. Write him today.

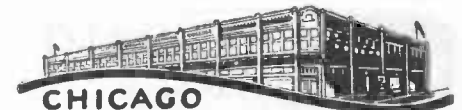

### CHICAGO TECHNICAL COLLEGE

{22nd YEAR}

Intensely practical training in Drafting and Engineering—civil, mechanical, electrical, structural—Architecture, 2 year Diploma; 3 year B.S. Degree; special short courses. Courses adapted to your needs. No time wasted. Instructors are experts. Our graduates are in constant demand. Opportunities for part-time work while studying. Day and evening classes. Athletics. Enter any time. Low tuition—easy terms. Write for 72-page illustrated Blue Book, describing opportunities open to our graduates. Chicago Technical College, 452—Chicago Tech. Building, Chicago, Ill.

Insure your copy reaching you each month. Subscribe to Science and Invention—\$2.50 a year. Experimenter Publishing Co., 53 Park Place, N. Y. C.

## Color of Life

YOU use silverware and linen, hang up curtains and pictures, wear fabrics carefully cut and adorned—all for the purpose of coloring the drab facts of food, shelter and clothes.

Advertisements enable you to put this color into your life. They bring you news of improvements to quicken your pleasure, increase your efficiency, lessen your work—to feed your hours with every comfort and convenience men have thought out for you.

Read the advertisements. Their timely messages, their intimate lessons in economy, their assurance that advertised goods will please—help you color your life even more.

When you choose from advertised goods, you choose from the safest goods known. They are value-true.

Read the advertisements in these columns. By their guidance you can obtain the best today; economize for the best tomorrow.

*Advertising reduces the cost  
of products that add pleasure and  
comfort to living*

### CHAPTER 11

"Pop," said Pep, after the radio concert was over, "I find now that I weigh only five pounds on the spring scales. Before we get any heavier I want to do a little circus stunt with you and Miggs. Don't say 'no,' because I may never get another chance."

"What do you want to do?"

"I want to do a little balancing act. I want to hold you and Miggs in one hand. Come, Miggs, there's a good boy, let me lift you up. Now just stand on my hand and hold on to me while I lift the doctor up. Then you're to grab him, stand him up on your right hand and balance him there, and then when you're ready, you can let go of me and stand upright in my hand so that I'll be balancing the two of you at once. Gee! Won't it be fun!"

Doctor Hackensaw somewhat reluctantly consented to the experiment and a moment later he was perched upright on Miggs' hand while Miggs in turn stood on Pep's open palm. The young lady found she could easily balance them in this position, the two of them together weighing only about ten pounds.

### IMPORTANT

#### TO NEWSSTAND READERS

IN order to eliminate all waste and unsold copies it has become necessary to supply newsstand dealers only with the actual number of copies for which they have orders. This makes it advisable to place an order with your newsdealer, asking him to reserve a copy for you every month. Otherwise he will not be able to supply your copy. For your convenience, we are appending herewith a blank which we ask you to be good enough to fill in and hand to your newsdealer. He will then be in a position to supply copies to you regularly every month. If you are interested in receiving your copy every month, do not fail to sign this blank. It costs you nothing to do so.

To ..... Newsdealer

Address .....

Please reserve for me ..... copies of SCIENCE & INVENTION every month until I notify you otherwise, and greatly oblige,

Name .....

Address .....

Not satisfied, however, with this success, she decided to try to balance the two of them on her nose. Poor Doctor Hackensaw obediently allowed himself to be placed on the tip of Miggs' nose while Pep stood Miggs on the end of her own (Pep's) dainty nose, which flattened out somewhat under the ten pound weight.

Everything went on swimmingly for a minute or two, and then Pep tripped on the foot of the table that was fastened to the floor and down fell the human tower in an inglorious heap. Fortunately, the travellers weighed so little that no one was seriously hurt.

And so the time wore on, hour succeeding hour, each one bringing an increase of weight. Then suddenly the electric alarm-bell rang.

"Good gracious!" cried the doctor. "There must be some obstruction in the path. Your capers, Pep, have made me neglect keeping as sharp a watch as prudence demanded."

Long and earnestly the doctor peered forth down the shaft, but was unable to see any obstruction. And yet the alarm kept on ringing.

"I don't understand it," cried the doctor. "The selenium-cell alarm should ring only if there is some obstruction in the path that reflects back the rays of our search-light. Yet the pit seems as open as ever. Perhaps



## RAY-O-LITE POCKET LIGHTER

No wind or rain can put it out. It is indispensable to smokers and is guaranteed forever. It's different, better and sure lighting. No flint, no friction, always sure, safe, handy, clean and economical, and is no expense to the smoker.

If your sporting-goods dealer cannot supply you, send his name and 50c and we will send you one of these lighters.

*Money back if not satisfied.*

RAPID MFG. CO., 799 Broadway, Dept. I, NEW YORK, N. Y.



## Cuts Gasoline Cost to 10 Cents a Gallon

James A. May of 863-L st., Sioux Falls, S. D., has perfected an amazing new device that is enabling car owners to cut their gasoline bills in half by doubling their mileage from gasoline used. Many owners have made over 40 miles on a gallon. It also removes carbon, increases motor power and pep, prevents spark plug trouble and overheating. Anyone can install it in five minutes. Mr. May wants agents, and is offering to send one free to one auto owner in each locality. Write him today.

**1.25<sup>c</sup>**  
By MAIL

**QUESTIONS and ANSWERS**

Electricians' Examinations  
Diagrams, symbols, tables,  
notes and formulas for  
preparation for license.  
READE PUB. CO.  
296 Broadway, N. Y. City



there's a short circuit in the cell. Our gymnastics in the car may have shaken the wires around a little. I'll shut off the search-light for a minute to see."

Accordingly the doctor switched off the light, but the alarm continued ringing just the same. Yet an examination of the cell showed no visible short circuit.

"I don't see what the matter can be," he cried, "but I'll slow up a little, for it wouldn't do to have an accident down here, over twenty-nine hundred miles below the surface of the earth. Our friends would have some trouble in getting our bodies out!"

The necessary precautions taken, the journey continued at a slightly reduced speed, the doctor in the pilot-box keeping a sharp watch ahead, with hand ready to switch off the propeller and the other to apply the tentacle-like brakes. But time passed and yet no obstruction appeared, though the alarm rang louder and louder.

Doctor Hackensaw, more and more puzzled, took a telescope from among the miscellaneous instruments in the cupboard, and gazed long and earnestly down into the pit, suddenly he gave a cry:

"There's a light ahead of us!" he exclaimed.

Pep and Miggs each took a turn at the instrument—Sure enough—Miles ahead of them at the bottom of the pit there appeared a faint greenish phosphorescent light.

And now, as they advanced, the light became stronger and stronger, and an hour later the car emerged from the pit into an enormous cavern lit up with a sort of diffused phosphorescent light.

Doctor Hackensaw, with a dexterous turn of the rudder brought the car around so as to coast along the nearest wall of the cavern.

"Pep!" said the Doctor impressively, "I was right!" The earth is evidently hollow at the center, and here we are in the hollow center. But see, even here there are animals and plants of some kind, though like nothing with which we are familiar. Everything seems phosphorescent. See those strange shapes fastened to the rock-resembling plants, yet some of them like animals! See those others sprawling and crawling and emitting electric flashes from time to time. And see those curious creatures flying in the air over there, some with six feet, some with no feet at all, some with wings and others with fins or bladder-like balloons to propel them by ejecting air backwards. Truly we see before us one of the most marvelous sights ever witnessed by man!"

(To be continued)

What a whale of a difference just a few cents make

### The Experimenter

has come back! If you are one of the one hundred thousand readers of the old ELECTRICAL EXPERIMENTER, you will no doubt be glad to hear that the EXPERIMENTER is coming back BIGGER AND BETTER THAN EVER. PRACTICAL ELECTRICS has been changed into an entirely new kind of magazine entitled

### The Experimenter

In this magazine which has been greatly enlarged in point of contents, illustrations and circulation, you will find the following new departments:

- Experimental Radio
- Experimental Chemistry

There is an entirely new treatment of radio containing experiments only. 90% of the magazine contains pure experiments written by the foremost authorities in their respective fields, also a monthly editorial by the writer.

A fine roto-gravure section is now added to brighten up the magazine. If you want experiments, this is your magazine.

Be sure to reserve a copy from your news-dealer before the issue is sold-out. The next issue of THE EXPERIMENTER will be on sale at all newsstands beginning July 20th, 1925.

**Hugo Gernsback**  
Editor

## BLISS ELECTRICAL SCHOOL

A special technical school with concise but comprehensive course in Electrical Engineering. Non-essentials eliminated. Thorough knowledge of underlying principles emphasized. Theory and practice are closely interwoven in class-room and laboratory.

### Electrical Engineering in One Year

The course is designed for earnest, ambitious young men of limited time and means. Curriculum includes mathematics, mechanical drawing and intensive shop work. Students construct motors, install wiring, test electrical machines. Graduates are qualified to enter the electrical field at once.

Bliss men hold responsible positions throughout the world. Thoroughly equipped fire-proof dormitories, dining hall, laboratories and shops. Prepare for your profession in the most interesting city in the world. Established 1893. Send for catalog. Address

**BLISS ELECTRICAL SCHOOL, 248 Takoma Avenue Washington, D. C.**

**\$150 to \$300 PROFIT MONTHLY FROM HB ONE DAY BATTERY CHARGING**

You can easily start a battery charging business that will pay \$150 to \$300 clear monthly profits. No experience needed to operate H.B. One Day Battery Charger. Universal demand for quick charging of auto and radio batteries. Only \$35 cash brings a complete HB One Day Battery Charging Outfit, ready to use. Lowest-priced complete outfit on the market. Your monthly profits easily carry the small monthly payments. 30 days' free trial or money back guarantee. Write for free bulletin. Start your own money-making business.

**HOBART BROS. CO. Box 58 TROY, OHIO**

**MAKE YOURS THE SHOP WITH HB ONE DAY BATTERY CHARGING**

**The World at Your Feet!**



**8-POWER WAR BINOCULARS**

**ARRIVED!** Limited quantity GENUINE Imported French and German Army Officer's Binoculars. 8-Power. Achromatic lenses; Premier Quality—Genuine Prisms; high luminosity; remarkable light-gathering, light-transmitting property; Prisms in each barrel permit of great field of vision, many times the area of Field Glasses. We have supplied hundreds of them to U. S. Army and Navy Officers. Such powerful Binoculars usually sell for \$40 to \$50. Our price (while they last) complete with genuine leather case and carrying straps **\$21**

**10-DAYS' FREE TRIAL**

Send NO Money! NOTHING To Pay Postman! See them! Examine them! Try them! If satisfied, after 10 DAYS' TRIAL, you may pay at rate of **\$4 A MONTH**

or, if you wish to pay cash, after 10 DAYS, take \$1.50 Discount and send check or money order for **\$19.50**

**BROADEN** your field of vision! Don't live in a cooped-up area! A new world will open up for YOU with a pair of these wonder Glasses. You'll see things others can't. People. Scenes. Views. Games of ACTION brought right to your feet! The joys of outdoors are not complete without them. The greatest pleasure giving INVESTMENT one can make. Indispensable for sports—baseball games, motoring, camping, yachting, hunting, hiking, races, bird and nature study, etc.

Sent on 10 Days' FREE TRIAL!

**ACT! QUANTITY IS LIMITED! ORDER TODAY! Send NO Money!**



2 Generations of Honorable Dealings  
**WASHINGTON JEWELRY CO.**

Importers and National Mail Order House

365 Washington Street, Boston, Mass.

For Prompt Attention address Import Dept. 44

Gentlemen: Please send me 8-power Binoculars. I enclose NO money, and pay NOTHING to Postman. If I am satisfied after 10 DAYS' TRIAL, I have the privilege of paying for them at the rate of \$4.00 monthly—or of deducting \$1.50 and sending \$19.50 in FULL SETTLEMENT. Otherwise, I shall return them.

NAME \_\_\_\_\_  
ADDRESS \_\_\_\_\_

Please write PLAINLY! Tear this coupon out NOW! If you wish to tell us something about yourself it will be appreciated. SIAug.

**LEARN**



**AVIATION**

At Home in your spare time.  
Be an expert Airplane Engineer.

**Earn \$3,500 to \$10,000 a Year**

Practical course—takes only a few months. Write for special offer on free airplane parts and free catalog.

**WESTERN AIRPLANE CORPORATION**  
Dept. S-8 Monadnock Block Chicago



**"LIGHTING FIXTURES" READY TO HANG**

Direct from the manufacturer. Completely wired including glassware. Send for new Catalogue No. 27 (Just reduced prices)

Special Proposition to Dealers  
**ERIE FIXTURE SUPPLY CO.**  
Desk B Erie, Pa.

**Motor Hints**

By **TOM C. PLUMRIDGE**  
**CLUTCH TROUBLE AND CURES.**

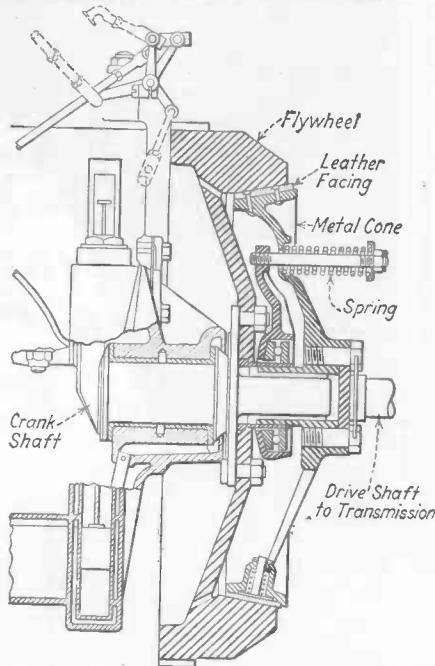

Cross-section of a typical cone clutch is shown above. All of the component parts are plainly marked for future reference.

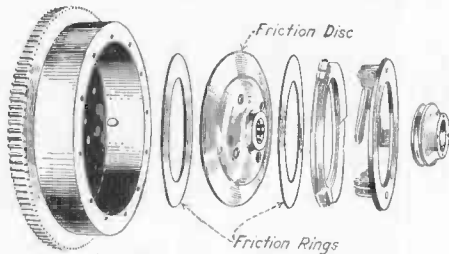

A disassembled single plate clutch. The flywheel acts as one clutching surface against which a fabric ring makes contact. A metal disk, marked friction disk, and a second friction ring complete the power transmission members.

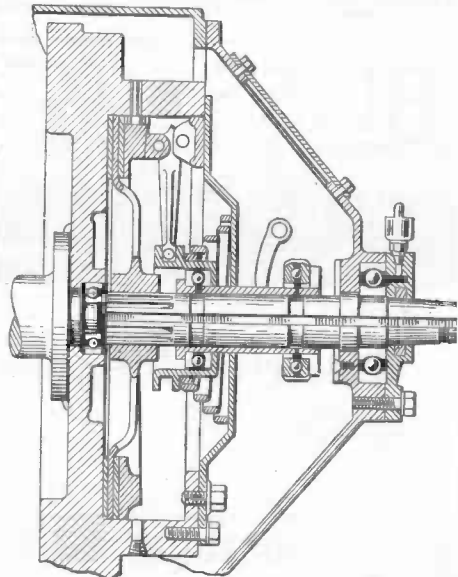

An assembled single plate clutch is shown in cross-section above. The single disk is moved by means of a toggle arm which in turn is actuated by the clutch pedal, thereby removing the pressure between the single disk and the friction ring pressing against the flywheel.

*A new Parks!*

**Cabinet Shop Special**

No. 7

**\$250**

AS ILLUSTRATED WITH MOTOR



**THE MOST POPULAR MACHINE PARKS EVER BUILT!** A winner from the start. A real machine, yet convenient size for the small shop. Does everything in woodworking. Has circular rip and cut-off saw, 6-inch jointer, 16-inch bandsaw. Lathe and shaper attached if desired at small cost. Operates from any light socket. Just plug in and go to work!

Write for interesting circular

**The Parks Ball Bearing Machine Co.**

1553 Knowlton St., Cincinnati, Ohio

Canadian Fac: 200 Notre Dame East, Montreal, Can.

**PARKS**  
WOODWORKING MACHINES

**New Easy Way to Learn CARTOONING**



You can now quickly learn to make comics, sport cartoons, animated and serious cartoons, etc. Cartooning is lots of fun—and fun that pays big money! Learn cartooning at home in spare time this amazingly easy way.

Send for Free Book

Mail postcard or letter today for Free Book on Cartooning. It tells all about this easy method perfected by one of America's most successful cartoonists—also is filled with interesting facts about cartooning. Mail card TODAY! Give Age if under 16 years.

**Washington School of Cartooning**  
Room 268-C, 1113-15th St., N. W., Washington, D. C.

**FREE Electrical Training Book**

Mail postcard for amazing FREE book on electricity. Shows you how to earn \$150 to \$600 a month in this immense field. Famous S & H shop-type training fits you quick at home for big jobs. Exclusive system. Lack of experience or education no bar. Write.

**S & H ENGINEERING CO.,**  
1422 W. Monroe St., Dept. K-2, Chicago, Ill.

**Young Men— Turn Your Spare Time Into Money**

Earn big profits, prizes, and awards selling **RADIO NEWS, SCIENCE & INVENTION, THE EXPERIMENTER, and MOTOR CAMPER & TOURIST** in your neighborhood. We train you as our salesman and pay you liberally for your time. Write at once and we will help you to get started.

M. BRIDWELL.

**The Experiment Publishing Co.**  
53 Park Place, New York, N. Y.

# Become a Commercial ELECTRICAL ENGINEER



In One Year  
Or an ELECTRICAL SPECIALIST  
In Three Months  
AT THIS FAMOUS SCHOOL

Modern industry demands Electrically trained business men, consulting and efficiency engineers, men who can handle Commercial, Automotive and Engineering problems.

Twenty years of earnest research and careful study of prevailing conditions in the electrical world have induced this recognized school to offer this unexcelled course, which covers:

1. LIGHT, HEAT AND POWER WIRING AND TESTING
2. D.C. AND A.C. MOTORS AND GENERATORS, POWER TRANSMISSION, ARMATURE WINDING, MAINTENANCE AND REPAIR, MOTOR GENERATOR WORK.
3. AUTOMOTIVE ELECTRICITY, including IGNITION, STARTING, LIGHTING AND STORAGE BATTERIES FOR AUTOMOBILES, TRUCKS, TRACTORS, AEROPLANES, ETC.
4. RADIO SALES, SERVICE, BUILDING AND BROADCASTING

EACH SECTION COMPLETE IN ITSELF, REQUIRING THREE MONTHS. Tuition reasonable. In addition to these sections, C. E. E.'s will receive training in Commercial Law, and Academic subjects. Write for Information. Be sure to mention age, education and course interest in

## SCHOOL OF ENGINEERING of Milwaukee

Dept. S&I-925, 415-417 Marshall St., Milwaukee, Wis.

# Will You Wear This Suit?



Show it to your friends and neighbors as a sample of our fine quality, hand-tailored All-Wool Suits, guaranteed \$40 values at amazing low price of \$23.50, take their orders, keep handsome profit for yourself and send orders to us.

## Agents Making BIG MONEY

\$3.00 to \$5.00 an hour in spare time, \$75 to \$150 a week for full time. We supply handsome Swatch Line Outfit, large size samples and all latest styles in elegant Leather Case. Positively finest selling outfit ever furnished salesmen. Write for yours at once, pick out your suit and get started making the Big Money right away. Address Dept. 133

**JAMES OLIVER, Inc.**

848 W. Adams Street Chicago  
Write name and address below and mail at once.

Name.....  
St. and No..... R. F. D..... Box.....  
Town..... State.....

## BLANK CARTRIDGE PISTOL

Protection against Burglars, Tramps, & Dogs

PRICES  
50c.  
\$1.00



Well made and effective model of latest type of Revolver; appearance alone is enough to scare a burglar. When loaded it may be as effective as a real revolver without danger to life. It takes standard 22 Cal. Blank Cartridges obtainable everywhere. Price 50c., Superior quality \$1.00 post-paid. Blank Cartridges, by express, 50c per 100.

JOHNSON SMITH & CO., Dept. 402 Racine, Wis.



Jobbers, Dealers, Agents—Make big money selling NOGLARE Attachments for Automobile Headlights. Made of steel that will not break or wear. NOGLARE Attachments simply fit in back of original lens, eliminating the glare entirely. It takes the place of dimming lights, buying special lens or painting them. Send \$1.00 for sample set and further particulars. Featured in 30 National Magazines. NOGLARE MFG. CO., 22 Quincy St., Chicago

Insure your copy reaching you each month. Subscribe to Science & Invention—\$2.50 a year. Experimenter Publishing Co., 53 Park Pl., N. Y. C.

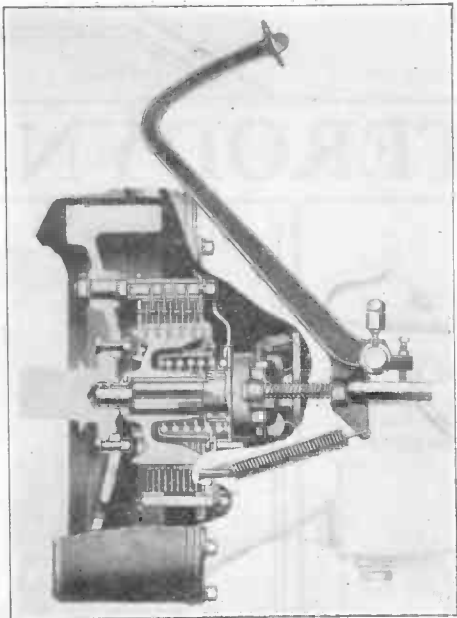

A third type of clutch known as the multiple disk is shown above. A series of disks between which are fabric rings attached to metal rings, constitutes the friction surfaces. The metal rings slide on keys which are on drums attached to the fly-wheel, while the combination fabric and metal rings are attached to the clutch spider which turns with the driven shaft.

Treat facing with neats foot oil after roughing with a file

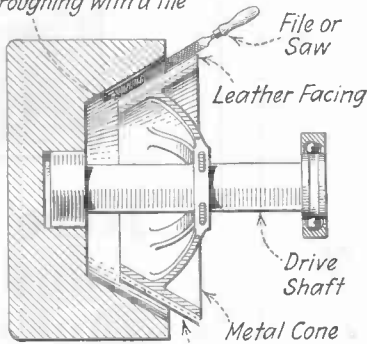

Block clutch pedal so that cone will stay in this position

When a cone clutch starts to slip, it means that the surface of the leather cone has either become glazed or that it is covered with grease and oil. In either event, block out the clutch as shown, roughen the surface of the leather with a file or saw blade and then treat with neatsfoot oil. Leave clutch in this position until oil has a chance to soak into leather. In emergency use Fuller's earth.

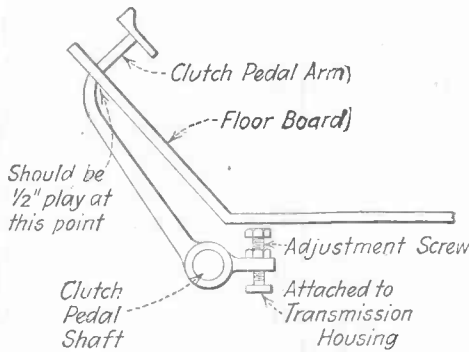

Should be 1/2" play at this point

Another cause of slippage in a clutch that is often overlooked is that the clutch pedal arm may be touching the floor board as shown above. The remedy is to change the adjustment screw until there is one-half inch play at the point indicated. The clutch may then be readjusted. A weakened clutch spring may be a further cause of slippage. The tension should be increased or a new spring provided.

# Learn Electricity by Actual Work



Students Winding Huge Stator

# In the Great Shops of Coyne

## Complete Training in 12 Weeks

Get into the BIG PAY FIELD. The whole world of Electricity is open to you as a COYNE-trained Electrical Expert. 12 weeks from now you can be an Electrical Expert no matter what you are doing today. Make this the most profitable and enjoyable summer of your life. Come to Chicago on beautiful Lake Michigan, the greatest Summer Resort City and the Electrical Center of the world. I'll pay your Railroad Fare from any place in the United States! Clip Coupon Now for Full particulars and for Big Free Book.

## Earn \$60 to \$200 a Week

Coyne training is practical, money-making training—not correspondence. You work on the greatest outlay of Electrical Machinery in any school in the country, everything from Doorbells to Power Plants—everything to make you a thoroughly-trained BIG-PAY EXPERT.

## You Don't Need Education or Experience

It makes no difference how little education you have had, or what kind of work you are doing now, I'll make you an Electrical Expert through the COYNE LEARN-BY-DOING METHOD! I have done it for thousands—I will do it for you!

## Radio—Auto Electricity Course and Railroad Fare FREE!

I'll pay your Railroad Fare to Chicago, from any place in the United States if you act quick! And right now I am including absolutely free of extra charge, my complete Radio Course and Auto, Truck, and Tractor Electricity. CLIP COUPON NOW!

### Hear Coyne On the Air

250 Meters  
Be sure to listen in on the Coyne Radio Station. Tuesday, June 16 and June 23, 10:30 P. M., Daylight Saving Time. H. C. Lewis will speak.

### Earn While You Learn

My Employment Department helps you get a job to earn a good part of your expenses and assists you to a good job on graduation.

### Send Coupon NOW!

Don't delay a minute—get my big Free Book and full particulars of my special offer.

## COYNE ELECTRICAL SCHOOL

Dept. C533  
1300-10 W. Harrison St.  
CHICAGO, ILLINOIS

# FREE RAILROAD FARE!

MR. H. C. LEWIS, Pres.  
Coyne Electrical School, Dept. C533  
1300-10 W. Harrison St., Chicago  
Dear H. C. I sure want one of those Big handsome 12 x 15 books, with 151 actual Photographs in two colors. Send it quick. I'll be looking for it on the next mail. I'll be looking without placing me under any obligation. Be sure and tell me about the Free Railroad Fare and Two Free Courses.

Name.....  
Address.....  
City..... State.....

# The SUPER-HETERODYNE

## USE THIS BLANK TO ORDER

Just clip out this coupon, check the patterns or books you want and mail it to us with full remittance.

The Consrad Co., Inc.  
233 Fulton St., New York, N. Y.

Gentlemen: I have checked below the patterns and books I desire. Enclosed find \$....., the full price. Kindly send me the items checked postpaid.

### Consrad Patterns—50c each

- .... No. 2. How to Make a Two-Stage Amplifier.
- .... No. 4. How to Make a Reinartz Receiver.
- .... No. 5. How to Make a Reflex Receiver.
- .... No. 6. How to Make a Cockaday Receiver.
- .... No. 7. How to Make a Neutrodyne Receiver.
- .... No. 8. How to Make the Autoplex Receiver.
- .... No. 9. How to Make the S. T. 100 Receiver.
- .... No. 10. How to Make the Ultradyne Receiver.
- .... No. 11. How to Make a Five Tube Cockaday Receiver.
- .... No. 12. How to Make a Portable Receiver.
- .... No. 13. How to Make a Harkness Receiver.
- .... No. 14. How to Make the Original Genuine Super-Heterodyne. List \$1.00.
- .... No. 15. How to Make a Low Loss Receiver.
- .... No. 16. How to Make a Tropadyne Superadio.
- .... A. Radio Map of the U. S. on Cloth.
- .... B. 20 Radio Diagrams and Hook-ups. New Edition.
- .... C. All About Aerials and Their Construction.
- .... D. Radio Amateurs Practical Design Data.

### Radio Books—25c each

- .... No. 1. Tips for the Radio Constructor.
- .... No. 2. How to Make Practical Radio Receivers.
- .... No. 3. Radio Questions Answered.
- .... No. 4. Radio Frequency Amplification.
- .... No. 5. Loud Talkers and How to Build Them.
- .... No. 6. How to Tune Your Radio Set.
- .... No. 7. One Hundred Radio Hook-ups. New Edition.
- .... No. 8. All About Radio Parts.
- .... No. 9. History and Operations of Vacuum Tubes.
- .... No. 10. The Neutrodyne and All About It.
- .... No. 11. How Radio is Received.
- .... No. 12. How to Locate Troubles in Your Radio Set.
- .... No. 13. Reflex Radio Receivers.
- .... No. 14. The Super-Heterodyne Theory and Construction.

### Special Books

- .... Radio News Amateurs' Handibook.....\$1.00
- .... Radio Log Book..... .50
- .... Wireless Course in 20 Lessons—Leather Binding 2.00
- .... The Radio Instructor..... 1.00
- .... The Radio Listeners' Guide & Call Book..... .35
- .... The Radio Review, 35c the copy.....\$2.50 the year

Name .....

Address .....

City ..... State.....

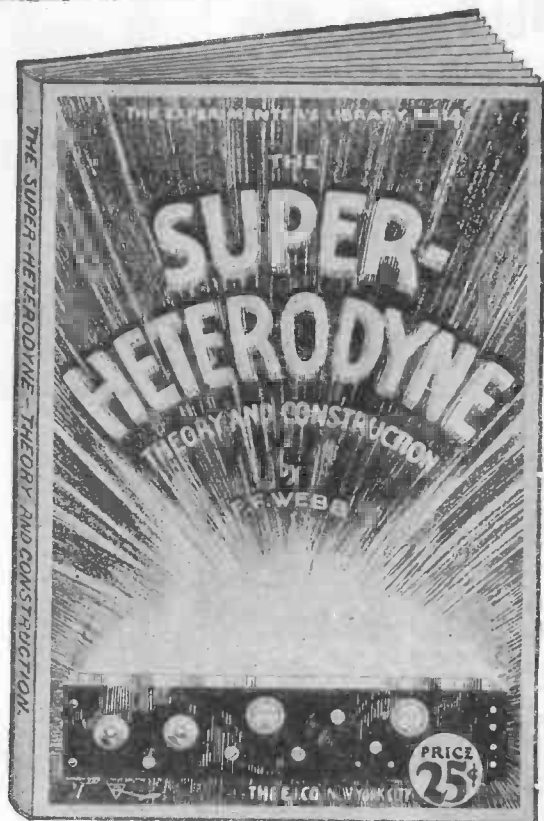

Here's the finest, most complete book of data and information ever compiled on the Standard Super-Heterodyne.

This is the big book of instruction and information on the various standard "supers" in common use today; a complete, up-to-the-minute, impartial 64-page book covering all the builder or user of this type of set might want to know. The Super-Heterodyne is written by a radio authority who not only has years of trade and practical experience but is constantly designing modern radio apparatus. It is a handy useful size, 5½ x 7½ inches, printed clearly, profusely illustrated, easy to read and bound with a handsome two color cover.

This is the very latest of the complete library of Experimenters Handbooks on radio, a list of which is printed on this page. These books are complete practical guides to almost every important phase of radio transmission and reception.

The famous Consrad patterns are also listed on this coupon for your convenience. They are radio's finest patterns for the building of the most successful standard receivers.

You can get any of these books or patterns at your radio or news dealer or direct from us by using the coupon attached to this page.

## The CONSRAD COMPANY

Sole distributors to the E. I. COMPANY  
233 Fulton St. New York, N. Y.

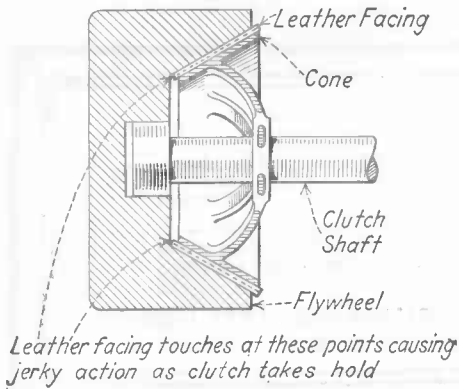

A clutch that "grabs" or engages so suddenly that the car is jerked ahead is often caused by the facing extending beyond the edge of the cone as shown above, whereupon this facing, not backed by the steel cone will touch the fly-wheel first and then upon further engagement of the clutch, the rest of the leather facing will be suddenly forced into contact with the fly-wheel, causing a terrific jerk.

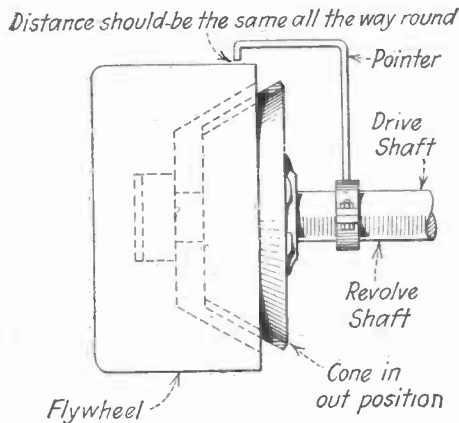

Another cause of a grabbing clutch is the shafts being out of line. This can be determined as shown above. Attach a pointer to the inner cone shaft and with the clutch in the disengaged position, revolve the shaft. The pointer should be so adjusted that it is close to the fly-wheel as shown. If the distance varies during rotation, the shafts are out of line. If the pointer indicates the same position throughout the entire revolution, the shafts are true and need no adjustments.

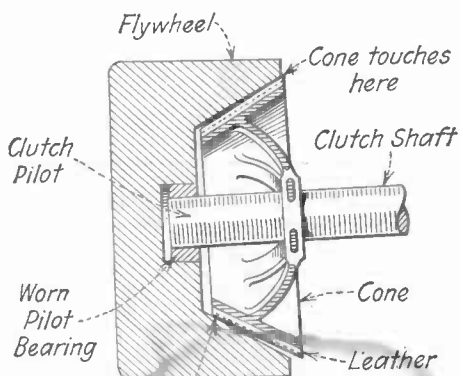

Cone touches here. Causes drag and hard gear changing

When a cone clutch does not readily disengage to allow easy changing of gears, the trouble is often caused by the clutch pilot bearing becoming worn, causing the front end of the clutch shaft to drop down as shown above. This is also a cause for a grabbing or jerky clutch. The only remedy for trouble of this nature is the installation of a new pilot bearing.

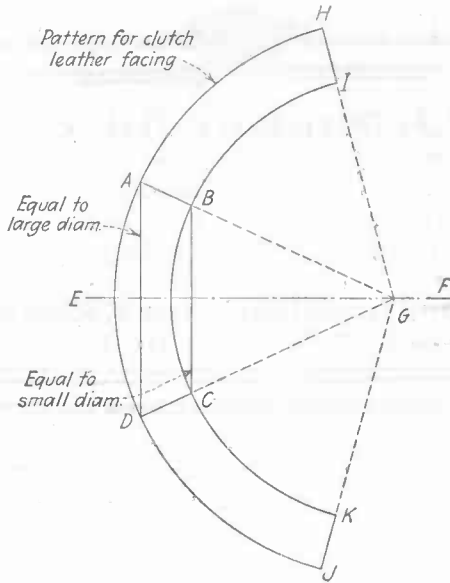

After a period of use, the clutch leather on a cone clutch must be renewed. If possible, the lining should be purchased from the manufacturer in one piece, but if not, a pattern may be made as above and a facing cut from leather. First measure the small diameter of the cone, then the large diameter, and lay out on a large piece of paper a figure as shown above marked ABCD. Draw a center line EF and extend lines AB and DC to meet at G. Draw the arcs HADJ with point G as a center and IBCK. Cut the length of the leather slightly shorter than is required.

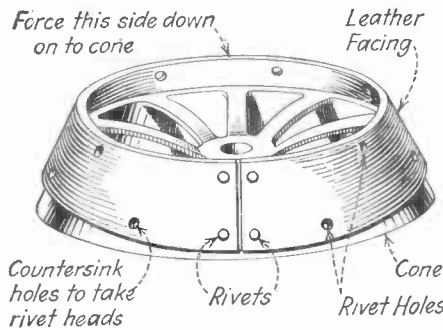

The next procedure is to rivet the two ends in place on the cone as shown, and then force the leather facing down over the steel cone. Rivet in place, countersinking the holes in the leather so that the rivet heads will be below the surface. Troubles and cures for disk clutches will be taken up in an early issue.

### Electric Typewriter

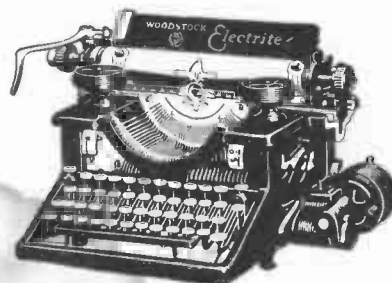

An electric typewriter which types each character with an even impression is illustrated above. The operator touches the keys lightly and electricity does the rest. The machine operates as fast or as slow as the typist desires.



## Needed in Aviation!

Do you love adventure? Do you want to make big money? Although aviation is still in its infancy there is a crying demand for men with courage, nerve, and self-reliance—ambitious men who are looking for a new field. For those who qualify there will be thousands of highly paid jobs.

### Amazing Opportunity in the Airplane Industry

Yes, as yet, aviation is in its infancy, but now is the time to get in. In the automobile industry and in the moving picture business hundreds of men got rich by getting in at the start. They made their success before others woke up.

Think how much aviation has progressed in the last few years. Commercial air lines have already proved themselves successful both in Europe and America. Great men predict that in the near future there will be air-freight lines—organizations as large as our railroads are today. AVIATION IS NEW. It clamors for every young man.

### Be an Aviation Expert—\$50 to \$100 a week

The study of aviation is as fascinating as the actual work. Only one hour of spare time a day at home and we teach you the basic training. You will find every lesson packed full of interest. Student S. F. McNaughton, Chicago, says, "Your lessons are like a romance, and what is more, after one reading the student gets a thorough understanding." Men who have had actual experience guide you carefully through your training. They select the lessons, lectures, blueprints, and bulletins. Once you start you can't get enough of it. Here are some real jobs. Which one do you want? Aeronautical Instructor, Aeronautical Engineer, Aeronautical Contractor, Aeroplane Salesman, Aeroplane Repairman, Aeroplane Mechanician, Aeroplane Inspector, Aeroplane Assembler, Aeroplane Builder.

### Big Aviation Book FREE

Send coupon below for our new FREE book just out entitled, "Opportunities in the Airplane Industry." It is interesting and instructive. Get yours before edition is exhausted.

**AMERICAN SCHOOL OF AVIATION**  
Dept. 142C 3601 S. Michigan Ave., Chicago

**AMERICAN SCHOOL OF AVIATION**  
Dept. 142C 3601 S. Michigan Ave., Chicago  
Without any obligation send me your free book "Opportunities in the Airplane Industry," also information about your Home Study Course in Practical Aeronautics.

Name.....  
Address.....  
City..... State.....

## Opportunity Ad-lets

**YOU** will find many remarkable opportunities and real bargains in these columns. It will pay you to read and investigate the offerings made every month by reliable firms, dealers and amateurs from all over the country. No matter what you may be seeking, whether supplies, automobile accessories, the opportunity to make money, or anything else, you will find listed here the best and most attractive specials of the month.

Advertisements in this section twelve cents a word for each insertion. Name and address must be included at the above rate. Cash should accompany all classified advertisements unless placed by an accredited advertising agency. No advertisement for less than 10 words accepted. Ten per cent. discount for 6 issues, 20 per cent. discount for 12 issues. Objectionable or misleading advertisements not accepted. Advertisements for the October issue must reach us not later than August 10th.

**The Circulation of Science and Invention is over 175,000 and climbing every month**

EXPERIMENTER PUBLISHING CO., INC., 53 Park Place, New York City, N. Y.

### Agents Wanted

**Agents—Best seller; Jem Rubber Repair** for tires and tubes; supercedes vulcanization at a saving of over 800 per cent; put it on cold. It vulcanizes itself in two minutes and is guaranteed to last the life of the tire or tube; sells to every auto owner and accessory dealer. For particulars how to make big money and free sample, address Amazon Rubber Co., Dept. 601, Philadelphia, Pa.

**Agents—Write for Free Samples.** Sell Madison "Better-Made" Shirts for large Manufacturer direct to wearer. No capital or experience required. Many earn \$100 weekly and bonus. Madison Mfgs., 511 Broadway, New York.

**Big money and fast sales.** Every owner buys gold initials for his auto. You charge \$1.50; make \$1.35. Ten orders daily easy. Write for particulars and free samples. American Monogram Co., Dept. 71, East Orange, N. J.

**Earn big money fast applying gold initials to autos.** Every owner buys—\$1.45 profit on \$1.50 sale—particulars and samples free. Write quick. Lithogram Co., Dept. 19, East Orange, N. J.

**Earn \$10 daily silvering mirrors, plating and refinishing** metalware, chandeliers, bedsteads, headlights. Outfits furnished. N. Decie Laboratories, 1133 Broadway, New York.

**\$60—\$200 a week.** Genuine Gold Letters for store windows. Easily applied. Free samples. Liberal offer to general agents. Metallic Letter Co., 441 B., North Clark, Chicago.

**Write and learn how to start profitable business without** capital or experience. Silvering mirrors, refinishing auto headlights, tableware plating. Outfit furnished. International Laboratories, Dept. 25, 309 Fifth Ave., New York.

**\$10 daily silvering mirrors, plating and refinishing lamps,** reflectors, autos, beds, chandeliers by new method. Outfits furnished. Write Gunmetal Co., Ave. D, Deatur, Ill.

**Wonderful invention eliminates needles for phonographs.** Preserves records. Abolishes scratching. Day's supply in pocket. \$20 daily. Sample on approval if requested. Everplay, Desk H8, McClurg Bldg., Chicago.

**Agents Wanted Full or Part Time to Sell on liberal** commission new Thermostatic Automatic Carburetor control Attachment for Ford cars. Increases mileage 100%. No holes to drill. Attached in 2 minutes. Does automatically what Ford Manual instructs driver do by hand. Cadillac now using Thermostatic Carburetor Control under Blanche license. Write at once. A. C. Blanco & Co., Dept. 863LX, 602 W. Lake St., Chicago.

**Rummage Sales Make \$50 Daily.** Offer wonderful values. We start you. Wholesale Distributors, Dept. 171, 609 Division St., Chicago.

**Big Money and fast sales; every owner buys gold initials** for his auto. You charge \$1.50, make \$1.44, 10 orders daily easy. Samples and information free. World Monogram, Dept. 32, Newark, N. J.

**Make \$25 to \$50 week representing Clows' Famous Philadelphia** History, direct from mill—for men, women, children. Every pair guaranteed. Prices that win. Free book "How to Start" tells the story. George Clows Company, Desk 27, Philadelphia, Pa.

**Skat Sales Agents Wanted.** All or Part Time for Skat Hand Soap, Metal Polish, etc. Strictly Commission. The Skat Company, Hartford, Conn.

**New camera takes and finishes photos in one minute.** Make money selling cameras or taking photos. Exclusive territory. Crown Co., Dept. 966, Norwalk, Conn.

**Agents—Make \$75 to \$100 a week.** "Fixit" Rubber Repair seals punctures and blowouts. Sample free. Marquette Rubber Company, 2325 N. Wolfram St., Chicago.

**Easy Money Applying Gold Initials.** Monograms on automobiles. Anyone can do it. Simply transferred from paper; takes 5 minutes. Make \$1.50, cost 5c. Samples free. "Ralco," 325 Harrison, Boston, Mass.

**More Agents Needed: Our famous Food Products, Soaps,** Beauty Creams, now sold on Credit. Get new plan quick. Blair Laboratories, Dept. 56, Lynchburg, Va.

**Do You Want to earn money in your spare time? We** have a wonderful offer to make ambitious men and women; no previous experience necessary; no money required; write today for plans. American Products Co., 2366 American Bldg., Cincinnati, Ohio.

**Succeed With Your Own Products—Formulas, Processes,** Trade-Secrets. Modern Master methods. Catalog free. D. Thaxly Co., Washington, D. C.

**Fords! 60 Miles on one gallon of gas! It has been** proven such mileage can be made. Airlock guaranteed to increase gas mileage. Prevents radiator boiling in Summer, Freezing in Winter. Positively Cools. Fuels. Decarbonizes Ford motor. Agents making big money distributing our products. Airlock Products, Box 703E, Willow Street, Long Beach, Calif.

### Agents Wanted (Continued)

**Your spare time—You can make from \$3.00 to \$5.00 an** hour in your spare time for every hour you put in, provided you really put it in and really work. If you are willing to do this, we are willing to take you, train you and fit you out with an outfit that will make it possible for you to make such money sure and from the very start. But make no mistake about it—this is no get-rich-quick, easy-money scheme. It is a straightforward legitimate selling proposition for men who are salesmen or ambitious to be and want to put their spare time to good use. Ordinarily we don't bother with spare-time men, but we are willing to take and train a few men of character who will really work and make it worth their while and ours. If you are such a man let us hear from you. We'll consider your application carefully and give you a quick decision. Address Dept. 531, William C. Bartlett, Inc., 850 West Adams Street, Chicago.

**Only one sale a day means \$200 per month! Marvelous** new adding machine. Retail \$15.00. Work equals \$550 machine. Adds, subtracts, multiplies, divides, automatically. Computes feet and inches. Speedy, accurate, durable, handsome. Five year guarantee. Offices, stores, factories, garages, lumbermen buy one to dozen. A fortune for five agents. Write quick for protected territory and free trial. Lightning Calculator Co., Dept. W, Grand Rapids, Michigan.

**Representative wanted for this territory.** Wonderful value Men's, Women's, Children's shoes direct, saving Wearer over 40%. 72 Styles. Experience unnecessary. Permanent steadily increasing income. Write today. Tanners Shoe Mfg. Co., 7-468 C St., Boston, Mass.

**Agents—Sell my Gillette style razor blades.** Sample dozen 25c. Liberal commission. P. Wetterquist, 1635-S 13th Ave., Rockford, Ill.

### American Made Toys

**Opportunity to start Manufacturing Metal Toys and Novelties.** No experience necessary. Enormous demand exceeds supply. We furnish, at cost, casting forms for production and buy entire output, also place yearly contract orders. Casting forms made to order. Catalog, advice and information free. Metal Cast Products Co., 1696 Boston Road, New York.

### Battle Photos and War Relics

**For Dens: Relics Collected from Europe's Battlefields.** Firearms, medals, helmets, etc. Illustrated catalogue and sample War photographs 25c. Lieut. Welch, 1889 Albany Ave., Brooklyn, N. Y.

### Books

**Free—Upon request will send you my literature illus-** trating the following books. Astrology, Character, Clairvoyance, Concentration, Healing, Hypnotism, Magnetism, Mediumship, Personal Magnetism, Personality, Physiology, Salesmanship, Seership, Success, Sex, Will, Yoga Philosophy, Gazing Crystals, etc. A. W. Martens, E. E. 6, Burlington, Iowa.

**"Stepping Stones To Wealth."** This book contains 1,000 plans, formulas and trade secrets. A sure money maker. Price \$1.00. Wittman Agency, 3629 E. 50th St., Cleveland, Ohio.

### Business Opportunities

**Dollars yearly in your backyard.** No mushroom dope. Particulars free. Metz, 319 East 89th, New York.

**You can have a business-profession of your own and earn** big income in service fees. A new system of foot correction; readily learned by anyone at home in a few weeks. Easy terms for training, openings everywhere with all the trade you can attend to. No capital required or goods to buy, no agency or soliciting. Address Stephenson Laboratory, 18 Back Bay, Boston, Mass.

**Stop Plodding! Be Successful.** Operate a Tire Repair Shop. Make big profits in any locality. We teach you and furnish complete equipments \$100 up. Book of Opportunity free. Haywood's, 1312 South Oakley Avenue, Chicago.

**Get Money in Your Mail.** "Lambert's Mail Order Secrets" contains successful methods never before published. \$1.00 postpaid. Particulars free. Leon Lambert, Wichita, Kansas.

**Import Your Own Goods.** Big German Export Magazine published in English offers thousands of bargains in latest novelties. Sample copy 50c. Opportunity for obtaining profitable agencies. K. Abea Specialty Co., 263 5th Ave., New York City.

**Do you know even a little about Drafting or Engineering?** Thousands of Opportunities in new expert profession. Calculating Strength of Beams, Girders and Machine Parts. Needed on every modern building, bridge, machine. We teach principles and "short cuts." Write for free book. Pleasant Work, High Salaries. Lightning Method Publishers, Long Beach, Calif.

**Mail Order Business is your opportunity for independent** business. Start in spare time and grow. Let us show you how. Special three months subscription 25c. Mail Order Bee, Woodville, Okla.

### Chemistry

**Learn Chemistry at Home.** Dr. T. O'Connor Sloane noted educator and scientific authority, will teach you. Our home study correspondence course fits you to take a position as chemist. See our ad on page 301 of this issue. Chemical Institute of New York, 66 W. Broadway, New York City.

### Correspondence Courses

**Used correspondence courses of all schools sold, rented** and exchanged. List free. (Courses bought.) Lee Mountain, East Chattanooga, Tenn.

### Electric Motors

**Motors \$2.98.** Good, Practical, 115 volt alternating-direct current, twentieth horsepower. Order now. Pay Postman. Perry Trading Company, Dept. 17, 815 Lake, Racine, Wis.

**Motors \$2.98.** Good, Practical twentieth horsepower, 115 volt alternating direct current. Order now. Pay Postman. Perry Trading Company, Dept. 18, Lake, Racine, Wis.

### For Inventors

**We Develop Your Ideas Into commercial shape for pre-** sentation to purchasers making working models, drawings, experiments or tests. Courtesy, efficiency, secrecy and ample equipment; 30 years' experience. Ducorron-Rich Engineering Co., 504 Pacific Mutual Bldg., Los Angeles, Cal.

**Unpatented Ideas Can Be Sold.** I tell you how and help you make the sale. Free particulars (Copyrighted). Write W. T. Greene, 808 Jenifer Bldg., Washington, D. C.

**Your Chemical problems solved and working process fur-** nished for Five Dollars. Write me. W. Stedman Richards, Consulting Chemist, Box 2102, Boston, Mass.

**Patents are expensive.** Your ideas can be sold without this expense. Complete instructions. \$2. Box 61, Pontiac, Michigan.

### For the Photographer

**Have you a Camera? Write for free sample of our big** magazine, showing how to make better pictures and earn money. American Photography, 118 Camera House, Boston, 17, Mass.

### Games and Entertainment

**Free with \$25 order our large die box.** Send 20c for our large catalogue of tricks, puzzles, wigs, sensational escapes, Oaks Magical Co., Dept. 549, Oshkosh, Wis.

**Magic Trick Cards that are absolutely guaranteed.** Free samples. Write me today. C. D. Blankenship, Adrian, W. Va.

**Book of Magic and Illustrated Catalogue 10c.** Piedmont Novelty Shop, Box 631, Danville, Va.

### Health

**Free—Stop using tobacco.** We will give free information how to conquer habit easily and permanently. Results guaranteed. Anti-Tobacco League Box M, Omaha, Neb.

### Help Wanted

**Silvering Mirrors, French plate.** Easily learned, immense profits. Plans free. Wear Mirror Works, Excelsior Springs, Mo.

**All men-women, 18 to 65, wanting to qualify for Govern-** ment Positions, \$140-\$300 monthly, home or traveling, write, Mr. Ozment, 293, St. Louis, Mo., quickly.

**Detectives Earn Big Money.** Travel. Excellent opportunity. Great demand everywhere. Experience unnecessary. Particulars free. Write, American Detective System, 1974 Broadway, N. Y.

**Men to Build Radio Sets in spare time.** Leon Lambert, 670-H Kaufman Bldg., Wichita, Kansas.

**Government Jobs.** Become Railway Mail Clerks. Men 18-35. Commence \$1900. Common education sufficient. Specimen examination questions free. Write immediately. Franklin Institute, Dept. F21, Rochester, N. Y.

**Easy Money!** Silvering mirrors, auto parts, tableware. Outfits; Plans Free. Sprinkle, Plater, 955 Marion, Indiana.

**Absolutely no competition selling Val-Style millinery.** Every woman buys. You make \$25 to \$150 a week. Write for Special Offer and Exclusive Territory. Val-Style Hat Co., A82, Val-Style Building, Cincinnati, Ohio.

Help Wanted (Continued)

Detectives Needed Everywhere. Work home or travel. Experience unnecessary. Write, George Wagner, former Government Detective, 1968 Broadway, New York.

Instruction

Learn Chemistry at Home. Dr. T. O'Conor Sloane, noted educator and scientific authority, will teach you. Our home study correspondence course fits you to take a position as chemist. See our ad on page 301 of this issue. Chemical Institute of New York, 66 W. Broadway, New York City.

Correspondence Courses sold complete; one-third usual prices because slightly used; easy terms; money back guarantee. All schools and subjects. Write for special Free Catalog. Courses bought for cash. Economy Educator Service, H202, West 49th St., New York.

Machinery and Tools

Concrete Building Block Machines and Molds. Catalogue free. Concrete Machine Co., 305 South Third St., St. Louis, Mo.

Miscellaneous

Beautiful registered bull pups cheap. Bulldogs, 501 Rockwood, Dallas, Texas.

Pean-Orange Groves "On the Gulf" \$10 monthly. Guaranteed Care; soon produce \$500 yearly. Suburban Orchards, Dept. I, Biloxi, Mississippi.

Financial service, covering incorporating, organizing and financing by reputable corporation. Sampson Bond and Mortgage Company, Inc., Sampson Building, 65 Wall St., New York.

Moving Pictures

Movie films, 1000 ft. reels. Complete stories, \$2.50 each; shipped anywhere on receipt of remittance with order. Independent Films, 77 Golden Gate Ave., San Francisco, Calif.

Motorcycles—Bicycles

Don't buy a Bicycle Motor Attachment until you get our catalogue and prices. Shaw Mfg. Co., Dept. 6, Galesburg, Kansas.

Musical Instruments

Violins—Deep, Mellow, Soulful—on easy credit terms. High grade, wonderful instruments of my own make. Development of many years' experience. Write for book. Gustav A. Henning, 2424 Gaylord St., Denver, Colo.

Old Coins

United States 2c Bronze and bargain Price List 10c. Robert Cohen, Box 483, Muskogee, Okla.

Old Money Wanted

\$2 to \$500 Each paid for hundreds of Old or Odd Coins. Keep all old money. It may be very valuable. Send 10c for new illustrated Coin Value Book, 4x6. Guaranteed Prices. Get Posted, We pay Cash. Clarke Coin Company, 14 Street, LeRoy, N. Y.

Patent Attorneys

Patents. Send for free booklet. Highest references. Best results. Promptness assured. Send model or drawing for examination and opinion. Watson E. Coleman, Patent Attorney, 644 G Street, N. W., Washington, D. C.

Inventors write me about patents. My fees payable monthly. Booklet free. Frank Fuller, Washington, D. C.

Unpatented Ideas Can Be Sold. I tell you how and help you make the sale. Free particulars (Copyrighted 1923). Write W. T. Greene, 809 Jenifer Bldg., Washington, D. C.

Lacey Patent-Sense. "The book the inventor keeps." Free. See page 370.

"Inventors' Guide" free on request; gives valuable information and advice for all who have original ideas or improvements. Frank Ledermann, Registered Attorney and Engineer, 17th Floor Woolworth Bldg., New York.

Herbert Jenner, Patent Attorney and Mechanical Expert, 606 F Street, Washington, D. C. I report if patent obtainable and exact cost. Send for circular.

Millions spent annually for ideas! Hundreds now wanted! Patent yours and profit! Write today for free book—tells how to protect yourself, how to invent, ideas wanted, how we help you sell, etc. American Industries, Inc., 212 Kresge Bldg., Washington, D. C.

Inventors—Send for form "Evidence of Conception" to be signed and witnessed. Form, fee schedule, information free. Lancaster and Allwine, Registered Patent Attorneys in United States and Canada, 242 Ouray Bldg., Washington, D. C.

Monroe Miller, Ouray Bldg., Washington, D. C. Patent Attorney; Mechanical, Electrical Expert. Free Blue Book gives candid advice.

Patents Procured; Trade Marks Registered—A comprehensive, experienced, prompt service for the protection and development of your ideas. Preliminary advice gladly furnished without charge. Booklet of information and form for disclosing idea free on request. Richard B. Owen, 130 Owen Bldg., Washington, D. C., or 41-T Park Row, New York.

Patent Attorneys (Continued)

Get your own patents. Application blanks, complete instructions \$1. Cutting Bros., Campbell, Calif.

Patents. Time counts in applying for patents. Don't risk delay in protecting your ideas. Send sketch or model for instructions or write for Free book, "How to Obtain a Patent" and "Record of Invention" form. No charge for information on how to proceed. Communications strictly confidential. Prompt, careful, efficient service. Clarence A. O'Brien, Registered Patent Attorney, 9294 Security Bank Building (directly across street from patent office), Washington, D. C. See page 369.

Patents

Inventions commercialized. Patented or unpatented. Write Adam Fisher Mfg. Co., 205 Enright, St. Louis, Mo.

Personal

Lonely Hearts—Exchange letters; make interesting new friends through our romantic club. Write Eva Moore, Box 908, Jacksonville, Florida.

Get acquainted. Make new friends. Exchange Letters. Enclose stamped envelope for plan. The Lilly Club, Station II, Cleveland, Ohio.

Lonesome! Make new friends. Write Dolly Gray Club, Box 186K Denver, Colorado. Stamp appreciated.

Exchange Cheery Letters with new friends. Write Betty Lee, Inc., Box 820, City Hall Station, New York City. Stamp appreciated.

Lonesome! Make friends everywhere through our Club. Write Eva Burchard, Box 75, Portland, Oregon, for particulars.

Printing Outfits and Supplies

Print your own cards, stationery, circulars, paper, etc. Complete outfits \$8.85; Job Presses \$12, \$35; Rotary \$150. Print for others, big profit. All easy, rules sent. Write for catalog presses, type, paper, etc. Press Company, A-6 Meriden, Conn.

Used Printing Presses, Supplies. List. Norfolk Press Works, 1 Ballentine, Norfolk, Va.

Radio

Attention! 50 Vacuum Tube Hook-Ups. The greatest collection of Vacuum Tube Circuits ever brought under two covers at such insignificant cost. These diagrams will be found in the great "Rascos" catalogue which contains raw materials and parts in a greater profusion than any other catalogue. 15c in stamps or coin will bring the catalogue to you. Radio Specialty Company, 100 Park Place, New York City.

Boys, don't overlook this! The "Rascos" Baby Detector. Greatest detector ever brought out with molded base. Fully adjustable. See former advertisements in this publication or our catalogue. Detector with Galena Crystal complete, 50c; the same Detector with Radiocite Crystal, 75c, prepaid. Send for yours today. Radio Specialty Co., 100 Park Place, New York City.

2650 Miles Distance with one tube. Any Novice understands our Simplified Instructions. Big Free booklet tells the story. Vesco Radio Co., Box 11751, Oakland, Calif.

200,000 satisfied customers hear distant stations on Lambert Crystal Sets. Copyrighted plans \$1.00. Complete kit and plans \$5.00. Leon Lambert, 670, Wichita, Kansas.

Want to Memorize the Wireless Code? The Corydon Snyder Code Method, Patented, is quickest. Send 50c stamps, coin or M. O. to C. G. Snyder, 1423 Elmdale Ave., Chicago, Ill.

Powerful, ultra selective, four tube receiver covering 40 to 600 meters. Circuit with instructions, \$3.00. Easy when you know how. W. G. Conger, Independence, Missouri.

Salesmen—You want the greatest return for your efforts. You get it with our line of all wool suits and overcoats made to special order at low price of \$31.50. This price includes \$5.00 profit for you which you get cash with order. We also pay big cash bonuses to producers and give protected territory. Our selling outfit is without an equal in selling field. Our services unexcelled, the co-operation of our sales organization powerfully effective. If you are looking for a proposition that is genuine, and you yourself are genuinely in earnest and sincere, let us hear from you. We'll send you the full facts at once. Address Dept. 732, Goodwear Chicago, Inc., 844 W. Adams St., Chicago.

Lightning strange battery compound. Charges discharged batteries instantly. Eliminates old method entirely. Gallon free to agents. Lightning Co., St. Paul, Minn.

Envelope Sealer selling \$4 seals 8500 envelopes hour! Tremendous Demand. Exclusive Territory. Big Repeats. Write today. Free particulars. Red-E, 5110 Colonial Bldg., Boston.

Distributors—Wonderful Pricing System all stores. Absolute Protection! Exclusive Territory. Immediate repeat sale. Possibilities \$10,000 yearly! Write Millen Mfg., 100F Boylston, Boston, Mass.

A Salesman wanted in every town or city within 25 miles of a broadcasting station to sell Radiogem, the complete radio receiving set that retails for \$2.50. With Radiogem there is nothing else to buy—the outfit includes the Radio fit. The cheapest radio outfit on the market—yet as practical as the most expensive. Big money to the right men. Send \$2.00 for sample outfit. The Radiogem Corp., 66R West Broadway, N. Y. City.

Radio (Continued)

Experimental Electricity Course in 20 lessons. By S. Gernsback and H. W. Secor, E.E. A course of the theory and practice of Electricity for the Experimenter. Every phase of experimental electricity is treated comprehensively in plain English. New experiments are described and explained and nearly every application of Electricity in modern life is given. 264 pages—400 illustrations. Flexible leather cover, \$2.00 postpaid. Experimenter Publishing Co., Book Dept., 53 Park Place, New York City.

The How and Why of Radio Apparatus, by H. W. Secor, E.E. This newest book on radio matters fulfills a distinct gap in wireless literature in that, while the treatment is made as understandable and as free from mathematics as possible, it at the same time incorporates a wealth of technique and instruction for the Radio Amateur—the Radio Operator—the Installation and Designing Expert—as well as teachers and students of the subject in general. A very broad field has been covered by the author, at the same time giving a great deal of information not found in other text books. If you are engaged in any branch of the Radio or allied arts at all you will surely need this latest contribution to radio literature, which is destined to be found on every radio man's book shelf before long. A glance at the following list of chapters gives but a very scant idea of the extensive and useful radio knowledge provided in its text: The Induction Coil; The Alternating Current Transformer; Radio Transmitting Condensers; The Spark Gaps; Radio-Transmitting Inductances; Radio Receiving Tuners; Radio Receiving Condensers; Detectors; Telephone Receivers; Radio Amplifiers; Construction of a Direct Reading Wavemeter and Decimeter; Antenna Construction; The Calculation and Measurement of Inductances; Appendix containing very useful tables, covering all subjects treated in this very unusual book. This newest of Radio Works, cloth bound in vellum de Luxe, Gold Stamped and Hand Sewed, has 160 pages. Size of book 6x9 inches. The How and Why of Radio Apparatus. Postpaid, \$1.50. Experimenter Publishing Co., Book Dept., 53 Park Place, New York City.

BOYS — BIG MONEY EVERY MONTH!

WE WANT LIVE BOYS IN EVERY TOWN TO ACT AS SALES AGENTS FOR RADIO NEWS, SCIENCE AND INVENTION. THE EXPERIMENTER, AND MOTOR CAMPER & TOURIST. GENEROUS PAY—EASY WORK. WRITE TODAY! M. BRIDWELL, EXPERIMENTER PUBLISHING COMPANY, 53 PARK PLACE, NEW YORK CITY.

Salesmen Wanted

Newest Invention! Automatically takes slack and kinks from cords on telephones, electric irons, etc. \$25 daily. Sample on approval if requested. Neverknot, Dept. 87, McClurg Bldg., Chicago.

Can You Sell? All-wool, union made, tailored-to-measure suits for \$19.75. Universal Tailors, 399 Bedford Street, Boston.

Song Poems

Song Poem Writers—Send for proposition. Ray Hibelber, D24, 4040 Dickens Ave., Chicago.

Songwriters

Songwriters—We will pay \$250 advance Royalty upon publication or songs found suitable. Submit manuscripts or write for free booklet. Equitable Music Co., 1652 Broadway, New York.

Stamps and Coins

500 Mixed Stamps from 40 different countries. Australia, North, Central, and South America, Russia, Africa, China, Japan, British, French, Colonies, War issues, etc. Also 500 stamp hinges, pocket stock book, perforation gauge, and 3 United States stamps issued before 1872 all for 25c. Biggest bargain ever offered, satisfaction guaranteed or money back. Hussman Stamp Co., Dept. S.1., St. Louis, Mo.

California Gold, quarter size, 27c; half-dollar size, 53c. Columbian nickel and catalogue, 10c. Norman Shultz, Box 146, Colorado Springs, Colo.

Stamps 100 All Different 3 cents. S. I. Quaker Stamp Company, Toledo, O.

Technical School

Chicago Technical College offers short, intensely practical courses in Drafting and Engineering—civil, mechanical, electrical, structural—Architecture, Building, Construction, Plan Reading, etc. Courses fitted to your needs. No time wasted. Instructors are experts. Graduates in demand at big salaries. Opportunities for part-time work while studying. Day and evening classes. 22nd year. Enter any time. No special preliminary training required. Low tuition—easy terms. Write for 52-page illustrated Blue Book, describing opportunities open to our graduates. Chicago Technical College, 24 Chicago Tech. Building, Chicago.

Typewriters

Typewriters, all standard makes, \$10 up. Fully guaranteed. Free trial. Write for complete illustrated lists. Northwestern Exchange, 121 N. Francisco Ave., Chicago.

Wanted

Detectives Earn Big Money. Work home or travel. Experience unnecessary. Write, George Wagner former Government Detective, 1968 Broadway, N. Y.

Wanted to Buy

Mail us your discarded Jewelry, Gold, Crowns and Pridces, Watches, Diamonds, Silver, Platinum, and old False Teeth. Money promptly mailed. Goods returned if offer refused. United States Smelting Works, (The Old Reliable), Dept. 73, Chicago.



**325**  
**RADIO Storage "B" Battery**  
 Lasts Indefinitely—Pays for Itself  
 Economy and performance unheard of before. Recharged at a negligible cost. Approved and listed as Standard by leading Radio Authorities, including Pop. Radio Laboratories, Pop. Sci. Inst., Standard, Radio News Lab., Lefax, Inc., and other important institutions. Equipped with **Solid Rubber Case**, an insurance against acid and leakage. Extra heavy glass jars. Heavy, rugged plates. Order yours today!

**SEND NO MONEY** Just state number of batteries wanted and we will ship day order is received. Extra Offer: 4 batteries in series (96 volts), \$12.75. Pay expressman after examining batteries. 5 per cent discount for cash with order. Mail your order now!

**WORLD BATTERY COMPANY**  
 1219 So. Wabash Ave., Dept. 83, Chicago, Ill.  
 Makers of the Famous World Radio "A" Storage Battery  
 Prices: 6-v., 100 Amp. \$11.25; 120 Amp. \$13.25; 140 Amp. \$14.00. All equipped with Solid Rubber Case.

**World FOR STORAGE BATTERIES RADIO**  
 KDKA - WEAF - WGN - WJZ - KHJ - KGO - KFAY - WJY - KOP

**ADDING MACHINE VEST POCKET SIZE**

Does Work of \$100 Machine. Guaranteed for 5 yrs. Not a toy. Anyone can operate it. Will not make mistakes. Let this machine do your figuring. First cost is last cost. Everybody needs one for figuring.

**ADD SUBTRACT MULTIPLY DIVIDE**

**\$2.50** Total Cost

**FREE TRIAL—Send No Money** Just write "Send me a Baby Calculator" and give your name and address. We will ship it immediately, all charges prepaid. On delivery pay postman \$2.50. You can return it after 10-day trial for full refund if the Baby Calculator is not the greatest time and labor saver you ever used.

This is the lowest priced practical calculating machine made. Order today.

**BABY CALCULATOR SALES CO.**  
 P. O. Box 1118, Chicago, Ill., Dept. 10

**AGENTS** Every business firm, man or woman, will buy the Baby Calculator on sight. **Big Commission.**

**Free Book**

Begin Today—Write for My **FREE BOOK**! I can make a good penman of you at home during spare time. Write for my **FREE BOOK**, "How to Become a Good Penman." It contains specimens and tells how others mastered penmanship by the Tamblin System. Your name will be elegantly written on a card if you enclose stamp to pay postage. Write today for book.

**F. W. TAMBLIN, 424 Ridge Bldg., Kansas City, U.S.A.**

**PIMPLES**

Your Skin Can Be Quickly Cleared of Pimples, Blackheads, Acne Eruptions on the face or body, Barbers Itch, Eczema, Enlarged Pores and Oily or Shiny Skin.

**FREE** Write today for my **FREE BOOKLET**, "A CLEAR-TONE SKIN,"—telling how I cured myself after being afflicted 15 years.

**E. S. GIVENS, 168 Chemical Bldg., Kansas City, Mo.**

**RADIO** **LOUD SPEAKING** **FACTORY GUARANTEED SET** **only \$29.50**

SEND FOR testimony of users and **SPECIAL OFFER.**

**MIRACO GETS 'EM COAST TO COAST**

**AGENTS DEALERS WRITE** **MIDWEST RADIO CORP'N**  
 Pioneer Builders of Sets  
 409-P E. 8th St., Cincinnati, O.

**Free** Leatherette Carrying Case Free with Big 8 Foot Wonder Telescope. 5 sections. Brass bound. Powerful lenses. See people and objects miles away as if they were close. See moon and stars as never before. Useful and entertaining.

Could tell color of a boy's hair from a school 2 miles away. — Mrs. Horn. "Read numbers on freight cars mile away." — Mrs. A. C. Peiser. "Thousands pleased." — Watch. "Send No Money" On arrival of Big 3 scope with **FREE Case and Strap**, deposit with Postman only \$1.85 plus few pennies postage. Satisfaction guaranteed or deposit returned. Order Now.

**FERRY & CO., Dept. C 125, 3224 N. Halsted St., Chicago**

**FREE RADIO BOOK**

Write for 64 page Handy Book on Principles of Radio by eminent radio authority. Contains book up and other valuable data. Send 4c stamp to cover mailing and postage.

**Dietzen, Inc., Dept. A2 71 Cortlandt St., N.Y.C.**

**RADIO WRINKLES**

**UNDER** this heading we are going to publish items of interest to everyone who likes to build radio instruments. In order to continue this department it is necessary for our readers to tell us about their latest experiments. Write us a short description of some time- or money-saving kink you have discovered and send it to us along with a few sketches. Our regular prizes will be paid for this material. Be brief and try to put everything in the drawing. Don't be too elaborate. Address "RADIO WRINKLES" editor, care of Science and Invention.

**Rheostat**  
 CARBON FILAMENT LAMPS IN SERIES

Six or eight carbon filament lamps connected in series and each interconnection wired to a switch point makes a handy rheostat. A connection is taken from the first lamp and from the switch blade. With the switch blade on the point that is wired to the first interconnection, one lamp will be in the circuit. As the number of switch points are increased, the resistance in the circuit will become greater. On the end switch point, all of the lamps will be in the circuit and the resistance of the unit will be at its greatest. —Charles D. Savage.

**Aerial Mast**

SCREW EYES FOR GUY WIRES AND PULLEY

HINGES

A simple aerial mast for mounting on a flat roof which can be put up quickly and taken down when necessary is illustrated above. The upright is of the size desired and is supported by two large steel strap hinges. Provide screw eyes for the guy wires and pulleys.

—Allen Cunningham.

**Easy to Play**  
**Easy to Pay**

**BUESCHER**  
**True-Tone Saxophone**

**BENNIE KRUEGER**  
 Director Bennie Krueger and His Orchestra. Brunswick Records.

Easiest of all instruments to play and one of the most beautiful. Three first lessons each free give you a quick easy start—in a few weeks you can be playing popular tunes. No teacher necessary. You can take your place in a band or orchestra in ninety days, if you so desire. Most popular instrument for dance orchestras, home entertainments, church, lodge and school. A Saxophone player is always popular socially and has many opportunities to earn money. Six Days' Trial and easy payments arranged. (105)

**Free Saxophone Book** Shows all models and gives first lesson chart; also pictures of famous professionals and orchestras. Just send your name for a copy. Mention any other instrument in which you may be interested.

**BUESCHER BAND INSTRUMENT CO.**  
 Everything in Band and Orchestra Instrument.  
 722 BUESCHER BLOCK • ELKHART, INDIANA

**The Richardson Slide Rule**

This is a standard 10 inch, Mannheim Slide Rule, that includes the Add and Subtract and Direct-reading features. The Scales are Engine-divided, permanently accurate and grease and waterproof, with frameless, hairline Ruler. Undoubtedly the greatest slide rule value on the present market, as comparison will prove. A 100 page instruction book, "The Slide Rule Simplified," is sent with each rule. This book shows how to get the greatest use and efficiency out of your slide rule.

Price, with Case and Book, \$3.00. Cash or C.O.D. More than 100,000 satisfied purchasers. Your money back if you are not satisfied.

**GILSON SLIDE RULE CO.** Niles, Mich.

**Tire Agents Wanted**

Use and Introduce **MELLINGER CORD TIRES**  
**15,000 MILES GUARANTEED**

Lowest Wholesale Prices in America. Shipped prepaid on approval. Make big money all or part time. No capital or experience. Sample sections furnished.

**YOUR TIRES FREE!** Simply send name today for **FREE BOOK**, tells how thousands do big business. Special Agents' C.T., Wholesale Prices and **FREE Sample Kit.**

**MELLINGER TIRE & RUBBER CO.**  
 Dept. 311, Philadelphia, Pa., or Kansas City, Mo.

**895**

**MILITARY AUTOMATIC 32 Cal.**  
 20 SHOT

Biggest bargain. Flash-like, accurate, hard hitting. Blue steel, checkered grip. A real he-man's gun. With extra magazine. Shoots 20 quick, hard and straight shots. Send no money. Pay postman our price, plus postage. Money refunded if you are not satisfied.

**FEDERAL MAIL ORDER CORPORATION**  
 414 BROADWAY, NEW YORK, Dept. B-80

**Free** **Mailing Lists**

Will help you increase sales. Send for **FREE** catalog giving counts and prices on thousands of classified names of your best prospective customers—National, State and local—Individuals, Professions, Business Concerns.

**99% Guaranteed 5¢ each** by refund of 5¢ each

**ROSS-Gould Co., 10th St. St. Louis**

**Young Men—Turn Your Spare Time Into Money!**

Earn big profits, prizes, and awards selling **RADIO NEWS, SCIENCE & INVENTION, THE EXPERIMENTER, and MOTOR CAMPER & TOURIST** in your neighborhood. We train you as our salesman and pay you liberally for your time. Write at once and we will help you to get started.

**M. BRIDWELL**  
**THE EXPERIMENTER PUBLISHING CO.**  
 53 Park Place, New York, N. Y.



# The New Radio Stamp Fad

Here is the DX Radio Stamp Album just like the ones we owned in our youth, in which were placed the rare stamps of the countries of the world. Some were hard to get, some couldn't be purchased for love or money; but the fun of the hobby was the seeking of rare stamps and the eventual possession. So it will be with the DX Radio Stamp Album. There will probably be some stamps you will

never be able to own, but there will be many you will be proud to have and be able to show to other radio enthusiasts. It's an interesting game. Below the Album is shown the "Proof of Reception Cards" of which a generous supply is furnished with each Album. A dime placed in the hole in the card and sent to the station you heard brings back a stamp for your Album.

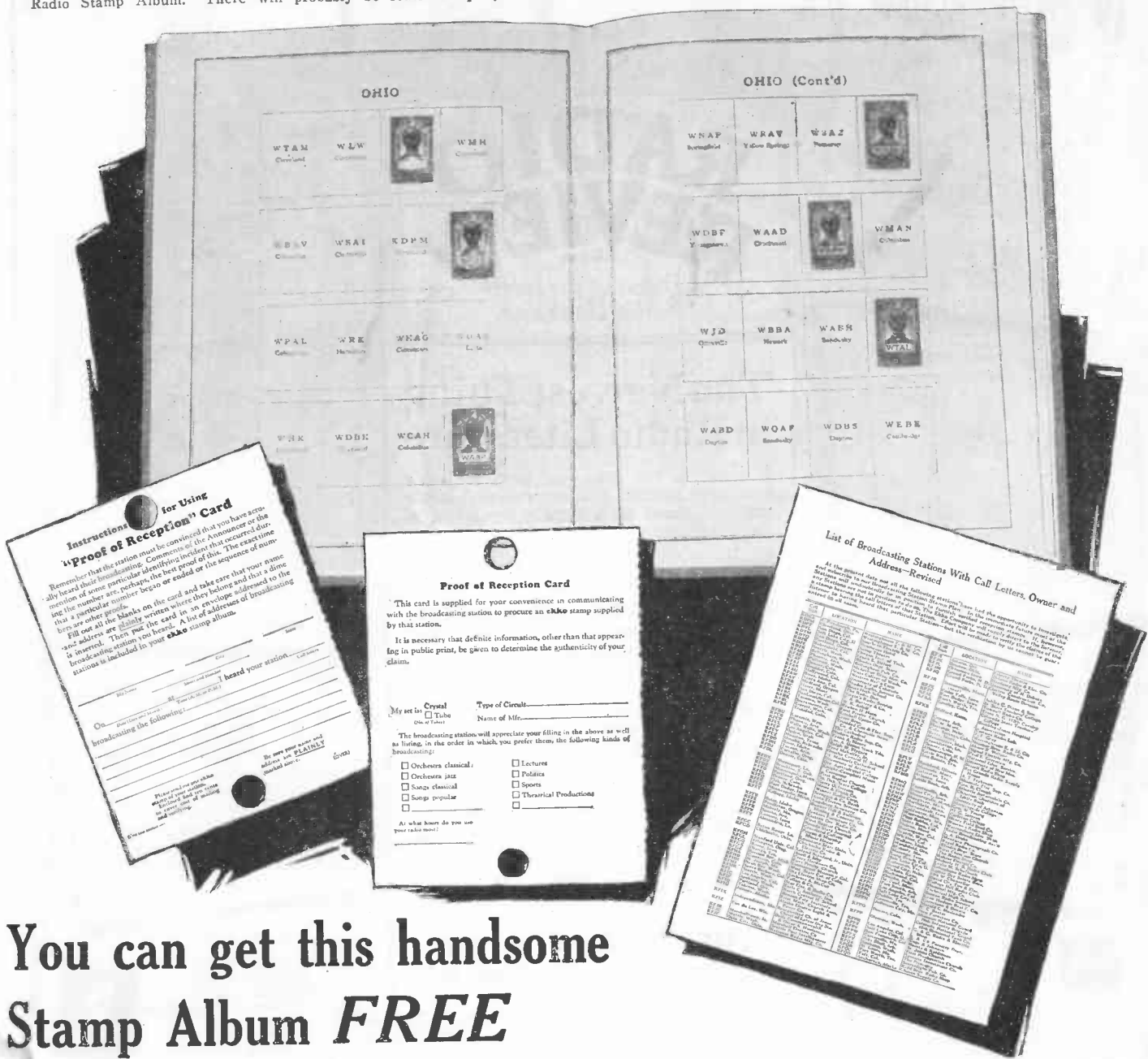

## You can get this handsome Stamp Album *FREE*

This beautiful EKKO Stamp Album, illustrated above, will be given away absolutely free with a subscription to any one of our four magazines: "Radio News," "Science and Invention," "The Experimenter," "Motor Camper and Tourist."

Don't pass up the opportunity to get this valuable premium. With this album, you can keep through the means of beautiful engraved stamps, a certified record of every broadcast station you have heard on your radio set. Your friends will enjoy seeing it.

The album consists of 96 pages, size 9 x 12 and is bound in extra heavy stiff cover.

With the Album is furnished a large Cram's comprehensive radio map of the United States and Canada; a supply of "Proof of Reception Cards" and also some stickers. The Album contains a list of broadcast stations of the United States and Canada with wave-lengths and columns for recording dial setting, a table of stations arranged according to wave-lengths and a section for log records.

We have acquired 1,000 of these Albums especially for our subscribers. The coupon on this page filled out and mailed to us with \$2.50 will entitle you to a twelve months' subscription to any one of our four magazines and one of these EKKO Stamp Albums free.

EXPERIMENTER PUBLISHING CO., INC., 53 Park Place, New York, N. Y.

Gentlemen: I have decided to take advantage of your special offer. I am enclosing \$2.50 for 1 year's subscription to ( ) "Radio News," ( ) "Science and Invention," ( ) "The Experimenter," ( ) "Motor Camper and Tourist" and one EKKO Stamp Album which you will send me free. (Mark to which magazine you wish to subscribe)

NAME ..... CITY .....  
ADDRESS ..... STATE .....

DON'T FAIL TO USE THIS COUPON

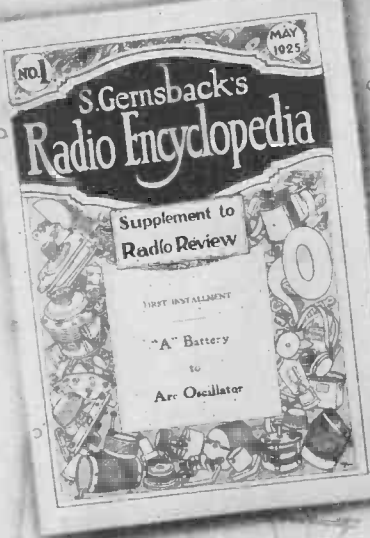

# RADIO REVIEW

Reg. U.S. PAT. OFF.

*A Digest of the Latest Radio Hookups*

## The Newest Thing in Radio Literature

A complete 100 page illustrated magazine containing hookups and constructional Radio articles, gleaned from the entire radio press the world over.

Large magazine size 9 x 12 inches, printed on fine paper and profusely illustrated.

**IN EVERY ISSUE A 16-PAGE SUPPLEMENT OF ONE INSTALLMENT OF S. GERNSBACK'S RADIO ENCYCLOPEDIA**

This real Encyclopedia of Radio explains every word used in Radio, by means of photographs, drawings, charts or tables. (Some sample pages are shown in this advertisement). This supplement is arranged in loose-leaf form.

*35c the copy on all Newsstands and Radio Stores*

*Subscription price \$3.50 for 12 issues*

Published by

**THE CONSRAD CO., Inc.**  
233 Fulton St., New York, N.Y.

-----  
 THE CONSRAD CO., Inc.,  
 233 FULTON STREET, New York.  
 Enclosed find \$3.50 for which enter my sub-  
 scription to RADIO REVIEW for 12 issues.  
 Name .....  
 Street .....  
 Town .....  
 State .....

Let These Guides

Solve Your Problems



# Electricity at your finger ends

## HAWKINS ELECTRICAL GUIDES IN TEN VOLUMES

**3500 PAGES**  
**4700 PICTURES**

**\$1 A VOLUME**  
**\$1 A MONTH**

**SEND NO MONEY—SEND ONLY THIS COUPON**

Know the facts in Electricity. They mean more money and better position for you. Hawkins Guides tell you all you need to know about Electricity. Every important electrical subject covered so you can understand it. Easy to study and apply. A complete, practical working course, in 10 volumes. Books are pocket size; flexible covers. Order a set today to look over.

### LEARN ALL ABOUT

Magnetism—Induction—Experiments—Dynamometers—Electric Machinery—Motors—Armatures—Armature Windings—Installing of Dynamometers—Electrical Instrument Testing—Practical Management of Dynamometers and Motors—Distribution Systems—Wiring—Wiring Diagrams—Sign Flashers—Storage Batteries—Principles of Alternating Currents and Alternators—Alternating Current Motors—Transformers—Converters—Rectifiers—Alternating Current Systems—Circuit Breakers—Measuring Instruments—Switchboards—Wiring—Power Stations—Installing—Telephone—Telegraph—Wireless—Bells—Lighting—Railways. Also many Modern Practical Applications of Electricity and Ready Reference Index of the ten numbers.

### SHIPPED FREE

Not a cent to pay until you see the books. No obligation to buy unless you are satisfied. Send Coupon now—today—and get this great help library and see if it is not worth \$100 to you—you pay \$1.00 a month for ten months or return it.

**THEO. AUDEL & CO.,**  
**72 Fifth Ave., New York City**

Please submit me for free examination, HAWKINS ELECTRICAL GUIDE (Price \$1 a number). Ship at once prepaid, the 10 numbers. If satisfactory, I agree to send you \$1 within seven days and to further mail you \$1 each month until paid.

Name .....

Occupation .....

Employed by .....

Home Address .....

Reference .....

S. I. August

Not a Toy

Not a Fad—A Proven Scientific Instrument

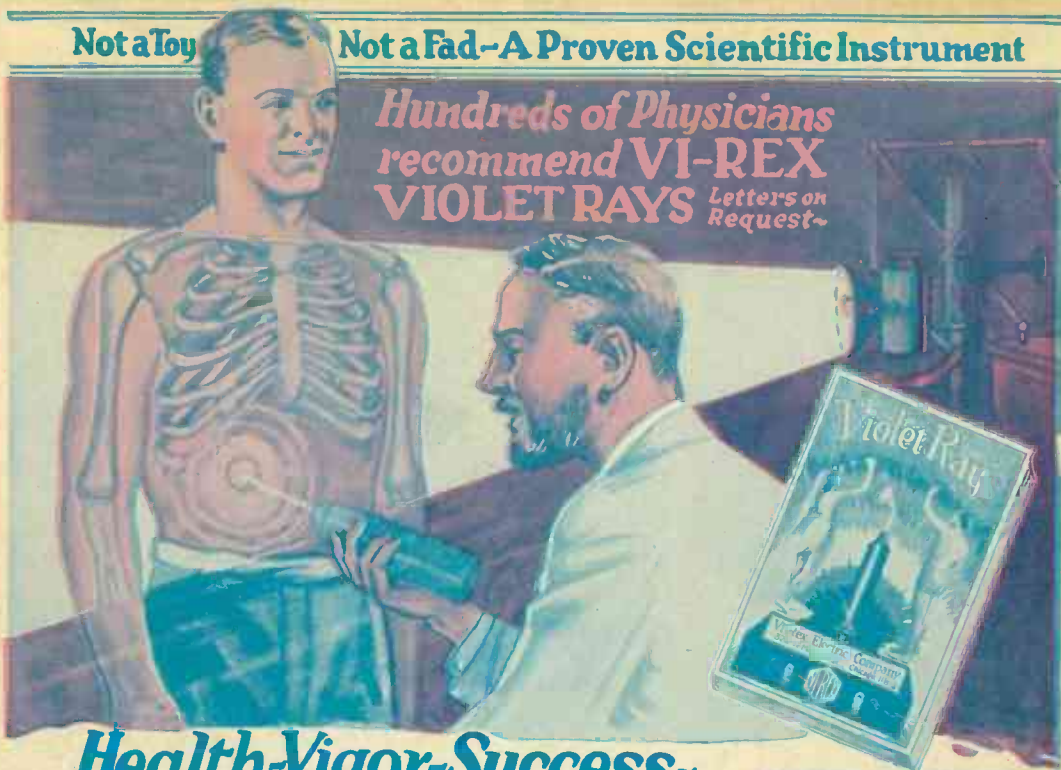

Hundreds of Physicians  
 recommend VI-REX  
 VIOLET RAYS *Letters on Request*

**Health-Vigor-Success-**

**By means of Marvelous-VIOLET RAYS**

**Use it Yourself at Home**

**FREE  
Book**

We offer FREE this wonderful book describing the marvelous, strange new force, Violet Rays. Explains in simple words and pictures how Violet Rays revitalizes every cell and works apparent miracles in helping to overcome pain and sickness.

Practicing physicians and plain home folks explain in this book how Violet Rays has made them well, strong and happy. 60 pages, illustrated with actual photographs, scientific charts and diagrams. It's FREE.

**A Proven Aid To BEAUTY**

Brings natural, magnetic beauty of health, no dieting, exercises or drugs. Home treatments save money.

**Acts Instantly—No Delay, No Waiting**

Violet Rays work at once, you feel results immediately. "Violet Rays is the finest thing I ever used to relieve congestion in any part of the body, and to relieve pain. Treat-

ments are so pleasant that all my patients like it," writes Dr. Duncan, Kewanee, Ill. You can use it at home and get equally good results yourself.

**The New Way—No Medicines**

Acts without drugs or medicine, it's scientific, goes after the cause, that's why it gets results. Note the list of ailments Violet

Rays treats successfully, and many others. Success in Business and Social affairs depends on health, it is in your easy reach.

**Send FOR NEW FREE BOOK**

**REVEALS MARVELOUS SCIENTIFIC METHODS**

Explains how Nikola Tesla discovered Violet Rays, how it works, why it heals. Tells what doctors and plain folks accomplish in conquering pain, disease and nervous troubles. Shows charts of human body, explains where pains start, how to banish them. Offered FREE for a limited time only, to introduce Violet Rays.

**Liberal Pay To Representatives**

Men and women, without experience, earn liberal profits in spare time showing Violet Rays to neighbors. Proves results first demonstration, sells on sight. Wholesale price and permanent territory to representatives.

**Check Your Ailment Below for Free Advice**

Here is a partial list of ailments successfully treated with Violet Rays:

Catarrh	Eye Disease	Nervousness	Sore Throat
Chilblains	Falling Hair	Neuralgia	Sprains
Colds	Hay Fever	Neuritis	Tonsillitis
Constipation	Headache	Paralysis	Whooping Cough
Deafness	Goitre	Piles	Asthma
Earache	Insomnia	Rheumatism	
Eczema	Lumbago	Skin Diseases	

**VI-REX ELECTRIC CO.,** 211 SOUTH PEORIA ST. DEPT. 408 CHICAGO

Please send me without any cost or obligation your free book describing your VI-REX Violet Ray Outfits, and details of your free trial offer.

Name .....

Address .....

City..... State.....