

March

25 Cents

Science and Invention

IN PICTURES

THE PERPETUAL
MOTION MYTH

See Page 1078

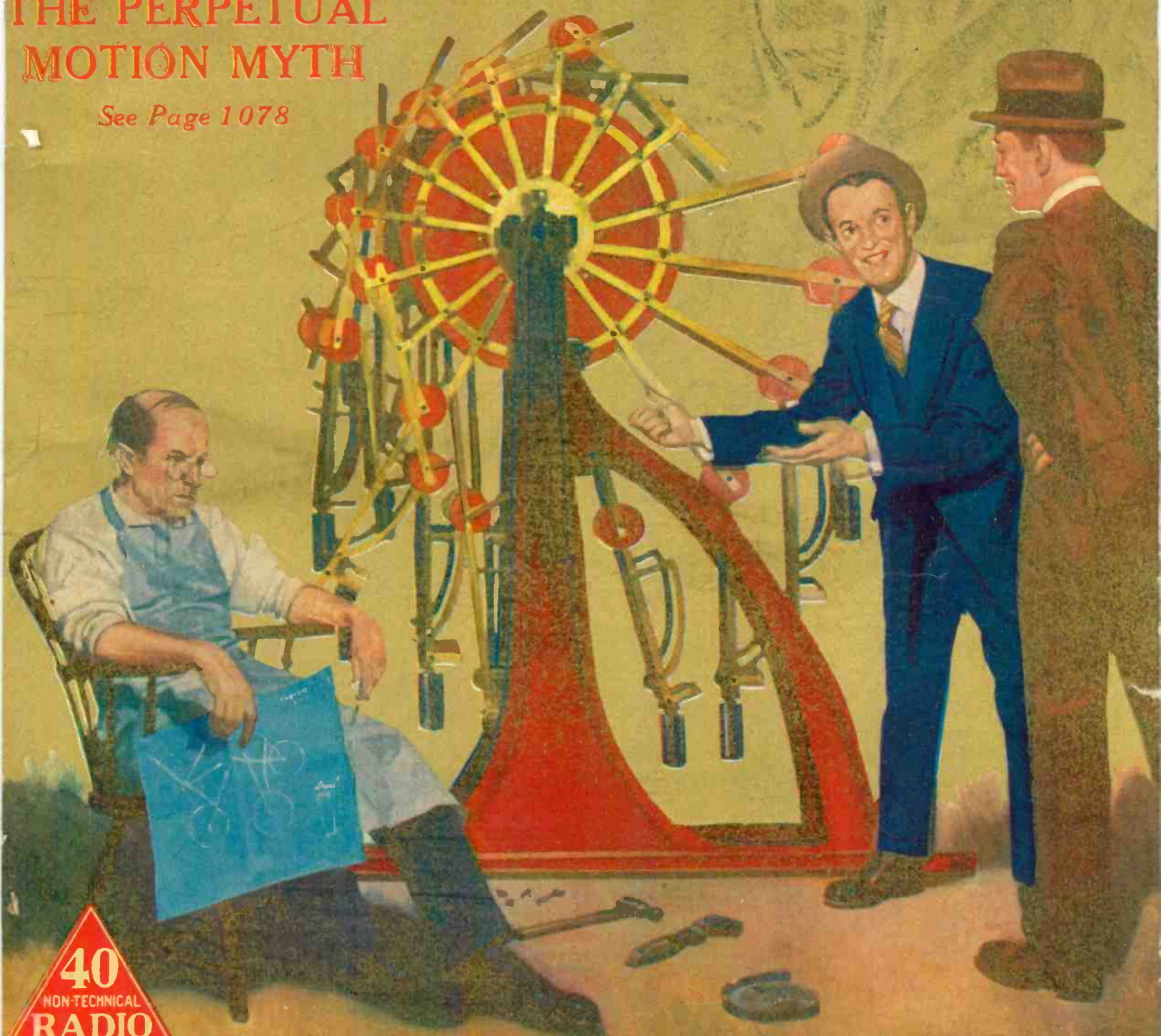

40
NON-TECHNICAL
RADIO
ARTICLES

EXPERIMENTER PUBLISHING COMPANY, NEW YORK, PUBLISHERS OF
RADIO NEWS - SCIENCE & INVENTION - THE EXPERIMENTER - MOTOR CAMPER & TOURIST

Combines distance, selectivity, power, deep full tone, beauty and simplicity!

Looks like—and performs like—a \$200 radio set



BUILT TO GIVE LOUD SPEAKER ENTERTAINMENT FROM STATIONS THOUSANDS OF MILES DISTANT WHILE LOCAL STATIONS ARE BROADCASTING

A real entertainer that will throng your home with friends!

"Coast to Coast" reception

verified by Miraco Users

NOTE! Do not judge Miraco sets by their prices. Enormous production makes them cost less. They are built—by pioneer set makers—of highest grade parts. They embody improvements, refinement and features used in the most costly sets. Every Miracouser is an enthusiastic booster—these letters are typical of the many we receive.

Maryland Hears Europe

During International Radio Week I received European stations several times upon my Miraco. Who wouldn't be satisfied with results like this?—Jos. E. Cook, Owings Mills, Md.

California Hears East Coast

Miraco works fine. Last night I got Cuba on loud speaker. I also pick up East Coast programs in spite of local interference.—Clinton Elliott, Long Beach, California.

Illinois Hears London

Miraco operates wonderfully. Thursday night I heard the program from the Hotel Savoy, London, for about 35 minutes.—Carl Mackey, White Heath, Ill.

Bermuda Hears California

On my Miraco I have received KGO at Oakland, Cal., a distance of over 3,000 miles four times in last four weeks. Also have received five stations about 2,000 miles away and about twenty over 1,000 miles away.—J. O. L. Spurling, Spanish Pt., Bermuda.

Nevada Hears Cuba

Am able to get all Eastern Coast stations with my Miraco as well as Havana, Cuba and Mexico City. Also all Canadian stations. Had Havana loud enough to broadcast same over telephone a distance of 300 miles.—A. A. Ewing, Rox, Nevada.

Vermont Hears Mexico

I have received stations as far as Mexico City, Mexico, Calgary, Canada, Cuba and Texas on my Miraco.—A. V. Little, Verennes, Vt.

Mass. Hears Belgium

Nov. 22nd at 11:25 P. M. I heard 2L.O. London, England, on the Miraco. Nov. 29th at 12:40 P. M. heard BBR, Brussels, Belgium. You can't get a better set for the money.—M. J. Discoe, Pittsfield, Mass.

N. Y. Minister Hears Europe

I tuned in four different European stations last week on my Miraco. My guests and I heard 2NO, Newcastle, England, very clearly—plunging solo from Rigoletto. Also heard voice in Italian announce IRO, Rome, Italy. Concerts from other stations came through but static crashed at their conclusion—the ones in Flemish.—Rev. Thos. E. Owen, St. Patrick's Rectory, Rosie, N. Y.

Pennsylvania Hears Calif.

Have listened to Cuba, California and possibly 30 other stations. All who hear Miraco proclaim it the best they have ever heard.—G. H. Stevens, Altoona, Pa.

Mississippi Hears Hawaii

Installed the Miraco myself and I had never had any experience with radio at all. Have gotten Havana, Cuba, and Honolulu.—H. Kittle, Shaw, Miss.

Nebraska Hears Cuba

Miraco is a wizard. I have handled radios for two years—have not seen its equal under \$200. Heard Havana, Cuba, Saturday night despite that their language is hard to discern on a radio.—C. G. Stockman, Synder, Neb.

The Marvelous MIRACO Ultra 5

- costs only \$ **75**

[FIVE TUBE OUTFIT IN BEAUTIFUL SOLID MAHOGANY CASE]

Send coupon for SPECIAL OFFER!

Completely built, thoroughly tested and factory guaranteed by one of America's oldest and most reliable manufacturers of quality sets! Years of experience and quantity production explain its almost incredible price. Users, who have deluged us with commendations, say that friends who see and hear it are amazed that it sells for less than \$150 or \$200. Radio experts, who know good construction and quality parts, are equally astonished. You, too, will be delighted, thrilled, amazed with your big five-tube Miraco "Ultra 5" in its beautiful hand-rubbed solid mahogany cabinet! You'll be envied by radio friends who paid big prices for their outfits. Imagine getting all this for \$75—a beautiful sweet

toned "coast to coast loud speaker" set, composed of finest parts, housed in solid mahogany, equipped with the latest improvements, refinements and features found on costliest sets—and factory guaranteed! An instrument approved by radio's highest authorities! A set anyone can connect and operate. Even beginners learn quickly to cut through the "locals," get distant stations loud and clear, log stations and return to them at will. (Full directions with each set.) It is non-radiating, non-distorting, non-howling. Has cut-out switch—and a first stage phone jack for tuning—on Bakelite panel. All wiring concealed under Bakelite sub-base. Works on storage battery or dry cells. Literature describes other newest features.

Other Miraco Long Distance Sets \$14³⁵ up



Users tell us that Miraco Model R justly deserves its title, "Radio's finest low priced quality receiver." One tube acts as a tuned radio frequency amplifier and detector combined. A great distance getter. Easy to operate and log. Covers all wave lengths 150 to 625 meters. Like all Miraco sets, it operates on a storage battery or dry cells. Never such value before at only \$14.35

MIRACO RADIO GETS 'EM COAST to COAST

This wonderful new Miraco Model R-3 is the three-tube, long distance, loud speaker set that has created such a sensation. Easy to tune and log. Covers wave lengths 150 to 625 meters. Detector acts also as a tuned radio frequency amplifier. 2 stages audio frequency amplification. Has no equal for simplicity, volume, range of clearness at anywhere near its price. **Miraco R-3 only \$29.50**



The famous Miraco Model MW four tube "coast to coast loud speaker" outfit which users all over the country report outperforms and outdistances much costlier sets. Comes in a solid mahogany cabinet. The improved 1925 model is equipped with cut-out switch, first stage phone jack for tuning (removing plug automatically switches program to loud speaker) and other latest features. Employs one stage of radio frequency amplification, detector and two stages of audio frequency amplification. Another unmatched Miraco value, \$54.50.

These Miraco sets are as easy as a phonograph to operate. Built throughout of highest grade parts. Full directions for connecting and operating supplied with each set. No experience necessary. The three and four tube sets have cut-out switch and first stage phone jack. Each set completely built, thoroughly tested and factory guaranteed.



All the Proof you want is waiting for You!

Reports from the many users in every state prove Miraco Tuned Radio Frequency Receivers—at rock bottom prices—have efficiency of sets costing up to three times as much. Remember that Miraco Sets are the product of a long established, reputable manufacturer—pioneer builders of sets. Send for further evidence that they are Radio's finest, moderately priced receivers. All Miraco sets bear the endorsement of radio's highest authorities. Mail coupon now for latest bulletins and plenty of additional testimony from users leaving no doubt that "Miraco Radio Gets 'em Coast to Coast."

DEALERS! JOBBERS! Write for the new Miraco proposition. Nation-wide use and popularity of Miraco Sets, their amazingly low prices and our extensive advertising, makes them wanted everywhere. Send coupon.

AGENTS! The wonderful tone, volume and distance-getting ability of Miraco Sets makes them easy to sell. Send coupon for proposition; good territory open.

Send coupon for free bulletins [or order direct from this ad]

MIDWEST RADIO CORPORATION
Pioneer Builders of Sets
Cincinnati, Ohio

409 - W East Eighth Street

Send free literature, your SPECIAL OFFER and all particulars regarding Miraco Sets. () Jobber. () Dealer. () Agent. () User.

Name

Address

Learn Electricity

in Great Shops!



**Not by Correspondence
All PRACTICAL Work at
COYNE**



IN 12 WEEKS

Earn \$60 to \$200 a Week

Why work at dull uninteresting work, at low pay, with no future? In 12 weeks I will train you for a big pay job where you can command \$60 to \$200 a week as a COYNE TRAINED MASTER ELECTRICAL EXPERT or you can go in business for yourself with very small capital and make up to \$15,000 a year. Men trained as I train them are in demand everywhere. The great development of the Electrical industry makes the demand for trained men tremendous. Big opportunities and advancement for those who prepare now. The Coyne school was founded 23 years ago and my thousands of SUCCESSFUL GRADUATES are living proofs of what my training can do for ANY AMBITIOUS man. Many of these fellows will tell you in my big free book what Coyne has done for them.

Complete Electrical Training in 12 Weeks

I train you thoroughly on the greatest outlay of ACTUAL ELECTRICAL machinery ever assembled in any school. You work with your hands on all kinds of Electrical apparatus, door bells, house wiring, armatures, switchboards, dynamos, everything to make you an all around ELECTRICAL EXPERT. This REAL WORK with REAL tools, on REAL machinery trains you many times FASTER, many times MORE THOROUGH than trying to learn in the field or by books or lessons.

**No Books—No Lessons—No Classes
—You Do Actual Work!**

I do not attempt to teach you by books or lessons. I train you to work with your head and hands on the same kind of Electrical Machinery used in power houses, industrial plants and on the outside, under actual working conditions, with instructors at your side. I have no classes, every student gets individual training.

Free Radio and Auto Course

For a short time only I am including ABSOLUTELY FREE my big new Radio Course and Auto, Truck and Tractor Electrical Course.

COYNE

Electrical School

1300-1310 W. Harrison St., Dept. 533-3 CHICAGO, ILL.

You Don't Need Education or Experience

You don't need a lot of schooling to master my course. You don't have to be a high school graduate or even a grammar school graduate. My method of instruction is clear and plain, and yet thorough, and if you can understand plain English I will make you an electrical expert even though you haven't a lot of education or any previous electrical experience.

Coyne Trains You For Life

You can get a free life scholarship which enables you to stay longer than the required time if you care to, or you may return at any time to take up new work I'm constantly adding to my school to make it the most modern at all times.

Earn While You Learn

My employment department will assist you to a part time job where you can make a good part of your living expenses while training, and they will assist you to get a BIG PAY job on graduation.



H. C. LEWIS, President

Get My Free Book

This big, handsome new book just off the press—size 12x15 in.—shows actual photographs of my big shops. Cost me a dollar to print, but it's yours FREE if you mail coupon. You owe it to yourself to get the facts.

H. C. LEWIS
President
COYNE
Electrical School
1300-10W. Harrison St.
Dept. 533-3
Chicago, Illinois

Dear Sir:—Please send me absolutely FREE your big new book and full particulars of your special offer and two courses FREE.

GET MY BIG FREE BOOK NOW!

Name.....
Address.....
City.....
State.....

MAIL THIS COUPON NOW!

Science and Invention

FORMERLY
ELECTRICAL EXPERIMENTER

IN OUR NEXT ISSUE

Did You Ever See a Battle of Colors?

The story will be told of how colors are made to appear on a screen, swirl around each other, push each other from side to side, and finally form a whirling mass of beautiful colors. Other effects, including the introduction of human figures in shadow and complete flower gardens, are possible with the new chemical optic device perfected by Max Teuber.

Is Another Ice Age Possible?

If the saying that history repeats itself is true, the United States should soon be visited by an ice sheet similar to those of prehistoric times. A prominent scientific authority on geographical subjects will discuss this subject clearly. In this article you will see an imaginative drawing, depicting the appearance of New York City buried under a mile thick sheet of ice.

How the Outdoors Is Brought Into the Studio

Motion picture directors and producers have always been noted for their ability to make the audience see something that was not actually photographed. This article will deal with effects that seemingly were taken in the open, but in reality were reproduced in the studio.

Aerial Taxicab at 20c a Mile

In the near future you may be able to call a taxicab, be transported to a flying field and there board an aerial taxicab which will transport you to or near your destination at the figure mentioned above. The new planes that make this possible will be described in detail.

Due to the lack of available space, the article dealing with Sun Dials which was mentioned in this column in our last issue must be held over until a future date.

The above are just a few of the treats in store for our readers in the next issue.

HOW TO SUBSCRIBE FOR "SCIENCE AND INVENTION." Send your name, address and remittance to Experimenter Publishing Co., 53 Park Place, New York City. Checks and money orders should be made payable to Experimenter Publishing Co., Inc. Mention the name of the magazine you are ordering inasmuch as we also publish RADIO NEWS, THE EXPERIMENTER and MOTOR

SCIENCE AND INVENTION is published on the 10th of each month. There are 12 numbers per year. Subscription price is \$2.50 a year in U. S. and possessions. Canada and foreign countries \$3.00 a year. U. S. coin as well as U. S. stamps accepted (no foreign coin or stamps). Single copies, 25 cents each. A sample copy will be sent gratis on request. All communications and contributions to this journal should be addressed to Editor, SCIENCE AND

New York City
General Advertising Dept.
53 Park Place

Western Advertising Representatives
Finucan & McClure
720 Cass St., Chicago, Ill.

Pacific Coast Advertising Representatives
A. J. Norris Hill Co.
Hearst Bldg., San Francisco, Calif.

Kansas City Advertising Representatives
George F. Dillon
Republic Building, Kansas City, Mo.

Member Audit Bureau of Circulations
EDITORIAL & GENERAL OFFICES: 53 Park Place, New York City
Published by Experimenter Publishing Company, Inc.
(H. Gernsback, Pres.; S. Gernsback, Treas.; I. W. DeMott, Sec'y).
Publishers of SCIENCE & INVENTION, RADIO NEWS, THE EXPERIMENTER
and MOTOR CAMPER & TOURIST.

Contents for March

POPULAR ARTICLES

| | |
|---|------|
| Editorial | 1073 |
| By Hugo Gernsback | |
| Tornado in Movies | 1074 |
| By Edwin Schallert | |
| New York City 100 Years Hence | 1076 |
| By H. Winfield Secor, Associate Member I.R.E. and A.I.E.E. | |
| The Perpetual Motion Myth | 1078 |
| By Joseph H. Kraus | |
| Improving the Heating System | 1081 |
| High-Powered Portable X-Ray | 1081 |
| Ice and Water Illumination | 1082 |
| By Hugo Gernsback, Member American Physical Society | |
| Navigation Instruments on "Los Angeles" | 1083 |
| By Dr. Alfred Gradenzwit | |
| The Latest in Helicopters | 1084 |
| Animals Which Become Invisible | 1085 |
| The Artificial Larynx | 1086 |
| By J. Kay London | |
| What Happens in the X-Ray Tube | 1087 |
| By Harold Deem | |
| Wonders of Our Body | 1087 |
| To End Air Crashes | 1088 |
| The Mechanical Prompter | 1088 |
| By James McEvoy | |
| Bringing Down the Zeppelin | 1089 |
| By F. Fissi | |
| The Living Death | 1090 |
| By John Martin Leahy | |
| Roman Perfume Lamps | 1092 |
| By Charles Beecher Bunnell | |
| If We Had Animal Senses | 1093 |
| Dr. Hackensaw's Secrets | 1094 |
| By Clement Fesandic | |
| Jelly Fish Destroy Fish | 1096 |
| More Gambler's Tricks Exposed | 1097 |
| By Mark Mellen | |
| Handkerchief Tricks | 1098 |
| By Walter B. Gibson | |
| Magic for Everybody | 1099 |
| By Prof. Joseph Dunninger | |
| Scientific Problems and Puzzles | 1100 |
| By Ernest K. Chapin | |
| How Amateur Actors Make Up | 1101 |
| By L. B. Robbins | |
| Readers' Forum | 1109 |
| Book Review | 1145 |

AUTOMOBILES

| | |
|---------------------|------|
| Motor Hints | 1161 |
| By Tom C. Plumridge | |

ELECTRICITY

| | |
|--|------|
| The Perpetual Motion Myth | 1078 |
| Improving the Heating System | 1081 |
| High-Powered Portable X-Ray | 1081 |
| Ice and Water Illumination | 1082 |
| Navigation Instruments on "Los Angeles" | 1083 |
| Artificial Larynx | 1086 |
| What Happens in the X-Ray Tube | 1087 |
| Patent Advice | 1132 |
| Edited by A. P. Peck | |

RADIO ARTICLES

| | |
|--------------------------------|------|
| Apartment House Radio | 1110 |
| Police-men of the Air | 1111 |
| Chelmsford, G5XX | 1112 |
| What Causes Radio Interference | 1113 |
| Paper Cone Loud Speaker | 1114 |
| Radio Tube Testers | 1115 |
| By Leon L. Adelman, A.M.I.R.E. | |
| A Page for the Novice, Part 2 | 1116 |
| A Two-Tube Reflex | 1117 |
| By Alfred R. Marcy, A.M.I.R.E. | |
| Short Wave Condensers | 1117 |
| Radio Oracle | 1118 |
| Radio Wrinkles | 1150 |
| Edited by Leon L. Adelman | |

CONSTRUCTOR ARTICLES

| | |
|----------------------------------|------|
| Making Your Own Antiques | 1104 |
| By Dr. Ernest Bade | |
| Improved String Telephone | 1105 |
| By C. A. Oldroyd | |
| Current Producing Selenium Cells | 1106 |
| By W. S. Gripenberg | |
| Celestial Camera | 1106 |

CHEMISTRY ARTICLES

| | |
|--------------------------------|------|
| Testing Milk | 1105 |
| By Dr. Ernest Bade | |
| Wrinkles, Recipes and Formulas | 1108 |
| Edited by S. Gernsback | |

PRIZE CONTESTS

| | |
|---|------|
| Perpetual Motion, \$5,000 in Prizes | 1078 |
| Inner Tube Contest | 1102 |
| Scientific Humor—Prizes for Best Jokes | 1121 |
| Awards in \$1,000 Monthly Contest | 1124 |

CAMPER & TOURIST. Subscriptions may be made in combination with the other publications just mentioned at special reduced club rates. Send postal for club rate card. Subscriptions start with the current issue unless otherwise ordered. ON EXPIRATION of your subscription we enclose a renewal blank in our last number to you, and notify you by mail. Then unless we receive your

INVENTION, 53 Park Place, New York City, N. Y. Unaccepted contributions cannot be returned unless full postage has been included. ALL accepted contributions are paid for on publication. SCIENCE AND INVENTION, Monthly, Application as second class matter made at New York, N. Y. with additional entry at Long Island City, N. Y. Post Office, under act of Congress of March 3, 1879, formerly dated at Jamaica, N. Y. Entered on

order and remittance for a renewal, delivery of the magazine is stopped. CHANGE OF ADDRESS: Notify us as far in advance as possible, giving your old address as well as the new one to which future magazines are to go. It takes several weeks to make an address change on our records.

Sept. 15, 1924, at Post Office, Atlanta, Ga., Chicago, Ill., Los Angeles, Cal., San Francisco, Cal. Title Registered at the Patent Office. Copyright, 1925, by E. P. Co., Inc., New York. The Contents of this Magazine are copyrighted and must not be reproduced without giving full credit to the publication. SCIENCE AND INVENTION is for sale at all newsstands in the United States and Canada; also at Brentano's, 37 Avenue de l'Opera, Paris. Member of the Audit Bureau of Circulations.



Big Radio Book

Send For it At Once

Send For This Sensational Radio Bargain Book-FREE

Order Direct From This Page! Save About One-half!

Compare our prices with others. Only highest grade nationally known GUARANTEED parts. OUR GUARANTEE PROTECTS YOU. Money cheerfully refunded if you are not satisfied. Be sure to write your order and state prices plainly. Send post office or express money order or bank draft for total amount to insure prompt shipment. ALL PRICES ON THIS PAGE INCLUDE SHIPPING CHARGES RIGHT TO YOUR DOOR if you are east of the Rocky Mountains. Refer to any bank or commercial agency regarding our reliability. If your favorite circuit is shown here, order direct from this ad. No skill required to build your own radio with Randolph parts. Panels are all drilled. Instructions are simple and complete. Everything comes ready to assemble. Order direct! All shipping charges prepaid.

THIS 5-TUBE SET \$39.50

FULLY BUILT AND WIRED COMPLETE IN DARK HEAVY MAHOGANY CABINET OF BEAUTIFUL DESIGN

The Biggest 5-Tube Value on the Market

which will bring in all distant stations on the loud speaker in clear loud tones. A value of three times the price. Shipped on a guarantee of satisfaction or money back. A wonder set constructed on the new principle that requires no neutralizers and is self-balanced. Special features are low-loss coils, engraved bakelite panel, distortionless transformers and pure bakelite sockets. Wiring of the latest loose safety type. Perfect logging of stations. The set alone, shipped prepaid, is

\$39.50

This Set with All Accessories, Including American Bell Loud Speaker, with adjustable unit, 5 R.C.A. UV201-A Tubes, 2 45-volt "B" batteries, 1 6-volt 90 amp. hour storage battery, complete antenna equipment, including approved lightning arrester, shipped prepaid, east of the Rocky Mountains

\$81.30

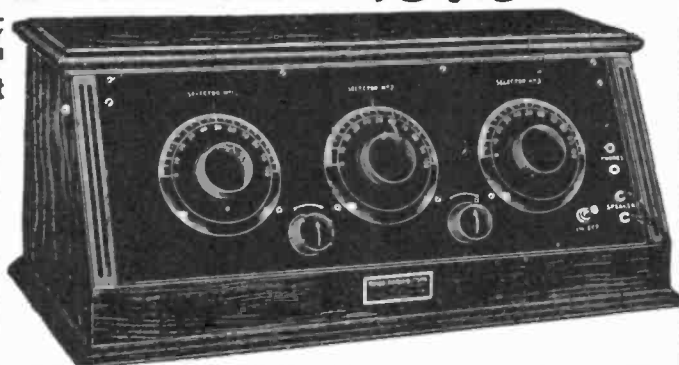

COMPLETE PARTS FOR 8-TUBE SUPER-HETERODYNE

- 2 23-Plate Duplex or Laboratory Type Low Loss Condensers
- 3 Remler or Columbia Intermediate Frequency Transformers
- 1 Remler or Columbia Tuned Circuit Transformer
- 1 Special Oscillator Coupler
- 1 Midget Condenser
- 8 Bakelite Sockets
- 2 Thordarson or Columbia A. F. Transformers
- 1 Connecticut Filament Switch
- 2 Bakelite 6-ohm Rheostats
- 2 Bakelite 30-ohm Rheostats
- 1 Bakelite Potentiometer, 400 ohms
- 1 Carter Double Circuit Jack
- 1 Dubilier 1 mfd. Condenser
- 1 .006 Mica Condenser
- 1 .0005 Mica Condenser and 2 megohm Grid Leak
- 3 .0025 Mica Condensers
- 10 Binding Posts
- 1 .00025 Mica Condenser
- 1 Bakelite Terminal Strip for Binding Posts
- 1 Multicord Cable for connecting batteries
- 1 7x30x1/4 Drilled Bakelite Panel
- 1 Baseboard
- 35 ft. Hook-up Wire
- 2 4-in. Bakelite Dials
- 2 4 1/2-volt C Batteries

\$59.75

Complete wiring diagrams, base board layout, blue-prints and instructions.

COMPLETE PARTS FOR

- ACME 1-Tube REFLEX..... **\$17.45**
- ACME 4-Tube REFLEX..... **\$39.85**

with Genuine Acme parts as specified, drilled bakelite panel and full wiring diagram.

COMPLETE PARTS FOR 2-TUBE HARKNESS SET

including Licensed Harkness Coils, Drilled Panel and wiring diagram. Easy to build. Wonderful results..... **\$17.95**

COMPLETE PARTS FOR REINARTZ

- 1-Tube Rein-artz Set..... **\$10.45**
- 3-Tube Rein-artz Set..... **\$17.55**



COMPLETE PARTS FOR 5-TUBE NEUTRODYNE RECEIVING SET

Genuine Hazeltine Licensed Fada, or other Genuine Licensed Parts

- 1 7x24x1/4 Drilled Panel
- 2 Thordarson or Columbia Audio Transformers
- 3 4-in. Bakelite Dials
- 2 Precision Jacks
- 1 Bakelite Rheostat, 30-ohm
- 1 Bakelite Rheostat, 6-ohm
- 1 Bakelite Binding Post Strip
- 7 Marked Binding Posts
- 1 Grid Leak and Condenser
- 5 Bakelite Sockets
- 1 .001 Condenser
- 1 .006 Mica Condenser
- 35 feet Hook-up Wire
- 1 Kit consisting of 3 Hazeltine Licensed Neutrodyne Transformers and 2 Neutrodyne
- 1 Baseboard
- 3 Bezels
- Complete blue-prints and working diagrams.

\$33.45

COMPLETE PARTS FOR 5-TUBE IMPROVED COCKADAY RECEIVING SET WITH RESISTANCE COUPLED AMPLIFICATION

As designed by L. M. Cockaday. Including drilled panel and wiring diagram, complete, ready to wire.

\$39.65

Easy to Build Your Own Radio Set

All complete parts for sets on this page consist of standard advertised guaranteed parts and include drilled bakelite panels and wiring diagrams for easy set construction. Everything guaranteed on money-back basis. All transportation charges paid. Don't forget! Only genuine guaranteed parts used. Lack of space does not permit us to itemize individual parts, but you are fully protected by our money-back guarantee. Our Service Division is behind you.

FREE BIG MONEY SAVING RADIO CATALOG

containing a thousand bargains of everything on radio—parts, supplies, complete parts for sets, complete sets, etc., also a mine of very latest information on all different circuits, complete list of broadcasting stations, and other valuable, up-to-the-minute radio data. Send your name and address on a card or letter. Also the names of a few friends. We will send catalog free.

Free Service Department

Our radio engineers will help you solve all your radio problems, and furnish up-to-date information on set construction, operation and improvement. This service is free to our customers.

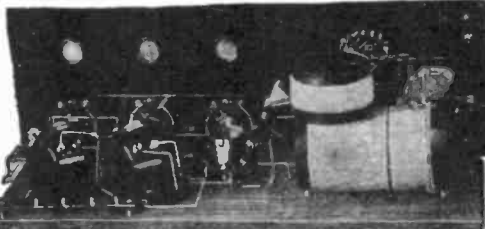

COMPLETE PARTS FOR 3-TUBE COCKADAY RECEIVING SET

- 1 Cockaday Coil
- 2 23-Plate Hy-Grade Cond.
- 1 Bakelite Rheostat, 6-ohm
- 2 Bakelite Rheostat, 30-ohm
- 3 Bakelite Sockets
- 1 high ratio Columbia or Thordarson Transformer
- 1 Single Circuit Jack
- 1 low ratio Columbia or Thordarson Transformer
- 2 Double Circuit Jacks
- 2 3-in. Bakelite Dials
- 1 Grid Leak and Mica Cond.
- 7 Switch Points, 2 Stops.
- 1 Bakelite Binding Post Strip
- 7 Binding Posts
- 1 7x21x1/4 in. Drilled Bakelite Panel
- 3 Bezels
- 1 Baseboard
- 1 Switch Lever
- 24-ft. Hoop-up Wire
- Complete blue-prints and wiring diagrams.
- 1-Tube Set **\$10.10**

\$18.55

RANDOLPH RADIO CORPORATION
159 North Union Ave. Dept. 395 Chicago, Illinois

| | |
|--|---------|
| Genuine Radio Corporation Tubes UV201-A, UV99, WD12 or WD11..... | \$ 3.55 |
| Home Charger, 6-volt..... | 12.95 |
| Soldering Iron..... | .95 |
| Soldair Tube..... | .19 |
| Approved Lightning Arrester..... | .35 |
| Cockaday Coils..... | 1.59 |
| Balancing Condensers, per pr..... | .59 |
| Harkness Coils, per set..... | 1.95 |
| Hydrometer, Best Quality..... | .44 |
| Battery Meters, 0 to 50 volts..... | .89 |
| Magnavox, M4, Loud Speaker..... | 20.95 |
| Baldwin Loud Speaker..... | 21.45 |
| Brandes Table Talker..... | 8.45 |
| Atlas Loud Speaker..... | 21.95 |
| Multiple Four Phone Plug..... | .89 |
| Two Phone Plug..... | .24 |
| Complete Antenna Outfit, including Lightning Arrester..... | 2.59 |
| Bakelite Moulded Variometer..... | 3.25 |
| Low Loss Condensers: | |
| 11-plate..... | \$1.85 |
| 23-plate..... | 2.05 |
| 43-plate..... | 2.85 |
| Bakelite Rheostats: | |
| 6-ohm..... | \$0.35 |
| 30-ohm..... | .38 |
| Amperites: | |
| For all tubes..... | \$0.94 |
| Bakelite Dials: | |
| 2-inch..... | \$0.26 |
| 3-inch..... | .35 |
| 4-inch..... | .48 |
| Composition Dials: | |
| 2-inch..... | \$0.13 |
| 3-inch..... | .17 |
| 4-inch..... | .29 |
| Accurate Dials..... | \$3.14 |
| Audio Transformers | |
| Thordarson: | |
| 3 1/2 to 1..... | \$3.25 |
| 6 to 1..... | 3.65 |
| Acme..... | 3.95 |
| Columbia: | |
| 3 1/2 to 1..... | \$3.79 |
| 6 to 1..... | 3.89 |
| American Bell: | |
| 3 1/2 to 1..... | \$2.45 |
| 6 to 1..... | 2.70 |
| Randolph Special: | |
| 3 1/2 to 1..... | \$1.80 |
| 6 to 1..... | 2.16 |
| Randolph Special Headphones..... | \$2.24 |

SCIENCE and INVENTION READERS' BUREAU

Time and Postage Saver

IN every issue of SCIENCE and INVENTION you undoubtedly see numerous articles advertised about which you would like to have further information.

To sit down and write an individual letter to each of these respective concerns, regarding the article on which you desire information, would be quite a task.

As a special service to our readers, we will write the letters for you, thus saving your time and money.

Just write the names of the products about which you want information, and to avoid error the addresses of the manufacturers, on the coupon below and mail it to us.

If the advertiser requires any money or stamps to be sent to pay the mailing charges on his catalogue or descriptive literature, please be sure to enclose the correct amount with the coupon.

We will transmit to the various advertisers your request for information on their products.

This service will appear regularly every month on this same page in SCIENCE and INVENTION.

If there is any Manufacturer not advertising in this month's issue of SCIENCE and INVENTION from whom you would like to receive literature, write his name, address and the product in the special section of the coupon below.

TEAR ALONG THIS LINE

READERS' SERVICE BUREAU,

S&I 3-25

Experimenter Publishing Co., Inc., 53 Park Place, New York, N. Y.

Please advise the firms listed below that I would like to receive detailed information on their product as advertised in the issue of SCIENCE and INVENTION.

THIS FORM SHOULD NOT BE USED FOR TECHNICAL QUESTIONS

| NAME | ADDRESS (Street—City—State) | List here specific article on which you wish literature. | If Catalogue of complete line is wanted, check in this column. |
|-------|--------------------------------|--|--|
| | | | |
| | | | |
| | | | |
| | | | |
| | | | |
| | | | |
| | | | |
| | | | |

THIS FORM SHOULD NOT BE USED FOR TECHNICAL QUESTIONS

If you desire information from a manufacturer whose advertisement does not appear in this month's issue, use this space.

| NAME | ADDRESS |
|-------|---------|
| | |
| | |
| | |

Your own name here.....

If you are a dealer check here.

Address.....

City..... State

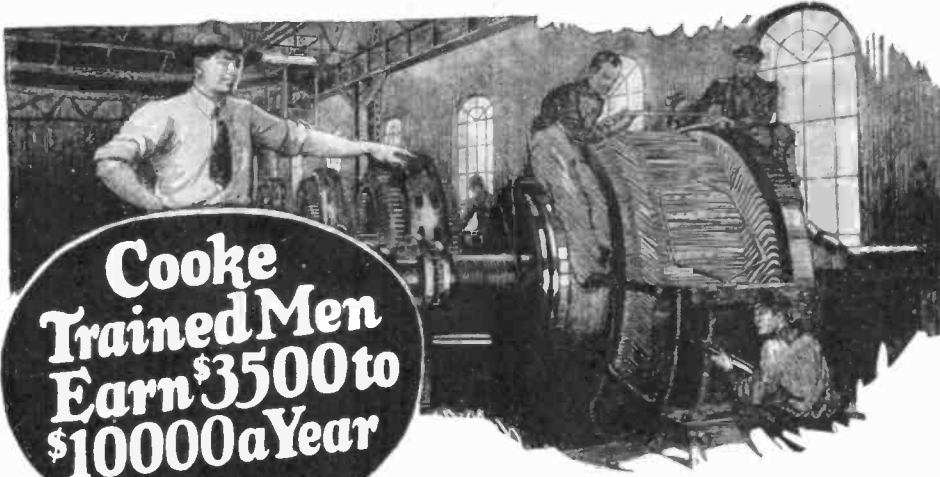

**Cooke
Trained Men
Earn \$3500 to
\$10000 a Year**

Electricity Needs You I Will Train You at Home



**L. L. COOKE,
Chief Engineer**

GET INTO ELECTRICITY .The world's biggest and most fascinating business needs you. Ordinary electricians earn \$8 to \$10 a day, but thousands of the biggest jobs—the ones that pay \$12 to \$30 a day—are going begging for want of *trained* men to fill them. Why stick to your small-pay, no-future job? In a few short months time with my training you can be an Electrical Expert earning \$70 to \$200 a week and not work half so hard as you do now.

Why Trained Electrical Men Are Needed

Thousands of new power stations — millions of automobiles — the wildfire spread of Radio and an undreamed of demand for electric light and power—all these things demand more and more trained men. The industry will be sadly crippled without these men — they must be had at any cost. That's why salaries are high and why they will stay high in Electricity.

I Can Train You Best

I am an engineer with college training and 20 years of practical experience. I have employed and directed the work of thousands of electrical men. I know what a man needs, to be a big success in Electricity. That's what I give you in my course—20 years of practical experience simplified, and made easy for you to understand. My Course is the recognized best and most successful training of its kind in America

JOBS—How I Get Them For My Students

I am spending over \$25,000 a year to get jobs for my students. This money is actually spent on Employment Service alone. And I do get jobs for my students, even before they finish my course. They don't have to wait until they graduate. It is easy for me to do this because employers of electrical help know that "Cooke" Trained Men KNOW Electricity. They know that "Cooke" Trained Men are the best men they can get.

My 16 Big Guarantees

I don't promise you anything—I Guarantee it with a signed bond backed up by a Million Dollar Institution. It says, "you get your money back

if you are not satisfied." There are no strings to this guarantee—you alone are the judge. Among the things I guarantee besides Free Employment Service are—use of my big Laboratory—Accommodations when you visit Chicago—Lifetime subscription to monthly Engineering Magazine—Consultation and Vocational Service—a big outfit of Tools and Apparatus—all FREE. Most of these things are exclusive with my training—you can't get them anywhere else.

Investigate! Get the Proof! Big Electrical Book FREE

You want proof! You want facts! These I give you in my big book—The "Vital Facts" about Electricity—Proof that opportunities more wonderful than you ever dreamed of await you—Proof that "Cooke" Trained Men do get the big jobs in Electricity and that I can do more for you than anyone else; Send for my book now. Be a "Cooke" Trained Electrical Expert—Earn \$70 to \$200 a week. Mail the coupon NOW!

**L. L. COOKE, Chief Engineer
Chicago Engineering Works
2150 Lawrence Ave.
Dept. 23 Chicago**



Home of the Chicago Engineering Works, the Million Dollar Institution which backs up my guarantees.

Right, Above—The Electrical Laboratory.

Left, Below—The Administration Building.

The "Cooke" Trained Man is the "Big Pay" Man

My "Boys" Get the Big Jobs in Electricity

\$800 to \$1000 a Month for Jirinec



In business for himself doing Electrical work, John Jirinec, 1133 Fourth Avenue, Astoria, L. I., New York, makes over \$10,000.00 a year. He says "Cooke" Training alone is responsible for his success.

Pence Earns Over \$750 Every Month

W. E. Pence, Albany, Ore., specializes in Auto Electricity and makes \$750.00 a month. Was formerly a mechanic earning \$30.00 a week, Pence has the only "white collar" job in Automobile work. The repair man gets the grease and dirt—electrical experts get the money.



Montrose Makes \$800 in 23 Days



Earl R. Montrose, Mono Lake, Calif., gets electrical contract, completes it in 23 days and collects \$800.00 profit. Montrose says, "You not only taught me electricity, but you showed me also how to make money out of it."

Use My Money to Go Into Business For Yourself

Every month I start two of my students in business for themselves. I give them all the money they need, help them get started and help them to a big success. Get the detail of this great offer—the greatest in history of home-study schools—from my big FREE book.

Mail this Coupon for my FREE BOOK

**L. L. COOKE,
Chief Engineer,
Chicago Engineering Works,
Dept. 23 2150 Lawrence Ave., Chicago**

Send me your book "The Vital Facts About Electricity," full particulars of your Home Study Course, and your 16 Guarantees, including your plan for helping me earn extra money while learning and details of your Free Employment Service. This does not obligate me to enroll for your Course.

Name.....

Address.....

City..... State.....

Occupation.....

EXPERIMENTAL RADIO!

Experimental Harmonics

By John L. Reinartz, IQP, IXAM.

A Crystal Set Loud Speaker

(Continued)

Experimental Flewelling Receiver

By Rufus T. Turner

The EXPERIMENTER
Radio Data Sheets

By Sylvan Harris

The EXPERIMENTER
Radio Data Sheets

By Sylvan Harris

Two Tube Reflex Experiments

By Clyde J. Fitch

Experiments with Various Voltages on Standard Tubes

By L. W. Matry

Measuring the Amplification Factor of a Vacuum Tube

By H. Diamond, Dept. of Electrical Engineering, Lehigh University

Experimental Short-Wave Receivers

By A. L. Groves, 3B1D

Experimental Radio Frequency Circuits

By W. L. Pearce

Schenectady Short Wave Broadcasting Plant

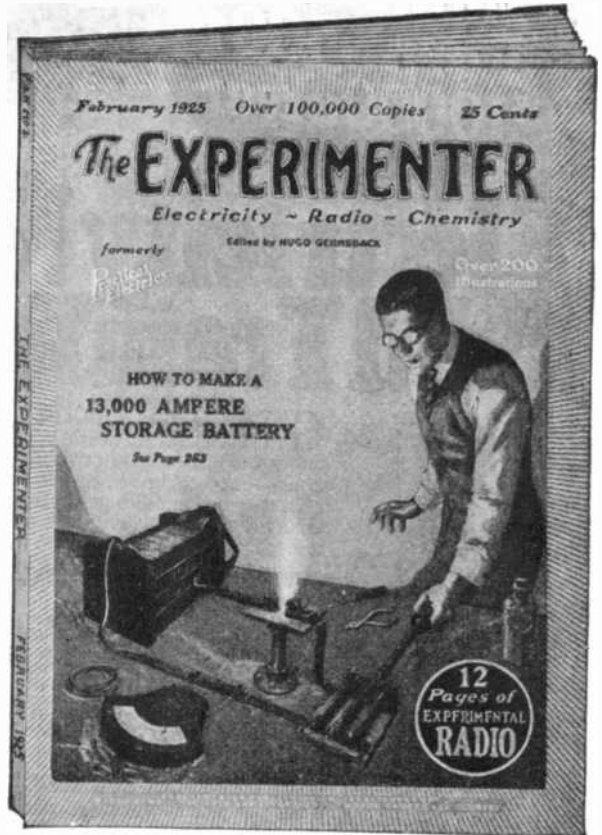

These are Opportunity Days in Radio

Radio has tremendous possibilities for every experimenter. In fact it has been only by constant inventing and research work on the part of many engineers and designers that broadcasting has come into existence. Opportunity knocks at everyone's door today—Radio has a hundred problems waiting for you to solve.

The EXPERIMENTER, the one and only magazine expressly for the person who experiments, carries each month many pages of radio that detail the major problems of the industry that are waiting to be solved. The EXPERIMENTER covers completely the field of radio from the standpoint of the development of the industry.

A FEW TITLES OF THE RADIO ARTICLES IN PREVIOUS ISSUES OF THE EXPERIMENTER ARE SHOWN ON THIS PAGE.

The EXPERIMENTER

Now on Sale at All

Radio and News Dealers

GERMOTT PUBLISHING CO., Owners

Licensed Publishers, The Experimenter Pub. Co., Inc., 53 Park Place, New York, N. Y.

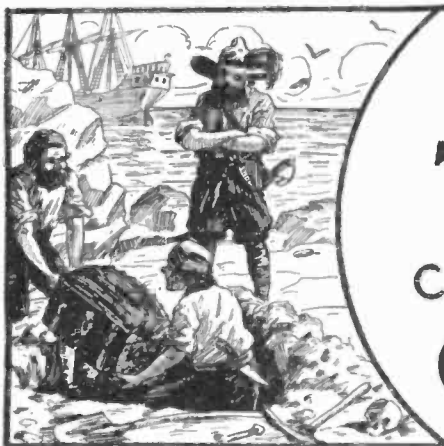

BURIED TREASURE

can still be found in

CHEMISTRY



Good Chemists Command High Salaries

and you can make yourself independent for life by unearthing one of chemistry's yet undiscovered secrets.



T. O'CONNOR SLOANE.
A.B., A.M., LL.D., Ph.D.

Noted Instructor, Lecturer and Author. Formerly Treasurer American Chemical Society and a practical chemist with many well known achievements to his credit. Not only has Dr. Sloane taught chemistry for years but he was for many years engaged in commercial chemistry work.

Do you remember how the tales of pirate gold used to fire your imagination and make you want to sail the uncharted seas in search of treasure and adventure? And then you would regret that such things were no longer done. But that is a mistake. They are done—today and everyday—not on desert islands, but in the chemical laboratories throughout your own country. Quietly, systematically, the chemist works. His work is difficult, but more adventurous than the blood-curdling deeds of the Spanish Main. Instead of meeting an early and violent death on some forgotten shore, he gathers wealth and honor through his invaluable contributions to humanity. Alfred Nobel, the Swedish chemist who invented dynamite, made so many millions that the income alone from his bequests provides five \$40,000 prizes every year for the advancement of science and peace. C. M. Hall, the chemist who discovered how to manufacture aluminum made millions through this discovery. F. G. Cottrell, who devised a valuable process for recovering the waste from flue gases, James Gayley, who showed how to save enormous losses in steel manufacture, L. H. Baekeland, who invented Bakelite—these are only a few of the men to whom fortunes have come through their chemical achievements.

What Some of Our Students Say of This Course:

I have not written since I received the big set. I can still say that it far exceeded my anticipations. Since I have been studying with your school I have been appointed chemist for the Seranton Coal Co. testing all the coal and ash by proximate analysis. The lessons are helping me wonderfully, and the interesting way in which they are written makes me wait patiently for each lesson.—**MORLAIS COUZENS.**

I wish to express my appreciation of your prompt reply to my letter and to the recommendation to the General Electric Co. I intend to start the student engineering course at the works. This is somewhat along electrical lines, but the fact that I had a recommendation from a reliable school no doubt had considerable influence in helping me to secure the job.—**H. VAN BENTHUYSEN.**

So far I've been more than pleased with your course and am still doing nicely. I hope to be your honor graduate this year.—**J. M. NORBUS, JR.**

I find your course excellent and your instruction, truthfully, the clearest and best assembled I have ever taken, and yours is the fifth one I've studied.—**JAMES J. KELLY.**

From the time I was having Chemistry it has never been thus explained to me as it is now. I am recommending you highly to my friends, and urging them to become members of such an organization.—**CHARLES BENJAMIN.**

I shall always recommend your school to my friends and let them know how simple your lessons are.—**C. J. AMDAHL.**

I am more than pleased. You dig right in from the start. I am going to get somewhere with this course. I am so glad that I found you.—**A. A. CAMERON.**

I use your lessons constantly as I find it more thorough than most text books I can secure.—**WM. H. TIBBS.**

Thanking you for your lessons, which I find not only clear and concise, but wonderfully interesting. I am—**ROBT. H. TRAYLOR.**

I received employment in the Consolidated Gas Co. I appreciate very much the good service of the school when a recommendation was asked for.—**JOE. DECKER.**

Now Is the Time to Study Chemistry

Not only are there boundless opportunities for amassing wealth in Chemistry, but the profession affords congenial employment at good salaries to hundreds of thousands who merely follow out its present applications. These applications are innumerable, touching intimately every business and every product in the world. The work of the chemist can hardly be called work at all. It is the keenest and most enjoyable kind of pleasure. The days in a chemical laboratory are filled with thrilling and delightful experimentation, with the alluring prospect of a discovery that may spell Fortune always at hand to spur your enthusiasm.

You Can Learn at Home

To qualify for this remarkable calling requires elaborate specialized training. Formerly it was necessary to attend a university for several years to acquire that training, but thanks to our highly perfected and thorough system of instruction, you can now stay at home, keep your position, and let us educate you in Chemistry during your spare time. Even with only common schooling you can take our course and equip yourself for immediate practical work in a chemical laboratory. Dr. Sloane gives every one of his students the same careful, personal supervision that made him celebrated throughout his long career as a college professor. Your instruction from the very beginning is made interesting and practical, and we supply you with apparatus and chemicals for performing the fascinating analyses and experimental work that plays such a large part in our method of teaching, and you are awarded the Institute's official diploma after you have satisfactorily completed the course.

Easy Monthly Payments

You don't have to have even the small price of the course to start. You can pay for it in small monthly amounts—so small that you won't feel them. The cost of our course is very low, and includes everything, even the chemistry outfit—there are no extras to buy with our course. Our plan of monthly payments places a chemical education within the reach of everyone. Write us and let us explain our plan in full—give us the opportunity of showing you how you can qualify for a highly trained technical position without even giving up your present employment.

Special 30 Day Offer

Besides furnishing the student with his Experimental Equipment, we are making an additional special offer for a short while only. You owe it to yourself to find out about it. Write today for full information and free book "Opportunities for Chemists." Send the coupon right now while it is fresh in your mind. Or just write your name and address on a postal and mail it to us. But whatever you do, act today before this offer is withdrawn.

DON'T WAIT—MAIL COUPON NOW!

NAME

ADDRESS

CITY STATE

B.I., Mch. '25

CHEMICAL INSTITUTE OF NEW YORK
Home Extension Division 3
66-S—West Broadway
New York City



Experimental Equipment Furnished to Every Student

We give to every student without additional charge this chemical equipment, including forty-nine pieces of laboratory apparatus and supplies, and forty different chemicals and reagents. These comprise the apparatus and chemicals used for the experimental work of the course. The fitted heavy wooden box serves not only as a case for the outfit but also as a useful laboratory accessory for performing countless experiments.

CHEMICAL INSTITUTE OF NEW YORK, Inc.

Home Extension Division 3

66-S—WEST BROADWAY

NEW YORK CITY



Master Electricity By Actual Practice

The only way you can become an expert is by doing the very work under competent instructors, which you will be called upon to do later on. In other words, *learn by doing*. That is the method of the New York Electrical School.

Five minutes of actual practice properly directed is worth more to a man than years and years of book study. Indeed, Actual Practice is the only training of value, and graduates of New York Electrical School have proved themselves to be the only men that are fully qualified to satisfy EVERY demand of the Electrical Profession.

The Only Institution of the Kind in America

At this "Learn by Doing" School a man acquires the art of Electrical Drafting; the best business methods and experience in Electrical Contracting, together with the skill to install, operate and maintain all systems for producing, transmitting and using electricity. A school for Old and Young. Individual instruction.

Over 9,000 Graduates are Successful Men in the Electrical World

No previous knowledge of electricity, mechanics or mathematics is necessary to take this electrical course. You can begin the course now and by steady application prepare yourself in a short time. You will be taught by practical electrical experts with actual apparatus, under actual conditions.

The N. Y. E. S. gives a special Automobile Ignition Course as an advanced training for Auto Mechanics, Garage Men and Car Owners. The course covers completely all Systems of Ignition, Starters, Lighting and other electrical equipment on automobiles, motor boats, airplanes, etc.

Let us explain our complete courses to you in person. If you can't call, send now for 64-page book—it's FREE to you.

New York Electrical School
29 W. 17th St., New York, N. Y.

Please send FREE and without obligation to me your 64-page book.

..... NAME
 STREET
CITYSTATE

New York Electrical School

29 West 17th Street, New York

Science and Invention

H. GERNSBACK, EDITOR AND PUBLISHER
H. WINFIELD SECOR, ASSOCIATE EDITOR
T. O'CONNOR SLOANE, Ph.D., ASSOCIATE EDITOR

Editorial and General Offices, - - - 53 Park Place, New York

"Those Who Refuse to Go Beyond Fact Rarely Get As Far As Fact" - - - HUXLEY

Boys as Inventors

By HUGO GERNSBACK

THERE are indications that at last Youth will be coming into its own. No longer, it appears, will experienced, middle-aged, trained workers be used exclusively by our large corporations, but it seems that the young boy will have a chance to show what is in him.

Edward H. Jewett, it would appear, is now using his million-dollar radio factory, near Detroit, to show to the world that Youth can invent and can perfect devices, if given a chance.

In a recent interview to a Detroit paper, Mr. Jewett said as follows:

I BELIEVE THAT:

No invention was ever perfected without enthusiasm.

"Give the boy a chance. I want any youngster who thinks he has an idea or an invention to come right up to my office and tell me about it."

The next day the place was stormed by several hundred boys ranging from ten to nineteen years old. The police were called to keep the lads in line,

and Mr. Jewett told them that because the response was so unexpectedly large all would have to submit their propositions in writing. They did, with the result that three of the most promising boys were turned loose in a room.

"This is your room," Mr. Jewett told them. "Do what you want. Come when you please, go when you please. All the apparatus you require is at your service. When you get an idea work it out. If you think it successful, take it to the chief engineer and let him try it. If it passes the scientific test I'll buy it."

The three boys in this room worked out the device which, with minor perfections by the plant's technical staff, has come to be the principal product of the Jewett factory. The company is erecting a ten-acre plant at Pontiac, Mich., not far from Detroit, and there one whole floor of one of the buildings will be available to young inventors who may put their ideas to the test.

"It has long been a fixed idea of mine that in any such inventive field as radio, the viewpoint, the enthusiasm, particularly the fresh vision of youth, is valuable," said Mr. Jewett, explaining his innovation. "Of course the idea is not original with me. I remember reading years ago how Marconi sought suggestions from the young.

"But somehow, manufacturers seldom will be bothered with youth. So many of their young ideas are already old to experienced men; the majority are so futile that they simply will not bother with them. The result is that the occa-

sional brand new, probably revolutionary idea is lost or delayed by years. Moreover, a young fellow's most valuable quality—enthusiasm—is quenched or dimmed.

"In our plant we value experience highly; we must. But, on the other hand, we keep a wide-open eye and ear for anything youth may send to us. It has been a good thing for both our business and the youngsters. I am glad to give credit for much of what we have done and are doing to youth, and it is not far from the actual fact when you say that the inventive genius of young lads is in large part responsible for the new plant at Pontiac.

"Radio naturally appeals to the youngsters more than other scientific fields. It has been said that every home where there is a radio is a sort of amateur laboratory. In the home laboratory an inquisitive, ambitious lad may hit upon something that will greatly improve existing methods.

Our plant offers him full technical opportunities to test it out. We do not condemn beforehand. We check youth with experience, but we never discourage it.

"I was lucky in my own boyhood by being generally understood. But I did have a few experiences where some man threw cold water on my suggestions just because he was much older and because he sat behind a desk marked 'Manager.' Those experiences taught me a lesson I have never forgotten, and ever since I have been in business I have sought to encourage the boys.

"If all employers would do this the world would be greatly changed. It costs nothing to listen to a young person's ideas. A manager does not have to commit himself to a suggestion. But an attentive, sympathetic ear may be just the thing required to develop a boy or girl, to start him or her on the path to full development.

"My experience has been that the young people are grateful for sympathy and understanding, and this gratitude becomes a loyalty which never can be measured in dollars.

"In scientific and technical fields such as the automobile and radio, immediate results are frequently seen. But ordinary business or commercial life profits equally, if not perceptibly, by encouraging and stimulating the fertile mind and buoyant spirit of youth. I began this policy because I remembered my own small beginning. I hope that is the real reason I am continuing it. But the fact remains that it has meant thousands and thousands of dollars to me."

I BELIEVE THAT:

Life's greatest thrill comes with an inspiration.

I BELIEVE THAT:

Inventors being pioneers, they should be treated as such.

THE GOLDEN AGE OF SCIENCE

is now symbolized by the golden cover of SCIENCE & INVENTION, LOOK FOR THE GOLD COVER every month!

Tornado in Movies

By EDWIN SCHALLERT



1. Storm clouds with the sun shining through were photographed and inserted at several places in the film for effect.

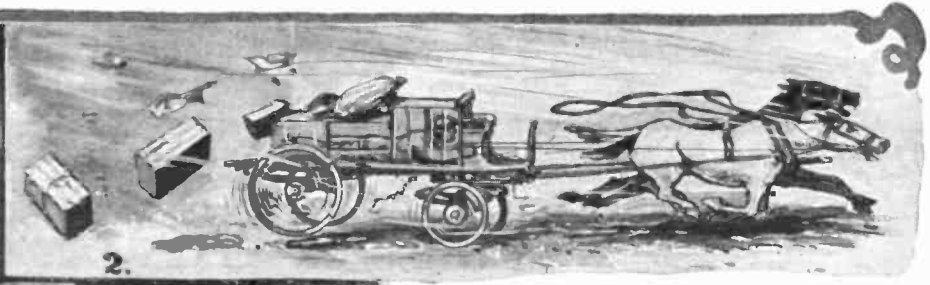

2. During the storm, a team of horses, seemingly driverless, were driven across the scene by a man hidden as shown above.

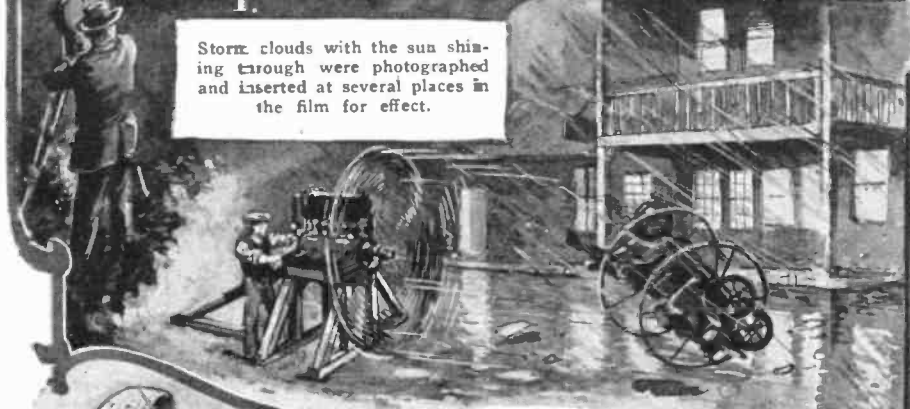

3. During the storm, a light automobile rolls over and over covers the street. The effect was produced as above.



4. BABY CARRIAGE DRAWN BY WIRE

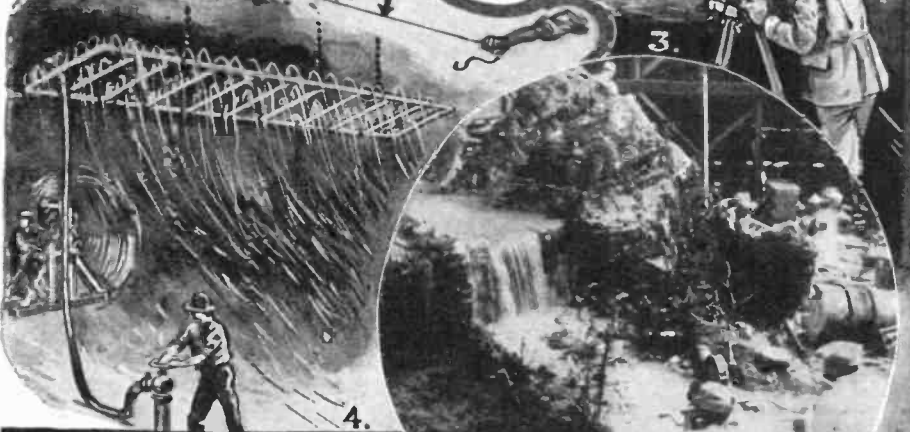

THE story of *The Tornado*, Universal's latest film thriller, is in brief as follows. The hero, House Peters, known as *Tornado*, is the masterful boss of a large lumber camp. One day, just after his crew of workers has collected a large log boom in readiness to send it down the river as soon as the water rises, he goes into the nearby town. On the porch of a store, he recognizes a girl with whom he had had a love affair. The girl is now married and accompanied by her husband. It is *Tornado's* belief that the reason that the young lady left him years before was because she did not reciprocate his love. The true facts were different, however, and the young lady, although married, still wishes to continue their friendship. One evening she goes to *Tornado's* cabin to see him and to attempt to explain to him the real reason for their former misunderstanding. She is directed to the cabin by a little boy who is later questioned by the husband as to whether or not he has seen the young lady. The boy tells the husband that his wife has gone to see *Tornado*. When the young lady returns, the husband, his mind inflamed with evil thoughts and drink, beats her. *Tornado*, wandering around the town, hears cries and goes to the rescue. He knocks the husband out. The next morning, the woman and her husband leave town on a combination freight and passenger train. A storm is brewing as the train leaves, and soon the surrounding country is battered by a terrific deluge of rain and wind. The river rises rapidly and the logs in the river jam against the booms. *Tornado* hastens to attempt to break the chains that hold the logs in restraint and after a battle with the elements succeeds in doing so.

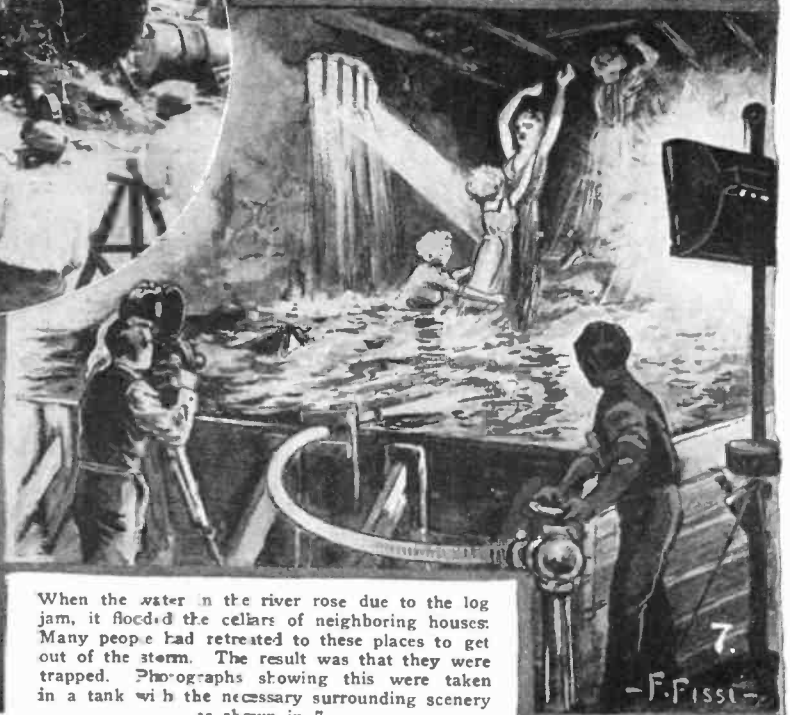

7. When the water in the river rose due to the log jam, it flooded the cellars of neighboring houses. Many people had retreated to these places to get out of the storm. The result was that they were trapped. Photographs showing this were taken in a tank with the necessary surrounding scenery as shown in 7.

-F. FISS-

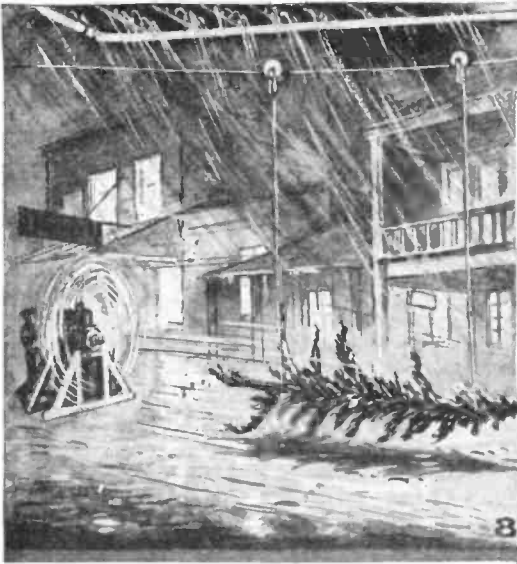

Left: Trees are seemingly blown down the street. The effect was photographed as shown, the trees being supported on almost invisible wires and blown by an airplane propeller on a powerful motor.

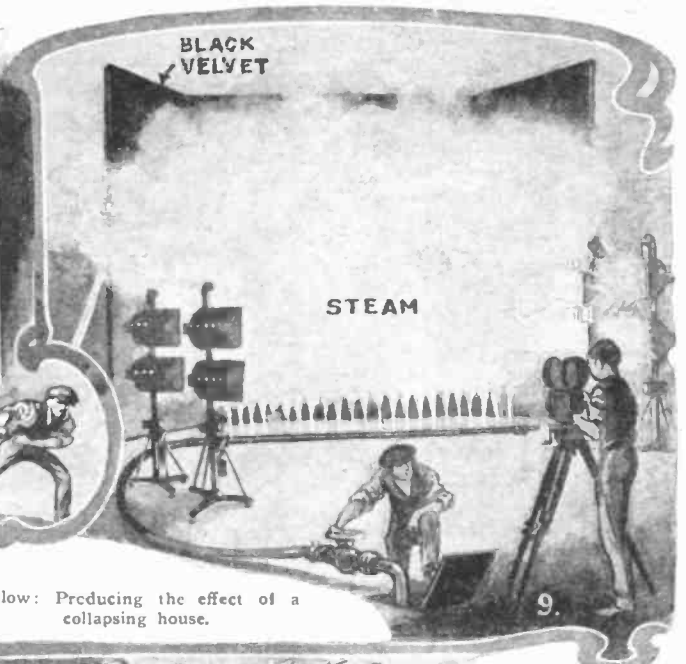

Right: Photographing steam to be used for effect in various parts of the film.

THE rising waters had flooded cellars and imprisoned many people therein. The released logs floated down the river and again jammed against a railroad bridge. As the train bearing the woman and her husband crossed the bridge, piers gave way and wrecked the train. Tornado rides down the river on a log and rescues the girl, although the husband drowns.

The close-ups of Tornado breaking the jam were taken in a tank as shown in 6, rain pipes as shown in 4 supplying the effect, while a wind machine blew the water as if lashed by a storm. Many of the scenic effects in this picture were taken in miniature as in 5. The wreck of the miniature train is shown in detail in Figs. 11 and 12. The entire action was photographed in a tank, and as the train reached the desired spot, the underpinnings were pulled out and the wreck occurred. The last car in which the woman and her husband were riding was partially above water as shown in 14. This scene was prepared in the tank as shown in 13. The hero comes to the rescue as in 14, treading over rafts made as in 15 for safety and saves the girl. Tornado returns to rescue the girl's husband after removing her, and just before he reaches the car the props are pulled out as in 16 and the remainder of the car sinks. Strips of film taken on the scene of a real log jam were cut into the film at various points to give the effect that the hero is working on a genuine jam. The section of film at the right illustrates this. (A) shows the genuine log jam and (B) the hero at work. (C) indicates the sides of the tank in which the imitation jam took place.



Below: Producing the effect of a collapsing house.



Left: A dilapidated "prop" house was pushed partially into the camera lines as shown and then given a final shove to collapse it. The wind and rain machines furnished the rest of the effect.

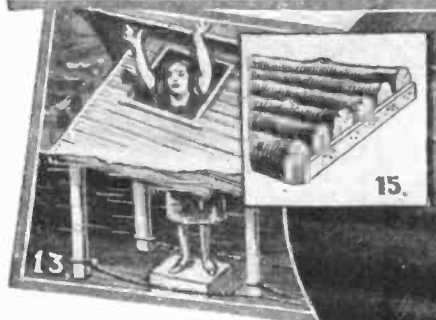

13.



14. TO THE RESCUE

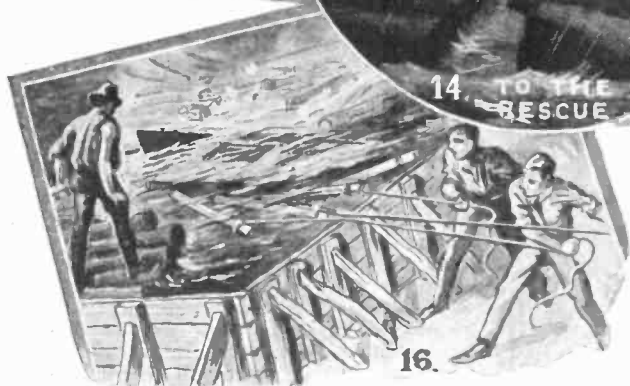

16.

All the scenes of the rescue were taken in a tank as illustrated in 16. Here as in other scenes of a similar nature, the hero walked on rafts of logs instead of separate ones as would have been the case in a genuine jam.

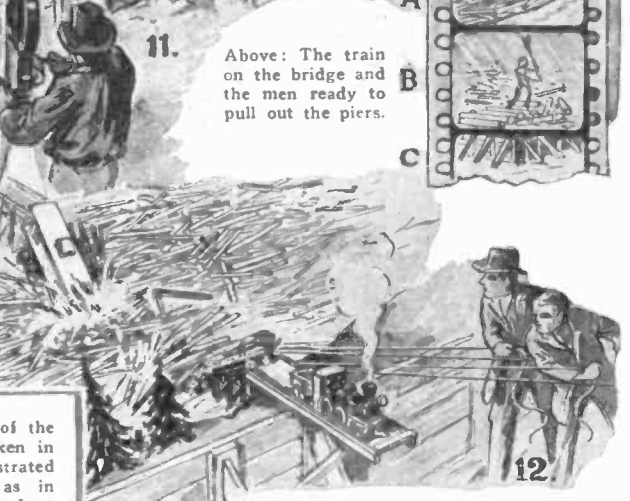

Above: The train on the bridge and the men ready to pull out the piers.

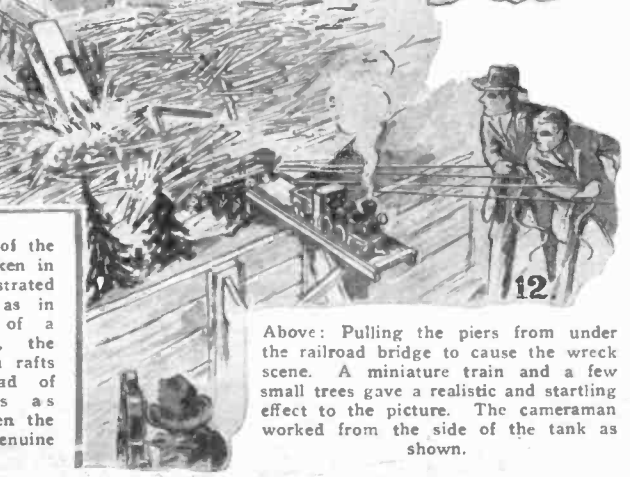

12.

Above: Pulling the piers from under the railroad bridge to cause the wreck scene. A miniature train and a few small trees gave a realistic and startling effect to the picture. The cameraman worked from the side of the tank as shown.

New York 100

By H. W.

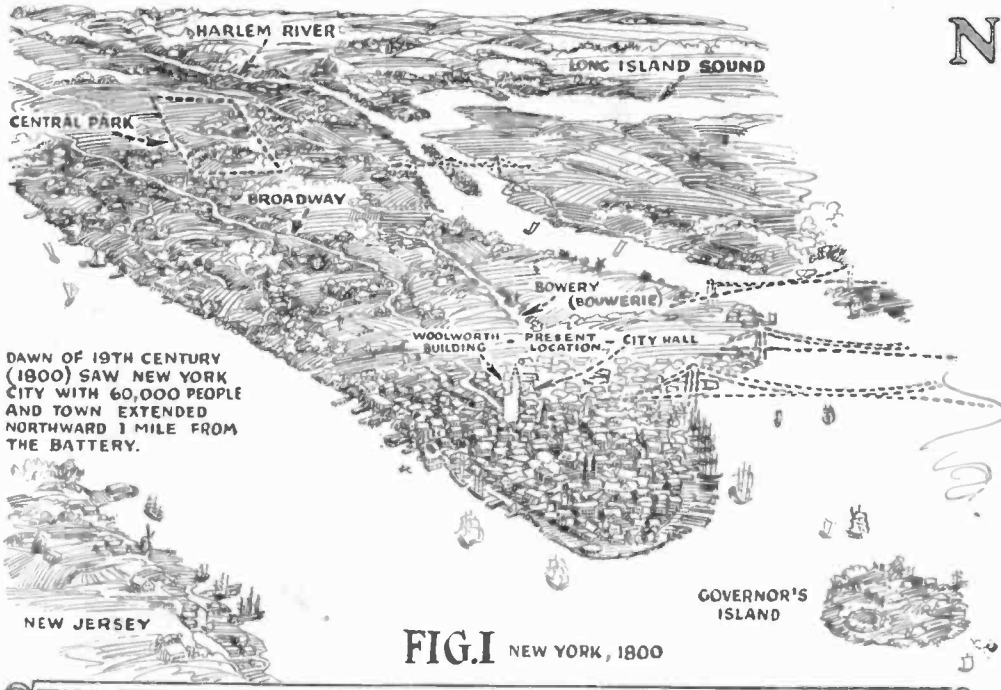

DAWN OF 19TH CENTURY (1800) SAW NEW YORK CITY WITH 60,000 PEOPLE AND TOWN EXTENDED NORTHWARD 1 MILE FROM THE BATTERY.

FIG. I NEW YORK, 1800

A GREAT metropolitan city like New York will of course grow to an unbelievable proportion in a century, or even half that time, and the pictures herewith will help to convey some idea as to how experts believe the foremost city of America will expand in the future. At the left we have an interesting perspective picture of "little old New York" at the dawn of the nineteenth century, when the population comprised about 60,000 people, a city about one-half the size of Paterson, or Trenton, N. J., today. New York in that day, 1800, extended northward about a mile from the Battery or southernmost point of Manhattan Island, as shown in the picture. The rest of Manhattan Island was occupied by farms, while ships from Europe and other parts of the world were beginning to find this a thriving sea-port. The positions of the principal bridges of today, as well as Central Park, are indicated by the dotted lines.

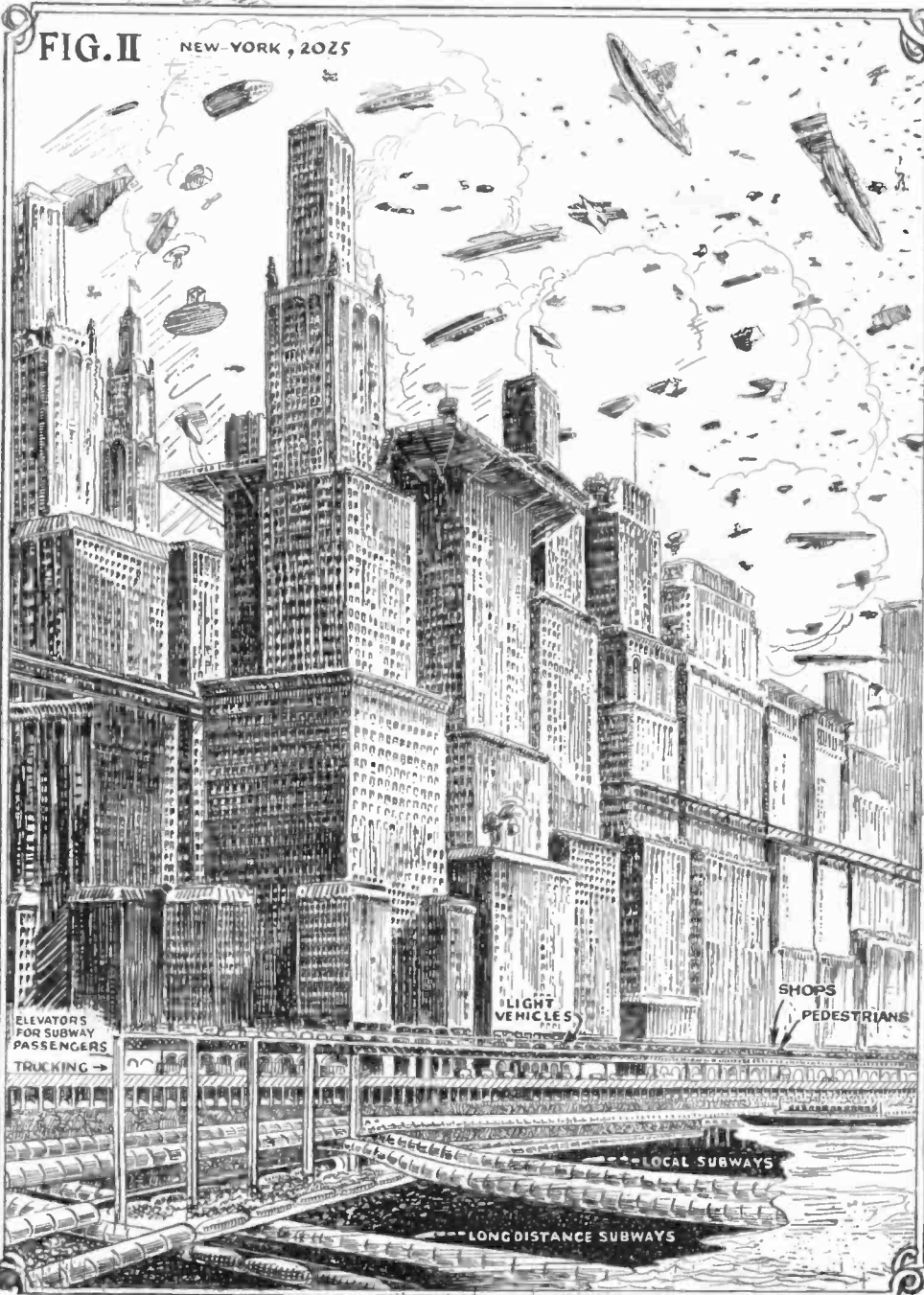

FIG. II NEW-YORK, 2025



IN the illustration, Fig. 2, at left, we gain a good idea of the probable appearance of New York's skyscrapers in the year 2025, or a century hence. Other large cities will of course have similar tall buildings without a doubt, as well as numerous underground subways and triple as well as quadrupled-decked streets. The lower level of future city streets will be occupied by motor trucks, while the level above this will be occupied by lighter vehicles, such as pleasure cars. The sidewalks, some moving type, in the next twenty-five to fifty years, will doubtless be built above the motor vehicle street level and be arranged inside of arcades within the buildings themselves. This will not only enclose the sidewalks at least overhead, as an insurance against rain and snow, but this arrangement will provide much better show window display facilities for stores. In twenty-five years we of this generation will doubtless see the sky filled with aircraft.

Years Hence

SECOR

A COMMUTER of fifty to one hundred years hence will live in a different atmosphere than does the commuter of the present day. Twenty-five miles is about the average distance the commuter of today travels, but fifty years from now the commuting zone for New York business men will have reached out to a fifty-mile radius. predict such able experts as Thomas N. McCarter, President of the Public Service Corporation of New Jersey. This great metropolitan area of half a century hence will reach out as far as Trenton, N. J., and Stamford, Conn., while high-speed subways and aerial express routes will carry the commuter to and from his work. Air "flivvers" for the fifty-mile commuter will be common. Looking at the illustration at the right again we see, according to such experts as Mr. McCarter, that the vast New York of one hundred years hence may easily reach out to a radius of one hundred miles, and have the tremendous population of seventy-five to one hundred million people.



The accompanying bird's-eye view showing the growth of Greater New York in the next fifty to one hundred years, depicts how high speed railways and the electrified railways will carry the commuter out in every direction like the spokes of a wheel. Of course not everyone will work at the hub of this beehive of industry, but the system of transportation shown, amplified by auxiliary cross-web subways, as well as aerial arteries of traffic, will serve the public's requirements.



FIG. IV

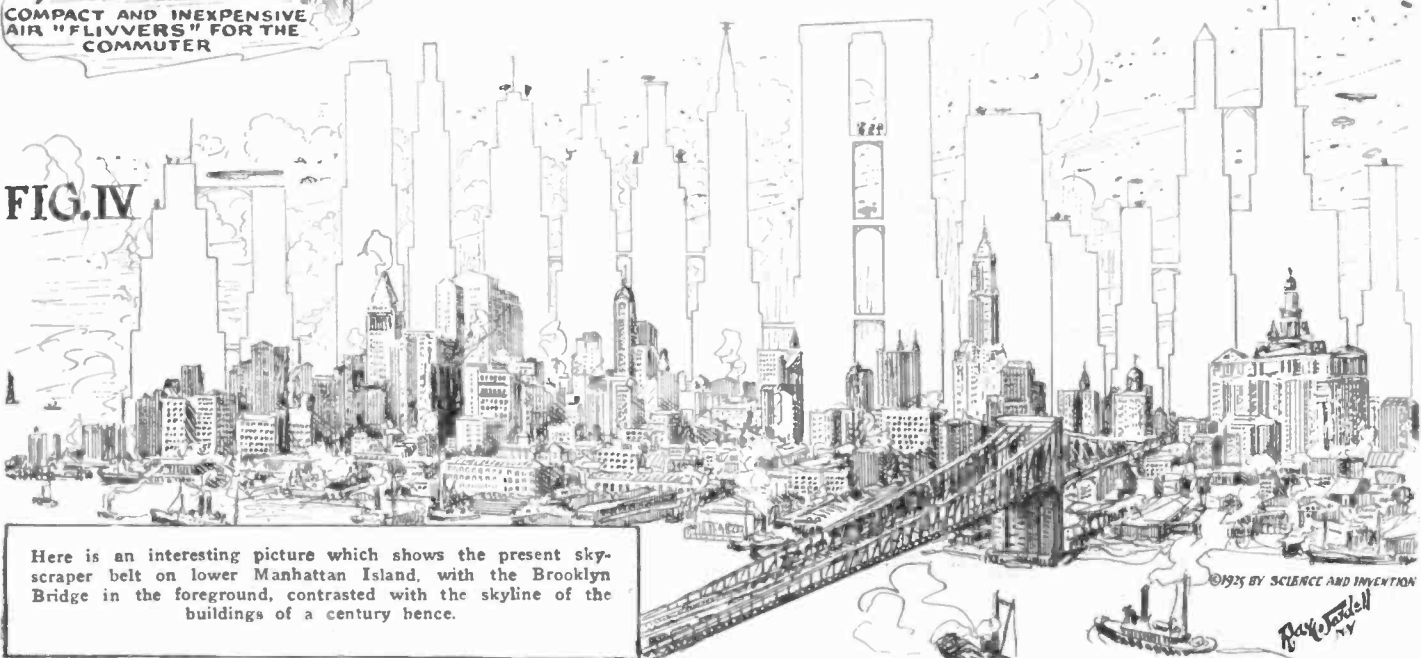

Here is an interesting picture which shows the present skyscraper belt on lower Manhattan Island, with the Brooklyn Bridge in the foreground, contrasted with the skyline of the buildings of a century hence.

Raymond
1925

The Perpetual —\$5,000

By JOSEPH

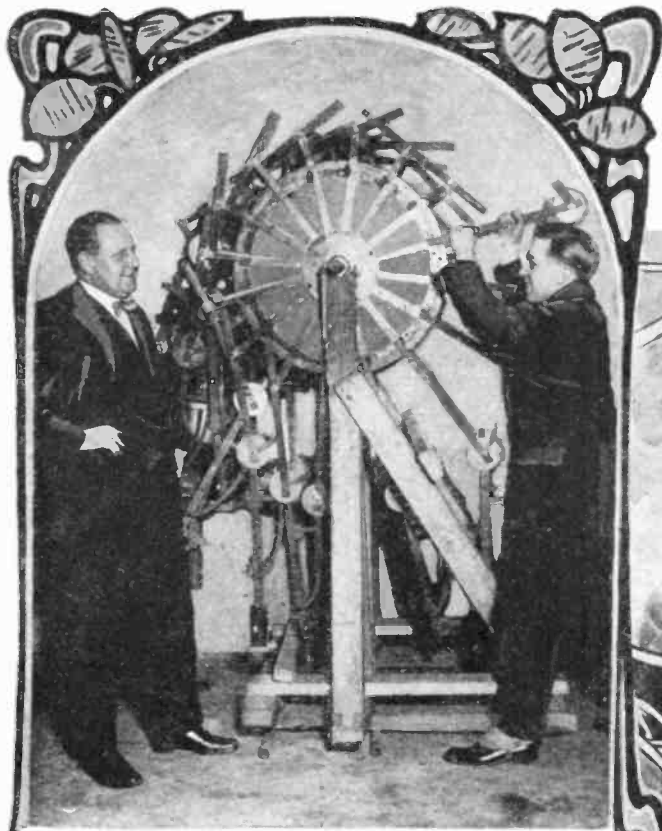

The perpetual motion machine illustrated above was built in England. Like all other similar devices, it did not work, and after spending years of fruitless energy in building it, its inventor disappeared, leaving the model behind. The machine resisted all efforts to turn it.

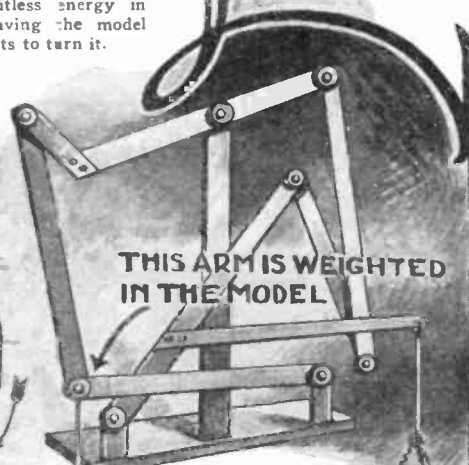
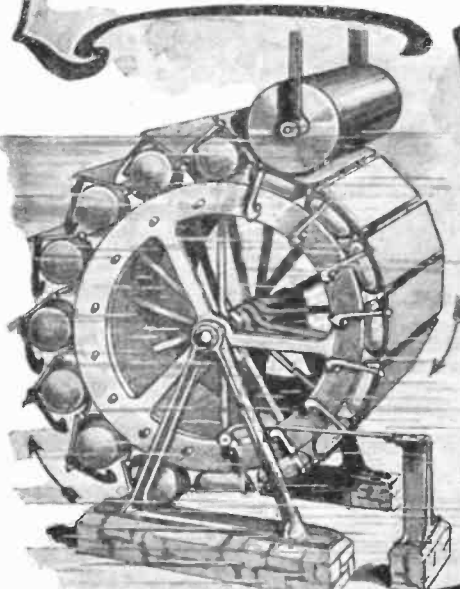
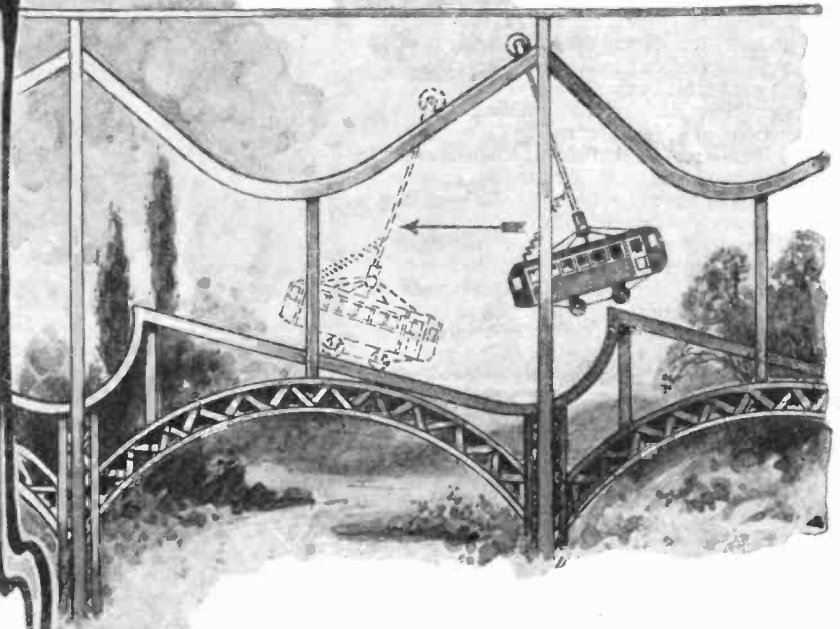

**THIS ARM IS WEIGHTED
IN THE MODEL**

The hoax of Bluske of Asheville, N. C. above and a photo of model below and diagonally to the left. Bluske claims that a weight on one side of the pan will lift twice as much on the other side through the same arc. To make it do so, he weights one pan of the balance.

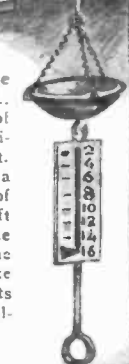

\$5,000.00 IN PRIZES

As elusive as the quest for the pot of gold at the end of the rainbow is the search for perpetual motion. Machines working by natural forces such as winds, tides, temperature changes, etc., are not perpetual motion machines. By perpetual motion one means a machine, which without assistance of any external force except gravity, shall keep on moving until its parts are worn out. It is not necessary that the machine evolve more power than that which is required to run it. The mere fact that it continues to run would of itself be of great value. Perpetual motion inventors may be divided in two classes. First, those who are laboring under a delusion, developing absurd ideas, and second, those who are perpetrating deliberate frauds. The first group can sometimes be reasoned with; the second group "knew" that they have developed perpetual motion, but bring forth the logical (?) argument, "Why should I show anyone my perpetual motion machine actually working. They would steal the idea and I would get nothing for it." To this group **SCIENCE AND INVENTION MAGAZINE** says, "If you will bring or ship your working model of a perpetual motion machine to the offices of this publication, and if it is a perpetual motion machine coming under the classification above indicated, this publication will pay the sum of \$5,000.00 and will give you publicity on the machine if you so desire for merely being permitted to watch the machine in operation. In order to conform with post office regulations, this offer is made to expire on March 1st, 1926. Further information concerning this award is found on the next page.

The machine above is submerged in water. The balloons on one side are inflated. A roller at the top forces the air from upper balloons to the bottom. Buoyancy of half the wheel makes it run. The device at the extreme right is another mechanism working on the water principle. Neither of the two are operative.

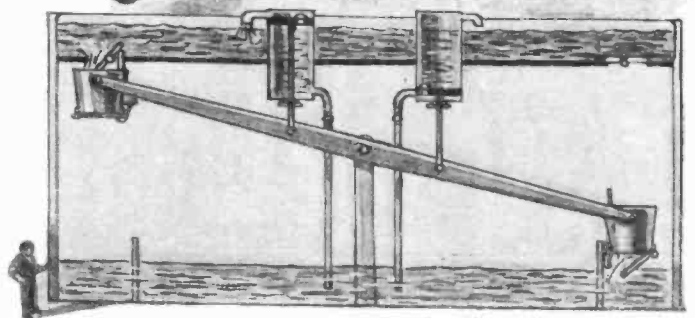
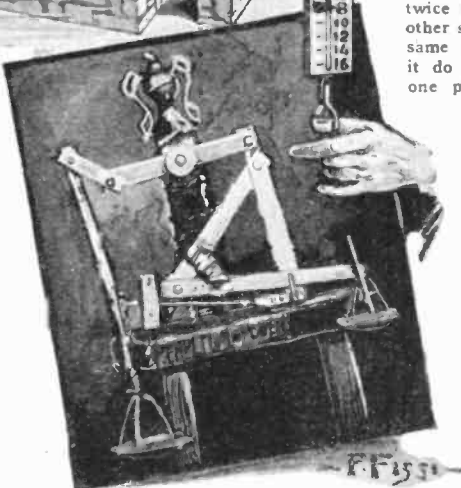

Motion Myth in Prizes

H. KRAUS

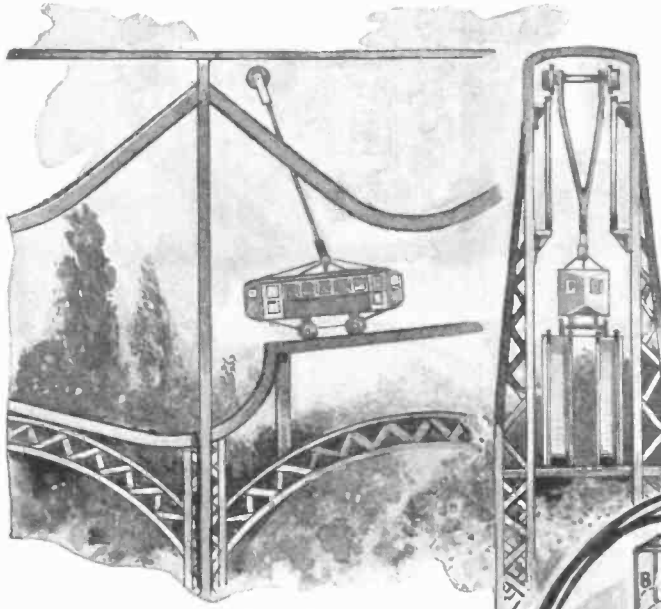

The automatic aerial railroad depicted above was patented in the U. S. This would-be perpetual motion device never worked.—G. Miller.

The railway at the left rolled down-hill. When it gathered momentum the trolley at the top lifted the entire car to the top of the next incline. The mechanism at the right is supposed to operate by buoyancy and gravity. Balls floating on the surface of the water rise up the column of water, and descend on the endless belt. The cover rises and falls and the valves work automatically.

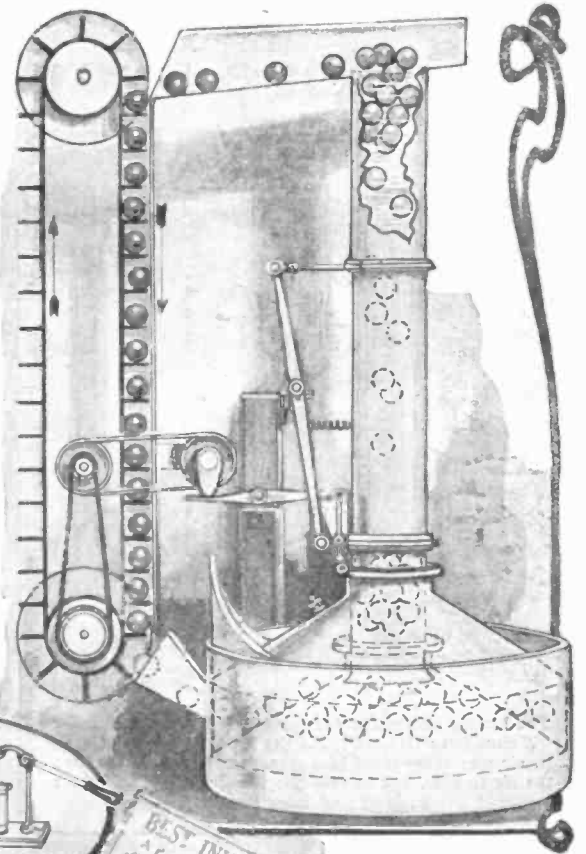

Left, a typical advertisement clipped from a newspaper proclaiming discovery of perpetual motion. We wonder how many fell for this?

THE reason that SCIENCE AND INVENTION MAGAZINE is offering an award of \$5,000.00 for a working model of a perpetual motion machine may be given in a few words. Throughout the country we see advertisements, placards, and postal cards advising the public to invest in means of developing perpetual power. Some of these advertisements are reproduced on these pages. Always the inventor claims to be the proud possessor of the one and only working perpetual motion machine. Invariably the inventor claims to be looking out for the investor's individual welfare. He does not want to give the system to the "crooked politicians" who are anxiously waiting to give him several hundred thousand dollars for his rights to the invention. He glibly paints a wonderful picture of the earning capacities of such an invention and zealously and covetously guards his secret. If he gets your ten cents or a hundred dollars for a share in the invention, he gloats over his success. The next time one of these inventors call to see you, show him a copy of this publication, tell him there are no strings tied to the offer. Tell him SCIENCE AND INVENTION does not want the rights to his invention. They merely want to see it working, and if it does so, they will praise it from the housetops and give it not \$100.00, but \$5,000.00. Should two or more contestants tie for this award, a duplicate prize will be paid to those so tying.

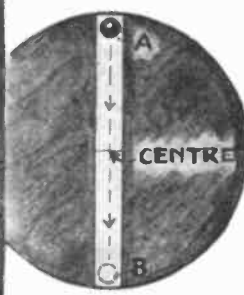
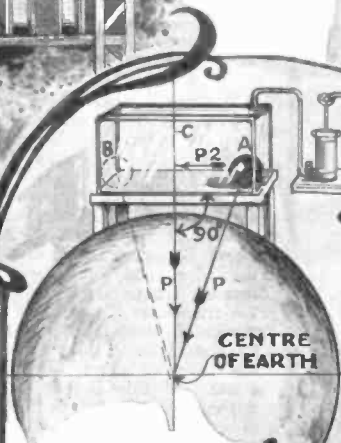

The two perpetual motion systems illustrated above should work if all conditions are applied. First the surface of the plate will have to be perfectly plane and the ball perfectly spherical. There must be no air resistance nor friction between the ball and plate. When started the ball will oscillate back and forth. A ball dropped through the center of the earth would do likewise if there were no friction. Centrifugal force is not considered.—C. A. Oldroyd.

The device at the right is a typical fallacy. The inventor believes that the weights at the right of the wheel being further from the center than those at the left, the wheel should continue to run. The only difficulty is that it will not do so. Note that there are five weights at the left.

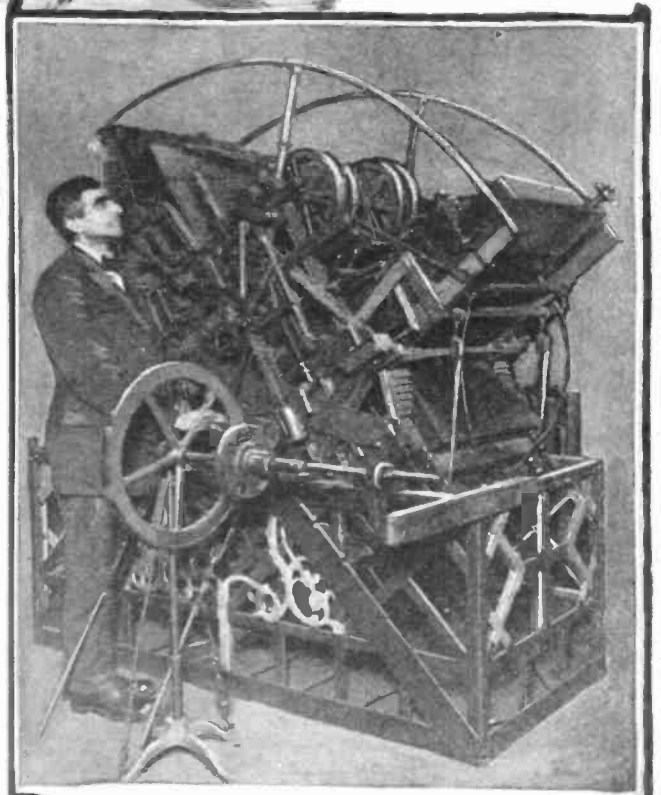
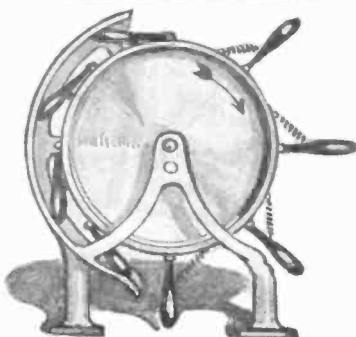

Mr. Ulram and his perpetual motion machine are shown above. He tells investors that when he has enough mercury he will make the machine work. He has admitted to the editors that there is something wrong with the machine.

More Frauds

(Continued from preceding page)



The bicycle above was described in a London paper, the "Westminster Gazette." As the rider bounced along on it, air was compressed in a storage tank which operated the air turbine, and in turn the wheel (?)—result—more bounces and more speed?!X

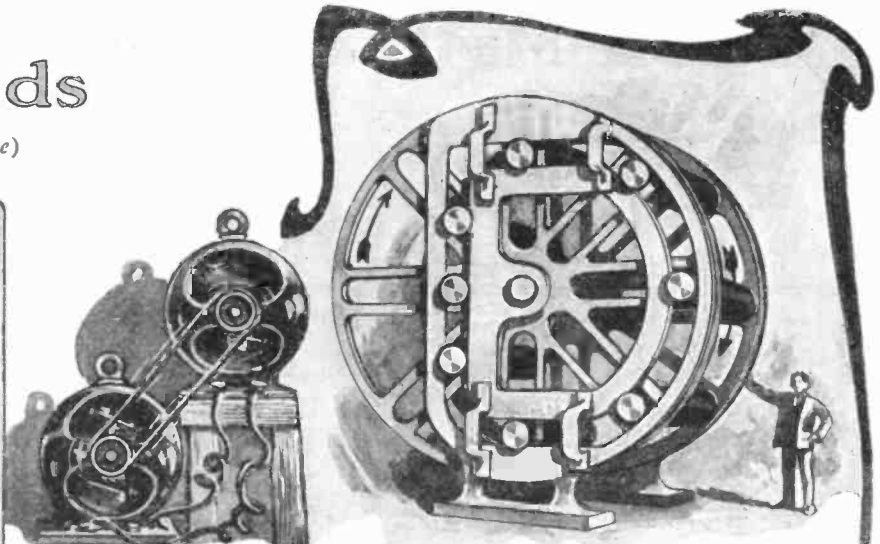

The weights further from the center on one side are supposed to cause the wheel to turn.

FOR A METHOD, formula, process that will prevent the freezing of asphaltic concrete. Offer expires 1925. Address: S. D. H.heimer, Land Title Bldg., Philadelphia, Pa.
 \$500 FOR A SIMPLE DESIGN for a motor generator set or rotary converter, in which the motor obtains excitation from the generator it drives. Both offers expire May 1, 1925. Address: William H. Mitchell Co., Troy, Ohio.
 ENGLAND 57th St. makes a monthly award and illustrates

IN those devices where the weights are further from the center on one side of the wheel than on the other, there is always a preponderance of weight on the ascending side. The most that a device of this nature could do is to reach a state of stable equilibrium where of course it will not work. In the device at the right, one has of course friction in the bearings of the axle of the wheel B, power is required to bend and unbend the rope, and there is friction in passing it through the water, but the most serious of all is the friction at the point D. If the water is to be prevented from flowing out through D, then the joint must be so tight as to prevent movement of the rope or other buoyant body through the water. If this is not quite tight enough, the water will pour out of D until it reaches a state of equilibrium. Connecting the motor and generator together as indicated above, has never worked and never will operate, because the efficiency of two pieces of electrical apparatus of this nature can never be one hundred per cent. There are losses in transmission, in wiring, and in the generation of currents as well as in their transformation. We do not brand all seekers of perpetual motion as charlatans. We do brand those as charlatans who claim to have produced perpetual motion and who are unwilling to lay their proofs before the scientific world. This article will not close the discussion, and we realize that we shall receive many letters as a result of this exposé.

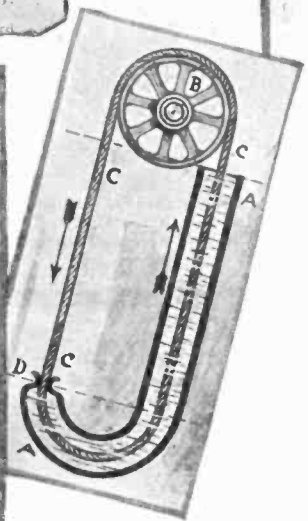

Above A is a column of water. C is a buoyant rope. One side is thought lighter than the other, but friction at the point D prevents it from operating.

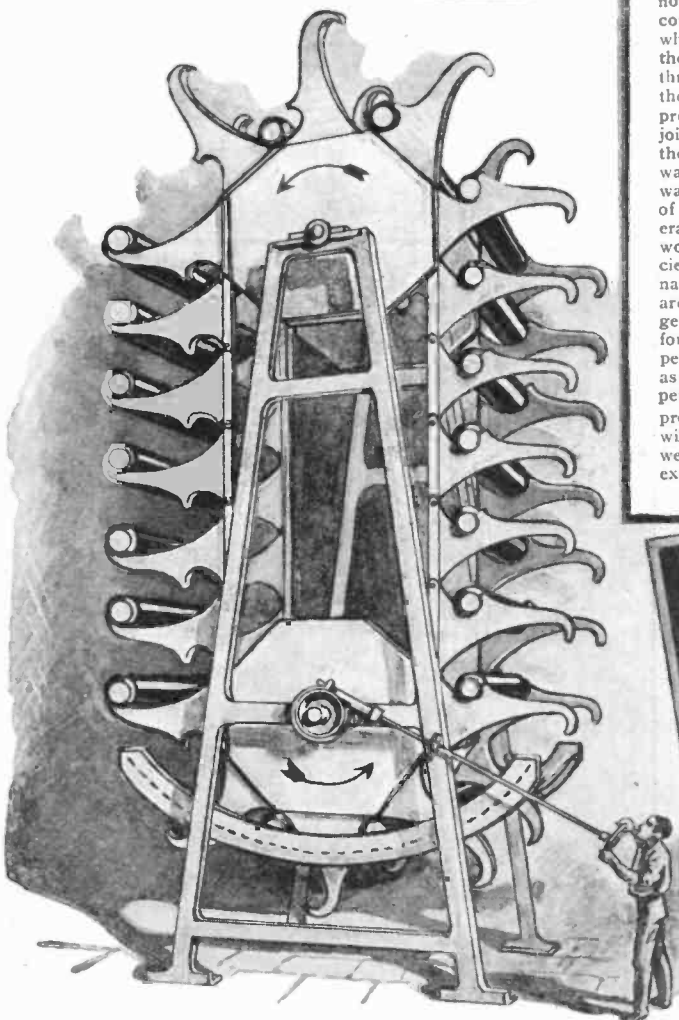

A patent has actually been taken out on the device above illustrated. The inventor does not state that the device is perpetual motion but this seems to be the claim. The mechanism is equipped with a brake to prevent it from going too fast, and in patent claims is provided with a motor to start it. WITHOUT A MOTOR IT CANNOT WORK.

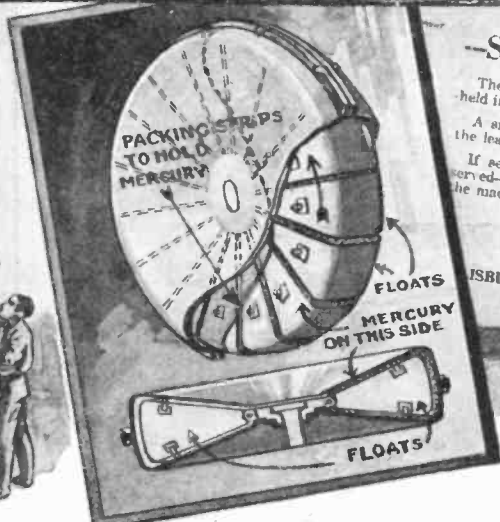

The mechanism above illustrated and the postcard describing it is another self-motive power machine. Mercury is supposedly held on one side of the machine by packing strips, and the other side is buoyant. The inventor does not consider the friction resulting from the packing strips which are to hold the mercury in place. The device is inoperative.

FF1551

—Self Motive Power—

The Dotted side contains Mercury, held in position by spring packers. A small Automatic Pump takes care of the leakage.

If set LEVEL no movement will be observed—TILTED toward HIGH or LOW the machine turns in either direction.

JOS. E. BISSELL.
 Tony Tank.
 ISBURY, MD.

Improving the Heating System

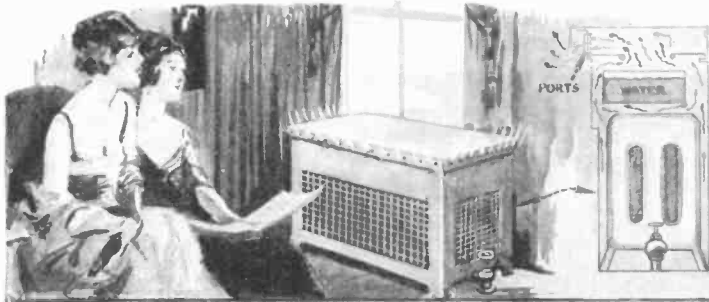

A decorative casing to be placed around radiators and to contain water for humidifying the air has recently been placed on the market. It is illustrated in perspective and cross-section.

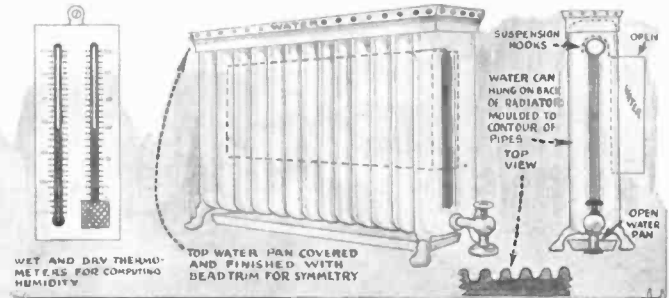

A wet and dry thermometer aids in computing humidity. Right: Cans of water placed as shown will assist greatly in humidifying the air when heated by the radiator.



Lower left: New evaporator for humidifying air from hot air furnace. Below: Same device electrically operated.

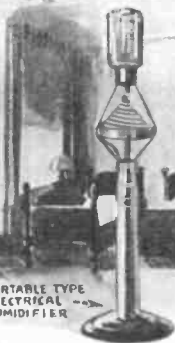

PORTABLE TYPE ELECTRICAL HUMIDIFIER

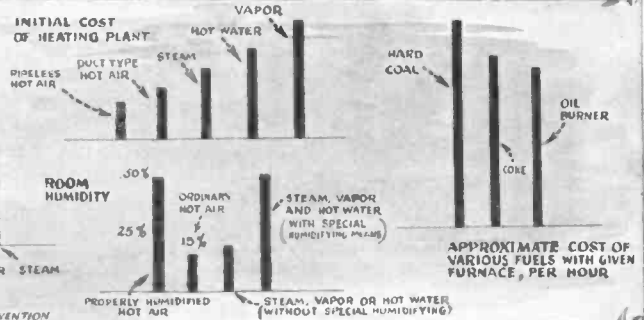

© 1925 BY SCIENCE AND INVENTION

One of the greatest drawbacks to most of our modern heating systems is the fact that the air is not properly humidified and therefore is not conducive to good health. Some of the ideas herewith show how to rectify this. Above: Comparisons of initial cost, operating cost, coal consumption and humidity with various types of present day furnaces.—H. W. Secor.

High Power Portable X-Ray



Portable X-ray outfit weighing 20 pounds is shown at left. It may be used for industrial purposes or by doctors and dentists. The type and size of tube used is shown below. Right: X-ray photograph through wall of house. Pipes, conduits and wires can thus be located.

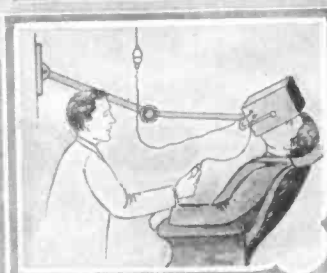
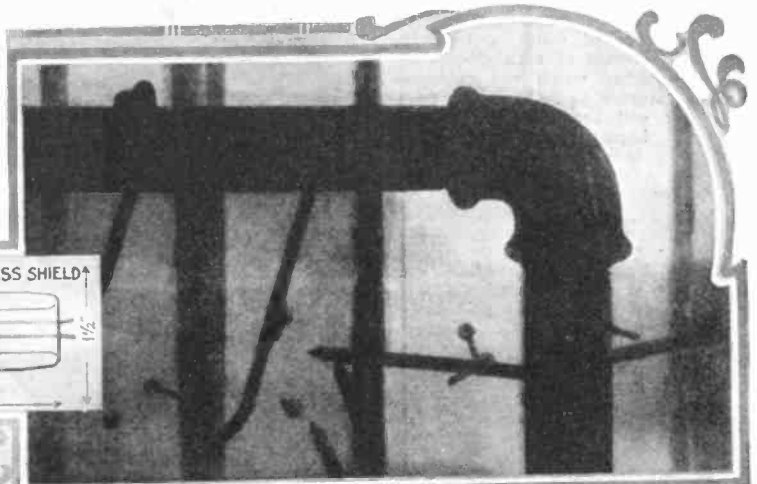
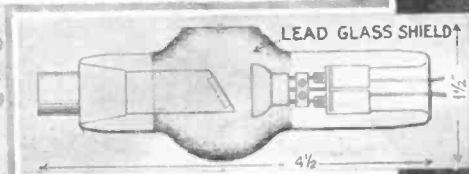

Left: Locating pipes in wall. Above: Using portable X-ray outfit on dental patients. Special arm holds unit in place.

Below: A cross-sectional view of portable X-ray outfit. Tube and transformer which delivers 56,000 volts and operates on house current are immersed in oil. Special chamber provides for expansion of oil due to heat.

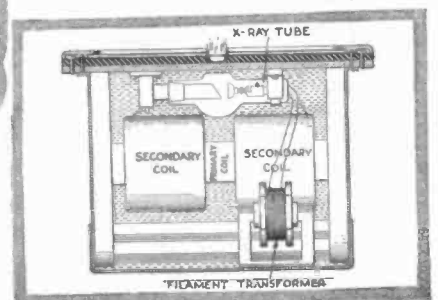

Ice and Water Illumination

By HUGO GERNSBACK

Member American Physical Society

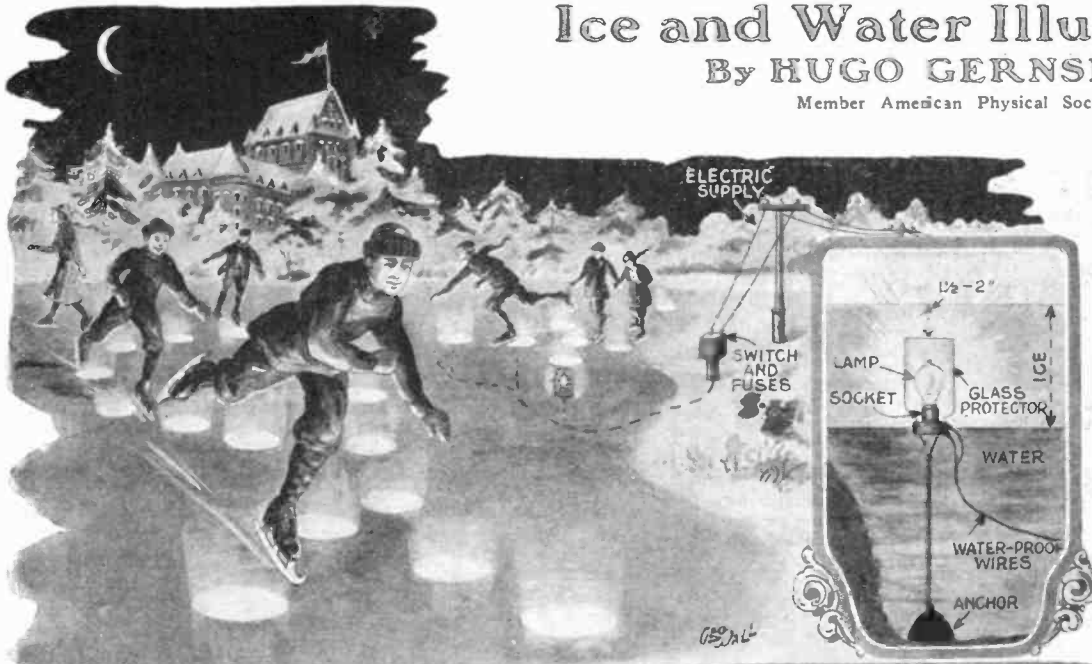

THE writer presents a novel scheme for under-ice and under-water illumination. There are of course, outdoor skating rinks now in existence, on which lighting is provided by means of overhead electric lamps. The writer produces a novel and weird effect by lighting the ice by means of electric lamps suspended in the water in the manner shown in the small illustration. Each lamp has a glass protector, and the lamp is kept in place by means of an anchor. The glass protector also acts as a sort of heat insulation between the lamp and the ice, to keep it from melting. The lamps are about two inches below the surface of the water before the latter freezes. Once the water freezes it surrounds the electric lamp and, when turned on, it provides a weird and fascinating spectacle.

IN this view we see how a large steamer is guided by means of an under-water system of the same class as the one used for the ice illumination explained above. Channels, inlets, and other dangerously shallow bodies of water, can be marked by means of such electric lighting systems, which will guide the large steamer so that grounding the latter will become almost an impossibility.



HERE we have a similar scheme to the ones described above, with the exception that here a small lake is partly illuminated at night. It should be noted that by means of an illumination of this kind it is not only the spot directly above the lamp that is illuminated, but also the surrounding water becomes faintly luminous, due to diffusion of the light through the water. Colored lights can, of course, be used to give pretty effects if such should be wanted. The cost of lighting systems of this kind is rather moderate, the only necessity being good insulation which is easily available to-day. The above form the subject of a patent application.

Navigation Instruments on "Los Angeles"

By DR. ALFRED GRADENWITZ

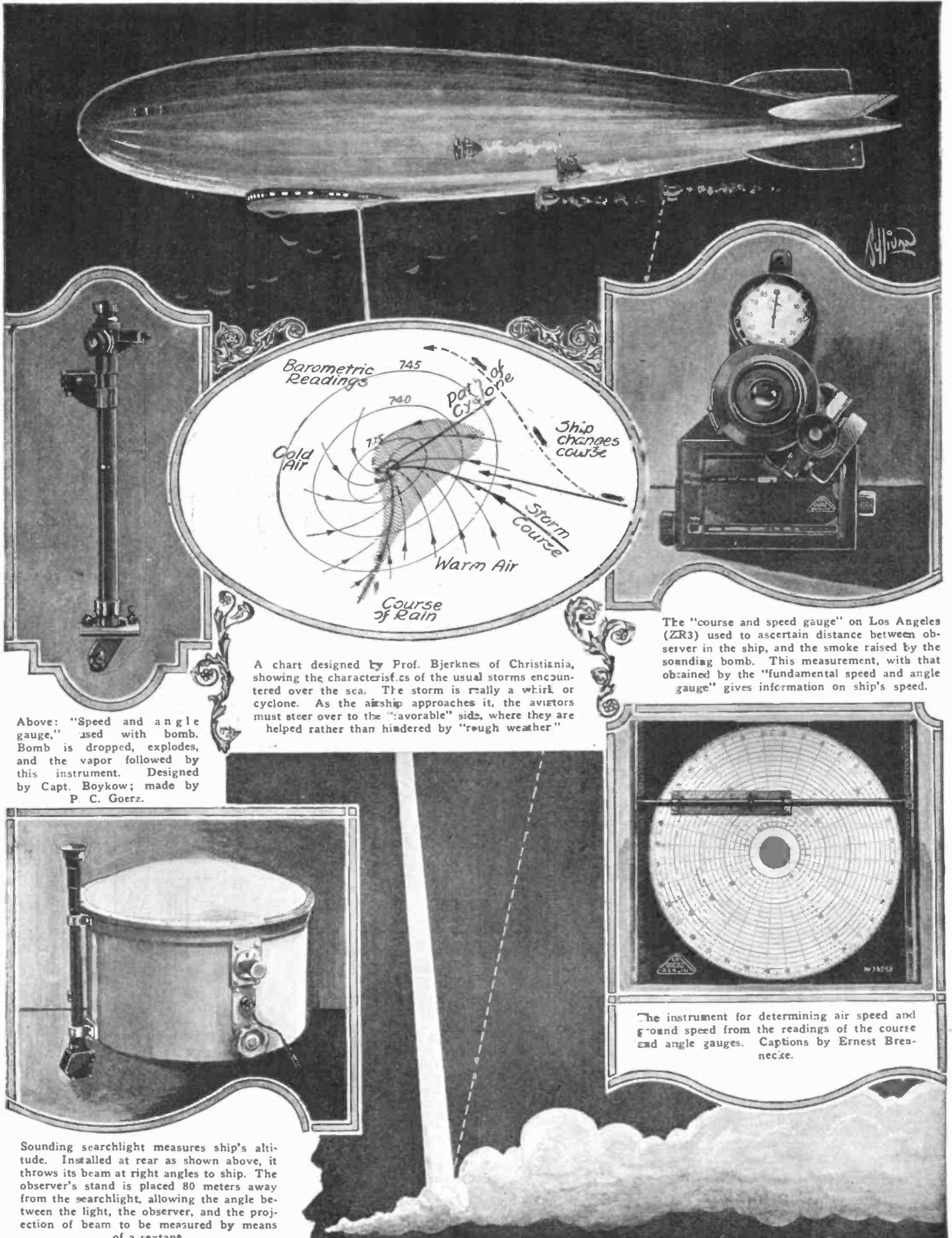

Above: "Speed and angle gauge," used with bomb. Bomb is dropped, explodes, and the vapor followed by this instrument. Designed by Capt. Boykow; made by P. C. Goerz.

A chart designed by Prof. Bjerknes of Christiania, showing the characteristics of the usual storms encountered over the sea. The storm is really a whirl or cyclone. As the airship approaches it, the aviators must steer over to the "favorable" side, where they are helped rather than hindered by "rough weather"

The "course and speed gauge" on Los Angeles (ZR3) used to ascertain distance between observer in the ship, and the smoke raised by the sounding bomb. This measurement, with that obtained by the "fundamental speed and angle gauge" gives information on ship's speed.

The instrument for determining air speed and ground speed from the readings of the course and angle gauges. Captions by Ernest Brennecke.

Sounding searchlight measures ship's altitude. Installed at rear as shown above, it throws its beam at right angles to ship. The observer's stand is placed 80 meters away from the searchlight, allowing the angle between the light, the observer, and the projection of beam to be measured by means of a sextant.

The Latest in Helicopters

ALTHOUGH helicopters have been considered to be rather out of the question in the field of practical aeronautics up to the present time there have been many experimental models of such devices built. The most notable and one of the latest of these is the Perry helicopter designed by Thomas O. Perry, backed by Chicago Helicopters, Ltd., for entry in the British World-Wide Helicopter Competition and illustrated here. In essence, the device may be described as follows: A one hundred and ten horse-power rotary engine drives two sets of wing panels or aerofoils, each four feet wide by eighteen feet long. The ship is sixteen feet high and weighs about 2,200 pounds without fuel, oil or crew. Controls are so arranged and designed that the angles or tilt of the wings can be controlled equally or when desired each wing can be controlled individually. Automatic arrangements allow the blades, when it is necessary, to be "feathered" as illustrated.

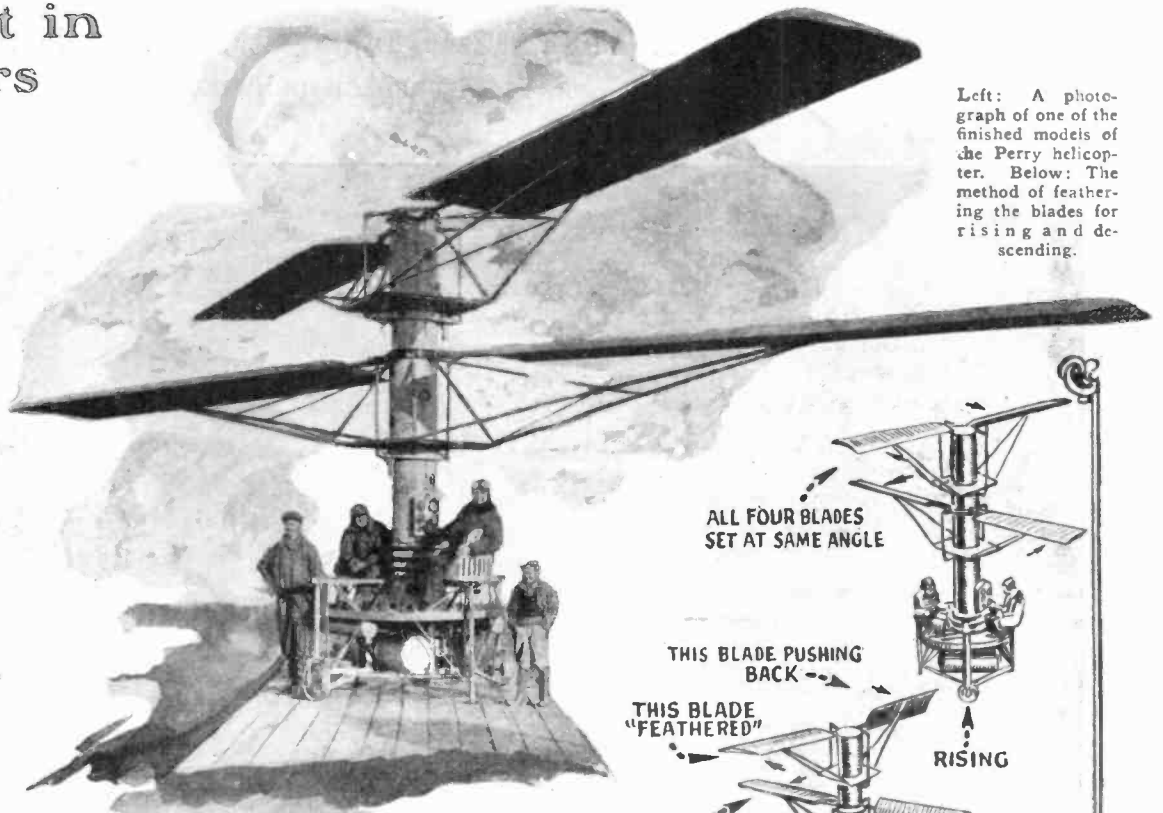

Left: A photograph of one of the finished models of the Perry helicopter. Below: The method of feathering the blades for rising and descending.

ALL FOUR BLADES SET AT SAME ANGLE

THIS BLADE PUSHING BACK

THIS BLADE "FEATHERED"

RISE

THIS BLADE IS "FEATHERED" (SAME PRINCIPLE AS IN ROWING)

THIS BLADE IS PUSHING BACK (ALMOST VERTICAL)

DIRECTION OF TRAVEL

DESCENDING (BLADES SET NEARLY HORIZONTAL)



Above: The Perry helicopter ready for one of its test flights, with the cabin around the occupants removed.

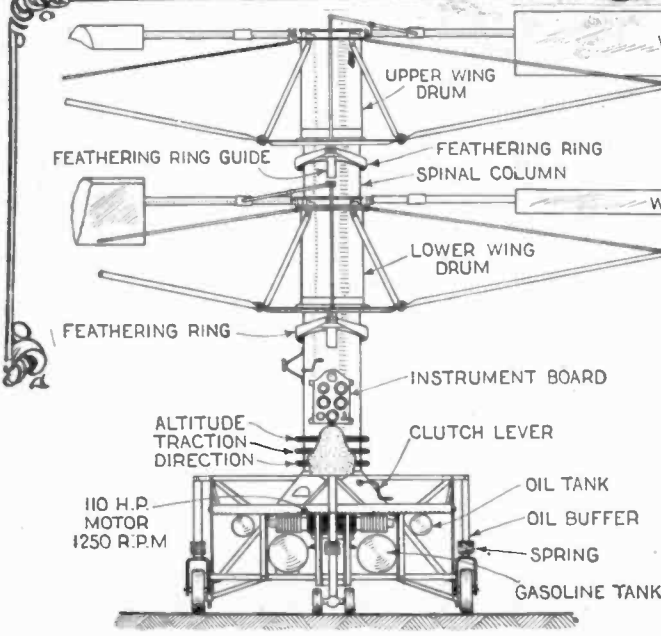

At the left and right respectively are shown front and side views of the helicopter depicting the controls operated by the pilot and the various essential parts of the mechanism. Note the simple yet efficient method of feathering the wings which allows the ship to travel forward. The principle of this feathering process is the same as that used in rowing a boat. In descending, the wings, nearly horizontal, provide the means of deceleration.

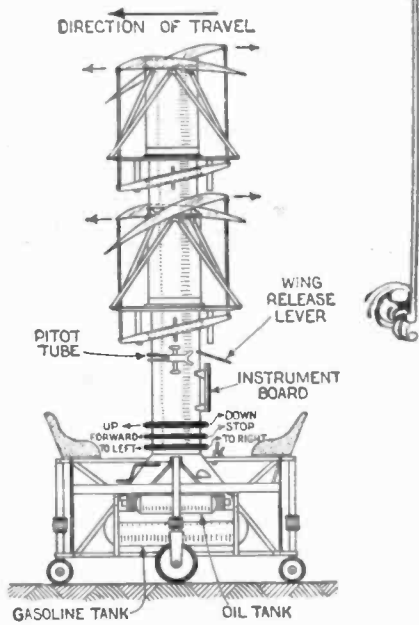

Animals Which Become Invisible

By DR. ERNEST BADE



NATURE seems to play tricks, for many animals know how to make themselves invisible. Just see the butterfly, No. 1 which resembles a dry leaf; even the middle vein is imitated. Next to it, No. 2, is darning needle at rest. Its colored, slender body is pressed next to the stem and its wings, which are as transparent as glass, can hardly be seen.

And not only are the insects and the smaller animals provided with protection of this nature as there are hundreds of other examples to be found in every locality. Witness the snow rabbit of the northern countries which is practically invisible on expanses of snow, his fur blending perfectly with the background. Probably the most striking example of protective coloration is the zebra of the jungle countries whose stripes blend perfectly with the streamers of sunlight which filter through the trees.

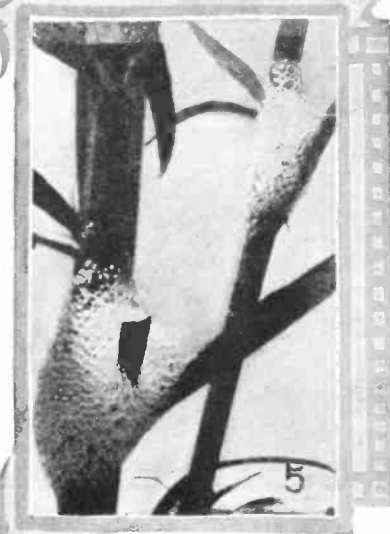

Illustrations Nos. 3 and 6 depict a night moth which, strange to say, has two sets of wings, one of them brightly colored and the other of a dull coloration that serves as a protection. In No. 3, both sets of wings are shown, while in No. 6 the drab front wings cover and conceal the rear wings.

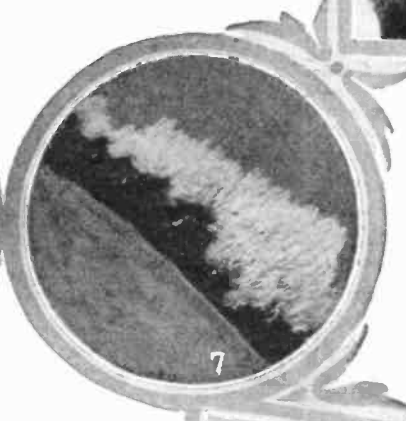

Above in No. 5 we show the hiding place of the spittle insect. The tiny animal is concealed beneath the froth which it has produced upon the grass and which protects the insect from enemies. A similar hiding place is shown in No. 7. Here is shown the white, waxy and hairlike substance with which the woolly apple louse covers itself for protection.

The insect known as the walking stick and which may be either green or brown is shown in No. 4. When feasting on the limbs of trees it resembles a twig so closely that it is thereby protected from enemies.

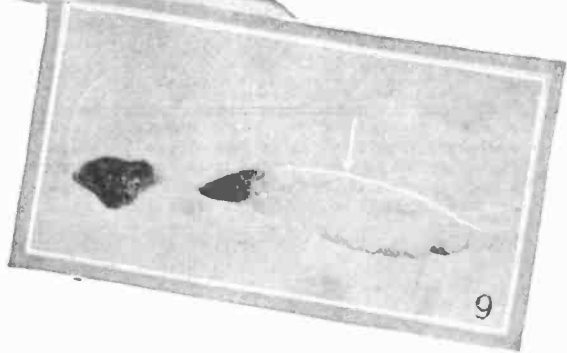
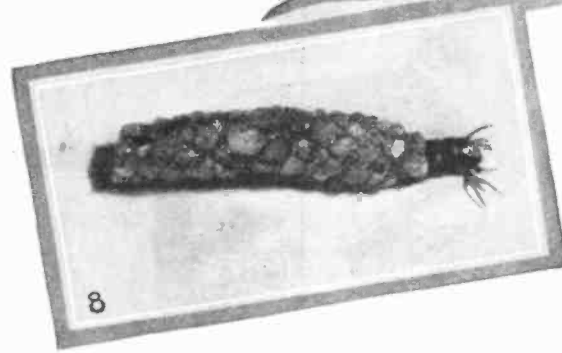

The caddis worm, which lives in the water, builds a home from small pebbles and grasses and after this building operation is completed, it carries its house around on its back as illustrated in No. 8. It is obvious that when such a creature is exploring the bed of a stream, this house or coating of hard substances will be inconspicuous as the materials from which the coating is made are the same as those found in the locality being traversed. The hard coating also protects the delicate creature from unforeseen accidents or attacks.

Among the fish of all the waters of the world we often find weaker creatures that cannot protect themselves against their more ferocious relations in a physical way and which must therefore resort to subterfuge. The flounder illustrated in No. 9 is an excellent example of this. Not only has the flounder the habit of changing its color to approximate that of the bottom of the sea where it happens to be, but it may further protect itself by digging into the sand as shown, until only the eyes and the mouth are visible.

The Artificial Larynx

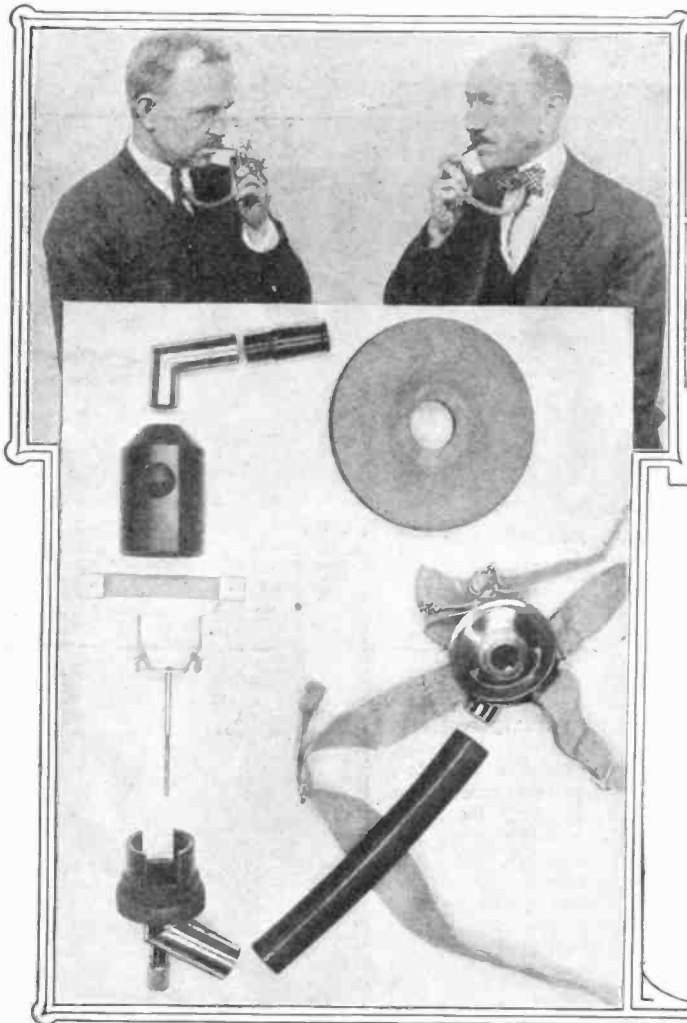

ONE of the most remarkable inventions of the year is the artificial external larynx or vocal chords. In those individuals upon whom an operation for cancer of the throat has been performed, the larynx is removed and the trachea opens at a hole at the lower part of the neck. Naturally, these people cannot speak because no air moves past the vocal chords and causes them to vibrate. Accordingly, Dr. McKintey and engineers of the Western Electric Company, Dr. Harvey Fletcher, Ph.D., and C. E. Lane, M.Sc., and R. L. Wengel, A.B., developed and demonstrated to us the artificial larynx illustrated below.

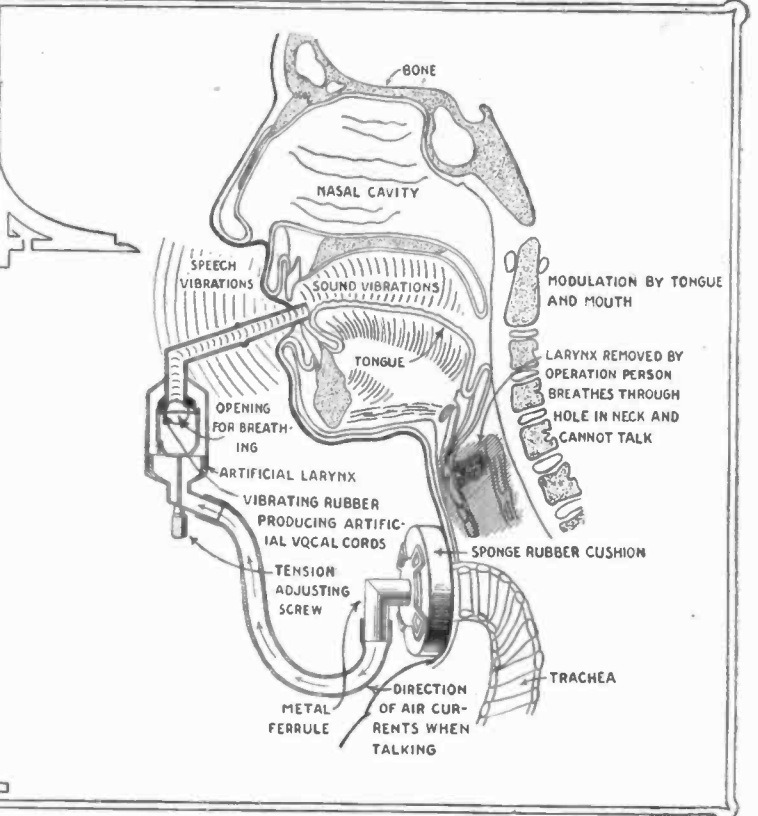

The above photo shows two patients using the artificial larynx and conversing with each other. The mode of action is as follows: By opening the air intake, air is inhaled into the lungs and on being forced out, it must pass into the mouth. In doing so it vibrates a small rubber diaphragm, producing a grunt-like sound. This sound is conveyed into the mouth by a sort of pipe stem where the shape of the mouth and the movements of the

tongue and lips modulate the sound, producing clear audible speech. Many victims of cancer of the throat need no longer worry about losing their speech and will not wait until the last minute before they decide upon an operation. The instrument taken apart is illustrated in the photo at the left. Science is slowly but surely developing substitutes for diseased or exhausted human organs. —J. Kay London.

Deadly Carbon Monoxide

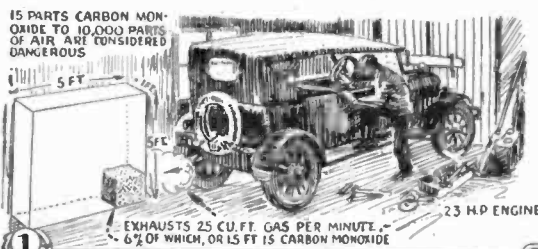

1 A small twenty-three horsepower automobile engine discharges twenty-five cubic feet of gas per minute containing six per cent. carbon monoxide, or one and a half cubic feet of the deadly gas. Fifteen parts carbon monoxide in 10,000 parts of air is dangerous.

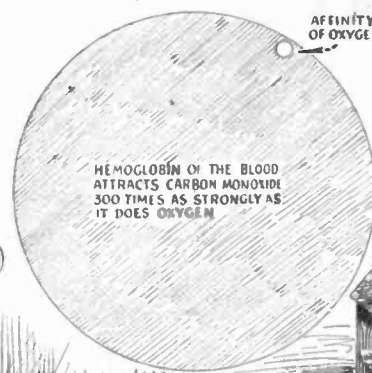

2 Carbon monoxide is colorless, tasteless, and almost odorless. Its affinity for the hemoglobin in the red cells of the blood is about three hundred times as strong as for oxygen. The red corpuscles are thus prevented from giving up oxygen to the tissues, death resulting from paralysis of the respiratory apparatus.

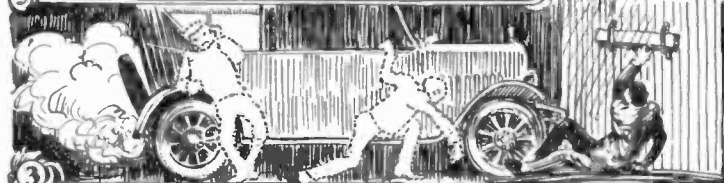

3 A small twenty-three horsepower engine giving off only one cubic foot of carbon monoxide per minute, would contaminate the air of a small closed garage ten by ten by twenty feet to the danger point, in three minutes. The attack comes on insidiously and consciousness is gradually lost.

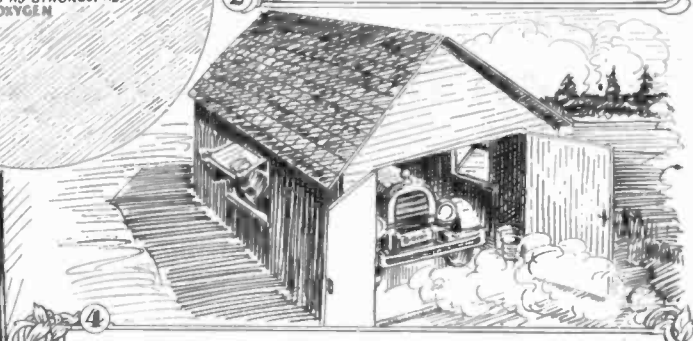

4 The automobile worker in a small garage is most frequently the victim. It, therefore, behooves every person who intends running his engine in a small garage for even three minutes, to see to it that the windows and doors are wide open, and that the place itself receives proper ventilation. Better play safe!!

What Happens In the X-Ray Tube

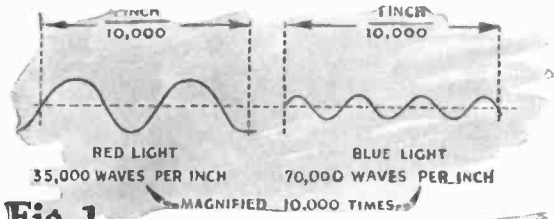
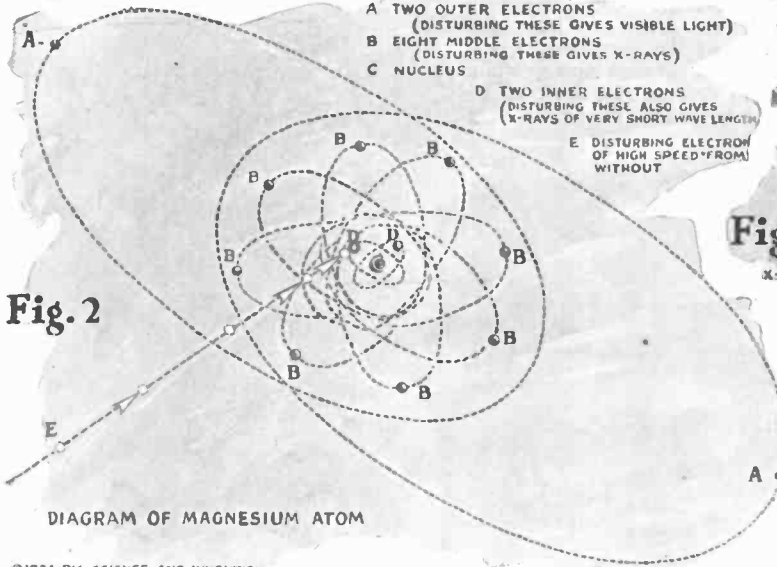

Fig. 1



©1924 BY SCIENCE AND INVENTION

An electron being forced into a magnesium atom disturbs one of the inner electrons B or D, causes them to give rise to very short vibrations, resulting in X-rays. If the two outside electrons A, are disturbed, the resultant vibrations will be light rays. (Fig. 2.) Fig. 1 shows by comparison the difference between red and blue light. Fig. 4 shows the difference be-

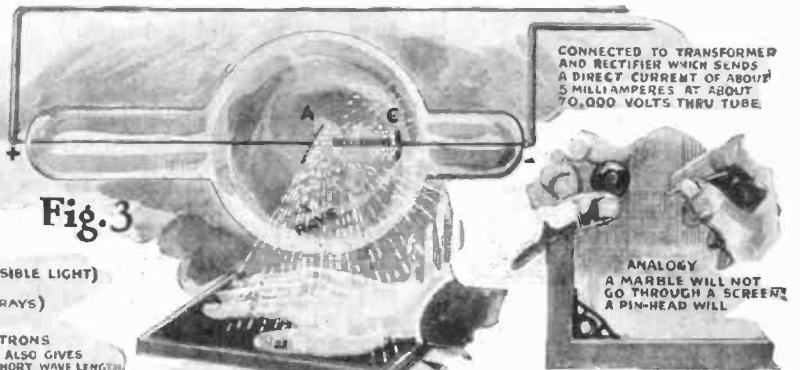

Fig. 3



Fig. 6



Fig. 5

tween visible light and X-rays. Fig. 3 shows an ordinary X-ray tube, while Fig. 6 illustrates the penetrability of X-rays. The vibrations are so swift and small, as shown in Fig. 4, that they are enabled to pass between the atoms of ordinary substances. The analogy is that a marble will not go through a screen, while a pin goes through without difficulty.—Howard Deem.

Wonders of Our Body

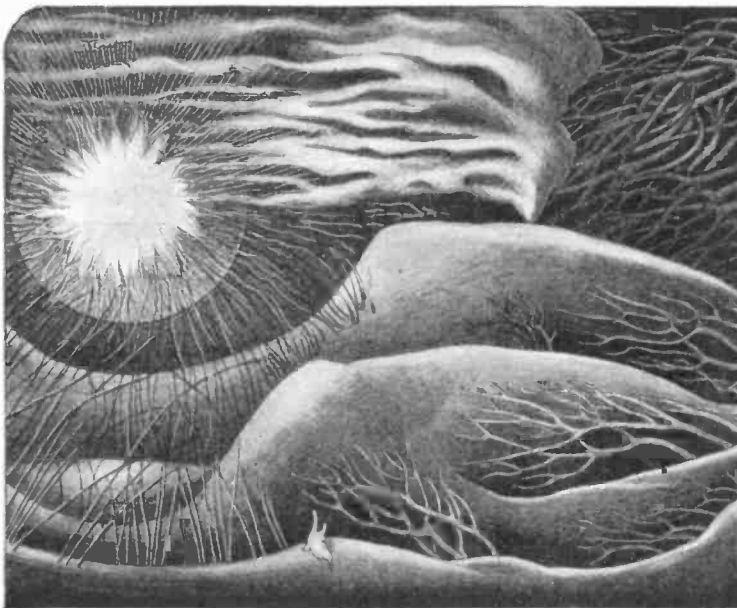

Above is shown the interior of the nose. The mountainous appearing elevations are nose muscles. The interlaced veins through the agency of which the breath is heated before it is taken into the lungs, may be plainly seen at the right. The volcano-like affair is evaporating tear water. The opening of the nostril is seen at the left, as well as the heavy mat of hairs which acts as a screen to keep out the dust.—Kosmos.

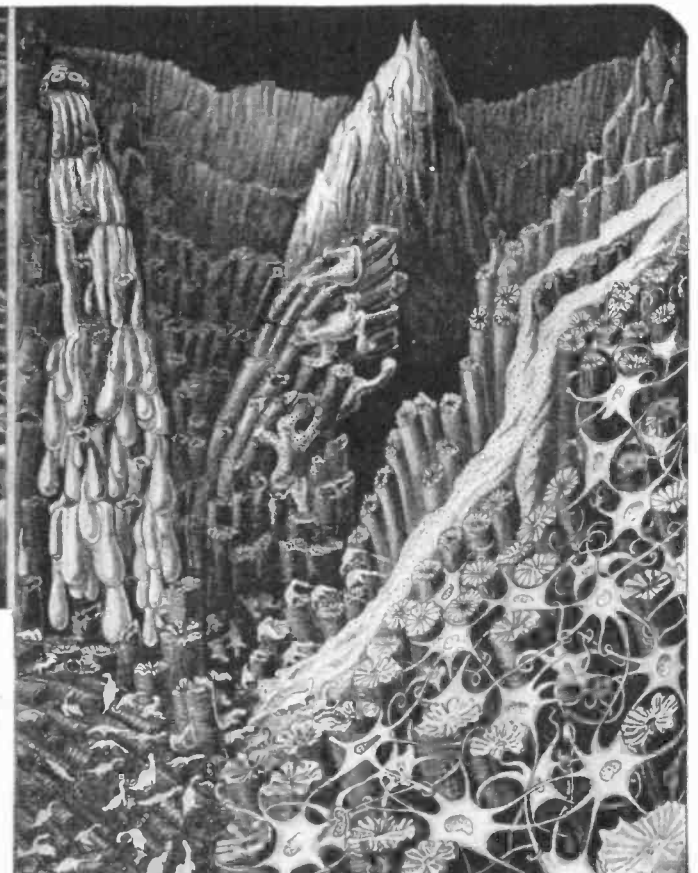

At the right is shown the interior of a flesh wound. At the left are shown the drops of venal blood pouring into the wound. The flower-like affairs in the lower right corner are new cells knitting together to cover the surface, and heal the wound. Just above them is seen the flow of arterial blood into the wound, and just above the blood may be seen the broken ends of muscle fibres. The blood engages in a fight with bacteria.

To End Air Crashes

THE French military aviation service has been conducting experiments with Captain Lipente's inventions. As indicated in diagram 1, on either side of the fuselage of the plane, a repeating gas fuse is established. This gas fuse is exploded by the pilot in case he desires to reduce his landing speed. The series of successive explosions produced by the fuse act like a spring and render the rapid descent harmless to the pilot and occupants of the machine. Should the engine stop while the plane is in the air, the gas fuses may be reversed and be used to assist in propelling the machine to a safe landing. Figs. 2, 4 and 5 show an airplane in which the fuselage is the parachute. When the plane is in distress, the pilot pulls the emergency lever and cuts the wings and tail free of the parachute, which parts of the plane go hurtling through space, while the pilot makes a successful descent. As long as he does not try that trick over a large city, his descent may be harmless to all.

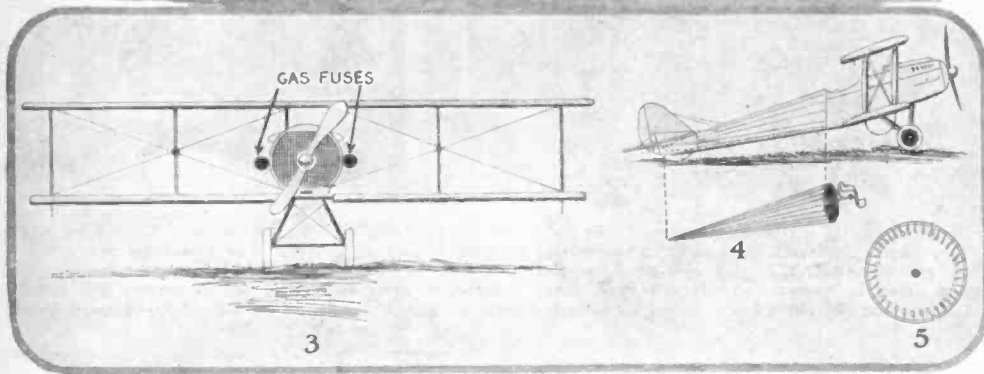
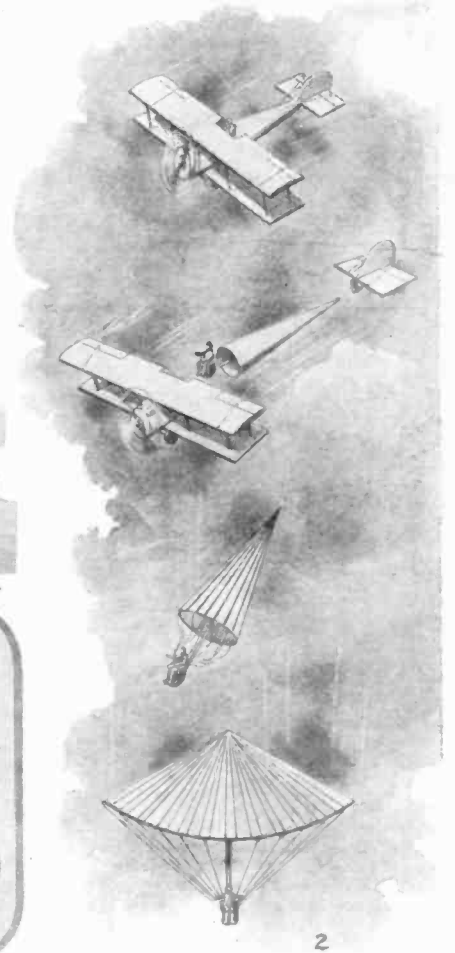
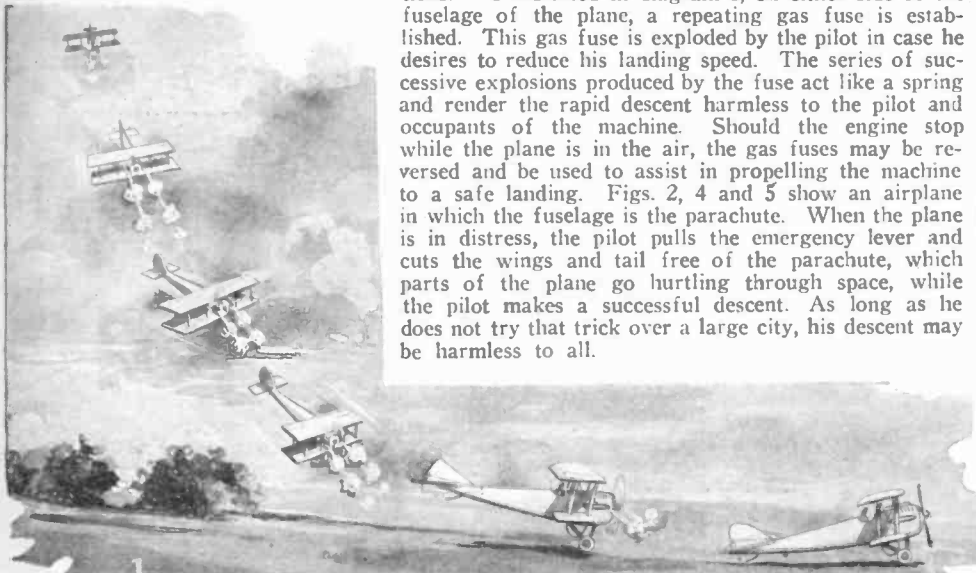

The Mechanical Prompter

In amateur theatricals, there is always a prompter behind the scenes who helps the speaker in time of need. A more suitable system is the mechanical prompter illustrated herewith, in that there is no whisper heard by the audience. The device consists of a celluloid drum containing a lamp. The speech is printed upon a roll of paper and passes over the drum, while a long magnifying glass is mounted under the stage floor. All that the performer has to do is to glance down to get his next line. A button switch in the floor connected with a miniature lamp beneath the stage stimulates the operator here located and signals him to go ahead if he cannot hear the performer.

—James McEvoy, Reporter No. 8096.

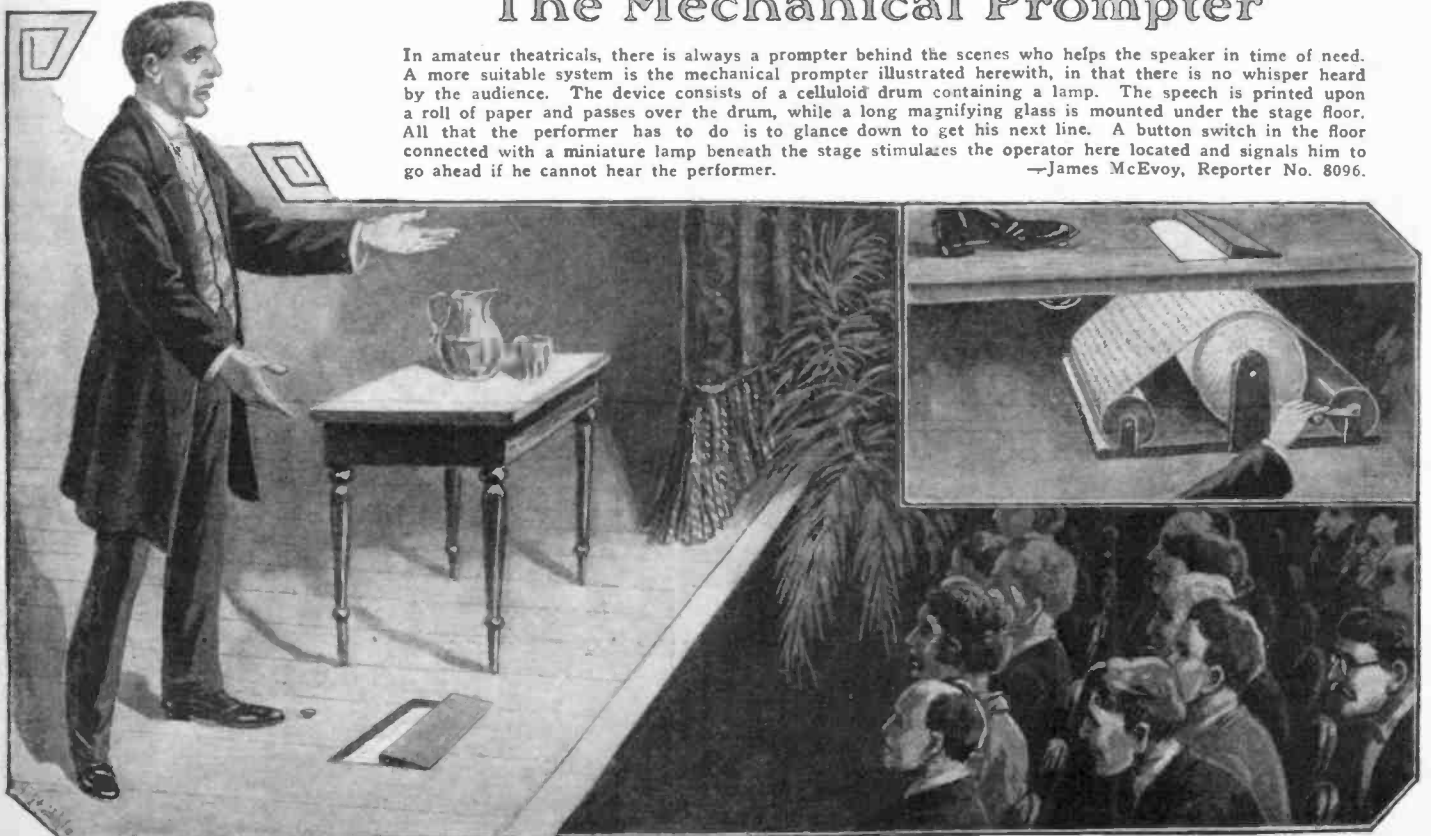

Bringing Down a Zeppelin

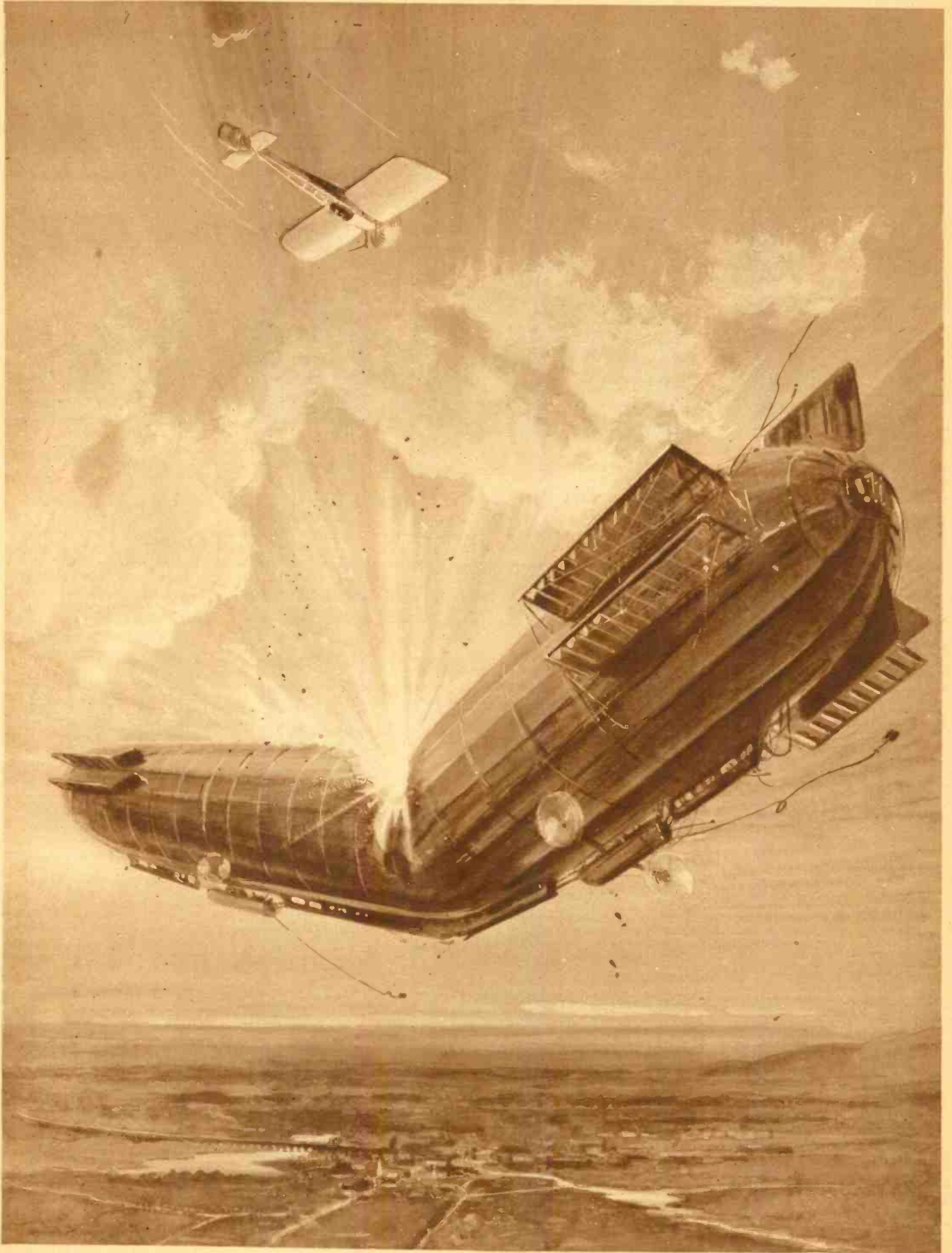

During the World War, Zeppelin raids on England were a nightly affair. The illustration above was made by an eye witness to the bringing down of a Zeppelin at Potter's Bar near London. The Zeppelin was at a great height. English pursuit planes were sent up. The ground guns ceased firing and a

pilot named Robertson dropped a bomb on the huge ship. With a roar, the Zeppelin burst into flames and fell. The force of the explosion turned Robertson's plane completely over but he righted it and descended in safety. The entire German crew was killed.—F. Fissi, illustrated by the author.

The Living Death

By JOHN MARTIN LEAHY

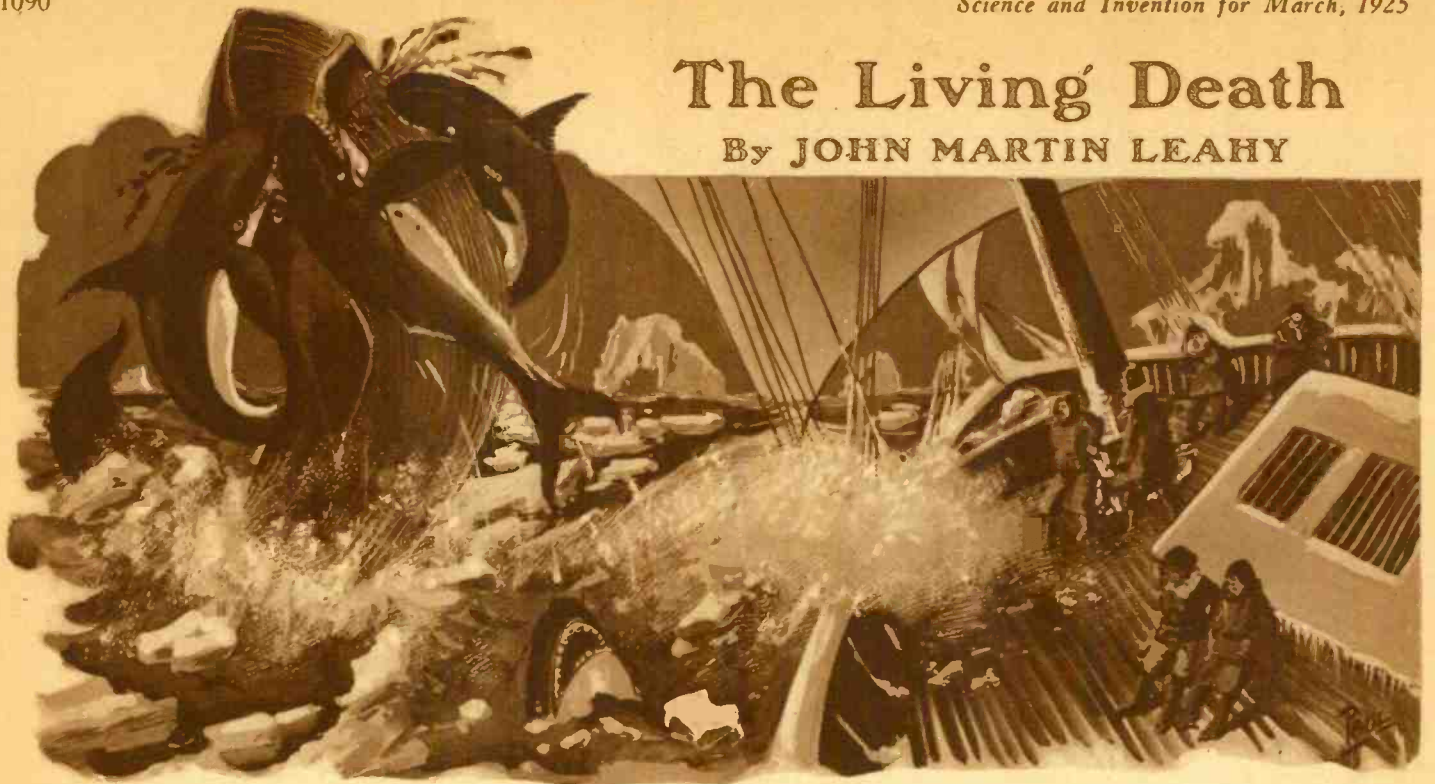

Back came the "Multnomah" on her roll to starboard. And up rose the great back of the whale. I thought that the monster was going to come crashing through the bulwarks and upon the deck.

SYNOPSIS

Captain Livingstone, an Antarctic explorer, calls into conference a famous scientist, Darwin Frontenac, who has distinguished himself in research work involving methods of inducing hibernation in mammals. In the presence of Mr. McQuestion, a reporter, Captain Livingstone recounts a weird tale of exploration and discoveries in the Antarctic. He tells how, with a well-equipped ship and a hearty crew, he started for the South Pole and how, far south of the Antarctic circle, land was discovered. Leaving part of the crew at this point and traveling overland, the explorers found the air to become warmer and to their great astonishment they discovered a land, surrounded by high mountains, the temperature of the region being far above the freezing point and there palm trees and luxurious flowers flourished. During part of their exploration trip, a "Thing" unknown to them killed all of the explorers with the exception of Captain Livingstone and a man by the name of Hampden. Leaving this Garden of Paradise, as this spot had been named at first, the two men traveled onward. Some distance further on they discovered a cave, the floor of which was covered with a thick coating of ice and encased in that ice they found the body of a beautiful young woman, clothed as only inhabitants of a tropical country would be. The Captain formed the opinion that this girl was not dead, but was in a state of suspended animation—in other words, neither living nor dead.

It was with this girl in his mind that the Captain approached Darwin Frontenac. His object was to induce the scientist to exercise his knowledge toward bringing this beautiful young girl back to life. After the facts stated above had been recounted to Frontenac and Mr. McQuestion, they agreed to go to the Antarctic regions and attempt to revive the girl.

After receiving this assurance the Captain continued with his story. He told how he and Hampden proceeded further into the cave and there found a huge stone doorway guarded by a tremendous carved figure of a harpy. Unable to open the door, the two men retraced their steps to the mouth of the cave and started back toward their depot. On the way, Hampden, with his sled and dogs, fell into a crevasse and was lost. The sled carried all photographic records and left the Captain without any substantiation of his story. Reaching the depot, the Captain returned to the United States, where he met Frontenac with the result described above.

Preparations got underway for the long trip to the Antarctic. One hundred and two dogs are to be carried, and to save their strength and at the same time to conserve food, Frontenac decides to artificially kill all of the dogs, place them in a refrigerator on board ship and keep them there until the trip is completed. Then he will revive them and they will be used for hauling sleds. The killing of the dogs is accomplished and, with another scientist, Professor Archimedes Bukink, the party leaves for the Antarctic on board the ship Multnomah.

SIXTH INSTALLMENT

CHAPTER XVIII

THE KILLERS

WE were running through the great Strait of Juan de Fuca, that inlet once so mysterious and fabled—and completely missed, by the way, by the celebrated Captain Cook. To the north, stretched the dark wooded hills of Vancouver Island; to the south, lay the Washington shore, its hills, too, dark and wooded, the mountains striking in their somber beauty, with the summit of Olympus (the Santa Rosalia of the Spanish captains) rising above all, eight thousand feet aloft.

It was one of those days of blue sky and cloud, of bright, crispy sunshine and sudden shadow. There seemed to be something threatening in the air. One moment the sea would be a dark, wondrous blue in the sunlight; the next moment everything would be involved in shadows somber and awful!

Shorter and shorter grew those intervals

of sunlight, denser the clouds and deeper the gloom.

And, when at length we had Tatoosh on our lee beam, the dark masses closed in over the last spot of blue, the hue of the sea, under the gloom cast by the unbroken canopy of cloud, turning leaden and sinister.

This I thought no auspicious omen; but neither the captain nor any of the watch seemed to pay any particular attention to this change, in which, so it seemed to me, there was something ominous.

There had been no change, however, in the wind, which was still blowing from the north in what seamen term a fresh breeze—in other words, twenty-eight or thirty miles per hour.

The patent log had been over for some time now, the reading having been noted (and recorded) on the *Multnomah's* passing that point directly north of Tatoosh light. This the captain called *taking the departure*, and it was then that the dead reckoning began.

The ship's course (true) was south-south-west. But one other vessel was visible, a bark, hull-down, in the southern bow, close hauled on the starboard tack.

The day was drawing to a close. Suddenly the cloud-curtain lifted far in the west. A dull streak of light appeared along the horizon. It became brighter and brighter—a vivid yellow. The yellow turned to orange, and, in that streak of garish light, suddenly appeared the upper limb of the sun—its color the dark, terrible red of blood. Slowly it sank into the black waters, and I likened it to some monstrous evil eye slowly concealed by a lid even more evil and monstrous.

The light lingered for a few moments, dull and wrathful; then the cloud curtain settled down again.

The gloom rapidly deepened, and then of a sudden a dense



He dropped to his knees, hugged the dog to him and rocked him back and forth, murmuring endearing swear words.

obscurity settled on the sea, as the rain which the dark sky had long threatened began to descend with great violence. A few moments, and one could not see more than fifty fathoms.

A NEAR COLLISION

Immediately the *Multnomah's* fog-horn began its melancholy sounding—three blasts in succession.

Came at length the sound of another horn, that of the bark. And thereafter we heard it at pretty regular intervals—one blast being sounded.

Then, after a longer interval, two blasts came.

"On the other tack!" exclaimed Captain Livingstone. "The damned fool, is he going to lay across our forefoot?"

And then suddenly we saw her, nearly dead ahead and almost upon us—a shadowy, uncertain mass, her port light gleaming angrily through the driving rain, the starboard one shining as though with ghostly fire.

The *Multnomah's* helm was put up, bringing the wind almost dead astern. As for the stranger (who had the right of way) he put his helm down, bringing the ship's head into the wind until, for a moment, I thought that she would be taken aback. But she fell off again, and in a moment the ships were driving past, so close that some of the spray thrown up from the other's bows fell upon our decks.

"You blink-blanked fool!" cried Captain Livingstone, shaking his fist at the receding vessel.

It had been a close call.

"Must be full of hop or hootch!" the captain ejaculated.

The stranger had disappeared into the gloom. Came again the melancholy sounding of his fog-horn.

"Snort away," said the captain, "and see if old Flattery will heed your warning."

"He'll have to go some," Ben Rainier remarked, "to weather the cape on that tack."

Morning found a clear sky and the *Multnomah*, her course still south-southwest, logging six knots, the wind from the northwest.

As soon as the sun had risen a dozen de-

grees or so above the horizon (for below that the correction for refraction is uncertain) Captain Livingstone took a time sight and azimuth. Of course, dead reckoning gave him the ship's position with a high degree of exactitude. For instance, when he made his observation, about half-past seven, the *Multnomah* had, since taking her departure, sailed ninety-five knots. Her course being south-southwest, she had made good eighty-eight miles of southing and thirty-six miles (nautical) of westing. With these data it were a simple matter to mark the ship's position upon the chart and say:

"There she is!"

But Stanley Livingstone did not do things that way.

This morning observation gave him his longitude. At midday, he took another sight—the meridian altitude of the sun. From this he obtained his latitude. It was an easy matter to obtain the noon longitude from the longitude given by the morning sight, and so he had the *Multnomah's* precise position at noon. At this point a new departure was taken. Another observation was made in the afternoon.

And so it went, day after day, none of this work ever being omitted when it was possible to take an observation.

And, as I watched this poor doomed man carrying on his work thus, I would think what a strange thing a human being is, after all, and often a lump would rise in my throat. He might at any moment drop to the deck a corpse. He knew it. But he would go on with his work to the last. It would be no weakling that would fall when Death smote him in the breast; it would be Stanley Livingstone, master to the end of the good ship *Multnomah*.

But, if I could have peered into the future, visioned the killers, seen the awful end that fate had in store for this man already doomed—well, it had been a merciful stroke had Death burst the captain's aneurism and stretched him dead at our feet.

What, with the possibility that Captain Livingstone might drop dead at any moment, I would often wonder how we should find things when Mr. Ben Rainier, the first mate (his place in turn taken by the second mate), became captain. Of course, Frontenac was

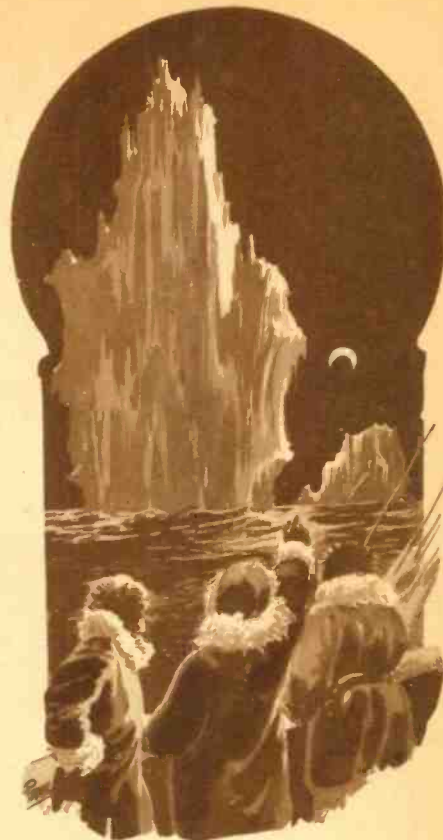

... a curious phenomenon and one that I had never seen mentioned in a single scientific book: the moon (and, indeed, every other celestial object) had turned upside down!

commander of the expedition, but Mr. Ben Rainier would be master of the *Multnomah*—and would things go on as smoothly then? Near the thirteenth parallel of north latitude, we lost the anti-trades and entered the calms of Cancer. Then came the great north-east trade, and at length the belt of the equatorial calms or the doldrums.

This region of equatorial calms, however, is not so tranquil a place as the name implies. We had frequent squalls, some of them accompanied by deluges of rain, and once we found ourselves in a storm in which the wind seemed to be doing its level best to blow from three directions at the same time.

Just north of the equator, we fell in with the southeast trade.

It was on the 21st of October, at three o'clock in the afternoon, and in longitude 127° W., that the *Multnomah* crossed the line.

We lost the southeast trades about the thirtieth parallel of south latitude, passed through the calms of Capricorn and caught the "brave west winds," which sent us along through the roaring forties toward the wild and tempestuous seas of Cape Horn.

WE SEE OUR FIRST ICEBERG

We saw our first iceberg near the fifty-second parallel. It was eight or nine hundred feet long and much worn—sculptured into fantastic towers and pinnacles.

The sight brought strange, sad thoughts of Sleeping Beauty—far away in the midst of that unutterable desolation and silence. Poor little kid!

The days were long, the sun rising about four o'clock. Indeed—the sun's declination now being about 20°—twilight, when the weather was fair, lingered throughout the night.

It was now that I noticed it for the first time—a curious phenomenon and one that I had never seen mentioned in a single scientific book: the moon (and, indeed, every other celestial object) had turned upside down!

(Continued on page 1126)

... at that very moment the second killer came crashing up, breaking clean through.

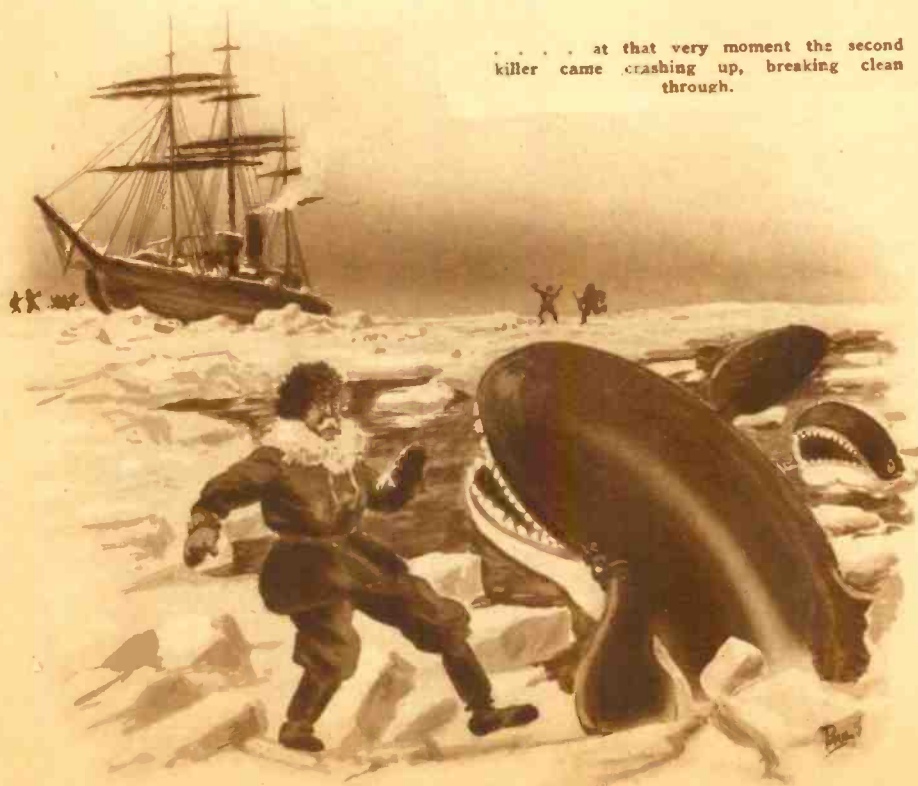

Roman Perfume Lamps

By CHARLES BEECHER BUNNELL

Illustrations by the author,

IN the lives of the ancient Romans perfume played a large part. In fact, Nero the Tyrant used it all over his body and clothes, even including his shoes. He put perfume in his wines and had it freely distributed over carpets and furniture. The people of this time used various distributing means. Some of them are illustrated on this page. Scented lights were in general use, two of them being illustrated at the left and right of Fig. I. The latter is an official incense box. Fig. D is a "Lekythos" or incense bottle for the dead, while S is a society perfume bottle and G a perfume oil can, also used for massaging. F is a gas producer. Water, 1, falls through 2 into 3, forms compression which is transmitted through 5 to 6 in compartment 7, forcing oil through 8 where it exudes at 9 and is vaporized by a gas flare.

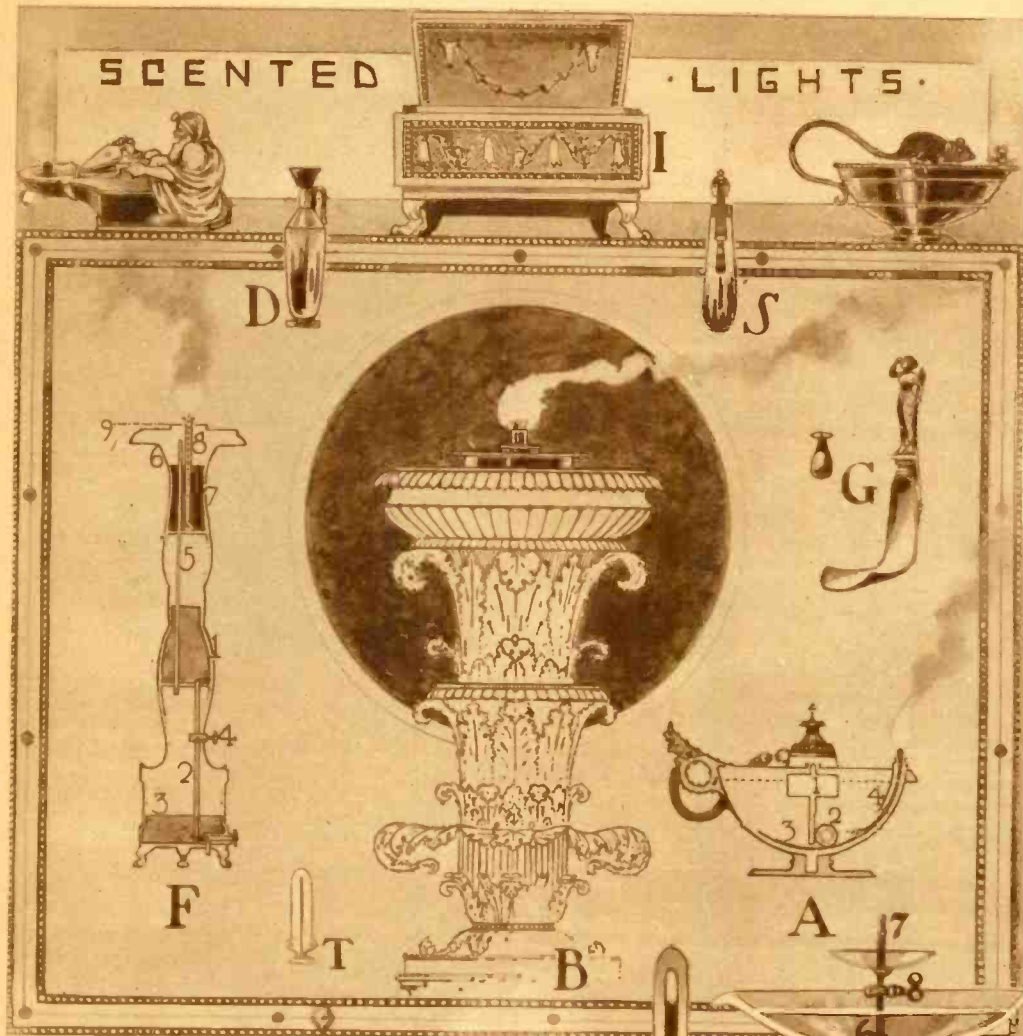

THE illustration B shows a combination candelabra, stand and lamp holder. Scented candles were used in this device. A illustrates an automatic self-feeding wick in which 1 is a float which engages cog 2 which, as the oil level sinks, actuates 3 and forces wick 4 up as the oil level sinks. This was used by Nero. N is an exuder used with an "Alabastrum" T which contains the perfume. Nozzle of T rests on silk surface and will keep a room perfectly scented for months.

The other three devices are for vaporizing liquid perfume. L utilizes lung compression. In operation, valve 2 is blown into with the mouth and then closed. Opening valve 3, atomized perfume rushes out jet 1. H is a hydro-pneumatic vaporizer. Water poured in 1 flows through 4 into 3, forcing air through 5 into 2 where pressure forces perfume F through 6 out of jet 7 whenever valve 8 is opened. M is a mechanical pneumatic dispenser. 1 is half filled with perfume. Pump 2 is operated by hand, compressing air in space above perfume. This pressure forces perfume through tube 3 out of the jet in the universal joint at the top. The jet can be depressed to a 45-degree angle, allowing perfume to be thrown in all directions. Depressing jet to 90 degrees stops flow.

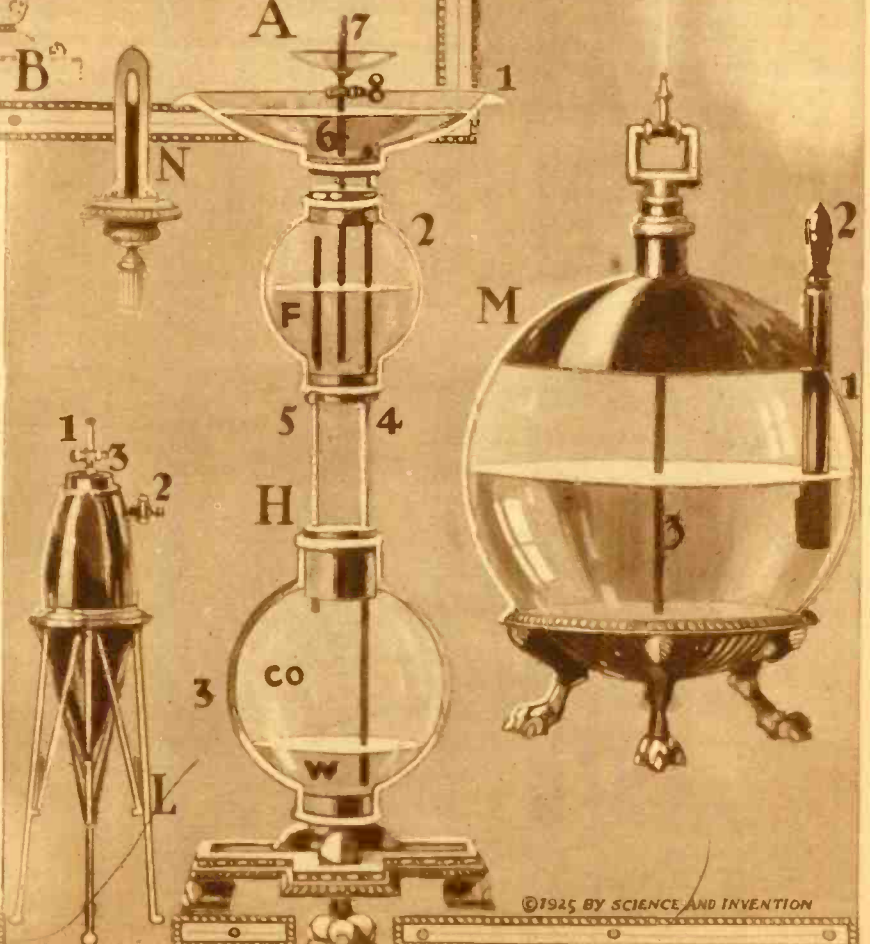

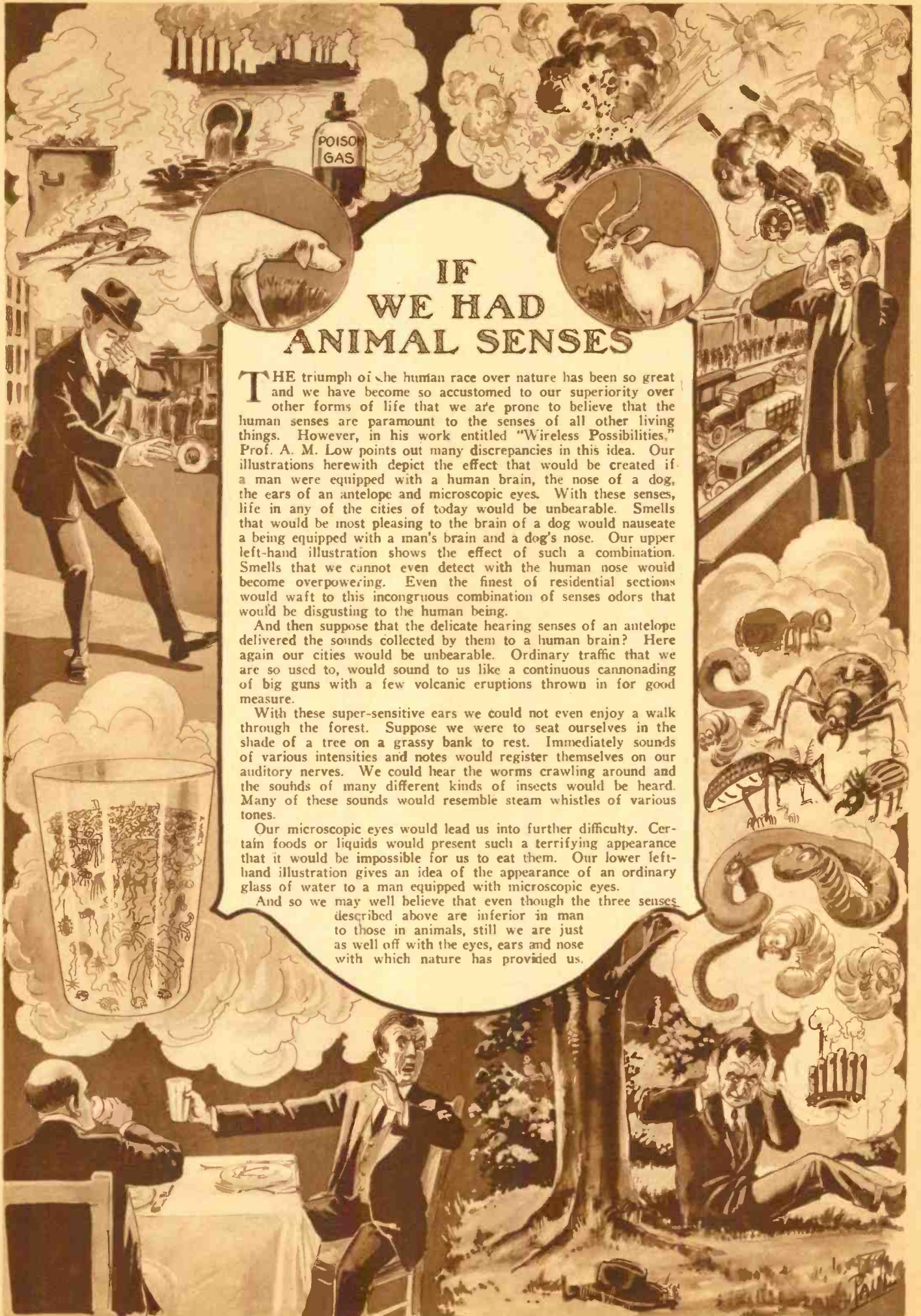

IF WE HAD ANIMAL SENSES

THE triumph of the human race over nature has been so great and we have become so accustomed to our superiority over other forms of life that we are prone to believe that the human senses are paramount to the senses of all other living things. However, in his work entitled "Wireless Possibilities," Prof. A. M. Low points out many discrepancies in this idea. Our illustrations herewith depict the effect that would be created if a man were equipped with a human brain, the nose of a dog, the ears of an antelope and microscopic eyes. With these senses, life in any of the cities of today would be unbearable. Smells that would be most pleasing to the brain of a dog would nauseate a being equipped with a man's brain and a dog's nose. Our upper left-hand illustration shows the effect of such a combination. Smells that we cannot even detect with the human nose would become overpowering. Even the finest of residential sections would waft to this incongruous combination of senses odors that would be disgusting to the human being.

And then suppose that the delicate hearing senses of an antelope delivered the sounds collected by them to a human brain? Here again our cities would be unbearable. Ordinary traffic that we are so used to, would sound to us like a continuous cannonading of big guns with a few volcanic eruptions thrown in for good measure.

With these super-sensitive ears we could not even enjoy a walk through the forest. Suppose we were to seat ourselves in the shade of a tree on a grassy bank to rest. Immediately sounds of various intensities and notes would register themselves on our auditory nerves. We could hear the worms crawling around and the sounds of many different kinds of insects would be heard. Many of these sounds would resemble steam whistles of various tones.

Our microscopic eyes would lead us into further difficulty. Certain foods or liquids would present such a terrifying appearance that it would be impossible for us to eat them. Our lower left-hand illustration gives an idea of the appearance of an ordinary glass of water to a man equipped with microscopic eyes.

And so we may well believe that even though the three senses described above are inferior in man to those in animals, still we are just as well off with the eyes, ears and nose with which nature has provided us.



Accordingly, sharp at midnight, the skeleton appeared again. This time, however, it was mounted on a skeleton horse with wings.

Doctor Hackensaw's Secrets

By CLEMENT FEZANDIÉ

No. 37. The Mystery of the Walking Skeleton.

DOCTOR I. HACKENSAW was, first of all, an inventor; and an inventor is a man who, when absorbed in some great idea, is utterly oblivious to the external world. It is related that Sir Isaac Newton once started to boil an egg, but boiled his watch instead, holding the egg in his hand for a time-piece. Doctor Hackensaw, however, could have given Sir Isaac a double discount. One day that he had cooked himself an omelet in his laboratory, he was seen to throw the omelet into the stove mistaking it for a shovelful of coal. On another occasion his newspaper not having come one morning, he hastily dressed and went to the corner newsstand for a copy. He noticed that people stared at him, but it was not until he was safely home again that he discovered that he had forgotten a somewhat necessary article of his wearing apparel—namely, his trousers. As this was in New York City, the omission might have led to unpleasant consequences had a policeman chanced to see him.

Doctor Hackensaw was wealthy, for, while not a business man, he had made so many inventions of world-wide application and had increased the wealth of the country by so many billions of dollars, that a few millions couldn't help clinging to him. The consequence was that the doctor had a number of laboratories for his research work, and employed several hundred assistants.

Among these assistants was an eighteen-year-old young lady called Pepita Perkins, or more familiarly "Pep" Perkins. Doctor Hackensaw looked upon her as an adopted daughter, and she reciprocated by calling him "Pop."

It was one night when Miss Pepita Perkins was returning home at midnight from

a fancy-dress ball, that she first saw the walking skeleton.

Now, Pep was a brave girl—on many a previous occasion she had showed that she by no means lacked courage, but the sight of a ghostly form walking the earth at midnight is enough to strike terror in the bravest heart, and Pep might well be excused for losing her head.

The trouble all began with a stalled automobile. The gentleman who was taking Pep home in his car chanced to stall when within a few rods of Doctor Hackensaw's summer cottage in New Jersey. Pep, too impatient to wait, left her escort tinkering with his machine, while she took a short cut home through the country graveyard.

Not the slightest fear did she experience, and it was without a tremor that she passed through the churchyard without even deigning to cast a look behind her. Doctor Hackensaw's grounds lay just beyond, and were surrounded by a long, high stone wall, for the worthy doctor had always many inventions in hand that he was not yet ready to make known to the general public. Bitter experience had taught him the inadvisability of taking the public into his confidence until an invention was completed and thoroughly tested.

Pep Perkins reached the massive gates that gave entrance to the grounds, was admitted by the lodge keeper, and was walking briskly toward the house when, at a sudden turn in the road, she saw it! It appeared suddenly, apparently coming out of nowhere! It appeared first as a greenish light, without any definite form, but as she gazed at it, startled, it slowly assumed the figure of the skeleton of a man, every bone glowing with a strange fire. Nor was the skele-

ton standing still—it was slowly walking directly toward her.

Pep's heart jumped into her throat, and when the skeleton opened its bony jaws, and with chattering teeth gave vent to a sepulchral laugh, and then in mournful tones droned out the words, "Hollow! Hollow! Hollow!" the poor girl almost fainted from terror.

With one wild shriek, however, she tore past the ghostly vision and rushed for the house, where with fumbling hands she had difficulty in opening the door with her latch key. To her relief the light was still burning in Doctor Hackensaw's library, showing that he had not yet gone to bed, so she rushed in, wild-eyed and breathless.

"Pop!" she cried, "do you believe in ghosts?"



Pep's heart jumped into her throat when the skeleton opened its bony jaws.

"Scarcely, Pep," though I must humbly confess that as in all men, however much advanced, there lingers something in the back of my mind, some hereditary influence from our remote ancestors, that produces a slight nervousness occasionally in the dark, but I am always ready, and even anxious to investigate any ghostly phenomena that come to my notice."

"Then your wish is granted!" retorted Pep. "If you will go to the gate you will find a walking skeleton that chased me home because I was foolish enough to pass through the graveyard at midnight!"

Doctor Hackensaw leaned back in his chair and laughed heartily. "I'm afraid I'm the guilty one, Pep," said he, "and I must ask your pardon if I frightened you. I wasn't expecting you home so soon, as you usually don't return from a dance until the wee small hours of the morning. It was really my skeleton you saw!"

"Your skeleton?"

"Well, the words are ambiguous. I know, but you will understand the whole affair if you will listen to me.

"All right, start your explanation! As I won't get a wink of sleep to-night, I'll keep you up as long as I can talking to me and reassuring me. I was never so upset in my life! I've got the 'creeps' in the very marrow of my bones."

"To begin with," said Doctor Hackensaw, "I must inform you that the existence of this walking skeleton is a profound secret. You are not to speak of it to anyone. I cannot even tell you the purpose for which it is intended, as I have promised absolute secrecy. But I will tell you all that I can. To begin with, do you know anything about radium?"

"Yes, I know that a pinch of it costs a fortune and that it is continually shooting off particles and changing into lead."

"Precisely. The half period of radium, that is to say, the time required for half a given weight of radium to disintegrate, has been calculated as about 1690 years. In other words, unless new radium is forming, there must have been twice as much radium on earth 1690 years ago as there is at present, four times as much 3380 years ago and so on. By making the calculation we find that one hundred thousand years ago or less the whole earth must have been one solid mass of radium! This, of course, is an impossibility for our geologists have proved that one hundred thousand years ago the earth was pretty much as it is now. Consequently, the inference is that new radium must be produced continually to replace the old one that is used up. Scientists argued that if radium was being produced at present, the substance from which it was produced must be found close to the radium in every locality where radium was found, and always in the same proportion. Such a substance is Uranium. Uranium is much more common than radium and always exists with it, and the proportion present is constant. In all radium ores there is about three million times as much Uranium as radium. Hence, it is evident that Uranium is disintegrating into lead, though no direct proof of the fact has yet been had. The fact is that the half period of Uranium is five billion years and consequently many years must elapse before a perceptible amount of product can be obtained. Professor Soddy tried the experiment some years ago. The Uranium itself is soon decomposed. It throws off helium gas—one atom of helium being given off by each atom of Uranium. The product is called Uranium X, and although Doctor Soddy started the experiment in 1912, seven years later in 1919 he was unable to detect the formation of any radium. Just think of it! Seven years of experimenting! Yet the experiment continues and the triumph of science will be great on the day that the presence of radium

in his tube shows that the actual transformation of Uranium into radium shall be made manifest. Doctor Soddy calculated that if he continues the experiment sixty thousand years he will produce about one cent's worth of radium—not a very satisfactory financial result, but scientists are seldom good financiers!"

Pep Perkins yawned and wished that she had remained at the ball. This lecture on radium was as bad in its way as the sight of the phosphorescent walking skeleton, and she determined to make a diversion.

"Pop," said she, "it's too late to-night for all that josh about radium. All I want to know is what that skeleton was that I saw near the park gate."

"Well, that was just what I was explaining to you," returned Doctor Hackensaw patiently. Uranium is the heaviest metal known, having an atomic weight of 238. It is continually disintegrating very slowly into other substances, finally producing Uranium X, with an atomic weight of 234. This is really Uranium with a helium atom (atomic weight 4) thrown off. This Uranium X, doesn't live two minutes, but also disintegrates, finally producing ionium, and this in turn produces radium whose atomic weight is 226, thus showing that radium is nothing but Uranium with three atoms of helium expelled from each atom of radium. Now the radium itself disintegrates. It begins by . . ."

"Good night!" cried Pep, stamping her foot impatiently. "Do you think I'm going to stand here at one o'clock in the morning listening to a lecture. I'm going to bed!"

"All right, Pep," assented the doctor, mildly. "And by the bye, if you want more particulars about the walking skeleton, you can get them if you come with me to-morrow. I am starting to-morrow for a month's trip to Africa, and Sam, which is the name I have given the skeleton, comes along with me.

CHAPTER II

"Isn't this glorious!" cried Doctor Hackensaw, as his express airplane, *The Arrow*, skimmed gracefully through the azure sky while the deeper blue billowing waves of the Atlantic played below them.

"Yes, it's dandy!" echoed Pep, "and now that we're on our way perhaps you will condescend to give me some explanation as to where we are going and what we are going to do, and what 'Skeleton Sam,' as you call him, has to do in the matter."

"All right, Pep; there is no reason why I should keep the matter secret any longer. Did you ever hear of Robert Houdin?"

"Yes. He was a famous conjurer, wasn't he?"

"Precisely. Well, though he has been dead many years, he is responsible for the

(Continued on page 1140)

The sentinels suddenly saw appear before them a giant skeleton with luminous bones shining with a baleful greenish fire!



Jelly Fish Destroy Fish

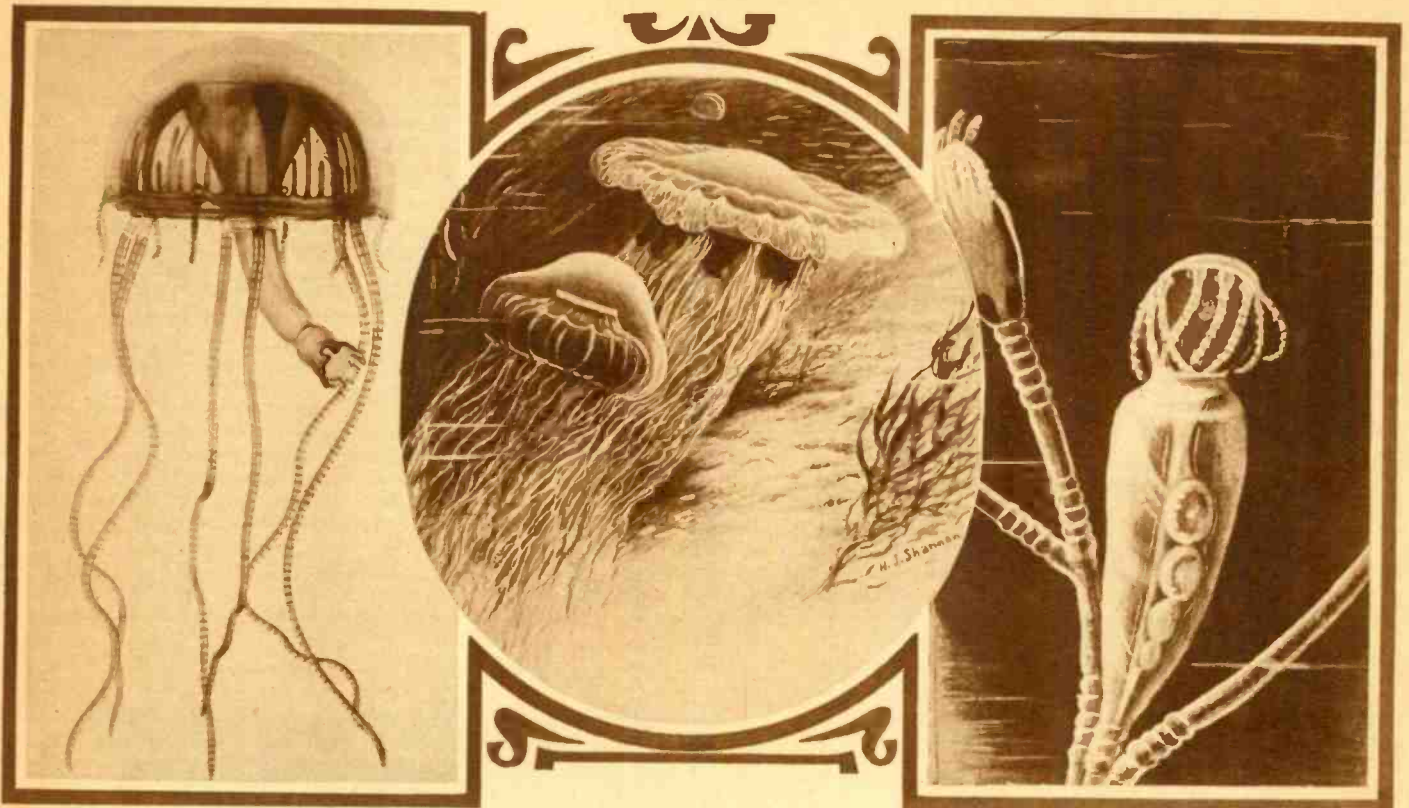

Jellyfish, those useless, flabby denizens of the sea, have developed an appetite for herring and haddock and threaten to soon banish these fish from the North Sea where the jellyfish have appeared in large numbers.

Jellyfish one to six feet in size are now common in the waters of the North Sea. Swimmers stung by them have been known to go temporarily insane. Illustrations above show jellyfish in action.

Above: A type of jellyfish found in the waters about Jamaica Bay, L. I. This type of jellyfish has not as yet seriously interfered with the supply of food fish for which the shallow waters of this bay have been celebrated—H. J. Shannon.

Flying Boat

THE very latest development in the line of vehicles for water travel is the newly completed Rohrbach flying boat illustrated directly below. The device resembles a cross between a common sail boat and an airplane. The hull is built along lines similar to the fuselage of an aerial hydroplane, which gives the boat a very small draft and reduces its resistance to the water. To further aid in cutting down this hindrance to speed, airplane wings are mounted on the sides and the tail is equipped with a horizontal rudder. The vertical rudder is for steering. The boat obtains its motive power from a pair of sails and two airplane engines equipped with air screws. This vehicle is reported to have broken many speed records.

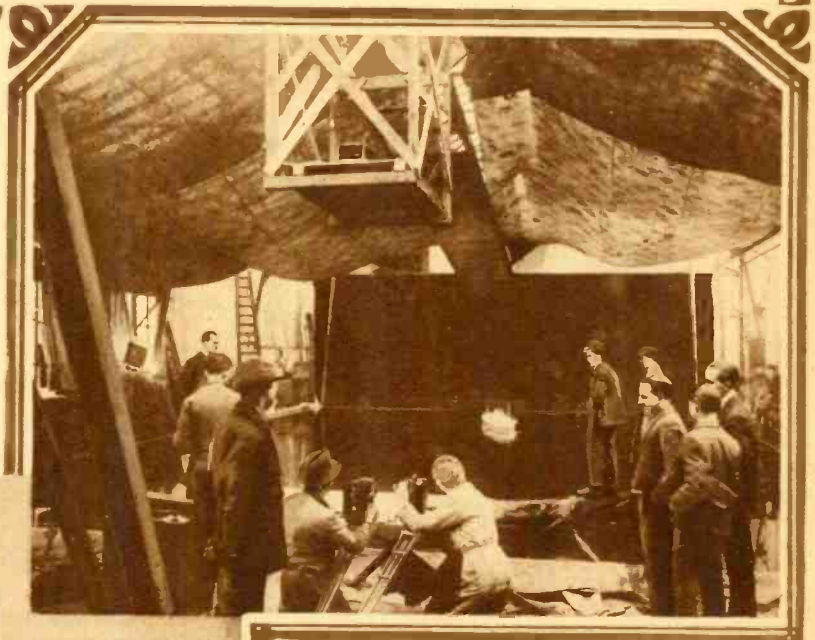

Sinking Movie Ship

AMONG the many tricks used in motion picture photography today, those employing miniature scenes are probably the most effective. The illustration directly above shows operators in the act of photographing a sinking ship scene. When the finished film is thrown on the screen, the effect is one of a storm at sea wherein the ship, apparently full size, is damaged and sinks. The entire illusion is accomplished with miniature scenery.

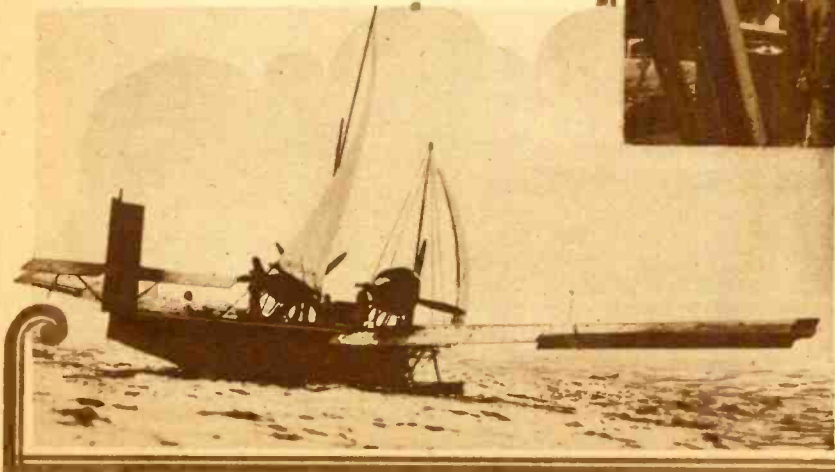

Handkerchief Tricks

By WALTER B. GIBSON

Can you make a handkerchief stretch? Can you tie a knot in a handkerchief without letting go of the ends? Can you demonstrate that a handkerchief is fire-proof, and can you prove that one from four equals five? All of these effects may be produced by duplicating the systems illustrated on this page.



A handkerchief first folded in the hand can be made to stretch as indicated below.



Fold the arms as indicated above, grasp the ends of a handkerchief and unfold the arms without letting go of the ends. A knot will form in the handkerchief.

A knot can be tied in a handkerchief with one hand as shown below. Shake the hand so that the loop slides off the fingers. One from four equals five, cut one corner from a handkerchief. It now has five corners.

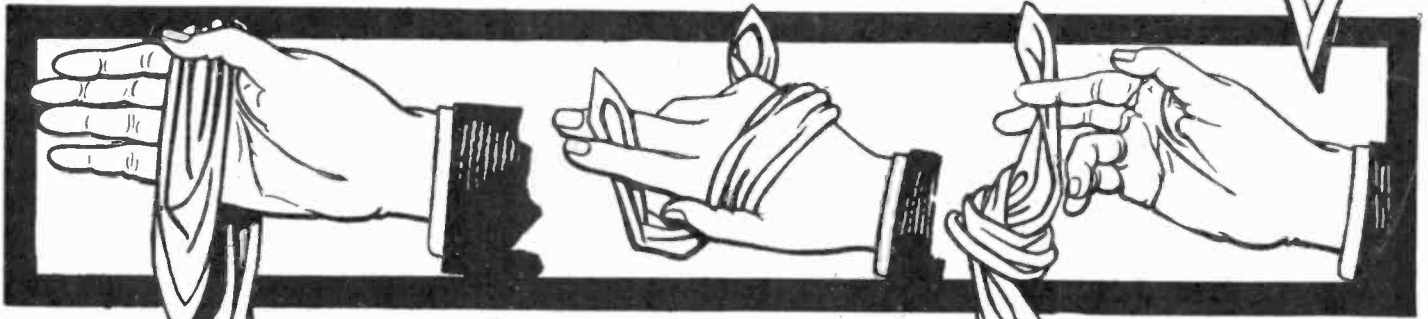

The four corners of a cloth containing a watch are pushed through a napkin ring, and the watch removed, as shown.

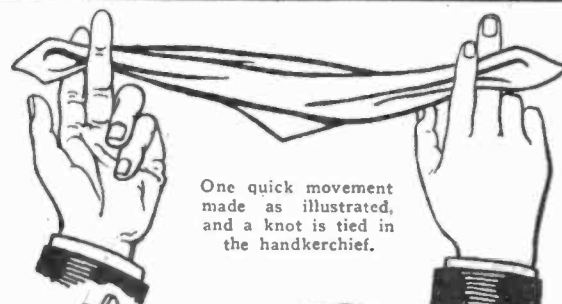
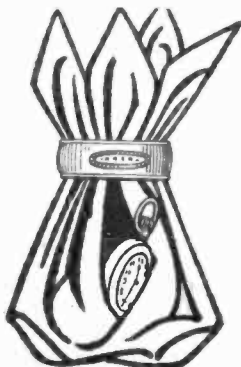

One quick movement made as illustrated, and a knot is tied in the handkerchief.

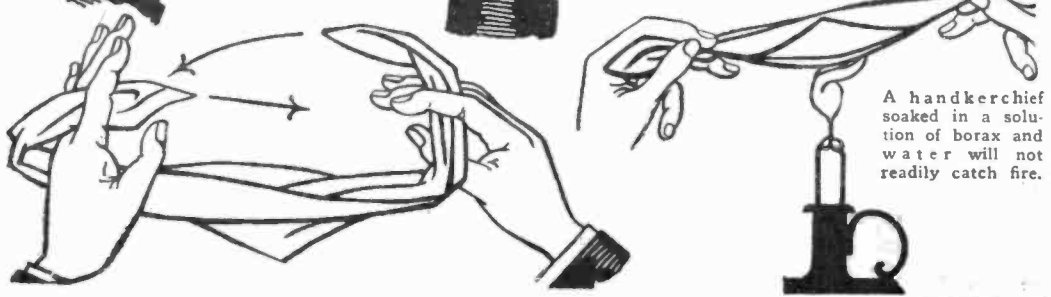
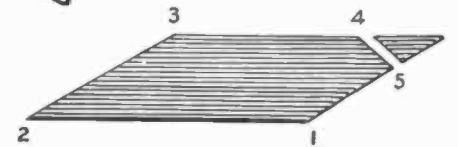

A handkerchief soaked in a solution of borax and water will not readily catch fire.

Magic for Everybody

By PROF. JOSEPH DUNNINGER
NO. 24 OF A SERIES

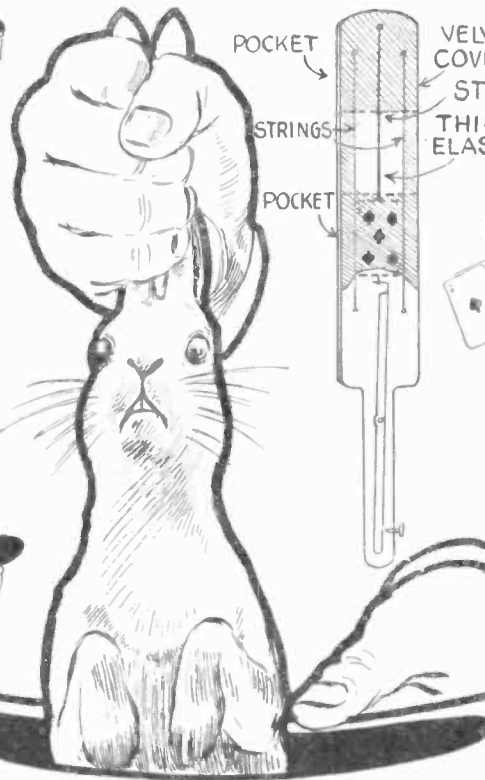
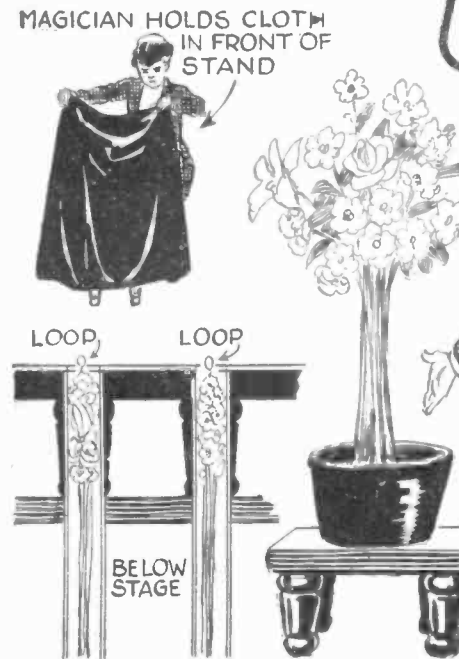
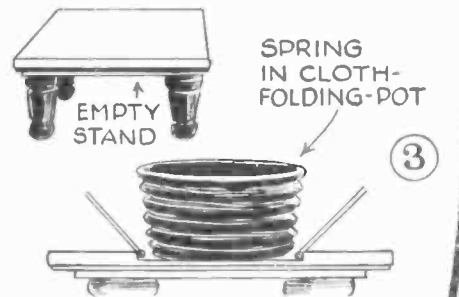
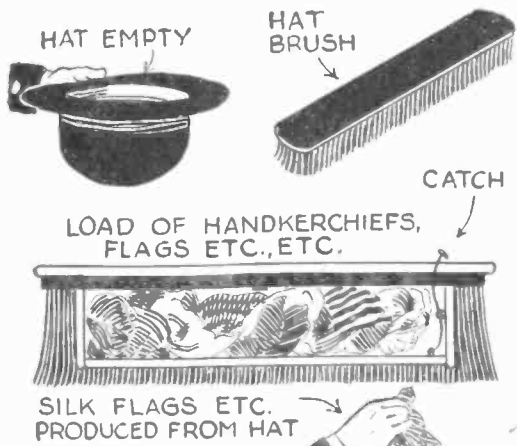

A very good method of loading materials into a hat is illustrated in Fig. 1. The performer borrows a hat, drops it; he brushes it off with the mechanical brush illustrated, and drops the load into the hat.

Fig. 2 illustrates the paddle selector. The performer forces a card upon one of the audience, then tosses a duplicate deck into the air. His assistant swats at the deck and the selected card appears upon the paddle. The paddle is covered with velvet and has a secret pocket holding a duplicate of the forced card.

A low stand as in Fig. 3 is placed in the center of the stage which the magician covers with a cloth. On drawing the cloth away an immense flower pot full of flowers is visible. The flowers are concealed in the legs and pass down beneath the stage.

The string of the pull illustrated in Fig. 4 passes through the vest pocket and down the trouser leg. With its aid a coin may easily vanish from a handkerchief.

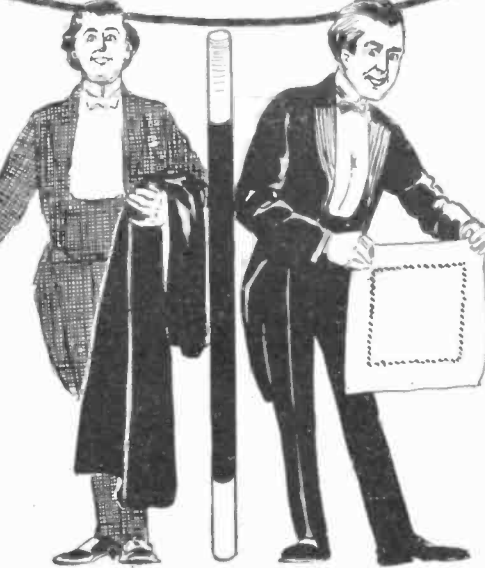
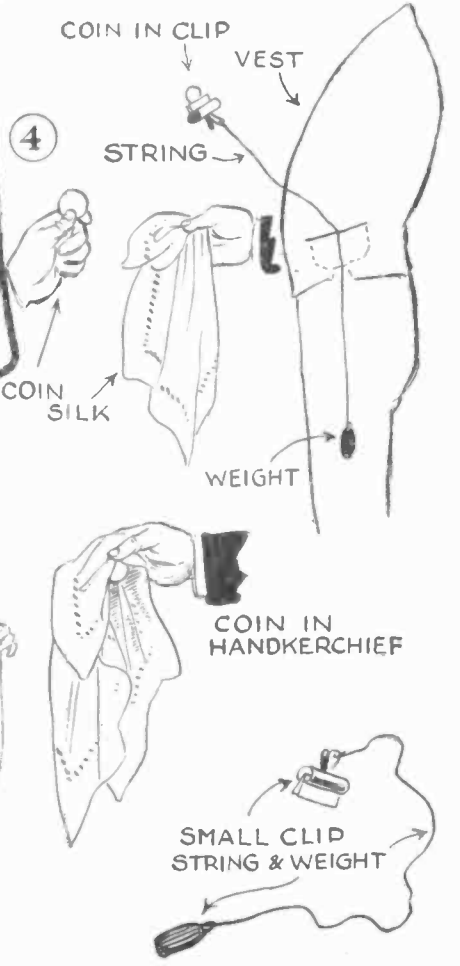

Scientific Problems

By ERNEST K. CHAPIN

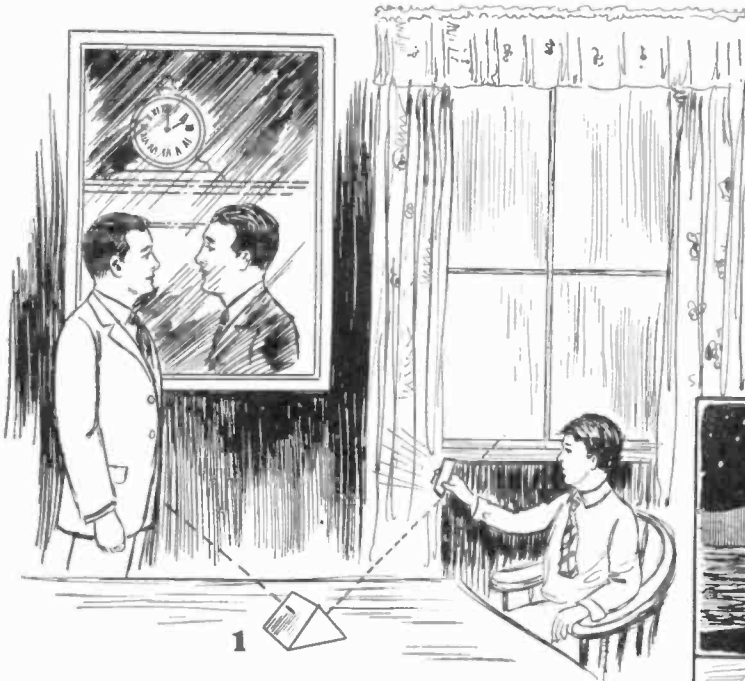

Directly above we show an illustration in which there are scientific discrepancies. Note the position of the man in reference to the mirror, the position of the reflection, the refraction through the prism, and the position of the mirror in the boy's hand. What is wrong?



It is very difficult and often impossible to swat a bumble bee with an unperforated paddle, while it is relatively easy to hit one with a paddle through which a number of holes have been drilled. Why is this true?

In the case with the man with the paddle illustrated above and to the right, a paddle of thin metal and one of wire mesh might be substituted for those mentioned.

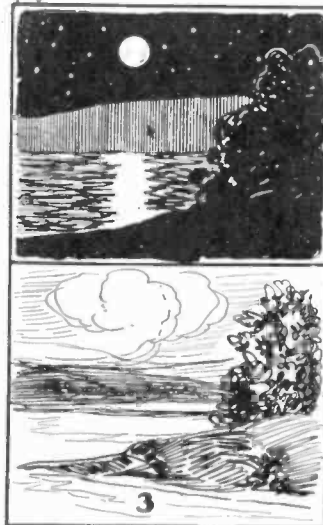

Which, in the course of a year, averages longer, day or night?

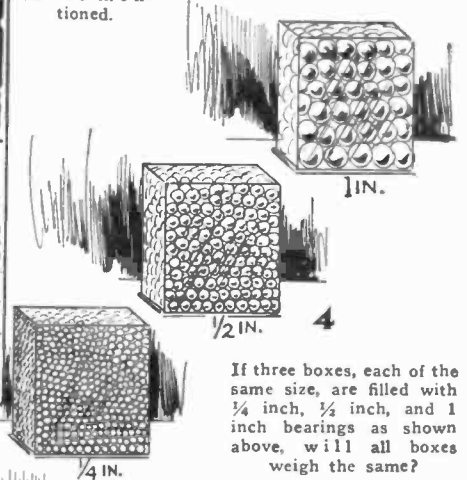

If three boxes, each of the same size, are filled with $\frac{1}{4}$ inch, $\frac{1}{2}$ inch, and 1 inch bearings as shown above, will all boxes weigh the same?

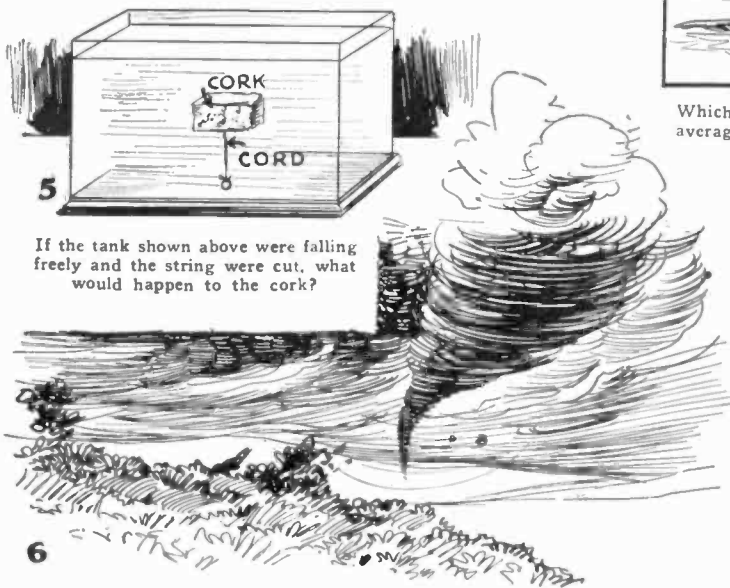

If the tank shown above were falling freely and the string were cut, what would happen to the cork?



Can a bottle of water under any circumstances set fire to a building?

The illustration directly above shows a well-known type of storm that is often illustrated and called a cyclone. Is this the name of this type of storm?

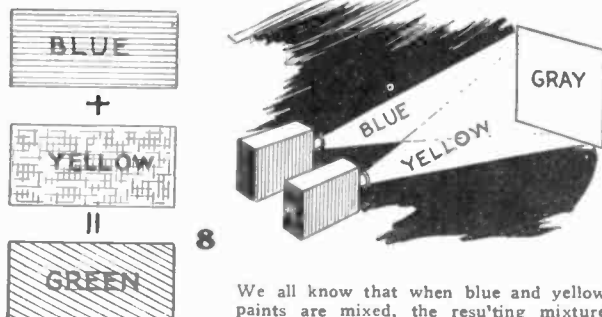

We all know that when blue and yellow paints are mixed, the resulting mixture appears green. However, can you account for the fact that these two colors when projected on a white screen produce a grayish tint?

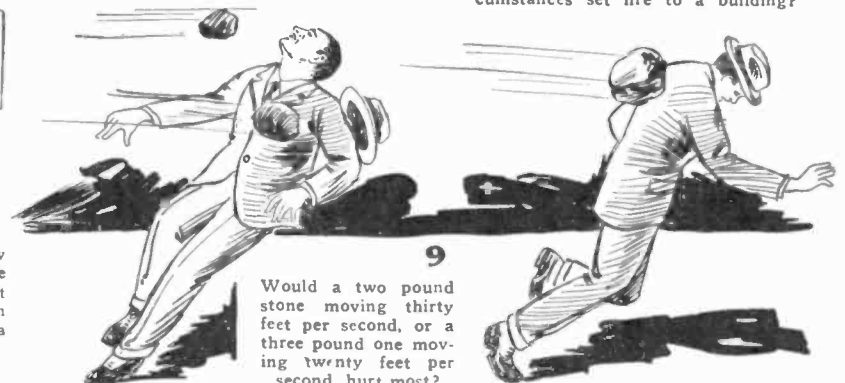

Would a two pound stone moving thirty feet per second, or a three pound one moving twenty feet per second, hurt most?

How Amateur Actors Make-Up

By L. B. ROBBINS

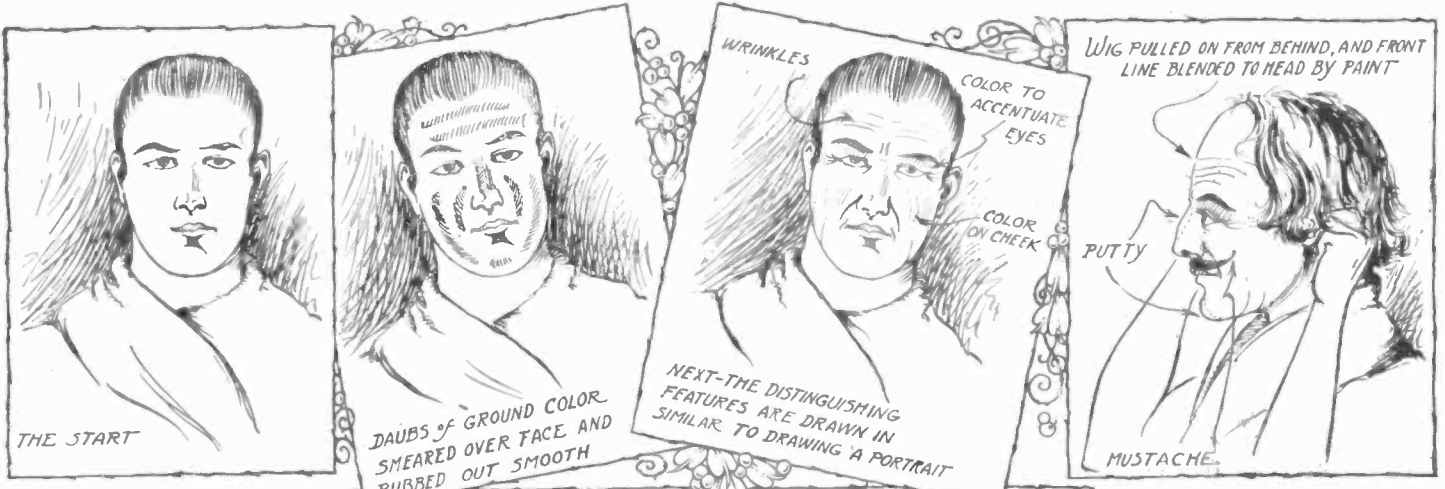

In the figure above the actor is ready to put on his make-up. To the right he is seen with the daubs of ground color spread out over his face. The next figure to the right illustrates how the distinguished facial expressions are applied. The wig is then pulled down over the head after the nose has been built up with putty, and the mustache applied. As illustrated below, the semblance of missing teeth can be produced by using black wax which is molded over the teeth.

The two illustrations to the left indicate the final touches in the amateur make-up. To heighten the eyes and enlarge them, the eyebrows are darkened with paint and the lashes touched up. Then a dark line is drawn above and below the edges of the lids to meet at the outer corner of the eye. Features may be altered with nose putty as illustrated on this page, and a plump hand is made to appear aged and scrawny, by giving them a neutral shade and then coloring as illustrated below left.

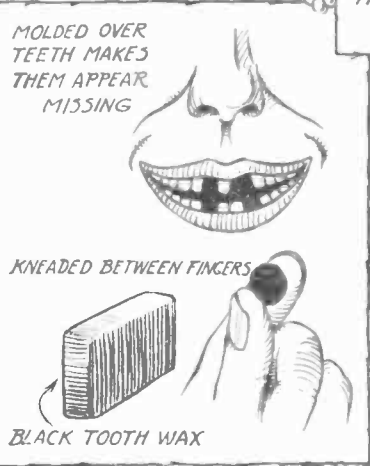
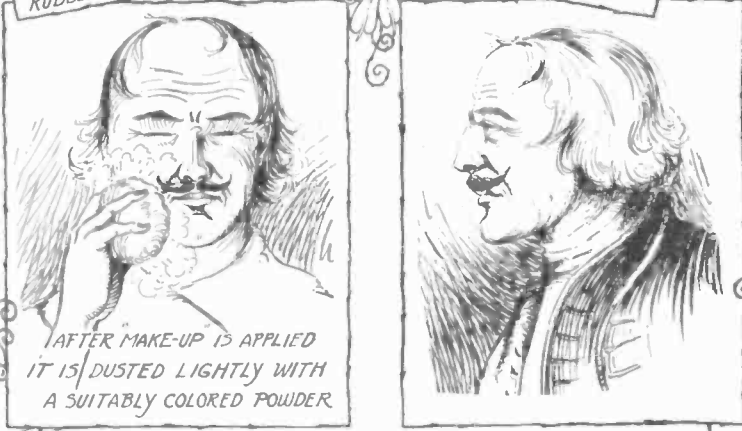

The use of tooth wax is shown above.

MANY amateur theatricals fall flat in one essential, namely that of stage make-up. When one considers the art as a whole, he will find that making up for the play is very simple. In order to simplify the process still more, the illustrations on this page are made in such a way that each process is clearly brought forth. The colors and paints are scientifically prepared and are available in handy containers ready for instant use. All that the actor really has to do is to visualize the character in his mind and then prepare his own features with color and line to form that character. The process in general is as follows: The actor seats himself before a well lighted mirror with the powders and grease paints spread out in front of him on the table. A towel or cloth is wrapped around the neck for protection, and then cocoa butter or cold cream is rubbed thinly into the skin to fill the pores and prepare a suitable surface to work on. Making wrinkles successfully is an art in itself. They are first drawn in the required place with a sharp lining stick, then just above each line or between two adjacent ones, a line of lighter color than the flesh is filled in. This is the high light; the dark line is shadow. These two lines are then softly blended with the finger to tone them down. The other features of the make-up are shown on this page.

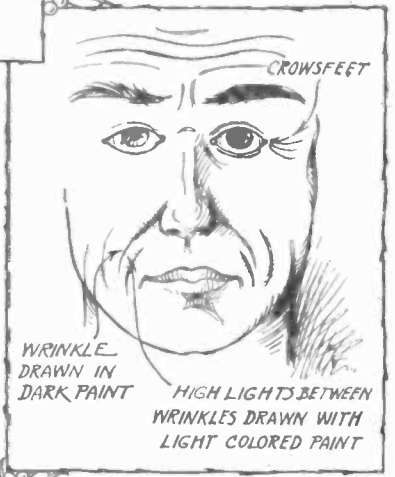

Above one sees the method of producing wrinkles.



How a plump hand looks when aged.



The natural eye and the effect upon it when properly made up, is here illustrated.



How nose putty can alter the features.

Inner Tube Contest

Thirty-five Combination

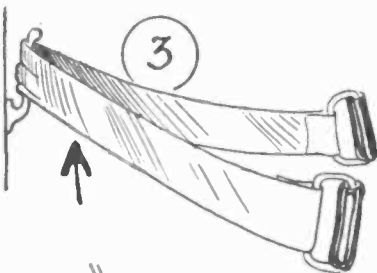
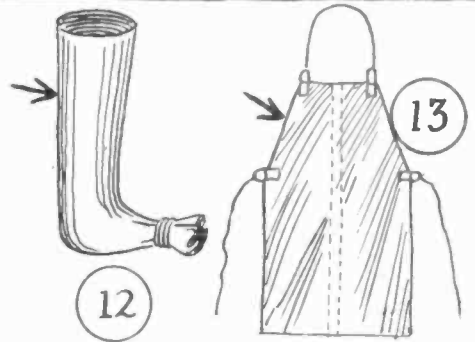
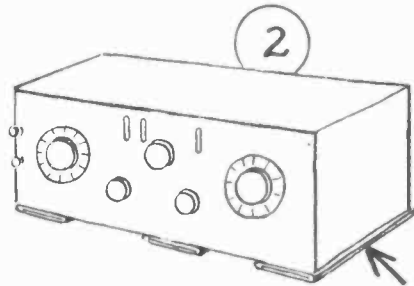
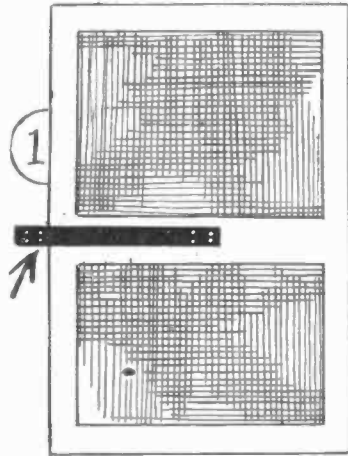

THIS beautiful combination of pen and pencil in one unit will be given away to those submitting the best suggestions or uses of inner tubes in this contest. The point is so'd fourteen karat gold. The pen is of the self-filling type and the pencil at the opposite end propels, repels and expels the lead. The pen is engraved with the words, "Awarded by Science & Invention Magazine". The thirty-five suggestions thought best in the opinion of the judges will receive the awards. In event of ties for any of the awards, contestants so tying will also receive the combination pen-pencils. Contest closes in New York City, Friday, May 1st, 1925, at 12 noon. All entries must be in our hands at that time.

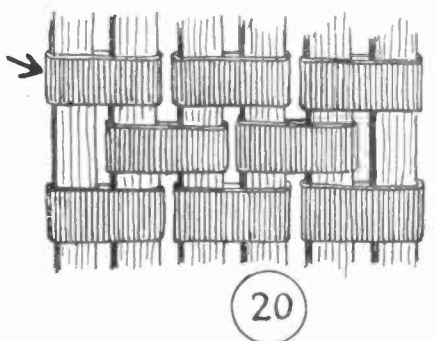
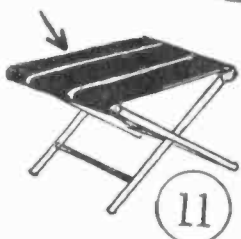
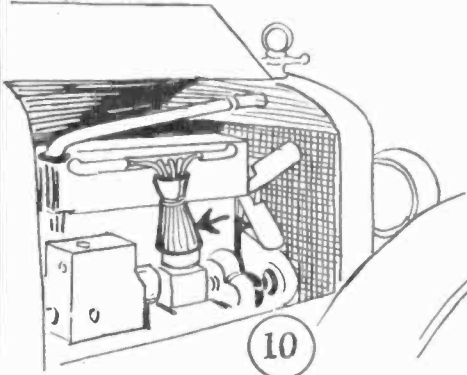
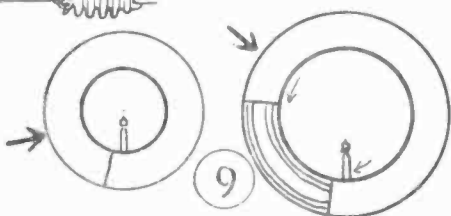
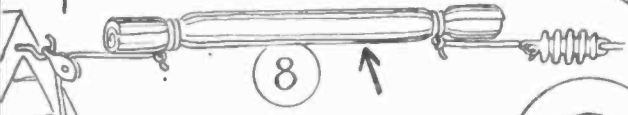
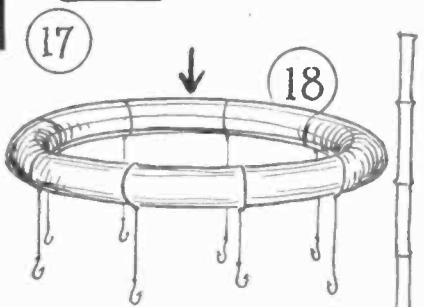
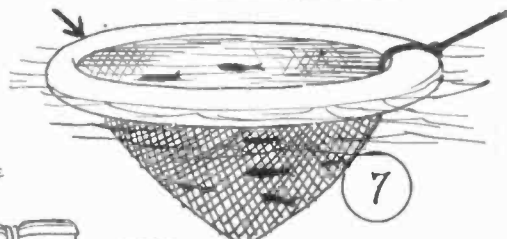
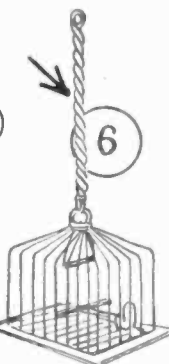
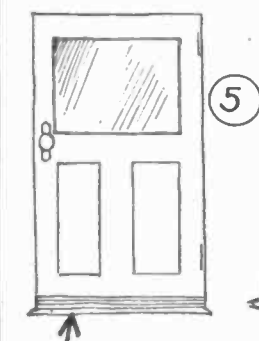
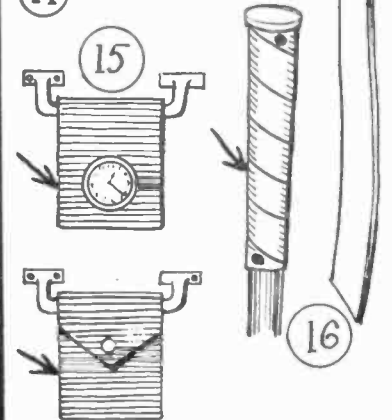
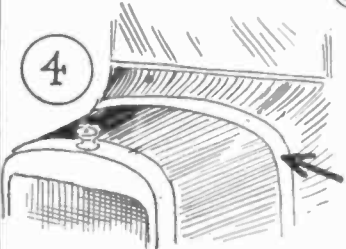
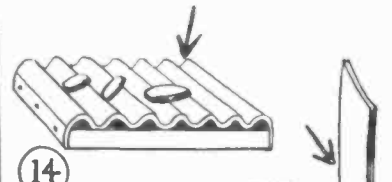

---Special Prizes

Pen-Pencils to Be Given

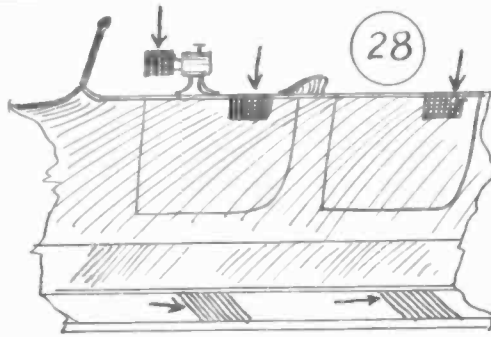
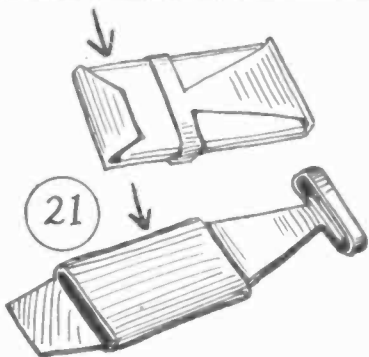

33

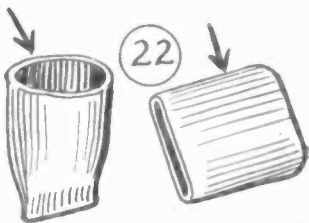

IN this contest any kind of inner tube or tubes may be used, and the tubes may be riveted together, sewed or cemented, to make articles of various types similar to the suggestions found on this page. No suggestion on this page will be awarded a prize. Briefly, the items described are as follows: 1—Screen door spring. 2—Shock absorber for radio set. 3—Exerciser. 4—Anti-rattler for cars. 5—Weather strip. 6—Bird cage spring. 7—Minnow net. 8—Strain insulator. 9—Pneumatic seat. 10—Distributor shield. 11—Camp chair. 12—Boot. 13—Apron. 14—Change tray. 15—Watch holder for cars. 16—Handle for clubs. 17—Car change purse. 18—Multiple float and gaff for fishing. 19—Replacing shoe soles. 20—Lath and rubber mat. 21—Document envelope. 22—Drinking cup. 23—Hot water bottle. 24—Tool holder. 25—Socket mounting. 26—Rubber bands. 27—Mat of woven strips. 28—Running board mat, door protector and horn protector. 29—Life preserver. 30—Suspenders. 31—Life preserver. 32—Fly swatter. 33—Bathing bag. 34—Film developing tank. 35—Flower pot. 36—Pouch pillow. 37—Socket protection. 38—Chair skids. 39—Phone cushions. Address manuscripts or models to Editor, Inner Tube Contest, c/o Science and Invention Magazine, 53 Park Place, New York City.



34

35

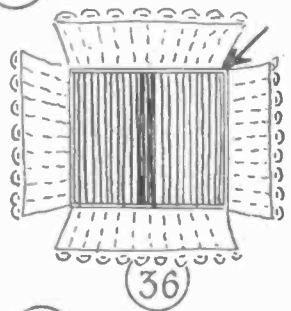
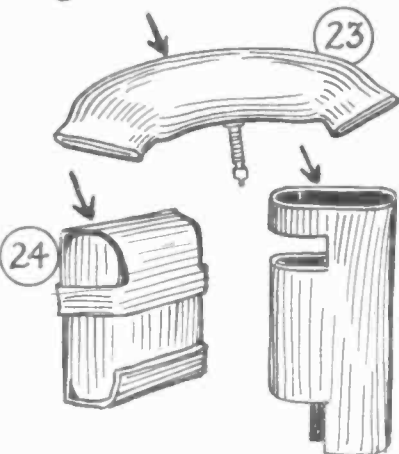

36

37

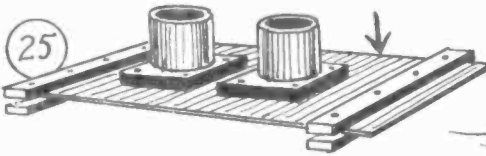

29

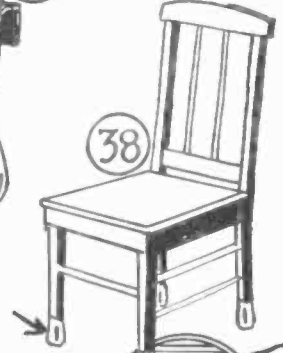
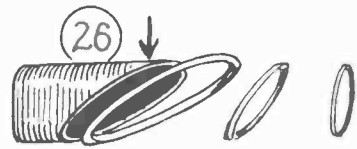

38

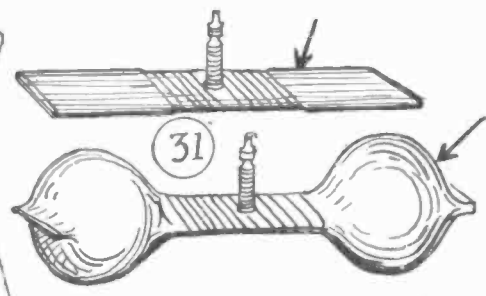
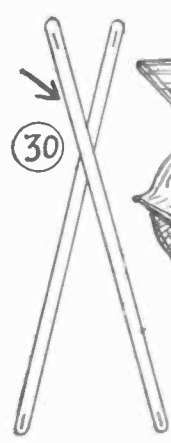
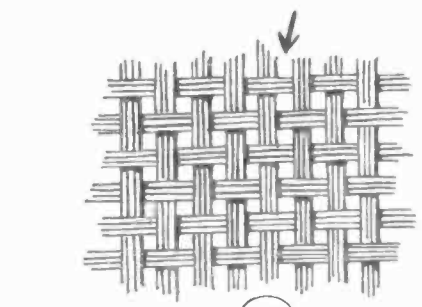

31

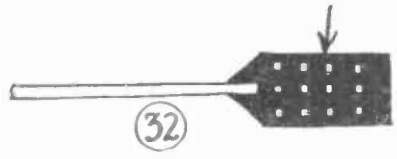
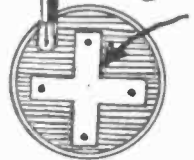

32

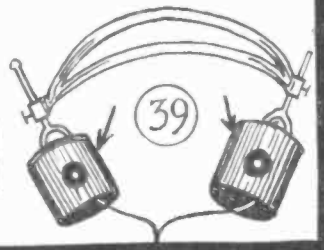

39

27

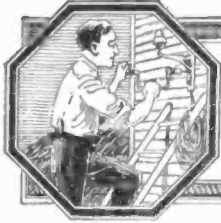

THE CONSTRUCTOR



Making Your Own Antiques



Above: When a cavity is to be in the finished object, it is formed in the still plastic clay with a round tin can.

ALTHOUGH clay is most frequently used for molding, still it can be carved if care is used and decorative articles of an antique appearance made from it. Select clay that is as soft as talcum and feels oily or soapy to the touch. Be sure it contains no grit or sand. This may be had in many colors and often two or three colors may be used in one article effectively. Mix the clay to the consistency of thick dough and mold roughly to the desired shape. Always make the rough mold slightly larger than the finished object is to be, in order to provide sufficient material for carving. Be sure no air pockets are present.



The roughly molded block is shaved to shape with a thin, but not necessarily sharp, knife.



Above: Accomplishing the carving with a small pen knife. The design may be lightly traced on the clay and the surrounding parts cut out so that the design stands in relief. This work is done after the inside cavity has been smoothed. The walls should be $\frac{3}{4}$ " to 1" thick, although for smaller objects $\frac{1}{2}$ " will be sufficient. To preserve these objects, two or more coats of hard drying varnish should be applied. Colloidion may also be used.—Dr. Ernest Bade.



Above: Some of the decorative objects made by the process described herewith.



Above: A smoker's set of unique design made of clay.

Odd Uses for Rope

Short ends of rope that are no longer useful for their original purpose may be put to other uses as illustrated herewith. Left: Handles for boxes made by passing the rope through two holes in the side of the box and knotting inside. Lower left: A chair seat made by running several strands of rope across the chair and nailing in position. Below, left center: Nailing ropes in place provides a good weather strip. Below, right center: A short stub of rope makes a temporary cork. Lower right: A rope mat made by sewing the rope together in the form shown. Right: A rough brush may be made by fraying the ends of a piece of rope, clamping in a tin tube as shown and fastening a handle in place. The end of the brush is trimmed off square.

—Arthur Flinnee.

HANDLE FOR BOX



KNOTTED ON INSIDE

CHAIR SEAT

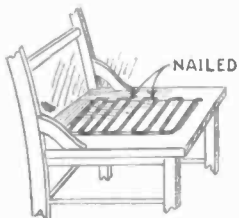

NAILED

KEEPS COLD FROM COMING UNDER DOOR



DOOR

NAILED TO FLOOR

TEMPORARY CORK

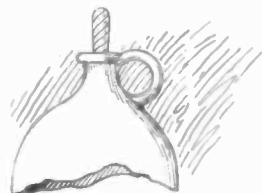

BRUSH FOR ROUGH JOBS

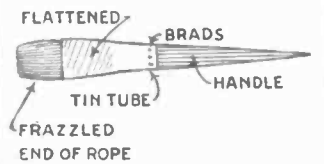

FLATTENED

BRADS

TIN TUBE

HANDLE

FRAZZLED END OF ROPE

TABLE MAT

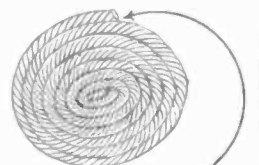

SEWED LIKE RAG RUG

Improved String Telephone

By C. A. OLDROYD

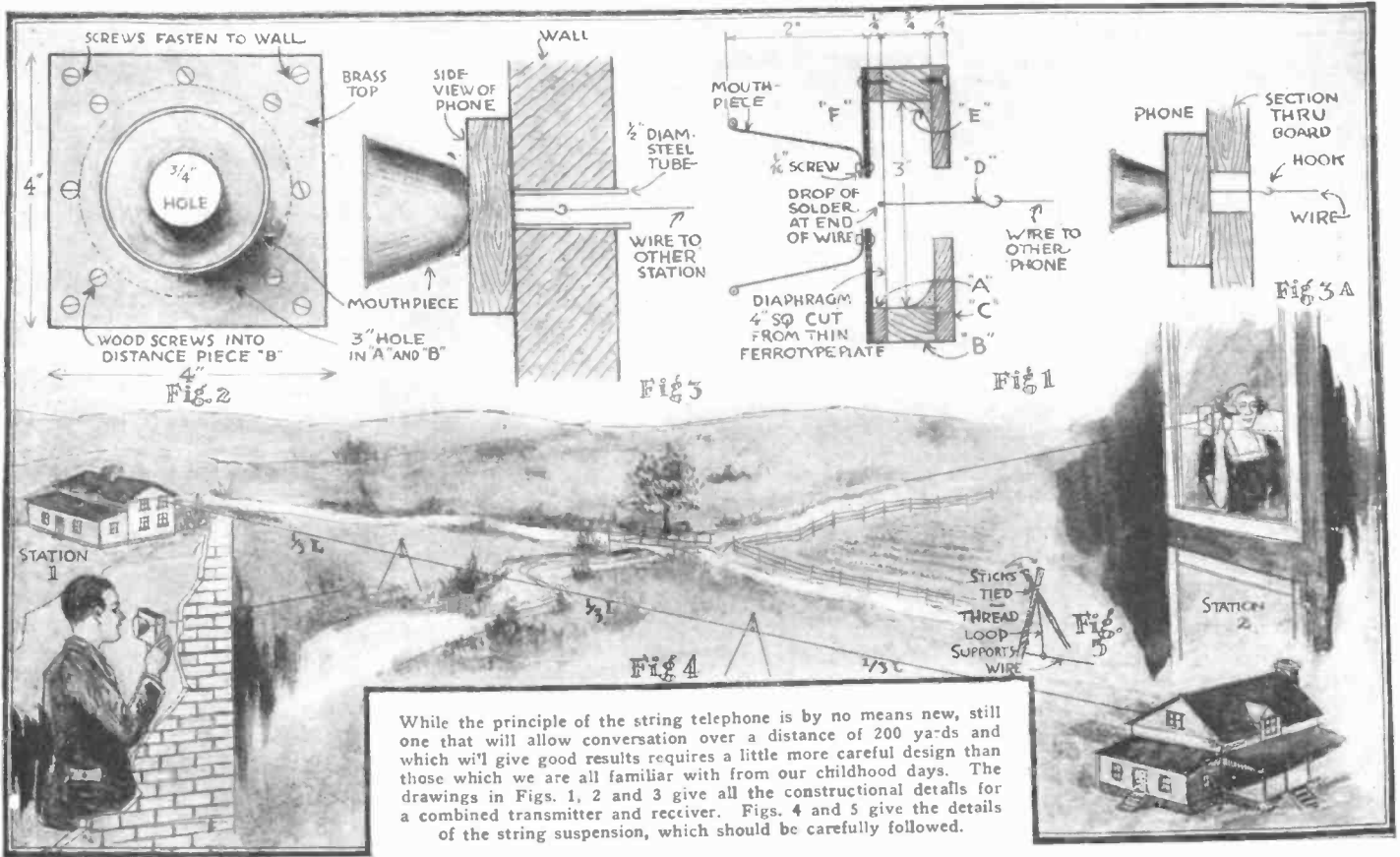

While the principle of the string telephone is by no means new, still one that will allow conversation over a distance of 200 yards and which will give good results requires a little more careful design than those which we are all familiar with from our childhood days. The drawings in Figs. 1, 2 and 3 give all the constructional details for a combined transmitter and receiver. Figs. 4 and 5 give the details of the string suspension, which should be carefully followed.

Testing Milk

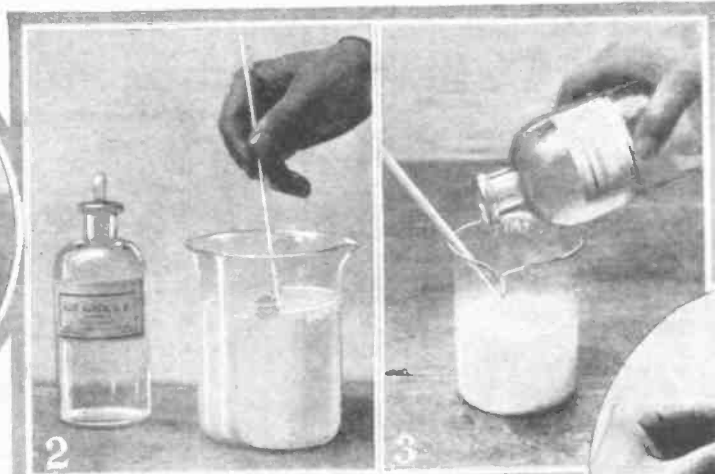

Formaldehyde is often found as a preservative of milk and can be readily detected. Dilute the milk with an equal volume of water, stir in a few drops of ferric chloride. Carefully add sulphuric acid. A violet ring formed where the two solutions meet indicates formaldehyde. Placing the tube in hot water (1) intensifies the ring.

(2) Casein may be precipitated from milk by the addition of acetic acid.
 (3) Pure crystals of milk sugar may be precipitated with alcohol.

5 C.C. OF MILK.-ADD 15 C.C. IODIDE SOLUTION AND 4 C.C. HCL SOLUTION

85°C

ADD 1 C.C. OF STARCH SOLUTION.

COLD WATER

RED COLOR DENOTES PRESERVATIVE

7 GRAMS POTASSIUM IODIDE IN 100 C.C. OF WATER

10 C.C. HCL + 20 C.C. OF WATER

1 GRAM STARCH BOILED IN 100 C.C. OF WATER

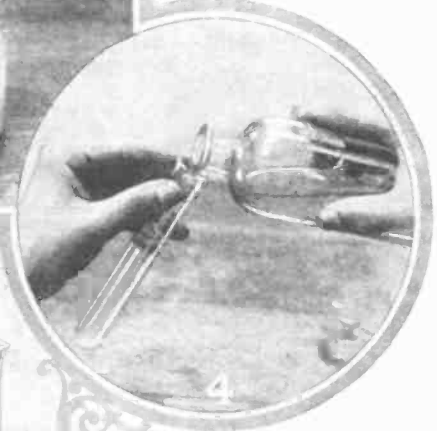

Left: Hypochlorites and chloramines, involuntary adulterants, may be detected as shown. Make up the three solutions shown in the beakers and add the two that are indicated to milk in a test tube, heating to 85° C. Add starch solution and place in cold water. Reddish blue color denotes adulterant.

—Dr. E. Bade.

Current-Producing Selenium Cells

Their Dependence On Moisture.

By W. S. GRIPENBERG, Selenium Cell Specialist

Fig. 1 Constant Type
Fig. 2 Inconstant Type
Fig. 3 FRITTS CELL
Fig. 4 KUNDT-ULJANIN CELL
Fig. 5 GRIPENBERG CELL
Fig. 6 Heating process

Experiments conducted by the author which covered several months of research work with the various types of cells illustrated herewith have shown that selenium cells depend upon moisture for their action.

Current produced by light
 Current produced by light
 Current produced by light
 Current produced by light

Meter
 Cell
 Meter
 Cell
 Meter
 Cell
 Meter
 Cell

Brass
 Selenium plate adhering to the electrodes
 Semitransparent Gold leaf
 Glass coated with semitransparent platinum film
 Selenite plate adhering to the electrodes
 LIGHT
 LIGHT
 LIGHT
 LIGHT

One of the experimental types of selenium cells particularly adapted to the moisture experiments is shown above.
 The loose selenium plate in the Gripenberg cell was first inserted in the frame and tested. It produced a current. The plate was then heated to remove the moisture.
 The heated plate, when replaced, gave no current.

Celestial Camera

KODAK BELLOWS
 DOUBLE CONCAVE LENS
 CONVEX LENS
 SHUTTER
 ELT COVERING

A. Sashie

A camera attachment for taking photographs of the heavenly bodies may readily be made as shown above. A tube with a focusing arrangement is first provided and fitted at one end with a convex lens. A double concave

lens is placed in the other end in the manner shown. By setting the camera on a rigid tripod, focusing and experimenting with the length of exposure, excellent results can be obtained. Left—moon. —C. B. Johnson.



HOW-TO-MAKE-IT

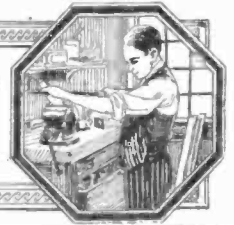

Shop Fan

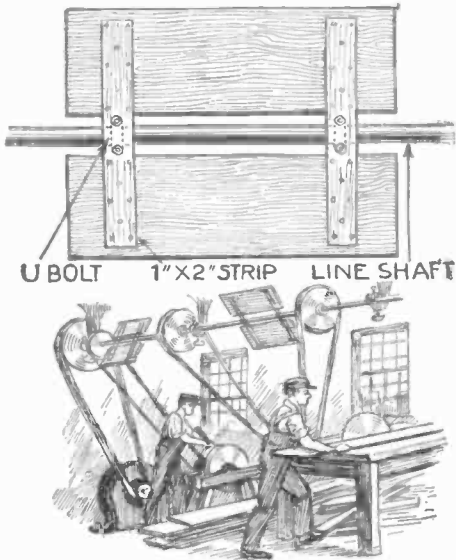

A fan for use in machine shops may be quickly and easily made as shown above. It is to be clamped on a line shaft and will give excellent results with a very low power consumption. —E. L. Edwards.

Torches

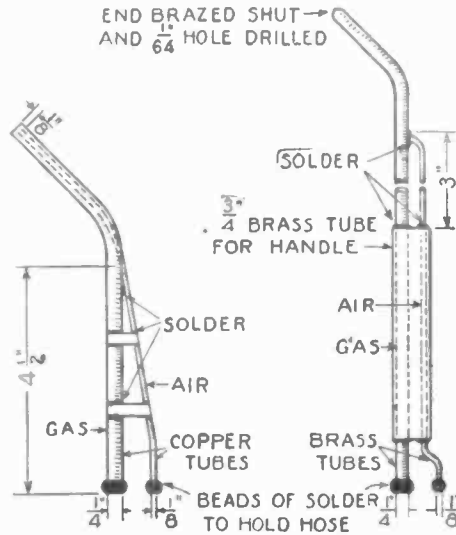

LOW PRESSURE TORCH FOR BATTERY WORK ETC. **HIGH PRESSURE TORCH FOR BRAZING ETC.**
Torches for high and low pressure use may be made as shown above at the right and left respectively with brass or copper tubing. Rubber tubes lead to the tanks. —K. B. Thompson.

Phosphorescent Light

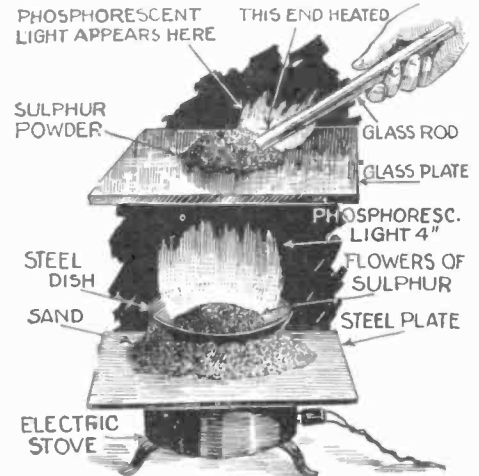

Two interesting chemical experiments in the production of phosphorescence are illustrated above. Sulphur, when heated by any of the two methods illustrated, produces a very weird luminous effect. For all experiments in phosphorescence the room should be quite dark. —C. A. Oldroyd.

Test Set

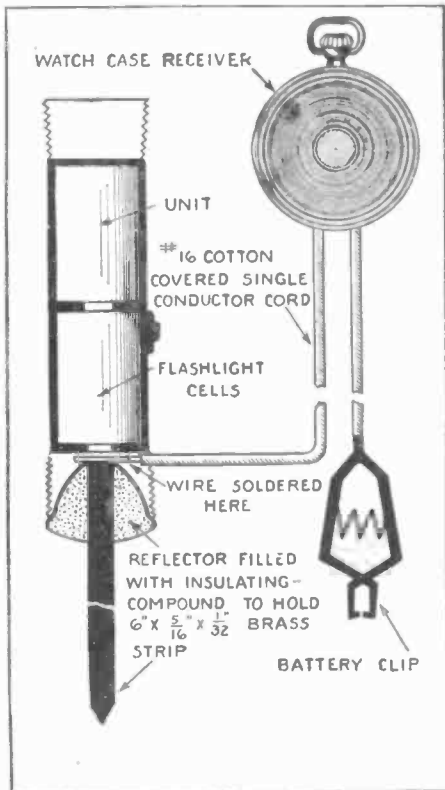

For use on all kinds of electrical apparatus and radio sets, the above illustrated tester gives excellent results. Two flashlight cells in a reconstructed case furnish power. The watch case receiver is the detecting element. —W. B. Clark.

Tire Pump

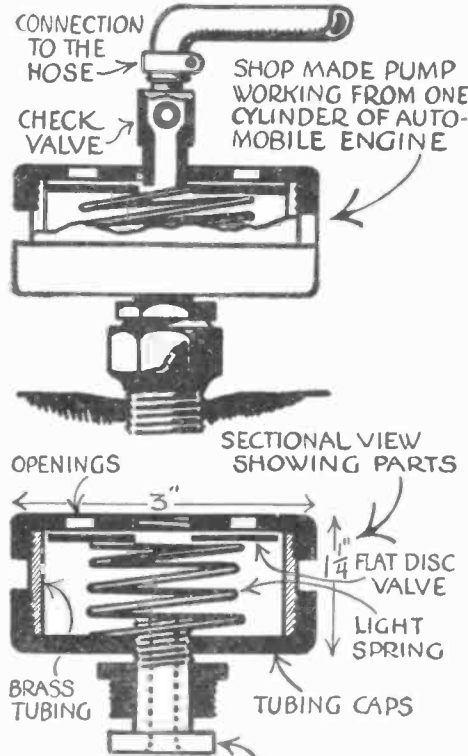

CONNECTIONS TO SPARK PLUG SHELL

The simple tire pump illustrated above is attached to a spark plug shell. The shell is screwed into one cylinder in place of the plug and the engine operated when a tire is to be inflated. —G. A. Luers.

Train Speed

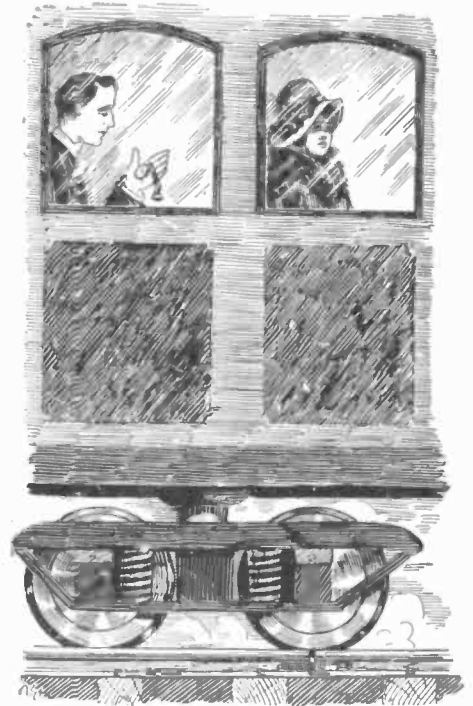

When traveling on a railroad train, one often wishes to know just how fast he is traveling. Here is a method that is much quicker than timing the distance between mile posts and which is of use during day or night. Merely count the number of clicks heard as the wheels of the train pass from one rail to the next in 20.4 seconds. This number will be the speed of the train in miles per hour.

—Elliot R. Weyer.



WRINKLES

RECIPES & FORMULAS



Fire-Proof Paper

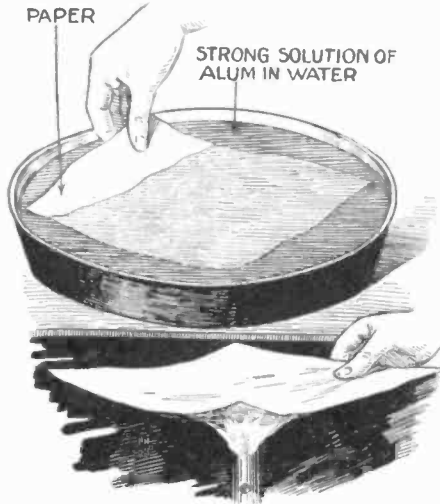

Paper which will not burn when held in a flame is often desired for various purposes. Ordinary paper may be used in this way by saturating it three times in a strong solution of alum in water, drying it after each saturation. —F. S. Yamamoto.

Graduate Repair

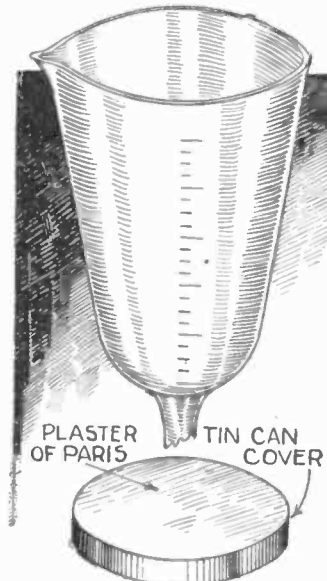

When the base of a graduate breaks, a sturdy repair may be made as illustrated above. The plaster will hold the graduate rigidly. —Joe Windle.

Removing Cork

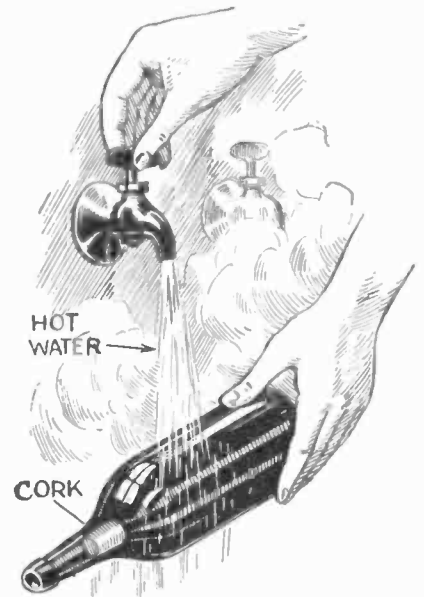

Get the cork to the mouth of the bottle as shown. Applying hot water will usually force it out. —Robert G. Nicholl.

Cleaning Paper



Soiled wall paper may be quickly and easily cleaned by stroking lightly and in one direction only with a mass of dough made up of bread flour and water to a consistency that will not stick. Never go over the same place twice. —Mrs. Jean Wagar.

Luminous Switch

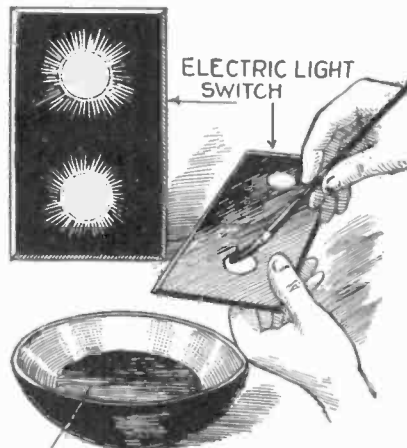

A mixture as described above makes luminous paint for application as shown. —Claude G. Minnich.

Microscope

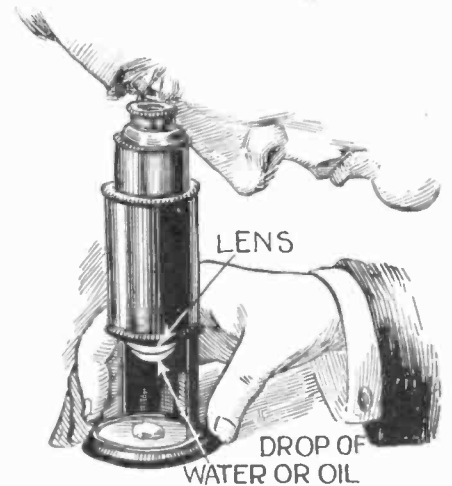

The power of a microscope may be improved by placing a drop of oil or water on the objective as shown above. —L. M. Brooks.

Metal Etching

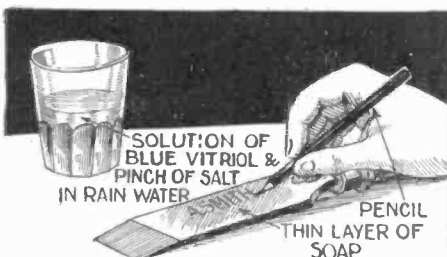

Coat the metal to be etched with soap and scratch the marking through the soap to the metal with a pencil. Apply blue vitriol solution. In about five minutes, wash it off. —E. C. Timlick.

Blue Prints

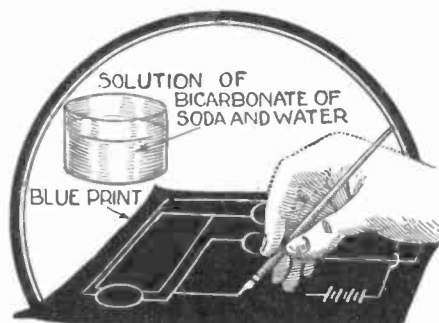

White lines may be drawn on blue prints with the solution shown above. —A. A. Blumenfeld.

Transparent Paper



Transparent paper for various uses may be made by immersing cotton or linen paper in the solution indicated above. —F. R. Moore.

Readers Forum

READING BACKWARDS

Editor, SCIENCE AND INVENTION:

When I read Mr. Ringstrom's idea of beginning books at what is now the back, I thought of an explanation for a reader starting the book in this way. A right handed person naturally begins to turn the pages with his right hand. The pages slip over easier with the palm of the hand toward the book and the thumb, letting them spring open one by one. This places the right thumb at the back of the book. When turning in this manner, the advertising is read (or passed over) first. This suits me all right. Better have a bad beginning and a good ending than an interesting start and end in some "ad." with no more hope until the next month. I do not think Mr. Ringstrom's plan would be popular because it would be hard to become accustomed to look to the left for the next page when we are used to looking to the right. It would also be awkward reading to the right and turning to the left. Turning to the left and reading to the left would be worse. *kos kniht uoy t'nOD.* (Looks a little queer, eh?)

EDWARD C. JOHNSTON, Pittsburgh, Pa.

(You are right in assuming that a right-handed person naturally begins to turn the pages of a book over with his right hand, and it is much easier to hold the entire book in the left hand and turn the pages with the right, but begin turning with pages nearest the hand turning them, viz., the back of the book; at least that seems to be the case with the majority of right handed individuals, and if you care to observe the readers of newspapers, you will find that this is their general procedure. The reason for this may lie in the fact that a great many of the newspapers have their comic and magazine sections near the end of the paper, i. e., on the last, next to the last, or third from the last sheets. Business men and women enjoy comics, some of them to a greater extent than they do the heavy news, and it may be that they unconsciously turn toward the end of a book due to force of habit in handling newspapers. Of course, printing a book backward would not be a good system, and, as you say, reading type from right to left is infinitely worse.—EDITOR.)

BENDING LIGHT RAYS

Editor, SCIENCE AND INVENTION:

It seems that if the new quartz lens which will make a beam of light turn a hundred and eighty degrees angle be mounted in a telescope, one could see objects miles away in the same plane as that of the eye. This would be of great benefit to the police department because the escaping bandit could be watched by means of the telescope, even though the bandit is around the corner several blocks away. The light would pass through a wide arc from the bandit's automobile over the high buildings to the telescope. Then radio equipped motorcycle cops could trap the bandits. Instead of looking at distant planets with a telescope, ships could be watched across the ocean, even though they could not be seen with an ordinary lens because of the curvature of the earth. If a common lens can gather light rays from a planet millions of miles away in a vacuum, why could not a ship be seen a few thousand miles in this denser air with a quartz lens?

THERREL J. SNYDER, St. Johns, Mich.

(Your impression concerning the operation of a quartz lens is distorted. Although a light beam can be made to follow a curve by means of a quartz bent cylinder, the quartz operates, not by refraction, but by internal reflection. In other words, if we desire to bend the beam of light through 180 degrees of a semi-circular arc, we have to have a quartz bar or cylinder curved through such arc. The light is bent along the interior of this solid quartz glass rod and will take the curvature of the rod. The instant the beam reaches the end of the rod, it emerges and goes through the atmosphere via the ether in a straight line. Consequently, in order to make a telescope which will "look around the corner," the telescope would have to have a long glass rod bent through an arc of 90 degrees, and it would have to be so situated that the bend would be located at the corner around which the observer desires to see, and in order to observe a ship crossing the ocean, it would be necessary that the lens be long enough to make such an observation practical. Such a telescope would have to be approximately three miles long to see the ship when it is hull-down for an observer at sea level.—EDITOR.)

INTELLIGENCE OF FISH

Editor, SCIENCE AND INVENTION:

The September issue of SCIENCE AND INVENTION contains a drawing of an eel in a bath tub. The eel has its tail around the water outlet on the tub and is holding the water in. The picture is entitled "Intelligence of Eel." Under the drawing is the following: "Kosmos, a German scientific journal, quotes an observation made by one of their readers which would seem to point to a more than usual degree of intelligence found in an eel. When the stopper of the bath tub in which he was living was removed he took care to preserve his life by using his tail as a dam as shown."

I wish to take exception to the statement that the eel shows intelligence and that he intention-

ally dammed up the water. In the first place, when the stopper is removed from a bathtub full of water, the water runs out. While running out it creates a small whirlpool or suction around the outlet. I believe that the eel's tail was drawn around the outlet by the suction of the water and was not put there by the eel. Perhaps we can explain the position of the eel's tail by saying that it was due to the unusual degree of intelligence found in the water in the bath tub while it was running out. I have never found anything but bones in fishes, and I think the eel is no exception. If the eel had any intelligence, would it be in the bath tub? No, it would be in some creek where there was no danger of the water leaking out. Even at that, the eel showed more intelligence than the man who put it into the bath tub. What is becoming the matter with those scientific Germans? But the eel's intelligence is nothing to the intelligence of a pet snake I once had. I once found a small garter snake and put it into a bottle. I put a cork in the bottle, ran a string through the cork and knotted it on the inside of the bottle. I then hung the bottle up by the string. The snake became restless and then stopped its crawling around inside of the bottle and was motionless. I watched it closely and I saw it raise its head, take a look at the knot, then look at the floor. It then got hold of the knot with its mouth and pulled. The knot came unfastened and the bottle fell to the floor and broke. The snake then crawled away and disappeared into a rat hole before I could catch it again.

N. CAMPION, Greenville, Ohio.

tally would question the authenticity of the snake episode or the ability of an animal to untie knots. We will guarantee that no garter snake living would untie a knot which we tied. There are times when we can't do it ourselves. We wonder if it was a booby.—EDITOR.)

THE SPIRIT QUESTION

Editor, SCIENCE AND INVENTION:

In looking through one of the back numbers of your magazine (December, 1923), I noticed you have conducted a test on the genuineness of spiritualism, and to ascertain the source and cause of the so-called phenomena. I am very much interested in knowing the results of the tests conducted by your staff of investigators, as I have been troubled at night by strange phenomena in my room, such as knockings and table moving. On such occasions many times when I attempted to quickly turn on a light, I found to my disgust and terror that the bulb had been unscrewed from the socket and was, as near as I could tell, dangling in the air some place near the socket. Will you kindly have one of your staff furnish me with a report?

G. W. ALEXANDER, Chicago, Ill.

(The phenomena of which you write are certainly unusual, and it will be interesting to investigate them. We have seen no demonstrations of psychical phenomena which were not fraudulent. We are still looking for them, and our \$11,000.00 award has not yet been earned by anyone. We have condemned so-called procedures of alleged psychical performers as being willingly fraudulent. The fact that no so-called "spiritualists" have come forward to demonstrate their capabilities tends to verify this conclusion. We would suggest that you purchase a flashlight, seal it and make use of this when you think there are others in the room moving tables or doing various other tricks. Spirits ordinarily will not break seals.—EDITOR.)

PLAGIARISM

Editor, SCIENCE AND INVENTION:

As one of your reporters I am writing this letter as a sort of protest against these fellows who are sending you in "old stuff," as the saying goes, and passing it off on you as original matter and getting away with it too and just think of the money prizes you are paying out to make SCIENCE AND INVENTION one of the most popular and interesting of magazines. I hate to see this sort of thing being pulled off while a lot of the rest of us are striving to send you really new and interesting materials.

Take, for example, the prize of \$10.00 you paid to Fred Ayres and another to Gus Oline for the articles you published in this October issue on page 586. I know both of these to be old and not original. I knew the idea of converting one of the long copper-covered can openers into a coarse sewing needle was old, and that I had seen it published three or four years ago; and also the idea of passing a small machine screw through a piece of paper to hold it while setting the screw within some difficult place, so I took the trouble to look them up to convince you I am correct in my statement. I could not locate the article about the screw, but was able to find the one about the can opener, which I inclose for your guidance. It was published in March, 1921. I think such correspondents as these should be dropped from your rolls and requested to return the prize money they have accepted, unless they can prove in some manner or other that they are entirely innocent and believed they were sending original matter. I have had occasion to invite the attention of the publishers of another magazine to some of the same class of contributors who were sending in old matter, and they were promptly dropped by the editor who wrote and thanked me for calling his attention to their methods. I think it is only right to endeavor to protect those of us who are striving to send you interesting new material. While on the other hand you are publishing and paying out money for old material such as I have pointed out.

LEIGHTON POWELL, San Francisco, Calif.

(As will be noticed, Mr. Gus Oline received no prize for his article. We have every reason to believe that Mr. Fred Ayres did not attempt to copy the article which you found originally in another publication. If Mr. Ayres has done this intentionally or purposely, we will make it our duty not to accept further manuscripts from him. We believe, however, that Mr. Ayres is absolutely sincere in the belief that the article was original. We have no use for plagiarism and all ways fight against it when we can do so. Of course, occasionally a man will unintentionally plagiarize another article, and particularly if it is short, one cannot quite hold him materially responsible for doing so. If the editors know that an article of a certain type has been published before in another periodical, a rejection slip is immediately clipped to the article, and the reason for its rejection is marked on the slip.

Nevertheless, we thank you very much for calling this matter to our attention, and we will be indebted to any of our other readers who bring proof of plagiarized articles to our attention at any time.—EDITOR.)

(Continued on page 1143)

The Experimenter

has come back! If you are one of the one hundred thousand readers of the old ELECTRICAL EXPERIMENTER, you will no doubt be glad to hear that the EXPERIMENTER is coming back BIGGER AND BETTER THAN EVER. PRACTICAL ELECTRICS has been changed into an entirely new kind of magazine entitled

The Experimenter

In this magazine which has been greatly enlarged in point of contents, illustrations and circulation, you will find the following new departments:

Experimental Radio
Experimental Chemistry

There is an entirely new treatment of radio containing experiments only. 90% of the magazine contains pure experiments written by the foremost authorities in their respective fields, also a monthly editorial by the writer.

A fine roto-gravure section is now added to brighten up the magazine. If you want experiments, this is your magazine.

Be sure to reserve a copy from your news-dealer before the issue is sold out. THE EXPERIMENTER will be on sale at all newsstands beginning February 20th, 1925.

Hugo Gernsback
Editor

(The suction created by water flowing out of a bath tub is certainly not strong enough to cause an eel to curl around the outlet of a bath tub, as indicated in the article above alluded to. The muscular structure of an eel is very powerful and could easily overcome the "suction" in question. There is considerably more than "just bones" in an eel. As a matter of fact, the structure of an eel is highly organized, its digestive organs being complete. A brain is found, and nerves, spinal cord, heart and blood vessels are all in evidence. It would take too long to describe the structure of an animal of this nature, but a good book on biology would not be a bad suggestion. The writer of the above communication evidently gives greater credit to a garter snake than to an eel. We cer-

RADIO

Apartment House Radio

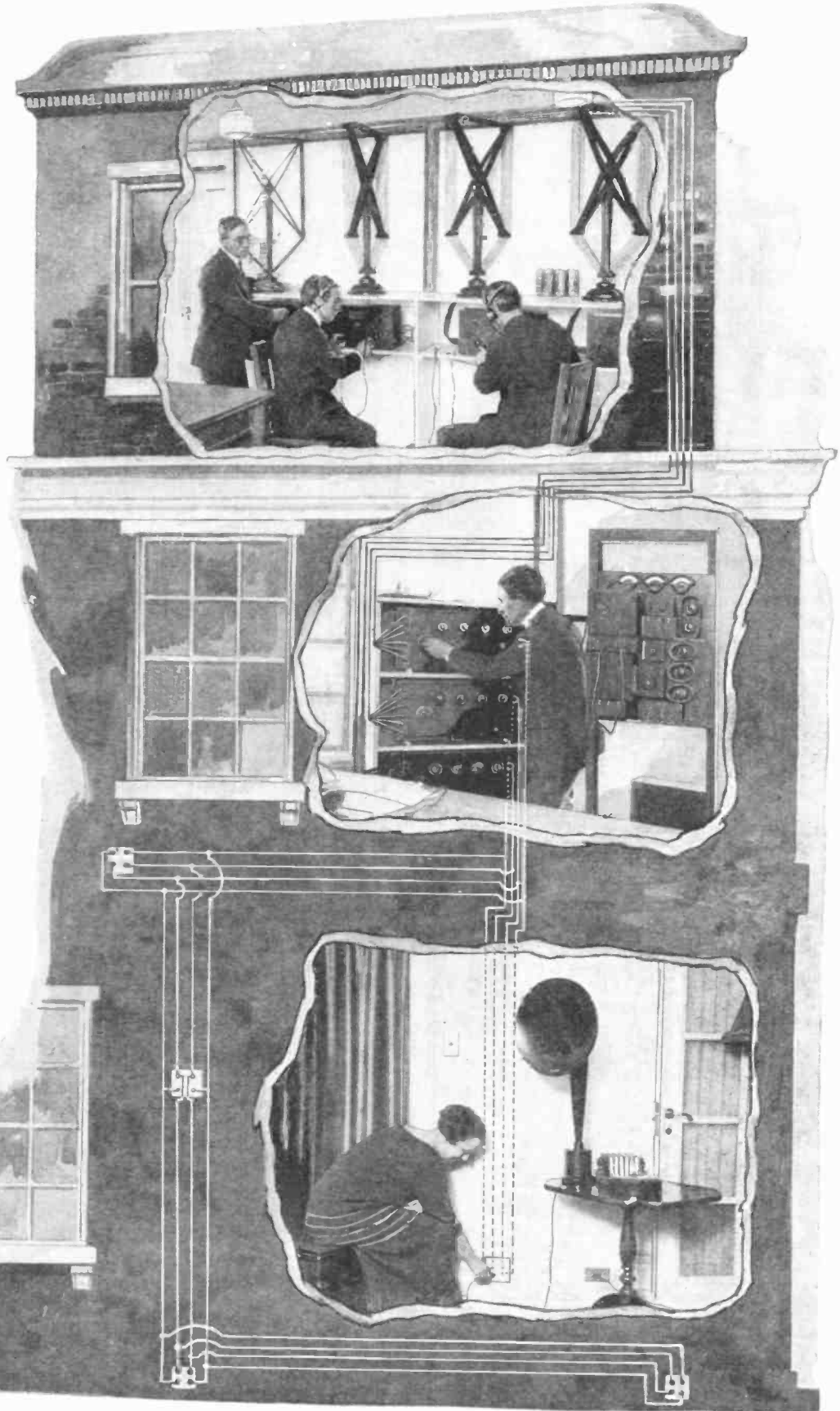
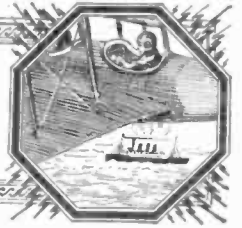

AN enterprising and enthusiastic landlord—yes, there are still a few left—has equipped his Riverside Drive apartment house with a magnificent radio installation. Contained within a specially built radio room on the roof, are four loop receivers. Three of these are for the reception of local stations, while the fourth is used for DX. The receiving sets are connected to an amplifier system which furnishes sufficient energy to operate a loud speaker placed in every apartment suite. When Madam decides that she wants an operatic selection, a lecture on home economics or a snappy jazz orchestration, or perhaps listen to what Mrs. Smith-de-Puyster has to say on birth control, she naturally uses her best judgment and simply “plugs in.” If she wants a particular selection which she noted in the newspaper, she phones the radio operator who willingly obliges to his best ability. How much better than the average situation: that of the sight of numerous and fantastic and grotesque looking antenna systems dangling on the housetops of many of our beautiful buildings. Don't you well remember the day when you first asked your landlord, then begged him, and implored and beseeched, and, in fact, did everything but convince him that the erection of your antenna would not disfigure nor injure nor harm his property? And with a sigh you now wish he were your tenant!

Many other apartment owners are following suit and are likewise installing similar outfits for the benefit and enjoyment of their lessees. As can be readily seen from the photo-diagram, the wiring of the system is relatively simple. A four-plug baseboard faceplate facilitates ready connection, tapping the secrets of the ether and bringing joy and happiness to everyone.

“If I allow the owner to wire my rooms for radio reception, I'm afraid he'll raise my rent,” you may think. However, this service will, and should, be entirely free. In this way, it will stimulate greater interest in the wonderful programs now being daily broadcast entirely free of charge to us, by a young and rapidly growing American institution—our Broadcasting Stations.

Policemen of the Ether

The Government's Valuable Work

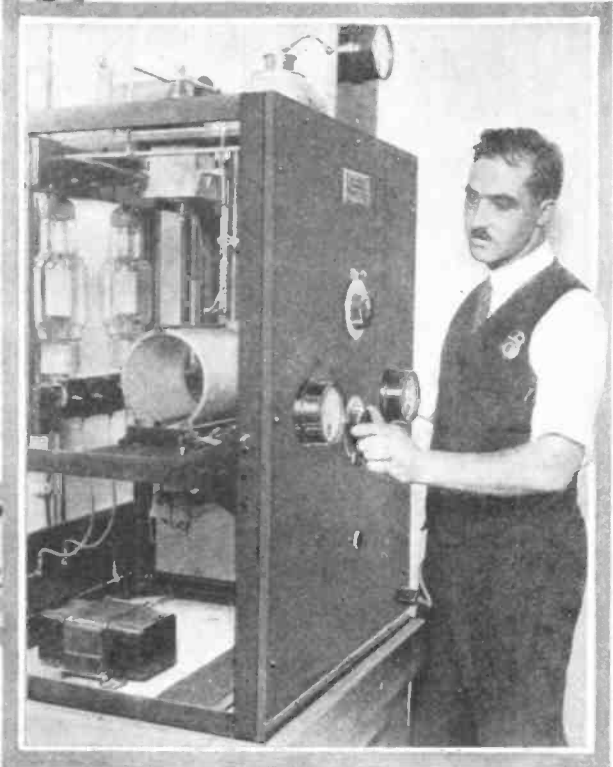
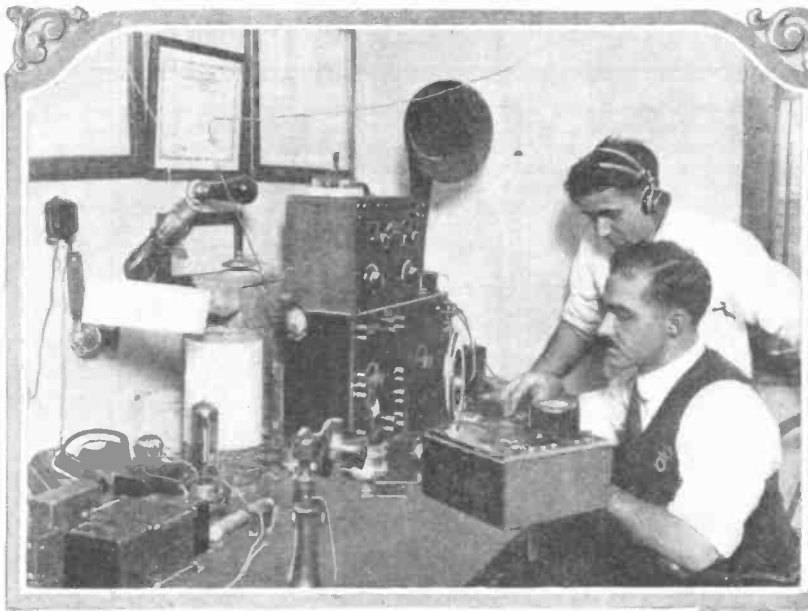

FEW radio fans know that the Federal Government employs radio inspectors to keep a vigilant watch on all broadcast and amateur stations in the country. To attest for it, the above photo shows one of the officers of the law, carefully checking up to see whether there are any errant transmitters on the air. Whenever he does come across one, a note of warning is sent to the offender. A second offense may mean the confiscation of the entire radio apparatus. It is up to the radio inspector to preserve absolute tranquility in the air, a duty which is indeed a difficult task with so many transmitters working. To the right is shown the Bureau of Standards' Radio Traffic Officer who keeps tabs on all those he is able to hear. It may be safely stated that there are very few stations in the country which he is not able to record. Measurements are taken with precision wavemeters.



Not only do the duties of the Radio Inspector require him to listen in, but he must visit the transmitting stations regularly. When on a tour of inspection, it falls to his lot to correct any incursion on the law. Above shows a district radio officer readjusting the transmitter of a broadcasting station whose emitted wave-length differed slightly from that allotted by the government. The discrepancy was not much, but nevertheless it was there. It's the little things that count.

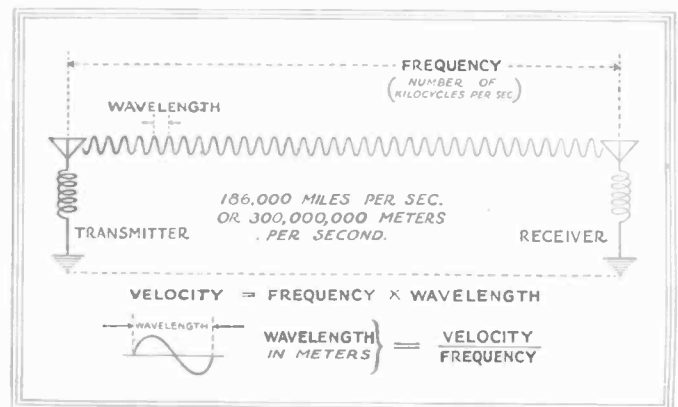
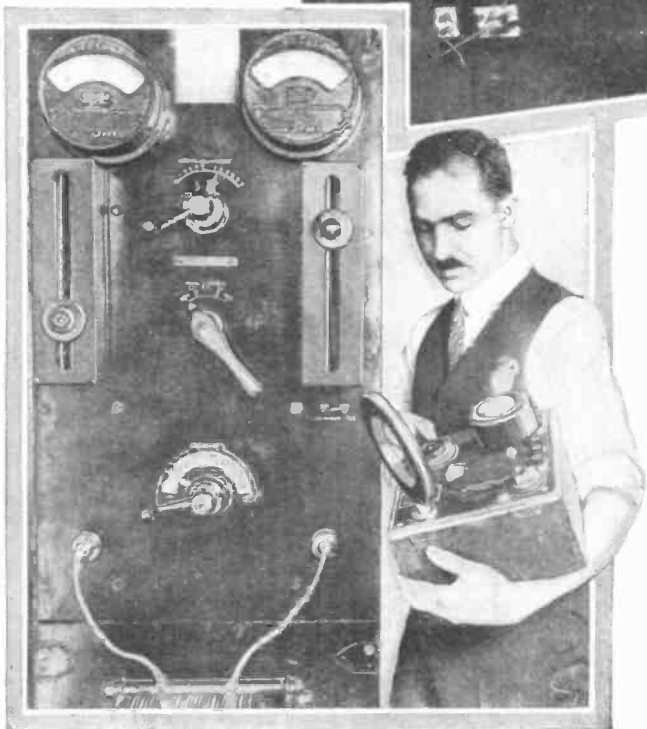

The beginner is somewhat confused as to the real meaning of wave-length, and its relation with the velocity and frequency of radio waves. This point has been fully clarified in the above diagram. Radio waves travel with the speed of light, 186,000 miles per second. By definition, wave-length is the distance between particles in the same phase. Hence, the velocity is equal to the frequency times the wave-length. Broadcasting stations are assigned between 220 and 575 meters. This means a frequency range of from approximately 1,400,000 to 500,000 cycles per second.

Chelmsford, G5XX

Powerful Broadcast Station at Chelmsford, England.

One of the most powerful radio broadcast stations in the world was opened recently at Chelmsford, England, and is now known as G5XX. Operating on the high wave of 1600 meters with a 25-kilowatt input (sufficient to light nearly 4,200 sixty-watt lamps), the station has already been brought to the fore and into prominence through its repeated trans-oceanic transmissions. For the first time in the history of broadcasting, special programs will be sent to America daily and it will be but a matter of a few months before an exchange of programs will take place.

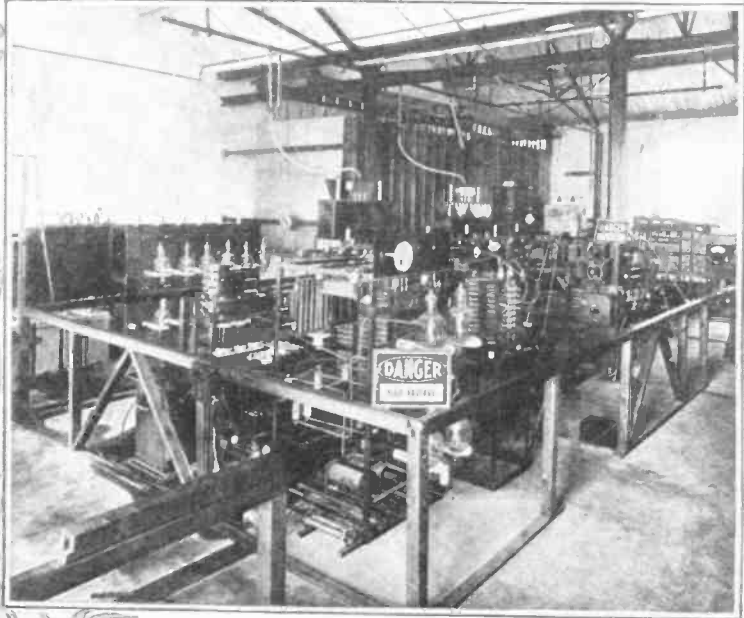
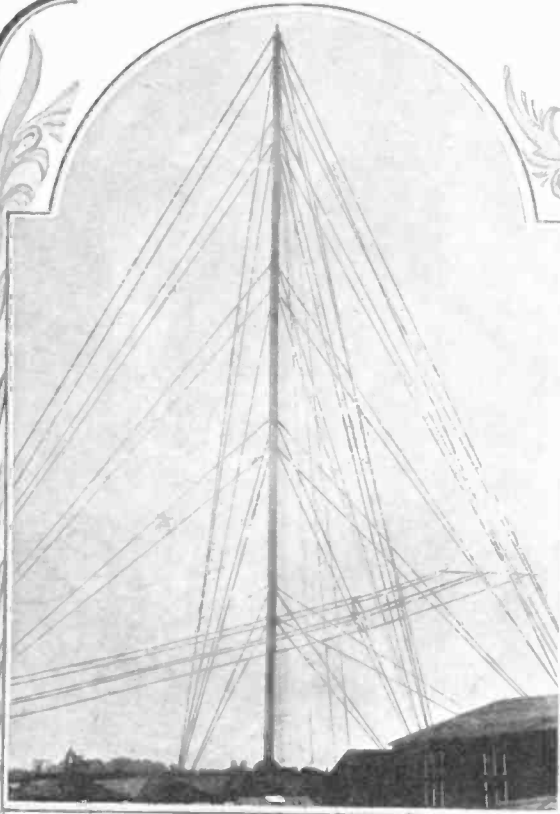

One of the great 400-foot masts with the immense net work of guy wires, antenna system and counterpoise standing towering up into space. It will be noted that the construction differs from those in this country in that the masts are not self-supporting. Thus, the most powerful station in the world, located at Rocky Point, WQK, uses self-supporting masts which extend to the dizzy height of 600 feet. Below can be seen some of the special high tension transmitting apparatus whose design also vastly differs from ours. This assemblage represents a step towards super broadcasting, a condition which does not meet with favor in the eyes of the American public. Note the multiplicity of meters, power tubes, condensers and connecting wires.

In comparison with the most powerful broadcast stations in the United States, which use but a meager 1500-watt input, Chelmsford is more than 15 times as powerful and should be heard with ease by the average five-tube set. Note the special rectifying tubes in the above photo. Due to the extremely high voltage employed, special insulation must be used.

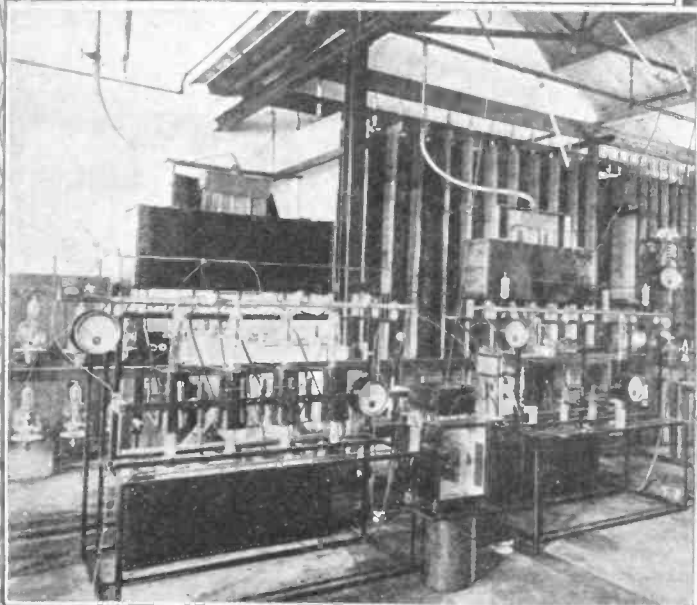

The cage type lead-in connected to a gigantic wall insulator is shown above. Extra precaution was taken in the construction of the antenna system since even a small leak would result in series loss of energy. The insulators were carefully tested and retested so that the chance for break-down was minimized. In order to keep the antenna resistance low, very heavy conducting wires were used. At night it is possible to see with distinct visibility many points of corona discharge.

What Causes Radio Interference

Parasites Which Take The Joy Out of Radio

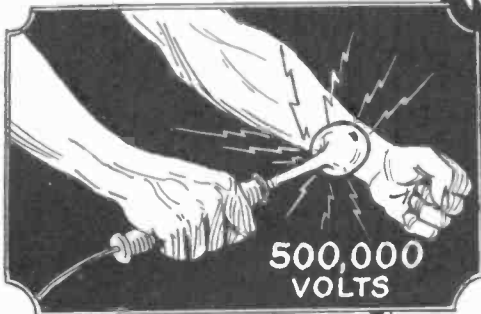

500,000 VOLTS

VIOLET RAYS

Your neighbor's violet ray outfit may be the unsuspected cause of the unearthly noises you are hearing.

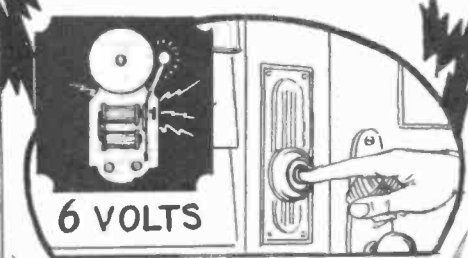

6 VOLTS

DOOR BELLS

Every time a door-bell in your block is rung you may think that you're receiving Martian signals.

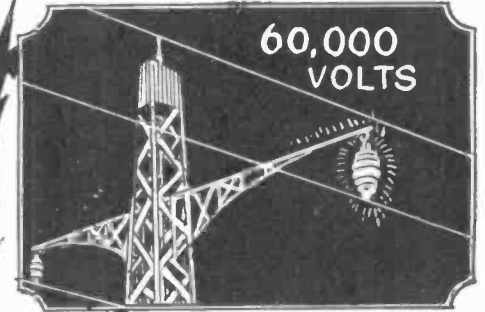

60,000 VOLTS

POWER LINES

High tension insulators are apt to leak badly in rainy weather. This is one of the worst nuisances.

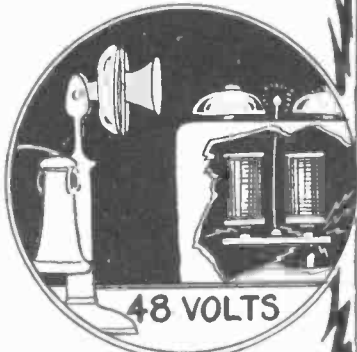

48 VOLTS

TELEPHONE RINGERS

Reasonable assurance that you are wanted on the telephone—but most of the time it's your neighbor's.

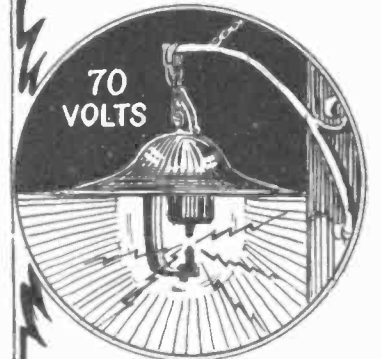

70 VOLTS

ARC LAMPS

Do you ever suspect the arc lamp on the corner for causing that terrible sound which wont tune out.

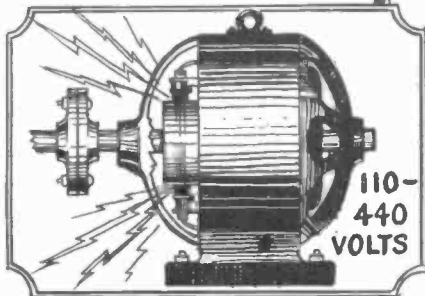

110-440 VOLTS

MOTORS

If you are in the vicinity of a factory in which many motors are in constant operation, it's high time to move.

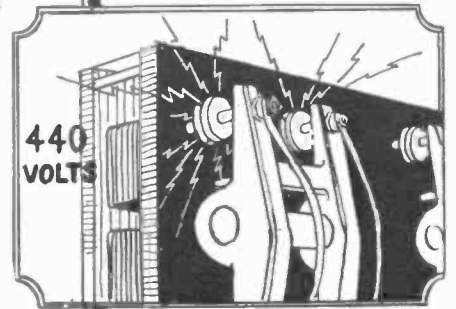

440 VOLTS

ELEVATORS

If you live in an elevator apartment—not getting too personal now—you might put your radio in a balloon and send it aloft.

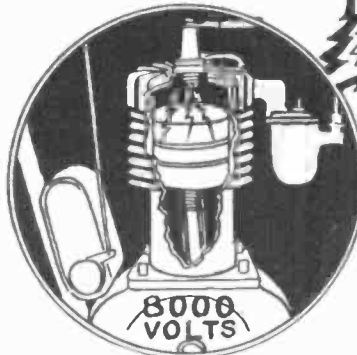

8000 VOLTS

ENGINES

Gas engines, farm lighting plants, and even nearby automobiles are responsible in a great measure for causing you unwarranted exasperation. The sources of such disturbances can easily be traced by the regularity of their occurrence.

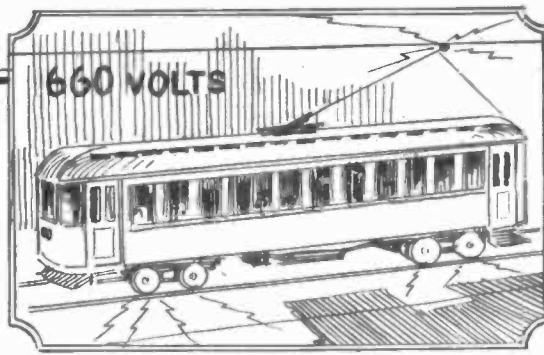

660 VOLTS

TROLLEY CARS

Did you ever notice an increasing amount of "static" when the street car passed down the block? This source of trouble is difficult to remedy, although by the judicious placing of the antenna or by using a loop, it is possible to overcome it successfully.

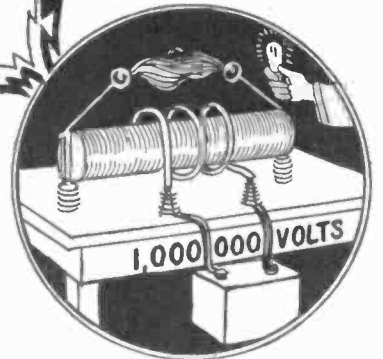

1,000,000 VOLTS

H. F. APPARATUS

When little Willie next door starts his new high frequency apparatus going, shut off the set and go out for a walk. This is a situation which you cannot cope with, unless the house current for your section is shut off.

New Paper Cone Speaker

An Exceptionally Fine Reproducer

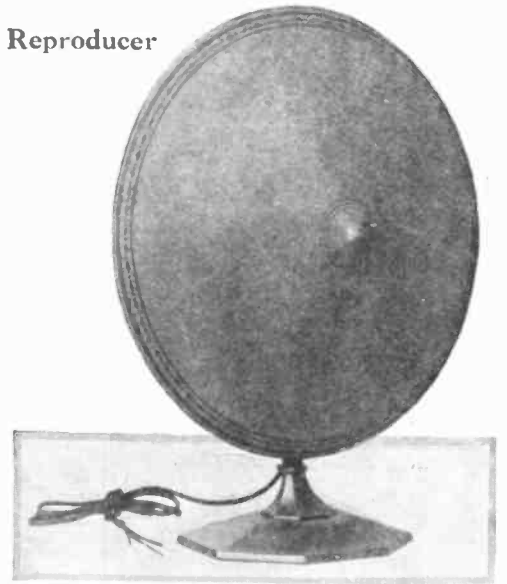
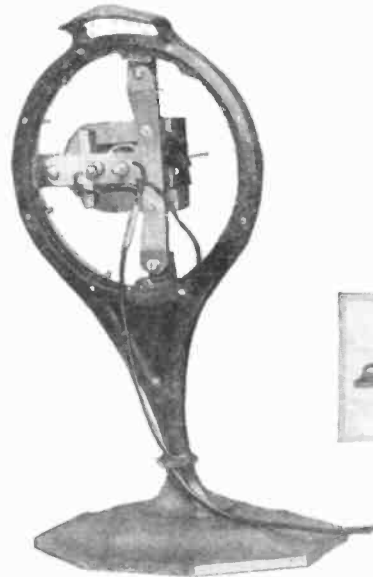

Witness now the last word in loud speaker design. Decidedly different in every respect from the ordinary horn type of speakers, this one employs a large paper cone specially treated. Note its original features and its radical departure from the average loud speaker. It was found to be able to reproduce the lower musical notes very beautifully.

The speaker is of the adjustable type having a small thumb screw which is used to tighten the cone. This is necessary to compensate for the expansion or contraction caused by atmospheric conditions. Note pleasing appearance.

Due to its excellent mechanical construction and electrical efficiency, it was found to give musical programs an air of realism. Orchestra music is exceptionally good.

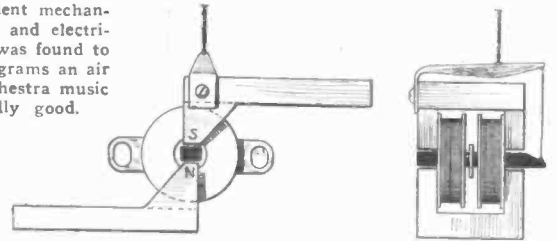
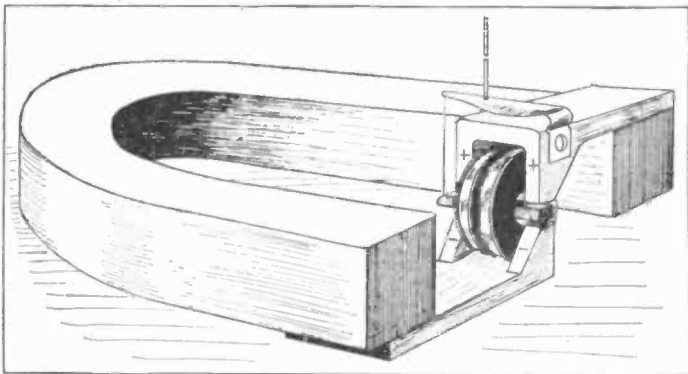

The above diagrams show how the speaker operates. Suspended between the pole pieces of a powerful permanent magnet is a pivoted armature. Two magnet coils are so arranged as to give maximum movement of the armature to which is attached a small rod which in turn connects to a long pin. This pin actuates the paper cone.—Photos courtesy of the Western Electric Co.

High Power Transmitting Tubes

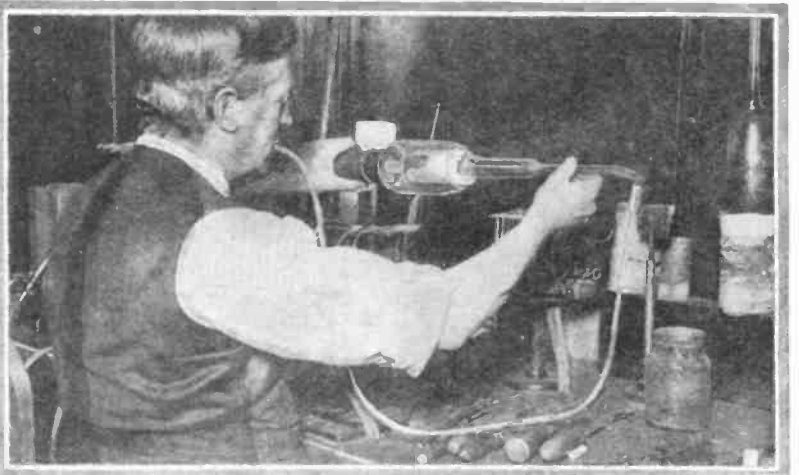

Here we show stages in the construction of the powerful transmitting tubes used for trans-oceanic communication. The tubes are designed for operation on 10,000 volts and D. C. and in order to withstand the strong current, are equipped with a water cooling jacket. Much of the work has to be done by hand, the photo above showing a step in the sealing of the terminal connections. At left: operator watching the action of the elements under a test of 15,000 volts. At this dangerous voltage, the slightest mechanical jar means disaster to the tube.

Are You Buying Good Tubes?

Dependable Tube Testers

By LEON L. ADELMAN, A.M., I.R.E.

Audio Frequency Oscillator

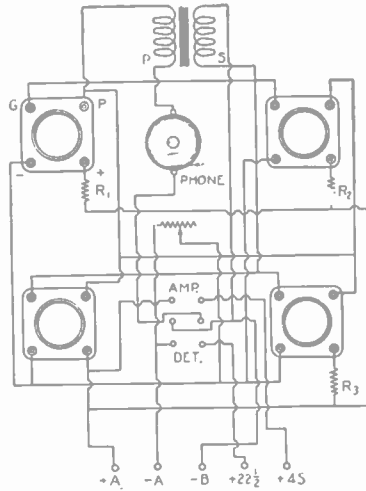
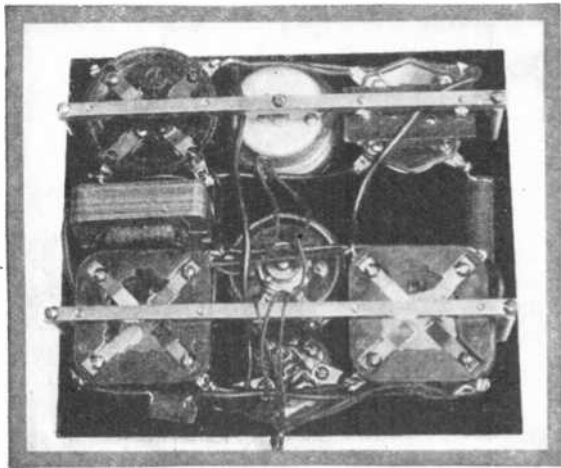

When you enter a radio store, to buy new tubes for your receiver, do you ask the salesman to test them for you? Are you satisfied when he merely shows you that the filament lights and concludes that the tube must be a good one? You may be misled and are making a mistake. You are entirely within your rights to demand a more thorough test, the instruments shown here, being for that purpose.

The tube tester shown above allows tubes to be tested for their audio frequency oscillations, it being understood that if a tube will oscillate audibly, it will also do so at radio frequencies. Four different sockets are provided for their respective tubes, and are connected through specific resistances, thus allowing filament operation from one "A" battery source.



Direct Current Characteristics

The "static" or direct current characteristics of a vacuum tube, if properly checked, are a direct means of ascertaining whether a tube will act at highest efficiency either as a detector, an oscillator, or an amplifier. The instrument shown herewith is readily adaptable for measuring the mutual conductance, the amplification constant and output impedance. Contrary to general opinion, the amplification constant is not the main consideration in a tube, but the mutual conductance should be noted carefully when purchasing them.

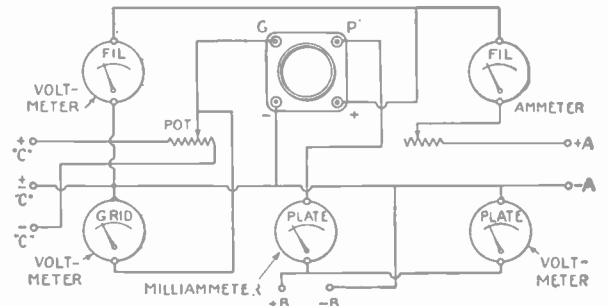

For a given rated "A", "B" and "C" battery voltage, the larger the reading shown by the plate milliammeter, the better the tube. Remember, good tubes mean good results.

The most important tests in the radio field at the present time are those on vacuum tubes. There is now available a great variety of tubes which have widely varying characteristics. Be careful when buying them and do not take the criterion of low price and exaggerated performance. These standard meters are designed to protect you.

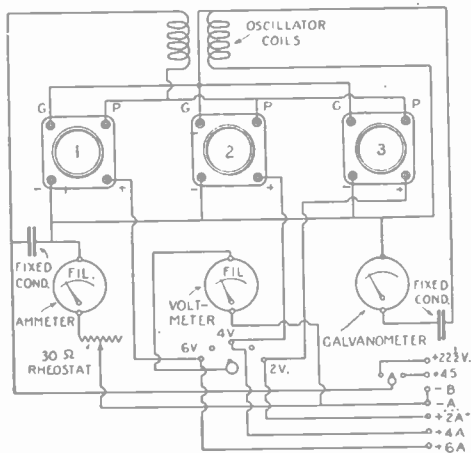

The circuit shown above allows any of the standard tubes to be checked. Ask to see the readings on the meters before purchasing.



Radio Frequency Oscillator

Perhaps the surest means of accomplishing the thorough testing of tubes is that of measuring their radio frequency output, at normal input rating. For this purpose, a current-square galvanometer is used in conjunction with a filament voltmeter and ammeter.

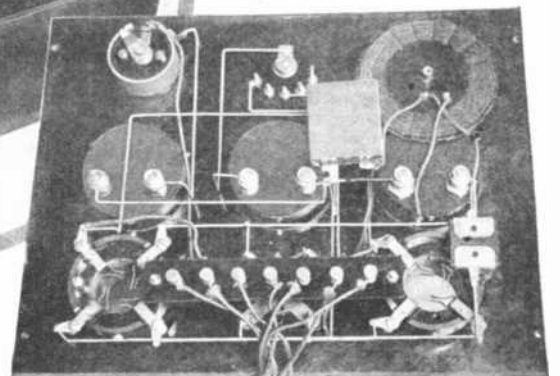

Because of the fact that the three element tube patents expire next year, there is bound to be a large influx of inferior vacuum tubes.—Names of manufacturers of testers will be given on request. Every dealer should have one of these indispensable outfits for the protection of his customers.

Where these meters are not used by a radio store, persist in having the tubes tested in a receiving set, under normal operating conditions.

A Page for the Novice

PART II.

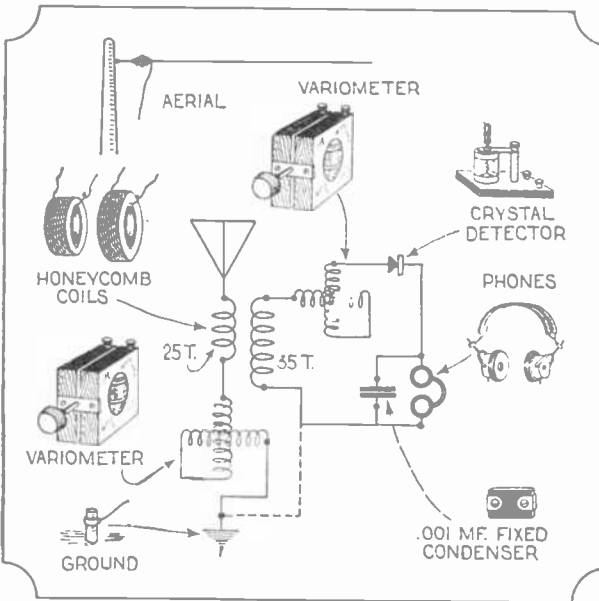
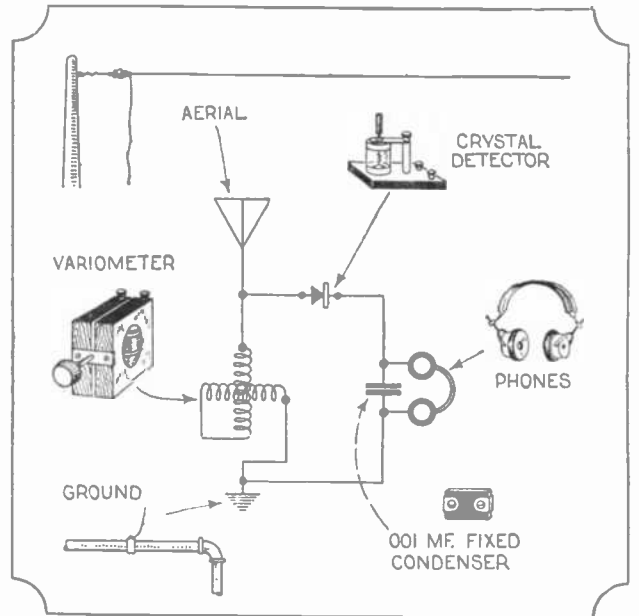
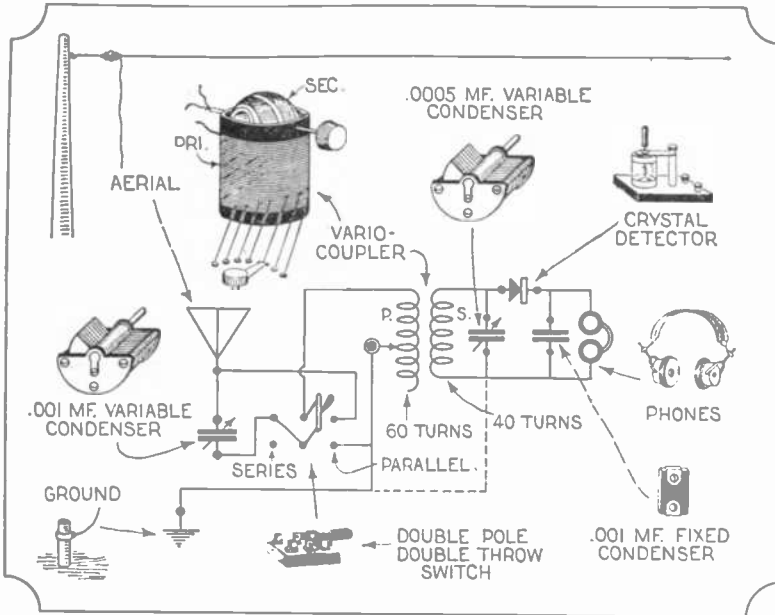

The diagram in the upper left shows the use of a series-parallel switch in a crystal set hook-up. Its function is to place the antenna condenser in series or in shunt with the primary inductance. When in series, shorter wave-lengths can be obtained; when in parallel, longer wave-lengths are received. The variometer-tuned sets to the left are simple sets to construct, which give results. The principle of the variometer is readily understood. When the rotor and stator windings are in the same direction, the inductance is a maximum; when opposing, it is minimum.

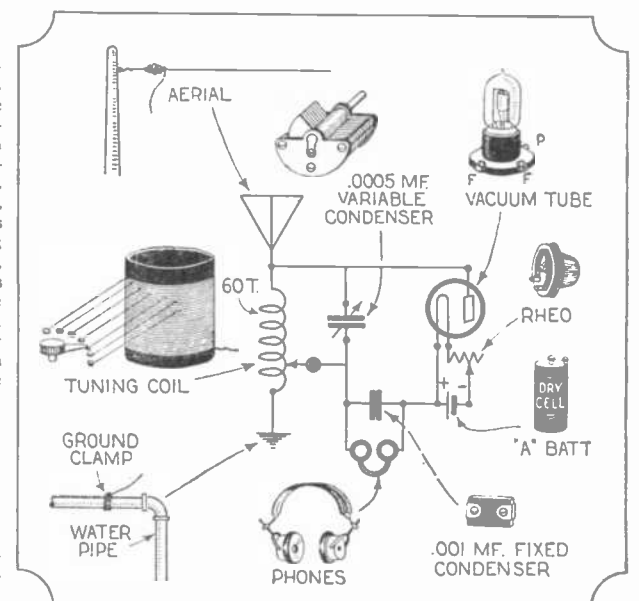

The diode or two element tube, since its inception by Fleming, has been used with success in many simple circuits. Its action depends upon the well-known "Edison effect." Edison found that electrons were emitted from a heated filament and were attracted to a cold metal plate positively charged. This at once led to the discovery of the rectifying action of the diode tube. Two circuits are given herewith showing how the tube is used with and without a "B" battery and in both conductively and inductively coupled circuits. A single dry cell is all that is required to operate the filament. Louder signals can be had than with a crystal detector. The tube has what is known as an amplification factor which increases the signal strength.

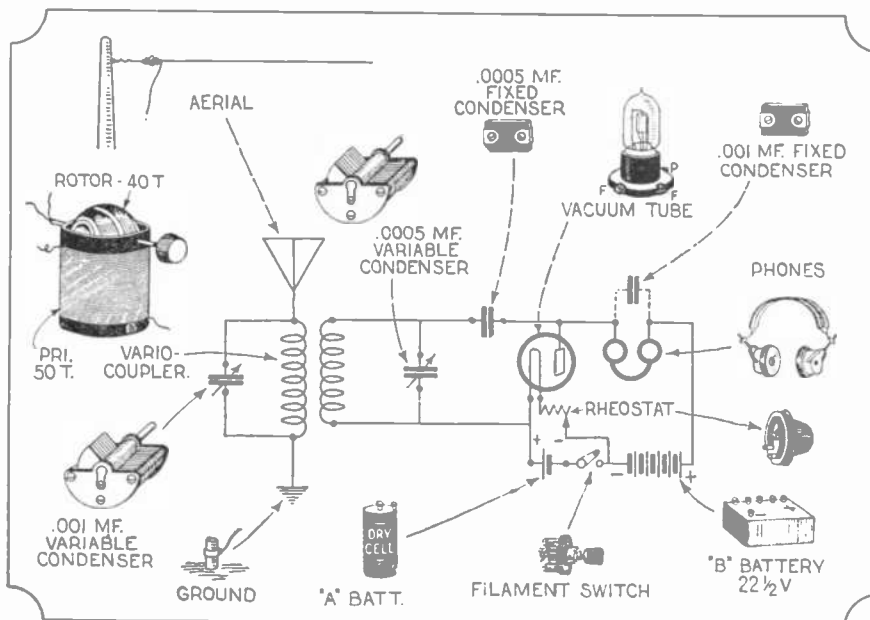

It is well to keep in mind when purchasing variable condensers that a .001 has 43 plates; a .0005, 23 plates; a .0003, 15 plates; a .00025, 11 plates. Fixed condensers are rated, not according to the number of plates they contain, but to their capacity in microfarads. When buying them, specify whether you want a grid condenser, .00025 to .006; a phone by-pass, .001 to .006; "B" battery by-pass, .002 to 2 mf., or antenna series, from .00025 to .006. It is best to use heavy wire, well insulated, when wiring a set. A very minimum of soldering paste or resin should be used when making connections. All leads should preferably be short, but the instruments should not be crowded together. Remember not to connect the "B" battery before testing the "A" battery circuit.

A Two Tube Reflex

A Circuit Which Gives Excellent Results

By ALFRED R. MARCY, A.M., I.R.E.

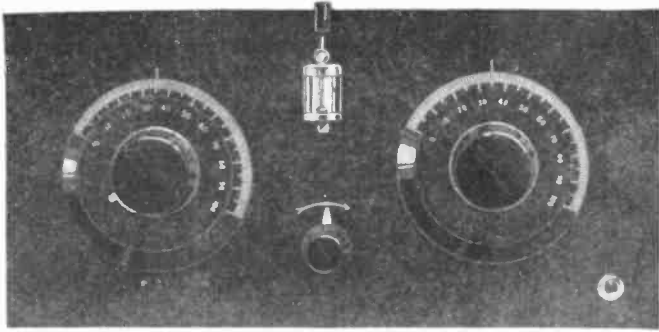

THE reflex circuit is well known for its simplicity of control, clarity of reproduction and volume. Using but two 201A tubes, such stations as KDKA, WDAP, WGY, WBZ, WSAI, WTAM and many of the other large broadcasting stations within a radius of 1000 miles are heard regularly with loud speaker volume. Distant stations such as WDAF, WOAW, KFKX and WFAA come in very nicely on the headphones. To secure such good results necessitated the selection of reliable parts and great care was used in the construction. Mounted on a panel 7 x 14 are two neutroformers, a glass enclosed sensitive crystal detector and a six-ohm rheostat. A single circuit jack is also incorporated as well as four binding posts. Behind the panel are placed two audio frequency transformers and two standard sockets.

Looking down upon the set showing how the neutroformers are mounted at the proper angle of 54.7°. The neutroformers are composed of a variable condenser of 13 plates and two inductances, one the primary of 15 turns, and the other the secondary of 65 turns of No. 26 D. S. C. wire.

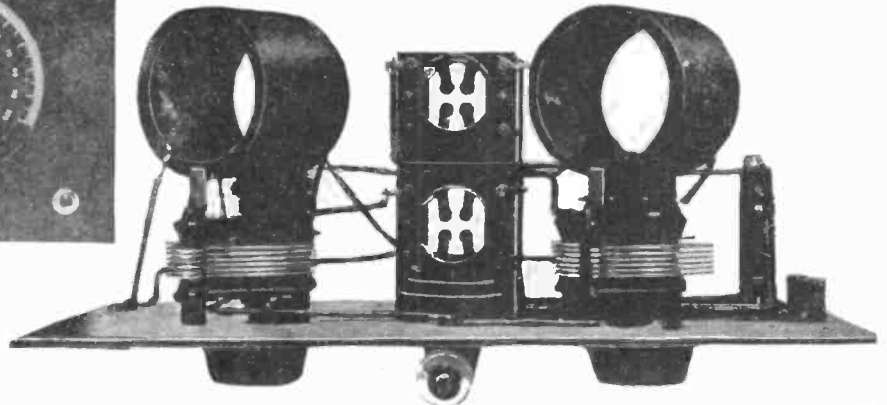

Besides the rest of the apparatus mentioned, a .0005, a .00025 and two .006 mfd. fixed condensers are requisite. These values should not be deviated from since the successful operation of the set is controlled in a great measure by them. It must be remembered, however, that the entire operation of the set depends upon the sensitiveness of the crystal detector.

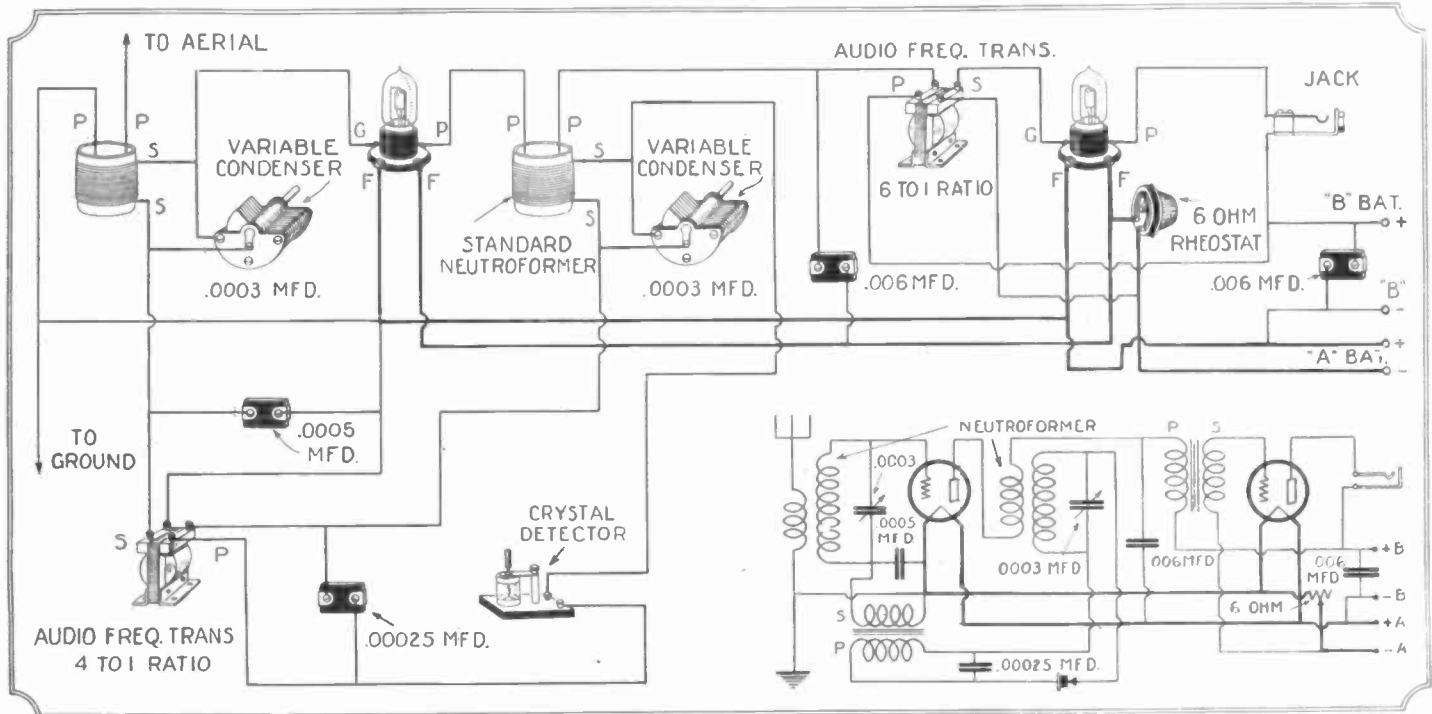

Short Wave Condensers

By 2DK

With the incentive of the short waves appealing to both amateur and broadcast stations, it becomes necessary in order to follow them, to meet the conditions, by changing both capacitive and inductive apparatus. It is by far easier to remove some turns on an inductance, but as that capacity is used to change the wave-length, the absolute necessary minute adjustment, is obtainable. This is due to the fact that with short waves a small change in dial reading very greatly affects the wave-length. Hence it is necessary to alter our condensers.

Three simple and effective ways in which to change the maximum capacity value of a condenser are depicted herewith. One is to cut the stator plates as shown at the left. A better way perhaps is that of cutting the rotor plates so that a given change in dial reading corresponds to a very small change in capacity. Those already having a short wave condenser and desiring a vernier action will do well to follow the suggestion shown in the photograph. Here, each successive plate is cut shorter than the one adjacent to it. Burrs should be filed off.

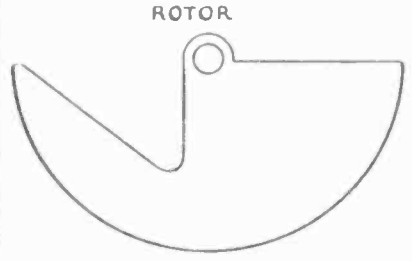
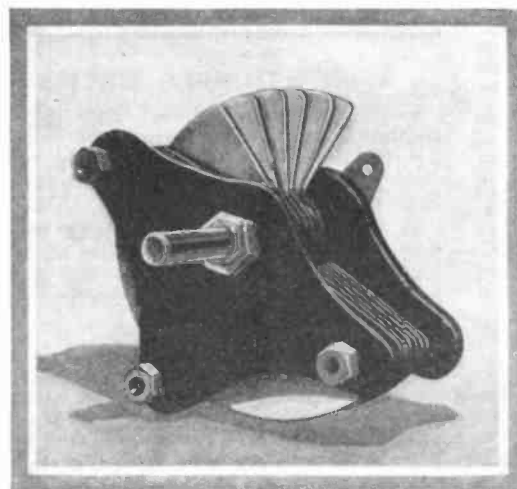
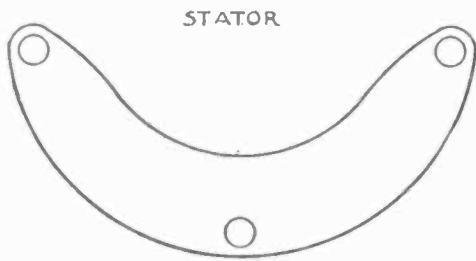

Radio Oracle

In this Department we publish questions and answers which we feel are of interest to the novice and amateur. Letters addressed to this Department cannot be answered free. A charge of 25c. is made for all questions where a personal answer is desired.

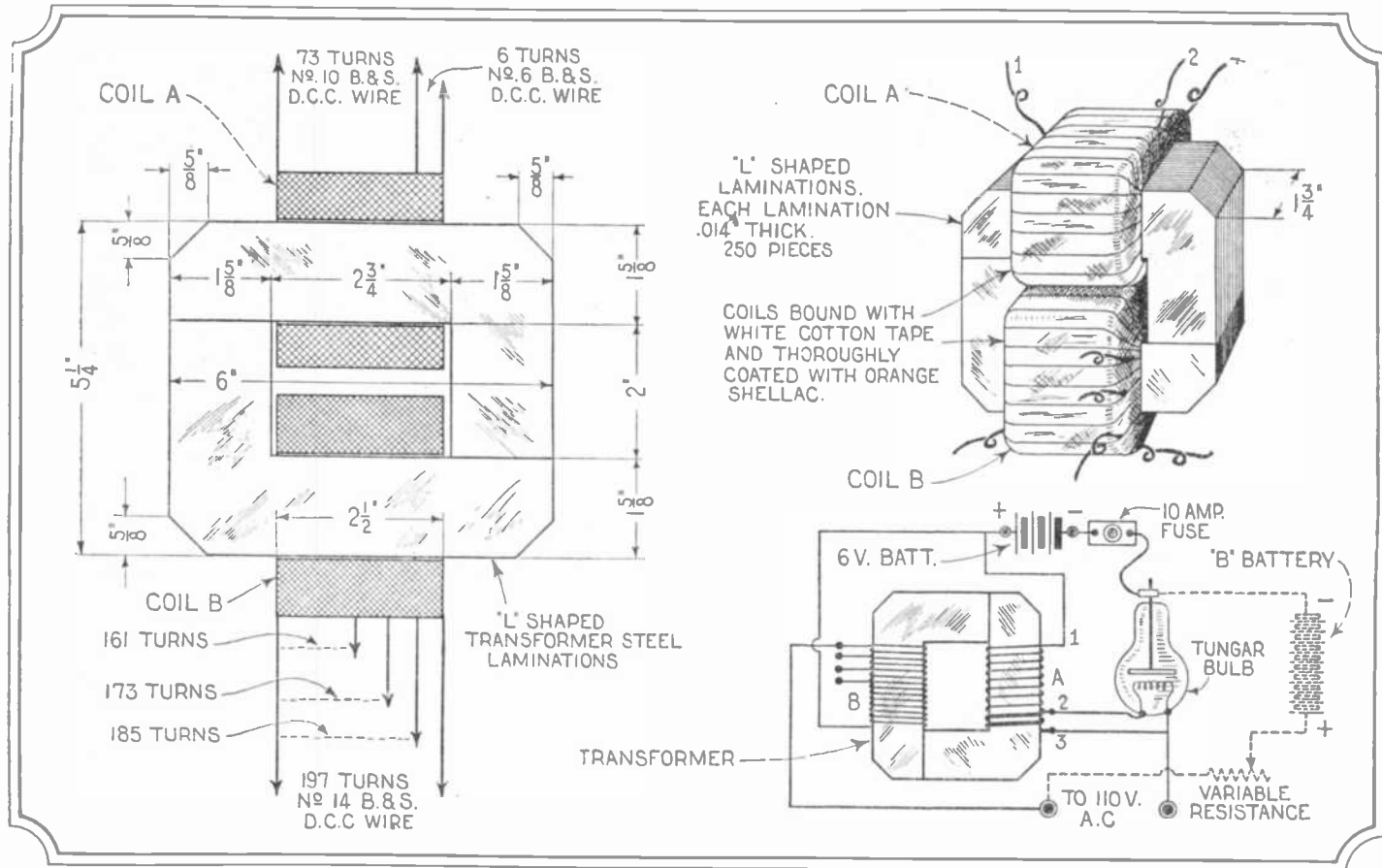

A transformer for the purpose of charging both the "A" and "B" batteries is detailed clearly above. It is well worth the trouble to construct. It is

designed for operation on 110 volt, 60 cycle alternating current, and if carefully built will last indefinitely.

BATTERY CHARGER

(334) B. Steinmetz, West New York, N. J., asks for:

Q. 1. Constructional details of a transformer to be used in conjunction with a 5-ampere-hour capacity Tungar rectifier tube.

A. 1. The time has come when the re-charging of storage batteries, both "A" and "B" types, necessitates a much more convenient way than the carrying them several blocks to the nearest battery station, with, perhaps, the dire results accruing from spilling the acid over one's clothes. The best means of overcoming this difficulty is to charge them at home. A transformer for that purpose has been designed along the lines given in the above diagram and will meet all requirements. It is of the auto-transformer type, having three different windings on it. The core is made of laminated silicon steel, "L" shaped, in two sections, which are butted together and securely fixed after the coils have been put in place.

One hundred and twenty-five laminations are placed in a pile 1 3/4 inches high and constitute one leg of the core. Two or three layers of tape are wound tightly over it, after the laminations have been squeezed together as tightly as possible. On this are wound 197 turns of No. 14 B. & S. D.C.C. wire, taps being taken off at the 161st, 173rd and 185th turns. The winding must be con-

finied within a space 2 1/2 inches wide. This is shown as coil "B" in the diagram.

After having prepared the second leg of the transformer as outlined above, six turns of No. 6 B. & S. D.C.C. wire are wound on and serve as the filament winding. Directly over this are wound 73 turns of No. 10 B. & S. D.C.C. wire, which furnishes the current for charging the "A" battery. It will be noted that the two coils are connected in series with the winding on leg "B".

Having finished the windings, they are carefully taped and shellacked. The legs are then butted together and securely held together with wooden cleats. The variable resistance shown is a bank of five 40-watt lamps which is used to regulate the charging current. A 10-ampere fuse is connected in series with the battery and prevents over-charging. The transformer should be mounted on a slate or asbestos base.

STANDARD FREQUENCIES

(335) Milton Sills, Staten Island, N. Y., requires information concerning the time of the transmission of standard frequencies from WWV, the station of the Bureau of Standards, located at Washington, D. C.

A. 1. The Bureau of Standards transmits, twice a month, radio signals of definitely announced frequencies, for use by the public in standardizing wavemeters and

transmitting and receiving apparatus. The signals are transmitted from the Bureau's station, WWV, at Washington, D. C., and from Station 6XBM, Stanford University, California.

The transmissions are by unmodulated continuous-wave telegraphy. A complete frequency transmission includes a "general call," a "standard frequency signal" and "announcements." The "general call" is given at the beginning of the eight-minute period and continues for about two minutes. This includes a statement of the frequency. The "standard frequency signal" is a series of very long dashes with the call letters (WWV or 6XBM) intervening. This signal continues for about four minutes. The "announcements" are on the same frequency as the "standard frequency signal" just transmitted and contain a statement of the measured frequency. An announcement of the next frequency to be transmitted is then given. There is then a four-minute interval while the transmitting set is adjusted for the next frequency.

The signals can be heard and utilized by stations equipped for continuous wave reception at distances within 500 to 1,000 miles from the transmitting stations. Information on how to receive and utilize the signals is given in Bureau of Standards Letter Circular No. 92, which may be obtained on application from the Bureau of Standards.

WANTED!!! RADIO ARTICLES

WE want descriptions of new radio ideas which you have worked out in practice. Take photographs of the important parts and make pencil or pen and ink sketches of the hook-ups or mechanical details, et cetera. We are particularly

desirous of obtaining new hook-ups and descriptions of single tube sets, reflex and other types which have proven satisfactory. We like articles on new single tube receptors. We will pay good prices for your ideas. —Editor.

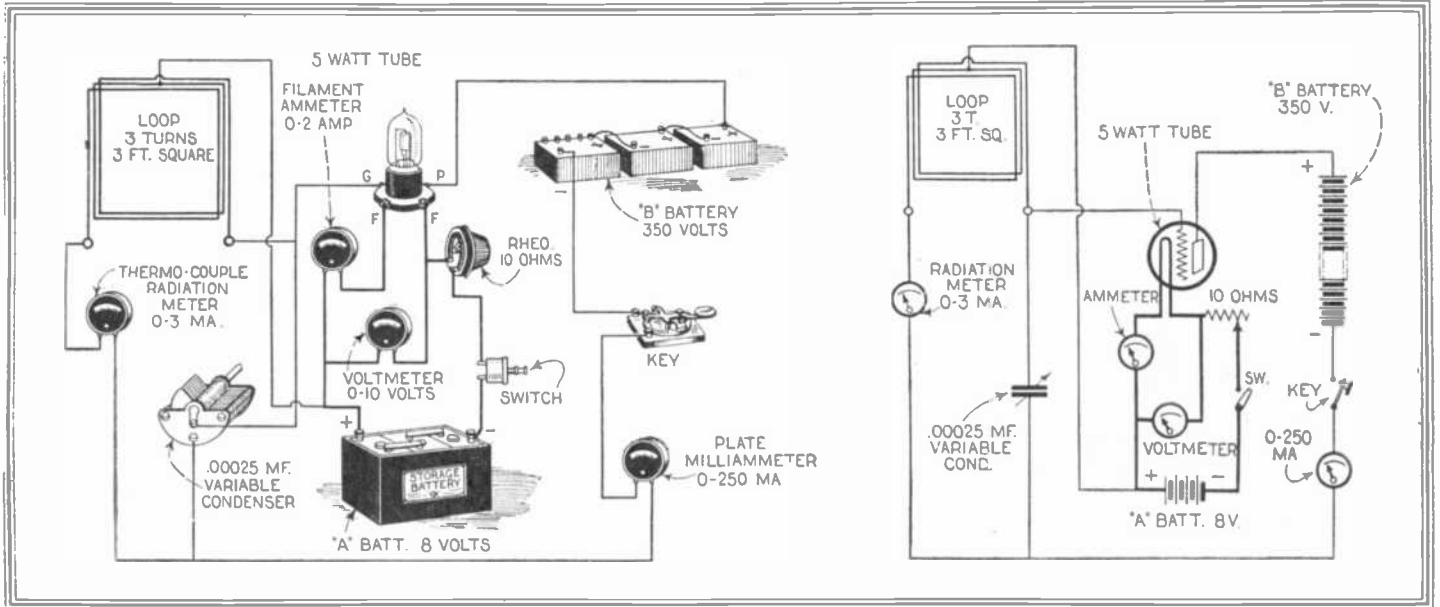

A simple loop "C.W." transmitter. When properly built this set will give excellent service. Its low first cost and up-keep should make it very popular with the beginner. It can readily be equipped for phone transmission.

LOOP TRANSMITTER

(336) Robert T. Morris, New York City, asks:

Q. 1. Will you please publish a diagram using a 5-watt transmitting tube in conjunction with a loop antenna and the other necessary materials to be used in a set capable of covering a range of approximately 25 miles?

A. 1. As a foreword, your attention is called to the fact that unless one has an operator's license from the Government, he cannot lawfully operate a radio transmitting set.

The circuit shown in the diagram has been found to be a very efficient one and under ordinary conditions has easily covered the 25-mile range. This set should be tuned, for best results, to 100 meters or thereabouts. By turning the loop, directional effects can be obtained very nicely. The indicating meters can be dispensed with if so desired, but for maximum efficiency, should be included. The loop is wound with three turns of No. 12 enameled copper wire spaced two inches apart and has a tap at its exact center. The .00025 variable condenser is of the double spaced type so that it can withstand high voltages. Anywhere from 90 to 350 volts of "B" battery can be employed, the higher the voltage the more power radiated. If desired, a grid leak and grid condenser can be connected in the circuit, in which case it is possible to control the tube's oscillations more readily.

For phone transmissions, a 3-to-1 ratio audio frequency transformer is connected with its secondary in series with the grid and loop. A microphone and a 6-volt battery are connected in series with the primary of the transformer, which completes the modulation system. Of course, the transmitting key is closed when transmission of the voice is desired.

Care should be taken to prevent overloading the tube by allowing too much filament

current to operate it. A slight increase of filament current is far more dangerous to the longevity of a tube than a rather large increase of plate potential.

BODY CAPACITY

(337) Richard Larson, Kansas City, Mo., wants to know:

Q. 1. What is the body capacity and how can I overcome it? It causes me a great deal of annoyance and I would like to know whether there is anything wrong with my circuit.

A. 1. Body capacity, or hand capacity, is the term applied to the property of the human body which makes it act as a member of an electric condenser. Your body is not a good condenser. Compared to the variable condensers in a receiving set it has an extremely small capacity. The trouble is that even an extremely small variation in either the capacity or inductance of a set can throw fine tuning out of adjustment.

Each time the operator's hand takes hold or lets go of a knob in the process of tuning, the capacity of the set varies by a small amount, because some of the body capacity is communicated to the set while the hand is in contact with it. Then you know too well what happens.

A very fine adjustment of the total capacity of a set can be obtained with modern vernier knobs rotating the parts of the condensers, which supply practically all of the capacity of the circuit. In the same way a very fine adjustment of the total inductance is obtained by rotating the parts of the coils which supply nearly all of the inductance in the circuit. Thus these two elements in the set itself can be very closely controlled.

Some radio enthusiasts who can build anything from a pocket crystal set to a Super-Heterodyne do not know just why this adjustment of capacity and inductance

values is so important in its effect on reception. As the voltage supplied to the set by batteries or lighting circuit is constant, minimum resistance means maximum current. With the maximum current flowing through the set, you have reached the point of resonance—the point at which signals are strongest.

Attempts have been made to eliminate body capacity by various methods, but the most effective has been the protection of the panel, or in some cases of individual parts of the set, with a metallic shield. The shield, until recently, had to be applied either by the user or by the dealer, but an "anti-capacity" panel of hard rubber is now being made with a shield vulcanized in place. Shielding, while decreasing the effects of body capacity, does not detract in any way from the quality or volume of the tone.

In order to make shielding thoroughly effective, care must be used in making connections in the circuit. The grid and plate terminals are most sensitive to body capacity effects. Keep the parts of the coil or apparatus to which the grid or plate is connected as far as possible from the panel. The filament circuit must be properly grounded. When variable condensers are mounted on the panel, connect the rotor plates to the ground or filament side. There are variable condensers on the market with end rotor plates, which can therefore be termed self-shielding. With a series condenser in the antenna, the rotor plates should be connected to the antenna; with the condenser in the ground circuit, the rotor plates should be connected to the grounded side. A condenser across the secondary should have the stationary plates connected to the grid.

Body capacity manifests itself more readily when the receiving tubes are overloaded, either by too much filament current or too high plate voltage.

DeForest and Fessenden—Read Their Biographies

In the October issue of *Radio News*, there started a biography of Dr. Lee DeForest, inventor of the Audion. This biography will run for 12 months in *Radio News* and we hope all SCIENCE

AND INVENTION readers will read this important work by the famous inventor. Prof. Reginald A. Fessenden's biography started, in the January number.

LIST OF ARTICLES TO APPEAR IN THE MARCH ISSUE OF 'RADIO NEWS'

Marconi's Radio Beam Transmitter
By Lt.-Col. Chetwood Crawley, M.I.E.E.
The Navy's World-Wide Radio Net
By G. K. Spencer, U.S.N.R.P.
Is Radio Earthbound?
By D. C. Wilkerson

An Ultra Short Wave Receiver
By the Staff of Radio News
The First Annual Radio Set Directory
By Hugo Gernsback

When Buying Vacuum Tubes
By Vernon C. McNabb
Notes on the Super-Heterodyne
By Wilfred Taylor
The Radio Uni-Set
By H. M. Towne, 1ADG



LATEST PATENTS

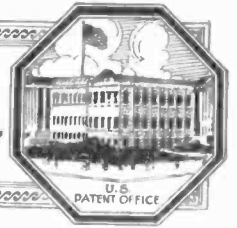

Blotter Holder



No. 1,514,920 issued to Tsuta Miyaski concerns a little device that should interest every business executive, bookkeeper or clerk who has frequent recourse to the use of a blotter. The device consists of a U shaped member, composed of a strip of spring material. Two clips on either end hold a strip of blotting paper in place for use as shown.

Pouring Spout

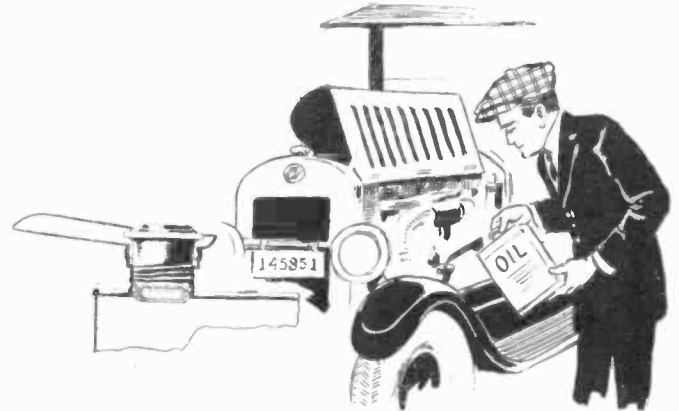

No. 1,515,219 issued to Joseph H. Lambert covers a new type of pouring spout designed to be attached to standard gallon cans of oil. The hole in the spout is so designed that the flanged edges fit within the opening on the can. This is designed to be attached when the can is manufactured. The spout provides an easier method of pouring the oil as shown.

Smoking Pipe



No. 1,517,448 issued to Albert Ulysses Montgomery relates to an improvement in the construction of pipes for use with smoking tobacco. As will be seen from the above drawing, smoke issues from the bottom of the inserted bowl, rises and follows the spirally cut groove to the horizontally extending portions of the pipe where it in turn enters the tube and thence goes to the mouth. A very cool smoke results from the long passage.

WANTED

ARTICLES pertaining to automobiles such as handy kinks, roadside repairs and anything of interest to the man who drives a car. \$50.00 in prizes every month are offered by **MOTOR CAMPER AND TOURIST** for such articles. Get a copy at your newsstand and see what is wanted. If your newsdealer cannot supply you send for free sample copy to:

MOTOR CAMPER & TOURIST
53 Park Place,
New York City.

Vanity Case



No. 1,518,103 issued to Salvatore Piciotto was granted on a novel type of vanity case which is illustrated above. Essentially, the case is shaped in the same manner as an automatic pistol. Hinged in the center, the sections open and disclose various necessities for the female toilet. Placed where the muzzle of the gun would be is a vial of perfume with a plunger inserted. Pulling the trigger ejects the liquid.

Tooth Brush Holder

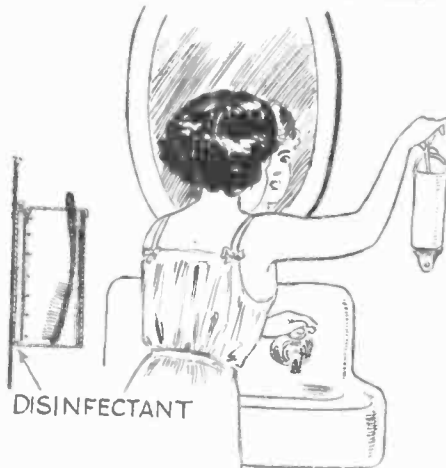

No. 1,517,575 issued to Marie Nordstrom and Elliott R. Brown covers a device that should be used in every home. It is a tooth brush holder that at the same time contains an active disinfectant, the fumes of which circulate through the bristles of the brush, effectively preventing the propagation of germs. The disinfectant holder which is situated at the back of the tooth brush container, is removable therefrom so that the disinfectant may be renewed. The brush holder is also equipped with a cover which excludes dust and other foreign matter.

Safety Headlight

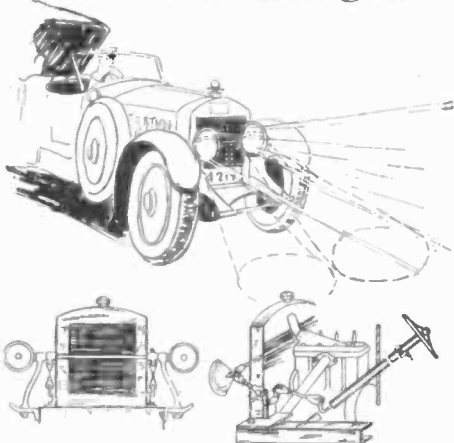

No. 1,510,699 issued to T. Parker relates to a new and simplified type of automobile headlight which is capable of being tilted downward so as to avoid throwing a glare of light in the eyes of approaching drivers. The mechanism and effect is shown above.

Fused Socket

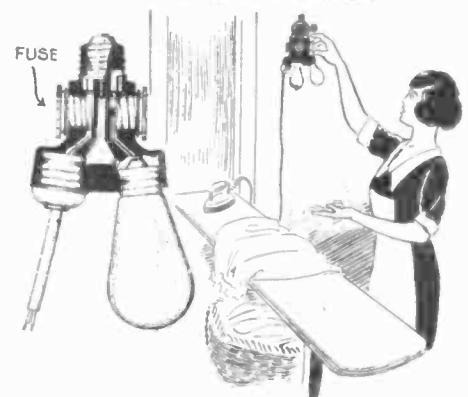

No. 1,516,520 issued to Louis Cross pertains to an improvement in multiple electric-light plugs. In the circuit of each of the sockets of the plugs is placed a fuse socket in which fuses are to be placed, said fuses being capable of protecting the main fuses and the wiring of the house. Low amperage fuses are used at the socket and since they are always in sight are very easy to replace.

Scientific Humor

THEN HE GETS BOILED

Doc: "What precautions do you take against microbes?"
 PAT: "First I boil the water—"
 Doc: "Yes, and then?"
 PAT: "Then I sterilize it—"
 Doc: "That's right, and then?"
 PAT: "I drink nothing but beer."—*Chas. Grill, Reporter No. 15,542.*

WARDEN, THROW THE SWITCH



PROFESSOR: "What is a tissue?"
 HONOR STUDENT: "A tissue is a collection of similar cells."
 PROFESSOR: "Illustrate!"
 HONOR STUDENT: "Sing Sing!" — *Louis Rosenfeld, Reporter No. 4,358.*

—AND FLAPPERS IF THEY SMOKE, COMBUSTION ENGINEERS

If barbers are to be called chirotonsors, then egg dealers should be called embryologists, and street cleaners, sanitary engineers, and fish dealers should be called ichthyologists.—*Louis Rosenfeld, Reporter No. 4,358.*

APPLE SAUCE

PHYSICS TEACHER (in an English Grammar School): "And can anyone tell me what thought passed through Sir Isaac Newton's head when the apple fell on it?"
 VOICE FROM CLASS: "Jolly glad it wasn't a brick."—*Jack H. Grant.*

MARS WAS DOUTBLESSLY OUT WITH VENUS

"Astronomers looking at Mars see green."
 "That's nothing. I do the same thing every time I spy my rival with my girl."—*Les Van Every.*

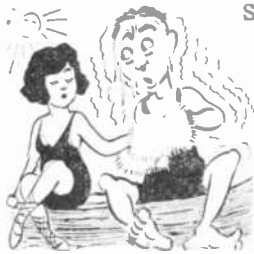

SPECIFIC HEAT

The freezing point may be 32 degrees Fahrenheit, but I met a flapper last summer who froze me up when it was 90 degrees in the shade.—*Sol Kats.*

A WEAK RETORT!

SPEAKMORE: "What is the oldest and most popular weekly in America?"
 SAYLESS: "The bath, of course."—*Peter P. Udre.*

SOMETHING ABOUT THE POLES

PROFESSOR: "Why is it so cold near the north and south poles?"
 STUDENT: "To keep the earth's bearings cool."—*E. R. Lamarche.*

S O S

These are radio days. An indignant lady said to a gang on her block: "And what did the poor little dog do when you brutal boys tied a can to his tail?"
 "Oh, he just went broadcasting down the street," was the reply.—*Merle Holmes.*

HE DIDN'T USE HIS EMERGENCY

KIND LADY: "How did you lose your teeth, sonny?"
 SONNY: "Shifting gears on a lollypop."—*John Gray Moxey, Jr.*

First Prize \$3.00 REVENGE AT LAST!

BARBER (in radio store): "Gimme a filament switch."
 RADIO DEALER: "How about a 'B' battery?"
 BARBER: "No, just a filament switch today."
 RADIO DEALER: "We have some very fine dry cell batteries, some new tubes, and oh, yes, some excellent head phones."
 BARBER: "No! No! Gimme my switch, will ya?"
 RADIO DEALER: "All right, but remember when I come in to get a shave, don't try to talk me into a haircut, shampoo, massage and all the other trimmings."—*Hymen Bushlowitz.*



THE FLIVVER IS NOT AN AUTO.

HANK: "What are you writing?"
 FRANK: "I'm writing a biography of Henry Ford."
 HANK: "Hain't you better make that an auto-biography?"—*I. Daansen.*

WE receive daily from one to two hundred contributions to this department. Of these only one or two are available. We desire to publish only scientific humor and all contributions should be original if possible. Do not copy jokes from old books or other publications as they have little or no chance here. By scientific humor we mean only such jokes as contain something of a scientific nature. Note our prize winners. Write each joke on a separate sheet and sign your name and address to it. Write only on one side of sheet. We cannot return unaccepted jokes. Please do not enclose return postage.

All jokes published here are paid for at the rate of one dollar each, beside the first prize of three dollars for the best jokes submitted each month. In the event that two people send in the same joke so as to tie for the prize, then the sum of three dollars in cash will be paid to each one.

BUT THE STUDENT'S HEAD WOOD

PROF.: "Suppose you had a tomato can full of dynamite and you should drop it. Would it explode?"
 STUDENT: "No, but the dynamite."
 PROF.: "Sir, dynamite can't be exploded by dropping. can it?"
 STUDENT: "No, but a tomato can."—*C. E. Weinland.*

IT WAS A LECTURE ON SOUND

HINEY: "How ya feeling?"
 VIC: "Rotten."
 HINEY: "Whasamatter?"
 VIC: "Got insomnia."
 HINEY: "How come?"
 VIC: "Woke up twice in Physics this morning."—*Israel Brightman.*



PUTS A FULL STOP TO THE MAN'S CAREER

This month's cyanide sandwich goes to the prison warden who maintains that the electric chair is a piece of period furniture—because it ends a sentence.—*C. E. Weinland.*

PAGE THE BEES

CUSTOMER: "Does this set use honeycomb coils?"
 DEALER: "Yes."
 CUSTOMER: "I suppose that's where it gets its sweet tone."—*Clifton Ask.*

PROFIT IF HE GETS IT

PROFESSOR OF ECONOMICS: "Jones, will you kindly tell us the relation between capital and labor?"
 JONES (serenely): "Whenever I lend any of my friends money it represents 'capital,' but when I try to get it back it is a case of 'labor.'"—*E. Keller.*



HE NEEDED A FLOW OF BLOOD TO HIS BRAIN

TEACHER (to her physiology class): "What vein controls and balances the flow of blood in the body?"
 JOHNNY (after much thought): "The Jugular vein, ma'am!"—*G. Fashua, Reporter No. 16026.*

THE ENGLISH PROFESSOR TAKES UP SLANG

- 1—Cease masticating the fabric.
- 2—Torrid canines!
- 3—It is the feline's facial hirsute adornments.
- 4—Atta young male of the species "homo sapiens."
- 5—I will announce to the third planetary satellite of the sun.
- 6—It is the small, succulent fruit.

WHAT DID HIS WIFE SAY THEN?

PHYSICS PROF.: "Can anyone in the class tell me what Benjamin Franklin got when he went out in a thunderstorm and flew his kite?"
 SMART STUDENT: "Yes. Rheumatism."—*A. Robustos Compton.*



GENIUS, LIKE MURDER, WILL OUT

RUE: "What have you invented this time?"
 DUB: "A cigar humidior to fit the inside of a policeman's cap."—*Paul S. Powers.*

IS THIS HIGHER EDUCATION?

PHYSICS STUDENT (to prostrate professor who has stumbled over a stone): "Did you fall?"
 PROFESSOR: "How utterly imbecilic! Of course not! My body possessing motion produced an impact with a stationary solid substance, which by the law of inertia resisted the force applied to it and destroyed my equilibrium. So not being able to defy or break the law of gravitation, I succumbed to the inevitable and assumed this horizontal position."—*Vladimir Babikoff.*



THE ORACLE



The "Oracle" is for the sole benefit of all scientific students. Questions will be answered here for the benefit of all but only matter of sufficient interest will be published. Rules under which questions will be answered:

1. Only three questions can be submitted to be answered.
2. Only one side of sheet to be written on; matter must be typewritten or else written in ink, no penciled matter considered.

3. Sketches, diagrams, etc., must be on separate sheets. Questions addressed to this department cannot be answered by mail free of charge.

4. If a quick answer is desired by mail, a nominal charge of 25 cents is made for each question. If the questions entail considerable research work or intricate calculations a special rate will be charged. Correspondents will be informed as to the fee before such questions are answered.

WINDOW DISPLAY

(1808) J. K. Mitchell, Beaver Falls, Penna., wants to know:

Q. 1. Kindly give me details for an attractive window display?

A. 1. While the question you ask is indeed a very broad one, we are giving you herewith one of the thousand and one methods of attracting attention. It is based on the principle of total reflection and if three or four of these devices are arranged in a semi-circle, each employing a different color screen, the result has a very pleasing and startling effect. A wooden or metallic container has one or more electric bulbs

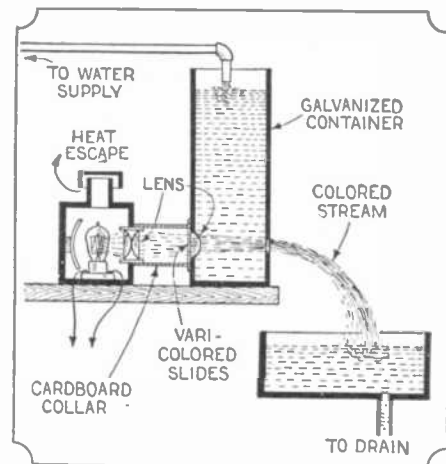

A window attraction which is beyond par is clearly depicted above. By interposing colored screens in the path of the light rays, a beautiful effect is obtained. The phenomena is due to total reflection.

placed within it and is fitted with two condensing lenses. A rather large galvanized iron tank is filled with water running continuously, it being connected to the water supply. At one end near the bottom there is a hole about one inch in diameter. By inserting a colored screen as is shown in the accompanying diagram, and turning on the water supply, the light from the lamp is carried completely down with the water, thus giving a startling attraction. Of course, it is necessary to hide the unsightly feature of the apparatus, by the necessary signs and other display paraphernalia. A wonderful fountain effect is gained when several of these devices are placed in a circle, each using a different color.

RESISTANCE WIRE

(1809) George Heins, Luana, Iowa, asks:

Q. 1. Kindly give me a list of resistance wires.

- | | |
|--------------|---------------|
| A. I. | Calido |
| Advance | German silver |
| Ferro-Nickel | Manganin |
| Krupp metal | Superior |
| Nickel | Excello |
| Climax | Ideal |
| Ia, Ia | Nichrome, II |
| Monel metal | Yankee silver |
| Therol | |

Calido and Nichrome II will stand the greatest heat, both incidentally having the highest specific resistance, while nickel has about 1/10th the resistance, but will stand a temperature of 1/2 that of the other two.

TEMPERATURE OF MARS

(1810) John K. Dudley, Hollywood, Calif., asks:

Q. 1. What are the approximate temperature conditions on Mars?

A. 1. Recently, measurements made by Dr. Coblentz of the Bureau of Standards point to the fact that the surface temperatures on Mars are well above the freezing point in the daytime and may compare favorably with those found on earth. In fact, it was found that the surface of the planet was warmer than the thermopile with which the measurements were taken and that the morning side is much cooler than the evening side; that the polar caps are icy cold and that the dark areas are hotter than the bright areas. The temperature, estimated under a high sun, would be equal to that of a good warm summer day.

Interesting Articles to Appear In March Issue of "The Experimenter"

High Frequency Experiments at the University of California, By Lester Reukema.

The Klydonograph; Electric Surge Recorder, By Earle R. Caley.

Experiments in Spontaneous Combustion, By Raymond B. Wailes.

Making and Using a Capillary Electrometer, By Raymond B. Wailes.

How Much Does Your Amplifier Amplify? By William Grunstein, E.E.

Lessons in Elementary Glass Working.

The measurements were made at the Lowell Observatory using a very sensitive thermopile to measure the heat received from the planet's surface. In some of these measurements the thermopile was exposed directly in the telescope, while others were made with various kinds of screens interposed to cut off light- and heat-rays of certain ranges of wave-lengths.

Q. 2. What are the temperatures found to be existing on Venus?

A. 2. Further work by Dr. Coblentz at the Flagstaff Observatory reveals that the dark side of the planet, Venus, is very warm, while the southern hemisphere is warmer than the northern, the middle portion of the dark being warmer than either. On account of the great density of clouds surrounding Venus, the planet's axis has not been determined as yet but Dr. Coblentz believes that provided the heat distribution turns out to be seasonal as it is on the earth and Mars, astronomers will be enabled to determine the exact position of its axis. Instead of a sensitive thermopile, a sensitive vacuum thermocouple invented by the doctor and used in his stellar measurements ten years ago was employed. Measurements of the heat received from the Moon, Mars, Jupiter, Saturn and Uranus have been made with it. In conjunction with this, color screens and a water cell were used to cut out

certain ranges of wave-lengths of light and radiant heat, thus affording a comparison of the readings with and without these screens to ascertain the correct temperature of the surface. The period of rotation of Venus has long been a matter of dispute among astronomers, some believing that the planet always keeps the same face towards the sun. Even the spectroscope has failed to give any evidence of its rotation. Astronomers believe that it would do so if the period of rotation were less than twenty days. Venus receives about twice as much light and heat from the sun as does the earth, but less than one-third as much as Mercury.

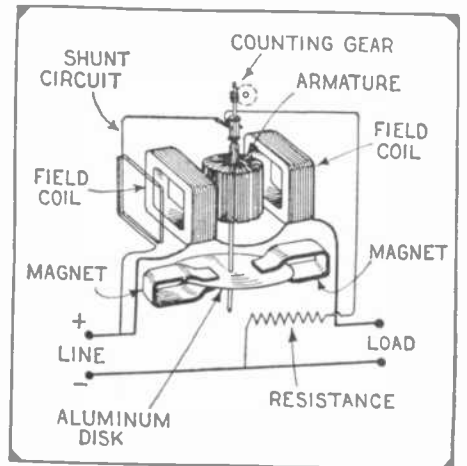

The direct current watt-hour meter is in reality a simple compound-wound motor. Both increases of current and potential cause it to rotate faster.

WATT-HOUR METER

(1811) James Lundy, Springfield, Mass., asks: Q. 1. Kindly give me some information concerning the construction and operation of the current measuring meter usually found in every home using electricity?

A. 1. Perhaps the Thomson supply meter is the most generally used meter for measuring electrical power. Its operation is described as follows. If a current passes through the armature of a small motor, which has a constant field and has its speed controlled purely by eddy current friction in an aluminum disk revolving between magnet poles, its speed will be at every instant proportional to the current. Hence, it is readily seen that such a motor when attached to a suitable counting train of wheels, will serve as a meter, the total number of revolution being proportional to the ampere-hours. Elihu Thomson's motor meter which records watt-hours has a revolving armature wound with fine wire and obviously having a high resistance, connected as a shunt, while the fixed field coils serve to pass the whole current being used. The torque produced by the revolving armature is proportional to the watts and at the same time, an aluminum disk revolving between the permanent magnet poles acts as a brake and keeps the speed proportional to the torque. A small auxiliary field coil is connected into the shunt circuit and compensates for the inevitable losses by friction in the pivots and gearing. As little as 1 per cent. or less of the normal load should be required to operate a good meter.

FREE INFORMATION

IF you want additional information concerning any of the subjects illustrated and described in this number of SCIENCE AND INVENTION we shall be glad to give you other data we have at our command. To make this work as easy as possible for our editors, please be brief. Write only on one side of the paper and state exactly in a few words just what it is you desire further information on. We have the original manuscripts and drawings of many of these articles in our files and can furnish much additional data in most cases. Please do not fail to send stamped and self-addressed envelope. Make all questions concise and specific.

Address all inquiries of this nature to INFORMATION EDITOR c/o Science and Invention, 53 Park Place, New York City.

FREQUENCY METERS

(1812) Leon Bradley, New Orleans, La., asks:
 Q. 1. Kindly give me information concerning meters for recording accurately the frequencies used in electrical work?
 A. 1. In considering the transmission of electric current we encounter frequencies ranging from 25 cycles to 133 cycles per second.

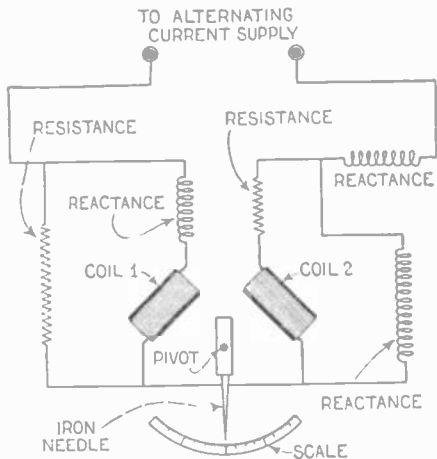

One type of frequency recording meter. These instruments are indispensable in checking up the alternations of electric currents. Note simple design.

There are three types of instruments in general use for recording the frequency of power lines furnishing alternating current. These are classified as follows: The vibrating-reed type; the differential-voltmeter type and the iron-needle type. The Frahm frequency meter which is of the vibrating type is based upon the principle of mechanical resonance, the property by virtue of which a body, when subjected to rhythmic impulses of the same frequency as the natural period of vibration of the body itself, will vibrate vigorously.

A number of special spring steel reeds carefully tempered and of slightly different lengths are placed in front of a small electro-magnet. When the meter is connected across the source of alternating current, whose frequency is to be determined, the magnet will cause one of the reeds to vibrate in unison. As will be at once seen, the device having no pivoted parts or jewel bearings is of very sturdy construction and has the advantage that it is independent of the voltage or wave form of the supply. Added to this is the fact that its energy consumption is very small and that it is not affected by external magnetic fields. The differential-voltmeter type of frequency meter is a combination of two induction voltmeters, in essence. Two split-phase electro-magnets act in opposite directions on an aluminum disk, the whole constituting a differential-voltmeter. The winding of one of the electro-magnets is connected in series with an inductance, while the winding of the other is connected with a resistance. This allows the meter to record changes in frequency, while that through the circuit containing the inductance, decreases as the frequency increases. Thus, the electro-magnet in the resistance circuit causes the pivoted aluminum disk, to which is attached a pointer, to rotate in one direction at a rate proportional to the alternations of the current.

The iron-needle frequency meter employs two coils, perpendicular to each other. Between them is pivoted an iron needle, free to rotate. In series with one coil is connected a reactance while with the other, a resistance. Shunted around the first combination is a resistance, while around the second is another reactance. The apparatus is then connected in series with a reactance, across the source of supply. When the frequency is low, a relatively large current flows through coil 1 and a smaller amount through coil 2. There is thus a stronger magnetic field resulting in coil No. 1 so that the iron needle takes a corresponding position which is indicative of the frequency. At a higher frequency the field, due to coil No. 2, is stronger and thus within limits, there is a definite position of the iron needle for every frequency. The reactance in series, serves to cut down the higher harmonics in the supply voltage, and by proper design, the instrument has been made practically independent of fluctuations in the supply.

As we reach the higher frequencies, we run into the lower radio frequencies. The best means for measuring these is what is known as a wave meter which consists of a combination of inductance and capacity.

RADIATION DETECTORS

(1813) Irving Rossoff, Bronx, New York, asks:
 Q. 1. What are the different instruments employed in the detection of radiant energy?
 A. 1. The heating effect of radiation is detected usually by the thermopile, the radio micrometer, the bolometer and the radiometer. A

sensitive thermopile is one made of fine copper wires in conjunction with constantan, a nickel alloy. The mass to be heated is made very small so that it warms quickly when exposed to radiation. The wires from the instrument connect to a sensitive galvanometer and the radiation is read directly from the degree of deflection of the needle. The thermopile is usually mounted in a metal case so that only one of its ends is exposed to the source of heat to be investigated. The radio micrometer is an instrument in which a simple circuit of bismuth and antimony is suspended by a fine quartz fibre between the poles of a powerful magnet. One of the junctions hangs in an opening so that the radiation may be directed upon it, while the other is protected by the surrounding instrument. The slightest difference of temperature causes an electro-motive force to be produced and since the resistance of so short a circuit is very small, a comparatively large current is produced which, on reacting with the magnetic field, causes the suspended circuit to turn. A small light mirror mounted on the suspended system turns with it so that the angular deflection may be read by a telescope and scale.

The bolometer has a thin strip of platinum, perhaps 0.01 mm. thick and 0.5 mm. wide, one surface of which is blackened. This is used in connection with a Wheatstone bridge and galvanometer so that its resistance may be balanced. When radiation falls on the strip, it is heated and in consequence its electrical resistance rises slightly, thus disturbing the balance of the bridge and causing a current to pass through the galvanometer. The platinum strip is so small that the change in its temperature takes place almost instantaneously when radiation

falls upon it, and an instrument of this nature can be made so sensitive that a change in temperature as small as one millionth of a degree C. in the strip can be detected.

falls upon it, and an instrument of this nature can be made so sensitive that a change in temperature as small as one millionth of a degree C. in the strip can be detected. In the radiometer, a light cross arm of wire carries on each end a small mica disk blackened on one side and having a small mirror hung from it. The whole is suspended by a fine quartz fibre in a chamber from which the air can be completely exhausted. These mica disks are placed vertically with their edges towards the axis of suspension and the blackened sides of each face towards the same direction. When a high degree of exhaustion is reached, the slightest radiation falling on the blackened side of one of the disks causes it to be repelled, thus tending to rotate the whole system. The small glass mirror reflects a tiny beam of light and radiation is again measured by means of a telescope and scale. It must be remembered that radiant energy passes with perfect facility through a complete vacuum and must be distinguished from the other modes of transmission of heat, namely, by conduction and by convection.

IMPORTANT

TO NEWSSTAND READERS

In order to eliminate all waste and unsold copies it has become necessary to supply newsstand dealers only with the actual number of copies for which they have orders. This makes it advisable to place an order with your newsdealer, asking him to reserve a copy for you every month. Otherwise he will not be able to supply your copy. For your convenience, we are appending herewith a blank which we ask you to be good enough to fill in and hand to your newsdealer. He will then be in a position to supply copies to you regularly every month. If you are interested in receiving your copy every month, do not fail to sign this blank. It costs you nothing to do so.

To _____ Newsdealer
 Address _____
 Please reserve for me _____ copies of
SCIENCE & INVENTION every month
 until I notify you otherwise, and greatly
 oblige,
 Name _____
 Address _____

falls upon it, and an instrument of this nature can be made so sensitive that a change in temperature as small as one millionth of a degree C. in the strip can be detected.

In the radiometer, a light cross arm of wire carries on each end a small mica disk blackened on one side and having a small mirror hung from it. The whole is suspended by a fine quartz fibre in a chamber from which the air can be completely exhausted. These mica disks are placed vertically with their edges towards the axis of suspension and the blackened sides of each face towards the same direction. When a high degree of exhaustion is reached, the slightest radiation falling on the blackened side of one of the disks causes it to be repelled, thus tending to rotate the whole system. The small glass mirror reflects a tiny beam of light and radiation is again measured by means of a telescope and scale. It must be remembered that radiant energy passes with perfect facility through a complete vacuum and must be distinguished from the other modes of transmission of heat, namely, by conduction and by convection.

SOURCES OF HEAT

(1814) John McCarthy, Bridgeport, Conn., asks:
 Q. 1. What are all the sources from which heat may be obtained?

A. 1. Heat as we understand it today is a vibration of the molecules of matter. Its sources are the sun and stars, from friction, from the interior of the earth, from electricity and from combustion or oxidation, and from radio-activity. Heat is readily manifest by its effects on various substances, such as causing them to expand as in the case of solids, gases and liquids. There are three modes by which heat is transferred—by conduction, by convection and by radiation. These give rise to what is known as temperature change and may result in,—depending of course upon the relative temperature of the body,—whether sublima-

tion, evaporation or condensation, melting or freezing will take place.

The most practical means of producing heat is that resulting from combustion. In this large field, industrial furnaces, heat engines, wood and coal ranges, gas ranges, steam heat systems, hot air and hot water heating systems, together with the vapor system find the greatest use. Of course by far, the heat obtained from the sun is the largest in quantity and it is this heat alone that keeps man from perishing in what otherwise would be a frigid climate. Even the ice box, the fireless cooker, the thermos bottle, and the ammonia freezing plant are all directly connected as having to do with heat.

The very nature of heat and its occurrence leads to what is known as the manifestation or phenomenon of fire. Thus again, when fire-extinguishers and fire-apparatus are mentioned, they should be closely allied with heat.

Through our sense of touch, by means of air, water, kerosene, alcohol and mercurial thermometers, and the other heat detectors mentioned elsewhere on this page, as well as wet and dry bulb thermometers, the manifestation of heat is at once verified.

When we speak of heat, we must also remember that ventilation is closely allied with it. Proper ventilation in the home means a healthy and responsive attitude of our body towards everyone and everything.

The future will bring out many new facts regarding heat, its uses and its production. Who knows but what heat will be used to cure most of our deadly diseases, since it already finds a ready application in many cases. As nature's vast store-wards of coal will in all probability run out in the next few hundred years at the present rate of consumption, other means than combustion will have to be resorted to and it is our prediction that electricity will be mainly responsible for the heat which will give warmth to this planet of ours.

EXPLOSIONS BY LIGHT

(1815) John Dennison, Bronx, New York, asks:

Q. 1. Has light been found to be instrumental in assisting or acting as a catalytic agent in chemical reaction?

A. 1. Everyone is familiar with the fact that photography depends upon light reflected from the object to be photographed. Under the influence of the actinic rays of the sun, the light emitted by burning magnesium, the light from the powerful electric arc and the calcium light, elements are made to combine and compounds are decomposed into their elements or broken down into the simple and more stable compounds. Other chemical elements are converted into allotropic modifications. If a mixture of pure chlorine and hydrogen is sealed up in a glass bulb, and exposed to diffused daylight, the gases gradually combine and form hydrochloric acid. This combination does not take place in the dark. If the mixture is exposed to direct sunlight, an explosion takes place instantaneously and the bulb is shattered. This is an example of chemical synthesis brought about by the action of light. Decomposition resulting from the effect of light is more pronounced by the greater number of cases taking place. Thus, mercurous oxide has to be kept in the dark as does silver nitrate and hydrogen peroxide. When exposed to light, the mercurous oxide forms mercuric oxide and mercury. Similarly, hydrogen peroxide breaks up into water and hydrogen. An interesting fact is observable when potassium bichromate is added to glue or gelatin, thus rendering it insoluble and leathery when exposed to light. This property is made use of in rendering glue joints watertight.

STOP SIGNAL

(1816) Benjamin B. Hecht desires data which will enable him to equip his car with an automatic stop signal to be operated by the foot-brake.

A. 1. The accompanying diagram shows that with a few odds and ends you can make a practical warning signal device. A single pole, single throw switch is used with a special blade in conjunction, and a short length of wire and fairly heavy spring.

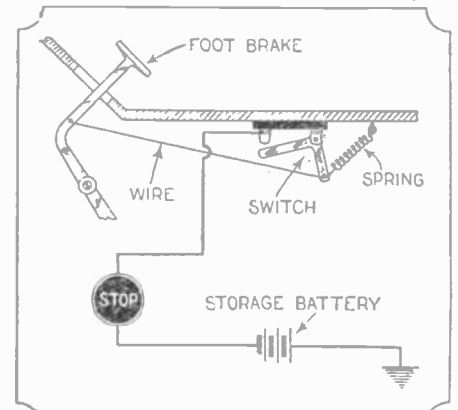

With the increasing congestion of traffic, extra precautionary methods should be taken. Equipped with this device, you are reasonably safe.

Awards in \$1000 Monthly Contest

The Regular Departments Pay Prizes of Their Own. Authors on Contract Receive Their Own Rates; this, With Other Special Payments Makes the Total Paid for Articles in Excess of \$1500.00 Monthly.

| | |
|---|--|
| FIRST PRIZE \$100.00 | |
| Tornado in Movies, by Edwin Schallert.....1074, 1075 | |
| SECOND PRIZE \$75.00 | |
| Navigation Instruments on "Los Angeles," by Dr. Alfred Gradenwitz.. 1083 | |
| TWO PRIZES OF \$50.00 EACH | |
| Animals Which Become Invisible, by Dr. Ernest Bade..... 1085 | |
| Roman Perfume Lamps, by Charles Beecher Bunnell..... 1092 | |
| THREE PRIZES OF \$35.00 EACH | |
| What Happens in the X-Ray Tube, by Howard Deem..... 1087 | |
| Current-Producing Selenium Cells, by W. S. Gripenberg..... 1106 | |
| A Two-Tube Reflex, by Alfred R. Marcy..... 1117 | |
| FIVE PRIZES OF \$25.00 EACH | |
| Mechanical Prompter, by James McAvoy, Reporter No. 8096..... 1088 | |
| Handkerchief Tricks, by Walter B. Gibson..... 1028 | |
| How An Actor Makes Up, by L. B. Robbins..... 1101 | |
| Making Your Own Antiques, by Dr. E. Bade..... 1104 | |
| Odd Uses for Ropes, by Arthur Finner..... 1104 | |
| FIVE PRIZES OF \$20.00 EACH | |
| For Suggestion, Automatic Railway, by Gustave Miller, Rep. No. 3309.. 1079 | |
| Artificial Larynx—Interview—Dr. Harvey Fletcher..... 1086 | |
| Testing Milk, by Dr. E. Bade..... 1105 | |
| Improved String Telephone, by C. A. Oldroyd, Rep. No. 4433..... 1105 | |
| Short Wave Condensers, by 2 DK..... 1117 | |
| TEN PRIZES OF \$15.00 EACH | |
| Navigation Instruments on "Los Angeles," Captions by E. Brennecke.. 1083 | |
| Celestial Camera, by C. B. Johnson..... 1106 | |
| Torches, by K. B. Thompson..... 1107 | |
| Shop Fan, by E. L. Edwards..... 1107 | |
| Phosphorescent Light, by C. A. Oldroyd, Rep. No. 4433..... 1107 | |
| Tire Pump, by Geo. A. Luers..... 1107 | |
| Train Speed, by Elliot R. Weyer..... 1107 | |
| Pencil Rheostat, by Ross J. Drew, Rep. No. 16663..... 1151 | |
| Variable Coupler, by Geo. V. Krabach..... 1151 | |
| Collapsible Speaker, by W. J. Warringer..... 1153 | |
| FIFTEEN PRIZES OF \$10.00 EACH | |
| Test Set, by W. B. Clark..... 1107 | |
| Graduate Repair, by Joe Windle..... 1108 | |
| Removing Cork, by Robert G. Nicholl..... 1108 | |
| Microscope, by L. M. Brooks..... 1108 | |
| Transparent Paper, by F. R. Moore..... 1108 | |
| Phone Connectors, by C. F. Motsch, Rep. No. 12,926..... 1150 | |
| Coil Taps, by Richard Anderson, Rep. No. 10,509..... 1150 | |
| Phone Switch, by Wm. J. Cummings, 1ABP..... 1150 | |
| Peep Hole Mirror, by B. G. Switzer..... 1151 | |
| Tuned Loop, by Thomas E. Perdue, Rep. No. 5376..... 1153 | |
| Combination Switch, by George Vatcher, Rep. No. 9608..... 1153 | |
| Grid Control, by B. G. Switzer..... 1154 | |
| Filament Control, by F. W. Peters..... 1154 | |
| Flexible Shield, by C. F. Feistead, 6CU..... 1154 | |
| Compass Detector, by Lloyd Mallett..... 1154 | |
| TEN PRIZES OF \$5.00 EACH | |
| Fire-proof Paper, by F. S. Yamamoto..... 1108 | |
| Cleaning Paper, by Mrs. Jean Wagar..... 1108 | |
| Metal Etching by E. C. Tim.ick..... 1108 | |
| Luminous Switch, by C. G. Minnich..... 1108 | |
| Blue Prints, by A. A. Blumenfeld..... 1108 | |
| Inner Tube Contest, Suggestion No. 5, 11, 32, by Jesse J. Currier..... 1102 | |
| Inner Tube Contest, Suggestion No. 1, by Ed. Ruhling..... 1102 | |
| Inner Tube Contest, Suggestion No. 10, by W. T. Markowski..... 1102 | |
| Inner Tube Contest, Suggestion No. 3, by L. B. Robbins..... 1102 | |
| Inner Tube Contest, Suggestion No. 31, by G. E. Hendrickson..... 1102 | |
| FIFTEEN PRIZES OF \$2.00 EACH | |
| Inner Tube Contest, Suggestion No. 20, by G. E. Hendrickson..... 1102 | |
| Inner Tube Contest, Suggestion Nos. 7, 18, by G. E. Hendrickson..... 1102 | |
| Inner Tube Contest, Suggestion No. 8, by C. E. Connelly..... 1102 | |
| Inner Tube Contest, Suggestion No. 34, by Elbert Harris..... 1102 | |
| Inner Tube Contest, Suggestion No. 15, 17, by Geo. Darby, Rep. No. 10,625..... 1102 | |
| Inner Tube Contest, Suggestion No. 21, 22, by Horace Evans, Rep. No. 13,377..... 1102 | |
| Inner Tube Contest, Suggestion No. 14, by G. E. Hendrickson..... 1102 | |
| Inner Tube Contest, Suggestion No. 23, 24, by Horace Evans, Rep. No. 13,377..... 1102 | |
| Inner Tube Contest, Suggestion No. 37, by Marshall Mueller, Rep. No. 7198..... 1102 | |
| Inner Tube Contest, Suggestion No. 39, by Glen F. Stillwell..... 1102 | |
| Inner Tube Contest, Suggestion No. 13, by Arthur T. Law, Rep. No. 10,977..... 1102 | |
| Inner Tube Contest, Suggestion No. 16, by Richard Anderson, Rep. No. 10,509..... 1102 | |
| Inner Tube Contest, Suggestion No. 2, by Fred Ebel, Rep. No. 6774..... 1102 | |
| Inner Tube Contest, Suggestion No. 9, by Daniel J. Spillane, Rep. No. 1170..... 1102 | |
| Inner Tube Contest, Suggestion No. 28, by Enrique Corral..... 1102 | |
| ADDITIONAL CONSOLATION PRIZES OF \$1.00 | |
| Inner Tube Contest, Suggestion No. 19, by Daniel J. Spillane, Rep. No. 1170..... 1102 | |
| Inner Tube Contest, Suggestion No. 35, by Cecil Kuever..... 1102 | |
| Inner Tube Contest, Suggestion No. 38, by J. Van Sluys..... 1102 | |
| Inner Tube Contest, Suggestion No. 12, by G. G. Stone..... 1102 | |
| Inner Tube Contest, Suggestion No. 36, by F. Donald Byers..... 1102 | |
| Inner Tube Contest, Suggestion No. 30, by Kenneth Harbison, Rep. No. 8946..... 1102 | |
| Inner Tube Contest, Suggestion No. 33, (author send address)..... 1102 | |

\$13,320.00 in Prizes Paid Last Year

WITH the December issue our \$12,000 a year prize contest came to a happy conclusion. Not only did we pay out \$12,000 in prizes as announced in our November, 1923 issue, but we did actually pay out in prizes alone, not less than \$13,320.00 to 1,112 winners. These prizes every month ranged from the first prize of \$100.00 down to the smallest prize winner of \$1.00 each.

Up to the time of going to press, SCIENCE & INVENTION had no less than 19,000 reporters scattered over every section of the globe. These reporter-contributors have sent in an avalanche of material, and their efforts have been fruitful in that they have won prizes.

SCIENCE & INVENTION aims to print the news first, if it is inter-

esting and to otherwise excel in the reporting of science and invention. Small wonder then that with the enthusiastic co-operation of our thousands of Reporter-Correspondents, SCIENCE & INVENTION today occupies an enviable position in the scientific press.

The \$12,000.00 prize arrangement has worked out so satisfactorily during the year just closed that we have decided to extend it for another year and we hope that our correspondents will be as successful in winning prizes for the coming year as they have been during the past one. We wish to thank all of our friends for their co-operation and wish them the best of luck for the coming year.

Note New Prize Schedule.

Here Is How You Can Get in the Contest:

\$12,000 or More in Gold

EVERY month SCIENCE AND INVENTION pays \$1,000 or more in gold in prizes. Every text article published will receive a prize—(most of the departments have awards of their own which they give every month). Ideas are what the Editors want. The ideas must be told simply, so that your mother or your sister can understand them—in pictures or sketches or both. But the idea must be new and must have something to do with science or invention.

The Editors want pictures and sketches—must have them—but what they want most

82 monthly prizes will be given as follows:

| | |
|----|---------------------------------|
| | FIRST PRIZE \$100.00 |
| | SECOND PRIZE \$75.00 |
| | 2 PRIZES OF \$50.00 each |
| 3 | " " 35.00 " |
| 5 | " " 25.00 " |
| 5 | " " 20.00 " |
| 10 | " " 15.00 " |
| 15 | " " 10.00 " |
| 10 | " " 5.00 " |
| 15 | " " 2.00 " |
| 15 | " " 1.00 " |

\$12,000 or More in Gold

is IDEAS. These ideas will be handsomely paid for. We have published a pamphlet showing the rules of the contest which we shall be glad to send to anyone free on receipt of a postal card with your name and address. The pamphlet gives full details, the rules and how to submit articles. The magazine itself shows you what is wanted. Study it closely and submit your ideas.

The closing date for all prize contributions is the 15th of the month preceding date of issue, i.e., the 15th of March for the May issue, the 15th of April for the June issue, etc.

WILL YOU BE OUR REPORTER?

IN connection with our \$12,000 prize contest announced herewith, it goes without saying that you will have to do a little work in order to win a prize. The Editors do not wish to make it hard for you, quite the contrary. We want pictures and ideas and we cannot have too many of them.

Herewith is reproduced our reporter's card. Up to now we have issued over 19,000 of these. Note in our awards how our reporters are winning prizes right along. We shall be glad to send the reporter's card free to anyone who makes an application for it. By means of this card you will be able to secure entry into industrial plants, business houses, mot on picture studios, steamships, docks, public buildings, etc. This reporter's card will prove an open sesame to you in many instances. Every card is numbered and only one is given to a correspondent. A postal card from you and a request for this reporter's card is all that is necessary to obtain one. It will be sent to you by return mail. With it we will send you a pamphlet giving rules of the contest and how to proceed in order to get photographs, to send in sketches, and other information in order to obtain a valuable prize. Not only will this card help you to obtain material for this magazine, but it will train you to become a news gatherer, and will be the means of helping you to earn a good deal of money during your spare hours.

Address Field Editor, SCIENCE AND INVENTION, 53 Park Place, New York

REPORTER

Science and Invention

CORRESPONDENT
REPORTER'S
IDENTIFICATION

NO. 10000

L. W. Shackner

THE BEARER OF THIS CARD IS AN AUTHORIZED CORRESPONDENT-REPORTER OF SCIENCE AND INVENTION MAGAZINE THE PUBLISHERS OF SCIENCE AND INVENTION WILL APPRECIATE ANY COURTESY EXTENDED THEIR REPRESENTATIVE.

EXPERIMENTER PUBLISHING CO.

(over) *Herbert C. Bell* PRESIDENT

How to Finish Furniture —New and Old

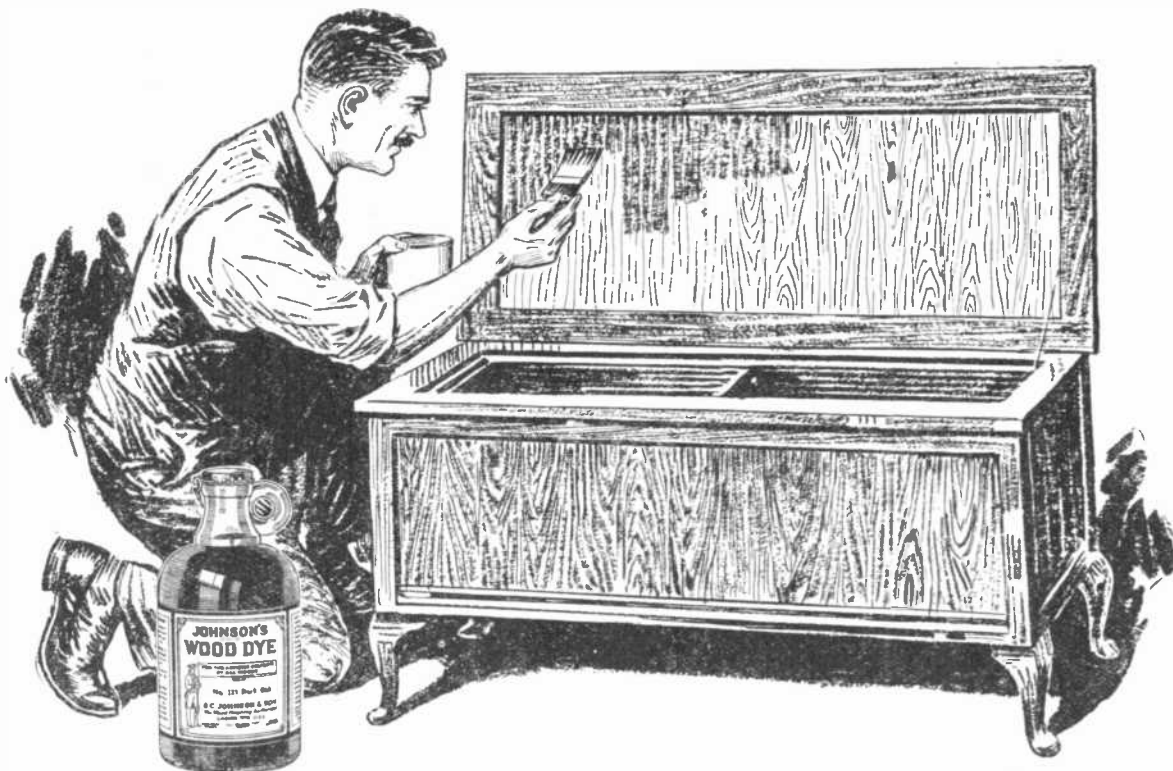

JOHNSON'S WOOD DYE

(Penetrating)

If you have a hobby for making chests, cabinets, furniture, porch swings, radio boxes, etc., you will find our book on Wood Finishing invaluable. For, naturally, you want to give your handiwork a beautiful finish.

Our Book gives complete instructions for finishing new and refinishing old wood—soft or hard. It tells how to stain wood artistically—how to remove old paint and varnish—how to secure a beautiful enamel finish.

Johnson's Wood Dye is for the artistic coloring of all wood. It is very easy to apply—dries in four hours and will not rub off or smudge—penetrates deeply, bringing out the beauty of the grain. Made in 17 beautiful shades, among the most popular of which are:

- | | |
|--------------------|----------------|
| 123—Dark Oak | 131—Walnut |
| 129—Dark Mahogany | 126—Light Oak |
| 127—Brown Mahogany | 124—Golden Oak |

Order Johnson's Wood Dye from your dealer by name and number.

—FREE—25c BOOK ON WOOD FINISHING—



Ask for a FREE copy of the Johnson Book at stores displaying the sign shown at right. These stores carry Johnson's Artistic Wood Finishes and will be glad to show you wood panels—and answer questions on how to properly finish wood. If no store in your locality can supply the Johnson Book—mail this coupon for a copy Free and Postpaid.

YOUR DEALER'S NAME

Your Name

Your Address

City and State

Mail to: S. C. JOHNSON & SON, Dept. S14, RACINE, WIS.
"The Wood Finishing Authorities" (Canadian Factory: Brantford)





Enter the Profession of

ELECTRICITY

Through This New Kind of Home Training System

The great field of Electricity has never before been so badly trained. Trained Men—men who are skilled in every department of this fascinating profession. The electrical industry is ready and glad to pay big salaries to the men who really know! Commercial Electrical Engineers, Master Electricians, Electrical Engineers, Automotive Electrical Experts, are needed everywhere, and they command handsome incomes. We will fit you for one of these splendid places quickly and thoroughly, right in your home, while you hold your present job.

Unlike All Other Schools

No other school furnishes its students with the elaborate Home Laboratory Units—actual working size instruments, chemicals and electrical equipment. This gives you actual practice, along with the theory, making you a skilled expert ready to take a big job. In addition, our official Broadcasting Station WSOE broadcasts educational lectures on Electricity, richly supplementing the studies and experiments of our home-study students.

FREE HOME LABORATORY OUTFIT COMPLETE

No models, or miniature parts, but actual size apparatus and equipment, the same as you work upon when out in the field. Do not confuse these Laboratory Units with the models sometimes furnished by correspondence schools. They are sent to your home without cost to you, as a part of your course. It is only through the enthusiasm and cooperation of our myriad of students that we can go to this enormous expense. You will get complete details of this amazing plan when you write.

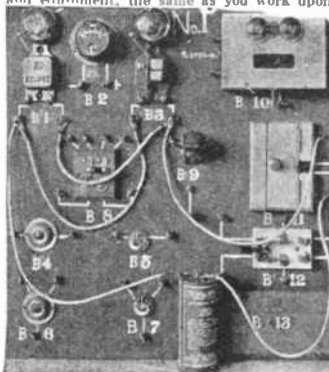

No models, or miniature parts, but actual size apparatus and equipment, the same as you work upon when out in the field. Do not confuse these Laboratory Units with the models sometimes furnished by correspondence schools. They are sent to your home without cost to you, as a part of your course. It is only through the enthusiasm and cooperation of our myriad of students that we can go to this enormous expense. You will get complete details of this amazing plan when you write.

Satisfaction Guaranteed

Backed by This Great School

This marvelous training is backed by the largest and best equipped electrical school in America. The School of Engineering is endorsed and linked with some of the largest Commercial Concerns and Power Companies in the country, the employers of the Big Pay Men.

Catalog Sent FREE

Write quick, just mailing the coupon, for complete details and catalog. It will point the sure way to success.

Extension Division

SCHOOL of ENGINEERING of Milwaukee

Dept. SI-A

415 Marshall St. Milwaukee, Wisc.

SCHOOL OF ENGINEERING OF MILWAUKEE, Dept. SI-A, 415 Marshall St., Milwaukee, Wisc.

Please send me your Free Catalog and details of your new home training system in Electricity.

Name..... Age.....

Address.....

City..... State.....

The Living Death

By JOHN MARTIN LEAHY

(Continued from page 1091)

On the 12th of December we passed Cape Horn. The weather was beautiful, the wind from the west-northwest, and the *Multnomah* sailed in close to this weather-beaten and dreaded promontory.

Frontenac had got the cinematograph-camera ready, and some truly wonderful views were obtained of this gloomy and terrible place—gloomy even with the sunshine flooding sea and land.

Banks of cumuli gathering in the southwest told us that our beautiful weather was not going to last long.

The *Multnomah* bore away to the eastward. A number of icebergs were in sight, enhancing the somber aspect of the desolate scene.

And, sure enough, morning found a gale from the southwest howling through our rigging, a tremendous sea running and the air so thick with rain, mist and sleet that often our horizon was within the radius of a hundred yards. Bergs were known to be about us in various directions, and this knowledge, what with our circumscribed horizon, was one by no means conducive to rosy thoughts and speculations.

The wind hauled round to the west and finally to the northwest; by midnight the gale had blown itself out.

When the sun came up, which he did about three o'clock, the *Multnomah* was standing on her course, with everything set save her topsails.

Squalls were of frequent occurrence during the day. Many birds were about the ship—albatrosses, cape pigeons, Antarctic and snowy petrels. Several bergs were seen, and in the afternoon two big rorquals passed within a quarter of a mile of us. The rorqual, by the way, is said to be the largest mammal that has ever existed. The sight of these enormous creatures was a stirring one. It threw Professor Archimedes Bukink into a scientific ecstasy. Out came notebook and pencil, and Bukink proceeded to slap down his observations in whirlwind fashion. He got so excited, however, that he made notes that neither himself nor any one else could make head or tail of. They were about as decipherable as so many Maya hieroglyphics.

"Oh, well," said the professor, "I must fall back upon my visual impressions and imbibe comfort from the certitude that my cacography will be caligraphy on the next occasion when I am favored with the opportunity of making observations upon *Balaenoptera Sibbaldi*."

Some days passed and brought us near that meridian on which Captain Livingstone planned to enter the pack.

ISLANDS OF ICE

It was seldom that we did not have at least one berg in sight, and sometimes there were dozens. Some bergs were of great size, were, in fact, ice-islands. One measured three miles and a half in length, its height three hundred and eighty feet. It was greatly worn, sculptured into obelisks, pinnacles, towers and great castles, the fantastic forms giving the mass the appearance of a ghost city adrift upon the waters.

Captain Livingstone had seen bergs more than five hundred feet in height. Reports of masses much higher than this, however, are on record.

"One of our most celebrated and talented naval surveyors," says Pindlay, "informed me that he had seen icebergs in southern regions 800 feet high. The *General von*

Geen, August 6th, 1840, passed an iceberg 1,000 feet high."

And this in latitude 37° 32' S.

It was on the afternoon of the 22nd of December (corresponding, of course, to the 21st of June in northern latitudes) and in latitude 60° 15' S. that we entered the ice.

A fine breeze was blowing from the northwest at the time, and the *Multnomah* thrust the brush aside as though it were so much thistledown. But this was too good to last long. An hour, and we were in the pack itself. The engine was going now, the ship pushing her way through toward a lead running to the southeastward. It was a tussle, but we got there, and the *Multnomah* went gliding down that lane like a sea bird.

There was hardly any swell here; an eerie silence had fallen, broken only by the soft rustle of the ice. There was an indescribable, ghostly something in that sound.

After about an hour's run, the lead closed. The *Multnomah*, however, drove straight ahead into the ice. Twice she was brought to a complete standstill; but each time her powerful engine drove her on, the third time clean through into open water again.

The sun disappeared about nine o'clock, down in the southwest. A dead calm had fallen. It was a strange, weird scene, and one beautiful beyond description in the wonderful colors of sunset.

Ten o'clock found us hemmed in by great floes—the *Multnomah* at last indeed at a standstill. There was nothing to do but wait for an opening. One might occur in an hour, in five minutes, in twenty-four hours, or a week. For these movements of the ice are as uncertain and unaccountable as the proverbial operations of the feminine mind. The phenomenon, it seems to me, must, in a large measure, be due to the action of wind or current, or more frequently of both. Undoubtedly, too, the tides play an important part. In this instance, the wind could have had nothing whatever to do with it: the ice opened up about one o'clock, and at that time there wasn't a breath of wind, nor had there been for hours.

Rainier was officer of the watch, and he at once sent the *Multnomah* into the opening—conning the ship from the crow's-nest. Though so near the noon of night, it really was not night; rather, it was ghostly day. The sun was less than ten degrees below the horizon, the sky clear, and so a strong twilight flooded the pack.

Yes, that was what it was—not night, but a day, meet for the wanderings of disembodied souls. And yet here were we making our way through this ghostly scene, to wrest from the Unknown some of those grim secrets over which she had held vigil from age unto age—secrets strange and wondrous; weird, horrible things.

When I came on deck at four o'clock, the end of the middle and the beginning of the morning watch, the *Multnomah* was ploughing her way through mushy drift. Floes were all about, however; a number of bergs in sight, two of these monstrous things; while the strong blink to the southward showed us that we should, in all likelihood, ere long have a dense pack to contend with.

The sun was, of course, risen—a blood-red ball of fire low to the horizon down in the southeast-by-east. A wind was springing up from the southwest, and the sky had a chill and angry look.

At seven o'clock, Captain Livingstone took a sight, the sun then being on the

(Continued on page 1128)

EVEREADY HOUR
EVERY TUESDAY AT 9 P. M.
 For real radio enjoyment, tune in the
 "Eveready Group." Broadcast through
 stations

| | | | |
|------|------------|------|--------------|
| WEAF | New York | WFI | Philadelphia |
| WJAR | Providence | WCAE | Pittsburgh |
| WEEI | Boston | WGR | Buffalo |

*Dry "B" Batteries
 are an economical,
 dependable and
 convenient source
 of plate
 current!*

There's more life in Eveready Batteries

Buy Eveready "B" Batteries and you get electricity in its surest, safest and most compact form. They reduce your operating expense. New developments in the Union Carbide and Carbon Research Laboratories, Inc., have been converted into new manufacturing processes in the Eveready factories. Good as they always have been, Eveready "B" Batteries are much better today.

The Eveready achievement of giving you more hours of "B" Battery service for less money has cut the cost of running receivers in half, and in some cases the new Evereadys make "B" Battery expense only a third of what it used to be.

There is an Eveready Radio Battery for every radio use.

Manufactured and guaranteed by
NATIONAL CARBON COMPANY, INC.
 Headquarters for Radio Battery Information
 New York San Francisco
 Canadian National Carbon Co., Limited, Toronto, Ontario

EVEREADY Radio Batteries —they last longer



No. 7111.
 1½-volt
 Dry Cell
 "A"
 Battery
 for all
 dry cell
 tubes



No. 772.
 45-volt
 Large
 Vertical
 Price
 \$3.75



No. 770.
 45-volt
 Extra
 Large
 Vertical
 for heavy
 duty
 Price
 \$4.75



No. 771.
 4½-volt
 "C"
 Battery
 improves
 quality,
 saves "B"
 Batteries
 Price 60c.



How I Make \$400⁰⁰ a Month in RADIO

"A few months ago I was plodding away on a dull, small-pay job. Now, I am in business for myself. I am my own boss. I make over \$400 a month—and the amazing thing about it all is that until a few months ago when I started with you I didn't know the first thing about Radio."

Every week letters like this arrive at the office of the director of National Radio Institute—letters which indicate the amazing successes made by graduates of this school.

Radio offers golden opportunities today. Thousands of trained men are wanted as Radio Executives, Radio Salesmen, Radio Engineers, Radio Operators, etc.

We Help You to Big-Pay Positions

You can easily qualify at home for any one of these big pay positions during your spare time. The National Radio Institute—the biggest and best—will guarantee to make you a Radio expert in a few months. All necessary instruments are furnished you free. You can take the easy, quick road to wealth that thousands of others have taken.

Hardly a week goes by without our receiving urgent calls for our graduates. "We need a competent Radio Engineer"—"We want men with executive ability in addition to radio knowledge to become our local managers"—"We require the services of several resident demonstrators"—these are just a few small indications of the great variety of opportunities open to our graduates.

FREE—Receiving Set and Special Parts

Our course of practical instruction includes not only several of our own special patented instruments, but in addition we furnish material and diagrams for building receiving sets, and finally this complete receiving set—all without additional cost.

Send for BIG BOOK

Radio will pay you ten times more money than any other field just now. Let us show you what wonderful salaries our graduates are making—read about the splendid positions now open to you in Radio. Send today for free 32-page book, "Rich Rewards in Radio," and see how easy it is to become a Certified Radio Expert in your spare time, and how you can qualify for a splendid radio position, paying from \$50 to \$250 a week! Mail coupon now for this "big-pay" book. National Radio Institute, Dept. 14EB, Washington, D. C.

NATIONAL RADIO INSTITUTE
Dept. 14EB, Washington, D. C.

Send me the book, "Rich Rewards in Radio," which tells all about the opportunities in Radio, how spare time study at home will qualify me quickly as a Certified Radiotrician so I can get one of these splendid positions, and how your Free Employment Service helps me to secure a good position.

Name Age

Address Occupation

City State

The Living Death

(Continued from page 1126)

prime vertical or exactly east of us, his altitude twenty-seven or twenty-eight degrees.

The prospect by this time was not a rosy one. The *Multnomah* was threading her way through a sinuous lead. A mile or two, though, and we would be at the end, the way then barred by floes jammed together. Open water was visible to the south but could we get through?

Well, the ship did get through, after much ramming and jamming.

And scarcely had she glided out into the open water when a great mass broke the surface within a hundred feet of our starboard bow.

"There she blows!"

It was a rorqual. A short distance off, another object appeared, an object from which projected a long fin-like dagger.

"Killer!" said Captain Livingstone.

"And there's another!" said Frontenac, pointing.

"And another," I said.

"By Heaven," the captain exclaimed, "they're after him!"

A BATTLE BETWEEN TWO GIANTS OF THE SEA

Of these vicious creatures I had both heard and read some strange and terrible things. Here is one from the great Cuvier himself: we are told that the killer "is a cruel enemy to the whale, which it attacks in troops, tormenting it till it opens its mouth, when they devour the tongue."

What a heartless, soulless, horrible thing Nature is, after all!

The rorqual had taken the alarm, but it was too late. There was a rush, a great disturbance by his head, and a killer had got him by the lower jaw. The whale lashed himself about, turning the sea into a caldron of blood-streaked foam. He threw his head twenty feet into the air, but the killer kept his hold like a bulldog.

Came another rush, another and another; the killers were on him now! Of what followed I can give no adequate description. Fierce as had been the struggle of the whale, it was as nothing to that which followed. It was a horrible and yet a wonderful thing to see. And matters suddenly assumed a rather unpleasant aspect: the combatants were drawing in toward the *Multnomah*, and we could not swing away from them, because already, on the port side, we had the ice close aboard.

The rorqual was a giant even for a rorqual; our estimates placed his length at over one hundred feet. And it was an amazing and awful sight to see the huge creature throw himself—the three killers clinging to his jaws—clean out of the water. But he could not shake them off, and, as he fell, two more of his enemies threw themselves upon him and gripped and slashed with their terrible teeth.

The *Balaenopter* was doomed. Already his struggles were growing weaker; the sea for yards was red with his blood.

At length he lay rolling sluggishly, like a monstrous log.

Came a sudden outburst. The huge beast threw himself half out of the water. Foam and bloody spray showered upon our deck. Then came a shock—a shock under which the *Multnomah* shivered from stem to stern and heeled over until the water came bubbling in through the port scuppers.

It was a breathless, appalling moment; but the most vivid memory of that wild scene is not the terrible things that flashed into my

mind or the great laboring body of the whale alongside, but of Professor Archimedes Bukink in pursuit of his notebook!

I honestly believe that he was not in the least alarmed, that he was so engrossed in the scientific aspect of the business (whatever that was) as to be utterly unconscious of the dire possibilities it presented.

For my part, I expected to see whale and killers land on top of us or that monstrous tail sweep the deck.

Back came the *Multnomah* on her roll to starboard. And up rose the great back of the whale. I thought that the monster was going to come crashing through the bulwarks and onto the deck. But, at the very instant that this horror seemed inevitable, a frightful convulsion flung the body away from us. A few moments, and the *Multnomah*, to my profound relief, had got clear. And it was well that she had. For the whale flung himself back again. Up into the air he rose, his mouth wide open, foam and blood flying in all directions. Down he came smashing against the floe, shattering and cracking the ice as though it were glass, crushing one of his enemies against the sharp edge and killing him almost instantly.

"Hooray, old fellow!" shouted Frontenac. "Do it again!"

But that was the last great effort that the *Balaenopter* made to free himself from those clinging horrors. It was patent that his strength was ebbing swiftly now. Already the tragedy had entered upon its final phase.

The *Multnomah* was standing steadily on through the lead, much to the surprise and chagrin of Archimedes Bukink, who wanted the ship to return to the scene of the combat—or at least stand by so he could witness the end.

"What for?" the captain roared.

"For science," quoth the professor, nothing daunted by the vehemence that the other had displayed.

Whereupon Captain Livingstone said that science could go to the pericci of Paradise.

And that (so we thought) was the last of the killers.

One of them, by the way—the second to appear—had his great dorsal fin cut off to a mere stump. We could tell that fellow if we saw him again. At the time, though, I never thought of that.

I hasten now to the awful end.

CHAPTER XIX

SUB-FIN

There were times when the *Multnomah* made but very little headway during the whole of the twenty-four hours. Indeed, once we did not gain a single foot; we lost. We encountered heavy hummocked pack that day; there was nothing to do but wait for the ice to open; and, while we waited, the current carried us back for some miles.

At other times, though, we made sixty or seventy miles of southing during the twenty-four hours; and once—that was on the 2nd of January, and we were in open pack—the ship made a run of a little over one hundred miles.

On the 8th of January, about nine o'clock in the morning, the *Multnomah* crossed the Antarctic circle. We made a fairly good run that day and had the sun at midnight.

Each day now found the sun at the noon of night a little higher above the horizon and a little lower in the northern sky at midday. Had we been at the Pole itself, we should, of course, have had the sun—save

(Continued on page 1130)



Radio Headquarters

Why not buy your set or parts at Radio Headquarters? Only tested and approved radio equipment is sold. Every set sold by us is guaranteed to give satisfactory results.



Ward's Radio Catalogue

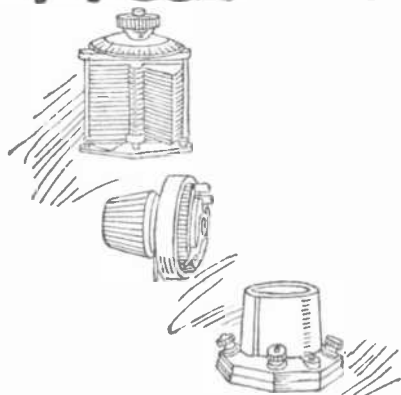

The best Radio Experts made this catalogue—men who devote their entire time to Radio—who are up to the minute with everything new, who tell you the best hook-ups, who have selected for you the best tested parts, who have chosen the best sets—so simple that you yourself can easily install them—so reliable that we guarantee them to give satisfaction.

Write for your copy of this Catalogue. See for yourself the

low prices. Buy your radio at Radio Headquarters.

Our 53 Year Old Guarantee

Ward's has dealt with the American people for 53 years under a definite guarantee of "Money back if you are not satisfied." All our Radio sets are guaranteed to give satisfactory results and back of this guarantee is a proven reliability that for 53 years has not been questioned. Address our house nearest you. Dept. 40-R.

ESTABLISHED 1872 Montgomery Ward & Co.

The Oldest Mail Order House is Today the Most Progressive

Chicago

Kansas City

St. Paul

Portland, Ore.

Oakland, Calif.

Ft. Worth



Choose as Your Profession ELECTRICAL ENGINEERING

Electricity offers a brilliant future to the young man who is about to choose his career. Never before has there been such wonderful opportunity in this great field. Big paying positions in electrical work the world over are open to trained men—men who possess specialized, practical knowledge. Come to the School of Engineering of Milwaukee—the largest and best equipped electrical school in America. Here you are trained in both theory and practice by a faculty of experts. You learn in large, finely equipped laboratories. If you have 14 high school credits or equivalent, you can become an Electrical Engineer with a Bachelor of Science degree in 3 years. If you lack these credits they can be made up in our Institute of Electrotechnics in a short, intensive course.

Practical Electrical Education

Learn by the thorough approved scientific methods which our twenty years of specializing enable us to give you. In addition to Electrical Engineering, the following complete courses are given: A. C. and D. C. Armature Winding—Wiring and Testing—Practical Electricity—Drafting—Electrotechnics—Commercial Electrical Engineering—Auto Electrical Service Engineering and Automotive Electricity.

EARN WHILE YOU LEARN

You can earn money to help defray your expenses while learning. Our wonderful co-operative plan brings an Electrical Career within the reach of every ambitious man. Our Free Employment Department secures positions for those students who wish to earn part or all of their expenses. In addition, the Department will help you get a good position in the Electrical industry when your training is completed. Daily Broadcasting W.S.O.E.

New Term Opens February 16th

Big Book FREE

Mail the coupon today for our big new illustrated catalog. Mention the course that interests you most and we will send you special information. Read about the school that trains men for practical and quick success. See how easy it is for you to get the training that will enable you to step to a splendid position and a handsome income. Mail the coupon right NOW. No cost or obligation.

SCHOOL of ENGINEERING of Milwaukee

Dept. SI-B
415 Marshall St., Milwaukee, Wis.

SCHOOL OF ENGINEERING OF MILWAUKEE

Without obligating me in any way, please mail free 32-page illustrated book, "Electricity and the One Best Way to Learn It," and particulars regarding the course I have marked with an X.

..... Electrical Engineering.
 Electrotechnics.
 Commercial Electrical Engineering.
 Automotive Electricity.
 Auto Electrical Service Engineering.
 Radio Sales and Service.
 A.C. and D.C. Armature Winding.
 Light, Motor, Wiring and Testing.
 Practical Electricity.
 I am interested in your "Earn While You Learn" Plan.

Name..... Age.....
 Address.....
 City..... State.....
 Education.....

The Living Death

(Continued from page 1128)

for his change in declination, and that would have been imperceptible without an instrument—riding as high in the heavens at midnight as at noon.

But we weren't at the Pole, and we were not bound for the Pole. Instead, we were bound for things—but, there, did we really, after all, know what we were bound for?

We had seen numbers of penguins—emperors and adélies. As yet, but a single skua gull had been sighted. Seals had at times been rather plentiful—most of them crab-eaters, the others Weddells. Once Frontenac had spotted a Ross seal. This we had been anxious to secure as a specimen, for this animal is now becoming pretty scarce; but the creature had got away, much to the chagrin of Archimedes Bukink. Some sea-leopards had appeared—creatures graceful in a certain sinister, snaky fashion. Numbers of whales, too, had been in sight—a few of them humpbacks. The humpback, it is to be feared, is doomed to early extinction. There had been very few killers—no more than three or four.

As we drew near the seventieth parallel, a strong water sky appeared in the south. The open pack became very open pack; finally the *Multnomah* was moving through drift ice, and, hooray! at last she was in open sea!

To the southward, and to the east and the west, not a single cake of ice was to be seen anywhere. It had a curious magical quality—this sudden change. There was a placid swell in this open water, and there was positively something exhilarating in the gentle rise and fall of the *Multnomah's* deck. A fine breeze was blowing, and so off went the engine, and away the ship went gliding on the wind.

The sky was almost cloudless, the sea a deep, wonderful blue. Many snowy petrels were about us. In all directions, whales were blowing. The scene was animated, a beautiful one. It made a man breathe deeply, for the very joy of it, and tell himself:

"It is a wonderful thing, after all, this hard old world of ours, and life is good!"

And I wondered what this scene, at the moment so beautiful, but at other times so gloomy and dreary and terrible, had been like when Sleeping Beauty lived and perhaps loved—if, indeed, there had been any sea at all here then!

But all things must end; after a run of a hundred and fifty miles through this wonderful open sea, came the pack again.

In latitude 74° 45', the *Multnomah* encountered close pack, some of it hummocky, extending as far as the eye could reach. Until the ice opened, progress was simply out of the question. So the ship was moored to a floe, and the game of watchful waiting was on.

Thirty or forty bergs were in sight. One of them, a mile or so on our starboard beam, had a height of over four hundred feet. It was much worn and towered up out of the waste of ice like a great ruined castle.

A day passed, but there was no change in the ice that barred our way to the south, though some of the leads behind us had closed, others had opened up and even new ones had appeared. The only living things in sight were some penguins, emperors, several of which were shot.

Then, in the afternoon of the second day, came the horror.

About three o'clock a seal was discovered off to the westward, a mile or so distant, and Frontenac and I started off in hopes of

getting the creature, he carrying the rifle. I had no weapon of any kind.

A boisterous game of football, on the floe to which the *Multnomah* was moored, was in progress at the time. Shortly after quitting the ship, we passed Captain Livingstone.

He was sitting, probably fifty feet from the edge of the floe his chin was resting on his left hand, and he was gazing away to the southward with a strange and abstracted look.

Of what was he thinking? In all likelihood, I told myself, of that poor girl he had found down there in her bed of crystal.

He neither saw our approach nor heard it, and we, for our part, did not choose to disturb his reverie.

We passed within twenty feet of the man, but he never knew it. That picture often rises before my eyes—the dark seated figure, immovable, sitting in the very shadow of sadness and doom, gazing away to the south.

"Poor chap!" said Darwin Frontenac. "I wish I knew his thoughts."

"I am glad," I told him, "that mine aren't of the same cast."

"'Tis no pleasant thing truly," he returned, "to know that you are carrying an aortic aneurism in your breast; but there are worse fates."

At this point I find a hiatus in my recollection; I too had fallen into a profound reverie.

"Perhaps you—both of you—will love her, too."

These words were being murmured in my brain when I was suddenly brought back to my immediate surroundings by the voice of Darwin Frontenac.

"What was that?" I queried.

He regarded me for a moment in quizzical fashion.

"Somnambulating, Bond?" he smiled.

"I was thinking. But what was it that you said?"

"I said that our crab-eater is gone."

I looked; there was certainly no seal in sight.

"So it seems."

"Yes," he smiled, "it seems so. He may, however, be hidden by one of these hummocks. We might as well go forward and make sure."

We went forward, to the edge of the lead, but our seal had vanished. A few moments, and we began to retrace our steps.

Again I fell into a reverie—out of which I was jerked by a sharp exclamation from Frontenac.

"Look there!" he cried, pointing.

We were within a hundred yards of the captain, who sat in the very same posture as when we had passed him. Within a few yards of the edge of the floe, a big fin, shaped like a curved dagger, was sinking from sight.

"Killers!" I exclaimed.

There were three of those terrible creatures.

"And look at that!" I cried. "See that stub of a fin! That fellow was one of those that attacked the whale!"

"I recognized the brute!" muttered Darwin Frontenac.

"And see," said I, "they're sounding, too. They are going under the ice, heading in the direction of—"

"Good God!" burst from Frontenac. "They're after the captain!"

(Continued on page 1135)

PATENTS

TRADE MARKS-COPYRIGHTS

PROTECT YOUR IDEAS

ANY NEW article, machine, design or improvement thereof, or any combination of parts or improvements in any known article which increases its efficiency or usefulness, may be patented, if it involves invention.

IF YOU HAVE ANY NEW IDEAS

which you feel are useful, practical and novel, take prompt action to protect your rights. If you have invented any new machine or new combination of parts or improvement, or any new design or process, SEND DRAWING, MODEL OR DESCRIPTION of it for information as to procedure to secure protection.



Drafting and Specification Room of Clarence A. O'Brien, Registered Patent Lawyer, Washington, D. C.

ALL COMMUNICATIONS are held in strict confidence. My personal, careful and thorough attention is given to each case. I offer you efficient, reliable and prompt service—based upon practical experience. Highest references. **NO CHARGE FOR ABOVE INFORMATION.**

WRITE TODAY FOR FREE BOOKS, "HOW TO OBTAIN A PATENT" and "INVENTION AND INDUSTRY" and blank form "RECORD OF INVENTION."

These books will give you valuable information, and they may save you much time and effort. Send for them, NOW. My practice is devoted exclusively to United States and Foreign Patents and Trade Marks. Write me freely, frankly and with full confidence; it is very probable that I can help you.

USE THE COUPON attached, and immediately upon its receipt I shall send you the form Record of Invention to be returned to me with drawing, description or model of your idea; promptly upon receiving your idea I shall write you as to procedure and costs.

CLARENCE A. O'BRIEN

REGISTERED PATENT LAWYER

Member of (COURT OF APPEALS, DISTRICT OF COLUMBIA, UNITED STATES COURT OF CLAIMS;
Bar of (SUPREME COURT OF UNITED STATES, SUPREME COURT, DISTRICT OF COLUMBIA
Practice Confined to Patents, Trade Marks and Copyrights

FREE COUPON

CLARENCE A. O'BRIEN, Registered Patent Lawyer

539C Security Savings and Commercial Bank Building Directly Across Street from Patent Office WASHINGTON, D. C.
Please send me your free books, "HOW TO OBTAIN A PATENT" and "INVENTION AND INDUSTRY" and blank form, "RECORD OF INVENTION," without any obligation on my part.

Name

Address

IMPORTANT—WRITE OR PRINT NAME CLEARLY.

FREE



These books free

U.S. PATENTS

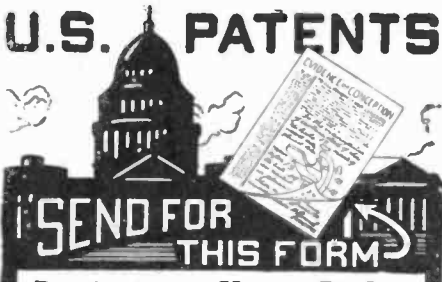

SEND FOR THIS FORM

Don't Lose Your Rights

Before disclosing your invention to anyone send for blank form "Evidence of Conception" to be signed and witnessed. A sample form together with printed instructions will show you just how to work up your evidence and establish your rights before filing application for patent. As registered patent attorneys we represent hundreds of inventors all over the U. S. and Canada in the advancement of inventions. Our schedule of fees will be found reasonable. The form "Evidence of Conception" sample, instructions relating to obtaining of patent and schedule of fees sent upon request. Ask for them,—a post card will do.



Registered Patent Attorneys in U.S. and Canada
255 Ouray Bldg., Washington, D. C.
"Originators of form Evidence of Conception"

PATENTS

TO THE MAN WITH AN IDEA

I offer a comprehensive, experienced, efficient service for his prompt, legal protection and the development of his proposition.

Send sketch, or model and description, for advice as to cost, search through prior United States patents, etc. Preliminary advice gladly furnished without charge.

My experience and familiarity with various arts frequently enable me to accurately advise clients as to probable patentability before they go to any expense.

Booklet of valuable information and form for properly disclosing your idea, free on request. Write today.

RICHARD B. OWEN, Patent Lawyer
164 Owen Building, Washington, D. C.
41 V Woolworth Bldg., New York City

PATENTS

Trade-Marks, Copyrights and Patent Litigation
Write for advice and instructions how to proceed, costs, etc.
Hand Book with Illustrations of 100 Mechanical Movements sent free on request.

ALBERT F. DIETERICH

Patent Lawyer and Solicitor

Successor to Fred G. Dieterich & Co.
602 OURAY BLDG. WASHINGTON, D. C.

INVENTORS PROTECT YOUR IDEAS

Send for our Guide Book, **HOW TO GET A PATENT**, and Evidence of Invention Blank, sent Free on request. Tells our terms, methods, etc. Send

Name

Street

City

model or sketch and description of your invention for instructions. No charge for the above information.

RANDOLPH & CO.

Dept. 172, WASHINGTON, D. C.



PATENT ADVICE

Edited by
A. P. Peck

In this Department we publish such matter as is of interest to inventors and particularly to those who are in doubt as to certain patent phases. Regular inquiries addressed to "Patent Advice" cannot be answered by mail free of charge. Such inquiries are published here for the benefit of all readers. If the idea is thought to be of importance, we make it a rule not to divulge all details, in order to protect the inventor as far as it is possible to do so.

Should advice be desired by mail a nominal charge of \$1.00 is made for each question. Sketches and descriptions must be clear and explicit. Only one side of sheet should be written on.

NOTE:—Before mailing your letter to this department, see to it that your name and address are upon the letter and envelope as well. Many letters are returned to us because either the name of the inquirer or his address is incorrectly given.

RADIATOR DECORATION

(874) James V. Steinman, Wint, Okla., submits a sketch of a device which sketch is reproduced herewith, which is to be attached to the radiator cap of an automobile. As the car pro-



A moving figure such as illustrated above would, when used as a radiator cap decoration, distract the attention of the driver.

ceeds, the breeze created causes the propeller to revolve and through a crank, causes comical movements of the figures. He asks our opinion on a device of this nature.

A. Devices of this nature have been proposed before; they are usually merely passing novelties and do not enjoy a wide sale. In order to sell at all, they have to be very cheaply made and, therefore, their construction will be very flimsy. They will not last long and will soon be discarded. The writer drives a good deal and is sure that he would not want a flapping device such as the one suggested by you in front of him all the time. We would not suggest that you invest any money in this device either toward patenting it or commercializing it.

PERPETUAL MOTION

(875) V. W. Puryear, Rochester, New York, asks what prize this magazine is offering for a perpetual motion machine, and whether or not we will publish a description of the machine in this magazine.

A. 1. This magazine is offering a prize of \$ 5,000.00 for a working model of a perpetual motion machine. The device must measure up to all of the specifications of a perpetual motion machine and a complete working model must be submitted to these offices. **SCIENCE AND INVENTION** Magazine reserves the right to publish the results of any or all investigations along this line. You need not worry that such publication will hurt your chances of developing your machine, for the results will be entirely the opposite. Publication of the details of a device in a magazine protects that device for a period of two years and serves to establish priority in case the inventor desires to apply for a patent.

ROADSIDE SIGN

(876) Walter M. Price, Easton, Pa., submits a design of a proposed improvement on roadside sign post, which is supposed to make the reading of the sign easier. The general idea of the proposed sign is illustrated herewith. He asks our opinion on this subject.

A. 1. We do not think much of your idea for roadside sign posts. The main objection is that the total ad would only be visible from one particular point of the road. Also it would only be visible to those passing in one direction, as those going the other way would not be able to see the sign until they had passed. Ordinary flat roadside signs which are worded properly and painted with contrasting colors are not hard to read, and when they are placed properly can be read by passengers in vehicles going in either direction.

We would not suggest that you apply for a patent on your sign because of the facts outlined above.

(Continued on page 1134)

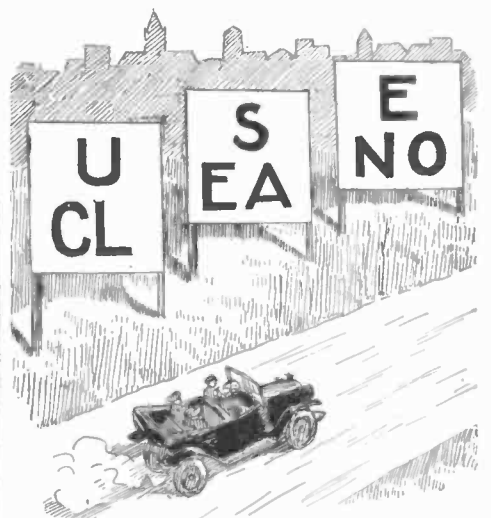

A roadside sign such as illustrated above would be visible from one point only.

PATENTS TRADE-MARKS AND COPYRIGHTS

OUR OFFER:

Your first step

Before disclosing an invention the inventor should write for our blank form "RECORD OF INVENTION." This should be signed, witnessed and returned to us together with model or sketch and description of the invention for INSTRUCTIONS.

NO CHARGE FOR THE ABOVE INFORMATION

Our Four Books Mailed Free to Inventors

Our Illustrated Guide Book

HOW TO OBTAIN A PATENT

Full instructions regarding U. S. Patents. Our Methods, Terms, and 100 Mechanical Movements illustrated and described

OUR TRADE MARK BOOK

Shows value and necessity of Trade Mark Protection. Information regarding *Trade Marks and unfair competition in trade.*

OUR FOREIGN BOOK

We have Direct Agencies in Foreign Countries, and secure Foreign Patents in shortest time and at lowest cost.

Progress of Invention

Description of World's Most Pressing Problems by Leading Scientists and Inventors

ALL COMMUNICATIONS AND DATA STRICTLY CONFIDENTIAL INTERFERENCE AND INFRINGEMENT SUITS PROSECUTED



Private Office, Victor J. Evans, with View of Patent Office Through Window

Highest References Prompt Attention Reasonable Terms

VICTOR J. EVANS & CO., Patent Attorneys

Main Offices: 779-9th Street, N. W., Washington, D. C.

Gentlemen: Please send me FREE OF CHARGE your books as described above.

**FREE
COUPON**

Name.....

Address.....

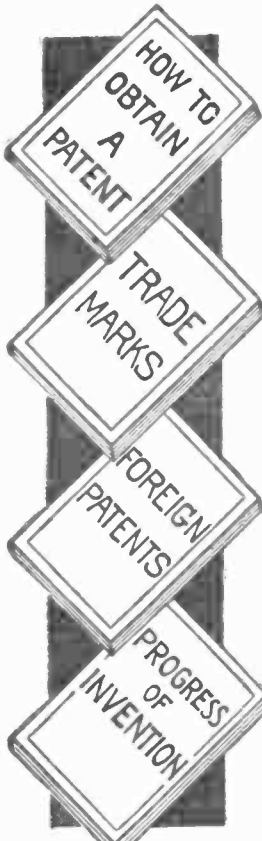

Chicago, Ill., Office
Suite 1114 Tacoma Bldg.



Pittsburgh, Pa., Office
Suite 514, Empire Bldg.

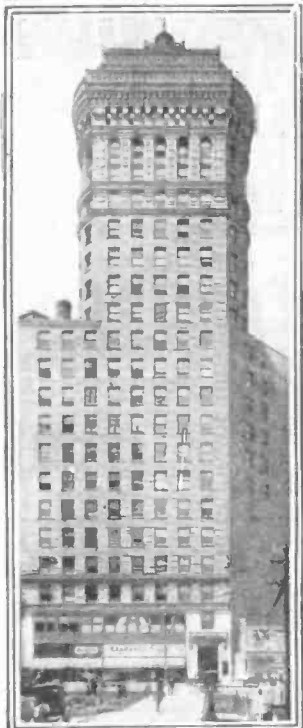

San Francisco, Cal., Office
Suite 1010 Hobart Bldg.

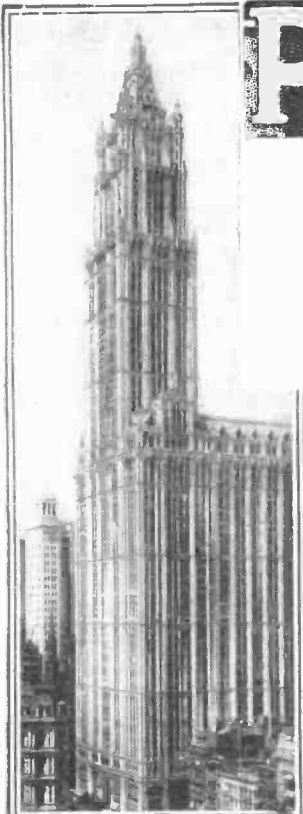

New York Office
Suite 1007 Woolworth Bldg.

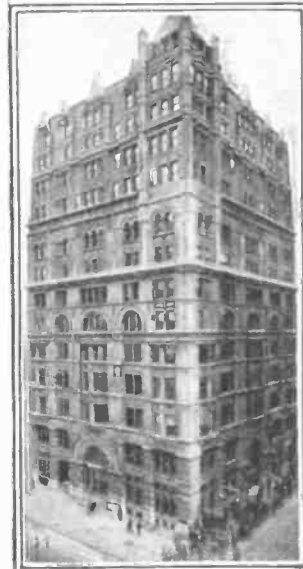

Philadelphia, Pa., Office
Suite 714-715 Liberty Bldg.



Washington, D. C., Office
Victor Bldg.

PRICES REDUCED

Only \$3 Down



A Year to Pay

Yes, lowest prices on **UNDERWOOD, REMINGTON, L. C. SMITH, ROYAL,** and all standard makes on easiest terms ever offered. Re-manufactured like new by the famous "Young Process."

10 Days' Trial—5 Years Guarantee
Our liberal "direct from factory plan" saves half. You actually use the typewriter 10 days without obligation to buy. Let us prove we have the greatest typewriter bargains ever offered. Big saving.

Big Illustrated Catalog Free
This interesting valuable book explains fully how "Young Process of Re-Manufacturing" guarantees you highest quality, perfect service and satisfaction.

YOUNG TYPEWRITER CO. Est. 1911
Send Coupon Now

Young Typewriter Co., Dept. 1163
654 W. Randolph St., Chicago

Send me Free book and Special Reduced Prices. This does not obligate me in any way.

Name.....
Address.....
City..... State.....

EYEGGLASS LENSES

(877) M. D. Nasby, Cedar Falls, Iowa, suggests that a set of colored lenses to be slipped over the regular lenses in eyeglasses, made as illustrated herewith. He wants to know if such device could be patented.

A. 1. There is nothing new in your system of colored lens attachments for eyeglasses. We doubt very much that you could patent an idea of this nature.

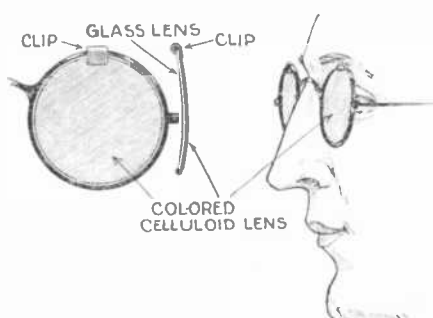

CLIP GLASS LENS CLIP
COLORED CELLULOID LENS

Colored lenses to be clipped over eye glasses as illustrated above are not new and do not constitute patentable material.

TOOTH BRUSH

(878) Homer Randolph, Ravenscroft, Tenn., has designed a tooth brush that is to be manipulated by hand and which produces a rotary motion of the brush unit, thereby enabling the user to brush his teeth with both an up and down and a side motion. He asks whether or not we believe the device to be worthy of a patent.

A. 1. The tooth brush you have designed is not new. As a matter of fact several patents have been taken out on a tooth brush of a similar nature in fact, so similar that we doubt you could secure a patent on your idea.

There is great difficulty in placing a system of this nature on the market, and it certainly would not be an advisable procedure unless you are in a position to market the same yourself. Causing a tooth brush of this nature to whirl around while held upon the tooth will likewise produce a movement of the brush, inasmuch as it cannot be held steadily and is liable to greatly irritate the gums of the user of the device.

QUARTZ SIGN

(879) Richard Freeman, Great Falls, Mont., has designed an electric sign which is to make use of a peculiar property of quartz, whereby the quartz can conduct light around corners. The idea is illustrated in these columns and Mr. Freeman desires our advice on the same.

A. 1. The light delivered from a sign of the type you mention will be rather poor, indeed. We would not advise you to patent the idea for this and one other reason. That is, that quartz is very expensive and the saving in electricity will be so small that it will not be compensated for by the use of the quartz.

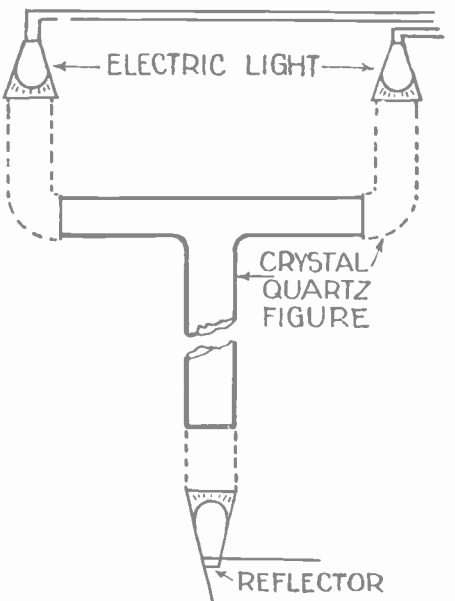

Quartz glass letters such as shown above would be very expensive.

Mason, Fenwick & Lawrence

Trade Mark and Patent Lawyers

Washington, D. C. :: New York :: Chicago

Established over 60 years. Write us.

References: National Confectioners' Association, Chicago; National Cannery Association, Washington, D. C.; Life Savers, Inc., Port Chester, N. Y.; Bon Ami Co. and U. S. Clear Co., New York City; Hershey Chocolate Co., Hershey, Pa.; Stephen F. Whitman & Son, Philadelphia, Pa., and many others.

Inventions protected. Trade marks registered.

TRADE MARKS

PATENTS · DESIGNS
FOREIGN PATENTS

MUNN & CO.

PATENT ATTORNEYS

Associated since 1846 with the Scientific American

618 Woolworth Bldg. 325 Scientific Amer. Bldg.
New York City Washington, D. C.
414 Tower Bldg., Chicago, Ill.
367 Hobart Bldg., San Francisco, Cal.
222 Van Nuys Bldg., Los Angeles, Cal.

PATENTS

As one of the oldest patent firms in America we give inventors at lowest consistent charge, a service noted for results, evidenced by many well known Patents of extraordinary value. Book, Patent-Sense, free. Lacey & Lacey, 644 F St., Wash., D. C. Estab. 1899.

C. L. PARKER

Ex-Member Examining Corps, U. S. Patent Office

Attorney-at-Law and Solicitor of Patents

American and Foreign Patents secured. Searches made to determine patentability, validity and infringement. Pamphlet of Instructions sent upon request

MCGILL BUILDING WASHINGTON, D. C.

Inventions Developed

If you have an undeveloped invention, consult us. We will prepare practical designs for you, also procure your patent rights. Write for FREE BOOKLET.

Manufacturers Patent Co., Inc.

70 Wall St., New York

PATENTS

BOOKLET FREE HIGHEST REFERENCES
PROMPTNESS ASSURED BEST RESULTS

Send drawing or model for examination and report as to patentability

WATSON E. COLEMAN, Patent Lawyer
644 G Street, N. W., Washington, D. C.

INVENTORS

Have your invention patented. Complete information in my booklet "Patents." Copy free.

AMBROSE T. BUCKLEY

Patent Attorney

150 Nassau St. New York City

Get a Handy Binder for your SCIENCE AND INVENTION. Holds and preserves six issues, each of which can be inserted or removed at will. Price 65c. Experimenter Pub. Co., Inc., Book Dept., 53 Park Place, New York.

SEXUAL KNOWLEDGE

320 Pages; Illustrated; Cloth
By Winfield Scott Hall, M.D., Ph.D.
SEX FACTS MADE PLAIN

What every young man and every young woman should know—What every young husband and every young wife should know—What every parent should know.

\$1.00 Postpaid Mailed in plain wrapper

Table contents and commendations on request

AMERICAN PUB. CO., 345 Winston Bldg., Philadelphia

MAKE MONEY AT HOME

YOU can earn good money at home in your spare time making show cards for us. No canvassing or soliciting. We show you how by our new simple instructograph method. We supply both men and women with work at home no matter where you live and pay you cash for all work completed each week. Full particulars and booklet free. Write today.

AMERICAN SHOW CARD SYSTEM, LTD.
110 Adams Building Toronto, Canada

Wrestling Book FREE

Learn to be an expert wrestler. Know scientific wrestling, self-defense, and jiu-jitsu. Develop a splendid physique, and have perfect health. Join this popular school and learn by mail. The famous world's champions—the marvelous

Frank Gotch and Farmer Burns

offer you a wonderful opportunity. Wrestling is easily and quickly learned at home by mail. Men and boys write now for splendid free book. Learn all the science and tricks. Be able to handle big men with ease. Accept this wonderful offer NOW. Send for free book today, stating your age.

Farmer Burns School of Wrestling, 1253 Ranger Bldg., Omaha, Neb.

INVENTORS!

Our facilities to assist you in securing patents, models, capital, etc., and our complete service to members will interest you. Dept. A.

INVENTORS INTERNATIONAL INSTITUTE
15 Park Row, New York

Insure your copy reaching you each month. Subscribe to SCIENCE & INVENTION—\$2.50 a year. Experimenter Publishing Co., 53 Park Pl., N. Y. C.

The Living Death

(Continued from page 1130)

He gave a loud cry. That seated figure slowly turned its head.

"Look out!" yelled Frontenac, starting forward. "Killers!"

I followed.

Captain Livingstone came to his feet. The movement, however, was a slow one; it was clear that he had not caught the dire import of Frontenac's warning.

"Killers!" Darwin yelled. "They're after you!"

THE END OF CAPTAIN LIVINGSTONE

The captain started from the spot in-stanter, heading in our direction. He had taken but three or four steps, however, when the first killer struck.

The ice cracked and heaved, and the man went down flat. In a moment he was up again, but at that very moment the second killer came crashing up, breaking clean through.

The captain disappeared. In a moment, though, as the ice settled, we saw him once more. For the third time he arose. Then it was that the third killer struck.

We were now close, and—how I shudder to think of it, let alone to write it down—we saw that hideous stub fin appear, then we saw the great jaws close on Stanley Livingstone's body.

That scream the man gave—oh, if I could only forget that sound! The killer reared his head high in the air, holding his victim in his mouth as a cat holds a mouse; then he began to sink from sight.

With a cry of horror, Frontenac threw the rifle to his shoulder. The next instant, the sharp report rang out. If the bullet struck the killer, it did so innocuously. It is my belief that it went wild.

The next instant, a second head came up and seized upon the man.

Then the killers were gone with their victim.

Remained only the smashed ice and those horrid stains of scarlet.

CHAPTER XX

SUMMER HAVEN AND A NEW CAPTAIN

It was on the 20th of January that we sighted land. We were running through open pack that day and through a thin fog (lifting now and then) that rendered our surroundings dim and ghostly. But, along in the afternoon—it was about four o'clock—the fog suddenly vanished, when was heard the welcome and thrilling cry:

"Land ho!"

Captain Ben Rainier, from his dead reckoning, had placed the ship's noon position at forty miles from land. Since then, keeping a sharp lookout, we had made twenty-four miles of southing, and there lay the land right where it was supposed to be, distant some fifteen miles.

I say land, but not a spot of land itself was to be seen anywhere. There, however, was the snow that covered it, rising in high rounded masses, and in the background two mighty, majestic peaks towered up, indistinct of outline, lovely as some Turnerian vision and yet grim as terrible sentinels, too.

"Mounts Theodore Roosevelt and Woodrow Wilson," said Captain Ben Rainier.

By seven o'clock we were off the entrance to Multnomah Pass, but here we were held up by pack ice, and it was not until eight in the morning that we got through.

A few minutes then, and we were standing into the entrance. Dark volcanic rock was now visible in places. Then came the first turn and that remarkable mass of rock which Captain Livingstone had named Multnomah Castle.

"Seems like coming home again!" said Ben Rainier. "Poor Captain Livingstone,

FREE

A Valuable Book on Transformers
If You Subscribe Now for

THE LIBRARY OF PRACTICAL ELECTRICITY

The great Croft Pay-raising Set

A Combined reference library and home-study course in practical electricity

No course, no set of books offers a quicker, surer method of mastering electricity than the Croft Library. It is a complete electrical educator. It is founded on practice—on work as it is actually done. It is jammed from cover to cover with the kind of hard-headed facts you want. Written so that the beginner can easily understand it, yet so sound, so thorough, that it is the daily guide of thousands of highly paid electrical workers and engineers.

Croft and success go hand in hand. If your electrical training is obtained from these great books you are certain to win your way to the top.

Know Electricity as Experts Know It Earn Expert Pay

You will never know how easy it is to master electricity until you see the Croft Library.

And you will never know how much a knowledge of electricity means to you in dollars and cents until you gain this knowledge.

The man who knows the most about his work is the man who gets the most in his pay envelope. Croft will teach you as he has taught 40,000 others—teach you by a new, revolutionizing method that saves you time, effort and money. He will teach you electricity as practiced by experts and qualify you for an expert's pay.

These books make promotion sure

The Croft Library contains three thousand pages, with twenty-one hundred of the clearest illustrations ever put into book form. Croft tells you the things you need to know about motors, generators, armatures, commutators, transformers, circuits, current, switchboards, distribution systems—installation, operation and repair of electrical machinery—wiring for light and power—wiring of finished buildings from estimating to completion—Illumination in its every phase—the latest and most improved methods of lighting—lamps and lighting effects, etc.

FREE
with the
Library—
Taylor's
Transformer
Practice
—but you
must start
NOW!

**Will 1925 be
your year?**
Next year you'll
be a year older.
Will you be a
year advanced?
Will your job be
a year better?
Will your pay be
a year bigger?
Act now!

Examine the
Library
Free

SEND
NO
MONEY

We pay all charges—take all the risk. You pay nothing unless you decide to keep the books. Then only \$1.50 in ten days and the balance \$2.00 a month. When your first payment of \$1.50 reaches us, your free copy of Taylor's book will be sent. Act now!

**FREE EXAMINATION
No Money Down**

7c a day pays for this
great pay-raising set

and Taylor's
TRANSFORMER PRACTICE

Free if you act NOW!

Mail this
Coupon!



McGraw-Hill Book
Co., Inc.,
370 Seventh Avenue,
New York.

Gentlemen:—Please send me the Croft Library of Practical Electricity (shipping charges prepaid) for 10 days' free examination. If satisfactory, I will send \$1.50 in ten days and \$2.00 a month until the special price of \$19.50 has been paid. If not wanted I will write you for return shipping instructions. On receipt of my first payment of \$1.50, you are to send me a copy of Taylor's Transformer Practice without charge.

Name.....

Address.....

Position.....

Company.....

S.I.3-1-25

Good Times Waiting



—when you pass this Free, New

Holton TALENT TEST



GOOD times, new friends, big pay—how do you know they couldn't be yours? Hidden to thousands—to you, most likely—is an unsuspected gift for music, waiting only for something to call it forth. That you have hesitated, wondering if you had talent, does not mean that a life-long ambition to play yourself cannot now be turned into delightful, endless hours of reality. Now is provided, by the Holton Talent-Test, a new free method by which thousands are proving they can play this easiest-to-learn of all saxophones, the

Holton New Revelation SAXOPHONE

The Talent-Test is Frank Holton's personal and climaxing contribution in a lifetime of service to music-loving America. In just a few interesting minutes it reveals any hidden talent—measures your musical ability. No obligations, no responsibilities—you determine everything to your own satisfaction.

Your request for booklet brings you appointment card entitling you to the Talent-Test in the privacy of any Holton dealer's studio, or in your own home with the aid of a Holton Saxophone and our copyrighted record on which the Talent-Test is recorded.

FRANK HOLTON & CO.
ELKHORN, WIS.
"America's Greatest Band Instruments"



Without obligation, I want to determine my talent for the easy-to-learn Holton New Revelation Saxophone. (Check below if interested in any other instrument.)
Cornet () Trombone () Baritone () Trumpet ()

Name _____
Street Address _____
Town _____ State _____ (6)

how he wanted to see this place again before he died!"

Came the second turn, the third, and a few minutes later the *Multnomah* was gliding out into the placid waters of Summer Haven.

And there of a sudden rose the column of boiling water from Hero's Fountain, the steam from it ascending to a height of a half mile or more.

At length I went forward and stood beside Nunatak, who was gazing upon the strange scene with a curious, wistful eagerness and in utter silence.

"Well," I queried, "what do you think of it?"

"Think of it! I was just tellin' myself what a queer place this old world of ours really is."

He waved a hand to the southward and said in a lowered voice:

"And *this* is nothin' to what is down *there* somewheres!"

"Nothing."

"Tis my idee," Nunatak added, "that of all livin' men none but yourself and Frontenac there knows what Cap Livingstone found in that place."

"None," I told him.

"And a fine pickle this we are in now!" he ejaculated.

"How so?"

"How so? Why, here we are with this long mush before us, and the Lord only knows what at the end of it, and all our dogs dead in that cursed freezer—dead as so many dried herrin's."

I laughed.

"You wait and see."

"I don't have to wait. I've already seen, ain't I? You tell me this, McQuestion: did you ever see Frontenac bring a dog in that fix back to life again?"

"I never have. But I saw him resuscitate a fish—a fish incased in solid ice."

"A fish! If 'twas some humans, now, that I could name, I could entertain some hopes in the matter; but a dog ain't a fish. No, McQuestion, they're dead, them dogs is; they're dead as sardines. The boss is a fine gink, and all that, and a regular *hyas* 'tyme when it comes to brains; but I'll never be able to forgive him for what he done to them poor dogs."

"So you believe that, if we are to get south, we'll have to tug the sleds ourselves?"

"That's just what we will have to do, unless—"

"Unless what?"

Nunatak leaned closer, and his manner became gravely esoteric.

"Shoot!" I told him.

"Unless," he whispered, "we can harness up a team of these here seals."

"It won't be long," I returned, "before you see all those dogs scampering around the landscape as peppy as they ever were at their peppiest."

"I'll see a canned oyster playin' a tambourine first! I know. When a dog's *memaloose*, McQuestion, he'll never do any more scamperin' around any landscape nor snowscape—unless, that is, it's in them happy huntin'-grounds."

"But look at them geysers. See them spout—like a school of whales. The Valley of Ten Thousand Smokes is a sight for a man to see; but this Summer Haven, I have to admit, sure has got it beat."

"And now, speakin' of our mush after them same palm-trees, and the good Lord only knows what else, I sure do hope, McQuestion, that this here Cap Rainier don't have charge of the provision-supply."

"Why so?"

"Why so? So's we won't have no dearth of *muckymuck*, that's why. Close! Why, that feller is so parsimonious with supplies that, if he owned the air, he wouldn't let a catbird whistle!"

VESCO SMILES AT MILES

ON ONE TUBE
BIG FREE BOOKLET tells the story. California users of CROSS COUNTRY CIRCUIT hear Atlantic Coast, Canada, Cuba, Mexico and Hawaii. Atlantic Coast users hear England to California. Our new plan makes this set easiest and cheapest to build. One hour puts in operation. One tuning control. No soldering. Any novice can do it. BIG BOOKLET FREE or complete instructions for 25c stamps or coin.
VESCO RADIO CO. Box SI-117 Oakland, Calif.

The Traffic Cop of the Air

FERBEND WaveTrap

Add a Ferbend Wave Trap to your Radio Set and "Police" your reception. Regulate traffic. Guaranteed to tune out any interfering station. Widely imitated but never equalled. The original and only successful WAVE TRAP. Now in its third year. Sent Postpaid upon receipt of \$3.50 or C. O. D. plus postage. Send for Free Booklet
FERBEND ELECTRIC CO. 31 E. So. Water St. Chicago

RADIO ENCYCLOPEDIA

Thousands of radio bargains standard sets standard parts for sets, vacuum tubes etc. at one-third less than regular prices. Also latest information on all circuits complete list of broadcasting stations and other valuable data. Send name and address we'll send you 50c book FREE! FREE SERVICE DEPARTMENT. Mr. Deane of N.Y. Etc. World-wide help you save your radio problems and furnish up-to-date information on set construction apparatus improvement. This service FREE to our customers. Write today
NORWALK RADIO CORP.
Dept. 528 66 RADE ST., NEW YORK

Straightens Shoulders

—Increases Pep
THE NATURAL BODY BRACE—Corrects stooping shoulders, straightens the back, gives the lungs chance for normal expansion, induces proper breathing. Brings restful relief, comfort, energy, and pep. For men and women.
Costs nothing to try it
Write for 30 days free trial offer and free book.
NATURAL BODY BRACE CO.
Howard C. Rash, Ft. 286 Rash Bldg., Salina, Kansas

Free Mailing Lists

Will help you increase sales. Send for FREE catalog giving counts and prices on thousands of classified names of your best prospective customers—National, State and Local—Individuals, Professions, Business Concerns.
99% Guaranteed 5¢ each
ROSS-GOULD CO. 513 N. 10th St. St. Louis

SEND FOR THE INTERNATIONAL CATALOG

Our net price list. Full line of auto bodies and accessories for Fords at Wholesale Prices. Save big money on bodies by buying Direct from Factory.
FOR FORD—Prices from \$27.85 up. Factory to consumer direct—Pay only One Profit
International Body Works, 914 W. Ohio St., Dept. 4, Chicago, Ill.

A PERFECT NOSE

shaped at home while you sleep. Rapid, painless and safe. The ANITA is the genuine, unique and most comfortable NOSE ADJUSTER absolutely guaranteed. Highly recommended by physicians. Winner of Gold Medal Feb. 1923. Write for FREE booklet. THE ANITA CO. Dept. 373 Anita Bldg., Newark, N.J.

OWN THE WORLD'S BEST!

Sporting goods, binoculars, telescopes, body armor, ultra modern arms, etc. Catalog L free. Pacific Arms Corp., San Francisco, Calif.

"BECOME A LIGHTNING TRICK CARTOONIST"

Make money chalk talking. Send for snappy program of trick drawings, with instructions by professional cartoonist. Satisfaction guaranteed. Circular free. Balda Art Service, Dept. 4, Oshkosh, Wis.

The ship stood steadily on, drawing in slowly towards the western shore. At length we opened the *Multnomah's* little cove; not far away was the hut, a strange sight and one melancholy too in this deserted and desolate spot. There was but very little snow on these hills, which rose in long gentle swells like waves. And, towering above all, there in the south, were those mighty peaks—twin Rainiers, each rising fifteen thousand feet into the sky, the beauty of them wonderful, grim and awful.

WE DROP ANCHOR

The *Multnomah* turned into the cove. The engine stopped, an anchor was let go, and the ship swung round to her cable and became stationary.

Here we were at last, and the long, long voyage was ended! But the adventure was not ended. Indeed, this was, after a manner of speaking, only the beginning. What awaited us there in the south? What tales would we have to tell on our return—the terrible Gardens of Paradise explored, Sleeping Beauty, in her block of ice, on one of the sleds? If, indeed, we did not leave our bones down there!

But what was the use of addressing questions to Fate? Did she ever give answers? Never any at all. We must wait. Time only would tell—slow, cruel, inexorable Time. Patience was our only consolation. And in the meantime work—work conducive to strength of body; and thoughts—thoughts conducive to strength of heart and strength of soul.

For surely we should need it all.

CHAPTER XXI

"I WISH THAT HE HAD!"

A boat was at once lowered, and Frontenac, Rainier, Nunatak and myself were rowed ashore and went up to the hut.

"Just as we left her," said Ben Rainier. "I shouldn't think," Nunatak remarked, "that visitors would be very frequent in these here parts."

"All the same," Rainier answered, "it wouldn't have surprised me at all if we had found somebody here. I thought some fellow would come—well, to see if our descriptions were exaggerated. Nothing, you know, in all Antarctic history, surprised people more than the discovery of this Summer Haven."

"How about the palm-trees?" queried Frontenac.

Captain Ben Rainier had taken a key from a nail above the entrance to the hut; this he had been on the point of inserting in the padlock. But now he turned and looked at Darwin Frontenac earnestly.

"That was different," he said. "We had proof of this discovery. Do you, after all, actually believe that Captain Livingstone actually did find palm-trees down there?"

"Why not?" "Palm-trees within the Antarctic circle. I'm afraid that I can't believe that."

"Here's Summer Haven." "Summer Haven," returned Ben Rainier, "isn't palm-trees."

"How," Frontenac asked, "do you explain the severed heads of Wilkie, Thompson and Bogardus?"

"I don't believe that their heads were cut off at all. I don't believe that Captain Livingstone knew any more about what became of those men than I know. In short, it is my belief that those severed heads, the palm-trees and all the rest of it, no matter what the rest of it was—all that, delirium!" said Ben Rainier.

"We shall see!" said Darwin Frontenac. Busy were the days that now succeeded, the novelty of our surroundings rendering those days very interesting ones.

Frontenac, Archimedes Bukink, Nunatak and myself moved into the hut forthwith; the others preferred the *Multnomah*.

Try DRAFTING FREE



Charles W. Morey, B.S.—M.E., President Chicago Technical College

FREE Trial Lesson Places Your Future Clearly Before You

IN ALMOST any other field you may be worth \$50 a week, if given a chance to prove it; but in drafting, if you are worth \$50 a week, you can get it without question.

\$35 to \$100 per Week

A big income in Drafting is open to every man . . . Will you join the thousands who earn \$35 to \$100 per week and more? Bear in mind . . . few good draftsmen earn as little as \$35 per week . . . and we can train you to be an expert . . . at home . . . in ten months time or less. No special preparation or talent is required. We have been teaching drafting for 21 years. Thousands of our graduates are in high salaried positions today.

FREE Trial Lesson

We send you, without obligation, a trial home-study lesson. Before you enroll, we want you to know what drafting is like . . . and how we teach by mail. Here is an opportunity to prove your fitness and liking for one of industry's highest-paid professions. Here is vocational guidance of the highest order.

Book of Facts, Free We send you also a 40-page Book. It tells you all about Drafting . . . and our drafting courses. What prominent men say . . . where draftsmen are employed . . . their salaries . . . their opportunities . . . what our students have done and are doing . . . how many have increased their salaries even before finishing their courses.

Professional Work Drafting is a profession of great opportunity. Everything today . . . from skyscrapers to battleships—from monkeywrenches to turbine engines . . . is built from drawings made by draftsmen. The American Bridge Co., alone, employs between 600 and 750 draftsmen. Industry calls for 50,000 new men yearly. The draftsman works hand in hand with the architect, the engineer, the designer, the builder. Is it any wonder that most engineers, architects and designers, high up in their professions today, started as draftsmen?

\$25 Outfit Included When you enroll, you will need drafting instruments; so included in the cost of the course is a \$25 "lifetime" set. If you have instruments, credit will be allowed. Note that we do not claim to give you these instruments "free." Tuition is low—payments, easy.

Today, Mail Coupon Find out what Drafting may mean to you. Prove that you like it . . . that here is a field in which you can work and win. We have made the test easy for you . . . for, with no obligation, we send you a trial lesson, free. Note the fairness of this offer . . . and the absence of exaggerated promises. Mail coupon today.



Chicago Technical College, founded in 1904, is known as "America's Oldest and Largest School of Specialized Engineering." Each year over 1000 men enroll in resident day and evening courses.

Diplomas in Civil, Mechanical and Electrical Engineering and in Architecture are granted at the end of two years. The Degree of B.S. is conferred at the end of three years in the day course. Short courses are also offered in Drafting, Plan Reading, Estimating, etc. Evening classes for day workers.

90% of our students secure positions immediately upon graduation . . . 50% of our students accept part-time positions before graduation.

Home-Study Course from this famous college We offer you . . . by correspondence . . . the same training in Drafting as is offered at the college . . . the same expert engineers for your instructors . . . the same help in securing positions.

Opportunities in Chicago to Earn while you Learn For those who can come to Chicago, there is a splendid opportunity to learn Drafting, Engineering or Architecture while earning expenses in part-time positions. If interested, write for 62 page Blue Book.

CARPENTERS, BRICKLAYERS and men in BUILDING TRADES—Send for Home-Study

Catalog B and Free Book "How to Read Blue Prints" Increase your worth by mastering Plan Reading, Estimating, Superintending and higher branches of building, fully covered in the Chicago Technical Builders' Course.



Chicago TECHNICAL College

Dept. 345-B, 118 East 26th Street, Chicago

CHICAGO TECHNICAL COLLEGE
 Dept. 345-B, 118 E. 26th Street
 Chicago, Illinois

TRIAL LESSON FREE

Name _____
 Address _____
 City _____
 State _____

GENTLEMEN: Send me, without cost or obligation, your free Vocational Test Lesson and your 40-page Book of Facts About Drafting.



Was *this* part of your marriage contract?

DID you tell her that she would have to do the washing? That she would have to wear last year's clothes? That she would have to skimp and save to buy even the necessities of life?

For her sake—for the sake of the children who are growing up—for *your own sake*—don't let the precious hours of spare time go to waste.

Make up your mind right now that not another day shall pass until you make your start toward success. Simply say "I will," and the International Correspondence Schools will come to you with the very help you need. Do it to-day!

Mail the Coupon for Free Booklet!

INTERNATIONAL CORRESPONDENCE SCHOOLS

Box 6201-D, Scranton, Penna.

Without cost or obligation on my part, please tell me how I can qualify for the position or in the subject before which I have marked an X.

BUSINESS TRAINING COURSES

- | | |
|--|---|
| <input type="checkbox"/> Business Management | <input type="checkbox"/> Salesmanship |
| <input type="checkbox"/> Industrial Management | <input type="checkbox"/> Advertising |
| <input type="checkbox"/> Personnel Organization | <input type="checkbox"/> Better Letters |
| <input type="checkbox"/> Traffic Management | <input type="checkbox"/> Show Card Lettering |
| <input type="checkbox"/> Business Law | <input type="checkbox"/> Stenography and Typing |
| <input type="checkbox"/> Banking and Banking Law | <input type="checkbox"/> Business English |
| <input type="checkbox"/> Accountancy (including C.P.A.) | <input type="checkbox"/> Civil Service |
| <input type="checkbox"/> Nicholson Cost Accounting | <input type="checkbox"/> Railway Mail Clerk |
| <input type="checkbox"/> Bookkeeping | <input type="checkbox"/> Common School Subjects |
| <input type="checkbox"/> Private Secretary | <input type="checkbox"/> High School Subjects |
| <input type="checkbox"/> Spanish <input type="checkbox"/> French | <input type="checkbox"/> Illustrating |

TECHNICAL AND INDUSTRIAL COURSES

- | | |
|---|--|
| <input type="checkbox"/> Electrical Engineering | <input type="checkbox"/> Architect |
| <input type="checkbox"/> Electric Lighting | <input type="checkbox"/> Architects' Blue Prints |
| <input type="checkbox"/> Mechanical Engineer | <input type="checkbox"/> Contractor and Builder |
| <input type="checkbox"/> Mechanical Draftsman | <input type="checkbox"/> Architectural Draftsman |
| <input type="checkbox"/> Machine Shop Practice | <input type="checkbox"/> Concrete Builder |
| <input type="checkbox"/> Railroad Positions | <input type="checkbox"/> Structural Engineer |
| <input type="checkbox"/> Gas Engine Operating | <input type="checkbox"/> Chemistry <input type="checkbox"/> Pharmacy |
| <input type="checkbox"/> Civil Engineer | <input type="checkbox"/> Automobile Work |
| <input type="checkbox"/> Surveying and Mapping | <input type="checkbox"/> Airplane Engines |
| <input type="checkbox"/> Metallurgy <input type="checkbox"/> Mining | <input type="checkbox"/> Agriculture and Poultry |
| <input type="checkbox"/> Steam Engineering <input type="checkbox"/> Radio | <input type="checkbox"/> Mathematics |

Name.....
 Street..... 3-6-24
 Address.....
 City..... State.....

Occupation.....
 Persons residing in Canada should send this coupon to the International Correspondence Schools Canadian, Limited, Montreal, Canada

Deafness



Perfect hearing is now being restored in every condition of deafness or defective hearing from causes such as Catarrhal Deafness, Relaxed or Sunken Drums, Thickened Drums, Roaring and Hissing Sounds, Perforated, Wholly or Partially Destroyed Drums, Discharge from Ears, etc.

Wilson Common-Sense Ear Drums

"Little Wireless Phones for the Ears" require no medicine but effectively replace what is lacking or defective in the natural ear drums. They are simple devices, which the wearer easily fits into the ears where they are invisible. Soft, safe and comfortable. Write today for our 168 page FREE book on DEAFNESS, giving you full particulars and testimonials.

WILSON EAR DRUM CO., Incorporated
 743 Inter-Southern Bldg. LOUISVILLE, KY.

Insure your copy reaching you each month. Subscribe to Science and Invention—\$2.50 a year. Experimenter Publishing Co., 53 Park Place, N. Y. C.

On the third day a big killer whale—he must have been thirty feet in length—rose near the ship, which apparition elicited from Nunatak some solicitude on the score of Mr. Orca Gladiator's health: the change from the icy waters of the sea to this warmth of Summer Haven might, quoth Nunatak, "give the poor critter pneumonia."

THE DOGS BROUGHT TO LIFE

It was on this day, too, that Darwin Frontenac began the resuscitation of the dogs. I was the only witness of the actual restoration itself, which was by no means so simple and easy a matter as the suspending of the vital functions had been.

And never shall I forget that look on Nunatak's face when I brought the first dog up on deck, Skookum by name—the creature as bright-eyed and frisky as though he had just been aroused from a natural snooze.

The musher stared, rubbed his blue eye and stared again, rubbed his black eye and stared harder than ever.

"Can it really be!" he exclaimed. "Is it really you, Skookum—after bein' dead for so long?"

He dropped to his knees, hugged the dog to him and rocked him back and forth, murmuring endearing swear words.

"And I thought that he couldn't do it! Yes, Skookum, old *tillicum* (partner), I thought that Frontenac had murdered you and all the rest, that you was all as dead as so many canned lobsters. But I'll never doubt the boss no more. He can do anything. He's goin' to find them same palm-trees, that everybody thought was so many pipe-dreams, and the good Lord only knows what else besides. I'll head with him for hell itself—and may be that's where we are goin', Skookum—and I'll never ask a single question but just mush along after."

The others were crowding around, gazing at the dog in wonder and perhaps in awe.

I left them and returned to Frontenac.

On being removed from the freezer—five were taken at a time, after the revivification of Skookum—the dogs were placed in another room, the temperature of which stood at thirty-two degrees Fahrenheit. It was slowly increased. At the end of an hour it was fifty degrees. Frontenac now used his antidote. This was a bright purple fluid, its appearance unpleasantly oily, and it was injected into the neck. I tasted this stuff, at Frontenac's suggestion and assurance that it was perfectly innocuous. It had an indescribable, sweetish taste—the strangest imaginable. There was no effect whatever that I was aware of, except a slight tingling on the tongue.

"Weak stuff, after all," I remarked.

Darwin Frontenac smiled a little.

"That's because you are warm."

"Warm?"

"Just so. If your body was cold like these, the effect, I fancy, would be powerful enough—though, of course, you wouldn't be aware of that."

"Then the warmth neutralizes it?"

"I suppose one could put it that way."

"Why, then, did you bring them here?"

They were colder there in the freezing-room."

"Because the action of the antidote alone will not raise the body to a blood temperature. And, besides, raising the temperature of the body is not its real function, though a very important one, I admit. It's real action—and without that action recovery from a state of suspended animation would be impossible—is upon the blood."

"But," I said, "the blood is not circulating. As far as any vital process is concerned, the animal is as dead as a doornail. How, then, can this antidote be absorbed, permeate the whole circulatory system?"

One Radio Book Everyone Reads

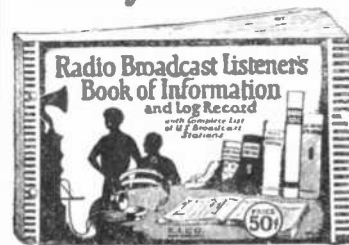

The Radio Broadcast Listener's Book of Information and Log Record

is not only a complete, practical book of those essential Radio facts that everyone who owns a radio should know, but it is also a handy log record for those who want to keep a record of the stations they receive. The book is enclosed in a handsome two-color cover, bound in Loose-leaf fashion, so that new pages can be inserted if necessary. It contains 80 pages, each one containing information more valuable than the last. The following is a brief summary of the information contained in this book:

- Information for the Broadcast Listener: Vacuum Tube Table; Meter wave lengths; Radio Batteries; Wireless code chart; Station log chart;
- Complete list of Broadcast Stations of the United States, giving Power, wave length, and Time of Operation each day of the week. Log Sheets for tabulating the dial settings of the stations you receive on your radio. Size of Book, 6 in. by 9 in., with handsome 2-color cover.

Postage **PRICE 50¢** Paid

Published by THE E. I. COMPANY
 The Consrad Company
 Sole Distributors
 233 Fulton St.
 New York, N. Y.

Consrad

"RADIO'S FOREMOST PUBLISHERS"



Make Money! Taking Pictures!

Women delighted with new dignified pleasant way to make \$50 and more a week.
 We train you quickly at home. No experience necessary. Spare time or full time. Professional camera free. Photographs in big demand by magazines, newspapers, advertisers, etc. Also train you to take better portraits than the average professional photographer! Equip you to make \$50 to \$100 a week in business of your own. New plan. Nothing else like it. Write today for amazing details.

International Studios, Inc.
 Dept. 1423 3601 Michigan Ave., Chicago, Ill.

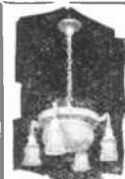

"LIGHTING FIXTURES"

READY TO HANG
 Direct from manufacturer.
 Completely wired including glassware.
 Send for Catalogue No. 26
 (Just off the Press)

Special Proposition to Dealers
ERIE FIXTURE SUPPLY CO.
 Desk B Erie, Pa.

Insure your copy reaching you each month. Subscribe to SCIENCE & INVENTION—\$2.50 a year. Experimenter Publishing Co., 53 Park Pl, N. Y. C.

"I think," Frontenac returned, a smile somewhat esoteric on his lean features, "that a little reflection will give you the answer to that."

For some time after the injection of the antidote—twenty or thirty minutes—there was no perceptible change whatever in the body. But, though not perceptible, a great change was taking place—a change that, at the expiration of the time mentioned, began to make itself manifest. The eyes began to lose that weird, horrible glassiness, the limbs their terrible rigidity. And at length the heart—so long stilled—began to beat and the animal to breathe.

A few minutes, and the animal would yawn and stretch himself, then get up and move around as though nothing untoward had happened to him.

That first day fifteen of the dogs were restored to life, so to speak. The next twenty-five, the day following thirty-two, and the fourth day saw the last body taken from the freezing-room.

Then I would think of Sleeping Beauty, and strange, indeed, were the thoughts that came to me at such moments. Was she really in that strange state that men called one of suspended animation? Was her soul locked up within her body there in her tomb of paleocrystic ice, or was it a corpse that was imbedded there? Poor little kid!

For a time we were exploring around and recovering our land legs, which I was very glad, certainly, to get under me once more.

And for a time our plans were uncertain. Should we lay down depots, then go into winter quarters here at Summer Haven, or should we at once begin our march for the Gardens of Paradise and winter there?

There was much to be said on both sides, and much discussion did we have upon the subject. To pass the winter among the palm-trees—if, that is, we could keep our heads on our shoulders—would, from a scientific point of view, and, indeed, from any other, be an experience replete with extraordinary interest. But, on the other hand, there was our lack of experience to be considered and the uncertainty with regard to the supply of food. To take grub along sufficient to tide us through the winter was out of the question. Could we depend upon providing the necessary food-supply after reaching that wonderful and terrible place? It was Frontenac's belief that we could. Such, too, was my own.

However, the decision which we reached was to get down depots as far to the south as we could, go into winter quarters at Summer Haven and start for the Gardens of Paradise in the spring.

So now came the depot journeys. Three times we left Summer Haven, our faces to the south. On the third journey—"mush" in the vernacular of Louis Louisiana—we got our depot twenty miles or so beyond Captain Livingstone's Depot Number Three. "Everything so far," said I, "is just as poor Livingstone described it."

"And so," said Darwin Frontenac, "will be everything else. The fate of the discoverer seems to be a hard one—Columbus in chains, Galileo on his knees, our Captain Stanley Livingstone a man grievously, cruelly wronged."

Nunatak turned his face to the southward, and his gaze was a strange and wistful one.

"Palm-trees!" he murmured. "I wish, now, that I knew everything that poor Cap Livingstone found down there."

"So do I," Frontenac said, a wan smile passing athwart his lean face. "Bond and I know what he saw."

"Well," the musher queried, giving the other a quizzical look, "didn't he see what he found?"

"Not in every instance," was Frontenac's answer. "I wish that he had!"

(To be continued)

Your Lifetime Opportunity to Learn Newspaper Work

250 COURSES AT SPECIAL REDUCED RATE

YOU CAN LEARN NEWSPAPER WORK

Experienced Editor Will Teach You How to Become a Reporter

FASCINATING WORK—GOOD PAY

Only a Few Months' Work Required to Qualify You for a Better Position

Regular reporters earn from \$40 to \$125 a week. Good deskmen on a daily paper are paid from \$60 to \$100 a week. A "Star" Reporter can command his own salary. Hundreds of ambitious men and women enhance their income materially by corresponding for newspapers or writing for magazines in their spare time.

We Will Teach You at Home

We can develop your talent for writing and lead you into this well paying profession. Our Practical Course in Journalism was personally prepared by Henry J. Brockmeyer, Assistant City Editor of the New York Evening Post. Mr. Brockmeyer has trained hundreds of men and women, many of whom have, under his guidance, developed into front rank reporters or feature writers.

Mr Brockmeyer's course will teach you what it would take years of actual newspaper work to learn. It consists of six comprehensive lessons just brimful of everything a reporter must learn. The following are only a few of the subjects covered.

Starting in Journalism. What is a Newspaper? What is News? Start and Finish of a News Story. Technical Terms. The Type Point System. Styles of Type, Proof Reading. Capitalization and Punctuation. A Late Fire Bulletin. Court Stories. Libel Laws, Copyright. Hints to Reporters. Personal Conduct. Re-Writing and Condensing Stories. Paragraphs and Short Items. Good and Bad Styles. Broadening the Vocabulary. Aids to Good Style. Special Stories. Suggestions for Stories. Rhetoric. Preparing Your Story. Don'ts for Writers. Office Organization. Syndicated Matter. Business Office. Mechanical Department. Hints for Headline Writers. The Make-Up. The Country Correspondent, etc., etc.

ORIGINAL
Price of
Course \$10
Complete
Course Now
Special at
\$2.98

Send No Money!

Just mail your name and address and we will forward the course to you, upon receipt of which you pay the postman \$2.98 plus a few cents postage.

ORIGINAL
Price of
Course \$10
Complete
Course Now
Special at
\$2.98

Send No Money!

Just mail your name and address and we will forward the course to you, upon receipt of which you pay the postman \$2.98 plus a few cents postage.

Only 250 at this Special Price—Applicants will receive preference as letters are received

-----USE THIS COUPON-----

THE PRESS GUILD, INC.
66-R West Broadway, New York, N. Y.

Please mail me Henri J. Brockmeyer's complete Course in "Practical Journalism" at \$2.98 which I will pay to the postman upon receipt of books.

Name
Address
City State

Reading Architects' BLUE PRINTS

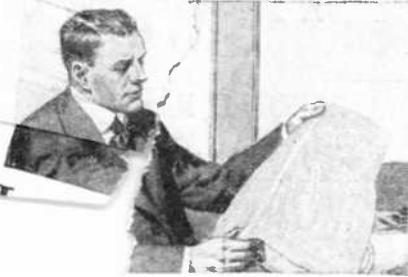

Learn at Home!

Building trades are booming. Employers everywhere are looking for men can read architects' blue prints. Splendid salaries and rapid advancement are offered men who have this special training.

There is an easy, delightful way to learn. The International Correspondence Schools will teach you right at home in an hour a day of the spare time that now goes to waste.

You will like the course because it is so PRACTICAL. You work on actual blue prints—the same blue prints a contractor would use if asked for an estimate, or a foreman would receive from a contractor.

In a surprisingly short time you can acquire a knowledge of blue prints that will be of great value to you in a salary way the rest of your life.

Mail the Coupon To-day!

INTERNATIONAL CORRESPONDENCE SCHOOLS
Box 6199-D, Scranton, Penna.

Without cost or obligation on my part, please tell me how I can qualify for the position or in the subject before which I have marked an X:

- | TECHNICAL AND INDUSTRIAL COURSES | |
|--|---|
| <input type="checkbox"/> Architects' Blue Prints | <input type="checkbox"/> Electrical Engineering |
| <input type="checkbox"/> Contractor and Builder | <input type="checkbox"/> Electric Lighting |
| <input type="checkbox"/> Architectural Draftsman | <input type="checkbox"/> Mechanical Engineer |
| <input type="checkbox"/> Concrete Builder | <input type="checkbox"/> Mechanical Draftsman |
| <input type="checkbox"/> Structural Engineer | <input type="checkbox"/> Machine Shop Practice |
| <input type="checkbox"/> Chemistry <input type="checkbox"/> Pharmacy | <input type="checkbox"/> Railroad Positions |
| <input type="checkbox"/> Automobile Work | <input type="checkbox"/> Gas Engine Operating |
| <input type="checkbox"/> Airplane Engines | <input type="checkbox"/> Civil Engineer |
| <input type="checkbox"/> Agriculture and Poultry | <input type="checkbox"/> Surveying and Mapping |
| <input type="checkbox"/> Mathematics | <input type="checkbox"/> Metallurgy <input type="checkbox"/> Mining |
| | <input type="checkbox"/> Steam Engineering <input type="checkbox"/> Radio |
| BUSINESS TRAINING COURSES | |
| <input type="checkbox"/> Salesmanship | <input type="checkbox"/> Business Management |
| <input type="checkbox"/> Advertising | <input type="checkbox"/> Industrial Management |
| <input type="checkbox"/> Better Letters | <input type="checkbox"/> Personnel Organization |
| <input type="checkbox"/> Show Card Lettering | <input type="checkbox"/> Traffic Management |
| <input type="checkbox"/> Stenography and Typing | <input type="checkbox"/> Business Law |
| <input type="checkbox"/> Business English | <input type="checkbox"/> Banking and Banking Law |
| <input type="checkbox"/> Civil Service | <input type="checkbox"/> Accountancy (including C.P.A.) |
| <input type="checkbox"/> Railway Mail Clerk | <input type="checkbox"/> Nicholson Cost Accounting |
| <input type="checkbox"/> Common School Subjects | <input type="checkbox"/> Bookkeeping |
| <input type="checkbox"/> High School Subjects | <input type="checkbox"/> Private Secretary |
| <input type="checkbox"/> Illustrating | <input type="checkbox"/> Spanish <input type="checkbox"/> French |

Name Street City State
Address
City State

Occupation
Persons residing in Canada should send this coupon to the International Correspondence Schools Canadian, Limited, Montreal, Canada.

Agents Wanted!

Salesmen-Distributors

to use and introduce attachment that makes Ford's run on 94% air. THERMOSTAT on exhaust automatically turns down needle valve as engine warms exactly as Ford Manual says do by hand.

Blanche Auto Thermo

An Automatic Carburetor Control Makes Ford's start easier winter or summer—saves half gas and oil—cuts repair bills one-half—reduces carbon formation one-half. Sells on sight to every Ford owner as easily as giving him a \$100 bill, because it saves \$100 every 10,000 miles. Cadillac now uses as standard equipment thermostatic carburetor control under Blanche license. You can make Big Money selling this wonderful proven device. Experience not necessary. Blanche plan will start you without capital in a business of your own that makes you from \$250 to \$2,000 a month profit.

Write for free circulars Now!

A. C. Blancke & Co. 602 W. Lake Street Dept. 1021 Chicago

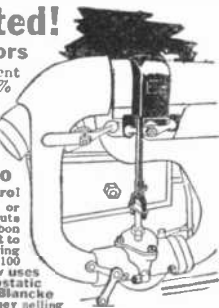

Doctor Hackensaw's Secrets

By CLEMENT FEZANDIÉ
(Continued from page 1095)

fix in which I find myself to-day. You must know that Robert Houdin in his memoirs tells about a trip he made to Algeria on behalf of the French government. There was a plot on foot for an uprising of the natives and the French decided wisely that to send a prestidigitator like Robert Houdin to the affected provinces would impress them far more than the finest army they could organize. The course of events showed the wisdom of their act. Houdin's feats of magic convinced the natives that the whites were powerful magicians and all idea of revolt was nipped in the bud. To see Robert Houdin allow one of their chiefs to load a pistol with a marked bullet, and shoot at him, and then see Houdin catch the marked bullet in his teeth, convinced them that the French were invulnerable.* And when Robert Houdin shot the same bullet at a white wall and drew blood from the wall (a wax bullet filled with blood was used), their astonishment knew no bounds.

"Then, to cap the climax, Houdin asked that the strongest man in the audience should come forth, and offered to take away all his strength and leave him weaker than a woman.

"The challenge was accepted by a husky fellow who had a well-earned reputation for strength. He came forward smiling, and when Robert Houdin asked him if he could lift a fifty-pound iron chest, the fellow scornfully put out his left hand and lifted the box with ease.

"Very well," said Houdin, "now I'm going to take all your strength away from you and leave you weaker than a woman." He made a few passes with his hands before the man's face, and then said, "Now, try to lift that box!"

"The fellow with still greater scorn than before put forth a hand. But the box resisted. Amazed, the man clasped the box with both hands, and bracing himself exerted every particle of strength of which he was capable. His muscles stood out from his body like sinewy cords, and the perspiration dripped in streams from his body, but he was unable to budge the box an inch. Then the poor fellow fell on his knees and begged Houdin to give him back his strength. And, of course, the clever Frenchman did so. A few reverse passes and the man was again able to lift the box with ease."

"That was clever," said Pep. "How was the trick managed?"

"Simply enough. The iron casket rested on a powerful electromagnet. When there was no current, the box was easy to lift. When the current was turned on, however, the powerful current caused the box to adhere to the floor so firmly that it was very difficult to move.

"Well, Miss Pep, you may perhaps know that there has been a recent uprising in the African possessions of one of the European powers. I chanced to meet the ambassador of this power, and remembering Robert Houdin's success I thoughtlessly boasted that I could put down the revolt alone, and without any bloodshed.

"He took me up at once, and the result is that you and I, Pep, are now traveling

*Note.—To perform this trick, Robert Houdin used a special ramrod. In the gun was a loose tube into which the powder and marked bullet were rammed. The ramrod fitted tightly into this tube, so when Houdin pulled out the ramrod, the bullet came with it and he was able to place it in his mouth, unperceived.

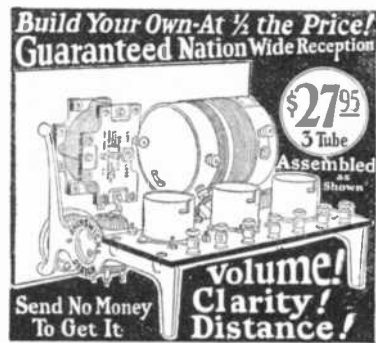

Build Your Own At 1/2 the Price!
Guaranteed Nation Wide Reception

\$27.95
3 Tube Assembled

volume! Clarity! Distance!

Send No Money To Get It

THE NEW DE LUXE AMBASSADOR
With Special Features—Can Be Wired Easily—Quickly

THIS kit enables you to build a set that will compare with any factory built set. Will bring in all the distance you want—loud, clear, distinctive. Wiring and assembling chart that comes with kit, makes building simple, easy. Plug in ear phones or loud speaker and get Princeton or New York. By building it yourself you save 60%.

KIT CONSISTS OF

- 1 Drilled 7x10 Mahogany Cabinet, Engraved in Gold.
- 1 Genuine Ambassador Master 3-Circuit Litzendracht Tuning Coil.
- 1 Genuine Brunswick Low Loss Condenser.
- 1 Triploid Mounting Socket.
- 1 Premier Hegehog Audio Transformer.
- 4 Brunswick Underlug Foundation Brackets.
- 2 Brunswick Jacks with Gold-Plated Fronts; 1 for phones; 1 for loud speaker.
- 1 Freshman Mica Grid Condenser.
- 1 Standard Glass-Enclosed Grid Leak.
- 2 30-Ohm Shackton Bakelite Rheostats.
- 2 Moulded Mahogany Dials grained to match panel.
- 1 Length Professional Round Bus Bar.
- 1 Set of 7 Instrument Finish Blinding Posts completely mounted.
- 1 Special Blue Print for this circuit. Not an ordinary hook-up, but in clear picture form any child can understand and make.

All packed in handsome box. Complete \$27.95 c.o.d. Only

Send no money—just mail postal or letter today. Written money buy guarantee with every order. **RADIO SHACK, America's Largest Radio Dealers, 65 Vesey St., Dept. C19 New York.**

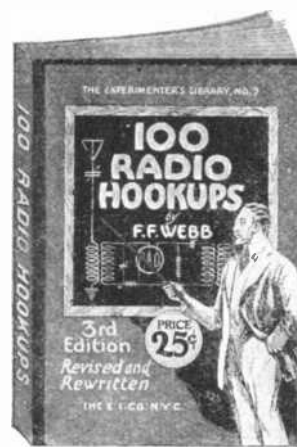

100 HOOKUPS
3rd REVISED EDITION
ENLARGED
New Material, Modern Circuits,
Complete Diagrams
Price 25c

At Your Radio or News Dealer
Distributed by
THE CONSRAD CO.
233 Fulton St., New York, N.Y.

13 WEEKS FOR 15 CENTS

The Pathfinder

SHOWS THE WAY THROUGH THE JUNGLE OF EVENTS

You've heard your neighbor praise this wonderful weekly magazine that 3 million people read. Unbiased digest of national and world affairs. Check full of the kind of reading you want. Science, politics, travel, fun, question box, books, health, home, radio—entertainment and instruction for all. Send 15c (coin or stamps) today for this paper on trial 13 weeks, or \$1 for 1 year (52 issues). **PATHFINDER, 586 Langdon St., Washington, D. C.**

MAKE MONEY SELLING MADISON SHIRTS

Direct from our factory to wearer. Easily sold. Over one million satisfied wearers. No capital or experience required. Large steady income. Many earn \$100 to \$150 weekly. Territory now being allotted. **Write For Free Samples.**

MADISON MILLS MFRS., 562 B'way, New York

Insure your copy reaching you each month. Subscribe to **SCIENCE & INVENTION—\$2.50 a year.** Experimenter Publishing Co., 53 Park Pl., N. Y. C.

together to Africa, and that we two are expected to nip in the bud this uprising of thousands of Arabs and negroes."

"Gee!" exclaimed Pep, much impressed. "You didn't tell me I was going to war! You'll have to appoint me general-in-chief. Well, I'm ready now to hear about the radium. I suppose you are going to use that walking skeleton to frighten the natives."

"Precisely. The figure is really solid—not a skeleton at all, but the metal surface is so brightly polished that it is practically invisible except the ribs and other bones which are painted with a composition of my own invention. I could have used phosphorescent paint, but I concluded I could get better results with radium emanation. I suppose you know what radium emanation is?"

"Not exactly."

"If you dissolve some radium chloride in water, the radium will be found to have lost most of its radio-activity and will not regain it for a month—the time required to produce a new stock of emanation. The emanation is really in the water and can be obtained in the form of a gas. It is this gas—this radium emanation and not the radium itself—that produces the principal effects attributed to radium. The life of this emanation is short, however, for in four days it has lost half its activity.

"For my purpose, however, this shortness of life is of no consequence. My skeleton, as you have probably surmised, is an automatic figure which I can control from a distance by radio. Different lengths of waves will cause different portions of the figure to move. I can make it walk, dance, gesticulate and even talk by means of a phonograph inside. As you probably know, radium emanations to become phosphorescent must be thrown on a screen. Originally it was platino-cyanide of barium that was used for the fluorescent screen, but I use a special powder of my own which I mix with the gas—that is, the radium emanation, and I blow the two together through suitable openings in the body of the skeleton, utilizing the force of the compressed gas for the jet. This enables me to make the skeleton luminous or dark at will, so that the skeleton seems to vanish and reappear. By using different powders with the emanation I can produce fluorescence of different colors. But what is the use of explaining. To-morrow night you will get a practical demonstration."

CHAPTER III

In the rebel camp there was great activity, for the morrow was to see the first real battle between the Arab and negro troops and the enemy's soldiery. General Blank, at the head of the government army, had received orders to try conciliation, and under no circumstances to commence or provoke hostilities, but he realized full well that the rebels were massing their forces and that the morrow would see the first real hostilities. He had only scorn for Doctor Hackensaw's project of frightening the natives, but he placed all facilities at the doctor's disposal.

And that night, about midnight, the walking skeleton made its first appearance in front of the rebel camp. The sentinels suddenly saw appear before them a giant skeleton with luminous bones shining with a baleful greenish fire! The skeleton uplifted its hands and came forward, its jaws working, as by means of an amplifying device it thundered forth the words: "Balek! Balek! Balek!" the Arabic equivalent of "Beware! Beware! Beware!" The sentinels shot at the figure and it suddenly vanished from their sight with a loud mocking laugh, and then reappeared some distance away and repeated its cry again. The whole camp was now up in alarm, and they all saw with terror the figure appear a third time. Then it vanished and was seen no more that night.



Give us Telephones

Following the war, when business and social life surged again into normal channels, there came the cry from homes, hospitals, schools, mills, offices—"Give us telephones." No one in the telephone company will ever forget those days.

Doctors, nurses and those who were sick had to be given telephones first. New buildings, delayed by war emergency, had to be constructed, switchboards built and installed, cables made and laid, lines run and telephones attached.

The telephone shortage is never far away. If for a few years the telephone company was unable to build ahead, if it neglected to push into the markets for capital and materials for the future's need, there would be a recurrence of the dearth of telephones. No one could dread that eventuality so much as the 350,000 telephone workers.

Bell System engineers measure and forecast the growth of communities; cables, conduits, switchboards and buildings are planned and developed years ahead of the need, that facilities may be provided in advance of telephone want. Population or business requirements added to a community must find the telephone ready, waiting.



AMERICAN TELEPHONE AND TELEGRAPH COMPANY
AND ASSOCIATED COMPANIES
BELL SYSTEM
One Policy, One System, Universal Service

WANTED

RAILWAY POSTAL CLERKS

\$1600 to \$2300 Year

TRAVEL—See your country
MEN—BOYS. 18 UP
SHOULD MAIL COUPON IMMEDIATELY
Steady work. No layoffs. Paid Vacations
Common Education Sufficient



COUPON
FRANKLIN INSTITUTE,
Dept. A182, Rochester, N. Y.
Sirs: Send me without charge: (1) Sample
Railway Postal Clerk Examination coaching
lessons; (2) Schedule showing places of coming
U. S. Government examinations; (3) List of many
Government jobs now obtainable.
Name
Address

Week

Business

EARN big money as a cartoonist!
Millions of dollars were spent last year on comic strips, political and sport cartoons, animated cartoons, etc. Thousands of new cartoonists are needed now to meet the ever-increasing demand for this work. Never before have the opportunities

in this fast-growing field been so many, so varied or so high-paying.

Easy to Learn CARTOONING at Home in Spare Time

Regardless of how little you know about cartooning now, you can easily qualify for a position in this attractive, high-salaried business. This home-study method starts you at the simplest fundamental principles of cartoon-making and takes you through every branch of humorous and serious cartooning. You will be amazed at how quickly it teaches you to draw salable work. Many students of this method began to sell their drawings before they were half through their courses. The training paid for itself long before they finished it.

Learn cartooning this easy way. Enjoy the fascinating life of a successful cartoonist—easy hours, freedom from routine, your own boss, and \$3,000 to \$15,000 a year for this work that is play!

Send for FREE BOOK

Learn more about the wonderful opportunities in Cartooning, and details about this remarkable home-study method. A handsomely illustrated booklet has just been prepared which, upon request, will be sent to you without the slightest obligation. This booklet gives a thorough outline of the cartooning field, and explains in detail this wonderful new method of teaching Cartooning. Send for it today! Washington School of Cartooning, Room 263C, 1113-15th St., N.W., Washington, D.C.



Washington School of Cartooning
Rm. 263C, 1113-15th St., N.W., Washington, D.C.
Please send me, without obligation, your Free Booklet on Cartooning and full details of your home-study method of teaching Cartooning.

Name
(Print Name Plainly)
Address
City State
(If under 16, please give age.....)

Play a Conn SAXOPHONE

This Free Book tells about exclusive features which make the Conn easiest of all wind instruments to play. Send now for your copy and details of Free Trial; Easy Payments on any Conn instrument for band or orchestra.

C. G. CONN, Ltd.
356 Conn Bldg., Elkhart, Ind.



Creighton Hale, famous movie star and accomplished saxophonist uses a Conn, as do most prominent stars

"That was a clever performance of yours last night, Doctor Hackensaw," remarked General Blank next morning, "but as I told you it has had no effect. The rebels are continuing their preparations. My spies tell me, however, that there is some demoralization among the troops. The exhibition may have been of some use!"

"I'll give them a second dose to-night," said Doctor Hackensaw. Accordingly, sharp at midnight, the skeleton appeared again. This time, however, it was mounted on a skeleton horse with wings. And this time the luminous emanation shot forth from all parts of the figure in jets of colored fire like the coronal streamers of the sun. And this time the phonograph sent forth peals of reverberating thunder, while lightning flashed at intervals from the figure. And as it circled over the rebel camp it discharged upon them gases with a fearful stench. A combination of asafetida, skunk fluid and Limburger cheese would have been like Attar of Roses compared to the horrible smell emitted by the figure, while the words: "Maout! Maout! Maout!" came from the skeleton's moving jaws—the Arabic equivalent of, "Death! Death! Death!"

The natives in terror all fell upon their knees, and at once sent messengers to General Blank, tendering their submission. As a result, the following night there appeared a flying cherub over their camp and scattered fragrant jessamines among the natives—a flower of which the Arabs are very fond. The uprising was at an end. Doctor Hackensaw in two days, at a trifling expense, had accomplished without bloodshed results such as a large army could not have accomplished in months and then only at the expense of many thousands of lives and millions upon millions of dollars!

PUNCTURE-PROOF TIRE

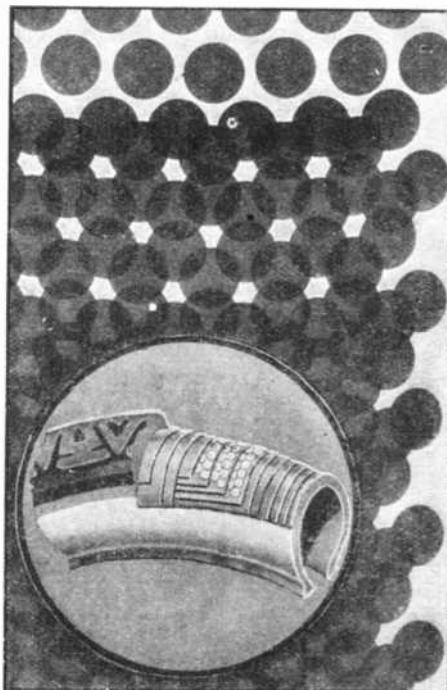

The only automobile tire on the market today that actually fulfills the manufacturer's claims of being puncture-proof is illustrated in a cut-down section in the circle above. Note that three layers of the casing are studded with brass plated, case-hardened steel disks. The X-ray photograph above shows how the steel disks overlap. From top to bottom is shown first one, then two and finally three layers of the disk studded strips. This construction prevents the entrance of nails or even bullets.

FREE!
This \$15.00
HAWAIIAN GUITAR
YOU CAN PLAY IT
Just Like
The Expert
Hawaiians

BECAUSE OUR NATIVE HAWAIIAN INSTRUCTORS WILL SHOW YOU HOW!

Be the Most Popular Member of Your Set. Play "What'll I Do", "Memory Lane", "Lazy". All the late song and dance hits. You can play First Selection in Half an Hour and Harmonious Chords at ONCE. Entertain your friends. Play for money. Don't be a wallflower. Be the Life of the Party.

FAMOUS HAWAIIANS TEACH YOU TO MASTER QUICKLY THEIR SECRETS OF THIS FASCINATING MUSIC
The instructions you receive from such world famous experts as Lawrence Kaluluki, Walter Kolomoku, Frank Ferera, Carl Seville and others are invaluable. NO OTHER Conservatory can even begin to give you the expert teaching and knowledge you gain through us. **ONLY 4 EASY MOTIONS**—to learn to be able to play any music, popular, dance, classical, native Hawaiian Airs or old time melodies and hymns. Just think of it! You need never have read a musical note in your life. For that matter, even though you haven't the slightest knowledge of any musical instrument, we guarantee to teach you to play just like native Hawaiians.

NEW INVENTION MAKES IT EASY
Our method is so simple, plain and easy that you begin a piece your first lesson. In half an hour you can play it! Thousands of successful students prove this to be true. No matter how little your knowledge of music may be, you can learn to play by our plain, easy picture method.

COMPLETE CONSERVATORY COURSE

You get 52 complete lessons. An entire conservatory course. Nothing is omitted. Success is assured. Real Hawaiians instruct you. This is the only Conservatory teaching Hawaiian Guitar exactly as played by the Hawaiians. It is your good fortune as well as ours, that these Native Masters of Hawaiian Guitar come to this Conservatory to teach. **WE FURNISH YOU WITH EVERYTHING.** When you enroll as a student in this conservatory, you receive FREE a handsome, sweet toned, Genuine Hawaiian Guitar—valued at \$15.00—52 specially arranged lessons, as well as all the necessary Ficks, Steel Playing Bar, etc. There is NOTHING extra to buy; everything furnished.

You use Free! We mean it. There are no strings tied to this generous offer. You get it absolutely free as soon as you enroll for our course of 52 easy lessons, taught by real Hawaiians. You can't possibly lose, so mail the coupon at once for full information.

GUITAR WORTH \$15.00. Yes, that is the price charged in the music stores for these beautiful Hawaiian Guitars. We can afford to give them away free of charge to every pupil because we manufacture them in huge quantities in our own factory, which is the largest stringed instrument factory in the world! **SWEET TONED.** You will get the same haunting, soothing, plaintive fascinating tunes that the real native Hawaiians get on these same instruments. Plays any kind of music. 40,000 pupils prove all our claims are true.

SPECIAL COURSES UNDER FAMOUS TEACHERS, TENOR BANJO, VIOLIN, BANJO - UKELELE AND UKELELE

TEAR OUT AND MAIL

FIRST HAWAIIAN CONSERVATORY OF MUSIC, Inc.
Dept. 40, 233 B'way, (Woolworth Bldg.) New York, N.Y.

Gentlemen: Please tell me all about your FREE HAWAIIAN GUITAR offer, and all about the course of lessons under native Hawaiian Instructors, by your patented picture method.

Name
Local Address
City & State

Reader's Forum

(Continued from page 1109)

LIKES S AND I

Editor, *Science and Invention*:

Allow me, as a sincere reader of **SCIENCE AND INVENTION**, to give my personal estimation of your publication. I was a reader of many scientific periodicals, expecting to gain some knowledge from them. Instead of learning something from them, I was only more confused after reading them. I then decided to center my subscription on one magazine. Naturally I had to look for the best scientific magazine published for my subscription. After a deep search I found that the magazine with the golden cover was to be my selected magazine. I have never regretted the day I sent in my subscription.

A magazine like **SCIENCE AND INVENTION**, containing no long, lengthy articles, but illustrations and explanations perfectly clear, written in good English, publishing only worthwhile important articles, publishing no thick issues with nothing in them, has no contemporary superior. For school work, and my own laboratory experiments, it is a veritable storehouse of reference. For interesting reading it has none superior in its field. Let me take this opportunity to thank and congratulate the editors, contributors, and all connected with this company for their earnest labor in publishing a magazine so fine as **SCIENCE AND INVENTION**.

LEONARD KALSON,
Pittsburgh, Pa.

(Thanks, Mr. Kalson, it is very nice of you to give credit to us for our efforts in giving you what you want, and we are glad to know that in another case we have succeeded.)

The rapid strides in increased circulation further indicate our success in pleasing our readers. We hope we shall continue to merit your praise and if we don't, just tell us.—Editor.)

THOUGHT WAVES

Editor, *Science and Invention*:

For a number of years I have read your magazine and have always found it interesting and stimulating. Now, I would not go without it. I have met some people who appear to think that some of the "stuff," as they call it, in the magazine is of little or no value. I am referring to those articles that are dealing with what I may perhaps term scientific imagination. I belong to those who believe that the dreams of the scientific thinker of today are the realities of tomorrow. I believe that your magazine cannot fail to act as a powerful spur on the imagination and efforts especially of the young scientific reader and inventor. That, I believe, is one of its greatest missions.

But now, I would like to have your opinion on some ideas that I have had in mind for some time. It is now believed by many that when a man thinks, some material changes are taking place in his brain. In their nature these changes may be molecular, atomic or electronic. If so, they may be considered as energy in a material sense and in that case they will produce waves in the ether. Now, if we assume that nothing is lost in the universe, this energy, in the form of ether waves, must go on through space forever. Then, in this respect they are analogous to the waves of heat, light, electricity and for aught we know, gravitation. If this is correct, then every thinking brain is a broadcast station in a real sense. Hence, we are receiving energy in the form of thought waves from all directions, not only from this planet, but from every inhabited planet in space.

Would it not be reasonable to believe that an instrument could be constructed that could register these waves and amplify and even transform them? Some claim that the brain, under conditions, can act as a receiving station. Our instrument could, therefore, be constructed along lines already laid out by nature in building up the human brain. We have such instruments now. The camera is one of them. The eye being an optical instrument registers certain kinds of energy waves and transfers them to the brain, which translates them in terms of vision. Our instrument need not necessarily be a thought-reader in detail. But it could well indicate the general trend of one's thoughts, whether they be good or evil. It would be useful to indicate the combined thoughts of large groups of individuals, as the transactions of a large company or the maneuverings of a political party or, as between nations, such important questions as a choice between war and peace. The owner of such an instrument would know instantly and accurately about many things that it would take others thousands and millions of dollars to find out. As for communication with other planets, almost infinite possibilities would be opened to the investigator. For example, that which is seen by a brain on another planet is by that brain broadcast through space in the form of waves. These waves are received by our mechanical brain here on earth, amplified, transformed if

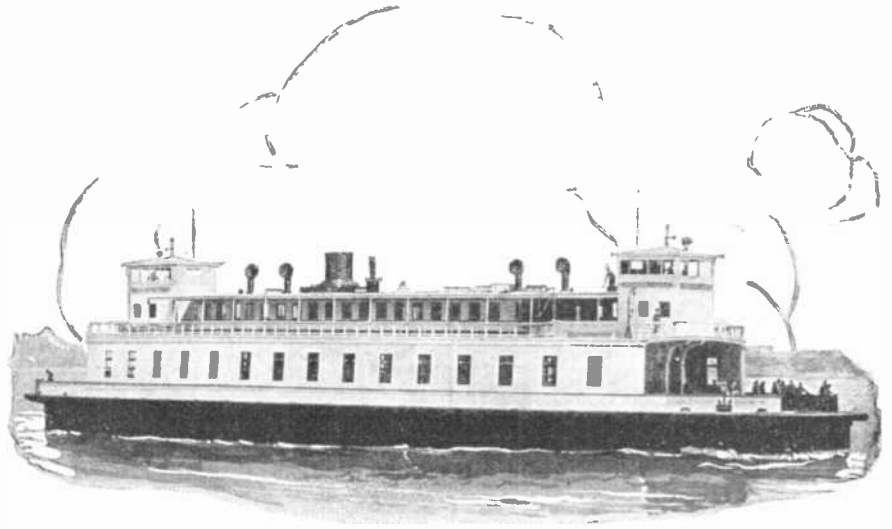

The General Electric motors of the ferryboat *Golden Gate* push her smoothly along at fifteen knots between San Francisco and Sausalito.

The right boat for the bay

On such a beautiful sheet of water as San Francisco Bay a smart and shipshape ferry is particularly welcome.

So efficiently have two of these boats performed that the Golden Gate Ferry Company has ordered another. Their engines use one barrel of fuel oil an hour; a steam ferryboat on the same line burned three.



This monogram is on the motors which drive electric ferryboats, fireboats, cargo boats, and great U.S. battleships. It is the emblem of the General Electric Company, an organization which produces machinery by which electricity does more and better work.

GENERAL ELECTRIC

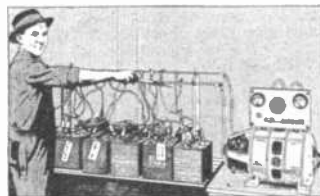

HB ONE DAY BATTERY CHARGING EARLY CLEARANCE \$150 #300

No experience is needed to start making big monthly profits with HB One Day Battery Charging. Only \$35 puts an HB outfit in your shop complete with bench, bus-bars, connectors, cable, etc. Your big monthly profits easily carry the small monthly payments. 30 days' free trial on money-back guarantee. HB Voltage Regulator insures best results for day and night charging. Write today for free bulletin 247.

HOBART BROS. CO., Box 53 Troy, Ohio

LOWEST PRICES - EASIEST TERMS - YOUR BEST MONEY MAKER

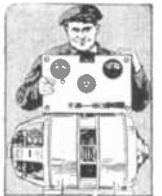

ARTIST'S OUTFIT FREE

Learn NOW at home in spare time, by new method. Commercial Art, Cartooning, Illustrating, Designing. Delightful work in big demand. \$50.00 paid for one drawing. Hand some book free explaining everything. SEND FOR IT TODAY. Washington School of Art, Inc. Rm. 263C, 1115-15th St., N.W. Washington, D. C.



HONEYCOMB COILS
The Universal all-wave inductance. Back and front panel mountings. Send 25c for Super Het., R. F. and Honeycomb Coil Circuits and Complete Catalog. Chas. A. Branston, Inc. Dept. 4, 815 Main St. Buffalo N. Y.

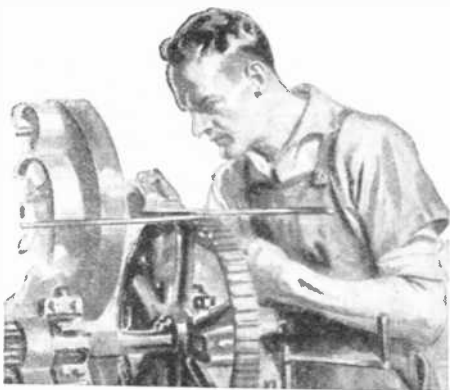

Expert Toolmakers and Diemakers in Demand

EMPLOYERS everywhere are searching for trained men and are willing to pay them good money.

The manager of one of the largest machine tool works in the world, in a letter requesting us to help him secure the services of technically trained mechanics, wrote—"There is not much difficulty in obtaining average talent—but we must have men of superior ability."

Be one of these trained men. You can do it if you really try. Right at home, in the odds and ends of spare time that now go to waste, the International Correspondence Schools will teach you all you need to know about Toolmaking, Diemaking, Machine Shop Practice or any other subject in which you are interested.

Mail the Coupon To-day for Free Booklet!

INTERNATIONAL CORRESPONDENCE SCHOOLS
Box 6188 - D. Scranton, Penna.

Without cost or obligation on my part, please tell me how I can qualify for the position or in the subject before which I have marked an X:

BUSINESS TRAINING COURSES

- | | |
|--|---|
| <input type="checkbox"/> Business Management | <input type="checkbox"/> Salesmanship |
| <input type="checkbox"/> Industrial Management | <input type="checkbox"/> Advertising |
| <input type="checkbox"/> Personnel Organization | <input type="checkbox"/> Better Letters |
| <input type="checkbox"/> Traffic Management | <input type="checkbox"/> Show Card Lettering |
| <input type="checkbox"/> Business Law | <input type="checkbox"/> Stenography and Typing |
| <input type="checkbox"/> Banking and Banking Law | <input type="checkbox"/> Business English |
| <input type="checkbox"/> Accountancy (Including C.P.A.) | <input type="checkbox"/> Civil Service |
| <input type="checkbox"/> Nicholson Cost Accounting | <input type="checkbox"/> Railway Mail Clerk |
| <input type="checkbox"/> Bookkeeping | <input type="checkbox"/> Common School Subjects |
| <input type="checkbox"/> Private Secretary | <input type="checkbox"/> High School Subjects |
| <input type="checkbox"/> Spanish <input type="checkbox"/> French | <input type="checkbox"/> Illustrating |

TECHNICAL AND INDUSTRIAL COURSES

- | | |
|---|--|
| <input type="checkbox"/> Electrical Engineering | <input type="checkbox"/> Architect |
| <input type="checkbox"/> Electric Lighting | <input type="checkbox"/> Architects' Blue Prints |
| <input type="checkbox"/> Mechanical Engineer | <input type="checkbox"/> Contractor and Builder |
| <input type="checkbox"/> Mechanical Draftsman | <input type="checkbox"/> Architectural Draftsman |
| <input type="checkbox"/> Machine Shop Practice | <input type="checkbox"/> Concrete Builder |
| <input type="checkbox"/> Railroad Positions | <input type="checkbox"/> Structural Engineer |
| <input type="checkbox"/> Gas Engine Operating | <input type="checkbox"/> Chemistry <input type="checkbox"/> Pharmacy |
| <input type="checkbox"/> Civil Engineer | <input type="checkbox"/> Automobile Work |
| <input type="checkbox"/> Surveying and Mapping | <input type="checkbox"/> Airplane Engines |
| <input type="checkbox"/> Metallurgy <input type="checkbox"/> Mining | <input type="checkbox"/> Agriculture and Poultry |
| <input type="checkbox"/> Steam Engineering <input type="checkbox"/> Radio | <input type="checkbox"/> Mathematics |

Name.....
Street..... 3-6-24
Address.....
City..... State.....

Occupation.....
Persons residing in Canada should send this coupon to the International Correspondence Schools Canadian, Limited, Montreal, Canada

TRUTH INFALLIBLE! ACCURATE and SCIENTIFIC

Haven't you been waiting and hoping that one day you would gain that profound knowledge which would give you the key to all your desires? Haven't you longed for some strange power which would make you a master of things? Haven't you often wished that you could suddenly find yourself in an enchanted path, and that you could there discover an Aladdin's Lamp?

The Lamp of Knowledge

Address will give you all of this!
ROBERT MARTIN, La Jolla, California
In Canada: MARY RITHERDON, 90 Marlowe Avenue, Montreal, Quebec.

Insure your copy reaching you each month. Subscribe to Science & Invention—\$2.50 a year. Experimenter Publishing Co., 53 Park Pl., N.Y.C.

necessary, and projected upon a screen in the form of a picture. We could then, on short notice, be anywhere in the universe among the stars or, which is more true, the stars would reach down to us, as in very truth they are doing right now.

Cannot your matchless Doctor Haekensaw construct such an instrument and show us how it works?

ARTHUR JOHNSON,
Portland, Oregon.

(Mr. H. Gernsback, editor of this magazine, showed the possible construction of such a machine called the "thought recorder" in the May, 1919 issue of SCIENCE AND INVENTION MAGAZINE. Then known as The Electrical Experimenter. Up to the present time no one has demonstrated such a machine and it is possible that the device will not appear for years to come because we do not as yet know what thought "waves" really are or if they exist. Several claims for the construction of a device of this nature have been made, and one man has even taken out a patent on the system of doing just this, but even those claims must be ignored on the basis of the fact that the results cannot be duplicated by identically similar apparatus. The inventor himself has not thought it wise for reasons best known to himself to give demonstrations of the system in operation. Many of his supposed scientific statements are at such variance with known scientific facts and laws, that his claims must be seriously doubted.

The successful inventor of such a system will undoubtedly reap fortunes for his idea and will perpetually inscribe his name in the Hall of Fame for making the most worthy scientific contribution of the era. Medical science will likewise make an important advancement based on the demonstration of the principle of such a method. —Editor.)

NOT A QUITTER

Editor, SCIENCE AND INVENTION:

"Your prize contest is positively unfair." Some of your contributors seem to be so lacking in sound judgment as to permit that uncanny thought to creep into their minds, and finally into a hot package for the editors. I have the same reason to make the same assertion. However, it is a simple fact that any and every contribution can't be accepted. The result of accepting too many would be a disastrous waste far greater than would be suspected. Out of seven contributions I have not yet had an acceptance, but I am not going to be a quitter. My motto is, "Once in the game, never get yellow." I find a rejection to be a universal pointer to attainment of perfection.

JOHN M. SKEEN, Lake Creek, Texas.

(You are right, Mr. Skeen. The judges have a difficult and sometimes, we think, a thankless job in awarding prizes. They try to do their very best, and all decisions are unanimously voted. Of course, it's an absolute impossibility to please everyone all the time, but then those that get the prizes haven't even as much as entered one single complaint. Evidently, we pleased more than 13,000 people last year in addition to a steadily increasing number of readers.

We are glad you intend to try again, and hope you will be successful to the extent of winning a healthy sized check.—EDITOR.)

A SATISFIED READER

Editor, SCIENCE AND INVENTION:

I have been a reader of SCIENCE AND INVENTION for many years and even though I may travel all over the earth, I always get a copy even if it is many months old. I have seen many magazines all over the world, but not one equal to SCIENCE AND INVENTION since the elimination of many words and subsequent explanation by the pictures. Once in a while I read many complaints from our friend readers and I want to say right here that they would be better off if they would stop to think before they complain. Many fire their guns at Mr. J. H. Kraus of the Patent Advice Department because he gives them the right advice. Twice Mr. Kraus advised me not to apply for patents on two certain inventions and on the third one I refused to listen and now I am short about \$150.00. I read the "whys" of our friend reader from Spokane, Wash., Elsie Brierheath, and if she desires to have a longer answer than yours, she can find same in the Cosmopolitan Magazine of October, in an article by Rupert Hughes. Mr. H. Gernsback's admonition, "Those who refuse to go beyond fact rarely get as far as fact," should be gold plated and placed in the bedrooms of every SCIENCE AND INVENTION reader.

PAUL MITCHELL,

U. S. S. Sumner, San Diego, Calif.

(Sorry you had such trouble with your invention. SCIENCE AND INVENTION magazine never advises that a patent be applied for unless the device is of probable financial value to the inventor. We try to weigh each and every argument in favor of the inventor and then look at the other side of the same story. If one pan of the balance is heavier than the other, we try to follow such indication. If correction is impossible, we advise against attempting to patent the device upon which the request for advice is made.—EDITOR.)

Build Your Own Low Loss RECEIVER



A Simplified Pattern for the Construction of this Famous Receiver

Just off the press! A new pattern on the standard, high efficiency LOW LOSS receiver embodying every notable advance in this type of receiver. The blueprint of the wiring diagram incorporates a new idea that simplifies radio receiver building. The wiring of each circuit is shown in a separate color, thus: GREEN for the aerial circuit, YELLOW for the low potential or ground, RED for the plate and "B" Battery and WHITE for the grid circuit.

Each pattern contains two extra large blueprints size 14x19 inches, giving special wiring diagram in four colors, a panel layout and a complete 16 page booklet. All is enclosed in a handsome heavy color folder size 9x12 inches.

PRICE 50c

SOLD BY ALL RADIO AND NEWS DEALERS

The Consrad Company
233 Fulton Street
New York, N. Y.

Consrad

"RADIO'S FOREMOST PUBLISHERS"

BLANK CARTRIDGE PISTOL

Protection against Burglars, Thieves, & Dogs
PRICES
50c.
\$1.00



Well made and effective model on latest type of Revolver. Appearance alone is enough to scare a burglar. When loaded it may be as effective as a real revolver without danger to life. It takes standard .22 Cal. Blank Cartridges obtainable everywhere. Price 50c., Superior quality \$1.00 post-paid. Blank Cartridges, by express, 50c per 100. JOHNSON SMITH & CO., Dept. 316 Racine, Wis.

Cal. 30

U. S. ARMY KRAG CARBINES

All Carbines have the new model 1898 stocks. The barrels, actions and parts are either new or have been refinished by the Government and are equal to new. \$15
Krag Rifles \$12.50 Krag Sporting Rifles \$14.00
Sprgd. 45 Shot Guns 4.50 Sprgd. 45 Carbines 3.50

Send for Catalog
W. STOKES KIRK, 1627-FK, N. 10th St. Phila., Pa.

Insure your copy reaching you each month. Subscribe to SCIENCE & INVENTION—\$2.50 a year. Experimenter Publishing Co., 53 Park Pl., N. Y. C.

Book Review

THE YOUNG CHILD'S HEALTH, by Henry L. K. Shaw, M. D. **FOOD FOR HEALTH'S SAKE—WHAT TO EAT**, by Lucy H. Gillett, M. A. **THE QUEST FOR HEALTH**, by James A. Tobey, M. S. **THE HUMAN MACHINE—HOW YOUR BODY FUNCTIONS**, by W. H. Howell, M. D. **TAKING CARE OF YOUR HEART** by T. Stuart Hart, M. D. Flexible cloth covers, size 4 inches by 6 inches each, 50 to 75 pages each, published by Funk & Wagnalls Co., New York City.

An association composed of various other societies for the improvement of the public health, named the National Health Council, is publishing a series of most attractive little books on the various subjects relating to health. The best way to give our readers an idea of what is being done, is to say that when completed there will be twenty of these little manuals, with about sixty or seventy pages to each. Special subjects treated and to be treated, include the baby's health, the heart, cancer, maa and the microbes, tuberculosis, etc. Each one of these little treatises, and there are more to come, is written by specialists, and it seems certain that the needs realized or not realized of almost everyone of us, will be reached by some of the twenty manuals. The printing is effective, and the binding and general make-up is quite attractive and a good example of how to produce such a series.

ESSENTIALS OF PRINTING. By Frank S. Henry, 187 pages, cloth covers, illustrated, 7 3/4 x 5 1/4", price \$1.25, published by John Wiley & Sons, Inc.

Who has not looked at a printed page and wondered how the printer that set up the type could get the righthand margins so even and not have them staggered as in ordinary typewriting? The art of printing is simple, yet to the layman it seems rather complex. This work of Mr. Henry's puts forth the main points of printing in a simplified manner.

He begins at the very beginning of the subject and describes type and type cases. The pages then go on to describe the process of setting up type by hand and the method of spacing the type so that the ends of the line are even and the work is "justified." Throughout the work, type sizes and fonts are described. The measurements used in printing are detailed and their various uses fully dealt with. From then on the beginner is led through various stages such as the making and correcting of proofs and the use of various machinery which makes typesetting faster and easier.

Page composition is then dealt with and various illustrations show how a set up page is to be placed in the press and printed. The last chapter deals with the paper used in printing and classifies it as to size and weight.

This book is valuable to anyone interested in learning the printing trade as it is elementary and simple to understand. It deals entirely with hand type setting and does not describe linotype or monotype machines. However, as a text book for the beginner it has an excellent place and can be heartily recommended as an authoritative work.

DETAILS OF TYPICAL MECHANISM.

By C. M. Linley, 103 pages, cloth covers, illustrated, price \$2.00, published by the D. Van Nostrand Publishing Co., New York City.

The mechanic or inventor very frequently desires to obtain the mechanism which will do a certain work in the simplest manner, but has no way of finding out just what type to use. This volume is intended to do away with such difficulties as it explains in detail most of the common types of mechanism used in all classes of modern machinery. Each and every device is completely illustrated and fully described in the text. As an aid to a student of mechanical engineering or in fact of any type of engineering or to the inventor, this book should prove a great help.

FLYING. By Major W. T. Blake, 221 pages, 7 1/2 x 5", published by George Allen & Unwin, Ltd., England. Price, six shillings (\$1.50).

To the general public, the science of aviation is somewhat of a mystery and as such it receives little or no attention. Aviation is a subject which can be made extremely interesting if presented in the proper light and everyone at all interested in science in general will welcome this new volume. The reason is that the book is written for the layman and for those who do not have a deep



What a whale of a difference
just a few cents make

Magnified 225 Diameters

This is what the tip of a fly's leg is like when seen thru the



\$7.50 for Complete Outfit Prepaid.

Scientists and teachers are using this instrument. Gives enormous magnification and perfect definition. Send \$7.50 for complete outfit. Send for descriptive literature.

Scientific Apparatus Corp., Dept. 203, Milton, Pa.

ULTRALENS MICROSCOPE

Any amateur can immediately start using his Ultralens to examine the edge of a razor, the mesh of a cotton shirt, the bacteria in dirty water. No technical training required, yet hundreds of scientists and teachers are using this instrument. Gives enormous magnification and perfect definition. Send \$7.50 for complete outfit. Send for descriptive literature.

NEW VEST POCKET ADDING MACHINE

Adds as rapidly and accurately as a \$300 machine, yet fits the vest pocket. Mechanically perfect. Easy to operate—nothing to get out of order. Everyone who uses figures should own one. Counts Up to 999,999,999

2⁹⁵

Total visible at all times. A pull of the finger clears it. Don't carry a pocket full of pencil stubs and scrap paper to do your figuring. Carry a Ve-Po-Ad.

10 Days Trial Send no money. Just name and address and we will send machine postpaid. Pay postman on delivery \$2.95. Use it for 10 days to prove it does all we claim. If not perfectly satisfied we will refund your money. Limited supply. Send order today.

Reliable Adding Mach. Corp., Dept. 143 170 W. Washington St., Chicago, Ill.

Here's a money maker. Everybody wants one. Splendid profit. Write for special offer.

AGENTS

PIMPLES

Your Skin Can Be Quickly Cleared of Pimples, Blackheads, Acne Eruptions on the face or body, Barbers Itch, Eczema, Enlarged Pores and Oily or Shiny Skin. Write today for my **FREE** BOOKLET, "A CLEAR-TONE SKIN,"—telling how I cured myself after being afflicted 15 years. **E.S. GIVENS, 168 Chemical Bldg., Kansas City, Mo.**



DEAFNESS IS MISERY

I know because I was Deaf and had Head Noises for over 30 years. My invisible Antiseptic Ear Drums restored my hearing and stopped Head Noises, and will do it for you. They are Tiny Megaphones. Cannot be seen when worn. Effective when Deafness is caused by Catarrh or by Perforated, Partially or Wholly Destroyed Natural Drums. Easy to put in, easy to take out. Are "Unseen Comforts." Inexpensive. Write for Booklet and my sworn statement of how I recovered my hearing.

A. O. LEONARD Suite 369, 70 5th Avenue -- New York City



\$3 brings genuine UNDERWOOD

Yes, only \$3 down puts this genuine standard Shipman-Ward Rebuilt Underwood in your home. Then—small monthly payments, or if convenient, pay cash. Either way you get the world's standard typewriter at a big cash saving.

WHY PAY RENTAL?

Think of it! You pay little more than rental, and the machine is yours! We offer the same three models of the Underwood Typewriter which are being made and sold by the Underwood Company today. The only difference is that Shipman-Ward machines are priced lower and are rebuilt like new by experts. You can't tell them from brand new machines. Visible writing—the FULL LINE of typewriting is visible at all times. STANDARD 4-ROW SINGLE SHIFT KEYBOARD. Two color ribbon, back spacer, stencil device, automatic ribbon reverse, tabulator, etc.

TEN DAYS' FREE TRIAL

See for yourself! Try the typewriter ten days. You must be satisfied or the entire transaction won't cost you a penny. Act today! Get our big illustrated catalog and full particulars. Write NOW.

FREE TRIAL COUPON

Typewriter Emporium SHIPMAN-WARD MFG. CO.
2163 Shipman Bldg., CHICAGO

Send by return mail Bargain Offer No. 2163 of a Standard Visible Writing Underwood. This is not an order and does not obligate me to buy.

Name.....
Street or R. F. D. No.....
Postoffice..... State.....

Music Lessons WITH AN ACCREDITED SCHOOL At Home

A Complete Conservatory Course By Mail Wonderful home study music lessons under great American and European teachers. Endorsed by Paderewski. Master teachers guide and coach you. Lessons a marvel of simplicity and completeness.
Any Instrument Write telling us course you are interested in—Piano, Harmony, Voice, Public School Music, Violin, Cornet, Mandolin, Guitar, Banjo, or Reed Organ—and we will send our Free Catalog with details of course you want. Send now.
UNIVERSITY EXTENSION CONSERVATORY
69 Siegel-Myers Bldg. Chicago, Illinois

FREE \$20 Fine Tone Musical Instruments

We have a wonderful new copyrighted system of teaching notes music by mail. To first pupils in each locality we will give free a \$20 superb Violin, Tenor Banjo, Ukulele, Hawaiian-Guitar, Banjo, Mandolin, Banjo-Ukulele, Banjo-Mandolin, Cornet or Banjo-Guitar absolutely free. Also teach Piano and Organ. Very small charge for lessons only. Four lessons will teach you several pieces. Over 100,000 successful players. We guarantee success or no charge. Complete outfit free. Write today, Dept. 149, no obligation.
Slingerland School of Music, 1815 Orchard St., Chicago, Ill.

ADULTS! SEX KNOWLEDGE BOOKS
Instructive, authoritative, profusely illustrated in natural colors, etc. The worth-while sort. Contains everything one should know both before and after marriage to enjoy health and happiness. Large Catalogs, 10c.
F. SMETANA & CO. OWOSSO, MICH.

knowledge of mathematics and other subjects which enter into the design and construction of airplanes.

Major Blake in treating the subject considers the future possibilities of aircraft. He next takes up the construction of airplanes both land, sea planes and flying boats. One chapter is devoted to a discussion of the fundamental principles underlying airplane construction, but no complicated formulas are given, as it is only intended to present the main points of the subject. Further on in the volume, a short resumé is given telling just how a pilot operates an airplane under different conditions and gives the physical characteristics which a person must have in order to become a successful pilot.

Other subjects touched upon are the construction of aerodromes and air terminals for commercial flying and the effect of atmospheric conditions on the possibilities of flight.

The author's knowledge of flying enables him to make many suggestions toward the improvement of flying conditions as well as of airplane engines and parts. He discusses in a very clear and concise manner the principles of the different types of airplane engines in use today.

A further chapter is devoted to the subject of gliding and in it the principles involved are discussed and also the relation of gliding to flying with motor-driven airplanes. He considers the science of gliding to be very valuable for the aviator, and he points out how gasoline can be saved by making use of air currents in the proper places and allowing the plane to glide with the motor throttled very low.

Taken as a whole, the book is an excellent treatise on the subject of flying and the manner in which it is written will make it a valuable addition to the library of anyone interested in aviation.

FOIBLES AND FALLACIES OF SCIENCE. By Daniel W. Hering, C. E., Ph. D. LL. D., illustrated, 294 pages, 8 1/2 x 5 1/2", price \$2.50 cloth covers, published by the D. Van Nostrand Publishing Co., New York City.

Although perpetual motion and kindred subjects are products of the medieval ages, still it is surprising to note the wide interest which they command among present day inventors and mechanical workers. As the author of this work rather broadly states, it seems that practically every person you meet, who is at all interested in mathematics, either has in his mind at that time or has had an idea about perpetual motion which he fondly believes is workable. And perpetual motion is not the only fallacy that engages minds today, as there are still to be found many believers in such subjects as astrology and the divining rod.

In the book at hand, the author has touched on almost every one of the features indicated by the title in an authoritative and clear manner. Perusing this volume would undoubtedly quench the desire of hundreds of searchers for perpetual motion and the philosopher's stone. Explanations of many devices are given and reasons are assigned to each one showing just why it will not work.

A glance through the table of contents reveals the wide range of subjects covered in this interesting volume. Some of them are astrology, transmutation of metals, perpetual motion, divination, hoaxes, prophecies, charlatanism, and other ancient chimeras such as the universal solvent.

To review thoroughly the treatment of the subjects in this excellent work would require too much space. It is sufficient to say that the book is wonderfully interesting and it is well worth reading for the general information contained therein. If more of our readers who are convinced that perpetual motion is a possibility would read this volume and consider it seriously, we are sure that they would change their ideas.

PIONEER INVENTIONS AND PIONEER PATENTS. By Frank Keiper. 152 pages. Cloth Cover. 10 3/4" x 7 1/4". Published by Pioneer Publishing Co., Rochester, New York. Price, \$3.00 net.

The book is written from the manuscript of a lecture delivered to students at Purdue University. The author is a member of the patent bar and is a well known advocate. In this work, the subject of patent law, usually considered as a dry abstract subject, is treated in such a manner that it becomes interesting reading. The author begins his book with a resumé of pioneer inventions in different fields of endeavor, covering points that we of the present day do not often look upon as inventions. Chief among these is the alphabet in use today.

Following this are several pages devoted to the reproduction of various basic patents on such well-known subjects as the telegraph and rubber vulcanizing. Many points in connection with radio vacuum tubes, which have received much notice of late, due to patent litigation, are brought forth. The second part of the book is devoted to a discussion of the various problems confronting the inventor and tells how some of them may be overcome. Directions are given for the recording of patents and for the selling of same.

ADDING MACHINE VEST POCKET SIZE

ADDS SUBTRACTS \$2.50
MULTIPLIES DIVIDES

NEW Does Work of \$100 Machine. Total Visible at all Times.
FREE TRIAL—Send No Money

Anyone Can Operate It. Guaranteed for Life
Just write "Send me a Baby Calculator" and give your name and address. We will ship it immediately, all charges prepaid. On delivery pay postman \$2.50. You can return it after 10-day trial for full refund if the Baby Calculator is not the greatest time and labor saver you ever used. This is the lowest priced practical calculating machine made. Order today.
BABY CALCULATOR SALES CO.
P. O. Box 1118, Chicago, Ill., Dept. C

Electrical Engineering Course for men of ambition and limited time. Over 4000 men trained. Condensed course in Theoretical and Practical Electrical Engineering including the close-related subjects of Mathematics and Mechanical Drawing taught by experts. Students construct motors, install wiring, test electrical machinery. Course complete **In One Year**

Established in 1893. Prepare for your profession in the most interesting city in the world. Free catalog.
BLISS ELECTRICAL SCHOOL
106 Takoma Ave., Washington, D. C.

DON'T WEAR A TRUSS

BE COMFORTABLE—

Wear the Brooks Appliance, the modern scientific invention which gives rupture sufferers immediate relief. It has no obnoxious springs or pads. Automatic Air Cushions bind and draw together the broken parts. No salves or plasters. Durable, cheap. Sent on trial to prove its worth. Beware of imitations. Look for trade-mark bearing portrait and signature of C. E. Brooks which appears on every Appliance. None other genuine. Full information and booklet sent free in plain, sealed envelope.
BROOKS APPLIANCE CO., 172A State St., Marshall, Mich.

MODEL SLIDE VALVE MARINE ENGINE

1/2" bore, \$12.75, or 3/4" bore, \$15.75
You will probably wish to make your own model boat hull, but what about your power unit? We are builders of working model engines and hollers of many types. We can supply you with a power unit that will meet the requirements of your particular model boat. Huller, Ship and Naval fittings. Serial work. Large illustrated catalogue, 20c.
BATHE MFG. CO.
Dept. 2, 5214 Woodland Ave., Phila., Pa.

STUDY AT HOME

Directed by **The University of Chicago**

Courses in English, History, Chemistry, Business, Mathematics, Education, Psychology, and 35 other subjects command credit toward a Bachelor degree. Begin any time. Address 27 Ellis Hall, University of Chicago, Chicago, Ill.

Start to Succeed

Begin Today—Write for My FREE BOOK, I can make a good penman of you at home during spare time. Write for my FREE BOOK, "How To Become a Good Penman." It contains specimens and tells how others mastered penmanship by the Tamblin System. Your name will be elegantly written on a card if you enclose stamp to pay postage. Write today for book.
F. W. TAMBLIN, 424 Ridge Bldg., Kansas City, U. S. A.

LATEST WHOLESALE RADIO CATALOG

FREE Simply send name TODAY for big 48-page catalog of latest radio goods at Wholesale. Live dealers and agents wanted.
STANDARD RADIO CO., 112 East 13th, Kansas City, Mo.

The Midget

"Five-in-One" Slide Rule is a combination Mannheim, Polymeric, Log-Log, Binary, Add and Subtract Slide Rule. It will instantly add, subtract, multiply and divide any combination of whole numbers, fractions, mixed numbers and decimals. Gives every root and power, also Logs, Sines and Tangents. Made of aluminum with scales on white celluloid. Size 4 in. Approved and adopted by colleges. Price with instructions, \$1.50. Leather Case like extra. Sent C. O. D. if desired. Catalog Free.
GILSON SLIDE RULE CO., Miles, Mich.

The book is very well written throughout, and should be of great assistance to the prospective inventor as well as to anyone at all interested in patent law.

AUTOMOTIVE CONSTRUCTION AND OPERATION. By J. C. Wright and Fred C. Smith. 446 pages. Cloth cover. 9 1/4" x 6". Published by John Wiley & Sons, Inc., New York. Price \$3.00 net.

The subject of automotive construction and operation is such a broad one, due to the many types and makes of automobiles on the road today, that it takes a very well planned book to cover the subject intelligently and thoroughly. This book does just that. The subjects are so arranged that, beginning at the front of the book, each and every one is treated in the proper sequence. A short historical survey is first given, and then the various types of automobiles are considered. The power plant and how it operates is treated in detail and each and every part of the engine is described. A survey of the fuel question is then given and various fuels other than gasoline are mentioned. The chapters following deal with the functions of the various parts of the car's plant, such as the carburetor, the ignition system, and cooling system. In one part of this book will be found an excellent treatise on automotive electricity, covering the principal systems used and describing each one.

The last chapter of the book is one which will be found to be of great value to anyone at all interested in this subject. It is headed "Useful Information" and contains data on various topics classified in such a way that any particular subject is very easy to find. The facts given in this last chapter are well worth the price of the book alone. Many of the matters so treated are of great assistance when looking for trouble with an engine.

The book is written in such a way that it is of great value not only to the layman who expects to purchase a car, but also to experienced drivers and mechanics.

HOUSEHOLD PHYSICS. By Joseph M. Jameson. 437 pages. Cloth cover. 8" x 5 3/4". Published by John Wiley & Sons, Inc., New York. Price \$1.90 net.

In the library of every person interested in science in general or in any one science in particular, there must be at least one or more books devoted to the subject of physics. In every science, there will be found one or more points depending entirely upon various laws of physics. A book of a type such as this one is very valuable. It contains much information, but the technical points are so expressed that they can be understood by practically everyone. True enough, all the subjects are treated with their household applications in view. This, however, tends to make the book very interesting as it connects up various scientific facts and theories with our everyday life. Such subjects as heat and methods of heating homes are discussed in detail. Then what in a sense is the opposite subject, refrigeration, is discussed. Ice boxes and refrigerating machines are described and thoroughly illustrated in detail.

Next the subject of electricity in the home is treated in a very simplified manner. The uses of electricity for heat and the electric power used by household appliances are given, and hints for the efficient operation of various devices are described. The subject of color and its relation to artificial lighting is taken up, and discussed and treated in detail.

Then such everyday subjects as water meters and various household measures and scales are described and their shortcomings pointed out.

Taken as a whole, the book is one which merits careful reading. As an assistance to the High School student, its value can not be underestimated. Also for those who are through with intensive education, but who desire to keep certain facts available, this book will be found of great value.

STORAGE BATTERIES. By George Wood Vinal. Hard cloth covers. 9 1/4" x 6". 394 pages. Price \$4.50. Published by John Wiley & Sons, Inc., New York City.

Although storage batteries are very common things, and their form and use are well known to everyone, still there have been a comparatively small number of books and very little authoritative literature published on their design and construction. The book before the reviewer at this time, makes up for all the former scarcity of material on this subject. It is the fullest book on the subject of storage batteries that has ever come to our attention. It describes every possible point in connection with the construction of storage batteries and discusses each point in complete detail. All the various types of batteries are considered

(Continued on page 1149)

YOU Are Wanted for a Better Job



Roy C. Claflin, President

AND you can get it with our help, because we've already helped thousands of men to bigger pay and better positions. Mail the coupon and get the Proof that we can Raise Your Pay. Now read these pay-raising facts.

From \$2 a Day to \$200 a Month

We helped John Braund from a Laborer at \$2 a day to an expert draftsman at over \$200 a month. Thomas English jumped from machinist's helper to expert draftsman immediately upon securing our training. Joseph Ohaus was advanced from mill hand to expert draftsman with Public Service Gas Co. P. A. For jumped from \$65 a month to successful drafting business of his own. From low paid vulcanizer to expert draftsman in eight short months tells the story of L. R. McGlashan. M. B. Ulerly received a \$15 raise after six months of our help.

\$275 Extra in 3 Days

One man received \$275 for a drawing he made in 3 days' spare time after taking our training. But these are just a few—clip the coupon and get all the startling proof that we can do the same for you.

"Columbia" will train you, in your spare time, at home to be an expert Mechanical Draftsman in a field where men are always wanted by big concerns, at big pay.

Promotion Is Quick

We'll qualify you for a high salaried position in the Drafting field and keep you in touch with openings for Draftsmen in the big machine shops, industrial plants and United States Government Departments.

Men who start as Draftsmen are often advanced to Chief Draftsmen, Chief Engineers, Production Managers, and so on.

Get the Right Training

Mr. Roy C. Claflin, the founder and director, stands personally in back of the Columbia School of Drafting. You spend no time in long-winded theories—useless and expensive to you. You start on actual drawing work the day you receive your first lesson.

You Need No Previous Training

The course is easy to understand and easy to follow. Many students secure big paying positions even before they complete the course.

Success Calls Men of Action Only

If you are a man of action—clip the coupon now and show that you are. Keep right on top of this opportunity to make real money. Don't go looking for a pair of scissors. Tear the coupon off and mail it right now. Get started today.

COLUMBIA SCHOOL OF DRAFTING

ROY C. CLAFLIN, President

Dept. G-126 14th and T Sts., N. W., Washington, D. C.



FREE DRAFTING OUTFIT

We give you free with our course this professional Drafting outfit of high-grade instruments, equipment and supplies. It is yours to keep when you complete the course.

What We Give You

FREE BOOK. Send in the coupon today. I will immediately send you our book "Drafting—Your Success" which tells about Drafting and its opportunities and contains proof that I can raise your pay.

PRACTICAL PROBLEMS. You will be carefully coached in practical Drafting work.

I HELP YOU GET A JOB. I will help you get a position as a practical Draftsman and will give you real, personal help, such as I have given to thousands of others. **PERSONAL INSTRUCTION** and Supervision throughout the Course. You will receive the personal instruction and help of Roy C. Claflin, President of the Columbia School of Drafting and a practical Draftsman of many years' experience.

DRAFTSMAN'S EQUIPMENT. I will furnish you with a full set of first-class drawing equipment and Drafting Instruments, as shown in the picture below, after you enroll. You keep both sets on completing the course.

CONSULTATION PRIVILEGES. You are free to write me at any time for personal advice and suggestions regarding your progress.

DIPLOMA. The diploma I will give you on completing the course attests to your proficiency as a Draftsman. It is an entering wedge to success.

ADVICE REGARDING GOVERNMENT POSITIONS. The following are a few of the many positions open in the Government Departments from time to time. The salaries are starting salaries, subject to increase: Architectural Designer—\$1,000 a year. Chief Draftsman, Naval Aircraft Factory—\$15.04 a day. Aeronautical Draftsman, Field Service, Navy Department—\$12.50 to \$12.50 a day.

We will advise you as to other government openings from time to time.

FREE BOOK COUPON

COLUMBIA SCHOOL OF DRAFTING
Dept. G126, 14th and T Sts., N. W., Washington, D. C.
Please send me without charge your free illustrated book on Drafting, telling me how I can secure your complete home study course and your help in securing a position as Draftsman.

Name

Address

City..... State.....

Young Men—Turn Your Spare Hours Into Money

Earn big profits, prizes, and awards selling RADIO NEWS, SCIENCE & INVENTION, The EXPERIMENTER, and MOTOR CAMPER & TOURIST in your neighborhood. We train you as our salesmen and pay you liberally for your time. Write at once and we will help you get started. M. BRIDWELL

THE EXPERIMENTER PUBLISHING CO.
53 Park Place
New York, N. Y.

RADIO LISTENER'S GUIDE

"JUST OUT!"

AND

CALL BOOK

35c



The Only Radio Book That Combines All the Information the Radio Listener Needs!

Size 9 by 12 inches

Contains 100 Pages

Bound with Beautiful Stiff Two-Color Cover

Published Twice a Year

Contents

- Information for the Broadcast Listener.
- Radio Broadcast Stations of the U. S., by Call Letters.
- Radio Broadcast Stations of the U. S., by States.
- Radio Broadcast Stations of Canada, by Call Letters.
- Foreign Radio Broadcast Stations, by Countries.
- Special Land and Experimental Radio Stations of the U. S.
- Table for Making Time Transitions.
- Time in All Parts of the World.
- Time Signals.
- Weather, Hydrographic, and Market Reports.
- American Radio Relay League and Directory.
- Amateur Radio Stations of the U. S., by Districts.
- Amateur Radio Stations of Canada, by Districts.
- Amateur Radio Stations of Europe and All Foreign Countries.
- Radio Maps of the U. S., North and South America, Canada, Europe, Asia, Africa, and Australia.

100 LARGE PAGES OF REAL, PRACTICAL INFORMATION—NO ADVERTISING

Published by

The Consrad Company, Inc.
 (Formerly The Consolidated Radio Call Book Co.)
 233 Fulton Street, New York, N. Y.

Consrad

"RADIO'S FOREMOST PUBLISHERS"

On Sale at All Newsstands and Radio Stores

The Consrad Co., Inc., 233 Fulton Street, New York, N. Y.
 Please find enclosed 35c for which send me one *Radio Listener's Guide and Call Book.*

Name

Address

City

State

and their component parts illustrated and described in full. In this work one can find almost anything he desires to know in connection with the manufacture, the care and the charging of storage batteries. The difference between various types of batteries is discussed and the kind of battery that is particularly suitable to any certain work is mentioned and the reason for the choice is given.

This book should be of very great value to anyone engaged in work where he has continual contact with storage batteries. Also the layman, the student of electricity and the experimenter will undoubtedly want this book in his library. It contains page after page of useful information and data that cannot be found readily elsewhere.

LIGHT. By H. M. Reese. Hard cloth cover. 9 1/4" x 6". 295 pages. Published by the Missouri Book Company, Columbia, Missouri.

Although to the average layman light appears to be an exceedingly simple subject, still the student of physics finds that it is very much more complicated than would at first be imagined. This book on light delves deeply into the subject instead of just skimming the surface as many books do. Furthermore, it is written in a rather simplified form, for as the author states, it was planned for students who have never had any training in calculus. The book starts with the usual introduction, covering the velocity of light and the methods used in studying the light waves. From there on, the text becomes more complicated as reflection and the various types of mirrors are dealt with. Lenses, telescopes and projection lanterns are discussed in detail and the principles upon which each depend are outlined. Throughout the volume, methods of studying the construction and effects of light are continually described and profusely illustrated. The book is one which should be of interest to all students of physics and to those who are particularly interested in astronomy.

THE POULSEN ARC GENERATOR. By C. F. Elwell, B.A., E.E. Hard cloth covers. 8 1/2" x 5 1/2". 192 pages. Published by the D. Van Nostrand Publishing Co., New York City. Price \$4.00.

Although the author of this book states in the preface that it is not intended to be a technical treatise on the Poulsen arc generator, it does give the theory of that generator in a simplified and concise manner. The greater part of the text is given over to the account of the history of the Poulsen machine.

Those radio experimenters who are familiar with or interested in the C.W. transmission as accomplished by the use of vacuum tubes, will find much of interest in its pages. It deals with the machine which enables radio transmitting stations to employ a power of 25 kilowatts and higher, a feat not usually and economically obtained with vacuum tubes. In the days before broadcasting, the whine of arc stations was familiar to every receiving fan. Today but few of those interested in broadcasting ever listen to the stations that carry on the most important traffic in radio. These are the larger commercial and government stations which are continually transmitting press news and business messages across oceans and continents. The Poulsen arc generator is the heart of many of these stations and as such is certainly deserving of a place in the history of radio. This volume attempts to place the arc generator in that niche of fame and accomplishes the purpose quite well.

EVOLUTION. By Vernon Kellogg. Octavo, stiff cloth covers. 291 pages. Published by D. Appleton & Co., New York. Price \$1.75.

Ever since William Jennings Bryan began his crusade to put down evolution in the schools, there has been a veritable flock of ideas on the subject, some good, some bad, from the hands of more or less eminent men. The present volume by an author well known to followers of this column, is among the best for the lay reader that has come to our hands in some time. His method of organization in the volume is particularly adapted to the reader who lacks the time to go into the subject in a professional way. The first chapter is an explanation of evolution, something which has long been lacking, that is, as far as the lay reader is concerned. One finds that the development of man from the anthropoid ape is not the primary thesis of this great doctrine in spite of various Christian though unlightened gentlemen. Then follows a number of chapters dealing with evolution in the several divisions of life, which includes a section on plants, vertebrates and invertebrates, and lastly homo sapiens, with conclusions on societal evolution and a prospect for the future.

They Speed the World's Business

Nearly 3,000,000 UNDERWOOD typewriters now in use

UNDERWOOD TYPEWRITER CO. INC. UNDERWOOD BLDG. N.Y. Branches in all Principal Cities



For Inventors: —to provide for individual inventors and companies owning or having developed inventions an introduction of their achievements to the public.

EXPOSITION OF INVENTIONS

Write for Information

The AMERICAN INSTITUTE

OF THE CITY OF NEW YORK

Executive Office

47 West 34th St., New York

1828-1925

—the Institute's 94th National Exhibition and a continuation of its service to American inventors and industry.

SENSATIONAL SALE

GUARANTEED TYPEWRITERS



Limited quantity fully guaranteed standard make typewriters. 5 Days Free Trial. Lowest prices ever offered. Some at \$45.35. Easy payments as low as \$3 monthly. Send today for FREE booklet of Valuable Typewriter Information and Special Sale Bulletin.

Smith Typewriter Sales Co., 303 3rd E. Grand Ave., Chicago, Ill.

You can be quickly cured, if you STAMMER

Send 10 cents for 988-page book on Stammering and Stuttering, "Its Cause and Cure." It tells how I cured myself after stammering 20 yrs. B. N. Bogue, 8114 Bogue Bldg., 1147 N. Ill. St., Indianapolis



I Guarantee You Can Play Any String Instrument in 1 Minute

Professor Schneider's remarkable music invention Guarantees INSTANT PLAYING on any string instrument. A child can play right off. No Notes or tedious study. Pronounced a wonder by prominent musicians. Money Back Guarantee

After test you can't play fastenly with this new method. Your money quickly refunded.

Instrument FREE

Choice of beautiful Tenor Banjo —Hawaiian Guitar—Mandolin, Panjo, Violin or others given free with each course.

WRITE TODAY!

Limited offer—Special Reduced Price NOW. Get full details and free instrument offer—Quick!

238 Vermont St. SCHNEIDER SCHOOL OF MUSIC, Dept. U. 3 Blue Island, Ill.



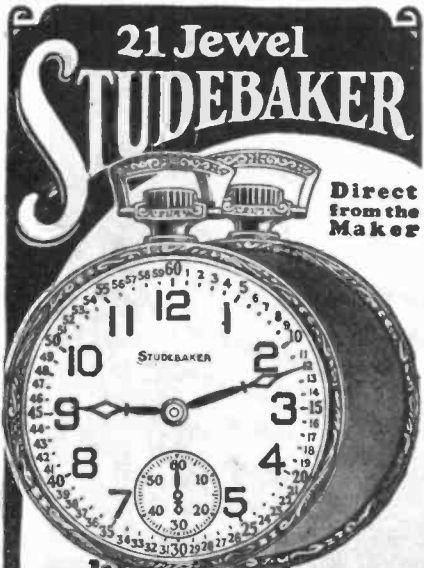

Only \$1.00 DOWN

America's greatest Watch value sent you for only \$1.00 down! The balance in easy monthly payments. The famous 21-Jewel Studebaker Watch—

Insured For a Lifetime!

You may choose from 54 new Art Beauty Cases and 8 handsome dial designs. 8 adjustments—to the second—for heat, cold, isochronism and 5 positions. Sold direct from the maker at lowest prices ever named for equal quality. Mail coupon today for Free Book and Special Offer.

Watch Chain FREE
For a limited time, we are offering a beautiful Watch Chain FREE. Write now while this offer lasts.

WRITE FOR BOOK

Send at once and get a copy of this book—FREE! See the newest, beautiful advance styles in Studebaker Art Beauty Cases and Dials. Read how you can buy a 21-Jewel Studebaker Insured Watch direct from the maker—save big money—and pay for it in easy monthly payments. Get Free Chain offer while it lasts. Mail coupon today.

STUDEBAKER WATCH CO.
Dept. 197 South Bend, Indiana
Canadian Address: Windsor, Ont.
Ask for Ladies' Bracelet Watch Folder

STUDEBAKER WATCH CO.
Dept. 197 South Bend, Indiana
Gentlemen: Please send me your Free Book of Advance Watch Styles and particulars of your \$1.00 down offer.
If you live in Canada send your inquiry to Canadian Office, Windsor, Ontario

Name

Address

City

State

Check here for Ladies' Watch Folder. Check here for Jewelry Store.

Chlorine Gas

In Home, Office, Factory or Hospital the Chlorinator—a newly invented apparatus to give Chlorine Gas—is successfully used to treat and prevent colds, influenza, bronchitis and other germ diseases of the respiratory tract. Gives the same gas used by President Coolidge and other officials in Washington. Chlorine Gas destroys the bacteria of adult and childhood diseases to which all are exposed daily. Any person—anywhere can now use Chlorine Gas with absolute safety and almost miraculous results with the Chlorinator. Low in price—cost per treatment is practically nothing. Not a patent medicine—used and endorsed by physicians. First successful Chlorine Gas machine for general use. Sold on absolute guarantee. Write for information.

Hubert A. Myers Laboratories, 156 Erie St., Toledo, O.

Insure your copy reaching you each month. Subscribe to SCIENCE & INVENTION—\$2.50 a year. Experimenter Publishing Co., 53 Park Pl., N. Y. C.

RADIO WRINKLES

UNDER this heading we are going to publish items of interest to everyone who likes to build radio instruments. In order to continue this department it is necessary for our readers to tell us about their latest experiments. Write us a short description of some time- or money-saving kink you have discovered and send it to us along with a few sketches. Our regular prizes will be paid for this material. Be brief and try to put everything in the drawing. Don't be too elaborate. Address "RADIO WRINKLES" editor, care of Science and Invention.

PHONE CONNECTORS

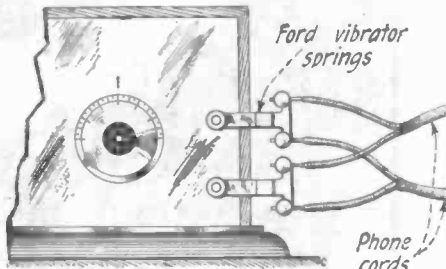

A very convenient method of connecting two pair of phones in parallel, is to utilize worn-out Ford coil vibrator springs. They are equipped with small binding posts and mounted as shown above.

—Carl F. Motsch, Reporter No. 12926.

COIL TAPS

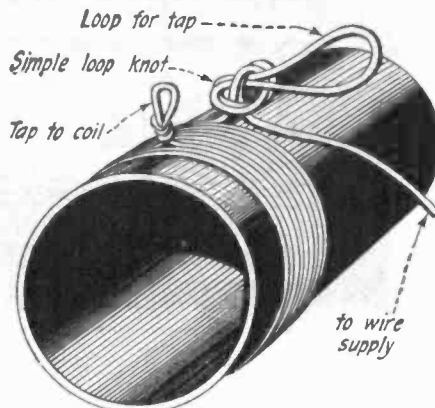

The process of taking taps off a coil is very easily accomplished by simply making a knot in the form of a loop. The wire should be scraped so that its insulation is removed where the knot occurs. In this way, making taps becomes a pleasure instead of the bug-bear it usually has been.

—Richard Anderson, Reporter No. 10509.

PHONE SWITCH

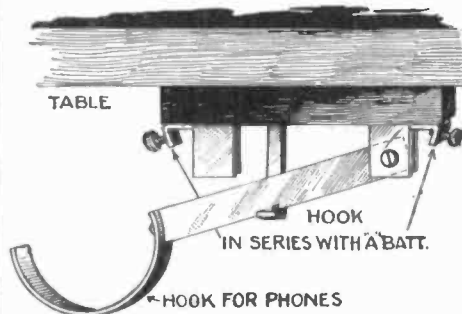

In order to prevent the tubes from burning after one has retired for the night, a small single pole switch in series with the "A" battery supply serves the purpose admirably. The weight of the phones opens the circuit.

—Wm. J. Cummings, 1-ABP.



RADIO Storage "B" Battery
Lasts Indefinitely—Pays for Itself

Economy and performance unheard of before. Recharged at a negligible cost. Approved and listed as Standard by leading Radio Authorities, including Pop. Radio Laboratories, Pop. Sci. Inst. Standards, Radio News Lab., Lojax, Inc. and other import and installers. Equipped with Solid Rubber Case, an insurance against acid and leakage. Extra heavy glass jars. Heavy rugged plates. Order yours today!

SEND NO MONEY Just state number of batteries wanted and we will ship day order is received. Extra Offer: 4 batteries in series (96 volts), \$13. Pay expressman after examining batteries. 5 per cent discount for cash with order. Mail your order now!

WORLD BATTERY COMPANY
1219 So. Wabash Ave., Dept. 83, Chicago, Ill.
Makers of the Famous World Radio "A" Storage Battery
Prices: 6-volt, 100 Amp. \$18.50; 120 Amp. \$14.50; 140 Amp. \$16.00.
All equipped with Solid Rubber Base.

World FOR STORAGE BATTERIES RADIO
KOMA = WEAF = WGN = WJS = KHU = KGO = KFAP = WJY = KOF

RADIO BOOKS
For Everybody

Complete, impartial 64 page books on the important questions of the present day radio. Each size 6 by 8 inches, fully illustrated, price 25c.

Complete List of Books

- 100 Radio Hookups
- How to Locate Troubles in Your Radio Set
- All About Radio Parts
- How Radio is Received
- The Neutrodyne—All About It
- Radio Reflex Receivers
- History and Operation of the Vacuum Tube
- Tips for the Radio Amateur Constructor
- How to Make Practical Radio Receiving Sets
- Radio Frequency Amplification
- Radio Questions Answered
- How to Tune Your Radio Set
- Radio Reflex Receivers
- The Super-Heterodyne

Published by
The E. I. Company
233 Fulton St. New York, N. Y.

High School Course in Two Years

Lack of High School training bars you from a successful business career. This simplified and complete High School Course—specially prepared for home study by leading professors—meets all requirements for entrance to college and the leading professions.

30 Other Courses No matter what your business inclinations may be, you can't hope to succeed without specialized training. Let us give you the practical training you need. Check and mail Coupon for Free Bulletin.

American School
Drexel Ave. and 58th St.
1924 Dept. H 326, Chicago

Money Back When You Finish If Not Satisfied

American School, Dept. H 326 Drexel Ave. and 58th St., Chicago
Send me full information on the subject checked and how you will help me win success.

- | | |
|----------------------------|---------------------------|
|Architect |Business Law |
|Building Contractor |Lawyer |
|Automobile Engineer |Mach. Shop Practice |
|Auto Repairman |Mechanical engineer |
|Civil Engineer |Shop Superintendent |
|Structural Engineer |Employment Manager |
|Business Manager |Steam Engineer |
|Cart. Pub. Accountant |Foremanship |
|Accountant & Auditor |Sanitary Engineer |
|Bookkeeper |Surveyor & Mapping |
|Draftsman & Designer |Tel. & Tel. Engineer |
|Electrical Engineer |High School Graduate |
|General Education |Wireless Radio |
|Personal Analysis |Undecided |

Name

Address

Insure your copy reaching you each month. Subscribe to SCIENCE & INVENTION—\$2.50 a year. Experimenter Publishing Co., 53 Park Pl., N. Y. C.

\$11,275.65 IN THREE MONTHS SO REPORTS V. A. MARINI

of Santa Cruz, Cal., (Nov. 1924.) J. Gordon, of New Jersey, says \$4000 profit in two months. Alexander, of Penn., \$3000 profit in 4 months. Ira Shook, Flint, \$365.75 in one day. Bram, bought one outfit, then 10 more within a year. Mrs. Lane, Pa., sold 8000 packages in 1 day. J. R. Bert, Ala., "only thing I ever bought that equaled advertisement." Patillo, Ocala, writes: "Crispettes all you claim and then some." Kellog, \$700 ahead end of second week.



WE START YOU IN BUSINESS!

Furnish secret formulas, raw material, and equipment. Small capital required; no experience needed.

Build Business of Your Own

No limit to the sale of Crispettes. Everybody likes them. It's a delicious food confection made with or without sugar. Write for facts about a business that will make you independent. Start in your town.

Profit \$1000 Month Easily Possible

Send postal for illustrated book of facts. It contains enthusiastic letters from others—shows their places of business, tells how and when to start, and all information needed. Free. Write now!

Long-Eakins Co. 353 High St. Springfield, O.

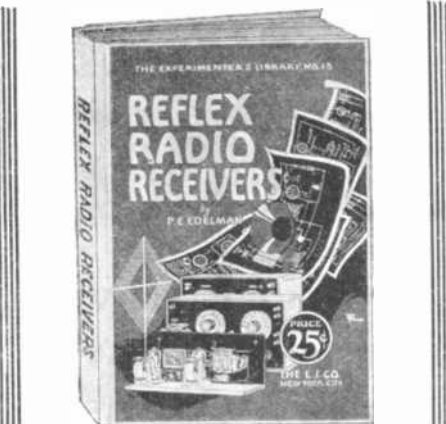

RADIO REFLEX RECEIVERS

Here is the only complete, impartial book on the various reflex hookups in use today. Contains 64 pages, size 5 by 8 inches, bound with stiff two color cover and printed in plain language that anyone understands.

Sold by all radio and news dealers

PRICE 25c.

Published by

The E. I. Co., 233 Fulton St., N. Y.

AGENTS 10 to 25 DAILY!

Men or Women here is your life-time opportunity! \$10.00 to \$25.00 every day selling America's Finest Shirts direct from our own big, honorable factory. Easy work, lowest factory prices, individual patterns and remarkable values. Big steady demand in every locality.

No experience or money necessary. We show you how and furnish everything you need. Your success is assured with a steady income every month. Every customer satisfied—Big Repeat Business. Be our factory agent and supply big demand for Packard Tailored Shirts in your locality. Failure impossible.

Write Now for Free Samples! Just send your name and address now for FREE Samples. Be first before some one beats you to it.

WRITE TODAY
Packard Manufacturing Co.
Dept. 121 829 Orleans St.
Chicago, Ill.

Insure your copy reaching you each month. Subscribe to SCIENCE & INVENTION—\$2.50 a year. Experimenter Publishing Co., 53 Park Pl., N. Y. C.

PEEP-HOLE MIRROR

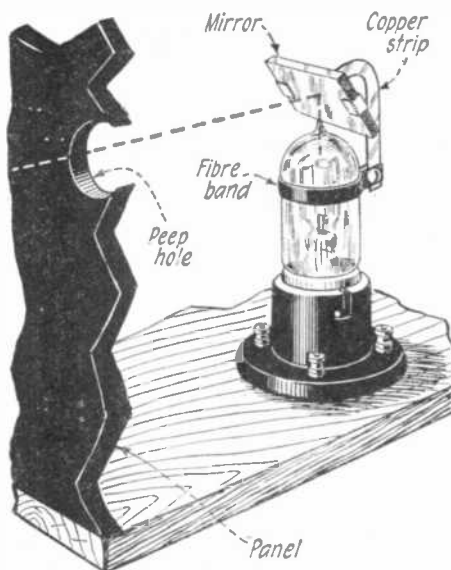

The filaments of the tubes such as UV199 and WD12s are very hard to see through the ordinary peep hole in the panel. By providing them with a small mirror mounted as shown in the sketch, it becomes possible to overcome this at a very small expense.

—B. G. Switzer.

PENCIL RHEOSTAT

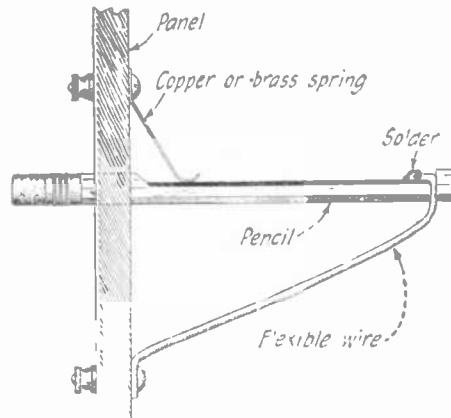

By splitting the wooden barrel from an ordinary soft pencil it is possible to use it as an improvised filament control when the ordinary rheostat is not procurable. A flexible wire is soldered to one end of the pencil, while the other projects through the panel and allows of adjustment.

—Ross J. Drew, Reporter No. 16663.

VARIABLE COUPLER

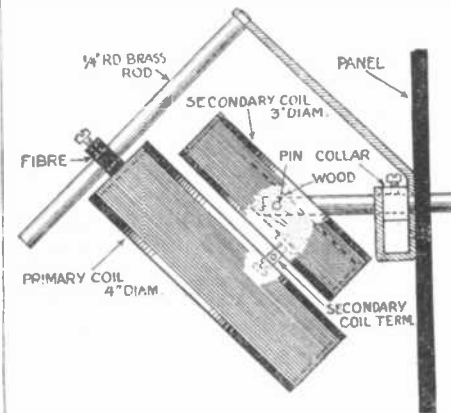

An efficient variocoupler whose design is commendable from the standpoint of flexibility can be constructed by adhering to the outline given from the details in the above drawing. The degree of coupling between the primary and secondary is variable by means not only of a rotary secondary but by the adjustable primary. Litz wire is to be preferred in this type of "low-loss" construction.

—Geo. V. Krabach.

(Continued on page 1153)



How This Man Won Success As an Electrical Expert

General Manager of his company at 28 years of age! His own home—owns his home—married and happy and prosperous—that's the remarkable success achieved by Wallace H. Rohrschneider, now General Manager, Secretary and Treasurer of the Hustisford Light, Power and Manufacturing Company of Hustisford, Wisconsin.

Mr. Rohrschneider got his start toward his quick and brilliant success at School of Engineering of Milwaukee. There he received the practical, intensive and specialized training that enabled him to make good in a big way.

Why Don't You Get Into This Big Pay Field?

The same kind of training that put Mr. Rohrschneider into the ranks of the highly-paid Electrical Specialists will qualify you for brilliant success in this fascinating field of unlimited opportunities. Come to America's Greatest Institution of Electrical Education. Learn by actual practice in our big laboratories with their magnificent equipment, including motors, dynamos, switchboards, ignition and lighting systems, etc. Recognized experts give you personal instruction every step of the way.

Earn Your Way Through This Great College

You can earn money to help defray your expenses while you are learning. Our wonderful co-operative plan brings an Electrical Career within the reach of every ambitious man. Our Free Employment Department secures positions for those students who wish to earn part of their expenses. In addition, the Department will help you get a good position in the Electrical Industry when your training is completed.

BIG BOOK FREE—Mail the coupon today for our big new illustrated catalogue. Check the course that interests you most. We will send you special information. Read about the School that trains men for practical and quick success. See how easy it is for you to get the training that will enable you to step to a splendid position and a handsome income. Mail the coupon right NOW. No cost or obligation.

SCHOOL of ENGINEERING of Milwaukee

Dept. S.&I.-C, 415 Marshall St., Milwaukee, Wis.

MAIL COUPON NOW

SCHOOL of ENGINEERING of MILWAUKEE
Dept. S.&I.-C, 415 Marshall St., Milwaukee, Wis.

Please send me without any cost or obligation, full particulars of the electrical course I have checked and your big Free Book telling about your institution and how it will fit me for a big position in the electrical field. Also tell me about your Earn-While-You-Learn plan.

(Check courses interested in, and be sure to give your education.)

- School of Practical Electricity—6 months or 1 year course. Complete general course, covering entire electrical field.
- Institute of Electrotechnics—12 to 30 months' course. Practical electrical training combined with thorough Academic education.
- College of Electrical Engineering—3 years' course. Regular collegiate work granting B. S. Degree. 14 High School units or diploma from our Institute of Electrotechnics required for entrance.
- Commercial Electrical Engineering—1 year course. Thousand of Trained Men wanted in this new profession. 11 High School units or diploma from our Institute of Electrotechnics required for entrance.
- School of Automotive Electricity
- Auto Electrical Service Engineering—1 year course.
- Automotive Electricity—2 to 6 months.
- Radio Sales and Service.
- A.C. and D.C. Armature Winding and Motor Generator Course—3 to 6 months' course. Brief, but intensely practical leading to well-paying positions.
- Electrical Home-Service Training with laboratory facilities, for those who cannot come to Milwaukee.

Name

Street

City..... State.....

Age..... Education.....

Radio's Greatest Super-Heterodyne Sensation



PATTERNS
50¢
EACH

Every Circuit a Separate Color

The new Consrad Patterns contain every possible idea that will be of assistance to the user of these patterns while constructing the receiver. The latest innovation is the printing of the wiring diagram on the new patterns in four colors, thus: GREEN for the Tuner-Oscillator circuit, YELLOW for the low potential wiring or "A" battery circuit, RED for the plate and "B" battery circuit and WHITE for the grid circuit.

This unique idea makes the wiring of the set much easier and prevents any possibility of making a mistake by misreading the blueprint.

The TROPADYNE

The Superadio—THE ONLY Radio Receiver with "Tunable" Intermediate Transformers

The new Tropadyne circuit is spreading like wildfire. Front pages of many radio magazines and newspapers are featuring this circuit. The secret of its tremendous popularity is in the TUNABLE Intermediate Transformers called Tropafomers. Tropafomers enable you, after the set is built, to tune the intermediate transformers so that you have no worries about balance. They take a big question mark out of your Super-Heterodyne.

Consrad is again right up to the minute by publishing in its usual complete form a pattern on the authentic Tropadyne circuit. This pattern contains two extra large sized blueprints (19 by 22 inches). The blueprint of the wiring diagram is printed in the latest Consrad method explained elsewhere on this page. With these blueprints comes a large 16 page booklet complete in every detail, fully illustrated and written in plain understandable English.

Altogether every modern aid toward making a radio diagram easy to understand and easy to follow is incorporated in this latest Consrad Pattern.

ON SALE AT ALL RADIO AND NEWS DEALERS

Published by

The Consrad Company, 233 Fulton St., New York City

Consrad

RADIO'S FOREMOST PUBLISHERS—Everything in Books, Patterns and Diagrams

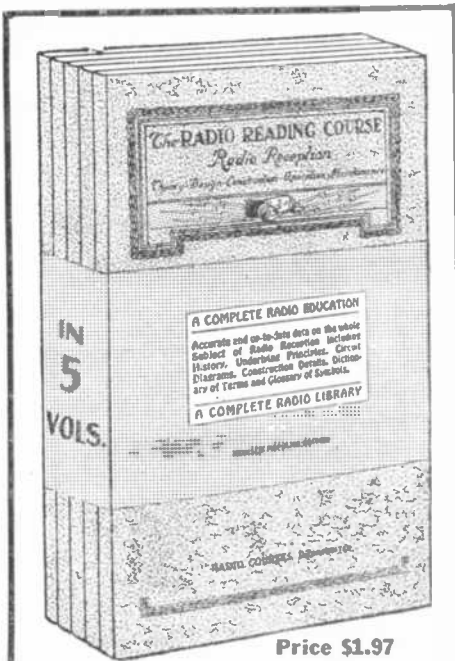

Price \$1.97

A RADIO EDUCATION

IN FIVE VOLUMES

Theory, Design, Construction, Operation and Maintenance

LEARN AT HOME

These five component parts of a complete Radio Instruction Course are outlined in five volumes that contain not merely the essentials as so many books do, but more, they contain all that any modern, up-to-the-minute textbook on any subject would cover. They are in themselves a COMPLETE radio education teaching every possible portion of Radio science.

Size of each book 6 by 9 inches, containing — pages, handsomely bound and illustrated with charts, diagrams, descriptions of equipment, etc.

SEND NO MONEY for these books. Just forward your name and address. We send you the books at once; on receipt of same you pay the postman \$1.97 plus a few cents postage and then they are yours.

Distributed by

THE CONSRAD CO.
233 Fulton St. New York

STAMMER NO MORE

Kill the fear of stammering. Re-education the key. The widely famed Hatfield Method fully outlined in an accurate, dependable, worthwhile book, "HOW TO STOP STAMMERING." It has inspired thousands. Free copy today.

THE HATFIELD INSTITUTE, 109 N. Dearborn, Chicago, Ill.



Wonderful, new device, guides your hand; corrects your writing in few days. Big improvement in three hours. No failures. Complete outline FREE. Write C. J. Ozment, Dept. 44 St. Louis, Mo.

WHY NOT spend Spring, Summer and Fall gathering butterflies, insects? I buy hundreds of kinds for collections. Some worth \$1 to \$7 each. Simple outdoor work with my instructions, pictures, price-list. Send 10 cents (not stamps) for my Illustrated Prospectus before sending butterflies. Mr. Sinclair Bx. 1424, Dept. 33, San Diego, Calif.



Print Your Own
Cards, Stationery, Circulars, Paper, etc. Complete outfit \$9.85 up. Save money. Print for others, big profit. All easy, rules sent. Write for catalog presses, type, paper, etc. **THE PRESS CO.,** L-47, Meriden, Conn.

TUNED LOOP

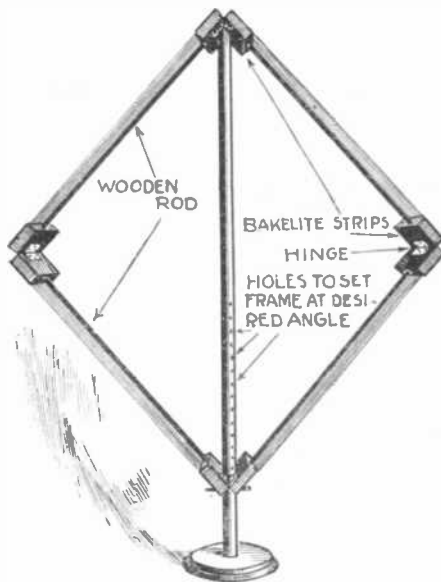

A loop antenna which is capable of being tuned by varying the area of enclosure by means of holes in the frame, allowing its lower portion to be raised or lowered, is readily constructed in the above manner. For the average broadcast wave-length 15 turns of No. 18 wire wound on a form 3 1/2 feet square will do nicely.

—Thos. E. Perdue, Reporter No. 5376.

COMBINATION SWITCH

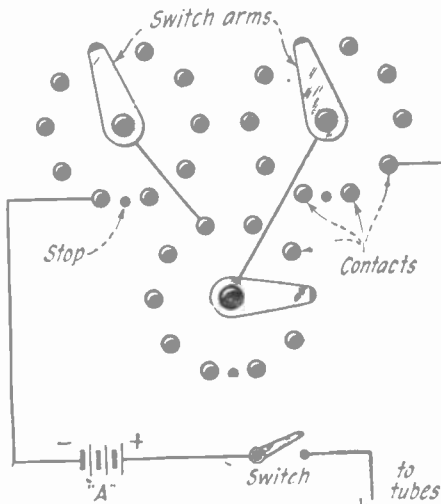

When little Willie starts "monkeying," it is high time to provide the set with an arrangement which will render it difficult for him to burn out the tubes or run down the batteries. Here is how to do it. Caution—don't forget the combination!

—George Vatcher, Reporter No. 9608.

COLLAPSIBLE SPEAKER

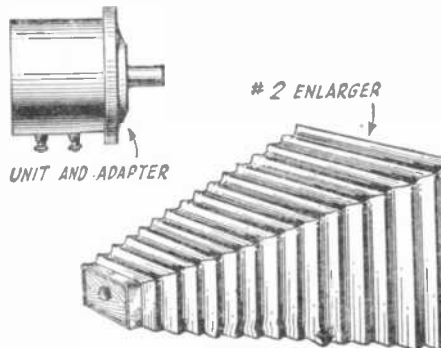

A portable loud speaker is something which is often desired and harder to procure. By using a collapsible camera enlarged bellows, the problem is solved. Fitting a loud speaker unit to the end of the bellows completes the arrangement which gives very satisfactory results.

—W. J. Warringer.



Big Money and a Barrel of Fun

First-Class Saxophonists make big money, and the work is easy and pleasant. You might easily become a wizard like Tom Brown or Ross Gorman, or a great record-maker like Clyde Doerr or Bennie Krueger or Jos. Smith. \$100 to \$500 weekly is not unusual for such musicians to earn.

Talk About Fun!

There is always a good time for the Saxophone player. It's the ideal instrument for social entertainment. It is a key to social popularity. At parties, everywhere, the Saxophone player is the center of attraction.

Easy to Play - Easy to Pay

The Saxophone is the easiest of all instruments to play. You don't have to "study" it as you do other instruments. There's no practice drudgery. You don't have to be "talented".

3 LESSONS SENT FREE with the instrument start you. In a week you can play popular airs.

Besides being so easy to play - we make it very easy to pay for one of these Buescher Saxophones with our simple plan of deferred payments. Play and earn while you pay.



Free Saxophone Book

-Very interesting. Tells all about the various Buescher Saxophones, with pictures of the famous professionals and orchestras. Send coupon for a copy. Mention any other instrument in which you may be interested. 155

BUESCHER BAND INSTRUMENT CO.

Everything in Band and Orchestra Instruments
313 Buescher Block Elkhart, Ind.

Buescher Band Instrument Co.,
313 Buescher Block, Elkhart, Ind.

Gentlemen:
I am interested in the instrument checked below.
Saxophone... Cornet... Trombone... Trumpet...
(Mention any other instrument interested in)

Name.....
Street Address.....
Town..... State.....

When grandfather was a little boy

EVERY fall there would come a day when his mother would say to his father, "John, it's time to see about the children's shoes."

Shoes were matters to reckon with in great-grandfather's family. As in many other families of the countryside, calves had to be killed and skinned. The skins were taken to a tannery across the river, and in due time young John would set off with the leather to the cobbler to have his measure taken.

Old Sam, the cobbler, was a friend of the family. They knew him. They knew his work. They knew the quality of the leather they had furnished him. They could have estimated pretty accurately the time young John's shoes would wear him.

Those days are gone forever. No longer do you know personally the makers of your shoes. Your clothing, your food, your furniture, your household utilities are produced by men and women you will never see.

That element of confidence, however, which in former days came from personal contact of neighbor with neighbor and friend with friend is still present.

Nowadays, advertising is the bond between manufacturer and consumer; between merchant and patron.

Through advertising, maker and dealer build with you their reputations.

Through advertising, they make a bid for your friendship.

To them, your friendship is essential, and to assure it, they see to it that their goods are as advertised.

By reading advertisements, you know where and what you can buy with confidence.



In buying advertised goods the element of risk is removed

Ford Runs 57 Miles on Gallon of Gasoline

A new automatic and self-regulating device has been invented by John A. Stransky, 29 Fourth St., Pukwana, South Dakota, with which automobiles have made from 35 to 57 miles on a gallon of gasoline. It removes carbon and reduces spark plug trouble and overheating. It can be installed by any one in five minutes. Mr. Stransky wants distributors and is willing to send a sample at his own risk. Write him today.—Adv.

DE LUXE STATIONERY

100 Double Sheets, 100 Envelopes, Fine Paper, with your name, address and city, on both in beautiful raised letters, regular price \$7.50; postpaid to you, \$2.50. Same order printed, \$1.50.

Order today.

SERVICE PRINT SHOP, D
1289 Genesee Street Buffalo, N. Y.



FREE
This \$12.00 DARCHÉ
Call-Me

Electric Alarm CLOCK
Free. Operated by battery in clock case. No home complete without one. Write for particulars.

DARCHÉ MFG. CO.
641 Washington Blvd., Chicago

GRID CONTROL

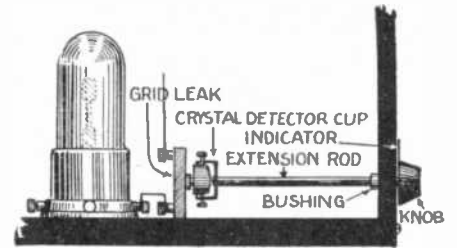

Inasmuch as it is best to keep the grid connection as short as possible and away from the panel, the grid leak is provided with a long fibre extension rod which allows of minute adjustment, and "remote" control.

—Boyd G. Switzer

FILAMENT CONTROL

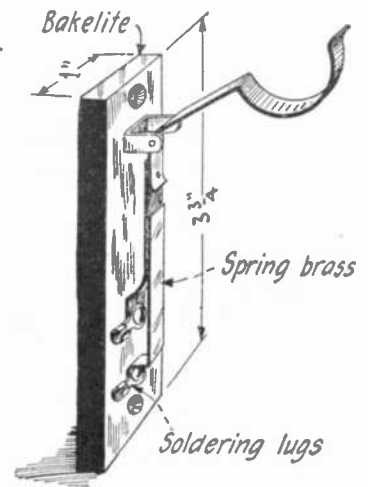

Another way in which the running down of batteries may be avoided is through the use of a simple phone hook and filament control switch combined. Three pieces of spring brass are bent into the shapes as shown above and connections are made so that when the phones are placed on the hook, the storage battery is disconnected.

—Floyd W. Peters.

FLEXIBLE SHIELD

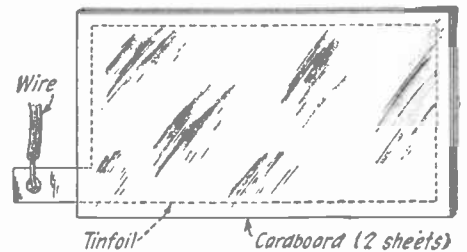

Flexible shields can be made in any size to suit specific needs. They are very helpful in shielding the different instruments of a set and are superior to the large metallic shields. They are made by pasting a sheet of tin foil between two sheets of Manila paper or cardboard, of the required size.

—Chas. F. Felstead, 6CU.

COMPASS DETECTOR

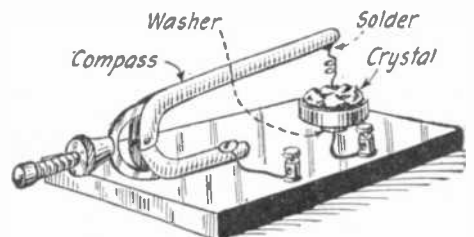

Again, the much abused dividers or compass finds employment, this time, as a very fine adjustable detector unit. One leg of the compass is cut off short and is fastened as shown. Adjustment is made by rotating the knurled knob.

—Lloyd Mallett.

Insure your copy reaching you each month. Subscribe to Science & Invention—\$2.50 a year. Experimenter Publishing Co., 53 Park Place, N. Y. C.

Answers to Scientific Problems

(Continued from page 1100)

PUZZLE PICTURE

The image of the man should face the same way that the man does. It should appear to be directly behind the mirror and of the same size as the man. The figures on the dial of the clock should appear reversed.

The angle at which the ray leaves the mirror should equal the angle at which it strikes the mirror and a plane in which the incident and reflected rays lie should appear to be perpendicular to the face of the mirror.

The passage of a ray of light through the prism is incorrectly represented for a ray on striking a prism from the direction indicated will be deflected toward the thicker portion of the prism and not toward the corner as represented in the picture.

SWATTING BUMBLE BEES

It is difficult to swat a bumble bee with an unperforated paddle because the movement of the paddle tends to set air currents sweeping around the side of the paddle which carry Mr. Bumble Bee with them. If holes are drilled in the paddle, some of the air at least moves through the holes and thus carries the bee against the paddle.

DAY AND NIGHT

The day appears to average longer than the night because of the refraction of the atmosphere which makes the sun visible in the morning before it has actually cleared the horizon. For the same reason the day is lengthened in the evening, the total effect being to increase the day by from four to eight minutes.

THE BOXES OF BALL BEARINGS

If the boxes are equally well packed, they should contain the same weight of bearings, for if the radius of a bearing is r inches, one could pack $L/2r$ bearings along each dimension or $L^3/8r^3$ bearings in all (L being the length of one edge of each box). Now the volume of each bearing would be $4/3 \pi r^3$ and the volume of all the bearings in any one box would be $L^3/8r^3 \times 4/3 \pi r^3$ or $\pi/6 L^3$ cubic inches. But since r , the radius of a bearing does not appear in this expression for the total volume, it is evident that the volume of steel enclosed in each box must be the same regardless of the size of the bearings. Hence, the weight of each box should be the same.

THE FALLING TANK

If the tank and contents fell freely, that is with the acceleration due to gravity (980 cm. per sec. per sec.), the tank, water, block and all would cease to weigh anything. The water would not exert any pressure on the bottom of the tank or anywhere else for that matter, and so it could not exert any buoyant force on the cork. The cork would then remain submerged even after the cord was severed.

CYCLONES AND TORNADES

Cyclones and tornadoes are terms often used to mean the same thing. Technically, however, they are quite different. The term "cyclone" should be applied to a storm, periodical in occurrence, of large area, about a thousand miles or so in diameter. It is of common occurrence and not necessarily violent or destructive. A tornado, on the other hand, is a much smaller and more violent storm of brief duration and causing only local disturbance. The picture represents a tornado.



What Other Typewriter Can Do These Things?

- Interchangeable type styles and sizes.
- Variable spacing to fit the size.
- 17 different sizes and styles of print.
- Over fifty different languages.
- Automatic touch assuring uniform impression whether the key is pressed lightly or heavily.



is certain to fit your need. Write for new booklet describing how it accomplishes its wonders.

Hammond Typewriter Corp., 72 Brook Ave. at 132nd St., New York

Easy! To Own

A LATHE of Your Own

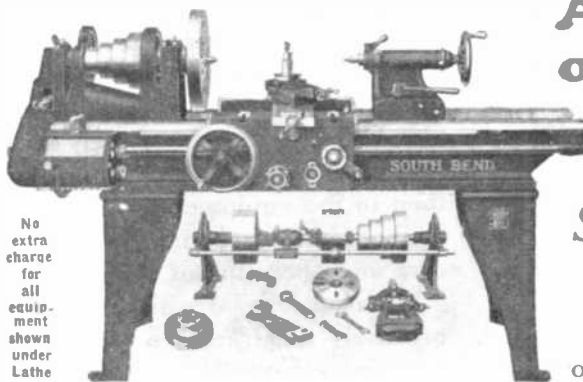

No extra charge for all equipment shown under Lathe

Get our easy-payment plan on this 16" x 6" Quick Change Gear

SOUTHBEND LATHE

Only \$466 Complete

Other Lathes as Low as \$197 on Terms

32 Major Improvements

The New South Bend Lathe embodies 32 major improvements made in the last 2 years—all insuring extreme accuracy, efficiency, economy and convenience.

Our easy-payment plan enables you to use your South Bend Lathe while you are paying for it. You make a payment down, and the Lathe is shipped at once or 30 days' trial. Convenient monthly payments may be arranged for the balance. In this way the Lathe earns its own cost, and you secure the same high quality product used in America's leading shops.

CATALOG FREE! — Showing 96 Styles—All Sizes

Let us send you a copy of this Free Book. Then you can select just the Lathe you need compare our money-saving prices and liberal terms with what others offer. Write to us

South Bend Lathe Works 395 East Madison Street South Bend, Ind., U.S.A.

Amateur Mechanics—Model Makers—Students



Price \$28 F. O. B. New York. Free Circulars. THE GEROLD COMPANY Dept. S-7, 120 Liberty Street New York

WADE BENCH-LATHE (cap: 4" dia. x 12" length. Slidest in travel entire length of bed. Lead screw inside bed. Hollow spindle. Turning, facing, boring, drilling, winding, thread-cutting.



Fortune Telling Globe!

THE GENUINE CRYSTAL ORACLE answers every question—Love, Marriage, Money, Luck! Mystifying, thrilling, fascinating game. Gift includes 5 inches round Crystal Globes 168 pg. Book on Divination by Crystal Dreams, etc.; also book "How to Converse with Spirits." C. t. Price \$2.45. Send 25c for postage. Pay the balance (\$2.25) when delivered. PARK PUB. CO. Park Row Bldg., New York Dept. S

Insure your copy reaching you each month. Subscribe to Science & Invention—\$2.50 a year. Experimenter Publishing Co., 53 Park Place, N. Y. C.

Complete List of Titles in the E. I. Co. Books

All About Radio Parts

Everyone who constructs a radio set should know the simple fundamentals of the various parts of his set. The E. I. Company has set these forth in a compact little book that is valuable at all times.

Book No. 8—Price 25c

History and Operation of the Vacuum Tube

The Vacuum Tube is a marvelous piece of apparatus. A short study of it as given in this book gives you the principle on which every Vacuum Tube Radio Receiver operates.

Book No. 9—Price 25c

The Neutrodyne—All About It

Everybody knows the famous Neutrodyne hookup. One of the finest Radio Receivers in use today. This 51-page E. I. Company book gives an explanation of every detail of the Neutrodyne and how it all works.

Book No. 10—Price 25c

How Radio is Received

The simplest and yet most complete Radio Guide Book for any amateur broadcast listener. In print only two weeks, fresh from the press.

Book No. 11—Price 25c

How to Locate Troubles in Your Radio Set

Anyone with this handy book as a guide can repair and keep in order his own radio set. Covers every detail of the modern radio sets and tells how to locate and repair any trouble.

Book No. 12—Price 25c

Radio Reflex Receivers

Just off the press. Hookups galore on the finest and most up-to-date reflex circuits in use today. Diagrams and descriptions on every modern reflex.

Book No. 13—Price 25c

Tips for the Radio Amateur Constructor

Many men fall in building their Radio sets because of some trivial error that could easily have been corrected before it was too late. The E. I. Company has compiled a book that will help you avoid all the common pitfalls while building your Radio sets.

Book No. 1—Price 25c

How to Make PRACTICAL Radio Receiving Sets

The man who wants to build only those PRACTICAL Radio Sets that are guaranteed to give good results when properly constructed will need this book. Gives the principal successful hookups of practical Radio Construction.

Book No. 2—Price 25c

Radio Questions Answered

Question No. 1—What is Radio? This is the nature of the questions that this book answers. Then it answers questions on all the principal parts of a Radio Receiver. It is a handy book to keep in your Radio File.

Book No. 3—Price 25c

Radio Frequency Amplification

Distance lends enchantment—and it's the Radio Frequency Amplification that brings in the distance on your Radio Receiver. If you contemplate adding any Radio Frequency to your set you will want this book at your side.

Book No. 4—Price 25c

How to Tune Your Radio Set

Don't struggle in the dark, looking for stations—here is an inexpensive book that gives you detailed instructions on just how to handle your Radio set. You will be surprised at the increased results that can be obtained through proper tuning.

Book No. 6—Price 25c

100 Radio Hookups

No better book for your work bench. Gives diagrams, hook-ups and details on Radio Hook-ups galore. One of the most complete hook-up books published. Authentic and up-to-date in every respect. Third edition now ready.

Book No. 7—Price 25c

E. I. Co. Books

are sold throughout the
country by all Radio and
News Dealers

If Your Dealer Cannot Supply
You, Write Direct

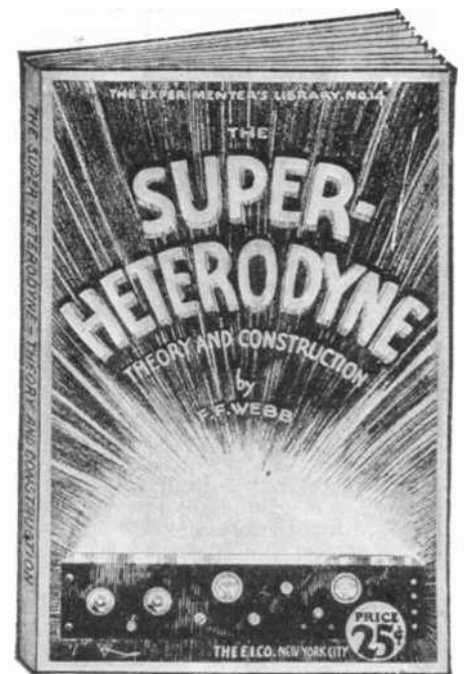

Direct from the Presses

Latest data and construction details on the famous reflex and super-heterodyne circuits

Here are the E. I. Company's latest and finest books. These books are fresh, not only in that they have just come off the presses, but fresh and new because they are, in every detail, right up to the minute in the information they contain.

Each book goes completely over the receivers they describe, beginning with the origin, usefulness and special qualities of the receiver, then to the equipment necessary for construction, thirdly to the best methods and essentials in the actual construction and, lastly, to the care and operation of the completed receiver.

Each book is of a handy size, 5 by 8 inches, containing 64 pages, profusely illustrated and written in every-day language that everyone can understand. They are bound with a special long wearing cover handsomely printed in colors.

Price 25c. each

For Sale at All Radio and News Dealers

Published by

E. I. Company, Inc.

The Conrard Co
INC.

Sole Distributors

233 Fulton Street

New York, N. Y.

Build the Set you have dreamed of TROPADYNE SUPERADIO OUTFIT

**Superior to
Super-Heterodyne**

THIS Superadio 6 Tube Set brings in Station KFKX (Hastings, Nebraska), 1200 miles, in New York City, clearly on a loud speaker, using only the small loop which comes with the outfit.

The outfit advertised here is complete, as listed below, everything needed is included, down to the last screw. The charts, blueprints, directions and photos furnished are so complete and explicit that anyone can build this set and have it working within a few hours. There is nothing additional to buy except the necessary batteries and tubes. Price includes mahogany cabinet and folding loop aerial.

You can pay \$150 or more for an outfit, or \$200 or more for a set, but you cannot possibly buy a better set than this one.

Your Money Refunded if this set does not satisfy you in all respects—if after 5 days' fair trial you do not proclaim the TROPADYNE the best radio set you ever listened to.

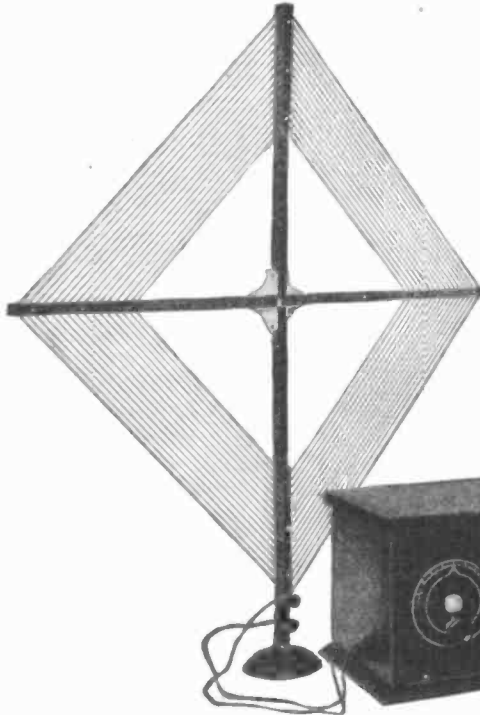

\$ 60⁵⁰
SEND NO MONEY

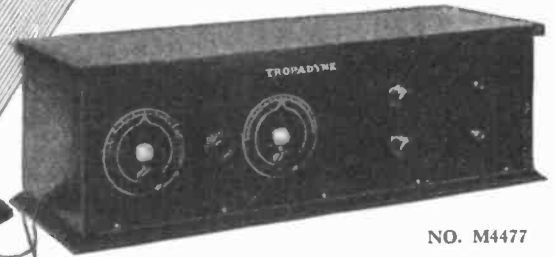

NO. M4477

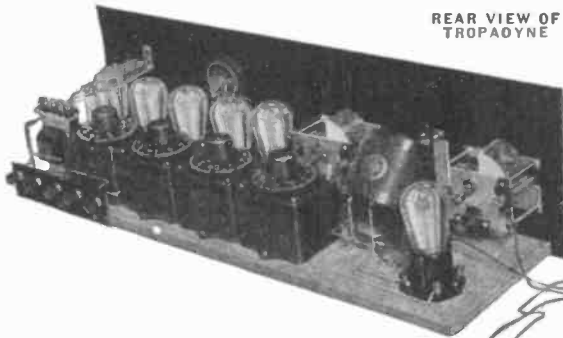

REAR VIEW OF TROPADYNE

Note These Important Features:

DISTANCE, VOLUME AND TONE QUALITY equal to any 8 tube set sold anywhere at any price.

LOOP RECEPTION—Outside aerial not to be used with this set—the complete loop is included in outfit.

PERMANENT LOGGING OF STATIONS—Follow chart furnished; there are only two tuning controls and you always find the same station at the same spots on the dials. Our log chart shows you at what point to find any station.

MICROMETER VERNIER DIALS giving you the full advantage of the exceptionally sharp tuning.

OUTFIT IS ABSOLUTELY COMPLETE—Drilled panel, Mahogany Cabinet and everything else needed, except tubes and batteries.

ECONOMY and SIMPLICITY—This is not a reflex, yet six tubes do the work for which other sets require eight to ten.

The Editor of Radio News

In the August 1924 Issue, said this about the Tropadyne: "Here is a remarkable receiver which we warmly recommend to our readers. It has several new and unusual features. In the first place only 6 tubes are used giving as much volume as the average 8 tube Heterodyne. The selectivity of this set is unusual. Unequalities of the intermediate transformers have now been done away with by tuning each transformer. After the transformer has been tuned, it can be left this way, no further tuning being necessary."

"This system makes for maximum sharpness and maximum volume. Another outstanding point of superiority of the Tropadyne circuit is that it practically does not radiate, thereby not interfering with other nearby receiving stations. A saving of two tubes as well as an increase of selectivity is obtained with this new circuit."

Complete List of Parts:

4 RICO Tropoformers; 1 Standard Variocoupler; 2 Certified Low Loss 23-plate Condensers; 1 Calibrated Transformer; 2 Jacks; 3 Fixed Condensers; 6 Bakelite Sockets; 2 Vernier Dials; 1 Rheostat; 1 Potentiometer; 1 7x24 Panel; 1 7x24 Mahogany Cabinet and Baseboard; 40 ft. Bus Bar Wire; 1 Folding Loop Aerial; 1 Grid Leak and Mounting; Binding Posts; Flexible Wire; 1 Bakelite Binding Post Strip; 4 doz. Screws; Full Directions.

RADIO SPECIALTY COMPANY,

98 PARK PLACE, NEW YORK

Tropadyne Gets Europe!

"Received 2BD, Aberdeen, on November 25th. Results good, except noises. 11:30 to 11:40 talk, from 11:40 to 12:00 piano number. Piano number good, talk poor. Used Tropadyne Circuit."

J. ZIMMER, 157 James St., Newark, N. J.

The above has been verified by "RADIO NEWS"

SEE OUR 2-PAGE AD ON PAGES 1618 and 1619 RADIO NEWS

SEND NO MONEY
RADIO SPECIALTY CO., 98 Park Place, New York, N. Y.
Please send at once one complete Tropadyne Superadio Outfit as advertised in February Radio News. I will pay postman or expressman \$60.50 upon arrival.

NAME

STREET or R.F.D.

CITY STATE

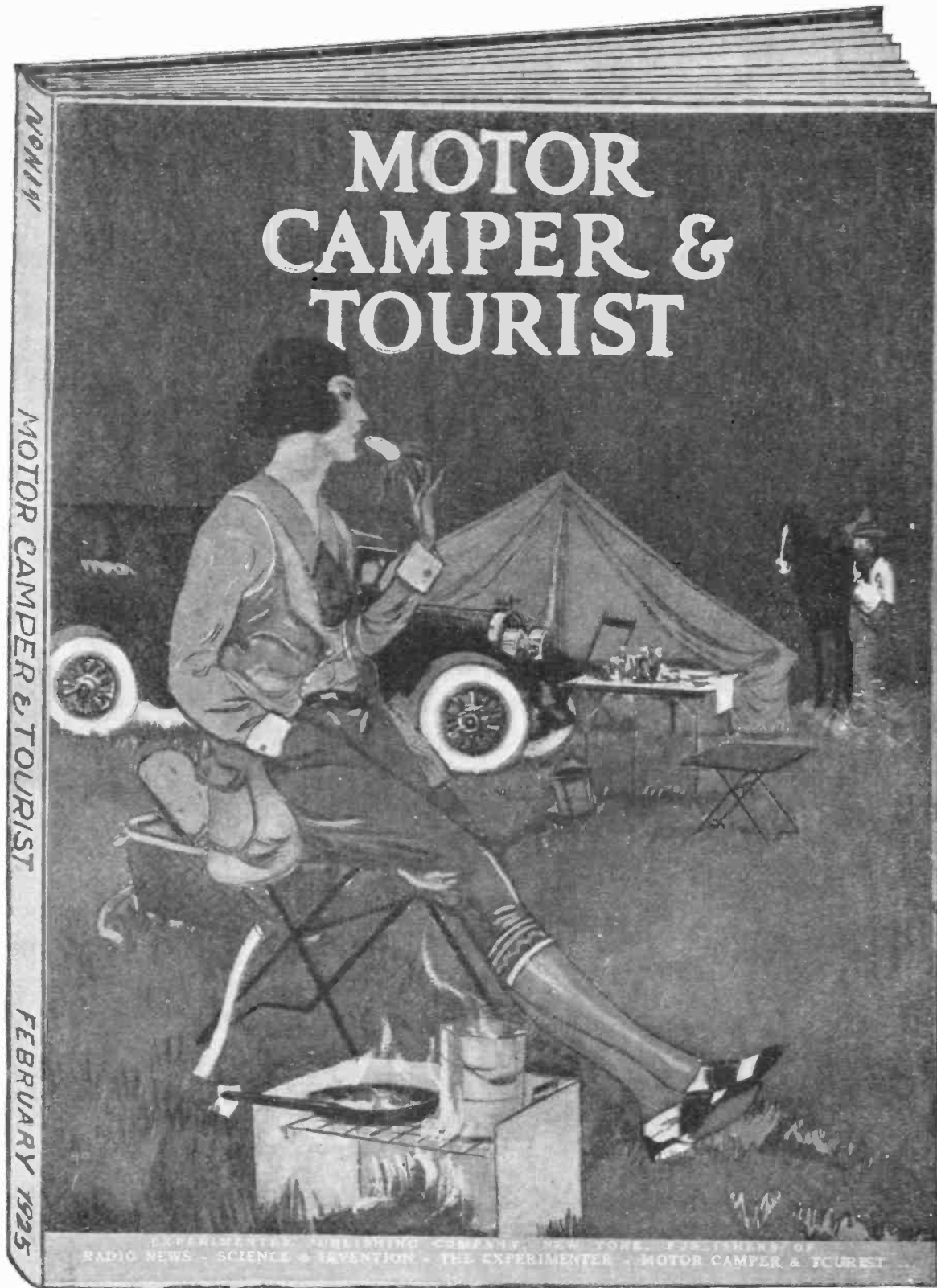

TOURING LIFE—"Down by the Rio Grande"

Featured in the February Issue of "MOTOR CAMPER & TOURIST"

Aside from the great number of beautiful hotels and stopping places in the State of Texas there are over 250 special camps entirely for Motor Tourists.

Motor Camper & Tourist is featuring the great state of Texas in its February Issue, giving a complete comprehensive survey

in pictures and editorial matter of this most interesting section of the United States.

Every Motor Tourist will do well to become acquainted with Texas and its famous Rio Grande.

February Issue of MOTOR CAMPER & TOURIST Now On Sale.

GERMOTT PUBLISHING CO., Inc., Owners

Licensed Publishers—The Experimenter Publishing Co., Inc.

53 Park Place, New York, N. Y.

Be An Auto Expert

\$60.00 Home Training Automotive Course

NOW FREE

Now you can start training at once for auto jobs at \$2000 to \$8000 a year, and without paying the usual tuition fee.

NEW TRAINING METHOD!

This amazing new-way training method developed by National Automotive. "The million-dollar training headquarters for auto experts," has revolutionized automotive training methods. It combines Home Training and Actual Shop Practice—and saves you one-fourth usual training time.

Earn \$2000 to \$8000 A YEAR

— Make up your mind today to become an auto expert and earn big money. Take advantage of this remarkable offer, get the \$60.00 Home Training Course Free, start training for bigger pay right in your own home. — Mail coupon now for complete information, and for big 84-page auto book.

You Can Succeed!
Hundreds of men write:
 "I have increased my earnings 100%," "I am now making \$250 a month," "I earn \$4000 a year, three times my former salary," "I have been promoted to sales manager, at \$6000 a year," "I have built a wonderful garage business and owe it all to National."

FREE Course Offer — Mail Coupon!
 NATIONAL AUTOMOTIVE,
 Dept 326, 4004 S. Figueroa, Los Angeles.
 Mail at once your free course offer, also your big, FREE, 84-page illustrated auto book.

Name _____
 Address _____

Carrying Case **FREE** with Big 3 ft. Telescope

See people and objects miles away just like they were closer see moon and stars as never before. Opens over 3 ft. long, 5 sections, brass bound, powerful lenses. Useful and entertaining.

"Could tell color of aeroplane 6 miles away," "Mrs. Tarbough. Watch my boy arrive at school 2 miles away," "Mrs. Horn. Read numbers on freight cars mile away, see mountains on moon," — A. G. Palmer. Thousands pleased.

Send No Write today on arrival of Big 3 ft. Telescope with FREE Carrying Case and Money Strip per Postman only \$1.36 plus a few pennies postage. Satisfaction Guaranteed.

FERRY & CO., 3222 N. Halsted St., Dept. 1253e CHICAGO

Go Into Business for Yourself

Make storekeepers' profits without storekeepers' troubles or expenses. No investment necessary. We furnish everything and carry all stock for you. We have started hundreds of men who are now making \$4000 to \$10,000 a year. We can do the same for you. Write for facts at once. Address Dept. 561, GOODWEAR Chicago, Inc., West Adams St., at Peoria, Chicago.

To the Radio Dealer

Let us explain how you can make the sale of our publications a worth while, well paying part of your business.

Write now and prepare for the Winter and Spring trade.

Experimenter Publishing Company
 53 Park Place New York City

Answers to Scientific Problems

(Continued from page 1155)

COLOR MIXING VS. PIGMENT MIXING

White light as we understand it is a combination of all the colors of the rainbow in just the right proportion to affect our visual sense with the impression of "whiteness." When such light falls upon various objects some of the light is absorbed and some of it reflected. The color of the light that escapes absorption we call the "color of the object." Thus, yellow paint appears yellow because it reflects mostly yellow light, while blue paint appears blue because it reflects principally blue light. Both yellow and blue paint, however, reflect some green light so that when mixed they absorb all colors but green.

When blue and yellow lights are cast upon the same white screen, they are both reflected equally well to the eye. There are processes induced by blue and yellow light affecting the eye in identical regions which seem to mutually inhibit each other, and neither process is effective in producing a sensation of color unless one or the other is particularly dominant. If pure colors are used and combined in just the right proportion, the screen will appear gray instead of either yellow or blue.

WHICH WOULD HURT THE MOST?

The energy of a moving body can be shown to be proportional to the mass of the body and to the square of its velocity. The kinetic energies of the two moving stones, then, would be in the ratio 2×30^2 to 3×20^2 or in the ratio 1800 to 1200 or three to two. Thus, the faster moving body would have half again as much energy as the slower moving one, and hence would inflict the most pain if it struck anyone.

FIRE AND WATER

An instance is known in which a round-bottomed flask filled with water set fire to a blotter upon which it stood by concentrating the rays of the sun upon it just as a "burning glass" may be used to concentrate light upon a piece of paper and set fire to it.

GASOLINE FILTER

GASOLINE IS DRAWN THROUGH CHAMOIS CONE, WHICH IS MADE IN FOLDS TO GIVE GREATER FILTERING SURFACE.

This interesting filter for autos strains all gasoline fed to the carburetor. Chamois is the filtering agent. The device is safe and insures perfect engine operation in all weather. Filters water and dirt.

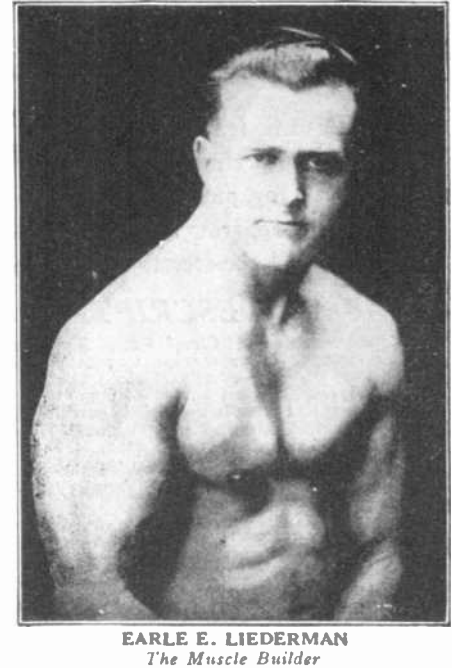

How Long Do You Expect to Live?

Make your own answer. It's up to you. I know you might be hit on the head with a brick or be pushed off the end of a dock. But barring accidents, what then? If you take care of an automobile it will last for years—abuse it and you might as well cash it in after the first year. This is just as true of your own body.

IF YOU DO—YOU DIE

Go ahead with your careless living if you want. Eat and drink what you like. Abuse your body—it's yours to do with as you please. You may think you're having a good time. But are you? You get up in the morning feeling half dead. You drag yourself through the day. Don't you know your body is clogging up with poison? Don't you know your lungs are starving for oxygen? Don't you realize your inner cells are breaking down and you are not doing a thing to replenish them? You're dying, man—and you don't know it.

I ADD YEARS TO YOUR LIFE

You need exercise. You must have it. Tie your arm to your side and it will wither away—but use your muscles and you have more muscle to use. Every vital organ is completely surrounded with muscles which make that organ function. Exercise and you strengthen the organ itself. You wear down the dead tissue. The white corpuscles of your blood carry it off and the red corpuscles supply new healthy tissue. You drive death and disease out and bring new life to a worn down and famished body.

YOU NEED A TEACHER

Just any kind of exercise won't do. I have had men come to me who were literally broken down from work in factory or mill. With scientific instruction I brought them back to strength and power.

My system has been tried and proven. It never fails. Some claim, eh? Well, it's true. I don't care what your present condition is. I'll knock those microbes higher than a cocked hat. I'll shoot you full of life and vitality. And muscle! That's my mid'd's name. In three months I'll build up every muscle in your body. I'll broaden those shoulders and deepen your chest. Every breath will bring deep loads of oxygen to your lungs, purifying your blood and shooting a thrill throughout your entire system. I'll brighten your eyes and clear your skin. I'll make you anvil of steel you will feel like shouting out to the world: "I'm a man and I can prove it!"

And remember, fellows, I don't just promise these things—I guarantee them. Do you doubt me? Make me prove it. That's what I like, because I know I can do it. Come on, then. Snap into it. Are you ready? Let's go.

Send for new 64-page book
"MUSCULAR DEVELOPMENT"
 It is FREE

It contains forty five full page photographs of myself and many of my prize winning pupils. Some of these came to me as pitiful weaklings, imploring me to help them. Look them over now, and you will marvel at their present physiques. This book will prove an impetus and a real inspiration to you. It will literally thrill you. All I ask is 10 cents to cover the cost of wrapping and mailing. This will not obligate you at all, but for the sake of your future health and happiness, do not put it off. Send today, right now, before you turn this page.

EARLE E. LIEDERMAN
 Dept. 203, 305 Broadway, New York City

EARLE E. LIEDERMAN, New York City.
 Dear Sir:—I enclose herewith 10 cents, for which you are to send me, without any obligation on my part whatever, a copy of your latest book, "Muscular Development." (Please write or print plainly.)

Name _____
 Street _____
 City _____ State _____

A Chemistry Laboratory for \$7.00

Think of it, fellows! Here is a *real* chemistry outfit with regular chemical apparatus that performs those fascinating, actual chemical experiments. This outfit is not a toy, put up merely to amuse, but a practical laboratory set, with all the chemicals, apparatus and reagents necessary to perform real work and to teach the beginner all the secrets of inorganic chemistry.

DESCRIPTION OF THE OUTFIT

The outfit consists of 44 Chemicals and Reagents all C. P. put up in appropriate wooden boxes, glass bottles, and hermetically closed jars. The acids are put up in glass bottles with ground-in glass stoppers, and there is a sufficient quantity of chemicals supplied (mostly one to two ounces) to make dozens of experiments with each.

The apparatus furnished are all of the best obtainable make and of standard laboratory size and shape.

The *Instruction Book* is a *real Chemistry Course for the Beginner*. Some of the Contents are: *Division of Matter*: This is a Treatise on Elementary Chemistry and deals with the theory of the Elements, Molecules and Atoms, etc. *Chemical Nomenclature*: This explains in simple language the derivation of the chemical names of the elements and their compounds. There is a chapter on *Laboratory Operations*; *Glass Working*; *First Aid*; *Fire Extinguishers*; *Experimenters' Aphorisms*, etc.

A good part of the book is devoted to Weights and Measures. The Metric System, The English System and the U. S. System are fully explained.

The following tables are furnished: Symbols and Atomic Weights of the Elements; Measures of Weights, Volume, Capacity and Length; per cent solutions; Conversion of Measure expressed in parts; poisons and their antidotes; technical and common name of chemical substances; formulas for cleaning various substances, etc., etc.

Among the 100 Experiments are:

How to make chemical tricks; How to make invisible and magic inks; How to test flour; How to test soil; How to make chlorine gas and smoke (German War Gas); How to bleach cloth and flowers; How to produce Oxygen and Hydrogen; How to make chemical colors; How to test Acids and Alkalies and hundreds of interesting hints and formulæ.

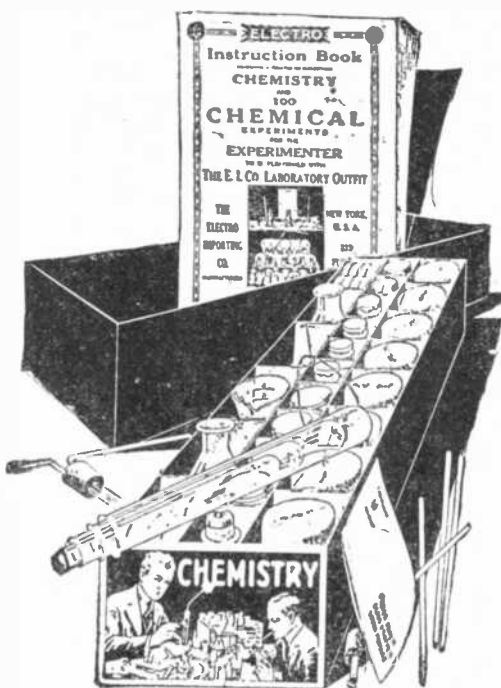

Complete, \$7.00 Sh. Wght., 10 lbs. (Shipped by Express only)
 (We guarantee shipment within 24 hours after your order is received)

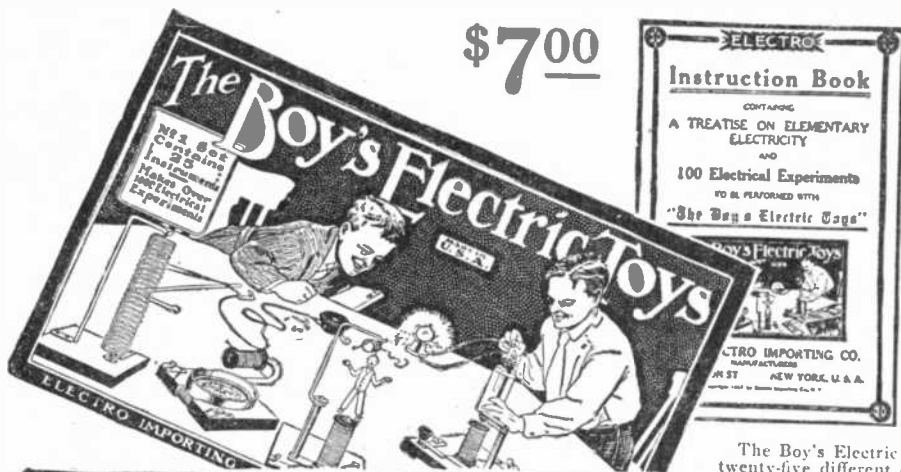

\$7.00

Every Fellow Wants the
BOY'S ELECTRIC TOYS



The Boy's Electric Toys contains: Enough material to make and complete over twenty-five different electrical apparatus without any other tools except a screw-driver furnished with the outfit. Student's chromic plunge battery, compass-galvanometer, solenoid, telephone receiver, electric lamp, etc. Enough various parts, wire, etc., are furnished to make the following apparatus:

Electromagnet, electric cannon, magnetic pictures, dancing spiral, electric hammer, galvanometer, voltmeter, hook for telephone receiver, condenser, sensitive microphone, short distance wireless telephone, test storage battery, shocking coil, complete telegraph set, electric riveting machine, electric buzzer, dancing fishes, singing telephones, mysterious dancing man, electric jumping jack, magnetic geometric figures, rheostat, erratic pendulum, electric butterfly, thermo-electric motor, visual telegraph, etc., etc.

With the instruction book we furnish one hundred experiments that can be made with this outfit, nearly all of these being illustrated with superb illustrations. No other materials, goods or supplies are necessary.

The outfit contains 114 separate pieces of material and 24 pieces of finished articles ready to use at once.

The size over all of the outfit is 14 x 9 x 2 3/4. Shipping weight 8 pounds. "The Boy's Electric Toys" outfit as described, \$7.00. Immediate shipment.

SEND NO MONEY

We have so much confidence in these sets that we desire to ship either one to you by express C.O.D. with the privilege of inspection. In other words, we ship on approval. It does not cost you one cent to take a good look at whichever outfit you want, and see if it comes up to your expectations. If it does, pay the express man \$7.00, plus express charges. If not, you need not accept it, and we will pay the return charges as well.

ELECTRO IMPORTING CO., 233 Fulton St., New York City

ELECTRO IMPORTING CO.,
 233 Fulton St., New York
 Please send me by express THE CHEMICAL LABORATORY. If I don't like it I need not accept it. If I want it I only pay \$7.00 plus the few cents express charge.

S&I-3-25

ELECTRO IMPORTING CO.,
 233 Fulton St., New York
 Please send me by express THE BOY'S ELECTRIC TOYS. If I don't like it I need not accept it. If I want it I only pay \$7.00 plus the few cents express charge.

S&I-3-25

5 TUBE RADIO SET \$38.50 COMPLETELY ASSEMBLED



10 DAYS FREE TRIAL

Coast to Coast

Direct from Factory to you at Less Than Dealer's Cost

Marvelous 5 tube radio set. La test and most efficient TUNED RADIO FREQUENCY circuit. Approved by America's Leading Radio Engineers and the Instituto of Standards. Easy to operate. Dials can be logged. Turn in your favorite stations instantly, on the same dial numbers every time. No guessing. Mr. Howard, of Chicago, said, "While 5 out-of-town stations were on the air, I tuned in 17 Chicago Broadcasting Stations from 40 to 1,000 miles away, on my loud speaker, very loud and clear, as though they were all in Chicago."

Description: 5 tube set. Comes completely assembled in beautiful mahogany cabinet, size 25x7 1/2 x 7 1/2. Has 2 stages Tuned Radio Frequency, Detector and 2 stages Audio Frequency. Equipped with the highest quality, approved standard low-loss parts. Genuine Bakelite Panel. Bakelite dials. Use any standard tubes and batteries.

10 DAYS' FREE TRIAL

Don't miss this chance to buy this high grade 5 tube set direct from factory. Regular value \$100.00. Our factory price only \$38.50. Send no money. Sign and mail coupon. Pay only \$38.50 when delivered, (plus small transportation charges). Try it 10 days. If you are not delighted with results—if you do not consider it equal or better than any \$100.00 set, send it back and we will cheerfully refund your money.

METRO ELECTRIC CO.

400 N. Michigan Ave., Dept. 80, Chicago, Ill.

Gentlemen: Ship me on approval your 5 tube long distance radio set. I will pay \$38.50 on arrival (plus transportation charges) with the understanding that if I am not fully satisfied after 10 days' free trial, I may return it and you will refund my money.

Name.....
Address.....
City.....

EVERY WOMAN A BUYER!
Lambs Wool Powder Puff

SELF-FEEDING and REFILLABLE

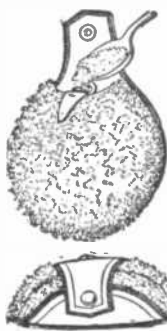

Holds several weeks' supply of Face Powder. Practical, durable, convenient. Real merchandise. Every buyer delighted! 3 inches diameter. Made of natural Lamb's skin, wool face, white kid back. Cut shows method of filling, also puff rolled and fastened for carrying in purse.

Light and easy to carry—demonstrate in one minute. No matter what you may be selling—if you deal with women you need this puff as a side-line.

150% to 200% PROFIT

Retails for 50c. You make from 150% to 200% profit, according to quantity you order. Send 35c for sample puff, filled with powder and ready for demonstrating. Let me tell you about my original selling plan—Two Sales and Two Profits with One Demonstration!

F. A. KOCH, Dept. 58, 8718 Arcadia Ave., Detroit, Mich.

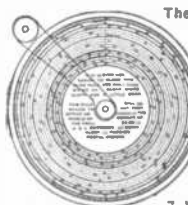

The Famous KON-VER-TER Slide Rule Instantly adds, subtracts, divides, multiplies, converts fractions or decimals of an inch. Gives sines, co-sines, versed sines, co-versed sines, tangents, co-tangents, secants co-secants of angles directly. Gives square roots, squares, cube roots, cubes and fifth roots and powers of all numbers. Logarithms, co-logarithms, anti-logarithms. Instructions with rule. DeLuxe Model \$3. Cash or C.O.D. J. C. HAMILTON

7 Water St., Dept. B Boston, Mass.

Motor Hints

By TOM C. PLUMRIDGE
Curing Knocks and Noises.

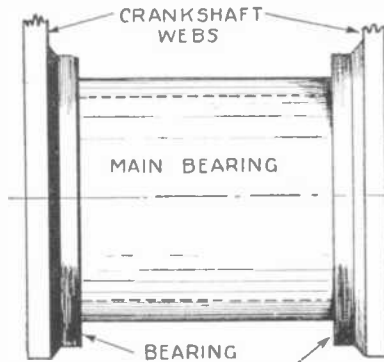

FIG. 1

One main bearing in every engine is flanged as shown above. Play between flanges and crank shaft web results in knock. New bearings may be inserted or repair made as in Fig. 2. This play should be the first thing taken care of.

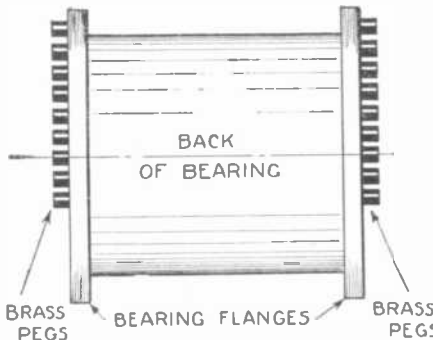

FIG. 2

To repair flanged main bearing, drill series of holes in ends of bearing, tap and insert small brass pegs as shown. Pegs are then filed down until main bearing will give snug fit between crankshaft webs.

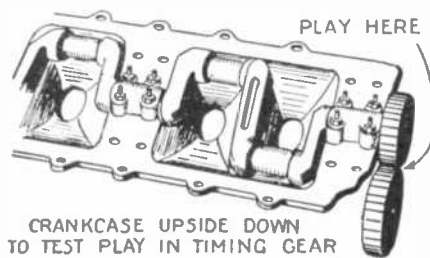

FIG. 3

Before scraping bearings, to take up up-and-down play, be sure that there is sufficient play in the timing gears as shown above. If not, every one of the main bearings should be raised slightly by means of shims, being sure to raise each bearing the same amount.

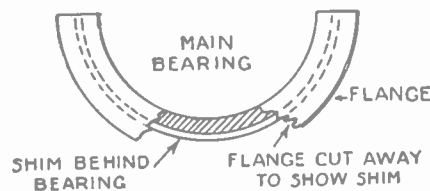

FIG. 4

Fig. 4 shows how shim material is placed under the main bearing to effect the repair mentioned above. Use no more shim material than is absolutely necessary.

(Continued on page 1163)



“What would I do if I lost my job?”

SUPPOSE your employer notified you to-morrow that he didn't need you any longer? Have you any idea where you could get another position?

Don't have this spectre of unemployment hanging over your head forever. Train yourself to do some one thing so well that your services will be in demand. Employers don't discharge such men. They promote them!

Decide to-day that you are going to get the specialized training you must have if you are ever going to get—and keep—a real job at a real salary. It is easy if you really try.

Right at home, in the odds and ends of spare time that now go to waste, you can prepare for the position you want in the work you like best. For the International Correspondence Schools will train you just as they are training thousands of other men—no matter where you live—no matter what your circumstances.

At least find out how, by marking and mailing the coupon printed below. There's no cost or obligation, and it takes only a moment of your time, but it may be the means of changing your whole life.

Mail the Coupon To-day!

INTERNATIONAL CORRESPONDENCE SCHOOLS

Box 6200-D, Scranton, Penna.

Without cost or obligation on my part, please tell me how I can qualify for the position or in the subject before which I have marked an X:

BUSINESS TRAINING COURSES

- | | |
|--|---|
| <input type="checkbox"/> Business Management | <input type="checkbox"/> Salesmanship |
| <input type="checkbox"/> Industrial Management | <input type="checkbox"/> Advertising |
| <input type="checkbox"/> Personnel Organization | <input type="checkbox"/> Better Letters |
| <input type="checkbox"/> Traffic Management | <input type="checkbox"/> Show Card Lettering |
| <input type="checkbox"/> Business Law | <input type="checkbox"/> Stenography and Typing |
| <input type="checkbox"/> Banking and Banking Law | <input type="checkbox"/> Business English |
| <input type="checkbox"/> Accountancy (including C.P.A.) | <input type="checkbox"/> Civil Service |
| <input type="checkbox"/> Nicholson Cost Accounting | <input type="checkbox"/> Railway Mail Clerk |
| <input type="checkbox"/> Bookkeeping | <input type="checkbox"/> Common School Subjects |
| <input type="checkbox"/> Private Secretary | <input type="checkbox"/> High School Subjects |
| <input type="checkbox"/> Spanish <input type="checkbox"/> French | <input type="checkbox"/> Illustrating |

TECHNICAL AND INDUSTRIAL COURSES

- | | |
|---|--|
| <input type="checkbox"/> Electrical Engineering | <input type="checkbox"/> Architect |
| <input type="checkbox"/> Electric Lighting | <input type="checkbox"/> Architects' Blue Prints |
| <input type="checkbox"/> Mechanical Engineer | <input type="checkbox"/> Contractor and Builder |
| <input type="checkbox"/> Mechanical Draftsman | <input type="checkbox"/> Architectural Draftsman |
| <input type="checkbox"/> Machine Shop Practices | <input type="checkbox"/> Concrete Builder |
| <input type="checkbox"/> Railroad Positions | <input type="checkbox"/> Structural Engineer |
| <input type="checkbox"/> Gas Engine Operating | <input type="checkbox"/> Chemistry <input type="checkbox"/> Pharmacy |
| <input type="checkbox"/> Civil Engineer | <input type="checkbox"/> Automobile Work |
| <input type="checkbox"/> Surveying and Mapping | <input type="checkbox"/> Airplane Engines |
| <input type="checkbox"/> Metallurgy <input type="checkbox"/> Mining | <input type="checkbox"/> Agriculture and Poultry |
| <input type="checkbox"/> Steam Engineering <input type="checkbox"/> Radio | <input type="checkbox"/> Mathematics |

Name.....
Street..... 3-6-24
Address.....
City..... State.....

Occupation.....
Persons residing in Canada should send this coupon to the International Correspondence Schools Canadian, Limited, Montreal, Canada

PERSONAL STATIONERY
200 SHEETS and \$1.00
100 ENVELOPES \$1.00

Printed with your Name and Address

Clear, white bond paper, with envelopes to match. Your name and address printed in beautiful, rich blue ink, on both paper and envelopes, and sent to you postpaid for only \$1.00. (West of Mississippi river and outside of U. S. \$1.10.) If inconvenient to send the money, we will ship C.O.D. Money returned if you are not more than satisfied. Order today. Write name and address plainly.

AGENTS MAKE BIG MONEY taking orders for us. Write us today for our agent's proposition.

ELITE STATIONERY COMPANY

5030 Main Street Smethport, Pa.

Insure your copy reaching you each month. Subscribe to SCIENCE & INVENTION—\$2.50 a year. Experimenter Publishing Co., 53 Park Pl., N. Y. C.

For the Hookup Enthusiast!

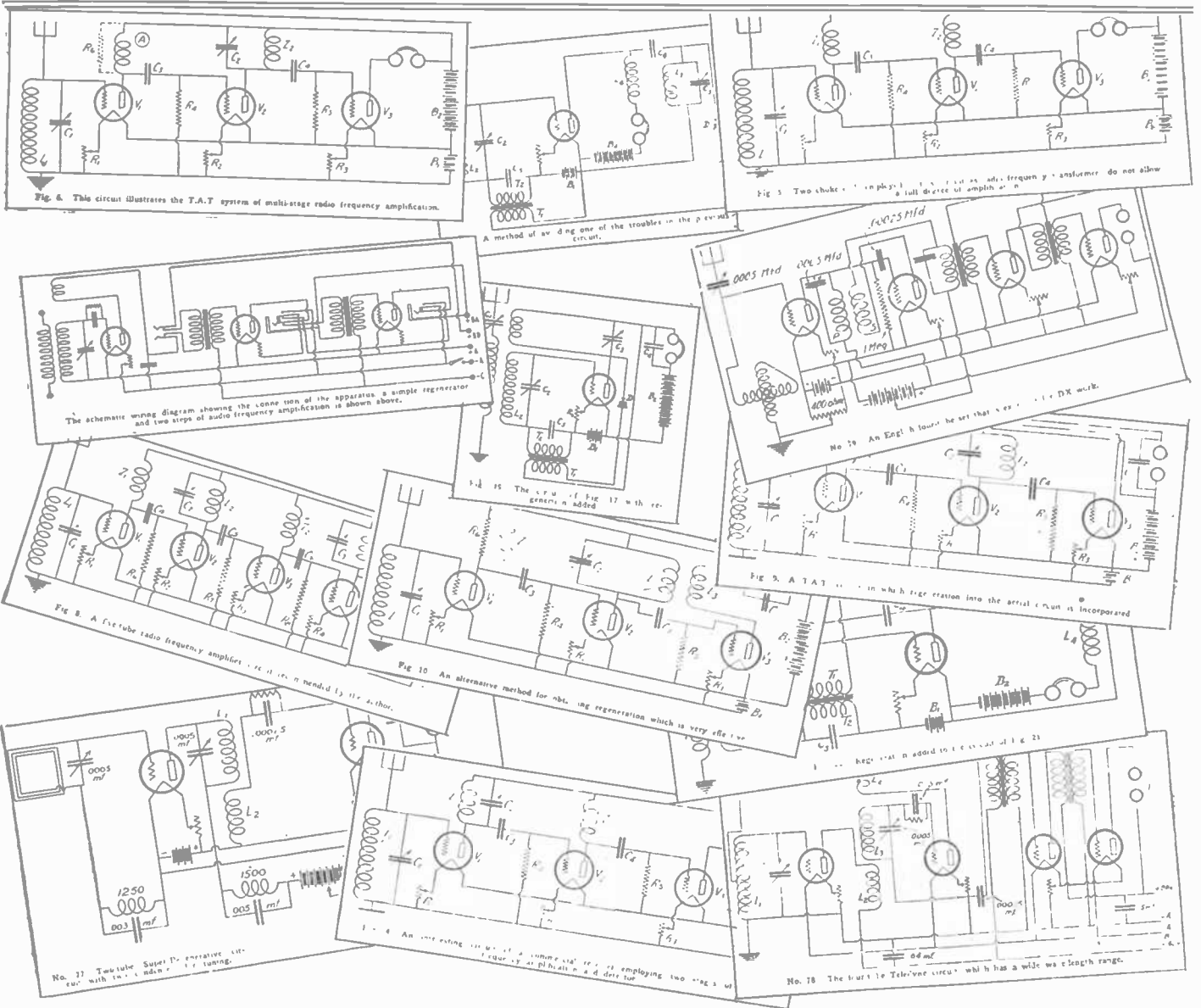

Radio's Latest Hookups and Plenty of them Every Issue

When you're looking for new ideas in hookups and the circuits worked out by the best and foremost radio engineers, you will find them in RADIO NEWS. The February issue of RADIO NEWS alone carried over 45 hookups. Plenty for the most critical or ardent radio enthusiast.

And every RADIO NEWS hookup is the latest and best that is developed. In the majority of cases RADIO NEWS is first in printing the new hookups.

If you are a hookup enthusiast there is only one radio magazine for you. Ask your local newsdealer to show you a copy of RADIO NEWS the next time you pass his stand or store.

Radio News is Sold on All Newsstands
25c. the Copy

Published by

The Experimenter Publishing Co., Inc.
53 Park Place, New York, N. Y.

1925 Edition

"20 Radio Hookups"

Each Hookup Given in Two Ways — Perspective and Schematic

Twenty of the finest, most up-to-date hookups on the best receivers. A gold mine of Radio circuit diagrams.

All given in the latest Consrad style which shows not only a perspective view of the complete set, but also a complete schematic circuit diagram of each circuit.

Pattern contains 20 blue-prints size 9 by 12 inches together with a 4-page instruction folder that shows how to read each circuit and also a complete chart of Radio symbols. Pattern is size 9¼ by 12½ inches and is printed in handsome colors.

Price 50c.

ON SALE AT ALL RADIO AND NEWS DEALERS

Published by

The Consrad Co.
233 Fulton Street
New York, N. Y.

HAMMER HERE TO DRIVE BEARING INTO PLACE

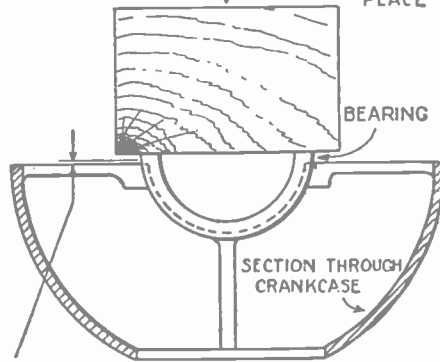

DISTANCE BEARING MAY STAND ABOVE CASE, WHEN IN POSITION
FIG. 5

Replacing main bearing after inserting shims. Hammer on the hardwood block and if necessary file surface of bearing edges off.

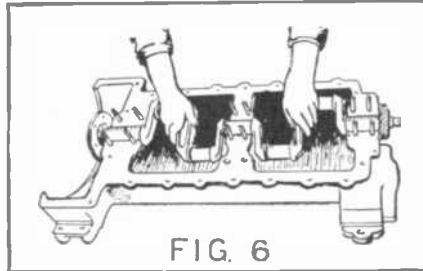

Determining fit. Place thin coating of blue chalk on shaft, place in position, rotate and blue chalk is found on bearing high spots.

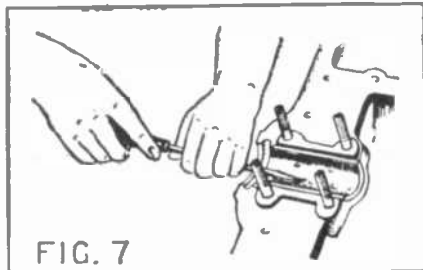

High spots on bearing should now be scraped with bearing scraper and then tested again as in Fig. 6 until no high spots are found.

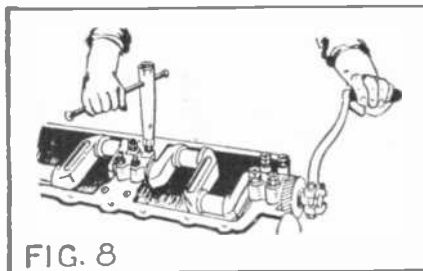

Tightening bearing caps. Place chalk on caps and bolt in place. Rotate with handle fitted as shown. Scrape down high spots.

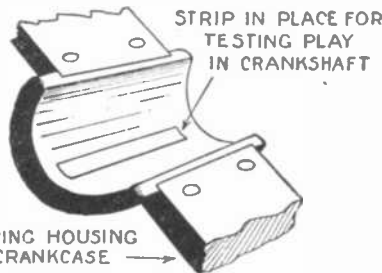

FIG. 9

Place quarter-inch wide strip of shim metal on bearing as above. If shaft can be easily turned, bearings are not tight enough. If slight drag is felt, bearings are fitted properly. Do not forget to remove shim metal.

Every Question ANSWERED for only \$1



JUST OUT 514 PAGES

Compiled by **HARRY F. DART, E.E.**

Formerly with the Western Electric Co., and U. S. Army Instructor of Radio.

Technically edited by **F. H. Doane**

NO MORE need you turn from book to book, hoping to find what you want. It is all here, in 514 pages crammed full of every possible radio detail. Written in plain language, by engineers for laymen. More than 100,000 sold.

IT EXPLAINS: Electrical terms and circuits, antennas, batteries, generators and motors, electron (vacuum) tubes, every receiving hook-up, radio and audio frequency amplification, broadcast and commercial transmitters and receivers, super-regeneration, codes, etc.

Send \$1 to-day and get this 514-page I. C. S. Radio Handbook—the biggest value in radio to-day.

International Correspondence Schools

Box 6202-D, Scranton, Penna.
I enclose One Dollar. Please send me—post-paid—the 514-page I. C. S. Radio Handbook. It is understood that if I am not entirely satisfied I may return this book within five days and you will refund my money.

Name
Address
Check here and enclose \$1.50 if you wish the de luxe edition, bound in Leatheroid.

Opportunity Ad-lets

(Continued from page 1166)

Stamps and Coins

California Gold, quarter size, 27c; half-dollar silver, 53c. Columbian nickel and catalogue, 10c. Norman Shultz, Box 148, Colorado Spring, Colo.

Stamps 100 All Different 3 cents. S. I. Quaker Stamp Company, Toledo, O.

158 Genuine Foreign Stamps. Mexico War Issues. Venezuela, Salvador and India Service, Guatemala, China, etc., only 5c. Finest approval sheets, 50 to 60%. Agents Wanted. Big 72-p. Lists Free. We buy stamps. Established 20 years. Hussman Stamp Co., Dept. 156, St. Louis, Mo.

You'll get profit and pleasure collecting old coins. Send 10c for genuine old coin and large coin catalog. This is just a get-acquainted offer. Send today. You'll be delighted with it. B. Max Mehl, Numismatist, Dept. N, Mehl Building, Fort Worth, Texas. Largest Coin Firm in U. S.

French Colonies Free—Pretty picture set, Native Chiefs, Tigers, 2c postage. Empire Stamp Company, 351 Lippincott, Toronto, Canada.

Telegraphy

Telegraphy—Morse or Radio taught at home. 808. Broadcasters silent. Human tragedy at sea. Learn the code, get the greatest thrill of radio. Booklet 118 free. Learn-O-Graph Co., Ridgefield Park, N. J.

Typewriters

Typewriters, all standard makes, \$10 up. Fully guaranteed. Free trial. Write for complete illustrated lists. Northwestern Exchange, 121 N. Francisco Ave., Chicago.

Wanted

Detectives Earn Big Money. Work home or travel. Experience unnecessary. Write, George Wagner former Government Detective, 1968 Broadway, N. Y.

Wanted to Exchange

Tanned mountain lion or alligator skin for correspondence course in marine engineering or high school. E. Adams, Box 814, New Orleans, La.

Price

\$1.00

Summary of Contents

Two hundred and twenty-eight pages, hundreds of photos, drawings, circuits, charts and diagrams.

Chapters devoted exclusively to each type of radio Receiver beginning with the typical amateur receiver and ending with special Super and super-regenerative outfits.

Then there are complete chapters on Coupling, Antennas, Condensers, Detectors, Transformers, Vacuum tube efficiency, Operation and care, High frequency resistance, etc.

No more complete book of its kind has ever been published and it is authoritative, backed by Radio's greatest magazine, RADIO NEWS.

Size of book, 6 by 9 inches.

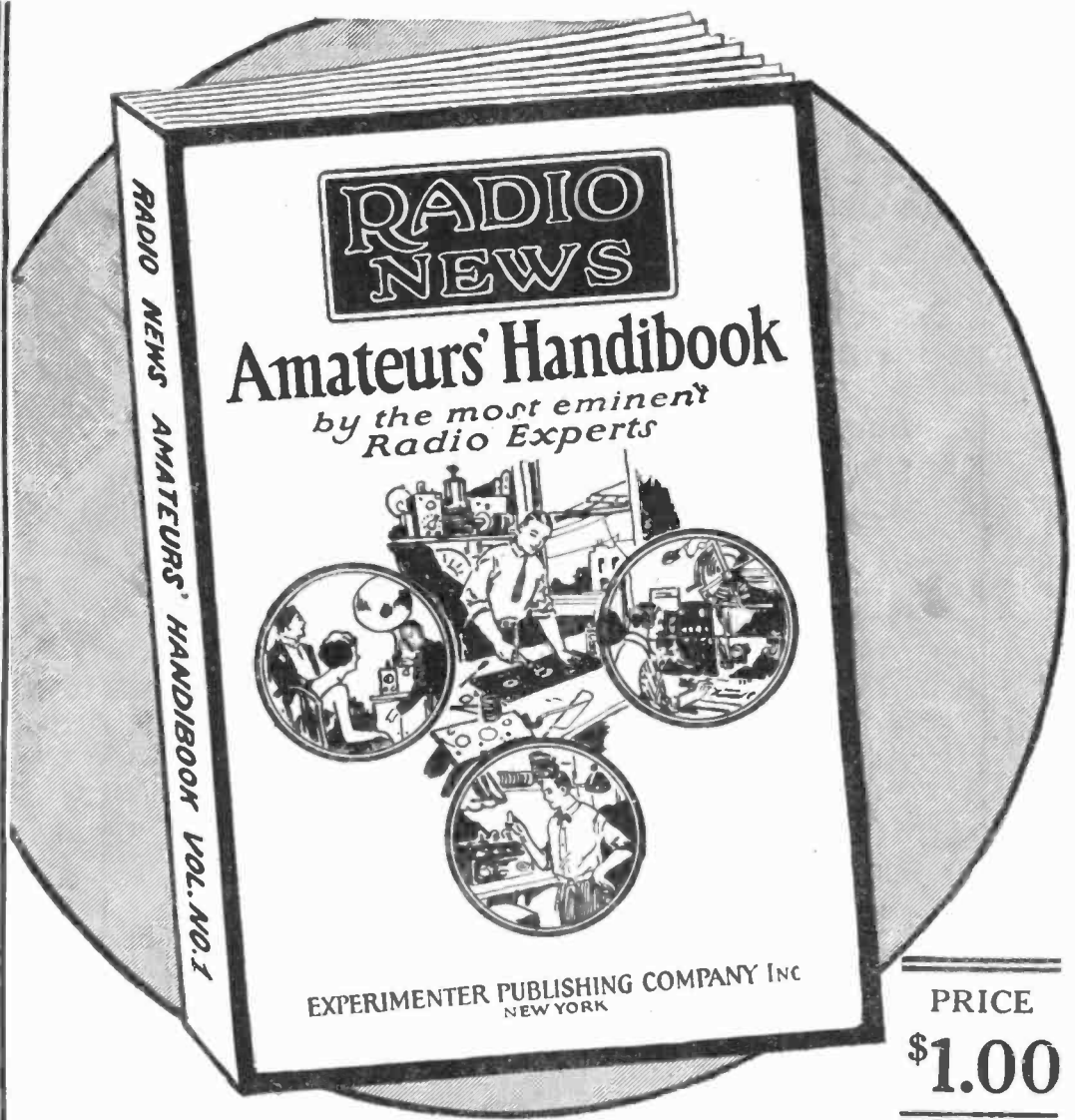

PRICE
\$1.00

Use
this
Coupon

Radio!

Complete in one great book

Radio's most complete handibook, written by the foremost radio authorities. Contains 228 pages, over 375 illustrations including wiring diagrams, complete sets, special parts, etc. Sections include articles on receiving sets and sundry apparatus, transmitters and accessories, radio theory, vacuum tube data, and practical hints and helps for the amateur. Just enclose a dollar bill or money order and the book will be forwarded to you at once postpaid.

Published by the Publishers of
"RADIO NEWS"

The Experimenter Publishing Co., Inc.
53 Park Place
New York, N. Y.

Enclosed find \$1.00 for which please send me at once one copy of the "Radio News Amateurs' Handibook".

Name

Address

City

State

53 Park Place, New York

Opportunity Ad-lets

YOU will find many remarkable opportunities and real bargains in these columns. It will pay you to read and investigate the offerings made every month by reliable firms, dealers and amateurs from all over the country. No matter what you may be seeking, whether supplies, automobile accessories, the opportunity to make money, or anything else, you will find listed here the best and most attractive specials of the month.

Advertisements in this section twelve cents a word for each insertion. Name and address must be included at the above rate. Cash should accompany all classified advertisements unless placed by an accredited advertising agency. No advertisement for less than 10 words accepted. Ten per cent. discount for 6 issues, 20 per cent. discount for 12 issues. Objectionable or misleading advertisements not accepted. Advertisements for the May issue must reach us not later than March 10th.

The Circulation of Science and Invention is over 150,000 and climbing every month

EXPERIMENTER PUBLISHING CO., INC., 53 Park Place, New York City, N. Y.

Agents Wanted

Agents—Best seller; Jew Rubber Repair for tires and tubes; supercedes vulcanization at a saving of over 800 per cent; put it on cord. It vulcanizes itself in two minutes and is guaranteed to last the life of the tire or tube; sells to every auto owner and accessory dealer. For particulars how to make big money and free sample, address Amazon Rubber Co., Dept. 601, Philadelphia, Pa.

Agents—Write for Free Samples. Sell Madison "Better-Made" Shirts for large Manufacturer direct to wearer. No capital or experience required. Many earn \$100 weekly and bonus. Madison Mills, 564 Broadway, New York.

Big money and fast sales. Every owner buys gold initials for his auto. You charge \$1.50; make \$1.35. Ten orders daily easy. Write for particulars and free samples. American Monogram Co. Dept. 71, East Orange, N. J.

Only one sale a day means \$200 per month. Five sales, \$1,000 per month. Marvelous new adding machine. Retail \$15. Work equals \$350 machine. Adds, subtracts, multiplies, divides automatically. Speedy, accurate, durable, handsome. Five-year guarantee. Offices, stores, factories, garages buy one to dozen. A fortune for live agents. Write quick for protected territory and free trial offer. Lightning Calculator Co., Dept. W., Grand Rapids, Mich.

Earn big money fast applying gold initials to autos. Every owner buys—\$1.35 profit on \$1.50 sale—particulars and samples free. Write quick. Lithogram Co., Dept. 19, East Orange, N. J.

Earn \$10 daily silvering mirrors, plating and refinishing metalware, chandeliers, bedsteads, headlights. Outfits furnished. N. Deele Laboratories, 1133 Broadway, New York.

\$60—\$200 a week. Genuine Gold Letters for store windows. Easily applied. Free samples. Liberal offer to general agents. Metallic Letter Co., 441 E. North Clark, Chicago.

\$25.00 a day easy! Best line of brushes on the market. 90 varieties, including famous Auto Fountain Washer. Excellent territory available. Write immediately. Philadelphia Brush Co., Dept. 26, Vineland, N. J.

Write and learn how to start profitable business without capital or experience. Silvering mirrors, refinishing auto headlights, tableware plating. Outfit furnished. International Laboratories, Dept. 25, 309 Fifth Ave., New York.

Agents—Be independent, make big profit with our soap, toilet articles and household necessities. Get free sample case offer. Ho-It-Co., 2719 Dodder St., St. Louis, Mo.

Make \$17 Day.—Finest extracts, food products, toilet preparations, household necessities. Credit; sample case free. Write for amazing offer. Perkins Products, B-30, Hastings, Nebr.

At Last! Diamond Rival Discovered! Amazing blue white Rajah Gem astounds jewelry world and deceives experts! Beautiful Sample Case Free! \$100 weekly! Write Quick! Rajah Diamond Co., Dept. F45, Salisbury, N. C.

Wonderful invention eliminates needles for phonographs. Preserves records. Abolishes scratching. Day's supply in pocket. \$20 daily. Sample on approval if requested. Everplay, Desk H2, McClurg Bldg., Chicago.

Agents—\$15 a day. Easy, quick sales. Free auto. Big weekly bonus. \$1.50 premium free to every customer. Simply show our beautiful, 7-piece, solid aluminum handle cutlery set. Appeals instantly. We deliver and collect. Pay daily. New Era Mfg. Co., 803 Madison St., Dept. 88E, Chicago.

\$10 daily silvering mirrors, plating and refinishing lamps, reflectors, autos, beds, chandeliers by new method. Outfits furnished. Write Gunmetal Co., Ave. D, Decatur, Ill.

Earn money at home. Addressing, mailing circulars. Experience unnecessary. No selling. We pay weekly. York Supply Co., Dept. 120, 309 Fifth Ave., New York.

Agents: 500 per cent profit. "Happy Home Maker Shampoo" builds your own big business. Martin of Indiana made \$75.00 in one day. Missouri man made \$750.00 one month. Exclusive territory. Geo. A. Schmidt & Co., 236B West North Ave., Chicago.

Build splendid business making etched glass number and name plates. Particulars free. Simplex Co., Dept. 93, 1133 Broadway, New York.

Wanted—District Purchasing Agents, no experience or money required. Write Purchasing Manager, Dept. 13 K, 5336 Berenice, Chicago.

Marvelous New Invention—400 per cent profit. Johnson's Liquid Quick Mend. Tremendous demand. Plan unique. Act quick. Over hundred other fast-selling specialties. J. E. Johnson & Co., Dept. 57, 321 W. Chicago Ave., Chicago, Ill.

Distributors—Screw-holding Screw Driver. Handiest Tool ever invented. Unlimited Market. Exclusive Territories. Big repeat earnings! Write Coburn Tool, 733Y Boston, Boston, Mass.

Agents Wanted (Continued)

Agents—90c an Hour to advertise and distribute samples to consumer. Write quick for territory and particulars. American Products Company, 2361 American Bldg., Cincinnati, Ohio.

Succeed with your Own Products—Formulas by experts. Manufacturing processes. Trade-secrets. Modern master methods. Catalog. D. Thaxly Co., Washington, D. C.

Clothing Sensational! New line of men's clothing. All-wool suits, all at one low price of \$23.50. Nothing higher. We pay biggest commissions cash with order, supply finest selling outfit and give powerful co-operation. 3 to 6 orders a day gives you income of \$60.00 to \$125.00 a week. Experience isn't necessary. If you're honest, earnest and willing to work we'll train you. Address Dept. 351, William C. Bartlett, Inc., 850 W. Adams St., Chicago.

American Made Toys

Opportunity to start Manufacturing Metal Toys and Novelties. No experience necessary. Enormous demand exceeds supply. We furnish, at cost, casting forms for production and buy entire output, also place yearly contract orders. Casting forms made to order. Catalog, advice and information free. Metal Cast Products Co., 1696 Boston Road, New York.

Battle Photos and War Relics

For Dens: Relics Collected from Europe's Battlefields. Firearms, medals, helmets, etc. Illustrated catalogue and sample War photographs 25c. Lieut. Welsh, 2117 Regent Place, Brooklyn, N. Y.

Books

Free—Upon request will send you my literature illustrating the following books. Astrology, Character, Clairvoyance, Concentration, Healing, Hypnotism, Magnetism, Mediumship, Personal Magnetism, Personality, Physiology, Salesmanship, Seership, Success, Sex, Will, Yogi Philosophy, Gazing Crystals, etc. A. W. Martens, E. E. 6, Burlington, Iowa.

Pocket Guide to 2000 tourists' camps; auto trails; airplane landings together with two 40 in. maps. One Dollar. 530 Flisk Bldg., 250 West 57th, New York City.

Nature's Finer Forces. Marvelous Scientific Disclosures: Lights; Colors; Tones; Vibrations; Odic-Auras; Cold-lights; Radio; Inventions; 270 pages, \$3.00. Satisfaction Guaranteed! Circulars Free. E. J. Stevens, Publisher, 242 Powell, San Francisco, Calif.

Business Opportunities

Dollars yearly in your backyard. No mushroom depots. Particulars free. Metz, 313 East 89th, New York.

You can have a business-profession of your own and earn big income in service fees. A new system of foot correction; readily learned by anyone at home in a few weeks. Easy terms for training, openings everywhere with all the trade you can attend to. No capital required or goods to buy, no agency or soliciting. Address Stephenson Laboratory, 18 Back Bay, Boston, Mass.

Stop Plodding! Be Successful. Operate a Tire Repair Shop. Make big profits in any locality. We teach you and furnish complete equipments \$100 up. Book of Opportunity free. Hayward's, 1512 South Oakley Avenue, Chicago.

Get Money in your mail. "Lambert's Mail Order Secrets" contains successful methods never before published. Particulars free. Leon Lambert 870-D Kaufman Bldg., Wichita, Kansas.

Formulas. New, Different. Make your own extracts, flavors, syrups, beverages, etc. Name-address brings valuable information free. Meriden Co., 3522 M. White Bldg., Seattle, Wash.

Earn \$25 weekly, spare time, writing for newspapers, magazines. Experience unnecessary. Copyright book free. Press Syndicate, 987, St. Louis, Mo.

Free Instructive Book. Start little mail order business; home employment evenings. Outfit furnished. Pier, 867 Cortland Street, N. Y.

Free Booklet. How to become Successful in Real Estate. Macdonald Cooperative Realty, San Diego, California.

Boys Earn Big Money. Our Free New Plan makes it easy. Write today. Dept. B3, Arab Products, Niagara Falls, N. Y.

Chemistry

Learn Chemistry at Home. Dr. T. O'Connor Sloane noted educator and scientific authority, will teach you. Our home study correspondence course fits you to take a position as chemist. See our ad on page 1071 of this issue. Chemical Institute of New York, 66 W. Broadway, New York City.

Correspondence Courses

Used correspondence courses of all schools sold, rented and exchanged. List free. (Courses bought.) Leo Newman, East Chattanooga, Tenn.

Correspondence Courses bought and sold. Handling, 799-a Broadway, New York.

Educational

Correspondence Courses—All schools sold complete at lowest prices. Easy terms, money-back guarantee. Courses bought for cash. Catalog Free. Mention Subject. Economy Educator Service, 442-H Sansone, San Francisco.

Farm Lands

Seized and Sold for Taxes. \$45 for 5 acres beautiful lake front. \$50 for 10 acres, hunting camp site. \$92 for 50 acres, mixed farming, good market. \$315 for 160 acres, wheat and dairy farm. Manitoba \$278 for claim near mines that have paid millions. Lots from 1/4 acre to 2 square miles suitable for hunting, fishing, farming, mining, lumbering, summer cottages, camp sites, etc. All offered at ten cents on the dollar of their value. \$5 and \$10 down and easy monthly payments. Send for illustrated list describing the above and hundreds of properties seized and sold for taxes. Send no money, send for list to-day so you will have first choice. Tax Sale Service, 72 Queen Street West, District 218, Toronto, Ontario, Canada.

For Advertisers

24 words—355 Rural Weeklies \$14.20. Ad-Meyer, 4112 St. Hartford, St. Louis, Mo.

For Inventors

We Develop Your Ideas into commercial shape for presentation to purchasers making working models, drawings, experiments or tests. Courtesy, efficiency, secrecy and ample equipment; 30 years' experience. Duorron-Rich Engineering Co., 501 Pacific Mutual Bldg., Los Angeles, Cal.

Unpatented Ideas Can Be Sold. I tell you how and help you make the sale. Free particulars ("copyrighted"). Write W. T. Greene, 808 Jenifer Bldg., Washington, D. C.

Your Chemical problems solved and working process furnished for Five Dollars. Write me, W. Steidman Richards, Consulting Chemist, Box 2102, Boston, Mass.

Patents are expensive. Your ideas can be sold without this expense. Complete instructions. \$2. Box 61, Pontiac, Michigan.

Patents—Send for booklet. Contains valuable information for inventors. Bank and commercial references. Prompt service, twenty years experience. Talbert & Talbert, Registered Patent Lawyers, 557 McGill Building, Washington, D. C.

Formulas

Money-making Banks, Plans, Formulas, Catalogue Free. Ideal Book Shop, 5501-E, North Robey, Chicago.

What do you want to manufacture? \$2 will bring guaranteed formula for any product, complete instructions. Consulting Chemists Bureau, Box 1703, Boston, Mass.

For Sale

Typewriter—Cost \$100—will sell for \$35. Carnegie College, Rogers, Ohio.

For the Photographer

Have you a camera? Write for free sample of our big magazine, showing how to make better pictures and earn money. American Photography, 118 Camera House, Boston, 17, Mass.

Games and Entertainment

Tricks, Puzzles, Jokes, Magical Apparatus, Plays, Stage Supplies, Mind-Reading Acts and Sensational Escapes. Send 10c for 160-page illustrated 1922 professional catalogue. Oaks Magical Co., Dept. 549, Oshkosh, Wis.

Health

Free—Stop using tobacco. We will give free information how to conquer habit easily and permanently. Results guaranteed. Anti-Tobacco League Box M, Omaha, Neb.

Help Wanted

Detectives Needed Everywhere. Work home or travel. Experience unnecessary. Write, George Wagner, former Government Detective, 1968 Broadway, N. Y.

Silvering Mirrors, French plate. Easily learned, immense profits. Plans free. Wear Mirror Works, Excelsior Springs, Mo.

Detectives Earn Big Money. Travel. Excellent opportunity. Great demand everywhere. Experience unnecessary. Particulars free. Write, American Detective System, 1974 Broadway, N. Y.

Earn \$1.20 an hour cutting blanks at home; anywhere; spare time. Men only. Send addressed reply envelope. Goodbear Sy., 117 W. 23d St., New York.

Men to Build Radio Sets in spare time. Leon Lambert, 670-H Kaufman Bldg., Wichita, Kansas.

Become a Landscape Architect. Overcrowded profession of wonderful opportunity for money-making. Easily mastered by mail. Earn while you learn. Write for book, American Landscape School, 69-E, Newark, New York.

Be a Detective—Exceptional opportunity; earn big money. Travel. Big rewards. Established 1909. Particulars free. Write C. T. Ludwig, 1117C Westover Bldg., Kansas City, Mo.

Earn \$25 weekly, spare time, writing for newspapers, magazines. Experience unnecessary. Copyright book free. Press Syndicate, 986, St. Louis, Mo.

Get Posted—Good prices paid for butterflies, insects. See Sinclair display advertisement page 1153.

Money Silvering Mirrors, Autolight, Radiators, tableware, Methods Free. Write Sprinkle, Plater, 955, Minton, Indiana.

Men, 18 to 35, Heenan Railway Postal Clerks. Common \$1600 year. Common education sufficient. Specimen examination questions free. Write immediately. Frank-Pa Institute, Dept. A 23, Rochester, N. Y.

Firemen, Brakemen, Baggage-men. Sleeping car, train porters (colored). \$110-\$200. Experience unnecessary. 897 Railway Bureau, East St. Louis, Ill.

Wanted—Mail Clerks to handle mail on trains (travel). Forest Rangers, Guard Forest Reserves, Special Agents, make investigations, Big Pay. Write Ozment, The Coach, 293, St. Louis, Mo., quickly.

Insects Wanted

Get Posted—Good prices paid for butterflies, insects. See Sinclair display advertisement page 1153.

Instruction

Learn Chemistry at Home. Dr. T. O'Connor Sloane, noted educator and scientific authority, will teach you. Our home study correspondence course fits you to take a position as chemist. See our ad on page 971 of this issue. Chemical Institute of New York, 66 W. Broadway, New York City.

Correspondence Courses sold complete: one-third usual prices because slightly used; easy terms; money back guarantee. All schools and subjects. Write for special Free catalog. Courses bought for cash. Economy Educator Service, H202, West 49th St., New York.

Languages

World-Romic System, Masterkey to All Languages. Primers, \$1.91. Chinese, French, Spanish, Pronunciation-Tables, 30c. Dictionaries, \$1.98. Languages, 8 West 40th, New York.

Machinery and Tools

Concrete Building Block Machines and Molds. Catalogue free. Concrete Machine Co., 305 South Third St., St. Louis, Mo.

Manufacturers

Patented Articles Models, Brass Work, Machine Construction; Dies Made. Baum's Metal Specialties, Kansas City, Mo.

Manufacturing

To order: Metal articles, simple, or complicated machinery. Models, tools, patterns. Experimenting. Parma Engineering Works, Brooklyn Station, Cleveland, Ohio.

Miscellaneous

Beautiful registered bull pups cheap. Bulldogs, 501 Rockwood, Dallas, Texas.

Get Posted—Good prices paid for butterflies, insects. See Sinclair display advertisement page 1153.

Artificial Marble, sanitary flooring instructions, ornamental casting, concrete, plaster, papier-mache, decoration garden furniture, 15 years instructing the public, particulars and 200 illustrations free. C. Mahler, Huntington, N. Y.

Miscellaneous (Continued)

Stroppers for Gillette razor blades \$1. Basement 3825 Flourney St., Chicago, Ill.

Polmet—The wonderful polishing cloth that cleans all metal without liquid, paste or powder. Approved by "Good Housekeeping" and "Modern Priscilla"—sells fast at 25c. Sample free. F. C. Gale Co., 117 Edinboro St., Boston.

Friendship Magazine, Classy Illustrated, 10c. 81 Box 178, New Haven, Conn.

Motorcycles—Bicycles

Don't buy a Bicycle Motor Attachment until you get our catalogue and prices. Shaw Mfg. Co., Dept. 6, Galesburg, Kansas.

Musical Instruments

Violins—Deep, Mellow, Soulful—on easy credit terms. High grade, wonderful instruments of my own make. Development of many years' experience. Write for book. Gustav A. Henning, 2121 Gaylord St., Denver, Colo.

Novelties

Magie goods, cards, books, novelties, tricks. Catalog free. Clifford Fenner, 2101 Jefferson, Louisville, Ky.

Trick cards that are absolutely guaranteed, free samples. C. D. Blankenship, Adrian, W. Va.

10c Real Sport Game—Thrilling, Fascinating. Strand, Dept. M, Box 527, Fort Rye, N. Y.

Patent Attorneys

Patents Sent for free booklet. Highest references. Best results. Promptness assured. Send model or drawing for examination and opinion. Watson E. Coleman, Patent Attorney, 614 G Street, N. W., Washington, D. C.

Get your own patents. Application blanks, complete instructions \$1. Cutting Bros., Campbell, Calif.

Inventors write me about patents. My fees payable monthly. Booklet free. Frank Fuller, Washington, D. C.

Unpatented Ideas Can Be Sold. I tell you how and help you make the sale. Free particulars (Copyrighted 1923). Write W. T. Greene, 809 Janifer Bldg., Washington, D. C.

"Inventor's Advisor," the valuable Patentbook with 109 Mechanical movements and illustrations, sent free upon request. M. I. Labiner, Patent Attorney, 3 Park Row, New York.

M. P. Laughlin, Patents. Engineer-Attorney, 47 West 42nd Street, New York.

Patents—Write for our Guide Books and "Record of Invention Blank" before disclosing inventions. Send model or sketch of your invention for Examination and Instructions. No charge for the above information. See advertisement on page 1133. Victor J. Evans & Co., 191 Ninth, Washington, D. C.

Inventors: Send sketch or model for free opinion concerning patentable nature and exact cost of patent. Book "How to Obtain a Patent" sent free. Tells what every inventor should know. Established twenty-eight years. Highest references. Prompt service. Reasonable charges. Chandler & Chandler, 476 Seventh, Washington, D. C.

Lacey Patent-Sense. "The book the inventor keeps." Free. See page 1134.

"Inventors' Guide" free on request; gives valuable information and advice for all who have original ideas or improvements. Frank Ledermann, Registered Attorney and Engineer, 15-E Park Row, New York.

Herbert Jenner, Patent Attorney and Mechanical Expert, 606 F Street, Washington, D. C. I report if patent obtainable and exact cost. Send for circular.

Millions spent annually for ideas! Hundreds now wanted! Patent yours and profit! Write today for free book—tells how to protect yourself, how to invent, ideas wanted, how we help you sell, etc. American Industries, Inc., 212 Kresge Bldg., Washington, D. C.

The Patent-me. Impartial advice to Inventors and Manufacturers. Mailed on request. Anderson & Son, Patent and Trade Mark Lawyers, Established 1865. 637 F St., Washington, D. C.

Inventors' Educator: 800 Mechanical Movements. 50 Practical Motions. How to measure and sell patents. Mechanical Movements greatly assist inventors, suggest new ideas. Price \$1.50. Postage Free. Albert E. Dieterich, 620A Ouray Bldg., Washington, D. C.

Inventors—Send for form "Evidence of Conception" to be signed and witnessed. Form, fee schedule, information free. Lanesier and Albine, Registered Patent Attorneys in United States and Canada, 242 Ouray Bldg., Washington, D. C.

Monroe Miller, Ouray Bldg., Washington, D. C. Patent Attorney; Mechanical, Electrical Expert. Free Blue Book gives candid advice.

Patents. Write for my free Guide Books "How to Obtain a Patent" and "Invention and Industry" and "Record of Invention" blank before disclosing inventions. Send model or sketch of your invention for instructions. Promptness assured. No charge for above information. Clarence A. O'Brien Registered Patent Lawyer, 290C Security Bank Building, directly across street from Patent Office, Washington, D. C. See page 1131.

Patents Procured: Trade Marks Registered—A comprehensive, experienced, prompt service for the protection and development of your ideas. Preliminary advice gladly furnished without charge. Booklet of information and form for disclosing idea free on request. Richard B. Owen, 130 Owen Bldg., Washington, D. C., or 41-T Park Row, New York.

Patents

M. P. Laughlin, Patents. Engineer-Attorney, 47 West 42nd Street, New York.

Inventions commercialized. Patented or unpatented. Write Adam Flaher Mfg. Co., 205 Enright, St. Louis, Mo.

Japanese Patents. If you wish to obtain Japanese patents entrust to me through my associates in your country. Takeaki Mori, Registered Patent Attorney, 307 Harajuku, Sendagaya, Tokyo, Japan.

Inventors: Will finance good invention for interest if patented or pending. Describe. Roy Mead, 811 Ashland Block, Chicago, Ill.

Personal

Free to Men or Women—Information of a scientific nature that has brought physical vigor and happiness to thousands. No charge; no obligation. Write Fair Sales Co., Dept. 216-1, Colorado Springs, Colo.

Lonely Hearts—Exchange letters; make interesting new friends through our romantic club. Write Eva Moore, Box 908, Jacksonville, Florida.

Get acquainted. Make new friends. Exchange Letters. Enclose stamped envelope for plan. The Lulu Club, Station 11, Cleveland, Ohio.

Lonely—Join our Club. Make friends everywhere. Particulars free. Write Mrs. Manews, Box 28, Oakland, Calif.

"Know Thyself"—Wonderful Three-Lake Horoscope—your talents, character, love, friends, enemies, business. Send birthdate, year, specimen of handwriting and 10c. Garguis, Box 2771 GG, Boston, Mass.

Lonesome! Make new friends. Write Dolly Gray Club, Box 186A, Denver, Colorado. Stamp appreciated.

The Key to Mesmerism, hypnosis, etc. A wonderful new book with simple easy instructions. Develops a magnetic personality. Cures illness. Stops bad habits. Price \$1.25. Sold exclusively by Calvin, Ltd., 7014 Normal Ave., Chicago, Ill.

Phonographic Supplies

Build Your Phonograph. Spring Motors, Electric Motors, Tonearms, Amplifiers, Accessories. Latest Equipment also in Radio Mechanism and Cabinets. Catalog mailed for ten cents. Hoosier Mfg. & Supply Co., Baldwin Block, Indianapolis, Ind.

Photoplays, Stories, Etc.

\$ \$ \$ For Ideas. Photoplay Plots Accepted any form; revised, criticized, copyrighted, marketed. Advice free. Universal Scenario Corporation, 223 Security Bldg., Santa Monica & Western, Hollywood, California.

Photoplay Idea—Original, for sale. Lucreal Asencio, P. O. Box 3811, Station D, Philadelphia, Pa.

Printing

500 "Neargravurs" Printed Letterheads—Envelopes \$5.25 postpaid. Solliway's, Knox, Indiana.

Radio

Attention! 50 Vacuum Tube Hook-Ups. The greatest collection of Vacuum Tube Circuits ever brought under two covers at such insignificant cost. These diagrams will be found in the great "Hisco" catalogue which contains raw materials and parts in a greater profusion than any other catalogue. 15c in stamps or coin will bring the catalogue to you. Radio Specialty Company, 100 Park Place, New York City.

Boys, don't overlook this! The "Hisco" Baby Detector. Greatest detector ever brought out with moulded base. Fully adjustable. See former advertisements in this publication or our catalogue. Detector with Galena crystal complete, 50c; the same Detector with Hadiocite crystal, 75c, prepaid. Send for yours today. Radio Specialty Co., 100 Park Place, New York City.

2650 Miles Distance with one tube. Any Novice understands our Simplified Instructions. Big Free booklet tells the story. Vesco Radio Co., Box 85-117, Oakland, Calif.

Salesmen Wanted

Can You Sell? All-wool, union made, tailored-to-measure suits for \$19.75. Universal Tailors, 399 Bedford Street, Boston.

A Salesman wanted in every town or city within 25 miles of a broadcasting station to sell Radiogem, the complete radio receiving set that retails for \$2.50. With Radiogem there is nothing else to buy—the outfit includes the Radiogen receiving apparatus, 1,000-ohm phone, and aerial outfit. The cheapest radio outfit on the market—yet as practical as the most expensive. Big money to the right men. Send \$2.00 for sample outfit. The Radiogem Corp., 633 West Broadway, N. Y. City.

Distributors: Wonderful Pricing System for all Stores. Absolute protection. Immediate sales! Tremendous Earnings!! Millen Mfg. Co., Dept. JF, 100 Baylston, Boston, Mass.

Distributors—Amazing New Invention selling \$2 seals 2500 envelopes hour! Tremendous Demand! Exclusive Territories available! Red-E Co., Dept. O F, Colonial Bldg., Boston, Mass.

Stamps for Collectors

1000 Different Stamps, wonderful quality \$1.00 C. E. Nickles, 2912 Rodman, Washington, D. C.

Additional Opportunities Ad-lets on page 1163

SPECIAL WINTER SUBSCRIPTION OFFER



RADIO'S LEADING MAGAZINE

Everything that is worthwhile in the radio industry appears in RADIO NEWS. The most popular new circuits are fully described and diagrammatically illustrated. The latest notes from the broadcast stations are commented upon. New radio equipment of every description is displayed together with reports of novel sets and unusually successful radio hook-ups. Every important advance in radio broadcast or reception in any part of the world is fully written up. In a word, RADIO NEWS covers everything big, active and worthwhile in the radio field.

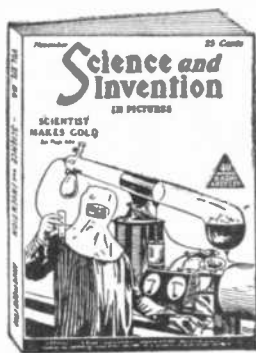

PRACTICAL SCIENCE ILLUSTRATED

SCIENCE AND INVENTION is a sensation—the first scientific magazine in which the illustrations and captions tell a complete story. Explains and illustrates every latest development in the field of science, invention, mechanics, radio, in an entirely different and decidedly original way.

Published for the layman, in pictures so that every feature can be easily understood and quickly grasped. More interesting, twice as much editorial matter, more attractive than ever before.



EVERY DAY THE EXPERIMENTER FOR EVERYBODY

The EXPERIMENTER is probably the most novel magazine of its kind ever conceived. It is personally edited by H. Gernsback, who founded the old "Modern Electrics" as well as the "Electrical Experimenter," knows thoroughly what his readers want and have wanted for many years. The EXPERIMENTER covers electricity, chemistry, and radio, eclipsing the best that was in "Modern Electrics" and "Electrical Experimenter."

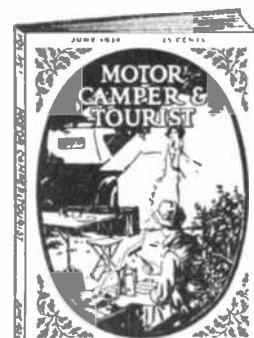

MOTURING WINTER, SUMMER, AUTUMN AND SPRING

This magazine is dedicated to the vast army of campers and tourists who want to know how and where to go. The interesting and instructive article, photos, and sketches each month will help you to decide correctly these most important points. It covers articles on almost every outdoor sport that can be indulged in while Motor Camping, such as when Mother, Dad, Sister and Brother and the kids swim, hunt, fish, golf, hike, snap photos, play tennis, climb mountains, listen in on their camp radio, and otherwise indulge in their innumerable pet hobbies.

This Book FREE With every Subscription TO ANY ONE OF THESE FOUR PUBLICATION

Chock full of radio constructive and instructive articles from cover to cover. Sections include articles on Receiving Sets and Sundry Apparatus, Transmitters and Accessories, Radio Theory, Vacuum Tube Data, and Practical Hints for the Amateur. Serves as a ready reference and should find a place in the library of every amateur.



The "Radio News" Amateurs' Handbook contains 224 pages. It is a veritable modern textbook on radio. It is compiled by the most eminent radio experts. There are over 375 illustrations on complete mounted sets, circuit diagrams, graphs, photos of special parts, etc. The full size is 6 x 9 inches and it is bound with a beautiful color cover.

HOW YOU SAVE MONEY ON THIS OFFER

| | | | |
|---------------------------------|---------------|-----------------------|---------------|
| Regular Subscription Price..... | \$3.00 | You Pay | \$2.50 |
| Handbook (shown above) | 1.00 | (on this offer) | |
| TOTAL | \$4.00 | YOU SAVE | \$1.50 |

TEAR OFF ON THIS LINE AND MAIL WITH CHECK OR MONEY ORDER

EXPERIMENTER PUBLISHING CO., INC., 53 Park Place, New York City.

Gentlemen:—I am enclosing \$2.50 for a special Winter subscription to RADIO NEWS SCIENCE & INVENTION THE EXPERIMENTER MOTOR CAMPER & TOURIST It is understood that I will receive one RADIO NEWS Amateurs' Handbook free of charge postpaid.

NAME

CITY

ADDRESS STATE

BARAWIK AMERICA'S PIONEER RADIO DISTRIBUTORS

Offer You a Radio Service Unequaled

250,000 customers from every part of the world have purchased their Radio needs from us

SEND FOR THIS FREE CATALOG

Contains all the newest parts, sets and kits at prices that save you money

THIS GUARANTEE PROTECTS YOU

Examine the goods we ship you. They must suit you in every respect. If you are not satisfied with your purchase return the goods at once and we will refund the price you paid.

VACUUM TUBES
Standard Brands—Cambridgeham, Radlotron. Every one guaranteed new and perfect and in original cartons. We will ship brand in stock unless you specify otherwise.

P105 Detector, UV200, C300, Each\$3.59
P112 Amplifier, UV201A, C301A, Each 3.59
P118 5-Watt Transmitter, 7.70
P107 WD11, C11, Each... 3.59
P101 WD12, C12, Each... 3.59
P102 UV109, C299, Each 3.59

ADAPTERS
To use dry cell tubes in standard base sockets, simply insert one of these adapters in the socket.

P104 For 199 or 299 tubes...35c
P109 For WD11 or C11 tubes 35c

BAKELITE SOCKET
P140 Standard base...30c
P141 UV109 base...30c
P136 C1139c

Moulded of genuine red brown bakelite. Binding post connections. Strong contacts. Real values.

METAL TUBE SOCKET
P134 Each25c

Nickel plated brass tube set in best grade composition base. Plainly marked binding posts. An excellent value.

STANDARD TUBE SOCKET
P150 Single Gang...\$76
P153 Three Gang...2.25

Bakelite base. Polished nickel tube. Highest quality socket on the market. Best insulation. Positive contact. Marked terminals. For base or panel mounting.

SUPERIOR RHEOSTATS
P147 6 ohm. Each...62c
P148 20 ohm. Each...66c
P149 30 ohm. Each...70c

One of the finest rheostats we have ever seen at a price that makes it the best value obtainable anywhere. Genuine bakelite base. Beautifully shaped with white. Single hole mounting. A rheostat you will be proud to have in your set.

P156 400 ohm Potentiometer. Matches above rheostats. Each...85c

FILAMENT CONTROL RHEOSTATS
P132 6 ohm. Each...32c
P129 20 ohm. Each...35c
P131 30 ohm. Each...39c
P125 6 ohm Vernier...79c

Best grade. Will give real service. Durable and lasting. High heat resisting base, diam. 2 1/4 in. Tapered polished black knob 1 1/4" diam. Potentiometers. Match above rheostats. Same high grade construction.

P151 200 ohm. Ea. 52c P152 400 ohm. Ea. 56c

RADIO "BAKELITE" PANELS
We supply genuine Bakelite, Condensite, Celeron or Formica, all of which have practically identical properties. Machines well without chipping. Won't warp. Waterproof. One side has attractive natural polished black finish which can be sanded and oiled. Other side mahogany finish. Either side may be used as front.

| Panel Size Inches | 3/8" thick | | 3/16" thick | | 1/4" thick | |
|-------------------|------------|--------|-------------|--------|------------|--------|
| | Art. No. | Price | Art. No. | Price | Art. No. | Price |
| 6x7 | P450 | \$5.55 | P460 | \$8.89 | P470 | \$1.15 |
| 6x10 1/2 | P451 | .86 | P461 | 1.10 | P471 | 1.60 |
| 7x10 | | | P455 | 1.28 | | |
| 7x12 | | | P456 | 1.64 | | |
| 7x14 | P458 | 1.38 | P463 | 2.27 | P473 | 2.35 |
| 7x18 | P453 | 1.78 | P462 | 2.65 | P472 | 3.15 |
| 7x21 | P457 | 2.05 | P469 | 2.97 | P477 | 4.10 |
| 7x24 | P459 | 2.42 | P462 | 3.25 | | |
| 7x26 | | | P464 | 2.35 | P474 | 3.15 |
| 9x14 | | | P465 | 2.97 | P475 | 3.98 |
| 12x14 | | | P466 | 4.25 | P476 | 5.70 |
| 12x21 | | | | | | |

COMPOSITION DIALS
Handsome dials moulded in one piece of polished composition. 2 inch size has 270° scale marked 0 to 100 finely engraved in contrasting white enamel. 3 and 4 inch size have 180° scale marked 0 to 100.

| No. | Black | | Diam. | Shaft Size | Mahogany | |
|------|-------|-----|-------|------------|----------|-----|
| | Price | No. | | | Price | No. |
| P921 | 16c | 2" | 3/16 | P926 | 19c | |
| P922 | 16c | 2" | 1/4 | P927 | 19c | |
| P923 | 22c | 3" | 3/16 | P928 | 26c | |
| P924 | 22c | 3" | 1/4 | P929 | 26c | |
| P925 | 29c | 4" | 1/4 | P930 | 34c | |

The Very Latest

Radio Book

Free

This Book Full of Radio Bargains.

Shows Big Savings on parts, sets and accessories.

Our prices are lowest on highest quality standard goods.

Send for your copy today

ALL ORDERS SHIPPED SAME DAY RECEIVED

STANDARD BRAND LOUD SPEAKERS AND UNITS

P618 Brandes Table Talker...\$7.95
P616 Atlas Loudspeaker...21.95
P620 Baldwin Loud Speaker...19.50
P603 Magnarox M1 Loudspeaker...21.00
P612 Magnarox H3 Loudspeaker...31.75
P614 Magnarox M1 Loudspeaker...26.50
P757 Morrison Adjustable Unit...4.35
P755 Genuine Baldwin Type C unit 4.75
P608 Atlas Unit. Each...10.75

STANDARD BRAND HEADSETS

P754 Baldwin Type C...\$9.80
P764 Frost, 2000 ohm...3.50
P766 Frost, 3000 ohm...4.35
P751 Murdock 56, 2000 ohm...3.25
P752 Murdock 56, 3000 ohm...3.60
P765 Brandes Superior, 2000 ohm...4.85
P769 Brandes Navy, 3000 ohm...6.85

DUBILIER MICADON TYPE 601

P502 .0001 .28c P507 .0025 .32c
P503 .00025 .28c P508 .003 .40c
P504 .0005 .28c P509 .001 .40c
P505 .001 .32c P510 .005 .48c
P506 .002 .32c P511 .006 .60c

DUBILIER MICADON 601G

Some style condenser as above with mounting for tubular grid leak. No grid leak included.

P581 .00025. Ea.38c
P582 .0005. Ea.38c

ANTENNA INSULATORS

P263 Ribbed Porcelain Insulator, 2 1/2 in. long. Ea. 5c
Dozen50c
P265 Ribbed Porcelain Insulator—5 inches long. Each 15c

STRANDED ANTENNA WIRE

Cabled of fine copper strands. Very flexible. High tensile strength. Best for aeriels.

P248 100 ft. coil 5c P249 500 ft. coil \$2.60

SUPERIOR RADIO SWITCH

P283 Each26c

A switch fully equal to any on the market at a price about half what is usually asked for a switch of anywhere near equal quality.

SUPERIOR RADIO JACKS

Finest grade jacks. Improved design. Best materials. Phosphor bronze springs. Silver contact points. Nickel finish. Mount on panels 3/8 to 1/2 in.

P290 Open circuit. Each32c
P291 Closed circuit. Each39c
P292 Two circuit. Each49c
P293 Single circuit filament control. 46c
P294 Two circuit filament control. 59c

You take no risk in dealing with us. We are one of the oldest and most reliable radio supply houses. Science and Invention guarantees our reliability. Our guarantee protects you. Let us serve you and save money for you. All orders shipped same day received.

ORDER DIRECT FROM THIS PAGE. You will find many items you will need on this page. Send your order in for them at once. Prices quoted on this page are transportation charges prepaid in U. S. A. east of the Rocky Mountains.

Dealers send for our wholesale catalog.

PANEL MOUNTING VARIABLE CONDENSERS

These are especially high grade condensers and we guarantee them to be mechanically and electrically perfect. Fine polished end plates of heavy bakelite. Shafts 1/4 inch diameter. Sturdy, heavy aluminum alloy plates perfectly spaced to insure smooth, even reliable capacity. Dial and knob on vernier type. No dial on plain type. Our low prices save you money.

| No. Plates | Max. Cap. | Plain Type | Vernier Type |
|------------|-----------|-------------|--------------|
| 3 | | P815 \$7.79 | |
| 5 | | P816 .89 | |
| 17 | .00025 | P814 1.00 | P825 \$1.85 |
| 23 | .0005 | P817 1.20 | |
| 43 | .001 | P813 3.00 | P824 2.25 |
| | | P812 1.45 | P826 2.46 |

GROUND ROTOR LOW LOSS VARIABLE CONDENSERS

P797 .0003\$2.75
P798 .00053.25
P799 .0013.95

The most efficient condenser made. Low losses, grounded rotor, straight wave line. Made of the best grade materials throughout. Heavy aluminum plates. Well insulated.

STANDARD BRAND VARIABLE CONDENSERS

P810 Acme .0005 Vernier.....\$5.65
P784 Coto .00025 Vernier.....3.95
P785 Coto .0005 Vernier.....4.25
P786 Coto .001 Vernier.....4.95
P787 Cardwell .000253.95
P788 Cardwell .000354.35
P789 Cardwell .00054.60
P790 Cardwell .0015.55
P791 Marco .000254.45
P792 Marco .000354.45
P793 Marco .00054.95
P794 Marco .0015.85
P795 Flewelling .00025 Vernier...4.50
P796 Flewelling .0005 Vernier...4.95

OUR SPECIAL A. F. TRANSFORMER

P549 3 to 1 ratio. \$2.25
P550 5 to 1 ratio. 2.45

In quality of tone and volume of sound, the things a transformer is built for, we guarantee it to equal or surpass any other transformer. Next in appearance. Carefully made. Fully mounted with plainly marked binding post connections. Wonderful results on one, two or three steps without distortion or howling. A quality item in every respect.

OTHER STANDARD BRAND AUDIO FREQUENCY TRANSFORMERS

Fresh, Clean Stock in Original Containers.

P587 Thordarson Ratio 3 1/2 to 1.....\$3.30
P588 Thordarson Ratio 6 to 1.....3.70
P589 Thordarson Ratio 2 to 1.....3.95
P590 Thordarson Push Pull. Pair...11.20
P531 All American 10 to 1. Each \$4.25
P532 All American 5 to 1. Each 4.25
P533 All American 3 to 1. Each 4.05
P534 All American Push Pull. Pair 10.80
P535 Rauland Lyric8.10
P553 Acme3.85
P597 Erla 6 to 1.....4.05
P598 Erla 3 1/2 to 1.....3.60
P591 Modern 10 to 1. Each...4.50
P592 Modern Push Pull. Pair...9.90
P555 Federal No. 226. Each.....4.45
P556 Federal No. 65. Each.....6.35
P712 Radio Corp. Each.....5.70

STANDARD BRAND RADIO FREQUENCY TRANSFORMERS

PF42 Dubilier Duratron\$3.45
P565 Acme R23.95
P566 Acme R33.95
P567 Acme R43.95
P568 Erla Reflex No. 1.....4.45
P579 Erla Reflex No. 2.....4.45

RESISTANCE COUPLED AMPLIFICATION

P570 1st Stage Unit \$2.30
P571 2nd Stage Unit 2.30
P572 3rd Stage Unit 2.49

Amplifies without distortion. Replaces audio frequency transformers using same circuit. Each unit consists of a mounting with condenser, grid leak, and resistance of proper value for best results.

\$47.50



5 Tube Bargain

The greatest radio value ever offered

A five-tube radio frequency set that brings in the distant stations on the loud speaker. All the volume you could want with the finest tone quality, clear and sweet. Careful designing with big quantity production make our low price possible. Only the finest quality materials used throughout. New style efficient low loss condensers and transformers. Bakelite panel size 7x18 in. Handsome mahogany finish cabinet. Neat convenient dials. We can recommend this set for either city or country use. Will not radiate and will bring in stations from coast to coast. No set approaches this for value. Equals many sets selling at double and triple our price. Try it for ten days. If you are not satisfied return it and we will refund your money.

P867 Set, only\$47.50
P868 Set complete with five 201A tubes, 90 volts B battery, 100 ampere storage battery, one P613 Special Speaker, and complete antenna equipment. Nothing extra to buy. Price\$88.00

The Barawik Co.

102 So. Canal St. Chicago, Ill.

Let These Guides

Solve Your Problems

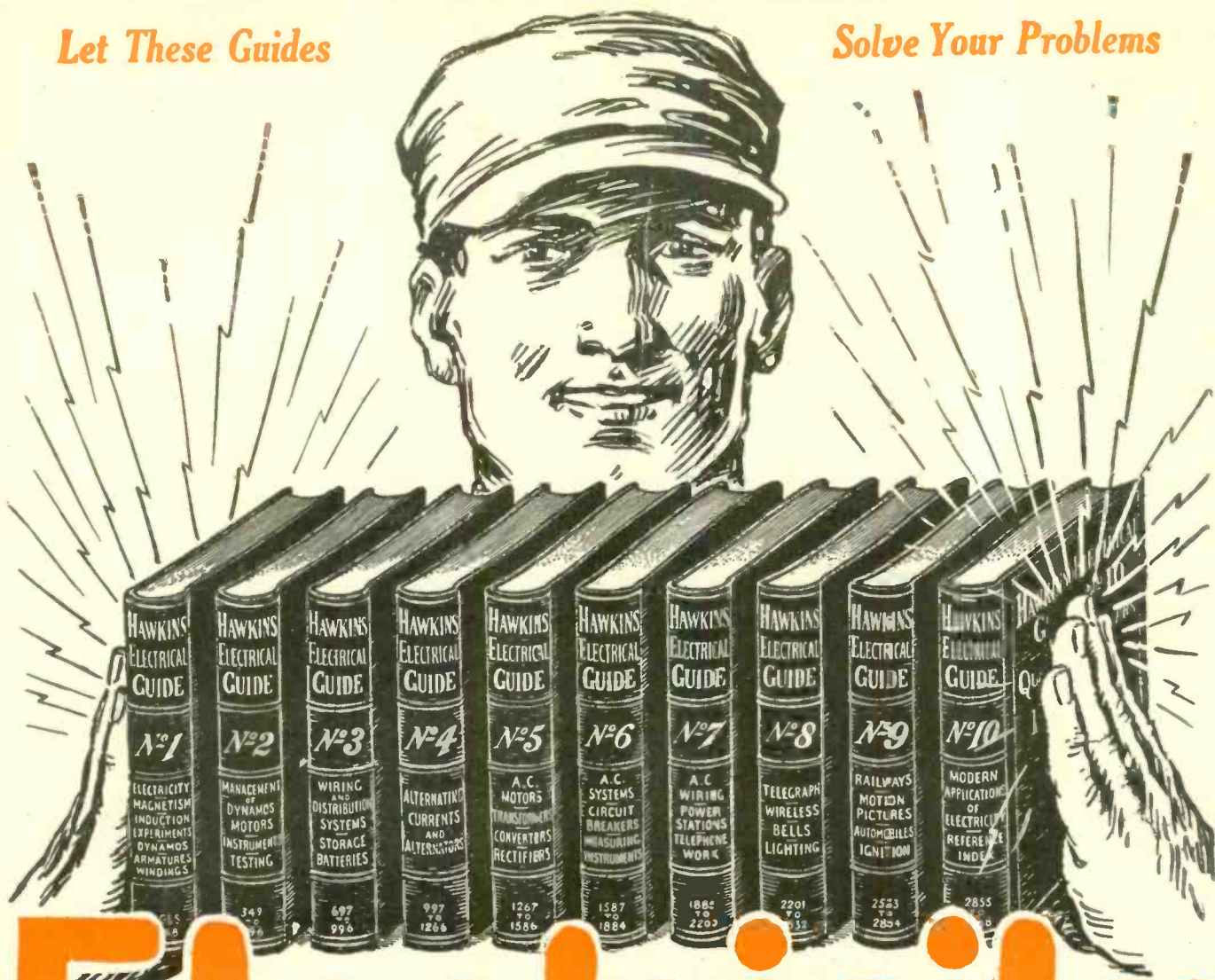

Electricity at your finger ends

HAWKINS ELECTRICAL GUIDES IN TEN VOLUMES

3500 PAGES
4700 PICTURES

\$1 A VOLUME
\$1 A MONTH

SEND NO MONEY—SEND ONLY THIS COUPON

Know the facts in Electricity. They mean more money and better position for you. Hawkins Guides tell you all you need to know about Electricity. Every important electrical subject covered so you can understand it. Easy to study and apply. A complete, practical working course, in 10 volumes. Books are pocket size; flexible covers. Order a set today to look over.

LEARN ALL ABOUT

Magnetism—Induction—Experiments—Dynamoes—Electric Machinery—Motors—Armatures—Armature Windings—Installing of Dynamoes—Electrical Instrument Testing—Practical Management of Dynamoes and Motors—Distribution Systems—Wiring—Wiring Diagrams—Sign Flashers—Storage Batteries—Principles of Alternating Currents and Alternators—Alternating Current Motors—Transformers—Converters—Rectifiers—Alternating Current Systems—Circuit Breakers—Measuring Instruments—Switchboards—Wiring—Power Stations—Installing—Telephone—Telegraph—Wireless—Bells—Lighting—Railways. Also many Modern Practical Applications of Electricity and Ready Reference Index of the ten numbers.

SHIPPED FREE

Not a cent to pay until you see the books. No obligation to buy unless you are satisfied. Send Coupon now—today—and get this great help library and see if it is not worth \$100 to you—you pay \$1.00 a month for ten months or return it.

THEO. AUDEL & CO.,
72 Fifth Ave., New York City

Please submit me for free examination, HAWKINS ELECTRICAL GUIDE (Price \$1 a number). Ship at once prepaid, the 10 numbers. If satisfactory, I agree to send you \$1 within seven days and to further mail you \$1 each month until paid.

Name

Occupation

Employed by

Home Address

Reference

S. I. March

**"You Made Us Quit Digging
Ditches and Gave Us Our Own
Big Electrical Business"**

**I'll Fit You, too, for
Your Own Big Pay
Electrical
Business in
20 WEEKS**



From ditch digging to their own profitable electrical business through the famous shop type training of the S & H Engineering Company and the Lincoln Institute of Technology is the story of D. Farina and J. Unholz, now owners of the U & F Electric Company, Chicago, Ill. Hundreds of others have stepped into their own business and big pay electrical jobs. Read what this amazing new way to train will do for you.

There Is No Other Training Like This

Do you want a big business of your own like the U & F Electric Company? The owners, Unholz and Farina, were common laborers, but quickly stepped into success with S & H Training. Do you want a big money electrical job like C. P. Dennis? He earned 45c an hour as a common laborer, but stepped out into a \$65 a week electrical job. You can do it now right in your own home with the remarkable S & H Shop Type training. You can get this training nowhere else. It is copyrighted.

FREE

To S & H Students

Free Employment Bureau.
Free Consultation and Advisory Service.
Free Working Outfit.
Free Aid on Electrical Inventions.
Free Specializing Service.

been perfected by experts who know exactly what you need to get the big money. This training has enabled hundreds to rise from small pay jobs to good positions.

Hundreds of men have seized the opportunity now offered to you. Fill in the coupon below and start on the road to success.

**I Fit You for \$5,000 a
Year or I Don't Want
One Penny**

I will take all the risk. You take none. Either you qualify for the \$5,000 a year opportunities, after completing my course, or this training costs you absolutely nothing.

But do not delay. You must act at once. Fill out and mail the coupon today. Learn of my big special FREE offer of won-

derful electrical equipment to make your training easy and fascinating.

Also I'll send you our big free book telling you a hundred things you want to know about the big electrical field. Act now.

**S & H
ENGINEERING
COMPANY**

In Affiliation
with Lincoln
Institute of
Technology



1422 W. Monroe St., Dept. C-2 Chicago, Ill.

S & H ENGINEERING COMPANY,
1422 W. Monroe St., Dept. C-2,
Chicago, Illinois.

Please send me immediately your big free book and tell me of your shop type training and special offer of free equipment.

Name

Address

City State

\$3,500 to \$10,000 a Year

Just think of it. In only 20 weeks, right in your own home, you can be fitted for your own business or the big pay jobs. Electricity is crying for men. And this amazing training has