

February

THE NEW

25 Cents

Science and Invention

IN PICTURES

THE SUBMARINE-LAND
DREADNAUGHT

See Page 966

IN
PRIZES
\$12,000.00
FOR
PICTURES

See Page
968

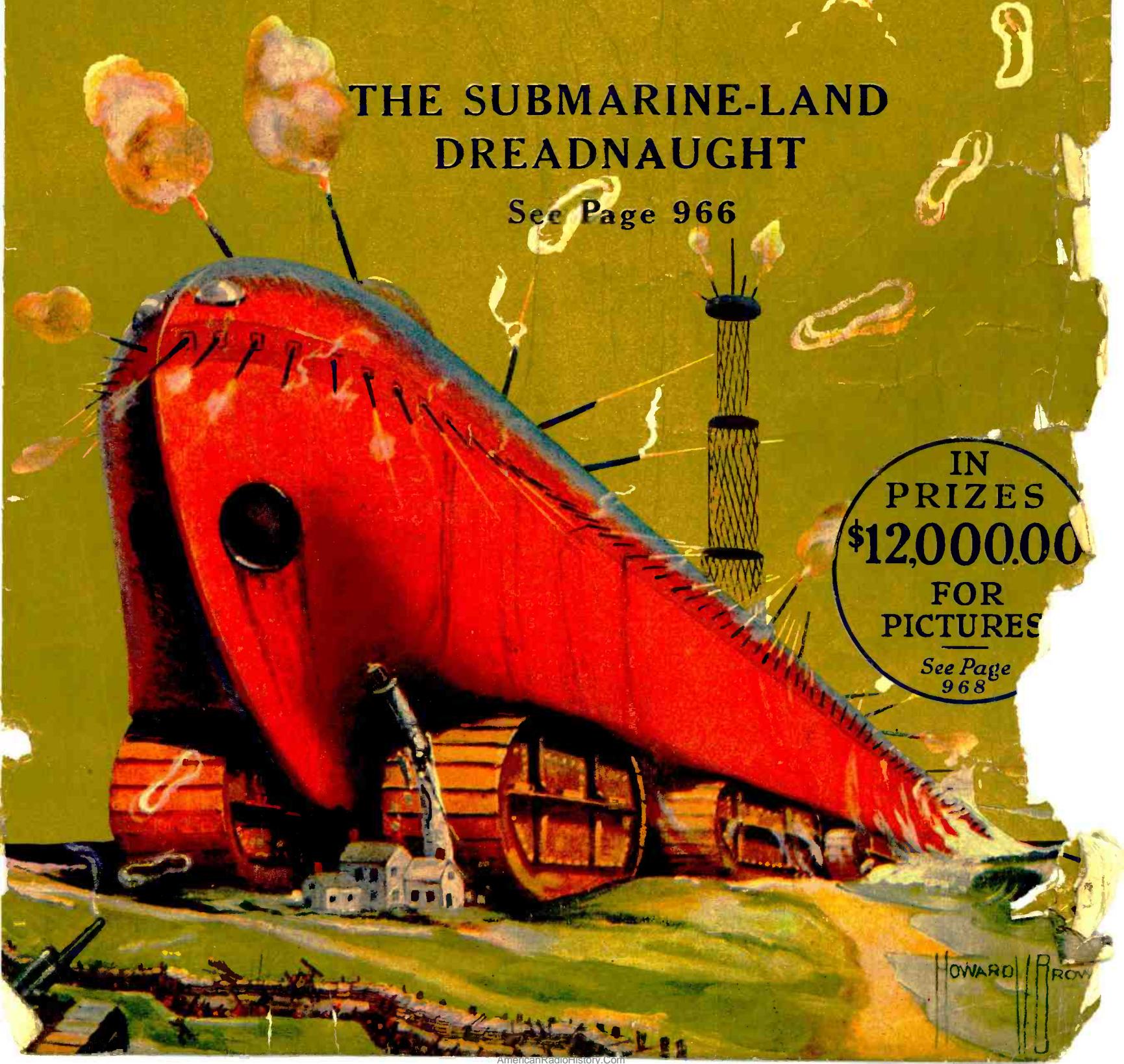

LEARN



ELECTRICITY

In the Great Steps of
COYNE

Be An Electrical Expert

THE whole world of electricity is open to the Coyne trained Electrical Expert. Come to Chicago—the Electrical Center of the World. Get your training at Coyne—the oldest, largest and best school of practical electricity in the country—the only school endorsed by the Electrical Industry. Coyne trains you in all branches of electricity. We do not offer a number of individual courses—we give you just one *Complete* course so that you will be an *Electrical Expert* capable of commanding big pay. Let ordinary electricians do the small jobs. You can become an *Expert* and get the big money in any branch of electricity if you seize this chance to come to Coyne. Opportunities for *Experts* are unlimited. Get started now!

Greatest Outlay of Electrical Apparatus in the Country

No books or useless theory. You are trained on the greatest outlay of electrical apparatus of any institution in the entire country, in 3½ months (stay longer if you wish). Every thing from door bells to power plants. You work on Circuits, Housewiring, D. C., A. C., Armature and Stator Winding, Drafting, Auto, Truck and Tractor Electricity, Battery Building and Repairing and Radio—everything to make you an expert ready to step right into a position paying from \$65 to \$150 a week, or go into business for yourself and make up to \$20,000 a year.

Coyne Trains You for Life

We furnish every student with a Life Scholarship which enables you to stay as long as you want or come back for further training at any time without charge. We also assist students to good paying positions after graduation.

We give you free a course in Radio—the marvel of the age. Constructing, installing and operating. You can build your own radio receiving set.

Hundreds of Coyne graduates are making big money as Electrical Experts. You can do the same if you get started at once. The electrical industry is crying for EXPERTS—don't pass up a chance to train yourself for one of these big paying jobs.

Earn while you learn! We help students to secure jobs to earn a good part of their expenses while learning

IN 3½ MONTHS

MAKE \$250 to \$600 A MONTH

Send this Coupon Now

Coyne Electrical School,
 1300-1310 W. Harrison Street,
 Dept. 53-32 Chicago, Illinois

Gentlemen: Please send me free your big catalog and full information about your 3½ month's practical training and special offer.

Send this coupon now. Determine today that you are going to become a part of the world's greatest force—electricity. Assure your future by sending this coupon now. It brings you full information. Think of it—if you send the coupon today, you can be fully equipped for a fine paying electrical job in a few months. Send coupon now before the special offer we are making is withdrawn.

Name.....

Address.....



Endorsed by Electrical Industry

1300-1310 W. Harrison St., Dept. 53-32 Chicago, Ill.

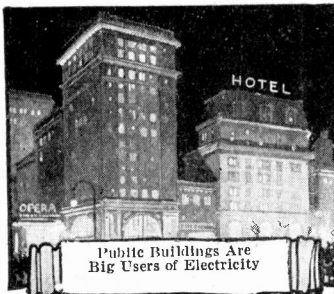

Public Buildings Are Big Users of Electricity

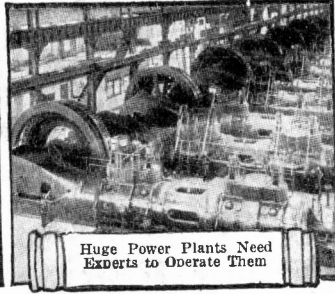

Huge Power Plants Need Experts to Operate Them

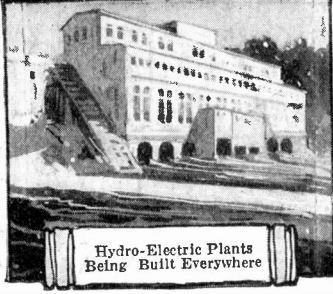

Hydro-Electric Plants Being Built Everywhere

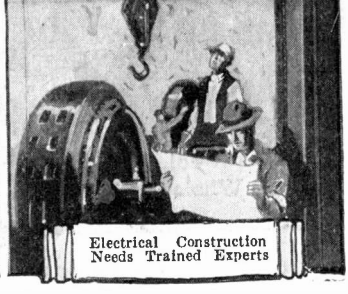

Electrical Construction Needs Trained Experts

Be a Certificated Electrical Expert

Earn \$3500 to \$10000 a Year

In This Big Pay Field

TRAINED "Electrical Experts" are in great demand at the highest salaries, and the opportunities for advancement and a big success in this line are the greatest ever known.

"Electrical Experts" earn \$70 to \$200 a week. Fit yourself for one of these big paying positions. Big jobs everywhere are waiting for trained men to fill them.

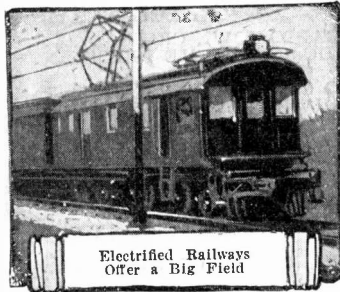

Electrified Railways Offer a Big Field

It is the most simple, thorough, and successful Electrical Course in existence, and offers every man, regardless of age, education, or previous experience, the chance to become, in a very short time an "Electrical Expert," able to make from \$70 to \$200 a week.

I Give You a Real Training

As Chief Engineer of the Chicago Engineering Works, I know exactly the kind of training a man needs to get the best positions at the highest salaries. Hundreds of my students are now earning \$3,500 to \$10,000 a year. Many are successful ELECTRICAL CONTRACTORS. Every branch of Electricity is open to you when you have finished my course. My experience as a practical engineer and my most unusual course makes this possible. I even have special lessons for those who want to go into business for themselves.

ments absolutely FREE. I also furnish them with all supplies, including examination paper, and many other things that other schools don't furnish. You do PRACTICAL work—AT HOME with this Outfit. You start right in after the first few lessons to WORK AT YOUR PROFESSION in a practical way.

You Owe Yourself the Best Why Not Get It?

To make yourself the big success you want to be—to get the big money and make a name for yourself—you need the best training you can get. Get it right here—Now—Where results are guaranteed.

Learn at Home to Earn \$12.00 to \$30.00 a Day

Today even the ordinary Electrician—the "screw driver" kind—is making money—big money. But it's the trained man—the man who knows the whys and wherefores of Electricity—the "Electrical Expert"—who is picked out to "boss" ordinary Electricians—to boss Big Jobs—the jobs that pay. You, too, can learn to fill one of these jobs—spare time only is needed. Be an "Electrical Expert"—Earn \$70 to \$200 a week.

Age or Lack of Experience No Drawback

You don't have to be a College Man; you don't have to be a High School graduate.

If you can read and write English, my course will make you a big success.

Some Features of My Course That Make SUCCESS Certain

Home Study Training Revolutionized

1. Practical Money-Making Instruction—no useless, high-sounding theory.
2. Free Electrical Outfit—Finest outfit ever sent out for home experiment and practical use.
3. Free Employment Service. (Helps you get a good job.)
4. Free Consulting Service. (No chance to get stuck on anything, while studying or afterward.)
5. Free Engineering Magazine.
6. Free use of my Electrical Laboratory.
7. Extra Courses Free—Radio—Electrical Drafting.
8. Spare Time Work—Special earn-while-you-learn lessons, prices on all Electrical Supplies.
9. Reduced prices on all Electrical Supplies.
10. Cash Refund Guarantee Bond.

These features are all explained in my big Free Book.

I give each student Outfit of Electrical Tools. Materials and Measuring Instru-

Get Started Now—Mail Coupon

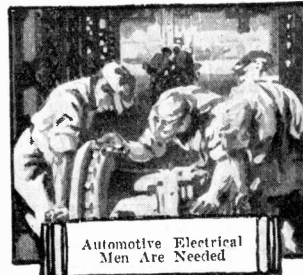

Automotive Electrical Men Are Needed

I want to send you the "Vital Facts" of the Electrical Industry, including my electrical Book, Proof Lessons, and a sample of my guarantee bond all FREE. These cost you nothing and you'll enjoy them. Make the start today for a bright future in Electricity. Send in the coupon—NOW.

Your Satisfaction Guaranteed

So sure am I that you can learn Electricity—so sure am I that after studying with me you, too, can get into the "big money" class in electrical work, that I will guarantee under bond to return every single penny paid me in tuition if, when you have finished my course, you are not satisfied it was the best investment you ever made.

FREE—Electrical Working Outfit—FREE

L. L. COOKE, Chief Engineer
Chicago Engineering Works
Dept. 22
2150 Lawrence Ave. Chicago, Ill.

L. I. COOKE, Chief Engineer,
Chicago Engineering Works.
Dept. 22, 2150 Lawrence Ave., Chicago, Ill.
Dear Sir:—Send at once the "Vital Facts" containing Sample Lessons, your Big Book, and full particulars of your Free Outfit and Home Study Course—all fully prepaid, without obligation on my part.

Name

Address

The "Cooke" Trained Man is the "Big Pay" Man

Science and Invention

FORMERLY
ELECTRICAL EXPERIMENTER

Vol. XI.
Whole No. 130

February, 1924
No. 10

Member Audit Bureau of Circulation.

PUBLICATION OFFICE: 18.430 Jamaica Ave., Jamaica, N. Y.
EDITORIAL & GENERAL OFFICES: 53 Park Place, New York City
Published by Experimenter Publishing Company, Inc. (H. Gernsback, Pres.; S. Gernsback, Treas.; R. W. DeMott, Sec'y).
Publishers of SCIENCE AND INVENTION, RADIO NEWS, and PRACTICAL ELECTRICS

18 Table of Contents for February

POPULAR SCIENTIFIC ARTICLES		AUTOMOBILES	
EDITORIAL			
CAN WE VISIT THE PLANETS?.....	By Don Home. 961	AUTO CIGARETTE LIGHTER.....	982
THE RADIO TOWN CRIER.....	By H. Gernsback. 963	DETECTOR FOR CHAUFFEUR'S JOY RIDES.....	983
AUDIENCE SMELLS AND SEES ORANGE GROVE IN NEW PLAY.....	By W. B. Arvin 964	NEW FRENCH AUTOMOTIVE DEVELOPMENTS.....	986
SUBMERSIBLE DREADNAUGHT OF TOMORROW (Cover Article).....	966	RUM-RUNNERS ADOPT SMOKE SCREEN.....	990
PRIZE WINNERS—\$1,000.00 AWARDS IN OUR MONTHLY PHOTOGRAPH CONTEST.....	968	MOTOR HINTS.....	By Tom C. Plumridge. 1062
SCIENCE SERVES IN NEW HOTEL.....	969	ELECTRICITY	
THE MAN ON THE METEOR, PART 2.....	970	SCIENCE SERVES IN NEW HOTEL.....	969
TOY SHIPS THAT RUN.....	972	TRAVELING WALK TO REPLACE SUBWAY.....	984
GIANT DIRIGIBLE OF NEW DESIGN.....	974	ORACLE—QUESTION AND ANSWER BOX.....	1015
SCIENCE SELECTS OCCUPATION.....	975	PATENT ADVICE.....	Edited by Joseph H. Kraus 1036
TIDES TO DEVELOP POWER.....	By Joseph H. Kraus. 976	RADIO ARTICLES	
SPACE CAMERA PHOTOGRAPHS EARTH.....	977	THE RADIO TOWN CRIER.....	By H. Gernsback. 963
DR. HACKENSAW'S SECRETS—NO. 26—THE SECRET OF PERPETUAL YOUTH.....	978	BROADCASTING THE PRESIDENT'S SPEECH.....	1002
CONTRA-PROPELLER SPEEDS SHIPS.....	980	RADIO CHEERS HOSPITAL PATIENTS.....	1003
THE SAFEST PLACE IN A THUNDER-STORM.....	980	THE DIVERSIFIED USES OF RADIO.....	1003
AS EVER, THE PERPETUAL MOTION.....	981	PHOTOS OF BROADCASTING STATIONS.....	1004
THE COMPLETE LIMESTONE CYCLE.....	982	RADIO FOR THE BEGINNER—NO. 24—SINGLE TUBE RECEIVING SETS.....	By Armstrong Perry. 1005
DETECTOR FOR CHAUFFEUR'S JOY RIDES.....	983	TROUBLE SHOOTING IN THE RADIO SET.....	1006
AIRPLANE THAT CAN BE FOLDED FOR TRANS- PORTATION.....	983	VARIOMETER AND VARIABLE CONDENSER RECEIVING SETS.....	By W. L. Pearce. 1007
TRAVELING WALK TO REPLACE SUBWAY.....	984	SHORT AERIALS INCREASE SELECTIVITY.....	1007
SHIPS LIGHTER TRAVELING EAST.....	985	PRIZE AWARDS IN OUR \$200.00 SINGLE TUBE CONTEST.....	1008
MOVIE GENII FROM BOTTLE.....	986	HOW TO BUILD A STORAGE "B" BATTERY.....	1010
NEW FRENCH AUTOMOTIVE DEVELOPMENTS.....	986	RADIO ORACLE.....	1011
ANIMALS WITH STRANGE CUSTOMS.....	987	RADIO WRINKLES.....	Edited by A. P. Peck. 1056
BUOYANCY OF ICE TO RAISE SHIPS.....	988	CONSTRUCTOR ARTICLES	
PRACTICAL SCIENTIFIC NOVELTIES.....	989	MYSTERIOUS SHADOW ILLUSION.....	996
RUM-RUNNERS ADOPT SMOKE SCREEN.....	990	ALARM FOR BATH.....	997
SCIENTIFIC PROBLEMS AND PUZZLES.....	991	SKETCHING ATTACHMENT FOR MICROSCOPE.....	998
THE HEAVENS IN FEBRUARY.....	992	METHOD OF MAKING CONCRETE BASINS.....	998
By Isabel M. Lewis, M.A., of the U. S. Naval Observatory. MAGIC FOR EVERYBODY—NO. 11 OF A SERIES.....	993	A SERVICEABLE CAMERA STAND.....	By T. J. Carver. 999
LATEST TRICKS WITH MATCH BOXES.....	994	AN EFFICIENT FIRE ALARM.....	999
By Ernest K. Chapin.		By Frank W. Nightingale.	
By Charles Marton.		CHEMISTRY ARTICLES	
By Walter Gibson.		EVERYDAY CHEMISTRY.....	
PRIZE CONTESTS		By Raymond B. Wailes. 995	
PRIZE WINNERS—\$1,000.00 AWARDS IN OUR MONTHLY PHOTOGRAPH CONTEST.....	968	WRINKLES, RECIPES AND FORMULAS.....	
HOW-TO-MAKE-IT DEPARTMENT — \$30.00 IN PRIZES.....	1000	Edited by S. Gernsback. 1001	
PRIZE AWARDS IN OUR \$200.00 SINGLE TUBE CONTEST.....	1008	ASTRONOMY ARTICLES	
SCIENTIFIC HUMOR—PRIZES FOR BEST JOKES.....	1014	CAN WE VISIT THE PLANETS?.....	By Don Home. 962
By Prof. Joseph Dunninger.		SPACE CAMERA PHOTOGRAPHS EARTH.....	977
By Ernest K. Chapin.		By Raymond F. Yates.	
By Isabel M. Lewis, M.A., of the U. S. Naval Observatory.		THE HEAVENS IN FEBRUARY.....	992
By Prof. Joseph Dunninger.		By Isabel M. Lewis, M.A., of the U. S. Naval Observatory.	
By Walter Gibson.			

HOW TO SUBSCRIBE FOR "SCIENCE AND INVENTION." Send your name, address and remittance to Experimenter Publishing Co., 53 Park Place, New York. Mention the name of the magazine you are ordering. We also publish RADIO NEWS and PRACTICAL ELECTRICS. RATES AND TERMS: The subscription rate for SCIENCE AND INVENTION is \$2.50 per year, (12 numbers.) When remitting do so by check, money order or registered letter, if cash is enclosed. Avoid sending cash through the mail if possible. Subscriptions for less than one year are not accepted. Subscriptions may be made in combination with RADIO NEWS or PRACTICAL ELECTRICS with considerable saving. Send postal for special rates. Subscriptions start with the current issue, unless otherwise ordered. POSTAGE: We prepay postage in all parts of the United States, Mex-

SCIENCE AND INVENTION is published on the 25th of each month. There are 12 numbers per year. Subscription price is \$2.50 a year in U. S. and possessions. Canada and foreign countries \$3.00 a year. U. S. coin as well as U. S. stamps accepted (no foreign coin or stamps). Single copies, 25 cents each. A sample copy will be sent gratis on request. Checks and money orders should be drawn to order of EXPERIMENTER PUBLISHING CO., Inc. If you change your address notify us promptly, in order that copies are not misrouted or lost.

All communications and contributions to this journal should be addressed to Editor, SCIENCE AND INVENTION, 18,430 Jamaica Avenue, Jamaica, New York, or 53 Park Place, New York City, N. Y. Unaccepted contributions

New York City. Western Advertising Representatives.
General Advertising Dept., Fincan & McClure,
53 Park Place, 720 Cass St., Chicago, Ill.

ico and island possessions. For foreign or Canadian subscriptions we require 50 cents in addition to the subscription price for additional postage charges.

CHANGE OF ADDRESS. Notify us as far in advance as possible. It requires several weeks to make an address change on our records. Always write clearly, giving your old address as well as your new.

ON EXPIRATION of your subscription we enclose a renewal blank in our last number to you and notify you otherwise. Unless we receive your order for a renewal, with your remittance, we stop our delivery to you on expiration.

COMMUNICATIONS to us should always bear your full name, address and when possible the number which appears on your wrapper every month.

cannot be returned unless full postage has been included. ALL accepted contributions are paid for on publication. A special rate is paid for novel experiments: good photographs accompanying them are highly desirable.

SCIENCE AND INVENTION, Monthly. Entered as second-class matter at Jamaica, N. Y., Post Office, under act of Congress of March 3, 1879. Title Registered at the Patent Office. Copyright, 1924 by E. P. Co., Inc., New York. The Contents of this Magazine are copyrighted and must not be reproduced without giving full credit to the publication.

SCIENCE AND INVENTION is for sale at all newsstands in the United States and Canada; also at Brentano's, 37 Avenue de l'Opera, Paris. Member of the Audit Bureau of Circulation.

Pacific Coast Advertising Representatives, Kansas City Advertising Representative.
A. J. Norris Hill Co., George F. Dillon,
Hearst Bldg., San Francisco, Calif. Republic Building, Kansas City, Mo.



Who Else Wants a New Head of Hair?

No matter how nearly bald you are—no matter how many kinds of treatment you've tried without results—this method is *guaranteed to grow hair for YOU*—or your money will be instantly refunded! Simply mail the coupon below for free proof.

By Alois Merke, Founder of Merke Institute

ACTUAL RESULTS

Scores of Other Letters
Tell the Same Story

Can't Praise Too Much

"I have been bothered with dandruff for twenty years and had lost nearly all of my hair. I have used your treatment 30 days now and have a good growth of hair coming in. I cannot say too much in praise of the Merke Treatment."

C. H. B.
Parsons, Kansas.

Bald for Years

"Kindly allow me to praise and recommend the wonderful Merke Treatment to any one who may be looking for a hair treatment which positively shows quick results. After five weeks' treatment a new growth of hair has shown on each side of the temple, where I have been bald for years."

New York City.

Does Everything Claimed

"Am glad to say I can see such great change in my hair. It is growing longer and my head is full of young hair that has made its way through since I have been using Merke Treatment. I can't say enough for it. It will do everything you claim it to do."

Mrs. G. G.
Houston, Tex.

Improvement Daily

"After using the Merke Treatment as per your instructions, my scalp is now showing improvement daily, and I think in time I will have more hair than I had two years ago. I was practically bare on the top, but now it is gradually filling in from the back."

J. S. W.
Attleboro, Mass.

Was Skeptical Once

"I must frankly state I was decidedly skeptical as to your claims for the Merke Treatment, but a faithful use of it for a month has removed all doubt, and three of us are obtaining unbelievable results both in looks and steady growth. It has also worked wonders with the scalp, stopping all dandruff and falling hair."

L. W. F.
Chelsea, Mass.

Head Covered With Hair

"I am dropping you a few lines to let you know about your wonderful Merke Treatment. The top of my head is almost covered with new hair. I have been trying for the last five years but never could find anything that could make hair grow until I used your treatment."

T. C.
Cleveland, Ohio.



FOLKS wonder how I can make such an amazing offer. No one ever dared to do it before—to guarantee absolutely to grow hair or the treatment costs nothing at all! Here's the answer. Read the letters printed on this page—letters from those who have tried this startling new method. These are just a few of the many that pour into my office every day—letters which show without a shadow of doubt that my home treatment—in the great majority of cases—positively *does grow hair!*

I don't say my treatment will grow hair in every case. There are some cases of baldness that nothing in the world can help. But I've secured such amazing results in so many other cases that I am perfectly willing to have you try my treatment at my risk! And if after 30 days you are not more than delighted with the results—if you cannot actually see a new growth of hair—then all you need to do is tell me—and without the slightest question I'll mail you a check refunding every bit of your money! I don't want a cent of your money unless I can actually grow hair on your head—and you are the sole judge of whether or not it grows!

Entirely New Method

My treatment is the result of 17 years of experience gained in treating thousands of cases of baldness. This included many long years which I spent in such famous scientific research centers as Heidelberg, Berlin, Paris, Cairo and Geneva. At the Merke Institute, Fifth Avenue, New York, many have paid as high as \$500 for the results brought. Yet now—through the Merke Home Treatment—these same results may be secured at home—for just a few cents a day!

My method is entirely different from anything known or used before. There is no massaging—no singeing—no "mange cures"—no unnecessary fuss nor bother of any kind. Yet results are usually noticeable after the very first few treatments.

My treatment proves that a big percentage of baldness, even of years' standing, is caused—not by dead hair roots—but by dormant hair roots which now can be awakened and made to grow again. Already scores of men and women who suffered for years from falling hair and partial baldness, have acquired a thick, healthy growth of hair through this amazing method, which for the first time provides a way of penetrating to the hair roots and furnishing nourishment direct to them. This treatment can be taken in any home in which there is electricity.

Free Booklet Explains Treatment

If you will merely fill in and mail the coupon below I will gladly send you—without cost or obligation—an interesting 32-page booklet describing my treatment in detail.

This booklet contains much helpful information on the care of the hair—and in addition shows by actual photographs what my treatment is doing for thousands of others.

If you are bald—or if right now you are merely troubled with falling hair and dandruff—this free book will prove to be of the greatest value to you. So mail the coupon now—and it will be sent you by return mail without cost or obligation.

ALLIED MERKE INSTITUTES, Inc.
Dept. 462 512 Fifth Avenue, New York City

MORE RESULTS

Bald Spot Growing Smaller

"Concerning the Merke Treatment will advise that it has undoubtedly benefited my hair and scalp. The 'bald spot' seems slowly but surely growing smaller, and Merke Treatment seems to be doing the work."

H. C. G.
Baltimore, Md.

Hair Growing Again

"I wouldn't take \$50 for your treatment. It was far beyond my expectations. My hair was dead and had no lustre. Now it is restored to its brilliancy and has begun to grow again. Thanks."

J. B. C.
Hillsboro, Tex.

New Hair in 20 Days

"Have been using Merke Treatment 20 days and have received great results. My hair has been falling out for four years and your Treatment has checked it. I had two bald spots on my head where there was not even any fuzz, and there is new hair growing on them now. I wouldn't take \$50 for the Merke Treatment. I think it's the best in the world."

J. M.
Smackouer, Ark.

Satisfied With Results

"I am satisfied with results. Lots of hair is growing where I was bald. I mean in front where one mostly loses hair first. It was just as bare as the palms of my hands. Now hair is coming again."

C. F.
Brooklyn, N. Y.

ALLIED MERKE INSTITUTE, Inc.,
Dept. 462, 512 Fifth Ave., New York City

Please send me, without cost or obligation on my part, a copy of the new booklet describing in detail the Merke Institute Home Treatment.

Name State whether Mr., Miss, or Mrs.

Address

City State.....

Get This Big Radio Book!

224 Pages. 375 Illustrations.

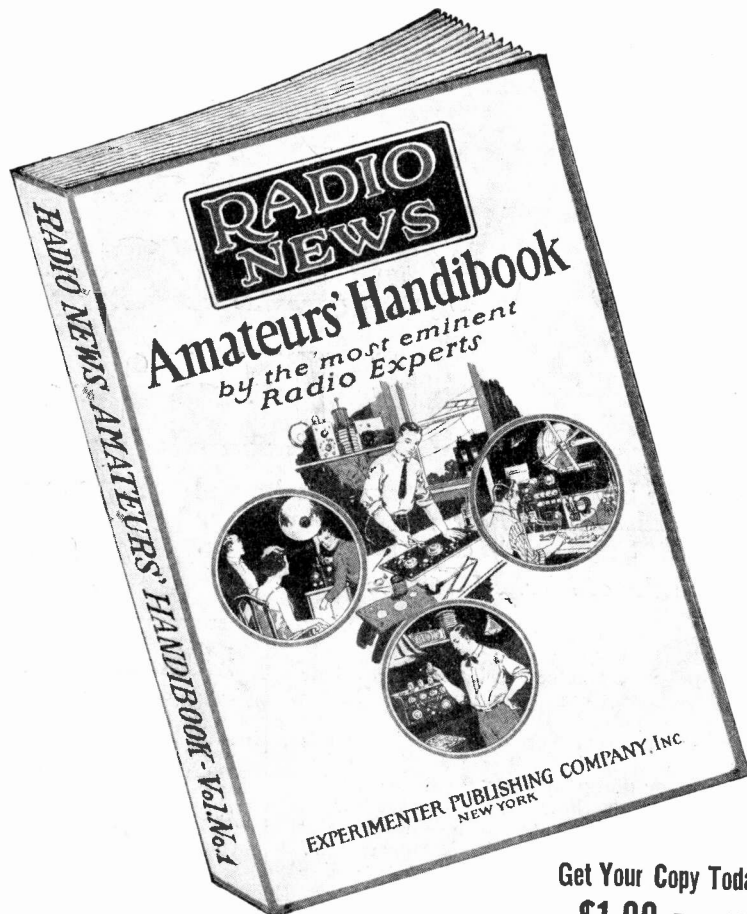

RADIO NEWS

Amateurs' Handibook

Volume No. 1

Tells how to build various types of receivers, transmitters, and sundry apparatus. Every description is extensively treated and illustrated with sketches, diagrams, and photos. A separate portion of the book is especially devoted to the operation, characteristics, and adaption of vacuum tubes. Another portion takes in radio theory, dealing with the antenna, regeneration, super-regeneration, radio frequency amplification, damping, impedance, high frequency resistance, etc., etc. A good part also gives numerous hints for construction of apparatus and general radio kinks.

All in all, the edition is just cram full of the sort of material which delights the heart of the radio fan. It should find a permanent place on the bookshelf of every amateur.

Bound in multi-colored heavy board.
Size 6 x 9 inches.

Get Your Copy Today
\$1.00 Prepaid

Some of the articles included in the Radio News Amateurs' Handibook are:

A Typical Amateur Receiver, A Radio Flivver, A Universal Receiver, A Radio Frequency Receiver, A Multi-Range Regenerating Receiver, A Reinartz Set, A 3-Tube Reflex Receiver, A 1-Tube Super-Regenerative Receiver, A Honeycomb Coil Receiver, A Compact Super-Regenerative Set, An Efficient Receiving Set, A Super-Sensitive Receiver, An Armstrong Super-Regenerative Receiver, A well designed Super-Regenerative Receiver, How to Make a Portable Receiver, a Practical Receiver, A Detector-Amplifier Unit, Modern Hook-ups for the Amateur, Dual Amplification Circuits, A Simple Reflex Circuit, An Efficient Amateur Receiving Circuit, A Long Distance Hook-Up, A Receiver Using Rectified A.C. Supply, How to Make D-Shaped Variometers, Regenerative Tuners to B.F. Amplifiers, Head Sets, Reducing Interference With Single Circuit Sets, Broadcast Receiving and Receivers, Hints on Loud Speaker Unit Operation, Amateur Reception on Honeycomb Coils, A Portable Wavemeter, A Wavemeter for Short Wave-Lengths, An Aerial Cleaner, The Construction of a Loop Aerial, Wiring the Radio Set, The Construction of a 10-Watt Transmitter, A 5-Watt Telephone and Modulated C.W. Set, A Spark Coil C.W. Set, A Vacuum Tube Transmitter Operating on a 6 Volt Storage Battery, A C.W. Measurement Set, Construction of an Electrolytic Rectifier, A High

Frequency Buzzer, Construction of a Modulation Transformer, Two Practical Radiophone Circuits, Loading Coil Design, Meters for C.W. Sets, A Dial Indicator, Regeneration and Super-Regeneration, Radio Frequency Amplification, Damping, Matching Impedances, High Frequency Resistance, Different Types of Coupling, Principles of the Antenna System, The Relation of the Antenna to Detection Efficiency, Theory of Crystal Detector Operation, Condensers, Monographic Charts for Measuring Capacity, Inductance and Wave-Length, Fundamental Operation of Vacuum Tubes, Operating Characteristics of Vacuum Tubes, Practical Points on Amplifier Operation, Vacuum Tube Facts, Basket-Wound Coils, Winding G-R Solid Wire Coils, An Arc Buzzer Practice Set, A Storage Battery for 1½ Volt Vacuum Tubes, Amplifier Trouble, Notes on Crystal Detectors, Practical Pancake Coils, A Sensitive Detector, Simple Mounting for Variocoupler Secondaries, A Method of Mounting Coils, A Practical Method for Writing Code, Form Wound Coils, Cores for Transformers, An Inexpensive Amplifying Transformer, A Silver Dial, Duo-Vertical Coil Winding, How to Solder Connections, Connecting Phones, How to Wind Duo-Lateral Coils, A Spider-Web Coil Mounting, A Carbon Disc Rheostat, A Device to Eliminate Dial Scratch.

Experimenter Publishing Co.,
53 Park Place, New York City, N. Y.

Gentlemen:
Kindly send me, prepaid, a copy of the RADIO NEWS AMATEURS' HANDBOOK. I enclose one dollar in payment of the same.

Name

Address

On sale at all leading radio stores. If your dealer cannot supply you, pin a dollar bill to this coupon with your name and address and book will be forwarded to you postpaid.

Experimenter Publishing Co., Inc.,
53 Park Place, New York City.

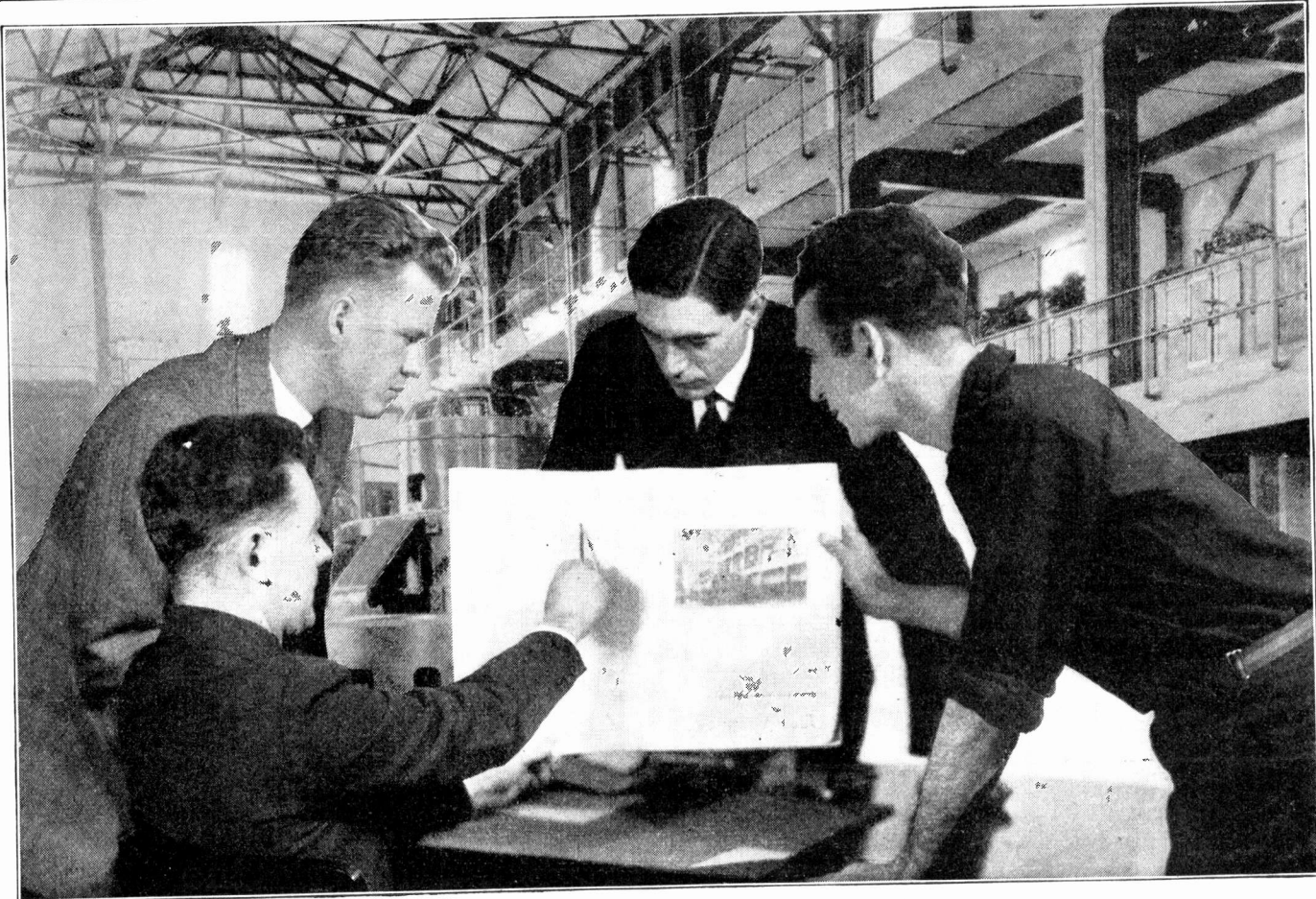

FREE! The Book That is Bringing Thousands Big Money in **ELECTRICITY!**

There is no field in the world that offers such great money making possibilities to trained men, as electricity. Thousands are qualifying the new way by actual S & H Shop Type training. A few weeks during spare time in your own home, then you are equipped to step right into jobs paying from \$50 to \$150 per week. Get this wonderful book which tells you just how you can do this. Sent free.

Train at Home for \$3,000 to \$10,000 Jobs

Don't stand back on account of education, experience, age, or location. No matter where you live, or what you are now doing, through my course you have the chance to become in a very short time a big pay "electrical expert."

Actual Shop Methods in Your Own Home

For I have devised a wonderful new system that gives you the benefit of actual shop experience in your own home. Never before has this been possible. But now, after finishing my training you will be at home in the biggest electrical plant, in a sub-sta-

tion, in a battery station, or with expert maintenance men, or on automobile and tractor starting, lighting and ignition work because you will have had actual experience, which means everything.

Backed by Lincoln Institute of Technology

This new system of teaching electricity has proved so successful that it has been highly recommended and endorsed by the great Lincoln Institute of Technology. When you enroll you know that you are backed by a great institution. You receive free, employment service and expert advisory service as long as you live.

Free Outfit

There is such a call for men now that we are giving free an electrical outfit for experimental and practical home use if you enroll now. Think what it will mean to leave forever the low pay rut to become a trained, efficient electrical technician, capable of managing and supervising ten or five hundred men on the biggest jobs; to travel, to be a man of influence—to have a salary of \$5,000 to \$10,000 per year. Find out now how

you can do this. You cannot afford to delay a day. Send right now for this wonderful free book that is pointing the way for thousands to big money in electricity. The coupon brings you this book entirely free, without obligation. Fill it out.

S & H ELECTRICAL WORKS

Affiliated with the Lincoln Institute of Technology

Dept. B2, 1422 W. Monroe St., Chicago, Ill.

**FREE BOOK — FREE OUTFIT
COUPON**

S & H Electrical Works,
Division of Lincoln Institute of Technology,
Dept. B2, 1422 W. Monroe St.,
Chicago, Ill.

Please send me at once your big book "How to Get the Better Jobs in Electricity," and full particulars of your course in practical electricity, your free outfit and your free employment service offer. I am not obligated in any way.

Name

Address

City State.....

Give age if under 16

A Chemistry Laboratory for \$7.00

Think of it, fellows! Here is a *real* chemistry outfit with regular chemical apparatus that performs those fascinating, actual chemical experiments. This outfit is not a toy, put up merely to amuse, but a practical laboratory set, with all the chemicals, apparatus and reagents necessary to perform real work and to teach the beginner all the secrets of inorganic chemistry.

DESCRIPTION OF THE OUTFIT

The outfit consists of 44 Chemicals and Reagents all C. P. put up in appropriate wooden boxes, glass bottles, and hermetically closed jars. The acids are put up in glass bottles, with ground-in glass stoppers, and there is a sufficient quantity of chemicals supplied (mostly one to two ounces) to make dozens of experiments with each.

The apparatus furnished are all of the best obtainable make and of standard laboratory size and shape.

The Instruction Book is a real Chemistry Course for the Beginner. Some of the Contents are: Division of Matter: This is a Treatise on Elementary Chemistry and deals with the theory of the Elements, Molecules and Atoms, etc. Chemical Nomenclature: This explains in simple language the derivation of the chemical names of the elements and their compounds. There is a chapter on Laboratory Operations; Glass Working; First Aid; Fire Extinguishers; Experimenters' Aphorisms, etc.

A good part of the book is devoted to Weights and Measures. The Metric System, The English System and the U. S. System are fully explained.

The following tables are furnished: Symbols and Atomic weights of the Elements; Measures of Weights, Volume, Capacity and Length; per cent solutions; Conversion of Measure expressed in parts; poisons and their antidotes; technical and common name of chemical substances; formulas for cleaning various substances, etc., etc.

Among the 100 Experiments are:

How to make chemical tricks; How to make invisible and magic inks; How to test flour; How to test soil; How to make chlorine gas and smoke (German War Gas); How to bleach cloth and flowers. How to produce Oxygen and Hydrogen; How to make chemical colors; How to test Acids and Alkalies and hundreds of interesting hints and formulas.

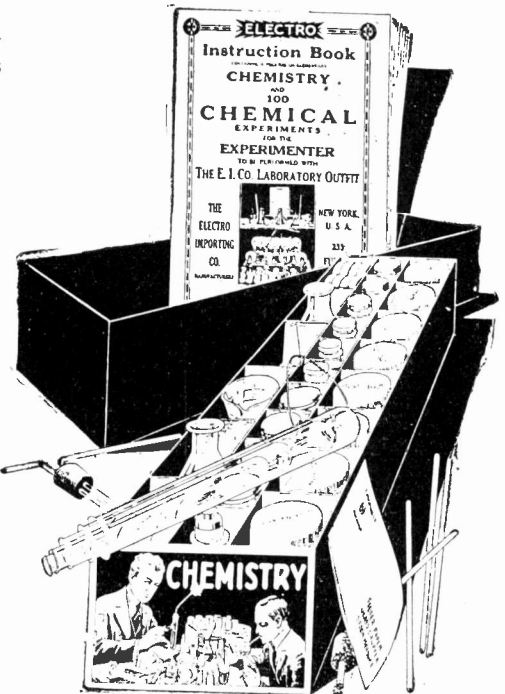

Complete, \$7.00 Sh. Wght, 10 lbs. (Shipped by Express only)

(We guarantee shipment within 24 hours after your order is received.)



Every Fellow Wants the
BOY'S ELECTRIC TOYS

The Boy's Electric Toy contains: Enough material to make and complete over twenty-five different electrical apparatus without any other tools except a screw-driver furnished with the outfit. Student's chromic plunge battery, compass-galvanometer, solenoid, telephone receiver, electric lamp, etc. Enough various parts, wire, etc., are furnished to make the following apparatus:

Electromagnet, electric cannon, magnetic pictures, dancing spiral, electric hammer, galvanometer, voltmeter, hook for telephone receiver, sensitive microphone, short distance wireless telephone, test storage battery, sensing coil, complete telegraph set, electric riveting machine, electric buzzer, dancing fishes, singing telephones, mysterious dancing man, electric jumping jack, magnetic geometrical figures, rheostat, erratic pendulum, electric butterfly, thermo-electric motor, visual telegraph, etc., etc.

With the instruction book we furnish one hundred experiments that can be made with this outfit, nearly all of these being illustrated with superb illustrations. No other materials, goods or supplies are necessary.

The outfit contains 114 separate pieces of material and 24 pieces of finished articles ready to use at once.

The size over all of the outfit is 14 x 9 x 2 3/4. Shipping weight, 8 pounds.

"The Boy's Electric Toys" outfit as described, \$7.00
Immediate shipment.

SEND NO MONEY

We have so much confidence in these sets that we desire to ship either one to you by express C.O.D. with the privilege of inspection. In other words, we ship on approval. It does not cost you one cent to take a good look at whichever outfit you want, and see if it comes up to your expectations. If it does, pay the express man \$7.00, plus express charges. If not, you need not accept it, and we will pay the return charges as well.

ELECTRO IMPORTING CO., 233 Fulton Street, New York City

ELECTRO IMPORTING CO.,
233 Fulton St., New York
Please send me by express THE CHEMICAL LABORATORY. If I don't like it I need not accept it. If I want it I only pay \$7.00 plus the few cents express charge.

ELECTRO IMPORTING CO.,
233 Fulton St., New York
Please send me by express THE BOY'S ELECTRIC TOYS. If I don't like it I need not accept it. If I want it I only pay \$7.00 plus the few cents express charge.

S.&I.-2-24

S.&I.-2-24

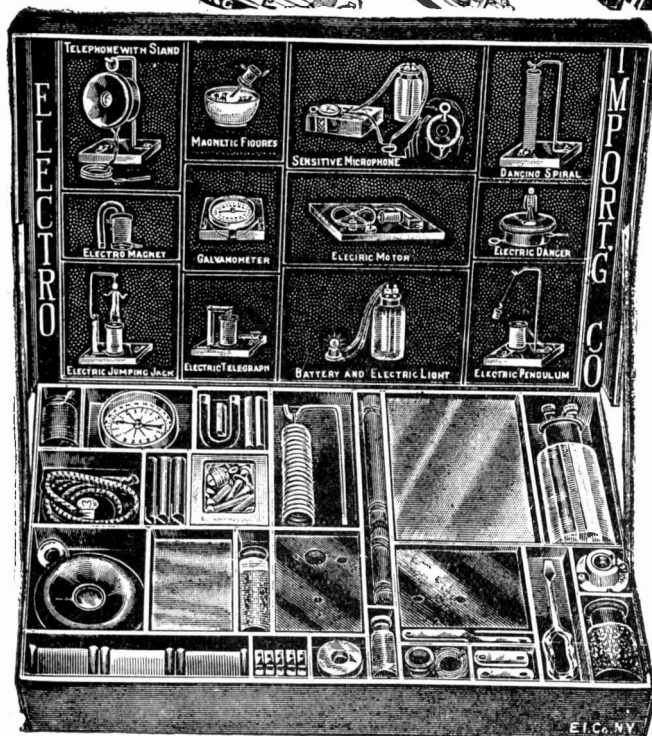

Great Inventors Now Teach You Secrets of Practical Invention

How would *you* like to be the inventor of the tin cap that now corks millions of bottles—and who gets a royalty on every one? How much money would *you* have now if you had invented the simple idea of putting a rubber tip on pencils? The inventor of the Gillette Safety Razor is said to have made as high as \$2,500,000 a year! The inventor of the tiny snap fastener last year paid an *income tax* of \$29,000. The man who invented the Autographic Kodak sold his patent rights for \$500,000!

JUST a single idea can make *you* independently wealthy in a short time. Little things—like the crimped hairpin, the paper safety-match, the metal-tip shoe-lace—brought their inventors hundreds of thousands of dollars. Only recently *Success Magazine* told how one woman built up a splendid business from an invention based on a little wedge-shaped piece of wood!

Couldn't *you* develop an invention as simple as these? Haven't *you* some ideas—even now—for one of these little inventions which can pay you for its such money?

What Invention Is

After all, invention is nothing more than the science of "fixing things." And how many times a day you do "fix things." A leaky faucet, a rattling window, a broken strap—you fix hundreds of things just like these almost every day. You may not know it, but when you "fix things" you are using the principles upon which Inventive Science is based.

Prove it for yourself. Here is shown a very simple problem in invention. See how quickly you can solve it. What would you put on Shaft "A" to force members "BB" to move back? Think of something you know now which can give you the answer. If you have an ordinary electric light switch you will find it in a second.

Invention is not guesswork or blind luck—it is not a God-given faculty possessed by a few favored mortals. The truth is that invention is based upon exact laws which anyone can learn. It is merely a matter of first *seeing* something to be fixed and then of *thinking* of some principle which will fix it. That's all. The whole thing rests on being able to think inventively. The simple problem shown here proves that when you think inventively the whole science of invention becomes as easy to learn as reading or writing.

This test shows how easily you can develop your ability to invent.

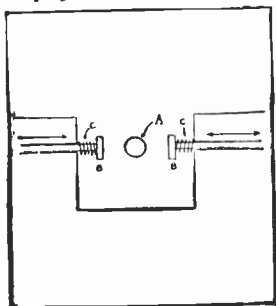

Here is an interesting little problem and its solution will be found very simple, if we really think hard. "A" is the end of a shaft. The two members "B B" are free to move in either direction indicated by the arrows. If they are pushed back, the springs "C C" will immediately pull them forward again. Our problem is to put some kind of an attachment on the revolving shaft "A" so that the members "B B" will be pushed back both at the same instant every time the shaft "A" makes a single revolution. The device on shaft "A" must also allow the two members "B B" to come forward once in every revolution. What would you suggest putting on the shaft "A"?

Why More Inventions Are Needed Now

Hundreds of years ago, the world didn't need many new things. That is why few inventions were made each year. But now the world has more needs, more things to be "fixed." And that is why, in the United States alone, over 50,000 inventions are patented every year!

The world wants better and cheaper light and power. It wants an electric light that will be heatless. It wants new motors that will weigh less and produce more power. It wants faster and less costly aeroplanes, motor cars, steam engines. It wants new inventions which will make cooking and housework easier; that will save time and labor in the home, the farm, the factory and the office. It wants new ideas for toys and other amusements. It wants its present inventions to be developed so that they will work better and more economically.

Surely you have at least one idea for an invention—no matter what it is—no matter how great or how small—the world will pay handsomely for even the simplest idea. Every day you see things which can be improved or which must be "fixed." Every day you can get ideas for new inventions. It can be a new kind of mechanical toy, or some device which will make your wife's housework easier. It can even be something as simple as the common nutcracker. The man who invented the Kiddie-Kar, it is reported, made over \$5,000,000!

What Edison Says

Could you ask the advice of any greater authority than Thomas A. Edison? He says: "INVENTION IS A SCIENCE AND SHOULD BE TAUGHT AS A PROFESSION."

And now, for the first time, you can profit by Edison's advice. You can actually learn invention as a profession—exactly as other people are learning electricity, automobile mechanics, law, medicine, as a profession. The Bureau of Inventive Science offers you the first course in practical invention ever devised, it has written down the easy-to-learn principles of Inventive Science so everybody could read them and learn to use them. You want the ability to invent—NOW. All you need, to become successful is this easy, fascinating training which will develop your ability so it will be worth real money.

Learn Invention by Actual Practice at Home

Hitherto inventors had to work out the principles of invention alone. But at what a terrific price in long years of discouragement, lost time, wasted money! Now you can quickly learn, in your spare time at home, the secrets of invention which brought wealth and fame to Edison, Marconi and other great inventors.

Today fifteen famous inventors tell you **WHAT TO INVENT** and **HOW TO INVENT**. They tell you the secrets of inven-



Little inventions like these have brought fortunes to their inventors



Raymond C. Yates, who with fourteen other famous inventors now makes it easy for you to learn how to invent in your spare time at home.

tion which every successful inventor knows. They explain how to originate ideas, how to develop and perfect them,

how to get patents. But they tell you even more: Thousands of inexperienced inventors have been defrauded of their rewards because they did not know how to protect their patent rights. This great course tells you everything you want to know—how to sell your invention, how to get royalties—how to get the most money for your ideas.

New FREE Book

The most fascinating part of this great new course is that it teaches invention by actual practice, right in your own home. With each lesson you are sent some problem in invention—just like the one you worked out here. This fascinating exercise in solving actual problems in invention, sharpens your instinct to fix things. Better than anything else, it gives you an unforgettable, instinctive habit of thinking inventively, which is worth more than you realize. In fact the lessons and exercises are so simple, so easy to understand, so interesting, that they seem more like a pleasant game than like instruction which can make you a successful inventor.

A wonderful new book, just printed, tells you more about the Bureau of Inventive Science and its simple new course in invention. It explains in detail just how this course develops your ability to invent. It tells you how great inventors work, how to develop your ideas, how to get a patent, how to protect your invention, the best way to sell your invention, how to convert a simple little idea into big money, how to learn all the secrets of successful invention. It costs nothing, so send the coupon at once. This bureau is not connected with patent attorneys or manufacturers. Its only purpose is to teach you the principles of practical invention used by every successful inventor. Write for the FREE BOOK now.

Bureau of Inventive Science

Dept. 72

Wisner Building, Rochester, N. Y.

BUREAU OF INVENTIVE SCIENCE,

Dept. 72, Wisner Building,
Rochester, N. Y.

Please send me your free book, "The Science of Invention."

Name

Address

City State



Master Electricity By Actual Practice

The only way you can become an expert is by doing the very work under competent instructors, which you will be called upon to do later on. In other words, *learn by doing*. That is the method of the New York Electrical School.

Five minutes of actual practice properly directed is worth more to a man than years and years of book study. Indeed, Actual Practice is the only training of value, and graduates of New York Electrical School have proved themselves to be the only men that are fully qualified to satisfy EVERY demand of the Electrical Profession.

The Only Institution of the Kind in America

At this "Learn by Doing" School a man acquires the art of Electrical Drafting; the best business methods and experience in Electrical Contracting, together with the skill to install, operate and maintain all systems for producing, transmitting and using electricity. A school for Old and Young. Individual instruction.

Over 8,000 Graduates are Successful Men in the Electrical World

No previous knowledge of electricity, mechanics or mathematics is necessary to take this electrical course. You can begin the course now and by steady application prepare yourself in a short time. You will be taught by practical electrical experts with actual apparatus, under actual conditions.

The N. Y. E. S. gives a special Automobile Ignition Course as an advanced training for Auto Mechanics, Garage Men and Car Owners. The course covers completely all Systems of Ignition, Starters, Lighting and other electrical equipment on automobiles, motor boats, airplanes, etc.

Let us explain our complete courses to you in person. If you can't call, send now for 64-page book—it's FREE to you.

New York Electrical School

29 West 17th Street, New York

New York Electrical School
29 W. 17th St., New York, N. Y.

Please send FREE and without obligation to me your 64-page book.

..... NAME

..... STREET

.....CITYSTATE

Science and Invention

H. GERNSBACK, EDITOR AND PUBLISHER
H. WINFIELD SECOR, ASSOCIATE EDITOR
T. O'CONOR SLOANE, Ph.D., ASSOCIATE EDITOR

FEBRUARY
1924
No. 10

Editorial and General Offices, - - - 53 Park Place, New York

"Those Who Refuse to Go Beyond Fact Rarely Get As Far As Fact" -- HUXLEY

Sleep

By H. GERNSBACK

THERE are few subjects that are understood as little as sleep. Most of us go to sleep every night, as a matter of fact, but how many people really know why we sleep, what the functions of sleep are, and what occurs in our brain when we do sleep. Strange to say, the subject, fascinating as it is,

I BELIEVE
¶ THAT many a fact often turns out to be only a near fact.

is one of the great unexplored spheres of knowledge. There are few books in existence today treating on sleep and every encyclopedia you come across will give a different theory. Summing it up, it would seem that we really know nothing about it at all and that one man's theory is as good as that of the next. Some investigators believe that sleep is due to a gradual accumulation of poisons in the body, a sort of auto-intoxication that finally benumbs our brain, thus putting us to sleep; a plausible theory, which, however, has been disproved as not being founded upon fact. Another theory is that the brain simply tires—just as our muscles become fatigued—and upon relaxing, a sort of suspended animation sets in, thus producing the condition of sleep.

There are different kinds of sleep which might be classified as follows:

1—Natural sleep. 2—Hypnotic sleep. This particular sleep is distinguished from all other varieties by the fact that the subject under hypnosis can sleep with his eyes open. 3—Narcotic sleep produced by drugs. This sleep, similar to the hypnotic sleep, is very sound and much deeper than natural sleep. 4—Sleep produced by blows or by fainting. Also called unconsciousness. 5—Hibernating sleep found in many animals such as bears, etc. This is probably a true hypnotic sleep. During such sleep the animal suspends practically all animation. The heart action, as well as the action of the respiratory organs are greatly decreased. The hibernating sleep is by no means found only in animals, but in human beings as well. The East Indian, particularly, can produce the hibernating sleep. During such sleep the tongue is usually rolled back into the mouth and the subject's body becomes more or less stiff as in a cataleptic stage. Many East Indian performers can thus sleep for weeks at a time without taking any nourishment whatsoever and rising from the long sleep unharmed.

A tremendous amount of research work will have to be done before we really know what happens when we fall asleep. In the meanwhile, the writer ventures a few remarks on the subject which may or may not be disproved in the future.

In the first place, sleep is a habit like many other habits, inbred and inborn in us since prehistoric times. When our ancestors had as yet not reached the human stage, all animation ceased with sun-down, as is the case with most animals today. It appeared dangerous to prowl around during the darkness. After sunset the animal sought its lair or cave and gradually its movements became less until the animal finally stretched out and relaxed. There being no light, the eyes shut tight and soon a total relaxation set in. This is the case today with nearly all animals, including the human race as well. It should be noted here, and the writer lays particular stress upon it, that there seems to be a relation between the optic nerve and the sleep producing

causes, for as long as you keep your eyes open you do not sleep, except hypnotically. This is the case with nearly all animals, with few exceptions. Fish, on the other hand, which do not close their eyes, do not as a rule sleep, with some few exceptions. If you have gold fish in your home you know that they do not relax nor sleep. They keep on swimming ceaselessly. Evidently, they can get along without sleep.

We also know by experience that when we are lying in bed and trying to ward off sleep, one of the best ways to do so is to open the eyes. This would seem to disprove completely the auto-intoxication or poison theory. The writer ventures to say that sleep itself is not absolutely necessary as long as the physical exertions are kept down to a minimum. It is possible that future generations will be able to get along without sleep at all.

Indeed, while we are asleep, the brain itself is not asleep, as might be thought. It still has to take care of all the various functions of the body such as respiration, circulation of the blood and dozens of others. In other words, the brain itself never sleeps. The writer has proven this in connection with his hypno-bioscope, now used commercially to teach things to subjects while sound asleep.

Summing up, the writer is of the opinion that sleep is a partial hypnotic effect produced by a slight self-hypnosis. In other words, in order to sleep you must will to sleep, either consciously or subconsciously. You can fight off sleep merely by mental exertion as everyone knows and it is thus possible to stay awake for many hours. But the instant you have the actual will or desire to sleep, relaxation sets in, while a slight hypnotic state begins which wears off as the night wanes until the room in which you sleep becomes light. Finally, if the sun shines, you will wake up automatically in most cases. A partial proof of this theory would be that you can wake yourself up at a pre-determined hour. For instance: You say to yourself before going to sleep that you will wake up at 5:30 in the morning, and you will unfaillingly do so if you simply will it strongly enough. This would prove in part the self-hypnotic theory in natural sleep.

It should be understood that the above theory relates only to normal-natural sleep. By this is meant the sleep that comes to us under normal, every day conditions. We might call an abnormal-natural sleep, the sleep produced through physical exhaustion. For instance, after taking abnormal exercise for an extended period, we find that we readily fall asleep. While this form of sleep still falls under the normal classification it should be noted that the self-hypnotic influence is not nearly so great in this case as in normal-natural sleep. Of course even when we are exhausted physically we still can keep awake if we will it strong enough, but the effort to stay awake becomes tremendous. In this case it is really the muscular-exertion-reflex that unconsciously forces the mind to will the sleep and we then fall asleep almost automatically.

To prove that we can get along without sleep, in case of necessity we can go for two, three and sometimes four days without any.

I BELIEVE
¶ THAT the quest of knowledge is man's greatest and most exciting sport.

I BELIEVE
¶ THAT ideas of a feather flock together.

THE GOLDEN AGE OF SCIENCE

is now symbolized by the golden cover of SCIENCE & INVENTION. LOOK FOR THE GOLD COVER every month!

Can We Visit the Planets?

Some of the Problems of Such a Journey.

BY DON HOME.

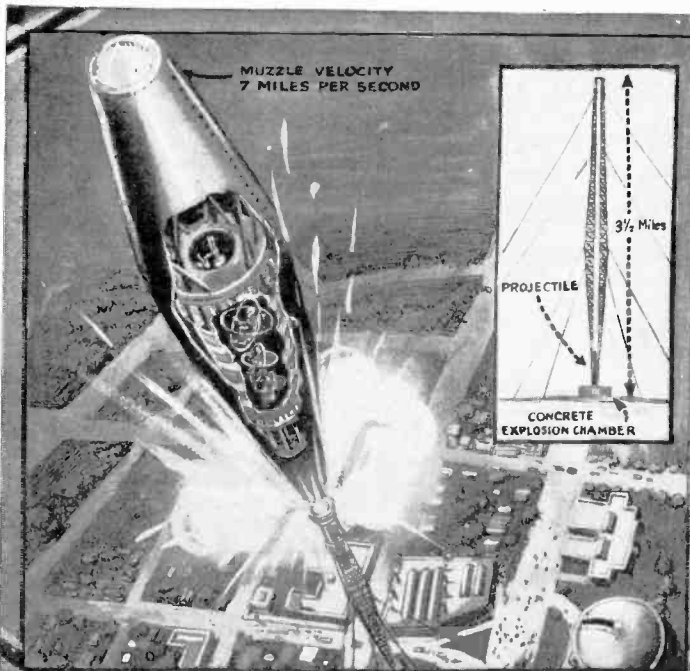

FOR centuries it has been the vision of man to visit other worlds than our own. To do this there is a large number of almost insurmountable problems whose solutions must be found. Not the least of these is a method of obtaining the initial velocity of seven miles per second that must be attained by the projectile which is to carry the man making the visit away against the Earth's power of gravitation, into the realms of space. One of the most obvious devices for gaining such a velocity would be a giant cannon with a barrel $3\frac{1}{2}$ miles long.

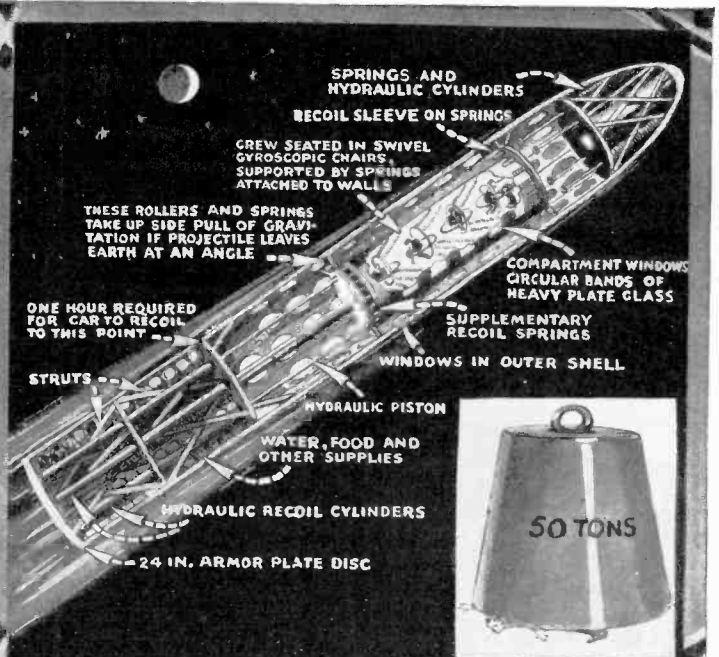

Another grave problem attached to leaving the Earth's surface in any type of vehicle is a means of counteracting the terrific force that the initial velocity would exert on the men in the vehicle. Assuming the initial velocity of seven miles per second, the occupants of the car would be thrown against its walls with a force of more than fifty tons, crushing them into pulp, unless some means of taking up the thrust over a period of an hour could be installed in the car. Above is illustrated one method of absorbing this powerful thrust.

The primary problem of taking up this monstrous thrust might be solved by the hydraulic piston method shown above. Such an arrangement, however, would still leave a considerable power at the end of the operative period of the pistons that would be by no means small. This subsidiary thrust would have to be taken up by another set of springs and pads fixed in the end of the steel cylinder compartment which would serve as the car for the travelers. Each voy-

ager would be fixed, seated, in a gyroscopic swivel chair. The outside framework of the car would be of extra braced steel framework covered with a heavy steel plate. All along the outside walls of the cylinder housing the passengers' cylinder and completely around its circumference there would be glass windows. Near the seat of each of the crew there would also be a window. No matter what position the sliding inside cylinder took the occupants could see out.

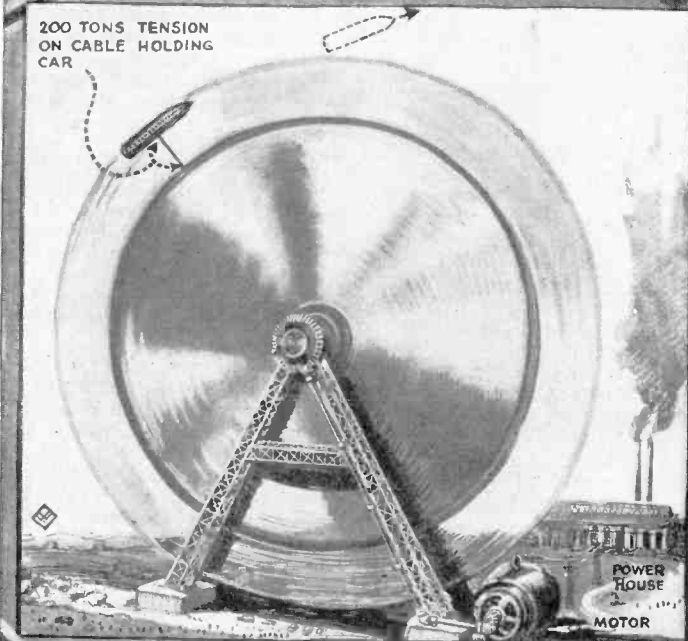

Another method suggested for launching an interstellar vehicle into space against the Earth's gravitational pull is illustrated above. A vehicle more or less in the form of a projectile would be lashed to the circumference of a giant fly-wheel and the wheel would be rotated at a circumference speed of a little more than seven miles per second. In such a case some means of protecting the occupants from the crushing power of the centrifugal force would be necessary just as something would be necessary to take up the end thrust in the previous case.

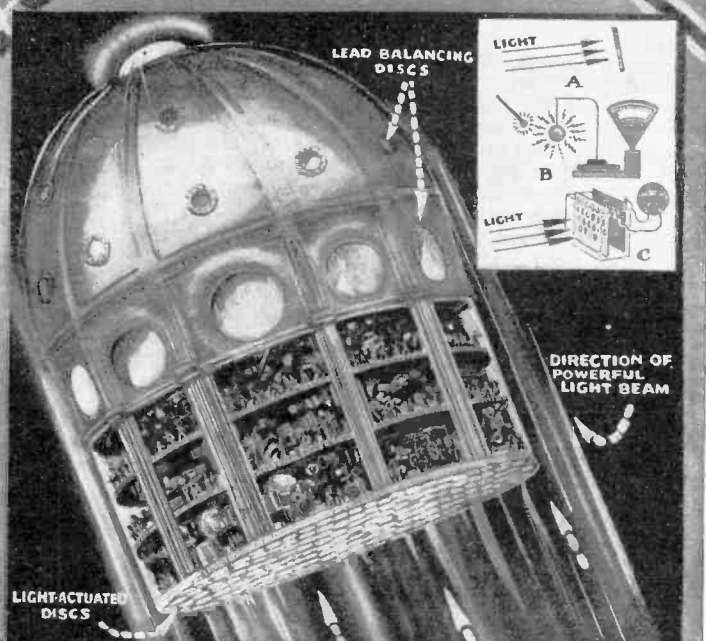

It has been proven that light exerts force on the surface it strikes. (A) Here is a car which would use that force, provided some means of counter-acting gravitation could be found. It has also been noted that by electrification of a lead ball its weight can be lessened, (B), which might be considered ground for the assertion that a means of controlling gravitation will be discovered. Also, light falling on certain bi-metallic cells generates electricity (C), giving another force to move the car.

Radio Town Crier

By H. Gernsback.

THE accompanying illustration shows a gigantic radio loud-speaker which probably will be known in the future as the Municipal Announcer. Experiments made for the past few years have shown that it is possible to so amplify the human voice, by means of huge horns and vacuum tubes, that it will be heard over a radius of from three to five miles so that each and every word will be understood clearly. In our *Electrical Experimenter* of November, 1919 issue, there was illustrated how huge horns placed in a church tower projected sound four to five miles.

The idea of the Municipal Loud Speaker is as follows: Huge sky-scrapers, as shown in the illustration, would be equipped with a number of concrete or non-vibrating metallic horns, pointing downward as shown. In this position, the sounds will be dispersed towards the street and buildings, and will also prevent rain and snow entering the horn itself. In cities like New York and Chicago, such horns would be erected every one or two miles. It goes without saying that present buildings can be equipped with such horns, but in the future probably a new sort of architecture will be evolved to take care of them.

The purpose of these Municipal Announcers will be simple. Any news, either of civic or national importance, can be broadcast so that the whole city can hear every word. By opening your office or home window, it will be possible to listen to every word spoken. Thus a Presidential speech, a talk by the Mayor of the city, or any other important feature can be instantly transmitted to the entire populace.

For police work, such a device will be of tremendous importance. Suppose a robbery or a murder is committed; the police headquarters can immediately broadcast this news so that every citizen in the neighborhood will be on the look-out for a certain car and will have a description of the law-breaker. The important part is that the information will be instantaneous, which in the detection of crime, is of utmost importance.



Science Takes Hand In Beauty

Appeal to Another Sense Makes Scene More Beautiful.

AT THE THEATRE

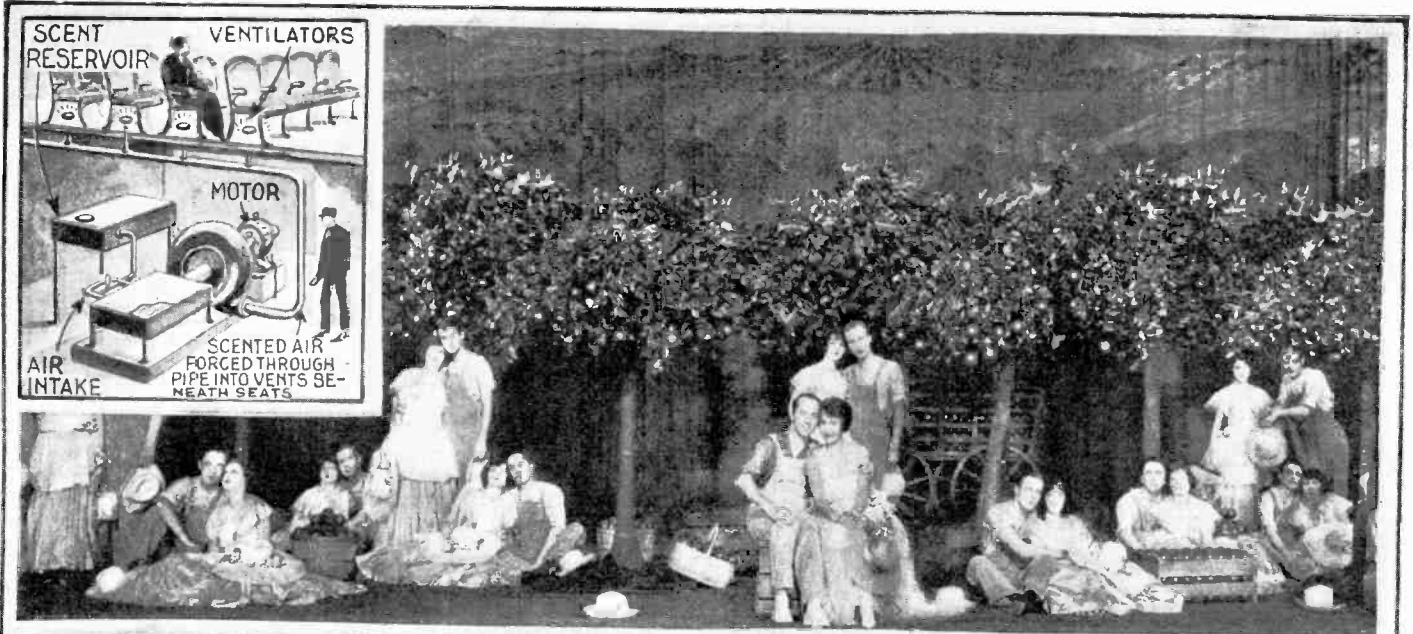

In order to increase the reality, and thereby the beauty and effectiveness of a song setting, Hassard Short, in staging the "Music Box Revue" hit upon the simple expedient of appealing to another of the senses. Ordinarily, on the stage, beauty is gained by appealing to the eye and ear. Here science has gone a step further and not only these two organs are appealed to, but the nose is added to the list. The scene is laid in an orange grove of California (above). Shortly after the characters appear and begin the song a gentle scent floats up over the audience, the magic scent of oranges. Then the lights are dimmed and the oranges on the trees begin

to glow and the scent becomes stronger until at the end of the scene it pervades the whole theatre. The trick is simply done. In the basement there is a large carburetor-like machine, consisting of a large, flat pan containing a synthetic scent—the nature of which the producers refuse to give since it is not patentable—and a centrifugal blower which draws a draft of warm air over the scent. (Insert) This scent impregnated air is forced up through the ventilation pipes to the vents beneath the seats in the theatre. The oranges on the trees, in the crates and in the wagon all house small lights (3,000 are used in the scene) lit at the proper instant.



An even more gorgeous effect is achieved in another scene in the same production with the aid of lights on costumes using complimentary colors. Directly above are seen the figures as they first appear. The body of the costume is an iridescent purple while the trimmings are a pale yellow. The hangings behind the scene follow the same plan. The foot board which rises to the rear of the stage is black, covered with

what seems to be sparkling jewels. Then there is a sudden change in the lights—so sudden that it is imperceptible until it has happened. The audience gives a little gasp. The costumes have become checked in gold and purple. Even the hats have become checked. The song continues and the background follows the design of the costumes (above), through all the changes in costume color there

is not the slightest change in the flesh tints of the cast in spite of the changing colors. Then again in the finale (above) the costumes take on other hues with the repetition of the almost unnoticed light change. They become light maroon and gold checked while the trimmings shine out with a tint all their own. The lights that cause the change are all passed through colored gelatine screens.

Mechanics of Gorgeous Revue

Sixty-three Mechanics Necessary to Operate Stage Devices.

BY W. B. ARVIN

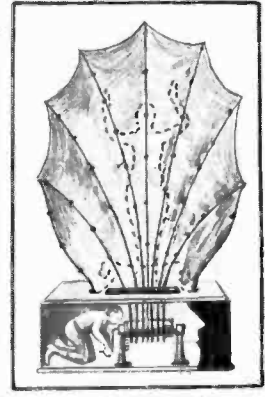
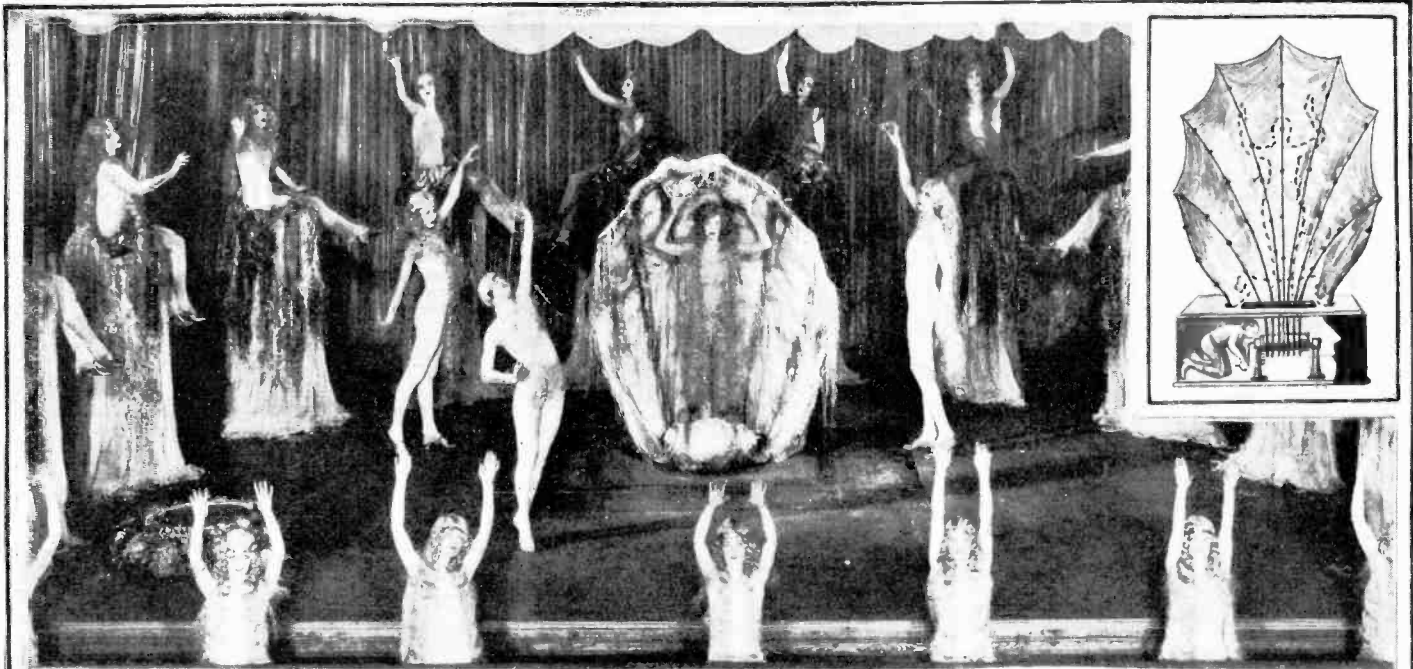

The scene "The Fisherman's Dream" depicted above opens with dim lights on a small fishing craft. The craft is lifted up into the wings out of sight of the audience. Then, as mermaids, flocks of girls appear on the stage. The chiffons that are between the audience and the figures when the scene opens are drawn away and in the center of the stage there arises a closed sea-shell. It begins slowly to open until, when it is full sized, another mermaid appears standing in it. Following this at the front of the stage there is seen gradually arising from beneath it, eight

more of the under-sea maidens, while at the same time a semi-circle of them begin to float up on clumps of seaweed around the rear of the stage. Then the central maiden steps back into the shell, it closes and drops slowly out of sight as do all the other figures. At the insert is shown how the sea shell is made to work. It is constructed of silk held in place by spring steel rods. A boy is secreted in its base and at the proper time he unrolls the cords off the windlass, which cords allow the steel rods to expand into a straight position thereby opening the shell.

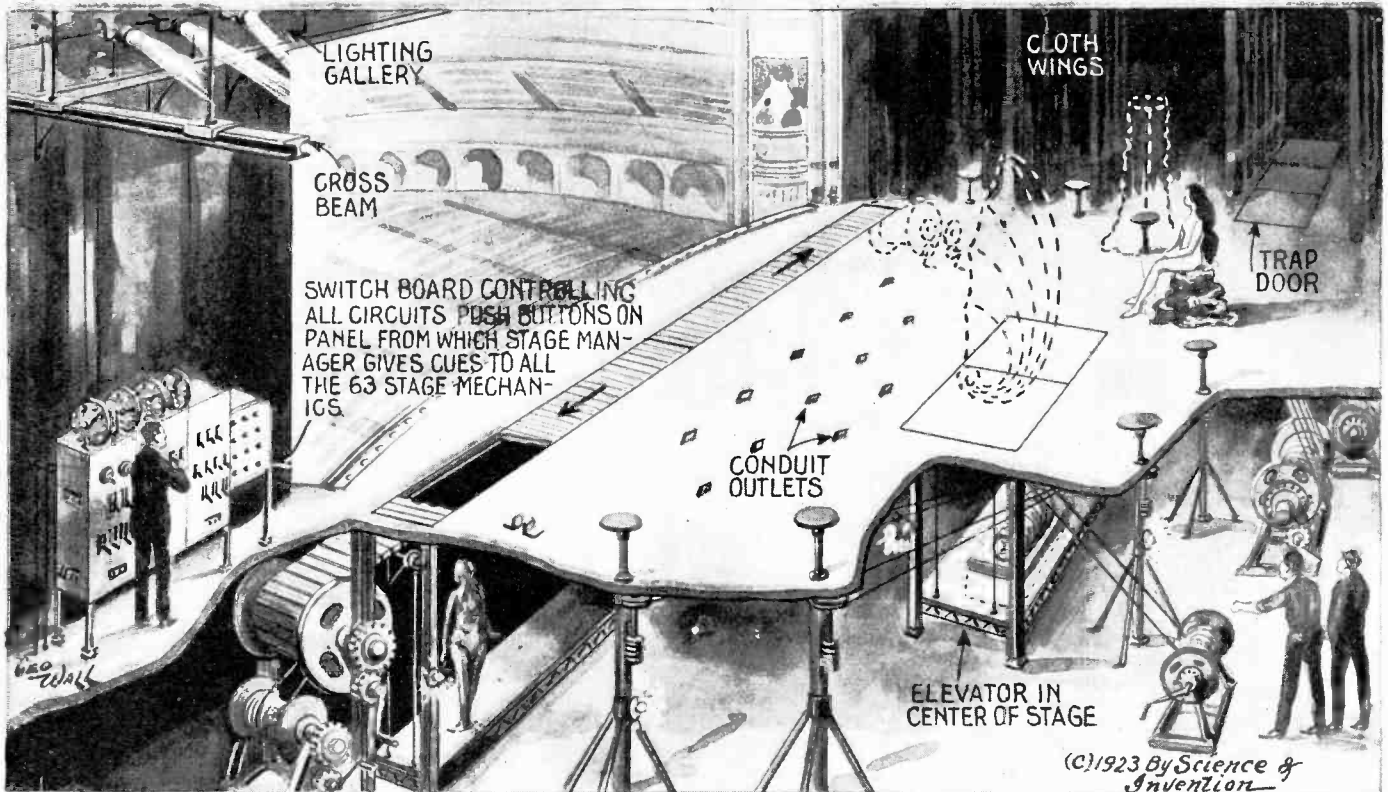

Here is shown the mechanical end of the stage which requires 63 men for its operation. A third of the mechanics are in the scene galleries above the stage, another third of them are in the basement beneath. None of these men have ever seen the show from the front, and those who work in the basement have never seen the actual happenings on the stage. All are kept in perfect time by the simple device of having them all work by signal light. The stage manager has a small switch-board which operates all the cue lights and with this he keeps the whole crew in step. Along the front of the stage may be seen the elevator which raises the girls in

the foreground in the scene illustrated at the top of the page. When the elevator is not in use it is covered much like a roll-top desk. This cover is rolled away by a winch as can be seen in the cut-away portion. The elevator is also lifted by the same winch. The stool-like affairs are simply steel rods running in guides (also seen in the cut-away portion). When they are not in use they are flush with the stage floor. The stool tops are removable. All twelve of these stools and the elevator in the center of the stage work from a master winch and clutches. There is a signal light for every piece of apparatus.

(C) 1923 By Science & Invention

The War Machine of Tomorrow

THAT the war machine of tomorrow will be an amphibious machine capable of carrying out its deadly aims equally well in two—and possibly three—elements is almost a certainty. Perform, a certainty, since it must be able to do damage equally in water, on land, and in the air if it is to be anything but obsolete. Here is illustrated such an engine of war. In this illustration it is shown cruising at the surface of the water. Runways for landing aircraft, catapults for launching them, a collapsible mast for observations, a conning tower for use under water and a vast array of armament and anti-aircraft guns are visible. All these adjuncts work perfectly in their own sphere and yet they are combined into one complete fighting unit.

Not only will this giant fighting machine be able to travel equally well on land or in water but it will be able to crawl along the floor of the sea. This is made possible, by the large caterpillar tractor treads which carry the vessel on land. There will be four or more such units.

One of the most important abilities built into this new vessel is its ability to carry within its hull submarines. This idea is due to Mr. Lyman Mason. They are a part of the vessel and use it as a base of operations. There are two ports fore from which the submarines leave the ship.

Above is shown the method of installing the caterpillar treads. The dotted line shows how the housing slides into the hull of the vessel when it is running in water.

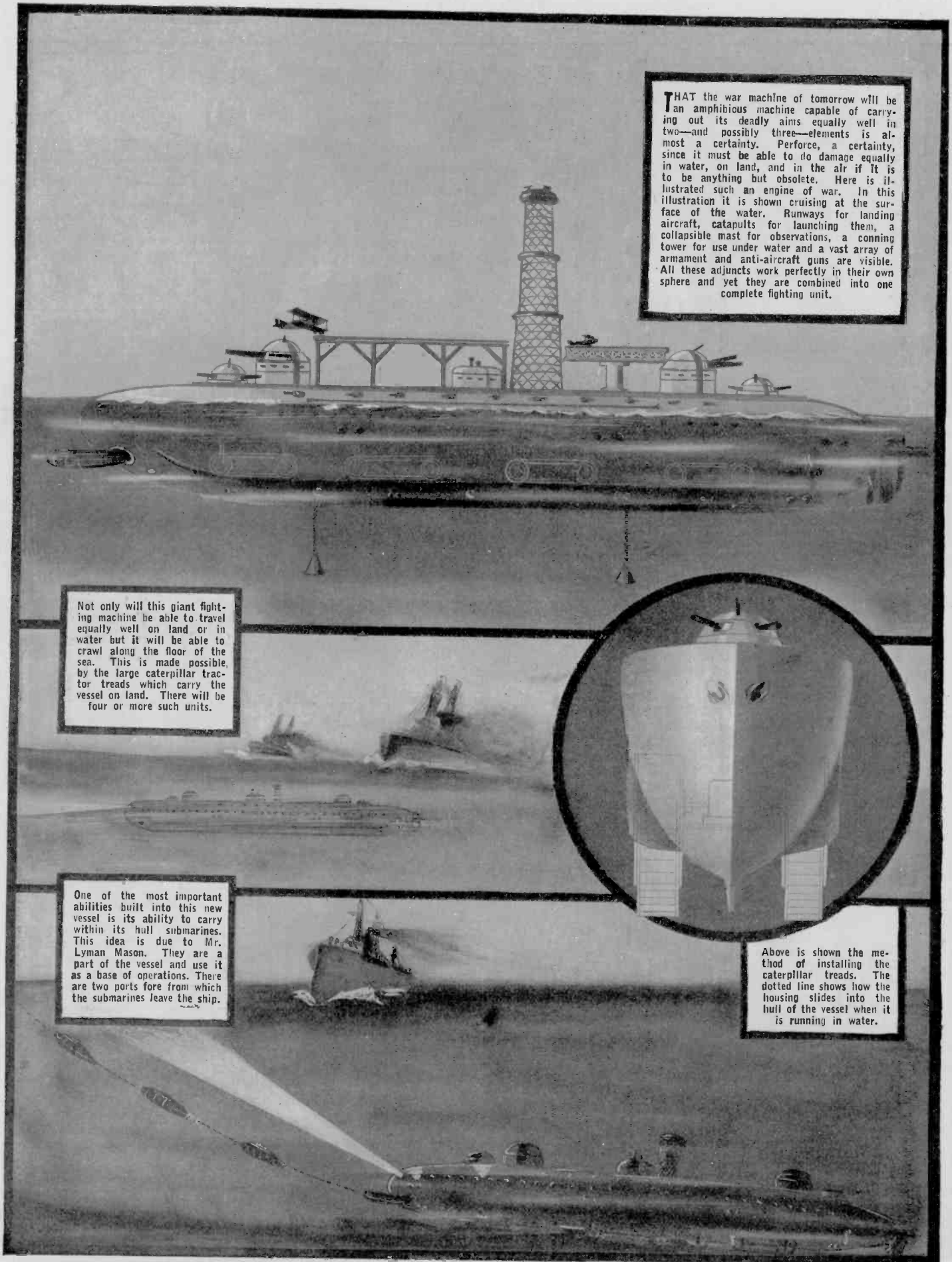

An Amphibian Beast of Prey

In battle the machine would be a veritable infernal machine. As is illustrated below, a naval battle in which it would engage would be prepared for somewhat as follows: Floating at the surface of the water, airplanes would be sent out from the deck in a trip of reconnaissance. Plans completed, they would return and the boat would be cleared for action. The anti-aircraft guns would be trained to wait for the approach of the enemy. Submarines would be launched from the two apertures of the vessel, the giant depth bombs would be set in place ready for use to war on enemy submarines. It is noted here that in the hull of the vessel there are sensitive microphones and in each of its family of subs there is a small transmitter that sends out a certain signal familiar to the bombers.

When she had conquered the enemy's sea defense the Captain would merely give orders to proceed to their nearest land fortification. As the vessel approached the shore the tractor treads would be let down and the vessel (or vessels) would proceed to the business of demolishing the fortresses and land forces. The depth bomb and submarine ports would be closed and in place of them a line of small guns would appear along the vessel's third deck. The secondary and primary batteries could, of course, be used without change. Below is seen the monster as it would appear making land. In view of its total length, possibly eleven hundred feet or more, it would have no trouble in making its way over any kind of terrain, since it would be equipped with the caterpillar treads. It would be supplied with the largest bore guns possible and extra powerful engines.

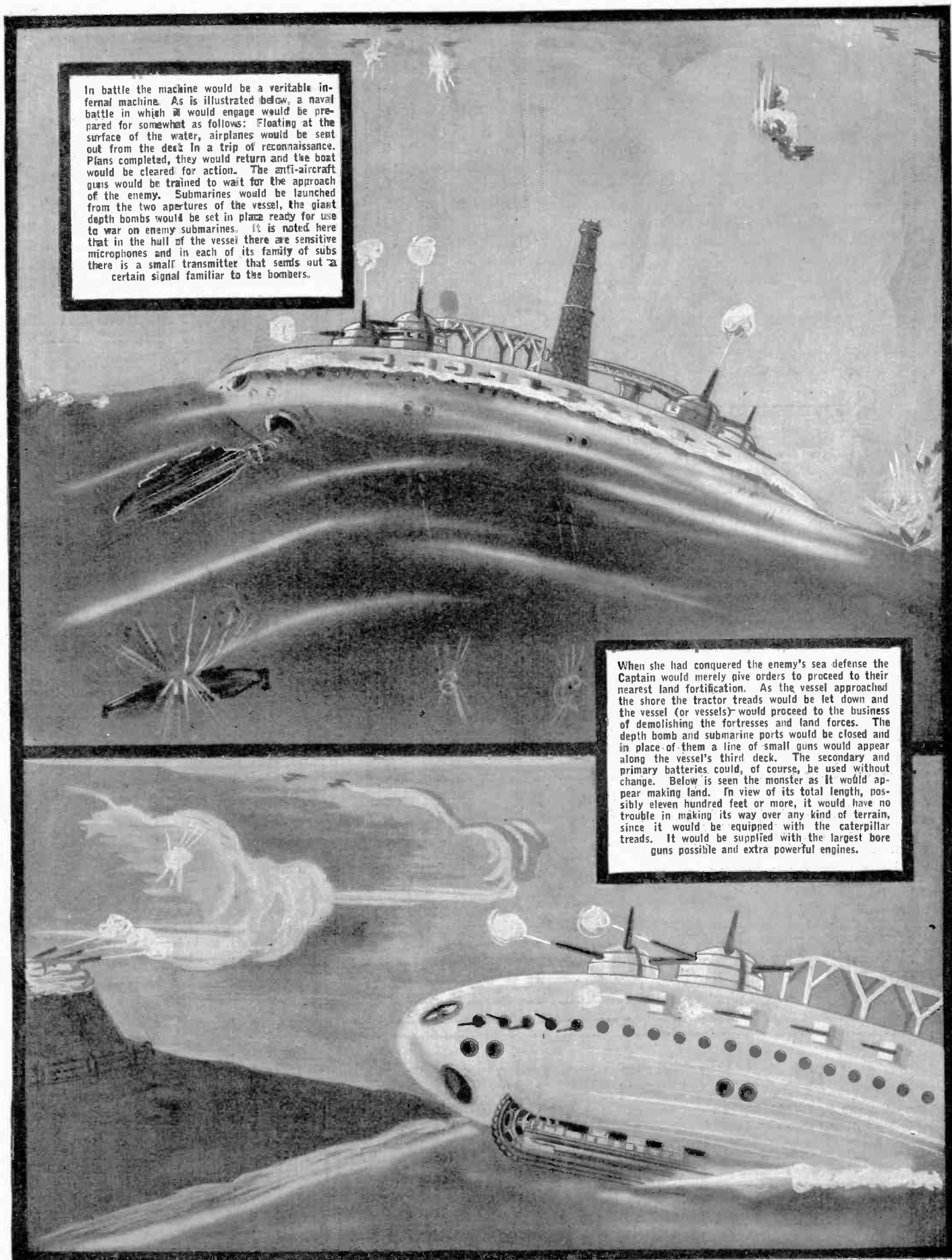

Awards of \$1000 Monthly Prizes.

Uniformity of Quality Makes Work of Awards Hard for Judges.

Name	Page	Name	Page
FIRST PRIZE \$100.00			
Raymond Francis Yates	977	Frank W. Nightingale	999
TWO PRIZES \$50.00 EACH			
Don Home	962	M. Wiley, Reporter No. 3527	1003
C. A. Oldroyd	974	Walter Johnson	1010
TEN PRIZES \$25.00 EACH			
Lyman Mason	966	TWENTY PRIZES \$10.00 EACH	
Dr. Albert Neuburger	975	Charles G. Percival	982
Dr. Armin DeMuth	980	Dale R. Van Horn	983
Ismar Ginsberg, B. Sc., Chem. Eng.	982	S. Leonard Bastin	983
Phil Gersdorf	986	Dr. Albert Neuburger	983
Laurence H. Snyder	987	Thomas Reed (Joy Ride Detector)	983
Chas. Marton	988	Dr. Albert Neuburger	984
Harry H. Dunn	990	E. S. Norton	989
L. J. Smith	996	Author of Fly-Gun Article	989
Armstrong Perry	1005	Dr. Albert Neuburger	997
FIVE PRIZES \$20.00 EACH			
George A. Luers	990	Dale R. Van Horn	997
Walter Gibson	994	Dr. Albert Neuburger	997
Leonard J. Edick	996	Harold Jackson	997
W. L. Pearce	1007	Author of "Illusion" Article	999
Paul Oard	1007	V. B. Rickcy	999
TEN PRIZES \$15.00 EACH			
Adolph Ruhland	981	Dr. E. T. Sonendriker	1000
A. F. Anderson	981	Dr. Albert Neuburger	1001
Geo. A. Luers	981	Raymond B. Wailes	1001
L. H. Stuart	981	Orhan R. Coblentz	1001
P. Cedric Wenger	998	J. L. Griggs	1001
Dale R. Van Horn	998	A. O. Wright	1060
J. T. Garver	999	TEN PRIZES \$5.00 EACH	
Twenty Prizes \$2.00 Each			
(No entries)			
Ten Prizes \$1.00 Each			
(No entries)			

Here Is How You Can Get in the Contest:

\$12,000 or More in Gold

Beginning with the January issue, SCIENCE AND INVENTION will pay \$1,000.00 or more each month of the year in prizes. Every article published in the regular news section will receive one of them.

(The departments have awards of their own which they will continue to give.)

Ideas are what the editors want. They must be told simply—so your mother or sister can understand them—in pictures and sketches. Be sure they are NEW and have something to do with science or invention. The editors want pictures and

88 monthly prizes will be given as follows:

FIRST PRIZE \$100.00

2 PRIZES of \$50.00 each

10	"	"	25.00	"
5	"	"	20.00	"
10	"	"	15.00	"
20	"	"	10.00	"
10	"	"	5.00	"
20	"	"	2.00	"
10	"	"	1.00	"

\$12,000 or More in Gold

sketches—must have them—but ideas are wanted most of all.—And they will be handsomely paid for. The rules of the contest will be found on page 534 of the October issue. If you haven't a copy, one will be mailed you free on receipt of your name and address. It will give full details of the rules and hints on submitting articles. The closing date for all prize contributions will be the 15th of the month preceding date of issue, i.e., 15th of December for the February number; the 15th of January for the March number, etc.

WILL YOU BE OUR REPORTER?

IN Connection with our \$12,000.00 prize contest announced last month, it goes without saying that you will have to hustle to win a prize. The Editors do not wish to make it hard for you; quite the contrary. We want the pictures and want them badly. Herewith is reproduced our reporter's card. We shall be glad to send it to anyone who makes an application. By means of this card you will be able to secure entry into industrial plants, business houses, motion picture studios, steamships, mines, etc. This card will prove an open sesame to you in many instances. Each card is numbered and only one is given to a correspondent. A postal card from you and a request for this reporter's card is all that is necessary for obtaining one. It will be sent you by return mail. Address Field Editor, SCIENCE AND INVENTION, 53 Park Place, New York City.

REPORTER	Science and Invention	CORRESPONDENT REPORTER'S IDENTIFICATION
	NO. 999	
	THE BEARER OF THIS CARD <i>John Roe</i>	
	IS AN AUTHORIZED CORRESPONDENT-REPORTER OF SCIENCE AND INVENTION MAGAZINE THE PUBLISHERS OF SCIENCE AND INVENTION WILL APPRECIATE ANY COURTESY EXTENDED THEIR REPRESENTATIVE.	
(over)	EXPERIMENTER PUBLISHING CO.	<i>H. G. Balk</i> PRESIDENT

SCIENCE SERVES IN NEW HOTEL

Multitude of Mechanical Appliances Make Life Luxurious

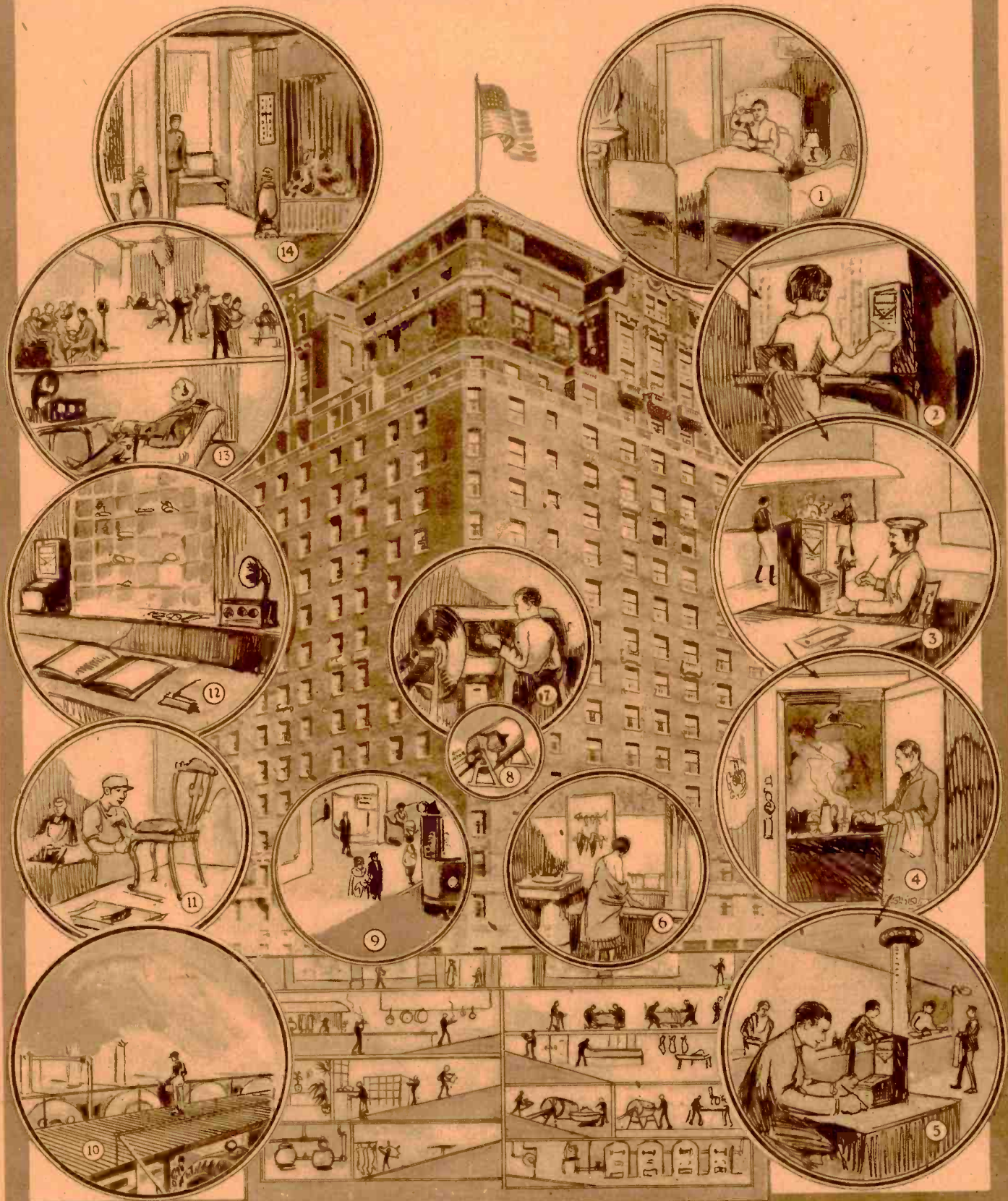

In the recently completed Alamac Hotel, New York, begin at the insert 1 and follow through to 5 and see how by one operation of the telephone operator the guest gets his breakfast served to his room without disturbance. The telephone operator takes the order from the guest's telephone, writes it on the telautograph, with the result that the chef, the head waiter, and the bookkeeper all get the order. At the same time the guest leaves an order for the valet. Both orders are copied at the same time and there is no duplication. The servidor enables the hotel attaches

to leave the food for the guest without disturbing him, since the door houses the food (Fig. 4). A microphone on the roof carries music from the orchestra to a broadcast station. Guests in the rooms with receiving sets hear the music without leaving their easy chairs. At 7 and 8 is shown the automatic silver polisher; at 10 the water filters which clean all water used in the hotel; at 11 is shown the repair shop. At 14 are the elevators equipped with seats. At 12 the radio set in the office. Below, four floors beneath the street connected with inclined planes.



The fire came to the surface. The vicinity of the cave was glowing with molten, burning rocks. The ground all around the cave-mouth soon fell inward. A seething crater was exposed where the cave had been—a bottomless pit of lurid, licking flames with black smoke rolling up from it, and the hissing of steam below.

The Man On the Meteor

By RAY CUMMINGS

PART II.

SYNOPSIS OF "MAN ON THE METEOR"

CHAPTER I

WITH no memory of past events, a young man suddenly comes to his senses on a meteor which is part of one of the Rings of Saturn. He finds that, due to the small size of the meteor, his body weighs very little and he experiences great difficulty in walking. Being hungry and thirsty, he looks around for nourishment and finds the mouth of a cave. As he looks toward the cave a girl comes into view. At the same time she catches sight of him. Suddenly she leaps into the air with a motion similar to that of a swimmer in water and sails gracefully away.

The young man, who calls himself Nemo, enters the cave and after traversing some little distance finds it to be illuminated by the phosphorescence of the rocks forming its walls. He finds flowing a stream of milky white fluid. He drinks and refreshes himself and discovers some food.

Lying down on the girl's couch, he soon is lost in slumber. Upon awakening he sees her standing nearby and starts toward her, whereupon she leaps into the air and "swims" to a nearby ledge. He pursues her, but she constantly evades him. Soon, exhausted, he lies down once more and sleeps. He is awakened by the young lady stroking his hair. They become friends. She teaches him how to jump thousands of feet into the air and return, using a peculiar swimming motion. Soon after, they enter the cave, and the girl catches and kills a huge lizard-like creature. They cook and eat the flesh of the animal. Nona, as Nemo has named the girl, watches him intently. Nona comes over to his side. For a moment they are silent, Nemo's heart racing madly. Suddenly, he takes her into his arms.

Thus Nemo has found his habitable world and his mate—beyond which the legitimate needs of man do not go.

YOU ask me to tell you more about Nona and our life on the meteor? You shall have it, of course. But if you are among those who doubt me—if you are the sort inclined to scoff at everything beyond your own knowledge or your intellectual capacity—I beg you to read no further. My narrative is not for such as you.

You will recall that my first recollection

of my existence was when I found myself a man of twenty, according to earthly standards, on a tiny meteor in the Rings of Sa-

turn. I detailed my meeting with a girl—woman fashioned like myself—our primitive love and union.



The cave was full of smoke. Beside me was what seemed a pit of fire. The heat from it was intolerable. Across the cave we stood trembling with fright, regarding the red monster of fire that had eaten for itself an open pit in the cave-floor.

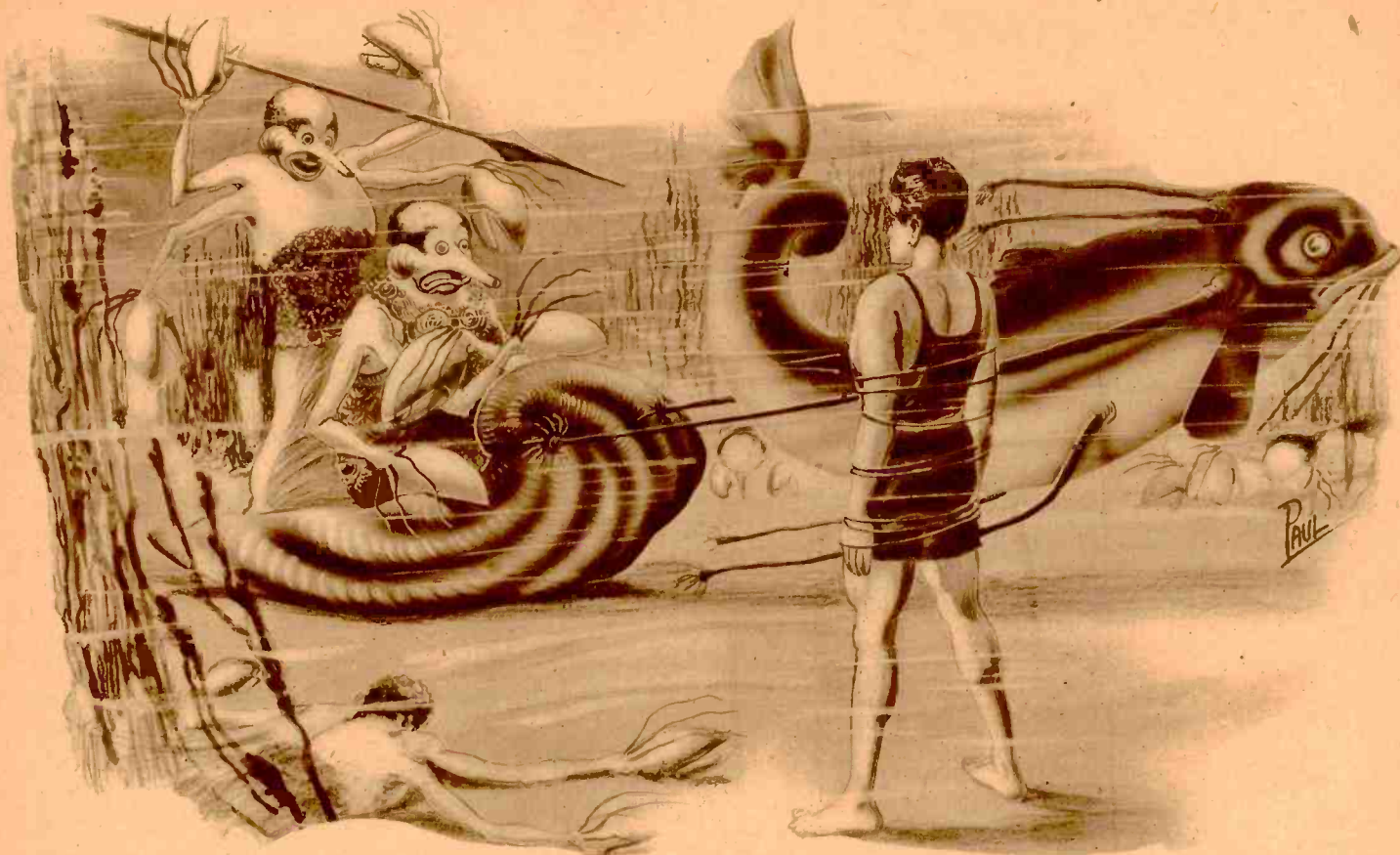

In the sleigh were two Marinoid men—the larger of them elaborately clothed. The sleigh halted abreast of us. The smaller of its occupants stood up and shouted vehemently.

And suddenly I realized that he was shouting at me! My captors were lying prone on the sand, and had pulled Nona down with them. . . . but left me standing alone.

The days that followed were happy ones for us both. We lived in our cave and seldom left it. The securing of food, preparing it, eating it, and sleeping until we were hungry again—this was our life.

Animals, yet both of us with the latent intelligence of civilized human beings! Our spoken language came very fast. We seemed to be pent up with words, which once spoken were remembered almost without conscious

effort. So it is with your Earth-child who are the despair of their parents because sometimes they do not talk until they are almost two years old. They have it stored up—and when they do give voice, their fluency is amazing.

Our language? I cannot tell you what it was; I do not know. It seemed almost as though we were inventing it as we went along. Yet all languages seem identical to

their native users; and my English translation here will suffice.

Nona, in her spiritual and mental existence, was the counterpart of myself. Who she was, where she had come from—those questions she could not answer: Her mental life had started on the meteor with herself almost a matured woman. One's mental life, you will realize, is dependent exclusively upon memory. And Nona's memory previous to the time of our meeting, was short and dim. Perhaps human memory only exists with spoken language—or social intercourse or a similar kind. I do not know. Even your hermit speaks, or has spoken to his fellow man.

OTHER INHABITANTS

So much for Nona. As I say, we lived and loved in our cave—two human creatures alone on our world. That was a fallacy, as you will shortly see. There were thousands of others—not like ourselves indeed—but “human” never-the-less—on our little meteor. But we did not know it then.

Time passed. How much time I cannot say. A month—five months perhaps. Time is as inconstant as the wind itself, as you would very soon perceive were you to live in semi-darkness, eating when you could get the food, sleeping when you were tired—and with no mechanical timepiece or its equivalent to measure arbitrarily your passing existence.

The securing of a steady and varied supply of food gave us trouble. I mention this because it had a direct bearing upon the extraordinary change in our existence soon to follow. The day came when we could not capture a lizard. The fungus-like stuff Nona was growing I had begun heartily to dislike. I had searched every corner of the cave and its passageways for a lizard and had come back unsuccessful.

Nona had started a fire and was sifting beside it drying her hair. Water was evap-

(Continued on page 1042)

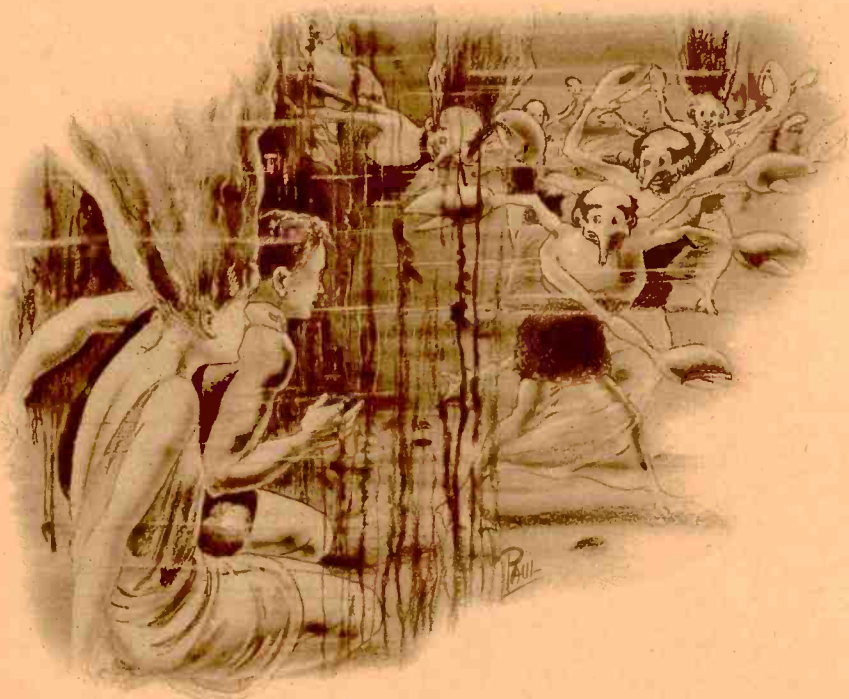

Living things! I would capture and kill one for food. But as they came steadily closer, I saw that each of them was nearly as large as ourselves—and there were ten or more of them. I trembled; and Nona and I drew back into the fern to hide. The things continued to advance. Soon I saw that they were upright, coming along the sand as though walking, slowly but steadily.

Toy Ships that Run

Construction of Toy Ship Models Is America's New Industry and Pastime.

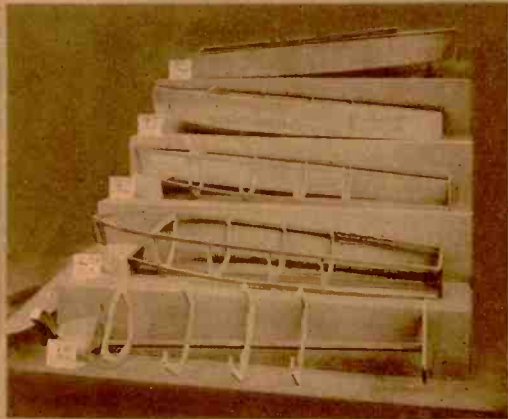

With the increase in speed demanded of boats the "V" bottom has become more and more prominent in the construction of hulls. Above is shown a model boat, with this form of body, under construction.

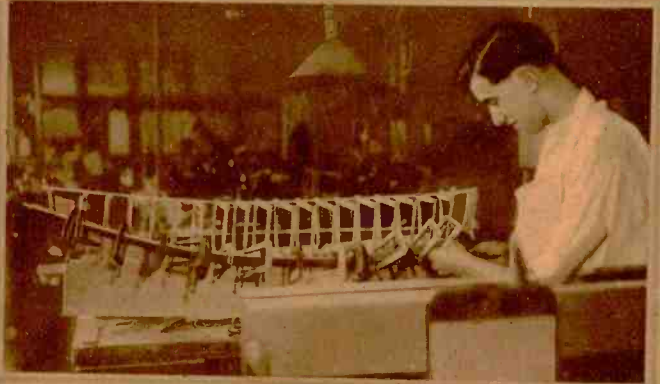

In many cases the same methods of construction are adhered to in the building of a small model as are used in the erection of the large one. Above is shown a workman placing ribs in the framework of the boat. Note the use of the keel.



Above: A model of a steam power boat is shown traveling at full speed. This model measures 48" over-all and is capable of a speed of 12 miles per hour. The boiler is tested to 200 pounds pressure.



In some cases the models are built up out of laminations, each one cut the exact size of the body. Above is shown a workman gluing the laminations together to form the body of a small racing yacht. This is a slower process but results in a strong model.

The boat shown below is furnished with a spring motor. It is finished in black with a red underbody, and the deck is varnished. It will run for about five minutes at a speed of five miles an hour, even though it measures only 24" over-all. This model is furnished complete and ready to run, or in knock-down parts to be assembled.

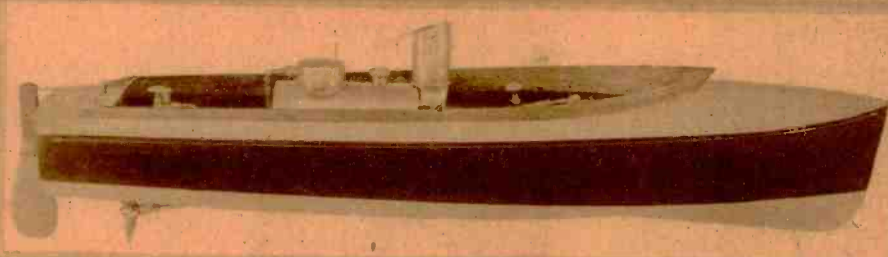

The vessel shown above can be obtained in knock-down form or complete. It is steam-driven, and has a four-cylinder engine and a steam boiler which supplies a super-heated steam to the driving mechanism.

In order that a model sailing boat will be a perfect sailer when it is placed into the water, both sides of the vessel's hull must be exactly alike so that the boat will be perfectly balanced. Below is shown a workman in the process of scraping a completed boat into perfect balance. This work requires great skill.



Realism In Ship Models

Small Replicas of Ships Exactly Like the Originals

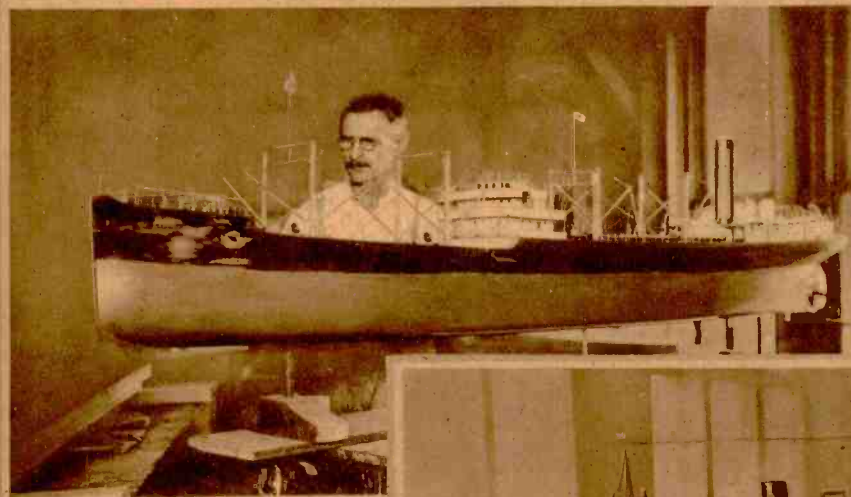

In making this model of the United States Shipping Board boat, "President Madison," practically the same class of skilled workmen were required as were used in the erection of the original. The woodwork involved in making a model such as the one shown to the left requires the services of the most expert pattern-makers and wood carvers.

Although only the best of materials and workmanship go into the construction of models, rough handling and extreme changes in weather conditions cause them to suffer mishaps that make extensive repairs necessary. Below is shown a model in the shop for repair. It is set upon the work table in much the same manner as its larger counterpart is set in the drydock.

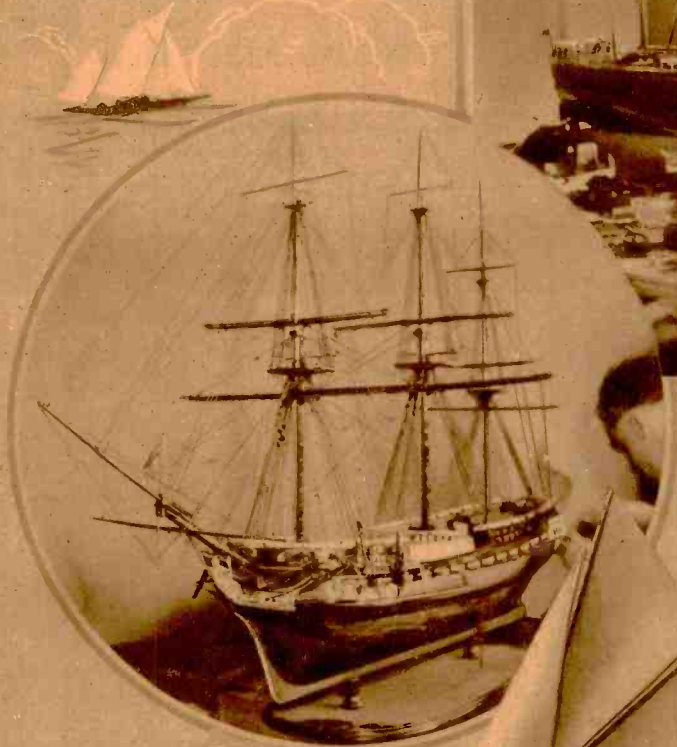
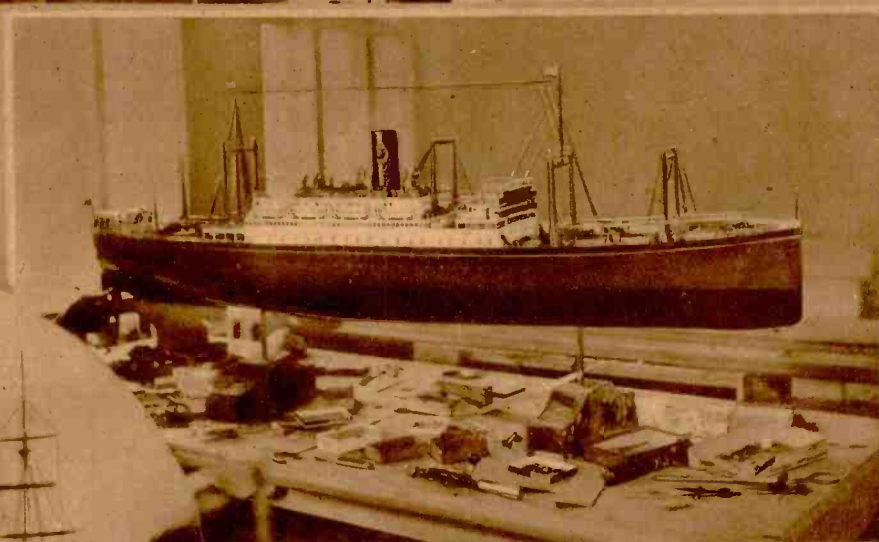

Above is shown one of the old British Admiralty models in the shop for repairs. Some of these models cost upwards of \$10,000, not only on account of the exquisite workmanship in them but also on account of their extreme age and the historic value connected to them. Frequently models are the only historic records.

The model of the racing yacht shown to the right is exactly like its original except for size. Mounted as though she were plying under full sail, the owner of the boat might well enjoy almost all the thrills of a real race while sitting before his fire comfortably with the wintry winds howling outside, so real is the effect of the model.

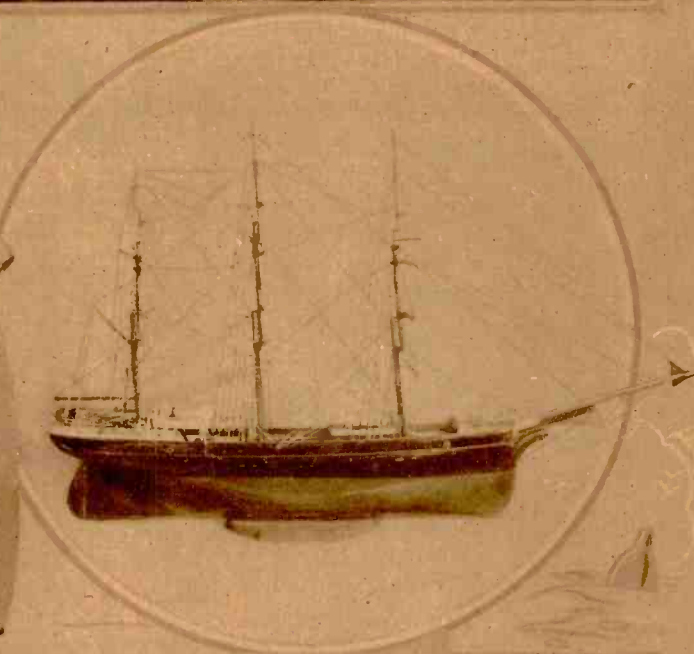

The craze for collecting marine models, such as the above, has taken great hold in the United States in the last few years so that models which used to be a drug on the market now constantly find buyers and many times bring fabulous sums. In the old days sailors on wind-jammers taking long cruises, many times carved some of the most exquisite models of their ships. In port, at the end of the journey, they brought possibly \$5.

Giant Dirigible of New Design

Air Liner For Trans-Oceanic Service Being Constructed.

BY C. A. OLDROYD.

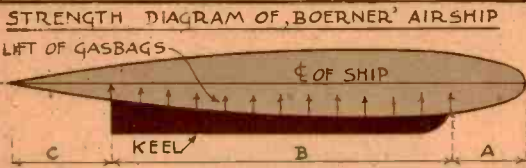
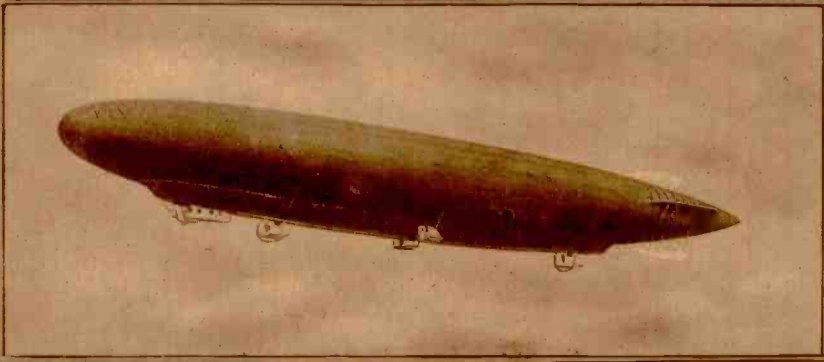

The latest semi-rigid airship called the "P. L. 27." Note the keel underneath the ship and also the engine cars which are arranged as in any modern rigid airship. In the photo above the six propeller car units are spaced evenly along the bottom. The framework and keel are of unit construction. Engine cars, however, would not be found in the Boerner vessel, the propellers of which are secured to out riggers.

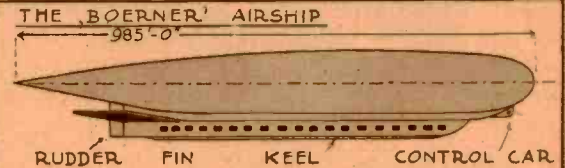

FOLLOWING the keel type construction, the new Boerner trans-oceanic dirigible—the strength diagram of which is shown above—will have a gas capacity of ten million cubic feet and a total lifting power of three hundred tons. The motivating force that will carry it at an average speed of ninety miles per hour will be twenty-four engines developing a total of 6,240 horsepower. It will carry 300 people.

Below is shown a cross-section of the ship. Note that the gas bags or compartments are arranged in units and the air carried under them in order that the bags and the gas will have ample opportunity to expand as the ship rises to great altitudes. For the sake of safety there is a layer of inert nitrogen placed between the air and the hydrogen bags. The ship is fitted with pontoons so that it may land at sea.

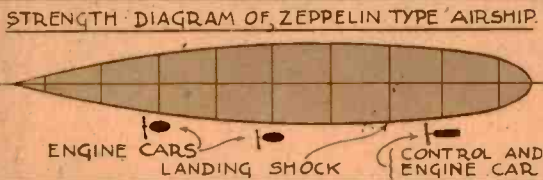

In view of the speed the ship will be able to make it will undoubtedly be one of the outstanding mail carriers. Here is illustrated the mail room that is being installed.

SECTION THROUGH BOERNER AIRSHIP

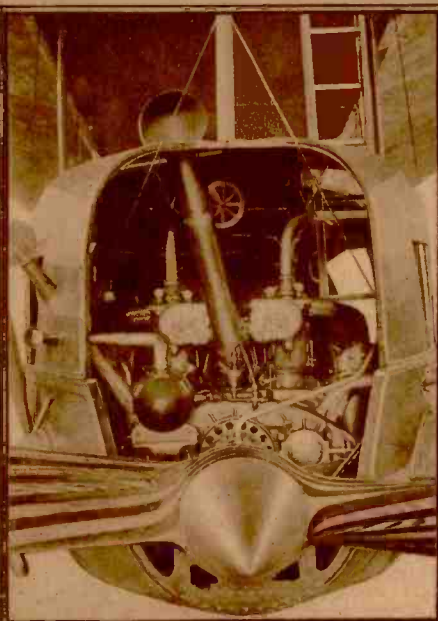
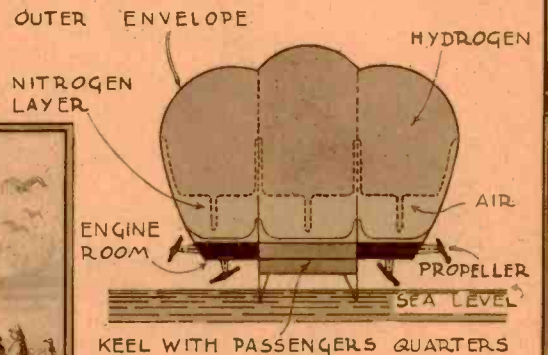

Above is shown one of the power units in the stern car of the "Nordstern." This is the latest type of commercial Zeppelin airship. In the Boerner vessel a ventilating system will be used to drive off all the gas vapors that may be developed.



According to the present plans the accommodations for passengers in this ocean air liner will be fully as good as those on steamships.



The keel structure of the "P. L. 27" is seen in the above illustration. Note the fuel tanks. At the extreme rear of the ship may be seen one of the power cars. Where it is impossible to land the giant vessel on water on account of its destination being inland, great mooring masts are to be used.

Science Selects Occupation

Tests For Determining the Occupation Best Fitted to Individual

By observing how an individual matches the two halves of the square shown in the photo below, psychologists are able to determine his visual power, according to recent exhaustive tests made by German professors.

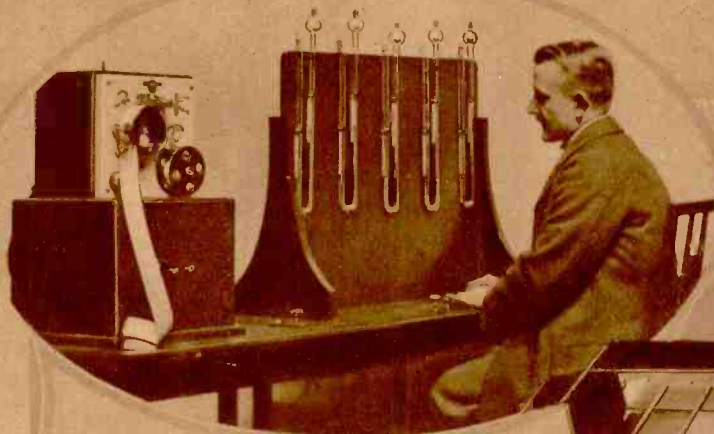
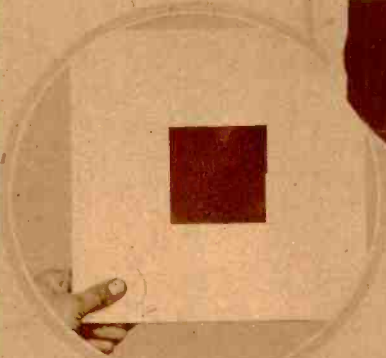

Below is shown the apparatus used in testing the tactile sense of the person considering selection of a mechanical career. Obviously, if the individual has no keen sense of touch he could hardly be expected to make an expert



For determining the initial observation point and the ability of the candidate to concentrate, Dr. Porkonsky, the psychologist, uses the above machines consisting of five pressure glasses with keys which the subject must operate in order to keep the liquids in the tubes in a certain relation.



A memory test. Words appear in the slot of the circular machine on the table. After a certain number have passed the candidate must call them.



Below is another form of the device shown above. Here the subject must concentrate on the positions of the black dashes on the cloth belts revolving at different speeds and, by key adjustment, keep the dashes opposite each other.



The small discs have two sets of holes, one that fit the wires and one that does not. Stringing them tests the operator's dexterity and nerves.



Test for color sense. The angle of the revolving color disc is changed and the ability of the person tested to differentiate slight shades is noted.

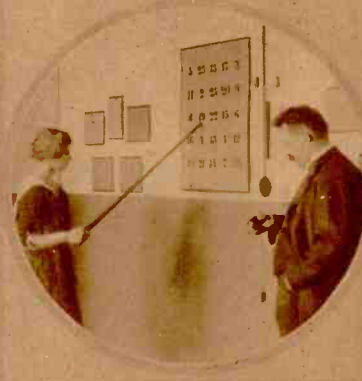

The mental dexterity of an individual with figures is tested by asking her to point to a number called out and then marking the time consumed doing it.

Tides to Develop Power

Making Tides Act as Air Compressors and Using the Power So Developed.

BY JOSEPH H. KRAUS

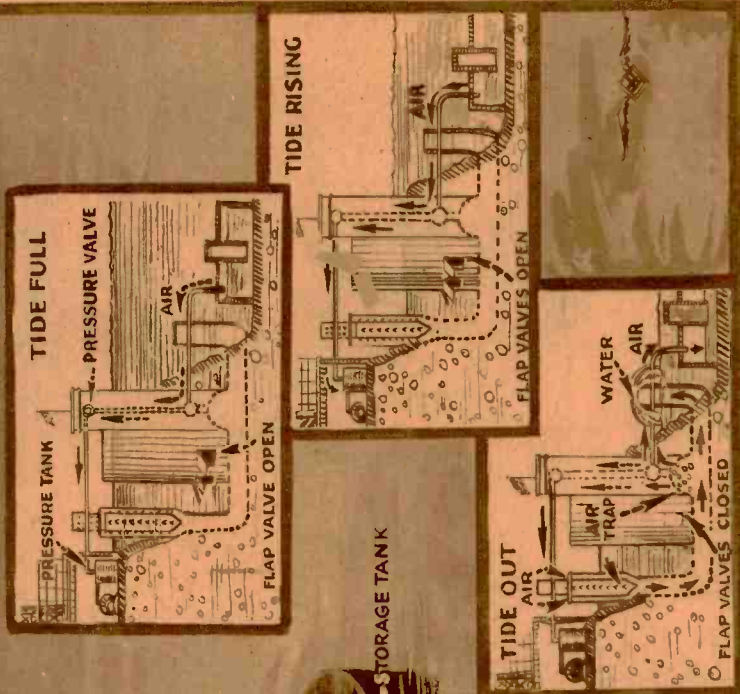
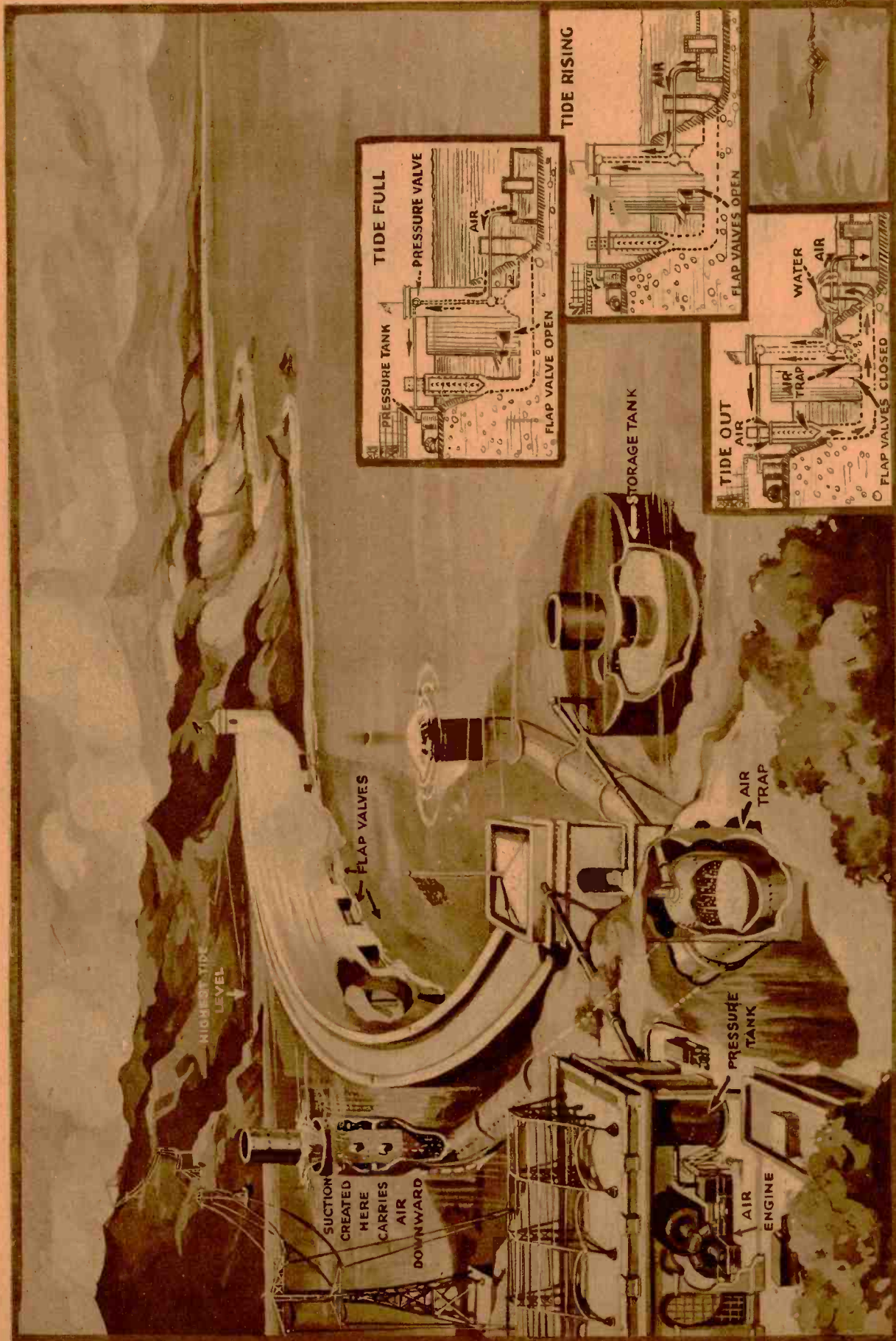

©—1924—By Science & Invention

The inventor of this system of producing power from the tides, John S. Leger Ginn, intends to build a wall with crest rising above the highest tide across a natural basin. The wall has openings with hinged gates or flap-valves to allow the water to pass into the basin when the tide is rising, but which will close when the tide falls, preventing the water from leaving the basin. Within the basin a pipe will be built which will pass through the wall to the sea, through which pipe the water as it escapes will flow in. In doing so the water will carry a great quantity of air with it, which is

caught in an air trap. This air, under the pressure it has attained, will then be used to drive the air engines and generators. The question arises, "what happens when the tide is rising or full?" This is answered in the small illustrations. When the tide is full, it is obvious that no power will be developed by the system, because no water is flowing from the basin into the sea. However, there is a storage tank from which the air passes to the generating station. The small tube in the center of the reservoir allows water to pass downward into the storage tank and forces the air out at the top.

Picture of the Earth

Radio Television to Photograph Earth from Space.

BY RAYMOND FRANCIS YATES

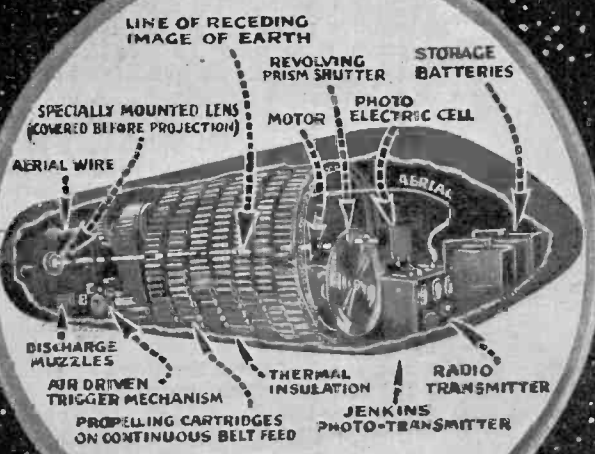
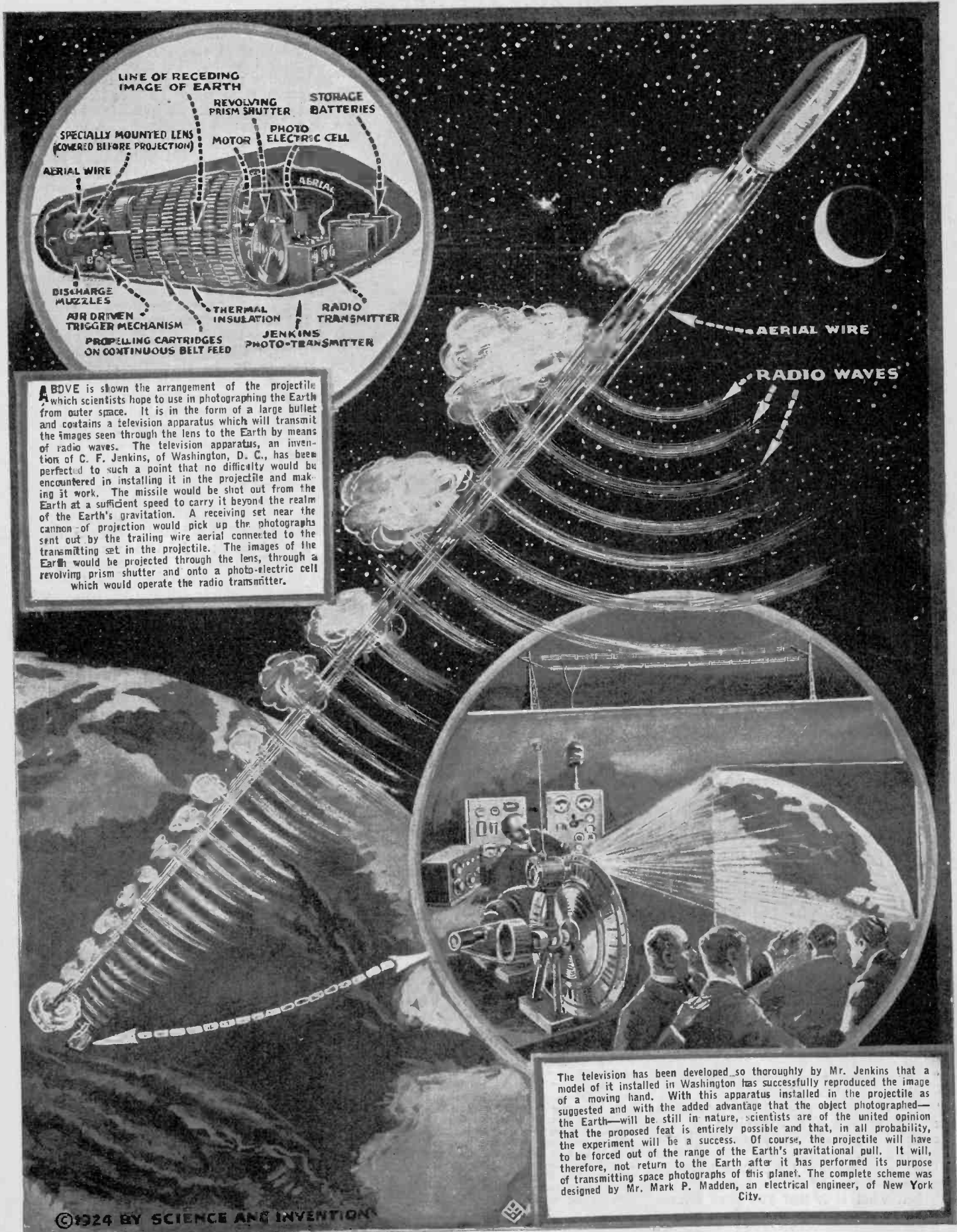

ABOVE is shown the arrangement of the projectile which scientists hope to use in photographing the Earth from outer space. It is in the form of a large bullet and contains a television apparatus which will transmit the images seen through the lens to the Earth by means of radio waves. The television apparatus, an invention of C. F. Jenkins, of Washington, D. C., has been perfected to such a point that no difficulty would be encountered in installing it in the projectile and making it work. The missile would be shot out from the Earth at a sufficient speed to carry it beyond the realm of the Earth's gravitation. A receiving set near the cannon of projection would pick up the photographs sent out by the trailing wire aerial connected to the transmitting set in the projectile. The images of the Earth would be projected through the lens, through a revolving prism shutter and onto a photo-electric cell which would operate the radio transmitter.

The television has been developed so thoroughly by Mr. Jenkins that a model of it installed in Washington has successfully reproduced the image of a moving hand. With this apparatus installed in the projectile as suggested and with the added advantage that the object photographed—the Earth—will be still in nature, scientists are of the united opinion that the proposed feat is entirely possible and that, in all probability, the experiment will be a success. Of course, the projectile will have to be forced out of the range of the Earth's gravitational pull. It will, therefore, not return to the Earth after it has performed its purpose of transmitting space photographs of this planet. The complete scheme was designed by Mr. Mark P. Madden, an electrical engineer, of New York City.

Doctor Hackensaw's Secrets

By CLEMENT FEZANDIE

AUTHOR'S NOTE.—The average duration of human life has about doubled in the last hundred years. Before the next century has passed, it is quite possible that the average life of a man may be raised to eighty or one hundred years. The remote future may see this increase extended to a thousand years or more. Scientists have

No. 26. The Secret of Perpetual Youth

"I have discovered 'Reversible Metabolism!' I have discovered how to make the body cells remove the old, decayed portions of the tissue, and so restore to them their

METHOD OF RESEARCH

"I started out with the knowledge that life is practically immortal, or to put the phrase more correctly, every animal alive today is nothing but a continuation of the splitting up of the original speck of protoplasm from which all animals and plants have descended. Every man's ancestry must go back in an unbroken line to this primordial speck. Now an individual whose tissues are already old and decaying can still produce sperm cells or ova capable of starting not only one new life, but a perpetual succession of new lives—in other words, a life that may last hundreds of thousands of years—until all life on this earth is extinct.

"I spent years in my researches. I first studied old age in plants. Why does a tree die? Certain olive trees are said to be two thousand years old. Why should they not live forever? But the study of plants did not help me much. A tree dies because the new wood forms on the outside of the old trunk, while the inner wood decays, leaving the center hollow. The conditions with human beings are totally different: old age may be due to the improper digestion of the food, to troubles with the lungs or the other organs of respiration, or to troubles with the circulation of the blood, or the nervous system—"

"But, doctor," interrupted Mrs. Young, yawning, "I'm afraid I'm too stupid to understand all your scientific terms, and I want to get home in time to attend to the 'metabolism' of my family—my children and grandchildren; and I want the dinner to be especially nice today because I am expecting Mr. Trimble. Mr. Trimble is a widower of forty-five, and to tell you the truth, doctor, I have fallen in love with him. Now I learned that you have discovered the 'Elixir of Youth,' and I came to see if you wouldn't consent to make me young again. I am a rich woman, Doctor Hackensaw. My husband was a multimillionaire and he left me the bulk of his property. I am eighty-five years old now, and I will gladly pay you a million dollars if you succeed in making me young again—"

"And if I fail?"

"If you fail, I lose nothing. I have been suffering lately from a general debility, and the doctors tell me I have only three months more to live—probably three months of pain



Without a tremor, Mrs. Young drew up her sleeve. He then withdrew a few drops of blood, which he wished to have as a control, and he placed them in a test-tube filled with Carrel's solution. Then he injected into the arm a small amount of the pure culture of the new microbe.

only begun to study the causes of old age, and much may be hoped for from systematic research along the path already opened by Metchnikoff and others.

"IS it possible, Doctor Hackensaw, that you have discovered the secret of perpetual life?"

The speaker was a somewhat decrepit old lady of eighty-five, Mrs. Linda Young by name, who had hobbled into the doctor's office on hearing rumors that the doctor was seeking the "Elixir of Life"; that will-of-the-wisp that had been sought, for centuries, by the old alchemists.

Doctor Hackensaw smiled. "No, Mrs. Young," said he, "I should hardly call it 'perpetual life.' But I have discovered what biologists would call 'reversible metabolism.' I suppose you know what anabolism and catabolism are?"

"They're some new-fangled varieties of Socialism, aren't they?"

"No, nothing of the sort. They are terms used in physiology. Anabolism is the growth of any tissue, and catabolism is the decay and death of the tissue. Metabolism is 'life,' and consists in the continual growth and decay of tissue."

"Then what is it that you have discovered?"

freshness and youth. The reason a man grows old and dies is that the tissues of one or more of his organs grow old, that is to say, the tissues either decay or harden; or, through the accumulation of foreign matter, the organ becomes unable to perform its functions properly. The hardening of the walls of the blood-vessels, is, according to Metchnikoff, the chief cause of senility; that is to say, of old age. There are, of course, many other contributing causes, as I discovered when I began my researches on the subject.

But in spite of these efforts, Linda became a babbling eight-months-old baby, incapable of making her wants known except by simple gestures. She could, however, answer Doctor Hackensaw's questions by affirmative or negative gestures, so by calling off the letters of the alphabet in turn he could learn any of her wishes. She retained her liking for cigarettes and cocktails, and it was curious to see this eight months old baby attempting to smoke a cigarette, or sucking a cocktail from her milk bottle. One day she asked to see her children and grand children, wishing to be held by each in turn, and she took a malicious pleasure in striking them and scratching their faces, to make up for the many times they had done the same to her when they were babies.



and suffering. I will most willingly risk losing these three months on the chance of being restored to youth again—"

Doctor Hackensaw hesitated. "My experiments so far," said he, "have all been on animals. I can take a tough old rooster or a cow old enough to make boarding-house steak, and restore them to their pristine youth. I make a business of taking old and worn-out thoroughbred horses and after making them young again, selling them at a handsome profit. Especially am I interested in the finest pedigreed stock whose owners are willing to pay fancy prices for the rejuvenation of a full-blooded bull or stallion. But my experiments on human tissue have been comparatively few, and only on amputated arms and legs—never on an integral human being. Besides, while I have succeeded in making animals grow younger, I have not yet discovered the means of checking this process of reversible metabolism. In other words, even if I should succeed, you would continue growing younger and younger unless I have the good luck of discovering some antidote."

"I will take all risks and assume all the responsibility. I will have my lawyer draw up a paper absolving you from all blame. As I said before, I have nothing to lose, and everything to gain."

"Very well, madam," said the doctor. "Make your will, set your affairs in order and come back next Monday morning. I shall have everything ready for you by that time."

* * *

READY FOR THE OPERATION

"Will the operation be very painful, doctor?" asked Mrs. Young, as she took her seat on the operating chair.

"No more than an ordinary vaccination," replied Doctor Hackensaw. "Had you come to me a year ago I should have had to put you under an anaesthetic while I cut one of your arteries and inserted a T-piece provided with a stop-cock at the cut, so as to be able to remove old blood or inject new ingredients. In fact, in my early experiments I made Siamese twins of my subjects. I attached a young animal to the old one. I wished to rejuvenate, and would daily re-

move a small amount of the old blood. It was thus fresh young blood that coursed through both bodies, and the older animal profited to a great extent by the vitality of the young one. But the process was clumsy, and I found that new blood would not com-

probe that I was able to secure real results."

"Your new microbe?"
 "Yes, the *Bacillus Hackensavii*. While experimenting with a new stain for staining microbes, I came upon an altogether unknown species of bacillus, possessed of the



One day Doctor Hackensaw was electrified by a vision of fairy-like loveliness that swept into his office—an exquisite young girl, looking not more than eighteen entered the doctor's office one night, and astonished that gentleman by throwing her arms around his neck and kissing him affectionately.

pletely restore the hardened or decayed tissues. It would only partially soften the hardened walls of a blood vessel, and it would not remove from the bones the deposits of lime that the years leave, and that change the soft cartilaginous bones of the infant into the brittle bones of the old man. It was not until I discovered my new mi-

most wonderful properties. Instead of attacking healthy tissue, like the disease germs, this one seems only to attack old and decayed tissue. Such being gradually removed, the body can replace the old tissue with fresh new cells."

"But can an old body produce young and fresh cells?"

"Yes, indeed. All new cells when first produced are young and new and capable of indefinite growth. Now, if you will kindly bare your arm, I shall proceed to make the inoculation."

Without a tremor, Mrs. Young drew up her sleeve and Doctor Hackensaw deftly made a slight incision with his lancet. He then withdrew a few drops of blood, which he wished to have as a control, and he placed them in a test-tube filled with Carrel's solution. Then he injected into the arm a small amount of the pure culture of the new microbe.

"There madam," said Doctor Hackensaw, "it's all over!"

"Is it possible? Is that all? Well, doctor, if that little scratch is going to make me young again, you will have earned your million dollars pretty easily—"

"Madam," replied the doctor, "I'll guarantee that, barring accidents, you will soon begin to regain your youth, but as I told you, I cannot promise to stop the process, as I have as yet found no way of checking the action of the microbe."

"Never mind," cried the old lady gayly, "I feel younger already. You needn't be in any hurry about hunting for the antidote!"

A week later Mrs. Young again repaired to the doctor's office.

"I'm afraid something has gone wrong, doctor," she said. "Not only do I not feel any younger than I was, but I feel somewhat older and weaker."

(Continued on page 1053)



And still she grew younger. Doctor Hackensaw would spend hours pacing the floor, with this baby widow in his arms, reading her the newspaper or passages from Milton's "Paradise Lost." Meanwhile his powerful brain was striving hard to devise some means to check the fatal catastrophe that seemed about to terminate the experiment which had begun so favorably.

Contra-Propeller Speeds Ships

Efficiency of Ship's Screw Increased 15 per Cent.

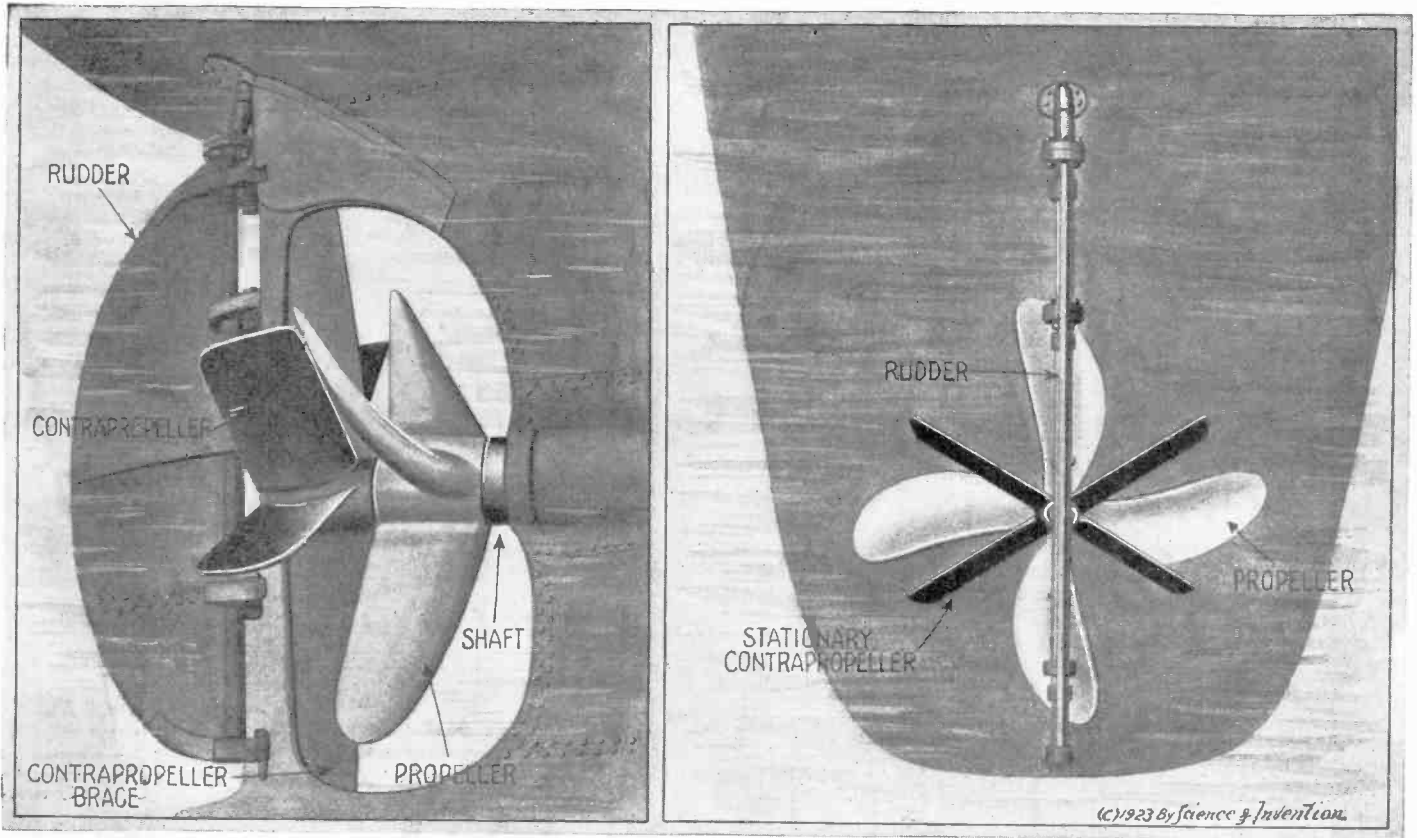

The contra-propeller for vessels is a four-bladed stationary affair placed just in back of the engine driven propellers. It has been definitely proven that this stationary set of blades materially increase the speed of the ship without increasing power consumption to the extent of even 15 per cent. It has been given a thorough test on sea-going vessels and as

a matter of fact is part of the equipment on a modern German trans-Atlantic liner. The theory of operation is that the whirl of water produced by the propeller ordinarily prevents that portion of the blade nearest the hub from effectively acting on the water. The contra-propeller breaks up the whirl. Contributed by Dr. Armin Demuth.

The Safest Place in a Thunder-Storm

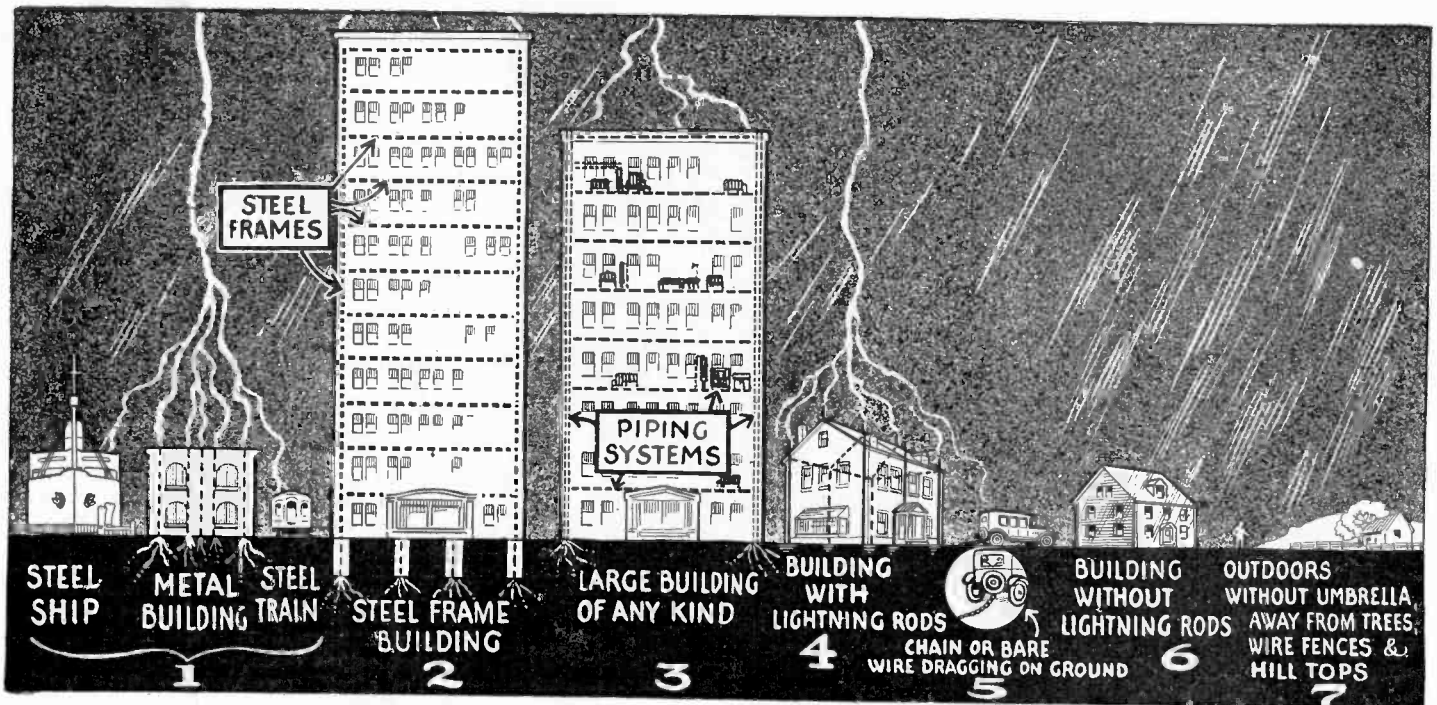

That a modern skyscraper with its mass of steel as a frame-work, is the safest possible place in an electrical storm is the dictum of S. M. Schoon, Chairman of the committee for Protection Against Lightning, of the National Fire Prevention Association. He ranks the places of safety as follows: Steel ships and buildings, first; steel framed skyscraper and

large building of any kind, second and third; a building protected with lightning rods, fourth; steel or metal bodied automobile with chain dragging on the ground, fifth; building without lightning rods, sixth; out of doors without umbrella and away from fences and hill tops last. And keep away from grounded metal objects in houses.

As Ever, the Perpetual Motion

Science & Invention Will Pay \$1,000.00 to Anyone Who Will Demonstrate That Any of These Models Work

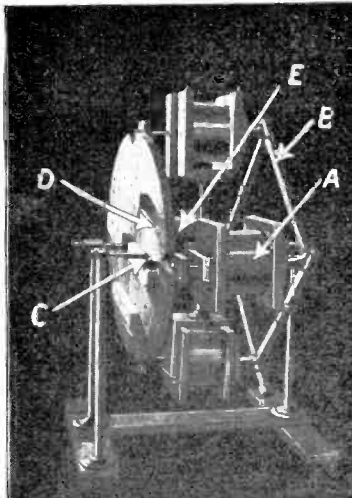

A machine invented by Adolph Ruhland is composed of two collapsible cylinders connected in such a way that the bottom cylinder is filled with air through the pipe, B, from the top cylinder when the two are vertical. The air forced into bottom cylinder raises it to the top where the action repeats.

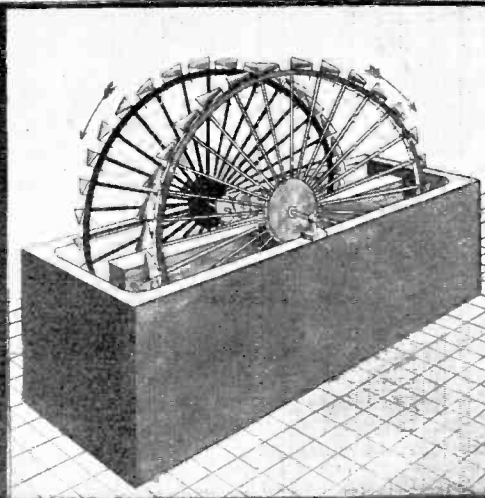

Here the buoyancy principle is again involved. The little triangle-like affairs around the rim of the wheel are bellows. As the wheel descends into the water, pistons in the spokes connecting with the bellows fall and force air into the collapsible chambers giving them buoyancy. When they reach the top portion of the stroke they return to their former position in the spoke deflating the chambers and so are supposed to keep the wheel moving.

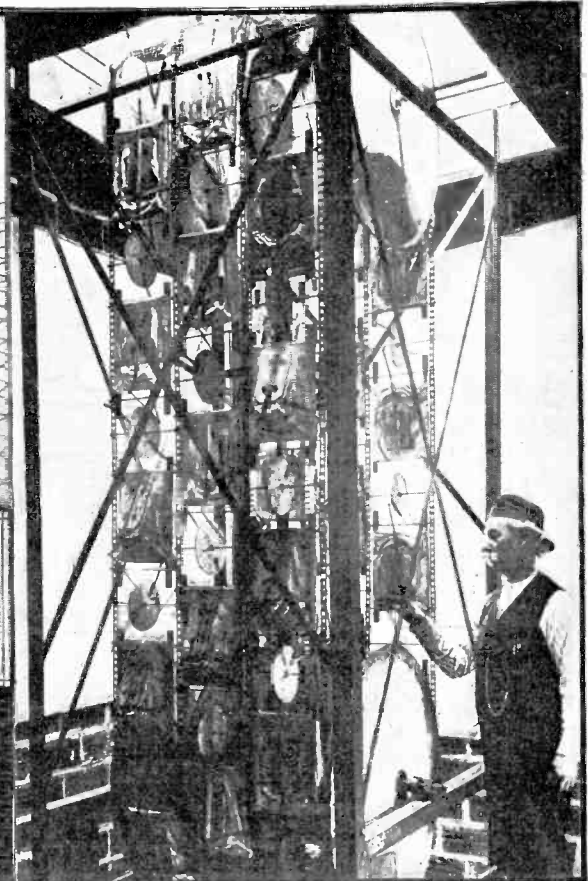

The inventor of this device, Rufus Ames, claims not only that he has invented a perpetual motion machine but that its operation will revolutionize the laws of physics. He calls the contraption the "Still Water Motor," and says that it is the latest source of power. No official tests of the machine have been made. Note the three separate series of rotors. The whole thing is built on a steel frame and the rotors are carried by regular cog chains.

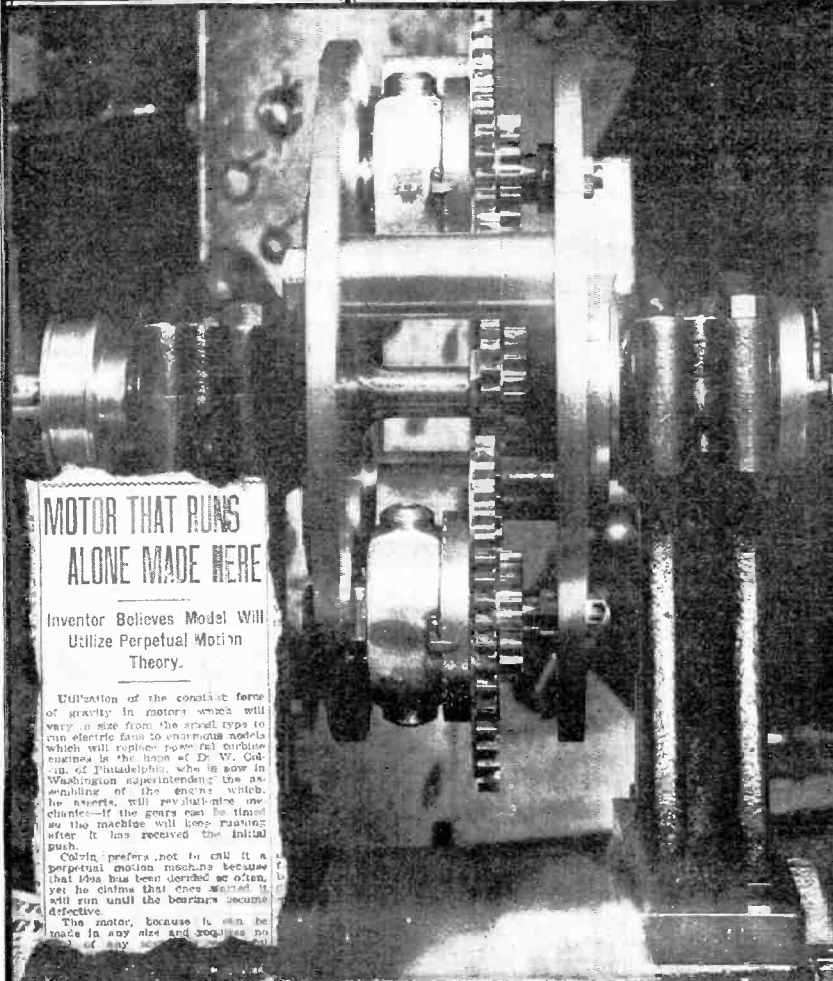

MOTOR THAT RUNS ALONE MADE HERE

Inventor Believes Model Will Utilize Perpetual Motion Theory.

Utilization of the constant force of gravity in motors which will vary in size from the small type to run electric fans to enormous models which will replace power-ful turbine engines is the hope of Dr. W. Colvin of Philadelphia, who is now in Washington supervising the assembling of the engine which, he asserts, will revolutionize one class—if the gears can be timed so the machine will keep running after it has received the initial push.

Colvin prefers not to call it a perpetual motion machine because that idea has been described so often, yet he claims that once started it will run until the bearings become defective.

The motor, because it can be made in any size and requires no fuel of any kind.

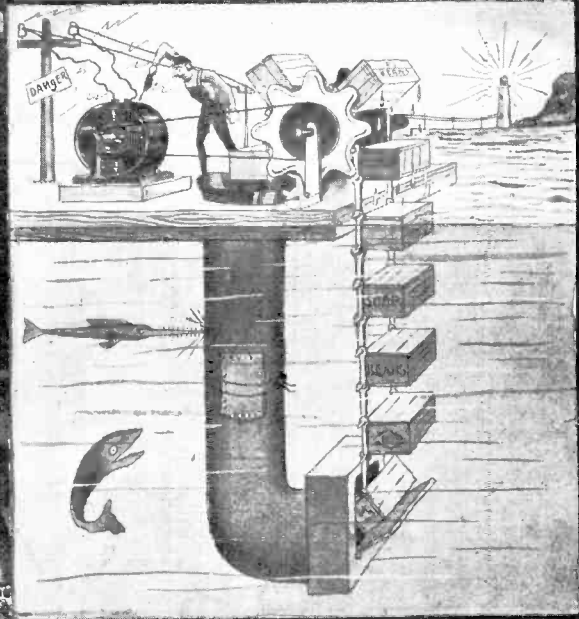

But here is the real one! Soap boxes are fastened to a chain which revolves around the gear-like pulley on the float, as shown in the illustration. The boxes go down into the water through a large pipe and pass through a water tight valve. Once in the water they become buoyant and lift themselves up, causing the motor to run. The only trouble with the machine is that no account has been taken of getting the boxes out of the pipe. L. H. Stuart.

More powerful claims yet are made for the machine shown in the above photo. The inventor, W. D. Colvin, of Philadelphia, claims that here (as elsewhere on this page), the constant force of gravitation will be utilized to do the work of the world. At the present time the inventor is in Washington supervising the assembly of a model of his apparatus which he hopes will gain the attention of the scientists. It is said by the inventor that the machine can be made in all sizes and that it will be used in the future to take the place of powerful turbines. G. A. Luers is the reporter of this curious attempt at the impossible.

Auto Cigarette Lighter—Novel Pump

Exhaust Suction and Incandescent Coil Form Car Lighter.

Cigarette cases that throw the cigarette to the smoker are more or less common, but one that drops them into the smokers' fingers lighted, are more or less uncommon. Attached to the dash of a car, the little device shown above does just that. The cigarettes from the package drop into a holder. One end rests against an incandescent coil while the other fits into a receptacle attached to the exhaust which draws a draft of air through the cigarette, lighting it. It then drops to the smoker's fingers.

At the right is shown an English pump with which one man may raise 1,000 gallons of water from a depth of 300 feet per hour. A coil-like cable simply revolves through the water, causing capillary attraction, thus causing a constant stream of water to flow to the top of the well.

—Chas. G. Percival.

The Complete Limestone Cycle

How Artificial Stone Is Made for Building Purposes.

By ISMAR GINSBERG, B. Sc. Chem. Eng.

BLASTED LIMESTONE

GROUND LIMESTONE

INTERMITTENT KILN. CONTINUOUS KILNS ARE FIRED BY GAS, OIL AND COAL OR WOOD

$+ \text{HEAT} = + \text{CO}_2$

HARD ROCK LIMESTONE

QUICKLIME POWDER

CARBON DIOXIDE GAS

BAG OF QUICKLIME

SAND AND WATER

GIVES SAND HYDRATED LIME

$\text{SAND} + \text{WATER} + \text{LIME} = \text{HYDRATED LIME (MORTAR)} + \text{HEAT}$

APPLIED TO WALLS IN ROOMS.

$\text{CO}_2 \text{ IN AIR UNITES MORTAR TO GIVE ORIGINAL LIMESTONE}$

MILD FIRE IN ROOM TO INCREASE CO_2 AND AID IN SETTING OF LIME

THIS PROCESS IS A COMPLETE CYCLE

$\text{LIMESTONE} + \text{HEAT} = \text{LIME} + \text{GAS } \text{CO}_2$

$\text{LIME} + \text{WATER} = \text{MORTAR} + \text{HEAT}$

$\text{MORTAR} + \text{CO}_2 \text{ (in air)} = \text{LIMESTONE} + \text{WATER (dried out)}$

THUS, IN BUILDING WALLS, MORTAR HARDENS TO SOLID MASS OF LIMESTONE

The illustration tells graphically how limestone is reduced to lime so that it may be ready for use in building and how it is again turned into stone to give the building strength. The rough stone is heated. The fuel reduces part or all of the carbon dioxide in the stone to carbon monoxide which has no affinity for the calcium of the stone. At the conclusion of

the heating the rock lime is removed and barrelled for sale. In use it is slaked with water which changes the calcium oxide to calcium hydroxide. This is mixed with sand and used in buildings for plaster and mortar. The carbon dioxide of the air then unites with the calcium hydroxide, forming the original limestone again.

Quite Cool

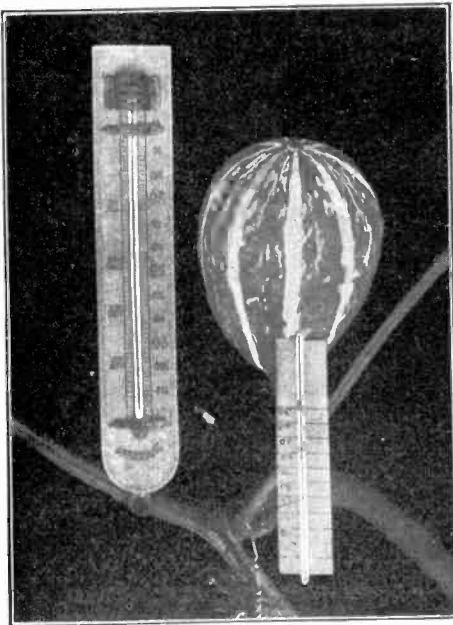

You might be cool as a cucumber and yet lack something in tridity; but to be cool as a squash is quite the bee's knees, so to speak. Above, the photograph shows the interior temperature of the squash to be sixty degrees while the surrounding air swelters at 118.—S. Leonard Bastin.

Pigs' Feet Nature's Feat



Otherwise healthy in every respect, this pig raised on a Nebraska farm has a wealth of toes—24 of 'em. Its six brothers and sisters born at the same time it was are perfectly normal in every way. —Dale R. Van Horn.

Airplane That Can Be Folded For Transportation

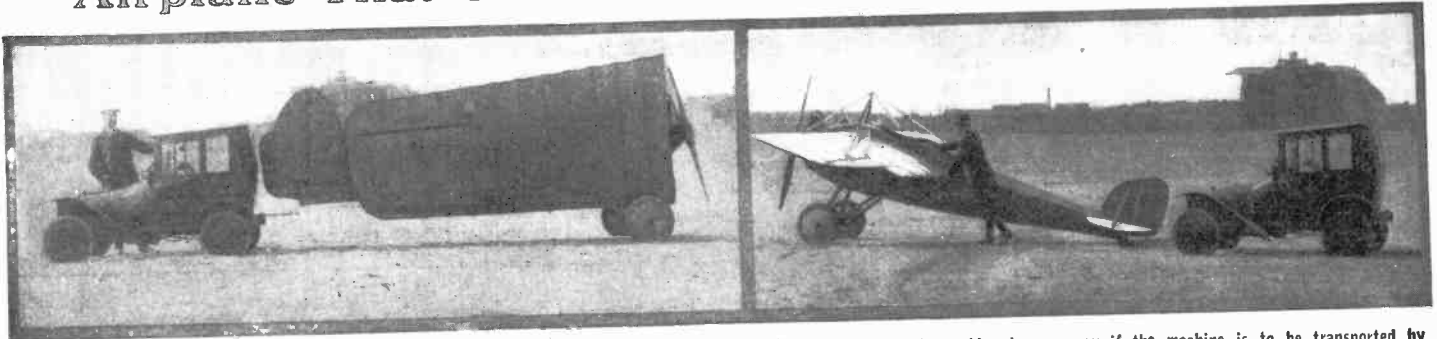

This small one-seater airplane of German make is constructed so that the wings fold on their longitudinal axis and fold back around the body and tail. One man can fold or unfold the plane. No packing is necessary if the machine is to be transported by rail. —Dr. Albert Neuburger.

DETECTOR FOR CHAUFFEUR'S JOYRIDES

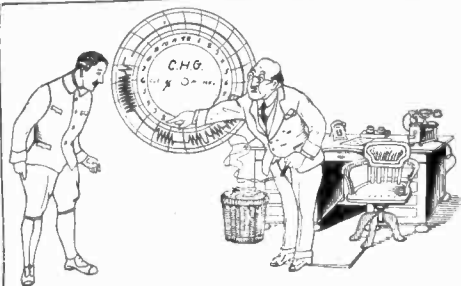

"He figured it would be all right, that chauffeur did, to take his girl and a gang of his cronies for a nice little jaunt," said Brown, the chauffeur's boss, "and he would have gotten away with it, too, and six gallons of my gas, only he didn't know that the garage put in this little card and a dingus to make it register the movements of the car." And here he brought a disk out of his desk. It was circular and had markings for the hours. Around the outside of the disk was a crooked broken line. "That," he said, as he ground his cigar between his teeth, "is where my gas has been going. See that jagged part of the line between nine P. M. and two in the morning. Well, he was out usin' my gas then and thought I

didn't know it, but this disk was revolving on the hour spindle of a clock, under the back seat, and a pen at the end of a spring fixed over the revolving disk bounced up and down on it with the vibrations of the car and gave me the undisputable evidence. Sure I fired him." This instrument is of German manufacture. The idea, however, was put forward in the September, 1919, issue of SCIENCE AND INVENTION, page 414.

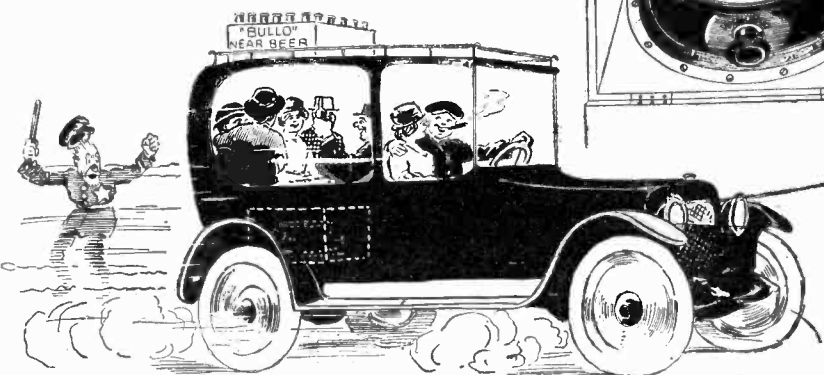
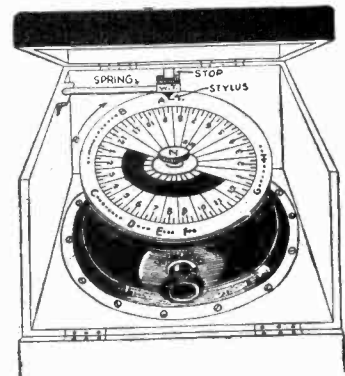

THE CHAUFFEURS' "DETECTIVE" UNDER THE SEAT

Traveling Walk to Replace Subway

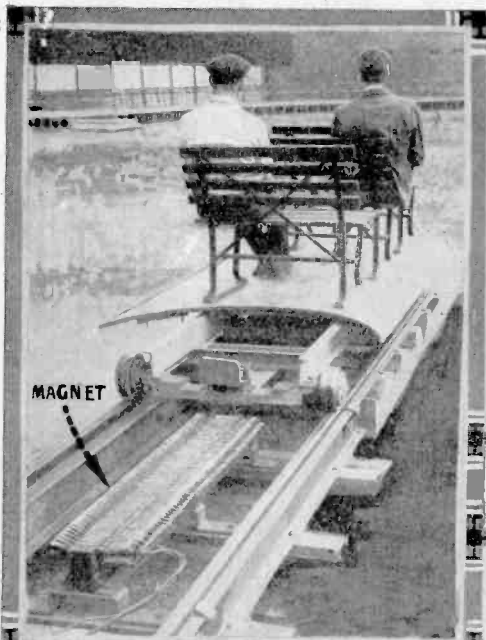

THE world famous subway shuttle across Forty-Second Street in New York City, may be replaced with a moving sidewalk built in three sections running at three, six, and nine miles per hour, respectively. A company has been organized to build the new magnetically propelled carriage and complete working models have been constructed. Above is shown a section of the model and its method of operation. Benches are installed on the fastest moving platform.



Above is shown a section of the complete arrangement with the three moving platforms. The slots marking the connection point between the sections out of which the device is made may be easily seen. Each section is approximately six feet in length. The floors are of wood, the frames of fabricated steel.

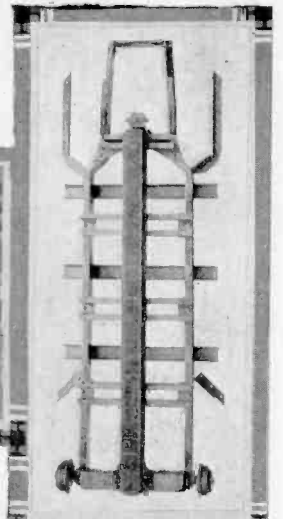

Above is shown the skeleton of one section. The two wheels at the rear run on rails. The front of the platform is supported on the rear of the one before it, to which it is attached.

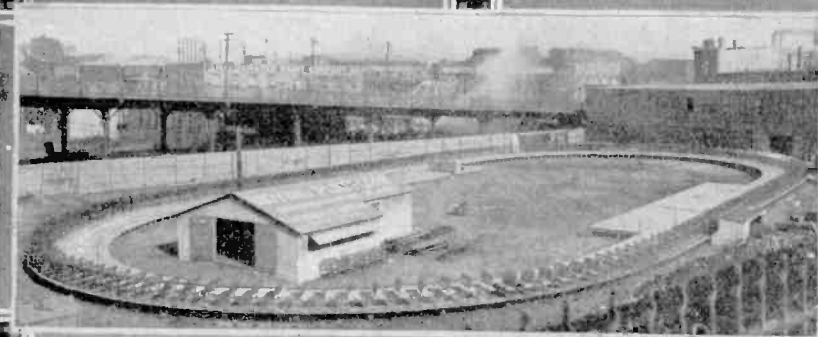
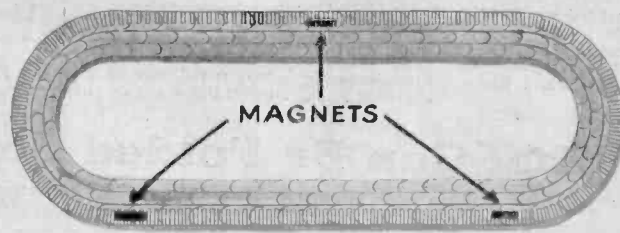

Along the bottom of each section there is a laminated core through which extend copper rods which are connected at both sides of the core. This, similar to the armature of a "squirrel cage" induction motor, running over the top of large field magnets (12 feet long placed beneath the tracks which act as does the field in an induction motor) furnishes the only motive power for the moving platform. Alternating current at three different frequencies are supplied to the field coils.

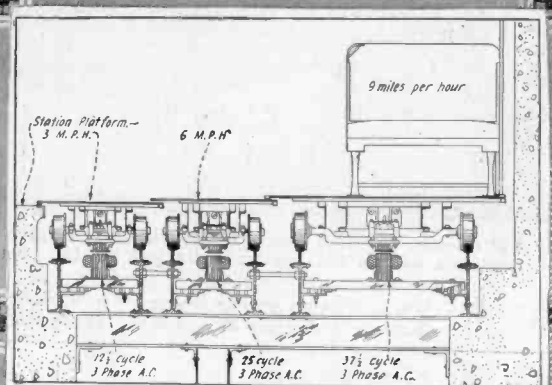

Above is shown a cross-section plan of the installation of the platforms, showing the placement of the magnets and rails.

Carbon Dioxide Forces Growth of Plants

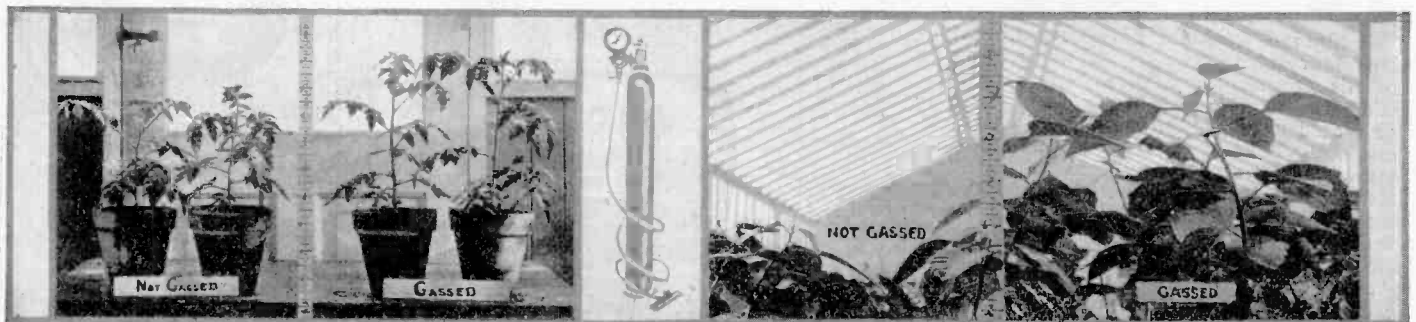

A German scientist, Dr. Riedel, in studying the causes of coal formation and the amount of carbon dioxide in the air found that by subjecting growing plants to a heavy blanket of the gas, mixed with a large amount of water vapors the plants' production could be increased four-fold. In the above two photographs is shown graphically the difference

between plants of the same age and species which were gassed and those which were not submitted to the treatment. Tomato plants were used in the left picture while poinsettias are the subjects in the right one. The experiments were made with gasses drawn from smelting plants.

—Dr. Albert Neuberger,

Ships Lighter Traveling East

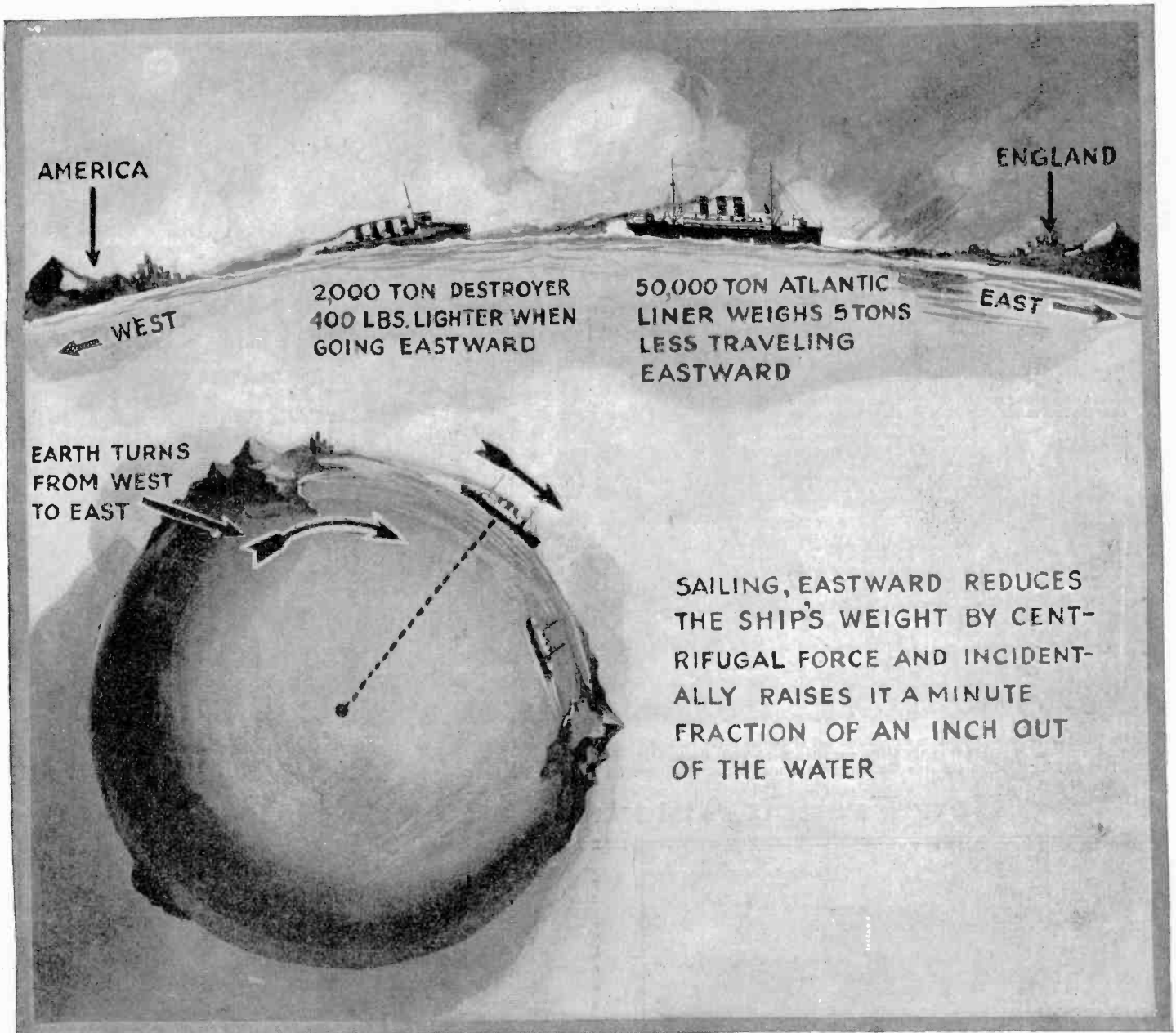

An English scientist, Professor W. G. Duffield, discovered, during recent experiments, that the centrifugal force of the rotation of the earth has a very appreciable effect on the weight of vessels. He ascertained that a 50,000-ton trans-Atlantic liner lost slightly more than five tons of its weight when going due east or nearly so, as against the same ship's weight

for the westward journey. This difference in weight is accounted for by the fact that the centrifugal force is helped along by the revolution of the earth in the same direction. The difference in weight between the vessel in motion and the vessel stationary was not determined. The force also raised the vessel slightly out of the water.

WORKING MODEL OF SUBMARINE

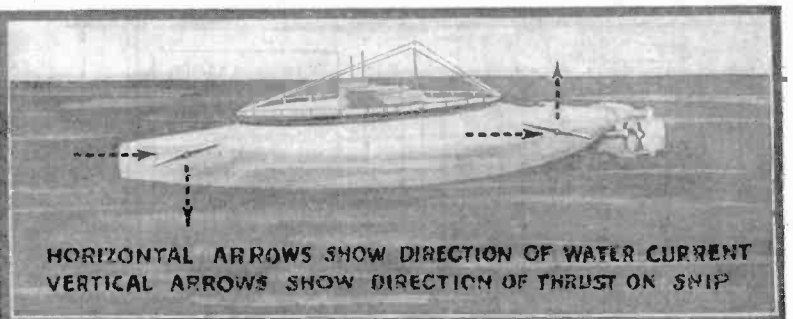
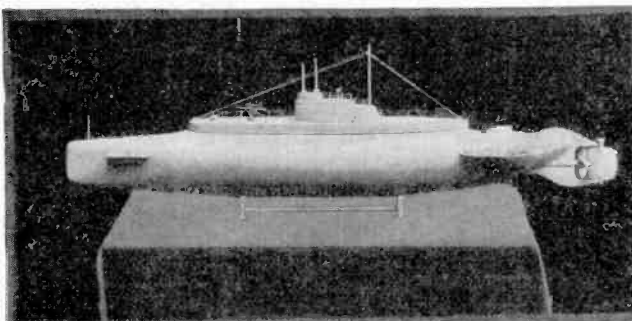

An English shipbuilding firm is marketing the three-foot submarine model shown in the above photograph for the use of inventors and students of Naval warfare. The model is fully equipped with motors, propellers, control devices, and a full set of rigging. It can be made to dive, to run just submerged, or to navigate the surface of the water. The drive as

well as all work of control within the boat is performed electrically, power being furnished by a substantial battery. The boat dives with the aid of a ballast tank and of the hydroplanes shown fore and aft at the sides of the boat. By referring to the sketch at the right the method of operation of these hydroplanes will be understood.

Movie Genii from Bottle

Double Exposure Brings Human Figure from Small Bottle.

BY PHIL GERSDORF

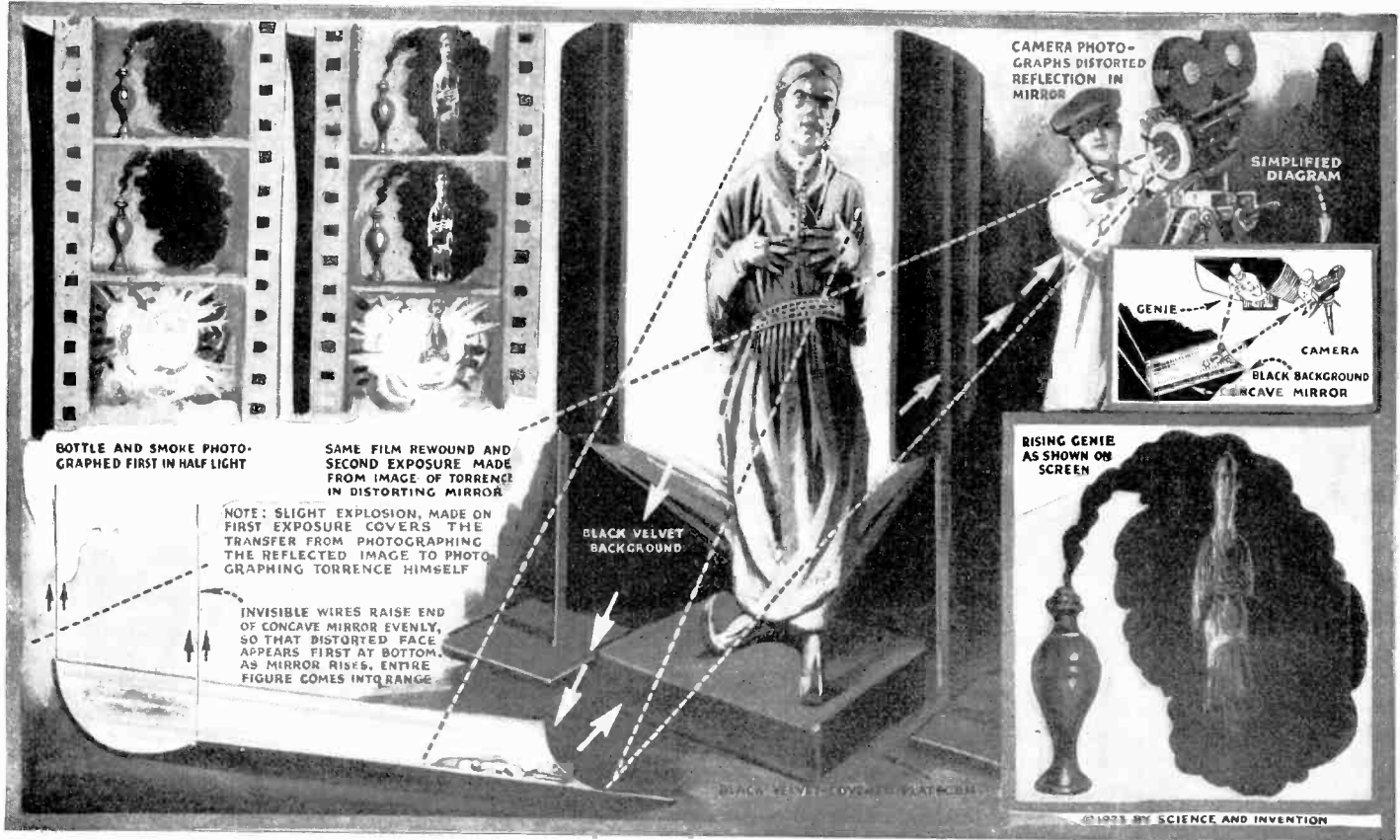

In filming "The Brass Bottle," the hero materialized out of a brass bottle no higher than his knee. A close-up, in half light of the bottle was taken first. Then, the hero (Ernest Torrence) was photographed on the same film through a concave mirror which gave the

image an eerie effect. By beginning the picture with the mirror down and raising it, the head first appeared out of the smoke from the bottle and then the remainder of the body. The figure changed from the ghostly thing into one of flesh and blood.

New French Automotive Developments

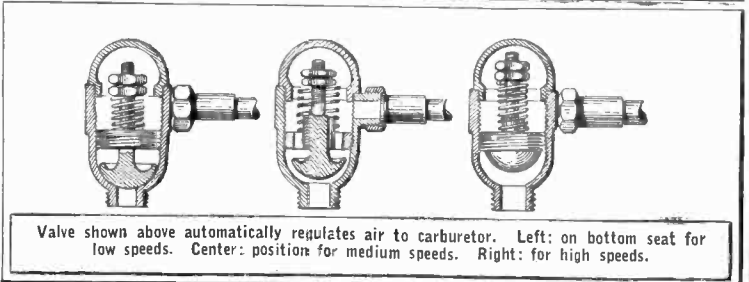
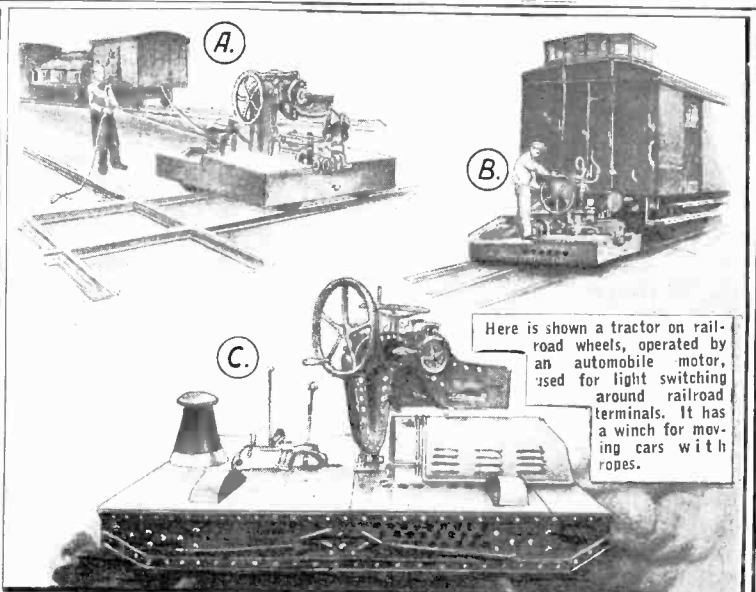
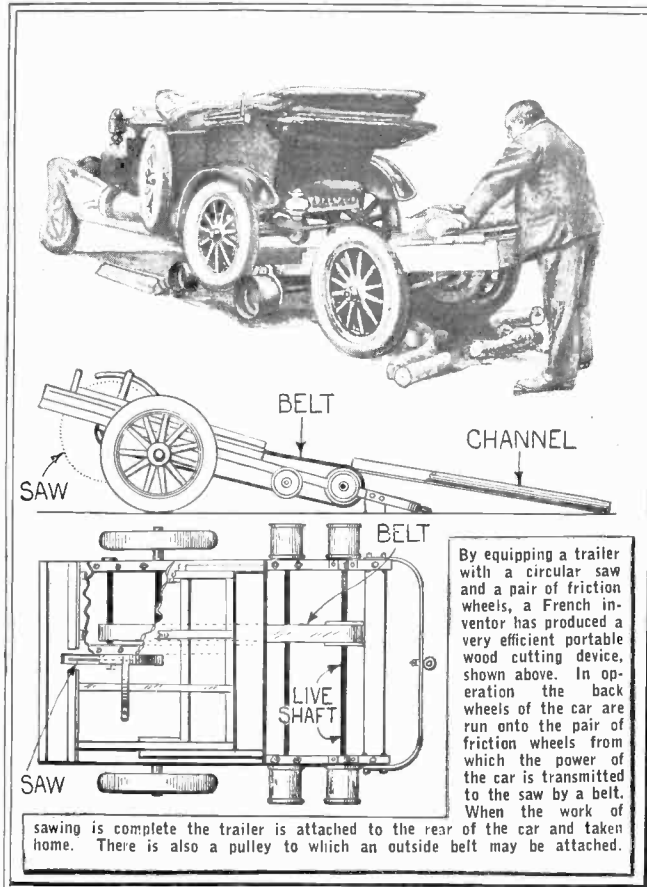

Animals With Strange Customs

Mammals Departing from the Regular Habits of Their Kind.

By LAURENCE H. SNYDER.

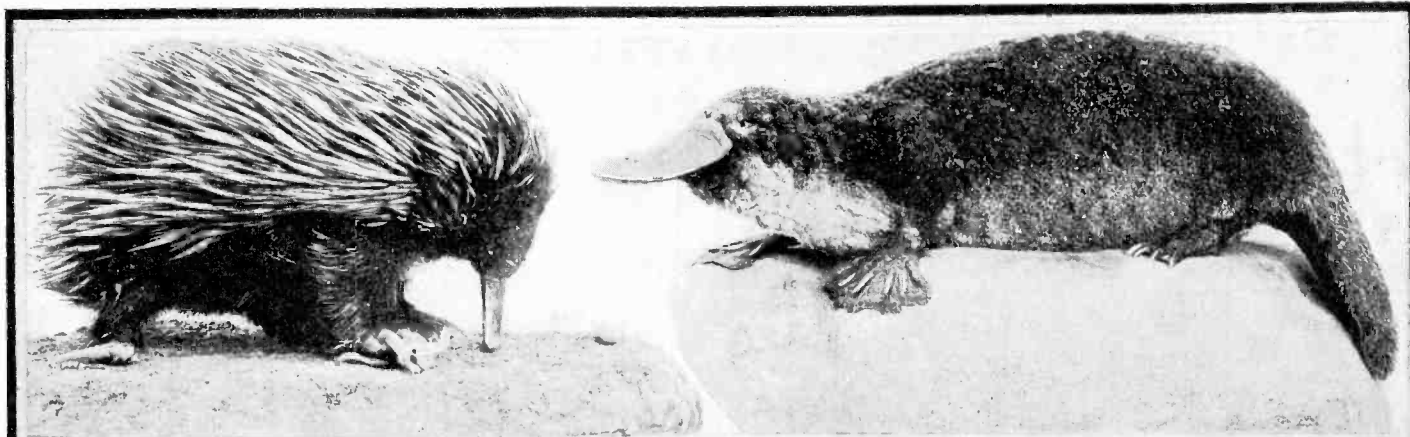

The opossum is the only marsupial of North America. (Below) It carries its young in a pouch on its back and when in danger feigns death. The young of the opossum are born very immature and for some time after birth are helpless.



The duck bill and the spiny ant-eater lay eggs and hatch their young from them, although they are true mammals. They provide milk for their young. The young of the duckbill lick the milk from the mother's hair.



having a membrane connecting the hind and fore legs and the body. This acts as a wing. The duckbill is more or less of an aquatic animal, having webbed feet and making the entrance to its burrow underneath water. In spite of the fact that this animal lays eggs from which the young are hatched it is classed as a mammal and is warm blooded. Other mammals than the bats inhabit the air. The flying squirrel represents a class known as gliders. It does not really fly but by virtue of a fold of skin connecting the animal's fore and hind legs it is enabled to glide from a higher to a lower altitude, sailing through the air. The colugo of South America belongs to this type of mammal, though it is more closely connected with the mole family than it is with the squirrels. Although the general rule is for the mammals to inhabit the earth, the flying squirrels are not alone in the peculiar deviation from the rule. The beaver, muskrat, otter and mink are well known. They are mammals and are warm blooded but they are quite at home in water. They have kept their four-footed anatomy, how-

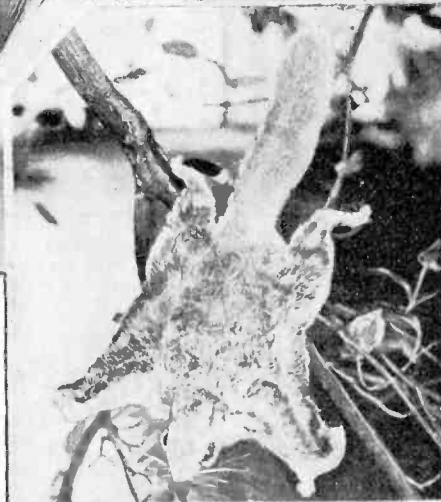

ever, while some other mammals, like the whale and the seal, have been greatly modified. Whales, in adult life even have no teeth. All the water inhabiting mammals, however, breath air through lungs and must come to the surface frequently in order to breathe.

THOUGH mammals are supposed to belong to one great class which bears its young alive and nurses them with milk, there are a number of interesting deviations from this rule. For instance: The bats really fly,

Photos Courtesy of the American Museum of Natural History, N. Y.

A French Electro Culture Idea

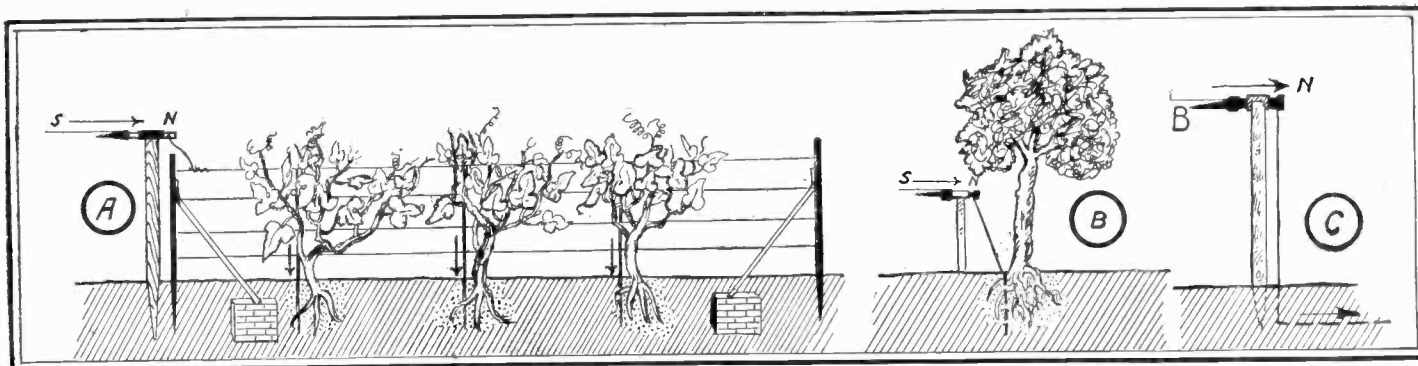

The Abbey Nollet in 1749 and the Abbey Bertholon in 1783 were credited with work on the application of atmospheric electricity to plants, the latter producing some apparatus called the "Electrovegetometer." They are the first on record and were followed by others, and now a French inventor, M. Christoffeau has constructed the apparatus shown in our illustrations, which he calls the "Electro-magnetic Terro-celeste," certainly an imposing name.

At two meters above the surface of the ground, a pointer is placed which is set rigorously north and south. From its unpointed end the wire is taken down to the soil, so as to reach the roots of the plants, or it may by means of a trellis be caused to first traverse their branches and leaves, and then be conducted to the soil with a ground wire for each plant. Very extensive claims are made for this apparatus.

Buoyancy of Ice to Raise Ships

Large Cake of Ice about Sunken Hull Brings it to Surface.

BY CHARLES MARTON.

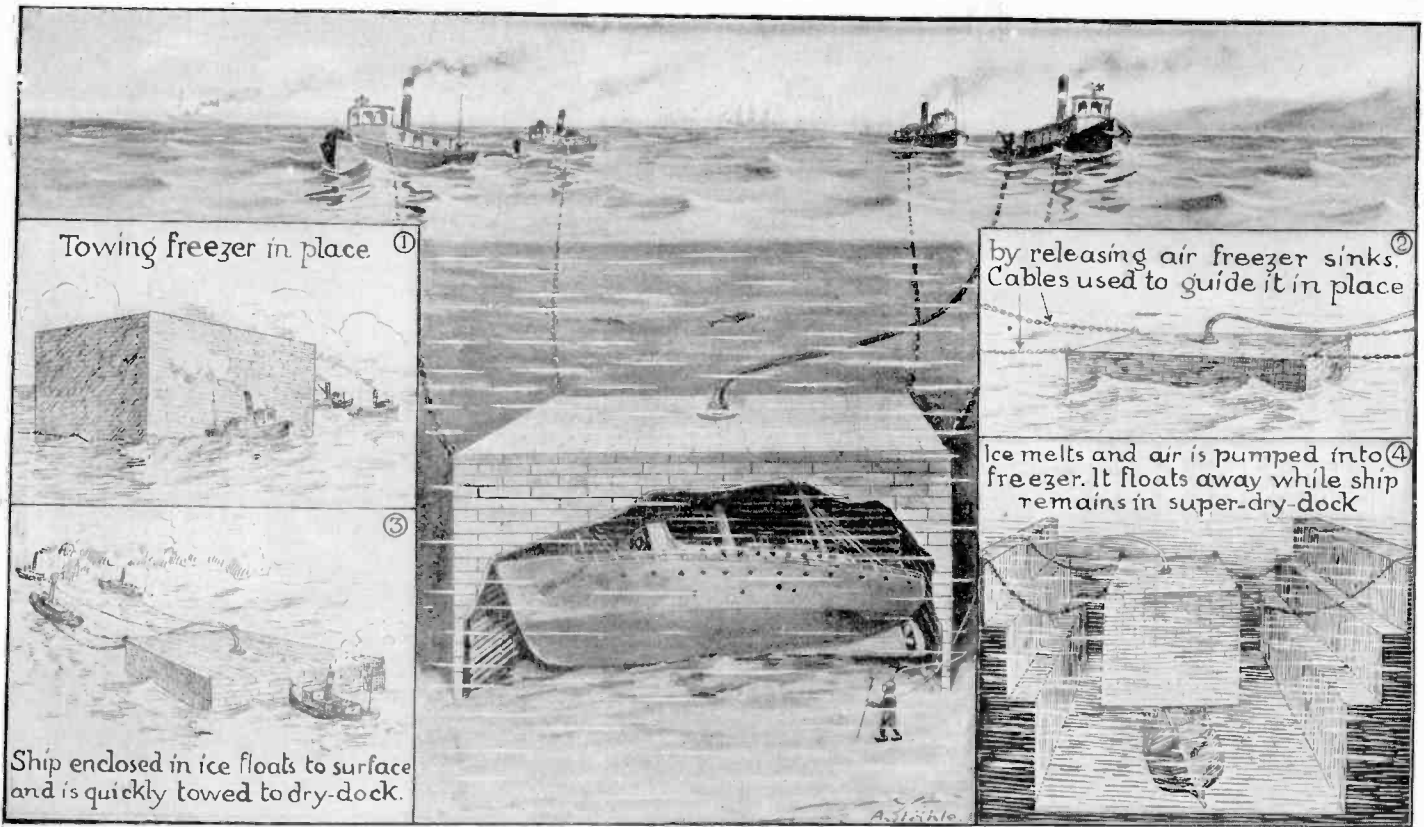

Towing freezer in place ①

by releasing air freezer sinks. ②
Cables used to guide it in place

Ice melts and air is pumped into ④
freezer. It floats away while ship
remains in super-dry-dock

Ship enclosed in ice floats to surface
and is quickly towed to dry-dock.

By using a large shell, vacuum lined, sinking it over a sunken ship, and then forcing a freezing mixture through cold-storage pipes inside the shell, a large mass of ice is frozen around the hull. Since the specific gravity of ice is less than water, when the freezing is

completed the ice and hull will raise to the surface of the water. It is then towed to dry-dock. The steel shell is fitted with valves for sinking. Attending ships are equipped with refrigerating machinery which is connected to the coils in the caisson by tubes.

Perspiration On Order--Movie Invention



When the cold wintry winds drive you from the street into the movie palace where a close-up shows a star perspiring freely after the terrible work of rescuing the boy hero from the brutes of the stoke-hold, don't envy the star, thinking that the pictures were actually taken next to a red-hot boiler head. In the close-up, remember the boiler head isn't visible and that the pictures may have been made at 30 below.

Here is the way it is done. The camera is set for the close-up and the director's assistant takes a firm grip on the perspiration bulb which is filled with glycerine and water. He holds it tightly and then the director tells him to squeeze it. Then he yells "camera," and behold, in half a second the hard working actress is showing all the signs of her grinding toil. She looks as if she had spent the day sweeping the Sahara Desert. But—

Here is the harness that gives the effect, with a lot less exertion on everybody's part and even does it more effectively. The bulb, filled with glycerine and water is connected with a number of small tubes that run from the back of the actress' neck, through her hair to a point just above the forehead. When the bulb is pressed literal showers of perspiration are released and come tumbling down the actress' face.

Practical Scientific Novelties

Modern Science Lends An Ear to Our Everyday Wants.

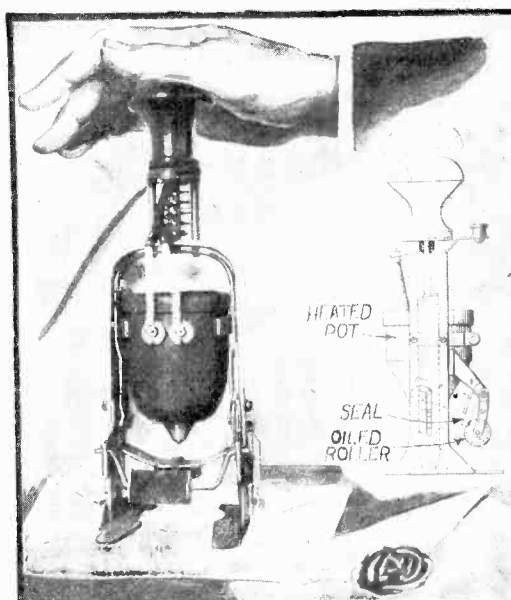

The electric sealing device shown is very ingenious. Pressing upon the handle the first time causes the seal to slide to one side brushing against the oil roller. A quantity of the wax flows upon the envelope. The second pressure imprints the seal.



The check protector shown above is one of those pocket devices which stamp the amount directly into the check, perforating the check at the same time. Each section of the check protector has a numeral upon it, which numerals are made of small needle-like points. In the upper compartment of each section is a small felt pad moistened with ink.

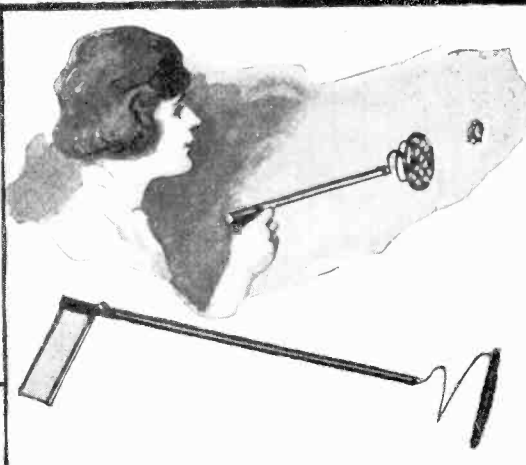

The fly-gun shown above will make it more interesting for the average housewife to eliminate these pests found in every household. A spring in the handle forces the swatting end forward at a rapid speed. The trigger, which fits into a notch in the tube, twists out of this notch when the gun is fired.



The socket wrench for radio outfits is a very desirable accessory to the tool outfit of any one who constructs his own radio set. The socket wrenches come in sets of three fitting the ordinary sized nuts. They are inexpensive, and will find many uses.



The system of poker chips and banking device shown above, is made of the finest quality pyralin. There are chip racks made of mahogany for individual players, and a box holding the entire outfit on the back of which is found a banking device. A small square hole in the center of the chips allows them to be placed on pins and mounted on the chip racks. These pins are calibrated in a way which permits the player to tell at a glance the exact number of chips in his possession. The device on the back of the box is made to correspond to the letters with which each chip rack is designated. The banker inserts a peg in one of the holes opposite a letter indicating the standing of the player to whom the letter applies.

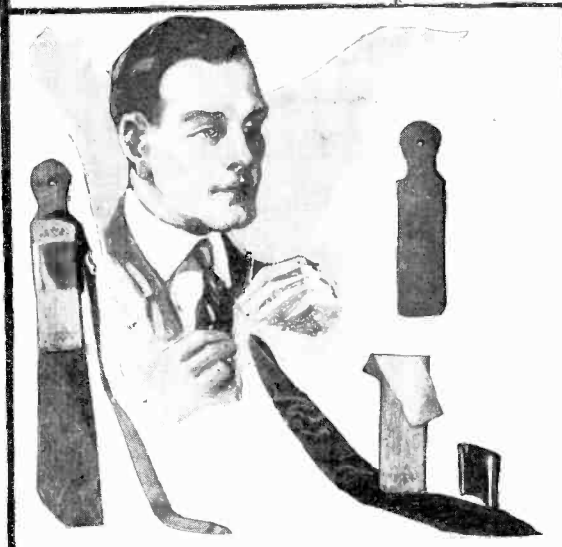
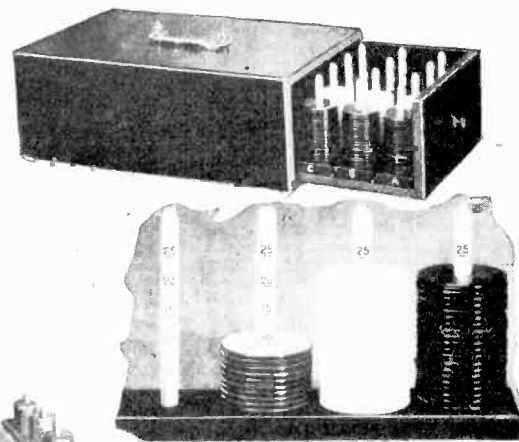

The neck-tie press shown above is made of two pieces of polished mahogany or oak, a small tapering clamp, and a small pad of felt. This felt is moistened and then the neck-tie is placed upon one of the boards, the moist felt pad on top of this, and then the second board is used as a cover, the whole being clamped together.



The ingenious knife sharpener illustrated above is made of aluminum, and two hardened steel balls, which rotate in opposite directions when the knife is drawn across them, as illustrated.



The candy container illustrated above acts just opposite to a cigar humidor. In the cover of this candy container we find a small receptacle containing a hygrosopic chemical which absorbs moisture very readily, preventing the candy from becoming sticky.

Rum Runners Adopt Smoke Screen

Dense Smoke Screen Hides Road from Pursuers.

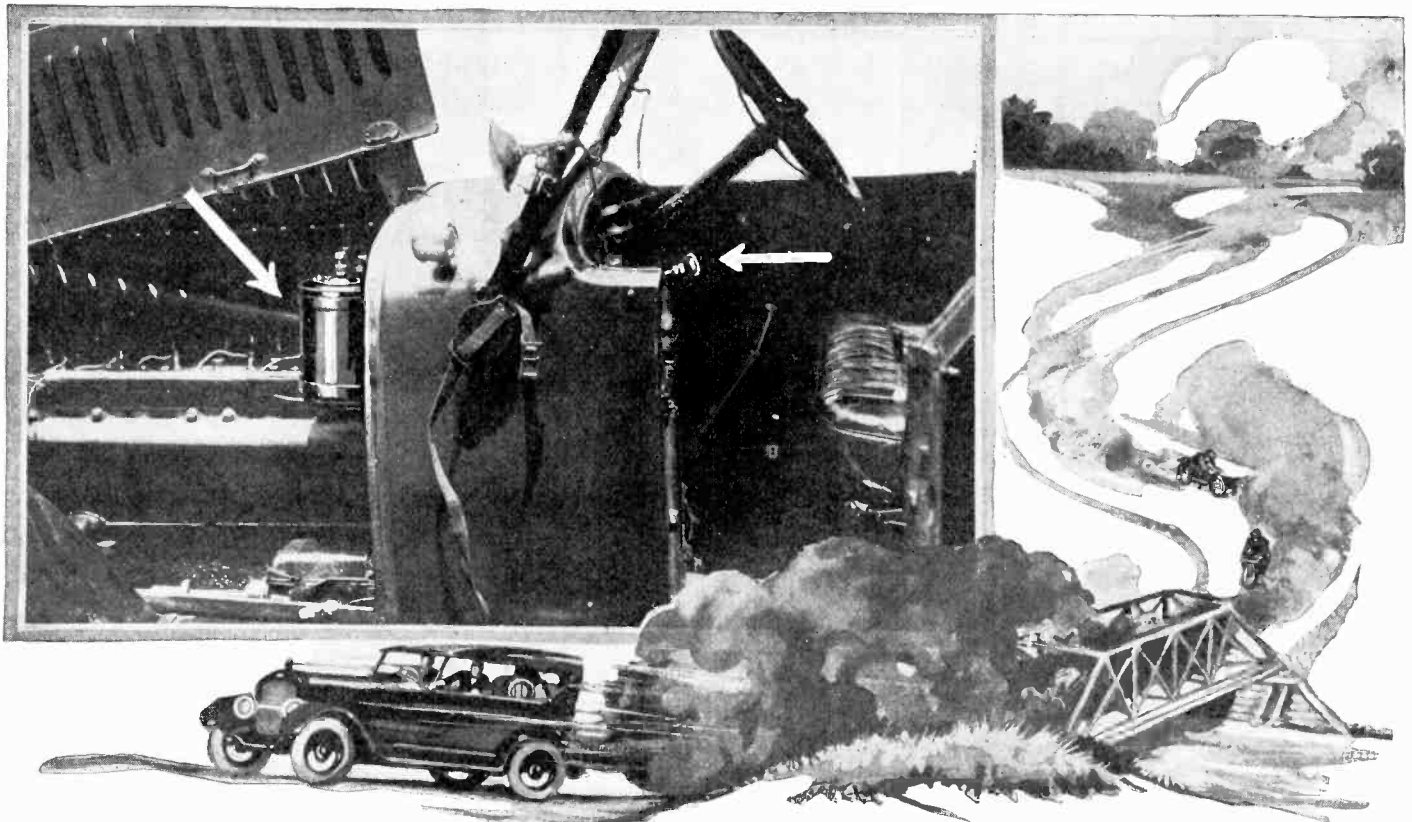

Driving 75 miles per hour, Washington, D. C., police, following alleged rum-runners, were confronted with a cloud of smoke so dense that they could not see their speedometers, last month. The road was practically obliterated for them. On capturing the car it was found that a tank of liquid, supposedly ammonia and glycerine, had been installed back of

the dash of the car and the liquid led to the muffler where it was burned into smoke. The officers were unable to follow their quarry until the fluid had been burned out. The men had no liquor and so could only be charged with creating a smoke nuisance. The smoke burned nearly twelve minutes.

—George A. Luers.

Voice Transmitted Through Arm

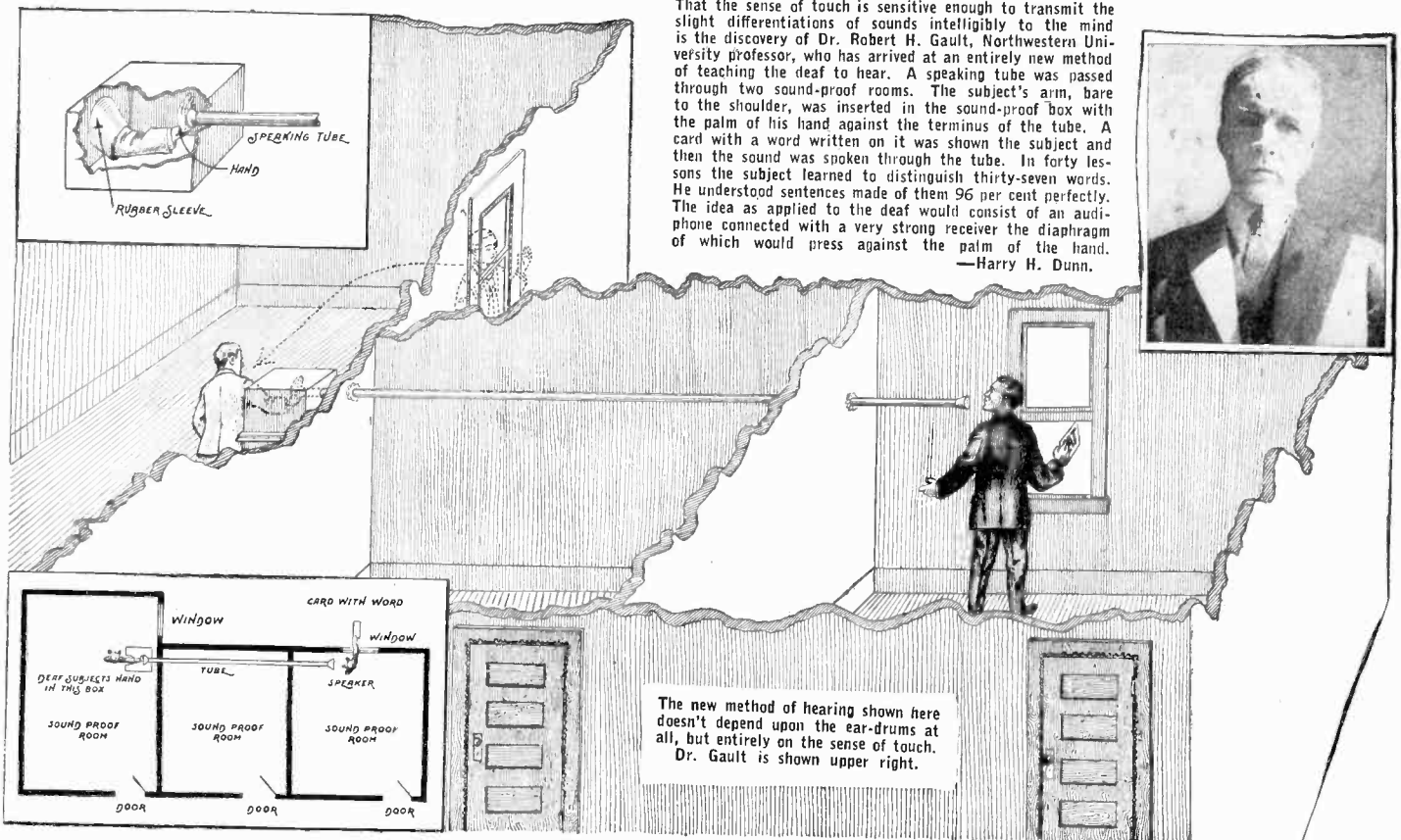

That the sense of touch is sensitive enough to transmit the slight differentiations of sounds intelligibly to the mind is the discovery of Dr. Robert H. Gault, Northwestern University professor, who has arrived at an entirely new method of teaching the deaf to hear. A speaking tube was passed through two sound-proof rooms. The subject's arm, bare to the shoulder, was inserted in the sound-proof box with the palm of his hand against the terminus of the tube. A card with a word written on it was shown the subject and then the sound was spoken through the tube. In forty lessons the subject learned to distinguish thirty-seven words. He understood sentences made of them 96 per cent perfectly. The idea as applied to the deaf would consist of an audiophone connected with a very strong receiver the diaphragm of which would press against the palm of the hand.

—Harry H. Dunn.

The new method of hearing shown here doesn't depend upon the ear-drums at all, but entirely on the sense of touch. Dr. Gault is shown upper right.

Scientific Problems and Puzzles

A Number of Everyday Scientific Questions That Are Interesting.

BY ERNEST K. CHAPIN, M.Sc.

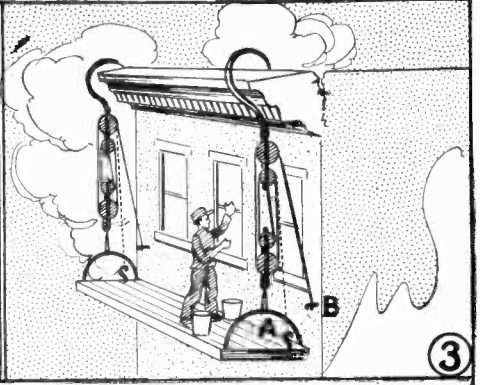
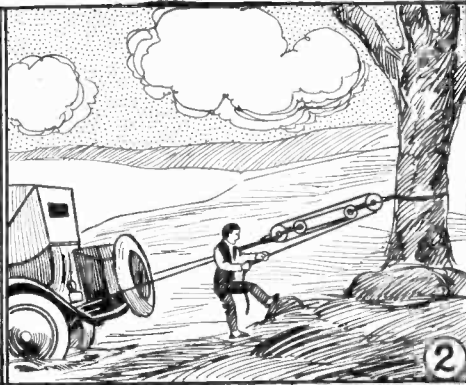
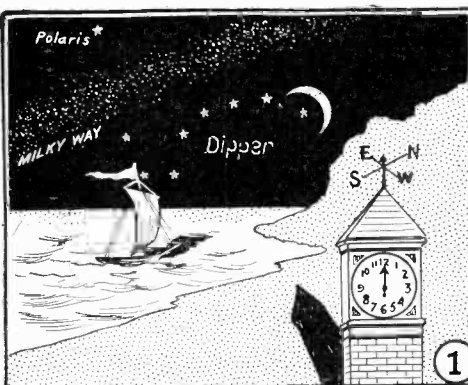

How many scientific errors can you see in this picture? Examine it closely. How many things would have to be changed in order to make it correct? The answer to these questions will be found on page 1051.

Is the motorist in the above illustration doing his best scientifically to get his automobile out of the mud? If not, how could he change his tactics with the block and tackle in order to work more efficiently?

The painter attached his rope holding the scaffold to a peg in the wall at B instead of lashing it to the hook provided in the scaffold itself at A. Why did the cornice break when it held with the rope in the correct position?

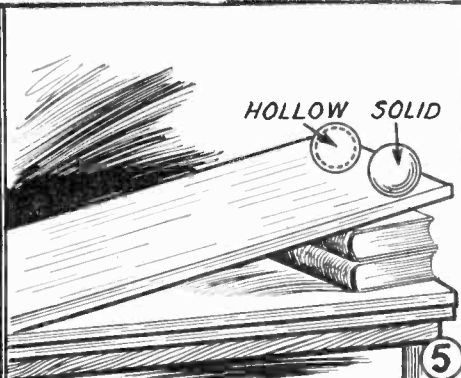
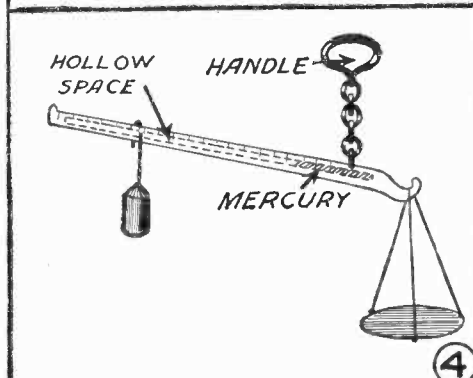

A clever Chinese merchant uses the steelyard shown above. It has a mercury counter-balance. If his customer insists on weighing the goods (as he usually does), will not the merchant be cheated at least half the time?

If two balls, one of which is hollow, identical in size and made of the same material, are released from the top of an inclined plane at the same time, which of the two will reach the foot of the plane first? Why?

Many times, housewives place large tubs of water in cellars to prevent vegetables and fruit from freezing in cold weather. Will the water keep the fruit and vegetables from freezing and, if so, how?

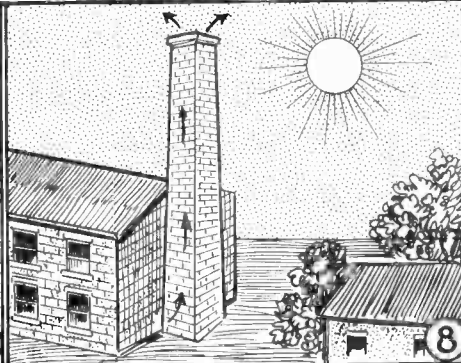
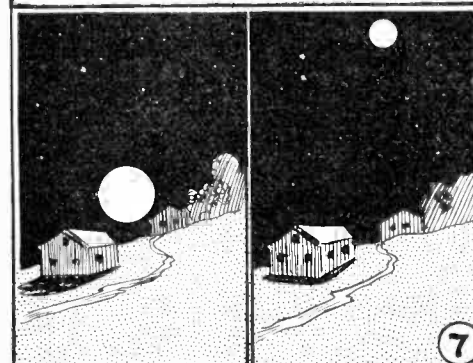

If the moon is seen when it hangs low down next the horizon where it seems close to trees and houses it seems much larger than when it is riding high up in the sky. Is the moon larger? If an illusion, what accounts for it?

Many times there is considerable draft in tall chimneys although there is no fire in their base. How is this accounted for? Upon what does the establishment of this draft without fire depend?

The white clothes of the washerwoman to the left are not dry while the dark ones of the other, hung out at the same time, are. Why did the dark clothes dry before the white ones when they were in the same temperature?

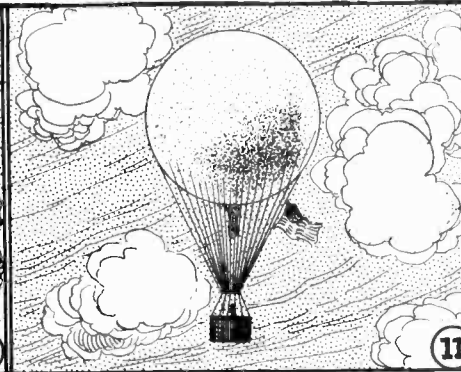

How is the total weight of water against the face of a dam calculated? Does it depend upon the distance the water runs back from the dam, on the velocity of the stream, the depth of the water, or what?

What is the power of ascension of a balloon? Is it the buoyancy of the gas in the bag that furnishes the lifting power? If so, how does it act? Why must the gas used be much lighter than air?

Is it the "power of suction" that causes the soda to be forced up through the straw? If not, what action takes place when the girl sips on it? (Answers on page 1051.)

The Heavens in February

By ISABEL M. LEWIS, M. A.
of the U. S. Naval Observatory

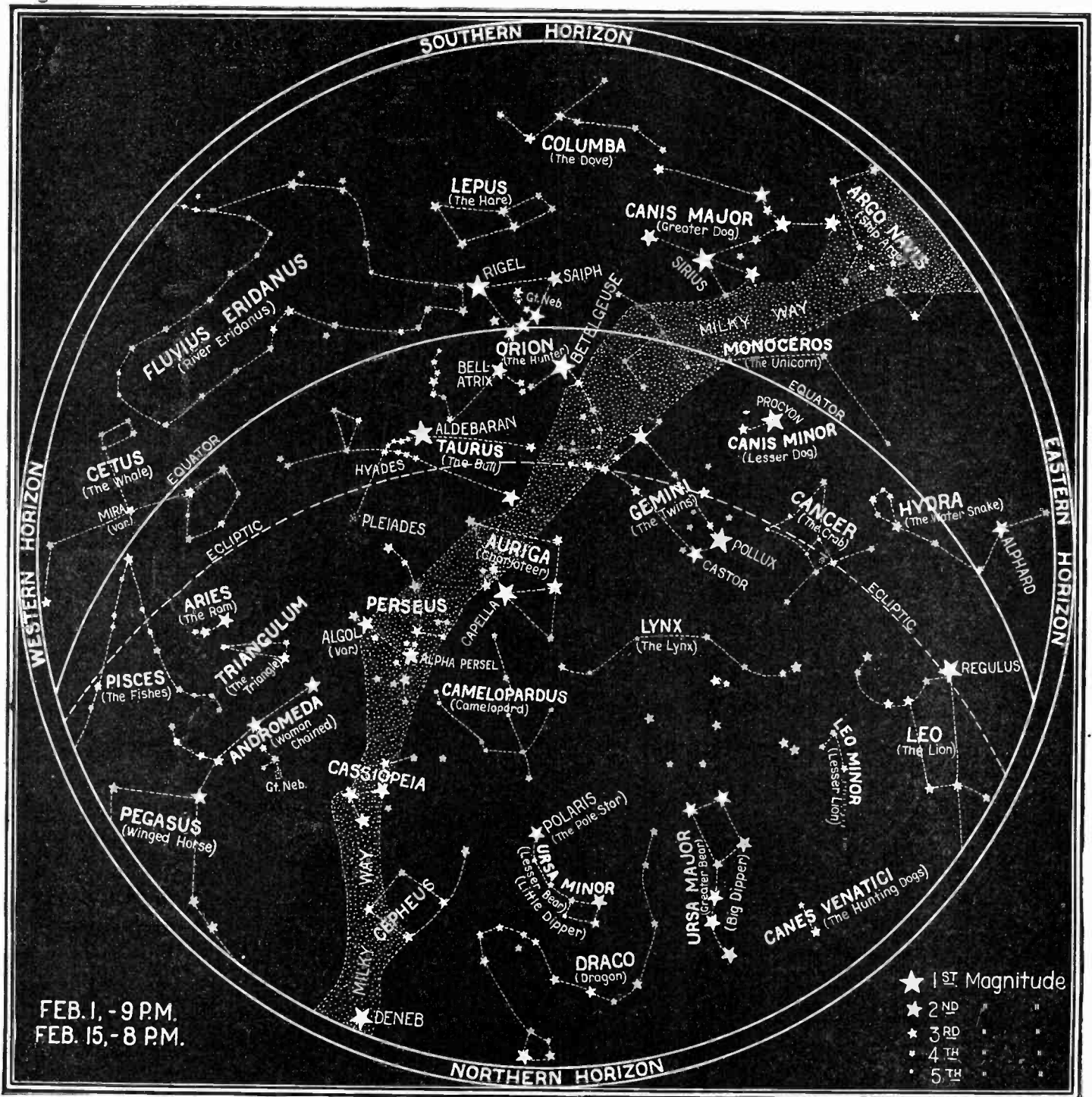

Above is the star map for the month of February. If the chart is held over the head with the "Northern Horizon," north, at nine P. M., February first or eight P. M., February fifteenth the location of the stars in the heavens will coincide with their position on the map and can easily be found.

BY nine o'clock in the evening, the first of February, or eight o'clock on the fifteenth, the magnificent constellation of Orion, the finest in the heavens, will be found a little to the west of south. No one can fail to distinguish this constellation. The three second-magnitude stars evenly spaced a degree apart in a line exactly three degrees long that form the Belt of Orion, immediately attracts the attention of anyone gazing at this part of the heavens. Then there is the huge quadrilateral that outlines the body of Orion. The red Betelgeuse and blue-white Rigel are in diagonally opposite corners, both first-

magnitude stars, and in the other two corners are Bellatrix, in the left shoulder and Saiph in the right knee. stars of the second magnitude. Just below the Belt in the Sword of Orion is the Great Orion Nebula, the finest object of its kind in the heavens. The distance of the nebula and its associated stars is estimated to be approximately six hundred light years. To the east and southeast of Orion and now well up above the horizon will be seen the two dogs that follow at the heels of Orion, Canis Major, The Greater Dog, and Canis Minor, The Lesser Dog. Sirius in Canis Major, is by far the brightest of

all the stars and is at a distance of only eight and eight-tenths light years from the earth. Next to Alpha Centauri it is the nearest of all the first-magnitude stars. Canopus the second brightest star in the heavens lies about thirty-five degrees nearly due south of Sirius and cannot be seen north of the thirty-eighth parallel of latitude. It is so distant that its parallax cannot be determined by the trigonometric method. It must be at least several hundred light years from the earth, perhaps much more than this, so intrinsically it is one of the most luminous stars in the heavens, not de-
(Continued on page 1039)

Magic for Everybody

BY PROF. JOSEPH DUNNINGER.

NO. 11 OF A SERIES

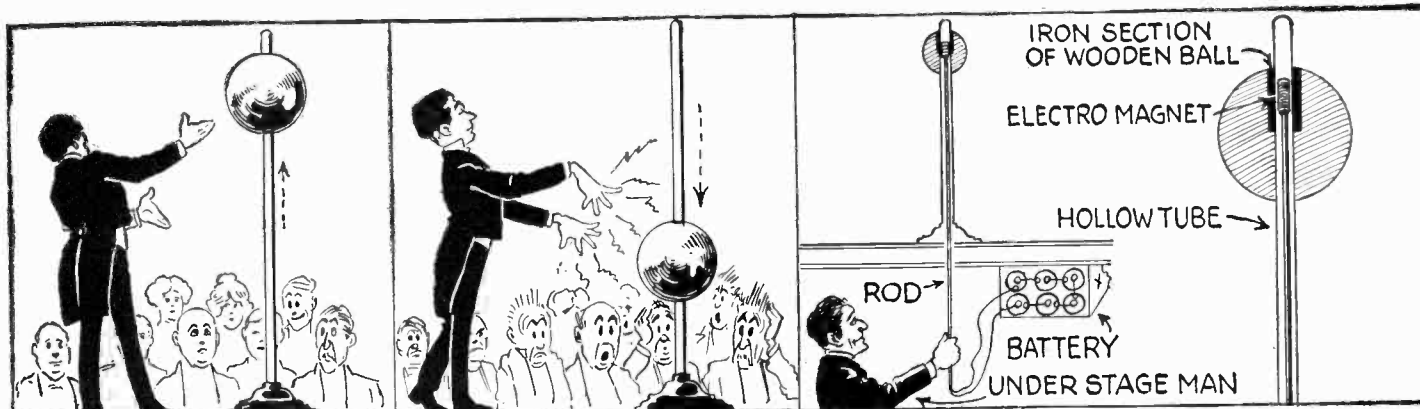

A hollow brass rod secured to a stand is passed for examination, as is a wooden ball with a hole through it, allowing it to move freely on the rod. At the word of command, the ball can be made to rise or fall on the rod. An assistant below the stage is supplied with

another rod sliding freely within the rod of the stand. To the upper end of this a magnet is secured which receives its energy from the batteries beneath the stage floor. The under-stage man causes the ball to rise and fall by sliding the rod up and down.



A polite spectator drops a ring into a fish bowl full of water. The magician washes and dries his hands thoroughly to prove that they are unprepared, and then plunges his hand

into the water and withdraws the ring. To the spectator's astonishment, his hands are perfectly dry. Use lycopodium powder, sprinkled upon the water prior to the trick.

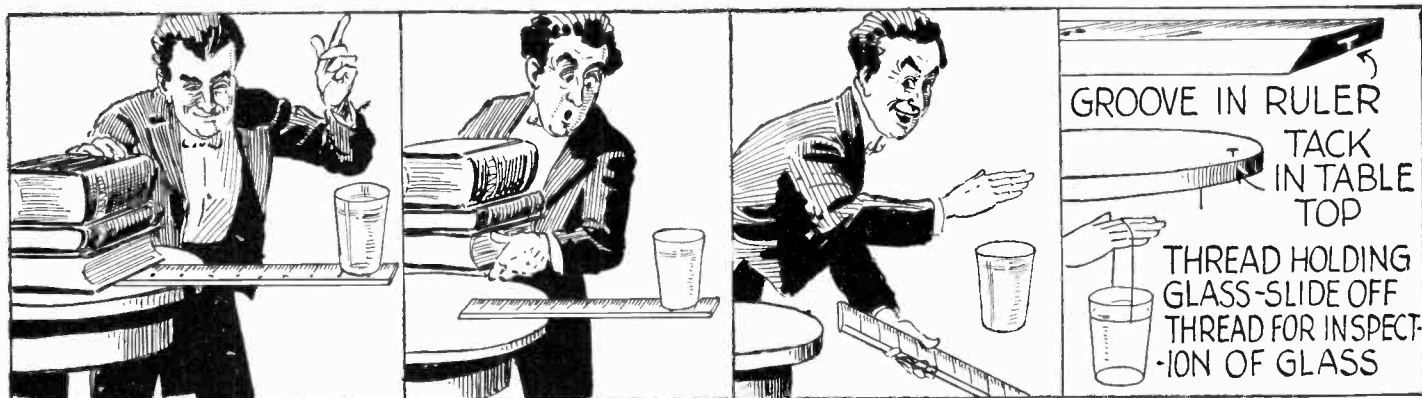

A ruler is placed on the edge of the table. A glass of water is balanced on the free end, while the other is held with a few books. The books are now removed, but the glass and ruler still maintain their positions. Finally the ruler is also taken away, but the glass

remains suspended in mid-air. For holding the ruler on the table, the tack in the table and the slot in the base of the rule are very effective. In suspending the glass in mid-air a thin thread is used. This drops off when the glass is passed out for examination.

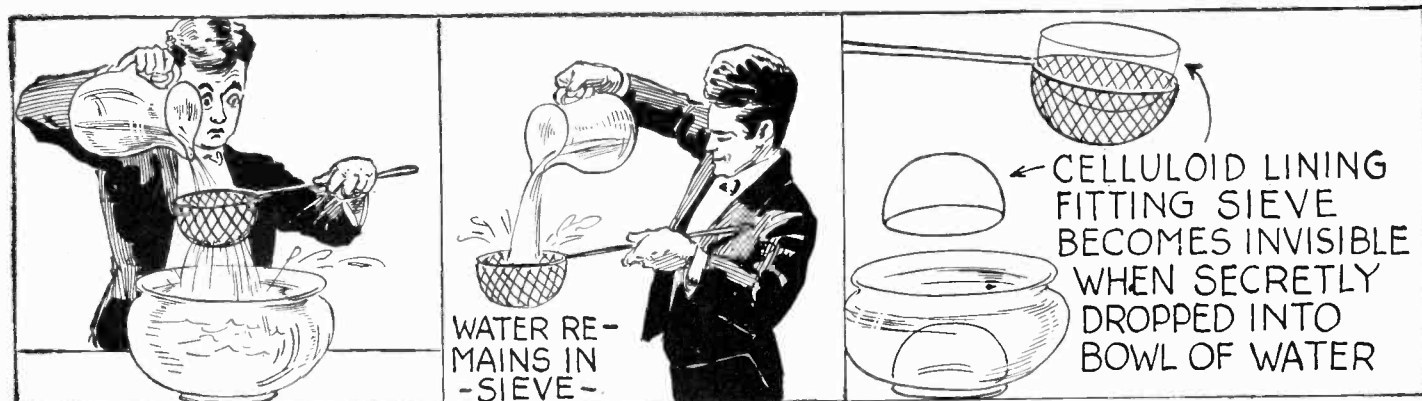

The performer pours water into a sieve and it flows through freely. He repeats the operation, but this time the water remains in the sieve. The water is then poured out by

tipping the sieve as though it were a dipper, and the sieve passed for examination. The performer slipped the invisible celluloid lining out of the sieve when he tipped it.

Scientific Match Box Puzzles

Interesting Tricks Performed With the Aid of Ordinary Matches.

BY WALTER B. GIBSON

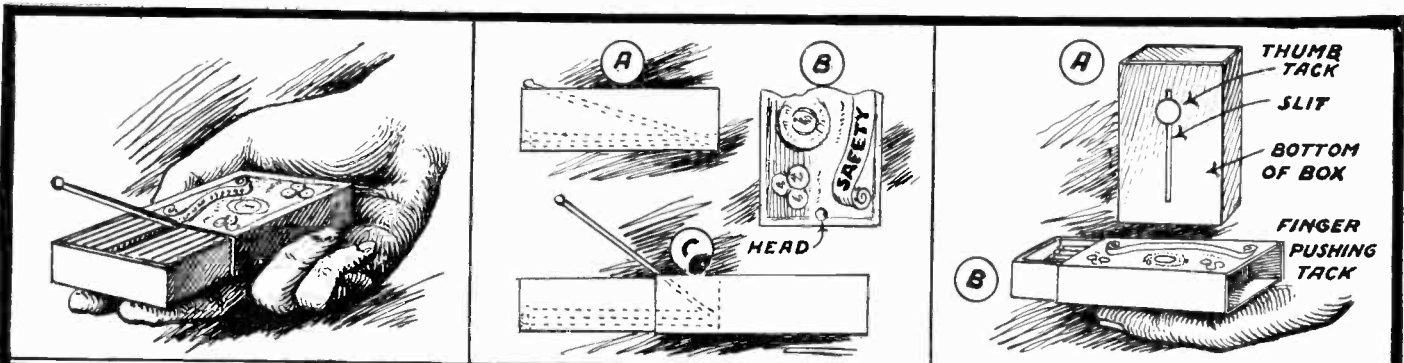

The obliging match box. An ordinary safety match box is held in the right hand, and with no apparent motion of the hand, the box slowly opens and one match raises its head. The left hand removes the match and the drawer automatically slides back.

A match raises from the box. A tiny hole is cut in the top of the match box near one end, and with the drawer closed, a match is pushed in through the hole until only the head protrudes. Figs. A, B and C indicate the position of the match.

A slot is cut lengthwise in the bottom of the cover of the match box, and at one end of this a thumb tack is inserted into the drawer. Pushing on the thumb tack with the forefinger held underneath the match box, causes the drawer to slide out.

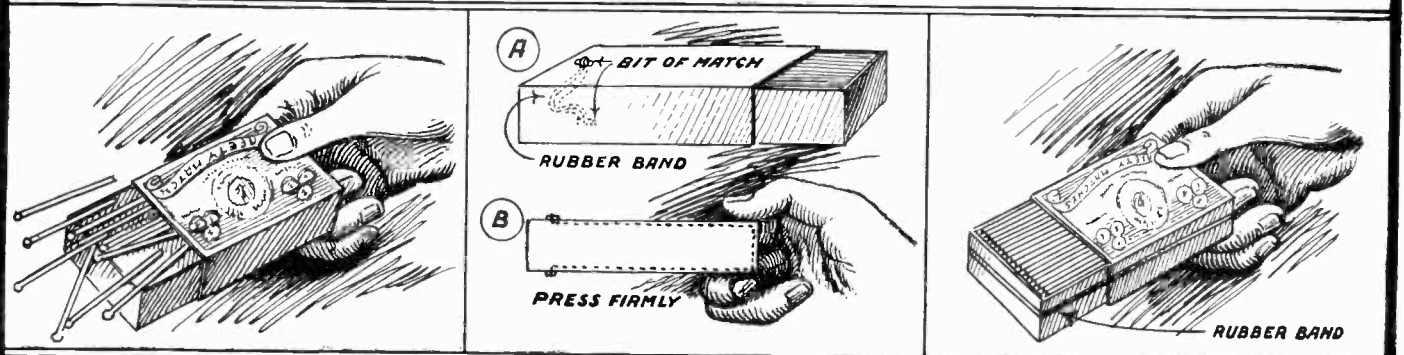

Another more startling automatic match box is shown above. With the query "Have a match?" the drawer of the box slides open and a dozen matches fly out at the surprised spectator. The match box is held in one hand when the trick is performed by the method shown.

A rubber band is passed from cover to cover of the match box, and held in place by bits of matches to which the rubber band has been fastened. As shown at A the match box acts in the ordinary manner. At B it forms a veritable gun.

An open box of matches is held out to some one and just as he reaches for them, the match box closes. A rubber band is slipped around the box. Press firmly at the rear to hold it open; when pressure is released the box slides closed.

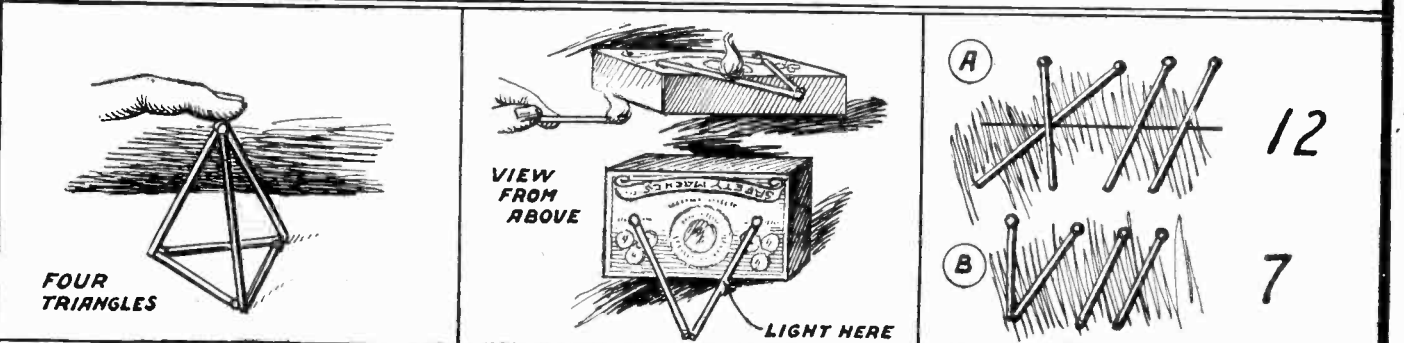

Lay six matches on the table and challenge anyone to form four equilateral triangles from the six matches. None of the matches may be broken. The problem seems impossible, but the drawing shows how it can be done.

Lay two matches as shown, and light one of them. Then ask how many seconds it will take for the burning match to ignite its companion. Answer is never, because the match burns and curls away from the other.

Half of twelve is seven! Oh, yes, you can prove it. Simply lay matches on the table so as to indicate the Roman numeral 12 and then separate them as shown in the straight line, taking away exactly half of each figure. The result is seven.

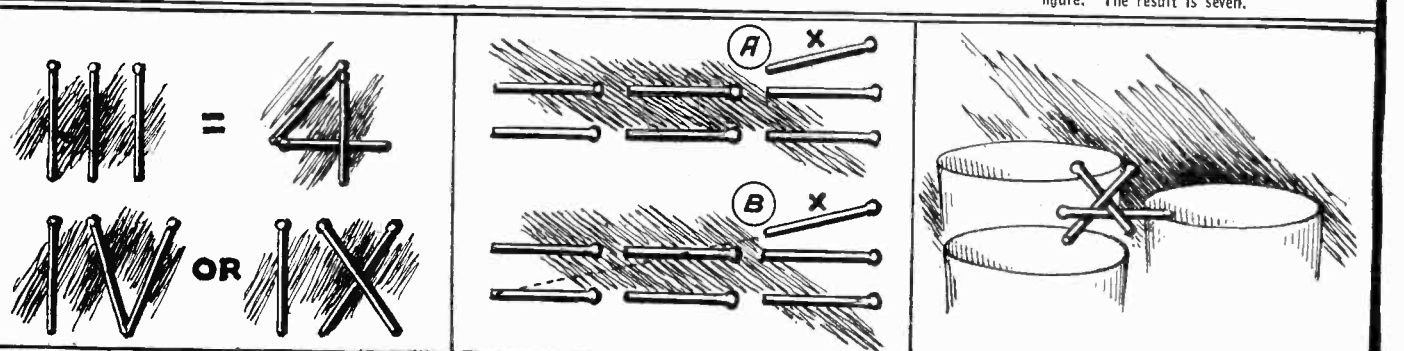

How can you make four matches out of three matches without breaking any of them? The answer is very simple. Set the three matches to form the figure four or five Roman figure IV.

Lay seven matches as shown, and ask where X points. Most will say it points to the head of the first match at the bottom. But it points to the lower end, as is proved with a ruler.

Above is shown a simple method of constructing a bridge which will connect three drinking glasses. The head of each match is to rest on one of the glasses, but the other end must not touch a glass.

Everyday Chemistry

Some Kinks and Compounds in Everyday Use Explained.

BY RAYMOND B. WAILES

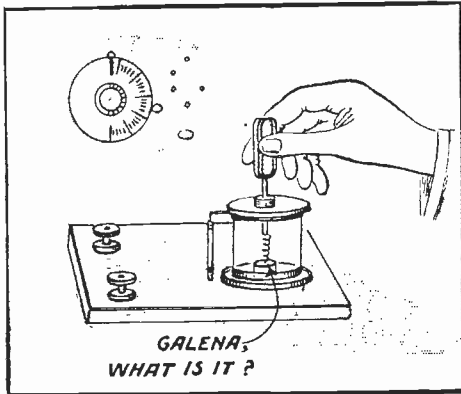

**GALENA,
WHAT IS IT ?**

Galena is native lead sulphide having the formula PbS . It occurs sometimes in massive cubic or octahedral crystals. It is the principal ore of lead, often containing comparatively large quantities of silver.

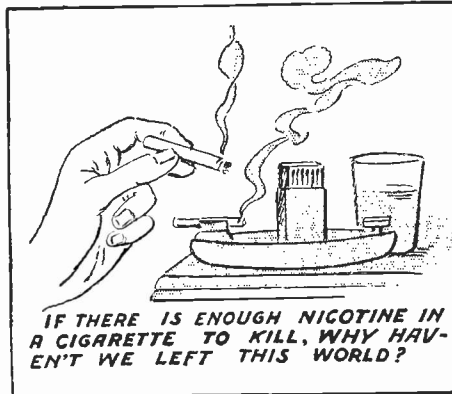

**IF THERE IS ENOUGH NICOTINE IN
A CIGARETTE TO KILL, WHY HAV-
EN'T WE LEFT THIS WORLD ?**

The reason that the nicotine in a cigarette has very little effect on the smoker is because most of it is burnt up. If the nicotine were extracted and administered internally, it would be fatal.

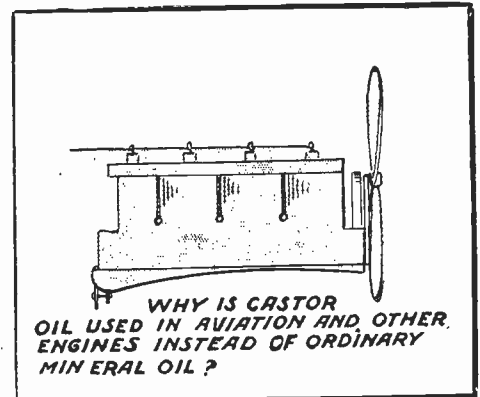

**WHY IS CASTOR
OIL USED IN AVIATION AND OTHER
ENGINES INSTEAD OF ORDINARY
MINERAL OIL ?**

The reason that castor oil is used in aviation engines in preference to ordinary mineral oils, is because this oil does not mix with gasoline, and consequently is not thinned down, thus maintaining its lubricating quality.

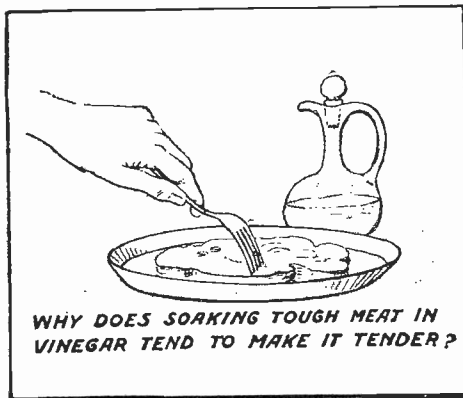

**WHY DOES SOAKING TOUGH MEAT IN
VINEGAR TEND TO MAKE IT TENDER ?**

Soaking meat in vinegar tends to make it tender because the collagen present in the meat swells. By continuous boiling of the meat, this collagen is converted into gelatin. Collagen is a proteid.

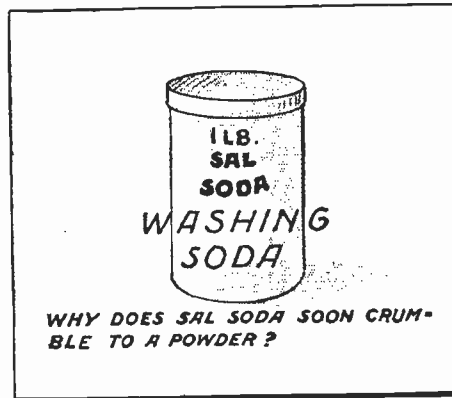

**WHY DOES SAL SODA SOON CRUM-
BLE TO A POWDER ?**

Sal soda and washing soda—the same substances—contain water of crystallization. When this water is driven out by heat, the crystal crumbles to a powder. The water causes the salt to maintain its crystalline form.

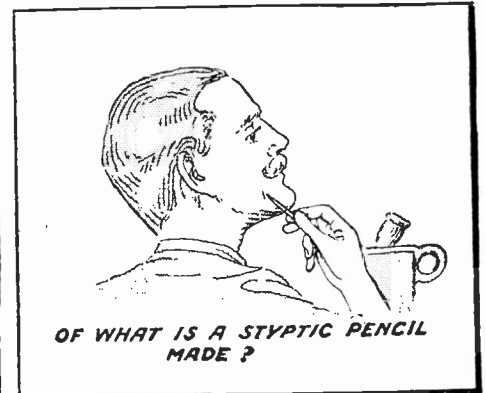

**OF WHAT IS A STYPTIC PENCIL
MADE ?**

The ordinary styptic pencil is made of seventy-five per cent of alum and twenty-five per cent saltpeter. Its astringent properties cause the edges of the wound to constrict, limiting the flow of blood.

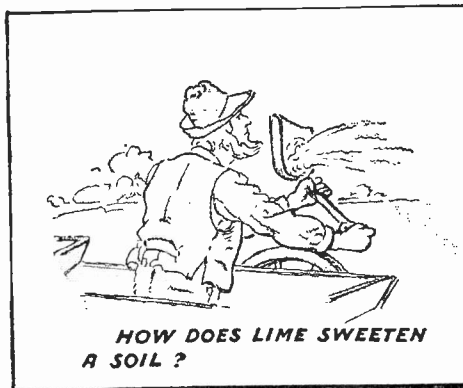

**HOW DOES LIME SWEETEN
A SOIL ?**

Lime when sprinkled on the soil, although not actually sweetening the soil, neutralizes the acids of the soil and thus removes the sourness. Such treatment facilitates the raising of greater crops.

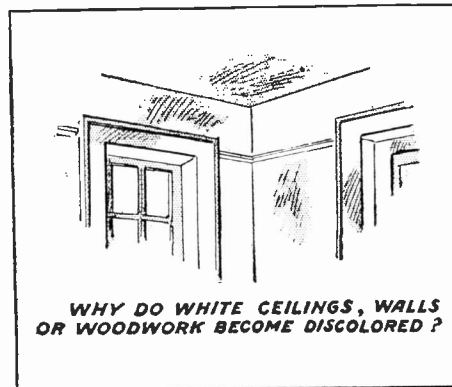

**WHY DO WHITE CEILINGS, WALLS
OR WOODWORK BECOME DISCOLORED ?**

If a special white paint is used, white walls will not discolor in impure air charged with sulphuretted hydrogen. Sometimes zinc white is used as a substitute for white lead.

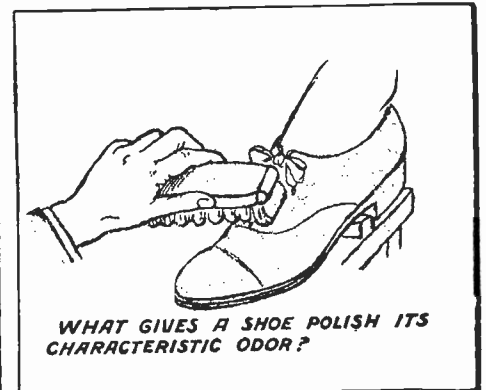

**WHAT GIVES A SHOE POLISH ITS
CHARACTERISTIC ODOR ?**

The odor of a shoe polish is due to nitro-benzene. This dye base is used in large quantities in the preparation of aniline. The liquid is a pale yellow fluid and is produced by the action of nitric acid on benzene.

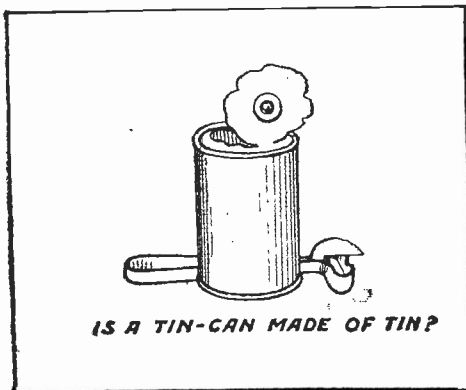

IS A TIN-CAN MADE OF TIN ?

A tin can is not made entirely of tin. Sheet iron forms the base and is coated with tin. This tinning process prevents the iron from rusting. The use of tin entirely would make the cans very expensive.



**WHY WILL A RUBBER BAND
DISCOLOR SILVER ?**

A silver spoon is discolored when a rubber band is placed upon it because of the sulphur in the rubber band. Sulphur is used in the vulcanizing process; it combines with the silver forming silver sulphide.

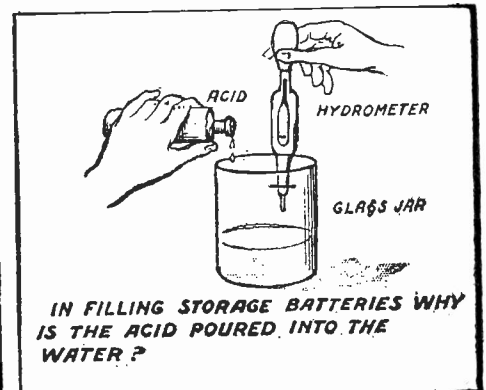

**IN FILLING STORAGE BATTERIES WHY
IS THE ACID POURED INTO THE
WATER ?**

In making a quantity of electrolyte for a storage battery, acid should be poured into the water because the water dissipates the heat of solution. Reversing the process may result disastrously for the mixer.

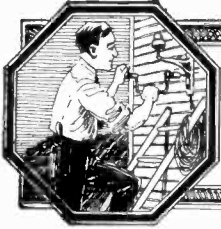

THE CONSTRUCTOR

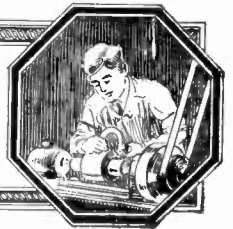

Mysterious Shadow Illusion

Novel Stage Effect Gained With the Aid of Lighting Plan.

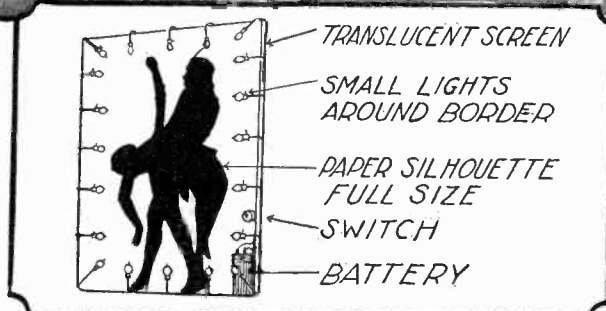
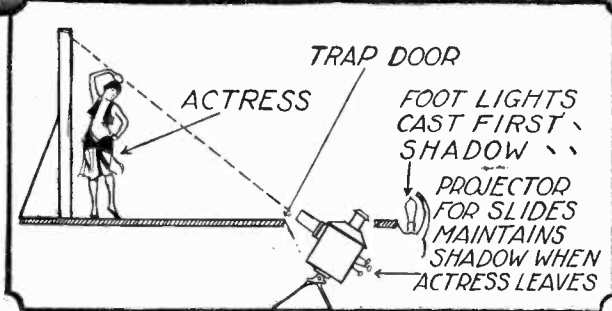
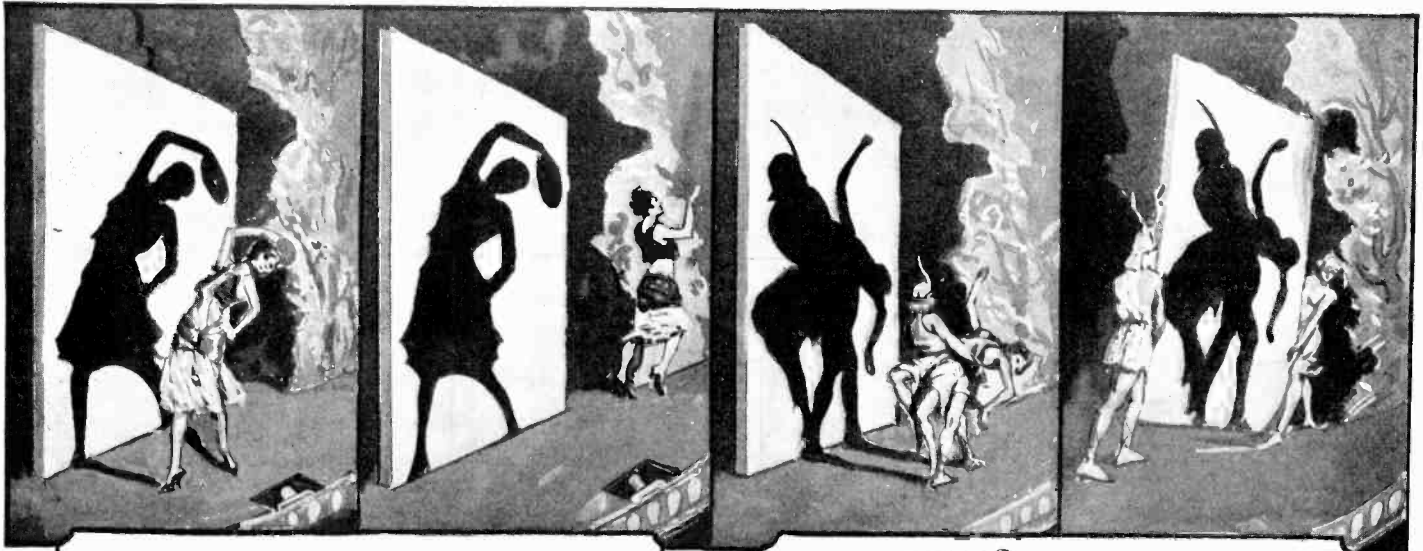

In the illustration above a large silhouette is seen on a screen. The lights are dimmed and the actress steps out from behind the screen while the shadow still remains. The screen is removed from the stage with the shadow still in place. The illusion is gained by using a projector in connection with the concentrated silhouetting lights in front of the screen. The method is illustrated in the sketch. The actress poses in the

predetermined position. The audience sees her shadow. The lights fade but the silhouette remains, thanks to the projector which casts the same silhouette of the actress which is on the slide upon the screen. In the last act the man and girl carry the screen with their shadows still in place off the stage. Two life-sized silhouettes are back of the screen, illuminated by small lights, as shown.

—L. J. Smith.

Perfect Safety for the Hand Luggage

Split in center
Suitcase

Handle slides into receiver
Grip

Wingnuts
Leather handle
Slot for wingnuts

By adjusting small knob handle can be released
Removable handle
Combination
Travelling Bag

Leather handle
Metal combination plug lock
Travelling bag

Removable handle
Any sort of combination, hook, joint, plug or lock
Suitcase

Perfect safety for the hand luggage is guaranteed by the simple device illustrated here. By a simple expedient of using removable handles, all danger of lost or stolen luggage is removed. As shown at the left, the handles can be made in various shapes and forms. At the right is shown a more complicated arrangement where the handles are fitted with locking devices, so that only the handle belonging to the bag may be used with it. Above is shown a handle equipped with a combination lock which not only serves to carry the bag, but also to lock it. It is also suggested that identification numbers be placed on the bag and on the handle, so that the owner at check stands or similar storage places, will have only to present his handle to redeem his bag, thus doing away with the annoyance of carrying checks.

—Leonard J. Edick.

Alarm for Bath

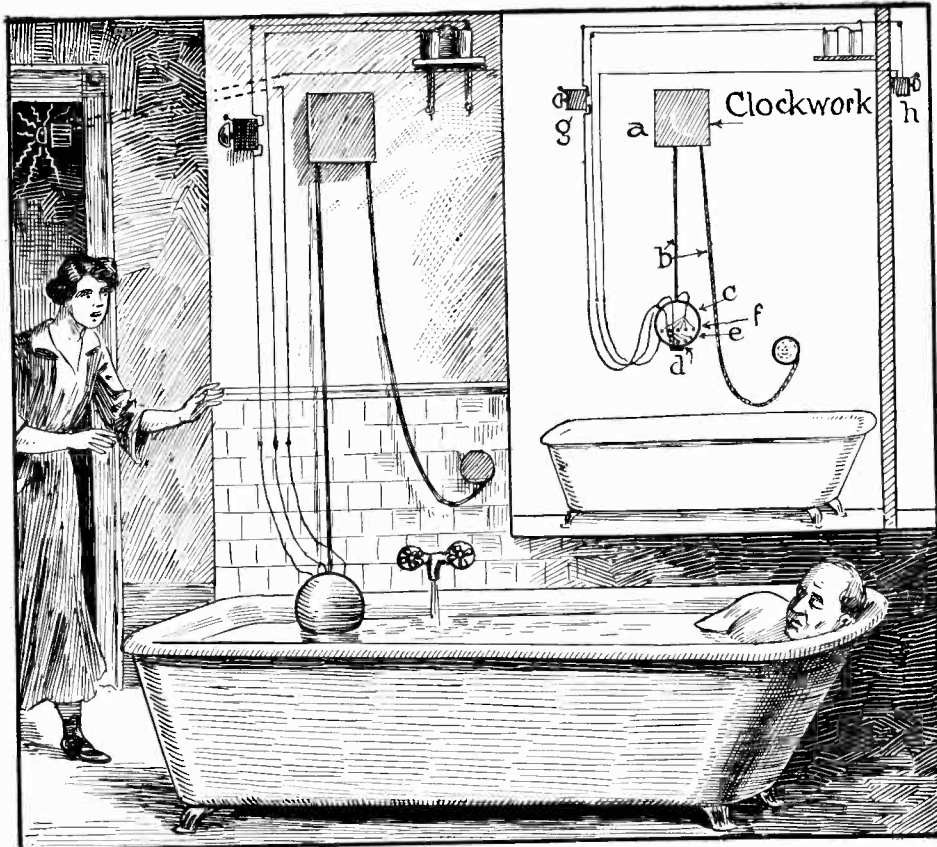

Many accidents are caused by persons falling asleep or being struck with a sudden illness while in the bathtub. Such mishaps may be easily avoided by applying an apparatus such as the one shown in the above illustration. The ball housing the contacts is allowed to gradually sink to the surface of the water by clock-work. If nothing is amiss the bather pulls the ball up to its first position. If something has happened to the bather the ball sinks into the water, ringing the bell in the bathroom; if it is not pulled up, it sinks further, ringing a bell outside the bathroom.

—Dr. Albert Neuberger.

Farm Elevator

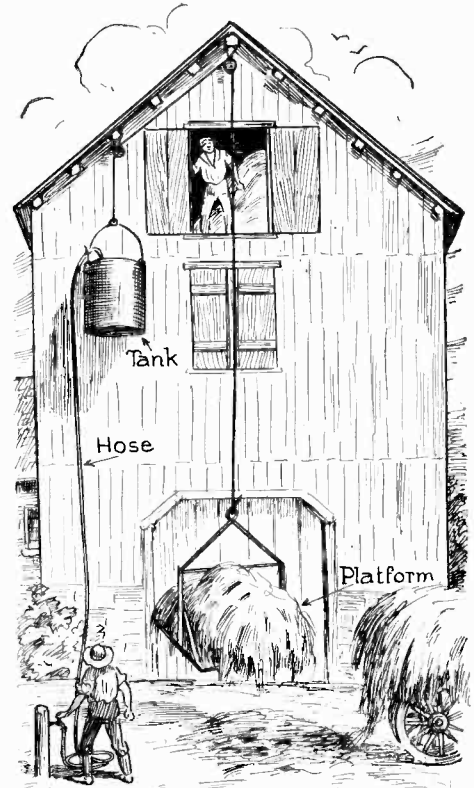

Where a supply of water is available, a serviceable elevator for farm work may be easily constructed as shown above. A length of garden hose fills the large container with water, over-balancing the weight of the load, and carrying it up. The water is then turned out of the container, and the elevator is lowered for another loading.

—Dare R. Van Horn.

Thimble Ice Factory

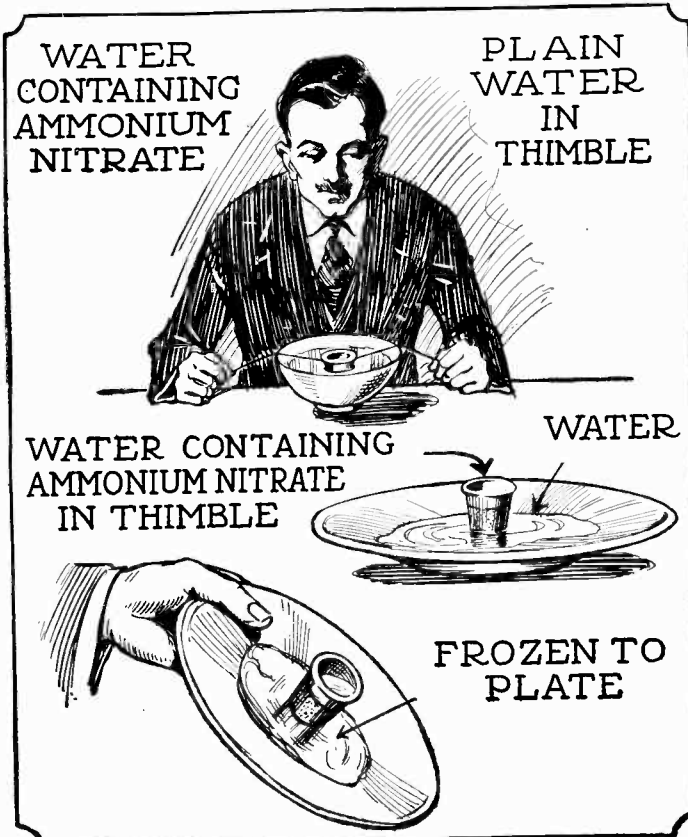

Because of the great amount of heat taken up by the solution of ammonium-nitrate in water, ice is made in a saucer on the hottest day by simply placing a thimble full of the salt dissolved in water in the center of a saucer containing a little water.

—Dr. Albert Neuberger.

Simple Shower Bath



By drilling a few holes in the hose connection attached to the bathroom faucet, and inserting a stopper, as shown above, a very serviceable shower bath attachment is made. A string directs the spray.

—Harold Jackson.

Sketching Attachment for Microscope

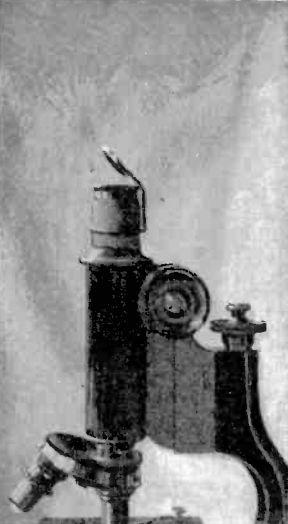

MORE often than not the amateur chemist is unable to look at his subject through a microscope with one eye and with the other sketch the subject as it appears magnified. With the aid of the very simple device shown here it is possible to project the image directly on to a piece of white paper, making it only necessary for the observer to follow the lines and images cast on the paper with his pencil, in order to have a perfect reproduction of the specimen. The whole appliance consists of a paper collar and a dentist's mirror.

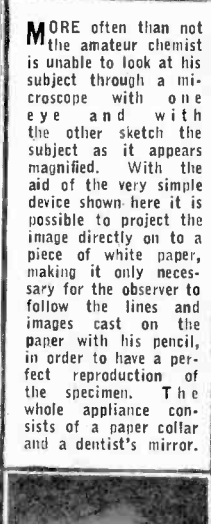





DENTIST MIRROR
SLIDE
SHIELDED HOUSING (TIN CAN)



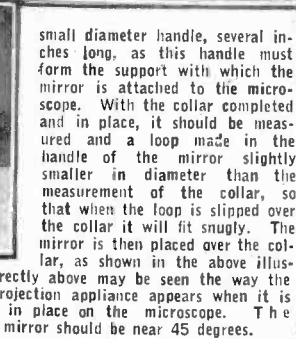

small diameter handle, several inches long, as this handle must form the support with which the mirror is attached to the microscope. With the collar completed and in place, it should be measured and a loop made in the handle of the mirror slightly smaller in diameter than the measurement of the collar, so that when the loop is slipped over the collar it will fit snugly. The mirror is then placed over the collar, as shown in the above illustration. Directly above may be seen the completed projection appliance appears when it is finished and in place on the microscope. The angle of the mirror should be near 45 degrees.

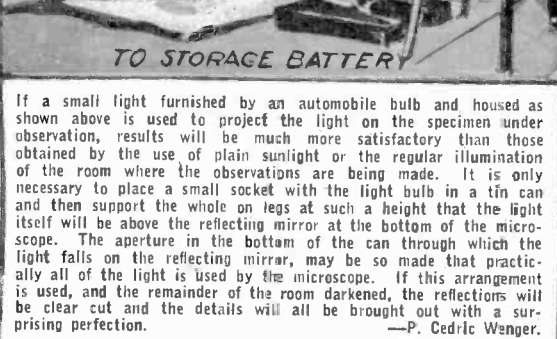



TO STORAGE BATTERY

If a small light furnished by an automobile bulb and housed as shown above is used to project the light on the specimen under observation, results will be much more satisfactory than those obtained by the use of plain sunlight or the regular illumination of the room where the observations are being made. It is only necessary to place a small socket with the light bulb in a tin can and then support the whole on legs at such a height that the light itself will be above the reflecting mirror at the bottom of the microscope. The aperture in the bottom of the can through which the light falls on the reflecting mirror, may be so made that practically all of the light is used by the microscope. If this arrangement is used, and the remainder of the room darkened, the reflections will be clear cut and the details will all be brought out with a surprising perfection.

—P. Cedric Wenger.

Method for Making Concrete Basins









Many uses present themselves for concrete containers or basins but few of them are used by the layman and amateur on account of the difficulties connected with making the forms in which they must be cast. By the method shown here, using two ordinary kitchen pans of different sizes basins of almost any capacity may easily be made with minimum work. The outside pan must be several inches higher than the one used inside to allow for the thickness of the base. A mixture of one part cement and three parts finely screened sand will be found to be most practicable in the manufacture of these dishes. The inside pan is placed carefully concentric with the outer pan and the concrete is mixed to a consistency which will allow its being puddled. The cast should be allowed to dry three days before it is put into use. The finished basin should be painted with cement and water.

—Dale R. Van Horn.

Serviceable Camera Stand

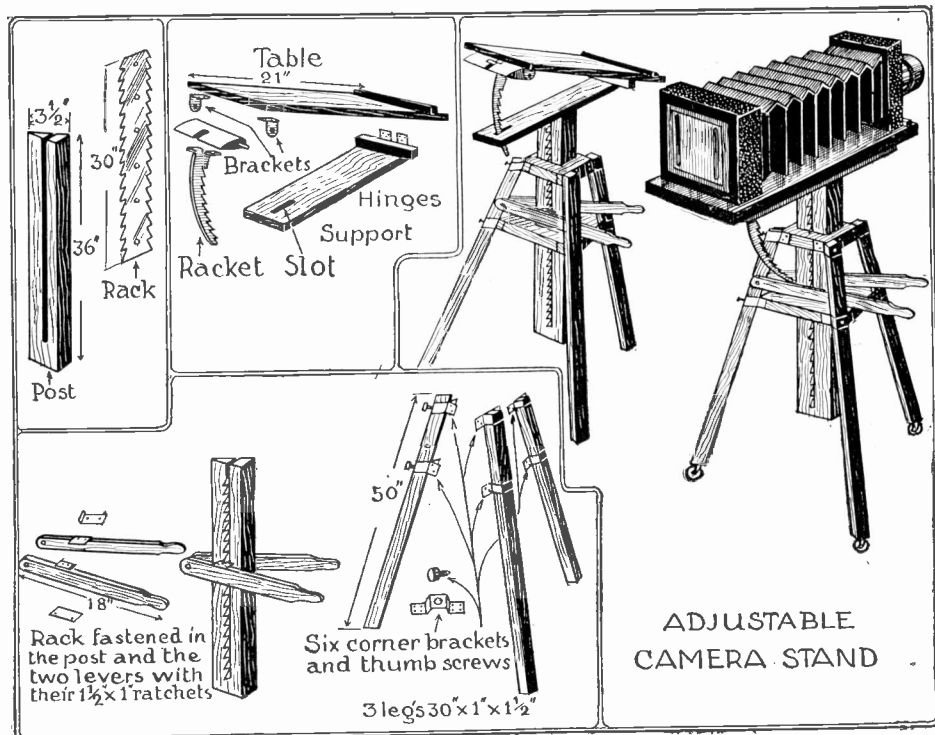

The amateur with a long bellows camera will experience no little difficulty in focusing close-ups on the ordinary tripod or well known stack of books. Just an ordinary camera adequately mounted is half the battle. The sketches illustrate a camera stand constructed by the author which meets all requirements. The sheet iron corner brackets are bent to fit around the legs, which may be easily inserted and are held in place by six thumbscrews. The top or table is 11 by 21 inches, adapting the stand to all sizes of cameras. The camera is raised and lowered vertically by the two levers and tilted by a rack as shown. The triangular shaped vertical post, which has $3\frac{1}{2}$ inch faces and is 36 inches long, is slotted with a rip-saw to receive the rack. This rack, cut out with tin-snips from sheet iron, is 30 inches long. The table is hinged to its support. This support, which is screwed to the top of the post, is slotted to receive the tilting rack. This rack, cut from sheet iron, is mounted on a block of wood which is pivoted with brackets at the sides as shown. —J. T. Garver.

Small Drill

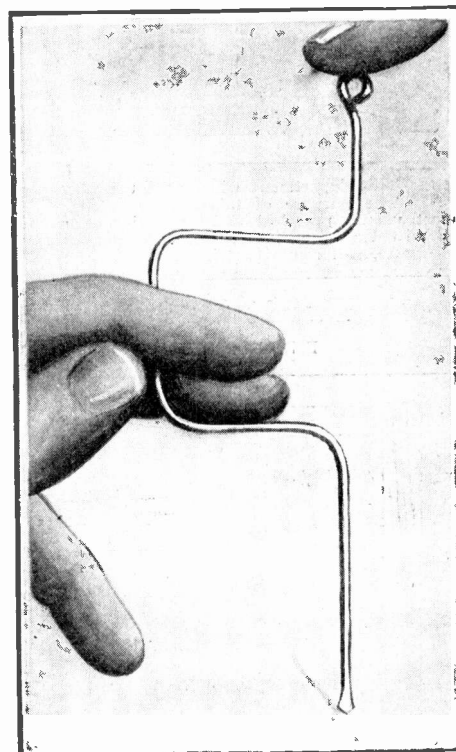

The photograph shows how a small drill may be made in an emergency. The point, of course, must be filed drill-fashion and then tempered. The bent corners should also be tempered unless the wire is very thick and is not in danger of bending under the pressure needed. —V. B. Rickey.

AN INTERESTING ILLUSION

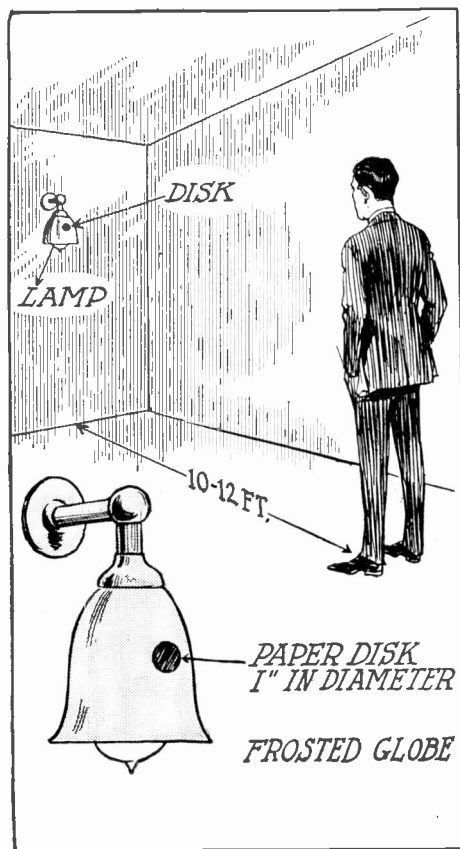

EFFICIENT FIRE ALARM

If a paper disk about an inch in diameter is pasted to a frosted lamp shade as shown at the left, and is looked at from a distance of ten or twelve feet, it will seem only about half its regular size when it first comes into the range of vision. It will then gradually grow to normal.

In the illustrations below is shown a very efficient method for equipping a basement, garage or barn with a dependable fire alarm cheaply. Between the rafters or studding, a heavy cord is stretched and one end is connected with a switch, as shown. A strong spring is attached to the handle of the switch tending to close it. The connection is held open by the cord. Across the room laterally and connected to the main cord, are attached smaller ones. They are tightened in such a way as to leave the main cord in a zig-zag course, as shown, so in case any one of the lateral cords is burned or broken it will immediately release enough of the main cord to close the switch. The switch is attached to dry batteries and a gong. The circuit is equipped with a second switch allowing the bell to be taken out of circuit in case repairs are necessary. —Frank W. Nightingale.

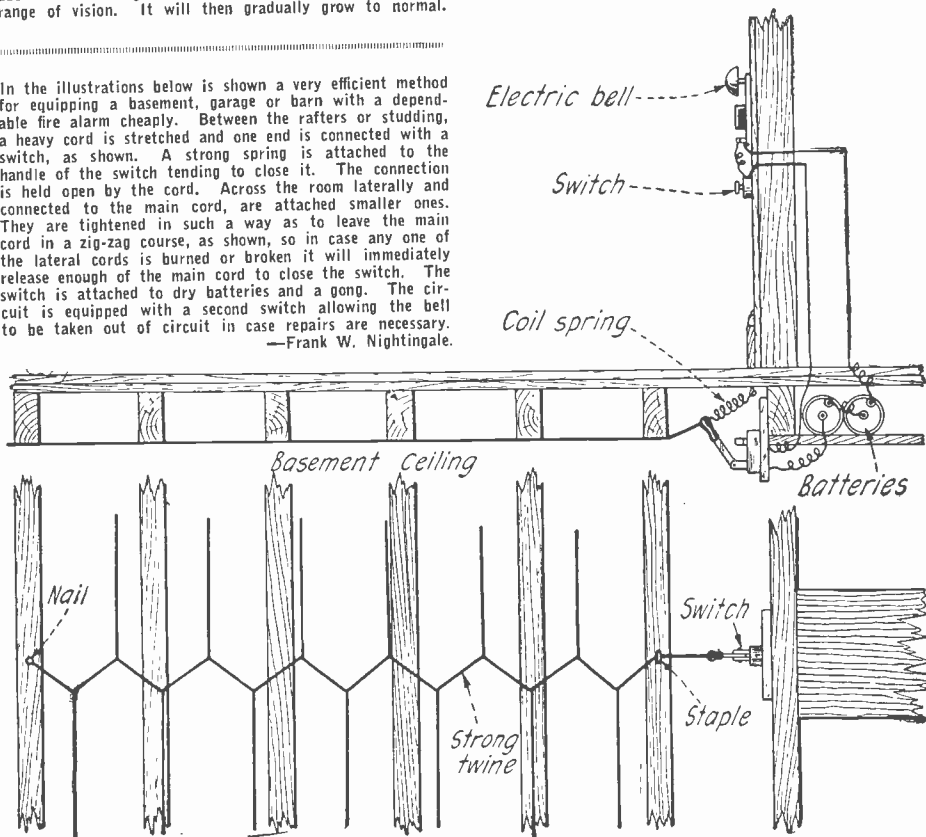



HOW-TO-MAKE-IT



This department will award the following monthly prizes: First prize, \$15.00; second prize, \$10.00; third prize, \$5.00. The purpose of this department is to stimulate experimenters toward accomplishing new things with old apparatus or old material, and for the most useful, practical and original idea submitted to the Editors of this department a monthly series of prizes will be awarded. For the best idea submitted a prize of \$15.00 is awarded; for the second best idea a \$10.00 prize, and for the third best a prize of \$5.00. The article need not be very elaborate, and rough sketches are sufficient. We will make the mechanical drawings. Use only one side of sheet. Make sketches on separate sheets.

Fruit Press

FIRST PRIZE \$15

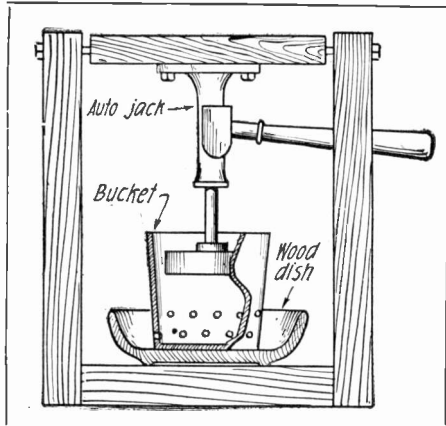

Into a large wood frame constructed as shown above, put a large bucket with two lines of holes drilled around the bottom. Place the fruit to be pressed in the bucket, and on top of it place a circular wooden block, which will fit snugly inside the bucket. Press the fruit by using an automobile jack between the wooden frame and the block on top of the fruit. It is then only necessary to run the jack down, squeezing the fruit through the small holes. For convenience keep a pan beneath the bucket.

—Charles H. Carr.

Magic Lantern

SECOND PRIZE \$10

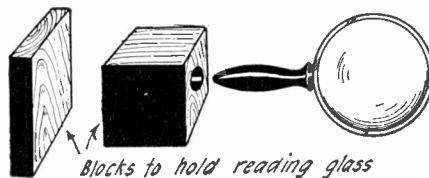
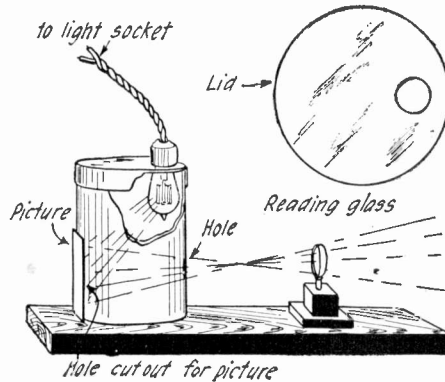

Shutter Trip

THIRD PRIZE \$5

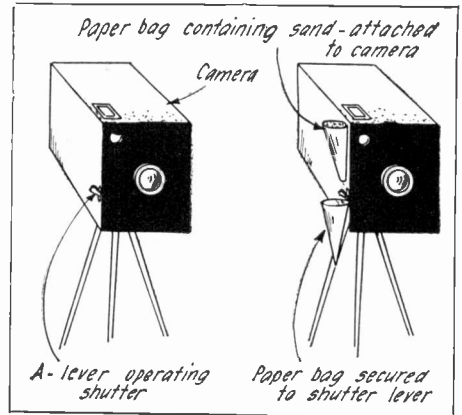

By fastening a paper cone to the shutter of a camera and then placing a second cone of sand above it, allowing the sand to fall into the first one, a time trip is made.

—J. Stevenghagen.

If the light from an ordinary 60-watt lamp is caused to fall on a picture, and the rays passed through a reading glass, a satisfactory magic lantern results. The light and picture are fixed in a bucket or can, as shown. The beams then pass through a hole in the front of the can, then through the reading glass.

—George W. Morton.

Watch Crystal Lens

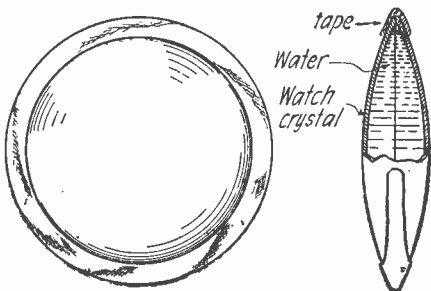

A very serviceable lens can be made by filling two watch glasses, which have been thoroughly waxed and polished, with water, and then sealing the edges. A little grease (vaseline) is smeared carefully around the edges of the glasses, after which they are dipped into the water and put together. Be careful that no air is allowed to remain between them. The lens is then removed, bound with surgeon's adhesive tape, and the edges given a slight coat of vaseline.

—Carlyle Weiss.

Electrical Centrifuge

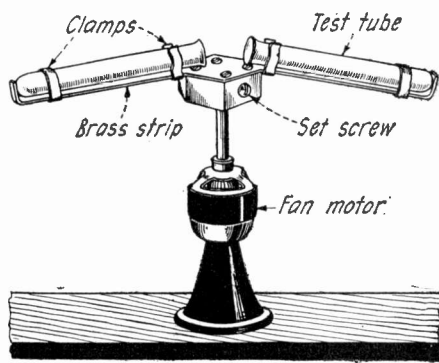

By cutting a strip of sheet iron to hold test tubes, as shown above, screwing it tightly to the wooden block, which has a set-screw, and making the whole fast to a fan shaft, an electrical centrifuge is made.

—Dr. E. T. Sonendriker.

Receiver Silencer

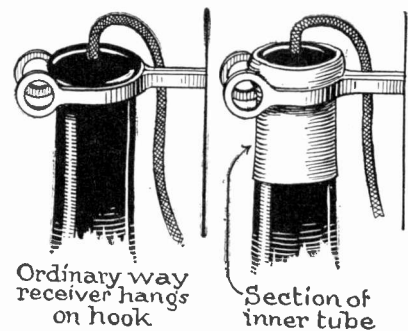

The clatter and mishaps befalling frequently used telephones may be avoided by covering their tops with a short length of inner tube or large rubber hose, as shown above. This precaution will pay for itself many times in broken receiver caps and tempers.

—L. B. Robbins.

Nipple Placer

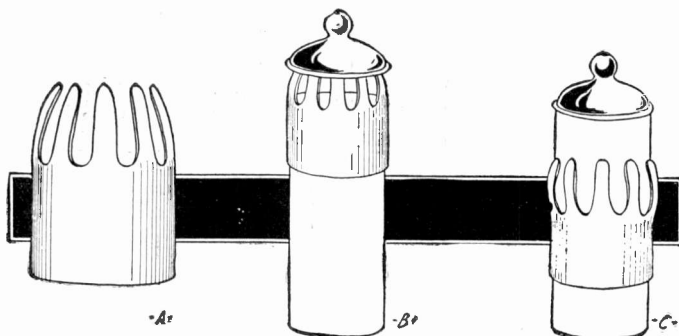

By using the metal cone, constructed as shown in the accompanying illustration, the trouble experienced in placing a nipple on the large-mouthed baby bottles, will be greatly reduced. After use, the cone is removed over the body of the bottle as shown.

—Jay G. Hobson.

Sheets of tin about 20 inches high, cut and fitted with springs, as shown, set behind a typewriter, make excellent copy holders. On the one to the right, the sheets to be copied are merely set on the protruding lugs, while on the one to the left the stenographer's notebook is placed under the spring wire clips.

—Jacob Schmidt.

Typist's Help

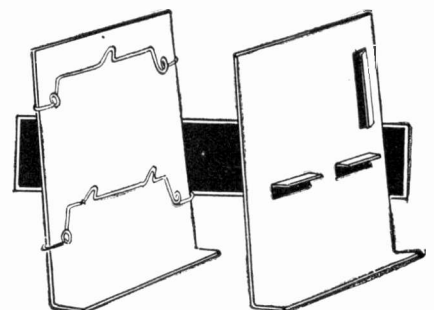



WRINKLES

RECIPES & FORMULAS



Edited by S. GERNSBACK

Sugar-Soap Experiments



Above is illustrated an experiment showing the difference of effects caused by the currents formed on top of a basin of water by substances which are porous and non-porous, and are dissolved in water. Small particles of candle grease are dropped on the edge of the water in the basin, as shown. If a lump of sugar is placed in the center of the pan, the particles are attracted to it. If soap is used instead, they are repelled.

—Dr. Albert Neuburger.

Measured Chemicals

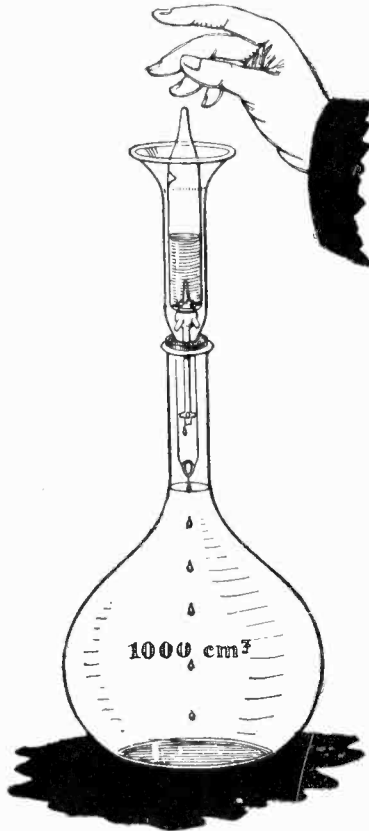

Knowing the difficulty of amateur chemists in analytical work on account of the high price of the necessary balances on which to weigh chemicals in quantitative work, a New York firm has placed small containers of chemicals very accurately weighed, on the market. The chemical comes dissolved in a known amount of distilled water in an hermetically sealed tube. This tube is broken into a special funnel as shown in the drawing above. By this method the amateur may carry on his work with the accuracy of the expert.

—Raymond B. Wailes.

Fire Under Water Stunt

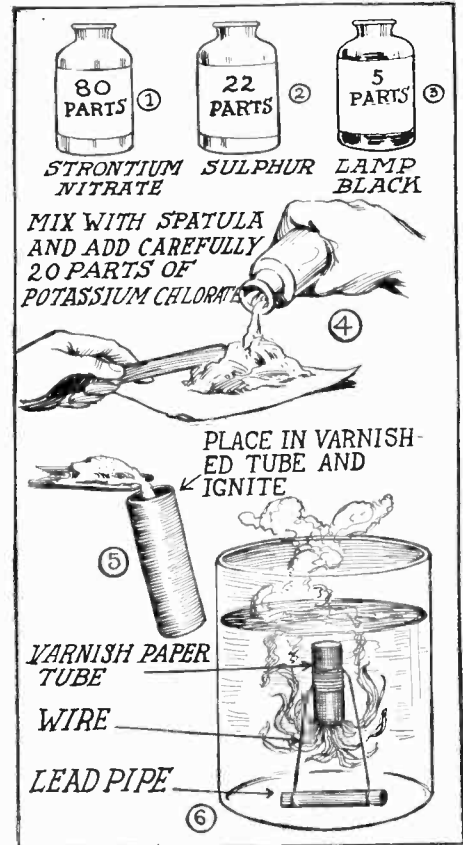

By mixing the chemicals in the ratios shown in the above sketch very carefully, adding the potassium chloride last, and placing them in a varnished tube supported by wires, attached to a lead pipe, igniting the chemicals and placing the whole in a jar of water, the fire can be made to burn and the flames pass up through water. The lead pipe is used to hold the tube and chemicals under the water.

—Orhan R. Coblentz.

Hot Water Bottle

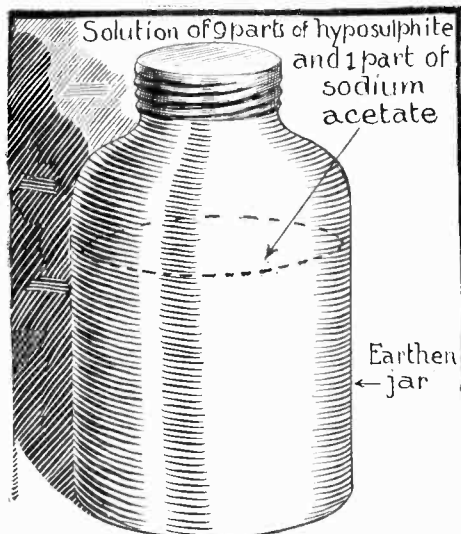

Above is shown the construction of a simple chemical hot water bottle. An earthenware jar is used into which a solution of nine parts of sodium hyposulphite and one part of sodium acetate are poured.

—Poly Rene.

Specific Gravity Balance

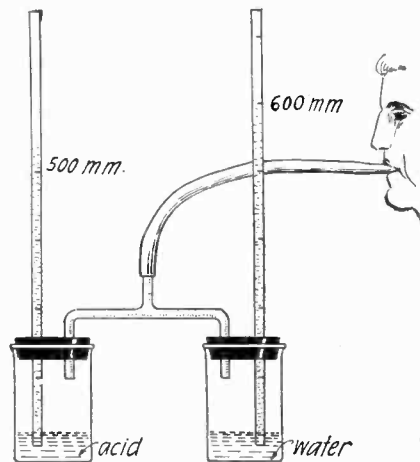

By comparing the height of an unknown liquid with the height of water in two equally sized tubes, under the same amount of air pressure, as shown, the specific gravity of the unknown liquid may be ascertained by calculating the ratio of the height of the two liquids used. Fifty centimeter beakers and six millimeter inside-diameter tubes serve well.

—J. L. Gripps.

Pendulum Graph

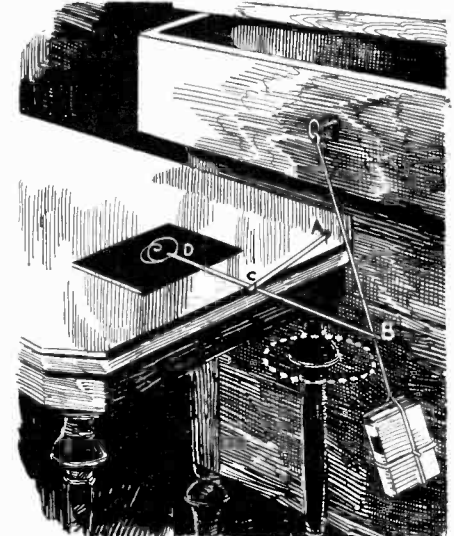

A pendulum made to swing so that it will not pass and re-pass through its vertical position will describe an ellipse which turns slowly about its center. This is proven with the graph apparatus, constructed as shown above.

—Ben Zyt.

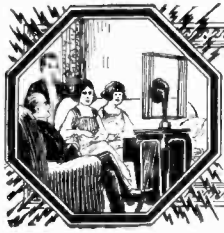

RADIO

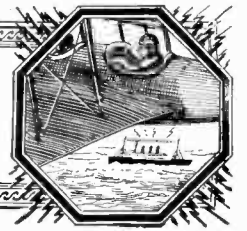

Broadcasting the President's Message

By A. P. PECK.

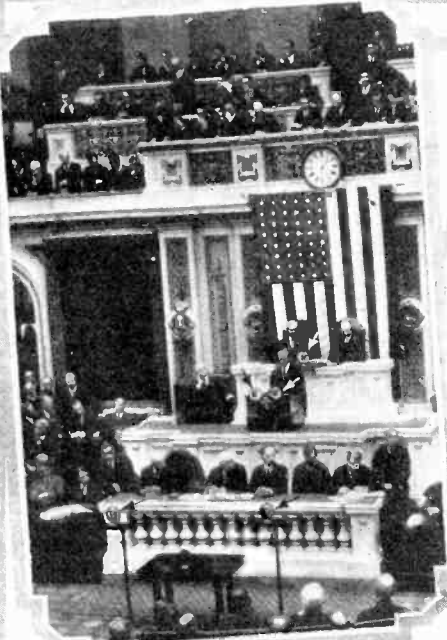

For the first time in the history of our country, microphones for use in broadcasting speech were installed in the halls of Congress and were used for broadcasting President Coolidge's message to Congress and as a result hundreds of thousands of citizens throughout the United States were able to hear clearly and distinctly every word of the message. The photograph at the left shows the President as he stood delivering his message. Two microphones directly in front of him are indicated by arrows. Other microphones were installed in the House at the places indicated. By means of this system it was possible to send out electric currents fluctuating in accordance with the President's voice to six radio stations throughout the United States. At these stations the message was transformed into radio waves and broadcast. Many telephone engineers of the Bell System were busily engaged for several days in installing the special apparatus used and testing the circuits so that no mishap would occur during the course of the message. Thousands of people also congregated in front of the Capitol and loud speakers were installed on the steps, which worked from the power amplifiers stationed in the basement.

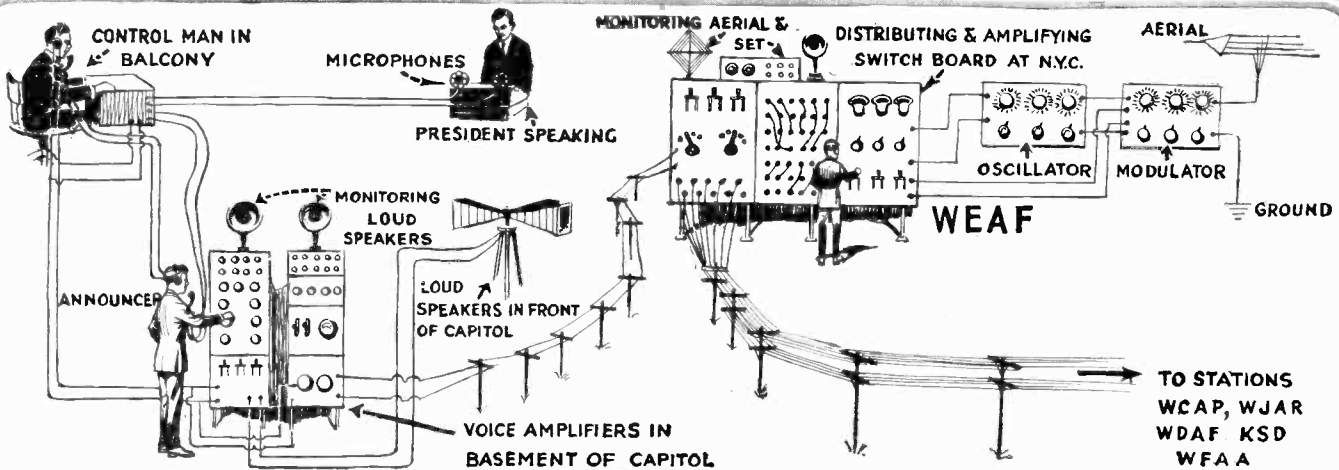

The drawing above shows, in simplified form, the apparatus used for broadcasting the President's address. The microphones directly in front of the President were controlled by an engineer stationed in the gallery of the House. The microphone of the announcer was also connected to the control box. By this arrangement the engineer in the gallery watched the President and other speakers and communicated with the announcer, thus keeping the system working in perfect unity. At this control either the microphone of the announcer or those in front of the President were cut into the voice amplifier circuit. It is interesting to know that every piece of apparatus used in this broadcasting feat was provided in duplicate and so arranged that either one or the other of the instruments could be used. This was just another safeguard provided by the broadcasting company. Every piece of apparatus was carefully watched by a competent telephone engineer and frequently tested.



The photograph at the left shows the control engineer with a small switchboard located in the gallery. Note in the diagram, how after being amplified by the instruments in the basement of the Capitol the modulated electric currents were sent out over telephone lines and underground cables to station WEAF, located at 195 Broadway, New York City. Another check-up was made at this point by means of the monitoring set indicated. From the control board at station WEAF telephone lines extended to the various other stations indicated. These stations are located throughout the United States and enabled everyone with a radio set within the borders of the country to hear the President's speech. At various points along the telephone lines from WEAF to Washington and from WEAF to the various other broadcasting stations were located repeater or amplifying stations. These amplifying stations were provided with vacuum tubes which stepped up the incoming current and sent it out on the line again. The current strength was thus maintained until it reached the broadcast station.

Radio Cheers Hospital Patients

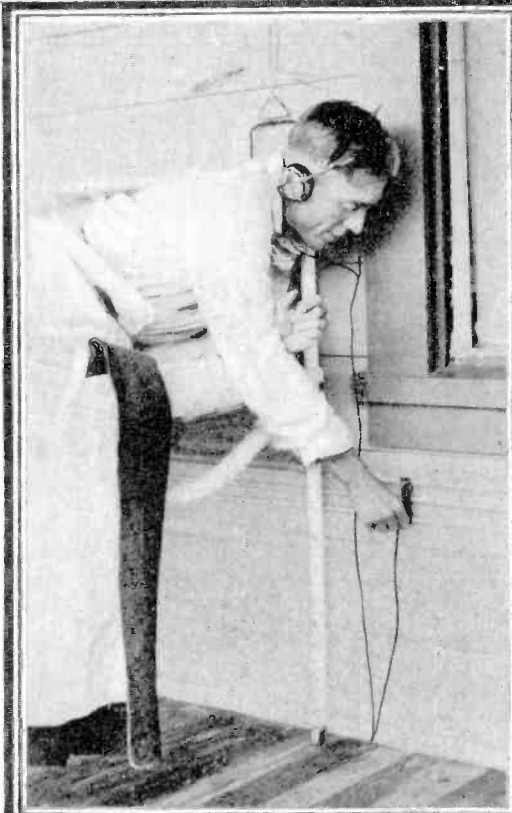

The patient in the above photograph is plugging in his head phones on a circuit used for distributing the radio music throughout the hospital. A special type of jack is used so that the volume remains constant at each pair of phones, regardless of the number plugged in the circuit. The volume of music is just sufficient to be plainly audible in the receivers and when a patient does not desire entertainment, all he has to do is remove the plug and take off the phones.

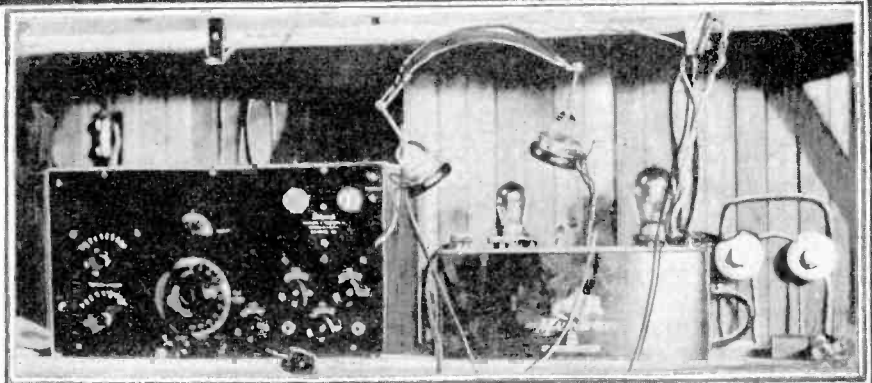

Above will be seen the receiving set used in hospital No. 64, Camp Kearney, California, where convalescent war veterans are cared for. The set consists of a standard short wave broadcast receiver with an external power amplifier so arranged that the signals will be audible in special head phones throughout the building. This is the largest radio installation of its kind in this country.



The above photograph is a view of one of the hospital wards, showing the many patients with receivers on their heads. This form of entertainment has proven highly successful and contributes greatly to the comfort of the inmates of the institution. In this installation 9,000 feet of wire are used for connecting to seven separate wards. One hundred and twenty phones are used.
—M. Wiley—Reporter No. 3527.

The Diversified Uses of Radio

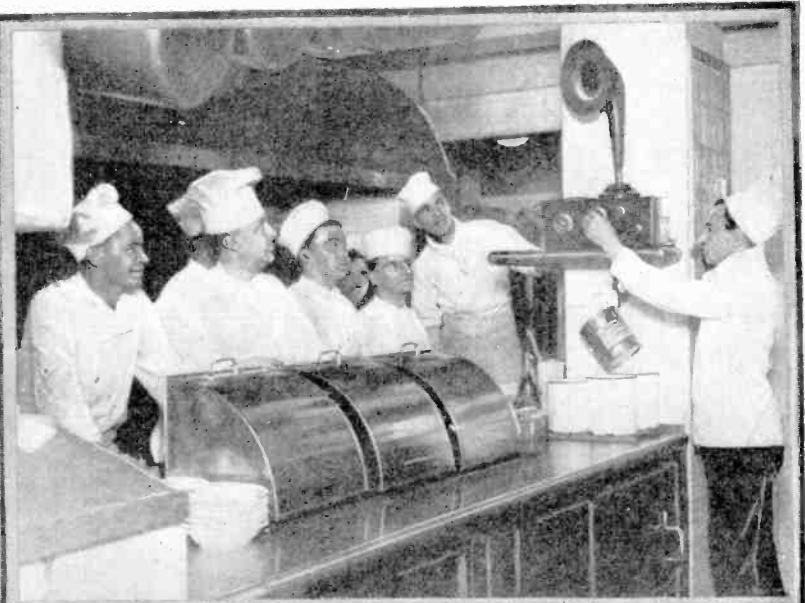

No longer need one who desires a haircut or shave listen to the rambling conversation of the barber. At the left will be seen the method used for eliminating this annoyance. A radio set has been installed in the barber shop and music is constantly forthcoming, thereby turning a duty that used to be borne of necessity into an actual pleasure. Directly above is shown another use of radio by means of which the chefs in a large hotel kitchen are entertained by good music and thereby influenced to turn out better meals. The strains of radio music seem to be an exhilarating effect and cause the men to work faster and take an interest in their duties.

BROADCAST ÷ STATIONS



THE question "What becomes of the hams?" has been asked time and again by those who trouble themselves over such things. The picture at the top and to the right will show what has become of one "ham," as the more advanced amateur radio operators are called. These two photos are of broadcasting station WRAY, Scranton, Pennsylvania, which is owned and operated by John Harvard Jones, known to the listeners acquainted with his wave length and his station as "Casey." The two photos of the station show the interior of the studio. The construction follows the usual principles. One of the greatest problems in connection with operating a broadcasting station in a town of comparatively small population is the problem of supplying talent when there is a program to be given every night. This was one of the greatest problems that confronted the owner and operator of WRAY. He solved it in a truly workmanlike way by running a private wire to the town's two chief places of amusement—a theatre and a concert hall. By careful construction and much experimenting all the kinks were taken out of the land line business until it now delivers the voice to the radio microphone with all clearness.

In the photo below is seen station WIAO, at the School of Engineering, Milwaukee, Wisconsin. The broadcasting is done on a two tube 100 watt set.



Radio for the Beginner

Information on Circuits of Interest to All Amateurs.

By ARMSTRONG PERRY

No. 24.—Single Tube Circuits.

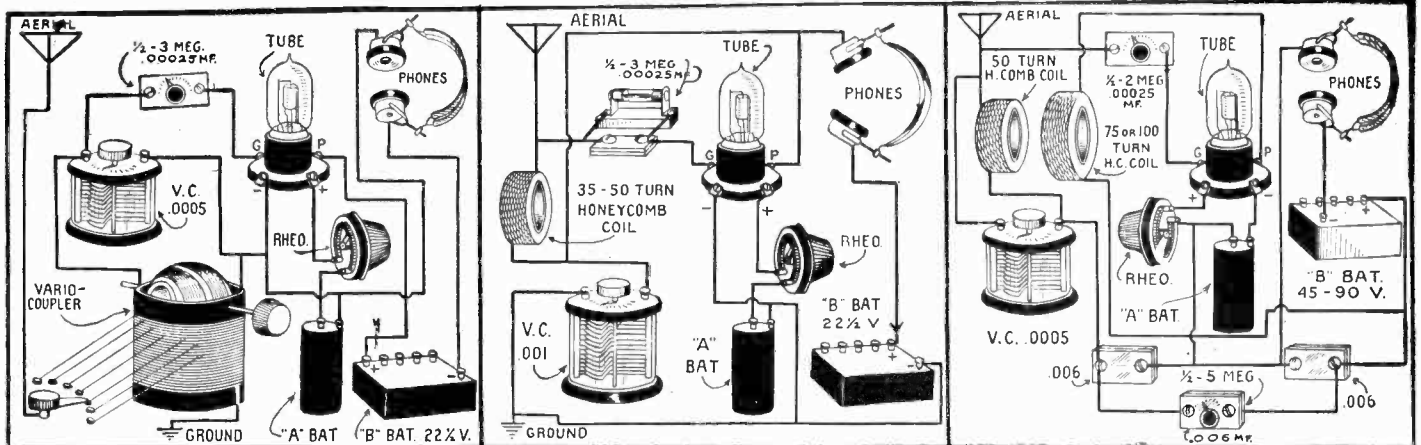

The above circuit diagram shows a vacuum tube connected as a straight detector. This circuit serves very well to study the action of the detector tube. For short range reception it gives very clear signals. Practically no distortion will be found in this circuit because of the absence of regeneration.

An adaptation of the De Forest ultra-audio or oscillating circuit is shown above. In this set the tuning controls are reduced to one—the variable condenser. Honeycomb coils of various sizes should be tried in this circuit until the size which gives best results is found. For broadcast reception, use a 35, 50 or 75 turn coil.

A simplified "super" of the Flewelling type is shown above. Three fixed condensers with a capacity of .006 mf. give rise to the variation frequency; a distinctive feature of any super. Shunted directly across the lowermost condenser in the diagram above is a variable resistance, ranging from one-half to five megohms.

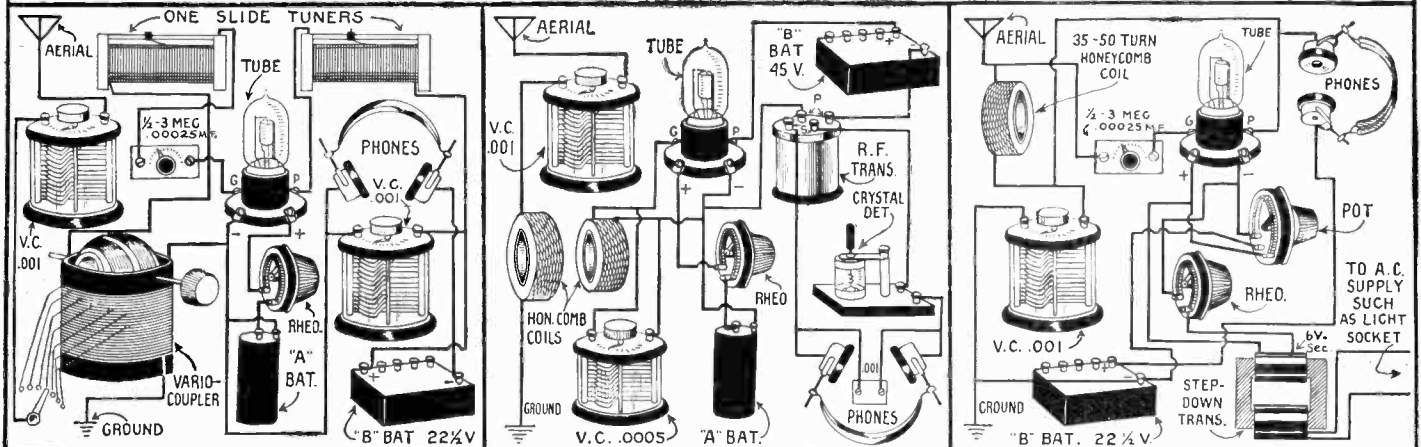

A variation of the standard three circuit tuner consisting of a variocoupler and two variometers is shown above. The two variometers are replaced in this circuit by two one-slide tuners. The operation of this set is similar to a three-circuit tuner. The sliders on the coils, however, are used instead of the knobs of the variometers.

In the circuit diagram shown above, a vacuum tube is employed as a radio frequency amplifier and a crystal detector is placed in the circuit for rectification. The antenna and secondary circuits are tuned with honeycomb coils. Even though no regeneration is used, very good results on "DX" reception may be expected.

It is possible to employ 110-volt A. C. circuit for lighting the filament of a vacuum tube. The hum caused by the A.C. can be cut down by shunting a 200-ohm potentiometer directly across the filament circuit and connecting the grid return to the center post. The potentiometer is varied until the hum is reduced.

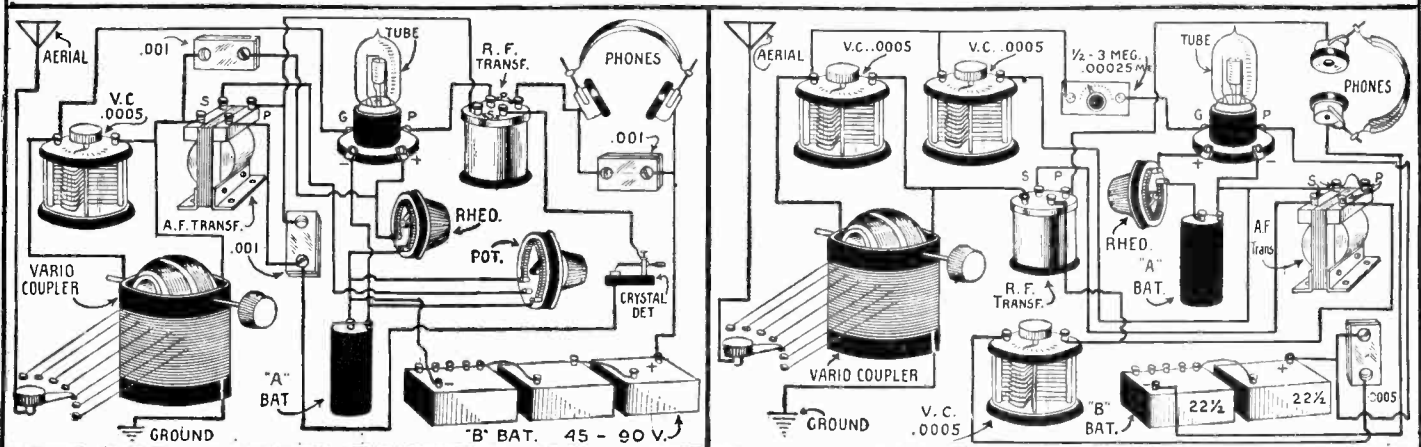

Radio and audio frequency amplification may be accomplished with one tube, using a crystal detector for rectification as shown above. In experimenting with a circuit of this type, the amateur should always have at hand two or three different types of both radio and audio frequency transformers, so that he may experiment with them and check the working qualities of the various types against each other. It is often found that certain types of radio frequency transformers will not give good results.

The above circuit diagram shows how both radio and audio frequency amplification as well as rectification may be obtained with the same vacuum tube. This circuit is very critical and is not one of the type which can be hooked up and made to work properly at once. Considerable experimentation is necessary in connection with the various instruments. Radio frequency amplifying transformers should be carefully selected and tested in a set of this type before one of them is permanently mounted.

Radio Trouble Shooting

Illustrating Several Places Where Trouble May Be Encountered.

BY JACK MILLIGRAM.

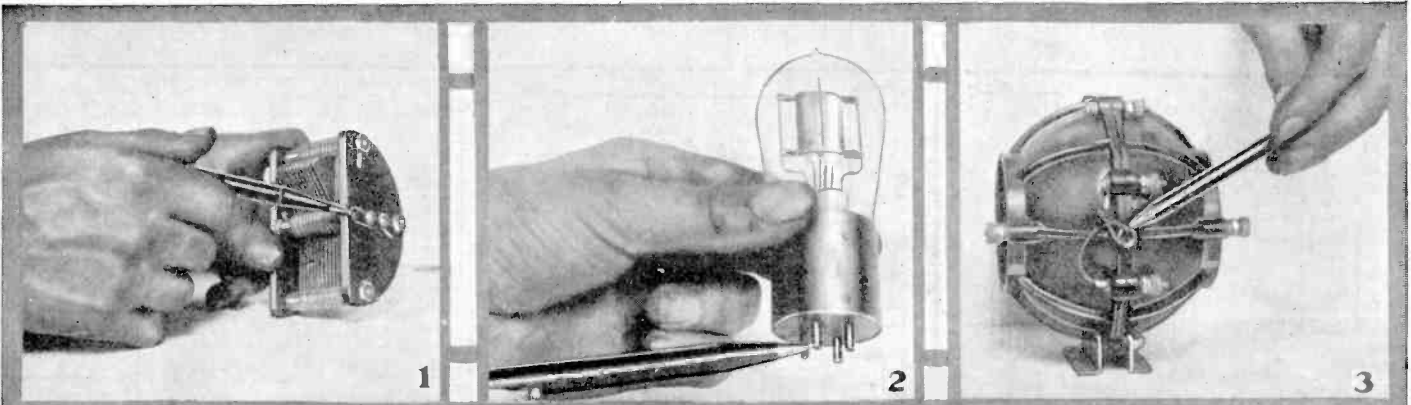

One of the greatest bug-bears of radio instruments is the sliding contact. In the above photo, the pencil points to a sliding contact by means of which connection is made to the rotating plates of a standard type of variable condenser. Great losses are very often found here especially when the contact lever becomes loosened. Such connections should be avoided. If it is necessary to purchase instruments of this type, a flexible lead wire should be used.

Very often the base of a vacuum tube is the seat of trouble in a radio receiving set, but usually this is the last point considered by the amateur when hunting trouble. The pencil in the above photograph points to the end of one of the prongs of a vacuum tube. This point should be carefully cleaned with fine emery paper, making sure that no traces of the emery are left in the soft solder found at this point. Corrosion should not be tolerated at these prongs.

Variometers also have their troubles when it comes to the question of making connections to the interior or rotor coil. Above is shown one of the best forms of making such connections. The shaft on which the rotor is mounted is a hollow brass tube and through it are brought the leads from the rotor windings. These leads are of the flexible or "pigtail" type. Stops must be employed so that the rotor will not turn through more than 360 degrees.

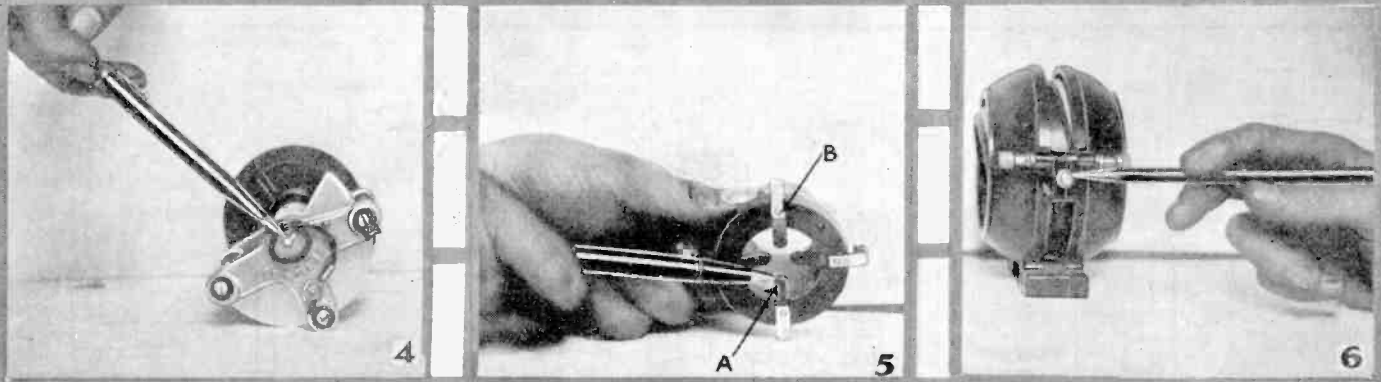

The main trouble with rotary variable condensers was illustrated in Fig. 1. Above in Fig. 4 is shown a standard type of variable condenser in which this trouble is eliminated by the manufacturer. It is necessary for the "pigtail" to turn so as to follow the rotary shaft. Therefore, it must be thoroughly flexible so that it will not break after being turned several times. Here again stops should be provided so that the pigtail cannot twist too far.

Now we come to the troubles of the sockets into which the vacuum tube illustrated in Fig. 2 fits. Many radio ailments are attributed to innocent sources when in reality the blame should be laid on the vacuum tube socket. In the type illustrated above, point A shows one of the lugs bent out so that it does not make contact with the base of the tube. Point B shows where poor contact is very often found between the binding post support and the spring.

The best type of connection for the rotor coils of a variometer is shown in Fig. 3. Above, in Fig. 6, we illustrate a type of variometer which depends upon a sliding contact to connect the rotor coils to the external circuit. Sometimes this works very well, but after much use the bearings usually become enlarged from constant wear and fail to make proper contact. Obviously, such points cannot very well be lubricated and, therefore, the wear increases greatly.

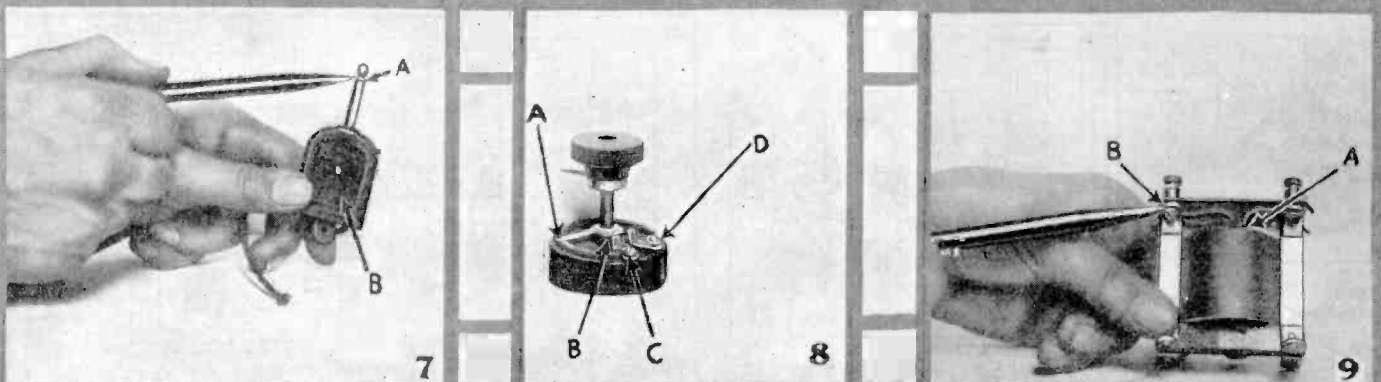

A indicates the small insulating disc placed between the two parts of the plug which make contact with two separate springs in the jack. Very often this ring is made of fibre and when it absorbs moisture from the air it becomes a partial conductor. This point should be watched carefully. B indicates the portion of the plug in which contact is made between the phone tips and the plug. Only the type of plug which grips the phone tips firmly should be used.

There are several points on a rheostat which can give rise to trouble. In the above illustration, A indicates the contact arm. Sometimes this arm becomes loosened or the spring is weakened whereupon it fails to make contact with the coil. B indicates the connection between the switch arm and the shaft. This should be kept tight. At C is connected one end of the resistance wire. The binding posts at C and D should always be kept tight.

Very often the troubles in transformers are due to something which may readily be fixed. For instance, the connection indicated by B very often becomes loose, or if it is soldered, it sometimes becomes unfastened from the base of the binding post. A indicates the connection between the leads to the binding post and the actual windings of the transformer. No amount of strain, however small, should be placed on these leads under any condition.

Variometer and Variable Condenser Receiving Set

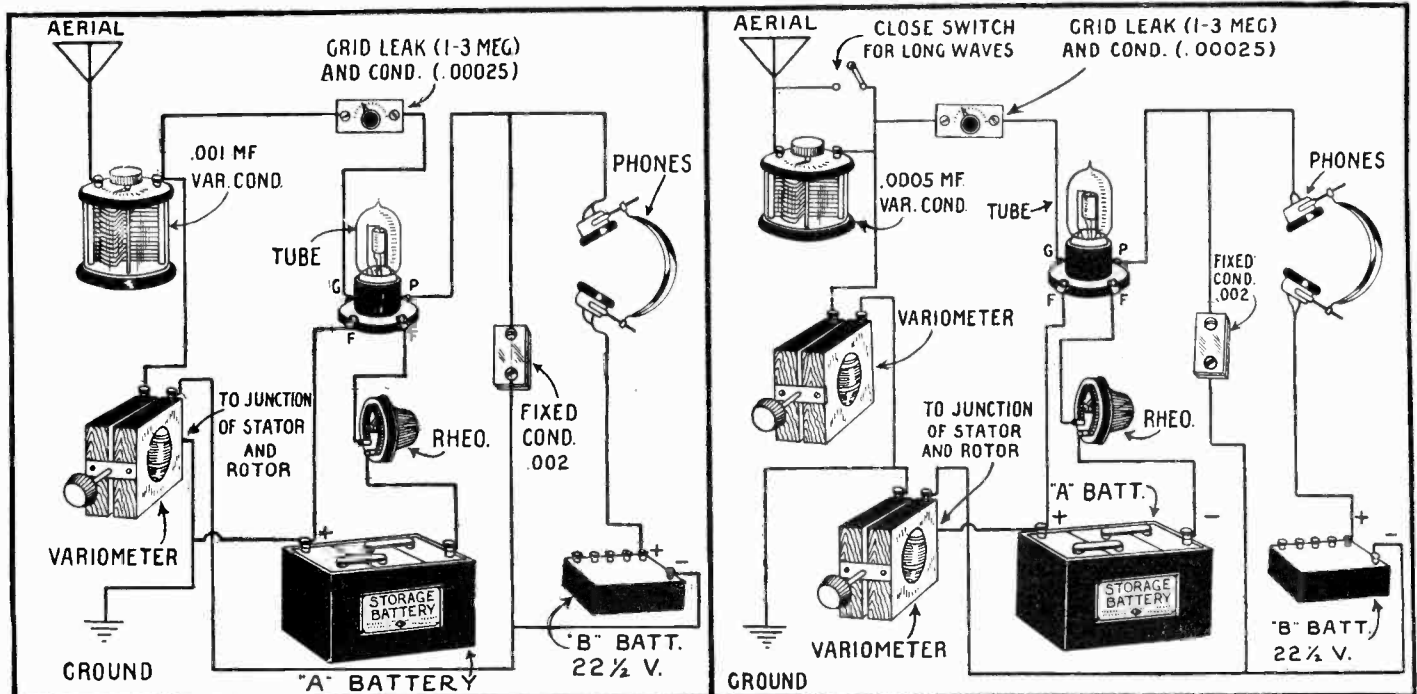

A regenerative receiver having but two controls may be connected up as shown above. Note that the ground lead goes to the junction of the rotor and stator. Since this is the case, only one-half of the total inductance of the variometer tunes the antenna circuit. Therefore, this instrument should be of quite a large size. The "B" battery should be variable from 16 to 22½ volts. Regeneration is accomplished in this case by means of the well known ultra-audion effect. If trouble is found in reaching the required wave-length, the variable condenser may be connected across the variometer from the antenna binding post to the center tap which connects to the ground. In this case, the antenna should be connected directly to the side of the grid leak which goes also to one side of the variometer.

The above circuit diagram shows two variometers connected up in a manner very similar to that originally used by Major Edwin H. Armstrong when experimenting with regenerative circuits. This utilizes a feed-back in which the lower variometer acts both as a feed-back coil and the pick-up coil for the secondary circuit. The antenna circuit is tuned by means of the variable condenser and the upper variometer and the secondary or grid circuit is tuned by means of the latter mentioned instrument. A switch is provided to short-circuit the variable condenser for longer wave-lengths and for still higher results, the variable condenser may be shunted directly across the upper variometer.

—W. L. Pearce.

Short Aerials Increase Selectivity

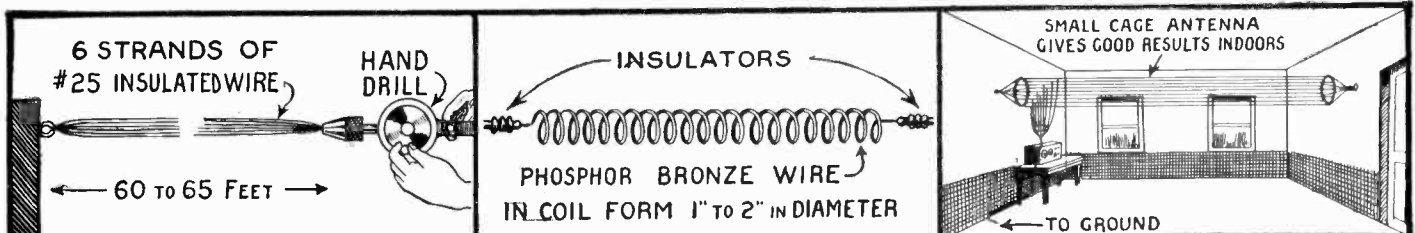

Excellent antenna wire for a short stretch may be made by twisting together six strands of wire with a hand drill as illustrated. The resulting length should be long enough to make both antenna and lead-in.

A coil form of antenna recently placed on the market is illustrated above. This is a coil of phosphor bronze wire about one inch or so in diameter which can be stretched out to as long as 100 feet.

For inside use with a very good receiving set, a cage antenna should be constructed. This aerial may have from 4 to 10 wires and the lead to the set should be composed of the same number.

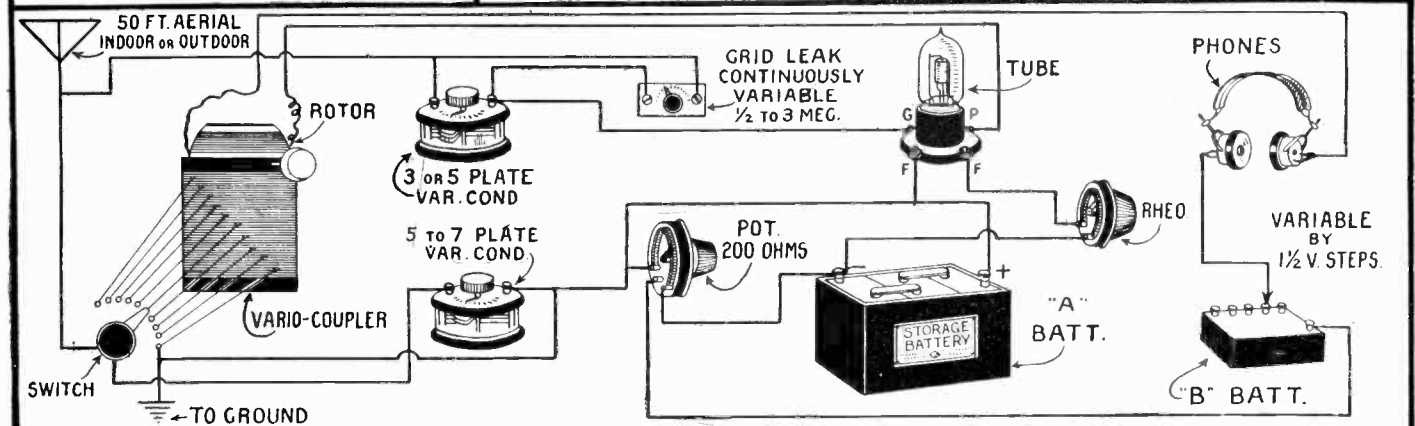

Where very short antennae are used, it will be found that selectivity will be increased considerably and if careful attention is paid to the adjustment of the instruments, there need be no loss in efficiency or volume. In order to obtain these results, only the best of instruments must be used. Bakelite insulation should be demanded on all instruments and that composition known as "mud" should be carefully avoided. The latter causes comparatively great losses as it is very often a

partial conductor. Also in order to attain good results, practically everything on the set should be variable. A variable grid condenser should be used, which should have a maximum capacity of .0003. The ground condenser may be slightly larger, in some cases even as high as .0005 mf. being advisable. A potentiometer should be used in connection with the "A" and "B" battery and the latter should be variable by 1½ volt steps as indicated above.

—Paul Oard.

"DX" Prize Winning Circuits

These Five One-Tube Circuits Won \$100.00 in Prizes.

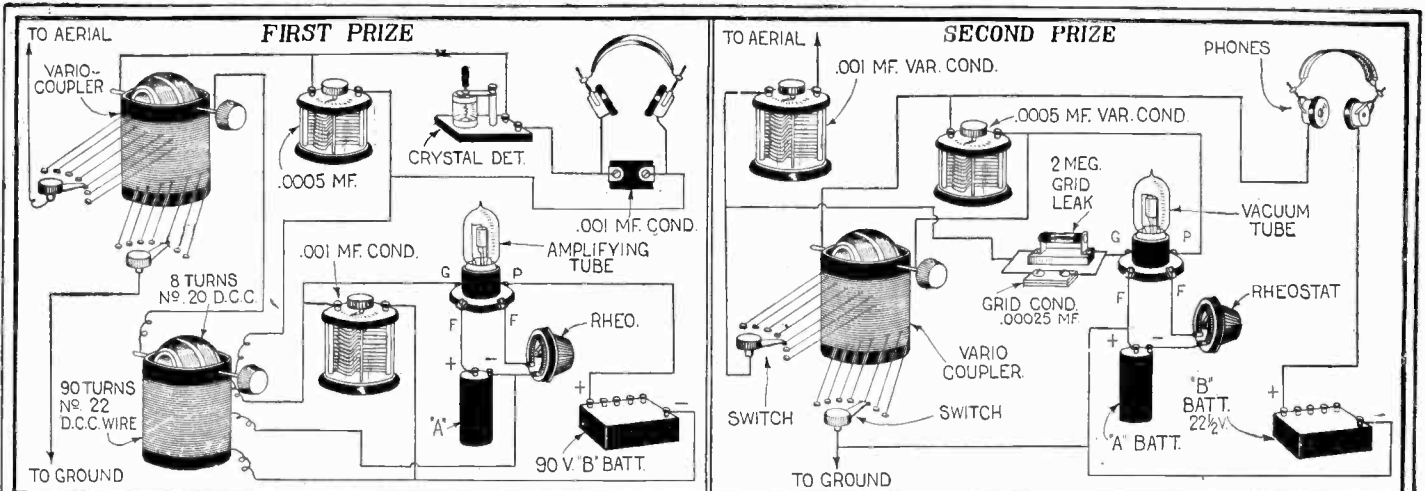

The circuit winning first prize was designed and built by Mr. R. D. B. Washburne and for it he gets a prize of \$50. The circuit is plainly shown above. It consists of an oscillator using a vacuum tube and acting upon a crystal detector circuit. All data on the necessary instruments is given in the circuit diagram. The set is tuned by tuning the coupler in series with the antenna and the .0005 mf. variable condenser. The rotor of the oscillation coupler and the .001 mf. variable condenser are then balanced until the best results are obtained.

The second prize, \$20, goes to Mr. Harry Ackerson. The circuit diagram of Mr. Ackerson's set is shown above. At first glance, it would seem that it is nothing more than a standard single circuit tuner, but there is one addition and therein lies the secret. This is a variable condenser with a small capacity which is shunted across the rotor. This condenser should have a capacity of approximately .0005 mf. The addition of this condenser allows very close tuning and it should be equipped with a vernier so that the set can be handled properly.

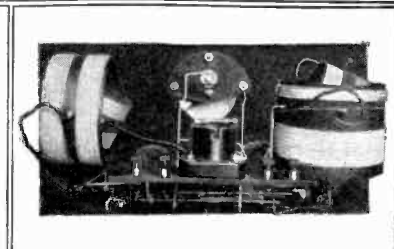
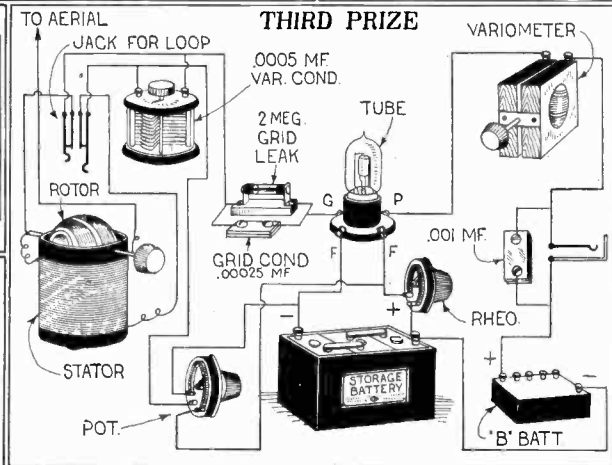
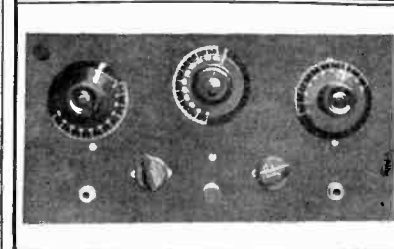

The receiving set designed by Mr. E. H. Cook is illustrated in the photograph above and to the extreme right center of this page. The prize for this set is \$15. The circuit diagram of Mr. Cook's set is shown herewith. Note particularly that no ground is used and that the variocoupler is not hooked up in the standard manner. A double circuit jack is included in the secondary circuit so that a loop may be used for local reception. Mr. Cook states that there are three different types of antennas which will operate satisfactorily with this set. One is a four-foot loop with ten turns of No. 20 wire, the second is an ordinary water pipe and the third is a standard single wire outdoor antenna 75 feet long. He states that with the second type, results almost equal to an outdoor antenna were obtained. The constructional details of the variocoupler and variometer are as follows. The stator of the former is wound

on a bakelite tube 3 1/4 inches long by 4 inches in diameter. It consists of 55 turns of No. 26 D.C.C. wire. The secondary or rotor is wound on a tube 2 inches long by 3 inches in diameter, 60 turns of No. 28 D.C.C. wire being necessary. The variometer has 65 turns of No. 26 D.C.C. wire on the stator and a like number of turns of No. 28 D.C.C. wire on the rotor. Both instruments are assembled in the usual manner and may be mounted as illustrated in the photograph. This receiving set was designed to operate over a band of wave-lengths from 200 to 600 meters. During the winter, Mr. Cook states that he had no difficulty in bringing in stations over a distance of 1,000 to 1,500 miles. He also states that the quality of the reproduced signals is very good and in many cases equal in tone to that brought in by a crystal set, while at the same time the volume is much greater.

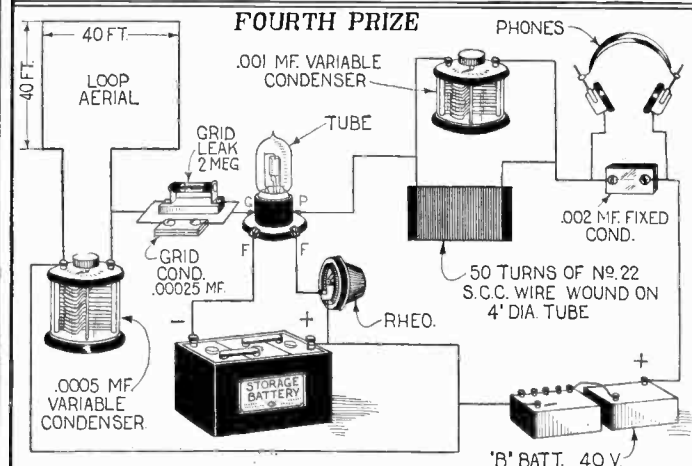

The fourth prize of \$10 goes to Mr. Jack Rogers. He has designed an extremely efficient single tube set to operate on a large outdoor loop placed in a horizontal position. The circuit diagram is given above. This set is an excellent combination of a loop receiver and a tuned plate circuit. The loop being horizontal, does not have a very great directional effect. Because no ground is used, selectivity is increased greatly and no difficulty should be found in bringing in stations over quite a long distance.

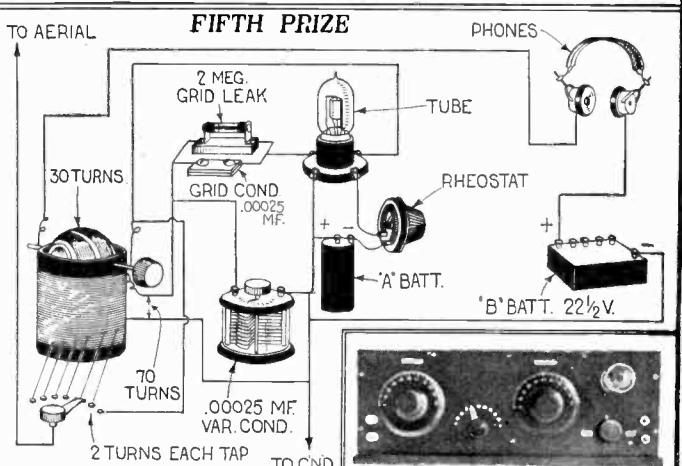

Mr. George E. Johnson, winner of the fifth prize, is awarded \$5.00. The circuit diagram of his "DX" receiver is shown above, while a photograph of the front of the set appears in the lower right corner. The variocoupler stator is wound on a 4-inch tube. Seven switch points are used, six of them connected to taps on the stator and one to the plate. By placing the switch blade on this point, an excellent oscillating circuit is obtained for use in the reception of C.W. signals. On phone and spark, this set tunes rather sharply and will bring in "DX" signals very well.

Loud Talker Set Prize Winners

These Five Circuits Were Selected for the Volume Obtained.

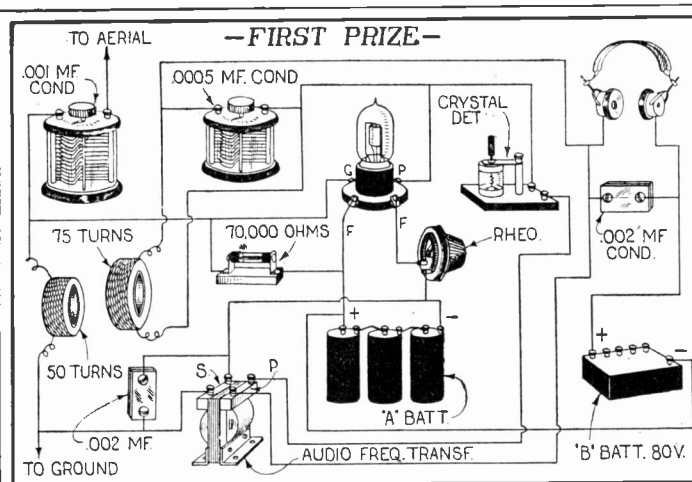

The first prize, \$50, in our Single Tube Loud Talker Contest is awarded to Mr. Harry Hahlbohm for the set; circuit diagram given above. Radio frequency amplification is obtained by means of the tickler feed-back which acts as a tuned impedance radio frequency amplifying coil. Audio frequency amplification is obtained through a standard audio frequency amplifying transformer. The main feature of this circuit which must be followed carefully is the 70,000 ohm resistance connected from the grid to the positive side of the "A" battery.

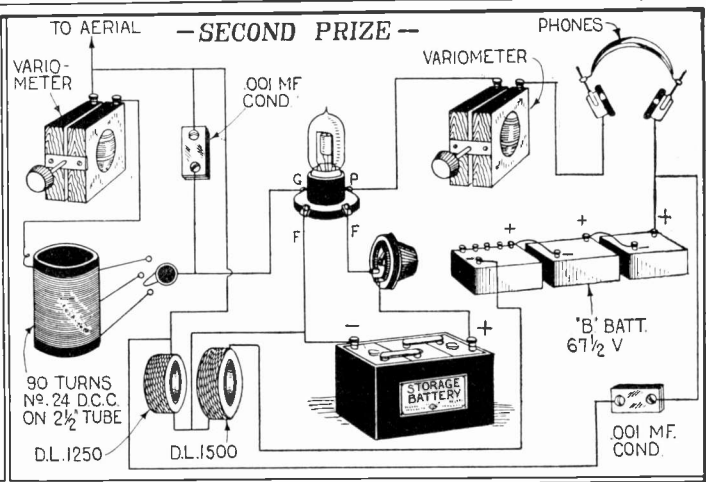

The second prize of \$20 goes to Mr. K. J. Dupee for a variation of the Armstrong super-regenerative circuit which is illustrated above. It will be noted that there are only two tuning controls and one control of regeneration. Two standard types of variometers are used and an extra coil, consisting of 90 turns of wire wound on a 2 1/2-inch tube, is connected in series with the grid variometer. This is tapped in three places. The two honeycomb coils need not be coupled together, but may be laid six to eight inches apart in the same plane.

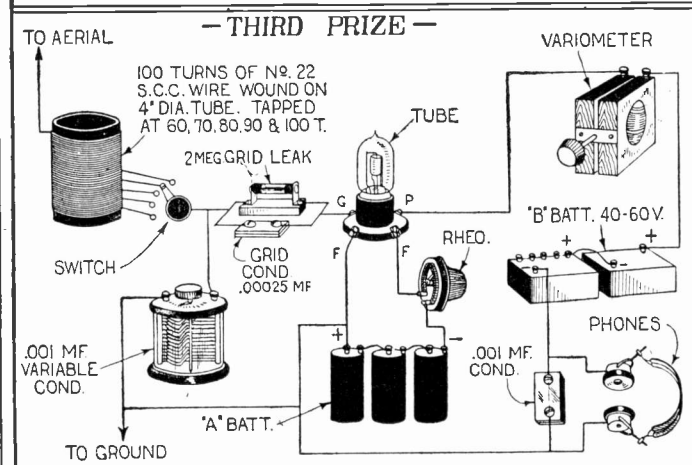

Mr. John H. Odenbach gets the third prize of \$15 for a loud talker circuit employing the tuned plate method of regeneration. The data on the antenna tuning inductance is given above. The variometer should be of a large size so as to cover a wide band of wave-lengths. Either a detector or amplifier tube may be used in this circuit and as much "B" battery as possible should be applied to the plate. Any one of the standard tubes from the 1 1/2-volt dry cell tubes up to the 6-volt tubes will give excellent results.

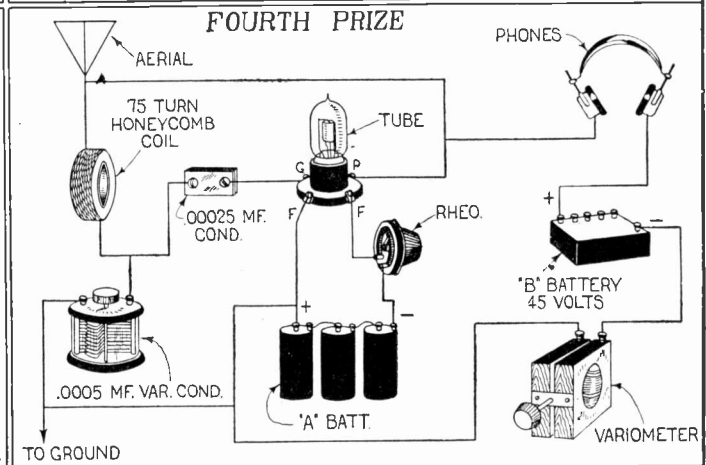

The fourth prize of \$10 is awarded to Mr. A. Ch'pka, Jr. As will be noted his set is a combination of the deForest ultra-audion oscillating principle and the Armstrong tuned plate method of regeneration. Excellent results are obtained with this circuit in selectivity as well as volume. The ultra-audion effect makes oscillation possible over a wide band of wave-lengths. The size of the honeycomb coil used for tuning the antenna should be determined by experiment and three or four coils should be kept on hand so that they may readily be exchanged and different sizes tried.

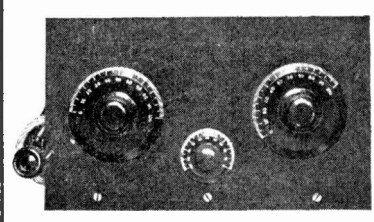

Mr. Bernard Guth, a New York City amateur and an enthusiastic experimenter with receiving sets, is awarded a \$5 prize for his set, capable of operating a loud talker on local stations. Mr. Guth's set is of the super-regenerative type and is quite similar to the Autoplex receiver. The main difference between Mr. Guth's set and the Autoplex is that instead of using a variometer to tune the grid circuit, he uses two honeycomb coils placed in variable inductive relation, connected in series and shunted by a variable condenser. This gives very critical adjustment of the capacity and inductance of the grid circuit. Mr. Guth employs two honeycomb coils mounted in a manner original with him. One of the coils is mounted on a short piece of bus bar wire which in turn extends through the panel and has a knob attached. This bus bar wire passes through the center of the stationary coil. By moving the knob

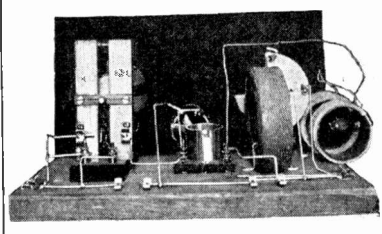
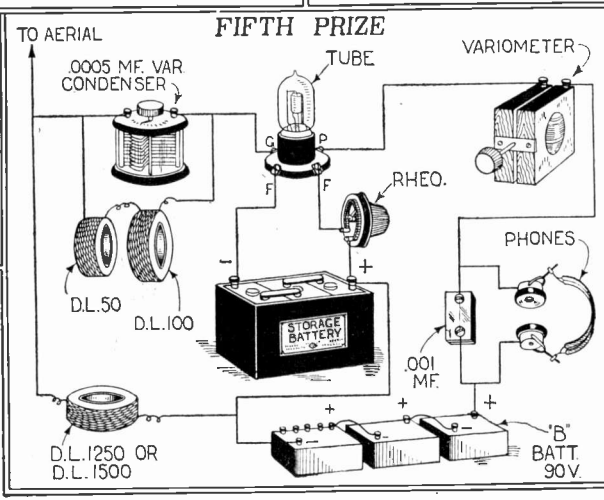

closer to or further away from the panel it is possible to adjust the inductive relation between these two coils. At the same time the variable condenser and the plate variometer are to be balanced until the signals are brought in loudest. Only one large honeycomb coil of either 1,250 or 1,500 turns is necessary to produce the variation frequency or "super" effect. The plate inductance consists of a standard type of variometer, but it should be of a large size and have at least 60 turns of wire on both stator and rotor. A hard or amplifying tube is to be used in this circuit and the "B" battery voltage should be as high as possible. This set, as well as the others awarded prizes in this contest, is subject to considerable experimentation. The instruments should be temporarily connected and tested. Slight changes and additions can then be made until the best operating conditions are found.

Simple Storage "B" Battery

LEAD PLATE
3"
1/8" THICK

SIDE BRACES (TWO)
1/2" LONGER THAN ASSEMBLED ELEMENTS

RUBBER RING

CONNECTION LUGS

FILLER HOLES

END PIECE TWO REQUIRED

CUT OUT ASSEMBLED BATTERY

TOP VIEW OF ASSEMBLED PARTS

Cut from sheet lead three inches square, circles of metal as indicated in the upper left hand corner of this diagram. A lug is formed on one side for connections. There should be as many of these plates as you desire to make cells, plus two extra plates for the ends. Each cell will give approximately 2 volts. Now obtain a quantity of rubber fruit jar rings and cut out a section as indicated. These rings and lead plates are now assembled as shown directly at the left and placed in an assembly frame, the dimensions of which are given above. The appearance of the finished battery is also shown. The rubber jar rings are cemented with rubber cement to the lead plates and placed immediately in the framework as shown. After the cement sets, paint the entire outside of the battery with asphaltum. At least two coats of this paint should be applied, allowing each to dry. Now fill each cell nearly full of a mixture of chemically pure sulphuric acid and distilled water. The electrolyte should have a specific gravity of 1.275. Charge and discharge the battery several times at a rate of one-eighth of an ampere until the plates are formed. It can then be put in use.
—Walter Johnson.

Using a Buzzer Test

to ground post on receiving set switch

X
Y

Buzzer

.001

3 V.

Dry cells fastened to table

Table top

Strap key

Supported by rubber bands

Buzzer

Fish globe or box

Cotton

to set

50 turns #22 D.C.C.
RESONATOR COIL

A buzzer test is a valuable asset to any crystal detector receiving set. Not only will it help to adjust the crystal to its greatest sensitiveness, but sometimes when a signal starts to fade, it can be brought back to its original strength by closing the switch and actuat-

ing the test buzzer for a second. A resonator coil is very often of great assistance, and may be connected in series at X-Y. At the right, in the above illustration, will be seen a suggested mounting for all the buzzer test apparatus.

The Dynaphone--A New Receiver

Earpiece casing

Coil

Diaphragm

Permanent magnet

Hard rubber cap

Diaphragm

Permanent magnet

Coil

A

Earpiece casing

Above will be seen the details of a new radiophone receiver which has recently made its appearance in England. It does not have the usual pole pieces with wire wound thereon

as is found in the average phone. Instead, the coil is wound in pancake form and placed within a soft iron casting. The diaphragm is placed over this.

Radio Oracle

In this Department we publish questions and answers which we feel are of interest to the novice and amateur. Letters addressed to this Department cannot be answered free. A charge of 25c is made for all questions where a personal answer is desired.

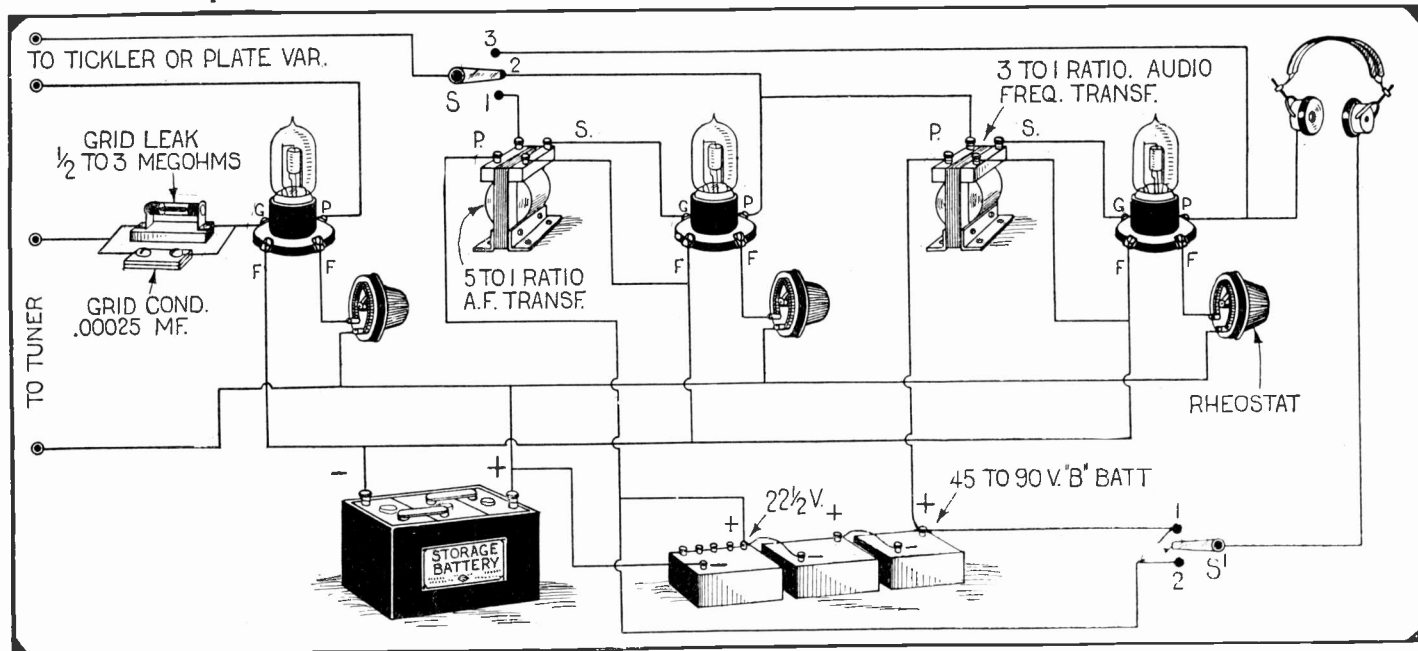

Q. 218. Since jacks are rather inefficient instruments and often cause trouble because of a slight amount of grit or dirt between the contact points causes an open circuit, they should be avoided. An efficient way of eliminating jacks is to make use of two switches, one of the three point type and the other of the two point type. All the necessary connections are indicated above and the manipulation of the switches is described in the text.

A. F. AMPLIFIER WITH SWITCHES

(218) G. H. Gillis, M. D., Yatesboro, Penna., asks:

Q. 1. Can you give me a circuit diagram of a detector and two stage amplifier unit used either with a single circuit tuner or a three circuit tuner and include thereon a switch for changing from detector to one or two stages of audio frequency amplification without the use of jacks?

A. 1. In the diagram in these columns we show a detector and two stages of audio frequency amplification. Two switches are indicated. When switch S is on switch point 3 and switch S1 is on switch point 2, the detector alone is being used. With switch S on point 2 and S1 on point 1, the detector and one stage of audio frequency amplification are being used. The third tube then acts as the audio frequency amplifier. With switch S on point 1 and switch S1 on point 1, all three tubes are being used.

CHANGING TYPE OF TUBES

(219) C. O. Dieter, Rittman, Ohio, asks:
Q. 1. If I decide to substitute U. V.-199 vacuum tubes for those contained in my set at the present time, will any changes have to be made? The tubes I am using now are a U. V.-200 detector, and U. V.-201 amplifier.

A. 1. In regard to the use of U. V.-199 tubes in your radio set, we would say that no radical changes will be necessary. You will, however, have to either substitute sockets for these tubes as they have different bases than the standard tubes, or else obtain adapters so that the 199s can be used in standard sockets. The above mentioned sockets or adapters can be obtained from companies advertising in the columns of this magazine. You will also have to substitute three dry cells for your present "A" battery and it is advisable to use 30 ohm rheostats.

LEAD-IN CONNECTION

(220) George Rice, Brooklyn, N. Y., asks the Radio Oracle:

Q. 1. What is the best way, mechanically and electrically, to connect a lead-in wire to a standard flat top aerial?

A. 1. We illustrate in these columns one of the best methods of making this connection. The connection between the flat top wire and the lead-in or down-lead has no mechanical strain exerted upon it and, therefore, its

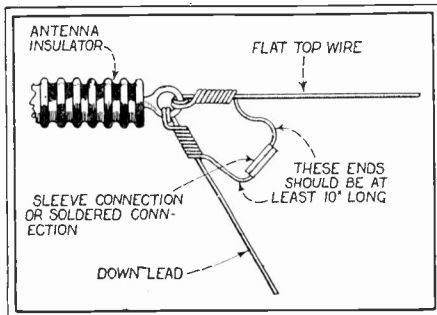

Q. 220. Careful attention should be paid the connection of the lead-in to the aerial proper. Above is illustrated the best method for making this joint so that it will be strong and electrically perfect.

electrical qualities are not subject to change thereby. The joint may either be made with a copper sleeve connector or may be soldered.

INCREASING SELECTIVITY

(221) M. C. Baker, Los Angeles, Calif., asks:

Q. 1. How can I improve the selectivity of my crystal receiving set consisting of a variocoupler with ten taps and a variable condenser across the rotor?

A. 1. The selectivity of your set may be increased somewhat by placing a variable condenser either in series with the antenna or across the stator as may be found best by

experiment. This condenser should have a capacity of .0005 mf.

Since you do not state the length of your antenna it may be that it is too long. If such is the case, you should cut down the length so that it will be no more than 80 to 90 feet long, including the lead-in to the set.

DRY CELLS WITH CRYSTAL SET

(222) C. H. Dorman, Buchanan, Iowa, wants to know:

Q. 1. Can I connect dry cells in the circuit with my crystal receiver so as to increase the efficiency?

A. 1. We would advise you that you cannot use dry cells on this set with any increase in efficiency; in fact, it would decrease the results obtained. Only in the use of certain crystals can dry cells be used and it has been proven by experiment that such crystals do not give as loud reception and as great range of reception as galena or any one of the other crystals sold on the market today.

TROUBLE WITH CRYSTAL SET

(223) T. A. Dew, Bronx, N. Y., says that he has a crystal receiving set which does not operate properly. He states that all his instruments are in good condition and that he is using a short piece of copper wire as a cat-whisker. He asks:

Q. 1. Can you suggest some point that could be the trouble with my set?

A. 1. Since you say that your apparatus is all in good shape and tests up correctly, we would say that the trouble is probably in your crystal. Undoubtedly, the latter is not very sensitive. It may be, however, that your instruments are not connected up properly and we would advise you to send us a circuit diagram for inspection. We would further advise that you use a piece of fairly fine phosphor bronze wire as a cat-whisker, having the same coiled in a spiral.

WANTED!!! RADIO ARTICLES

WE want descriptions of new radio ideas which you have worked out in practice. Take photographs of the important parts and make pencil or pen and ink sketches of the hook-ups or mechanical details, et cetera. We are particularly

desirous of obtaining new hook-ups and descriptions of single tube sets, reflex and other types which have proven satisfactory. We want articles on the latest single tube receptors which require a minimum current from the filament battery.—Editor.

INVERSE DUPLEX

(224) J. P. McKenzie, Ensley, Ala., asks:
 Q. 1. What is the advantage of the inverse duplex type of receiver over the standard reflex circuit?
 A. 1. We will take the circuit diagram published in these columns as an example. Here we see that the first tube on the left acts as the first stage of radio frequency amplification and as the second stage of audio frequency. The center tube acts as the second stage of radio frequency and the first stage of audio frequency. Obviously, the load imposed on the tubes by causing them to act as amplifiers is more equally distrib-

detector, a two stage audio frequency amplifier, without changing the connections therein?
 A. 1. The only way to increase your range to any great extent will be the addition of one or two stages of radio frequency amplification. Unless you are fairly familiar with radio work, however, we would not advise you to attempt this addition as good results would not be obtained without considerable experimental work. If, however, you desire to try such a circuit, send us a description of the tuner, enumerating all the instruments used therein and give a hook-up of the same. We will then show you how

get as many turns of wire as possible without making the receiver too clumsy. The simplest way to rate a telephone would be by its resistance except for one thing—the temptation to dishonest people of putting iron or German silver wire in the coil. This gives resistance, but reduces the ampere turns.

TUNED IMPEDANCE RADIO FREQUENCY AMPLIFICATION

(227) John Moore, Hoboken, N. J., refers to an article appearing on page 258 of the July, 1923, issue of SCIENCE AND INVENTION and asks:

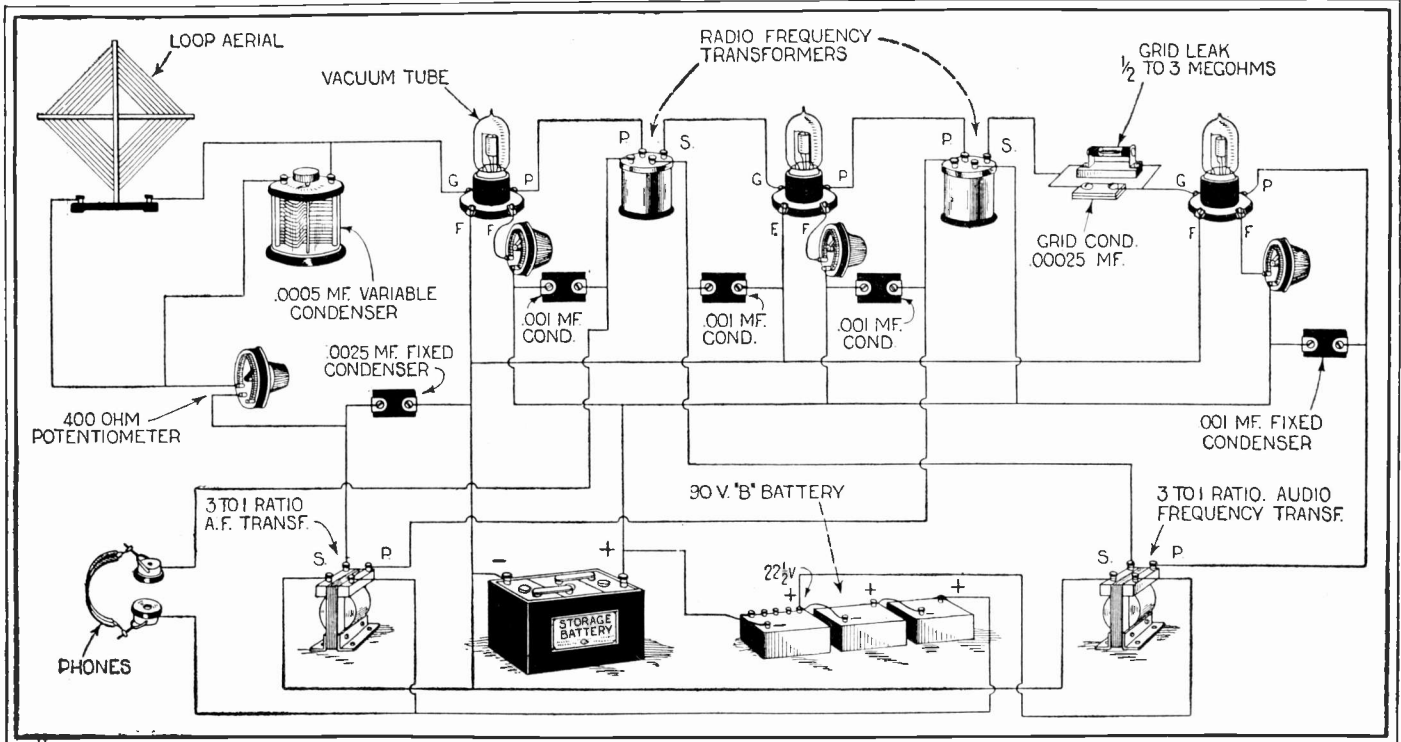

Q. 224. The inverse duplex receiver has the advantage of not overloading the tubes and rendering them inefficient as is the case in the standard straight type of reflex circuit. The connections for a three-tube set of the inverse duplex type are given above. Two radio and two audio frequency transformers are used in connection with the three tubes giving practically the same form as two stages of radio frequency, detector and two stages of audio frequency amplification.

uted than in the standard straight reflex. In the latter circuit, the first tube is the first stage of both radio and audio frequency and the second tube is the second stage of both types of amplification. Therefore, the second tube is severely taxed and does not function properly at all times.

Q. 2. Kindly show a circuit diagram of a three tube inverse duplex receiver using a vacuum tube detector.
 A. 1. The circuit diagram will be found in these columns.

RADIO FREQUENCY AMPLIFICATION

(225) Roy L. Grant, Eureka, Kansas, asks:

Q. 1. How can I increase the receiving range of a set and can the extra instruments be added to a set comprising a tuner,

to add radio frequency amplification in front of your tuner.

RESISTANCE OF PHONES

(226) O. E. Kaufman, Plains, Kan., asks:

Q. 1. Does the actual resistance of phones have anything to do with their efficiency?

A. 1. The resistance of receivers in radio work has very little to do with the efficiency of the phones. It is the number of ampere turns on the magnets that counts. Phones might much better be rated at their impedance, as for very best results this value should be nearly equal to the internal impedance of the vacuum tube. The talking current actuating a telephone is so light that the question of ohmic resistance plays but a small part in practice. The great point is to

Q. 1. What are the capacities of the condensers C3, C4 and C5?

A. 1. Regarding the capacity of condenser C3, we would advise you to use .001 mf. For C4 and C5 use .00025 or .0005 mf.

Q. 2. Kindly give me the correct data for use in winding the radio frequency amplifying impedance coils.

A. 2. In regard to the tuned impedance radio frequency amplifier that you mention, we would advise you to experiment somewhat with the construction of the impedance coil. The best way would be to wind a 3-inch tube with 45 turns of No. 24 wire, tapped at the 25th, 30th, 35th, and 40th turns. Connect up these taps to switch points and you can experiment until you find out exactly what number of turns will give the best results with your particular tubes.

200 ILLUSTRATIONS—100 ARTICLES

is the average of every issue of RADIO NEWS. We doubt if there is a radio magazine in print that can show the diversity of articles and illustrations that is found in this magazine.

But above all, it is the quality of the material that is of prime importance to the man interested in radio. RADIO NEWS appeals to all factions; the Scientist, the Amateur, the Experi-

menter, the Broadcast Listener, and the Manufacturer. Each will find articles written especially for him. Every issue of RADIO NEWS is a radio education by itself. Sold on 35,000 newsstands in the United States and in every international book store in every civilized country the world over

A LIST OF INTERESTING ARTICLES APPEARING IN THE FEBRUARY ISSUE OF RADIO NEWS.

The First European Radio-Telephone Service, By Dr. Alfred Gradenwitz.
 Transient Phenomena in Audio Frequency Transformers, By Allen D. Cardwell.

A New Invention For Selective Reception, By John Scott-Taggart, F. Inst. P.
 Engineering Trans-Atlantic Radio Telephony.

The Theory, Construction and Use of an Inductance-Capacity Bridge, By Palmer G. Craig.
 Ultradyne Receiver, By Robert E. Lacault.

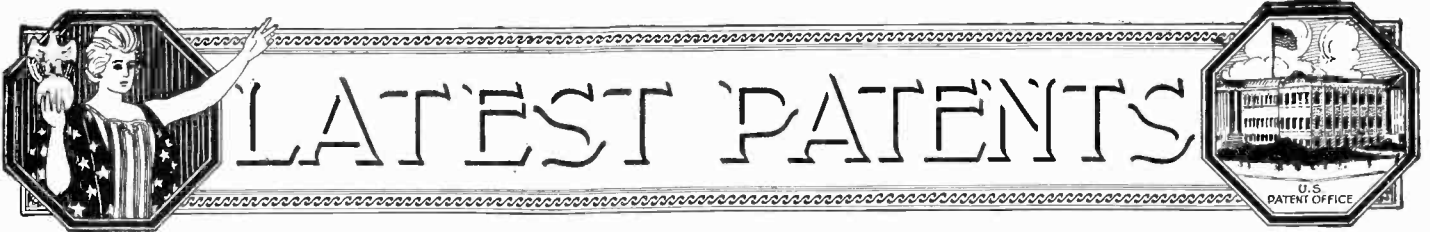

LATEST PATENTS

Reflecting Telescope

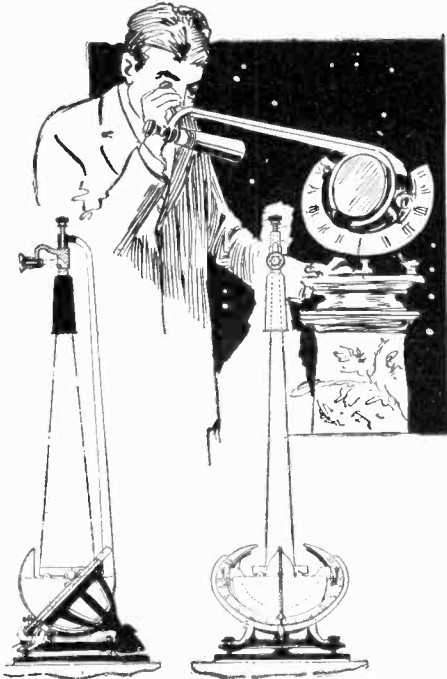

No. 1,468,973 issued to Russell W. Porter. This ornamental garden telescope is capable of relatively rough usage. It comprises an ocular, a concave paraboloidal mirror and a prism or silvered diagonal. The ocular and prism are held at a fixed distance from the mirror, but are capable of adjustment therewith about the polar axis and about the axis of declination. The ocular and prism are likewise rotatable about the optical axis of the mirror, for the convenience of the observer. The entire device is placed out in a garden and protected from the elements merely by its rugged construction.

Hedge Trimmer

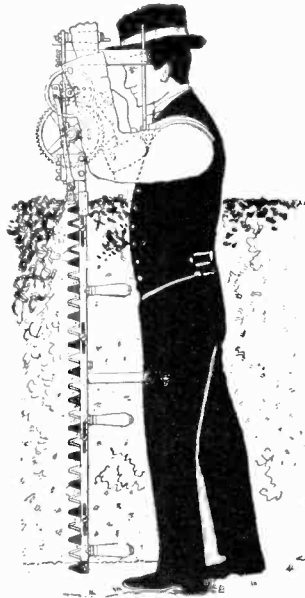

No. 1,471,453 issued to John C. Dettra. This hedge trimmer is of light sturdy construction and may be used in various positions so as to enable the trimmer to trim the sides, tops and other portions of the hedge. The actuating mechanism may be adjusted to various positions with respect to the reciprocating cutting blades. This mechanism comprises the operating handle and a train of gears, one of which is connected by means of a rod to the cutting teeth. The device is carried by the user, as illustrated above.

Self-Lubricating Razor Hone

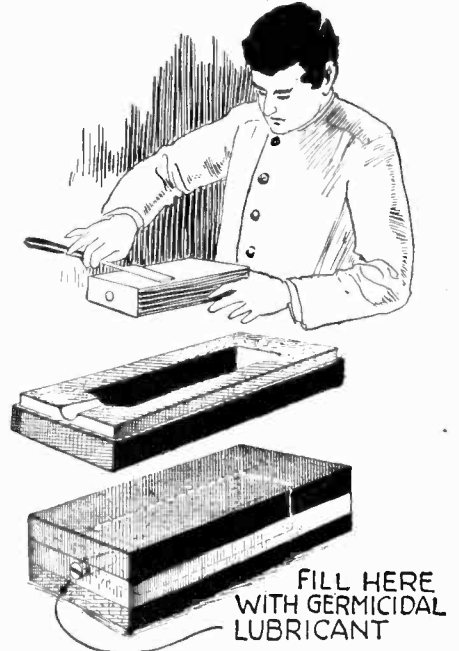

No. 1,470,762 issued to Jesse Lee Renau. Heretofore hones for sharpening razors have been used, but an external lubricant was applied to the exterior of the hone. This lubricant was generally of a germicidal nature, but it soon became absorbed and it was necessary to re-supply the hone with the germicidal material. The inventor of this device has designed a razor hone, which has a recess within it into which the germicidal lubricant is poured. This percolates through the pores of the hone and keeps the surface constantly moist.

Individual Sanitary Saliva Ejector



No. 1,471,207 issued to Napoleon B. Riddle. Ejecting saliva from the mouth of a patient when undergoing dental operations, which make it practically impossible or undesirable to swallow the saliva, is usually done in high-class dental parlors, but the former method was quite unsanitary unless the tube was carefully sterilized. For that reason the inventor believes that the plan which he has patented will serve the purpose. In this method the upper portion of the saliva ejector is made of paper similar to that used in the manufacture of drinking straws found at the soda fountains. This is reinforced and may, of course, be replaced after a patient has used the same.

Pen Holder



No. 1,453,667 issued to James John Gillis. This invention is without a doubt very practical. Every teacher has noticed that her pupils when beginning to write with a pen, press very firmly upon the pen. With this device such pressure will be impossible because the pen point will slide up into the handle of the pen as soon as undue pressure is brought to bear upon it, calling attention that the child is exerting too much pressure in writing. This tension is under control of the teacher who can adjust the collapsing pressure.

Phonograph Records



No. 1,471,862 issued to John J. Reinhold. One has often noticed how difficult it is to remove records from phonograph turn-tables, especially when they are thin. A great number of attachments have been made for the purpose of assisting the player in removing the record more easily. The inventor of this system employs a groove around the edge of the disk, which will engage the finger nails so that the record can be easily lifted from the turn-table or if the records are stacked one on top of the other, the top one may be easily removed without the necessity of sliding the records upon each other.

Scientific Humor

The "Mile-Age."—FIRST STENOG. (reading): "Think of those Spaniards going 3,000 miles on a galleon."

SECOND STENOG: "Aw, forget it. Yuh can't believe all yuh hear about them foreign cars."—*Paul K. Beemer.*

The Spendthrift.—There is a New York scientist who is greatly interested in coal mining. He decided to subscribe to a press clipping bureau, to get every new slant on coal. So he said to the service bureau: "I want everything you can find printed about coal."

The first clipping he got was an article about a man who was suing his wife for a separation because she hit him on the head with a lump of coal!—*I. H. Motes.*

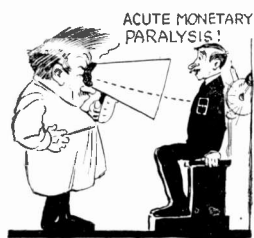

This Is Very Transparent.—MR. SHORT: "If an X-ray operator is preparing to take an X-ray picture of you, does he first look through you to determine just what portion of your body he wishes to photograph?"

MR. LONG: "Yes; and not only that, he even looks through your pocketbook to determine whether or not he wishes to photograph any portion of your body at all."—*J. E. Melton.*

Relic of Antiquity.—In the motion picture, "Robin Hood," Lady Marian desires to send a message to the Earl of Huntington and chooses Little John to act as her messenger. She hands John a scroll which is protected by a black case or tube. A small boy in the audience asked his mother what it was. "That is a flashlight," she answered aloud.

"Don't show your ignorance Mary," snapped her husband. "They didn't have flashlights in those days. That's a thermos bottle."—*M. Kipp.*



Coming Dear!—JONES: "Pat's in the hospital with a broken head!"

BROWN: "How come?"

JONES: "He was up trying out that new helicopter of his, and his

wife saw him and motioned for him to come down."

BROWN: "Well?"

JONES: "He did!"—*Merle Holmes.*

My Stars!—TEACHER: "What is the hardest science to master?"

STUDENT: "Astronomy."

TEACHER: "Why?"

STUDENT: "It's all over my head."—*W. J. Shea.*

A "Sticker."—PHYSICS INSTRUCTOR: "Johnny, define and give an example of adhesion."

JOHNNY: "Adhesion is a force that holds unlike particles together, such as powder on a lady's face."

PHYSICS INSTRUCTOR: "Correct! Now define and give an example of cohesion."

JOHNNY: "Cohesion is a force that connects like particles, such as lips in a kiss."—*Kenneth Guth.*

First Prize \$3.00



He Must Be Yellow!—FIRST STUDENT: "See that chap coming out of the Lab., that's Brown, our Chemistry Prof., he likes girls, but he's so bashful he

acts like litmus paper."

SECOND STUDENT: "How's that?"

F. S.: "Why, when he's with a girl he turns pink, and when he's alone he gets blue."—*Fred L. Leonard.*

Flour-Sacks in the Air.—An Institute visitor saw a non-insulated water-pipe running across the basement ceiling. It was dripping water upon flour-sacks which had congealed upon it from the atmosphere.—*Baking Technology (Chicago).*

We receive daily from one to two hundred contributions to this department. Of these only one or two are available. We desire to publish only scientific humor and all contributions should be original if possible. Do not copy jokes from old books or other publications as they have little or no chance here. By scientific humor we mean only such jokes as contain something of a scientific nature. Note our prize winners. Write each joke on a separate sheet and sign your name and address to it. Write only on one side of sheet. No letters acknowledged unless postage is included.

All jokes published here are paid for at the rate of one dollar each, besides the first prize of three dollars for the best jokes submitted each month. In the event that two people send in the same joke so as to tie for the prize, then the sum of three dollars in cash will be paid to each one.

Oh? But He's Beyond the 3-Mile Limit.

PLANETARY GOSSIP (Venus to Saturn over the celestial back fence): "Didn't you hear what happened to old man Sol the other day?"

SATURN: "Why no. What happened to him?"

VENUS: "He was pinched for making moon shine!"—*Emil Guidici.*



A Short Circuit.—PROFESSOR (to boy who has been sent to him for misconduct): "Son, what is your name and why did the teacher send you here?"

BOY: "Sir, my name is Sparks, the teacher saw me gap and it shocked her."—*Thomas J. Adams.*

Perpetual Motion.—Rags make paper. Paper makes money. Money makes banks. Banks make loans. Loans make poverty. Poverty makes Rags.—*G. Clear.*

He Should Try a Radio.—"Ah," said the inventor of mechanical toys, "I've only had one failure in my life."

"And what was the matter with that?" asked his friend.

"It was too realistic."

"What was?"

"I made a toy tramp and it wouldn't work."—*G. Clear.*

Also the First Amplifier.

RAY: "Who was the first radio engineer?"

DIO: "A dam because the first loud speaker was made from his spare parts."

RAY: "Ooo—Oh!"—*L. Grummwadder.*



Chickenfeed.—JOHNSON: "Does you know dat a chicken is the most scientific bird of de world?"

RASTUS: "How come dat?"

JOHNSON: "Yo can eat 'em befo dey is born, and after dey is dead!"—*Foster C. Kitchen.*

An "Antique" Joke.—ARCHIMEDES: "Give me a fulcrum upon which I may place my lever, and I'll move the earth."

SOCRATES: "Use the moon."

DIOGENES: "But what shall we use for a lever?"

SOCRATES: "A sunbeam."—*Frank L. Culley.*

Gassed!

DENTIST: "What! You don't want gas? You insisted on having gas the last time."

VICTIM: "You haven't been eating garlic this time."—*Herman L. Gottlieb.*



As a Matter of Fact.—Carl was in the science class talking with the girls while the teacher was explaining the lesson on the composition of matter.

All of a sudden the voice of the irate teacher was heard:

"What is the matter Carl?"

Carl all surprised answered:

"Matter is anything that occupies space."—*Carlos Otal, Jr.*

Nobody 'Ohm.—PROF: "I wonder why there is so much electricity in my hair?"

SMART SENIOR: "Because it is attached to a dry cell."—*Fred L. Leonard.*

Boy! Page the Missus.—SIMPLE: "They have machines now that can tell when a man is lying. Ever seen one?"

SIMPLER: "Seen one? By gosh, I married one!"—*Merle Holmes.*



THE ORACLE



The "Oracle" is for the sole benefit of all scientific students. Questions will be answered here for the benefit of all, but only matter of sufficient interest will be published. Rules under which questions will be answered:

1. Only three questions can be submitted to be answered.
2. Only one side of sheet to be written on; matter must be type-written or else written in ink, no penciled matter considered.

3. Sketches, diagrams, etc., must be on separate sheets. Questions addressed to the department cannot be answered by mail free of charge.

4. If a quick answer is desired by mail, a nominal charge of 25 cents is made for each question. If the questions entail considerable research work or intricate calculations a special rate will be charged. Correspondents will be informed as to the fee before such questions are answered.

MEASURING VOLTAGE

(1616) Morris Black, Jersey City, N. J., asks:
Q. 1. How may the voltage of a battery be measured without a volt meter?

A. 1. This work may be done without the use of a volt meter by connecting up apparatus as shown in the illustration. A standard cell with a

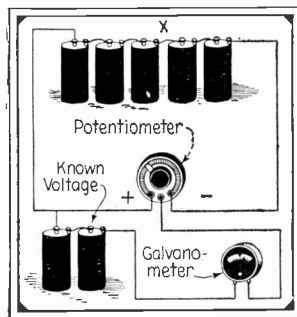

At the left is shown a circuit diagram for connecting a galvanometer and potentiometer so that the unknown voltage of a battery may be found by comparison. For quickest results, the potentiometer should be graduated so that it may be read directly.

known voltage is used as indicated. The slider on the potentiometer should be regulated until the galvanometer indicates that no current is flowing through it. At this point on a potentiometer, count the number of turns between the slider and the positive end and place this number in an equation as being equivalent to the voltage of the standard cell. From this we will get a certain number of turns being equal to one volt. Dividing this number into the total number of coils on the entire potentiometer, we have the voltage of cell X.

An example will not be out of the way. Suppose that the potentiometer has a total of 100 turns, and that the voltage of the standard cell is 2 volts. Then suppose that a balance takes place when the slider is 20 turns from the positive end. Therefore, we will form the equation of $2 = 20$ and from this we get that $1 = 10$. Dividing 100 by 10 we find that the value of the unknown battery is 10 volts.

LIGHT YEARS

(1617) Frank H. Cottrill, Port Washington, Wis., asks:
Q. 1. How is the length of a light year measured?

A. 1. The speed of light per second is 186,000 miles approximately. There are approximately 31,557,600 seconds in a year. By multiplying these two figures together you will get very nearly the distance in miles of the astronomical light-year used as a unit of measurement of stellar space.

Interesting Articles in February "Practical Electrics"

- Power Now Transmitted Without Wires The Radiotron; A Vacuum Tube
By B. S. Havens of General Electric Co.
Simple Oscillograph
By Carter Fiske
- Electrical Animals
Tidal Electric Power
By Albert Staehle
- Voltage Finder
Electrical Destruction of Atoms
By Professor Rogers D. Rusk
- Electric Camera Shutter
By A. Kiedis, Jr.
- Carbon Contact Rheostat
Goertz-Beck Arc Lamp
Analogies and Others
By T. O'Connor Sloane, Ph.D.

EXPANSION OF GASES

(1618) V. C. McKenzie, Brice, Texas, asks:
Q. 1. Are the rates of expansion of various gases different?

A. 1. All the so-called permanent gases expand at very nearly the same rate in accordance with a well known law of physics. A gas at zero degrees C. will expand $1/273$, of $1/49$ of its volume for every degree (Centigrade and Fahrenheit respectively) of rise in temperature.

NICKEL-IRON STORAGE BATTERY

(1619) George M. Lilly, Detroit, Mich., wants to know:

Q. 1. How can I put into service a nickel iron alkaline storage battery which has been idle for some time?

A. 1. Wash out the entire battery thoroughly with warm distilled water. Also make sure that none of the plates are buckled or broken. Then mix the electrolyte as follows: Make a 20 per cent solution of phosphoric acid in distilled water and add enough ordinary household ammonia to neutralize the solution. The neutralization point can be determined by the use of red and blue litmus paper. When neither of the two papers change color when dipped into the solution, it is neutral. After filling your cells to the required depth with this solution, pour a thin layer of mineral oil over the electrolyte in order to retard evaporation. The above solution, while not standard, was recommended to us by a reader who obtained excellent results with the same.

SPUN GLASS

(1620) Milton Peterson, Baltimore, Md., asks the Oracle:

Q. 1. Can you tell me how to spin a small quantity of glass without the use of expensive apparatus? I desire to use the resulting glass as bristles in a brush for use with strong acids.

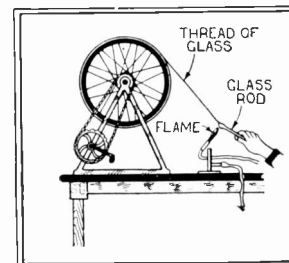

Fine threads of glass are occasionally desired for constructing small brushes for handling strong acids. These very fine threads may be made by the experimenter by setting up a wheel as shown at the right.

A. 1. The illustration herewith shows a wheel such as a bicycle wheel mounted in a frame and driven by means of a crank. Start the wheel spinning with one hand and melt the end of a good sized rod of glass. Now draw out a thread of molten glass and carry it around the wheel as the latter spins. After the knack of this is obtained, you will find that the thread of glass will grip the rim and by continuing to turn the wheel by hand and at the same time keeping a fresh supply of glass molten, that the wheel will continue to take up a thread of glass. The rod which is supplying the material must not be advanced too far into the flame for if such is done the end from which the thread is being taken will cool and the thread will break. Also the rod must be advanced far enough so that the flame will not melt the thread. When as much glass as desired has been spun, a knife may be drawn across the multiple threads of glass whereupon it will break and the entire quantity may be removed from the rim. This fine glass may then be used in any way desired.

ETCHING GLASS AND STEEL

(1621) J. M. Martin, Pauls Valley, Okla., wants to know:

Q. 1. Can you give me formulas or tell me what chemicals must be used for the etching of glass and tool steel?

A. 1. Probably the best material for you to use for etching glass would be hydrofluoric acid. The part which you do not desire to etch can be protected by means of wax. Dilute nitric acid or sulphuric acid, or solution of copper sulphate (blue vitriol) will readily etch steel tools and in this case wax may also be used for protecting the surface which is not to be attacked by the acid.

OUR \$12,000 PRIZE CONTEST

It will be noted from last month's issue and the present one that our prize contest has been a whale of a success. Over \$1,000 has been paid out this month for worth while contributions to SCIENCE AND INVENTION, either in pictures, suggestions, ideas or articles. We now have on our staff, close to 7,000 correspondent reporters who are scouting the world for

new material that can be written up for SCIENCE AND INVENTION. And the formula is simple—just keep your eyes open. Even if you were totally deaf or blind, you could still win a prize by simply using your head and sending us ideas of a scientific nature, or of a nature directly or indirectly attached to new inventions.

ARTICLES FOR MARCH SCIENCE AND INVENTION

- The Man on the Asteroid—Part III
By Ray Cummings
- The Red Sea Parted—How the Movies Did It
By Edwin Schallert
- What is Luminous Paint?
By Ismar Ginsberg, B.Sc., Chem. Engr.
- Why Our Naval Guns Should Be Elevated
By Graser Schornstheimer, Naval Expert

- Staging Historic Battle Scene for the Screen Old-Fashioned Weather Predictions—Are They Correct?
By E. B. "Farmer" Dunn
- Prize Winners in "Psychic Motor" Contest How to Bind Your Own Books
By Dr. Ernest Bader
- Push-Pull Audio-Frequency Amplifier—How to Build It
By Joseph H. Kraus

- The Airplane Super-Charger—How it Enables Aviators to Fly to Unprecedented Heights
- New York's Need of New Under-River Subways to New Jersey
- Over 40 Popular Radio Articles—Filled With Details You Need to Know in Building Your Own Set

FREE INFORMATION

If you want additional information concerning any of the subjects illustrated and described in this number of SCIENCE AND INVENTION, we shall be glad to give you other data we have at our command. To make this work as easy as possible for our editors, please be brief. Write only on one side of the paper and state exactly in a few words just what it is you desire further information on. We have the original manuscripts and drawings of many of these articles in our files and can furnish much additional data in most cases. Please do not fail to send stamped and self-addressed envelope.

Address all inquiries of this nature to INFORMATION EDITOR c/o Science and Invention, 53 Park Place, New York City.

TWO-CYCLE GASOLINE ENGINE

(1622) J. M. Osborne, Detroit, Mich., wants to know:

Q. 1. Has the two-cycle gasoline engine ever been used in large sized power plants such as used in airplanes and other machines propelled by gasoline?

A. 1. The two-cycle gasoline motor has never proven itself efficient when used in high power installations such as are necessary for airplanes. This type has been applied with a fair degree of success to automobiles and motorcycles. It is used for the majority of small boat engines. It has, however, been found practically impossible to get a perfect exhaustion of the burnt gases and a perfect intake of the explosive mixture in this type of motor, with the result that when the mixture in the firing chamber is ignited, the explosion is not as powerful as it should be. Obviously, this is a great disadvantage in airplane use. Also, the gas mixture, being drawn in through the crank case, dilutes the oil therein, resulting in decreased efficiency.

Q. 2. What is the principle of the operation of a two-stroke or two-cycle gasoline engine?

A. 2. The accompanying illustrations show the principle of operation. In Fig. B the piston is at the bottom of its stroke and two actions are taking place. A gasoline and air mixture is entering the cylinder from the crank case through the by-pass port. The burned gas is passing out through the exhaust port. Therefore, we have intake and exhaust occurring simultaneously. As

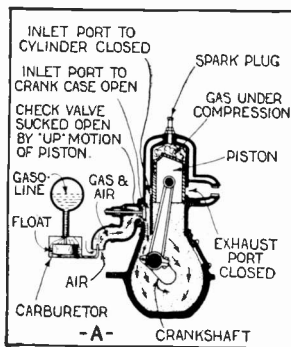

At the left in "A" will be seen the piston of a two cycle gasoline engine very nearly at the top of its compression stroke. When it reaches the top, a spark flashes and the piston will be forced downward by the explosion of the gas. Note that the vaporized gasoline first enters the crank case.

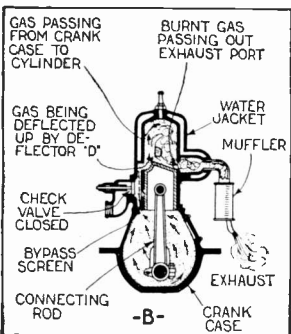

At the left a two-cycle gasoline engine is shown at the end of its firing stroke. The burned gases are now passing out through the open exhaust port and at the same time fresh gasoline vapor is coming in from the crank case to the cylinder. The next upward stroke will compress this gas.

will be noticed, the incoming mixture is thrown up toward the top of the cylinder by means of the deflector D on the piston. In Fig. A the piston is very nearly at the top of its stroke. Here again two actions take place. The gas is being compressed by the piston and the spark is just about to take place. Fresh gas is entering the crank case from the carburetor through the inlet port. When the piston reaches the top of its stroke, the spark plug will fire the mixture and the piston will be forced to the position shown in Fig. B, whereupon the action will be repeated.

FRictionAL ELECTRICITy

(1623) L. B. Edgars, Syracuse, N. Y., asks: Q. 1. What is frictional electricity and how can I produce it experimentally?

A. 1. Frictional electricity may be produced and its results seen by rubbing a stick of sealing

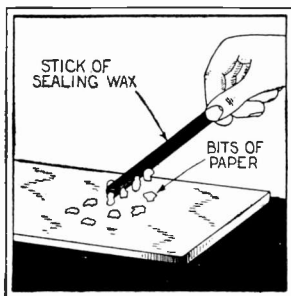

Frictional electricity may be made in an experimental manner by means of a stick of sealing wax and a piece of flannel cloth. The former should be briskly rubbed with the latter, whereupon it will be found that the wax will attract bits of paper.

wax or hard rubber vigorously with a dry warm flannel cloth. Bring the end of the wax or rubber near some shreds of paper and they will fly to it. The electricity so formed is known as static or electricity at rest.

PERPETUAL MOTION?

(1624) A reader has referred to an article appearing on page 225 of the July, 1923, issue of SCIENCE AND INVENTION and states that according to his reasoning the device described therein is actually perpetual motion. He asks our opinion.

In order to obtain an unbiased view of this subject, we have requested Professor Harold F. Richards, a well known authority on scientific matters, to give us his opinion of the practicability of this device. His answer is as follows:

"Theoretically the device is perfectly feasible and can be made to operate. The practical use of the apparatus is, however, another matter.

"There are two kinds of perpetual motion, as the classification goes. One kind is that in which an engine, once started, continues to run without receiving any input of energy. This type is theoretically possible, but not practically so, since all man-made machines have friction. The stellar system approximates to a perpetual motion device of this first class.

"The second type of perpetual motion is that which delivers useful power without requiring any input of power, or, in other words, which delivers more power than it receives. In a machine of such a character there would be actual creation of energy, in violation of the principle of conservation of energy, and, furthermore, in violation of the second law of thermodynamics, which states that heat will not, of itself, pass from a colder to a hotter body. Such a device cannot possibly be made to work, even if we assume ideal con-

IMPORTANT

TO NEWSSTAND READERS

IN order to eliminate all waste and unsold copies it has become necessary to supply newsstand dealers only with the actual number of copies for which they have orders. This makes it advisable to place an order with your newsdealer, asking him to reserve a copy for you every month. Otherwise he will not be able to supply your copy. For your convenience, we are appending herewith a blank which we ask you to be good enough to fill in and hand to your newsdealer. He will then be in a position to supply copies to you regularly every month. If you are interested in receiving your copy every month, do not fail to sign this blank. It costs you nothing to do so.

To Newsdealer

Address

Please reserve for me copies of SCIENCE & INVENTION every month until I notify you otherwise, and greatly oblige,

Name

Address

ditions and a perfect efficiency of every working part.

"The article on drawing energy from the hot surface layers of sea-water presents no violation of the foregoing principles. Whenever two sources of heat at different temperatures are available, a power-delivery machine is theoretically possible. In the device in question there are two such sources, and the poor conductivity of the water serves to separate them in the same manner, although not as efficiently, as an insulating wall. A hot and a cold source are available, heat tends to flow from a hotter to a colder body, and so a power-generator is possible.

"So far as practical considerations are concerned, the efficiency will be very low, and probably too low for any utility, on account of the small difference of temperature available. Assuming that the high and low temperatures are 25° and 5° Centigrade, respectively, the ideal or theoretical maximum efficiency would be only 7%, since the limiting efficiency is equal to the difference of the two temperatures divided by the absolute temperature of the hot reservoir. Even this low efficiency cannot possibly be realized in practice, since the working parts cannot be perfectly efficient, and if the generator (electric) has an efficiency of 90%, and the turbine an efficiency of 50%, the resulting efficiency, disregarding losses in pumps, would be the product of all the efficiencies listed above, or (.07), (.90), (.50), which is 0.0315, or about 3%. Even this low efficiency cannot be realized in practice, since work must be done in order to bring the hot and cold reservoirs to the same gravitational level, and it seems quite possible that the work necessarily done by the pumps, together with the frictional losses in the long pipes, would wipe out the remaining 3% of useful efficiency. Even so, the device is not a perpetual motion proposition, since theoretically it can be made to work. However, you will easily see from the foregoing figures that any money invested in the proposition would in all probability be lost.

"The simple reasoning given above shows the way to get at the heart of a suggested invention. The 7% is a limiting efficiency towards which engineers may strive in developing the device, although they cannot possibly hope to attain it, for the reasons given. For your information, I may say that one pound of water would, in cooling 1 degree Fahrenheit per second, liberate 1 B. T. U. per second, or 1.058 kilowatts of energy, so that 1,000 pounds of water, cooling 30 degrees Fahrenheit per second, would liberate 31,740 kilowatts of heat power. Not all of this power would be useful. To change 1 lb. of ammonia from liquid to vapor at 75 degrees Fahrenheit would require the cooling of about 19 pounds of water from 75 to 45 degrees F.

"I think you will see from the foregoing that it is hardly worth while to consider the efficiencies of turbines and pumps in order to find out the exact value of the exceedingly small part of the limiting efficiency (of 7%) which would remain. Practically, I should say, the invention is worthless."

PRINCIPLE OF THE AIRPLANE

(1625) Richard Frank, Louisville, Ky., requests:

Q. 1. Can you explain in a simple manner the comparison between the forces which keep an ordinary kite in the air and those which allow the use of airplanes?

A. 1. The diagram herewith shows the principles of both of the two devices mentioned. In A is an ordinary type of kite which is kept in the air by means of the wind streams marked W.

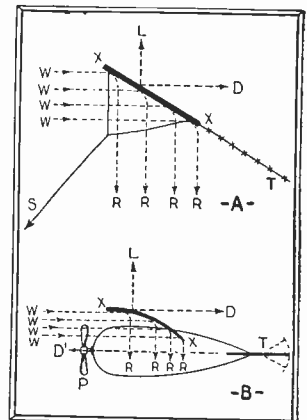

At the right in Fig. A, will be seen the action of air currents on a kite. The currents coming in the direction W, are deflected toward R, giving rise to the different forces indicated by L and D, known respectively as the lift and drag forces. At B is shown a diagrammatic view of an airplane showing how the same forces act on the plane as on the kite.

When these streams strike the surface they are deflected downward and the reaction of this deflection produces a vertical lift indicated by the arrow L. The kite is held against the pressure of the air stream by the string. The horizontal force which is indicated by the arrow D tends to carry the kite in that direction and is known as the drift force. The tail, T, presumes a stabilizing function and it maintains a constant angle between the surface and the wind.

B in the diagram herewith shows an airplane and the common points between this and the kite can be readily seen. In place of the string on the kite we have the propeller, P, which supplies the resultant required to overcome the drag force indicated by D.

WEHNELT INTERRUPTER

(1626) E. Lucyinski, Snow Hill, Ala., wants to know:

Q. 1. Can you give a diagram showing the construction of a Wehnelt interrupter and tell what solution is used therein?

A. 1. The diagram herewith shows the details of such an interrupter. The anode or central electrode consists of a platinum point and the wiring connecting this point to the external circuit is encased in a porcelain tube. The amount of the anode exposed is so arranged that it can be adjusted by means of sliding the porcelain tube up

A very good form of electrolytic rectifier is illustrated at the right. This takes the place of the mechanical interrupter often found on spark coils and small transformers. It operates without the usual noise and sputter of a magnetic interrupter.

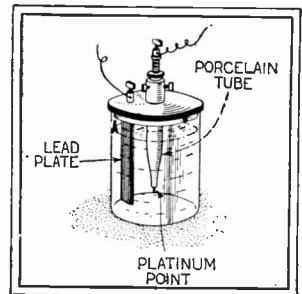

and down. The cathode is a large lead plate as illustrated. The electrolyte used in this cell consists of dilute sulphuric acid at a density of approximately 1.2. It is sometimes found advisable to add a very small quantity of CuSO₄.

"THE AIR IS FULL OF THINGS YOU SHOULDN'T MISS"



Eveready "Three"
 4½ volts, three distinct uses.
 Length, 4 in.; width, 1¾ in.;
 height, 3 in.; weight, 14 oz.
 At all reliable radio dealers.

This "C" Battery is a Wonder Worker

YOU can make the loud speaker respond with a new fullness and naturalness of tone. You can save money by adding months to the life of your "B" Batteries. These things you can do by using the new Eveready "Three" as a "C" Battery.

You already have an "A" Battery for the filament and a "B" Battery for the plate. A "C" Battery is connected to the third element of your vacuum tube, the grid, affording a control that is marvelous in action on audio frequency amplifiers.

As a "C" Battery the Eveready "Three" prevents distortion and excessive flow of current from the "B" Battery, lengthening its life. It is a wonder worker that saves its small cost many times over. Connect it in your audio frequency amplifier and note the difference. Full directions on the label and

in "How to Get the Most Out of Your 'B' Battery," a booklet on "B" and "C" Batteries, sent free on request.

This triple-use battery can also be used as an "A" Battery in portable sets. Light and full of pep. Its third use is as a "B" Battery booster.

Use the Eveready "Three"—a tested product of the world's leading electro-chemical battery laboratory. It serves more radio uses and effects more economies than any radio battery heretofore developed.

If you have any battery problem, Radio Battery Information Headquarters will solve it for you. Write G. C. Furness, Manager, Radio Division, National Carbon Company, Inc., 209 Manley Street, Long Island City, New York.

NATIONAL CARBON COMPANY, INC., New York—San Francisco

Headquarters for Radio Battery Information

CANADIAN NATIONAL CARBON CO., Limited Factory and Offices: Toronto, Ontario

EVEREADY
Radio Batteries
—they last longer

Dental Laboratory EXPERTS WANTED

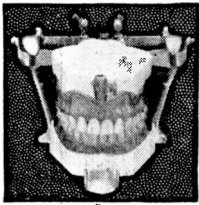

Learn to make Rubber Plates, Bridge Work, Crowns, Metal Base Dentures.

for Laboratories for each EXPERT capable of operating one!

60,000 DENTISTS NEED LABORATORIES!

Only a few hundred Laboratories in all the U.S.—most of them in Chicago and New York. Dentists can't afford to do their own mechanical jobs. They can buy the services of a Laboratory Expert at \$3.00 an hour and sell their own time at \$6 to \$15 an hour, and they want better, quicker, service than they can get now!

OPEN A LABORATORY of your OWN!

Jow Wilk of Chicago started a couple of years ago ALONE. Today he employs 60 Experts and his Laboratory is one of the biggest in the U. S. Boos in Minneapolis is reported to employ 125 men and to clear \$40,000 to \$50,000 a year. You can start your own Laboratory with as little as \$100 investment.

EARN While You LEARN!

Day students make all or part cost of course by part-time night work. Night students can find plenty of good jobs in Chicago "to see them thru."

We'll Help You!

Interesting Catalog FREE! Catalog tells you how quickly and easily you can get ready, how hundreds of others have SUCCEEDED! Tells you how you learn in few months BY DOING ACTUAL LABORATORY JOBS under world's greatest Mechanical Dentists! Brings you FREE R. R. FARE offer and other big inducements. Write for free catalog today!

McCARRIE SCHOOL OF MECHANICAL DENTISTRY
Dept. 103, 34 and 36 W. Lake St., Chicago

McCarrie School of Mechanical Dentistry
Dept. 103, 34 and 36 W. Lake St., Chicago

Without obligation please send me your FREE R. R. Fare Offer and free catalog with complete information about how I may become a Dental Laboratory EXPERT.

Name.....
St. No. or R. F. D.....
City.....State.....

Radio Broadcast

Revised and corrected to date.

First group of figures indicate the power in watts in the antenna of the transmitting station. The second group gives the wave-length.

Call Letters	Name	Location	Power & Wave Length	Call Letters	Name	Location	Power & Wave Length
KDKA	Westinghouse Electric & Mfg. Co., East Pittsburgh, Pa.		1,000—326	KFDL	Knight-Campbell Music Co., Denver, Colo.		5—360
KDPM	Westinghouse Electric & Mfg. Co., Cleveland, Ohio		250—270	KFDO	H. Everett Cutting, Bozeman, Mont.		50—248
KDPT	Southern Electrical Co., San Diego, Calif.		50—244	KDFP	Hawkeye Radio & Supply Co., Des Moines, Iowa		100—278
KDYL	Telegram Publishing Co., Salt Lake City, Utah		50—360	KFDR	Bullocks Hardware & Sporting Goods (Robert G. Bullock), York, Neb.		10—360
KDYM	Savoy Theatre, San Diego, Calif.		50—252	KFDU	Nebraska Radio Electric Co., Lincoln, Neb.		20—240
KDYQ	Oregon Institute of Technology, Portland, Ore.		5—360	KFDV	Gilbrech & Stinson, Fayetteville, Ark.		200—360
KDYS	The Tribune, Great Falls, Mont.		50—360	KFDX	First Baptist Church, Shreveport, La.		100—360
KDYW	Smith Hughes Machinery Co., Phoenix, Ariz.		20—360	KFDY	South Dakota State College of Agriculture and Mechanic Arts, Brookings, S. D.		100—360
KDYX	Star Bulletin, Honolulu, Hawaii		100—360	KFDZ	Harry O. Iverson, Minneapolis, Minn.		5—360
KDZB	Frank E. Siefert, Bakersfield, Calif.		100—240	KFEC	Meier & Frank Co., Portland, Ore.		50—360
KDZE	The Rhodes Co. (Dept Store), Seattle, Wash.		100—455	KFEJ	Guy Greason, Tacoma, Wash.		10—360
KDZF	Automobile Club of Southern California, Los Angeles, Calif.		500—278	KFEL	Winner Radio Corp., Denver, Colo.		50—360
KDZI	Electric Supply Co., Wenatchee, Wash.		50—360	KFEP	Radio Equipment Co. (Jos. L. Turre), Denver, Colo.		10—240
KDZK	Nevada Machinery & Electric Co., Reno, Nev.		25—360	KFEQ	J. L. Scroggin, Oak, Neb.		150—360
KDZQ	Nichols Academy of Dancing (Hal G. Nichols), Denver, Colo.		10—360	KFER	Auto Electric Service Co., Fort Dodge, Iowa		20—231
KDZR	Bellingham Publishing Co., Bellingham, Wash.		50—261	KFEV	Radio Electric Shop, Douglas, Wyo.		100—263
KDZT	Seattle Radio Association, Seattle, Wash.		10—360	KFEX	Augsburg Seminary, Minneapolis, Minn.		100—261
KFAD	McArthur Bros. Mercantile Co., Phoenix, Ariz.		100—360	KFEY	Bunker Hill & Sullivan Mining and Concentrating Co., Kellogg, Idaho		10—360
KFAE	State College of Washington, Pullman, Wash.		500—360	KFEZ	Amer. Society of Mechanical Engineers (F. H. Schubert), St. Louis, Mo.		100—360
KFAF	Western Radio Corporation, Denver, Colo.		500—360	KFFA	Dr. R. O. Shelton, San Diego, Calif.		50—242
KFAJ	University of Colorado, Boulder, Colo.		100—360	KFFB	Jenkins Furniture Co., Boise, Idaho		10—240
KFAN	The Electric Shop, Moscow, Idaho		50—360	KFFE	Eastern Oregon Radio Co., Pendleton, Ore.		10—360
KFAP	Standard Publishing Co., Butte, Mont.		100—360	KFFO	Dr. E. H. Smith, Hillsboro, Ore.		5—229
KFAR	Studio Lighting Service Co. (O. K. Olsen), Hollywood, Calif.		200—280	KFFP	First Baptist Church, Moberly, Mo.		100—275
KFAU	Independent School District of Boise City, Boise High School, Boise, Idaho		150—270	KFFQ	Marksheffel Motor Co., Colorado Springs, Colo.		100—360
KFAV	Abbot Kinney Co., Venice, Calif.		5—224	KFFR	Nevada State Journal (Jim Kirk), Sparks, Nev.		10—226
KFAW	The Radio Den (W. B. Ashford), Santa Ana, Calif.		10—280	KFFV	Graceland College, Lamoni, Iowa		100—360
KFAZ	Virgin's Radio Service (W. J. Virgin), Medford, Ore.		50—283	KFFX	McGraw Co., Omaha, Neb.		250—278
KFBB	F. A. Buttrey & Co., Havre, Mont.		50—360	KFFY	Pincus & Murphey, Alexandria, La.		100—275
KFBC	W. K. Azbill, San Diego, Calif.		20—278	KFFZ	Al G. Barnes Amusement Co., Dallas, Texas (portable)		20—226
KFBE	Reuben H. Horn, San Luis Obispo, Calif.		10—360	KFGC	Louisiana State University, Baton Rouge, La.		100—254
KFBG	First Presbyterian Church, Tacoma, Wash.		50—360	KFGD	Chickasha Radio & Electric Co., Chickasha, Okla.		20—248
KFBK	Kimball-Upson Co., Sacramento, Calif.		100—283	KFGH	Leland Stanford University, (P. O.) Stanford Univ., Calif.		500—360
KFBL	Leese Bros., Everett, Wash.		10—224	KFGJ	Missouri National Guard, 138th Infantry, St. Louis, Mo.		250—266
KFBS	Trinidad Gas & Electric Supply Co., and Chronicle News, Trinidad, Colo.		15—360	KFGL	Arlington Garage, Arlington, Ore.		5—234
KFBU	The Cathedral (Bishop N. S. Thomas), Laramie, Wyo.		50—283	KFGP	Cheney Radio Co., Cheney, Kan.		100—229
KFCB	Nielsen Radio Supply Co., Phoenix, Ariz.		10—238	KFGQ	Crary Hardware Co., Boone, Iowa		10—226
KFCD	Salem Electric Co. (F. S. Barton), Salem, Ore.		20—360	KFGV	Heidbreder Radio Supply Co., Utica, Neb.		10—224
KFCF	Frank A. Moore, Walla Walla, Wash.		50—360	KFGX	First Presbyterian Church, Orange, Texas		500—250
KFCH	Electric Service Station, Inc., Billings, Mont.		10—360	KFGZ	Emmanuel Missionary College, Berrien Springs, Mich.		10—268
KFCI	Colorado Springs Radio Co., Colorado Springs, Colo.		10—258	KFHA	Western State College of Colorado, Gunnison, Colo.		50—252
KFCL	Los Angeles Union Stock Yards, San Antonio, Calif.		500—360	KFHB	Rialto Theatre (P. L. Beardwell), Hood River, Ore.		5—280
KFCM	Richmond Radio Shop (Frank T. Doeing), Richmond, Calif.		100—360	KFHD	Utz Electric Shop Co., St. Joseph, Mo.		100—226
KFCP	Ralph W. Flygare, Ogden, Utah		25—360	KFHF	Central Christian Church, Shreveport, La.		150—266
KFCV	Fred Mahaffey, Jr., Houston, Texas		10—360	KFHH	Ambrose A. McCue, Neah Bay, Wash.		50—283
KFCY	Western Union College, Le Mars, Iowa		50—252	KFHJ	Fallon & Co., Santa Barbara, Calif.		100—360
KFCZ	Omaha Central High School, Omaha, Neb.		100—258	KFHQ	Curtis Bros. Hardware Store (Alfred E. Fowler), Los Gatos, Calif.		5—242
KFDA	Adler's Music Store, Baker, Ore.		5—360	KFHR	Star Electric & Radio Co., Seattle, Wash.		100—270
KFDD	St. Michaels Cathedral, Boise, Idaho		10—252	KFHS	Clifford J. Dow, Lihue, Hawaii		30—275
KFDH	University of Arizona, Tucson, Ariz.		150—360				
KFDJ	Oregon Agricultural College, Corvallis, Ore.		50—360				

(Continued on page 1020)

Tighten Your Grip on a Trade

Be An Electrical Expert At \$75 to \$200 a Week

Every up-to-date fellow knows what a future there is in electricity. Big pay—fascinating work on land or sea—rapid advancement in a field where jobs are ten times more numerous than trained men to fill them, where \$75.00 a week is just a fair starter, where top notchers pull down ten thousand dollars or more a year—in a field, where any man if he wishes, can easily have a business of his own, have men working for him, **be his own boss!** But what the average young man does NOT know, is what a simple, easy, A-B-C sort of a job it is to get started.

You Can Start Right Now!

Yes, you. You don't need a thing you don't already have! You can read. You can write. You can figure. You can think. And in your breast is the fire of ambition—the desire to get ahead! All right, that's all you need—we can help you just as you are—just as we have helped scores, yes, thousands of other two-fisted young fellows determined to get out of the rut and into the electric field—into work that will be pleasant—easy—and all in your home, during spare time.

Fascinating Home Study As You Hold Your Old Job

With the help we will give you, you can slip right into one of these big pay—be-man jobs and never lose a day's work. After a few weeks' start, you can earn enough in installation and electric repair jobs alone to more than pay for the Course and lay a foundation for an Electrical Contracting or Repair Shop Business of your own. When the proper time comes, we will tell you the easy way to go about doing it.

The Most Practical, Thorough and Condensed Electrical Course Ever Written

This is the only home study electrical course that gives you the combined practical and theoretical training you must have before you can be a successful electrician without which you cannot succeed—with which you cannot fail.

Written not by ONE man, with the narrow one-man viewpoint, but by 22 of the brainiest, most successful, electrical experts ever drawn from the field of practice and theory. Gives you the complete mastery of the subject—qualifies you as electrical expert to boss jobs—fits you right into the kind of a job you want—and does it in shortest time—at lowest cost—with the

Most Binding Guarantee of Results Ever Offered!

Satisfaction guaranteed or no sale! We not only SAY we can make you an electrical expert, we Guarantee it! If you are not absolutely satisfied when you have finished our Practical Electrical Course, we will refund every nickel you sent us.

FREE! Experimental Outfit Worth \$30
Drafting Course Worth Another \$30
Big Electrical Library Worth \$25
Find out all about our offer. Find out about the thousands who have taken this course in preference to all others and MADE GOOD. Find out about the Electric Library—four elegant volumes—worth \$25, but free. About the free Drafting Course worth another \$30. The free Experimental and Demonstration Outfit, including a real, not a make-shift Electric Motor, Wheatstone Bridge, etc.—the most scientific, high-grade and complete Experimental Outfit ever supplied with a Course in Electricity. Get all the facts without obligation, without expense! Just send the coupon!

American School

Dept. E-226

Drexel Ave. and 58th Street, Chicago

**FREE
Electrical
Coupon**

American School,
Dept. E-226, Chicago
Please rush all information relative to your Course in Electricity. This obligates me in no way whatever.

Name.....

Address.....

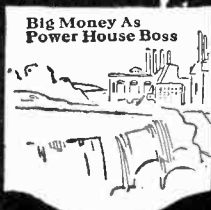
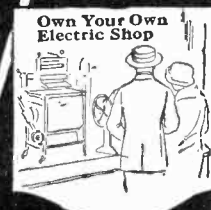



"They've tripled your salary, dear"

"I TELL you, Tom, it was a lucky day for both of us when you sent in that I. C. S. coupon. You'd never be where you are to-day if you hadn't decided to study in spare time just when you did."

Spare-time study with the I. C. S. is winning promotions for thousands of men and bringing happiness to thousands of homes all over the world. In offices, shops, stores, mines, mills and on railroads, I. C. S. trained men are stepping up to big jobs, over the heads of older men, past those whose only qualification is long service. There is a job ahead of YOU. Some man is going to be picked for it. The boss can't take chances. He is going to choose a trained man with sound, practical knowledge of the work.

Get busy right now and put yourself in line for that promotion. You can do it in spare time in your own home through the International Correspondence Schools, just as thousands of other men and women have done.

The first step they took was to mark and mail this coupon. Make your start the same way—and make it right now.

MAIL THE COUPON TO-DAY!

INTERNATIONAL CORRESPONDENCE SCHOOLS

Box 6222-C, Scranton, Penna.

Without cost or obligation on my part, please tell me how I can qualify for the position or in the subject before which I have marked an X:

BUSINESS TRAINING COURSES

- | | |
|--|---|
| <input type="checkbox"/> Business Management | <input type="checkbox"/> Salesmanship |
| <input type="checkbox"/> Industrial Management | <input type="checkbox"/> Advertising |
| <input type="checkbox"/> Personnel Organization | <input type="checkbox"/> Better Letters |
| <input type="checkbox"/> Traffic Management | <input type="checkbox"/> Show Card Lettering |
| <input type="checkbox"/> Business Law | <input type="checkbox"/> Stenography and Typing |
| <input type="checkbox"/> Banking and Banking Law | <input type="checkbox"/> Business English |
| <input type="checkbox"/> Accountancy (including C.P.A.) | <input type="checkbox"/> Civil Service |
| <input type="checkbox"/> Nicholson Cost Accounting | <input type="checkbox"/> Railway Mail Clerk |
| <input type="checkbox"/> Bookkeeping | <input type="checkbox"/> Common School Subjects |
| <input type="checkbox"/> Private Secretary | <input type="checkbox"/> High School Subjects |
| <input type="checkbox"/> Spanish <input type="checkbox"/> French | <input type="checkbox"/> Illustrating |

TECHNICAL AND INDUSTRIAL COURSES

- | | |
|---|--|
| <input type="checkbox"/> Electrical Engineering | <input type="checkbox"/> Architect |
| <input type="checkbox"/> Electric Lighting | <input type="checkbox"/> Blue Print Reading |
| <input type="checkbox"/> Mechanical Engineer | <input type="checkbox"/> Contractor and Builder |
| <input type="checkbox"/> Mechanical Draftsman | <input type="checkbox"/> Architectural Draftsman |
| <input type="checkbox"/> Machine Shop Practices | <input type="checkbox"/> Concrete Builder |
| <input type="checkbox"/> Railroad Positions | <input type="checkbox"/> Structural Engineer |
| <input type="checkbox"/> Gas Engine Operating | <input type="checkbox"/> Chemistry <input type="checkbox"/> Pharmacy |
| <input type="checkbox"/> Civil Engineer | <input type="checkbox"/> Automobile Work |
| <input type="checkbox"/> Surveying and Mapping | <input type="checkbox"/> Airplane Engines |
| <input type="checkbox"/> Metallurgy <input type="checkbox"/> Mining | <input type="checkbox"/> Agriculture and Poultry |
| <input type="checkbox"/> Steam Engineering <input type="checkbox"/> Radio | <input type="checkbox"/> Mathematics |

Name.....
Street.....
Address.....

City..... State.....

Occupation.....

Persons residing in Canada should send this coupon to the International Correspondence Schools Canadian, Limited, Montreal, Canada

MAKE MONEY AT HOME

YOU CAN make \$1 to \$2 an hour writing show cards at home in your spare time. Quickly and easily learned by our new simple method. No canvassing or soliciting. We show you how, guarantee you work at home no matter where you live and pay you cash each week. Full particulars and booklet free. Write to-day. AMERICAN SHOW CARD SYSTEM LTD. Authorized and Fully Paid Capital, \$1,000,000. 110 Adams Bldg. Toronto, Canada

Send To-day for the

"Electrical Worker's Friend"

An electrical book of 66 motor drawings with complete instructions for rewinding and reconnecting A. C. motors. Special at.....

\$3.00

Or write for full particulars of this valuable book. SMITH & SMITH PUBLISHING CO. Dent. B., 7428 Hermitage St., Pittsburgh, Pa.

RADIO BROADCAST

(Continued)

Call Letters	Name	Location	Power & Wave Length
KFHU	M. G. Sateren, Mayville, N. D.		50—261
KFHX	Robert W. Nelson, Hutchinson, Kan.		50—229
KFI	Earle C. Anthony, Inc., Los Angeles, Calif.		500—469
KFIB	Franklin W. Jenkins, St. Louis, Mo.		10—244
KFID	R. Arbuckle's Garage, Iola, Kan.		20—246
KFIF	Benson Polytechnic Institute, Portland, Ore.		100—360
KFIK	Gladbrook Electrical Co., Gladbrook, Iowa		20—234
KFIL	Windisch Electric Farm Equipment Co., Louisburg, Kan.		30—234
KFIO	North Central High School, Spokane, Wash.		50—252
KFIQ	Yakima Valley Radio Broadcasting Association, Yakima, Wash.		50—234
KFIU	Alaska Elec. Light & Power Co., Juneau, Alaska		10—226
KFIV	V. H. Broyles, Pittsburg, Kan.		20—240
KFIX	Reorganized Church of Jesus Christ of Latter Day Saints, Independence, Mo.		250—240
KFIY	Brott Laboratories, Seattle, Wash.		15—236
KFIZ	Daily Commonwealth and Oscar A. Huelman, Fond du Lac, Wis.		100—273
KFJA	Central Power Co., Grand Island, Neb.		100—244
KFJB	Marshall Electrical Co., Marshalltown, Iowa		10—248
KFJC	Seattle Post Intelligencer, Seattle, Wash.		100—233
KFJD	Weld County Printing & Publishing Co., Greeley, Colo.		50—236
KFJE	National Radio Mfg. Co., Oklahoma City, Okla.		20—252
KFJH	The Sugar Bowl (H. R. Shaw), Selma, Okla.		10—273
KFJI	Liberty Theatre (E. E. Marsh), Astoria, Ore.		10—252
KFJJ	Carrollton Radio Shop, Carrollton, Mo.		50—236
KFJK	Delano Radio & Electric Co., Bristow, Okla.		100—233
KFJL	Hardsag Mfg. Co., Ottumwa, Iowa		10—242
KFJM	University of North Dakota, Grand Forks, N. D.		100—229
KFJR	Ashley C. Dixon & Son, Stevensville, Mont. (near)		50—253
KFJV	T. H. Warren, Dexter, Iowa		10—224
KFJW	Le Grand Radio Co., Towanda, Kan.		10—226
KFJX	Iowa State Teachers College, Cedar Falls, Iowa		50—229
KFJY	Tunwall Radio Co., Fort Dodge, Iowa		50—246
KFJZ	Texas National Guard, 112th Cavalry, Fort Worth, Texas		20—254
KFKA	Colorado State Teachers College, Greeley, Colo.		50—248
KFKB	Brinkley-Jones Hospital Association, Milford, Kan.		500—286
KFKH	Denver Park & Amusement Co., Lakeside, Colo.		10—226
KFKQ	Conway Radio Laboratories (Ben H. Woodruff), Conway, Ark.		150—224
KFKV	F. F. Gray, Butte, Mont.		50—283
KFKX	Westinghouse Electric & Mfg. Co., Hastings, Neb.		500—286
KFKZ	Nassau Bros. Radio Co., Colorado Springs, Colo.		10—234
KFLA	Abner R. Willson, Butte, Mont.		5—283
KFLB	Signal Electric Mfg. Co., Menominee, Mich.		20—248
KFLD	Paul E. Greenlaw, Franklinton, La.		20—234
KFLE	National Educational Service, Denver, Colo.		25—268
KFLH	Erickson Radio Co., Salt Lake City, Utah		50—261
KFLP	Everette M. Foster, Cedar Rapids, Iowa		20—240
KFLQ	Bizzell Radio Shop, Little Rock, Ark.		20—261
KFLR	University of New Mexico, Albuquerque, N. M.		100—254
KGB	Tacoma Daily Ledger, Tacoma, Wash.		50—252
KGG	Hallock & Watson Radio Service, Portland, Ore.		50—360
KGN	Northwestern Radio Mfg. Co., Portland, Ore.		100—360
KGU	Marion A. Mulrony, Honolulu, Hawaii		250—360
KGW	Portland Morning Oregonian, Portland, Ore.		500—492
KGY	St. Martins College, Lacey, Wash.		5—258
KHJ	Times Mirror Co., Los Angeles, Calif.		500—395
KHQ	Louis Wasmer, Seattle, Wash.		100—360

(Continued on page 1022)



"From This Day You Get Bigger Pay"

"And so I was promoted. The boss seemed surprised, until I told him I had been studying nights—to learn more about my job, and how to do it better."
An American School Course will put you in the way of earning big money in the line of work you like best. Look over the Coupon, check the Branch you want to learn, mail it and we will send you full information FREE. Pay no money until you know all about what we can do for you. The cost is low, the terms easy and the results insured by our money-back guarantee. The pay increases you will get will more than pay for your course in a few weeks' time.

We have thousands of successful graduates holding big jobs today. You can join this money-making class. Fill out the coupon, mail it today. Get your start in life.

American School, Dept. G-226, Drexel Ave. & 58th St., Chicago, Ill.

American School, Dept. G-226, Drexel Ave. & 58th St., Chicago

Send me full information on the subject checked.

<input type="checkbox"/> Architect	<input type="checkbox"/> Business Law
<input type="checkbox"/> Building Contractor or Carpenter	<input type="checkbox"/> Lawyer
<input type="checkbox"/> Automobile Engineer	<input type="checkbox"/> Machine Shop Practice
<input type="checkbox"/> Automobile Repairman	<input type="checkbox"/> Photoplay Writer
<input type="checkbox"/> Civil Engineer	<input type="checkbox"/> Mechanical Engineer
<input type="checkbox"/> Advertising Manager	<input type="checkbox"/> Shop Superintendent
<input type="checkbox"/> Business Manager	<input type="checkbox"/> Employment Manager
<input type="checkbox"/> Financial Manager	<input type="checkbox"/> Steam Engineer
<input type="checkbox"/> Sales Manager	<input type="checkbox"/> Foremanship
<input type="checkbox"/> Cert. Public Accountant	<input type="checkbox"/> Sanitary Engineer
<input type="checkbox"/> Accountant and Auditor	<input type="checkbox"/> Surveyor—and Mapping
<input type="checkbox"/> Bookkeeper	<input type="checkbox"/> Telephone Engineer
<input type="checkbox"/> Draftsman and Designer	<input type="checkbox"/> Telegraph Engineer
<input type="checkbox"/> Electrical Engineer	<input type="checkbox"/> High School
<input type="checkbox"/> General Education	<input type="checkbox"/> Fire Insurance Expert
<input type="checkbox"/> Personal Analysis	<input type="checkbox"/> Wireless Radio
	<input type="checkbox"/> Undecided

Name..... Address.....

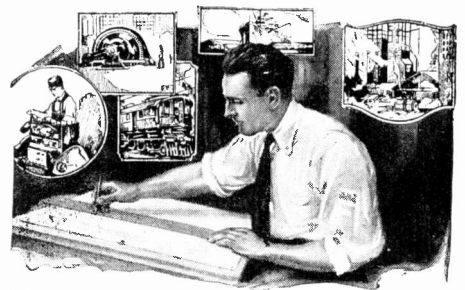

WE'LL TRAIN YOU FREE as Drafting Specialist

EARN \$35 TO \$100 A WEEK

After you have completed our Course in Drafting (mechanical drawing), we will give you free training in your choice of one of our courses in a specialized branch of drafting.

WHAT YOU GET FREE

We also furnish you free with complete drawing and drafting equipment when you enroll for our Course. Free consultation privileges at any time, during your course or after you've taken your position. We help you to get a position as draftsman and send you free subscription to Draftsman's Publication "The Compass."

FREE BOOK: Write to-day for free book, "Drafting—Your Success," giving details of our home study course in drafting and telling how you can qualify for a position paying \$35 to \$100 a week.

ROY C. CLAFLIN, President

COLUMBIA SCHOOL OF DRAFTING
Dept. 2282, 14th and T Streets, N. W., Washington, D. C.

MUSIC LESSONS FREE

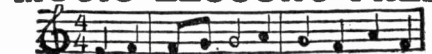

You can read music like this quickly IN YOUR HOME. Write today for our FREE booklet. It tells how to learn to play Piano, Organ, Violin, Mandolin, Guit., Banjo, etc. Beginners or advanced players. Your only expense about 2c per day for music and postage used. AMERICAN SCHOOL OF MUSIC, 57 Lakeside Bldg., Chicago



Charles Cassell

“What’s the print allow you, Bill?”

“Two thousandths under — nothing over.”

“*With* no chance to fit and try *and* a fine chance of getting fired if you spoil it. All I got to say is it’s a good thing you own a set of Starrett ‘Mikes’.”

THE L. S. STARRETT CO.

The World’s Greatest Toolmakers—Manufacturers of Hacksaws Unexcelled
ATHOL, MASS.

The Micrometer Head illustrated at the right is part of the Starrett Inside Micrometer Set No. 124. A wonderfully accurate tool beautifully finished and built to give a lifetime’s service. Furnished in four size combinations ranging from 2 to 8 inches to 2 to 32 inches. See pages 180 to 186 in the Starrett Catalog for complete description of these fine Micrometers. Free. Write for Catalog No. 22 “LE”

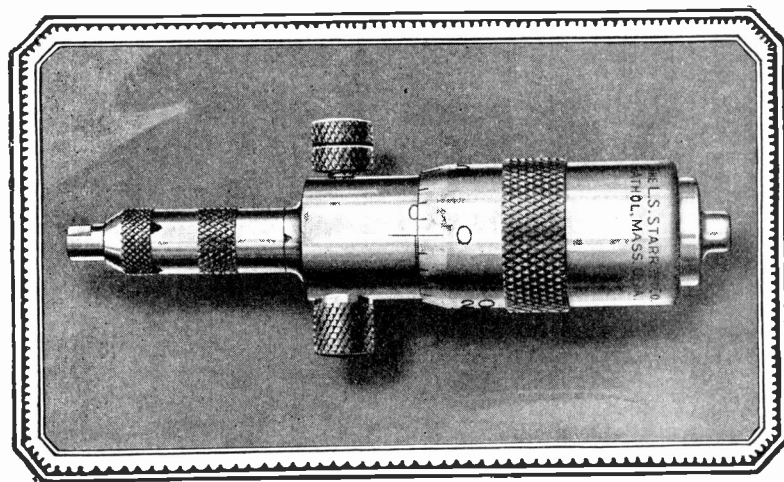

Use Starrett Tools

6021



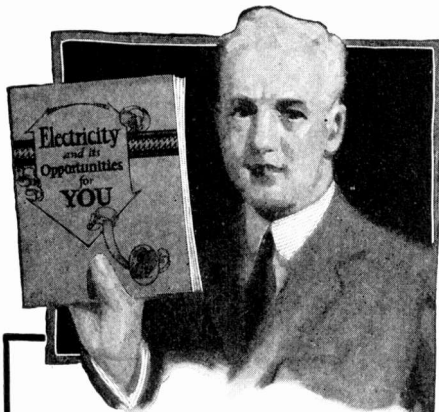

GET THE FACTS about the high-pay opportunities in ELECTRICITY

Do you want the real, "brass tacks" facts about your chances in the electrical field?

A big new 64-page book issued by the Associated Electrical Engineers of America, gives you these facts, straight from the shoulder! Here is the answer to your questions. You can have it—FREE—by asking for it on the coupon below.

NOW as Never Before Your Chance is in the High-Pay Electrical Jobs

You may think, right now, that there isn't as big an opportunity for you—in electricity—as we tell you there is. But the bed-rock facts of the case show beyond question that there is an ever-increasing shortage of trained electrical workers, a shortage that can't be overcome for five years, at least.

If you want to know—if you want to be convinced—you'll find the facts you're looking for, in the pages of our great book. You'll find out why you can

EARN \$15 TO \$30 A DAY AS AN ELECTRICAL EXPERT OR IN BUSINESS FOR YOURSELF

Spare time training at home, under direction of the A.E.E.'s engineers puts you in line for the sort of opportunities you are seeking—real jobs, with real pay!

NEW, COPYRIGHTED METHOD OF TRAINING GETS RESULTS

Your progress under the A.E.E. methods of training is swift and sure. Practical, clear, understandable information covers every branch of Electricity—General, Automotive, Radio, and the Business side, too. Nothing else like it. Shows how to make more money right from start—how you can Earn while you Learn.

DON'T LET LACK OF EDUCATION STOP YOU

You don't need much book-education to get the meat in this training. Everything in it is perfectly clear and understandable.

Backed by a Legal Guarantee of Satisfaction

You're not taking the slightest risk in sending for our book, or in taking our training, either. If you train in the A. E. E. you are backed by a straight, legally binding guarantee of satisfaction that protects you every step of the way. So once again we say, "GET THE FACTS." Write us right now for copy of the book.

SEND NOW About Electrical Opportunities

ASSOCIATED ELECTRICAL ENGINEERS

Here's Opportunity's Wide Open Door

Send this coupon to Associated Electrical Engineers of America Dept. 324, 537 S. Dearborn St., Chicago, Ill.

Without obligation, send me your 64-page illustrated book on Electricity, together with full details of your remarkable plan of home training and membership in the A. E. E.

Name.....

Address.....

City.....

RADIO BROADCAST

(Continued)

Table with columns: Call Letters, Name, Location, Power & Wave Length. Lists radio stations from KJFU to WABE.

(Continued on page 1024)

Make Money Taking PICTURES



Tremendous, big-paying opportunities are open for ambitious men in Modern Photography. This is the picture age. Magazine and newspaper publishers buy thousands of photographs each year.

Got \$100 for Flood Pictures "I took pictures of a flood and sold them for \$100. I have been able to buy my house and lot from the sale of pictures."

C. M. Cole, Washington. \$97 in Two Days! "I made \$285 in December. Went out two days last week on home portrait work and made \$97."

Every home wants portraits. Photography is a business running into millions of dollars each year.

EARN \$3,000 to 10,000 a Year Hundreds of men are earning big money and establishing their own businesses. Even during spare time, while training, you can make \$75 a week easily—no matter where you live!

Amazing New Easy Method I show you, at home, how to do the kind of work turned out by the big studios in New York and Chicago! I show you how to make big money within 30 days! C. M. Cole bought a home with money he had made when only half way through his training.

Send to return every cent of your tuition if you are not thoroughly satisfied.

Professional View Camera FREE!

Write at once for Free Camera Offer—I give you, free, a splendid professional view camera. You will be astonished and delighted. This offer open for short time only—so act quick! No obligation. INTERNATIONAL STUDIOS, Inc. Dept. 7452 3601 Michigan Ave., Chicago, U.S.A.

YOU TOO CAN PLAY THE HAWAIIAN GUITAR JUST AS THE HAWAIIANS DO! PLAY ALL THE LATEST HITS



After Your FIRST LESSON You Will Play a Complete Selection. We Guarantee That— Our method is so simple, interesting and appealing that you begin in your first lesson to learn the famous Hawaiian Folk Song "ALOHA". Think how happy you will be when you surprise your friends by playing the fascinating Hawaiian Guitar.

Only Four Motions—and You Master Them Quickly! In a few minutes you acquire the four motions necessary to play any piece—after that a short period of practice and you will have mastered this thrillingly sweet music. Complete course of 62 lessons includes FREE beautiful Hawaiian Guitar, necessary picks, steel bar, etc. No extras.

No Previous Musical Knowledge Necessary If you never read a musical note in your life—if you haven't even the slightest knowledge of music, we can quickly and positively teach you to play this wonderfully popular instrument. Don't be just a "listener" when you can easily be the center of interest among your friends. Over 40,000 successful students.

Just Mail a Post Card for Details of our remarkable FREE Hawaiian Guitar Offer—simply write: "I am interested" but do it today.

First Hawaiian Conservatory of Music, Inc. Desk 40 - 233E 4way (Woolworth Bldg.) New York City

FREE A Beautiful Hawaiian Guitar

Electrical Engineering

men with training are in demand. For more than a quarter of a century this school has been training men of ambition and limited time for the electrical industries. Condensed course in Electrical Engineering equates to secure good positions and promotions. Theoretical and Practical Electricity. Mathematics. Steam and Gas Engines and Mechanical Drawing. Students construct dynamos, install wiring and test electrical machinery. Course with diploma complete

In One Year

Over 3000 men trained. Thoroughly equipped fireproof dormitories, dining hall, laboratories, shops. Free catalog. 31st year begins Sept. 26, 1923 BLISS ELECTRICAL SCHOOL 106 TAKOMA AVE., WASHINGTON, D. C.

\$4.00 ADDING MACHINE

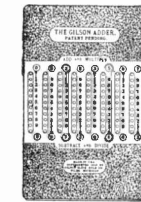

The GILSON ADDER will do your figuring easily, quickly and with absolute accuracy. It adds, subtracts, multiplies and divides and automatically carries from one column to the next. Capacity 109,999,999 or \$1,099,999.99. Size 3 1/2" x 6" x 1 1/4". Made with aluminum case and steel operating parts. Written Two-Year Guarantee. Catalogue free.

Price, postpaid, \$4.00 Your money back if you are not satisfied.

GILSON SLIDE RULE CO., NILES, MICH.

BECOME A LIGHTNING TRICK CARTOONIST

Make money chalk talking. Send \$1.00 for snappy program of trick drawings, with instructions by a professional cartoonist. Satisfaction guaranteed. Circular free. Balda Art Service, Dept. 4, Oshkosh, Wis.

Know electricity as experts know it and get an expert's pay

THE salary of the electrical worker is steadily advancing. Especially is this true of those who are educating themselves in the finer points of electrical practice. Fit yourself for one of the really big jobs by knowing electrical practice complete, including inside and outside work, central stations, and the whole subject. With the aid of the Croft books you can know electricity as experts know it and put yourself in line for an expert's pay.

THE CROFT LIBRARY OF PRACTICAL ELECTRICITY

8 volumes, 3,000 pages, 2,100 illustrations, flexible binding

THOUSANDS of men are coming to recognize the importance of books founded on actual electrical practice, as is the Croft Library—free from theory. They see in this Library the actual record of work that is being done every day in the world of electricity. They see the plain facts, plainly stated and plainly illustrated—understandable even to the beginner.

Examine it for 10 days FREE

efforts to one branch of work only. In order to broaden his knowledge and fit himself for the bigger position, he must read. **BUT HE MUST READ STANDARD BOOKS.** Not haphazardly compiled nor amateurish books, but books by men who can pull off their coats and do the work they write about.

Terrell Croft tells you in 3,000 pages and 2,100 illustrations all that he has learned in twenty years' electrical practice.

The electrician in practice usually confines his

Thousands of electrical questions answered

Between the covers of these eight books are thousands of first-hand facts, short cuts and methods—thousands of clear, specially-drawn illustrations—thousands of practical, easily understood answers to puzzling electrical questions.

Consult your set regularly, acquire just one new fact a day, and in a few years you will be a broadly informed electrical man, equipped to earn an expert's salary.

Croft tells you the things you need to know about motors, generators, armatures, commutators, transformers, circuits, currents, switchboards, distribution systems—electrical machinery of every type and installation, operation and repair—wiring for light and power—how to do it mechanically perfect, in accordance with the National Electrical Code—wiring of finished buildings—underwriters' and municipal requirements—how to do a complete job, from estimating it, to completion—illumination in its every phase—the latest and most improved methods of lighting—lamps and lighting effects, etc.

The way to bigger accomplishment

No matter how much nor how little you know of electricity, the Croft Library will be found of assistance every day. You will immediately recognize the fact that the author is a practical man. You will immediately see the great difference between these and other books on the subject which you possess.

Every page is taken from every-day electrical practice.

Every day you use these great books you will learn something that will help to make you a better electrical worker.

Croft deals only with the kind of problems you meet in daily work. Own a set and join the 40,000 men who have found the Croft Library to be a real working companion to bigger accomplishment in the electrical field.

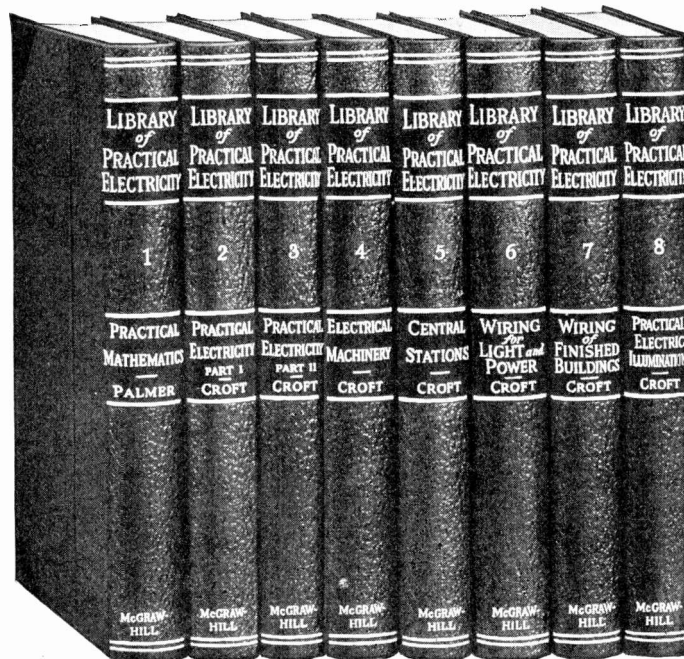

These books put money in your pocket

If you had to pay \$200.00 for the Croft books instead of \$19.50, you would still have a good investment. Put \$200.00 in the bank at 4% interest and you get a little over \$8.00 a year interest. Put only one-tenth of \$200.00 into the Croft books together with a little spare-time study, and you should get back anywhere from ten to several hundred times \$8.00.

Free examination

No money in advance

Small monthly payments

Name

Home Address

City and State

Employed by

Occupation

McGraw-Hill Book Co., Inc., 370 Seventh Ave., New York.

Gentlemen:—Send me the CROFT LIBRARY OF PRACTICAL ELECTRICITY (shipping charges prepaid), for 10 days' free examination. If satisfactory, I will send \$1.50 in ten days and \$2 per month until the special price of \$19.50 has been paid. If not wanted I will write you for return shipping instructions. (Write plainly and fill in all lines.)

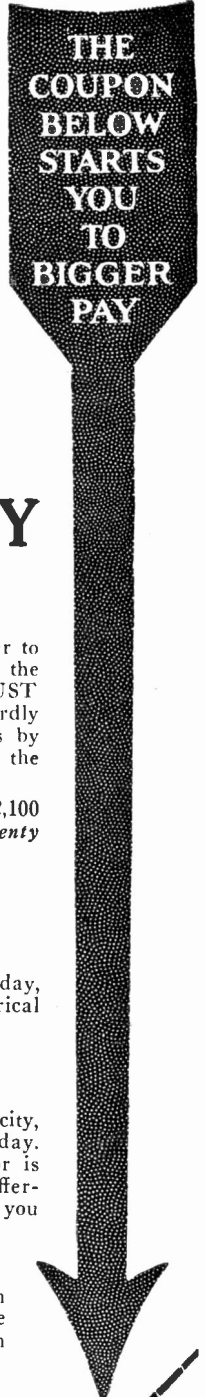

Every Question ANSWERED for only \$1

At last you have under one cover a Complete Radio Handbook

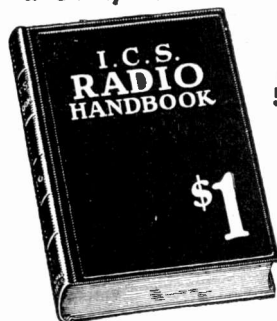

JUST OUT 514 PAGES

Compiled by **HARRY F. DART, B.S.E.E.**

Formerly with the Western Electric Co., and U. S. Army Instructor of Radio.

Technically Edited by F. H. DOANE

NO more need you turn from book to book, hoping to find what you want. It is all here, in 514 pages crammed full of every possible radio detail. Written in plain language, by engineers for laymen. Clears up the mysteries, tells you what you want to know. A complete index puts everything within your reach in a few seconds.

IT EXPLAINS: Electrical terms and circuits, antennas, batteries, generators and motors, electron (vacuum) tubes, every receiving hook-up, radio and audio frequency amplification, broadcast and commercial transmitters and receivers, super-regeneration, codes, license rules. Many other features.

Under one cover. Yes, it is all in one volume of 514 pages of clear type with hundreds of diagrams and illustrations. Takes the place of eleven or more specialized texts, each costing from two to ten times the dollar you pay for this single book. Belongs in every radio-equipped home, on every amateur's table.

Send \$1 to-day and get this 514-page I. C. S. Radio Handbook—the biggest value in radio to-day. Money back if not satisfied.

TEAR OUT HERE
INTERNATIONAL CORRESPONDENCE SCHOOLS
Box 6224-C, Scranton, Penna.

I enclose One Dollar. Please send me—post-paid—the 514-page I. C. S. Radio Handbook. It is understood that if I am not entirely satisfied I may return this book within five days and you will refund my money.

Name.....
Address.....

Learn How to WRESTLE

In Your Own Home By Mail

Yes, learn to become an expert wrestler right in your own home, by mail, from the greatest wrestler the world has ever known. Be an athlete, be strong, be healthy. Learn how to throw and handle big men with ease. Learn to defend yourself. Learn from the World's Champions.

Farmer Burns and Frank Gotch

Farmer Burns, who taught Frank Gotch—trainer of SEVEN World's Champions, will teach you Scientific Wrestling—Physical Culture—Jiu-Jitsu and Self-Defense. Your name, age and address on a post-card or letter, brings you our Fine Illustrated athletic and wrestling Book absolutely FREE—no obligations of any kind. Grasp this wonderful opportunity. State age.

Farmer Burns, 1252 Ry. Exch. Bldg., Omaha, Neb.

Wrestling Book Free

GOVT. HELP NEEDED

All men, women, boys, girls, 17 to 65, willing to accept Government Positions, \$117-\$250, stationary, at or near home, or traveling. Write, Mr. Ozment, 383, St. Louis, Mo. immediately.

RADIO BROADCAST

(Continued)

WABF	Mount Vernon Register-News Co., Mount Vernon, Ill.	100-234
WABG	Arnold Edwards Piano Co., Jacksonville, Fla.	10-248
WABH	Lake Shore Tire Co., Sandusky, Ohio	20-240
WABI	Bangor Railway & Electric Co., Bangor, Maine	50-240
WABJ	The Radio Laboratories, South Bend, Ind.	10-240
WABK	First Baptist Church, Worcester, Mass.	10-252
WABL	Connecticut Agricultural College, Storrs, Conn.	100-283
WABM	F. E. Doherty Automotive & Radio Equipment Co., Saginaw, Mich.	100-254
WABN	Waldo C. Grover, LaCrosse, Wis.	250-244
WABO	Lake Ave. Baptist Church, Rochester, N. Y.	10-252
WBAA	Purdue University, West Lafayette, Ind.	250-360
WBAD	Sterling Electric Co., Minneapolis, Minn.	100-360
WBAH	The Dayton Co., Minneapolis, Minn.	500-417
WBAN	Wireless Phone Corporation, Paterson, N. J.	100-244
WBAO	James Millikin University, Decatur, Ill.	50-360
WBAP	Wortham-Carter Publishing Co. (Star-Telegram), Fort Worth, Texas	750-476
WBAV	Erner & Hopkins Co., Columbus, Ohio	500-390
WBAW	Marietta College, Marietta, Ohio	250-246
WBAX	John H. Stenger, Jr., Wilkes-Barre, Pa.	20-360
WBAY	Western Electric Co., New York, N. Y.	500-492
WBBA	Newark Radio Laboratories, Newark, Ohio	20-240
WBBC	Sterling Radio Equipment Co., Sterling, Ill.	50-229
WBBD	Barbey Battery Service, Reading, Pa.	50-234
WBL	T & H Radio Company, Anthony, Kan.	100-261
WBS	D. W. May (Inc.), Newark, N. J.	20-360
WBT	Southern Radio Corp., Charlotte, N. C.	500-360
WBU	City of Chicago, Chicago, Ill.	500-286
WBZ	Westinghouse Electric & Mfg. Co., Springfield, Mass.	750-337
WCAD	St. Lawrence University, Canton, Ohio	250-280
WCAE	Kaufman & Baer Co., Pittsburgh, Pa.	500-462
WCAG	Clyde R. Randall, New Orleans, La.	50-268
WCAH	Entrekin Electric Co., Columbus, Ohio	100-286
WCAJ	Nebraska Wesleyan University, University Place, Neb.	500-360
WCAK	Alfred P. Daniel, Asst. Division Mgr., A. R. R. L., Houston, Texas	50-360
WCAL	St. Olaf College, Northfield, Minn.	250-360
WCAM	Villanova College, Villanova, Pa.	150-360
WCAO	The Sanders and Stayman Co., Baltimore, Md.	50-360
WCAP	Chesapeake & Potomac Telephone Co., Washington, D. C.	500-469
WCAR	Alamo Radio Electric Co., San Antonio, Texas	150-360
WCAS	Wm. Hood Dunwoody Industrial Institute, Minneapolis, Minn.	100-246
WCAT	South Dakota State School of Mines, Rapid City, S. D.	50-240
WCAU	Durham & Co., Philadelphia, Pa.	250-286
WCAV	J. C. Dice Electric Co., Little Rock, Ark.	20-360
WCAX	University of Vermont, Burlington, Vt.	50-360
WCAY	Kesselman O'Driscoll Co., Milwaukee, Wis.	250-261
WCAZ	Carthage College, Carthage, Ill.	50-246
WCBA	Charles W. Humbach, Allentown, Pa.	5-280
WCBB	K & K Radio Supply Co. (Charles H. Katzenberger), Greenville, Ohio	100-240
WCBD	Wilbur G. Voliva, Zion, Ill.	500-345
WCE	Findley Electric Co., Minneapolis, Minn.	250-360
WCK	Stix Baer & Fuller Dry Goods Co., St. Louis, Mo.	100-360
WCM	University of Texas, Austin, Texas	500-360
WCX	The Detroit Free Press, Detroit, Mich.	500-517

(Continued on page 1026)

How to Become a Marvel of Muscular Development

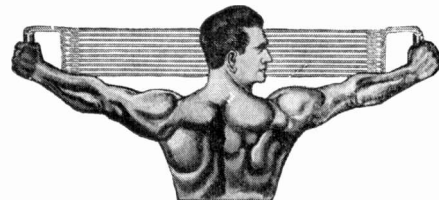

You Can Develop Enormous Muscles with this Newest and Greatest Invention in Physical Culture Apparatus

If you want to be a real strong man, if you want to build up a powerful, muscular body that will make you stand out among men, you can do it simply by using the McFadden Patented 10 Cable Progressive Exerciser, which can be instantly converted into two 5 cable progressive exercisers. Can be adjusted to give you as much resistance as you want up to 200 pounds.

NEWLY PATENTED STIRRUP

This ingenious device is a new addition to the McFadden 10 Cable Progressive Exerciser and is provided to give you the proper exercise to build up the most powerful legs.

ADJUSTABLE PATENTED HEAD-GEAR Increases the size of your neck one inch in 30 to 90 days.

This apparatus is simplicity itself and with it you can accomplish most wonderful results. It is adjustable and will fit any man or boy. By using it in connection with my Progressive Exerciser there is no reason why you cannot become just as strong as you want to be.

12 Weeks Home Instruction Course FREE

The introductory price of the whole outfit is only \$8, a very small cost for what it includes. If you are not fully satisfied your money will be refunded without quibble or question. Send NOW for this great outfit. Delays do not make strength. Order TODAY.

MICHAEL McFADDEN

Dept. 10, 103 E. 13th St., New York City

Conn Saxophone Book FREE



The saxophone is today's most popular instrument. With a Conn you can learn the scale in one hour—master popular music in a short time. Entertain yourself and friends—make more money. Saxophonists are in demand for orchestra and solo work.

This Free Book explains exclusive features which make the Conn saxophone easiest to play, beautiful in tone, reliable in action. Tells why world-famous artists such as Isham Jones, Paul Biese and scores more prefer the Conn. Free Trial; Easy Payments on any Conn instrument for band or orchestra. Send now for Free Book and details.

C. G. CONN, Ltd.

256 Conn Building Elkhart, Indiana



New 1/4 H. P. 110 Volt Guaranteed Motors

60 cycle A.C. Complete with cord, plug and pulley

Gen. Elec. 1725 speed	\$10.00
Gen. Elec. 1/2 H.P. Rep. Ind.	\$39.00
Master 3/4 H.P. Rep. Ind.	\$52.50
Master 1 H.P. Rep. Ind.	\$60.00
Master 1 1/2 H.P. Rep. Ind.	\$68.00

All makes and sizes up to 100 h.p. both new and rebuilt. Motors bought, repaired, exchanged. Let us quote on your needs.



ONE YEAR GUARANTEE

Satisfaction guaranteed or money refunded
Illustrated Catalog of Motors and Supplies FREE

HYRE ELECTRIC CO.

631-M So. Dearborn St., Chicago, Ill.

RADIO WALL MAP 10c

Up to date, just off the press. Shows call letters, location, wave length, and kilocycles of all radio broadcasting stations also American Relay divisions and radio districts. Complete with scale for measuring distances. Size 28x34 in. printed in three colors. Postpaid for 10c. OZARKA, INC., 868 Washington Blvd., Chicago

NATIONAL Apparatus of Simplicity and Perfection

For Reflex and Crystal Sets

The Monodyne circuit is one of the most radical advances in Radio engineering. Parts heretofore considered essential are omitted. One simple tuning control gives selectivity, equal if not superior to sets costing hundreds of dollars.

Only One
Tuning Control
All Wave Lengths

NATIONAL
MONODYNE

No Storage
Batteries



PAT. TRADE MARK PDG.
TUBE SET
MODEL GT-1

ANNOUNCING
Our New
AMPLIFIER
Designed for
Amplification of
MUSIC and VOICE

One or more Stages will
operate a Loud-Speaker
without distortion
or howling

Without
Tube
\$8.50



Uses but one dry cell tube, preferably WD-12, or any other standard dry cell tube. Local and distant broadcasting comes in clear and loud.



THE SINGLE TUBE
Performs the Function of 2-Tubes
AS RADIO FREQUENCY AMPLIFIER
AND DETECTOR

**3000 Miles
on the
MONODYNE**

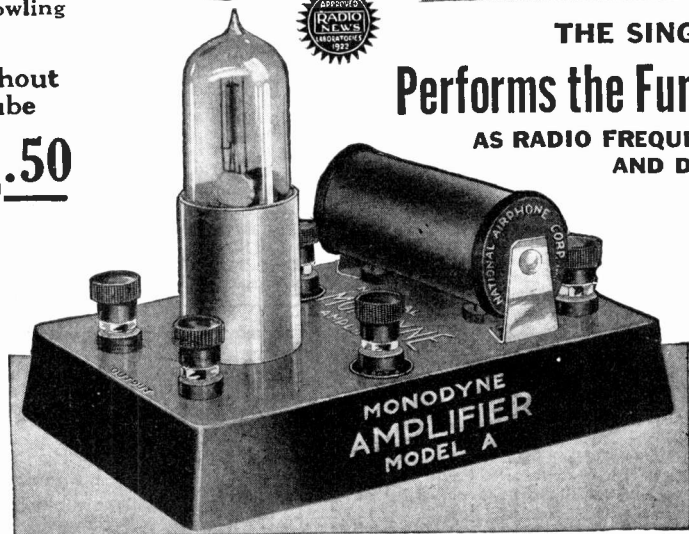

On Tuesday night, Nov. 27th, between 10:12 and 10:21, I heard on your National Monodyne Single Tube Set, hooked up with two stages of amplification, London, England, broadcasting speech, piano and violin solo. I also heard Liverpool, between 10:26 and 10:30 broadcasting dance music very clear.

FRANK DONDA,
341 East 56th St.
New York City.

The Monodyne Amplifier works on any receiver with any standard hard tube. W.D.-12 and U.V.-199 dry battery tubes are recommended.

Dealers, Jobbers and Distributors—Send for Samples and Prices:

NATIONAL AIRPHONE CORPORATION
REG. U.S. PAT. OFF.
20 HUDSON ST., NEW YORK

----- **SEND NO MONEY** -----

NATIONAL AIRPHONE CORPORATION S.I.-2-24
20 Hudson St., New York, U. S. A.

Please send me prepaid the articles crossed, for which I will pay postman upon delivery the advertised price.

One National Monodyne
One Audio Amplifier
One Interference Eliminator
One Panel Detector

NAME

STREET

CITY STATE



Corner of One of the Seven Laboratories

Take This Short Cut to Accomplish your Ambition

The field of electrical engineering offers wonderful opportunities for trained men to direct and carry out great industrial and commercial projects. Get a thorough and practical training here in our course of

ELECTRICAL ENGINEERING with B. S. Degree in 3 Years

A faculty of specialists is leading hundreds of ambitious young men to sure success. Why not you? If you are lacking some preparatory studies you can make them up here as you go along. This is an exceptional opportunity to become an electrical engineer in the shortest possible time.

ELECTROTECHNICS

From 1 to 2 years in this course makes you a completely trained electrotechnician—prepared to fill such positions as general plant superintendent, director of construction, superintendent of maintenance, chief draftsman, etc. The Electrotechnician is the man between the Electrical Engineer and the Electrician—a well paid position and a stepping stone to higher executive work. A grade school diploma or equivalent admits you without examination. New term opens every 6 weeks.

COMMERCIAL ELECTRICAL ENGINEERING In 1 Year

Unparalleled opportunities for brilliant, successful careers in the new field of Commercial Electrical Engineering. To meet the extraordinary present-day demands for trained electrical business men, consulting and efficiency engineers, we offer this thorough, condensed and very practical training, especially adapted to high school graduates.

PRACTICAL ELECTRICITY

In this complete 6 months' Electrical Course—8 hours daily—you can learn house, factory and theatre wiring, testing and meter work, A.C. and D.C. Armature Winding and all necessary mathematics.

A 3 months' course in A.C. and D.C. Armature Winding, or a 3 months' Course in Light and Motor Wiring and Testing is offered to those with limited time and means.

AUTOMOTIVE ELECTRICITY

Electrical specialists who instinctively diagnose and locate automotive electrical troubles command high positions and are well paid. Specialize in starting, lighting, ignition and storage batteries and command a big job at a big salary.

"EARN WHILE YOU LEARN"

We agree to provide, for a limited number of worthy young men, half-time jobs at good wages, and permanent positions with unlimited prospects to all duly qualified graduates. Here is the opportunity of your life to acquire a thorough, practical training for big-paying profession that is in urgent need for trained men.

ESTABLISHED 18 YEARS AGO

The S. of E. stands absolutely alone in the field of thorough, practical electrical education and in commercial and electrical engineering.

NO NEED OF YOUR BEING WITHOUT AN S. OF E. TRAINING

It does not matter how old you are or what schooling you have had. Students from 16 years up to 50 are in attendance here.

Fill out the following coupon and mail it to-day.

SCHOOL of ENGINEERING of Milwaukee

Founded 1905

SCHOOL OF ENGINEERING OF MILWAUKEE S&T-C-224, 415-17 Marshall Street, Milwaukee, Wis.

Without obligating me in any way, please mail free 72-page illustrated book "Electricity and the One Best Way to Learn It" and particulars regarding the course I have marked with an X.

- ... Electrical Engineering.
- ... Electrotechnics.
- ... Commercial Electrical Engineering.
- ... Automotive Electricity.
- ... Armature Winding.
- ... Light, Motor Wiring and Testing.
- ... Practical Electricity.
- ... I am interested in your "Earn While You Learn" Plan.

Name Age

Address

City State

Education

RADIO BROADCAST

(Continued)

Call Letters	Name	Location	Power & Wave Length
WDAD	Central Kansas Radio Supply Co. (Wm. L. Harrison), Lindsborg, Kan.		10-360
WDAE	Tampa Daily Times, Tampa, Fla.		250-360
WDAF	Kansas City Star, Kansas City, Mo.		500-411
WDAG	J. Laurance Martin, Amarillo, Texas		100-263
WDAH	Trinity Methodist Church (South), El Paso, Texas.		100-268
WDAI	Hughes Radio Corp., Syracuse, N. Y.		100-246
WDAK	The Courant, Hartford, Conn.		100-261
WDAL	Florida Times-Union, Jacksonville, Fla.		100-360
WDAO	Automotive Electric Co., Dallas, Texas		50-360
WDAP	Board of Trade, Chicago, Ill.		500-360
WDAR	Lit Bros., Philadelphia, Pa.		500-395
WDAS	S. A. Waite, Worcester, Mass.		5-360
WDAU	Slocum & Kilburn, New Bedford, Mass.		100-360
WDAX	First National Bank (Appamoose County Farm Bureau), Centerville, Iowa		100-360
WDAY	Radio Equipment Corp., Fargo, N. D.		50-244
WDBC	Kirk, Johnson Co., Lancaster, Pa.		50-258
WDBF	Robert G. Phillips, Youngstown, Ohio		50-261
WDM	Church of the Covenant, Washington, D. C.		50-360
WDT	Ship Owners' Radio Service, New York, N. Y.		500-405
WDZ	J. L. Bush, Tuscola, Ill.		10-278
WEAA	Frank D. Fallain Police Building, Flint, Mich.		150-280
WEAB	Standard Radio Equipment Co., Fort Dodge, Iowa		500-360
WEAF	American Telephone & Telegraph Co., New York, N. Y.		500-492
WEAG	Nichols-Hineline-Bassett Laboratory, Edgewood, R. I.		10-231
WEAH	Wichita Board of Trade, Wichita, Kan.		50-244
WEAI	Cornell University, Ithaca, N. Y.		500-286
WEAJ	University of South Dakota, Vermillion, S. D.		200-360
WEAM	Borough of North Plainfield (W. Gibson Buttrick), North Plainfield, N. J.		100-252
WEAN	Shepard Co., Providence, R. I.		100-273
WEAO	The Ohio State University, Columbus, Ohio		500-360
WEAP	Mobile Radio Co., Mobile Ala.		100-360
WEAR	Baltimore American News Publishing Co., Baltimore, Md.		50-360
WEAS	Hecht Co., Washington, D. C.		50-360
WEAU	Davidson Bros. Company, Sioux City, Iowa		100-360
WEAY	Will Horwitz, Jr., Houston, Texas		250-360
WEB	Benwood Co., St. Louis, Mo.		500-360
WEV	Hurlbut-Still Electrical Co., Houston, Texas		50-360
WEW	St. Louis Univ'ty, St. Louis, Mo.		100-261
WFAA	The Dallas News, The Dallas Journal, Dallas, Texas		500-476
WFAB	Carl F. Woese, Syracuse, N. Y.		200-234
WFAF	H. C. Sprattley Radio Co., Poughkeepsie, N. Y.		20-360
WFAH	Electric Supply Co., Port Arthur, Texas		150-236
WFAJ	Hi-Grade Wireless Instrument Co., Asheville, N. C.		50-360
WFAM	Times Publishing Co., St. Cloud, Minn.		20-360
WFAN	Hutchinson Electric Service Co., Hutchinson, Minn.		100-360
WFAQ	Missouri Wesleyan College, Cameron, Mo.		10-360
WFAT	The Daily Argus-Leader, Sioux Falls, S. Dak.		100-360
WFAV	University of Nebraska, Dept. E. E., Lincoln, Nebr.		500-275
WFI	Strawbridge & Clothier, Philadelphia, Pa.		500-395
WGAL	Lancaster Elec. Supply & Const. Co., Lancaster, Pa.		10-248
WGAN	Cecil E. Lloyd, Pensacola, Fla.		50-360
WGAQ	Glenwood Radio Corp., (W. G. Patterson), Shreveport, La.		100-360
WGAR	Southwest American, Fort Smith, Ark.		20-360
WGAU	Radio Mfg. & Service Co., (Marcus G. Limb), Wooster, Ohio.		20-226
WGAW	Ernest C. Albright, Altoona, Pa.		100-261
WGAY	North Western Radio Co., Madison, Wis.		100-360
WGAZ	The South Bend Tribune, South Bend, Ind.		50-360
WGI	American Radio & Research Corp., Medford Hillside, Mass.		500-360

(Continued on page 1028)



Ten years, and no breakdowns

That's the record which James Bishop's Auto-Wheel Coaster has made. He says: "I have had an Auto-Wheel Coaster for ten years. Have hauled heavy loads most every day on rough ground, but the wagon went through it all without a breakdown."

Auto-Wheel

Superior construction makes Auto-Wheel Coasters sturdy. Bolsters of hard maple; mortised joints; self-contained roller bearings; hound brace; hand brake, special hub cap and locking pin; rubber-tired disc wheels (oversize tires on three largest), or steel-tired disc or wood spoke wheels. Write for catalog of all models of the Auto-Wheel and the Auto-Cart (for little brother or sister). If you send names and addresses of three coaster wagon dealers in your town, telling which sell Auto-Wheel, we give you a year's subscription FREE to the "Auto-Wheel Spokes-man," our magazine.

Auto-Wheel Coaster Co., Inc.
North Tonawanda, N. Y.

Standard of Spanish Army Genuine Astra

\$7.75



Adopted by French During World War

The finest European pistol—Drop Forged Blue Steel Throughout—uses standard ammunition, an accurate, hard-hitting, brand-new weapon.

Bought before recent tariff raise. Buy now from sole U. S. importers and save about 1/2 on these fine guns.

- \$7.75 25 cal., 7 shot ASTRA, C. O. Q. Automatic.
- 8.95 25 cal., 7 shot ASTRA, Automatic.
- 9.98 25 cal., 7 shot ASTRA, triple safety.
- 10.95 32 cal., 10 shot ASTRA, extra magazine.
- 16.95 32-20 and 38 cal. swing-out cyl. revolvers.

Write for firearms catalogue. We guarantee perfect workmanship and material; every gun brand new; of drop forged steel throughout. Before buying any gun insist on this guarantee. Send no money unless you wish. Pay postman on delivery plus postage. Money cheerfully refunded if not fully satisfied. ACT NOW to get these SPECIAL LOW PRICES. WRITE TODAY.

CALIFORNIA TRADING COMPANY
Dept. 25-2, Terminal Bldg., Los Angeles, Cal.

BE A RAILWAY TRAFFIC INSPECTOR

EARN UP TO \$250 Per Mo.



Expenses Paid

Enter this fascinating, uncrowded profession. Many opportunities; meet big railway officials; advancement rapid. Travel or remain near home; healthful, steady, outdoor work.

How You Can Prepare

Any average man can qualify in 3 mos. spare-time study at home. Easy to understand. Upon graduation, we get you position as per Guarantee Notice. You take no risk!

POSITION GUARANTEED

Guarantee states that tuition will be refunded if, upon graduation, position is not obtained for you, paying at least \$110 per month and expenses.

Must Train More Men
Hundreds of positions to be filled. Decide now to get particulars, a wonderful opportunity. Send coupon today.

STANDARD BUSINESS TRAINING INSTITUTE
Buffalo, N. Y.

Standard Business Training Institute
Buffalo, N. Y.

Send me, entirely free, Booklet No. D-37 giving full particulars about course in Railway Traffic Inspection.
Name,
Street,
City

"BUILD YOUR OWN" WITH "RASCO" PARTS!

Buy from the Oldest and Original Exclusive Radio Parts House in the United States

We pay all transportation charges in U. S. ALL GOODS SENT PREPAID IN 24 HOURS

Order direct from this page.

NOTE NEW PRICES FOR THIS MONTH ONLY

Money refunded if goods do not satisfy

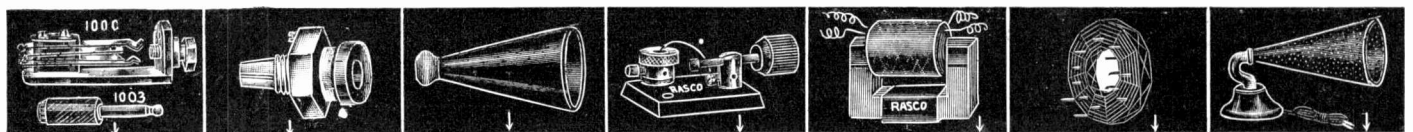

<p>Jacks and Plugs Best materials. Silver contacts. Factory making Postal Telegraph jacks, makes these.</p> <p>F1000 Jack 4 springs \$.65 F1001 Jack 3 springs .75 F1002 Jack 5 springs .80 F1003 Plug .55</p>	<p>Cord Tip Jack Takes place of binding posts. Cord tip firmly gripped by jacks. Made of brass, nickel plated. Screw to attach lead wire. No soldering necessary.</p> <p>F1500 Cord tip jack Each\$1.15</p>	<p>Phonehorn Base consists of Phonodapter into which fits a fine enameled fibre horn. Size of horn 12"; bell 6 1/2". Slip Phonodapter end on a single telephone receiver.</p> <p>F1321 Phonehorn, prepaid\$1.45</p>	<p>Radiocite Detector Base solid black composition. Automatic crystal holder. Triple adjustments. Smallest, neatest detector made. Radiocite crystal. 200,000 in use.</p> <p>F1899 Detector\$.60 F1898 Galena detector\$.50</p>	<p>Audio Frequency Transformer No better transformer made. Highest class materials. Impregnated coils. Silicon steel stampings used. Save 50 per cent by assembling it yourself.</p> <p>F1100 Ratio 4 1/2 to 1 \$2.00 F1150 Ratio 6 1/2 to 1 \$2.00</p>	<p>Duo-Spiderweb Coil For Reinartz circuit, 200-600 meters. 19 taps. Size 4 1/4" diam.; 1 1/2" center opening. Coil is firm and will not fall apart.</p> <p>F2650 Spider-web Reinartz coil\$1.15 F2660 Coil for panel mount. 225-600 met. \$1.90</p>	<p>Melotone Loud Speaker Best popular loud speaker. Fibre horn, heavy metal base, five ft. cord. Nickel goose-neck. Greatest tuned (adjustable) talker. Horn length 11 1/2"; bell 6 5/8"; total height 9".</p> <p>F255 Melotone Speaker\$4.90</p>
---	--	--	--	--	---	--

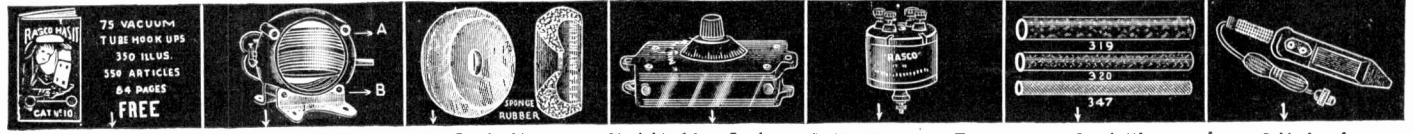

<p>75 VACUUM TUBE HOOK UPS 350 ILLUS. 350 ARTICLES 64 PAGES FREE</p>	<p>Molded Variometer Highly substantial instrument. Silk windings. 1/4" shaft. Flange B when placed into AB direction makes instrument panel mounting. 180 to 650 meters. Money back if this instrument is not all that we claim for it.</p> <p>F5353 Variometer\$3.00</p>	<p>Fonokushions Made of sponge rubber. Make wearing your receivers a pleasure. Positively exclude all noises and make reception a pleasure. Sponge rubber will last for years. Light as a feather.</p> <p>F5050 Fonokushions, set of two\$1.50</p>	<p>Straight Line Condenser Simplest and most practical type of condenser.</p> <p>F4500 "Rico" Condenser .001 mfd. 43 plate capacity\$1.75 F4230 .0005 mfd. 23 plate capacity\$1.75 F4110 .00025 mfd. 11 plate capacity\$1.75 All types no dials \$1.50</p>	<p>Radio Frequency Transformers Best Radio Frequency Transformer developed so far. Designed by R. E. Lacault, Associate Editor RADIO NEWS. Air core type.</p> <p>F2800 Transformer, size 7 1/2"x2 1/2"\$1.50</p>	<p>Spaghetti Varnished flexible cambric tubing. 319 takes No. 22 wire; 320 takes 18 to 20 wire; 21 takes 16 to 18 wire; 344 takes 22 to 28 wire.</p> <p>F319-320-321 Per ft. \$.06 F344 Flexible soft rubber tubing; 10 feet for. \$.20</p>	<p>Soldering Iron Smallest and handiest made. Fits any flat iron or percolator plug. Plug then becomes handle. 5" long. Complete but without plug or wire.</p> <p>F2200 Soldering Iron\$1.45</p>
---	---	---	---	---	--	---

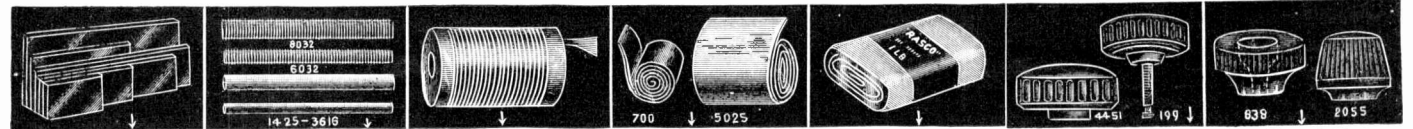

<p>Formica Panels Clearance Sale As we are discontinuing these particular sizes, this material is now offered at cost. All 3-16" thick.</p> <p>F352 9x12" each 1.75 F354 6 1/2x19 1/4" each 1.90 F356 6x14" each 1.60 F357 6x4" each65</p>	<p>Brass Rods Sold in 6" lengths only.</p> <p>F8032 Rod 8-32" thread, length\$.08 F6032 Rod, 6-32" thread, length\$.06 F1425 Rod, plain 3/4" round, length\$.10 F3616 Rod, plain 3-16" round, length\$.06</p>	<p>Litz Wire Prices are per foot. E = equals.</p> <p>F823 E No. 25 R&S \$.02 F890 E No. 28 R&S .01 F891 E No. 21 R&S .03 F892 E No. 20 R&S .04</p> <p>10 per cent discount in 100 foot lots.</p>	<p>Copper Ribbon .005" thick.</p> <p>F700 5/8" wide; F701 1/4" wide; F702 3-16" wide. All sizes per foot.....\$.01</p> <p>Copper Foil .001" thick. 4" wide.</p> <p>F5025 Copper Foil per foot\$.10 10-foot length\$.80</p>	<p>Tin Foil All our tin foils come 4" wide. Uniform product throughout.</p> <p>Best grade only. F850 has 1500 sq. inches per lb. F851 700 sq. inches to lb. F850 Tin foil.....lb .35 F851 Tin foil.....lb .35</p>	<p>Switch Knob</p> <p>F199 Knob. 1 1/4" dia. height 5/8"; 8-32 screw. F4451 has 8-32 or 10-52 bushing, no screw.</p> <p>F199 Knob\$.10 F4451 Knob\$.06</p>	<p>Marconi Knob Has central hole of 5-32" and seat to hold screw, dia. 1 1/4", height 1/2".</p> <p>F838 Knob, each\$.13 Fluted Knob With 8-32" bushing. Black composition.</p> <p>F2055 Knob 1" high 1 1/4" diam. each\$.15</p>
---	--	---	--	--	---	--

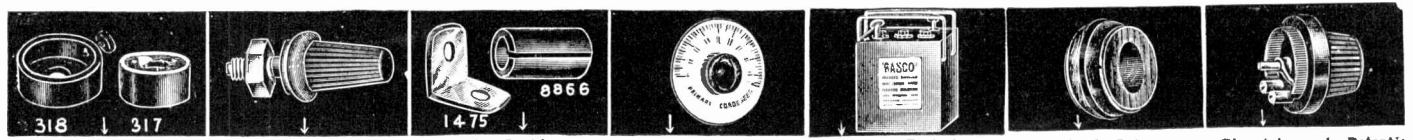

<p>Mounted Crystal-Cup Cup has screw and adjustment nut. Fits all standard mounted crystals. Nickel plated, polished.</p> <p>F318 Nickel Cup\$.20 Radiocite Best most sensitive mounted crystal. U. S. Navy using it. Each tested.</p> <p>F317 Radiocite Crystal\$.25</p>	<p>Rasco Vernier Why use a vernier attachment when a vernier attachment will do anything and everything a vernier condenser accomplishes. Cleverest vernier made. Can be used with any dial. Soft rubber ring engages dial. Nothing to come apart.</p> <p>F1450 Vernier\$.30</p>	<p>Angle Bushing Angle piece used to mount panels on boards, tubes on panels etc. 1,000 uses. 1 1/2" wide, height 7-16".</p> <p>F1475 Angle piece. Each\$.03</p> <p>Adapter Bushing Makes 3-16" dial fit 1/4" shaft. 1/2" long.</p> <p>F8866 Bushing\$.04</p>	<p>Silver Dials Silver surface black enamel lettering. For 3/4" shaft. No set screw required. All 2 1/2" dia.</p> <p>F800 Plate Variometer; F801 Prim. Con.; F802 Sec. Cond.; F803 Coupler; F804 Fil. Rheo.; F805 Grid Variometer. Each style,\$.20 each. Set of six\$1.15</p>	<p>Storage Batteries Guaranteed for two years. Only NEW material used. Acid proof terminals, Patent vents.</p> <p>F2400 Two volt. 40 amp. hours.\$3.90 F640 Six volt. 40 amp. hours 7.25 F666 Six volt. 60 amp. hours 9.50</p> <p>Shipped express collect.</p>	<p>Vario-Rotor Made of hard wood, accurately turned. Takes any finish. Large hole 2" diameter. Width 2", diameter 3 3/4", 2 shaft holes.</p> <p>F343 Rotor\$.30</p> <p>"Rasco" Universal Bearing. Especially made to take above rotor for panel mounting.</p> <p>F1375 Uni. Bearing \$.25</p>	<p>Rheostats and Potentiometers High heat dielectric base. Come with tapered, knurled knob. 2 1/2" dia. Complete with pointer.</p> <p>F4310 6 ohm\$.45 F4311 30 ohm65 F4312 Potentiometer, 200 ohms\$.85</p>
--	---	---	---	--	--	---



<p>Phone Plugs Sold from 75c. to \$1.00 everywhere. Hard rubber composition shell and patented cord tip holder. Finest workmanship thru-out.</p> <p>F1030 Rasco Telephone Plug, each\$.35</p>	<p>Bakelite Socket Octagon shape. Four nickel binding posts, phosphor bronze contact springs. Best brown bakelite.</p> <p>F6510 Bakelite socket \$.40 F6500 Tube Socket. Made entirely of composition. Best made. Each\$.35</p>	<p>Condensers Best make, paper-impregnated condensers. Capacity guaranteed.</p> <p>F5050 Phone Condenser. .001\$.20 F5056 Grid Condenser. .00025\$.20 F5059 Grid Leak Condenser. .00025\$.30</p>	<p>Name Plates All name plates brass with silver letters. For 3/4" shaft. Comes in 35 styles.</p> <p>F809 Comes in 35 styles. Any denomination, each style\$.04 Metal Scale. 2 1/2", 30". Metal, silver background, black lettering.</p> <p>F715 Scale, Each\$.15</p>	<p>Binding Post Name Plates Dia. 3/4". These styles: Phones, Ground, -, Output, "A" Bat., "B" Bat., -, Loud Speaker, "C" Bat., Aerial, + Input, "A" Bat., +, "B" Bat., +, Loop "C" Bat., +.</p> <p>F6000 Name Plates all styles, each\$.03</p>	<p>"Rasco" Posts Made of black composition.</p> <p>F650-51 Each\$.08 F202 Has nickel-plated bottom, each\$.08 Dozen, each style\$.90 F122 Initialed Binding Posts. Six popular styles. Each\$.12</p>	<p>Cord Tips Standard phone cord tips, nickelled.</p> <p>F315 Each\$.03</p> <p>Separable Cord Tips No solder required. Wire goes in ferrule. Shank holds it tight. Nickel plated.</p> <p>F2900 Each\$.06</p>
--	--	---	--	---	---	---

AUTOPLEX CIRCUIT

The famous Autoplex circuit described in RADIO NEWS has taken the country by storm. The only single tube outfit that works a loud-talker. Result guaranteed.

1—F714 Mahogany Cabinet, 7x14"\$3.35
1—F7140 Dilectryte Panel 7x14" 1.20
2—F5353 Moulded Variometer 6.00
2—F3076 4" Dials 80
1—F5014 1250 turn Honeycomb coil 1.95
1—F6500 Vacuum Tube Socket35

Our special price, Complete \$15.25
Complete with Melotone Loud-speaker \$20.00

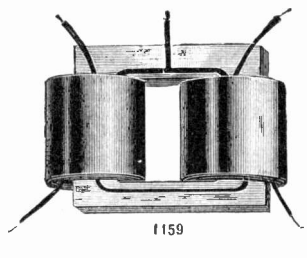

New! New!! 2 Stage Amplifier

Push Pull Transformer for many new circuits. See any radio magazine. Made of best materials. Coils impregnated. Silicon steel laminations. Save 50 per cent by assembling yourself. Simple instructions furnished. Fully Guaranteed.

F1159 Push Pull Transformer. Ratio 6 1/2 to 1\$4.00

1—F710 Mahogany Cabinet. \$2.60
1—F7100 Dilectryte Panel95
2—F1100 A. F. Transformers 4.00
2—F1100 Double Circuit Jacks 1.30
1—F1003 Rasco Plug55
2—F6500 Tube Sockets70
2—F4311 30 ohm Rheostats 1.30
10—F6050 Post Name Plates .30
10—F201 Rasco Binding Posts 1.00
30 Bg. F6400 Bus Bar Wire 75
Blue Prints and directions... .50

Total, \$13.90

Our Price \$13.50

RADIO SPECIALTY CO., 100 Park Place, New York City

Factories: Brooklyn, N. Y. Elkridge, Md.

This advertisement copyright 1924 by R. S. Co., N. Y.



Wins a Welcome

You are always welcome with a sweet-toned Buescher Saxophone. Thousands of men and women, of all ages, have found it a certain key to social popularity. For home entertainment, for church, school or lodge affairs, the Saxophone is the most popular and adaptable instrument. Saxophone players enjoy, also, many opportunities of earning money.



TRUE-TONE SAXOPHONE

The new Buescher Saxophone is a marvelous instrument. It is one of the most beautiful of all musical instruments—by the range and wealth of its tones it takes the place of almost every other instrument—yet it is so perfected and simplified that it is the easiest of all instruments to play.

See How Easy It Is

With the aid of the first three lessons, which are sent free (upon request) with each new Saxophone, the scale can be mastered in an hour; in a few weeks you can be playing popular music. Practice is a pleasure because you learn so quickly. You can take your place in a band within 90 days, if you so desire.

Try It In Your Own Home

You may order any Buescher Saxophone, Cornet, Trumpet, Trombone or other Band or Orchestral Instrument and try it six days in your own home, without obligation. Easy terms of payment may be arranged if preferred. Mention the instrument interested in and a complete catalog will be mailed free.

Buescher-Grand Trumpet

Especially easy to blow, with an improved bore and new proportions. With the mute in, it blows so softly and sweetly that practice never annoys. A splendid home instrument.



Free Saxophone Book

We have prepared a very interesting book on the history and development of the Saxophone. It tells which saxophone takes violin, cello and bass parts and many other things you would like to know. Also illustrates first lesson. Every music lover should have a copy. It is sent free on request. Just send your name for a copy.

BUESCHER BAND INSTRUMENT CO
Everything in Band and Orchestra Instruments
6017 Buescher Block, Elkhart, Indiana

Buescher Band Instrument Co.,
6017 Buescher Block, Elkhart, Ind.

Gentlemen:

I am interested in the instrument checked below:
Saxophone... Cornet... Trombone... Trumpet...
(Mention any other instrument interested in)

Name

Street Address

Town State.....

RADIO BROADCAST (Continued)

Call Letters	Name	Location	Power & Wave Length
WGL	Thomas F. J. Howlette,	Philadelphia, Pa.	500—360
WGR	Federal Telephone and Telegraph Co.,	Buffalo, N. Y.	500—319
WGV	Interstate Electric Co.,	New Orleans, La.	100—360
WGY	General Electric Co.,	Schenectady, N. Y.	1000—380
WHA	University of Wisconsin,	Madison, Wis.	500—360
WHAA	State University of Iowa,	Iowa City, Iowa	100—283
WHAB	Clark W. Thompson,	Galveston, Texas	200—360
WHAC	Cole Bros. Electric Co.,	Waterloo, Iowa	10—360
WHAD	Marquette University,	Milwaukee, Wis.	100—280
WHAG	University of Cincinnati,	Cincinnati, Ohio	200—222
WHAH	Hafer Supply Co.,	Joplin, Mo.	250—360
WHAI	Radio Equipment & Mfg. Co.,	Davenport, Iowa	50—360
WHAK	Roberts Hdwe. Co.,	Clarksburg, W. Va.	15—258
WHAL	Lansing Capital News,	Lansing, Mich.	20—248
WHAM	University of Rochester (Eastman School of Music),	Rochester, N. Y.	100—360
WHAP	Otta & Kuhns,	Decatur, Ill.	50—360
WHAQ	Semmes Motor Co.,	Washington, D. C.	10—360
WHAR	Paramount Radio & Electric Co., (W. H. A. Paulus),	Atlantic City, N. J.	10—231
WHAS	Courier-Journal and Louisville Times,	Louisville, Ky.	500—400
WHAU	Wilmington Electrical Specialty Co., Inc.,	Wilmington, Del.	50—360
WHAZ	Rensselaer Polytechnic Institute,	Troy, N. Y.	500—380
WHB	Sweeney School Co.,	Kansas City, Mo.	500—411
WHD	West Virginia University,	Morgantown, W. Va.	250—360
WHK	Radiovox Co., (Warren R. Cox),	Cleveland, Ohio	500—360
WHN	George Schubel,	New York, N. Y.	100—360
WIAB	Joslyn Automobile Co.,	Rockford, Ill.	50—252
WIAC	Galveston Tribune,	Galveston, Texas	100—360
WIAD	Howard R. Miller,	Ocean City, N. J.	10—254
WIAF	Gustav A. DeCortin,	New Orleans, La.	10—234
WIAH	Continental Radio & Mfg. Co.,	Newton, Iowa	10—258
WIAI	Heer Stores Co.,	Springfield, Mo.	20—252
WIAJ	Fox-River-Valley Radio Co.,	Neenah, Wis.	100—224
WIAK	Journal-Stockman Co.,	Omaha, Neb.	200—278
WIAO	School of Engineering of Milwaukee,	Milwaukee, Wis.	100—360
WIAQ	Chronicle Publishing Co.,	Marion, Ind.	10—226
WIAR	Paducah Evening Sun,	Paducah, Ky.	100—360
WIAS	Home Electric Co.,	Burlington, Iowa	100—360
WIAT	Leon T. Noel,	Tarkio, Mo.	15—360
WIAU	American Trust & Savings Bank,	Le Mars, Iowa	20—360
WIK	K & L Electric Co.,	McKeesport, Pa.	500—234
WIL	Continental Electrical Supply Co.,	Washington, D. C.	10—360
WIP	Gimbel Bros.,	Philadelphia, Pa.	500—509
WJAB	American Electric Co.,	Lincoln, Neb.	500—360
WJAD	Jackson's Radio Engineering Laboratories,	Waco, Texas	150—360
WJAF	Press Publishing Co.,	Muncie, Ind.	10—360
WJAG	The Norfolk Daily News,	Norfolk, Neb.	200—360
WJAK	Clifford L. White,	Greentown, Ind.	30—254
WJAM	D. M. Perham,	Cedar Rapids, Iowa	20—268
WJAN	Peoria Star,	Peoria, Ill.	100—280
WJAQ	Capper Publications,	Topeka, Kan.	100—360
WJAR	The Outlet Co., (J. Samuels & Bro.),	Providence, R. I.	50—360
WJAS	Pittsburgh Radio Supply Co.,	Pittsburgh, Pa.	500—360
WJAT	Kelley-Vawter Jewelry Co.,	Marshall, Mo.	10—360

(Continued on page 1030)

MILLIONS Listen in Daily

for the voice of the

“Man of Mystery”

J. Andrew
WHITE

The Premier Broadcaster of Them All Tells the Inside Story of Radio Exclusively to the Readers of

SUCCESS

“The Human Magazine”

The first official statement ever issued by the “Man of Mystery.” Millions have heard him for he has talked to the largest audience ever addressed by a human being. His popularity is tremendous—he has a larger personal “fan” mail than any of our American celebrities, not even excepting the movie favorites—but few have ever seen him.

An Amazing Story of the Experiences of the Man Who Has Humanized Radio Broadcasting.

His forecast of the miracles to come.

Major White's article is just one of a score of absorbing features in

SUCCESS

“The Human Magazine”

For FEBRUARY

Leave your order with the
newsdealer today.

Agents: 90c an Hour



Introduce “Boderose.” A new wonder. A pure solder in paste form. Works like magic. Stops all leaks. For mending water buckets, cooking utensils, milk pails, water tanks, tin roofs—everything including granite ware, agate ware, tin, iron, copper, zinc, etc.

Quick Sales—Nice Profit

Everybody buys. Housewives, mechanics, electricians, jewelers, plumbers, tourists, automobilists, etc. No leak too bad to repair. Just apply a little “Boderose,” light a match and that's all. Put up in handy metal tubes. Carry quantity right with you. Write for money-making proposition.

AMERICAN PRODUCTS CO., 200 American Bldg., Cincinnati, Ohio



Save $\frac{1}{3}$ on Guaranteed Radio Equipment

Write us a post card

Address Dept. 40-R

and we will send you free this 52 page catalogue of radio sets and parts. It also contains explanation of radio terms, map and list of broadcasting stations and much radio information, including an explanation of successful hook-ups and circuits.

You will be amazed at the low prices Ward's quote. A complete tube set having a range of 500 miles and more, including tube, head set, batteries, and antenna equipment, as low as \$23.50.

This catalogue contains everything for the expert and amateur. Complete sets and every improved part for building sets, all the most up-to-date devices—at the lowest possible prices.

Headquarters for Radio

Montgomery Ward & Co. is headquarters for Radio, selling everything direct by mail without the usual "Radio-profits." Why pay higher prices? Ward quality is the best and the prices will often save you one-third. Everything sold under our Fifty Year Old Guarantee—Your Money Back if You Are Not Satisfied. Write today for your copy of this complete 52-page Radio Book.

Write to our house nearest you. Address Dept. 40-R

Chicago Kansas City St. Paul Portland, Ore.
 Ft. Worth Oakland, Cal.

**This Radio
Catalogue
FREE**

Established 1872
Montgomery Ward & Co.

The Oldest Mail Order House is Today the Most Progressive

ONLY \$3

**Brings You This
Genuine Underwood
Typewriter
on 10 Days' FREE TRIAL**

*A perfect machine,
complete in every
detail. Read all
about this great offer*



**Yes, We Will Positively
Ship You**

this splendid Underwood upon receipt of only \$3.00. This is by far the most liberal typewriter offer that has ever been made on so perfect a machine. Nearly two million Underwoods have been made and sold, proving conclusively that it is superior to all others in appearance, mechanical perfection and all-round excellence.

Ten Days' Free Trial

We want you to see for yourself that this is the typewriter you ought to have, and, therefore, we make our great free trial offer. You merely send us the three dollars deposit and we ship the machine for you to try for ten full days before you decide to keep it. If not satisfied, every penny of your money will be returned to you.

Rebuilt Like New

Every Underwood we sell is rebuilt just like new. It is dismantled right to the very bottom, and remanufactured to make it just like a new typewriter, with new enamel, new nickel, new platen, new key rings, new type; a complete, perfect typewriter, with two-color ribbon, back spacer, stencil device, automatic ribbon reverse, tabulator, key shift lock, etc. Impossible to tell it from a brand new Underwood, either in appearance, durability or quality of work.

Easy Monthly Payments

Our easy monthly payment plan makes it possible for YOU to own this splendid machine without having to pay out any big sum of money. You will hardly know you are paying for it. REMEMBER, you have the full use of the machine, just the same as though it was fully paid for.

Over 325,000 Sold

Over 325,000 people have purchased and been satisfied with our product. What better proof could anyone ask of the perfection of our typewriters and the integrity of this firm?

Your Money Back

Yes, you can have your money back if you want it. After you have examined the typewriter carefully, used it to write letters, if you decide for any reason whatever that you do not care for it, you may return it to us at our expense and every penny you have paid will be cheerfully and promptly refunded.

No Obligation on Your Part

When you send in the coupon for either further information about our great typewriter offer or for the typewriter itself on our free trial plan, you are under no obligation whatsoever until after you have tried it and have decided for yourself that you want to keep it.

**Write Now for Our Big
Typewriter Book**

telling all about our great big typewriter factory. In this book we illustrate and describe all of the various processes of re-enameling, re-nickeling and assembling this splendid Underwood. It tells in an interesting way how each part is examined and tested carefully and thoroughly to insure the finished machine being one you will be proud to own.

**Write Right Today
Use Coupon Below**

SHIPMAN-WARD MFG. CO.
2162 Shipman Bldg., Chicago

Send me your big bargain catalog and complete details of your surprising offer, without obligation on my part.

NAME

STREET

CITY..... STATE.....

RADIO BROADCAST

(Continued)

Call Letters	Name	Location	Power & Wave Length
WJAX	Union Trust Co.,	Cleveland, Ohio	500—390
WJAZ	Chicago Radio Laboratory,	Chicago, Ill.	1000—273
WJD	Richard H. Howe,	Granville, Ohio	50—229
WJII	Wm. P. Boyer Co.,	Washington, D. C.	50—273
WJX	De Forest Radio Telephone & Telegraph Co.,	New York, N. Y.	500—360
WJY	R. C. A.,	New York, N. Y.	500—405
WJZ	R. C. A.,	New York, N. Y.	500—455
WKAA	H. F. Paar,	Cedar Rapids, Iowa	100—268
WKAD	Charles Loeff,	(Crescent Park), East Providence, R. I.	10—240
WKAF	W. S. Radio Supply Co.,	Wichita Falls, Texas	100—360
WKAN	United Battery Service Co.,	Montgomery, Ala.	15—226
WKAP	Dutce W. Flint,	Cranston, R. I.	200—360
WKAQ	Radio Corp. of Porto Rico,	San Juan, Porto Rico	100—360
WKR	Michigan Agriculture College,	East Lansing, Mich.	250—280
WKAS	L. E. Lines Music Co.,	Springfield, Mo.	10—360
WKA	Laconia Radio Club,	Laconia, N. H.	50—254
WKA	Turner Cycle Co.,	Beloit, Wis.	10—242
WKA	William A. MacFarlane,	Bridgeport, Conn.	15—231
WKA	Brenau College,	Gainesville, Ga.	10—280
WKC	Joseph M. Zamoiski Co.,	Baltimore, Md.	20—360
WKY	W. K. Y. Radio Shop,	Oklahoma, City, Okla.	100—360
WLAC	North Carolina State College	Raleigh, N. C.	750—360
WLAG	Cutting & Washington Radio Corp.,	Minneapolis, Minn.	500—417
WLAH	Samuel Woodworth,	Syracuse, N. Y.	250—234
WLAJ	Waco Electrical Supply Co.,	Waco, Texas	150—360
WLAK	Vermont Farm Machine Corp.,	Bellows Falls, Vt.	500—360
WLAL	Naylor Electrical Co.,	(Sim Naylor), Tulsa, Okla.	100—360
WLAN	Putnam Hardware Co.,	Houlton, Me.	250—283
WLAP	W. V. Jordan,	Louisville, Ky.	15—360
WLAQ	Arthur E. Schilling,	Kalamazoo, Mich.	20—360
WLAT	Radio & Specialty Co.,	Burlington, Iowa	10—360
WLAV	Electric Shop,	Pensacola, Fla.	15—254
WLAW	Police Dept.,	New York, N. Y.	500—360
WLAX	Putnam Electric Co.,	Greencastle, Ind.	10—231
WLB	University of Minnesota,	Minneapolis, Minn.	100—360
WLW	Crosley Manufacturing Co.,	Cincinnati, Ohio	500—309
WMAB	Radio Supply Co.,	Oklahoma, Okla.	100—360
WMAC	J. Edw. Page (Olive B. Meredith),	Cazenovia, N. Y.	200—261
WMAF	Round Hills Radio Corp.,	Dartmouth, Mass.	100—500—360
WMAH	General Supply Co.,	Lincoln, Neb.	100—254
WMAJ	Drovers Telegram Co.,	Kansas City, Mo.	250—275
WMAK	Norton Laboratories,	Lockport, N. Y.	500—360
WMAL	Trenton Hardware Co.,	Trenton, N. J.	50—256
WMAN	First Baptist Church,	Columbus, Ohio	10—286
WMA	Utility Battery Service,	Easton, Pa.	50—246
WMAQ	Chicago Daily News,	Chicago, Ill.	250—448
WMAV	Alabama Polytechnic Inst.,	Auburn, Ala.	500—250
WMA	Kingshighway Pres byterian Church,	St. Louis, Mo.	100—280
WMAZ	Mercer University,	Macon, Ga.	50—268
WMC	Commercial,	Memphis, Tenn.	500—500
WMI	The Precision Equipment Co.,	Cincinnati, Ohio	10—248
WMU	Doubleday-Hill Electric Co.,	Washington, D. C.	100—261
WNAC	Shepard Stores,	Boston, Mass.	100—278
WNAD	University of Oklahoma,	Norman, Okla.	100—360

(Continued on page 1032)

**You Can Be A
General Manager**



Wallace Rohrschneider

became General Manager of the Mustisford (Wisconsin) Electric Light and Power Company at 28 years of age. He took his training and got his start at the School of Engineering of Milwaukee, and advanced rapidly to his present splendid position.

**Why Don't You Get Into
This Big Pay Field?**

The same kind of training that put Mr. Rohrschneider into the ranks of the highly-paid Electrical Specialists will qualify you for brilliant success in this fascinating field of unlimited opportunities. Come to America's Greatest Institution of Electrical Education. Learn by actual practice in our big laboratories with their magnificent equipment, including motors, dynamos, switchboards, ignition and lighting systems, etc. Recognized experts give you personal instruction every step of the way.

**Earn Your Way Through
This Great College**

You can earn money to help defray your expenses while you are learning. Our wonderful co-operative plan brings an Electrical Career within the reach of every ambitious man. Our Free Employment Department secures positions for those students who wish to earn part or all of their expenses. In addition, the Department will help you get a good position in the Electrical industry when your training is completed.

BIG BOOK FREE—Mail the coupon today for our big new illustrated catalog. Check the course that interests you most and we will send you special information. Read about the School that trains men for practical and quick success. See how easy it is for you to get the training that will enable you to step to a splendid position and a handsome income. Mail the coupon right NOW. No cost or obligation.

**SCHOOL of ENGINEERING
of Milwaukee**

Founded 1905

Dept. S-I-B224, 415 Marshall Street, Milwaukee, Wis.

MAIL COUPON NOW

SCHOOL OF ENGINEERING OF MILWAUKEE
Dept. S-I-B224, 415 Marshall St., Milwaukee, Wis.

Please send me without any cost or obligation, full particulars of the electrical course I have checked and your big Free Book telling about your institution and how it will fit me for a big position in the electrical field. Also tell me about your Earn-While-You-Learn plan. (Check courses interested in, and be sure to give your education.)

- School of Practical Electricity—6 months or 1 year course. Complete general course, covering entire electrical field.
- Institute of Electrotechnics—12 to 30 months' course. Practical electrical training combined with thorough Academic education.
- College of Electrical Engineering—3 years' course. Regular collegiate work granting B. S. Degree. 14 High School units or diploma from our Institute of Electrotechnics required for entrance.
- Commercial Electrical Engineering—1 year course. Thousands of Trained Men wanted in this new profession. 11 High School units or diploma from our Institute of Electrotechnics required for entrance.
- School of Automotive Electricity—3 to 6 months. Covers all systems of starting, lighting, ignition, and storage batteries for automobiles, tractors, air-craft, etc. Intensive practical course.
- Armature Winding and Motor Generator Repair Course—3 to 6 months' course. Brief, but intensely practical, leading to well-paying positions.
- Electrical Home-Service Training with laboratory facilities, for those who cannot come to Milwaukee.

Name

Street

City

State

Age

Education

Has the Fountain of Youth Been Discovered — At Last?

Get This 144 Page FREE Book

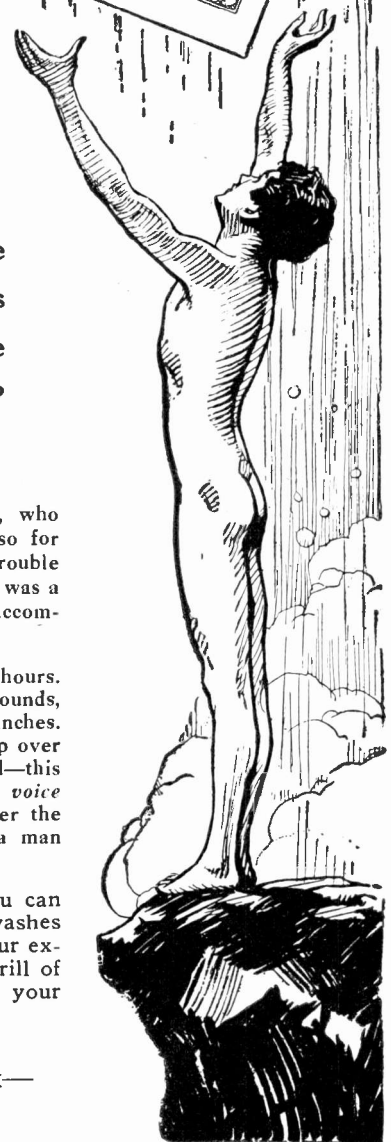

Is the Miracle of Rejuvenation an Accomplished Fact? Can we make Old Bodies Young—Weak Bodies Strong—Sick Bodies Well—Almost Overnight? Can We Banish Disease—Cheat the Advancing Years and Regain the Vigor and Vitality of Youth?

IT sounds too amazing for belief. Think of it! A fountain where all may bathe and emerge reborn and vigorous! A fountain where aging, ailing, discouraged humanity may regain the health, strength and energy of youth.

Is it true? Can it be true? Christos Parasco, who has suddenly leaped from obscurity into the limelight as a discoverer, says yes. Dr. Benedict Lust, prominent New York Physician, and an expert on hydrotherapy, says yes. Bernard Macfadden, world famous exponent and teacher of physical culture, says yes, as do many others who can speak with authority.

When this new, wonderful discovery is revealed, it promises to startle the world. Men and women who have made the tests say that "it has made them over." That it has freed them from the shackles of disease; that the years have slipped from their shoulders like a discarded cloak; that they are throbbing once more with energy, vigor and power.

Treatment Amazingly Simple

So amazingly simple are the means employed that it comes as a revelation to all who hear of it.

When Dr. Lust first heard of it, he couldn't believe it. He said: "I know a lot about this kind of treatment. I've been administering it most of my life, but I have never struck anything like this."

Later, after he had personally observed its action on others, and finally tried it himself, he said, "There is nothing in any way comparable to this treatment. I am not exaggerating when I say that it made me, a man of sixty, feel twenty-five years younger.

"Then there is the case of Dr. Warsaw, who weighed 240 pounds and was not well. Also for a year he had had a stubborn bronchial trouble which had prevented him from singing. This was a great trial to him, for he had long been an accomplished singer.

"He took the new treatment for eight hours. At the end of that time he had lost fourteen pounds, and his waist measure had been reduced two inches. He was so light on his feet that he could leap over the table on which he had been lying. And—this is the most wonderful part of it—he had his voice back. With my own ears I heard him render the Prologue from Pagliacci perfectly. He is a man of seventy."

You owe it to yourself to learn all you can about this amazing discovery—which washes away your years, your ills, your aches, your extra pounds; which makes you feel the thrill of renewed desires and impulses, and tunes your body once more to the call of Youth.

Get This Remarkable Book—FREE

Mr. Macfadden arranged with Dr. Lust to write a book covering every detail of the treatment. This book is not for sale. So anxious is Mr. Macfadden to put this priceless knowledge within the reach of everyone, that he has decided to give the book FREE with a four months' subscription to Physical Culture, beginning with the current issue.

The price of the four months' subscription is only \$1.00. Simply fill in the coupon below, attach a dollar bill and send it today. Don't miss the great opportunity to learn the secret of renewed health, vigor and vitality. Remember, the 144 page book is FREE. Attend to this right away.

Macfadden Publications, Dept. SI-2
1926 Broadway, New York

Here's the dollar. Please enter my name for four month's subscription to Physical Culture, starting with the current issue, and send me the FREE 144-page book by Dr. Lust explaining in detail the marvelous treatment described above. Money back if not satisfied.

Name

Address

City State

Your Choice 75c a Week



No matter what your occupation, one of the home study sets listed below will quickly fit you for a better job and bigger pay. Any set you select will be sent for seven days' examination, and if you decide to buy you may pay the rock-bottom price at the rate of only 75c a week. But you must act now! The rising cost of paper and binding materials won't permit us to continue the present low prices much longer.

These books are the work of recognized authorities. They are written in plain, easily understood language, by recognized authorities, and contain hundreds of photographs, diagrams, tables, etc., that make difficult points as simple as A-B-C. Handsomely and durably bound in half or full morocco leather (except as noted), and stamped in gold.

Pay-Raising Books At Greatly Reduced Prices

- Business Management, 8 vol., 2500 pages, 1000 pictures. Was \$52.50 Now \$29.80
- Carpentry and Contracting, 5 volumes, 2138 pages, 1000 pictures. Was \$37.50 Now 19.80
- Civil Engineering, 9 volumes, 3900 pages, 3000 pictures. Was \$67.50 Now 34.80
- Electrical Engineering, 8 volumes, 3800 pages, 2600 pictures. Was \$60.00 Now 29.80
- Automobile Engineering, 6 volumes, 2600 pages, 2000 pictures. Was \$45.50 Now 21.80
- Machine Shop Practice, 6 volumes, 2300 pages, 2500 pictures. Was \$45.00 Now 21.80
- Steam and Gas Engineering, 7 volumes, 3300 pages, 2500 pictures. Was \$52.50 Now 24.80
- Law and Practice (with reading course), 13 volumes, 6000 pages, illustrated. Was \$97.50. Now 49.80
- Fire Prevention and Insurance, 4 vols., 1500 pages, 600 pictures. Was \$30.00 Now 14.80
- Telephony and Telegraphy, 4 volumes, 1728 pages, 2000 pictures. Was \$30.00 Now 14.80
- Sanitation, Heating and Ventilating, 4 volumes, 1454 pages, 1400 pictures. Was \$30.00 Now 14.80
- Drawing, 4 volumes, 1578 pages, 1000 pictures, blue prints, etc. Was \$30.00 Now 14.80

Send No Money Shipped for 7 Days' Trial

Yes, we'll gladly ship any set right to your home or office upon your simple request. Pay only shipping charges when the books arrive. Don't send a penny until after you have used them seven days, then remit only \$2.80 or return them at our expense. Pay balance at the rate of \$3.00 a month—75c a week.

Act now—while these splendid books are being offered at 20% to 50% less than regular prices. This offer is open to every person within the boundaries of the U. S. and Canada. Grasp your opportunity—fill in and mail the coupon now.

American Technical Society Dept. X 225, Chicago

American Technical Society, Dept. X 225, Chicago, U.S.A.

Please send me set of.....

.....

for 7 days' examination, shipping charges collect. I will examine the books thoroughly and, if satisfied, will send \$2.80 within 7 days and \$3.00 each month, until I have paid the special price of.....

If I decide not to keep the books, I will notify you at once and hold them subject to your order. Title not to pass to me until the set is fully paid for.

Name.....

Address.....

Employed by.....

RADIO BROADCAST (Continued)

Call Letters	Name	Location	Power & Wave Length
WTC	Nushawg Poultry Farm,	New Lebanon, Ohio	50—234
WQAA	Horace A. Beale, Jr.,	Parkersburg, Pa.	500—360
WQAB	Southwest Missouri State Teachers College,	Springfield, Mo.	10—236
WQAC	E. B. Gish,	Amarillo, Texas.	100—360
WQAD	Whitall Electric Co.,	Waterbury, Conn.	50—242
WQAE	Moore Radio News Station,	Springfield, Vt.	50—275
WQAF	Sandusky Register,	Sandusky, Ohio	5—240
WQAH	Brock-Amerson Electrical Eng. Co.,	Lexington, Ky.	10—254
WQAI	Coles County Telephone & Telegraph Co.,	Mattoon, Ill.	10—258
WQAM	Electrical Equipment Co.,	Miami, Fla.	100—360
WQAN	Scranton Times,	Scranton, Pa.	100—280
WQAO	Calvary Baptist Church,	New York, N. Y.	100—360
WQAQ	West Texas Radio Co. (Abilene Daily Reporter),	Abilene, Texas	100—360
WQAS	Prince-Walter Co.,	Lowell, Mass.	100—266
WQAV	Huntington & Guerry (Inc.),	Greenville, S. C.	15—258
WQAW	Catholic University,	Washington, D. C.	5—236
WQAX	Radio Equipment Co.,	Peoria, Ill.	10—360
WQAZ	Greensboro Daily News,	Greensboro, N. C.	30—360
WRAA	Rice Institute,	Houston, Texas	200—360
WRAD	Taylor Radio Shop,	Marion, Kansas	10—248
WRAF	The Radio Club (Inc.),	Laporte, Ind.	10—224
WRAH	Stanley N. Read,	Providence, R. I.	10—231
WRAL	Northern States Power Co.,	St. Croix Falls, Wis.	100—248
WRAN	Black Hawk Electrical Co.,	Waterloo, Iowa	10—236
WRAO	Radio Service Co.,	St. Louis, Mo.	100—360
WRAP	Winter Park Electrical Construction Co.,	Winter Park, Fla.	20—360
WRAU	Amarillo Daily News,	Amarillo, Texas	10—360
WRAV	Antioch College,	Yellow Springs, Ohio	100—360
WRAW	Avenue Radio Shop,	Reading, Pa.	10—238
WRAX	Flaxons Garage,	Gloucester City, N. J.	100—268
WRAY	Radio Sales Corp.,	Scranton, Pa.	100—280
WRAZ	Radio Shop of Newark, (Herman Lubilsky),	Newark, N. J.	50—233
WRC	Radio Corp. of America,	Washington, D. C.	500—469
WRK	Doron Bros. Elec. Co.,	Hamilton, Ohio	200—360
WRL	Union College,	Schenectady, N. Y.	500—360
WRM	University of Illinois,	Urbana, Ill.	500—360
WRR	City of Dallas Police and Fire Signal Dept.,	Dallas, Texas	20—360
WRW	Tarrytown Radio Research Laboratory (Koenig Bros.),	Tarrytown, N. Y.	150—273
WSAB	South East Missouri State Teachers College,	Cape Girardeau, Mo.	100—360
WSAC	Clemson Agricultural College,	Clemson College, S. C.	500—360
WSAD	J. A. Foster Co.,	Providence, R. I.	100—261
WSAG	City of St. Petersburg, (Loren V. Davis),	St. Petersburg, Fla.	10—244
WSAH	A. J. Leonard, Jr.,	Chicago, Ill.	500—248
WSAI	United States Playing Cards Co.,	Cincinnati, Ohio	500—309
WSAJ	Grove City College,	Grove City, Pa.	100—360
WSAK	Foster Egner, (Daily News Pomerooy, O.),	Middleport, Ohio	70—258
WSAL	Franklin Electric Co.,	Brookville, Ind.	10—246
WSAN	Allentown Radio Club,	Allentown, Pa.	10—229
WSAP	Seventh Day Adventist Church,	New York, N. Y.	250—360
WSAR	Doughty & Welch Elec. Co.,	Fall River, Mass.	10—254
WSAT	Donohoo-ware Hardware Co.,	Plainview, Texas	20—268
WSAW	John J. Long, Jr.,	Canadaigua, N. Y.	100—275

(Continued on page 1040)

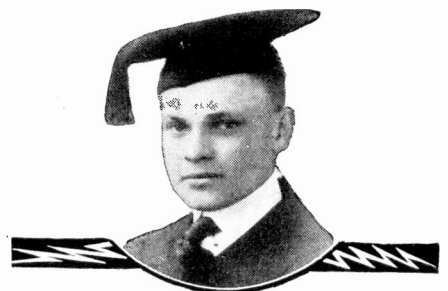

BECOME A COMMERCIAL ELECTRICAL ENGINEER IN ONE YEAR At this Famous School

No calling offers such unbounded opportunities to the modern ambitious young man as that of Commercial Electrical Engineering. It is for this reason that this great school has organized a special course in Commercial Electrical Engineering that may be completed in one year.

Within recent years the Electrical field has become so wide and diversified that there has sprung up a great demand for Electrically trained business men, consulting and efficiency engineers, men who can handle Commercial and Engineering problems. This special course offers a thorough, condensed, and very practical Electrical Engineering training, especially adapted to high-school graduates.

Here, you will also find any other kind of Electrical education which you might desire. School of Engineering is the largest institution in America devoted exclusively to the teaching of Electricity and allied subjects.

ELECTRICAL ENGINEERING With B.S. Degree In 3 Years

A faculty of specialists is leading hundreds of ambitious young men to a sure and substantial success. Why not you? If you lack some of the educational requirements, you can make them up as you go along. This gives you the opportunity of becoming an electrical engineer in the shortest possible time.

ELECTROTECHNICS

Only one or two years of this course, and you are a fully trained electrotechnician—prepared to fill such positions as general plant superintendent, director of construction, superintendent of maintenance, chief draftsman, etc. This course will equip you for a position between that of an electrical engineer and that of an electrician, which is a well paying position, leading to higher executive work. A grade school diploma or its equivalent admits you without examination. New terms open every six weeks.

PRACTICAL ELECTRICITY

This complete six months' electrical course teaches you house, factory and theatre wiring, testing and meter work, A.C. and D.C. motor installation, repairing and maintenance, including shop work in A.C. and D.C. armature winding and all necessary mathematics.

A three months' course in A.C. and D.C. armature winding, or in light and motor wiring.

AUTOMOTIVE ELECTRICITY

Electrical specialists who instinctively diagnose and locate automotive electrical troubles command high positions and are well paid. Specialize in starting, lighting, ignition and storage batteries and command a big job at a big salary!

There are millions of automobiles, motor trucks, tractors, motorcycles, aircraft, farm lighting plants, but few real experts who can put their fingers right on electrical troubles.

Specialists teach this course on actual standard equipment—three months day school, or through home study. Come any time and we will put you in the thick of the work.

Fill out the coupon and mail it today.

SCHOOL of ENGINEERING of Milwaukee

Founded 1905

School of Engineering of Milwaukee,
S. I.-A224, 415 Marshall Street, Milwaukee, Wis.

Without obligating me in any way, please mail free illustrated book and further particulars on the course I have marked with an X.

...Commercial Electrical Engineering..... Practical Electricity
 ...Electrical Engineering,.....6 mo. complete course
 ...B.S. Degree.....3 mo. Armature Wind-
 ...Electrotechnics.....ing Course
 ...Drafting.....3 mo. Light and Motor
 ...Automotive Electricity..... Wiring

Name..... Age.....

Street..... City..... State.....

Education.....

What Do Chiropractors Mean

by Innate Intelligence ?

THE temperature of a normal human body is approximately 98.6 degrees. You may sit in a room the temperature of which is 80 degrees, or go out of doors when the thermometer registers zero and your temperature, if you are in health, will not vary a single degree, because, resident in your body is an intelligence that generates, distributes and regulates the heat of the body, and instantly adapts it to the change in temperature.

If you start in June to take a plunge in the lake every morning and continue it every day until December, this same power resident in the body will intelligently adapt the body to the seasonal change in temperature.

This innate power gave the polar bear his long hair, that he might live in the land of eternal ice, and the gentle deer his speed, that he might escape his less swift foe. It is this power that in the struggle for existence gave wings to the birds and cunning to the fox, spots to the leopard and strength to the lion. It is this power that elongated the neck of the giraffe so that he could reach the high-hanging foods and for obvious reasons webbed the feet of the duck and goose. This inborn power adapted the stomach of the carnivora to a meat diet, the stomach of the herbivora to a vegetable diet, and the stomach of man to both.

maintains its vigor and then slowly lets the house in which we live decay. During all the circling three-score years and ten it coordinates the physical functions, heals the body's wounds, mends its breaks, adapts it to the change of season, occupation and pursuit and performs the miracle of changing common food into living, breathing, sensate bone and flesh.

It laughs at all our efforts to locate it or to imitate its work and yet some people, because they cannot find it, weigh it or measure it, question its existence and say "Vital force is a chemical phenomenon."

Call it what you will, it's there—a rose by any other name is just as sweet.

This "power within" Chiropractors call Innate Intelligence and all their philosophy, science and art is built upon this fundamental fact. They teach that "Innate Intelligence" functions through the brain and nervous system, and that disease is but the abnormal expression of one or more of the nine primary physical functions. Any pressure of a harder tissue (bone) upon the soft nervous tissue, impairs the conductivity (function or work) of that tissue and results in disease. All that is necessary for a complete restoration to health, is that the impinging tissue be adjusted to normal position, which permits the nerve again to function normally.

Scientists call the *modus operandi* of the "power within" the law of adaptation. Among the professions engaged in getting the sick well, chiropractors alone recognize the existence of the thing itself, and the law of its expression, through the nervous system.

That is the reason Chiropractic succeeds where other methods fail.

This power develops the body from a blastoderm to its full growth in thirty-five years; for ten or more it

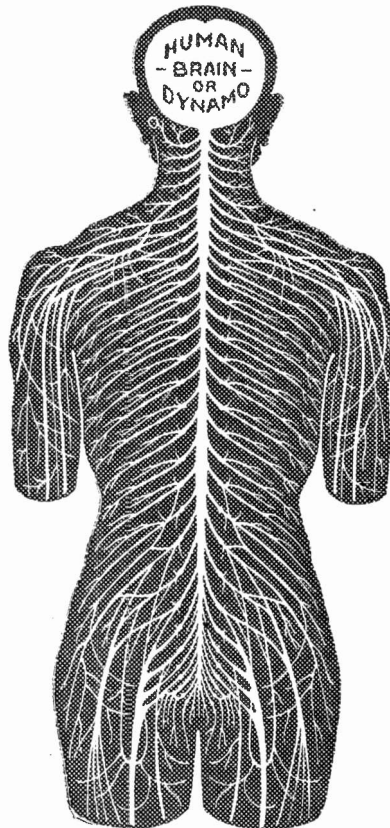

DEFINITION
The practice of Chiropractic consists of the palpation and adjustment, with the hands, of the movable segments of the spinal column to normal position for the purpose of releasing the prisoned impulse.



Write for information regarding Chiropractors
or Schools to the

Universal Chiropractors' Association
Davenport, Iowa, U. S. A.

U.S. PATENTS



SEND FOR THIS FORM

Don't Lose Your Rights

Before disclosing your invention to anyone send for blank form "Evidence of Conception" to be signed and witnessed. A sample form together with printed instructions will show you just how to work up your evidence and establish your rights before filing application for patent. As registered patent attorneys we represent hundreds of inventors all over the U. S. and Canada in the advancement of inventions. Our schedule of fees will be found reasonable. The form "Evidence of Conception" sample, instructions relating to obtaining of patent and schedule of fees sent upon request. Ask for them,—a post card will do.



LANCASTER & ALLWINE
255 OURAY BLDG.,
WASHINGTON, D. C.

"Originators of form Evidence of Conception"

PATENTS

TO THE MAN WITH AN IDEA

I offer a comprehensive, experienced, efficient service for his prompt, legal protection and the development of his proposition.

Send sketch, or model and description, for advice as to cost, search through prior United States patents, etc. Preliminary advice gladly furnished without charge.

My experience and familiarity with various arts, frequently enable me to accurately advise clients as to probable patentability before they go to any expense.

Booklet of valuable information and form for properly disclosing your idea, free on request. Write today.

RICHARD B. OWEN, Patent Lawyer
164 Owen Building, Washington, D. C.
2276-8 Woolworth Bldg., New York City

PATENTS

BOOKLET FREE HIGHEST REFERENCES PROMPTNESS ASSURED BEST RESULTS
Send drawing or model for examination and report as to patentability.

WATSON E. COLEMAN, Patent Lawyer
644 G Street, N.W., Washington, D. C.

INVENTORS PROTECT YOUR IDEAS

Send for our Guide Book, **HOW TO GET A PATENT**, and Evidence of Invention Blank, sent Free on request. Tells our terms, methods, etc. Send model or sketch and description of your invention and we will give our opinion as to its patentable nature.

RANDOLPH & CO.

Dept. 172, WASHINGTON, D. C.

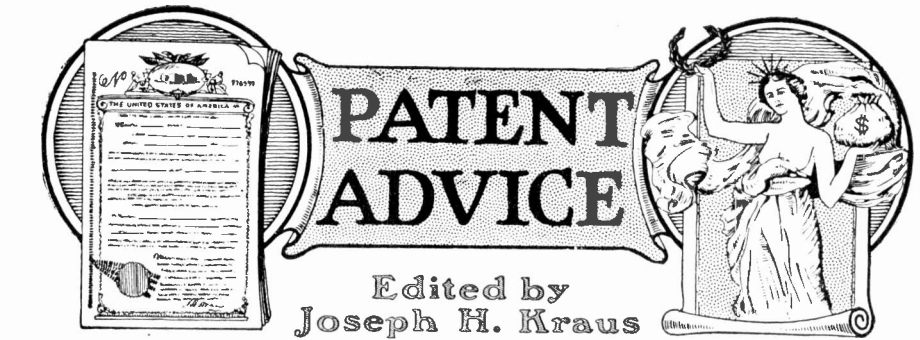

Edited by Joseph H. Kraus

In this Department we publish such matter as is of interest to inventors and particularly to those who are in doubt as to certain Patent Phases. Regular inquiries addressed to "Patent Advice" cannot be answered by mail free of charge. Such inquiries are published here for the benefit of all readers. If the idea is thought to be of importance, we make it a rule not to divulge all details, in order to protect the inventor as far as it is possible to do so.

Should advice be desired by mail a nominal charge of \$1.00 is made for each question. Sketches and descriptions must be clear and explicit. Only one side of sheet should be written on.

NOTE:—Before mailing your letter to this department, see to it that your name and address are upon the letter and envelope as well. Many letters are returned to us because either the name of the inquirer or his address is incorrectly given.

RAILROAD CROSSING SAFETY DEVICE.

(774) J. A. Pickens, Easley, S. C., has designed a railroad crossing safety system, which comprises a large mound to be erected at the center of the road, diverting truck traffic and causing the driver to "go slow" in making the crossing.

A. Your suggestion for a railroad crossing is not always feasible, as there are so many places where such a large crossing detour could not be employed. Furthermore, diversion of truck traffic, as well as horse and wagon traffic, is not a very good suggestion, as a team ordinarily having a straight haul finds it a good deal easier to get across the railroad tracks than in places where sharp turns are necessary. It makes it very difficult to remove wreckage from such a crossing, and in general, instead of improving the safety of the crossing, acts oppositely. The railroad right of way must be increased in size and cost of the installations are much greater than if the entire road were elevated or depressed above or below the street level. We do not advise that you apply for a patent on this suggestion.

WHY WE DO IT

(775) John C. Clark, New York City, asks why it is that so many of the opinions printed in this column are adverse to the inventor and why the Editor of this column does not advise more inventors to attempt to secure patents upon their ideas.

A. The purpose of this department is to stop inventors from making foolish mistakes. It is to teach them the right way to go about securing a patent and apply for patents on those things of value which are almost assured of acceptance. Of course, even the best article may never be placed upon the market due to the fact that the inventor expects to either secure too much for the patent rights, or that he does not handle the project in the proper manner. In other words, he may be a good inventor, but a poor business man. A great many of our decisions are, however, favorable. In fact, we should judge that thousands of favorable decisions have been given. Many of the inventors courteously enough write to the Editor of this department and let him know that their invention has been sold, or that changes have been made in the plans, so as to make the device more marketable. The Editor of this department has received quite a number of letters claiming that inventions have been sold in some cases for thousands of dollars. These letters further advise that the individuals followed comments or suggestions made here. Few of these letters are printed. Many of the good suggestions are kept on file, giving the inventor ample opportunity to proceed with any

improvement he may desire, or permitting him to file his claims. None of the letters on which personal advice is given are published, consequently this limits the number of queries which are published. Do not for one moment suppose that all of our criticisms are adverse. Whenever we can conscientiously give favorable comment upon an idea we do so, even if we modify that favorable opinion.

CRYSTAL DETECTORS

(776) Clyde D. Pace, Detroit, Mich., submits two diagrams of crystal detectors, the first of which is quite ordinary, and the other a multi-point detector.

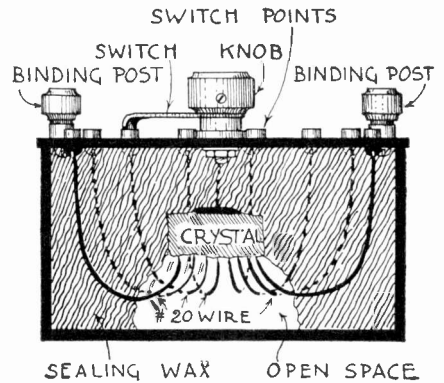

Cost and difficulty of construction are the main objections to this device.

A. The first suggestion of a crystal detector is not new at all, and we do not believe that you could secure any basic patent upon the idea whatever. The second idea is a little more novel, but presents many difficulties in manufacturing. For this reason, we would advise that you build a dozen or more of these detectors, and attempt to place them upon the market, perhaps through one of your local radio stores. You will find that in order to adjust the detector each individual point will have to be sealed to the crystal, one at a time, and tested for sensitivity before being sealed. This will present innumerable difficulties in manufacturing, as before stated. In addition, the switching arrangement is expensive, and after all of the twenty points of the crystal have been burned out it can be practically thrown away, there being no method of changing or replacing it. We would be very skeptical about advising you to apply for a patent upon the idea.

COMBINATION PENCIL, PAINT BRUSH AND ERASER

(777) Ralph M. Williams, Oberlin, Ohio, submits a design of a pencil, paint brush and eraser and requests our opinion.

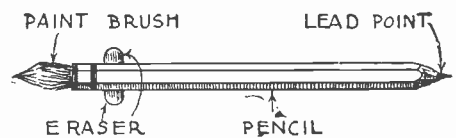

A quite useless combination.





EXPERIENCE **SERVICE**

CLARENCE A. O'BRIEN

PATENT ATTORNEY

REGISTERED IN UNITED STATES PATENT OFFICE
 MEMBER OF THE BAR OF
 SUPREME COURT OF UNITED STATES, COURT OF APPEALS DISTRICT OF COLUMBIA,
 SUPREME COURT DISTRICT OF COLUMBIA, UNITED STATES COURT OF CLAIMS.
 PRACTICE CONFINED TO PATENTS AND TRADE MARKS.

PATENTS

PROTECT YOUR IDEAS

ANY NEW article, machine, design or improvement thereof, or any new combination of parts or improvements in any known article which increases its efficiency or usefulness, *may be patented*, if it involves invention.



Drafting and Specification Room of Clarence A. O'Brien, Registered Patent Attorney, Washington, D. C.

IF YOU HAVE ANY NEW IDEAS

which you feel are useful, practical and novel, *take prompt action to protect your rights*. If you have invented any new machine, or new combination of parts of improvement, or any new design or process, **SEND DRAWING, MODEL OR DESCRIPTION** of it for information as to procedure to secure protection.

Write Today for Blank Form

"Record of Invention"

USE THE COUPON attached, and immediately upon its receipt I shall send you this form to be returned to me with drawing, description or model of your idea; promptly upon receiving your idea I shall write you fully as to procedure and costs.

No Charge for This Information

All communications are held in strict confidence. My personal, careful and thorough attention is given to each case. I offer you efficient, reliable and prompt service—based upon practical experience. *Highest references*.

WRITE TODAY for free book "How to Obtain a Patent." This book will give you valuable information, and it may save you much time and effort. *Send for it, NOW!*

My practice is devoted *exclusively* to United States and Foreign Patents and Trade Marks. Write me freely, frankly and with full confidence; it is very probable that I can help you. *Write TODAY!*

CLARENCE A. O'BRIEN, Patent Attorney, 53B Security Savings & Com'l Bank Bldg.

Directly across street from Patent Office, Washington, D. C.

Please send me your free booklet "How to Obtain a Patent" and blank form "Record of Invention" without any obligation on my part.

Name

Address
(IMPORTANT: WRITE OR PRINT NAME CLEARLY)



SCIENCE
INVENTION
INDUSTRY

ECONOMY
EFFICIENCY
INITIATIVE

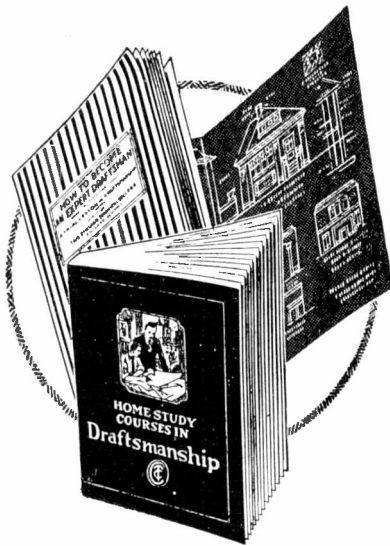

HOME STUDY COURSES IN Draftsmanship

FREE Trial Lesson DRAFTING

The coupon below brings this Free Trial Lesson, prepared by the Chicago Tech. experts. Learn from it, before you pay out a penny, how well qualified you are to take up Drafting. While other schools require enrollment and payment of fees at once, Chicago Tech. sends you this lesson first and also information on how to get into the high salaried profession of Drafting by utilizing your spare hours.

Big Jobs Waiting

Become an expert Draftsman and you can "write your own ticket." Chicago Tech. training enabled Rex Cary to make 4 times his former salary; A. S. Ross soon had a salary increase of \$225 a month and J. A. DeCosta who was a laborer became manager through the same training. Your opportunity is as good as theirs. All you need is this training.

Train at Home

You can get this training without leaving your present position. The Chicago Tech. experts will teach you by mail, giving you the knowledge that will make your services always in demand by big industries. No useless theories, no dry text books to study. You work on practical problems and learn the ways of successful high-salaried Draftsmen.

FREE Drawing Outfit

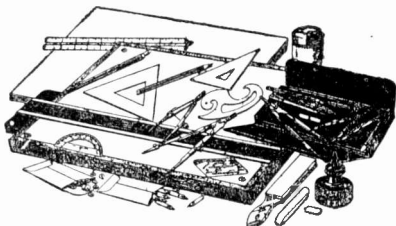

Home study students receive this complete professional Drawing Outfit (retail price \$25) without extra charge—or credit for fees if they have outfits.

Send the Coupon

Mail the coupon and get the Free Trial Lesson—also catalogs and full information about the Chicago Tech. Method of teaching Drafting by mail. No cost to you—no promise or obligation on your part. Send today.

CHICAGO TECHNICAL COLLEGE

Dept. 245, Chicago Tech. Bldg., 118 East 26th St., Chicago, Ill.

Without cost or obligation on me please send instructive matter about opportunities in line I have marked with "X."

- () Drafting. (The Big Salary Course). No experience necessary. Free Lesson sent now.
- () Building Trade Course. For men in the building lines.

Name

Address

Post Office

State

A. We do not doubt but that you could obtain a patent on your combination pencil, eraser and paint brush, but we would not suggest such patent inasmuch as we do not believe that you could ever realize a value commensurate with the time and money spent in patenting the same or in attempting to place it upon the market. The practical utility of the device is extremely limited.

AIRPLANE LADDER

(778) Harvey Witter, Harrisburg, Pa., submits a design for an airplane ladder which will hoist a man up to the cock-pit of an airplane when he grasps the same.

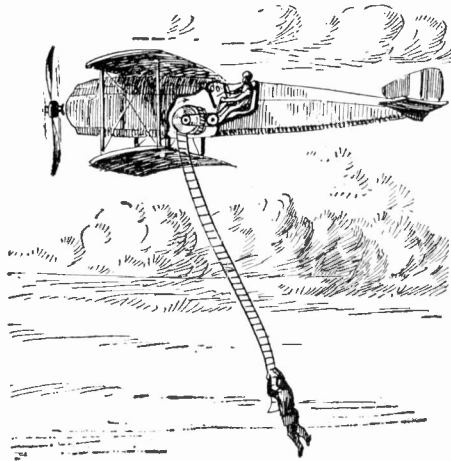

A device for which no practical use can be found.

A. Your suggestion for an airplane ladder is absolutely worthless. It is just as simple for a man to climb up a ladder suspended from an airplane, as it is to hoist him up into safety.

Besides, the number of individuals "hopping" on this ladder from the ground when the airplane is in motion is very limited indeed. Perhaps one movie actor does so once in his lifetime. Often no attempt is made to ruin his features, and a substitute is employed.

TELESCOPIC REFLECTING MIRROR

(779) L. F. Wright, Buffalo, N. Y., asks our advice on a reflector for telescopes made of a large metallic disk with a piece of glass secured to it. The whole is to be rotated at high speed. His other suggestion is to make use of many pieces of glass welded together.

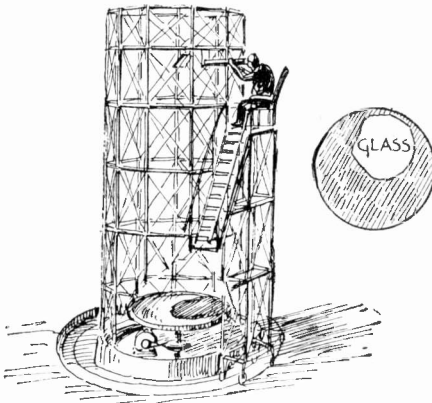

An impractical method of making large telescopes.

A. It is quite impossible to mold together a whole series of small pieces of glass as suggested by you in your recent communication. There is a concern making metal reflectors which they are placing on the market. Those reflectors are just as efficient as the glass reflectors, and may be made in larger sizes. Neither of your suggestions for the use of glass is applicable to telescopic construction, because it would be impossible to weld this glass together without producing air bubbles, crevices or cracks, which are naturally developed in attempted welding processes to a more marked degree than elsewhere.

Mounting pieces of glass upon a large metallic area makes it difficult to grind the glass down, because of the different hardness of the two substances. Of course, an attempt at this would probably be partially satisfactory, and if the entire device were rapidly rotated, some results would be obtained, but they would not be as satisfactory as with those reflectors now employed.

Although your suggestion could be illustrated and probably made the topic of a small feature article, its marketable possibilities are practically negligible, and we would, therefore, not advise any attempt at patenting the idea.

CAN YOU

think of a simple, practical idea that will fill one of the many requests we have on file for new inventions? It may mean a fortune for you. Thousands of things are needed Right Now. Your brains can help. Send today for our great new book—"Inventions and Trade Marks, Their Protection and Exploitation" and learn more about making money from ideas than you ever knew before. It tells many things that are wanted, too.

A postal will do— it is free.

We help our clients, without charge, to get the dollars out of their ideas—having facilities none others possess.

Advice Free. Don't delay—get the book at once.

AMERICAN INDUSTRIES, INC. 225 Patent Dept. WASHINGTON D.C.

PATENTS ADVERTISED For SALE FREE

In Invention and Manufacturing Supplement.

Published for the man with an idea. Send for free sample copy. One year's subscription 50c.

PATENTS

Trade-Marks, Copyrights and Patent Litigation. Write for advice and instructions how to proceed, costs, etc.

Hand Book with illustrations of 100 Mechanical Movements sent free on request.

ALBERT E. DIETERICH Patent Lawyer and Solicitor Successor to Fred G. Dieterich & Co. 601 OURAY BLDG. WASHINGTON, D. C.

PATENTS

Hand Books on Patents, Trade-Marks, etc., sent free. Our 77 years of experience, efficient service, and fair dealing assure fullest value and protection to the applicant. The Scientific American should be read by all inventors.

MUNN & CO., 618 Woolworth Building, New York Tower Bldg., Chicago, Ill. Scientific American Bldg., Washington, D. C. Hobart Bldg., 582 Market St., San Francisco, Cal.

C. L. PARKER

Ex-Member Examining Corps, U. S. Patent Office

Attorney-at-Law and Solicitor of Patents

American and Foreign Patents secured. Searches made to determine patentability, validity and infringement. Pamphlet of instructions sent upon request.

McGILL BUILDING WASHINGTON, D. C.

INVENTORS

who derive largest profits know and heed certain simple but vital facts before applying for Patents. Our book Patent-Sense gives those facts: free. Write Lacey & Lacey, 644 F St., Washington, D. C. ESTABLISHED 1869.

MODEL MAKING

When you have made your Model Roller, you will naturally wish to mount it with the best Steam Fittings obtainable. We can supply accurately made miniature Steam and Water Gauges, Steam Valves, Pumps, etc., also finished Engines and Boilers suitable for Model boats and stationary purposes. Special work to order. Large illustrated catalog 20c (refunded on first order).

BATHE MFG. CO., Dept. 2, 5214 Woodland Ave., Phila. Pa.

LATHES

9 to 18-inch Swing

List price \$135.00 and up, according to size. When ready to buy, send for Lathes Catalog and prices.

W. F. & John Barnes Co, 442 Ruby Street ROCKFORD, ILLINOIS

Print Your Own

Cards, circulars, labels, book, paper, Press \$12. Larger \$35 Job press \$150. Save money. Print for others, big profit. All easy, rules sent. Write factory for press catalog, TYPE, cards, etc. THE PRESS CO., D-47, Meriden, Conn.

The Heavens in February

By ISABEL M. LEWIS, M.A.
(Continued from page 992)

pendent for its splendor upon nearness as is the case with Sirius. Compared with this glorious giant star Sirius is but a pigmy.

Procyon, the first-magnitude star in Canis Minor, The Lesser Dog, nearly due east of Betelgeuse, is also a near neighbor of the solar system at a distance of about twelve light years. Both Sirius and Procyon are attended by massive but extremely faint companion stars. Due north of Procyon are the Twins; Castor and Pollux, in Gemini. Pollux is the brighter of the two stars at the present time but there is reason to believe that the relative brightness of the two stars has changed for Pollux is known as Beta, and Castor as Alpha, Geminorum and it was the custom of the ancients to name the brightest star in a constellation Alpha, the second in brightness Beta and so on. The distance of Pollux is about thirty-five light years, that of Castor about forty-five light years from the earth. Castor is the more interesting of the two stars for it is a double star in which each of the two components has a close companion star, making in all a system of four suns. The two principal stars have a long period of revolution about their common center of gravity that at least several centuries are required to complete.

To the northwest of Gemini is Auriga The Charioteer, with its brilliant Capella, The Sea-Goat with The Giedi or Kids, the three faint stars forming a small triangle, close by. Capella is one of the three brightest stars of the northern hemisphere, the other two being Vega and Arcturus.

The Unicorn lies east of Orion and south of Gemini. This group consists of faint stars and are of no particular interest, while it would strain the imagination to see in them any resemblance to the animal they are supposed to represent.

Monoceros is located, in one of the most brilliant portions of the Milky Way which at this time of year stretches from the large and brilliant southern constellation of Argo Navis, a small portion of which now appears in the southeast, in a broad band nearly through the zenith to the north-western horizon. Another brilliant cloud of the Milky Way lies half-way between Perseus and Cassiopeia and in this cloud is the famous cluster of the "Sword Handle of Perseus" a fine object even for a small telescope. Nearly all of the constellation of Perseus lies within the Milky Way in a particularly rich portion. This luminous band composed of the blended light of countless stars too distant to be seen as individual points of light is one of the most beautiful features of the brilliant winter skies as it arches high overhead in this part of its course. It is hopeless to look for it under the glaring lights of our city streets, however. To see the Milky Way in all of its beauty and magnificence one must get out in the open away from all lights except those supplied by the heavens alone on clear, dark moonless nights.

Venus, the most brilliant of all the planets, is now a magnificent object in the evening sky, setting about three hours after the sun the first of February.

Mars, Jupiter and Saturn are still in the eastern heavens visible to the early riser.

PATENTS TRADE-MARKS AND COPYRIGHTS

OUR OFFER: No Charge for Examination and Instructions

HAVE YOU AN IDEA?

YOUR FIRST STEP Before disclosing an invention, the inventor should write for our blank form

"Record of Invention" This should be signed and witnessed and returned to us together with model or sketch and description of the invention for examination and instruction

No charge for the above information.

Our Three Books Mailed Free to Inventors

Our Illustrated Guide BOOK

How to Obtain a Patent

Contains full instructions regarding U. S. Patents. Our Methods, Terms, and 100 Mechanical Movements illustrated and described, Articles on Assignment or SALE OF PATENTS, Patent Practice and Procedure, and Law Points for inventors.

Our Trade Mark Book

Shows the value and necessity of Trade-Mark Protection and gives information regarding Trade-Marks and unfair competition in trade.

Our Foreign Book

We have Direct Agencies in all Foreign Countries. We secure Foreign Patents in shortest time and lowest cost.



Highest References—Prompt Attention—Reasonable Terms

WRITE TODAY

Free Coupon

VICTOR J. EVANS & CO.

Patent Attorneys

New York Offices 1007 Woolworth Bldg. Philadelphia Offices 714-715 Liberty Bldg. Pittsburgh Offices 514 Empire Bldg. Chicago Offices, 1114 Tacoma Bldg. San Francisco Offices, Hobart Bldg.

Main Offices, 779 Ninth Street, Washington, D. C.

Gentlemen: Please send me FREE OF CHARGE your books as described above.

Name Address.....

ONE THOUSAND AGENTS WANTED

WE want one thousand agents to sell subscriptions to RADIO NEWS, SCIENCE & INVENTION and PRACTICAL ELECTRICS. We will pay a generous commission for this work and help you in every way. Our three publications are leaders in their fields, ready sellers and this is an offer well worth your while. A few spare hours a day will bring you a handsome return. Write regarding our proposition at once and be the first one to get started in your vicinity.

Experimenter Publishing Co.

HERBERT H. FOSTER, Sales Manager

53 Park Place

New York

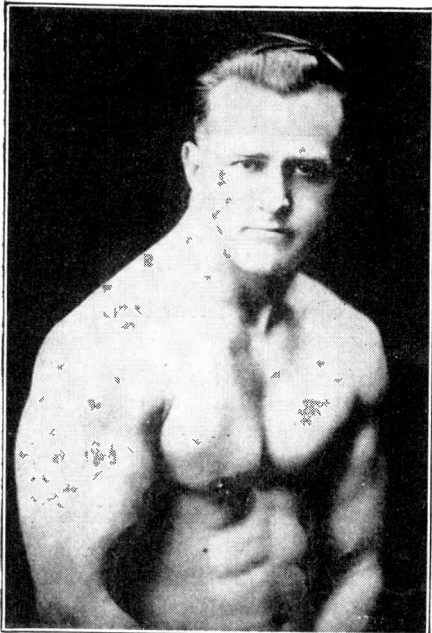

EARLE E. LIEDERMAN as he is today

Are You Ready for the Ash Can?

Do you realize what it means to neglect your body? Do you know that you will clog up with waste matter and deaden your life just as ashes do in a furnace? Are you going to drag yourself through a life of misery and be ready for the undertaker when you should really be only starting to enjoy life? Come on and brace up. Take a good hold of yourself and shake those cobwebs out of your brain. Give me a chance at that weak backbone of yours and let me put a pair of man sized arms into those narrow shoulders.

Pills Never Made Muscles

I am not a medical doctor. I don't claim to cure disease. Neither do I put any self-assumed title of Professor before my name. I am a builder of muscle—internal as well as external. I claim and can prove that by proper exercise you can even build muscle in and around your heart and every vital organ. The kind that shoots a thrill through your veins and reaches every crevice of your body. I add years to your life, and oh boy! what a kick you get out of every day you live. And talk about big, brawny arms and legs, or broad backs and husky chests—just take a look through this winter's copies of Physical Culture Magazine and see for yourself. You will see a few pictures of my pupils there—living examples of the Earle Liederman system—doctors, lawyers, business men, but every last one of them good enough to pose as professional strong men. Some are in better shape than men who are now acting as instructor to others.

Pep Up

What are you going to do about it? Don't sit idle and wish for strength. That will never bring it. Come on and get busy. You must have it, and I'm going to give it to you. I don't promise it, I guarantee it. You don't take any chance with me, so come on and make me prove it.

Send for My New 64-Page Book

MUSCULAR DEVELOPMENT

It contains forty-three full-page photographs of myself and some of the many prize-winning pupils I have trained. Some of these came to me as pitiful weaklings, imploring me to help them. Look them over now and you will marvel at their present physiques. This book will prove an impetus and a real inspiration to you. It will thrill you through and through. All I ask is 10 cents to cover the cost of wrapping and mailing and it is yours to keep. This will not obligate you at all, but for the sake of your future health and happiness, do not put it off. Send today—right now, before you turn this page.

EARLE E. LIEDERMAN

Dept. 202, 305 Broadway, New York City

EARLE E. LIEDERMAN,
Dept. 202, 305 Broadway, New York City

Dear Sir: I enclose herewith 10 cents, for which you are to send me, without any obligation on my part whatever, a copy of your latest book, "Muscular Development." (Please write or print plainly.)

Name

Street

City State.....

RADIO BROADCAST

(Continued)

Call Letters	Name	Location	Power & Wave Length
WSAX	Chicago Radio Lab.,	Chicago, Ill.	20-268
WSAY	Irving Austin (Port Chamber of Commerce),	Chester, N. Y.	100-233
WSAZ	Chase Electric Shop,	Pomeroy, Ohio	50-258
WSB	Atlanta Journal,	Atlanta, Ga.	500-429
WSL	J. & M. Electric Co.,	Utica, N. Y.	100-273
WSY	Alabama Power Co.,	Birmingham, Ala.	500-360
WTAB	Fall River Daily Herald Pub. Co.,	Fall River, Mass.	10-248
WTAC	Penn. Traffic Co.,	Johnstown, Pa.	150-360
WTAD	Robert E. Compton, (First Presbyterian Church),	Carthage, Ill.	10-229
WTAF	Louis J. Gallo,	New Orleans, La.	20-242
WTAG	Kern Music Co.,	Providence, R. I.	10-258
WTAH	Carmen Ferro,	Belvidere, Ill.	10-236
WTAJ	The Radio Shop,	Portland, Me.	50-236
WTAL	Toledo Radio & Elec. Co.,	Toledo, Ohio	10-252
WTAM	Willard Storage Battery Co.,	Cleveland, Ohio	1000-390
WTAN	Orndoff Radio Shop,	Mattoon, Ill.	100-240
WTAP	Cambridge Radio & Elec. Co.,	Cambridge, Ill.	50-242
WTAQ	S. H. Van Gorden & Son,	Osseo, Wis.	100-226
WTAR	Reliance Elec. Co.,	Norfolk, Va.	100-280
WTAS	Charles E. Erbstein,	Elgin, Ill. (near)	500-275
WTAT	Edison Electric Illuminating Co.,	Boston, Mass. (Portable)	100-244
WTAU	Ruegg Battery and Electric Co.,	Tecumseh, Neb.	10-360
WTAW	Agricultural & Mechanical College,	College Station, Texas.	50-280
WTAX	Williams Hardware Co.,	Streator, Ill.	20-231
WTAY	Jodar-Oak Leaves Broadcasting Station,	Oak Park, Ill.	15-226
WTAZ	Thomas J. McGuire,	Lambertville, N. J.	15-283
WTG	Kansas State Agricultural College,	Manhattan, Kansas	1000-485
WWAB	Hoenig, Swern & Co. (John Rasmussen),	Trenton, N. J.	10-226
WWAC	Sanger Bros.,	Waco, Texas	50-360
WWAD	Wright & Wright, Inc.,	Philadelphia, Pa.	50-360
WWAX	Wormser Bros.,	Loredo, Texas	50-360
WWB	Daily News Printing Co.,	Canton, Ohio	100-268
WWI	Ford Motor Co.,	Dearborn, Mich.	50-273
WWJ	Detroit News (Evening News),	Detroit, Mich.	500-517
WWL	Loyola University,	New Orleans, La.	100-280
WWZ	John Wanamaker,	New York, N. Y.	100-360

PEDAL PANTS PREVENT DRAUGHTS

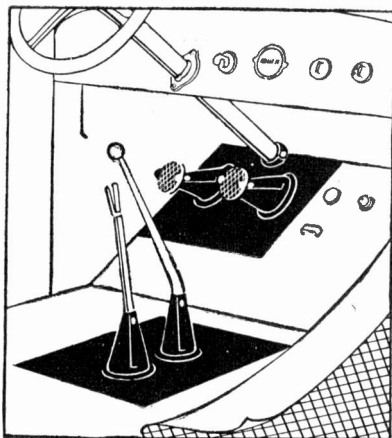

A protector placed under the floor mat that fits around the steering post and levers; shuts out cold winds and keeps out dirt.



LET US TRAIN

YOU TO BECOME AN AUTO MECHANIC AND ELECTRICIAN

After years of careful planning and research we have developed a method whereby YOU may learn to be an auto electrician and mechanic in your own home.

Expert auto mechanics earn from \$50 to \$100 per week. You can do the same. We can secure one of these positions for you.

No matter what your education may be our engineers, Mr. E. W. Towne and Mr. A. Metela, will teach you thoroughly and quickly to become expert in this line.

Each student will receive our personal attention and individual help as required.

The benefit of our twenty years' experience is yours for the asking.

"Chicago's Best Automobile School" is the quotation that expresses the opinion of thousands of satisfied students.

For particulars write

SIMPLEX AUTO SCHOOL

CHICAGO, ILLINOIS
1834-1836 West Van Buren Street

3 WEEKS FOR 15 CENTS

The Pathfinder

SHOWS THE WAY THROUGH THE JUNGLE OF EVENTS

You've heard your neighbor praise the Pathfinder, the wonderful weekly news and story magazine with over half a million subscribers. Unbiased digest of national and world affairs. Check full of just the kind of reading you want. Fun, fashions, question box, books, health—entertainment and instruction for all. Exciting serial and short stories. Send 15c (coin or stamps) today for this big \$1 paper 13 weeks. Money back if not satisfied. * Sample copies free. **PATHFINDER, 555 Langdon Sta., Washington, D. C.**

BLANK CARTRIDGE PISTOL

Protection against Burglars, Tramps, & Dogs

PRICES 50c! \$1.00!

POST-PAID

Well made and effective model on latest type of Revolver. Appearance alone is enough to scare a burglar. When loaded it may be as effective as a real revolver without danger to life. It takes standard .22 Cal. Blank Cartridges obtainable everywhere. Price 50c. Superior quality \$1.00 post-paid. Blank Cartridges, by express, 50c per 100.

JOHNSON SMITH & CO., Dept. 66 Racine, Wis.

FREE \$20

Fine Tone Musical Instruments

We have a wonderful new copyrighted system of teaching note music by mail. To first pupils in each locality we will give free a \$20 superb Violin, Tenor Banjo, Ukulele, Hawaiian-Guitar, Banjo, Mandolin, Banjo-Ukulele, Banjo-Mandolin, Organ. Very small charge for lessons only. Four lessons will teach you several pieces. Over 100,000 successful players. We guarantee success or no charge. Complete outfit free. Write today. Dept. 149 No obligation. **Stingerland School of Music, 1815 Orchard St., Chicago, Ill.**

5 Master Keys

Work like magic in emergencies or prove whether your door or padlocks are burglar-proof. Open and test thousands of different locks. Recommended by users in ten different nations. Most wonderful and only keys of their kind. Send \$1 today. Novel key chain FREE with set.

MASTER KEY CO., 78 West Water St., Milwaukee, Wis.

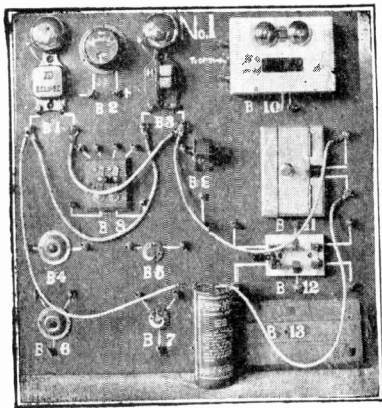

This is Board No. 1 of the Series of Electrical home-laboratory equipment furnished to every student. (Size 24 by 24 inches.)

Wages of
Workers
to \$1.25
an hour.

If An Ordinary
Electrical Worker
Can Command \$60 per Week,
You, As a Graduate, Can Easily

EARN \$100.00 WEEKLY

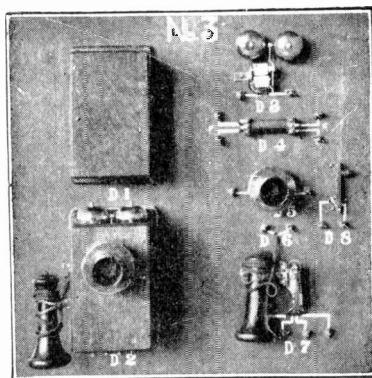

Board No. 3 of this wonderful new plan of studying electricity at home.

The field of opportunity for the well-trained electrical man is practically unlimited. Billions of dollars are invested in this great industry. Thousands of men are employed in it—but the demand today is for men who are *trained specialists*. These men command handsome salaries—\$2,500 to \$6,000 and up to \$10,000 a year and more. Why don't you get into this fascinating, highly paid field of work?

You can complete our Home Study Course in Practical Electricity within six months from the day you sign the coupon below. Electricity offers a better chance for advancement and a bigger starting salary than any other trade or profession.

With our certificate of qualification you can enter this great profession and as you advance in knowledge and expertness, your salary will be increased surprisingly.

A Short-Cut to Big Money

Sign the Coupon Today

We make it easy for you to learn. Don't delay, as our offer will be withdrawn when one thousand additional students are enrolled.

SCHOOL OF ENGINEERING OF MILWAUKEE
Milwaukee, Wisc.

EXTENSION DIVISION,
School of Engineering of Milwaukee,
Dept. S&T-J124, 415 Marshall St., Milwaukee, Wisc.

Please send me free and without any obligation on my part copy of the "President's Message," and full details of your special offer to home students in Practical Electricity.

Name

Address

City State.....

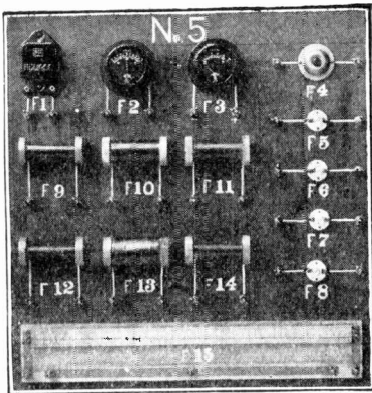

Board No. 5 for electrical testing.

We operate, in Milwaukee, the largest Electrical School in the United States. The lessons are written in simple language, and anyone who can read a newspaper can understand them. With the help we offer students, who study at home an hour or two each evening, through the President's lectures given in our Radio Broadcasting Department, reaching every city, town and hamlet in the United States, you get, twice a week, free, knowledge that will help you amazingly in your studies.

The outfits shown in this advertisement are only three of the twelve big electrical equipment boards which we furnish for the help of every student in his studies. Other helps and suggestions are sent as fast as you are ready for them. Every student receives the personal instruction of the President of this famous school.

Give us the opportunity of putting all the facts before you—of telling you about what we can do to help you get started.

If you live within 100 miles of any large city write us for our remarkable special offer that will mean dollars in your pocket.

Fellers!

This is Some Set

Receiving Radius
600 Miles

Armstrong
Regenerative Set

Licensed under the Armstrong Patent No. 1113149 for amateur experimental and scientific uses only.

\$23.25

and plainly marked. Easy to tune. Order NOW! Shipping weight, 12 pounds. Shipped from CHICAGO or PHILADELPHIA store. 57AB9366.....\$23.25

HERE is a money saving Radio Outfit that will bring the news of the world—concerts, lectures and stock reports—into your home. Sold complete with head set, tube, batteries, aerial and ground wires, for only \$23.25! Connections simple. Order NOW! Shipping weight, 12 pounds. Shipped from CHICAGO or PHILADELPHIA store. 57AB9220.....\$2.98



3000 Ohms Head Set \$2.98

Order Direct From This Advertisement.

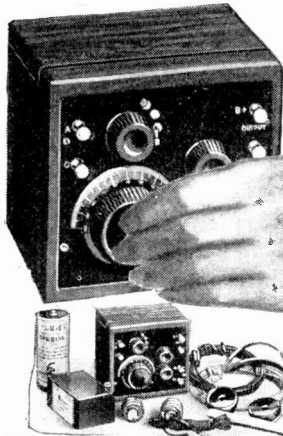

At last—the inexpensive, efficient head set you've been looking for, and only \$2.98! Makes clear those distant signals. Fits your head as comfortably as your cap. Complete with five feet of good grade cord. Excellent workmanship. Order NOW! Shipping weight, 1 1/2 pounds. Shipped from CHICAGO or PHILADELPHIA store. 57AB9220.....\$2.98

Save On All Radio Supplies.

Save money on your radio supplies, and get guaranteed quality! Our big FREE Book shows hundreds of bargains in complete sets and parts. Many new hookups, complete list of broadcasting stations. Contains "How to Build an Aerial." Mail coupon!

Mail coupon today to store nearest you for Free Radio Catalog.



Sears, Roebuck and Co., Chicago—Philadelphia.

Send me FREE Radio Book No. 83S67

Name.....

P. O.....State.....

Rural Route.....Box No.....

Street and No.....

Sears, Roebuck and Co. CHICAGO—PHILADELPHIA

THE WORLD'S BIGGEST MAIL ORDER HOUSE.

Ad 9967—Size 4 1/2 x 5 3/4 Inches.

"THERE'S MONEY IN IT"

LEARN TELEGRAPHY AT HOME

MORSE AND WIRELESS

TEACH YOURSELF

in half usual time, at trifling cost, with the wonderful Automatic Transmitter THE OMNIGRAPH. Sends unlimited Morse or Continental messages, at any speed, just as an expert operator would. Adopted by U. S. Government, and leading Universities, Colleges and Telegraph Schools. 3 styles. \$14 to \$30. Catalog free.

If you own a Radio Phone Set and don't know the Code, you are missing most of the fun.

OMNIGRAPH MFG. CO. 22 Hudson St., NEW YORK



HB 8 HOUR BATTERY CHARGING PAYS BIG
\$200 to \$300 Profit Every Month

\$300 PROFIT Monthly from HB 8 Hr. Battery Charging
Small cash payment brings HB 8-hour charging outfit. Easy terms of only \$20 monthly let your profits pay balance with nice surplus besides. Thirty day free trial on money-back guarantee. You can easily clear \$150 to \$300 every month. Hundreds of HB users, with no previous experience are making big money. You can, too. Write today for Bulletin 327.
HOBART BROS. CO., Box S26 TROY, OHIO
Pays For Itself ~ Earns Big Profits

Start Making Big Profits CHARGING BATTERIES
\$20 Monthly Pays for Your Outfit

How to Get A Position with the U. S. Government

Thousands of appointments are made yearly. Good salaries—short hours—liberal vacations. Positions open now in Washington and other cities and in Alaska, Porto Rico, Hawaii and the Philippines.

Write to-day for 48-page FREE BOOKLET on CIVIL SERVICE, which tells you how you can get a good-paying position with the United States Government.

INTERNATIONAL CORRESPONDENCE SCHOOLS
Box 6225-C, Scranton, Penna.



VACCU-PUMPS

Needed by every Doctor, Dentist, Chemist, Mechanic, garage repair shop, radio experimenter, college and laboratory.

Many Uses

Will exhaust vacuum tubes, start a syphon, empty auto gas tanks by suction, draw liquid from inaccessible places, transfer acids, and supply a vacuum for any medical or laboratory use. Price with gauge, hose, and bottle, \$16.00. Without gauge, \$6.00. Circulars on request.

A. B. C. LABORATORIES CO.

100 Lawrence St., N. Y. West 126th St.

THE MAN ON THE METEOR

By Ray Cummings

Part II

(Continued from page 971)

orating from her shoulders; she had been in the stream. A few molluscs, or something of the kind, lay at her feet.

"See!" she cried triumphantly. "They are to eat. My man Nemo can get them—they are in the water."

I broke them open and ate one. It was good. I kissed her approvingly and her arms clung about my neck. Nona always was happiest in my approbation; she seemed to think of nothing save how to win it.

When her caresses were passed, I stood up.

"How do I get them?" I demanded. "Nona must show me once—then I will get very many of them for us to eat."

The experience that followed was extraordinary; that is to say it would be so to you here on Earth. To me, that day on the meteor, it was merely frightening. Nona led me to the stream and we waded into it waist deep. I had bathed here, but I had never been further along. Nona had, however. She led me forward to where the water went under a low archway of our cave and thence into the bowels of the meteor.

The river-bed under my feet began sloping downward. The water deepened around me—to my chest, shoulders, almost to my neck. I was terrified. I pulled back from Nona's hand which was drawing me along. Her hair was floating out like golden seaweed around us. The milk-white water was under her uptilted chin.

Her eyes smiled at me tenderly. "No," she said. "My man Nemo never can be afraid."

Afraid! I could not let her see that. I grunted scornfully, and we went forward.

The water rose to my own chin. We were well underground now—the ceiling of this subterranean passageway was hardly a foot above my head. In front of me I could see where the ceiling touched the water.

Suddenly I remembered Nona. One of her hands still held mine—the other was braced against a projection of the side wall to hold us against the gentle current that pressed us forward. The water now almost reached the top of her head. I could see her face beneath the surface. Her mouth was opened round and wide; a stream of air bubbles came gurgling up from it. Her chest was expanding and contracting rhythmically and swiftly, seemingly with great effort, like a man panting after an exhausting fan. *She was breathing the water!*

II

I stared at Nona silently. The air bubbles from her mouth grew less, until soon there were almost none of them. The tidal air in her lungs had been forced out; water had taken its place. Through her opened mouth she was drawing in the water and expelling it—rapid respirations taxing the intercostal muscles almost to their limit.

Nona smiled up at me through the water, which in spite of its milk-white color, was curiously limpid and transparent. I felt the tug of her hand; I stepped forward, and in the deepening water my face went under.

Whatever may have been my previous existence, an experience such as this quite evidently was no part of it. My instinct was to hold my breath. I did so until I could no longer. I struggled against Nona's hand and tried to get my head above the surface. But she held me; and my fear of having

her know me to be afraid was greater than my fear of the water.

BREATHING WATER

At last I let out my pent-up breath. It gurgled from my mouth in bubbles. Then, in a gulp of desperation, I inhaled. The water choked me. I tried to cough; but could not—or at least the cough became my exhalation.

My ears were roaring as though the torrents of your Niagara were rushing past them. My head and chest seemed bursting—icy cold at first, then burning with fire.

My eyes were open. I was standing beside Nona and she was looking up at me. Through the half-light of the water I could see her almost as plainly as through air. She smiled encouragingly at me, and I tried to smile back.

I was drawing the water in and out swiftly now, with my mouth held extended like an expiring fish. It was a tremendous effort, this respiration. The muscles of my chest and diaphragm were tired in a moment. A weight in my chest seemed smothering my heart; I seemed on fire inside—a million inflamed little lung passages rebelling at this unaccustomed medium.

Spots were dancing before my eyes. I was losing consciousness through lack of oxygen. The poisoned venous blood was dulling my brain.

Then I began to feel better. I was respiring now almost as swiftly as Nona, and with far less effort than I had used at first.

You are skeptical? Because you cannot breathe your Earth-water, you assume that I could not breathe this water on my meteor. What quaint logic that is! Yet I find all you Earth-people think on similar lines. It is your inadequate mentality, I suppose, so I must hasten to enlighten you.

There are two fundamental objects of respiration. First: the introduction into the system of oxygen by which the products resulting from the disintegration of the muscular, nervous and other tissues of the body may be converted into compounds easily eliminated. Secondly: the direct removal of the most noxious and therefore most important of these waste products—carbonic acid gas.

In man, as you know him on Earth, this is accomplished by the lungs. The venous blood, charged with its carbonic acid and its waste products, needing a renewal of oxygen and a removal of the carbonic acid, is pumped by the heart through the lungs. These by their construction present an immense amount of internal surface covered by a vascular net-work, through which the blood flows in innumerable minute streamlets.

In respiration, the inhaled air is separated from the blood only by an extraordinarily thin membrane—less than 1/20,000 of an inch in thickness. Through this membrane the blood absorbs oxygen from the air, giving in return to the air its noxious carbonic acid gas.

Such is the basic process in you Earth-men. In the case, let us say, of your Earth-fishes breathing your water, there is little fundamental difference. The blood in their gills is brought practically into contact with a steadily moving stream of water. But fishes do not get their oxygen from the water in some mysterious fashion. Did you think they did? They get the oxygen, not from water, but from air—the air that is held in solution in the water.

But for two things, you on Earth could breathe your water. First, your lung passages are too minute to receive a substance so heavy, so *unvolatile*, let me say, as is the water of Earth. Secondly, there is not proportionally enough air in your water.

Both these conditions were different on my meteor. You ask perhaps, are my lungs

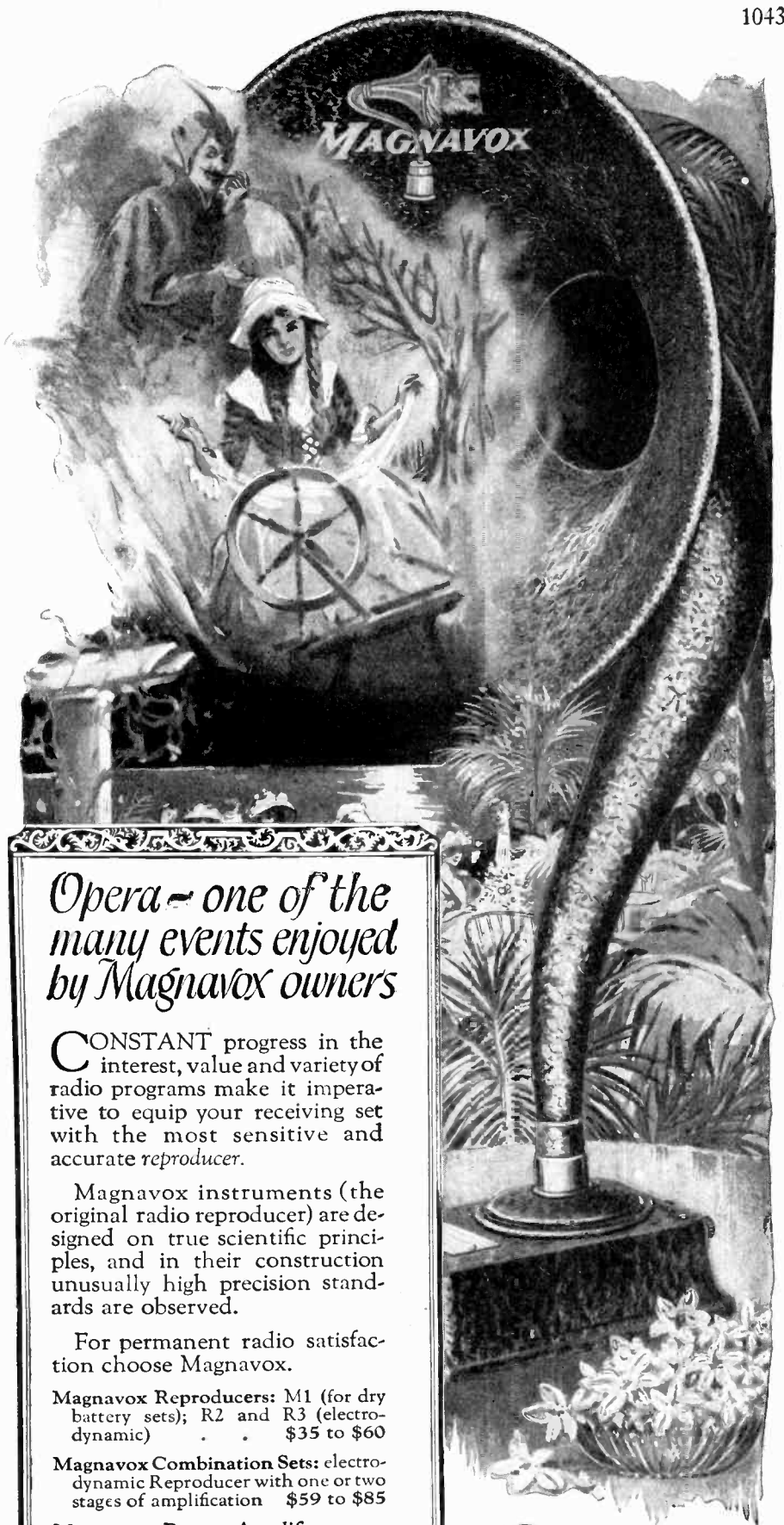

Opera - one of the many events enjoyed by Magnavox owners

CONSTANT progress in the interest, value and variety of radio programs make it imperative to equip your receiving set with the most sensitive and accurate reproducer.

Magnavox instruments (the original radio reproducer) are designed on true scientific principles, and in their construction unusually high precision standards are observed.

For permanent radio satisfaction choose Magnavox.

Magnavox Reproducers: M1 (for dry battery sets); R2 and R3 (electro-dynamic) . . . \$35 to \$60

Magnavox Combination Sets: electro-dynamic Reproducer with one or two stages of amplification \$59 to \$85

Magnavox Power Amplifiers: may be had in one, two or three stage (audio-frequency) \$27.50 to \$75

Magnavox Products are for sale at good dealers everywhere. Write for Catalogue.

THE MAGNAVOX CO.
Oakland, Cal.

New York Office: 370 SEVENTH AVE.
Perkins Electric Limited; Toronto, Montreal,
Winnipeg, Canadian Distributors

For every receiving set there is a / MAGNAVOX



Stain It Any Color You Wish

Small odd pieces of modern furniture add greatly to the attractiveness and convenience of every home. You, yourself, can easily make them for your family. There is no particular trick to constructing porch swings, tables, telephone sets, cabinets, etc. And the finishing of them is a very simple matter if Johnson's Artistic Wood Finishes are used. Our method involves practically no expense. All you need is a little time, a brush, and

JOHNSON'S WOOD DYE

Johnson's Wood Dye is very easy to apply—it goes on easily and quickly, without a lap or a streak. It penetrates deeply bringing out the beauty of the grain without raising it—dries in 4 hours and does not rub off or smudge. Made in fourteen beautiful shades.

FREE-This Book on Home Beautifying

This Book tells how to finish wood in artistic stained and enameled effects. Gives practical suggestions on making your home artistic, cheery and inviting. Tells just what materials to use and how to apply them. Includes color card—gives covering capacities, etc. Use coupon below.

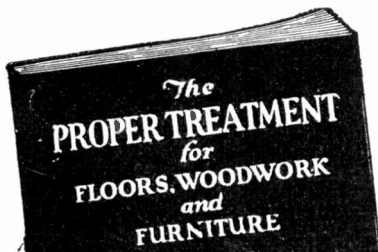

S. C. JOHNSON & SON, Dept. S.I.2.
Racine, Wis., (Canadian Factory—Brantford)

Please send me free and postpaid your Instruction Book on Home Beautifying and Wood Finishing.

The best dealer in paints here is.....

.....

MY NAME

MY ADDRESS

CITY & STATE

the same as yours? I think so, but I do not know. At my death you of Earth will find out, for I have willed my organs to your scientific men.

HOW IT WAS POSSIBLE

But this I do know: this water on my meteor was very different from water as you know it. I have already said it was light and thin. To be exact, I estimate that on your Earth it would have a specific gravity of no more than .18, placing your water at 1.00.

In your sea-water a normally fleshy man will float with a small margin to spare. This water on my meteor was not saline; but more than that, Nona and I stood submerged in it with hardly any perceptible feeling of buoyancy.

Let me make my point still clearer. The low specific gravity of this water compared to yours was principally caused by the large amount of air it held in solution. It was, in a word, highly aerified to an extent proportionally eleven times more than is your average water on Earth. For this reason, my lungs needed but one-eleventh the amount of it from which to secure the necessary oxygen.

On Earth, your normal respiration varies widely; sixteen to twenty times per minute for a healthy adult at rest might be taken as a fair average. I was breathing this water at approximately eighty respirations per minute.

I do not know how long I stood there under the surface with Nona before I attained a semblance of normality. But gradually the burning in my chest and the smothering of my heart subsided. My brain cleared.

I looked about me curiously. The water was clear and transparent to a remarkable degree. There seemed inherent light diffused through it, like a phosphorescence.

We had taken several steps forward and were well below the surface now. Underneath my feet was a sandy soil. To the right and left were rocky walls—the sides of the submerged tunnel. And ahead lay open water, dim in the distance, with the narrow sandy floor sloping downward like a path down a hillside.

Everything was slightly blurred in outline. Nona's hair floated out and above her. The freedom of movement we had had in the air above was gone. We were hampered in moving by the friction of the water.

But it was nothing like the friction of walking in your water. Indeed, it was far more like your Earthly existence on land. Often now, on an oppressively heavy, foggy day here on Earth, I am reminded of it.

I am very specific in detailing these sensations. You will see why in a moment; you will see that this experience was the means of saving both our lives—Nona's and mine—and projecting us into a new era of my existence.

For after the very next time of sleep, the catastrophe to our tiny world overtook us.

III

We found our molluscs and struggled back up the sloping path to shallow water. On the bank I lay and coughed, gasping and struggling to remove the residual water from my lungs and replace it with air. The transition back was far worse than entering the water. Nona, who quite evidently had done it several times before, recovered more quickly than I. As I lay panting and choking upon our couch, she made up a fire. The two stones which she rubbed together ignited in a moment—a slow, sulphurous-looking flame with a little smoke which the slight current of air through the cave carried away. Then, when the first stones were burning, she added other stones which glowed like coal.

New Hook-Ups Are Easy Now

To save hours of labor—to get connections as solid as soldering, spin the radio nuts tight with

Stevens SPINTITE Wrenches

Hollow stem goes down over projecting screws. Hex socket secures a firm grip. Comfortable ebony handle provides strong leverage and easy reach in difficult places. Approved by Radio News and Radio Broadcast—used by radio manufacturers.

Send \$1.00 for Set of 3 Radio Sizes

STEVENS & CO. Toolsmiths since 1899 379 B'way, New York

Stevens SPEED-UP Tools

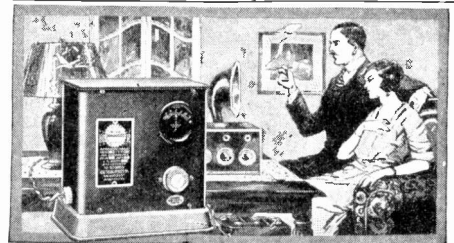

Charge Your Radio or Auto Battery at Home for a Nickel with the

GOLD SEAL HOMCHARGER

Simple, dependable, practically silent and absolutely safe. Charges in one-half the time and at one-third the cost of most other chargers. Beautifully finished in mahogany and gold. Sold by all good dealers, complete with ammeter, charging cable, clips, etc. \$18.50 (\$25.00 in Canada).

FREE Ask your dealer or send direct for free HOMCHARGER list of broadcasting stations and GOLD SEAL bulletin.

Insist on the GOLD SEAL

It's your guarantee against substitution and appears on name-plate and package. No other charger is just as good.

The AUTOMATIC ELECTRICAL DEVICES CO., 116 West Third St., Cincinnati, O. Largest Manufacturers of Vibrating Rectifiers in the World

MASTER ELECTRICITY AT HOME

Send for my HOME-STUDY CATALOG, which is a STRAIGHT-FROM-THE-SHOULDER TALK about your future in the Electrical field. It contains no misleading promises such as "EARN \$10,000 A YEAR" or "BECOME AN ELECTRICAL EXPERT IN A FEW MONTHS." If you are seeking to better yourself, you are far too intelligent to believe such rot.

DO YOU WANT A BETTER JOB?

I am in business to help deserving men. Let me help you as I have helped thousands. My instructions are right to the point. My catalog speaks volumes for any man who wants to be a success in the electrical field. Write for it TODAY.

Electrical Handbook and Slide Rule Course presented to every one who answers this advertisement for prompt enrollment.

BURGESS ELECTRICAL SCHOOL

Yorke Burgess, Superintendent
Dept. 2, 745 E. 42nd Street, Chicago, Ill.
Canadian Branch, 201B Crawford St., Toronto

ELECTRICAL HANDBOOK

We have prepared a pocket size note book for practical men. Contains drawings and diagrams of electrical machines and connections, over 200 formulas, with problems worked out. THE BURGESS BLUE BOOK contains drawings for Motor Starters, Centrifugal Pumps, Reversing Switches, Lighting Circuits, Calculations include Electrical Mathematics, Units, Resistance, Wire Gauge Rules, Ohm's Law, Unknown Resistances, Dynamo Troubles. Also Alternating Current Calculations, Finding Impedance, Frequency, Speed, Power Factor, Formulas for Line Losses. Price only \$1.00 postpaid on money back guarantee.

AGENTS WANTED: Write for special proposition to THE BURGESS COMPANY, Consulting Electrical Engineers 745 East 42nd St. Radio Apparatus and Supplies Chicago, Ill.

We ate our meal, and I lay again upon our couch with Nona sitting beside me. I was dozing, thinking over the experience I had undergone and planning how I could get more of this water food.

THE FIRE

I was awakened by a sense of burning and smothering. I sat up, coughed, and twitched at Nona's hair to arouse her.

The cave was full of smoke. Beside me was what seemed a pit of fire. The heat from it was intolerable. I flung Nona into the air and followed her myself with a leap.

Across the cave we stood trembling with fright, regarding the red monster of fire that had eaten for itself an open pit in the cave-floor.

Nona had forgotten to extinguish the fire of our evening meal. These rocks were inflammable. The fire had eaten its way downward, as a fire on your Earth would eat downward into a bed of coal, spreading out beneath the ground.

Nona and I did not reason it out that way at the time. All we knew was that the red fire-monster had broken loose, and we were afraid of it. Blue and red tongues of flame licked up from the mouth of its lair; its hot, poisonous breath was stifling us even across the cave.

I was inactive only for a moment. Bidding Nona keep away, I tried to throw dirt into the little crater-mouth.

But the dirt had no effect. I might have extinguished it with water you say? True, I might, though I think now that the volatile, highly aerated water would have been of little avail.

I did not try the water. I did not know that water and fire were traditional enemies. Nor did Nona. How were we to know that, unless we had chanced to discover it for ourselves, which we had not.

Nona screamed at me and I gave up my futile efforts. The air in the cave was almost suffocating; and with the instinct that comes to any trapped animal underground, we scrambled up the passageway to the surface of the meteor.

It was night, with silver Saturn filling the overhead sky. Trembling, we stood and watched the cave-mouth from which a visible line of smoke was now issuing. Our home was down there; the fire-monster had it—and we could not go down and take it from him.

We never went back to the cave. The meteor's swift days and nights passed in rapid succession; and during several of them we stood helplessly watching.

Presently the fire came to the surface. I realize now that it was eating its way downward as well as upward until the entire vicinity of the cave was glowing with molten, burning rocks.

The ground all around the cave-mouth soon fell inward. A seething crater was exposed where the cave had been—a bottomless pit of lurid, licking flames with black smoke rolling up from it, and the hissing of steam below.

We took instant flight, swimming through the air over our tiny world, until, on its opposite hemisphere we found sanctuary.

There was no evidence of the fire here. We were pleased. We would find another cave, another river, and build our home anew.

We were both famished. I caught a lizard and we ate it—uncooked, for we were both afraid to unleash again the monster that had all but overcome us.

Then we slept; and again, when two of the meteor's brief days and nights were passed, and Saturn was sinking below the horizon to give place to dawning sunlight, we searched for a new cave.



Learn Public Speaking

10 LESSONS FREE

Write — quick — for particulars of this extraordinary offer; an opportunity you will never forget if you take advantage of it. Ten lessons in effective public speaking absolutely FREE to those who act promptly, to introduce our course in localities where it is not already known.

We teach you by mail to become a powerful and convincing speaker—to influence and dominate the decisions of one man or an audience of a thousand. We have trained hundreds and helped them to increase their earnings and their popularity. Learn, in your spare time at home, how to overcome "stage fright" and conquer fear of others; how to enlarge your vocabulary; how to develop self-confidence and the qualities of leadership; how to RULE others by the power of your speech alone; how to train your memory. Our

WHAT THE COURSE TEACHES YOU

- How to talk before your club or lodge;
- How to address board meetings;
- How to propose and respond to toasts;
- How to make a political speech;
- How to tell entertaining stories;
- How to make after-dinner speeches;
- How to converse interestingly;
- How to write better letters;
- How to sell more goods;
- How to train your memory;
- How to enlarge your vocabulary;
- How to develop self-confidence;
- How to acquire a winning personality;
- How to strengthen your will power and ambition;
- How to become a clear, accurate thinker;
- How to develop your power of concentration;
- How to be the master of any situation.

New Easy Method

perfected and taught only by Prof. R. E. Pattison Kline, former Dean of the Public Speaking Department of the Columbia College of Expression, can be learned in 15 minutes a day. Prof. Kline is one of the foremost authorities in the country on public speaking and mental development. Do not let this chance escape you.

Offer Limited

Send This Free Coupon Now

This Special Offer of TEN LESSONS FREE is made strictly for advertising purposes and will be withdrawn without notice. Write now, before it expires, and receive full particulars with enrollment blank by return mail. No obligation of any kind. Just tear off and mail this free coupon—or a postal will do.

FREE LESSONS COUPON

NORTH AMERICAN INSTITUTE,
Dept. 7442, 3601 Michigan Ave., Chicago, Ill.

I am interested in your course in Effective Public Speaking and your offer of ten lessons free. Please send particulars. It is understood that this request places me under no obligation of any kind.

YOU CAN LEARN NEWSPAPER WORK

**Experienced Editor Will Teach You
How to Become a
Reporter**

FASCINATING WORK--GOOD PAY

**Only a Few Months' Work Required
To Qualify You for a
Better Position**

Regular reporters earn from \$40 to \$125 a week. Good deskmen on a daily paper are paid from \$60 to \$100 a week. A "Star" Reporter can command his own salary. Hundreds of ambitious men and women enhance their income materially by corresponding for newspapers or writing for magazines in their spare time.

We Will Teach You at Home

We can develop your talent for writing and lead you into this well paying profession. Our Practical Course in Journalism was personally prepared by Henry J. Brockmeyer, Assistant City Editor of the New York Evening Post. Mr. Brockmeyer has trained hundreds of men and women, many of whom have, under his guidance, developed into front rank reporters or feature writers.

Mr. Brockmeyer's course will teach you what it would take years of actual newspaper work to learn. It consists of six comprehensive lessons just brimful of everything a reporter must learn. The following are only a few of the subjects covered.

Starting in Journalism. What is a Newspaper? What is News? Start and Finish of a News Story. Technical Terms. The Type Point System. Styles of Type, Proof Reading. Capitalization and Punctuation. A Late Fire Bulletin. Court Stories. Libel Laws, Copyright. Hints to Reporters. Personal Conduct. Re-Writing and Condensing Stories. Paragraphs and Short Items. Good and Bad Styles. Broadening the Vocabulary. Aids to Good Style. Special Stories. Suggestions for Stories. Rhetoric. Preparing Your Story. Don'ts for Writers. Office Organization. Syndicated Matter. Business Office. Mechanical Department. Hints for Headline Writers. The Make-Up. The Country Correspondent, etc., etc.

This Complete Course For \$10

The price for the entire course is only \$10, and entitles the student to full consulting services which are directed by Mr. Brockmeyer personally, including any questions in connection with journalistic work.

Five Days' Trial

Just pin a check, money order or ten dollar bill to the coupon below and mail. Then take five days after the course arrives to decide whether you want to keep it. If not, return it at our expense and your money will be immediately refunded.

Or Write For Free Circular "S"

THE PRESS GUILD, Inc., 66-S—West Broadway, N. Y.

THE PRESS GUILD, Inc.,
66-S—West Broadway, New York City

Enclosed find \$10 for which you are to ship me at once, prepaid, Henry J. Brockmeyer's complete course in Practical Journalism with the distinct understanding that if I return the course in five days my full \$10 will be refunded and no questions asked.

(Name)
(Address)
(City) (State)

No cave was to be found. But there was water. A river several hundred yards wide bubbled up from the ground and flowed in a broad shallow stream toward the horizon. We followed it to a tiny line of hills. Into a hole in a cliff-face it plunged downward with an impetuous current.

THE NEW HOME

Here we decided to build our home. There were blue rushes along the river bank. Nona gathered them; she would dry them, plait them into robes for our couch.

Once I flew back to the fire. I could not get very close to it, for the air choked me. The fire seemed to be burning itself out. It was dull, with flickering puffs of flame in the midst of a thick pall of smoke which hung motionless in the still air.

I returned to Nona. "The fire-monster is dying," I said. "But it has eaten our cave."

We were both pleased that it was dying. I know now what was happening. The fire was being smothered for lack of fresh air to sustain its combustion. Had there been any wind I do not doubt but that the entire surface of the meteor would have been consumed.

An almost equally great danger threatened us, however—and presently we were made aware of it. The smothering, smouldering fire gave off steadily a tremendous volume of unconsumed gases. Even without any wind they diffused themselves throughout the meteor's atmosphere, it was so small a world, with so thin a blanket of air about it—an infinitesimal fraction of the air that envelops your Earth. Rapidly it became polluted with poisonous gases from the half-smothered fire—polluted throughout its entire extent.

For a day we were uneasy. Then we grew frightened. There was little evidence of smoke—only a blue haze. But the air seemed to choke us. It was the poisonous breath of the fire-monster come to make us sick.

We tried to go somewhere to escape it. But we were on the opposite side of the world from it already, and no matter which direction we took, inevitably we approached it.

Except upward. We tried higher altitudes. The air was purer up there, but also it was thinner, and we could not live in it for any length of time. Nor could we sustain ourselves aloft indefinitely—to say nothing of sleeping and eating.

Once in desperation we tried swimming off the meteor into Space. But the lack of any breathable air at all soon brought us struggling downward.

That night there was a gentle wind. The breath of the fire-monster swept up over the horizon and came upon us with a deadly blast. We woke up, choking. It was daylight, with a small red-yellow sun dim and blurred by the poisonous haze that enveloped us.

Nona was crying. But suddenly I laughed, triumphantly, for I realized now that the fire-monster could not harm us.

We were lying at the river bank. I seized Nona in my arms and flung her headlong downward into the water. And I plunged in after her. The water here was deep—thirty feet perhaps, as you on Earth would measure it. With arms flying, we sank like stones to the river bottom.

IV

I was presently breathing the water with fair normality. Indeed, after the noxious air we had been struggling with so long, it came almost as a relief. Nona's arms were about my neck; I loosed them, but she clung to my hand. Together we tried to stand upright.

We Teach COMMERCIAL ART

Meyer Both Company, the largest Commercial Art Organization in the World offers you an unusual opportunity for practical training, based upon twenty-three years of success. This nationally known organization each year produces and sells to advertisers over 15,000 commercial drawings. Meyer Both instruction is the difference between successful fact and experimental theory. This well paid profession equally open to men and women. Home study instruction.

Get Facts Before You Enroll in Any School

Ask the Advertising Manager of the leading newspapers in your city, anywhere in the United States, Canada, England or Australia about the Meyer Both Company—let them tell you about us. Write for our illustrated book, telling about the success of our students—for one-half the cost of mailing—four cents in stamps.

MEYER BOTH COMPANY

Department of Art Instruction

Michigan Ave. at 29th St., Dept. 64 CHICAGO, ILL.

Note—To Art and Engraving Firms: Secure practical artists among our graduates. Write us.

SEND NO MONEY FOR THESE AUTOMATICS

Lowest Prices in the Country

20 SHOT MILITARY MODEL \$8.45
32 cal. with Extra Magazine FREE



25 Cal. 6 SHOT BLUE STEEL \$ 6.05
25 Cal. 8 SHOT MAUSER \$ 10.75
32 Cal. 7 SHOT MAUSER \$ 11.45

CYLINDER SHINGS OUT Best Grade made 6 SHOT HAND EJECTOR

32 Cal. \$15.45 32²⁰ or 38 Cal. \$16.45

32 or 38 Cal. Break-Open REVOLVER \$8.25

Hand Ejector 6 SHOT

GENUINE GERMAN LUGER \$16.25 32 32²⁰ or 38 Cal. Specially Reduced \$13.45 Brand New Guns Use Standard Ammunition

Satisfaction Guaranteed or Money Refunded
Pay Postman Our Price Plus Postage
EDWARDS IMPORT TRADING CORP.
258 BROADWAY Dept. 84 NEW YORK CITY



Try Any Instrument In Your Own Home

You may now have any musical instrument for a week's free trial in your own home. Examine it, show it to your friends, play it as much as you wish. No obligation to buy—no expense for the trial.

Easy Payments

If you decide to buy, payments are arranged in convenient small monthly sums. A few cents a day will pay for your instrument. Special offers on complete outfits. The exceptional tone quality of Wurlitzer instruments is the result of 200 years' experience in musical instrument building. Used by leading professional musicians, prominent bands and orchestras. Usually easy to play.

SEND New Catalog

Describes and illustrates every known musical instrument—many shown in full colors. Special factory prices direct to you. All details of free trial, easy payment plan. All sent free—no obligation. Write today!

Rudolph Wurlitzer Co., Dept. 1252
120 W. 42nd St., New York 117 E. 4th St., Cincinnati
329 S. Wabash Ave., Chicago—250 Stockton St., San Francisco
Copyright 1924, Rudolph Wurlitzer Co.

STUDY AT HOME

Directed by The University of Chicago
Courses in English, History, Chemistry, Business, Mathematics, Education, Psychology, and 35 other subjects command credit toward a Bachelor degree. Begin any time. Address 27 Ellis Hall, University of Chicago, Chicago, Ill.

This river bottom seemed a gray sand. But we could not maintain footing. The water was empty—by which I mean there was no marine vegetation here—nothing that we could grip with our hands. And from behind us, the current wafted us gently but irresistably forward.

I soon discovered that normally we would float in an upright position. We held ourselves so with our toes occasionally touching the soil, bouncing along like feathers in a gentle breeze.

The scene around us now more resembled a misty gray day on one of your sandy Earth-deserts than anything else I can call to mind. The ground was undulating gray sand, sloping upward to one side, and with a steady incline downward in front. And down this slope we were blowing.

Swim, you say? It never occurred to either of us! We were frightened; we clung to each other, striving to remain upright.

Very soon the light from overhead seemed to deepen. But other light—the diffused light inherent to the water itself—grew brighter by contrast. We were swept forward much faster—and down a much steeper hill. I know now that the change was caused by the river having plunged into that cliff-face, to become subterranean.

How far we were carried I cannot say. A mile perhaps. Or more. Rocky cliffs now seemed to pen us in; it was as though we were in a steep canyon, with a powerful wind driving us down through it.

Then abruptly we came to the end of the canyon. Open country lay before us. There were hills in the distance, with the level floor of the sea between us and them. Long stalks of vegetation reared themselves up through the water—so high that I could not see to their tops—slender spires of growing things, rooted below, branching out above with huge air-bladders to keep them floating—the whole waving slowly to and fro. On some of them there seemed what you might term fruit.

THE SUB-SEA HOME

It was a strange, but a beautiful and peaceful scene. This, then, was our new home—our new world! And how much better, more hospitable, it was than the one we had left! My heart swelled with pride as, standing beside my mate, I gazed at our new possessions.

A small living thing—slender and elongated and with a flat, waving tail—went past us waist-high. I clutched at it clumsily; but it eluded me and darted away.

On the ground beneath our feet were living things in shells. I seized one, ate it, and called to Nona.

Sounds? It was very still and quiet down here—but no more so than on the surface of the meteor above. The sound of my voice carried to Nona. Indeed, sounds here in the water carried very far, though somewhat muffled and blurred.

Having eaten of the shell-fish, the berries and the fruits, we lay down on the sand with Nona's hair floating above us. We were in the shelter of a tenuous clump of ferns which spread out like an arbor above us. I twisted my leg in them to hold us from possible drifting; and Nona clung to me.

We would rest and then build our home here.

V

How long we slept I do not know. Nona brought me back to consciousness; she was twitching at my arm and whispering in my ear frantically.

"What?" I demanded; but she silenced me. She was pointing with a trembling hand. I saw what it was. Half a mile

No Matter What Your Vocation

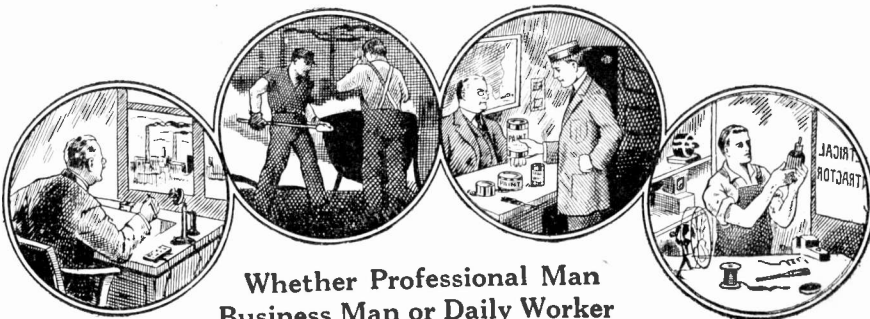

Whether Professional Man
Business Man or Daily Worker

**A Thorough Training In
CHEMISTRY
Will Help You To Get Ahead**

TO be successful today is to know Chemistry! Every line of business, every branch of industry depends upon Chemistry in some form. You may not realize it, but your own proficiency in whatever work you are doing would be increased by a knowledge of Chemistry. In many lines such knowledge is absolutely essential. In others it is a guarantee of promotion and more money.

The keen competition that exists in every commercial activity today requires that a man know all there is to know about his vocation. If you have something to sell—no matter what—Chemistry enters into its make-up. The salesman who knows the chemical composition of his article can talk about it more intelligently than the one who lacks this information, and his sales are proportionately larger. In the building trades Chemistry is of prime importance. The mason, electrician or painter who knows something about Chemistry can do better work and command more money than the one who does not. Through Chemistry a shop-keeper learns how to attract the most trade, and even in clerical positions one can capitalize his chemical skill.

Chemistry should be as much a part of your mental equipment as the ability to calculate or to write correct English. The world is paying a thousandfold more for ideas than for actual labor. The big rewards go to the man who can show how to turn out a little better product at a little lower cost. And Chemistry will give you the ideas that will save money for yourself or your firm in the very fundamentals of your business. There is nothing remarkable about this; it is going on every day. If you have not heard of it before, it is because the general public has been slow to recognize the tremendous value of chemical training. People have been content to leave Chemistry in the hands of a few trained chemists who could not possibly develop the subject to anywhere near its greatest extent.

Now we are on the eve of a great awakening. Our heritage from the World War has been an intense development of the chemical industries in the United States and a tremendous interest in all the applications of Chemistry. People are taking up the subject merely for the good it will do them in their own line of business.

It is no longer necessary to enter college in order to learn this fascinating science. Our Home Study Course trains you just as thoroughly, and with the same assurance of success, as those who took the longer way. And our methods are so simple that we can teach you no matter how little previous education you may have had. Many of our graduates now hold responsible positions or have materially increased their incomes from private enterprises as a result of taking our course. Hundreds of letters from students testifying to the benefits they have derived from our training are here for your inspection.

Remember that you do not need to study Chemistry with the idea of actually practicing as a chemist, although a great many of our students are taking our course with this object in view. If you want to know more about what Chemistry will do for you, if you want to know what our home study course offers, sign and mail the coupon today for **FREE BOOK "Opportunities for Chemists."**

**Chemical Institute
of New York, Inc.**

HOME EXTENSION DIVISION 2
66-D West Broadway, New York City

**DR. T. O'CONOR SLOANE Will
Teach You Chemistry In
Your Own Home**

The Chemical Institute of New York, of which Dr. T. O'Conor Sloane is Educational Director, was founded to fill the need of ambitious, far-sighted men who realize and recognize the splendid future Chemistry offers them, but who cannot spare either the time or the money to attend college. Dr. Sloane, a foremost authority on Chemistry, will teach you and will give you any individual help you may require. He will personally go over your papers, correct them, point out your faults, teaching you in a practical and interesting way. No special education required other than the ability to read and write English. One student has characterized our lessons as "The course that takes the mystery out of Chemistry."

**Read What One of Our Recent
Graduates Reports**

"I thought I would let you know of my success. I finished your course about two months ago and now have a fine position as chemist at the DuPont Dye Works. I am getting along fine with my work and like it very much. It was through your course alone that I have been so successful. It is wonderful and I hope you have great success with it."
(Name and Address on request).

Easy Monthly Payments

You do not have to have even the small price of the course to start. You can pay for it in small monthly payments—so small that you won't feel them. The cost is very moderate, and includes everything, even the Laboratory Equipment—there are no extras to buy with our course. Our plan of monthly payments places a chemical education within the reach of everyone.

**Laboratory Equipment Given
To Every Student Without
Additional Charge**

We give to every student without additional charge his chemical equipment, including forty-two pieces of laboratory apparatus and supplies, and seventeen different chemicals and reagents. These comprise the apparatus and chemicals used for the experimental work of the course.

Special 30-Day Offer

For a short period we are making a special offer that will be worth your while to take advantage of. Write for particulars, using the coupon below or simply a postal card. This will not obligate you in the least. Do not wait until to-morrow. Send the coupon now while you think of it.

**Sign and Mail the Coupon for
FREE BOOK**

CHEMICAL INSTITUTE OF NEW YORK, Inc.
Home Extension Division 2,
66-D—West Broadway, New York City

Please send me at once without any obligation on my part, your Free Book "Opportunities for Chemists," and full particulars about the Laboratory Equipment furnished to every student. Also please tell me about your plan of payment and your special 30 day offer.

NAME

ADDRESS

CITY

STATE

S.&I.,2-24

Be An AUTO-EXPERT
Make \$75 to \$200 A WEEK

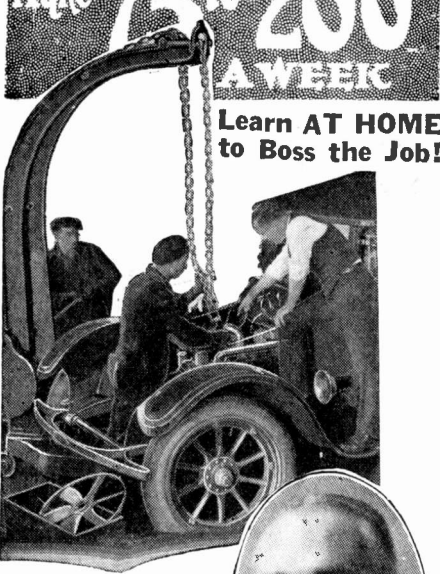

Learn AT HOME to Boss the Job!

I WILL

make you a successful AUTO EXPERT, prepare you to go into business for yourself, train you for positions paying \$3,000 to \$10,000 a year! Keep your job—stay home—loan me a part of your spare time. As Directing Engineer of the big CHICAGO AUTO SHOPS I train you the "JOB-WAY"—not with books.



B. W. COOKE,
 Directing Engineer
 CHICAGO AUTO SHOPS

I Train You

AT HOME! Schools make Auto Mechanics—my home-training make Auto EXPERTS! I prepare you to BOSS THE JOB! My "Job-Way" instruction makes you MASTER of every branch of automotive work: Mechanical, Electrical, Battery, Taxicabs, Busses, Ignition, Farm Power Plants, Welding, Brazing, Vulcanizing, etc. You cannot get all this training anywhere else on earth.

Free Outfit!

Big repair and testing outfit free to my Students. Use it to do my JOBS, use it to make money, use it to make this training pay for itself!

Free Jobs!

Employment department helps you get big pay jobs without one penny of cost!

Go into Business!

—make \$5,000 to \$15,000 Yearly

Biggest opportunities to go into business with small capital when you have my training. Auto experts run their own business and make \$5,000 to \$15,000 net profits a year. The same opportunity is open to YOU thru my guaranteed "Job-Way" instruction.

Start Now!

Inducements you cannot resist to help you START RIGHT NOW! Easy terms within your reach. One week's pay as AUTO EXPERT pays for my wonderful training. Let me tell you this wonder story personally. Mail coupon or address:

B. W. COOKE, Directing Engineer
 CHICAGO AUTO SHOPS
 Dept. 228,
 1553 W. Madison St., CHICAGO

B. W. COOKE, Directing Engineer
 Chicago Auto Shops, Dept. 228,
 1553 W. Madison St., CHICAGO
 Please send me Free Book and complete information about your "Job-Way" training at home. Tell me about the opportunities today for Auto Experts, how to secure FREE REPAIR OUTFIT.

Name

Address

City State

Occupation



away perhaps, over the sand hills, I could see figures moving. Living things were advancing toward us along the water-bottom! I sat up, alert. Living things! I would capture and kill one for food.

But as they came steadily closer, I saw that each of them was nearly as large as ourselves—and there were ten or more of them. I trembled; and Nona and I drew back into the fern to hide.

The things continued to advance. Soon I saw that they were upright, coming along the sand as though walking, slowly but steadily. I thought they had not seen us. Nona and I lay very quiet, with our hearts pounding with fright. Soon the things were so close that I could examine them in detail. They were apparently human as ourselves—made after a general plan like our own.

I have since named them Marinoids—a name that may serve as well as any other. The males—or shall I call them men?—were some five feet in height. Their bodies were pink-white, smooth, with a glistening skin. They were clothed—crude greenish garments wrapped around them tightly. They had feet and jointed legs, which, however, were connected by a flapping membrane. Their chests were over-large. There were four arms, two at each shoulder. The arms waved in the water sinuously, like the tentacles of an octopus. At the ends of the arms were fingers—very long and slim—and a huge pincer, like that of a crab.

Yet for all that, these beings seemed in human form. The heads were hairy and round, with two eyes only slightly protruding, a nose, and a mouth not much different from my own save that it was larger.

The women were slightly shorter and more slender than the men, with long dark hair that floated habitually above them.

In this party which now approached us were ten individuals—four of them women. In spite of their size, there was about them—both women and men—a curious aspect of *unsolidity*. I felt less afraid of them as I realized it. They looked as though I could crush them in my arms. Their chests especially seemed no more than thin, inflated membranes, expanding and contracting with extraordinary rapidity.

I wondered, with a sudden flush of triumph, if these things would be good to eat. I whispered it to Nona.

"I can capture one," I said confidently.

"Wait!" she cautioned.

The Marinoids were still walking toward us along the sand—slow dragging footsteps combined with a sort of waddle for their legs were hampered by the membrane which connected them. Their arms were waving back and forth. The backs of most of them were bent, with their faces downward as though they were examining the sand.

I must have made some movement. They saw us! They stopped, and seemed to grow suddenly alert. The men consulted together, pointing at us; the women drew partially behind them as though for protection.

I struggled upright, in spite of Nona's warning and her restraining hold. I would fight these things—kill them for our food. It would be a glorious feast; my Nona was hungry.

THE FIGHT

I plunged forward. The Marinoids were alarmed—startled, would described their aspect better. The men stood their ground; the women darted upward through the water, swimming on one side with legs waving the connecting membrane like a great fish's tail.

One of the Marinoid men had shouted something. I could hear his voice plainly—words seemingly—a rasping order. Nona was behind me, following me closely, ready to help me fight.

MAKE MORE MONEY!

\$3,000 PROFIT IN 4 MONTHS!

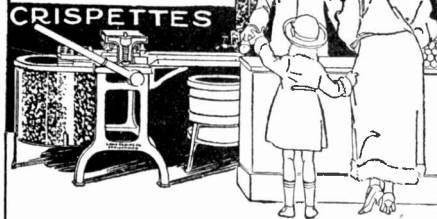

CRISPETTES

GEORGE ALEXANDER of Pennsylvania made \$3000.00 in 4 months making and selling CRISPETTES with this outfit. (Nov. 7th, 1923).
 Jacob Gordon, New Jersey, (November 2nd, 1923), says: "Profits over \$4000.00 in 2 months"! Mesner of Baltimore \$250.00, in one day! M. L. Cronen, Ohio, (November 3rd, 1923), writes: "Doing big business—sold over 200,000 packages Crispettes last year". Mrs. Lane, Pittsburgh, says: "Sold 8,000 packages in ONE day".

We Start You In Business

Crispettes easy to make, easy to sell. We furnish everything—complete outfit, secret formulas, raw materials, full directions, wrappers, etc. No experience needed. Little capital starts you on road to wealth. Open a retail store of your own. Sell wholesale to groceries, drug stores, etc.

Build a Business of Your Own

Crispettes sell fast everywhere. Everybody likes them. They're a delicious confection. We'll tell you how to build a business of your own. Start now, in your town.

Profit \$1,000 a Month Easily Possible

Send for illustrated BOOK OF FACTS. Tells how many people in small towns and big cities are making big successes of Crispette Business. Shows how, when and where to start. Full of valuable information. It's FREE. Write now. Postal brings it.

LONG EAKINS COMPANY
 253 HIGH STREET SPRINGFIELD, OHIO

World's Greatest BATTERY BARGAIN

FREE Written 2-Year Guarantee Your Proof of Performance

START THE NEW YEAR RIGHT
 SAVE 50 PERCENT
 and get a "B" Battery and Hydrometer or a Nickered Auto Spotlight Free

Thousands of Science & Invention Readers will do just that than this amazing World Battery offer. They will buy the famous 2-year guaranteed World Battery at the lowest price ever quoted and with it they will get free a hydrometer and a "B" Battery or a nickered Auto Spotlite. Compare These Prices

5 Per Cent Discount for Cash with Order	Radio Prices
Automobile Prices	Special 2 Volt Storage Battery
6 Volt, 11 Plate - \$12.25	For W. D. 11 and W. E. 12 Tubes. Will run 200 hours on one charge. Rechargeable.
Ford, Chev., Mitchell, Hup., Grant, Elgin, Velle, Saxon.	Special 4 Volt Storage Battery
6 Volt, 13 Plate - \$14.00	For 1 V. 195 Tubes. Same features as 2 Volt.
Overland, Buick, Reo, Paige, Hudson, Nash, Stude, Dort.	6 Volt, 60 Amps. - \$8.50
12 Volt, 7 Plate - \$17.00	6 Volt, 80 Amps. - 10.00
Maxwell, Dodge, Regal, Frank., Briscoe and Crow.	6 Volt, 100 Amps. - 12.50
Elkhart.	6 Volt, 120 Amps. - 14.50
Give year and model of car	6 Volt, 140 Amps. - 16.00

SEND NO MONEY

You need not send a penny. Just clip this ad. and mail with your name and address. The battery you specify will be shipped to you the day your order is received. When the battery arrives, inspect it—read our 2-year guarantee before you pay one penny. Convince yourself you are protected from every angle—that the World Battery saves you 50 per cent. Got the "B" Battery and hydrometer, or Auto Spotlite FREE. Clip the ad. and send your order today.

WORLD BATTERY CO.
 Dept. 19 1219 So. Wabash Ave., Chicago, Ill.

Your Choice Nickered Auto Spotlight

FREE

"B" Battery and Hydrometer

Try This on Your Hair 15 Days

Then let your mirror prove results Write Today for FREE Trial Offer. (Your hair need not thin out, nor need you become bald, for there is a way to destroy the microbe that destroys the hair. This different method will stop thinning out of the hair, lifeless hair, remove dandruff, darken gray hair or threatened or increasing baldness, by strengthening and prolonging life of the hair for men and women. Send your name now before it is too late for 15 days' free trial offer.)

AYMES CO., 3932 N. Robey St., M461 Chicago

"Quick!" I shouted. "Catch one, Nona!" It was so futile! The Marinoid men left the sand and darted at us so quickly that we could not have eluded them had we tried. They were upon us in an instant: I was helpless as they threw me down and with surprising strength in those three-foot long tentacles, wrapped them around me and held me.

Three of the men were thus engaged with me; and two were holding Nona. But they did not attempt to hurt us; indeed, they seemed to avoid doing so.

The sixth Marinoid—he who had shouted the order—was hastily gathering long, rope-like segments of the vegetation. At his command, Nona and I were raised upright. The women came down to the sand and they all inspected us curiously, talking among themselves with words to us unintelligible, but gestures which seemed wholly rational.

At last they bound our arms tightly against our sides and started us walking along the sand. They were leading us away, out over the sandy open spaces toward a line of hills in the distance.

The women swam above us; the men walked in a group, pushing Nona and me in front. We could run faster than they, and once we broke away. But they swam after us and caught us in an instant. And one of them warned us with a gesture which was unmistakable.

Soon I saw what this party had been doing before they encountered us. We passed occasionally, huge receptacles made seemingly of woven sea-vegetation. Into these baskets they had gathered various living, shell-backed creatures of the water-bottom. And these baskets in turn would be gathered up and carted away by other Marinoids.

I learned this later; Nona and I understood none of it at the time.

As we advanced, the aspect of things around us changed continually. The vegetation grew thicker, until soon we were in a veritable forest of it. And we seemed to be following a road—a pathway which had been cleared.

Abruptly I heard a shout ahead. The Marinoid women swimming above us came suddenly down. Our leader said something, and they all drew back from the road, pulling us with them.

The shout ahead of us grew louder. A moving object came into view—a sort of sleigh made of a huge shell. It was gliding over the sandy road toward us, pulled by a strange swimming animal.

In the sleigh were two Marinoid men—the larger of them elaborately clothed. The sleigh halted abreast of us. The smaller of its occupants stood up and shouted vehemently. And suddenly I realized that he was shouting at me! My captors were lying prone on the sand, and had pulled Nona down with them. But in their excitement and awe—for this was the ruler of their world—they had left me standing alone.

I stared stupidly at the angry figure in the sleigh; and suddenly, in his wrath at the effrontery of my upright posture before his Monarch, he launched something at me. I saw it leave his hand. It was long, thin and pointed. It came through the water like a spear thrown through air. It hit my head a glancing blow.

I sank down to the sand. I heard shouts around me—Nona was screaming. Then my senses faded into blackness.

VI

You have read my tale of the Marinoids—a brief glimpse, and only a glimpse, for I am an old man and my memory is full of strange lapses.

One of your Earth-poets has said: "There are more things in Heaven and Earth than

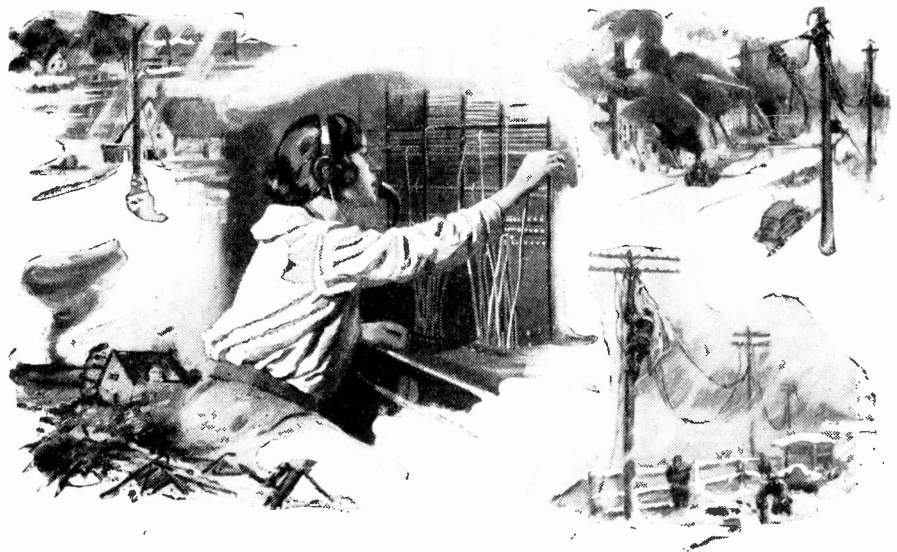

Priceless Service

Despite fire or storm or flood, a telephone operator sticks to her switchboard. A lineman risks life and limb that his wires may continue to vibrate with messages of business or social life. Other telephone employees forego comfort and even sacrifice health that the job may not be slighted.

True, the opportunity for these extremes of service has come to comparatively few; but they indicate the devotion to duty that prevails among the quarter-million telephone workers.

The mass of people called the public has come to take this type of service for granted and use the telephone in its daily business and in emergencies, seldom realizing what it receives in human devotion to duty, and what vast resources are drawn upon to restore service.

It is right that the public should receive this type of telephone service, that it should expect the employment of every practical improvement in the art, and should insist upon progress that keeps ahead of demand. Telephone users realize that dollars can never measure the value of many of their telephone calls. The public wants the service and, if it stops to think, cheerfully pays the moderate cost.



AMERICAN TELEPHONE AND TELEGRAPH COMPANY
AND ASSOCIATED COMPANIES
BELL SYSTEM

One Policy, One System, Universal Service

\$300 Profit Monthly with 8 HOUR BATTERY CHARGING

Your Best Winter MONEY-MAKER

Big Profits in 8 Hour Constant Potential Battery Charging

Make \$150 to \$300 monthly charging batteries. Small cash payment puts HB outfit in your shop, complete ready to connect up and operate. 30 days' free trial on money-back guarantee. Only \$20 monthly pays for your outfit. No experience needed to operate. Own your own money-making battery charging business. Make big steady profits. Write today for information.

HOBART BROS CO., Box S2 TROY, OHIO

Small Cash Investment - Increased Profits Carry Balance

8 Hour Battery Charging PAYS BIG!

Pays for Itself on Easy Terms

LEARN WATCHWORK, JEWELRY WORK AND ENGRAVING

A fine trade commanding a good salary and your services always in demand or you can start in business for yourself. At

BRADLEY INSTITUTE

The greatest school for watchmakers in the world. Address Horological Department S.T., Bradley Polytechnic Institute, Peoria, Illinois for our latest catalogue. Its free for the asking.

ONE THOUSAND AGENTS WANTED

We want one thousand agents to sell subscriptions to **RADIO NEWS, SCIENCE AND INVENTION** and **PRACTICAL ELECTRICS**. We will pay a generous commission for this work and help you in every way. Our three publications are leaders in their fields, ready sellers and this is an offer well worth your while. A few spare hours a day will bring you a handsome return. Write regarding our proposition at once and be the first one to get started in your vicinity.

EXPERIMENTER PUBLISHING CO.
Herbert H. Foster, Sales Manager
53 Park Place New York

Learn Electricity



In the Great Shops of
Coyne

Student Winding a Stator

Chicago

The Electrical Center of the World

The whole world of electricity is open to the Coyne trained Electrical Expert. Come to Chicago—the Electrical Center of the World. Get your training at Coyne—the oldest, largest and best school of practical electricity in the country—the only school endorsed by the Electrical Industry. Coyne trains you in all branches of electricity. We do not offer a number of individual courses—we give you just one Complete course so that you will be an Electrical Expert capable of commanding big pay. Let ordinary electricians do the small jobs. You can become an Expert and get the big money in any branch of electricity if you seize this chance to come to Coyne. Opportunities for Experts are unlimited. Get started now

Learn in 3½ Months

No books or useless theory. You are trained on the greatest outlay of electrical apparatus of any institution in the country. We give you FREE a complete course in Radio—the marvel of the age. Constructing, installing and operating. We also give you FREE a life Membership which enables you to stay as long as you want or come back for further training at any time without charge.

Earn \$250 to \$600 a Month!

You work on motors, generators, housewiring, autos, batteries, radio, switch-boards, power plants—everything to make you an expert ready to step right into a position paying from \$65 to \$150 a week. You get a complete practical training in Circuits, Housewiring, D. C., A. C., Armature and Stator Winding, Drafting, Auto, Truck and Tractor Electricity, Battery Building and Repairing, and Radio.

Earn While You Learn!

We help students to secure jobs to earn a good part of their living expenses while studying.

Send Coupon Now

Don't delay a minute—send that coupon right now for our big free catalog and full particulars of special offer. Act now!



Endorsed by Electrical Industry

1300-1310 W. Harrison St., Dept. 93-32, Chicago

Coyne Electrical School, Dept. 93-32
1300-1310 W. Harrison St., Chicago

Dear Sir: Please send me free your big catalog and full particulars of your special offer.

Name.....

Address.....

are dreamed of in your philosophy." How very true that is! You who breathe air and live on land—on one and only one tiny little Earth among all the billions upon billions of worlds that throng our Universe—how little you dream of the existence of other beings.

I tell you only simple facts, within the failing memory of my own human lifetime. I do not expect you to credit me—your life has been too narrow, your experience limited to one infinitesimal rut in the Creator's vast plan. And though I cannot altogether blame you, since you are thus limited, it makes me smile to realize how fatuous you are with your self-importance. "I have not seen this—I cannot understand it—so it cannot be!"

Only one point in my narrative I wish you to grasp and ponder over. I assume you agree that although Nona and I at the time were merely at the beginning of our mental life, we had latent within us an intelligence the equal of your own. Let us say, we were broadly representative of you. Yet Nona and I were not the intelligent, superior human beings, captured by some strange marine animals—as a man in your waters might be set upon by sharks. Quite the reverse. It was we who were the inferior humans; to those Marinoids we were unknown, savage things who had invaded their world.

That is not theory; it is fact. And so, if by the recital of this narrative, I have even made you stop and think that perhaps you and your kind are not all-important in the Creator's plan—my purpose will have been accomplished.

(To be continued)

Can We Visit the Planets?

BY DON HOME

(Continued from page 962)

Even if such an ideal machine might be made, the possibility ever of spanning the twenty trillion miles to the nearest star is negligible when we consider the time required to get there. Granting that man can withstand a reasonable pressure, and allowing time for starting and stopping the projectile, it is just possible that the trip might be made in less than a life time.

The philosophical results of the theory of relativity lead to an interesting speculation. According to Einstein, no object can attain a velocity greater than that of light and it would be possible for our projectile to approach that speed in about ten years. It happens, however, that the greater his speed the slower his clocks move; in other words, the nearer he reaches the speed of light, the less is his sense of the time passing. The secret of eternal youth, therefore, is to rush on at the terrific speed of 186,000 miles a second. A man might visit the edge of space after only a few years of his time, but centuries of our own, had elapsed.

In the Einstein theory, time and space are inseparable. We ordinarily admit that a person can be two times at the same place, but it seems a paradox that one could be two places at the same time. Nevertheless, this is possible. In order to accomplish this, a person should leave the spot with the speed of light, at which velocity all organic processes would cease and, as he would be conscious of no advance in time, it would seem merely the next instant when he arrives in a part of space far removed from his starting point.

But what may we expect to gain from interplanetary visits? Surely we are not the only living beings throughout infinity! Such egotism is inexcusable.

How to Hook - Up A Transmitter Button to Make an Efficient Loud Talker

A Transmitter button with a few dry cells and a telephone receiver will make a remarkably simple and efficient loud talker. A Microphonic amplifier of this type is just the thing for use with a radio set. The weak music and signals may be amplified many times their original value. It is possible to entertain a large audience with a simple radio equipment if a transmitter button is used in the circuit as explained in diagram A.

The cost is extremely low and the results are comparable with those produced by highest grade of expensive loud talkers.

As may be seen in the diagram, two dry cells or a small storage battery are connected in series with the transmitter button and a 4 to 75 ohm telephone receiver. The transmitter button is secured to the diaphragm of the telephone in the radio receiving set. To accomplish this properly, scrape off the enamel (if diaphragm is enameled) on the face of the diaphragm and solder the small hexagon nut supplied with the button to the exact center. Care should be taken that the thin diaphragm is not bent or otherwise

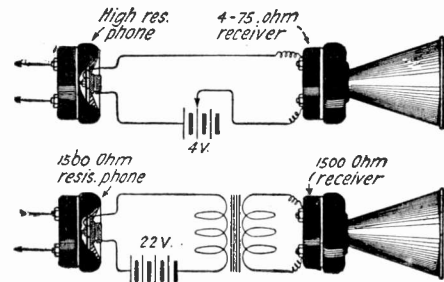

Diagram B, which includes a step-up transformer, is to be used with loud talking receivers of high resistance. The primary of the transformers should have a resistance of about 75 ohms. An ordinary telephone induction coil will serve as the transformer in this circuit. You can get the above-described transmitter button FREE in subscribing to "Practical Electrics Magazine" at \$2.00 per year (12 months). Send your subscriptions today. Make all remittances payable to Practical Electrics Co, 53 Park Place, New York City.

—Adv.

Other life than ours in the solar system seems improbable. It is thought that our four outer planets, Jupiter, Saturn, Uranus and Neptune are very cold—a hundred degrees below zero, Centigrade—perhaps almost entirely composed of ice particles, and surrounded by heavy impenetrable clouds. Mars, though blessed with water and a very thin atmosphere, is also very cold, seldom rising above the freezing point. Venus possesses a heavy atmosphere which appears, however, to contain no oxygen or water vapor. It is probably a desert, scorched by burning winds which so fill the air with dust that our telescopes can never penetrate to the solid layer. Under the blazing sun, the airless bodies, Mercury and the Moon, reach temperatures above boiling water, and during the night rapidly lose any stored up heat from the day time. Evidently there is small chance for life, as we know it, to exist on any of our sister planets.

"But," you say, "Is it not possible that life may take other forms that we know nothing of?" We answer, "Your imagination is as good as ours."

Nevertheless, we prefer to adopt the scientific viewpoint, that life has adapted itself to the requirements of our earth, rather than that we are here merely because the earth is suited to our needs. It will be decades, perhaps centuries, before these problems will be solved. And let us be thankful that science cannot be hurried. The working out of any part of the problem would bring the affair to a climax and the world is not ready for such a step. Be not too hasty for a glimpse behind the veil! As yet no one has solved the mystery of life, but when the other projects have been accomplished, this, too, will cease to be a problem. And pray that the world may be prepared for such a revelation!

Answersto Scientific Puzzles

(Continued from page 991)

1—THE PUZZLE PICTURE

THE following mistakes are represented in the picture:

1. The dipper is shown in the east instead of the north.
2. In the handle of the dipper is shown four stars. In the real dipper there are only three.
3. When the dipper is right side up the handle appears to the left instead of on the right as shown in the picture.
4. The Milky Way never appears in the constellation of the dipper.
5. A crescent moon near the horizon is visible only when the moon is setting. Hence such a moon could not be seen at midnight.
6. The shadows in the picture are toward the moon instead of away from it.
7. A star cannot be seen between the tips of the moon, for a star in such a position would be eclipsed by the moon.
8. The directions on the weather vane are contradictory.
9. The curvature of the crescent cannot be convex upward at night because the curvature must be toward the sun which at night is below the horizon.
10. The pennant and the sail of the boat are indicating that the wind is blowing two ways at once.

2—GETTING THE AUTO OUT

The block and tackle should be reversed so the man will be pulling in the direction in which he wishes the auto to move. At present if he can exert a pull of a hundred pounds on the rope a force of 400 pounds will be applied to the car. But if he turns the block and tackle around a pull of 100



"I Was At The End of My Rope"

"WE LIVED in a fairly comfortable home, but it was a terrific struggle to make both ends meet. I couldn't save a cent and I was deeper in debt than I dared confess to my wife.

"I hadn't had a decent raise in years, and there were nights—too many of them now—when I lay awake for hours wondering what we would do if I ever lost my position.

"Other men were getting ahead of me and I knew that I couldn't stand still. I had either to go up or down. And I was afraid it was going to be down!

"Then suddenly one night it came to me like a flash that the reason I wasn't getting anywhere was mainly because I had never made any definite effort to make myself more valuable to the firm.

"I knew my own little routine job, but that was all. I was just one of the force to my employers. There was really no reason why they should think of me when a better position was open.

"That night I made my decision. 'If the I. C. S. can raise the salaries of other men,' I said to myself, 'it can raise mine. If it can help other men to win promotion and have happier, more prosperous homes, it can help me, too. To-night, right now, I'm going to send in that coupon and find out what the I. C. S. can do for me.'

"It was the best move I ever made. My employers heard about my studying and started to take an interest in me. Six months after I enrolled with the I. C. S. I received my first increase in salary. Within two years I was head of my department. And I'm going still higher."

An International Correspondence Schools course will help you just as it helped this

man whose letter is reproduced here. It will help you to have the happy home—the bigger salary—the comforts that you want for your wife and your family.

For spare-time study is that vital something which makes one man succeed where one hundred fail—that lifts a man out of the rut and makes him a trained worker instead of just a "hand."

One hour a day, spent with the I. C. S. in the quiet of your own home, will prepare you for the position you want in the work you like best. Put it up to us to prove it!

MAIL THE COUPON TO-DAY

INTERNATIONAL CORRESPONDENCE SCHOOLS
Box 6221-C, Scranton, Penna.
Without cost or obligation on my part, please tell me how I can qualify for the position or in the subject before which I have marked an X:

- | BUSINESS TRAINING COURSES | |
|---|--|
| <input type="checkbox"/> Business Management | <input type="checkbox"/> Salesmanship |
| <input type="checkbox"/> Industrial Management | <input type="checkbox"/> Advertising |
| <input type="checkbox"/> Personnel Organization | <input type="checkbox"/> Better Letters |
| <input type="checkbox"/> Traffic Management | <input type="checkbox"/> Show Card Lettering |
| <input type="checkbox"/> Business Law | <input type="checkbox"/> Stenography and Typing |
| <input type="checkbox"/> Banking and Banking Law | <input type="checkbox"/> Business English |
| <input type="checkbox"/> Accountancy (including C.P.A.) | <input type="checkbox"/> Civil Service |
| <input type="checkbox"/> Nicholson Cost Accounting | <input type="checkbox"/> Railway Mail Clerk |
| <input type="checkbox"/> Bookkeeping | <input type="checkbox"/> Common School Subjects |
| <input type="checkbox"/> Private Secretary | <input type="checkbox"/> High School Subjects |
| <input type="checkbox"/> Spanish | <input type="checkbox"/> French |
| <input type="checkbox"/> Illustrating | |
| TECHNICAL AND INDUSTRIAL COURSES | |
| <input type="checkbox"/> Electrical Engineering | <input type="checkbox"/> Architect |
| <input type="checkbox"/> Electric Lighting | <input type="checkbox"/> Blue Print Reading |
| <input type="checkbox"/> Mechanical Engineer | <input type="checkbox"/> Contractor and Builder |
| <input type="checkbox"/> Mechanical Draftsman | <input type="checkbox"/> Architectural Draftsman |
| <input type="checkbox"/> Machine Shop Practices | <input type="checkbox"/> Concrete Builder |
| <input type="checkbox"/> Railroad Positions | <input type="checkbox"/> Structural Engineer |
| <input type="checkbox"/> Gas Engine Operating | <input type="checkbox"/> Chemistry |
| <input type="checkbox"/> Civil Engineer | <input type="checkbox"/> Pharmacy |
| <input type="checkbox"/> Surveying and Mapping | <input type="checkbox"/> Automobile Work |
| <input type="checkbox"/> Metallurgy | <input type="checkbox"/> Airplane Engines |
| <input type="checkbox"/> Steam Engineering | <input type="checkbox"/> Agriculture and Poultry |
| <input type="checkbox"/> Radio | <input type="checkbox"/> Mathematics |

Name.....
Street.....
Address.....
City.....State.....

Occupation.....
Persons residing in Canada should send this coupon to the International Correspondence Schools Canadian, Limited, Montreal, Canada

YOU should be ARRESTED if you are thinking of spending money to go to an ordinary Trade School

Thousands of Trade School graduates are looking for a job and can't get one at their trade.

Get into the Automobile Electrical game as Manager of one of our Chain Ignition Stations.

Take training with a company that has a real future mapped out for you. Don't Delay! Get started while we need men. Training for you any place in U. S. Write to

MOTOR CAR IGNITION CO., Inc. TRAINING DEPARTMENT
5036-38 W. 25th St., Cicero, Chicago, Ill.
Chain Ignition Service Stations—Coast to Coast

Insure your copy reaching you each month. Subscribe to SCIENCE & INVENTION—\$2.50 a year. Experimenter Publishing Co., 53 Park Place, N. Y. C.

Interchangeable Type Styles

on this wonderful Typewriter

WHY should the typewritten page be limited to one monotonous style and size, any more than the printed page?

The printer uses many styles for HEADLINES, *Italic*, **BOLDFACE**, and various sizes to lend legibility, interest and beauty to the written word.

And now every typewriter user can have these same advantages—interchangeable types in many styles, sizes and languages all on the same Hammond typewriter.

Think of a single typewriter than can use over 50 different types—all instantly interchangeable!

By the marvelous Variable Spacing each size of type is perfectly spaced, closely or farther apart, according to the width of the characters.



STUDENTS improve the appearance of their class work and do it more quickly with a Folding Hammond. It has all the technical and scientific characters required.

It All But Speaks!

THE NEW Hammond TYPEWRITER

VARIABLE SPACING
CHANGEABLE TYPE

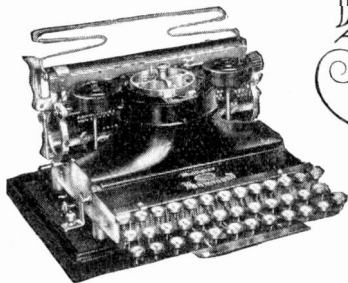

THE NEW FOLDING HAMMOND has every feature of the desk type machine, yet weighs only about 8½ pounds.

A Fascinating New Folder

which illustrates the unlimited uses of the New Hammond, tells how it accomplishes its wonders. SEND FOR IT TODAY.

HAMMOND TYPEWRITER CORPN.
544-A East 69th Street New York

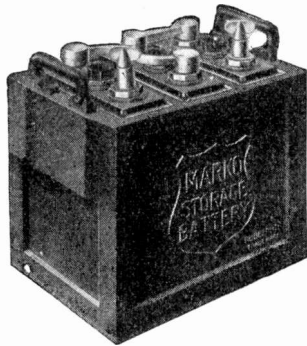

MARKO "A" BATTERY

90 AMP. HRS.

IN RUBBERLITH CASE

Ornamental As Well As Efficient

The Rubberlith case is a composition case with a high gloss giving the appearance of ebony. It is moulded in one piece, including handles and cells—no jars to break—and is practically indestructible. A worthy addition to your set.

ALL SIZES, FROM 2 VOLT BATTERIES UP, CARRIED IN MAHOGANY FINISH CASES

DISTRIBUTED BY

- MARKO STORAGE BATTERY CO., 210 West 54th St., New York, N. Y.
- MARKO STORAGE BATTERY CO., 102 Jefferson Ave., Brooklyn, N. Y.
- RADIO DISTRIBUTING CO., 8 W. Park St., Newark, N. J.
- ALBANY RADIO CORPORATION, 356 Broadway, Albany, N. Y.
- TRUE & BLANCHARD CO., Inc., Newport, Vt.
- SCHIMMEL ELECTRIC SUPPLY CO., 526 Arch St., Philadelphia, Pa.
- CONSOLIDATED WIRE & MCHY CORP., Green & Congress Sts., Chicago, Ill.

Sold by Radio Supply Stores and all Marko Service Stations

MADE BY

MARKO STORAGE BATTERY CO.

1402 ATLANTIC AVENUE, BROOKLYN, N. Y.

MAKE BIG MONEY

Put Yourself On Easy Street

Learn the trade and master the art of making beautiful, sparkling, highly polished, marble, granite, agate, and turquoise, faced brick, building blocks, tile table tops monuments and kindred products from common Portland cement at one tenth cost. For full particulars address,

MASTER CEMENT WORKER OF THE WORLD
433 W. 46th Street, Los Angeles, Calif.

SEND NO MONEY Big 3 foot Telescope in 5 Sections

See people and objects miles away just like they were close, see Moon and Stars as you never did before. Brass bound, useful and entertaining. "Could tell color of aeroplane 4 miles away"—Mrs. Yarbrough. "Watch my boy arrive at school 2 miles away"—Mrs. Horn. "Read numbers on moon"—A. C. Palmer. Thousands pleased. SPECIAL OFFER. Send just your name. On arrival pay postman \$1.85 plus few cents postage. Satisfaction Guaranteed or money back.



FERRY & CO., 75 W. Van Buren, Dept. 1252 Chicago, Ill.

pounds on the rope will yield him a force of 500 pounds on the car.

3—THE PAINTER'S SCAFFOLD

When the free end of the rope is attached to the scaffold the cornice supports only the weight of the scaffold and whatever is on it, but when the rope is connected to a peg in the wall the cornice has to support in addition the tension in this rope—a force which in this case would be equal to one-fourth the weight of the scaffold and its load.

4—THE MERCHANT'S STEELYARD

The merchant was practically never cheated by his own steelyard. In practice he handed the balance to the customer and let him do his own weighing. If the man were buying from the merchant, the buyer's own cupidity would lead him to adjust the weight so that the arm of the balance would slant upward from the pan. This would let the mercury run toward the pan end of the balance and hence give him short weight for his money. On the other hand, if the man were selling to the merchant the seller would unwittingly adjust the movable weight as far toward the end of the arm as he dared, make this end tip down enough to let it fill with mercury and so in the final adjustment leave the mercury counterbalancing a portion of his goods for which he would receive no pay.

5—THE BALL RACE

A hollow ball will roll down hill more slowly than a solid one because the mass of the hollow ball is concentrated to a considerable degree near the periphery where its inertia or tendency to resist change of motion is most effective.

6—PREVENTING THE FREEZING OF VEGETABLES

Placing tubs or pails of water in a basement often prevents fruit and vegetables from freezing because of the heat given out by the ice when it freezes. Thus each gram of ice on freezing gives out as much as 80 calories of heat, or enough to retard the fall of temperature of the basement until the danger of freezing is over. As most fruits can stand a temperature as low as that of freezing ice but cannot stand a much colder temperature this method for preventing them freezing is quite successful.

7—THE APPARENT SIZE OF THE MOON

The enlarged appearance of the moon when it is near the horizon cannot be attributed to anything but an optical illusion, probably produced by its contrast with buildings and trees which can, at that time, be seen in the same field of vision. The effect disappears when one looks at the moon through a tube that prevents sight of other objects. If the angle of the moon is measured with a sextant it will be found to be always the same.

8—THE DRAFT IN THE CHIMNEY

Most materials of which a chimney is built absorb heat more readily than air. Hence if the sun is shining or has been shining upon an empty chimney the air within the chimney is naturally a little warmer, and therefore lighter than the air surrounding it. The draft is then produced in the usual manner, the lighter and warmer air being forced upward by the pressure of the colder and heavier air entering at the bottom.

9—SOME CLOTHES DRY FASTER THAN OTHERS

Dark objects absorb heat readily; white objects reflect it. Hence water evaporates more rapidly from dark or colored clothes than it does from white goods because the white clothes do not so readily receive the heat that reaches them, much of it being reflected.

10—PRESSURE AGAINST A DAM

The force of water against a dam is independent of the length of the body of

water behind it. The total side push of the water depends only upon the depth and density of the water and upon the area of the dam itself.

11—WHY A BALLOON ASCENDS

A balloon ascends because it is lighter than the air it displaces and not because of any peculiar buoyant force of the gas within the balloon. In fact, if a balloon could be made strong enough to withstand the pressure of the air and yet light enough to make it weigh less than the air which it displaces an empty balloon would be better than one filled with any kind of gas.

12—THE "FORCE OF SUCTION"

Contrary to common opinion, soda water does not rise in a tube because of any "force of suction" pulling the liquid upward. In sucking a liquid through a tube merely the air pressure is reduced within the tube, and the greater pressure of the atmosphere on the surface of the liquid in the bottle or glass forces the liquid upward.

DR. HACKENSAW'S SECRETS

By Clement Fezandié

(Continued from page 979)

Doctor Hackensaw's face grew troubled, but after carefully examining the arm, his countenance cleared.

"It's all right, Mrs. Young," said he. "The microbes I injected are multiplying fast, but there are not yet enough of them to do much good work. You really are a week older than when you came here last. But the bacilli I injected will keep on increasing at a geometrical ratio, and you will soon begin to feel their effects."

"I hope so. But, doctor, what would the insurance and other companies do if people could buy life-annuities or pensions and then go on living forever?"

Doctor Hackensaw laughed. "I guess the companies would find means of stopping the payments after a hundred years or so," he observed.

OPERATION SUCCESSFUL

The doctor was correct. A month later, the old lady was perceptibly better, and after three months she could hold herself erect and walked into the office with a firm tread.

"Doctor," said she, with a laugh. "The charm is working—I feel ever so much younger."

Doctor Hackensaw carefully felt her pulse and listened to her breathing.

"Madam," said he, "allow me to congratulate you. You are really ten years younger than you were when I performed the operation."

"Indeed! That makes me seventy-five. When I get back to forty I shall marry John Trimble. Meanwhile, here is part of the fee I promised you, and the remainder you'll have on my wedding-day!"

A couple of months passed, when one day a lady, apparently about forty years old and remarkably pretty for her age, was ushered into the doctor's sanctum.

"You wish to see me, madam?" asked that worthy.

The lady laughed, a rich, warm laugh. "You do not recognize me, then? I am Mrs. Linda Young. Have I changed so much?"

Doctor Hackensaw gazed at her in astonishment.

"You? Mrs. Young?" he exclaimed, gazing at the luxuriant black hair that had replaced her white locks, and noting her firm,

Why Good Dancers Are Popular

Good dancers are invited to every social affair because dancing is the most popular form of recreation, and those who can dance all the newest dances and latest steps are always welcome.

Thousands of successful men and women got their start in the right direction through their popularity as dancers.

Besides gaining for you introductions to the kind of people you want to meet, dancing also gives poise to the body, grace of movement, helps one overcome timidity and awkwardness when meeting strangers. If a man is a fine dancer women look with favor on him and invite him to their social affairs because they never forgive themselves if their little party is not a success in every way.

Arthur Murray has perfected a method through which you can learn to dance, in the privacy of your own home, any of the latest steps in a few minutes—and all of the latest dances in a short time. Instructions are so simple that even a child can quickly master them without assistance, and an entire family can learn from the one set of instructions. In one evening you can master the steps of any single dance. Partner or music are unnecessary. After learning you can dance with the most perfect dancer and not make a single mistake.

Five Dancing Lessons Free

About 5,000 people a month are learning to become perfect dancers through Arthur Murray's methods, and so sure is he that you will feel delighted with his amazingly simple methods of teaching that he has consented, for a limited time only, to send FIVE FREE LESSONS to all who sign and return the coupon.



Posed by Ann Forest, famous movie star and Arthur Murray, the world's foremost dancing instructor.

These five free lessons are yours to keep—you need not return them. They are merely to prove that you can learn to dance without music or partner in your own home.

Write for the five lessons today—they are free. Just enclose 10c (stamps or coin), to pay cost of postage, printing, etc., and the free lessons will be promptly mailed to you. These five free lessons are (1) The Secret of Leading, (2) How to follow Successfully, (3) How to Gain Confidence, (4) A Fascinating Fox Trot Step, (5) A Lesson in Waltzing. Don't hesitate. You do not place yourself under any obligation by sending for the free lessons. Write today—

ARTHUR MURRAY,
Studio 40,
801 MADISON AVENUE, NEW YORK

ARTHUR MURRAY, Studio 40,
801 Madison Ave., New York City

To prove that I can learn to dance at home in one evening you may send the FIVE FREE LESSONS. I enclose 10c (stamps or coin) to pay for the postage, printing, etc.

Name

Address

City State.....

Also at 150 Southampton Row, London, Eng.

He Had Never Danced Before

Last Saturday I went to a dance and as it was my first occasion I sure was surprised to find your lessons so easy and yet so interesting that I sure will tell others about your wonderful system.
Clarence V. Mortensen
Earl, Wisc.

Receives Many Compliments

I had wonderful success with your dances and have been complimented on my dancing since taking your lessons. I also had a surprise for my friends when I informed them that I learned from your wonderful method of teaching by mail.
Walter Rieh,
Chester, Mass.

Learns In Short Time

I received your course in dancing a few days ago and have been to a couple of dances already. I was much pleased with your instructions.
Arthur Hossack,
Flint, Mich.

WHAT KIND OF A MAN ARE YOU?



Lionel Strongfort
Perfect Man Dept. 1371

Are you strong, healthy, vigorous, filled with pep and vitality? Or are you weak, thin, nervous—an apology for a real man—afflicted with Constipation, Indigestion, Vital Depletion, or other ills caused by bodily neglect and abuse?

No matter what your condition, or what caused it, you can revive your flagging powers, and gain perfect Health, Strength and Vitality. I guarantee it. I have helped thousands. I can help YOU. Send for my great FREE BOOK, "Promotion and Conservation of Health, Strength and Mental Energy." It's a man-builder and a life-saver. Send ten cents to cover postage.

LIONEL STRONGFORT
Physical and Health Specialist
Newark, New Jersey

Insure your copy reaching you each month. Subscribe to Science & Invention—\$2.50 a year. Experimenter Publishing Co., 53 Park Place, N. Y. C.

FREE 1924 ATLAS WITH MAPS OF NEW EUROPE

To the readers of Science & Invention who take advantage of this offer now made in connection with

Webster's New International Dictionary

The Only Grand Prize

(Highest Award) given to dictionaries at the Panama-Pacific International Exposition was granted to Webster's New International and the Merriam Series for superiority of educational merit.

Words of Recent Interest

rotogravure, Flag Day, vitamin, fourth dimension, skidnā, fascists, realtor, overhead, soviet, Blue Cross, camp-fire girl, Esthonia, Devil Dog, broadcast. These are but a few from the thousands of late words—all clearly defined in this Great Work.

"The Supreme Authority"

The Merriam Webster

A Complete Reference Library in Dictionary Form—with nearly 3000 pages and type matter equivalent to a 15-volume Encyclopedia, all in a single volume. India-Paper-Edition in Rich, Full Red Leather or Government Test Tan Buckram Binding also Regular Edition in strong, Red Fabrikoid, can now be secured by readers of Science & Invention on the following remarkably easy terms.

THE ENTIRE WORK (WITH COMPLETE 1924 ATLAS)

DELIVERED FOR \$1.00 with easy monthly payments thereafter (in United States and Canada) on SUPERIOR INDIA PAPER

Reduced About ONE-HALF

In Thickness and Weight

India-Paper EDITION

Printed on thin, opaque, strong, superior India paper. It has an excellent printing surface, resulting in remarkably clear impressions of type and illustrations. What a satisfaction to own the new Merriam Webster in a form so light and so convenient to use! This edition is only about one-half the thickness and weight of the regular edition. Size 12½ in. x 9¾ in. x 2¾ in. Weight 8¼ lbs.

Regular-Paper EDITION

Printed on strong book paper of the highest quality. Size 12½ in. x 9¾ in. x 5½ in. Weight 16¼ lbs.

Both editions are printed from the same plates and indexed.

Over 407,000 Vocabulary Terms, and, in addition, 12,000 Biographical Names, nearly 32,000 Geographical Subjects besides thousands of other References. Nearly 3,000 Pages. Over 6,000 Illustrations.

To Those Who Mail This Coupon at Once! G. & C. Merriam Co. Springfield, Mass.

Home Office Dept. S (Publishers of Genuine Webster Dictionaries for over 75 Yrs.)

Please send me free of all obligation or expense, a copy of "Dictionary Wrinkles" containing an amusing "Test in Pronunciation" (with key) entitled "The Americanization of Carver"; also "125 interesting questions" with references to their answers, and striking "Facsimile Color-Plate" of the new binding. Please include specimen pages of India and Regular paper with terms of your free Atlas offer on Webster's New International Dictionary to Science & Invention readers.

Name
Address



"To have this work in the home is like sending the whole family to college." The only dictionary with the New Divided Page, characterized as "A Stroke of Genius."

The Atlas

Is the 1924 "New Reference Atlas of the World" containing 148 pages, with 96 pages of maps beautifully printed in colors, including changes brought about by the Great War, New Census Figures, Parcel-Post Guide, etc., all handsomely bound in red cloth, size 9½ x 12½.

"Boxing" for \$1.97

including Wrestling & Jiu-Jitsu

We'll send you the famous Marshall Stillman Course for 10-day trial—send no money. In 10 days you will learn the fundamentals of boxing—how to strike heavy blows with the weight of the body behind them, how to block, duck, feint and clinch scientifically. Then if you're not convinced that this course is worth many times more than its price—if you are not eager to go on with your instruction—you may return the course.

The course also includes instruction in the blows and guards of such wizards as Jack Dempsey, Benny Leonard, Kid McCoy, Bob Fitzsimmons, etc. Also how to subdue an armed opponent by the terrible Japanese art of Jiu-Jitsu—to throw him if he grabs you from behind, to break his strangle hold on your throat, and to cripple him, if necessary with a bone-breaking hold. Wrestling, too—the best holds used by champions, including the Gotch Toe Hold, the Stecher Scissors Hold, the Head-lock, etc.

SEND NO MONEY

FREE: With the course you get a History of Boxers. Right up to date with ringside pictures of the Dempsey-Willard, Firpo-Willard, Dempsey-Firpo bouts, etc.

Mail the trial coupon right away to Marshall Stillman Association, Dept. 1424-B, 42nd Street, and Madison Ave., New York.

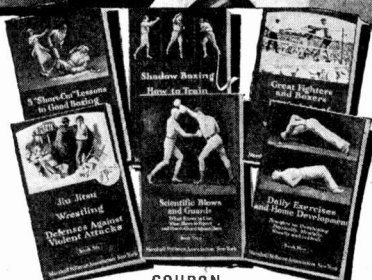

COUPON

MARSHALL STILLMAN ASSOCIATION
Dept. 1424-B, 42nd St. and Madison Ave., New York

You may send me on approval the Marshall Stillman Course. I will deposit 97 cents (plus actual postage) with the postman, with the understanding that if, after 10 days, I wish to return the course, I may do so and my money will be instantly refunded. If I keep the course I am simply to send you \$1 in final payment.

Name
Address
(Canadian and foreign orders must be accompanied by cash (\$1.97 U.S. funds) subject to money back guarantee if not entirely satisfactory.)

elastic tread, and the fire of youth that burned in her eye.

"Yes, doctor, your experiment has been successful beyond my wildest dreams, and I have come to invite you to my wedding with Mr. John Trimble. I shall now have two families, for John has a son called Jack, and Jack, who is also a widower, has a little boy named James. But my changed appearance is causing me many complications. The trouble first began at the banks. My new strong signature did not tally with my old feeble one, so I had to learn to forge my own signature, imitating my old scrawl. And when the cashier sent for me, personally, my youthful appearance made him very suspicious. I have been obliged to sell all my real estate, and I must keep changing my banks and my safe-deposit vaults. All my fortune is now invested in coupon bonds, payable to bearer, so that I need not be identified when I want money. All this has cost me a pretty penny, but you can't pay too high a price for youth.

"Would you believe it, doctor, I am now taking dancing lessons, and can fox-trot and shimmy like a giddy young flapper. But I have been obliged to leave my own family, on the pretext of a trip abroad. Just think of it—I am now younger than my own son!"

AND STILL IT WORKS

Another three months elapsed, and then one day Doctor Hackensaw was electrified by a vision of fairy-like loveliness that swept into his office—an exquisite young girl, looking not more than eighteen, and clad in the daintiest of ball dresses, entered the doctor's office one night, and astonished that gentleman by throwing her arms around his neck and kissing him affectionately.

"Doctor," she cried, "How can I ever repay you for what you have done for me!"

"Excuse me, miss," said the doctor, nonplussed, but you have the advantage of me. There is something familiar about your face, but it must be years since I saw you last, for I should never have forgotten such a charming young lady."

"Why, doctor, don't you recognize me? I am Linda Young—Mrs. Linda Young. Your 'Elixir of Youth' is still working in my veins, and seems more potent every day, for I keep growing younger and younger. You have certainly found the fabled 'Fountain of Youth' that Ponce de Leon sought for in vain in Florida."

"Is it possible!" cried Doctor Hackensaw, astonished. "You're not really Mrs. Young, the feeble eighty-five year old woman who hobbled into my office less than a year ago?"

"There's no mistake about it, doctor, and I am on my way to a ball now with my fiancée, Jack Trimble. When I found I was still growing younger I decided that John was too old for me, so I broke the engagement, disappeared for awhile, and have now returned as a different young lady and have won Jack's heart. But I want you to keep me at my present age, because if I keep getting younger at this rate, I don't know what I shall do. I don't want to have to go back to school again!"

"But my dear madam," exclaimed the doctor in dismay, "I have not yet succeeded in finding the antidote. I am no more able to keep you from getting younger than mankind was able, before my time, to keep you from getting older."

"Don't call me 'madam,' please," interrupted the young girl. "It would seem so strange if anyone should hear you. Please do your very best for me. Meanwhile, I want to ask permission to come and live with you as your niece. People are very suspicious of a young girl of eighteen who lives all by herself and has difficulty in furnishing references. I also want you to have

free access to my safe deposit vault, for I experience more and more trouble in doing business with the banks.

"By the way, doctor, why don't you try some of your own elixir? You must have been a handsome man when you were young. Perhaps I might marry you instead of Jack."

"Tut! tut! young lady! Don't talk so. I shall be only too glad to have you as my niece and to take charge of your affairs, but I am afraid you will prove something of a handful to the man who marries you. Besides, I haven't yet found the antidote that will check your growing younger, and I have no desire to go back to babyhood with you."

Matters were accordingly arranged, and next day Doctor Hackensaw's "niece" Linda came to live with him. But, alas, she kept growing younger and younger at such a rapid rate that she was soon obliged to go away and return as her own younger sister. But even this subterfuge was not sufficient. The doctor was obliged to have two apartments and keep moving from one to the other, as a series of new nieces, each younger than the last, came to visit him. Mrs. Linda Young was now a little girl of eight, but curiously enough, she still retained the memories she had possessed before her rejuvenation. Just as in old age, memories of our youth cling to us, so in her return to youth, her adult memories remained, though somewhat obscured.

Linda's great dread was that she would have to be sent back to school again. Fancy a woman of 85—and a married woman at that—having to go back to school as a girl of eight. Retaining, as she did, all the memories of a life-time, think of having to sit all day at a desk surrounded by children studying their first reader! The thought was maddening. She had no desire of passing as an infant prodigy, and she begged the doctor to hasten his experiments!

"Unless you make haste," she cried, "I shall be a baby again before you know it!"

NECESSITY URGES

The poor doctor needed no urging. He saw the troubles ahead as plainly as she did. The microbes were, of course, multiplying now with lightning-like rapidity. The increase was in geometric progression. At the start there had been only the few microbes injected in Mrs. Young's arm. These had grown and split into double the number. The third generation had doubled again, and so the increase went on. Now the change was so rapid that the doctor was obliged to keep Linda confined in her room and attend to all her wants himself. He had no longer the resource of hiring a new servant every day, for even in one day the change was perceptible.

Day and night did he work, using Linda's room as a laboratory, seeking for the much-wished-for antidote. Surely there must be some means of checking or destroying these new microbes without injuring the body tissues! But the days passed by and the doctor found nothing.

When Linda reached the age of four, the doctor resolved on heroic measures. No longer satisfied with experimenting on animals, he determined to experiment on the child herself. He tried everything he could think of, even to the transfusion of blood from an elderly person. But in spite of these efforts, Linda became a babbling eight-months-old baby, incapable of making her wants known except by simple gestures. She could, however, answer Doctor Hackensaw's questions by affirmative or negative gestures, so by calling off the letters of the alphabet in turn he could learn any of her wishes. She retained her liking for cigarettes and cocktails, and it was curious to

(Continued on Page 1061)

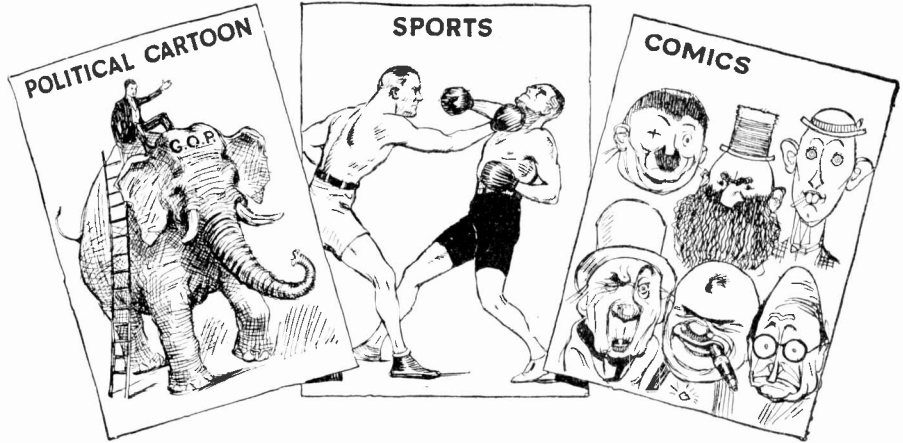

Thousands Can Draw CARTOONS Who Have Never Even Tried

Cartoonists earn from \$60 to far over \$300 a week. Why tie yourself to work that is drudgery when through a remarkable new method you can easily learn at home in spare time to draw cartoons that SELL?

THOUSANDS of men to-day are working at routine, uninteresting jobs who could be successful cartoonists. Many are earning pitiful salaries who could make wonderful salaries in cartooning. Briggs, Fox, Fisher, Goldberg and other leading cartoonists are credited with earning *more than the President*. Yet a few years ago many of our most successful cartoonists never dreamed they could draw a good cartoon!

The World's Easiest, Pleasantest and Best Paying Profession

Just watch a cartoonist work. A few little lines—a couple of simple curves—a splash of black here and there—and then you see a splendid cartoon before you. With a few strokes of his pen he has taken some little incident of his day's experience—some humorous or sad scene he has witnessed—and produced a cartoon which tells the entire story to thousands of newspaper readers.

New Easy Way to Learn Cartooning

This fascinating ability to draw cartoons can now easily be *yours*—this ability which can mean so much real pleasure and profit to you. Through a wonderful new method you receive right at home through the mail a complete training in Cartoon making, and *personal corrections on all of your work from*

one of America's most prominent cartoonists! With his help you can, in *an amazingly short time*, learn to draw the comic strips, humorous, political, and animated cartoons which are in such big demand.

**Learn More About Cartooning
Send for FREE BOOK**

Never have cartoons been so popular. Millions of dollars were spent last year on cartoons of all kinds—and every week newspapers increase the amount of cartoons used. Get full details on the amazing opportunities in this fast growing field of Cartooning and full information on this remarkable home-study method. Mail coupon for FREE BOOKLET *to-day*.

Washington School of Cartooning
Room 262, 1113-15th St., N. W., Washington, D. C.

Washington School of Cartooning
Room 262, 1113-15th St., N. W., Washington, D. C.

Please send me without obligation, your illustrated FREE BOOKLET on Cartooning.

Name
(Write name plainly)

Address

City State

If under 16 years, please state age

TYPEWRITER BARGAINS!
A real writing machine, standard keyboard, all improvements, rebuilt like new in Oliver's own factory, for a fraction of what you'd expect to pay! Easy terms. Send now for new offer. Act quick, and get yours from 1,000 machines just put through! Address—Rebuilt Machine Dept., 361 Oliver Typewriter Co., 362 Oliver Typewriter Bldg., Chicago

The Tone and Quality Long Looked For
Used by Helfetz, Kreisler, Casals and all other great artists
This Modern Scientific Construction has improved the almost perfect instruments since their Creation.
Try it and compare. If not satisfactory money refunded.
Free Catalog of 1923-1924 on request.
E. J. & J. VIRZI, 503 Fifth Avenue, New York City

LEARN RADIO
Here's your opportunity. Radio needs you. Win success in this fascinating field. Trained men in demand at highest salaries. Learn at home, in your spare time.
Be a Radio Expert
I will train you, quickly and easily, to design, construct, install, operate, repair, maintain, and sell all forms of Radio apparatus. My new methods are the most successful in existence. Learn to earn **\$1,800 to \$10,000 a Year**
FREE Wonderful, home-construction, tube receiving set, of latest design. Write for "Radio Facts" free. Engineer Mohaupt.
American Electrical Association
Dept. 62 4513 Ravenswood Ave., Chicago

Insure your copy reaching you each month. Subscribe to Science and Invention—\$2.50 a year. Experimenter Publishing Co., 53 Park Place, N. Y. C.

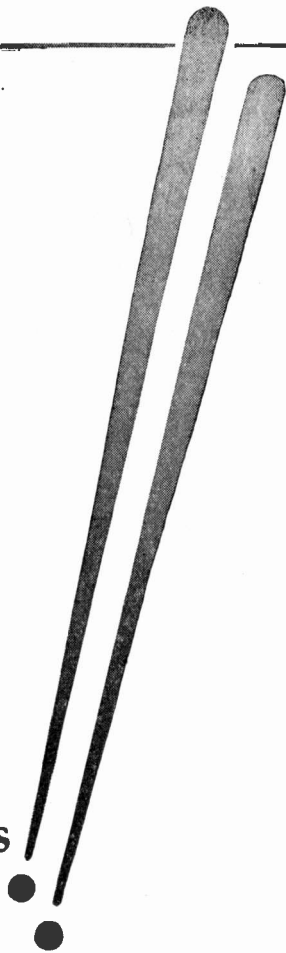

“What a whale of a difference just a few cents make”

All the difference between just an ordinary cigarette and the most skillful blend in cigarette history.

FATIMA

— a mild cigarette

RADIO WRINKLES

EDITED BY
A. P. PECK,

Associate Member Institute Radio Engrs.

UNDER this heading we are going to publish items of interest to everyone who likes to build radio instruments. In order to continue this department it is necessary for our readers to tell us about their latest experiments. Write us a short description of some time- or money-saving kink you have discovered and send it to us along with a few sketches. Our regular prizes will be paid for this material. Be brief and try to put everything in the drawing. Don't be too elaborate. Address "RADIO WRINKLES" editor, care of Science and Invention.

Honeycomb Coil Mounting

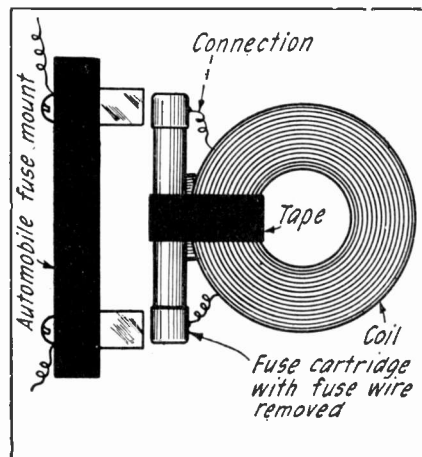

An old fuse block is always a potential mounting for a honeycomb coil and the finished instrument made therefrom is illustrated above. The fuse wire is removed from the cartridge and the metal caps replaced. The coil is then fastened to the cartridge by means of tape. The two leads from the coil are then soldered to the brass caps and two clips may be mounted directly on the panel. This provides means whereby coils may be changed at will and also provides a movable mounting. When necessary, the polarity of the coils may easily be reversed; a thing that cannot readily be done with the standard mounting. —Robert Mackenzie.

Small Soldering Iron

A small soldering iron is very useful in radio work and can often be used in small spaces where a large iron will not work. The iron may be made from a section of No. 1 or No. 0 copper wire as illustrated above. The point is then tinned as shown in the lower part of the above illustration. This iron will hold its heat for a fairly long time and can readily be brought to a working heat in a small alcohol flame. —Evermont Fisel.

SUPER VALUES

OUR POLICY 20% OFF LIST PRICES ON ALL STANDARD RADIO APPARATUS

SPECIAL NEW N. & K. MODEL D 4000 OHMS **\$6.50**
Manufactured by Neufeldt & Kuhnke, Kiel, Germany

Reinartz Circuit Complete

	OUR Price	List Price	OUR Price
Complete Reinartz Coil endorsed by John L. Reinartz and bearing his signature. The only genuine coil for this circuit on the market. All others are imitations	2.50	2.00	
One 7x10x3-16 Radion Panel	1.25	1.00	
National Bakelite Socket	1.00	.40	
Vernier Rheostat	1.50	1.00	
Two 23 Plate Variable Condensers at \$3.00 each	6.00	3.00	
Switch Points and Nuts	.80	.40	
Six Switch Stop Points and Nuts	.40	.20	
Freshman Grid Leak and Condenser	1.00	.65	
Seven Binding Posts		.70	.35
25 Ft. Tinned Bus Bar		.50	.30
3 Switch Levers with Knobs		.75	.35
One Baseboard for mounting		.75	.40
One Fixed Phone Condenser		.40	.25
One Single Jack		1.00	.25
Blue Prints with complete instructions for assembly and mounting		.50	.50
Regular Price		\$19.05	

OUR PRICE \$11.05

All the necessary screws, nuts and miscellaneous small parts which are necessary to complete the set are included in the above prices. Any part in either of these circuits may be purchased independently at the advertised cut prices.

SEND MONEY ORDER, INCLUDING POSTAGE

WRITE FOR OUR CATALOGUE F.

The Radio Mail Order House Known for Our Low Prices



3 West 29th St. New York City



Wonderful, new device, guides your hand; corrects your writing in few days. Big improvement in three hours. No failures. Complete outline FREE. Write C. J. Ozment, Dept 44 St. Louis, Mo.

You can be quickly cured, if you

STAMMER

Send 10 cents for 288-page book on Stammering and Stuttering, "Its Cause and Cure." It tells how I cured myself after stammering 20 yrs. B. N. Bogue, 8101 Bogue Bldg., 1147 N. Ill. St., Indianapolis.

BUILD YOUR SET BETTER-AT LOWER COST

SUPERIOR 180° VARIOCOUPLER

N521 Each.....\$8c
A wonderful value, produces excellent results. Green silk windings on bakelite tubes. Rigid mounting support for table or panel mounting. Primary tapped for fine tuning. $\frac{1}{4}$ inch shaft. Range 200 to 600 meters.
N522 Variometer—same style. Each...\$9c

SUPERIOR VARIOCOUPLER

N523 Each.....\$3.15
A handsome instrument of superior design and construction. Stator tube and rotor ball of moulded red brown bakelite. Large size green silk windings insure highest efficiency. Table or panel mounting. $\frac{1}{4}$ inch shaft. Superior results in circuits for 180 to 650 meters. Tapped primary for finest tuning. Noiseless contacts.
N526 Special single circuit type...\$3.60

SUPER MOULDED VARIOMETER

N412 Each.....\$2.60
Polished black moulded rotor and stator forms. Maximum inductance with greatest efficiency and minimum distributed capacity. A high grade instrument that will get the best results. Wave length 180 to 600 meters.

EXCEL MOULDED VARIOMETER

N524 Each.....\$4.45
A wonderful value at our price. Properly designed and constructed. Polished black bakelite rotor and stator forms. Large size green silk wire insures greatest efficiency. $\frac{1}{4}$ inch shaft. Noiseless pigtail connection. Table or panel mounting. Split stator winding with binding post connections.

SUPERIOR VARIOMETER

N525 Each.....\$3.68
Forms moulded of red brown bakelite. A neat handsome instrument. Green silk windings calculated for highest efficiency. $\frac{1}{4}$ inch shaft. Noiseless pigtail connections. Table or panel mounting. Produces superior results in any type circuit 180 to 650 meters.

RADIO INDUCTANCE COILS

Carefully made—fine looking coils. Highest efficiency. Low distributed capacitance effect, low self inductance—high self impregnation. Very firm. Range given in meters when used with .001 variable condenser. Mounted coils have standard plug mountings.

Turns	Range	No.	Mtd.	Art Price	No.	Mtd.	Art Price
25	120-250	N301	\$0.32	N320	\$0.75		
35	175-450	N302	.37	N322	.90		
50	250-720	N303	.43	N323	.96		
75	390-910	N304	.48	N324	.92		
100	500-1450	N305	.52	N325	1.07		
150	600-2000	N306	.57	N326	1.11		
200	900-2500	N307	.66	N327	1.20		
250	1200-3500	N308	.72	N328	1.29		
300	1500-4500	N309	.76	N329	1.30		
400	2000-6000	N310	.91	N330	1.51		
500	2800-8100	N311	1.06	N331	1.57		
600	4000-10000	N312	1.20	N332	1.72		
750	5000-12000	N313	1.36	N333	1.87		
1000	7900-15000	N314	1.64	N334	2.18		
1250	9750-19500	N315	1.86	N335	2.35		
1500	14500-26500	N316	2.10	N336	2.50		

INDUCTANCE COIL MOUNTINGS

N340-3 Coil. Each.....\$3.35
N341-2 Coil. Each.....\$2.67
Sturdy, rigid durable construction. Made of polished black bakelite.

BACK OF PANEL MOUNTING

Mounts back of panel, with knobs or dials on front of panel. Helps make a neat efficient set. N342—Each...\$4.45

COIL MOUNTING PLUGS

Moulded of genuine bakelite. N344 Plug for mounting "honeycomb" inductance coils.....\$3c
N345 Stationary plug to fasten mounted coil stationary to panel.....42c
N346 Movable plug to fasten mounted coil to panel so it can be rotated.....89c
N343 Fibre strip to hold coils for mounting. Two foot piece.....15c

SPIDER WEB COILS

N290—25 turn 39c N292—50 turn 47c
N291—35 turn 42c N293—75 turn 54c
N294—100 turn. Each.....68c
A new popular type of inductance of highest efficiency. Lowest distributed capacity and lowest high frequency resistance. Firm green silk windings with fibre mounting strips.

YOU SAVE MONEY WHEN YOU BUY FROM US

We Pay Transportation Charges East of the Rockies
THE PRICES QUOTED DELIVER THE GOODS TO YOUR DOOR
FAST SERVICE — TRY US AND BE CONVINCED

THIS GUARANTEE PROTECTS YOU—Examine the goods we ship you. They must suit you in every respect. If you are not satisfied with your purchase return the goods at once and we will refund the price you paid.

OUR SPECIAL VARIOMETER AND VARIOCOUPLER

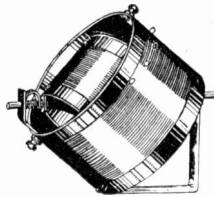

N418 Variocoupler. Each.....\$2.45
The most efficient type of coupler, insures better tuning and louder signals. Primary and secondary wound on natural uncolored genuine bakelite tubes. Handsome green silk windings. Primary tapped for fine tuning. Can be panel or table mounted. 3-16 inch shaft.

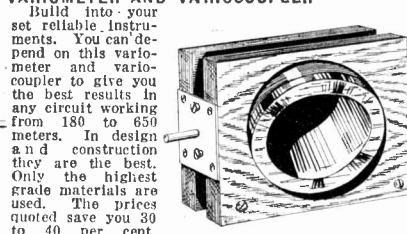

N410 Variometer. Each.....\$2.10
Perfect in design and construction. Accurate wood forms thoroughly seasoned. Correct inductive ratios. Solid baked windings. Plenty of large sized wire insures highest efficiency. A strong high grade instrument that will give you lasting service. 3-16 inch shaft.

SOLID BARE COPPER WIRE

Solid bare copper wire for aerials, leads or wiring instruments.

Solid Bare Copper Wire, size 14.
N240 100 ft. coil 48c N242 500 ft. coil \$2.25

Solid Bare Copper Wire, Size 12.
N244 100 ft. coil 67c N245 500 ft. coil \$3.05

STRANDED ANTENNA WIRE

Cabled of fine copper strands. Very flexible. High tensile strength. Best for aerials.
N248 100 ft. coil 58c N249 500 ft. coil \$2.75

MAGNET WIRE

Insulated copper wire. Best quality even drawn wire, one piece to a spool. Prices quoted are for 8 oz. spools unless otherwise stated. Note, our prices are prepaid.

Double Cotton Covered	Enameled Insulation	Green Silk Covered	
Number N990	Number N992	Number N991	
Gauge	Price	Gauge	Price
18	39c	20	35c
20	43c	22	32c
22	48c	24	30c
24	52c	26	28c
26	56c	28	26c
28	60c	30	24c
30	64c	32	22c
32	68c	34	20c
34	72c	36	18c
		38	16c

ANTENNA INSULATORS

N260 Size 1x3/4. Composition, metal eyelets. Two for.....17c
N263 Ribbed Porcelain insulator, 2 1/2 in. long. Ea. 6c. Dozen.....55c
N265 Ribbed porcelain insulator—5 inches long. Each.....15c

LEAD-IN INSULATORS

N270 For 4 inch walls or less.....42c
N271 For 9 inch walls or less.....69c
The only practical lead-in insulator for aerial wires. Small, neat, effective, durable. Fits 1/8 inch hole. Securely locked by two adjustable nuts.

OUTDOOR LIGHTNING ARRESTER

N980 Price.....\$1.55
Protect your instruments with this lightning arrester. Weatherproof porcelain case. Air gap type. Permanent. Durable. Underwriters approved.

JEWELL LIGHTNING ARRESTER

N981 Each.....85c
A dependable protector, always on guard. Small and compact. Weatherproof porcelain case. Easily fastened and connected. Underwriters approved. Lists for \$1.10.

PANEL MOUNTING VARIABLE CONDENSERS

These are especially high grade condensers and we guarantee them to be mechanically and electrically perfect. Fine polished end plates of heavy bakelite. Shafts 1/4 inch diameter. Sturdy, heavy aluminum alloy plates perfectly spaced to insure smooth, even, reliable capacity. Our low prices save you money. These condensers are of the very best make and are not to be compared with many inferior, cheap condensers offered. We guarantee them to please you or your money back. The vernier style has one separately controlled plate which permits of the finest tuning. Quality considered, these values are unapproached by others.

REGULAR STYLE

N815—3 plate.....58c
N816—5 plate.....97c
N814—11 plate .00025 mfd.....\$1.13
N813—31 plate .0005 mfd.....1.27
N812—43 plate .001 mfd.....1.47

VERNIER STYLE

Including Dial and Knobs
N825—14 plate .00025 mfd.....\$2.45
N824—26 plate .0005 mfd.....2.70
N826—46 plate .001 mfd.....2.95

OUR SPECIAL AUDIO FREQUENCY AMPLIFYING TRANSFORMERS

N550 Each.....\$2.25
In quality of tone and volume of sound, these things a transformer is built for we guarantee it to equal or surpass any other transformer. Neat in appearance. Carefully made. Fully mounted with plainly marked binding post connections. Wonderful results on one, two or three steps without distortion or howling. A quality item in every respect.



NATIONAL SHIELDED TRANSFORMER

N551 3 1/2 to 1 Ratio \$2.48
N552 6 to 1 Ratio...2.68
Note that our price is prepaid. The same high grade style of transformer as above enclosed in a metal case which completely shields it from any outside magnetic influences. Free from howling and local disturbances.

OTHER STANDARD BRANDS AUDIO FREQUENCY TRANSFORMERS

Fresh, clean stock in original containers.
N232 THORARSON Ratio 3 1/2 to 1 \$3.30
N233 THORARSON Ratio 6 to 1.....3.70
N553 Acme. Each.....4.20
N554 Coto. Each.....4.45
N555 Federal. Each.....4.45
N712 Radio Corp. Each.....5.70
N234 All American 10 to 1 Shielded 3.80
N239 All American 5 to 1 Shielded 3.80
N236 All American 3 to 1 Shielded 3.60

TRICOIL RADIO FREQUENCY AMPLIFYING TRANSFORMER

N560 For 201A or 301A Tubes.....\$1.58
N561 For 199 or 11 or 12 Tubes.....1.58
This transformer will produce wonderful results in any type of regular or reflex radio frequency circuit. Perfect for one, two or three stages. Compact, convenient form, easily mounted. Range 175 to 600 meters.



OTHER STANDARD BRANDS RADIO FREQUENCY TRANSFORMERS

N568 Our special—as good as any of them.....\$.48
N502 Dubilier. Each.....4.45
N563 Coto. Each.....4.45
N565 Acme. First stage. Each.....4.45
N566 Acme. Second stage. Each.....4.45
N567 Acme. Third stage. Each.....4.45
N714 Radio Corp. Each.....5.95
N995 All American. Each.....3.95
N575 Eria. First stage. Each.....3.45
N576 Eria. Second stage. Each.....3.45
N577 Eria. Third stage. Each.....3.45
N578 Eria. Reflex No. 1, 2 or 3. Each 4.35

LONG NOSE PLIERS

N970 Price.....95c
The handiest pliers for radio work. Made of fine hardened steel. Length, 5 in.



DIAGONAL JAW NIPPERS

N972 Price.....95c
For fine electrical work, made of hardened steel. Length, 5 inches.



FOUR-IN-ONE DRIVER

N974 Each.....55c
Especially suitable for radio work. Will handle any size screw used. Smaller drivers nest inside larger one and are held in place with screw cap. Made of steel, nickel finished.



TINOL

N969 Per tube.....19c
A combined solder and flux in handy form. Put a little on the connection, heat with a match, torch or solder iron and you have a neat electrically and mechanically perfect joint.

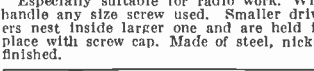

AUTOMATIC BLOW TORCH

N543 Each.....\$1.19
Burns denatured alcohol. Automatically generates pointed flame in a few seconds. Easy to solder joints in hard places. Lights with a match. Burns 20 minutes on one filling. 5 1/2 inches high, 3/4 inch diameter cylinders. Works fine with Tinol listed above.

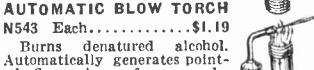

SUPER BLOW TORCH

N544 Each.....39c
Burns denatured alcohol. Vest pocket size. Blowing on tube produces a hot pointed flame. Lights with a match. Works fast. Burns 10 minutes on one filling. Easy to solder joints in hard places. 3 in. high, 7/8 in. cylinder. Long rubber tube. Produces fine joints with Tinol listed above.

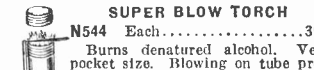

WITH BARAWIK QUALITY RADIO GOODS

VACUUM TUBES
Standard Brands—Cunningham, Radiotron. Every one guaranteed new and perfect. We will ship brand in stock unless you specify otherwise.

- N105 Detector UV200 C300 Each \$4.18
- N112 Amplifier, UV201A (301A) Each 5.42
- N118 5-Watt Transmitter..... 7.70
- N107 WD11 C11, Each..... 5.42
- N101 WD12 C12, Each..... 5.42
- N102 UV199 (299), Each..... 5.42
- N104 UV199 Adapter fits 199 tube to standard socket 39
- N108 WD11 Socket, Each..... 31
- N109 WD11 Adapter, Each..... 45

BAKELITE TUBE SOCKET
N140 Standard base.....39
N141 UV199 base.....39
Moulded of genuine red brown bakelite. Binding post connections. For table or panel mounting. Neat and strong.

199 SOCKET
N145 Each.....49c
Moulded of high insulating material. Sponge rubber base prevents ringing in tube. Plainly marked binding post connections. Neat and compact.

STANDARD TUBE SOCKET
N150 Each.....59c
Bakelite base. Polished nicked tube. Highest quality socket on the market. Best insulation. Positive contact. Marked terminals. For base or panel mounting.

FILAMENT CONTROL RHEOSTATS
N132 6 ohm, Each.....38c
N129 20 ohm, Each.....40c
N131 30 ohm, Each.....44c
N135 6 ohm Verrier.....95c
Best grade. Will give real service. Durable and lasting. High heat resisting base, diam. 2 1/4 in. Tapered polished black knob 1 1/4" diam. Potentiometers. Match above rheostats. Same high grade construction.

OTHER STANDARD BRAND RHEOSTATS and POTENTIOMETERS
N207 Filostat, Each.....\$1.90
N208 Bradleystat, Each.....1.74
N209 Bradleystat 200 ohm, Each.....1.89
N210 Bradleystat 400 ohm, Each.....2.36
N211 Howard 6 ohm Plain Rheo, Ea. .85
N212 Howard 6 ohm Ver. Rheo, Ea. 1.25
N213 Howard 25 ohm Plain Rheo, Ea. .85
N214 Howard 25 ohm Ver. Rheo, Ea. 1.25
N215 Howard 40 ohm Plain Rheo, Ea. .85
N216 Howard 40 ohm Ver. Rheo, Ea. 1.25
N217 Howard 200 ohm Potentiometers, Each.....1.45
N218 Howard 400 ohm Potentiometers, Each.....1.69
N219 Klossner 6 ohm Verrier, Each.....1.19
N221 Klossner 30 ohm Verrier, Each 1.45
N222 Amperite with mounting......95

SUPERIOR RHEOSTATS
N153 6 ohm, Each.....69c
N154 20 ohm, Each.....76c
N155 30 ohm, Each.....83c
The finest rheostats ever made. Even action. Best design, best workmanship. Supplied with attractive dial and knob. A rheostat for high grade sets.
Potentiometers to match above rheostats with dial and knob.....98c
N156 30 ohm.....

QUICK ACTING RHEOSTAT
N124 6 ohm, Each.....79c
N125 15 ohm, Each.....88c
N126 30 ohm, Each.....99c
Verrier adjustment at every degree of resistance. Pushing knob in turns off the filament.

COMPOSITION DIALS
N921 Diam. 2 in. for 3-16 in. shaft, Ea. 16c
N922 Diam. 2 in. for 1/4 in. shaft, Ea. 16c
N923 Diam. 3 in. for 3-16 in. shaft, Ea. 22c
N924 Diam. 3 in. for 1/4 in. shaft, Ea. 22c
Handsome dials moulded in one piece of polished black composition. 2 inch size has 270° scale marked 0 to 100 finely engraved in contrasting white enamel. 3 inch size has 180° scale marked 0 to 100.

BAKELITE DIALS
N931—2 in. Diam for 3-16 in. shaft, Each.....35c
N932—2 in. Diam for 1/4 in. shaft, Each.....35c
N933—3 in. Diam for 3-16 in. shaft, Each.....39c
N934—3 in. Diam for 1/4 in. shaft, Each.....39c
N935—4 in. Diam for 1/4 in. shaft, Ea. 46c
Moulded in one piece of genuine bakelite in polished black finish. Finely engraved scale in contrasting white enamel. Sure grip knob that fits the fingers. Higher grade dials for good sets. Match perfectly.

VERNIER DIAL ADJUSTER
N941 Each.....19c
Easily installed at edge of dial, gives finest vernier adjustment of condenser or inductance. A great value. Polished black knob.

WE PAY TRANSPORTATION CHARGES EAST OF THE ROCKIES PRESERVE THESE PAGES—ORDER FROM THEM AND SAVE MONEY

FAST SERVICE—TRY US AND BE CONVINCED
THE PRICES QUOTED DELIVER THE GOODS TO YOUR DOOR
OUR GUARANTEE PROTECTS YOU—We handle only the best goods, carefully tested and checked by expert radio engineers. You are assured of getting guaranteed apparatus that will give superior results. And while our goods are best, our prices are lowest. Our goods equal or surpass the claims we make for them. We do not attempt to deceive or mislead. Our reputation for fair dealing is our most valued asset.

ENCLOSED DETECTOR
One of the finest crystal detectors on the market, supersensitive galena crystal enclosed in heavy glass shield. Quick, positive adjustment. Brass parts polished nickel finish.
N730 Each.....89c

GALENA DETECTOR
Easy fine adjustment. Crystal mounted in cup. Moulded base and knob. Brass parts polished nickel finish. An unequalled value.
N732 Each.....59c

DETECTOR CRYSTALS
N736 Galena, Arlington tested, piece 19c
N738 Silicon, Arlington tested, piece 19c
N735 Tested, Galena, Mounted, piece 9c
N737 Tested, Silicon, per piece.....9c
N739 Genuine million point crystal, Ea. 29c

STANDARD BRAND FIXED CRYSTAL DETECTORS
The latest development in Crystal Detectors. Give better results and more reliable than old style. Used in Reflex circuits.
N742 Grewol Detector, Each.....\$1.48
N743 B Metal Detector, Each.....2.18
N744 B Metal Crystal, Each.....1.28
N745 Gold Bar Detector, Each......83
N745 Yellow Tip Detector, Each.....1.79
N746 Du-Pee Crystal, Each......27

SUPERIOR VARIABLE GRID RESISTANCE
N167 Each.....80c
N168 With .00025 Condenser.....98c
Eliminates hissing, clarifies signals. Capacity smoothly varied from 0 to 6 megohms by half turn of knob. Easily mounted on any panel.

TUBULAR GRID LEAKS AND CONDENSERS
Very convenient. Permit of quick change of leaks or condensers of varying capacity. Cut shows leak mounted. Leaks and condensers have same appearance. Each part priced separately.
N849 Grid Leak, Each.....15c
Resistances—1/2, 1, 1 1/2, 2, 3, 5, 7, and 10 megohms. Specify which size is wanted.

GRID AND PLATE CONDENSERS
N831 Grid and Plate Condensers, Ea. 39c
Capacities .000025, .0001, .00025, .0005 mfd. Specify which size is wanted.

Mountings. Bakelite base.
N840 Single mounting, Each.....28c
N842 Double mounting, Each.....47c
N844 Triple mounting, Each.....67c

STANDARD BRAND VARIABLE GRID LEAKS
N177 Freshman back of panel style.....59c
N178 Freshman back of panel style with .00025 Condenser 79c
N171 Freshman back mounting type with .00025 Condenser.....79c
N172 Durham Variable Grid Leak with Mounting.....89c
N173 C.R.L. Variable Grid Leak.....\$1.19
N175 C.R.L. Variable Grid Leak with grid condenser.....\$1.48

FRESHMAN MICA CONDENSERS
N512 .00025 mfd.....26c
N513 .0005 mfd.....26c
N514 .01 mfd.....31c
N515 .002 mfd.....31c
N516 .008 mfd.....60c
N517 .01 mfd.....80c

DUBILIER MICADON TYPE 601
N502 .001.....28c N507 .0025.....32c
N503 .00025.....28c N508 .003.....40c
N504 .0005.....28c N509 .004.....40c
N505 .001.....32c N510 .005.....48c
N506 .002.....32c N511 .006.....60c

BARAWIK QUALITY HEADSETS
N770 Per Set, 2000 ohms.....\$2.98
These headsets have proven on rigid tests to be one of the very best on the market. The tone quality is excellent with an unusual volume. Skilled workmen make them from the best selected materials. The receiver cases are fine polished finish with polished black ear pieces. Fabric covered head band comfortably and quickly fitted to the head. Supplied with 5-foot cord. These sets were designed to sell for much higher prices than we ask, and at our price are a wonderful bargain. We guarantee that you will be pleased with them and agree that they are the best value by far yet offered. If they don't suit you we will cheerfully return your money.

STANDARD BRAND HEADSETS
N754 Baldwin Type C with N764 Frost, 2000 ohm \$3.30
universal jack plug \$10.45 N766 Frost, 3000 ohm \$3.95
N755 Western Electric \$9.50 N759 Federal \$3.25
N756 Murdock 56, 2000 ohm.....\$3.25
N757 Murdock 56, 3000 ohm.....\$3.90
N758 Dictograph Aristocrat.....\$6.60

PLATE CIRCUIT "B" BATTERIES

You can make real savings on these batteries. We guarantee them to equal any on the market regardless of price. Extra long life. Don't throw away your money on cheaper inferior useless batteries.
N180 Signal Corps type, small size. 15 cells, 22 1/2 volts. Each.....\$1.10
N182 Large size. 5 taps 10 1/2, 18, 10 1/2, 21 and 22 volts. Each.....\$1.45
N184 Variable Large Navy size. 16 1/2 x 4 3/4 inches 5 taps, giving range from 16 1/2 to 22 1/2 volts in 1 1/2 volt steps. Each \$1.95
N188 Combination Tapped 45 volts, 30 cell. 3x1x3 battery. Tapped to give 45, 22 1/2, 21, 19 1/2, 18 and 16 1/2 volts. Handles both detector and amplifier tubes. Ea. \$3.28

"B" BATTERY METER
N189 Each.....98c
Reads 0 to 50 volts. Accurately tells you the exact condition of your B Battery. Convenient watch size. Polished nickel case with wire lead.

STORAGE "A" BATTERY
A high grade battery. Guaranteed for three years. Made of best new materials. Full capacity. The best battery buy on the market. Try one of these batteries on your set for 10 days. If at the end of that time you are not fully satisfied with the battery return it and we will refund the purchase price.
N194 6 volt, 40-80 ampere size. Ea. \$ 9.90
N196 6 volt, 80-120 ampere size. Ea. \$13.25

HOMECARGER BATTERY CHARGING RECTIFIER
Charge your battery at home overnight for a few cents. Simply connect to any 110 volt 60 cycle light socket, turn on current and rectifier does the rest automatically. Will work for years without attention. Simple connections. Give a tapering charge which batteries should have. You can make it pay a profit charging your friends' auto batteries. Long connecting cords with pair of battery clips.
N201 For 6 volt battery.....\$12.95
N203 For 12 volt battery.....12.95

HYDROMETER
N190 Each.....48c
Accurately tells you the condition of your storage battery. Helps you keep your battery in better condition.

BATTERY CLIPS
N198 Two for.....28c
Clip onto storage battery terminals, lead cord. Make positive non-corrosive contact at all times.

WIRE CONNECTING CLIPS
N199 Per dozen.....30c
Small connecting clips for quickly fastening leads on to binding posts, etc. Handy and useful. Every radiolist should have at least a dozen.

MELTONE LOUD SPEAKER
N611 Price \$4.85
One of the best popular priced speakers. Talks loud and clear. Compares favorably with more expensive makes. Fibre horn. Heavy metal base. Five foot cord. Nickered goose neck. 6 1/4 in. bell. Size over all 14 1/2".

STANDARD BRAND LOUD SPEAKERS AND UNITS
N610 Murdock Loudspeaker.....\$4.38
N613 Barawik with Baldwin unit.....11.25
N615 Pathe Loudspeaker.....15.95
N616 Atlas Loudspeaker.....22.50
N612 Magnavox R3 Loudspeaker.....32.50
N614 Magnavox R1 Loudspeaker.....32.50
N617 Music Master Loudspeaker.....27.00
N615 Genuine Baldwin type C unit.....5.10
N619 Murdock Special Unit.....2.60
N618 Brandes Table Talker.....8.75
N620 Baldwin Loud Speaker.....22.50
N609 Dictograph Dictogrand.....21.50
N608 Atlas Unit, Each.....10.75
N607 Western Electric Unit, Each.....10.75

PHONODAPTER
N771 Each.....39c
The Phonodapter will fit any phone. Metal tube fits any standard phonograph. Make your phonograph a loud talker. Fits Columbia, Victor and Sonora phonographs. It is made entirely of pure soft rubber with brass tube insert.

THE BARAWIK CO. Chicago's Original Radio Supply House Beware of Imitators 102 South Canal St., Chicago, Ill.

IT IS EASY TO BUILD YOUR OWN RADIO SET

GUARANTEED QUALITY GOODS

at money saving prices. There are no strings tied to our prices. Order what you want—be your order large or small. You will get immediate service from the most reliable exclusive radio supply house. Before you consider buying elsewhere, ask your banker as to our responsibility and financial rating. You will find that we stand high in the commercial world and we have earned our standing only through fair dealing, prompt service and by offering merchandise of high quality at prices unequalled by others.

FAHNESTOCK CONNECTORS



N366 Single. Dozen25c
N367 Double. Dozen39c
Handy and convenient for connecting wires or making connections on binding posts or other parts of instruments. Wires held firmly in spring grip but may be instantly removed.

UNIVERNIER CONTROL DIAL

N918 For 3-16 inch shaft.....\$1.15
N919 For ¼ inch shaft.....1.15
Replaces ordinary knob or dial. Gives perfect vernier control on condenser, variometer, variocoupler, tickler, etc. Positive easy action. Looks fine. Easily installed. Especially desirable in tuning neodydyne sets.

RADIO SWITCH

N287 Each28c
Cuts current on and off instantly by a push or pull. Very neat. Well made. Durable. Saves tubes and batteries.

BEZELS

N399 Diameter ¾ inch. Each.....15c
N400 Diameter 1 ½ inch. Each.....15c
Polished nickel finish. Finest quality. Fit any thickness panel. Greatly improve appearance of panel.

CABINETS

Fine looking cabinets solidly built. Elegant hand rubbed dark mahogany finish. You will be proud of your set mounted in one of these cabinets. Hinged tops. Front rabbeted to take panels. Panels not included. Prices are transportation paid. Note that our prices are prepaid.



Panel Size | **Inside Dimensions** | **Art. No.** | **Price Each**

Panel Size	Inside Dimensions	Art. No.	Price Each
6x7"	5 ½" x 6 ½" x 7"	N420	\$1.95
6x10 ½"	5 ½" x 9 ½" x 7"	N422	2.45
7x10"	6 ½" x 9 ½" x 7"	N421	2.60
7x12"	6 ½" x 11 ½" x 7"	N424	3.05
7x14"	6 ½" x 13 ½" x 7"	N423	3.20
7x18"	6 ½" x 17 ½" x 7"	N426	3.45
7x21"	6 ½" x 20 ½" x 7"	N425	3.85
7x24"	6 ½" x 23 ½" x 7"	N429	4.35
7x26"	6 ½" x 25 ½" x 7"	N431	5.50
8x14"	6 ½" x 13 ½" x 10"	N428	3.55
13x14"	11 ½" x 13 ½" x 10"	N430	4.00
13x21"	11 ½" x 20 ½" x 10"	N432	5.05

RADIO "BAKELITE" PANELS

Notice our very low prices on this fine quality material. Others ask as much for hard rubber panels which are worth much less. We supply genuine Bakelite. Condensite Celeron or Formica, all of which are materials of practically identical mechanical, chemical and electrical properties. Machines well without chipping. Won't warp. Waterproof. Highest mechanical and dielectric strength. Attractive natural polished black finish which can be sanded and oiled. Note that our prices are prepaid.

RUBBER COMPOUND PANELS

Made of a special compound having a rubber base. Equal in appearance and in all essential points to any other class of panels. Fine smooth polished finish. Can be drilled or cut without chipping. Guaranteed not to warp and to be a perfect insulator for radio use. Smooth, clean edges. Thickness 3/16 inch. Size given is in inches.

PANELETYPE RADIO PANELS

A new practical radio panel. High dielectric strength, rigid and durable. Easy to drill, tap or refinish. Black in color, polished on one side, matte grain on other side. 3-16 inch thick.

Art. No.	Price	Art. No.	Price	Art. No.	Price
N491	7x10.....\$0.88	N484	7x18.....\$1.60		
N492	7x12.....1.05	N483	7x21.....1.85		
N483	7x14.....1.22	N486	7x24.....2.10		
		N490	7x18.....\$1.28		
N487	7x10......75c	N491	7x21.....1.44		
N488	7x12......84c	N492	7x24.....1.69		

Over 30,000 Barawik Radio Sets Are Operated All Over the World

All of these sets were built with Barawik Standard Radio Parts mostly by persons without any previous radio experience. These home-made sets equal in results the best factory made sets—many are even superior and at a cost only a fraction of the cost of the factory made sets. You can easily equal these results by following directions given in the numerous magazine articles on radio. Also directly below you will find listed Blue Prints, Instruction Packs and Books. With the help of these anyone can successfully make a Radio Set.

RADIO BOOKS

That every Home Builder and Amateur needs. Written in plain simple language everyone can understand.
N631 100 Radio Hookups. Each.....25c
Shows hookups from the simple crystal set to the more elaborate and latest tube circuits. Numerous types of Reflex super-Regenerative, super-Heterodyne, Neodydyne, Reinartz, Flewelling, Bishop, etc.
N632 How to Tune Your Radio Set. Each.....25c
N633 How to Build Loud Talkers. Each.....25c
N634 How to Make Radio-Phone Receiving Sets. Each.....25c
N635 How to Make Radio Frequency Amplifiers. Each.....25c

SPIDER WEB COIL FOR REINARTZ CIRCUIT

N296 Each.....\$1.15
Lists for \$2.50. A very unusual bargain. Made of green silk covered wire, spiderweb wound to produce greatest efficiency and lowest losses, 21 taps so arranged that crossing is avoided. Two fibre strips and wooden rod furnished permit various styles of mounting. With this coil a high grade set can be built at a low cost. Directions included.

ULTRA AUDION COIL

N297 Each.....85c
Spider web wound of green silk covered wire. Four taps. Produces wonderful results. Fibre strips and wooden rod for mounting included. Directions furnished.

COCKADAY COILS

N298 Per Set...\$1.95
Complete set coils for Cockaday circuit. Properly calculated and made to give best results on this new wonder circuit.

NEODYDYNE TRANSFORMERS

N571 Each \$1.75. Per set of three. \$4.95
An air core transformer for use in neodydyne method of reception. Can also be used for tuned radio frequency or as a fixed couple with condenser across secondary. Proper design for results and efficiency. Green silk windings on bakelite tubes with adjustable mounting brackets to fit most any condenser.

NEUTRALIZING CONDENSERS

N572 Per set of two.....40c
Simple, inexpensive, efficient precision type. Micrometer adjustment is attainable. Easily mounted in circuit.

STANDARD NEODYDYNE PARTS

N851 WorkRite Neodydyne (combined transformer and condenser). Each.....\$4.78

N852 WorkRite Neodydyne Kit.....\$14.95
Includes 3 WorkRite Neodydyne parts, 2 WorkRite Neodydyne panel layout, paper template and book of instructions.

N854 Amso Compensating Condenser. Each.....\$2.89
A 3 electrode condenser for balancing the grid charge on amplifying tubes. Stops all local oscillations without detuning amplifier. Shielded against hand capacity. Complete with 2 inch dial. Provides perfect and rapid control of tube.

N853 WorkRite Neodydyne. Each......43c
A very accurate and easily adjusted condenser for neutralizing tube.

N855 Fada Neodydyne Parts.....\$25.00
A combination package of three neodydyne transformers and two neodydyne parts with instruction book.

N856 Fada Parts for 4 tube set. Complete.....\$64.00
N857 Fada Parts for 5 tube set. Complete.....\$65.60
Contain all necessary parts including drilled panel, careful instructions, sockets, dials, condensers, transformers, bus bar wire and fine mahogany finish cabinet.

ANTENNA LEAD-IN

N259 Each.....25c
Solves a hard problem. With it you can bring in the antenna wire without drilling a hole for an insulator. Place on window sill and window can be closed down tight and locked as before. Takes but a minute to install. Perfectly insulated. Can be bent into any shape. Made of copper strip properly insulated. Neat and durable. Place on nearly all standard goods not listed on these pages. Send us your order—we give you the right price.

PRINTS OF POPULAR CIRCUITS

These prints give a full-size panel layout schematic hookup, hook-up showing parts wired and explanatory notes. With them as a guide anyone can build a set that will operate perfectly and bring in the long distance stations.
N621 One Tube Reflex and Amplifier. Each.....10c
N622 Single Circuit Tuner. Each.....10c
N623 Reinartz Tuner using Spider Web Coil. Each.....10c
N624 Radio and Audio Frequency Amplifier. Each.....10c
N625 Short Wave Regenerative Set, using two Variocouplers. Each.....10c
N626 Honeycomb Coil Circuit and Amplifier. Each.....10c

"CONSOLIDATED" RADIO PLAN PACKETS

Designed and laid out by the foremost radio engineers. With their help you can build an outfit that will give the finest results. Every packet contains complete instruction for the construction and tells what tools and parts are needed. Detailed directions for drilling, mounting and wiring, also how to handle set after it is built. Thousands of sets have been built from these plans and are in perfect operation. Folder giving detailed description of each packet sent on request. For more complete description of these packets see the Conrad Co. advertisement in this magazine. Price per packet.....42c

Order item wanted by article number.
N640 How to make a Neodydyne Receiver.
N641 How to make a Reinartz Receiver.
N642 How to make a Regenerative Receiver.
N643 How to make a Cockaday Receiver.
N644 How to make a Reflex Receiver.
N645 How to make Detector and Amplifier Units.
N646 All about aerials and their construction.
N647 Twenty Radio Diagrams of Latest Hook-ups.
N648 14 Radio Formulas and Diagrams.
N649 How to make an Autoplex Receiver.

Complete Sets of Parts for Popular Circuits

Only high grade parts are used in these sets and each part is guaranteed to be perfect. Each one of these circuits has been tried and successfully operated under many different conditions. The detailed instructions and diagrams supplied with each set make it easy for any one without previous experience to build an outfit that will give most satisfactory results.

HAZELTINE NEODYDYNE 5 TUBE CIRCUIT

N858 Complete set parts.....\$38.50
Essential parts licensed under HazelTine patents. A set that will give really wonderful results. Only the highest grade parts are used. The following items are included:
1—7x24x3-16 Formica panel.
2—Rheostats with dials.
3—4 inch Bakelite dials.
5—Bakelite sockets.
8—Composition top binding posts.
3—0005 Bakelite end variable condensers.
1—24 high grade cabinet.
3—Neodydyne transformers.
2—Neutralizing Condensers.
1—Variable grid leak and condenser.
2—Barawik audio transformers.
1—Base board for mounting.
30 ft. tinned bus bar wire.
Instructions for assembling and wiring.

ERLA SINGLE TUBE REFLEX CIRCUIT

N859 Complete set parts.....\$18.95
The following parts are included:
1—Erla Reflex No. 1 Transformer.
1—Audio Transformer.
1—Variocoupler silk windings on bakelite tube.
1—0005 Bakelite end Variable Condenser.
2—Bakelite standard base sockets.
1—002 Mica condenser.
1—001 Mica condenser.
1—00025 Mica condenser.
1—Fixed detector.
1—High grade rheostat.
2—3 inch polished black dials.
8—Binding posts with composition tops.
1 dozen switch points and 4 stops.
2—Switch levers.
1—7x14 ½ Bakelite panel.

N423 Fine 7x14 Cabinet mahogany finish. Extra.....\$3.20

AUTOPLEX CIRCUIT

N860 Complete set parts.....\$13.25
A single tube circuit that brings in signals loud enough for a table talker. The following parts are included:
1—Wood form Variometers silk windings.
1—1x12 ½ Bakelite panel.
2—3 inch polished black dials.
1—1250 turn honeycomb coil.
1—Bakelite socket with standard base.
1—6 ohm rheostat.
8—Composition top binding posts.
8—Name plates.
10 feet bus bar wire.
1—Consolidated Autoplex pattern.
1—Fine 7x12 cabinet mahogany finished.

COCKADAY CIRCUIT

The following parts are included:
N861 Complete set parts.....\$11.35
1—Set Cockaday Coils.
2—3 inch polished black Bakelite dials.
1—Bakelite socket for standard base.
1—Vernier Rheostat.
1—Double Circuit Jack.
8—Composition top binding posts.
2—High grade switch levers.
1 dozen polished nickel switch points.
1—7x14 ½ Formica panel.
1—0005 Bakelite end variable condensers.
1—Base board for convenient assembling.
10 feet nickeled bus bar wire.
Diagram and instructions.
N423 Cabinet extra.....\$3.20

MIGNON VERNIER VARIABLE CONDENSERS

N827 .0002 M.F. Each.....\$2.30
N828 .0005 M.F. Each.....2.70
N829 .001 M.F. Each.....2.95
Highest grade instruments. Accurate rating. Extremely low dielectric losses. Independent friction vernier control insures perfect positive adjustment. ¼ inch shaft. No dial included.

FLEWELLING CIRCUIT

N864 Complete set of parts.....\$12.39
The following parts are included:
1—7x12x3-16 panel.
1—0005 Bakelite end variable condenser.
3—006 Mica condenser.
1—2 coil honeycomb mount.
1—Variable grid leak and condenser.
1—50 turn honeycomb coil.
1—75 turn honeycomb coil.
2—Coil mounts with straps.
1—3 inch polished black dial.
1—Bakelite socket for standard base.
1—Vernier 6 ohm rheostat.
8—Binding posts with composition top.
1—Base board for assembling.
Instructions for assembling and wiring.

REINARTZ CIRCUIT

N862 Complete set parts.....\$10.75
The following parts are included:
1—7x18x3-16 Bakelite panel.
1—Bakelite socket standard base.
1—Vernier Rheostat.
1—0005 Bakelite end variable condenser.
1—00025 Bakelite end variable condenser.
2—3 inch polished black dials.
3—Switch levers.
1—Green silk insulated coil.
1—Freshman variable grid leak with condenser.
1 dozen insulated top binding posts.
30 ft. tinned bus bar wire.
1—Instructions for assembling and wiring.
N426 Fine 7x18 Cabinet mahogany finish. Extra.....\$3.45

Note:—The above does not include amplifier. Set can be supplied with 2 additional sockets, 2 audio transformers, 2 additional rheostats, and size 7x21 panel.

N863 Complete with two stage amplifier.....\$17.95
N425 Fine 7x21 Cabinet mahogany finish. Extra.....\$4.65

ULTRA AUDION CIRCUIT

N865 Complete set parts.....\$8.95
The following parts are included:
1—Spider web coil with taps.
1—0005 Bakelite end variable condenser.
1—7x12x3-16 panel.
1—Bakelite socket for standard base.
1—Variometer with silk windings.
1—Vernier 6 ohm Rheostat.
1—Variable grid leak with condenser.
8—Binding posts with composition tops.
1—Base board.
10 feet nickeled bus bar wire.
Diagrams and instructions.

N424 Fine 7x12 cabinet mahogany finish. Extra.....\$3.05

The ultra audion circuit gives fine results with two stages of amplification added.

Set as above with 7x18 panel and 2 audio transformers, 2 additional bakelite sockets and 2 additional rheostats.

N866 Complete.....\$15.95
N426 Fine 7x18 cabinet mahogany finish. Extra.....\$3.45

LIGHT SOCKET ANTENNA

N251 Each......97c
Screws into any light socket. Replaces the regular outdoor antenna. Very satisfactory for nearby stations and under favorable conditions will bring in distant stations. Easy to install. No danger. Gives clear reception with little static interference. Ideal for people in apartment buildings.

RADIO SOLDER SET

N538 Complete.....83c
Handy for soldering radio connections or for general small repair jobs. Consists of soldering copper with handle, sal ammoniac, soldering salts, solder and sand paper.

"TUNE IN" with Rosendal "B" Batteries

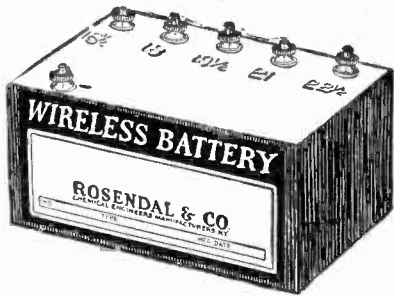

"TUNE IN" with a Rosendal and realize the full joy of Radio broadcasting. See how clearly your signals will come in—how delightful the reception.

It is not how much you pay for a battery that determines its service. It is how good a battery you can get for the money that you pay. Rosendal batteries provide a happy combination of the two.

It is first of all, a dandy battery made of finest materials to give extra service. Rosendal Batteries don't stand around on dealers shelves. They come to you direct from the

manufacturer eliminating middleman's profit and that is the reason you pay so little for them. In addition to that every Rosendal battery is guaranteed. It must either please you or you are entitled to your money back.

Try a Rosendal once and you will be a steady user.

Send Money Order or Order C. O. D.

Shipment prepaid at the following direct to consumer prices.

	Large	Medium	Small
22½ Volt plain	\$1.66	\$1.33	\$0.93
22½ Volt variable	1.84	1.50	1.00
45 Volt plain	3.33	2.33	—
45 Volt variable	3.66	2.66	—

ROSENDAL & CO

Chemical and Radio Engineers
2 and 4 Stone Street New York

Phonograph Record Set

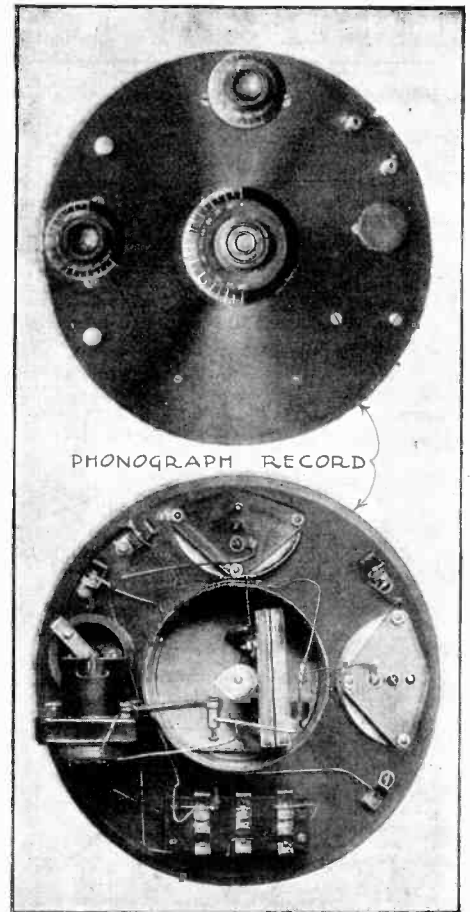

PHONOGRAPH RECORD

The above illustration shows a complete receiving set, including tuner and detector, mounted on a standard 12-inch phonograph record. The tuner consists of an inductance coil and three variable condensers. One of the latter is of the book type, operated by a cam, and is mounted within the inductance coil. If desired, a standard type of condenser may be used in this place, providing the inductance coil is wound on a tube large enough to contain the condenser. With a little ingenuity, almost any type of receiving set may be mounted on a record in this manner and be made to give very good results. Some type of mounting should be devised and this could probably take the form of two brackets which would support the record on edge. Another good scheme would be to make a round box, the bottom composed of a circular disc of wood and the sides of the thin wood used in making cheese boxes. This could readily be bent into the shape required and the phonograph record mounted at the top of this box. Such a set would not only be useful, but ornamental and novel.

—A. O. Wright.

A New RICO Product

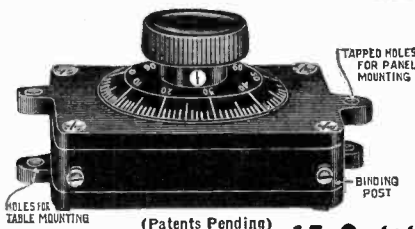

CAPACITY EQUALS 43 PLATE CONDENSER
REQUIRES ¼ THE SPACE

THE "RICO" STRAIGHT LINE CONDENSER

This condenser marks a revolution in condenser building. It is the simplest and most practical type of condenser as yet developed for broadcast and amateur work. This condenser has been developed by our engineers after considerable research work and has been pronounced perfect by experts.

15 Outstanding Features

- 1—Large capacity (.001 Mf.).
- 2—Replaces a 43-plate condenser.
- 3—Uses a minimum of space, size 3¼"x2¼"x1¼".
- 4—For panel mounting or for table mounting—universal in its scope.
- 5—One complete revolution of dial adjusts condenser from minimum to maximum.
- 6—Vernier effect.
- 7—Absolute straight line curve.
- 8—Accumulates no dust between plates as is the case with air condensers entirely enclosed.
- 9—Light weight. Condenser only weighs 3 oz.
- 10—Less than 1-30th amount of parts as used in old style mesh plate condenser.
- 11—Can never get out of order.
- 12—Impossible to short circuit. Finest India Mica dielectric used.
- 13—Works in any position, vertical or horizontal. No counterweights needed.
- 14—Lowest in price for high class condenser.
- 15—Compactness. Size only 3¼"x2¼"x1¼" over all. The Rico Straight Line Condenser must be seen to be appreciated. Made of the best materials that money can buy. Stands in a class by itself. All metal parts finished in nickel plate. Money refunded if this condenser is not all we claim for it. No. 450 "Rico" Straight Line Condenser complete with molded dial, \$1.75. No. 451, same condenser but without dial (shaft is for ¼ inch), \$1.50.

SEND NO MONEY

S.&I.-2

Radio Industries Corp., 131 Duane St., New York City
Gentlemen: Please send me by Parcel Post No.
....."Rico" Condenser for which I will
pay the postman the amount of
Name
Street
City State

RADIO INDUSTRIES CORPORATION

131 DUANE STREET, NEW YORK CITY
Cable Address: Ricotrade, New York

Adjustable Switch Arm

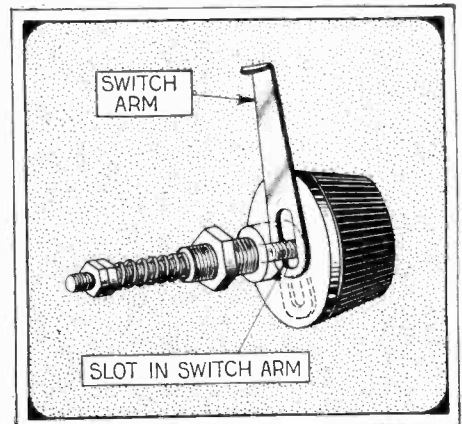

SWITCH ARM

SLOT IN SWITCH ARM

No more need the amateur drill holes for switch points on his panel and then find that the switch arm will not reach to them or is a little bit too long. The use of the adjustable switch arm illustrated above eliminates this possibility. A slot is cut in the arm as shown and a threaded collar holds the same firmly in place. By loosening the collar, the length of the arm may be adjusted. This switch is now on the market and the above illustration shows all the constructional details.

SEND NO MONEY POLICE AUTOMATIC

This is a 15-shot super automatic like those used by German military officers. Extra magazine free. Never before was any 32-Cal. Automatic offered at this price... \$8.75
Latest Model 9 shot Mauser automatic, lies flat in pocket, 25 Cal. Special at... \$10.75
32 Cal. Mauser \$11.45
World's Famous Luger 30 Cal. \$17.25
Top Break Revolver 32 or 38 Cal., Special at... \$7.95

SATISFACTION GUARANTEED

Send No Money. Pay Postman Our Price, Plus Postage.

Brand-New Guns. Use Standard Ammunition
Pocket Automatic



\$6.75

For dependable construction and smoothness of action this 7-shot 25-cal. automatic cannot be beat \$6.75

WATTS TRADING CO.

11 Warren St., Dept. 651, New York City

\$1

Postpaid with Instructions

SEND FOR YOUR FREE COPY

TESTED HOOK-UPS

SUBMITTED BY USERS OF OUR
WONDERFUL TRANSMITTER
BUTTON FOR LOUD SPEAKERS
AMPLIFICATION EXPERIMENTS

K. ELECTRIC CO.
15 PARK ROW NEW YORK

Dr. Hackensaw's Secrets
(Continued from page 1055)

see this eight months old baby attempting to smoke a cigarette, or sucking a cocktail from her milk-bottle. One day she asked to see her children and grand-children, wishing to be held by each in turn, and she took a malicious pleasure in striking them and scratching their faces, to make up for the many times they had done the same to her when they were babies.

And still she grew younger. Doctor Hackensaw would spend hours pacing the floor, with this baby widow in his arms, reading her the newspaper or passages from Milton's "Paradise Lost." Meanwhile his powerful brain was striving hard to devise some means to check the fatal catastrophe that seemed about to terminate the experiment which had begun so favorably.

THE LAST MEASURE

When the baby was only five days old, Doctor Hackensaw prepared a baby incubator, and by the time she was minus one day old she was duly installed in her new dwelling. Her rate of rejuvenation had now decreased and she went back through the prenatal stages at about the same rate as she had originally come through them eighty-five years previously. When the foetus was about seven months old, Doctor Hackensaw transferred it to a glass jar full of a suitable culture-fluid, and watched with growing anxiety as she reverted to the tadpole stage, with a well developed tail and gill-slits. It was evident that Mrs. Young would soon be nothing more than the original egg-cell from which she had started. And then what would happen? Would she vanish into nothingness?

Doctor Hackensaw determined on one final effort. He had carefully preserved the few drops of blood he had originally taken from the lady's arm. The foetus was now so minute it could only contain a relatively small number of the microbes of youth. The doctor resolved to risk everything in one final attempt. By the use of an anaesthetic, he endeavored to stop the activities of the microbes, and then introduced into the foetus the drops of blood he had preserved. And then he waited. Anxiously he watched. To his joy he saw that the process of growing younger had ceased. Two, three days passed, and then the foetus began to grow again in the normal manner. Nine months later Mrs. Young was a normal baby again, but her rate of growth now was that of an ordinary child, and she was obliged to pass through all the phases of childhood and youth and finally, at the age of twenty—or, rather, when one hundred five years old—married James Trimble, the grandson of the man to whom she had been originally engaged.

But Dr. Hackensaw gave up his search for the secret of perpetual youth. Of course, to a scientist, it would be a great advantage to remain alive and young for a thousand years or more.

On the other hand, think what a disadvantage it would be to the human race, if all men had an indefinite tenure of life. Progress would be greatly checked; for old ideas and habits are difficult to eradicate. It is the new generations, freed from the prejudices of their parents, that carry the race forward.

Then, too, the physical and mental powers of the race would remain stationary. It is by the survival of the fittest in the past ages, that man has obtained his wonderful intellectual powers, and it is only by the survival of the fittest in coming generations that he can hope to increase them.



Super-service

Wide-awake radio fans refuse to miss a good program because of storage battery weakness. For super-service they keep the battery fully charged from the house current with a Tungar. Likewise they use Tungar to charge the auto battery at home. The result is longer battery life and more "pep"—plus convenience.

In homes with electricity Tungar recharges the run-down radio or auto battery over night at a saving.

Sold by Electrical, Auto-accessory and Radio dealers.



The home completely wired is ready for every convenience and comfort that Electricity can furnish.

The book — "The Home of a Hundred Comforts" tells how to plan for a completely wired home. Thousands have sent for it. Write for your free copy.

Address Section SV 2
Merchandise Department
General Electric Company
Bridgeport, Conn.



Tungar
BATTERY CHARGER

Tungar operates on alternating current. Two sizes \$18.00 and \$28.00 (60 cycle). Prices east of the Rockies.

GENERAL ELECTRIC

48-2

CATALOG E19-100 PAGES FREE

EVERYTHING IN RADIO
One of the largest complete stocks in the world. 40 diagrams of latest Hookups.
DEALERS ALL OVER THE U. S.
Making big profits handling our supplies. 24-hour service. Goods shipped same day order received.



WHOLESALE RADIO DISTRIBUTORS
Dept. F. 107 E. 13th St. Kansas City, Mo.

IMPROVED GROUND CLAMP

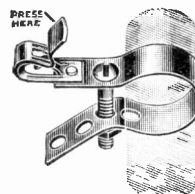

Equipped with Fahnestock Patent Wire Connectors Easily Attached

No Soldering—For Radio Use Only
AT YOUR DEALERS.

FAHNESTOCK ELEC. CO.
Long Island City, N. Y.

Insure your copy reaching you each month. Subscribe to Science and Invention—\$2.50 a year. Experimenter Publishing Co., 53 Park Place, N. Y. C.

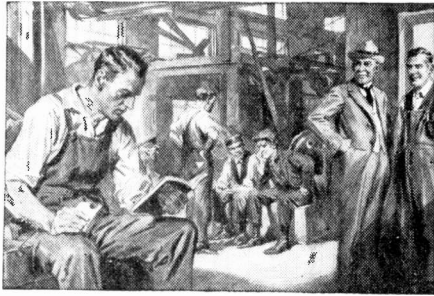

"There's One Man We're Going to Keep"

"Ed Wilson, there, is one of the most ambitious men in the plant. I notice that he never fools away his spare time. He studies his International Correspondence Schools course every chance he gets.

"It's been the making of him, too. He hasn't been here nearly so long as Tom Downey, who was laid off yesterday, but he knows ten times as much about this business.

"I'm going to give him Tom's job at a raise in salary. He's the kind of man we want around here."

How do you stand in your shop or office? Are you an Ed Wilson or a Tom Downey? Are you going up? Or down?

No matter where you live, the International Correspondence Schools will come to you. No matter what your handicaps or how small your means, we have a plan to meet your circumstances. No matter how limited your previous education, the simply-written, wonderfully-illustrated I. C. S. textbooks make it easy to learn.

This is all we ask: Without cost, without obligating yourself in any way, put it up to us to prove how we can help you. Just mark and mail this coupon.

INTERNATIONAL CORRESPONDENCE SCHOOLS

Box 6223-C, Scranton, Penna.

Without cost or obligation on my part, please tell me how I can qualify for the position or in the subject before which I have marked an X:

BUSINESS TRAINING COURSES

- | | |
|---|---|
| <input type="checkbox"/> Business Management | <input type="checkbox"/> Salesmanship |
| <input type="checkbox"/> Industrial Management | <input type="checkbox"/> Advertising |
| <input type="checkbox"/> Personnel Organization | <input type="checkbox"/> Better Letters |
| <input type="checkbox"/> Traffic Management | <input type="checkbox"/> Show Card Lettering |
| <input type="checkbox"/> Business Law | <input type="checkbox"/> Stenography and Typing |
| <input type="checkbox"/> Banking and Banking Law | <input type="checkbox"/> Business English |
| <input type="checkbox"/> Accountancy (including C.P.A.) | <input type="checkbox"/> Civil Service |
| <input type="checkbox"/> Nicholson Cost Accounting | <input type="checkbox"/> Railway Mail Clerk |
| <input type="checkbox"/> Bookkeeping | <input type="checkbox"/> Common School Subjects |
| <input type="checkbox"/> Private Secretary | <input type="checkbox"/> High School Subjects |
| <input type="checkbox"/> Spanish | <input type="checkbox"/> French |
| <input type="checkbox"/> | <input type="checkbox"/> Illustrating |

TECHNICAL AND INDUSTRIAL COURSES

- | | |
|---|--|
| <input type="checkbox"/> Electrical Engineering | <input type="checkbox"/> Architect |
| <input type="checkbox"/> Electric Lighting | <input type="checkbox"/> Blue Print Reading |
| <input type="checkbox"/> Mechanical Engineer | <input type="checkbox"/> Contractor and Builder |
| <input type="checkbox"/> Mechanical Draftsman | <input type="checkbox"/> Architectural Draftsman |
| <input type="checkbox"/> Machine Shop Practice | <input type="checkbox"/> Concrete Builder |
| <input type="checkbox"/> Railroad Positions | <input type="checkbox"/> Structural Engineer |
| <input type="checkbox"/> Gas Engine Operating | <input type="checkbox"/> Chemistry |
| <input type="checkbox"/> Civil Engineer | <input type="checkbox"/> Pharmacy |
| <input type="checkbox"/> Surveying and Mapping | <input type="checkbox"/> Automobile Work |
| <input type="checkbox"/> Metallurgy | <input type="checkbox"/> Airplane Engines |
| <input type="checkbox"/> Steam Engineering | <input type="checkbox"/> Agriculture and Poultry |
| <input type="checkbox"/> | <input type="checkbox"/> Mathematics |

Name.....
 Street.....
 Address.....
 City..... State.....

Occupation.....
 Persons residing in Canada should send this coupon to the International Correspondence Schools Canadian, Limited, Montreal, Canada

EARN MONEY AT HOME

YOU can make \$15 to \$60 weekly in your spare time writing show cards. No canvassing or soliciting. We instruct you by our new simple Directograph System, supply you with work and pay you cash each week. Write today for full particulars and free booklet.

WEST-ANGUS SHOW CARD SERVICE LIMITED
 Authorized Capital \$1,250,000.00
 67 Colborne Building, Toronto, Can.

Learn to Write

Begin Today—Write for My FREE BOOK. I can make a good penman of you at home during spare time. Write for my FREE BOOK, "How To Become a Good Penman." It contains specimens and tells how others mastered penmanship by the Tamblin System. Your name will be elegantly written on a card if you enclose stamp to pay postage. Write today for book.

F.W. TAMBLIN, 424 Ridge Bldg., Kansas City, U.S.A.

Motor Hints

Carburetion and Carburetor Adjustments

By **TOM C. PLUMRIDGE**
 Automotive Expert

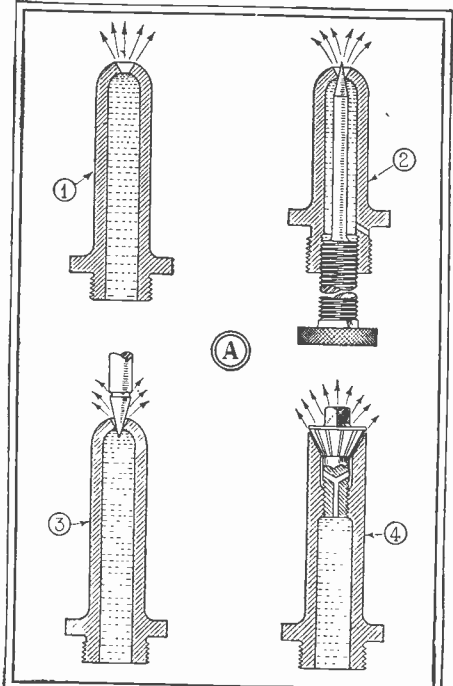

The basis of good operation in an automotive engine is good compression. The basis of economical operation of the same engine is, however, dependent upon good carburetion. One of the most important parts of the carburetor is the spray, or jet that throws the gasoline out into the current of air. Above is illustrated four principal types of jets. At 1 is the plain type which consists of a hollow tube with an aperture at the top. At 2 is a more efficient variety. The internal needle screws up into the hole forcing the gasoline into a better spray. The same principle is used in the spray at 3. The needle fits onto the top instead of beneath the hole. At 4 is the cone type, where a cone is substituted for a needle.

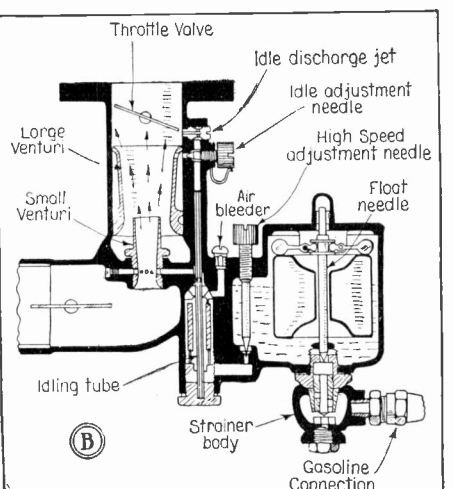

To help vaporization, and suck out the gas from the jet and to thoroughly mix the gas and air, a venturi, or choke tube is used. It is of peculiar shape and formed so that there is a greater velocity of air through the carburetor without restriction. Sketch "B". The air passes through the venturi in a whirling motion which sucks the gasoline from the jet, a small vacuum is formed in the middle of the tube and the gasoline entering this is thoroughly vaporized. The sides of the tube are heated and the gasoline particles that fall on them are vaporized so that all particles are used providing the gasoline is supplied in the correct quantity. The Stromberg carburetor is one that is widely used. This make of carburetor has two adjustments on some models and on others it has three. They are high speed, low speed or idling jet, and the economizer. Sketch "B" shows very plainly the flow of gasoline through the carburetor, and also shows the different positions of the adjustments.



The Improved MIRACO GETS 'EM FROM COASTS TO COASTS

Clearly and distinctly, too! For our users tell us that Cincinnati hears Frisco, Denver hears Schenectady, New York hears Havana! Scores of long distance records were made on these instruments last year so with the many new refinements incorporated the result obtained now will be far better than ever.

HIGHEST QUALITY AT LOWEST PRICE

This has always been the MIRACO key-note and the thousands of sets now in use are a fitting tribute to MIRACO'S excellent performance. Many new improvements, such as new sockets resting on shock-absorbing pads—a refinement found only in the most expensive sets—rheostats with multiple resistance windings, making it possible to use either dry cell or storage battery tubes, and a new aluminum shield that prevents annoying body capacity effects, are embodied.

Cabinet is of solid mahogany—workmanship the finest—operation extremely simple yet always dependable.

2 tube outfit shown above\$29.50
1 tube outfit 18.50
4 tube outfit shown below 54.50

Write for our new bulletin today.

DEALERS—JOBBERS
 Write for our proposition quickly.
AGENTS!
 There's still some territory open—write or wire.

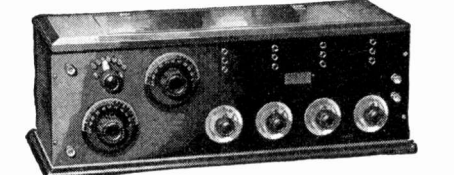

THE MIDWEST RADIO COMPANY,
 809 Main Street, Cincinnati, Ohio.

EDSON

Tone Tested
Radio Headsets

\$3 POST PAID

2000 OR 3000 OHMS

THE lowest-priced first quality headset on the market today. Compare with headsets costing twice our price. Return ours if not satisfied. Our written guarantee protects you. Send \$3 by registered mail or money order. Buy direct of us and save the difference. We ship, postage prepaid, same day order is received. Ask for our

Free Catalog of Radio Parts

EDSON RADIO SALES COMPANY
 4 Elmwood Providence, R. I.

SAVE ON RADIO

Stop paying exorbitant prices for radio apparatus. We can supply you any standard parts at greatly reduced prices.

WD11 TUBES, SPECIAL PRICE.....	\$5.75
UV 201A AND C301 A TUBES.....	\$5.75
BRANDES SUPERIOR PHONES.....	\$4.95
22½ VOLT B BATTERY.....	\$1.30

You can save money on the latest and best in radio at our rock-bottom prices. Orders shipped same day received, C. O. D., under absolute money-back guarantee.

We pay postage on orders accompanied by check.

FREE Write today for our Price-slashing bargain list. **STANDARD RADIO CO.**
 1237 Walnut St., Kansas City, Mo.

1.25 By MAIL

QUESTIONS and ANSWERS

Electricians' Examinations
 Diagrams, symbols, tables, notes and formulas for preparation for license.

READE PUB. CO.
 296 Broadway, N. Y. City

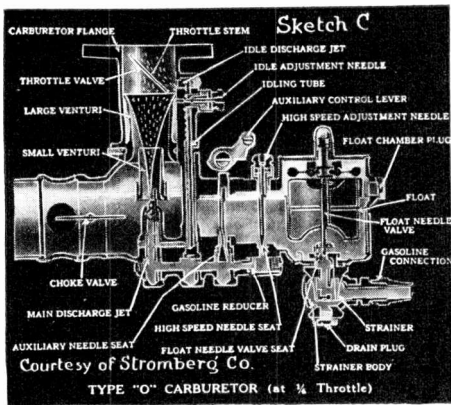

If this sketch is compared with sketch "B" it will be noticed that there is a little different arrangement in sketch "B". The small venturi acts as a jet, but in sketch "C" a jet is used. If the venturi is enlarged in size the amount of air is also increased. The size of the venturi is determined at the factory and should never be changed. Before any attempt be made at adjustment the engine should be run until thoroughly warmed up to normal operating temperature. Although there are several different models of this make of carburetor they are all adjusted in the same manner.

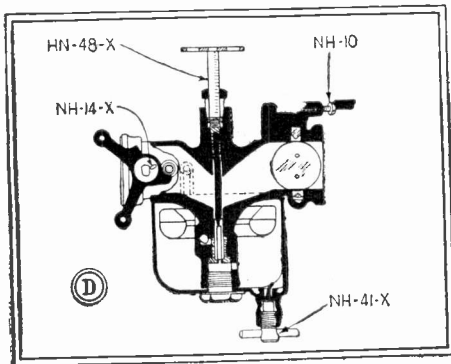

The Holley carburetor is the kind that is fitted to Ford cars and is of the external needle type, and is one of the easiest to make adjustments on. Referring to sketch "D," the adjustment needle HN 48 X is the only adjustment as far as gasoline regulation is concerned, and the adjustment is made as follows: After the engine has thoroughly warmed up set the ignition lever a little below half advance and the throttle slightly open, screw in the adjustment HN 48 X, until the engine starts to slow down or miss fire, then screw out until the engine runs evenly.

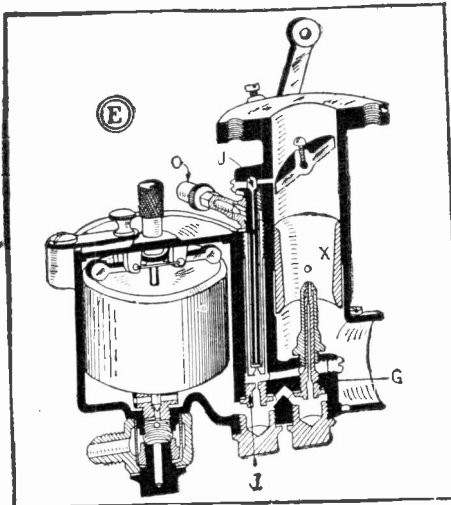

The Zenith carburetor is one that has one adjustment; this is the slow speed or idling adjustment. Referring to sketch "E," after the engine has warmed up, the idling adjustment is made by screwing in the screw O to give less air, and outward to give more air. This screw controls the suction in the idling tube J, through which the gasoline is drawn when the engine is running at idling speed. The sizes of the choke tube X, the compensator I, and the main jet G, are determined at the factory and should not be altered.

(Continued on page 1065)

Metering pin carrier

By comparing sketch "H," the Stewart Carburetor, with the other illustrations the absence of needle valves and adjustments will be noticed. The operation of this type of carburetor is very interesting. The flow of gasoline into the float bowl is controlled in the usual way, but the operation of the carburetor is very different. When the suction comes there is a vacuum formed in the mixing chamber which causes the metering valve to lift from its seat and air is admitted in exactly the right proportion to the gasoline which is drawn up through the aspirating tube. There is only one adjustment which raises or lowers the tapered metering pin, and thereby increases or decreases the amount of gasoline supplied through the aspirating tube. This adjustment can be operated from the dash board at the will of the operator.

Reduce Tubes by Half With Erla Synchronizing Transformers

Vacuum Tubes
in ERLA Duo
Reflex Circuits

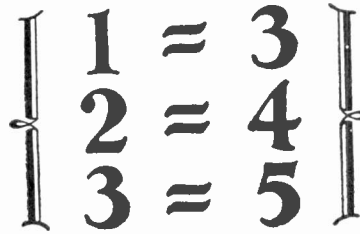

Vacuum Tubes
as Ordinarily
Employed —

Nation Wide Loud Speaker Reception With Only Three Tubes

Greater range and volume with fewer tubes than ever before are attained through Erla Duo-Reflex circuits, using Erla synchronizing radio and audio transformers.

In Erla circuits, tubes do triple duty, as simultaneous amplifiers of received radio frequency, reflexed radio frequency, and reflexed audio frequency currents. Through accurate superimposition of currents identical in phase and frequency, by means of Erla synchronizing transformers, this triple function is flawlessly performed, resulting in tremendously magnified amplification without distortion.

Even one tube provides excellent loud speaker reception over a wide range; two tubes blanket the zone ordinarily covered by four; while three tubes bring in stations on the loud speaker from coast to coast.

Other notable improvements, contributing vitally to the superiority of Duo-Reflex circuits, are the Erla fixed crystal rectifier and Erla tested capacity condensers. Combining advanced characteristics for reflex work with unduplicated uniformity, they are indispensable to complete stability and purity of reproduction.

Detailed diagrams and descriptions of Erla Duo-Reflex circuits are presented in Erla Bulletin No. 16. Ask your dealer, or write, giving your dealer's name.



Increased amplification and elimination of distortion inevitably follow installation of Erla transformers. Reflex and cascade types. \$5



Erla audio transformers add tremendously to the purity and volume of any receiving unit in which they are used. Ratios 3 1/2 and 6 to 1. \$5



Crystal troubles vanish on installing an Erla rectifier. No adjustment required. Proof against jolt and jar. Lasts indefinitely. List \$1

Jobbers—Sweeping success of Erla circuits fosters continually increasing demand for Erla products. Write for terms and discounts.

Electrical Research Laboratories
Dept. S 2515 Michigan Avenue, Chicago

ERLA

The Real Metal Solder in Paste Form

SOLDERALL

Introducing Our New
SOLDERALL BLOW TORCH
of Heavy Solid Brass

Indispensable in the Home, Garage and to the Electrician. For Soldering Radio, House Wiring, Jewelry, Ignition, Kitchen Utensils, Etc.

IMPROVED \$1.25
BRASS TORCH

SOLDERALL TUBE 25¢

SOLDERALL CO. Dept. S Newark, N.J.

RUSONITE

RADIO CRYSTAL

Entire Surface Sensitive
The Recognized Standard Crystal Rectifier
Used all Over The World

Hundreds of Thousands of Satisfied Users. Rusonite Has Revolutionized Crystal Radio Reception.

"THE PERFECT SYNTHETIC CRYSTAL"
Guaranteed
Price mounted 50¢
RUSONITE CATWHISKER 14K. GOLD
Supersensitive; will not oxidize
Price 25¢

Order from your dealer or direct from
Rusonite Products Corporation
15 Park Row, New York, N. Y.

WANTED

Railway Mail Clerks

\$1600 to \$2300 Year

MEN—BOYS 18 Up

Mail Coupon Immediately

Steady work. No layoffs. Paid vacations.
Common education sufficient.
Travel—See your country.



Franklin Institute, Dept. F-183, Rochester, N. Y.
Sirs: Send me without charge, (1) Sample Railway Postal Clerk Examination questions. (2) List of Government jobs now obtainable. (3) Send free illustrated book, "How to Get Government Jobs."

Name

Address

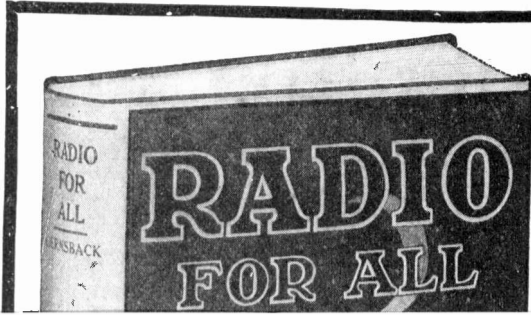

RADIO FOR ALL

By H. GERNSBACK

Editor "Radio News," "Science and Invention" and "Practical Electrics"

With over 130 illustrations and diagrams, and 12 photographs, 300 pages, size 8 1/4" x 5 1/2".

What the novice in radio needs is a book in which he can get all the information necessary for him to understand radio telephony and telegraphy, to make or buy a receiving set suitable to his means, to know how to operate his set, and after he has an understanding of the radio art, information that will enable him to understand

Get the Consrad Cloth Radio Map of the U. S.

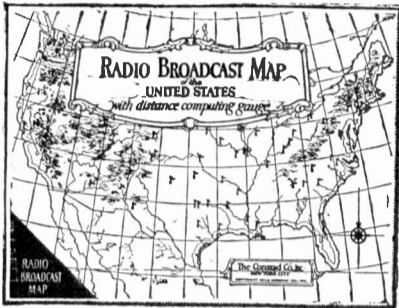

The Consrad Radio Map is different from all other maps in that it is printed on CLOTH and with proper care will last a lifetime.

The Map measures 17x22" and contains a special distance computing gauge of our own design which enables one to find any broad-casting station at a moment's glance.

A measuring rule is also furnished to help find the distance from any point in the United States to the station which is being received.

The broad-casting stations are contained on a separate sheet which can be fastened to the map by ordinary paper fasteners. The list is up to date and contains the new wave lengths.

The map is furnished in two colors and with the sheet of broad-casting stations, is enclosed in a two color heavy manilla envelope 9 1/2 x 12".

Consrad Pattern No. 9. How to Make the ST100 Receiver

The S. T. 100 receiver employing a circuit devised by John Scott-Taggart of London, has proven to be one of the most efficient sets of reflex variety for broad-casting reception.

While only two tubes, a crystal detector are used, the energy amplified of incoming signals is powerful enough to operate any type of loud speaker without additional amplification.

The quality of reception will astonish those who are familiar with the performance of other circuits.

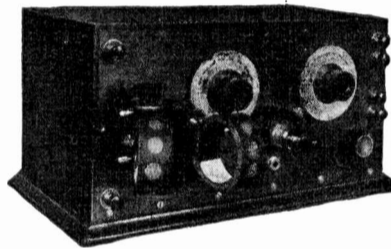

Another important feature is that the set tunes sharply, which is one of the utmost requisites of an ideal receiver.

The packet consists of blue prints for drilling the panel, wiring the apparatus, and a four-page instruction pamphlet giving complete details as to the parts required, tools needed, and even how to tune.

All these are contained in a two color heavy manilla envelope, 9 1/2 x 12".

50c.

\$1.25 Here is Your Chance to Learn All You Can About RADIO The \$10.00 "Radio Reading Course" Special at \$1.25

All the technical details and a thorough explanation of radio reception, written in easily understood, non-technical language by a foremost radio engineer and inventor. The five Lecture Books with over 100 graphic drawings give you the knowledge to intelligently buy, design, build, operate and maintain radio receiving apparatus. Tells you how to locate and correct troubles, how to make your

apparatus more efficient and gives you a thorough knowledge of radio science. This set of five handsome Lecture Books are a complete radio library. To own them is like having a trained engineer or instructor at your side, answering questions, pointing the way. No matter what your interest in radio, take advantage of this attractive special offer and be the owner of this fine set of books.

This set can be gotten at your dealers or direct from us on receipt of \$1.25. If you prefer we will send it C.O.D. and you can pay the postman on receipt.



The Consrad "Making Your Own" series consists of plans for the construction of the most popular radio circuits and are gotten up so that anyone can construct a receiving set as easily as a woman can sew the simplest dress. Blue prints are furnished for drilling the panels and wiring the parts and a four-page pamphlet contains complete instruction even as to tuning. Each pattern is contained in a two colored heavy manilla envelope 9 1/2 x 12" and sells at **50c.**



The Titles in this Series:

- No. 1 How to Make a Short Wave Regenerative Receiver.....50c
- 2 How to Make Detector and Amplifier Units50c
- 3 How to Make a Radiophone Crystal Set50c
- 4 How to Make a Reinartz Receiver50c
- 5 How to Make a Reflex Receiver50c
- 6 How to Make a Cockaday Receiver50c
- 7 How to Make a Neutrodyne Receiver50c
- 8 How to Make an Autoplex Receiver50c
- Packet B 20 Radiophone Diagrams with Supplements.....50c
- C 14 Radio Formulae and Diagrams50c
- D All About Aerials and Their Construction50c

On Sale at All Reliable Radio Dealers or Direct from us.

THE CONSRAD CO. Publishers and Sales Agents 233 Fulton St., N. Y. C.



Two New E. I. Books for the Radio Fan

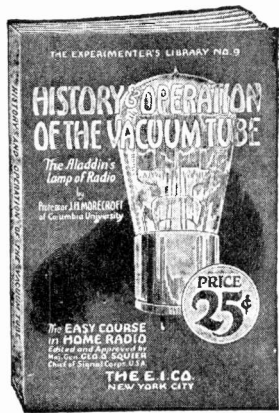

History and Operation of the Vacuum Tube

By PROF. J. H. MORECROFT

Associate Professor of Electrical Engineering, Columbia University

Edited and Approved by

MAJOR GENERAL GEO. O. SQUIER, Chief of the Signal Corps, U. S. A.

This book serves an interesting study of the fundamental principles, historical evolution, and practical application of the vacuum tube as used in radio apparatus of every description. Since the vacuum tube is one of the most important parts in the modern radio set, and has been largely responsible for making present-day radio entertainment possible, this book has been entirely devoted to the subject of that one particular instrument. It is written in simple everyday language with all technical terms thoroughly explained so as to make matters easily understood by everyone.

The book contains chapters on the phenomena of vacuum tubes in general; the operation of vacuum tubes as detectors and amplifiers; and the junction of the vacuum tube used in various transmitting and receiving circuits, etc., etc.

52 pages printed in legible type; 24 illustrations and diagrams; bound in two-color cover; size 5½ x 7½ inches; Price, 25c.

All About Radio Parts

By THOMAS W. BENSON

This book gives an extensive description of the various parts used in all types of receivers, especially explaining the features of certain apparatus and circuits. It also describes why the different parts are used and how they operate. There has been nothing overlooked.

To begin with, the book tells how radio waves are collected by means of an aerial, giving details of construction of different types and their advantages. Then detection is explained and various types of crystal and vacuum tube detectors described. Amplification, including regeneration, radio and audio frequency, is simply told.

This very instructive book will prove to be of great value in the hands of anyone interested in radio as it is very explicit and thorough.

Contains 52 pages, 36 illustrations and diagrams; bound in a two-color cover—size 5½ x 7½ inches. Price, 25c.

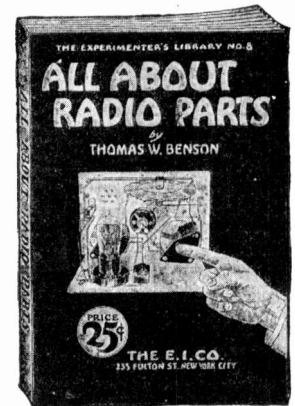

Other Books in the "Experimenters' Library"



No. 2—How to Make a Radiophone Receiving Set.....25c

No. 3—Radio Questions Answered.....25c

No. 4—Radio Frequency Amplifiers.....25c

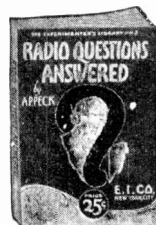

No. 5—Loud Talkers and How to Build Them.....25c

No. 6—How to Tune Your Radio Set.....25c

No. 7—100 Radio Hook-Ups.....25c

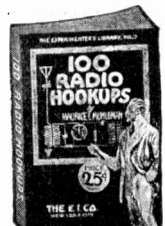
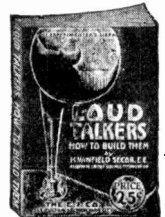
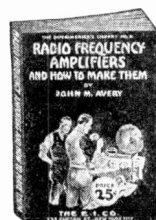

The "Experimenters' Library" is being increased at the rate of at least one new title each month. Every book is written by an authority and in language easily understood by everybody.

On Sale by All Reliable Radio Dealers

The E. I. Company (The Consrad Co., Selling Agents) 233 Fulton St., N. Y. C.

Opportunity Ad-lets

YOU will find many remarkable opportunities and real bargains in these columns. It will pay you to read and investigate the offerings made every month by reliable firms, dealers and amateurs from all over the country. No matter what you may be seeking, whether supplies, automobile accessories, the opportunity to make money, or anything else, you will find listed here the best and most attractive specials of the month.

Advertisements in this section twelve cents a word for each insertion. Name and address must be included at the above rate. Cash should accompany all classified advertisements unless placed by an accredited advertising agency. No advertisement for less than 10 words accepted.

Ten per cent. discount for 6 issues, 20 per cent. discount for 12 issues. Objectionable or misleading advertisements not accepted. Advertisements for the April issue must reach us not later than February 15.

The Circulation of Science and Invention is over 160,000 and climbing every month

EXPERIMENTER PUBLISHING CO., INC., 53 Park Place, New York City, N. Y.

Agents Wanted

Agents—Best seller; Jem Rubber Repair for tires and tubes; supersedes vulcanization at a saving of over 800 per cent; put it on cold. It vulcanizes itself in two minutes, and is guaranteed to last the life of the tire or tube; sells to every auto owner and accessory dealer. For particulars how to make big money and free sample, address Amazon Rubber Co., Dept. 601, Philadelphia, Pa.

Big money and fast sales. Every owner buys gold initials for his auto. You charge \$1.50; make \$1.35. Ten orders daily easy. Write for particulars and free samples. American Monogram Co., Dept. 71, East Orange, N. J.

Make \$25 to \$50 week representing Clows' Famous Philadelphia Hosiery, direct from mill—for men, women, children. Every pair guaranteed. Prices that win. Free book "How to Start" tells the story. George Clows Company, Desk 27, Philadelphia, Pa.

Wonderful Invention—Eliminates all needles for phonographs. Saves time and annoyance. Preserves records. Lasts for years. 12,000,000 prospects. \$15.00 daily. Free sample to workers. Everplay, Desk 27, McClurg Bldg., Chicago.

We want Salesmen and Agents, either whole or side line, to sell our low priced radio books to the trade. Excellent proposition for live wires. The E. I. Company, Publishers, 233 Fulton Street, New York City.

Write and learn how to start profitable business without capital or experience. Silvering mirrors, refinishing auto headlights, tableware, plating. Outfit furnished. International Laboratories, Dept. 25, 369 Fifth Ave., New York.

Earn big money fast applying gold initials to autos. Every owner buys—\$1.35 profit on \$1.50 sale—particulars and samples free. Write quick. Lithogram Co., Dept. 19, East Orange, N. J.

Only one sale a day means \$200 per month! Five sales, \$1,000 per month! Marvelous new adding machine. Retail \$15. Work equals \$350 machine. Adds, subtracts, multiplies, divides automatically. Speedy, accurate, durable, handsome. Five-year guarantee. Offices, stores, factories, garages, buy one to dozen. A fortune for live agents. Write quick for protected territory and free trial offer. Lightning Calculator Co., Dept. W., Grand Rapids, Mich.

\$60—\$200 a week. Genuine Gold Letters for store windows. Easily applied. Free samples. Liberal offer to general agents. Metallic Letter Co., 441 B, North Clark, Chicago.

Agents—\$15 a day—Easy, quick sales—Free Auto—Big weekly bonus—\$1.50 premium free to every customer. Simply show our Beautiful, 7-piece, Solid Aluminum Handle Cutlery Set. Agents instantly. Free delivery and collect. Pay daily. New Era Mfg Co., 803 Madison St., Dept. 88H, Chicago.

Agents—Big returns, fast office seller; particulars and samples free. One Dip Pen Co., 12 Daily Record Bldg., Baltimore, Md.

Rummage Sales make \$50.00 daily. We start you. Representatives wanted everywhere. Wholesale Distributors, Dept. 32, 609 Division Street, Chicago.

Earn \$10 daily silvering mirrors, plating and refinishing metalware, chandeliers, bedsteads, headlights. Outfits furnished. N. Dele Laboratories, 1133 Broadway, New York.

Agents—Our soap and toilet article plan is a wonder; get our free sample case offer. Ho-Ro-Co., 2719 Dodder, St. Louis.

We start you without a dollar. Soaps, Extracts, Perfumes, Toilet Goods. Experience unnecessary. Carnation Co., Dept. 232, St. Louis.

Greatest Article produced; nine out of ten women will buy on sight. Particulars free. Reliable Sales Co., Dept. S1, 868 East 172d St., New York.

Agents—Make \$10 to \$20 daily selling the famous Nerv-Ease Foot Comforts. Big demand. Ever 100 per cent profit. Write today. Manhattan Products Co., 2520 E. Bailey Ave., New York.

Sell Tailoring—the quickest selling, most profitable line in the selling field. Our one-price line shows more than 100 All-Weather fabrics for tailored-to-measure suits and topsuits all at one amazing low price. Every order pays you good profit, cash in hand. Tailoring experience not necessary. We furnish handomest selling outfit and most effective selling helps. Write at once. Address Dept. 760, Goodwear Chicago, Inc., 844 W. Adams St., Chicago.

Two-in-One-Line. Something new for Tailoring or Raincoat agents. Great for men who have been waiting to break into this profitable business. Union made-to-measure suits or overcoats at \$23.50. Raincoats \$39.5. A money maker from start to finish. Big repeater. Satisfied customers guaranteed. Real sales help. Offer will soon be withdrawn. Agency equipments are limited. Get in line for one of our \$100.00 a week jobs. Elliott Bradley, Inc., 1028 W. VanBuren, Dept. A26, Chicago.

Agents Wanted—(Continued)

Men's Shirts. Easy to sell. Big demand everywhere. Make \$15.00 daily. Undersell stores. Complete line. Exclusive patterns. Free Samples. Chicago Shirt Manufacturers, 241 W. VanBuren, Factory 212, Chicago.

Agents—Sodereze; we are paying \$2 an hour taking orders for this best invention; send for free outfit and samples. American Products Co., 1827 American Bldg., Cincinnati, Ohio.

New Wonderful Seller. Over 100 per cent profit on every sale of Harper's Ten-Use Set. Needed in every home. Washes and dries windows, sweeps, scrubs, mops, etc. Greatest year 'round seller. Write Harper Brush Works, 152—2nd St., Fairfield, Iowa.

Rug Salesmen—Get next to the biggest seller of the year—Loomrite Felt Rugs. Sell at slight at \$2.50, cost \$15 dozen. Big, complete Rug Catalog, Free. Malsley-Payne Mfg. Co., 104-S Hanover St., Boston, Mass.

Agents sell Wolverine Laundry Soap. Wonderful repeater and good profit maker. Free Auto to hustlers. Wolverine Soap Co., Dept. B46, Grand Rapids, Mich.

Formulas, Processes, Trade-Secrets—Different, dependable, profitable. Catalog free. D. Thaxly Co., Washington, D.C.

\$10 daily silvering mirrors, plating and refinishing lamps, reflectors, autos, beds, chandeliers by new method. Outfits furnished. Write Gunmetal Co., Ave. D, Deatur, Ill.

Use our handsome Catalog; get orders from every home for Dr. Blair's famous home products. Liberal pay. Dr. Blair Laboratories, Dept. 535, Lynchburg, Va.

American Made Toys

Manufacturers on large scale, also homeworers, wanted to manufacture Metal Toys and Novelties, Barking Dogs, Wag-Tail Pups, Wild Animals, Automobiles, Indians, Cow-Boys, Baseball Players, Cannons, Toy Soldiers, Crowding Roosters, Statues of Liberty, Miniature castings of Capital, Bathing Girl Souvenirs and others. Unlimited possibilities. Guaranteed Casting forms furnished manufacturers from \$5.00 up, with complete outfit. No experience or machinery necessary. Hundreds made complete per hour. We buy goods all year and pay high prices for finished goods. Cash on Delivery. Contract orders placed with manufacturers. Enormous business waiting to be taken care of in 1924. Catalog and information free. Correspondence invited only if you mean business. Metal Cast Products Co., 1696 Boston Rd., New York. Established since 1912.

Automobiles

Automobile owners, garagemen, mechanics, send for free copy America's popular motor magazine. Contains helpful, money-saving articles on repairing, overhauling, ignition, carburetors, batteries, etc. Automobile Digest, 541 Butler Bldg., Cincinnati.

Build It Yourself—A Real Automobile that any handy man or boy can build. A low-slung, speedy cycle car. Power supplied by famous 2½ H.P. Shaw Motor. Send stamp today for Descriptive Circulars or send 25c for Complete Book of Easy-To-Follow Plans. Shaw Mfg. Co., Dept. S1-1, Galesburg, Kansas.

Battle Photos and War Relics

For Dens: Relics Collected from Europe's Battlefields. Firearms, medals, helmets, etc. Illustrated catalogue and sample War Photographs 25c. Lieut. Welch, 2117 Regent Place, Brooklyn, N. Y.

Farms, Land, Etc.

Buy these Bargains by Mail. \$73 for 12 acres, choice lake frontage. \$75 for 25 acres trout stream-accessible. \$97 for 50 acres beautifully wooded-shooting. \$378 for 160 acres sunny Alberta. \$105 for 50 acres hunting camp site. \$19 for small acreage, Georgian Bay. \$125 for good acreage, big game district. \$215 for large acreage hunting camp site. \$285 for mining claim, may be worth a million. Also beautifully situated hunting camps and fishing lodges; where there is real hunting and fishing. Summer cottage sites, islands of all sizes, heavily wooded acreages situated in Muskoka, Georgian Bay District, with its ten thousand islands, Algonquin Park with its 300 lakes, Highlands of Ontario, Lake of Bays and the famous Muskoka Lakes region. All offered at ten cents on the dollar of their value, and on easy monthly payments of \$5.00 and upwards. Send for illustrated list of the above and one hundred other properties seized and sold for taxes. If you are interested in the forthcoming boom in Canadian Gold and Silver Mines, and would like a mine all your own for two or three hundred dollars, send for list 240A. Every property is fully described and offered at a stated price. Send no money. Send for list today, so you will have first chance. If you wish you may make your payments to your local trust company. Tax Sale Service, 72 Queen Street, West, District 24, Toronto, Ontario, Canada.

Books

Free—Upon request will send you my literature illustrating the following books. Astrology, Character, Clairvoyance, Concentration, Healing, Hypnotism, Magnetism, Mediumship, Personal Magnetism, Personality, Physiognomy, Salesmanship, Seership, Success, Sex, Will, Yogi Philosophy, Gazing Crystals, etc. A. W. Martens, E. E. 6, Burlington, Iowa.

"Lights, Colors, Tones and Nature's Finer Forces," including Vibrations; Odic-Auras; Electro-Magnetism, Gold-Lights; Radio; Coming Inventions, 270 pages. Satisfaction Guaranteed; \$2.00, Circulars Free. Stevens Research Laboratories, 242 Powell Street, San Francisco, Calif.

Perpetual Motion, by Percy Verance. A history of the efforts to discover same from earliest days to the present, together with a scientific discussion regarding the possibility of its ultimate achievement. Profusely illustrated, 357 pages. Price postpaid, \$2.00. The Enlightenment Specialty Co., 305 Fourth St., Edwardsville, Ill.

Diseases and Their Innate Healer. Book 50 cents. Arthur Stevens, Wausau, O.

Hypnotism Astounds, controls. Wants gratified. 25 easy Lessons \$2.75. "Mindreading" (Any distance) Wonderful. Genuine. Guaranteed \$2.75. "Book of Wonders, Mysteries and Disclosures" \$20.00 worth for \$2.00. All three \$5.00. Catalogs free. Science Institute, 8V111-Belmont, Chicago.

Sleep Quickly Produced, Self or others. Infallible. Priceless. Guaranteed \$1.10. "How to Live Right" 10c. "Way to Win" 10c. Prof. Deprado, 8V357 Oak, Chicago.

1,000,000 Industrial Facts, Calculations, Receipts, and Trade Secrets for every Mechanic. Moore's Universal Assistant and Complete Mechanic, 1016 pages, 500 Engravings, cloth, \$2.00 postpaid. Henry S. Collins Co., 197 Fulton Street, Brooklyn, N. Y.

Business Opportunities

You can have a business-profession of your own and earn big income in service fees. A new system of foot correction: readily learned by anyone at home in a few weeks. Easy terms for training, openings everywhere with all the trade you can attend to. No capital required or goods to buy, no agency or soliciting. Address Stephenson Laboratory, 18 Back Bay, Boston, Mass.

Stop Plodding! Be Successful. Operate a Tire Repair Shop. Make big profits in any locality. We teach you and furnish complete equipments \$100 up. Book of Opportunity free. Haywood's 1312 South Oakley Avenue, Chicago.

Dollars yearly in your backyard. No mushroom dope. Particulars free. Metz, 315 East 89th, New York.

For \$5 will write three catchy, classified advertisements that will simply have to bring you business. We'll name rates of most profitable magazines, how to use them, etc. Martinek Company, 54 Humphreys Street, Corona, N. Y.

Free Booklet describes four methods of making money. \$50 starts you. Dept. X, Paul Kaye, 119 Broadway, N. Y.

Earn \$50 to \$150 Weekly writing Jokes, Epigrams and Humorous Stories for Publications. We teach you how. American Institute of Humor, Office E, 414 Park Bldg., Cleveland, Ohio.

Free Advice. How to be successful in real estate. Particulars, Macdonald Cooperative Realty, San Diego, Calif.

53 Business Plans. Start in business with small capital. Particulars 2c. Pioneer Sales Co., Box 214, Marietta, Ohio.

Start clean business manufacturing our Acme Doughnut Flour. Makes pure, wholesome, delicious doughnuts. Ready Sales. Full directions Two Dollars. American Cereal Company, Everett, Washington.

Duplicating Devices

"Modern" Duplicators save Time, Labor and Money. Gets Business. Reproduces Typewritten or penned letters, Drawings, Lessons, Music, Menus, Bids, Notices, Specifications, Maps or anything in one or more colors. Prints two per minute. Special Sale On 30 Days' Free Trial. \$2.25 up. Booklet Free. B. J. Durkin-Reeves Co., Pittsburgh, Pa.

Exchange

For Sale. Complete outfit for the manufacture of Radio Variable Condensers, including dies, jigs, parts, finished and unfinished condensers. Exceptionally cheap. Write for detailed information. Zeimert Mfg. Co., 1752 North Park Ave., Chicago, Ill.

Chemistry

Learn Chemistry at Home. Dr. T. O'Connor Sloans, noted educator and scientific authority, will teach you. Our home study correspondence course fits you to take a position as chemist. See our ad on page 1047 of this issue. Chemical Institute of New York, 66 W. Broadway, New York City.

Any Product, formula, duplicated, improved, cheapened. Harding, P.O. 1029, Chicago.

Experimental Chemicals and Apparatus. Price list 5c. George Ott, 1218 Chestnut St., Reading, Penna.

Chemical apparatus and supplies. Dozen 6" test tubes 25c. Send for bargain price list. Washington Scientific Co., 2109 Fourteenth Street, Washington, D. C.

Headquarters for all kinds of chemicals. Special attention to experimenters' needs. Thatcher, 491 Atlantic Ave., Brooklyn, N. Y.

Experimenters—Book of over 100 chemical experiments only 25c. Oliver Stalter, Oshawa, Ontario, Canada.

Experimenters—We carry a complete supply of chemicals and glassware for your chemical laboratory. Catalogue 5c. National Scientific Supply Co., 211 Pa. Ave., Washington, D. C.

Chemicals and Apparatus—Prices reasonable. Write for catalogue. Midwest Chemical Co., 2752 Armand Place, St. Louis, Mo.

Correspondence Courses

Used correspondence courses bought and sold. Bargain catalogue 1000 courses free. Students' Exchange, Dept. 4, 47 West 42d St., New York.

Used Correspondence courses of all schools sold, renewed and exchanged. New 1924 catalogue free. (Courses bought). Lee Mountain, Pisgah, Alabama.

Ford Owners

Sport Cars. Fast, saucy, hug the turns and stick to the road—make you glad you're a Ford owner. Can easily be built by aid of life size "Red-I-Kut" patterns and picture instructions. The "Pal" system delivered complete with pressed metal streamline tail for \$6.40. Garage men make big money building them. Send for prospectus on making sport cars—Judy Tops and Gosum windshields. Kuempel Co., 1100 Kuempel Bldg., Guttenberg, Iowa.

For Inventors

Inventions developed and perfected. Working drawings for models. Machine designing. Technical problems solved. H. Wettstein, M. E., 150 Nassau St., New York.

Your Chemical problem solved and working process furnished for Five Dollars. Write me. W. Stedman Richards, Consulting Chemist, Box 2402, Boston, Mass.

Specialized service for inventors. You furnish the idea, we'll work it out. Exact machine designing. Drafting. Opinions given on practicality of ideas. Confidential dealings. Your ideas fully protected. Write for full particulars. Otis Engineering Co., Desk EF, Omaha, Nebraska.

Commercialize your ideas according to my Cooperative Plan before patenting. Booklet free. Ralph Burch, Patent Lawyer, Jenifer Building, Washington, D. C.

Get your own patents. Application blanks, complete instructions \$1. Cutting Bros., Campbell, Calif.

Formulas

Moneymaking Books, Plans, Formulas. Catalog Free. Ideal Book Shop, 5501-E, North Robey, Chicago.

For the Photographer

Have you a Camera? Write for free sample of our big magazine, showing how to make better pictures and earn money. American Photography, 118 Camera House, Boston, 17, Mass.

Games and Entertainment

Tricks, Puzzles, Jokes, Magical Apparatus, Plays, Stage Supplies, Mind-Reading, Acts and Sensational Escapes. Send 10c for 160-page Illustrated 1923 professional catalogue. Oaks Magical Co., Dept. 549, Oshkosh, Wis.

Greatest mind reading act ever sold. Not a toy. Easily mastered. Cannot be detected. Postpaid for \$1.00. The Benwills Co., P. O. Box 797, Macon, Ga.

Health

Free to Men—Information of a scientific nature that has brought physical vigor and happiness to thousands. No charge; no obligation. Enclose stamp for reply. C. I. Wood & Co., Colorado Springs, Colorado.

Improved Made Toys

Wanted Manufacturers and Houseworkers to manufacture Metal Toys and Novelties. Wonderful opportunity. Millions needed. In Whistling Birds, Wild Animals, Wag Tail Pups, Crowing Roosters, Automobiles, Baseball Players, Statue of Liberty, Indians, Toy Soldiers, Barking Dogs, and 50 others. No experience or tools necessary. Guaranteed casting forms with complete outfit, at cost. From \$3.50 up. We buy goods all year. Cash on delivery. Higher price for finished goods. Contract orders placed. Send for catalog and information free. The Improved Metal Casting Co., 342 East 145 St., New York.

Help Wanted

We want Salesmen and Agents, either whole or side line to sell our low priced radio books to the trade. Excellent proposition for live wires. The E. I. Company, Publishers, 233 Fulton Street, New York City.

Detectives Earn Big Money. Travel. Excellent opportunity. Great demand everywhere. Experience unnecessary. Particulars free. Write, American Detective System, 1974 Broadway, N. Y.

Get posted—Good prices paid for butterflies, insects. See Sinclair display advertisement page 1070.

Railway Postal Clerks—Start \$133 month. Railroad pass; expenses paid; questions free. Columbus Institute, H-4, Columbus, Ohio.

Be a Detective; Excellent opportunity; good pay; travel. Write C. T. Ludwig, 1417 Westover Bldg., Kansas City, Mo.

Make Money in spare time mailing letters. Rare opportunity now. Men, send addressed envelope for special plan. Normande R, 147 W. 23d St., New York.

All men, women, boys, girls, 17 to 65, willing to accept Government positions, \$117-\$250, traveling or stationary, write Mr. Ozment, 293 St. Louis, Mo., immediately.

Silvering Mirrors, French plate. Easily learned, immense profits. Plans free. Wear Mirror Works, Excelsior Springs, Mo.

Earn \$25 Weekly, spare time, writing for newspapers, magazines. Experience unnecessary; details free. Press Syndicate, 5665 St. Louis, Mo.

Firemen, Brakemen, Baggage-men. Sleeping car, train porters (colored). \$140-\$200. Experience unnecessary. 897 Railway Bureau, E. St. Louis, Ill.

Wanted—Railway Mail Clerks. \$1600. Experience or correspondence course unnecessary. Write, Mr. Selby, D78, Willow Hill, Ill.

Wanted—Names, men, boys 18 up wishing become Railway Mail Clerks, \$133-\$192 month. Travel—see your country. Answer immediately. Franklin Institute, Dept. F24, Rochester, N. Y.

Indian Goods

Hunting Bows, Relics, minerals, geology, stamps, butterflies. Thousand Indian articles. Catalogue 10c. Indiancraft, -Co., 466 Connecticut, Buffalo, N. Y.

Insects Wanted

Get posted—Good prices paid for butterflies, insects. See Sinclair display advertisement page 1070.

Instruction

Instruct Yourself for desired Successes. Illustrative chart shows Success(ive) Steps. Postpaid 50 cents. J. E. Morvey, Box 304, Madison Sq. Sta., N. Y.

Learn Chemistry at Home. Dr. T. O'Connor Sloans, noted educator and scientific authority, will teach you. Our home study correspondence course fits you to take a position as chemist. See our ad on page 1047 of this issue. Chemical Institute of New York, 66 W. Broadway, New York City.

Correspondence Courses sold complete; one-third usual prices because slightly used; easy terms; money back guarantee. All schools and subjects. Write for special Free catalog. Courses bought for cash. Economy Educator Service, H202, West 49th St., New York.

Languages

World-Romie System. Masterkey to All Languages. Printers, 23 languages, \$1.94 each language: English, French, German, Italian, Portuguese, Spanish. Pronunciation Tables. 102 languages, 30c each language. Language Publishing Company, 8 West 40th Street, New York.

Machinery and Tools

Concrete Building Block Machines and Molds. Catalogue free. Concrete Machine Co., 305 South Third St., St. Louis, Mo.

Manufacturing

To order: Metal articles, simple, or complicated machinery. Models, tools, patterns. Experimenting, Parma Engineering Works, Brooklyn Station, Cleveland, O.

Miscellaneous

Kodak + Hospital. Camera-Exchange. Used Cameras sold, exchanged, bought (any condition). Expert Camera Repairing a specialty. Send your broken Camera. Turner, 1679 Ave. A, N. Y.

We Develop your ideas into commercial shape for presentation to purchasers, making working models, drawings, experiments or tests. Courtesy, efficiency, secrecy and ample equipment; 30 years' experience. Ducorron-Rich Engineering Co., 504 Pacific Mutual Bldg., Los Angeles, Cal.

Get posted—Good prices paid for butterflies, insects. See Sinclair display advertisement page 1070.

Learn drawing the economical way. Address Box 32A, Helmsburg, Indiana.

Developing ideas and manufacturing our specialty. Absolute satisfaction. 33 years experience, write us. The Eagle Way & Stop Signal Co., 2016 Elm St., Cincinnati, Ohio, Dept. A.

Miscellaneous—Continued

Tricks, magic, cards, books. Catalog free. Clifford Fenner, 2491 Jefferson, Louisville, Ky.

Razor Blades Resharpened. Roseto Hanery, Roseto, Pa. (Cheapest, best work.)

Chemical Gardens. Complete outfit 30c. Hurley, 18 Phillip Street, New Haven, Conn.

Gasoline Lamps and Lanterns. Catalog Free. Little Wonder Light Co., Terre Haute, Ind.

Bargain Sale. Chemicals, laboratory apparatus, Salesman Course, sea shells, microscope; Butterflies mounted, 40 Science and Invention, write for prices. Michels, 525 North 5 Street, Arkansas City, Kansas.

Motion picture machines, films, stereopticons. National Equipment Company, Duluth, Minn.

What have you for Analysis? Ores, all metals, gold, silver, commercial articles, etc. Write today. Penn Laboratories, 222 Market St., Newark, N. J.

Motion Picture Business

Films: For Home Motion Picture Projectors Code Standard, assorted subjects. Fifteen feet. One Dollar Fifty prepaid. Daniel J. Goff, 518 W. Washington St., Chicago.

Motorcycles—Bicycles

Don't buy a Bicycle Motor Attachment until you get our catalogue and prices. Shaw Mfg. Co. Dept. 6, Galesburg, Kansas.

Novelties

The Universal Multicode. 312 codes in one. Wonderfully simple, simply wonderful. Nobody can decipher your messages. Send for it today; 50c postpaid. Charles L. Smith, 8114 Crockett Blvd., Los Angeles, Calif.

Patent Attorneys

Patents. Send for free booklet. Highest references. Best results. Promptness assured. Send model or drawing for examination and opinion. Watson E. Coleman, Patent Attorney, 644 G Street N. W., Washington, D. C.

Inventors write me about patents. My fees payable monthly. Booklet free. Frank Fuller, Washington, D. C.

Herbert Jenner, Patent Attorney and Mechanical Expert, 624 F Street, Washington, D. C. I report if patent obtainable and exact cost. Send for circular.

Lacey Patent-Sense. "The book the inventor keeps." Free. See page 1038.

M. P. Laughlin, Patents. Engineer-Attorney, 48 East 41 Street, New York.

H. F. Lowenstein, Registered Patent Attorney, Radio Expert, 825 McLachlin Building, Washington, D. C.

"Inventors' Guide" free on request; gives valuable information and advice for all who have original ideas or improvements. Frank Ledermann, Registered Attorney and Engineer, 15-E Park Row, New York.

"Inventor's Advisor," the valuable Patentbook with 139 mechanical movements and illustrations, sent free upon request. M. I. Labiner, Patent Attorney, 3 Park Row, New York.

Unpatented ideas can be sold. I tell you how and help you make the sale. Particulars free. Write W. J. Greene, Jenifer Building, Washington, D. C.

Safety—Before disclosing your invention or applying for patent, get our "Bulletin 7"—vital to the man who wants every dollar his invention is worth. It's free. American Patents Corporation, Barrister Building, Washington, D. C.

Patents Procured; Trade Marks Registered—A comprehensive, experienced, prompt service for the protection and development of your ideas. Preliminary advice gladly furnished without charge. Booklet of information and form for disclosing idea free on request. Richard B. Owen, 139 Owen Bldg., Washington, D. C. or 2278-T Woolworth Bldg., New York.

Patents Procured. Send sketch or model today for examination, prompt report and advice. No charge for preliminary advice. Write for free booklet and blank form on which to disclose your idea. Highest references. Promptness assured. Clarence A. O'Brien, Registered Patent Lawyer, 92-B Security Bank Building, Directly across the street from Patent Office, Washington, D. C.

Inventors! Record invention legally before disclosing to others. Our Invention Record and Data Sheet shows how. Sent free and valuable information given on patent procedure, costs, etc. Report on patentability includes copies of patents nearest your idea. O'Connell & O'Connell, 400 Jenifer Building, Washington, D. C.

Montee Miller, Ouray Bldg., Washington, D. C. Patent Attorney; Mechanical, Electrical Expert. Free Blue Book gives candid advice.

Inventors—Send for form "Evidence of Conception" to be signed and witnessed. Form, fee schedule, information free. Lancaster and Allwine, 242 Ouray Bldg., Washington, D. C.

Millions spent annually for ideas! Hundreds now wanted! Patent yours and profit! Write today for free books—tell how to protect yourself, how to invent, ideas wanted, how we help you sell, etc. 212 Krage Bldg., American Industries, Inc., Washington, D. C.

The Patentome is free. A liberal education in patents. Anderson & Son, attorneys, estab. 1855—657 F. St., N.W., Washington, D. C.

PIMPLY SKIN made WELL

When a few applications of this wonder working lotion has cleared faces of pimples, blackheads, acne eruptions on the face or body, enlarged pores, oily or shiny skin, you can realize why CLEAR-TONE has been tested and approved in over 100,000 Test Cases.



The simplicity of the treatment. The Story of How I Cured Myself are all explained in my free booklet. Write for your copy today and learn of the results gotten by thousands of men and women.

E. S. GIVENS
168 CHEMICAL BLDG. KANSAS CITY, MO.

DON'T WEAR A TRUSS BE COMFORTABLE



Wear the Brooks Appliance, the modern scientific invention which gives rupture sufferers immediate relief. It has no obnoxious springs or pads. Automatic Air Cushions bind and draw together the broken parts. No salves or plasters. Durable. Cheap. Sent on trial to prove Mr. C. E. Brooks its worth. Beware of imitations. Look for trade-mark bearing portrait and signature of C. E. Brooks which appears on every Appliance. None other genuine. Full information and booklet sent free in plain, sealed envelope.

BROOKS APPLIANCE CO., 172 State St., Marshall, Mich.



SEX

Facts other sex books don't dare discuss are plainly told in "Where Knowledge Means Happiness." Creates a new kind of married love. One reader says: *It contains more real information than all other sex books put together.*

From "Where Knowledge Means Happiness" turn mail, for \$1.00, cash, Copyright 1921 money order, check or stamps Dept. 39 COUNSEL SERVICE, 257 W. 71st St. N.Y.

Straightens Shoulders - Increases Pep



THE NATURAL BODY BRACE—Corrects stooping shoulders, straightens the back, gives the lungs chance for normal expansion, induces proper breathing. Brings restful relief, comfort, energy, and pep. For men and women.

Costs nothing to try it
Write for 30 days free trial offer and free book. **NATURAL BODY BRACE CO.**
Howard C. Rash, Pt. 286 Rash Bldg., Selina, Kansas

A PERFECT NOSE

shaped at home while you sleep. Rapid, painless and safe. The ANITA is the ORIGINAL and only comfortable NOSE ADJUSTER absolutely guaranteed and highly recommended by physicians. Winner Gold Medal, Feb. 1923. Write for FREE booklet. **THE ANITA CO., Dept. 273, Anita Bldg., Newark, N.J.**

STAMMER NO MORE

Kill the fear of stammering. Re-education the key. The widely famed Hatfield Method fully outlined in an accurate, readable, worthwhile book—"HOW TO STOP STAMMERING." It has inspired thousands. Free copy today.

THE HATFIELD INSTITUTE, 109 N. Dearborn, Chicago, Ill.

WHY NOT IMPROVE YOUR PERSONAL APPEARANCE.

Send for booklet showing photos of Men with and without the (PERFECT LEG FORMS) for BOW LEGS and KNOCK-KNEES. Also BRACES, for children for PERMANENT CURE.
Perfect Sales Co., 140 N. Mayfield Ave., Dept. 50 Chicago, Ill.

WHY NOT spend Spring, Summer and Fall gathering butterflies, insects? I buy hundreds of kinds for collections. Some worth \$1 to \$7 ea. Simple outdoor work with my instructions, pictures, price-list. Send 10c. (not stamps) for my illustrated Prospectus before sending butterflies. Mr. Sinclair, Dealer in Insects, Dept. 33, Ocean Park, Calif.

ADULTS! SEX KNOWLEDGE BOOKS

instructive, authoritative, profusely illustrated in natural colors, etc. Not the cheap sort. Contains everything one should know both before and after marriage to insure health and happiness. Large catalog 4c.
A. K. SMETANA & COMPANY, OWOSSO, MICH.

ARE YOU SELF-CONSCIOUS?

Embarrassed in company, lacking in self-control? Let me tell you how you can overcome these troubles. **VERITAS, Desk 15, 1400 Broadway, New York City**

Patents For Sale

Brush's Pad, No. 1,224,581 for \$16,000.00. C. B. Tylford, 617 Bailey St., Zanesville, Ohio.

Personal

Exchange jolly letters with new friends. Lots fun! Send stamp. Eva Moore, Box 908, Jacksonville, Fla.

Lonely Hearts, Join our Club, be happy, correspondence everywhere, many wealthy, descriptions, photos free; either sex, most successful method, 23 years' experience. Standard Corr. Club, Grayslake, Ill.

Correspondence Club—Many wealthy members everywhere. Fascinating particulars free. Smith, Box 1167Y, Denver, Colo.

Exchange Cheery Letters with new friends. Write Betty Lee Inc., 4254 Broadway, New York City. Stamp appreciated.

Lonesome? Make New Friends. Write Dolly Gray Club, Box 189K, Denver, Colorado. Stamp appreciated.

Leading Club, largest, most reliable for lonely people. Established 19 years. Many wealthy members. Quick results. Mrs. Wrubel, Box 26, Oakland, Calif.

Questions correctly answered, on any subject, \$1.00 each. Money returned if answer cannot be given. Investigations and reports arranged by correspondence. Leslie Stamey, 741 Central Ave., Los Angeles.

British Girls desire American correspondents. Proposition 10c. Inclare, 16 Cambridge St., London, S. W., England.

Create International Friendships. Fascinating Magazine. Information, 5c. "Universalist," 1034S West Eighteenth St., Chicago, Illinois.

Phonographic Supplies

Build Your Phonograph. Quality phonoparts. Famous Sorenado Motors. Also original Perfection Motors. Electric Motors, tonearms, reproducers, amplifiers, case material, accessories. Free blueprints and building instructions. Big Savings. Wonderful results. Prompt delivery. Catalog mailed for ten cents. Hooster Mfg. & Supply Company, 321 Baldwin Block, Indianapolis, Indiana.

Photoplays, Stories, Etc.

Wanted. Men and women ambitious to make money writing Stories and Photoplays. Send for wonderful Free Book that tells how. Authors' Press, Dept. 131, Auburn, N. Y.

Big money writing photoplays, stories, poems, song. Send for free copy America's greatest magazine for writers. Tells you how to write and sell. Writer's Digest, 637 Butler Bldg., Cincinnati, Ohio.

\$\$\$ For Ideas. Photoplay Plots Accepted any form; revised, criticized, copyrighted, marketed. Advice free. Universal Scenario Corporation, 223 Security Bldg., Santa Monica & Western, Hollywood, California.

Publishers Choices

Radio Fans send for radio price list of bargains. Satisfaction guaranteed. H. J. Frank, Box 950, East Pittsburgh, Pa.

Salesmen Wanted

"Salesmen Wanted" Amazing Invention—almost human. The Little Dratt-Man—a wonderful labor saver, automatically opens furnace or boiler while owner sleeps. Pays for itself in fuel saved. Simple, efficient, can be installed by anyone in five minutes. 100 percent profit. Thousands being sold. \$25 daily easily made. Act quick, Address: Little Dratt-Man Co., Dept. C, Grand Rapids, Michigan.

Make \$120 Weekly in Spare Time—Sell what the public wants—long distance radio receiving sets. Two sales weekly pays \$120 profits. No big investment, no canvassing. Sharpe of Colorado made \$855 in one month. Representatives wanted at once. This plan is sweeping the country—write today giving name of your county. Ozarka, 825 Washington Blvd., Chicago.

Short Stories, Manuscripts Wanted

Earn \$25 Weekly Spare Time writing for newspapers, magazines. Experience unnecessary; details free. Press Syndicate, 546 St. Louis, Mo.

Stories, Poems, Descriptive Articles, Plays, etc. Are Wanted for Publication. Monthly cash prize. Submit Mss. or write Literary Bureau, 165, Hannibal, Mo.

Song Poems Wanted

Write the Words for a Song. We compose music. Our Chief of Staff wrote many big song-hits. Submit your song-poem to us at once. New York Melody Corp., 412H Romax Bldg., New York.

Poems wanted—Sell your song-verses for cash. Submit Mss. at once, or write New Era Music Co., 145, St. Louis, Mo.

Stammering

St-Stu-t-t-tering and Stammering cured at home. Instructive booklet free. Walter McDonnell, 105 Potomac Bank Bldg., Washington, D. C.

Telegraphy

Telegraphy—Both Morse and Wireless taught thoroughly and quickly. Tremendous demand. Big Salaries. Wonderful opportunities. Expenses low; chance to earn part. School established fifty years. Catalog free. Dodge's Institute, Bane St., Valparaiso, Ind.

Stamps and Coins

Stamps—50 varieties, Brazil, Peru, Cuba, etc., 10c. 50 different U. S., 25c., 1,000 values, 10c., 1,000 mixed, 40c. list free. C. Stegman, 5955 Cote Brillante, St. Louis, Missouri.

California Gold, quarter size, 27c; half-dollar size, 63c. Columbian nickel and catalogue, 10c. Norman Schulz, Box 146, Colorado Springs, Colo.

Extra Special—California Gold Dollars. Quarter Size, 27c. Half Dollar Size, 53c. Very attractive coins. Alexis P. Mengelle, 525 N. Weber St., Colorado Springs, Colo.

Stamps—100, All Different, 3 cents. S. I. Quaker Stamp Company, Toledo, O.

Danzig Free—Nice Set Danzig Stamps with Biggest Catalogues Issued, 2c postage. Midland Stamp Co., Station B 12, Toronto, Canada.

Typewriters

All standard makes \$10 up. Fully guaranteed. Free trial. Write for complete illustrated lists. Northwestern Exchange, 320 Goethe St., Chicago.

Wanted

Detectives Earn Big Money. Work home or travel. Experience unnecessary. Particulars free. American Detective System, 1974 Broadway, N. Y.

Wireless

Attention! 50 Vacuum Tube Hook-Ups. The greatest collection of Vacuum Tube Circuits ever brought under two covers at such insignificant cost. These diagrams will be found in the great "Rasco" catalogue which contains raw materials and parts in a greater profusion than any other catalogue. 15c in stamps or coin will bring the catalogue to you. Radio Specialty Company, 100 Park Place, New York City.

Boys, don't overlook this! The "Rasco" Baby Detector. Greatest detector ever brought out with molded base. Fully adjustable. See former advertisements in this publication or our catalogue. Detector with Galena Crystal complete, 50c; the same Detector with Radiocite Crystal, 75c, prepaid. Send for yours today. Radio Specialty Co., 100 Park Place, New York City.

Radio Generators—500 Volt 100 Watt \$28.50 each Battery Chargers \$12.50—High Speed Motors, Motor-Generator Sets all sizes. Motor Specialties Co., Crafton, Penna.

Motors—G. E. 1/4 HP. \$15.00—1/2 HP. \$32.50—1 HP. \$62.50. Generators 3 volt 10 amp \$15. 32 volt 500 watt \$30. Other sizes. Low prices. Motor Specialties Co., Crafton, Penna.

Bound Volume No. 9

May, 1921—April, 1922

CONTAINS

1200 Pages with over 1500 Illustrations

and

Over 700 Articles by the Foremost American and Foreign Writers

We have also a limited amount of the following Bound Volumes of *Science and Invention* (Electrical Experimenter):

Vol. No. 6—May, 1918, to April, 1919.

Vol. No. 8—May, 1920, to April, 1921.

Each volume bound in stiff board covered with green velum and gold stamped.

Price for vol. No. 9.....\$2.25

Price for vol. 6 or 8..... 2.00

ALL THREE VOLUMES 6.00

Send Express Collect.

EXPERIMENTER PUBLISHING CO.
53 Park Place, N. Y.

Gentlemen:
Enclosed find \$..... for which send me bound vol. of S. & I. No. 6 (), No. 8 (), No. 9 (), by express collect.

Name.....
Address.....
Town..... State.....

\$200 Miniature Electric Prize Contest

THIS prize contest conducted by PRACTICAL ELECTRICS magazine, promises to be one of the most interesting that has been staged in recent years.

Here at last is something worth while. Not only can you win an attractive prize, but you will derive a tremendous amount of personal satisfaction from this contest. The illustration on this page shows the smallest electrical motor that has been built. Its dimensions are as follows: 11/64" high; 19/64" long. It weighs 5.5 grains.

This little motor is along the lines of our new contest except that we will not be quite so hard on the participants. *We require miniature electric models, the largest dimensions of which must not be more than 3/4".* Any electrical appliance, any electrical apparatus, any radio instrument that will be reproduced in a working condition in miniature, is eligible for entry in this contest.

World's Smallest Electric Motor

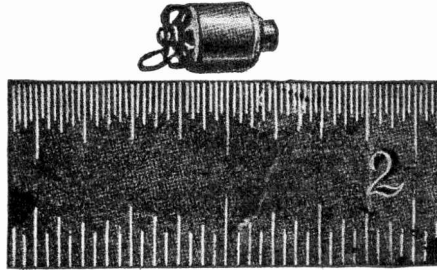

Total weight slightly above 5 grains. The tiny armature, .09" in diameter, has 4 pole pieces and is wound with No. 40 silk copper wire. Silver brushes are used. The over-all dimensions of the motor measure 19-64" long and 11-64" high. When connected to a small flash light battery, the motor runs at a very high speed.

The judges will welcome miniature models of the following: Electric bells, switches, all kinds of electric heating appliances, electric generators, telephones, microphones, telephone desk stands, telegraph instruments, any and all radio apparatus, static machines, electric lamps, batteries, rheostats, measuring instruments, fans, transformers, in fact any electrical apparatus or electrical appliance. *One of the rules of the contest is that the miniature models must work.* Dummies cannot be entered in this contest. The builders of these miniature models will come in for a goodly share of publicity as many newspapers and periodicals will feature these models.



All particulars for entering the miniature models in this contest, closing date, rules and restrictions, etc., will be found in full in the February issue of PRACTICAL ELECTRICS.

\$200 IN GOLD	
First Prize	\$75
Second Prize	50
Third Prize	20
Fourth Prize	20
Fifth Prize	10
Sixth Prize	10
Seventh Prize	5
Eighth Prize	5
Ninth Prize	5

The Electrical Magazine
for Everybody
Now Greatly Enlarged



One-third More Text and
Reading Matter than
Heretofore

This Magazine is Edited by
H. GERNSBACK
Also Editor of
Radio News
and
Science & Invention

100 Articles
Over 100 Illustrations
For Sale At All News Stands
25c. the Copy
\$2.50 a Year
Canada and Foreign
\$3.00 a Year

SEND FOR
FREE
SAMPLE COPY TODAY
See Coupon Below for
SPECIAL OFFER

PRACTICAL ELECTRICS is probably the most novel magazine of its kind ever conceived. It is personally edited by H. Gernsback, editor of SCIENCE & INVENTION and RADIO NEWS. Mr. Gernsback, who founded the old "Modern Electrics" as well as the "Electrical Experimenter," knows thoroughly what his readers want and have wanted for many years. PRACTICAL ELECTRICS, the 100% electrical magazine eclipses the best that was in "Modern Electrics" and "Electrical Experimenter."

Electricity covers such a tremendous field that the man who does not keep abreast with it does himself a great injustice. PRACTICAL ELECTRICS covers that field from every angle. It is written in plain every-day language that all can understand. It portrays the entire electrical development of the month faithfully in non-technical language. It caters to everyone interested in electricity, be he a layman, an experimenter, an electrician or an engineer—each will find in this magazine a department for himself and plenty more.

The February issue now on the news-stands contains 64 pages, over 100 different articles and over 150 illustrations, with an artistic cover in three colors. Professor T. O'Connor Sloane, Ph.D., is associate editor of the magazine.

INTERESTING ARTICLES IN FEBRUARY "PRACTICAL ELECTRICS"

- The Radiotron: A Vacuum Tube By B. S. Havens of General Electric Company
- Simple Oscillograph By Carter Fiske
- Electric Animals
- Tidal Electric Power By Albert Staehle
- Voltage Finder
- Electrical Destruction of Atoms By Professor Rogers D. Rusk
- Electric Camera Shutter By A. Kiedis, Jr.
- Carbon Contact Rheostat
- Goertz-Beck Arc Lamp
- Analogies and Others By T. O'Connor Sloane, Ph.D.

PRIZES

This magazine offers a number of prizes, as follows:
Our \$50.00 Prize Contest for Junior Electricians and Electrical Experimenters includes as its elements simplicity, as great a degree of novelty as possible, and practicability.

A new contest offering \$200 in prizes for best miniature working models of electrical apparatus.

Also a new prize contest giving four prizes amounting to \$37.50 for the best account of an odd electrical experience.

\$3.00 for the best article on Elec-Tricks, the new department.

\$3.00 for the best "short-circuit," the semi-humorous department.

In addition to this, the magazine pays high prizes for all electrical experiments, electrical articles, etc. See current issue for full details.

This issue also contains articles by some of the greatest electrical writers, workers and students. The magazine will prove a revelation to any one interested in electricity.

Every issue besides its many other features contains the following departments:

- "New Things Electric"
- "Experimental Electrics"
- "Electrical Digest"
- "Junior Electrician"
- "Elec-Tricks"
- "Motor Electrics"
- "Short Circuits"
- "How and Why" (Questions and Answers.)

Make all checks payable to: "Practical Electrics Co."

SPECIAL OFFER

Gentlemen:
Although your regular price is \$2.50 per year, you will accept my subscription at \$2.00 per year (Canada and foreign \$2.50). I enclose the money herewith and I have written my name and address in margin below.

S.&I. 2-24

Complete RADIO Outfit!

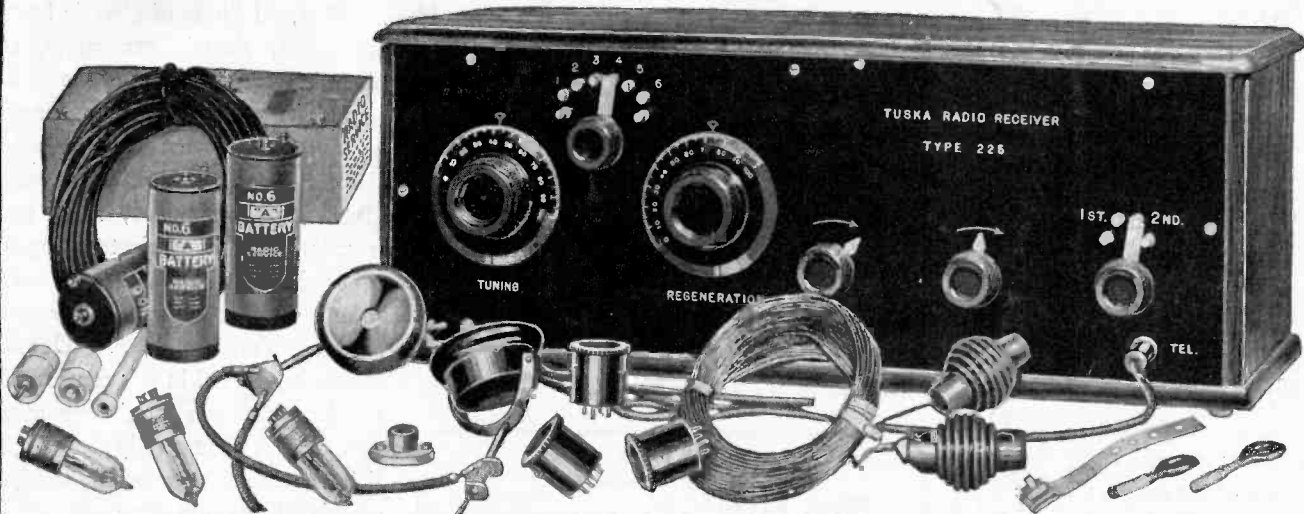

**This
Famous**

TUSKA

**Armstrong Regenerative
Receiver and Two-Step
Amplifier, Complete**

only \$5 Down

**Balance in Easy
Monthly Payments**

This great offer makes the finest of radio equipment available to every home. Why tinker with home made sets! Why confine your radio reception to the few local stations reached by a crystal set! For only \$5 down you can have a radio set that will reach out hundreds—even thousands of miles away and “bring in” your choice of all the wonderful programs broadcasted from the Atlantic to the Pacific. It has ample volume to operate a loud speaker on far distant stations. In the TUSKA we offer a set designed by Mr. C. D. Tuska—a famous radio engineer—and built complete under his personal supervision. In results—in appearance—in workmanship—it is the equal of outfits costing twice the price we ask. Send the coupon below for our Great Special Offer made for a limited time only.

No Accessories to Buy

The radio outfits we sell are absolutely complete. Most others make an offer on the bare set and leave you to buy all the extras like tubes, phones, etc., in addition. The outfit we offer you includes the Regenerative Receiver and 2-step Amplifier all enclosed in a solid mahogany case. Also the batteries, head-phones, tubes, aerial, lightning arrester, and full wiring installation equipment. You start operating without investing another single penny. Your \$5 payment brings it all.

UV 199 Tubes and Dry Cells Reduce Upkeep to Almost Nothing

Equipped with 3 of the latest type of dry battery UV 199 tubes. Use only .06 ampere current. Most perfect tube both for detecting and amplifying. Battery expense reduced to the absolute minimum.

Send Coupon for Great Special Offer

Just mail the coupon. Get all the details without any obligation. Don't think of buying an ordinary set without finding all about this new and better way. Very easy terms. Free Trial. The highest quality of radio equipment possible to have.

BABSON BROS., 2843 West 19th St., Chicago, Ill.

Dept. 53-32

LOOK!

Here Is What You Get

Tuska Regenerative Receiver and 2 step Amplifier; Handsome genuine mahogany cabinet; Genuine Bakelite Panel; 3 UV 199 Radiotrons [tubes]; 3 adapters, permitting the use of UV 199 tubes in standard sockets; “B” battery, 45 volt capacity; 3 “A” dry batteries; set of lightweight, marvelously sensitive head-phones; 50 feet of lead-in wire; 100 ft. aerial wire; insulators for both ends of aerial and for turning corners; lightning arrester and all things necessary for complete installation.

**BABSON BROS., Dept. 53-32
2843 West 19th St., Chicago, Ill.**

Please send me your special offer on a Complete Tuska Radio Outfit on terms of \$5 down and monthly payments.

Name

Address