

"ELECTRICITY IN MODERN WARFARE" IN THIS NUMBER

THE ELECTRICAL EXPERIMENTER

MAR.
1915

5¢



VOL. 2

No. 11

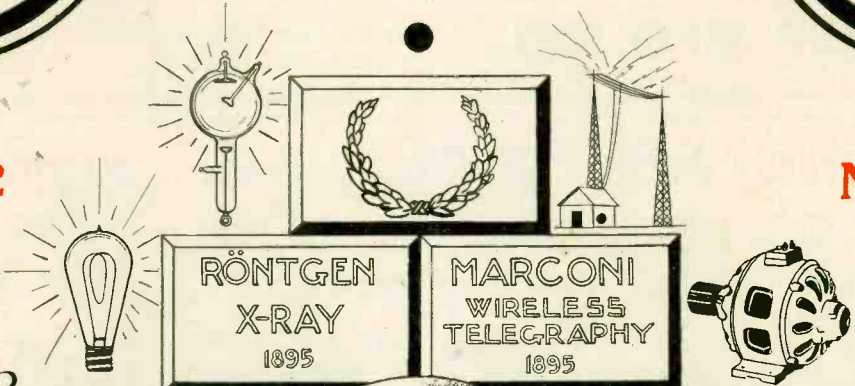

RÖNTGEN
X-RAY
1895

MARCONI
WIRELESS
TELEGRAPHY
1895

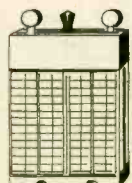

EDISON
INCANDESCENT
LAMP
1878

TESLA
INDUCTION
MOTOR
1890



CONTENTS

Electricity in Modern Warfare.
By H. Winfield Secor.

Course Lesson on Mathematics.

The New "Chaffee" Radiophone Spark Gap.
Connections for Radio-Telegraphic Sets.

The How-to-make-it Department.
Electrical Magazine Review.

Map of Trans-Oceanic Radio Stations.
Among the Radio Amateurs.

The De Lange Thermal Telephone.

BELL
TELEPHONE
1876

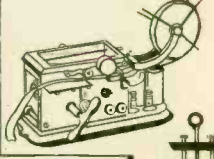

MORSE
TELEGRAPH
1837

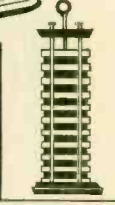

OERSTED
ELECTRO
MAGNETISM
1820

GALVANI
GALVANIC
ELECTRICITY
1770

VOLTA
VOLTAIC
ELECTRICITY
1800

THE EXPERIMENTERS' MAGAZINE



1000 TO 1000000 VOLTS

LOUIS STEINBERGER'S PATENTS

Adopted by **U. S. NAVY**

and all the Commercial Wireless Telegraph Companies

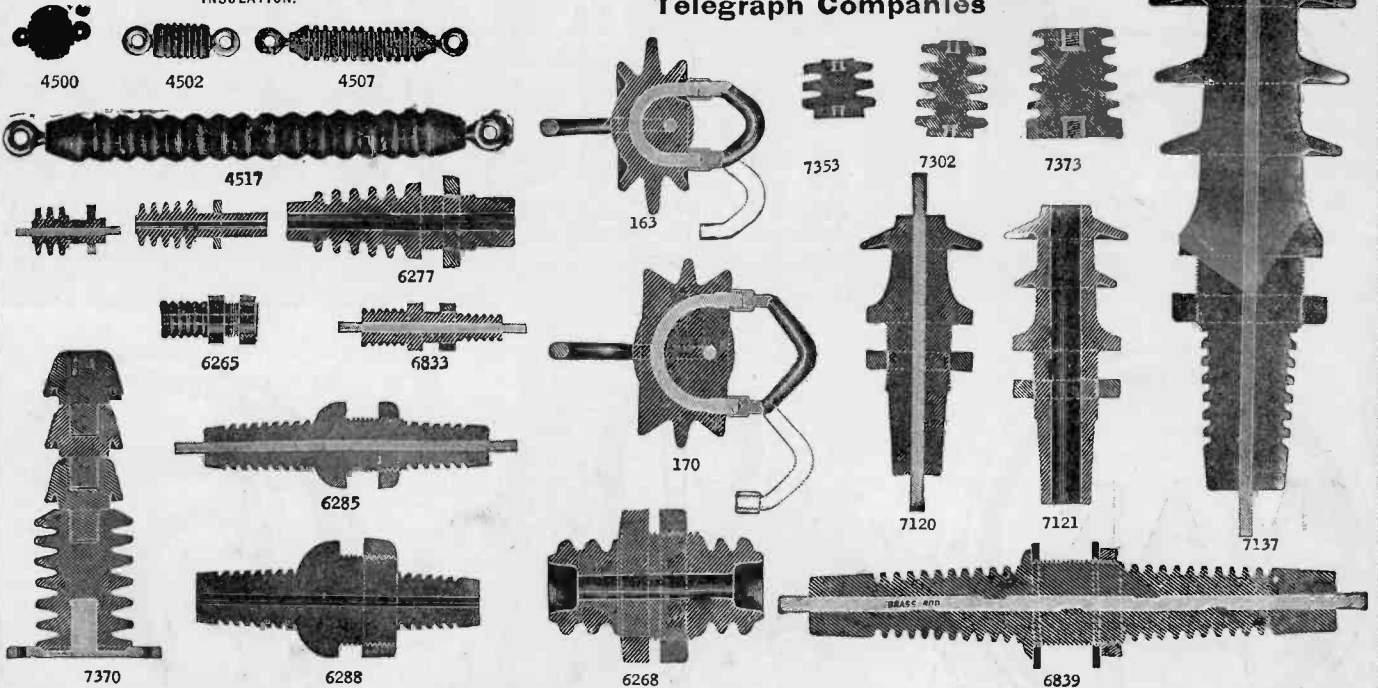

ELECTROSE MFG. CO.,

60-72 Washington St.
66-76 Front St.

**BROOKLYN, N. Y.
AMERICA**



Everybody Needs *The* **BEERS** *Lantern*

GIVES LONG SERVICE AT VERY LOW COST

Burns from 40 to 60 Hours

Made to use a common dry cell battery which can be bought anywhere for 25 cents.

Not a toy but a reliable, practical, electric lantern, sure to displace the old unsafe oil lanterns and uncertain flashlights.

Durable, handsome, compact, absolutely safe. A sensible, economical

article for every day use. Indispensable for housekeepers, automobilists, farmers, sportsmen, yachtmen, watchman, deliverymen, etc.

Permanent and intermittent contact switch. Tungsten lamp. Imported optical lens. Silver plated reflector.

Dealers write quick for sample and further information

Prices delivered anywhere in the United States
No. 1005 Pressed Steel, black rubber finish, \$2.00
No. 1000 Solid Brass, highly polished..... 2.50
No. 1002 Solid Brass, nickel plated..... 3.00

THE BEERS SALES COMPANY

1008 E BROAD STREET . . . BRIDGEPORT, CONN.

Electric Light for Your Home

This newly invented system enables every rural home to make their own electric current; and operates from one to fifty lights and will drive small electric motor, electric iron, toaster, etc. Everything complete in one compact unit; no batteries or switchboard. Uses standard lamps and fixtures that any dealer can supply. Nothing to watch but the small, high-speed gasoline motor, which requires slight attention once a week.

The ideal electric lighting system for country homes. Nothing like it ever sold before. Costs less than other systems to buy and to operate. Will last for years.

Waterman Motor Company

182 E MT. ELLIOTT AVENUE
DETROIT, MICH.

Write today for descriptive literature and prices.

Uni-Letric
GASOLINE-ELECTRIC UNIT
LIGHTING SYSTEM



Learn Wireless At the ONLY School in New England Specializing in Wireless Telegraphy

Our instructors have seen SERVICE with the U. S. Government, Fessenden and Marconi Wireless Tel. Companies. Therefore we assure you of a PRACTICAL day or evening course. Fall classes commence Sept. 8th. Reserve your seat early. Call, write or phone.

EASTERN RADIO INSTITUTE 899-E Boylston St., BOSTON, MASS.

A Fortune to the Inventor

who reads and heeds it, is the possible worth of the book we send for 6 cents postage. Write us at once. R. S. & A. B. LACEY, Dept. E, Washington, D. C.

You Benefit by Mentioning "The Electrical Experimenter" When Writing to Advertisers

- THE - ELECTRICAL EXPERIMENTER

VOL. II

MARCH, 1915

NUMBER 11

Electricity in Modern Warfare

By H. Winfield Secor

ELECTRICITY plays a more important part in the modern war game than some people believe. Probably the most spectacular and modern application of electrical energy to war problems is that of wireless telegraphy. Truly, it has surely worked a wonderful change in the plans

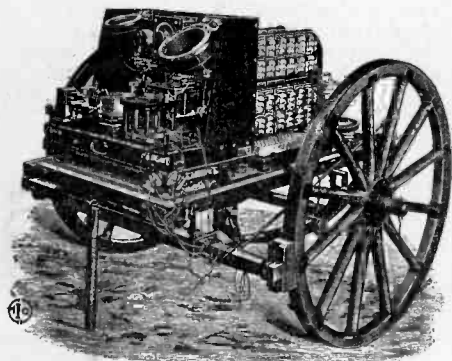

Military Radio Wagon Set.

of the military or naval strategist of today. In years gone by it was no uncommon occurrence for countries or parts of countries to be entirely cut off from communication with the rest of the world during the reign of war. Take the case of Germany in the present titanic struggle; it is nearly isolated from the rest of the world, as regards the communication of intelligence in the ordinary way. Thanks, however, to the wonderful radio towers rising majestically 800 feet into the air at Nauen and Hanover in Germany, and at Sayville and Tuckerton in the United States, direct news communication is effected between the Kaiser's Empire and ourselves, as well as with other countries and ships at sea.

The applications of radio-telegraphy have been probably much more widespread for military requirements in Europe than in America. The Germans particularly at an early date realized the great possibilities of this wonderful messenger which could travel over the heads of their enemies at the speed of 185,000 miles per second.

One type of radio trunk set, mounted on a two-wheel cart, to be hauled by mules or horses, is illustrated here. The cart set shown was developed by the

Telefunken Co., and has an average communicating range of 150 to 200 miles.

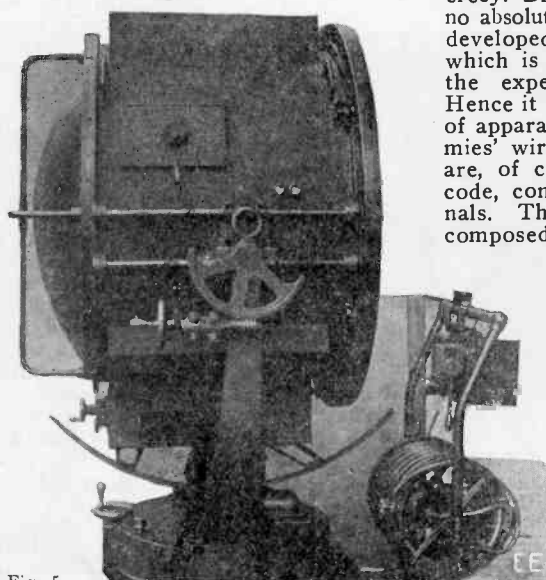

Fig. 5

Powerful Search-Light with 36 inch Lense.

The range, of course, depends upon the height of the elevated aerial wires employed, weather conditions, etc. Portable steel masts are carried by the Signal Squad for use with these portable radio sets. They are so cleverly designed and built that a couple of soldiers can erect an 80 ft. mast in a few minutes anywhere desired. By this means various divisions of an army can keep

in constant touch with headquarters.

A question in the popular mind regarding the use of radio in war is that of secrecy. Briefly, it may be said that, so far, no absolutely secret tuning means has been developed and applied in one country which is not pretty well understood by the experts of every other country. Hence it is always possible to make a set of apparatus which will pick up the enemies' wireless message. Such messages are, of course, sent by the telegraphic code, consisting of long and short signals. The letter A, for instance, being composed of a short and long signal successively, etc., a French operator would send his message in that language and supposing a German operator to have intercepted it, it is an easy matter for one of the staff to translate the received message word for word. In mili-



The German Crown Prince, an interesting onlooker at manoeuvres. Note Boy Scout with portable field telephone.

(Copyright by Underwood and Underwood)

tary radio work, owing to the state of affairs as just mentioned regarding tun-

"The Electrical Experimenter" is published on the 15th of each month at 233 Fulton Street, New York. There are 12 numbers per year. The subscription price is 50 cents a year in U. S. and possessions, as well as Canada. Foreign countries 75 cents a year. U. S. coin as well as U. S. stamps accepted (no foreign coin or stamps). Single copies 5 cents each. A sample copy will be sent gratis on request. Checks and money orders should be drawn to order of the Electro Importing Co.

If you change your address, notify us promptly, in order that copies are not miscarried or lost.

All communications and contributions to this journal must be addressed to: Editor, "The Electrical Experimenter," 233 Fulton Street, New York. We cannot return unaccepted contributions unless full return postage has been included. ALL accepted contributions are paid for on publication. A special rate is paid for novel experiments; good photographs accompanying them are highly desirable.

Application for entry as second-class matter at the Post Office at New York pending. Title registered U. S. Patent Office. Copyright 1915 by E. I. Co., New York. Title registered U. S. Patent Office. Copyright 1915 by E. I. Co., New York.

The Electrical Experimenter. Monthly. Published by the Electro Importing Co., 233 Fulton Street, New York.

ing, the "cipher code" system is always employed invariably. As an illustration, suppose the enemy picks out of the ether the message: "The cat is in the well." Now, unless the recipient of such a "code message" has a copy of the code system governing the transmission of such a statement, he has no idea whatsoever as to the meaning of it. It might be a command from headquarters to the effect that a certain regiment was in need of assistance, etc., ad lib.

Our old friends the telegraph and telephone must not be forgotten, for they

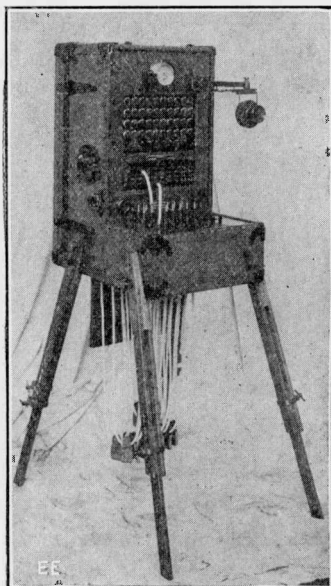

Signal Corps style of telephone switchboard in folding case. (Left Photo)

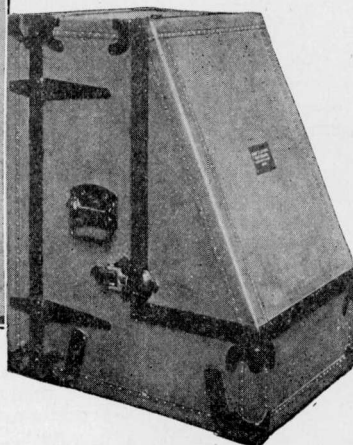

The same switchboard closed for transportation. (Right Photo)

play a very important part in the handling of troops, etc. Our illustration herewith shows a proud German Boy Scout (now in active army service) carrying a field telephone set on his back. An officer is observed using the instrument at manoeuvres, while the German Crown Prince is seen standing at the right.

Of course, these telephone and telegraph instruments require a complete metallic or semi-metallic circuit for their operation. Usually a single wire is laid along the ground or insulated on fence posts in some instances, the apparatus being joined to the ends of same, and the return circuit being completed by a connection to earth at either station. The telephones are designed for hard duty for army use.

The telegraph sets usually operate on the buzzer principle, the received signals consisting of short and long buzzes in a pair of telephone receivers strapped to the operator's head. It is simply wonderful what these buzzer telegraph sets

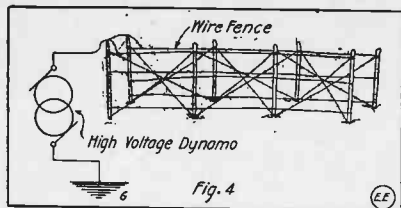

Fig. 4

can accomplish in transmitting messages under unfavorable conditions. It has occurred that, using a ground return, the wire line lying on the ground has become severed, several yards separating the two ends, but the signals were re-

ceived just the same. Connected to the two rails of a standard steam railroad, these signals will carry for several miles, notwithstanding the fact that several trains may lie in between the stations, which, of course, short-circuit the two telegraph lines or rails.

The arrangement of such buzzer telegraph sets is indicated plainly in Fig. 1. An extra inductance or kicking coil is used in series at I to boost the strength of the current taken from across the buzzer vibrator V. A battery and telegraph key complete the outfit.

The electric detonating of high explosive mines is widely used in land and harbor defenses. The principle of their application will be grasped by referring to Fig. 2, where the loaded land mines are placed at an opportune moment under some earth, etc., to hide them, so that when the enemy makes a dash onto the land so mined or part of it, all or any part of it can be blown heaven-ward in an instant by pressing the corresponding

push button at the officer's position S. A battery is generally utilized to melt a fine piece of wire in each mine, the make-up in detail of the fuse being observed from Fig. 3. The current enters the wires C C, and melts the fusible wire E, which ignites the powder B. A similar method is used in firing heavy dynamite charges used to blow up bridges, railways or buildings.

Floating mines, properly anchored, are used in harbor defense, each mine

having an insulated wire running from it to the shore. By means of range-finding telescopes and the application of mathematics, the exact position of a warship over the mined area is quickly determined. It then remains but to push an electric button corresponding to the spot where the ship lies and the mine does its work.

In land defenses, considerable use has been made of electrically charged barbed wire structures, as shown at Fig. 4. Usually the wire fence is connected to one pole of a high voltage dynamo (say, 2,000 volts or more) and the other pole of the dynamo is connected to earth. If a soldier attacks the barbed wire with nippers or wire cutters, he is killed instantly in most cases, the current passing thru his body to earth and so back to the dynamo. Wherever Central Stations are near the battle-field they provide the electric energy for this hellish purpose, or isolated portable type dynamo and petrol engine outfits are impressed for the work.

So that the enemy may not get too much time to sleep, monster searchlights sweep their dazzling beams over the battlefield, showing the gunners their prey.

A typical searchlight of this class built by the Carlisle-Finch Co. and having a lens 36 inches in diameter, is illustrated in Fig. 5. This massive arc light is fitted with electric motion controlling devices so that it can be placed in a field by itself and controlled by an electric wire from a distance. Its powerful beam can be seen for several miles. The projector is here illustrated just before being mounted on an automobile truck, which can transport it rapidly to any

point desired. Imagine a battery of these mammoth searchlights throwing their weird white beams back and forth over the battlefield, with a perfect rain of bullets and exploding shells all about, and some idea of the 20th century night battle is gained.

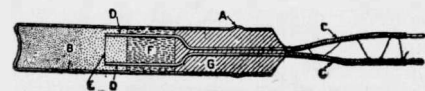

Fig. 3. Mine Detonating fuse.

Finally, we should not overlook the merciful work the field and hospital X-Ray apparatus is performing for thousands of injured men. The Hughes electrical induction balance is also in use for locating bullets and shell splinters in the body. Beyond a doubt, electricity has made decided changes in modern military strategy and warfare; changes that our forefathers wouldn't even have dreamed of, much less believed to be a possibility.

Few people know the important and varied use of electricity in this great war of the nations. The great navies of the warring countries could hardly be operated without electricity. It carries the wireless signal from ship to ship, from station to station. It revolves the gun turrets, manipulates the guns, carries the ammunition and controls the gun fire. Every part of the ship is connected by telephone and signal systems. It lights the searchlights, drives

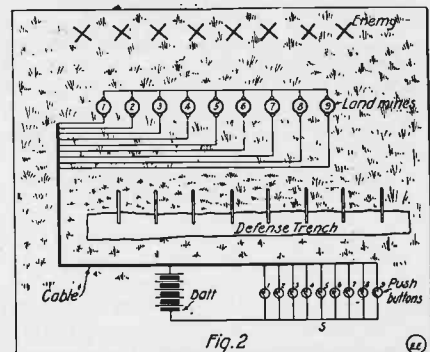
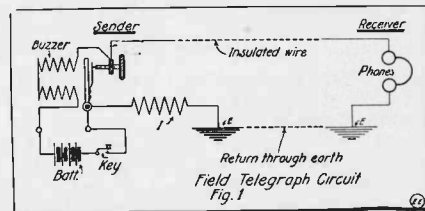

Fig. 2

the submarines beneath the waves, and sparks the motors for the air craft. It is even used for cooking the food on a modern battleship.

In the field with the great armies electricity is no less useful and important. Here it is extensively used for portable wireless stations to establish lines of communication between army corps and division, between the firing lines and the supply bases. Buzzer signal systems, telephones and telegraphs are also used for this purpose. Portable search lights are carried by the infantry. Thousands and thousands of horses are still used by the armies of Europe, but huge auto trucks and high-speed automobiles are



Field Telegraph Circuit Fig. 1

employed whenever possible. Of course, these cars could not be operated without electricity to ignite the gas. This is equally true of the huge air craft and flying machines. Electricity is used to fire mines and dynamite charges when there are railroads, bridges, etc., to destroy.

THE COLIN-JEANCE RADIO MICROPHONE.

The microphone used by the Colin-Jeance radiophone system is composed of nineteen microphone cells, each formed of pulverised carbon pressed against by a thin plate of carbon. The

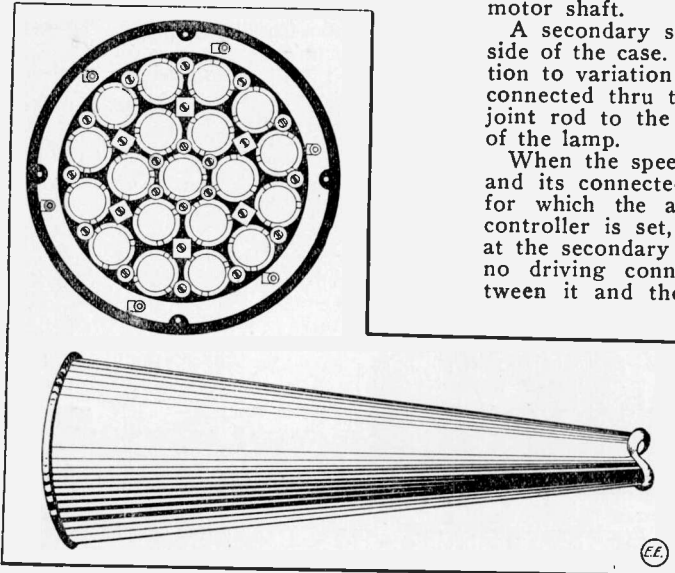

cells are arranged on a circular disk, as may be seen in the illustration, and are covered by the mouth of the large 24 inch megaphone which is shown detached in the illustration. One of the turns of the resonator inductance is connected to earth through the microphone. This arrangement eliminates the sputtering noises that are heard when the microphone is inserted directly in the antenna circuit, and removes the limitation to the energy supplied to the antenna.

The operating table is furnished with two microphones and their megaphones, which are used alternately for short periods in order to prevent overheating. The change is made simply and quickly by means of a commutator.

In the experiments recently made at the laboratory of the Compagnie Generale Radiotelegraphique, waves from 900 to 1,100 meters in length were employed for transmission. Trumpet calls can be produced at the receiving station, with the aid of a keyboard connected with the oscillating circuit of the sending station.

The Italian scientists, Majorana and Vanni, are endeavoring to increase the range of wireless telephony by utilizing the vibrations of liquid veins. Other pioneers are working in the field, and we may expect to be able, one of these days, says the *Scientific American*, to telephone from Paris to New York.

A NEW ARC CONTROLLER FOR THE "MOVIES."

It had to come as a reality sooner or later, so now we have with us a small motor driven clutch and feeding attachment for keeping the arc carbons in motion picture machines at a constant distance, and furthermore it relieves the operator of the extra work always required in attending the arcs. The new "arc controller," as it is known, has been thoroughly tried out by the leading theatres, including the Strand, in New York City, with entire success. It is illustrated here by a simple sketch to explain its clever action only.

As related to exterior conditions, the Controller consists of an oil tight re-

taining case, which acts as a frame work for the inner mechanism; the latter, it being sufficient to state for present purposes, is of very rugged construction and not subject to derangement, and is purely mechanical in operation.

A Primary shaft projects at one end thru the case and is direct coupled to the motor shaft.

A secondary shaft projects from one side of the case. It is subject in its action to variation of motor speed. It is connected thru the agency of a toggle joint rod to the feeding handle or rod of the lamp.

When the speed of the primary shaft and its connected motor is below that for which the adjusting spring of the controller is set, no action takes place at the secondary shaft, because there is no driving connection established between it and the primary shaft, so it remains at rest.

When the speed of the primary shaft arrives at, or exceeds, that of the adjustment mentioned, there is a positive connection effected between the two shafts, primary and secondary, and the latter is forced to revolve as long as the speed is, even

in the minutest degree, above the point desired.

This revolution of the secondary shaft is utilized to adjust conditions so as to reduce the motor speed to the normal desired, in the manner described hereafter.

The motor is very sensitive in speed to changes in voltage at its terminals, it being operated continuously, and connected simply as a shunt across the arc.

Assuming all parts to be assembled is applied to the moving picture outfit, the controller and motor—the latter

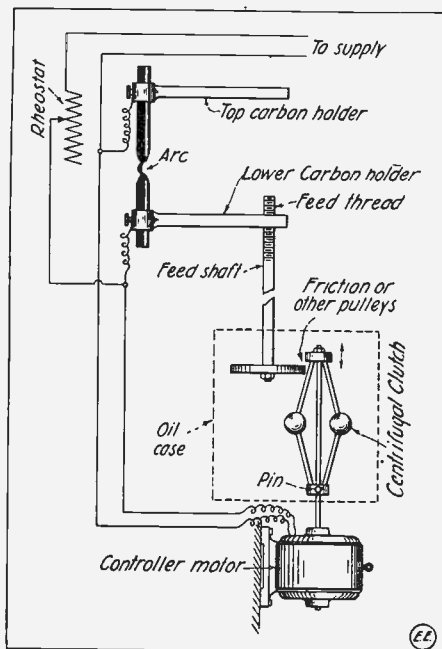

properly enclosed—located on the floor under the lamp house, or up on a suitable bracket from the lamp house pedestal; the lamp in proper position for projection, and the toggle joint rod connect-

THE "NITE-LITE" ON A TRANSFORMER.

To meet the demand for a small, low wattage lamp for all night service the General Electric Company has brought forward a device, consisting of a miniature transformer contained in a brass shell connected to a small tungsten lamp, which may be screwed into an ordinary lighting socket. The function of the transformer is to step the line voltage down to a pressure of about seven volts. The complete apparatus, which is called the "nite-lite" transformer lamp, is designed especially for lighting door num-

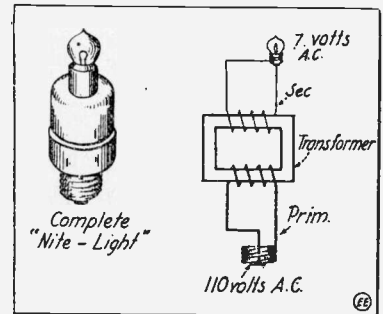

bers, sick rooms, a low C. P. all night light, etc., and, of course, is adapted to alternating current circuits only. It is big improvement over the familiar "turn-down" sockets which employ a resistance to dim the light, as naturally energy is wasted in heating such a resistance, which is a dead loss to the consumer.

ing the feed handle of the lamp to the controller, the usual wires being connected to the lamp.

Two small wires are run from the motor, one to each lamp connection, no attention being paid to their polarity. The motor is then in shunt to the arc, and the speed of the motor will be in proportion to the size of the arc after the latter is "struck" or started by hand.

The slightest burning away of the carbons causes a minute widening of the arc, resulting in increased motor speed (i. e., a greater voltage drop across the arc and hence giving more voltage to the motor), and causing the controller to feed the carbons just enough to compensate for the amount of carbon consumed.

These operations, or feeds, occur at very frequent intervals and are of great power, enabling them to overcome without effort, frictional resistance which would positively stop any "automatic" lamp, it is claimed.

The voltage across the terminals of an arc controlled by an arc controller is practically unvarying, at the point adjusted for by the operator.

Means are provided for instantly altering the size of the arc to be maintained at the will of the person in charge.

It was said that during 1913 about \$300,000,000 was received for electric lighting in the United States. Estimating the population at 100,000,000, this means that each person, regardless of age, pays \$3 per year for electric light. This is equal to about 1 cent per person per day, or, in other words, two lamp-hours per day per person.

Experimental Electricity Course

S. Gernsback and H. Winfield Secor

LESSON 18. ELECTRICAL MEASURING INSTRUMENTS (Continued).

pointer B, swinging over a graduated scale C. The needle is pivoted at I, and to help in the adjustment, a fine spiral spring J is adjustable from the screw D. When no current passes thru the instrument, the needle is adjusted to read zero. When a current is passed, the platinum wire E tends to heat up and elongates or lengthens, the degree depending upon the quantity of current. Alternating and direct current both give the same heating effect so that the hot wire meter is applicable to measuring both kinds of current. The hot wire meter in this country is employed principally for the measurement of radiation currents in wireless stations. It is well adapted to this purpose, owing to the extremely high voltage used, which are not very easily passed thru any form of small coil of wire containing a number of turns.

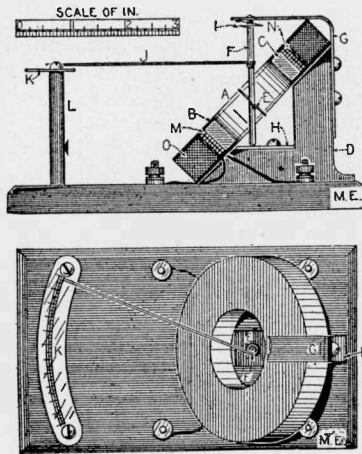

Fig. 16

Another form of measuring instrument adapted to reading high potentials, say, above 5,000 volts, is the Electro-static Voltmeter. Its arrangement is shown at Fig. 18. The active part is simply two or more segments of metal, one set of them being mounted on a pivoted staff, to which is secured the index needle, and the other set stationary. When a high potential current is connected to the respective sets of segments, they are charged, and the strength of the charge is dependent upon the value of the current connected to it. The electro-static reaction between the fixed and moving plates causes the moving ones to swing around a certain amount, and the needle indicates the potential, on the scale, previously calibrated by means of a standard or by the air gap method.

The standard measuring instrument for electrical work, in this country, is the Weston type, built upon the D'Arsonval galvanometer principle. Its principal parts and their functions are represented at Fig. 19. A powerful and steady magnetic field is provided by the permanent hardened steel magnet P. This is carefully aged by hitting and boiling in hot water to make its magnetic strength as nearly constant as possible. Two soft iron pole pieces, B B, are screwed to the inner sides of the magnet poles, to form a symmetrical armature space. The moving element, C, is composed of a small copper bobbin, having a number of turns of fine wire wound about it, and their terminals connected to two hair springs at top and bottom of the coil. The current to be measured is passed from the binding posts, T T, thru the two hair

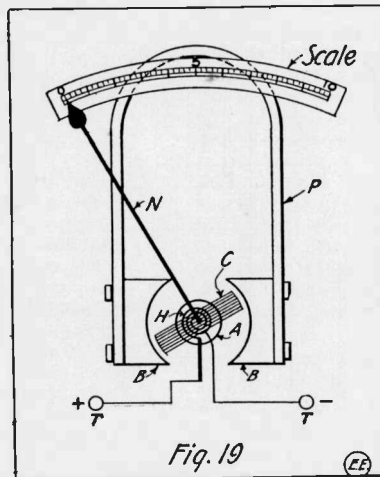

Fig. 19

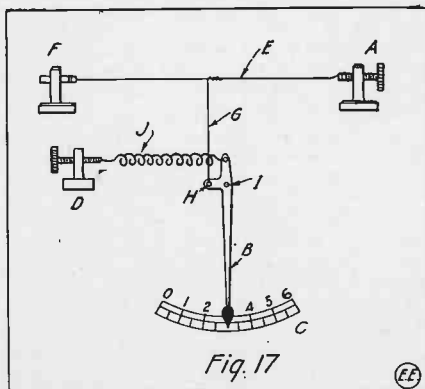

Fig. 17

springs, and thence around the coil of wire. A magnetic field is set up within the wire coil, and it tends to move one way or the other, according to the direction of the current. Its action is similar to that of a motor, with a permanent field magnet, and if a commutator was substituted for the hair springs, the coil would revolve the same as any motor armature.

Within the moving coil is secured a soft iron core, to make the path of the magnetic lines of force from pole piece to pole piece more conducting or permeable. Weston instruments have marked dead-beat qualities, i. e., they come to rest quickly, and do not swing to and fro to any appreciable extent. This is accomplished by the coil of wire being wound on a copper bobbin. Whenever the coil and bobbin move, Eddy currents, tending to arrest its motion, are set up in the copper. The chief features of the Weston instruments are their reliability, permanence, dead-beat and portability.

In direct current circuits, the product of the volts by the amperes gives the energy in watts. An instrument reading direct in watts must necessarily combine the action of the voltmeter and the ammeter. Such a combined instrument is illustrated diagrammatically by Fig. 20. The fine wire moving coil is F. The ampere-meter part of the instrument is composed of a heavy wire winding, as H H. The two windings produce independent magnetic fields, and the reaction between them is proportional to the voltage and amperage of the circuit, or since these two quantities represent the components of the watts in the circuit, the instrument's deflection, when correctly calibrated, reads direct in watts.

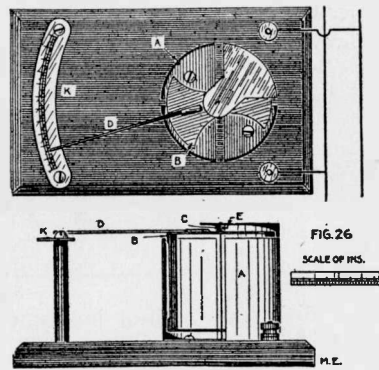

Fig. 18

The commonest form of the watt-meter is the integrating or recording watt-hour meter used to measure the amount of electrical energy consumed by a customer of Electric Light and Power Companies. It is really a miniature motor, having no iron in it, and whose speed is proportional to the voltage and amperage of the circuit. It is connected the same as Fig. 20, but the moving coil has a silver bar commutator, and silver brushes for conducting the current to the armature coils. The armature spindle engages a gear wheel of a train of integrating gears, and the consumption of current in watt-hours or kilowatt-hours is indicated on a row of dials on the front of the instrument. The sum of the dials is read

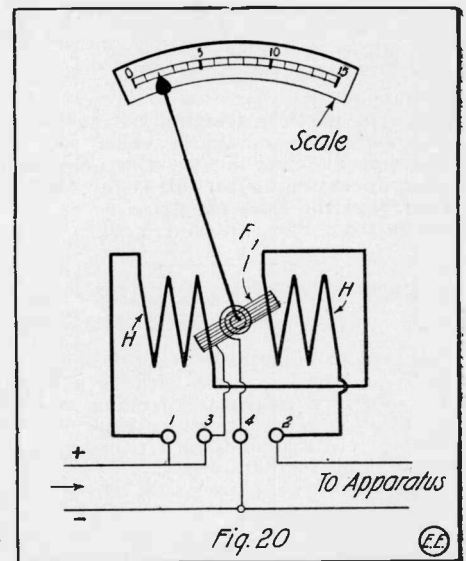

Fig. 20

BOOK No. 19. PRACTICAL MATHEMATICS.

THE science of arithmetic or mathematics enters more or less into all branches of human endeavor to-day, and the young experimenter and student will do well to get a firm grasp on at least the elementary principles of this subject.

The following paragraphs have been devoted to the explanation of the more practical applications of mathematics,

with a few examples showing their value in everyday problems.

The process of evolution and involution of roots and powers of numbers will first be gone over.

Involution is the process of raising any given number to a certain power of that number, thus:— 2^4 means, 2 to the 4th power or 2 multiplied by itself 4 times, or $2 \times 2 \times 2 \times 2$ equals 16.

Evolution is the science of evolving or extracting one of the equal factors constituting the given number. The square root of a number is one of the two equal factors composing the number, i.e. suppose, 4^2 equals 4×4 or 16, then the square root of 16 is 4. Also 4^3 equals 64 and the cube root of 64 is 4, since $4 \times 4 \times 4$ is 64. The cube root represents one of the three equal factors which when multiplied together produce the number.

There are several ways of expressing powers and roots, the usual modes being as follows:—The power of a number such as 6, for example, may be written 6^2 or 6^{-2} . If 6^2 , it

means 6×6 or 36, but 6^{-2} means 1 over 6^{-2} or $\frac{1}{6^2} = \frac{1}{36}$.

Powers of ten are much used for various formulæ, and a simple method of reading their value at sight is as follows: Thus, 10^6 means one with 6 ciphers after it, 10^9 , one with 9 ciphers after it, or 1,000,000,000.

Roots to be extracted are generally represented or indicated by the radical sign $\sqrt{\quad}$ with the number of the root placed over the V of the radical, thus; $\sqrt[2]{\quad}$, $\sqrt[3]{\quad}$, etc. If no number appears over the radical, then 2 is understood, or the square root is to be taken.

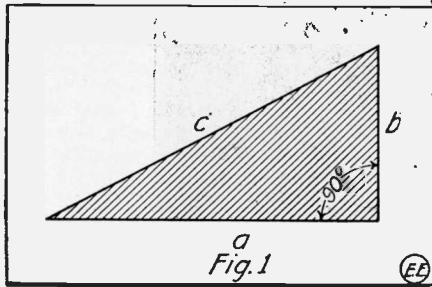

Sometimes the power and root of a number are indicated in the following manner:— $312^{\frac{1}{2}}$ means the second or square root of 312 raised to the first power, or the $\sqrt[2]{312}$. Again it might occur, thus:— $46^{\frac{2}{3}}$ meaning the cube root of 46 to the second power. The fourth root of a number is found by extracting

the square root twice, or the square root of the square root. The 6th root may be ascertained by finding the square root of the cube root of the given number. Such powers as $42^{1.8}$ and high powers are best found by the use of logarithms. These require the use of a set of logarithm tables, and no explanations will be given here, as nothing will be accomplished without them. Suffice it to say that many otherwise impossible problems are easily solved by their application. Any root, such as 7th, 11th, 17th, etc., is readily found by logarithms. A set of logarithm tables can be bought for 50 cents to one dollar, including instructions. They can also be read from ordinary slide rules, another great boon to those having occasion to use figures much. The ordinary slide rule reads to from 3 to 4 places, and hence is not accurate for large figures, but for figures not extending over 5 to 6 places, it is very handy and gives the result at once. Division and multiplication are quickly performed on them, as well as the extraction of square and cube root, logarithms, trigonometric functions, such as cones, tangents, etc.

The process of extracting the square root of a given number is as follows:—Suppose the square root of 217,668.9025 is to be found; begin by pointing off the number into groups of two figures each, starting at the decimal point, and pointing off left and right, as shown below:—

```

      ) 21,76,68.90,25 | 466.55
      16                sq. root.
(a) 86 ) 576
        516
(b) 926 ) 6068
          5556
(c) 9325 ) 51290
           46625
(d) 93305 ) 466525
            466525
              000000
    
```

The procedure employed to solve the above is this:—Start, by finding the largest even square in the couplet to the extreme left, viz., 21. Upon reflection, it is evident that the largest even square in 21 is 16, since 5 times 5 is 25, hence

it must be 4×4 or 16. The 16 is put down under the 21, and subtracted as shown, at the same time bringing down 76, or the next couplet, of two figures. The square root of 16 or 4 is placed in the quotient, to form the first figure of the root wanted,—also 4 multiplied by two or 8 is placed at (a) to form the first trial divisor. Then say 8 into 57 goes 6 times, place the 6 in the quotient after the 4, and 6 also after the 8 in the divisor (a). Now multiply 86 by 6, giving 516. Subtracting leaves a balance of 60, plus 68 brought down from the dividend.

Now to get the next trial divisor (b), multiply the 46 of the quotient by two, giving 92; then say 92 into 606 will go 6 times, place 6 in the quotient, and also after the 92 in (b) divisor, and 6×926 is 5556. This subtracted from 6068, leaves 512, and 90 brought down. The trial division (c) is found by multiplying 466 of the quotient, by 2 or it equals 932, and 932 into 5129 goes 5 times. Place 5 in the quotient and also in the divisor, and multiplying 9325 by 5 gives 46625. Subtracting we have 466525. The trial divisor (d) is arrived at by multiplying 4665 of the quotient, by two, or it is 9330. This into 46652 goes 5 times. Place 5 in the quotient, also in the divisor, and multiply; the subtraction being zero, finishes this case. The pointing off of places in the quotient or square root, is done

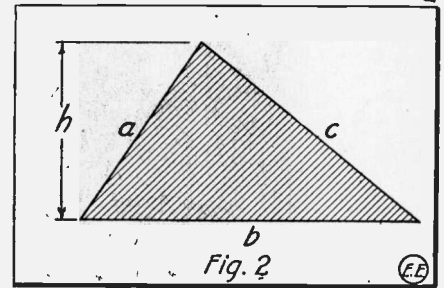

by observing the number of couplets pointed off in the dividend to the left of the decimal point. Here 3 couplets appear in the dividend to the left of the decimal point, hence 3 places counting from the left are pointed off in the quotient, or the square root of 217,668.9025 is 466.55. This is readily proved by squaring the root, i.e., multiplying 466.55 by itself, which will give the dividend.

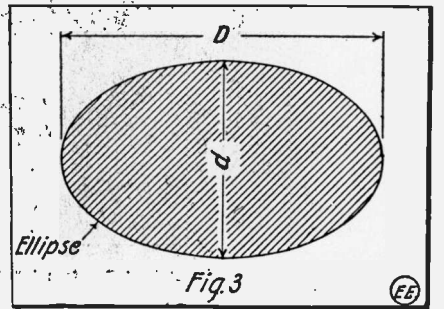

THE METRIC SYSTEM OF MEASUREMENT.

Measures of Length

1 Millimeter (mm.) =	0.03937079 inch, or about 1/25 inch
10 Millimeters=1 Centimeter (cm.) =	0.3937079 "
10 Centimeters=1 Decimeter (dm.)=	3.937079 "
10 Decimeters=1 meter (m.) =	.39.37079 inches, 3.2808992 feet, or 1.09361 yards
10 Meters=1 Decameter (Dm.) =	32.808992 feet
10 Decameters=1 Hectometer (Hm.)=	19.927817 rods
10 Hectometers=1 Kilometer (Km.)=	1093.61 yards, or 0.6213824 mile
10 Kilometers=1 Myriameter (Mm.) =	6.213824 miles
1 inch=2.54 cm., 1 foot=0.3048 m., 1 yard = 0.9144 m., 1 rod = 0.5029 Dm., 1 mile = 1.6093 Km.	

Measures of Weight

1 Gramme (g.)=	15.4324874 gr. Troy, or 0.03215 oz. Troy, or 0.03527398 oz. avoird.
10 Grammes=1 Decagramme (Dg.)=	0.3527398 " "
10 Decagrammes=1 Hectogramme (Hg.)=	3.527398 " "
10 Hectogrammes=1 Kilogramme (Kg.)=	2.20462125 lbs.
1000 Kilogrammes=1 Tonne (T.)=	2204.62125 lbs., or 1.1023 tons of 2000 lbs., or 0.9842 ton of 2240 lbs., or 19.68 cwts.
1 grain=0.0648 g., 1 oz. avoird.=28.35 g., 1 lb.=0.4536 Kg., 1 ton 2000 lbs.=0.9072 T., 1 ton 2240 lbs.=1.016 T., or 1016 Kg.	

Measures of Capacity

1 Liter (l.)=1 cubic decimeter=	61.0270515 cubic in., or 0.03531 cu. ft., or 1.0567 liquid qts., or 0.908 dry qt., or 0.26417 Amer. gal.
10 Liters=1 Decaliter (Dl.)=	2.6417 gal., or 1.135 pk.
10 Decaliters=1 Hectoliter (Hl.)=	2.8375 bu.
10 Hectoliters=1 Kiloliter (Kl.)=	61027.0515 cu. in., or 28.375 bu.
1 cu. foot=28.317 l., 1 gallon, Amer.=3.785 l., 1 gallon, Brit.=4.543 l.	

(To be Continued)

Talking from New York to San Francisco

On Oct. 9, 1876, Alexander Graham Bell and Thomas A. Watson talked by telephone to each other over a two-mile wire stretched between Cambridge and Boston. It was the first wire con-

the first human voice heard across the American continent. The hundreds at both ends of the line broke into enthusiastic applause.

After talking for a minute or two

to San Francisco through the instrument at which hundreds had laughed in derision in 1875. This, to him, he confessed, was the most touching incident of the afternoon.

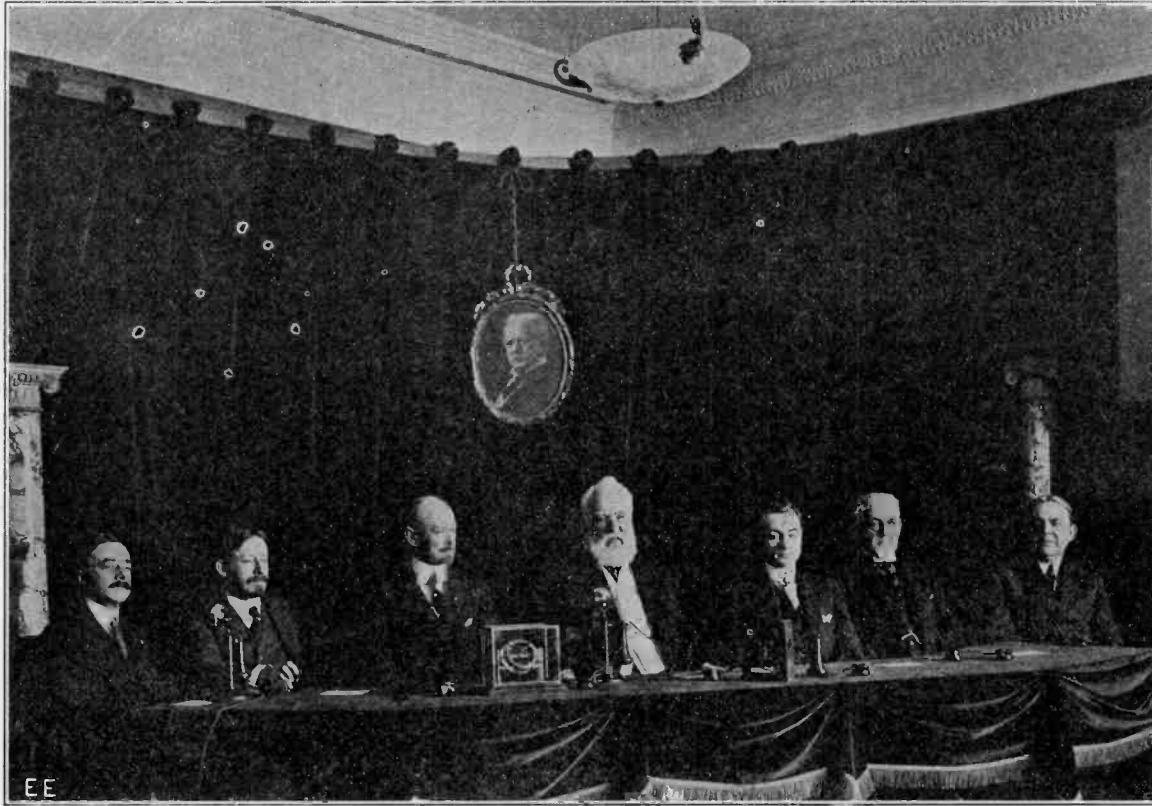

Names of distinguished guests seated, reading from left to right:—John J. Carty, Chief Engineer of the A. T. & T. Co., Honorable George McAneny, President Board of Aldermen, New York City, Mr. U. N. Bethell, Senior Vice President A. T. & T. Co., Dr. Alexander Graham Bell, inventor of the telephone, Mayor John Purroy Mitchell, C. E. Yost, President Nebraska Telephone Company, Honorable William Prendergast, Comptroller City of New York.

versation ever held. On Jan. 25 last the same two men talked by telephone to each other over a 3,400 mile wire between New York and San Francisco. Dr. Bell, the veteran inventor of the telephone, was in New York, and Mr. Watson, his former associate, was on the other side of the continent. They heard each other much more distinctly than they did in their first talk thirty-eight years ago.

The completion of the first transcontinental telephone line was celebrated in New York, San Francisco, Washington, Boston, and Jekyll Island, Ga. In the afternoon congratulatory messages were exchanged between President Wilson in Washington and President Moore of the Panama-Pacific Exposition in San Francisco, and between the Mayor of New York and the Mayor of San Francisco.

The record for long-distance talking was established when Theodore N. Vail, President of the American Telephone and Telegraph Company, on Jekyll Island, talked by way of Boston to Mr. Watson in San Francisco, the wire being stretched 4,750 miles. Previously Mr. Vail had talked to Mr. Watson through New York, a distance of 4,300 miles.

At 4:30 P. M. here, when it was 1:30 in San Francisco, John J. Carty, chief engineer of the company, announced that all was ready, and Dr. Bell picked up the receiver in front of him as Mr. Watson, in San Francisco, picked up his receiver. Then, speaking in an easy tone, Dr. Bell said:

"Mr. Watson, are you there?"

And Mr. Watson replied that he was and that he heard distinctly. Thus was

through a modern instrument, Dr. Bell picked up an exact duplicate of the telephone made for him by Mr. Watson in 1875, the original of which is in the Smithsonian Institution in Washington. This was connected with the San Francisco wire and Dr. Bell spoke through it.

"Hello, Mr. Watson," he said. "Can you hear me?"

"I hear you perfectly," Mr. Watson replied.

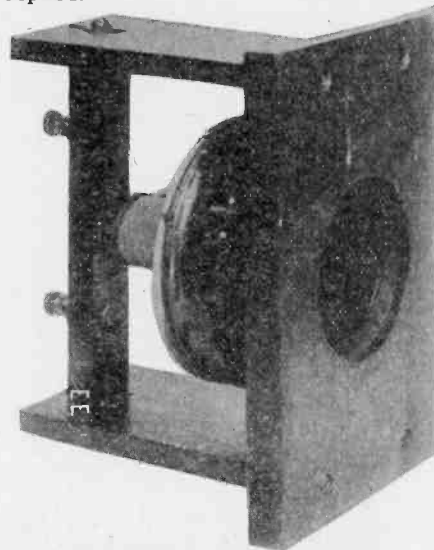

Model of Bell's first telephone which was used in long distance talk.

A pleased smile spread over Dr. Bell's face as he realized that he had talked

After Dr. Bell had switched back to the modern telephone to resume his talk he heard a sound that at first he thought was due to some imperfection in the transmission of the voice over the long wire, but in a moment he realized that Mr. Watson had turned away from his telephone to tell the San Francisco audience what Dr. Bell had said, and that the noise he had heard had been the applause of the audience, 3,400 miles away.

The telephone line used across the continent will be opened for commercial purposes on March 1. It was announced that the charge for a telephone conversation between New York and San Francisco would be \$20.70 for the first three minutes, and \$6.75 for each minute thereafter. When one man in New York talks to a man in San Francisco \$2,000,000 worth of apparatus will be tied up and cannot be used for the duration of the conversation for any other purpose. It is expected that, in normal conditions, it will require about ten minutes to put a call "through" across the continent.

In the line there are two physical and one phantom circuits and in each physical circuit there are two wires and 6,800 miles of hard drawn copper wire. There are 870 pounds of copper wire in each circuit mile and 2,960 tons in the entire line. The line crosses thirteen States and passes through Salt Lake City, Denver, Omaha, Chicago, and Buffalo, with a branch that runs through Pittsburgh, Washington and Philadelphia. In the main line there are 130,000 poles.

It is a splendid scientific achievement of the very highest character. The

(Continued on page 188)



A Miniature Electric Show

THE following is a description of a small electric show which, if made correctly, will cause considerable amusement and well repay the experimenter for his trouble. No tools or material are required which are not found in every experimenter's workshop. All details will be left to the experimenter's ingenuity; only the principle

non-magnetic material is placed over the opening in the stage. The magnets are now adjusted so that the core of each one presses against the bottom of the copper. I should have stated that the magnets should not be over $\frac{3}{4}$ to 1 inch apart (center to center) for good results. The small strips around the edge of the copper hold it in place and also keep anything from rolling off.

have been run to the keyboard, they may be grouped into a cable and bound with tape. The keys are nothing but small strips of brass, held at one end by a brass tack and making contact, when pressed, to another brass tack. The small D. P. D. T. switch can also be made from these brass strips. The connection for reversing the motor, which was a "Little Hustler," are not given, since most readers know how this is done or can find it in any electrical book.

Contributed by
WILL P. RATHERT.

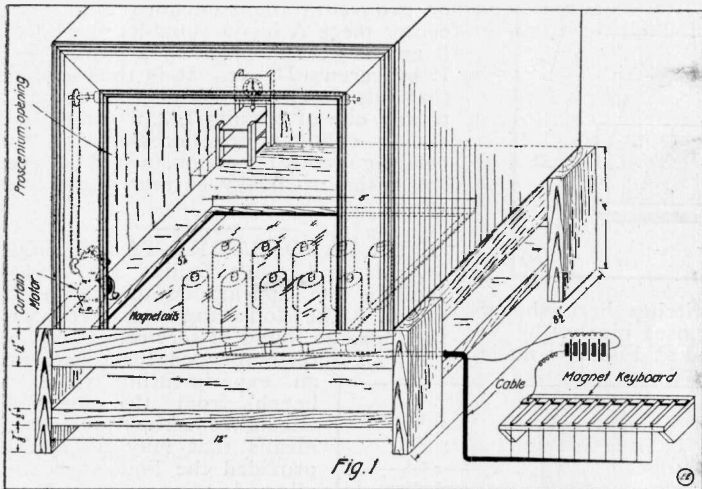

A diagram of the curtain is shown in Fig. 3. A light $\frac{1}{4}$ " round wooden pole is used for curtain roller and soft cotton cloth for the curtain. Heavy thread is used to draw it up and passes over hooks or, better, pulleys, at the top of curtain and then to the winder or else direct to the shaft of the motor. The motor is connected to a small D. P. D. T. switch mounted on switch-board so that it may be reversed to lower the curtain.

A LAMP BANK SWITCH.

A lamp bank is usually an awkward thing to regulate but this one is as easy to operate as a rheostat. It is built so the lamps can be thrown in circuit by turning a semi-circular piece of brass. Obtain a board 12 by 18 inches and arrange 12 lamp sockets in a space 12 by 9 inches. Four inches from the bottom on the center line of the board is placed the semi-circular slider which is made of a piece of sheet metal 6 inches in diameter. Drill a hole in the center large enough to slip over a $\frac{8}{32}$ screw and cut of the disc $\frac{1}{4}$ inch above the hole. Fasten it to the base with a $\frac{8}{32}$

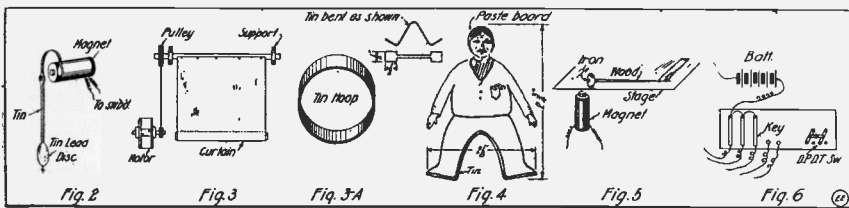

upon which it works and the materials and dimensions will be given.

First construct the stage of $\frac{1}{2}$ inch soft pine and according to the dimensions given in the diagram. A square opening is left in the center of the stage $5\frac{1}{4}$ "x8", as shown. The front of the stage is constructed as shown by the dotted lines. Also sides and a back are very desirable. However, these may be made of colored pasteboard or other light material.

About $\frac{1}{8}$ " from the bottom of the legs is pasted another floor upon which the magnets rest or are fastened.

Next we will consider the magnets, which are really the main part of this show. As many of these may be made as the experimenter desires, in fact, the more there are, the better the results obtained will be. In the show I made, two rows of six magnets each were used. Each magnet was $2\frac{1}{4}$ " high and contained 6 layers of No. 20 S. C. C. magnet wire. Eight volts A. C. from a step-down was used to operate them, or 6 volts D. C. For the core of the magnets I used 20 penny iron nails, cutting them off the right length, and they are best annealed before using. They are now mounted in rows across the stage, of course resting on the first floor, as shown in the diagram. One wire from each magnet is now fastened to one main wire which leads to one of the poles of the battery. The other wires from each magnet are lead out separately and numbered 1, 2, 3, etc. Next a sheet of copper or other very thin but strong

A small miniature hall clock is made as shown in Figs. 1 and 2. The dial off of an old watch makes a good face for the clock. The key must be pressed for each swing of the pendulum.

Next I will give a few of the many things that can be made to act on the stage.

Small tin chairs, table and cradle not over 2 or $2\frac{1}{2}$ " high, purchased at any toy store, can be made to rock and sometimes move about. Also a very small tin automobile is useful.

A light tin hook $\frac{3}{8}$ " wide and 1" in diameter will cut very peculiar figures upon the stage when the keys are pressed in the right order. See figure.

Small ball bearings act in a similar manner.

A small man that can walk and jig fine can be made as in Fig. 4.

An acrobatic stick is made as in Fig. 5 of iron and wood.

The man and hoop when worked at the same time can (with a little practice) be worked so that the man will almost appear to roll the hoop. The magic stick can also be made to set up as often as the operator desires.

A great many other things may be added to the show, such as scenery and two or three small footlights behind small tin reflectors.

Alternating current is more desirable than direct current on account of the vibrating movement it gives to the objects. The keyboard is shown in Fig. 6. I would advise that it be about two feet from the stage. When all the wires

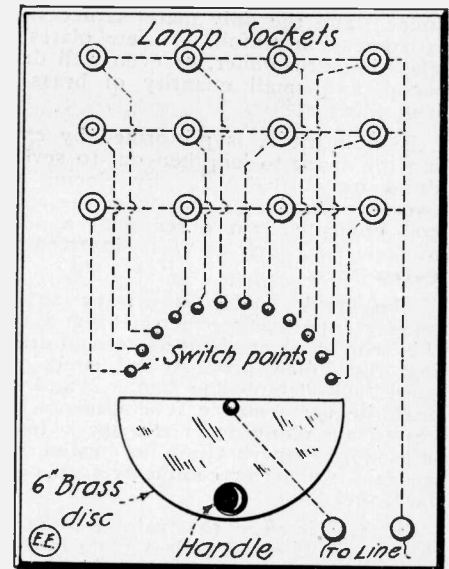

screw. Now arrange the contact screws so the rotating disk will pass over them; connections are shown in drawing.

Contributed by
RALPH HITESHEW.

ELECTROPLATING MIRRORS.

A new method of silvering mirrors consists of depositing the metal on the glass by means of a high potential electric current. A plate of metal is placed against the glass; these are laid flat on a table and the air above them is exhausted to a high degree of vacuum. Then a small quantity of hydrogen gas is introduced and the current is turned on thru a negative pole attached to the metal plate. In thirty seconds the glass has been silvered.

The Colombian Government ordered the removal of the high-powered wireless station at Cartagena, after England protested that it was operated by Germans.

SPECTACULAR EFFECTS WITH SPARK COILS.

Spark coils are used by probably every electrical dabbler, and those possessing such a coil, even tho of small size, will be interested most possibly, in a few spectacular experiments as described here. These are very easily

TWO CIRCUIT SWITCH CONSTRUCTION.

For laboratory and other electrical requirements it is often desired to quickly transpose two distinct circuits or to connect both poles of one circuit to another distinct circuit. The several styles

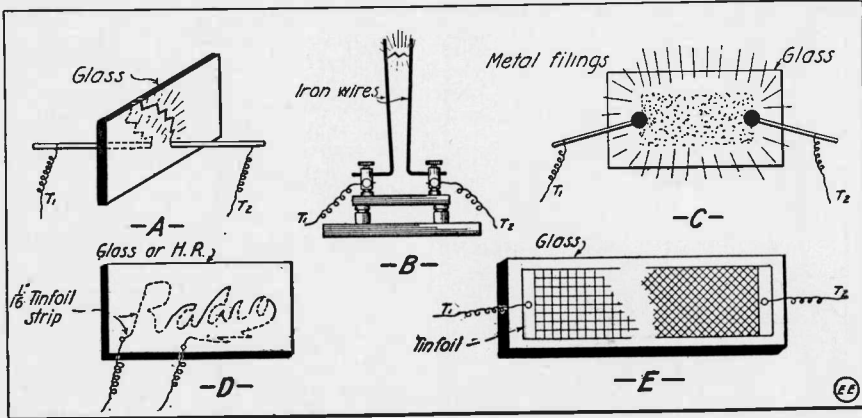

conducted without any appreciable expense and are very attractive for electrical and wireless demonstrations at parties, evening gatherings, and radio club meetings.

The stunts shown in the sketch, Figs. A—E will be found quite satisfactory, indeed, and the only material necessary is some thin tinfoil. A few plates of glass or hard-rubber, or even well dried wood, and small quantity of brass or iron filings.

Experiment A is performed by causing the spark to lengthen out to several times its normal value by placing the two secondary terminals from the spark coil opposite each other with a sheet of dielectric, such as glass, inserted between them.

The spark ladder is always an intensely interesting experiment and two thin iron wires are bent as seen in drawing B. Once properly adjusted, the spark will "climb the ladder," and repeat the performance indefinitely. The heated air rising from the spark tends to make the spark climb, as heated ionized air is a better conductor than ordinary air.

Stunt C is very pretty, and to make the apparatus up, the glass plate is shellacked. When dry, some coarse iron or brass filings are sprinkled over it even and not too thickly. Then if the plate is heated gently over a stove, the filings will be found to have secured themselves after the shellac has cooled. The spark is passed thru the filings by connecting as shown.

Illuminated names are often desired and these are arranged by using some 1/16 to 1/8 inch tinfoil strips, and pasting it on glass as Fig. D shows. After it dries, a penknife cut across all the letter forming parts of the strip is made, about 1/16 to 1/8 inch apart, depending upon the spark rating of the coil used.

A simple but beautiful spark board is made after the fashion illustrated by Fig. E. Here a piece of tinfoil is glued or shellacked to a sheet of glass, etc., and after drying, it is criss-crossed by penknife cuts also, the cuts being made either diagonally or at right angles as at Style 1 or 2. Once you have tried some of these experiments you will aver that the spark coil is beyond any doubt one of the best friends the electrical experimenter has.

of double circuit switches here shown will serve these purposes nicely.

The switch outlined at Fig. 1 is made

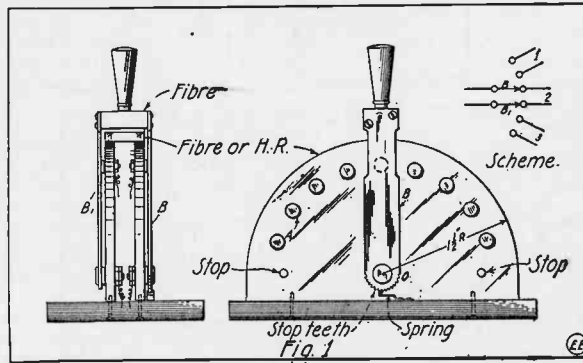

up of two semi-circular discs of fibre, hard wood, etc., or of marble and slate, in large units, and around these discs are

arranged in a semi-circle, the switch points A. Two distinct blades B and B, makes contact with the points in the manner evident, making it possible to switch a circuit connected to the moving blades pivoted at O, onto any other circuit desired. The blade B may have teeth filed or cut into its base as shown and a stop spring resting in the notches, so that the tendency will be to stop the blade exactly over a switch point. The switching scheme will readily be grasped by looking at the scheme detail, Fig. 1.

At Fig. 2 is depicted the make-up of a switch much used in laboratories for transposing circuits, etc. It consists in brief of two switch blades of about 1/32 or 3/64 inch spring brass 1/2 inch

wide, bent as shown and fastened between a split disc of insulating material as at C and D, the lower half disc being secured to the upper part C by flat-head machine screws. The switch handle C is best made of fibre or hard rubber, with the edge knurled to facilitate gripping it better. The switching scheme is indicated as before.

A switch which has been used considerably for heavy dynamo currents on power switchboards is illustrated at Fig. 3. Here the knife switch blades C, of standard design, are rotatively mounted on a circular center section A, arranged to swing or revolve in a rabbit or groove in the switchboard B. The center piece A has a shoulder turned on it and is held in place by a second disc E by screws D, etc. It is thus evident that this permits of connecting circuit 5 to any one of circuits 1, 2, 3 and 4. No sliding contacts are necessary on the rotating central portion, which adapts the design to heavy current and power work.

YOUR LABORATORY TABLE TOP.

Acids and other liquids are always spoiling the appearance of laboratory tables. The following treatment will therefore be found of service. It can be

recommended for preserving an experimenting table or bench from the injurious effects of strong acids and alkalis that may be spilled, provided the liquids are not allowed to remain on too long. Two solutions are required, say H. J. Ralli, in "Model Engineer," London:

The first consists of one part blue stone and one part chlorate of potash dissolved in eight parts of boiling water. For the second solution, dissolve 1 1/2 parts aniline hydrochloride (which a chemist can obtain to order) in 10 parts of water. Having

thoroughly cleaned the table, apply the first solution as hot as possible with a flat brush. Give another coat as soon

as the first is dry, then two coats of the second solution. When quite dry, rub with raw linseed oil till polished, and wash with hot soapy water. A good black surface is thus given to the wood, in addition to the acid-resisting qualities. A little raw linseed oil rubbed on with a cloth now and again will be an advantage.

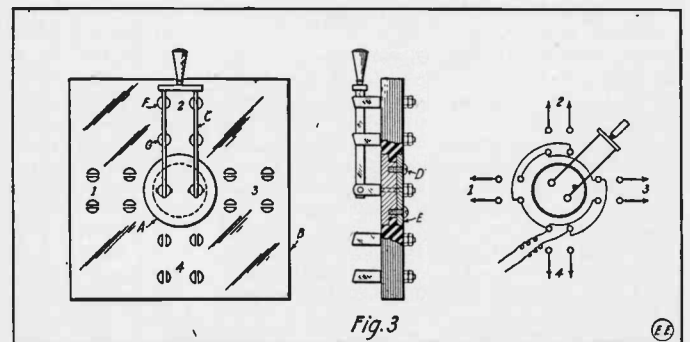
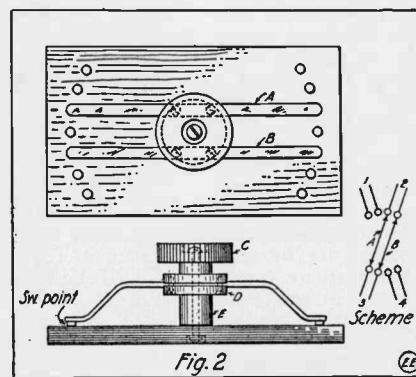

Wireless is used to fire fog signal guns along the English coast.

A SELENIUM RELAY FOR RADIO CURRENTS.

UP to now the most sensitive relay was the Siemens polarized relay, which would close its contacts with about 0.00005 ampere. The new selenium relay invented by Mr. G. Allstrom is said to respond to less than 0.0000000001 (one hundred billionth) ampere. This would make it even more sensitive than a telephone receiver, and experiments have shown that

With suitable means the oscillations of A can be dampened so that it will return in its original position immediately after the current had passed through M. In further detail it may be said that a magnet coil having 7,000 to 8,000 ohms resistance will be sufficient for the etheric wave relay coil M. Such a coil may have a very soft iron core about 3/8 inch in diameter and 5 inches long. Two fibre or hard rubber end discs are mounted at either end, whose diameter

high frequency machines, developed by the Wappler Electric Mfg. Co. Our illustration shows two of these new gaps; the upper one being insulated with thin mica rings as in standard radio type gaps.

The most important function in a high frequency generator is performed by the sparkgap and this particular instrument has gone thru a long process of development. They have succeeded in constructing a very simple sparkgap which is highly efficient and requires hardly any attention. Dr. DeKraft discovered that the quenching, the magnetic deflection, and the hydrogen gas are unnecessary if provision is made for maintaining certain temperative conditions. That they have successfully met all requirements in their new construction is borne out by the fact that it operates faultlessly on transformers from 1/2 to 4 kilowatt and on voltages from 2,000 to 100,000. The noise of the discharging sparks is reduced to a mere hissing by reducing the distance of the jumps to a minimum, and provisions are made to select the number of gaps so that it has great adaptability for the various modalities, such as auto-condensation, diathermy, fulguration and stimulation of muscles. The insulated handle projecting from the left of the gap frame controls the number of gaps in series, and the more it is pushed in, the more gap plates it short-circuits

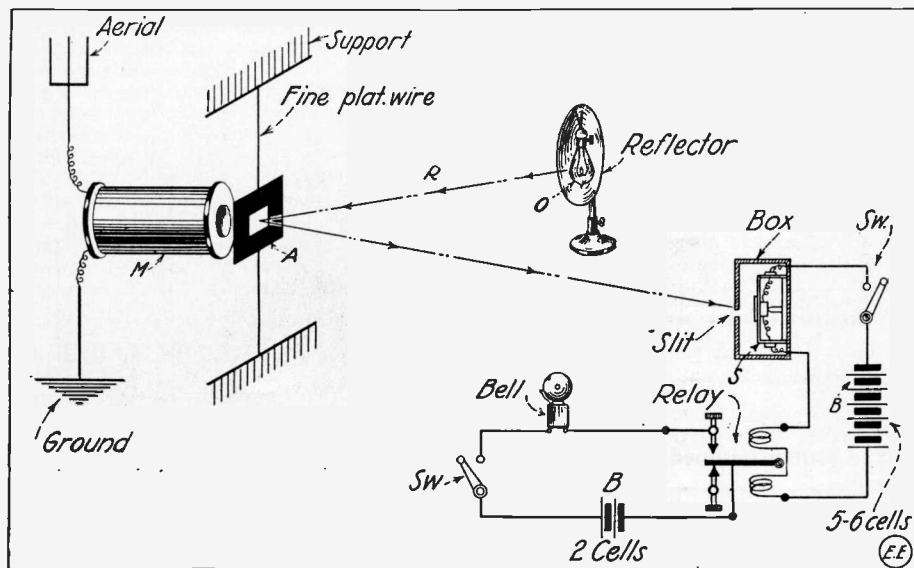

for wireless work it is well adapted to radio work, for calling, etc. The instrument was used lately in connection with electrolytic detectors, which were always thought successful only in connection with telephone receivers. Loud, audible signals were never obtained so far with such detectors, but the Allstrom selenium relay makes it possible to use a sounder or tape register with any kind of detector, no matter how sensitive.

This will come as good news to wireless telegraph experimenters, and we describe herewith the arrangement of the apparatus:

An extremely light piece of sheet iron A, is hung between two platinum wires of the minute diameter of 0.0001 inch, etc. In the centre of the iron sheet a small, very light mirror is cemented. An electro-magnet M, which may have a resistance as high as 10,000 ohms, is placed immediately behind the iron foil, so that the magnet core almost touches the iron.

Some distance away a sensitive selenium cell S, is stationed. The cell itself is enclosed in a box, which at the front has a narrow slot. A source of light O, is placed behind and directly over the selenium cell, and the room must of course be dark. By means of a parabolic mirror a beam of light R, is thrown upon the small suspended mirror on A.

This beam is reflected towards S, but as long as the foil A, is motionless, the beam of light does not fall through the slot of S.

However a minute current—such as a wireless wave—passing through the windings of M, will magnetize its core sufficiently to turn the very light mirror on A, and the ray can now fall through the slot of S, which reduces the resistance of the selenium cell. This is sufficient to operate relay R, which in turn will actuate bell B.

is roughly 2 3/4, by 1/4 inch thick. The iron core is insulated with a couple of layers of heavy waxed paper. The coil can then receive about 11 ounces of No. 36 B. & S. gauge enameled copper magnet wire. This gives approximately 7,284 ohms resistance for the magnet M, which adapts it nicely to the minute radio currents.

Further, the damping of the iron vane A, can be magnetic in character, so as to leave the vane free of an unbalanced weight. A permanent steel magnet, placed several inches from the iron vane, will have the desired effect in causing the moving member to come to rest quickly. Other methods are also applicable.

DIAGNOSIS BY ELECTRICITY.

For the benefit of the nervous cases that come to the doctor, it has been asserted authoritatively that it is just as necessary to know how emotional they are as it is to know how high the temperature is in a case of fever. Moreover, in many cases it is necessary to find out what experiences in the past or present life of the patient produce emotions.

For this purpose the patient sits at ease with hands on the electrodes, which may be so concealed in the arms of his chair that he is unaware that the most intimate processes of his soul are being registered as various words are spoken or various topics of conversation are discussed, the galvanometer showing when a sensitive subject has been touched.

QUENCHED SPARK GAPS FOR ELECTROTHERAPEUTICAL MACHINES.

In radio circles, the vast superiorities of the quenched spark gap are well known and this principle has been applied to some new gaps for physician's

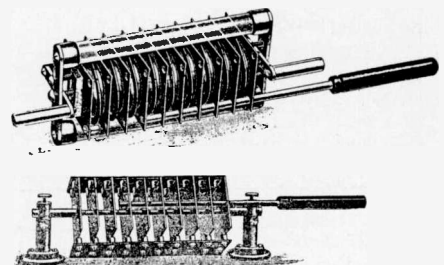

or cuts out. The plates are held between glass rods, forming a cradle.

NEWCASTLE, ENGLAND, WIRELESS ASSOCIATION.

At the monthly meeting of the above Association held recently Mr. N. M. Drysdale continued his excellent course of instruction on "Wireless Telephony." The various types of microphones, hydraulic and otherwise, speaking arcs, and other methods of wireless transmission of speech were described.

Rhumer's researches in light telephony were exhaustively dealt with. The construction and action of monochromatic selenium cells were explained in detail. Specimens of selenium were exhibited, after which "Multiplex Wireless Telephony" employing one beam of light composed of various colours was fully gone into, the lecturer showing clearly how the various colours were picked out by the cells designed to respond to the particular colours blended in the beam. Before concluding his lecture, Mr. Drysdale with the aid of the blackboard, described the construction in detail of a novel microphone suitable for experiments of wireless telephony.

A spirited discussion followed, after which Mr. Drysdale was thanked by the Chairman on behalf of the members, Mr. Drysdale replied and the meeting ended. The Club sends Greetings to all old members at home and abroad.

Hon. Secretary, A. W. Bridges, 29, Ridley Place, Newcastle-on-Tyne, England.

WIRELESS DEPARTMENT

THE "CHAFFEE" RADIOPHONE SPARK GAP.

Undamped oscillations for wireless telephony are produced at any frequency desired, it is said, by the employment of a minute spark gap in hydrogen, as devised by E. L. Chaffee. The illustrations at Figs. 1 and 2 show the Chaffee gap and how it is connected up for radiotelephony.

At Fig. 1 is seen the gap in cross-section. Here two distinct electrodes of small size, a and b, are mounted in ribbed cooling supports, c and d, which are joined together by an insulating washer e. The bolts clamping the two metal supports, c and d, are insulated on one plate by insulating sleeves and washers, I. Hydrogen may feed the arc chamber thru a pipe as shown. Of interest is the fact that one electrode is made of copper, while the opposite spark electrode is composed of aluminum. Both electrodes are otherwise exactly similar and mounted symmetrically on the base.

In using this gap for radiotelephony, it is connected thru choking coils (adjustable) CK, Fig. 2, to a direct cur-

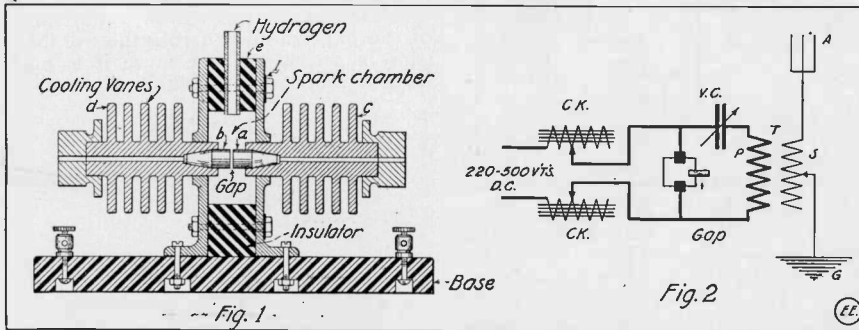

rent circuit of 220 to 500 volts potential. Further, the usual oscillation condenser VC and oscillation transformer primary P are shunted across the gap as seen. Aerial and ground connections are joined to the secondary of the oscillation or air core transformer T. The primary circuit VC, P, etc., is not an oscillating circuit, however, in this case, as the gap is a rectifier, permitting only direct current impulses flowing in a direction from the copper to the aluminum thru the gap to pass. One of these impulses starts the secondary circuit oscillating, and the secondary oscillations impose potential ripples on the primary so as to trigger off successive primary impulses at just the proper time for maintaining the secondary current. The recurrence of the primary impulses may be made of any desired frequency, says Prof. G. W. Pierce, with respect to the secondary current, by adjusting the primary condenser and inductance and also the main D. C. supply current. The Chaffee gap is adapted to produce frequencies as great as 30,000,000 cycles per second (35,000 upper limit of audibility, according to Tyndall). A single gap has an output of high frequency energy rated at about 1/2 kilowatt when a frequency of 1,000,000 cycles per second is employed, corresponding to 300 meters wave length.

TALKING FROM NEW YORK TO FRISCO.

(Continued from page 184)

power that sends the human voice out over the telephone is scarcely greater than that of a breath, yet the means have been provided by which this tiny, almost imaginary impulse, made up of as many as 2,000 separate vibrations a second, can be picked up by a delicate in-

WIRELESS AN OLD IDEA?

That a system of wireless telegraphy existed more than 3,000 years ago among the savage tribes of South America was the information brought home recently by Capt. J. Campbell Besley, adventurer and explorer.

"It was in the Juamara region that we first learned of this wireless system," said Captain Besley. "We were met at the entrance of a village by a number of natives. They had evidently been expecting us, and when we asked how they knew that we were coming they pointed to a crude looking arrangement suspended between two tree stumps on a horizontal bar. Through our Indian interpreter we learned that it was a wireless apparatus for sending and receiving messages from the various tribes throughout the Amazon Valley. The transmitter was a hollow trunk of a tree suspended from the pole so that the base was slightly off the ground. Inside it had been arranged very much like our violins. It was explained that when the instrument was struck smartly with a small rubber hammer a vibration was created that car-

ried for miles over the hills. The receiver is very similar to the transmitter, except that it is placed on a hardwood platform, the base of the hollowed tree trunk being grounded on the platform. When the message is struck in the neighboring village, sometimes thirty miles away, this receiver catches the vibrations, causing a jerky singing sound. I understand that this sound system can be read by the members of the tribe and that in this way news of victories and other happenings are told throughout the countryside.

We learned from the Maratos and the Haumbais tribes that this method of telegraphy has been used by the various tribes in that district for thousands of years."

strument, conserved over a distance of 3,400 miles, and reproduced perfectly and instantly across the continent. The human voice has been made to travel as fast as light, faster than sound unaided by technical apparatus; indeed, it rivals thought even, in the swiftness of its flight.

In this work the experimental and research department of the Bell System, has been engaged ever since the telephone became a commercial possibility, less than 40 years ago. With no traditions to follow and no experience to guide, this department, which is now directed by a staff of over 550 engineers and scientists, including former professors, post graduate students, scientific investigators—the graduates of 140 universities—has created an entirely new art—the art of telephony, and has given to the people of this country a telephone service that has no equal.

WIRELESS LIFE BOATS FOR R. M. S. "AQUITANIA."

The accompanying illustration shows the type of wireless telegraph equipped motor life boats carried by the R. M. S. "Aquitania," the latest addition to the fleet of liners belonging to the Cunard Steamship Co., Ltd., of Liverpool. Most of the recommendations made by the Board of Trade Departmental Committee on Ships' Boats and Davits are included in the construction of these boats. They

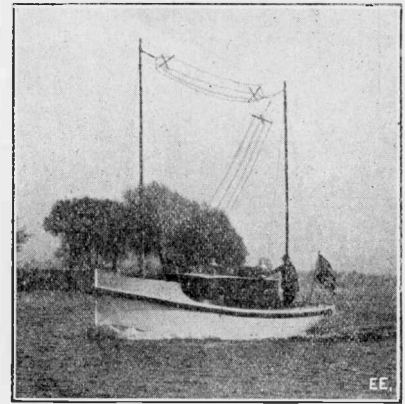

measure in length 30 ft. 0 in., and in breadth, 9 ft. 6 in., while the depth is 4 ft. 6 in.

It may be stated that each motor life boat is fitted with a Thornycroft Paraffin Motor developing 30 B. H. P. These motors are arranged to start on gasoline until the vaporizer is sufficiently heated, and then turned over to oil, thus ensuring an immediate start.

The forward end is divided off by a soundproof bulkhead forming a room for the Marconi wireless apparatus. These compartments are lighted by eight portholes, and ventilated from the roof by mushroom ventilators. Wells are placed fore and aft of the cabin, each being fitted with large relieving valves. This arrangement, whilst being criticised by some, was specified by owners and is found to be very satisfactory for handling purposes, when the water drains off from the floors (which are placed well above the water line) very quickly.

An important feature with this type of craft, is the wireless installation already referred to, by means of which the boats can be kept in touch with other vessels in the line of shipping. The receiving range for these sets is about 300 miles. The aerial wires are carried on two 25 ft. bamboo masts, which may be lowered on to chocks when not in use. Sling gear is fitted and the boat is slung from davits in a similar manner to the ordinary lifeboat.

In the case of the Titanic disaster the different boats, after leaving the ship, became very scattered, some being overloaded. With a boat as described above, in such a crisis, the whole complement of the shipwrecked boat's lifeboats could be shepherded and cared for until outside help arrived.

FRANK C. PERKINS.

HONOLULU RADIO HEARD AT ALDENE, N. J.

With receivers just completed at the Aldene, N. J., plant of the Marconi Wireless Telegraph Company, the testers there have no difficulty in receiving messages from the station at Honolulu, T. H. The factory experimenters can also receive messages that are received at the big station in Sayville, L. I.

ELECTROLYTIC INTERRUPTER KINKS.

This class of spark coil interrupter, widely used for operating X-Ray and wireless coils, is often of considerable trouble to the amateur, especially where it has to be operated for any appreciable length of time. Under such conditions the interrupter tends to boil or become very hot. This trouble, of course, is partly obviated by artificially cooling the jar or its solution. The simplest cooling scheme is shown in the sketch at "A." Here the interrupter is placed inside a larger jar of glass or metal, and this outer cooling tank is filled with cold water, which should be changed periodically, or better yet, continuously circulating cold water is passed thru the tank by means of a rubber hose connected to a spigot over a sink; the discharge water simply spilling over the top of the jar into the sink. If the outer jar is of metal, then a discharge tube may be soldered or screwed into it. The cold water, in any case, is best fed in at the bottom, as "A" indicates.

The diagram "B" illustrates a common form of cooling attachment for electrolytic interrupter, made of several turns of lead pipe, which is inserted directly in the electrolyte bath of same. The cold water is supplied thru a rubber hose from a spigot, and the discharge from the cooling worm is piped to a sink or cesspool, etc. As most electric circuits of 110 volts potential are grounded, the cooling water for the "B" scheme should be supplied by an insulated tank and a small rotary pump, such as used on gasoline engines. By placing the tank out of doors, the water will be cooled and can then be pumped on around thru the interrupter system again, and so on, continuously. The whole layout is shown at "E" in sketch,

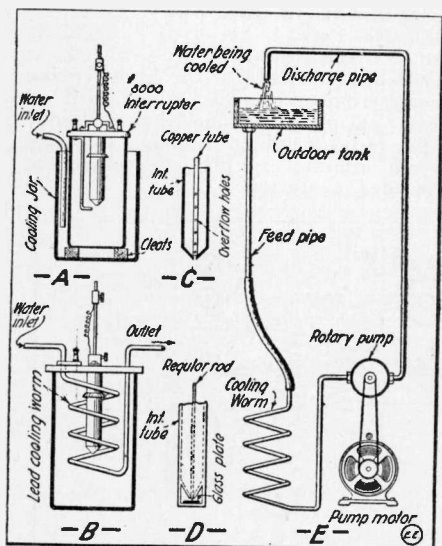

the rotary pump being driven by a small electric motor or by a water motor of the usual type, etc. The discharged water is allowed to drop as a spray into the tank, so that it will be cooled as much as possible by the air.

Some users of the Gernsback type electrolytic interrupter have found a small copper tube, drilled thru with overflow holes, as indicated at "C," of service instead of the solid composition rod supplied with the instrument, also another dodge claimed to work very well indeed is illustrated at "D" where the usual solid rod is allowed to project slightly from the tube orifice and to rest its point upon a piece of glass

WHAT S. O. S. MEANS.

In talking with the wireless operator, many ship passengers ask the meaning of the three letters used in the distress signal, "S. O. S." There seems to be a general opinion that the letters are the abbreviation of three separate words with a definite meaning. Persons of an imaginative trend will tell you that the letters stand for "Save our ship," "Send out succor," "Sink or swim," or some such meaning. The letters signify nothing but that a ship is in distress and in need of assistance. The call is used by all nations as a universal code, so that any wireless operator, regardless of the language he speaks, can immediately intercept the call of distress. Inasmuch as the call is in use by all countries, it can be seen that the signal can have no meaning in any language. The character of the code makes it a call that can be picked out easily from other signals, being composed of three dots, three dashes, three dots.

supported just under the opening. This is said to promote regular operating of the interrupter.

A word about the electrolyte: The usual solution mixture is made of 5 parts water and 1 part pure sulphuric acid (by volume), the acid being poured into the water and not vice versa, also a strong sodium chloride (common salt) solution will work quite well, but considerable chlorine gas is evolved by the electrolytic action taking place. For 110 volt A. C. or D. C. circuit the acid solution above given is good; for 220 volt service the solution should be made weaker (2/3 the strength given). For battery operation the solution should be very strong and must be used hot, the solution being heated artificially before starting to operate, and 15 to 25 volts at least is best. In some of these interrupters used abroad means is provided for keeping the solution hot by steam, electric heat, etc., also for battery operation the solution* is frequently composed of a saturated solution of ordinary alum or sulphate of magnesium. For battery operating the electrolyte should be kept at 85 to 90° Centigrade.

The solutions last suggested do not give off strong fumes, like sulphuric acid and they can also be used on 110 volts cold.

The Gernsback electrolytic interrupter passes about 6 to 8 amperes nicely on 110 volt circuit. For radio work it is seldom cooled artificially but should be for best efficiency; any size spark coil can be operated by this interrupter, but for small ones on 110 volt circuits; an extra impedance or choke coil should be connected in series with the interrupter.

*See "The Theory and Design of Induction Coils," by H. Armagnat.

RADIO TIME SIGNALS

AND THE PUBLIC.

Jewelers the country over are fast adopting the wireless system for receiving absolutely correct time from the Government Radio Stations at Arlington, Key West, New Orleans, or San Francisco, etc., but in general there is

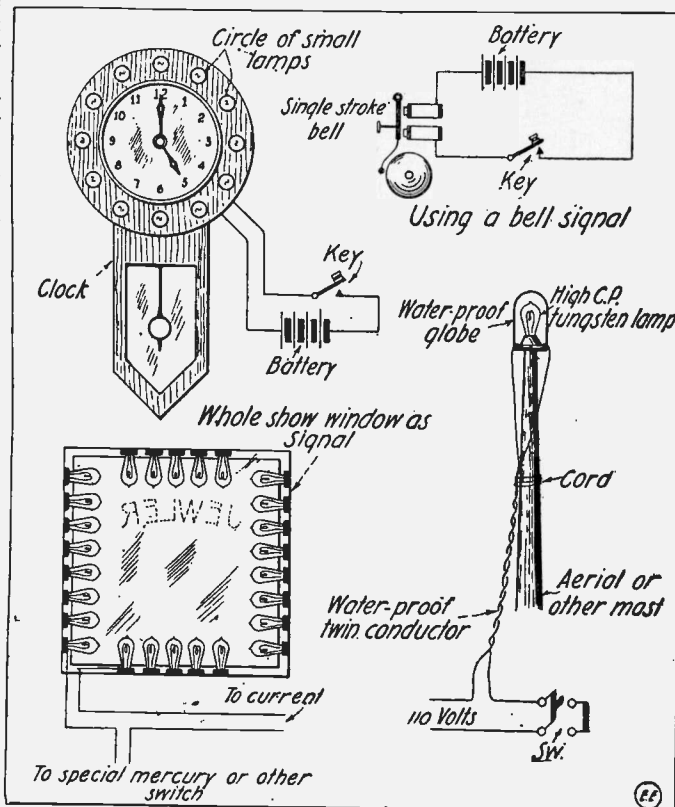

no direct means available to inform the public when the exact hour occurs. A simple way to do this is by means of an independent electric gong or lamp.

A bell of whatever size desired is installed in the show window or outside the store and this can be connected up with a few batteries and a telegraph key, and the person receiving the radio time signals with the usual head 'phones, simply taps the bell circuit key at every dot as received in the 'phones; and by having a sign near the bell, so that the public may fully understand the matter, it is possible to give very good time service to the public in this way. By having the radio apparatus located in a quiet place, or in another room from the store, the bell will not be heard by the person receiving the time signals, as this might interfere with his hearing same clearly. If a lamp is used to flash the receipt of the signals, no interference will, of course, be occasioned. The sketch herewith depicts several effective methods of employing this advertising scheme.

COLLEGE RADIO CLUB NEWS.

At the last meeting of the Club, an election of officers for the ensuing year resulted as follows: Wm. C. Nolan, president; Earl S. Shader, vice-president; Phil. W. Pelts, secretary, and O. C. Pavia, treasurer. Jack Forsythe is stenographer. Several new members were admitted and a plan for the year's work outlined.

We hope this notice will help to stimulate interest in *Wireless* among *Memphis Amateurs*.

PHILIP W. PELTS, Secretary, 612 Adams Avenue, Memphis, Tenn.

Connections for Radio-Telegraphic Sets

We present herewith a number of wireless telegraph diagrams both for receiving and transmitting. In the chart of transmitting diagrams we show the simplest form at Figure 1. Here we have an

rent used in the primary circuit as well as the general operation of the Electrolytic Interrupter. In adjusting the high voltage circuit in connection with the aerial and ground, the clips on the primary and secondary windings of the oscil-

be seen, a standard antenna switch is used for switching the aerial and ground to the transmitting and receiving set, respectively. The transmitting set will, of course, be understood from the previous explanations and diagrams, and the receiving set is covered in the following paragraphs.

A lightning grounding switch, rated at 600 volts and 100 amperes, is used as indicated to ground the antenna when the station is not in use, and especially when electric storms are in the vicinity. The No. 4 ground wire runs from the lightning switch contact to a separate and distinct ground which must not be used for the station connections, and an independent ground should be used for this purpose. The lightning grounding switch and its ground connecting wire must be run outside of the building in practically every case; in accordance with the Fire Underwriters' Rules. A water pipe ground is usually preferred and gas pipes should not be used. Steam pipes are occasionally used for ground connections, and where no ground such as this is available a substitute may be utilized, comprising a piece of iron pipe driven several feet into good damp ground, etc. Ordinary bell wire may be used for connecting up the receiving instruments, also lamp cord is very good indeed. For the transmitting instruments No. 14 or 12 rubber covered copper wire should be used in every case where 110 volts circuits are to be handled, and the wire should of course, be run on cleats, et cetera, in accordance with the Fire Underwriters' Rules. Particular care should be taken in bringing in the leading wire from the aerial, through the wall of the building, and one of the heavy Electro-se Insulators should be used; especially when transmitting sets are utilized, as a very slight leakage of the high tension current from the sending set will of course, naturally reduce the efficiency of the radio sending station, and this will of course, directly decrease the range of the station.

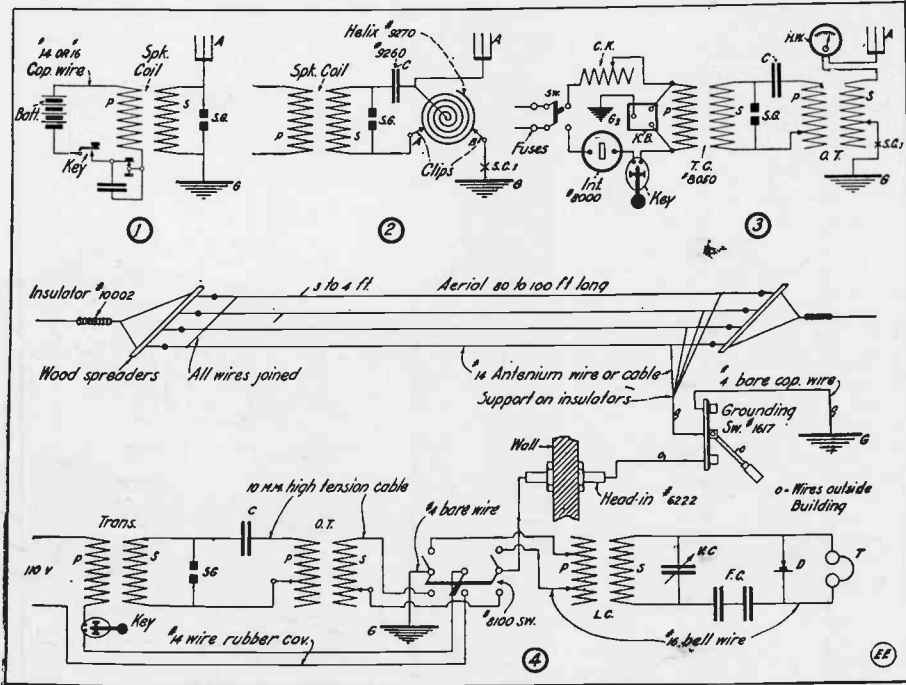

Radio Transmitting Diagrams.

ordinary spark coil connected with a battery and key in the primary circuit and simply a spark gap S. G. in the secondary circuit connected of course to the aerial A and ground G. At Figure 2, we have a simple tuned wireless transmitting set, utilizing a spiral helix such as are on the market. In adjusting this set the clip A, controls the wave length adjustment of the spark gap circuit; while clip B, controls the wave length adjustment of the aerial and ground portion of the circuit and the helix. Both of these clips of course, should be adjusted simultaneously to tune the set to maximum activity, or until the maximum current is radiated in the aerial. This set as shown at Figure 2, is shown as a close-coupled set; while that indicated at Figure 3, utilizing an Oscillation transformer O. T. connecting the spark gap circuit with the aerial-ground circuit, is known as a Loose-Coupled Set, and permits of much finer tuning all around of course. This arrangement as shown at Figure 3, is practically imperative, now that the United States Wireless Law demands that a logarithmic decrement of not more than two-tenths, shall be used; and also that the wave form shall be of practically a single peak.

In the diagram at Figure 3 a transformer or transformer coil, No. 8050 type, is indicated for charging the condenser, etc., and the primary circuit of same is protected by a kick-back preventer K. B. connected to a separate ground as shown as G 2. An adjustable choke coil is indicated as C K, providing a No. 8050 transformer coil or other transformer is used, with a No. 8000 Electrolytic Interrupter on a 110 volt A. C. or D. C. circuit; the choke coil serving to control the amount of cur-

lation transformer O. T., should of course, be adjusted until the maximum radiation is obtained. A hot-wire meter is indicated at H W, and if a series condenser is to be used in series with the ground lead it is connected at S C 1. This of course, is only used where the aerial itself has such a long wave length that it is impossible to radiate a wave not exceeding 200 meters in length. A 110 volt transmitting set should of course, be protected by suitable fuses in the primary circuit, as indicated.

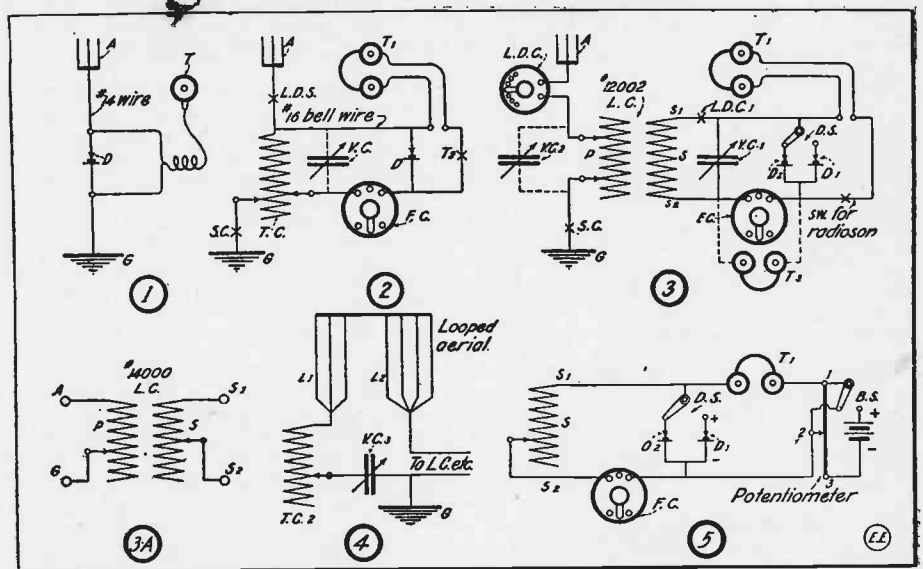

Radio Receiving Diagrams.

Referring to Figure 4, a complete radio transmitting and receiving station is shown in diagrammatic form, and as will

Referring to the receiving diagram chart, we show the simplest hook-up as Figure 1; where D, is an ordinary crystal

A "Wireless" Scene in New York City.

detector, and T a telephone receiver, such as a 75 ohm type or of higher resistance. A is the aerial and G is the ground, and ordinary bell wire may be used throughout the system or any other conductor of good size. The set of course as shown at Figure 1, is not tunable and for a tuned receiving set we refer the reader to Figure 2, where a tuning coil T C is employed of the double slide type. A fixed condenser is shown at F C; while at V C is placed a variable condenser. A second telephone receiver may be connected at T 2 in series with the ordinary set at T 1, if desired; where two persons are to listen in at the same time. A second pair of telephone receivers are sometimes connected on parallel with the first set. As will be seen, the tuning of the closed and open oscillation circuits of the receiving sets at Figure 2, are controlled by the movement of the two sliders, and these should be adjusted practically at the same time, or nearly so, until a station is heard the best. A loading coil or inductance is connected at L D S in series with the aerial lead wire, for tuning in longer wave lengths than the set will ordinarily respond to; and for very short wave lengths, below that of the natural period of the antenna, a series condenser is connected at S C in the ground wire. Telephone receivers at T 1, are sometimes connected across the fixed condenser at F C, or, in some cases, the telephone receivers and detectors are simply connected in series and no fixed condenser is employed.

At Figure 3, is shown a complete receiving set utilizing a loose-coupler L C, of the double slide primary type, etc., and here the aerial circuit is of course linked inductively with the detector circuit. The detector circuit is tuned by adjusting the variable condenser connected across the secondary inductance, at L. C. 1. Two or more detectors may be utilized as we show with a multi-point switch D S connected to the various detectors D 1, D 2, etc. The dotted line indicates the connections of the telephone receivers T 3, across the

Fixed condenser, F C, which of course, is optional with the operator. By noting the leads at S 1 and S 2, and following this connection over to 3 A, on our diagram chart; the connection for single slide primary loose-coupler, of latest pattern is indicated; and as will be seen, the primary and secondary coils are both adjustable.

Looking at the diagrams Figure 4, we see the old United Wireless Co.'s connection for a looped aerial, which has been widely employed for experimental and commercial radio receiving stations. It is claimed that considerable static and interference can be cut out by the static tuning loop, indicated at L 1, T C 2 down thru V C 3 to ground. The larger loop of the aerial is connected in the usual manner to the loose-coupler L C or tuning coil of the receiving set. Seven wires in the looped aerial used to be quite common with the United Wireless Co. In the diagram at Figure 5 is shown the usual connection for a potentiometer 1, 2, 3, together with bat-

tery and switch B. S. for same which thrown to the right, connects the battery with the potentiometer and detector; with the switch blade in the center no battery current is connected at all, and with the switch to the left the potentiometer and battery are cut out, and the 'phones simply shunted across the detector; which in this case would most probably be a crystal type or a batteryless "Radioson" type, etc. The lead marked S 1 and S 2 in Figure 5 connect of course, in the usual manner to the secondary winding of the loose-coupler or also to a tuning coil as the case may be. The usual fixed condenser is indicated at F C. Detectors D 1, D 2, etc., may be connected as desired to a multi-point switch D S. The telephone receivers are indicated at T1.

The connections for the receiving apparatus are very well made of stranded lamp cord, and for best results every joint should be soldered. The battery used with the potentiometer is usually composed of two to three dry cells of small or large size.

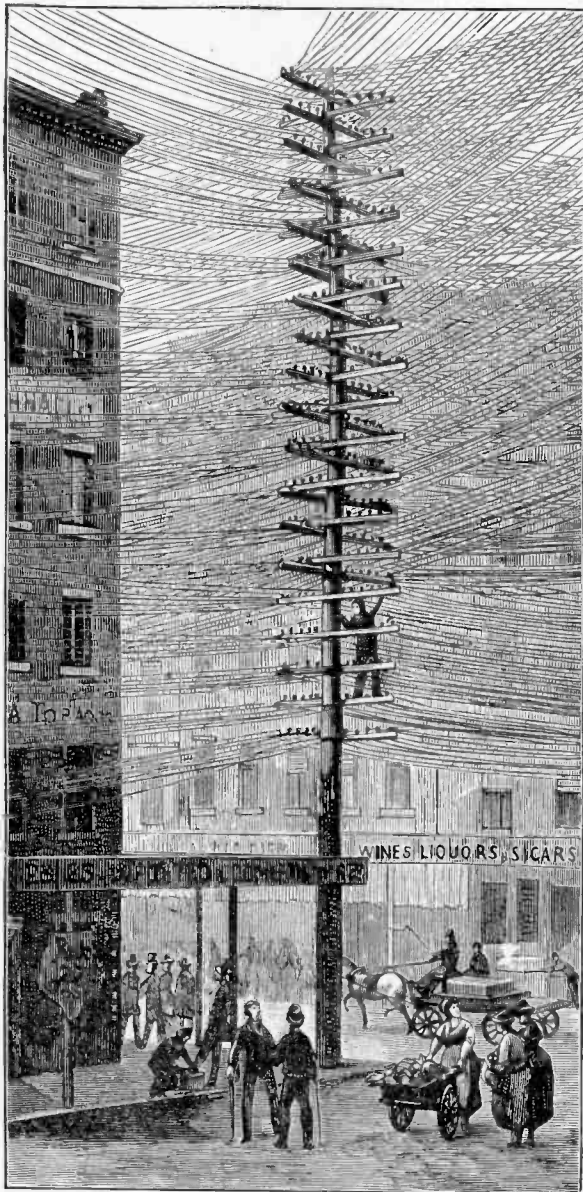

No. 25 Fulton Street, New York, 30 years ago. Note the wires. From an old wood cut



The same corner to-day. All the wires are underground. Note the difference.



HOW-TO-MAKE-IT DEPARTMENT



This Department will award the following monthly prizes: FIRST PRIZE \$3.00; SECOND PRIZE \$2.00; THIRD PRIZE \$1.00. The idea of this department is to accomplish new things with old apparatus or old material, and for the most useful, practical and original idea submitted to the Editors of this department, a monthly series of prizes will be awarded. For the best ideas submitted a prize of \$3.00 will be given; for the second best idea a \$2.00 prize, and for the third best a prize of \$1.00. The article need not be very elaborate, and rough sketches are sufficient. We will make the mechanical drawings.

FIRST PRIZE \$3.00. AN ELECTRIC BASEBALL GAME.

Secure a wooden base 8" square and $\frac{1}{2}$ " thick. Now get a motor and place it upon the center of the base so that the long end of armature shall be sticking up. Make four uprights 3" long and $\frac{1}{2}$ " wide. Fasten an upright on each of the

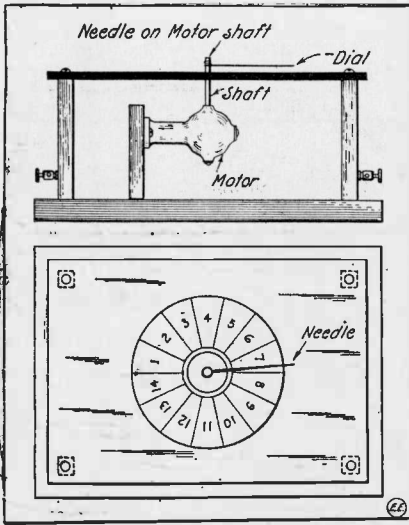

four corners of the base. Get a piece of cardboard and draw a circle upon it (diameter 6"). Draw another circle inside the other one (diameter 4").

Divide the circles into 14 equal parts, as in Fig. 1. Into each part place the following: Into No. 1 place "Home Run;" into No. 2 put "Single;" into No. 3 put "Two-base Hit;" into No. 4 put "Four Balls;" into No. 5 put "Three-base Hit;" into No. 6 put "Hit by Pitched Ball;" into No. 7 put "Strike Two;" into No. 8 put "Out on First;" into No. 9 put "Out on a Fly;" into No. 10 put "Strike Three;" into No. 11 put "Base on Balls;" into No. 12 put "One Ball;" into No. 13 put "One Strike;" into No. 14 put "Foul Ball." Cut a $\frac{1}{2}$ " hole in the center of the circle to admit the shaft. Fasten the cardboard on the uprights having the shaft sticking thru the hole in the cardboard. Get a piece of wire 5" long and wind 3" around the shaft, leaving 2" outstretching for a pointer. Now connect up to a battery and a switch and it is ready for use.

In operating it, turn on the switch and the pointer will spin around. In about 10 seconds, turn it off again and the pointer will stop at some notice such as "Home Run." This may be repeated by the player until he gets three out; then the player repeats what the first player did until he gets three out. Nine innings makes a game.

Contributed by THOMAS VAIL.

RADIO TIME SET WORKS PERFECTLY.

The wireless receiving station, just installed at the jewelry store of A. D. Sturges, at Norwich, N. Y., has been completed, and the time signals are received at ten o'clock from Arlington, Va.

SECOND PRIZE \$2.00.

AN ELECTROLYTIC KICK-BACK PREVENTER.

Herewith find drawings illustrating how to make an Electrolytic Kick-Back Preventer, working on the principle that sodium-phosphate forms an insulating coating on aluminum which is not broken down by the ordinary 110-volt light current, but which is broken down by the high voltage current of a spark coil or transformer, such as a surge.

The materials needed are:

- 1 pint size Mason "Golden State" fruit jar;
- $10\frac{1}{2}$ in. aluminum bar $\frac{1}{2}$ in. x $\frac{3}{16}$ in. (about this size);
- 10 brass-headed upholstery tacks;
- 1 piece seasoned oak $\frac{3}{4}$ in. thick, $3\frac{1}{2}$ in. diameter;
- 3 No. 1919 hard rubber binding posts;
- $\frac{1}{4}$ lb. Sodium Phosphate;

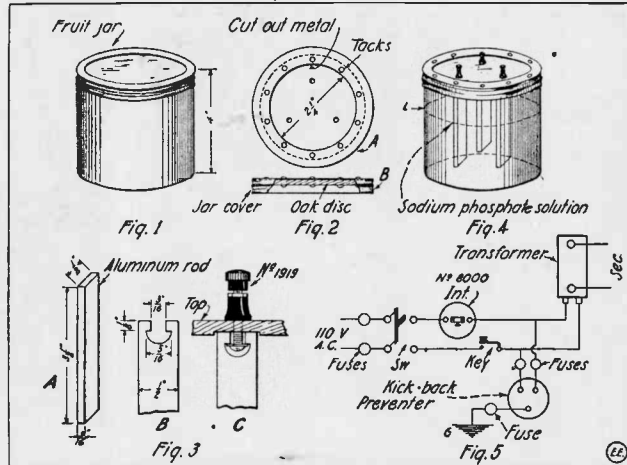

1 pint distilled water. The first step is to cut a $2\frac{1}{4}$ inch disc out of the top as in A, Fig. II.

The oak disc is then given 3 or 4 coats of shellac, dried, and three holes $\frac{3}{16}$ inches diameter, are bored; then the disc is fastened to the top by the brass tacks, as in Fig. II.

The aluminum rod is cut into $3\frac{1}{2}$ inch lengths, a $\frac{5}{16}$ inch hole is drilled in each near the end, as in B, Fig. III.

A slot is then sawed in the end to admit the shank of the screw in the binding post, as in C, Fig. III; this enables the rod to be clamped into position.

A rod is secured thus to the top through each of the holes.

The solution is then made up in the proportion of 1 part sodium phosphate to 5 parts distilled water. (It is important that it is distilled water).

This is filled to about the level L in Fig. IV.

The cover is then screwed on and the instrument is ready for use.

It is best to leave the cover loose until the insulating coating is formed, as heat is generated in the process. An hour or so will usually suffice to form the cell if a lamp load, etc., is connected to it during the forming period. When the lamps grow dim the plates are formed.

Contributed by PERRY SPANGLER.

THIRD PRIZE \$1.00.

A TRANSFORMER FROM TWO SPARK COILS.

I give you a diagram and description of a closed core transformer which I made out of two 1" coils. The transformer gives a heavy $\frac{1}{2}$ " spark on 110 volts A. C. without overheating.

Obtain two 1" coils or $1\frac{1}{2}$ " and remove the vibrators. At the opposite side saw a notch the width of the core (which can be seen under the vibrator). The notch is sawed parallel to the top of the coil the same distance from the top as it is at the vibrator side. Set the coils together and measure the distance between the outside end of the cores. Make a laminated sheet iron bar the length you measured and the width and thickness being that of the diameter of the core. Bolt the laminations together as shown. Drill a $\frac{1}{4}$ " hole thru the middle

of both bars. These holes are drilled by clamping the laminated bars in a vise and drilling the holes parallel with the width of the laminations. The bars are clamped to the cores by threaded rods.

Empire cloth should be placed under the bars where they touch the coil. The primaries and secondaries of one coil are connected in series respectively with those of the other coil. Connections should be changed around so as to give the best spark as transformer would not work well if the windings of both coils were not connected in the right direction. This transformer works well on

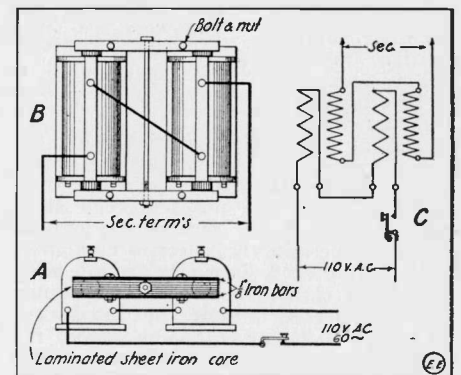

110 volts A. C. 60 cycles, and does not overheat, besides requiring no choke coil in the primary circuit.

Contributed by RALPH HITESHEW.

NOTICE!!!

We wish to buy May, '13, Oct., '13 and Jan. '14 copies "E. E." Address the Editor.

Wrinkles—Receipts—Formulas—Hints

By S. Gernsback.

Under this heading we will publish every month useful information in Mechanics, Electricity and Chemistry.

This department will be edited monthly by Mr. S. Gernsback.

We shall be pleased, of course, to have our readers send us any recipes, formulas, wrinkles, new ideas, etc., useful to the experimenter, which will be duly paid for, upon publication, if acceptable.

FORMULA NO. 7

Alloys.

German Silver, First Quality Castings—Copper 50 lbs.; zinc 25 lbs.; Nickel 25 lbs.

German Silver for Rolling—Copper 50 lbs.; zinc 20 lbs.; nickel 25 lbs.

German Silver for Bells and other Castings—Copper 60 lbs.; zinc 20 lbs.; nickel 20 lbs.; lead 3 lbs.; iron, (that of tin plate is the best) 2 lbs.

Alfenide—Contains a trace of iron, copper 60 parts; zinc 30 parts; nickel 10 parts.

Fine Silver Colored Metal—Tin 100 lbs.; antimony 8 lbs.; copper 4 lbs.; bismuth 1 lb.

Genuine German Silver—Iron 2½ parts; nickel 31½ parts; zinc 25½ parts, copper 40 parts.

Sundry Compositions.

Organ Pipe Metal—consists of lead alloyed with about half its quantity of tin to harden it. Lead 100; tin 33 parts; or lead 100 and tin 20 parts answer very well. The mottled or crystalline appearance so much admired shows an abundance of tin.

Cannon Metal—Tin 10 parts; copper 90 parts.

Gong Metal—Copper, 78 parts; tin, 22 parts.

Alloy for Cymbals—Copper, 80 parts; tin, 20 parts.

Cock Metal—Copper 20 lbs.; lead 8 lbs.; litharge 1 oz.; antimony 3 ozs.

Metal for taking Impressions—Lead 3 lbs.; tin 2 lbs., bismuth 5 lbs.

Electrum—Copper 8; nickel 4; zinc 3½ parts. This compound is unsurpassed for ease of workmanship and beauty of appearance.

Alloy, for Mechanical Instruments—Copper 1 lb.; tin 1 oz.

Fusible Metals—Melt together: 8 parts of bismuth; 3 parts of tin; 5 parts of lead.

This mixture becomes liquid at 212°F.

Another—Melt together: 2 parts of Cadmium; 2 parts of lead; 4 parts of tin.

A GOOD GLASS CEMENT.

Formula No. 1.

Pulverized glass, 10 parts; powdered fluorspar, 20 parts; soluble silicate of soda, 60 parts. Both glass and spar must be of finest powder; the mixture must be made by quick stirring, and when incorporated, must be used at once.

Formula No. 2.

This is used for mending valuable articles of glass. A strong solution of gelatine, to which is added for every 5 parts of gelatine 1 part solution acid chromate of lime. The mixture becomes insoluble in water under the action of light. In consequence of the partial reduction of the solution, cover the surfaces to be united as evenly as possible; press them together and tie them. Expose the glass to the sun a few hours. Boiling water has no effect on the oxidized cement, and the fracture can scarcely be recognized.

Contributed by H. C. BOYER.

BOY SCOUTS USE RADIO.

The Freeland, Pa., Troop of Boy Scouts are arranging to erect a wireless station in town. They have secured permission to erect the station on the top of Edgar Alberts' four story building, which is the highest building in town.

FIRE AND BURGLAR

ALARM CIRCUIT.

I show herewith a simple arrangement for fire, burglar and ordinary door alarm utilizing one bell and a common battery. The diagram explains itself, I think, and it is, of course, best to only use the bell shown for special alarms, to avoid a

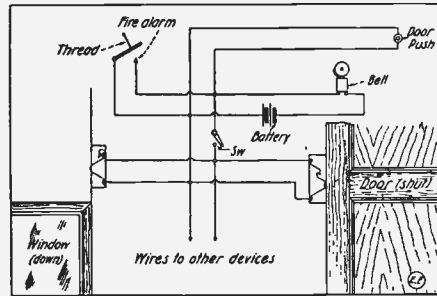

misunderstanding. The fire alarm is easily made of a piece of fine thread holding up against gravity a contact arm pivoted at one end as indicated.

Contributed by W. McALEXANDER.

LEARNING THE RADIO CODES.

Having to be perfect in signals I designed the following set for learning the International radio code. L is a lamp for learning the code visually. R is a receiver for learning it by sound and

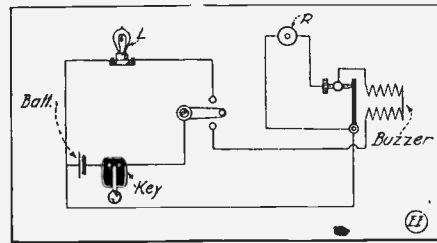

which resembles a wireless set in action. The buzzer must be muffled at all times. The set can be bought very cheaply from a supply house. The diagram of connection is as shown.

Contributed by

CHAS. W. FRALLEY,
U. S. S. Delaware.

A HOME MADE AUTOMATIC TRANSMITTER.

An apparatus which will work quite well can be made as follows, for about one-tenth of the price usually charged for a professionally made article.

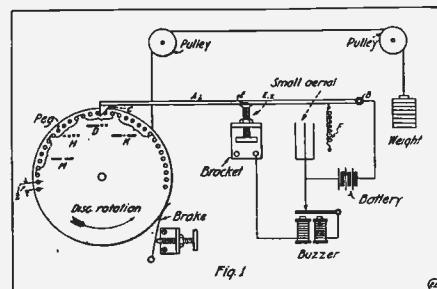

Cut a wooden disc 18 inches in diameter and ½ inch thick, and mount it to run on the short shaft. Mark a 17 inch circle on one face and drill holes ⅜

inch deep, ½ inch apart, round the circumference of the circle. This will give 105 holes, and a space over. Make a set of pegs to fit the holes fairly tight, ⅜ inch brass wire is suitable; also 20 spacing pegs, as in Fig. 2 to occupy two holes. (A) Fig. 1 is a light bar pivoted at (B) and having at the other end a triangular-shaped piece (C). (A) carries a contact (E) which connects with the adjustable contact (E2) where (C) falls between adjacent pegs, thus actuating a buzzer, which is used to give signals in one's receiving set. To deaden the click, the working edge of (C) is covered with rubber. The spring (F) ensures the bar

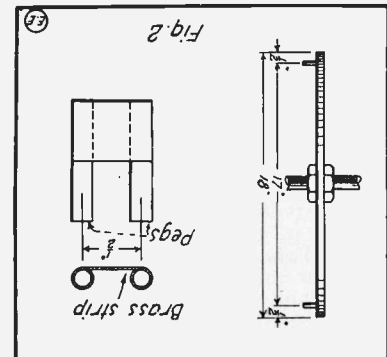

falling. At (Fig. 2) is a side view of the disc showing pegs. You may drive the disc either by gearing it to clock-work, or by a string and a falling weight as indicated in sketch; the speed of rotation is varied by a spring arranged to bear against the disc. The pegs can be arranged so as to give any arrangement of letters desired.

Contributed by

STEPHEN W. PILLING,
Bacup, England.

"BATTERY CARBON" RHEOSTAT.

Old dry cells are usually thrown away, but a novel use for the carbons in same is to make a variable resistance or rheostat, as the sketch clearly shows. The carbons are placed against one another in a wood box or frame, and means provided by a hand screw and pressure block, for squeezing them more or less

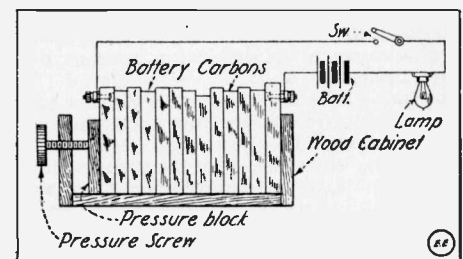

tightly together, the principle being the same as in the commercial carbon pile regulators used for storage battery regulation, et cetera. This rheostat lends itself nicely to lamp current regulation for battery systems, small motor speed control, and many other purposes. It is also non-inductive.

The German wireless station at Sayville, L. I., is being increased to twice its former size and power.



A NOVEL RHEOSTAT SUITABLE FOR HEAVY CURRENTS.

In experiments involving the accurate regulation of currents of 100 amperes and above, it is often a matter of some difficulty to provide a suitable rheostat. The commercial types are expensive, and substitutes operating on the metallic resistance and sliding contact principle are not easy to make, on account of the

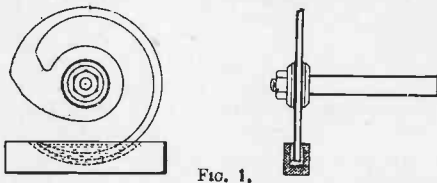

FIG. 1.

necessity for very substantial construction of the contacts, says R. G. Van Name, in *American Journal of Science*. Electrolytic resistances (iron plates in sodium carbonate solution, and the like), tho very easily constructed, are not always satisfactory. When used with direct current, their resistance cannot on account of the polarization, be gradually reduced to zero, as with other types of rheostat, and this is often a disadvantage, especially with low-voltage currents, and in general when economy of energy is a consideration. Below is described a form of rheostat which may be employed under a wide range of conditions, but is especially suitable for large currents, including those of low voltage for which an electrolytic rheostat is nearly or wholly useless. It was devised and used by the writer for the control of a 25-volt current of about 200 amperes. This rheostat possesses the advantage that the resistance element can be quickly removed and another of different dimensions inserted, thus altering the range. Extra resistors are easily made, at trifling cost, and may be used indefinitely.

Essentially, the rheostat consists of a curved rod of graphite, submerged in water and so mounted that its effective length is varied by rotating an axle which serves at the same time as one of the current leads. The graphite resistor, which has the general form shown in Fig. 1, is sawed out of a plate of Acheson graphite, conveniently $\frac{1}{4}$ in. thick. It is centrally mounted on a stout horizontal axle, so that its rim runs with liberal clearance in a suitably shaped hollow milled in a block of copper. This hollow is filled with mercury, thus providing electric contact between the copper and graphite. Cooling is effected by enclosing the whole in a wooden box thru which water circulates. It is evident that by rotating the axle the resistance interposed between the axle and the copper block may be varied from practically zero up to a maximum determined by the shape and dimensions of the graphite resistor, in particular by the thickness of its "tail." Since this part of the resistor is not subject to any mechanical strain, it may, if desired, be given a very small cross section.

Direct currents may be connected to flow thru the rheostat in either direction but it is better, when practical, to connect the axle with the negative pole, as a protection against corrosion by the working current.

VARIABILITY OF SPARKS BETWEEN UNLIKE METALS.

Contrary to former impressions, the experimental results obtained by Prof. Daniel M. Rich, University of Michigan, seem to indicate that electric sparks take place from positive electrodes of certain metals more readily than from those of other metals, says *"Electrical World."* Applying an alternating-current potential to a spark-gap between a copper electrode and a zinc electrode, and rapidly photographing the spark discharges, the experimenter found that while discharges from the copper electrode during one-half cycle were quite limited, many sparks were given off from the zinc during the following one-half cycle of reverse direction. To account for this phenomenon, Professor Rich recently explained, before the American Physical Society, his belief that the potential must be built up to a higher value before it will jump from the copper as the positive electrode than is the case from the zinc as positive. It was also observed that an even number of sparks always occurred from one electrode while an odd number took place from the other.

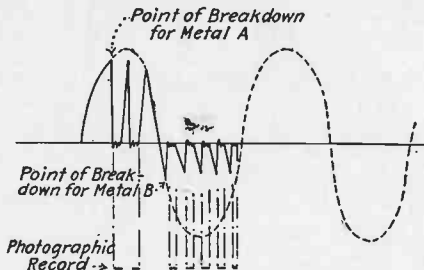

Oddly enough, these number sequences did not follow the law which they might be expected to obey, for, instead of the last spark oscillation occurring from the electrode which had the lowest breakdown value, the reverse was true. Professor Rich thinks that the ionizing effect of the arc may perhaps rightly be held accountable for this unexpected occurrence.

THE ACTION IN SELENIUM CRYSTALS.

Prof. F. C. Brown, State University of Iowa, Iowa City, in speaking before the American Physical Society on fundamental electro-mechanical, photo-electrical and electrical relations in crystals of metallic selenium, said that his work had shown that light of all portions of the visible spectrum alters the conductivity of crystals of metallic selenium of two systems, says the *Electrical World*. Furthermore, when the light is removed the recovery is rapid. If the entire crystal is illuminated, equilibrium is reached in less than 0.2 second. The maximum sensibility for a given amount of energy is in the ultra-violet.

Specific conductivity of the crystals also increases with the applied voltage. While light action may be transmitted almost undiminished throughout the crystal, pressure effect is not transmitted outside the region affected by the mechanical stress.

The effect of an applied electric potential is not transmitted beyond the region of the electrical stress, nor does it manifest itself except in the direction of the electrical field. The absolute sensibility of the crystals to light increases with mechanical pressure and is proportional to the relative conductivities for corre-

POLARITY TESTER FOR MOTORS AND DYNAMOS

The illustration given herewith shows a simple and reliable field pole tester employed by the British Westinghouse Electric & Manufacturing Company on the test floor, says the *"Electrical World."* An ordinary search coil, preferably with a small iron core and completely insulated on the outside, is used. The coil is fastened to the end of a wooden handle and flexible wires connect the ends of the coil to the terminals of a direct-current millivoltmeter. If the coil is moved toward a magnet, a certain electromotive force is induced in the coil and the needle of the millivoltmeter shows a momentary deflection. A greater deflection can generally be obtained if the coil, after being carefully brought quite near to the pole, is quickly withdrawn. Naturally, the direction in which the needle moves depends on the polarity of the magnet from which the coil is withdrawn. If it is withdrawn from a north pole, the needle will move, say, to the right, and if withdrawn from a south pole, to the left. Thus, by testing all the poles in rotation, it is possible to ascertain whether the connections have been made correctly or incorrectly.

When winding a search coil of given size, it is advisable to take a wire of such diameter that the total resistance of the search coil corresponds approximately with that of the millivoltmeter, which is usually from 1 ohm to 2 ohms. For the test in the Westinghouse works, a coil has been used with an outside diameter of 1.75 in., inside diameter of 0.75 in., and 2 in. long, the core consisting of a 0.5 in. iron rod 2.50 in. long. The spool is wound with 580 turns of single cotton-covered wire, 0.032 in. in diameter and giving a total resistance of approximately 1.5 ohms. If a thinner wire had been used, the advantage gained by increasing the number of turns would not have outweighed the disadvantage of increasing the resistance. But, after all, the disadvantage of high resistance simply means that the deflection of the needle is reduced. Quite useful results can be obtained with a wide range of coil resistance. If no millivoltmeter is at hand, then a moving coil ammeter with the shunt disconnected may be employed. A low-reading voltmeter—1 volt or 3 volts—may also give distinct readings, but in this case the search coil must be wound with many

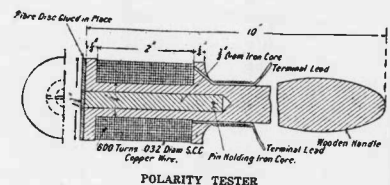

turns of the thinnest wire, because the internal resistance of a 1-volt or 3-volt instrument is several hundred ohms. A very suitable instrument to use is a Weston galvanometer, which is very sensitive.

sponding pressures in the dark. If a crystal is partly under pressure, this increased sensibility takes place only at the place where the pressure is applied. But the increase of sensibility holds for the transmitted light action as well as the direct action of light. The action is transmitted in the crystal at a rate greater than 2 cm per second.

LATEST PATENTS

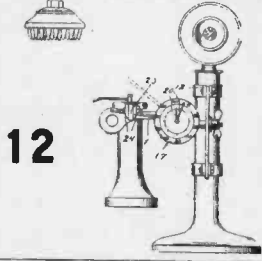
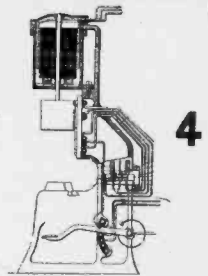
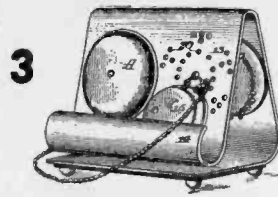
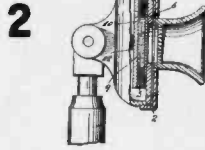
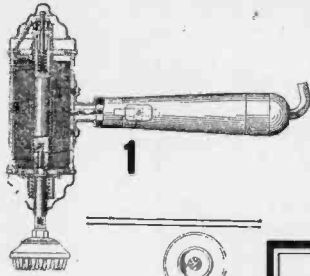

ELECTRICAL MASSAGE MACHINE (Fig. 1)—A suction electro-magnet pulls the applicator forward, which action breaks the magnet circuit. A spring returns the applicator, et cetera.
NOVEL TELEPHONE TRANSMITTER (Fig. 2)—Mr. H. Gernsback has here produced a new form of carbon grain microphone. The whole diaphragm, 6, moves against the granules, 9. The back electrode is seen at 22.

AUDIPHONE TRANSMITTER STAND (Fig. 3)—Improvement for supporting Audiphone Transmitter, comprising a base, a vibratory member mounted thereon, and a plate, 14, for carrying the sensitive transmitter supported by the vibratory member.

ELECTRIC DROP HAMMER (Fig. 4)—A standard form of drop hammer actuated by powerful electro-magnetic windings at the top of the frame.

DISPLAY DEVICE (Fig. 5)—In a machine of the character described, a member rotatable about an axis, said member being provided with patches of different colors which are adapted to be successively presented to view by the rotation of said member, and means for revolving said member about another axis.

BINDING POST (Fig. 6)—A binding post arranged with an insulating cover, 21, intended to press against the wire, 8, at 11 and 12, etc., the wire being suitably overlapped in horizontal and transverse spiral grooves as shown.

FLAT IRON (Fig. 7)—The electrical heating unit is placed in same and the inside, H, filled with sand, which is fused near the heating element, forming a silica insulation.

MAGNETIC FRICTION COUPLING (Fig. 8)—Improved form of shafting clutch actuated when desired by a magnetic coil, 2.

RADIO DETECTOR STAND (Fig. 9)—Another detector stand for use with minerals, etc., in a cup as shown, the crystal floating in mercury.

EXTRACTION OF METALS FROM THE BODY (Fig. 10)—System for removing metals from the body by electrolysis. Current from a battery passes from foot pall thru body, out thru hand basin, thereby taking with it electrolytically metal salts from the body.

TELEPHONE RECEIVER ATTACHMENT (Fig. 11)—A sanitary pad of paper sheets, 8, held by a spring clamp, 4, on any receiver, the paper discs having an opening for speech at 10. The ear thus rests against fresh paper for each time used.

TELEPHONE MESSAGE RECORDER (Fig. 12)—Actuated by the regular hook, tripping the finger, 1; the counting is done by hands, 20, rotating around the graduated dial, 17.

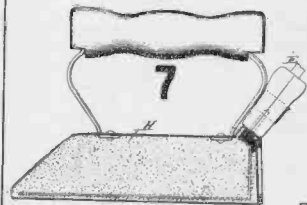
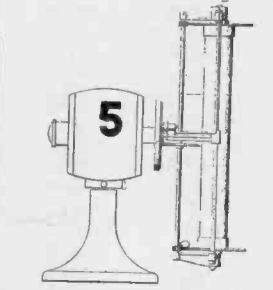
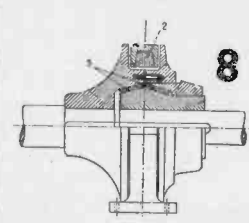
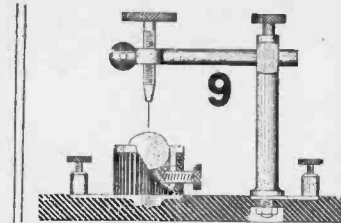
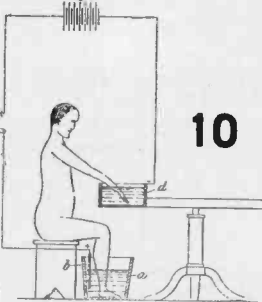
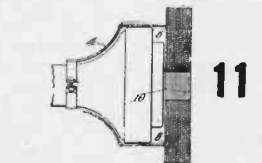

THE INSTITUTE OF RADIO ENGINEERS.

The annual meeting of the Institute was held Wednesday evening, January 6, in Fayerweather Hall, Columbia University, New York.

There were two papers represented; one by Roy A. Weagant, Designing Engineer of the Marconi Wireless Telegraph Company of America, on "The Design and Construction of Guy-Supported Towers for Radio Telegraphy," and the other by Cyril F. Elwell, Chief Engineer of the Universal Radio Syndicate (Poulsen System) of England, on "Wooden Lattice Masts."

Mr. Weagant described methods of determining the stresses in these steel towers, and of designing the tower to meet them. Mr. Elwell's paper gave in detail the design, construction and guying of the much-abused type of lattice mast. The paper was fully illustrated.

These two papers were highly appreciated by the members of the Institute who attended the meeting, for one thing, as the sponsors of the papers were reliable and experienced engineers who have encountered the design features of such aerial masts in their practical work. Radio masts are one of the most important parts of modern installations of this character.

RESEARCH FELLOWSHIPS AT ILLINOIS UNIVERSITY.

To extend and strengthen the field of its graduate work in engineering, the University of Illinois has since 1907 maintained ten research fellowships in the engineering experiment station. These fellowships, for each of which there is an annual stipend of \$500, are open to graduates of approved American and foreign universities and technical schools. Appointments are made and must be accepted for two consecutive collegiate years, at the expiration of which period, if all requirements have been met, the master's degree will be granted. Not more than half of the time of the research fellows is required in connection with the work of the department to which they are assigned, the remainder of the time being available for graduate study.

Nominations are based upon the character, scholastic attainments, and promise of success in the principal line of study or research to which the candidate proposes to devote himself. Preference is given those applicants who have had some practical engineering experience following their undergraduate work. Research work may be undertaken in architecture, architectural engineering, chemistry, civil engineering, electrical engineering, mechanical engi-

HAVE YOU AN IDEA?

Are you using a new device or an improved modification of such, in your wireless or electrical laboratory? If so, why not write it up and send to us with a photo or sketch? Drawings invariably have to be made over by our draughtsman, and just so you express your ideas concretely and as briefly as possible, we are always glad to publish them, when the article possesses merit. Look over this issue carefully, re-read the articles twice, and you will soon pick up the knack of writing articles, and moreover, we pay you well for your efforts. Why not get busy to-day and get in the swim? Be a live, wide-awake Electrical Experimenter! Boost your paper and boost yourself. It's very easy!

Make all sketches on separate sheets of paper, and write only on one side of your text sheets. Send all contributions to "Editor," The Electrical Experimenter, 233 Fulton St., New York City.

neering, mining engineering, municipal and sanitary engineering, physics, railway engineering, and in theoretical and applied mechanics.

Four vacancies are to be filled at the close of the current academic year. Additional information may be obtained by addressing the director of the engineering experiment station, University of Illinois, Urbana, Ill.



AMONG THE AMATEURS



First Prize \$3.00.

EMPEROR'S MEDAL FOR RADIO EXPERIMENTER.

Master Eugene Dynner, of Guttenberg, N. J., but 14 years of age, who has the distinction of being the youngest Commercial wireless operator in the world, will be decorated with a medal by the Austrian Ambassador at Washington, in behalf of the aged Emperor Franz Josef, as soon as it reaches Washington.

Both the medal, and the hand written letter are now on their way, being sent

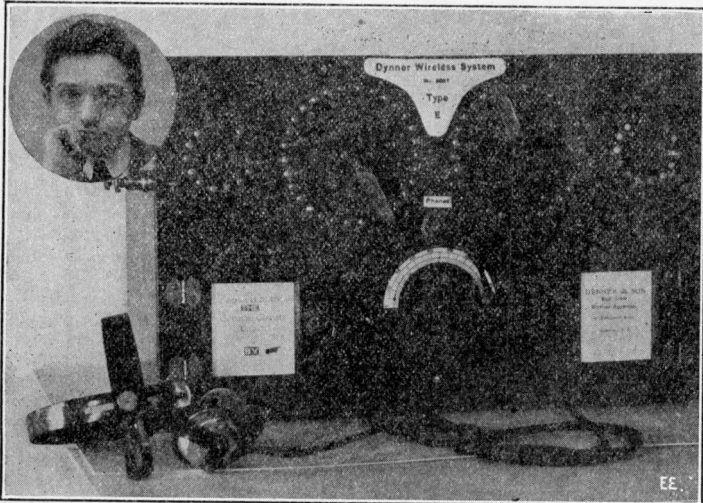

in response to a wireless message of good will that young Dynner sent to the Emperor under his own name while he was operating the wireless station at the recent Charity Bazaar for the widows and orphans of the German, Austrian and Hungarian soldiers, held at the Seventy-first Regiment Armory, New York.

A special fifteen-day license was issued by the government at Washington to Master Dynner to send long distance messages via Sayville, and the apparatus used was his own invention and patent. A model of this same apparatus was specially manufactured at the Dynner shop and is shown in the illustration. It was sold at the Bazaar, netting nearly \$5,000 for the cause.

The message to Emperor Joseph stated that the sender was taking the liberty, as a 14 year old member of an Austro-Hungarian family, of sending to him the first message from the Fair, over wireless apparatus which he had himself patented, to give to the Emperor of his country his best wishes for his Fatherland.

A wireless reply was received from Count Lichtenstein, chief of the cabinet, in the name of the Emperor, thanking him and stating that a hand written reply had been sent. A notice from Washington soon followed, advising him that a medal had been sent from Austria, with which he would be decorated upon its arrival.

A message was also sent over the same apparatus to Kaiser Wilhelm, from Mrs. Emma Schwartz Ruppert.

An exciting little incident occurred during the time while Dynner was receiving at the Bazaar station. His station 2 N. A. had been called, and he was receiving news of a German victory in Poland, when two English cruisers within the radius put out some waves to disturb the vibrations and prevent him from receiving any more.

BOYS FORM WIRELESS CLUB AT LINCOLN, ILL.

Lincoln now has a regularly organized wireless telegraph company.

The Lincoln United Wireless Association, with a membership of boys, was formed this week, rules to govern the members were laid down and officers were elected.

William Mayer was chosen president and Clark Gallagher, secretary. The other members of the association are Ralph Atlass, Paul Coddington, Hubert Bradburn, John Gordon.

The chief wireless station is at the home of Ralph Atlass and the experiment station is at the Mayer residence, 1010 North Kickapoo street. All members of the association have wireless stations receiving 1,000 miles and sending 200 miles. Each member has studied wireless telegraphy for the past two years and is familiar with the code.

"Please keep out. This is the press," sent young Dynner.

"We are English cruisers and you are receiving German messages. We won't keep out," flashed back the English.

Then young Dynner wired to Washington of his difficulty and Secretary Redmond ordered the cruisers not to interfere with his messages, after which he had no more trouble.

The young operator was quite a lion at the Bazaar, all the notables present coming up to make his acquaintance. They included the Turkish, German and Austrian Consuls, and Baron Lyman of the German Embassy. The Turkish Consul pulled a Turkish newspaper out of his pocket, and showed Dynner a picture of himself in it, to his great surprise as he could not imagine how the paper had obtained it.

Mayor Mitchell and Judge Goff were also among his callers, as well as Elizabeth Schumann and Margaret Ober, of the Metropolitan Opera Company.

Master Eugene Dynner was born in Paris, August 11, 1901, coming to New York in 1905. In 1912 he successfully passed the Government examinations with the second highest marks in his class, as a commercial wireless operator. He served in this capacity on the "Seminole," Clyde Line, and on the "Imperator," now in German waters. At present he is conducting a private wireless station at Guttenberg, limited by the general rule governing such stations that forbids sending further than within a 60 mile radius. He is also assisting in the manufacture of his wireless apparatus, on which he holds a patent. The apparatus shown in the accompanying illustration shows the receiving cabinet only. The detector is behind one of the small doors shown. Only the phones are outside the cabinet. It was pronounced a perfect set by the Telefunken Wireless Co.

ROSS GUNN'S WIRELESS AND ELECTRICAL LABORATORY.

Here is a photo of my radio set. It is the outcome of four years of experimenting and is the third receiving set I have had.

To the left is the receiving set, which consists of receiving transformer, loading coil, silicon detector, Blitzen variable condenser, and also another small variable condenser, and pair of Brandes' 2,800-ohm phones.

To the right is the sending set; it consists of an E. I. Co. open core transformer, an oscillation transformer, a 10-ampere key and a mercury interrupter. My current supply consists of a 110-volt 3-ampere direct current generator run by a gasoline engine. I have heard N. A. X., N. A. R., N. A. A., W. S. L., W. S. C., and many others. I can read N. A. A. sometimes with the phones 3 feet from my head.

My license, which is on the table, is a *Second Class Commercial*, No. 4896, and my call is 8 J. A. I attribute my success to my aerial, which is 75 feet long and is made of No. 12 copper, six wires and a lead-in of No. 6 B. & S. wire.

I like the *Electrical Experimenter*, as it usually has some useful hints in it.

ROSS GUNN,
Oberlin, Ohio.

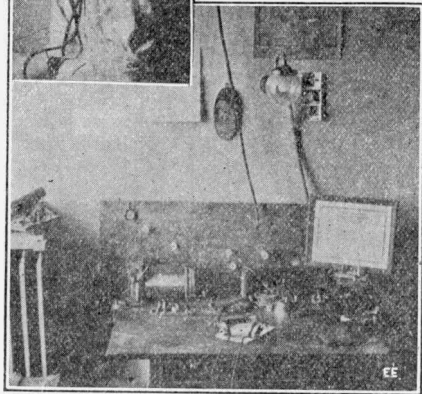

A CORRECTION.

Editor *Electrical Experimenter*:—In a recent issue of your magazine, *Electrical Experimenter*, there appeared an article, which stated that the L. W. O. of W. N. Y. had disbanded and that the loyal members had formed a club called the Queen City Radio Association. We wish to brand this as a mis-statement and wish to state that The Licensed Wireless Operators of Western New York have not disbanded nor have we any intention of doing so. The club is still holding meetings on the regular meeting nights.

The dissention, which we are sorry to acknowledge occurred, was stirred up by one of the officers who, not liking the management of the club, formed this other association from the inactive members of the club.

We have revised our constitution, strengthening it where it was weak, and have a new form of application.

Yours very truly,

THE LICENSED WIRELESS OPERATORS OF WESTERN N. Y.,

A. H. Benzal, Jr., Secretary,
207 Summer Place, Buffalo, N. Y.



QUESTION BOX



This department is for the sole benefit of the electrical experimenter. Questions will be answered here for the benefit of all, but only matter of sufficient interest will be published. Rules under which questions will be answered:

1. Only three questions can be submitted to be answered.
2. Only one side of sheet to be written on; matter must be typewritten or else written in ink, no penciled matter considered.
3. Sketches, diagrams, etc., must be on separate sheets. Questions addressed to this Department cannot be answered by mail.

ELECTRIC ENGINE H. P.

(220.) L. D. Few, Apalachee, Ga., inquires as to the horsepower, etc., of electro-magnetic engines of the Mesco type:

A. 1. We might suggest that you should use direct current at about 110 to 220 volt potential, for efficiently exciting electro-magnets, etc. If we understand your letter correctly, you have the intention of building a large size electric motor similar to the cut of the Mesco electric toy engine enclosed with your letter, and we wish to state that these are only useful as a toy, and are not sufficiently efficient and satisfactory for large commercial applications.

However, we may say that the horsepower of such a device is most easily and accurately ascertained by applying a Prony or friction brake to the fly-wheel of same in your case, and in this way, of course, the foot pounds, etc., are readily deduced. We shall be pleased to inform you on dynamos, as you mention when you know just what you intend to do in the matter, or you can get information from some of our advertisers.

MINIMUM POLARIZED RELAY CURRENT.

(221.) B. F. M., W. Lafayette, Ind., wants to know the minimum tripping current necessary for standard polarized relays suitable for use with selenium cells:

A. 1. The standard high grade polarized relays of the 500 and 1000 ohm precision type require from 6 to 8 milliamperes to operate them for the minimum tripping current. The prices given in most catalogues are net on these relays.

WIRELESS TRANSFORMERS.

(222.) William B., Topeka, Kans., writes relative to radio type closed core transformers built after data given in the June, 1913, issue:

Answering your questions relative to the closed core transformer you have built after the data given in the June, 1913, *Electrical Experimenter*, will say that the magnetic shunt will, of course, help you to control the operation of transformer and the current consumed, etc., to a large degree. Also you may increase your primary impedance by using more turns of wire on this coil, and again a great many radio stations, even of commercial type, make use of an adjustable choke coil in the primary circuit, which may correspond in size, etc., with the primary of your transformer, and which helps to vary the current as well as the resonance point of the transformer discharge.

In regard to kick-back prevention, will say that undoubtedly the two lamps you mention connected across the primary mains in series with their centre connection grounded, will do fairly well for this work, but we would prefer condensers as regularly specified by the Fire Underwriters' rules, each condenser to be of 1/2 M. F. capacity, etc., as made up in the regular standard Kick-Back Pre-

venter, and to our best knowledge, the Electric Light Companies or the Fire Underwriter's Electrical Inspector will not pass the form of preventer composed of lamps as you describe.

Want to Swap?

If you have anything to buy, sell or exchange and want to make sure of doing it quickly and at an insignificant cost advertise in the

Scientific Exchange Columns

OF The Electrical Experimenter

You will find advertised in these columns:

Photographic supplies, Phonographs, Wireless Apparatus, Electrical goods, Bicycles, Motorcycles, Rifles, Gasoline Engines, Microscopes, Books, Skates, Typewriters, Etc.

The owners of these things wish to "swap" them for something else, something which you may have.

The Rates

One cent per word (name and address to be counted; minimum space 3 lines. Average 7 words agate to the line. Remittance must accompany all orders.

The Classified Columns of the ELECTRICAL EXPERIMENTER GET RESULTS

More than 30,000 Electrical Experimenters will see your ad.

SPECIAL RHEOSTAT.

(223.) Jerome D. Kriz, Snyder, Neb., writes us for lowest price on a special battery charging rheostat:

A. 1. The Cutler Hammer Co. supply an adjustable rheostat of standard type capable of handling 19 amperes and fitted with 16 switches pts., at \$24.00 net. This rheostat would have a resistance of 2 ohms and would be suitable for currents of 8 to 20 amperes. It is fitted with a switch lever permitting of rapid adjustability.

TUNING IN EXTRA LONG WAVE LENGTHS.

(224.) N. W. Stolba, of Fitchburg, Mass., asks several questions. We advise him as follows:

A. 1. Will say that data on spark coil and radio transformer construction that you desire is given in our 25c treatise entitled, "Construction of Induction Coils and Transformer."

We do not know the exact wave length

used by the Glace Bay Radio Station, but suffice it to say it is very long and in the neighborhood of 7000 to 8000 meters. The Trans-Atlantic Marconi Station at New Brunswick, N. J., uses a transmitting wave length of 16,000 meters, and, of course, a very large amount of inductance and capacity must be used to tune in such long waves.

STEEL ELEVATOR SHAFT AS ANTENNA.

(225.) Leslie Jones, of Maryville, Tenn., asks us about using a steel elevator cage or shaft as an aerial for receiving wireless signals:

A. 1. Replying to your question, would say that we do not know just how you would make out using the metal cage of an elevator shaft as an aerial and this would have to be tried out experimentally. We would strongly advise, however, the use of a 60 to 75 ft. aerial, comprising 4 strands, spaced 3 feet apart, for your work, and, of course, a somewhat smaller aerial can be used if your surroundings demand it, but using more strands in it.

THUNDER STORM DETECTORS.

(226.) A. J. W., Rochester, N. Y., wants data on Thunder Storm Detectors in Central Station work:

A. 1. Relative to radio type Thunder Storm detection apparatus, would say that undoubtedly you will find the standard type coherer receiving set for wireless and static signals, of service for your requirements.

These coherer sets will indicate the presence of electric storms when several miles away, so as to give plenty of time in which to get extra generators ready for an increased lighting load. An aerial 75 to 100 feet long, of 4 strands, will serve.

RECTIFIER CHARGING IMPEDANCE COIL.

(227.) H. P. K., Allentown, Pa., asks for data on suitable impedance coil for

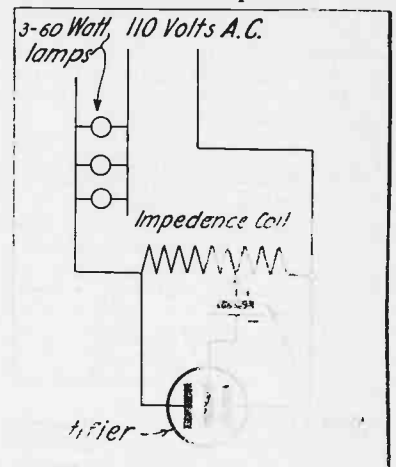

use with an electrolytic rectifier of the regular type, but using only 3 electrodes, as in diagram below:

A. 1. We wish to advise that the impedance coil shown in your diagram

for use with a rectifier may be very well composed of a laminated sheet iron or iron wire core, about 12 inches long by 1 inch in diameter. This core should be insulated with several layers of oiled linen or "Empire" cloth, and then wound with about six layers of No. 14 magnet wire. You should bring out a tap from the end of the third layer for your center connection which you show in your diagram as leading to the storage cell, under charge; and also you should bring out taps from the ends of the winding so that you can insert varying impedances in the circuit until best results are obtained. Also if this impedance coil is not sufficient, you can put on a couple more layers of wire. It is best to wind half the coil on either half of the core with a center dividing disc between them.

SERIES LINE TELEPHONES.

(228.) H. Michelson, of Garwin, Ia., wishes diagram on connecting a series telephone:

A. I. Answering your query will say that we are pleased to hand you herewith diagram of connection for a stand-

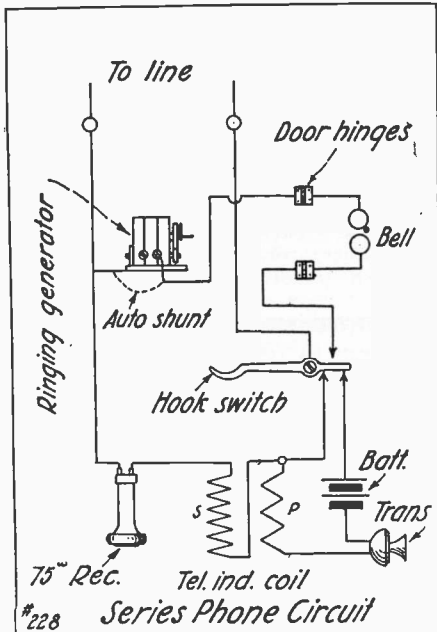

ard type series line telephone with magneto ringing generator and induction coil, etc., such as the \$7.00 instrument supplied by the Deveau Co., for circuits up to 20 miles in length.

16,000 METER WAVE LENGTHS.

(203.) Harley Stevens, Manson, Montana, asks a number of radio queries:

A. I. Replying to your queries would say that of course experience as a telegraph operator will help you very materially in the radio line, and by using a good loading coil you can, of course, then tune your receiving set to receive 2500 to 4500 meter wave lengths, etc., very easily.

The rating of 2500 meter wave lengths as used by the Arlington station refers, of course, to the length of the emitted ether wave, and not to the distance over which this station can send messages. For instance, we may mention in this case, that the new Marconi radio station intended for transatlantic service, and located at New Brunswick, N. J., employs a transmitting wave length of 16,000 meters, and of course in this case it would be necessary to have sufficient tuning coils and condensers, so that the receiving set in use could be tuned up to this oscillation period.



\$2500⁰⁰ a Year

Yes, that is what a full fledged Signal Engineer gets—\$2,500 a year. Many are making more than that. Even while you are learning you can hold one of the positions under a Signal Engineer paying you a handsome salary. Our profession is young. We need ambitious men and will pay you big money when you have the proper training. Send the coupon and find out about the opportunities that await you and how you can learn to become a Signal Engineer right in your own home—during your spare time.

Be a Signal Engineer

Join the ranks of a profession that is not overcrowded and in which big money is being paid. The work is fascinating. Upon your knowledge will depend the safety of thousands of lives and millions of dollars worth of freight. You are the boss,—the man who knows—and the man who gets the fat pay envelope. You can get just the kind of practical training that you need right in your own home,—during your spare time.

More Men Needed

Railroads are constantly looking for competent Signal Engineers. Thousands and thousands of miles of track are now being equipped with automatic block signals. Positions paying big money are open this very minute. The men who are trained are getting the jobs. Send the coupon for the New Signal Book.

Two Big FREE Outfits
Complete Signal Engineer's Outfit and Complete Draftsman's Outfit given away absolutely free to students.

Send the Coupon For Big New Book

Put your name and address on the coupon or on a letter or post card and send it to us at once. We will send you the Big New Signal Book absolutely free and prepaid. Absolutely no obligations. The book and full particulars of our special offer are free. Send the coupon now.

Department of Signaling
Room 3382

1810 Wilson Ave., Chicago, Ill.

GENTLEMEN: Please send me absolutely free and prepaid your big new Signal Book. Also full particulars about your great special free outfit offer. It is distinctly understood that I assume no obligations of any kind.

Department of Signaling
Room 3382, Ravenswood Station
1810 Wilson Ave., Chicago, Ill.

Name.....
Address.....
Age.....Occupation.....

*** KNAPP * KNAPP ***
BOY ELECTRICS
THE KNAPP LEADER
-THE BEST PRICE **\$2.50**
Guaranteed as Represented

Many other motors at all prices. Live dealers everywhere. Order direct or ask your dealer to show you the Knapp line and insist on getting Knapp goods. Dealers not already handling the Knapp line should ask for prices. Catalog illustrating full line of dynamos, motors and electrical novelties on request.
Knapp Electric & Novelty Co.
523 West 51st St. New York
*** KNAPP * KNAPP ***

New York Electrical School
THE only school in the world devoted to teaching every angle of Electrical Industry by "actual practice." All ages from sixteen to sixty enter this school on the same level and are shown "how" and "why" in a manner that ensures absolute success.
No preparation needed to become a "learner" in this school. You can start this course any day of any week throughout the whole year.
We particularly desire to have it known that all VISITORS are heartily welcomed at this unique training institution.
Drop a postal card for free Catalogue
New York Electrical School
29 WEST 17th ST., NEW YORK

EARN TELEGRAPH
Morse and Wireless—R. R. Accounting (Station Agency) taught. Splendid opportunities. Positions secured. Marconi Co. takes our wireless graduates. We own and exclusively occupy two large modern buildings equipped with R. R. and Western Union wires and complete \$3,000 Marconi Wireless Station. Largest School—established 40 years. Investment \$25,000. Endorsed by Railroad, Marconi and Western Union Officials. Expert practical teachers. Low living expenses; easily earned if desired. Tuition low. Easy payments. Correspondence courses also. Catalogs free.
Dodge's Telegraph Ry. & Wireless Institute
E 8th Street Valparaiso, Ind.

You Benefit by Mentioning "The Electrical Experimenter" When Writing to Advertisers

TRANSFORMER DESIGN EQUATIONS.

(204.) G. E. H—, of Dothan, Ala. wishes data on computing current and voltage taken by transformers.

A. 1. With reference to wireless transformer and current taken by same, would say that it will be best for you to select some suitable text-books on the subject of transformer design. A great part of the data and formulae necessary for your problem is given in the transformer section of the "Standard Handbook for Electrical Engineers," price \$5.00.

We give you herewith several formulae for calculating the primary current taken by a transformer winding and also the formula for the primary volts and primary turns which will give you some idea as to the relations existing between these quantities. The formula for the primary volts is:

$$P_v = \frac{4.44 \times M \times T_p \times f}{10^8}$$

Where: M is the total flux lines in the core and T_p is the primary turns; while f is the frequency in cycles per second of the primary current.

The formula for the primary turns is:

$$T_p = \frac{P_v \times 10^8}{4.44 \times M \times f}$$

where the symbols are as before.

The formula for the primary current is:

$$P_i = \frac{\text{Volts in prim.}}{\sqrt{R^2 + (2\pi f L)^2}}$$

Where R is ohmic resistance of the coil or winding; f is the frequency as before, while L is the inductance of the coil in Henrys. P_i is primary current in amperes;

The inductance in Henrys may be approximately calculated by the following formula:

$$L = \frac{4 \times \pi \times T_p \times U \times A}{10^9 \times l}$$

Where U = permeability of the iron core at the flux density in use, which can be found, of course, from any iron magnetization table.

A = the area of the magnetic circuit or core in square cm. and l = the length of the magnetic circuit in cm.

In the Standard Handbook previously referred to you will find the necessary explanations and formulae for correctly calculating the full load current, as well as simply magnetizing current for any transformer, also explanations for calculating the wattless component, etc.

SMALL SHUNT MOTOR ON A. C.

(231.) Oscar H. Reiser, Buffalo, N. Y., has a 1/30 H. P. shunt-wound D. C. motor which he desires to operate on low voltage A. C.

A. 1. Such motors when used on A. C. are usually series wound and relative to using your type S. S. machine on low voltage A. C., will say that as this is a shunt machine, you will do best to convert same into a series type motor by connecting the fields on parallel and also in series with the armature on same.

GORDON PRIMARY CELLS.

(232.) L. L. Fleuret writes for data on Gordon Cells to be used in operating a Bing electric train.

A. 1. Replying to your question, will say that Gordon primary cells will



Play Billiards at Home!

Under our easy payment plan, the expense is scarcely noticeable. You will be surprised to find how easily you can own a

BURROWES

Billiard and Pool Table

No special room is needed. The Burrowes Table can be set on your dining-room or library table, or mounted on its own legs or folding stand, and quickly set aside when not in use. Burrowes tables are splendidly made and correct in every detail. The most expert shots, calling for skill of the highest order, can be executed with the utmost precision. Some of the leading professionals use Burrowes Tables for home practice. Sizes range up to 4 1/2 x 9 ft. [standard.]

THE COST IS TRIFLING

A few cents a day (far less than it costs to play in a public poolroom) will soon make you the owner of a handsome Burrowes Table. You can play on the Table while paying for it. Why not own your Table and play with family and friends in the home atmosphere instead of spending a greater amount, with nothing to show for it, for rental of a public table?

FREE TRIAL—NO RED TAPE

On receipt of first instalment we will ship Table. Play on it one week. If unsatisfactory return it, and on its receipt we will refund your deposit. This insures you a free trial. Write today or mail the attached coupon:



E. T. BURROWES CO., 110 Free St., Portland, Me.
Please send catalog of Billiard Table offers.

Name

Address

Insist on Burrowes Rustless Insect Screens and Folding Card-Tables

THE BEACON FOUNTAIN FLASH LIGHT

The finest example of flashlight Novelty, Convenience and Quality. Clip prevents loss, acts as a contact in use, and prevents short circuit in the pocket. Only one of the BEACON products of quality in Flashlights, Batteries, and Electrical Novelties. For sale by all good dealers.



THE "NIFTIEST" FLASH LIGHT EVER CONCEIVED
BEACON MINIATURE ELECTRIC CO.
108-110 DUANE ST., N. Y. CITY
11-17 S. DESPLAINES ST., CHICAGO

PATENTS That Protect and PAY

Send for Free 96-page book
Advice Free. Terms Reasonable. Highest References. Best Results.
Send sketch or model for FREE examination and opinion.

Recommended Patent Lawyer in the Bankers' Register and Special list of selected lawyers. Also in Martindale's Law Directory, Sharp and Alleman's Directory of Lawyers. The Gast-Paul Directory of Lawyers, and Kime's International Law Directory.

ALL BUSINESS GIVEN PROMPT and PROPER ATTENTION

A large list of strong recommendations furnished free.

WATSON E. COLEMAN PATENT LAWYER 622E-F ST., N. WASHINGTON, D. C.

be all right for operating your Bing electric train, but as these trains require about 4 to 6 volts, you will have to use several Gordon cells in series, as these only yield .7 volts each. Of course, these cells have a very high ampere-hour capacity and will last a long time, and this high current value they possess will not make it necessary for you to use a rheostat in series as you state, unless you want the variable control feature.

25-MILE BATTERY WIRELESS SET.

(233.) W. J. T—, Leland, Mich., is interested in a 25-mile battery type radio transmitter.

A. 1. With regard to small radio transmitting and receiving sets for 25-miles range, etc., to be located on ship-board, would advise you as follows:

For your transmitting set to have 25-mile range under average conditions and to operate on about 12 dry cells or on a couple of type 6-volt 60 ampere-hour storage batteries, we would recommend the following outfit:

One 4" spark coil; 1 key; 1 Helix; 1 antenna switch; 1 condenser; 1 spark gap.

For receiving purposes you would do very well to employ a Mignon receiving coupler with a pair of 2,000-ohm phones and a Radioson or galena detector.

THE HORSE-POWER OF WATER WHEELS.

(234.) H. S. P—, West Granby, Conn., wishes to know how to measure or determine the horse-power of a water-wheel. We give below briefly the usual method with Prony brake, etc.

A. 1. Relative to the water-wheel which you have constructed, etc., will say that diagram is given herewith

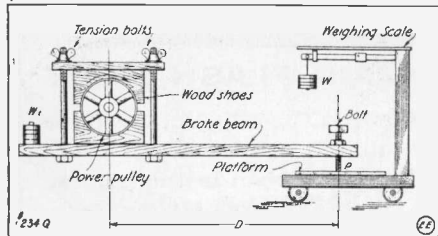

showing how to attach and use a Prony brake for testing the H. P. of your water-wheel and also the formula to be used in calculating same from the constants measured. In the sketch, W₁ is a balancing weight to exactly balance the lever or beam. The tension screws are tightened until proper friction is obtained. The horse-power is given by the formula:

$$H. P. = \frac{2 \times 3.1416 \times T \times S}{33,000}$$

Where: T = distance "D" in feet as shown in drawing \times the pressure "P" in lbs., indicated or balanced on scale. Hence if D was 4 ft., and the scale pressure 50 lbs., then the torque "T" would be equal to 4×50 or 200 ft. lbs.

S = speed of pulley as indicated by tachometer or ordinary speed counter. The speed is taken in revolutions per minute (R. P. M.).

KICK-BACK PREVENTERS.

(235.) Clinton J. S—, Rockford, Ill., asks whether a kick-back preventer should be used if only a small spark coil is connected with an electrolytic interrupter to 110-volt circuit.

A. 1. Wherever a wireless transformer or spark coil, however small, with electrolytic interrupter, is connected to commercial lighting or power circuits, it is quite necessary that a kick-back pre-

venter of approved form, such as those made up of two 1/2 M. F. condensers connected in series, be connected in the primary circuit to protect the electric company's meter, etc.

AERIAL LEAD-IN ARRANGEMENT.

(236.) Donald Tiffany, Ashley, Pa., sends us sketches of lead-in wires brought down from the far and near end of his aerial flat-top. He wishes to know which is best.

A. 1. Regarding aerial construction, will say that usually the best method is to connect the lead-in wire to the end of the flat-top section nearest the instruments. Some have used the aerial arrangement you show with the lead-in joined to the far end of the flat-top, however, to increase their natural wave length period.

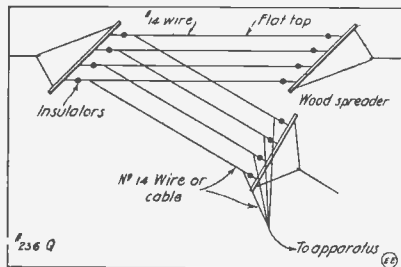

In this case, however, the lead-in strands should be brought down at a straight angle with the flat-top, as our sketch shows.

HEATING EFFECT OF ELECTRICITY.

(237.) H. W. Waning, Haverhill, Mass., asks about electric heaters.

A. 1. Most all electrical dealers and supply houses handle resistance wire, and in regard to the heating effect of an electric circuit, will say that this is equivalent to the I²R effect or, in other words, it is proportionate to the current in amperes multiplied by itself, times resistance of the circuit or heating coil in ohms.

Also the heating effect is in proportion to the watts expended in the circuit; the watts equal the volts multiplied by the amperes.

RADIO TROUBLES.

(238.) Harold C. Spencer, LaHarpe, Kans., asks us about using galena detectors for radio receptors.

A. 1. You can, of course, bend the "cat-whisker" wire contact on the detector so that the point of the wire will rest on the smooth top surface of the crystal. No battery is required with galena.

Regarding indoor aerials, would say that you should always use as much wire as possible and in some cases a form of umbrella style aerial is very good indoors, to get the greatest spread possible in a small space.

The iron pipes running through the house for gas and water have some effect on the aerial but no great amount usually, especially if the pipes run at approximately right angles to your aerial construction.

DO YOU

think this number contains 4 1/10 cents worth of information? Last month 1946 people thought so. They subscribed, at 50 cents a year. Don't you wish to join them, now—to-day?

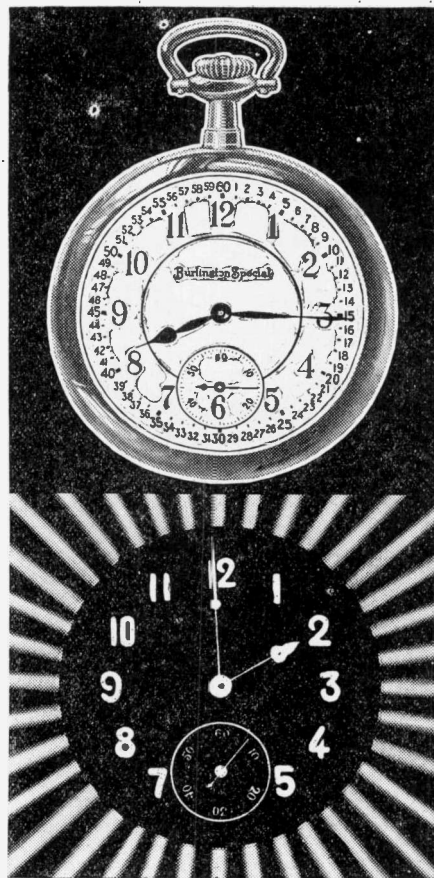

Startling New Ideas in Watches

Tell Time At Night!

Send for watch catalog describing, among others, the new radium dials that shine at night—the remarkable discovery that enables you to read time plainly in pitch darkness!—Also other new ideas:

- Ribbon designs
- Enamel monograms
- Rich gold and color effects—

your initials in colors on a rich gold background. The new catalog shows many other novel ideas in Burlington Watches.

On Approval:

The New radium dial Burlington or any other Burlington, with your own monogram engraved on the superb gold strata case, will be sent to you on approval, prepaid, without a cent in advance. You risk absolutely nothing—you pay nothing—not one cent, unless you want this exceptional offer after seeing and thoroughly inspecting the watch.

If—after examination—you decide to keep it, pay only the direct rock-bottom price—he same price that even the wholesale jeweler must pay. And in order to encourage everybody to secure this watch now we allow this rock-bottom price, either for cash or \$2.50 a month. Remember—we send this watch on approval.



Send the Coupon for New Watch Book

Learn the inside facts about watch prices and the many superior points of the Burlington over double-priced products. Just send the coupon or letter or postal. Don't delay—write today—get this offer while it lasts.

Burlington Watch Co.
19th Street and Marshall Blvd.
Dept. 3382 Chicago, Ill.
Please send me (without obligations and prepaid) your free book on watches, with full explanation of your cash or \$2.50 a month offer on the Burlington Watches.

Name.....
Address.....
Burlington Watch Co.
19th St. and Marshall Blvd.
Dept. 3382 Chicago, Ill.

CRYSTALOI

The New Permanent Wireless Detector

NEW NEW

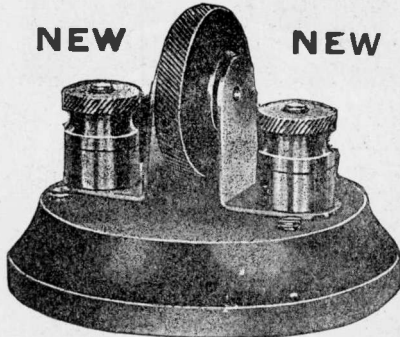

EXTREME LONG DISTANCE MICROMETRIC ADJUSTMENT

This WONDERFUL LITTLE DETECTOR is the height of Mechanical and Electrical achievement and will simply astonish you in its performance. IT WILL NOT BURN OUT OR GO DEAD and will last indefinitely. All elements are sealed in the little cylinder which is revolved to secure finest adjustment. The "CrystalOI" is positively the most sensitive and thoroughly practical detector ever designed. It is not a make-shift. It is a precision instrument in every sense of the word, and is beautifully finished. EACH "CRYSTALOI" is tested for extreme long distance at our station, which insures the one you get being absolutely perfect or money refunded. WRITE TO-DAY for full information. Immediate delivery.

Price \$3.50, including postage

WIRELESS DIVISION

EUGENE T. TURNEY CO.

2595-B THIRD AVE., NEW YORK CITY



Never be without one. So small it can be carried in pocket or bag.

This Pocket Stove—only 50c

Burns Lava Fuel—Alcohol Solidified

No liquid to spill or explode. No bulky bottle, no wick, no smoke, no

odor. Saves trouble and time many times a day. Has no equal for cooking a hasty meal, heating a chafing dish, boiling water, warming baby's milk, heating curling irons; invaluable for campers and travelers.

ORDER ONE NOW—Send 50c and we will mail the Lava Heater, prepaid, with fuel ready for instant use. An excellent gift. Guaranteed satisfactory or money refunded. Keep extra supply of Lava Fuel on hand; large can, 25c. Descriptive literature and name of dealer on request. Write today.

THE ELLANEM CO., Inc.
72 E. East 131st Street
New York City

LAVA HEATER
Patented, Trade Mark



A useful gift. A necessity for dining room, bedroom, bathroom, kitchen.

TELEGRAPHY TAUGHT

in the shortest possible time. The Omnigraph Automatic Transmitter combined with standard key and sounder. Sends you telegraph messages at any speed just as an expert operator would. Five styles, \$2 up; circular free.

OMNIGRAPH MFG. CO.

30 East Cortlandt Street

New York

THE DE LANGE THERMAL TELEPHONE.

DR. DE LANGE recently read a paper before the Royal Society upon his improved thermophone. In what follows we give an abstract of this paper, and, in addition, we describe more fully the instrument itself, and we give our impressions of a private experimental demonstration in which we had the privilege of taking part, says *The Electrician*, London.

Some of the models which Mr de Lange had brought with him from Holland were made in the laboratory of the University of Utrecht, under the supervision of Prof. Zwaardemaker, by his assistant, Mr. Stellema. In order to trace the origin of this interesting instrument it is necessary to go back 36 years to the work of Theodor Wiesendanger and two years later to that of Sir William Preece. Sir William (who gave an account of his arrangement before the Royal Society in 1880, and whose Paper is found in No. 204 of the "Proceedings" of the Society) attached a fine platinum wire to a diaphragm, thus transmitting the movement of the wire to the diaphragm, the latter acting as the source of sound waves.

The essential points of further development are best given in the following abstract of Mr. de Lange's Paper.

"Sir William Preece, by fixing a wire to a membrane, kept his invention connected with mechanical operation—namely, by the extension and contraction of the wire being transmitted to the diaphragm, thus causing it to speak. Herein lies the great difference between his invention and that of the thermophone, as the thermophone does not depend upon mechanical operation, but simply and solely depends upon change of temperature in a wire without attachment to any diaphragm. In fact the wire speaks without a diaphragm.

The basis of this invention has been laid by the Russian engineer, Mr Gwozdz. About seven years ago Mr. Gwozdz made various experiments in a small village in the neighborhood of Lodz, in Poland, with a thermo-telephone without a membrane and without

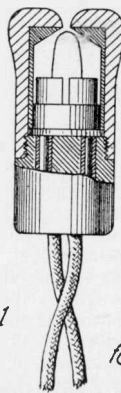

Fig. 1

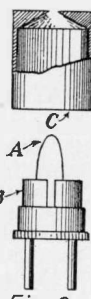
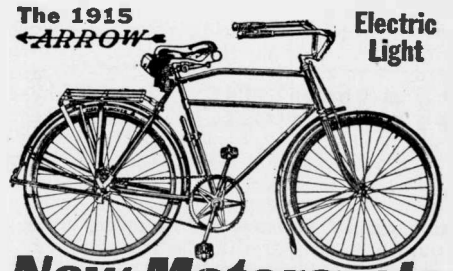

Fig. 2
Thermophone
for use in the ear.

an electro-magnet. Gwozdz placed a Wollaston wire in an insulating medium, and then treated the Wollaston wire with acid. He obtained thereby a good thermophone, but (as far as I know) it was impossible by this process to obtain thermophones which conveyed the required volume of sound and Gwozdz never succeeded in rendering the thermophone of any practical utility.

Curiously enough, at the same time Prof. Abraham, of Paris, made some experiments with a thin platinum wire, which he connected with electrodes in a straight line and then again with a trans-



New Motorcycle Type

Write for New Catalog. The biggest bicycle value ever built. Read the wonderful new 1915 improvements. Nothing like this ever offered before. The New 1915 Arrow—a positive wonder for beauty, speed, easy riding and comfort. A perfect motorcycle type. All sizes for men, boys, women. Write today for new catalog.

1915 Features Electric Light

Re-inforced motorcycle frame. Large, easy motorcycle saddle. New Departure coaster brake. Long, rubber-grip motorcycle handlebars. Special motorcycle pedals. Motorcycle mudguards, stand and spare rack. Fisk red tread clincher tires. Write today.

Special

Pay As You Ride

Write today for our special, rock-bottom direct offer. Just a very small amount down and we will ship you this sensational 1915 Arrow. Start riding and enjoying this bicycle wonder right away—and pay for it while you ride. Write for full details.

Write Today Send for free catalog of this wonderful motorcycle type, 1915 Arrow. Also particulars of our special, rock-bottom direct offer. No obligations. Just send a postal today.

Arrow Cycle Co., 19th Street and California Avenue, Dept. 3322, Chicago, Ill.

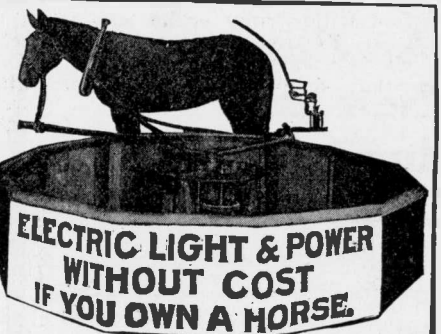

ELECTRIC POWER FOR THE FARM

No gasoline to buy; no fire risk; no engine to get out of order; always ready; two-year guarantee; patented. Every farmer can afford it. Six hours' work of the horse makes electric light for a week or more. Write for prices and circulars. Farmer agents and dealers wanted everywhere.

The Electric Horsepowers Co., Mfgs.
908 Elm Street Cincinnati, Ohio

Wide Awake Agents!

MAKE BIG MONEY
BE YOUR OWN BOSS



You need no experience. Our line sells itself. We have the most complete, fully guaranteed, line of knives, razors, strops and cutlery specialties. Golden Rule Knives are hand forged, made of genuine English razor steel. We will put any photo or logo emblem on one side of the transparent handle and name and address on the other.

Write for catalog and terms—exclusive territory.
GOLDEN RULE CUTLERY CO., 552 W. Lake St., Dept. E, 179, Chicago



200 Kinds Iron, Wood, Wire & Steel Puzzles
Catalog and sample 10c—3 leaders for 25c
WESTERN PUZZLE WORKS
Dept. 30 St. Paul, Minn.

You Benefit by Mentioning "The Electrical Experimenter" When Writing to Advertisers

STAMPINGS Metal Spinnings and Stampings a specialty. All sorts of die work and metal patterns. Manufacturers of patent specialties and novelties. Can get out samples at moderate cost. Experts in black enameling. Prices reasonable. Prompt delivery.
The Standard Spinning and Stamping Co.
 E STREET TOLEDO, O.

Copy This Sketch and let me see what you can do with it. You can earn \$20.00 to \$125.00 or more per week, as illustrator or cartoonist. My practical system of personal individual lessons by mail will develop your talent. Fifteen years successful work for newspapers and magazines qualifies me to teach you. Send me your sketch of President Wilson with 6c in stamps and I will send you a text lesson plate, also collection of drawings showing possibilities for YOU.
THE LANDON SCHOOL of Illustrating and Cartooning
 1438 E Schofield Building, Cleveland, O.



Another New and Improved Tool of Millers Falls Make

Here is a new hand drill designed to do a better job in quicker time with less effort and less trouble and fulfilling each purpose perfectly.

MILLERS FALLS HAND DRILL No. 306

It is provided with a simple and effective ratchet, located on the crank handle, which is of great convenience when working in cramped corners or on a delicate job. The handle is detachable and hollowed for holding twist drills up to the largest size within the capacity of the chuck. The chuck is of the famous STAR three jaw pattern closing evenly on, and centering accurately, round shanks from 0 to 1/4 inch in diameter. Jaw springs are protected from injury.

Solid steel frame. Cut gears with a small steel working gear and steel idler gear to equalize bearings, both encased and rendered dirt-and-dust-proof. Choice hardwood stained handle, all metal parts handsomely nicked with exception of large gear.

The splendid quality of material and workmanship in this drill is typical of all tools of Millers Falls Make. Ask your dealer to show you Hand Drill 306 and also Millers Falls Bit Brace 732, Automatic Borer 8 and Hack Saw Gauge 53, new tools that include new features to make work easier.

Send for pocket catalog showing complete line.

Millers Falls Co.
 DEPT. E MILLERS FALLS, MASS.

mitter. These experiments also did not give a practical result, because the stretched wire had no freedom, and thereby was exposed to too great a danger of breaking by the alternate extensions and contractions.

In my invention I follow the process of Gwozdz regarding the treatment of the Wollaston wire, but I claim that my invention is of the greatest practical value. By fixing a wire of a diameter of from 2 to 12 microns in a gothic curve I claim to have succeeded in making the thermophone of practical every day use, because the silver of the Wollaston wire is thereby removed by solution, whilst the whole Wollaston wire is freely suspended in the acid in such a way that at any time such part of the platinum wire can be set free as is considered desirable, without it being liable to breakage. Thermophones are only of value if they are made on this basis.

The result of measurements determined that the sound increased with the number of platinum wires, but not in the same ratio. Thin wires of 2 microns have a greater acoustic effect than wires of 5 microns, the joulean heat remaining the same.

The thermophone, listened to in the open air, sounds extremely weak. As soon, however, as the platinum wire is placed under a cover which has a small opening or several small openings, the sound at once becomes clear and distinct. The volume of the sound increases in accordance with the decrease of the size of the cover. Evidently the cover functions as a resonator. It is a telephonic advantage to make the cover as small as possible, because in that case the high notes and the consonants produce a better effect. The size of the opening in small covers should not be made too large, because in that case the resonance becomes too high, and produces a curious sound in addition to the human voice. I am trying to find an explanation for this most curious phenomenon.

The maximum size of the cover appears to vary between, comparatively speaking, wide limits. The size which is approximately the same as that of the human ear funnel seems to be the most suitable. Metal covers are better than those of ebonite, and by surrounding these with some cooling substance the acoustic effect—if measured with Lord Rayleigh's mirror—becomes twice as great. In this case the sound is conducted through a rubber tube of small bore.

It is difficult from results obtained in tests to construct the theory of the thermophone. The most I can say is that the decrease and increase of heat in the platinum wire of the telephone takes place isochronously with the vibrations in the microphone. The air surrounding the platinum wire is thereby immediately heated or cooled in accordance with the increase and decrease of heat in the wire, and, if that air is retained within a closed compass of the cover, the expansions and retractions will be noticed as sound."

The construction of the receiver will be understood more readily from Figs. 1 and 2, which show the smallest size for insertion in the ear. The Wollaston wire is seen at A, attached to two small brass half-circular blocks, B, from which there project two small pins. These pins fit into a small socket, embedded in ebonite, to form the complete receiver as seen in Fig. 1. The metal cap C, with a very small opening at the top, is slipped over the terminal blocks, B and forms a resonator. An ebonite cap completes the whole. If a larger receiver is desired, such as can be placed against the ear in the ordinary way, half a dozen platinum

HAWKINS LIBRARY OF ELECTRICITY
 In 6 Leather & 1 Pocket Books
 Price per \$1 Volume

Here is a set of books that no man in the ELECTRICAL FIELD should do without. This is the ELECTRICAL AGE in which we live; ELECTRICITY now controls more trades, directs more men, offers more opportunities than any other power that man has yet discovered. Do you wish to know the underlying principles of MODERN ELECTRICAL PRACTICE?

If so, HAWKINS ELECTRICAL GUIDES will give you the information. In reality they are a school within themselves, containing a complete study course with QUESTIONS, ANSWERS AND ILLUSTRATIONS, written in plain everyday language so that a practical man can understand the "HOW, WHEN AND WHY" OF ELECTRICITY.

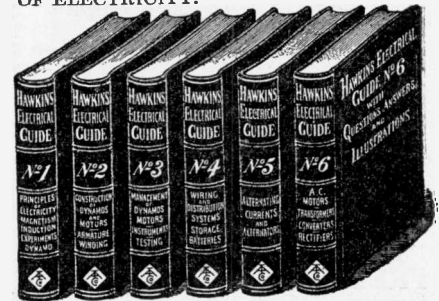

"THAT'S JUST WHAT I NEED"
 They are handsomely bound in flexible black leather with gold edges and will readily go in the pocket. THEY ARE NOT ONLY THE BEST, BUT THE CHEAPEST WORKS PUBLISHED ON ELECTRICITY.

Each book is complete in itself and will be supplied \$1.00 per copy, but we believe that the complete set is the best bargain.

The books can speak for themselves and a careful examination, page by page, and illustration by illustration, will convince you of their big value.

If you will fill out the following coupon giving all the information requested, WE WILL SUBMIT THE SIX VOLUMES FOR EXAMINATION ON CONDITIONS NAMED

FREE EXAMINATION OFFER

Theo. Audel & Co., 72 5th Ave., New York

Please submit me for examination HAWKINS ELECTRICAL GUIDES (Price \$1 each.)

Ship at once, prepaid the 6 numbers; if satisfactory I agree to send you \$1 within seven days and to further mail you \$1 each month until paid.

Signature
 Occupation
 Business Address
 Residence
 Reference J. E. E.

SMALL ENGINES

Our 1/2, 1 and 1 1/2 H. P. Gasoline Engines for Farm and Shop are the best small engines made because we specialize on them. The

"SIEVERKROPP"
 at \$19.50 will run a washing machine, grinder or any small machine. Buy one for your Boy! Shipped on trial. Send stamp for Booklet and Special Offer

SIEVERKROPP ENGINE CO.
 E1224 18th St. Racine, Wis.

INVENTORS Our Brain

Belongs to You. Our Ideas Are Free of Charge.

All we want in return is to build your model, special machinery, dies, tools, and jigs to manufacture sheet metal goods, etc. We are expert mechanics, over thirty years' experience and have one of the best equipped shops in the country. Ask for Booklet No. 17. Consultation free. Experimental work strictly confidential.

A. NACKE & SON
 J. Uhrmann, Prop's
 A. Heldrich, Prop's
 236 E. S. 9th St.
 Philadelphia, Pa.

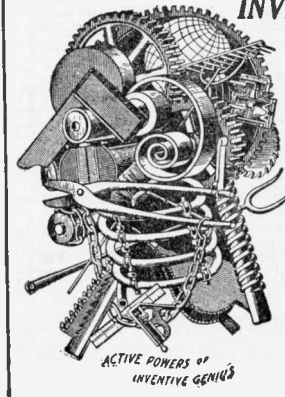

ACTIVE POWERS OF INVENTIVE GENIUS

FREE-SEND FOR THIS

Large Illustrated Catalogue of

Home-Study BOOKS

ON

Electricity, Engineering, Carpentry, Building, Painting, Business

Check the subjects you are interested in and mail with your name and address. We will send full particulars by return mail.

... MOTION PICTURE OPERATING	... Gas Engine Engineer
... Electrical Engineering	... Automobile Mechanician
... Elec. Light and Power Supt.	... Bookkeeper
... Electrical Wiring	... Plumber
... Telephone Expert	... Mason and Bricklayer
... Architect	... Carpenter
... Building Contractor	... Painter, Signs and Card Writing
... Architectural Draftsman	... Letter Writing
... Concrete Engineer	... Railroad
... Mechanical Draftsman	... Motorman
... Steam Engineer	... Traction Farming
... Stationary Engineer	... Civil Service
... Telegraphy	

FREDERICK J. DRAKE & CO.
1325 E Michigan Ave. CHICAGO, ILL.

SOME CAR! BOYS! Send for Booklet Today



The Lad's Car

Send 20c today for Booklet, telling how to build this automobile. Complete instructions and descriptions of parts and sizes, illustrated with diagrams, blue print, cuts made from photographs, and price list of parts.

Special Inducement to first boy in your town

NIAGARA MOTOR CAR CORP'N
Dept. EE, Niagara Falls, N. Y.

"VIM" ENGINE COMPLETE \$25



Save money by using a VIM 1 1/4 H. P. Farm Motor for churning, washing, pumping, separating, spraying, etc. Women operate easily. No valves, cams, gears or complicated parts. Water Cooled, automatic positive lubrication, sensitive governor. Weighs only 75 lbs. Comes ready to run. Fully guaranteed. Get catalog and special agency offer.

THE VIM MOTOR CO.
801 E WATER ST. SANDUSKY, OHIO

Carleton Lighting Generators

Direct Current—6 Volts—8 Amperes (48 C.P.)



With unique, accurate, adjustable, governor and cut-out if desired.

A perfect lighting outfit at a price lower than ever before published. Can be attached to any automobile or motor boat, or used for charging storage batteries anywhere.

Special Ford Brackets allow attachment to Ford cars by using wrench and screwdriver only.

THE CARLETON COMPANY
Fans, Imp Torches—Generators—Storage Batteries
178E Summer Street Boston, Mass.

5 H.P. 1915 Peerless Motorcycle



with Free Engine-Bosch Magneto, together with the best there is in Motorcycle construction, Power, Speed, Silence, Endurance, and those wearing qualities so essential for low cost of maintenance

5 Miles for One Cent
Agents Wanted—Liberal Discount
PEERLESS MOTORCYCLE CO., 179 E Hunting Ave., Boston, Mass.

AGENTS \$24 A WEEK
R. M. King Made \$45 in 6 Days



15 IN ONE

Forged steel. Patented. Low priced. Sells to auto owners, farmers, mechanics in the shops and the home. Not sold in stores. No competition. Sales easy. Big profits. Ten-inch sample to workers. Write at once.

THOMAS TOOL CO., 2499 West St., Dayton, Ohio

Sunshine Lamp 300 Candle Power FREE

To Try In Your Own Home

Turns night into day. Gives better light than gas, electricity or 18 ordinary lamps at one-tenth the cost. For Homes, Stores, Halls, Churches. A child can carry it. Makes its light from common gasoline. No wick. No chimney. Absolutely SAFE.

COSTS 1 CENT A NIGHT

We want one person in each locality to whom we can refer new customers. Take advantage of our SPECIAL FREE TRIAL OFFER. Write today. AGENTS WANTED.

SUNSHINE SAFETY LAMP CO.
298 Factory Bldg., Kansas City, Mo.



PATENTS C. L. PARKER
Formerly Member Examining Corps. U.S. Pat. Office
Patent Lawyer

Patents, Trade Marks, Copyrights, Patent Litigation Handbook for Inventors, "Protecting, Exploiting and Selling Inventions" sent free upon request.

210 MCGILL BLDG. - WASHINGTON, D. C.

TELEGRAPHY The Only Trade that is steady employment and good wages. Promotion is assured for the ambitious. We are official instructors for the Western Union Telegraph Co., and the only school instructing Western Union employees.

Largest attendance of any Telegraph School; also authorized school for Illinois Central R.-ilway Company. Agency course free. Practical instructors; n.a.u. line wires. Employment furnished to earn expenses if desired.

JONES SCHOOL OF TELEGRAPHY, D-pt. E, 305 S. LaSalle St., CHICAGO, ILL.



WIRELESS COURSE

JUST ADDED, PERFECT EQUIPMENT FOR INSTRUCTION IN WIRELESS TELEGRAPHY

Write for full particulars

THE BEST Evening Course in Wireless in New York

If you live nearby and wish to hold your present position, while studying at night. Complete equipment—twelve instructors. Prepare for a government license—under a Marconi Engineer

Day Courses in Operating and Construction
Evening Courses in Engineering, Operating and Drafting. Spanish for Operators
New Class in Engineering starts soon.

Y. M. C. A. TELEGRAPH SCHOOL
145 East 86th Street, NEW YORK

wires are arranged in parallel. The platinum wire, which may be as small as 2 microns (0.002 mm. or .00007874 inch) is, of course, actually much finer than the line in the diagram, being invisible.

This receiver is intended to be worked simply in series with the transmitter and, therefore, the usual transformers would be omitted. Mr. de Lange is confident that long lengths of line can be worked in this simple way. There should, therefore, be a cheapening of line material. In regard to the cost of the receiver itself it is obvious that it must be very much cheaper than the usual electro-magnetic type. As to the life of such instruments it is rather early to say much, but there is no obvious reason against a lengthy life, owing to the extreme simplicity. Mr. de Lange states that he has been demonstrating with his present models for the past six months, and that they show no signs of wear.

CONCERNING PORT JERVIS RADIO STATIONS.

Editor Electrical Experimenter:
Dear Sir:

In regard to notice published in your January issue, concerning Port Jervis Radio Installation, would say that part of the work was performed as follows:

We installed a 75-foot aerial, the average height 50 feet about the ground. This is supported by wooden flag pole at one end and special steel pole at the other end. The instruments consist of special jeweler's receiving set for time service, comprising loading coil, loose coupled transformer, licensed silicon detector, 2,000-ohm Brande's head set and test buzzer, all mounted on polished mahogany base.

We also installed for Hulse Bros., Jewelers, in Middletown, N. Y., a Blitzen receiving set for time service. The aerial on this installation was 125 feet long and about 40 feet at the lower end and about 100 feet at the upper end, with 200 feet lead-in wire.

Both of these installations are giving very satisfactory service. Thanking you for your courtesy in this matter, we are

Very truly yours,
ENTERPRISE ELECTRICAL CO.,
Per Frank Wren.
Middletown, N. Y.

TUCKERTON RADIO STATION CLAIMED BY FRANCE.

Whether the great wireless station at Tuckerton, with its 850-foot mast of steel, which at the direction of President Wilson has been under the supervision of the United States naval authorities since Sept. 7, 1914, is the property of a French or a German corporation, is a question the New Jersey Court of Chancery has now been called upon to decide.

A petition was filed recently by the Compagnie Universelle de Telegraphie et de Telephonie Sans Fil, against the United States Service Corporation, the Hochfrequenz-Maschinen Aktiengesellschaft fur Drahtlose Telegraphie, Rudolph Goldschmidt of Charlottenberg, Prussia, and Emil F. Mayer, of Tuckerton, who is a German subject. The complainant is a French corporation with its principal offices in Paris, while the headquarters of the defendant concern are in Berlin. The French company submits that the German firm is now in control of the station, but that a contract was entered into some months ago for the sale of the plan and all patent rights for use in any part of the world except the German Empire.

The German company, previous to the execution of the agreement, acquired the Tuckerton property and conveyed it to Goldschmidt. A radio-telegraphic station was then erected. The French company, the petition states, was to pay them 4,500,000 francs, and also 50,000 founder's shares of the concern. The agreement further provided that the Tuckerton plant should be completed for the purchaser, but that not more than 2,000,000 francs should be expended without consent.

The German concern also had begun the erection of a station at Eilvese, Province of Hanover, Prussia, and the agreement required that the German company complete that plant also. The contract called for the station at Tuckerton to be able within nine months after completion to transmit 3,000 words in twenty-four consecutive hours. The petition shows that the money was paid, the stock delivered, and that the station did transmit the stated number of words in the given period of time, this occurring May 30, 1914.

SLIGHT DIFFERENCE IN LEAD AND RADIUM G

Some strange variations in the atomic weight of lead have just been explained by recent researches in radium. According to the latest theory, the final product of the disintegration of uranium, known as radium G, is an element that cannot be distinguished from lead, although it has a different atomic weight.

The transformation of uranium into radium takes place by the discharge of three atoms of helium, and from radium to radium G by the discharge of five particles, and each of these discharges lowers the atomic weight by 4.07. So we have the following atomic weights: Uranium, 238.18; radium, 225.97; radium G, 205.62.

The purest pitchblende, containing 60 per cent. of radium oxide, also contains from 2 to 3 per cent. of lead. It is probable that part of this lead is radium G, for the atomic weight of the lead obtained from pitchblende averages 206.7, or 0.4 less than that of ordinary lead.

INTERNAL AND EXTERNAL HEATING HAVE SAME EFFECT ON WIRE.

Prof. H. L. Dodge, State University of Iowa, experimenting on the comparative effects of electric heating and external heating upon the elasticity of mild-steel, copper and aluminum wire, has found that the effects of internal and external heating are the same. With increases in temperature Young's modulus decreases for all metals, it is declared, with increasing rapidity. Professor Dodge described his experiments before the recent Chicago meeting of the American Physical Society.

WELL, WELL.

WAR certainly is hell! Just look at the prices we have to pay now for the following chemicals; the advance being from 20 to 35% since the war started. No wonder life becomes harder and harder every day:

- Methylenedigallate\$.75
- Dimethylaminobenzaldehyde (Para) Oz. 4.00
- HexamethylenetetramineLb. .78
- AcetylparaoxyphenylurethaneOz. 4.00
- Hexamethylenamine Salicylate...Oz. 1.00
- OrthonitroparaphenetidinLb. 7.00
- Dymethylamidoazobenzosulfonic (Para)Lb. 10.00
- Dymethylparaphenyldiamine.Oz. 4.00

FREE! for New Subscriptions.

HERE is your chance to get valuable electrical and wireless articles free of all cost to you, by simply showing THE ELECTRICAL EXPERIMENTER to your friends. Most anybody will give half a dollar for 12 issues of a bright, newsy, up-to-date electrical paper like this one. When you get the number of subscriptions necessary for the premium desired, send us the total remittance with the names and addresses of the new subscribers, (or renewals), and state issue to start them with. Every article of standard quality and guaranteed to give satisfaction.



Midget Flashlight. Smallest made. Measures only 2 1/2 x 1 1/4 x 1 1/16". Beautifully finished in nickel. Fitted with high grade 2 1/2 volt Tungsten lamp. Fits vest pocket. No. 3418 Flashlight sells for 75c. Shipping weight 4 oz.

No. 3418

Given free for 3 yearly subscriptions.

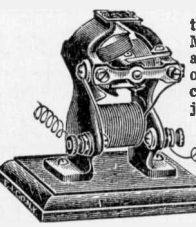

Little Hustler Battery Motor. Runs at high speed on one dry cell. Built just like the large motors of commercial type. 3 pole armature; starts in any position. Stands 3 1/2" high, perfectly finished. No. 100 Motor sells for 85c. Shipping weight 1 lb.

No. 100

Given free for 4 yearly subscriptions or 2 two-year subscriptions.



Galena Detector, with Rotary Cup, rubber base. This detector will enable you to hear radio signals over long distances, with a small aerial. No. 9700 Detector costs \$1.25. Shipping weight 1 lb.

No. 9700

Given free for 4 yearly subscriptions or 2 two-year subscriptions.

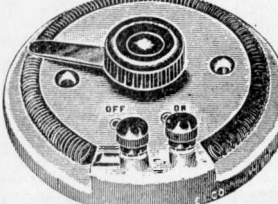

Rheostat Regulator. Resistance 10 ohms, finely adjustable. Porcelain base, air cooled. Capacity about 40 watts, 2 amperes rating. Fine for controlling speed of battery motors, electrocautery work, dimming battery lamps, etc. No. 5000 rheostat costs 60c. Shipping weight 1 lb.

No. 5000

Given free for 2 yearly subscriptions or 1 two-year subscription.

SEE NOTE BELOW HOW TO CALCULATE FOR MORE THAN ONE SUBSCRIPTION.



Geissler Tube, 3 inches long. Most beautiful tube you ever used on your spark coil. Several colors show. A 1/4" or 1/2" spark coil lights tube nicely. Gives a very weird effect. No. 1125A Geissler tube sells for 30c. Shipping weight 1 lb.

No. 1125A

Given free for 1 yearly subscription.



Jr. Fixed Condenser. Hard rubber comp. case. Widely used in radio receiving circuits. Should be used with tuner, phone and detector here shown, etc. Cap. .0465 M. F. size 2 1/2 x 1 1/2 x 1 1/4". No. 10010 condenser sells at 50c. Shipping weight 4 oz.

No. 10010

Given free for 2 yearly subscriptions or 1 two-year subscription.



Pony Telephone Receiver. Single pole, 75 ohms resistance. Hard rubber comp. shell. Two of these receivers connected without batteries will carry talk up to 150 feet. Excellent with galena detector for wireless.

No. 1024

No. 1024 receiver, regular price 40c. Shipping weight 1 lb.

Given free for 2 yearly subscriptions or 1 two-year subscription.

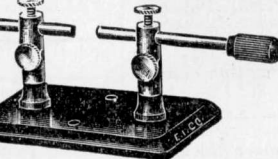

Zinc Spark Gap, works on any spark coil. Can be used as an anchor gap or break gap in "break-key" systems. Zinc rods are 3/16" in diameter, and fitted with two insulated handles. Handsome instrument. Base is hard rubber comp. No. 9220 spark gap sells for 60c. Shipping weight 1 lb.

No. 9220

Given free for 2 yearly subscriptions or 1 two-year subscription.



Static Machine. Gives 3" spark without batteries, dynamos, etc. Simply turn handle and crackling blue-white spark leaps the ball gap. Two 7" Electrite plates. Lots of experiments available. Best machine made. Size 8x5x10 1/2". Price \$3.75. Shipping weight 6 lbs.

No. 9000

Given free for 12 yearly subscriptions or 6 two-year subscriptions.



Jr. Tuning Coil. A beautiful instrument. Bare wire wound. Polished hard rubber composition ends. Two sliders. A useful loading coil, 400 meters wave length capacity. No. 9950 tuner sells at \$2.00. Shipping weight 2 lbs.

No. 9950

Given free for 6 yearly subscriptions or 3 two-year subscriptions.



1000 Ohm Wireless Receiver. Very sensitive. Single pole. Moulder shell. Steel magnet powerfully magnetized. Coil wound with enameled copper magnet wire. Well made throughout. No. 1024A 1000 ohm receiver sells at \$1.00. Shipping weight 1 lb.

No. 1024A

Given free for 4 yearly subscriptions or 2 two-year subscriptions.



"Interstate" Wireless Receiving Set. Receives messages up to 300 miles on fair size aerial. Has tuning coil, detector, condenser and 75 ohm receiver. Hard rubber comp. base and top. No. 1500 Interstate set sells for \$3.75. Shipping weight 4 lbs.

No. 1500

Given free for 12 yearly subscriptions or 6 two-year subscriptions.



Jr. Tuning Coil. A beautiful instrument. Bare wire wound. Polished hard rubber composition ends. Two sliders. A useful loading coil, 400 meters wave length capacity. No. 9950 tuner sells at \$2.00. Shipping weight 2 lbs.

No. 9950

Given free for 6 yearly subscriptions or 3 two-year subscriptions.



1000 Ohm Wireless Receiver. Very sensitive. Single pole. Moulder shell. Steel magnet powerfully magnetized. Coil wound with enameled copper magnet wire. Well made throughout. No. 1024A 1000 ohm receiver sells at \$1.00. Shipping weight 1 lb.

No. 1024A

Given free for 4 yearly subscriptions or 2 two-year subscriptions.



"Interstate" Wireless Receiving Set. Receives messages up to 300 miles on fair size aerial. Has tuning coil, detector, condenser and 75 ohm receiver. Hard rubber comp. base and top. No. 1500 Interstate set sells for \$3.75. Shipping weight 4 lbs.

No. 1500

Given free for 12 yearly subscriptions or 6 two-year subscriptions.

NOTE—Your own subscription may be included in the above offers. If you are a subscriber already we will extend your subscription. Example: Suppose you desire the No. 9700 Galena Detector; you may get four friends, each to subscribe for 1 year; or three friends and yourself for 1 year; or two friends for 2 years; or two friends for 1 year and yourself for 2 years; or finally yourself for 4 years, etc., etc., whichever way you like. Collect the \$2.00 for us and the Detector is yours.

The Electrical Experimenter
 Premium Dept. 233 Fulton Street New York City

Opportunity Exchange

YOU will probably find more opportunities and real bargains in these columns than anywhere else in the country. Most good things in life are hard to find and worth going after—these little ads illustrate that point; you alone will be the real loser if you don't take the time to scan through these columns.

Advertisements in this section 4c a word for each insertion. Count 7 words per line. Name and address must be included at the above rate. Cash should accompany all classified advertisements unless placed by an accredited advertising agency.

Ten per cent discount for 6 issues, 20 per cent discount for 12 issues from above rate. Objectionable or misleading advertisements not accepted.

Advertisement for the April issue should reach us not later than March 10th.

THE ELECTRICAL EXPERIMENTER, 233 Fulton Street, New York, N. Y.

BOOKS

"TRAFFIC in Souls." This book is based upon the most widely discussed motion picture production. It is a powerful study of vice conditions in New York, and the facts upon which it is based were compiled from the Rockefeller White Slave Report. Illustrated with striking photographs. 300 pages. Sent prepaid for 60 cents. Hesse Mercantile Company, 12 East 22d Street, New York.

HANDSOME premiums to new subscribers' list; catalogue of three thousand publications, four cents. Edwards Magazine Agency, Atlantic City, N. J.

"HUNDRED Ways to Kiss a Girl" and other things. Something real good. Price, 25c. Bronx Girls Club, 417 E. 151st St., N. Y.

PIGEONS—The finest Pigeon Magazine, \$1.00 a year, or send 25 cents for four months' trial. Pigeons Magazine, 948 Advertising Bldg., Chicago.

MODERN Dances—Best Instruction Book for beginners. 17 dances fully illustrated. 25c prepaid. Danse Publishing Co., 500 Fifth Ave., N. Y.

ENGINEERS' questions and answers for license, by Hobson, for twenty-five cents, postpaid. Send stamps. Reilly's Book Store, Philadelphia, Pa.

BICYCLES AND MOTORCYCLES

CLOSING Out Sale high grade, slightly used motorcycles. We have about 50 left to sell, in standard makes which we are offering at big bargains such as twin and single cylinder Indians, Yales, Harley-Davidsons, Merckels, Thors, Excelsiors, Popes, 4-cylinder Hendersons and Pierces. These motorcycles we want to close out this year. No reasonable offer will be refused. Write today for our list giving description and prices. Gotham Sporting Goods Co., 57 Warren St., New York City.

FOR Sale, cheap. 1914 Harley-Davidson twin. Write for particulars. Walter Goerke, 321 Washington St., Newark, N. J.

1908 H. D. SINGLE with clutch and magneto, \$30. 1910 H. D. battery model. A-1 condition, \$35. 1911 H. D. single magneto model and clutch, \$40. 1910 H. D. clutch and magneto, \$45. 1 Indian motorcycle motor with magneto and Schebler carburetor, \$25. 1 Excelsior motorcycle motor, \$25. C. H. Lang, 1704 Michigan Ave., Chicago, Ill.

\$50 TO \$150 buys the best Motorcycles, every make and model, in our large stock—must be cleared. Half price. Send for list today. Talking Machines, \$5 and up. Brown Music Co., 9119 Commercial Ave., Chicago, Ill.

SEND for latest Bulletin of real Motorcycle Bargains, used and slightly used, all makes, models and prices; if you have \$25 and really want a powerful Motorcycle, send for this Bulletin; hundreds of machines at all prices, new ones on easy payments; tell us what you want and how much you can pay; we can fix you up. Peerless Motorcycle Co., Dorchester, Mass.

USED Motorcycles, all makes, bargains. Send for list. Ward Bros., 212 Broadway, Camden, N. J.

OUR folder showing the new '15 Eagle 2-speed models is ready for mailing. Write for this and for the agency today. Sterling Motor Company, Brockton, Mass.

RIDERS: Write for our catalogue of motorcycle accessories and supplies. Andrews Specialty Co., 55 Warner Street, Rochester, N. Y.

5-HORSE Pierce, single cylinder, magneto, Schebler carburetor, new tires, perfect running order, \$125.00. Fred Gile, 50 Forest Ave., Portland, Maine.

GET copy of "Motor Cycle" published in England. Special War Issues received here weekly. Price 15 cents. Two for 25 cents. Distributors, 143 So. Wabasha, St. Paul, Minn.

WE have twenty-five used motorcycles from \$20 up. Ask for list. Will save you money. Answer quick. Sterling Motor Company, Brockton, Mass.

1914 MODEL R Pope, Two-Speed Motorcycle—Will exchange for 18-inch swing Engine Lathe. E. H. E. Thieroff, Sherwood, Ohio.

BIG bargains in good motorcycles we have taken in exchange on new ones. Send for special bargain list. Shaw Mfg. Co., Galesburg, Kansas.

MOTORCYCLES—Everybody rides them. You're next. New and rebuilt motorcycles; every motorcycle fully guaranteed. Singles and twins, \$25 to \$100. Tire casings, \$3; belts, \$4; carburetors, \$6; automobile tires, \$3. Send for catalogue. Deninger, the price cutter. Rochester, N. Y.

MOTORCYCLES cheap now. Write me what you want and price. Chas. Walsh, 878 St. Paul, Detroit, Mich.

MOTORCYCLES, all makes, rebuilt, guaranteed good as new. Indians, Harleys, Excelsiors, Readings, Kulteres, Merckels, Single and Twins, \$25 to \$100. Buy direct, save dealers' profits. Denninger Cycle Co., Rochester, N. Y.

DON'T buy a Bicycle Motor Attachment until you get our catalogue and prices. Shaw Mfg. Co., Dept. 27, Galesburg, Kansas.

YALE, Pope, Thor, bargains. Late models. Walter Munger, Excelsior, Minnesota.

FORMULAS

LATEST FAD. The celebrated everlasting fragrant rose beads can be easily made and sold with big profit. Strings sell as high as \$3.50 to \$5.00. Formula with full instructions for making same, 25c coin. J. C. Regan, 1162 Broadway, N. Y.

IS the formula you want worth a quarter? State exact requirements. Raymond, Roosevelt, N. Y.

1,000 TRADE secrets and formulas, 25c. 500 selected formulas, 20c. Resilver mirrors, guaranteed process, 20c. Make Sneezing Powder and Itch Powder, 10c each. Entire lot, 50c. Service Bureau, 3111-T, Belleplaine Ave., Chicago.

MAKE Candy evenings; pays; receipt, 10c. Elmer Zimmerman, 1435 Walnut, Harrisburg, Penn.

START factory making candies, gums, crack-erjack, orangeade, ciders, etc. Sells fast. Nearly all profit. \$15 course \$1.00. Catalog, 2c. Robert Hamilton, Barnes City, La.

SIX Valuable formulas for sympathetic inks, 50c. Wayne Thomas, Ithaca, N. Y.

FORMULAS for inks, black, blue, red, gold, green, silver, indelible, 15c each. 7 for \$1.00. Stephen Rafferty, 2122 Arch St., Philadelphia, Pa.

PRINTING

OUR splendid plan of Publishing a Magazine of your own, will increase your business. Let us send you free particulars. Co-operative Magazine Co., 2530 N. Clark St., Chicago, Ill.

PREPAID, Printing (600 miles) 1,000 bond letter heads, \$2.39; envelopes, \$2.14; return envelopes, \$1.77; imitation typewritten letters, 150 words, \$1.73; 300 words, \$2.64; 6x9 circulars, \$1.75; art ad slips, \$1.00. Ask for prepaid prices on any printing. Good's Quick Print, Harrisonburg, Va.

PHOTOGRAPHIC

WE buy, sell and exchange. Bargains in Microscopes, Telescopes, Binoculars, Cameras, etc. Bargain list sent. Kahn & Son, Opticians, No. 64 John St., New York. Established 62 years.

SPOT Cash paid for high-grade Kodaks, Lenses and Cameras. Send full description, stating lowest price. Cameras exchanged. In business since 1885. David Stern Co., Dept. M, 1047 W. Madison St., Chicago.

FILMS developed 10c, all sizes. Prints 2 1/4-3 1/4, 3c; 2 1/2-4 1/4, 3 1/2-3 1/2, 3 1/4-4 1/4, 4c; Post Cards; 50c doz. Work guaranteed and returned 24 hours after receiving. Postpaid. Send negatives for samples. Girard's Commercial Photo Shop, Holyoke, Mass.

ROLL Films developed 10c per roll. Printing Post Cards, 3c each. 15 years' experience. Give me a trial. You will be pleased. F. C. Hoyt, Sac City, Iowa.

EXPERT Kodak Finishing! Send for price list. Electric Studio, 162 Stephenson St., Freeport, Ill.

KODAK films developed, 5c, all sizes; Prints 3c, each, any size. P. Johnson, 100 W. Bridge St., Oswego, N. Y.

TRANSFER pictures to china, etc.; no formulas; particulars. Flinn, 286 West 142nd St., New York City.

THINK OF IT! Only \$20 for finest German Double Anastigmat in Ibsco shutter, for 3A Kodaks and postal card cameras. Send for matter describing best Lenses on earth at way down prices. Lafbury Co., 305 North Fifth Ave., Chicago.

FILMS developed 10c, all sizes, prints 2 1/4-3 1/4, 3c; 2 1/2-4 1/4, 3 1/2-3 1/2, 3 1/4-4 1/4, 4c; Post Cards, 50c dozen. Work guaranteed and returned 24 hours after receiving. Postpaid. Send negatives for samples. Girard's Commercial Photo Shop.

\$54 CENTURY Grand, bargain, \$25. Magnificent Ensign Reflex, Zeiss Triotar Anastigmat, complete, \$65. \$22.50 Autographic Kodaks, \$19.75. Silpin Calendar Mounts, assortment, \$1. Catalogues mailed. Newark Photo Supply Co., Newark, New Jersey.

HEADQUARTERS for selling or exchanging Cameras of all kinds. Carry a full line latest Kodaks. Graflex, Premos, foreign Cameras. Write for big bargain list. Gloeckner & Newby Co., 171 Broadway, New York.

KODAK Films Developed, 10c per roll, any size. Prompt attention given mail orders. Prints, 2 1/4x3 1/4 to 3 1/4x4 1/4, 3c; 4x5 to 3 1/4x5 1/2, 4c. J. M. Manning, Box B, 1062 Third Ave., New York City.

MAIL ORDER OPPORTUNITIES

EVERYTHING in the mail order line; State your wants and we will do the rest. Pacific Specialties Co., Los Angeles, Cal.

EUROPEAN War Map and chances to start a profitable business of your own, 10c. C. S. Mathews, 69 East 87th St., Portland, Ore.

FREE—A 1-4 kt. Amsterdam Gem, can't tell from a genuine diamond, set in a Tiffany ring. Send 10 names and addresses from friends and 12c to pay postage. S. E. Muller, Maplewood 5, Malden, Mass.

MAIL Order Men. Would you like to know how 61 successful mail order men do business? Especially if these men tell you their own experience in their own words. The Mail Order Business Builder gives you such information direct from these men's private offices from month to month. Send dime for sample copy of this 68 page magazine. Randolph Rose, Publisher, No. 8 Broad St., Chattanooga, Tenn.

You Benefit by Mentioning "The Electrical Experimenter" When Writing to Advertisers