

THE ELECTRICAL EXPERIMENTER

JUNE
1913

5¢

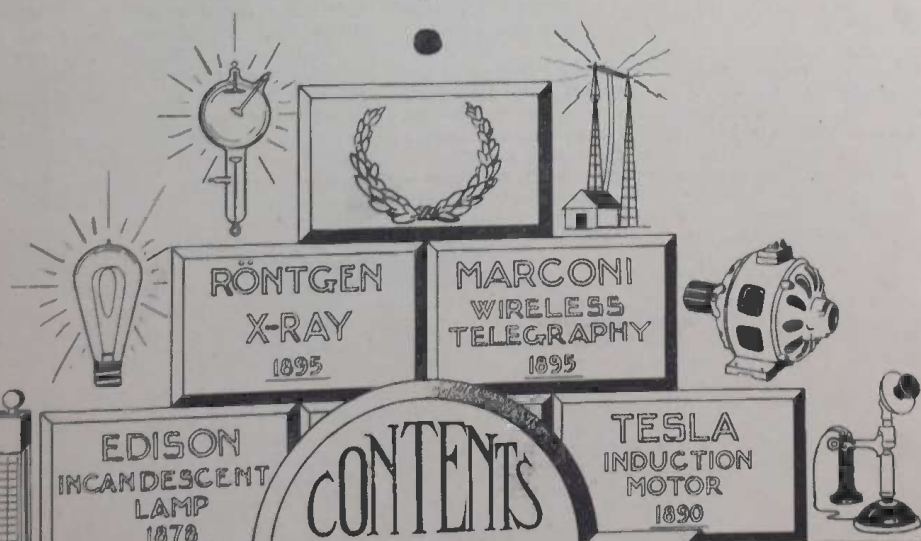
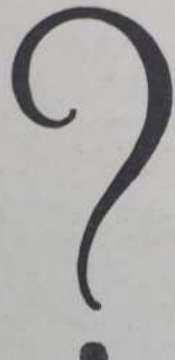

RÖNTGEN
X-RAY
1895

MARCONI
WIRELESS
TELEGRAPHY
1895

EDISON
INCANDESCENT
LAMP
1878

TESLA
INDUCTION
MOTOR
1890

CONTENTS

○ Treatise on Wireless Telegraphy.
By H. Gernsback.

Experimental Electricity Course.
By S. Gernsback and H. W. Secor.

○ How to Construct a 1/4-K.W. Wireless
Transformer.

How to Build a Unique High Frequency
Set.
By Alexander Cortwright, E. E.

Recent Development in the Work of the
Federal Telegraph Company.
By Lee De Forest, Ph.D.

How to Make an Electric Carillon.
By H. Gernsback.

○ How to Construct an Oscillation Trans-
former.
By S. W. Hector.

BELL
TELEPHONE
1876

MORSE
TELEGRAPH
1837

VOLTA
VOLTAIC
ELECTRICITY
1800

PLANTÉ
STORAGE
BATTERY
1860

OERSTED
ELECTRO
MAGNETISM
1820

GALVANI
GALVANIC
ELECTRICITY
1770

- THE - ELECTRICAL EXPERIMENTER

VOL. I.

JUNE, 1913

NUMBER 2

A Treatise on Wireless Telegraphy

(Concluded.)

By H. Gernsback.

SUPPOSE you live in the city of Columbus, Ohio. The nearest state line is Kentucky, about 86 miles in a direct line from Columbus. If you do not wish to be licensed you can use any spark coil up to 10-inch spark, or a ½ K.W. close core transformer.

Suppose your home is in Austin, Texas. The nearest state line is Louisiana, a distance of 230 miles. Thus you could with perfect safety use, for instance, an E. I. Co. No. S.O. 200 outfit, which does not reach more than 200 miles.

It is also pointed out that if you live within five miles of a Government wireless station you cannot use more than ½ K.W. power, though the next state border might be 100 miles or more distant.

Of course if you live close to another state, as for instance, in New York City, you are required to take out a license for any size transmitter.

What the License Is.

The license has not been created to muzzle you; it is the other way around. Uncle Sam gives you a written order telling you that you can send messages to your heart's content, and no one can tell you to stop sending, as long as you do not create mischief.

The license is free, it costs not a penny. All that is required of you is that you are familiar with the law and that you can transmit messages at a fair degree of speed.

The law does not require that you take an examination in person if you are located too far from the next radio inspector. All you have to do is to take an oath before a notary public that you are conversant with the law and that you can transmit a wireless message. If you wish to be licensed—and we urge all amateurs to do so, as it is a great honor to own a license—write your nearest Radio Inspector (see below), and he will forward the necessary papers to you to be signed.

Radio inspectors are located at the following points: (Address him at the Customs House):

Boston, Mass., New York, N. Y., Baltimore, Md., Savannah, Ga., New Orleans, La., San Francisco, Cal., Seattle, Wash., Cleveland, Ohio, and Chicago, Ill. Also the Commissioner of Navigation, Department of Commerce and Labor, Washington, D. C.

In an interview with the *New York Times*, W. D. Terrell, United States Radio Inspector for the port of New York, said in discussing the new law:

"The new law regulating wireless messages will work no hardship to the amateur operator. It is the intention first, to classify the various operators and place each operator in his proper class. They will then be permitted to work or play as much as they please, but under an intelligent, general supervision. Only those stations are affected which are near enough to the coastal stations to offer interference, or which work across the state lines which brings them under the supervision of the inter-State laws. I would like to make it very clear that the license costs the amateur nothing, and that the Government is willing to facilitate the wireless operators in every way possible to secure their license."

So much for the law. Everybody will now understand that the law is just and fair and that it gives the amateur a distinct standing in America, a standing which he does not enjoy in any other country. He knows what he can do and what he can't do, and no one can come to him and boss or abuse him, as Govern-

ment or Commercial wireless operators were wont to do before the enactment of the law.

With sending outfits the reasoning is almost the same as with the receiving outfits.

In order to select an outfit you must, of course, know where and how far you wish to send. Upon this all depends.

As a rule two or more friends get the "Wireless bug" and order two or more complete transmitting sets. Of course, the outfits selected must necessarily be powerful enough to cover the intervening distance between the houses of the friends, and this only you know.

Therefore if you and your friend decide to converse by wireless and if the distance between your two houses is 10 miles you will buy either the E. I. Co. outfits No. SO-10 or SO-15 (S.O. stands for Sending Outfit, the number indicates the mileage that the outfit will cover). Of course, a more powerful set may be used, although there is no particular advantage in doing so, except, perhaps, that the incoming signals of necessity will be louder with the more powerful sets. It goes without saying that almost ANY receiving outfit which the E. I. Co. list can be used with ANY of the sending outfits. Bear in mind that the selections which they give with their sending outfits do not have to be used if not wanted. Thus their "Interstate" outfit or even their "Transcontinental" receiving outfit can be used with their SO-¼ set. For if you and your friend live one-quarter of a mile apart and both of you have SO-¼ Sending outfits, you probably want to have a receiving outfit with which both of you can pick up messages 2,000 miles distance. In that case you would order two SO-¼ sending outfits only, and two RO-2000 outfits, or else two "Transcontinental" receiving outfits. If either you or your friend feel that you cannot afford such a set, why then get the set that you can afford best and that suits you best. As you see there is no hard and fast rule about the relation of sending and receiving outfits. On the other hand we don't have to tell you that if you wish to obtain two S.O.-200 outfits you require of necessity a good receiving outfit, else you couldn't hear the station 200 miles off. A little common sense will help everyone decide just what combination to order.

Like receiving sets, the transmitting sets are divided into two groups. The untuned (open circuit) and the tuned (closed circuit) ones.

The untuned ones have, 1st—a spark coil, 2nd—source of power, usually dry cells or a storage battery, 3rd—the spark gap, 4th—the key.

Such outfits can be used only for very short distances and should never be used above three miles. When connections are made by following the blue prints, which is supplied with all sets, the pressing of the key gives a strong spark in the spark gap. The spark gap (the open space between the zinc plugs) from the smallest to the largest sets, must never be more than one-eighth to three-sixteenths of an inch. A bigger gap does not work. Pressing the key long gives a dash, pressing it but for a fraction of a second gives a dot. Combinations of these represent the telegraphic characters; the code can be learned in a few weeks, practicing twice a day from one-half to one hour. (See Lesson No. 15, of The E. I. Co. Wireless Course.)

In the tuned outfits, we have in addition to the above enumerated apparatus: 5th—The Leyden jars, or condenser; 6th—The Helix, or oscillation transformer. The Leyden jars change the red spark obtained from a spark coil, into an intense blue-

"The Electrical Experimenter" is published on the 15th of each month at 233 Fulton Street, New York. There are 12 numbers per year. The subscription price is 50 cents a year in U. S. and possessions, as well as Canada. Foreign countries 75 cents a year. U. S. coin as well as U. S. stamps accepted (no foreign coin or stamps). Single copies 5 cents each. A sample copy will be sent gratis on request. Checks and money orders should be drawn to order of the Electro Importing Co.

If you change your address, notify us promptly, in order that copies are not mis-carried or lost.

All communications and contributions to this journal must be addressed to: Editor, "The Electrical Experimenter," 233 Fulton Street, New York. We cannot return unaccepted contributions unless full return postage has been included. ALL accepted contributions are paid for on publication. A special rate is paid for novel experiments; good photographs accompanying them are highly desirable.

Title registered U. S. Patent Office. Copyright 1913 by E. I. Co., New York.

This journal accepts no advertisements.

white crashing spark. The Leyden jars also create a train of fast oscillations and go to make the outfit far more powerful although no more battery power is required. The Leyden jars also give better "carrying power," as the signals can be heard more distinctly and not "mushy" as if no Leyden jars were used. For each outfit the best jars or condensers have been selected by the company and no changes should be made here.

The helix as well as the oscillation transformer, are, to the sending outfit, what the tuner and the loose coupler respectively, are to the receiving outfit. The helix or the oscillation transformer is the tuning coil pure and simple for the transmitting station. Like the tuning coil the helix and the oscillation transformer have sliders or else clips by means of which more or less wire convolutions can be put in the circuit of the aerial. Therefore more or less wire, and consequently more or less wave length is added to your aerial. Again there is not much of a mystery here. Anyone understands it. (See E. I. Co. Wireless Course Lesson No. 14.)

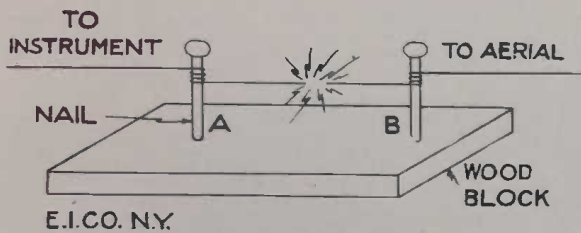

In the larger sets where the battery power is insufficient as well as un-economical we have two methods open to fill the gap. One is the Gernsback electrolytic interrupter working on 110 volts Direct or Alternating current, which supplies the spark coil (transformer coil) with the power; the other method requires the use of a CLOSED core transformer operating without any kind of interrupter direct from the alternating current supply. This kind of transformer, however, does not work on the direct current, not even in connection with the electrolytic interrupter. The choice, for this reason lies entirely with you.

The aerial switch is an absolute necessity where both a sending and receiving set is used in one station. If you are through receiving a message from your friend, you, of course, wish to answer him. You therefore, must switch the receiving set off from your aerial and switch the sending set onto the aerial. The aerial switch does all this in one operation.

For sets using nothing higher than a 2½-inch spark coil an ordinary double pole, double throw switch may be used. For heavier sets using more power the E. I. Co. Antenna switch No. 8100 must be used, as the smaller switch cannot carry the necessary power.

Sending a Message.

In order to send messages it goes without saying that you must know how to "tap the key." The easiest way to learn, and the cheapest way at the same time, is to get a buzzer set as explained under "Reception of Messages." With this set, which represents a first class learner's outfit, you can send yourself dots and dashes to your heart's content until your wrist has limbered up sufficiently to do rapid sending. After a few weeks' practice it will be as easy to send a telegraphic message as to write on a typewriter.

If your friend has a wireless and starts learning the code with you, it becomes very simple for both of you to soon become proficient in the art. Each will send to the other, the Morse or Continental alphabet, which is sent back and forth till the right speed is obtained. After this certain words are exchanged between the stations; later on short sentences are sent and so forth, till it becomes possible to converse freely by wireless.

There is but little adjusting to do when sending. As a rule amateurs converse with only one, seldom two, and rarely three stations. For this reason much adjusting is unnecessary. When using a small set comprising spark coil, Leyden jars and helix it becomes first necessary to adjust the Leyden jars. Either more or less jars (which adds more or less capacity to the circuit) are used till the spark sounds loudest in the spark gap and appears most powerful. A little experimenting will quickly tell when the right capacity is used. *It is important to understand that the capacity should be adjusted only when the spark gap is connected to aerial and ground.* (See Lesson No. 14, E. I. Co. Wireless Course.)

The next important adjustment is in the helix (or oscillation transformer if this is used in place of a helix). To change the clips around the helix (or on the oscillation transformer) it is necessary that a small gap is first made in the aerial circuit. This is done best by driving two nails in a piece of very dry wood, and connecting the aerial wires to each nail as shown in sketch. The two wires, A and B are brought close together now and when the key is pressed down a small spark will jump from A to B showing that you are charging the aerial and that energy is radiated from same. Now change the adjustment on the helix (or oscillation transformer) till the longest and fattest sparks

jump between A and B. To do this A and B are separated until a point is reached where the spark cannot jump any further. You know now that you are radiating the maximum of energy and the point on the helix (or adjustment on the oscillation transformer) should be carefully marked so you will know at any time just where the maximum is. It goes without saying that you should also note how many Leyden jars (or how many condensers) you are using when making the test and you should write this information down, for if you were to use more or less Leyden jars (or condensers) you would have to change the adjustment on the helix (or oscillation transformer) as explained above. Now after the maximum "radiation" has been ascertained, the test block with the nails is discarded and the break in the aerial wire connected again. You know now that your station is radiating the maximum energy and adjustments of the sending set will not be required for some time to come. Indeed they may be left undisturbed indefinitely.

We believe that we have made everything as plain as possible and that by reading this treatise the elementary points of "Wireless" must become plain to even the layman. If, however, you desire additional information, we will be only too glad to answer your questions promptly and explicitly. Now it's up to you to get busy and "start something"!!

A CURIOUS ELECTRICAL ROCKER.

As most of our ideas associated with electricity and motion, are linked with the more or less common form of rigid electrical machine designs, such as the motor, bell, etc., the apparatus here described is certainly quite a novelty, especially as it utilizes direct current, and the circuit is not interrupted or reversed to create a changing magnetic field as is usual in direct current apparatus producing motion.

This rocker requires for its operation, a fairly strong direct current of several amperes; such as given by a couple of storage cells, or other source.

The rocker is shown in the sketch, and consists of two metal plates, mounted on vertical standards, one of the plates being of lead preferably (the darker one), and the other of iron or brass. The rocker shaft itself is of brass, and has a small V-shaped groove cut in its side at one end. The two edges of the groove rest upon the lead plate edge, and the pendulum is secured in the manner shown.

Usually about 6 to 8 amperes and 1 to 2 volts, is sufficient to cause the rocker to start oscillating or swinging from a position of rest; and the pendulum may easily swing over an arc of 30 degrees, in a few seconds time after it starts to oscillate.

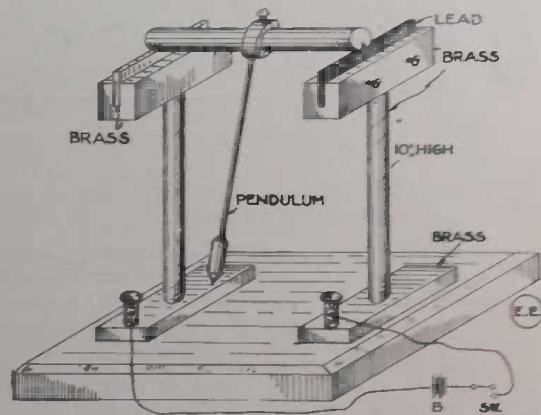

The philosophy of this peculiar action, which is different from any other direct current, motion producing apparatus in general use, is due to the fact that the current of several amperes applied is sufficient to heat the edges of the groove on the rocker shaft and the lead plate upon which it rests, and when this occurs the lead expanding where it is in contact with the groove edge, causes the shaft to turn slightly. When this happens, the lead quickly cools, and the shaft swings back again, aided by the heating on the other side of the groove edge and lead plate. This keeps up as long as current is applied to the apparatus, and if the pendulum is removed, the rocking bar gives out a musical hum.

The Telefunken Wireless Telegraph Company, which has been experimenting in wireless telephone work in connection with its general wireless plant at Sayville, has succeeded in developing a 125-mile range. It is said that the plant has not as yet been able to communicate with Manhattan because of atmospheric and electrical interference. Localities in New England, 125 miles away, have been reached, however.

If you don't subscribe to the "E. E." we both lose.

Experimental Electricity Course

EDITORIAL NOTE.

This course is a comprehensive treatment of Experimental Electricity in twenty lessons. Each principal electrical subject receives special consideration as to its use in experimental and practical work.

The authors give an explanation on all electrical phenomena, also complete instructions as to the working of all the Electrical apparatus, their connections, use, construction, etc.

The arrangement is up-to-date, so that the course may be used as a text-book by those beginning to study electricity, but it will be priceless to the Experimenter, as it will give him all the practical information he needs, and at the same time he will become educated to a high degree, in electrical matters, as all of the lessons cover the theory as well as the very essential practical details. Everyone interested in electricity in any way whatever, even though it be ever so slightly, cannot afford to miss this series of specially prepared papers. No expense has been spared in making special cuts to facilitate the understanding of every line in the text.

These papers have been especially written at great expense by well-known authors, who know the ground thoroughly, and every effort has been made to clearly explain every little detail, so that he who runs may read and learn.

Mr. Sidney Gernsback, who is Vice-President of The Electro Importing Co., and a member of their "Engineering Staff," brings to bear upon this subject a wealth of authentic information, gleaned through his long experience and studies in the best Technical Schools of Europe.

Mr. H. W. Secor, formerly of the "Engineering Staff" of The Western Electric Co., has written innumerable articles on electrical and wireless matters, for the past several years and was collaborator with Mr. S. Gernsback on the "Wireless Course" produced by the E. I. Co., which has had a phenomenal circulation.—THE EDITOR.

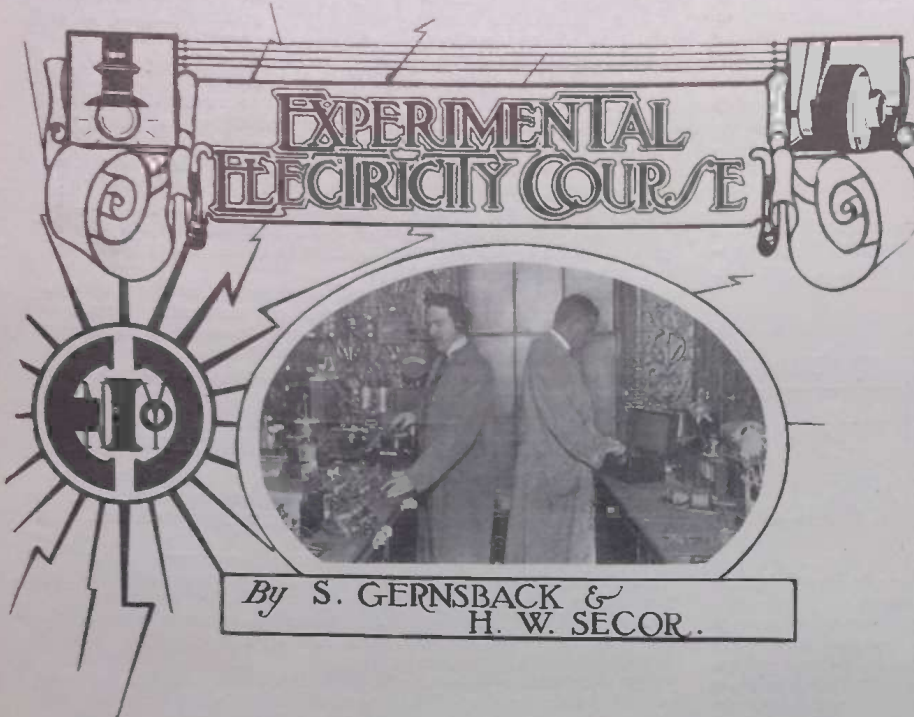

Table of Contents

Lesson No. 1. Bells, Buzzers, Annunciators, Switchboards.	Lesson No. 12. Spark Coils and Experiments with Geissler Tubes, etc.
Lesson No. 2. Primary Batteries, Dry Cells.	Lesson No. 13. Experiments with X-Rays.
Lesson No. 3. Storage Batteries.	Lesson No. 14. High Frequency Currents (Tesla Transformer Experiments, etc.).
Lesson No. 4. Rectifiers, Transformers.	Lesson No. 15. Copper Plating.
Lesson No. 5. Small Electric Lighting Plants.	Lesson No. 16. Nickel Plating.
Lesson No. 6. Wires, Cables, Resistance, Calculations. Useful information.	Lesson No. 17. Static Electricity, Exp't. with Static Machine.
Lesson No. 7. Telegraph and Telephones.	Lesson No. 18. Voltmeters, Ammeters, Wattmeters, (Elect. Measuring Insts.).
Lesson No. 8. Motors and Dynamos.	Lesson No. 19. How to make things. (The use of Raw Material.)
Lesson No. 9. Switches, Burglar Alarms, and other connections.	Lesson No. 20. Mathematics, Pract. Geometry, Glossary of Elect. Terms, etc.
Lesson No. 10. Electro-Physics and Electro-Chemistry (Exp't.).	
Lesson No. 11. Electro-Therapeutics.	

LESSON 1.

"ELECTRIC BELLS, BUZZERS AND ANNUNCIATORS."

ELECTRICITY, when utilized for signalling purposes, generally involves the use of electrical bells, buzzers, or annunciators, and so these apparatus will be described in order; also the best methods to pursue in properly wiring for same.

It is advisable, perhaps, to start with a description of the ordinary vibrating bell. The action of it is very simple, and may be the more readily understood by looking at the schematic drawing, Fig. 1.

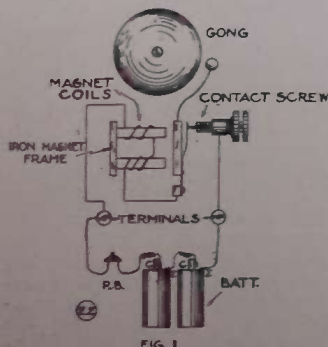

FIG. 1

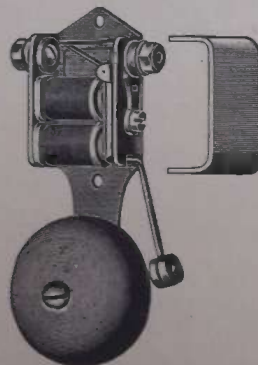

Fig. 2

In this drawing are shown the various parts of the simplest bell circuit. Included in the circuit are: the bell itself, of the vibrating type; the battery, of one or more cells, and

a push button for the control of the bell. The bell acts upon the principle that whenever an electric current, as from the battery here shown, passes through a coil of several turns of insulated wire, there will be produced within the coil and about it, an electromagnetic field of force, as it is termed. This electro-magnetic effect, produced whenever a current traverses a coil of wire, is introduced in the bell, in the manner illustrated. There are two coils in most bells, but some types contain but one. Now, if the push button is pressed, the two contact springs in it are brought together, making an electric circuit, through which the battery current passes, and so on around through the electro-magnet coils on the iron frame of the bell. The iron cores of the magnets become suddenly strongly magnetized, attracting the soft iron pivoted armature, which carries the gong hammer. When the armature is thus attracted, and drawn forward, two things happen:—first, the hammer hits the gong, giving out a signal; and second, the contact spring carried by the armature, breaks contact or leaves the contact screw shown in the figure.

The consequence of this is, that the armature is no longer attracted because its forward movement has broken the battery circuit, and no current traverses the magnet coils. Hence the armature, which is normally held away from the magnet cores, but against the contact screw by a spring, at once flies back to this position, or away from the magnets; as soon as this happens, however, the electric circuit is once more completed, the magnets are energized, and the armature is again attracted, striking the gong. As long as the push button is depressed, this action continues, the armature vibrating at a high rate of speed, giving rise to a continuous ringing of the gong. The number of strokes per minute, and the action of the armature are easily regulated by adjusting the contact screw, the tension of the armature spring, and the distance separating the magnet cores from the armature.

A typical vibrating bell of the so-called iron box type, is depicted in Fig. 2, while at Fig. 3 is shown a complete electric bell outfit, including bell, push-button, battery, wire and

staples for securing it in place. This outfit forms a very efficient front door bell set, or in any other application for distances not exceeding fifty feet. In Fig. 4, are illustrated, a few ornamental brass push buttons.

It is not always desirable that the electric signal be that of the somewhat noisy bell, and for this class of service, resort is had to an instrument known as a *buzzer*. This is nothing else but a neatly made bell mechanism, without any gong or striking arm, so that the armature in it can vibrate quite rapidly, sending out a loud buzzing sound, similar to that of a bee. It is much employed in offices, or other quiet places, where the bell is too noisy, or sometimes it is used in conjunction with a bell, so that either the buzzer or the bell ringing, will indicate one or the other of two different signals. For instance, in many private houses, the bell and buzzer are mounted side by side in the kitchen, and so connected to two push buttons that the bell indicates someone at the front door, and the buzzer a call from the dining-room table, etc. Sometimes a number of bells with different toned gongs are arranged in a set, the meaning of each being quite distinct. Common forms of the odd gongs are: the cow bell, the cocoa wood; the sleigh bell; the split gong; the chime gong, etc. A neat and well made buzzer is seen at Fig. 5.

A recent innovation in the realm of electric signalling devices is the *electro whistle*. This instrument gives out a more or less shrill whistling note, quite distinct from any other device. It is built on the same principle as the vibrating bell, excepting that the armature of the bell is substituted by an iron rod and a thin diaphragm, as shown at Fig. 6. Whenever current is supplied to the terminal binding posts, Ter. 1, and Ter. 2, its path is around through the magnetizing coil, and closed contacts, A. At this juncture, however, the magnetizing coil has drawn forward the iron disc and rod shown, and this also moves the diaphragm, to which the rod is attached. The movement of the rod and disc, simultane-



Fig. 3.

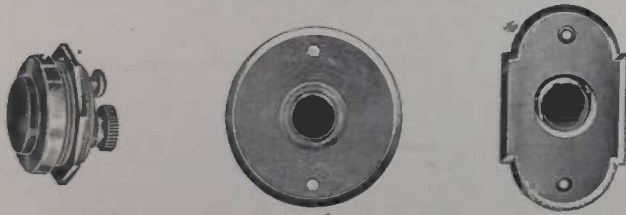

Fig. 4

ously breaks the contact between the springs, A, and the rod and its parts return to their original position. In practice, this attraction and release of the iron rod and also the diaphragm occurs at a very high rate, resulting in a whistling sound being emitted by the diaphragm. This sound may be greatly amplified and directed by attaching a brass or other metal horn to the front of the instrument. This arrangement gives very satisfactory service as a telephone call in power houses or other noisy locations.

The apparatus so far mentioned, form the usual complement of audible electric signalling devices, but before taking up the study of circuits and other details, reference will be made to a very important instrument, variously called an *indicator* or *annunciator*. A cut of a 6 position annunciator, or one capable of indicating 6 distinct calls, individually, is portrayed at Fig. 7. The annunciator is a very extensively used instrument, particularly in hotels, and other places, where a great number of different calls are to be registered at one central point, such as a hotel office.

Its principle of action is based upon the electro-magnet, as described in connection with the bell previously. In most cases a bell or buzzer is arranged to operate whenever a call is registered upon the annunciator, but the annunciator itself emits no appreciable sound at all. Each shutter or drop, bearing any desired number, name or letter, is normally held out of sight, in the type shown in the cut. When an electric current is sent from a certain

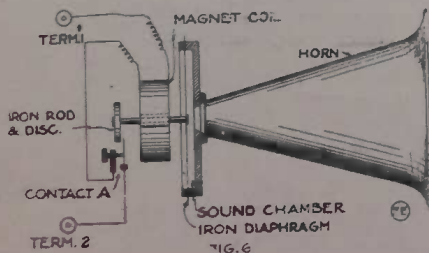

FIG. 6

corresponding push button, however, the shutter is instantly released by an electro-magnet, and drops down into sight. In the cut, Nos. 1, 3 and 5, have been released by the electro-magnets operating them. The shutters are reset, to await another call, by pushing up on a button at the bottom of the cabinet, after each indication. In some annunciators this resetting of the shutters or indicating needles, is accomplished automatically by each succeeding call. This is both a good and a bad feature, inasmuch as the second call may occur, resetting all previous calls, before they have been seen or answered. Hence the manually reset type is generally the most desirable. A sketch of the working action of an annunciator drop, is shown schematically at Fig. 8.

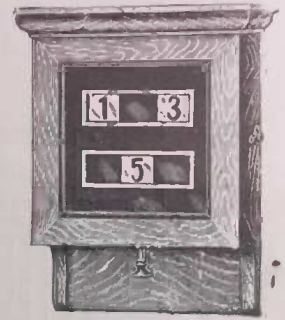

Fig. 7

An electro-magnet is arranged with a pivoted soft iron armature, to which is attached a trip bar, so that when the magnet is energized by passing a current through it, the armature will be attracted, raising the trip bar or finger, and releasing the shutter or drop, which rests on a pivot also. The shutter is reset out of range of the window in the cabinet frame, by pushing upward on a button at the base of the cabinet. This reset button, B, is secured to a metal rod, A, which, when pushed upward, presses the shutter upward also, and the slanting edge of the trip finger allows it to rise and then fall over the edge of the shutter, thus retaining it in place, until another call occurs. There are many different styles and makes of annunciators upon the market, but they all operate by means of an electro-magnet and armature of some form.

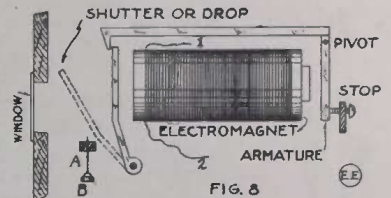

FIG. 8

THE WIRING.

For ordinary electric bell installations it is usual to employ copper wire, about No. 18 gauge, B. & S. (Browne & Sharpe), with two coatings or wraps of waxed cotton over it for insulation. The number of feet per pound of office and annunciator wire, used for bell work, etc., is as follows:

Office wire:	Feet per lb.
No. B. & S. gauge.	
No. 12	35
No. 14	55
No. 16	95
No. 18	135
Annunciator Wire:	Feet per lb.
No. B. & S. gauge.	
No. 18	180
No. 20	225

The annunciator wire, or common bell wire, has two layers of cotton merely wrapped around the conductor, which is then soaked with paraffine wax. It is easily unravelled.

Office wire has two cotton layers braided, which is not so easily unravelled and consequently more preferable. The inner braiding is filled with a moisture repellent compound. The cheapest wire to buy, of course, would be No. 20, gauge, as it contains the greatest number of feet to the pound, but it is only suitable for comparatively short lines, as it has too much resistance for the low voltages utilized in bell work. No. 18 is permissible for bell or annunciator circuits up to a distance of 100 feet one way or 200 feet of wire in the circuit. For circuits of 100 feet to 150 feet one way, use No. 16 gauge wire. Circuits from 150 feet to 200 feet, No. 14 wire, and circuits of 200 to 250 feet one way, use No. 12 wire. For circuits of greater length than these it is not practical to ring the bells direct, as they require too much current in amperes, which necessitate a very large battery to compensate for the volts drop in the line or circuit, and also large copper wire. For long bell circuits, the most practical arrangement is that involving the use of a high resistance relay, which is actuated directly by the push button and battery, over the long line; and the relay then closes a local circuit containing several feet of wire, a battery of a few cells, and the bell. The relay is wound to a higher resistance than the bell, and does not require nearly as much current in amperes, so that smaller line wire may be used. Relays are quite sensitive, and are the same as used on telegraph lines, the resistance varying from 20 to 100 ohms or more, depend-

(Continued on Page 28.)



THE CONSTRUCTOR



How To Construct A Simple 1/4 K.W. Wireless Transformer

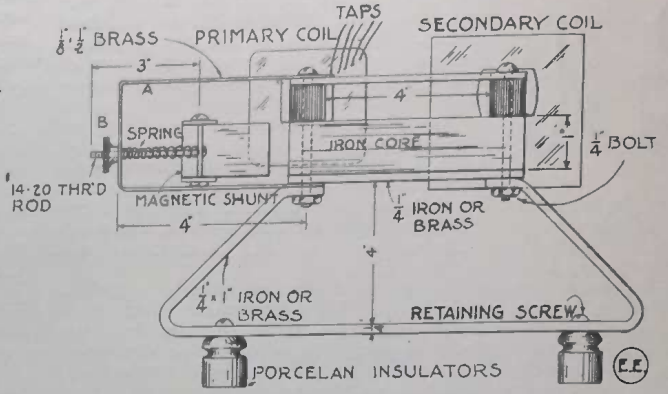
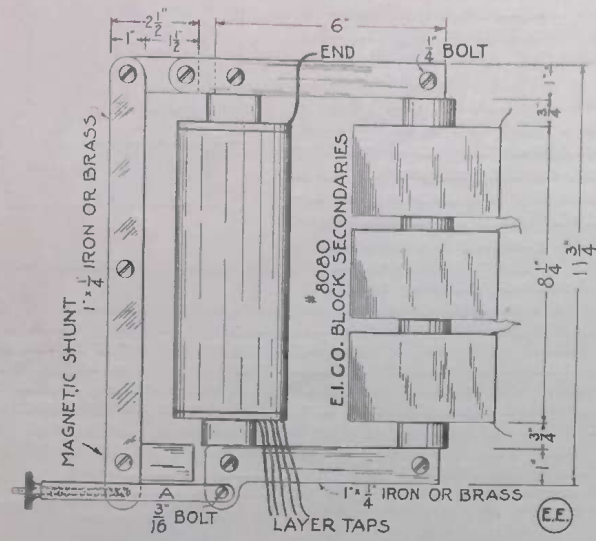

Fig. 4

MOST wireless telegraph stations to-day are using high potential step-up transformers, either of the open or closed core type; probably the closed core type predominates. The following article describes how to easily construct a 1/4 K.W. closed core transformer suitable for operation on a 110 volt, 60 cycle A. C. circuit. No impedance coils or other current limiting devices are required for its operation, as it has a magnetic reactance shunt incorporated in its design.

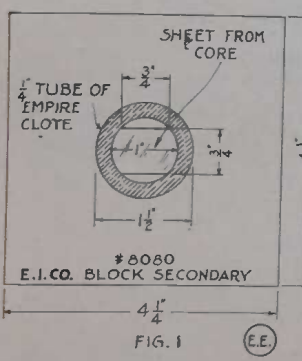

FIG. 1

The basic design feature of this transformer lies in the secondary winding; and this bugaboo of the average amateur is completely done away with here, as the secondary winding employed is composed of three E. I. Co. No. 8080 block secondaries such as used in their No. 8050 transformer coil.* The secondary voltage of this transformer can be varied from 12,000 to 20,000 volts by the variation of the number of turns in the primary circuit, as explained later on. The smaller the number of turns used in the primary, the higher the secondary voltage, and vice versa. For the experimenter this transformer will be of great service, as the three secondary units may be connected in various ways, as desired, either in series or parallel. The primary current is controlled by adjusting the position of the magnetic shunt, shown in

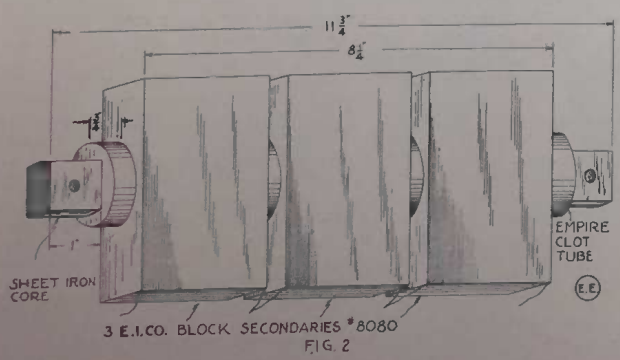

FIG. 2

accomplished by means of a multi-point switch, connected as shown in the wiring diagram for the transformer, Fig. 5.

The block secondary coils measure 4 1/2 x 4 1/2 x 2 1/4 inches long and the diameter of the opening in the center of same is 1 1/2 inch. Hence, three of these secondaries placed side by side will measure 8 1/4 inches over all, and when built into the transformer, 3/4 inch clearance at least should be left at either end, see Fig. 2, so that the discharge will not jump in to the iron, and thus short-circuit the winding. This space at the ends of the secondary should be filled up with insulating compound, or wood blocks soaked in paraffine wax.

At Fig. 1 is shown an enlarged section of the secondary, and also the laminated sheet iron core; the iron being made of No. 30 U. S. S. gauge stock, which comes in sheets 20 x 28 inches,† about nine sheets are required for the whole transformer. The secondary core leg, measuring 1 x 3/4 x 11 3/4 inches, should be insulated by wrapping around it about ten layers of No. 6983 E. I. Co. Empire cloth, the width of the

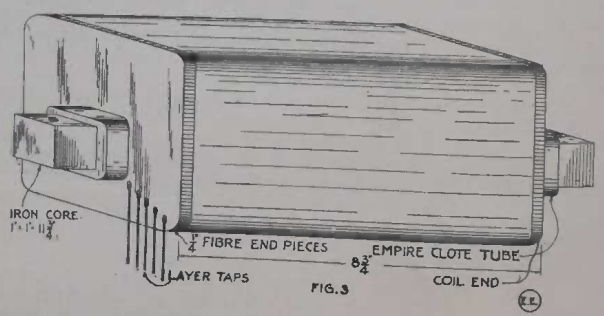

FIG. 3

cloth being 9 3/4 inches.† The primary core leg, 1 inch square in cross-section, see Fig. 3, should be insulated by wrapping six layers of the same Empire cloth, 9 3/4 inches wide, around it. Over this is wound six layers, 8 3/4 inches long, of No. 14 B. & S. D.C.C. or enameled magnet wire, bringing out taps from the end of the second, third, fourth, fifth and sixth layers, and connecting these to a multi-point switch, as shown in the diagram, Fig. 5.

The general assembly of the transformer is shown at Fig. 4, and, as shown here, the primary and secondary core legs are simply clamped onto the two yokes as shown, but if desired, although it is not necessary for all practical purposes, the four sections of the cores may be interlaced in the usual manner.

the drawing, Fig. 4. and also by varying the number of layers of the primary wire included in the circuit, which is readily

*E. I. Co. No. 8080. Price each \$2.75.

*E. I. Co. No. 30. Price per sheet \$0.21.

†Price per yard \$0.50.

The magnetic shunt for controlling the primary current, and also the general operation of the transformer, is mounted as shown in the sketch, so that by turning the thumb-screw on the pivoted, threaded rod, the position of the shunt pole piece may be moved to or away from the iron core proper. The clamping pieces, holding the core laminations together, may be made of brass or iron, preferably brass; and the bolts shown may be ordinary machine screws and nuts, or stove bolts. The transformer should be mounted on suitable insulators, as shown, to keep the high voltage secondary cur-

rent from leaking. Care should be exercised in connecting the secondary units, so that the current travels around the core always in the same direction.

and the best way to mount this contact, and also the soft iron armature, is to drill a hole through the center of the iron piece, and have a small stem about 3/32 inch in diameter turned on the German silver contact, which may then be passed through the hole in the iron, and riveted over. This high frequency outfit employs a step-up transformer of the Oudin type, which is illustrated in detail at Fig. 4. The basis of construction for this coil is a hard rubber or fibre rod, 7/8 in. in diameter by 3 in. long, having a hole drilled in one end, in which is placed the lock-nut securing the brass rod, passing through the center of the hard rubber. The secondary of this Oudin transformer is wound about one end of the hard rubber rod, as shown, and the starting lead is connected to the metallic rod passing through the center of the hard rubber. The size of wire used for this coil is No. 33 B. & S. enameled copper magnet wire; and the first layer is wound about the hard rubber rod, making its length about 5/8 inch. Forty layers of this wire wound evenly is thus placed about the end of the hard rubber rod; and between every wire layer is inserted a layer of four mil (.004

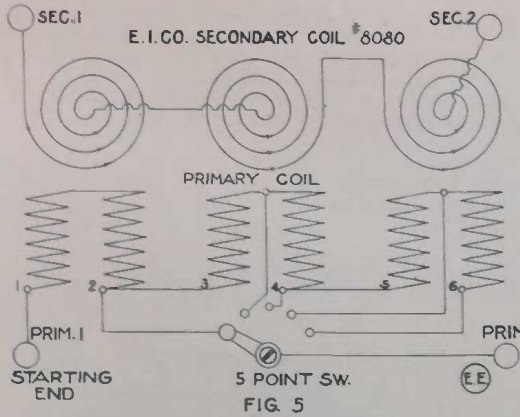

FIG. 5

HOW TO BUILD A UNIQUE HIGH FREQUENCY SET.

By Alexander Cortwright, E.E.

THE following article describes how to construct a very unique high frequency set, which can be used for various experiments with high frequency current, and is also very applicable to physicians' requirements. It operates directly from a 110 volt direct current and can be plugged into any convenient lamp socket.

The first part to be described is the vibrator coil, and the vibrator spring itself, shown in figures 1 and 2, respectively. The vibrator coil is composed of a soft iron wire core, 5/8 inch in diameter, by 3 1/2 inches long; which is encased in a fibre or cardboard tube, 3/4 inch outside diameter, having a wall of 1/16 inch thick. On the ends of this fibre tube are secured two end cheeks 1 3/8 inch square by 1/2 inch thick, and these may be made of fibre or hard rubber. To complete this part of the apparatus the bobbin so formed is wound full, in even layers, with No. 28 B. & S. D. C. C. or preferably enameled magnet wire.

The details of the vibrator spring, and contact screw, are shown in Fig. 2. Here, A, is a piece of square brass bar of the dimensions shown, and is to carry the threaded contact screw, D. The contact screw may be No. 14-24 or 14-20, brass or iron flat head machine screw fitted into a hard rubber or fibre disk, as depicted in sketch. The edge of this disk should be knurled to permit of a better grip on same, when being adjusted, and it is held in the disk by a lock-nut. At the other end of the contact screw is inserted a piece of German silver rod 1/4 inch in diameter and 1/4 inch long; having a somewhat smaller stem turned on one end, to fit a 3/32 inch hole, drilled into the end of the screw. The pillar, C, of 1/2 inch square brass rod, carries one of the spark gap electrodes at its upper end; and the vibrator spring, B, is also screwed to it by means of two 6-32 screws tapped into same.

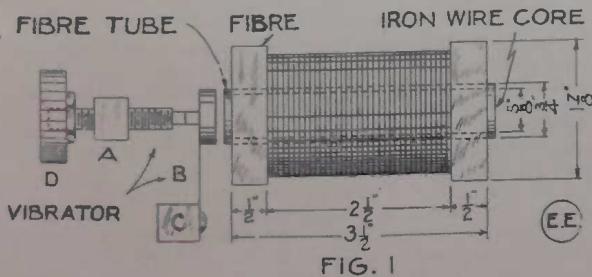

FIG. 1

The vibrator spring, B, may be of about 1/32 inch by 5/8 inch spring brass, German silver, or steel; and at one end is mounted a piece of soft iron, 1/4 inch thick and 5/8 inch in diameter, as shown. At this point is also secured another German silver contact, 1/4 inch in diameter, and 1/4 inch long;

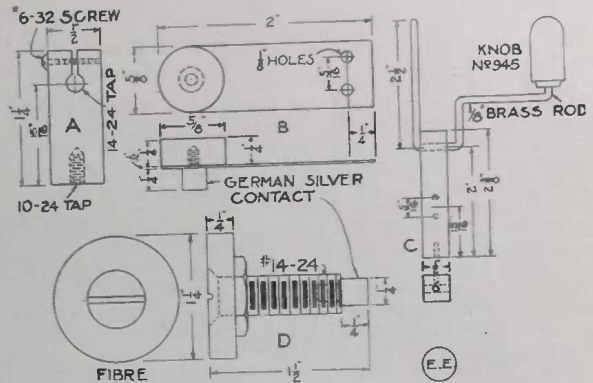

FIG. 2

inch) paraffined paper, as the voltage stress in this coil is very high.*

Having wound the secondary of the Oudin coil, the primary is next constructed, and it should have a clearance of

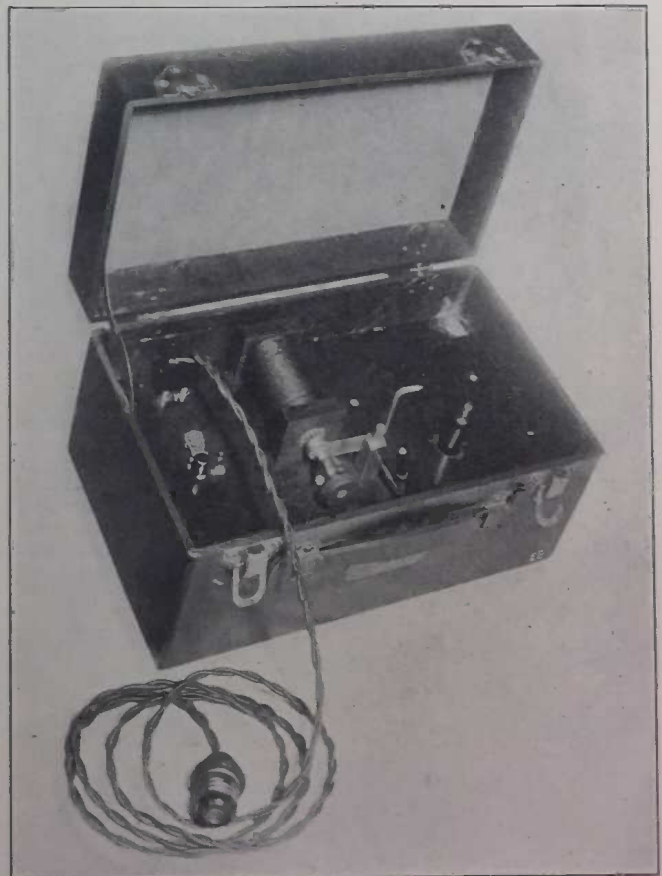

Fig. 8

*The E. I. Co. furnishes the complete secondary for this coil for \$4.50.

at least $\frac{3}{8}$ inch all around between it and the secondary winding. The primary winding is composed of five turns of No. 14 B. & S. D. C. C. or enameled magnet wire; spacing the turns about $\frac{1}{8}$ inch apart. The complete Oudin transformer should be placed in a small, shallow wood box, about 2 inches deep by 4 inches by 4 inches, and then poured full of insulating compound or paraffine wax.

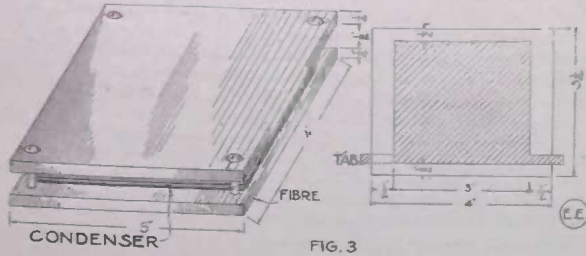

FIG. 3

Before impregnating the transformer, however, the outside lead of the secondary coil should be soldered to the primary winding in such a manner that the current will travel around the coils in the same direction, as will be seen by looking at Fig. 4.

One of the most important parts of this high frequency instrument, is the small condenser shunting the vibrator break and Oudin primary winding, as shown in wiring diagram, Fig. 5. This condenser is composed of 50 sheets of tinfoil $2\frac{1}{4}$ inches by $3\frac{1}{4}$ inches, placed between black E. I. Co. Empire paper leaves 3 inches by 4 inches, this paper being about 10 mils thick, corresponding to the E. I. Co.'s stock No. 6473. Every other tinfoil sheet (E. I. Co., tinfoil No. 6251), should have a tab projecting from opposite ends of the condenser, as shown in Fig. 3, and when it is assembled, all of the tabs at either end are joined together to form a common terminal. A good method of joining the tabs together is to use a machine screw and nut, and also a couple of washers, clamping the tinfoil ears between these washers. The complete condenser is clamped between two fibre pieces as in Fig. 3, slightly larger than the Empire cloth. Four stove bolts through the corners hold the fibre pieces together.

The action of this apparatus depends upon the fact that the vibrator breaks the 110 volt circuit through the primary

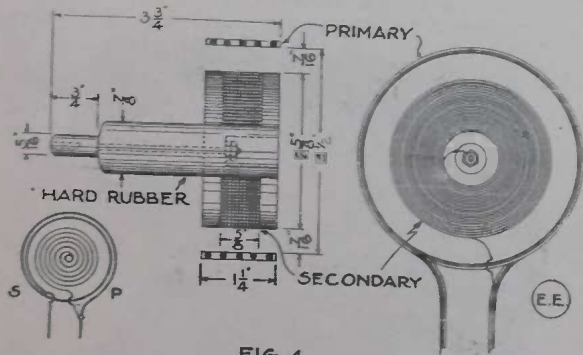

FIG. 4

of the Oudin transformer, and due to the fact that quite a heavy arc or spark occurs at the vibrator, when it breaks the circuit; the condenser charges and discharges a great number of times per second, thus giving rise to the generation of high frequency oscillations; which pass around the circuit, through the condenser, vibrator gap, and Oudin primary winding. This, of course, sets up corresponding high frequency oscillations in the secondary winding of the Oudin coil, of very high voltage. These secondary induced oscillations are

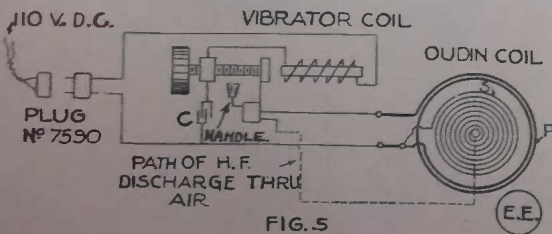

FIG. 5

raised to a very high voltage, due to the great number of turns in this coil as compared to the few turns in the primary winding. When properly operated this apparatus delivers a heavy 3 inch brush discharge from the center terminal of

the Oudin coil; or if the discharge is passed between the movable electrode mounted on the vibrator post C, and the center Oudin coil terminal; a very heavy $2\frac{3}{4}$ inch steady flame discharge is obtained, which is of great Therapeutical value and also for demonstrations, etc.

This apparatus can readily be mounted complete in one of the E. I. Co.'s Type B, polished mahogany cabinets, price 65 cents, as shown in Fig. 6, and a number of treatment tubes and geissler tubes may be mounted in the cover of the cabinet. The apparatus is best provided with a separable attachment plug, such as the E. I. Co. No. 7590, together with a 6 ft. length of flexible lamp cord No. 14 B. & S. gauge, with an attachment plug at its free end, enabling the set to be readily connected to any convenient lamp socket supplying 110 volts Direct Current.

This instrument is widely used by the Electro-Medical profession, for various kinds of treatments, and it is particularly efficacious in the treatment of nervous diseases.

The application of high frequency currents to the body in various ways, was first developed by Prof. d'Arsonval of Paris, and he made a number of different tests, to ascertain the effect of various currents applied to the body, and hav-

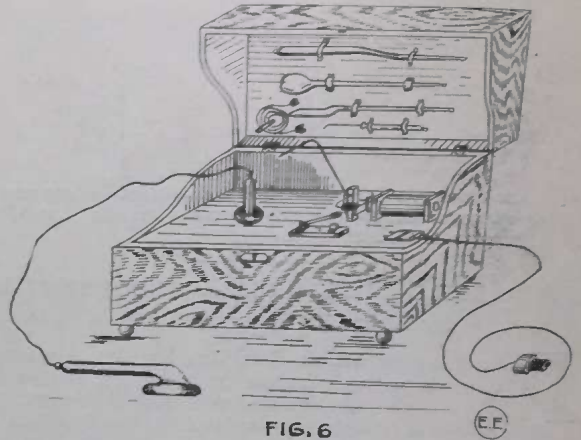

FIG. 6

ing different frequencies. When the current applied did not have a frequency greater than 15 cycles per second it was found that a succession of separate or "Clonic" Muscular Contractions were produced. With a frequency of 20 to 30 cycles per second a series of continuous contractions or in other words, a "Tetanus," or "Tonic Spasm," occurred. When the frequency of the oscillations or currents were increased beyond this point, the Tetanus effect was also increased. When a Periodicity of alternation approximating 3000 cycles per second, was employed, the maximum intensity in the muscular contractions took place; and a further increase of frequency caused a decrease in the strength of the contractions, until at a frequency of 10,000 cycles per second absolutely no effect was produced upon either the Motor or Sensory Nerves. Therefore an alternating or oscillating current, which alternates at 10,000 or more cycles per second, is termed a "High Frequency Current" from a Therapeutical point of view.

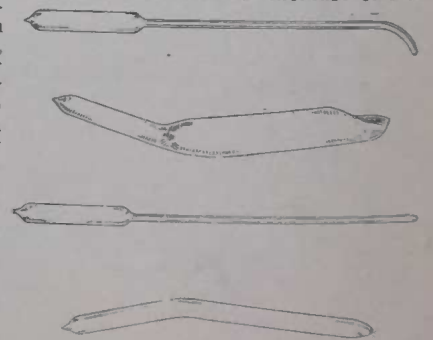

Fig. 7

In figure 7, is shown a set of various shaped glass electrodes containing different stages of Vacuum, for the application of High Frequency Currents, and for a more detailed explanation of the method of applying these currents to the body for the various diseases, etc., the reader is referred to the very excellent Treatise on the subject, by Dr. Frederick Finch Strong, "Modern Electro Therapeutics," which is supplied by the E. I. Co. at \$1.15 prepaid, and for those readers who are desirous of obtaining an exhaustive Treatise on this subject which covers High Frequency currents, and all other physicians' use, Dr. Strong's work entitled, "High Frequency Currents" at \$3.20, postpaid, is highly recommended. The glass Electrodes shown in Fig. 7 are supplied by the E. I. Co. at \$1.00 each, net, and they supply the complete high frequency set described in this article also. The complete set as supplied in hard-wood cabinet, is shown in the photograph, Fig. 8. The price is \$33.00.

Recent Developments in the Work of the Federal Telegraph Company

By Lee De Forest, Ph. D.

THE Federal Telegraph Company is unique in several respects. Among these, it enjoys the distinction of employing no press agents. Consequently in the East almost nothing is known of what is being done in the West. This is, of course, regrettable from a technical standpoint.

The present chain of stations of the company comprises those at Seattle, Portland, Medford, Central Point, Sacramento, Phoenix, San Diego, El Paso, Fort Worth, Chicago and others. Though messages have been sent from San Francisco to Chicago, the service is not of the same character as that maintained on the Pacific Coast, which latter is strictly commercial. The largest of all these stations are those at San Francisco and Honolulu. Each of these has a power of 40 kilowatts, which is to be increased to 60 kilowatts.

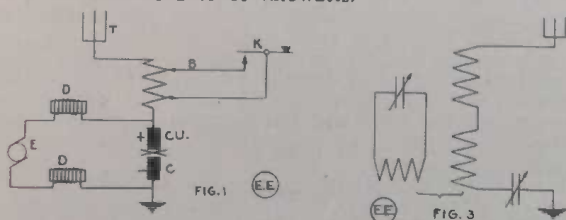

We operate under the Poulsen patents. But the apparatus imported from Denmark in 1910, showed many commercial defects and lack of reliability. The cooling appliances were inadequate, and the insulation faulty.

The system, as now in use, is the simplest imaginable, particularly at the transmitter end. Referring to Figure 1, E is a direct current generator of 500 to 1,000 volts or even more, D are choke coils intended to prevent the alternating current from the arc flowing back to the generator and also intended to keep the generator direct current constant, A is the arc itself, B a tuning or loading inductance and T the antenna. The arc itself plays between a copper positive electrode and a carbon negative electrode. It is always water cooled. It is in an intense magnetic field, and the atmosphere surrounding it is usually illuminating gas. Where this cannot be obtained, denatured alcohol is used instead. If desired, ether can be added to the denatured alcohol.

In this system the transmitting key is used, not as in most stations to change the amount of energy emitted, but only to alter slightly the wave length. This is accomplished by connecting the key K as shown across one or two turns of the inductance B. When the key is pressed, the wave emitted is lengthened by say five per cent. So that all the time transmission is going on the antenna is radiating. This makes matters interesting but unsatisfactory for the amateur interloper who naturally fails to separate the two waves and interpret the messages. The wave not used for receiving, which is usually the shorter one, is termed the "compensation" wave, and the tuning at the receiving station must be sufficiently sharp to ensure that the compensation wave shall not be heard. It has been found that smaller amateur stations even in the neighborhood of the twelve kilowatt station cannot tune up to the longer wave, and this fact ensures their reception of what may be called reversed, and of course unreadable messages. We feel responsible for a state of thorough disgust on the part of said amateurs.

Furthermore, when in the immediate neighborhood of a powerful station of the Poulsen type, the received signals from other stations are considerably fainter when transmission is going on from the arc station. This may be due to either a surplus of energy passing through the detector and rendering it insensitive; or to rendering partially opaque the transmitting medium by the undamped radiations. I must admit that I cannot see just how this latter alternative can be the case though it is difficult otherwise to explain the fact that even with the Audion detector the smothering effect is shown. For the effect mentioned, the arc may be as much as five miles distant, from the detector affected, and yet the signals from spark stations will drop to a marked degree.

It is of interest that the arc length or changes in it have practically no effect on the radiation, at least for telegraphy. For telephony, the constant conditions required are naturally more severe. For telephony, the double circuit arrangement shown in Figure 2 is used. The conditions being more critical in this case, the operator is required to watch the arc and

keep it steady by occasional manipulation. The skill required is not great.

The receiving circuit ordinarily employed is shown in Figure 3. The coupling between the antenna circuit and the closed circuit is usually very loose. Thus with pancake shaped-coupling coils such values of the angle between the coils as 88° are usual. This is exceptionally loose coupling and ensures sharp tuning of a quality unattainable in spark systems. The tuning is remarkably sharp and we have done much work in the direction of eliminating damping in the receiving circuits. In particular we have found it necessary to avoid leaky condensers. And because of the undamped nature of the radiation we can get all the advantages of loose coupling.

The detector used is the ticker. The old-style ticker is an intermittent contact operated by an electric buzzer. The contacts themselves are between two gold wires, one of them fixed and the other attached through an insulating piece to a diaphragm which is maintained in continual vibration by the buzzer armature. The contact wires are connected to the terminals of the tuning condenser in the closed tuning circuit and also to a considerably larger fixed condenser (value about 0.02 mfd.), which latter condenser is also connected to the low resistance receiving telephones. The action of the ticker is to permit alternating currents of large amplitude to build up in the secondary tuning circuit, and at more or less regular intervals to discharge the variable condenser through the telephones producing at each discharge a click. The telephones are the ordinary 75 ohm double head band type. The note produced is not a pure musical one because the ticker cannot be arranged so as to interrupt the alternating current which charges the condenser at the same point of the cycle at successive interruptions. In consequence some clicks are louder than others and the note is not clear. It may be characterized as a hissing sound not altogether agreeable to the ear. If a rectifier is placed in the ticker circuit the note becomes much purer. But the signals are weakened.

The difference between the two waves emitted from the transmitter is small. Thus when the sending key is up the wave may be 3000 meters and it may be 3150 meters when the key is depressed.

An efficiency of twenty per cent. is considered good for the Poulsen transmitter. Though this is only about one-third what is obtained by the use of the quenched spark, yet it is found that in practice we can work far greater distances than with the latter. This may be because the ticker telephone combination is by far the most sensitive and efficient detector in existence.

As examples of what is done as regular service, we work from Los Angeles to San Francisco, a distance of 350 miles with 12 kilowatts direct current. San Diego, with 5 kilowatts D. C. is in communication with San Francisco at night. In the winter, the conditions are naturally much better. With 12 kilowatts D. C. we even work from San Francisco to El Paso in the daytime, a distance of 900 miles; not sufficiently continuously for commercial service but still very frequently; it being practically a daily performance.

The power utilized is limited by two considerations. One of these is the capacity of the antenna and the other is the voltage at the arc. We have worked up to 1200 volts but

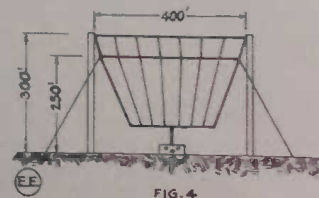
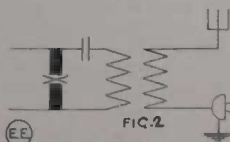

higher voltages than this are not excluded. As to the antennae, we have adopted as standard the double harp, twin-mast system. Its construction is clearly shown in Figures 4 and 5 which are those of a typical antenna of 0.005 mfd. capacity. The new antenna for the large South San Francisco station is supported by twin towers 440 feet high, 600 feet apart. The antenna capacity is here 0.012 mfd. Because of the low voltages employed, insulation difficulties are minimized. The type of tower now used is triangular in cross section and does not taper. For it special timbers have to be sawed. The plan of the guying system is shown in Figure 6. It will be seen that the construction lends itself to great rigidity. As

the results of our tests with the 12 Kilowatt stations we have reached the conclusion that this type of masts and antenna is the best for our system. In some of our stations, we employ the flat top aerial of less height for receiving. But we regard the flat top aerial as inferior to the harp type. The harp type also has the mechanical advantage that by its use the danger of twisting of the spreaders disappears.

The ground employed is the radial type with connection to earth at outer points. It is shown in Figure 7, where S is the station house. The ground wires, which are buried two or three feet below the surface radiate in all directions, and are heavily bonded together at their outer extremities, B.

At the South San Francisco station, the antenna current is about 40 amperes when 35 kilowatts is drawn from the direct current generator at 600 volts. The Honolulu Station is exactly like the South San Francisco one. The system as now improved is simple in operation and installation. As evidence of this, Mr. Elwell, Chief Engineer of the company, went to Honolulu on two days notice, and within sixty days the Honolulu station was in operation. And yet in this case there were considerable difficulties to be overcome. All the apparatus and supplies had to be shipped from San Francisco, and the Chinese workmen, who were the only ones available, would not work at heights above one hundred feet. The distance covered by this station is 2300 miles. Since August, not less than 1500 to 2500 words of press have been transmitted daily.

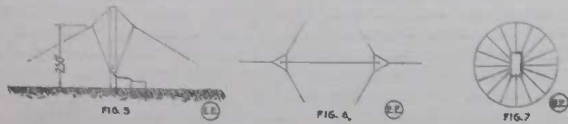

There are in addition a considerable number of paid messages. The rate is 25 cents a word against 35 cents of the cable companies. At the present time, we can operate up to 8 in the morning. When the new 60 kilowatt sets are installed, we expect to operate throughout the day.*

Between Los Angeles and San Francisco two to three hundred messages are sent every day, and this is strictly paid business, of a kind where accurate service is required. Of course, a certain type of customers is specifically catered to. Thus the California Fruit Growers Association do much business between Los Angeles and San Francisco. They demand a thirty minute service, that is, between sending the message and receiving the answer, and we have kept up that service for over a year now. This is a very strict test because these messages are all in an unpronounceable code. The Publishers' Press Association has also used our service from five to nine in the evening for a period of ten months or more.

An extremely interesting phenomenon has been observed in this work with undamped radiations of slightly different wave lengths. It is that at certain times daily, practically throughout the year, and under certain meteorological conditions, very surprising variations in the strength of the received signals occur when definite wave lengths are used, and only when these wave lengths are used. For example, the Los Angeles station works with a wave of 3260 meters and a compensation wave of 3100 meters, and the shorter wave is radiated continuously with the exception of the time during which the dashes or dots are being sent.

Now it will suddenly happen that the longer wave will become very weak or even be entirely lost at the San Francisco station, distant 350 miles north, whereas it will be received with normal strength at the Phoenix, Arizona station, distant 300 miles to the east. Nevertheless the shorter compensation wave, which differs in wave length by only about 5 per cent., will be received in San Francisco with full strength, or even with greater intensity at times.

This phenomenon of the extinction of the waves occurs frequently, particularly at our stations near the Pacific Ocean; for weeks it was observed every evening and at other times was entirely absent. In consequence the operators have arranged to send on either of the two waves used.

The duration of this fading effect is often several hours after nightfall; then it suddenly vanishes and thereafter both waves have their normal intensity. This alteration of intensity is sometimes for one wave, and sometimes for the other, and rarely for both; and in the last mentioned case the operator can find a third wave on which he can receive clearly. Usually, however, one of the waves remains of normal intensity; in other words, waves which differ in length by several hundred meters do not vanish simultaneously.

This selective absorption does not seem to be limited to specific localities, appears mostly at sunset, lasts far into the night, but is seldom observed near noon.

At first I thought that the effect could be explained by altered conditions at the transmitter or receiving station, as, for example, through alteration of antenna capacity because

* Since this paper was prepared 24-hour service, both ways, has been instituted and is daily successfully maintained.

of the presence of fog, etc. But the persistency with which it occurred, and the fact that no amount of tuning at the receiving station remedied matters although simultaneously other stations were receiving this wave perfectly, prevents the acceptance of an explanation on the grounds of atmospheric absorption, that is, such an explanation as is employed to clear up the daylight absorption at long ranges.

Clearly it is impossible that a wave of 3260 meters previously of satisfactory intensity can be absorbed completely at a distance of 350 miles while at the same time a wave of 3100 meters remains of full strength. And there is not much to be said in favor of the assumption that alterations of the refractive power of low-hanging cloud banks or of layers of clouds produce a bending of the wave trains which causes them to pass over the receiving station, while at the same time waves of only 5 per cent. difference in length are received as well, or even more strongly (as is frequently observed).

It is however possible, that under certain atmospheric conditions, which may be caused by clouds or masses of fog (which are found with great regularity at certain seasons on the Pacific coast), or by partially ionized masses of air at greater heights, the energy of the upper part of the wave may be deflected or bent downward. Dr. Eccles at the Dundee meeting of the British Association pointed out that a bending of the wave as it traveled might be produced if the upper layers of air were even partly conducting. The appearance of the bending wave front as it travels from left to right is shown in Figure 8. Under such conditions there are acting at the receiving stations two trains of waves which have traveled over paths of unequal lengths or which have traveled with unequal velocities. Consequently there will be a phase displacement between them and interference at certain localities. These are the nodes at which total or partial extinction of the oscillations occurs.

The possibility of such an interference has already been mentioned by several authors in their speculations concerning the propagation of electric waves over the surface of the earth. For example, Professor Pierce, of Harvard University, states in his book: "Principles of Wireless Telegraphy," "The upper layers of the atmosphere which have been rendered conducting through the action of sunlight, may act to a certain extent as reflectors of electric waves and thus limit their propagation over the surface of the earth; the transmission would then be superior in the day time, with the exception of the case where a possible interference occurred between the direct and reflected waves. This interference, if it exists, would strengthen waves of certain length and might annihilate waves of different length, so that this interference could be made of assistance by altering the wave length by an amount corresponding to half the period. No such effects however have been observed."

Dr. Pierce's conclusions regarding the superiority of daylight transmission are, as you know, contradicted by the experimental results. The ionization of the air at lower levels is able to counteract the influence of the reflection at the upper layers. On the other hand I believe that there is now ample evidence to concede the existence of such reflection as darkness approaches. In Figure 9, the conducting layer of air at U is shown and the path of the wave with its reflection at U is also shown.

How shall we account for the fact that the reflection effect was not observed till recently? In spark telegraphy two waves of nearly equal length were rarely used (with the exception of the case of those due to coupling of the open and closed oscillating circuits). Alterations in the wave length used in transmission are seldom attempted or else are of considerably greater



magnitude than those used in our work with continuous oscillations, which latter therefore bring the desired effect into greater prominence. It would be interesting to observe whether similar observations have been recorded with sustained radiation in other climates, or whether these effects are limited to the particular atmospheric conditions and localities in which we have observed them.

Because of the great commercial demands on the stations up to the present time I have not been able to undertake a careful series of observations altering the transmitting wave by successive small steps in order to ascertain between what intervals of wave length these effects of interference or disappearance pass through maxima and minima. Before an exact statement can be made theory and practice must work together for some time."

Lecture delivered before The Institute of Radio Engineers, at Fayerweather Hall, Columbia University.



HOW-TO-MAKE-IT DEPARTMENT



This Department will award the following monthly prizes: **FIRST PRIZE \$5.00; SECOND PRIZE \$2.00; THIRD PRIZE \$1.00.** The idea of this department is to accomplish *new* things with *old* apparatus, or *old* material. In order to win a prize, the apparatus, goods, supplies, parts or materials must be of "E. I. Co." make. The more original the idea, and the more "E. I. Co." goods are used in accomplishing the new thing or the new effect, the better the chance to win the first prize.

Read the following article by Mr. Gernsback. You will note that he uses nothing but regular "E. I. Co." stock material, except the bottles. He has found a new, useful purpose for the electric bell, as well as the other articles. This is the kind of article which wins a \$5.00 prize. Suppose you try an article; you will be surprised how easy it is to win a prize. And remember, it's the *idea* for which we pay the prize, never mind if it is well written up or not—we'll attend to that part, if you have no experience in writing articles.

How to Make an Electric Carillon

By H. Gernsback.

THE following musical instrument, which is played like a piano, can be made by any one handy with tools; it will afford genuine entertainment to persons who care for this variety of music, which is not unlike the kind produced by the xylophone.

The instrument originally was conceived by the writer, when he was about 12 years old, and it proved such a great source of pleasure to him, that he decided to publish the construction of it. The carillon is very easily made and costs but little. It can be made to suit anyone's pocketbook, and may with ease be constructed as well on an elaborate as on a simple scale. The instrument described herewith comprises three octaves (24 keys) and consequently quite a few simple songs can be played. It is not advisable to use less than two octaves (16 keys), but of course as many more as desired, say up to eight octaves (64 keys) can be used. The more keys, the better the musical range of the instrument.

The "chimes" used in this carillon are French white quart bottles, easily obtained from any wine or liquor store. The bottles should be clear and white and as free from flaws and blow-holes as possible. Do not use dark green bottles, they do not give nearly as clear sounds. Next we must tune up the bottles. This can be done either by ear, or better, by means of a piano. Start the octave wherever desired, and sound the first note on the piano. With a piece of wood strike the first bottle and notice the sound. Now fill the bottle with water by means of funnel and pitcher, and continue striking it till you reach the point where it comes in tune with the particular note of the piano which you are sounding. This takes but a few seconds to do; correcting the sound of the bottle is accomplished, of course, either by adding or pouring off water. After the bottle is in tune, label it with its note and stopper it up tightly, so the water cannot evaporate, which, in time, would lower the note of the bottle. After all the bottles are tuned up perfectly, they are ready to be hung on the wooden frame, as shown in our Fig. 1. They are attached to the cross beams, by means of stout twine, simply knotted around the necks of the bottles, as shown clearly in illustration.

In front of the bottles, level with their bottoms, is a board, B, which carries the electric bells C, C², C³, etc.

The bells are ordinary electric bells, such as the "Electro" Bell No. 951, price 25c. The gongs of these bells should now be removed, as shown in Fig. 2, and the frame, which carries the gong, should be sawed off with a hacksaw. This frame is shown in dotted lines in Fig. 2.*

Instead of the metal clapper, M, Fig. 2, a hard-wood ball about 3/4 inch in diameter should be substituted. This wooden ball may be forced on the metal clapper, and must, of course, fit tightly, so it will not come off when striking against its bottle. A better method is, of course, to thread the end of the clapper rod with, say an 8/32 thread, and screw the wood ball onto rod, using glue or shellac, to keep the ball from unscrewing. Each bell **MUST** be mounted in

such a manner that the wooden ball strikes against the bottle on the *forward* stroke, NOT on the *back* stroke. When all the bells are attached securely, they are tested out with about three or four dry cells, and the clapper rod must then be bent and adjusted till each bottle gives a clear, pleasing note.

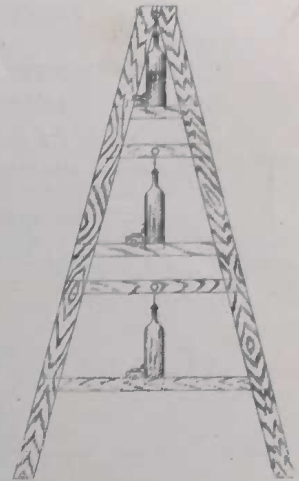
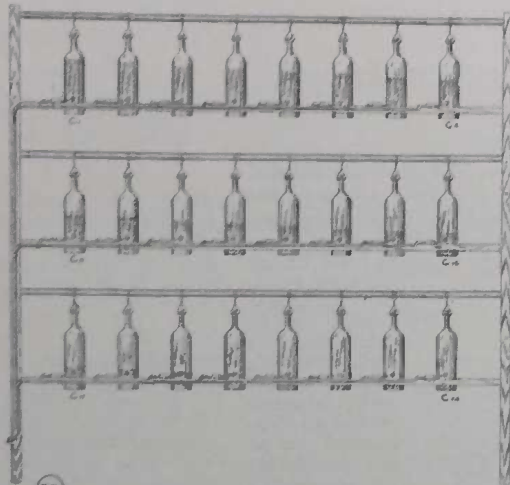

FIG. 1

If the adjustment is right, the noise of the clapper itself should not be noticed. If the sound is too loud for certain purposes, a layer of cloth may be wrapped around the wooden ball, which softens the sound considerably.

The keyboard, Fig. 4, is simple, and consists of a hard-wood board, B, a brass rod, R, and wooden keys, K. These keys should be of the same width as the keys of a piano, and about eight inches long. They should be absolutely square and true, and should come close together without binding each other. The brass rod, R, goes through each key, as shown, and keeps the keys up. The rod itself is held up from the board, B, by means of the wooden blocks, V.V. The keys are kept from touching each other by brass or iron washers, O, O, which also fit the rod, R. These washers are from 1/32 to 1/16 inch thick. Under each key there is a contact point and each key carries another contact, so that when K is depressed, G will make contact with S. A brass or phosphor bronze spring, H, secured to the board, B, is located under each key, and serves the purpose to raise the key automatically, after it has been depressed. A flexible conducting cord W* goes to the contact, G, of each key, as shown. This keyboard can be made as simple or as elaborate as desired, and no dimensions are given, as it is built to suit individual tastes.

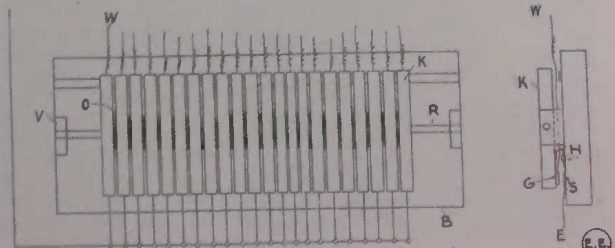

FIG. 3

The electrical connections are shown in Fig. 5. The dotted lines represent the keyboard. The battery, B, consists of three or four good dry cells, such as the "Electro" or "Columbia." If the instrument is played for considerable

*The E. I. Co. sells a bell without gong and frame, made for above purpose, for 24 cents each.

*E. I. Co. flexible cord No. 1020, per yard, 4 cents.

periods, a larger battery, with cells in multiple, or better, a storage battery should be used. It is, of course, understood, that as many keys as desired can be depressed simultaneously, the bottles will sound as long as these keys are depressed.

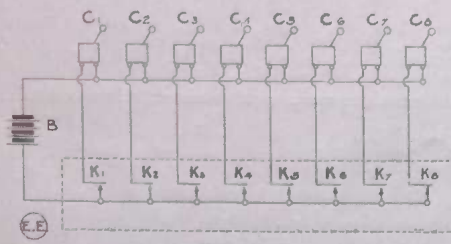

FIG. 4

keyboard behind the scenes, it will mystify many persons, as the carillon seems to be playing without anyone touching it.

FIRST PRIZE \$5.00.

HOW TO CONSTRUCT AN OSCILLATION TRANSFORMER.

By S. W. Hector.

IN the present stage of Amateur Wireless Telegraphy, the transmitting set must be loosely coupled to the aerial oscillating system, so that the wave-form shall be as smooth as possible. When ordinary helices or single coil oscillation transformers are employed for tuning

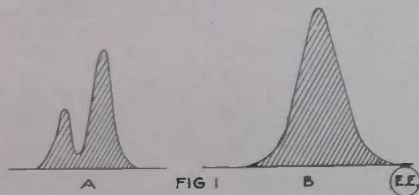

FIG. 1

the high potential condenser circuit, with that of the aerial, the wave emitted by the aerial is usually double-humped; or of an interfering nature. Such a wave possesses characteristics that make it extremely difficult to tune out in a receiving station.

Hence the Government Wireless law exacts that all licensed wireless stations, whether amateur or professional, shall emit a pure wave. At Fig. 1, A, is shown the nature of a double-humped wave form, resultant from the use of a helix in the transmitting set; while at B is depicted a practically pure wave form, having but one pronounced hump or peak. A double humped wave-form is made manifest in receiving, by the difficulty encountered in tuning it out. A sharply defined wave-form, such as emitted by a well-tuned, loosely coupled transmitting set, is very easily cut out on the receiving apparatus, generally, and, therefore, every amateur should use a transmitting oscillation transformer, not only for the above reason, but also the sending range, in most cases, is greatly enhanced by its employment.

The oscillation transformer here described can be easily and cheaply made by anybody, in a few minutes' time. It requires for its construction two of the

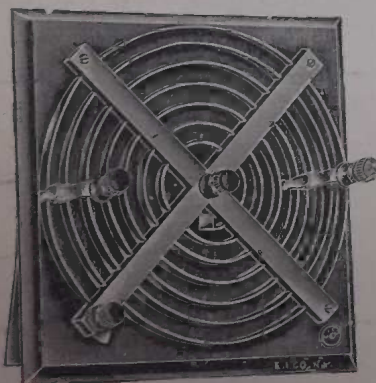

Fig. 2.

No. 9000 standards, nickel plated (E. I. Co. supply them at 20c each), by passing 2 round head wood screws through the feet of the stands, into the wood base. Before securing the two standards on the base about 10 inches apart, they should have two holes drilled through them near the top, or 3 9/16 inches above the foot, to accommodate the brass guide rod, R.

The keyboard may be placed at any distance within reasonable limits, from the bottle rack, and if the wiring on the rack is carefully concealed and the instrument placed on a stage with the bells turned away from the audience, and the

The brass rod, R, may be 3/16 inch stock, threaded for about 1 inch at either end, with a No. 10-24 die (E. I. Co. No. 6426 Die), or other convenient thread which the maker may have at hand. Two nuts, No. 10-24 thread, are placed on either end of the brass rod, to secure it in position on the standards. The two helices No. 9270 may be mounted face to face, or back to back. The latter method gives the greatest facility for attaching the connecting wires.

Usually the inside turns of the helices are employed, but this depends upon the size of the sending condenser. The position of the two helices, with respect to one another is varied until the maximum current is radiated in the aerial

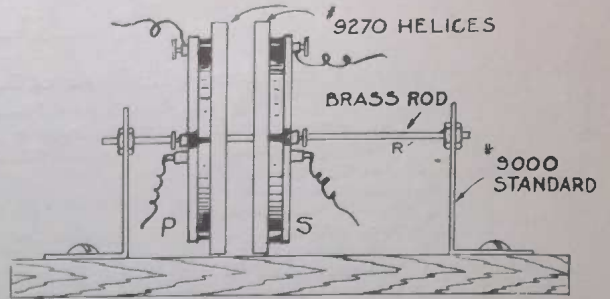

EE

FIG. 3

circuit with a smooth wave form. A small space usually exists between the two helices, when properly tuned. The connections for the oscillation transformer are shown at Fig. 4, for a spark coil transmitter. Here, A, is the aerial, G, the ground, HM, the hot-wire ammeter, anchor gap,

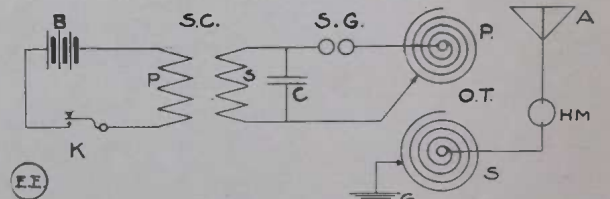

FIG. 4

or geissler tube to indicate when maximum radiation occurs, OT, the oscillation transformer, C, high potential condenser, SG, spark gap, and the balance of the instruments as indicated.

EXPERIMENTAL ELECTRICITY COURSE.

(Continued from Page 21.)

ing upon the length of the line. A long distance bell circuit with relay is shown at Fig. 9.

In this arrangement, whenever the push button is depressed, current from the battery is sent over the line which actuates the relay electro-magnets at the other end. The magnets then pull forward the iron armature shown, closing the contacts of the local circuit, and allowing the bell to ring from its local battery. A spiral spring holds the relay armature normally away from the magnet poles and contact screw, leaving the local bell circuit open.

In general to ring an ordinary bell of medium size, the battery required either of dry cells or wet cells (sal-ammoniac-carbon-zinc), is about 2 cells for circuits up to 50 feet, one way; circuits up to 75 feet 3 cells; 100 feet 4 cells, etc. The number of cells required will depend upon the size of the bell to be operated and the length of the circuit. The standard sizes of bell gongs vary from 2 inches up to 12 inches, the latter requiring about 8 dry cells to operate on a circuit not exceeding 75 feet in length one way.

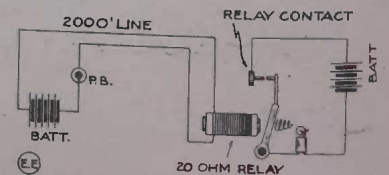

FIG. 9

The Electro Audion detector is being rapidly adopted in all first class amateur and commercial stations. Its great freedom from constant adjustment, and wonderful sensitivity are only some of its leading characteristics.



AMONG THE AMATEURS



One of the latest additions to the high school laboratory, at Perth Amboy, N. J., is a complete wireless telegraph outfit. The first message was received just recently.

The Wheeling Wireless Association was formed at a meeting of young men of Wheeling, W. Va., and vicinity who are interested in the development and practical working of the wireless telegraph, held last evening at the home of John Stroebel in Pleasant Valley. After listening for some time to commercial messages from along the Atlantic coast, received at the station of their host, the boys organized by electing the following officers:—President, John Stroebel; vice-president, Blair Prossitt, of Aetnaville; secretary, Ray Covert, of Bellaire; sergeant, Robert Smith.

Amateur wireless telegraph systems in Chicago, will be doomed, if they are not careful. The federal government has inaugurated a crusade against the embryo wireless hobby, because it interferes with the transmission of messages between the Marconi station on the Congress Hotel, and steamers on Lake Michigan.

The wireless telegraph club of Richmond, Ind., composed of 20 students of the high school, will have their apparatus arranged soon, and will receive their first messages from various parts of the country. Messages have already been received from cities on the Great Lakes.

The Central Pennsylvania Wireless Association of Harrisburg, Pa., is now making every effort to secure the names of persons conducting amateur stations. The secretary is asking all persons to send in their names so that they will be able to reach them. At the present time there are about fourteen wireless stations in the city of Harrisburg.

The Science Club of the Troy, N. Y., high school, has secured the tower of the city hall for an aerial station for wireless telegraphy. The board of education has contributed \$50 toward the purchase of the instruments. The high school building will be the other station. Between the two stations there is an 850 foot stretch. Work will be begun immediately and plans will be perfected at a meeting shortly.

Skowhegan has a wireless station which is owned and conducted by two high school boys, Gerald Marble, a senior, and Allan Wentworth. They have constructed a couple of wireless instruments and are able to send and receive messages from distant points, including vessels off Portland harbor and vicinity, one of which was signed "Governor Dingley." They also catch various other messages.

Professor T. O. Wanner of Fargo College, Fargo, N. D., is overseeing the installation of a wireless station at Dill Hall. The station when completed will be one of the finest in the state and will be used for demonstrations and communication with other schools. The station will be in one of the lecture rooms at Dill Hall. The highest point of the aerial will be 125 feet, and the length of the aerial will be about 200 feet.

Ulysses S. Grant, the fifteen year old son of Rev. Milton E. Grant, pastor of the Newton, N. J., Methodist Church, has received the first wireless operator's license in this section. He passed an examination a few days ago conducted by Federal Radio Inspector R. Y. Cadmus, of Baltimore, and had just received license No. 189 signed by Charles Nagel, formerly Secretary of Commerce and Labor. The station is located in the Methodist parsonage and is attached to a large aerial stretching across the back yard. He uses E. I. Co., material.

Hugo Martens, owner of a wireless operating plant at Sixteenth and Harrison street, Davenport, La., while seated at his instrument heard numerous wireless stations endeavoring to get the operator at Fort Omaha. After trying for nearly three hours Chicago gave up. Other cities continued, however, but received no response.

Ardent enthusiasts of aerial communication will be interested to learn that the U. S. Army, is in urgent need of telegraph and radio operators, according to a statement made by Corporal A. W. Jewett, in charge of the recruiting office at Binghamton, N. Y. The position of radio and telegraph dispatchers in the army are very few, and are among the most profitable offices in the ranks.

The boy scouts of Red Bank, N. J., have organized a wireless patrol. They meet every night in the home of Frank Merritt, assistant scoutmaster. Merritt teaches them the use of the wireless apparatus.

Colgate has installed a wireless station on the top of Lathrop Hall, the science building on the hill, at Waterville, N. Y. The building has been attuned with the station operated by the New York Herald, on Long Island, and arrangements have been made to receive flashes of the important news of the day, in addition to the baseball scores.

For some time past, interest in wireless telegraphy has been increasing in Rochester, N. Y. Recently a meeting was held at the home of James Hewitt, 405 Portland avenue, at which a club was formed for the promotion of interest in radio-communication in Rochester, and vicinity. The club will be known as the Rochester Wireless Association. President, Lawrence Hickson; vice-president, Everett Kennell; secretary, Karl Miller; treasurer, C. Irving Lu-sink.

In a recent communication to the E. I. Co., Mr. J. W. Stepp, of Washington, D. C., says:—

"It may interest you to hear of the excellent results obtained with some of the E. I. Co. products. On February 3, 1913, at about 11.45 p. m., I copied a message from NAX (Colon, CZ) to NAR (Key West, Fla.), and verified it word for word, when Key West repeated it back to NAX. On the same night, at about 10.30, I copied a message pertaining to aeronautical equipment for the Naval aviation camp at Guantanamo, sent from the latter place to the Washington Navy Yard.

The receiving outfit consisted of an E. I. Co. double-slide commercial tuner No. 8486A; E. I. Co. fixed condenser No. 10,000; a set of 2000-ohm E. I. Co. phones, and silicon detector. The antenna consisted of 6 strands of No. 14 aluminum wire, about 75 feet from end to end, and about 40 feet high.

Thus far forty-six American ship stations and eighteen coast stations have been licensed. All told, 685 amateur stations have been licensed. The wireless apparatus on ocean passenger steamers has been inspected before about 1,500 sailings from the United States in the four months.

MAN EQUALS 25 K. W.

Some genius has discovered that the average man dissipates about 25 kilowatt hours of energy a day in motion, muscular action, mental exertion and heat radiation. This is equivalent, it is said, to a continuous expenditure at a rate of about 100 watts, or the rating of a one-eighth horse power motor.

In spite of high body temperature—98.6 degrees Fahrenheit—and large radiating surface, man's heat losses are surprisingly small—about 50 watts an hour, or about one-half of the total energy expenditure. As a heating device the average man is thus about equal to a 16-candle power carbon filament lamp.

3,407 WIRELESS LICENSES.

In the first four months of the operation of the act to regulate radio communication, which took effect on Dec. 13, 1912, the Department of Commerce, through the Bureau of Navigation, has issued 3,407 licenses to wireless operators and stations in the United States. The first-grade commercial operators' licenses number 1,279, second grade 186, while 1,185 amateurs have been licensed. Eight operators' licenses of the experiment and instruction grade have been issued.

GET YOUR TIME FREE.

The correct time by wireless for the benefit of inland jewelers and clock makers and ships at sea, is a project inaugurated now by the Navy Department and the Naval Observatory time service. The Navy Department announces that in addition to its 12 o'clock, noon, time service, there has been installed a wireless time service, operative each night at 10 o'clock, which will be relayed through the Arlington station. The night service through the radio stations, it is said, will have a much greater radius than the signals flashed in the daytime.

Jewelers and other commercial concerns all over the country, it has developed, are erecting wireless masts over or close to their places of business to catch the officially correct time flashed at 10 o'clock every night from the navy's powerful wireless station at Arlington, Va. Local jewelers have seized upon the idea and members of the trade in other cities also are said to be taking up the plan.



QUESTION BOX



This department is for the sole benefit of the electrical experimenter. Questions will be answered here for the benefit of all, but only matter of sufficient interest will be published. Rules under which questions will be answered:

1. At least one of the questions must deal with "E. I. Co." apparatus or instruments, or "E. I. Co." merchandise.
2. Only three questions can be submitted to be answered.
3. Only one side of sheet to be written on; matter must be typewritten or else written in ink, no pencilled matter considered.
4. Sketches, diagrams, etc., must be on separate sheets. Questions addressed to this Department cannot be answered by mail.

CONTROL BY WIRELESS.

(17.) David H. Graham, Ind., asks:

Q. 1. Has the E. I. Co., any more of those little New York motors which sold at 45 cents?

A. 1. No, they do not have any more of the New York motors for sale.

Q. 2. Are there any boats in our Navy, or elsewhere, which are controlled by wireless; if so are they in use and are they efficient and reliable; if not, if one could be successfully invented that would be efficient and reliable, would it be of much use?

A. 2. To our knowledge there are not at present any successful wirelessly controlled apparatus used by the U. S. Government; but there have been several efforts made along this line with a fair degree of success, and undoubtedly there would be a good field for apparatus of this type, providing the control of same was absolutely positive.

Q. 3. As to length, height, breadth, etc., in what way must two aerials be alike, to be in tune?

A. 3. Generally speaking, two aerials which are to correspond with each other as regards their natural wave length, should be nearly alike in height, length, number of spans, etc., as a variation in these different factors often causes a radical change in the wave length, depending upon the conditions surrounding the aerial, such as buildings, metal roofs, etc.

QUENCHED SPARK GAPS.

(18.) Fred E. Gould, Mass., writes us:

Q. 1. Please give full description as to size, and kind of dielectric and size and grade of tinfoil used in the E. I. Co.'s No. 10,000 "Electro" Fixed Condenser, and No. 10,010 "Electro" Junior Fixed Condenser?

A. 1. We do not supply the dimensions and data of the construction of the E. I. Co., Fixed Receiving Condensers; but they are carefully balanced out, so as to have the correct capacity with the maximum dielectric strength.

Q. 2. Which is most efficient, a rotary spark gap or a Quenched Spark Gap?

A. 2. The Quenched Spark Gap is by far, the most efficient of any disruptive spark gap now in use, and enables Wireless Transmitting sets of fairly large size to transform their low voltage current into high frequency oscillations in the aerial circuit, with a gross efficiency of from 60 to 75 per cent.

Q. 3. Which is the best wire for aerials: stranded phosphor bronze, or stranded Antenium cable?

A. 3. Either of these two aerial conductors may be employed successfully.

ELECTRICAL BICYCLE LIGHTS.

(19.) Tom Wright, Texas, inquires:

Q. 1. Where can I obtain a complete electrical bicycle head-light?

A. 1. Regarding bicycle electric head lights, would say that the E. I. Co. sell a special outfit which we are sure will please you at \$10.00 net, consisting of a special imported dynamo of very small dimensions with clamp for fastening on bicycle, and to be driven by the wheel of same; also a very fine head-light, nickel plated, with Parabolic Reflector of fine focus, and bull's-eye lens 5 inches in diameter complete with connecting wire and Tungsten lamp of 6 c. p. This outfit is carefully designed and forms a harmoniously working arrangement.

NEON GAS TUBES.

(20.) A. H. Hoffman, Ames, Iowa, asks us:

Q. 1. What is the price of "Neon" gas tubes?

A. 1. The E. I. Co., supply "Neon" gas tubes 10 inches long at \$28.00 net.

TELEPHONE INDUCTION COILS.

(21.) Lloyd E. Durston, Queenstown, Canada, inquires:

Q. 1. Can liquid shellac be sent by express?

A. 1. Shellac in liquid form can be sent by express alright to your city.

Q. 2. What kind of sheet iron shall I use for making telephone receiver diaphragms?

A. 2. In reference to thin iron sheet suitable for making telephone receiver diaphragms, would say that sheet iron No. 30 gauge, can be used.

Q. 3. What are the dimensions, etc., of the E. I. Co. telephone induction coil?

A. 3. Regarding the construction of the E. I. Co. telephone coil, would say that in general the dimensions of such coils have been carefully determined from very extensive tests by the large telephone companies, and we do not believe it would pay you to build same, but you might experiment if you so desire; and build one of these coils. A fine iron wire core about 3 inches long by $\frac{3}{8}$ inch in diameter is insulated with two layers of shellacked paper; and over this is wound four layers of No. 22 B. & S. cotton covered magnet wire. Six layers of shellacked paper should be placed over the primary coil, and sufficient layers of No. 30 B. & S. cotton covered magnet wire should be wound on the coil, so that the secondary will have a resistance of 50 to 75 ohms. With this induction coil, an ordinary telephone should work satisfactorily up to five or ten miles, over a metallic circuit of two wires.

MAGNETO FOR WIRELESS.

(11.) Howard Haines, New York City, writes us:

Q. 1. I have a four-bar 10,000-ohm magneto generator and wish to know whether or not I could employ same in any way for wireless signalling purposes, and if so, how?

A. 1. Yes, This machine may be employed for wireless signalling purposes in connection with a spark coil of probably 1 to $1\frac{1}{2}$ inch spark capacity, if the armature of the generator is re-wound with heavy copper wire. The armature should be wound with about No. 18 or 20 B. & S. gauge, cotton or enameled insulated magnet wire, filling the space completely with the wire, and winding same in even layers. Also a small two segment commutator and brushes should be fitted on the end of the armature shaft, and the two ends of the winding should be connected to the segments of this commutator. This generator could be driven very nicely by one of the E. I. Co. Hercules 6 inch water motors and should give good satisfaction. The E. I. Co. sell a suitable commutator at 50 cents.

AERIAL PROBLEM.

(12.) C. H. Meredith, Long Island, asks:

Q. 1. I am constructing a large aerial for wireless purposes and wish to know if it makes any difference as regards the efficiency of the aerial, if the wire used in constructing same be bare or insulated?

A. 1. It does not make any difference whether the wire is bare or insulated for aerial construction purposes, and we would recommend that you employ antenium wire, which is very strong; and also any joints in same are very easily soldered.

Q. 2. Will you please advise me what effect a fairly long lead-in terminal has on an aerial of given size; and does it lower the efficiency of a certain aerial to have a long lead-in system running parallel to the ground?

A. 2. In regard to this question, would say that the natural wave length period of any aerial is a function of its length, roughly speaking, and thus it will be seen that the longer the lead-in terminal is, the longer the natural wave length period of such an aerial system will be. The general practice is to run the lead-in in as straight and direct a line as possible from the aerial, and we do not believe from our experiences in the matter, that a long lead-in running parallel to the ground, (and especially if it is close to the ground), is at all satisfactory. In fact, Marconi, in his early researches along this line, ascertained that it was possible to entirely prevent the reception of signals on a certain wireless set, when the lead-in wire was run parallel to the earth for a considerable distance; when this wire was located a few feet above the earth.

Q. 3. I wish, if possible, to utilize the directional effect of aerials at my station, and as my aerial, as at present contemplated, is to be of the inverted L type, kindly give sketch

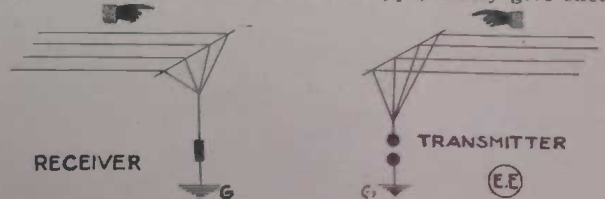

showing the direction of maximum activity for both sending and receiving, with this type of aerial; also state, if possible, at what large wireless telegraph stations this effect is made use of.

A. 3. We give below diagram, the arrows indicating the direction of the maximum activity of an inverted L type aerial; and this effect is utilized at the large Marconi transatlantic stations.

LARGE WATER MOTORS.

(13.) D. Bienveun, St. Hyacinthe, Canada, writes:
Q. 1. Does the E. I. Co. handle or supply larger size water motors or turbines than those listed in catalogue No. 11, copy of which I have?

A. 1. Yes. The E. I. Co. supply various sizes of water motors similar to their *Hercules* type; and at a price of \$20.00 a 12 inch wheel and developing about 2.33 horse power on 60 lbs. water pressure from a 3/4 to 1 inch main, or approximately 3.4 horse power on 80 lbs. water pressure, from a similar size main. This water motor is equipped with wood pulley for belt drive of any desired diameter up to 4 inch.

Q. 2. What is the approximate efficiency of their large size water motors?

A. 2. The efficiency of the above described water motor is probably in the vicinity of 65 to 70 per cent, but on larger size machines, the efficiency often reaches 85 per cent.

40-VOLT DYNAMOS.

(14.) The Winona Service Co., Indiana, write us:
Q. 1. Will you please advise us if the E. I. Co. can supply a 40-volt, 10 ampere, or 400 watt D. C. dynamo of the shunt wound type complete with all accessories for belt drive, and what the price of same may be?

A. 1. The price of a 40-volt, 10 ampere, direct current shunt wound generator, operating at a speed of 2,000 R. P. M. is \$52.25 net, F. O. B. New York City. This machine is of special construction throughout, having extra heavy commutator and brushes to care for the heavy current, and the machine is equipped with slide rails, pulley and field rheostat.

Q. 2. We also desire price on a good grade voltmeter registering 0 to 50 volts, and also on an ammeter reading 0 to 50 amperes.

A. 2. They supply a jewel bearing permanent magnet type voltmeter reading 0 to 50 volts at \$9.00 net F. O. B. New York City, and at the same price, a similar type of ammeter reading 0 to 50 amperes. The instruments are first-class in every respect and very carefully calibrated.

Q. 3. What size gasoline engine would you recommend for driving the above 400-watt D. C. dynamo at full load and what would it cost?

A. 3. We believe you would find a standard 1 H. P. gasoline engine fully suitable for driving the 400-watt dynamo at full capacity, and the E. I. Co. supply this size engine ready to operate with ignition outfit, and all other details, with the exception of dry batteries, at \$65.50, F. O. B. New York City.

CHARGING STORAGE CELLS ON 500 VOLTS D. C.

(15.) W. A. Hardman, Oregon, inquires:
Q. 1. I have one of the E. I. Co. 100 ampere hour storage batteries of the 6-volt type, and wish to know how I can recharge this battery from a 500-volt D. C. trolley circuit, by means of incandescent lamps arranged in the proper manner.

A. 1. We give below diagram showing how to connect

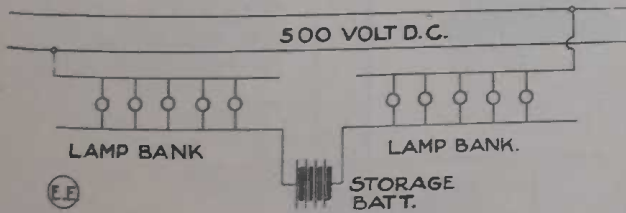

two banks in series parallel, of 250 volt lamps, of whatever candle power you may happen to have. The usual charging rate in amperes for a 100 A. H. storage battery is about 12 1/2 amperes, and you can readily calculate how many amperes you are passing through the battery, by noting the number of 250-volt lamps you have connected in each bank. A 250-volt, 32 C. P. carbon filament incandescent lamp consumes about 1/2 ampere and a 16 C. P. lamp of this voltage about 1/4 ampere. The more lamps, of course, you have connected on multiple, the more current will pass through the battery.

Q. 2. Can you give me a quotation on about a 1/15 H. P., 110-volt, 60-cycle A. C. motor of the variable speed type?

A. 2. You can procure a very good motor of this type, having a variable speed readily controlled by a lever mounted on the machine itself, at \$18.15 net from the E. I. Co. This motor will stand considerable over-load, and is of the automatic self-starting type, its speed being variable from 1,000 or less up to 5,000 R. P. M.

DYNAMO FAILS TO GENERATE.

(16.) B. L. Conterman, New York, asks us:

Q. 1. I have one of the E. I. Co. type S, 6-volt, 4-ampere generators and have not been successful in getting same to operate at this writing, and would be very highly pleased to have you advise me as to what may be the trouble, as the machine looks to be in very good shape.

A. 1. If you have tested the machine when being driven at approximately 3,000 R. P. M. and it fails to generate any current, we would advise that you carefully examine the brushes and see that they are properly spaced about the commutator, and also that they make good contact with same, as this is often the greatest source of trouble in low voltage machines and frequently overlooked in a casual inspection. With a new machine, it sometimes occurs that there is not sufficient residual magnetism in the iron field frame and pole pieces, so that the machine can build itself up; and it is advisable that you magnetize the field before starting the machine, by passing the current from a few battery cells through the field windings. This need be done only for a few minutes, and if the machine does not appear to generate when speeded up, it may be necessary to reverse the direction of rotation of the armature, or the field winding leads, where they connect to the armature, may have to be reversed. If the dynamo still does not generate, the trouble may be due to an open circuit in the windings, and the easiest way to test this out is by means of an ordinary telephone receiver and a dry cell.

Dr. Michael I. Pupin, professor of electro-mechanics at Columbia University, the discoverer of new theories of sound, who has been working for years to perfect the transmission of wireless waves, has an invention which other scientists declare may revolutionize the wireless systems of the world.

Doctor Pupin's discovery may make it possible in the future to send wireless messages around the world. It will eliminate the interference and uncertainty which now exists and which sends messages drifting or prevents them from reaching their intended destination.

By means of a motor to give power of rotation to a secondary coil, contained in an outside coil, through which the sound waves are transmitted, Doctor Pupin would add energy to the waves, amplify them and make it possible for the receiver of the message to transfer it to another station in an unbroken current.

When the sound is caught, instead of letting it die out or become enfeebled, the radiations in the inner coil strengthen it and render it so energetic that it may be sent along again to another antenna.

OBITUARY.

Professor Adolf Slaby, the electrical expert, recently died in Berlin, Germany. Professor Slaby was at one time a co-worker with Guglielmo Marconi in experimenting in wireless telegraphy. The German system of wireless is based on Professor Slaby's discoveries.

We Want You

to bear in mind when reading this magazine, that this publication does not accept or print advertisements. 96 per cent. of the magazine is text. It does not take an expert to calculate that the publication on account of this MUST necessarily be operated at a LOSS. The 5 cents we charge per copy does not go to pay for the paper and printing, let alone editorial cost, designs, cuts, mailing, etc. Naturally we strive to make up for our loss indirectly, and it is here where we must look to you.

If you wish to get the "Electrical Experimenter" regularly—and we have fond hopes that you do,—we trust that you will patronize our Company, to make it worth our while to continue publishing this magazine. As we have installed an elaborate checking system, in order to ascertain if the "Electrical Experimenter" brings us business, we ask you to be kind enough to cut out the coupon below and paste or pin it on your order, when you order goods from us. We surmise that you wish to buy such goods on account of wishing to make something, due to reading an article in this magazine, and the 5 per cent. discount we allow on all our catalogue goods is given to make it worth your while to help us in checking our results from this magazine. Please remember that this discount is only given if the coupon accompanies the order.

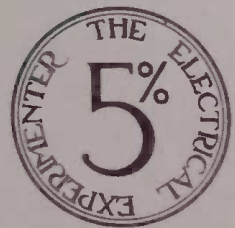

The Electro Importing Co.

E. I. Co. NEWS

SOME OF THE GOODS
CONTROLLED BY
THE E. I. Co.

MANUFACTURED
IN THEIR
OWN
FACTORIES

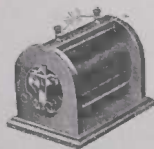

No. 4360—"Electro"
Bull Dog Spark Coil,
\$3.45



No. 8000—The Gerns-
back Interrupter, \$2.25



No. 8050—"Electro"
1/2 KW Transformer
\$8.00

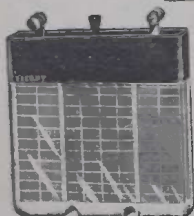

No. 1251—R. E.
Storage Battery,
\$2.00



No. 1600—Transcontinental
Receiving Outfit, \$24.00

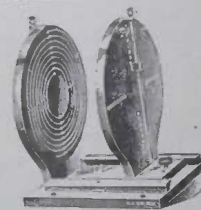

No. 9600—Commer-
cial Oscillation Trans-
former, \$10.00

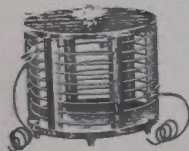

No. 8271—"Electro"
Sending Helix, \$6.00



No. 8486A—"Electro"
Tuner, \$3.50



No. 530—"Electro"
Adjustable Condenser,
\$5.00



No. 3500—Gernsback
Rotary Variable Con-
denser, \$4.00

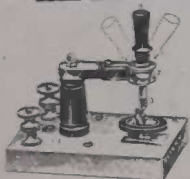

No. 9500—"Electro" Com-
mercial Detector Stand,
\$3.75



No. 8200—"Electro"
Audion, \$5.00

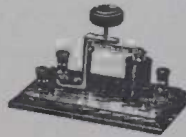

No. 1107—The Gernsback
Relay, \$1.00



No. 7777—New Universal
Detector, \$1.50



No. 8070
"Electro"
Amateur
Wireless
Phone
\$4.50

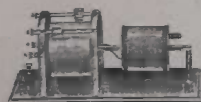

No. 12002—"Electro"
Loose Coupler, \$4.00



No. 5000—"Electro"
Rheostat Regulator, 60c.



No. 7000—"Electro"
Tesla Transformer, \$5.50

No. 9000
"Electro"
Static
Machine
\$4.50



Absolutely FREE! With every E. I. Co. Order Complete Course of Wireless Instruction, By S. Gernsback, A. Lescarbours and H. W. Secor We are the first concern in the United States giving a free wireless course, and there is no string attached to this offer. This course embraces twenty lessons, not only on Wireless Telegraphy, but also on Electricity in general. By the time you are through with this course you will be an expert on Wireless and will have a fine knowledge of Electricity. This Course is not a gift—we owe it to you—it is your discount for cash on your orders. See our Cyclopeda, page 200, about free "Wireless Course"

Fac-Simile of our complete Free Wireless Course (20 Lessons).

Size
7x10 in.
160 full
printed
pages
Each lesson
8 pages



More than
400 illustra-
tions, tables,
formulas,
diagrams,
etc.

Send to-day 5 cents postage for our famous 212 page Cyclopeda No. 11, 2nd Edition, containing over 400 illustrations and over 1,600 electrical apparatus and supplies. No postals answered. "The Most Complete Electrical Experimental Catalog in the U. S." THE ELECTRO IMPORTING CO., 236 Fulton St., New York City. "EVERYTHING FOR THE EXPERIMENTER." Retail Store, 69 W. Broadway N. Y. New York and suburban customers will save themselves unnecessary steps by calling at our retail store, not 236 Fulton Street.