

3.00

Radio Call Book Magazine and Technical Review

Established
1921

25¢

April, 1932

In This Issue:

Permanent Magnet Dynamic Speakers
Low Range Ohmmeter
Short Wave Receiver
Tube for Amateurs and Experimenters
Weighing with a Beam of Light
Complete Set Analyzer
Sectionalized Rectifiers
Filter Design by Graphs
Professional Service Combination
Radiart GXC2 Power Amplifier

Performance Curves and Schematics of:

All American Lyric S-6, Hammarlund Comet,
Howard DL, Philco 70, Silver-Marshall J, Strom-
berg-Carlson 22, United American Bosch 20, U. S.
Radio Apex 7-A, Universal Auto Radio 70, Wells-
Gardner Arcadia 50

*Frequency Assignments of All Broadcast,
Short Wave Relay, Police, and Visual Stations*

SERVICE - ENGINEERING - SALES

Over **25,000 Men**

have been trained under
my supervision for the

**Better Jobs
in RADIO**



PROOF

R. L. DUNCAN, *President*
Radio Training Schools



As a graduate and a student under your supervision, I have only the highest praise and satisfaction to offer. Any man of ordinary intelligence wanting to learn Radio could not help but master it by your method of training.

GEORGE A. KRESS,
2997 Montclair Ave., Detroit, Michigan



I am a Projectionist in charge at the Andalus theatre, recently completed. You may quote me at any time or place; refer to me, if you wish, anyone who may be interested in this vast virgin field of all that pertains to Radio and its many allied industries, and I shall be delighted to champion honestly without any reservation, your courses.

A. H. STRENGE,
3905 Woodburn Ave., Cincinnati, Ohio.



To study Radio under R. L. Duncan is to learn it properly and in a way that is pleasant and fascinating. Once again thank you for your kind assistance and helpfulness.

E. E. PRICE,
351 Coteau St., W.,
Moose Jaw, Sask., Canada.



Although it has not yet been a year since I enrolled for a course under your excellent supervision, I have opened a Radio Service Shop that is effective, successful and profitable. People come for my services from everywhere.

RUSSELL PEARCE,
936-18th Street, Des Moines, Iowa.

IN hundreds of Broadcasting Stations . . . in Radio Manufacturing Plants throughout the country . . . in Radio Laboratories . . . in Wholesale and Retail Radio Stores . . . in Radio Servicing . . . in Sound Motion Picture activities . . . on hundreds of ships that sail the Seven Seas . . . and even in the latest Television developments—you will find ambitious men who have been trained under my direct supervision.

I have devoted the last twelve years exclusively to the training of men for all branches of Radio. Employers in the Radio field recognize my methods of qualifying men and young men. I have geared my training to the rapid growth and development of the Radio industry. My courses, text books, methods and equipment are based on years of practical experience.

And now, with the organization of my own *independent* Radio Training Schools, Inc., I am better prepared to help you than ever before, in training for the opportunities which the future of the ever-growing Radio industry will have to offer.

**You too can train for Future Success
in Radio**

The next few years will offer more prospects than ever before. The past several months offer positive proof that the trained man has the best chance. You still can get that training which will qualify you to gain a foothold in Radio. Study at home, in spare time, at minimum expense. Earn while you learn. Capitalize your idle and spare time and reap the benefits of a trained man in a progressive industry—Radio.

**Make your Idle and Spare Time
Profitable**

My courses include everything needed for thorough training. There are no "extras" or "specials" to cost you extra money. The lessons, text books, methods, correcting, grading and returning of examinations, all the extra help and personal consultation you need . . . everything is provided until you complete your training.

RADIO TRAINING SCHOOLS, INC.
326 Broadway New York City

And in addition you are assured *practical* as well as theoretical training.

Pick Your Branch of Radio

I am offering four distinct Radio training courses:

1. Talking Motion Pictures—Sound
2. Radio and Broadcast Operating
3. Practical Radio Engineering
4. Radio Service and Mechanics

Each course is complete. Each starts out with simple principles well within your grasp. Each is right up to date, including latest developments such as Television. Each prepares you for a good paying position. Each leads to a Certificate of Graduation.

Advanced Training for Radio Men

My Practical Radio Engineering Course is an advanced course intended for Radio men who want to go still higher. It provides that necessary engineering background which, combined with practical experience, qualifies the man for the topmost job.

Ask for Facts—Write Now!

Let me sit down with you for an hour or two at your convenience. Let's go over the possibilities in Radio. This we can best do by means of the book I have just prepared. It covers the many branches of Radio and the kind of training required. Be sure to get your copy . . . it is free.



Mr. R. L. DUNCAN, *President*
Radio Training Schools, Inc.
326 Broadway, New York City

4-C.B.

Without incurring the slightest obligation on my part, please send me a copy of your latest book, "Facts About Radio."

Name

Address

City..... State.....

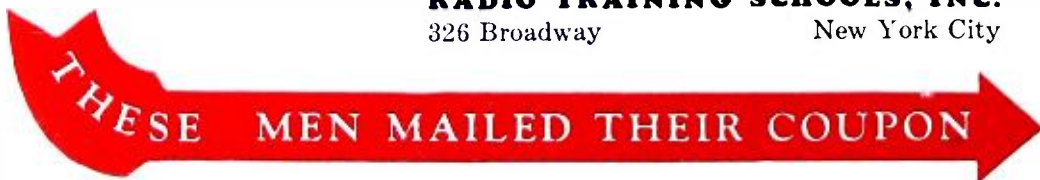

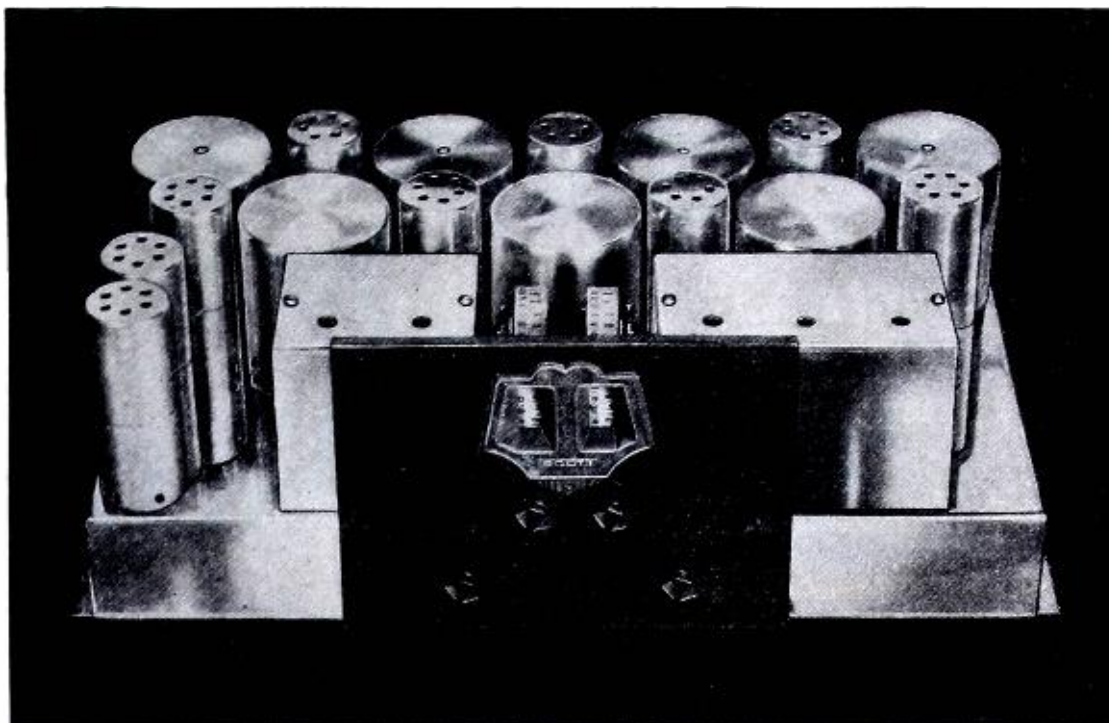

The **ONLY**



RECEIVER *that dares to promise*
daily 'round the world
Performance

**From all over the world
come letters like these**

Excellent Program From Germany

"I have received with ample volume Rome, Italy; FYA, France, its three wave lengths; G5SW, England; ZEESSEN, Germany; and half a dozen HK's from South America, not forgetting VK2ME, Australia. I was particularly pleased with the excellent reception from Zeesen, Germany."
F. S., New York City, N. Y.

**Wished He Knew a Dozen
Languages**

"If I knew a dozen different languages I could have put them all to good use today. At 10:30 A. M. today I tuned in a French station and stuck with it until 11:00 A. M. when they quit after playing a phonograph record entitled 'Marseilles.' I received two Spanish stations I could not identify. Another station that sounded very much like Chinese, also went by the board. I was well repaid for my patience when I tuned in 12RO, Rome. Here was real reception—volume great enough to fill an auditorium, clear as a bell, no fading and no static at all. I held this station from 1:30 to 3:50 and heard every word uttered although I did not understand much of the language. Their signal was coming in very strong until 5:30 P. M."
S. M., McKeesport, Pa.

Indo-China Every Morning

"I get F31CD, Indo-China, every morning from six to eight our time and enjoy their program very much as it is very clear. Can also tune in stations in South America nightly."
F. L. F., Boise, Idaho

Italy and France All Week

"I have picked up these two stations all last week—12RO, Rome, Italy; FYA, Paris, France, from 2:30 P. M. until 5:00 P. M. with tremendous volume. I was able to listen to a program from England from 3:00 to 4:30 P. M. Sure was good reception. I can also get Spanish and South American stations."
A. M., Louisville, Ky.

**HEAR
Radio Transmis-
sion from**

- 1 Foreign Broad-
cast Stations
- 2 Airplanes in
flight
- 3 Amateur phones
- 4 Transatlantic
phones
- 5 Ships at sea
- 6 Police depart-
ments
- 7 Code stations all
over world
- 8 Domestic Sta-
tions

Out of the maze of radio claims and counter-claims—one FACT is outstanding. *The Scott All-Wave not only claims ability to tune in stations clear 'round the world, but presents undeniable proof of its world-wide prowess.* Then it crowns proof of range with proof of regularity—thereby establishing the Scott All-Wave as a 15-550 meter receiver you can depend upon to bring the whole world to your ears whenever you choose.

Here's the proof: During the last 8 months every bi-weekly broadcast (excepting three) put on the air by VK3ME, Melbourne, Australia—9,560 miles from Chicago—has been received here, recorded on disc and verified. You can hear these recordings at the Scott laboratories any time you wish. You

can also hear records made of reception from Japan, France, Germany, England, and South America; reception picked up by a Scott All-Wave right here in Chicago. In other words, you can have ACTUAL PROOF of this receiver's ability before you buy it! And if you came here to the Scott laboratories you would see why the Scott All-Wave can promise *daily 'round the world* performance—and why all Scott All-Wave Receivers are identical in capability.

The reason, of course, is advanced design and precision work—every step of the job actually done in the laboratory and to strict laboratory standards. And every receiver actually tested on reception from London and Rome before shipping!

Get the only receiver that can promise *daily 'round the world* performance, and live up to it. Write now for full particulars of the Scott All-Wave. You'll be agreeably surprised at the most reasonable price.

The E. H. SCOTT RADIO LABORATORIES, INC.

(Formerly Scott Transformer Co.) 4450 Ravenswood Ave., Dept. CB42, Chicago, Ill.

*In a class by itself
—above comparison.
The Scott All-Wave
is the unchallenged
champion of the
radio world.*

SCOTT
ALL-WAVE
15-550 METER
Superhetrodyne

THE E. H. SCOTT RADIO LABORATORIES, INC.
4450 Ravenswood Ave., Dept. CB42, Chicago, Ill.
Send me full particulars of the Scott All-Wave 15-550
meter Superhetrodyne.

Set Builder Dealer DXer

Name

Street

Town..... State.....

Readrite



Licensed by A. T. & T. Co.

RADIO SERVICE TEST OSCILLATOR

Indispensable to the Serviceman

**A REMARKABLE INSTRUMENT
AT A POPULAR PRICE**

No. 551

\$18 Net to Dealer
\$30 List

No. 550

\$21 Net to Dealer
With Output Meter

YOU cannot service a present day super-heterodyne without the use of an Oscillator, and this Readrite Test Oscillator will fulfill your every need.

A sturdy modulated instrument, carefully made. Completely shielded with separate battery compartment. Furnished with 22½ v. and 3 volt batteries and one '30 tube. Reads directly broadcast band (550-1500 k. c.) and intermediate band (120-185 k. c.). Other i. f.'s obtained by sharp harmonics. Operating instructions attached in case cover with shielded wire leads.

Very compact, light weight and easy to handle. Comes in strong leatherette case

6 x 11½ x 5½ inches. It is made not only of the best materials throughout and assembled for lasting durability, but its beautiful and trim appearance will be the pride of every serviceman to own and use.

One of the serviceman's most important instruments. Used to align r. f. gang condensers, locate defective r. f. transformers, adjust i. f. transformers, check oscillator stage, compare gain in tubes and determine the sensitivity of a receiver. Furnished with or without output meter built in the panel. A truly remarkable instrument at a remarkable price. Get yours today!

Write for Catalog of Servicing Instruments

READRITE METER WORKS

Established 1904

10 College Avenue

BLUFFTON, OHIO

OPPORTUNITIES *are many* for the Radio Trained Man

Don't spend your life slaving away in some dull, hopeless job! Don't be satisfied to work for a mere \$20 or \$30 a week. Let me show you how to get your start in Radio—the fastest-growing, biggest money-making game on earth.

Jobs Leading to Salaries of \$50 a Week and Up
Prepare for jobs as Designer, Inspector and Tester—as Radio Salesman and in Service and Installation Work—as Operator or Manager of a Broadcasting Station—as Wireless Operator on a Ship or Airplane, or in Talking Picture or Sound Work—HUNDREDS of OPPORTUNITIES for a real future in Radio!

Ten Weeks of Shop Training

We don't teach by book study. We train you on a great outlay of Radio, Television and Sound equipment—on scores of modern Radio Receivers, huge Broadcasting equipment, the very latest and newest Television apparatus, Talking Picture and Sound Reproduction equipment, Code Practice equipment, etc. You don't need advanced education or previous experience. We give you—RIGHT HERE IN THE COYNE SHOPS—the actual practice and experience you'll need for your start in this great field. And because we cut out all useless theory and only give that which is necessary you get a practical training in 10 weeks.

TELEVISION *and* TALKING PICTURES

And Television is already here! Soon there'll be a demand for THOUSANDS of TELEVISION EXPERTS! The man who learns Television now can have a great future in this great new field. Get in on the ground-floor of this amazing new Radio development! Come to COYNE and learn Television on the very latest, new-

est Television equipment. Talking Picture and Public Address Systems offer opportunities to the Trained Radio Man. Here is a great new Radio field just beginning to grow! Prepare NOW for these wonderful opportunities! Learn Radio Sound Work at COYNE on actual Talking Picture and Sound Reproduction equipment.

All Practical Work At COYNE In Chicago

ALL ACTUAL, PRACTICAL WORK. You build radio sets, install and service them. You actually operate great Broadcasting equipment. You construct Television Receiving Sets and actually transmit your own Television programs over our modern Television equipment. You work on real Talking Picture machines and Sound equipment. You learn Wireless Operating on actual Code Practice apparatus. We don't waste time on useless theory. We give you the practical training you'll need—in 10 short, pleasant weeks.

Mail Coupon Today for All the Facts

H. C. LEWIS, President
Radio Division, Coyne Electrical School
500 S. Paulina St., Dept. 42-5A, Chicago, Ill.

Dear Mr. Lewis:— Send me your Big Free Radio Book, and all details of your Special Offer.

Name

Address

City State



Many Earn While Learning

You get Free Employment Service for Life. And don't let lack of money stop you. Many of our students make all or a good part of their living expenses while going to school and if you should need this help just write to me. Coyne is 32 years old! Coyne Training is tested—proven beyond all doubt. You can find out everything absolutely free. Just mail coupon for my big free book!

H. C. Lewis, Pres. RADIO DIVISION Founded 1899
COYNE Electrical School
500 S. Paulina St., Dept. 42-5A, Chicago, Ill.

Radio Call Book Magazine

AND TECHNICAL REVIEW

Established 1921

Advertising Representatives

Chicago—C. O. STIMPSON, *Adm. Mgr.*
Phone Wabash 1901, 508 South Dearborn St.
New York—J. J. LAMSON,
Phone Wisconsin 7-5681,
Room 1125, 154 West 42nd St.
Los Angeles—NED BRYDONE-JACK,
Petroleum Securities Bldg.
San Francisco—THOMAS EMORY, Russ Bldg.

Executive Offices:

508 So. Dearborn St., Chicago, Ill.
Member Audit Bureau of Circulations

GEO. H. SCHEER, JR., *Editor*

E. H. PETERSON, *Service Dept.*

APRIL, 1932

Vol. 13, No. 4

Table of Contents

U. S. Broadcasting Stations	6-9	Stromberg-Carlson 22	24
U. S. Broadcasting Stations by Frequencies	10	Bosch 20	25
List of Police Broadcasting Stations	11	U. S. Radio, Apex 7-A	26
U. S. Visual Broadcasting Sta- tions	11	Universal Auto Radio 70	27
U. S. Relay Broadcasting Sta- tions	11	Wells-Gardner, Arcadia 50	28
Simple Time Chart	11	Service and Repair Section	29-30
Foreign Broadcasting Stations	12-13	Jewell Professional Service Combination	30-31
Foreign Short Wave Phone Stations	14	Low Range Ohmmeter	31
Permanent Magnet Dynamic Speakers	15-16	Sectionalized Rectifiers	32-33
Tube for Amateurs and Ex- perimenters	17	Complete Set Analyzer	34-35
Receiver Performance Curve Section	18	Weighing with a Beam of Light	35
All American Mohawk, Lyric S-6	19	Radio Engineering Section	36-37
Hammarlund Comet	20	Short Wave Receiver	38
Howard DL	21	Eveready 239 Characteristics	38
Philco 70	22	Power Amplifier Systems	39
Silver-Marshall J	23	Receiver Voltage Analyses	41-42
		New Products Section	43-45
		Brief Items Section	46, 48-54
		Blue Print Page	60
		Index to Advertisers	62

Editorial

Our attention has been called a number of times to a very lamentable condition existing in the service field. Its prevalence is now assuming almost alarming proportions, and we wish to invite the cooperation of our service men readers with the sincere hope that the thing may be completely wiped out. We refer to the self-termed "service man" who should in no way be allowed the name. He is the man who, when he cannot find the trouble in a receiver, makes alterations, etc., to give evidence of having repaired the receiver so that he may collect a fee, without having corrected the real trouble which eluded him. Or this type of individual might correct a small fault, and charge for additional service work not performed or unnecessarily performed. Such startling instances have reached our publication recently, that we felt that we could not pass up the criticisms without calling them to the attention of our readers with the hope that none of them can be placed in this category. Our every effort has been to give all of the information possible to the service man so that his trouble shooting and service work might be facilitated and done in the proper manner. As is usually the case, the minority is causing a reflection on the majority who are honest workers and do not attempt to racketeer. Will you cooperate with us?

We feel greatly pleased to give our readers the first treatise on Permanent Magnet Dynamic Speakers by an eminent authority on the subject. A complete discussion will be found on pages 15 and 16 with comparative data and an illustration of this latest development.
—Editor.



Broadcasting stations employ trained men continually for jobs paying up to \$5,000 a year.



Operators on ships see the world and get good pay plus expenses.



Aviation is needing more and more trained Radio men. Operators employed through the Civil Service Commission earn \$1,620 to \$2,800 a year.



Television—the coming field of many great opportunities—is covered by my course.

Special Free Offer!

For the first time this authoritative book on Television is made available to the general public. Until now only my students could have it. Act promptly, and I'll send you a copy FREE in addition to my big free book "Rich Rewards in Radio." This book on Television gives you the fundamental facts about Television, its status, a comparison of sound and visual communication, and describes in detail the typical devices used in the six fundamental steps of Television. Get the facts about this coming field of great opportunity. Mail the coupon NOW.

You'll Get Thrills-Adventure BIG PAY in RADIO



J. E. Smith, Pres.

I will Train You at Home
for a Fascinating Radio Job

Get My Free Book-Many Radio Experts Make \$50 to \$100 a Week

You like action, romance, thrills! You get them in Radio—plenty of them! Good pay, too. That is why I urge you to mail the coupon below for my free book of startling facts on the variety of fascinating, money-making opportunities in this great live-wire field. It also explains how you can quickly learn Radio through my amazingly simple 50-50 method of home-study training, even though you may not now know the difference between a "Screen Grid and a Gridiron." Hundreds of men who knew nothing about Radio before taking my course are today making real money in jobs with a real future.

Many Interesting Branches of Radio to Choose From

Don't continue to struggle along at a dull, low-pay job with no prospect of anything better. Find out what Radio offers you. Radio operators on shipboard travel, see the world, with board and lodging free, and get good pay, too. Air-

craft Radio, talking movies, and broadcasting are other fields where thousands of trained men are well paid for fascinating work. And think of the great, thrilling future for men with Radio training in Television. My free book tells all about these and many other interesting branches of Radio that pay good money and make life pleasant. Men with Radio training have many opportunities not found in other fields. And my training, in particular, is the only training that makes you a RADIO-TRICIAN—that means valuable recognition for you in whatever type of Radio work you take up after graduation. You'll see why, when you receive my interesting book.

Many N. R. I. Men Have Made \$200 to \$1,000 in Spare Time While Learning

You don't have to quit your present job to take my course! You stay right at home, hold your job, and learn in your spare time. My N. R. I. Course teaches you to begin making extra money shortly after you enroll. My new practical method makes this possible. I give you experimental outfits that teach you to build and service practically every type of receiving set made. Many of my students have earned

\$15, \$20, \$30 weekly while learning. Lynn Henderson, 817 Elgin Court, Jackson, Mich., writes: "I have made at least \$1,500 servicing and repairing Radio sets and I am just starting my thirty-third lesson."

Get My Free Book

Send the coupon below for my 64-page book of opportunities in Radio and information on my home-study training. It has put hundreds of fellows on the road to bigger pay and success. It will tell you exactly what Radio offers you, and what my Employment Department does to help you get into Radio after you graduate. I back my training with a signed agreement to refund every penny of your money if, after completion, you are not satisfied with the Lesson and Instruction Service I give you. Fill in and mail the coupon NOW!

J. E. SMITH, Pres., Dept. 2DE
National Radio Institute
Washington, D. C.



Act Now
Mail Coupon Today

J. E. SMITH, President
National Radio Institute, Dept. 2DE
Washington, D. C.

Dear Mr. Smith: I want to take advantage of your Special Offer. Send me your two books "The Principles of Television" and "Rich Rewards in Radio." I understand this does not obligate me and that no salesman will call.

NAME.....
ADDRESS.....
CITY.....STATE.....
AGE.....

Travelled 75,000 Miles

"Dear Mr. Smith: I have worked as Junior Operator on board S. S. Dorchester and Chief Operator of the Chester Sun. I have travelled from 75,000 to 100,000 miles, visited ports in various countries, fished and motored with millionaires, been on airplane flights, etc." Robin D. Compton, Radio Station KSAC, Manhattan, Kansas.



\$400 a Month

"The Radio field is getting bigger and better every year. I have made more than \$400 each month and it really was your course that brought me to this." J. G. Dahlstead, Station KYA, San Francisco, Cal.

Employment Service to all Graduates

American Broadcasting Stations

Station assignments shown in the following pages were made by the Federal Radio Commission. This list is revised from issue to issue and is therefore up-to-the-minute. Initials such as E, C, M, and P denote Eastern, Central, Mountain and Pacific time.

- KABC**—1420 kc, San Antonio, Texas, Alamo Broadcasting Co., 100 w, C.
KARK—890 kc, Little Rock, Ark., Arkansas Radio & Equip. Co., 250 w.
KBPS—1420 kc, Portland, Ore., Benson Polytechnic School, 100 w, P.
KBTM—1200 kc, Paragould, Ark., Beard's Temple of Music, 100 w, C.
KCRC—1370 kc, Enid, Okla., Champlin Refining Co., 100 w, C.
KCRJ—1310 kc, Jerome, Ariz., C. C. Robinson, 100 w.
KDB—1500 kc, Santa Barbara, Calif., Santa Barbara Broadcasters, Ltd., 100 w, P.
KDFN—1210 kc, Casper, Wyo., D. L. Hathaway, 100 w, P.
KDKA—980 kc, Pittsburgh, Pa., Westinghouse E. & M. Co., 50,000 w, E.
KDLR—1210 kc, Devils Lake, N. D., KDLR, Inc., 100 w.
KDYL—1290 kc, Salt Lake City, Utah, Intermountain Broadcasting Corp., 1000 w, M.
KECA—1430 kc, Los Angeles, Calif., Earle C. Anthony, Inc., 1000 w, P.
KELW—780 kc, Burbank, Calif., Magnolia Park, Ltd., 500 w, P.
KERN—1200 kc, Santa Maria, Cal., The Bee Bakersfield Bdstg. Co., 100 w, P.
KEX—1180 kc, Portland, Ore., Western Broadcasting Co., 5000 w, P.
KFAB—770 kc, Lincoln, Nebr., KFAB Broadcasting Co., 5000 w, C.
KFAC—1300 kc, Los Angeles, Calif., L. A. Bdstg. Co., 1000 w, P.
KFBB—1280 kc, Great Falls, Mont., Buttrey Broadcast, Inc., 1000 w, M.
KFBK—1310 kc, Sacramento, Calif., James McClatchy Co., 100 w, P.
KFBL—1370 kc, Everett, Wash., Leese Bros., 50 w, P.
KFDM—560 kc, Beaumont, Tex., Magnolia Petroleum Co., 500 w, C.
KFDY—550 kc, Brookings, S. D., State College, 500 w, C.
KFEL—920 kc, Denver, Colo., Eugene P. O'Fallon, Inc., 500 w, M.
KFEQ—680 kc, St. Joseph, Mo., Scroggin & Co., 2500 w, C.
KFGQ—1310 kc, Boone, Iowa, Boone Biblical College, 100 w, C.
KFH—1300 kc, Wichita, Kan., Radio Station KFH Co., 1000 w, C.
KFI—640 kc, Los Angeles, Calif., Earl C. Anthony, Inc., 50,000 w, P.
KFIO—1120 kc, Spokane, Wash., Spokane Broadcasting Corp., 100 w, P.
KFIU—1310 kc, Juneau, Alaska, Alaska Elec. Light & Power Co., 10 w.
KFIZ—1420 kc, Fond du Lac, Wis., Reporter Printing Co., 100 w, C.
KFJB—1200 kc, Marshalltown, Iowa, Marshall Electric Co., 100 w, C.
KJFE—1480 kc, Oklahoma City, Okla., National Radio Mfg. Co., 5000 w, C.
KFJI—1210 kc, Klamath Falls, Ore., KFJI Broadcasters, Inc., 100 w, P.
KFJM—1370 kc, Grand Forks, N. D., University of North Dakota, 100 w, C.
KFJR—1300 kc, Portland, Ore., Ashley C. Dixon, KFJR, Inc., 500 w, P.
KFJY—1310 kc, Ft. Dodge, Iowa, Cedar Rapids Broadcast Co., w, C.
KFJZ—1370 kc, Ft. Worth, Texas, Ralph S. Bishop, 100 w, C.
KFKA—880 kc, Greeley, Colo., Mid-Western Radio Corp., 500 w, M.
KFKB—1050 kc, Milford, Kan., KFKB Bdstg. Assn., 5000 w, C.
KFKU—1220 kc, Lawrence, Kan., University of Kansas, 500 w, C.
KFKX—See under KYW.
KFLV—1410 kc, Rockford, Ill., Rockford Broadcasters, Inc., 500 w, C.
KFLX—1370 kc, Galveston, Texas, Geo. Roy Clough, 100 w, C.
KFMX—1250 kc, Northfield, Minn., Carleton College, 1000 w, C.
KFNF—890 kc, Shenandoah, Iowa, Henry Field Seed Co., 500 w, C.
KFOR—1210 kc, Lincoln, Neb., Howard A. Shuman, 100 w, C.
KFOX—1250 kc, Long Beach, Calif., Nichols & Warriner, Inc., 1000 w, P.
KFPL—1310 kc, Dublin, Texas, C. C. Baxter, 100 w, C.
KFPM—1310 kc, Greenville, Texas, The New Furniture Co., 15 w, C.
KFPW—1340 kc, Ft. Smith, Ark., John Brown Schools, 50 w, C.
KFPY—1340 kc, Spokane, Wash., Symons Broadcasting Co., 1000 w, P.
KFQD—1230 kc, Anchorage, Alaska, Anchorage Radio Club, 100 w.
KFQU—1420 kc, Holy City, Calif., W. E. Riker, 100 w, P.
KFQW—1420 kc, Seattle, Wash., KFQW, Inc., 100 w, P.
KFRC—610 kc, San Francisco, Calif., Don Lee, Inc., 1000 w, P.
KFRU—630 kc, Columbia, Mo., Stephens College, 500 w, C.
KFSD—600 kc, San Diego, Calif., Airfan Radio Corp., 500 w, P.
KFSG—1120 kc, Los Angeles, Calif., Echo Park Evan. Assn., 500 w, P.
KFUL—1290 kc, Galveston, Texas, W. H. Ford, 500 w, C.
KFUO—550 kc, St. Louis, Mo., Concordia Theological Seminary, 500 w, C.
KFUP—1310 kc, Denver, Colo., Fitzsimons General Hospital, 100 w, M.
KFVD—1000 kc, Culver City, Calif., Los Angeles Broadcasting Co., 250 w, P.
KFVS—1210 kc, Cape Girardeau, Mo., Hirsch Battery & Radio Co., 100 w, C.
KFWB—950 kc, Hollywood, Calif., Warner Bros. Broadcasting Corp., 1000 w, P.
KFWF—1200 kc, St. Louis, Mo., St. Louis Truth Center, Inc., 100 w.
KFWI—930 kc, San Francisco, Calif., Radio Entertainments, Inc., 500 w, P.
KFXD—1420 kc, Nampa, Idaho, Frank E. Hurt, 100 w, M.
KFXF—920 kc, Denver, Colo., Colorado Radio Co., 500 w, M.
KFXJ—1310 kc, Edgewater, Colo., Western Slope Broadcasting Co., 50 w, M.
KFXM—1210 kc, San Bernardino, Calif., Lee Bros. Broadcasting Co., 100 w, P.
KFXR—1310 kc, Oklahoma City, Okla., Exchange Avenue Baptist Church, 100 w, C.
KFXV—1420 kc, Flagstaff, Ariz., Mary M. Costigan, 100 w, M.
KFYO—1420 kc, Abilene, Texas, Kirksey Bros., 100 w, C.
KFYR—550 kc, Bismarck, N. D., Meyer Broadcasting Co., 1000 w, C.
KGA—1470 kc, Spokane, Wash., Northwest Broadcasting System, Inc., 5000 w, P.
KGAR—1370 kc, Tucson, Ariz., Tucson Motor Service Co., 100 w, M.
KGB—1330 kc, San Diego, Calif., Don Lee, Inc., 500 w, P.
KGBU—900 kc, Ketchikan, Alaska, Alaska Radio & Service Co., 500 w.
KGBX—1310 kc, St. Joseph, Mo., KGBX, Inc., 100 w.
KGBZ—930 kc, York, Nebr., Geo. R. Miller, 500 w, C.
KGCA—1270 kc, Decorah, Iowa, Chas. W. Greenley, 50 w, C.
KGCR—1210 kc, Watertown, S. D., Greater Kampeska Radio Corp., 100 w.
KGCU—1240 kc, Mandan, N. D., Mandan Radio Association, 250 w, M.
KGCX—1310 kc, Wolf Point, Mont., First State Bank of Vida, 100 w, M.
KGDA—1370 kc, Mitchell, S. D., Mitchell Broadcasting Corp., 100 w, M.
KGDE—1200 kc, Fergus Falls, Minn., Jaren Drug Co., 100 w, C.
KGDM—1100 kc, Stockton, Calif., E. F. Peffer, 250 w.
KGDY—1200 kc, Huron, S. D., J. A. Loesch, 15 w, C.
KGEF—1300 kc, Los Angeles, Calif., Trinity Methodist Church, 1000 w, P.
KGEK—1200 kc, Yuma, Colo., Beehler Elec. Equip. Co., 100 w, M.
KGER—1360 kc, Long Beach, Calif., Consolidated Bdstg. Corp., 1000 w, P.
KGEW—1200 kc, Ft. Morgan, Colo., City of Ft. Morgan, 100 w, P.
KGEZ—1310 kc, Kalispell, Mont., Donald C. Treloar, 100 w, M.
KGFF—1420 kc, Shawnee, Okla., KGFF Bdstg. Corp., 100 w, C.
KGFG—1370 kc, Oklahoma City, Okla., Oklahoma Broadcasting Co., Inc., 100 w, C.
KGFI—1500 kc, Corpus Christi, Texas, Eagle Broadcasting Co., 100 w, C.
KGFL—1200 kc, Los Angeles, Calif., Ben S. McGlashan, 100 w, P.
KGFK—1500 kc, Moorhead, Minn., Red River Broadcasting Co., Inc., 50 w, C.
KGFL—1370 kc, Raton, N. Mex., KGFL, Inc., 50 w, M.
KGFW—1310 kc, Kearney, Neb., Central Neb. Bdstg. Co., 100 w.
KGFX—580 kc, Pierre, S. D., Dana McNeil, 200 w, C.
KGGC—1420 kc, San Francisco, Calif., Golden Gate Broadcasting Co., 100 w, P.
KGGF—1010 kc, South Coffeyville, Okla., Powell & Platz, 500 w.
KGGM—1230 kc, Albuquerque, N. Mex., New Mexico Broadcasting Co., 250 w.
KGHF—1320 kc, Pueblo, Colo., Ritchie & Finch, 250 w, M.
KGHI—1200 kc, Little Rock, Ark., O. A. Cook, 100 w.
KGHL—950 kc, Billings, Mont., Northwestern Auto Supply Co., 1000 w, M.
KGIQ—1320 kc, Twin Falls, Idaho, Radio Broadcasting Corp.
KGIR—1360 kc, Butte, Mont., KGIR, Inc., 500 w, M.
KGIW—1420 kc, Trinidad, Colo., Leonard E. Wilson, 100 w, M.
KGIX—1420 kc, Las Vegas, Nev., J. M. Heaton, 100 w.
KGIZ—1500 kc, Grant City, Mo., Grant City Park Corp., 100 w, C.
KGKB—1500 kc, Tyler, Tex., Tyler Commercial College, 100 w, C.
KGKL—1370 kc, San Angelo, Tex., KGKL, Inc., 100 w, C.
KGKO—570 kc, Wichita Falls, Tex., Wichita Falls Broadcasting Co., 250 w, C.
KGKX—1420 kc, Sandpoint Idaho, W. W. von Cannon, 100 w, P.
KGKY—1500 kc, Scottsbluff, Nebr., Hilliard Co., Inc., 100 w, C.
KGMB—1320 kc, Honolulu, Hawaii, Honolulu Broadcasting Co., 250 w, P.
KGMP—1210 kc, Elk City, Okla., Bryant Radio & Elec. Co., 100 w, C.
KGNF—1430 kc, North Platte, Nebr., H. L. Spencer, 500 w, M.
KGNO—1210 kc, Dodge City, Kans., Dodge City Broadcasting Co., Inc., M.
KGO—790 kc, San Francisco, Calif., National Broadcasting Co., Inc., 7500 w, P.
KGRS—1410 kc, Amarillo, Texas, Gish Radio Service, 1000 w, C.
KGU—940 kc, Honolulu, Hawaii, Marion Mulrony, Advertising Publ. Co., 1000 w.
KGVO—1420 kc, Missoula, Mont., Mosby's, Inc.
KGW—620 kc, Portland, Ore., Oregonian Pub. Co., 1000 w, P.
KGY—1200 kc, Lacey, Wash., KGY, Inc., 100 w, P.
KHJ—900 kc, Los Angeles, Calif., Don Lee, Inc., 1000 w, P.
KHQ—590 kc, Spokane, Wash., Louis Wasmmer, Inc., 1000 w, P.
KICK—1420 kc, Red Oak, Iowa, Red Oak Radio Corp., 100 w.
KID—1320 kc, Idaho Falls, Ida., KID Broadcasting Co., 250 w, M.
KIDO—1350 kc, Boise, Idaho, Boise Broadcasting Station, 1000 w, P.
KIT—1310 kc, Yakima, Wash., C. E. Haymond, 100 w, P.
KJBS—1070 kc, San Francisco, Calif., Julius Brunton & Sons Co., 100 w, P.
KJR—970 kc, Seattle, Wash., Northwest Broadcasting System, Inc., 5000 w, P.
KLCN—1290 kc, Blytheville, Ark., C. L. Lintzenich, 50 w, C.
KLO—1400 kc, Ogden, Utah, Interstate Bdstg. Corp., 500 w, M.
KLPM—1420 kc, Minot, N. D., John B. Cooley, 100 w, C.
KLRA—1390 kc, Little Rock, Ark., Arkansas Broadcasting Co., 1000 w.
KLS—1440 kc, Oakland, Calif., Warner Bros., 250 w, P.
KLX—880 kc, Oakland, Calif., Tribune Pub. Co., 500 w, P.
KLZ—560 kc, Denver, Colo., Reynolds Radio Co., Inc., 1000 w, M.
KMA—930 kc, Shenandoah, Iowa, May Seed & Nursery Co., 500 w, C.
KMAC—1370 kc, San Antonio, Texas, W. W. McAllister, 100 w, C.
KMBC—950 kc, Kansas City, Mo., Midland Broadcasting Co., 1000 w, C.
KMED—1310 kc, Medford, Ore., Mrs. W. J. Virgin, 100 w, P.
KMJ—1210 kc, Fresno, Calif., J. McClatchy Co., 100 w, P.
KMLB—1200 kc, Monroe, La., Liner's Bdstg. Station, Inc., 100 w, C.

- KMMJ**—740 kc, Clay Center, Neb., The M. Johnson Co., 1000 w, C.
- KMO**—860 kc, Tacoma, Wash., KMO, Inc., 500 w, P.
- KMOX**—1090 kc, St. Louis, Mo., Voice of St. Louis, Inc., 50,000 w, C.
- KMPC**—710 kc, Beverly Hills, Calif., R. S. Macmillan, 500 w, P.
- KMTR**—570 kc, Los Angeles, Calif., KMTR Radio Corp., 500 w, P.
- KNX**—1050 kc, Hollywood, Calif., Western Broadcast Co., 5000 w, P.
- KOA**—830 kc, Denver, Colo., National Broadcasting Co., Inc., 12,500 w, M.
- KOAC**—550 kc, Corvallis, Ore., Oregon State Agricultural College, 1000 w, P.
- KOB**—1180 kc, State College, N. M., N. M. College of Agri. & Mech. Arts, 20,000 w, M.
- KOCW**—1400 kc, Chickasha, Okla., Oklahoma College for Women, 250 w, C.
- KOH**—1370 kc, Reno, Nevada, Jay Peters, Inc., 500 w.
- KOIL**—1260 kc, Council Bluffs, Iowa, Mona Motor Oil Co., 1000 w, C.
- KOIN**—940 kc, Portland, Ore., KOIN, Inc., 1000 w, P.
- KOL**—1270 kc, Seattle, Wash., Seattle Broadcasting Co., 1000 w, P.
- KOMO**—920 kc, Seattle, Wash., Fisher's Blend Station, Inc., 1000 w, P.
- KONO**—1370 kc, San Antonio, Tex., Mission Broadcasting Co., 100 w, C.
- KOOS**—1370 kc, Marshfield, Ore., H. H. Hanseth, Inc., 100 w, P.
- KORE**—1420 kc, Eugene, Ore., Eugene Broadcast Station, 100 w, P.
- KOY**—1390 kc, Phoenix, Ariz., Nielsen Radio & Sporting Goods Co., 500 w, M.
- KPCB**—650 kc, Seattle, Wash., Queen City Broadcasting Co., 100 w, P.
- KPJM**—1500 kc, Prescott, Ariz., A. P. Miller, 100 w, M.
- KPO**—680 kc, San Francisco, Calif., Hale Bros. & The Chronicle, 5000 w, P.
- KPOF**—880 kc, Denver, Colo., Pillar of Fire, Inc., 500 w, M.
- KPPC**—1210 kc, Pasadena, Calif., Pasadena, Presbyterian Church, 50 w, P.
- KPQ**—1500 kc, Wenatchee, Wash., West-coast Broadcasting Co., 50 w, P.
- KPRC**—920 kc, Houston, Texas, Houston Printing Co., 1000 w, C.
- KQV**—1380 kc, Pittsburgh, Pa., KQV Bdstg. Co., 500 w, E.
- KQW**—1010 kc, San Jose, Calif., Pacific Agric. Foundation, 500 w, P.
- KRE**—1370 kc, Berkeley, Calif., First Congregational Church, 100 w, P.
- KREG**—1500 kc, Santa Ana, Calif., Pacific-Western Broadcasting Federation, 100 w, P.
- KRGV**—1260 kc, Harlingen, Texas, KRGV, Inc., 500 w.
- KRLD**—1040 kc, Dallas, Texas, KRLD, Inc., 10,000 w, C.
- KRMD**—1310 kc, Shreveport, La., Robert M. Dean, 50 w, C.
- KROW**—930 kc, Oakland, Calif., Educational Broadcasting Corp., 500 w, M.
- KRSC**—1120 kc, Seattle, Wash., Radio Sales Corp., 50 w, P.
- KSAC**—580 kc, Manhattan, Kan., Kansas State Agricultural College, 500 w, C.
- KSCJ**—1330 kc, Sioux City, Iowa, Perkins Bros. Co., 1000 w, C.
- KSD**—550 kc, St. Louis, Mo., Pulitzer Pub. Co., 500 w, C.
- KSEI**—900 kc, Pocatello, Idaho, Radio Service Corp., 250 w, M.
- KSL**—1130 kc, Salt Lake City, Utah, Radio Service Corp., 5000 w, M.
- KSO**—1380 kc, Clarinda, Iowa, Iowa Bdstg. Co., 500 w, C.
- KSOO**—1110 kc, Sioux Falls, S. D., Sioux Falls Broadcasting Assn., 2000 w, C.
- KSTP**—1460 kc, St. Paul, Minn., National Battery Broadcasting Co., 10,000 w, C.
- KTAB**—560 kc, San Francisco, Calif., Associated Broadcasters, 1000 w, P.
- KTAR**—620 kc, Phoenix, Ariz., KTAR Broadcasting Co., 500 w, M.
- KTAT**—1240 kc, Ft. Worth, Tex., S. A. T. Broadcasting Co., 1000 w, C.
- KTBR**—1300 kc, Portland, Ore., M. E. Brown, 500 w, P.
- KTBS**—1450 kc, Shreveport, La., Tri-State Broadcasting Co., 1000 w, E.
- KTFI**—1320 kc, Twin Falls, Idaho, Radio Broadcasting Corp., 250 w, M.
- KTHS**—1040 kc, Hot Springs, Ark., Chamber of Commerce, 10,000 w, C.
- KTLC**—1310 kc, Houston, Tex., Houston Broadcasting Co., 100 w, C.
- KTM**—780 kc, Los Angeles, Calif., Pickwick Broadcasting Corp., 500 w, P.
- KTRH**—1120 kc, Houston, Tex., Rice Hotel, 500 w, C.
- KTSA**—1290 kc, San Antonio, Texas, Lone Star Broadcast Co., 1000 w, C.
- KTSL**—1310 kc, Shreveport, La., Houseman Sheet Metal Works, Inc., 100 w, C.
- KTSM**—1310 kc, El Paso, Tex., W. S. Bledsoe and W. T. Blackwell, 100 w, C.
- KTW**—1220 kc, Seattle, Wash., First Presbyterian Church, 1000 w, P.
- KUJ**—1370 kc, Walla Walla, Wash., KUJ, Inc., 100 w, P.
- KUOA**—1390 kc, Fayetteville, Ark., University of Arkansas, 1000 w, C.
- KUSD**—890 kc, Vermillion, S. Dak., University of South Dakota, 500 w, C.
- KUT**—1500 kc, Austin, Tex., KUT Bdstg. Co., 100 w, C.
- KVI**—760 kc, Tacoma, Wash., Puget Sound Radio Broadcasting Co., 1000 w, P.
- KVL**—1370 kc, Seattle, Wash., KVL, Inc., 100 w, P.
- KVOA**—1260 kc, Tucson, Ariz., R. M. Riculfi, 500 w.
- KVOO**—1140 kc, Tulsa, Okla., Southwestern Sales Corp., 5000 w, C.
- KVOR**—1270 kc, Colorado Springs, Colo., W. D. Corley, 1000 w, M.
- KVOS**—1200 kc, Bellingham, Wash., KVOS, Inc., 100 w, P.
- KWCR**—1310 kc, Cedar Rapids, Iowa, Cedar Rapids Bdstg. Co., 100 w, C.
- KWEA**—1210 kc, Shreveport, La., Hello World Broadcasting Corp., 100 w, C.
- KWG**—1200 kc, Stockton, Calif., Portable Wireless Tel. Co., 100 w, P.
- KWJJ**—1060 kc, Portland, Ore., KWJJ Broadcasting Co., Inc., 500 w, P.
- KWK**—1350 kc, Kirkwood, Mo., Thos. Patrick, Inc., 1000 w, C.
- KWKC**—1370 kc, Kansas City, Mo., Wilson Duncan Broadcasting Co., 100 w.
- KWKH**—850 kc, Shreveport, La., Hello World Broadcasting Corp., 10,000 w, C.
- KWLC**—1270 kc, Decorah, Iowa, Luther College, 100 w, C.
- KWSC**—1220 kc, Pullman, Wash., State College of Washington, 1000 w, P.
- KWWG**—1260 kc, Brownsville, Texas, Brownsville Herald Publishing Co., 500 w, C.
- KXA**—570 kc, Seattle, Wash., American Radio Tel. Co., 500 w, P.
- KXL**—1420 kc, Portland, Ore., KXL Broadcasters, Inc., 100 w, P.
- KXO**—1500 kc, El Centro, Calif., Irey & Bowles, 100 w, P.
- KXRO**—1310 kc, Aberdeen, Wash., KXRO, Inc., 100 w, P.
- KXYZ**—1420 kc, Houston, Texas, Harris County Broadcasting Co., 100 w, C.
- KYA**—1230 kc, San Francisco, Calif., Pacific Broadcasting Corp., 1000 w, P.
- KYW**—1020 kc, Chicago, Ill., Westinghouse E. & M. Co., 10,000 w, C.
- NAA**—690 kc, United States Navy Department, Washington, D. C., 1000 w, E.
- WAAB**—1410 kc, Quincy, Mass., Bay State Bdstg. Corp.
- WAAF**—920 kc, Chicago, Ill., Drivers Journal Pub. Co., 500 w daytime, C.
- WAAM**—1250 kc, Newark, N. J., WAAM, Inc., 1000 w, E.
- WAAT**—940 kc, Jersey City, N. J., Bremer Broadcasting Corp., 300 w, E.
- WAAW**—660 kc, Omaha, Neb., Omaha Grain Exchange, 500 w daytime, C.
- WABC**—860 kc, New York City, N. Y., Atlantic Broadcasting Corp., 50,000 w, E.
- WABI**—1200 kc, Bangor, Maine, Pine Tree Broadcasting Co., 100 w, E.
- WABO**—See under WHEC.
- WABZ**—1200 kc, New Orleans, La., Coliseum Place Baptist Church, 100 w, C.
- WACO**—1240 kc, Waco, Tex., Central Texas Broadcasting Co., Inc., 1000 w, C.
- WADC**—1320 kc, Tallmadge, Ohio, Allen T. Simmons, 1000 w, E.
- WAGM**—1420 kc, Mars Hill, Me., Aroostook Bdstg. Corp., 100 w.
- WAIU**—640 kc, Columbus, Ohio, Associated Radiocasting Corp., 500 w, E.
- WALR**—1210 kc, Zanesville, O., Roy W. Waller, 100 w, E.
- WAPI**—1140 kc, Birmingham, Ala., Alabama Polytechnic Institute, 5000 w, C.
- WASH**—1270 kc, Grand Rapids, Mich., Kunsky-Trendle Bdstg. Corp., 500 w, C.
- WAWZ**—1350 kc, Zarepath, N. J., Pillar of Fire, 250 w, E.
- WBAA**—1400 kc, Lafayette, Ind., Purdue University, 500 w, C.
- WBAK**—1430 kc, Harrisburg, Pa., Pennsylvania State Police, 500 w, E.
- WBAL**—1060 kc, Baltimore, Md., Consolidated Gas, Elec. Co., 10,000 w, E.
- WBAP**—800 kc, Ft. Worth, Tex., Carter Publications, Inc., 10,000 w, C.
- WBAX**—1210 kc, Wilkes-Barre, Pa., John H. Stenger, Jr., 100 w, E.
- WBBC**—1400 kc, Brooklyn, N. Y., Brooklyn Broadcasting Corp., 500 w.
- WBBL**—1210 kc, Richmond, Va., Grace Covenant Presbyterian Church, 100 w, E.
- WBBM**—770 kc, Chicago, Ill., WBBM Bdstg. Corp., 25,000 w, C.
- WBBR**—1300 kc, Brooklyn, N. Y., People's Pulpit Association, 1000 w, E.
- WBBZ**—1200 kc, Ponca City, Okla., C. L. Carrell, 100 w, C.
- WBCM**—1410 kc, Bay City, Mich., James E. Davidson, 500 w, E.
- WBCN**—See under WENR.
- WBEN**—900 kc, Buffalo, N. Y., WBEN, Inc., 1000 w, E.
- WBEO**—1310 kc, Marquette, Mich., Lake Superior Bdstg. Co.
- WBGF**—1370 kc, Glens Falls, N. Y., W. Parker & N. Metcalf, 50 w, E.
- WBHS**—1200 kc, Huntsville, Ala., Hutchens Co., 50 w.
- WBIG**—1440 kc, Greensboro, N. C., North Carolina Broadcasting Co., 500 w, E.
- WBIS**—See under WNAC.
- WBMS**—1450 kc, Hackensack, N. J., WBMS Broadcasting Corp., 250 w.
- WBNX**—1350 kc, New York, N. Y., Standard Cahill Co., Inc., 250 w, E.
- WBOQ**—See under WABC.
- WBOW**—1310 kc, Terre Haute, Ind., Banks of Wabash, Inc., 100 w, C.
- WBRC**—930 kc, Birmingham, Ala., Birmingham Broadcasting Co., 500 w, C.
- WBRE**—1310 kc, Wilkes-Barre, Pa., Louis G. Baltimore, 100 w, E.
- WBSO**—920 kc, Needham, Mass., Bdstg. Service Org., Inc., 250 w, E.
- WBT**—1080 kc, Charlotte, N. C., Station WBT, Inc., 5000 w, E, shared.
- WBTM**—1370 kc, Danville, Va., Piedmont Bdstg. Corp., 100 w, E.
- WBZ**—990 kc, Boston, Mass., Westinghouse E. & M. Co., 25,000 w, E.
- WBZA**—990 kc, Springfield, Mass., Westinghouse E. & M. Co., 1000 w, E.
- WCAC**—600 kc, Storrs, Conn., Connecticut Agricultural College, 250 w, E.
- WCAD**—1220 kc, Canton, N. Y., St. Lawrence University, 500 w, E.
- WCAE**—1220 kc, Pittsburgh, Pa., WCAE, Inc., 1000 w, E.
- WCAH**—1430 kc, Columbus, Ohio, Commercial Radio Service Co., 500 w, E.
- WCAJ**—590 kc, Lincoln, Neb., Nebraska Wesleyan University, 500 w, C.
- WCAL**—1250 kc, Northfield, Minn., St. Olaf College, 1000 w, C.
- WCAM**—1280 kc, Camden, N. J., City of Camden, 500 w, E.
- WCAO**—600 kc, Baltimore, Md., Monumental Radio, Inc., 250 w, E.
- WCAP**—1280 kc, Asbury Park, N. J., Radio Industries Broadcast Co., 500 w, E.
- WCAT**—1200 kc, Rapid City, S. D., South Dakota State School of Mines, 100 w, M.
- WCAU**—1170 kc, Philadelphia, Pa., Universal Broadcasting Co., 10,000 w, E.
- WCAX**—1200 kc, Burlington, Vt., Burlington Daily News, 100 w, E.
- WCAZ**—1070 kc, Carthage, Ill., Superior Broadcasting Co., 50 w.
- WCHA**—1440 kc, Allentown, Pa., B. B. Muselman, 250 w, E.
- WCBD**—1080 kc, Zion, Ill., Wilbur Glen Voliva, 5000 w, C.
- WCBM**—1370 kc, Baltimore, Md., Baltimore Broadcasting Corp., 100 w, E.
- WCBS**—1210 kc, Springfield, Ill., Dewing & Meester, 100 w, C.
- WCCO**—810 kc, Minneapolis, Minn., Northwestern Broadcasting Inc., 5000 w, C.
- WCDA**—1350 kc, New York, N. Y., Italian Educational Broadcasting Co., 250 w, E.
- WCFL**—970 kc, Chicago, Ill., Chicago Federation of Labor, 15,000 w, C.
- WCGU**—1400 kc, Brooklyn, N. Y., U. S. Broadcasting Corp., 500 w, E.
- WCHI**—1490 kc, Chicago, Ill., People's Pulpit Association, 5000 w, C.
- WCKY**—1490 kc, Covington, Ky., L. B. Wilson, 500 w, E.
- WCLB**—1500 kc, Long Beach, N. Y., Arthur Faske, 100 w, E.
- WCLO**—1200 kc, Janesville, Wis., WCLO Radio Corp., 100 w, C.
- WCLS**—1310 kc, Joliet, Ill., WCLS, Inc., 100 w, C.
- WCMA**—1400 kc, Culver, Ind., General Broadcasting Co., 500 w, C.
- WCOA**—1340 kc, Pensacola, Fla., Pensacola Bdstg. Co., 500 w, E.
- WCOC**—880 kc, Meridian, Miss., Mississippi Broadcasting Co., 500 w, C.
- WCOD**—1200 kc, Harrisburg, Pa., Keystone Broadcasting Corp., 100 w, E.
- WCOH**—1210 kc, Yonkers, N. Y., Westchester Broadcasting Corp., 100 w, E.

- WCRW**—1210 kc, Chicago, Ill., Clinton R. White, 100 w, C.
- WCSC**—1360 kc, Charleston, S. C., Lewis Burk, 500 w, E.
- WCSH**—940 kc, Portland, Me., Congress Square Hotel Co., 1000 w, E.
- WDAE**—1220 kc, Tampa, Fla., Tampa Publishing Co., 1000 w, E.
- WDAF**—610 kc, Kansas City, Mo., Kansas City Star Co., 1000 w, C.
- WDAG**—1410 kc, Amarillo, Texas, National Radio & Broadcasting Corp., 250 w, C.
- WDAH**—1310 kc, El Paso, Texas, W. S. Bledsoe, 100 w, M.
- WDAS**—1370 kc, Philadelphia, Pa., WDAS Broadcasting Station, Inc., 100 w, E.
- WDAY**—940 kc, Fargo, N. D., WDAY, Inc., 1000 w, C.
- WBBJ**—930 kc, Roanoke, Va., Times-World Corp., 250 w, E.
- WBDO**—1120 kc, Orlando, Fla., Orlando Broadcasting Co., 1000 w, E.
- WDEL**—1120 kc, Wilmington, Del., WDEL, Inc., 250 w, E.
- WDEV**—1420 kc, Waterbury, Vt., H. C. Whitehill, 50 w.
- WDGY**—1180 kc, Minneapolis, Minn., Dr. Geo. W. Young, 1000 w, C.
- WDIX**—1420 kc, Texarkana, Ark., North Mississippi Broadcasting Corp., 100 w, C.
- WDOD**—1280 kc, Chattanooga, Tenn., WDOD Broadcasting Co., Inc., 1000 w, C.
- WDRC**—1330 kc, Hartford, Conn., Doolittle Radio Corp., 500 w, E.
- WDSU**—1250 kc, New Orleans, La., Jos. H. Uhalt, 1000 w, C.
- WDZ**—1070 kc, Tuscola, Ill., James L. Bush, 100 w.
- WEAF**—660 kc, New York, N. Y., National Broadcasting Co., Inc., 50,000 w, E.
- WEAI**—1270 kc, Ithaca, N. Y., Cornell Univ., 1000 w, E.
- WEAN**—780 kc, Providence, R. I., Shepard Broadcasting Service, 250 w, E.
- WEAO**—570 kc, Columbus, Ohio, Ohio State University, 750 w, E.
- WEBC**—1290 kc, Superior, Wis., Head of The Lakes Broadcasting Co., 1000 w, C.
- WEBQ**—1210 kc, Harrisburg, Ill., First Trust & Savings Bank, 100 w, C.
- WEBR**—1310 kc, Buffalo, N. Y., Howell Broadcasting Co., 100 w, E.
- WEDC**—1210 kc, Chicago, Ill., Emil Denmark, Inc., 100 w.
- WEDH**—1420 kc, Erie, Pa., Erie Dispatch-Herald, 30 w, E.
- WEEI**—590 kc, Boston, Mass., Edison Elec. Illum. Co., 1000 w, E.
- WEIU**—830 kc, Reading, Pa., Berks Bdstg. Co., 1000 w.
- WEHC**—1350 kc, Emory, Va., Emory and Henry College, 500 w, E.
- WEHS**—1420 kc, Evanston, Ill., WEHS, Inc., 100 w, C.
- WELL**—1420 kc, Battle Creek, Mich., Enquirer-News Co., 100 w, E.
- WENR**—870 kc, Chicago, Ill., Great Lakes Radio Broadcasting Co., 50,000 w, C.
- WEPS**—See under WORC.
- WEVD**—1300 kc, Brooklyn, N. Y., Debs Memorial Radio Fund, 500 w, E.
- WEW**—760 kc, St. Louis, Mo., St. Louis University, 1000 w, C.
- WEXL**—1310 kc, Royal Oak, Mich., Royal Oak Broadcasting Co., 50 w, E.
- WFAA**—800 kc, Dallas, Texas, Dallas News and Journal, 50,000 w, C.
- WFAM**—1200 kc, La Porte, Ind., South Bend Tribune, 100 w, C.
- WFAN**—610 kc, Philadelphia, Pa., Keystone Broadcasting Co., Inc., 500 w, E.
- WFBC**—1200 kc, Knoxville, Tenn., First Baptist Church, 50 w, E.
- WFBE**—1200 kc, Cincinnati, Ohio, Post Publ. Co., 100 w, E.
- WFBG**—1310 kc, Altoona, Pa., William F. Gable Co., 100 w, E.
- WFBL**—1360 kc, Syracuse, N. Y., The Onondaga Co., Inc., 1000 w, E.
- WFBM**—1230 kc, Indianapolis, Ind., Indianapolis, Power & Light Co., 1000 w, C.
- WFBR**—1270 kc, Baltimore, Md., Baltimore Radio Show, Inc., 250 w, E.
- WFDF**—1310 kc, Flint, Mich., Frank D. Fallain, 100 w, E.
- WFDV**—1310 kc, Rome, Ga., Dolies Goings, 100 w, E.
- WFDW**—1420 kc, Talladega, Ala., R. C. Hammett, 100 w, C.
- WFEA**—1430 kc, Merrimack, N. H., New Hampshire Bdstg. Co., 500 w.
- WFI**—560 kc, Philadelphia, Pa., Strawbridge & Clothier, 500 w, E.
- WFIW**—940 kc, Hopkinsville, Ky., WFIW, Inc., 1000 w, C.
- WFLA**—620 kc, Clearwater, Fla., Clearwater Chamber of Commerce and St. Petersburg Chamber of Commerce, 250 w, E.
- WFOX**—1400 kc, Brooklyn, N. Y., Paramount Broadcasting Corp., 500 w.
- WGAL**—1310 kc, Lancaster, Pa., WGAL, Inc., 100 w, E.
- WGAR**—1450 kc, Cleveland, Ohio, WGAR Broadcasting Co., 500 w, E.
- WGBB**—1210 kc, Freeport, N. Y., Harry H. Carman, 100 w, E.
- WGBC**—See under WNBR.
- WGBF**—630 kc, Evansville, Ind., Evansville on the Air, Inc., 500 w, E.
- WGBI**—880 kc, Scranton, Pa., Scranton Broadcasters, Inc., 250 w, E.
- WGCM**—1210 kc, Gulfport, Miss., Great Southern Land Co., Inc., 100 w, C.
- WGCP**—1250 kc, Newark, N. J., May Radio Broadcast Corp., 250 w, E.
- WGEO**—1000 kc, York, Pa., York Bdstg. Co., 1000 w, E.
- WGES**—1360 kc, Chicago, Ill., Oak Leaves Broadcasting Corp., 500 w, C.
- WGH**—1310 kc, Newport News, Va., Hampton Roads Broadcasting Corp., Inc., 100 w, E.
- WGL**—1370 kc, Ft. Wayne, Ind., Allen-Wayne Co., 100 w, C.
- WGMS**—See under WLB.
- WGN**—720 kc, Chicago, Ill., Tribune Co., 25,000 w, C.
- WGR**—550 kc, Buffalo, N. Y., Buffalo Broadcasting Corp., 1000 w, E.
- WGST**—890 kc, Atlanta, Ga., Georgia School of Technology, 250 w, E.
- WGY**—790 kc, Schenectady, N. Y., General Electric Co., 50,000 w, E.
- WHA**—940 kc, Madison, Wis., University of Wisconsin, 750 w, C.
- WHAD**—1120 kc, Milwaukee, Wis., Marquette University, 250 w, C.
- WHAM**—1150 kc, Rochester, N. Y., Stromberg-Carlson Tel. Mfg. Co., 5000 w, E.
- WHAP**—1300 kc, New York, N. Y., Defenders of Truth Society, Inc., 1000 w, E.
- WHAS**—820 kc, Louisville, Ky., The Courier Journal Co. & Louisville Times Co., 10,000 w, C.
- WHAT**—1310 kc, Philadelphia, Pa., Independence Broadcasting Co., 100 w, E.
- WHAZ**—1300 kc, Troy, N. Y., Rensselaer Polytechnic Institute, 500 w, E.
- WHB**—860 kc, Kansas City, Mo., WHB Broadcasting Co., 500 w, C.
- WHBC**—1200 kc, Canton, Ohio, St. John's Catholic Church, 10 w, E.
- WHBD**—1370 kc, Mt. Orab, Ohio, F. P. Moler, 100 w, E.
- WHBF**—1210 kc, Rock Island, Ill., Beardley Specialty Co., 100 w, C.
- WHBL**—1410 kc, Sheboygan, Wis., Press Pub. Co., 500 w, C.
- WHBQ**—1370 kc, Memphis, Tenn., Station WHBQ, Inc., 100 w, C.
- WHBU**—1210 kc, Anderson, Ind., Anderson Bdstg. Corp., 100 w, C.
- WHBY**—1200 kc, Green Bay, Wis., St. Norbert's College, 100 w, C.
- WHDF**—1370 kc, Calumet, Mich., Upper Michigan Bdstg. Co., 100 w, C.
- WHDH**—830 kc, Boston, Mass., Matheson Radio Co., Inc., 1000 w, E.
- WHDI**—1180 kc, Minneapolis, Minn., Dr. G. W. Young, 500 w, C.
- WHDL**—1420 kc, Tupper Lake, N. Y., Tupper Lake Broadcasting Corp., 100 w, E.
- WHEC**—1440 kc, Rochester, N. Y., Hickson Electric Co., Inc., 500 w, E.
- WHFC**—1420 kc, Cicero, Ill., WHFC, Inc., 100 w, C.
- WHIS**—1410 kc, Bluefield, W. Va., Daily Telegraph Printing Co., 250 w, E.
- WHK**—1390 kc, Cleveland, Ohio, Radio Air Service Corp., 1000 w, E.
- WHN**—1010 kc, New York, N. Y., Marcus Loew Booking Review, 250 w, E.
- WHO**—1000 kc, Des Moines, Iowa, Central Broadcasting Co., 50,000 w, C.
- WHOM**—1450 kc, Jersey City, N. J., New Jersey Broadcasting Corp., 250 w, E.
- WHP**—1430 kc, Harrisburg, Pa., WHP, Inc., 500 w, E.
- WIAS**—1420 kc, Ottumwa, Iowa, Poling Electric Co., 100 w, C.
- WIBA**—1280 kc, Madison, Wis., Capital Times Co., 500 w, C.
- WIBG**—930 kc, Elkins Park, Pa., WIBG, Inc., 25 w, E.
- WIBM**—1370 kc, Jackson, Mich., WIBM, Inc., 100 w.
- WIBO**—560 kc, Chicago, Ill., Nelson Bros. Bond and Mortgage Co., 1000 w, C.
- WIBU**—1210 kc, Poynette, Wis., W. C. Forrest, 100 w, C.
- WIBW**—580 kc, Topeka, Kan., Topeka Broadcasting Assn., Inc., 1000 w, C.
- WIBX**—1200 kc, Utica, N. Y., WIBX, Inc., 100 w, E.
- WICC**—600 kc, Bridgeport, Conn., Bridgeport Broadcasting Station, Inc., 500 w, E.
- WIL**—1200 kc, St. Louis, Mo., Missouri Broadcasting Co., 100 w, C.
- WILL**—890 kc, Urbana, Ill., University of Illinois, 250 w, C.
- WILM**—1420 kc, Wilmington, Del., Delaware Broadcasting Co., Inc., 100 w, E.
- WINS**—1180 kc, New York, N. Y., American Radio News Corp., 500 w, E.
- WIOD**—1300 kc, Miami, Fla., Isle of Dreams Broadcasting Co., 1000 w, E.
- WIP**—610 kc, Philadelphia, Pa., Gimbel Bros., Inc., 500 w, E.
- WIS**—1010 kc, Columbia, S. C., South Carolina Broadcasting Co., Inc., 500 w, E.
- WISJ**—See under WIBA.
- WISN**—1120 kc, Milwaukee, Wis., Evening Wisconsin Co., 250 w, C.
- WJAC**—1310 kc, Johnstown, Pa., Johnstown Automobile Co., 100 w, E.
- WJAG**—1060 kc, Norfolk, Neb., Norfolk Daily News, 1000 w, C.
- WJAK**—1310 kc, Marion, Ind., The Truth Pub. Co., Inc., 50 w.
- WJAR**—890 kc, Providence, R. I., The Outlet Co., 500 w, E.
- WJAS**—1290 kc, Pittsburgh, Pa., Pittsburgh Radio Supply House, 1000 w, E.
- WJAX**—900 kc, Jacksonville, Fla., City of Jacksonville, 1000 w, E.
- WJAY**—610 kc, Cleveland, Ohio, Cleveland Radio Broadcasting Corp., 500 w, E.
- WJBC**—1200 kc, LaSalle, Ill., Kaskaskia Broadcasting Co., 100 w, C.
- WJBI**—1210 kc, Red Bank, N. J., Monmouth Broadcasting Co., 100 w, E.
- WJBK**—1370 kc, Highland Park, Mich., J. F. Hopkins, 50 w, C.
- WJBL**—1200 kc, Decatur, Ill., Commodore Broadcasting Co., 100 w, C.
- WJBO**—1420 kc, New Orleans, La., Valdemar Jensen, 100 w, C.
- WJBT**—See under WBBM.
- WJBU**—1210 kc, Lewisburg, Pa., Bucknell University, 100 w, E.
- WJBW**—1200 kc, New Orleans, La., C. Carlisen, Jr., 30 w, C.
- WJBY**—1210 kc, Gadsden, Ala., Gadsden Broadcasting Co., 100 w, C.
- WJDX**—1270 kc, Jackson, Miss., Lamar Life Ins. Co., 1000 w, C.
- WJJD**—1130 kc, Chicago, Ill., Loyal Order of Moose, 20,000 w, C.
- WJKS**—1360 kc, Gary, Ind., Johnson-Kennedy Radio Corp., 1000 w, C.
- WJMS**—1420 kc, Ironwood, Mich., Johnson Music Store, 100 w.
- WJR**—750 kc, Detroit, Mich., The Goodwill Station, Inc., 10,000 w, E.
- WJSV**—1460 kc, Alexandria, Va., WJSV, Inc., 10,000 w.
- WJTL**—1370 kc, Oglethorpe University, Ga., 100 w, E.
- WJW**—1210 kc, Mansfield, Ohio, Mansfield Broadcasting Association, 100 w, E.
- WJZ**—760 kc, New York City, N. Y., National Broadcasting Co., 30,000 w, E.
- WKAQ**—890 kc, San Juan, Porto Rico, Radio Corp. of Porto Rico, 250 w, E.
- WKAR**—1040 kc, East Lansing, Mich., Michigan State College, 1000 w, E.
- WKAV**—1310 kc, Laconia, N. H., Laconia Radio Club, 100 w, E.
- WKBB**—1310 kc, Joliet, Ill., Sanders Bros., 100 w, C.
- WKBC**—1310 kc, Birmingham, Ala., R. B. Broyles Furniture Co., 100 w, C.
- WKBF**—1400 kc, Indianapolis, Ind., Indianapolis Broadcasting Corp., 500 w, C.
- WKBH**—1380 kc, LaCrosse, Wis., WKBH, Inc., 1000 w, C.
- WKBI**—1420 kc, Chicago, Ill., WKBI, Inc., 100 w, C.
- WKBN**—570 kc, Youngstown, Ohio, WKBN Bdstg. Corp., 500 w, E.
- WKBO**—1450 kc, Jersey City, N. J., Camith Corp., 250 w, E.
- WKBS**—1310 kc, Galesburg, Ill., Permil N. Nelson, 100 w, C.
- WKBV**—1500 kc, Connersville, Ind., Knox Battery & Electric Co., 100 w, C.
- WKBW**—1480 kc, Buffalo, N. Y., WKBW, Inc., 5000 w, E.
- WKBZ**—1500 kc, Ludington, Mich., K. L. Ashbacher, 50 w.
- WKJC**—1200 kc, Lancaster, Pa., Lancaster Bdstg. Service, Inc., 100 w, E.
- WKRC**—550 kc, Cincinnati, Ohio, WKRC, Inc., 1000 w, E.
- WKY**—900 kc, Oklahoma City, Okla., WKY Radiophone Co., 1000 w, C.
- WKZO**—590 kc, Kalamazoo, Mich., WKZO, Inc., 1000 w, C.
- WLAC**—1470 kc, Nashville, Tenn., Life & Casualty Ins. Co., 5000 w, C.

- WLAP**—1200 kc, Louisville, Ky., American Broadcasting Corp. of Kentucky, 100 w, C.
- WLB**—1250 kc, Minneapolis, Minn., University of Minnesota, 1000 w, C.
- WLBC**—1310 kc, Muncie, Ind., Donald A. Burton, 50 w.
- WLBF**—1420 kc, Kansas City, Kan., WLBF Broadcasting Co., 100 w, C.
- WLBG**—1200 kc, Petersburg, Va., WLBG, Inc., 100 w, E.
- WLBL**—900 kc, Stevens Point, Wis., Wisconsin Department of Agriculture, 2000 w, daytime, C.
- WLBW**—1260 kc, Oil City, Pa., Radio-Wire Program Corp., 500 w, E.
- WLBX**—1500 kc, Long Island City, N. Y., John N. Brahy, 100 w.
- WLBZ**—620 kc, Bangor, Me., Maine Broadcasting Co., 500 w, E.
- WLCI**—1210 kc, Ithaca, N. Y., Lutheran Assn. of Ithaca, 50 w, E.
- WLEY**—1370 kc, Lexington, Mass., Lexington Air Station, 100 w, E.
- WLIT**—560 kc, Philadelphia, Pa., Lit Brothers, 500 w, E.
- WLS**—870 kc, Chicago, Ill., Agricultural Broadcasting Co., 5000 w, C.
- WLSI**—See under WPRO.
- WLTH**—1400 kc, Brooklyn, N. Y., Voice of Brooklyn, Inc., 500 w, E.
- WLVA**—1370 kc, Lynchburg, Va., Lynchburg Broadcasting Corp., 100 w, E.
- WLW**—700 kc, Cincinnati, Ohio, Crosley Radio Corp., 50,000 w, E.
- WLWL**—1100 kc, New York, N. Y., Missionary Society of St. Paul, 5000 w, E.
- WMAC**—See under WSYR.
- WMAL**—630 kc, Washington, D. C., M. A. Leese Co., 250 w, E.
- WMAQ**—670 kc, Chicago, Ill., National Broadcasting Co., 5000 w, C.
- WMAZ**—1180 kc, Macon, Ga., Southeastern Broadcasting Co., 500 w, E.
- WMBA**—1500 kc, Newport, R. I., LeRoy Joseph Beebe, 100 w, E.
- WMBC**—1420 kc, Detroit, Mich., Michigan Broadcasting Co., Inc., 100 w, E.
- WMBD**—1440 kc, Peoria Heights, Ill., Peoria Bdstg. Co., 500 w.
- WMBF**—See under WIOD.
- WMBG**—1210 kc, Richmond, Va., Havens & Martin, Inc., 100 w, E.
- WMBH**—1420 kc, Joplin, Mo., Edwin Dudley Aber, 100 w, C.
- WMBI**—1080 kc, Chicago, Ill., Moody Bible Institute Radio Station, 5000 w, C, shared.
- WMBJ**—1500 kc, Wilkesburg, Pa., Rev. John W. Sproul, 100 w, E.
- WMBO**—1310 kc, Auburn, N. Y., WMBO, Inc., 100 w, E.
- WMBQ**—1500 kc, Brooklyn, N. Y., Paul J. Gollhofer, 100 w.
- WMBR**—1370 kc, Tampa, Fla., F. J. Reynolds, 100 w, E.
- WMC**—780 kc, Memphis, Tenn., Memphis Commercial Appeal, Inc., 500 w, C.
- WMCA**—570 kc, New York, N. Y., Knickerbocker Broadcasting Co., Inc., 500 w, E.
- WMIL**—1500 kc, Brooklyn, N. Y., Arthur Faske, 100 w, E.
- WMMN**—890 kc, Fairmont, W. Va., Holt Rowe Novelty Co., 250 w, E.
- WMPC**—1500 kc, Lapeer, Mich., First Methodist Protestant Church, 100 w, E.
- WMRJ**—1210 kc, Jamaica, N. Y., Peter J. Prinz, 10 w, E.
- WMSG**—1350 kc, New York, N. Y., Madison Square Garden Broadcast Co., 250 w, E.
- WMT**—600 kc, Waterloo, Iowa, Waterloo Broadcasting Co., 500 w, C.
- WNAC**—1230 kc, Boston, Mass., The Shepard Broadcasting Service, 1000 w, E.
- WNAD**—1010 kc, Norman, Okla., University of Oklahoma, 500 w, C.
- WNAX**—570 kc, Yankton, S. Dak., Gurney Seed & Nursery Co., 1000 w, C.
- WNBK**—1500 kc, Binghamton, N. Y., Howitt-Wood Radio Co., 100 w, E.
- WNBH**—1310 kc, New Bedford, Mass., New Bedford Broadcasting Co., 100 w, E, shared.
- WNBO**—1200 kc, Silver Haven, Pa., J. B. Spriggs, 100 w, E.
- WNBZ**—1430 kc, Memphis, Tenn., Memphis Broadcasting Co., 500 w, C.
- WNBW**—1200 kc, Carbondale, Pa., Home Cut Glass & China Co., 10 w, E.
- WNBX**—1200 kc, Springfield, Vt., First Congregational Church Corp., 10 w, E.
- WNBZ**—1290 kc, Saranac Lake, N. Y., Smith & Mace, 50 w, E.
- WNJ**—1450 kc, Newark, N. J., Radio Investment Co., 250 w, E.
- WNOX**—560 kc, Knoxville, Tenn., WNOX, Inc., 1000 w, C.
- WNYC**—570 kc, New York, N. Y. Department of Plant & Structures, 500 w, E.
- WOAI**—1190 kc, San Antonio, Texas, Southern Equipment Co., 50,000 w, C.
- WOAN**—See WREC.
- WOAX**—1280 kc, Trenton, N. J., WOAX, Inc., 500 w, E.
- WOBU**—580 kc, Charleston, W. Va., WOBU, Inc., 250 w, E.
- WOC**—1000 kc, Davenport, Iowa, Central Broadcasting Co., 50,000 w, C.
- WOCL**—1210 kc, Jamestown, N. Y., A. E. Newton, 50 w, E.
- WODA**—1250 kc, Paterson, N. J., Richard E. O'Dea, 1000 w, E.
- WODX**—1410 kc, Mobile, Ala., Mobile Bdstg. Corp., 500 w, C.
- WOI**—640 kc, Ames, Iowa, Iowa State College, 5000 w, C.
- WOKO**—1440 kc, Albany, N. Y., WOKO, Inc., 500 w, E.
- WOL**—1310 kc, Washington, D. C., American Broadcasting Co., 100 w, E.
- WOMT**—1210 kc, Manitowoc, Wis., Francis M. Kadow, 100 w.
- WOOD**—1270 kc, Grand Rapids, Mich., Walter B. Stiles, Inc., 500 w, C.
- WOPI**—1500 kc, Bristol, Tenn., Radiophone Broadcasting Co., 100 w, E.
- WOR**—710 kc, Newark, N. J., J. Bamberger Broadcasting Service, Inc., 5000 w, E.
- WORC**—1200 kc, Worcester, Mass., A. F. Kleindienst, 100 w, E.
- WOS**—630 kc, Jefferson City, Mo., John D. Heiny, 500 w, C.
- WOV**—1130 kc, New York, N. Y., International Broadcasting Corp., 1000 w, E.
- WOW**—590 kc, Omaha, Neb., Woodmen of the World, 1000 w, C.
- WOWO**—1160 kc, Ft. Wayne, Ind., Main Auto Supply Co., 10,000 w, C.
- WPAD**—1420 kc, Paducah, Ky., Paducah Broadcasting Co., 100 w, C.
- WPAP**—See under WQAO.
- WPAW**—1210 kc, Pawtucket, R. I., Shertenberg & Robinson, 100 w, E.
- WPCC**—560 kc, Chicago, Ill., North Shore Congregational Church, 500 w, C.
- WPCH**—810 kc, New York, N. Y., Eastern Broadcasters, Inc., 500 w, E.
- WPEN**—1500 kc, Philadelphia, Pa., Wm. Pen Broadcasting Co., 250 w, E.
- WPFB**—1370 kc, Hattiesburg, Miss., Hattiesburg Bdstg. Co., 100 w, C.
- WPG**—1100 kc, Atlantic City, N. J., WPG Broadcasting Corp., 5000 w, E.
- WPOR**—See under WTAR.
- WPRO**—1210 kc, Providence, R. I., Cherry & Webb Bdstg. Co., 100 w, E.
- WPSC**—1230 kc, State College, Pa., Pennsylvania State College, 500 w, day, E.
- WPTF**—680 kc, Raleigh, N. C., Durham Life Insurance Co., 1000 w, E.
- WQAM**—560 kc, Miami, Fla., Miami Broadcasting Co., 1000 w, E.
- WQAN**—880 kc, Scranton, Pa., Scranton Times, 250 w, E.
- WQAO**—1010 kc, New York, N. Y., Calvary Baptist Church, 250 w, E.
- WQBC**—1360 kc, Vicksburg, Miss., Delta Broadcasting Co., 300 w, C.
- WQDM**—1370 kc, St. Albans, Vt., A. J. St. Antoine, 100 w, E.
- WQDX**—1210 kc, Thomasville, Ga., Stevens Luke, 100 w, E.
- WRAK**—1370 kc, Williamsport, Pa., C. R. Cummins, 50 w, E.
- WRAM**—1370 kc, Wilmington, N. C., Wilmington Radio Association, 100 w, E.
- WRAW**—1310 kc, Reading, Pa., Reading Broadcasting Co., 50 w, E.
- WRAX**—1020 kc, Philadelphia, Pa., WRAX Broadcasting Co., 250 w, E.
- WRBL**—1200 kc, Columbus, Ga., WRBL Radio Station, Inc., 50 w, E.
- WRBQ**—1210 kc, Greenville, Miss., J. Pat Scully, 250 w, C.
- WRBX**—1410 kc, Roanoke, Va., Richmond Development Corp., 250 w, E.
- WRC**—950 kc, Washington, D. C., National Broadcasting Co., 500 w, E.
- WRDO**—1370 kc, Augusta, Me., Albert S. Woodman, 100 w, E.
- WRDW**—1500 kc, Augusta, Ga., Davenport's Musicove, Inc., 100 w, E.
- WREC**—600 kc, Memphis, Tenn., WREC, Inc., 500 w.
- WREN**—1220 kc, Lawrence, Kan., Jenny Wren Co., 1000 w, C.
- WRHM**—1250 kc, Minneapolis, Minn., Minnesota Broadcasting Corp., 1000 w, C.
- WRJN**—1370 kc, Racine, Wis., Racine Broadcasting Corp., 100 w, C.
- WRNY**—1010 kc, New York, N. Y., Aviation Radio Station, 250 w, E.
- WROL**—1310 kc, Knoxville, Tenn., Stuart Broadcasting Corp., 100 w, C.
- WRR**—1280 kc, Dallas, Texas, City of Dallas, 500 w, C.
- WRUF**—830 kc, Gainesville, Fla., University of Florida, 5000 w, E.
- WRVA**—1110 kc, Richmond, Va., Larus Bros. & Co., Inc., 5000 w, E.
- WSAI**—1330 kc, Mason, Ohio, Crosley Radio Corp., 500 w, E.
- WSAJ**—1310 kc, Grove City, Pa., Grove City College, 100 w, E.
- WSAN**—1440 kc, Allentown, Pa., Allentown Call Pub. Co., 250 w, E.
- WSAR**—1450 kc, Fall River, Mass., Doughty & Welch Electrical Co., Inc., 250 w, E.
- WSAZ**—580 kc, Huntington, W. Va., WSAZ, Inc., 250 w, E.
- WSB**—740 kc, Atlanta, Ga., Atlanta Journal Co., 5000 w, E.
- WSBC**—1210 kc, Chicago, Ill., World Battery Co., 100 w, C.
- WSBT**—1230 kc, South Bend, Ind., South Bend Tribune, 500 w, C.
- WSEN**—1210 kc, Columbus, Ohio, Columbus Broadcasting Corp., 100 w, E.
- WSFA**—1410 kc, Montgomery, Ala., Montgomery Bdstg. Co., 500 w, C.
- WSIX**—1210 kc, Springfield, Tenn., 638 Tire & Vulcanizing Co., 100 w, C.
- WSJS**—1310 kc, Winston-Salem, N. C., The Journal Co., 100 w, E.
- WSM**—650 kc, Nashville, Tenn., National Life & Accident Ins. Co., 5000 w, C.
- WSMB**—1320 kc, New Orleans, La., WSMB, Inc., 500 w, C.
- WSMK**—1380 kc, Dayton, Ohio, Stanley M. Krohn, Jr., 200 w, C.
- WSOC**—1210 kc, Gastonia, N. C., A. J. Kirby Music Co., 100 w, E.
- WSPA**—1420 kc, Spartanburg, S. C., 100 w, E.
- WSPD**—1340 kc, Toledo, Ohio, Toledo Broadcasting Co., 1000 w, E.
- WSUI**—880 kc, Iowa City, Iowa, State Univ. of Iowa, 500 w, C.
- WSUN**—See under WFLA.
- WSVS**—1370 kc, Buffalo, N. Y., Seneca Vocational High School, 50 w, E.
- WSYB**—1500 kc, Rutland, Vt., Weiss Music Co., 100 w, E.
- WSYR**—570 kc, Syracuse, N. Y., Clive B. Meredith, 250 w, E.
- WTAD**—1440 kc, Quincy, Ill., Illinois Broadcasting Corp., 500 w.
- WTAG**—580 kc, Worcester, Mass., Worcester Telegram Pub. Co., Inc., 250 w, E.
- WTAM**—1070 kc, Cleveland, Ohio, National Broadcasting Co., 50,000 w, E.
- WTAQ**—1330 kc, Eau Claire, Wis., Gillette Rubber Co., 1000 w, C.
- WTAR**—780 kc, Norfolk, Va., WTAR Radio Corp., 500 w, E.
- WTAW**—1120 kc, College Station, Texas, Agri. & Mech. College of Texas, 500 w, C.
- WTAX**—1210 kc, Springfield, Ill., WTAX, Inc., 100 w.
- WTBO**—1420 kc, Cumberland, Md., Associated Bdstg. Corp., 100 w, E.
- WTEL**—1310 kc, Philadelphia, Pa., Foulkrod Radio Eng. Co., 50 w, E.
- WTFI**—1450 kc, Athens, Ga., Toccoa Falls Bdstg. Co., 500 w, E.
- WTIC**—1060 kc, Hartford, Conn., Travelers Broadcasting Service Corp., 50,000 w, E.
- WTJS**—1310 kc, Jackson, Tenn., Sun Publishing Co., 100 w, C.
- WTMJ**—620 kc, Milwaukee, Wis., Milwaukee Journal, 1000 w, C.
- WTNT**—1470 kc, Nashville, Tenn., Life and Casualty Ins. Co. of Tenn., 5000 w, C.
- WTOC**—1260 kc, Savannah, Ga., Savannah Broadcasting Corp., 500 w, E.
- WTSL**—Laurel, Miss.
- WWAE**—1200 kc, Hammond, Ind., Hammond-Calumet Broadcasting Corp., 100 w, C.
- WWJ**—920 kc, Detroit, Mich., Evening News Assn., 1000 w, E.
- WWL**—850 kc, New Orleans, La., Loyola University, 10,000 w, C.
- WWNC**—570 kc, Asheville, N. C., Citizens Broadcasting Co., 1000 w, E.
- WWRL**—1500 kc, Woodside, N. Y., Long Island Broadcasting Corp., 100 w.
- WWSW**—1500 kc, Pittsburgh, Pa., Walker & Downing Radio Corp.
- WWVA**—1160 kc, Wheeling, W. Va., West Virginia Broadcasting Corp., 5000 w, E.
- WXYZ**—1240 kc, Detroit, Mich., Kunsky Trendle Broadcasting Co., 1000 w, E.

U.S. Broadcasting Stations by Frequencies

- 550 Kilocycles, 545.1 Meters:**
KOAC, WGR, WKRC, KFUO, KSD, KFDY, KFYR
- 560 Kilocycles, 535.4 Meters:**
WLIT, WFI, KFDM, WNOX, KTAB, KLZ, WIBO, WPCC, WQAM
- 570 Kilocycles, 526.0 Meters:**
WNYC, WMCA, WSYR, WMAC, WKBN, WNNC, KGKO, WNAX, KXA, KMTR, WEAO
- 580 Kilocycles, 516.9 Meters—Canadian Shared:**
WTAG, WOBU, WSAZ, KGFX, KSAC, WIBW
- 590 Kilocycles, 508.2 Meters:**
WEEL, WCAJ, WOW, KHQ, WKZO
- 600 Kilocycles, 499.7 Meters—Canadian Shared:**
WCAO, WREC, WOAN, KFSD, WCAC, WMT, WICC
- 610 Kilocycles, 491.5 Meters:**
WFAN, WIP, WDAF, KFRC, WJAY
- 620 Kilocycles, 483.6 Meters:**
WLBZ, WTMJ, KGW, WFLA, WSUN, KTAR
- 630 Kilocycles, 475.9 Meters—Canadian Shared:**
WMAL, WOS, KFRU, WGBF
- 640 Kilocycles, 468.5 Meters:**
WAIU, KFI, WOI
- 650 Kilocycles, 461.3 Meters:**
WSM, KPCB
- 660 Kilocycles, 454.3 Meters:**
WEAF, WAAW
- 670 Kilocycles, 447.5 Meters:**
WMAQ
- 680 Kilocycles, 440.9 Meters:**
WPTF, KPO, KFEQ
- 690 Kilocycles, 434.5 Meters—Canadian Wave:**
- 700 Kilocycles, 428.3 Meters:**
WLW
- 710 Kilocycles, 422.3 Meters:**
WOR, KMPC
- 720 Kilocycles, 416.4 Meters:**
WGN
- 730 Kilocycles, 410.7 Meters—Canadian Wave:**
- 740 Kilocycles, 405.2 Meters:**
WSB, KMMJ
- 750 Kilocycles, 399.8 Meters:**
WJR
- 760 Kilocycles, 394.5 Meters:**
WJZ, WEW, KVI
- 770 Kilocycles, 389.4 Meters:**
KFAB, WBBM, WJBT
- 780 Kilocycles, 384.4 Meters—Canadian Shared:**
WTAR, WPOR, KELW, KTM, WMC, WEAN
- 790 Kilocycles, 379.5 Meters:**
WGY, KGO
- 800 Kilocycles, 374.8 Meters:**
WBAP, WFAA
- 810 Kilocycles, 370.2 Meters:**
WPCB, WCCO
- 820 Kilocycles, 365.6 Meters:**
WHAS
- 830 Kilocycles, 361.2 Meters:**
KOA, WHDH, WRUF, WEEU
- 840 Kilocycles, 356.9 Meters—Canadian Wave:**
- 850 Kilocycles, 352.7 Meters:**
KWKH, WWL
- 860 Kilocycles, 348.6 Meters:**
WBOQ, WABC, KMO, WHB
- 870 Kilocycles, 344.6 Meters:**
WLS, WENR, WBCN
- 880 Kilocycles, 340.7 Meters—Canadian Shared:**
WOAN, WGBI, WCOC, KLX, KPOF, KFAK, WSUI
- 890 Kilocycles, 336.9 Meters—Canadian Shared:**
WJAR, WMMN, WGST, KARK, WILL, KUSD, KFNF, WKAQ
- 900 Kilocycles, 331.1 Meters:**
WKY, WLBL, KHJ, KSEI, KGBU, WJAX, WBN
- 910 Kilocycles, 329.5 Meters—Canadian Wave:**
- 920 Kilocycles, 325.9 Meters:**
WWJ, KPRC, WAAF, WBSO, KOMO, KFXF, KFEL
- 930 Kilocycles, 322.4 Meters—Canadian Shared:**
WIBG, WDBJ, WBRC, KGBZ, KMA, KFVI, KROW
- 940 Kilocycles, 319 Meters:**
WCSH, WFIW, KOIN, KGU, WHA, WDAY, WAAT
- 950 Kilocycles, 315.6 Meters:**
WRC, KMBC, KFWB, KGHL
- 960 Kilocycles, 312.3 Meters—Canadian Wave:**
- 970 Kilocycles, 309.1 Meters:**
KJR, WCFL
- 980 Kilocycles, 305.9 Meters:**
KDKA
- 990 Kilocycles, 302.8 Meters:**
WBZ, WBZA
- 1000 Kilocycles, 299.8 Meters:**
WHO, WOC, KFVD, WGEO
- 1010 Kilocycles, 296.9 Meters—Canadian Shared:**
WQAO, WPAP, WHN, WRNY, KGGF, WNAD, KQW, WIS
- 1020 Kilocycles, 293.9 Meters:**
KYW, KFKX, WRAX
- 1030 Kilocycles, 291.1 Meters—Canadian Wave:**
- 1040 Kilocycles, 288.3 Meters:**
WKAR, KTHS, KRLD
- 1050 Kilocycles, 285.5 Meters:**
KNX, KFKB
- 1060 Kilocycles, 282.8 Meters:**
WBAL, WJAG, KWJJ, WTIC
- 1070 Kilocycles, 280.2 Meters:**
WTAM, WCAZ, WZD, KJBS
- 1080 Kilocycles, 277.6 Meters:**
WBT, WCBD, WMBI
- 1090 Kilocycles, 275.1 Meters:**
KMOX
- 1100 Kilocycles, 272.6 Meters:**
WPG, WLWL, KGDM
- 1110 Kilocycles, 270.1 Meters:**
WRVA, KSOO
- 1120 Kilocycles, 267.7 Meters—Canadian Shared:**
WTAW, WISN, WHAD, KFSG, KRSC, WDEL, WDBO, KFIO, KTRH, KMSC, KMBC
- 1130 Kilocycles, 265.3 Meters:**
WOV, KSL, WJJD
- 1140 Kilocycles, 263.0 Meters:**
WAPI, KVOO
- 1150 Kilocycles, 260.7 Meters:**
WHAM
- 1160 Kilocycles, 258.5 Meters:**
WWVA, WOWO
- 1170 Kilocycles, 256.3 Meters:**
WCAU
- 1180 Kilocycles, 254.1 Meters:**
KEX, KOB, WHDI, WDG, WMAZ, WINS
- 1190 Kilocycles, 252.0 Meters:**
WOAI
- 1200 Kilocycles, 249.9 Meters: Canadian Shared:**
WABI, WNBX, WORC, WIBX, WHBC, WBHS, WLBG, WNBO, WKJC, WNBW, WABZ, WJW, WBBZ, WFBZ, WRBL, WJBC, WJBL, WVAE, WFAM, KFJB, WCAT, KGDY, KFVF, KGDE, WCLO, WHBY, KERN, WIL, KVOS, KGY, KGEK, KGEW, KGHI, WCAX, WCOD, WFBE, KBTM, WEPB, KMLB, KGFJ, KWG, WLAP
- 1210 Kilocycles, 247.8 Meters—Canadian Shared:**
WJBI, WGBB, WCOH, WOCL, WLCI, WPAW, WPRO, WLSI, WJW, WBAX, WJBU, WMBG, WSIX, WJBY, WRBO, WPCM, KWEA, KDLR, KGCR, KFOR, WBU, KFVS, WBOQ, WQDX, WCRW, WEDC, WCB, WTAX, WHBF, WQMT, WSBC, KDFN, KMJ, KFXM, KPPC, WALR, WBBL, WMRJ, KGMP, KGNO, WSEN, WSOC, WIBU, KFJI
- 1220 Kilocycles, 245.6 Meters:**
WCAD, WCAE, WREN, KFKU, WDAE, KWSC, KTW
- 1230 Kilocycles, 243.8 Meters:**
WNAC, WBIS, WPSC, WSBT, WFBM, KFQD, KYA, KGGM
- 1240 Kilocycles, 241.8 Meters:**
WACO, KTAT, WXYZ, KGCU
- 1250 Kilocycles, 239.9 Meters:**
WGCP, WODA, WAAM, WLB, WGMS, WRHM, KFMX, WCAL, KFOX, WDSU
- 1260 Kilocycles, 238.0 Meters:**
WLBW, KWWG, KRGV, KOIL, KVOA, WTOC
- 1270 Kilocycles, 236.1 Meters:**
WEAI, WASH, WOOD, KWLC, KGCA, KOL, KVOR, WFBR, WJDX
- 1280 Kilocycles, 234.2 Meters:**
WCAM, WCAP, WOAX, WDOD, WRR, KFBB, WIBA, WISJ
- 1290 Kilocycles, 232.4 Meters:**
WNBZ, WJAS, KTSB, KFUL, KLCN, KDYL, WEBC
- 1300 Kilocycles, 230.6 Meters:**
WBBR, WHAP, WEVD, WHAZ, KFH, KGEF, KFAC, KFJR, KTBR, WIOD, WMBF, WOQ
- 1310 Kilocycles, 228.9 Meters:**
WKAV, WEBR, WNBH, WOL, WGH, WHAT, WFBG, WRAW, WGAL, WSAJ, WBRE, WKBC, WTJS, KRMD, KFPM, WDAH, KFPL, KFXR, WKBS, WCLS, WKBB, KWCR, KFJY, KFGQ, WBOW, WJAK, WLBC, KTSB, KFUP, KFXJ, KFBK, KGEZ, KMED, KTSB, KGCC, WJAC, WSJS, KNRO, KGFV, KFIU, KGBX, KIT, WMBO, KCRJ, KTLC, WEXL, WROL, WTEL, WBEQ, WFDV
- 1320 Kilocycles, 227.1 Meters:**
WADC, WSMB, KID, KTFI, KGHF, KGMB, KGIQ
- 1330 Kilocycles, 225.4 Meters:**
WDRG, WTAQ, KSCJ, WSAI, KGB
- 1340 Kilocycles, 223.7 Meters:**
KFPW, WCOA, KFPY, WSPD
- 1350 Kilocycles, 222.1 Meters:**
WMSG, WCDA, WBNX, KWK, WAWZ, WEHC, KIDO
- 1360 Kilocycles, 220.4 Meters:**
WBOC, WGES, KGIR, KGER, WFBL, WCSC, WJKS
- 1370 Kilocycles, 218.8 Meters:**
WSVS, WCBM, WHBD, WJBK, WIBM, WRAK, WDAS, WHBQ, WRAM, KGFQ, KFJZ, KGKL, KFLX, KGDA, KRE, WPOE, KFBL, KWKC, WRJN, KGAR, KVL, KGFL, WHDF, KOOS, WGL, KFJM, KCRC, WMBR, WPFB, WLEY, WBGF, WBTM, WLVA, WQDM, WRDO, KONO, KMAC, KUJ, WJTL, KOH
- 1380 Kilocycles, 217.3 Meters:**
KQV, KSO, WKBH, WSMK
- 1390 Kilocycles, 215.7 Meters:**
WHK, KLRA, KUOA, KOY
- 1400 Kilocycles, 214.2 Meters:**
WCGU, WFOX, WLTH, WBBC, WCMA, WKB, KOCW, WBA, KLO
- 1410 Kilocycles, 212.6 Meters:**
KGRS, WDA, KFLV, WHBL, WBCM, WODX, WSA, WAAB, WRBX, WHIS
- 1420 Kilocycles, 211.1 Meters:**
WTBO, WKBI, WEDH, WMBC, KGFF, KABC, KFYO, KICK, WIAS, KGCC, WLB, WMBH, KFIZ, KORE, WILM, KGIW, KGKX, KFQ, KLPM, KXL, WHDL, WHFC, WEHS, KFQ, KFXD, KGIX, WBO, WEL, WFDW, WPA, WSPA, KBPS, KFX, KXYZ, WAGM, WDEV, KGVO, WJMS, WDX
- 1430 Kilocycles, 209.7 Meters:**
WHP, WCAH, WGBC, WNBR, WBAK, KECA, KGNF, WFEA
- 1440 Kilocycles, 208.2 Meters:**
WHEC, WABO, WOKO, WCBA, WTAD, WMBD, KLS, WSA, WBIG
- 1450 Kilocycles, 206.8 Meters:**
WBMS, WNJ, WKBO, WSAR, WGAR, WTFI, KTBS, WHOM
- 1460 Kilocycles, 205.4 Meters:**
WJSV, KSTP
- 1470 Kilocycles, 204.0 Meters:**
KGA, WTNT, WLAC
- 1480 Kilocycles, 202.6 Meters:**
KFJF, WKBW
- 1490 Kilocycles, 201.6 Meters:**
WCKY, WCHI
- 1500 Kilocycles, 199.9 Meters:**
WMB, WNB, WMBQ, WLB, WWRL, WKBZ, WMP, WOPI, WPN, KGKB, WKBV, KPJM, KDB, KGFI, WMBJ, KREG, WCLB, WRDW, KGIZ, KGKY, KPO, KUT, KXO, KGFK, WSYB, WWSW

LIST OF POLICE BROADCASTING STATIONS

Call	Kilocycles	Meters	Location	Call	Kilocycles	Meters	Location
WFDO	2,458	122.05	Akron, Ohio	WRDS	1,682	189.51	Ingham, Mich.
WFDY	2,452	122.34	Atlanta, Ga.	KGPE	2,422	123.86	Kansas City, Mo.
WPEP	1,712	175.2	Arlington, Mass.	WPDT	2,470	121.50	Kokomo, Ind.
KOPB	2,416	124.17	Bakersfield, Calif.	WPDL	2,440	123.00	Lansing, Mich.
KOPJ	1,712	175.23	Beaumont, Tex.	KGPL	1,712	175.23	Los Angeles, Calif.
KRW	2,410	124.50	Berkeley, Calif.	WPDE	2,440	123.00	Louisville, Ky.
WFT	1,506	187.97	Boston, Mass.	WPEC	2,470	121.50	Memphis, Tenn.
WPEZ	2,450	122.4	Brooklyn, N. Y.	WPDK	2,452	122.34	Milwaukee, Wis.
WRDU	1,566	187.97	Brooklyn, N. Y.	KGPE	2,416	124.17	Minneapolis, Minn.
WJJ	2,422	123.86	Buffalo, N. Y.	WPY	438	685.00	New York, N. Y.
WBR	257	1,165.00	Butler, Pa.	WPY	500	600.00	New York, N. Y.
KGOZ	2,470	121.50	Cedar Rapids, Iowa	WCF	1,596	187.97	New York, N. Y.
WFDY	2,458	122.05	Charlotte, N. C.	WPEF	2,450	122.4	New York, N. Y.
WFDH	1,712	175.23	Chicago, Ill.	WPEG	2,450	122.4	New York, N. Y.
WFDG	1,712	175.23	Chicago, Ill.	KGPH	2,452	122.34	Oklahoma City, Okla.
WKDU	1,712	175.23	Chicago, Ill.	KGPI	2,470	121.50	Omaha, Neb.
WRBH	2,452	122.34	Cincinnati, Ohio	KGJX	1,712	175.23	Pasadena, Calif.
WFDI	2,416	124.17	Cleveland, Ohio	WPDG	2,440	123.00	Philadelphia, Pa.
KVI	1,712	175.23	Columbus, Ohio	KGPP	2,416	124.17	Pittsburgh, Pa.
KOPN	2,470	121.50	Dallas, Tex.	WPDH	2,416	124.17	Portland, Ore.
WPDH	2,416	124.17	Davenport, Iowa	WPDH	2,416	124.17	Richmond, Ind.
KOPX	2,442	122.8	Dayton, Ohio	KGPC	1,712	175.23	Rochester, N. Y.
KOPV	2,506	180.51	Denver, Colo.	WPDH	2,416	124.17	St. Louis, Mo.
WKDT	1,596	187.97	Des Moines, Iowa	KGPP	2,470	121.50	St. Paul, Minn.
WCK	2,410	124.50	Detroit, Mich.	KGPD	1,596	187.97	Salt Lake City, Utah.
WPDH	2,410	124.50	Detroit, Mich.	KGPD	2,410	124.50	San Francisco, Calif.
WPDF	2,440	123.00	Detroit, Mich.	KGPM	2,410	124.50	San Francisco, Calif.
KOPR	1,712	175.23	Flint, Mich.	KGPA	2,416	124.17	San Jose, Calif.
WMP	1,662	180.51	Ft. Worth, Tex.	WPEA	2,458	122.2	Seattle, Wash.
KOZA	2,416	124.2	Framingham, Mass.	KOPK	2,470	121.50	Syracuse, N. Y.
WPEB	2,440	123.00	Fresno, Calif.	WRDQ	2,470	121.50	Sioux City, Iowa
WJL	257	1,165.00	Grand Rapids, Mich.	WPDH	2,416	124.17	Toledo, Ohio
WRDR	2,410	124.50	Greensburg, Pa.	WPDH	2,410	124.50	Tulare, Calif.
WBA	257	1,165.00	Grösse Point Village, Mich.	KGPI	2,410	124.50	Vallejo, Calif.
WMO	2,410	124.50	Harrisburg, Pa.	WPDH	2,410	124.50	Washington, D. C.
KOPQ	2,452	122.35	Highland Park, Mich.	WMB	257	1,165.00	West Reading, Pa.
KQZB	1,712	175.2	Honolulu, T. H.	KGIZ	2,452	122.3	Wichita, Kans.
WMDZ	2,440	123.00	Houston, Tex.	WDX	257	1,165.00	Wyoming, Pa.
			Indianapolis, Ind.	WPDG	2,458	122.05	Youngstown, Ohio

U. S. VISUAL BROADCASTING STATIONS

Call	Kilocycles	Meters	Owner	Call	Kilocycles	Meters	Owner
WIXAU	1,500	193.6	Short Wave & Television, Boston, Mass.	W3XAD	48,500	6.18	RCA-Victor, Camden, N. J.
WIXAV	2,950	101.8	Short Wave & Television, Boston, Mass.	W3XAD	60,000	5.00	RCA-Victor, Camden, N. J.
WIXAB	2,750	109.10	Atlantic Broadcasting, New York, N. Y.	W3XAD	2,100	142.90	RCA-Victor, Camden, N. J.
WEXBC	2,750	109.10	United Research Corp., Long Island City, N. Y.	W3XX	2,000	150.00	Jenkins Laboratories, Wheaton, Md.
WEXBU	2,000	150.00	Harold E. Smith, Beacon, N. Y.	W6X4H	2,000	150.00	Pioneer Mercantile Co., Bakersfield, Calif.
WEXCD	2,000	150.00	DeForest Radio Co., Passaic, N. J.	W6XAO	43,000	6.97	Don Lee, Inc., Los Angeles, Calif.
WEXCR	2,100	142.90	Jenkins Television, Jersey City, N. J.	W6XS	2,100	142.90	Don Lee, Inc., Los Angeles, Calif.
WEXCR	2,000	150.00	Jenkins Television, Jersey City, N. J.	W8XAV	2,100	142.90	Westinghouse, East Pittsburgh, Pa.
WEXCW	2,100	142.90	General Electric, Schenectady, N. Y.	W9XAA	2,750	109.10	Federation of Labor, Chicago, Ill.
WEXDA	1,544	194.30	Atlantic Broadcasting, New York, N. Y.	W9XAB	1,564	191.82	Federation of Labor, Chicago, Ill.
WEXDH	43,000	6.98	Jenkins Television, New York, N. Y.	W9XAO	2,000	150.00	Western Television Corp., Chicago, Ill.
WEXDH	48,500	6.19	Jenkins Television, New York, N. Y.	W9XAP	2,100	142.90	National Broadcasting, Chicago, Ill.
WEXDH	60,000	5.00	Jenkins Television, New York, N. Y.	W9XD	43,000	6.97	Journal Company, Milwaukee, Wis.
WEXDF	43,000	6.97	National Broadcasting, New York, N. Y.	W9XD	48,500	6.18	Journal Co., Milwaukee, Wis.
WEXDF	48,500	6.18	National Broadcasting, New York, N. Y.	W9XD	60,000	6.00	Journal Co., Milwaukee, Wis.
WEXDF	60,000	5.00	National Broadcasting, New York, N. Y.	W9XG	2,750	109.10	Purdue University, W. Lafayette, Ind.
W2XR	2,850	105.30	Radio Pictures, Inc., Long Island City, N. Y.	W9XR	2,850	105.30	Great Lakes Broadcasting, Chicago, Ill.
WIXAD	43,000	6.97	RCA-Victor, Camden, N. J.				

U. S. RELAY BROADCASTING STATIONS

Call	Kilocycles	Meters	Owner	Call	Kilocycles	Meters	Owner
WIXAL	6,040	49.67	Short Wave Bdcstg. Corp., Boston, Mass.	W6XAF	2,938	112.10	Dept. Agriculture, Sacramento, Calif.
WIXAL	11,800	25.42	Short Wave Bdcstg. Corp., Boston, Mass.	W6XAF	5,870	51.11	Dept. Agriculture, Sacramento, Calif.
WIXAL	15,250	19.67	Short Wave Bdcstg. Corp., Boston, Mass.	W6XAL	6,080	49.34	Pacific-Western Broadcasting, Westminster, Calif.
WIXAL	21,400	13.97	Short Wave Bdcstg. Corp., Boston, Mass.	W6XAL	15,250	19.67	Pacific-Western Broadcasting, Westminster, Calif.
WIXAZ	9,570	31.35	Westinghouse Elec., East Springfield, Mass.	W6XAL	21,500	13.95	Pacific-Western Broadcasting, Westminster, Calif.
WIXAZ	15,340	19.58	General Electric, Schenectady, N. Y.	W6XN	12,850	23.35	General Electric, Oakland, Calif.
WEXAF	9,530	31.48	General Electric, Schenectady, N. Y.	W8XAL	6,060	49.50	Crosley Radio Corp., Cincinnati, Ohio
WEXAG	550	545.00	General Electric, Schenectady, N. Y.	W8XK	6,140	48.86	Westinghouse, East Pittsburgh, Pa.
WEXAG	660	455.00	General Electric, Schenectady, N. Y.	W8XK	9,570	31.35	Westinghouse, East Pittsburgh, Pa.
WEXAG	700	380.00	General Electric, Schenectady, N. Y.	W8XK	11,880	25.25	Westinghouse, East Pittsburgh, Pa.
WEXAG	1,150	260.00	General Electric, Schenectady, N. Y.	W8XK	15,210	19.72	Westinghouse, East Pittsburgh, Pa.
WEXAG	1,500	200.00	General Electric, Schenectady, N. Y.	W8XK	17,780	16.87	Westinghouse, East Pittsburgh, Pa.
WEXAG	6,120	49.02	Atlantic Broadcasting, Jamaica, N. Y.	W8XK	21,540	13.93	Westinghouse, East Pittsburgh, Pa.
WEXE	11,840	25.34	Atlantic Broadcasting Co., Jamaica, N. Y.	W9XAA	6,080	49.34	Federation of Labor, Chicago, Ill.
WEXE	15,280	19.63	Atlantic Broadcasting Co., Jamaica, N. Y.	W9XAA	11,840	25.34	Federation of Labor, Chicago, Ill.
WEXZ	610	491.50	National Broadcasting, Bellmore, N. Y.	W9XAA	17,780	16.87	Federation of Labor, Chicago, Ill.
WEXAL	6,100	49.18	National Broadcasting, New York, N. Y.	W9XF	6,020	49.83	Great Lakes Broadcasting, Chicago, Ill.
WEXAL	6,425	46.70	National Broadcasting, New York, N. Y.	W9XF	11,800	25.42	Great Lakes Broadcasting, Chicago, Ill.
WEXAU	9,590	31.28	Universal Broadcasting, Newton Township, Pa.	W9XF	21,500	13.95	Great Lakes Broadcasting, Chicago, Ill.
WEXAU	9,590	31.28	Universal Broadcasting, Newton Township, Pa.	W9XU	6,060	49.50	Mona Motor Oil Co., Council Bluffs, Iowa
W4XA	2,368	126.7	Miami, Fla.				

SIMPLE TIME CHART

(Time changes every 15 degrees of Longitude East or West)

LONGITUDE WEST OF GREENWICH	180°	165°	150°	135°	120°	105°	90°	75°	60°	45°	30°	15°	0°
PLACES ON, OR NEARLY ON, THE MERIDIAN INDICATED.	FIJI ISLANDS	UNALASKA	SEWARD	JUNEAU	LOS ANGELES	DENVER	CHICAGO	NEW YORK	BUENOS AIRES	RIO JANEIRO	AZORES	ICELAND	(GREENWICH) LONDON
TIME	Midnight	1 a.m.	2 a.m.	3 a.m.	4 a.m.	5 a.m.	6 a.m.	7 a.m.	8 a.m.	9 a.m.	10 a.m.	11 a.m.	Noon

↑ International date line. When it's Monday East of 180° it is Tuesday West of 180°. ↓

LONGITUDE EAST OF GREENWICH	0°	15°	30°	45°	60°	75°	90°	105°	120°	135°	150°	165°	180°
PLACES ON, OR NEARLY ON, THE MERIDIAN INDICATED.	(GREENWICH) LONDON	BERLIN	ODESSA CAIRO	ADEN	MAURITIUS ISL.	LAHORE	CALCUTTA	BATAVIA	MANILA	KOBE	EASTERN AUSTRALIA	NEW CALEDONIA	FIJI ISLANDS
TIME	Noon	1 p.m.	2 p.m.	3 p.m.	4 p.m.	5 p.m.	6 p.m.	7 p.m.	8 p.m.	9 p.m.	10 p.m.	11 p.m.	Midnight

FOREIGN BROADCAST STATIONS

Table with columns: Call, Location, Kc., Call, Location, Kc., Call, Location, Kc. It lists broadcast stations for various countries including Algeria, Argentina, Australia, Austria, Belgium, Bermuda, Bolivia, Brazil, Canada, Chile, China, Chosen, Colombia, Costa Rica, Cuba, Czechoslovakia, Danzig, Denmark, Dominican Republic, Dutch East Indies, Egypt, Estonia, Finland, France, Germany, and others.

Table with columns: Call, Location, Kc. It lists radio call signs and frequencies for various countries including Great Britain, Guatemala, Haiti, Holland, Honduras, Hong Kong, Hungary, Iceland, India, Irish Free State, Italy, Japan, Kenya, Kwantung, Latvia, Lithuania, Luxemburg, Mexico, Monaco, Morocco, Newfoundland, New Zealand, Norway, Peru, Philippine Islands, Poland, Portugal, Rumania, Salvador, Samoa, Siam, Spain, Sweden, Switzerland, Tunisia, Turkey, Union of Soviet Socialist Republics, and Yugoslavia.

FOREIGN SHORT WAVE PHONE STATIONS

Call	Location	Kc.	Call	Location	Kc.	Call	Location	Kc.
ARGENTINA			FINLAND			MEXICO CITY		
LSX	Buenos Aires	10,352	FYR	Agen	9,760	XFD	Mexico City	6,667
LSG	Buenos Aires	19,900	FYR	Lyons	7,463	XFD	Mexico City	9,091
LSN	Buenos Aires	21,200	FYR	Lyons	5,172	XFD	Mexico City	11,111
AUSTRALIA			FRANCE			MEXICO CITY		
VK3ME	Melbourne	9,510	F8AV	Nancy	19,350	XFA	Mexico City	6,977
VK6AG	Perth	7,194	F8AV	Nogent	3,750	XFA	Mexico City	7,143
VK2ME	Sydney	10,526	FLJ	Paris	9,230	XFA	Mexico City	21,249
VLK	Sydney	10,526	F8LIH	Paris	7,317	MONACO		
AUSTRIA			F8GC	Paris	6,860	MOROCCO		
.....	Vienna	13,514	F8GC	Paris	4,918	CN8MC	Casablanca	6,881
UOR2	Vienna	11,801	Pontoise-Seine-et-Oise	11,720	CN8MC	Casablanca	5,882
OUTH	Vienna	8,060	Pontoise-Seine-et-Oise	11,905	Rabat	12,610
UOR2	Vienna	6,072	Pontoise-Seine-et-Oise	15,243	Rabat	9,300
OHK2	Vienna	4,274	F8BP	Rugles	5,455	Rabat	12,005
BELGIUM			FTD	St. Assise	19,840	Rabat	9,300
BOLIVIA			FRO	St. Assise	19,417	NEWFOUNDLAND		
BRAZIL			FRE	St. Assise	19,417	VO8A	St. Johns	6,800
PPU	Rio de Janeiro	6,122	FTM	St. Assise	19,355	NEW ZEALAND		
PPU	Rio de Janeiro	19,270	FTO	St. Assise	18,248	ZL2XX	Wellington	9,550
BRITISH COLONIES			FTE	St. Assise	18,248	NORWAY		
VRY	Georgetown, Guiana	6,726	FSE	St. Assise	13,441	PERU		
TJW	Hamilton, Bermuda	9,500	FQO	St. Assise	12,161	PHILIPPINE ISLANDS		
.....	Mombasa, Kenya	13,895	FQE	St. Assise	12,161	KA1XR	Manila	12,245
.....	Mombasa, Kenya	8,230	FTN	St. Assise	12,265	KZRM	Manila	11,840
VQ7LO	Nairobi, Kenya	6,100	FTL	St. Assise	9,950	KZRM	Manila	9,570
VS6WX	Singapore	7,190	FTF	St. Assise	7,770	KZRM	Manila	6,140
CANAL ZONE			FTB	Touraine	7,500	POLAND		
CANADA			Toulouse	6,122	Poznan	11,001
VE9GW	Bowmanville, Ont.	6,095	FRENCH COLONIES			Poznan	8,900
VE9GW	Bowmanville, Ont.	11,810	FM8KR	Constantine	7,009	PORTUGAL		
VE9GW	Bowmanville, Ont.	24,380	FM8KR	Constantine	3,750	PT1AA	Lisbon	7,143
VE9CG	Calgary, Alta.	6,110	GERMANY			Oporto	12,000
VE9CA	Calgary, Alta.	6,030	Elberswalde	7,407	ROUMANIA		
VE9CA	Calgary, Alta.	6,030	Kothen	7,042	YO1	Bucharest	13,950
VE9CA	Calgary, Alta.	11,860	Nauen	11,760	SALVADOR		
VE9DR	Drummondville, Que.	11,780	Nauen	15,200	SHIP PHONE STATIONS		
VE9CF	Halifax, N. S.	6,050	Nauen	6,020	GMJQ	SS. Belgenland	17,650
VE9CL	Middlechurch, Man.	6,150	Nauen	17,760	GMJQ	SS. Belgenland	13,040
VE9DN	Montreal, Que.	6,005	Nauen	9,580	GMJQ	SS. Belgenland	8,570
VE9DN	Montreal, Que.	9,580	GREAT BRITAIN			GMJQ	SS. Belgenland	4,762
VE9DN	Montreal, Que.	11,895	Bodmin	18,105	DDDX	SS. Bremen	11,710
VE9BA	Montreal, Que.	6,130	Bodmin	9,260	DDDX	SS. Bremen	7,560
VE9BA	Montreal, Que.	11,705	Chelmsford	11,750	IBDX	SS. Electra (Marconi's Yacht)	11,240
VE9BA	Montreal, Que.	15,190	Rugby	16,164	SS. Hamburg	13,040
VE9AK	Red Deer, Alta.	2,830	Rugby	18,310	GDLJ	SS. Homeric	12,380
VE9BL	St. John, N. B.	6,090	Rugby	18,138	GDLJ	SS. Homeric	4,754
VE9CS	Vancouver, B. C.	6,070	Rugby	14,493	WSBN	SS. Leviathan	8,830
CURACAO			GRU	Rugby	12,290	WSBN	SS. Leviathan	6,637
PJZ	Curacao	11,718	GRX	Rugby	12,195	WSBN	SS. Leviathan	4,392
CZECHOSLOVAKIA			GBS	Rugby	12,195	WSBN	SS. Leviathan	3,429
.....	Bratislava	5,000	GBW	Rugby	12,195	GFVV	SS. Majestic	17,590
OK1MPT	Prague	5,119	GRW	Rugby	12,195	GFVV	SS. Majestic	13,228
OK1MPT	Prague	4,412	GRU	Rugby	12,195	GFVV	SS. Majestic	4,430
CHILE			GHS	Rugby	9,020	GFVV	SS. Majestic	4,180
CHINA			GHS	Rugby	6,993	GLSQ	SS. Olympic	12,387
XCTE	Shanghai	5,000	GBS	Rugby	9,020	GLSQ	SS. Olympic	16,456
COLOMBIA			G2MN	Sonning-on-Thames	14,320	GLSQ	SS. Olympic	8,840
HKA	Barranquilla	5,837	HAITI			SIAM		
HKD	Barranquilla	6,993	GUATEMALA			HS2PJ	Bangkok	10,169
HKF	Bogota	7,194	HOLLAND			HSP2	Bangkok	9,500
HKF	Bogota	7,610	Hague	6,438	HSP2	Bangkok	7,300
HKC	Bogota	6,250	Hilversum	9,590	SPAIN		
HKX	Bogota	6,977	Hilversum	15,220	EAJ1	Barcelona	15,789
HKX	Bogota	7,143	Huizen	17,775	EAR96	Barcelona	6,522
COSTA RICA			Kootwijk	18,400	EAR25	Barcelona	6,000
TIH	Heredia	9,734	Kootwijk	17,836	EAR58	Las Palmas, Canary Islands	7,210
TITR	San Jose	11,790	HONDURAS			EAR110	Madrid	7,026
CUBA			HRB	Tegucigalpa	6,170	EAR125	Madrid	7,026
CM2LA	Havana	10,007	HUNGARY			EAJ25	Malaga	3,000
CM2MK	Havana	9,360	HAT	Szekesfehervar	9,125	EAR113	Viscaya	6,522
CM6XJ	Tuinucu	15,008	ICELAND			SWEDEN		
DANZIG			VUC	Calcutta	11,870	Motala	6,070
EK4ZZZ	Danzig	7,500	INDIA			SWITZERLAND		
DENMARK			F31CD	Chi-hoa	6,122	HB90C	Berne	9,130
OXZ	Skamlaback	9,520	FZR	Saigon	16,216	HB9XD	Zurich	9,380
DOMINICAN REPUBLIC			FZR	Saigon	12,043	HB9XD	Zurich	7,229
H1X	Santo Domingo	4,610	IRISH FREE STATE			HB9XD	Zurich	3,488
DUTCH EAST INDIES			ITALY			TURKEY		
PMB	Bandoeng	20,620	12RO	Rome	11,811	UNION OF SOVIET SOCIALIST REPUBLICS		
PLB	Bandoeng	18,830	12RO	Rome	3,750	RW15	Khabarovsk	4,273
PLG	Bandoeng	15,957	1MA	Rome	6,897	RW3KAA	Leningrad	8,333
PMY	Bandoeng, Java	5,172	12RO	Rome	3,750	Leningrad	11,111
PK2AF	Djoejacorta, Java	6,000	Turin	3,750	Leningrad	10,526
PK6KZ	Makassar	11,765	HVJ	Vatican City	5,968	RW62	Minsk	6,420
PK2AG	Semarang, Java	2,609	HVJ	Vatican City	15,120	RW61	Moscow	51,724
PK3AN	Surabaya, Java	6,036	JAPAN			RW38	Moscow	5,514
.....	Surabaya	2,143	JIAA	Kemikawa	17,391	RW59	Moscow	6,000
PK1AA	Weltevreden, Java	4,000	JIAA	Kemikawa	8,000	Moscow	6,611
ECUADOR			JUGOSLAVIA			RW50	Moscow	11,924
.....	Riobamba	7,540	Belgrade	10,000	RW65	Peredvijka	3,560
EGYPT			LATVIA			RW19	Tomsk	8,111
ESTONIA			LITHUANIA			URUGUAY		
FIJI			MADAGASCAR			UNION OF SOUTH AFRICA		
VPD	Suva	14,430	Tananarive	6,000	ZTJ	Johannesburg	9,380
MEXICO			MADEIRA			VENEZUELA		
XDA	Mexico City	14,634	CT3AG	Funchal	6,383			
XDA	Mexico City	9,380	MEXICO					
XDA	Mexico City	6,818	XDA	Mexico City	14,634			

Permanent Magnet Dynamic Speakers

By H. S. Knowles *

ALTHOUGH Permanent Magnet dynamic speakers have been in production less than a year in this country, they have gained the same widespread acceptance that was accorded the electro-dynamic during its first year. Neither the idea nor Permanent Magnet speakers themselves are new. Some of the earliest moving coil receivers used permanent magnets. Dynamic speakers of this type have been in general use in Europe for over two years. Their acceptance in this country, however, has awaited the introduction of designs comparable in both performance and cost with electro-dynamic types.

The P-M dynamic speaker is a dynamic speaker in its essential constructional features and in its performance. It uses a moving coil and cone assembly of the same type used in electro-dynamic speakers. It differs from the latter only in that instead of having an electro magnet, it has a permanent magnet which supplies the requisite flux in the gap. It therefore resembles the ordinary "magnetic" speaker only in that no source of field current is required. It does not have a "reed" or soft iron armature nor any of the lever system connecting the reed or armature to the cone assembly.

This difference in construction is importance since, in the P-M, the voice coil movement is restricted only by the cone and cone support design. In the magnetic type the sensitivity falls off rapidly as the gap is opened up to permit the armature the greater excursion which is needed at the low frequencies. It is this difference in the low frequency response which has brought about the widespread acceptance of the permanent magnet and electro-dynamic speakers. The latest P-M designs have sensitivities which are comparable with corresponding electro-dynamic speakers with a field excitation of $3\frac{1}{2}$ to 4 watts. Where the excitation in the electro-dynamic type is increased to 6 or 8 watts, which is the maximum recommended for small structures, the sensitivity of the electro-dynamic is from 2 to 3 decibels greater than that of the P-M dynamic.

Because of the magnet cost, P-M dynamic speakers are slightly more expensive than the DC type of electro-dynamic, although quite a bit less expensive than the electro-dynamic types which provide their own field excitation, that is, the types which

* Chief Engineer, Jensen Radio Manufacturing Company.

have a dry or tube rectifier and supply the field excitation from the 110 volt-AC line.

Its application is therefore logical in places where electro-dynamic performance is wanted but without the disadvantage of having to supply field current. It is therefore of primary value in battery operated receivers. It is also of value as a second speaker to be used on an extension line from the usual radio receiver, or as a second speaker in a two-speaker set design. In both of these cases a self-excited speaker is required because

equivalent. In general, a high voltage distribution system to the fields is used, and this, with its attendant wiring and installation problem, greatly increases the *installed* cost of the electro-dynamic speaker. In the P-M dynamic, although the initial cost of the speaker is a trifle higher, the installed cost is very much less, since by supplying the voice coil circuits through low impedance lines, all of the wiring can be of the open or semi-open type. Then, too, no provision has to be made for cutting off the field excitation at the speaker.

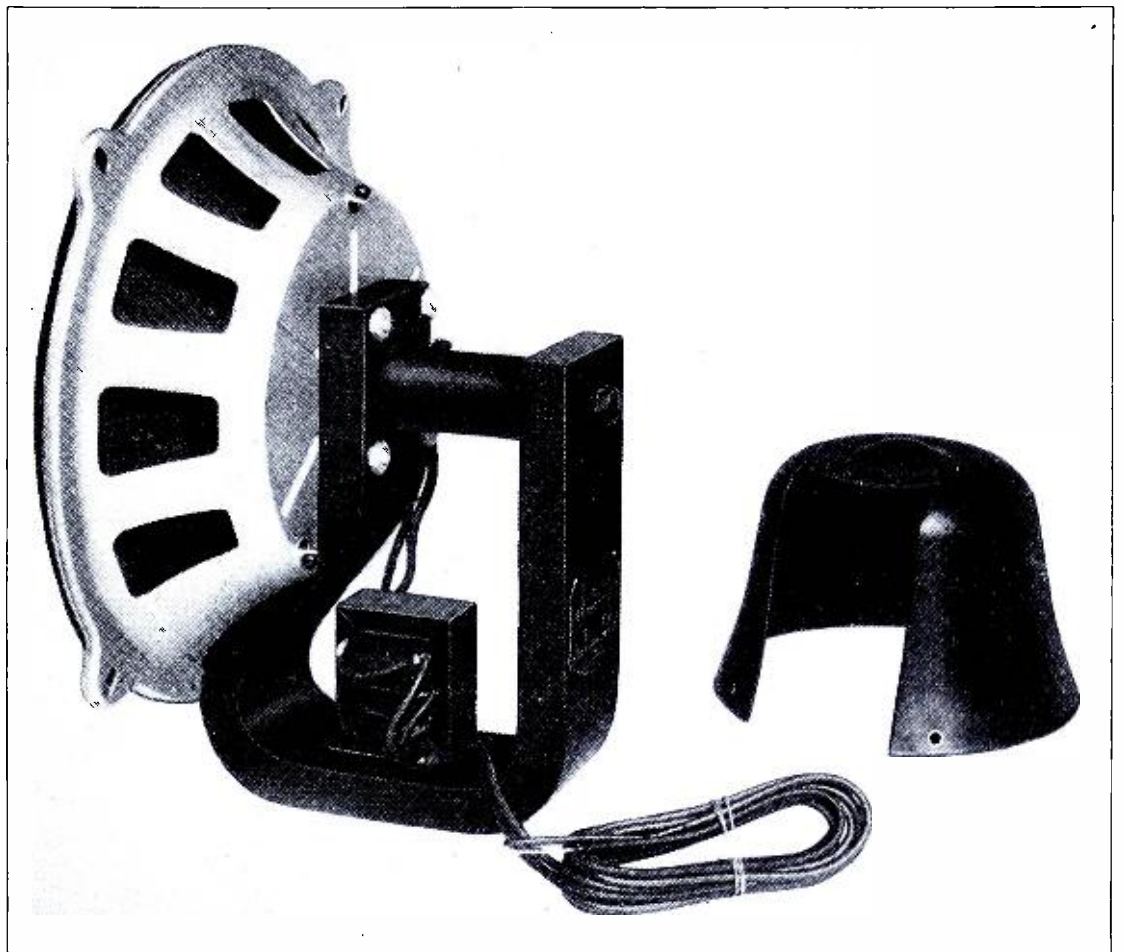

A Permanent Magnet Type Dynamic Reproducer with the Cover Removed to Show Constructional Details of This New Type Speaker

the radio set, unless specifically designed to do so, does not supply field current for the second speaker. Ordinarily, when such a speaker is added, it either has to have its own rectifier system, or if field current is taken from the receiver, it drops the operating voltages of the tubes in the receiver and affects their performance.

The P-M dynamic speaker is also very valuable in public address systems. Electro-dynamic speakers have not been generally used for this purpose because of their field excitation requirements. In most cities, lines carrying over 12 volts have to be run in armored cable, conduit, or the

The apparent sensitivity of most magnetic speakers is high because of the fact that the moving system is tuned to a frequency between 150 and 350 cycles. This rise in the middle of the range, in which the fundamental frequencies of speech occur, produces unnatural or "yappy" reproduction. It does, however, increase the apparent sensitivity. Recourse is had to the same design practice in the smallest and least expensive electro-dynamic types where high apparent sensitivity at the cost of fidelity is wanted.

The clear reproduction of the low frequencies, while highly desirable
(Continued on next page)

Permanent-Magnet Dynamic Speakers

(Continued from page 15)

for high-grade reproduction, does have one disadvantage. It has been found in the cheaper type of building construction which is now prevalent that the sound transmission through the thin walls is sufficient at the low frequency end to introduce the problem of "cross-talk" between rooms. In high grade installations the trend, therefore, appears to be toward the use of a speaker in a small attractive cabinet as a part of the room furniture. This also takes care of the problem of baffling the speaker and greatly simplifies the installation of the speaker where the building is already constructed.

The separate speaker idea is also gaining headway in hotels. If the speakers are supplied only at the request of the guest, the average number of speakers in use is usually about 50% of the number that would be required if every room were provided with a built-in speaker. This considerably reduces the initial cost of the installation and permits an extension of the service as needed. In this case, nothing is provided in the wall except a flush outlet box with a jack into which the speaker is plugged and the station selector switch and volume control where needed.

Although, as pointed out above, the dynamic speaker does not have the same apparent sensitivity as the largest types of magnetics (although the average is the same when the entire register is considered), even this difference in apparent sensitivity is offset in a case of battery operated receivers by the use of Class B or "push-push" amplifiers. This type of amplifier, which is being used in the latest battery operated receivers with dynamic speakers, results in as much acoustic output as can be secured from electro-dynamic speakers excited with 6 or 8 watts and using the same tubes in push-pull. In other words, Class B amplifiers have permitted the use of P-M dynamic speakers with electro-dynamic fidelity on battery operated receivers.

The fidelity of the PM-1 speaker in a 3 ft. baffle (which corresponds to a good size console cabinet) is shown in Figure 1-A. The same speaker run in a small table type cabinet is shown in the same figure, Curve B. It will be noted that due to the smaller effective baffle size of the table type cabinet the low frequency output is reduced. Figure 2, Curve A, shows a magnetic speaker now commonly supplied for P.A. systems but run in a 3 ft. baffle under conditions corresponding exactly to Curve A, Fig. 1. Curve B, Fig. 2, shows a very great reduction in low frequency response when the

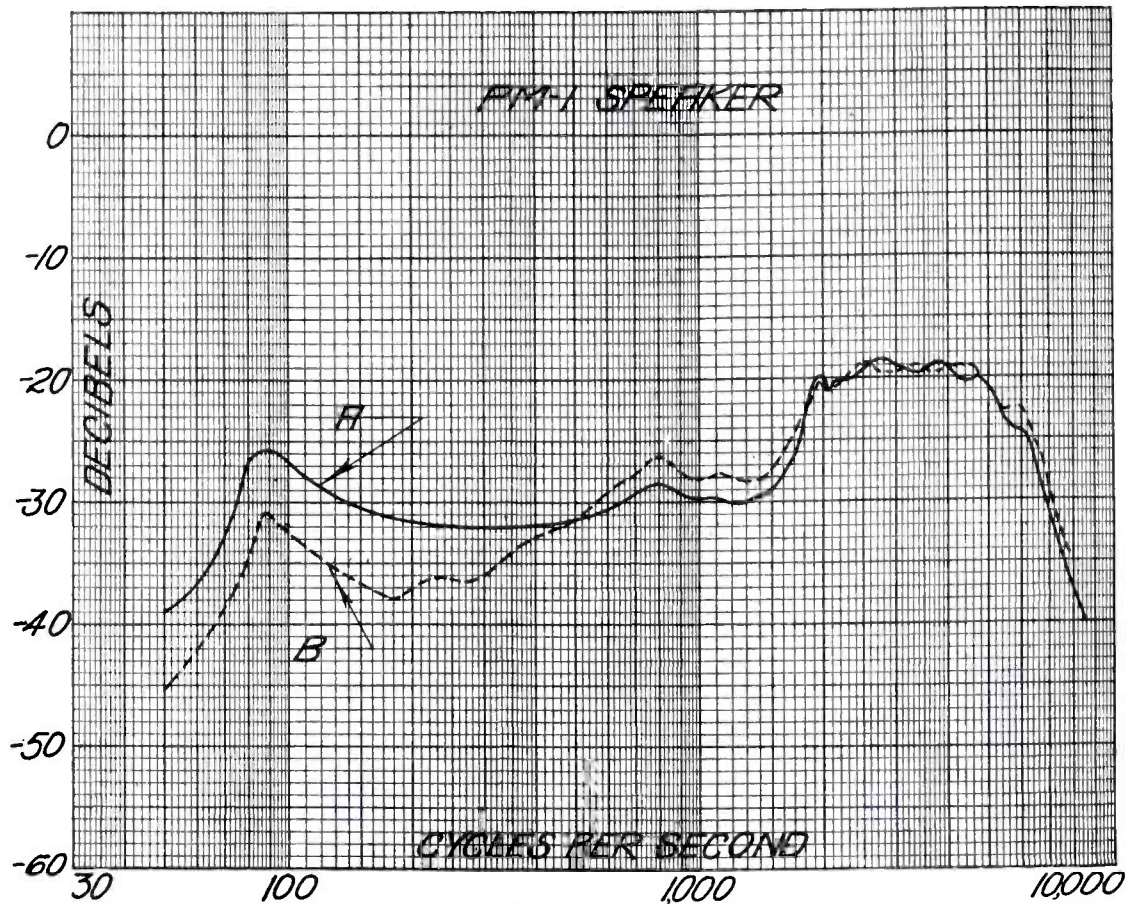

Figure 1

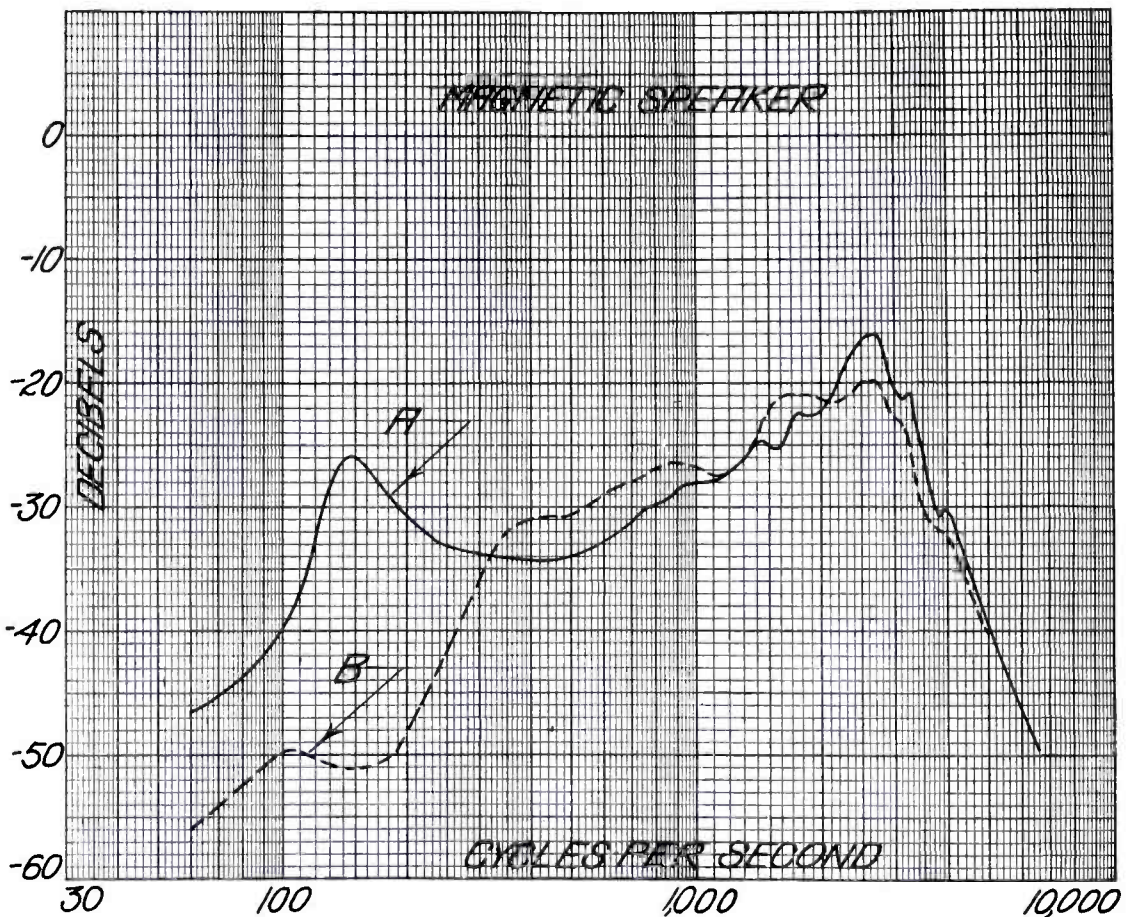

Figure 2

magnetic speaker is put into the flush mounting case with which it is supplied for P.A. installations. The reduction in output at the low end is due to the complete enclosure and the absence of venting. A comparison between Curve B, Fig. 1, and Curve B, Fig. 2, shows the improved low and high frequency response of the P-M type speaker, even when it is used in a small baffle.

The apparent bass of the magnetic designs is frequently increased by re-

ducing the high frequency response. This effect is also clearly shown in the curves.

Speakers with fidelity curves which differ from those given in Fig. 1 can also be supplied to improve the combined fidelity of the speaker and P.A. system.

The impedance of the electro-dynamic type is much more uniform than a magnetic type and is an almost ideal load into which to work out of

(Continued on page 46)

Tube for Amateurs and Experimenters

RCA Radiotron Co., Inc., and E. T. Cunningham, Inc., have recently made available for amateurs and experimenters a voltage amplifier tube designated as Radiotron UX-841 and Cunningham CX-841.

The 841 is a three-electrode, high vacuum tube which resembles the '10



type in general appearance and filament characteristics but has a high amplification factor. It is designed primarily for use as a voltage amplifier in resistance or impedance coupled circuits. In addition to this use, the 841 may also be employed to advantage in amateur transmitters as an oscillator, a crystal-controlled oscillator, a radio-frequency power amplifier, and a frequency doubler.

Characteristics and typical operating conditions for different applications of the 841 are given in the accompanying table. For convenience in presentation, the information has been tabulated in four divisions. The first division, *General Data*, includes information common to all applications. The other three divisions, under the headings of *Class A*, *Class B*, and *Class C Service*, cover operating conditions for specific applications. These three classifications are the accepted ones used by radio engineers for broadly identifying tube applications.

Class A Service is employed in the operation of well-designed audio-frequency and radio-frequency amplifiers of radio receivers. For this use, fidelity of signal reproduction is of prime importance. However, fidelity is obtained at the expense of power output and at relatively low efficiency. The 841 as a Class A Amplifier is operated under such conditions that its dynamic characteristics are essentially linear.

Class B Service is employed in radio-frequency power amplifiers and in balanced or push-pull modulators of radio telephone transmitters. It is also finding application for power output stages of some of the more recent designs of radio receivers. For these uses, large power output is obtained without distortion and with good efficiency. However, to obtain this large power, a large exciting grid voltage is required. The 841 as a Class B Amplifier is operated under such conditions that with no exciting grid voltage applied to the tube, the plate current is very small. Under these conditions when excitation voltage is applied, only the least negative half of this voltage produces power output.

Class C Service covers those applications where tubes are employed as oscillators or radio-frequency power amplifiers for transmitters. For these uses very large power output with high efficiency is of primary consideration. However, this high output is obtained at the expense of considerable harmonic distortion. This distortion introduced in the output may be an advantage, as for example in the case of frequency doubler circuits. In the case of a transmitting power output

stage, the harmonics are removed from the fundamental frequency by means of suitable filters. The 841 as a Class C Amplifier is operated under such conditions that the grid is biased well beyond the point at which plate cur-

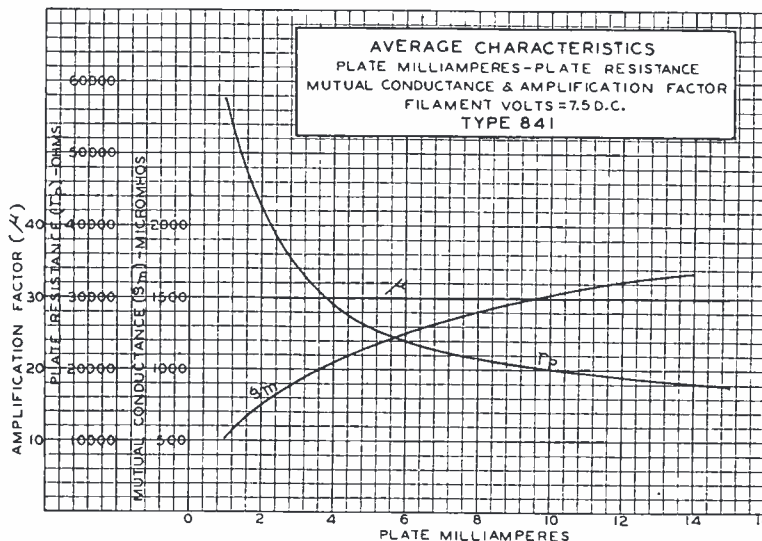
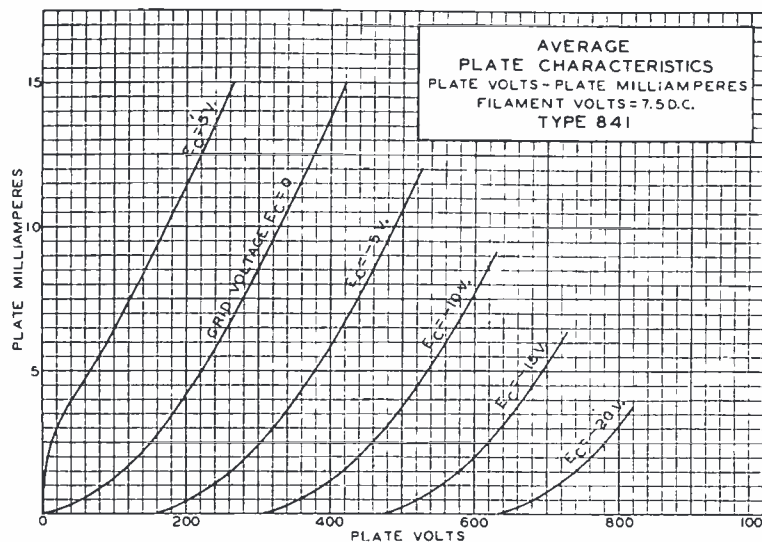

rent starts. Under these conditions when excitation voltage of sufficient magnitude is applied, large peaks of plate current are obtained in the output of the tube. Below are the operating conditions for Class A service.

Operating Conditions and Characteristics—Class A Service

Maximum Operating Plate Voltage.....		425 Volts
Maximum Plate Dissipation.....		12 Watts
Typical Operation:		
Filament Voltage (D.C.).....	7.5	7.5 Volts
Plate Supply Voltage.....	425*	1000 Volts*
Grid Voltage†.....	-5.8	-9.2 Volts
Load Resistance.....	250000	250000 Ohms
Amplification Factor.....	30	30
Plate Resistance.....	63000	40000 Ohms
Mutual Conductance.....	450	750 Micromhos
Plate Current.....	0.7	2.2 Milliamperes
Peak Grid Swing.....	5.8	9.2 Volts
Output Voltage (5% 2nd Harmonic).....	126	225 Volts

* The voltage effective at the plate is less than the supply voltage by an amount equal to the voltage drop in the load resistance.
† If grid leak resistor is used, its value should not exceed 0.5 megohm.

Receiver Performance Curve Section

SERVICE men, dealers and technicians will find on this page our conception of an ideal set of curves. The composite graph may be used to visualize the best possible receiver performance. The more a receiver's curves near parallelism with the ideal, the better the receiver. These curves are not capable of interpretation by a layman. They should be translated only by a service man, dealer, technician or engineer.

Measurements made in our engineering laboratory cover sensitivity, selectivity and electrical fidelity. Standards for these three qualities have been set by the IRE and RMA engineering committees. No standards have yet been adopted for sound pressure measurements. Until a standard is selected, our laboratory will measure only electrical fidelity, which disregards speaker response curves. The fourth measurement appearing with the sensitivity, selectivity and electrical fidelity curves represents power overload curves, or automatic volume control curves, as the case may be.

Definitions of the three major characteristics of a receiver are:

Sensitivity is that characteristic of a receiver which determines to how weak a signal it is capable of responding. It is measured quantitatively in terms of the input voltage required to give standard output. The ideal sensitivity, according to the graph on this page, would fall between the two lines, ranging from 10 to 5 microvolts (absolute) or less. This is an arbitrary value.

Selectivity is the degree to which a receiver is capable of differentiating between the desired signal, and signals of other carrier frequencies. This characteristic is not expressible by a single numerical value, but requires one or more graphs for its expression.

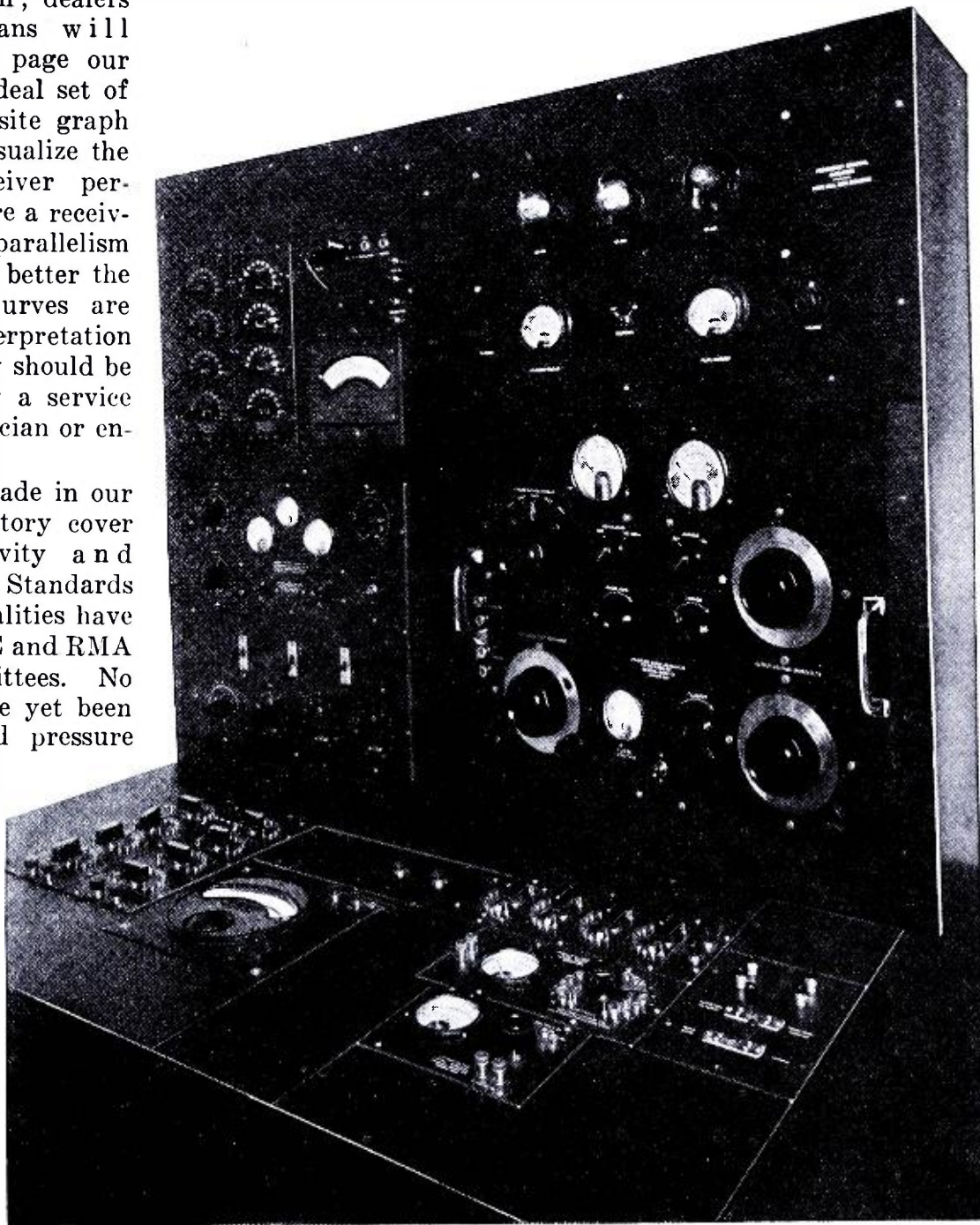

sides would be 10 kilocycles apart nearly all the way up the graph sheet. Selectivity as measured by our laboratory only concerns itself with energy entering the receiver via the input circuit (disregarding shielding effectiveness), since no standard has as yet been adopted to simulate selectivity conditions in the field.

Fidelity is the degree to which the receiver accurately reproduces at its output terminals, the modulated form of the received wave impressed upon it. Ideal electrical fidelity curve would be a horizontal line almost flat over the frequency range from 60 to 5000 cycles. This range is also of

Best selectivity possible would be somewhat like a "chimney" whose

an arbitrary width.

The photograph illustrates the equipment used in making the measurements. It conforms to the specifications of the IRE and RMA Standardization Committees. All test frequencies are determined by zero beat of a crystal-controlled dynatron oscillator. Voltmeters and microvoltmeters are periodically checked against calibrated standards for accuracy of adjustment. Individual conditions of measurement pertaining to each receiver will be found in the text accompanying each family of curves.

Since curves of all receivers are taken under the same conditions, it may be said that such curves constitute a yardstick by which receivers of the same general class may be compared, as long as this analysis is made by those technically competent to do so.



Ideal Composite Curve

All American Mohawk, Lyric Model S-6

OVERALL performance curves on the All-American Mohawk, Lyric model S-6 are given herein.

A dummy antenna standard of 20 uh, 200 uuf and 25 ohms fed the signal to the receiver antenna circuit.

changes were made in the alignment of the tuned circuits, and the tubes employed were furnished as standard equipment with the chassis. The receiver drain was .61 amperes with an a-c line voltage of 118.

An average sensitivity of 33.4

of 3.52 watts is taken, but this value does not take into account the harmonic contents of the audio wave form. Tabulated band widths will be found under the selectivity curves of column 3.

The schematic wiring diagram will

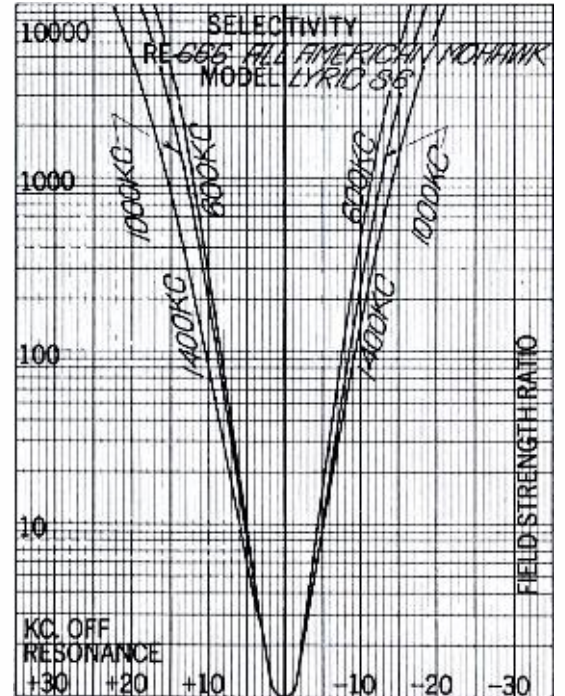
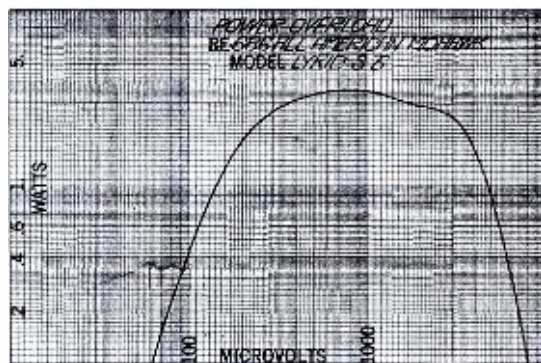
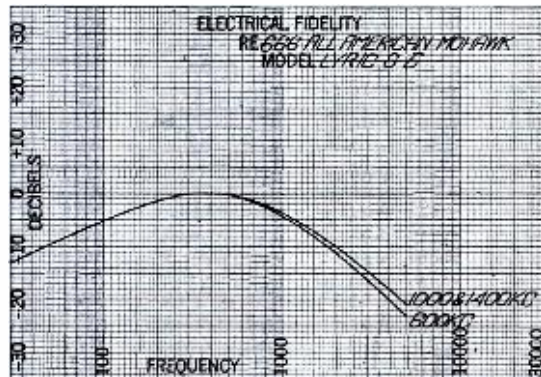
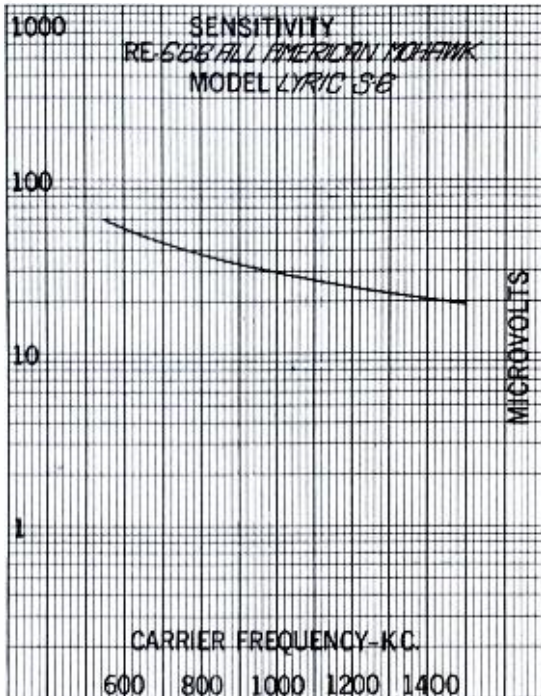

To match the 247 pentode output tube, a load resistance of 7000 ohms was connected across the plate circuit, and the output indicating device was in turn capacitatively coupled to it. An audio level of .05 watts output was maintained except for the power overload curve. To prevent any errors due to reflected impedance, the voice coil circuit was opened during measurements.

In all tests, the volume control was turned to its maximum position, no

microvolts absolute is taken from the curve of column 1. This is equivalent to 8.35 microvolts per meter. Noise levels were 2.8 per cent at 1400 kc, and 1.2 per cent at 600 kc, the maximum and minimum respectively. With the dial adjusted to 1000 kc, the measured image ratio was 1675. From the power overload curve of column 3, the maximum audio output

be found under this article. Tubes required for operation are, a 224 first detector, 227 oscillator, 235 second i-f. 224 second detector, 247 pentode, and a 280 rectifier.

Band Widths

Times Field Strength	Kilocycles width		
	600 kc.	1000 kc.	1400 kc.
10	9.5	10	11.5
100	16	17.5	20
1000	23.5	25.5	30
10000	33.5	37.5	43.5

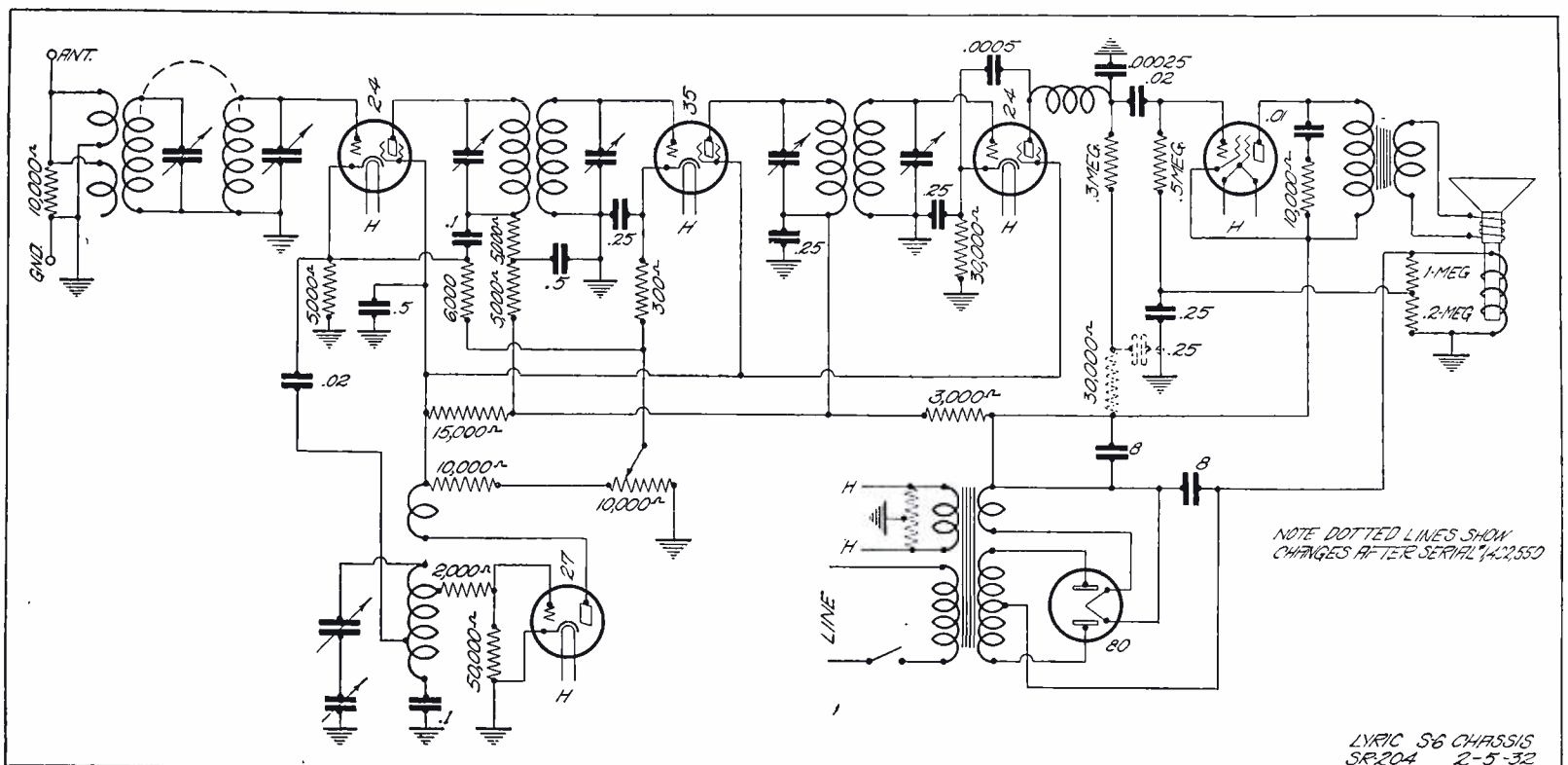

Hammarlund Comet Model

MEASUREMENTS made on the Hammarlund Comet model combination broadcast and shortwave superheterodyne will be found on this page.

Signal generator output was fed to the receiver input circuit by means of

was made on the tuned circuits, and average tubes were used because none was furnished with the receiver. With an a-c line voltage of 110 volts, the power transformer primary drain was .79 amperes.

Average sensitivity is computed to

into consideration the harmonics present in the wave form across the primary of the output transformer. In tabular form, under the selectivity curves of column 3, are the band widths taken from them.

Below is the schematic wiring dia-

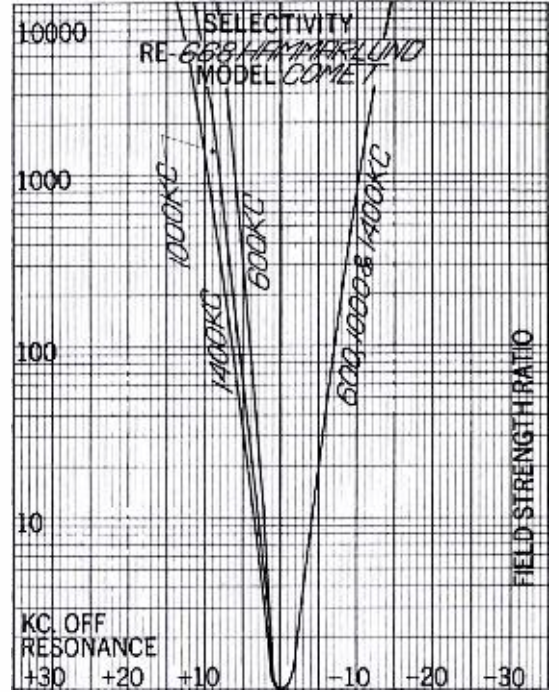
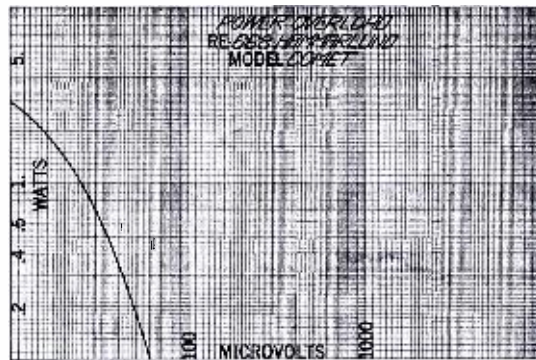
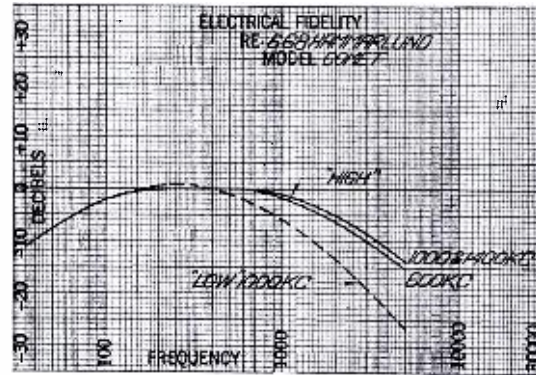
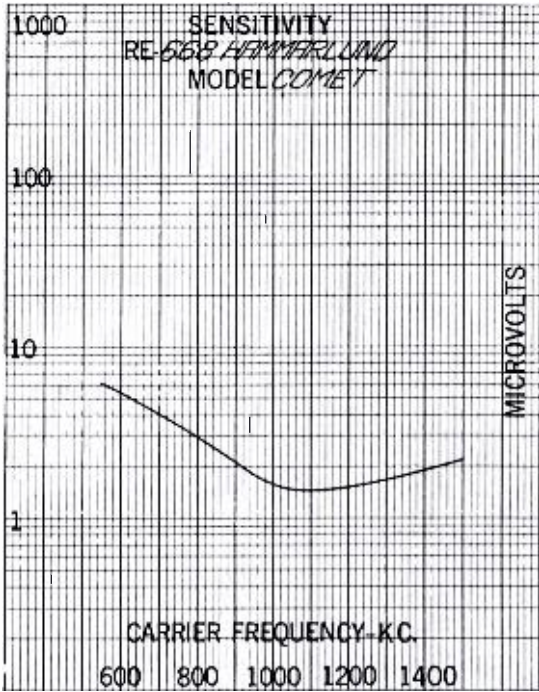

a dummy antenna standard of 20 uh, 200 uuf and 25 ohms. To match the optimum impedance of the single 247 output tube, a non-inductive load resistance of 7000 ohms was connected across the plate circuit, and the output indicating voltmeter was capacitatively coupled to the plate, indicating the standard level of .05 watts except for the power overload curve. To prevent impedance reflection errors, the voice coil circuit was broken during all tests.

For all measurements, the volume control was adjusted for maximum receiver sensitivity, no realignment

be 2.72 microvolts absolute from the sensitivity curve of column 1. This value is the same as .68 microvolts per meter when employing the standard height antenna. Noise level maximum and minimum values were 85% at 1400 kc and 61% at 600 kc respectively. At a dial setting of 1000 kc, the measured image ratio was found to be 3110. From the power overload curve of column 2, the maximum audio output measured 2.88 watts, but this value does not take

gram of the Comet superheterodyne. From it the tubes required for operation are found to be, a 227 oscillator, 227 short wave oscillator, 224 first detector, 235 second i-f, 235 third i-f, 224 second detector, 247 pentode power tube, and a 280 full wave rectifier for supplying the B voltage necessary for the operation of the receiver.

Times Field Strength	Band Widths		
	Kilocycles width		
	600 kc.	1000 kc.	1400 kc.
10	6.5	7.5	8
100	11	12.5	14
1000	16.5	18.5	20
10000	23	26	28

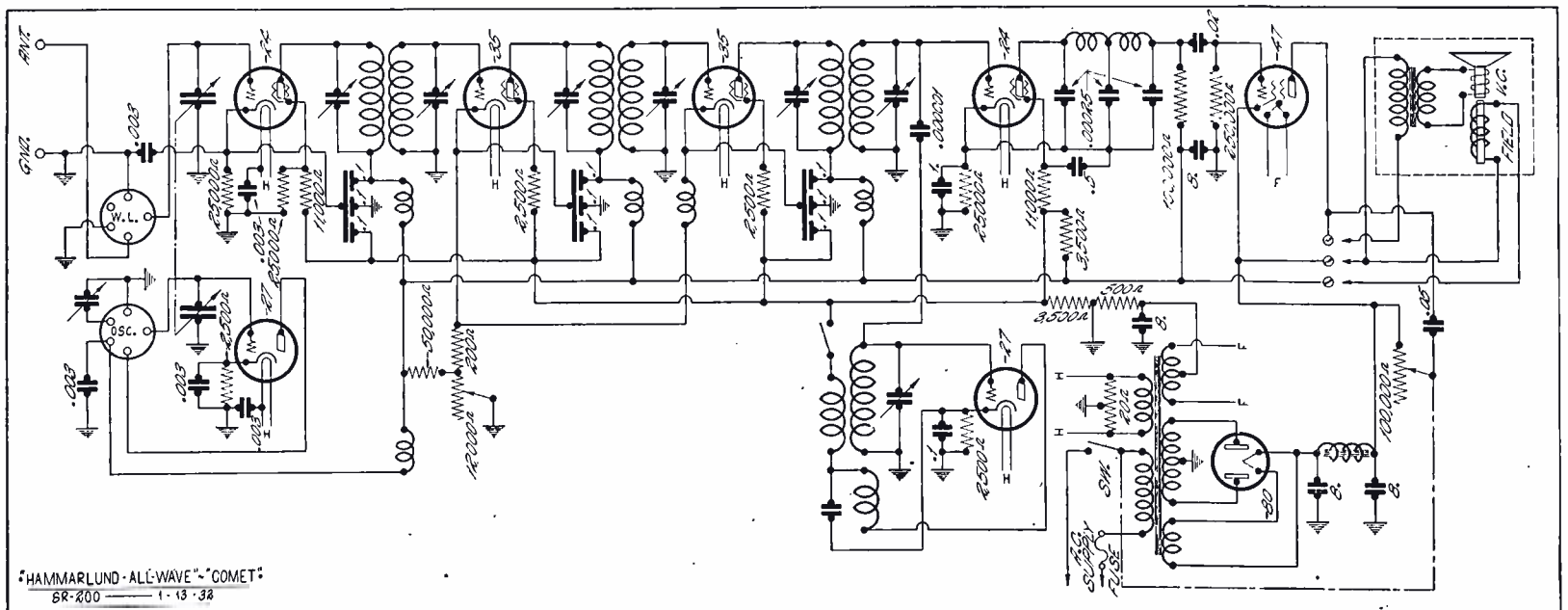

HAMMARLUND ALL-WAVE "COMET"
8R-200 1-13-38

Howard Model DL

HOWARD'S model DL fifteen tube superheterodyne, when measured in our laboratory, gave the included performance curves.

Input was through the dummy antenna standard of 20 uh, 200 uuf and 25 ohms. Because of the special output arrangement, special matching

2.76 microvolts absolute which corresponds to .69 microvolts per meter. At 1400 kc. the noise level measured 57.6%, the maximum, and at 1000 kc. the minimum of 26.6% was found. At 1000 kc. the measured image ratio was 122,000 times. A maximum power output of 19.2 watts is taken

given at the bottom of the page. The fifteen required tubes are, a 235 first r-f, 235 second r-f, 235 first detector, 235 second i-f, 235 third i-f, 227 second detector, 227 oscillator, 227 automatic volume control tube, 227 special phonograph amplifier, four 247 pentodes, and two 280 rectifiers. Two

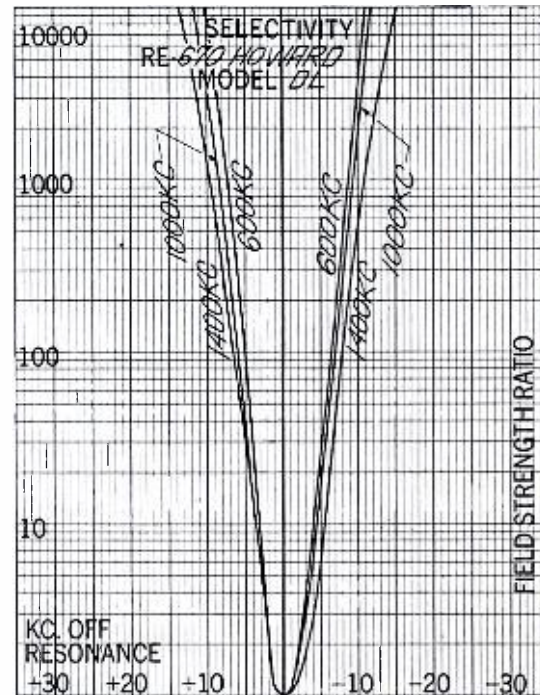
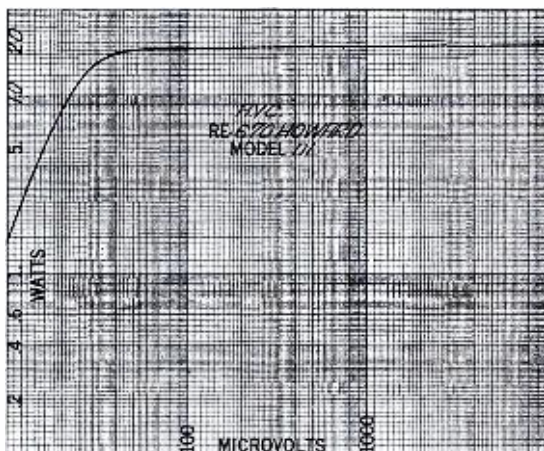
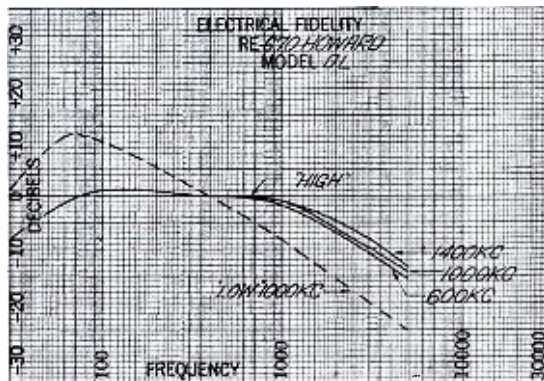
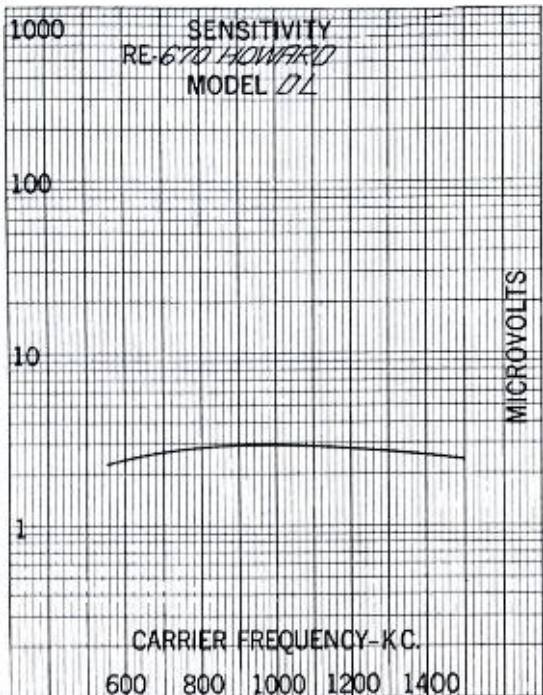

was required for the double set of push-pull pentodes. The voice coil circuit was disconnected during measurements, and the output level maintained at .05 watts.

With an a-c line voltage of 112 volts, the current drawn was 1.02 amperes. No changes were made in alignment, the volume control was at maximum, and tubes as furnished were employed in testing.

Average sensitivity is found to be

from the automatic volume control curve of column 2. However, no consideration of harmonic content of the waveform is made. Tabulated band widths are given under the selectivity curves of column 3.

A schematic wiring diagram is

speakers are employed, coupled to the push-pull tubes by one secondary, while the primary is made up of two windings.

Band Widths

Times Field Strength	Kilocycles width		
	600 kc.	1000 kc.	1400 kc.
10	7	8	9
100	11.5	13	14.5
1000	16.5	18	20.5
10000	21	23.5	28.5

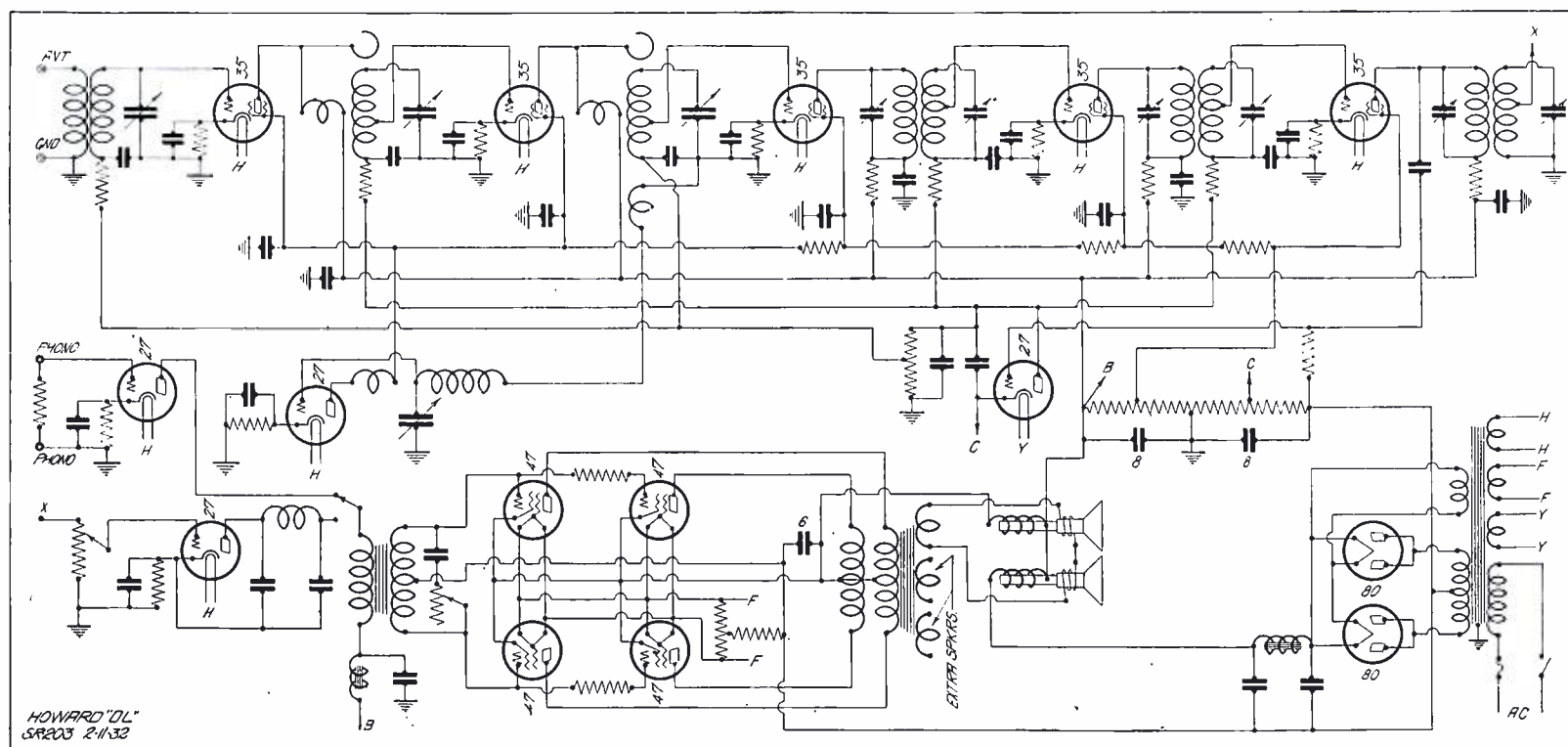

Philco Model 70

PHILCO'S model 70 superheterodyne when recently measured in our laboratory gave the overall performance curves printed on this page.

For receiver input, the signal generator was coupled to the antenna

by the manufacturer with the receiver as standard equipment were used, the volume control was adjusted for maximum receiver sensitivity, and no changes were made in the factory alignment of tuned circuits. An average sensitivity of 10.8 microvolts

column 3 are the band widths measured from them, given in tabular form.

At the bottom of the page is the complete schematic wiring diagram of the model 70. Required tubes are seen to be, a 224 r-f, 224 first detec-

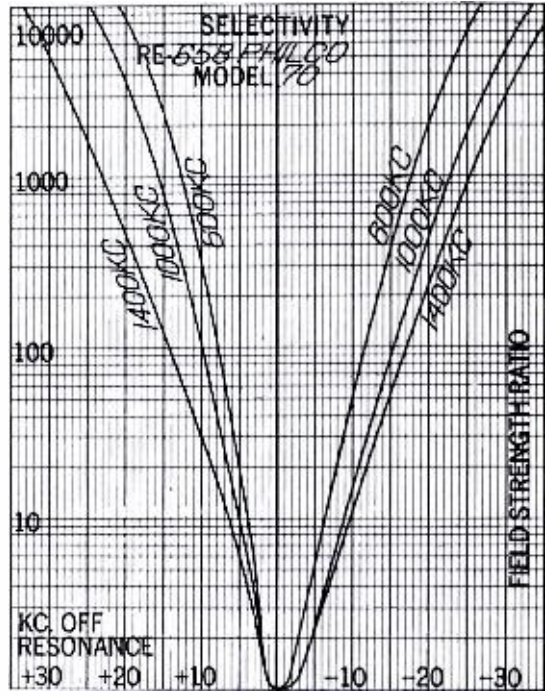
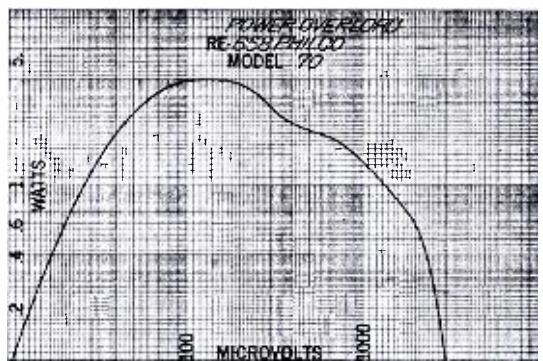
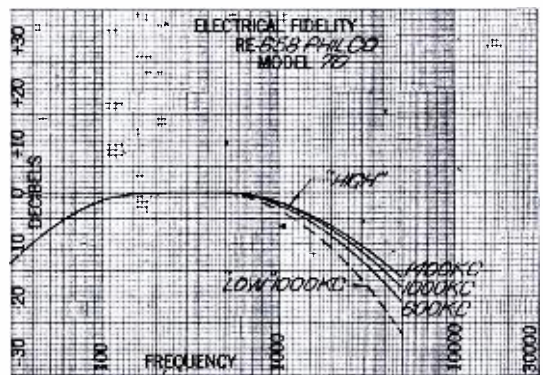
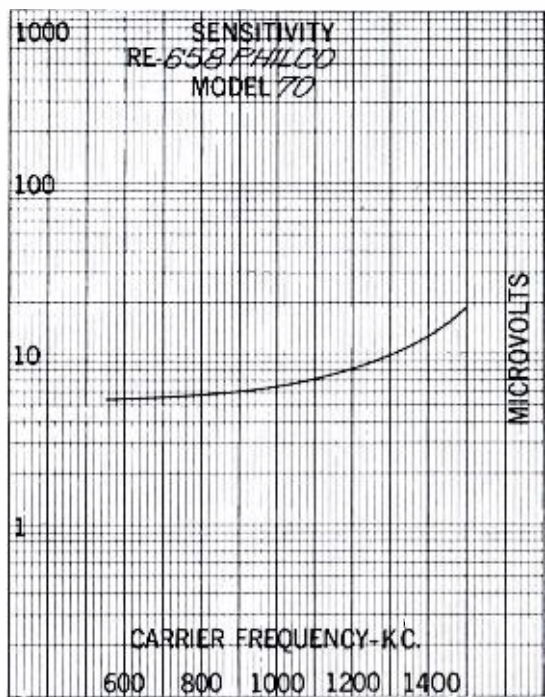

circuit through the dummy antenna standard of 20 uh, 200 uuf and 25 ohms. A non-inductive load resistance of 7000 ohms was connected across the output circuit to match the correct operating impedance of the single 247 output pentode. The output indicating voltmeter, which read the standard level of .05 watts, was capacitatively coupled to the plate. The voice coil circuit was opened to prevent any error due to reflection of secondary circuit impedance on the primary circuit.

An a-c line voltage of 118 volts gave the receiver a drain of .75 amperes. In all tests, tubes as furnished

absolute was measured from the curve of column 1. This value corresponds to 2.7 microvolts per meter when using a standard four-meter antenna. The maximum noise level of 14.5 per cent was found at 800 and 1000 kc and the minimum of 9 per cent at 600 and 1400 kc. With the receiver adjusted to 1000 kc, the resultant image ratio was 8900. In column 2 the power overload curve gives a maximum audio output of 4.92 watts, which figure disregards the harmonics produced in the output waveform. Below the selectivity curves of

tor, 227 oscillator, 224 second i-f, 224 second detector, 247 power pentode, and a 280 full wave rectifier for high voltage supply to the receiver. A choke unit tuned for hum elimination by a .09 mfd condenser is used as a series unit in the plus B side with the speaker field in series with the bleeder circuit.

Band Widths

Times Field Strength	Kilocycles width		
	600 kc.	1000 kc.	1400 kc.
10	10.5	14	16.5
100	19	25.5	32
1000	30	38	48.5
10000	47	58	71

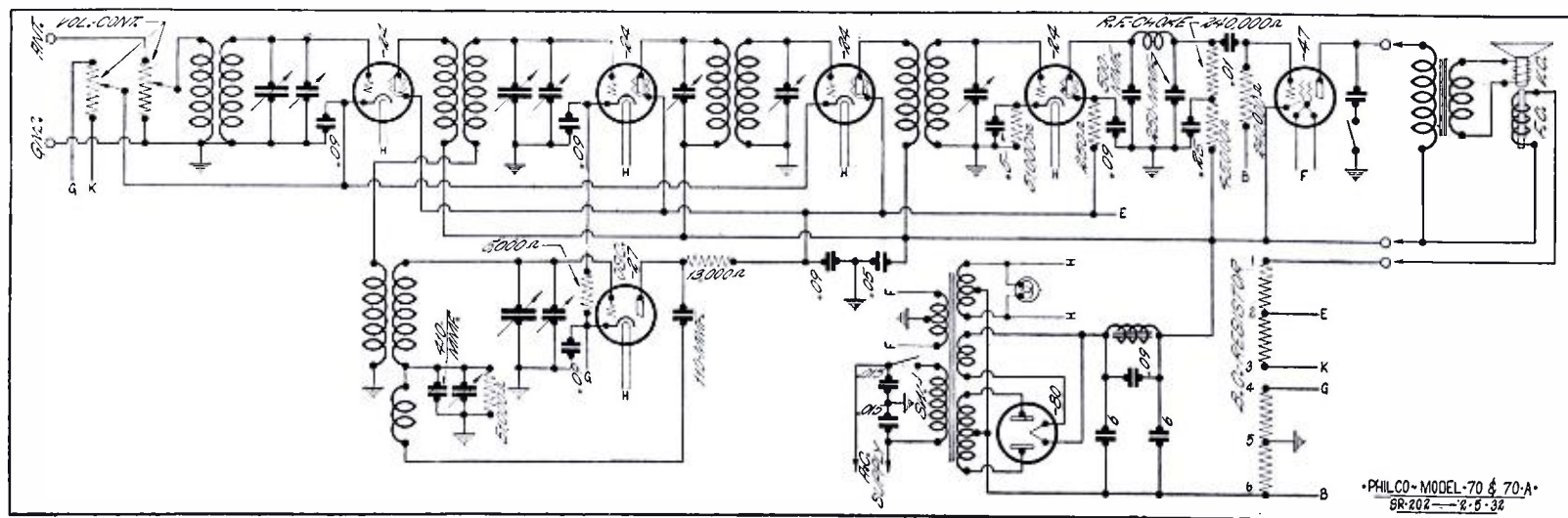

Silver-Marshall Model J

SILVER-MARSHALL'S model J gave the included overall performance curves after recent measurement in our laboratory.

Output of the signal generator was coupled to the receiver input circuit through a standard dummy antenna

were made in the alignment of the receiver circuits. The power transformer primary current was .94 amperes with a a-c line voltage of 113 volts.

From the sensitivity curve of column 1, an average of 4.92 microvolts

tivity curves of column 3 will be found the band widths from which they were taken.

A schematic wiring diagram of this superheterodyne will be found below. The ten required tubes are a 551 r-f, 224 first detector, 227 oscillator, 551

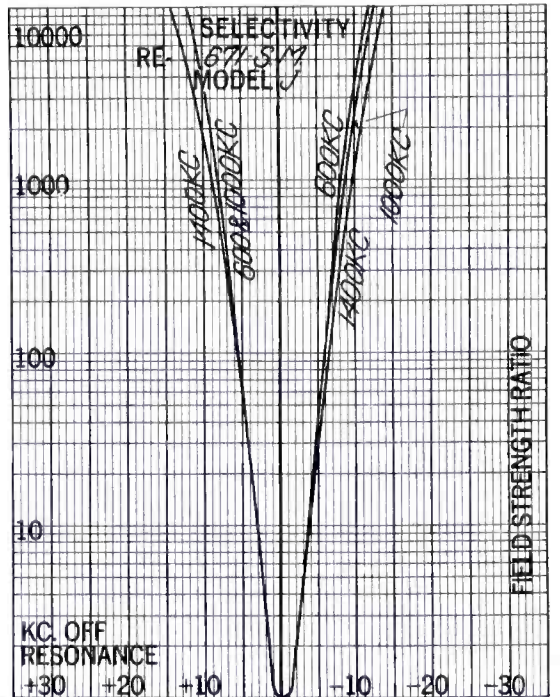
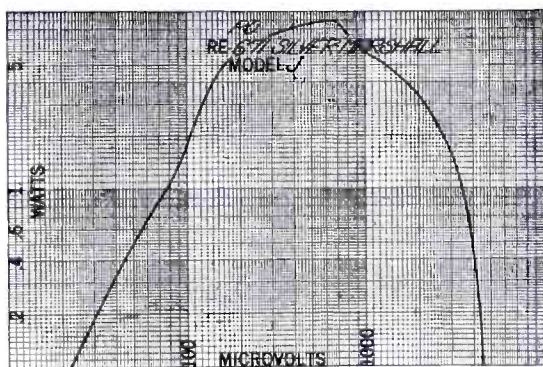
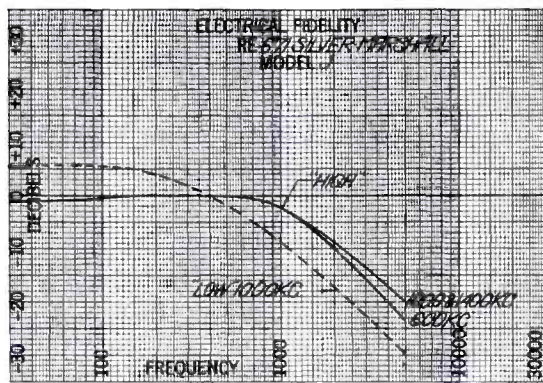
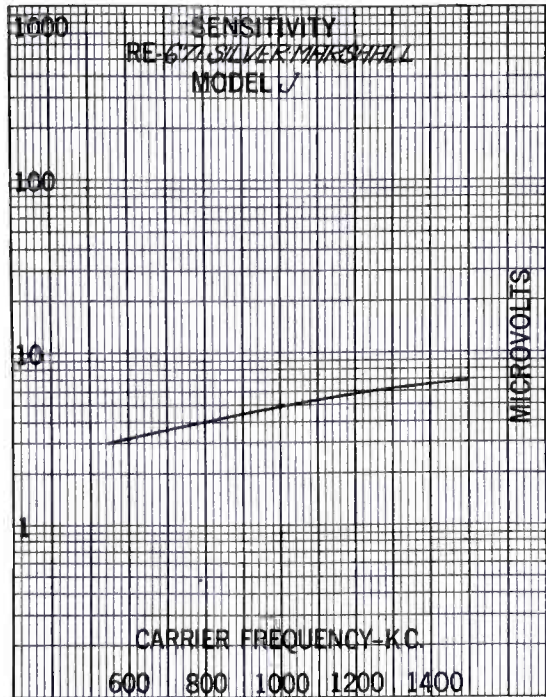

of 20 uh, 200 uuf and 25 ohms. To match the optimum operating impedance of the push-pull pentodes, a non-inductive load resistance of 14,000 ohms was connected across the plates. The output indicating tube voltmeter, which read an audio level of .05 watts for all tests except the power overload, was capacitatively coupled to the output circuit. In order to prevent a reflection of impedance from the secondary to the primary of the output transformer, the voice coil circuit was broken.

Tubes as furnished by the manufacturer with chassis were employed, the volume control was turned to its maximum position, and no alterations

absolute was taken or 1.23 microvolts per meter, assuming a standard height antenna is used. At 1400 kc the maximum noise level of 26 per cent occurred, and at 600 kc a minimum of 18.5 was measured. An image ratio of 3980 was recorded with the receiver tuned to 1000 kc. In column 2, the power overload curve gives a maximum audio output of 7.8 watts. However, this figure disregards the harmonic content of the wave form across the primary of the output transformer. Under the selec-

second i-f, 551 third i-f, 227 diode detector, 227 first audio, push-pull 247 pentodes, and a 280 full wave rectifier for B voltage supply. A bucking coil is furnished with the speaker to eliminate excess hum. Bias for the push-pull pentodes is obtained by the drop across a 220 ohm resistor from the center tap of the filament to ground.

Band Widths

Times Field Strength	Kilocycles width		
	600 kc.	1000 kc.	1400 kc.
10	6.5	6.5	7
100	11.5	11.5	12.5
1000	16.5	17	18
10000	23.5	24	28

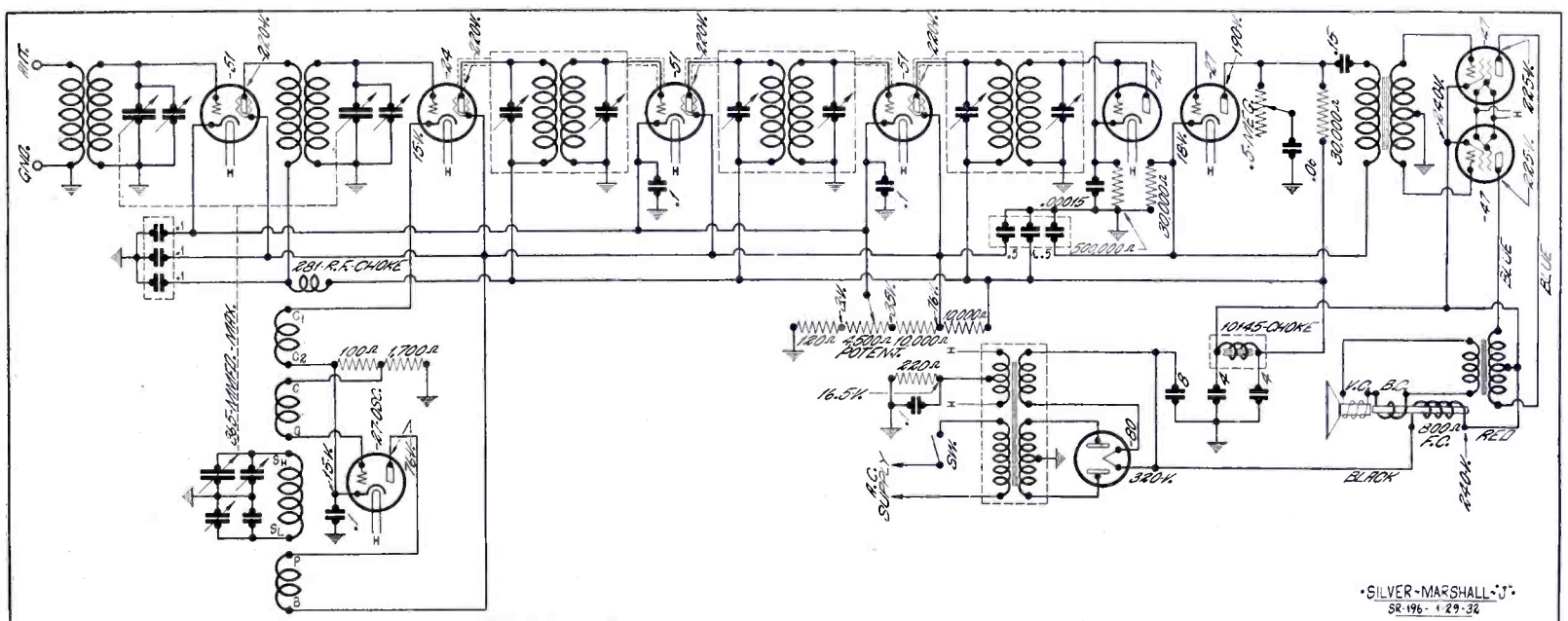

Stromberg-Carlson Model 22

RECENT measurements made on the Stromberg-Carlson model 22 superheterodyne receiver gave the overall performance curves given on this page. A very good automatic volume control is incorporated.

alignment of tuned circuits from factory adjustment, the volume control was turned on full, and the tubes employed in the receiver were those furnished by the manufacturer with the set.

From the sensitivity curve of

lated band widths will be found under the selectivity curves reproduced in column 3.

A schematic wiring diagram of the model 22 is given in detail at the bottom of the page. Tubes required for operation consist of, a 235 r-f, 235

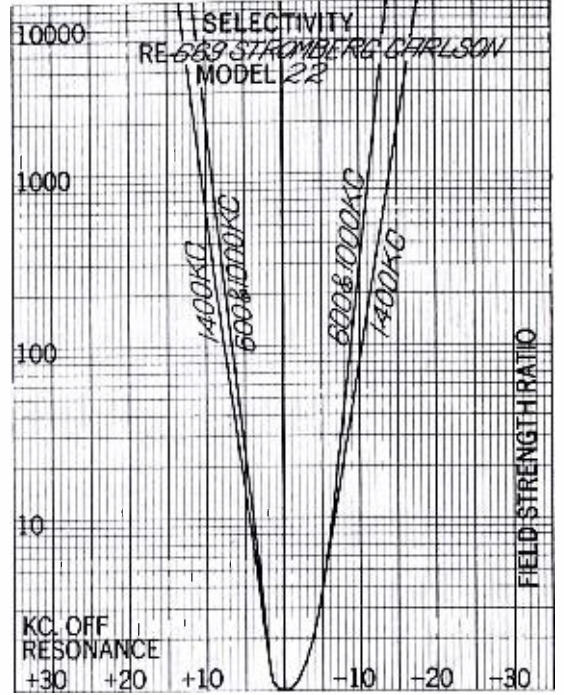
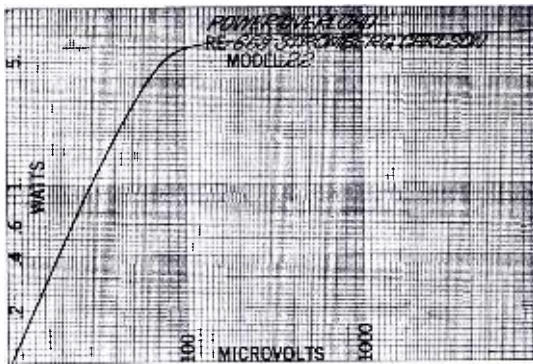
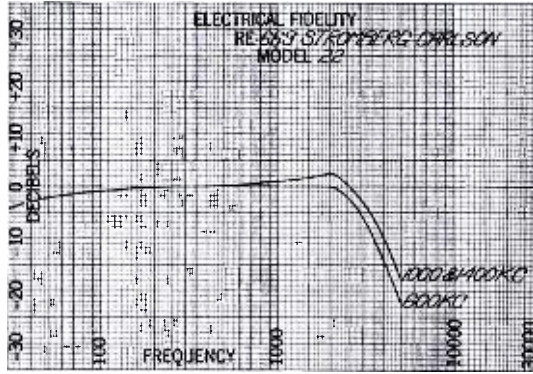
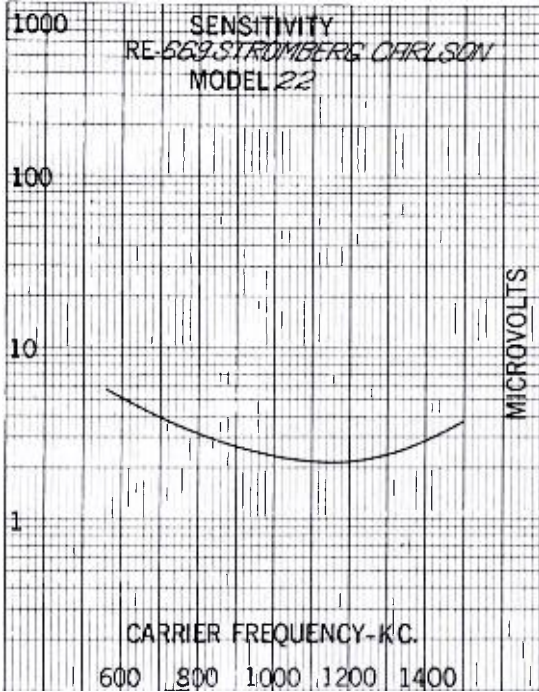

A dummy antenna of 20 uh, 200 uuf and 25 ohms served to conduct the signal from the generator to the antenna circuit. To match the push-pull 245 power tubes, a non-inductive load resistance of 7800 ohms was connected across the plates, which in turn were capacitatively coupled to the output indicating voltmeter reading the standard output level of .05 watts except for the power overload curve. To prevent a reflection of the secondary load to the primary of the output transformer, the voice coil circuit was opened during all tests.

A line current of 1.02 amperes a-c was drawn with a line voltage of 117 volts. No changes were made in the

column 1, the average is computed to be 2.8 microvolts absolute, corresponding to .7 microvolts per meter when using the standard four meter antenna. At 1000 kc, an image ratio of 346,000 times was measured. From the power overload curve of column 2, the maximum output is seen to be 7.32 watts of audio power at an input of 10000 microvolts. This figure disregards the harmonics present in the output wave form. At 600 kc the minimum noise level of 52% was measured, while at 1200 kc was found the maximum value of 74%. Tabu-

first detector, 227 oscillator, 235 second i-f, 235 third i-f, 227 automatic volume control tube in conjunction with a visual resonance indicating meter, 227 second detector, push-pull 245 power tubes, and a 280 full wave rectifier for all high voltages necessary for tube circuits and field excitation. A "silent key" is used for grounding the voice coil circuit while tuning.

Band Widths

Times Field Strength	Kilocycles width		
	600 kc.	1000 kc.	1400 kc.
10	10	10	11
100	15	15	18
1000	20	20	24
10000	25.5	25.5	31

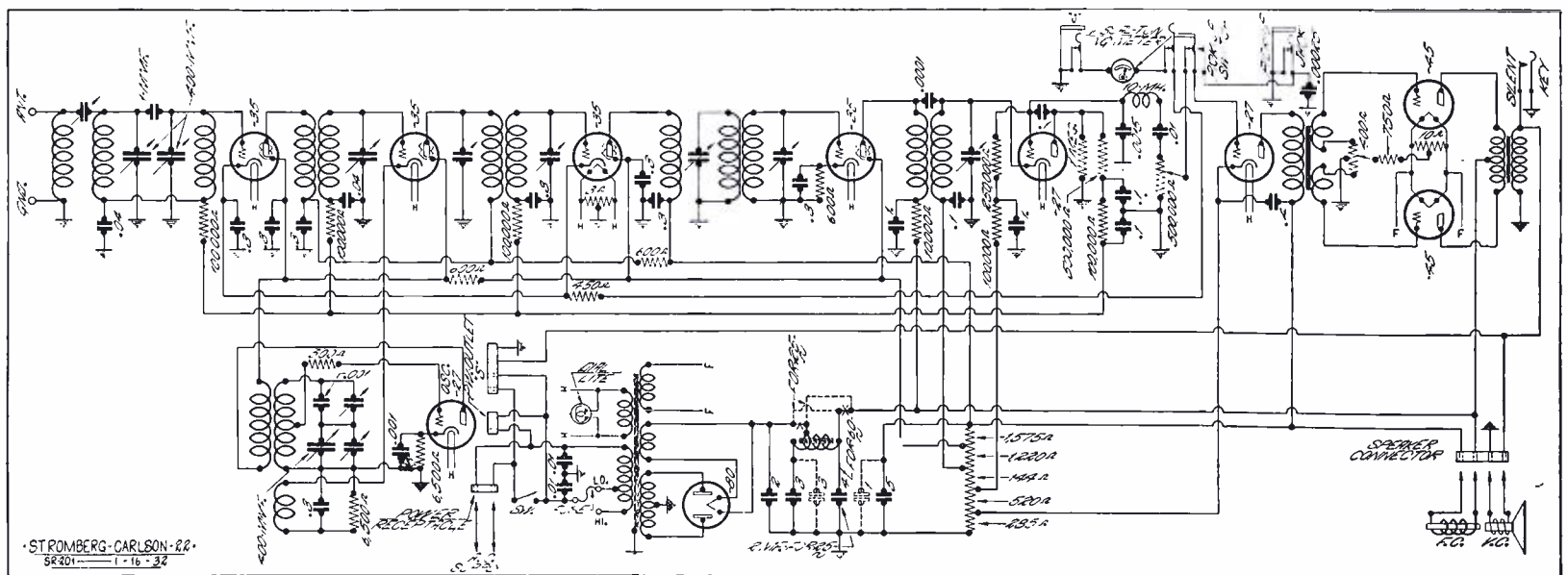

United American Bosch Model 20

OVERALL performance curves on the United American Bosch model 20 are given herein as indicative of its performance.

Input to the receiver was through the dummy antenna standard of 20 uh, 200 uuf, and 25 ohms while the

furnished as standard equipment, the factory alignment of the tuned circuits was not disturbed, and the volume control was set for maximum receiver sensitivity.

Average sensitivity, as taken from the curve of column 1, is found to be

Under the selectivity curves of column 2 are the band widths in tabular form.

Below is the schematic wiring diagram of this superheterodyne. Required tubes are, a 551 r-f, 551 first detector, 227 oscillator, 551 second

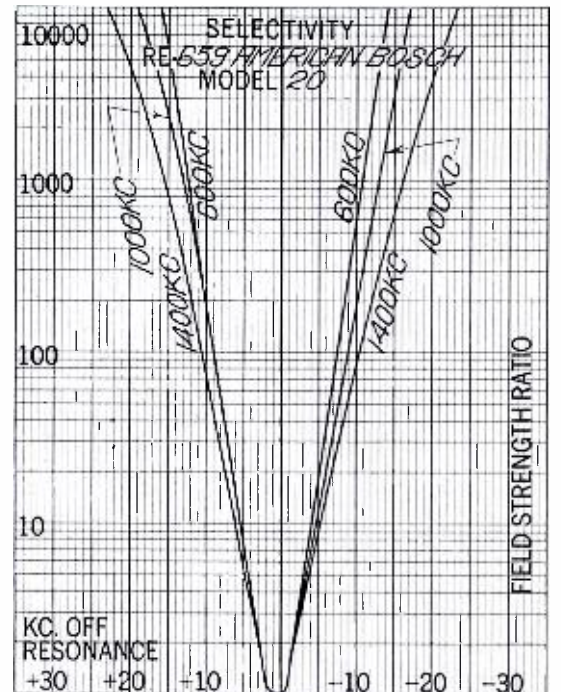
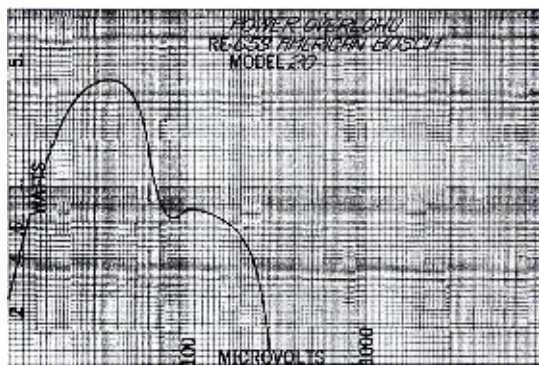
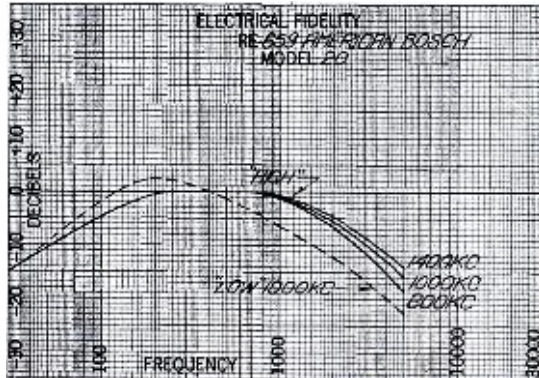
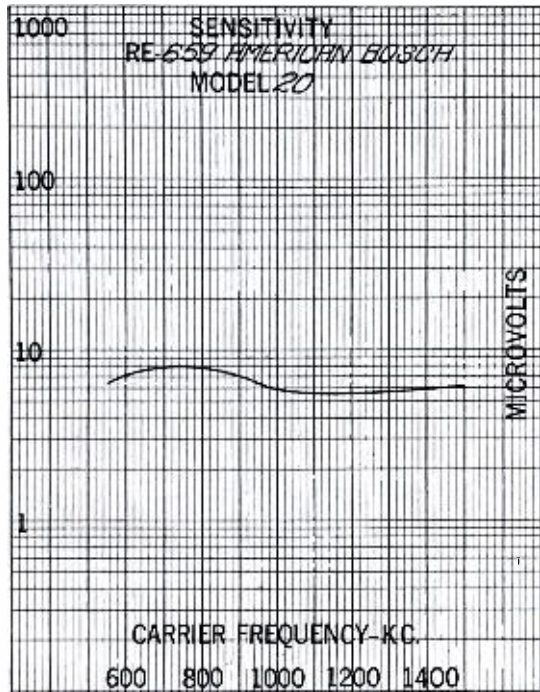

output of .05 watts was maintained for all tests but that of power overload. A resistance of 3500 ohms was connected across the output circuit to properly match the load for two pentodes employed in parallel. The vacuum tube voltmeter was capacitatively coupled to the plate circuit, while the voice coil circuit was opened to prevent a reflection of the secondary load to the primary of the speaker transformer.

An a-c line current of .95 amperes was drawn by the receiver with an impressed voltage of 117 volts. In all measurements the tubes used were

6.5 microvolts absolute which corresponds to 1.625 microvolts per meter when a standard height antenna is used. Noise level maximum and minimum values were 7.6% at 600 kc, and 1.1% at 1400 kc respectively. At 1000 kc the measured image ratio was 1880 times. From the power overload curve of column 2, the greatest output is found to be 4.00 watts of audio power, but this figure does not take into account the harmonics produced in the output wave form.

i-f, 227 second detector, two 247 power pentodes in parallel, and a 280 full wave rectifier for receiver B supply. A tapped choke is employed in the B return lead, and the dynamic speaker field is used as a filter unit.

Band Widths

Times Field Strength	Kilocycles width		
	600 kc.	1000 kc.	1400 kc.
10	9.5	10	11.5
100	16.5	18	21
1000	23	26	31.5
10000	29.5	36	46

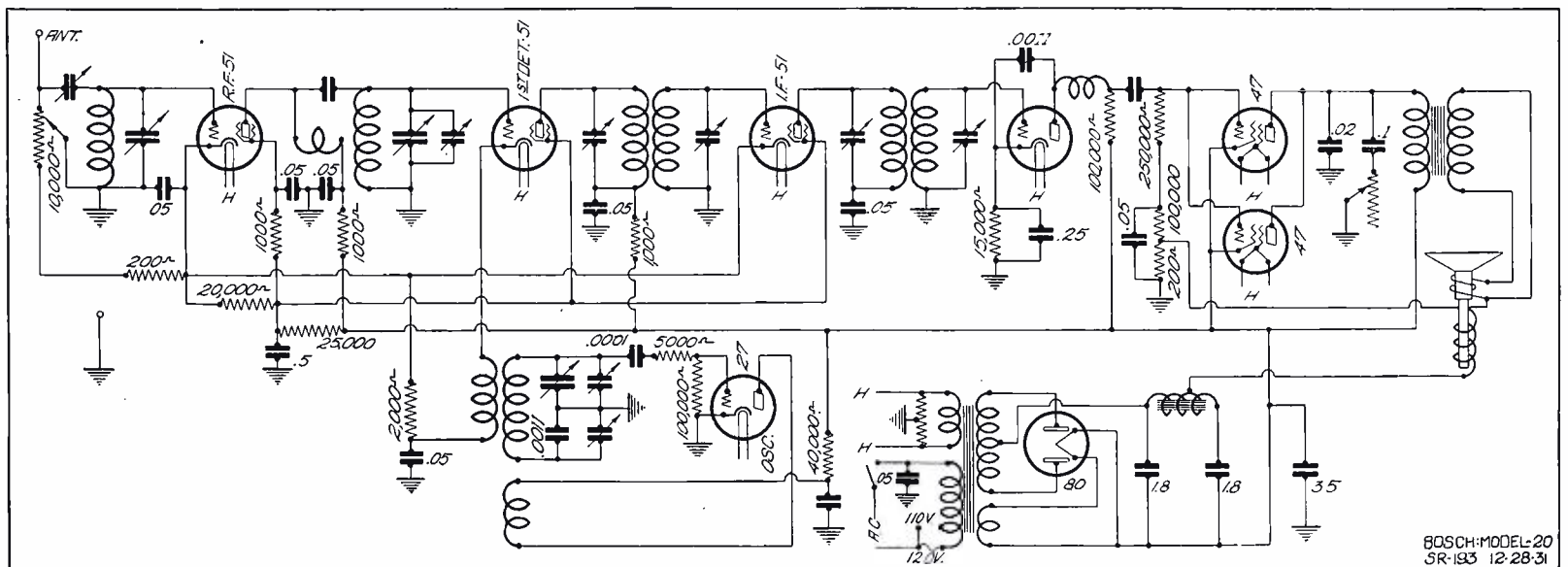

BOSCH: MODEL 20
SR: 193 12-28-31

U. S. Radio, Apex Model 7-A

CURVES made from our recent measurements on the U. S. Radio and Television Apex Model 7-A are given on this page.

For receiver input, the signal generator was coupled to it by means of the dummy antenna standard of 20

put transformer.

With a line voltage of 117 volts, the current drawn by this receiver was .80 amperes a-c. For all measurements, no realignment of tuned circuits was made, the volume control was turned to the maximum posi-

the automatic volume control curve of column 2 the maximum output is seen to be 2.88 watts with an input of 10000 microvolts. This figure gives no consideration to the harmonic content of the wave form across the primary of the output transformer,

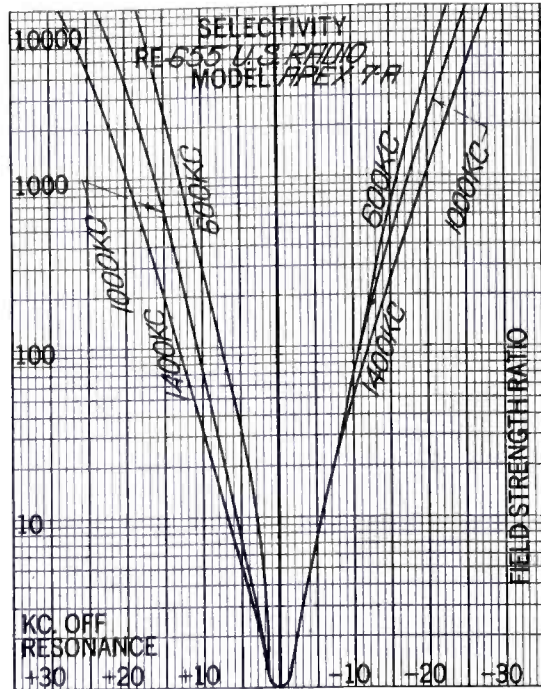
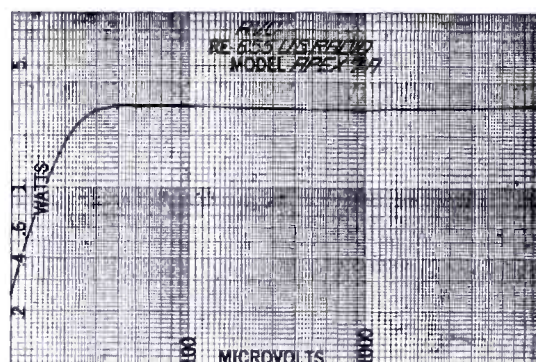
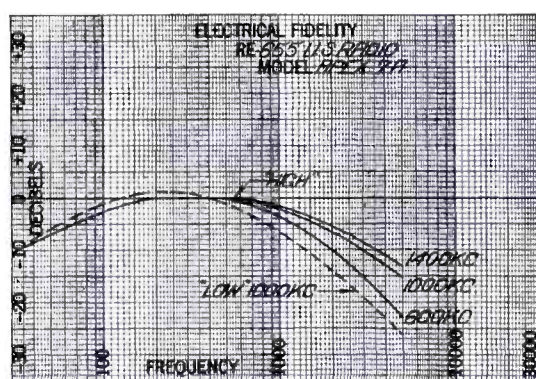
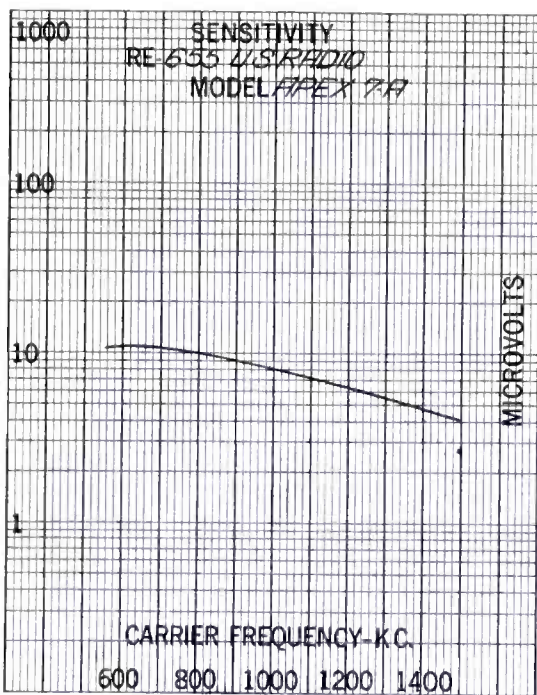

uh, 200 uuf and 25 ohms. To match the optimum operating impedance of the single 247 pentode, a non-inductive load resistance of 7,000 ohms was connected across the output circuit, which was coupled to the output voltmeter indicating the audio output standard of .05 watts. The voice coil circuit was broken to prevent any error entering the measurements due to impedance reflection from the secondary to the primary of the out-

tion, and the tubes used were those furnished by the manufacturer.

An average sensitivity of 8.00 microvolts absolute or 2.00 microvolts per meter is taken from the sensitivity curve of column 1. A maximum noise level of 17.8% was found at 1400 kc, with a minimum value of 1.4% at 600 kc. At 1000 kc the image ratio measured 17,100 times. From

however. Under the selectivity curves of column 3 are the tabulated band widths, and at the bottom of the page is the schematic wiring diagram of the model 7-A.

Band Widths

Times Field Strength	Kilocycles width		
	600 kc.	1000 kc.	1400 kc.
10	9	11.5	13
100	18.5	21.5	25
1000	29	33.5	40
10000	40.5	46	56.5

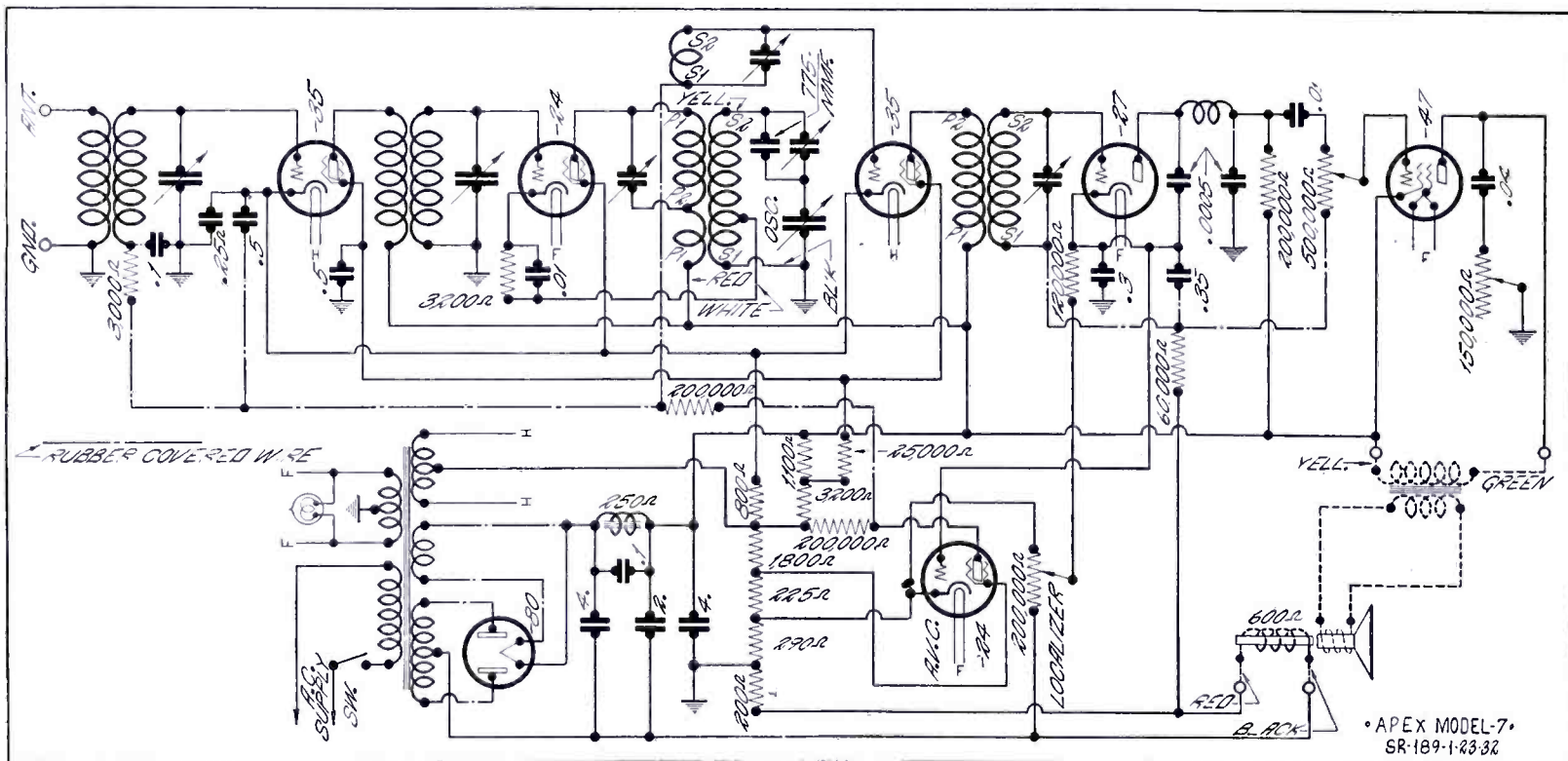

Universal Auto Radio Model 70

PERFORMANCE curves, made in our laboratory, on the Universal Auto Radio model 70 are included on this page.

For receiver input, a dummy antenna of 20 uh, 200 uuf and 25 ohms coupled the standard signal

Receiver drain was 45 milliamperes as measured in the negative B lead. During all measurements, tubes as furnished by the manufacturer were employed, no realignment of tuned circuits was made, and the volume control was turned to its maximum

the harmonic content of the wave form. This output is exceedingly high considering the normal output of Class A 238 push-pull tubes. Tabulated band widths will be found in column 3 under the selectivity curves, from which they were measured.

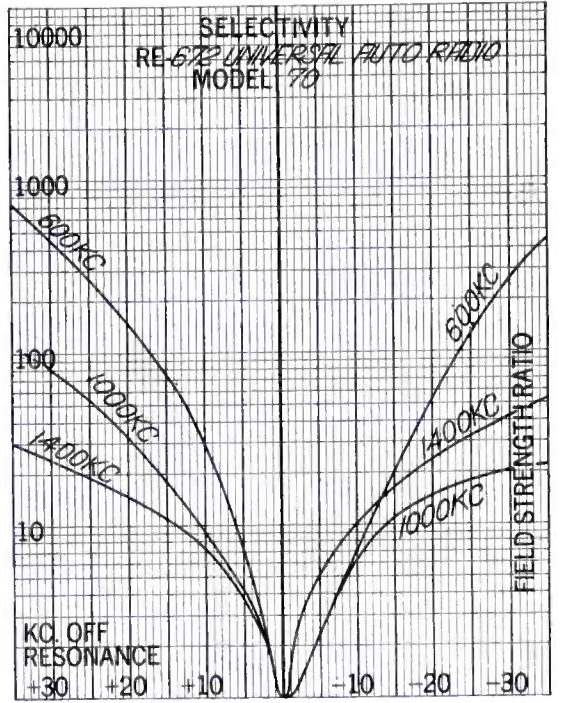
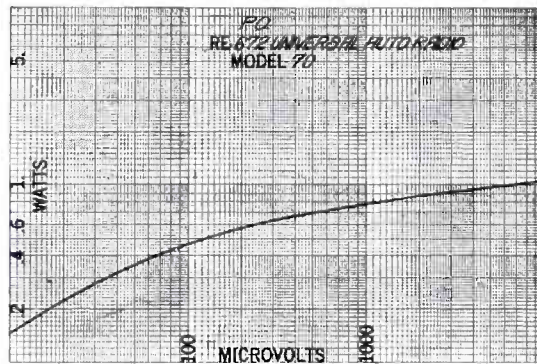
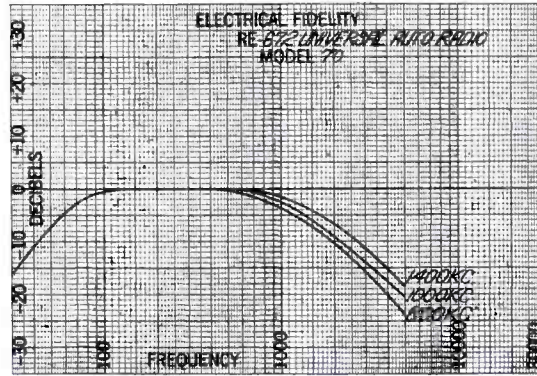
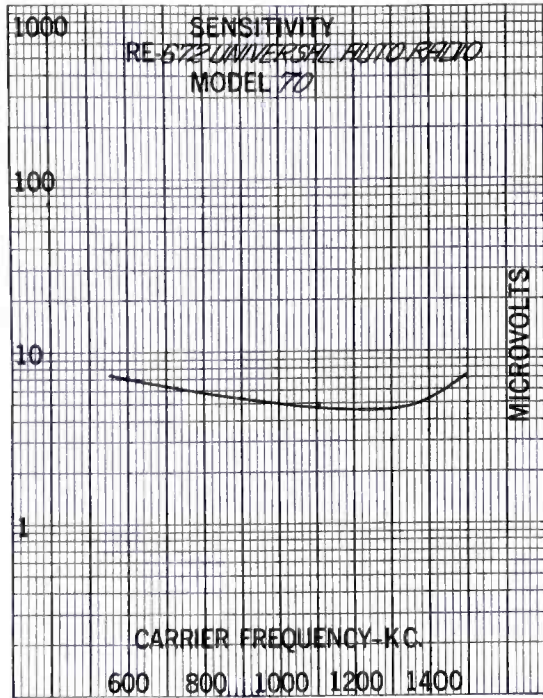

generator to the antenna circuit. A non-inductive load resistance of 30,000 ohms was connected across the plates of the push-pull 238 tubes to match their operating impedance, which in turn were capacitatively coupled to the vacuum tube voltmeter used to record the standard output level of .05 watts expect for the power overload curve. To eliminate any error due to the secondary circuit reflecting its impedance to the primary, the voice coil circuit of the speaker was opened during measurements.

position. An average sensitivity of 5.55 microvolts absolute, which is equivalent to 1.38 microvolts per meter, was measured from the curve of column 1. Noise levels, maximum and minimum values, were 6.7 per cent at 1200 kc, and 2.5 per cent at 600 and 1400 kc. An audio output of 1.05 watts is reached at an input of 10,000 microvolts, but no account is taken of

A schematic wiring diagram of this receiver is found below. Tubes necessary are, a 239 first r-f, 239 second r-f, 239 detector, 237 automatic volume control tube, a 237 first audio, and push-pull 238 pentodes.

Band Widths

Times Field Strength	Kilocycles width		
	600 kc.	1000 kc.	1400 kc.
10	16.5	24.5	24
100	41
1000	85
10000

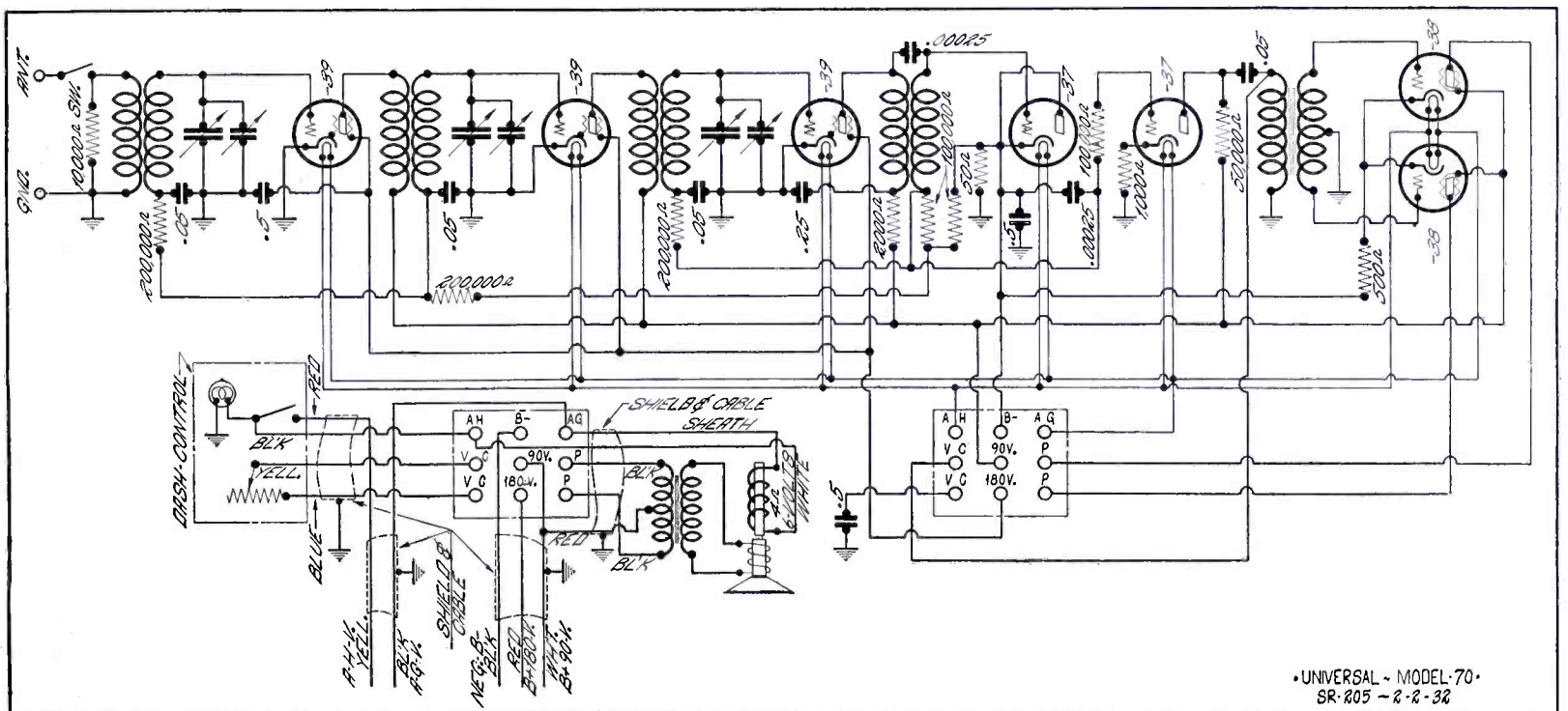

•UNIVERSAL - MODEL-70•
SR-205 - 2-2 - 32

Wells-Gardner Arcadia Model 50

DATA made from measurements on the Wells-Gardner Arcadia model 50 produced the included overall performance curves.

Receiver input from the standard signal generator was through the dummy antenna standard of 20 uh,

age tubes were employed. No changes were made in circuit alignments, and the volume control was adjusted to maximum. The receiver drain was .78 amperes with an a-c line voltage of 115 volts.

From the curve in column 1, the average sensitivity is computed to be

volume control curve of column 2. However, no account was taken of the harmonics introduced in the wave form at this audio level. Band widths, taken from the selectivity curves in column 3 are found listed under them.

At the bottom of the page is the

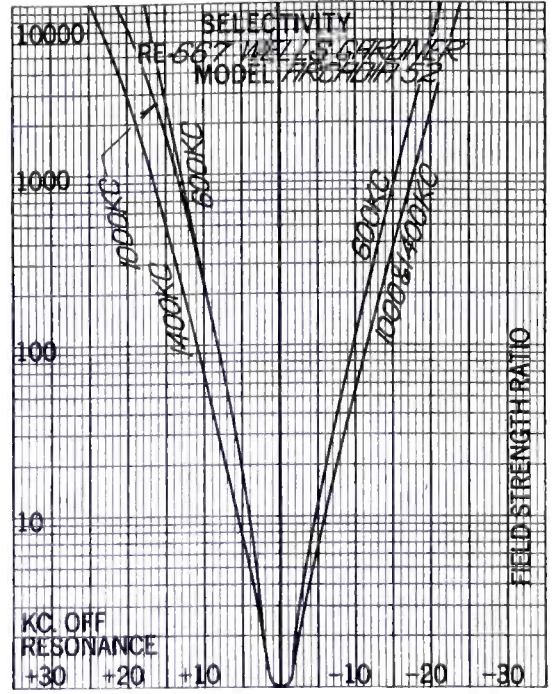
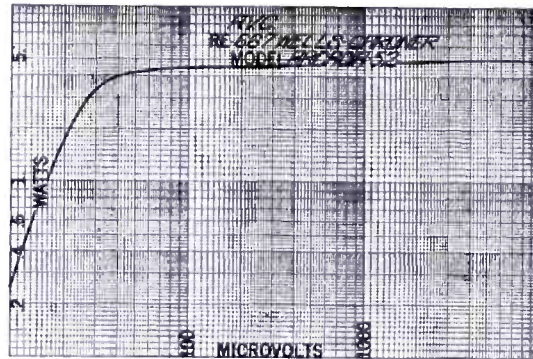
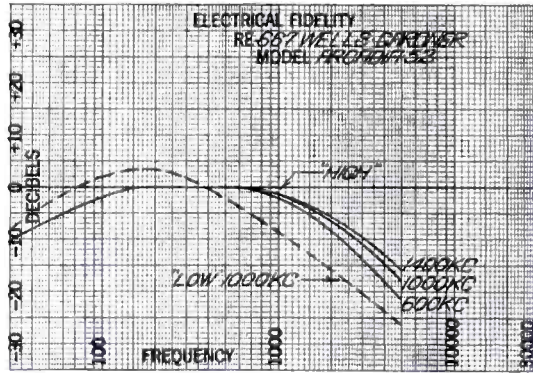
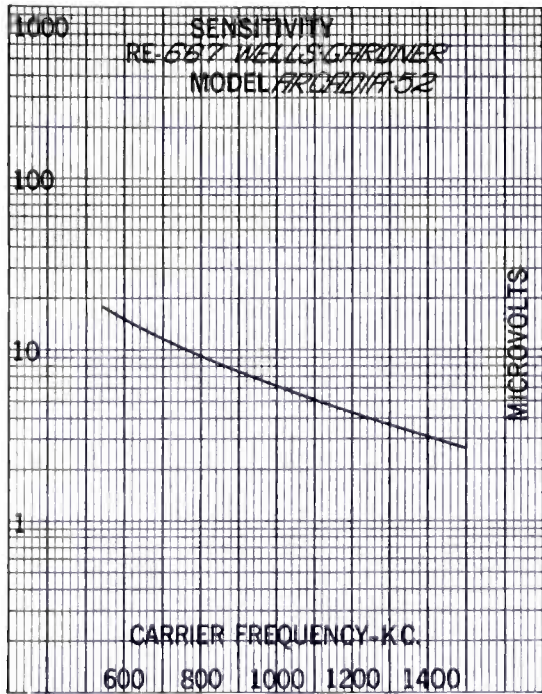

200 uuf and 25 ohms. A non-inductive load resistor of 7000 ohms was connected across the single pentode output circuit to match its optimum operating load. The plate was capacitatively coupled to the vacuum tube voltmeter which indicated the standard output level of .05 watts except for the automatic volume control curve. The voice coil circuit was broken during measurements so that the secondary impedance would not be reflected to the primary circuit and thus introduce error.

Tubes were not furnished, so aver-

7.8 microvolts absolute which corresponds to 1.95 microvolts per meter when the standard four meter antenna is used. At 1400 kc the maximum noise level of 32.4% was measured, and at 600 kc the minimum of 1.3%. An image ratio of 14,100 times was measured at a dial setting of 1000 kc. At the greatest signal input, i. e. 10000 microvolts, the power output reached a maximum value of 5.00 watts as found from the automatic

complete schematic wiring diagram of this Arcadia model. For operation the following tubes are required: a 235 r-f, 224 first detector-oscillator, 235 second i-f, 224 automatic volume control, 224 second detector, 247 output, and 280 rectifier.

Band Widths

Times Field Strength	Kilocycles width		
	600 kc.	1000 kc.	1400 kc.
10	8.5	10	11.5
100	18	20	22.5
1000	28.5	31.5	34.5
10000	38.5	45.5	49

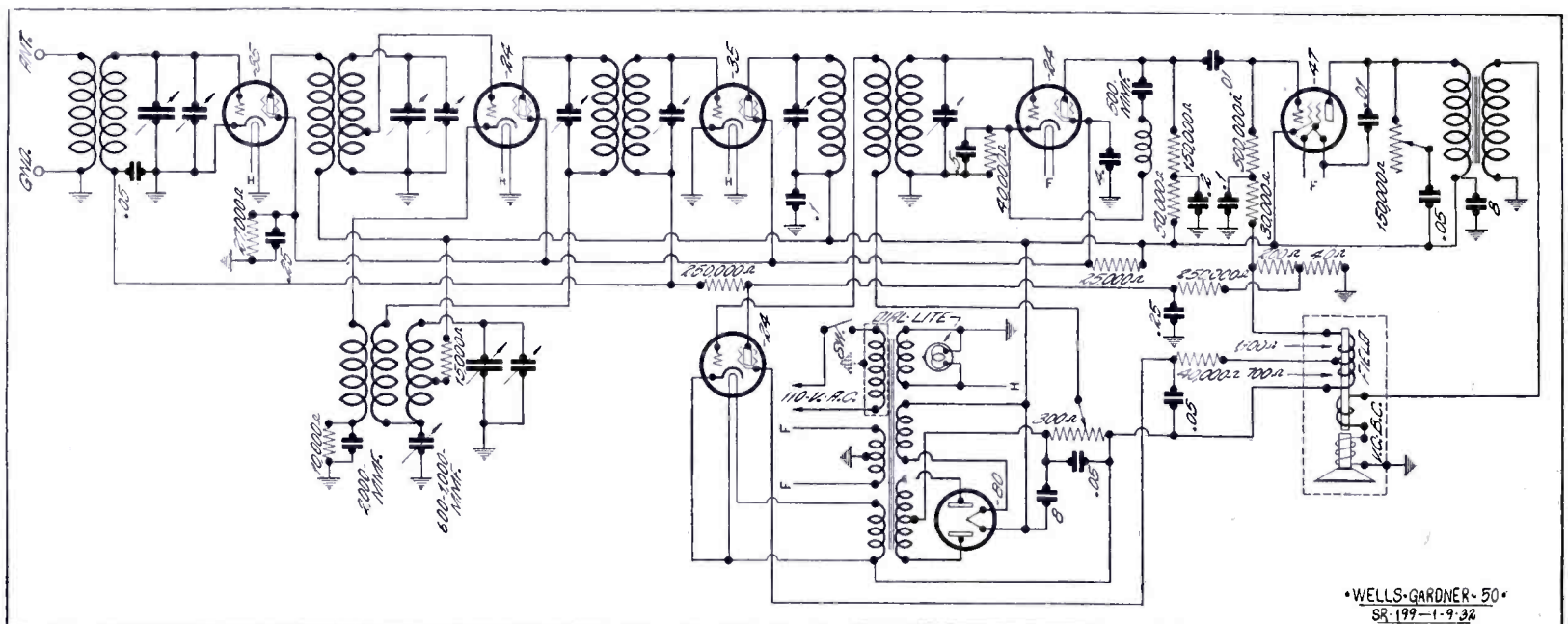

•WELLS-GARDNER-50•
SR-199-1-9-34

Service and Repair

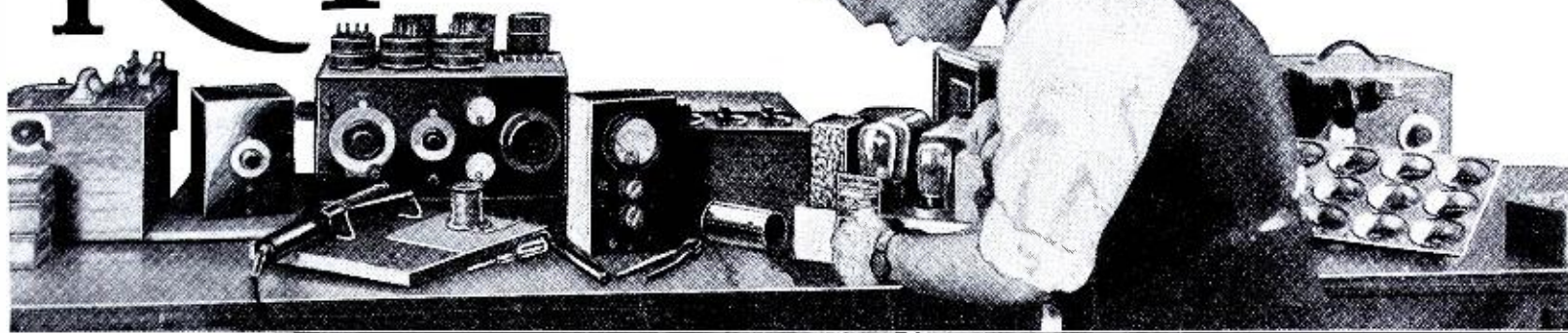

SCHEMATICS PUBLISHED TO DATE

Model	Published	Drawing No.	Model	Published	Drawing No.	Model	Published	Drawing No.
A. C. Dayton			Brunswick			Freshman		
Navigator	November, 1929	SR24	3KRO	November, 1929	SR23	2-N-12	September, 1929	SR14
Acme Mfg. Co.			15, 22, 32 and 42	November, 1930	SR86	General Electric		
AC7	March, 1929	SR3	S14	November, 1930	SR71	H-32	January, 1932	SR166
AC4	March, 1929	SR4	11, 12, 16	October, 1931	SR148	S-22	January, 1932	SR137
All-American Mohawk			17, 24	December, 1931	SR164	K-62	March, 1932	SR168
Lyric 90	November, 1930	SR74	E	February, 1932	SR183	General Motors		
Lyric 6	March, 1929	SR1	Colonial			A	November, 1930	SR68
Lyric 8	March, 1929	SR2	31AC	January, 1930	SR29	120-A	November, 1931	SR116
Lyric J	October, 1931	SR128	33 and 34 a-c	November, 1930	SR95	S3A	November, 1931	SR154
Lyric B-7	December, 1931	SR165	47-48	December, 1931	SR160	S9A	January, 1932	SR173
Lyric S-8	January, 1932	SR170	Crosley			S-10A	February, 1932	SR179
Amrad			Roamio	September, 1930	SR67	Gilfillan Bros.		
70	November, 1929	SR22	40S, 41S, 42S, 82S	September, 1930	SR57	100	January, 1930	SR32
81	March, 1930	SR44	608 Gembox	March, 1930	SR41	Graybar		
84	January, 1931	SR106	705 Showbox	March, 1929	SR6	600	March, 1930	SR42
Apex			Jewelbox 704B	March, 1929	SR5	Grebe		
48	November, 1930	SR80	77	November, 1930	SR83	7AC	November, 1929	SR17
31 (U. S. Radio)	January, 1931	SR108	53, 54, 57	January, 1931	SR103	AH1	November, 1930	SR96
10B (U. S. Radio)	March, 1932	SR191	120	October, 1931	SR133	Gulbransen		
Atwater-Kent			121-1	November, 1931	SR149	Nine-in-Line	March, 1930	SR40
38	January, 1930	SR28	124	December, 1931	SR150	161	March, 1931	SR110
55, 55C (Cap.)	September, 1930	SR51	125	January, 1932	SR174	10, 13	February, 1932	SR175
55, 55C (Ind.)	September, 1930	SR52	127	March, 1932	SR187	23	March, 1932	SR186
66	March, 1931	SR114	Dayfan			Howard		
H-2	December, 1931	SR131	5080	September, 1929	SR11	S. G. A.	September, 1930	SR56
Audiola			Delco			Green Diamond 8	September, 1929	SR16
Series 31 (t.r.f.)	November, 1930	SR79	Auto Radio	September, 1930	SR66	H	October, 1931	SR145
Super 31	March, 1931	SR111	Edison			SG-B	November, 1931	SR130
Junior	March, 1931	SR112	R4, R5, C4	November, 1930	SR49	O	December, 1931	SR163
13-S7	February, 1932	SR181	R6, R7	January, 1931	SR99	AVH	March, 1932	SR177
Balkeit			Erla			Jesse French, Jr.		
A	September, 1929	SR12	Duo Concerto R-2	January, 1930	SR33	G	March, 1931	SR118
Bosch			Eveready			Kellogg		
48	November, 1930	SR73	50	March, 1931	SR50	523-528	November, 1930	SR77
58	January, 1931	SR109	Fada			Kennedy		
60	March, 1931	SR117	7AC	September, 1929	SR13	20	March, 1930	SR48
28-29	November, 1929	SR21	35-35Z	November, 1930	SR70	26	November, 1930	SR81
Auto	November, 1930	SR94	KW28-29	December, 1931	SR158	10	January, 1931	SR38
7DC	November, 1931	SR160	Federal			30-32	November, 1931	SR129
31	March, 1932	SR198	H	November, 1929	SR19	52	February, 1932	SR184
Bremer-Tully			Freed-Eisemann			56	March, 1932	SR185
7-70	September, 1929	SR10	NR80	November, 1929	SR20			
81-82	November, 1930	SR75						
S81-82	October, 1931	SR126						

Model	Published	Drawing No.	Model	Published	Drawing No.	Model	Published	Drawing No.
King						Stromberg-Carlson		
J	January, 1930	SR31	106B	March, 1931	SR113	846	September, 1930	SR54
Kolster			108A	October, 1931	SR146	635-636	November, 1929	SR18
K20, K22, K25	September, 1929	SR8	108	November, 1931	SR123	12-14	November, 1930	SR93
and K27			111	November, 1931	SR155	10-11	November, 1931	SR134
K21, K23, K24			Silver			19-20	November, 1931	SR151
and K28	March, 1930	SR45	36A	January, 1931	SR105	Transformer Corp.		
K-43	November, 1930	SR72	30B	September, 1930	SR53	50	November, 1930	SR78
K80	November, 1931	SR159	30	January, 1930	SR35	80-81	October, 1931	SR139
90, 92	February, 1932	SR182	35-A	November, 1930	SR82	Temple		
Kylectron			782	October, 1931	SR120	8-60, 8-80, 8-90	March, 1930	SR37
70	November, 1930	SR65	726SW	October, 1931	SR144	SG 8-61, 8-81, 8-91	October, 1931	SR125
Majestic			D-E	November, 1931	SR152	Transitone		
70	September, 1929	SR7	F	December, 1931	SR140	Auto Radio	November, 1930	SR69
90B	September, 1930	SR55	G	January, 1932	SR153	Trav-Ler		
130-A	November, 1930	SR84	A	February, 1932	SR169	C	March, 1931	SR120
50	January, 1931	SR98	Slagle (Continental)			U. S. Radio		
20	October, 1931	SR124	9	January, 1930	SR27	37	March, 1930	SR39
60	October, 1931	SR138	R-20	March, 1930	SR46	26P	October, 1931	SR143
15	November, 1931	SR157	Sonora			99A	January, 1932	SR171
25	February, 1932	SR178	5R	November, 1929	SR25	Victor		
Philco			Sparton			R32, RE45, R52	September, 1930	SR61
86-82	November, 1929	SR26	AC89	September, 1929	SR9	R35, R39, RE57	January, 1931	SR101
95	September, 1930	SR60	589	September, 1930	SR63	Westinghouse		
90-90A	November, 1931	SR156	600, 610, 620	March, 1931	SR91	WR-5	November, 1930	SR92
112	January, 1932	SR172	25-26	December, 1931	SR161	WR-4	January, 1931	SR107
Pilot			10	February, 1932	SR180	WR10-12	November, 1931	SR137
148	February, 1932	SR176	15	March, 1932	SR192	WR15	January, 1932	SR168
Radiette			Splitdorf			Zaney-Gill		
F14	January, 1931	SR104	E175	January, 1930	SR36	54	March, 1931	SR119
Radiola			Steinite			Zenith		
60	January, 1930	SR30	261	September, 1929	SR15	52, 53, 54, 522,		
66	September, 1930	SR64	70, 80, 95	November, 1930	SR76	532 and 542	March, 1930	SR43
44	January, 1931	SR102	600, 605, 630, 635	November, 1931	SR132	71, 72, 73 and 77	November, 1930	SR97
18	October, 1931	SR127	Stewart-Warner			A, B, C, D	November, 1931	SR141
RCA-Victor			950	September, 1930	SR62	91, 92	March, 1932	SR190
R-7	October, 1931	SR137	Series 900	January, 1930	SR34			
R50-55	December, 1931	SR166	R100	January, 1931	SP85			
R11	January, 1932	SR168	102A	October, 1931	SR147			
Sentinel			R-102A	March, 1932	SR195			
11, 12, 15, 16	March, 1931	SR115						

Jewell Professional Service Combination

So great is the need for increased accuracy, both in the determination of voltages and currents in receiver circuits, and in the adjustment of radio frequency circuits, that servicemen have found complete and rapid servicing of modern receivers to be very nearly impossible without the use of both a set analyzer and test oscillator.

Many servicemen have wanted a single unit that would provide complete facilities for making every necessary service test and adjustment. To meet their needs the Professional Service Combination has been designed.

This instrument is comprised of a sturdy leatherette carrying case which houses: a set analyzer to provide for all receiver voltage, current, resistance, continuity, and output tests; an oscillator for all radio frequency circuit adjustments; and a power supply unit that provides all voltages necessary for testing tubes with the analyzer independently of the receiving set. The analyzer and test oscillator units may be slipped from the case

when desired.

Engineers who developed this unusual instrument started with this important consideration as their objective: Service instruments are only

of value to the servicemen when they enable him to make more rapid and more accurate tests and adjustments than he would be able to make with—
(Continued on next page)

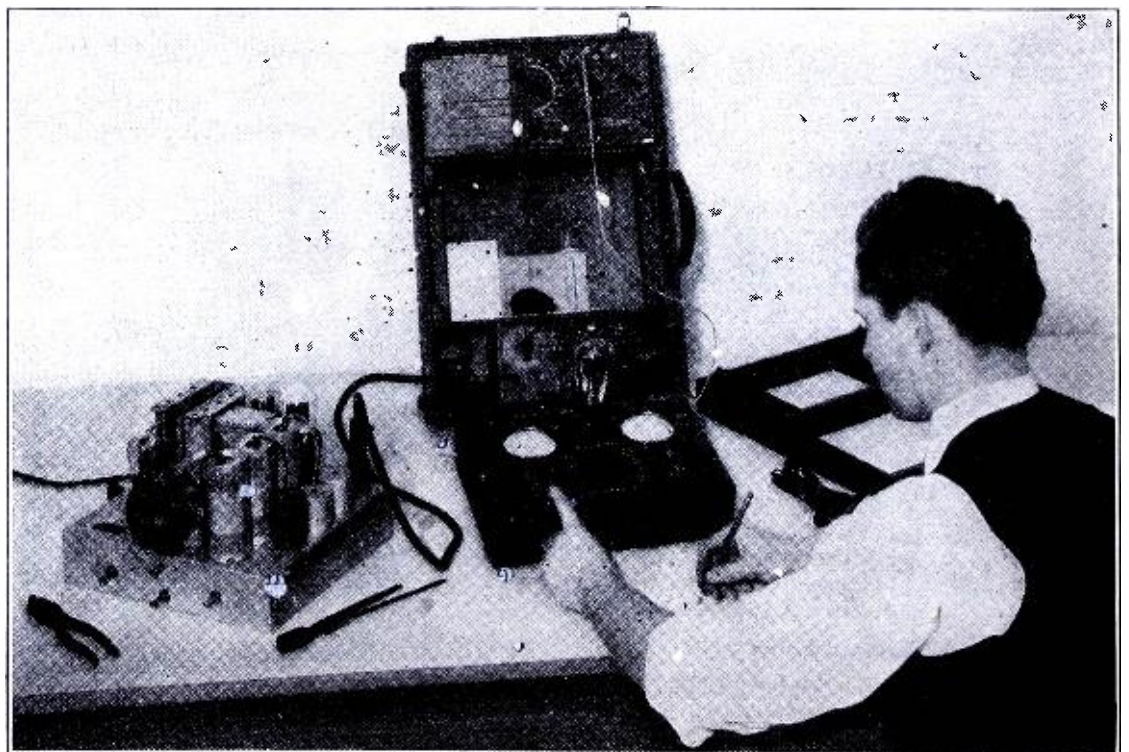

out the instrument. With this in mind, it is easy to see why service instruments must be accurate and simple to use if they are to be of value to the serviceman. Thus the analyzer unit of this instrument is provided with large meters having unusually long scales and the resistance networks which make possible multiple measuring ranges with each meter are very carefully calibrated. These features assure accurate readings of all receiver voltages and currents. Reference to the circuit diagram of this instrument, printed on page 27 of the January issue of *Radio Call Book Magazine and Technical Review*, shows this network. Though it has been greatly simplified by careful design, it still remains rather complicated.

When designing the test oscillator, it was found that "stray" or "wild" radiations from the oscillator to the receiver being adjusted must be practically eliminated. Otherwise close adjustment of the receiver circuits is not possible. This precluded the use of an alternating current operated oscillator, as too large filters would be

necessary to prevent feedback to the receiver through the power lines. A battery operated design was evolved, completely housed in a metal shielding case. Even the batteries are car-

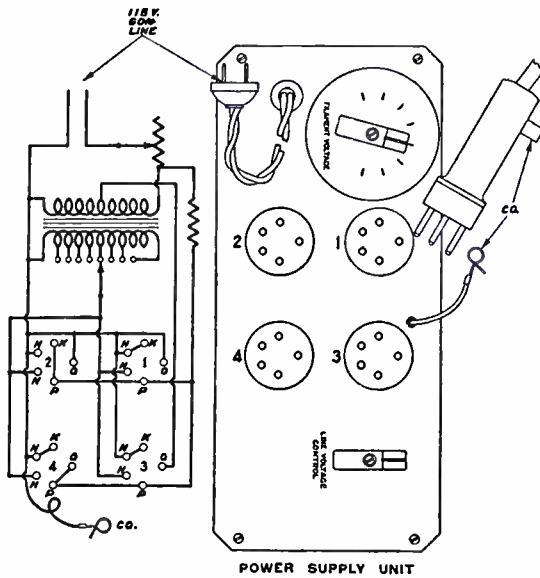

ried within the shielding. The radio frequency output is conveyed by means of a shielded lead to the exact receiver circuit desired. Of course, the battery operated oscillator has the added advantage of ability to service

auto, aviation, and farm battery operated sets.

Output is provided on three frequency bands: broadcast 550-1,500 K.C., low intermediate 125-175 K.C., and 160-280 K.C. These ranges are all fundamentals and allow adjustment of all radio frequency circuits in tuned radio frequency sets and all superheterodyne intermediate frequency circuits, including those using 130, 175, 185, and 275 K.C. The confusion possible when the upper band is covered by harmonics is eliminated.

Perhaps the most novel feature of this instrument is the power unit that makes possible accurate testing of tubes in the analyzer independently of a receiving set. This unit plugs into a 110 volt, 60 cycle socket and supplies standard test voltages to the analyzer. An extremely accurate tube check can then be made by reading the change in plate current for two values of direct current grid bias. The three volt battery in the analyzer supplies this grid bias. A rheostat is placed in the power transformer primary circuit to allow compensation for fluctuations in line voltage.

Low Range Ohmmeter

AS a companion to the Three Range Ohmmeter described on page 28 of the February, 1932, issue of the *Radio Call Book Magazine and Technical Review*, we present this instrument which covers the lower range of resistance values, with a scale which enables accurately determining resistances as low as two ohms. The upper practical limit of the scale is 10,000 ohms.

A Weston type 301, 0-10 milliamperere meter is used, the greatest item of cost. The remaining parts consist of a fixed wire wound resistance unit

of 100 ohms, and a Yaxley rheostat of 75 ohms. A single large flashlight cell is enclosed with the instrument in its case. Binding posts are

rheostat by means of its knob, found on the panel.

In column 1 is the front panel view showing the location of the meter, the adjusting knob, and the binding posts for connection to the unknown resistance. A back panel view is given in column 2. It shows clearly the layout of all parts and the connections made to the various circuit elements. In column 3 is the schematic wiring diagram, which is extremely simple and should require no additional explanation for clarity. A special meter scale will be furnished upon receipt of 50c.

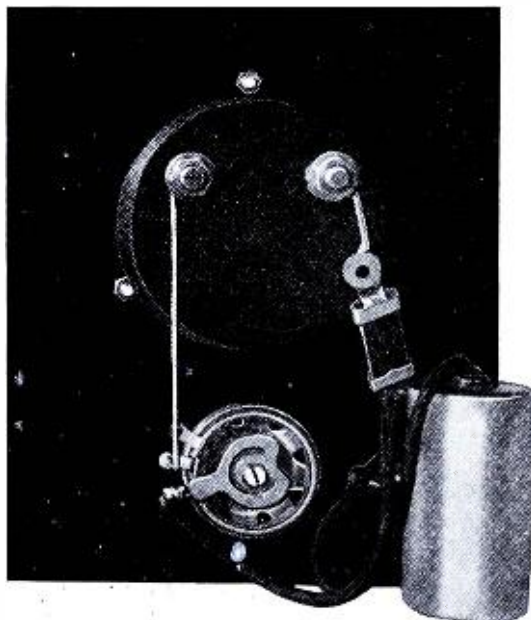
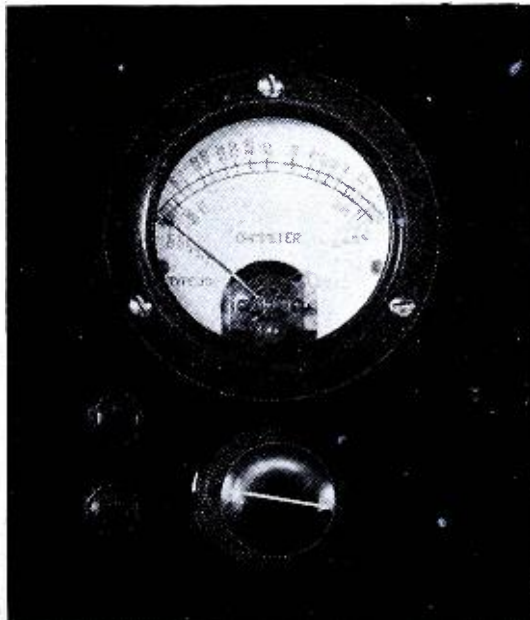

brought out on the panel for connections to the resistance to be measured. In use, the meter pointer is first adjusted to the left end of the scale, with the terminals open, by means of the screw adjustment found on the meter face. Then a short piece of copper wire is connected across the terminals on the panel, and the pointer is adjusted to the zero ohms point on the scale by varying the

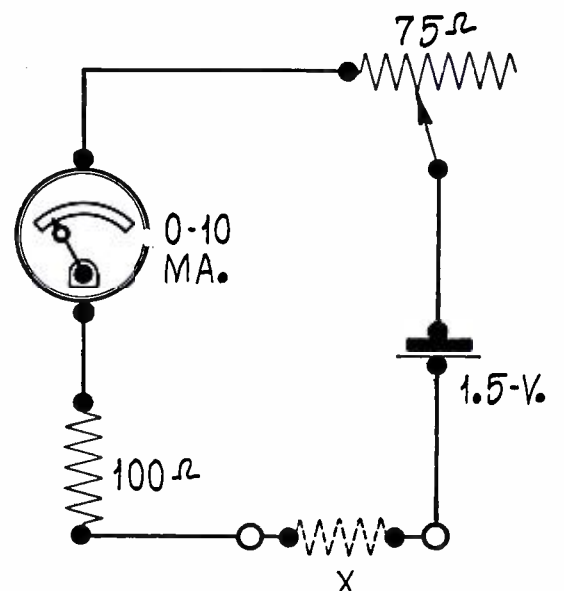

Sectionalized Rectifiers

By A. L. Atherton, Circuit Breaker Engineering Dept., Westinghouse Electric & Manufacturing Company *

BASIS for the sectional type mercury arc rectifier lies in the obvious, but apparently heretofore unrecognized fact that the best possibilities inherent in the principle are realized only in the smaller sizes. Efficiency, reliability, economy, and flexibility of both application and use are all far better in small than in large units. The advantages appear to be fundamental and, therefore, permanent.

Many familiar things are inherently at their best in small sizes; some become impossible or impractical to

scheme as natural and, therefore, right. In suspension insulator units, a large part of the insulation material is shunted by metal, assembly operations are duplicated many times in a single unit of use, and the distribution of potential along the string is wrong unless corrected; but the mechanical

transmission received a major stimulus.

So with the metal tank mercury arc rectifier. Subdivision into unit sections introduces both advantages and disadvantages, but the advantages so far outweigh the disadvantages that, once the conception is seriously considered and the sectional design actually worked out, doubts disappear and it seems the right and natural way to proceed.

Development through the past twenty-nine years has resulted in rectifiers of small capacity, 500 kw. for example, with a high degree of reliability, a reasonable cost, and an efficiency which makes available for the higher voltage conversion applications the unique quietness and freedom from mechanical wear which has provided the major incentive throughout the development. When size is increased to get larger output capacity, however, the quality decreases markedly. Reliability decreases not only in proportion to size as might be expected, but more rapidly because the complexity of the problem of control of the hurricane flow of vapor from the cathode is increased many fold when size is even doubled. The "outage time" per year with 3,000 kw. rectifiers is several times as great as with 500 kw. units. Cost per unit of output does not decrease with increase of size, as it does with some apparatus, be-

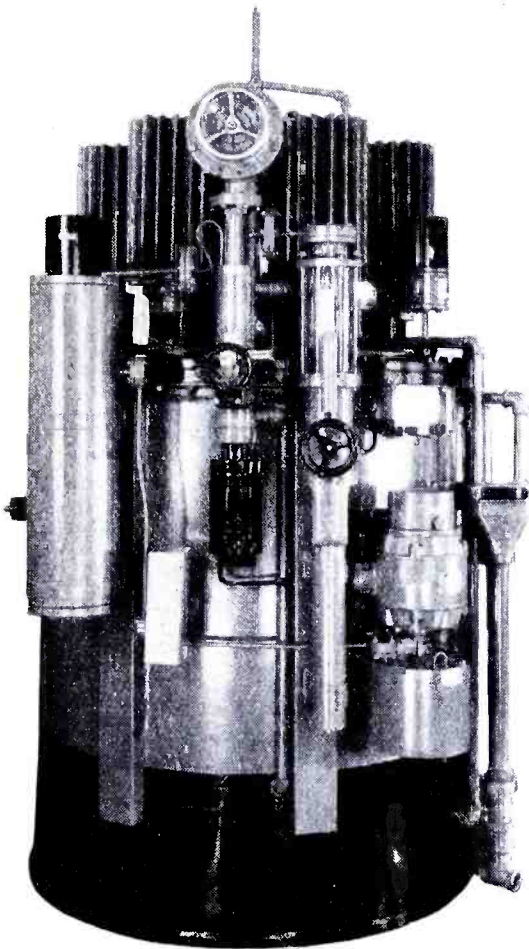

Figure 1

make or to use above a small unit size. A book, a bar of soap, a lead pencil among common things; the cylinders of an internal combustion engine, or the engine as a whole, in mechanics; and among electrical things, suspension insulators and incandescent lamps, are examples. In each of these, and almost innumerable other cases, some kind of utility is added by the subdivision of the required amount into smaller unit parts.

Established and common "unit type" things are so well known that we have come to overlook the limitations and inefficiencies introduced by the subdivision and to accept the

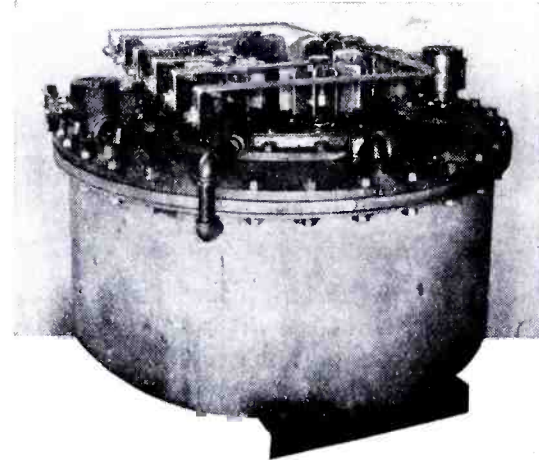

Figure 2

strength, flexibility, adaptability to all voltages, and the economy of concentrating manufacture and stocks in a single unit are so much more important that the disadvantages almost vanish from our thoughts. Because the benefits outweighed the disadvantages, the introduction of the idea of sectionalization in line insulators created a new utility, and because the increase in utility was great, the whole of the associated art of long distance

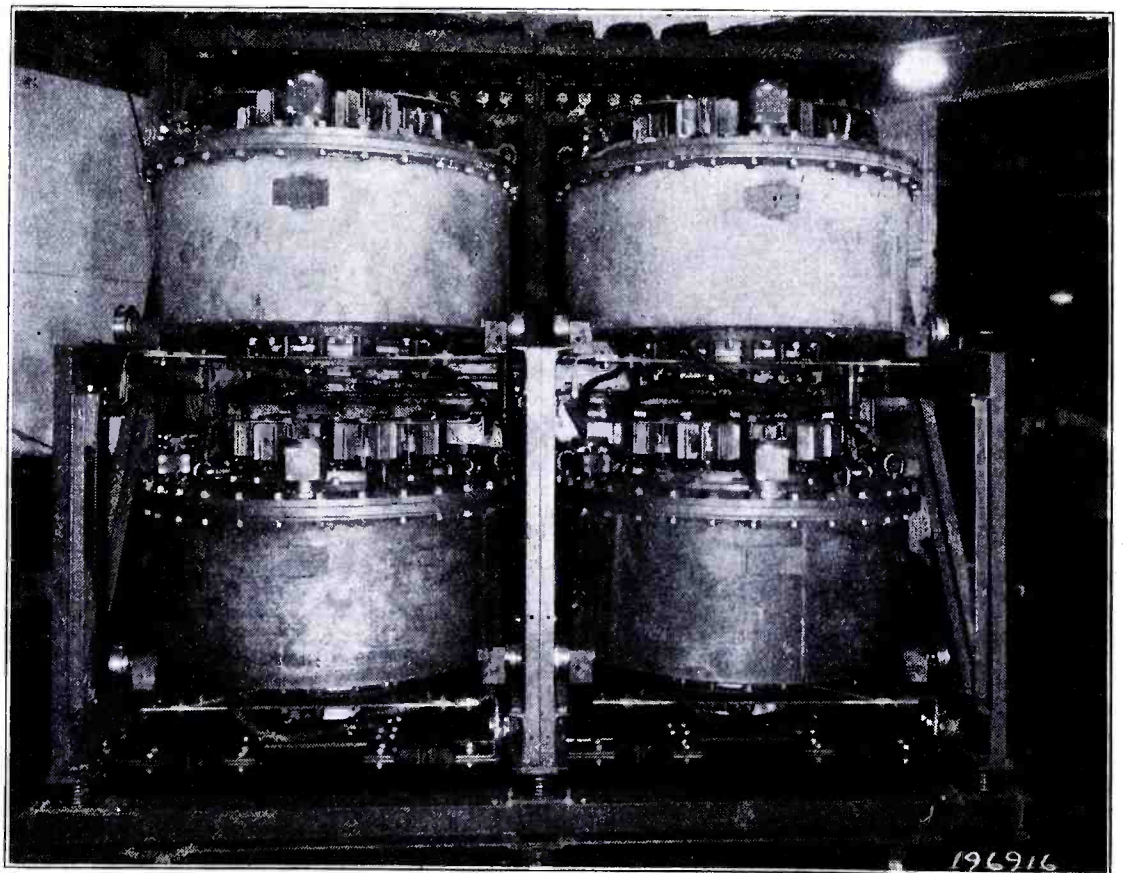

Figure 3

* Presented before the A. I. E. E. Winter Convention, New York, Jan. 25-29, 1932.

cause manufacturing problems increase faster than in proportion to size, and because the total requirement for this kind of equipment, with capabilities and limitations as they are even in the smaller sizes, will not support organized "line manufacture" for the larger capacities. Efficiency falls off with increase in size because of the longer arc and greater exposure to deionizing surfaces, and because loss of reliability makes necessary an increase in loss producing devices to get acceptable quality. With present designs, the internal losses for a 500 kw. unit are approximately 25% less than for a 3,000 kw. unit, both based on 600 volt operation. The major disadvantages which go with size appear to be fundamental and permanent, whatever advances may be made in the art. Larger units will always be less efficient, and the reliability and cost

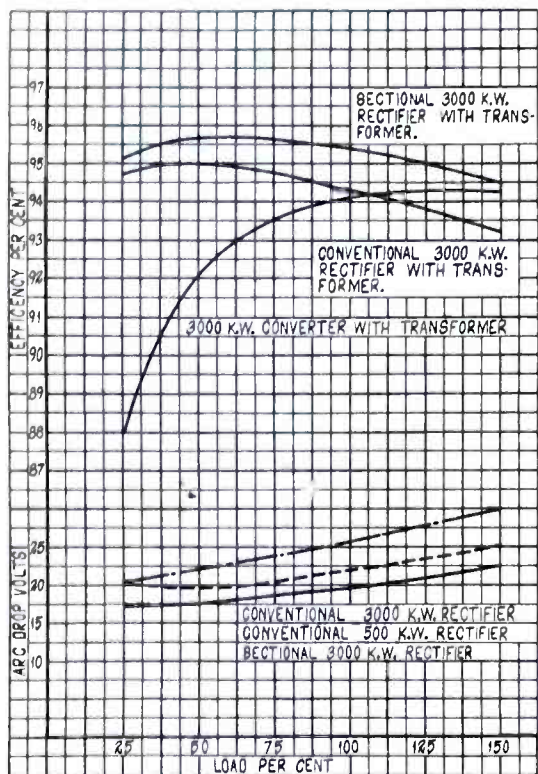

Figure 4

disadvantages will probably persist.

If we think of multiple installations of conventional small capacity units of the sort which have been available in the past, we realize that the project is impracticable. The space required is too great and the multiplicity of control and protective devices appears questionable. But when we think of subdivision of a large capacity, taking advantage of space economies resulting from recent advances in the art, building the structure in sections but installing, controlling, protecting and using it as a whole, the project becomes feasible and the desirable qualities of the small rectifier are made available for the larger capacities, while the disadvantages of sectionalizing are so reduced as to become negligible.

Our work with rectifiers of conventional size and characteristics has resulted in the conviction that the limi-

tation in capacity for a given design, for instance the 500 kw. unit shown in Figure 1, lies in local limitations of the various parts. For example, the limits of conductivity and heating at the anode, and not the perhaps more fundamental and difficult tendency to arc back at the higher currents. Such a unit carries a nominal current of 833 amperes continuously, 1,250 amperes for two hours, and 2,500 amperes for one minute. In all our test-

rially to reduce the size of the containing tank without affecting the ability of the unit to carry the loads required by its rating. Experiments along these lines have verified this conclusion.

As a further step, a rearrangement of parts made possible a still further reduction in size for a given rating, and at the same time brought about some reduction in the internal losses. The rearrangement was based on the

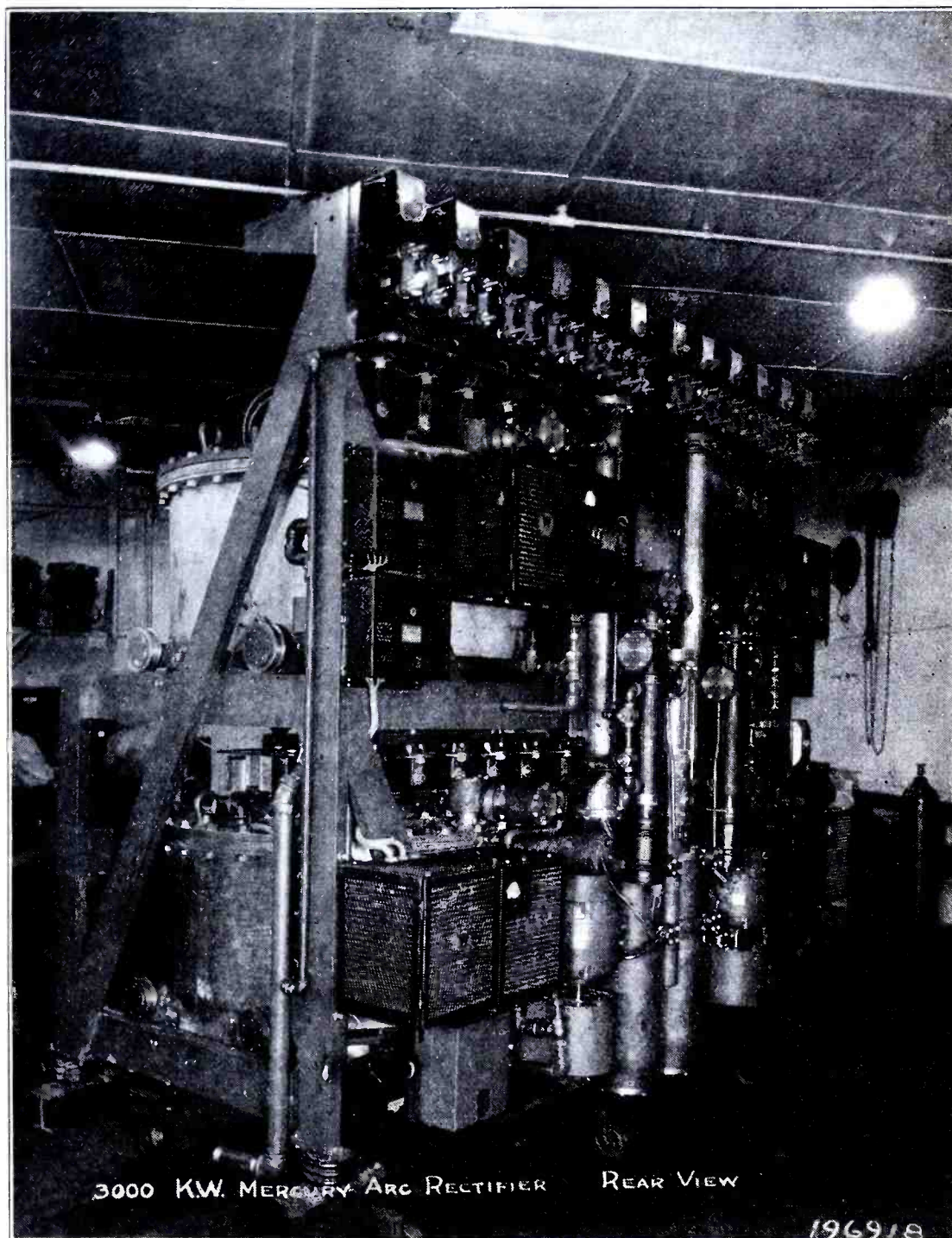

Figure 5

ing, which includes use at currents up to 17,000 amperes on short circuit, and which includes considerable experimental experience of loads of 2,000 to 2,500 amperes for periods of 5 to 30 minutes, dependent on temperature rise, we have not experienced arcing back as a limitation. Extended service experience with a limited number of installations gives the same result. Evidently, change in the details, leaving the general arrangement unaltered, would make it possible mate-

knowledge gained in our experimental experience as to the effect of the way the vapor flows from the cathode to the condensing wall and the position of the anode structures in relation to this stream of ionized vapor on the limiting current of which the rectifier unit is capable, without excessive arcing back. Although the whole mechanism of vapor flow and its effect on arcing back are far from known, several factors which influence performance have
(Continued on page 38)

Complete Set Analyzer

NUMEROUS requests for construction data on a low priced analyzer has prompted us to run the following article. This analyzer will make all the necessary tests on any receiver with the exception of testing rectifier tubes. However, most service men carry extras and the efficiency of the tube in the receiver can be determined by substitution. The constructor should not, however, expect all the tests that are possible with a factory built instrument to be made with the home constructed article, due to the fact that this type of instrument, in order to be worth while, must be held to a price limit.

Fig. 1 shows the test instrument complete in a small carrying case, which is what is commonly known as an "overnight bag." The meter shown at the left-hand side is a Weston type 476, 0-3 volts a-c. Directly below this meter is located a small knob which controls a single pole single throw switch, allowing the meter range to be raised to 15 volts by connecting in series with it a resistance of approximately 72 ohms. This meter can also be used as an output meter for aligning of receivers. The leads from it are brought out to the front of the panel for this purpose and terminate at two binding posts marked "a-c." This meter, as used in the test kit, measures filament voltages and is continually in the circuit.

You will also note below the meter an arrowed knob. This actuates a 10,000 ohm resistor, which is connected in series with a push button switch labeled "mu," seen at the right of the meter. The resistance and the switch are connected across the clip lead and the cathode lead of the five-prong socket. It is not, however, shown in the schematic. This is used to get

a rough mutual conductance reading. By pushing the button you adjust the resistor so as to cut the grid voltage a fraction of its original value. The

ranges as shown on the nine-point switch in Fig. 2 and may be purchased from this office by mailing 60c. Directly below this meter a nine-point



Figure 1

change in plate current is then divided by the change in grid voltage and the result multiplied by one million, giving the answer in micromhos.

The center meter is a Jewell pattern 54, 0-1 milliammeter, using special scale

switch changes the range of this voltmeter from a 0-20 to 0-1000 volts. To the right and the left of the nine-point switch you will note two arrowed knobs. These control double pole, double throw, three-position switches and by drawing into their various positions, plate, screen grid and cathode voltages are read on the voltmeter. The two D.P.D.T. switches just mentioned, and the nine-point switch are made by General Radio Co.

Two leads are brought out to the front of the panel from the voltmeter so that it may be used externally. To the right of the voltmeter is a double pole, double throw, two-position switch, which reverses the polarity of the meter. The meter at the extreme right is a Weston type 301, 0-20 milliammeter. Directly below this is located the single pole single throw switch which allows the meter range to be raised from a 20 ma full scale to 100 ma, by shunting a resistor of approximately .3 ohms across the in-

(Continued on next page)

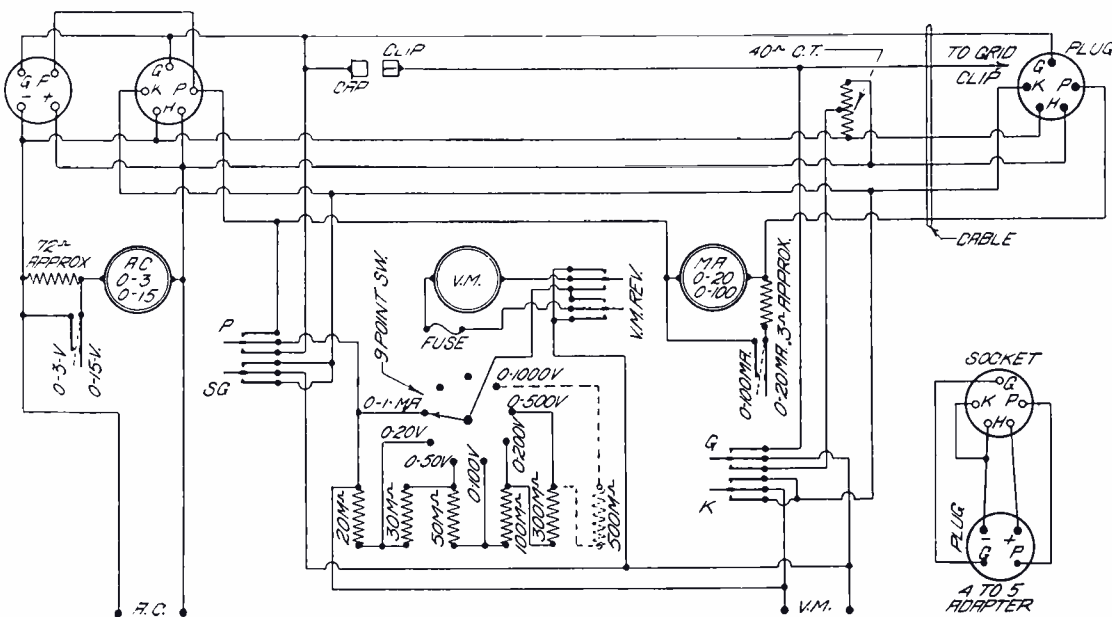

Figure 2

strument. This meter shows the plate current and is continually in the circuit.

Located at the lower right-hand corner are two fuse mountings, one of which contains a spare. The fuse in use is of 1/64 ampere capacity and is used to protect the voltmeter. These fuses are made by the Littlefuse Co. In order to test output pentodes all that is necessary is to plug the five-prong adapter into the socket, insert the tube in the test kit, make the plate and grid test as usual and to get a voltage reading on the extra screen, the switch should be thrown into the cathode reading position.

In Fig. 2 you will note at the upper
(Continued on page 46)

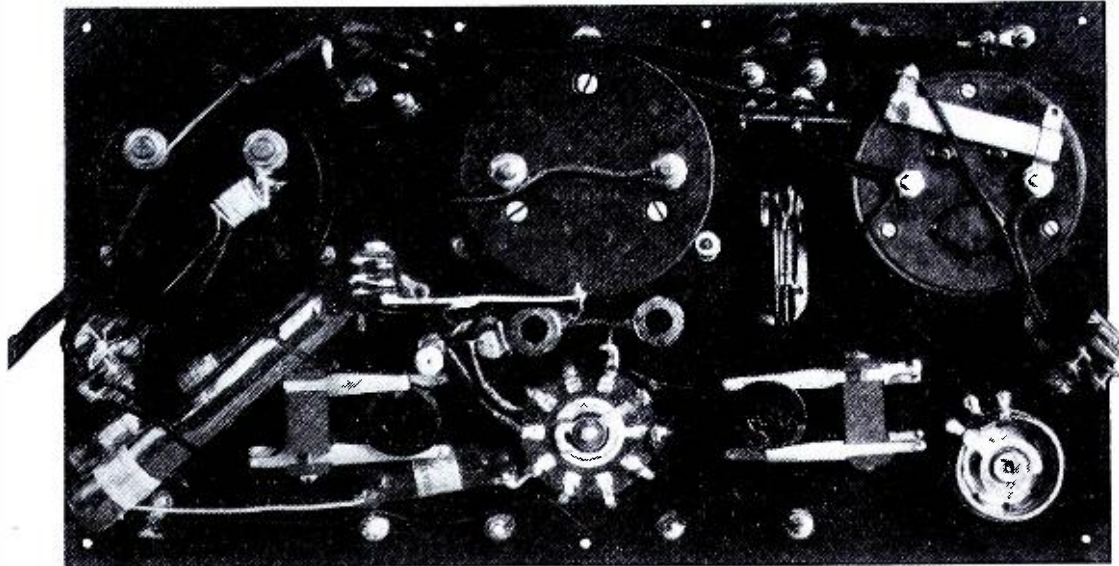

Figure 3

Weighing With a Beam of Light

ACCURATELY weighing the steady flow of material passing by on a conveyor belt; keeping careful count of the tons that have been handled; and finally, recording on a time chart the belt loadings throughout the twenty-four hours of the day—such is the latest job undertaken by an electric eye and an ingenious electric brain. This application of the light-sensitive cell and electrical integrator or counter, to use plain terms, represents a notable advance over the means heretofore employed in accomplishing this task, mainly by way of simplicity, lower cost and more positive adjustment. While the general scheme of weighing a continuous flow of material remains the same, the means whereby passing weights are converted into corresponding electrical impulses for the operation of the integrator, has been radically changed with the introduction of the light sensitive cell.

To better understand the latest light-control application, let us begin with the main principle. To obtain the weight of a continuous flow of material, it is necessary to combine the size of the stream with the speed at which it moves. The speed may be constant, but the size of the stream may range from zero pounds per foot to the full capacity of the conveyor. Consequently, any variation of load must be instantaneously noted at the controller so that true integration of weight may be obtained.

At the point where the continuous stream of material is to be weighed, a short section of belt is installed, mounted in such manner that its varying weight is communicated to the weight checking equipment placed directly above. With the varying weight of the load on the conveyor belt, the beam of the weight checking

mechanism is actuated. The scale load at one end causes the fulcrumed beam to swing over the scale of the load indicator at the far or free end. This, of course, indicates the instantaneous weight, but there is still need for some device to keep tally of the continuous procession of varying weights. It is at this point that the

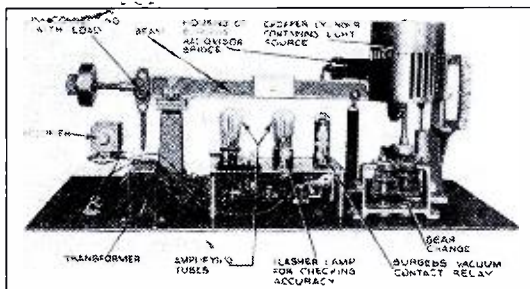

electric eye gets to work.

Close to the free end of the swinging beam is mounted a cross arm carrying a Burgess Radiovisor Bridge or simplified form of light-sensitive cell, and a light source lamp. These members are so mounted that one is outside, while the other is inside a revolving light-chopper cylinder which is driven in step with the speed of the belt. The light-chopper cylinder derives its name from the fact that it carries 32 parallel longitudinal slots which serve to interrupt the passage of the beam of light between light source and bridge. However, the slots are of varying lengths. The first is equal in length to the distance traveled by the scale beam from zero to full load. Each succeeding slot is shortened an equal amount at the bottom, so that a line drawn from the bottom of slot 1 around the cylinder to the bottom of slot 32 would form a true helix, touching the bottoms of all slots.

The bridge or cell is mounted in a housing provided with a window directly opposite the sensitive plate.

The condensing lens of the light source is adjusted to concentrate an intense beam of light through the window and on to the light-sensitive plate. However, the wall of the rotating chopper cylinder comes between, allowing the light beam to pass only when a slot is in line. Each admission of light reaching the bridge sets up an electrical impulse, which impulse in turn drives the mechanism of the integrator or electric brain that keeps tally, as well as the time chart recorder.

With no load on the belt, the free end of the beam is down, with the focused point of light just below the bottom of slot 1 of the chopper cylinder. Hence no impulses result, since no light reaches the bridge. As load is placed on the belt the beam swings upward proportionately, bringing the focused point of light higher and higher on the chopper cylinder, so that more and more slots admit light and

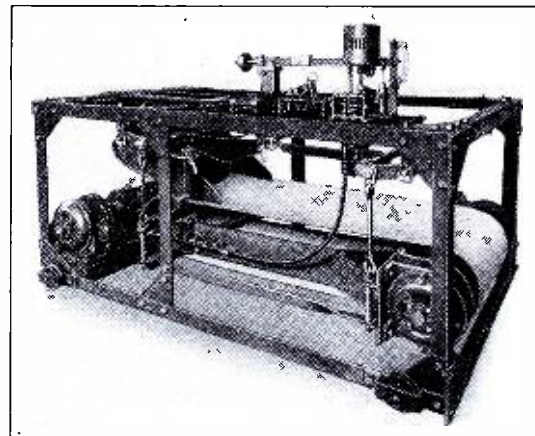

cause a corresponding number of impulses to actuate the electrical integrator. The number of impulses are always proportional to the load, from zero to the capacity at which the scale is calibrated. At full load there are 32 contacts per revolution of the chopper cylinder. With 350 contacts per
(Continued on page 40)

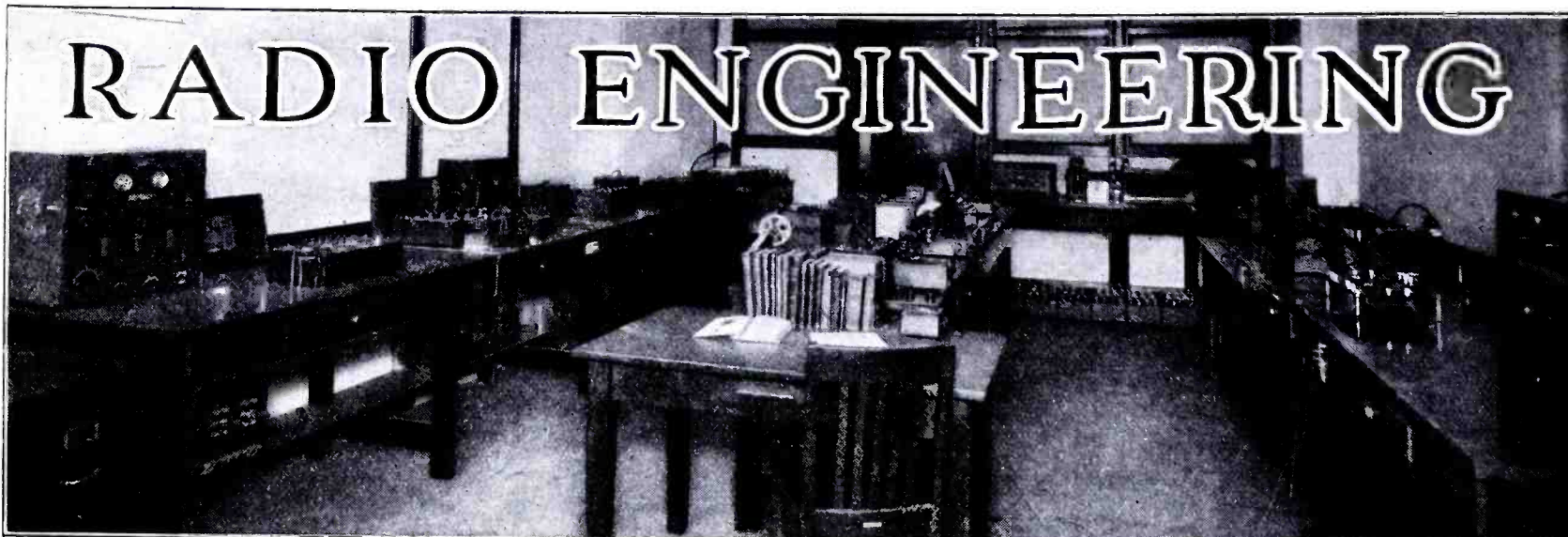

Filter Design by Graphs

PART I

RUMOR has it that when brow-beating, bullying, and Black Magic have failed, the next best way to intimidate some people is to show them a graph. It is claimed that when all other avenues of escape have been cut off, these people will contend that, being at best poor mathematicians, they do not hope to comprehend an array of curves which they already suspect of being heavily fraught with mathematical significance.

It seems incredible that such should be the case, for, after all, graphs present matters in the simplest of all languages, the language of pictures; and, in fact, if one could imagine an event, statistical or purely mathematical, leaving behind it a trail of dust, and then could imagine some enterprising young photographer creeping up and taking a picture of that trail of dust, one might safely say that the photographer now had in his possession scarcely more or less than a graph of the progress of that above-mentioned event.

In Figure 1, for instance, how much easier it is to say that the frequency of resonance is the frequency at which two lines cross each other than it is to take paper and pencil and regard the frequency of resonance as the reciprocal of the product of two numbers, one of which is already the square root of the product of two other numbers (which it undoubtedly is). Many of us must decide at once in favor of the graph.

Of course, in any discussion of resonance, graphical or not, we ought first to reach some semblance of an agreement upon what resonance really is. For one thing, we recognize in resonance an electrical condition without which the development of radio, tele-

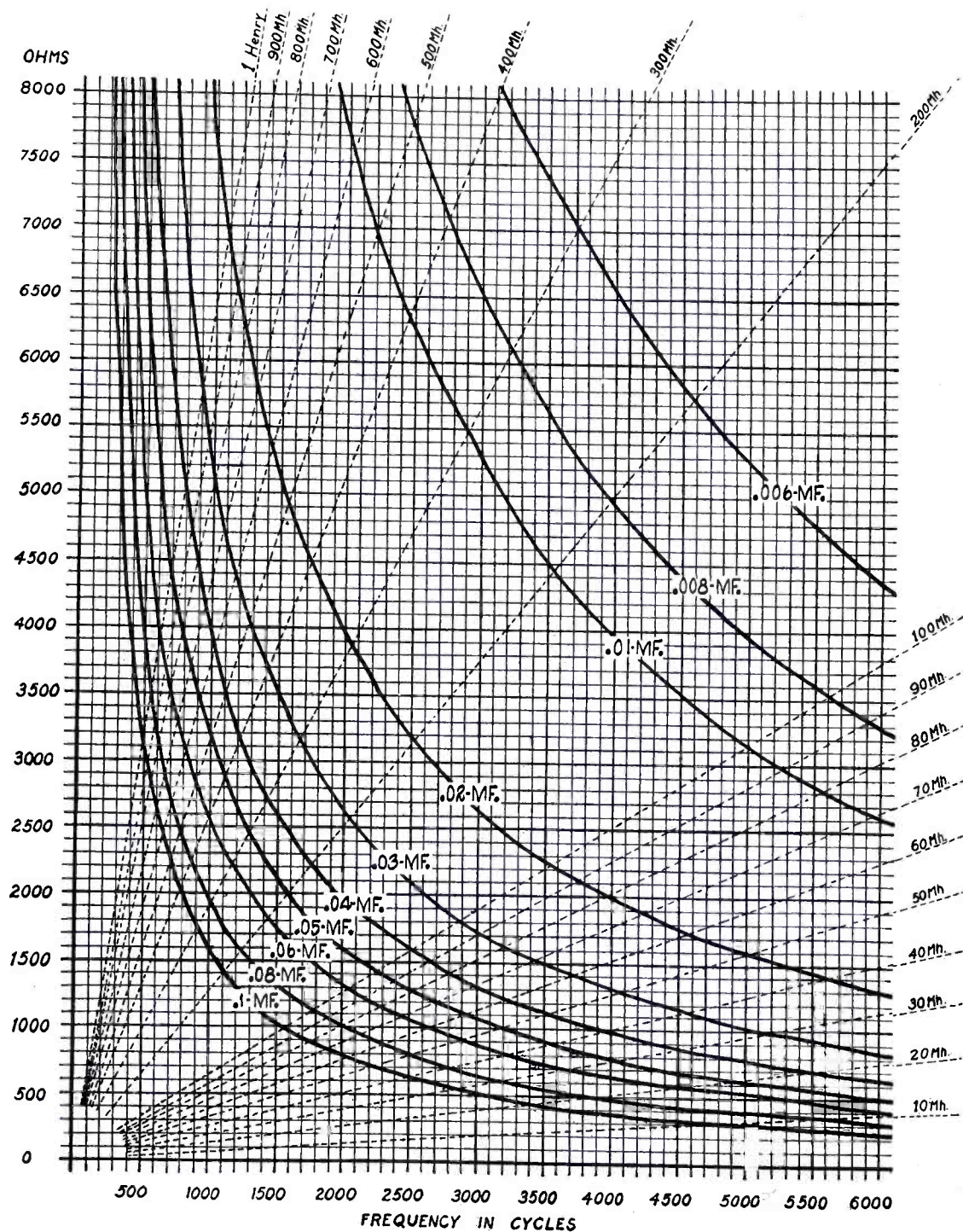
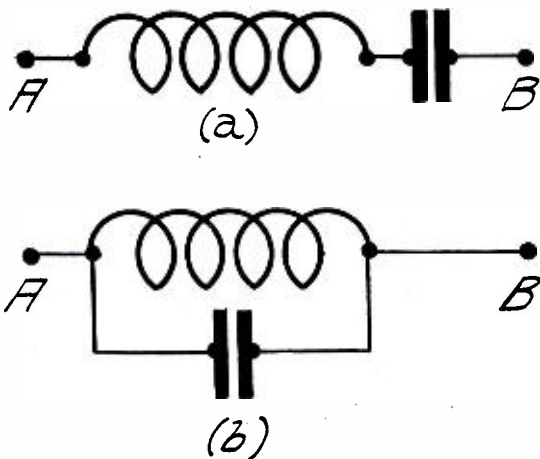

Figure 1

vision, and power to their present state would be highly improbable. For this reason alone we could be justified in even a lengthy discussion of the subject. Looking at the mechanical aspects of resonance we find that it always involves inductance, a property common to coils of wire, and capacitance, the chief attribute of a condenser.

If we were to take a coil of wire (inductance) and pass an alternating current through it, we should find that the very act of admitting the changing current in the first few turns of wire had given rise to a disturbance throughout the electric field of the coil, and that this disturbance, in turn, had induced an electro-motive force in



all the other turns of wire, which force, unfortunately perhaps, had an opposite direction to the initial current which gave rise to it. Consequently, as the current proceeds through the next few turns of wire, it must spend some of its energy in overcoming the resisting electro-motive force. If we should measure the electrical energy in the whole circuit, it would become evident that power was being lost somewhere in the coil, and since we are accustomed to suspect that whenever power is lost it has been used in overcoming resistance, we may properly conclude that the coil has some form of resistance which we proceed to measure in ohms. However, since it is necessary to differentiate between this apparent resistance due to opposing electro-motive forces and the usual kind of resistance resulting from friction and manifesting itself in heat losses, we call the former "inductive reactance" and the latter simply resistance.

If, instead of an alternating current, we had put a direct current through the coil, we might measure an appreciable frictional resistance, but there would be no measurable inductive reactance. The reactance effect requires that the current be changing (alternating) and experiment shows that the reactance is directly proportional to the frequency; that is, the greater the number of alternations per second the greater becomes the expression in ohms of inductive reactance.

On the other hand, if we had passed alternating current through a condenser instead of a coil, we might have observed what is called capacity reactance. This sort of reactance is not due to an induced opposite electro-motive force, but is more to be accounted for by observing that the condenser behaves like an elastic storage container which, while being filled, admits current readily at first, but becomes increasingly difficult to fill as it nears its elastic limit. It is this difficulty in charging to capacity against an elastic restoring force that we recognize as capacity reactance. If a direct current were put through a condenser it might enjoy a momentary surge, but very shortly the capacity of the condenser would have been reached and at the given voltage no more current could be forced against the large elastic restoring force. This would give the effect of an infinitely high capacity reactance (just the opposite from the inductive reactance effect). In fact, with capacitance, the higher the frequency the lower becomes the reactance, since with high frequency of alternation a current doesn't travel long enough in one direction to charge the condenser to a point of strain.

It is particularly instructive at this point to recall a mechanical analogy suggested several years ago by the famous physicist, Lord Kelvin. He pointed out that an inductance possesses properties of a heavy mass, especially in respect to its inertia, the quality of being hard to start and hard to stop. A current starting out in an inductance promptly meets a high opposing electro-motive force and is retarded, while, on the other hand, a current once started and tending to decrease or stop in an inductive circuit is urged by a contrary electro-motive force to keep going. Lord Kelvin went on to show that a condenser has the property of elasticity, that is, when strained it exerts a force to restore it to its previous equilibrium. There is much in this to remind us of a weight suspended on a steel spiral spring, the other end of which is on a fixed hook. Here the weight has inertia, while the steel spring has elasticity, and the two together form a system which, when started, oscillates up and down with a uniform period. For any particular value of spring and weight there is a definite natural frequency of oscillation which may well be termed the frequency of resonance. It is to be noted that if spring or weight were taken separately, much labor could be performed in lifting them up and down, whereas, when they are together, a slight touch at regular intervals (depending on the resonant frequency) is sufficient to maintain the oscillation indefinitely. We might notice also

that if we were to apply energy to this system at any intervals other than those determined by the resonant frequency, we should be lifting the weight part of the time when it would naturally have tended to go down, and we should be pulling down against the spring when the natural tendency of the system was to go up. Obviously if we supply alternating energy at any other but the resonant frequency we must encounter some resisting force or reactance.

Returning to the condition of electrical resonance, we find that the mechanical analogy has its parallel here in several respects. In Figure 1 has been represented most of the important part of the audible frequency band, namely, frequencies from zero to 6,000 cycles. Starting at the lower left corner and reading to the right, each added small square means an increase in frequency of 100 cycles. Reading upward, each square represents 100 ohms reactance. The heavy curved lines represent capacity values. Thus, if we wished to find the reactance of a one microfarad condenser at 1,000 cycles, we start on the 1,000-cycle line, go up to where it crosses the heavy curved line marked 1Mfd. and note that this point is on a horizontal level with approximately 1,590 ohms. The answer is simply that the 1Mfd. condenser has 1,590 ohms reactance at 1,000 cycles. What size condenser will have a reactance of 4,000 ohms at 2,000 cycles? Read up along the 2,000-cycle line to the 4,000-ohm level, and the nearest capacity line appears to be .2Mfd., which is the value we were trying to determine.

The broken lines radiating from the lower left corner represent inductance values (designated around the margin). Suppose we want to know the reactance of 90 millihenrys at 4,500 cycles. We merely find the intersection point of the 4,500-cycle line with the broken line marked in the margin 90Mh. and observe that this point is in the horizontal reactance level of about 2,540 ohms. If we should put a coil of 200 millihenrys inductance in series (as in Fig. a) with a condenser whose capacity is .1 microfarad, what would be the resonant frequency of the combination, or, in other words, at what frequency would their combined reactance be zero? (The reactances of inductance and capacity are opposite in their effect and tend to cancel each other out. If they were equal and opposite, the net effect would be zero reactance.) If we follow the broken line marked 200Mh. to the point where it crosses the heavy curved line .1Mfd., we find this point at a frequency level of approximately 3,550 cycles. Longhand calculation shows this to be 3,559 cycles, so we are

(Continued on page 40)

Sectionalized Rectifiers

(Continued from page 33)

been established. The design shown in Figure 2 is an attempt to take these as yet rather intangible and, it must be admitted, somewhat uncertain factors into account in the most satisfactory way possible at the present time.

The anode support and shielding arrangement also offered an opportunity for progress and a rather extended series of experiments resulted finally in the anode structure shown. Processing to eliminate foreign material and keep the gas evolution under operation at as low a value as possible have progressed along with the design development.

As a result of these improvements, the rectifier section shown in Figure 2 is capable, with a reasonable margin, of a standard nominal rating of 750 kw. at 600 volts, and even of higher short time overloads as sometimes required.

This section, at 750 kw., 600 volts rating, is required to carry a normal current of 1,250 amperes, with 50% overload, or 1,875 amperes for two hours. Owing to the fact that final temperatures are reached in times of the order of two hours, it is felt that the two-hour capacity can best be indicated by continuous operation at the 50% overload value and our experimental tests have been made in this way, thus including in a single test some margin of safety along with a degree of acceleration of the test. Double load, or 2,500 amperes, is required by standard nominal rating for a period of one minute following full load. Experimental tests have been made at this current up to 5 minutes' duration.

In all these operations, arcing back is very infrequent, if it occurs at all, and it is a requirement that the rectifier can be put into operation again immediately following such an occurrence.

The internal losses in the rectifier are determined by the arc drop, or voltage from anode to cathode during the conducting period. This value varies with load current and can be indicated by a curve of voltage drop against load current. The value that determines efficiency is the average for the various anodes. Figure 4 shows average arc drop curve for the unit indicated by Figure 2. The dotted curve shows the value for the older, conventional, unit shown by Figure 1. As the size of a rectifier is increased, the arc path becomes longer and losses per kw. output become greater. Experimental rectifiers of 3,000 kw. with a single tank have had arc drop values as shown by the dot and dash curve of Figure 4. It is seen that at full

(Continued on page 40)

SHORT WAVE RECEIVER

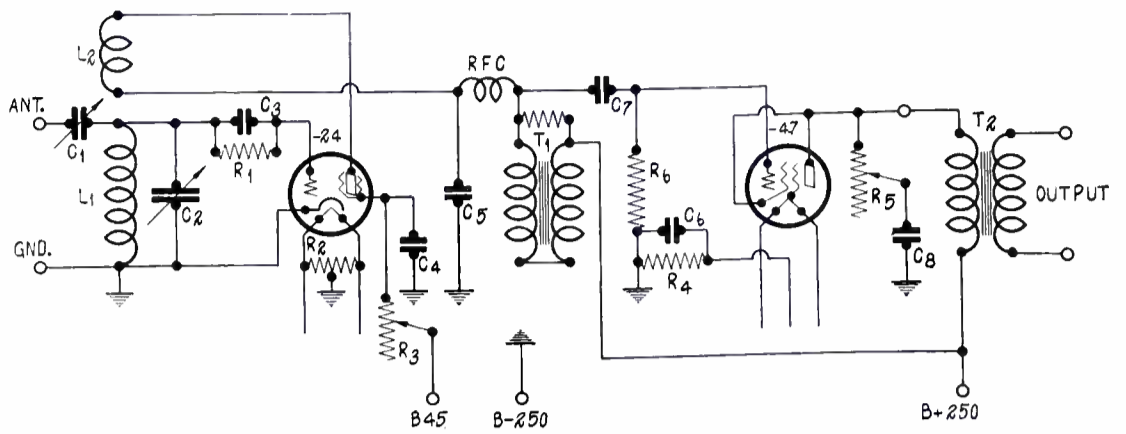

By W. H. Henton, Slater, Mo.

- C₁=5 plate midget condenser.
 - C₂=.00012 mfd. condenser.
 - C₃=.0001 mfd. condenser.
 - C₄=.5 mfd. condenser.
 - C₅=.0002 mfd. condenser.
 - C₆=4 mfd. electrolytic.
 - C₇=.01 mfd. condenser.
 - C₈=.03 mfd. condenser.
 - R₁=5 to 10 megohms.
 - R₂=20 ohm center-tapped resistor.
 - R₃=100,000 ohm resistor.
 - R₄=400 ohm resistor.
 - R₅=50,000 ohm tone control.
 - R₆=1 megohm.
 - L₁, L₂ wound on tube base.
 - RFC=85 mh.
 - T₁=Audio transformer with primary and secondary in series, shunted with a 200,000 ohm resistor.
 - T₂=pentode output transformer.
- | | | |
|-------------------------------------|---------------------|------------------|
| 20-40 Meters | 40-80 Meters | 80-160 Meters |
| L ₁ =11 turns, 28 D.C.C. | 20 turns, 28 D.C.C. | 30 turns, D.C.C. |
| L ₂ =6 turns, 28 D.C.C. | 9 turns, 28 D.C.C. | 10 turns, D.C.C. |
| Wound on tube base | | |

EVEREADY 239 CHARACTERISTICS

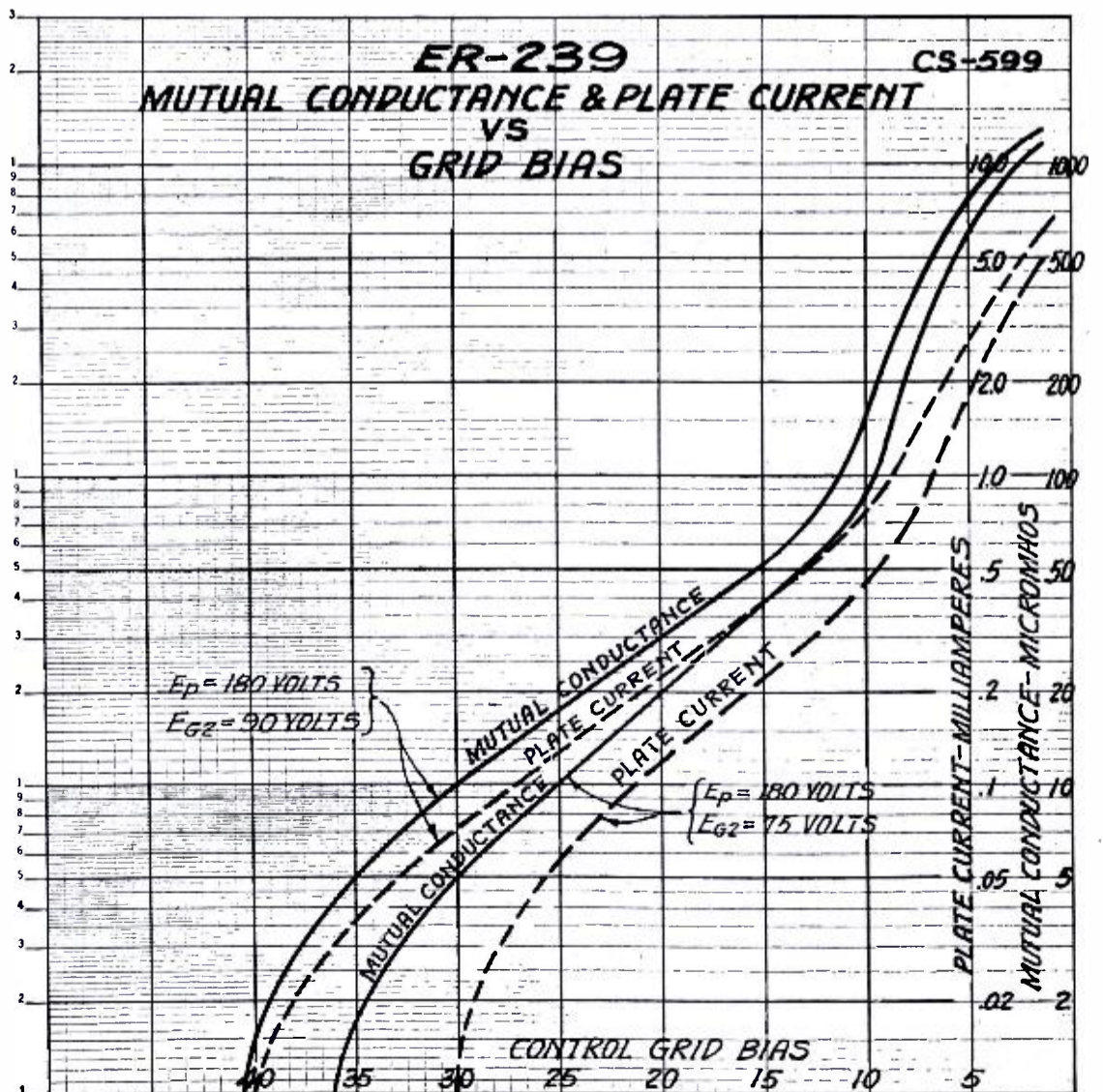

Power Amplifier Systems

RADIART MODEL GXC2

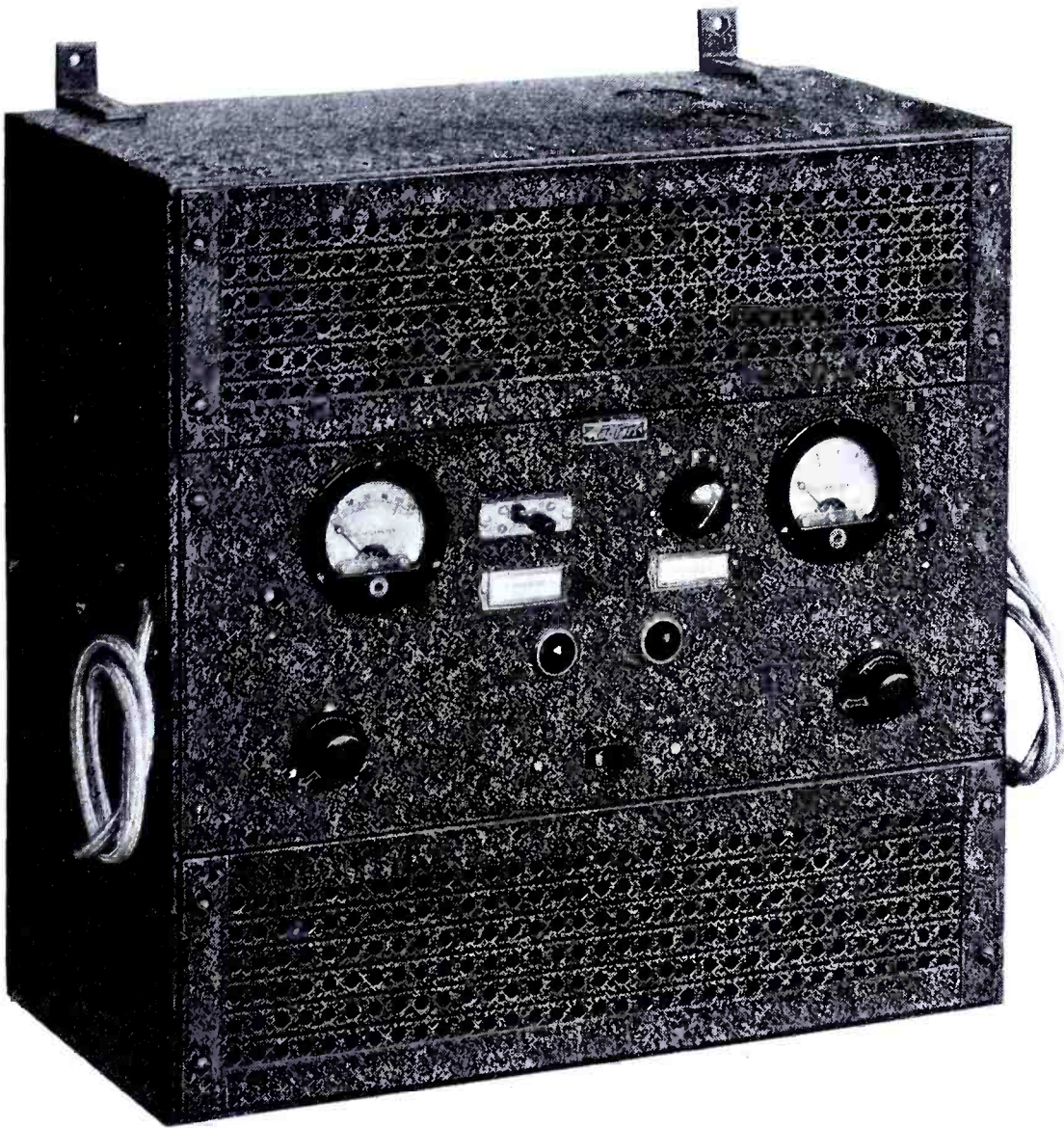

PERFORMANCE curves on the Radiart model GXC2 amplifier, made in our laboratory recently, are given in the included curves. It will be noted that two different curves are given on the graph, the upper one representing the fidelity of the amplifier with the tone adjustment set for maximum bass response, and the lower one with the adjustment made for least bass response. Any electrical fidelity between these limiting curves may be had by variation of the tone control from one extreme to the other.

This amplifier, in addition to being entirely a-c operated, has a transformer incorporated in it to supply heating current to either 4 or 7½ ampere exciter lamps used in projectors. An output transformer enables matching to dynamic speaker voice coil circuits, a standard 500 ohm line, and, in addition, has a winding to

match a 4,000 ohm monitoring circuit.

No external volume control or level-setting device is required since it is included in the amplifier. On the panel are the a-c line voltmeter and an ammeter for measuring the exciter lamp current; also the switch for changing from one projector to the other, and the on-off switch. Provision is made for connections to a microphone or a disc pickup which makes available every form of operation to be met. Separate controls make possible voltage adjustment for two photo-electric cells so that no change in reproduced output level need occur when changing from one projector to another.

No measurable hum existed in this amplifier. Other features include knock-outs for permanent wiring so that conduit or BX can be run directly to the amplifier proper. The power output should be sufficient to permit installation in theaters with seating capacities up to 1,000 persons.

Tubes required for operation are, a 224 first audio, 227 second audio, 245 third audio, push-pull 250's and two 281 rectifiers.

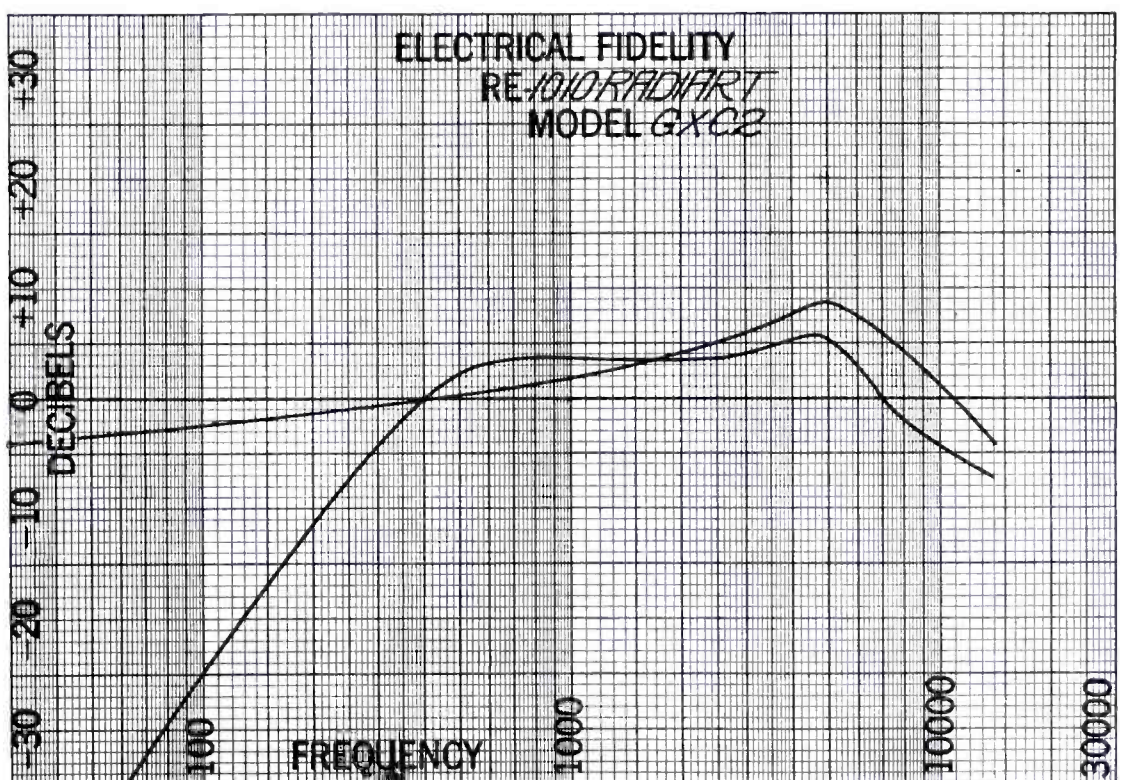

Sectionalized Rectifiers (Continued from page 38)

loads the difference between these experimental single tank 3,000 kw. rectifiers and the section shown in Figure 2 amounts at full load to approximately 6 volts, or 1%, on the basis of 600 volts output. With ordinary load factors and rates for power, this difference in 3,000 kw. rating saves from \$600 to \$1,500 per year power cost, which represents an added value of from \$4,000 to \$10,000.

The proportions of the new units are such as to make it feasible to mount them in service one above another. Thus, a 3,000 kw. unit can be made of four 750 kw. sections mounted two side by side and two deep. The floor space required for such an assembly is approximately 118 inches wide, by 68 inches deep over all parts, including auxiliary equipment. The overall height is 113 inches, and the ceiling height of the room necessary to accommodate this equipment need not exceed this value except for electrical clearance of a few inches and whatever may be necessary to provide for adequate working space, certainly not more than two feet. It is evident that there is a considerable space economy.

The problem of paralleling is the same as in the case of a single tank rectifier using the same number of anodes and, except in detail, is the same as for any rectifier using twelve or more anodes. Load balancing is inherently approximately correct owing to the fact that the voltage across the arc rises with increasing current after a minimum at about 40% load is passed. To get a closer balance, anode balancing coils are used and these are so arranged as to introduce no appreciable impedance into the circuit under normal operation. In the event that it is desired to take a section out of service, for maintenance or any other reason, the corresponding balancing coil sections are short circuited by connection links provided for the purpose.

One arrangement of vacuum pumping is indicated in Figure 5. Use is made of two independent pumping systems, connected through manifolding to the various sections and with cross connections so arranged as to permit the use of either pumping system on any or all of the tanks. The various sections of the rectifier are connected to the vacuum manifold through two valves of unique design, provided with a sealing plate as an extra precaution against outside air. Even if such a valve should develop a leak, this safeguard would prevent any leakage into the tanks except at a very slow rate and for the minute or less while the valve position is being changed. The use of two valves per-

mits the separation of a single section from the balance of the structure without admitting air to either part. In the event that maintenance work is required, it is thus possible to put the repaired section on condition by pretreatment, then install it and by proper manipulation of the valves, exhaust it completely without admitting air to either that unit or any part of the operating system. With the pumping arrangement shown, this requires the operation of one of the other units with valves closed for some time, but experience has indicated that if properly made and treated out the rectifier unit will carry normal loads without pumping for several hours, or even several days, without damage.

Sectionalizing inherently provides the utility that any damage which occurs is likely to be limited to a relatively small part of the total structure and that the load can be carried during the period of maintenance with the balance of the structure. With the arrangement in Figure 5, a faulty section is segregated from the others by removing the connection links and closing the valves, requiring only a few minutes, before load can again be carried. Although a maintenance operation is required to remove a unit from the structure for repairs requiring two hours or so, this can be done during a light or no load period. It would be possible to arrange with jack connections and separate systems of auxiliary equipment or flexible pumping and water connections so that the operator could pull the unit forward a few inches and go on with operation with the balance of the equipment after an interruption of one or two minutes. The choice between these two plans depends on the frequency with which interruptions are likely to occur. The inherent quality in the design, together with the experience thus far, indicates that the interruptions requiring maintenance will be so infrequent as to make the simpler plan preferable.

The project for sectionalizing, together with the development in working out sections of suitable dimensions and proportion, thus makes available an increased degree of reliability, increased flexibility in application and use, improvement in manufacturing requirements, and an efficiency advantage of 1% or more. Beyond this is the belief that as time goes on and as we acquire a clearer understanding of the fundamental knowledge gained from our research but not yet fully used in design, further improvement will be made in respect to efficiency and size. It is to be expected that, as this progress occurs, the development will be along the lines of sectional structures rather than along the lines of single unit arrangements.

Filter Design by Graphs (Continued from page 37)

in error one-third of one percent. At this stage there may be some protest that whereas the claim is made that this particular combination of inductance and capacity is at its resonant frequency and should necessarily have a reactance of zero, the lines actually cross at a reactance level of 4,460 ohms. The answer is simply that if either inductance or capacity were taken separately, the reactance of each would have been 4,460 ohms, but when they are combined in a series circuit the reactance is 4,460 minus 4,460, which is zero.

Weighing with a Beam of Light (Continued from page 35)

minute and a belt speed of 350 feet per minute, an impulse is obtained for each foot of belt, which is representative of a certain amount of material passing over the scale.

Balancing the scale is a simple operation. A test weight is provided which represents exactly half load when hung on the beam. A switch serves to cut out the integrator and throw in a small lamp which flashes at each impulse. A change gear is provided, which slows up the revolutions of the chopper cylinder so that the flashes may be counted. With no load on the moving belt, there should be 16 flashes for each complete cycle if the machine is properly balanced. If out of balance, the scale is balanced with a balance ball as required, until 16 flashes are obtained per revolution. The test weight is then removed.

The bridge, light source and chopper cylinder serve to produce the necessary electrical impulses which are amplified by means of a two-stage amplifier designed and built by the engineering staff of the Burgess Battery Company of New York City. The amplifier output operates a Burgess vacuum contact relay capable of handling all the current required for the operation of one or more integrators or counters, which may be located at any distance from the scale. A rectifier converts stepped down A.C. into low-voltage D.C., for the operation of the integrator and scale chart, in accordance with the makes and breaks of the vacuum contact relay. The integrator is simply an electro-magnetic counter with a number of units to represent the grand total of integrated weights.

The telepoise, as the ingenious continuous weighing and recording mechanism is termed by its designer, E. J. White of the staff of John Chatillon & Sons, pioneer builders of scales, is finding many applications in mines, power plants, warehouses, factories and other establishments where bulky materials are weighed in motion.

Receiver Voltage Analyses

Stromberg Carlson 22, 24

Tube	Position	Fil. Volts	Plate Volts	Grid Volts	Cath. Volts	Plate Ma.	S. G. Volts
35	R. F.	2.4	135	.3	5	4.1	74
35	1st Det.	2.4	135	3.8	9.5	1.3	69
27	Osc.	2.4	80		6	1.0	
35	I. F.	2.4	160	18	1	.8	88
35	I. F.	2.4	220	3.1	3.2	4.9	80
27	2nd Det.	2.4	-15		36	0	
27	A. F.	2.4	135		12	2.1	
45	P. P.	2.4	230	42		33	
45	P. P.	2.4	230	42		33	
80	Rect.	4.6				110	

Sparton 25, 26

Tube	Position	Fil. Volts	Plate Volts	Grid Volts	Cath. Volts	Plate Ma.	S. G. Volts
35	R. F.	2.5	220		4	8	100
35	1st Det.	2.5	220		14	1.8*	100
35	I. F.	2.5	220		4	8	100
35	I. F.	2.5	220		4	8	100
27	Osc.	2.5	100				
27	2nd Det.	2.5	205		20	1	
27	A. V. C.	2.5			50	0	
45	P. P.	2.5	270	45		30	
45	P. P.	2.5	270	45		30	
80	Rect.	5	440			116	

Westinghouse WR 10, 12

Tube	Position	Fil. Volts	Plate Volts	Grid Volts	Cath. Volts	Plate Ma.	S. G. Volts
35	R. F.	2.4	240		3.5	5	70
27	Osc.	2.4	65		2.5	5.5	
24	1st Det.	2.4	235		5	.5	70
35	I. F.	2.4	240		3.5	5	70
27	2nd Det.	2.4	220	5*	25	.5	
45	P. P.	2.4	245	30*		25	
45	P. P.	2.4	245	30*		25	

Brunswick 11, 12, 16, 33

Tube	Position	Fil. Volts	Plate Volts	Grid Volts	Cath. Volts	Plate Ma.	S. G. Volts
51	R. F.	2.25	230	3.5		3.4	70
24	1st Det.	2.25	220	5.8		.4	62
51	I. F.	2.25	220	3.8		9	60
24	2nd Det.	2.25	115	.2		.3	60
24	Osc.	2.25	35	0		1.2	22
47	Output	2.25	220	1*		33	220
80	Rect.	4.7	530			52	

Crosley 27

Tube	Position	Fil. Volts	Plate Volts	Grid Volts	Cath. Volts	Plate Ma.	S. G. Volts
32	1st R. F.	2	134	3			65
32	2nd R. F.	2	134	3			65
32	Det.	2	60	3			20
31	A. F.	2	140	26			
31	P. P.	2	150	26			
31	P. P.	2	150	26			

Kennedy 52

Tube	Position	Fil. Volts	Plate Volts	Grid Volts	Cath. Volts	Plate Ma.	S. G. Volts
51	R. F.	2.3	225		2.6		95
24	1st Det.	2.3	225		2		30
27	Osc.	2.3	100		8.5		
51	I. F.	2.3	225		2.6		95
27	2nd Det.	2.3	160		21		
47	Output	2.3	225	14			225
80	Rect.	4.8	335				

Receiver Voltage Analyses

Howard AVH

Tube	Position	Fil. Volts	Plate Volts	Grid Volts	Cath. Volts	Plate Ma.	S. G. Volts
51	R. F.	2.3	170		3.5	4.5	88
51	1st Det.	2.3	167		7	.75	84
27	Osc.	2.3	87		5.5	3	
51	I. F.	2.3	165		3.5	2.5	95
27	2nd Det.	2.3	137		15.5	2.5	
47	P. P.	2.25	237	16.5		30	255
47	P. P.	2.25	237	16.5		30	255
27	A. V. C.	2.35	36*				
80	Rect.	4.6	375			130	

RCA-Victor R-11

Tube	Position	Fil. Volts	Plate Volts	Grid Volts	Cath. Volts	Plate Ma.	S. G. Volts
35	R. F.	2.2	205	.1*	2	5	75
27	Osc.	2.2	60	0	8	5	
24	1st Det.	2.2	200	7	7	.5	70
35	I. F.	2.2	205	.1*	2	5	75
27	A. V. C.	2.2	25	0	0	0	
27	2nd Det.	2.2	180	8*	20	.5	
47	P. P.	2.2	205	10		25	210
47	P. P.	2.2	205	10		25	210

United American Bosch 31, 32

Tube	Position	Fil. Volts	Plate Volts	Grid Volts	Cath. Volts	Plate Ma.	S. G. Volts
51	1st Det.	2.2	260	7	10	2	80
27	Osc.	2.2	75	*	*	5	
51	I. F.	2.2	260	3	3	4	80
24	2nd Det.	2.2	50	1	3	.1*	5*
47	Output	2.2	250	3*			250
80	Rect.	4.8				44	

General Motors S-3A

Tube	Position	Fil. Volts	Plate Volts	Grid Volts	Cath. Volts	Plate Ma.	S. G. Volts
27	Osc.	2.1	65	.3	7	5	
35	R. F.	2.1	230	.5	2.5	6	77
24	1st Det.	2.1	230	5	5	1	65
35	I. F.	2.1	230	.5	3	5	77
35	I. F.	2.1	230	5	10	8	60
27	2nd Det.	2.2	205	23	23	1	
27	A. V. C.	2.2	25	2.5	30	0	
45	P. P.	2.2	230	20		30	
45	P. P.	2.2	230	20		30	
80	Rect.	4.5	330				

Colonial 47

Tube	Position	Fil. Volts	Plate Volts	Grid Volts	Cath. Volts	Plate Ma.	S. G. Volts
35	R. F.	2.44	240	1.7-40			65
27	Osc.	2.44	40				
35	1st Det.	2.44	230	10			65
35	I. F.	2.44	240	1.7-40			65
24	2nd Det.	2.44	160	20			20
47	P. P.	2.45	235	16			240
47	P. P.	2.45	235	16			240
80	Rect.	4.85	350				

U. S. Radio, Gloritone 26P

Tube	Position	Fil. Volts	Plate Volts	Grid Volts	Cath. Volts	Plate Ma.	S. G. Volts
24	1st R. F.	2.2	250	2	2	2.1	55*
24	2nd R. F.	2.2	250	2	2	2.1	55*
24	Det.	2.2	130	2.8	2.8	.25	40*
47	Output	2.3	238	18		27	250
80	Rect.	4.65				56	

NEW PRODUCTS FOR THE TRADE

Radio Coil and Wire Intermediate Frequency Transformer

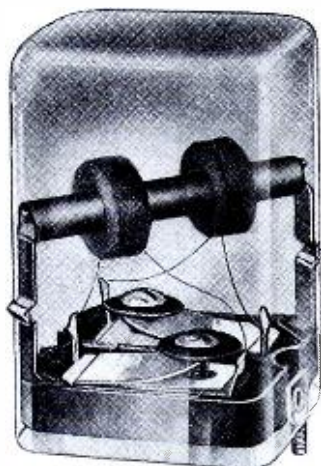

Because of the trouble and annoyance experienced in receiver sensitivity and selectivity, due in a great measure to temperature changes, a unique angle of approach was made by the laboratories of the Radio Coil and Wire Corp. in designing this new intermediate frequency transformer unit. The manufacturer issued the following statement:

"Months of intensive study, research and experimenting were spent in designing a unit to withstand extreme changes of temperature and humidity conditions.

"Tests of 2,350 various types of coils and windings were made indicating that the use of definite wire spacings and traverses decreased the effective resistance of coils so they would more nearly approach the ideal resonance curve shape.

"Final results in this research and development has resulted in an advanced design of an i-f unit which will stay peaked at 175 kc, with a steady, even gain, although subjected to extreme temperature and humidity changes.

"It is small in size. Ruggedly constructed. Easily mounted with positive ground to chassis, accomplished with two hold-down spade-bolts. The coils are mounted on a low loss coil form. Extremely efficient in selectivity and gain. Wide capacity

range. Easy to adjust. Compactly assembled and mounted on a newly developed material known as Learite. Enclosed in a satin finished can. Furnished for either upright or inverted mounting."

International Resistance Resistor Kit



In response to the demand by service men and radio experimenters for a compact, inexpensive resistor kit, the International Resistance Co., Philadelphia, Pa., announces its metallized resistor replacement kit. A handy box with sliding cover contains twenty-one-watt resistors of the most used resistance values from 500 ohms to 3 megohms. By following the instructions packed with each kit, thousands of resistance values may be obtained to meet precise requirements. The factory seal applied to this certified kit insures new and genuine resistors of the indicated values.

Janette Makes B-Power for Auto Radios

A number of auto radios have been developed to a point where they give very good reception, when the batteries are at full strength.

The following statement is made by the manufacturers:

"As everyone knows, B batteries begin to lose their power rapidly the minute they are put in service. And sometimes they do not deliver full

power when first installed, due to age, frequent testing or other reasons beyond the control of the man who sells them to the user. That's why the Janette auto B-Power has won the approval of dealers and auto radio owners. This device generates



full rated B power when first installed and use causes no drop in its efficiency. Uniform B-Power is guaranteed the user. The owner gets better reception than he has obtained with a B battery and the reception does not weaken or deteriorate. The expense of repurchasing and the bother of replacing the B battery are both eliminated.

"The Janette auto B-Power is a compact, beautiful unit driven right off the regular auto battery, transforming 6 volts d-c to 180 volts d-c, with a very low current consumption. It is manufactured by the Janette Mfg. Co., 556 W. Monroe St., Chicago, manufacturers of electrical motors, generators and converters."

Electrad Announces New Catalog

Electrad, Inc., 175 Varick St., New York City, announces the completion of their new catalog, showing their complete line of volume controls, voltage dividers, vitreous resistors, Truvolt adjustable resistors, amplifiers and other devices for radio and electrical industries, which will be mailed free of charge upon request.

NEW PRODUCTS ITEMS

Manufacturers who have items that come within the scope of this department will find it of advantage to keep our name on their mailing list for announcements of new products. Halftones or electros should not exceed 2 1/4 inches in width.

Address—New Products Editor, care this magazine.

New Short Wave Super Converter

Radio Service Laboratories, Clinton, Ia., announce a new low priced short wave superheterodyne converter, consisting of two tubes, as shown in the illustration.



The converter is ideal when used with any size of receiver employing the pentode tube. It will give the user much enjoyment and many thrills listening to police calls, aeroplane reports, ship-to-shore communication, and trans-Atlantic programs. The converter can be left connected permanently to the radio set without interfering with its regular reception.

Gen-Ral RFD No. 10 Special Coil

The RFB No. 10 special coil has been developed to fill a demand for a very small r-f coil, the efficiency of which is not hampered by the small size. It requires a mounting space of only $1\frac{7}{8}$ inches in diameter and $2\frac{1}{4}$ inches high. Considerable research work was done to derive the best possible combination of coil length, diameter and shield reactance.

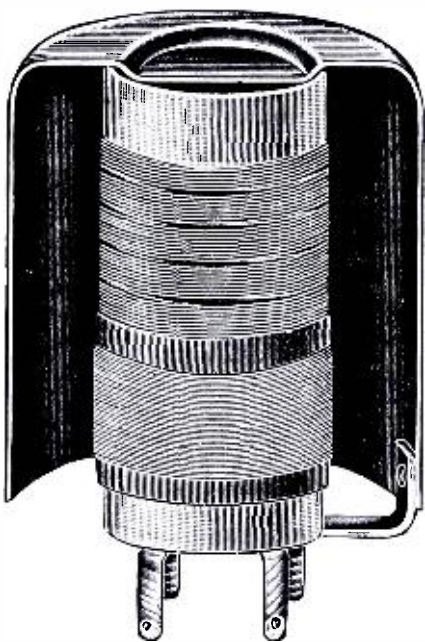

The secondary is bank wound, with Litz wire, resulting in a coil of exceptional high gain (62.5 at 1500 kc and 42.5 at 550 kc).

Mounting of the coils in the shield and matching eliminates a great deal of testing and adjusting by the set manufacturer, which facilitates the operation of phasing the r-f system. Screw lugs are provided for mounting the entire assembly either above

or below the chassis in exactly the same space and holes as provided by a standard $1\frac{3}{4}$ inch wide tube socket die, a feature which avoids special tools for punching the chassis to mount the radio frequency transformer.

The low r-f resistance due to the bank wound Litz wire extends the range of the unit and with any good condenser of correct minimum (tests were made with the Radio Condenser Co.'s condenser) a band from approximately 1700 kc (police signals) to 550 kc can be effectively tuned.

Western Television Corp. Announces

"Junior Western" for Amateurs

This new set known as the "Junior Western" consists of five integral parts, (1) a high powered lamp-house, (2) an accurately made scanning disc, (3) a synchronous motor, (4) an optically fine projection lens, (5) a pick-up unit consisting of two highly responsive photocells.

The mechanical and optical parts are mounted rigidly in their proper relative positions on a special chassis frame. In view of the fact that the scanning unit may often be placed on the same table or bench as experimental equipment, the chassis frame is rubber insulated and prevents vibration being transmitted to sensitive amplifiers and delicate electrical equipment.

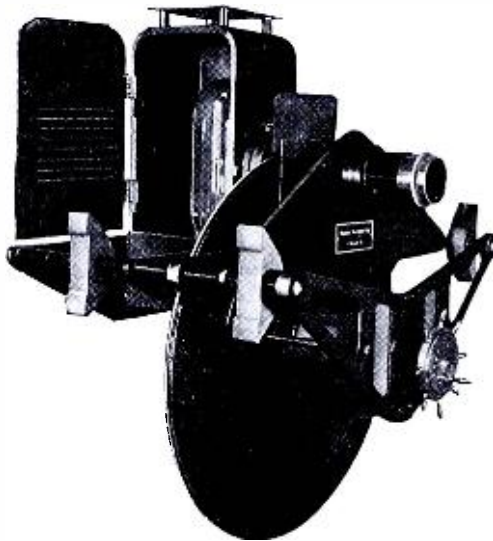

The photocell units may be located in the proper position on each side of the scanning beam in order to pick up a maximum of light from the transmitted subject. The position of the photocell may be carried to suit the ideas of the experimenter on the proper angle of pick-up for his own special work. The effect of the photocell placement on the television picture is as if the photocells were flood lamps illuminating the subject from a similar position.

The photocells used in this unit are made of a specially prepared alkali metal in a bulb approximately 6 inches in diameter; the same as are used in broadcast station transmitters

built by the engineers of the Western Television Corp. They are highly sensitive, with linear characteristics in both light and frequency response and are designed for operation at comparatively low voltages.

Illumination for scanning is furnished by a 1000 watt Mazda projection lamp mounted in a compact ventilated lamp house with reflector and condensing systems for concentrating the light. The lamp is inserted in a prefocus socket, aligned at the factory for greatest efficiency. Replacement lamps will align without adjustment. This feature allows for quick replacement.

The condensing lens system, consisting of two high-powered plano-convex lenses is held in a removable unit. When this unit is inserted in the hole provided, it is the correct position for efficient concentration of the light through the apertures of the disc.

Dubilier Meter Bypass Capacitor

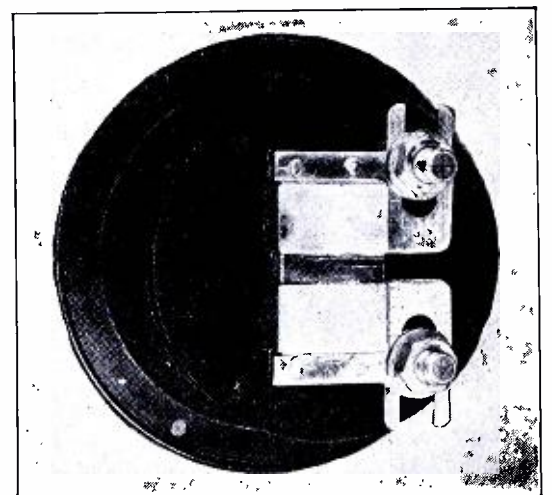

To provide ample protection for transmitting set meters against the heavy surges caused by induced radio frequency currents, the Dubilier PL-357-9 meter bypass capacitor is now available. This mica capacitor is designed with slotted terminal lugs to fit standard meters, the terminal studs of which may vary from 1 to 2 inch spacing. The terminal lugs are sufficiently heavy and wide to take care of the heaviest radio frequency surges that may be encountered in the circuits to which meters are connected. The capacitor is capable of handling up to 10 amperes of radio frequency energy, thereby affording the utmost protection to meters. It is available in any capacity up to .02 mfd., according to its manufacturers, the Dubilier Condenser Corp., New York City.

Jewell Portable Tube-Seller

A portable tube-seller has just been announced by the Jewell Electrical Instrument Co., 1650 Walnut St., Chicago. This instrument enables

any salesman or service man to make a convincing test of tubes in the customer's home.



Tube value is indicated directly on an attractive three-color instrument dial in terms the customer can understand: Satisfactory, Doubtful, and Unsatisfactory. A short-check circuit with four indicating lights is provided to test tubes for internal shorts. The line voltage indicating meter and adjustment assure accurate tests despite the variations in voltage found in customers' homes.

The pattern 540 is housed in a leatherette carrying case with a heavy strap handle. By removing the cover it may be easily converted for counter testing when not in use outside the store.

Synthane Data Chart

Synthane Corp., Oaks, Pa., manufacturers of Synthane laminated bakelite, have prepared a valuable data chart on "Standards of Quality, Properties and Applications of Laminated Phenolic Sheets." Copies may be secured free by addressing Synthane Corp. at the above address.

CeCo "Mertact"

CeCo Mfg. Co., Providence, R. I., has recently announced an additional item to add to their line of radio tubes, in the form of a mercury switch which will be marketed under the trade name of "Mertact."

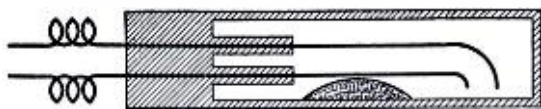

Mertacts are being made in all sizes ranging from one ampere at 200 volts to 50 amperes at 220 volts. The design of Mertacts at the present time is that of the rolling or tilting type, where contact is established by rolling or tilting the switch approximately ten degrees from the horizontal plane. Mertacts will be used on many industrial devices where a high contact is necessary. E. A. Zuley, in charge of engineering in the company's Chicago office, claims that on

life tests Mertacts have made as many as 150 million contacts without any great damage to the switch itself, which, the company claims, is attributable to the superior glass used in this device.

Clarostat Ad-A Switch Control

As a further convenience to jobbers and service men, Clarostat now has available a new Ad-A-Switch line of volume controls. These controls are made up in the general style and design of wire-wound potentiometers, and are obtainable in any taper or resistance up to 50,000 ohms. They have the added feature that a switch may be slipped on any of them without the use of tools.

The Ad-A-Switch arrangement enables one to simplify line-up of his stock on volume controls to a point where duplication of resistance on controls carried in stock will no longer be necessary. Any Ad-A-Switch volume control without switch can be converted at will into a complete unit with switch by replacing the usual dust cap with the special snap-on switch.

These switches are the compact bakelite type, built into the metal cover so as to take up very little room. They are Underwriters' approved for 3 amperes, 110 volts. The Ad-A-Switch volume controls are more completely described on page 7 of the new 1932 Clarostat Control Handbook and Catalog which also covers the whole line of Clarostat devices for the radio, sound and electrical industries.

A particular feature of this 32 page handbook is that a special section is devoted to real helpful information on circuits and applications of resistance control devices. A copy may be obtained without charge by writing to the Clarostat Mfg. Co., Inc., 285 N. 6th St., Brooklyn, N. Y. In writing, please mention this magazine.

New Light Weight Portable Public Address System

A new compact P. A. system, especially designed for radio service men to use as a source of revenue in rental to banquets, conventions, sporting events, impromptu public gatherings, political meetings, outdoor overflow audiences, dances, etc., has been recently developed by the Webster Co., 848 Blackhawk St., Chicago.

This system, known as the style PT-463 midget portable public address system, is built complete in one carrying case, weighs less than 40 pounds, and consists of the following equipment: push-pull amplifier employing screen grid and pentode tubes, phonograph turntable driven by electric motor which plays either 33 $\frac{1}{3}$ or 78 r.p.m. records, one microphone, the control providing for the

possible mixing of phonograph and microphone input, allowing musical background for vocal announcements, one high grade dynamic speaker, provision being made for plugging in one additional speaker when desired, 15

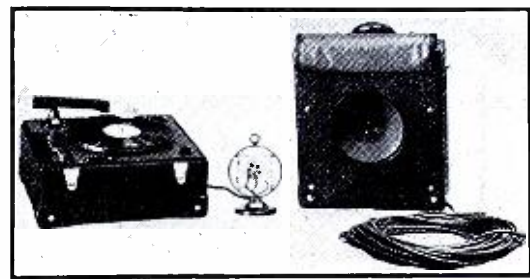

feet of microphone cable, the polarized plugs preventing possibility of wrong connections, 30 feet of speaker cord, and all-electric filament and plate power supply, deriving current from 110 or 220 volt, 50-60 cycle alternating current.

It is said that one man can easily transport the entire system, which when packed measures only 13 in. by 14 in. by 15 $\frac{1}{2}$ in. He can set it up, ready for operation, in five minutes or less. The system has an output of more than 6 watts, sufficient volume without distortion to fill a medium size auditorium.

Extensive Range of Rheostat Resistance Values

D. T. Siegel, general manager, Ohmite Mfg. Co., 636 N. Albany Ave., Chicago, announces that the line of 50 watt rheostats manufactured by this company and announced several months ago has been increased and now includes several new resistance values.

The manufacturer's bulletin reads as follows: "The Ohmite rheostat, which may also be used as a potentiometer, is of an unusual type, as there are no organic materials used in its construction. It employs a porcelain base and horseshoe-shaped porcelain core to support the winding. The entire unit with the exception of the surface on which the contact arm rides is vitreous enameled. This construction is new to the rheostat field but has been used by this company for many years in the manufacture of vitreous enameled fixed resistors. Thus the best features of the fixed resistor are now incorporated with the mechanical construction of the rheostat for the first time.

"These rheostats were formerly made in a range of values from 2 ohms to 10,000 ohms. This has now been increased to include values from 1 ohm up to 35,000 ohms. And although these units are only 2 $\frac{1}{4}$ inches in diameter and less than 1 $\frac{1}{4}$ inches in depth, they are conservatively rated at 50 watts.

DEPENDABLE MIDGET RELAYS

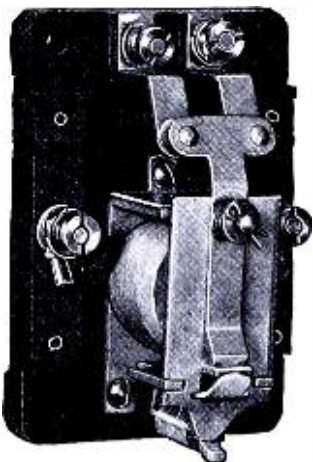

for
Remote Control in Radio Sets
Time Limit Devices
Various Uses in Experimental
Work
Photo Electric Cell Work
Coil Requires Only 2 Watts for
Operation
A.C. 6 to 120 Volts—D.C. 2 to 24
Volts

This is our type ABTX-1 at \$3.50. Single Pole, Single Throw, Double Break. Base measures only 1 1/2 in. x 2 3/4 in. Contacts rated 6 amperes, 110 volts A.C., 1 ampere, 115 volts D.C. A Double Pole, Single Throw Relay with the same operations may be had for a slight increase in price.

In every way DUNCO MIDGET RELAYS meet the high standards of quality set by Dunco Relays of larger size. We have a wide variety—tell us your requirements—special types to meet your needs.

Immediate Delivery—Literature and Wiring Diagrams Sent Upon Request



144 N. JUNIPER ST. PHILADELPHIA, PA.

DUNCO CORE RELAYS

There is a Dunco Relay to meet your requirements

Permanent Magnet Dynamic Speakers

(Continued from page 16)

a distributing system, since over a great part of the range it behaves like a highly resistive load. Transformers can, of course, be supplied to operate the speaker out of a line of any characteristic impedance. It is usually desirable to select 500 ohms, since volume controls are available to work into and out of this load.

Magnets for both permanent magnet dynamic and magnetic speakers are usually aged during the manufacturing process, so that little further aging takes place in the field. Unless magnets are run at temperatures in excess of 100° F. a well designed unit will lose less than 2 decibels in sensitivity in the first five or six years of operation, and less than 1 decibel during the five succeeding years.

Where speakers are to be mounted in public places, that is, in dining rooms, lobbies, etc., there is no possibility of the low frequency transmission through a wall disturbing anyone, and in this case the speakers can be mounted in flush wall type boxes. This is also simplified because in these cases the box can usually be several inches deep. Careful tests should be made, however, to be sure that the type of box used does not result in the very great change in performance shown in Fig. 2 which resulted from the use of a speaker in a shallow box with no venting and no absorbing material.

Complete Set Analyzer

(Continued from page 35)

part of the drawing two symbols, one marked "clip" and the other "cap." The cap is an ordinary terminal taken from the top of an old 224, soldered to a screw and mounted on the panel. The clip is fastened to a flexible lead so as to allow it to be transferred on the panel to the cap of a screen grid tube in either the four or five-prong socket. This method of changing from the control grid prong to control grid cap eliminates the use of an extra switch.

Looking at Fig. 3 you will note on the meter to the left, which is the milliammeter, a small coil of wire. This is the shunt. On the meter to the right, which is the a-c voltmeter, is mounted a flat resistor, the original value being 100 ohms. It is cut down to its correct value, approximately 72 ohms, by bridging some of the turns with solder. The high value resistors used in this tester should be of the wire-wound type and accurate to within 1%.

Stop! Wasting Your Money

On High Priced "Junk" Radio Parts
We carry nothing but Brand New Radio Parts—doubly guaranteed at LOWEST prices!

New tubes—for SPARTON radios—S82B, S83, S85 and S84 types.....	\$0.99
McCullough Type A-C radio tubes.....	1.98
Rauland Lyric Lab. model Audio transformers.....	1.95
All-American 3 1/2 to 1 audio transf.....	1.17
Audio transf. 3 1/2 to 1—shielded—same as GRC.....	.79
Audio transf. unshielded 3 1/2 to 1.....	.50
Surge Proof condensers, 1 1/2 mfd. 32c; 2 mfd.....	.39
Freshman Voltage Dividers—for model N sets.....	.70
2 Watt Carbon Resistors—all capacities.....	.15
RCA R.F. Chokes, 48 Millihenries unmtd.....	.29
Sprague midget condensers, .01 mfd. 1500 volts test.....	.15
Tungsol tubular condensers .5 mfd. 200 D.C.V. .1 mfd.; 600 D.C.V. and .25 mfd.;	
300 D.C.V. each cap.....	.23
Tungsol 8 mfd. Electrolytic condensers.....	.32
RCA Victor Hand Mikes with cord.....	2.49

Distributors for all nationally known radio parts manufacturers. Write for prices. Our prices are always the lowest! No order too small for us to ship. Foreign orders solicited. 20% with order required—postage extra. Do not send stamps as payment. FREE bulletin—write for it.

Maurice Schwartz & Son

710-712 Broadway
Schenectady, N. Y.

BRIEF ITEMS

OF INTEREST TO MANY

A. S. Hediger, San Francisco, Calif.: Are you likely to publish something soon on the prospects for radio receivers giving reasonably uniform response throughout the 35-8000 cycle band, for the transmission of which network channels and pick-ups are now being equipped? Ans. It does seem a bit strange that the new lines being installed for broadcast station program transmission have flat characteristics from 35 to 8000 cycles, whereas most receivers have serious cut-off in audio fidelity long before they reach 3000 to 4000 cycles. This is especially true of very selective receivers and superheterodynes in general. In this respect, we might also mention the attitude of the public, which makes necessary tone controls on practically all receivers sold today which always gives faulty reproduction as far as the high frequencies are concerned. But what can the poor manufacturers do since the fad is started and the public seems to be accustomed to listening

(Continued on page 48)

UNIVERSAL MODEL "BB"

1932 Value—New Design
List Price \$25.00



No other 2-Button microphone can give such superlative value for such a low price. Extra large size. Rugged construction. Built especially for voice pick-up, public address work and amateur broadcasts. 24 Kt. Pure Gold Spot Centers. Duralumin Diaphragm. Frequency range to WELL over 4000 cycles.

Guaranteed Performance at Rock Bottom Price.
UNIVERSAL MICROPHONE CO., Ltd.
424 Warren Lane, Inglewood, Calif., U. S. A.

LOW RANGE FUSES

Littelfuses for Instruments: Amps.: 1/100, 1/32, 1/16—20c ea. 1/8, 1/4, 3/8, 1/2—15c ea. 1, 2—10c ea. For meters, tube testers, set analyzers, etc. Use 1/8 amp. for radio B circuits.

High Voltage Littelfuses: 1000, 5000, 10,000 volt ranges in 1/16, 1/8, 1/4, 3/8, 1/2, 3/4, 1, 1 1/2, 2 amps. Renewable. Price 35c to \$1.25 ea. Order thru your dealer or jobber or direct, giving dealer's name. Write for Bulletin 4-H.

LITTELFUSE LABORATORIES
1774 Wilson Ave. Chicago

"Quicker than a Short Circuit"

LITTELFUSES

Train *with* R.T.A. *for* Radio Service Work

Important and far-reaching developments in Radio create sudden demand for specially equipped and specially trained Radio Service Men.



*This excellent
set analyzer
and trouble
shooter included
with our course
of training*

MANY skilled Radio Service Men are needed now to service all-electric sets. By becoming a certified R. T. A. Service Man, you can make big money, full time or spare time, and fit yourself for the big-pay opportunities that Radio offers.

We will quickly give you the training you need to qualify as a Radio service man . . . certify you . . . furnish you with a marvelous Radio Set Analyzer. This wonder instrument, together with our training, will enable you to compete successfully with experts who have been in the radio business for years. With its help you can quickly diagnose any ailing Radio set. The training we give you will enable you to make necessary analysis and repairs. Serving as a "radio doctor" with this Radio Set Analyzer is but one of the many easy ways by which we help you make money out of Radio. Wiring rooms for Radio, installing and servicing sets for dealers, building and installing automobile Radio sets, constructing and installing short wave receivers . . . those are a few of the other ways in which our members are cashing in on Radio.

As a member of the Radio Training Association, you receive personal instruction from skilled Radio Engineers. Upon completion of the training, they will advise you personally on any problems which arise in your work. The Association will help you make money in your spare time, increase your pay, or start you in business. The easiest, quickest, best-paying way for you to get into Radio is by joining the Radio Training Association.

This amazing Radio Set Analyzer plus the instructions given you by the Association will transform you into an expert quickly. With it, you can locate troubles in all types of sets, test circuits, measure resistance and condenser capacities, detect defective tubes. Knowing how to make repairs is easy; knowing what the trouble is requires expert knowledge and a Radio Set Analyzer. With this Radio Set Analyzer, you will be able to give expert service and make big money. Possessing this set analyzer and knowing how to use it will be but one of the benefits that will be yours as a member of the R. T. A.

Write for No-Cost Membership Plan

We have worked out a plan whereby a membership enrollment need not cost you a cent. Our thorough training and the valuable Radio set analyzer can be yours. Write at once and find out how easily both of these can be earned.

Now is the time to prepare to be a Radio Service Man. Greater opportunities are opening up right along. For the sake of extra money in your spare time, bigger pay, a business of your own, a position with a future, get in touch with the Radio Training Association of America now.

Send for this No-Cost Membership Plan and Free Radio Handbook that will open your eyes as to what Radio has in store for the ambitious man. Don't wait. Do it now.

RADIO TRAINING ASSOCIATION OF AMERICA
Dept. RCB-4 4513 Ravenswood Ave. Chicago, Ill.

Fill Out and Mail Today!
RADIO TRAINING ASSOCIATION OF AMERICA,
Dept. RCB-4, 4513 Ravenswood Ave., Chicago, Ill.

Gentlemen: Send me details of your No-Cost Membership Enrollment Plan and information on how to learn to make real money in radio quick.

Name

Address

City State

“GEM”

Super-Shortwave Converter

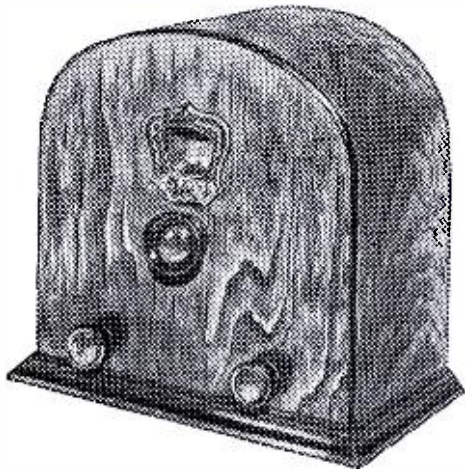

Get Short Wave Reception
with Your Present Radio

Install It Yourself

No Coils to Change

Covers
Entire Short Wave Band

Make Your Radio
a Superheterodyne
Short Wave Receiver

List Price
Less Tubes \$26.50

INTRODUCTORY PRICE \$15⁹⁰

For This Issue Only—Postpaid in U. S. A.

If not satisfied within ten days, money will be refunded

The “GEM” super-shortwave converter is the ultimate in systems for obtaining short-wave stations on your present A. C. broadcast receiver. It will give you police calls, ship to shore, shortwave phones and all other desirable features in the 15 to 200 wave length.

Astounding results have been obtained with this specially shielded, highly engineered, quality product. Factory tests, conducted under adverse conditions, give highly gratifying results, a number of foreign stations having been heard with good volume.

DESCRIPTION

Single, illuminated dial tuning. Self contained power supply. No plug in coils. Selective but not super sharp. Fully shielded metal chassis. Uses 2—24, 1—27, and 1—80 tubes. Cabinet of Walnut. Operates with only two controls. Covers shortwave band from 15 to 200 meters. Does not have to be disconnected when regular broadcast is desired. Dimensions: 7 1/2" wide x 5 1/2" deep x 10" high. Weight, 8 lbs.

ESSEBEE RADIO DEVICES COMPANY. RCB
732 Mather St., Chicago, Ill.
Enclosed find my payment of \$15.90 for “Gem” Super-Shortwave Converter, sent postpaid.

Name.....
Address.....
City..... State.....

SERVICEMEN-DEALERS

Did You Receive Your Copy of Our

OFFICIAL 1932 RADIO PARTS GUIDE

featuring

THE NEWEST FLASH-O-GRAM

“Hours of Servicing
Cut to Minutes”



COPIES
LIMITED
SEND FOR YOURS TO-DAY

Send 5c in Coin or Stamps

Dixon Radio & Electric Corp. 112 East 23rd Street
New York City, N. Y.

SERVICE MEN AND DEALERS



Get in line for big profits with FILTERMATIC PRODUCTS. Take advantage of FREE newspaper advertising. The Super-Tone control is not an ordinary tone control. It is designed to suit any circuit, and has several distinctively new features, can be installed in one minute, and allows you a very good profit. Unit installed in an attractive crystallized Gold and Black case. Will bring out the most pleasing tones from any set. List price \$2.50. Send us a check or money order for \$1.25 and we will send you a sample postpaid. Be sure to write your order on your business correspondence to prove you are a Service man or dealer. Write for particulars of other products. Satisfaction guaranteed or money refunded.

Dept. C. B.

FILTERMATIC MFG. CO.
4458 Frankford Ave., Phila., Pa.

CANDO HMS

ARMoured WIRE WOUND RESISTORS

WILL LOWER YOUR COSTS—MAY WE SAMPLE AND QUOTE

The Muter Company

1255 S. Michigan Ave.

CHICAGO, ILL.

Brief Items

(Continued from page 46)

to muffled programs? With these facts in view, it seems hardly probable that receivers will be sold having good response up to even 5000 cycles, which would give the necessary ten kilocycle band width. We have recently published a few radio receivers which have compensation for side band cutting, but this does not seem to be the general trend of the industry. Until something is done in this line, it seems hardly reasonable to expect that we shall have receivers which have less than 10 or 15 decibels drop at 5000 cycles.

John A. Taylor, Foxboro, Mass.: After reading the many comments under “Brief Items of Interest” in the last RADIO CALL BOOK MAGAZINE AND TECHNICAL REVIEW, I feel the urge to let you know how I feel about it. I heartily welcomed the announcement of the monthly publication instead of quarterly. The first few months, however, I was keenly disappointed, but the wonderful improvement shown lately has completely allayed my fears. I don’t see how the copy I received yesterday could have been better. Ans. Thanks, Mr. Taylor! Impossible as you may consider it, we believe that we can make the book better with each succeeding issue.

Eugene A. Palmer, Richmond Hill, L. I., New York: I have been a constant reader of your magazine for a number of years and wish to thank you for your splendid articles which appear each month now. I am especially interested in receiver performance curves and hope to see you continue this department. Ans. Since our magazine is primarily based on precise performance curves of receivers, you need have no fear that this department will be discontinued.

C. C. McIllyar, Cleveland, Ohio: I am a subscriber to your magazine and it is certainly the best one we have ever seen. The articles are just what I want and the curves are great. I wish you would publish an explanation of noise level and field strength as spoken of in relation to these charts. Ans. In making noise level measurements we take the sensitivity with 30% modulation, as usual, and obtain an output voltage reading corresponding to five-hundredths of a watt audio output. Then the modulation is cut off, but the radio frequency is left as it was and the output is measured. This power reading compared with the normal power output is what we call noise level. We make note that there is no standard procedure with regard to receivers at present.

Chester E. Simpson, Mattapan, Mass.: I have just purchased the February number of the RADIO CALL BOOK MAGAZINE AND TECHNICAL REVIEW and I want to let you know how pleased I was to read in the editorial that you intend to publish voltage charts with all receiver schematics in the future. I also will be pleased when you can make up the voltage charts on receivers in the past four issues. You surely have a wonderful magazine and the addition of the voltage charts will make it 100%.

Delcore Radio Service, Mansfield, Ohio: We like the new issues of your magazine, especially because it is the only publication in the service field. We are subscribers and have cancelled subscriptions to two radio magazines, since they are far inferior to yours.

George J. Davis, Detroit, Mich.: Since I am contemplating a change in address, I will not send in my subscription until I am permanently located. You may rest assured I am not missing a single issue of RADIO CALL
(Continued on next page)

Brief Items Continued

BOOK MAGAZINE in the meantime, since I think it is wonderful. However, I think a more uniform system in receiver schematics would be very welcome. By this I refer to the voltage charts. Ans. You undoubtedly know by this time that voltage charts are incorporated as a regular feature.

Wm. A. Schofield, Philadelphia, Pa.: Please advise me as to the method used in computing the average measured sensitive (absolute) and microvolts per meter from the curve. You state that the ideal sensitivity would be 10 microvolts absolute or less. From observation of numerous curves I notice that a set can test below 1 microvolt absolute. Is this proof that such a set is more desirable than others of less sensitivity, noise levels being equal? Ans. Average sensitivity is computed by taking the actual sum of the sensitivity at 600, 800, 1000, 1200 and 1400 kc, and dividing by 5. For micro volts per meter, since the standard height antenna is four meters, it is only necessary to divide any absolute figure by 4 to obtain microvolts per meter. If noise levels were the same, a receiver with a sensitivity of 10 microvolts absolute would not be as desirable as one of 1 microvolt sensitivity. This, however, is never the case because the noise level increases rapidly as the sensitivity is increased due to more or less normal inherent qualities.

Clark Bros. Radio Co., Albia, Ia.: We want to compliment you on the excellence of your magazine and tell you that we would not want to be without it in our line of work. Enclosed herewith is check for renewal of subscription.

J. Martin, U. S. Navy Yard, Portsmouth, N. H.: In your issue of February, 1932, I note in the receiver performance curve section various values given for the image ratio ranging from 540 to 134,000. As I have not noted any description as to how these values have been computed, I would be greatly obliged if you would inform me in detail as to how they were obtained. Ans. If we take a receiver which has an intermediate frequency of 175 kc and standard operation, in which the oscillator frequency is higher than the incoming signal, we can see immediately from the resultant series of beat note phenomena that we shall have two frequencies of 175 kc if there happens to be a station of higher frequency than that being received, removed from the signal by 350 kc. As an average, let us take a signal at 1000 kc. This means that the normal oscillator frequency with a 175 kc intermediate amplifier would be 1175 kc, because beating 1000 kc with 175 kc gives the difference of frequency as 175 kc, which is the intermediate frequency signal. There would also be a beat note of 175 kc if a broadcast station were at 1350 kc, since the difference between 1350 kc and 1175 is also 175 kc. The only way to eliminate such an image, as the last signal is termed, would be to have sufficient radio frequency selectivity in the broadcast band to prevent this signal from ever reaching the first detector, since the intermediate frequency amplifier cannot discriminate against it. In our measurements of image ratio, we tune the receiver to 1000 kc and introduce a signal at 1350 kc, which is 350 kc removed in the case of a 175 kc amplifier. This frequency, of course, is determined by the intermediate frequency, with the receiver tuned to 1000 kc. The input necessary for standard output at this image frequency is measured and the ratio to the input necessary at 1000 kc is known as the image ratio.

Henry Claeys, Anchorville, Mich.: I am a radio service man and a subscriber to the RADIO CALL BOOK
(Continued on next page)

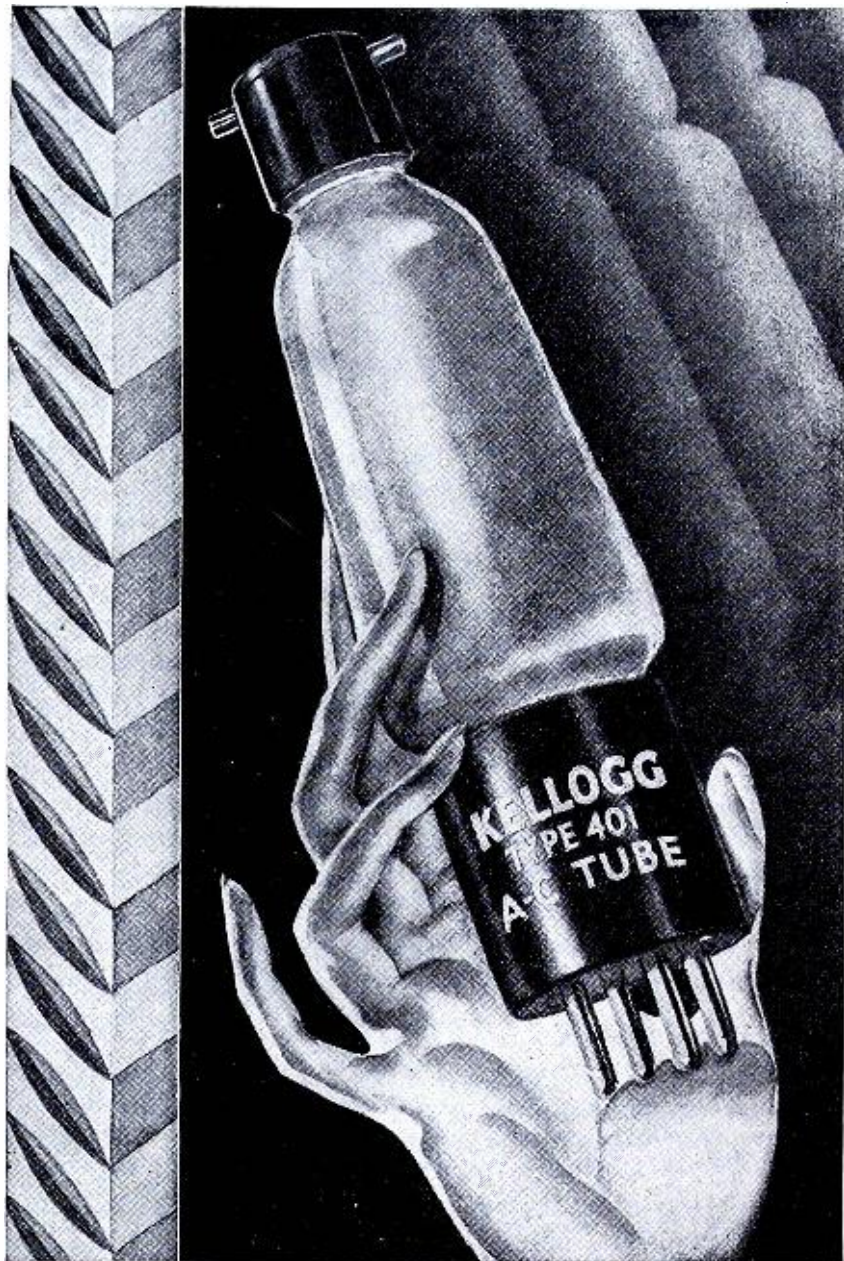

THIS IS A *Profitable* TUBE for DEALERS and JOBBERS

Every customer of yours who owns or operates any of the following sets, must use Kellogg 401 A.C. tubes for replacements. All these set owners are constant buyers.

KELLOGG Sets—510, 511, 512, 514, 515, 516, 517, 518, 519, 520, 521. McMILLAN Sets—26, 26PT. MOHAWK Sets, SPARTON Sets—62, 63, A-C 7. DAY FAN Sets—5143, 5144, 5145, 5148, 5158. MARTI Sets—TA2, TA10, DC2, DC10, CS2, CS10, 1928 Table, 1928 Console. CLEARSTONE Sets—110. And the first A.C. models of the following: Bell, Walbert, Wurlitzer, Pathe, Shamrock, Bush & Lane, Minerva, Crusader, Liberty, Metro, Supervox and Case.

Get your share of business from this profitable market by stocking and displaying Kellogg tubes now. Write Dept. 60 for name of your nearest jobber.

KELLOGG

SWITCHBOARD AND SUPPLY COMPANY

1070 West Adams Street » » » » CHICAGO, ILLINOIS

1932... the year for Bigger PROFITS in Servicing

Today 3 out of every 4 radio receivers are over one year old. They need servicing—at least new tubes. Aggressive energetic service men and dealers can make a mighty nice income this year by going after this business intelligently.

Hard work, knowledge of the different receivers... and good servicing equipment are fundamental requirements.

For this work, Weston Model 566, type 3, is the outstanding equipment. Complete, compact, handy—it makes all the necessary and required tests on any receiver. Checks all type tubes with voltages supplied by the set—easily and quickly. Extra wide instrument ranges plus an ingenious arrangement of switches and pin jacks speed up tests and cut out errors. Equipment designed for quick, accurate and profitable servicing.

SERVICE MANUAL FREE

With every Weston Model 566, type 3, a Complete Service Manual is furnished free. A practical handbook, it tells the causes of poor reception, how to locate and fix them. It gives many helpful tips—information that builds your profits.

WRITE TODAY FOR BOOKLET J

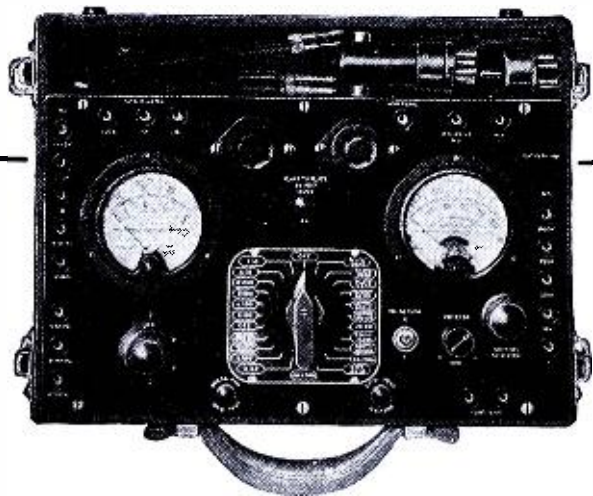

NEW FEATURES

MODEL 566—TYPE 3

- Tests Pentodes without aid of adapters.
- Double range, highly sensitive rectifier type Output Meter—5/100 volts.
- Double range Ohmmeter—100,000/10,000 ohms—battery voltage adjuster.
- Automatic "lock-arm" tester-plug adapter for U. X. tubes.
- Pin-jacks throughout.
- Large, easy-to-read dial plate for 24 point switch.

WESTON

ELECTRICAL INSTRUMENT CORP.

574 FRELINGHUYSEN AVENUE . . . NEWARK, N. J.

Brief Items Continued

MAGAZINE AND TECHNICAL REVIEW. The advent of short wave converters has greatly increased the demand for a really efficient means of coupling head phones to a modern electric receiver. Adapters, etc., are not very satisfactory when one tries to tune in Europe and I heartily wish the satisfactory detector tapping method used in battery sets could be used equally well with electric sets. Ans. Any method may be used in taking energy from the audio system of almost any receiver for head phone reception. We suggest that the phones be placed across a grid circuit rather than a plate circuit, since the energy transferred would be satisfactory and there will be no d-c potentials with which to contend. Perhaps satisfactory operation would be obtained by using one-half or all of the secondary of the push-pull output transformer.

We have been unable to answer a letter of January 24 written by Ray R. Hetherington, M. D., who gives his address as 719 N. Lang Ave., Homewood, because no state was given.

C. W. Brooks, Northville, Mich., says that month in and month out the "Call Book" is the best in print.

J. F. Davidson, Houston, Tex.: I have been buying your magazine from the news stand for sometime and I find it to be very handy in every respect. Why do I sometimes hear WBAL, Baltimore, listed on 1060 kc, on 760 kc with WJZ? For some time, announcements of WBAL have been coming in over the WJZ channel immediately after or sometimes with the WJZ announcements. The same thing occurs when listening to station WEAJ, only in this case an announcement of WTIC will be heard. Ans. These two stations have been perfectly synchronized and when broadcasting the same programs use the same wavelengths. In this way there is no objectionable beat note and the range of the stations is naturally increased. These experiments probably will be enlarged to include other stations in the near future, for it seems to be working successfully at present. When WTIC and WBAL are not broadcasting chain programs, their frequencies are those allotted to them and shown under their call letters in our broadcast list.

Wm. R. Brown, United Radio Service, Toledo, Ohio, writes: "I am one of your many readers of RADIO CALL BOOK MAGAZINE and wish to state that I think it first rate. I am very much pleased to hear that you are to publish voltage charts each month along with the curves which I think are just the thing for us service men. I hope you will continue to publish them in the same way that you have started because it makes it very easy to pull this page out and file it separately. I would like to request that you continue to publish articles on testing equipment for us poor (in purse, not in knowledge) service men who work in their attics and basements and cannot afford the high prices of good test equipment. I have built the ohmmeter which was featured in the February issue and thank you for this service. I hope to find more features in the following issues which I can build."

N. C. Meyer, president of Universal Auto Radio Co., makes the statement that the new Universal model 70, curves of which appear in this issue, represents the latest advance in auto radio design with regard to elimination of motor noise. A new B eliminator makes unnecessary the use of B batteries which are costly, bulky and heavy.

(Continued on next page)

Brief Items Continued

A later check on the model 15 Sparton superheterodyne gave these sensitivity and selectivity curves. They should be pasted over those given on page 24 of the March issue of the *Radio Call Book Magazine and Technical Review*. A new average sensitivity of 6.38 microvolts absolute is

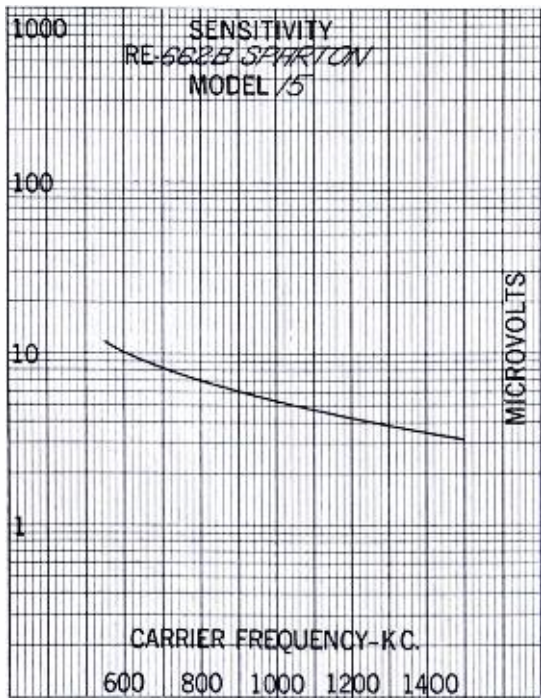

taken from the sensitivity curve. This value corresponds to 1.59 microvolts per meter with a standard height antenna. The old averages were 6.72 and 1.68, respectively, and a change in the shape of the curve will be noted. The later image ratio at 1000 kc is 95,000 compared with 82,000. No changes were found in the automatic volume control or fidelity curves, and the changes in selectivity

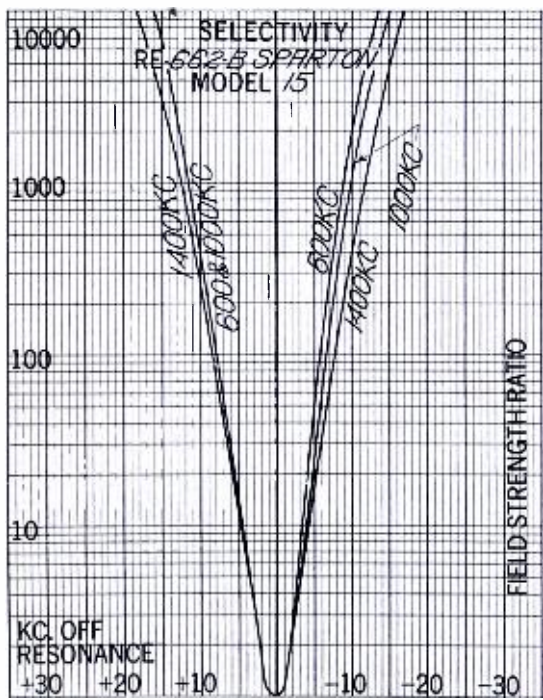

were slight, as can be seen from the included curve. The new band widths are given below:

Times Field Strength	Kilocycle Width		
	600 kc.	1000 kc.	1400 kc.
10	8	8.5	9
100	14	15	16.5
1000	20	21.5	24
10000	29.5	31	34.5

(Continued on next page)

PICK YOUR BRANCH OF RADIO

... then learn it at RCA Institutes

THERE is no industry more interesting than radio. And the next few years probably will see more happen and offer more prospects for advancement than ever before. With the right training, there may be a future for you in radio.

RCA Institutes offers you that training. Elementary and advanced courses in many branches of practical radio. Founded 22 years ago, today RCA Institutes is America's oldest radio school. In completeness of equipment, instructors, variety of courses it is unsurpassed. In addition, RCA Institutes is directly associated with the largest radio research laboratory in the industry. Four resident schools—New York, Boston, Chicago and Philadelphia. Extension courses available for those who cannot attend resident schools, with free scholarships for outstanding graduates. Special equipment



furnished with many courses. All tuition costs moderate.

Check one of the interesting branches of radio you see listed in the coupon below. Then mail it today for general catalog and full information.

RCA INSTITUTES
 "Practical instruction in radio and the associated electronic arts."
 A Radio Corporation of America subsidiary
 RCA Institutes, Inc., Dept. RC-4,
 75 Varick Street, N. Y.
 Gentlemen: Please send me your General Catalog. I am checking below the phase of radio in which I am particularly interested.
 Aviation Radio Radio Operating
 Broadcast Station Talking Pictures
 or Studio Servicing Home
 Television Entertainment
 Equipment
 Name
 Address
 Occupation..... Age.....



The WHEEL WITHIN the WHEEL...

INSIDE your radio business is ANOTHER business—A SERVICE BUSINESS—the "Wheel Within the Wheel."

And that SERVICE wheel is closer to the hub, that supports all, than many radio men realize.

Our observation shows that radio men who conduct their Service Departments as a business which should show a PROFIT, never fail to make a profit out of it.

A SURE way to make a PROFIT from your Service Department is to use ELECTRAD high-quality replacement parts. They save both time and money.



ELECTRAD TRUVOLT RESISTOR

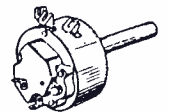

ELECTRAD VOLUME CONTROL

Mail the coupon for money-making service helps.

175 Varick St., New York, N.Y.
ELECTRAD

ELECTRAD, INC., 175 Varick St., N. Y.
 Please send me complete resistor folders and special replacement volume control guide.
 Name
 Address
 CB-4

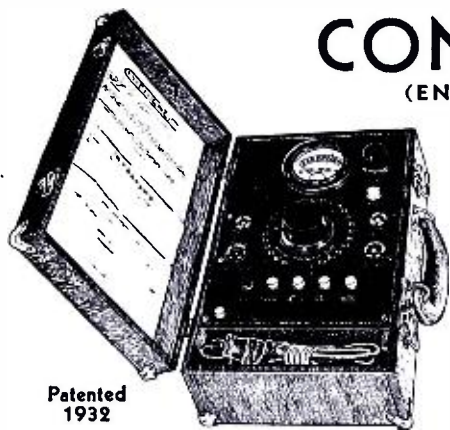

CONFIDENCE

(ENGLISH READING)

RADIO TUBE TESTER

FOR REPLACEMENT TUBE MERCHANDISING

Patented 1932

\$59.50 Net

The Confidence Portable Radio Tube Tester is the latest advancement in the art of testing tubes—it is marvelous—select your tube, press two buttons and in English it tells the condition—emission, spacing of elements, plate impedance, presence of gas—in fact everything necessary to know about the condition of a tube, all predetermined and interpreted into English. Originators of BAD—GOOD—GAS readings. Indicates on one jeweled lamp every possible short in a tube. High resistance cathode to heater shorts indicated.

This is the first scientific merchandiser of radio tubes—simple of operation—FOOL PROOF and has the confidence of your customers.

Take advantage of the free trial offer and unconditional factory guarantee, or buy through your jobber.

MANUFACTURED BY
APPARATUS DESIGN CO., Inc.
LITTLE ROCK, ARKANSAS

Buy through your jobber or ask us about free trial plan and also easy payment plan.

Also free tube sale plan printed matter.

The Confidence Portable Tube Tester reaches the 75% of public who cannot or will not remove their tubes from the radio to be taken to a store for tests—use this portable device and get most of the replacement tube business. It interprets everything and your customer believes it—they know what is happening because it is in English. Slipping cover removes for counter use.

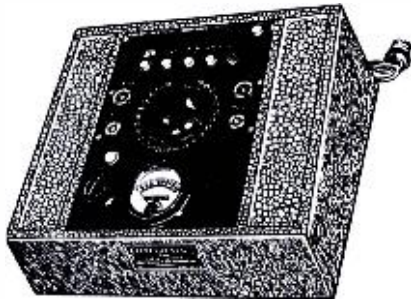

Counter type \$59.50 net. Meter faces customer, otherwise the instrument is same as Portable except it is housed in an attractive black leatherette covered counter housing. Placards are mounted on side panels reading, "Free Tube Testing."

Brief Items Continued

W. C. Engel, Danville, Ill.: Please correct the connections of the audio transformer given with the schematic diagram of the Universal Modulated Oscillator on page 29 of the January, 1932, issue. Also, what audio transformer ratio do you suggest? What do you mean by "E" sections and "I" sections of the laminations? How does this oscillator compare in efficiency with factory-built instruments? Ans. Due to a fault in the zinc cut which was used on page 29 of the January, 1932, issue, a break appears at the low end of the primary and secondary windings. Both of these points should be grounded. An audio transformer with a ratio of 3.5 to 1, or as high as 6 to 1, could be satisfactorily employed. When we refer to "E" laminations and "I" laminations, we mean the stampings which are shaped like the letters used to denote them. Occasionally an audio transformer is found in which the laminations are complete in one piece, with two cuts in the mid-section. If you happen to run across one of this type, we suggest that you remove about one-half of the laminations. To our knowledge, the efficiency of the oscillator is good enough to satisfy all requirements. In such an instrument, efficiency is of no important consideration.

John N. Naff, Camden, Texas: Enclosed please find the required amount to extend my subscription for six months. Maybe by that time things will be in better shape for me, although service work has picked up here a little. I certainly do enjoy reading the *Radio Call Book Magazine* and believe it is getting better than ever. I am enclosing a short wave hookup which may interest you. Ans. Thank you for the encouragement and for the interesting hookup which we hope we may be able to give to our readers in the near future.

Klokow's Radio Service Shop, Wausau, Wis.: There seems to be some difference of opinion as to whether or not the recent change in the *Radio Call Book* has been an improvement, and as to which data is the more important to publish. I have been a regular reader of the publication for some time past, and I wish to say that I am very much in favor of the monthly edition and of the increased number of schematics as a result. The Book is well worth the price for the drawings alone. Personally I felt that there was only one important thing missing, and that was the voltage charts, but in the March, 1932, issue, you have two pages containing twelve charts. I sincerely hope that you will continue to publish them, and also to publish them in the same manner and size so that they can readily be

(Continued on next page)

ROYAL SHORT-WAVE RECEIVER

SCREEN-GRID
—POWER PENTODE
WORLD-WIDE RECEPTION
GUARANTEED



ROYAL Model RP
List Price \$25

A NEW super-sensitive Short-Wave Receiver with these outstanding features:

High-gain coupling—Combination regeneration-volume control (with automatic switch) eliminates unnecessary controls—Micro-vernier full vision dial for easy tuning—Scientifically shielded for maximum results—Heavy cadmium plated chassis—Completely self-contained in attractive metal cabinet—Works on any antenna—Covers 14 to 200 meters (550-meter coil 75c extra)—Uses only two tubes—Use of screen-grid detector and power pentode gives extreme sensitivity with tremendous volume—Operates speaker or headphones (for weak stations)—The complete absence of AC hum (all non-battery sets have it) makes the operation of this set a distinct pleasure—Uses 1 UX-232, 1 UX-233, 3 "B" batteries, 1 22½-volt "C" and two dry cells (or a 2-volt cell).

All ROYAL Short-Wave Apparatus is designed by Government licensed operators with a vast experience in that field.

Representatives and Dealers wanted.
Write now!

Distributed by

HARRISON RADIO CO., Dept. B1, 189 FRANKLIN ST., New York City
Send for our FREE CATALOG of Short-Wave and Television Apparatus

SPECIAL PRICE
Set of Tubes . . . \$2.20 **\$14⁹⁵**
Batteries . . . 5.45

Brief Items Continued

put into notebook form. Ans. Your interest and kind words are greatly appreciated. We intend to publish twelve voltage charts every month until we have caught up on back numbers, when we shall run ten an issue.

James Wood (W1AYG), Millis, Mass.: I read *Radio Call Book Magazine* and like it very much. I think it is the outstanding publication dealing with broadcast receiver problems. Your diagrams contain more complete information than the expensive radio manuals which are available to service men. Every resistor and every condenser is marked. Keep it coming!

Henry Maathuis, Ogden, Utah: I have written you before congratulating you on putting out a monthly magazine instead of the quarterly, so I will not bring that up again. I am desirous of obtaining a formula for finding out the resonant frequency of a circuit using a certain size choke and condenser. I am planning a tuned audio frequency amplifier to use standard parts to keep the cost down. This amplifier, when completed, will raise the level of either the high notes or bass notes, either independently or at the same time, to make up for the deficiency of recorded programs, and also to improve the high response on a very selective tuner. This will also tend to improve the frequency of the network programs back here from New York, because the new cable, to my knowledge, has not yet been put into operation. Ans. A complete analysis of resonant phenomena is given in the December, 1931, issue under the Radio Engineering columns. We also suggest looking over all the issues since the October number for receiver schematics which include means of frequency response compensation.

Charles K. Wall, Middletown, Penn.: In the January issue of the *Call Book Magazine* you published a tube test circuit which covers the cathode type tubes. I tried this circuit for the four prong tubes, supplying the correct voltages, but I get no reading for a test. I just omit the cathode in the circuit. Ans. It is necessary that a return path be supplied for the plate current. In the types 227 and 224, etc., the cathode furnishes the return, but in using filament type tubes it will be necessary to place a center-tapped resistor of about 100 to 200 ohms across the filament terminals, and connect the center-tap to the B return, or to the portion formerly connected to the cathode of the original test circuit.



COME TO SUNNY CALIFORNIA
and Learn
RADIO-TELEVISION TALKING PICTURES

Come to California where many of the world's most famous Radio Stars make their homes—where the great Laboratories of the American Television Corporation are located—where hundreds of trained Sound Engineers and Mechanics are employed in the Talking Picture Studios and Theatres of Hollywood.

RAILROAD FARE ALLOWED

Don't worry about the expense of the trip. For a limited time we are allowing the railroad fare to Los Angeles from any point in the United States. This is deducted from your tuition, so the trip costs you nothing extra. Take advantage of this opportunity to visit Los Angeles and Hollywood and prepare for a good job at the same time!

PRACTICAL SHOP TRAINING

At the Oldest Trade School in the West

For over 25 years National has been training men by the practical shop method. Over 20,000 ambitious men from all over America have come to National for their training. You'll find National graduates working in the famous Studios of Hollywood, in Talking Picture Theatres, great Broadcasting Stations; for Radio Manufacturers and Dealers; while many have gone into the Radio business for themselves and are making big money as their own boss. What they have done, you can do!

SCORES OF JOBS WILL BE OPEN

10,000,000 Radio sets to be constantly serviced! 600 Broadcasting Stations employing trained Operators and Mechanics! 10,000 Theatres equipped for sound and the job only half done! Eight stations already sending out regular Television programs! New jobs will be opening up every day—hundreds of golden opportunities for the trained man! And you can prepare for them in 4 months at National.

FREE EMPLOYMENT SERVICE

Spare Time Jobs While at School

When you've finished National Training,—four months of practical work in the great National Television, Talking Picture and Radio Shops—then National's Employment Department will assist you in every possible way to get the job you want. And if you're short of money, National will gladly help you get a spare time job to pay your living expenses while at school.

MAIL COUPON FOR BIG FREE BOOK

Get all the facts! Mail coupon below for Big Free Book telling all about National's famous Shop Training and the many jobs opening up in this fascinating field. No cost or obligation. Just mail the coupon!

National Television, Talking Picture and Radio School,
 Dept. 437-E, 4006 So. Figueroa St.,
 Los Angeles, Calif.

Please send me your big new Free Book on Television, Talking Pictures and Radio, and all details of your Free Railroad fare offer.

Name

Street No.

City..... State.....

Convert Old Sets Into Dollars!

Replace worn-out condensers at little cost and put those old sets back into service. It's profitable business if you use the Special Dubilier Service Kit—a useful package containing 25 assorted sections for by-pass and filter block repairs, ranging from .1 to 2 mfd., 200 to 400 volts. List Price, \$10.50.



ORDER NOW! Carry the kit in your service bag and start cashing in on the profitable business of repairing old radio sets. Write for free copy of new General Catalog No. 121.

DUBILIER
Condenser Corp.



4377 Bronx Blvd.,
New York City

WHAT YOU NEED TO SUCCEED IN RADIO

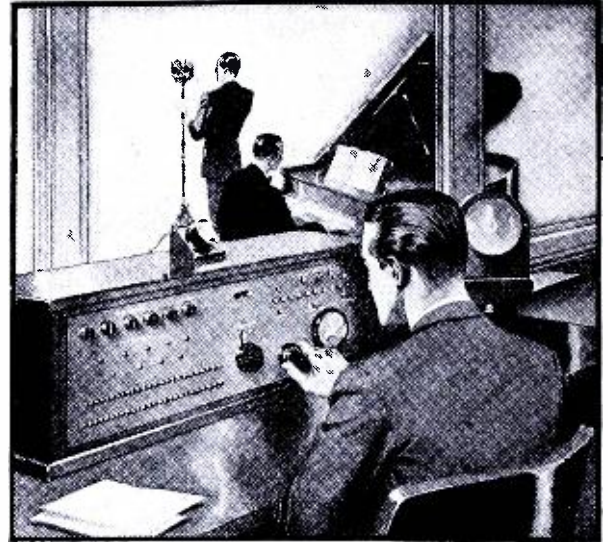

Radio Service Men:—

FREE color-code

INDICATOR

of resistor values

IF YOU ACT AT ONCE

Gives R.M.A. standard "color-signature" . . . for every resistor value . . . in a flash! Heavy celluloid, 4" by 1". Every service man needs one.

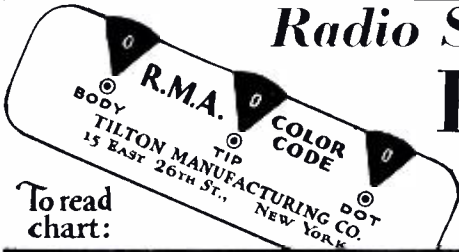

To read chart:

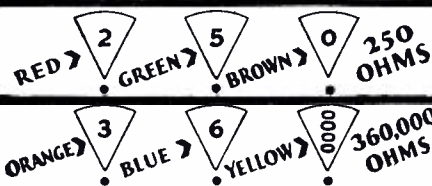

EX-STAT "SIX-KIT" * List \$1.80

(six EX-STAT resistors in the values you need most)

with **FREE 25c color-code CHART**

.. a \$2.05 value for 96 cents (plus postage)

Well-informed service men use more EX-STAT resistors daily. Because EX-STATS are identical with "original-equipment" in most quality sets. Guaranteed, precision resistors

you can trust! Now 40% less than 1931 prices. Introductory "Six-Kit" brings exact six values used most . . . six resistors you're sure to need . . . in handy vest-pocket package . . . with chart FREE. Take no risk. Read coupon below . . . mail before it's too late.



Six resistors in "most-used" values: 2,000-, 10,000-, 25,000-, 50,000-, 100,000-, 500,000 ohms

CLIP NOW: OFFER ENDS APRIL 10

Tilton Manufacturing Company (CB)
15 East 26th St., New York, N. Y.
Send "Six-Kit" of EX-STAT resistors postage prepaid. Include color-chart FREE. I enclose dollar bill. You agree to refund full price, if I return kit within 5 days.

Name

Address

LEROY M. E. CLAUSING

Consulting and Designing Radio Engineer

5509½ Lincoln Avenue

Ravenswood 9109

CHICAGO, ILL.

RADIO is a highly specialized business. As it develops it is becoming more exacting in its demands. But radio is the modern field of opportunity for those who keep step with its progress and pioneer in its opportunities!

There is a great demand for *trained* men in the radio industry. There is no place for *untrained* men. Experience must be accompanied by technical knowledge.

A pioneer in radio instruction, the International Correspondence Schools have kept apace of the times and offer courses prepared by authorities, which give practical instruction in fundamentals and latest developments alike. The courses were prepared and are constantly revised by the Who's Who of Radio!

Composed of 24 basic divisions, the Complete Radio Course is designed to give thorough instruction in the whole field of radio. The I. C. S. Radio Servicing Course was prepared specially for men who wish to become service experts. Study of it makes possible leadership over competition. The I. C. S. Radio Operating Course is vital to mastery of operating and transmitting.

We will be pleased to send you details of any or all of these subjects. Just mark and mail the coupon—the information will be forwarded without delay.

INTERNATIONAL CORRESPONDENCE SCHOOLS

Box 8317 F, Scranton, Pa.

Without cost or obligation, please tell me all about the
NEW RADIO COURSE

Name _____ Age _____

Street Address _____

City _____ State _____

If you reside in Canada, send this coupon to the International Correspondence Schools Canadian, Ltd., Montréal, Canada

The New
CLAROSTAT
TRADE MARK REG. U.S. PAT. OFF.

Ad-A-Switch

Volume Controls



STOCK VOLUME CONTROL

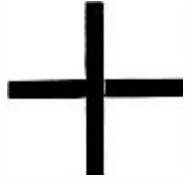

PLUS

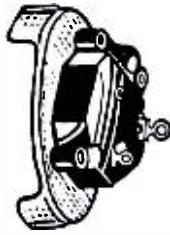

SNAP-ON SWITCH COVER



EQUALS

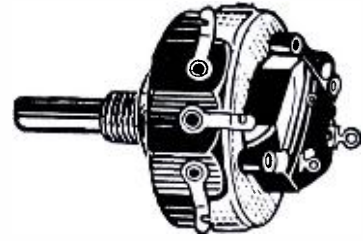

COMPLETE UNIT SWITCH ATTACHED

AS a convenience to jobbers and servicemen, Clarostat announces the new Ad-A-Switch line of wire wound volume controls.

The Ad-A-Switch arrangement enables one to simplify line up of his stock on Volume Controls to a point where duplication of resistance on controls carried in stock will no longer be necessary. Any Ad-A-Switch Volume Control may be converted at once into a complete unit with switch by replacing the usual dust cap with the special snap-on switch.

These and other Clarostat aids to the industry are fully

described together with very complete circuit data in the 1932 edition of the Clarostat Control Handbook and Catalog which will be sent without charge.

MAIL THIS COUPON TODAY!

CLAROSTAT MFG. CO., INC.
285 North 6th St., Brooklyn, N. Y.

Please send me FREE COPY of Clarostat Control Handbook and Catalog as offered in Radio Call Book Magazine.



Name

Address

City State

AS an extension of its recently inaugurated frequency checking service for broadcast stations, RCA Communications, Inc., is planning the erection of a laboratory on the West Coast similar to that now in operation at Riverhead, Long Island.

For several years RCA has maintained the Riverhead laboratory to keep close check of the frequencies on its own trans-oceanic stations and those of foreign correspondents. In this work several thousand separate frequency measurements are made each week. Recently facilities of this laboratory were made available through a service offered to American broadcasting stations, and among the many broadcasters utilizing the service have been stations situated as remotely from New York as California.

In commenting on plans for extension of the frequency checking service, Arthur A. Isbell, Manager of the Commercial Department of RCA Communications, said: "The location of the second laboratory will be Point Reyes, California, which is about fifty miles north of San Francisco and across the bay from this company's extensive plant at Marshall. Due to the extreme precision necessary in construction and installation of the apparatus we do not expect that the new laboratory will be placed in ac-

(Continued on next page)

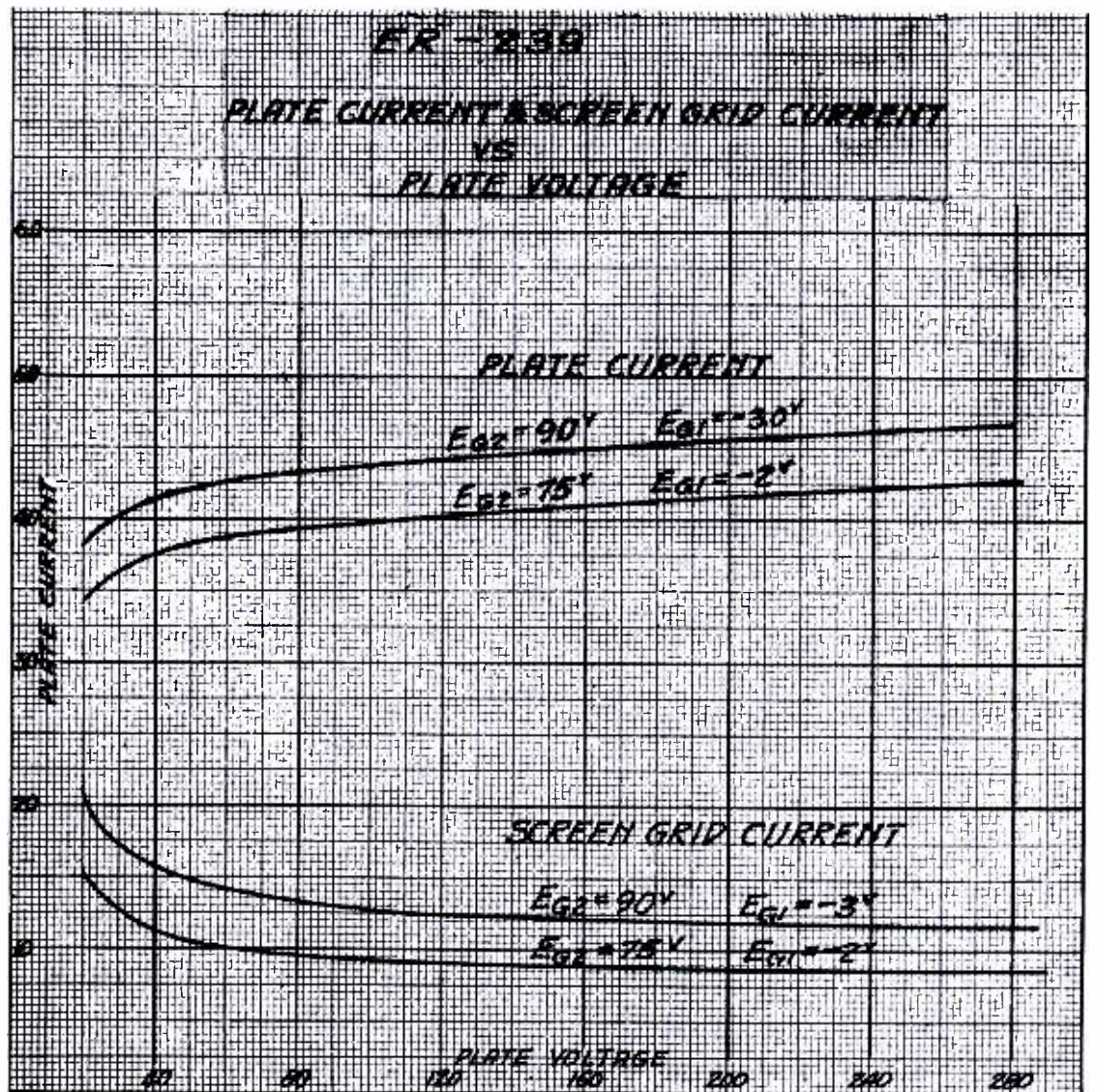

MICROPHONES OF ALL TYPES...
Write for Details
SHURE BROTHERS COMPANY
 Manufacturers-Engineers
 S. N. SHURE, Pres.
 337 WEST MADISON ST. CHICAGO, ILLINOIS



DOOLITTLE & FALKNOR, Inc.
Radio Engineering and Manufacturing
 Field Intensity Curves Allocation Engineering
 Station and Studio Installations
 Engineering Management
 1306-8 W. 74th Street Chicago, Illinois

SPECIAL INTRODUCTORY OFFER



We need immediately 100,000 users the country over to tell their friends of the improvement of using Pentode tubes in place of 245's, particularly in sets using 245 push-pull.
 There is a tremendous improvement in depth of tone and set sensitivity. The improved amplification brings in weak signals.
 The Pentode Tube is inserted in Na-ald 954KPC adapter and the adapter put in the socket in the set. No change in wiring.
 Money back—Adapters list at \$1.00—But for the first ten people that order from any town we will send two adapters for \$1.00 or—two pentode tubes and two adapters postpaid for \$3.00.
 If after trying them in your set, you are not more than pleased with the results, return your purchase anytime within five days and your money will be instantly refunded.
 This ad probably will not appear again. Order today.

ALDEN MANUFACTURING CO.
 Department C BROCKTON, MASS.

The Latest Data on the Construction and Repair of Radio Receivers

[Including Short-wave and Television Receivers]

WRITTEN by two widely known radio engineers these three books cover every phase of building, repairing and "trouble-shooting" on modern receiving sets. They include complete instructions for building short-wave and television receivers.

Radio Construction Library
 3 Volumes, 6x9, 993 Pages, 561 Illustrations

This practical Library includes: PRACTICAL RADIO—The fundamental principles of radio, and radio set-building, presented in an understandable manner. Illustrated with working diagrams. RADIO CONSTRUCTION AND REPAIR—Methods of locating trouble and reception faults and making workmanlike repairs. How to construct all types of sets, including television receivers. RADIO RECEIVING TUBES—Principles underlying the operation of all vacuum tubes and their use in reception, remote control and precision measurements. The library is up-to-the-minute in every respect and is based on the latest 1931 developments in the design and manufacture of equipment.

10 Days' FREE Examination!

No Money Down

Examine these books free for ten days. You will find them invaluable as a home study course and as a reference in the daily radio problems which you meet in your business. Simply fill in the coupon and the books will be sent to you postage prepaid; there is nothing to pay if they do not prove satisfactory.

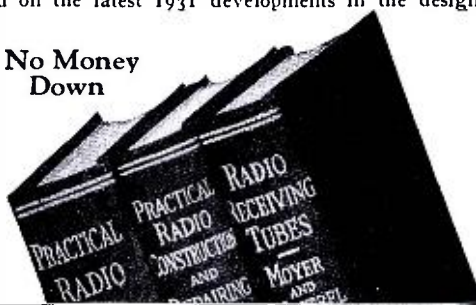

FREE EXAMINATION COUPON

McGRAW-HILL BOOK COMPANY, Inc. 330 W. 42nd Street, New York
 Send me the new RADIO CONSTRUCTION LIBRARY, three volumes, for 10 days' free examination. If satisfactory I will send \$1.50 in ten days, and \$2.00 a month until \$7.50 has been paid. If not wanted I will return the books.

Name

Home Address

City and State

Position

Name of Company

RCB-4-32

(Continued from page 55)

tive service much earlier than June of this year. When it is ready it will materially augment the Riverhead laboratory in the world-wide scope of service to commercial radiotelegraph stations besides facilitating the service to broadcasting stations in the West.

"Use of such facilities enables the stations to keep more accurately on their assigned frequencies and it tends to make less difficult the coordination of station operation with the supervisory activities of the Federal Radio Commission. This laboratory service could not be maintained by individual stations except at a prohibitive capital expenditure and operating expense.

"One typical example of the usefulness of the service was the assistance rendered to a group of broadcasters who wished to have their programs synchronized but whose limited station power and service range made the use of connecting land wires uneconomical. The frequency checking service has made it possible for these stations to operate with a considerably higher degree of effectiveness."

Ultra Short Waves

IT would be maddening if the human eye and ear could see and hear all the sights and sounds that exist in the world.

This surprising and puzzling statement was made by I. E. Mouromtseff, research engineer of the Westinghouse Electric and Manufacturing Company, as he was discussing the new use of ultra short radio waves as a means of communication. L. W. Chubb, director of research, has just announced and demonstrated this simple and economical transmission of beam radio of a 42-centimeter wave of sufficient power to be heard from a loud speaker.

Mouromtseff, who has had direct charge of the development work to give the idea practical application, points out that the difference between radio waves and light waves is quantitative, not qualitative. In other words, they are identical in every characteristic except wave length. As a matter of fact he says there is more difference between long and short radio waves than there is between short radio and long light waves. To illustrate this, he says the longest radio wave in use is 100,000,000 times as long as the shortest radio wave ever produced, whereas the shortest radio wave is only 1,000 times as long as the longest visible light ray.

Hence, he concludes, radio waves are merely "dark light." Visible light waves, those between the long red and the short violet, constitute a very small percentage of the total range, just as audible sounds are a small fraction of all existing noises. Many of these have wave lengths or frequencies much too high or too low to set up corresponding vibrations in the human ear drum, the scientist explains.

"Nature has been kind to impose these limitations on our eyes and ears," he says. "Certainly all would be chaos and confusion if we could see and hear everything. On the other hand, science would be seriously handicapped if it had not perfected instruments and apparatus to detect the invisible and inaudible.

"At different times certain people have interested themselves in the possibilities of communication with possible

(Continued on next page)

Ultra Short Waves

(Continued from page 56)

inhabitants of Mars. If anything of this sort is ever to be accomplished, it will probably have to be done by means of ultra short radio waves."

Some 25 years ago certain known facts of radio communication convinced Dr. A. E. Kennelly, professor of electrical engineering at Harvard, and Professor Oliver Heaviside, English scientist, that there must be a sort of cushion or atmospheric layer 100 or more miles from the earth's surface. This has since been known as the Kennelly-Heaviside layer.

"Of course, it is a theory just as atoms and electrons were created by theory to explain certain phenomena," resumes Mouromtseff, "but we are certain that not only heat and light waves can penetrate something like the Heaviside layer, but that all radio, or 'dark light' waves less than seven meters long will penetrate that layer and leave the earth.

"It is conceivable that the power we have succeeded in getting into our 42-centimeter beam is sufficient to pierce the Heaviside layer and travel the 35,000,000 miles to Mars. It is possible that such small power may carry to such great distances, because of the fact that practically all of the intervening space is really a high vacuum and does not, therefore, absorb the waves, once they get through the earth's atmosphere."

Today Westinghouse research engineers are talking on such a beam from station W8XI, on top of the research building, to the roof of the engineering laboratory, more than a mile away, where a parabolic metal mirror gathers the waves, and passes them through a special detector tube to an ordinary little radio receiving set, where they are amplified and made audible.

Radio beams are identical with light beams except that they are of different frequencies or wave lengths and invisible according to engineers. In actual service, communication on the radio-optical waves is dependable and almost immune to theft, interruption and interference. Its operation cannot easily be "jammed," or crippled by an enemy; the beam must be found before its message can be detected and, by means of reflecting surfaces, it can be sent long distances, says Mouromtseff.

In a searchlight, the rays originate at one point, reflect from a parabolic surface and pass out in a narrow beam. In the newest Westinghouse achievement, the waves reverse this process by striking the parabolic mirror where they are reflected to a short antenna and detector tube located at the focal point corresponding to the source of light in a searchlight. Since intervening hills or buildings absorb both types of beams, Westinghouse found a way to reflect the ultra short radio waves so this handicap could be overcome.

Chubb, Mouromtseff and their associates believe the ultra short wave will be adapted to many practical uses in the next few years and that it will prove of commercial value by supplementing radio and other present forms of communication.



The COMET

15 TO 550 METER
SUPER-HETERODYNE

YOU will search far to find the equal of the new Hammarlund COMET Custom-Built All-Wave Super-heterodyne.

A superbly efficient short-wave receiver, especially designed to cover also the regular broadcast channels up to 550 meters.

A.C. operated, using eight newest type tubes with Pentode output. Super-sensitive, super-selective, and has remarkably fine tone. Exclusive tuning features.

The ideal receiver for the home, office, laboratory, newspaper, police, airport, steamship.

Write Dept. CB-4 for descriptive folder.



The COMET

14-200 meter "PRO"

Custom-Built High-Frequency Receiver for professional operators. Super-heterodyne circuit. 8 tubes. Efficient band-spread tuning system, with special long-wave oscillator. Phone jack and speaker connections. Connection for external amplifier.

Write for Details

Console Cabinet for COMET All-Wave Receiver.



CUSTOM
BUILT

HAMMARLUND-ROBERTS, Inc.

424 W. 33rd St., New York

by HAMMARLUND

AUDIOLA

KNOWN FOR ITS TONE

HIGH GRADE SET BUILDERS SINCE 1921

AUDIOLA RADIO CO. 430 S. Green St. Chicago, Ill.

For Auto Radios —If you want real quality reproduction, insist on having the new Wright-DeCoster Vehicle Speaker installed. It has Wright-DeCoster quality throughout. Write for circular.

WRIGHT DECOSTER, Inc., 2215 University Ave., St. Paul, Minn.
Export Dept. The M. Simon & Son Co., 25 Warren St., N. E.
Cable Address: Simontrice

POLYMET PRODUCTS

Standard of the Industry

Send for the Special Service Men's Catalogue

Polymet Manufacturing Corp.

World's Largest Manufacturers of Radio Essentials
839-B East 134th St., New York City

Measure Receiver Distortion by This New Method

IMPORTANT as is a knowledge of the exact amount of distortion introduced by any given circuit element, the development engineer has had no easy means of securing data. Harmonic analyzers have been difficult to operate and even then the necessary information could usually be obtained only after laborious computation.

General Radio has developed a new and simple method of measuring the total harmonic distortion. It utilizes an instrument called a distortion-factor meter, so named because it is direct reading in percentage distortion factor.

With the new General Radio TYPE 536-A Distortion Factor Meter the distortion factor of any circuit can be determined in a few moments. It is merely necessary to adjust the distortion-factor meter for zero reading using the filtered fundamental frequency obtained from filter circuits contained therein. A throw of the switch and the percentage distortion factor is then obtained directly from a dial on the instrument.

Let us tell you more about this instrument. Its price is **\$140.00**.

GENERAL RADIO COMPANY
Cambridge A Massachusetts

—SEND— FOR



**NEW WHOLESALE
ELECTRICAL & RADIO
♦ CATALOGUE ♦**

IT'S
FREE

**33 YEARS
OF
SERVICE
TO THE
TRADE**

ROYAL-EASTERN ELECTRICAL SUPPLY CO.
... 16-18 WEST 22ND ST. ...
• NEW YORK — N.Y. •

MIDGET CONE SPEAKER

50c



NEVER before have we been able to offer this Midget Cone Speaker at such a low price—only 50c—and it will pay you to order yours today.

This midget speaker has many advantages and its perfect tone has delighted thousands who are using it.

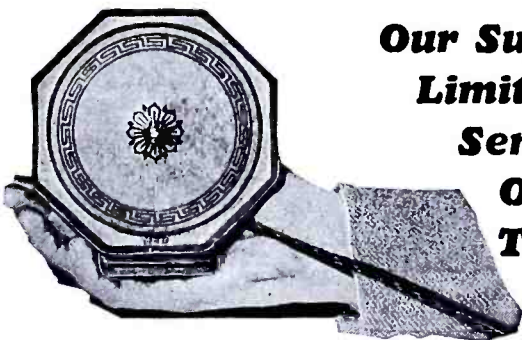

Our Supply Is Limited—So Send Your Order in Today—

CITIZENS RADIO SERVICE BUREAU
508 S. Dearborn Street
CHICAGO, ILL., U. S. A.

NEW! UNIVERSAL'S 7-Tube Auto Radio!

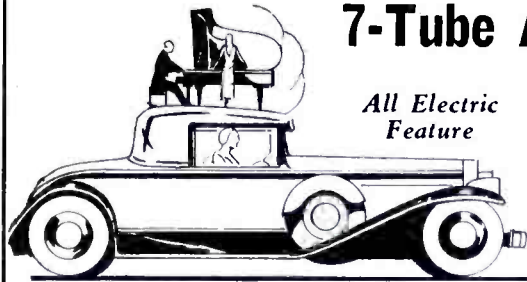

All Electric Feature

Here it is! The new 7-tube Universal receiver with all the latest features: Steering wheel remote control, high sensitivity—extreme se-

lectivity—strong volume—uniform reception—Super-Dynamic speaker—free automatic volume control—no fading under viaducts and other shielded spots—Coast-to-coast reception—A-1 quality—and only \$79.50. Uses 3 No. 236, 2 No. 237 and 2 No. 238 tubes! Investigate immediately the big profits in this sensationally performing—sensationally-priced 1932 leader in auto radio sets!

Other Quality Sets at Low Prices! Backed By a Strong Company!

Again, we lead the lower-priced field! The new, improved 6-tube set at \$69.50 gives you coast-to-coast reception—Super-Dynamic speaker, automatic volume control, remote control, and 6 tubes. The Standard 5-tube set has same features and sells for only \$59.50. All Universal receivers are compact, light, easy to install, and carry the Universal Guarantee! Write us at once!

UNIVERSAL AUTO RADIO

DEALERS! DISTRIBUTORS!

Get Our Liberal Franchise Offer

A few choice territories open now, but won't be long! Get details of our very attractive franchise which is backed by firmly established, nationally recognized company. Get these new big profits!

WRITE to us immediately. It will pay you. National Chain of Service Stations being established. Applications being considered now. Write for details. Hurry!

UNIVERSAL AUTO RADIO CORPORATION

1203 S. Michigan Ave. CHICAGO

We Are Establishing National Chain of Service Stations!

CLAR-A-TONE



•• Gives Volume—Reception, and Tone Your Radio Never Produced Before, Also a Perfect Antenna Tuner

\$1.65

Postpaid in U. S. A.

Money Back Guarantee—LESS POSTAGE

Pure, clear tone—greater volume—interference cut out instantly! Attach Clar-A-Tone to your set and enjoy tone you never thought your radio could produce.

Thousands of owners say Clar-A-Tone is amazingly ingenious. And radio engineers will tell you what a fine technical accomplishment it is.

Regular price, \$2.50—but now as a special introductory offer, we will ship you a Clar-A-Tone direct for only \$1.65. Mail the coupon below with check or money order, or currency. No C.O.D.'s. Money back any time within 10 days if you're not satisfied. Simple installation instructions complete on box.

In Canada and other countries 20c extra for postage.

ESSENBEE RADIO DEVICES COMPANY

732 Mather St., Chicago, Ill.

Enclosed find my payment of \$1.65 for Clar-A-Tone, sent postpaid.

NAME

ADDRESS

CITY..... STATE.....

SERVICE BLUE PRINTS

FOR SERVICE MEN, TECHNICIANS AND EXPERIMENTERS

ACCURATE, clear and dependable drawings of nearly every standard circuit. These schematics are drawn to a large scale and so simplified that the whole circuit may be visualized almost instantaneously. This enables the service man to work rapidly and accurately. There is no need for microscopes or clairvoyance in reading our prints.

No. SR24	A. C. Dayton Navigator	\$0.75	No. SR130	Howard SG-B	\$0.75
No. SR3	Acme AC7	.75	No. SR145	Howard H	.75
No. SR4	Acme AC4	.75	No. SR118	Jesse French Jr. "G"	.75
No. SR1	All-American Mohawk 6	.75	No. SR77	Kellogg 523	.75
No. SR2	All-American Mohawk 8	.75	No. SR38	Kennedy 10	.75
No. SR74	All-American Mohawk 96	.75	No. SR48	Kennedy 20	.75
No. SR165	All-American Mohawk (Lyric) B-7	.75	No. SR81	Kennedy 26	.75
No. SR167	All-American Mohawk (Lyric) S-7	.75	No. SR129	Kennedy 30 and 32	.75
No. SR170	All-American Mohawk (Lyric) S-8	.75	No. SR184	Kennedy 52A	.75
No. SR128	All-American Mohawk (Lyric) Model J	.75	No. SR185	Kennedy 56	.75
No. SR22	Amrad 70 A. C.	.75	No. SR31	King Model J	.75
No. SR44	Amrad 81	.75	No. SR8	Kolster K20; K22; K25 and K27	.75
No. SR106	Amrad 84	.75	No. SR45	Kolster K21; K23	.75
No. SR191	Apex 10	.75	No. SR72	Kolster K43	.75
No. SR180	Apex 48 Chassis	.75	No. SR159	Kolster 80 and 82	.75
No. SR108	Apex Series 31	.75	No. SR182	Kolster K-90	.75
No. SR28	Atwater-Kent 38	.75	No. SR65	Kylelectron 70	.75
No. SR51	Atwater-Kent 55 and 55C (Cap. Coupled)	.75	No. SR124	Majestic 20	.75
No. SR52	Atwater-Kent 55 and 55C (Inductive Coupled)	.75	No. SR178	Majestic 25	.75
No. SR114	Atwater-Kent 66	.75	No. SR157	Majestic Chassis 15	.75
No. SR131	Atwater-Kent Super H-2 Chassis	.75	No. SR98	Majestic Super Chassis 50	.75
No. SR181	Audiola 13-S7	.75	No. SR138	Majestic Super Chassis 60	.75
No. SR79	Audiola 31	.75	No. SR7	Majestic 70	.75
No. SR111	Audiola Super 1931	.75	No. SR55	Majestic 90; 90B; 91; 92 and 93	.75
No. SR112	Audiola Junior	.75	No. SR84	Majestic 130-A	.75
No. SR12	Balkeit A	.75	No. SR28	Philco 86-82	.75
No. SR162	Bosch 7 (D.C.)	.75	No. SR156	Philco 90 and 90-A, Series B	.75
No. SR193	Bosch 20	.75	No. SR60	Philco 95	.75
No. SR121	Bosch 28 and 29	.75	No. SR172	Philco 112 and 112-A	.75
No. SR198	Bosch 31 and 32	.75	No. SR176	Pilot 148	.75
No. SR73	Bosch 48	.75	No. SR104	Radiette F-14	.75
No. SR94	Bosch Auto Radio 80	.75	No. SR127	RCA 18	.75
No. SR109	Bosch 58	.75	No. SR102	RCA 44	.75
No. SR117	Bosch 60	.75	No. SR30	RCA 60	.75
No. SR10	Bremer-Tully 7-70	.75	No. SR64	RCA 66	.75
No. SR75	Bremer-Tully 81 and 82	.75	No. SR92	RCA 80	.75
No. SR126	Bremer-Tully S-81 and S-82	.75	No. SR107	RCA 48	.75
No. SR23	Brunswick 3KRO	.75	No. SR168	RCA Victor R-11	.75
No. SR148	Brunswick 11, 12, 16	.75	No. SR166	RCA Victor R-50 and R-55	.75
No. SR71	Brunswick S-14	.75	No. SR137	RCA-Victor Superette	.75
No. SR86	Brunswick 15, 22, 32, 42	.75	No. SR115	Sentinel 11; 15; 16; 12 and 12R	.75
No. SR164	Brunswick 17 and 24	.75	No. SR113	Sentinel 106-B	.75
No. SR183	Brunswick Chassis E, models 17, 24 and 25	.75	No. SR146	Sentinel 108-A	.75
No. SR78	Clarion 50	.75	No. SR155	Sentinel 111	.75
No. SR139	Clarion 80 and 81	.75	No. SR123	Sentinel Super Midget 108	.75
No. SR29	Colonial 31AC	.75	No. SR169	Silver-Marshall A	.75
No. SR95	Colonial 33 and 34 A. C.	.75	No. SR152	Silver-Marshall D and E	.75
No. SR160	Colonial 47 and 48	.75	No. SR140	Silver-Marshall F	.75
No. SR47	Columbia (Chicago) SG8	.75	No. SR153	Silver-Marshall G	.75
No. SR103	Crosley 53 and 54	.75	No. SR35	Silver-Marshall 30	.75
No. SR174	Crosley 125	.75	No. SR53	Silver-Marshall 30-B	.75
No. SR15	Crosley 608 Gembox	.75	No. SR82	Silver-Marshall 35-A	.75
No. SR6	Crosley 705 Showbox	.75	No. SR144	Silver-Marshall 726 SW	.75
No. SR41	Crosley Jewelbox 704B	.75	No. SR105	Silver Super 36-A	.75
No. SR57	Crosley 40S, 41S, 42S and 82S	.75	No. SR120	Silver Midget 782-12	.75
No. SR67	Crosley "Roamio" (Auto Radio)	.75	No. SR27	Slagle (Continental) 9	.75
No. SR53	Crosley 77	.75	No. SR46	Slagle (Continental) R-20	.75
No. SR133	Crosley 120	.75	No. SR25	Sonora Delux 5R	.75
No. SR149	Crosley 121	.75	No. SR180	Sparton 10	.75
No. SR150	Crosley 124	.75	No. SR192	Sparton 15	.75
No. SR187	Crosley 127	.75	No. SR161	Sparton 25 and 26	.75
No. SR11	Day-Fan 5080	.75	No. SR91	Sparton 600; 610 and 620	.75
No. SR66	Delco Auto Radio	.75	No. SR9	Sparton AC89	.75
No. SR87	Delco Police Short Wave Receiver 3003	.75	No. SR58	Sparton 931	.75
No. SR99	Edison R6 and R7	.75	No. SR63	Sparton 589	.75
No. SR49	Edison R4, R5, C4	.75	No. SR36	Splitdorf E-175	.75
No. SR33	Eria DuoConcerto R-2	.75	No. SR15	Steinite 261	.75
No. SR50	Eversady Series 50	.75	No. SR76	Steinite 70; 80 and 95	.75
No. SR158	Fada KW	.75	No. SR132	Steinite 600, 605, 630 and 635	.75
No. SR13	Fada 7AC	.75	No. SR147	Stewart-Warner 102 A and B	.75
No. SR70	Fada 35 and 35Z	.75	No. SR34	Stewart-Warner 900	.75
No. SR19	Federal H	.75	No. SR62	Stewart-Warner 950	.75
No. SR20	Freed-Eisemann NR-80	.75	No. SR85	Stewart-Warner R-100A, B and E	.75
No. SR14	Freshman 2-N-12	.75	No. SR195	Stewart-Warner R-102A, B, E	.75
No. SR92	General Electric H-31	.75	No. SR134	Stromberg-Carlson 10 and 11	.75
No. SR166	General Electric H-32	.75	No. SR93	Stromberg-Carlson 12 and 14	.75
No. SR107	General Electric T-41	.75	No. SR151	Stromberg-Carlson 19 and 20	.75
No. SR137	General Electric S-22	.75	No. SR18	Stromberg-Carlson 635 and 636	.75
No. SR168	General Electric K-62	.75	No. SR54	Stromberg-Carlson 846	.75
No. SR68	General Motors A	.75	No. SR37	Temple 8-60; 8-80 and 8-90	.75
No. SR154	General Motors S-3-A	.75	No. SR125	Temple 861; 881 and 891	.75
No. SR173	General Motors S-9-A	.75	No. SR69	Transitone Auto Radio	.75
No. SR179	General Motors S-10A	.75	No. SR121	Trav-Ler Model C	.75
No. SR32	Gillfillan 100	.75	No. SR143	U. S. Radio & Television (Gloritone) 26P	.75
No. SR42	Graybar 600	.75	No. SR39	U. S. Radio & Television 37	.75
No. SR92	Graybar 700	.75	No. SR171	U. S. Radio & Television 99	.75
No. SR107	Graybar 678	.75	No. SR119	Vitatone 54 (Zaney-Gill Corp.)	.75
No. SR96	Grebe Synchrophase AH-1	.75	No. SR101	Victor Micro-Synchronous R-35; R-39 and RE-57	.75
No. SR17	Grebe 7AC	.75	No. SR61	Victor R-32; RE45 and R52	.75
No. SR59	Grebe SK-4	.75	No. SR92	Westinghouse WR-5	.75
No. SR40	Gulbransen Nine-in-Line	.75	No. SR107	Westinghouse WR-4	.75
No. SR175	Gulbransen 10 and 13	.75	No. SR137	Westinghouse WR-10 and 12	.75
No. SR186	Gulbransen 23	.75	No. SR168	Westinghouse WR-15	.75
No. SR110	Gulbransen 161	.75	No. SR141	Zenith A, B, C and D	.75
No. SR177	Howard AVH	.75	No. SR97	Zenith 71; 72; 73 and 77	.75
No. SR16	Howard Green Diamond 8	.75	No. SR43	Zenith 52; 53; 54; 522; 532 and 542	.75
No. SR163	Howard 0	.75	No. SR190	Zenith 91 and 92	.75
No. SR56	Howard SG-A	.75			

PUBLIC ADDRESS SYSTEMS

No. SR100	Amer-Tran PA-86	\$0.75	No. SR88	Webster (Racine, Wis.) A37-50	\$0.75
No. SR90	Silver-Marshall 692	.75	No. SR89	Webster (Chicago) DH-250	.75
No. SR122	Silver 679-B Amp	.75			

The above drawings are intended for service purposes only and are not suitable for the construction of receivers from miscellaneous parts. They will be sent postpaid by return mail upon receipt of the proper amount. C. O. D. orders not accepted.

CITIZEN'S RADIO SERVICE BUREAU

508 South Dearborn Street, 7th Floor CHICAGO, ILLINOIS

ANNOUNCING

A Personal Course of Instruction in

TELEVISION ENGINEERING

By ARTHUR H. HALLORAN, Television Consultant

for radio men who want to be ready when
CATHODE RAY RECEIVERS
are commercialized. 1932's big promise.

THE course consists of 30 lessons which explain mechanical and electrical scanning, synchronization, generation, transmission and reception of television signals. Each lesson is accompanied by problems to be answered by the student and corrected and graded by the instructor before the next lesson is mailed.

A working knowledge of the fundamental principles of radio and trigonometry is prerequisite to the course. Only a limited number of enrollments can be accepted, preference being given to those who give evidence of a serious interest in the subject. This course is conducted in co-operation with engineers who have developed the cathode ray tube for television purposes. Its purpose is to prepare men for employment in this new industry wherein yesterday's science is today being engineered for tomorrow's sales.

The cost is moderate. A down payment of \$5.00 brings you the first lesson and four more thereafter as the problems are answered. Similar \$5.00 payments bring each succeeding set of 5 lessons, a total of \$30.00 for 30 lessons. Mail the attached enrollment blank with your initial \$5.00 payment. It marks a turning point in your career.

ENROLLMENT BLANK

ARTHUR H. HALLORAN,
430 Pacific Bldg., San Francisco, Calif.

Enclosed is \$5.00 for which enroll me as a student in your course on Television Engineering. I understand simple radio principles and trigonometry and expect to complete the course.

NAME.....

STREET AND NUMBER.....

CITY.....STATE.....

SERVICE-MEN FREE

SEND FOR THIS BOOK YOU NEED IT!

1932 RADIO PRICE GUIDE
TUBES, SETS, REPLACEMENT PARTS,
BATTERIES, ACCESSORIES
Everything for your business from the smallest screw to the finest mike in this book.

Guaranteed Quality Goods
Prices Lowest Ever Quoted
Fresh new dependable Merchandise
at Bargain Prices!
Leading Manufacturers' Lines

Radolek Co.
304 Canal Station,
Chicago, Ill.
Please send me without
obligation your Service
Man's Supply Book.

RADOLEK CO.
601 W. RANDOLPH ST.
CHICAGO, ILL.

PIN THIS COUPON TO YOUR LETTERHEAD

Name.....
Address.....
City..... State.....

BEN J. CHROMY

Counsellor in Patent Causes

710 Fourteenth Street
WASHINGTON, D. C.

"Radio Patent Service" Weekly

SERVICEMEN—DEALERS!

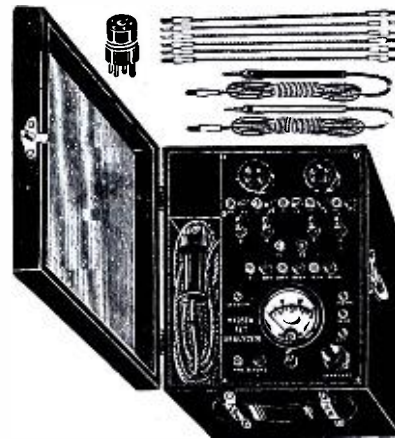

Get the New MADSEN

Set Analyzer

The most flexible analyzer made. Will make all circuit tests for current and voltage. Will test all types of tubes for mutual conductance, also provision made for testing new tubes, as brought out.

With LEATHERETTE CASE. Net Price **\$30.00**

With SOLID WALNUT CASE. Net Price **\$32.00**

Accurate Ohm Meter reading to 100,000 ohms guaranteed

Madsen Instrument Co.
98 Park Place New York City

AMAZING RECEPTION!

"Super Ball" Antenna

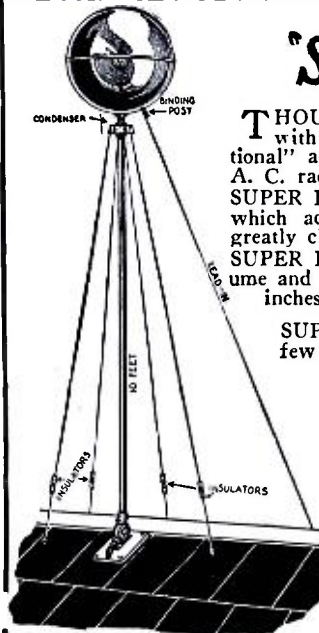

THOUSANDS of users are getting marvelous reception with the SUPER BALL ANTENNA, the "all directional" aerial, which brings out the hidden powers of all A. C. radio sets.

SUPER BALL ANTENNA features a patented condenser which acts as a neutralizer for the entire system and greatly clarifies tone.

SUPER BALL ANTENNA gives greater selectivity, volume and distance due to its conductive surface of 364 sq. inches.

SUPER BALL ANTENNA is easily installed in a few minutes and gives a lifetime of satisfaction.

Over 1,000,000 in Use

Send for prices for Super Ball with Condenser, also complete Kit for Installation and printed matter.

Get one to-day at your radio dealer

YAHR-LANGE
INCORPORATED

142 North Water St.

Milwaukee, Wis.

A new training FOR RADIO MEN!



To make real money in radio requires KNOWLEDGE! There is no substitute for it—not even practical experience. Our new advanced training is ideally suited for the experienced radio man who wants to equip himself for more important work.

Endorsed by Leaders

Our institute is highly recommended by Radio Service Managers Assn., Howard Radio, American Radio Relay League, etc. Thousands of students testify to our home study methods of instruction in basic radio engineering. That is because we teach the "WHY" of radio—the fundamental principles of radio theory.

Write for Booklet

Send for the details of our training. Absolutely free of charge or obligation. But don't put it off—do it now—while you have the time. State whether you are interested in Radio or Television. (Don't write if you have not had at least 2 years radio experience.)

CAPITOL RADIO ENGINEERING INSTITUTE

14th St. & Park Road, N. W.
(Dept. C-14)
Washington, D. C.

INDEX TO ADVERTISERS

	Page
A	
Alden Mfg. Co.....	56
Apparatus Design Co.....	52
Audiola Radio Company.....	57
C	
Capitol Radio Engineering Inst.....	62
Chromy, Ben J.....	61
Citizens Radio Service Bureau	
Blue Prints	60
Subscription Offer	64
Midget Cone Speaker.....	59
Clarostat Mfg. Co., Inc.....	55
Clausing, Leroy M. E.....	54
Coyne Electrical School.....	3
D	
Dixon Radio & Elec. Corp.....	48
Doolittle & Falknor, Inc.....	56
Dubilier Condenser Corp.....	54
E	
Electrad, Inc.	51
Essenbee Radio Devices Co.....	48-59
F	
Filtermatic Mfg. Company.....	48
G	
General Radio Company.....	58
H	
Halloran, Arthur H.....	61
Hammarlund-Roberts, Inc.	57
Harrison Radio Co.....	52
J	
J-M-P Mfg. Co., Inc.....	62
K	
Kellogg Switchboard & Supply Co.....	49
L	
Littelfuse Laboratories	46
M	
McGraw-Hill Book Company, Inc.....	56
Madsen Instrument Co.....	61
Midget Cone Speaker.....	59
Muter Co., The.....	48-63
N	
National Radio Institute.....	5
National Television, Talking Picture and Radio School.....	53
P	
Polymet Mfg. Corp.....	57
R	
RCA Institutes, Inc.....	51
Radio Training Assn. of America.....	47
Radio Training Schools, Inc.....	Second Cover
Radolek Company	61
Readrite Meter Works.....	2
Rider Publications, John F.....	Third Cover
Royal Eastern Electrical Supply Co.....	58
S	
Schwartz & Son, Maurice.....	46
Scott Radio Laboratories, Inc., E. H.....	1
Short Wave Craft.....	54
Shure Bros. Co.....	56
Silver-Marshall, Inc.	Fourth Cover
Struthers Dunn, Inc.	46
T	
Tilton Mfg. Co.....	54
U	
Universal Auto Radio Corp.....	59
Universal Microphone Co., Ltd.....	46
W	
Weston Electrical Instrument Corp.....	50
Wright-DeCoster, Inc.	57
Y	
Yahr-Lange, Inc.	61

ACROCYCLE \$17⁵⁰ OSCILLATOR

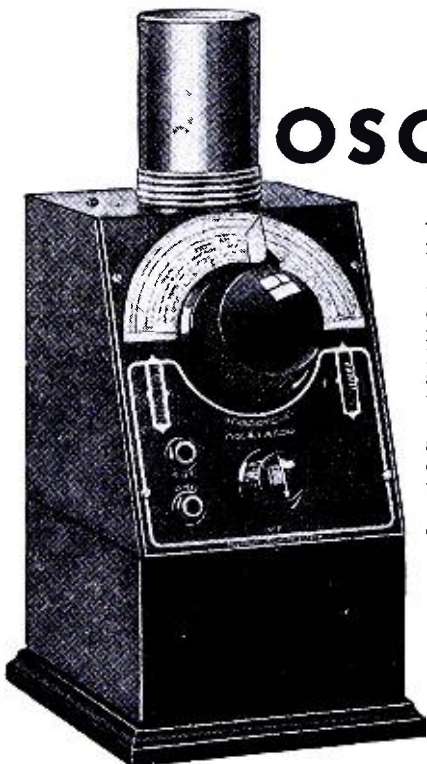

A SELF-CONTAINED, fully shielded oscillator, with full vision scale calibrated directly in Kilocycles—no charts used—micrometer slow motion dial—can be set at exactly any frequency from 115 to 1680 K.C. Uses four flashlight cells and one 22½ volt battery automatically connected when inserted. Uses one 30 tube self-modulated. Can be checked for accuracy when attached to any receiver by the "beat" method to within 20 cycles.

Dealer's Price—Oscillator with test leads \$17.50. Complete set of batteries and tube \$2.25 extra. Leatherette Carrying Case \$2.00 extra. If your jobber does not carry, order direct. Sent express collect or C.O.D. with a deposit of \$1.50. **Free circular.**

[This instrument is made by the manufacturers of the "Submariner" Short Wave Adapter now priced at \$12.50. The first adapter on the market built since 1926.]

ORDER TODAY!

J-M-P MANUFACTURING CO. INC.

(Established 1922)

3002—No. 34th St.
Milwaukee, Wisconsin, U. S. A.

**WIRE
WOUND**

CANDOHM

**FIXED
RESISTORS**

**ARMoured REPLACEMENT UNITS
STANDARD EQUIPMENT IN THE LEADING SETS**

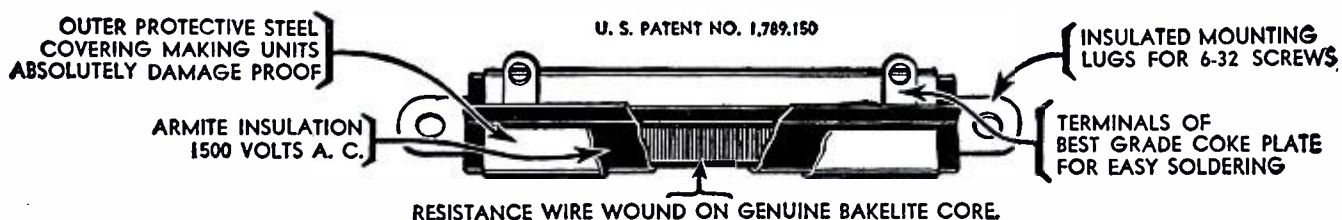

SPECIAL INTRODUCTORY MONEY MAKING OFFER

To Readers of Radio Call Book Magazine and Technical Review

\$15³⁰
VALUE

Complete assortment of 50 Candohms in 24 different values enabling immediate replacement of any service job

\$5⁰⁰
Prepaid

FOR ONLY

Contents of Service Men's Kit



Stock No.	Ohms	Quantity	List	Amt.
702	20	1	\$.20	\$.20
704	40	1	.20	.20
706	60	1	.20	.20
709	50	1	.20	.20
710	100	2	.20	.40
715	150	1	.20	.20
720	200	2	.20	.40
721	250	1	.20	.20
722	300	2	.20	.40
723	400	1	.20	.20
724	500	4	.20	.80
725	600	1	.20	.20
726	750	4	.20	.80
728	1000	5	.20	1.00
730	1250	1	.20	.20
760	1500	3	.40	1.20
762	2000	4	.40	1.60
764	2500	4	.40	1.60
765	3500	2	.40	.80
766	5000	4	.50	2.00
767	6000	1	.50	.50
768	7500	1	.50	.50
770	10000	2	.50	1.00
772	12500	1	.50	.50
Total		50		\$15.30

An actual photograph of the kit you will receive. By far the greatest value ever offered. Order yours today!

**THE MUTER COMPANY
1255 South Michigan Ave.
Chicago, Ill., U. S. A.**



CLIP—MAIL NOW!

**THE MUTER COMPANY
1255 South Michigan Ave., Chicago, Ill., U. S. A.**

- Please send Candohm Resistor Kit Prepaid. \$5.00 is enclosed.
- Send c.o.d.

Name

Address

City State

Get this New and Enlarged Edition of

RADIO SERVICE Schematics

with a
Full Year's Subscription
to

Radio Call Book Magazine and Technical Review

For Only **\$2.50**

(Foreign \$3.00—Canada \$3.50)

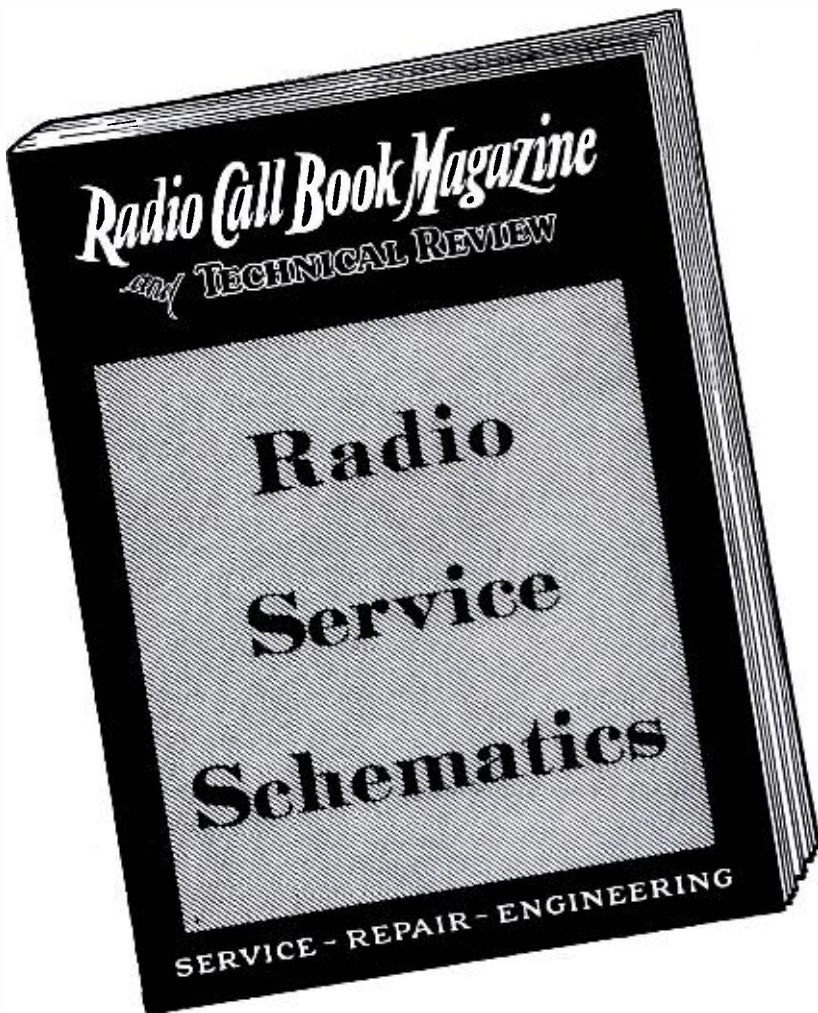

You Save \$1.50 by this Combination Rate!

If you purchased RADIO CALL BOOK MAGAZINE and TECHNICAL REVIEW on the newsstand each month, the cost would be \$3.00 for a full year; the regular advertised price of RADIO SERVICE SCHEMATICS is \$1.00, so ordinarily these two would cost \$4.00. *Here's your chance to save \$1.50 and obtain the magazines and schematics you are always in need of. Send your order in today!*

The New and Enlarged Edition of Radio Service Schematics Contains:

Over one hundred SCHEMATIC WIRING DIAGRAMS of Popular Factory Built Radio Receivers and Power Supplies, carefully drawn by our own expert drafting force.

Laboratory and workshop formulas in simplified form to aid the Serviceman and Engineer.

RECEIVER RESPONSE CURVES showing sensitivity, selectivity and electrical fidelity characteristics, prepared in our own laboratory as specified by the IRE and RMA are given, showing such popular brands as RCA, MAJESTIC, ATWATER KENT, CROSLLEY, SILVER, SPARTON, STEWART-WARNER, BRUNSWICK and others.

CLIP-MAIL NOW!

CITIZENS RADIO SERVICE BUREAU
508 S. Dearborn Street, Chicago, Ill.

Please find enclosed \$2.50 U. S. A. \$3.00 Foreign. \$3.50 Canada, for which send me the new and enlarged edition of RADIO SERVICE SCHEMATICS and enter my subscription to RADIO CALL BOOK MAGAZINE and TECHNICAL REVIEW for one year, starting with the..... number.

Name.....
Address.....
City..... State.....

Please put a check mark opposite your occupation:

- Dealer
- Serviceman
- Engineer
- Manufacturer
- Distributor
- Salesman
- Technician
- Experimenter

NOW — KEEP STEP WITH RADIO SERVICE PROGRESS

Announcing



A NEW MONTHLY MAGAZINE

Dedicated to and Written Expressly for the

RADIO SERVICE MAN

edited by
JOHN F. RIDER

SERVICE, a Monthly Digest of Radio and Associated Maintenance, was born to fill the demand for a magazine devoted solely to radio servicing and intended for distribution among service men only. The service branch of the radio is large and varied and today represents one of the most powerful influences in the entire radio world.

There are many radio magazines—but none written expressly for the Radio Service Technician. This place shall be filled by SERVICE. You—you—and you—earning a livelihood as service technicians do not have time to read long winded, lengthy articles. SERVICE will give you coverage of the entire radio industry and all its branches, broadcast receivers—auto-radio—short wave receivers—refrigeration—public address systems,

etc., in short, brief, but to the point service notes.

In it you will find abstracts of service articles appearing in every radio magazine published in the English language. You will also find an index of articles of interest to Radio Service Men, which have been published in all radio magazines.

The thousands of letters I have received from men who have purchased my various books show that I have given them their money's worth. I assure you, that every subscriber to SERVICE will get his money's worth. You will find this magazine to be of inestimable value in your business and work. You will find it educational—informative—modern—breezy and easy to read.

John F. Rider.

—and the price is LOW! \$1.00 per year in the U. S.

Full size 9x12 inches

Publication date is the 25th of every Month. Sold only by subscription.

If you want a sample copy, fill in the coupon and enclose a 10 cent stamp

..... COUPON

John F. Rider Publications
1440 Broadway
New York City

- Here is 10 cents in stamps. Send me a copy of Rider's NEW magazine SERVICE
- Here is \$1.00. Enroll me as a subscriber to Rider's NEW magazine SERVICE

Name

Address

City State.....



YOU

Can Make Money as an Authorized Silver-Marshall Service Station—



SPECIAL DISCOUNTS on 142 Catalog items. Chassis, tuners, amplifiers, all-wave sets, short-wave receivers, converters, speakers, and replacement parts.

SPECIAL RECEIVERS—a line of S-M Bearcat receivers especially for Service Stations.

MERCHANDISING HELP—by the whole Silver-Marshall staff of experts.

INSIGNIA OF AUTHORIZATION—identification card, authorization certificate.

If you have any connection with radio, you ought to have all the details. Send the coupon NOW.

If You Are a Radio Dealer » »

and not making the money you should, you ought to know all about the Silver-Marshall line. They are sold **DIRECT TO DEALERS**. The jobber's profit is used in more profit for **YOU** and lower list prices. It is a **COMPLETE** line. Full-size superheterodyne consoles to sell from \$49.95 to \$139.50 complete with Eveready Raytheon 4-Pillar tubes. Silver-Marshall dealers have **EXCLUSIVE** territory. These are some of the reasons why you ought to know about it. Send the coupon for **ALL** the details.



Model C-24. 12 tubes . . . superheterodyne . . . 3-unit construction . . . pentodes in push-pull . . . double tone control . . . built-in tone chamber . . . meter tuning . . . automatic volume control . . . built-in aerial . . . 45-inch door console. The finest receiver made. Complete with Eveready Raytheons . . . \$139.50 list.

SILVER-MARSHALL, Inc.
6413 W. 65th St.,
Chicago, U. S. A.

Please send me Service Station details.

Please send me Dealer details.

Name

Address

SILVER-MARSHALL, Inc.

6413 West 65th Street Chicago, Illinois

CANADA
75 Sherbourne Street
TORONTO

EXPORT
41 Water Street
NEW YORK CITY

WEST COAST
S-M Sales Co., 224 E. 16th
Street, LOS ANGELES