

Citizens

RADIO CALL BOOK MAGAZINE

50¢

© SPRING EDITION



A COMPLETE RADIO CYCLOPEDIA

This Advertisement also appeared in the SATURDAY EVENING POST of FEBRUARY 18th

SONATRON

The World's Largest Radio Tube Line



SONATRON tubes are manufactured by a nation-wide organization—a huge factory supplying four strategic distributing centers

Every SONATRON Radio Tube is guaranteed to deliver 1,000 hours of service—the world's broadest guarantee

Commanding the World's Attention

**33
DISTINCT
TYPES**

The SONATRON radio tube line covers every need in modern radio, including the latest tubes for AC electrical operation of receivers. We list below several general classifications; and any SONATRON dealer will give you full information.

AC TUBES
X226, Y227, and 225A to replace 225AC

POWER TUBES
X171, X112, X171A, X112A, X210, 200A

RECTIFIERS
X280, X281, 213, and the gas-filled 5H85

DRY CELL TUBES
199, X199, 199A

—and many others

SONATRON, resolving to bring a better tube service to the world of radio, pledged itself to a policy of progress which it has never relaxed. Today SONATRON, manufacturing 33 distinct types of tubes, commands the world's attention as the World's Largest Radio Tube Line!

SONATRON engineers, alert, resourceful, backed by a great organization, have time and again pioneered important tubes, often bringing them to the public months before other manufacturers! Every need in modern radio has been anticipated and promptly met. Through a vast army of dealers, SONATRON offers a tube service which a great

army of buyers has stamped with its approval.

Standard quality and long life make possible the remarkable SONATRON guarantee. Superlative methods of manufacture insure better-than-ordinary radio results—in tone, in volume, in distance-getting ability. Since tubes are the heart of your radio set, consider the importance of these things.

SONATRON Radio Tubes are sold by thousands of dealers, distributed by hundreds of jobbers, and endorsed by many radio manufacturers who use them as standard equipment! See your SONATRON dealer for the latest information in tubes—and mail the coupon below.

SONATRON TUBE COMPANY

16 Hudson Street, New York City

88 Eighth Ave., Newark, N. J.

108 W. Lake Street, Chicago
320 Lafayette Bldg., Detroit

Dealers! Jobbers!
Manufacturers!

Write for the famous SONATRON Proposition!

SONATRON TUBE COMPANY. (Address nearest office)
Gentlemen: Please send me the FREE book "How to take care of your Radio Tubes"

Name.....
Street Address or R. F. D.....
City and State.....
 Dealers, Jobbers and Manufacturers check here for the Sonatron Proposition.

FREE! Set owners! WRITE for your copy of this FREE BOOK: "How to take care of your Radio Tubes."



Only **4.87**

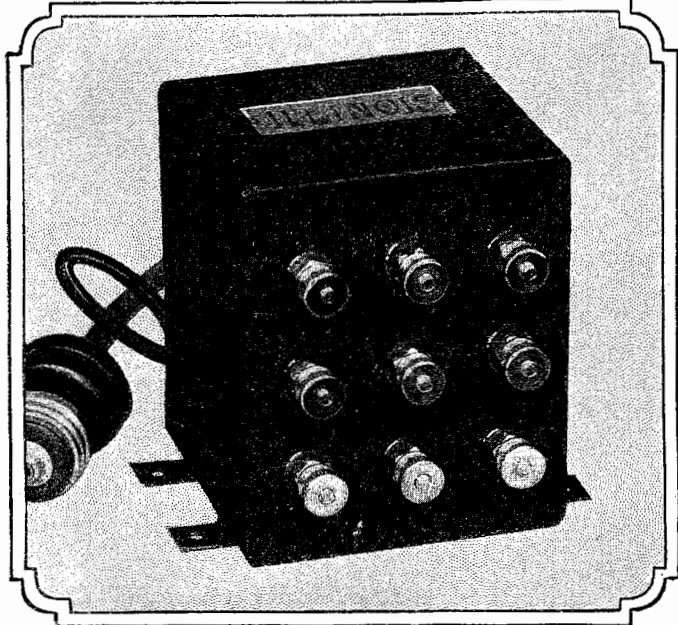

FOR THIS REGULAR \$12

A-C

Filament Supply TRANSFORMER

LOOP for SWITCH

The loop of wire shown in back of the transformer case is an extension of one side of the 110 volt line. It is provided for the convenience of those who wish to cut in a power switch to be mounted on the panel of the set.

Supplies Proper Voltages for All 226, 227 and 171 Tubes

With this A-C Filament Supply Transformer you can operate a set combining 6 type 226 A-C tubes, 2 type 227 tubes and 2 type 171 power tubes. Hence, the most elaborate super-heterodyne receiver may be operated with this unit. Each of the three secondaries are center tapped, thereby doing away with the need for center-tap resistances required by other types of filament transformers. Don't confuse the Illinois A-C Filament Transformer with others which supply only five and six tube sets.

Works Perfectly With the New A-C Harnesses

Use the Illinois A-C Filament Transformer with the new A-C conversion harnesses. Convert any battery operated set into an A-C set in a few minutes' time. Enjoy the freedom from "A" battery nuisance which these new harnesses and the Illinois

A-C Filament Transformer makes possible. Order one of these guaranteed units today. Take advantage of the low \$4.87 price.

\$1 DOWN

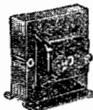

The Famous **ILLINOIS "All-Frequency" AUDIO TRANSFORMERS LIMITED OFFER 97c Each**

This is the most amazing radio value ever offered. Think of it! A \$4.00 audio transformer—a real "all frequency" unit of the finest musical capability, offered direct from the factory for only 97c. Never before such a bargain opportunity. Thousands have bought them. Sold with a positive guarantee of satisfaction or money back. Supplied in ratios of 1½ to 1, 3 to 1 and 5 to 1. Order now. Use coupon.

ILLINOIS TRANSFORMER CO.
646 No. Michigan Ave. Dept. 102 Chicago, Ill.

Now—at a reasonable cost—you can build a set using A-C tubes, or convert your present set into an A-C set. This new, advanced type, better quality, heavy duty A-C filament supply transformer is now available to you at the very low price of only \$4.87—instead of the \$12.00 price at which it has always sold. You can't buy the equal of this transformer any place for less than \$12.00 or \$14.00. Why pay more than \$4.87, when this unit is fully

GUARANTEED

Guaranteed to deliver the correct voltages at the taps as marked—Guaranteed against defect in material and workmanship—Guaranteed the best performing A-C filament supply transformer built.

TRY IT FREE

Test This Unit at Our Risk

Order it. Connect up to your set. Check the voltages with an accurate voltmeter, if you like. Put it to any test you wish. If you think, for any reason at all, that this unit is not the best A-C filament transformer you can buy, send it back and your money will be refunded to you *instantly*. You are the sole judge. Order NOW. Attach dollar bill to the coupon and mail right now. Pay postman \$3.87 plus few cents postage when the transformer arrives. Then, make your tests. Remember—you take no risk. Guarantee protects you. Clip coupon. Order today.

MAIL THIS COUPON

ILLINOIS TRANSFORMER CO., Dept. 102
646 No. Michigan Ave., Chicago, Ill.

- I enclose \$1.00. Please ship me one Illinois A-C Filament Transformer for 226, 227 and 171 standard tubes. I agree to pay postman \$3.87 balance and small postage. It is understood that I can have my money back if not satisfied.
- I enclose \$..... Ship me the following Illinois Audio Frequency Transformers: 1½ to 1; 3 to 1; 5 to 1. I understand I can have my money back if not satisfied.

Name
Street
Town State

BRAUN offers you SEASONABLE Lines Radio-Electrical-Auto Supplies SPORTING Goods

Keep Busy the Year 'Round —Make More Money

NO more Spring and Summer slumps for radio dealers. The W. C. Braun Co. has happily solved the problem for you. Now you can keep busy the year 'round because *Braun* lines round out your stocks and give you merchandise that keeps money rolling in and profits piling up Spring, Summer, Autumn and Winter.

Radio sets, circuits, parts and accessories for the busy Fall and Winter months; auto supplies for Spring and Summer; sporting goods for Summer; household appliances, electrical goods and other stable merchandise for all times and seasons.

Braun service is keeping things moving and rolling in the profits regularly every month—that's the kind of service that counts.

Monroe A-C Sets

A-C is the thing now. Monroe A-C sets are big sellers—remarkable quality at moderate prices. Everything from table models to deluxe highboys and super-panels. Electrified, battery-operated and dry cell models in many designs and at money-saving prices. Also a fine line of portable radio sets for Summer use, camping, etc. Big discounts, big profits, fast sellers.

Radio Accessories

The worth-while standard, guaranteed radio accessories from leading manufacturers—tubes, batteries, consoles, cabinets, speakers, eliminators, A-supply units, A-C converter harness—everything that a radio user needs to keep up to date.

Parts for All Circuits

We carry the largest stock of radio parts in the world, for all the leading radio A-C and battery-operated circuits—Tyrman, Silver-Marshall, Aero, Scott's World Record, Magnaformer 9-8, Madison-Moore, St. James, LC28, all the new Grid Tube circuits; in fact, everything published in the way of circuits by the Citizens Radio Call Book, Radio News, Radio Broadcast, Radio Listeners' Guide, Popular Radio, Radio Age, Radio, Radio Doings, Radio Digest, QST and all radio magazines. Special combination offers that afford big profits to dealers and custom set builders.

Tyrman "70"

Shielded Grid Amplifier

AERO-SEVEN RECEIVER

Magnaformer 9-8

Commander-in-chief of the Air



Scott's etc.

24-HOUR SERVICE

Send for Braun's Big Buyers' Guide

This is the Big Book that shows the fast selling merchandise, the big profit maker that you should have on hand to help you keep business humming throughout the Spring and Summer. It is free to dealers for the asking just send two wholesale references and a copy of your letterhead. Use the handy coupon now.

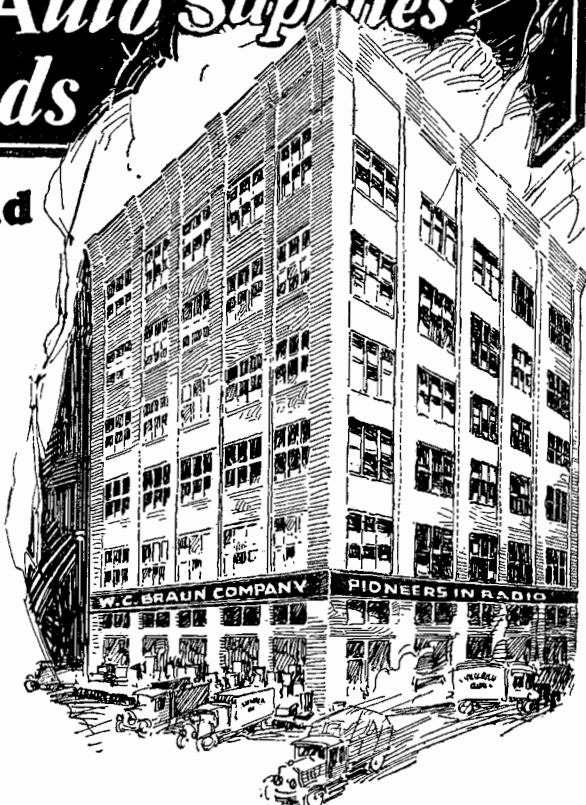

Sketch of W. C. Braun Co. headquarters in Chicago

Auto Supplies

The most complete line of auto supplies, including everything needed by the garage, auto dealer and auto supply shop. Standard quality guaranteed tires and tubes, seat covers, tools, tire gauges, pumps, jacks, luggage carriers, shock absorbers, springs, baskets, replacement parts, special accessories and parts for all Ford models—in fact, everything that a motorist needs for city, country or camping.

Sporting Goods

You will be surprised at our complete line of sporting goods, including golf clubs, bags, golf balls and other golf equipment; tennis goods, outing equipment, fishing tackle, just the kind of merchandise that goes big during the Spring and Summer months. Liberal discounts assure you big profits.

Electrical Goods

Here is a line that is closely affiliated with radio: that will sell in any radio shop at all seasons. Complete assortment of wiring materials, electrical stoves, heaters, grilles, percolators, waffle irons, curling irons, motors, tools, household appliances, vacuum cleaners, washing machines, etc.

Mail This Coupon for Free Copy—NOW!

W. C. BRAUN CO., 577A W. Randolph St., Chicago

Dear Sirs: Send me your newest Year 'Round Profit Guide at once.

Name _____

Address _____

City _____ State _____

Wholesale Reference _____

W. C. BRAUN COMPANY

Pioneers in Radio

577A W. Randolph St.



AT LAST!

A Real Radiophone Transmitter —at a reasonable price!

*Employs
Low Power*

*Surprisingly
Long Range*

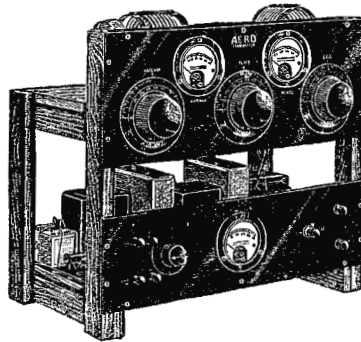

Easy to Build

Easy to Operate

*For All Low
Wave Work*

The Aero Radiophone Transmitter

—Ready to Plug Into Electric Light Socket

HERE is a low power radiophone transmitter that every true radio fan will want to own. An extremely efficient circuit, designed by some of the best known parts manufacturers, that is producing wonderful records on the government licensed low wave bands. Simple to operate, easy to build, its cost is no more than that of a good broadcast receiver!

500 to 1000 Miles on Phone—Several Thousand Miles on Code

The New Aero Radiophone is a thoroughly tried and proved transmitter. As installed at station 9DBM, Chicago, the results on 20 meters have been remarkably good. Reports varying from R-5 to R-7 have been regularly received from these typical stations: 1BBM, North Harwich, Mass.; 1ASF, Medford, Mass.; 1SW, Andover, Mass.; 2BSC, Glen Head, N. Y.; 3AKS, Philadelphia; 3CE, Baltimore; 4MI, Asheville, N. C.; and 8CVJ, Auburn, N. Y. In every instance the quality of speech has been reported to be very fine.

Adapted to code work, the Aero Radiophone Transmitter has produced outstanding results. From a location not of the best, all U. S. districts have been worked with CW on the 40 meter band, as well as NC5ZZ, Vancouver, B. C.

Outstanding Performance Assured By Carefully Selected Parts

Only the best quality parts have been incorporated into the Aero Radiophone Transmitter. Products of the following manufacturers—all with a national reputation—are specified exclusively:

Aero Products, Inc. Chicago, Ill.	Herbert H. Frost, Inc. Elkhart, Ind.	Silver-Marshall, Inc. Chicago, Ill.	Yaxley Mfg. Co. Chicago, Ill.
Allen D. Cardwell Co. Brooklyn, N. Y.	Polymet Mfg. Co. New York, N. Y.	Tube Deutschmann Co. Cambridge, Mass.	Westinghouse-Micarta Chicago, Ill.

**All Complete—Ready
to Plug Into Electric
Light Socket**

The parts for the Aero Radiophone Transmitter are standard parts and are available at all dealers—when completed is ready to plug into your electric light socket. All have been carefully chosen to give the maximum in transmitter performance. Complete drilled and engraved foundation units are also available.

Investigate NOW—Write for FREE BOOKLET

The Aero Radiophone Transmitter is worthy of your careful investigation. Send your name and address at once for complete illustrated, descriptive literature showing schematics, and listing parts, prices, etc. Simply ask for Supplement A. Do it today, and learn how easily you can get into the fascinating field of radiophone transmission. Address

AERO PRODUCTS INC.

1772 Wilson Avenue

Dept. 113R

Chicago, Illinois

Tell 'Em You Saw It in the Citizens Radio Call Book Magazine

Citizens Radio Call Book Magazine

Established 1921

C. O. STIMPSON, President
E. H. JAUDON, Vice-President
D. H. BELL, Secretary-Treasurer
H. ANHEISER, Assistant Treasurer

Executive Offices:
508 So. Dearborn St., Chicago, Ill.

F. A. HILL, Managing Editor
RICHARD K. PEW, Technical Editor
E. M. GIBSON, Advertising Manager
M. R. HARRIS, Circulation Manager

Member Audit Bureau of Circulations

MARCH, 1928

Vol. 9, No. 2

CONTENTS THIS ISSUE

American Broadcasting Stations.....	6
Broadcasting Stations by States.....	42
Simplified Log Sheet.....	44
Foreign Broadcasting Stations.....	46
Ampere Andy's Assistors.....	50
Laboratory Model Screened Grid Superheterodyne.....	54
Carter Adapter Harness Converts D. C. Sets.....	58
Custom Built Model Madison-Moore International "One-Spot".....	59
Aero Has Short Wave Radio Telephone Transmitter.....	63
Citizens 115 K. C. Super.....	67
Citizens Birnbach A. C. Four is Simple and Efficient Receiver.....	71
Design for Complete Electric Phonograph and Amplifier.....	75
Line Voltage Regulator is Easy for Fan to Build.....	78
Citizens Crystal Receiver is Entirely Self-Contained.....	79
Victoreen 1928 A. C. Circuit Fully Electrified.....	81
Simple "A" Supply for Delco Owners.....	85
Melo-Heald Hot-Spot 14 with Shield Grid Tube.....	87
Citizens R. F. Amplifier.....	91
Advance Operating Notes on the Tyrman 70 Amplimax.....	93
Vacuum Tube Voltmeter for Experimenter and Set Builder.....	95
Samson PAB-3 Amplifier and Eliminator.....	97
Harkness A. C. Counterfonic Receiver.....	99
AmerTran ABC Supply Unit.....	103
Ultradyne A. C. "Commander" and Power Supply.....	105
Silver-Marshall Shield Grid Four Tube Receiver.....	109
Thordarson Shield Grid Amplifier.....	112
Knapp A Power Unit.....	114
Samson Public Address System.....	116
Balancing the Battery Operated Nine-in-Line.....	118
Citizens Short Wave Shield Grid Receiver.....	120
Hagerman 210 A. C. Ensemble.....	124
What Goes in a Modern Laboratory.....	128
Editorial.....	130
With the Professional Set Builder.....	131
With the Accessory and Parts Manufacturers.....	133

With the Editor

FURTHER experimental work carried on with the shield grid tube is merely strengthening our conviction that this is a wonderful tube, when used in circuits properly designed for it. Frankly, in circuits where the tube merely takes the place of a 201-A, we doubt if the change is worth while in view of the added cost of the new tube. However, in cases where a circuit has been properly designed around this shielded grid tube, the results are more than encouraging. Readers are invited to read carefully the several applications of the shield grid tube.

With the tube capable of extremely high amplification without oscillation, the radio industry is now faced with the necessity of making a distinction between "selectivity" and "apparent selectivity." A single example will serve to illustrate. In the Citizens Shield Grid Short Wave receiver, illustrated on page 120 of this issue, the actual selectivity of the receiver is good only when the shield grid tube is operated below its minimum capability. When it is operated at its full amplification, the apparent selectivity of the set is bad. However, the controlling factor in this seems to be that when the set is insensitive, its selectivity is good, whereas when its sensitivity is heightened, it appears that its selectivity has departed. Experimenters must choose between insensitivity and selectivity on one hand and extreme sensitivity with poor apparent selectivity on the other. The case in question is considered only as regards the use of a single 222. Doubtless the filtering action of another stage of the same type would help considerably.

—EDITOR.

Copyright, 1928, by Citizens Radio Service Bureau, Incorporated, Publishers. Requests for permission to reprint any articles or other matter contained herein must be made in writing to the executive offices.

Citizens Radio Call Book Magazine is published four times a year and is on sale approximately the first of January, March, September and November. Subscription price \$1.75 per year in U. S. A. Canada and Foreign \$2.00 per year, payable in advance. Single copies 50 cents. Remit by check, draft or P. O. order. No foreign stamps or coins accepted. Mail subscriptions to 508 So. Dearborn Street, Chicago. We will not be responsible for cash sent for subscriptions unless registered.

Citizens Radio Call Book Magazine is for sale on all newsstands in the United States and Canada; also Department Stores and Book Stores; also can be purchased in most radio stores. Paris, France, Brentanos, Ave de L'Opera. England, R. A. Rothermel, Ltd., 24-26 Maddox St., Regent St., London, and W. H. Smith & Sons, London. Australia, McGills Agency, 179 Elizabeth St., Melbourne.

We also publish Citizens Radio Amateur Call Book, tri-annual, \$1.00 per copy, foreign \$1.10, listing all amateur transmitting stations in the world. Subscription price, \$2.50 yearly, foreign \$2.75. Published September, December and March.

Advertising Representatives:

Chicago—A. B. Mills, E. E. Hayes, 508 So. Dearborn St. Wabash 1901.
New York—(Branch Office) 1674 Broadway, Columbus 4693. Cor. 52nd St.

Entered as second class matter March 17, 1927, at the Postoffice at Chicago, Illinois, under the act of March 3, 1879

Announcing A GREAT, NEW RECEIVER SCOTT CHALLENGES THE WHOLE WORLD OF RADIO TO ANY KIND OF COMPETITIVE TEST



E. H. SCOTT

The New Scott Shield Grid 9 was designed by E. H. Scott, designer of the World's Record Super 10, which prior to the advent of this new model held all records for radio set performance.

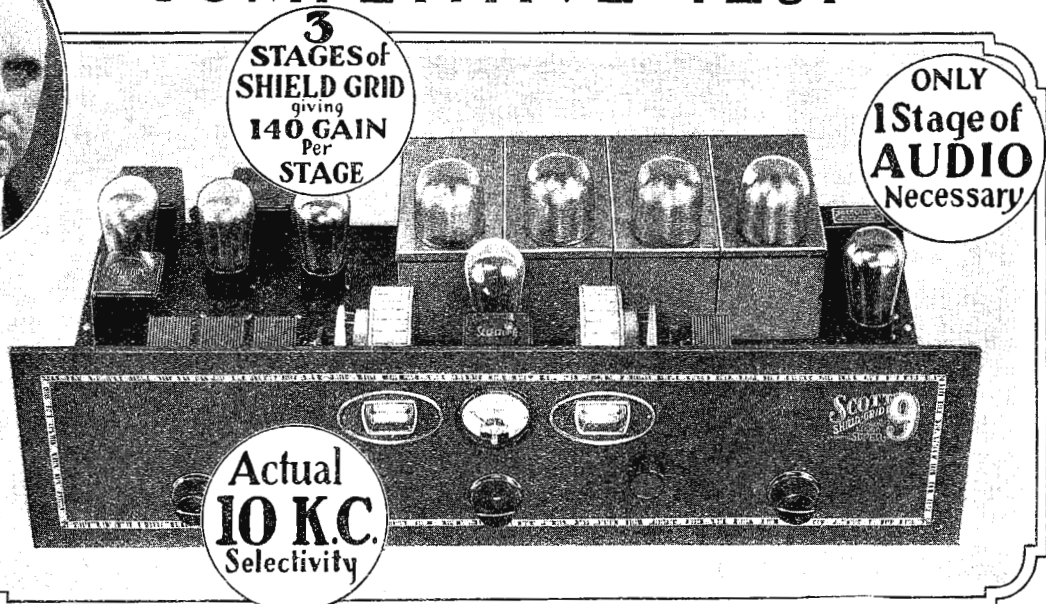

More Actual Amplification • More Distance and Volume than Any Other Existing Receiver Known to Us

This—we believe, is the most powerful, the most selective and the finest toned receiver in existence today. We draw this conclusion from having tested and scientifically measured every other receiver which might claim itself the equal of the SCOTT World's Record Shielded Grid NINE. And there is no question but that this radically new type of receiver will maintain its position of obvious superiority for years to come, for the features of circuit engineering responsible for its amazingly better performance are far ahead of any circuit developed to date.

UNLIMITED RANGE! Without aerial, ground or loop, the SCOTT Shielded Grid NINE brings Pacific Coast Stations to Chicago with loud speaker volume. And so tremendous is the amplification of the shielded grid long wave amplifier employed, that it is impossible to determine a range limit for this receiver when used with a short antenna and a connection to ground.

Shielded Grid Tubes Used in an Entirely New Way

Standard circuits commonly in use with the new shielded-grid tubes, provide actual amplification of approximately 40 per stage. The revolutionary new circuit used exclusively in the SCOTT Shielded Grid NINE, gives a practical amplification of 140 per stage, thereby making this receiver

many times more powerful than receivers using shielded-grid tubes in a conventional manner. It is this new circuit arrangement developed and used exclusively by us which enables us to challenge the whole world of radio to any kind of competitive test with assurance that the SCOTT Shielded Grid NINE will win.

Only One Stage of Audio Required! The second detector output of this receiver is so heavy that concert volume and clear, undistorted cathedral tone, even on the most distant stations, is obtained with but a single stage of 2 to 1 audio frequency amplification.

Easy to Build — Results Guaranteed Despite the fact that the SCOTT Shielded Grid NINE is one of the most elaborate receiving systems ever devised — and despite the fact that it embodies many features of circuit arrangement not known to common practice, it is a very easy set to build, and when you buy the kit of parts we positively guarantee that you will get the same results we get from our laboratory model. Both panel and sub-panel are drilled to receive each part and the shield-grid amplifier units come to you fully wired and tested—ready to be connected into the circuit just as though they were a transformer.

Why Pay More for Less?

Why pay more than the small cost of the Scott Shielded Grid NINE when no other receiver offers you so much? Why not have a receiver which provides actual 10 Kilocycle selectivity regardless of where located? Why not have a receiver with which you can listen in on all the world—no limit to its distance range. The Scott Shielded Grid NINE is, unquestionably the finest, most powerful, most advanced receiver of the day, and is, beyond all doubt, destined to hold its position of leadership, throughout the coming years. It is the ultimate. Build it—enjoy it NOW.

FREE

Circuit Diagram and Particulars

Find out all particulars of the Scott Shielded Grid NINE. Examine its circuit. See for yourself why it has unlimited range—unlimited power—perfect tone. Proof of the superiority of this great new receiver is FREE to you. Also copies of 6000 and 9000 mile reception verifications and other records made by the Scott World's Record Super 9 and the Super 10, the less powerful predecessors of the new Scott Shielded Grid NINE. Get this information now. Simply clip and mail the coupon. Mail it TODAY!

SCOTT TRANSFORMER CO.
7626 Eastlake Terrace ~ Dept. B
CHICAGO, ILL.

Mail this Coupon!

SCOTT TRANSFORMER CO.
Dept. B, 7626 Eastlake Terrace, Chicago, Ill.

Send me full particulars of the new Scott Shielded Grid NINE.

Name.....
Street.....
Town..... State.....



American Broadcasting Stations

Corrected up to the moment of going to press, this list, to the best of our knowledge, is identical with that of the Federal Radio Commission's bulletins. If mistakes occur in the list, we will be glad to have notice from our readers to that effect. Address communications to the CITIZENS RADIO CALL BOOK MAGAZINE, 508 So. Dearborn Street, Chicago, Illinois

KDKA Westinghouse Elec. & Mfg. Co., East Pittsburgh, Pa. 315.6 meters, 950 kilocycles, 50,000 watts. Week days, market and weather reports, 10 am, 12 noon, 4 & 5 pm. Time signals, 11:55 am; 6 pm, dinner concert. Evening program, 8 pm. Tues 7 pm. Wed, Fri, 7 & 7:15 pm, studio talks. Fri, 11:30 pm, concert. Sun, 10:45 am, church; 4 pm, organ; 4:45 pm, vespers; 6 pm, orchestra; 7 pm, church; 8:15, concert. Blue Chain Programs, Mon, 7:30-10 pm; Tues, Wed, Fri, 8-10 pm; Thurs, 8-11 pm; Sat, 8-10 pm; Sun, 8:15-10:45 pm. Eastern standard time.

KDLR Radio Elec. Co., Devils Lake, N. Dak. 230.6 meters, 1300 kilocycles, 15 watts. Daily ex Sun, 12:10 pm, weather; 6:15 pm, markets, sports, news, etc. Mon, 9:30-11 pm, studio program. Sun, 11 am, church; 4:30-6 pm, studio program. Central standard time.

KDYL Intermountain Broadcasting Corp., 1003-11 Ezra Thompson Building, Salt Lake City, Utah. 234.2 meters, 1280 kilocycles, 500 watts. Sun, 2-5 pm, 8-10 pm. Daily ex Sun, 10:30-12 am, 2-5 pm, 6-8 pm, studio programs. Mon & Wed, 8-11 pm. Tues, Thurs & Sat, 8-10 pm, 10 pm-12, midnight dance music. Sat, midnight-2 am. Mountain time. Slogan: "On the Air—Goes Everywhere."

KELW Earl L. White, Broadcasting Station, Magnolia Park, Burbank, Calif. 228.9 meters, 1310 kilocycles, 250 watts. Daily ex Sun, 10 am, 2 pm, Press hour, 6-10 pm, Studio program. Pacific standard time. Divides time with KPCC. Slogan: "The White Spot of the San Fernando Valley."

KEX Western Broadcasting Co., Terminal Sales Bldg., Portland, Ore. 239.9 meters, 1250 kilocycles, 2500 watts. Sun, 4:30-10 pm, music and church. Daily ex Sat & Sun, 9 am-12 midnight. Sat, 9 am-2 am. Pacific standard time. Slogan: "A Public Service Necessity."

KFAB Nebraska Buick Auto Co., 13th and Que St., Lincoln, Nebr. 319.0 meters, 940 kilocycles, 5000 watts daytime. Mon, Tues, Wed, Fri, Sat, 9:30-9:45 am, 10-10:30 am, 11:45 am-12:30 pm, 3:30-4 pm, 5:30-6:30 pm, 8-10:30 pm, Thurs, 9:30-9:45 am, 10-10:30 am, 11:45 am-12:30 pm, 3:30-4 pm. Sun, 9-10 pm. Central standard time. Divides time with KOIL. Slogan: "Home, Sweet Home."

KFAD Electrical Equipment Co., 312-16 N. Central av., Phoenix, Ariz. 272.6 meters, 1100 kilocycles, 500 watts. Daily ex Mon & Sun, 3-4 pm, 6-7 pm. Daily ex Mon, Thurs & Sat, 8-9 pm. Mon, Sat & Sun, 2-3 pm. Tues, Wed, Fri, Sat, 9-10 pm. Mountain standard time. Slogan: "Phoenix, Where Winter Never Comes."

KFAU High School, Boise, Idaho. 285.5 meters, 1050 kilocycles, 2000 watts night, 4000 watts daytime. Sun, 3-5 pm, musical program; 7:30-8:30 or 9 pm, church services. Mon, Tues, Wed, Thurs, Fri, 12:30-1:15 pm, weather, market reports, U. S. Dept. of Agriculture features. Tues, 7:30-8 pm, Children's Half Hour; 8-9:30 or 10 pm, entertainment, news. Thurs, 7:30-8 pm; 8-9:30 or 10 pm, news, entertainment. Mountain standard time.

KFBB F. A. Buttrey Co., Havre, Mont. 275.1 meters, 1090 kilocycles, 50 watts. Daily ex Sun, 12:30-1:45 pm, noonday program. Sun, 1-3 pm. Wed, 7:30-9 pm. Slogan: "Voice of the Treasure State."

KFBC Arthur W. Yale, M. D., Union League Station, Balboa Theater Bldg., San Diego, Calif. 247.8 meters, 1210 kilocycles, 100 watts. Sun, 10-12 am. Daily ex Sun, 9-10:30 am, 12-1 pm, 5-10 pm. Pacific standard time. Slogan: "Music for the Sick."

KFBK The Sacramento Bee-Kimball Upson Co., 607 K st., Sacramento, Calif. 535.4 meters, 560 kilocycles, 100 watts. Tues, Thurs & Sat, 7:30-10 pm, dance music and artist program. Pacific standard time. Slogan: "In the Heart of California."

KFBL Puget Sound Station, Leese Bros., 2814 Rucker ave., Everett, Wash. 223.7 meters, 1340 kilocycles, 50 watts. Daily, 7:30-8:30 pm. Sun, 11 am-12 noon. Mon, Wed, Fri, 6:30-8 pm. Tues, Thur, 7-8 pm, 9-10 pm. Sat, 9-11 pm. Pacific time. Slogan: "The Voice of Puget Sound."

KFBU St. Matthews Cathedral (Bishop N. S. Thomas), Laramie, Wyo. 483.6 meters, 620 kilocycles, 500 watts. Sun, 11 am, church. Daily ex Sun, 12 noon. Wed & Fri, 7:30 pm, studio programs. Mountain standard time. Slogan: "The Top of the World."

KFCB Nielsen Radio Supply Co., 311 N. Central av., Phoenix, Ariz. 243.8 meters, 1230 kilocycles, 125 watts. Sun, 9:30 to 10:30 am, Radio Community Bible Class. Mon, 7:30 to 8:30 pm, children's hour. Wed, 8 to 9 pm, musical. Thurs, 8 to 9 pm, educational program. Fri, 9 to 10 pm, dance music; 1-3 am, special Frolic 1st & 3rd Friday of each month. Sat, 9 to 10 pm, dance music. Sun, 9:30-10:30 am, community Bible class. Mountain standard time. Slogan: "Kind Friends Come Back."

KFCR Santa Barbara Broadcasting Co., Daily News Bldg., Santa Barbara, Calif. 211.1 meters, 1420 kilocycles, 50 watts.

KFDM Magnolia Petroleum Co., Box 798, Beaumont, Tex. 483.6 meters, 620 kilocycles, 500 watts. Sun, 8-9 pm, church services. Tues & Fri, 12:35 pm, band concert. Tues, 8-10 pm, orchestra. Fri, 8-10:30 pm, band concert. Central standard time. Divides time with WTAW. Slogan: "Kall for Dependable Magnolene."

KFDX First Baptist Church, Shreveport, La. 236.1 meters, 1270 kilocycles, 250 watts. Sun, 10:45 am, 7:45 pm, church services. Central standard time.

KFDY South Dakota State College Agriculture and Mechanical Arts, Brookings, So. Dak. 545.5 meters, 550 kilocycles, 500 watts. Daily ex Sat & Sun, 12:30-12:45 pm. Tues & Thurs, 7:30 pm, markets, weather, farm talks, news, music. Central standard time. Divides time with WDAY.

KFDZ Harry O. Iverson, 2510 Thomas av., South Minneapolis, Minn. 215.7 meters, 1390 kilocycles, 10 watts. Central standard time.

KFEC Meier & Frank Co., Portland, Ore. 214.2 meters, 1400 kilocycles, 50 watts. Daily ex Sun, 12 am, weather reports; 4-5 pm, music; 6-7 pm, weather, crop, market reports and music. Pacific time. Slogan: "Known for Every Courtesy." Divides time with KFIF.

KFEL Eugene P. O'Fallon (Inc.), Argonaut Hotel, Denver, Colo. 247.8 meters, 1210 kilocycles, 250 watts. Sun, 8:30 am, 9-10 am, church services. Daily ex Sun, 7:15 am, setting-up exercises; 10 am-12 noon, 2-6:45 pm, station programs. Mon & Sat, 11 pm, dance program. Tues, 8-10 pm, special program. Thurs, 8 pm-12 midnight, Sleepwalkers' program. Mountain standard time. Divides time with KOW. Slogan: "The Argonaut Station."

KFEQ Scroggin & Co. Bank, Robidoux Hotel, St. Joseph, Mo. 230.6 meters, 1300 kilocycles, 1000 watts. Sun, 10:45 am, church; 11 am-12 noon, organ. Daily 5-6 pm, 6:30-7:30 pm, 8:30-10 pm, music. Mon, 11 am-12 noon, orchestra. Central standard time.

KFEY Bunker Hill & Sullivan Mining & Concentrating Co., Y. M. C. A. & Union High School, Kellogg, Idaho. 232.4 meters, 1290 kilocycles, 10 watts. Sun, 11 am-7:30 pm, church services. Wed, 7:30-8:30 pm, musical. Thurs, 7:30, health talks. Sat, 9-10 pm, dance music. Pacific standard time. Slogan: "The Voice of the Coeur d'Alenes."

KFGL N. L. Cotter, 219 W. Main St., Trinidad, Colo. 222.1 meters, 1350 kilocycles, 50 watts.

KFGQ Boone Biblical College, Boone, Iowa. 209.7 meters, 1430 kilocycles, 10 watts. Sun, 2:30 pm. Western standard time.

KFH Hotel Lassen (Rigby-Gray Hotel Co.), Wichita, Kan. 245.8 meters, 1220 kilocycles, 500 watts. Sun, 9:30-10:30 am, 7:30-9 pm, church services. Daily ex Sun, 8:30-9 am, 10-11 am, 1-2 pm, markets; 7:30-9 pm, studio program. Central standard time. Slogan: "Kansas' Finest Hotel—In the Very Heart of God's Country."

KFHA Western States College of Colorado, Gunnison, Colo. 254.1 meters, 1180 kilocycles, 50 watts. Tues, Fri, 7 pm, kiddies' hour; 7:30 pm, musical. Mountain time. Slogan: "Where the Sun Shines Every Day."

Real Merchandise! New Birnbach Products

For Dealers—Set Builders—Amateurs—Radio Engineers—and Jobbers

Birnbach Acid-Proof Battery Cables

For Every Circuit and Purpose
These Battery Cables are composed of Stranded Wires insulated with Colored Rubber and enclosed in an attractive Braid over all wires. For use in connecting A, B and C Batteries or Eliminator to Set. Furnished with brass soldered lug terminals on all ends for neat and quick attaching of cable to batteries or eliminator. Each wire of separate Solid Color. Made in 5, 6, 7, 8, 9, or 10 Wires.



110—5 Wires, 54 inches.....	\$0.50
111—6 Wires, 54 inches.....	.60
112—7 Wires, 54 inches.....	.70
113—8 Wires, 54 inches.....	.85
126—9 Wires, 54 inches.....	1.00
119—10 Wires, 54 inches.....	1.15

The New Birnbach 10 Foot Battery Cable

Now you can place the Batteries or Eliminator in the basement or in another room—away from the Set with the BIRNBACH 10 Foot Battery Cable. All ends of wires complete with Soldered Lugs for neat and instant attaching of Cable to the Set and Batteries or Eliminator.

114—5 Wires, 10 foot.....	\$1.25
116—6 Wires, 10 foot.....	1.55
117—7 Wires, 10 foot.....	1.85
118—8 Wires, 10 foot.....	2.15
127—9 Wires, 10 foot.....	2.45
128—10 Wires, 10 foot.....	2.75

Birnbach Riga Battery Cable

This Cable is made of flexible stranded wires, and insulated with Colored Rubber. The wires for the A Battery are made of heavier gauge conductors and assembled with storage battery clips. Other wires furnished with Soldered Lugs. A Battery Cable for Heavy-Duty Service.



160—5 Wires, 60 inches.....	\$1.00
160—5 Wires, 54 inches.....	.90
161—6 Wires, 54 inches.....	1.05
162—7 Wires, 54 inches.....	1.20
163—8 Wires, 54 inches.....	1.40
164—9 Wires, 54 inches.....	1.55
165—10 Wires, 54 inches.....	1.70
150—5 Wires, 10 foot.....	1.60
152—6 Wires, 10 foot.....	1.80
153—7 Wires, 10 foot.....	2.25
154—8 Wires, 10 foot.....	2.55
155—9 Wires, 10 foot.....	2.85
156—10 Wires, 10 foot.....	3.15

Birnbach Battery Connectors

Made of Stranded Wires insulated with rubber and covered with a distinctive braid. All ends assembled with brass soldered lug terminals to fit the binding post or clips on all batteries. A handy accessory for use in connecting Dry Cell "A" Batteries, B and C Batteries. Carton contains 25 of each size.

RC 3—3 in. Connectors, each.....	\$0.04
RC 6—6 in. Connectors, each.....	.05
RC 8—8 in. Connectors, each.....	.06
RC12—12 in. Connectors, each.....	.07

Birnbach Bakelite Tuners In Attractive Duo Colors

Specified in the Citizens-Birnbach A. C. Four

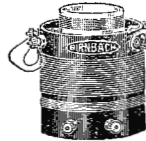

Decidedly new and attractive. Wound on genuine Colored Bakelite which does not warp or shrink. Makes your Set not only look better and different, but perform better. A marvel for performance—unusually accurate. Use BIRNBACH COLORED BAKELITE TUNERS for best tone quality, long range distance, and volume. Tuning range 200 to over 550 Meters.

60—Red Bakelite 3-Circuit Tuner for .0005 Condenser.....	\$2.00
61—Red Bakelite Radio Frequency Coil for .0005 Condenser.....	1.25
62—Green Bakelite 3-Circuit Tuner for .0005 Condenser.....	2.00
63—Green Bakelite Radio Frequency Coil for .0005 Condenser.....	1.25
635—Red Bakelite 3-Circuit Tuner for .00035 Condenser.....	2.00
636—Red Bakelite Radio Frequency Coil for .00035 Condenser.....	1.25
637—Green Bakelite 3-Circuit Tuner for .00035 Condenser.....	2.00
638—Green Bakelite Radio Frequency Coil for .00035 Condenser.....	1.25

Birnbach "360" Tuned Radio Frequency Kit

Kit consists of three matched coils, wound on colored Bakelite. Recommended for use with .00035 Condenser. Will make any set better in selectivity, tone and range.

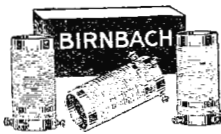

360—Kit of 3 Matched Coils.....	\$4.50
260—Kit of 2 Matched Coils.....	3.25

Birnbach "180" Bakelite 3-Circuit Tuner

Larger in size than the No. 60 Tuner. Wound on genuine colored Bakelite. One of the most accurate tuners ever designed. Distant stations can be tuned in with greater volume and the very best tone quality. Recommended for use with .0005 Mfd. Condensers. Tuning range 200 to over 570 Meters.

180—Colored Bakelite 3-Circuit Tuner.....	\$3.50
180—Colored Bakelite Radio Frequency Coil.....	1.50

New Birnbach Moisture-Proof Extension Cord Units

You can move your Radio Speaker into any room desired—bedroom, kitchen, dining room, baby's room, or living room, by connecting the cord of your Speaker to the BIRNBACH EXTENSION CORD UNIT. Attaches instantly.



BIRNBACH CORDS are made of Stranded Copper wires and insulated with rubber to protect the Copper Strands from moisture, which causes leakage from one conductor to another, and covered with a beautiful brown mercerized braid. All Cords furnished with Connectors.

160—10 foot, complete.....	\$0.75
120—20 foot, complete.....	1.00
121—30 foot, complete.....	1.40
122—40 foot, complete.....	1.80
123—50 foot, complete.....	2.20
124—100 foot, complete.....	4.20
101—20 foot Cord only.....	.65

Birnbach Cords In Beautiful Silk Colors

Now you can select a BIRNBACH CORD to harmonize with the Color Scheme of your home. Made in OLD GOLD, MAROON, and WHITE. A Color to satisfy every possible taste.

620—20 foot White Silk Cord.....	\$1.50
621—20 foot Old Gold Silk Cord.....	1.50
622—20 foot Maroon Silk Cord.....	1.50
630—30 foot White Silk Cord.....	1.90
631—30 foot Old Gold Silk Cord.....	1.90
632—30 foot Maroon Silk Cord.....	1.90
650—50 foot White Silk Cord.....	2.75
651—50 foot Old Gold Silk Cord.....	2.75
652—50 foot Maroon Silk Cord.....	2.75

Birnbach Cord Connector



Made in one piece. Built to withstand heavy wear and abuse. Neat in appearance—easy to use. Cord tips can be attached quickly without the use of tools.

151—Cord Connectors Only, each.....	\$0.30
-------------------------------------	--------

Birnbach Replacement Cords

These Cords are used in replacing worn-out cords from head sets or loud speakers. Five feet long.



102—Speaker Cord with Pin Tips.....	\$0.35
103—Speaker Cord with Pin and Spade Tips.....	.35
106—Speaker Cord with Pin and Eye Tips.....	.35
104—Head Set Cord with Pin Tips.....	.50
105—Head Set Cord with Pin and Spade Tips.....	.50
107—Head Set Cord with Pin and Eye Tips.....	.50

All good dealers carry these Quality Products. If you have any difficulty in securing any of them—write us for the address of the nearest dealer.

BIRNBACH RADIO CO.

254 West 31st Street, New York City, N. Y.



Tell 'Em You Saw It in the Citizens Radio Call Book Magazine

KFHL Penn College, Oskaloosa, Ia. 212.6 meters, 1410 kilocycles, 10 watts. Central standard time.

KFI Earle C. Anthony, Inc., 1000 S. Hope st., Los Angeles, Calif. 468.5 meters, 640 kilocycles, 5000 watts. Sun, 10 am, 11 am-12:30 pm, church; 5:30-10 pm, musical program. Wed, 5:30-10:30 pm. Wed, Fri, 10:45-11:05 am, household talk. Daily ex Wed, Sat, Sun, 5:30-10 pm. Sat, 5:30-11 pm. Pacific standard time. Slogan: "National Institution."

KFIF Benson Polytechnic School, Portland, Ore. 214.2 meters, 1400 kilocycles, 50 watts. Pacific standard time. Divides time with KFEC.

KFIO North Central High School, Spokane, Wash. 245.8 meters, 1220 kilocycles, 100 watts. Fri, 8-9:30 pm. Pacific standard time. Divides time with KFPY.

KFIU Alaska Electric Light & Power Co., Juneau, Alaska. 225.4 meters, 1330 kilocycles, 10 watts. Mon, Wed & Fri, 6-7 pm, daily news items, steamer sailings, music, vocal and instrumental. Alaska time. (Note: 6-7 pm Alaska time is equivalent of 7-8 pm, Pacific standard time.) Slogan: "A Voice from the Far North."

KFIZ Fond du Lac Commonwealth Reporter, Fond du Lac, Wis. 267.7 meters, 1120 kilocycles, 100 watts. Daily, 5 to 5:30 pm, markets, weather and news. Occasional evening programs of music. Sun, 6-7 pm, dinner hour concert. Central standard time.

KFJB Marshall Electric Co., 1603 W. Main st., Marshalltown, Iowa. 247.8 meters, 1210 kilocycles, 100 watts night, 250 watts daytime. Daily ex Sun, 10 am, market reports; 6-7 pm, musical. Tues & Fri, 8:30-11 pm, musical programs. Sun, 10 am-12 n; 7:30-9 pm. Central standard time. Slogan: "Marshalltown, the Heart of Iowa."

KFJF National Radio Mfg. Co., 406 N. Hudson st., Oklahoma City, Okla. 272.6 meters, 1100 kilocycles, 1000 watts daytime, 750 watts night time. Daily ex Sun, 9 am, 10 am, 12:30 pm, 4:30 pm, market service; 9:15 am, music; 6-7, orchestra; 7 pm, dinner musical; 9 pm, musical program. Sun, 9 am, 10 am, 11 am, 7:30 pm, 9:30 pm, church. Central standard time. Slogan: "Radio Headquarters of Oklahoma, the Tired Hand Announcing."

KFJI E. E. Marsh, Astoria, Ore. 249.9 meters, 1200 kilocycles, 15 watts. Wed, 9-10 pm, organ music. Sun, 12:30-1:30 pm. Sat, 10:30-11 pm. Pacific standard time. Divides time with KMED.

KFJM University of North Dakota, Grand Forks, N. Dak. 333.1 meters, 900 kilocycles, 100 watts. Limited coml. Sun, 10:45-12, church service. Daily, 12 n-1 pm, music records; 6-7 pm, orchestra. Central standard time.

KFJR Ashley Dixon & Son, 5th & Stark, Portland, Ore. 282.2 meters, 1060 kilocycles, 100 watts. Daily ex Sun, 12 noon-1 pm, 3-4 pm, 5-6 pm, 7-8 pm. Fri & Sat, 4-5 pm. Mon & Tues, 9-11 pm. Fri & Sat, 4-5 pm. Sat, 10-11 pm. Fri, 12 midnight-1 am. Pacific standard time. Divides time with KTBR.

KFJY Tunwall Radio Co., 1004 Central av., Ft. Dodge, Iowa. 232.4 meters, 1290 kilocycles, 100 watts. Sun, 11 am, church services. Daily ex Sun, daily, 5:45 pm, market and weather reports. Mon, Wed, Fri, 10-11 am, musical. Mon, 11-12 pm, musical. Thurs, 8:30 pm, musical program. Central standard time. Divides time with KFMR.

KFJZ W. E. Branch, 3219 Avenue L, Fort Worth, Tex. 249.9 meters, 1200 kilocycles, 50 watts. Sun, 7-10 pm, 11-12:30 mornings. Daily ex Sun & Wed, 8:30-9:30 pm, 9 am to 6 pm. Central standard time.

KFKA Colorado State Teachers' College, Greeley, Colo. 249.9 meters, 1200 kilocycles, 200 watts. Tues, 10-11 am. Thurs, 8-10 pm. Mountain standard time.

KFKB Dr. Brinkley's Hospital, Milford, Kan. 241.8 meters, 1240 kilocycles, 2500 watts daytime, 1500 watts night. Sun, 8 am, 10 am, Bible lecture; 6 pm, 6:30 pm-12 midnight, concert. Daily ex Sat, 10:15 am, 12 noon, 6 pm, 10 pm, markets and weather reports; 1 pm, 6:30 pm, 10 pm, lectures; 3-4 pm, matinee program; 5:30-6:30 pm, 8-10 pm, variety program. Daily, 12 noon-1 pm, Tiffin hour program. Tues & Thurs, 11 pm-1 am. Central standard time. Slogan: "The Sunshine Station in the Heart of the Nation."

KFKU University of Kansas, Lawrence, Kan. 254.1 meters, 1180 kilocycles, 500 watts. Sun, 3-4:45 pm, music. Mon, 8-9:30 pm. Thurs, 8-9 pm. (Also special broadcasting.) Central standard time. Divides time with WREN. Slogan: "Up at Lawrence on the Kaw."

KFKX Agricultural Station, Westinghouse Elec. & Mfg. Co., 509 S. Wabash Ave., Chicago, Ill. 526 meters, 570 kilocycles, 2500 watts. Daily ex Sat & Sun, 1:30 pm, 3 pm. Daily ex Sun, 10 am, 11 am, 12 noon, 5:15 pm, stock, grain, weather, government reports. Central standard time. Divides time with KYW.

KFKZ State Teachers College, 107 E. Harrison st., Kirksville, Mo. 225.4 meters, 1330 kilocycles, 15 watts. Sun, 3:30 to 4:30 pm. Mon, 8-9 pm, dance music; 9 pm, radio plays. Central standard time. Slogan: "Kirksville, the Home of Osteopathy."

KFLV Swedish Evang. Miss. Church, Rockford, Ill. 267.7 meters, 1120 kilocycles, 100 watts. Sun, 10:40 am. Mon, 8:15 pm. Central standard time.

KFLX George R. Clough, 3327 Avenue P, Galveston, Tex. 270.1 meters, 1110 kilocycles, 100 watts. Central standard time.

KFMR Morningside College, Sioux City, Iowa. 232.4 meters, 1290 kilocycles, 100 watts. Commercial. Daily ex Sat & Sun, 11:40 am-12:30 noon. Tues, Wed, Thur, Fri, 7:30-8:30 pm. Central standard time. Divides time with KFJY.

KFMX Carleton College, Northfield, Minn. 236.1 meters, 1270 kilocycles, 500 watts. Fri, 8:15-8:45 pm, lecture; 8:45-9:45 pm, musical program; 10-11 pm, organ. Central standard time.

KFNF Henry Field Seed Co., Shenandoah, Iowa. 461.3 meters, 650 kilocycles, 1000 watts night, 2000 watts daytime. Sun, 8:30-9:30 am, 10:45-12:15 pm, 2 pm, 3 pm, 6 pm. church services, etc. Daily ex Sun, 6-7:30 am, 11 am-1:30 pm, 6:30-7 pm. Mon, Tues, Wed & Thurs, 3:30-4 pm. Daily ex Sun & Thurs, 5-6:30 pm. Mon, 1:30-2:15 pm. Tues & Thurs, 7:40-7:50 am. Wed, 8:10-8:30 am, 4:30-5 pm. Thurs, 5-5:30 pm. Fri, 9:30-10 am, 4-4:30 pm. Sat, 4:30-5:30 pm. Central standard time. Slogan: "Known for Neighborly Folks."

KFOA Rhodes Dept. Store, 1321 2nd av., Seattle, Wash. 447.5 meters, 670 kilocycles, 1000 watts. Mon & Fri, 10 am-12 midnight. Tues, 12:30-11 pm. Wed, 10 am-10 pm. Thurs, 12:30 pm-10 pm. Sat, 4:30 pm-9 pm. Sun, 5:30-6:30 pm. Pacific standard time.

KFON Nichols & Warinner (Inc.), 212 Jergins Trust Bldg., Long Beach, Calif. 241.8 meters, 1240 kilocycles, 500 watts. Daily including Sun, 9:30 am-12 midnight. Varied programs. Pacific standard time. Slogan: "Where Your Ship Comes In."

KFOR Howard A. Shuman, Lincoln, Nebr. 217.3 meters, 1380 kilocycles, 100 watts. Daily ex Sun, 12:05-1:05 pm, 2-2:35 pm, 6-7 pm, 8-10 pm. Fri, 11 pm-1 am, midnight frolic. Central standard time.

KFOX Technical High School, Omaha, Nebr. 258.5 meters, 1160 kilocycles, 100 watts. Daily ex Sat & Sun, 12:30-2 pm. Tues, 7:30-9 pm. Central standard time. Divides time with WNAL & KOCH.

KFOY Maurice Gordon Goldberg, St. Paul, Minn. 222.1 meters, 1350 kilocycles, 250 watts. Sun, silent. Mon, 7 pm, popular hour. Mon, Tues, Fri, 9 pm, reports. Wed, Thurs, Sat, 9 pm, reports; 9:05 pm, dance music. Central standard time. Divides times with WAMD.

KFPL C. C. Baxter, 205 Grafton st., Dublin, Tex. 275.1 meters, 1090 kilocycles, 15 watts. Sun, 7:30 am, 1:30 pm. Mon & Thurs, 8-9 pm. Central standard time. Slogan: "Baxter's Place."

KFPM The New Furniture Co., Box 628, Greenville, Tex. 230.6 meters, 1300 kilocycles, 15 watts, Sun, 11 am, services. Mon, & Fri, 8 pm, music; Wed, 8 pm, music; 7:15, sports in season; 1 pm daily ex Sun, musical program. Central standard time. Slogan: "Biggest Little Ten Watts on the Air."

KFPR Los Angeles County Forestry, Los Angeles, Calif. 232.4 meters, 1290 kilocycles, 250 watts. Irregular schedule. Pacific standard time. Divides time with KFQZ.

KFPW Lannie W. Stewart, Cartersville, Mo. 263 meters, 1140 kilocycles, 50 watts. Sun, 1-2 pm, chapel service. Daily, 5:30-6:30 am, 1:30-2:30 pm. Central standard time. Slogan: "Keeping Pace with Christ Means Progress."

KFPY Symons Investment Co., Symons Block, Spokane, Wash. 245.8 meters, 1220 kilocycles, 250 watts. Sun, 7:45 pm-12 midnight. Mon, Tues, Wed, Thurs, Fri, 9:45-11 am, 3-5 pm, 6:15-10:30 pm. Pacific standard time. Divides time with KFIO.

KFQA The Principia, 5539 Page av., St. Louis, Mo. 234.2 meters, 1280 kilocycles, 1000 watts. Sun, 11 am, church services, Fourth Church of Christ, Scientist. Central standard time. Divides time with WMAY and KWK.

KFQB W. B. Fishburn, Inc., Ft. Worth, Tex. 331.1 meters, 900 kilocycles, 1000 watts. Daily ex Sun & Wed, 7:30-11 pm, musical. Sun, 10 am-12 pm, 3-10 pm, church services. Central standard time. Divides time with WJAD.

KFQD Anchorage Radio Club, Anchorage, Alaska. 344.6 meters, 870 kilocycles, 100 watts.

KFQU W. E. Riker, Holy City, Calif. 249.9 meters, 1200 kilocycles, 100 watts. Daily ex Sun, 6:30-7:30 pm, miscellaneous. Tues, 9:30-11:45 pm, musical. Wed, Thurs, Sat, 9-10 am, lecture. Fri, 9-11:30 pm, musical. Sun, 11 am-12 noon, 9-10 pm, lectures. Pacific standard time.

KFQW KFQW, Inc., Continental Hotel, Seattle, Wash. 217.3 meters, 1380 kilocycles, 100 watts. Sun, 10 pm-12 midnight, popular program. Daily ex Sun, 10-11 am, University District hour; 12 noon-1 pm, luncheon musicale; 4:30-5:30 pm, tea hour program; 5:30-6 pm, amusements; 6-11 pm, musical program. Pacific time. Slogan: "Gateway to Alaska and the Orient."



"I have used ACME PARVOLT Condensers for many years and have never had one break down."

S.W. Cokady

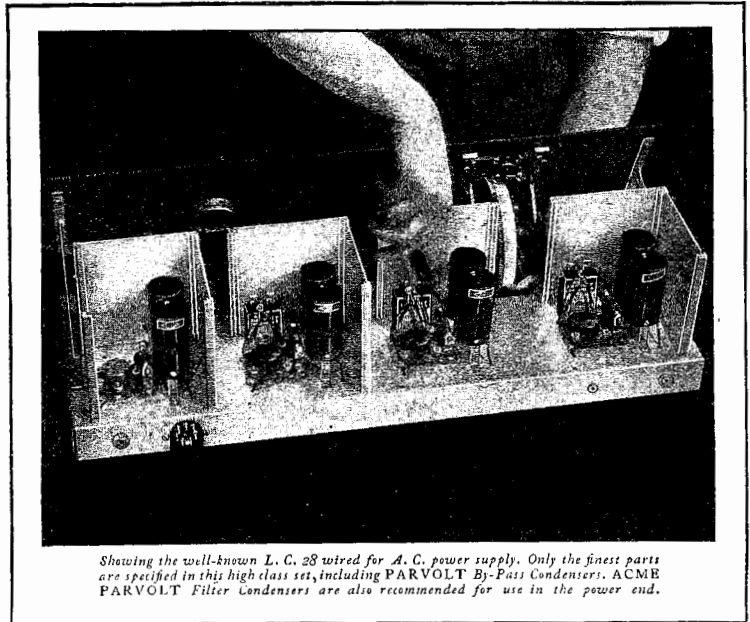

Showing the well-known L. C. 28 wired for A. C. power supply. Only the finest parts are specified in this high class set, including PARVOLT By-Pass Condensers. ACME PARVOLT Filter Condensers are also recommended for use in the power end.

Whether You Buy or Build a Power Supply Unit for Your Radio PLAY SAFE WITH PARVOLTS!

WHEN you buy an electrified radio or power supply unit for your receiver, look for ACME PARVOLT Condensers; they are your guide to quality in all other parts. They cost the manufacturer a trifle more, but they are both his and your guarantee against costly condenser break-down.

Should you build your own power supply, be sure to use ACME PARVOLT Condensers and be safeguarded against the possibility of break down. Remember that poor filter condensers have caused untold thousands of dollars worth of loss in the past year or two, for blown out condensers mean blown tubes, burned out transformers and frequently the ruination of speaker units.

Just as PARVOLT By-Pass Condensers have been used for years in high grade

receivers, so are PARVOLT Filter Condensers rapidly replacing ordinary condensers in electrified radio. These condensers are wound with the very finest insulating papers combined with highest grade foils. Every detail produced in one of America's most modern plants and under the supervision of experts in condenser design and manufacture.

Uniformity of capacity and uniformity of sizes are two big features. Accuracy of all ratings, based upon the R.M.A. standards, is another guarantee of uninterrupted service. Play safe with PARVOLTS!

Made by THE ACME WIRE CO., New Haven, Conn., manufacturers of magnet and enameled wire, varnished insulations, coil windings, insulated tubing and radio cables.

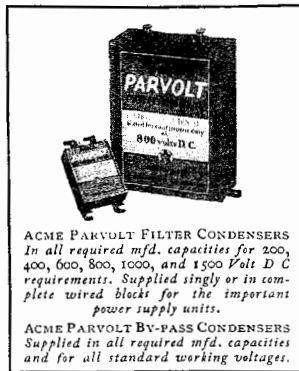

ACME PARVOLT FILTER CONDENSERS
In all required mfd. capacities for 250, 400, 600, 800, 1000, and 1500 Volt D.C. requirements. Supplied singly or in complete wired blocks for the important power supply units.
ACME PARVOLT BY-PASS CONDENSERS
Supplied in all required mfd. capacities and for all standard working voltages.

ACME PARVOLT CONDENSERS Made by the Manufacturers of ACME CELATSITE WIRE



**INDOOR AERIAL
and LOOP WIRE**
Enameled copper wire in both stranded and solid types. Also Acme Lead-in and Battery Cables.

**CELATSITE
FLEXIBLE and SOLID**
For all types of radio wiring. High insulation value; non-inflammable. 10 colors.

**ACME
SPAGHETTI**
A superior cambric tubing for all practical radio and other electrical requirements. Supplied in 10 colors.



Tell 'Em You Saw It in the Citizens Radio Call Book Magazine

KFQZ L. E. Taft, 5653 De Longpre ave., Hollywood, Calif. 232.4 meters, 1290 kilocycles, 100 watts. Tues, Fri, 9-11 pm, musical program. Pacific standard time. Divides time with KFPF.

KFRC Don Lee, Cadillac-LaSalle, 1000 Van Ness ave., San Francisco, Calif. 454.3 meters, 660 kilocycles, 1000 watts. Daily ex Sun, 7-1 pm, musical and studio program; 4:30-12 pm, dance music and studio program. Sun, 10-12 noon, concert; 12-1 pm, church services; 1-3 pm, recital; 3-5 pm, dance music and studio program; 5-6 pm, organ recital; 6-6:30 pm, Inspirational talks; 6:30-12, concert and dance orchestras. Pacific standard time.

KFRU Stephen's College, a Junior College for Women, Columbia, Mo., "The Athens of the West." 249.9 meters, 1200 kilocycles, 500 watts. Sun, 7:30 am, sunrise services; 9:20 am, Burrall class; 7:30 pm, church services. Daily ex Sun & Sat, 8:30 am, public school convocation; 4:30 pm, popular program; 6 pm, dinner hour. Wed, 9 pm, musical program. Thurs, 10 pm, musical program. Sat, 4:30 pm, popular program; 6:15 pm, weather news. Central standard time. Slogan: "Where Friendliness is Broadcast Daily."

KFSD Airfan Radio Corporation, U. S. Grant Hotel, San Diego, Calif. 440.9 meters, 680 kilocycles, 500 watts. Sun, 3-4 pm, musical program; 6:15-10 pm, musical program. Daily ex Sun, 6:15-11 pm, musical program. Pacific time.

KFSG Angelus Temple, 1100 Glendale Blvd., Los Angeles, Calif. 275.1 meters, 1090 kilocycles, 500 watts. Sun, 10:30 am-12:30 pm, 2:30-4:30 pm, 6:30-11 pm. Tues & Wed, 10:30 am-12:30 pm, 2:30-4:30 pm, 6:30-9:30 pm. Thurs & Fri, 10:30 am-12:30 pm, 2:30-4:30 pm, 6:30-11 pm. Sat, 10:30 am-12:30 pm, 2:30-4:30 pm, 6:30-9:30 pm. Church services, organ recitals, band concerts, sacred and classical musicales. Slogan: "The Church of the Air."

KFUL Thos. Goggan & Bro. Music Co., 2126 Market, Galveston, Tex. 258.5 meters, 1160 kilocycles, 500 watts. Daily, 1-2 pm. Mon & Fri, 8 pm. Central standard time. Slogan: "The City of Perpetual Sunshine."

KFUM Corley Mountain Highway, Mining Exchange Bldg., Colorado Springs, Colo. 282.8 meters, 1060 kilocycles, 1000 watts. Sun, 11 am. Mon & Fri, 5-7 pm. Tues & Sat, 8-10 pm. Thurs, 8 pm-12 midnight. Mountain standard time. Divides time with KFPF. Slogan: "Known for Unsurpassed Mountain Scenery."

KFUO Concordia Seminary (Lutheran), St. Louis, Mo. 345.1 meters, 350 kilocycles, 1500 watts daytime, 1000 watts night. Sun, 3:30 pm, 4 pm, Shut-in Hour, 9:15 pm. Mon, 6 pm, young people's hour. Tues, 6 pm, question hour and musical program. Wed & Fri, 6 pm, children's program; 6:30 pm, Bible class. Thurs & Sat, silent. Central standard time. Divides time with Station KSD. Slogan: "The Gospel Voice."

KFUP Fitzsimmons General Hospital, Educational & Recreational Dept., U. S. Army, Denver, Colo. 227.1 meters, 1320 kilocycles, 100 watts. Mountain time.

KFUR Perry Building Co., 420 Twenty-fifth st. (H. W. Peery, Mgr.), Ogden, Utah. 225.4 meters, 1330 kilocycles, 500 watts. Tues, Thurs, Sat, 9:50-11:50 pm, dance music. Mountain time.

KFUS Louis L. Sherman, 1444 Havenscourt Blvd., Oakland, Calif. 256.3 meters, 1170 kilocycles, 50 watts. Daily ex Sun, 6-7 pm, dinner concert. Tues, 2:30-3:30 pm, educational; 8-9 pm. Wed & Fri, 8-9 pm, sacred program. Thurs, 4:30-5 pm, educational; 5-5:30 pm, children's program. Sun, 9-9:30 am, S.S. lesson; 3:30-4:30 pm, sacred program. Pacific standard time. Divides time with KRE.

KFUT University of Utah, Salt Lake City, Utah. 249.9 meters, 1200 kilocycles, 50 watts. Tues, Wed, Thur, Fri, 7-8 pm. Mountain time.

KFVD W. J. & C. I. McWhinnie, Venice Ballroom, Venice, Calif. 208.2 meters, 1440 kilocycles, 250 watts. Sun, 6-12 pm, dance program. Daily ex Sun, 9:30 am-12 noon, 4:30-6 pm, 9 pm-12 midnight. Pacific time. Slogan: "The Voice of the Sea." Divides time with Station KGFJ.

KFVG First Methodist Episcopal Church, 204 S. Penn. ave., Independence, Kan. 225.4 meters, 1330 kilocycles, 50 watts. Sun, 10:55 am-12:30 pm & 7:30-9:15 pm, church services. Central standard time. Slogan: "Kansas Folks Very Good."

KFVI Headquarters Troop, 56th Cavalry Brigade, 305 Sabine st., Houston, Tex. 238 meters, 1260 kilocycles, 50 watts. Central standard time.

KFVS Hirsch Battery & Radio Co., 312 S. Frederick st., Cape Girardeau, Mo. 223.7 meters, 1340 kilocycles, 50 watts. Daily ex Sun, 12:15 noon, news and markets; 6:45 pm, musical. Central standard time. Slogan: "The City of Opportunity."

KFWB Warner Bros. Motion Picture Studios, Inc., 5842 Sunset Blvd., Hollywood, Calif. 361.2 meters, 830 kilocycles, 500 watts. Sun, 7:30-10 pm. Daily ex Sun, 10:10-40 am. Mon, Tues, Thurs, Fri, 11:45 am-2:30 pm. Mon, Tues, 4:45 pm-12 midnight. Sat & Wed, 11:45 am-12 midnight. Thurs & Fri, 4:15 pm-12 midnight. Pacific time.

KFWC L. E. Wall, San Bernardino, Calif. 222.1 meters, 1350 kilocycles, 1000 watts. Sun, 7 pm-12 midnight. Daily ex Sun, 9 am-1 pm, 2-5:30 pm. Mon & Wed, 7 pm-12 midnight. Tues, 7-8 pm, 10 pm-12 midnight. Thurs, 10 pm-12 midnight. Fri, 8 pm-12 midnight. Sat, 9 pm-12 midnight. Pacific standard time. Divides time with KWTC. Slogan: "The Voice of the Orange Empire."

KFWF St. Louis Truth Center, 4030 Lindell st., St. Louis, Mo. 214.2 meters, 1400 kilocycles, 250 watts, non-commercial. Sun, 10:45 am, 7:45 pm, 9 pm, organ & chimes. Thurs, 10:45 am, sunshine hour; 7:45 pm, sermon; 9 pm, music. Central standard time. Slogan: "The Voice of Truth."

KFWI Radio Entertainments, Inc., 1182 Market St., San Francisco, Calif. 267.7 meters, 1120 kilocycles, 500 watts. Sun, 7:50-11 pm. Daily ex Sat & Sun, 1-1:30 pm, 5-7:30 pm, 8-11 pm (Wed. 5-7:15 pm). Sat. 5-7 pm, 8 pm-12 midnight. Pacific standard time.

KFWM Oakland Educational Society, 1520 8th Ave., Oakland, Calif. 236.1 meters, 1270 kilocycles, 500 watts night, 1000 watts daytime. Sun, 9:30-11 am, 12:30-2:30 pm, 7:30-9:30 pm. Daily ex Sun & Wed, 8-10 pm. Tues, Wed, Fri, 2-3 pm. Tues, 12:30-1:30 pm. Thurs, 12:30-4:30 pm. Pacific standard time. Slogan: "The Most Good to the Most People."

KFWO Major Lawrence Mott, 346 Claressa av., Avalon, Catalina Island, Calif. 299.8 meters, 1000 kilocycles, 250 watts. Daily including Sun, 12:30-1:30 pm, 5-6 pm, 6-7:30 pm. Tues, 8 pm-midnight. Pacific standard time. Slogan: "Catalina for Wonderful Outings."

KFXD Service Radio Co., East Main St., Jerome, Utah. 204 meters, 1470 kilocycles, 15 watts. Daily at noon with news, markets, etc. Mountain time.

KFXF Colorado Radio Corporation, Republic Bldg., Denver, Colo. 282.3 meters, 1060 kilocycles, 500 watts. Mon, Wed, Fri, Sun, 6-12 pm. Mountain standard time. Divides time with KFUM. Slogan: "The Voice of Denver."

KFXJ R. G. Howell, Olinger Gardens, Edgewater, Colo. 215.7 meters, 1390 kilocycles, 50 watts. Daily ex Sun, 11 am-1 pm, 3-4 pm, 6-7 pm, 7-8 pm. Sun, 12 noon-1 pm. Mountain standard time. Slogan: "America Scenic Center."

KFXR Exchange Avenue Baptist Church, 1818 Linden St., Oklahoma City, Okla. 223.7 meters, 1340 kilocycles, 50 watts. Central standard time.

KFXV Mary M. Costigan, Flagstaff, Ariz. 205.4 meters, 1460 kilocycles, 25 watts. Tues, Thurs, Sat, 10-11 pm. Mountain time.

KFYO Kirskey Bros., Breckenridge, Tex. 211.1 meters, 1420 kilocycles, 15 watts. Sun, 10:30-11:30 am, 12 noon-1 pm, 8-9 pm. Silent Wed night. Daily ex Sun, 8-9 pm. Central standard time. Slogan: "Breckenridge, the Dynamo of West Texas."

KFYR Hoskins-Meyer, Inc., 200 4th st., Bismarck, N. Dak. 249.9 meters, 1200 kilocycles, 250 watts night time, 500 watts daytime. Sun, 9-12 noon, church; 3-5 pm, music. Daily ex Sun, 9:30-11 am, 12:30-1:30 pm, 6:30-8 pm, music, weather forecast, etc. First & 15th of each month, 12 midnight-1 am. Central standard time.

KGA Northwest Radio Service Co., Old National Bank Bldg., Spokane, Wash. 260.7 meters, 1150 kilocycles, 2000 watts. Sun, 11 am-12:30 pm, 7:30-9 pm, church. Daily ex Sun, 9-11 am, music; 11 am-12 noon; 12 noon-12:20 pm, stocks, weather, news, etc.; 12:30-5:30 pm, music; 5:30-6 pm, kiddies' program; 6 pm, time signals, weather reports, etc.; 6:15-7:15 pm, organ; 7:15-10 pm, 10 pm-12 midnight. Pacific standard time.

KGAR The Tucson Citizen, 80 S. Stone av., Tucson, Ariz. 234.2 meters, 1280 kilocycles, 100 watts. Sun, 11 am-12:30 pm, 7:30-9 pm, church services. Tues & Fri, 6-9 pm, musical program. Sat midnight frolic every 2nd week from 12 midnight to 3 am. Slogan: "Way Out on the Desert."

KGBU Alaska Radio & Service Co., Ketchikan, Alaska. 228.9 meters, 1310 kilocycles, 500 watts.

KGBX Foster-Hall Tire Co., 1221 Fred av., St. Joseph, Mo. 288.3 meters, 1040 kilocycles, 100 watts. Central standard time.

KGBY Thelen & Taddiken, Columbus, Nebr. 222.1 meters, 1350 kilocycles, 50 watts. Daily ex Sun, 12 noon. Mon & Thurs, 6 pm. Tues, Wed & Fri, 8 pm. Central standard time. Slogan: "The Voice of Shelby, in the Heart of the Corn Belt."

KGBZ Dr. George R. Miller, York, Nebr. 212.6 meters, 1410 kilocycles, 250 watts. Sun, 9 am, 11 am, 3 pm, 7:30 pm, church services, 5 pm, alternatively. Daily ex Sun, Tues, 12:30 pm, market, livestock; 2:30 pm, musical; 6 pm, organ; 6:30 pm, 7:30 pm. Thurs, Sat, 9 pm, dance music. Central standard time. Slogan: "The Swine and Poultry Station."

KGCA Chas. W. Greeley, Decorah, Iowa. 247.8 meters, 1210 kilocycles, 10 watts. Sun, 2-4 pm. Daily ex Sun, 12:30-1:30 pm. Wed, 7:30-8:30 pm. Central standard time. Divides time with KWLC.

KGCB Wallace Radio Institute, 105 W. 13th st., Oklahoma City, Okla. 215.7 meters, 1390 kilocycles, 50 watts. On air daily, programs irregular. Divides time with Station KGFG.

KGCH Wayne Hospital, Wayne, Nebr. 293.9 meters, 1020 kilocycles, 250 watts. Sun, 2:30-4 pm, 6 pm, sacred service. Tues, Wed, Thurs, Fri, 6:30-8 pm, featuring college educational and entertaining programs. Central standard time. Divides time with KGDW. Slogan: "Remember Us When U R Ill."

KGCI Liberto Radio Sales, San Antonio, Tex. 204.6 meters, 1360 kilocycles, 15 watts. Sun, 1:30-2:30 pm. Daily ex Sun, 9:30-10:30 am, 11:30 am-12:15 pm, 3-4 pm, 5:30-6:30 pm. Mon & Thurs, 9:30-10:30 pm. Tues, 7:30-8:30 pm. Central standard time. Divides time with Station KGRC, the Gene Roth Co., San Antonio, Tex. Slogan: "Radio Sam at San Antonio."

KGCL Piper & Taft, Inc., Sporting Goods Store, 1107 2nd Ave., Seattle, Wash. 230.6 meters, 1300 kilocycles, 50 watts. Mon, Wed, Thurs, 9 am-11 pm. Tues, Fri, Sat, 9 am-7:30 pm. Sun, 12 noon-11 pm. Pacific Standard time. Slogan: "Splittdorf Radio Center." Divides time with station KPCB, the Pacific Coast Biscuit Co.

Magic Silence

Our money making proposition for Set Builders is making the Knapp "A" Power Unit. Big Profits and Perfect Satisfaction Guaranteed.

the tinkle of profits is the only noise in this absolutely dry

"A" POWER UNIT FOR Set Builders

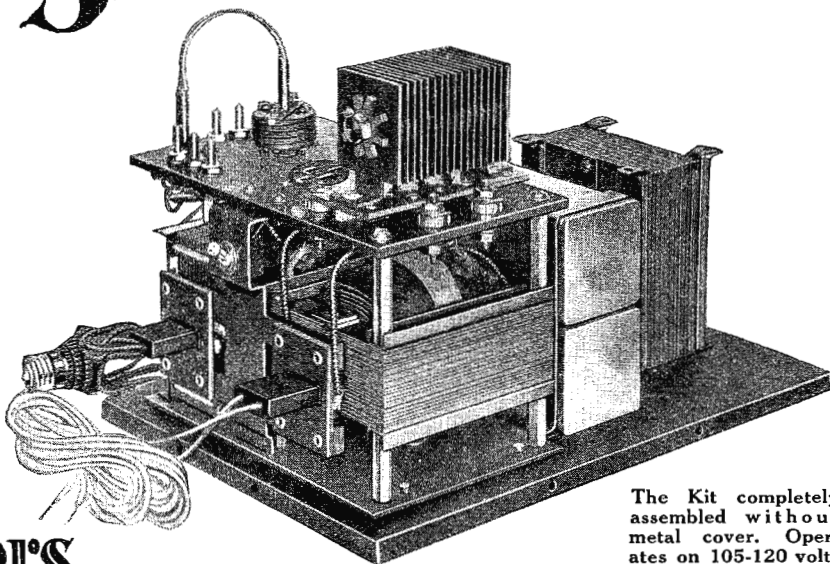

The Kit completely assembled without metal cover. Operates on 105-120 volts AC, 50 to 60 cycles.

Knapp "A" POWER KIT

No Tubes . . . No Attention . . . No Re-wiring

No expensive short lived AC Tubes, no troublesome re-wiring, no annoying hum. Increase instead of decrease the efficiency of your set. No waiting . . . the Knapp "A" Power gives you music *instantly* at the snap of a switch.

This absolutely dry "A" Power is not in any way a battery combination . . . not something to add to your battery . . . it is the most efficient "A" Battery Eliminator ever designed. It supplies unflinching "A" current to any set using 201-A or 6 volt tubes, regardless of number.

Magic Silence

So silent is Knapp "A" Power, that you can place a pair of head phones directly across the output and not be able to detect a hum. This is made possible by the efficient Knapp filter system, consist-

ing of 2 over sized chokes and 2 condensers of 1500 microfarads each. A new discovery makes these amazing capacities possible in the small space of 2x2x8 inches!

Absolutely Dry

There is not a drop of moisture in this absolutely dry unit. The condensers are baked so that not a drop of moisture remains. The unique, fully patented, solid, full-wave rectifier is absolutely dry. No water . . . no acid . . . no alkali . . . no tubes . . . no electrolytic action. Nothing to get out of order. Nothing that needs attention.

Assemble in Half an Hour

The Knapp "A" Power Kit is so easily assembled, that within an hour after you receive it, you can have it in operation.

The parts seem to fall in place. No drilling and very little soldering. Everything supplied, even to the screws, wire, drilled base-board and metal cover. Is so complete, that even a plug is supplied so that a "B" Eliminator may be operated from the same switch. We have never seen such simple instructions.

Big Profit for Set Builders

Our President, Mr. David W. Knapp, is offering the set builders of America, for a limited time only, a money-saving, profit-making plan which is unique in the annals of radio. Send the coupon today, before it is too late.



Knapp Electric Corporation
360 Fox Island Road
Port Chester, N. Y.

MR. DAVID W. KNAPP, Pres.
Knapp Electric Corporation
360 Fox Island Road, Port Chester, N. Y.
Send me complete information regarding the Knapp "A" Power Kit and your special discount to Set Builders.

Name.....
Address.....

- 5 advantages of the Knapp "A" POWER KIT**
1. Absolutely Dry, no acids, liquids or tubes.
 2. Perfect Rectification.
 3. Absolutely Silent.
 4. Easy to assemble—half hour enough.
 5. No Re-wiring.

The kit with metal cover in place.

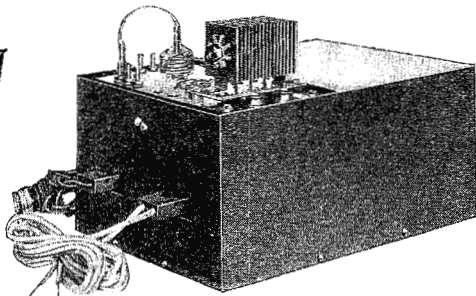

Tell 'Em You Saw It in the Citizens Radio Call Book Magazine

KGCN Concordia Broadcasting Co., Concordia, Kan. 208.2 meters, 1440 kilocycles, 50 watts. Sun, 11 am-12 noon. Daily ex Sun, 12:30-1:30 pm, 7:30-9 pm. Central standard time. Slogan: "KGCN—The Shamrock Station."

KGCR Cutlers Radio Broadcasting Service, 415 Main st., Brookings, S. Dak. 208.2 meters, 1440 kilocycles, 15 watts. Central standard time.

KGCU Mandan Radio Association (H. L. Dahners), Mandan, N. Dak. 239.9 meters, 1250 kilocycles, 100 watts. Sun, 11 am-12 noon. 4:30-6:30 pm. Daily ex Sun, 7-8 am, 12 noon-2 pm, 6:30-7:30 pm. Mountain standard time. Slogan: "The Voice of the West."

KGCX First State Bank of Vida, Vida, Mont. 243.8 meters, 1230 kilocycles, 10 watts.

KGDA Home Auto Co., Dell Rapids, S. D. 254.1 meters, 1180 kilocycles, 15 watts daytime.

KGDE Jaren Drug Co., Barrett, Minn. 205.4 meters, 1460 kilocycles, 50 watts. Daily ex Sun, 12:30 pm, 4 pm, 7 pm. Sun, 10:30 am, 3 pm, 6 pm, 8 pm. Central standard time.

KGDM Peffer Music Co., 42 S. California st., Stockton, Calif. 217.3 meters, 1380 kilocycles, 10 watts.

KGDP Boy Scouts of America, Pueblo Council, Pueblo, Colo. (John D. Price), 261.7 meters, 1340 kilocycles, 10 watts.

KGDR Joe B. McShane, 206 Laurel Hgts. Place, San Antonio, Tex. 206.8 meters, 1450 kilocycles, 15 watts. Sun, 9-10 am, classical. Daily ex Sun, 4-5:30 pm, tea dancing program. Wed, 9:30-11:30 pm, frolic. Thur, 7:30-8:30 pm. Central standard time. Slogan: "The Little Station with the Big Programs."

KGDW Frank J. Rist, Humboldt, Nebr. 293.9 meters, 1020 kilocycles, 100 watts. Central standard time. Divides time with KGCH.

KGDX William E. Antony, 1513 Laurel st., Shreveport, La. 212.6 meters, 1410 kilocycles, 250 watts. Divides time with KGGH.

KGDY J. Albert Loesch, Oldham, S. Dak. 206.8 meters, 1450 kilocycles, 15 watts. Thur, 7:45 pm, 11:45 pm. Central standard time. Slogan: "The Little Brick Town on the Prairie."

KGEF Trinity Methodist Church, Los Angeles, Calif. 263 meters, 1140 kilocycles, 500 watts.

KGEH Eugene Broadcast Station, W. E. Miner Bldg., Eugene, Ore., 201.6 meters, 1490 kilocycles, 50 watts.

KGEK Beehler Electric Equipment Co., Yuma, Colo. 263 meters, 1140 kilocycles, 10 watts daytime only. Daily, 12 noon-1 pm, stock markets, lectures, etc.

KGEM E. R., Irely & F. M. Bowles, El Centro, Calif. 225.4 meters, 1330 kilocycles, 15 watts.

KGEO Hotel Yancey, Grand Island, Nebr. 205.4 meters, 1460 kilocycles, 100 watts.

KGEQ Glenwood Radio Station, 920 5th av., No. Minneapolis, Minn. 204 meters, 1470 kilocycles, 50 watts. Mon, 7-8 pm, miscellaneous. Tues, Thur, 8:30-11 pm, miscellaneous. Wed, 6:30-8:30 pm, 10-11 pm. Fri, 6:15-9 pm, music, entertainment. Sat, 4:30 pm. Children's Story Hour. Central standard time. Slogan: "In the Land and Lakes and Rivers."

KGER C. Merwin Dobyns, Long Beach, Calif. 215.7 meters, 1390 kilocycles, 100 watts. 9 am to midnight. Pacific standard time. Slogan: "Service Club of the Air."

KGES Central Radio Electric Co., Central City, Nebr. 204 meters, 1470 kilocycles, 10 watts.

KGEU L. W. Clement, Lower Lake, Calif. 227.1 meters, 1320 kilocycles, 50 watts.

KGEW City of Fort Morgan, Fort Morgan, Colo. 218.8 meters, 1370 kilocycles, 200 watts daytime, 100 watts night. Sun, 11 am-12 noon, church; 2-4 pm, classical program. Daily ex Sat & Sun, 5:15-6 pm, markets & news. Tues, Thurs, Sat, 8-10 pm, varied programs. Sat, 12 noon-1 pm, talks. Mountain standard time. Slogan: "Fort Morgan, the City of Lights."

KGEY J. W. Dietz, Denver, Colo. 201.6 meters, 1490 kilocycles, 250 watts. Sun, 1-2 pm. Daily ex Sun, Thur, 7-8 pm. Western standard time.

KGEZ Flathead Broadcasting Association, Kalispell, Mont. 293.9 meters, 1020 kilocycles, 100 watts. Daily ex Sun, 12:30 pm-1:30 pm; 6:30-7:30 pm. Thurs, 9-10:30 pm. Sun, 11 am, church services. Mountain standard time. Slogan: "Located in the Switzerland of America—The Beautiful Flathead Valley."

KGFB Iowa City, Ia. 223.7 meters, 1340 kilocycles, 10 watts.

KGFF Earl E. Hampshire, 718 5th st., Alva, Okla. 205.4 meters, 1460 kilocycles, 25 watts. Programs irregular. Central standard time.

KGFG Full Gospel Church, "Old Glory" Station, Oklahoma City, Okla. 215.7 meters, 1390 kilocycles, 50 watts. Slogan: "The Whole Gospel to the Whole World."

KGFH La Crescenta, Calif. 223.7 meters, 1340 kilocycles, 250 watts. Divides time with KMIC.

KGFI San Angelo, Tex. 220.4 meters, 1360 kilocycles, 15 watts. Sun, 11 am-8 pm. Daily ex Sun, 10 am-12 noon, 3:30 pm, markets & weather; 8-10 pm, music. Central standard time. Slogan: "The Voice of West Texas."

KGFI Ben S. McGlashan, Washington Blvd. & Oak St., Los Angeles, Calif. 208.2 meters, 1440 kilocycles, 100 watts. Sun, 9 am-2:30 pm. Daily, 6:30-9:30 am, 12 noon-4:30 pm, 6-9 pm, 12 midnight-6:30 am, ex Thurs when on the air 2-6:30 am. Pacific standard time. Divides time with KFVD. Slogan: "Keep Good Folks Joyful."

KGFK Hallock, Minn. 223.7 meters, 1340 kilocycles, 50 watts. Mon, Wed & Friday, 12 noon-1 pm, talks, weather, news and market reports. Mon & Fri, 8-10:30 pm. Central standard time.

KGFL Raton, N. M. 222.1 meters, 1350 kilocycles, 50 watts.

KGFM Geo. W. Johnson, Yuba City, Calif. 211.1 meters, 1420 kilocycles, 15 watts. Daily ex Sun, 9:30-10:30 am, advertising; 2-2:30 pm, musical. Mon, Wed, Fri, 8-10 pm, entertainment. Pacific standard time.

KGFN Aneta, N. Dak. 199.9 meters, 1500 kilocycles, 15 watts.

KGFO Terre Haute, Ind. 204 meters, 1470 kilocycles, 100 watts.

KGFP Mitchell, S. Dak. 212.6 meters, 1410 kilocycles, 10 watts.

KGFW Ravenna, Neb. 296.9 meters, 1010 kilocycles, 10 watts. Central standard time.

KGFX Pierre, S. D. 234.1 meters, 1180 kilocycles, 200 watts. Central standard time.

KGGF Picher, Okla. 206.8 meters, 1450 kilocycles, 100 watts. Central standard time.

KGGH Cedar Grove, La. 212.6 meters, 1410 kilocycles, 250 watts. Central standard time. Divides time with KGDX.

KGHB Honolulu, T. H. 227.1 meters, 1320 kilocycles, 250 watts. Two and one-half hours later than Pacific time.

KGHF Pueblo, Colo. 209.7 meters, 1430 kilocycles, 250 watts. Mountain standard time.

KGHP Hardin, Mont. 263.0 meters, 1140 kilocycles, 500 watts. Mountain standard time.

KGO General Electric Co., Oakland, Calif. 384.4 meters, 780 kilocycles, 5000 watts. Sun, 11 am, 7:30 pm, church; 4 pm, 5:30-6:30 pm, concert; 9-10 pm. Daily ex Sun, 11:30 am; 4-5 pm, concert; 5:30 pm, Kiddies Klub; 6-6:55 pm, dinner concert; 9 pm, Book Review. Tues, Wed, Thurs, Fri, Sat, 9-10 pm, varied programs. Tues, Fri, Sat, 10-11 pm; Wed, 10 pm-12 midnight, dance music. Fri, 11 pm-12 midnight. Pacific standard time.

KGRC Gene Roth & Co., San Antonio, Tex. 220.4 meters, 1360 kilocycles, 50 watts. Divides time with KGCI.

KGRS Gish Radio Service, 108 E. 8th st., Amarillo, Tex. 243.8 meters, 1230 kilocycles, 150 watts. Daily ex Sun, 6:30 am-6:30 pm; 10 am, weather & markets. Mon, Wed, Fri, 9 pm. Sun, 11:30 am, 4:30 pm, 7:30 pm. Central standard time.

KGTT Glad Tidings Temple—Bible Institute, 1451 Ellis st., San Francisco, Calif. 206.8 meters, 1450 kilocycles, 50 watts. Sun, 2:30-5 pm, 8-10 pm. Mon, Tues, Thurs & Sat, 12:10-12:30, sacred. Wed, 12:10-12:30 pm, 2:30-3:33 pm, sacred. Fri, 12:10-12:30 pm, 3-4 pm, 8-10 pm, sacred. Pacific standard time. Slogan: "Voice of Glad Tidings."

KGU M. A. Mulrony, 217 King st., Honolulu, Hawaii, 270.1 meters, 1110 kilocycles, 600 watts. Two and one-half hours later than Pacific time. Sun, 6-9:30 pm, music, lectures, church, news. Daily, 12 noon-1:15 pm, 5-6 pm, stock, weather reports, music. Daily ex Sat & Sun, 7:30-9:30 pm, Hawaiian program, news, sports, music, etc. Slogan: "In the Land of Sunshine, the Future Playground of America."

KGW Oregonian Publishing Co., Portland, Ore. 491.5 meters, 610 kilocycles, 1000 watts. Sun, 8:30-9:15 am, Auntie Blossom and Winnie Winkle; 10 am-12 noon, church; 3-11 pm, concerts. Daily ex Sun, 10-11:30 am, Town Crier; 6-7 pm, concert. Mon, 7-11 pm, musical entertainment. Tues, 6 pm-12 midnight, music & educational program. Wed, 7-30 pm-12 midnight, diversified program. Thurs, 6 pm-12 midnight, concert. Fri, 7-9 pm, utility & musical entertainment; 9-10:30 pm, concert; 10:30-12 midnight, Hoot Owl Frolic. Sat, 7-11 pm, concert; 11 pm-12 midnight, dance music. Pacific standard time. Slogan: "Keep Growing Wiser."

The clearest and truest Electric Radio



Licensed under Andrews-Hammond patent

Balkite "A" Contains no battery. The same as Balkite "AB" but for the "A" circuit only. Not a battery and charger but a perfected light socket "A" power supply. One of the most remarkable developments in the entire radio field. Price \$35.



Balkite "B" One of the longest lived devices in radio. The accepted, tried and proved light socket "B" power supply. The first Balkite "B" after 5 years is still rendering satisfactory service. Three models: \$22.50, \$35, \$42.50.



Balkite Chargers

Standard for "A" batteries. Noiseless. Can be used during reception. High rate or trickle charging. Three models: \$17.50, \$9.50, \$7.50.

Special models for 25-40 cycles at slightly higher prices. Prices are higher West of the Rockies and in Canada.

Is a standard radio set equipped with Balkite Electric "AB"

Of course you want an AC electric receiver. For its convenience. Now you can have it, and yet use only tried and proved apparatus.

Simply by adding Balkite Electric "AB" to your present radio set. Balkite Electric "AB" replaces both "A" and "B" batteries and supplies radio power from the light socket. It contains no battery

in any form. It operates only during reception. It makes any receiver an electric set.

This method makes possible the use in electric reception of standard type sets and tubes. Both are tried and proved, and give by far the

clearest and truest reproduction—the same high standard of reception to which you are accustomed.

In this method there is nothing experimental, nothing untried. It consists of two of the most dependable products in radio—a standard set and Balkite. And if you should already own a radio set, the cost of equipping it with Balkite is only a fraction of the cost of a new receiver.

By all means go to AC reception. Its convenience is the greatest improvement in radio. But be as critical of an AC receiver as you would of any other.

Let your AC receiver be a standard set equipped with Balkite Electric "AB." Then it will be as clear and faithful in reproduction as any receiver you can buy.

Your dealer will recommend the Balkite equipment you need for your set.



Licensed under Andrews-Hammond patent

Balkite "AB" Contains no battery

A complete unit, replacing both "A" and "B" batteries and supplying radio current directly from the light socket. Contains no battery in any form. Operates only while the set is in use. Two models: "AB" 6-135, 135 volts "B" current, \$64.50; "AB" 6-180, 180 volts, \$74.50.

FANSTEEL PRODUCTS COMPANY, INC., NORTH CHICAGO, ILLINOIS

FANSTEEL Balkite

Radio Power Units

Tell 'Em You Saw It in the Citizens Radio Call Book Magazine

- KGY** St. Martins College, Lacey, Wash. 243.8 meters, 1230 kilocycles, 50 watts. Tues, Thurs, Sun, 8:30-9:30, PST concert. Pacific standard time. Slogan: "Out Where the Cedars Meet the Sea."
- KHJ** Don Lee, Los Angeles, Calif. 416.4 meters, 720 kilocycles, 500 watts. Sun, 9 am-2 pm, 4-10 pm. Daily ex Sun & Sat, 7:30-8:30 am. Daily ex Sun, 12:30-11 pm. Pacific time. Slogan: "Kindness, Happiness, Joy."
- KHMC** Harlingen, Tex. 236.1 meters, 1270 kilocycles, 100 watts. Central standard time.
- KHQ** Louis Wasmer, Inc., Peyton Building, Spokane, Wash. 370.2 meters, 810 kilocycles, 1000 watts. Sun, 11-12:30, 6-7:30, 7:30-10 pm, church services. Mon, Tues, Thurs, Fri, Sat, 2:30-4:30 pm, matinee; 5-6 pm, service hour. Thurs, Fri, Sat, 6-7 pm, concert. Mon, Tues, 7:30-12 pm, varied. Wed, 9-10 pm, dance music. Thurs, Fri, 8-10 pm, popular; 10:30-12 pm, KGW. Pacific time. Slogan: "In the Friendly City."
- KICK** Red Oak Radio Corp., Red Oak, Ia. 322.4 meters, 930 kilocycles, 100 watts daytime. Daily, 10 am-1 pm, 4-6 pm. Sat, 12:05 am. Central standard time. Divides time with WIAS.
- KJBS** Julius Brunton & Sons Co., 1380 Bush st., San Francisco, Calif. 220.4 meters, 1360 kilocycles, 50 watts. Sun, 1:30-5 pm. Daily ex Sat & Sun, 9 am-12 noon, 1:30-7:30 pm, 8-11 pm. Sat, 9 am-12 noon, 1:30-7:30 pm. Pacific standard time. Slogan: "The Voice of the Storage Battery."
- KJR** Northwest Radio Service Co., 604 Home Savings Bldg., Seattle, Wash. 348.6 meters, 860 kilocycles, 2500 watts. Sun, 9:30-11 am, 11-12:30 pm, church; 2:30-4 pm, 7-10:30 pm, music & church. Daily ex Sun, 9 am-12 noon, 12 noon-5 pm, 5 pm-12 midnight, news, talks, music, weather reports, etc., broadcast. Pacific standard time.
- KKP** City of Seattle, Harbor Department, Seattle, Wash. 265.3 meters, 1130 kilocycles, 15 watts.
- KLCC** Blytheville, Ark. 285.5 meters, 1050 kilocycles, 50 watts. Central standard time.
- KLDS** Midland Broadcasting Co., Kansas City, Mo., and Reorganized Church of Jesus Christ of Latter Day Saints, Independence, Mo. 238.9 meters, 1260 kilocycles, 1500 watts. Sun, 8:30-11 am, 3-6 pm, 9-15 pm. Mon, silent. Tues & Fri, 6:30 am, 7:30 pm. Tues, Thurs, Sat, 8 pm. Wed, silent. Slogan: "The Station Dedicated to Knowledge, Liberty, Divinity and Service."
- KLIT** Portland, Ore. 206.8 meters, 1450 kilocycles, 10 watts.
- KLS** Warner Bros. Radio Supplies Co., 2201 Telegraph av., Oakland, Calif. 245.8 meters, 1220 kilocycles, 250 watts. Sun, 10-11 am, church services. Pacific standard time. Divides time with KZM. Slogan: "The City of Golden Opportunity."
- KLX** The Oakland Tribune, Oakland, Calif. 508.2 meters, 590 kilocycles, 500 watts. Daily ex Sun, 10-11:30 am, 11:30 am-1 pm, 1-1:30 pm, 6:30-7:30 pm, 8-10 pm. Wed & Thurs, 4:30-5:30 pm. Daily ex Sat & Sun, 5:30-6:30 pm. Pacific standard time. Slogan "Where Rail and Water Meet."
- KLZ** Reynolds Radio Co., Inc., 17th & Broadway Denver, Colo. 296.9 meters, 1010 kilocycles, 1000 watts daytime, 750 watts night. Sun, 9:30-10:30 am, 11 am-12:30 pm, 3-4 pm, 7 pm-12 midnight. Daily ex Sun, 9-11 am, 3-4:30 pm, 6-10 pm. Sun, Tues, Fri & Sat, 10 pm-12 midnight, dance music. Mountain time. Slogan: "The Pioneer Station of the West."
- KMA** Earl E. May Seed & Nursery Co., Shenandoah, Ia. 394.5 meters, 760 kilocycles, 1000 watts. Sun, 8-9 am, sacred; 11 am, church service; 12:15-2:30 pm, music; 4-6 pm, sacred. Daily ex Sun, 6-7 am, 9-10 am, 11 am-1 pm, 2-3 pm. Daily ex Sun & Mon, 5-10:30 pm. Daily, 12:20 & 6:30 pm, markets. Central standard time. Divides time with KWAH. Slogan: "Keeps Millions Advised."
- KMED** W. J. Virgin, Sparta Bldg., Medford, Ore. 249.9 meters, 1200 kilocycles, 50 watts. Sun, 11 am-12:15 pm, 2-4 pm, 7:30-9 pm. Daily ex Sat & Sun, 10-11 am, 12:15-1:15 pm, 5:45-10 pm. Wed, 10-11 pm. Sat, 6:15-6:30 pm, 10-11:30 pm. Pacific standard time. Divides time with KFJI. Slogan: "See Crater Lake."
- KMIC** J. R. Fouch, Inglewood, Calif. 223.7 meters, 1340 kilocycles, 250 watts. Pacific standard time. Divides time with KGFH.
- KMJ** Fresno Bee, Fresno, Calif. 365.6 meters, 820 kilocycles, 50 watts. Mon, Wed, Fri, 7:15-9 pm. Pacific time.
- KMMJ** M. M. Johnson Co., Clay Center, Nebr. 285.5 meters, 1050 kilocycles, 500 watts daytime, 250 watts night. Sun, 9 pm. Daily ex Sun, 7:30-9:45 am, 11 am-12:15 pm, 1:45-3:30 pm, 6-6:30 pm, 8-10 pm. Central standard time. Divides time with WJAG. Slogan: "The Old Trusty Station."
- KMO** Hotel Winthrop, Tacoma, Wash. 254.1 meters, 1180 kilocycles, 250 watts. Sun, 11-12 am, 6:15-7 pm, 8-9 pm. Mon, 10-11 am, 2-4 pm, 7-8 pm. Tues, 10-11 am, 2-4 pm, 7:30-11 pm. Wed, 10-11 am, 2-4 pm, 8-9 pm. Thurs, 10-11 am, 2-4 pm, 8-10 pm. Fri, 10-11 am, 2-4 pm, 7-8 pm, 10-11 pm. Sat, 10-11 am, 2-4 pm, 6:15-7 pm, 10-11 pm. Pacific time.
- KMOX** "The Voice of St. Louis, Inc." St. Louis, Mo. 299.8 meters, 1000 kilocycles, 5000 watts. Daily ex Sun, 9:40 am-12 noon, 12 noon-6 pm, educational, musical, women's & farmers' programs. Daily ex Sat, 6 pm-1 am, varied and Columbia Chain programs. Sun, 2-10 pm, featuring Columbia Chain and studio program. Central standard time.
- KMTR** KMTR Radio Corp., 1025 N. Hollywood av., Hollywood, Calif. 526.0 meters, 570 kilocycles, 500 watts. Sun, 6:30-10 pm. Daily ex Sun, 7 am-11 pm. Programs vary. Pacific time. Slogan: "Your Friend in Hollywood."
- KNRC** Clarence B. Juneau, Municipal Auditorium Bldg., Santa Monica, Calif. 374.8 meters, 800 kilocycles, 500 watts. Sun, 10:45-11 pm. Daily ex Sat & Sun, 2-11 pm. Sat, 2 pm-2 am. Pacific standard time. Slogan: "The Station With a Smile."
- KNX** The Los Angeles Evening Express 6116 Hollywood Blvd., Hollywood, Calif. 336.9 meters, 890 kilocycles, 500 watts. Sun, 10 am, 2-4 pm, 5:15 pm, 6:30 pm, 7 pm, church; 8 pm, 9 pm, music. Daily ex Sun, 6:45-8 pm, exercises and inspirational talk; 8:55 am, time signals; 9 am, 6 pm, variety program; 6:30 pm, dinner hour concert; 7 pm, 8 pm, 10 pm, 11 pm. Mon, Wed, Thurs, 11 pm. Tues, 11:15 am, 12:45 pm. Fri, 2 pm. Sat, 2:15 pm, 7:45 pm & 12 midnight. Mon, 2:30 pm, 4:30 pm, 9:30 pm. Mon & Fri, 6:45 pm. Mon, Tues, Wed, Sat, 7:30 pm. Tues, Wed, Thurs, Fri, 9 pm. Pacific standard time. Slogan: "The Voice of Hollywood."
- KOA** Rocky Mountain Broadcasting Station, General Electric Co., 1370 Krameria st., Denver, Colo. 325.9 meters, 920 kilocycles, 5000 watts night, 2500 watts daytime. Sun, 10:30 am, 6:30 pm, dinner concert; 7:30 pm, church. Daily ex Sun, 11:45 am, weather, news; 12 noon, time signals; 12:05 pm, organ. Daily ex Sat & Sun, stocks, markets, etc.; 6:30 pm, dinner concert; 8:15 pm, studio program. Tues, Thurs, Fri, 3:30 pm, matinee. Tues & Fri, 4 pm, culinary hints; 4:15 pm, fashion review. Mon, Tues, Wed, Fri, 7:30 pm, varied programs. Thurs, 4 pm. Mountain standard time.
- KOAC** Oregon Agricultural College, Corvallis, Ore. 270.1 meters, 1110 kilocycles, 500 watts. Mon, Tues, Wed, Thurs, Fri, 7-9 pm. Pacific standard time. Slogan: "Science for Service."
- KOB** New Mexico College of Agriculture & Mechanical Arts, State College, N. M. 394.5 meters, 760 kilocycles, 5000 watts night, 7500 watts daytime. Daily ex Sun, 11:55 am & 9:55 pm, time signals; 12 noon & 10 pm, weather report, financial reports; 12:08-1 pm, concert. Mon, Wed, Fri, 7:30-8:30 pm. Mountain standard time. Divides time with KWSC & KTW. Slogan: "The Sunshine State of America."
- KOCH** Central High School, 20th & Dodge Sts., Omaha, Neb. 258.5 meters, 1160 kilocycles, 250 watts. Sun, 11 am-12 noon, church; 3-5 pm, classical. Tues, Wed, Thurs, Fri & Sat, 6-11 pm, musical and educational programs. Central standard time. Divides time with WNAL-KFOX.
- KOCW** Oklahoma College for Women, Chickasha, Okla. 252 meters, 1190 kilocycles, 250 watts. Mon, Tues, Thur & Fri, 12-1 pm, educational talk and music. Tues, Fri & Sat, 8-9 pm, musical program. Wed, 10-10:40 am, chapel services; 12-1 pm, musical. Sun, 11 am-12 n, church services; 2:30-3:30 pm, musical. Central standard time.
- KOIL** Mona Motor Oil Co., Council Bluffs, Iowa. 319 meters, 940 kilocycles, 5000 watts. Sun, 8-10 am, 12:30-4 pm, 5-6 pm, 7-8 pm, 9-10 pm, 11:30 pm-1 am. Daily ex Sun, 7-8 am, 9-10 am, 12:30-2 pm, 5-6 pm, 7-8 pm, 9-10 pm, 11 pm-1 am. Mon, 6 pm-12 midnight. Divides time with KFAB. Central standard time. Slogan: "The Hilltop Studio."
- KOIN** KOIN (Inc.), Portland, Ore. 319 meters, 940 kilocycles, 1000 watts. Daily ex Sun, 10 am-12 noon, housewife's hour; 12 noon-1 pm, organ concert; 1-1:15 pm, 3-4 pm, news; 5:15-6 pm; 6-7 pm, dinner organ concert; 7-7:15 pm, 7:15-8 pm, orchestra. Mon, Wed, Fri, 10-11:30 pm. Tues, 10-11 pm. Sat, 11 pm-1 am. Wed & Fri, 4-4:30 pm. Nightly ex Sat & Sun, 8-10 pm, diversified studio program. Sun, 3-4:30 pm, 6-7 pm, organ; 7-8 pm, orchestra; 8-9 pm, church services; 9-10 pm, orchestra. Pacific standard time. Slogan: "The Station of the Hour."
- KOMO** Fisher's Blend Station (Inc.), Seattle, Wash. 305.9 meters, 980 kilocycles, 1000 watts. Mon, Tues, Wed, Thurs, Fri & Sat, 10 am-12:30 midnight. Sun, 10 am-11 pm. Pacific time.
- KOW** The Associated Industries, Inc., Albany Hotel, Denver, Colo. 247.8 meters, 1210 kilocycles, 250 watts. Sun, 11 am-12 noon, church programs; 6-7 pm, 7:30-9 pm. Daily ex Sun & Thurs, 7-9 pm. Mountain standard time. Divides time with KFEL. Slogan: "The KOW Station Away Out West."
- KPCB** Snowflake Station, Central Bldg., Seattle, Wash. 230.6 meters, 1300 kilocycles, 50 watts. Sun, 8-9 pm. Daily ex Sun, 9:30-10:30 am, household talks. Mon & Wed, 5:30-6 pm, children's program; 6-6:30 pm, sport news. Mon, Wed, Thurs, 7:30-8:30 pm. Mon, Wed, Fri, 7:30 & 9:45 am. Tues, Fri, Sat, 7:30-11 pm. Evening programs, musical. Pacific standard time. Divides time with KGCL.
- KPJM** Prescott, Ariz. 214.2 meters, 1400 kilocycles, 15 watts. Mountain standard time.
- KPLA** Pacific Development Co., Los Angeles, Calif. 252.0 meters, 1190 kilocycles, 500 watts. Daily ex Sun, 11 am-11 pm, music, educational, news, etc. Sun, 7-10 pm. Pacific standard time.
- KPNP** Muscatine, Iowa. 211.1 meters, 1420 kilocycles, 100 watts.
- KPO** Hale Brothers & The Chronicle, San Francisco, Calif. 422.3 meters, 710 kilocycles, 1000 watts. Sun, 9:45 am, church services; 5 pm, chamber music; 6-10 pm, concert, orchestra. Daily ex Sun, 6:45-7:45 am, health exercise; 8-9 am, happy hour; 10:30 am-1 pm, time signals, market reports, etc.; 1-5:30 pm, features, organ music, 6-11 pm, concerts, orchestra, studio programs. Pacific standard time. Slogan: "The City by the Golden Gate."
- KPPC** Pasadena Presbyterian Church, Colorado & Madison sts., Pasadena, Calif. 228.9 meters, 1310 kilocycles, 50 watts. Wed, 6:45-9 pm, mid-week service. Pacific standard time. Divides with KELAV.

JEWELL



INSTRUMENTS

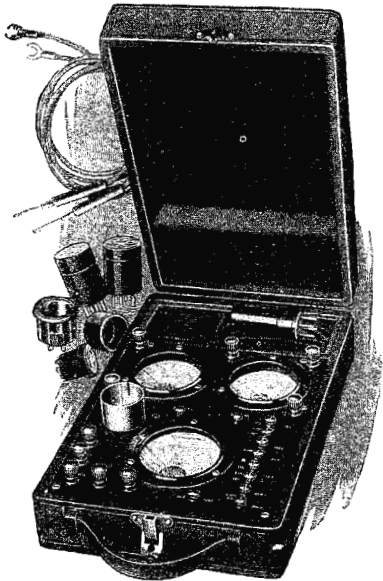

Pattern No. 137
For Radio Service

The Jewell Pattern No. 137 A. C. and D. C. radio set analyzer is the most popular development in radio service equipment. It is very easy to operate, for plainly marked individual push button switches indicate the tests to be made. The instruments incorporated are a 0-150 A. C. voltmeter for checking line voltage and filament voltages of tubes operated in series; a double range 0-3-15 A. C. voltmeter for adjusting filament voltage on the new A. C. tubes, and a D. C. voltmeter having a voltmeter resistance of 1000 ohms per volt; the ranges of this instrument are 0-10-50-100-500 volts and 0-10-100 milliamperes. It maintains the usual high quality of Jewell instruments and is complete in every way.

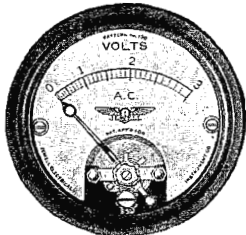

Pattern No. 190
For the Set Builder

The Pattern No. 190 is a flush type 2-inch A. C. voltmeter, which is being used in many of the new A. C. operated radio sets for filament control and for checking line voltage. It is furnished in ranges of 0-1.5, 0-3, 0-5, 0-8, 0-10, 0-15, and 0-150 volts. The movement of Pattern No. 190 is of the moving vane type with special modifications. The instrument is accurate and is designed for continuous service with a very small energy consumption. Movement parts are silver plated and the dial is silver etched with black characters. The pointer is equipped with a zero adjuster.

Satisfaction and Service are Assured with Jewell Instruments

There is an unusual measure of security combined with satisfaction in using Jewell instruments, for the Jewell Electrical Instrument Co. have associated very closely with the radio industry since its beginning and know just what is wanted in measuring instruments.

Every phase of the servicing and testing question is covered by an instrument especially designed for its intended use. New instruments are provided as the demand dictates so that proper testing equipment can be had at all times.

Manufacturers, jobbers, dealers, service men, amateurs, set builders, and set owners—all find Jewell instruments dependable at all times.

All Jewell Instruments are described in our Radio Instrument Catalog No. 15-C. Write for a copy.

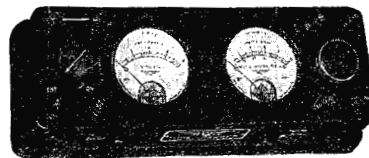

Pattern No. 110-A
For the Radio Dealer

Pattern No. 110-A is a tube tester for checking A. C. tubes. It provides for checking the usual UX tubes and the UV-201-A and 4-prong A. C. tubes. A special adapter is furnished for 5-prong A. C. tubes and also for the UV-199 D. C. tubes. Special binding posts are provided for additional "C" battery in checking power tubes. The instruments incorporated are a filament voltmeter of 0-7.5 volt range and a double scale milliammeter, reading 0-10-50 milliamperes. The scales are sufficiently long to permit close reading. This instrument enjoys the usual high quality in construction found in Jewell instruments and can be depended upon.

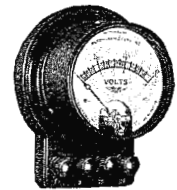

Pattern No. 77
For the Radio Dealer

In the Pattern No. 77 the radio dealer is provided with an instrument which is very flexible in its adaption to the problems arising with the increased use of A. C. radio sets and allied equipment. It enables checking line voltages, filament voltage and also the condition of transformer primaries and secondaries in charging devices. Any of the above troubles may be quickly located with the Pattern No. 77, for its combination ranges of 0-3-15-150 volts are ample to cover all transformer primary voltages and filament voltage for those sets having all tubes in series. It is the best addition that can be made to complete any service man's kit of service equipment.

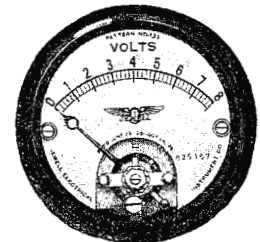

Pattern No. 135
For the Set Builder

Pattern No. 135 is a single reading panel voltmeter for "A" battery checking and for filament control. It eliminates the guess work and chance in the operation and tuning of your radio receiver. The case is two inches in diameter and finished in black enamel. Mounting is accomplished by drilling a hole in the panel which will clear two inches and inserting the instrument which is held securely by a special cup clamped over the back of the instrument. The scale is silver etched with black characters, and all movement parts are silvered. The instrument is very popular with set builders, because of its size and small energy consumption.

Jewell Electrical Instrument Co.

1650 Walnut Street - Chicago

“ 28 Years Making Good Instruments ”

KPRC Houston Post-Dispatch, Houston, Texas. 293.9 meters, 1020 kilocycles, 500 watts. Sun, 11 am, 7:30 pm, church services and music. Daily ex Fri, 7:30-10 pm, studio concert. Daylight broadcasts of weather, music, talks, 11 am, 12 noon, 3 pm. Central standard time. Slogan: "Kotton Port Rail Center."

KPSN The Pasadena Star-News, 525 E. Colorado st., Pasadena, Calif. 315.6 meters, 950 kilocycles, 1000 watts. Tues, Thurs, Sat, 8-9 pm, studio concert. Sun, 10:30 am, church services. Daily ex Sun, 12:15 pm & 6-6:15 pm, news. Slogan: "Pasadena, California, Station KPSN."

KQV Doubleday Hill Elec. Co., 719 Liberty av., Pittsburgh, Pa. 270.1 meters 1110 kilocycles, 500 watts. Mon, Wed, Fri, 4-9 pm. Tues, Thurs, 4-7 pm. Sun, 1 pm, sacred music. Eastern standard time. Slogan: "The Smoky City Station." Divides time with Station WJAS.

KQW California Farm Bureau Station, San Jose, Calif. 296.9 meters, 1010 kilocycles, 500 watts. Daily ex Sun, 1-2:30 pm, music, news, etc.; 5-5:30 pm, Children's Hour; 5:30-6 pm, studio program; 6-7 pm, 7-8 pm, 8-9 pm, studio program. Sun, 10:15 am-12:30 pm, church; 7:30-9:30 pm, church. Pacific standard time. Slogan: "For God and Country."

KRAC Caddo Radio Club, State Fair Grounds, Shreveport, La. 220.4 meters, 1360 kilocycles, 50 watts.

KRE First Congregational Church and Pacific School of Religion, Berkeley, Calif. 256.3 meters, 1170 kilocycles, 100 watts. Sun, 7:30-9 pm. Mon, Tues, Wed, Thurs, 12:30 noon-1 pm. Tues, 8-9 pm. Pacific standard time. Divides time with KFUS.

KRLD The Daily Times Herald & The Adolphus Hotel, Dallas, Tex. 461.3 meters, 650 kilocycles, 500 watts. Sun, 9:30-10:30 am. 11 am-12 noon, 3-4 pm. 5:30-6:30 pm. 6:30-6:45 pm, church; 6:45-7:30 pm, 7:30-9:30 pm, 10:30-11:30 pm. Daily ex Sun, 11-11:30 am, 12:30-2 pm, 3-3:30 pm, 5-6 pm, 7-8 pm, 9:10 pm, 11:30 pm-12:30 am, varied programs. Central standard time. Divides time with WRR. Slogan: "Down Where the Blue Bonnets Grow."

KRLO Los Angeles, California, 215.7 meters, 1390 kilocycles, 250 watts. Divides time with KGER.

KRSC Radio Sales Corp., 1202 Fifth av., Seattle Wash. 211.1 meters 1420 kilocycles, 50 watts.

KSAC Kansas State Agricultural College, Manhattan, Kan. 333.1 meters, 900 kilocycles, 500 watts. Daily ex Sat & Sun, 9-10:25 pm, 12:20-1:20 pm, 4-4:30 pm, 6:30-7 pm, 7-8 pm, varied programs. Sat, 12:35 pm, 7:30-8:30 pm. Central standard time.

KSBA Shreveport Broadcasting Association, Shreveport, La. 267.7 meters, 1120 kilocycles, 1000 watts. Sun, 11 am-12 noon, church services; 5-6 pm, musical; 7:30-9 pm, church services. Mon, Wed, Thurs, Fri, 8-9, musical. Tues & Sat, 9-11 pm, Hotel You're dance music. Mon, 11 pm-12 midnight, organ. Daily, 9:15 am, 12:15 pm and 2:15 pm, market and weather reports. Central standard time. Slogan: "Keep Shreveport Before America."

KSCJ The Sioux City Journal, Sioux City, Iowa. 243.8 meters, 1230 kilocycles, 500 watts night, 1000 watts daytime. Sun, 11-12 am, 2-4 pm, 7-9 pm. Daily ex Sun, 9:45-10:45 am, markets; 11:30 am-12:30 pm, noon program; 6-7 pm, dinner program; 8:30-midnight, studio program. Central standard time. Divides time with Station KWUC.

KSD St. Louis Post-Dispatch, 12th & Olive sts., St. Louis, Mo. 545.1 meters, 550 kilocycles, 500 watts. Sun, 2 pm, 6:20 pm, Capitol Family; 8 pm; 8:15 pm, Atwater-Kent hour. Daily ex Sun, 7-11 pm. Central standard time.

KSEI KSEI Broadcasting Association, Pocatello, Idaho. 333.1 meters, 900 kilocycles, 250 watts. Sun, 9-11 pm. Daily ex Sun, 3-4 pm, 6:30-7:30 pm, 9-11 pm. Mountain time. Slogan: "Kummunity Southeast Idaho."

KSL Utah Radio Service Corp., South Temple St., Salt Lake City, Utah. 302.8 meters, 990 kilocycles, 1000 watts. Sun, 10 am, 12 noon, 1:55 pm, 4-5 pm, 7:30-8:30 pm, 9-10 pm. Daily ex Sun, 10 am-12 noon, 4-5 pm, 6:30-8 pm, 9-10 pm, 11 pm, 12 midnight. Slogan: "The Voice of the Inter-Mountain Empire."

KSMR Santa Maria Valley R. R., Santa Maria, Calif. 272.6 meters, 1100 kilocycles, 100 watts. Daily ex Sat & Sun, 10:30 am-1 pm, 5-9:30 pm, music, home and farm. Sat, 7:30-8 pm, markets, reports, music, etc. Pacific time. Slogan: "The Valley of Gardens."

KSO Berry Seed Co., Clarinda, Iowa. 227.1 meters, 1320 kilocycles, 500 watts, Sun, 11 am, church services; 5 pm. Mon, Tues, Wed, Thurs, Fri & Sat, 6:30-8:30 am, 10:30-11 am, 12 noon, 1:15 pm, 3-4 pm, 6:30-9 pm ex Sat. when program is 7-10 pm. Sat, 6 am, 12 noon, 7-8:30 pm. Central standard time. Slogan: "Keep Serving Others."

KSOO Sioux Falls Broadcast Association, 219 Phillips Ave., Sioux Falls, S. D. 209.7 meters, 1430 kilocycles, 250 watts nights, 500 watts daytime.

KTAB The Associated Broadcasters (Inc.), 1410 10th av., Oakland, Calif. 280.2 meters, 1070 kilocycles, 500 watts. Sun, 9:45-12:30 pm, 1:30-2:30 pm, 7-9:15 pm, varied program. Daily ex Sun, 6:45 am, 1:30 pm, 4-7:30 pm, 8-11 pm. Pacific standard time. Slogan: "Knowledge, Truth and Beauty."

KTAP Radio Service Shop, 822 W. Mulberry St., San Antonio, Tex. 228.9 meters, 1310 kilocycles, 20 watts. Sun, 4-6 pm, varied musical program; 9:30-10:30 pm. Daily ex Sun, 6:30-8:30 am, 10:30-11:30 am, 12:30-2 pm. Mon, Wed & Sat, 6:30-8:30 pm. Daily ex Mon, 9:30-10:30 pm. Varied programs. Central standard time. Slogan: "The World's Biggest Little Station."

KTBI Bible Institute of Los Angeles, 536 S. Hope st., Los Angeles, Calif. 283.3 meters, 1040 kilocycles, 500 watts. Mon, Tues, Wed, Thurs, 8 pm, musical studio program. Fri, 7 pm, Sunday school lessons. Sun, 10:45 am, 7:15 pm, church services; 6 pm, vespers. Pacific standard time.

KTBR M. E. Brown, Commodore Hotel, 16th & Morrison Sts., Portland, Ore. 282.8 meters, 1060 kilocycles, 50 watts. Sun, 10:30 am-12 noon, church; 1-7:30 pm, 7:30-9 pm. Daily ex Sun, 9-11 am, 1-3 pm, 6-7 pm. Mon, Tues, Sat, 8-9 pm. Wed, Thurs, Fri, 8 pm-12 midnight. Pacific standard time. Divides time with KFJR.

KTHS The Arlington Hotel, Hot Springs National Park, Ark. 384.4 meters, 780 kilocycles, 1000 watts. Sun, 11 am-12:30 pm, 8-11:30 pm. Mon, Tues, Fri, Sat, 12 noon-1 pm. Mon & Wed, 7:30-10:30. Tues, 6-10:30 pm. Fri & Sat, 8-11 pm. Central standard time. Slogan: "Kum to Hot Springs."

KTNT Norman Baker, Muscatine, Iowa. 256.3 meters, 1170 kilocycles, 2000 watts. Sun, 12 noon, sacred program; 2:30-4 pm, varied program. Daily ex Sun, 6-7:30, 9-11 am; 12-1, 3-4:15, 6-9 pm. Central standard time. Slogan: "The Voice of the Iowa Farmers' Union."

KTSA San Antonio, Tex. 265.3 meters, 1130 kilocycles, 2000 watts.

KTUE Uhalt Electric Co., 614 Fannin St., Houston, Tex. 212.6 meters, 1410 kilocycles, 5 watts. Daily, 5:30-6:30 pm. Tues & Sat, 8-9:30 pm. Central standard time.

KTW First Presbyterian Church, 7th av. and Spring st., Seattle, Wash. 394.5 meters, 760 kilocycles, 1000 watts. Sun, 11 am to 1 pm, 3-4 pm, 7:30-9:30 pm. Pacific time. Divides time with KWSC & KOB.

KUJ Seattle, Wash. 199.9 meters, 1500 kilocycles, 10 watts. Pacific standard time.

KUOA University of Arkansas, Fayetteville, Ark. 296.9 meters, 1010 kilocycles, 500 watts. Sun, 7:30 pm. Mon & Thurs, 7 pm, radio school; 8 pm, musical program. Central standard time.

KUOM State University of Montana, Missoula, Mont. 461.3 meters, 650 kilocycles, 500 watts. Mon & Thurs, 8 pm, music & popular educational talks. Sun, 9:15 pm, sacred concert & sermon. Mountain standard time.

KUSD University of South Dakota, Vermillion, S. D. 483.6 meters, 620 kilocycles, 250 watts. Mon & Fri, 6:45-7:45 pm. Wed, 9-10 pm. College events broadcast as they occur. Central standard time.

KUT University of Texas, Austin, Tex. 232.4 meters, 1290 kilocycles, 500 watts. Mon, Wed & Fri, 8 pm. Studio program. Slogan: "Come to University of Texas."

KVI Puget Sound Radio Broadcasting Co., 15 N. Tacoma av., Tacoma, Wash. 234.2 meters, 1280 kilocycles, 50 watts. Sun, 11 am-12:30 pm, 7:30-9 pm. Daily ex Sun, 8-10 am, 3-10 pm. Pacific standard time. Slogan: "Puget Sound Station."

KVL Seattle, Wash. 202.6 meters, 1480 kilocycles, 100 watts. Pacific standard time.

KVOO South Western Sales Corp., Tulsa, Okla. 348.6 meters, 860 kilocycles, 1000 watts. Sun, 8 am-12 noon, church; 5:10 pm, musical entertainment. Daily ex Sun, 11 am, markets; 12 noon-1 pm, farmer's hour; 2:45 pm, markets; 3-4 pm, music; 6-10:30 pm, varied musical, Red, Blue & Mid-West network programs. Central standard time. Slogan: "The Voice of Oklahoma."

KVOS L. Kessler, Henry Hotel, Bellingham, Wash. 209.7 meters, 1430 kilocycles, 50 watts.

KWBS Schaeffer Radio Co., 226 E. 41st st., Portland, Ore. 199.9 meters, 1500 kilocycles, 15 watts.

KWCR H. F. Farr, 1444 2nd av. E., Cedar Rapids, Ia. 239.9 meters, 1250 kilocycles, 250 watts. Daily, 6:30 am, chapel services; 11:30 am, music hour; 4 pm, music; 5:30 pm; 6-7 pm, dinner hour. Mon, Wed, Fri, 9 pm. Central standard time. Divides time with WJAM. Slogan: "Voice of Cedar Rapids."

KWG Portable Wireless Telephone Co., 530 E. Market st., Port Stockton, Calif. 344.6 meters, 870 kilocycles, 50 watts. Sun, 4:30-5:30 pm, concert; 7:30-9:30 pm, services; 9:30-10:30, organ recital. Daily ex Sun, 4:5 pm, news & markets; 5-6 pm, part paragraphs; 6-7:30 pm, dinner concert; 8-9 pm, studio; 9-10 pm, studio. Pacific time.

KWJJ Wilbur Jerman Station, Route No. 1, Box 481, Portland, Ore. 228.9 meters, 1310 kilocycles, 50 watts. Studio at Broadway Theater, 220 Broadway st. Daily ex Sun, 10 am-12 noon, 3-4 pm. Mon & Wed, 5:30 pm-1 am. Tues & Thurs, 5:30 pm-12 midnight. Fri, 5:30 pm-12:30 am. Sat, 5:30-8 pm, 10 pm-12 midnight, dance music. Pacific standard time. Slogan: "The Voice from Broadway."

30 UP-TO-DATE Selections 30

with this **Portable Phonograph**



Folds Like a Suitcase

with snap locks and carrying handle. So light and convenient—easily carried wherever you want it. Take it along to parties where you want to dance and sing, or listen to good music. Take it with you on trips. Holds 15 records. Weighs only 17 lbs. Full size, not a toy.

When you play it, put it on the table, on the floor—anywhere that is handy. And when not in use, fold it up if you wish and put it away. You don't have to give up any space to this portable phonograph.

Sensational offer. A special assortment of up-to-date high-grade 75c records—30 selections in all, 15 double face records—are included on this wonderful offer. These records are made by the wonderful new electric process—more life like, more volume, less surface noise than ever. And they play longer. Very latest selections, popular songs, dance music, band and instrumental pieces—\$11.25 worth of brand new records included with this outfit. And we've picked out just the kind of records to please you most. Read our wonderful offer below.

30 Days Trial

Yes, we'll send this Puritone portable phonograph outfit, with 30 high grade selections, 15 double face 75c records, to your home on 30 days' trial for only \$1.00 with the coupon. Use it as your own and see what a wonderful convenience it is to have a phonograph that you can carry from room to room, from place to place, wherever and whenever you want it.

We Guarantee: that you get everything in this phonograph so far as concerns music reproduction that a \$250 phonograph can give you. True, you don't get the big furniture, but you do get (and we guarantee it) the exact reproducer, the exact style of tone arm and the same grade of records you get in the most expensive phonograph ever made. That's why you get, on this wonderful offer, absolutely the best in music that any phonograph ever gave.

\$2.60 a Month

Use the outfit on 30 days' trial, on that guarantee. If within 30 days you decide not to keep the outfit, send it back and we'll refund your \$1.00 plus all transportation charges. If you keep it, pay only \$2.60 a month until you have paid that sensational price on this special sale—only \$26.85. Think of it, a first-class high grade phonograph, more convenient and more

useful than an ordinary phonograph and 15 high-grade, up-to-date, double face records—(30 selections) a complete outfit, ready to play for only \$26.85!

Send NOW

Seize this opportunity on this special sale, while it lasts. Only \$1.00 with the coupon brings the complete outfit on 30 days' trial. Remember, 15 Double Face 75c New Electric Process records, 30 up-to-date selections—are included with this outfit. Send the coupon NOW.

FREE Catalog

of home furnishings sent on request with or without order. See coupon.

This Portable Phonograph

plays any make of 10-inch disc records including Edison, and plays two ten-inch records with one winding. Weighs 17 lbs. Waterproof imitation leather case, with hinged lid, closes up like a small suitcase with snap locks and carrying handle. Measures 14 1/2 x 12 x 7 1/2 in. Records placed inside of lid and secured so they will not rattle or break. Holds 15 records. Has quiet spring motor, tone arm and reproducer with indestructible diaphragm and wide throat for full sound volume. Reproducer is reversible for Edison records. Outfit includes 15 double face 75c New Electric Process records—30 selections. A complete record library without buying a single one! Shpg. wgt. packed about 25 lbs.

Order by No. W8824JA—only \$1.00 with coupon, \$2.60 monthly. Total price, \$26.85.

Straus & Schram, Dept. 1513 Chicago, Ill.

Enclosed find \$1. Ship special advertised Puritone Portable Phonograph with 15 Double Face 75c New Electric Process records—30 selections. I am to have 30 days free trial. If I keep the outfit, I will pay you \$2.60 monthly. If not satisfied, am to return the phonograph and records within 30 days and you are to refund my dollar and express charges I paid. Puritone Portable Phonograph and 15 Double Face Records, W8824JA, \$26.85

Name.....
 Street, R.F.D.
 or Box No.
 Shipping Point.....
 Post Office..... State.....
 Married..... Nationality.....
 or Single!..... or Color.....

If you want only our free catalog of home furnishings, mark X here

Straus & Schram, Dept. 1513 Chicago, Ill.

Tell 'Em You Saw It in the Citizens Radio Call Book Magazine

KWK Greater St. Louis Broadcasting Corp., 4965 Lindell Blvd., St. Louis, Mo. 234.2 metres, 1280 kilocycles, 1000 watts night, 2000 watts daytime. Central standard time. Divides time with KFQA & WMAV.

KWKC Wilson Duncan Studios, 39th & Main sts., Kansas City, Mo. 222.1 metres, 1350 kilocycles, 100 watts. Tues, Wed, Thurs, Fri, 7-9:15 pm. Central standard time. Slogan: "Keep Watching Kansas City."

KWKH W. K. Henderson Iron Works & Supply Co., Spring & Fanning sts., Shreveport, La. 394.5 metres, 760 kilocycles, 1000 watts. Divides time with KMA.

KWLC Luther College, Decorah, Iowa. 247.8 metres, 1210 kilocycles, 50 watts. Central standard time. Divides time with KGCA.

KWSC The State College of Washington, Pullman, Wash. 394.5 metres, 760 kilocycles, 500 watts. Mon, Wed, Fri, 7:30-9 pm. Pacific standard time. Slogan: "The Voice of the Cougars." Divides time with Stations KTW, KOB.

KWTC Dr. John Wesley Hancock, 1101 N. Ross St., Santa Ana, Calif. 222.1 metres, 1350 kilocycles, 100 watts. Daily ex Sun, 5:30-7 pm, dinner hour. Tues, 8-10 pm. Thurs, 7-10 pm, studio program. Fri, 7-8 pm, Farm Bureau Feature. Sat, 7-9 pm. Pacific standard time. Divides time with KFWC. Slogan: "Kum West to California."

KWUC Western Union College, Le Mars, Iowa. Commercial Studio, Wright Bldg., Sioux City, Iowa. 243.8 metres, 1230 kilocycles, 1500 watts. Sun, 4-5 pm, vesper service. Daily ex Sun, 9:30-11:15 am; 12:30-4 pm; 5-7 pm, musical, organ. Sat, 10 pm, college frolic. Central standard time. Divides time with Station KSCJ. Slogan: "The Station Surrounded by North America."

KWWG Lone Star Broadcast Company, Inc., Brownsville, Tex. 277.6 metres, 1080 kilocycles, 500 watts. Sun, church services at 2:30 pm. Mon, Tues, Thurs & Fri, 8:30-9:30 am, shoppers' hour; 12 noon and 4 pm, weather and market reports; 8:30-9:30 pm, musical program. Wed, midnight, Coat Hangers Club. Sat, 8:30-9:30 am, shoppers' hour; noon and 4 pm, weather and markets. Wed, Thurs, Fri, Sat, same as Tues. Slogan: "Goodnight, World."

KXL KXL Broadcasters, Inc., 7th floor Biedell Bldg., Portland, Ore. 220.4 metres, 1360 kilocycles, 50 watts. Slogan: "The Voice of Portland."

KXRO Brott Laboratories, 609 Washington Blvd., Seattle, Wash. 227.1 metres, 1320 kilocycles, 50 watts.

KYA Pacific Broadcasting Corp., West Coast Theaters Studio, 988 Market St., San Francisco, Calif. 309.1 metres, 970 kilocycles, 500 watts. Sun, 11 am-12:30 pm, 7:30-9 pm, church. Daily ex Sun, 9 am-12 noon, 5-7:30 pm, 8-11 pm. Pacific standard time.

KYW Westinghouse Elec. & Mfg. Co., roof of Congress Hotel, Chicago, Ill. 526.0 metres, 570 kilocycles, 5000 watts, after 10 pm 2500 watts. Sun, 11 am-12:15 pm, church; 1-2, 7:15-8:15 pm, 10:55-11 pm, time signals & weather reports. Daily ex Sun, 10:55 am, time signals; 5:45 pm, markets; 6 pm, Uncle Bob's Bedtime Story; 6:30 pm, weather report. Daily ex Mon, 10:55-11:05, time signals. Mon & Thurs, 12 noon-1 pm, studio program. Tues & Fri, 4 pm, Women's Hour; 7-9 pm, program from New York; 9-10:55 pm, music. Wed, Thurs, Fri, 6:32-7 pm, dinner concert. Mon, 6:30-7 pm, Roxy and His Gang from WJZ, N.Y. Wed, 7-7:30 pm, program from WJZ, N.Y.; 7:30-8 pm, studio program; 8-9 pm, program from New York; 9-10:55, musical program, etc. Thurs, 7-8 pm, studio program; 8-9:30 pm, program from New York; 9:30-10:55 pm, musical program. Sat, 7-10:55 pm, music, etc. Central standard time. Divides time with KFKX.

KZM Preston D. Allen, 13th & Harrison sts., Hotel Oakland, Oakland, Calif. 245.8 metres, 1220 kilocycles, 100 watts. Daily ex Sun, 6:30-8 pm, Hotel Oakland dinner orchestra. Sun, 8-10 pm, orchestra. Pacific standard time. Divides time with KLS.

NAA United States Navy, Washington, D. C. 434.5 metres, 690 kilocycles, 1000 watts. Daily weather broadcast 10:05 am, 3:45 pm, 10:05 pm. Fri, 7:30 pm, alternately, talks. Daily time signals, noon & 10 pm. This station is located at Navy Yard, Washington, D. C. Slogan: "Where the Time Signals Originate."

NAA United States Navy, Radio Station, Arlington, Va. Broadcast time signals daily at noon and 10 pm on the following meters or frequencies: Meters, 25.0, 12045; 37.3, 8030; 74.7, 4015; 2678.0, 112; 434.5, 690.

WAAD Ohio Mechanics Institute, Cincinnati, Ohio. 230.6 metres, 1300 kilocycles, 25 watts. Eastern standard time.

WAAF Chicago Daily Drivers Journal, 836 Exchange av., Chicago, Ill. 389.4 metres, 770 kilocycles, 500 watts. Daily ex Sun, & holidays, 8:45 am, markets; 10:30 am, weather; 10:50 am, markets; 11 am, estimated receipts of following day; 12:30 pm, weather; 12:50 pm, markets; 3 pm, markets; 4:30 pm, eastern meat trade conditions. Sat, 12:30 pm, final weather & market reports. Central standard time. Divides time with WJBT and WBBM.

WAAM I. R. Nelson Co., 1 Bond st., Newark, N. J. 267.7 metres, 1120 kilocycles, 250 watts night, 500 watts daytime. Sun, 11 am-12:30 pm, 3:30-6:30 pm. Daily ex Sun, 7-8 am, 11 am-1:30 pm. Mon & Thurs, 10 pm-12:30 midnight. Tues & Wed, 6-8 pm. Fri & Sat, 8-10 pm. Eastern standard time. Divides time with WNJ & WBCP. Slogan: "Sunshine Station."

WAAT Bremer Broadcasting Corp., Hotel Plaza, Jersey City, N. J. 245.8 metres, 1220 kilocycles, 300 watts. Sun, 9 am, 5:30-11 pm, mixed program. Daily ex Sun, 10:30-11 am, 6-6:45 pm. Tues, Wed, Fri, 11 am. Tues & Sat, 12 noon. Mon, 8-11 pm. Tues, 7-8:45 pm. Wed & Fri, 7 pm. Thurs & Sat, 7-9 pm. Eastern standard time. Divides time with Stations WEVD & WGBB. Slogan: "The Voice at the Gate of the Garden State."

WAAW Omaha Grain Exchange, Grain Exchange bldg., Omaha, Neb. 440.9 metres, 680 kilocycles, 500 watts daytime only. Daily ex Sun, 6 am, Oma-Tan Program Harness Bill; 9:30 am-1:40 pm, market reports; 1:30-2:30 pm, program; 5-6 pm, Oma-Tan program. Central standard time. Slogan: "Pioneer Market Station of the West."

WABC Atlantic Broadcasting Corp., Richmond Hill, N. Y. Studios, 113 W. 57th St., New York. 309.1 metres, 970 kilocycles, 2500 watts night, 5000 watts daytime. Sun, 10:50 am-1 pm, 7-9 pm. Daily ex Sun, 11:50 am-12:05 pm, weather reports & time signals, 1-2 pm. Daily ex Tues & Sun, 7:15 pm-12 midnight. Eastern standard time. Divides time with WBOQ.

WABF Markle Broadcasting Corp., 292 Wyoming av., Kingston, Pa. 205.4 metres, 1460 kilocycles, 250 watts. Sun, 9:30-10:30 am; 10:30 am-12 noon, church; 7:30-9 pm. Daily ex Sun, 12 noon-1 pm, luncheon program. Mon, 7-9 pm, music. Wed & Fri, 7:30-9 pm, music. Eastern standard time. Slogan: "The Voice of Wyoming Valley."

WABI First Universalist Church, Park st., Bangor, Me. 389.4 metres, 770 kilocycles, 100 watts. Sun, 10:30 am-12 pm, morning services; 7:30-9 pm, evening services. Eastern standard time. Slogan: "The Pinetree Wave."

WABW College of Wooster, Wooster, Ohio. 247.8 metres, 1210 kilocycles, 50 watts. No regular schedule. Eastern standard time.

WABY John Magaldi, Jr., 930 S. 8th st., Philadelphia, Pa. 247.8 metres, 1210 kilocycles, 50 watts. Eastern standard time. Divides time with WFKD.

WABZ Coliseum Pl. Baptist Church, 1376 Camp St., New Orleans, La. 238.0 metres, 1260 kilocycles, 50 watts. Sun, 10:55 am to 12:30-7:25 to 9:15 pm. Central standard time. Divides time with WJBW. Slogan: "The Station with a Message."

WADC Allen Theatre Broadcasting Station, Towell Cadillac Bldg., Akron, Ohio. 238 metres, 1260 kilocycles, 1000 watts. Sun, 10:30-11:45 am, 12:30-1:30 pm, 3-5 pm, 8-11 pm. Daily ex Sun, 11 am-12 noon, 5:30-6 pm. Daily ex Sat, 8-11 pm. Eastern standard time. Slogan: "Watch Akron Develop Commercially."

WAFD WAFD Broadcasting Co., Addison Hotel, Charlotte & Woodward Aves., Detroit, Mich. 230.6 metres, 1300 kilocycles, 100 watts. Menu service, 2 pm daily. Dinner music, 6:45 pm. Daily studio program, 7:30 pm daily ex Sat. Eastern standard time.

WAGM R. L. Miller, Royal Oak, Mich. 225.4 metres, 1330 kilocycles, 50 watts. Sun, Mon, Wed & Fri, 8-10:30 pm. Slogan: "The Little Station With the Big Reputation."

WAIT A. H. Waite & Co. (Inc.), 32 Weir st., Taunton, Mass. 214.2 metres, 1400 kilocycles, 10 watts. No regular schedule. Eastern standard time.

WAIU American Insurance Union, Columbus, Ohio. 282.8 metres, 1060 kilocycles, 5000 watts. Daily ex Sun, 10:30 through 12 noon. Daily ex Sat & Sun, 3-6:30 pm. Mon & Wed, 6-10 pm. Tues & Thurs, 6-6:30 pm. Fri, 6-10:30 pm. Talks, music, weather reports & chain programs. Sun, 3 through 4 pm, 7:15 through 10:30 pm. Eastern standard time. Divides time with WEO. Slogan: "The Radio Voice of the American Insurance Union."

WAIZ Appleton, Wis. 227.1 metres, 1320 kilocycles, 100 watts. Central standard time.

WALK Bethayres, Pa. 201.6 metres, 1490 kilocycles, 50 watts.

WAMD Radisson Radio Corp. & Stanley E. Hubbard, Minneapolis, Minn. 222.1 metres, 1350 kilocycles, 500 watts. Sun, 10:30 am, church; 12:30, funnies; 3 pm, popular program; 5:30 pm, concert; 9:30 pm, popular. Daily ex Sun, 10:30 am, musical; 11 am, Aunt Sammy; 12 noon & 5:30 pm, organ; 6:05 pm, farm feature; 7 pm, classical hour; 8-9 pm, popular program; 10 pm, dance music; 11:15 pm, organ. Central standard time. Divides time with KFOY. Slogan: "The Call of the North."

WAPI Alabama Polytechnic Institute, Auburn, Ala. 340.7 metres, 880 kilocycles, 1000 watts. Daily ex Sun, 12-1 pm, 9-10 pm Tues, Thurs, Fri. All programs include musical numbers, educational lectures and news. Central standard time. Divides time with WJAX.

WARS & WSDA Amateur Radio Specialty Co., Hotel Shelburne, Brooklyn, N. Y. 227.1 metres, 1320 kilocycles, 500 watts. Sun, 7-9 am, 12:30-3 pm. Mon, Wed, Thurs, Fri, 7-8 am, 9-10 am. Mon & Fri, 8-10 pm. Wed & Fri, 3-6 pm. Tues & Thurs, 12 noon-2 pm. Mon, 3-7 pm. Wed, 7-10 pm. Thurs, 6-7 pm, 10 pm-12 midnight. Sat, 7-9 am, 1-3:30 pm, 9 pm-12 midnight. Eastern standard time. Divides time with WBBC. Slogan: "The Voice of the Atlantic."

WASH Baxter Launderers & Cleaners, 747 Fountain st., N. E., Grand Rapids, Mich. 256.3 metres, 1170 kilocycles, 250 watts. Sun, 10-11:30 am, 4-5 pm, 6:45-8:30 pm. Daily ex Sun, 12:30-1:30, 5:30-6, 7-8 pm. Sat, 2:15 pm (football season only). Central standard time.

I Will Train You at Home to Fill a Big-Pay Radio Job



Here's the PROOF



Made \$185 in Three Weeks' Spare Time

"I have met with continued success. For instance, recently I realized a profit of \$185 in three weeks for spare time work. I charge \$1.50 an hour. Right now I am making more money in my spare time than I am making in my regular job. I am going to give up my present position and open a radio shop. The N.R.I. has put me on the solid road to success."

Peter J. Dunn, 901 N. Monroe St., Baltimore, Md.

Made \$588 in One Month
"The training I received from you has done me a world of good. Some time ago, during one of our busy months, I made \$588. I am servicing all makes of Radio receiving sets. My boss is highly pleased with my work since I have been able to handle our entire output of sets here alone." Herbert Reese, 2215 South "E" Street, Elwood, Indiana.



Earns Price of Course in One Week Spare Time

"I have been so busy with Radio work that I have not had time to study. The other week, in spare time, I earned enough to pay for my course. Recently I made enough money in one month spare time to pay for a \$375 beautiful console for all-electric Radio. When I enrolled I did not know the difference between a rheostat and a coil. Now I am making all kinds of money."

IF you are earning a penny less than \$50 a week, I send for my book of information on the opportunities in Radio. It's FREE. Clip the coupon NOW. A flood of gold is pouring into this new business, creating hundreds of big pay jobs. Why go along at \$25, \$30 or \$45 a week when the good jobs in Radio pay \$50, \$75 and up to \$250 a week. My book "Rich Rewards in Radio" gives full information on these big jobs and explains how you can quickly become a Radio Expert through my easy, practical home-study training.

Salaries of \$50 to \$250 a Week Not Unusual

Get into this live-wire profession of quick success. Radio needs trained men. The amazing growth of the Radio business has astounded the world. In a few short years three hundred thousand jobs have been created. And the biggest growth of Radio is still to come. That's why salaries of \$50 to \$250 a week are not unusual. Radio simply hasn't got nearly the number of thoroughly trained men it needs. Study Radio and after only a short time land yourself a REAL job with a REAL future.

You Can Learn Quickly and Easily in Spare Time

Hundreds of N. R. I. trained men are today making big money—holding down big jobs—in the Radio field. Men just like you—their only advantage is training. You, too, can become a Radio Expert just as they did by our new practical methods. Our tested, clear training makes it easy for you to learn. You can stay home, hold your job, and learn quickly in your spare time. Lack of education or experience are no drawbacks. You can read and write. That's enough.

Many Earn \$15, \$20, \$30 Weekly on the Side While Learning

My Radio course is the famous course "that pays for itself." I teach you to begin making money almost the day you enroll.

My new practical method makes this possible. I give you SIX BIG OUTFITS of Radio parts with my course. You are taught to build practically every type of receiving set known. M. E. Sullivan, 412 73rd Street, Brooklyn, N. Y., writes, "I made \$720 while studying." Earle Cummings, 18 Webster Street, Haverhill, Mass.; "I made \$375 in one month." G. W. Page, 1807 21st Ave., Nashville, Tenn. "I picked up \$935 in my spare time while studying."

Your Money Back if Not Satisfied

I'll give you just the training you need to get into the Radio business. My course fits you for all lines—manufacturing, selling, servicing sets, in business for yourself, operating on board ship or in a broadcasting station—and many others. I back up my training with a signed agreement to refund every penny of your money if, after completion you are not satisfied with the course I give you.

ACT NOW—64-Page Book Is FREE

Send for this book of Radio information. It won't cost you a penny. It has put hundreds of fellows on the road to bigger pay and success. Get it. Investigate. See what Radio has to offer you, and how my Employment Department helps you get into Radio after you graduate. Clip or tear out the coupon and mail it RIGHT NOW.

J. E. Smith, President, Dept. 3D, National Radio Institute, Washington, D. C.



You can build 100 circuits with the six big outfits of Radio parts I give you

3 of the 100 you can build

Find out quick about this practical way to big pay

Mail This FREE COUPON Today

J. E. SMITH, President, Dept. 3D, National Radio Institute, Washington, D. C.

Dear Mr. Smith—Kindly send me your big book "Rich Rewards in Radio," giving information on the big-money opportunities in Radio and your practical method of teaching with six big Outfits. I understand this book is free, and that this places me under no obligation whatever.

Name..... Age.....
Address.....
City..... State.....
Occupation.....

Employment Service to all Graduates Originators of Radio Home Study Training

Tell 'Em You Saw It in the Citizens Radio Call Book Magazine

WATT Edison Elec. Illuminating Co., 39 Boylston, Boston, Mass. (portable). 201.6 meters, 1490 kilocycles, 100 watts.

WBAA Purdue University, West Lafayette, Ind. 272.6 meters, 1100 kilocycles, 500 watts. Daily, 11:15 am, markets, etc. Mon & Fri, 7 pm, music and talks. Athletic contests and special features as announced. Central standard time. Divides time with WRM.

WBAK Pennsylvania State Police, 18th & Herr sts., Harrisburg, Pa. 299.8 meters, 1000 kilocycles, 500 watts. Daily ex Sun, 10:30 am, police reports; 1:30 pm, 4 pm. Mon & Thurs, 7 pm. Eastern standard time. Divides time with WPSC. Slogan: "The Voice of Pennsylvania."

WBAL Baltimore, Md. 285.5 meters, 1050 kilocycles, 5000 watts. Sun, 5:30-6:30 pm, church; 6:30-7 pm, travelogue; 7-8 pm, orchestra; 8 pm, special musical program. Daily ex Sat, 3:30-5 pm, 6-11 pm. Sat, 6:30-11 pm. Eastern standard time. Slogan: "The Station of Good Music."

WBAO James Millikin University, Decatur, Ill. 267.7 meters, 1120 kilocycles, 100 watts. Mon, Wed, 7-8 pm, music & lectures. Thur, Fri, Sat, basketball & football games whenever scheduled. Central standard time. Slogan: "Millikin at Decatur."

WBAP Carter Publications (Inc.), 400 W. 7th st., Fort Worth, Tex. 499.7 meters, 600 kilocycles, 5000 watts. Sun, 1-7 pm, 9-15 pm-12 midnight. Daily ex Sun, 8 am, 9 am, 10 am, 11 am, 12 noon, 1 pm, 2 pm, 3 pm, 6-7 pm. Mon, Thurs, Fri, 10 pm-12 midnight. Central standard time. Divides time with Station WOAI.

WBAW Waldrum Drug Co. & Braid Electric Co., 7th av., South & Broad sts., Nashville, Tenn. 239.9 meters, 1250 kilocycles, 500 watts. Divides time with WOAN.

WBAX John H. Stenger, Jr., 66 Gildersleeve, Box 104, Wilkes-Barre, Pa. 249.9 meters, 1200 kilocycles, 100 watts. 6:30 pm, studio. Mon, 7-8 dance music. Tues, 7-9 pm, main studio; 10:30 pm, classical. Thurs, 9-10:30 pm, recital; 3:15-5 pm, lectures; 11:15-2 am, witching hour. Sat, 10-12 pm, dance. Eastern standard time. Divides time with WBRE. Slogan: "In Wyoming Valley, Home of the Anthracite."

WBBC Brooklyn Broadcasting Corp., 16 Court St., New York, N. Y. 227.1 meters, 1320 kilocycles, 500 watts. Daily, 8-12 pm, musical. Eastern time. Divides time with WARS-WSDA & WSGH.

WBBL Grace Covenant Presbyterian Church, Richmond, Va. 234.2 meters, 1280 kilocycles, 100 watts. Sun, 11 am-7:45 pm. Tues, 8 pm. Eastern standard time. Slogan: "Richmond, the Gateway North and South."

WBBM WBBM Air Theatre, 306 S. Wabash av., Chicago, Ill. 389.4 meters, 770 kilocycles, 5000 watts. Daily ex Sun & Mon, 12:45-2 pm, 7-11 pm. Mon, 12:30-2 pm, 6-7 pm. Sat, 12 midnight-2 am. Silent Sun. Central standard time. Divides time with Stations WJBT and WAAF.

WBBP Petoskey High School, Petoskey, Mich. 239.9 meters, 1250 kilocycles, 100 watts. Program irregular. Central standard time. Slogan: "There's Only One Petoskey."

WBBR People's Pulpit Association, 117 Adams St., Brooklyn, N. Y. 256.3 meters, 1170 kilocycles, 1000 watts. Sun, 10-12 am, orchestra, lectures, lessons; 2-4:30 pm, concert; 7-9 pm, Bible questions, music. Daily ex Sun & Sat, 2-4 pm. Mon, Tues, Thurs, Fri, 7-9 pm. Wed, 6-7 pm. Eastern standard time. Slogan: "Watchtower."

WBBY Washington Light Infantry, 240 King st., Charleston, S. C. 249.9 meters, 1200 kilocycles, 75 watts. Irregular through week. Sat, 7-12 pm, orchestra, vocal, instrumental and talks. Eastern time. Slogan: "The Seaport of the Southeast."

WBBZ C. L. Carrell, 36 S. State st., Chicago, Ill. (Portable). 204.0 meters, 1470 kilocycles, 100 watts. Central standard time.

WBBCN Great Lakes Broadcasting Co., 306 S. Michigan Ave., Chicago, Ill. 288.3 meters, 1040 kilocycles, 250 watts. Sun, 10:30 am-12:15 pm, 4-6 pm, 7:30-9:30 pm, classical and religious. Daily ex Sun, 1-2 pm, 5-6 pm, classical; 7-8 pm, popular program. Central standard time. Divides time with WENR. Slogan: "Voice of Service."

WBES Bliss Electrical School, Takoma Park, Md. 265.3 meters, 1130 kilocycles, 100 watts. Eastern standard time.

WBET Boston Transcript Co., 324 Washington St., Boston, Mass. 288.3 meters, 1040 kilocycles, 500 watts. Divides time with WSSH.

WBIS & WNAC The Shepard Stores, Winter St., Boston, Mass. 461.3 meters, 650 kilocycles, 500 watts. Daily ex Sun, 7:45 pm-12 midnight. Sun, 11:45 am-5 pm, 6:30-11:10 pm. Eastern standard time.

WBKN Municipal Bank Bldg., 350 Stone av., Brooklyn, N. Y. 199.9 meters, 1500 kilocycles, 100 watts. Sun, 9-11 am. Daily ex Sun, 12 noon-1 pm, 3-5 pm. Mon, Fri, 8-10 pm. Tues, 10 pm-12 midnight. Wed, 12 midnight-2 am. Thurs, 6-8 pm. Sat, 6-8 pm. Eastern standard time. Slogan: "The Voice of Community Service." Divides time with Stations WVRL & WGOP.

WBMH Braun's Music House, Detroit, Mich. 211.1 meters, 1420 kilocycles, 100 watts.

WBMS Capitol Theater Bldg., Union City, N. J. 199.9 meters, 1500 kilocycles, 100 watts. Sun, 9 am-1 pm, popular program. Daily ex Sun, 9-11 am, 5-6 pm, dinner music. Tues, 8-10 pm, varied program. Wed, 6-8 pm, popular program. Thurs & Sat, 10 pm-12 midnight, varied program. Eastern standard time. Slogan: "The Radio Voice of Union City."

WBNY Baruchrome Corp., 400 E. 139th St., New York, N. Y. 236.1 meters, 1270 kilocycles, 500 watts. Daily ex Sun, 7-11 pm. Sun, 2:30-6 pm. Eastern standard time. Divides time with WHAP-WPUL. Slogan: "The Voice of the Heart of New York."

WBOQ New York Cty., N. Y. 309.1 meters, 970 kilocycles, 500 watts. Eastern standard time. Divides time with WABC.

WBRC Birmingham Broadcasting Corp., 1913 5th av. N., Birmingham, Ala. 241.8 meters, 1240 kilocycles, 250 watts. Sun, 10:45 am-12:30 pm, church; 6:30-7:30 pm, organ; 7:30-9:30 pm, church. Mon, Tues, Wed, Fri, 8-9 pm. Daily ex Sat & Sun, 1-2 pm. Central standard time. Slogan: "The Biggest Little Station in the World."

WBRE 16 N. Main St., Liberty State Bank & Trust Bldg., Wilkes-Barre, Pa. 249.9 meters, 1200 kilocycles, 100 watts. Sun, 9 pm-12 midnight. Mon & Fri, 6-11 pm. Wed, 6 pm-12 midnight. Eastern standard time. Divides time with WBAX.

WBRL Tilton, N. H. 232.4 meters, 1290 kilocycles, 500 watts. Eastern standard time.

WBRS North American Broadcasting Corp., 1062 Broadway, Brooklyn, N. Y. 211.1 meters, 1420 kilocycles, 100 watts. Eastern standard time. Divides time with WCDA-WRST.

WBSO Babson's Statistical Organization, Wellesley Hills, Mass. 384.4 meters, 780 kilocycles, 100 watts. Sun, 12 midnight, good cheer service. Daily ex Sat, Sun 4 pm. Daily, 12 midnight. Eastern standard time.

WBT C. C. Coddington, 500 W. Trade st., Charlotte, N. C. 258.5 meters, 1160 kilocycles, 750 watts night, 1000 watts daytime. Sun, 10:55 am, 1 pm, 7:30 pm, church; 8:30 pm, Capitol theater program; 9:15 pm. Daily ex Sun; 12:30 pm, weather reports, Radiola hour; 7 pm, farm school. Tues, Wed, Thurs, Sat, 12:40 pm. Mon, Wed & Thurs, 7:30 pm. Mon, 7:10 pm, 7:20 pm, 9:30 pm. Wed & Thurs, 8 pm. Fri, 10 pm. Sat, 7:45 pm, 8:45 pm, 10 pm, 11 pm. Thurs, Fri, Sat, 9 pm. Varied studio & chain programs. Eastern standard time. Slogan: "The Queen City of the South."

WBZ Westinghouse Electric & Mfg. Co., Hotel Kimball, East Springfield, Mass. 333.1 meters, 900 kilocycles, 15,000 watts. Broadcasts in synchronism with WBZA, Boston, Mass. Slogan: "The Broadcasting Station of New England."

WBZA Westinghouse Electric & Mfg. Co., Hotel Statler, Boston, Mass. 333.1 meters, 900 kilocycles, 500 watts. Broadcasts on a 24-hour schedule daily. Eastern standard time.

WCAC Connecticut Agricultural College, Mansfield, Conn. 535.4 meters, 560 kilocycles, 500 watts. Mon, 1-2 pm. Mon & Sat, 7-8 pm. Eastern standard time. Divides time with WTIC. Slogan: "Voice from the Nutmeg State."

WCAD St. Lawrence University, Canton, N. Y. 243.8 meters, 1230 kilocycles, 500 watts pm, 1000 watts am. Sun, 4-5 pm, organ recital. Daily ex Sun, 12:30-1 pm. Wed, 4:30-6 pm. Eastern standard time. Slogan: "The Voice of the North Country."

WCAE The Pittsburgh Press and Kaufman & Baer Co., Pittsburgh, Pa. 461.3 meters, 650 kilocycles, 500 watts. Sun, 9:30 am-10 pm. Daily ex Sun, 6:45 am-11 pm, inclusive. Programs include exercises, educational talks, musical programs, children's periods, news & recitals. Eastern standard time. Slogan: "Where Prosperity Begins."

WCAH C. A. Entreklin, 1304 Fort Hayes Hotel Columbus, O. 234.2 meters, 1280 kilocycles, 250 watts. Sun, 11:45 am-12:45 pm, church; 12:45-1:30 pm, 6-7:15 pm, 8:45-9:45 pm, church. Daily ex Sun, Mon & Wed, 12 noon-1 pm, 6-10:30 pm. Mon & Wed, 6-7:30 pm. Sat, 6 pm-12 midnight. Eastern standard time. Divides time with WMAN.

WCAJ Nebraska Wesleyan University, University Place, Nebr. 379.5 meters, 790 kilocycles, 500 watts. Sun, 11 am, church services; 4 pm, vespers. Daily ex Sat & Sun, 10 am, convocation program; 5 pm, weather, news, features. Tues & Fri, 12 noon, musical half hour. Central standard time.

WCAL St. Olaf College, Northfield, Minn. 285.5 meters, 1050 kilocycles, 500 watts. Daily ex Sun & Thurs, 9:45 am, chapel service. Sunday, 8:30 am, Norwegian Church service. Central standard time. Divides time with WDG. Slogan: "The College on the Hill."

WCAM City of Camden, Camden, N. J. 223.7 meters, 1340 kilocycles, 500 watts. Mon, Wed, Fri, 7:30-12 pm, mixed program. Eastern time. Divides time with WFA.

WCAO Monumental Radio, Incorporated, 842 N. Howard st., Baltimore, Md. 243.8 meters, 1230 kilocycles, 250 watts. Mon, Wed, Fri, 8-11 pm. Sun, 11 am-12 noon, church services; 3-4 & 4-5 pm, Columbia Chain Program; 8-9:30 pm, church services; 9:30 & 10 pm, Columbia Chain Program. Eastern standard time. Divides time with WFB. Slogan: "The Gateway of the South."

There are many fluxes for soldering but only one— is safe for Radio!

FLUX for soldering is a general term; it embraces, as a class, all types of soldering fluxes. To designate a flux as safe for radio construction is specific; *it means rosin*. Chloride pastes, acids and fluid solutions are soldering fluxes, and are well adapted for certain work, but *conductive and corrosive properties forbade their use for radio assembly*. Their active elements, zinc and ammonium chlorides, display spreading, creeping tendencies that promote leakage and will eventually cause increased resistance in the wiring.

Rosin, an organic mixture, *is a non-conductor and non-corrosive*. The glass-like surface of this material does not readily lend itself to the collection of dust (carbon particles) as will the sticky organic greases of paste. Nor will rosin attract moisture from the atmosphere; the chlorides of pastes and fluids will. *Moisture plus carbon particles defeat the best insulations produced. Moisture plus chlo-*

rides direct a slow but determined corrosive attack upon supporting metals. Such slow corrosion in wiring causes a steadily increasing resistance to the flow of electrical energy.

Kester Rosin Core Radio Solder scientifically combines radio's premier flux, Rosin, with a solder alloy of unvarying quality. The use of Kester Radio Solder furnishes the user with a means of accomplishing *Safer, Faster, and Cleaner* set wiring. Constructors who solder-protect wiring with Kester Radio Solder enjoy increased receptive range, improved tonal quality and the satisfying assurance that their receivers will never be forced into the discard through the corrosive and conductive action of a chloride flux.

A Kester Soldered Receiver Is a Better Set

Manufacturers of Radio Sets and Equipment: Tests conducted with the various types of commercial fluxes are under constant observation in our laboratory. Can we assist you in your soldering problems?



KESTER Radio SOLDER

CHICAGO SOLDER COMPANY
4226 Wrightwood Avenue, Chicago, U. S. A.

Originators and World's Largest Manufacturers of Self-fluxing Solder—Convince Yourself Without Expense

Use This Coupon Now!

CHICAGO SOLDER CO., 4226 Wrightwood Ave., Chicago, U. S. A.	C. R.—3-28
Gentlemen: Please send me a test sample of Kester Radio Solder, together with descriptive literature without any obligation whatsoever.	
Name.....	
Address.....	
City.....	State.....
Dealer.....	

Tell 'Em You Saw It in the Citizens Radio Call Book Magazine

WCAP Asbury Park, N. J. 239.9 meters, 1260 kilocycles, 500 watts. Eastern standard time. Divides time with WOAX.

WCAT South Dakota State School of Mines, Rapid City, S. Dak. 247.8 meters, 1210 kilocycles, 100 watts. Daily ex Sun, 9:30-9:45 am, weather; 12:30-1 pm, weather & agrigrams. Mountain time. Slogan: "WCAT, Station of the South Dakota State School of Mines at Rapid City."

WCAU Universal Broadcasting Co., Hotel Pennsylvania, 39th & Chestnut sts., Philadelphia, Pa. 260.7 meters, 1150 kilocycles, 500 watts. Mon & Fri, 5:15 pm-12 midnight. Tues, Thurs, Sat, 5:30 pm-12 midnight. Wed, 5:15 pm-1 am. Sun, 2 pm-12 midnight. Eastern standard time. Slogan: "Where Cheer Awaits U."

WCAX University of Vermont, Burlington, Vt. 254.1 meters, 1180 kilocycles, 100 watts. Fri, 7:30-8:30 pm, education & entertainment. Eastern standard time. Slogan: "The Voice of the Green Mountains."

WCAZ Carthage College, Carthage, Ill. 249.9 meters, 1200 kilocycles, 50 watts. Daily ex Sat & Sun, 11:40 am, church services. Mon, 7-8 pm, musical program. Athletic contests at various times. Central standard time.

WCBA Charles W. Heimbach (Queen City Radiophone Station WCBA), 1350 Allen St., Allentown, Pa. 222.1 meters, 1350 kilocycles, 100 watts. Wed & Fri, 8:15-11 pm, musical programs. Sat, 9:30-11 pm, dance program. Sun, 10 am, 5:30 pm, 7 pm, church services. Eastern standard time. Divides time with WSAW.

WCBD Wilbur Glenn Voliva, Temple Site, Zion, Ill. 344.6 meters, 870 kilocycles, 5000 watts. Sun, 9:10-4:45 am, 2:30-6 pm, 8-10:30 pm. Tues, 8-10:30 pm. Wed, 12:30-1 pm. Thurs, 2:30-3:45 pm, 9-10 pm. Divides time with WLS, Sears-Roebuck Station, Chicago.

WCBE Uhalt Bros. Radio Co., Hotel De Soto, New Orleans, La. 227.1 meters, 1320 kilocycles, 5 watts. Daily ex Sun, 7-9 am, 11:30-12:30 pm, music, news, etc. Sun, 12:30-2:30 pm, concert. Mon, Wed, Thurs, Sat, 7:30-8:30, varied. Central standard time. Slogan: "Second Post, U. S. A."

WCBM Hotel Chateau, Baltimore, Md. 225.4 meters, 1330 kilocycles, 100 watts. Sun, 6-8 pm, vocal & instrumental. Tues & Wed, 11 pm. Sat, 9:30 pm-12 midnight. Eastern standard time. Slogan: "At Dixie's Door." Divides time with Station WCAO.

WCBR C. H. Messter (Portable), 42 Doyle av., Providence, R. I. 201.6 meters, 1490 kilocycles, 100 watts. Daily ex Sun, 6:30 pm, 7:30 pm, 9-10 pm. Eastern time.

WCBS St. Nicholas Hotel, Springfield, Ill. 209.7 meters, 1430 kilocycles, 250 watts. Sun, 10:45 am-12 noon, church services; 12:30-2 pm, 6-7 pm. Mon, Tues, Fri, 8:30-10:30 pm, 11-12 pm. Wed, Thur, 8-11 pm. Central standard time.

WCCO Gold Medal Flour, Nicollet Hotel, Minneapolis, and Hotel Lowry, St. Paul, Minn. 405.2 meters, 740 kilocycles, 5000 watts night, 7500 watts daytime. Daily ex Sun, 9:30 am, 9:35 am, 9:45 am, 10:30 am, 11:30 am, 12 noon, 1:30 pm, news, markets, weather, noon concert. Mon, 6-10 pm. Tues, 6:10-30 pm. Wed, 6-11:30 pm. Thurs, 6-10:05 pm. Fri & Sat, 6:15-11:05 pm. Sun, 9:45-10:50 am, 4:10-11:45 pm. Central standard time. Slogan: "Service to the Northwest."

WCDA New York City, N. Y. 211.1 meters, 1420 kilocycles, 250 watts. Eastern standard time. Divides time with WBRW-WRST.

WCFL Chicago Federation of Labor, 623 So. Wabash av., Chicago, Ill. 483.6 meters, 620 kilocycles, 1500 watts. Sun, 11-12:30 noon, church; 2-6:30 pm, popular program; 7:45-9:15 am, Baptist Church; 9:15, Utah Hour. Mon, 10 am-2 pm, 4-6 pm, musical. Daily ex Sun & Mon, 10 am-2 pm, 4 pm-12 midnight, music and speakers. Central standard time. Divides time with WLTS & WEMC. Slogan: "The Voice of Labor."

WCGU Chas. G. Unger, New Perl House, Coney Island, New York. 218.8 meters, 1370 kilocycles, 500 watts. Eastern standard time. Divides time with WKBQ-WKBO.

WCLO C. E. Whitmore, Camp Lake, Wis. 227.1 meters, 1320 kilocycles, 100 watts. Sun, 2-5 pm, popular. Mon, Wed, Fri, Sat, 7 pm-midnight, popular program. Central standard time. Slogan: "The Playground of the Lake Region." Divides with WWAE and WJBC.

WCLS WCLS, Inc., 301 E. Jefferson st., Joliet, Ill. 215.7 meters, 1390 kilocycles, 150 watts. Sun, 9:30 am, services. 11 am, services; 8-11 pm, studio program. Tues, 8-11 pm, studio features. Wed, 7-8 pm, organ concert. Fri, 7-8 pm, organ & vocal; 8-11 pm, studio program. Sat, 8-11 pm, studio features, orchestra. Central standard time. Divides time with WKBB. Slogan: "Will County's Largest Store."

WCMA Culver Military Academy, Culver, Ind. 260.7 meters, 1150 kilocycles, 500 watts. Daily ex Sat & Sun, 3-4 pm, public service hour, highway reports, etc. Sun, 11 am, chapel service. Mon, 8 pm, hand concert & studio. Wed, 8 pm, dance music & studio. Central standard time. Slogan: "The Voice of Culver." Divides with WOOD.

WCOA Municipal Broadcasting Station, City Hall, Pensacola, Fla. 249.9 meters, 1200 kilocycles, 500 watts. Sun, 12:30-7:30 pm. Mon, Wed, Fri, 10:30 am, 12:30-11 pm. Tues, Thurs, Sat, 10:30 am-12:30 pm. Central standard time. Slogan: "Wonderful City of Advantages."

WCOC Crystal Oil Co., Columbus, Miss. 230.6 meters, 1300 kilocycles, 250 watts. Daily ex Sun, 5-6 pm, music. Tues, 8-10 pm, vocal & instrumental studio program. Fri, 8-10 pm, dance music. Central standard time.

WCOT Jacob Conn, Olympia Theatre, Olneyville sq., Providence, R. I. 225.4 meters, 1330 kilocycles, 100 watts. Daily including Sun, 2:30-4 pm. Daily ex Sun, 7:30-9 pm. Programs varied. Eastern standard time.

WCRW Clinton R. White, Embassy Hotel, Diversey parkway, at Pine Grove, Chicago, Ill. 223.7 meters, 1340 kilocycles, 500 watts. Daily ex Sun, 11:30 am-1 pm. Daily ex Mon, 6:30-7:30 pm, 9:30-10:30 pm. Sun, 6:30-7:30 pm, 10-11 pm. Central standard time. Divides time with WFKB, WPCC. Slogan: "For Your Entertainment."

WCSS Henry P. Rines, Congress Square Hotel, Portland, Maine. 365.6 meters, 820 kilocycles, 500 watts. Sun, 10:30-12 noon, 1:30-9:15 pm. Mon, 10-12 am, 12-1:30 pm, 3-4 pm, 6-11 pm. Daily ex Sun, same as Mon. Slogan: "The Voice from Sunrise Land."

WCSSO Wittenberg College, Springfield, O. 256.3 meters, 1170 kilocycles, 500 watts. Mon, Wed, 7-8 pm. Tues, 11 am-12 noon, 6:30-7:30 pm. Thurs & Fri, 7:30-8:30 pm. Thurs, 10:45 am-1 pm. Fri, 4-5 pm. Sat, 2-4:30 pm, 8-9:30 pm. Eastern standard time.

WCWK Chester W. Keen, Fort Wayne, Ind. 214.2 meters, 1400 kilocycles, 250 watts. Sun, 10:30 am, 6:30-7:30 pm, church services. Mon, Tues, Wed, Thurs, Fri, Sat, 11 am-12 noon, musical program. Mon, 4-5:30 pm, children's hour. Tues, Fri, 8-11 pm, musical program. Central standard time. Slogan: "The Hoosier Station."

WCWS The Connecticut Portable Broadcasting Station, Danbury, Conn. 265.3 meters, 1130 kilocycles, 100 watts. Divides with WICC.

WDAD Dad's Auto Accessories, Inc., 171-173 8th av., North Nashville, Tenn. 225.4 meters, 1330 kilocycles, 1000 watts. Sun, 3-4 pm, 6:30-7:30 pm. Mon, Wed, Sat, 11:45 am-1 pm, 3-4 pm, 9 pm-12 midnight. Tues & Thurs, 11:45 am-1 pm, 3-4 pm, 7-9 pm. Central standard time. Divides time with WLAC. Slogan: "Where Dollars Are Doubled."

WDAE Tampa Daily Times, Tampa, Fla. 267.7 meters, 1120 kilocycles, 500 watts. On air every afternoon and evening. Eastern standard time. Slogan: "WDAE, the Voice of the Times at Tampa."

WDAF The Kansas City Star, Kansas City, Mo. 370.2 meters, 810 kilocycles, 1000 watts. Sun, 3-4:45 pm, church concert and services; 7:15-9:15 pm. Daily ex Sun, 8-8:15 am, Bible lesson; 12 noon-1 pm, 3-4 pm, 5:30-10 pm; 11:45 pm-1 am, musical. Central standard time. Slogan: "Enemies of Sleep."

WDAG J. L. Martin, 605 E. 4th st., Amarillo, Texas. 263 meters, 1140 kilocycles, 250 watts. Week days, 6:30 am, radio farm school; 12:45 pm, chats, markets & weather; 9-10:30 pm, entertainment. Fri, 8-10 pm, entertainment. Sun, 9:45 am, Bible class; 7:30-9:30 pm, church services. Central standard time. Slogan: "Where Dollars Always Grow."

WDAH Trinity Methodist Church, El Paso, Tex. 234.2 meters, 1280 kilocycles, 100 watts. Sun, 9:30 am-12 noon; 7:30-9 pm. Wed, 7:30-8:30 pm. Mountain standard time.

WDAY Radio Equipment Corp., 119 Broadway, Fargo, N. Dak. 545.1 meters, 550 kilocycles, 250 watts night, 500 watts daytime. Sun, 10:30 am, church; 1 pm, church; 2 pm, lecture; 4-6, entertainment. Daily ex Sun, 7-9 am, music, news; 10:15 am, Concordia Chapel; 11:45 am-12:30 pm, farmers' musical hour; 3-4 pm, women's hour, music; 3:15 pm, Aunt Sammy talk; ex Sun, 10 am, 11 am, 11:45 am, 2 pm & 5:45 pm, markets. Mon, Wed, Fri, 7:30-8:15 pm, college program. Tues, 9-9:30 pm, bridge lesson. Central standard time. Divides with KFDY.

WDBJ Richardson Wayland Electric Corp., 106 Church st., S.W., Roanoke, Va. 230.6 meters, 1300 kilocycles, 250 watts. Sun, 7:30-8:30 pm, church services. Daily ex Sun, 12 noon-1 pm, 5:30-6 pm, 8-9 pm, musical. Wed, 9-11 pm. Fri, Sat, 9-10 pm, dance, sports, music. Eastern standard time. Slogan: "The Magic City."

WDBO Orlando Broadcasting Co., for Rollins College, Inc., Fort Gatlin Hotel, Orlando, Fla. 288.3 meters, 1040 kilocycles, 1000 watts daytime, 500 watts evening. Sun, 11 am-2:30 pm, 4-7:30 pm. Mon, 6:30 pm-12 midnight. Tues, Thurs, Fri & Sat, 6:30-11 pm. Tues, 12:30-3 pm. Eastern standard time. Slogan: "Down Where the Oranges Grow."

WDEL Wilmington Electric Specialty Co., 405 Delaware av., Wilmington, Del. 296.9 meters, 1010 kilocycles, 100 watts. Sun, 8-10 pm. Tues, Thur, 7:30-9:30 pm. Sat, 9:30-12 midnight. Eastern standard time. Slogan: "First City of the First State."

WDGY Dr. Geo. Young's Jewelry & Optical Station, Minneapolis, Minn. 285.5 meters, 1050 kilocycles, 500 watts. Daily ex Sat, 3-5 pm. Mon, Wed, Fri, 7-8 pm, 10-12 pm. Tues, 7-12 pm. Thurs, 7-10 pm. Sat, 7-8 pm, 12 midnight-2 am. Sun, 11:30 am-1 pm, 2-6 pm. Central standard time. Divides with WCAL.

WDOD Chattanooga Radio Co., Inc., 615 Market st., Chattanooga, Tenn. 243.8 meters, 1230 kilocycles, 500 watts. Sun, 11 am, church; 5 pm, 6:30 pm, ensemble; 7:30 pm, church. Daily ex Sun, 12 noon, WDOD Trio. Mon & Fri, 6 pm, dinner hour. Tues, Wed, Sat, 6:45 pm, dinner hour & studio program. Sat, 9 pm, dance program. Central standard time.



EARN \$75⁰⁰ a week in Your Spare Time

JOINING the Radio Association enables you to cash in on Radio *now!* Follow its success-proven plans and you can earn \$3 an hour, in your spare time, from the very first. Over \$600,000,000 is being spent yearly for sets, supplies, service. You can get your share of this business and, at the same time, fit yourself for the big-pay opportunities in Radio.

Founded on a New Idea

Members of the Association do not wait for months before they make money out of Radio. Without quitting their jobs, our members are earning \$25 to \$75 a week spare time by building "tailored" radio sets, serving as "radio doctors," selling ready built sets and accessories, or following one of the many profit-making plans of the Association.

Earned \$500 in Spare Hours

Hundreds earn \$3 an hour as "radio doctors." Lyle Follick, Lansing, Mich., has already made \$500 in spare time. Werner Eichler, Rochester, N. Y., is earning \$50 a week for spare time. F. J. Buckley, Sedalia, Mo., is earning as much in spare time as he receives from his employer.

We will start you in business. Our cooperative plan gives the ambitious man his opportunity to establish himself. Many have followed this plan and established radio stores. Membership in the Association has increased the salaries of many. Scores are now connected with big radio organizations. Others have prosperous stores.

A year ago Claude De Grave knew nothing about Radio. Today he is on the staff of a famous radio manufacturer and an associate member of the Institute of Radio Engineers. He attributes his success to joining the Association. His income now is 350% more than when he joined.

Doubled Income in Six Months

"I attribute my success entirely to the Radio Association," writes W. E. Thon, Chicago, who was clerk in a hardware store before joining. We helped him secure the managership of a large store at a 220% increased salary.

"In 1922 I was a clerk," writes K. O. Benzing, McGregor, Ia., "when I enrolled. Since then I have built hundreds of sets—from 1-tube Regenerative to Superheterodynes. I am now operating my own store and my income is 200% greater than when I joined the Association. My entire success is due to the splendid help it gave."

Easiest Way Into Radio

If ambitious to become a Radio Engineer, to fit yourself for the \$3,000 to \$10,000 opportunities in Radio, join the Association. It gives you a comprehensive practical and theoretical training and the benefit of our Employment Service. You earn while you learn. You have the privilege of buying radio supplies at wholesale. You have the Association behind you in carrying out your ambitions.

ACT NOW—if You Wish Special Membership Plan

To a limited number of ambitious men, we will give Special Memberships that may not—need not—cost you a cent. To secure one, write today. We will send you details and also our book, "Your Opportunity in the Radio Industry." It will open your eyes to the money-making possibilities of Radio. Write today.

What a Membership Can Do for You

- 1—Enable you to earn \$3 an hour upwards in your spare time.
- 2—Train you to install, repair and build all kinds of sets.
- 3—Start you in business without capital, or finance an invention.
- 4—Train you for the \$3,000 to \$10,000 big-pay radio positions.
- 5—Help secure a better position at bigger pay for you.
- 6—Give you the backing of the Radio Association.

A MEMBERSHIP NEED NOT COST YOU A SINGLE CENT

RADIO ASSOCIATION OF AMERICA
4513 Ravenswood Ave.
Chicago, Ill. Dept. RCB-3

Gentlemen:

Please send me by return mail full details of your Special Membership Plan and also copy of your book, "Your Opportunity in the Radio Industry."

Name.....

Address.....

City..... State.....

WDRC Doolittle Radio Corp., 70 College st., New Haven, Conn. 282.8 meters, 1060 kilocycles, 500 watts. Daily, 9:30 am-12 noon. Daily ex Sat & Sun, 5-10 pm, classical and popular program. Eastern standard time.

WDFW Dutee Wilcox Flint, Inc., Cranston, R. I. 260.7 meters, 1150 kilocycles, 250 watts. Eastern standard time. Divides time with WLSI.

WDZ James L. Bush, Star Store Bldg., Tuscola, Ill. 277.6 meters, 1080 kilocycles, 100 watts daytime. Daily ex Sat & Sun, grain markets, 9 am-2:15 pm, each half hour. Sat, 9 am-1:15 pm, each half hour. Central standard time. "The Buckle of the Corn Belt."

WEAF National Broadcasting Company, Inc. 711 5th Ave., New York City. 491.5 meters, 610 kilocycles, 50,000 watts. Sun, 1-11 pm. Daily ex Sat & Sun, 6:45-8:30 am, 11 am-12 midnight. Sat, noon-12 midnight. Eastern time.

WEAM Borough of North Plainfield, North Plainfield, N. J. 263.0 meters, 1140 kilocycles, 250 watts. Eastern standard time. Divides time with WJBI.

WEAN The Shepard Co., Westminster st., Providence, R. I. 275.1 meters, 1090 kilocycles, 500 watts. Sun, 10:45 am, 7-8:30 pm. Daily ex Sun, 11:55 am-1 pm, 4-5 pm, 6:30-10:30 pm. Eastern standard time. Slogan: "We Entertain a Nation."

WEAO Ohio State University, Columbus, Ohio. 282.8 meters, 1060 kilocycles, 750 watts. Daily ex Sun & holidays, 9:45 am, weather, market reports, agricultural bulletin; 11 am, market reports, music; 12:30 pm, market reports, music; 4 pm, markets. Mon, Wed, Fri, 10 am, Homemakers Half Hour. Tues, 7-11 pm, lectures, music (4 pm, Book Review). Wed, 7-9 pm, Farm Night program (4 pm, Story Hour). Thurs, 7-11 pm, lectures, music. Football and basketball games broadcast as per Ohio State schedule. Eastern standard time. Divides time with Station WAU.

WEAR The Willard Storage Battery Co., Union Trust Bldg., Cleveland, Ohio. 399.8 meters, 750 kilocycles, 1000 watts. Daily ex Sun, 11:30 am-12:05 pm, weather, markets. Daily ex Sat & Sun, 3:30-4:10 pm, weather, markets. Eastern standard time. Divides time with WTAM and WSBT.

WEBC Head of the Lakes, Walter C. Bridges, 1225 Tower st., Superior, Wis. 241.8 meters, 1240 kilocycles, 250 watts. Sun, 10:40 am, 7:45 pm, church services. Mon, 12:15 noon, musical; 5:30 pm, organ; 6 pm, musical; 6:45 pm, news & baseball, weather; 7:15 pm, childrens hour; 8 pm, feature music. Tues, Thur, Fri, Sat, 12:15 noon, musical; 6 pm, music; 6:45 pm, news; 7 pm, childrens hour; 7 pm, weather. Fri, Sat, 9 pm, organ, dance music. Wed, 10:30 am, cookery corner; 12:15 pm, music; 1:15 pm, weather; 6 pm, music; 6:45 pm, news; 8 pm, music. Slogan: "Where Sail Meets Rail."

WEBE Cambridge, Ohio, 247.8 meters, 1210 kilocycles, 10 watts.

WEBH Edgewater Beach Hotel, Chicago Herald & Examiner, 5349 Sheridan Rd., Chicago, Ill. 365.6 meters, 820 kilocycles, 500 watts. Daily ex Sun, Mon, 7-8 pm, 9-10 pm, 11 pm-1 am (Sat, 11 pm-2 am). Sun, 10:40 am-12 noon, church service; 5-6 pm, 7-9 pm, musical program. Central standard time. Divides time with WJJD. Slogan: "Where Everybody's Happy."

WEBJ Third Avenue Railway, 2396 Third St., New York, N. Y. 256.3 meters, 1170 kilocycles, 500 watts. Wed, 7-11 pm, & Fri, 9-11 pm, popular and educational. Eastern standard time. Divides time with WBBR & WLTH.

WEBQ Tate Radio Co., 1 N. Main St., Harrisburg, Ill. 223.7 meters, 1340 kilocycles, 15 watts. Daily ex Sun, 7:15-7:40 pm, local news, markets. Mon & Thurs, 7:30-10 pm, 10:45-12 midnight, musical programs. Sun, 7-8:30 pm, church services. Central standard time. Slogan: "The Voice from Egypt."

WEBR H. H. Howell, 54 Niagara st., Buffalo, N. Y. 241.8 meters, 1240 kilocycles, 200 watts. Mon, Wed, Fri, 8:30-11 pm, Sun, church services. Thur, 10:15 pm-12:15 am. Slogan: "We extend Buffalo's Regards."

WEBW Beloit College, Beloit, Wis. 258.5 meters, 1160 kilocycles, 500 watts. Sun, 4:25-5:40 pm, vesper services. Central standard time.

WEDC Emil Denmark Broadcasting Station, 3860 Ogden av., Chicago, Ill. 241.8 meters, 1240 kilocycles, 500 watts. Central standard time. Divides time with WGES.

WEEL The Edison Electric Illuminating Co. of Boston, 39 Boylston st., Boston, Mass. 508.2 meters, 590 kilocycles, 500 watts. Sun, 10:50 am-12 noon. Daily ex Sat & Sun, 6:45 am, 9:30 am-12 noon, 2-5 pm, 5:45-11 pm. Sat, 2-5 pm, 6-10:30 pm. Eastern standard time. Slogan: "The Friendly Voice."

WEHS Victor C. Carlson, 636 Church St., Evanston, Ill. 215.7 meters, 1390 kilocycles, 100 watts.

WEMC Emmanuel Missionary College, Berrien Springs, Mich. 483.6 meters, Daily ex Sat & Sun, 7:30-9 am, 10:10 am. Sun, 9-10:30, 7:30-10 pm. Mon, 10-11:30 pm. Tues & Thurs, 3-4 pm. Central standard time. Divides time with WLTS-WCFL. Slogan: "The Radio Lighthouse."

WENR Great Lakes Radio Broadcasting Co., 306 S. Michigan Ave., Chicago, Ill. 288.3 meters, 1040 kilocycles, 500 watts. Sun, 2-4 pm, 6-7 pm, 9:30-11 pm, classical music. Daily ex Sun, 11:30 am-12 noon. Home service feature; 12-1 pm, classical program; 2-5 pm, popular request program; 6-7 pm, dinner concert 8-9:30 pm, classical; 9:30 pm-12 midnight, popular program. Central standard time. Divides time with WBCN. Slogan: "Voice of Service."

WEPS Matheson Radio Co., Inc., Gloucester, Mass. 296.9 meters, 1010 kilocycles, 100 watts.

WEVD Union Course Laboratories, 9024 78th st., Woodhaven, N. Y. 245.8 meters, 1220 kilocycles, 500 watts. Sun, 12:30-4 pm. Mon, Wed, Fri, 1-6 pm, 11-12 pm. Tues, 1-6 pm, 9-12 pm. Thur, 1-6 pm. Eastern standard time. Divides time with WAAT & WGBB.

WEW St. Louis University, College Station, St. Louis, Mo. 352.7 meters, 850 kilocycles, 1000 watts. Daily ex Sun, 9-10 am, 2 pm, government reports. Mon, Wed, Fri, 5 pm, radio farm school. Tues, 5 pm, literary reading. Thurs, 5 pm, music, lectures. Sun, religion answered; 5 pm, lecture. Central standard time.

WFAA Dallas News & Journal, Dallas, Tex. 545.1 meters, 550 kilocycles, 500 watts. Sun, 1:45-6 pm, 6-7 pm, 11 pm-12 midnight. Daily ex Sun, each half hour from 6:30 am-6 pm, 7-8 pm, 9-10 pm. Tues & Sat, 11 pm-12 midnight. Central standard time. Divides time with WEAP. Slogan: "Working for All Alike."

WFAM St. Cloud Daily Times, St. Cloud, Minn. 252.0 meters, 1190 kilocycles, 10 watts.

WFAN Philadelphia, Pa. 223.7 meters, 1340 kilocycles, 500 watts. Eastern standard time. Divides time with WCAM.

WFBC First Baptist Church, Knoxville, Tenn. 234.2 meters, 1280 kilocycles, 50 watts. Sun, 10:30 am, 7:30 pm, church services; 4 pm, concert sacred music. Central standard time.

WFBE The Garfield Place Hotel Co., Cincinnati, Ohio. 245.8 meters, 1220 kilocycles, 250 watts. Eastern standard time. Divides time with WKRC.

WFBG Wm. F. Gable Co., Altoona, Pa. 267.7 meters, 1120 kilocycles, 100 watts. Sun, 10:45 am, 3:30 pm, 7:30 pm, church. Daily ex Sun & Mon, 3 pm, 6:30 pm, 8:30 pm. Tues, Wed, Thurs, 12:15 pm. Fri & Sat, 9:30 pm. Thurs & Sat, 7:30 pm. Wed, 6 pm. Thurs, 4 pm, 10 pm. Fri, 12 noon, 11:15 pm. Eastern standard time. Slogan: "The Original Gateway to the West and we wish you all the very best."

WFBJ St. Johns University, Collegeville, Minn. 272.6 meters, 1100 kilocycles, 100 watts. Wed, 8-9:30 pm. Fri, 4-5 pm. Central standard time. Slogan: "In the Heart of the Landscape Paradise."

WFBK The Onondaga Hotel, Syracuse, N. Y. 258.5 meters, 1160 kilocycles, 750 watts. Daily ex Sun, 3-3:30 pm, 6:30 pm-12 midnight. Sun, 2 pm-12 midnight. Eastern standard time. Slogan: "When Feeling Blue, Listen."

WFBM Indianapolis Power & Light Co., 48 Monument Circle, Indianapolis, Ind. 275.1 meters, 1090 kilocycles, 250 watts. Sun, 9:30 am-12 midnight. Daily ex Sun, 12 noon-12 midnight. Central standard time. Slogan: "The Crossroads of America."

WFBR Fifth Infantry Maryland National Guards, Fifth Regiment Armory, Baltimore, Md. 243.8 meters, 1230 kilocycles, 100 watts. Daily ex Sun, 12 noon, dance music; 7-10 pm, sporting results and news. Tues, Thurs & Sat, 12 noon, 7 pm, 10 pm, general programs. Sun, 11 am. Central standard time. Slogan: "Home of the Star-Spangled Banner." Divides time with WCAO.

WFBZ Knox College, Galesburg, Ill. 247.8 meters, 1210 kilocycles, 50 watts. Eastern standard time. Divides time with WRAN.

WFBI Frank Crook, Inc., 103 Exchange st., Pawtucket, R. I. 241.8 meters, 1240 kilocycles, 50 watts. Mon, Wed, Fri, 8-10 pm, entertainment. Eastern standard time. Divides time with WNBX. Slogan: "The City of Diversified Industries."

WFDF Frank D. Fallain, 513 S. Saginaw St., Flint, Mich. 272.6 meters, 1100 kilocycles, 100 watts. Divides time with WSKC.

WFI Strawbridge & Clothier, Market, 8th & Filbert sts., Philadelphia, Pa. 405.2 meters, 740 kilocycles, 500 watts. Daily ex Sun, 10:15 am, markets; 1-2 pm, orchestra; 3-4 pm, concert; 6:30-7:15 pm, dinner music. Tues, Thurs, Sat, 8-11:30 pm, musical program. Sun morning and evening, alternating, church services; 9:15 pm, Atwater-Kent Hour. Eastern standard time. Divides time with WLIT.

WFIW Hopkinsville, Ky. 260.7 meters, 1150 kilocycles, 750 watts night and 1000 watts daytime. Central standard time.

WFJC W. F. Jones Broadcasting Co., 140 E. Market st., Akron, Ohio. 227.1 meters, 1320 kilocycles, 250 watts. Eastern standard time. Divides time with WJAY.

WFKB Francis K. Bridgman, 4536 Woodlawn av., Chicago, Ill. 223.7 meters, 1340 kilocycles, 500 watts. Daily ex Sun, 2:30-4 pm, 7-8 pm, classical; 9-11 pm, popular. Central standard time. Divides time with WCRW, WPCC.

WFKD Foulkrod Radio Engineering Co., 1510 Oxford av., Philadelphia, Pa. 247.8 meters, 1210 kilocycles, 50 watts. Eastern standard time. Divides time with WABY.

GENERAL RADIO TYPE 441 PUSH PULL AMPLIFIER

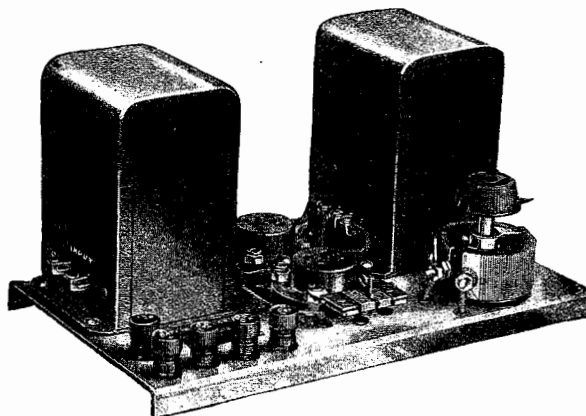

IN a search for an amplifier which would give the maximum in quality and volume, the push-pull method has proved particularly satisfactory. This type of amplifier in the last stage provides the speaker with ample power to faithfully reproduce the full frequency range that is now being broadcast without tube overloading.

A push-pull amplifier draws no alternating current from the plate supply, a fact of great importance if socket power is used, as the impedance of the power unit does not affect the amplifier. This results in improved reproduction of sustained notes, particularly of low frequency.

Other advantages of the push-pull system are, a reduction in hum when alternating current is used for filament supply and for equal power output, a reduction in the plate voltage required. The Amplifier is supplied completely wired.

TYPE 441 AMPLIFIER

For Use with UX 226, CX 326, UX 171, CX 371, UX 210 or CX 310 Tubes

Input Inductance.....	30 henries
Input turns ratio.....	1:2.25
Output impedance ratio.....	12:1
(Whole primary to secondary)	
Price completely wired.....	\$20.00

Licensed by the Radio Corporation of America for radio, amateur, experimental and broadcast reception only and under the terms of the R.C.A. license the unit may be sold only with tubes.

If we can be of any assistance to you in supplying technical information we welcome your correspondence. Have you a copy of our latest bulletin No. 929 in your files? If not, a post-card will bring one.

GENERAL RADIO COMPANY
 30 State St., Cambridge, Mass. 274 Brannan St., San Francisco, Calif.

Tell 'Em You Saw It in the Citizens Radio Call Book Magazine

WFLA The Clearwater Chamber of Commerce, Clearwater, Fla. 516.9 meters, 580 kilocycles, 750 watts. Daily ex Sun, 8:30 pm-12 midnight, studio programs, music, weather, markets, talks, etc. Eastern standard time. Slogan: "Inviting the World to the Springtime All the Time City."

WGAL Lancaster Elec. Sup. & Const. Co., 23 E. Orange st., Lancaster, Pa. 252.0 meters, 1190 kilocycles, 15 watts. Sun, 4:50 am-12 noon, church. Daily ex Sun, 9-9:15 am, talks; 12-12:05 noon, markets; 5:20-5:45 pm, Wed, Fri, 5:45-6:15 pm, dinner concert. Wed, 11:15-1 am, organ concert. Eastern standard time. Divides time with WKJC. Slogan: "World's Gardens at Lancaster."

WGBB Harry H. Carman, 217 Bedell st., Freeport, N. Y. 245.8 meters, 1220 kilocycles, 400 watts. Sun, 10:40 am-12:30 pm, 4-5:30 pm. Mon, 7-8 pm. Wed, Fri, 7-11 pm. Slogan: "The Voice of the Sunrise Trail." Divides time with Station WAAT-WEVD.

WGBC First Baptist Church, Memphis, Tenn. 228.9 meters, 1310 kilocycles, 15 watts. Sun, 9:55-10:55 am, 7:30-9 pm. Central standard time. Divides time with WMBR.

WGBF The Finke Furniture Co., 307 Upper Seventh st., Evansville, Ind. 236.1 meters, 1270 kilocycles, 250 watts. Daily ex Sun, 7:15 am, morning worship service; 12:10 pm, news, markets, weather, etc. Mon, 7-12 pm, musical program. Tues, 8-11 pm, music. Fri, 7-11 pm, musical program. Sun, 9 am, Bible class. Central standard time. Slogan: "Gateway to the South."

WGBI Scranton Broadcasters, Inc., 318 Adams Ave., Scranton, Pa. 230.6 meters, 1300 kilocycles, 250 watts. Eastern standard time. Divides time with WQAN.

WGBS Gimbel Bros., Inc., 33rd st. & Broadway, New York City, N. Y. 348.6 meters, 860 kilocycles, 500 watts. Sun, 9:15 pm, vocal & instrumental music. Daily ex Sun, 1:30-3 pm, 5:30-6:30 pm. Mon, Wed, Fri, 10-11 am. Tues, Thurs, Sat, 10:30-11 am, 7:30-9 pm-12:30 am. Programs consist of talks, vocal and instrumental selections. Divides time with WVIP and WOO—Mon, Wed, Fri. Eastern standard time.

WGCP Paramount Broadcasting & Artist Service, Inc., 519 Broad St., Newark, N. J. 267.7 meters, 1120 kilocycles, 500 watts. Mon, Wed, Fri, 12 noon-3 pm, 6-9 pm. Tues, Thurs, Sat, 9 am-12 noon, 3-6 pm, 9 pm-12 midnight. Sun, 12 noon-6 pm. Eastern standard time. Divides time with WNJ and WAAM.

WGES Oak Leaves Broadcasting Corp., 128 N. Crawford av., Chicago, Ill. 241.8 meters, 1240 kilocycles, 500 watts. Sun, 10:30 am-12 noon, church; 3-6 pm, 7:30-9:30 pm, 11:30 pm-1:30 am. Daily ex Sat & Sun, 4-6 pm, popular. Tues, 8:30-9:30, 10-11:30 pm. Wed, Thurs, Fri & Sat, 7:30-9:30 pm. Wed & Sat, 11:30-1:30 pm. Fri, 11:30 pm-3 am, Ozone Club. Sat, 2:30-6 pm. Central standard time. Divides time with WEDC. Slogan: "World's Greatest Entertainment Service."

WGHP George Harrison Phelps, Inc., Radio Division, Maccabee Bldg., Woodward and Putnam av., Detroit, Mich. 277.6 meters, 1080 kilocycles, 750 watts. Sun, 10:45 am-12:15 pm, 3-5 pm, 7:30 pm-12 midnight. Daily ex Sat & Sun, 1:15-3 pm, 6-11 pm. Eastern standard time.

WGL "Public Service Station," International Broadcasting Corp., 16 E. 42nd St., New York, N. Y. 293.9 meters, 1020 kilocycles, 500 watts. Eastern standard time. Divides time with WODA.

WGM Verne & Elton Spencer, 501 Cowan av., Jeannette, Pa. 208.2 meters, 1440 kilocycles, 50 watts. Sun, 1:30-3 pm, music. Daily ex Sun, Wed, Sat, 7:30-9 pm, dance music. Popular program. Eastern time. Slogan: "Voice from the Glass City, Voice from the Hilltop."

WGMU Atlantic Broadcasting Corp., New York City, 201.6 meters, 1490 kilocycles, 100 watts. Unlimited schedule. Eastern standard time. Divides time with WRMU.

WGN The Chicago Tribune Station on the Drake Hotel, Chicago, Ill. 416.4 meters, 720 kilocycles, 15,000 watts. Sun, 12 noon-5 pm, 6:10-11 pm. Daily ex Sun, 9-10:30 am, 11-11:30 am, 12:40-7 pm. Daily ex Sun & Mon, 8-11 pm. Central standard time. Divides time with Station WLIB.

WGOP Flushing, N. Y. 199.9 meters, 1500 kilocycles, 100 watts. Eastern standard time. Divides with WWRL and WBKN.

WGR Federal Radio Corp., Hotel Statler, Buffalo, N. Y. 302.8 meters, 990 kilocycles, 750 watts. Sun, 10:45 am, church; 7:45 pm, church; 9:15 pm, concert; 10:15-11:15, concert. Mon, 12 noon, reports; 1-1:30 pm, ensemble; 2:30 pm, program; 6:30, music; 7:30, reports; 1-1:30, ensemble; 2:30 pm, program; 6:30, music; 7:30, reports; 8-11 pm, program. Wed, 12 noon, reports; 1-1:30, ensemble; 2:30 pm, concert; 6:30 pm, music; 7:30, reports; 8-11 pm, program. Thurs, 12 noon, reports; 1-1:30, ensemble; 2:30 pm, program; 6:30 pm, music; 7:30, reports; 8-11 pm, program. Fri, 12 noon, reports; 1-1:30, ensemble; 2:30, concert; 6:30, music; 8 pm-1 am, program. Eastern standard time. Slogan: "Key City of Industry."

WGST Georgia School of Technology, Atlanta, Ga. 270.1 meters, 1110 kilocycles, 500 watts. Mon, 9:30-10:30 pm, "Tech Nite" program. Thurs, 7-8 pm, "Artist Series" program. Central standard time. Divides time with WMAZ. Slogan: "The Southern School with the National Reputation."

WGW Radiocast Corp. of Wisconsin, 144 Broadway, Milwaukee, Wis. 218.8 meters, 1370 kilocycles, 500 watts. Daily ex Sun, 10:30 am-12:30 pm. Sun, 10-11 am, 6-7 pm. Silent Saturdays. Central standard time.

WGY General Electric Co., 1 River Road, Schenectady, N. Y. 379.5 meters, 790 kilocycles, 50,000 watts. Daily ex Sun, 11:55 pm, 12:30 pm, 12:45 pm, 6 pm, 6:10 pm. Daily ex Sat & Sun, 6-11 pm. Mon, Tues, Thurs, Fri, 2-3 pm. Sat, 6:30 pm-12 midnight. Sun, 10:30 am-12 noon, 3-10:45 pm. Eastern standard time.

WHA University of Wisconsin, Madison, Wis. 333.1 meters, 900 kilocycles, 750 watts. Mon, Wed & Fri, 7-9:30 pm. Programs on these evenings consist of educational talks, music, athletic events, etc. Central standard time. Divides time with WLBL.

WHAD Marquette University, Milwaukee, Wis. 270.1 meters, 1110 kilocycles, 500 watts. Sun, 4:30-5 pm, organ recital. Daily ex Sat & Sun, 3:30-4 pm, 7:30-8 pm. Fri, 8-9:30 pm, musical program. Central standard time. Divides time with WSOE.

WHAM Stromberg Carlson Telephone Mfg. Co., Rochester, N. Y. 280.2 meters, 1070 kilocycles, 5000 watts. Sun, 10:30 am, church; 1 pm, Blue Network program; 3:30-10:15 pm, music & variety. Mon & Fri, 6:30-10 pm. Tues, 2:30 pm, 3 pm. Tues, Wed, Thurs, Sat, 6:30-11:05 pm. Varied studio & Blue network programs. Eastern standard time.

WHAP WHAP, Carlstadt, N. J. 236.1 meters, 1270 kilocycles, 1000 watts. Sun, 8-10 pm. Mon, 6:30-9:45 pm. Thurs, 6-8:30 pm. Wed, 9-12 pm. Sat, 9-11:30 pm. Eastern standard time. Divides time with WBNY, WMSG.

WHAR Pioneer Broadcasting Station of Atlantic City, the Hotel Seaside, Atlantic City, N. J. 272.6 meters, 1100 kilocycles, 1000 watts. Sun, 10:45-11 pm, 2:15-3:10 pm, 7:30-9 pm. Daily ex Sun & Wed, 2:15-3:15 pm, 7:45-9 pm. Eastern standard time. Divides time with WPG. Slogan: "Pioneer Broadcasting Station of Atlantic City."

WHAS The Courier-Journal Co. and The Louisville Times Co., Louisville, Ky. 322.4 meters, 930 kilocycles, 500 watts. Sun, 9:57-10:45 am, church services; 2-3 pm, 4:30-9:15 pm. Daily ex Sun, 3:30-5 pm, 7-10 pm. Central standard time. Slogan: "Old Kentucky Home." (On chimes.)

WHAZ Rensselaer Polytechnic Institute, Troy, N. Y. 305.9 meters, 980 kilocycles, 500 watts. Mon, 8 pm. Eastern standard time. Slogan: "Transcontinental and International Radiophone Broadcasting from the Oldest College of Engineering and Science in America, Rensselaer Polytechnic Institute, Troy, N. Y." Divides with WHT and WIBO.

WHB Sweeney Automotive and Electrical School, Kansas City, Mo. 340.7 meters, 880 kilocycles, 500 watts. Sun, 9:40-10:45 am, church services; 6:30-7:15 pm, church; 11:15 pm-12:15 am, organ. Daily ex Sun, 8:25-9:25 am, 10:25-11:20 am, 12 noon-1:25 pm, 2-3 pm, Ladies' Hour; 3 pm, markets. Mon, Tues, Thurs, Sat, 7-10 pm. Wed, Fri, 7-8 pm. Central standard time. Divides time with WOQ. Slogan "Kansas City, Missouri, the Heart of America."

WHBA Shaffer Music House, Oil City, Pa. 260.7 meters, 1150 kilocycles, 10 watts. Limited commercial broadcast. Mon, 8 pm until 11 pm, musical. Fri, 9 pm until 12 pm, musical. Eastern standard time.

WHBC Rev. E. P. Graham, 627 McKinley av., Canton, Ohio. 236.1 meters, 1270 kilocycles, 10 watts. Mon, 8-8:30 pm, lecture; sermon. Eastern time. Slogan: "Dispel Ignorance."

WHBD First Presbyterian Church, Bellefontaine, Ohio. 222.1 meters, 1350 kilocycles, 100 watts. Sun, 10:45 am, 7:30 pm. Eastern standard time. Slogan: "Ohio's Highest Point."

WHBF Beardsley Spec. Co., Inc., 217 18th st., Rock Island, Ill. 222.1 meters, 1350 kilocycles, 100 watts. Mon, Wed, 9-11 pm. Sat, 2-4, 7-9 pm. Central standard time. Slogan: "Where Historic Blackhawk Fought."

WHBL C. L. Carrell, 36 S. State st., Chicago, Ill. 204.0 meters, 1470 kilocycles, 100 watts. Central standard time.

WHBM C. L. Carrell (portable), 1506 No. American Bldg., 36 S. State st., Chicago, Ill. 201.6 meters, 1490 kilocycles, 100 watts, class A. Central standard time.

WHBP The Johnstown Automobile Co., 101 Main st., Johnstown, Pa. 228.9 meters, 1310 kilocycles, 250 watts. Daily ex Sun, 1:15 pm. Tues & Sat, 10 pm. Eastern standard time. Slogan: "The Voice of the Friendly City."

WHBQ Broadcasting Station WHBQ, Inc., Dermon Bldg., Memphis, Tenn. 232.4 meters, 1290 kilocycles, 100 watts. Sun, church services. Daily ex Sun, 7-8 pm, orchestra. Central standard time.

WHBU Citizens Bank, 1101 Meriden st., Anderson, Ind. 220.4 meters, 1360 kilocycles, 15 watts. Central standard time. Slogan: "First Hoosier Bank on the Air."

WHBW D. R. Kienzle, 4916 Chestnut st., Philadelphia, Pa. 220.4 meters, 1360 kilocycles, 100 watts. Tues., Thurs, Sun, pm. Eastern standard time.

WHBY St. Norbert's College, West De Pere, Wis. Green Bay-De Pere Broadcasting Station. 249.9 meters, 1200 kilocycles, 50 watts. Sun, 10-11 am. Daily ex Sun; 6:30 pm, weather & markets. Mon, 8-10 pm, musical entertainment. Wed & Fri, 5-6 pm, dinner hour. Central standard time. Slogan: "Prepared for All Good Works."

The New Excello Consoles



No. 37 for Radiola 17 and other standard sets.

for
RADIOLA-17
ATWATER KENT
CROSLY
FREED-EISEMANN
 and other Standard
A.C. Receivers

BEAUTIFY *your set!*

AS the new A.C. receivers represent the ultimate in reception, so the new Excello line embodies the ultimate in radio consoles. Adds to the appearance of your home as well as to the enjoyment of your set.

The cabinet work of Excello consoles is of the highest quality; doors of 5-ply matched butt walnut; rich piano finish.

See the new Excello console at your dealer's or write us for descriptive catalog

EXCELLO
 Radio Consoles

Dealers and distributors—write for interesting franchise offer

EXCELLO PRODUCTS CORPORATION

4820-28 West 16th Street, Cicero, Illinois (Suburb of Chicago)

Pacific Coast Representative: N. F. Andruss, 426 Larkin St., San Francisco, Calif.

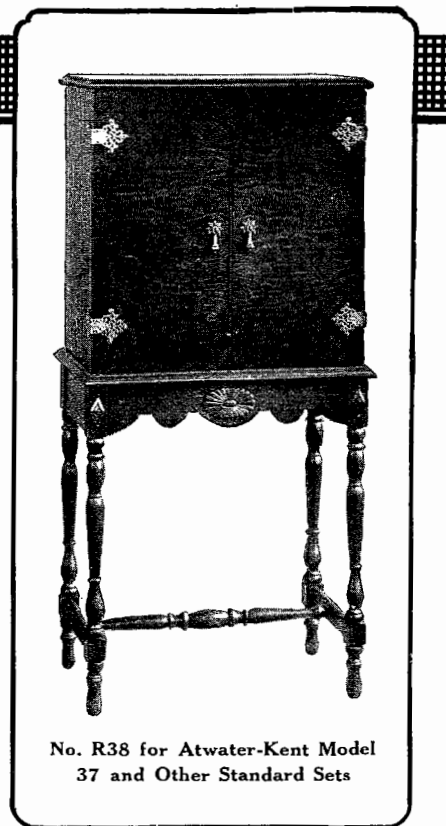

No. R38 for Atwater-Kent Model 37 and Other Standard Sets

The Excello Line of Consoles includes many models to fit any receiver and to beautify any home.

Tell 'Em You Saw It in the Citizens Radio Call Book Magazine

WHDI Dunwoody Industrial Institute, 818 Superior Blvd., Minneapolis, Minn. 245.8 meters, 1220 kilocycles, 500 watts. Daily ex Sun, 6:57-9:30 am. Mon, 8-9 pm. Wed, 8:30-10 pm. Fri, 9-10 pm. Central standard time. Divides time with Station WLB.

WHEC-WABO Hickson Electric Co., Inc., 36 South av., Rochester, N. Y. 254.1 meters, 1180 kilocycles, 500 watts. Sun, 10:30-12 noon, 8-10 pm. Daily ex Sun, 12 noon-3 pm, 6:30-9 pm. Fri, 10-11 pm. Eastern standard time.

WHFC The Goodson & Wilson Station, 4145 Broadway, Chicago, Ill. 215.7 meters, 1390 kilocycles, 200 watts. Sun, Tues, Wed, Thurs, Fri, Sat, 8-12 pm. Slogan: "Where Happiness First Commences." Divides with WKBI.

WHK The Radio Air Service Corporation, Inc., 1220 Huron road, Cleveland, Ohio. 265.3 meters, 1130 kilocycles, 1000 watts daytime, 500 watts night. Sun, 10 am, 1-9:30 pm. Daily ex Sat & Sun, 11 am-1:15 pm, 3:30-4 pm, 6 pm-midnight. Sat, 11-1:15 pm, 6 pm to midnight. Eastern standard time. Slogan: "Cleveland's Pioneer Station."

WHN Marcus Loew Booking Agency, 1540 Broadway, New York, N. Y. 394.5 meters, 760 kilocycles, 500 watts. Sun, 9-11 am, 12:30-3 pm, 5-7:30 pm, 9:45 pm-12 midnight. Daily ex Sun, 1-2 pm, 6 pm-12 midnight. Eastern standard time. Divides time with WQAO and WPAP. Slogan: "Voice of the Great White Way."

WHO Banker's Life Company, Des Moines, Iowa. 535.4 meters, 560 kilocycles, 5000 watts. Sun, 10 am, 11 am, 1 pm, 6:20 pm, 8:15 pm, 9:15 pm. Tues, Wed, Thurs, Fri, 8 am through 3 pm. Mon, 8 am through 3:30 pm, 6:30-11 pm. Sat, 8 am-1 pm, 6:30-10 pm. Tues & Wed, 4-10:30 pm. Thurs & Fri, 10 pm. Music, talks, weather reports & chain programs broadcast. Central standard time. Slogan: "W-H-O, Who? Banker's Life, Des Moines."

WHPP Bronx, New York. 206.8 meters, 1450 kilocycles, 10 watts. Eastern standard time. Divides time with WMRJ-WTRL.

WHT Radiophone Broadcasting Corp., Wrigley Bldg., 410 N. Michigan Blvd., Chicago, Ill. 305.9 meters, 980 kilocycles, 5000 watts. Daily, 10 am-2:15 pm. Daily ex Mon, 6-7 pm, 8:30-10 pm. Thurs, Fri & Sat, 11 pm-12 midnight. Central standard time. Divides time with WIBO-WHAZ. Slogan: "Write Home Tonight."

WIAD Howard R. Miller, 1301-5 Filbert St., Philadelphia, Pa. 288.3 meters, 1040 kilocycles, 100 watts. Tues, Thurs, Fri, 2 pm-12 pm. Eastern standard time. Divides time with WNAT.

WIAS Poling Elec. Co., 218 E. Main St., Ottumwa, Ia. 322.4 meters, 930 kilocycles, 100 watts. Daily ex Sun & Tues, 12 noon-1 pm, 2:30-3:30 pm, 5-6 pm. Central standard time. Slogan: "Burlington on the Mississippi." Divides with KICK.

WIBA The Capital Times, Strand Theater, Madison, Wis. 239.9 meters, 1250 kilocycles, 100 watts. Mon, 8-11 pm. Wed, 7-9 pm. Fri, 6:15-7 pm. Sun, 12-1 pm. Central standard time. Slogan: "The Four Lakes City."

WIBG St. Paul's Protestant Episcopal Church, Elkins Park, Philadelphia, Pa. 440.9 meters, 680 kilocycles, 50 watts. Sun, 10:45 am, 3:45 pm. Eastern standard time.

WIBJ C. L. Carrell, 36 S. State st., Chicago, Ill. (portable). 201.6 meters, 1490 kilocycles, 100 watts. Central standard time.

WIBM C. L. Carrell, 36 S. State st., Chicago, Ill. 201.6 meters, 1490 kilocycles, 100 watts. Daily ex Sun, 8:45-9:45 pm. Central standard time. Slogan: "The Gypsy Station."

WIBO WIBO Broadcasters, Inc., 6312 Broadway, Chicago, Ill. 305.9 meters, 980 kilocycles, 5000 watts. Sun, 8:45-10 am, 11 pm-1 am. Daily ex Sun, 2:30-5 pm. Daily ex Sun & Mon, 7-8:30 pm, 10-11 pm. Tues & Wed, 11 pm-1 am. Central standard time. Divides time with WHT & WHAZ.

WIBR Tri-State Service Co. (Thurman A. Owings, Mgr.), Steubenville, Ohio. 249.9 meters, 1200 kilocycles, 50 watts. Daily, 6:30-7:30 pm. Mon & Fri, 8:30-9:30 pm. Wed, 11:15 pm-12:45 am. Eastern standard time. Slogan: "Where Investments Bring Results."

WIBS New Jersey Broadcasting Corp., 80 Broad st., Elizabeth, N. J. 204.0 meters, 1470 kilocycles, 250 watts. Mon, Wed, Fri, 3-5 pm, 6-8 pm, 10:30 pm-12 midnight. Tues, Thurs, 3-7:30 pm. Sat, 2-4 pm, 6-11 pm. Sun, 10:30 am-12 noon, 5:30-7:30 pm. Eastern standard time. Divides with WLBX & WMBQ. Slogan: "The Voice of the Rail and Harbor City."

WIBU The Wisconsin State Journal, Electric Farm Station, Poynette, Wis. 217.3 meters, 1380 kilocycles, 20 watts. Sun, 2-3 pm, concert; 4-5:30 pm, vesper service. Mon, 9-12 pm., community program. Central standard time.

WIBW Topeka's Own Broadcasting Station, 901-2 National Reserve Life Bldg., Topeka, Kan. 204.0 meters, 1470 kilocycles, 100 watts. Sun, 12:15-1:45 pm, dinner music; 1:45-3 pm, studio program; 6:15-7:45 pm, string ensemble. Daily ex Sun, 12:15-1:15 pm, organ music; studio program, 5-7:30 pm, organ, weather, news, bedtime story, dinner music; 8:30-10 pm, studio program. Mon, 11 pm-12 midnight. Central standard time. Slogan: "Topeka—Where Investment Brings Wealth."

WIBX WIBX, Inc., Hotel Utica, Utica New York. 238.0 meters, 1260 kilocycles, 150 watts. Daily, 9:30-10:30, 10:30-11 am, 12-1 pm, music, news, etc.; 6-11 pm ex Wed night. Sun morning, church services, 6-11 pm. Eastern standard time.

WIBZ A. D. Trum, 217 Catoma st., Montgomery, Ala. 230.6 meters, 1300 kilocycles, 15 watts. Fri, 9-10 pm. Sun, 12-1 pm. Central standard time. Slogan: "We Interest Business Zeal."

WICC The Bridgeport Broadcast Station, Inc., 1044 Main St., Bridgeport, Conn. 265.3 meters, 1130 kilocycles, 500 watts. Sun, 10 am-12:30 pm, 2-5 pm, 7-9:30 pm. Daily ex Sun, 9-11 am, 12 noon-1:30 pm, 5-11 pm. Eastern standard time. Slogan: "The Industrial Capital of Connecticut." Divides with WCWS.

WIL Benson Broadcasting Corp., Missouri Hotel, 11th & Locust st., St. Louis, Mo. 258.5 meters, 1160 kilocycles, 250 watts. Sun, 5 pm-1 am. Daily ex Sun, 9:30-11:30 am, 2:45-5 pm, 8-11 pm. Central standard time. Slogan: "A Wave Length Ahead."

WIOD Carl G. Fisher, Miami Beach, Fla. 247.8 meters, 1210 kilocycles, 1000 watts. Slogan: "Wonderful Isle of Dreams."

WIP Gimbel Bros., Philadelphia, Pa. 348.6 meters, 860 kilocycles, 500 watts. Silent Mon & Fri. Tues, 10-10:30 am, 1-1:30 pm, 3-4:30 pm, 8-10 pm. Wed, 8-9 pm. Thurs, 10-30 am, 1-1:30 pm, 3-4:30 pm, 8-10 pm. Sat, 10-10:30 am, 1-1:30 pm, 3:45-4:30 pm, 6:30-7:30 pm, 9-11:30 pm. Sun, 10:30-12:30 am, alternating with WOO; 4-6 pm, 7-9:15 pm, alternating with WOO. Every other Sun, 10:15-11:15 pm for Symphony concert. Eastern standard time. Divides time with WOO & WGBS. Slogan: "Watch Its Progress."

WJAD Frank P. Jackson, 801 Austin av., Waco, Tex. 333.1 meters, 900 kilocycles, 500 watts. Sun, 1-2 pm, 6:30-7:30 pm. Daily ex Sun, 9:30-10:30 am, 11:30 am-12:30 pm. Daily ex Sat & Sun, 6:30-7:30 pm, 8:30-9:30 pm. Central standard time. Divides time with KFQB. Slogan: "Waco; Texas, All Around It."

WJAG Norfolk Daily News, Norfolk, Nebr. 285.5 meters, 1050 kilocycles, 500 watts daytime, 250 watts night. Daily ex Sun, 12:15 pm, features, sports, word pictures, etc. Wed & Sat, 6:30 pm, dinner hour orchestra. Sun, 3 pm, musical program. Central standard time. Divides time with KMMJ. Slogan: "Home of the Printers' Devil."

WJAK The Kokomo Tribune, Kokomo, Ind. 234.2 meters, 1280 kilocycles, 50 watts. Daily ex Sun, 11:45 am, radio chapel. Mon, 7:30 pm, musical program. Wed, Thurs, 6 pm, musical program. During basketball season, Fri & Sat, 7:30 pm. Central standard time.

WJAM D. M. Perham, 322 3rd av. W., Cedar Rapids, Iowa. 239.9 meters, 1250 kilocycles, 250 watts. Daily, 9:15 am, 1:15 pm, Chicago grain & livestock markets. Daily ex Sun, 8:30 am-12:30 pm, music & talks. Mon, Wed, Fri, 7-9 pm, music. Tues, Thurs, 9-11 pm, music. Divides time with KWCR.

WJAR The Outlet Company, 174 Weybosset st., Providence, R. I. 483.6 meters, 620 kilocycles, 500 watts. Daily ex Sun, 11:15 am, 1:05-1:30 pm. Mon, Tues & Sat, 10:45 am. Wed, Thurs & Fri, 10 & 11 am, 1:35 pm. Mon, 6:45 through 9:30 pm. Tues, 6:45 pm, 10 pm. Wed, 11:30 am & 7:30 through 9:30 pm. Thurs, 7:30 through 9 pm. Fri, 8 through 10 pm. Sat, 7:45 through 9 pm. Sun, 12 noon, 3 pm, 4 pm, 6:27 pm, 6:30 pm, 7:20 pm, 9 pm, 9:15 pm. Music, talks, reports, chain programs. Eastern standard time. Slogan: "The Southern Gateway of New England."

WJAS Pickering's, 10th St. & Penn Ave., Pittsburgh, Pa. 270.1 meters, 1110 kilocycles, 500 watts. Daily ex Sun, 10:30, music; 11:15 am, 11:30, music; 12 noon, church; 12:45 pm, 1:30 pm, news, etc.; 8 pm, code lesson, music, etc. Mon, Wed, Fri, 9-11 pm, Columbia chain. Sun, 11 am, 2 pm, church; 3-5 & 9-11 pm, Columbia chain. Eastern standard time. Divides time with KQV.

WJAX Jacksonville Municipal Radio Broadcasting Station, Waterworks Park, Jacksonville, Florida. 340.7 meters, 880 kilocycles, 1000 watts. Sun, 11 am, church; 6:30 pm, dinner hour concert; 7:30 pm, church, 10-11 pm. Daily, 11:55 am, time signals; 12 noon, weather. Mon, 7:45 pm-12 midnight, musical. Tues & Sat, 8-10 pm, musical. Wed, 7-8 pm. Thurs, 7:15-11 pm, musical. Fri, 7-10 pm, musical. Eastern standard time. Slogan: "WJAX—W for Wonderful, JAX for Jacksonville." Divides with WAPI.

WJAY Cleveland, Ohio. 227.1 meters, 1320 kilocycles, 500 watts. Eastern standard time. Divides time with WFJC.

WJAZ Zenith Radio Corp., 3620 Iron st., Chicago, Ill. Studio, Chez Pierre. 263.0 meters, 1140 kilocycles, 5000 watts. Sun, 7:30-9:30 pm. Tues, Wed, Fri, Sat, 7-8 pm, 9-11 pm. Thurs, 9-12 pm, Chez Pierre program. Divides time with Station WMBI, 8-9 pm, except Thurs, 7-9 pm. Sun, 3:30-7 pm. Central standard time.

WJBA D. H. Lentz, Jr., 301 Whitley av., Joliet, Ill. 247.8 meters, 1210 kilocycles, 50 watts. Tues, 8-11 pm. Central standard time.

WJBB The Financial Journal, Inc., Sarasota, Fla. 238.5 meters, 1260 kilocycles, 250 watts. Eastern standard time. Slogan: "The Pioneer Semi-Tropical Business Journal."

How's Your Old Audio Amplifier

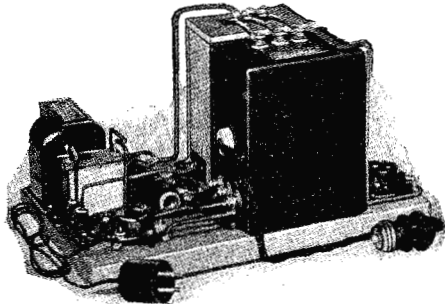
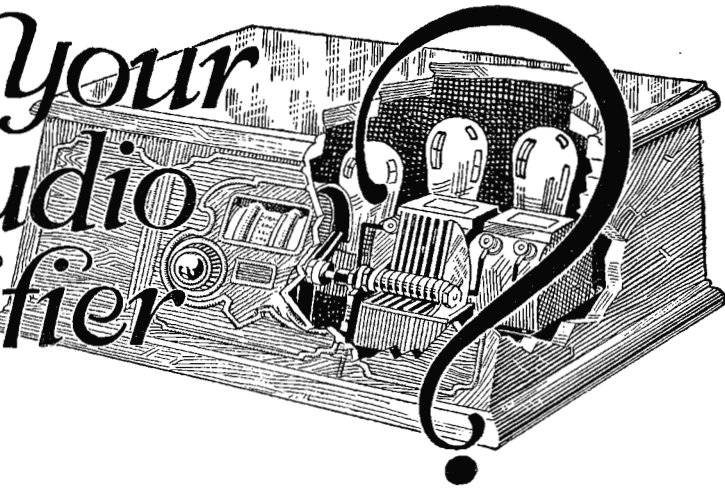

**THORDARSON 171 TYPE
POWER AMPLIFIER**

Built around the Thordarson Power Compact R-171, this power amplifier supplies "A," "B," and "C" current for one UX-171 power tube and B-voltage for the receiver. Employs Raytheon B. H. rectifier.

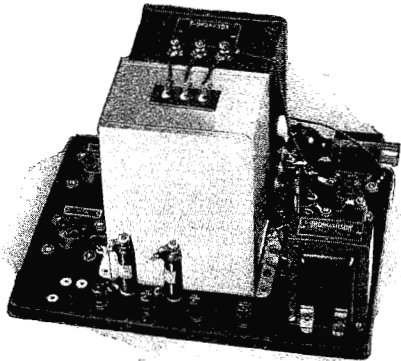

**THORDARSON 210 TYPE
POWER AMPLIFIER**

This amplifier, mounted on a special metal chassis, uses the Thordarson Power Compact R-210. Provides "A," "B," and "C" current for one UX-210 power tube and "B" voltage for the receiver. Employs one 216-B or 281 rectifier.

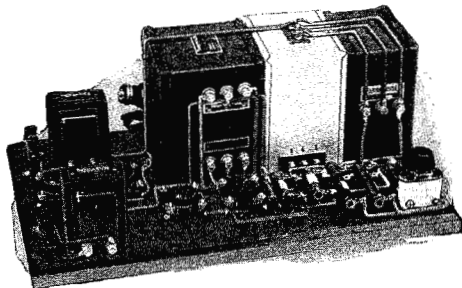

**THORDARSON 210 PUSH-PULL
POWER AMPLIFIER**

This heavy duty power amplifier operates two 210 power tubes in push-pull and has an ample reserve of power for "B" supply for the heaviest drain receivers. Built with Thordarson Power Transformer T-2098, and Double Choke Unit T-2099.

A Home Assembled Thordarson Power Amplifier Will Make Your Receiver A Real Musical Instrument

IMPROVEMENTS in the newer model receiving sets are all centered around the audio amplifier. There is no reason, however, why you cannot bring your present receiver up to 1928 standards of tone quality by building your own Thordarson Power Amplifier.

With a screw driver, a pair of pliers and a soldering iron you can build any Thordarson Power Amplifier in an evening's time in your own home. Complete, simple pictorial diagrams are furnished with every power transformer.

{ The fact that Thordarson power transformers are used by such leading manufacturers as Victor, Brunswick, Federal, Philco and Willard insures you of unquestionable quality and performance. }

Give your radio set a chance to reproduce real music. Build a Thordarson Power Amplifier.

Write today for complete constructional booklets sent free on request.

THORDARSON

THORDARSON ELECTRIC MANUFACTURING CO.
Transformer Specialists Since 1895
WORLD'S OLDEST AND LARGEST EXCLUSIVE TRANSFORMER MAKERS
Huron and Kingsbury Streets — Chicago, Ill. U.S.A.

3572

Tell 'Em You Saw It in the Citizens Radio Call Book Magazine

WJBC Hummer Furniture Co., Second and Joliet, La Salle, Ill. 227.1 meters, 1320 kilocycles, 100 watts. Sun, 10-11 am, Catholic church services; 7:30-9:30 pm, Baptist church services. Mon, 8-10 pm, studio program. Tues, Thurs, Sat, 12:30-1 pm, organ concert. Sat, 1-2 pm, children's program. Central standard time. Divides time with WVAE & WCLO. Slogan: "Better Homes Station."

WJBI Robert S. Johnson, 63 Broad st., Red Bank, N. J. 263 meters, 1140 kilocycles, 250 watts. Mon, 9-12 pm. Wed, 10-11 am, 4-6 pm, 10-12 pm. Fri, 9-10:30 am, 9-12 pm. Eastern standard time. Divides time with WEAM.

WJBK Ernest F. Goodwin, 803 Congress st., Ypsilanti, Mich. 220.4 meters, 1360 kilocycles, 15 watts. Central standard time.

WJBL Wm. Gushard Dry Goods Co., 301 N. Water st., Decatur, Ill. 212.6 meters, 1410 kilocycles, 250 watts. Mon, Wed & Sat, 9 pm. Sun, 3 pm. Central standard time.

WJBO Valdemar Jensen, 119 South st., New Orleans, La. 263.0 meters, 11:40 kilocycles, 100 watts. Daily ex Sun, 6:30-7:30 pm, merchants hour. Tues & Fri, 8 pm & 11 pm, dance programs. Sun, 3-4:30 pm, classical; 5-5:45 pm, church. Central standard time.

WJBT J. S. Boyd, Inc., 306 S. Wabash Ave., Chicago, Ill. 389.4 meters, 770 kilocycles, 500 watts. Sun, 10:30 am, 2:30 pm-12 midnight. Daily ex Sun, 11 am, 3 pm, 7 pm. Mon, 9-10 pm. Tues, 11 pm-1 am. Thurs, 12 midnight-2 am. Wed, Fri & Sat, 11 pm-12 midnight. Central standard time. Divides time with WBBM & WAAF.

WJBU Bucknell University, Lewisburg, Pa. 214.2 meters, 1400 kilocycles, 100 watts. Eastern standard time. Slogan: "In the Heart of the Keystone State."

WJBW Serve-U-Radio Co., 2743 Dumaine st., New Orleans, La. 238.0 meters, 1260 kilocycles, 30 watts. Tues, Fri, 7-8 pm. Central standard time. Divides time with WABZ. Slogan: "The Serve You Broadcasting Station at New Orleans."

WJBY Electric Construction Co., 517 Broad st., Gadsden, Ala. 234.2 meters, 1280 kilocycles, 50 watts.

WJBZ Roland G. Palmer and A. Coppotelli, 144 East 16th st., Chicago Heights, Ill. 208.2 meters, 1440 kilocycles, 100 watts. Tues & Fri, 7-10 pm. Central standard time. Slogan: "Crossroads of the Nation."

WJJD Loyal Order of Moose, Mooseheart, Ill. 365.6 meters, 820 kilocycles, 1000 watts. Children's programs from Mooseheart. Chicago programs from the Palmer House in cooperation with the Chicago Herald and Examiner. Sun, 3 hrs; Mon, 7 hrs; Tues, Wed, Thurs, 7 hrs 30 min; Fri, 5 hrs 30 min; Sat, 6 hrs 30 min. Central standard time. Divides time with WEBH. Slogan: "Every Child Is Entitled to a High School Education and a Trade."

WJKS Gary, Ind. 232.4 meters, 1290 kilocycles, 500 watts. Central standard time. Divides with WSBC.

WJPW J. P. Wilson, Ashtabula, Ohio. 208.2 meters, 1440 kilocycles, 30 watts.

WJR & WCX Richards-Oakland Co. & Detroit Free Press, 2914 Book-Cadillac Hotel, Detroit, Mich. 440.9 meters, 680 kilocycles, 5000 watts. Sun, 10 am, church; 12:30 pm, 2 pm, 3 pm, 4:15-4:30 pm, 6-10:30 pm. Daily ex Sun, 10-11 am, 12 noon-2 pm, 4-4:30 pm, 5:30 pm-12 midnight. Music, talks, weather reports & chain programs broadcast. Eastern standard time. Slogan: "The Good Will Station."

WJZ Radio Corporation of America, managed by National Broadcasting Co., 711 5th Ave., New York City, N. Y. 454.3 meters, 660 kilocycles, 40,000 watts. Sun, 9-10 am, 1-10:45 pm. Daily ex Sun, 12:30 pm-12 midnight. Eastern standard time.

WKAQ Radio Corp. of Porto Rico, Telephone Bldg., San Juan, Porto Rico. 322.4 meters, 930 kilocycles, 500 watts. Wed, 7-9 pm, Municipal Band of San Juan. Fri, 8:30-9:30 pm, Tropiko hour from studio. Spanish music only. Studio program. Slogan: "Porto Rico, The Island of Enchantment in the Caribbean Sea." Eastern standard time.

WKAR The Michigan State College, East Lansing, Mich. 277.6 meters, 1080 kilocycles, 1000 watts daytime, 500 watts night. Daily ex Sun, 12-12:30, markets, weather, educational program.

WKAU Laconia Radio Club, Auditorium of Public Service Co., Laconia, N. H. 223.7 meters, 1340 kilocycles, 50 watts. Sun, 5 pm. Fri, 7:30 pm. Eastern standard time. Slogan: "The Voice of the Winnepesaukee Lake Region."

WKBB Sanders Bros., 607 Jefferson st., Joliet, Ill. 215.7 meters, 1390 kilocycles, 150 watts. Wed, 6-8:30 pm, dinner program. Thurs, 8:30-12 pm, good time program. Sun, 3-5 pm, classical; 8:30-12 pm, frolics. Central standard time. Divides time with WCLS.

WKBC H. L. Ansley, 1428 N. 12th av., Birmingham, Ala. 241.8 meters, 1370 kilocycles, 10 watts. Tues, Thurs, Sat, 5:30-7 pm, music. Sat, Sunday school talks on lessons for Sunday. Central standard time.

WKBE K. & B. Electric Co., 59 Emerald av., Webster, Mass. 228.9 meters, 1310 kilocycles, 100 watts. Tues & Wed, 8-10 pm. Sat, 8-10:30 pm. Eastern standard time.

WKBF Noble Butler Watson, 902 N. Meridian St., Indianapolis, Ind. 252 meters, 1190 kilocycles, 250 watts. Slogan: "We Keep Building Friendships."

WKBG C. L. Carrell, 36 S. State st., Chicago, Ill. (Portable). 201.6 meters, 1490 kilocycles, 100 watts.

WKBH Callaway Music Co., 221 Main st., LaCrosse, Wis. 220.4 meters, 1360 kilocycles, 500 watts. Daily ex Sun, 10 am, weather report, talk & music; 12 noon, weather report, farm service, music. Sun, 10:30 am, church service; 6:30 pm, classical & vesper service. Mon, Wed, Fri & Sat, 8:30 pm, studio program. Wed, 9:30 pm, dance music. Fri, 7:30 pm. Central standard time.

WKBI Fred L. Schoenwolf, Lincoln Trust & Savings Bank Bldg., Chicago, Ill. 215.7 meters, 1390 kilocycles, 50 watts. Central standard time. Divides with WHFC.

WKBL Monrona Radio Mfg. Co., 16 S. Monroe, st., Monroe, Mich. 205.4 meters, 1460 kilocycles, 15 watts. Mon, 8-9 pm. Wed, 9-10:30 pm. Thurs, 8-10 pm. Fri, 8-11 pm. Sat, 9-12 pm. Slogan: "The Most Powerful 15-Watt Station in the World."

WKBN Radio Electric Service, 17-21 N. Champion st., Youngstown, Ohio. 214.2 meters, 1400 kilocycles, 50 watts. Eastern standard time. Divides time with WMBW.

WKBO Camith Corp., Jersey Observer Bldg., Jersey City, N. J. 218.8 meters, 1370 kilocycles, 500 watts. Eastern standard time. Divides time with WKBQ & WCGU.

WKBP Battle Creek Enquirer & News, Battle Creek, Mich. 212.6 meters, 1410 kilocycles, 50 watts.

WKBQ Starlight Amusement Park, 1100 E. 177th st., New York City, N. Y. 218.8 meters, 1370 kilocycles, 500 watts. Mon & Tues, 10 am-12 noon. Tues, 1-5 pm. Tues & Wed, 9 pm-12 midnight. Thurs, 1-3 pm. Thurs & Sun, 8 pm-12 midnight. Fri, 3-6 pm. Sat, 3-8 pm. Eastern standard time. Divides time with WKBO & WCGU.

WKDR Kenosha, Wis. 247.8 meters, 1210 kilocycles, 15 watts output. Sun, 2-3 pm, religious services. Sat, 11-12:30 pm.

WKBS Galesburg, Ill. 217.3 meters, 1380 kilocycles, 100 watts. Daily ex Sat & Sun, 10-11 am, 12:30-1 pm, 2:30-3:30 pm. Sun, 1:30-3 pm, church. Mon, Wed, Fri, 7-11 pm. Tues, Thurs, Sat, 7-9 pm, 10-11 pm. Wed, 6:30-7 pm. Sat, 12:30-1 pm, 3-4 pm, 11 pm-12 midnight. Central standard time. Divides time with WLBO. Slogan: "The Mayflower Station in the Renowned City of Colleges."

WKBT First Baptist Church, 3436 St. Charles av., New Orleans, La. 252 kilocycles, 50 watts. Sun, 11 am & 7:30 pm, church services & special music.

WKBV Knox Battery & Electric Co., 658 Main st., Brookville, Ind. 217.3 kilocycles, 100 watts.

WKBW Churchill Tabernacle, 1420-28 Main, Buffalo, N. Y. 217.3 meters, 1380 kilocycles, 500 watts night, 750 watts daytime. Sun, 9:30 am, 10:30 am, 3 pm, 7 pm, 10:15 pm-12 midnight. Daily ex Sun, 3-4 pm, music; 6:30-10 pm. Mon, 7:45 pm, talk. Wed, 9 pm, civil service exams; 9:15 pm, prayer service. Fri, 7:15 pm, Sunday School lesson, 7:45 pm. Sat, 6:30-8 pm. Eastern standard time. Slogan: "Well Known Bible Witness."

WKBZ Karl L. Ashbacker, First National Bank Bldg., Ludington, Mich. 199.9 meters, 1500 kilocycles, 15 watts.

WKEN Kenmore, Buffalo, N. Y. 204 meters, 1470 kilocycles, 250 watts. Sun, 11 am-12 noon, 7:30-8:30 pm. Daily ex Sun, 6-6:45 pm. Mon, Tues, Thurs, 8-11 pm. Eastern standard time. Divides time with Station WSVS. Wed, Fri evenings, 7:30-9:30 pm.

WKJC Kirk Johnson & Co., 16-18 W. King st., Lancaster, Pa. 252.0 meters, 50 watts, 1190 kilocycles. Sun, 9:30-12 noon, 7:30-9:30 pm. Mon, Wed, Fri, 7:30-9:30 pm. Sat, 2:30-4:30 pm. Eastern standard time. Divides time with WGAL.

WKRC The Kodol Radio Corp., 507 E. Pearl st., Cincinnati, Ohio. 245.8 meters, 1220 kilocycles, 500 watts. Sun, 11 am, church; 10 pm, classical; 11:15 pm, popular. Mon, Wed, 6 pm, dinner music; 8 pm, instrumental. Mon, 12 midnight, dance music. Wed, 8:30 pm, classical. Tues, 10 pm, vocal, instrumental; 11 pm, popular. Sat, 10 pm, dance program. Eastern standard time. Divides time with WFBE. Slogan: "WKRC—K. Kodol—R. Radio—C. Corporation."

WKY WKY Radiophone Co., Huckins Hotel, Oklahoma City, Okla. 288.3 meters, 1040 kilocycles, 150 watts. Daily ex Sun, 9:45 am, Sunshine Hour; 12 noon-1 pm, organ; 6:30-7:30 pm, dinner hour; 7:30-8 pm, organ; 8 pm-12 midnight, Huckins Hotel Studio. Sun, 11 am, 7:30 pm, church; 3-4 pm, concert. Central standard time.

Keep your Present Radio —but make it an AC Electric Set

Using the **NEW**
AC Tubes

+

Sterling
AC
TRIPower
OR
AC TUBE
TRANSFORMER

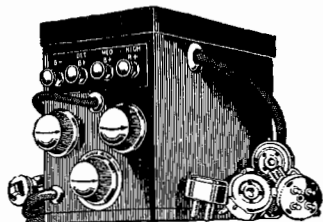
Sterling AC Tri-Power

A single Unit providing complete "A", "B", & "C" Power for AC tubes to Crosley Bandbox, Freed Eisemann, Fada, Kolster, etc. No rewiring or extra batteries. Attached to any set in ten minutes.

Model 810 \$38.00 including cable and adaptors for AC conversion.
Raytheon BH Tube \$4.50

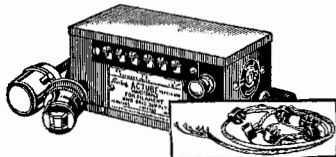

Sterling AC Tube Transformer

Adds "A" and "C" Power to "B" Powered sets for AC tubes. Like the Tri-power, this Transformer provides the right filament current for 226 and 227 AC tubes, and 112 and 171 Power Tubes.

Model 850 \$17.50
Cable and adaptors for AC tube conversion \$6.00 to \$8.00

**2 methods—
both are
Sterling!**

NOW you can have the choice of two ways to convert your present set into a full-fledged electrically operated AC receiver.

With a few simple changes your present 5 to 8 tube radio will give you

- improved tone quality
- permanent power supply
- freedom from service costs

To Use AC Tubes

If your old radio tubes are played out, replace them with the new AC tubes and use a Sterling "A-B-C" Tri-Power.

But if you already have a reliable "B" power unit, keep it in use and simply plug it into the Sterling AC Tube Transformer. Either of these methods converts your set to use AC tubes.

To use Your Old Tubes

If you have been using batteries, but want the advantages of AC power from your house line, without the added expense of AC tubes, then electrify with Sterling timed "A" and "B" Power Units.

Whether you use AC Tubes or DC tubes, if your set is Sterling-powered you are rid of batteries. You have automatic operation by the touch of a single switch. Permanently electrified radio. AC light socket convenience.

THE STERLING MFG. CO.
Cleveland, Ohio

Sterling AC Power Equipment for Radios

Using your
Ordinary
(DC) Tubes

+

Sterling
"A" & "B"
Power Units

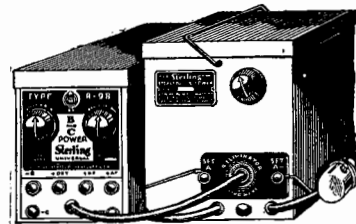
Sterling 6-volt Power Team

Provides AC operation for any 5 to 8 tube set without buying new tubes. Dry, permanent, service-free. Operates as a single unit, but sold separately as follows:

R-93 "A" Power \$39.50 (with Tungar Bulb)
R-98 "B" Power \$38.00 (with Raytheon Tube)

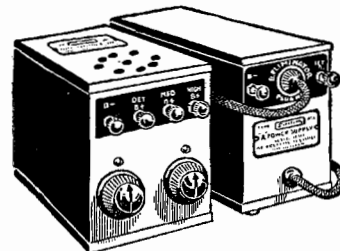

Sterling 4-volt Power Team

The one satisfactory AC Power Supply for Radiolas, Victor and Brunswick combinations. Best supers and other 4 v. sets. Operates as a single unit, but sold separately as follows:

R-94 4v. "A" Power with Tungar Bulb \$32.00
R-41 "B" Power with 213 or 280 tube \$28.50
R-81 "B" Power with Raytheon tube \$27.00
Special Connectors \$2.50

Tell 'Em You Saw It in the Citizens Radio Call Book Magazine

WLAC Life & Casualty Insurance Co. of Tennessee, Nashville, Tenn. 225-4 meters, 1330 kilocycles, 1000 watts. Sun, 6-7 pm. church; 9:15-10:15 pm. Daily ex Sun, 6:45-8:30 am, 12:20-12:55 pm. Mon, Wed, Sat, 6-9 pm. Tues & Thurs, 6-7 pm, 9-12 midnight. Central standard time. Slogan: "The Thrift Station."

WLAP Virginia Av. Baptist Church, 2600 Virginia av., Louisville, Ky. 267.7 meters, 1120 kilocycles, 30 watts night, 100 watts daytime. Sun, 11 am-12 noon, 7:30-8:45 pm. Central standard time.

WLB University of Minnesota, Minneapolis, Minn. 245.8 meters, 1220 kilocycles, 500 watts. Mon, 7:30-8 pm. Tues, 6-7 pm, 8-9 pm. Wed, 6:15-7 pm, 7:30-8:30 pm. Fri, 4-5 pm, 7:30-8 pm. Central standard time. Divides time with WHDI.

WLBC D. A. Burton, 2224 S. Jefferson st., Muncie, Ind. 209.7 meters, 1430 kilocycles, 50 watts.

WLBK Everett L. Dillard, 300-A E. 33rd st., Kansas City, Mo. 209.7 meters, 1430 kilocycles, 50 watts. Daily ex Sun, 10 am-11 pm, popular & classical; 7:30-10:30 pm, popular & classical. Central standard time. Slogan: "Where Listeners Become Friends."

WLBG R. A. Gamble, 126 N. Sycamore st., Petersburg, Va. 214.2 meters, 1400 kilocycles, 100 watts. Irregular programs daily.

WLBH Joseph J. Lombardi, Farmingdale, N. Y. 232.4 meters, 1290 kilocycles, 30 watts.

WLBK Wenona Legion Broadcasters, 107 Chestnut st., Wenona, Ill. 238.0 meters, 1260 kilocycles, 250 watts. Sun, 5 pm. church. Daily ex Sun, 10-11 am, 2-3 pm. Mon, 7-10 pm. Wed & Sat, 5-6 pm. Wed, 7 pm. Thurs & Fri, 7-8 pm. Central standard time. Slogan: "In the Heart of the Corn Belt."

WLBL Wisconsin Department of Markets, Stevens Point, Wis. 333.1 meters, 900 kilocycles, 1000 watts night, 2000 watts daytime. Daily ex Sun, 8, 9, 10 & 11 am, 12 noon, 1 pm. markets. Thurs & Sat, 8 pm, musical program. Central standard time. Divides time with Station WHA. Slogan: "Wisconsin, Land of Beautiful Lakes."

WLBK Boston, Mass. 230.6 meters, 1300 kilocycles, 50 watts.

WLBK William E. Hiler, 339 S. Homan av., Chicago, Ill. (Portable). 204.0 meters, 1470 kilocycles, 100 watts.

WLBK Frederick A. Trebbe, Jr., 526 Monmouth blvd., Galesburg, Ill. 217.3 meters, 1380 kilocycles, 100 watts. Central standard time. Divides time with WKBS.

WLBK E. Dale Trout, Atwood, Ill. 218.8 meters, 1370 kilocycles, 25 watts. Central standard time.

WLBK Alford Radio Co., Belvidere, Ill. 247.8 meters, 1210 kilocycles, 15 watts.

WLBK Harold Wendell, 317 E. North st., Crown Point, Ind. 247.8 meters, 1210 kilocycles, 50 watts. Central standard time.

WLBK Mansfield Broadcasting Association, Chamber of Commerce Bldg., Mansfield, Ohio. 206.8 meters, 1450 kilocycles, 50 watts. Sun, 10:30-12 noon, 4-5 pm, 7:45-10 pm. Daily ex Sun, 6-7 pm. Mon, Wed & Sat, 9-12 pm. Eastern standard time.

WLBK Northwestern Pennsylvania Broadcast Station, P. O. Box 163, Oil City, Pa. 272.6 meters, 1100 kilocycles, 500 watts. Daily ex Sun, 12:15 pm.: luncheon program; 3 pm, radio dealers' hour; 5:15 pm, dinner music. Mon, 9:30 pm & 12 midnight, miscellaneous program. Thurs, 10 pm, miscellaneous program. Sun, 3:30 pm, sacred. Eastern standard time.

WLBK John N. Brahy, 283 Crescent st., Long Island City, N. Y. 204.0 meters, 1470 kilocycles, 250 watts. Eastern standard time. Divides time with WBS & WMBQ.

WLBK Aimone Electric, 1236 Carpenter st., Iron Mountain, Mich. 209.7 meters, 1430 kilocycles, 50 watts.

WLBK Thompson L. Guernsey, Dover-Foxcroft, Me. 208.2 meters, 1440 kilocycles, 250 watts.

WLBK Lutheran Association of Ithaca, Ithaca, N. Y. 247.8 meters, 1210 kilocycles, 50 watts.

WLBK Lexington, Mass. 215.7 meters, 1390 kilocycles, 50 watts. Eastern standard time.

WLBK Liberty Magazine, Chicago, Ill. 416.4 meters, 720 kilocycles, 15,000 watts. Daily ex Sun & Mon, 10:30-11 am, 11:30 am-12:40 pm, 7-8 pm, 11-12:30 am. Sun, 5-6 pm, 11 pm-12:30 am. Central standard time. Divides time with WGN.

WLBK Lit Bros., Philadelphia, Pa. 405.2 meters, 740 kilocycles, 500 watts, class B. Daily ex Sun, 11 am-1 pm, 2-3 pm, 4:30-6 pm. Mon, 12 noon to 11 pm. Tues, 11 am to 8 pm. Wed, 12 noon to 11 pm. Thurs & Sat, 12 noon to 8 pm. Fri, 12 noon to 12 midnight. Eastern standard time. Divides time with WFI. Slogan: "The Quaker City Siren."

WLBK Chelsea, Mass. 211.1 meters, 1420 kilocycles, 100 watts. Eastern standard time. Divides with WMES.

WLBK Sears, Roebuck & Co., Chicago, Ill. 344.6 meters, 870 kilocycles, 5000 watts. Sun, 10:45-12:20, U. of C. church; 12:20-1, organ; 1-1:30, trio concert; 6-8, Little Brown church. Mon, markets; 9-9:10-10-10:30-11-11:30-11:45, markets every day ex Sun; R. F. D. program & markets, 12-1 pm; closing markets every day, 1:25-1:35; home makers' hour, Mon, Tues, Wed, Fri, 2:30-3:30 pm; organ every day ex Sat & Sun, 5:30. Birthday time, ex Sat & Sun, 5:45 pm. Supper bell program ex Sun, 6 pm. Sports time ex Sun, 6:30 pm. Mon, 7-10:30 pm. Tues, 5:30-8, 10:30-12:30 pm. Wed, 5:30-12 pm. Thurs, 5:30-8, 10:30-12:30 pm. Fri, 5:30-12 pm. Sat, 6-1 am. Central standard time. Divides time with WCBK. Slogans: "World's Largest Store," "Work Better, Live Better, Sell Better."

WLBK Lincoln Studios (Ind.), 335 Westminster St., Providence, R. I. 260.7 meters, 1150 kilocycles, 250 watts. Eastern standard time. Divides time with WDFW.

WLBK "The Voice of Brooklyn," Inc., Leverick Towers Hotel, Brooklyn, N. Y. 256.3 meters, 1170 kilocycles, 250 watts. Sun, 11 am-2 pm, 5-6 pm, 9-11 pm. Mon, 10 am-1 pm, 5-6 pm, 9-11 pm. Tues, Wed, Thurs, 4-7 pm. Tues, Wed & Sat, 9 pm-12 midnight. Thurs, 9 pm-2 am. Fri 5-7 pm. Sat, 4-6 pm. Eastern standard time. Divides time with WBBK & WEBJ.

WLBK Lane Technical High School, 1225 Sedgwick st., Chicago, Ill. 483.6 meters, 620 kilocycles, 100 watts. Daily ex Sat & Sun, 2-4 pm, musical & educational. Mon, 6-7 pm, musical. Central standard time. Slogan: "World's Largest Technical School." Divides time with WCFL & WEMC.

WLW The Crosley Radio Corp., Harrison, Ohio. 428.3 meters, 700 kilocycles, 5000 watts, 52.02 meters, 5764 kilocycles, 250 watts. Daily ex Sun, 8 am through 12 noon. Sat, 10 am through 12 noon, 12:45-11 pm. Mon, Tues, Wed, Thurs, 1:30-11 pm. Fri, 1:30-9 pm. Music, news, talks, chain programs, etc. Sun, 9:30, 11 am, church services; 3 pm, 4 pm, 7:10 through 10:15 pm. Eastern standard time.

WLWL Kearney, N. J. 370.2 meters, 810 kilocycles, 5000 watts. Daily ex Sun, 6-8 pm. Sun, 5-6 pm, 8-9:15 pm. Eastern standard time. Divides time with WMCA.

WMAC Clive B. Meredith, Cazenovia, N. Y. 225.4 meters, 1330 kilocycles, 500 watts. Sun, 3:30 pm, choral singing; 9:30 pm, popular program. Mon, 8:30, semi-classical program; 7:30, Weekly Letter to Dad. Daily ex Sun & Mon, 7:30 pm. Tues, Autobiography of Infamous Bugs. Wed, Chats with Weatherman; 8:30, popular program. Thurs, Primer for Town Farmers. Fri, 7:30 pm, Agricultural Interview; 8:30 pm, classical program. Sat, Farm News Digest. Eastern time. Divides time with WSYR. Slogan: "Voice of Central New York."

WMAF Round Hills Radio Corp., South Dartmouth, Mass. 428.3 meters, 700 kilocycles, 500 watts. Eastern standard time.

WMAK WMAK Studios, Inc., Liberty Bank Bldg., Buffalo, N. Y. 545.1 meters, 550 kilocycles, 750 watts. Sun, 10 am-12 noon, 2-5 pm, 7-11 pm. Daily ex Sun, 11 am-12 noon, 1:30-6 pm, 6 pm-12 midnight. Eastern standard time.

WMAL Washington Radio Forum, owned & operated by the M. A. Leese Radio Co., 720 11th st., N. W., Washington, D. C. 241.8 meters, 1240 kilocycles, 500 watts. Daily, 6:45-11 pm, varied programs. Eastern standard time.

WMAN W. E. Heskett Radio Station, First Baptist Church, Columbus, Ohio. 234.2 meters, 1280 kilocycles, 50 watts. Sun, 10:30 am-12 noon; 7:30-9 pm, church services. Eastern standard time. Divides time with WCAH.

WMAQ The Chicago Daily News, 15 N. Wells st., Hotel La Salle, Chicago, Ill. 447.5 meters, 670 kilocycles, 1000 watts. Daily ex Sun, 6:30-11 am, 12 noon-3 pm, 4-6 pm, 7-10 pm. Sun, 4-6 pm, 7-10 pm. Central standard time. Divides time with WQJ.

WMAY Kingshighway Presbyterian Church, St. Louis, Mo. 234.2 meters, 1280 kilocycles, 100 watts. Sun, 11 am-12 pm, 8-9 pm, church services. Central standard time. Divides time with KWK & KFQA.

WMAZ Mercer University, Macon, Ga. 270.1 meters, 1110 kilocycles, 500 watts. Tues, Wed & Thurs, 8-9:15 pm. Fri, 11 pm-12:15 pm. Eastern standard time. Divides time with WGST. Slogan: "Watch Mercer Attain Zenith."

WMBA Leroy J. Beebe, 13 Robinson st., Newport, R. I. (Portable). 204.0 meters, 1470 kilocycles, 100 watts.

WMBB American Bond & Mortgage Co., 6201 Cottage Grove av., Chicago, Ill. 252.0 meters, 1190 kilocycles, 5000 watts. Sun, 3-6 pm, popular concert program; 7:40-9 pm, Christian Science services; 9-11 pm, popular program. Daily ex Sun, Mon, 7-8:30 am, after dinner concert; 9-10 pm, popular program. Tues & Fri, 7-10 pm, quartet. Central standard time. Slogan: "World's Most Beautiful Ballroom."

Drilled and Decorated Kit Panels of Formica

PANELS for well-known kits available in Black or one of the handsome Formica wood-finishes include: Karas Knickerbocker Four; Karas A. C. Equamatic; Karas Battery Equamatic; Tyrman Seventy; Magnaformer; Bremer-Tully Electric—and many others.

Formica is headquarters for kit panels. The decoration on these panels is graceful, neat and thoroughly protected, so that it will not rub off or wash off with alcohol or solvents.

*Leading jobbers everywhere handle
the Line*

THE FORMICA INSULATION COMPANY

4666 Spring Grove Avenue
Cincinnati, Ohio

FORMICA
Made from Anhydrous Bakelite Resins
SHEETS TUBES RODS

Tell 'Em You Saw It in the Citizens Radio Call Book Magazine

WMBC Michigan Broadcasting Co. (F. G. Siegel), Hotel Savoy, Detroit, Mich. 243.8 meters, 1230 kilocycles, 100 watts. Sun, 6:30-10 pm, dinner hour, studio program. Daily ex Sun & Sat, 6-6:30 pm, Children's Hour; 6:30-10 pm, dinner hour, studio program. Sat, 6-6:30 pm, Children's Hour, 6:30-8 pm, dinner hour. Eastern standard time.

WMBD Peoria Heights Radio Laboratory, Peoria Heights, Ill. 205.4 meters, 1460 kilocycles, 250 watts. Sun, 11 am-12 noon, church. Daily ex Sun, 6:55-7:30 pm, markets; 8-10 pm, studio program. Central standard time. Slogan: "World's Most Beautiful Drive."

WMBE Dr. C. S. Stevens, St. Paul, Minn. 208.2 meters, 1440 kilocycles, 10 watts. Central standard time. Slogan: "The Winter Garden Station."

WMBF Fleetwood Hotel Corp., Miami Beach, Fla. 384.4 meters, 780 kilocycles, 500 watts. Daily, 6:30-11:30 pm, popular program. Eastern time. Divides time with WQAM. Slogan: "Wonderful Miami Beach Fleetwood."

WMBG Havens & Martin, 914 W. Broad St., Richmond, Va. 220.4 meters, 1360 kilocycles, 15 watts. Daily ex Sun, 2-3 pm, 6-8 pm. Eastern standard time. Divides time with WTAZ. Slogan: "The Daytime Station."

WMBH Edwin Dudley Aher, Joplin, Mo. 204.0 meters, 1470 kilocycles, 100 watts. Daily ex Sun, 5:30-7:30 pm. Daily ex Sun & Fri, 8:30-10:30 pm. Mon, Tues, Wed, Thurs, 12:15-1 pm. Fri & Sat, 12:30-1:15 pm. Sun, 10:50 am-12 noon, 6 pm, 7:30 pm. Central standard time. Slogan: "Where Memories Bring Happiness."

WMBI The Moody Bible Institute of Chicago, 153 Institute pl., Chicago, Ill. 263.0 meters, 1140 kilocycles, 5000 watts. Sun, 3:30-5 pm, 5-7 pm, Bible Exposition and sacred music. Daily ex Sun, 7-7:40 am, morning worship; 10:30-11:30 am, missionary hour, Bible study; 12:30-1:30 pm, organ program; 3:30-4:30 pm, reading & music; 8-9 pm, Bible study or sacred program. Central standard time. Divides time with WJAZ. Slogan: "The West Point of Christian Service."

WMBJ Wm. Roy McShaffrey, Monessen, Pa. 232.4 meters, 1290 kilocycles, 50 watts.

WMBK John C. Slade, Hamilton, Ohio, 205.4 meters, 1460 kilocycles, 100 watts. Sat & Sun, 2:30-4 pm, 10 pm-12 midnight. Daily ex Sun, 1-2 pm, 6:45-10:30 pm. Eastern standard time.

WMBL Benford Radio Studios, Lakeland, Fla. 228.9 meters, 1310 kilocycles, 100 watts. Sun, church services, morning & evening. Daily ex Sun, 10:30 am-1:30 pm, varied program; 2:30-3:30 pm, varied; 8-9:30 pm, classical; 9:30-10:30 pm, popular; 10:30-11:30 pm, dance program. Eastern standard time. Slogan: "Lakeland—The City of Heart's Desire."

WMBM Memphis, Tenn. 209.7 meters, 1430 kilocycles, 10 watts.

WMBO Auburn, N. Y. 220.4 meters, 1360 kilocycles, 100 watts.

WMBQ 95 Leonard St., Brooklyn, N. Y. 204 meters, 1470 kilocycles, 100 watts. Eastern standard time. Divides time with WBS, WLBX. Slogan: "The Home, Sweet Home Station of Williamsburgh."

WMBR F. J. Reynolds, 109 Franklin st., Tampa, Fla. 252.0 meters, 1190 kilocycles, 100 watts. Daily ex Sun, 1-2 pm, weather reports, organ; 7-8 pm, baseball returns, orchestra. Tues, 7-8 pm, orchestra. Wed, 9-10 pm, musical. Fri, 10 pm, fight returns. Sat, 8-10 pm, musical. Eastern standard time. Slogan: "WMBR, Everything for Radio at Tampa, Florida."

WMB S Macks Battery Service, 210 Locust st., Harrisburg, Pa. 234.2 meters, 1280 kilocycles, 250 watts. Sun, 9 am-9 pm. Daily ex Sat & Sun, 6-11:30 pm. Sat, 6 pm-2 am. Eastern standard time.

WMBW Youngstown, Ohio. 214.2 meters, 1400 kilocycles, 50 watts. Eastern standard time. Divides time with WKBN.

WMC Memphis Commercial Appeal, 30 N. 2nd st., Memphis, Tenn. 516.9 meters, 580 kilocycles, 500 watts. Sun, 11 am, 2 pm, church, services. Daily ex Sun, 9:45 am, 12 noon, 12:05 pm, 2:30 pm, 7-11 pm, music, markets, weather, etc. Central standard time. Slogan: "WMC, Memphis, Down in Dixie."

WMCA Hotel McAlpin (Greeley Square Hotel Co.), New York City. 370.2 meters, 810 kilocycles, 500 watts. Sun, 11 am-1 am. Daily ex Sun, 10:30 am-1 am. Eastern standard time. Divides time with WLWL. Slogan: "Where the White Way Begins."

WMES Boston, Mass. 211.1 meters, 1420 kilocycles, 50 watts. Eastern standard time. Divides with WLOE.

WMPC First Methodist Protestant Church, Lapeer, Mich. 234.2 meters, 1280 kilocycles, 30 watts. Sun, 10:30 am-1 pm, 4-5:30 pm, 7:30-10:00 pm. Daily ex Sat & Sun, 12 noon-1 pm. Mon, Tues, Wed, Fri, 7:30-10 pm. Programs include sermons, vocal, instrumental music, missionary, church & educational services. Eastern standard standard time. Slogan: "Where Many Preach Christ."

WMRJ Peter J. Prinz, 10-12 New York av., Jamaica, N. Y. 206.8 meters, 1450 kilocycles, 10 watts. Sun, 11:30 am-2:30 pm, 8:30-11:30 pm. Tues & Thurs, 8-11:30 pm. Eastern time. Slogan: "The Gateway of the Sunrise Trail." Divides with WTRL & WHPP.

WNAC The Shepard Stores, Winter st., Boston, Mass. 461.3 meters, 650 kilocycles, 500 watts. Sun, 10:45 am, church services; 12:15-5 pm, concert; 7:30-9 pm, church services; 9-11 pm, Columbia system. Daily ex Sun, 9:30-10:30 am, 10:30-11:30 am, Women's Club; 11:30 am-12:15 pm, 12:15-1 pm, church; 1-2 pm, luncheon concert; 4-5 pm, Theatre Hour, music; 6-6:30 pm, children's club; 6:30-7:30 pm, dinner dance; 7:30-8 pm, news & talks; 8-11 pm, concert; 11 pm-12 midnight, dance program. Eastern standard time.

WNAD University of Oklahoma, Norman, Okla. 239.9 meters, 1250 kilocycles, 500 watts. Mon & Thurs, 7:15-9:30 pm. Tues, 12:15-1 pm. Wed, 7:15-8:45 pm. Fri, 12:15-1 pm. Sat, broadcast of athletic events & special features. Central standard time. Slogan: "The Voice of Soonerland."

WNAL R. J. Rockwell, 5019 Capitol av., Omaha, Neb. 258.5 meters, 1160 kilocycles, 250 watts. Tues, Fri, 7:30-9 pm. Central standard time. Divides time with KOCH, KFOX. Slogan: "Pioneer Station of Omaha."

WNAT Lennig Bros. Co., Spring Garden & 9th st., Philadelphia, Pa. 288.3 meters, 1040 kilocycles, 100 watts. Tues, Wed, Sat, 8-11 pm. Eastern standard time. Divides time with WIAD. Slogan: "We Never Are Tired."

WNAX Gurney Seed & Nursery Co., Yankton, S. D. 302.8 meters, 990 kilocycles, 1000 watts daytime. Daily ex Sun, 6 am-6 pm. Sun, 9 am-6 pm. Central standard time.

WNBA Forest Park, Ill. 208.2 meters, 1440 kilocycles, 200 watts.

WNB F Howitt-Wood Radio Co., Inc., Endicott, N. Y. 208.6 meters, 1450 kilocycles, 50 watts. Sun, 12:30-2 pm, 7:30-9:30 pm. Thur, 7:30-10 pm. Eastern standard time. Slogan: "The Voice of the Triple Cities."

WNBH New Bedford Hotel, Pleasant st., New Bedford, Mass. 247.8 meters, 1210 kilocycles, 250 watts. Mon, Wed, Fri, 6-10:30 pm, musical program. Tues, Thur, Sat, 7-7:30 pm, news reports, sports. Eastern standard time. Slogan: "The Gateway to Cape Cod."

WNB J Knoxville, Tenn. 206.8 meters, 1450 kilocycles, 50 watts. Central standard time.

WNBL Bloomington, Ill. 199.9 meters, 1500 kilocycles, 15 watts.

WNBO Symplex Electrical & Radio Research Laboratories, George Washington Hotel, Washington, Pa. 211.1 meters, 1420 kilocycles, 15 watts. Sun, 11-12 noon, 10-11 pm, church services. Mon, Tues, Thur, Fri, 3:30-4:30 pm, 9-11:30 pm, orchestra, baseball, weather. Sat, 3:30-4:30 pm, 9:30-12 pm, orchestra, studio programs. Eastern standard time. Slogan: "The Voice of Washington, Pa."

WNBQ Rochester, N. Y. 205.4 meters, 1460 kilocycles, 15 watts.

WNB R Memphis, Tenn. 228.9 meters, 1310 kilocycles, 100 watts. Sun, 2:30 pm, musical program of sacred numbers & Columbia chain. Mon, Tues, Thurs, Fri, Sat, 6:30 pm, musical program. Tues, 6:30 pm, Old Time Melody Makers. Wed, 6 pm, music; 6:45 pm, Bible talk. Tues, Wed, Thurs, Fri, & Sat, 7:30 pm. Fri, 8 pm. Sat, 7 pm. Central standard time. Divides times with WGBC.

WNBW Home Cut Glass & China Co., 21 Salem av., Carbondale, Pa. 199.9 meters, 1500 kilocycles, 5 watts. Eastern standard time.

WNB X Springfield, Vt. 241.8 meters, 1240 kilocycles, 10 watts. Eastern standard time. Divides time with WFCL.

WNB Z Saranac Lake, N. Y. 232.4 meters, 1290 kilocycles, 10 watts. Eastern standard time.

WNJ Herman Lubinsky, 89 Lehigh av., Newark, N. J. 267.7 meters, 1120 kilocycles, 250 watts. Daily ex Mon & Thurs, 6-6:30 pm, 8:30-12 pm, dance music. Eastern standard time. Divides time with WGCP, WAAM. Slogan: "The Voice of Newark."

WNOX Peoples Tel. & Tel. Co., 313 Commerce st., Knoxville, Tenn. 265.3 meters, 1130 kilocycles, 1000 watts. Mon, Wed, Fri, 12 noon-9 pm. Central standard time. Slogan: "Smoky Mountain Station."

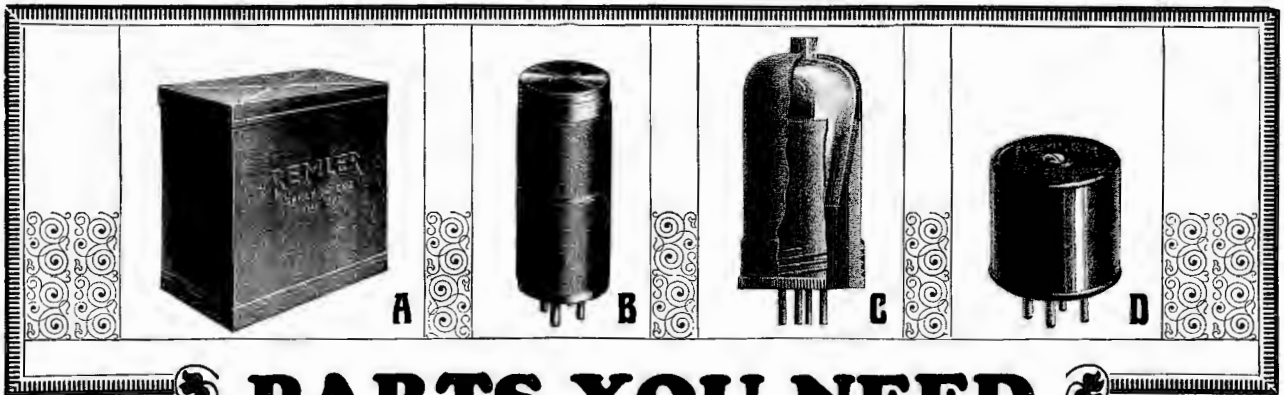

PARTS YOU NEED
 in the New Shielded Grid Tube Circuits
 — of course they carry the name...

REMLER

Radio grows—and grows—and grows. With every new and worthwhile development, there comes a Remler part to meet the exact requirements of the circuit. These parts are the result of exhaustive laboratory experiments, plus specialized factory experience. Ten years of radio knowledge is back of every Remler part. A reputation for absolute reliability is our greatest asset.

The new shield-grid tube circuits require parts of uniform high quality. That means that you need the four new items illustrated above.

- A.** A pure sheet copper shielding case which brings to the individual constructor a refinement heretofore available only to the manufacturer with elaborate facilities.
 No. 720—Remler Shielding Case.....Price \$3.00
- B.** A series of plug-in radio frequency transformers satisfying a large range of requirements, demanding a minimum of space and offering a maximum of convenience.
 No. 550—Interchangeable Inductance Antenna Coupler.....Price \$3.00
 No. 551—Interchangeable Inductance Antenna Coupler.....Price \$3.00
 No. 560—Interchangeable Inductance Interstage Transformers..... Price \$3.00

- No. 561—Interchangeable Inductance Interstage Transformers.....Price \$3.00
- No. 570—Oscillator Inductance.....Price \$4.50
- C.** A series of tube shields providing electro-static shielding and freedom from tube vibration and microphonic noise.
 No. 54—Ballast Shielding.....Price \$1.00
 No. 55—Ballast Shielding.....Price \$2.00
 No. 56—Tube Shield.....Price \$1.00
- D.** Long-wave coupling devices designed to meet the exacting requirements of the shield-grid tube; sharply tuned to 115 k.c.
 No. 612—Interchangeable Inductance (Input).....Price \$4.00
 No. 614—Interchangeable Inductance (Interstage).....Price \$4.00

The other Remler parts shown below also deserve a place in your shielded tube circuit. The fact that they are specified so often in leading circuits, is proof of their worth.

Sold Through Jobbers
 Remler Division of

GRAY & DANIELSON MANUFACTURING COMPANY
 260 FIRST STREET
 SAN FRANCISCO
 Eastern Warehouse: Elkhart, Ind.



3-in-Line Condenser

NEW YORK



Twin-Rotor Condenser



Improved Socket



Choke Coil

CHICAGO



Drum Dial

Tell 'Em You Saw It in the Citizens Radio Call Book Magazine

WNRC Wayne M. Nelson, Greensboro, N. C. 223.7 meters, 1340 kilocycles, 250 watts. Sun, 11:15 am & 7:30 pm, church. Mon & Wed, 6:45-9 pm. Tues, 7-9 pm. Thurs, 7-10 pm. Fri, 6:45-8:30 pm. Eastern standard time.

WNYC City of New York, New York City, N. Y. 526 meters, 570 kilocycles, 500 watts, class B. Daily ex Sun, 6-11 pm. Mon, Wed, Fri, 11 am-12:30 pm. Sun, irregular. Eastern standard time. Slogan: "Municipal Broadcasting Station of the City of New York."

WOAI Southern Equip. Co., San Antonio, Tex. 499.7 meters, 600 kilocycles, 5000 watts. Sun, 11 am-7:30 pm, church services. Daily ex Sat. Sun, 9-10 pm. Varied program. Central standard time. Divides time with WBAP. Slogan: "The Winter Playground of America."

WOAN The Vaughan School of Music, Lawrenceburg, Tenn. 239.9 meters, 1250 kilocycles, 500 watts. Daily ex Sun, 9-10 pm, musical. Central standard time. Divides time with WBAP. Slogan: "Watch Our Annual Normal."

WOAX Franklin J. Wolff, the Monument Pottery Co., Trenton, N. J. 239.9 meters, 1250 kilocycles, 500 watts. Daily ex Sun, 12:15-1 pm, music, weather forecast, etc. Wed, 7:30-9:30 pm, popular program. Fri, 7:30-9:30 pm, popular program. Fri, 7:30-8:30 pm. Sun, 7:30-8:30 pm, classical and dance orchestra. Eastern standard time. Divides time with WCAP. Slogan: "Trenton Makes, the World Takes."

WOBR Shelby, Ohio. 204.0 meters, 1470 kilocycles, 10 watts. Eastern standard time.

WOBT Union City, Tenn. 205.4 meters, 1460 kilocycles, 15 watts. Central standard time.

WOBU Charleston, W. Va. 267.7 meters, 1120 kilocycles, 50 watts. Eastern standard time.

WOC The Palmer School of Chiropractic, 1002 Brady st., Davenport, Iowa. 374.8 meters, 800 kilocycles, 5000 watts. Sun, 10:45 am-12 noon, church; 12-3 pm, WJZ & WEAF programs; 4:30-5 pm, WEAF program; 6-7 pm, old folks musical; 7-8 church, 8:15-9:45 pm, WEAF. Daily ex Sun, 6:45-7:45 am, 9:45 am-11 am, 2 pm. Wed, Fri, 10-10:15 am. Sat, 12:57-1:15 pm. Wed, 6:45-10 pm. Tues, 4-4:30 pm. Thurs, 7-10 pm. Mon, 6:30-10:30 pm. Fri, 4-5 pm. Tues & Fri, 6-10 pm. Daily ex Sat & Sun, 3-8:30 pm. Music, weather reports, talks, chain programs broadcast. Central standard time.

WOCL A. E. Newton, Jamestown, N. Y. 223.7 meters, 1340 kilocycles, 25 watts. Sun, 10:30 am & 7:30 pm, church service. Mon & Thurs, 6:30-7 pm. Eastern standard time.

WODA The O'Dea Temple of Music, 115 Ellison st., Paterson, N. J. 293.9 meters, 1020 kilocycles, 1000 watts. Sun, 10:30 am, 7:30 am, church services. Daily ex Sun, 12-1 noon; 5-7 pm, studio; 8-11 pm, studio. Tues, 11:30-12:30 am, Nite Club. Thurs, 11-12 midnight, Nite Club. Fri, 10:30-11:30 pm, dance; 11:30-12:30 am, Nite Club. Eastern standard time. Divides time with WGL. Slogan: "The Voice of the Silk City."

WOI Iowa State College, Ames, Iowa. 265.3 meters, 1130 kilocycles, 2500 watts night time, 5000 daytime. Daily ex Sun, 7 am, 7:30 am, 8:45 am, 9:30 am, 10 am, 10:30 am, 12-10-12:45 pm, 1 pm, music; 1:30 pm, 9:30 pm, market reports, weather, varied programs. Mon, 7-9 pm. Mon & Thurs, 7:30 pm, 7:45 pm, 8 pm. Sat, 4:15 pm. Talks, music, etc. Sun, 10:45 am, chimes; 11 am, church; 3:15 pm. Central standard time.

WOK & WMBB Neutrowound Radio Mfg. Co., Homewood, Ill. 252.0 meters, 1190 kilocycles, 5000 watts. Daily ex Sun, 6-7 pm, 8-9 pm, 11 pm-12:30 am. Sun, 6 pm-12 am, orchestra & popular program. Central standard time.

WOKO Harold E. Smith, Mt. Beacon, N. Y. 215.7 meters, 1390 kilocycles, 500 watts. Daily, 10 am-10 pm. Eastern standard time.

WOKT Titus-Ets Corp., Arlington Hotel, Binghamton, N. Y. 209.7 meters, 1430 kilocycles, 500 watts. Sun, 11 am-12:30 pm, religious. Daily ex Sun, 11 am-12 midnight, musical and educational programs. Eastern standard time. Slogan: "Where the Better Programs Are Broadcast From."

WOMT The Mikadow Theater, Manitowoc, Wis. 222.1 meters, 1350 kilocycles, 100 watts.

WOO John Wanamaker, Philadelphia, Pa. 348.6 meters, 860 kilocycles, 500 watts. Daily ex Sun, 11 am, music; 11:30, weather; 11:55 am, time signals; 12 noon, music; 4:40 pm, news reports; 4:45 pm, musical. Mon & Fri, 9:55 pm, time signals; 10:02 pm, weather report. Mon, Fri, 7:30-11 pm, concerts. Sun, 10:45 am or 7:45 pm, 2:15 pm, Sunday school musical program; 6 pm, organ recital. Eastern standard time. Divides time with WIP & WGBS.

WOOD Walter B. Stiles, Inc., Hotel Rowe, Grand Rapids, Mich. 260.7 meters, 1150 kilocycles, 500 watts. Sun, 9-10 pm. Daily ex Sun, 9-11 pm, popular request programs, vocal and dance programs. Central standard time. Divides time with WCMA. Slogan: "The Voice of the Whispering Pines."

WOQ Unity School of Christianity, 917 Tracy av., Kansas City, Mo. 340.7 meters, 880 kilocycles, 500 watts. Sun, 11 am-12:30 pm, 2:30-3 pm, 7:45-9 pm, church. Daily ex Sun & Thurs, 6-7 pm, concert; 11 pm, prayer service. Mon, 9-10 pm. Wed & Fri, 8-10 pm, concert. Sat, 10-11 pm, healing service. Central standard time. Divides time with WHB.

WOR L. Bamberger & Co., 46 Bank st., Newark, N. J. New York Studio, 1440 Broadway, New York City. 422.3 meters, 710 kilocycles, 3500 watts. Mon, 3:45 pm, 5:15-12 pm. Tues & Thurs, 5:15-7:30 pm. Wed, 5:15-11 pm. Fri, 5:15-6:30 pm. Sat, 3 pm, 6:30-12 pm. Eastern standard time.

WORD International Bible Students Association, 2150 Lincoln Park West, Chicago, Ill. 252.0 meters, 1190 kilocycles, 5000 watts. Sun, 10 am-12 noon, 2-4 pm, 6-7:30 pm. Daily ex Sun, 6-7 pm. Central standard time. Slogan: "The Watch Tower, Radio WORD."

WOS Missouri State Marketing Bureau, Capitol Bldg., Jefferson City, Mo. 422.3 meters, 710 kilocycles, 500 watts. Daily ex Sun, 9 am, 10 am, 11 am, 12 noon, 1 pm, 2 pm, 7 pm, 7:15 pm. Markets, weather reports, bonds, stocks, news, etc. Central standard time. Slogan: "Watch Our State."

WOW The Voice of the Woodmen of the World Life Insurance Association, Headquarters Bldg., Omaha, Neb. 508.2 meters, 590 kilocycles, 1000 watts. Sun, 9-11 am, 2-3 pm, 4-5:30 pm, 6-11 pm. Daily ex Sun, 8-9 am & 10-11:30 am, stock reports and commercial instructions; 12:30-2 pm, 3-5 pm, stock reports, news period & musical program; 6-7 pm, dinner concert; 7-11 pm, chain & other concert programs. Central standard time. Slogan: "The Omaha Station."

WOWO The Main Auto Supply Co., 215 W. Main st., Fort Wayne, Ind. 228.9 meters, 1310 kilocycles, 2500 watts night, 5000 watts daytime. Sun, 4-5 pm, church; 8-10 pm, Columbia chain. Daily ex Sat & Sun, 10:30 am-12 noon, news, reports, music, etc. Daily ex Sun, 12 noon-1:30 pm, musical program. Mon, 6:15-8 pm, 10-11:30 pm. Wed, Thurs, Fri, 7-8 pm. Mon, Wed & Fri, 8-10 pm, Columbia chain. Wed, 10-11 pm. Thurs, 8-9 pm, 9-11 pm. Sat, 6-6:45 pm, news, etc. Central standard time.

WPAP & WQAO Palisade Amusement Park, Cliffside, N. J. 394.5 meters, 760 kilocycles, 500 watts. Eastern standard time. Divides time with WHN.

WPCC North Shore Congregational Church, Chicago, Ill. 223.7 meters, 1340 kilocycles, 500 watts. Central standard time. Divides time with WFKB & WCRW.

WPCH Eastern Broadcasters, Inc., Park Central Hotel, New York City, N. Y. 325.9 meters, 920 kilocycles, 500 watts. Mon, 7-9 pm, 10 pm-midnight. Tues, 4-7 pm. Wed, 6-10 pm. Thurs, 4-12 pm. Sat, 4-7 pm, 11 pm-2 am. Sun, 6:30 pm-midnight. Eastern standard time. Slogan: "Voice of Central Park." Divides time with WRNY.

WPEP Waukegan Pep Station; 140 Hazel Court, Waukegan, Ill. 215.7 meters, 1390 kilocycles, 250 watts. Sun, 3-5 pm, 7:30-9:30 pm, 10-12 pm. Daily ex Sun, Mon, 7:30-9:30 pm, 10-12 pm. All programs popular and semi-popular. Central standard time. Slogan: "Where Pep Entertains Public."

WPG Municipality of Atlantic City, Atlantic City, N. J. 272.6 meters, 1100 kilocycles, 5000 watts. Sun, 3:15 pm, until 10 pm. Mon, Tues, Wed, Thurs, Fri, 1 pm to 11:30 pm. Sat, 6:45-12 midnight. Eastern standard time.

WPRC Wilson Printing & Radio Co., 1740 5th st., Harrisburg, Pa. 209.7 meters, 1430 kilocycles, 100 watts. Sun, 9-11 pm. Eastern standard time.

WPSC Pennsylvania State College Dept. of Elec. Engineering, State College, Pa. 299.8 meters, 1000 kilocycles, 500 watts. Tues & Wed, 6:30-8 pm. Sat, 2-5 pm. Sun, 11-11:15 am, 3-4:30 pm. Eastern standard time. Divides time with WBAK. Slogan: "The Voice of the Nittany Lion."

WPSW Philadelphia School of Wireless Telegraphy, 1533 Pine St., Philadelphia, Pa. 206.8 meters, 1450 kilocycles, 50 watts. Wed, 7 pm, radio questions & answers. Fri, 7 pm, talks on radio, care & operation. Eastern standard time. Slogan: "First Wireless School in America."

WPTF Raleigh, N. C. 545.1 meters, 550 kilocycles, 500 watts. Eastern standard time.

WPUB Madison Square Garden, 319 W. 49th st., New York, N. Y. 236.1 meters, 1270 kilocycles, 500 watts. Eastern standard time. Divides time with WHAP, WBNY.

WQAA Horace A. Beale, Jr., Parkersburg, Pa. 215.7 meters, 1390 kilocycles, 500 watts. Eastern standard time.

WQAM Electrical Equipment Co., 42 N. W. 4th st., Miami, Fla. 384.4 meters, 780 kilocycles, 750 watts. Sun, 10:45 am-12 noon, 8-9:15 pm, church. Daily ex Sun, 11:45 am-12:15 pm, organ, time signals, weather, stock reports; 7-8:15 pm, organ, dance, orchestra, weather, baseball results & studio programs. Divides time with WMBF.

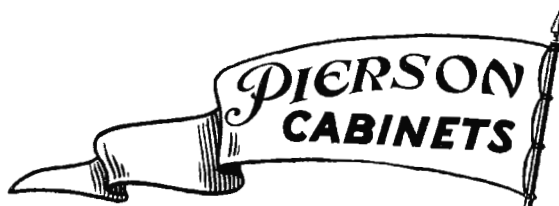

Above All Others—

Our claims are all superlative, and well do we appreciate the responsibility which we are assuming in making these claims.

Every person in the Pierson organization, from the men in the lumber yard up to the president, have keenly felt *“nothing but the best will do.”* With such a determination and with a foundation of rich experience to back it up, we stand four-square in the service of the American radio public.

America’s Finest—

America’s foremost line of Radio Furniture. Our challenge bids you investigate, for your own protection and benefit.

If you feel that Radio is worth while—if you feel that Radio gives more for less, than any other device or instrument ever invented or discovered—then you will feel as we do *“nothing but the best will do!”* That is why Radio deserves Pierson Cabinets—that is why you should know them.

QUALITY FIRST

The Avignon—Model 822—

THE magnificence of the court of Louis XIV is a matter of history—a period of lavish and refined culture bearing no equal. The decay that had set in was not yet apparent in the handiwork of the sturdy and well trained craftsmen of the period. In fact, some of the finest examples of architecture and furniture design developed during this period.

The *Avignon* is a worthy example of some of the most defined motifs of the period. The introduction of genuine imported Italian Marquetry, the deft application of delicate handcarvings on stretcher, apron and frieze, and a selection of 100% figured butt-walnut ornamented with pilasters of tropical blistered maple, coupled with a design, construction and finish that surpasses the efforts of the old French craftsmen, make the *Avignon* a gem of the cabinet maker’s art of unequalled merit.

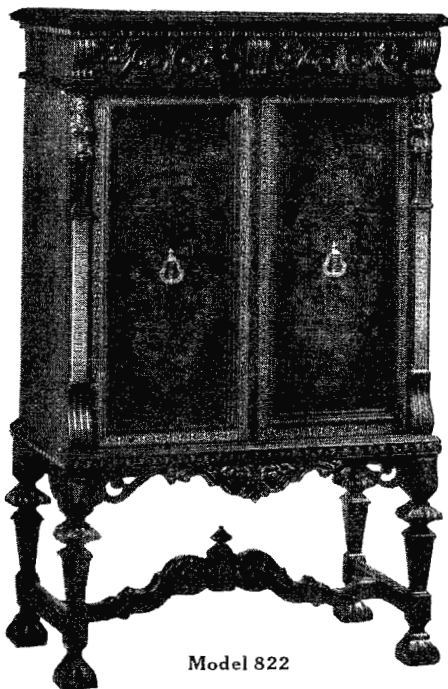

Model 822

A copy of our Catalog is worth while Reading for Every Home and Radio Lover.

WRITE FOR IT TODAY

THE PIERSON COMPANY

ROCKFORD, ILL.

Tell 'Em You Saw It in the Citizens Radio Call Book Magazine

WQAN Scranton Times, 222 Spruce st., Scranton, Pa. 230.6 meters, 1300 kilocycles, 250 watts. Daily ex Sun, 12:30-1 pm, 4:30-5 pm. Tues & Fri, 8-10:30 pm. Sat, 10:30-12 pm. Eastern standard time. Slogan: "The Voice of the Anthracite." Divides time with WGBI. Monday, Wed, Thurs nights & Tues, Fri, 6:45-7:55 pm.

WQAO & WPAP Calvary Baptist Church, Cliffside, N. J. 394.5 meters, 760 kilocycles, 500 watts. Wed, 8-9 pm, mid-week evening services. Sun, 11 am-12:30 pm, church services; 3-4:30 pm, Bible study class; 7:45-9:30 pm, evening services. Eastern standard time. Divides time with WHN. Slogan: "The Bible, the Whole Bible and Nothing but the Bible."

WQBA Tampa, Fla. 238.0 meters, 1260 kilocycles, 250 watts. Eastern standard time. Divides time with WJBB.

WQJ Calumet Broadcasting Co., operated by Chicago Daily News, Hotel La Salle, Chicago, Ill. 447.5 meters, 670 kilocycles, 500 watts. Sun, 10:45 am-12:30 pm, 2-4 pm, 6-7 pm, 10-11 pm. Daily ex Sun, 11 am-12 noon, 3-4 pm, 6-7 pm, 10 pm-1 am. Central standard time. Divides time with WMAQ.

WRAF The Radio Club (Inc.), 719 Michigan av., LaPorte, Ind. 208.2 meters, 1440 kilocycles, 100 watts. Sun, 10:45 am-12:15 pm, church services. Daily ex Sun, 12:15-7 pm. Central standard time. Slogan: "The Voice of the Maple City."

WRAH Stanley N. Read, 191 Alabama av., Providence, R. I. 199.9 meters, 1500 kilocycles, 250 watts.

WRAC Economy Light Co., 1105 Ludington st., Escanaba, Mich. 282.8 meters, 1060 kilocycles, 50 watts. Sun, 6:30-8 pm, classical. Mon and Fri, 10:30-11 am, household hints and weather forecast; 6:30-7:00 pm, late news and weather forecast followed by musical program. Tues & Thurs, same as Mon & Fri. Wed, 10:30-11:30 am, household hints & weather forecast. Sat, 10:30-11 am, household hints & weather forecast; 6-6:30 pm, late news & weather forecast, followed with dance program. Eastern standard time. Slogan: "The Gateway to Cloverland."

WRAM Lombard College, Galesburg, Ill. 247.8 meters, 1210 kilocycles, 50 watts. Mon, 7 pm, bedtime stories; 8 pm, educational; 9-11 pm, musical. Central standard time. Divides time with WFBZ.

WRAP Avenue Radio & Electric Shop, 460 Schuylkill av., Reading, Pa. 238 meters, 1260 kilocycles, 100 watts. Sun, 11 am, 1:30-3 pm. Tues, 8 pm. Thur, 8-10 pm. Eastern standard time. Slogan: "The Schuylkill Valley Echo."

WRAX Berachan Church (Inc.), 1608 Alleghany Ave., Philadelphia, Pa. 212.6 meters, 1410 kilocycles, 250 watts. Eastern standard time.

WRBC Immanuel Lutheran Church, Valparaiso, Ind. 238.0 meters, 1260 kilocycles, 250 watts. Sun, 7:30-9 pm, church service. Mon, 7:30-9 pm, diversified program. Central standard time. Slogan: "World Redeemed by Christ."

WRC Radio Corporation of America, 3308 14th st., N. W., Washington, D. C. 468.5 meters, 640 kilocycles, 500 watts. Sun, 11 am-12:30 pm, church services; 4-5:30 pm, church; 6:20-10:15, musical. Mon, Tues, Wed, Thur, Fri & Sat, 6:45 am to 11 pm, varied. Eastern standard time. Slogan: "The Voice of the Capital."

WRCV Radio Corp. of Virginia, Norfolk, Va. 209.7 meters, 1430 kilocycles, 100 watts. Wed, Fri, Sat, 2-5 pm, 7:30-9 pm. Sun, 10:30 am-12:15 pm, 7:15-8:45 pm. Eastern standard time. Slogan: "The Voice of the Business District."

WREC Wooten's Radio & Elec. Co., Whitehaven, Tenn. 249.9 meters, 1200 kilocycles, 100 watts. Daily, 7-8. Sun, 4-5:30 pm. Central standard time. Divides time with WSIX.

WREN Jenny Wren Co., Lawrence, Kan. 254.1 meters, 1180 kilocycles, 750 watts. Central standard time. Divides time with KFKU.

WRES Harry Leonard Sawyer, Quincy, Mass. 217.3 meters, 1380 kilocycles, 50 watts. Mon & Thurs, 8 pm, entertainment. Eastern standard time.

WRHF American Broadcasting Co., Colorado Bldg., Washington, D. C. 322.4 meters, 930 kilocycles, 150 watts. Daily ex Sun, 10-11:30 am, 6-7 pm. Sun, 5:30-7 pm. Eastern standard time.

WRHM Rosedale Hospital (Inc.), Nicollet & 44th st., Minneapolis, Minn. 260.7 meters, 1150 kilocycles, 1000 watts. Sun, 9:15 am, 10 am, Children's Bible stories; 11 am, church; 6:30 pm, dramatic hour; 7:45 pm, church; 9:30 pm, lecture. Mon, Wed, Fri, 9 am, Housewife's Hour. Daily ex Sun, 12 noon-2 pm, concert; 5-6 pm, Commercial Hour; 6 pm, dinner concert; 8 pm, popular; 9 pm, dance program. Central standard time. Slogan: "Welcome Rosedale Hospital, Minneapolis."

WRK John C. Slade, Hamilton Ohio. 205.4 meters, 1460 kilocycles, 100 watts. Sun, 2-3:15 pm, church; 7-9 pm. Daily ex Sat & Sun, 1-2 pm. Mon, Wed, Fri, 6:45 pm-12 midnight. Sat, 1-5 pm. Tues & Sat, 6:45-10:30 pm. Thurs, 11:30 pm-2:30 am early birds. Eastern standard time. Slogan: "The Voice of Hamilton."

WRM University of Illinois, Urbana, Ill. 272.6 meters, 1100 kilocycles, 500 watts. Sun, 3:45-4 pm, chimes; 4-5 pm, organ. Daily ex Sun, 5-6 pm, 7-8 pm, music & talks. Athletic events broadcast. Central standard time. Divides time with WBAA.

WRMU Atlantic Broadcasting Corp., New York City, N. Y. (Portable). 201.6 meters, 1490 kilocycles, 100 watts. Unlimited schedule. Eastern standard time. Divides time with WGMU.

WRNY Radio News, Hotel Roosevelt, 45th st. & Madison av., New York City, N. Y. 325.9 meters, 920 kilocycles, 500 watts. Sun, 10:30-1 pm, 1-7 pm. Mon, Wed, 10:30 am-7 pm. Wed, 9-12 midnight. Tues, 10:30-12. Thus, 10:30-1. Sat, 11 am-1, 7-9 pm. Eastern standard time. Divides time with Station WPCH.

WRPI Rose Polytechnic Institute, Hotel Deming, Terre Haute, Indiana. 208.2 meters, 1440 kilocycles, 100 watts. Sun, 9:30 am-12 noon, church. Daily ex Sun, 7 pm, markets. Mon, Wed, Fri, 8 pm, Popular programs. Central standard time. Slogan: "On the Banks of the Wabash."

WRR Municipal Station, Jefferson Hotel, Dallas, Tex. 461.3 meters, 650 kilocycles, 500 watts. Daily ex Sun & Wed, 11:30 am-12:30 pm, 6-7 pm, 8-9 pm. Mon & Thurs, 10-11 pm. Fri, 8-10 pm. Alternate Sun, 11 am-12:15 pm. 7:30-9 pm, every Sun, 9:30-10:30 pm. Central standard time. Divides time with KRLD. Slogan: "City of Achievements."

WRRS Racine Broadcasting Corp., Hotel Racine, Racine, Wis. 247.8 meters, 1210 kilocycles, 50 watts.

WRST Radiotel Mfg. Co., Inc., 76 Main st., Bay Shore, N. Y. 211.1 meters, 1420 kilocycles, 250 watts. Daily, 12 noon-1 pm, 4-5 pm. Daily ex Tues & Thurs, 7-8 pm. Tues, 8 pm-12 midnight. Eastern standard time. Divides time with WCDA-WBRS. Slogan: "Bay Shore, 'The Garden Spot of Long Island.'"

WRVA Edgeworth Tobacco Station, Richmond, Va. 254.1 meters, 1180 kilocycles, 1000 watts. Mon, Wed, Fri, 12 noon-2 pm, 8 pm-12 midnight. Tues, Thurs, 12 noon-1 pm. Thurs, 8 pm-12 midnight. Sun, 11 am-1 pm, 8-10 pm. Eastern standard time. Slogan: "Carry Me Back to Old Virginny."

WSAI United States Playing Card Co., Cincinnati, Ohio. 361.2 meters, 830 kilocycles, 5000 watts. Sun, 10:45 am, church; 12 noon, concert; 4 pm, 6:15 through 10:15 pm. Daily ex Sun & Sat, 10:35 am-1:10 pm. Mon, Tues, Thurs, 3:45 through 7 pm. Wed & Fri, 3:45-4 pm. Mon, Tues, 7:30 through 11 pm. Wed & Thurs, 7 through 11:30 pm. Fri, 7 through 11 pm. Sat, 6:45 through 11 pm. Talks, music, news, chain programs, etc. Eastern standard time. Slogan: "The Gateway to Dixie."

WSAJ Grove City College, Grove City, Pa. 223.7 meters, 1340 kilocycles, 250 watts. Irregular schedule. Eastern standard time.

WSAN Allentown Call Publishing Co., Inc., Allentown, Pa. 222.1 meters, 1350 kilocycles, 100 watts. Tues, Thurs & Sats, 8:15 pm, musical. Eastern standard time. Divides time with WCBA. Slogan: "We Serve Allentown Nationality."

WSAR Doughty & Welch, Elec. Co., 46 N. Main st., Fall River, Mass. 252.0 meters, 1190 kilocycles, 100 watts. Daily ex Sun, 12-1 pm. Sun, 10:30-12 m. Eastern standard time.

WSAX Zenith Radio Corp., 3620 Iron st., Chicago, Ill. 204.0 meters, 1470 kilocycles, 100 watts. (Portable.) Central standard time.

WSAZ McKellar Electric Co., 1143 4th av., Huntington, W. Va. 249.9 meters, 1200 kilocycles, 100 watts. Sun, 9 am-1 pm, 3-4 pm, 7:30-9 pm, 10-11 pm. Daily ex Sun, 12 noon-1 pm, 5:30-6:30 pm, 9:30-12: midnight. Eastern standard time.

WSB The Atlanta Journal, care Biltmore Hotel, Atlanta, Ga. 475.9 meters, 630 kilocycles, 1000 watts. Sun, 9:30 am-5 pm, church services, 6:20 pm & 8:15 pm, chain programs. Daily ex Sun, 10 am, 1-2:30 pm, 10:45 pm. Mon, Tues, Wed, Fri, 10:30 am, public school program. Wed & Fri, 11 am. Wed & Thurs, 5 pm. Thurs, 5:30 pm. Mon, 6:30 pm. Wed, 6:15-7 pm. Sat, 6-6:30 pm & 7 pm. Thurs & Fri, 7:30 pm. Mon, Wed & Fri, 8:30 pm. Tues & Thurs, 9 pm. Tues & Wed, 9:30 pm. Daily ex Fri & Sun, 8 pm. Music, talks, news, chain programs, broadcast. Central standard time. Slogan: "The Voice of the South."

WSBC The World Battery Company Station, 1219 S. Wabash av., broadcasting from New Southern Hotel, Chicago, Ill. 232.4 meters, 1290 kilocycles, 500 watts. Sun, 5-7 pm, classical; 9:30 pm-1 am, popular. Mon, 5-7 popular program. Tues, Wed, Thur, Sat, 5-7 pm, 9:30 pm-1 am, popular program. Fri, 6-8 pm, 9 pm-1 am, popular program. Central standard time. Divides time with WJKS. Slogan: "World Storage Battery Company."

WSBF Mississippi Valley Broadcasting Co., 6th & Washington Ave., St. Louis, Mo. 258.5 meters, 1160 kilocycles, 250 watts. Sun, 9-10 pm, theater. Mon, 1 pm, 3-4 pm. Tues, 1 pm, 3-4 pm, popular. Wed & Fri, 12 noon-1 pm, 3-4 pm, music. Thurs, 12 noon-1 pm, 3-4 pm, popular. Sat, 12 noon-1 pm, 3-4 pm. Daily ex Sun, 7:30-11 pm, studio program. Central standard time. Divides with WIL.

WSBT South Bend Tribune, 225 Colfax av., South Bend, Ind. 400 meters, 750 kilocycles, 500 watts. Sun, 11 am-12 noon, church. Mon, 7:30-10:30 pm, 12 midnight-1:30 am, popular program. Wed, 8-10 pm, 12 midnight-1 am. Fri, 7:15-10 pm, classical, 12 midnight-1 am. Central standard time. Divides time with WEAR-WTAM.

ACHIEVE SUCCESS! IN RADIO!



Mr. R. L. Duncan, Director
Radio Institute of America

Dear Mr. Duncan:

You have the heartiest support of the Radio Corporation of America in your work of radio instruction.

(Signed) J. G. HARBORD,
President,
Radio Corporation of America.

New course gives finest instruction obtainable

You can learn at home!

Good pay from the start, rapid advancement, and phenomenal success—a life profession of fascinating brain-work—that is what Radio holds for the man who knows his subject thoroughly. Right now on Mr. Duncan's desk there are letters from big radio companies offering employment to RIA graduates.

Since 1909 Radio Institute of America has trained thousands to become successful in the many branches of Radio. Are you going to plod along at a thirty-five dollar a week job when REAL MONEY is waiting for you in radio?

New course finest ever

Prominent radio men have enthusiastically greeted RIA's new course as the most complete and up-to-date offered today. All this first-quality equipment is furnished FREE WITH THE COURSE—parts for making many practical radio circuits and the Peerless Signagraph for code instruction.

RIA backed by RCA, G-E and Westinghouse

You get all the benefits of instruction conducted by RCA and sponsored by RCA's associates, G-E and Westinghouse. Our employment department is at the service of graduates.

Study at Home

Moreover you can STUDY AT HOME — when you please and as long as you please.

This new informative booklet describing the course is just off the press. If you want to learn more about the well paying positions in this fascinating profession send the coupon now for your copy. No obligation.

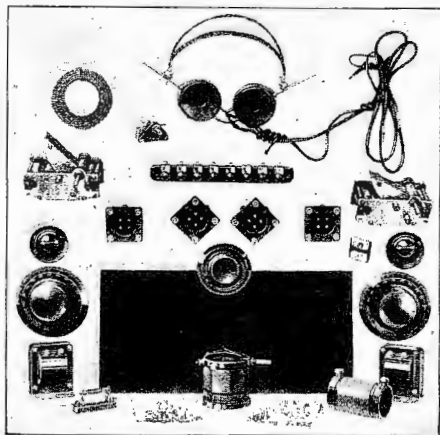

FREE WITH COURSE all this first-quality equipment for experimental work—all the parts to build many practical radio circuits, the Peerless Signagraph for code instruction.



RADIO INSTITUTE OF AMERICA
Dept. BP-3 326 Broadway, New York City

RADIO INSTITUTE OF AMERICA,
326 Broadway, New York City

BP-3

Dear Mr. Duncan:

Please send me your new catalog. I want to know more about your new radio course.

Name.....

Address.....

Tell 'Em You Saw It in the Citizens Radio Call Book Magazine

WSDA & WARS Amateur Radio Specialty Co., Hotel Shelburne, Brooklyn, N. Y. 227.1 meters, 1320 kilocycles, 500 watts. Sun, 7-9 am, 12:30-3 pm. Mon, Wed, Thurs, Fri, 7-8 am, 9-10 am. Mon & Fri, 8-10 pm. Wed & Fri, 3-6 pm. Tues & Thurs, 12 noon-2 pm. Mon, 3-7 pm. Wed, 7-10 pm. Thurs, 6-7 pm, 10 pm-12 midnight. Sat, 7-9 am, 1-3:30 pm, 9 pm-12 midnight. Eastern standard time. Divides time with WBBC. Slogan: "The Voice of the Atlantic."

WSEA The Virginia Beach Broadcasting Co., Norfolk, Va. 263 meters, 1140 kilocycles, 500 watts. Daily ex Sun, 11 am-2 pm, music; 5 pm, stocks, talks, police & weather forecast; 6 pm, news flashes; 6:45 pm, dinner music; 7 pm-10 pm, studio; 10-11 pm, organ; 11 pm-12 midnight, dance music. Sun, 3-5 pm & 7-9 pm, concerts. Eastern standard time. Slogan: "The Voice of Tidewater Virginia."

WSIX Springfield, Tenn. 249.9 meters, 1200 kilocycles, 150 watts. Divides time with WREC.

WSKC World's Star Knitting Co., Bay City, Mich. 272.6 meters, 1100 kilocycles, 250 watts. Daily ex Sun, 12 noon-1 pm, music. Tues, Thurs, Sat, 9-11 pm. Sat, 9-11 pm, 12 midnight-2 am. Sun, 11 am. Eastern standard time. Divides time with WFDF. Slogan: "Where the Summer Trails Begin."

WSM The National Life and Accident Ins. Co., Inc., Seventh av. N. & Union st., Nashville, Tenn. 336.9 meters, 890 kilocycles, 5000 watts. Sun, 6:20-9:15 pm. Daily ex Sat, Sun, 11:45-12:30 noon, 1 pm, concert, 5:30-6 pm. Mon, 6:15-11 pm. Tues, 7-11 pm. Wed, 7-11 pm. Thurs, 6:30-11 pm. Fri, 8-10 pm. Sat, 6 pm-12 midnight. Central standard time. Slogan: "We Shield Millions."

WSMB Saenger Theatres, Inc., & Maison Blanche Dept. Stores, 1401 Tulane Ave., New Orleans, La. 296.9 meters, 1010 kilocycles, 500 watts. Daily ex Sun, 12:30-1:30 pm, 6-7 pm. Mon, Wed, Thurs & Sat, 8:30-10:30 pm, entertainment. Central standard time. Slogan: "America's Most Interesting City."

WSMK S. M. Krohn, Jr., 20th fl. U. B. Bldg., Dayton, Ohio. 296.9 meters, 1010 kilocycles, 200 watts. Daily ex Thurs & Sun. 9-11 am, shippers guide; 12-1 noon, dinner bell program, 6-10 pm, studio program. Sat, 11 pm-3 am Sun. Central standard time. Slogan: "The Home of Aviation."

WSOE School of Engineering of Milwaukee, Oneida & Jackson sts., Milwaukee, Wis. 270.1 meters, 1110 kilocycles, 250 watts. Sun, 3:30-4:30 pm, 7:30-8:30 pm, religious program. Daily ex Sun, 1:30 pm, 2:15 pm, 2:30 pm, 5 pm, 5:50 pm, 6:15 pm, 8 pm. Thurs, 9 pm. Varied program. Central standard time. Divides time with WHAD.

WSRO Radio Company (Harry W. Fahrlander), Central & Canal sts., Middleton, Ohio. 236.1 meters, 1270 kilocycles, 100 watts. Tues & Fri, 8-10 pm. Sun, 2-4 pm. Central standard time. Slogan: "We Sell Radio Only."

WSSH Tremont Temple Baptist Church, Boston, Mass. 288.3 meters, 1040 kilocycles, 100 watts. Sun, 10:15 am-12 noon. 6:30-9 pm. Fri, 7:30-9 pm. Eastern standard time. Divides time with WBET. Slogan: "Stranger's Sunday Home."

WSUF & WTAR Reliance Elec. Co., Inc., 519 W. 21st Ave., Norfolk, Va. 236.1 meters, 1270 kilocycles, 500 watts. Daily ex Sun, 6 pm, weather, markets & news. Eastern standard time. Divides time with WBBW. Slogan: "Down in Old Virginia."

WSUI State University of Iowa, Capitol & Washington sts., Iowa City, Iowa. 475.9 meters, 630 kilocycles, 500 watts. Sun, 9 pm, hymns. Daily ex Sun, 9 am, markets, weather forecast; 10:30 am & 12:25 pm, news, music, 5 pm, radio review; 5:30 pm, 6 pm, dinner music. Wed, 9:10 am, high school program. Thurs, 10 am, organ. Athletic contests broadcast. Central standard time. Slogan: "The Old Gold Studio."

WSUN Chamber of Commerce, St. Petersburg, Fla. 516.9 meters, 580 kilocycles, 750 watts. Tues, Thurs & Sat, 3-5 pm, 7 pm-12 midnight, 8:30 & 9 pm, weather & citrus reports. Eastern standard time. Divides time with WFLA. Slogan: "Sunshine City."

WSVS Seneca Vocational School, 666 East Delavan Ave., Buffalo, N. Y. 204.0 meters, 1470 kilocycles, 50 watts. Wed & Fri, 8-9:30 pm, musical program. Eastern standard time. Divides time with WKEN. Slogan: "Watch Seneca Vocational School."

WSYR Voice of Central New York, Hotel Syracuse, N. Y. 225.4 meters, 1330 kilocycles, 500 watts. Sun, 7:30 am, church services; 6:30-7:30 pm, dinner concert. Daily ex Sun, 6:20 pm-10:30 pm, Varied programs. Eastern standard time. Divides time with WMAC.

WTAD Illinois Stock Medicine Broadcasting Corp., Quincy, Ill. 236.1 meters, 1270 kilocycles, 250 watts night, 500 watts daytime. Sun, 11-12 am, 2:30-3:30 pm, 10-12 pm. Daily ex Sun, 11:30 am-12:45 pm, 6-7 pm, 9-10 pm. Central standard time.

WTAG Worcester Telegram-Gazette Broadcasting Station, 18 Franklin st., Worcester, Mass. 516.9 meters, 580 kilocycles, 250 watts. Sun, 4-10:25 pm. Daily ex Sat & Sun, 10:30-11 am, 11:15 am, 12 noon, 12:30-1:05 pm, 6:30-11 pm. Sat, 11 am, 11:30 am, 12 noon, 12:30-1:05 pm, 7-11:10 pm. Eastern standard time. Slogan: "The Voice from the Heart of the Commonwealth."

WTAL Toledo Broadcasting Co., Waldorf Hotel, Toledo, Ohio. 239.9 meters, 1250 kilocycles, 250 watts. Sun, 10:45 am-9:30 pm. Daily ex Sat & Sun, 6-11 pm. Sat, 8-12 pm. Eastern standard time. Slogan: "The Gateway of the Sea."

WTAM Willard Storage Battery Co., 1100 Chester av., Cleveland, Ohio. 399.8 meters, 750 kilocycles, 3500 watts night, 5000 watts daytime. Sun, 11 am-2 pm, 3-5 pm, 5:30-6 pm-12 midnight. Daily ex Sun, 12:30-1:30 pm, 6 pm-12 midnight. Wed, Thurs, Fri, 11-11:15 am. Eastern standard time. Divides time with WEAR & WSRT. Slogan: "The Voice from the Storage Battery."

WTAQ Gillette Rubber Co., Eau Claire, Wis. 254.1 meters, 1180 kilocycles, 500 watts. Sun, 11 am, church service. Mon, Wed, Thurs, Sat, 12:15 pm, weather, news, etc. Daily ex Sun & Sat, 6 pm, markets, news, etc. Mon, Wed & Thurs, 6:30 pm, dinner hour. Tues & Fri, 12 noon, luncheon program. Mon, 7:30 pm, theater hour. Mon & Thurs, 10 pm. Tues, 9 pm, concert. Fri, 8 pm, studio program. Central standard time.

WTAR Reliance Elec Co., Inc., 519 W. 21st av., Norfolk, Va. 236.1 meters, 1270 kilocycles, 500 watts. Daily ex Sun, 12:30-1:30 pm, organ; 4-4:30 pm, popular program. 4:30-5:30, musicale; 6-6:30, dinner concert; 6:30-7, news, markets, weather; 7-7:30, studio program; 7:30-8, trio; 8-10, studio programs; 10-11, dance orchestras. Sun, 2-3 pm, concert; 4:15-5:45, vesper service & musicale; 5:45-7, twilight organ concert; 7-7:30, Bible lecture; 7:30-9, church services. Eastern standard time. Divides time with WBBW. Slogan: "Way Down in Old Virginia."

WTAS Illinois Broadcasting Corp., R.F.D., Elgin, Ill. 275.1 meters, 1090 kilocycles, 500 watts. Sun, 10 am-1 pm. Daily ex Sun, 12 noon-2:30 pm, 6-7 pm, 10 pm-1 am. Central standard time. Slogan: "Willie, Tommy, Annie, and Sammy."

WTAW Agricultural & Mechanical College of Texas, College Station, Texas. 483.3 meters, 620 kilocycles, 500 watts. Sun, 11 am. Mon, Tues, Wed, Thurs & Fri, 12:10 pm. Wed & Fri, 7 pm. Central standard time.

WTAX Williams Hardware Co., 115 S. Vermont St., Streator, Ill. 247.8 meters, 1210 kilocycles, 50 watts. Mon, 8-10 pm, Studio program. Wed, Fri, 8-10:30 pm, studio program. Thurs, 9-11 pm, dance program. Central standard time. Slogan: "Tappa Kugga Nails."

WTAZ Thomas J. McGuire, 48 N. Main st., Lambertville, N. J. 220.4 meters, 1360 kilocycles, 15 watts. Mon, 8-10 pm, musical. Eastern standard time. Divides time with WMBG.

WTFF Mt. Vernon Hills, Va. 202.6 meters, 1480 kilocycles, 10,000 watts. Eastern standard time. Divides time with WHBN.

WTFI Toccoa, Ga. 209.7 meters, 1430 kilocycles, 750 watts.

WTHS Atlanta, Ga. 227.1 meters, 1320 kilocycles, 200 watts. Central standard time.

WTIC The Travelers Insurance Co., 700 Main st., Hartford, Conn. 535.4 meters, 560 kilocycles, 500 watts. Mon & Thurs, 11:15 am-1 pm. Tues, 11 am-1 pm. Wed, 11-11:15 am. Fri, 10 am-1 pm, 6-11:30 pm. Mon, 6:25-12 midnight. Tues & Wed, 6:25-11:30 pm. Thurs, 6:25-10:10 pm. Sat, 6:25-10:30 pm. Sun, 3-9:15 pm. Eastern standard time. Divides time with WCAC. Slogan: "The Insurance City."

WTMJ The Milwaukee Journal Station, Milwaukee, Wis. 293.9 meters, 1020 kilocycles, 1000 watts. Sun, 11 am-12 noon, organ; 12 noon-1 pm, comics; 12:30-1 pm, 2-3 pm, WEAF program, music; 3:15-5 pm, Little Symphony; 6 pm, organ; 6-7 pm, dinner concert; 7-9:15 pm, music; 9:15-9:45 pm, chain program. Daily ex Sun, 10:10-15 am, 10:15-11:15 am, 11:15 am-12:30 pm, organ; 12:30-1 pm, 1-2 pm, music; 3-7 pm, music, talks, etc.; 7-10 pm, music & chain programs; 10 pm-12 midnight, dance music & studio program. Central standard time. Divides time with WHAD.

WTRL Technical Radio Laboratory, 28 Siccomac av., Midland Park, N. J. 206.8 meters, 1450 kilocycles, 15 watts. Sun, 2-4 pm, religious program. Tues, Fri, 7-9 pm, Sports & dance music. Eastern standard time. Divides time with WHPP, WMRJ.

WWAE C. F. Courier, 2024 S. Wabash av., Chicago, Ill. 227.1 meters, 1320 kilocycles, 500 watts, class A. Daily ex Sun & Mon, 7-9 pm. Central standard time.

WWJ Detroit News, Detroit, Mich. 352.7 meters, 850 kilocycles, 1000 watts. Sun, 7:20 pm, WEAF program. Daily ex Sat & Sun, 6 pm, dinner concert; 8 pm, program from WEAF. Eastern standard time.

WWL Loyola University, New Orleans, La. 245.8 meters, 1220 kilocycles, 500 watts. Sat, 7:30-8:30 pm. Central standard time.

WWNC Chamber of Commerce, Asheville, N. C. 296.9 meters, 1010 kilocycles, 1000 watts. Sun, 11 am & 8 pm, church; 4-5 pm, musical program; 9-10 pm, organ. Daily, 1-2 pm, 7-8. Tues, 8-10:45 pm. Thurs, 8 pm-12 midnight. Eastern standard time.

WWRL Long Island Broadcast Laboratories, W. H. Reuman, Director, 4130 58th St., Woodside, L. I., N. Y. 199.9 meters, 1500 kilocycles, 100 watts. Sun, 1-10:30 pm, popular program. Daily ex Sun, 11 am. Mon, Tues, Thurs, Sat, 1 pm. Mon & Fri, 10 pm-12 midnight. Sat, 12 midnight-4 am. Tues, 12 midnight-2 am. Wed, Thurs, 8-10 pm. Eastern standard time. Divides time with Stations WGOP, WBKN.

WWVA John C. Strobel, Jr., National Road, Wheeling, W. Va. 516.9 meters, 580 kilocycles, 250 watts. Daily ex Sun, 7 & 8 am, 11 am, 11:10 am, 12 noon, 2 pm, exercises. Sun, 10:35 am & 7:30 pm, church. Mon, 7 pm, children's hour. Sat, 11 pm, Mountaineer Club. Eastern standard time.

EVERY TYPE AND RANGE of RADIO INSTRUMENT for the Set Builder, Experimenter, Transmitter and Service Man



**Model
537**

The New Weston A. C. and D. C. Radio Set Tester

One of the most important radio instruments, and the most convenient and profitable for the dealer and service man, ever developed. It solves all the problems of radio set servicing—for both A.C. and D.C. receivers—without any other testing equipment being required. It is provided with two special 3 1/4" diameter instruments for both A.C. and D.C. readings. Connections are automatically made by an ingenious system of switches and binding posts. Complete with the necessary socket adaptors and instruction book.

ONLY a part of the complete Weston line of radio instruments are shown here. The matched lines of 2" and 3 1/4" diameter panel instruments for A.C. and D.C., as well as Thermo-Couple types, are of highest Weston quality. Their unusual electrical characteristics and construction, for instruments of such small size, are the talk of the scientific world. Then, too, there are the popular portable models of exquisite workmanship and convenient size, including the new *triple-range* Model 528 A.C. voltmeter—150/8/4 volts—for testing the A.C. supply and tube voltages of A.C. receivers. Write for the Weston booklet which contains a complete listing of all models and ranges and valuable descriptive information.

Where and How to Purchase

Prompt instrument deliveries can be made from points near your city. Write or 'phone our nearest representative for your local source of supply. Weston representatives are located in the following cities:—

Albany, Atlanta, Boston, Buffalo, Chicago, Cincinnati, Cleveland, Dallas, Denver, Detroit, Houston, Jacksonville, Knoxville, Los Angeles, Minneapolis, New Orleans, New York, Philadelphia, Pittsburgh, Portland, Rochester, St. Louis, San Antonio, San Francisco, Seattle, Spokane, Syracuse, Tacoma, Tampa.

Radio Plug

One of the great radio successes. Millions now in use. An automatic radio plug that fits any standard jack. No tools required to instantly attach or detach head set or loud speaker terminals.—\$0.60.

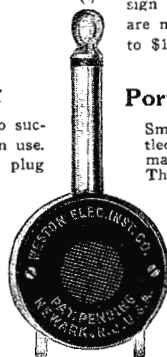

Portable A. C. Instruments

Small, compact instruments in mottled red and black bakelite cases, made as voltmeters and ammeters. The voltmeters are made with exceptionally high resistance, self-contained in double ranges up to 600 volts. Also furnished in a new triple-range model—150/8/4 volts—for A.C. receiver testing. Ammeters are made in ranges from 1 to 30 amperes.—\$13.50 to \$18.50.

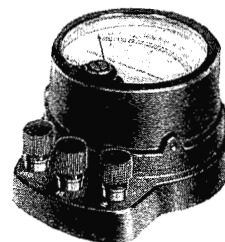

**Model 528
Portable Ammeters
and Voltmeters**



**D. C. Model 489
1000 Ohms per Volt**

A portable instrument with high internal resistance for measuring the true voltage output of B-Eliminators, as well as for any other D.C. voltage testing. It has double range combinations of 250/50 or 200/8 volts with a self-contained resistance of 1000 ohms per volt. A multiplier for increasing the range of the 250/50 volt instrument to 500 volts can be obtained when required.—\$28.00.

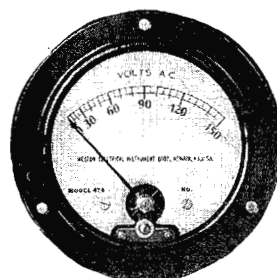

**A. C. and
D. C.
3 1/4" diam.
Also
Thermo-
Couple
Types**

Panel Type— Flush Style Instruments

A complete line of 2" and 3 1/4" diameter A.C., D.C. and Thermo-Couple instruments for flush panel mounting. Matched in size and appearance, and made in a comprehensive list of ranges for every radio receiver and transmitting requirement, as well as for general testing equipment. These instruments have a guaranteed accuracy of 2% and may be left in circuit continuously. High internal resistance and excellent damping. But notwithstanding their exquisite design and workmanship, they are moderately priced.—\$7.00 to \$15.00.

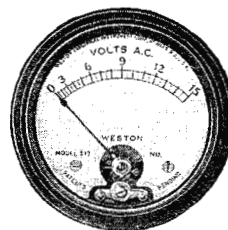

**A. C. and D. C. 2" diam.
Also Thermo-Couple
Types**

**WESTON
INSTRUMENT**
1 Frelinghuysen Ave.
Or write to our

**WESTON
RADIO
INSTRUMENTS**

**ELECTRICAL
CORPORATION**
Newark, New Jersey
nearest representative

Tell 'Em You Saw It in the Citizens Radio Call Book Magazine

U. S. Broadcasting Stations Listed by States

ALABAMA

Auburn, WAPI
 Birmingham, WLAB, WBRO, WKBO
 Gadsden, WJBY
 Montgomery, WIBZ

ALASKA

Anchorage, KFQD
 Juneau, KFIU
 Ketchikan, KGBU

ARIZONA

Flagstaff, KFXV
 Phoenix, KFAD, KFCB
 Prescott, KFJM
 Tucson, KGAR

ARKANSAS

Blytheville, KLCN
 Fayetteville, KUOA
 Hot Springs, KTHS

CALIFORNIA

Avalon, KFWO
 Berkeley, KRE
 Burkank, KELW
 El Centro, KGEN
 Fresno, KMMJ
 Hollywood, KFQZ, KFWB
 KATR
 Holy City, KFQU
 Inglewood, KMIC
 La Crescenta, KGFH
 Long Beach, KFOV, KGER
 Los Angeles, KFI, KPFR,
 KFSG, KGEF, KGFJ, KHJ,
 KNN, KPFA, KRLO, KTBI
 Lower Lake, KGEU
 Oakland, KFUS, KFWM,
 KGO, KLS, KX, KTAB,
 KZM
 Pasadena, KPCC, KPSN
 Sacramento, KFBK
 San Bernardino, KFWS
 San Diego, KFBC, KFSD
 San Francisco, KFRC, KFWI,
 KGTT, KJBS, KPO, KYA
 San Jose, KQW
 Santa Ana, KWTC
 Santa Barbara, KFOR
 Santa Maria, KSMR
 Santa Monica, KNRC
 Stockton, KGDH, KWG
 Venice, KFVD
 Yuba City, KGFM

COLORADO

Colorado Springs, KFUM
 Denver, KFEL, KFUP, KEXE,
 KGEY, KILZ, KOA, KOW
 Edgewater, KFJX
 Fort Morgan, KGEW
 Greeley, KFKA
 Gunnison, KFHA
 Pueblo, KGDP, KGHF
 Trinidad, KFGL
 Yuma, KGEK

CONNECTICUT

Bridgeport, WICO
 Danbury, WCWS
 Hartford, WTIC
 Mansfield, WCAO
 New Haven, WDRO

DELAWARE

Wilmington, WDEL

DISTRICT OF COLUMBIA

Washington, NAA, WMAL,
 WRC, WREB

FLORIDA

Clearwater, WFHH, WFLA
 Jacksonville, WJAX
 Lakeland, WMBL
 Miami Beach, WIOD, WMBF,
 WQAM
 Orlando, WDRO
 Pensacola, WCOA
 Sarasota, WJBB
 St. Petersburg, WSUN
 Tampa, WDAE, WMBR,
 WQBA

GEORGIA

Atlanta, WQBA, WGST,
 WSB, WTHZ
 Macon, WMAZ
 Toccoa, WTFI

HAWAII

Honolulu, KGHB, KGU

IDAHO

Boise, KFAU
 Kelloog, KFEY
 Pocatello, KSEI

ILLINOIS

Belvid, WLBO
 Blooming, WLBZ
 WNBZ

CAROLINA

Carthage, WCAZ
 Chicago, KFXX, KYW, WAAF,
 WBBM, WBBZ, WBCN,
 WCFL, WCRW, WESH
 WDFL, WENR, WFKB,
 WGES, WGN, WHBL,
 WHBM, WHFC, WHT,
 WIBL, WIBM, WIBO,
 WJAZ, WJBT, WKBG,
 WKBL, WLBH, WLII,
 WLS, WLTS, WMAQ,
 WMBB, WMBI, WPCO,
 WQJ, WSAX, WSPC,
 WVAE, WVRD

Chicago Heights, WJTB
 Decatur, WBAO, WJBL
 Elgin, WTAS
 Evanston, WEHS
 Galesburg, WFBZ, WKBS,
 WLBQ, WRAM
 Forest Park, WNBA,
 Harrisburg, WEBQ
 Homewood, WOK
 Joliet, WCLS, WJBA, WKBB
 La Salle, WJBC
 Moosheete, WJJD
 Peoria Heights, WMBD
 Quincy, WTAD
 Rockford, KFLV
 Rock Island, WHBF
 Springfield, WGBS
 Streator, WTAX,
 Tuscola, WTDZ
 Urbana, WRM
 Waukegan, WPEP
 Wrenona, WLBH
 Zion, WCBZ

INDIANA

Anderson, WHBU
 Brookville, WKVB
 Crown Point, WLBT
 Culver, WCMA
 Evansville, WGRF
 Fort Wayne, WCWK, WOWO
 Gary, WTKS
 Indianapolis, WFBM, WKBF
 Kokomo, WJAK
 La Porte, WRAF
 Muncie, WIRC
 South Bend, WYSB
 Terre Haute, KGFQ, WRPI,
 Valparaiso, WRBC
 West Lafayette, WBAA

IOWA

Ames, WOI
 Boone, KFQQ
 Cedar Rapids, KWCR, WJAM
 Clarinda, KSO,
 Council Bluffs, KOIL
 Davenport, WOC
 Decorah, KGCA, KWLO
 Des Moines, WHO
 Ft. Dodge, KFTY
 Iowa City, KGFB, WSUI
 Le Mars, KWUC
 Marshalltown, KFJB
 Muscatine, KPNP, KTNT
 Okaloosa, KFHL
 Ottumwa, WIAS
 Red Oak, KICK
 Shenandoah, KFNE, KMA
 Sioux City, KFMR, KSCJ,

KANSAS

Concordia, KGON
 Independence, KFVG
 Lawrence, KFBU, WREN
 Manhattan, KSAO
 Milford, KFKB
 Topeka, WIBV
 Wichita, KPH

KENTUCKY

Hopkinsville, WFTV
 Louisville, WHAS, WLAP

LOUISIANA

Cedar Grove, KGGH
 New Orleans, WABZ, WCBE,
 WJBO, WJWX, WKBZ,
 WSMB, WWL
 Shreveport, KFDD, KGDX,
 KRAC, KSBA, KWKH

MAINE

Bangor, WABI
 Dover-Foxcroft, WLBZ
 Portland, WCSH

MARYLAND

Baltimore, WBAL, WCAO,
 WCBZ, WFBZ
 Tacoma Park, WBES

MASSACHUSETTS

Boston, WATT, WBET,
 WBIS, WBZA, WEEL,
 WELM, WNAO, WSSH,
 WBS
 Chelsea, WLOE
 Dartmouth, WMAF
 East Springfield, WBZ
 Fall River, WBSR
 Gloucester, WLBZ
 Lexington, WLEX

NEW BEDFORD, WNBH

Quincy, WRBS
 Taunton, WAT
 Webster, WRBE
 Wellesley Hills, WBSO
 Worcester, WTAG

MICHIGAN

Battle Creek, WKBP
 Bay City, WSKC
 Berrien Springs, WEMC
 Detroit, WAJD, WBMH,
 WBC & WJR, WGHF,
 WMCB, WWJ
 Escanaba, WKAK
 Flint, WFDL
 Grand Rapids, WASH, WOOD
 Iron Mountain, WLBY
 Lapeer, WMPD
 East Lansing, WKAR
 Ludington, WKBB
 Monroe, WKBI
 Royal Oak, WAGM
 Petoskey, WBBP
 Ypsilanti, WJBK

MINNESOTA

Barrett, KGDE
 Collegeville, WFBZ
 Hallock, KGFJ
 Minneapolis, KFZD, KGEQ,
 WAMD, WCCO, WDGJ,
 WDDI, WLB, WRHM
 Northfield, KFMX, WCAL
 St. Cloud, WPFM
 St. Paul, KPOY, WMBE

MISSISSIPPI

Columbus, WCOO

MISSOURI

Cape Girardeau, KFVS
 Carterville, KFPW
 Columbia, KFBU
 Independence, KLDS
 Jefferson City, WOS
 Joplin, WMBH
 Kansas City, KWKC, WDAF,
 WLB, WLDF, WOQ
 Kirksville, KFZ
 St. Joseph, KGBX, KFEQ,
 St. Louis, KFQA, KFUO,
 KFWE, KSD, KMOX,
 KWK, WEW, WIL, WMAZ,
 WSBP

MONTANA

Hardin, KGHP
 Havre, KPHB
 Kallispell, KGEZ
 Missoula, KUOM
 Vida, KGXC

NEBRASKA

Central City, KGES
 Clay Center, KMMJ
 Columbus, KGHY
 Grand Island, KGEO
 Humboldt, KGDW
 Lincoln, KFAB, KFOR
 Norfolk, WJAB, KOCH,
 Omaha, WAAW, WNAL, WOW,
 Ravenna, KGFV
 University Place, WCAJ
 Wayne, KOOH
 York, KGBZ

NEW HAMPSHIRE

Lacouia, WKAV

NEW JERSEY

Asbury Park, WCAP
 Atlantic City, WHAR, WPG
 Camden, WCAM
 Carlstadt, WHAP
 Cliffside, WPAJ, WQAO
 Elizabeth, WBS
 Jersey City, WAAT, WKBO
 Kearney, WLWL
 Lambertville, WTAZ
 Midland Park, WTRZ
 Newark, WNY, WOJ, WGPC,
 North Plainfield, WEAM
 Paterson, WODA
 Red Bank, WJBI
 Union City, WBMS
 Trenton, WOAAX

NEW MEXICO

Raton, KGFL
 State College, KOB

NEW YORK

Auburn, WKBR, WMBO
 Bay Shore, WBSZ
 Binghamton, WOKT
 Bronx, WHPP
 Brooklyn, WARS, WSDA,
 WBBR, WBKN, WBBS,
 WLTB, WBOQ
 Buffalo, WBBR, WGR,
 WKBW, WKEN, WMAK,
 WSVS

Canton, WCAD
 Cazenovia, WMAO
 Endicott, WNBZ
 Farmingdale, WLBB
 Farmington, WBLB
 Flushing, WGOE
 Freeport, WGBB
 Ithaca, WLCT
 Jamaica, WMLJ
 Jamestown, WOCL
 Long Island City, WLB, WLBY
 Mt. Beacon, WOKO
 New York, WBBZ, WBNY,
 WBOQ, WODA, WOGU,
 WEAF, WERJ, WGBS,
 WGMU, WGL, WHN,
 WJZ, WKBQ, WMCA,
 WNYC, WPCB, WPUB,
 WBNY, WRUW
 Richmond Hill, WABC, WAOK
 Rochester, WABO, WHEM,
 WHEC, WNBQ, WOKT
 Saranac Lake, WNBZ
 Schenectady, WGY
 Syracuse, WFBL, WSyr
 Troy, WHAZ
 Utica, WIBX
 Woodhaven, WEVD
 Woodside, WIVRL

NORTH CAROLINA

Ashville, WVNC
 Charlotte, WBT
 Greensboro, WNRO
 Raleigh, WPTF

NORTH DAKOTA

Aneta, KQPN
 Bismarck, KFYY
 Devils Lake, KDLE
 Fargo, WDAY
 Grand Forks, KFJM
 Mandan, KGCU

OHIO

Akron, WADC, WFJC
 Ashabula, WJWP
 Bellefontaine, WHBD
 Canton, WHBC
 Cambridge, WEBE
 Cincinnati, WAAJ, WFBE,
 WKRC, WSAI
 Cleveland, WEAR, WFJC,
 WHK, WJAY, WTAM
 Columbus, WAIU, WCAH,
 WEAQ, WSMN
 Dayton, WSMK
 Harrison, WLW
 Hamilton, WMBK, WRK
 Mansfield, WLBY
 Middletown, WSRQ
 Shelby, WOBR
 Springfield, WCSO
 Steubenville, WBRB
 Toledo, WTAL
 Wooster, WABW
 Youngstown, WKBN, WMBW

OKLAHOMA

Alva, KGFF
 Tulsa, KVOO
 Chickasha, KOCW
 Norman, WNAD
 Oklahoma City, KFTE, KFRR,
 KGOB, KGFQ, WKY
 Picher, KGGF

OREGON

Astoria, KFJI
 Corvallis, KOAC
 Eugene, KGEH
 Medford, KMBD
 Portland, KEX, KFEC,
 KFPI, KFJR, KGW,
 KLIT, KTBR, KWBS,
 KWJJ, KXL, KOIN

PENNSYLVANIA

Allentown, WCBA, WSAN
 Altoona, WFBG
 Spokane, KFIO, KFPY, KGA
 Bethaysers, WALK
 Carbondale, WNBW
 East Pittsburgh, KDKA
 Grove City, WSAJ
 Harrisburg, WBAK, WMBS,
 WPRC
 Jeannette, WGM
 Johnstown, WHRP
 Kingstown, WABE
 Lancaster, WGLA, WKJC
 Lewisburg, WJBU
 Monessen, WMBJ
 Oil City, WHBA, WLWB
 Parkersburg, WQAA
 Philadelphia, WABY, WCAU,
 WFLD, WFKD, WHBB,
 WIAD, WBG, WIF,
 WLIT, WNAT, WOO,
 WRAX, WPSW, WFAN
 Pittsburgh, KQV, WCAE,
 WJAS

PORTO RICO

San Juan, WKAQ

RHODE ISLAND

Cranston, WDWV
 Newport, WMBZ
 Pawtucket, WFBI
 Providence, WCBB, WCOT,
 WEAN, WJAR, WLSI,
 WRAH

SOUTH CAROLINA

Charleston, WBBY

SOUTH DAKOTA

Brookings, KEDY, KGCB
 Dell Rapids, KGDA
 Mitchell, KGFP
 Oidham, KGRB
 Pierre, KGFJ
 Rapid City, WCAT
 Sioux Falls, KSOO
 Vermillion, KUSD
 Yankton, WNAX

TENNESSEE

Chattanooga, WDDO
 Knoxville, WFBC, WNBZ,
 WNOX
 Lawrenceburg, WOAN
 Memphis, WGBC, WHBQ,
 WMBM, WMC, WNRN
 Nashville, WBAW, WDAD,
 WLAZ, WSM
 Springfield, WSIX
 Union City, WOBT
 White Haven, WREC

TEXAS

Amarillo, KGRS, WDAQ
 Austin, KUT
 Beaumont, KFDM
 Bellville, KFBI
 Breckenridge, KFYO
 Brownsville, KWVG
 College Station, WTAW
 Dallas, KRLD, WFAA, WRR
 Dublin, KPPL
 El Paso, WDAH
 Fort Worth, KFJZ, KFQB,
 WFAA
 Galveston, KFJL, KFUL
 Greenville, KPFM
 Harlingen, KHMC
 Houston, KFVJ, KPBC, KTUE
 San Angelo, KGFT
 Sault Ste Marie, KGCI, KGDR,
 KGHC, KTAP, KTSB,
 WCAE, WOAI
 Waco, WJAD

UTAH

Jerome, KFSD
 Ogden, KFUR
 Salt Lake City, KDYL, KFUT,
 KSL

VERMONT

Burlington, WCAZ
 Springfield, WNBX

VIRGINIA

Arlington, NAA
 Mt. Vernon Hills, WFFF
 Norfolk, WRCV, WSEA,
 WTAR, WSVF
 Petersburg, WLBG
 Richmond, WBBL, WMBG,
 WRYA
 Roanoke, WDBJ

WASHINGTON

Bellingham, KVOS
 Everett, KFBL
 Lacey, KGY
 Pullman, KWSO
 Seattle, KFOA, KFQW,
 KCOL, KJR, KKP, KOMO,
 KPCB, KRSC, KTW, KVI,
 KUJ, KRXO
 Spokane, KFTO, KFPY, KGR,
 Tacoma, KMO, KVI

WEST VIRGINIA

Charleston, WOBZ
 Huntington, WSAZ
 Wheeling, WWVA

WISCONSIN

Appleton, WAIZ
 Beloit, WEBW
 Camp Lake, WCLO
 Eau Claire, WTAQ
 Fond du Lac, KFIZ
 Kenosha, WKBR
 La Crosse, WKBB
 Madison, WHA, WIBA
 Manitowac, WGMT
 Milwaukee, WGWV, WBAD,
 WISN, WISJ
 Poynter, WIBU
 Racine, WRRS
 Stevens Point, WLBI
 Superior, WBCB
 West De Pere, WHBY

WYOMING

Laramie, KFBW

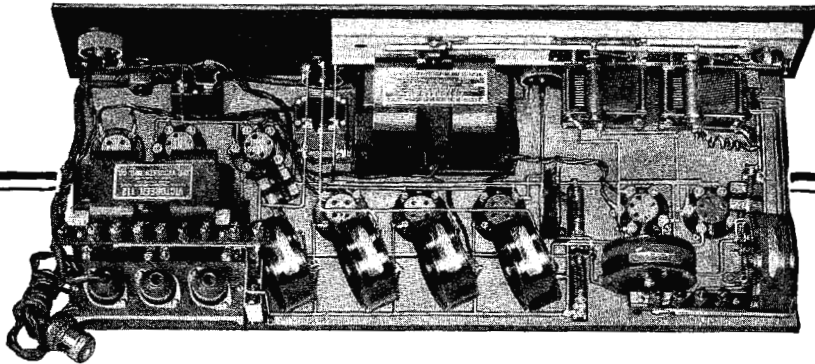

Announcing the New Victoreen A. C. Circuit

WORDS describing this new Victoreen Circuit would seem extravagant were they not so obviously and emphatically truthful.

For many months the scientists and engineers in the Victoreen Laboratory have been developing this new "Super" circuit. It is now offered as the last word in radio receivers, developing typical Victoreen efficiency, using the New A. C. Tubes.

The Victoreen A. C. Circuit has been designed for those who will never be satisfied with anything but the best in radio reception. It combines faithful reproduction of broadcast programs, with remarkable sensitivity and selectivity.

The heart of this new circuit, and the real reason for its remarkable efficiency, is the famous

Victoreen R. F. Transformers

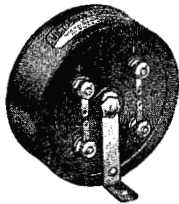

Due to the patented design developed in the Victoreen Laboratory, each transformer is adjusted to a precision within 1/3 of one per cent. Their sharp resonance curve means selectivity, and they are free from interstage oscillation.

In the new A. C. Circuit they are producing marvelous results. No. 170—price \$7.00.

Victoreen "112" Audio Transformer

Unique among audio transformers, producing a tone quality and faithfulness of reproduction that is little short of marvelous. Designed to handle up to 475 volts of "B" Supply in the last stage using a UX 210 tube, and 180 volts on the first stage, using a UY 327 tube. These requirements are for the A. C. circuit only. Enables the Western Electric Cone Speaker and similar high grade types to produce the marvelous tone quality of which they are capable. Price \$22.00.

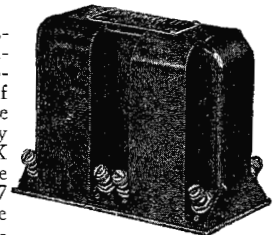

A New and Better "B" Power Supply

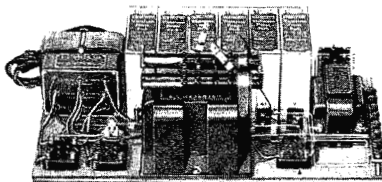

Here is smoothness and efficiency in a "B" power supply hitherto unknown. When you build the Victoreen power supply, you receive maximum satisfaction.

The output is approximately 475 volts—correct for the 210 power tube and for use with the Victoreen 112 Audio Transformer Unit. Has double wave rectification, using two UV 216-B or two UX 281 tubes.

For building this superlative "B" power supply and UX 210 amplifier, the following Victoreen parts are required:

Victoreen 116 Power Transformer, list.....\$16	Victoreen 316 Resistor, list.....\$3
Victoreen 115 Output Choke, list..... 10	If "B" supply only is required, omit the
Victoreen 216 Choke, list..... 15	115 Output Choke

Blueprints of the New Victoreen A. C. Circuit are ready. This, and blueprints of the Victoreen Universal Circuit sent free upon request.

The Geo. W. Walker Co. Merchandisers of Victoreen Radio Products 2825 Chester Ave., Cleveland, Ohio

Victoreen

STANDARDIZED HIGH QUALITY RADIO PARTS

Tell 'Em You Saw It in the Citizens Radio Call Book Magazine

KC	Meters	STATIONS	DIALS		KC	Meters	STATIONS	DIALS	
			1	2				1	2
1500	199.9				1020	293.9			
1490	201.2				1010	296.9			
1480	202.6				1000	299.8			
1470	204.0				990	302.8			
1460	205.4				980	305.9			
1450	206.8				970	309.1			
1440	208.2				960	312.3			
1430	209.7				950	315.6			
1420	211.1				940	319.0			
1410	212.6				930	322.4			
1400	214.2				920	325.9			
1390	215.7				910	329.5			
1380	217.3				900	333.1			
1370	218.8				890	336.9			
1360	220.4				880	340.7			
1350	222.1				870	344.6			
1340	223.7				860	348.6			
1330	225.4				850	352.7			
1320	227.1				840	356.9			
1310	228.9				830	361.2			
1300	230.6				820	365.6			
1290	232.4				810	370.2			
1280	234.2				800	374.8			
1270	236.1				790	379.5			
1260	238.0				780	384.4			
1250	239.9				770	389.4			
1240	241.8				760	394.5			
1230	243.8				750	399.8			
1220	245.8				740	405.2			
1210	247.8				730	410.7			
1200	249.9				720	416.4			
1190	252.0				710	422.3			
1180	254.1				700	428.3			
1170	256.3				690	434.5			
1160	258.5				680	440.9			
1150	260.7				670	447.5			
1140	263.0				660	454.3			
1130	265.3				650	461.3			
1120	267.7				640	468.5			
1110	270.1				630	475.9			
1100	272.6				620	483.6			
1090	275.1				610	491.5			
1080	277.6				600	499.7			
1070	280.2				590	508.2			
1060	282.8				580	516.9			
1050	285.5				570	526.0			
1040	288.3				560	535.4			
1030	291.1				550	545.1			

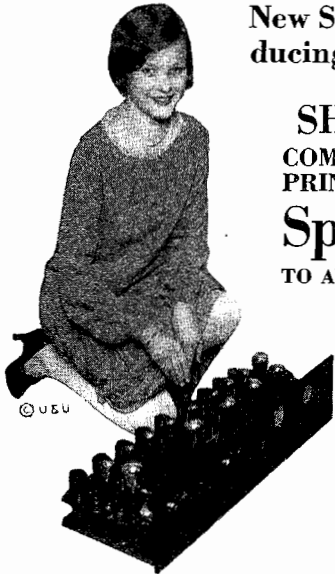

New Set-Builders' Offer Introducing the HOT SPOT "14"

WITH SHIELDED GRID TUBE

COMPLETE PARTS-LIST, PLANS, BLUE-PRINTS AND INSTRUCTIONS FREE WITH

Special Set-Builder Offer

TO ALL INTERESTED IN BUILDING RADIO RECEIVERS

List of Parts, Plans & Prints so complete that anyone can build—Screw-Driver, Pair of Pliers and a Soldering Iron is all the Equipment You Will Need

SHIELDED GRID TUBE construction in Super-Heterodyne Receivers has been receiving a great deal of attention lately. As usual, the Famous HOT SPOT FOURTEEN keeps in step with the times. Being as flexible in variations of construction as it is good in bringing in the greatest percentage of the broadcast band of all receivers, it lends itself nicely to Shielded Grid Tube installation for those who wish to increase the regular 200,000,000 amplification to more than One Billion from loop to speaker.

Complete prints and instructions will be supplied for Shielded Grid Tube, Sub-Panel and Baseboard types of construction to all who are interested in getting our new Special Set-Builders' Offer on this remarkable World's International Championship Receiver. Those who are interested in building the receiver for use with a Power Speaker will also be supplied free with Blue-Prints, Plans and Instructions for this type of Receiver, and the Power Amplifier to go with it. A screw-driver, pair of pliers and a soldering iron is all the extra equipment needed to build any type of HOT SPOT "14" Receiver.

Power Amplifier—"A" and "B" Eliminators—All Types of Accessories Are Specified

We Do Not Stop with the Chassis—We Tell You How to Build Complete Receiver with Cabinet, Speaker, Loop, "A" & "B" Supply—Any Type, Satisfactory Thruout



Not a detail has been overlooked in enabling you to provide yourself with the most complete and satisfactory radio receiver procurable. Our engineers have gone to great trouble and expense to test and develop with the manufacturers of other parts and accessories the proper type and design of every element that enters into building a complete set ready for operation. The most desirable speaker, unit, loop, cabinet, console, eliminator, amplifier, tube, or any other part have all been selected and specified to give a permanent result in keeping with the unbeaten records of this World's Championship Hot Spot Fourteen Receiver. Our Service Department will gladly co-operate with you in seeing that you are promptly, dependably and satisfactorily supplied when you are ready to build your receiver.

The well-known Robertson-Davis Melofomers and Melocouplers are the audio and radio frequency transformers used in constructing this King of the Magic Air. They permit stations to be heard only at one setting of the dials. The straight sides of the electrical peaks in the Melocouplers permit only a proportionately small amount of static to enter with the signal. The tuning is remarkably smooth on DX as well as locals. Stations slide in and out with amazing clearness from coast to coast. No Repeats—No Harmonics—Non-Critical Selectivity—Tremendous Clear Volume—Beautiful Tone. The testimonials we send you will speak for themselves. The HOT SPOT FOURTEEN is a revelation in sound harmony, and so simple to tune a child can do it. Read descriptive article in this issue of the Citizens Radio Call Book.



Fill in & Mail Coupon ROBERTSON-DAVIS COMPANY, Inc. 412 ORLEANS ST. CHICAGO, U. S. A. Designers of the Circuit

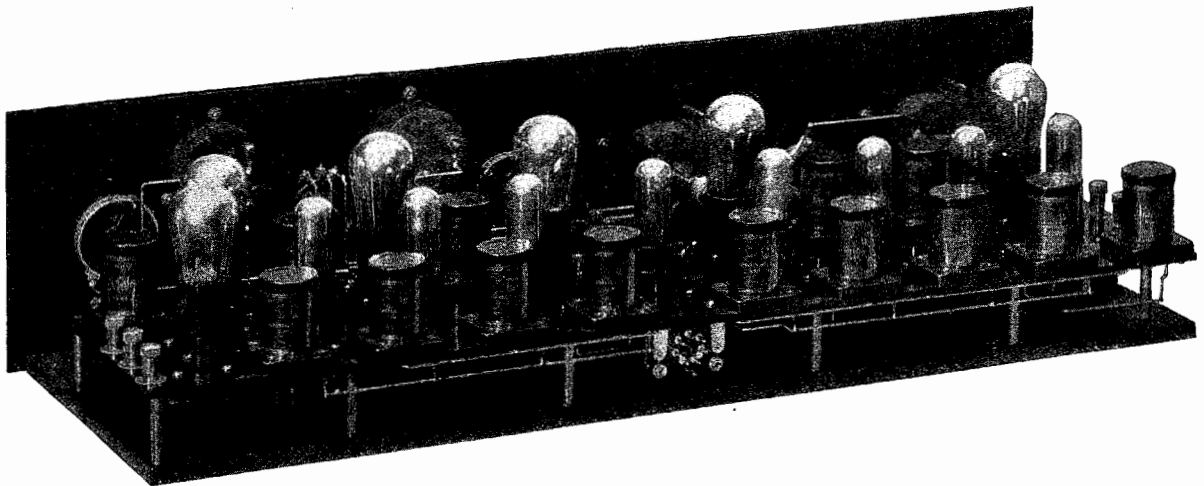

ROBERTSON-DAVIS HOT SPOT FOURTEEN

International Championship Receiver

Holds Undisputed Records for U. S. A. Reception

Tell 'Em You Saw It in the Citizens Radio Call Book Magazine

RCB-3

FREE

ROBERTSON-DAVIS COMPANY, Inc. CHICAGO

412 ORLEANS STREET

Gentlemen:

Send your **New Set-Builders' Offer** Free **Blue Prints** on the Famous **HOT SPOT FOURTEEN** Receiver. There is to be no charge or obligation whatsoever.

(Write or Print Clearly)

NAME _____

ADDRESS _____

TOWN _____

FREE BLUE PRINTS & PLANS IF YOU FILL IN & MAIL THIS COUPON PROMPTLY

Foreign Radio Broadcasting Stations

	Call	Wave	Power		Call	Wave	Power
ALASKA				New Brunswick			
Anchorage: Chorin Supply Co.	KFQD	227.1	100	Fredericton	CFNB	247.8	25
Juneau: Alaska Electric Light & Power Co.	KFIU	225.4	10	Moncton: Canadian National Railways	CNRA	322.4	500
ALGERIA				Quebec			
Algiers: Colin & Fils	SDB	310	100	Montreal: Northern Electric Co., Ltd.	CHYC	410.7	750
ARGENTINA				E. Fontains			
Buenos Aires: No data. Received at Pernambuco and Valparaiso	LOO	252	1000	La Presse Publishing Co.	CKAK	410.7	1200
No data	LB2	275	100	Canadian Marconi Co.	CFCF	410.7	1650
No data	LON	210	5000	Canadian National Railways. Uses equipment of other local stations.	CNRM	410.7	5
Argentine Association of Broadcasters	LOR	314.8	1000	Quebec	CHRC	340.7	5
No data	LOT	400	1000	Le Soleil	CHRC	340.7	22 1/2
Francisco J. Brusa	LOY	261.5	1000	St. Hyacinthe	CKCV	340.7	50
Grand Splendid Theatre	LOW	303	1000		CKSH	312.3	50
Radio Cultura Magazine	LOX	380	500	Ontario			
Radio Nacional	LOY	315.8	1000	Bowenville	CKCW	312.5	5000
University of La Plata	LOP	425	1000	Hamilton	CHCS	340.7	10
AUSTRALIA				Jack V. Elliott, Ltd.			
New South Wales				Kingston: Monarch Battery Co.			
Bathurst: Mockler Bros.	2MK	275	250	Burketon Junction	CKCW	340.7	50
New Castle: H. A. Douglas	2HD	288	20	Cobalt	CKMC	247.8	5
Sydney: Burgin Electric Co.	2BE	326	20	Huntsville: A. Staples	CHCO	247.8	5
Broadcasters, Ltd.	2BL	353	1000	Iroquois Falls: Abitibi Power & Paper Co.	CFCH	499.7	250
Farmers Broadcasting Co., Ltd.	2FC	442	2000	King: York Co.	CJQC	291.1	1000
Otto Sandel	2UW	263	100	Wentworth Radio Supply Co.	CKOC	340.7	50
Theosophical Broadcasting Service	2GB	326	1500	Cobalt	CKMC	247.8	5
Trades Hall Broadcasting Station	2KY	280	300	Huntsville: A. Staples	CHCO	247.8	5
Electrical Utilities Supply Co.	2UE	297	50	Iroquois Falls: Abitibi Power & Paper Co.	CFCH	499.7	250
Sydney	2WA	462	100	King: York Co.	CJQC	291.1	1000
Wagga: Otto Sandel	2UX	200	500	Queens University	CFRC	267.7	500
Victoria				Kitchener: O. Rumpel			
Brighton: Projected. No data	3BP	484	320	London: London Free Press Printing Co., Ltd.	CJGC	329.5	500
Melbourne: Associated Radio Co. of A. Pty. Ltd.	3AR	371	1000	Midland: E. O. Swan	CKPR	267.7	50
Broadcasting Co. of Australia Pty. Ltd.	3LO	255	500	Ottawa: J. R. Booth, Jr.	CHNC	434.5	250
Druleigh Business & Tech. College	3DR	319	20	Canadian National Railways	CNRO	434.5	500
O. J. Nilson & Co.	3UZ	303	20	other local stations	CKCO	434.5	100
L. J. Hellier, Wangaratta Sports Depot	3WR	296	20	Prescott: Radio Association of Prescott	CFLO	296.9	50
Mildura: R. J. Egge	3EO	296	20	Preston: Wallace Russ	CKPC	247.8	7 1/2
Queensland				Scarboro Station			
Brisbane: Dr. V. McDowell	4CM	278	50	Toronto: Star Publishing & Printing Co.	CFCA	356.9	500
Radio Manufacturers Ltd.	4MR	337	250	Toronto Radio Research Society	CHNC	356.9	500
Queensland Government	4QC	385	1000	Dominion Battery Co., Ltd.	CKCL	356.9	500
Rockhampton: Ditto	4RN	323	100	Canadian Broadcasting Corp. Projected	CKNG	329.5	5000
Toowoomba: Gold Radio Elec. Service	4GR	294	20	Canada National Carbon Co.	CKNC	356.9	500
South Australia				Northern Electric Co. Uses equipment of other stations			
Adelaide: Central Broadcasting Co.	5CL	395	1000	Jarvis Street Baptist Church. Uses equipment of other stations	CHIC	247.8	500
E. J. Hume. Operated by EDN Pty. Ltd.	5DN	313	100	Evening Telegram. Uses equipment of local stations	CJBC	247.8	500
Millwood Auto & Radio Co.	5MA	278	500	Canadian National Railways. Uses equipment of other local stations	CJSC	247.8	500
Marshall & Co.	5MC	250	1000	St. Michael's Cathedral	CNRT	291.1	1000
Sport Radio Broadcasting Station	5KA	250	1000	Thorold: D. J. Fendell. Suspended	CKSM	247.8	75
Western Australia				Manitoba			
Perth: Westralian Farmers, Ltd.	6WF	1250	1000	Winnipeg: Manitoba Telephone System	CKY	384.4	500
Tasmania				Canadian National Railways. Uses equipment of CKY			
Hobart: Tasmanian Broadcasters, Ltd.	7ZL	525	3000	CKY	CNRY	384.4	500
AUSTRIA				Saskatchewan			
Vienna: Oesterreichischer Radioverkehr A. G. broadcasts three 2-hour programs daily, including music (opera and popular), weather and market reports and news. Reception reported at Antwerp, تهران, Smyrna, Tunis	ORV	577	1500	Moose Jaw	CJRM	296.9	500
Oesterreichischer Radioverkehr A. G. Testing to place above station in the near future	ORV	517.2	7000	Regina: R. H. Williams & Sons, Ltd.	CHWC	312.3	15
Graz: Oesterreichischer Radioverkehr A. G.	ORV	365.8	500	Leader Publishing Co., Ltd.	CKCK	312.3	500
Innsbruck	ORV	294.1	500	Canadian National Railways. Uses Station CKCK equipment	CNRR	312.3	500
Klagenfurt: Relays Vienna	ORV	272.7	500	Sask. Co-op. Wheat Prod. Ltd.	CJBR	312.3	500
Linz: (Projected)	ORV	264.2	500	Saskatoon: The Electric Shop	CEQC	329.5	500
Rosenhugel	ORV	617.2	5000	International Bible Students' Association	CHUC	329.5	500
BELGIUM				Wheaton Electric Co.			
Antwerp: (General, 2 hours daily)	BAV	265.5	100	Canadian National Railways. Uses equipment of other local stations	CJVC	329.5	250
Brussels: Radio Belgique	BAV	608.5	1500	Unity: Horace N. Stovin	CHSC	267.7	50
Liege: Radio Walloon Station	BAV	205	100	Yorkton: Winnipeg Grain Exchange	CJGX	475.9	500
Radio Central Station	BAV	294.1	100	Alberta			
BOLIVIA				Calgary: W. W. Grant Radio, Ltd.			
La Paz: (Irregular)		175.300	50	The Alberta Pacific Grain Co., Ltd.	CKLC	356.9	2000
BRAZIL				Calgary Herald			
Bahia: Radio Sociedade do Bahia		465	50	Canadian National Railways. Uses equipment of other local stations	CNRC	434.5	500
Belo Horizonte: National Telegraph Service		400	50	Radio Service & Repair Shop	CJJC	434.5	250
Fortaleza: Radio Club		80	80	Edmonton			
Para		80	80	Edmonton: International Bible Students' Assn.	CHCY	516.9	250
Pernambuco: Radio Club. One hour daily and two hours three days each week		310	300	Alberta Pacific Grain Co., Ltd.	CKLC	356.9	1000
Porto Alegre: Radio Society. Broadcasts one hour daily. To be replaced by 50-watt station		380	80	Christian & Miss. Alliance	CHMA	516.9	250
Rio de Janeiro: Radio Society. Daily programs by local artists		400	1000	University of Alberta	CKUA	516.9	500
National Telegraph Service. Praia Vermelha Station. Operated by Radio Club. Daily news and concerts		312	500	Radio Supply Co., Ltd.	CFCK	516.9	50
Rio de Janeiro: No data. Phonograph records broadcast 2 to 4 pm daily, concerts from 7 to 9 pm three or four days each week		10	10	Edmonton Journal	CJCA	516.9	500
Santos: No data		10	10	Canadian National Railways. Uses equipment of other local stations	CNRE	516.9	500
Sao Paulo: Dias Carneiro & Co., operated by the Radio Club of Sao Paulo		380.420	100	Lethbridge: J. E. Pulmer	CJOC	267.7	50
Radio Club of Sao Paulo Broadcasts Hotel Terminus orchestra and phonograph records daily		360	10	British Columbia			
CANADA				Burnaby: International Bible Students' Assn.			
Nova Scotia				Kamloops: N. S. Daglish & Sons and Weller & Weller			
Halifax: (Carlton Hotel station, Northern Electric Co., Ltd.)	CHNS	322.4	100	Mission: City: E. R. Streeter	CJCU	247.5	5
Prince Edward Island				New Westminster: Westminster Trust Co.			
Charlottetown: General during winter	CFCY	312.3	100	Sea Island	CJOR	291.1	50
Summerside: R. T. Holman, Ltd.	CHGS	267.7	25	Vancouver: A. Holmstead & William Hanlon	CFDC	410.7	15
CANARY ISLANDS				G. W. Deauville			
La Laguna: Servando Ortoll Delmotte	EAJ5	280	50	A. Halstead & Wm. Hanlon	CKVX	410.7	10
Las Palmas: Canary Islands Radio Club		800	6	Central Presbyterian Church	CHPC	410.7	1000
Club Radio Canarias		800	6	Radio Corporation of Vancouver	CFYC	410.7	500
Teneriffe: Servando Ortoll Delmotte	EAR5	250.350	200	Daily Province	CKDC	410.7	1000
CEYLON				United Church of Canada			
Colombo		800	1500	Canadian National Railways	CNRY	291.1	500
				Sprout-Shaw Radio Co.			
				Pyramid Temple Society. Uses equipment of other local stations			
				CUKO			

CHILE			Call	Wave	Power				Call	Wave	Power
Antofagasta: Senor J. Pedreny.....	CHAO	345	1500			St. Etienne: Radio Club Forezien.....			220	50	
Concepcion.....	CMAI	360	1200			Strasbourg: Military station.....			200	15,000	
Santiago: El Mercurio, newspaper.....	CMAC	320	100			Radio Club.....	SGF		222.2	1500	
Fratelli Castagneto.....	CMAB	280	100			Toulouse: Radio du Midi.....			389.6	2000	
Chilean Broadcasting Society.....	CRC	355	350			Ministry of Posts, Telegraphs and Telephones. Astro-drome station.....	MRD		260	1000	
Commercial Radio Co.....		350	30			Radio Vitus.....			308	250	
Tacna: Chilean Government.....	CRCT	550	200			Reziens.....			178	500	
Valparaiso: Antonio Cornish.....		400	50								
CHINA						GERMANY					
Shanghai: Kellogg Switchboard & Supply Co. Operates four hours daily between 9:45 am and 11 pm.....		365	20			Berlin: Postal Authorities. Konigswusterhausen Station. Relays Vox Haus programs. Reception reported at Rome, Constantinople, Bergen, Algiers.....	LP		1300	12,000	
(Note: Stations have been reported in other Chinese cities, but the present operation is very doubtful. The above station is the only one mentioned in more recent reports.)						Postal Authorities, Vox Haus station.....			507	2250	
Seoul: Under construction.....	CHOSEN	345	1000			Magdeburger Platz.....			568	400	
COSTA RICA											
San Jose: Government. Under construction.....						Konigswusterhausen Station.....	AFT		1250	4000	
CUBA											
Central Elia: Elia Sugar Co.....		300	500			Konigswusterhausen.....	AFP		4000	10,000	
Salvador Rionda.....	7SR	350	500			Witzelben.....			488.9	4000	
Cienfuegos: Jose Ganduxa.....	8BY	260	200			Wolfs Bureau.....			252.5	5000	
Habana: Cuban Telephone Co.....	PVX	400	500			Yrebuerg.....			577	1000	
Bernardo Barrie.....	2BB	250	15			Bremen: Nordische Rundfunk A. G. Relays Hamburg.....			400	140	
Frederick W. Borton.....	2BY	260	100			Breslau: Schliesische Funkstunde. Received at Rome.....			315.8	750	
El Pais.....	2EY	355	400			Cassel.....			272.7	750	
Credito y Construction Co.....	2HP	285	100			Dortmund: Mitteldeutscher Rundfunk A. G. Relays.....					
Jose Lara.....	2LR	235	50			Leipzig programs.....			288	300	
Mannel y Guillermo Salas.....	2MG	284	20			Leipzig programs.....			294.1	700	
Mario Garcia Velez.....	2OK	350	100			Elberfeld.....			468.8	750	
Columbia Radio & Cycle Co.....	2OL	257	100			Frankfurt-on-the-Main: Sudwestdeutscher Runkfunkdienst.....			428.6	750	
Raoul Karman.....	2RK	315	20			Freiburg i. Br.....			577	750	
Roberto E. Ramlerz.....	2RW	270	20			Gleiwitz: Relays Breslau.....			250	750	
Renito Viera Ferro.....	2UP	275	10			Hanover: Nordischer Rundfunk A. G. Relays Hamburg.....			394.7	4000	
Santiago: Alberto Ravelo.....	8BY	250	100			Hanover: Nordischer Rundfunk A. G. Relays Hamburg.....					
Tuinucu: Frank H. Jones.....	6JK	272	100			programs.....			297	750	
Frank H. Jones.....	6KW	340	100			Kassel: Sudwestdeutscher Runkfunkdienst.....			272.7	750	
CZECHOSLOVAKIA											
Bratislava: Tues. Fri.....	OKR	300	500			Kiel: Relays Hamburg.....			254.2	750	
Brunn: Radio Journal.....	OKB	441.2	300			Konigsberg: Ostmarken Rundfunk A. G.....			329.7	4000	
Prague: Kbely.....	OKB	441.2	300			Langenberg: Rhineland.....			468.8	2500	
Radio Journal.....	OKP	1110	1000			Leipzig: Mitteldeutscher Rundfunk A. G.....			365.8	750	
		384.9	5000			Muenster: Same.....			241.9	1500	
DANZIG											
Danzig: Relays Koenigsburg.....		272.7	1500			Munich: Deutsche Stunde in Bayern.....			538.7	4000	
DENMARK											
Copenhagen: Radioadet.....		337	2000			Norddeich.....	KAV		1800	300	
Hjorring: Relay station. Government.....		1225	250			Nuremberg: Relays Berlin.....			303	750	
Kallundborg (projected).....		1150	7500			Stettin: Relays Berlin.....			252.1	750	
Lyngby: Relay station. Government.....		2400				Stuttgart.....			379.7	4000	
Odense: Relay station. Government.....		810	1000			GREAT BRITAIN					
Ryvang: Relay station. Government.....		1150	500			Aberdeen.....	2BD		500	1500	
Soro: Ministry of War. News and weather.....		1153.8	1500			Bradford.....	2LS		252.1	500	
Viborg.....		1110	1000			Birmingham: Received at Antwerp, Brussels, Rome.....	51T		326.1	1500	
		214.3	750			Bournemouth: Received at Antwerp, Tenerife, Jeru.....					
EGYPT											
Cairo.....	SRE	255				Cardiff: Received at Antwerp and Rome.....	5WA		353	1500	
ESTONIA											
Tallinn.....		1200	100			Chelmsford.....	2BR				
		408	500			Darenty: Received throughout Europe, northern Af.....			1600	16,000	
FINLAND											
Bjorenberg: Nuoren Voiman Litton Radioyhdistys. Daily, general.....		311	200			Dundee.....	5XX		294.1	200	
Hango: Same.....		260	200			Edinburgh.....	3PE		285.5	500	
Helsingfors: Civil Guard.....		500	1000			Glasgow.....	5BC		405.4	1500	
Mon. Wed. Fri. General.....		375	2000			Hull.....	6KH		294	200	
Helsinki: Same as Helsingfors.....		275.2	200			Leeds-Bradford.....	2LS		277.8	500	
Jakobstad: Irregular.....		297	200			Liverpool.....	6LV		297	200	
Jyvaskyla: N. V. L. Radioyhdistis. Irregular.....		318	180			London: Received at Tenerife, Strasbourg, Brussels.....			2LO	361.4	3000
Lahdis: Three programs weekly.....		318	180			Rome, Barcelona, Tunis.....	2ZY		384.6	1500	
Mikkeli: N. V. L. R.....		287	250			New Castle: Received at Brussels, Rome.....	5NO		312.5	1500	
Oulu.....		288	100			Nottingham.....	5NG		275.2	200	
Pietarsari: Same as Jakobstad.....		254.2	100			Plymouth.....	5PY		400	200	
Peri.....		254.2	100			Poldhu.....	2YT		272.7	200	
Tampere: Same as Tammerfors.....		561	500			Sheffield.....	6FL		294	200	
St. Michael: N. V. L. R.....		400	250			Stoke on Trent.....	6ST		294	200	
Tammerfors: Relays Hfors.....		250	250			Swansea.....	5SX		294	200	
Uleaborg: Relays Hfors.....		250	250			HAWAII					
FRANCE											
Agen: Department of Lot et Garonne.....	2BD	297	250			Honolulu: Marion A. Mulrony.....	KGU		270	500	
Angers: Radio Anjou.....		273.2	500			HAITI					
Bezier.....		95	100			Port au Prince.....	HHK		361.2	1000	
Blarritz: Cote d'argent.....		200				HUNGARY					
Bordeaux: Ministry of Posts, Telephones and Telegraphs.....		238.1	500			Budapest: Meugeytemi Radio Magyar Tavrati Iroda. Broadcasts market reports and news.....	MTL		555.6	2000	
Caen: Radio Club.....		419	1500						1050	400	
Dion.....		277.8	1500			ICELAND					
Greenoble: Ministry of Posts, Telegraphs and Telephones.....		207.5	1000			Reykjavik.....			333.3	100	
Juan Les Pines.....		280	500			INDIA					
Issy-Jes-Moulineaux: Ministry of War.....	QGA	1800	500			Bombay: Bombay Presidency Radio Club.....	2FV		387	100	
Lille.....		287	500			Walter Rogers & Co.....	2AX		320	50	
Limoges.....		330	500			Calcutta: Radio Club of Bengal.....	2BZ		800	500	
Lyon: Dubanchet & Troillet, Station Radio Lyon.....		291	500			Owner not reported.....	5AF		425	1500	
Dubanchet & Troillet, Station Radio Lyon.....		291.3	1500			Karachi: Karachi Radio Club.....			425	40	
Ministry of Posts, Telegraphs and Telephones, Station La Dona, named for suburb in which located.....	YN	480	1000			Madras.....	2GR		400	200	
Marsailles: Ministry of Posts, Telegraph and Telephones.....		390	300			Rangoon: Radio Club of Burma and Wireless Club of Burma. Broadcasts musical programs every Sunday.....	2HZ		350	40	
Mont de Marsen.....		390	300			IRELAND-NORTH					
Montpellier: Radio Montpellier station.....		338	200			Belfast.....	2BE		306.1	1500	
Nice.....		362	1000			IRISH FREE STATE					
Paris: Eiffel Tower station. Ministry of Posts, Tele- graphs and Telephones.....	FL	2650	4000			Cork.....	6CK		400	1000	
Journal Petit Parisien.....	5NG	333	500			Dublin: Government.....	2RN		819.1	1500	
Lucien Levy.....		350	500			ITALY					
Petit Parisien. Reception reported at Rome Societe Francaise Radioelectrique.....	FL	341	1000			Genoa (projected).....			272.7	1500	
Societe Francaise de Radioelectrique.....	SAJ	1780	100			Milan.....			322.6	1500	
Cie. Francaise de Radiophonie. Reception reported at Tenerife, Jerusalem, Brussels, Rome, Teheran, Smyrna, Barcelona.....		1750	4000			Unione Radiofonica Italiana.....	1MI		320	1500	
Superior School of Ministry of Posts, Telegraphs and Telephones. Reception reported at Rome.....		447.8	5000			Naples: Unione Radiofonica Italiana. Broadcasts con- certs and news, 8:30 to 11 o'clock pm daily. Re- ceptions reported at Antwerp, Jerusalem, Lille, Smyrna, Damascus, Barcelona, Tunis and Alex- andria. This is at present the station best re- ceived throughout the Levant.....	1NA		333.3	1500	
Paris: Radio Paris.....		1750	3000			Rome: Unione Radiofonica Italiana. Broadcasts con- certs and news, 8:30 to 11 o'clock pm daily. Re- ceptions reported at Antwerp, Jerusalem, Lille, Smyrna, Damascus, Barcelona, Tunis and Alex- andria. This is at present the station best re- ceived throughout the Levant.....	1RO		449	3000	
Ecole Superteure.....	FPPT	458	1000			Palero (projected).....	1CP		500	2000	
Pic du Midi.....		350				Venice (projected).....			254.2	1500	
JAVA											
Bandoeng: Vereeniging van Radio Amateurs voor Bandoeng en Omstreken.....	No call								810	6	
Batavia: Bataviasche Radio Vereeniging.....	JFC								220	40	
Soerabaja: Two concerts weekly.....									140	500	

	Call	Wave	Power		Call	Wave	Power
JAPAN				SPAIN			
Nagoya: Nagoya Radio Broadcasting Co. Broadcasts daily 9 am to 9 pm; Sundays and holidays, 12 m to 9 pm. Program consists of music, weather and market reports, etc.	JOCK	360	1000	Barcelona: Radio Barcelona Station.....	EAJ1	844	1000
Osaka: Osaka Radio Broadcasting Co. Programs in English and Japanese. 1500-watt station projected.	JOAK	385	1000	Radio Catalana.....	EAJ13	277.8	1000
Osaka Broadcasting station (Proj.).....	JIBK	385	1000	Bilabo: Radio Carlton Station. Radio Club Vizcaya.....	EAJ9	488	500
Tokyo: Tokyo Radio Broadcasting Co. Programs in English and Japanese. 155-watt.....	JOAK	875	1000	Radio Vizcaya Station. Don Armando de Otera.....	EAJ11	294.1	500
JUGOSLAVIA				Vizcaya Radio Broadcasting Station, broadcasts music, provided by local talent, and considerable advertising from 12 to 12 pm daily.....		294.1	2000
Agram (Zagreb).....		275.2	100	Cadiz: Don Francisco de la Liesca.....	EAJ8	344	500
Belgrade.....	HFF	225.6	2000	Radio Lehera.....	EAJ10	297	1000
KWANTUNG				Cartagena: Don Enrique de Orbe.....	EAJ16	294.1	500
Dairen: Government Bureau of Communications employs a commercial station. Daily programs broadcast, consisting of music, educational and entertainment numbers.....	JQAK	390	5000	Madrid.....	EJ2	400	500
LATVIA				Don Antonio Castilla.....	EJ4	275.2	3000
Riga.....	KCX	526.3	2000	Radio Iberica Station.....	EJ6	577	1000
LITHUANIA				Union Radio.....	EJ7	375	1000
Kovno.....		2000	2000	Radio Madrileña.....	EJ12	308	2000
LUXEMBURG				Association of Radio.....	EJ15	490	1000
Luxemburg.....	LOAA	217.4	250	Radio Espana.....	EJ2	393	3000
Luxemburg.....		1200	250	Malaga: Cia Iberia de Telecomunicacion.....	EJ25	50-25	100
MEXICO				Oviedo: Don Arburio Cima.....	EJ20	254.2	100
Chihuahua: Federal Government State Capital station.....	CZF	310	250	Salamanca.....	EJ22	201.3	100
Guadalajara: Federal Military Command.....	FAM	490	1000	Saragossa.....	EJ28	403	500
Radio Club.....		280	10	San Sebastian: Don Sabino Ucelayeta.....	EJ8	325	1500
Maracan: Castulo Llamas.....	CYR	475	250	Seville: Seville Radio Club.....	EJ5	272.7	500
Mexico City: Eifrian R. Gomez.....	CYA	300	500	Don Manuel Garcia Ballesta.....	EJ17	400	1000
Jose J. Reynosa, operated by El Buen Tono, cigarette factory.....	CYB	275	500	Don Jorge la Riva, projected.....	EJ21	344	500
Miguel S. Castro, operated by Le High Life, newspaper.....	CYH	375	100	Valencia: Radio Corporation.....	EJ14	500	500
Raoul Azcarraga, operated by Universal.....	CYL	400	500	Under construction.....	EJ24	360
Martinez y Zetina.....	CYO	425	100	Zaragoza.....	EJ23	566
El Excoisor—Parker.....	CYX	325	500	STRAITS SETTLEMENTS			
Department of Education.....	CZE	350	500	Amateur Wireless Society of Malaya: 2-hour program broadcast each Sunday evening, and children's concert on Wednesdays. Received at Colombo, Ceylon.....	ISE	330	100
Monterey: Roberto Reyes.....	CYM	275	190	SWEDEN			
Constantino de Tarnava.....	CYS	311	250	Boras.....	SMBY	230	250
Oaxaca: Frederico Zenilla.....	CYF	265	100	Drottningholm.....	SMFI	237	250
Puebla: Augustin del P. Zaenz.....	CYU	312	100	Boden: Radiojanst.....	SASE	454.5	1000
Tampico: El Mundo. Suspended.....		322	100	Eskilstuna: Radio Club. Relays Stockholm programs 4 days each week, broadcasts local programs other days.....	SMUC	275.2	250
Cipriano Sagon S en C.....	CYQ	322	100	Falun: Radio Club. Relays Stockholm programs 4 days each week, broadcasts local programs other days.....	SMZK	400	750
Local programs.....	CYZ		20	Gavle: Radio Club. Relays programs 4 days each week, broadcasts local programs other days.....	SMXF	204.1	250
Vera Cruz.....	CYD		Goteburg: Radiojanst.....	SASB	416.7	1000
Manuel Angel Fernandez. Recently inaugurated for broadcasting advertising of an American product.....	CYY	548	100	Halmstad.....	SASB	215.8	250
Yucatan: Partida Socialista del Sureste.....	CYY	548	100	Helsingborg.....	SMBB	235	250
MOROCCO				Hindksvaal.....	SMSL	248	250
Casablanca: Radio Club of Morocco, Omega Station.....	CNO	305	2500	Jonkopings: Jonkopings Runradiostation. Relays Stockholm programs 4 days each week, broadcasts local programs other days.....	SMZD	201.3	250
NETHERLANDS				Kalmar.....	SMSW	253	250
Amsterdam.....		760	Kalmar.....	SMSN	254.2	25
Amsterp.....		508.5	Karlsborg: Radiojanst. Relays Stockholm programs 4 days each week, broadcasts local programs other days.....	SASF	1365	5000
Bloemendall.....		566	Karlskrona: Relays Stockholm programs 4 days each week, broadcasts local programs other days.....	SMSM	201.3	250
DeBilt.....	PCFF	1100	1250	Karlstadt: Karlstadt Runradiostation. Relays Stockholm programs 4 days each week, broadcasts local programs other days.....	SMXG	220.6	250
Eindhoven: Philips Lamp Works.....	PCJJ	30.2	Kristinehamn.....	SMITJ	202.7	100
Hilversum: Netherlandische Seintoellen Fabriek and Hiversum Drendloze Omroep. Reception reported at Teleran.....	HDO	1060	1000	Linköping: Radio Club. Relays Stockholm 4 days each week, local programs other days.....	SMUV	568.2	250
Scheveningen-Haven.....		1950	2500	Malmö: Radiojanst.....	SASC	229	1000
NEW ZEALAND				Motala.....	SMV	1304.5	40000
Auckland: Radio Broadcasting Co. of New Zealand. General, two hours daily.....	IYA	420	500	Norrköping.....	SMVV	372.7	2500
Christchurch: R. B. Co. of N. Z.....	8AC	400	500	Orebro.....	SMTI	506	250
Dunedin: R. B. Co. of N. Z.....	4YA	380	110	Osterlund.....		720	1000
Osborne: Osborne Radio Co.....	2YM	260	50	Osäffe.....	SMPS	232.1	500
Wellington: R. B. Co. of N. Z.....	2YK	295	60	Stockholm: Radiojanst.....	SASA	416.7	1500
NORWAY				Sundsvall: Radiojanst.....	SASD	545.6	1000
Oslo: Broadcasting Company A. S.....		461.5	1500	Trollhattan.....	SMNQ	277.8	1000
Bergen: Bergen Broadcasters.....		370.4	1500	Uddevalia.....	SMZP	294.1	250
Fredrikstad: Relays Oslo.....		434.8	750	Umea: Relays Stockholm 4 days, local programs other days.....	SMSN	252.1	100
Hamar.....		566	750	Uppsala.....		500	250
Porsgrund: Relays Oslo.....		504	750	Varberg.....	SMISO	297	100
Rjukan: Relays Oslo.....		443	250	SWITZERLAND			
Trondjhem.....		243.9	Basel.....	HB3	1100	300
Notodden: Relays Oslo.....		447.8	Berne: Radio Berne Station, Radio Club of Berne.....	HBA	411	1500
Stavanger.....		277.8	250	General Post and Telegraph Office.....		302	1500
Tromso.....		500	Geneva: Radio Broadcasting Society of Geneva. Broadcasts music and news.....	HB1	760	500
PARAGUAY				Lausanne: Comp de l'Air Station (Societe Romande de Radiotelephonie Lausanne).....	HB2	850	600
Asuncion: General, Friday.....		12	Zurich: Hoeng Station. Radio Genossenschaft Zurich University. Reception reported at Antwerp, Brussels, Rome, Vienna.....	HBZ	500	1000
PERU				TUNISIA			
Lima: Peruvian Broadcasting Co. (Ltd.).....	OAX	360	1500	Carthage.....		100	50
PHILIPPINES				Carthage.....		1800	5000
Baguio.....	KZUY	359.9	500	Tunis: French Army. Two musical programs broadcast each week.....	TUA-OCTU	1450	100
Manila: I. Beck Dept. Store.....	KZIB	249.9	20	French Army. Two musical programs broadcast each week.....	OCTU	45
	KZKZ	210.1	100	TURKEY			
	KZRQ	222.1	500	Osmalieli.....		1200	6000
POLAND				UNION OF SOUTH AFRICA			
Cracow.....		422	1500	Cape Town.....		400	500
Lemberg: Under construction.....		247.9	1500	Durban: Town Council.....		400	1200
Posen.....		270.3	1500	Grahamstown.....		400
Warsaw.....	AXO	1111.1	8000	Johannesburg: Assn. Scientific and Tech. Societies.....	JB	438	900
Vilna (projected).....		234.4	2000	Cape Town: Cape Peninsula Broadcasting Assn., Broadcasts 54 hours per week, programs by paid orchestra and local talent.....		375	1200
PORTUGAL				UNION OF SOVIET SOCIALIST REPUBLICS (formerly Russia)			
Lisbon: Grandes Armazenas de Chiado. Irregular.....	IAA	267.8	500	Kiev.....	RA5	775	1000
Monte Santo.....	CTV	2450	1500	Leningrad.....	RA42	1000	10,000
PORTO RICO				Leningrad.....	RA6	940	2000
San Juan: Radio Corp. of Porto Rico.....	WKAQ	340.7	500	Moscow: Komzet.....	RDV	1450	40,000
RUSSIA (Now U. S. S. R.)				Radio Paredatcha.....	RA1	420	200
SALVADOR				Popoff.....		79
San Salvador: Govt. National Broadcasting. Mon, Wed, Fri, 8:15 p. m., C. S. T.....	RUS	452	500	Popoff.....		25
SENEGAL				Popoff.....		1010	2000
St. Louis: Senegal Radio Club. Projected.....		300	100	Trades Union.....	MSK	680	2000
SIBERIA				Nijni Novgorod.....	RA13	1400	1500
Tomsk.....	RA21	300	250	URUGUAY			
SPAIN				Montevideo.....	CWOB	350	500
STRAITS SETTLEMENTS					CWOF	300	100
SWEDEN					CWOG	280	10
SWITZERLAND					CWOS	380	500
TUNISIA				VENEZUELA			
TURKEY				Caracas: Empresa Venezolana de Radiotelefonía.....	AYRE	375	1000

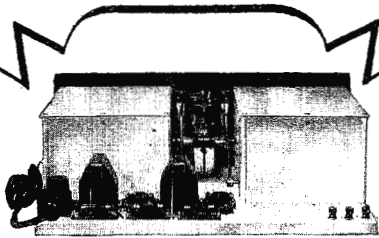

The Hammarlund "Hi-Q" Receiving Set which uses box shields of Alcoa Aluminum Sheet and special corner post moulding.

**NOW—
Finer Reception
for Amateurs**

ALUMINUM BOX SHIELDS will help you to get greater distance, better selectivity—closer tuning. Their use eliminates or greatly reduces interference. They are ideal for shielding circuits using the new shielded grid tubes.

The superiority of Aluminum is recognized by Hammarlund in the design of the "Hi-Q" receiver (above). Two special Hammarlund Box Shields made of Alcoa Aluminum Sheet are used.

Aluminum Company of America's standard box shields, designed especially for amateur sets, are made of heavy Alcoa Aluminum with satin-dip finish, size 5 in. x 9 in. x 6 in. high. They are easily adapted to smaller sizes. They require no soldering. They embody the ideal combination of high electrical efficiency, mechanical strength, lightness, fine appearance and long life.

Be sure to use Aluminum Box Shields, for finer results. If your dealer cannot supply you, send us your order and we will have an authorized dealer ship promptly at \$3.50 each (standard size). You simply pay the postman.

**ALUMINUM COMPANY
OF AMERICA**

2465 Oliver Bldg. Pittsburgh, Pa.

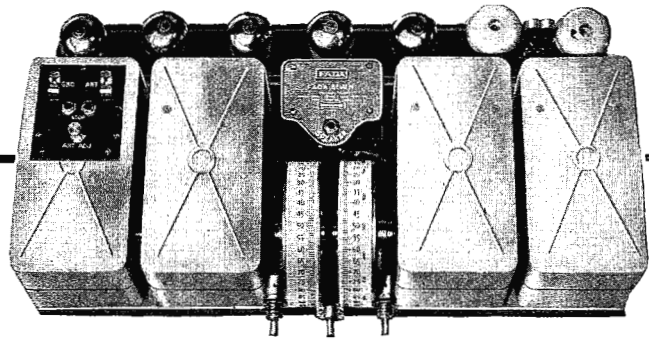

F. A. D. Andrea, Inc., uses Alcoa Aluminum for Shielding and other parts of "Fada" receiving sets.

**Expect Better Results When
You See This Metal in Radio**

WHEN you look at radio receivers using aluminum shielding or condenser blades; aluminum castings, front panels, chasses or sub-panels you will know that the manufacturer has chosen the one metal that most efficiently meets all the widely differing conditions encountered in radio design.

ers employ parts of Alcoa Aluminum so that the purchasers of their receivers may enjoy the best of radio reception.

These makers recognize the superiority of Alcoa Aluminum. They appreciate its ideal combination of high electrical conductivity, lightness, strength, and beauty. Look for Aluminum in the set you buy—

MR. L. M. CLEMENT
Chief Engineer of
F. A. D. Andrea, Inc.,
commenting on shielding
says, "In a radio receiver
aluminum, because of its
electrical conductivity,
makes a more efficient
shield than any other of
equal weight. The material
can be easily drawn
into the desired shape
and its finish is permanent
and pleasing to the
eye."

Such famous makers as Atwater Kent, Crosley, Fada, Freed-Eisemann, Grebe, Howard, R-C-A, Stewart-Warner, Stromberg - Carlson, Zenith and a host of oth-

when you find it you may expect the best results that the best radio engineers have yet achieved. Send for a copy of our new booklet, "Aluminum for Radio." It is free.

ALUMINUM COMPANY OF AMERICA

2465 Oliver Building

Pittsburgh, Pa.

ALUMINUM

The mark of Quality in Radio

Tell 'Em You Saw It in the Citizens Radio Call Book Magazine

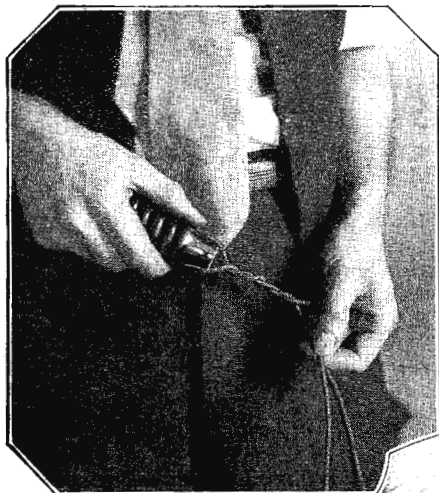
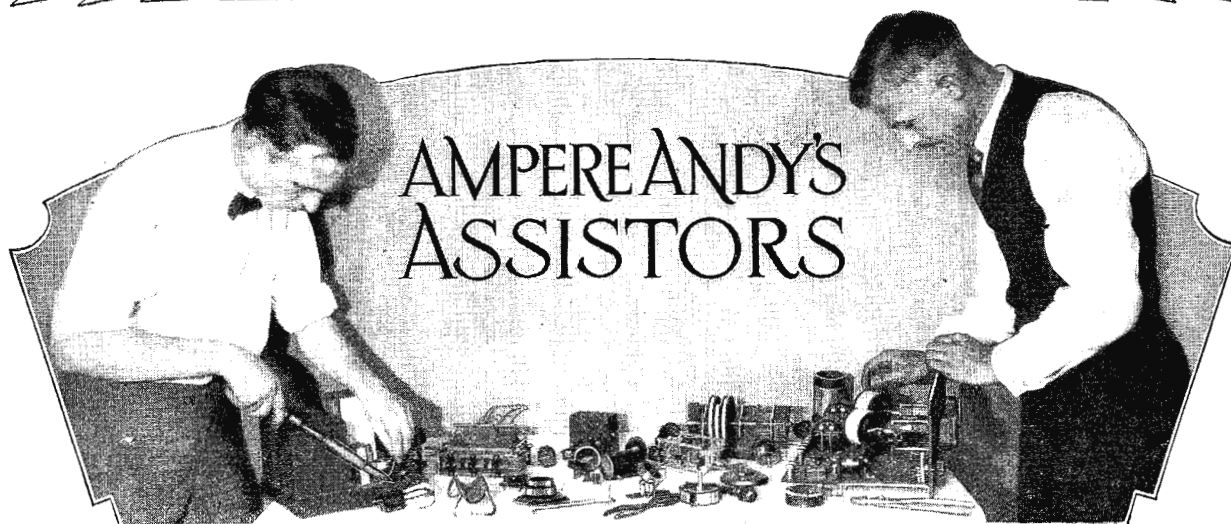

Antenna and Lead-in in One Piece

It is often desirable that the lead-in and antenna be in one continuous piece of wire. An insulator may be fastened to a single wire antenna at each end without breaking the lead-in wire in the following manner: One insulator is fastened at the extreme end opposite the lead-in wire in the usual manner. Then slip the other end of the wire which is to serve as the lead-in through one of the holes of the other insulator, allowing sufficient length for the antenna. Bend the wires together, and twist the insulator as shown in the accompanying illustration. The insulator being twisted about five times will secure it quite firmly. In this way the antenna may be installed without soldering or making any connections.

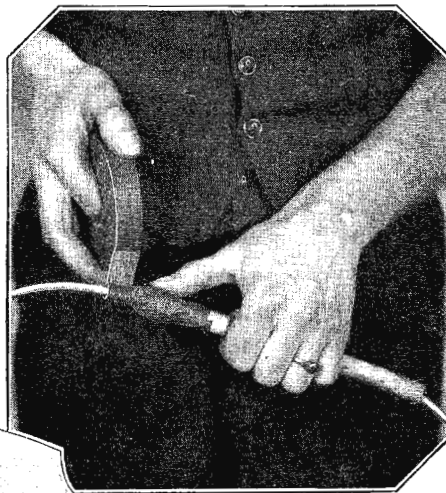

Insulating a Lead-in Wire

Oftentimes it is necessary that a lead-in wire be run over the edge of a building in such a manner as to make it impossible to keep it from rubbing against certain projecting parts of the structure, thus wearing off the insulation and exposing the bare copper. These places are usually inaccessible, thus making it impossible to fasten an insulator at this point. This may be easily overcome by dropping the lead-in over the edge of the building to determine the point where the wire comes in contact with the projection. The lead-in is then pulled up and the porcelain tube is slipped over it and fastened securely with tape at the point where the contact would take place, then when the lead-in is put back in place, the wear and tear will take place upon the tube leaving the wire intact.



Reviving the Finish on the Radio Cabinet

The radio cabinet is usually a much handled and battle scarred piece of furniture when in the hands of a chronic experimenter. Most of the minor scratches may be obliterated and the luster brought back by rubbing it lightly with a soft piece of flannel upon which linseed oil and pumice stone have been applied. Rub the cabinet lightly and in one direction.

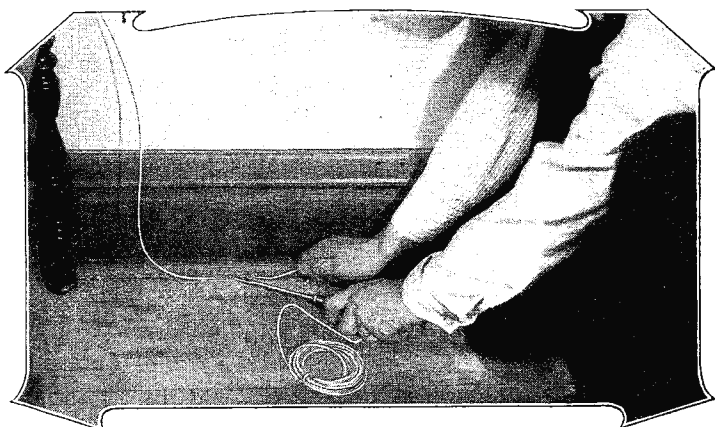

Concealing the Ground Lead

A ground wire is often hard to conceal satisfactorily. If it is run underneath the carpet to its destination, the carpet will soon show wear directly above the wire; or if it is run around the edge of the room it is usually unsightly and in the way when cleaning. This may be overcome by using bare wire about No. 16 and running it underneath the mouldings at the mop board. A heavy screw driver will usually suffice for prying up the mouldings slightly to enable the wire to be inserted. In this manner the entire length of wire from receiver to ground connection may be concealed underneath the mouldings.

Storage Battery Leads

It is a very good practice to use rubber covered wire in connecting up storage batteries, due to the fact that it is not affected by the acid fumes and spray caused by charging. Ordinary insulation in time soon burns off, leaving the wires bare and thus sometimes causing the short circuit which will ruin the battery or charger, and in some cases, may cause fire. Corrosion may also be eliminated from battery terminals and adjacent leads by a liberal coating of vaseline on both before the connection is made.

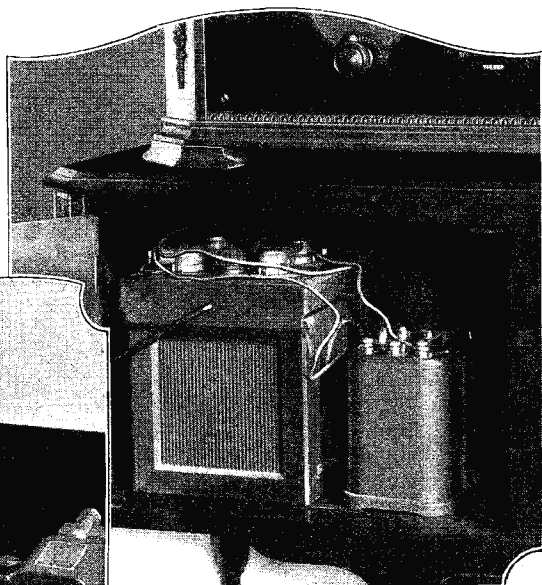

Mounting Instruments on Wood Baseboard

A lot of time can be saved when mounting instruments on a wood baseboard by the use of an ice pick as a means of starting the screws. Screws are usually hard to start in most any kind of wood without first drilling a hole of some sort. Due to the usually compact arrangement of apparatus in the present day set, a twist drill cannot at all times be used to advantage. The ice pick makes a good tool for this purpose. By forcing the pick into the wood a fair sized hole can be made in about one-third the time it would take to drill one. The screw then will start easily and take a firmer hold than if the hole had been drilled out.

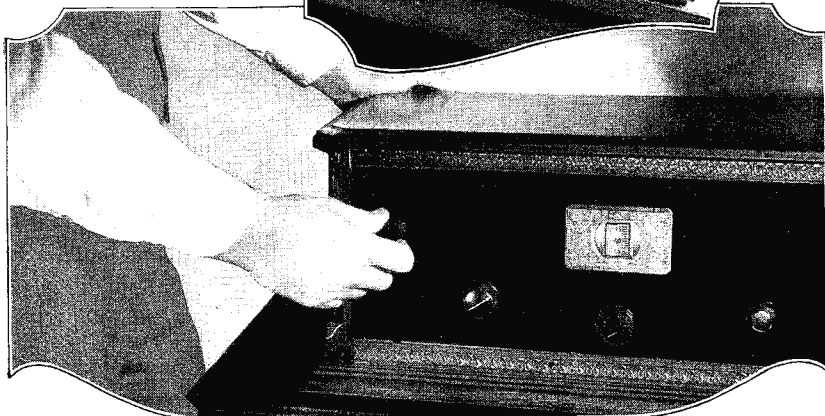
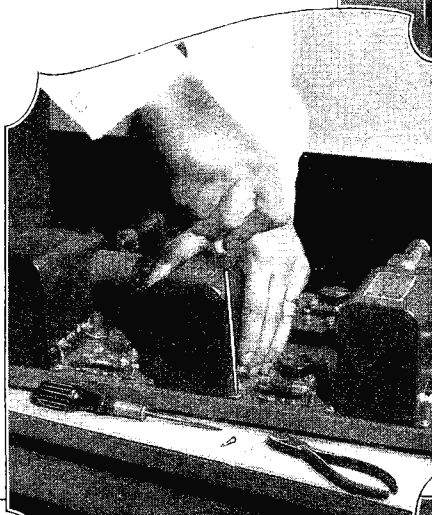

Protecting the "B" Eliminator

When a receiver has been equipped with a B eliminator in place of batteries, the following precaution should be taken when using the set: Always turn on the A supply first, then the eliminator. When the receiver is shut off the filament supply should be cut off ahead of the eliminator. This is done to prevent the filter condensers from breaking down, due to the fact that the voltage across them is considerably higher when the tube filaments in the receiver are cold. In case a relay is used to control A and B supply, the above mentioned is automatically taken care of.

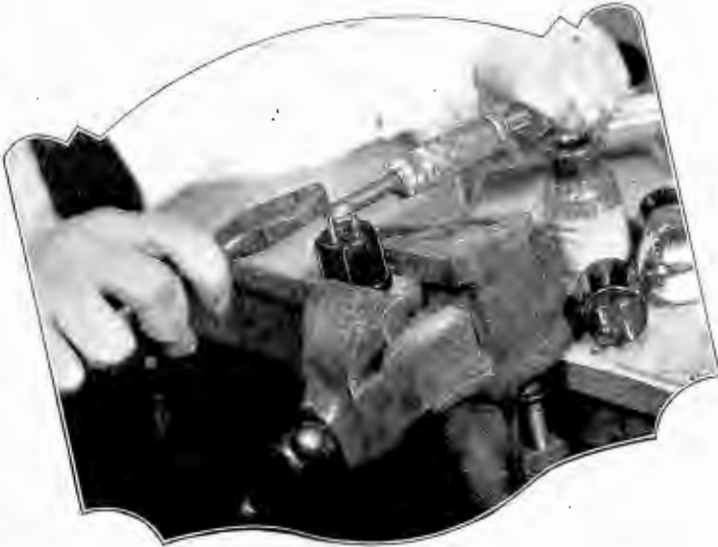

Converting Tube Bases

Many experimenters still have on hand tubes with the old type base, but find that they cannot be used very satisfactorily in some of the UX type sockets. This can be remedied by soldering additional lengths to the prongs of the tube. The prongs used for this purpose are easily cut from a useless tube with a hacksaw. When soldering on the extra length, be sure to solder the uncut ends to the prongs of the tube. This gives you two flat surfaces that can be easily jointed together without causing any offset. If the prongs are cut from a UX type base, be sure to solder the large and small prongs in the right position.



Wiring Without Solder Lugs

When attempting to wire a receiver with stranded wire without the use of solder lugs, much difficulty results from the tendency of the strands to fray out from underneath the cap of the binding post when it is screwed down. This is not only unsightly, but consequently makes a poor connection which invariably works loose, causing noises and short circuits. The proper way to do this is to first skin the wire the right length and not too long, then twist the strands well together, after which they should be slightly tinned. This procedure gives the skinned end of the lead the same rigid characteristics of busbar wire.

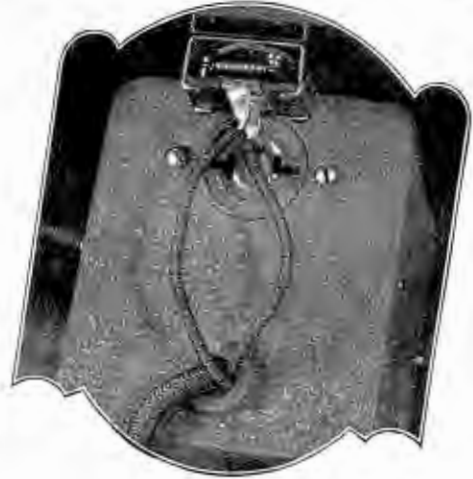

Correct Switch for A. C.

Many receivers are being converted from D. C. to A. C. This necessitates a number of changes, one of which is the filament switch. The filament transformer is usually so constructed that the 110-volt input into the primary is broken by a small snap switch on the front panel of the receiver. This switch in some cases is also used to break the "B" eliminator input. The ordinary battery switch should not be used for this purpose, as it is not designed for high voltage and may cause trouble by arcing. The proper switch for high voltages has in its construction heavier contacts.



Taking Taps Off a Coil

Taps may be easily taken off a coil by the following procedure: A short piece of match stick or tooth pick should be inserted under the turn to be tapped while the coil is in the process of winding. Thus when the coil is wound, the turns to be tapped will be elevated above the rest of the winding and can be easily scraped and soldered without difficulty or damage to adjacent turns.

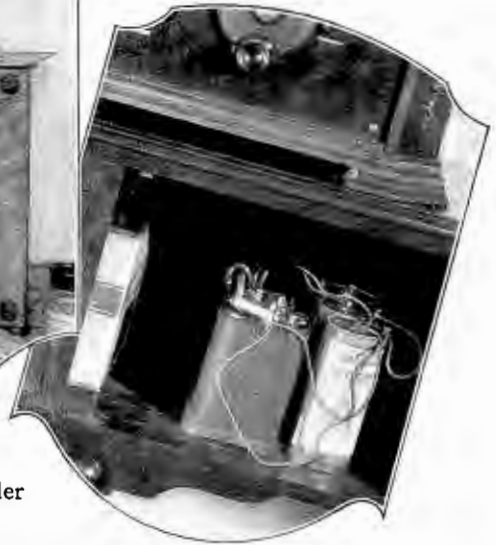

Increasing the Life of Dry "A" Batteries

Many of the early receivers still in operation employ dry cells for the filament supply. The useful life of the dry cell is comparatively short, consequently the receiver cannot at all times be operated at full efficiency. The remedy for this is as follows: Connect the trickle charger to the dry cells in the usual manner with one exception. Insert a 4-ohm resistor in one of the charging leads. Turn on the charger about a minute before the receiver is put into operation. The charger is left on throughout the reception and turned off about a minute after shutting off the receiver. This method keeps the batteries at a high point of efficiency.

AMERICA'S VERDICT

Engineers, Jobbers and Set Builders Acclaim the Tyrman "70" the Greatest Receiver for D-X Reception, Volume and Tone Quality

"Since the beginning of broadcasting no radio development submitted to the public has farther-reaching possibilities than this Shielded Grid Receiver."
 "The Tyrman "70" provides an ideal set for anyone who desires the utmost in sensitivity."
 "One of the interesting features of this new receiver is that it will not oscillate no matter how little or how much voltage is applied through the control rheostats."
 "The Tyrman "70" is not critical. Stations slide in and out without whistling background of carrier waves."
 "Getting extreme sensitivity and good loud speaker volume with seven tubes is something new in radio construction. The Tyrman "70" does it."
 "I have built during the past two years 30 different receivers of nearly every type but the Tyrman "70" certainly takes the gold medal."
Excerpts from letters, editorials, and reports



Tyrman "70" Shielded Grid Amplimax presents an appearance of a well-designed factory receiver

FROM every part of the country—from hamlet and city—from laboratories of engineers—from jobbers, dealers and set builders, come scores of letters praising the Tyrman "70" as the greatest receiver of all times for D-X Reception, Volume and Tonal Reception.

Tyrman "70" Embodies New Principle

The Tyrman "70" embodies the newly developed Shielded Grid tube. For months laboratories throughout the country had been experimenting with the Shielded Grid tube, and until the Tyrman "70" was announced, setbuilders had to content themselves with reading enthusiastic laboratory reports which stated that the Shielded Grid tube produced amplification ten times greater than obtained with the ordinary tube.

Thousands of set builders already knew of the new Shielded Grid tube and when the Tyrman "70" was announced, were ready to accept it. The result was astonishing because

Tyrman "70" is Designed Especially for the Shielded Grid Tube

The Shielded Grid tube necessitated an altogether different technique. It was necessary

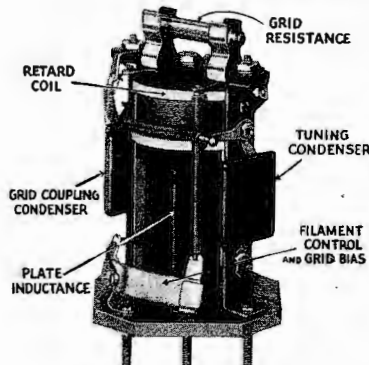

Tyrman Shielded R. F. Impedance Unit is responsible for the success of the Tyrman "70"



Tyrman "70" is especially designed for Shielded Grid Tube reception

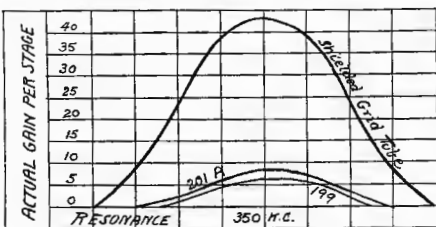

Amplification of Shielded Grid Tube many times greater than ordinary tubes

5 Points of Superiority

- 1 Sensitivity never approached before by any receiver regardless of construction or number of tubes
- 2 Amplification of weakest signals at a ratio of 50 per stage
- 3 Tube plate impedance for intermediate coupling
- 4 Hairline selectivity—Power—Faithfulness of tone
- 5 Low current consumption of 22 mill. B and 1 1/4 Amp. A Permits full A. C. or battery operation

to start from the bottom and design the parts around the tube. That is the secret of Tyrman "70". It is not just another circuit or a make-shift. It took months of experimenting under the supervision of Ernst Tyrman, one of America's outstanding engineers.

Needs No Outside Aerial

The Tyrman "70" needs no outside aerial—two to eight feet is ample which is conclusive proof that Tyrman "70" is correctly designed.

If you want to build a set that will give you real downright satisfaction, build a Tyrman "70".

If you want a real money maker—here is the opportunity to go to your customers with the first really new development in years—one where demonstrations mean sales.

Hundreds of Custom Built set builders tell us that the Tyrman "70" has put new life into their business and is making BIG money for them.

Get the facts—now while this is before you clip the coupon and send for diagrams and full details of the Tyrman "70".

MAIL COUPON TODAY!

TYRMAN ELECTRIC CORP.
 Dept. 328, 141 W. Austin Ave.
 Chicago, Illinois

Gentlemen:

Kindly send me, gratis, special literature describing the Tyrman "70" Shielded Grid Amplimax in detail.

Name.....
 Address.....
 City..... State.....

Tyrman "70"

Shielded Grid Amplimax

Tell 'Em You Saw It in the Citizens Radio Call Book Magazine

Laboratory Model Screened Grid Superheterodyne

Latest Improvement of the Laboratory Model Receiver, Adapted to
Take Full Advantage of the New Tubes

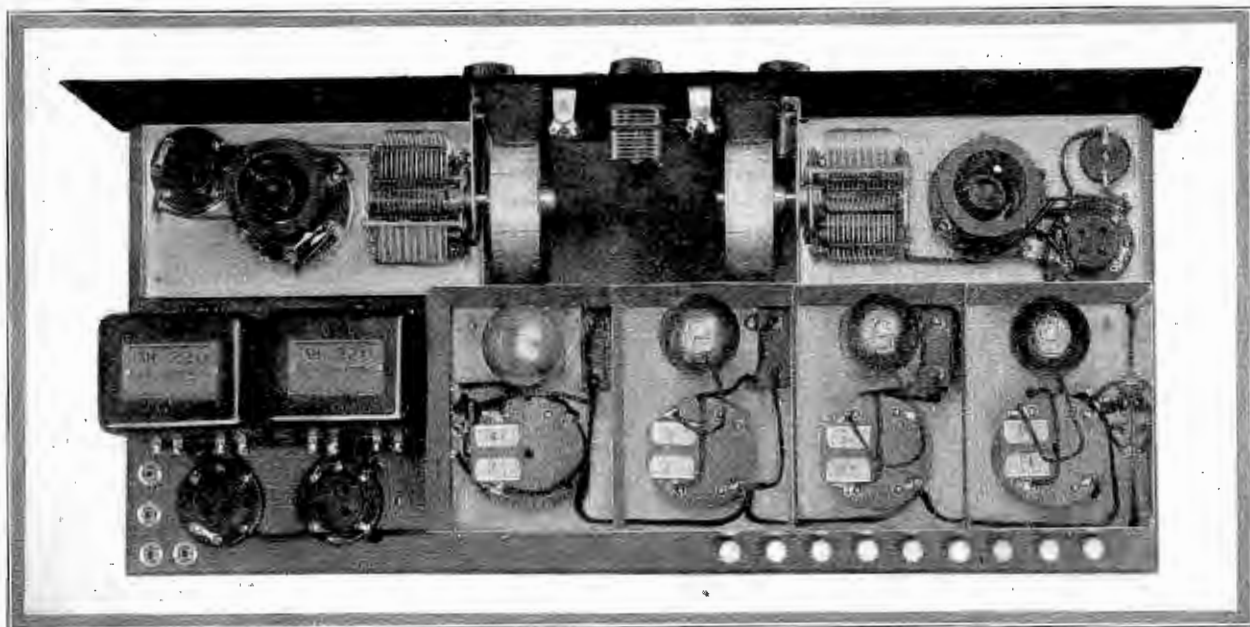

Figure 1. This photograph represents rear and top view of the screened grid super, the respective shield covers having been removed

DESCRIBED herewith is what is probably one of the most sensitive and selective superheterodyne receivers capable of easy, simple and sure home construction which it has yet been the pleasure of the editors to examine and test. This unusual receiver is made possible only through the recent introduction of the new 222-type screen grid radio frequency amplifier tubes with the tremendous gain in amplification which their use makes possible, and the entire freedom from amplifier troubles which they insure.

Many readers of this publication have built the "High Amplification Shielded Superheterodyne" described in the September, 1927, issue of the Call Book, and by them this new receiver design will be recognized as an improvement and development on the October receiver, which has probably headed the superheterodyne kit field this season in the number of sets which have been built. The original "High Amplification Shielded Superheterodyne," while capable of most remarkable results, nevertheless had to be most carefully operated and adjusted to get the full value of performance from it. The screen grid superheterodyne described herewith is free of the few complications which could be caused through improper operation and lack of knowledge of the earlier set, and one of the beauties of the new design is that all builders of the first set can change over easily by the addition of a few resistors and the new screen amplifier catacomb.

The Screened Grid Laboratory Model Superheterodyne is pictured in the accompanying illustrations and drawings, and is an eight tube set mounted upon a fully formed and pierced steel chassis 10 inches deep, 23 inches long and 1½ inches high, attached to a decorated walnut-grained metal control panel 7 inches high and 24 inches long. All tuning controls are grouped

in the central decoration, and consist of two vernier, illuminated drum dials tuning the antenna and oscillator circuits, a "Sensitivity" knob which introduces first detector regeneration if desired, a non-critical "Gain" knob controlling the amplification of the non-squealing, non-oscillating 112k.c. intermediate amplifier catacomb, and a "Filament" rheostat controlling the A battery voltage delivered to the first detector and oscillator tubes. The control could hardly be simpler, for the two illuminated drums do all tuning, logging exactly. In ordinary operation the "Sensitivity" knob is never used.

What the Circuit Contains

The circuit consists of a regenerative first detector circuit employing either a plug-in antenna coupler for all waves between 30 and 3000 meters, or any standard loop for .00035 mfd tuning condenser. Grid-condenser-leak detection is used to insure greatest sensitivity, and through a small tickler coil and the .000075 mfd midget condenser controlled by the "Sensitivity" knob, regeneration can be introduced to boost the first-detector sensitivity enormously; or not, just as desired. When a loop is used, regeneration in the detector circuit is absent. Coupled to the first detector grid circuit is a similarly designed oscillator circuit consisting of plug-in coil for ranges of 30 to 3000 meters, tube and .00035 mfd tuning condenser. Both antenna and oscillator coil sockets are elevated above the metal chassis, and oscillator pick-up leads are well isolated and insulated from the chassis. The first detector output frequency of 112k.c. is fed into a four tube intermediate amplifier-detector catacomb of sectionally shielded copper and brass construction. This is a laboratory designed, assembled and tested amplifier which comes as a unit all ready to install with but

(This receiver tested and all illustrations made in our laboratory)



Figure 2. Front view of the receiver is shown in the above photograph

eight connections. It consists of four stage compartments, each containing a tube socket, a specially designed radio frequency transformer exactly tuned and matched with a mica condenser to 112k.c., and the necessary by-pass condensers. In the first three amplifier stages three 222-type screen grid amplifier tubes are used to give great amplification, while in the extreme right hand compartment the spring-cushioned detector tube is located, operated with a negative C bias to insure selectivity and handling capacity. Aside from the fact that the 112k.c. amplifier is laboratory assembled and tested, an excellent feature is that either two or three intermediate amplifier stages may be used at will by simply shifting a clip lead in the amplifier from one tube to another, a convenience indeed, since but two intermediate stages will give about as much signal as the average listener will ever want.

The Audio System

Following this amplifier catacomb is the two stage audio amplifier using S-M 220 audio transformers, thus insuring fine reproduction for a certainty. However, if it is desired to operate the

set with a power pack, tip-jack provision is made for connection to first or second audio stage output, or one or both audio stages may be omitted in initial construction when a power-pack is to be used. The receiver is most economical of current consumption, requiring only 1.65 amperes at 6 volts for A power, 9 volts of C battery and 135 volts of B at a current drain of less than 30 milliamperes. It can actually be run from a storage battery and dry B batteries quite nicely for portable or semi-portable summer use, while complete light socket operation is obtained when using an Abox, Balkite or Sentinel 6 volt A power unit and an S-M 652 B power unit, for the two 4½ volt C batteries also needed have a life of over a year, so that the set may really be considered fully a.c. operated.

Oscillator and first detector stage shields, of aluminum, need not be used except in congested broadcast centers, though the oscillator shield is generally desirable no matter what the location. If the two S-M 320 condensers specified are used, the drums rotate in opposite directions for simultaneous wavelength increase or decrease. For uniform rotations, two S-M 316B removable shaft condensers should be substituted.

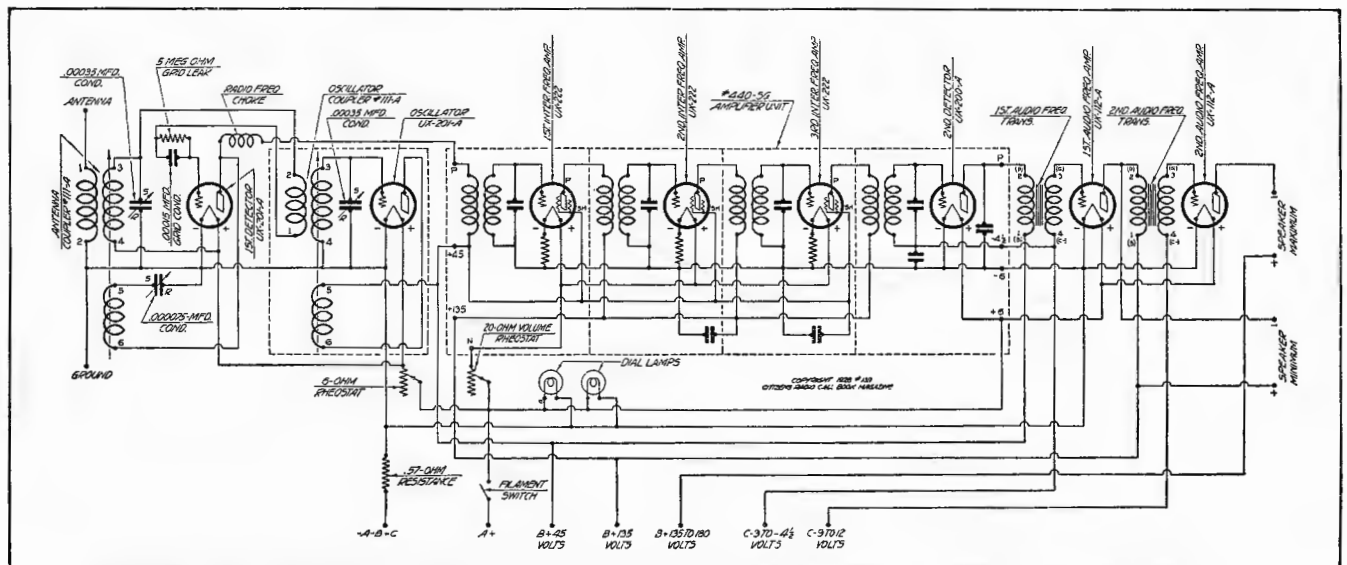

Figure 3. Professional set builders and experimenters will find the electrical connections for this super in the schematic diagram above

The first step is to mount all parts. The nine binding posts should be put in their holes in the left rear of the chassis, using extruded fibre insulating washers to insulate them from the chassis. However, the second post from the left is grounded to the chassis by using one mounting lug of the .57 ohm Carter resistor as a metal washer under the binding post screw head. The four tip-jacks are mounted at the right rear of the chassis, insulated from it with extruded fibre washers. The two audio transformers and the two audio tube sockets are mounted as in the diagram. Note that the rear socket mounting screw in each case is joined by means of a lug to the F— post of the tube socket, thus effecting a ground connection to the chassis. A similar arrangement is used to ground the F— posts of first detector and oscillator tube sockets, while the minus filament circuit of the 440 SG amplifier, grounded to its catacomb, naturally grounds to the chassis through metallic contact when the catacomb is mounted by four 8/32 screws accompanying it (tapped into the four corners of its base). The two coil sockets are elevated on $\frac{3}{4}$ -inch long hollow brass studs slipped over the mounting screws between coil sockets and chassis. The first detector grid condenser is mounted by means of two lugs soldered together joining one of its connections to the G post of the first detector tube socket. The midget .000075 mfd condenser is mounted in the "Sensitivity" hole of the front panel, with rear of panel scraped to make good metallic contact. The filament switch is mounted in the panel without insulating washer precautions, but the two rheostats must be very thoroughly insulated from the panel with extruded washers and thoroughly tested before wiring for absolutely positive insulation. If 320 condensers are used they should be hung on the drum dial brackets, using a brass washer supplied to bush the bracket holes to the condenser bushing size. If 316B condensers are used they should be mounted upon the chassis with both shafts projecting to the right. Then the shaft of the right or oscillator condenser should be pushed out to the left through the condenser by loosening and later retightening the condenser lock-collar set screws. The brackets eventually are screwed to the panel, scraped to make contact with them, and scraped again at mounting screw points to make good contact with the metal chassis, also scraped clean at adjacent points. The panel is not put on until all possible wiring has been done on the chassis, then it is fastened in place and the drum scales attached to the condenser shafts so that they



Figure 4. In the photograph above the screened grid super has been mounted on a Southern Toy console table

read 100 with condenser plates all in and zero with plates all out.

Wiring Up the Set

The wiring is thoroughly explained in the pictorial and schematic diagrams, and needs little attention with the exception of five leads. The two leads from the detector stage assembly should be run in bus-bar and spaghetti spaced at least $\frac{3}{4}$ inch below the chassis over to posts 1 and 2 of the oscillator coil socket at the right. The lead from post 5 of the detector coil socket to the stator lug of the .000075 mfd "Sensitivity" condenser should be similarly handled, as should the lead between post P of the detector tube socket, post 6 of the detector coil socket and one lug

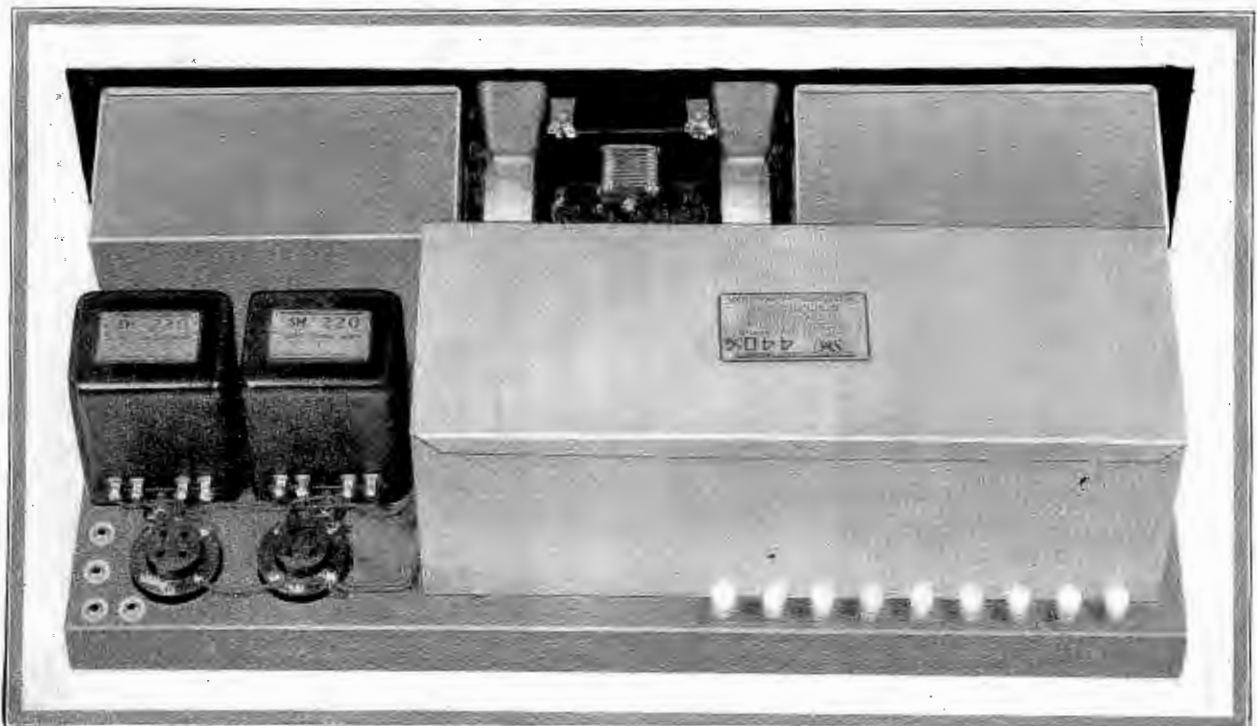

Figure 5. This photograph shows the rear view of the receiver after the shields have been placed in position

of the No. 275 r.f. choke, and the lead from the other lug of the No. 275 r.f. choke to post P on the left end of the 440SG amplifier. (By arranging a three point switch to disconnect this lead from the amplifier and throw it over to post 2 of the first [left] audio transformer, and then using two more switch contacts to turn out the oscillator and 440SG amplifier filaments, an excellent three tube local or short wave set results.) All other wiring can be laced into a common cable, as shown, after testing.

To test the receiver suitable batteries or socket power devices should be connected to the properly designated binding posts. All tubes should be inserted and ABC and C voltages measured with power on if a voltmeter is available. It should be connected to an antenna from ten to not over thirty or forty feet long, a water-pipe ground, and a good loud-speaker. With both rheostats almost on, and the "Sensitivity" condenser absolutely all out, stations should be tuned in on the "Antenna" and "Oscillator" drums. A 535 (or 545) meter station should be tuned in, and antenna cut down to reduce volume quite low with "Gain" knob all right and "Filament" half on. Then turns should be removed from the top end of the antenna 111A coil until the "Antenna" dial reads 95 or 96 (almost all in) for this station. The oscillator coupling coil should be rotated a full 360 degrees to get strongest signal, and left set as near right angles as practical for good volume. The "Oscillator" drum setting for 535 or 545 meters, which was about 60, should gradually be moved up to coincide with the new "Antenna" drum setting of 95 or 96 by removing turns in steps of five at a time, then three, and finally one turn at a time from the oscillator coil to make the dial readings coincide. This done, the set is finished.

On stations below 390 meters a second "Oscillator" drum reading will be found, above the regular reading. This setting should not be used in tuning, and if it is not, and only the lower "Oscillator" setting used, the dials will track alike on high wave stations, and gradually diverge on low wave stations. In tuning the "Sensitivity" knob should not be used except to strengthen very weak stations, for if it is turned to interleave condenser plates too far the first detector will oscillate and a mass of squeals spoil reception. (Squeals of practically constant pitch are trans-

mission faults, while squeals of pitch varying as dials are turned are receiver faults due to improper operation. To omit one intermediate stage, remove the clip lead in the 440SG amplifier from the left tube, pull it over the portion to the right and clip it into the second tube to the right, ignoring the second compartment clip ordinarily fastened to the second tube. To omit the last audio stage, move the loud speaker cord tips from the two maximum to the two minimum jacks, thus dropping the second audio (right) tube and transformer. Always use an output transformer external to the set if possible, an S-M 222 type being preferable.

The construction of the set is simplicity itself, the following parts being required, plus only a screw-driver, a soldering iron with paste and rosin-core solder and a pair of pliers and cutters:

Parts List

- 1—Van Doorn panel and chassis unit, pierced, with hardware
- 1—Carter .00015 mfd condenser with leak clips
- 1—Carter 20 ohm rheostat
- 1—Carter 6 ohm rheostat
- 1—Carter battery switch
- 4—No. 10 Carter tipjacks
- 1—Carter .57 ohm resistor
- 1—Polymet 2 megohm grid leak
- 2—220 Silver-Marshall audio transformers
- 4—511 Silver-Marshall tube sockets
- 1—440-SG Silver-Marshall time signal amplifier
- 2—805 Silver-Marshall vernier drum dials
- 1—275 Silver-Marshall r.f. choke
- 1—342 Silver-Marshall .000075 mfd midget condenser
- 2—515 Silver-Marshall coil sockets
- 2—111-A Silver-Marshall coils
- 9—XL binding posts
- 2—320 Silver-Marshall .00035 mfd variable condensers
- 2—631 Silver-Marshall stage shields (optional)
- 25—Feet Silver-Marshall hook-up wire
- 1—Package Kester radio solder
- 1—Ekko group clamp
- Miscellaneous—lugs, nuts, bolts, etc.

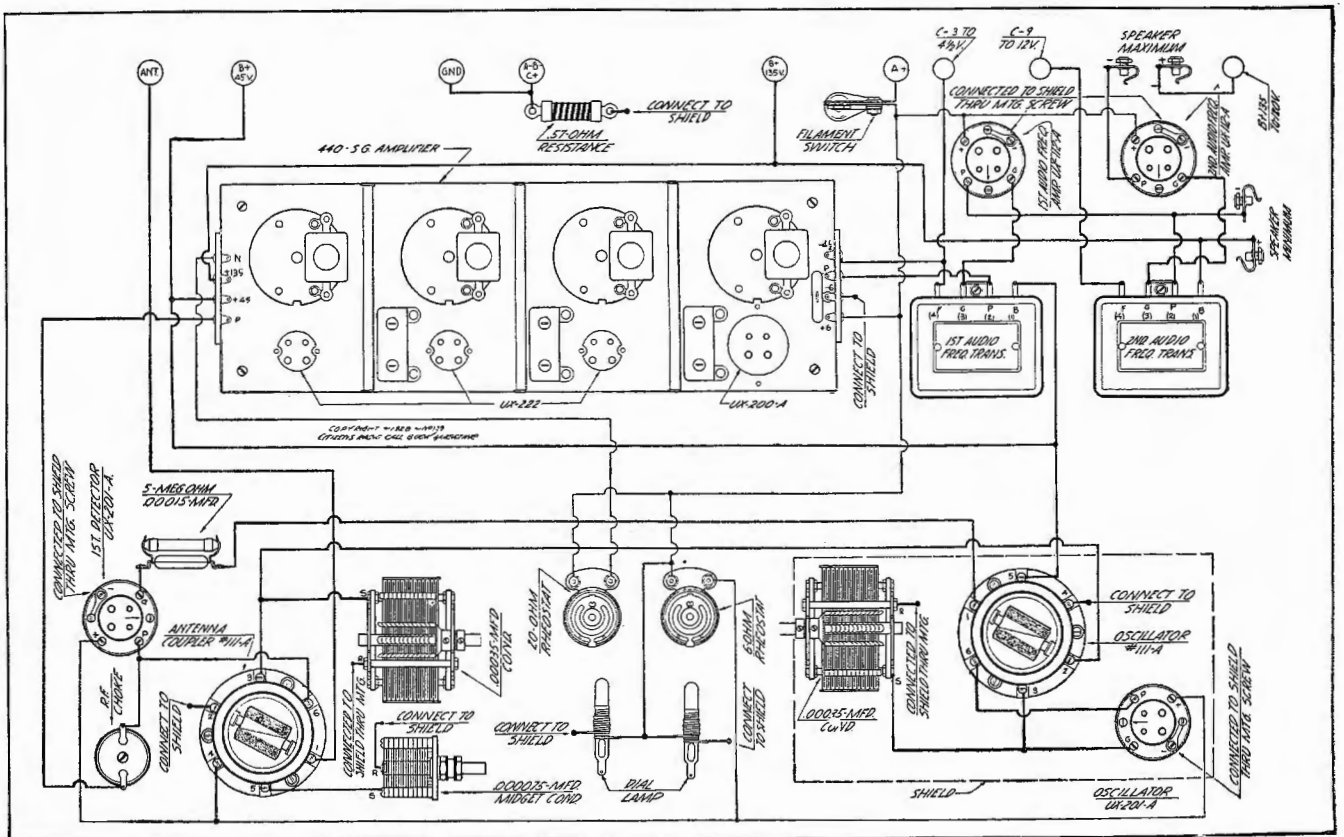

Figure 6. Wiring of the receiver should be accomplished by means of the graphic diagram illustrated above

Carter Adapter Harness Converts D. C. Sets

WITH the d. c. or battery operated receivers well established in the radio industry today the public is looking forward with well founded interest to the progress of the a. c. receiver. It is with this in view that we illustrate for our readers an adaptor which may be used in conjunction with a filament transformer to convert almost any battery operated set into an a. c. job.

The photograph in Figure 1 illustrates the simple method by which the harness can be installed in a receiver. To begin the conversion insert adapters for 226 type a. c. tubes into sockets in the r. f. and a. f. section of the circuit; then insert a type 226 a. c. tube into each of these adapters. Insert adapter for the 227 tube into the detector socket placing the type 227 tube into the socket. If a power tube (171 or 112 type) is used place the adapter for it into power tube socket and insert old power tube into adapter. If no power tube is used, this section of the unit may be ignored. Connect filament leads to corresponding terminals on filament transformer.

One of the virtues of this unit is that if at any time it is desired to change back to the original d. c. receiver the harness can be removed and the change is made without any bothersome internal re-wiring.

After making the above connections on the transformer and harness connect the 45 volt lead of detector adapter to detector B binding post on set or on B battery eliminator. Leave all plate terminals on receiver as they are. Connect C— and C+ terminals together; this may be done with a short piece of bus-bar connecting the two binding posts. The A battery binding posts are not used.

One of the two methods may be used for controlling volume. The first—by detuning, a method generally found satisfactory. The second by using an auxiliary volume control which is made for connection across the antenna and ground binding posts. The latter method is used in those cases where a broader range of volume is desired.

A device is incorporated within the r. f. part of the harness whereby the C bias and filament 1½ volt may be adjusted to the individual requirements of the receiver.

Figure 2 shows a graphic diagram of the harness and the corresponding tubes it will supply. The adapter harness supplies a. c. current to the tubes. The wires are twisted to prevent the a. c. from interfering with the rest of the circuit causing an un-

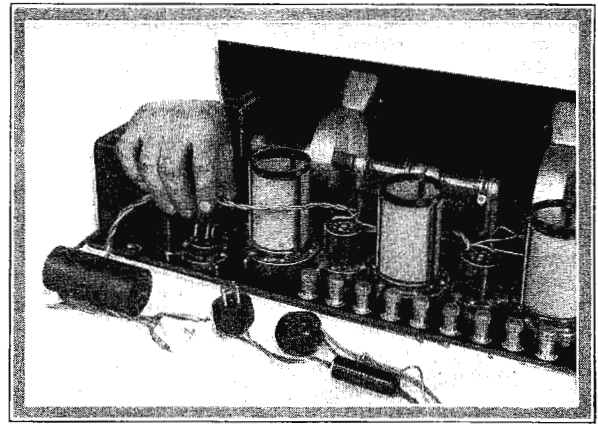

Figure 1. This photograph shows the Carter adapter harness placed in a storage battery operated receiver for conversion to alternating current

desirable hum. There are usually three different voltages supplied by the harness. The r. f. and a. f. use 1½ volts, the detector 2½ and the power tube, when used, requires 5 volts.

The power tube part of the adapter harness has a small container unit in which is located the necessary resistor to bias the power tube. This fixed resistor is of 2000 ohms and is suitable for either the 171 or 112 type power tube. It is advisable to use the type of power tube that was originally in the receiver.

The center tap of the 2½ volt winding is brought out in a flexible lead and marked Detector B+ or A—. It is advisable to try both of the connections mentioned above to ascertain just which of the two is best suited for your individual receiver.

The fact no tools are required to make the conversion and that none of the wiring in the original battery operated receiver need be changed makes this harness just the thing for the set-builder who has been hovering over the decision of whether to convert or not. The main reason for hesitating is that after making the change, one would like to change back to the d. c. receiver and this formerly necessitated hours of effort and at some expense, while with the present type of harness one has the d. c. or the a. c. receiver at his command.

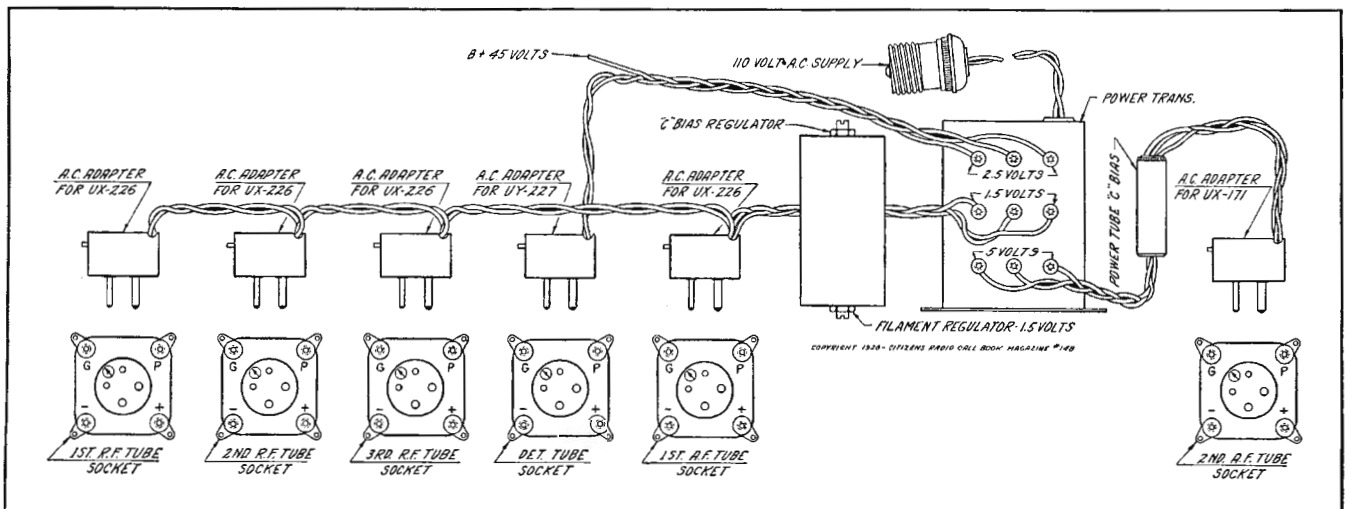

Figure 2. The above sketch shows the manner in which the harness is to be used when it is desired to convert d. c. to a. c. operation

This Unit Tested and All Illustrations Made in Our Laboratory

Custom Built Model Madison-Moore International "One-Spot"

Popular Receiver Redesigned on Sub-panel for Professional Set Builder's Benefit

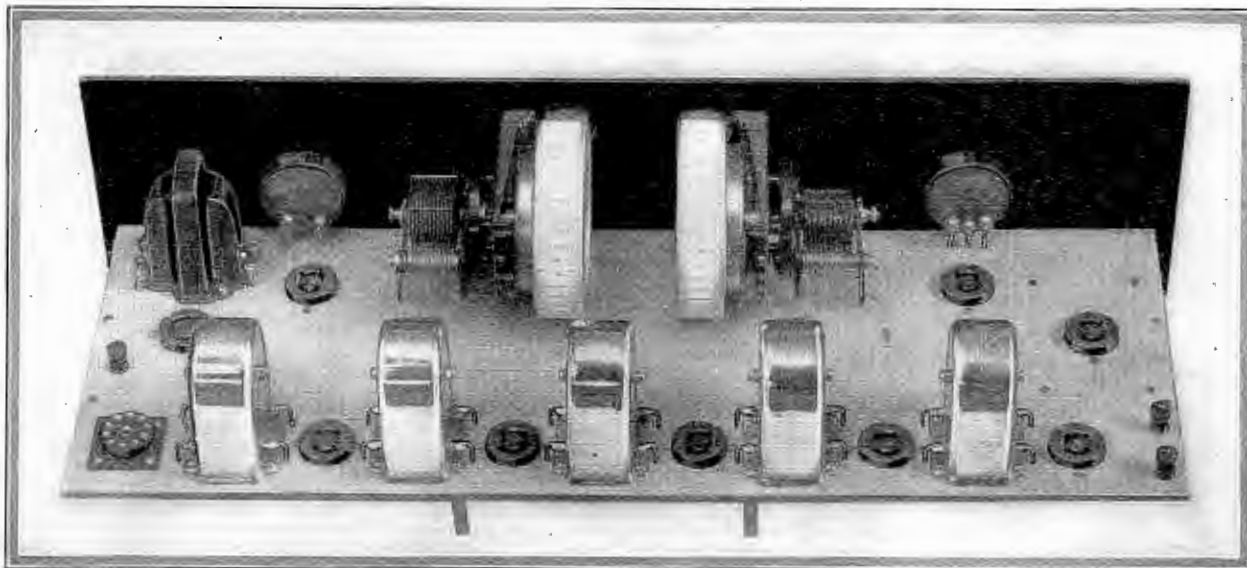

Figure 1. One glance at a receiver of this type is sufficient to convince a prospect of its desirability. The photograph above shows a rear view of the custom built model of the Madison-Moore receiver described in this article

PROFESSIONAL set builders have made so many demands upon our laboratory for a custom built design of the Madison-Moore International "One-Spot" which appeared originally in the November issue of this magazine, that this popular and efficient receiver has been changed over so that in its finished state it presents an appearance that should make it desirable for anyone contemplating the building or the purchasing of a radio set. The professional set builder has found in the past that in order to rapidly move his products and turn over a number of sets during the season, that these sets must be of the custom built variety and calculated to give a strong eye appeal to the prospect. A glance at the photograph of the receiver shown in Figure 1 should assure any builder of the beauty of the new design, while past experience with a receiver merely convinces him that this circuit, when properly built, is an ideal, all-around radio set with ample volume, faithful tone quality and sufficient selectivity for the preservation of all the desired frequencies.

Built on Sub-panel

Inspection of the rear photograph shown in Figure 1 will demonstrate the fact that this receiver can be built in a logical and symmetrical manner. It will be seen that about one-half of the material is located on the top of the sub-panel, and the remainder on the bottom of the sub-panel, as will be seen by referring to the photograph shown in Figure 3. The Madison-Moore units are placed in sequence at the rear of the sub-panel with the drum dials centrally located for greatest tuning ease. Wires from the oscillator and loop condensers are carried down through the sub-panel to their respective terminations. It will be observed that the sockets have been under-slung so as to increase the facility of wiring beneath and obviate the necessity of having

more than the holding screws coming through the sub-panel. This same procedure has been adopted in connection with the Hagel ten contact sub-panel mounting socket, which has been designed especially for the receiver itself. Thus, all of the A, B and C wires go beneath the sub-panel. A Hagel four foot double plug cable serves to connect the power amplifier with the receiver. By looking at the photograph of the power amplifier in Figure 2, the reader will note that the same sub-panel mounting socket is used on that unit, and when the double plug cable is used there are no loose wires to run or binding posts to tighten.

Looking at the rear of the receiver shown in Figure 1, the builder will find a 500,000 ohm potentiometer which spans the grid and filament terminals of the first intermediate transformer,

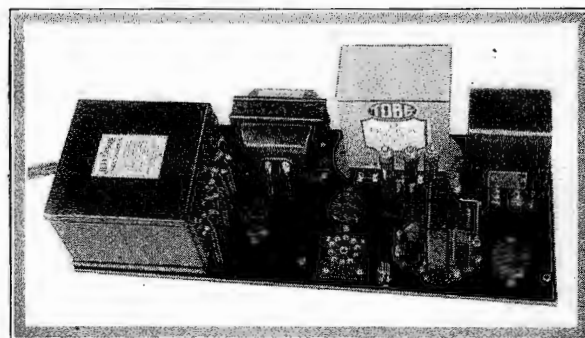

Figure 2. This photograph gives an idea of the power supply, which is used in conjunction with the receiver. It should be noted that this power supply is also built on a sub-panel for best appearance and accessibility

(This receiver constructed, tested and all illustrations made in our laboratory)



Figure 6. This photographic view gives a close-up of the front of the receiver in its cabinet

windings from the plate circuit of the 171. The bias voltage for the grid of the 171 is obtained by the drop across the 2250 ohm fixed resistance between the center tap of the 5 volt a. c. winding and the common ground line, which is also the center tap of the high voltage winding. The bias for the grid of the first audio tube, which is a 226, is secured by the drop across the filaments of the 199 tubes in the first and second stages of radio frequency amplification, the return of the series filament being to the center of a 20 ohm fixed resistance across the 1.5 a. c. winding.

Fuse the Supply Line

As a means of guarding against any possibility of a short circuit in the power supply system, it would be well for the builder to arrange to fuse the 110 volt line with at least a two ampere fuse. Then if any wrong connection is made, or if by some chance the operator short-circuits any connections on the power supply, the unit will be safeguarded by the blowing of the fuse.

Another point which it might be well to mention at this time is the fact that with the new a. c. tubes the operator has no indication by their brilliancy as to the voltage which is being applied. In the case of the storage battery tubes, this did not matter much, because the filament source rarely exceeded six volts and even when the rheostats were turned all the way on the tubes were not greatly overloaded. In the case of the battery operated tubes it was also possible to determine, after a fashion, the amount of voltage applied by judging the brilliancy of the filaments. However, this is no longer the case when considering

alternating current tubes. With the 227 type detectors, which utilize heaters, the operator can be easily misled as to the voltage applied because of the fact that when the tube is turned on, a bright spot is likely to appear at the very top of the heater element in the tube. This bright spot retains most of its brilliancy regardless of the voltage which is being applied. The important thing to remember is that these tubes, more than any other type with which the radio public has become acquainted, an excess voltage applied to the filaments will very materially decrease the life of the tube. These tubes are rated for a voltage of 2.5, but in practice it has been found they operate satisfactorily with voltages as low as 1.9. In the case of the 226 amplifier tubes, which are supposed to have 1.5 volts on the filament, a small overload on these will likewise result in jeopardizing the life of the tube. In operation these tubes will perform satisfactorily at voltages down as low as 1 and 1.1 volts. Therefore, it would seem to be desirable, if the operator has any regard for the life of his tubes, to make use of an a. c. voltmeter, preferably one of the O-3 types made by Jewell or Weston. If desired, this voltmeter may be located on the sub-panel of the receiver and by means of a switch placed first across one filament supply and then across the other. It is also possible to have this a. c. voltmeter in a small case and by means of clip connections determine the voltages placed on the tubes. Correct operating voltage for the 227 tube has been found to be 2.1 volts, while that of the 226 tubes should be 1.3 to 1.4 volts.

Some regulation of this nature is afforded in the special Jeffer-

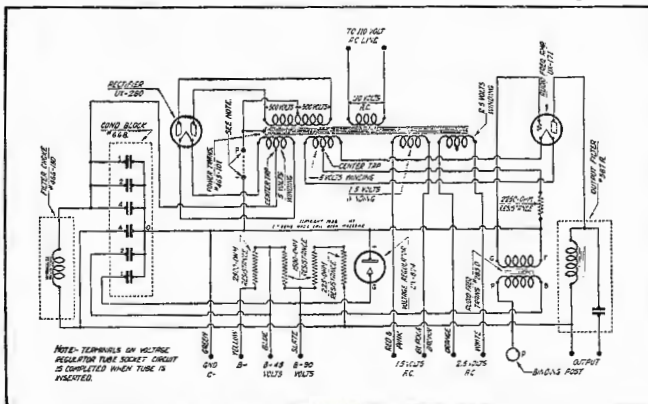

Figure 9. This drawing shows the schematic circuit of the power amplifier especially designed for the Madison-Moore International "One-Spot"

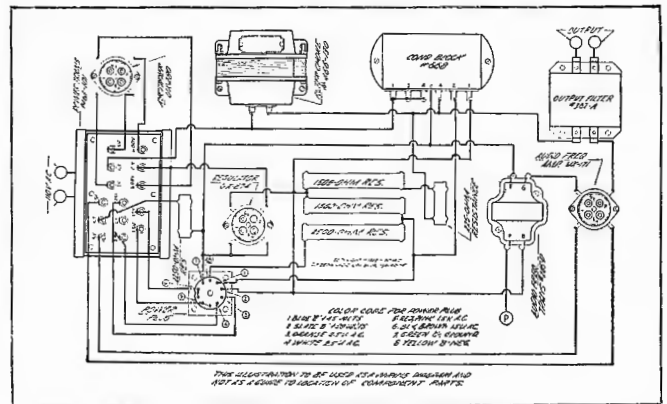

Figure 10. Professional set builders can save considerable time by wiring up the power amplifier by means of the graphic diagram illustrated above

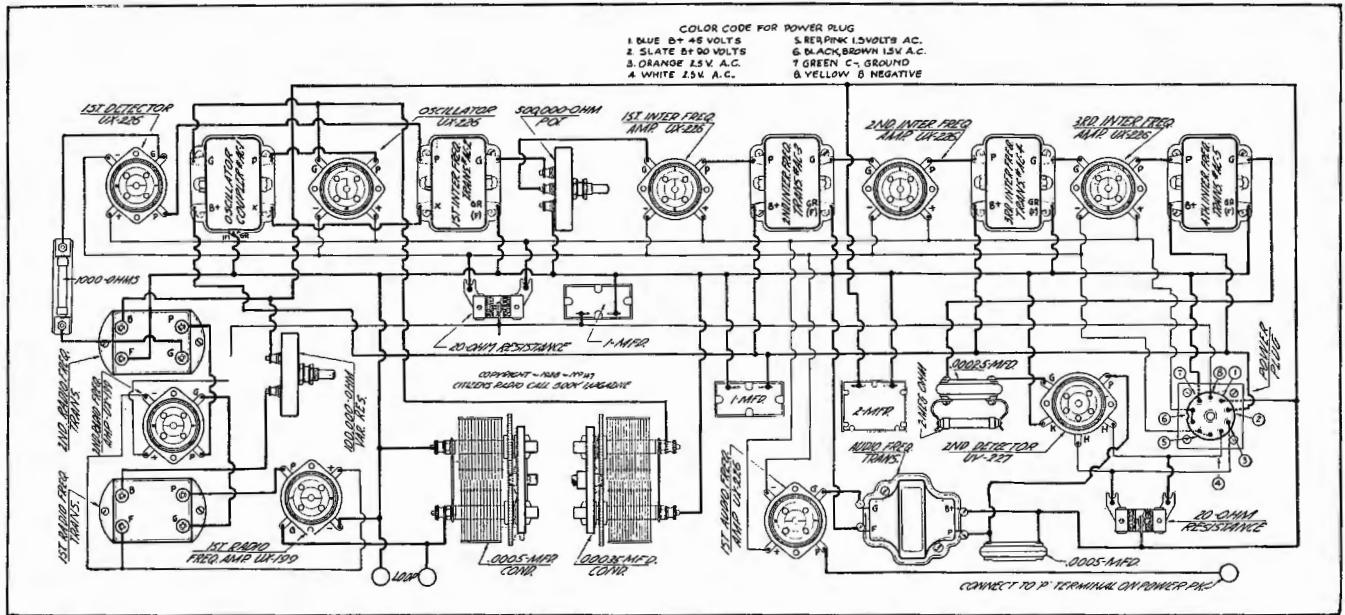

Figure 7. This graphic diagram should be followed by the builder for making all connections on the receiver described in this article. Please note that this drawing should not be used as a means of locating the apparatus. The one shown in Figure 8 should be used for that purpose

son transformer, which has a tapped primary switch to take care of line voltage variations where there is a marked deviation from the standard 110 volt input. However, even with such a switch, unless the operator has a meter, he is likely to be forced to depend on guesswork for knowledge of his voltages. With the standard 110 volt input and through the Hagel double plug cable, which has a length of four feet, the proper voltages are placed on the various tubes in the receiver. However, if the line voltage is much in excess of 110 volts, unless the operator knows this fact and changes his primary input accordingly, there is a possibility of the tubes being operated at a value beyond their safety factors.

Operating Hints

A few more operating hints may not be amiss for the benefit of those who wish to get the utmost from their receiver. First of all use good standard tubes, this especially being true in the case of the two 199's in the first and second r. f. stages. Also be sure that the loop leads are not too long, as it will throw the loop condenser too far out of line with the oscillator.

In tuning it was found that the two drum dials will have iden-

tical readings at about 700 kilocycles, or on station WLW. On the higher wavelengths stations on 600 kilocycles, such as WBAP, will come in at about 180 on the loop dial and 170 on the oscillator dial. Stations on 1000 kilocycles, as for example KMOX, will come in at about 63 on the loop dial and 73 on the oscillator dial. With these specific instances of location, the operator will observe that he should have no difficulty in covering the entire scale.

The following parts were used by the laboratory in the construction of the receiver described in this article:

Receiver

- 1—639 Remler .0005 mfd variable condenser
 - 1—639 Remler .00035 mfd variable condenser
 - 1—Sangamo .00025 mfd fixed condenser
 - 1—Sangamo .0005 mfd fixed condenser
 - 1—Tobe 2 mfd bypass condenser
 - 2—Tobe 1 mfd bypass condensers
 - 2—Dubilier 225-550 meter Duratrans
 - 1—Set Madison-Moore r. f. units AC-1 to AC-5 inclusive
- (Continued on Page 135)

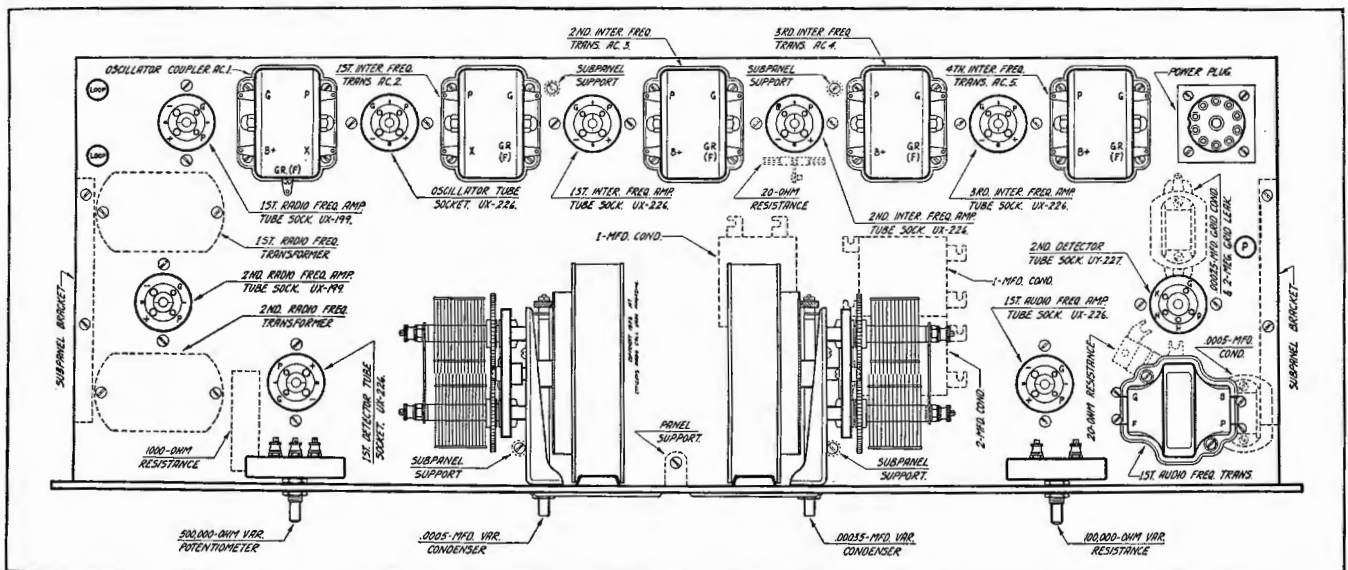

Figure 8. The above illustration is a sub-panel layout for the custom built model Madison-Moore receiver

Aero Has Short Wave Radio Telephone Transmitter

Surprising Distances Covered with Low Power Sets Under Average Conditions

ATTRACTED to a recently opened new field of radio telephony on the higher frequencies, many broadcast listeners and those experimentally inclined are beginning to exhibit a great deal of interest in short wave radio phone transmission. Much of this interest is being fostered because of the fact the government has recently released a few short wave channels on which transmission by voice is allowed. In the past there were restrictions on voice transmission on the lower waves and all of the work which has been carried on has been by telegraphic means rather than telephonic.

Covers Great Distances

This field is naturally attractive because of the remarkable records that are being established by amateurs all over the world. To supply the demand created by this growing enthusiasm, several well known parts manufacturers have co-operated in the design of a short wave radio phone transmitter, which may be built for approximately the same cost and with the same facility as a good broadcast receiver. While this design is necessarily of a low power type, it has been repeatedly demonstrated that low power is sufficient to carry on conversation over surprising distances.

Built on Two Decks

Referring to the photograph in Figure 1, it will be noted that the manner of construction in this particular transmitter permits the isolation of all parts carrying radio frequency currents to the upper shelf, while all of the circuits associated with the power or voice currents are on the lower deck. This form of construction insures that the masses of metal contained in power devices such as transformers, condensers and other metallic objects will

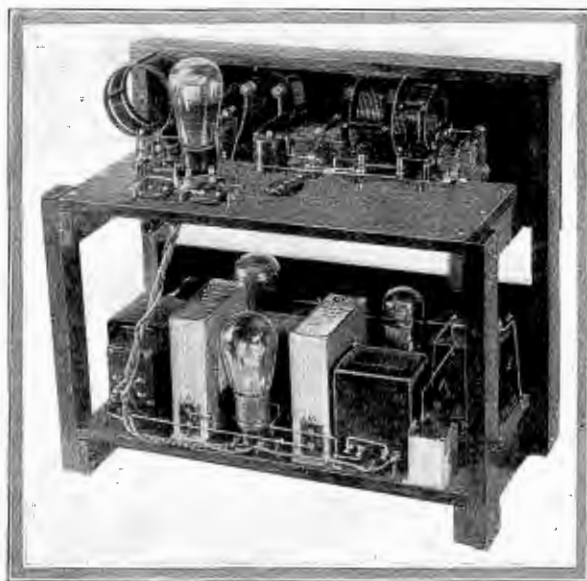

Figure 1. In this illustration is shown the rear view of the Aero short wave phone transmitter, which is built on two shelves, the power apparatus being on the lower and the actual transmitter itself on the upper

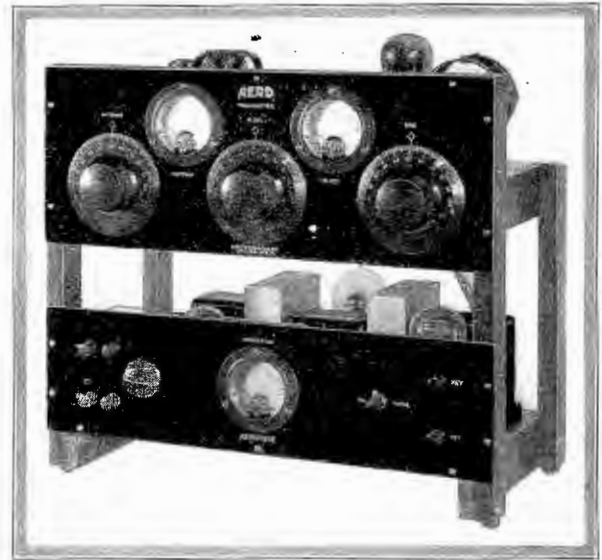

Figure 2. All controls of the short wave transmitter described in this article are grouped on the upper front panel so that tuning of the set is quite simple. The modulation indicator is located at the center of the lower panel

not be in the field of any of the radio frequency coils introducing losses therein. Corresponding to the arrangement of the circuits in decks, the front controls are also grouped. Thus on the upper front panel the reader will find controls for the tuning condensers and the antenna current meter, together with the plate current meter for the oscillator tube. On the lower deck will be found the plate current meter for the modulator tubes, the modulator C bias control, switch for changing from telegraphy to telephony and the necessary binding posts for the key, microphone and battery.

The circuit diagram is illustrated in Figure 3. The radio frequency portion of the circuit (on the upper deck) is the well known tuned-grid tuned-plate circuit that has been used for several years by amateurs, this preference being based on the fact that it is perhaps the simplest of all transmission circuits to tune and control. The only point of difference which might be noticed is the fact that where in most of the tuned-grid tuned-plate circuits the plate feed is in shunt, in this particular form of transmitter the series feed for the plate has been adopted in order to simplify the circuit and to prevent losses previously encountered in the choke coil when using shunt feed. On account of the high voltages developed between the plate coil and the ground by this method, it is necessary to use two condensers in series as a radio frequency bypass, these condensers being of .0005 mfd capacity.

The Power Supply

The power supply consists of a Silver-Marshall 328 transformer, which supplies the plate current, as well as lighting the filaments of the oscillator and modulator tubes. In order to secure a direct current, which is necessary for telephone operation, the high voltage of the 328 transformer is rectified by means of a No. 2721

(This transmitter constructed, tested and all illustrations made in our laboratory)

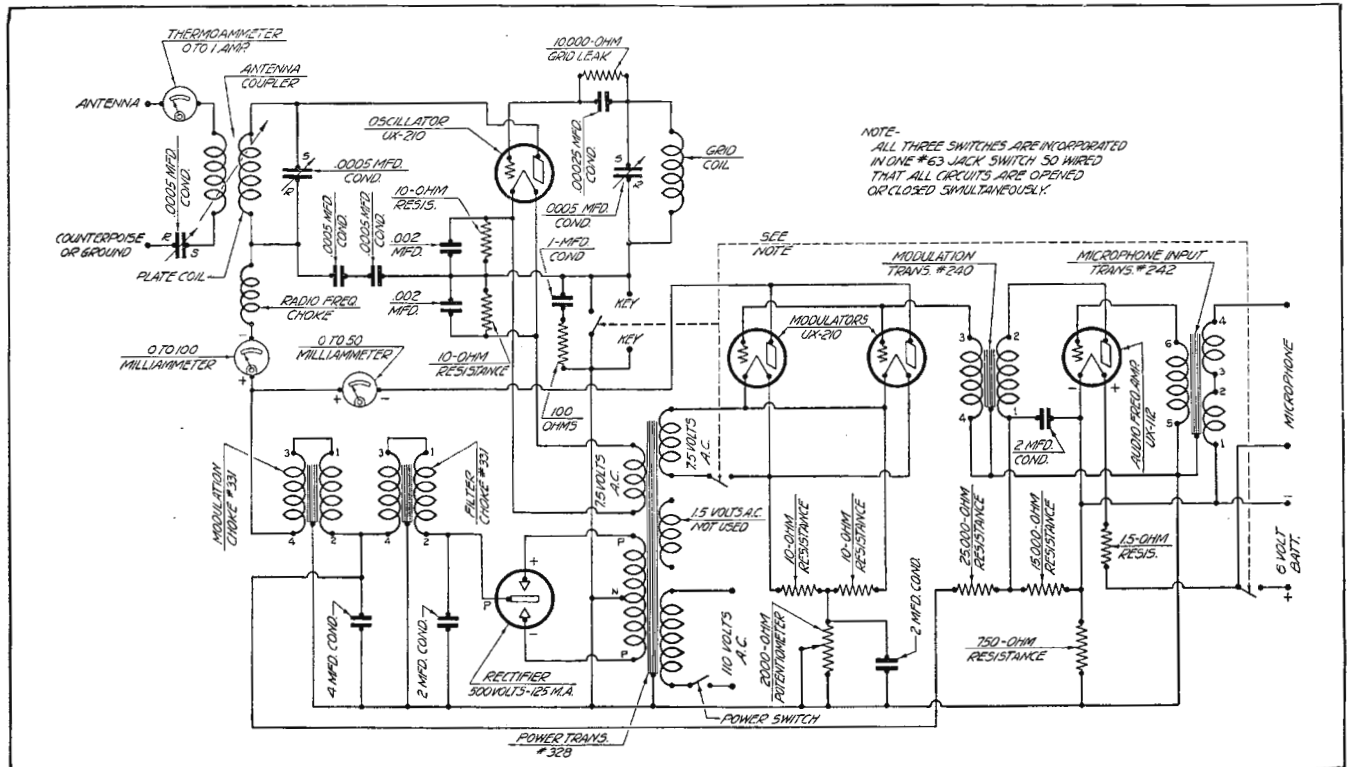

Figure 3. The schematic circuit shown above gives all of the necessary connections for hooking up a short wave transmitter, which may be used for either radio telephony or telegraphy on the higher frequencies

Manhattan gas rectifier, whose output is filtered by a Silver-Marshall 331 Unichoke and Tobe high voltage filter condensers. It will be noted that two modulator tubes are used in conjunction with one oscillator of the same type. This is in accordance with the best practice and while the set is perfectly operable with only one modulator, it is recommended two be used where the best quality of transmission is desired.

Amplifying the Speech

In order to operate the modulator tubes at maximum capacity, it is necessary to amplify the output of the microphone transformer, 242, to bring up the speech volume to the proper level. This amplification is accomplished by means of a 112 audio amplifier tube and a Silver-Marshall 240 modulation transformer. The proper plate voltage for the 112 tube is secured by the drop across the 25,000, 15,000 and 750 ohm resistances, the latter resistance supplying the necessary grid bias for the 112 tube. During the preliminary experimental work a 226 tube was used in place of the 112 and was lighted from the 1½ volt winding on the 328 transformer. However, in view of the fact that a 6 volt battery was necessary for the operation of the microphone, the same battery was finally decided upon as a means of lighting the 112 tube. This brought about a quieter signal from the transmitter. Accordingly the 1½ volt winding on the 328 transformer is not used in this particular transmitter.

Construction of the transmitter may well commence with the lower deck, layout details of which are shown in Figure 4. After all parts have been placed on the lower deck in accordance with the diagram in Figure 4, this much of the transmitter may be wired and tested before going ahead with the wiring of the balance of the set. This lower shelf is affixed to the frame by means of wood screws, all holes being marked on the template which accompanies the kit. After screwing down all of the parts and wiring them in accordance with the graphic diagram shown in Figure 6, the power unit may be tested separately before proceeding with the remainder of the work. In order to do this the unit is connected as it would be in operation with the microphone, battery, etc., and the switch on the panel is thrown to the "phone" position. Most of the resistance shown in the schematic

as a 2000 ohm potentiometer should be turned on. The tubes should all light properly and the modulator meter should jump upwards when the microphone is spoken into. In order to check the quality of modulation, a speaker should be connected across the modulation choke, the one shown at the left in the graphic diagram, Figure 6. The speaker should be connected by means of a long cord and placed in an adjoining room. It may be necessary to close the door between the rooms in order to keep the speaker from transmitting acoustical energy to the microphone and setting up a continuous howling noise. When the equipment on the lower deck is operated properly, the speech as heard by another observer at the speaker should be very clear and distinct. The 2000 ohm potentiometer should be adjusted during the test so that the speech is the clearest, at which time the modulation meter on the lower front panel will indicate current averaging from twenty to thirty milliamperes. This test is only one for modulation efficiency and has nothing to do with the effectiveness of the transmitter itself.

Check All Connections

The equipment on the upper deck should now be assembled in the same manner as that of the lower deck, after which the whole frame may be put together with wood screws, attaching the upper panel with its equipment last. Then the remainder of the wiring governing the radio frequency section of the transmitter may be accomplished. It would be well in this section of the set to thoroughly test and check all connections before applying high voltage.

After all the necessary wires have been run and the builder is certain of the accuracy of his connections, the oscillator should be checked to see that it functions properly. The plug is inserted in the 110 volt 60 cycle light socket and the switch on the front panel thrown to the "CW" position. With the switch in this position, only the oscillator tube should light. On shorting the "key" binding posts, current will be indicated in the plate milliammeter. It is possible this current will be almost full scale, but by varying the plate or grid tuning condensers the plate current will drop back to approximately twenty or thirty milliamperes at a certain point, indicating that the tube is oscillating.

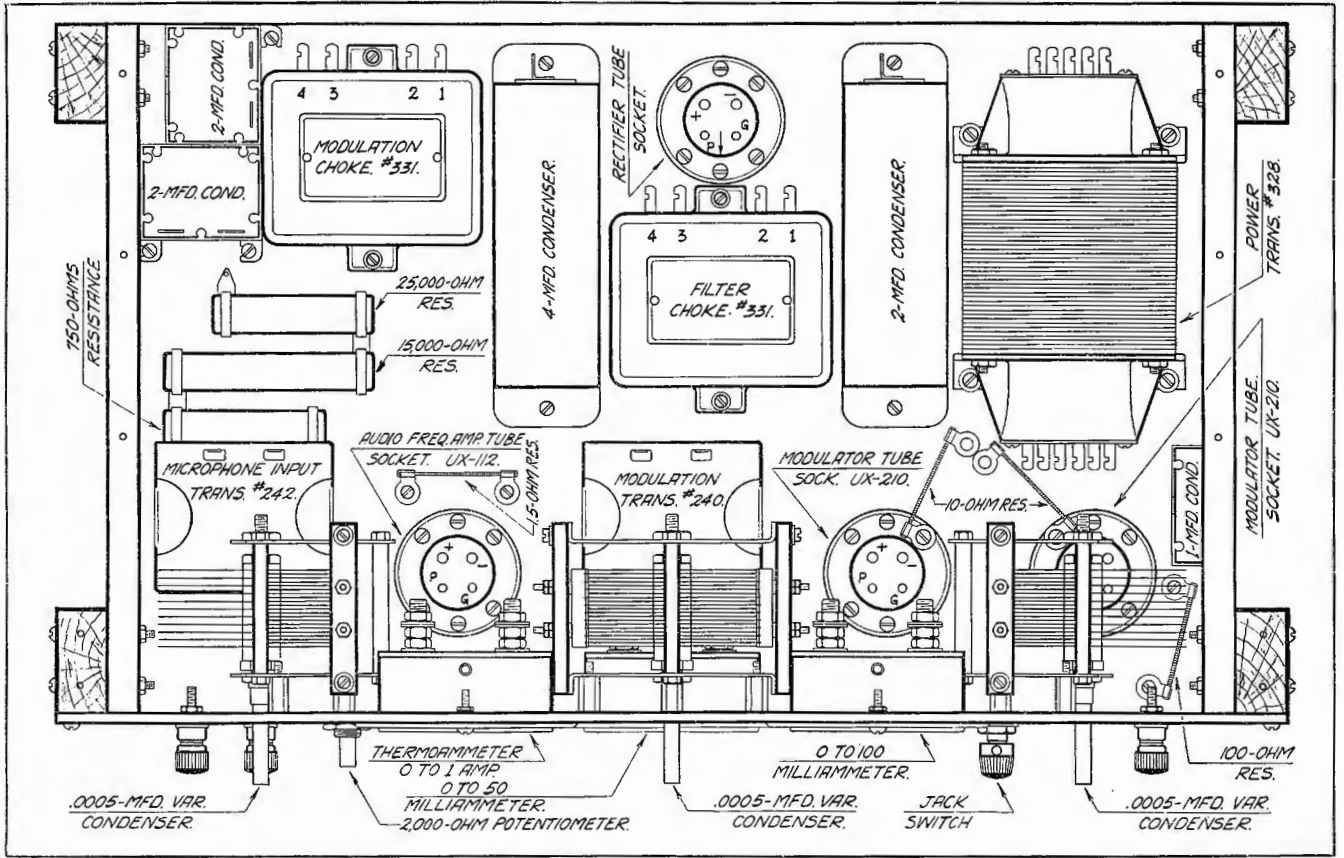

Figure 4. The baseboard layout shown above represents the manner in which parts should be placed on the lower shelf, where all of the power apparatus is located

On connecting an antenna and a counterpoise (or ground) and tuning the antenna condenser, this plate reading will be increased when resonance is established and at the same time some antenna current will be noted. If the coupling between the antenna coil and the plate coil is too close, the tuning of the antenna will have a tendency to stop the tube's oscillation.

Final tuning should always be done with a wavemeter in order that transmission may be within one of the band licensed by the government for such transmission. One of the features of the transmitter described in this article is the fact that through the interchangeable coils made by Aero, the transmitter may be tuned

on any wave band between 18 and 180 meters, so that the set is not rendered unserviceable by any slight changes in the wavelengths granted by the government.

Need Government License

It should not be forgotten that the operation of such a transmitter in the United States requires a government license. Details regarding the license and the requirements for securing such a license may be obtained by writing to the Radio Supervisor at key cities such as New York City, Chicago, San Francisco, Atlanta, Washington, Boston, Seattle, Baltimore and New Orleans.

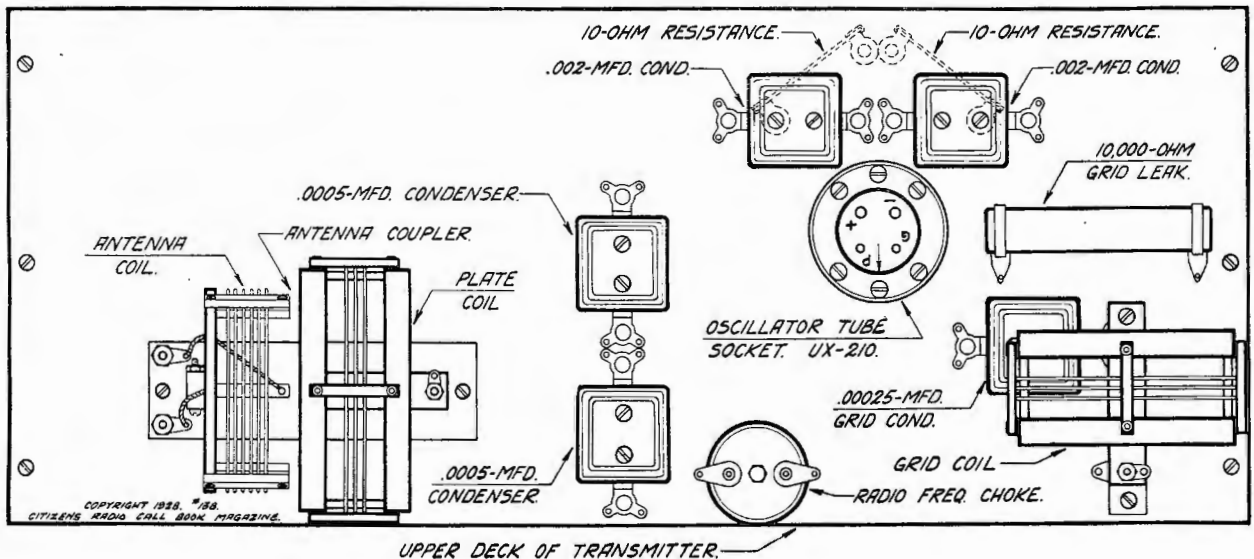

Figure 5. All apparatus involved in the oscillating circuit is placed on the top shelf in accordance with the layout illustrated above

Citizens 115 Kilocycle Super Designed for Set Builder

Efficient Shielded Receiver Using 201-A Tubes Has Four Shielded Grid Tubes for Extreme Amplification

KNOWING that the professional set builder, in order to make sales, must have a receiver showing a high degree of workmanship, the Citizens 115 Kilocycle Super described in the accompanying article has been designed for that express purpose. In order to simplify the building of the set as much as possible, sub-panel method of assembly and wiring has been employed, with the result that the completed receiver presents an especially attractive appearance which should at once be apparent to any prospect upon whom the professional set builder may call. Inspection of the photograph shown in Figure 1 will show that the receiver has been simplified to a high degree so that both from the constructional and operational standpoints the professional set builder should have little to bother him.

Uses Shield Grid Tubes

In view of the high amount of amplification which is secured by the employment of the four-shield grid tubes in this receiver and the additional fact that on many occasions the builder or operator will desire to use the receiver in conjunction with an existing power supply system already containing one stage of audio, in this particular design only one transformer coupled stage of audio is utilized. In laboratory tests and in other tests made with this receiver it has been found that with a single stage of audio ample signal strength is secured for comfortable operation of a speaker in the home.

For the benefit of those who do not choose to use a power amplifier in connection with this receiver and who find it necessary to have additional audio amplification, space is provided on the sub-base for the addition of another audio transformer and tube socket. It should be pointed out, however, that a power tube of the 371 type at least should be used for the last stage in order to give proper undistorted output. The 180 volt lead to the power tube and the 40½ volt negative C bias for the grid of the second audio can be made externally.

With these things in mind the design was made so that if it ever became necessary the operator could use another stage of amplification which is generally included in the power amplifier supply, whereas the usual builder who does not require a great deal of volume could be well satisfied with but a single stage of audio.

Peaked at 115 K. C.

Owing to the method of peaking the intermediate inductances and the fact that a wide degree of latitude is allowed the operator in this respect, after final adjustments have been made the operator may find an absence of repeat points, this particular feature being due in part to the fact that intermediate stages are peaked at 115 kilocycles (which would allow operation with only a few repeat points), the total absence of repeat points being assured by the ganging of two stages of radio frequency and the first detector on a three-gang condenser.

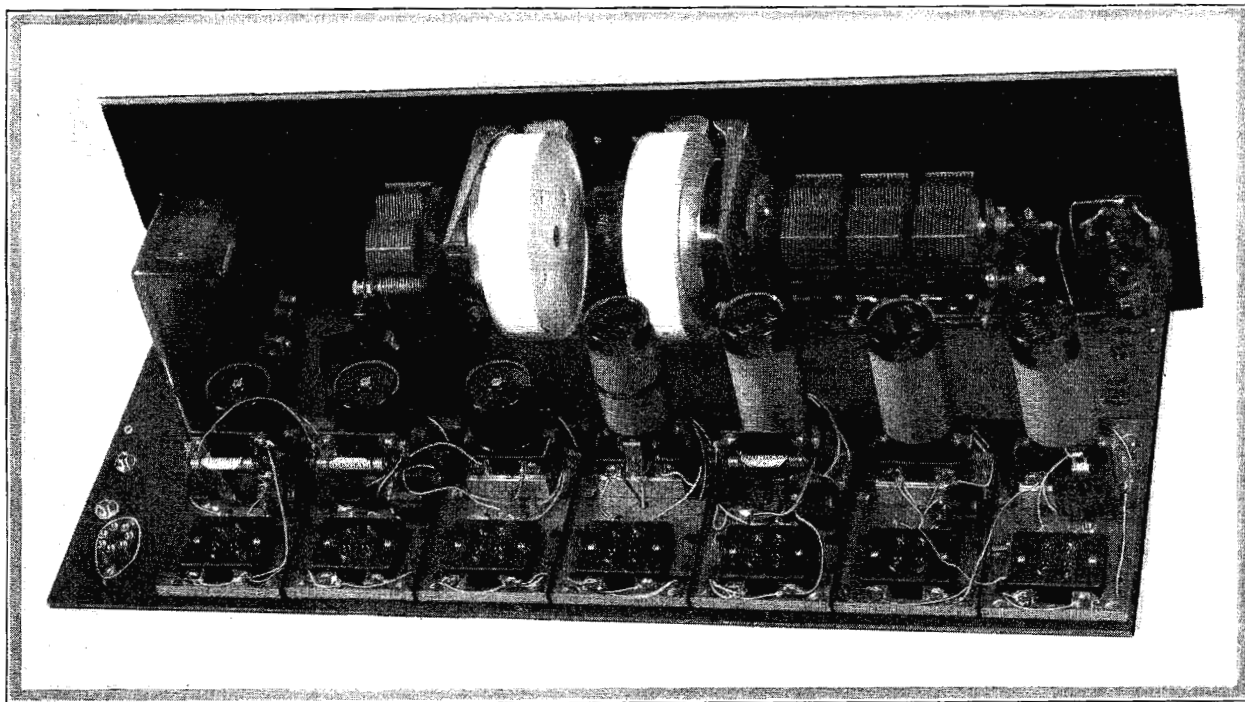

Figure 1. This photograph represents a rear view of the Citizens 115 Kilocycle Super with all of the seven shields removed so that the reader may gain a clearer idea of the various stages. It should be noted that all inductances used in the receiver are of the new type, with a very small field, so they may be included with safety inside of a shield

(This receiver constructed, tested and all illustrations made in our laboratory)

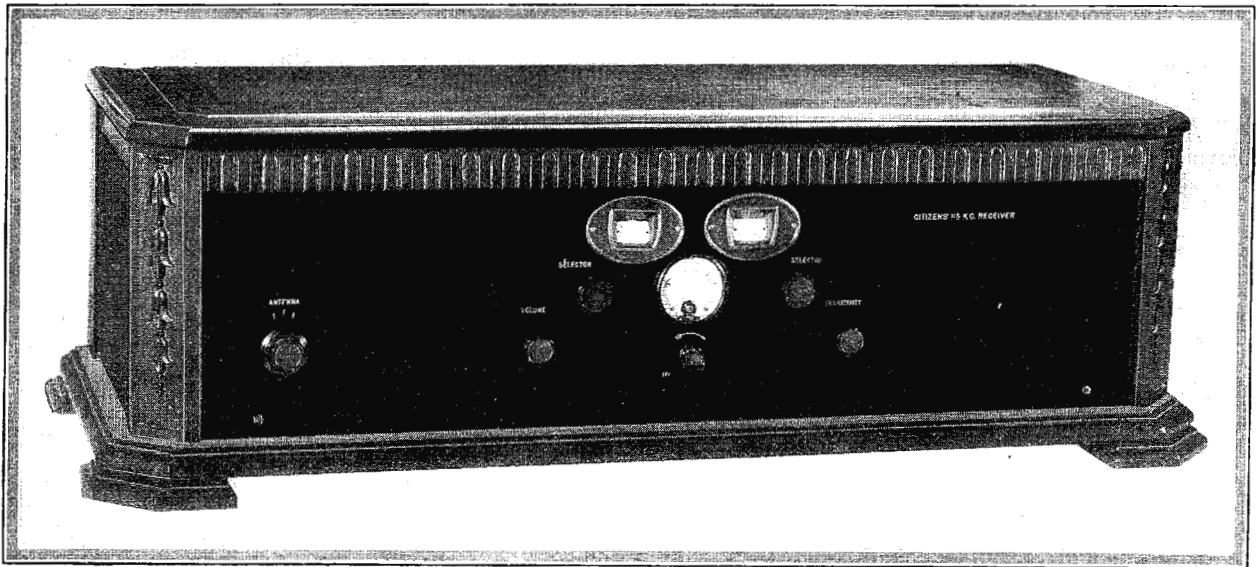

Figure 2. In this photograph the receiver has been placed in an appropriate cabinet

By inspecting the schematic diagram shown in Figure 3, the reader will notice that considerable flexibility is afforded the operator in the impedance coupled stages, inside of which units are located trimmer condensers which may be shifted by means of a setscrew located at the top of the one type 612 and two type 614 intermediate inductances. Adjustment of these screws is by means of a stick sharpened at one end like a screw-driver. By the proper manipulation of these trimmer capacities, the operator may be able to secure any degree of selectivity which he may desire. However, in operation, unless the operator is careful, he is likely to make the selectivity of the set too great, so that instead of securing good quality output, he will be cutting off side bands and thereby introducing considerable distortion. These trimmer condensers should be set on a fairly distant station.

Volume Control

Volume control on the receiver is a 500,000-ohm variable resistance, by means of which the plate voltage applied to the first two radio frequency tubes is varied. The regeneration control is a 2000-ohm potentiometer connected in shunt across the tickler coil. Variation in the grid bias applied to the radio frequency and the intermediate tubes is obtained by means of the 200-

ohm potentiometer, this resistor having a marked effect upon the quality of reproduction both on local and distant signals. It must, therefore, be carefully adjusted.

Interesting Features

Prospective builders of the receiver will find much of interest contained in the schematic circuit which is illustrated in Figure 3. It will be observed by the reader that the antenna circuit consists of the primary winding of the first radio frequency transformer type 550, which is attached to the 3-point switch by means of which either short or long antenna effects may be secured, through the use of the .00005 mfd and .0001 mfd fixed condensers placed at will in the circuit by manipulation of the previously mentioned 3-point switch. In the secondary circuit of the first radio frequency transformer type 550 may be seen an antenna compensator located between the bottom extremity of the secondary and the rotor of the first section of the 3 gang .00035 mfd condenser. The inclusion of this antenna compensator at this point in the circuit is made necessary by virtue of the fact that whereas on the short wavelengths the trimming capacity across the first section of the 3 gang condenser might be sufficient for balancing that stage against varying antenna condi-

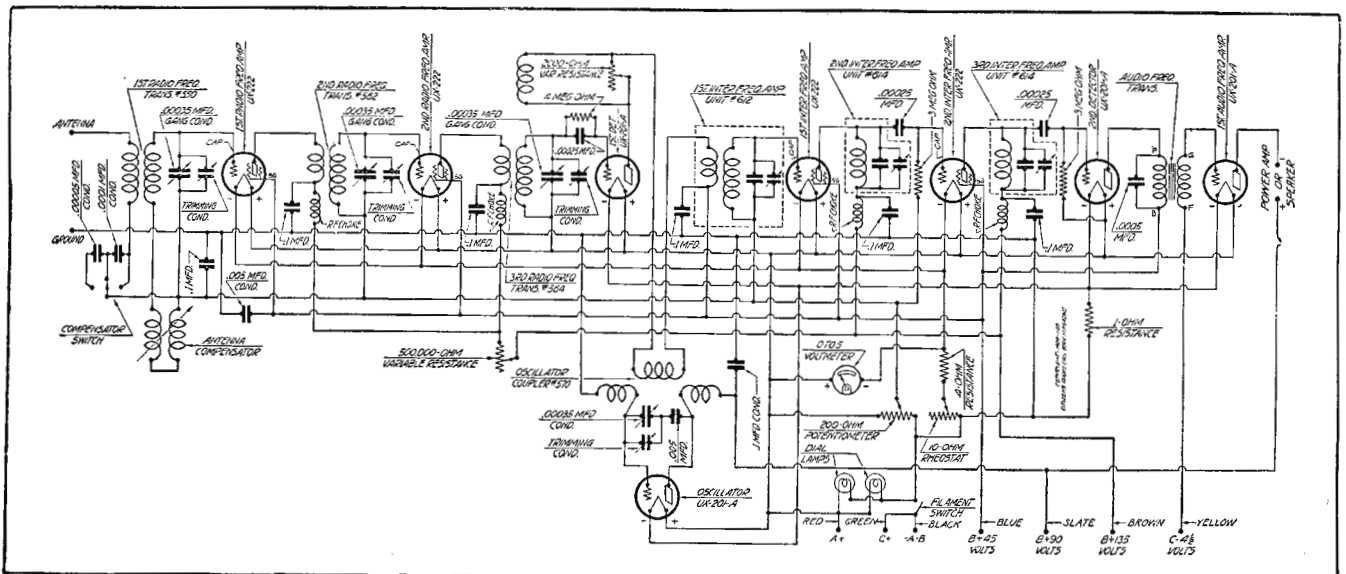

Figure 3. All of the electrical details of this circuit, which has been designed for the professional set builder, may be found by inspecting the schematic diagram printed above

tions, nevertheless when the receiver is operated at the high wavelengths, it is quite likely that the trimming capacity would not be sufficient to thoroughly balance the receiver. For that reason the compensator allows the operator an opportunity of balancing the secondary circuit of that particular stage more efficiently than if only the trimmer capacity were utilized.

Bias on S. G. Tubes

It will be observed that the shield grid tube is used in this first stage with the cap of the tube forming one side of the tuned circuit and the center arm of the 200-ohm potentiometer forming the balance of this first tuned circuit. This 200-ohm potentiometer allows the placing of a slight negative bias on the grids of the first and second radio frequency stages and the first and second intermediate stages. The shielded grid in the first stage as well as all other stages is given a positive potential of 45 volts when 135 volts is applied to the plates of these shielded grid tubes. While this is the recommended value of voltage for the shielded grid, nevertheless in operating it will probably be necessary for the operator to try for higher values, possibly running as high as 67½ volts in order to get maximum amplification from these new type of tubes. In laboratory tests sufficient difference could be found when using more than 45 volts to make it worth while to do so.

All Stages Trimmed

The second radio frequency transformer stage is that represented in the schematic by the No. 562 transformer which is also spanned by second section .00035 mfd gang condenser. In this stage the trimming condenser gives sufficient balancing properties over both the high and low waves because of the fact that this stage is far enough removed from the antenna to not require additional balancing means. The third radio frequency stage is represented by the No. 564 radio frequency inductance containing a primary, secondary and a third winding used for regenerative purposes. The secondary is spanned by the usual section of the .00035 gang condenser with its accompanying trimmer. Detection in the first detector is by means of the .00035 grid condenser spanned by a 4 megohm leak.

Regeneration in the plate circuit of this first detector is controlled by means of the 2000-ohm variable resistor placed across the extremities of the regenerative windings, in series with which may be seen the pick-up winding of the oscillator coupler No. 570 and the primary of the first intermediate frequency amplifier unit No. 612.

In considering the 612 and 614 intermediate inductances, it will be observed that each is spanned by a balancing condenser in addition to the main fixed tuning condenser located across the coil extremities. By means of these trimmers, it is possible for the operator to balance all three units to a point where maximum selectivity may be secured consistent with good tonal quality. The first and second intermediate frequency amplifiers employ the 222 shield grid tubes because of their inherent high amplification qualities. The first detector has a conventional 201A while the second detector is of the same type. The first audio tube is a 201A when the receiver is used in conjunction with a separate power amplifier embodying an additional stage of audio frequency amplification. However, in the event that the set is used by itself it might be advisable to utilize a 112A tube, although in-so doing it would probably be advisable to separate the lead from the plate of the last tube from the 90-volt terminal so that if desired

a voltage higher than 90 may be placed on the 112A.

Conventional Oscillator

The oscillator circuit as far as its tuning properties is concerned is of the conventional kind, a .00035 mfd variable condenser in series with the .005 mfd fixed condenser being placed across the grid and plate of the 201A oscillator tube. On account of the kind of condensers used in this receiver there is no body capacity present because both of the rotors are insulated from the metal shaft of the condenser. It will be noted in the schematic shown in Figure 3 that the trimming capacity is shown across the main .00035 mfd oscillator condenser. This is placed in this position especially for the purpose of allowing the operator to shift slightly either higher or lower the readings of the oscillator condenser in order to somewhat approximate the readings on the wavelength dial which turns the 3 gang condenser tuning the radio frequency stages ahead. This trimming condenser may also be of help in the event that the .00035 mfd oscillator condenser does not quite reach high enough in wavelength.

By referring now to Figure 6, which is the graphic diagram by means of which the builder should wire the receiver, it will be seen that each of the sections of the receiver are placed in copper stage shields so that when the receiver is completed and in operation there is no interaction between one stage and another. This method of shielding is made imperative by the employment of the four screen grid tubes, two of which are in the first and second radio frequency stages and the other two of which are located in the first and second intermediate stages. It is only by good shielding that these tubes are enabled to operate at maximum efficiency.

All wires leading into the cans are carried through appropriate holes in the bottom of the stage shields and thence down through the sub-panel to their respective terminals. By referring to photograph shown in Figure 1, it will be seen that in addition to the regular tube socket which is employed, there are also seven additional sockets into which are fitted the various radio frequency, intermediate and oscillator inductances. Therefore when wiring up

the receiver the builder should follow very carefully the diagram shown in Figure 6 and after all connections have been made, the whole job should be tested, wire by wire, against the graphic diagram to make sure that no errors have been made in connecting up the set.

The first thing to do in the operation of this receiver is to tune in a local station and by means of the small voltage control rheostat turn down the voltage on the shield grid tubes until the signal gets fairly weak, at the same time turning the three gang condenser back and forth over the scale in an attempt to find exact resonance. Then manipulate the antenna compensator to find a correct position for the antenna used. Turn the filaments of the shield grid tubes lower until the signal is hardly audible. Then by means of the wooden screw-driver, which comes with the three gang Remler condenser, adjust the trimming condensers to locate exact resonance. Then remove the top of the shields containing the intermediate frequency transformers. By the use of the same wooden screw-driver and continuing with a weak signal, very carefully adjust the first intermediate, second and third, being sure that each time you replace the top of the one can before attempting to adjust another can. If this is done



Figure 4. In this photograph the receiver has been placed in its console

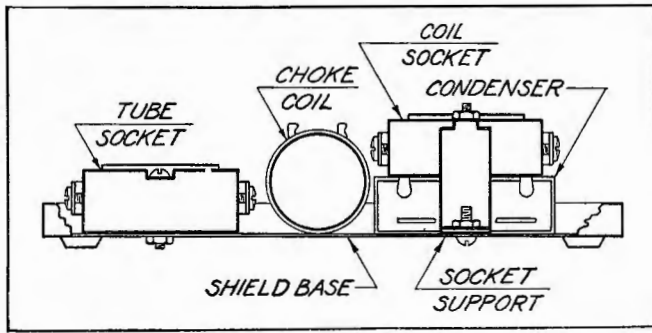

Figure 5. The above is a detailed drawing showing the side elevation of one of the shielded stages in the receiver

in this manner you will find that all intermediates will remain constant, otherwise there will be a change when the shields are put in place again.

In turning the volume control on the left of the receiver clear up and advancing the sensitivity of the regeneration control on the right of the panel, turn the filaments of the 222's up to about three volts and by the use of the screw-driver adjust the potentiometer, which is on the sub-panel between the two dials, until the signal is increased to maximum without oscillation, advancing slightly farther to a point just where it squeals. This should be done at about the middle of the scale or 300 to 350 meters. Then turn back the sensitivity control and the volume control slightly. Adjust the filament rheostat above and below three volts to determine if there is a point where it will oscillate other than where it was adjusted to oscillate. The receiver is now ready for operation.

Tune in some very distant station one thousand miles distant or so. Said station should have a very weak signal when volume is full. Then repeat the adjustment of the trimming condensers on the three gang condensers to again line up these capacities, at the same time rocking the condenser back and forth. Likewise adjust the intermediate frequency transformers as in the previous case. The trimming condenser, which is placed directly across the oscillator condenser on the right, is used only for lining up the two dials. The two dials should cross at about 125 on the scale. Of course, the dials will not track exactly above and below this point. The station should be logged directly on the paper scale after having the receiver adjusted.

At times it will be noticed that when two stations are say ten kilocycles apart and have a slight tendency to slop into each other, by means of the small variometer on the antenna compensator the two stations may be separated quite successfully. It may be found

necessary to readjust the trimming condensers and the intermediate transformers several times before finding the exact point of resonance, which is the most efficient point of operation.

Although the Remler type 55 tube shields are specified as optional equipment, they will be found to have a desirable effect in preventing microphonic noises particularly on the 222's, first and second detectors and audio stages.

List of Parts

Parts necessary to duplicate the receiver described here are:

- 1 502 Remler antenna compensator.
- 1 550 Remler interchangeable inductance.
- 1 562 Remler interchangeable inductance.
- 1 564 Remler interchangeable inductance.
- 1 570 Remler interchangeable inductance.
- 1 612 Remler interchangeable inductance.
- 2 614 Remler interchangeable inductances.
- 4 35 Remler r. f. choke coils.
- 1 633 Remler .00035 mfd gang condenser.
- 1 638 Remler .00035 mfd variable condenser.
- 3 Aerovox .00025 mfd fixed condensers.
- 1 Aerovox .005 mfd fixed condenser.
- 1 Aerovox .0005 mfd fixed condenser.
- 1 Aerovox .0001 mfd fixed condensers.
- 1 Aerovox .00005 mfd fixed condensers.
- 7 Tobe .1 mfd bypass condenser.
- 1 1885 Frost 500,000-ohm resistance.
- 1 1896 Frost 2000-ohm potentiometer.
- 1 S1910 Frost 10-ohm Gem rheostat with switch.
- 1 1822 Frost 200-ohm potentiometer.
- 1 Durham 4 megohm grid leak.
- 2 Durham 3 megohm grid leaks.
- 1 Frost 1-ohm fixed resistance.
- 1 Frost 4-ohm fixed resistance.
- 2 Frost tipjacks.
- 15 50 Remler sockets.
- 1 Formica 11 x 25 x 3/16-inch sub-panel.
- 1 Lignole Inlay 7x26x3/16-inch front panel.
- 1 220 Silver-Marshall audio transformer.
- 1 Hagel 7-contact socket.
- 1 506 Weston 0-5 d. c. voltmeter.
- 2 110 Remler drum dials.
- 7 720 Remler shielding cases.
- 2 Eby binding posts.
- 3 Karas sub-panel brackets.
- 1 pkg. Kester radio solder.
- 40 ft. Acme Celatsite hook-up wire.
- 1 Ekko ground clamp.
- Miscellaneous lugs, nuts, bolts, screws.
- 8 Remler No. 55 Tube Ballast Shields (optional)

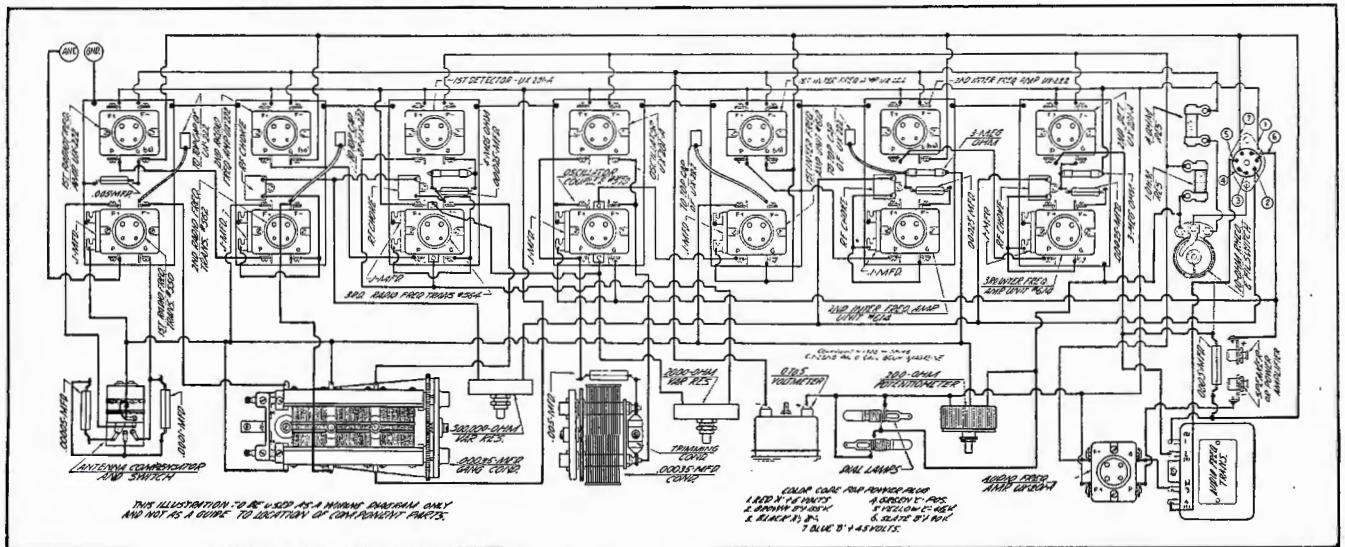

Figure 6. All of the wiring for this receiver should be done from the graphic illustration which is printed above, while the experienced set builder may be able to use the schematic which is printed in Figure 3. Nevertheless, a great deal of time may be saved by following the diagram above, since it shows the method of making all connections

Citizens Birnbach A. C. Four Is Simple and Efficient Receiver

Compact and Inexpensive Set Operated Direct from Lighting Mains
Should Prove Interesting to Four Tube Enthusiasts

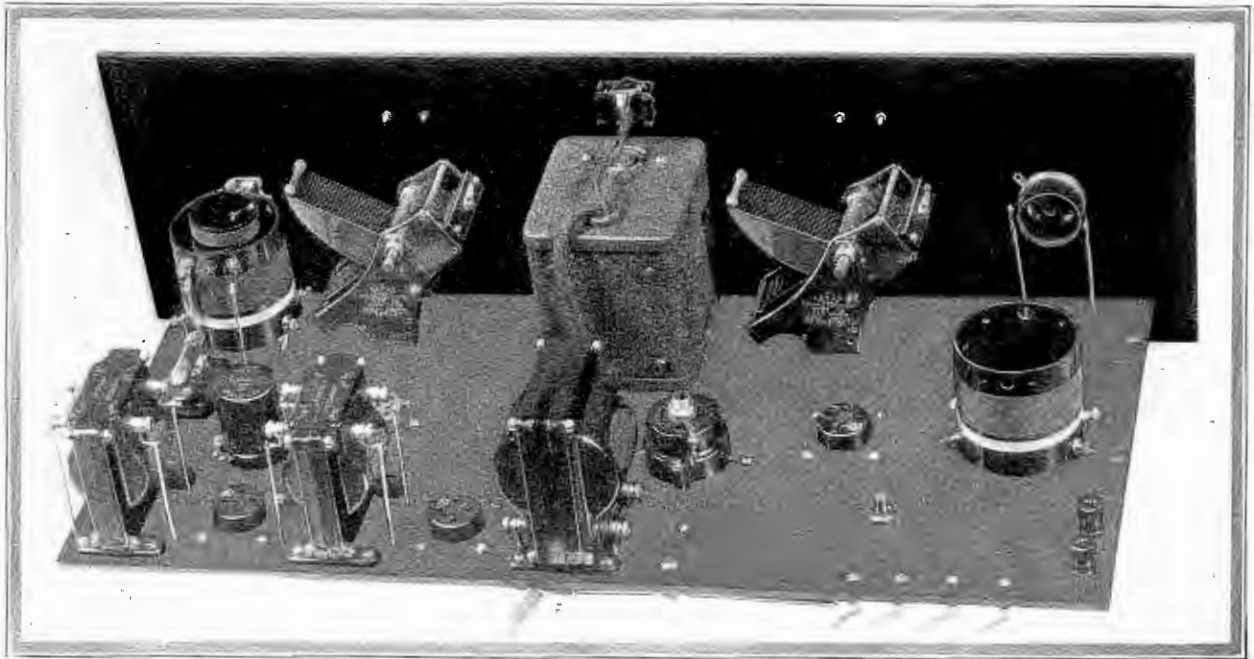

Figure 1. This photograph discloses the rear view of the Citizens Birnbach A. C. Four receiver recently constructed and tested in our laboratories

FREEDOM from batteries, relatively small initial cost and flexibility of operation are features of the Citizens Birnbach A. C. Four receiver, recently designed and constructed in our laboratory and about to be described in this article. In this particular model it was deemed advisable to incorporate the low voltage transformer for supplying the alternating current filaments directly on the sub-panel of the set so as to insure short leads and extreme compactness of assembly.

Electrically speaking, there is nothing radically new in the receiver itself, since it employs the time-honored one stage of controlled radio frequency amplification, succeeded by a regenerative detector and two stages of sturdy audio amplification, including the use of an output transformer in the last tube, which is a 171. The chief virtue of this model lies, however, in its ease of operation, economy of cost, and neatness of appearance. As a basis for the receiver, the Karas A. C. Former was utilized as a filament supply for the alternating current tubes. This transformer has a 110 volt a.c. primary and three low voltage secondaries. The 1.5 volt winding energizes the filaments of the 226 tubes, the 2.5 volt winding supplies the heater of the 227 tube and the 5 volt winding is used for the 171 filament. Other Karas parts used include two of their .0005 mfd variable condensers and three sub-panel brackets.

Birnbach Inductances

Inductances, comprising the radio frequency transformer and the three-circuit coupler are products of Birnbach, whose five-wire cable is used for the B voltages. The audio transformers

and the output transformer are Ferranti, the radio frequency choke is made by Hammarlund, while the Phasatrol used for radio frequency control is made by Electrad. Condensers are Muter, fixed resistances, rheostat, potentiometer, line switch and pin jacks are Carter. Both the four-prong and five-prong sockets are products of Benjamin, while National vernier dials are used on the front panel for tuning. Two Eby binding posts are used for antenna and ground connection, while the front and sub-panels are of Formica.

Referring to the schematic diagram shown in Figure 3, the radio frequency transformer is shown at the left, with its primary going to antenna and ground. The secondary of this coil is spanned by a .0005 mfd variable condenser with the stator going to the grid of the first radio frequency amplifier. The rotor is common with the bottom terminal of the coil, the bottom terminal of the secondary of the three-circuit coupler, the grid return of the first audio transformer, the iron cores of the first, second and output transformers and the ground.

R. F. Control

In the plate circuit of the first radio frequency amplifier is located the Phasatrol unit, which is used to balance this tube, and its connections may be seen in the schematic diagram. The secondary of the three-coupler inductance is connected across the PC and B terminals of the Phasatrol unit and is supplied with 135 volts positive from the green wire in the cable. This connection also furnishes plate potential for the first audio frequency amplifier. The secondary of the three-circuit coupler is tuned by

(This receiver constructed, tested and all illustrations made in our laboratory)



Figure 2. Placed in a Corbett cabinet, the Citizens Birnbach A. C. Four is illustrated above

another .0005 mfd variable condenser placed directly across the extremities of this coil, with the stator as usual being on the grid side of the circuit. The grid condenser used is .00025 mfd, while the grid leak is three megohm. It will be found in practice that either a smaller or larger leak will give different results and for that reason it would not be a bad idea for the operator to have several values of grid resistances on hand, so that he may use them until the best value is secured.

Regeneration in the detector circuit is afforded by means of the plate winding of the three-circuit coupler, which is in series

with the plate and radio frequency choke coil on the primary of the first audio frequency transformer. It should be noted that the .002 mfd fixed condenser shown between the top of the radio frequency choke and the common ground return is quite essential to the operation of the detector circuit, since this capacity acts as a by-pass across the windings of the radio frequency choke and primary of the first audio transformer. If by mistake the builder should place the condenser directly from the plate to the common ground connection, he will find that the detector will not operate regeneratively, because under those conditions the regen-

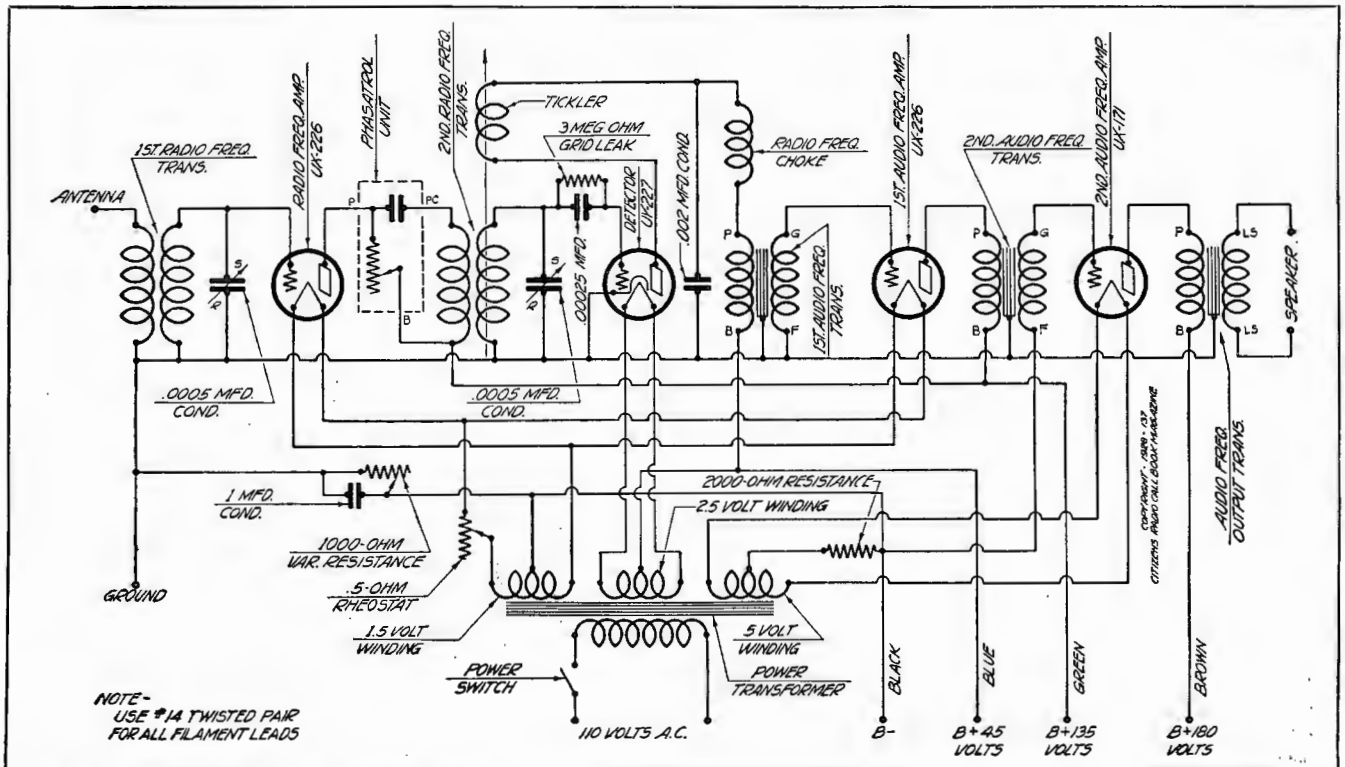

Figure 3. This schematic drawing gives the electrical details of the circuit used in the construction of the Citizens Birnbach A. C. Four receiver. This diagram may be used by those who are familiar with the construction work, although it is suggested the novice use the diagram shown in Figure 6, which is a much simpler one.

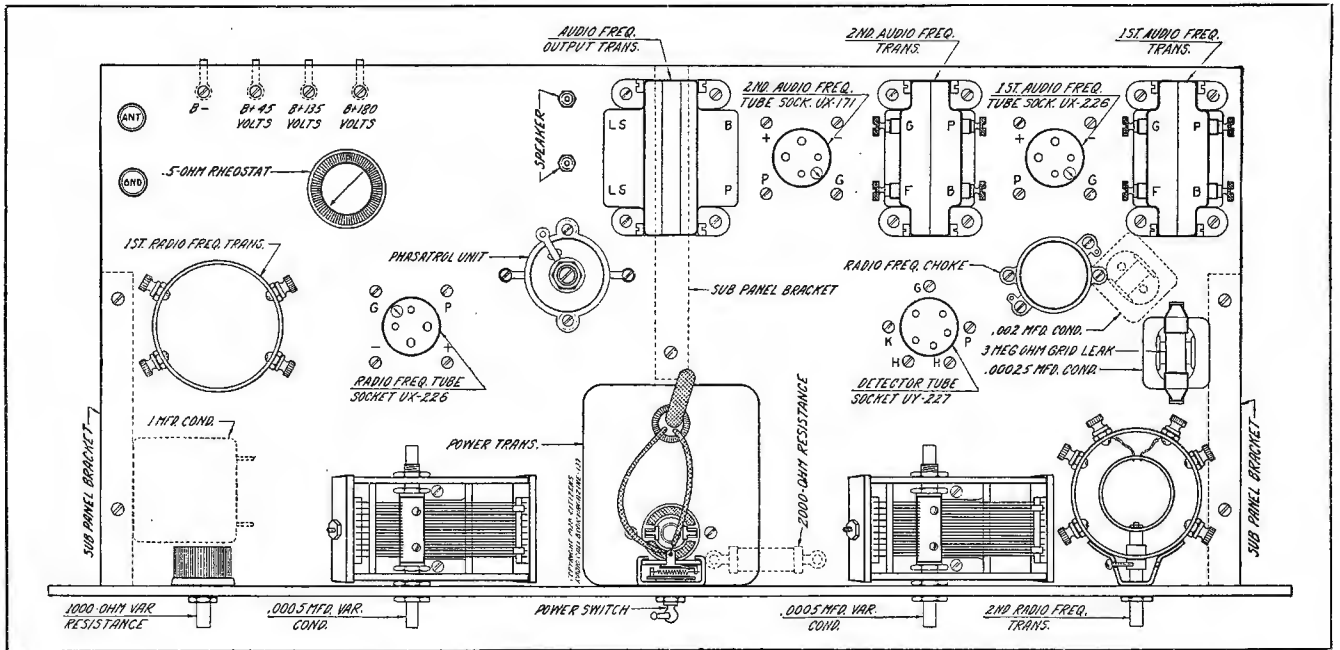

Figure 4. In this drawing we show the sub-panel layout for the receiver described in this article. Please note that all parts should be placed in strict accordance with this layout if equal results are to be secured when operating the set

erative coil would have been by-passed and that is not desired. It is, therefore, very essential that the builder follow exactly the method of connection shown in the diagram.

Variable Grid Bias

Grid bias on the first audio frequency amplifier is supplied through the drop across the 1000 ohm variable resistance between the center tap of the 1.5 volt winding and the common ground connection. This resistance is made variable so that the operator may shift the grid bias, within limits, on the first audio frequency amplifier, as well as on the first radio frequency amplifier. In practice it will be found that the maximum bias voltage available with this resistance will be approximately 10 volts, although that is not necessarily the best operating condition.

Although the detector stage in this receiver makes use of the heater type of detector, which is operated directly from alternating current, there is practically no difference in the operation of this kind of a tube and the conventional storage battery tube. So far as we know at the present there do not seem to be any single measurements that would show the difference in sensitivity between the battery operated and the alternating current operated detectors, but since the receiver is preceded by a stage of tuned radio frequency ahead of the detector, if the sensitivity of the 227 is at least equal to that of the old battery detector tubes, then the operator should have no cause for complaint because the signal will be built up somewhat in the first radio frequency stage.

Filament control of the receiver is by means of the snap switch located in series with 110 volt alternating current line and placed at the top center of the front panel, this being more clearly illustrated in the photograph shown in Figure 2. In drilling a hole for placing this snap switch, it would be advisable to make the hole a trifle over-size so as to allow easy placement of the switch. Reference to the photograph shown in Figure 1 will disclose the fact that a flush receptacle is provided atop the Karas transformer, into which the operator may plug either the B eliminator or power amplifier, the whole alternating current apparatus being turned on and off by the snap of the switch. The photograph in Figure 1 also shows at the rear of the sub-panel four terminals on to which the battery cable is affixed. It will be noted that although the battery cable used here has five leads, only four are used, these being the black, blue, green and brown. In the photograph shown in Figure 2, the tone control is the 1000 ohm variable resistance, which alters the bias on the first radio frequency and first audio frequency tubes, while the volume control is lo-

ated at the right and represents the variable plate coil of the three-circuit coupler. The left vernier dial controls the first radio frequency stage secondary, while the right dial controls the secondary of the three-circuit coupler. Assuming there is not a wide variation in antenna conditions, it is quite likely these two dials will run fairly close together.

Tuning the Set

Having constructed the receiver and wiring it in accordance with the graphic diagram shown in Figure 6, the operator is now



Figure 5. In the above photograph the receiver has been placed in a Corbett console

ready to test and tune the set. As previously stated, filament current for all of the tubes is derived from the A.C. Former, while the plate potential may be secured either from batteries, a good standard B eliminator or a power amplifier along the general lines laid out in the power amplifier design shown on page 68 of the January issue of this magazine, or the one described on page 69. After placing the 226 in the first socket, the 227 in the second socket, another 226 in the third socket and the 171 in the fourth socket or the last one to the right, and with the plate supplies connected, the receiver may be turned on by means of the power switch on the front panel. To balance the receiver it would be well to select a station on the higher wavelengths, say around 526 meters. Set the left and the right dials for the same signal from a high wave station, turn the volume control so as to increase volume on the received signal and then with a wooden stick sharpened like a screw-driver turn the Phasatrol screw until the receiver is caused to oscillate. Turn the left dial back and forth across the scale to make sure that it is the radio frequency tube oscillating and not the detector tube. When this fact has been determined, turn the Phasatrol in the opposite direction so as to stop the tube from oscillating and turn both dials to a station lower in the wavelength band than the one at first heard. Note that on a lower wavelength station the radio frequency tube will probably oscillate. Again turn the Phasatrol until oscillation ceases. In this manner, systematically work the receiver down from the highest station to the lowest station. When the lowest station has been reached and the Phasatrol has been shifted so that the tube just ceases to oscillate, the set will be balanced for operation over the entire band. By means of the volume control it will be possible to secure a good signal strength on all stations having a fairly good signal level.

Parts used in the construction of the receiver described in this article are as follows:

- 2—23 Karas .0005 mfd variable condensers
- 1—12 Karas A.C. Former
- 3—Sub-panel brackets
- 1—Muter .00025 mfd fixed condenser
- 1—Muter .002 mfd fixed condenser
- 1—Muter 1 mfd by-pass condenser
- 1—Muter 3 megohm grid leak
- 1—Birnback r.f. No. 60 coil
- 1—Birnback three-circuit tuner, No. 60
- 1—Birnback five-wire cable, No. 110
- 2—AF4 Ferranti a.f. transformers
- 1—Ferranti output transformer
- 1—85 Hammarlund r.f. choke
- 1—Electrad Phasatrol
- 1—H2000 Carter 2000 ohm fixed resistance
- 1—MW1/2 Carter 5 ohm rheostat
- 1—MW1000 Carter 1000 ohm potentiometer
- 1—110 Carter line switch
- 2—Carter pin jacks
- 1—Formica 7x24x3/16-inch front panel
- 1—Formica 10x22x3/16-inch sub-panel
- 2—Eby binding posts
- 3—9044 Benjamin sockets
- 1—Benjamin five-prong socket
- 2—B National vernier dials
- 1—227 Ceco tube
- 2—226 Ceco tubes
- 1—171 Ceco tube
- 40—Feet Acme Celatsite wire
- 1—Ekko ground clamp
- 1—Package Kester radio solder
- Miscellaneous—lugs, nuts, screws, etc.

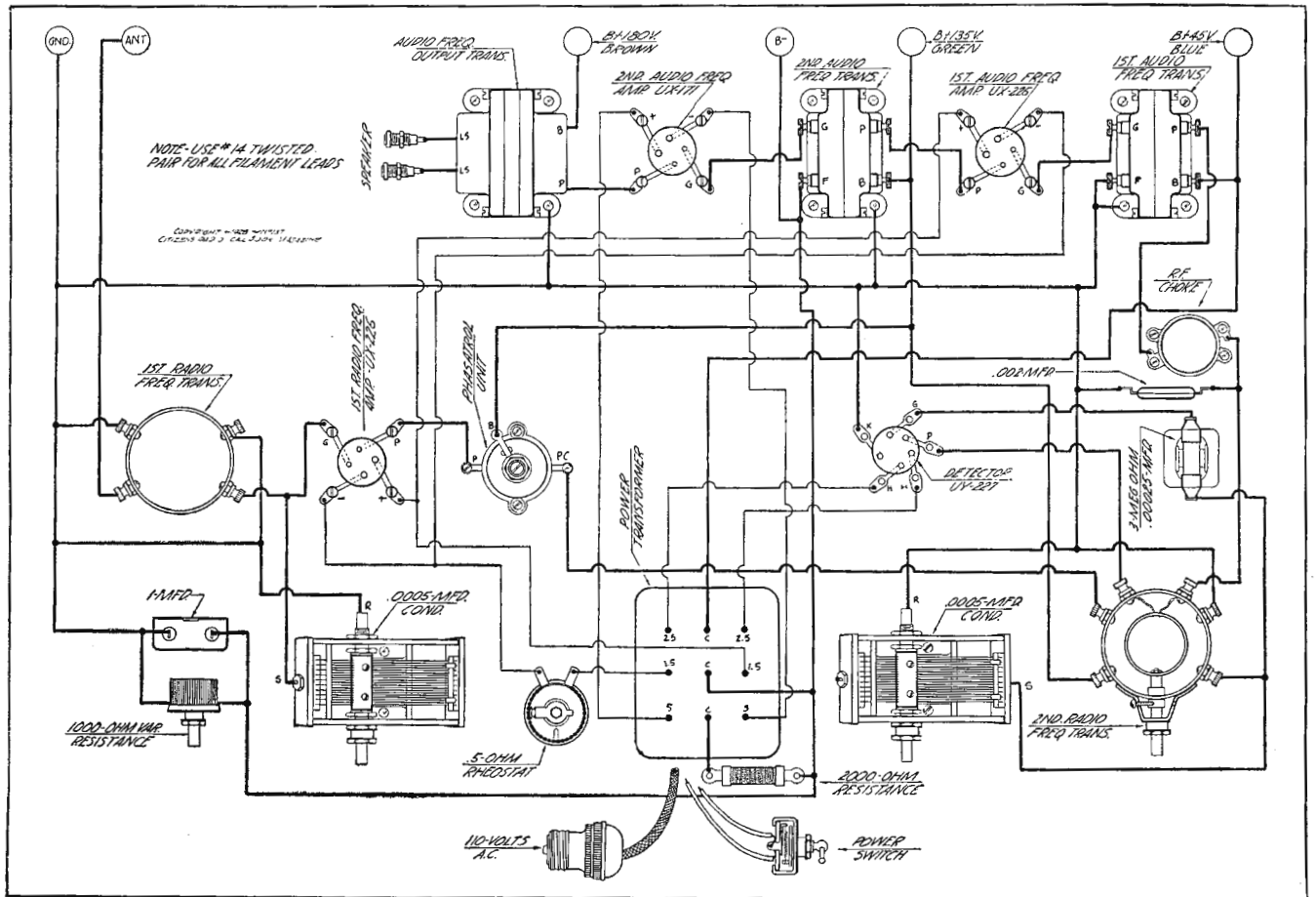

Figure 6. By closely following the diagram shown above, the set builder may readily wire up the receiver described in this article. This graphic form of drawing is very popular with set builders who wish to save time in puzzling out a schematic circuit, since this graphic shows where each connection goes regardless of the manner in which the receiver is laid out

Design for Complete Electric Phonograph and Amplifier

Electric Reproduction of Records and Quality Amplification Give Results Never Experienced with Older Models

WITH the advent of electrical means of recording phonograph records in order to fully enjoy all of the benefits of this method of recording, it is necessary to use an electrical method of reproduction. In an article on page 60 of the January issue of this magazine, a description was given of a means for combining a radio set and a phonograph pick-up unit, so that either the radio or the phonograph could be played at will. The article referred to aroused considerable interest on the part of those who already possessed both radio and phonograph sets, but did not take care of the individual who desired only an electric phonograph. Such a phonograph may easily be built in the home by following the diagrams and instructions contained in this article.

Mounted on Baseboard

By referring to Figure 2, the reader will observe that all of the power apparatus is mounted on a single baseboard. This power plant may be roughly divided into four sections, the first of which is the transformer with high and low voltage secondaries. The second section contains the choke followed by its filters, while the third section has the resistance bank. The fourth section of this unit is the audio amplifier, comprising two stages of audio frequency amplification fed into a push-pull power stage arrangement.

The power transformer is a type 2098 Thordarson, having a center tapped high voltage winding for the rectifiers, a center tapped $7\frac{1}{2}$ volt secondary for the filaments of the rectifiers and a center tapped $7\frac{1}{2}$ volt winding for the filaments of the 210 power tubes arranged in push-pull. Current for operation of the filaments of the first and second audio frequency amplifiers, where type 226 tubes are used, is derived from the $1\frac{1}{2}$ volt secondary of a Thordarson filament lighting transformer, type T-2445. This transformer is shown in detail in the graphic illustration in Figure 5. In the graphic diagram a .2 ohm rheostat is shown in series with the $1\frac{1}{2}$ volt winding to allow the operator cutting down the voltage on the two alternating current tubes when desired. These tubes are quite sensitive to filament overload and for that reason it would be well to always operate them at the rating stipulated by the tube manufacturer. There are two other windings on this T-2445 transformer which are

not used, if the arrangement shown in Figure 5 is to be followed. These two extra windings are a secondary for $2\frac{1}{2}$ volt filaments and another secondary for 5 volt filaments. The primaries of the 2098 and T-2445 are joined together and lead, through a power switch, to the 110 volt alternating current line.

High voltage is furnished the plates of the 281 rectifier tubes from connections H and H shown in the diagram in Figure 5.

Filament energy is supplied by the two terminals F and F below the high voltage windings, the center tapped connection of this $7\frac{1}{2}$ volt filament winding forming the positive terminal of the rectifier system, the negative terminal being the center tap on the high voltage winding. In order to smooth out the pulsations in the rectifier output, a filter choke, No. 2099, is used between the high voltage positive terminal of the rectifier and the plate circuit of the two tubes in push-pull. Suitable filter condensers located within the Tobe R-210 condenser block are placed across the input, center and output of the filter choke, while other condenser sections are placed across portions of the resistance bank.

Fixed and Variable Resistances

The resistance bank used in securing the necessary voltage drop between the high voltage of the rectifier and the negative terminal consists of a Carter 8000 ohm resistance unit and two 10,000 ohm resistances, one of which has a slider. These resistances are for the positive plate potentials. A single 2000 ohm Carter resistance with slider is provided for the C bias. The 8000 ohm section is located between the output of the filter choke and the top of the first 10,000 ohm fixed resistor, the second 10,000 ohm resistor with slider going to the negative side of the circuit. The resistor having the slider allows a little flexibility in voltage control in the event that either more or less than 45 volts is required in the input of the amplifier. This provision was included in the event that a builder desired to take the output of a detector and amplify it through the phonograph amplifier illustrated herein. If such an arrangement is wanted, the P terminal of the first audio transformer should be connected to the plate of the detector which is to be added. Thus, the plate voltage for this detector is supplied by the amplifier itself. Potential of 90 volts for the



Figure 1. Mounted in a Pierson console the electric phonograph is shown located in the front. Space is allowed at the right for records. Amplifier is placed at the bottom and rear of the console

(This amplifier constructed, tested and all illustrations made in our laboratory)

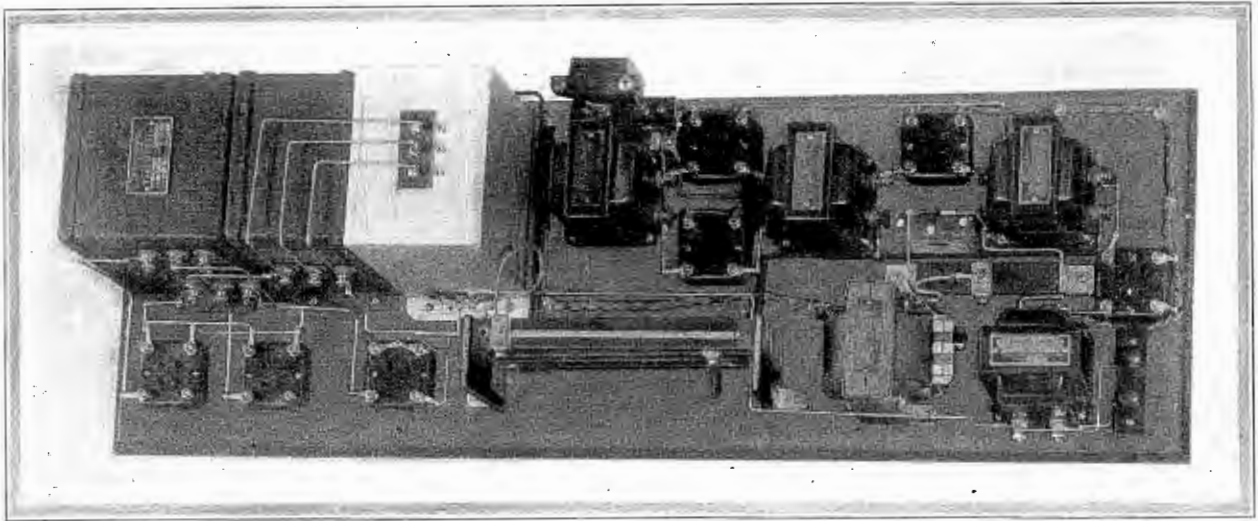

Figure 2. The complete power amplifier is depicted in the above photograph. All parts are laid out symmetrically and with sufficient room for accessibility

primary of the second audio transformer and the primary of the audio frequency input transformer is secured at the juncture of the 8000 ohm and the first 10,000 ohm fixed resistances, this voltage value being sufficient for the type 226 tubes used in these two amplifier stages. Of course, the high potential for the plates of the 210's is secured from the junction of the filter choke output and the 8000 ohm fixed resistance. It should be noted that instead of an output transformer being employed in the plate circuit of the 210 tubes, an audio frequency output impedance, type 2420, is utilized, with the speaker windings going across the outside extremities of this impedance. In operation, under certain conditions, the optional .01 to .1 mfd fixed condenser shown in the schematic in Figure 3 may be required. The use of such a condenser will depend largely upon the wishes of the operator and the type of speaker which is being operated at the time. In this amplifier, as in any other quality apparatus, it is well to use a high class speaker so as to do full justice to the amplifier system in the production of distortionless music and voice.

Automatic Grid Biasing

Biasing voltages for the amplifier are secured through two methods. For the grids of the 210 tubes arranged push-pull, a 750 ohm resistance has been located between the center tap of the 7½ volt filament winding for these two tubes and the negative terminal of the amplifier. The drop across this 750 ohm resistance will supply the grid circuit of the push-pull system with the proper voltage for operation when the maximum voltage of the rectifier is being applied to their plates. In practice the plate circuit of the power stage draws about 50 milliamperes, which would result in approximately 37½ volts being applied to the grids of the 210 tubes. In the event that through a high initial line voltage the rectifier gives an increased voltage output, it may be necessary to use a fixed resistance larger in ohmic value than the one specified, so as to supply sufficient grid voltage to keep down the plate current in the power stage to a safe value. This may be readily determined by means of a milliammeter temporarily placed between the B terminal of the audio frequency output impedance and terminal No. 2 on the filter choke unit. After the current reading obtained from this connection is noted, the milliammeter may be taken out and the solid connecting wire replaced.

Grid bias on the grids of the two 226 tubes is variable by means of the 2000 ohm potentiometer, which is connected between the center tap of a 64 ohm fixed resistance across the 1½ volt windings of the filament transformer and the negative terminal of the amplifier. This 2000 ohm potentiometer is bypassed by a 1 mfd condenser so as to eliminate the possibility of hum or other audio interaction in the grid circuits of the two amplifying tubes.

Regulator Tube Employed

In order to maintain an even voltage on the 90 volt terminal, a voltage regulator tube is employed, which is connected, with its G terminal going to the juncture of the 8000 ohm and 10,000 ohm resistances and its positive terminal going to the bottom of the entire resistance train, this line being the common negative for the amplifier. By looking at the photograph in Figure 2, it will be noted that the plus and minus terminals of the regulator socket (the third from the left) are joined together by means of two soldering lugs. This is done to secure the type of connection represented in the graphic diagram, Figure 5.

A protective device is afforded in the use of a voltage regulator tube in that the P and minus prongs on such a tube are connected internally by means of a strap, so that when the tube is withdrawn from the socket either the high voltage circuit is opened (as in the case of this particular amplifier), or the 110 volt primary line is opened, as is customary in some of the manufactured receivers on the market.

To conserve space in the mounting of the resistors, the resistance strips have been placed one over another, supported at each end by small Formica slotted strips so as to elevate the resistors

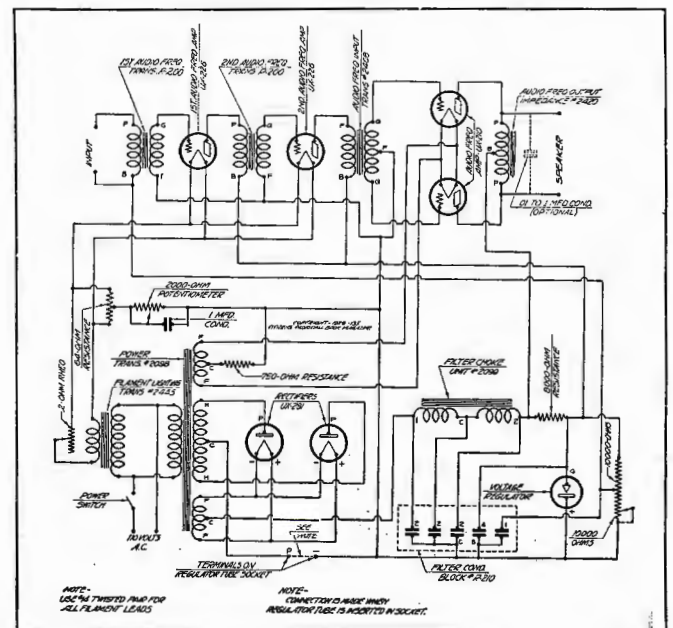

Figure 3. In the above schematic circuit are shown all of the necessary electrical connections. For wiring, it is suggested the graphic illustration shown in Figure 5 be utilized

above the baseboard and allow ample ventilation for heat dissipation. This feature is shown in the center of the photograph in Figure 2.

Electric Phonograph Motor

An electric phonograph motor is used for operating the turn table, on which the phonograph record is placed. This electric phonograph motor has been installed in a small box, such as is shown in the photograph in Figure 4, with a Formica top on which the electric pick-up, tone arm and speed regulator are mounted. This unit is located on a removable portion of the console and can be taken out or put in at will. The output from the pick-up tone arm in Figure 4 is carried into the box and thence to the two input terminals of the amplifier system shown on a terminal strip at the right of the photograph in Figure 2. One of these input terminals has a 45 volt potential applied to it in the event the builder of the amplifier system desires to operate a detector ahead of the amplifier for local reception, or in the case of a short wave single tube receiver, there are broadcast programs transmitted on extremely short waves. When it is desired to use the amplifier in that manner, the P terminal of the first audio frequency transformer is taken directly to the plate of the detector tube.

A speed control on the electric turn table is provided, either by means of a rheostat located in the motor line, or a friction device rubbing against the governor on the motor, the form of speed control depending on the type of electric phonograph motor secured.

Parts necessary for the duplication of this electric phonograph are:

- 1—2098 Thordarson power transformer
- 1—2099 Thordarson filter choke
- 2—R-200 Thordarson audio transformers
- 1—2408 Thordarson push-pull input transformer
- 1—2420 Thordarson push-pull output transformer
- 1—2445 Thordarson filament transformer

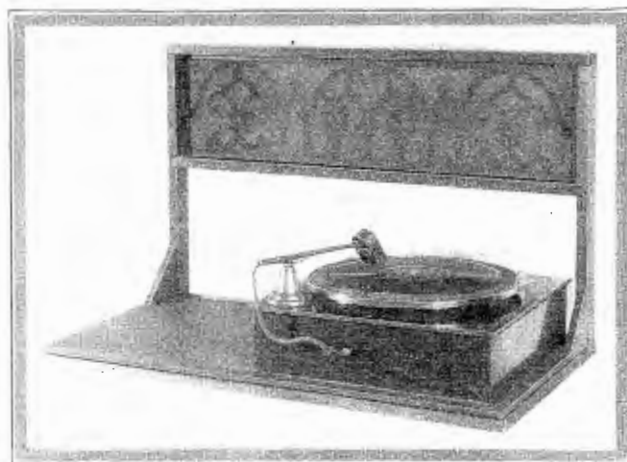

Figure 4. The front section of the Pierson console is removable as shown in the photograph herewith

- 1—R-210 Tobe condenser block
- 1—Tobe 1 mfd bypass condenser
- 7—530 Frost sockets
- 1—T-64 Frost center tap resistance
- 1—Carter 2,000 ohm fixed resistance with slider
- 1—Carter 8,000 ohm fixed resistance
- 2—Carter 10,000 ohm fixed resistance
- 1—Carter 10,000 ohm fixed resistance with slider
- 2—Frost tipjacks
- 2—Eby binding posts
- 1—9x28x3/4-inch wood baseboard
- 1—Electric phonograph motor with turn-table
- 1—Magnetic phonograph pick-up with volume control
- 20—Ft. No. 12 Belden hook-up wire
- 10—Ft. Belden rubber covered hook-up wire
- Miscellaneous—lugs, nuts, screws, etc.

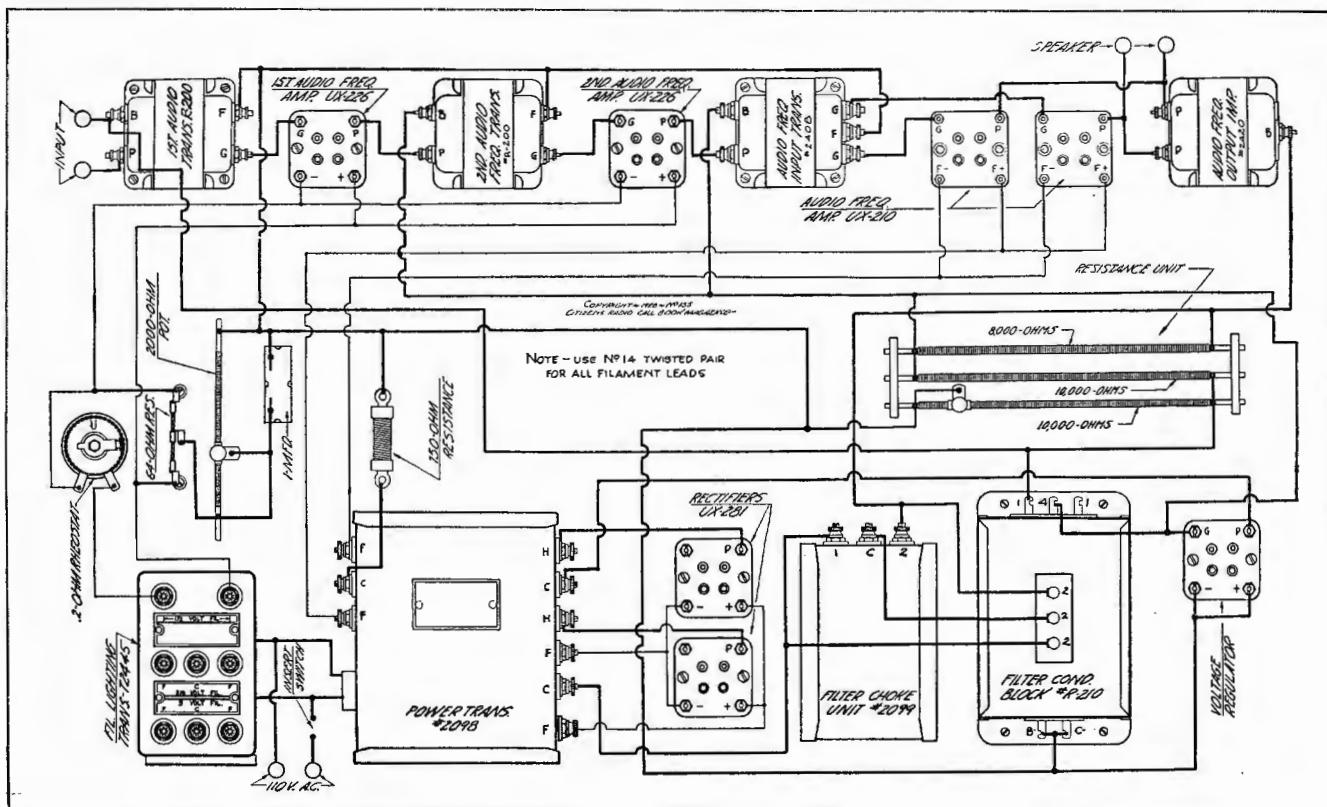

Figure 5. This graphic drawing makes the wiring of the amplifier quite simple and should be followed in preference to the schematic

Line Voltage Regulator Is Easy for Fan to Build

Small Device May Serve to Reduce Voltage on Lines Which Are High

IN many parts of the country readers complain of the fact that quite frequently for varying periods during the evening their line voltage seems to be high and as a result, if they are using a power supply and have a critical receiver, there is likely to be a tendency on the part of the set to go into oscillation when the voltage rises on the supply lines.

A simple means of offsetting the voltages in excess of 110 on these supply lines is to be found in the simple line voltage regulator which is illustrated in the drawings and picture accompanying this article. While this line regulator will take care of voltages in excess of 110 alternating current, nevertheless there is no provision in this type of regulator for occasions when the line voltage falls below a given value. Therefore, this regulator is a manually operated one and serves only for those who have found by experience that their line voltage is considerably higher than the stipulated value for their system.

Essentially the device described herein consists of a heavy duty six ohm rheostat in series with the 110 line and the primary of

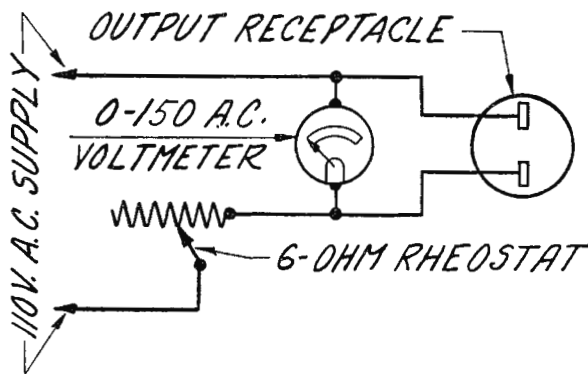

Figure 1. The above drawing represents the schematic circuit used in the line voltage regulator

whatever type of power supply is being used. Across the output terminals of the device is located a 0-150 alternating current voltmeter, which serves to indicate the voltage applied to the primary of the power supply or eliminator. This meter is permanently connected in the circuit and reads at all times the voltage available in that circuit. It therefore constitutes an ideal indicator for the set owner who may be curious as to line fluctuations to be encountered in his supply system.

When the device has been plugged in on the line and the voltage read by the operator, if the value is higher than 110, it may be reduced by turning the rheostat until the reading drops to its normal value. Of course, if the line fluctuations in the operator's home are very rapid, such a device would not necessarily be very effective, because the transition from the high to the low voltage might be too rapid for the listener to compensate for by a manual means. However, this device does come in handy in locations where there is a wide variation of voltage between afternoon, early evening and late night values. For example, in the early evening the chances are the voltage will be fairly high on account of a relatively small load on the local power plant. As the evening wears on, the voltage will probably drop, to be replaced later in the night by a much higher voltage, when most of the load has come off of the line.

(This regulator tested and all illustrations made in our laboratory)

List of Parts

Parts used in the construction of the line voltage regulator are:

- 1—HW6 Carter 6 ohm rheostat
- 1—Formica 6x6x3/16 inch front panel
- 1—74 Jewel 0-150 a.c. voltmeter

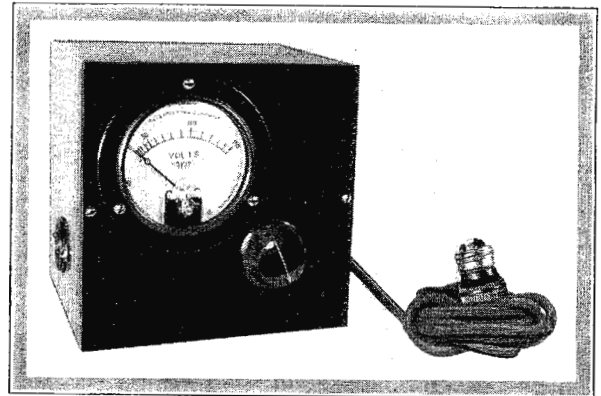

Figure 2. The above photograph shows the completed regulator placed inside of a small box. The knob on the front panel is that of the 6-ohm rheostat

- 1—Benjamin 110 volt flush receptacle
- 1—Benjamin separable plug and cord
- 4—Feet Acme Celatsite hook-up wire
- 1—Package Kester radio solder
- Miscellaneous—lugs, nuts, bolts, etc.

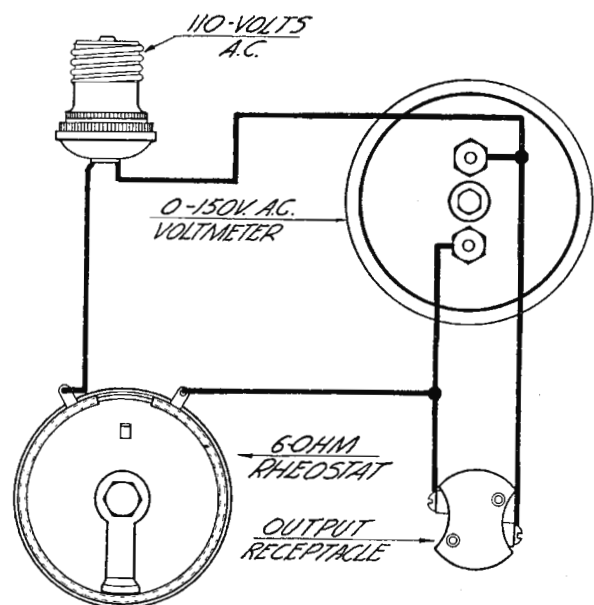

Figure 3. The graphic illustration above will serve as a means of wiring up the voltage regulator

Citizens Crystal Receiver Is Entirely Self-Contained

Inexpensive Portable Combines Carborundum Detector with Amplifier Tube

DESPITE its age the crystal detector still displays a great amount of animation, as is evidenced by the large number of these modest receivers which have been built in the past and a large number that are still being used in the metropolitan or other areas, where high power broadcasting stations are in existence. Those who have followed the radio art for any length of time will be able to remember the crystal clarity with which signals are received on a mineral detector.

Good Headphone Set

There are probably two types of individuals to whom a receiver

of this sort might have some appeal. The first is the relatively large number of shut-ins, who for some reason or other are confined to their homes and who possibly may find solace for some of their troubles by reception of broadcast programs.

Another field in which this receiver may be of interest is that of the Boy Scout, who may be desirous of taking a small set of this type on the Scout hikes. By a simple change an external A battery of greater capacity may be attached, which will considerably lengthen the period of usefulness of the receiver.

Instead of making use of an inductance and a variable condenser, it has been thought desirable for cutting down the number

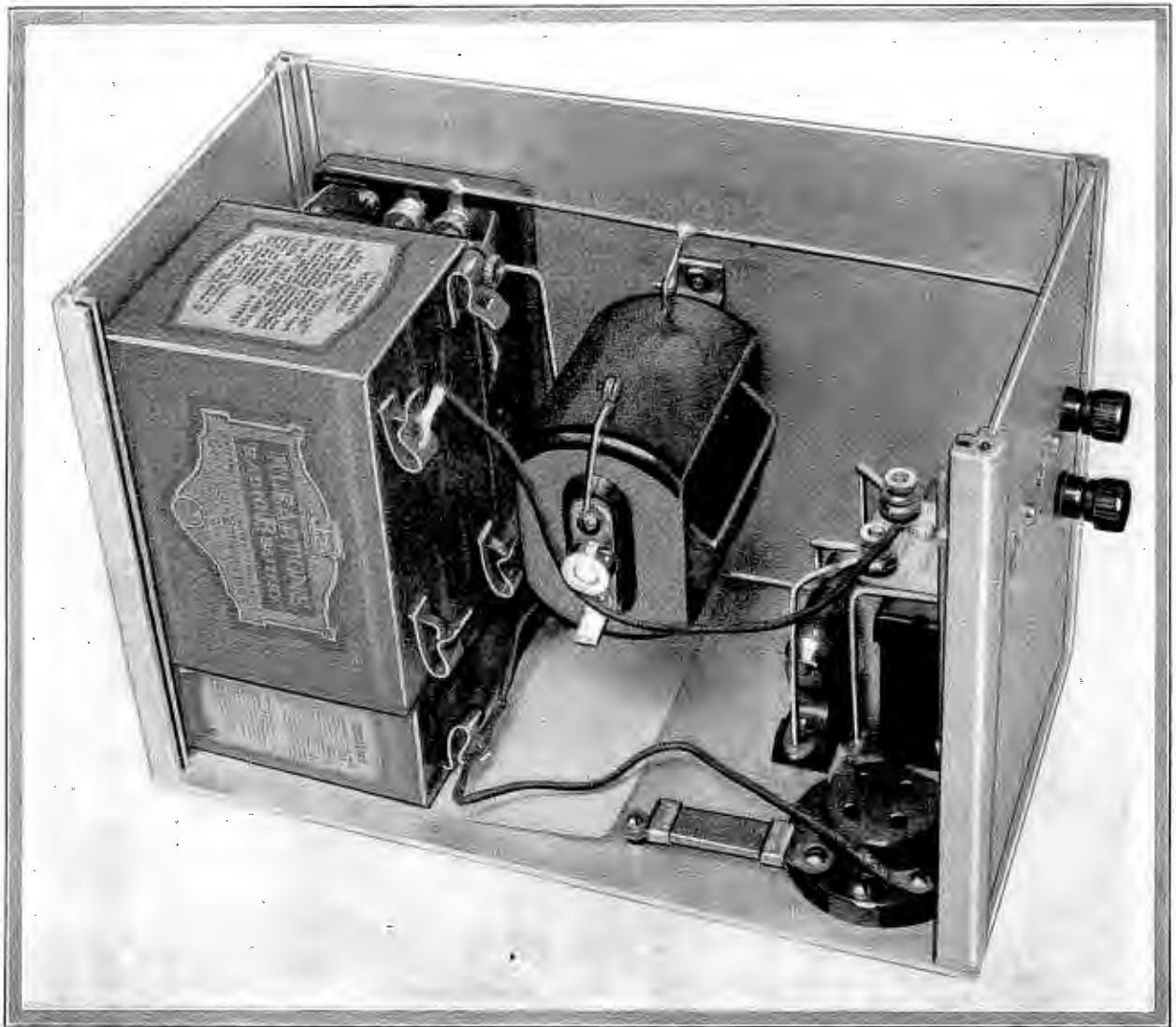

Figure 1. This photograph shows practically all of the details of this portable crystal and tube receiver. The shield acts as a common connection for ground and other terminals, which are disclosed in the schematic circuit

(This receiver constructed, tested and all illustrations made in our laboratory)

of working parts to use a variometer, such as the one made by General Radio and illustrated in the photograph in Figure 1. Best results were secured by using for the rectifier a Carborundum crystal unit, which embodies, in addition to the crystal itself, a small potentiometer, a fixed condenser and a clip into which is placed a small flashlight cell, the cell and the potentiometer serving to greatly increase the sensitivity of the crystal detector and to decrease the damping of the circuit, which fact increases somewhat the selectivity of the receiver.

As is shown in the photograph in Figure 1, a 4½ volt C battery is used for lighting the filament of the 199 amplifier, this battery being located on the bottom of the shield. On top of the A battery is a 22½ volt B battery block for supplying potential to the plate of the amplifier tube.

Range of Receiver

After the receiver has been wired in accordance with the graphic diagram shown in Figure 3, it may be put into commis-

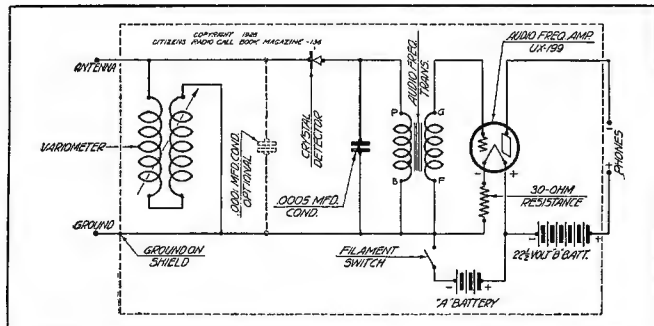

Figure 2. Above is shown a simple schematic circuit of the Citizens crystal receiver, which requires very little apparatus and when built as shown is portable

sion by connecting an aerial and ground, inserting the tube in the socket and adding the filament and plate batteries as shown. In the laboratory tests it was found desirable to place a .0001 mfd fixed condenser across the extremities of the variometer so as to bring up its range a trifle. In tests, using the electric light line for an antenna (through a socket aerial), the highest wave station heard was KYW at 526.0 meters, the dial reading for this station being 90 degrees. The lowest wave station found was that of WMBB at 252.0 meters, which appeared at 30 degrees on the dial. Between the lowest and the highest settings five stations were heard, all with good headphone volume. Selectivity is fair considering the type of aerial used on the tests. With average antenna and ground conditions, medium power stations within a range of

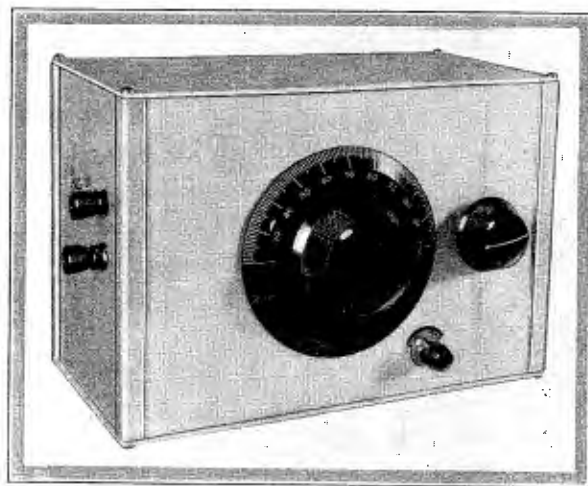

Figure 4. This photograph gives a front view of the crystal receiver with its simple tuning control, variable detector control and filament switch, all of these being located on the front. The two terminals shown at the left of the photograph represent the antenna and ground connections

200 miles may be heard, while freak distances of 1000 or 1500 miles are not uncommon.

This receiver may be duplicated by the use of the following parts:

- 1—Potter .0005 mfd cartridge fixed condenser
- 1—269 General Radio variometer
- 1—Thordarson 6-1 a.f. transformer
- 1—Carter 30 ohm fixed resistance
- 1—Lynch grid leak mounting
- 2—Eby binding posts
- 1—511 Silver-Marshall socket
- 1—Kurz-Kasch 4-inch plain dial
- 1—Yaxley filament switch
- 2—Yaxley pin jacks
- 1—Aluminum Co. of America shield
- 1—Carborundum crystal detector unit
- 1—Sonatron type 199 tube
- 1—Pair Frost 3000 ohm headphones
- 4—Feet Belden flexible rubber covered hook-up wire
- 1—Ekko ground clamp
- 1—Package Kester radio solder
- 1—Celeron 3/4x3 1/2x3/8-inch terminal strip
- Miscellaneous—lugs, nuts, screws, bolts

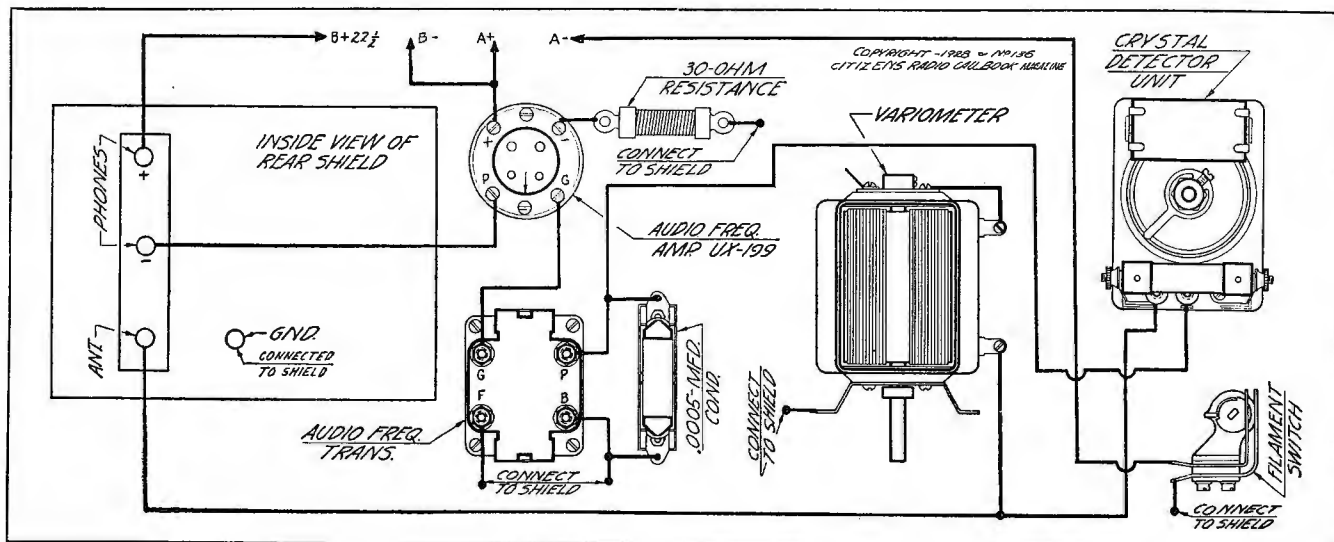

Figure 3. The receiver should be wired by the graphic illustration shown above. Parts for the set may be placed in accordance with the photograph shown in Figure 1

Victoreen 1928 A.C. Circuit Is Fully Electrified

Receiver Now Designed to Take Full Advantage of Alternating Current Operation with Power Amplifier

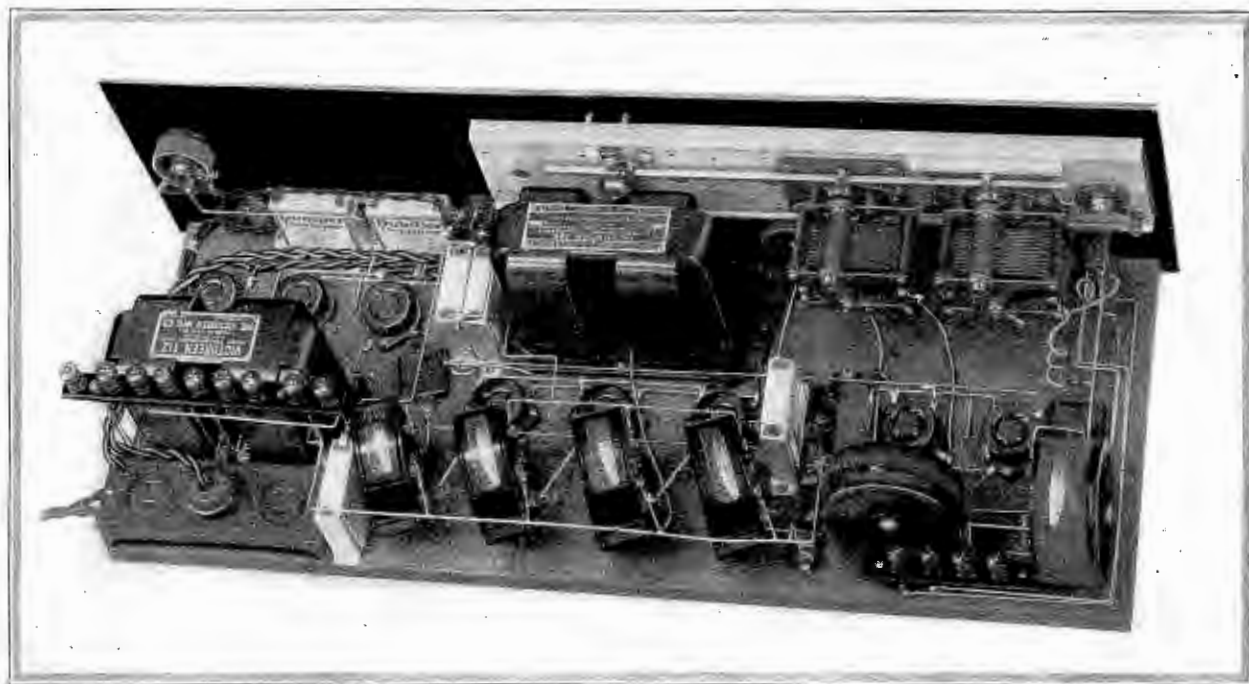

Figure 1. This photograph shows the rear view of the Victoreen A. C. super described in the accompanying article. Note that the low voltage transformer for all filaments is located at the center of the receiver

IN keeping with the modern trend, in the accompanying article is given a description of the new Victoreen 1928 A. C. circuit, which was developed to fill a long felt need for a completely alternating current operated set. Many thousands who have built the previous battery operated models of this receiver may be interested in conversion of their battery models to the newer alternating current type.

For the benefit of those who are already familiar with the previous designs of the Victoreen, it might be well to call attention to points of departure made necessary by the design of the receiver for complete alternating current operation. It will be noted that the oscillator and the first detector tubes are all of the heater type, while the second detector and the first audio are of the same type. These four tubes are operated from a 2.5 volt winding on the 326 filament transformer located on the base-board of the set. Three intermediate amplifiers use the 226 type of tube, filaments of these tubes being supplied by the 1.5 volt winding on the transformer previously mentioned. The last audio tube, which in the receiver under discussion is a type 112, receives its filament supply from the 5 volt winding on the same transformer. On account of the oscillator and first and second detectors using the heater type of tube, it has been possible to produce a receiver which does not have any a. c. hum.

Volume control in the intermediate stages is accomplished by means of a .5 ohm rheostat located in one side of the 1.5 volt line. While it is true that on account of the excessively heavy filaments this form of control might not be as rapid as the same rheostat in a direct current receiver, nevertheless it suffices for the purpose, in view of the fact that a rapid change is not necessary in operation. In addition to this fact the rheostat also serves as a

means of seeing that the proper voltage is applied to the filaments of the 226 tubes, and in this connection it might be advisable to remind the builder that with alternating current tubes it is more essential than ever that a suitable voltmeter be used to determine the exact voltage values applied. Since the a. c. tubes do not indicate by their filament brilliancy any operating characteristics, the builder in self-protection should have a meter to measure the voltage applied from the transformer. This is also true of the heater type filaments, where a voltage in excess of that stipulated by the manufacturer will result in a material decrease in the life of the tube.



Figure 2. The power supply used with the Victoreen receiver is shown in the above photograph

Loop on Antenna

In the design described in this article provision has been made for either antenna or loop operation, the change-over being accomplished by means of a jack switch located on the front panel, which throws the first detector and its associated tuning control on the secondary of an antenna coupler or the two terminals of a loop. As in previous models, both the oscillator and the first

This receiver constructed, tested and all illustrations made in our laboratory



Figure 3. In this picture the receiver has been installed in a Corbett console

detector tuning condensers are operated simultaneously by means of the Victoreen master control unit, so that when the set is properly adjusted and balanced there should be no difficulty from repeat points, because of the fact that the loop condenser will keep in step with the oscillator, which condition might not obtain if two individually operated controls were provided. Reference to Figure 1 will show the filament supply transformer located at the center of the baseboard, while the 112 audio unit, which comprises two audio transformers within a single case, is placed at the left in Figure 1. The general layout is practically the same as in the battery operated models, and the conversion from the old type to the new type may be accomplished without any

difficulty.

As a means of primary control, the Victoreen 333 switch and plug unit has been provided and is located at the left rear of the baseboard as shown in Figure 1. This unit is designed to obviate the necessity of any alternating current wiring connections by providing three receptacles in which the power leads for the A, B and C connections may be plugged. This unit comes equipped with a 110 volt switch permanently connected (this switch being located on the front panel) and with leads of proper length to facilitate the correct placement. An extension is also furnished with six feet of cord permanently connected to the plug unit. This unit is placed in the set and permits all the alternating current devices to be turned off by the switch on the panel.

Used with Power Amplifier

If the receiver is to be operated without a power amplifier, it is suggested that a 112 tube be used in the last stage and voltages as specified in the schematic, Figure 4, be utilized. Reference to the same schematic will disclose the fact that separate C biases should be used for the first and second audio stages, 10½ volts negative being used for the grid of the first audio tube, which is a 227, while the grid of the 112 tube should receive 9 volts if the plate voltage is to be 135, and a higher biasing voltage if the plate voltage on the last tube is higher. Inasmuch as 10½ volts is already used on the first audio, this same value could be applied to the grid of the second audio stage. Biasing of the intermediate frequency grids is by means of a 400 ohm potentiometer placed between the common cathode connection on the 227 tubes and the center tap on the 5 volt winding. It will be noted that a 25,000 ohm resistance is placed in series with the positive terminal of the oscillator coupler and the positive side of the 50,000 ohm fixed resistance, so that this value of resistance reduces the voltage applied to the plate of the oscillator to a point where harmonics, due to plate overhead, are not likely to be found.

Detection in the first detector is by means of a .0005 mfd grid condenser spanned by a two megohm grid leak, while the same method of detection is employed in the second detector. The intermediate transformers, which have a sharp resonance curve, are of the same type which have been utilized in previous models. Internal adjustments made at the factory prevent interstage reaction and require no matching of tubes, condensers or other circuit constants.

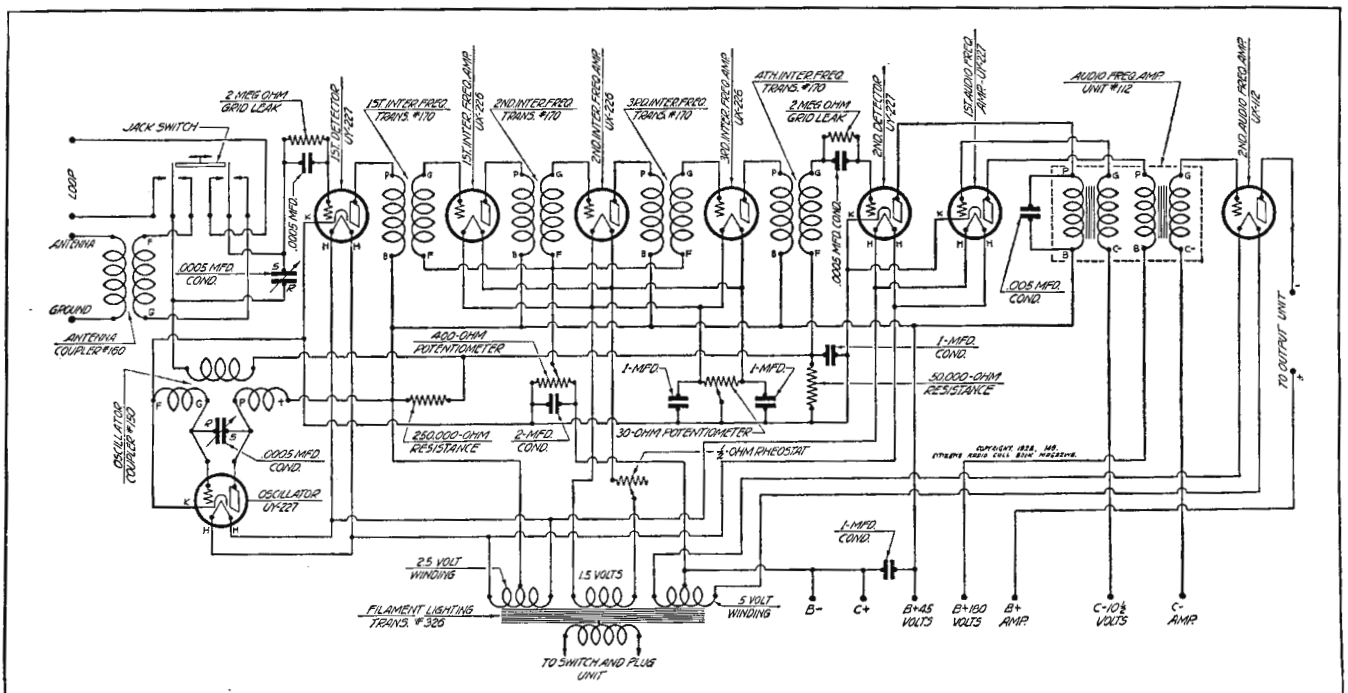

Figure 4. Electric details of the circuit may be found by consulting the schematic diagram shown above

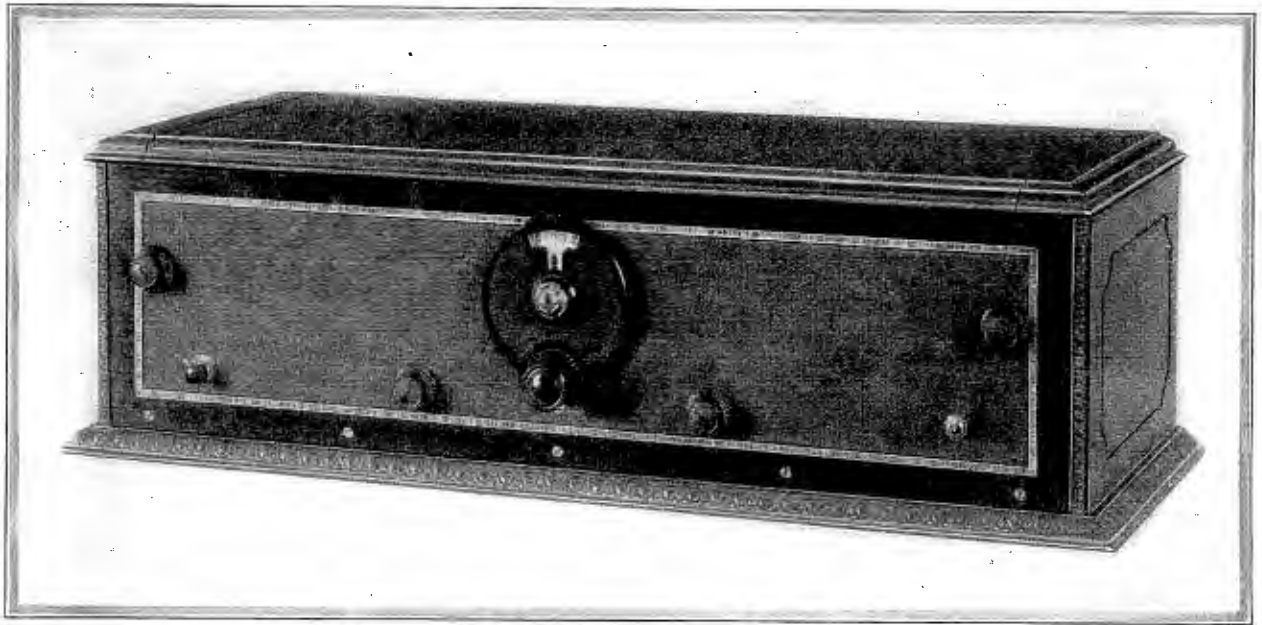

Figure 5. In this photograph the Victoreen has been placed in a Southern Toy cabinet

When a power amplifier is to be used with the receiver described herein, the one illustrated in Figure 2 may be built. This consists of a 210 power tube whose plate voltage is supplied by the two rectifiers arranged in full wave. In that event the 112 tube is left out of the receiver and the G binding post on the power amplifier is carried to the grid post on the last audio transformer on the receiver.

Looking at the schematic of the power amplifier shown in Figure 7, it will be seen that this consists essentially of a Victoreen 116 power transformer, which has a high voltage winding and two 7.15 volt windings, one of these windings being utilized for the filaments of the 210 power tube and the other 7.5 volt winding being used for the filaments of the 216-B or 281 rectifiers. Two resistance banks, No. 316, are placed in parallel across the extremities of the rectifier so as to allow the operation of the suggested that the loop be used, since it will give almost as good results as an outside aerial, with greater selectivity and with the additional fact that advantage may be taken of its directional qualities. There should be little, if any, hum in this receiver. Any hum present is likely to be caused by the a. c. filament of the 210 power tube. In the event hum is present to a marked degree, it may be caused by the 30 ohm potentiometer being open. The gested districts with an outside aerial. In these districts it is

unit without undue heating. Suitable taps are provided by means of a clip, so that any voltage desired within limits may be secured. When using the power amplifier, the speaker windings are not directly in the plate circuit, but are located across the two terminals on the Victoreen 115 output unit.

Safety Fusing Device

As a means of safety and to prevent the possibility of burn-outs and short circuits, the reader will observe that a 6 volt lamp is placed between the center tap of the high voltage winding and the common B negative line. Thus, if through some error a short circuit is made, the device will not be harmed, since the 6 volt lamp will either light up brightly or else burn out and thus give a warning that some connection is wrong in the circuit. As it should be customary with all set builders, all connections should be gone over very carefully against the original circuit to make sure tha nothing has been forgotten or connected erroneously.

Operating Hints

Operation of the receiver is not recommended in very con- 116 power supply transformer should always be placed at least 18 inches away from the audio end of the radio set to prevent inductive hum. A defective choke in the power supply may also cause a hum. If a dective part is suspected, it is lways well to borrow a set of batteries and substitute for power supply or C supply. Should the hum not cease when batteries are substituted, the hum must be in the radio set itself. Insufficient C bias may overload the power supply and cause a hum. Another source of

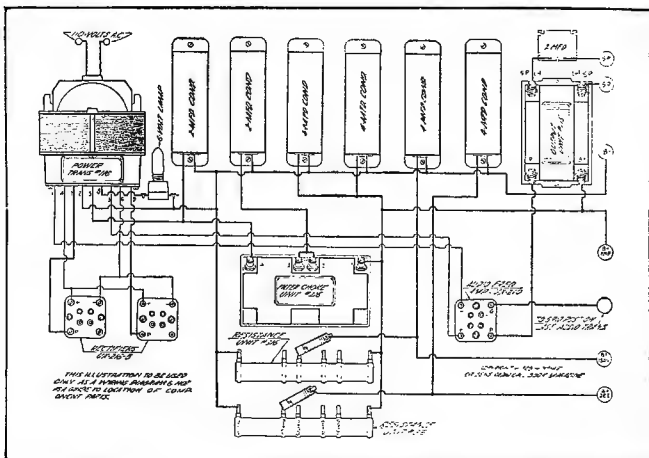

Figure 6. Diagram shown above is a graphic one, by means of which all connections may be made in wiring up the power amplifier

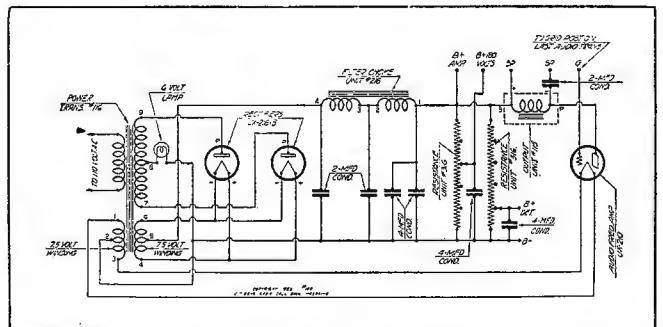

Figure 7. Here is shown the schematic circuit of the power amplifier which may be used for reference, but should not be used for wiring since the graphic, Figure 6, is simpler to follow

Simple "A" Supply Unit for Owners of 32 Volt Delco Plants

Stepped Resistance Bank Serves to Allow Operation of Sets Using from One to Nine Quarter-Ampere Tubes

PRACTICALLY every owner of a farm lighting plant using Delco 32 volt system has at some time or other since their acquisition of a radio set wished for a means of eliminating the inconvenience of running a pair of filament wires from the residence out to the lighting plant.

Inasmuch as there are nearly a half million owners of farm lighting plants using the 32 volt direct current method, it is quite likely that a scheme for obtaining the filament supply for a radio set directly from the light socket in the home will be interesting and acceptable.

Simplifies Receiver Operation

Many owners of radio sets who live in the country and who have not cared to buy a separate A battery for operating the receiver have been faced with the necessity of stringing a pair of insulated wires from their home to the point at which their farm lighting batteries are located. This line has then been clipped across one of the sections of the 32 volt battery to secure current for the receiver in the house. If the set were to be operated constantly from that single section, it would result in running down that particular battery and creating an unbalanced condition in the storage battery circuit. To obviate this condition, the operator has found it advisable to shift the clips from one battery to another, so that approximately an equal drain is given each one of the units making up the 32 volt bank. Naturally this is more or less of an inconvenience and for that reason any method of eliminating this procedure should prove of more than passing interest to the owner of a farm lighting plant. In addition to the inconvenience, the length of the filament circuit leads extending from the power plant to the house is such that the filament circuit becomes the equivalent of an aerial and decreases the amount of selectivity which would normally be expected from the receiver. In fact, in many locations with long leads from the lighting plant to the residence, it is possible to eliminate both antenna and ground and still secure a fairly strong signal on stations located two or three hundred miles away from the receiver.

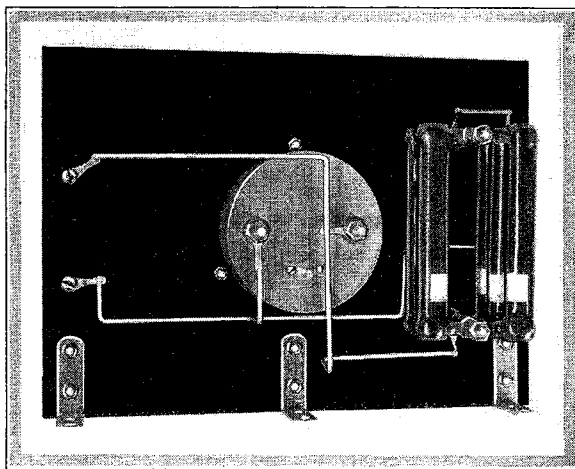

Figure 2. Rear photograph of the A supply unit for Delco 32 volt plants. The resistor bank is shown at the right

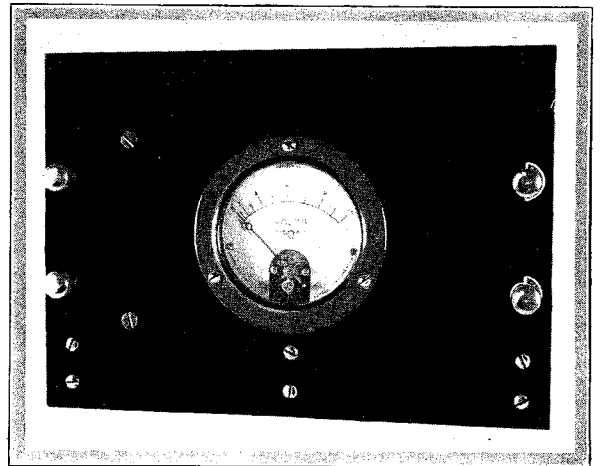

Figure 1. Photographic view of the Delco A supply with the binding posts for the 32 volt direct current input at the left and the 6 volt direct current output at the right

One of the simplest methods of eliminating this battery line difficulty is to make up a small unit containing a number of resistors in parallel so as to drop the 32 volt direct current down to a value where it may be utilized by the receiver. In causing this voltage drop in order to pass sufficient current, it is necessary that the resistance be placed in parallel, especially for operation of the larger receiving sets using from seven to nine tubes.

Small and Compact Unit

In the model which was recently designed and tested in our laboratory, the unit has been condensed into a very small job and uses only a 7x10x $\frac{1}{4}$ -inch panel, with suitable angle brackets at the bottom to maintain the panel in an upright position, five resistors, values of which will be given later in this article, a 0.10 direct current voltmeter, four binding posts and four 2 $\frac{1}{2}$ -inch 8-32 nickel plated brass screws. The completed unit is shown photographically in Figure 1, with the input terminals for the 32 volt system at the left and the output terminals for the 6 volt supply at the right. The resistances in parallel are placed at the right of the panel between the input terminals and the voltmeter, as may be seen by referring to the photograph of the rear view shown in Figure 2. When constructed, such a unit may be plugged in to the light socket in the home and the filament wires from the receiver placed on the output binding posts in the same manner as if a storage battery were being used. This supply unit may be kept alongside of the receiver or, if desired, it may be placed in the basement and suitable wires run through the front from the supply unit to the receiver. When doing the latter, however, it would be well to have a control switch near the set so that when the set is not to be used, the input circuit may be broken so it will not consume current when the set is standing idle.

Charging In the Daytime

In most 32 volt farm lighting systems, the house lights are run on batteries at night, while the motor is run in the daytime to

(This device designed, tested and all illustrations made in our laboratory)

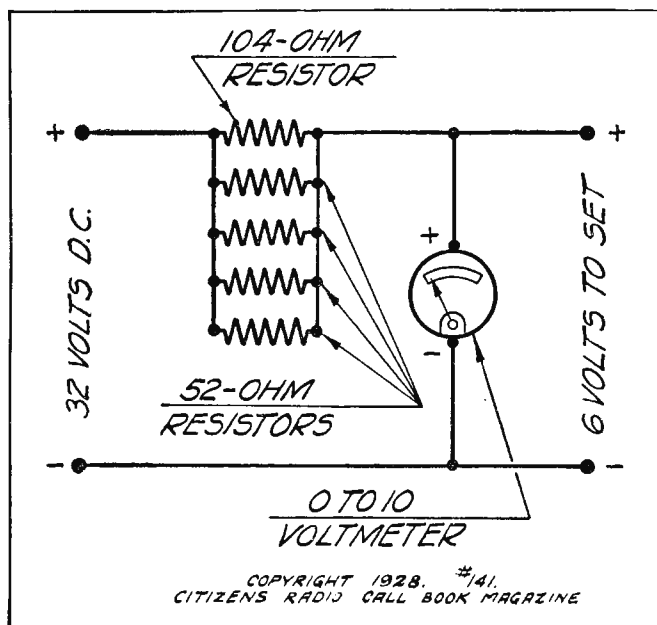

Figure 3. Schematic circuit of the unit is shown above. All five resistances are shown in position for the maximum load the set will be called upon to deliver. This unit will handle a receiver using nine quarter-ampere tubes

compensate for the amount of current used the night before. Under these conditions since the motor will not be running at night, there is no difficulty to be expected from commutation or noises incidental to the running of the generator.

The voltmeter shown in the unit is placed there for two reasons. The first is that the operator can always note the voltage applied to his receiver. The second, and one which is more important, the meter serves to show the user that the unit is plugged into the light socket with the proper polarity. If the voltmeter does not read but the needle kicks towards the left, on the scale, it is an indication of the fact that the plug has been placed in the socket in the wrong direction. It should then be removed and reversed. It is not a good idea to leave the plug improperly poled, because when improperly poled the meter is likely to be damaged if reversed polarity is left for any great length of time. Therefore, the meter serves two purposes, either one of which justifies its employment.

Ample Heat Dissipation

Any resistors which carry current should be mounted with due regard to a safety factor. As will be seen by examining the drawings and pictures accompanying this article, the resistors are mounted on 2½-inch nickel plated brass 8-32 screws, so resistance units may be added to or taken from the rack to secure the proper current for the receiving set. On account of the form of mounting, it will be readily seen that sufficient clearance has been allowed between the rear of the front panel and the resistors to permit ample ventilation.

Using the maximum number of tubes for which this unit was designed (nine one-quarter ampere), the total wattage for the resistors will be called upon to handle is 58½ watts.

If a single tube receiver is used, the 104 ohm resistor only has to handle 6½ watts. It will deliver 6 volts at a quarter-ampere.

Two values of resistance have been allowed. There are four 52 ohm resistors and one 104 ohm resistor. The single 104 ohm resistor when used in conjunction with the other resistors will give the proper resistance for the operation of any receiver ranging between one and nine tubes.

Thus, for a one tube set where a type 201-A tube is used, drawing a quarter-ampere, only one resistor is used, this having a value of 104 ohms and dissipating 6½ watts.

When two quarter-ampere tubes are used, the 104 ohm resistor is removed and one 52 ohm resistor substituted. This gives 6 volts at a half-ampere.

When three quarter-ampere tubes are used, one 52 ohm and one 104 ohm resistor are placed in parallel. This gives 6 volts at three-quarter amperes. If four quarter-ampere tubes are used, two of these 52 ohm resistors are paralleled.

With five quarter-ampere tubes in the receiver, the proper resistance unit would be two 52 ohm and one 104 ohm resistors in parallel.

For a six tube receiver, three of the 52 ohm resistors in parallel will give 6 volts at 1½ amperes.

A seven tube set would require 1¾ amperes and to secure this current it will be necessary to parallel three 52 ohm resistors and one 104 ohm section.

When using eight tubes of the quarter-ampere type, the operator will need to parallel four of the 52 ohm resistors.

Maximum current to be expected from the unit will be 2¼ amperes, which will be obtained when four 52 ohm resistors and one 104 ohm section are paralleled.

Since both the 112 and 171 tubes are now available in the quarter-ampere filament type (112-A, 171-A), it is very easy to determine which resistor is to be used from the foregoing description, since all tubes of the storage battery type will consume a quarter-ampere a piece.

No rheostat has been provided on this model, since it was felt that it was destined to take the place of a storage battery on 32 volt farm lighting systems and that the rheostats in the receiver itself would function in the same manner as if a battery were being employed.

Parts used in the construction of this A supply unit are as follows:

- 4—LH52 Ohmite power resistances
- 1—LH104 Ohmite power resistance
- 1—Celeron 7x10x¼-inch panel
- 4—XL binding posts
- 1—54 Jewel 0-10 d. c. voltmeter
- 3—Angle brackets
- 4—Nickel-plated brass screws 2½-inch long, 8-32
- 1—Pkg. Kester radio solder
- 1—Roll Belden hook-up wire
- Miscellaneous—lugs, nuts, bolts, etc.

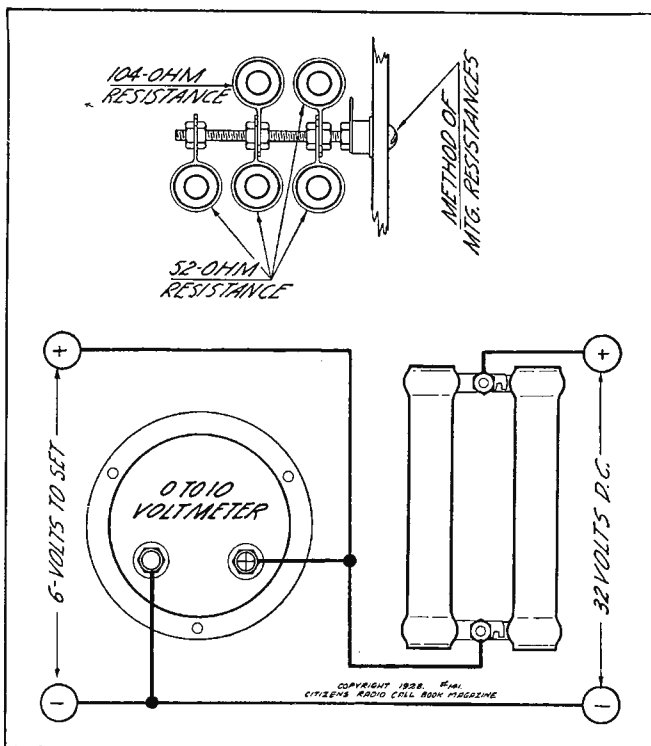

Figure 4. Above is the graphic diagram, by means of which the supply unit may be wired. In the detail drawing above the graphic is shown the method of mounting the resistors in parallel

Melo-Heald Hot Spot Fourteen Uses New Shield Grid Tube

An Excellent Receiver Improved by the Use of the New Tube and Power Amplifier

THE old style Melo-Heald Hot Spot Fourteen having met with great success in the ranks of the professional set-builder, our laboratory has received many requests for a conversion of this popular receiver, incorporating the new type 222 shield grid tube. After due experimentation, there has been produced this conversion which is illustrated and discussed in this article.

The model shown in the September, 1927, edition of the Call Book, although very selective and possessing an abundance of good volume, is not critical, a virtue not often found in radio receivers. It has always been a puzzle to radio designers, why the public insists on matched dial settings, when in every other respect a receiver is functioning perfectly. In this new receiver it will be noticed that the loop or left hand dial will be several divisions below the oscillator or right hand dial, this in no way detracts from the efficiency of the receiver. It will also be found that this difference increases as the wave length decreases, in the extremely low wavelengths it will be noticed that there is as much as eighteen degrees difference between the two dials. No difficulty should be experienced by this fact, since stations once logged will be found at the same setting providing no changes are made in tubes or power supply.

In tuning for distant stations, we would suggest determining its probable location on the dials by comparing the wavelength of the desired station to that of some known local, adjusting the receiver for maximum volume from that station, providing the local is interfering with the distant station. This is accomplished by turning the potentiometer away from the critical position in the direction that will reduce the volume without distorting the signal, and turning the loop regeneration knob toward the critical point. It may also be necessary, in determining a good setting

for resonance, to retard the volume control at the same time. After tuning the local station to its maximum volume rotate the loop to a point where the local signal is at a minimum.

The loop regeneration knob, in Figure 2 the small control between the two condenser dials, should be adjusted until the first detector tube is thrown into oscillation and then retarded just off this critical point. These adjustments should be made with the volume control set at maximum.

Rotating Dials in Resonance

It will seem, with the first few operations of this receiver, that it is very difficult to operate, this idea will be dissipated after the operator becomes acquainted with the peculiarities of it and after the knack of rotating the dials in resonance is acquired, there should be no difficulty in tuning in station after station. It seems only logical that a receiver of this kind, where such excellent results are obtained, requires no little skill in operating it.

Continuing with the instructions for operating this receiver, after making the adjustments outlined above, advance the potentiometer knob, the first knob to the left of the milliammeter in Figure 2, until the intermediate amplifiers break into oscillation and then retard it just off this critical point, thereby putting them in a state of efficient operation.

Rotate the dials slowly and simultaneously until the distant station is received. After a few nights of operation, when all of the receiver's characteristics are ironed out, the operator will be well pleased with the results obtained. It will be noted that some distant stations will be received within the same setting on the dial that is ordinarily covered by a local station. It has been found that a plate supply of 48 volts on the intermediates and oscillator during this process materially improves the quality of

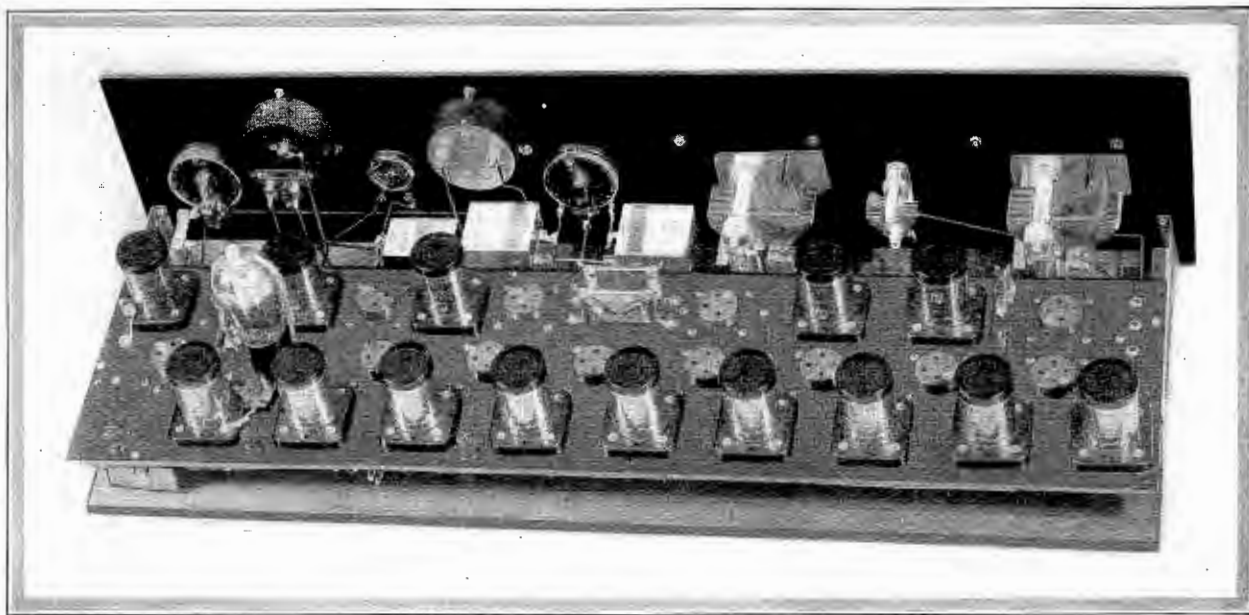

Figure 1. The neat, compact arrangement of parts shown in this rear-view photo is proof of its simplicity

(This receiver tested and all illustrations made in our laboratory)

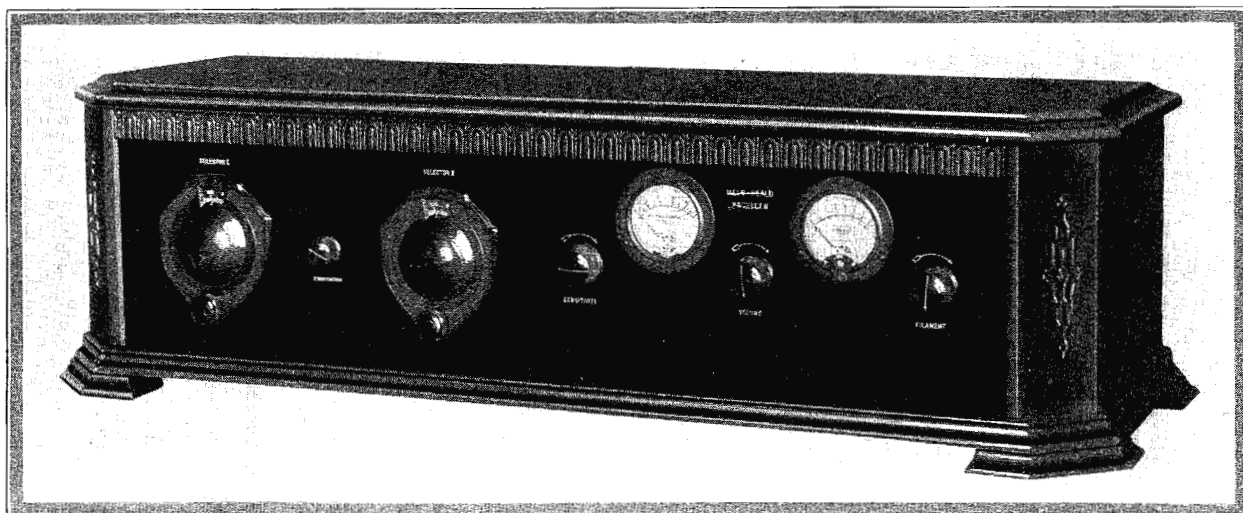

Figure 2. The completed receiver is shown here in a desk-type cabinet

the reception. Also when extreme selectivity is desired, it has been found that slightly better results are obtained when the intermediate amplifiers are supplied with less than the recommended 3 to $3\frac{1}{4}$ volts of filament voltage.

Figure 5 shows the graphic wiring diagram. This diagram is not to be used as a baseboard layout but is merely a wiring diagram and not a guide to location of component parts. After wiring the receiver it is advisable to check back the wiring diagram very minutely, before testing for actual reception, in order to rectify any errors that may have been made in its construction. From the grid post of the eighth intermediate transformer the reader will observe an armored section of wire with a cap connected at the free end, the cap is to be connected to the top of the UX 222 and the armor to be grounded to negative filament. Care should be taken in connecting the milliammeter that the polarity is not reversed, oftentimes when the needle is thrown violently in the opposite direction (as it will when the polarity is reversed) it will break off or cause an untrue reading when brought back to its original position.

Filament and Plate Readings

By means of a small switch located at the bottom of the Jewell voltmeter, readings may be taken of the filament voltage on the intermediates and of the plate voltages. This meter having a common negative lead with terminals for the high and low voltages conveniently placed on the rear of the instrument. Figure 2 shows the symmetrical arrangements of the various controls and meters on the front panel.

Sub-panel construction was used in this receiver to facilitate the wiring, which would be rather complicated if the baseboard arrangement were used. With the drilled panel and sub-panel, Figure 1 should give the prospective set-builder the approximate arrangement of parts for the construction.

Providing the loop is not defective it should be an easy matter to set the first detector tube into oscillation by turning up the loop regeneration knob, which controls the .000032 mfd nidget condenser. If it is not possible to throw this tube into oscillation by this method the loop should be tested and examined for any possible defects.

Use Good Tubes

If the loop shows no defects a different tube should be placed in the socket and tried in the same manner. Make sure that the tubes are of good standard make and that they have been tested. Melocouplers 420 and 460, mixing coupler and oscillator, should be re-checked to ascertain whether there are any errors in the wiring of these two units.

To determine if the oscillator is functioning satisfactorily place

one finger on the grid terminal of the oscillator socket and another finger of the same hand on the minus socket filament terminal. Then note the milliammeter reading, which should be about four milliamperes less than when the fingers are removed. If this change is not apparent when the test is made, a check-up on Melocouplers 420 and 460 should be made, testing them with a meter or any other method that might afford itself to the builder, to determine whether they are not open. The proper voltages have been found to be five volts on the filaments of the detector and oscillator and from 45 to 48 volts on the plates.

It has been found that better quality reception is noted when detection is accomplished by the use of a "C" bias in lieu of the conventional leak. It is possible to increase the sensitivity on the second detector by using a smaller bias, for instance, from $4\frac{1}{2}$ to 3 or to $1\frac{1}{2}$ volts negative. Care should be taken, however, in making this change, for it is necessary to run a separate lead from the terminal of the Melocoupler 469 to the C battery instead of merely changing the C battery clip since the first two stages of audio frequency amplification utilize this same bias and by changing the clip on the battery it would change the bias on them also, which is undesirable and objectionable in this case.

A rough way of checking the second detector tube and the audio amplifier is to throw the intermediates into oscillation. When this is done a thump or whistle should be audible in the loud speaker if these units are functioning properly.

In view of the fact the shield grid tube plate voltage should not exceed 135 volts, it will be necessary to use a 112 in the last stage of audio amplification instead of a 171, as is sometimes done when the "Hot Spot" Fourteen is constructed without the shield grid tube. An examination of the wiring diagram will show the reason for this.

Test All Windings

A fairly effective method of testing to be certain of the continuity of all circuits is to use a voltmeter with a sufficiently high reading so that the maximum plate voltage used on the tubes will not throw the meter off of its true scale. Adjust the receiver to its normal operating condition, and remove all the tubes, care should be taken, however, to turn off the filaments of the 199 tubes before attempting to remove them (the same care should be taken in inserting them after the test), since the removal of one or more of the tubes, while the others are burning, will increase the voltage and injure the tubes. When the tubes are removed, turn on the filament voltage and with the positive lead from the voltmeter touch the plate terminal of the last a.f. tube socket, with the negative terminal touch the grid terminal of the last a.f. tube socket. The reading on the voltmeter if the circuits are continuous should be the amount of B voltage applied to that tube plus, of course, the C voltage to that grid. This test

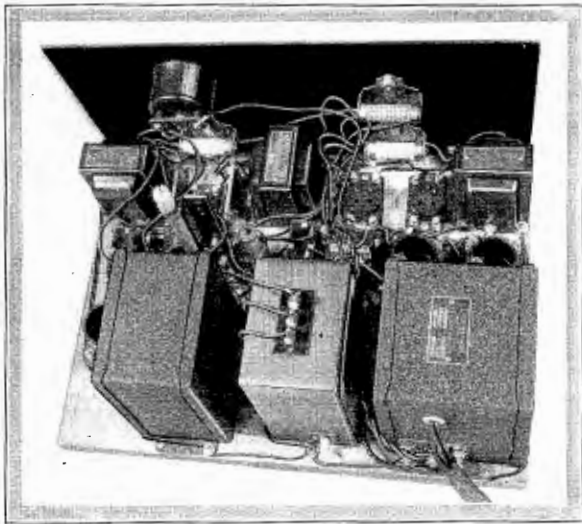

Figure 3. This rear-view photo of the power pack used in conjunction with this receiver illustrates completed unit

may be carried on in the same manner throughout the receiver. Care should be exercised in this regard to determine whether or not there are no other connections that would make the circuit in question appear continuous.

Any deviation of these readings will show the presence of an undesirable condition. It does not mean, however, that this method will show all trouble that might occur, but it is a fairly good indication of the most frequent difficulties that the average person will encounter. It is not necessary to operate this receiver on batteries. There are a number of good eliminators, both A and B, on the market which perform satisfactorily with this receiver. The best test for an eliminator is to try it in an actual receiving set, purchasing it with the understanding that if it proves unsatisfactory it may be returned.

The Hot Spot Fourteen was designed to eliminate the presence of a station at more than one place on the oscillator dial and this receiver if properly constructed in accordance with the specifications given below will function in this manner. In case repeat points are noted on a station it is the result of the loop being in a state of oscillation, battery leads over six feet in length, or a harmonic from the broadcasting station itself (a condition over which the reader has no control), or the intermediates in a state of sustained oscillation.

The Robertson-Davis Company is equipped to furnish all plans and specifications necessary to construct this receiver and, in addition, they will be pleased to answer any questions which may not have been covered in this article.

May Use Power Amplifier.

With the present desire for power amplification, some builders may wish to incorporate this feature in the "Hot Spot" Fourteen.

It is for this reason that we illustrate and discuss the amplifier shown in Figure 3 to be used in conjunction with this receiver. The schematic is plainly shown in Figure 4, and this unit can be wired from this wiring diagram. It is only necessary to connect the plate of the second detector to the plate of the first audio frequency transformer in the power amplifier, instead of making the connection to the first Meloformer. If this is done, however it is necessary to retain the .006 mfd bypass condenser already existing in the receiver proper. It will be noted that when using the power amplifier, no audio frequency is used in the set proper. This is because it has been found best to embody the entire a. f. power amplifier in one unit rather than separating it, part in the receiver and part in the power amplifier. Drilling templates for the panel and sub-panel may be secured by the prospective builder from the Robertson-Davis Co.

By referring to the photograph shown in Figure 3, the reader

will observe a rear view of the high voltage power supply and amplifier, the schematic for which is contained in the diagram shown in Figure 4.

Essentially, this amplifier consists of a Thordarson 2098 power transformer having a high voltage winding for the 281 rectifier tubes, a low voltage winding for the filaments of the rectifiers, a second low voltage winding for the filaments of the 210 tubes in the amplifier and a primary winding for the 110-volt supply; a filter choke 2099 which is contained in a separate unit; a 2408 Thordarson input transformer and a 2420 output transformer, together with the R-200 audio transformer. In addition to this there is an Acme Parvovolt R-210 condenser block for filtering purposes and suitable Electrad fixed and variable resistors so that besides the high voltage which is placed on the plates of the 210 tubes arranged in push-pull, voltages of 135, 90 and 45 may be secured. The necessary bias for the grids of the 210 tubes is secured by the drop across the 2,000 variable resistance located between the center tap of the low voltage secondary serving the 210 filaments and the common negative of the high voltage secondary, the common of the filter block and the bottom of the fixed resistance train. Bias for the grid of the 201-A used in the first audio stage is secured by the drop across the 500 ohm potentiometer located between the common negative line of the power supply and the B minus terminal of the set as shown in the schematic.

By referring to the schematic in Figure 4, it will be noticed that an 874 regulator tube is used between the positive 90 volt terminal and the common negative of the supply unit, this regulator tube being employed as a means of stabilizing voltages between 90 and the negative, so that regardless of the drain on the amplifier unit, these voltages will remain at a fixed value, a procedure which is quite necessary when used with a receiver employing an oscillating circuit, such as the superheterodyne. This stability of voltage permits the operation of the oscillator without a tendency towards modulation which might be expected if the power supply were not rugged and extremely stable in its operation.

Parts, as shown below, are required to build the receiver described in this article:

(Receiver)

- 14—9042 Benjamin spring sockets
- 1—669 Yaxley cable plug
- 3—Eby loop binding posts
- 2—Sangamo .006 fixed condensers
- 3—Eby "C" battery binding posts
- 1—Sangamo .00025 fixed condenser
- 1—Pair grid leak clips
- 1—Durham 4 megohm metalized grid leak
- 1—804 Yaxley 4 ohm fixed resistance
- 1—503 Yaxley 3 ohm semi-fixed resistance, double arm, base mounting

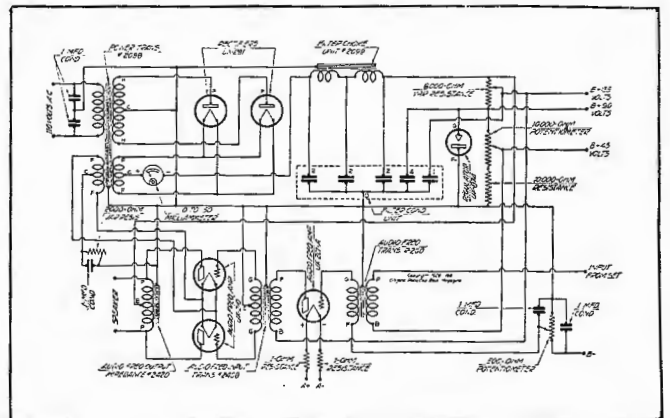

Figure 4. A wiring diagram for the power pack is shown schematically above

Citizens R. F. Amplifier May Be Used Before Any Receiver

Simple Unit Designed for Those Who Wish to Add a Stage of Radio Frequency Ahead of an Existing Receiver

MANY readers of this magazine have in the past written our Information Department for data on the construction of a simple radio frequency amplifier which might be added to an existing receiver, either as a means of increasing the overall radio frequency amplification of the set or, in congested districts, as a means of to some extent sharpening the tuning of an existing receiver.

It is in response to these requests for information that the radio frequency amplifier about to be described has been constructed by our laboratory staff and tested out in conjunction with a number of present day small receivers.

Long or Short Antenna

In designing a simple unit such as the one shown photographically in this article, it was desired to provide a means of changing from a long to a short antenna connection so that the builder would have a certain amount of flexibility that might be helpful in the operation of such a device. As a consequence, two binding posts are provided, one for a long and one for a short antenna connection. The equivalent of a long antenna condition is obtained by the use of a .00025 mfd fixed condenser placed in series with the antenna.

Uses Rice Bridge Circuit

In order to allow as efficient balancing as it is possible to secure in a radio frequency amplifier, the staff considered it advisable to make use of the well known Rice bridge circuit, where the tuning is across the extremities of the secondary coil, one end of which is linked back to the plate circuit of the tube through a .000025 mfd variable midget condenser, the actual grid return to filament being through the center tap on the secondary inductance. This method of bridge circuit allows balancing of the tube at any point within the range of the tuner. For example: the receiver can be made regenerative either at 200 meters or at 500 meters, as desired by the operator.

Cut In or Out Unit

To add further flexibility to the operation of the receiver, a switch is provided on the radio frequency amplifier unit by means of which the added radio frequency stage may be either cut in or out, in accordance with the wishes of the operator. When the switch is thrown in one direction, the amplifier is cut in, while in the opposite direction it is thrown out.

Essentially the radio frequency amplifier unit consists of a

home-made inductance, the details of which are shown in the sketch at the top and right of Figure 4; a .0005 mfd variable condenser, a .000025 mfd midget variable condenser for balancing purposes, a radio frequency choke and the several bypass condensers shown in the schematic circuit, Figure 2. The variable condenser is General Radio, the balancing condenser Silver-Marshall, the radio frequency choke coil shown a special one made by the Radio Service Laboratories, fixed condensers by Sangamo, bypass condensers by Acme, rheostat and jack switch

by Carter, socket by Benjamin, Kurz-Kasch dial, Eby binding posts, Formica front panel and terminal strips and Aluminum Company of America stage shield.

Referring to the schematic circuit shown in Figure 2, the reader will observe that when using a short antenna, the connection is made to the top binding post marked "short antenna," the signal energy traveling directly through the primary of the radio frequency inductance and thence to ground. The ground in this case is common with the shield, since that method considerably simplifies assembly and wiring. When using a long antenna the connection is onto the long antenna binding post through a .00025 mfd fixed condenser and thence through the primary to ground. This allows the operator a choice of either long or short antenna for best operation of the receiver.

One end of the secondary inductance goes directly to the grid of the tube and the stator of the .0005 mfd variable condenser. The center tap of the coil is common with the shield, while the lower extremity of the inductance goes to the rotor of the .0005 mfd variable condenser and the rotor of the .000025 mfd midget variable condenser, whose stator leads to the plate of the tube.

Winding Data

Windings each side of the center tap on the secondary inductance are of a like number of turns, number 26 double silk covered wire being utilized and 38 turns being wound in each section. The diameter of the coil form is $1\frac{3}{8}$ inches. The primary coil which is located at the lower end of the tube consists of twenty turns of the same size wire mentioned previously and a space of a quarter inch is allowed between the primary and secondary windings.

In the plate circuit of the radio frequency amplifier is located a radio frequency choke coil, which is bypassed by a .0005 mfd

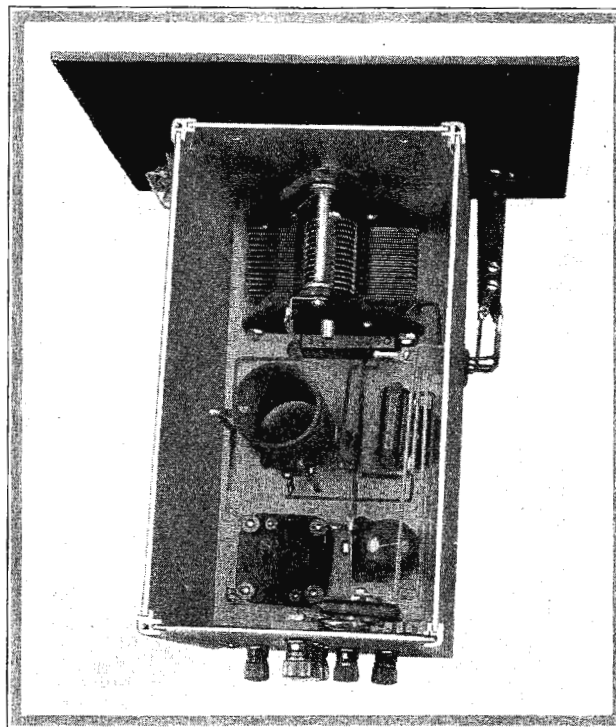

Figure 1. In this photograph may be seen the single stage r. f. amplifier described in this article

(This amplifier constructed, tested and all illustrations made in our laboratory)

fixed condenser, the plate supply for this stage being 90 volts. In the event that the operator's receiver does not have a bypass condenser located within the set from the 90 volt terminal to the filament, the .5 mfd bypass condenser shown in the schematic as being optional may be utilized.

After the amplifier unit has been wired in accordance with the graphic diagram, it would be well for the builder to thoroughly check all connections to make sure that they are tight and also to guard against a short circuit between any of the high potential sections of the unit and the shield. This is especially true

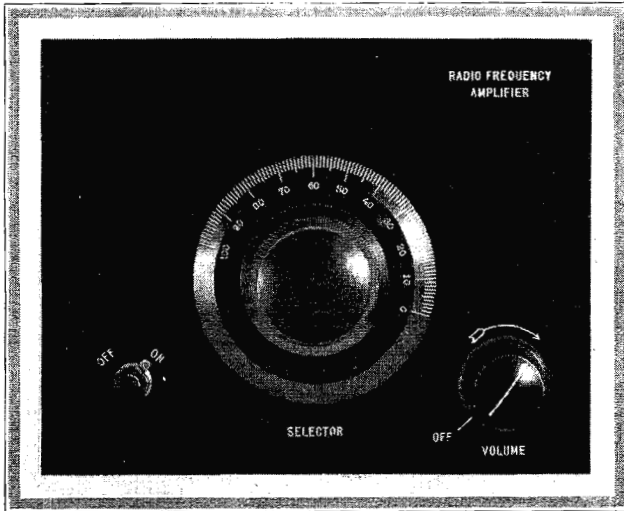

Figure 3. This photograph represents the front panel of the radio frequency amplifier

in the case of the stator of the midget condenser, the plate terminals of the tube or the terminals of the radio frequency choke. These parts as well as the .00025 mfd fixed condenser and the .0005 mfd fixed condenser are at high potential, and if not properly insulated, may short circuit against the shield, which would result in burning out a tube.

Balancing the Set

In selecting a circuit for this amplifier unit, two desirous conditions were met. First, an amplifier which would not oscillate; second, an amplifier which would not radiate energy. The Rice circuit was picked from several as being the most adaptable for the home constructor to build. It is necessary, however, to balance the unit so that it will not oscillate. This may be done in the following manner: Having a unit connected to a receiver and operating, select a station on the low end of the scale, i.e., short wave lengths, preferably at about 10 or 20 degrees. Tune in the station on the receiver alone, then turn in the amplifier with the switch and locate the station, then gradually turn down the filament rheostat, at the same time turning the dial in both directions across the signal. By this method the exact point of resonance will be obtained, as the unit becomes sharper as the filament is turned down. Having come to the lowest point on the rheostat and the exact point of resonance on the dial, turn the rheostat off entirely, which will turn off the tube, being sure that the dial is not moved. Then turn the .000025 midget condenser until the signal entirely disappears. If the station is local and is very loud, the signal will continue to come through the unit. If so, turn down your receiver until you can find the "dead" spot or the "balance" spot with the midget condenser. Then turn on the rheostat and the unit will be balanced. It should not oscillate and at the same time will not radiate energy.

Parts used in the construction of this amplifier were:

- 1—247 General Radio .0005 mfd variable condenser
- 1—Sangamo .00025 mfd fixed condenser
- 1—Sangamo .0005 mfd fixed condenser
- 1—Acme Par-volt .1 mfd bypass condenser
- 1—Silver-Marshall .000025 mfd balancing condenser
- 1—Home-made r. f. transformer as per specifications in article

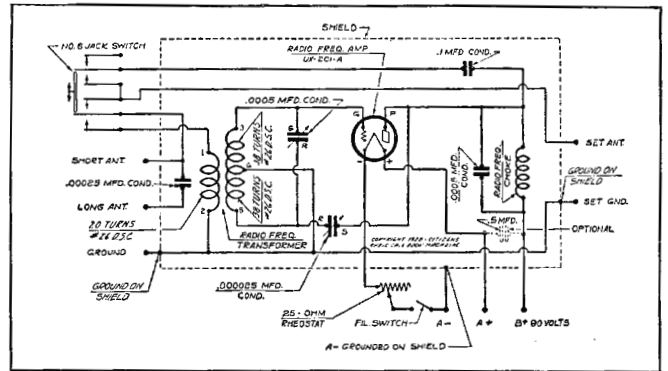

Figure 2. The schematic circuit showing all electrical connections is contained in the drawing shown above

- 1—Radio Service Laboratories r. f. choke
- 1—Carter 25 ohm rheostat and switch
- 1—Carter jack switch
- 1—Formica 7x9x3/16-inch front panel
- 2—Formica 3/4x4x3/16-inch terminal strips
- 8—Eby engraved binding posts
- 1—Benjamin socket
- 1—Kruz-Kasch 4-inch plain dial
- 1—Aluminum Co. of America stage shield
- 1—Sonatron type 201 A tube
- 1—Composition 3/8-inch bushing
- 40—Ft. Acme Celatsite hook-up wire
- 1—Pkg. Kester radio solder
- Miscellaneous—lugs, nuts, screws, etc.

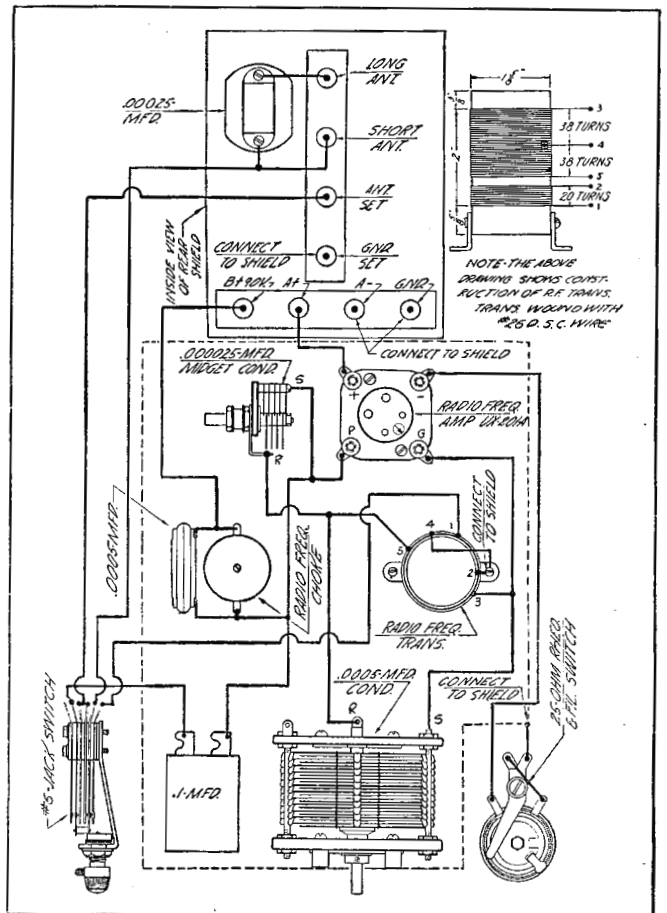

Figure 4. Wiring of this unit should be accomplished by means of the graphic illustration represented above. Details as to the number of turns and wire size are shown in the insert sketch at the top, at right

Advanced Operating Notes on Tyrman "70" Shield Grid Amplimax

Assembly and Wiring of Receiver May Be Greatly Simplified
by New Graphic Illustration

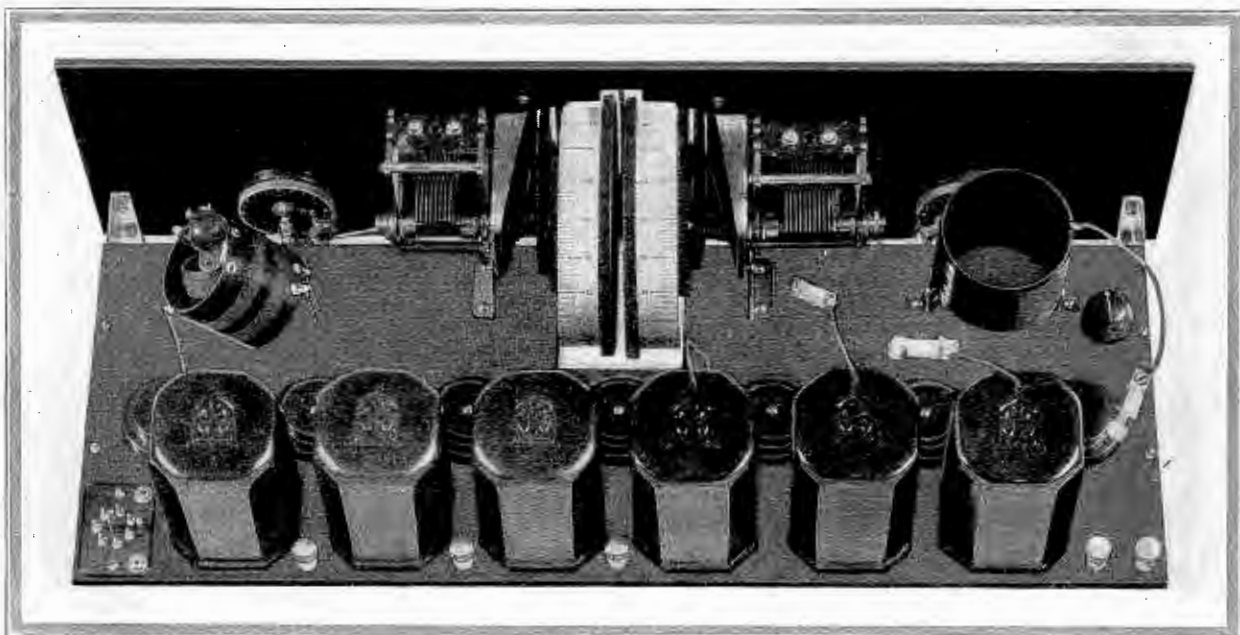

Figure 1. This photograph shows the rear view of the Tyrman Amplimax as constructed and described in our January issue

ORIGINALLY described in the January issue of this magazine, the Tyrman 70 Shield Grid Amplimax has proven to be one of the most outstanding and successful receivers which our laboratory has seen. The exceptional qualities of the shielded grid tubes have been utilized and the results obtained so satisfactory the set has gained instant popularity.

Since the publication of this original receiver, innumerable expert set builders have communicated their operating experiences, a portion of which experiences is contained in the following article. This data will be of benefit to those who have followed the first instructions without going into further details of the design. Therefore, to simplify the work of the set builder, the diagram in Figure 2 is published to show the exact position of all connecting leads. This diagram has been worked out in order to prevent regenerative feed back and seek the best possible location of all wires. As a further help, the photograph in Figure 3 is presented, since it represents the craftsmanship of an expert set builder.

It would be well to call to the attention of the set builder and operator that the determining factor in the apparent selectivity of the receiver lies in the type of antenna which is used. For example: if a 30, 40 or 50 foot antenna is used, it is quite likely the set will be broad. This broadness can be curbed to some extent and still retain a good amount of sensitivity if the antenna is cut down to reasonable lengths, such as from two to ten feet, depending on the location of the receiver. Even a ten foot antenna on the set, if located in the basement of a steel building, would not be likely to give satisfaction. The same ten foot length used on the top of a fifteen or twenty story building would be entirely too much, so after all, the length of antenna must be ascertained

by the operator after having tried several lengths for best results.

It should also be noted if the receiver is operated with a long antenna and at its maximum amplification, it is quite likely there will be a tendency for the detector tube to overload on strong local signals. This will be manifest at once by the blocking sound which occurs when a heavy signal is impressed on the grid of the second detector. As far as is known at present the only method of cutting down detector blocking is to decrease the amplification ahead of the detector so that it will not overload. Use of a 112-A tube in the second detector will help some in preventing distortion through detector overload, although even this tube has its limitations. Apparently what is required is a power detector, and that type of tube seems to be the next development on which research should be expended.

Another point for the operator to remember would be the fact that in tubes of this nature the filament is fairly sensitive to overload, and for that reason it is not advisable to operate the shielded grid tubes at more than their rated filament terminal voltage, this value being 3.3 volts with a current consumption of .132 amperes per tube. Filament current on the first detector in this receiver is governed by a 25 ohm rheostat in series with a 15 ohm fixed resistance, while the filaments of the first and second intermediate amplifiers are governed by a 15 ohm rheostat through fixed resistances. In practice the 25 ohm rheostat can be turned full on, except on local stations. The 15 ohm rheostat will then give sufficient control of volume.

Position of the wires when wiring up the receiver is very important and for that reason the wiring should be done exactly as outlined in Figure 2.

(This receiver tested and all illustrations made in our laboratory)

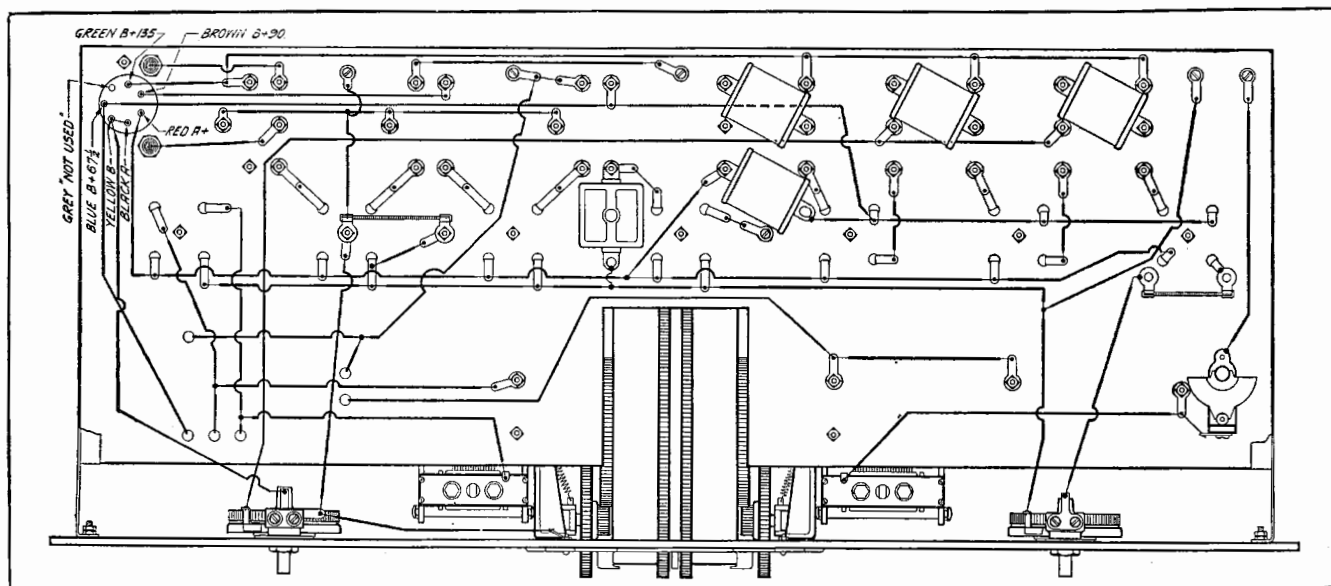

Figure 2. Professional set builders and others who are accustomed to wiring a number of sets will appreciate the simplicity of the graphic diagram shown above, which represents all the connections involved in constructing the receiver

As a protective measure, to prevent possibility of burning out the oscillator tube, it would be well for the builder to insert between the rotor of the oscillator condenser and the oscillator plate a .005 mfd fixed condenser. Then if the variable condenser plates are shorted, the tube will not be endangered. In removing the clip from the top of the shield grid tube, be sure not to twist this cap or else the tip may break off.

In case the receiver should manifest a tendency to oscillate, it is advisable to move the 1 mfd bypass condenser from its position shown in Figure 2, away from the vicinity of the second detector grid wire, and instead placed on the B post of the first audio transformer. Figure 3 shows the 1 mfd condenser located in that position. This photograph also shows all other details.

A few other items of interest to the operator are as follows: If further selectivity is desired, disconnect the wire on terminal 6 of the oscillator and lead it directly to 45 volts. In this model the schematic shows 67 volts on the oscillator, but better results may be secured by using 45 volts on the oscillator alone. Apparently while the shield grid tubes are aging they are microphonic, but at the end of ten or twelve days operation this micro-

phonic tendency ceases. There is a possibility of grid and filament shorts in these tubes, probably because of the high positive bias on the screen grid which apparently has a tendency to draw the filament towards the grid. When first testing out the tubes, light their filaments from a three volt C battery and then observe whether or not the filament is centered in its normal position, not leaning towards one side and possibly touching the grid. After the receiver is wired, be sure to check the oscillator coupler windings for open circuits. The position of the pick-up coil in the oscillator should be nearly at right angles to the plate-grid windings. In the model described in the last issue the mounting brackets were used as a portion of the return circuit and unless they make very tight contact, there is a likelihood of trouble. A drop of solder between the bracket and the condenser will rectify this trouble. It is also advisable to connect the escutcheon on the front panel to the negative filament, so that it is grounded. This will relieve body capacity. The bypass condenser from the plate of the second detector to the filament shown in the wiring diagram in Figure 2 should be .001 mfd instead of .0005.

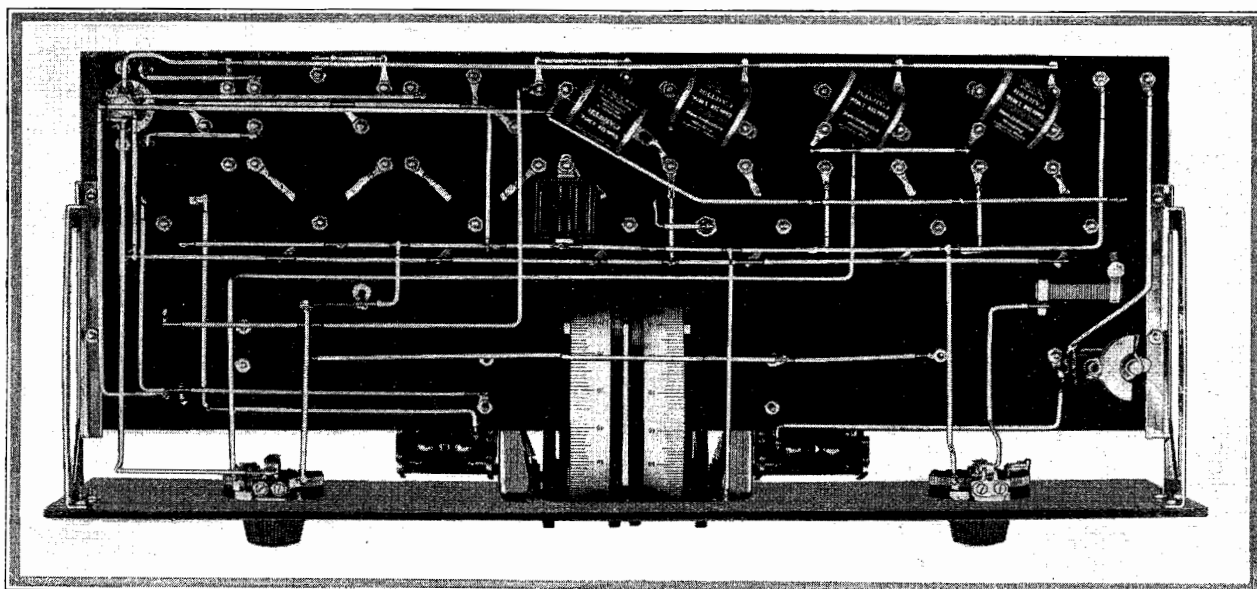

Figure 3. The above photograph represents the handiwork of a competent set builder, who desires a very symmetrical and efficient wiring job. While the diagram shown in Figure 2 is accurate, nevertheless this new photograph may help

Vacuum Tube Voltmeter for the Experimenter and Set Builder

Simple Apparatus Described by Means of Which Alternating and Direct Current Potentials May Be Measured

MANY professional set builders and experimenters in the past have indicated a certain amount of interest in a simple vacuum tube voltmeter, which could be used in the home laboratory or workshop, and to answer this demand the laboratory has recently completed and is illustrating in this article one of the several forms of vacuum tube voltmeters which are in use. If the interest in this subject warrants it, further work may be done on other types of vacuum tube voltmeters for future issues of this magazine.

What It Is

Simply stated, a vacuum tube voltmeter comprises a vacuum tube, a filament source, a plate potential supply and meters for measuring filament, grid and plate values. The voltmeter makes use of the well known tube amplification factor as a means of reading voltages of either a high or a low order. For example: Some types of vacuum tube voltmeters may be used on extremely high tension work, where the voltage to be read runs in the hundreds of thousands, while other forms of voltmeters may be constructed which will read minute voltages on the order of a few microvolts. In the case of the very sensitive tube voltmeter, the voltages are not read directly in microvolts, but rather are read in place current microamperes and then when the unit has been calibrated the equivalent voltages for the microampere readings will be known and will suffice for measurement purposes.

In the type of vacuum tube voltmeter described in this article, provision has been made for measuring grid voltage, filament voltage and plate voltage, as well as plate current.

With the present voltmeter it is also possible to determine the voltage amplification of any tube, as well as the operating condition of tubes and their characteristic curves.

Defining Amplification Constant

The amplification constant of a tube is defined as the quotient obtained by dividing a change in plate voltage by the corresponding change in grid voltage required to maintain a constant plate current. However, the amplification constant is not the same for all tubes and it also varies with the filament current, so that it is

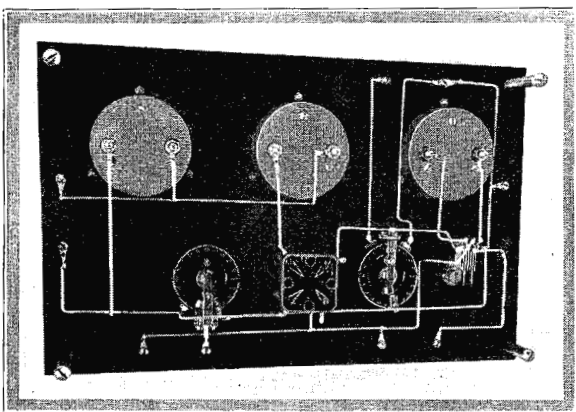

Figure 2. This picture shows a rear view of the vacuum tube voltmeter after all of the wiring has been accomplished

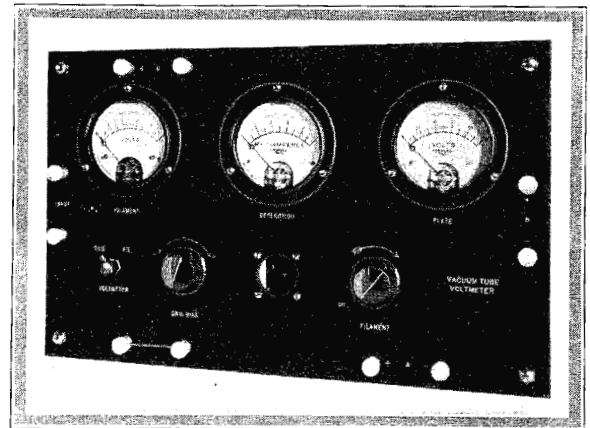

Figure 1. In the above photograph the completed vacuum tube voltmeter is illustrated

necessary that the filament current be kept constant.

To determine by measurement with this voltmeter the amplification factor of a tube, the tube is placed in the socket and the filament switch turned on. Throw the voltmeter switch so that the 0-5 voltmeter will read the filament voltage of the tube. Adjust the filament rheostat until the proper voltage reading for the type of tube is obtained. For example: in the case of the 199 the applied filament voltage should be 3 volts at .06 amperes. When the filament voltage has been read and set at the proper value, take the reading of the plate voltmeter. Two voltages should now be set down, one being the plate voltage shown on the high reading voltmeter and the other the grid voltage shown on the low reading voltmeter, which reading is obtained by switching the voltmeter from the filament connection to the grid connection by means of the switch on the front panel. Also take the milliampere reading under these conditions and note it.

Now increase the voltage of the plate battery by adding ten or fifteen volts, adjust the potentiometer until exactly the same milliampere reading is obtained as before and record the reading of the plate voltmeter. Then read the grid voltage. This will give four readings that are required. The first high voltage reading and the first grid reading represent the values which must be subtracted from the second high voltage reading and the second grid reading. The result of this will be a fractional value, which may be readily worked out. For example:

Measuring a Tube

Using 20 volts on the plate of the 199 in the voltmeter, the grid reading under test was 1.75 volts. The milliampere reading was .2 milliamperes. The second voltage reading, the higher one, was 35 volts in the plate circuit and 4.3 volts on the grid. Subtracting 20 volts from 35 leaves 15 volts, which is set down as the top portion of the fraction. Subtracting 1.75 volts from 4.3 volts gives 2.55, which is set down as the lower portion of the fraction. Then dividing 15 by 2.55 gives a result of 5.88, which is the amplification constant of the tube under measurement. As previously stated, it should be noted that the amplification factor will

(This voltmeter constructed, tested and all illustrations made in our laboratory)

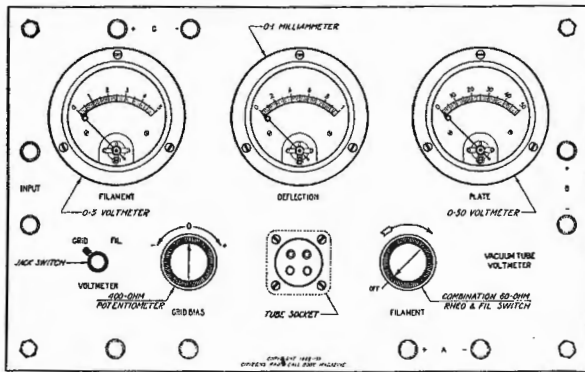

Figure 3. In this drawing the builder may see the manner in which the parts are laid out

change through a difference in the filament current, and for that reason when making a test it is advisable to allow the tube under test to burn for a few minutes and then carefully check its filament voltage to make sure that this voltage will remain constant.

Making Up a Graph

From the above test the reader will see that another way of describing amplification constant is to state that mu equals EB2-EB1 divided by EG2-EG1, EP being plate voltage and EG being grid voltage.

Another way of readily determining the voltage amplification factor of tubes is by making up a graph and plotting values of plate volts along the vertical axis and values of grid volts horizontally, meantime keeping the filament terminal voltage and the plate current constant.

A number of points on this graph are then obtained and a mean curve, which is essentially a straight line, drawn through the several points. The amplification factor may be then determined from this curve.

A somewhat simpler method of determining amplification, which is theoretically correct but which is perhaps not quite as good in practice, is to so adjust the plate and grid voltages that zero plate current is obtained and then divide the plate voltage by the grid voltage.

Some of the amplification factors of present day vacuum tubes may be learned by consulting the following paragraphs:

A 199 uses a filament voltage of 3 volts, draws .06 amperes in the filament circuit and when used at 45 volts has a milliampere consumption of 1 milliampere. When used as an amplifier, with 90 volts on the plate and a 4½ C bias, this same tube draws 2.2 milliamperes. Its voltage amplification factor is 6.6.

The 201-A tube with 5 volts on the filament, .25 amperes in the filament circuit and with 45 volts on the plate draws 1.5 milliamperes as a detector, whereas with 90 volts on the plate and 4½ volts C bias, the plate current is 2.5 milliamperes when used as an amplifier. The voltage amplification factor of this particular tube is 8.

In the case of the UX-222, which is the shielded grid tube, filament voltage is 3.3 and the filament current is .132 amperes. When 135 volts are placed on its plate, 1½ volts on the inner grid and 45 volts on the outer grid, the plate current drawn is 1.5 milliamperes. In this tube the voltage amplification factor according to the rating given by the manufacturers is 300, but while this is a theoretical ideal, so far this value has not been approximated in actual practice. This tube when used as an audio frequency amplifier has a voltage amplification factor of only 60.

In the case of the 226 tube, which is the alternating current correspondent of the 201-A, its voltage amplification factor is 8.2. The voltage amplification factor of the 112-A is 8, the same as the 201-A. On the 171-A the voltage amplification factor is only three, although in the 112-A and the 171-A the maximum undistorted output is greatly increased over the preceding type of tubes enumerated. The 210 has a voltage amplification factor of 8 and a tremendous maximum undistorted output.

Possibly the only one of the battery operated tubes which anywhere near approximates the voltage amplification of the new shield grid tubes is the type 240, which has an amplification factor of 30, although this tube does not have the virtue which the screen grid tube has, this virtue consisting of eliminating the necessity for neutralization or the possibility of oscillation when placed in a properly designed circuit.

Parts used in constructing this model of a vacuum tube voltmeter are:

- 1—Yaxley 60 ohm rheostat
- 1—Yaxley 400 ohm potentiometer
- 1—Formica sub-panel 10x16x¼-inch
- 10—XL binding posts
- 1—Frost socket
- 1—Yaxley jack switch
- 1—54 Jewel 0-50 d. c. voltmeter

- 1—54 Jewel 0-5 d. c. voltmeter
- 1—54 Jewel 0-1 milliammeter
- 40—Ft. Corwico Braidite wire
- 1—Pkg. Kester radio solder
- Miscellaneous—lugs, nuts, screws, etc.

It has always been the policy of our Editorial Department to produce articles which are of benefit to the greatest number of our readers. For that reason it is necessary that the Editorial Department have some indication of the interest which the reader manifests in these articles. Accordingly, we are glad to have the opinions of our readers as to whether they desire more material devoted to

experimental apparatus for either the professional set builder or the serious student of radio. Stating your preference as a reader will materially assist the Editors in their selection of forthcoming material.

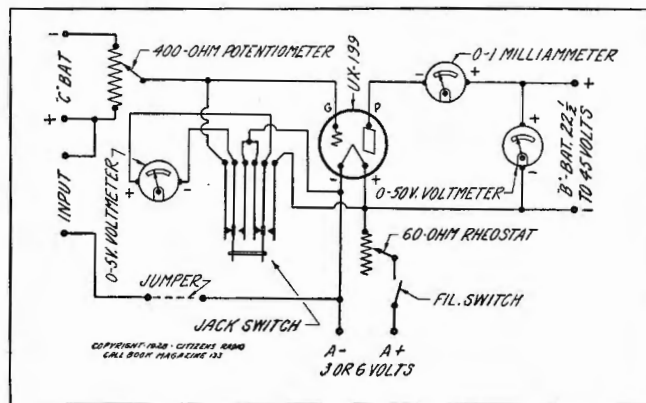

Figure 4. The schematic circuit shown above will serve as a guide for wiring the vacuum tube voltmeter

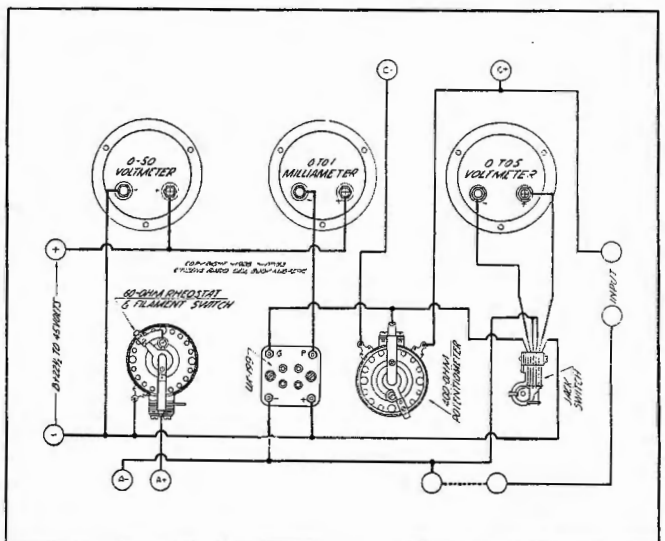

Figure 5. Those not accustomed to reading schematics may use the graphic for wiring

Samson PABC-3 B Eliminator and Power Supply

Push-Pull Amplification Available with This Form of Power Supply,
Which Also Furnishes Voltages for Balance of Receiver

DURING the past two years there have been a great number of B eliminators and power amplifiers placed on the market in "kit" form. Unfortunately a great number of these kit form eliminators have been sadly deficient from several stand-points and again with the coming of this year's receivers, there has been a change in the requirements necessary of an eliminator or power amplifier due to an increased number of tubes in every receiver and thus a greater current drain.

New Eliminators Designed

Some of these receivers will run from 60 to 100 mills, which most of the older type of eliminators would not provide. In order to cope with the new conditions, it has been necessary to design new eliminators which are capable of delivering the required voltages at a high current drain.

To do this it has been necessary to design new types of rectifier tubes, new power transformers, new filter condensers, a more efficient type of resistor, and in general do everything over in a bigger way than had been done two years previous.

We are at this time publishing a B eliminator and power amplifier which, we believe, stands out as one of the achievements in the design of these new type eliminators this year. This eliminator and combined power amplifier will very satisfactorily take care of any of the modern day receivers and there has been incorporated in the design sufficient margin for receivers having greater drains than may appear in the forthcoming years, which would otherwise make obsolete an eliminator not designed to carry an additional load other than of the present day demands.

Is Simple to Build

We believe that this eliminator and power amplifier is the paramount in home constructed units, inasmuch as it is very simple to construct a very efficient, yet it is pleasing to the eye which is uncommon in this type of unit.

The parts selected for this unit were selected from a standpoint of efficiency and ease of construction. As our description is limited, only the high points may be considered at this time. The power transformer as furnished by Samson is contained in a very handsome steel case, which also houses the filter chokes and the low voltage secondaries for the filaments of the power tubes and rectifier tube. The output leads of this transformer choke unit are brought out one end to a square bakelite terminal block, in which are small recesses containing a screw to which connections may be made without any possible chance of a short circuit due to any two wires coming in contact with each other. There is a similar square bakelite block which fastens over this

first block, which covers all leads and prevents any shocks or burns which might be received on contact if there were any exposed leads. The 110-volt source is brought into the opposite end of the transformer through a bakelite block by means of which the primary winding may be set for any particular line voltage available that is between 105 volts and 125 volts.

Has Wide Safety Margin

This transformer is very well designed and has been provided with a very wide margin of safety so that after several hours of continuous operation the case will be found to be perfectly cool. The high voltage condenser block which is used for filtration purposes, is contained in a case identical to that of the transformer choke unit and is made by Tobe. The condensers used for filtration purposes are of the 2000-volt break-down type, the terminals of which are brought out one end through bakelite

blocks in the same manner as the leads of the transformer choke unit. The leads from the by-pass condensers are brought out through the opposite end of the can through another set of these bakelite blocks. Each terminal of the condenser unit and transformer choke unit is marked with a number which corresponds to the numbers indicated in the graphic and schematic illustrations found on these pages which renders wiring very simple.

Heat Dissipation

The resistors used in the voltage dividing device are those of Hardwick-Field and have been especially designed for use in this unit. The power dissipation of these resistors vary from .36 watts to 4 watts, depending upon the requirements of their location in

the circuit. However, any resistor may be used providing it will dissipate 1 watt per square inch per external surface. These resistors are furnished with small angle brackets by means of which they may be very readily fastened to the baseboard. There is one variable resistance used for the variation of the 45-volt tap. As this resistor needs only to dissipate .05 watts a Frost 50,000 ohm variable resistance has been used in this position. This resistance is of the carbon strip type and gives a very smooth and efficient control of the voltage variation.

There has been incorporated in the unit an 874 voltage regulating tube which is, of course, across the 90 to negative terminals. By the use of this tube, perfect voltage regulation is insured when the radio frequency stage of the receiver is operated on 90 volts.

Steady Voltage Maintained

If filament control is used in the receiver the plate current of the tubes will very materially change with the filament temperature. In such case, if a voltage regulating tube is not used, the

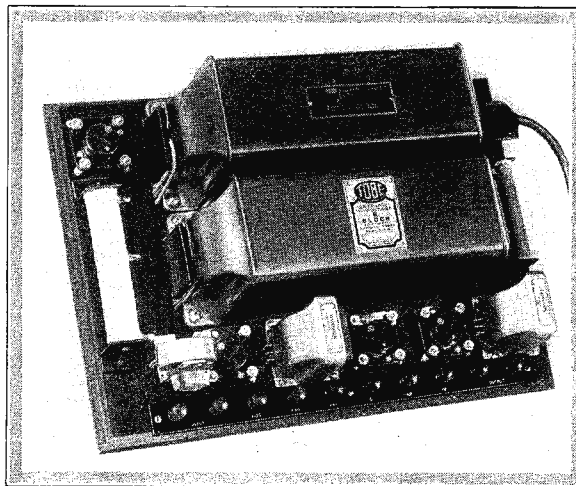

Figure 1. Photograph shown above gives an idea of the completed amplifier

(This power supply tested and all illustrations made in our laboratory)

Harkness A. C. Counterfonic Receiver and Power-Pack

Full Instructions Given for Construction of the Alternating Current Model or the Conversion of the Battery Operated Set

THE new a.c. model of the Harkness Counterfonic Six is designed for use with standard a.c. tubes. The set employs four type 226, one type 227 and one type 171. The filaments of all the tubes are heated by alternating current.

With the exception of a small $4\frac{1}{2}$ volt C battery, the set is operated entirely by the compact, inexpensive power-pack illustrated and described in this article. No storage battery, A eliminator, B batteries or any other accessories of this nature are required. The receiving set, power-pack, C battery, tubes, loud-speaker and cabinet represent a complete installation.

The power-pack may be placed directly behind the set, if desired. No hum will be generated, even if the power-pack is placed in the same cabinet with the set. If the cabinet is 14 inches deep, this can be done. Otherwise, the power-pack can be placed behind the cabinet which houses the set. The width of the power-pack is only $4\frac{1}{4}$ inches.

If a suitable B eliminator is already owned by the builder of this set, it is not necessary to build the new power-pack unless desired. Any standard B eliminator can be used to supply plate current for all tubes. In this case it is merely necessary to install a filament transformer with $2\frac{1}{2}$, $1\frac{1}{2}$ and 5 volt windings to supply the filament current for all tubes.

The use of a.c. tubes does not impair the efficiency of the set

in any way. On the contrary, even better reception is obtained. The tone quality is improved as the tubes are always supplied with sufficient filament and plate current. The set always operates at the peak of efficiency.

There is no a.c. hum. This set and power-pack have been thoroughly tested in different laboratories and under actual working conditions in various localities. At no time and under no conditions has a.c. hum interfered with reception.

Hum Balanced Out.

There are three separate a.c. filament circuits. The $1\frac{1}{2}$ volt winding of the power transformer supplies a.c. current to the filaments of the four 226 tubes, used as radio and audio frequency amplifiers. The $2\frac{1}{2}$ volt winding supplies the filament of the 227, used as a detector. The 5 volt winding supplies the filament of the 171 tube in the last stage of the receiver.

The 227 is a "heater" type of a.c. tube. The filament is surrounded by a special cathode which emits electrons when heated. No a.c. current passes through the cathode itself; consequently, no a.c. hum is developed in this tube. To prevent the heating filament from causing any hum, a fixed center-tapped 10 ohm resistance is connected across the filament, the center tap being connected to the 45 volt binding post. Similarly, a fixed center-

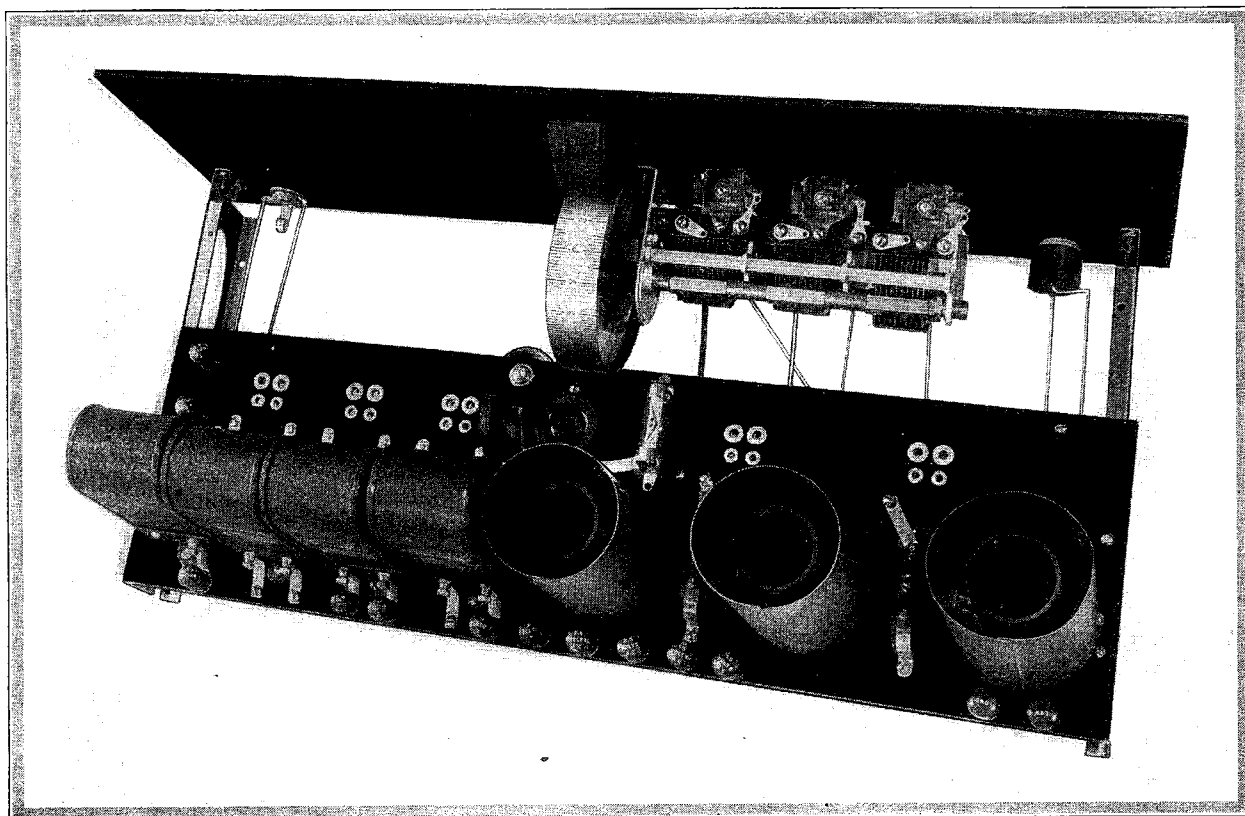

Figure 1. This photograph shows the rear view of the A. C. Counterfonic recently tested in our laboratory

(This receiver tested and all illustrations made in our laboratory)

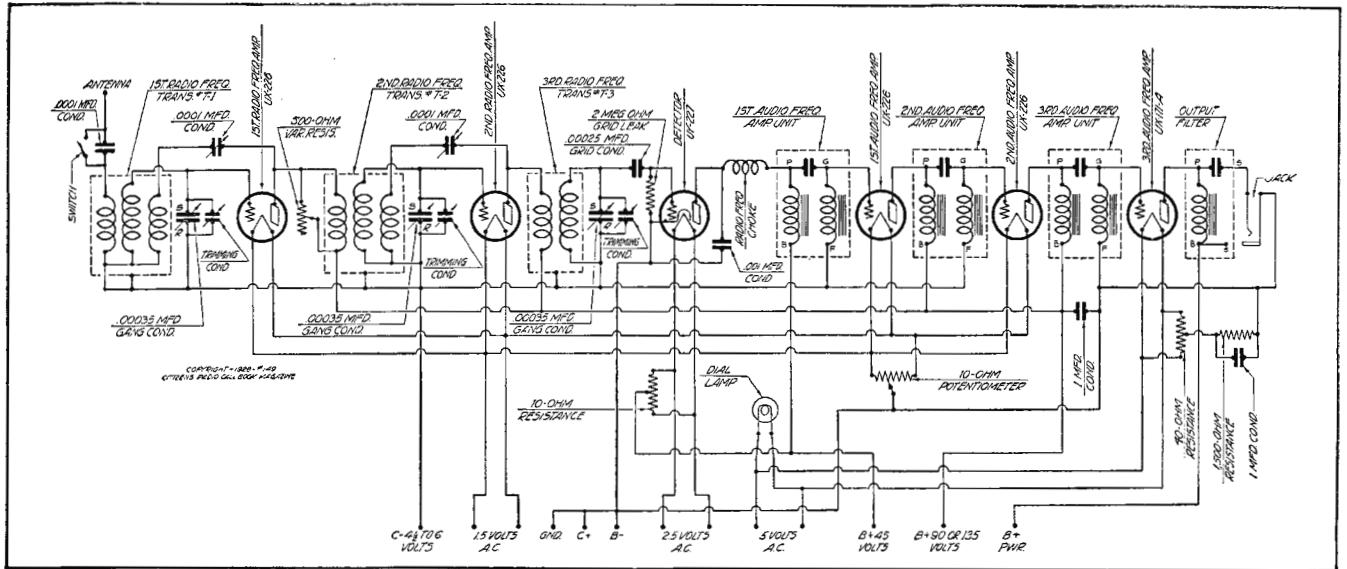

Figure 2. The schematic of this receiver is illustrated above and shows all of the electrical connections required

tapped 40-ohm resistance is connected across the 5 volt a.c. winding which supplies the filament of the 171 power tube. The center tap is connected, through a 1500 ohm resistance, to ground. The 1500 ohm resistance is used to provide a negative bias for the grid of the 171 tube and obviates the necessity of using a 40 volt C battery.

In the case of the 226 tubes, a variable 10 ohm potentiometer is connected across the filament circuit. A fixed resistance is not used as the adjustment is more critical. The center arm, which is connected directly to ground, must be turned to the exact point at which the hum disappears. The location of this potentiometer is also important. It is mounted on the sub-panel, near the first audio tube socket. The center-arm is turned by means of a screw-driver. Once adjusted, it requires no further attention.

To prevent hum it is also very important that the grids of the 226 tubes be held at a negative bias of at least 4½ volts with re-

spect to ground. It would be possible to obtain this negative bias by means of a resistor (as in the case of the 171 tube) and thus obviate the necessity of using a 4½ volt C battery. It was found, however, that a biasing resistor causes distortion when only one a.c. winding is used to heat the filaments of 226 tubes used as both radio and audio frequency amplifiers. The resistor, being common to the grid returns of the radio and audio frequency tubes, acts as a source of coupling between the two amplifiers and therefore causes distortion. Even when by-passed by a large capacity the distortion is still present. It was decided, therefore, to use a 4½ volt C battery to provide a negative bias. The battery lasts indefinitely, is inexpensive and compact, and eliminates all hum and distortion.

The plate circuits of all the tubes in the receiver are also supplied with current by the power-pack. The a.c. line current, stepped up to a suitable voltage by the power transformer, is

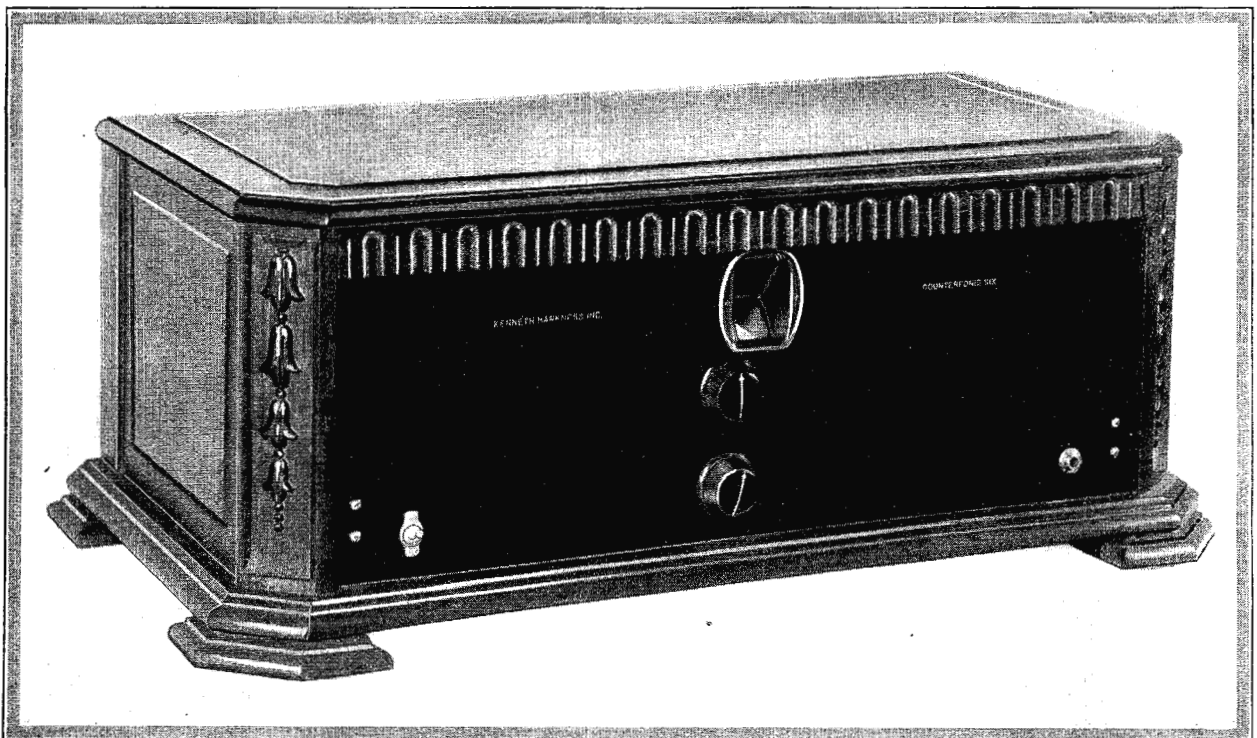

Figure 3. This photograph shows the receiver placed in a cabinet.

rectified by a gas tube rectifier and the pulsating direct current smoothed out by the filter system. The resistance unit, across the output of the filter, provides taps at 45, 90, 135 and 180 volts.

Volume is controlled by a special 500 ohm rheostat connected across the primary of the second radio frequency transformer. Many different methods of controlling volume were tested before adopting this system. It is undoubtedly the best method of controlling volume in an a.c. set. The rheostat is provided with an "off" position so that maximum volume can be used for the reception of distant stations.

General Features of Set

Some of the important features of the Counterfonic Six were outlined in the January issue of the Call Book in which the battery-operated (or eliminator-operated) model was described. The new a.c. model retains all the good features of the d.c. model. It is the same set, the only changes being the necessary adaptations to permit the use of a.c. tubes.

The outstanding characteristic of the set is its tone fidelity. When used with a good loudspeaker it reproduces music and the human voice with exceptional realism. This is made possible by the use of "tuned double impedance" audio amplification. The audio amplifier is tuned to emphasize low tones and thereby compensates for the deficiencies of loudspeakers at low frequencies. The loudspeaker output is made uniform over the entire range of sound frequencies, from 50 to 10,000 cycles. Moreover, loud signals do not cause distortion. The amount of volume which the set will handle, without distortion, is limited only by the characteristics of the tubes employed and the power supplied to them. The distortion and "tube blocking," formerly associated with impedance-coupled audio amplifiers, are completely eliminated by the use of grid impedances in place of high resistance grid leaks.

Another important feature is the method of securing practically 100 per cent efficiency with only one tuning dial. Stations are tuned in by turning a single knob. Ordinarily, three controls would be more efficient but special provision is made for balancing the three tuned circuits and the single control is just as effective as three separate controls. The "trimmers" shown in the wiring diagram are not on the front panel. They are attached directly to the triple-gang tuning condenser and, once adjusted, do not require further attention.

Special coil shields, of an exclusive design, are used to eliminate coupling between the radio frequency transformers. The shield is made in the form of a copper cylinder, open at each end. The shields eliminate magnetic and electro-static coupling between the coils but do not seriously increase the resistance of the coils. With the ends open, the shield can be kept small in diameter, making the set more compact and easier to build.

Each stage of the radio frequency amplifier is neutralized by a highly efficient system of neutralization. Oscillation is eliminated at all frequencies without reducing the sensitivity of the receiver.

The overall amplification is unusually high for a six-tube set. Stations within a radius of 1000 miles can usually be received with loudspeaker volume. More distant stations can, of course, be received when the conditions are favorable.

Construction of Set

The illustrations on these pages clearly show the assembly and

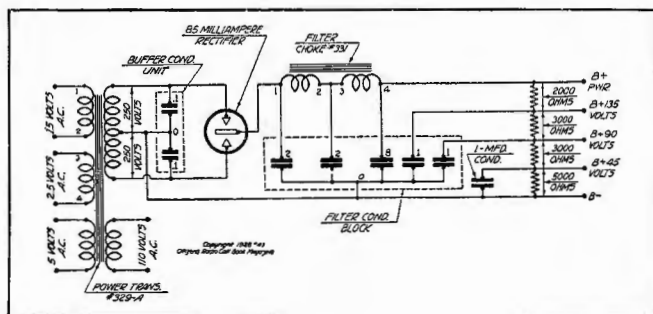

Figure 5. The schematic circuit of the power supply may be seen in the diagram printed herewith.

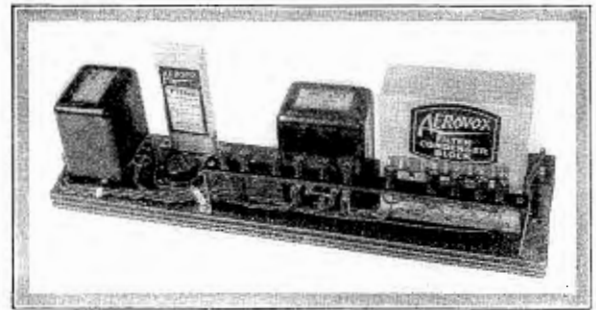

Figure 4. The power supply is very compact as is shown by the above photograph.

wiring of the receiver. Two flexible, insulated wires, twisted together, must be used for each of the three filament circuits; the wire should be heavy, with a resistance not greater than No. 14 B & S. The filament voltages are so low every precaution must be taken to reduce the resistance of the filament wiring.

The following parts are required to construct the A. C. Counterfonic Six:

- 1—Cortlandt front panel, 7x21 inches, drilled and engraved
- 1—Cortlandt sub-panel, 5 1/4x20 inches, drilled, with five tube sockets attached
- 1—Eby 5-prong socket
- 1—pair Harkness sub-panel brackets, 9 1/2 inches
- 3—Harkness r.f. transformers
- 3—Harkness coil shields
- 3—Harkness double impedance tuned audio couplers, 1st, 2nd, and 3rd stage types
- 1—Harkness audio output filter unit
- 1—Harkness r.f. choke
- 1—U.S.L. triple-gang condenser, .00035 mfd
- 3—Hammarlund equalizers
- 1—Silver-Marshall drum dial
- 1—Carter MW-500 rheostat
- 1—Carter CU-40 resistor
- 1—Carter CU-10 resistor
- 1—Carter AP-10 potentiometer
- 1—Carter H-1500 resistor
- 1—Carter No. 1 short jack
- 1—Carter Imp battery switch
- 3—Aerovox type 1450 condensers, .001, .00025 and .0001 mfd
- 1—Aerovox grid leak mounting
- 2—Aerovox type 250 condensers, 1 mfd each
- 1—Durham 2 megohm grid leak
- 2—X-L variodensers, .0001 mfd
- 13—Eby binding posts
- Miscellaneous lugs, screws, nuts, panel supports, etc.
- 1—Roll Belden rubber covered hookup wire
- 4—Sonatron 226 tubes
- 1—Sonatron 227 tube
- 1—Sonatron 171 tube

Construction of Power-Pack

The power-pack is very compact, being mounted on a wooden base-board 4x17 inches. The assembly and wiring are shown in

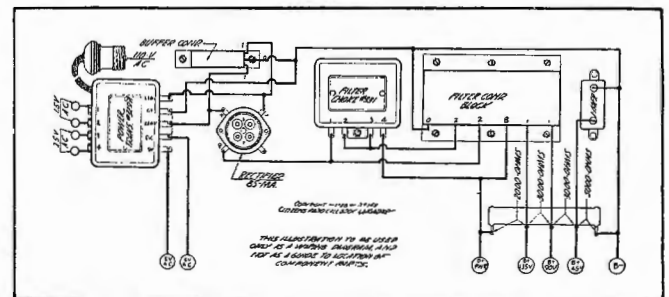

Figure 6. Assembly of the power supply may be made by following the connections shown in the graphic above.

the illustrations. Twisted, low resistance wires must again be used when wiring from the transformer to the A. C. filament binding posts.

The following parts are required to construct the power-pack:

- 1—Silver-Marshall 329A power transformer
- 1—Silver-Marshall 331 Uni-choke
- 1—Aerovox Pyrohm resistor, type 994-171
- 1—Aerovox BH-420 condenser block
- 1—Aerovox buffer condenser type 646
- 1—Aerovox type 250 condenser, 1 mfd
- 1—Eby UX socket
- 11—Eby binding posts
- 1—Cortlandt strip 1 1/2 x 3/4 inch, drilled
- 2—Brackets for strip
- 1—Wooden baseboard 4x17 inches
- 40—feet Acme Celatsite hookup wire.

Installation of Set and Power-Pack

To install the receiver and power-pack, the only accessories required are the tubes, cabinet, loudspeaker and 4 1/2 volt C battery. The tubes needed for the set are enumerated in the opening paragraphs of this article. The power-pack uses an 85 mil. rectifier.

The power-pack is attached to the receiving set by means of wires joining the two sets of binding post terminals, as marked. Use twisted wires for each of the three filament circuits. Do not place the power-pack more than a few feet away from the receiver as the filament leads must not be too long. Usually the power-pack can be placed directly behind the cabinet which houses the receiver, or in the same cabinet. The negative terminal of the 4 1/2 volt C battery is attached to the binding post marked C minus; the positive terminal of the C battery goes to the B minus post.

The set is switched on and off directly at the source, the a.c.

line. If desired, a push-switch can be connected in series with the wire leading from the power-pack to the a.c. outlet.

Unlike d.c. tube sets, a few seconds elapse after the set is switched on before it begins to operate. During these few seconds the cathode of the detector tube is being heated.

Converting D.C. to A.C. Model

Readers who have built the d.c. model of the Counterfonic Six, described in the last issue, can very easily change their sets to the a.c. model, at a very slight expense.

To make the change, the following parts, used in the a.c. model, but not used in the d.c. model, are required:

- 1—Carter MW-500 rheostat
- 1—Carter CU-40 resistor
- 1—Carter CU-10 resistor
- 1—Carter AP-10 potentiometer
- 1—Carter H-1500 resistor
- 1—Carter No. 1 short jack
- 1—Eby 5-prong socket
- 6—Eby binding posts

The binding posts are marked for the 1 1/2, 2 1/2 and 5 volt filament wires.

The jack takes the places of the switch on the right hand side of the d.c. model. The 500 ohm rheostat is substituted for the 10 ohm rheostat used in the d.c. model. The 5-prong socket takes the place of the 4-prong socket for the detector tube. The A plus, A minus and two loudspeaker binding posts in the d.c. model are removed and four of the new binding posts substituted. Mount the 5 volt posts in the holes formerly used for the loudspeaker posts and the 1 1/2 volt posts in the holes formerly used for A plus and A minus. Drill two holes at the rear for the 2 1/2 volt posts and one hole, near the first audio socket for the 10 ohm potentiometer. With these changes made it is then only necessary to re-wire the set to conform to the diagrams on these pages.

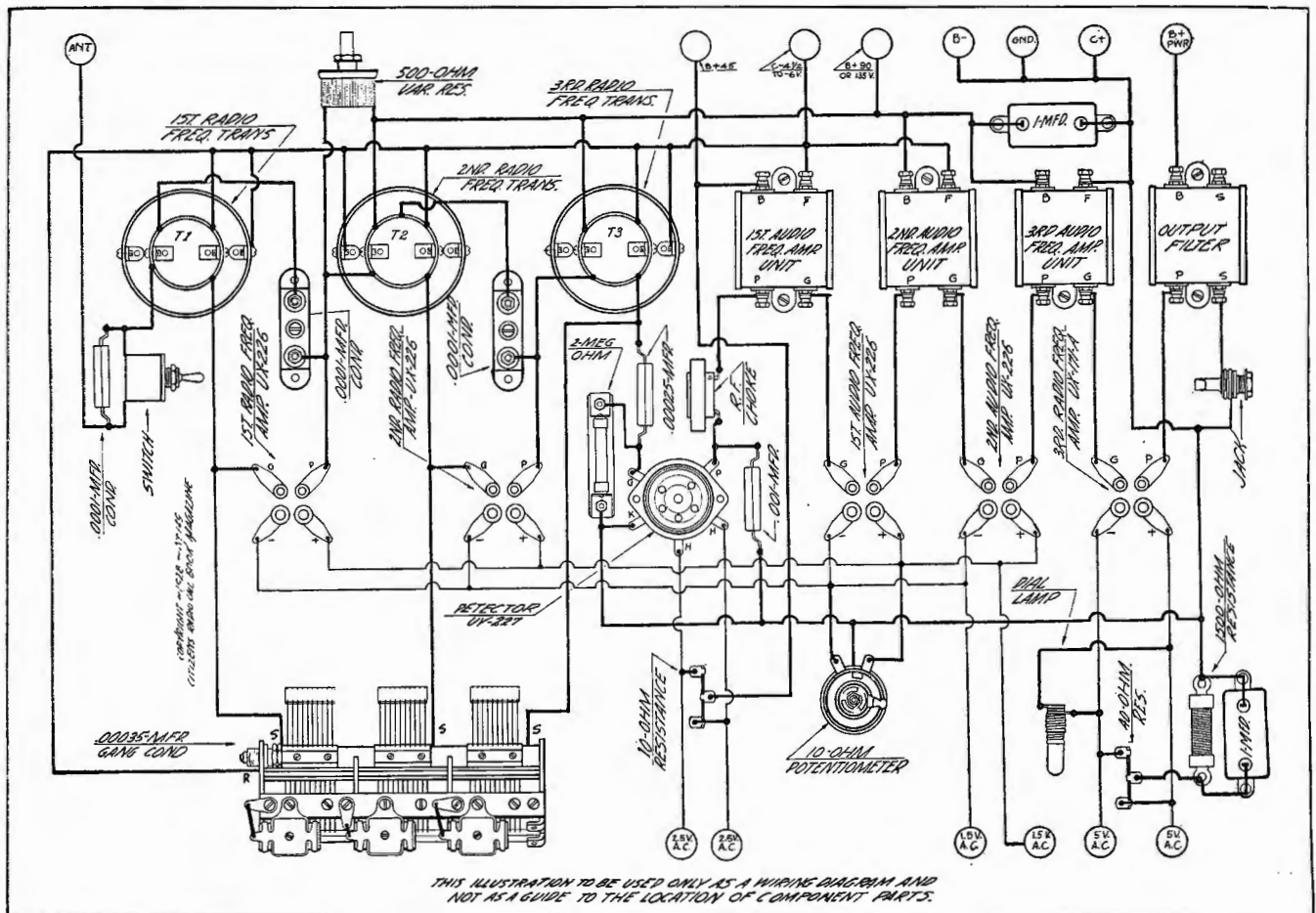

Figure 7. Builders of the receiver may follow this graphic diagram, which shows exactly where every wire in the receiver is placed.

AmerTran A. B. C. Power Supply Has Push-Pull Audio Stages

Millimeter in Power Bias Line Enables Operator to Adjust This Section for Best Results

WITH the advent of the a. c. tubes, radio builders and experimenters now find it possible to combine into one unit a power supply giving A, B and C voltages. This has resulted in the simplification of the problems of supplying filament, plate and grid voltages for a receiver. Such a device is described in the accompanying article and represents the AmerTran ABC unit, having push-pull audio amplification, which unit may be attached to any receiver or which may also be used in conjunction with an electric phonograph pick-up unit.

Operates Without Hum

Electrical details of the circuit are disclosed in the schematic diagram shown in Figure 2, while a photograph of the amplifier itself is shown in Figure 1. Under tests made in our laboratory, this unit operated without any hum.

The front view of the completed amplifier is seen in the photograph in Figure 3, while Figure 4 represents the graphic diagram by means of which all connections may be made in the supply unit. However, it is well to remind the builder that the graphic diagram should not be used as a means of locating the component parts, since it is only intended for showing the location of all wires connecting the several units.

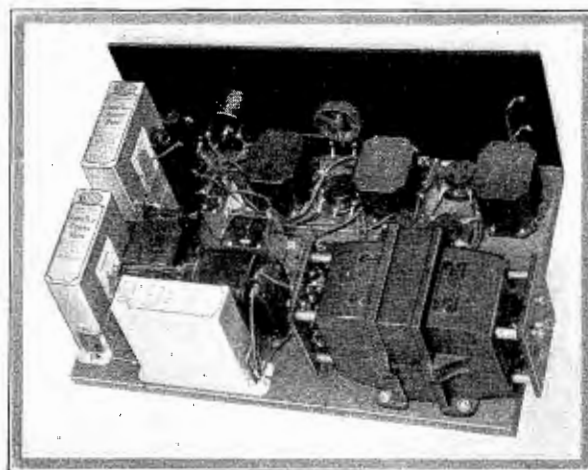

Figure 1. The photograph above shows a rear view of the completed power supply. Under laboratory tests this unit operated without hum

What It Contains

Basically the power supply unit described consists of an AmerTran PF281 power transformer having a 110 volt primary, a high voltage winding for the 281 rectifier, a 7½ volt winding for the filament of the 281, another 7½ volt winding for the filaments of the 210 tubes arranged in push-pull, and finally a 2½ volt winding and a 1½ volt winding, the former serving to energize the filament of the type 227 first audio frequency amplifier. In this particular unit the 1½ volt winding is not utilized unless the supply system should be used in conjunction with a receiver requiring that voltage for 226 tubes.

Two filtering chokes, 709 and 854, are placed in series with the positive high voltage line and are properly bypassed by means of the Tobe filter condensers, 2 microfarads at the input, 4 microfarads at the mid-point of the filter system and 4 microfarads at the output. Across the high voltage line is placed an AmerTran R-400 resistance unit with suitable taps allowing different voltages to be secured. A 100,000 ohm variable resistance is shown in the schematic as a means of giving a fairly wide range of voltage to the detector plate when such the amplifier is used in conjunction with a receiver. The plate voltage for the 227 tube is secured at one of the taps on the R-400 resistor unit, while the high voltage for the plates of the two 210 tubes is obtained by making a connection at the center point between the 709 choke and the 854 choke.

Bias for Power Stage

Bias for the grid of the first audio amplifier is secured by means of the drop across the 1,000 ohm resistance at the bottom of the resistance bank in the schematic, Figure 2. A 50,000 ohm resistance is placed in series with the center tap of the No. 151 audio frequency input transformer and is then led through a 2,000 ohm frequency input transformer and is then led through a 2,000 ohm variable resistance and a 0-50 milliammeter to the center tap of the 7½ volt winding, which supplies filament current for the 210 tubes. The presence of the milliammeter in this circuit enables

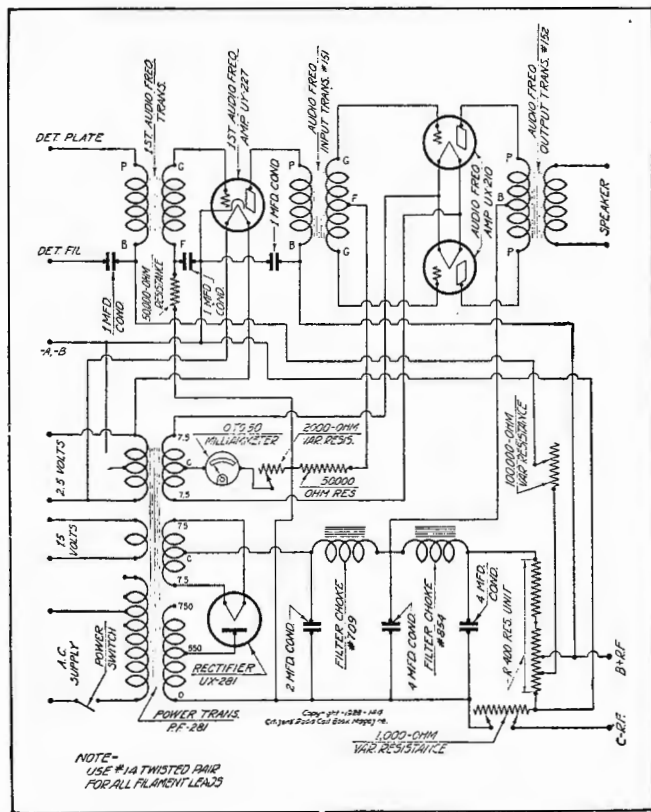

Figure 2. The schematic circuit illustrated above gives all electrical details of the unit

(This amplifier constructed, tested and all illustrations made in our laboratory)

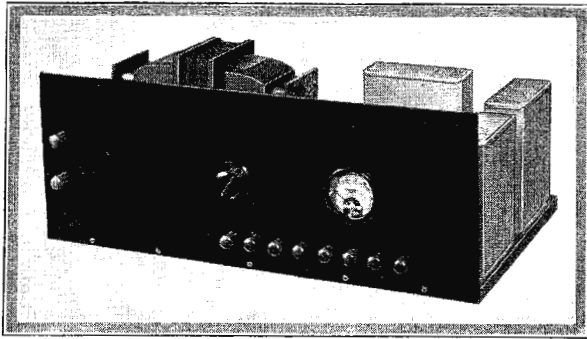

Figure 3. Front view of the completed amplifier is disclosed above

the operator to know the value of current existing in the circuit, and this value may be altered by means of a 2,000 ohm variable resistance until the best operating condition is obtained.

In order to minimize any possibility of a. c. hum in the unit, it would be well for the builder to use No. 14 twisted pair for all filament leads.

Wire by Graphic

When all parts have been located on the baseboard, the wiring may be accomplished by means of the graphic wiring diagram shown in Figure 4. Before putting the unit into operation, it is well to check thoroughly each and every connection to make sure that no errors have been made. When fully checked and certain that no wrong connections exist, the operator may proceed to put the amplifier into use. As previously stated, no hum was encountered with the amplifier assembled in the manner shown in the accompanying photographs. However, should a hum de-

velop, it may be eliminated by adjusting the position of the first stage audio transformer in relation to the power transformer and choke, so that a minimum magnetic coupling is secured and thereby a reduction of the hum. Shifting around of the first audio may be a little simpler than altering the position of the high voltage transformer.

List of Parts

Parts used in building the AmerTran power amplifier are:

- 4—Tobe 1 mfd 300 volt d.c. bypass condensers
 - 2—604 Tobe 1,000 volt d.c. filter condensers
 - 1—602 Tobe 1,000 volt d.c. 2 mfd filter condenser
 - 1—151 AmerTran input transformer
 - 1—152 AmerTran output transformer
 - 1—De Luxe AmerTran audio transformer
 - 1—PF281 AmerTran power transformer
 - 1—854 AmerTran filter choke
 - 1—709 AmerTran filter choke
 - 1—Aerovox 50,000 ohm Metalohm with mounting
 - 1—Centralab 2,000 ohm potentiometer
 - 1—Centralab 1,000 ohm potentiometer
 - 1—R400 AmerTran resistor
 - 1—Formica 7x18x3/16 inch front panel
 - 10—XL binding posts
 - 4—Silver-Marshall four prong sockets
 - 1—Silver-Marshall five prong socket
 - 1—Jewell 0-50 milliammeter
 - 1—Sonatron type 281 tube
 - 2—Sonatron type 210 tubes
 - 1—Sonatron type 227 tube
 - 40—Feet Acme Celatsite wire
- Miscellaneous lugs, nuts, screws, bolts

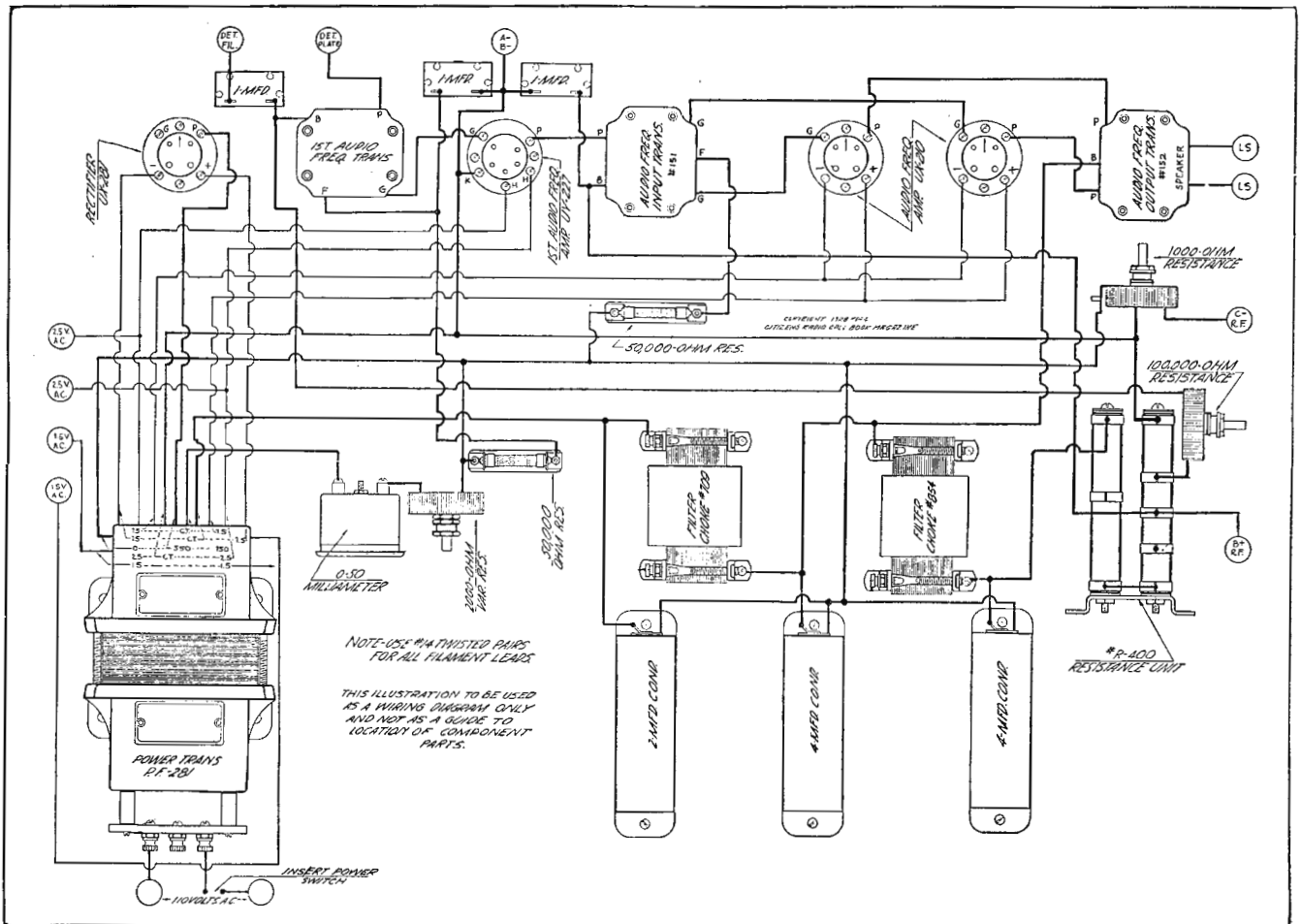

Figure 4. Builders should use the graphic diagram shown herewith as a means of wiring the entire unit

The Ultradyne A. C. Commander and Power Amplifier

Sensitivity and Selectivity Combined with A. C. Operation Through
Use of Modulation System and A. C. Tubes

THE Ultradyne A. C. Commander has numerous salient features which cannot all be credited to any other radio receiver ever developed. Speaking of it generally, it is a form of superheterodyne and has the usual oscillator and second detector together with three stages of intermediate frequency amplification. It departs from the usual superheterodyne first through the use of a single stage of high gain tuned radio frequency amplification in the input or antennae circuit; second, through the use of the modulation system which replaces the usual first detector; third, the most practical frequency band from all standpoints for the intermediate frequency amplification, and, fourth, the entire receiver from the input to the output has been designed to meet the requirements of the new A. C. tubes.

Modulation System

The most interesting and important feature of the Ultradyne A. C. Commander is the modulation system. The usual superheterodyne receiver employs a first detector tube whose grid-filament or input circuit is coupled directly to the antenna and ground and whose plate-filament or output circuit works into the intermediate frequency amplifier. The oscillator is coupled to this tube by a pick-up coil, or similar means, and the frequency of the oscillator adjusted so that its energy, induced into the input cir-

cuit of the first detector tube, will create a beat note equivalent to the frequency band of the intermediate frequency amplifier.

The principle of the superheterodyne operation is too well known to go into detail. The first detector tube, often referred to as the "mixer," does not function as efficiently as the usual detector. It plays a double role and is called upon to superimpose the oscillator frequency on the incoming signal frequency, rectify the beat note and pass it on to the intermediate frequency amplifier.

The modulation system produces an entirely different action. Instead of the modulator acting as a mixing tube and a rectifier, its role is nearer to that of a microphone in a broadcast transmitter. By referring to the circuit diagram the reader will note that the plate of the modulator tube is not connected to a source of "B" potential but rather is in circuit with the primary coil of the first Ultraformer or intermediate frequency transformer and the grid circuit of the oscillator tube. It is obvious the oscillations produced by the oscillator are impressed directly on the plate of the modulator tube and that this current will find a complete path from the grid circuit of the oscillator through the primary coil of the Ultraformer, to the plate of the modulator and thence to the filament through the medium of the electron emission. Since the grid of the modulator tube is interposed

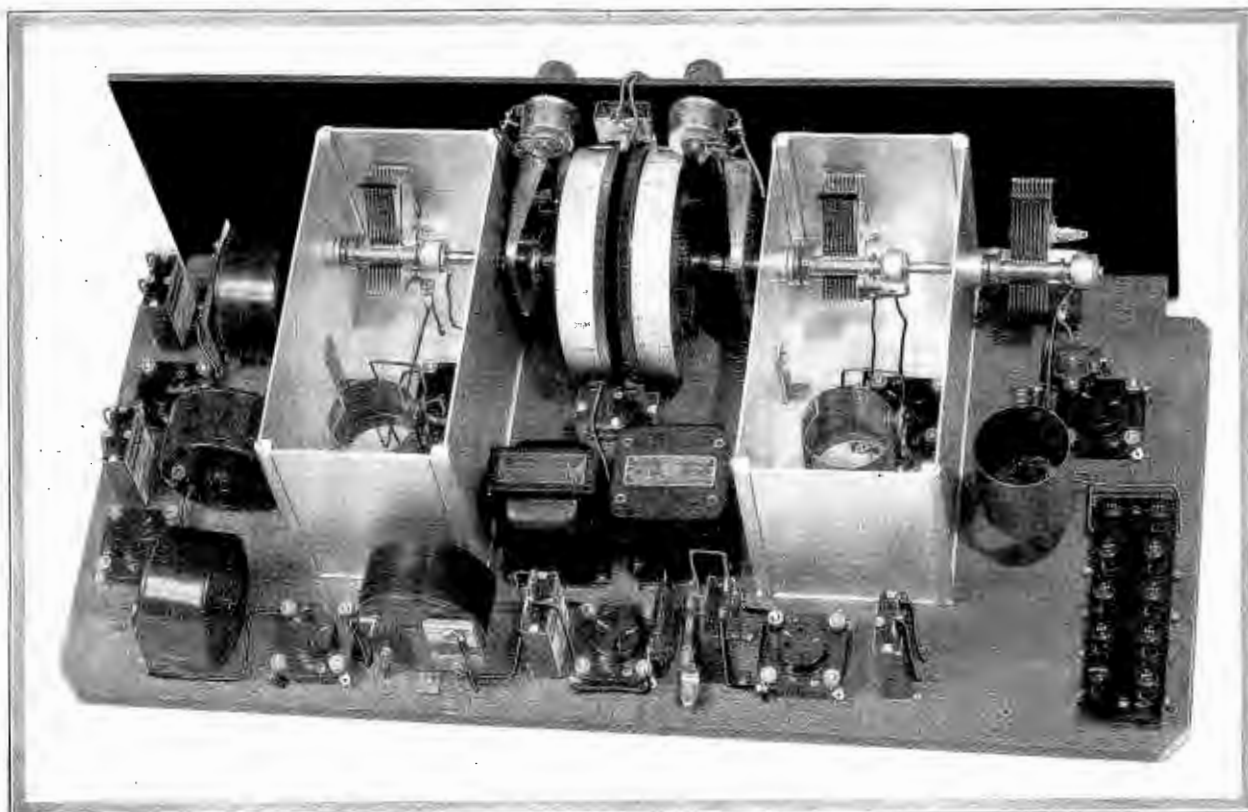

Figure 1. This shows the rear view of the completed Ultradyne A. C. Commander

(This receiver tested and all illustrations made in our laboratory)



Figure 2. In this photograph the receiver is shown placed in its Corbett cabinet

between the plate and the filament, any signal frequency impressed on the grid will tend to vary the amount of flow and finally the amplitude of the oscillations traversing the plate-filament circuit of the modulator tube. In other words, the incoming carrier frequency actually modulates the local oscillations and at the same time produces a resultant modulated beat frequency equal to the band frequency of the intermediate amplifier and of many, many times the energy of the carrier frequency picked up by the antenna system. No rectification takes place in the modulator tube.

Since the modulation system is similar to a trigger action, where a large amount of energy is made to follow the dictates of a very small amount of energy, it is obvious the modulator tube is capable of responding to very weak signals which the ordinary first detector tube might not rectify.

Input Tuned R. F. Stage

Due to the high output impedance of the modulator tube the individual gain is comparatively high and a greater amount of selectivity is obtained in the antenna circuit. In the Ultradyne A. C. Commander this selectivity has been increased further by the addition of a stage of high gain tuned radio frequency amplification in front of the modulator tube. Naturally, this r. f. amplifier also carries the sensitivity to a higher degree.

The three stage intermediate amplifier of the Ultradyne A. C. Commander is tuned to resonance at approximately 2,650 meters, which frequency provides the maximum amount of amplification obtainable without sacrificing selectivity or running into interfering frequency channels such as those employed by the long wave trans-Atlantic radio stations. The Ultraformers or intermediate frequency transformers employed are of the air core type

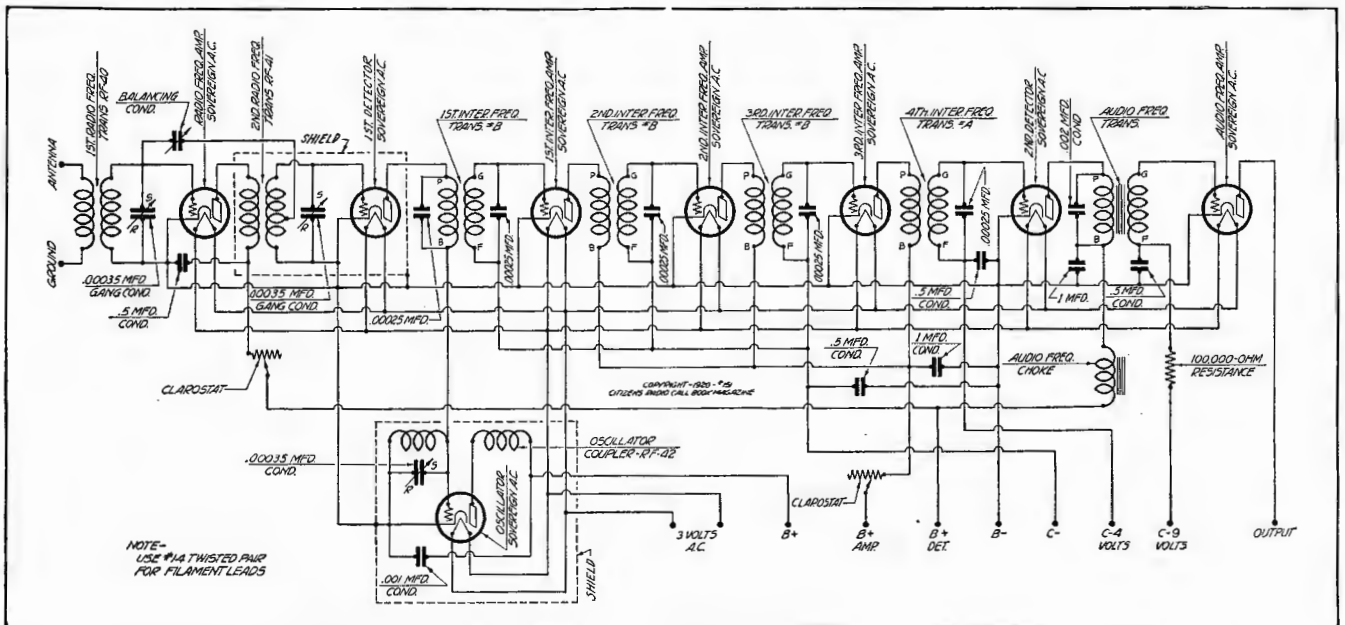

Figure 3. The above diagram represents the schematic circuit of the receiver

The Four Tube Screen Grid Universal Receiver

Experimentally Inclined Fans May Find Much of Interest in an Economical Design Incorporating a Shield Grid Tube as an R. F. Amplifier

MANY radio fans who have in the past experimented with a stage of radio frequency ahead of a regenerative detector have been confronted with the fact that when a 201A tube is used, the practical limit of that tube is very rapidly reached, and even though the circuit may be carefully balanced, nevertheless a very high gain may not always be secured. This has been principally due to the fact that with the 201A type of tube, if the amplification is forced, the tube has a tendency to go into oscillation, and even when such a tendency is curbed by the use of resistors or other balancing methods, a very high gain cannot be secured.

High Amplification

However, with the introduction of the screen-grid tube, upon which the radio public seems to be centering its attention, it has been possible to secure an extremely high amount of radio frequency amplification without recourse to balancing or "lossing." While in most instances in order to achieve exceptionally high amplification, it has been necessary to thoroughly shield the tube, nevertheless even in an unshielded job it is possible to secure a higher gain than with the conventional 201A tube.

The manner in which gain is secured is related further in this

article. For the present an inspection of the schematic diagram shown in Figure 2 will give the reader an idea of the electrical connections necessary for the construction of such a receiver. The input of the screen-grid tube is tuned by means of a .00035 mfd variable condenser between terminals 3 and 4 of the 111A Silver-Marshall 190-550 meter antenna coil. In the case of the antenna winding, this is located on a small rotor inside of the secondary and its terminal No. 2 is connected to No. 4 of the secondary so that this line forms A minus, B minus, C plus and ground connections of the receiver. As a means of placing a slight bias on the grid of the tube, the grid return of the inductance is to the bottom of a 15-ohm resistance in the negative side of the tube filament, which resistance will give a drop of approximately $1\frac{1}{2}$ volts negative. In the positive leg of the 222 radio frequency amplifier is located a 50-ohm rheostat by means of which the sensitivity of the shield tube may be governed.

Transformer Coupling

The plate circuit of the shield grid tube is a conventional one and consists of the inductance 5 and 6 of the Silver-Marshall 114SG 190-550 r.f. transformer coil between the plate of the tube itself and the plus 135-volt terminal on the receiver. It will be noted that the

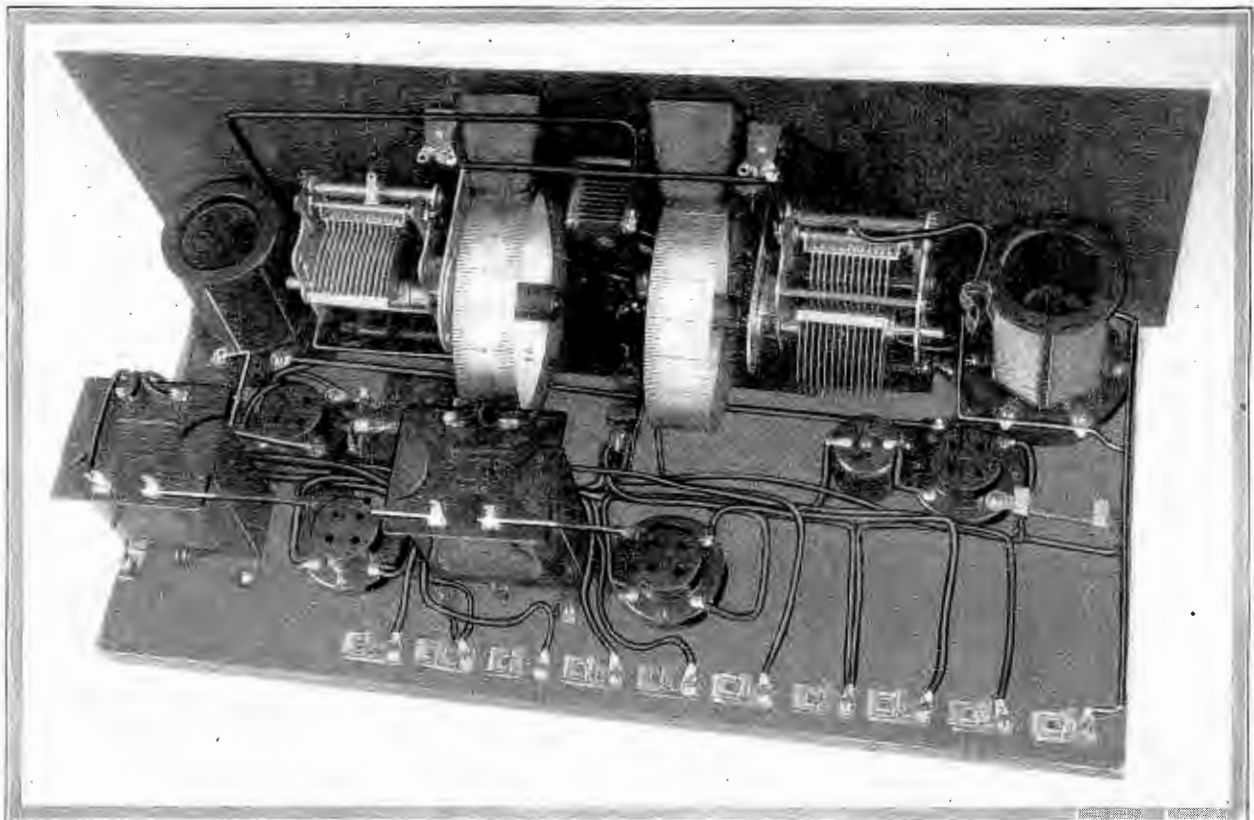

Figure 1. Rear photographic view of the efficient four-tube screen-grid receiver described in the accompany article

(This receiver constructed, tested and all illustrations made in our laboratory)

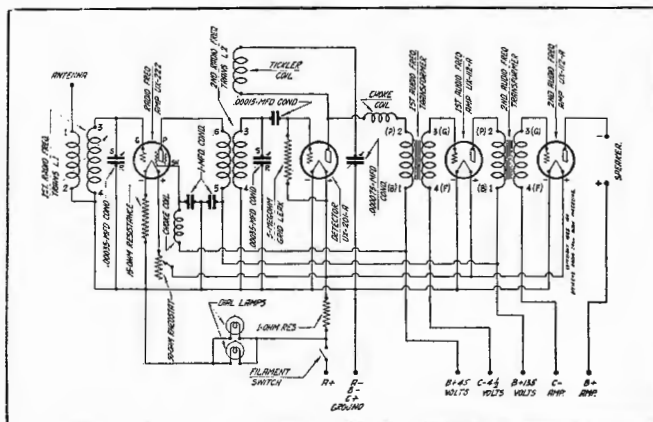

Figure 2. In this schematic may be seen the various electrical connections involved in the receiver

135 volt supply is bypassed by a 1 mfd condenser located between terminal 5 of the inductance and the negative line. From the plate circuit of this tube are induced the r. f. currents into the tuned circuit of the 201A detector stage. This stage is also tuned by a .00035 mfd variable condenser located across terminals 3 and 4 of the secondary inductance. The regenerative coil is connected to the plate of the detector tube, which also connects to the radio frequency choke coil and then the primary of the first audio transformer, which circuit is supplied with plate potential at 45 volts. At the lower end of the regenerative coil is placed the regenerative condenser .000075 mfd, with its stator to the regenerative coil and its rotor to the common negative line. The grid condenser in the detector circuit is a .00015 mfd condenser with a 5 megohm grid leak between the grid of the tube and the positive filament of the detector tube, thus insuring a positive bias on the detector, which is recommended for that particular type. The filament circuit of the detector and the two audio tubes is kept at a definite value by means of the 1-ohm fixed resistance located in the positive side of the circuit as shown in the schematic diagram in Figure 2.

Shield Is Bypassed

As a means of preventing any r. f. or pick-up currents from entering the shield of the tube, a radio frequency choke coil is placed between the shield of the 222 tube and the B45 terminal of the receiver. This radio frequency choke is also bypassed by a 1 mfd bypass condenser, the other side of which goes to the common negative line.

While the recommended value of 45 volts positive is placed on the shield of the 222 tube, nevertheless the experimenter may find it desirable to either raise or lower this voltage, it being most likely that better results will be secured with a voltage a trifle higher than 45. If the voltage applied to the shield of this tube is decreased, the tendency towards oscillation on the part of the tube becomes more pronounced, whereas when the voltage is increased the tube is completely stopped from exhibiting any oscillatory tendency. The 50-ohm rheostat placed in series with the positive filament of this tube may be used as a volume control when a high shield voltage is applied,

or if a low shield voltage is applied this same rheostat may be, a semi-regenerative control, depending upon the desires of the operator.

In the design of this efficient receiver, it was found that when tuned impedance coupling was employed and using the optimum value of coupling between the radio frequency amplifier and the detector, the selectivity of the set was very poor, although the amplification was very high. Knowing that many of the receivers would be operated in congested broadcasting centers, it became necessary to abandon the tuned impedance coupling and resort to the standard tuned radio frequency transformer having a secondary coil equivalent to the coil previously employed in the tuned impedance amplifier circuit. This transformer was provided with adjustable values of coupling and after a series of measurements was taken, the final transformer selected was found to utilize 90 turns of No. 26 plain enameled wire, wound on a threaded, moulded bakelite form with turns spaced to provide low radio frequency resistance. When this coil was tuned by a .00035 mfd variable condenser, the full wavelength range from 200 to 550 meters was successfully covered. The primary in this transformer consists of 55 turns of No. 32 double silk-covered wire wound on a 1½-inch tube slipped inside the secondary form, the primary winding being at the filament end of the secondary.

In order to do away with shielding, the inductances were kept at least 12 inches apart. This procedure might not be feasible in a receiver employing more than one stage of screen-grid tubes, but for this four-tube set it was found feasible. Although precautions were taken to keep the r. f. amplifier and detector circuit coupling at a minimum, it was found that some reaction was experienced when the detector was adjusted for critical regeneration. This reaction was eliminated by a radio frequency choke placed in the shield lead, being properly bypassed to the negative filament, as shown in the schematic, Figure 2.

The audio frequency amplifier employs 112A tubes in both the first and second stages. The first stage operates at 135 volts plate potential with a 4½-volt negative bias. This plate and grid voltage



Figure 6. With a standard record pickup and record turntable the set may be used for radio or record reproduction with good tone

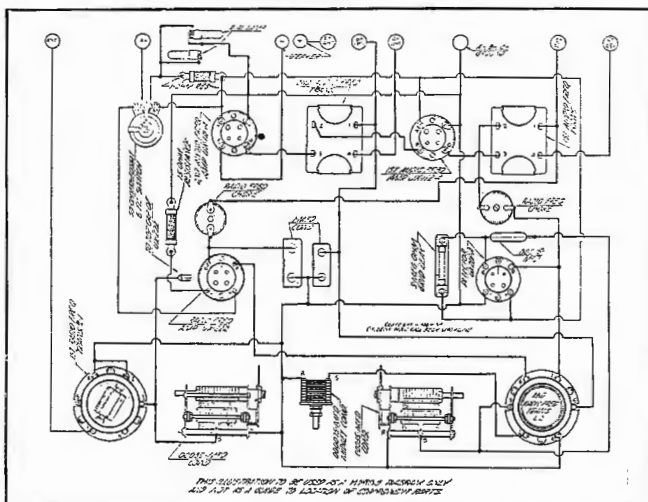

Figure 3. For minimized time and energy the builder should follow this diagram for all wiring

value insures a low plate impedance, good handling capacity, and good reproduction of bass notes. In the case of the second stage, the plate circuit should have from 135 to 180 volts of B potential with from 9 to 12 volts of C bias. The total current consumption of the whole set is about 15 milliamperes, which permits battery operation without the necessity of continuous renewal.

Simplicity of the front panel is in keeping with the general design of the receiver, which is simple in the extreme. All parts not on the panel are mounted on the wood sub-base. The antenna coil and coil socket are at the left end, and the radio frequency transformer and its socket at the right end of the baseboard. On the baseboard beneath the variable condensers are located the 1 mfd bypass condensers.

The assembly of the set is very simple. The condensers are first mounted on the dial brackets, the drums attached, and the brackets fastened on behind the front panel, which also carries the dial windows and the small dial lamp brackets. The rear of the panel should be scraped to insure good contact between the panel and the dial brackets.

The wiring is simple and is clearly illustrated in the photograph in Figure 1, and the schematic in Figure 2, and the graphic in Figure 3. It is preferable that the receiver be wired as shown in Figure 3, since it will save the builder considerable time for that work.

With the batteries connected and tubes in place, the rheostat should be turned full on, which will give approximately 3.3 volts to the 222 tube. With the midget condenser all in, the right tuning dial should be rotated until a squeal is heard. The squeal should be tuned in loudest by proper adjustment of the left-hand and right-hand drums. If the midget condenser is then turned out slowly, the squeal will disappear and the station program be heard. Volume may be controlled by the rheostat located in the filament of the 222 tube. In tuning for the local stations the regenerative condenser may be left about a quarter in, so that no squeals are heard. However, for tuning distant stations, it should always be tuned in far enough to make the detector oscillate and the stations first picked up as a squeal and then finally cleared up by turning the regenerative condenser out slowly. The rotor in the antenna coil may be adjusted to give greatest sharpness of tuning in the left-hand tuning dial. When this rotor is set at right angles to the coil form, greatest selectivity with least volume will be secured.

By using a 111A antenna coil and a 114D radio frequency transformer in the coil sockets, the set will tune from 500 to 1500 meters. A 111E and 114E coil will go from 1100 to 3000 meters. For wavelengths lower than 200 meters, the screen grid amplifier is cut out entirely and the antenna connected to post 3 of the detector coil socket, through a .000025 mfd variable midget condenser. With this connection, using the right-hand condenser dial only to tune the regenerative detector, the resulting 3-tube set will tune from 70 to 210 meters with a 114B coil, from 30 to 75 meters with a 114C coil. It is likely that with the 114C coil the experimenter will find most of the

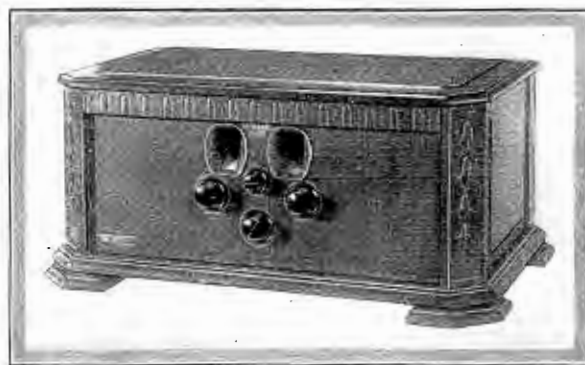

Figure 4. This photograph shows the completed receiver in its cabinet

short-wave broadcast stations such as 2XAF, KDKA, WLW, WRNY and others.

Suitable A or B power devices may be used with the receiver, the glow tube equipped B units being the most satisfactory.

As shown in two of the photographs accompanying this article, the receiver may also be adapted for use with a power amplifier and dynamic speaker, or if one desires to use a phonograph pick-up, such an arrangement may be easily accomplished by merely plugging the phonograph pick-up adapter into the detector socket.

List of Parts

The parts required for the construction of the receiver described in the preceding article are as follows:

- 1—111A Silver-Marshall 190 to 550 meter antenna coil
- 1—114SG Silver-Marshall 190 to 550 r. f. transformer
- 2—515 Silver-Marshall Universal interchangeable coil sockets
- 2—275 Silver-Marshall r. f. chokes
- 2—240 Silver-Marshall audio transformers
- 2—320 Silver-Marshall .00035 mfd variable condensers
- 1—342 Silver-Marshall .000075 mfd midget condenser
- 1—Sangamo .00015 mfd fixed condenser
- 2—Fast 1 mfd bypass condensers
- 1—Polymet 5 megohm grid leak and mounting
- 1—IR50S Carter 50-ohm switch rheostat
- 1—H1 Carter 1-ohm fixed resistance
- 1—H15 Carter 15-ohm fixed resistance
- 10—Fahnestock connection clips
- 4—511 Silver-Marshall tube sockets
- 2—805 Silver-Marshall illuminated Vernier drum dials
- 1—8x17x½-inch wood baseboard with hardware
- 1—Van Doorn 7 x 18-inch decorated metal panel

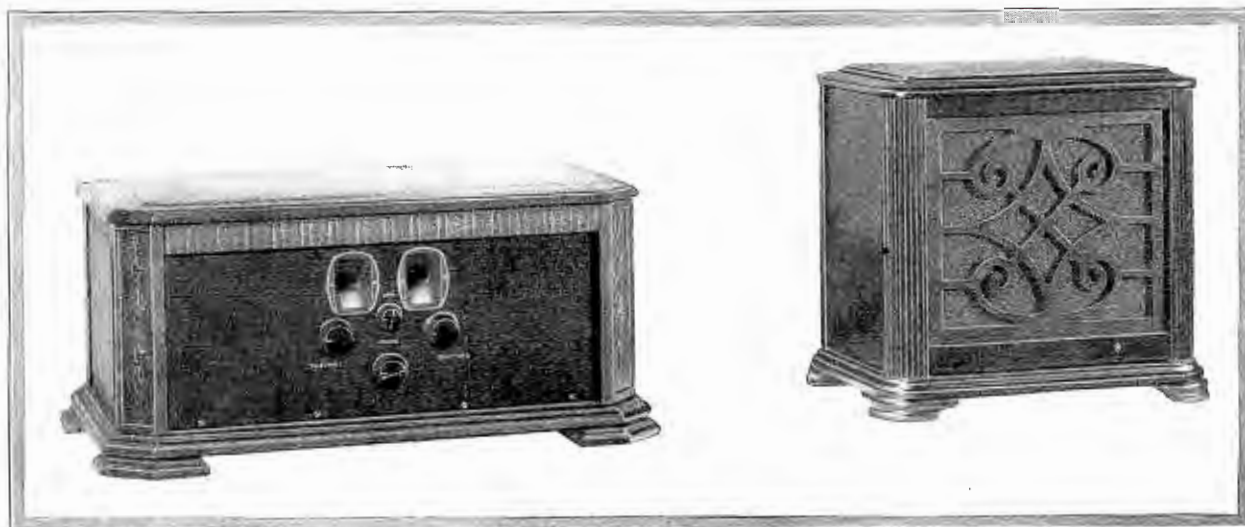

Figure 5. Those desiring to experiment with the receiver may use it somewhat after the fashion shown in the photograph above, where it is utilized with a dynamic speaker

Screened Grid Tube Used in Thordarson Power Amplifier

Two Stage Audio Coupler Has Complete Plate Power Unit and May Be Used with Any Receiver

THE screen grid tube, or shielded plate tube, has opened up a whole new field of development and has made it possible to build one stage of amplification which produces more real kick than two, or even three, ordinary stages. This is accomplished with no more chance for trouble than in a single stage using any of the older types of tubes. Now it is easily possible to take a mere whisper from the detector and step it up to a point that gives the power tube all it can handle in the way of signal voltage.

The full ability of the new method will not be appreciated on local and nearby stations because they provide enough strength for all the volume one wishes with any type of amplifier. But the first "DX" signal will be a revelation. Without pushing the radio amplifier anywhere near the point that means a howl, and without taking any chance of an overloaded detector, it will be possible to listen to both speech and music with a clarity, tone quality and volume that give pleasure in the listening and not only in the thrill of knowing the station is far away.

The unit includes a complete two-stage audio amplifier and a complete plate power unit or B-supply unit. It may be used in connection with any radio frequency amplifier containing at least a detector and usually one or more radio frequency amplifying tubes. The only other part required is either a A-power unit, a storage battery or a set of dry cells for filament supply.

The input for the power amplifier is taken from the detector tube of the radio frequency amplifier through a single wire. Plate current or B-power for the radio frequency tubes and for the detector tube is furnished from the new unit, doing away with the need of any separate B-power supply or B batteries. Grid biases are obtained through connections within the power amplifier so that no C batteries are needed. There are three tubes, one the screen grid "voltage amplifier," another the power tube feeding the speaker, and the third the rectifier tube for the plate power supply.

The laboratory tests on this new unit were made with the input from an ordinary two-tube radio frequency amplifier, two dial control, and an ordinary detector. Whether 201-A tubes or 199s were used in the radio frequency end and detector made little difference. The antenna was a single wire thirty-five feet long, elevated twelve feet above the ground. Such a combination does not deliver very much from the detector. Yet any broadcaster of ordinary power, located within twelve hundred miles of the receiver, was heard without effort, and many with such strength that the volume control would be lowered consistently while providing real entertainment in a large room. This sounds like making a claim that an audio amplifier will give long-distance

reception. In effect, that's just what happens.

The secret of combining volume with tone quality at the output or speaker when working on an exceedingly weak signal is found in the novel method of coupling used between detector and screen grid tube and again between this latter tube and the power tube.

The two features which interest us about this tube are its great amplifying power, by means of which a small voltage on its grid is changed to a big voltage in the plate circuit, and its very great plate impedance and resistance. The voltage amplifying ability is just what we want, but the plate resistance is something that calls for a different circuit than those suitable for other tubes.

A tube is no exception to the rule that any electrical generator will work in proportion to the work it is given to do. Another way of stating the same thing is to say that the work a tube will do is proportional to the impedance in its plate circuit. The higher the internal plate impedance of the tube, the higher must

be the impedance placed in the external plate circuit if that tube is to show what it is good for. That's where the Autoformers come in. They are a special form of impedance coupling and because they introduce impedance in its plate circuit the screen grid tube meets the occasion and delivers the voltage we are after.

The voltage from the plate or output side of the screen grid tube is first built up across part of the winding of an Autoformer in the plate circuit. Then there is a further step-up of voltage because this winding is made in two parts. This magnified voltage taken from the "high end" of the winding is delivered to the power tube's grid through a coupling condenser.

To avoid this "blocking" trouble we place another Autoformer be-

tween the grid of the power tube and the filament circuit of that tube. This makes a path of low resistance, to allow escape of the direct current which produces the blocking, yet at the same time it is a path of very great impedance between these points and so retains the full effect of the signal.

The required 40-volt negative bias for the power tube is secured by the voltage drop across the Electrad 2000-ohm fixed resistance connected to the center tap of the power tube filament winding on the power compact.

The screen grid tube is given a 1.8 volt negative bias on its control grid by using the voltage drop across the 15-ohm resistance in this tube's negative filament line. This bias handles without danger of distortion the greatest possible voltage which may be received from the detector.

Any grid biases for the detector and for the radio frequency tubes are, of course, cared for in the radio frequency amplifier.

Control of volume in the audio amplifier is provided by the Royalty 500,000-ohm variable resistance mounted on the front

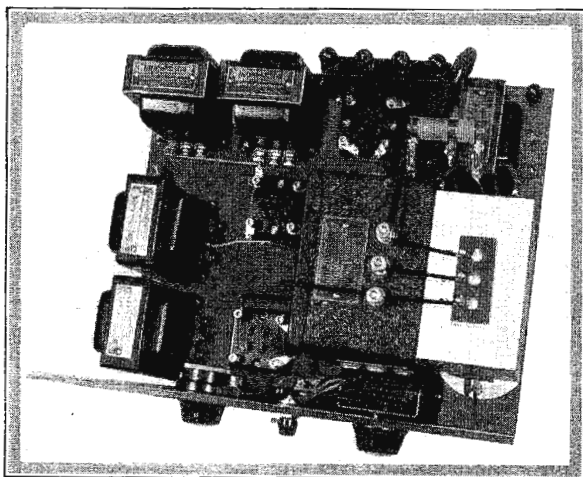

Figure 1. This photograph shows a rear view of the Thordarson Screened Grid Power Amplifier

(This amplifier tested and all illustrations made in our laboratory)

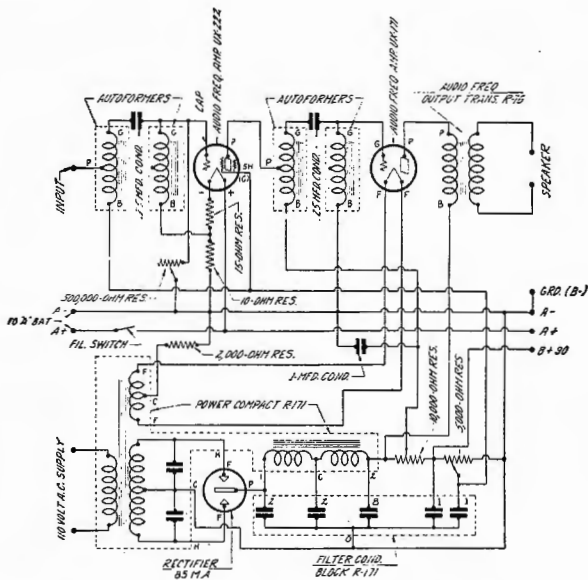

Figure 2. The schematic circuit of the power amplifier and the two autotransformer stages is shown in the above diagram

panel. This method of control allows the strongest of local signals to be reduced to a vanishing point on the one hand while giving the full power of the amplifier when desired.

The filament of the power tube is heated by alternating current taken from a special winding in the power compact. The filament of the screen grid tube may be operated either from an A-power unit, from a storage battery or from dry cells, whichever may be convenient or originally used for the radio frequency portion of the receiver. The diagram shows the filament resistances arranged for operation on a 6-volt A-power unit or on a 6-volt storage battery.

Since the screen grid tube's filament takes only 3.3 volts and .132 ampere for normal operation, it may be handled easily with

dry cells. Should dry cells be used, the only changes necessary from the arrangement in the diagram are to omit the 15-ohm filament resistance entirely and connect the grid return for this tube directly to the battery end of the remaining 10-ohm resistor. This grid return connection is the one made to a point between the 15-ohm and the 10-ohm resistances in the diagram. For dry cell operation this line is connected to the remaining 10-ohm resistance at the end farthest from the tube filament and nearest the binding post. These changes will provide the correct filament voltage and the correct grid bias with dry cell operation.

The Plate Power Device

Building the plate power unit and the audio amplifier together has many advantages. Not the least of these is the elimination of eight external wires otherwise required between separate parts. This portion of the apparatus consists of the Thordarson power compact, the Tobe filter and bypass condensers, the Electrad resistors for voltage control and the rectifier tube.

The power compact contains within its housing a transformer having one secondary winding for the plate supply and a separate secondary for the filament of the power tube. Within the same housing are the two filter chokes and also the two buffer condensers required for the rectifier tube.

Four different voltages are supplied to the various plate circuits. The highest voltage, that for the power tube, is taken directly from a terminal at the top of the power compact. From this point connection is made to the Electrad 10,000-ohm fixed resistance. A movable tap on this resistance takes off 135 volts which feeds the plate of the screen grid tube. From the other end of this 10,000-ohm unit is taken the 90-volt line for the plate circuits of the radio frequency amplifier. On the front panel is mounted the Truvolt variable resistance, from the movable arm of which is taken the 45-volt line for the plate circuit of the detector and for the screen of the screen grid tube.

The movable tap on the 10,000-ohm resistance is set once for all at the desired voltage. The arm of the Truvolt is moved by means of its knob to obtain the best tone quality and volume.

It is a simple matter to rejuvenate an old receiver and give it greatly increased distance ability with marked improvement in

(Continued on page 140)

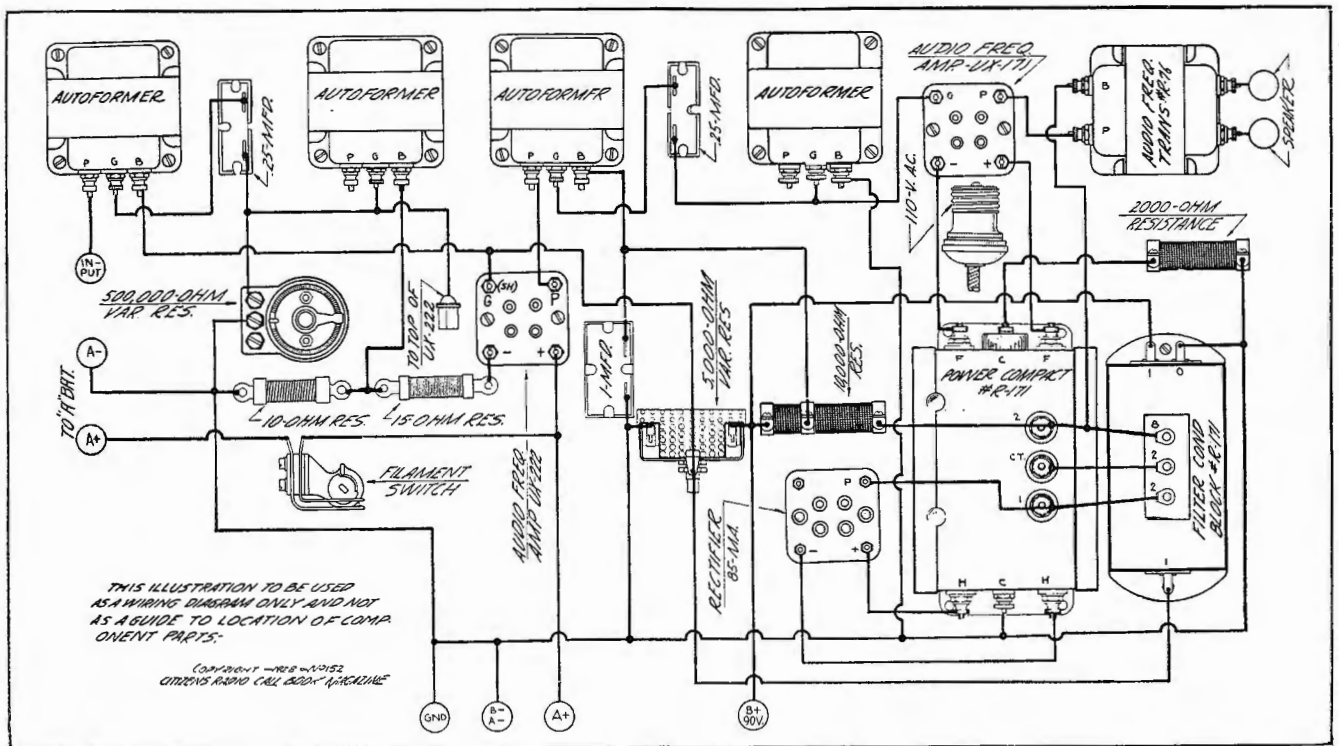

Figure 3. Set builders may readily wire up the amplifier described in this article by following faithfully all connections shown in the above diagram

The Knapp A Power Unit

An Efficient A Power Unit Easily Constructed

THE A Power Unit illustrated and discussed in the accompanying article is a neat and compact unit well constructed and will furnish an abundant supply of filament voltage for almost any receiver.

An interesting feature of this unit will be noticed in the primary side of the power transformer in Figure 3, a receptacle is placed across the 110-volt supply behind the power switch. This receptacle is incorporated in this manner so as to allow the operator to shut off the A supply and B eliminator with one turn of the switch. This receptacle is placed for the B eliminator supply plug and the switch may be extended to the front panel summing down the power control operation to the turn of one switch.

In constructing the unit the parts should be arranged in their places so far as this is possible. Two dissimilar plugs and sockets are provided with the parts so as to eliminate the possibility of connecting the a. c. supply to the receiver which would obviously have disastrous results.

With this new type of power unit the internal wiring of the receiver need not be changed as was necessary when the old type high current gaseous rectifiers were used.

The tapped secondary, as may best be seen in the schematic wiring diagram shown in Figure 3, allows the operator to adjust the unit to the proper voltage for his individual receiver and in this regard a reliable voltmeter should be placed across the A terminals of the receiver. If the flexible plug connection is placed in stud 1 (the stud numbers will be found on the graphic wiring diagram shown in Figure 2), the lowest available voltage and current is obtained and in a like manner the maximum output is obtained when the plug is inserted in post 8, which is the topmost stud. The various plugs should be tried until a reading of six volts is obtained while all of the tube filaments are burning. A six-volt supply is correct for all sets employing 201A, 112 and 112A, 171 and 171A type tubes. After this adjustment is made no further readings are required.

For small receivers such as those using three or four tubes it may be necessary to insert a six or ten ohm rheostat in the negative filament lead so as to reduce the filament output voltage to the required six volts. Under no circumstances should the tubes be operated above the rated terminal voltage specified by their manufacturer.

Since the internal wiring of the receiver is left unharmed, a screw-driver, a soldering iron and solder are all that is necessary in the construction of this unit, which permanently replaces the A battery with its cumbersome charging device. The tapped secondary step-down transformer, low resistance and high current choke coils, its rectifier and high capacity condenser sections all being new units in the radio field, it is doubted whether such parts can be found in the open market, and for such reasons we shall deal only with the standard kit of parts.

The wiring diagram shown in Figure 2 is clear enough so that

there is no need of elaborating on this subject. Care should be taken so as not to use the graphic wiring diagram shown in Figure 2 as a guide to location of component parts. This is merely a graphic wiring diagram and should be used only as such.

Care should be taken in wiring the primary of the power transformer to insert the toggle switch before it reaches the B eliminator receptacle, otherwise the B eliminator will be left on when turning the switch off. After wiring the receiver according to the wiring diagram, the entire unit should be checked carefully in order to make sure that there is no error in the wiring, and after rechecking the unit the builder may proceed with connecting the unit to the receiver.

While the drawings do not show the resistor unit connected, it is shown independently in the upper right-hand corner of the graphic wiring diagram (Fig. 2) and should be placed on stud "Z," the free end of the flexible connector is then connected to any of the eight studs to vary the voltage as was previously described in this article. The top plate and contact plate may

be used to mount the toggle switch if it is not desired to extend the switch to the front panel of the receiver.

To the upper L-shaped core clamp of the transformer attach two hexagonal scrapers by means of machine screws. The two mounting holes for the latter refer to those facing tapped secondary winding side, the taps in proper order and reading downward are 22, 1, 3, 5, 7, 2, 4, etc. The drilled base plate should be placed with the word "TOP" facing upward, the choke coil should then be mounted by means of four heavy machine screws and the six brass spacers furnished for that purpose.

Then mount transformer, also using machine screws. When looking at wide side of base plate the transformer taps should be facing left and not toward choke coil. The completely assembled base plate should in turn be mounted on the drilled wood baseboard by means of four 10/32 flathead machine screws.

There is a drilled bakelite top-plate that should next be assembled to the apparatus, this carries practically all of the wiring connections, the A voltage adjusted plug for B eliminator and the rectifier unit. It should be carefully assembled.

In the kit of parts will be found the four nuts and washers to be placed on the underside of top-plate studs of rectifier unit. These are numbered 13, 14, 15, 16 and 17, as shown in the upper left-hand corner of Figure 2.

Nine hex nuts should be placed on the underside of the eight transformer tap plugs marked 8 to 15 inclusive, and also on 18 the switch post connector all nuts and washers for binding post studs 9, 10, 11 and 12 are next put in place. The B eliminator plug should next be mounted to the top plate. Two screws fit through the latter into the flat, nickel-plated, tapped piece of the plug.

The high-capacity condensers should be mounted on the wood baseboard with their lead wires going in the same direction as

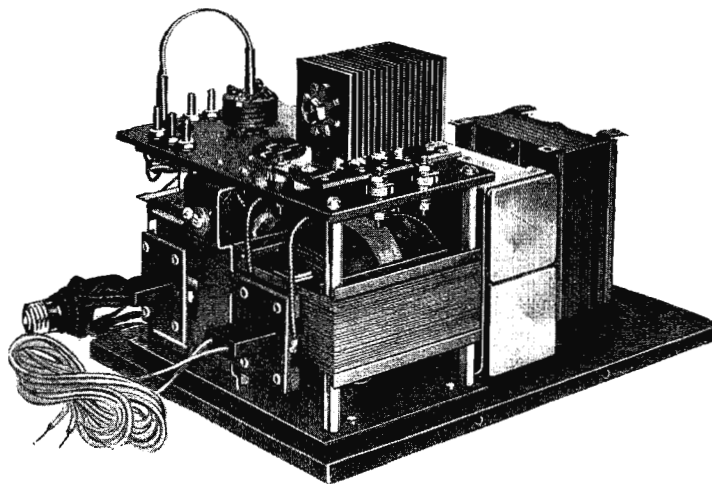

Figure 1. This photograph shows the unit completely assembled with protective cover removed

the transformer taps. The two condensers placed one on top of the other are held in place about 1½ inches away from the steel baseplate assembled by means of the two U-shaped copper clamps, and four wood screws.

The choke coil should next be mounted into place on the center line of the wood baseboard about midway of the remaining space, by means of heavy wood screws. All sub-assemblies now being completed, the wiring proper may then be gone ahead with.

Twenty-seven terminal clips are required. The mounting bracket with contact plate should first be wired up, then fit bracket lugs into baseplate, leaving former lay over at an angle. Take one of the transformer lead wires and together with one side of receptacle for B eliminator solder to one side of toggle switch. The other side of the transformer is soldered to the plug connection for the a. c. supply and the other side of B receptacle, and the remaining end of the a. c. supply plug is connected to the remaining end of the toggle switch.

Top plate should next be wired up, and in this regard it is well to ascertain whether all underside connections have been completed first. After making all concealed connections on the underside of top plate the completed plate may now be assembled over the several spacers on the choke coil and transformer by holding down with screws and washers. The contact plate and mounting bracket can also be made up fast by means of small screws, nuts and washers found in kit.

Make certain all transformer taps are well cleaned before soldering, otherwise poor A-power results must be expected. The loose lead wires from the polarity plug must be connected as shown in the diagrams. If after connecting it is found they are reversed, exhibited by the fact that the voltmeter will give a reverse reading, they should be transposed at the polarity plug. The Knapp rectifier unit should now be put into place by gently sliding its contact pieces over the stud washers on the top plate.

The maroon finished metal cover may now be put into place or it may be left until after the device has been tested. It should be fitted over the center of toggle switch and both a. c. and d. c. plug connectors. After being properly lined up it should be screwed fast to the wood base, using eight small wood screws.

Finally the a. c. line attachment plug and the d. c. plug may be connected up. The d. c. flexible rubber-covered wires then go directly to your set six-volt binding posts or plug.

tion but act as an almost perfect insulator to currents of reverse polarity. However, when this film becomes ruptured, in the case of copper oxide-aluminum and some other combinations, it places an overload on the couples remaining intact, and this of course means a relatively short life. Many purchasers of such types of

At this point a little history concerning the operation of the unit is not amiss. Rightly protected by patents, the Knapp rectifier unit consists of a series of couples made up of cupric sulphide disks facing others of magnesium. While ordinary copper oxide and copper couples do give good rectifying action, yet experiments show that the least overload and particularly a minute arc, is sufficient to completely destroy the rectifying film upon which these devices operate.

This film is of extremely thin section, and when in compression functions much like a series of small bubbles electrically charged which offer no resistance to current flowing in one direction. Research has

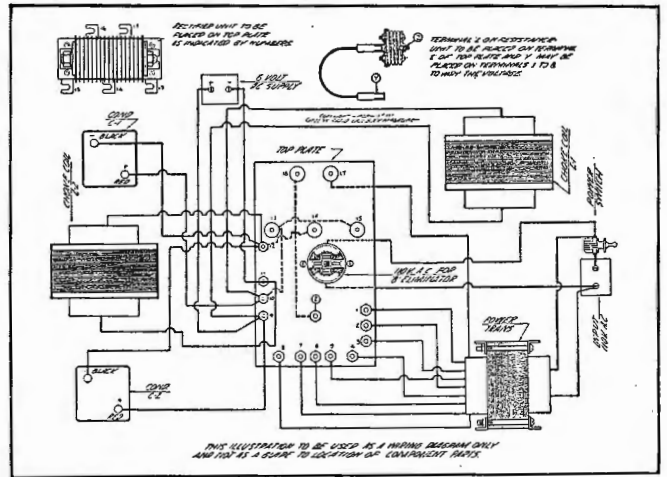

Figure 2. The wiring diagram is shown graphically above

shown that a cupric sulphide-magnesium coupling unit is self-healing in the event an arc momentarily breaks down the rectifying film. In other words, a chemical reaction between the two elements sets in immediately to rebuild the rupture. And as a result these units can be guaranteed to give at least 1,000 hours of life, whereas normal life, according to a long series of tests, is in excess of 3,000 hours, or about three years of radio service.

It is interesting to look over several oscillograph pictures of the wave shape of both the input a. c. and rectified output d. c. of the unit under discussion. This of course is almost impossible, everyone not having access to the oscillograph.

It is a well-known fact that of the several means of rectification thermionic or vacuum tube types are of the most efficient. Among other things, the ideal rectifier is one which will give the same output wave as that existing across its input.

Parts necessary in building the Knapp A unit are:

One Knapp A power kit containing the following materials:

- Transformer.
- Rectifier unit.
- Special high-capacity A power condenser.
- Choke coil with 6 brass spacers.
- Special high-capacity A power condenser.
- Choke coil.
- Drill baseplate (copper-plated steel).
- Drilled top plate (brown bakelite with studs in place).
- Contact plate with mounting bracket.
- Transformers mounting screws and nuts.
- Choke coil (L-1) mounting screws.
- Rectifier fastening nuts.
- Nuts for fastening wire to rectifier on underneath side of top plate.
- Plug for B eliminator.
- Nuts for holding transformer top leads.
- Screws and washers for mounting choke coil (L-1) to top plate.
- Screws and spacers for mounting transformer to top plate.
- H. & H. toggle switch.
- Screws, nuts and washers for mounting contact plate to top plate.
- Terminals.
- Condenser mounting bracket screws.
- Choke coil (L-2) mounting screws.
- Bottom plate mounting screws.
- Nuts and washers for terminal posts.
- Resistance unit.
- Switch post connector.
- Screws for fastening metal cover to baseboard.
- Condenser mounting brackets.
- Drilled baseboard.
- Metal cover.
- A. C. line attachment cord with plugs.
- Output cord for connecting to set with polarized plug.
- Flexible hook-up wire.

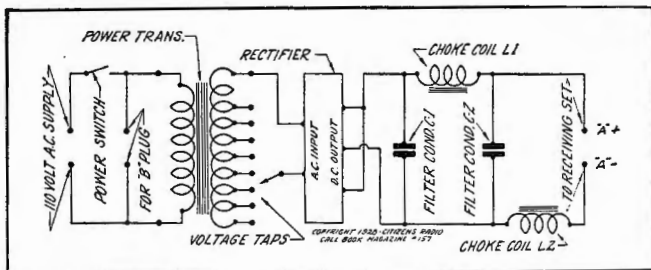

Figure 3. The schematic wiring diagram given above should be followed thoroughly for maximum efficiency

Samson Public Address System Has Ample Power for All Uses

Group Address Unit May Be Found Useful in Small Municipalities and Rural Districts

DUE to the number of recent requests from our readers, we are printing at this time a group address system, or when boiled down, a power amplifier which is capable of producing considerable power output for various uses. This group address system may be found to be very useful in the small municipalities and rural districts of the country where it is desired to amplify the voice of a speaker, or music on various occasions, such as commencement exercises, banquets, speeches, etc. It might also be readily applied to dance halls of most any size, as provisions are made whereby a radio receiver may be attached to the amplifier which will give a great amount of volume, making possible the reception of some famous orchestra and being able to reproduce at a great enough volume to fill a good-sized auditorium for dancing purposes.

Inasmuch as most commercially built group address systems will cost in the neighborhood of thousands of dollars to buy and install, this amplifier or group address system should be received by those who could not purchase such a device from a financial standpoint as a solution of their problems and as a means of commercializing their knowledge of radio and mechanical ability by constructing and either renting or selling this device.

The amplifier in general merely consists of one stage of impedance coupled amplification, two stages of high-grade transformer coupled amplification, and one stage of push-pull amplification with various switching devices whereby it may be used as a radio amplifier or an electric phonograph amplifier, as a group address system using a microphone for the input, or as a broadcast monitoring amplifier. The one impedance stage and the two transformer coupled stages are designed to use the standard 201-A type of tubes. However, sometimes it may be found advisable to use the UX-112A power tube in the second transformer coupled stage. The push-pull stage has been designed so that either the 171 or the 210 types of power tubes may be used at will, without making any changes within the unit itself.

Switches are provided by which the filament of the push-pull stage may be readily changed from six to eight volts, or eight

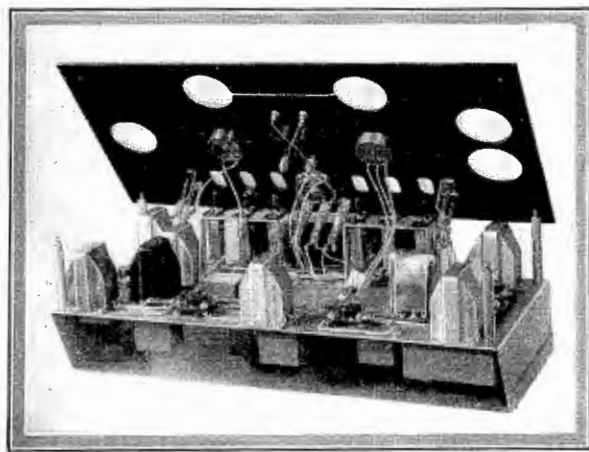

Figure 1. This photograph shows a view of the Samson group address system with the top elevated



Figure 2. This photograph shows the top of the group address system described in this article

to six volts, having compensating resistances for automatic control for the filaments in the circuits.

How It May Be Used

As will be noticed in the schematic wiring diagram, when a radio set is connected to the unit, there are two binding posts marked "P" and "B" positive for this purpose. When this is used the first or impedance coupled stage is not used, putting the signal directly upon the grid of the second stage of amplification through the coupling condenser and a resistance. Or if less amplification is desired, there is a second pair of binding posts provided by which the output of the radio receiver is placed upon the primary of the first audio frequency transformer which goes out the first two amplifier tubes and uses only one stage of push-pull. In using the unit as a phonograph amplifier, there are two binding posts provided marked "G" and "F" to which the output of the pick-up is connected which places the unit across the grid and the filament or the input circuit of the third stage of amplification which will then only use the last two and the one stage of push-pull.

For Monitoring Purposes

There is provided in the plate circuits of the first, second and third tubes a jack by which phones may be plugged into these circuits in order that the output of each stage may be readily checked for volume and quality, making the adjustments on each stage, thereby insuring satisfactory results when the entire amplifier is adjusted. There are also provided in several circuits additional jacks across which are placed 1.33 ohm shunts by which the Weston Model 3010-5 milliammeter may be plugged into the different circuits to determine the current flow in the circuits, so that in the microphone lines, or the push-pull lines, may be adjusted to equal proportions, thus insuring perfect reproduction and satisfactory operation. These shunts are provided as the current will be in excess of 5 milliamperes and will thus protect the meter. The above-mentioned jacks in the plate circuits of the three amplifying tubes may also be used with the milliammeter for the verification of plate current from which may be determined the amount of distortion, if any, that occurs during

(This unit tested and all illustrations made in our laboratory)

the amplification of each tube. These jacks are not provided with shunts as the current in these circuits will be less than the full range scale of the milliammeter, which is 5 mills.

On the left of the schematic will be noticed three binding posts to which the microphone is connected. With this circuit it is necessary that a two-button microphone is used such as the Kellogg or Western Electric standard microphone. The microphone control is the 200-ohm potentiometer, which will be found across the filament of the first tube. By means of this potentiometer and the milliammeter plugged into the two jacks on each side of the microphone, the current in each side of the "mike" may be adjusted so that they are equal at which time the microphone will operate correctly. There is placed across the secondary of the microphone input and transformer a .2 megohm variable resistance, by means of which the volume may be regulated.

Fixed Filament Control

All filaments are controlled by fixed resistors. The output of the amplifier may be directed in one of two ways to four binding posts which are provided for the purpose. By the use of these binding posts and a switch which will be noticed at the extreme right of the schematic diagram, the output of the amplifier may be directed into one of two channels or from a loud speaker to the monitoring line of the broadcasting station. This unit will very successfully operate from thirty to thirty-six high-grade speakers and will give an undistorted quality with a tremendous volume. From recent experiments with the completed unit, it has been found that very rarely has it been necessary to use more than one-quarter of the possible volume obtainable.

From the list of parts may be found the make and the type of parts used in the construction of the unit. In the construction of the unit it is necessary to ground all transformer and impedance cases. It is not advisable to substitute any parts which have been specified for this unit. The parts as specified have been designed into this unit and have been found to operate extremely satisfactorily, and if substitutions are made there is a question if complete satisfaction will be obtained from the unit.

As will be noticed from the photograph, the construction of the unit makes it rather compact, and no mechanical layouts have been printed, as the constructor will very probably want to use a mechanical layout of his own liking. We might mention, at

this point, that it has not been found satisfactory to use a B eliminator on this unit, as the sensitivity of the unit will pick up any hum that may be present in the eliminator. The storage type of B battery is recommended for this purpose if the unit is to be made a permanent set-up. If not, the standard dry B battery will be found to give very good service for this purpose.

Parts required for building this amplifier are:

- 25 Eby binding posts.
- 5 64-A Igrad 4 mfd bypass condensers.
- 3 44-A Igrad 4 mfd bypass condensers.
- 4 41-A Igrad 1 mfd bypass condensers.
- 1 Z Samson impedance.
- 1 Y Samson transformer.
- 1 Samson symphonic audio transformer.
- 2 P Samson plate impedances.
- 1 Samson microphone input transformer.
- 2 Samson 30 henry chokes.
- 5 9040 Benjamin sockets.
- 1 Anisco 1/2 megohm grid gate and mounting.
- 7 Yaxley closed circuit jacks.
- 4 1.33 ohm shunts.
- 1 Yaxley 200 ohm potentiometer.
- 1 Tobe .005 mfd fixed condenser.
- 1 895 Frost 500,000 ohm potentiometer.
- 1 Frost 200,000 ohm variable resistance.
- 2 Carter tip jacks.
- 1 301 Weston 0.5 milliammeter.
- 6 1424-W Federal anti-capacity switches.
- 1 6 x 10 x 3/16-inch panel.
- 1 12 x 24 x 3/16-inch panel.
- 4 3/4 x 1/2-inch brass rods.
- 1 11 1/4 x 23 1/4-inch panel.
- 3 Carter 4 ohm fixed resistances.
- 1 Carter 1 ohm fixed resistance.
- 1 Carter .17 ohm fixed resistance.
- Miscellaneous lugs, nuts, screws, bolts.

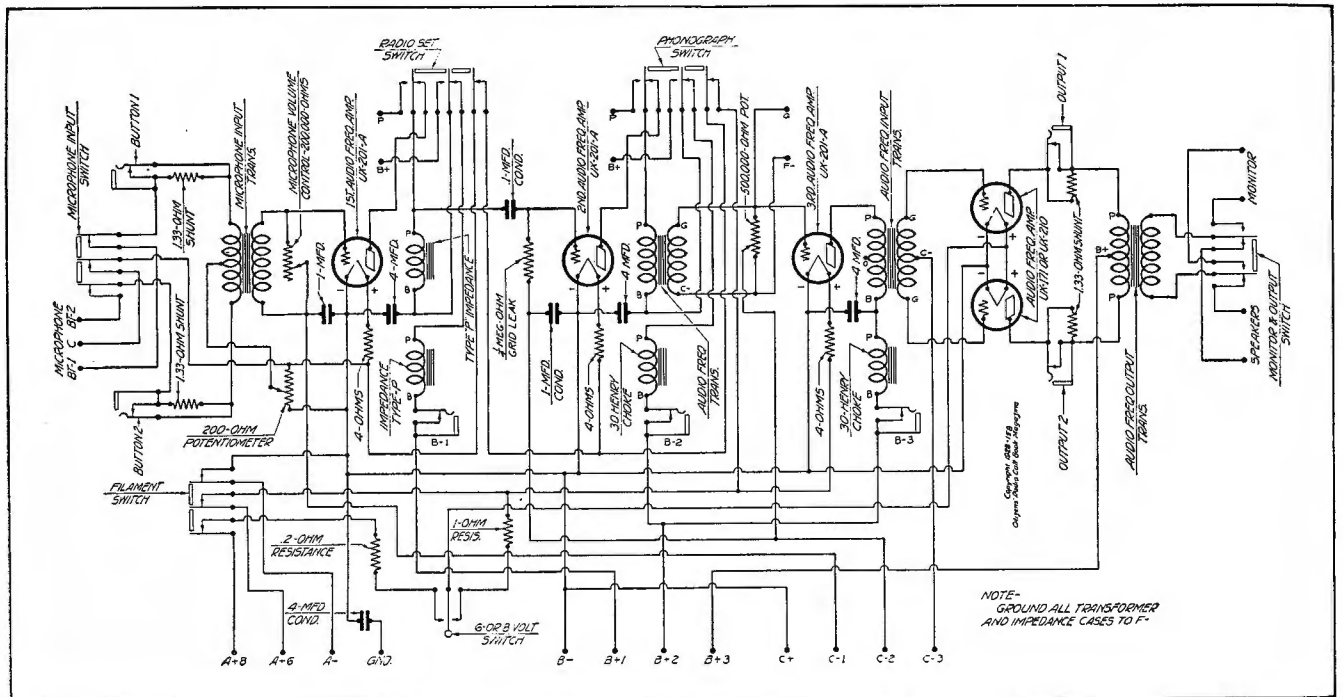

Figure 3. All necessary connections for building this amplifier are shown in the schematic circuit illustrated above

Balancing the Battery Operated H. F. L. Nine-in-Line

Simple Changes May Be Made by Operator to Insure a
Highly Efficient Receiver

PRESENTATION of the a.c. operated Nine-in-Line receiver in our last issue created such an unusual interest that a few hints on the operation of the battery operated receiver will be quite appropriate at this time. While it may be said that the receiver will operate satisfactorily if the instructions by the manufacturer are followed out to the last detail, however there is one point that may well be considered at this writing.

Everyone is familiar with the amount of amplification which is developed across the intermediate amplifier of the Nine-in-Line. Just this efficiency has resulted in trouble for some of our readers. This carefully balanced circuit which is steady in operation when the correct voltages are applied will become quite unruly when the voltages are allowed to shift over a 25 per cent limit. If a B unit is used which has a provision made for the insertion of a glow tube, then the Nine-in-Line will operate with no trouble whatever.

However, we realize that there are several thousands of Nine-in-Line owners who would not care to purchase a new B unit and a glow tube. In order that they may gain the maximum amount of efficiency from their receivers, we are about to outline a few slight changes in the circuit, which will compensate for the great variation in the manufacture of current supply units. The receiver incorporating these changes has been tested and approved by the High Frequency Laboratories, manufacturers of H.F.L. units.

Few Changes Necessary

Furthermore, should the operator at some future date replace his present B unit with a new current supply set, no additional changes in the receiver will be necessary. These few circuit

changes which we are about to describe can be considered as a permanent feature of the receiver and in no case will they harm the operation of the set.

It is seldom indeed that we receive complaints on any receiver because it is too sensitive. Nevertheless, this factor is directly responsible for some trouble. The intermediate amplifier in the Nine-in-Line receiver compares favorably with the amplifiers of the best shielded grid receivers on the market at this time. As this unusually high signal voltage builds up across the amplifier, there is a tendency toward oscillation, due to interstage coupling and the output voltage feeding back into the input circuits.

This oscillation can be controlled by reducing the filament current going into the intermediate amplifier tubes, or by reducing the plate voltage applied to this section of the amplifier, or by increasing the C bias applied to this same section. None of these methods are entirely satisfactory. In all cases, wherever possible, the A, B and C voltage values should be maintained and the device controlling oscillation and amplification should function in a manner that will not disturb these previously set-up values.

Now by referring to the schematic circuit which came with your kit of parts you will see how the Nine-in-Line is wired before these changes are made. The changes considered are: doing away with the variable rheostat which controls the intermediate amplifier tubes and replacing it with a fixed resistor. The switch which is an associate part of this rheostat may just as well be on the rheostat which controls the first detector tube.

How It Is Done.

With the fixed resistor inserted in the circuit, the filament voltage on the oscillator, the intermediate amplifier tubes and the

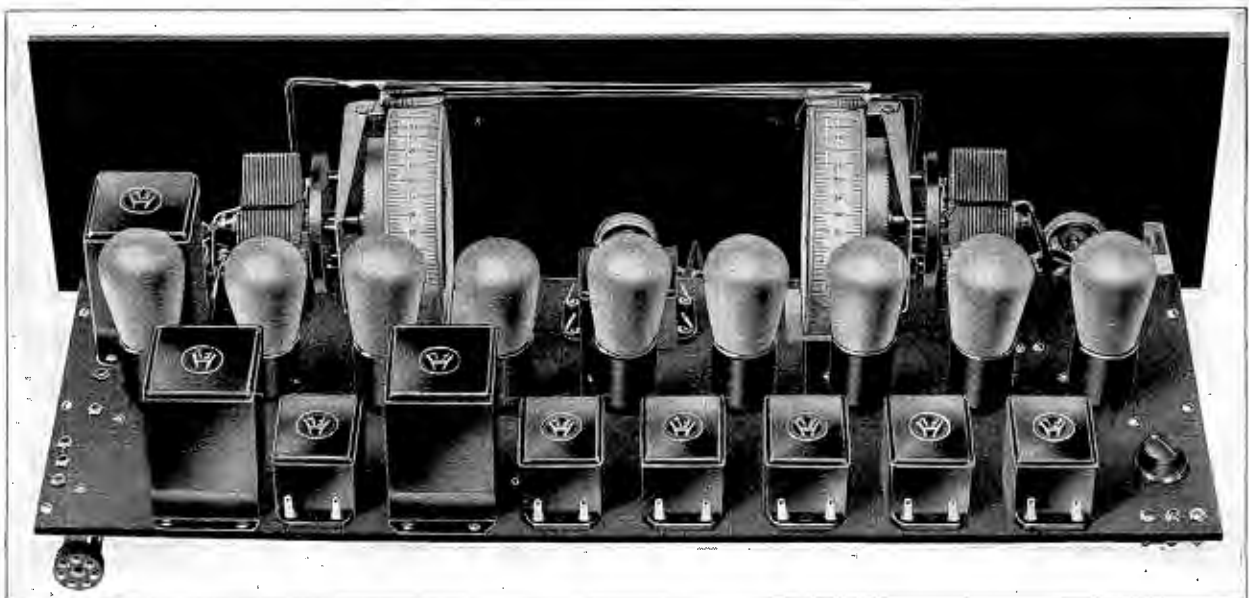

Figure 1. This photograph shows the rear view of the battery operated Nine-in-Line receiver, which is discussed in the accompanying article

(This receiver tested and all illustrations made in our laboratory)

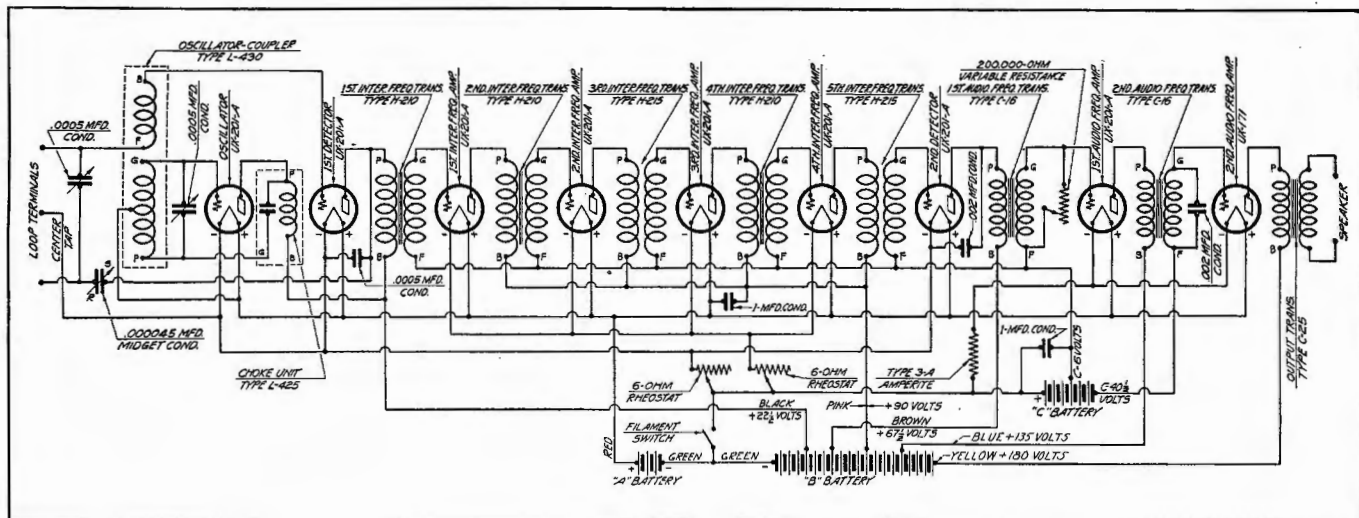

Figure 2. The schematic of the battery operated Nine-in-Line is given above for reference. Changes advocated to insure efficiency are contained in the text of this article

second detector tube must remain constant, however should the plate voltage be allowed to go above the maximum of 90 volts, the amplifier will break into oscillation and reception of distant stations will become quite difficult. Both oscillation and sensitivity can be controlled by a highly satisfactory method. This consists of shunting a 3000 ohm variable resistor across the second radio frequency transformer. For all general purposes, this one control will take care of the set in a highly satisfactory manner.

However, in a few isolated cases, there may still be some tendency toward oscillation. This can permanently be corrected by shunting a fixed resistor having a value of 10,000 ohms across the primary of the fourth radio frequency transformer.

In order to make the required changes you will need three additional pieces of equipment. These are, one Carter type M-20-S 20 ohm rheostat and switch. One Carter type MW 3000 ohm midget potentiometer and one Carter type H 2/3 ohm fixed resistance strip. In the other odd cases which were spoken of a 10,000 ohm resistor can be of any type such as a regular 10,000 ohm grid leak. Let us repeat again that only one case in several thousand will need this third resistor, so our readers can practically disregard it.

Making the Changes

The changes in the receiver are made in the following manner. Remove the 6 ohm rheostat from the left end of the panel and replace it with the 3000 ohm potentiometer. Remove the 6 ohm rheostat and switch from the center of the panel and replace it with the 20 ohm rheostat and switch. The type H 2/3 ohm resistor should be connected into the circuit so that it controls the filament voltage on the oscillator, four intermediate tubes and the second detector tube. One end of this type H 2/3 ohm resistor should connect to the six negative filament terminals on these tube sockets and the other end of the resistor will connect to one side of the side of the switch on the 20 ohm rheostat. The other side of the switch of course goes direct to the negative battery lead through the multi-plug connection. Connect the 20 ohm rheostat into the circuit so that it controls the first detector tube alone.

The 3000 ohm potentiometer can now be connected across the primary of the second radio frequency transformer. The center point of the potentiometer should connect to the B terminal on the transformer and the right hand terminal of the potentiometer (looking at it from the back of the receiver) should be connected to the P terminal on the second radio frequency transformer. This is the second iron core transformer immediately preceding the first type H 215 air core filter transformer.

Exceptional Cases.

For the other exceptional case, the 10,000 ohm fixed resistor

can be shunted in a like manner across the primary of the fourth radio frequency transformer (the one between the two filters). Simply connect it directly across the transformer from the P terminal to the B terminal.

Switch Disconnects Receiver

The switch on the 20 ohm rheostat and switch will serve to disconnect the entire receiver. The 20 ohm rheostat itself will control the first detector tube and act as an excellent threshold value control at this very sensitive point in the circuit. Since the intermediate amplifier tubes, the second detector and the oscillator are all held constant, variation of this 20 ohm rheostat will in no way affect the setting of the oscillator. Thus on extremely distant stations, the first detector tube can be boosted to a highly sensitive condition without disturbing any of the other voltage factors in the receiver. The type H 2/3 ohm resistor will control its associated tubes and maintain a constant value of five volts on these filaments.

The type MW 3000 ohm potentiometer will function to control perfectly oscillation in the intermediate amplifier. Using this device, the amplifier can be worked at all times just below the point of oscillation which is a highly desirable consideration, as maximum selectivity can be maintained at all times.

This is what we were aiming at in the first place. If the B unit supply should deliver voltages above 90 volts to the intermediate amplifier the potentiometer will still control the amplifier and oscillation will be eliminated completely.

The 10,000 ohm fixed resistor (if it is used at all) will function merely to stabilize the section of the amplifier taken up by the two filters and the iron core transformer between these two filters.

Makes Ideal Set

This makes an ideal receiver. We have a sensitivity control, a selectivity control and the 200,000 ohm Hi-Pot which appears at the right hand end of the panel will serve to control the volume in a very satisfactory manner. This 200,000 ohm volume control should always be set at about half the maximum setting while tuning as the local stations are liable to ruin the loud speaker if the full output of the receiver is allowed to go through the loud speaker coils.

Those persons who have built the A. C. operated Nine-in-Line receiver will note that these changes are already incorporated in the circuit which was presented for that receiver. Very little trouble has been experienced with this receiver, and at this writing there are no additional hints that we may give which would improve the operation of the set.

Citizens Shield Grid Short Wave Receiver for Experimenters

Universal Wave Length Range Secured with Aero Plug-in Coils;
Allen Bradley Resistance Coupled Audio Used

FEELING that ample justice has not been done the new 222 shield grid tube in most designs, and that if the tube is any good at all it is a wonderful amplifier, recent experimental work has been carried on with this newcomer to prove that such a tube has wonderful possibilities if the builder will take time and trouble to use a good design.

In considering the question of a design for the 222 tube, it has been apparent that so far none of the circuits have been utilizing that tube at its maximum efficiency. Most of this lack of efficiency has been due to two prime causes. The first is that tuning has been done only in the grid input circuit, while the second is the fact that thoroughly good shielding has not been performed. As a result after the decision was made to employ the shield grid tube in a plug-in receiver capable of covering more than one reception band, it was considered necessary to tune both the input and the output circuits of the tube, that is, the grid and the plate. In order to do this and do it successfully, it is imperative that shielding of a high order be utilized.

Five Shielded Sections

By referring to the photograph shown in Figure 1, the builder will observe that altogether there are five shielded cans employed in this

particular design of a short-wave receiver. In order to contribute to its universality of use and simplicity of construction only standard parts were selected, this being especially true of the Aero inductances which are of a type already available on the market. While it is true that other inductances, home made, might have been used for covering the various bands, nevertheless with the ones existing on the market at the present time it was found possible to cover the range from 20 meters to 550 meters. The lower section of the wave bands, that is, from 20 meters to 180 meters, functions with the greatest amplification and apparent selectivity. On the higher wave lengths, such as from 200 to 550, the amplification was all that was desired, but the apparent selectivity suffered thereby. However, to counteract the effect of this and to enable the builder to determine for himself the degree of selectivity desired, the filament circuit of the shield grid tube was supplied with a rheostat so that the sensitivity of the receiver could be changed at will.

Separately Shielded

In order to keep the tube from reacting against the inductance and the inductance in turn against the tuning capacity, the first section of the receiver comprising the antenna and secondary coil and the

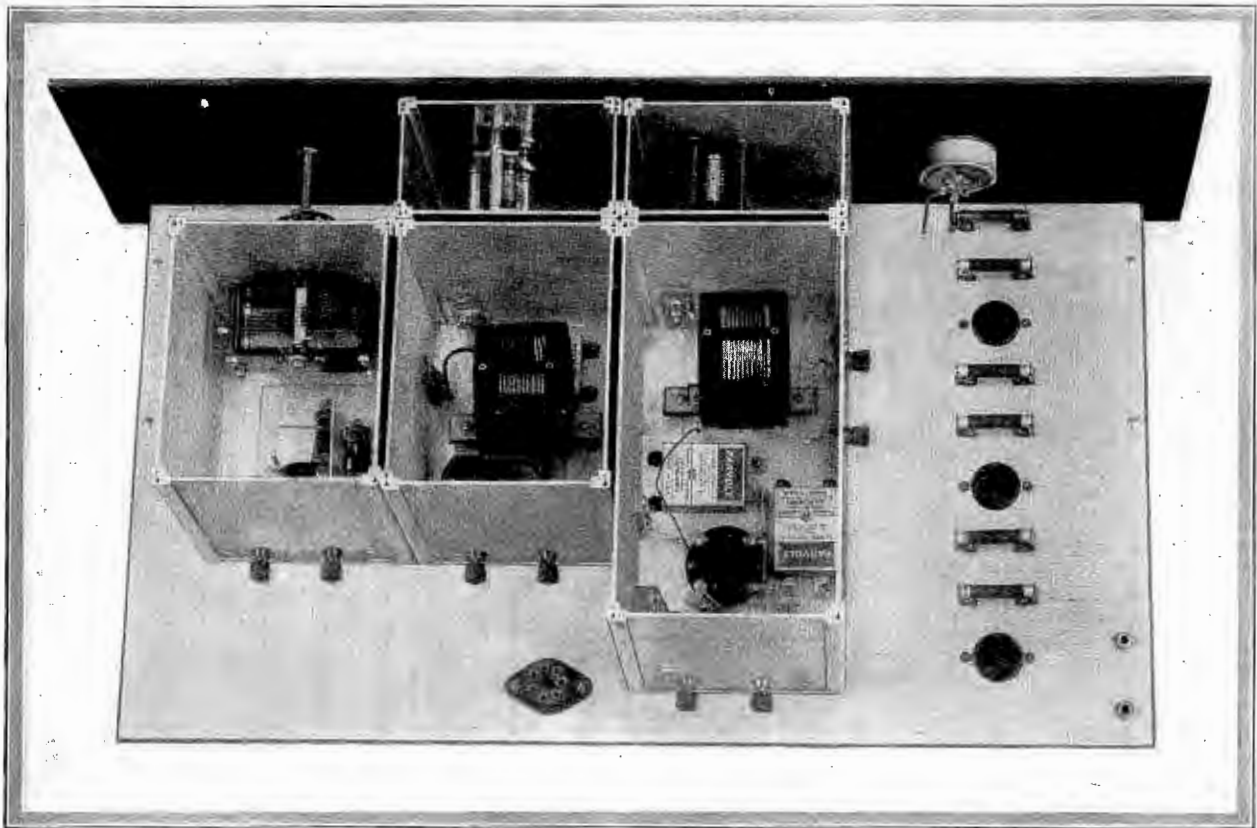

Figure 1. In this photograph the builder may see how the five cans are mounted on the sub-panel. The resistance coupled audio is located at the right in the photograph

(This receiver constructed, tested and all illustrations made in our laboratory)

tube were placed in a single box shield, the largest of those shown in the photograph in Figure 1, with the necessary bypass condensers and radio frequency chokes being contained therein. Then in operation a tube shield such as the one made by Remler was employed with a soldered connection on the metallic tube cover, so that this shield could also be grounded. The tuning condenser for the grid input of the tube is contained within a separate small can lying between the large shielded compartment and the front panel. The rotor of this condenser is common with the shield and also connects to the adjoining shield by the common grounding line, while the stator of the condenser is carried to a General Radio plug which meshes with a General Radio jack at the end of the large compartment and is carried thence to one end of the inductance and to the cap of the shield grid tube.

The plate inductance circuit of the shield grid tube is contained in an adjoining can containing only the inductance, a bypass condenser, a radio frequency choke and a coupling condenser which leads to the succeeding compartment containing the detector tube. As in the case of the tuned grid circuit, the variable condenser for tuning the plate inductance is also found in a separate can with the rotor of the condenser common with the shield and the stator leading through a General Radio plug and jack to the plate inductance. The tuning of this plate stage, in order to maintain the rotor of the condenser at ground potential, is accomplished through a 1 mfd bypass condenser which does not affect the tuning range of the variable condenser, but does allow the use of a grounded rotor condenser.

The detector compartment contains only the detector socket, the grid leak mounting and grid leak, the fixed filament resistance and the regenerative condenser. The regenerative condenser was placed inside this compartment because it does not have to be shielded separately from the detector. This condenser's rotor is also at ground potential and is connected to the front panel by means of a Hammarlund flexible coupling.

Resistance Coupled Audio

The output of the detector circuit (see schematic diagram in Figure 6) is carried through a 25,000-ohm coupling resistor and thence through the .05 mfd fixed condenser to the grid circuit of the first audio frequency amplifier, where a type 240 tube is used. The plate circuit of the first audio leads into the second audio, where another 240 tube is used and its output carried to the grid circuit of the third audio amplifier where a 112A tube is employed. Resistance

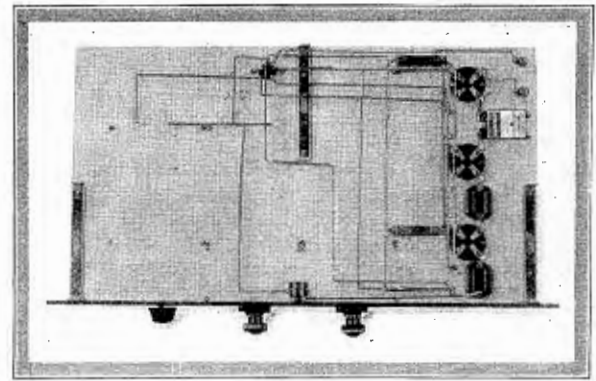

Figure 2. The bottom of the sub-panel is shown photographically above and gives an idea of the few wires required for connections

coupling was desired in this receiver in order to hold down its cost to a minimum and also because of the fact that with the Allen-Bradley resistors utilized, it was possible to get exceptionally good amplification and faithful tone quality on broadcast reception. On short-wave telegraphic work most all of the signals copied were taken on a speaker instead of the operator using the head phones.

The filament circuits of the detector and the audio stages are fixed by means of a combination of fixed resistors and amperites. A Hagel seven-contact sub-panel mounting socket was used and no filament switch provided. To disconnect the set all that is necessary is that the Hagel plug be removed from its socket.

In the case of the first inductance, the secondary of which is across the grid filament circuit of the shield grid tube, the small winding customarily used as a regenerative winding is employed as an aerial coil. Suitable antenna and ground binding posts, both insulated from the shield, are brought out to one side of the can. These binding posts are placed on a small Formica strip and bolted to the can, holes for the respective binding posts having been made sufficiently large to allow clearance. In the second inductance where the conventional secondary becomes the tuned plate inductance, the regenerative winding is used for the purpose for which it was designed. By this method it is possible to use the standard plug-in coils in the receiver without the necessity of having more than two windings in each coil.

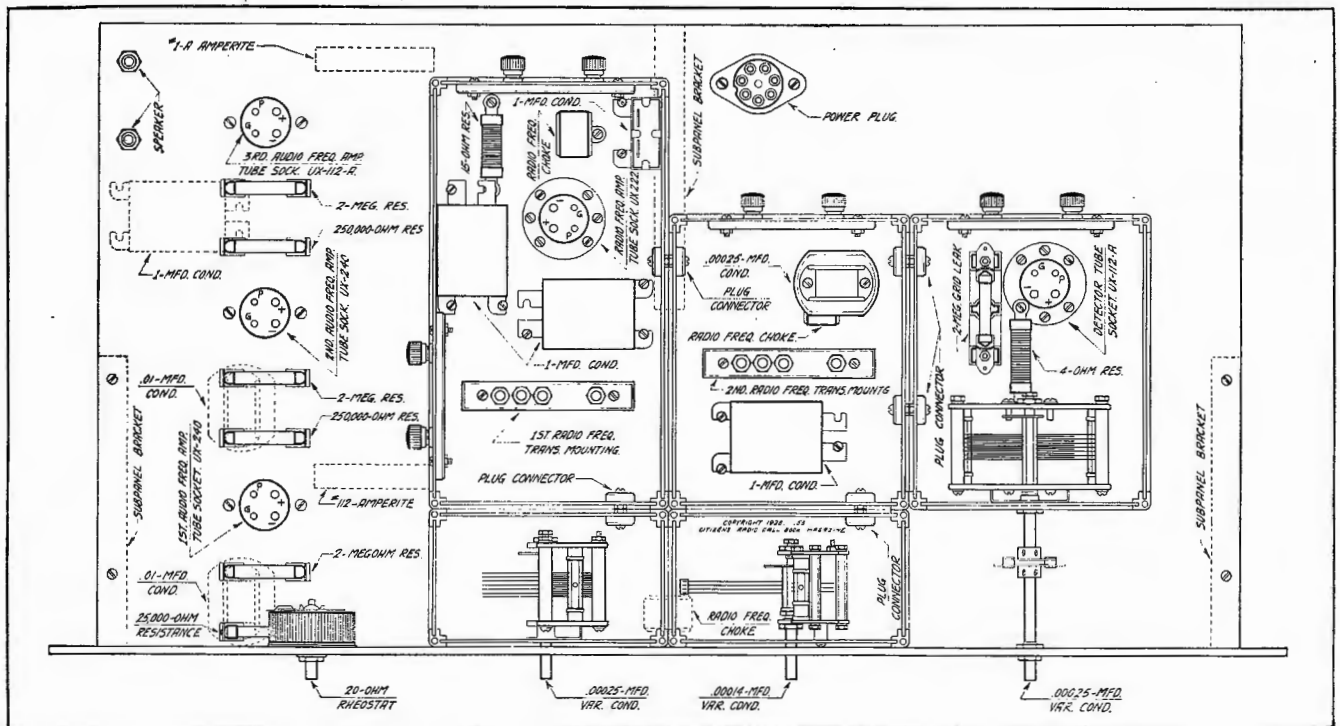

Figure 3. The drawing above gives the builder a clearer conception of how all parts should be mounted on the sub-panel

Hagerman 210-A. C.-Six Ensemble Has Interesting Features

Super Power Amplification, Complete A. C. Operation and Balanced Circuit Seen in New Offering

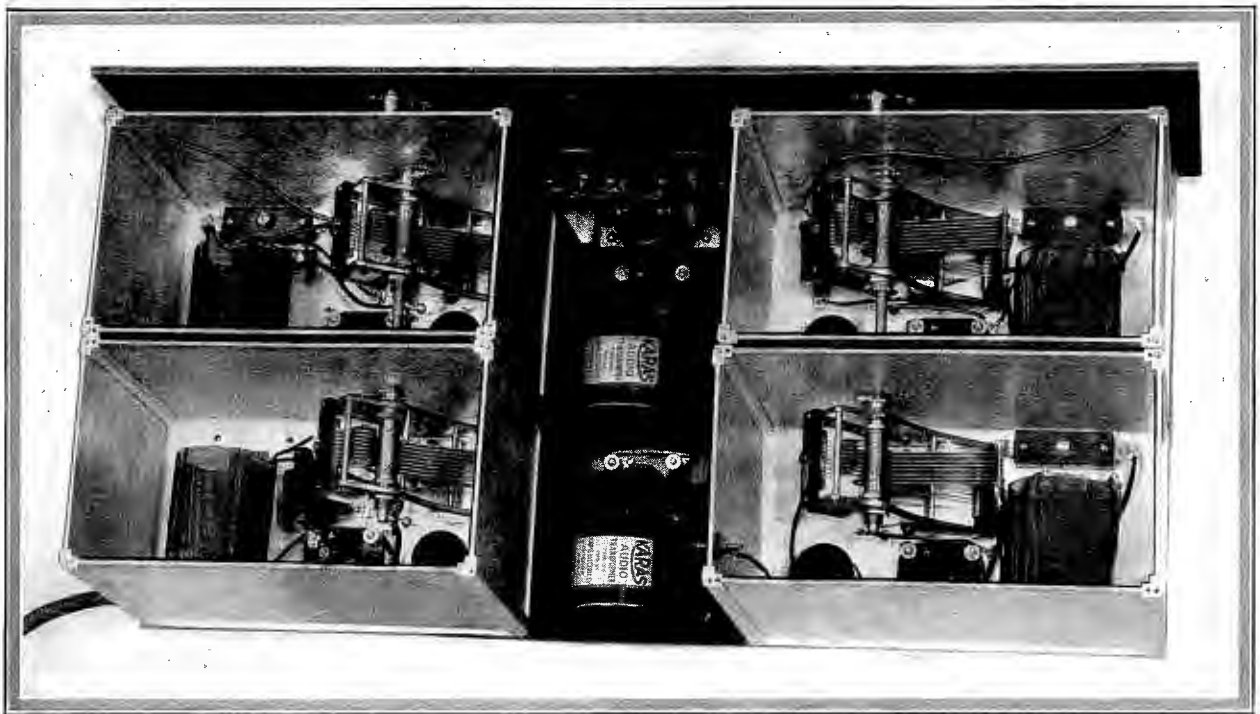

Figure 1. This photograph is taken of the top rear of the receiver and shows all parts located in their respective positions

A NEW radio receiver incorporating many new features including super power amplification, complete A. C. operation, with standard tubes and a perfectly balanced circuit consisting of three stages of completely tuned radio frequency amplification, individually and collectively controlled, is presented here.

The Hagerman 210-A.C.-Six Ensemble was created with the view of providing a radio receiver for the custom set builder that would enable him to have in one set every desirable new feature. To do this necessitated not only the designing of a receiver chassis but also the power and speaker circuit to accompany it. This has proven of great importance. It has been found that the majority of difficulties experienced by builders of custom-designed radio sets can be traced to inefficiencies in the power supply or speaker circuit.

The ensemble includes a six-tube chassis, "A," "B" and "C" power supply, and long tone chamber speaker. They will be discussed in this sequence.

The basic circuit of the set consists of three stages of tuned radio frequency, detector, and two stages of audio frequency amplification.

The radio frequency stages are individually tuned and completely shielded. A control of oscillation is employed that is very effective. Each stage can be so controlled that it will oscillate in exact unison with the other stages, or so that it will not oscillate at all. The set can be as critical or non-critical in tuning as the operator desires. This allows it to be adapted to any receiving condition, a very important factor, in view of the difficulty of reception in congested areas.

The audio end of the set is unique in that a 210 type power tube is

incorporated in the set itself. This creates a very efficient audio circuit. The resultant volume and tone equality is comparable with

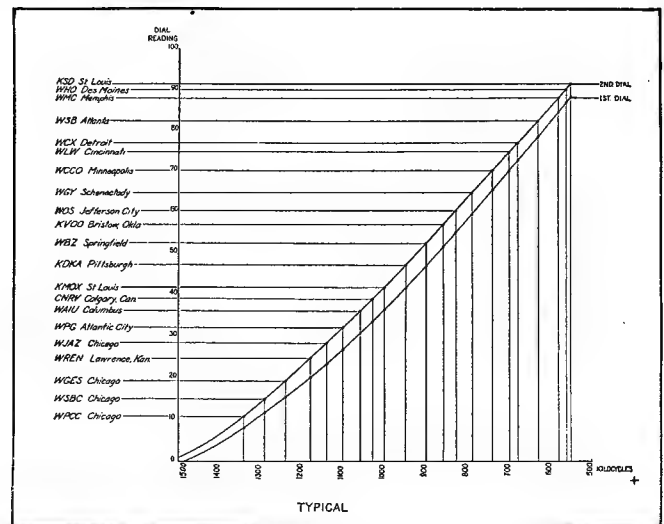

Figure 2. By means of the tuning graph above, the operator can readily determine the wave length of the receiver at any particular point. This will vary with different tubes

(This receiver constructed, tested and all illustrations made in our laboratory)

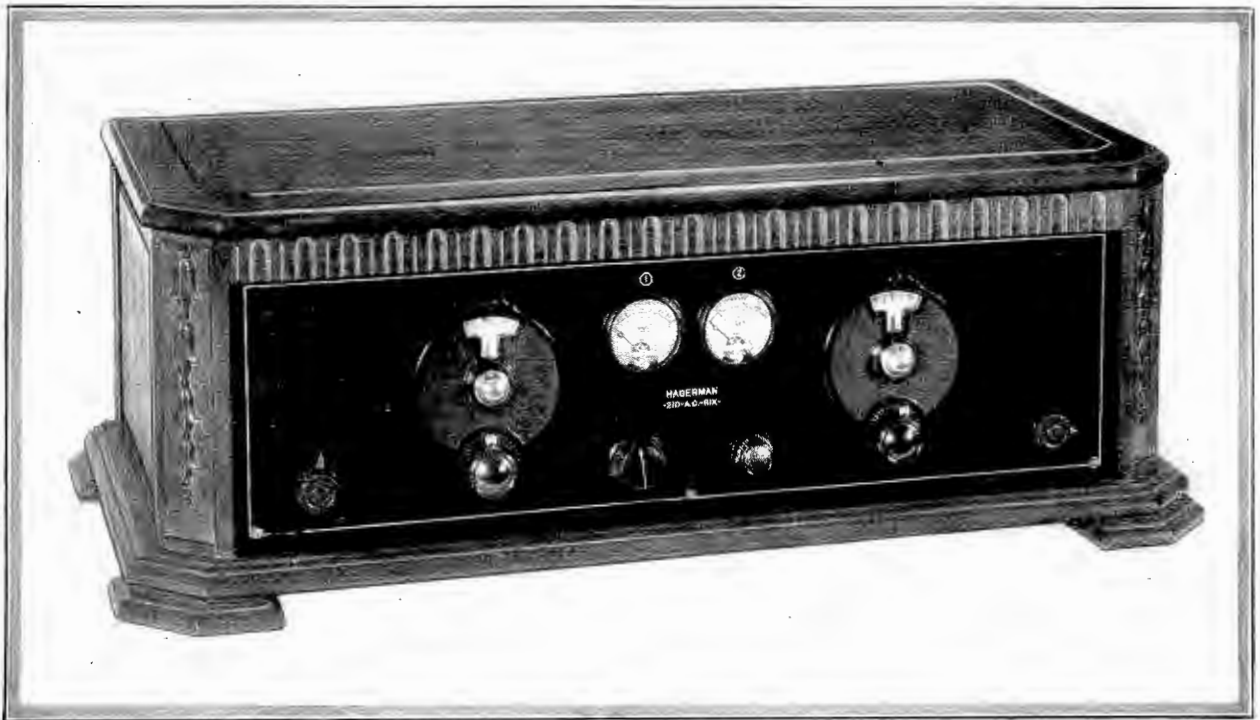

Figure 3. This photograph shows the front panel view of the receiver placed in an attractive cabinet

the most expensive of manufactured receivers. More satisfactory distant reception also results. Signals that with ordinary amplification would be scarcely audible, can be so amplified as to be of satisfactory speaker volume. This, of course, does not mean that the set is always loud or that volume is the only attribute of 210 tube amplification. The output can be modulated to a whisper or increased to orchestral volume without distortion. The effect, as one writer has put it, is "stereoscopic." All instruments in orchestral music stand out in bold relief; voice and instrumental music have a resonant depth, purity and soul that is a compliment to the original itself.

The use of the 210 tube requires a special power supply to deliver a plate voltage of approximately 450 volts, a grid bias of forty volts, and an alternating current filament voltage of seven and one-half volts.

The Hagerman power unit supplies these voltages and also the necessary plate, filament and grid voltages for the balance of the receiver. It consists of a "B," "C" and "A" power supply. The "B" and "C" supply uses a 281 type tube as rectifier that delivers a maximum of slightly over five hundred volts direct current, which by means resistance is reduced to the required plate voltages, both for the 210 tube and the balance of the set. Windings are also provided on the power transformer to provide the a. c. filament voltages for both the 210 and 281 tubes. The grid voltage for the 210 tube is obtained from a center tap of the filament winding of the power transformer in a series with which is a 1000-ohm resistor.

In this power supply is also incorporated a speaker protective circuit consisting of a special high voltage choke and condenser. Because of the great output of this set it is important that these units be exceptionally high in value. The condenser in particular must be able to withstand in excess of six hundred volts. The failure of this unit would result in burning out the reproducing unit in the speaker and might seriously injure other parts of the power supply. It is essential to follow specifications in every case, but particularly so here.

The "A" supply is important. Any variation in filament voltage is particularly noticeable with the tremendous amplification of the 210 tube. For this purpose the Abox "A" battery eliminator was chosen. This device consists of a transformer, rectifier and extremely high capacity filter that transforms the alternating current from the light socket to pure, direct current, ideal for filament voltage on standard tubes.

The efficiency of this unit is due to the tremendous filter capacity which is over 200,000 microfarads. Perfect rectification and elimination of all vestiges of alternating current characteristic is possible only with filtration using condensers of great capacity, such as the Abox.

The speaker is of the new long tone chamber type and is equipped

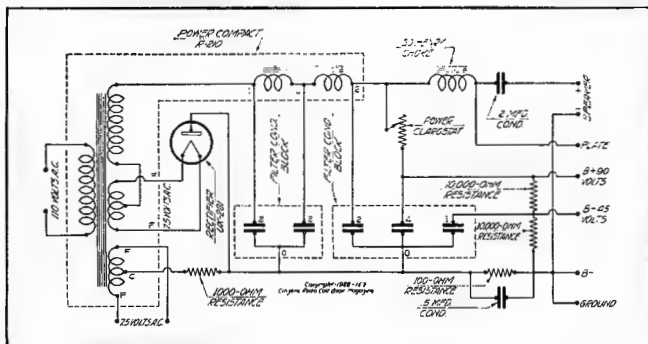

Figure 4. The schematic circuit of the power amplifier is disclosed in the above drawing, which may be used in wiring the amplifier shown photographically at the right



Figure 5. The completed power amplifier is shown in the above photograph

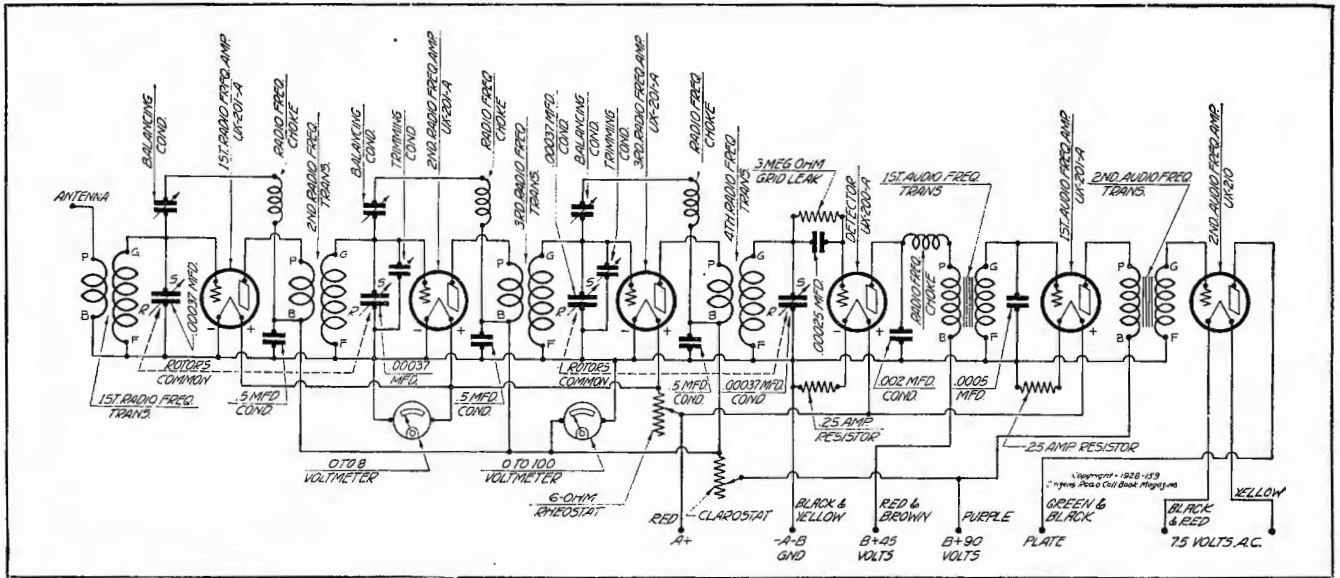

Figure 9. The schematic circuit of the receiver may be found by consulting the above diagram

The wiring of the power supply is not like any other power unit. If there are connections that do not seem exactly in accordance with your previous experience, make them as shown. The diagrams explain the circuit.

Operation

The Hagerman 210-A. C.-Six operates on either an indoor or outdoor antenna. This should be given every consideration. For an indoor antenna, a length of wire fifty to seventy-five feet in length around the molding or rug is sufficient. The outdoor antenna, which is much to be desired, should be from thirty-five to fifty feet in length in congested localities, and longer where there are few nearby stations. Belden makes two very good antenna kits for this purpose that include all the necessary equipment to construct an excellent indoor or outdoor antenna, including lead in, ground lead and clamp, window strip, lightning arrester, etc.

Putting the set into operation merely consists of connecting the cable to the power supply, attaching the loud speaker, inserting the tubes and plugging in the light socket. Be sure that the power Clarostat in the power supply is screwed all the way out and that the Variometers are set with the screws all the way up.

When the set is turned on, the Jewell meters on the panel should show a deflection. Adjust the rheostat so that the 0-8 voltmeter reads about 4 volts and the volume control Clarostat so that the 0-100 voltmeter reads about 50 volts. Before making this last reading, screw the knob of the power Clarostat in until the reading with the volume control all the way in is about 100 volts. Then decrease it with the volume control to the desired 50 volts.

Tuning

Turning the dials should now bring in a station. Adjust the trim- (Continued on page 143)

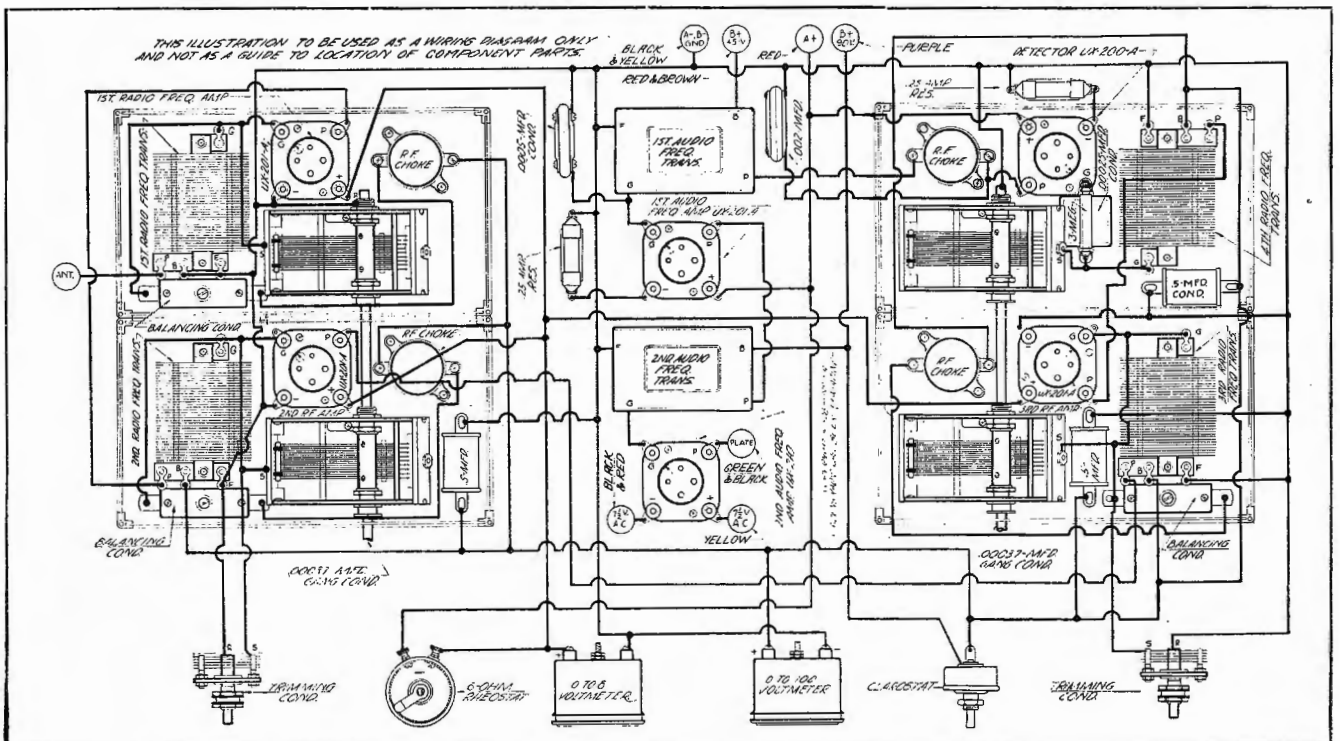

Figure 10. For connecting and easy wiring the builder should follow the graphic diagram shown here for all connections

What Goes on in a Modern Radio Engineering Laboratory

Readers Are Given an Intimate View of Processes and Steps Taken to Guarantee Efficiency of Receivers Described

EDITOR'S NOTE: *What goes on inside the modern laboratory is not half as much of a secret as the public may be led to believe. One of the principal reasons why so little is known of the laboratories, lies in the fact that the great majority of Engineers are inherently modest and shun publicity concerning their efforts and developments.*

However, in belief that the radio public is interested in what transpires in a modern research laboratory, the following brief article has been prepared by one of our Engineers who could be cajoled into describing some of the various processes in the development of a receiver.

IN the design of a radio receiver, there are a great many things to be considered before the Engineering Department takes hold of the project to develop it into a commercial possibility. What is expected of the receiver, the selling price of the receiver and the general characteristics have to be determined by the executives or head of the organization who are going to undertake the manufacture of a receiver or parts for a receiver.

After decisions of this nature have been made, the requirements are given to the Engineering Department for fulfillment. In some instances these tasks are of a simple nature and the desired results may be obtained in a very short period of time and on other occasions the task may take anywhere from one month to a year to develop the different constants of circuits or overcome mechanical difficulties before the desired results are obtained. To go into each detailed process in the development of a receiver would take considerable space; therefore, just the high points in the development of a receiver will be considered.

In the construction of a high grade receiver there is no detail that is left unconsidered. Possibly the engineers have some sort of a

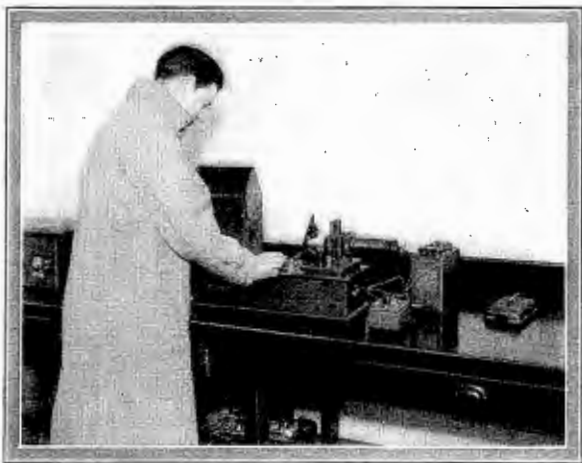

Figure 1. *In this photograph the Engineer is making an oscillograph test to determine the amount of A. C. ripple present in a B eliminator*

“trick” circuit, so to speak, which they favor, around which they are planning to develop the new receivers.

Tuning Methods

One of the first considerations is the tuning device which is usually a variable condenser. Measurements are generally made on this in-

strument for maximum and minimum capacity, power factor, phase angle and dielectric losses. Of course, mechanical efficiency is considered at the same time. When the most desirable condenser is found for this purpose, the very probable next consideration will be

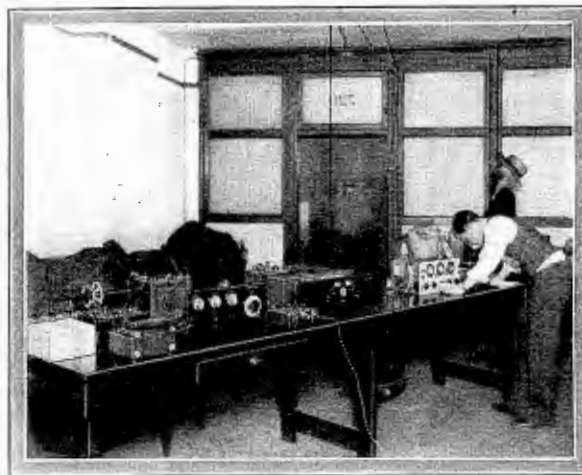

Figure 2. *In this photograph one of the receivers described in a recent issue of this magazine is being measured for its overall gain*

the type of radio frequency transformer to be used. There are a great many features about a radio frequency transformer that have to be considered in order to get a desirable mean of all the constants, such as magnetic fields, inductance, radio frequency resistance and distributed capacity, as all of these factors play a very important part in the successful and satisfactory operation of the receiver. At the same time the effective reactances in the input and output circuits of the radio frequency tubes are considered which will govern the input and output impedances of the radio frequency tubes, as in some circuits if these things were not considered the receiver would be practically worthless.

Measurements

If shielding is to be used, measurements will be made upon the effectiveness as a shield of different materials, thickness of materials and tensile strength. After the desired material has been selected for this purpose, a desirable mechanical size will be determined and measurements will be made with the parts in the shields as will be placed in the completed receiver, and measurements made to determine the effect that the shield is having upon the operation of the stage.

The next procedure is usually a measurement of the gain per stage, in order to determine the effective amplification per unit and by which the primary windings or plate load may be increased or decreased to suit the needs of the project under consideration. After this has been done, the audio frequency amplifier is considered from the standpoint of amplification necessary and tone quality. As audio frequency transformers are fairly well standardized at the present time there is no great length of time expended upon this subject.

Well Equipped Laboratory

In order to do the necessary research work of this type, it is necessary to have a fairly well equipped laboratory. Resistance, inductance

and capacity bridges are necessary with their accompanying oscillators and standards. Also the radio frequency oscillator, the tube voltmeter, thermo-couples, and microammeters with the various accessories that are necessary to complete the experimental set-ups. The engineer in charge of a development usually has, from experience, some idea of what is necessary to develop the receiver. The constants of the circuit are usually worked out mathematically and checked by actual measurement and from that point further development will take form from the apparent results obtained from these measurements. The great majority of the unknowing public have the conception that an engineer with a laboratory can develop receivers or such things in a very short period of time. This, however, is not the case. Oftentimes months and even years are spent in continuous research upon a subject, endeavoring to find the ultimate that on the face may appear to be a very simple problem worthy of only a few days consideration to find the result. The most important part of a research department is the accuracy of the instruments available and the patience of the engineer doing the work. Instruments must be of the very best available and an engineer must have learned to expect to put in great lengths of time with untiring efforts before success is attained.

Any type of receiver may be measured in the laboratory, and after all measurements are taken a very clear idea may be gained as to what performance may be expected from that particular receiver. This measurement involves the use of an oscillator for creating a signal voltage that is to be applied to the input of the receiver under measurement. Then with a vacuum tube voltmeter it is possible to read the amplification per stage or the amplification overall. In some cases where the receiver is thoroughly shielded very exact measurements may be secured.

Another interesting measurement, which is an electrical one but which nevertheless gives a visual indication, is the making of an oscillograph test to determine the amount of alternating current ripple present in a B eliminator. The amount of alternating current ripple found when the eliminator is being measured will be indicated on a plotted oscillograph screen, which may be watched by the operator. The pattern on the screen indicates to a nicety the amount of ripple present. Another interesting measurement which can be made is that covering the amplitude of modulation either from broadcast signals or from a phonograph amplifier unit. In this case the amplitude of the audio frequency surges is evidenced by the width of the pattern line and its irregularity. While this pattern measurement is one that gives a visual indication, nevertheless if a record should be made of it, it will be necessary to photograph the image on the screen, so that the frequency amplitude may be calculated.

Measurements of speakers are also quite interesting and enable the engineer to know just what frequency response may be expected from a certain type of speaker. In tests of this nature

an oscillator is utilized, which will create a signal frequency from about 12 cycles to approximately 10,000 cycles. This oscillator is continuously variable and when its output is amplified through a laboratory amplifier and the amplified signal fed into a speaker, the frequency response of the reproducer under test can easily be found. During tests of this kind the engineer frequently



Figure 3. This is a complete view of the Citizens Radio Engineering Laboratory showing apparatus set up permanently for measurement work

encounters resonant points on the horn in which distortion is present. If the engineer can follow the signal from a very low frequency to a high frequency, it is determined that the reproducing unit is a good one and will repeat faithfully those frequencies furnished it by the broadcast receiver.

The cost of developing a receiver in the completed form at the present time will reach almost unbelievable and stupendous amounts. The receiver that the public might be buying and paying from \$100 to \$150 for may have cost for development work alone hundreds of thousands of dollars. So it may be readily seen that the Research Department of any manufacturer or other institution plays a very important part in the manufacture of their merchandise.

With its completely equipped laboratory, the Citizens Radio Service Bureau is thus in position to offer its facilities to radio manufacturers desiring such service at a nominal rate. Correspondence is invited from manufacturers who desire the services of a highly efficient and trained organization to work out their problems. Correspondence may be addressed to the Citizens Radio Engineering Laboratory in care of this publication.

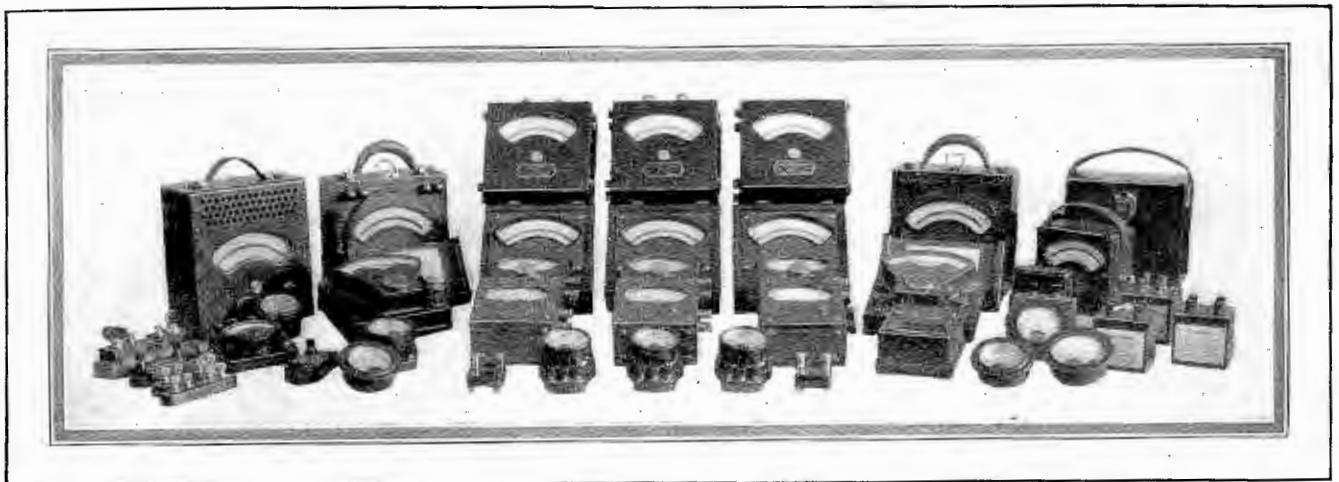

Figure 4. Meters represented in the photograph above are but a few of those required by a high class research or design laboratory

OUR POLICY

(An Editorial)



CCASIONALLY one of our readers inquires why our magazine goes to the time, trouble and expense of building, testing, illustrating and describing each circuit which appears in our columns. Perhaps the easiest answer to such a question is to relate the statement of a Milwaukee set builder who visited our booth during the last radio show. This set builder's words were: "The reason I like the CITIZENS RADIO CALL BOOK MAGAZINE is the fact that when I follow their specifications in building a receiver, *I know the set will work.*"

Other readers wonder why we do not content ourselves with merely printing a schematic from which the experienced radio man can build any set.

If our magazine were printed only for the benefit of our editors and other experts, such a policy might be advisable. But the fact remains this magazine is printed for a vast number of experienced radio fans, as well as a larger number of novices. Each and every year there are newcomers in the art and in order to give them fool-proof, sure-fire, accurate drawings and to guarantee that the sets will work if built in accordance with our specifications, it is necessary to be profuse in our illustrations.

This brings up the subject of specifications. This magazine has always contended that an article on a circuit without specifying definite component parts is worse than useless, because of the great danger underlying substitution by inexperienced set builders. We agree that perhaps ten or fifteen years from now, when radio is a part of every school curriculum and when the public is radio wise, a simple schematic circuit giving only the electrical values of the integral parts will be sufficient for radio fans to use in building a set.

This idealistic condition does not exist in the year 1928 and as a result we feel called upon to specify definite parts in every circuit, since the original model of the circuit has been made up in our laboratory with those particular items and we guarantee that such a receiver when built after our specifications will function properly. When an individual desires a suit of clothes he does not go into a store and remark to the clerk: "Give me one pair of trousers, one vest and one coat." By the same token, we do not believe that at this time it is feasible to allow vague and indefinite specifications in a list of parts for a receiver.

We believe the astonishing growth of this magazine from its first issue in the year 1921 is a positive indication of the wisdom of our editorial policy which has continued since the first issue of the book.

Another very obvious reason for the profuseness and exactness of our drawings and articles lies in the fact that the average set builder has neither the time, equipment, nor the inclination to make a wide range of experiments on each individual circuit in which he may be interested. Accordingly, he is content to allow this magazine to perform that work for him and deliver to the builder a concise, definite and accurate plan of set construction. The old adage that the "proof of the pudding lies in the eating thereof" is just as apt in this instance as is demonstrated by the fact that the CITIZENS RADIO CALL BOOK MAGAZINE is the leader in the set building field.

F. A. H.

Tell 'Em You Saw It in the Citizens Radio Call Book Magazine

With THE PROFESSIONAL SET BUILDER



WITH the inauguration of the department under the heading shown at the top of this page, we believe our readers would be interested in a recent release from the Radio Parts Committee of the Radio Manufacturers Association, which we are quoting in full:

"Many of the so-called radio nuts and circuit hounds of a few years back have found in their hobby not merely a fascinating pastime but a means of embarking in business on their own account, according to a statement recently issued by the Radio Parts Committee of the R. M. A. Many of them as custom set builders are enjoying incomes of from \$10,000 to \$15,000 yearly. It is estimated that 20 per cent of the receivers now in operation in the United States have been built by these specialists, who frequently operate from their own homes, from small shops or from radio, hardware or electrical stores. They are, for the most part, highly qualified individuals who serve a discriminating clientele that requires its radios, like its furniture and interior decorations, to be distinctive and individual.

"Commenting on the profits made by the custom set builder, one prominent manufacturer of parts says:

"We have many professional set builders on our list who have made a wonderful success of their business. We have a man right here near us who builds approximately 300 sets per year. He is now building our circuit with great success, and, over a period of several months, has sold about fifty sets. He operates from his home and depends on his friends rather than advertising to create sales. He advises me that last year he netted over \$10,000 profit. This, I would say, is a good example of what can be done by the professional set builder."

"For some time we have realized that the market for radio parts has been changing considerably, and, after analyzing the trend, we have reached the conclusion that the greater volume of our parts is being absorbed by professional set builders.

"Many of these men started in business by accident. They constructed sets for their own use with very satisfactory results. Friends, very favorably impressed, prevailed upon the experimenters to build similar receivers for them. After several sets have been constructed and disposed of in this manner, the experimenters decide to take up custom set building as a side line, and in this way they gradually develop into professional set builders.

"We find it mutually advantageous to establish close contact with custom set builders. In order to assist them we are supplying them with letterheads featuring their own names at considerably less cost than plain stationery could be obtained from the local printer. In several territories advertisements featuring our kits have also listed the names of custom set builders from whom completed receivers could be purchased."

"Another prominent manufacturer of radio parts has this to say of the custom set builder:

"It is very difficult to estimate the number of custom built

receivers constructed during the past year, as most manufacturers distribute their components through jobbers and therefore have no definite check as to how they are used. There is one custom set builder here in Rockford, Ill., who has made a conspicuous success of his business and is now devoting all his time and that of two or three others he employs to building receivers.

"Custom set building offers a wonderful opportunity to men who understand radio from a technical standpoint, and who are able to conduct their activities along business lines. Men with foresight are realizing that custom set building and servicing is the best branch of the business today for the individual. If he is capable of being in the radio business at all, he should be able to sell the public on the idea of the custom built receiver. There is a wonderful opportunity for individuals in each locality who will devote their hearts and souls and all their time to this particular field."

"Among the custom set builders with whom we are acquainted," states another manufacturer of radio parts, "there are several who are making a profit of at least \$15,000 a year."

"These men do little or no advertising, yet they have developed a large clientele through the reputations which they have acquired from the praise of satisfied users of their receivers. Many of these set builders report that, contrary to what might be supposed, the custom built receiver is not a serious competitor of the factory-made articles. To a great extent, the former is used in localities where unusual reception conditions require an exceptional receiver—in territories, for example, where extreme congestion on the part of broadcasters requires extreme selectivity.

"Again, the local dealer often is unwilling or unable to go to the trouble of tracing the source of the local interference or to devise suitable filters or other means of overcoming it; whereas, the local custom set builder is, and, incidentally, is thereby responsible, for the subsequent sale of many factory-made receivers that would otherwise remain unsold."

ONE of our readers, John Dollenbacher, Jr., Selah, Washington, brings up an interesting point in connection with testing of a receiver in different parts of the country. His letter is sufficiently interesting for us to quote portions of it, as follows:

"Having been a reader of your magazine since you started publishing, I wish to say that it is the only 100% radio magazine to date. There is just one thing that is not quite right and that is the fact that these different hook-ups apparently will not work the same every place. I believe that some of the larger sets should be tested in different parts of the United States. I know of three sets that I have tested for manufacturers, only one would do what they claimed and the other two were no good. I believe I have been the first person in the Northwest to test out a shield

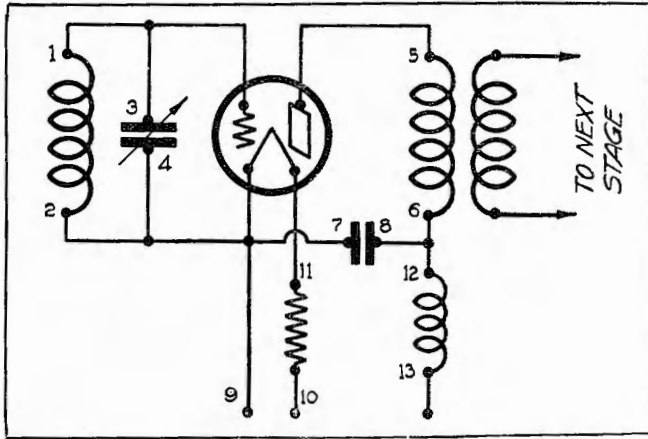

Figure 1

grid tube set, and wish to say that it sure was some set. Pulled in New York, Chicago, Texas at 12 midnight, also Japan. Australia and KGU after 3 a. m. I also have a five-tube r. f. set tuning from 32 to 2000 meters, on which I get WGY and KFKX like a coast local, this set having been made from a hook-up in your magazine. If I can ever be of any service to you, my shop is open, as I have same on my ranch. I am also now putting in television in co-operation with an Eastern manufacturer."

Our Editorial Department will be glad to hear from time to time from various professional set builders who may have items of interest to convey to their brothers, and we will be glad to let them utilize our columns as a medium of such experience. Many of the readers doubtless have run across various kinks or shop notes which might be of interest to others in the same line of work. Send in your ideas, and if suitable they will be printed for the benefit of the set builders at large.

ONE of the first things that any professional set builder must learn to do is to pursue a definite routine for shooting trouble on a receiver. In the following paragraphs some idea will be given as to a standardized method of checking almost any receiver.

In the schematic diagram shown with this article may be seen a typical vacuum tube circuit containing a tuned grid section, a plate circuit employing either an r. f. transformer or an intermediate transformer (or in some cases an audio transformer), with a suitable r. f. choke coil, bypass condenser and the necessary filament resistor. In Figure 2 is shown a simple sketch of a voltmeter, a C battery and two testing handles. By means of the voltmeter and C battery it is possible for the set builder to check any of the apparatus involved in the schematic circuit, Figure 1. For example: if it is desired to check the continuity of the inductance in the grid circuit of this receiver, or any receiver, the two testing handles are placed one on terminal 1 and one on terminal 2. If the voltmeter registers, it is an indication of the fact that the wire in the inductance is continuous and, therefore, not open. This form of testing is a standard test for continuity and may also be supplied to the inductance in the plate circuit of the tube marked 5 and 6. It may be likewise used in the r. f. choke coil by placing the test handles across Nos. 12 and 13. For continuity of resistance the same thing may be done across Nos. 11 and 11. This test may be applied to any circuit, regardless of how complicated or how simple, as long as the general procedure outlined above is carried out, and each and every inductance, choke, resistance or transformer. For example: if the test is to be made in the plate circuit of a detector, the test is made in the same manner as if the audio transformer primary were in the position shown at 5 and 6 in the diagram, Figure 1. The test for the secondary of the audio transformer would be the equivalent of the inductance shown at 1 and 2.

When testing condensers, the method is the same, although the

indications on the meter are the opposite. For example: when testing an inductance a continuous circuit is made evident by the reading on the voltmeter, which shows that the coil is O. K. On the contrary, when testing condensers no reading should appear on the meter, and if one does appear it proves either of two things: that in testing the condenser the operator has neglected to remove either a resistance or an inductance which may have spanned the condenser, or the condenser is actually shorted. To make this clear, if the operator wants to test the variable condenser shown in the grid circuit of the tube in Figure 1 and places the test handles across the rotor and stator, 3 and 4, the meter will give a reading because of the fact that the circuit is closed through the inductance 1 and 2. Therefore, in order to obtain a true idea as to whether the condenser is shorted or not, it is necessary to remove either the inductance connection No. 2 or that marked No. 1. When this is done and the test handles are applied to points 3 and 4, no reading should show on the meter. If one does show, it is an indication that the plates of the variable condenser are touching or that some metallic substance has lodged itself between the rotor and stator and consequently short circuited these two sections. To see whether the short circuit is a temporary one, turn the rotor back and forth and observe the meter. If the meter reading remains throughout the turning of the rotor back and forth, it can safely be assumed that the rotor plates scrape against the stator throughout the full travel of the rotor. If the meter reads when the rotor is unmeshed, that is, furthest removed from the stator, this indicates that a short circuit exists some place other than between the rotor plates and the stator. This might be caused by a wrong connection on the condenser, such as a piece of wiring joining the rotor and stator binding posts together and perhaps not being observed by the builder. This test of a variable condenser is the same regardless of where the test is applied. For example: the diagram in Figure 1 may be considered the grid circuit of an r. f. amplifier. This same test can also be tried on the detector stage, or an oscillator in a superheterodyne. When making any of the tests referred to it would be wise to remove A, B and C power from the receiver.

For testing a bypass condenser it is only necessary that the test handles be placed at the points marked 7 and 8 in Figure 1. If a reading occurs the condenser is shorted, unless it should happen that the builder has left the B battery in the circuit, in which event there would be return back to terminal 9, which would give a fictitious reading, since the reading would be that of the circuit existing between points 13 and 9 rather than between points 7 and 8. It is, therefore, wise not to have any battery connected or eliminators when this testing is done, since these would give a wrong reading.

In the next issue of the magazine further methods of testing in radio circuits will be detailed for the benefit of the professional set builders who may not have been acquainted with such test methods.

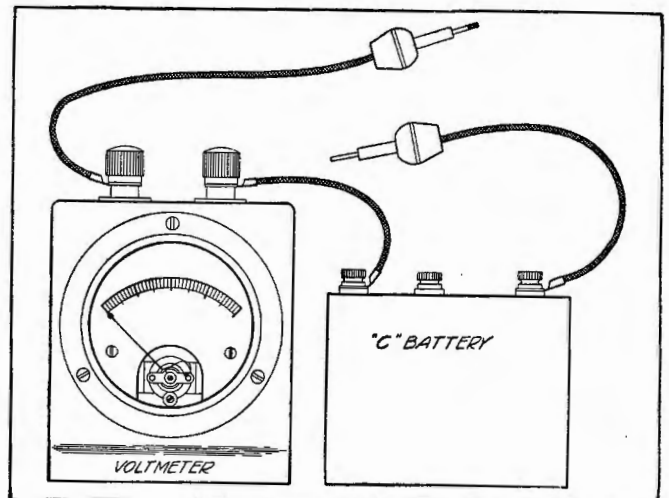
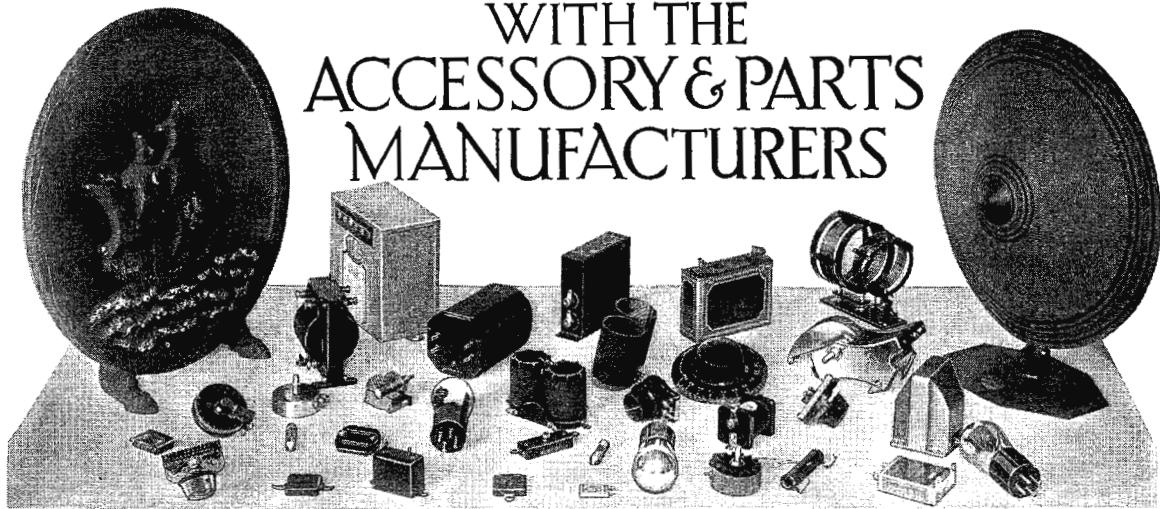

Figure 2



WITH THE ACCESSORY & PARTS MANUFACTURERS

Readers desiring any further information on products shown in these columns, may secure full data on writing to the Accessory and Parts Department, care of this magazine. Be sure to specify name of product on which information is desired

Na-ald A. C. Connectoralds Used in Battery Sets

WHEN the new a. c. tubes were announced it was not thought possible they could be used except in sets designed especially for them.

An ingenious device called a Connectorald has just been announced by a New England socket manufacturer, making it possible to put these new tubes in almost any set.

The thing Alden has endeavored to do in the designing of the a. c. Connectoralds is to make them just as universal as possible and at the same time making it very simple to install and obtain real efficiency of these new tubes.

To install the a. c. Connectoralds the first thing to do is to insert the five prong green Connectorald in the detector tube

socket. The next step is to put the orange or power tube Connectorald in the last audio stage. In the Na-ald A. C. Connectorald kit the power tube Connectorald has a ground tap. On this ground tap place the RY 500 resistor. The Connectoralds that go in the other socket are all red. One of these red Connectoralds in the kit has a ground tap, and on this are put two by-pass condensers and one RY 1000 resistance.

There are three wires that lead to the filament transformer, the orange one goes to 5½ volts and connects to the orange Connectorald on the power tube. The green goes to the 2½ volts and connects to the green Connectorald that holds the detector tube. The red goes to the 1½ volts to be connected to

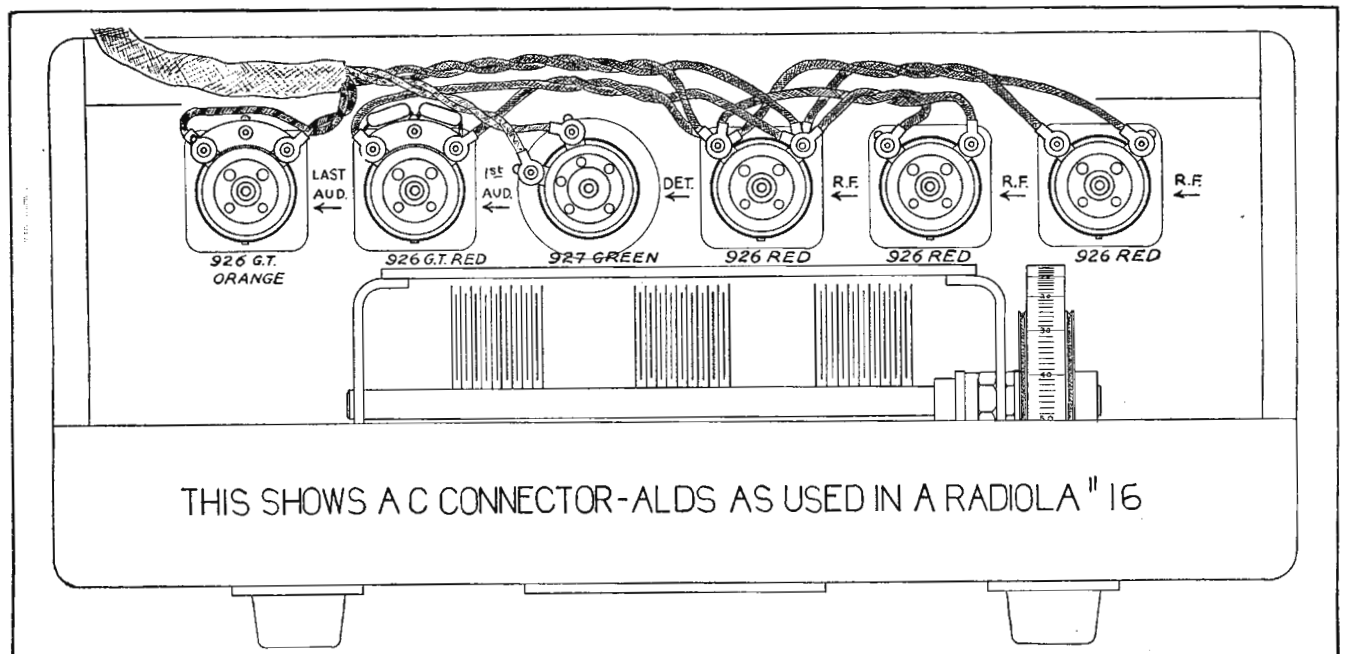

Figure 1. This sketch shows the manner in which the Connectoralds may be used in a factory-made receiver

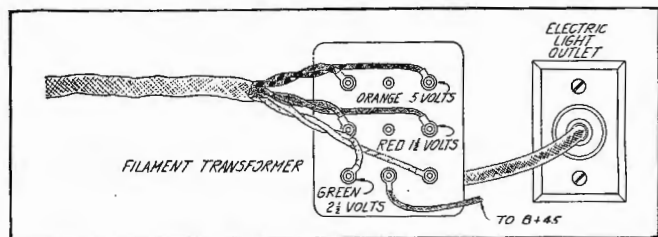

Figure 2. This simple diagram shows how the filament transformer is plugged into the light socket and thus supplies alternating current for the converted receiver

any of the red Connectoralds. Connect the jumper wires from the other Connectoralds to one with the 1½ volt wires, connect B supply in the usual way, and you are ready to operate.

The kit is designed this way so that it is possible to get the cable through the holes in the back of the set. If the adapters were fastened on to the cable, it would make it impossible to use in many sets. Construction also makes it easy to put Connectoralds in shielded sets. Only a very small hole is necessary to pass these jumper wires through for connection.

The Y tap resistances and by-pass condensers are included with the apparatus so that Connectoralds can be used in sets whether it has connections for the C battery bias on the power tube or not. The Y tap resistance gives a bias which works satisfactorily with most eliminators. However, if peculiar conditions are found in which the bias provided by the resistances is not correct, there is nothing to prevent using a C battery or different resistances.

The five, six and seven tube kits are identical except that the six has one more adapter than the five, and the seven has one more adapter than the six. The harness and Connectoralds are also made so that if one did not wish to use the ground tap resistors and Y tap resistances they can use other compensators on the filament transformers.

The volume control is made so that it is optional as to where you use it. It can be used in the antenna circuit and does not require any extra wiring. Of course, if one wishes to go to the trouble they can put it in the 90 volt circuit, controlling oscillation. It is not necessary to get into the wiring of the set to do this, as the wires on the volume control can be made long enough so as to go to the eliminator and allow the volume control to be placed in the front of the set.

The volume control is also made for "one hole panel mounting" so if one wishes to install it inside of the set it can be mounted on the front panel. On the other hand, it can rest in front of the set or, with cords of sufficient length, can be carried to a nearby chair and volume controlled at a distance.

Because there is a slight tendency for the alternating current tubes to oscillate more freely than battery tubes, Alden has made provision for putting suppressor resistances in the grid circuit. Each Connectorald has a little jack which makes a complete circuit when no resistance is used. When a resistor is inserted it automatically connects it in series. The resistors are made in various values so that you can get just the amount of suppression that you want without going to the point of cutting down selectivity.

In many instances the user of the set prefers to have some oscillation possible, as it increases the pickup, but whatever one's tastes are in this respect they can be gratified with Na-ald equipment. These are the right Connectoralds for the user to buy, because the dealer has the necessary additional Connectoralds, resistances and others part in stock so that the equipment can be used in its highest efficiency.

Na-ald Conectoralds, of course, are made to go in UV sockets as well as UX. Summed up, it makes it possible to use Alden equipment in practically any set with almost any good filament transformer and B supply without the need of a C battery for the power tube or other tubes.

It will thus be seen that the equipment is simple and easily installed, and, most of all, will give efficient operation. If any of

the details mentioned were not provided for it might operate, but, arranged as it is, nearly every user is enthusiastic about the greater range, good quality, volume, and constant power without fuss.

The Connectoralds are manufactured by the Alden Manufacturing Company, Springfield, Mass.

Kuprox A. C. Power Pack

A recent power pack made by the Kodak Radio Corporation, Cincinnati, Ohio, and called the Kuprox A. C. Power Pack, converts any set into an alternating current receiver using ordinarily 199 or 201-A tubes. It is not an ordinary battery eliminator, but eliminates all necessity for batteries. This new power pack operates any type of circuit direct from any alternating current lamp socket.

Until now the conversion of a battery set into an altering



Figure 1. The new Kuprox A. C. power pack made by Kodak is pictured above

current receiver was a complicated and expensive matter. Many changes in set wiring are necessary with most receivers to permit operation with a. c. tubes. Adaptors and harnesses must be used. Rheostats and controls must be eliminated. However, with the new Kuprox power pack any set can be made alternating current operated regardless of the circuit used. No changes are required in wiring. No new equipment is needed, not even harnesses or adaptors. The set remains exactly the same and the power pack is merely connected to the receiver like a set of batteries.

Several models are available, one type supplying A current only. This unit has been designed for those sets on which a B eliminator is now used. The Kuprox A. C. power combination model supplies all radio current for both filament and plate. The unit is simply connected into a set like a block of B batteries and plugged into the nearest lamp socket. Thus the receiver operates entirely from alternating current.

All models of the power pack are equipped with a voltage control that permits their use with any type of tube. Either four or six volts is available for use through this voltage control.

For the largest sensitive sets containing from eight to ten tubes, there is available the model 103, which supplies a. c. filament current for operating 201-A, 112, 171 and similar 6 volt tubes. Its maximum capacity is three amperes.

For all large receiving sets the model 110 furnishes plate current at 45, 90, 150 and 180 volts, with separate adjustment for the detector voltage.

The largest size combination power pack, which furnishes both filament and plate current, is that marketed as model 206, which supplies both plate and filament current for operating all receiving sets, using seven 201-A or six 201-A and one 171 power tube.

The model illustrated in Figure 1 is No. 106-X, which is a combination unit furnishing sufficient filament current for ten one-quarter ampere tubes and the necessary plate current.

(Continued on page 142)

Custom Built Model Madison-Moore International One Spot

(Continued from page 62)

- 1—285 General Radio audio transformer
- 2—General Radio center tapped 64 ohm fixed resistances
- 1—Centralab 500,000 ohm potentiometer
- 1—Centralab 100,000 ohm variable resistance
- 1—Durham 2 megohm grid leak
- 1—Tobe 1000 ohm cartridge resistor
- 1—Lignole inlay front panel, 7x28x3/16 inches
- 1—Formica ivory sub-panel, 9½x27x3/16 inches
- 3—Eby binding posts
- 8—Eby four-prong sub-panel sockets
- 1—Eby five-prong sub-panel socket
- 2—Remler 0-200 vernier drum dials
- 1—Hagel 10 contact sub-panel mounting socket
- 1—Lynch grid leak mounting
- 2—Benjamin sub-panel brackets
- 20—Feet solid bus bar wire
- Miscellaneous lugs, nuts, screws, bolts

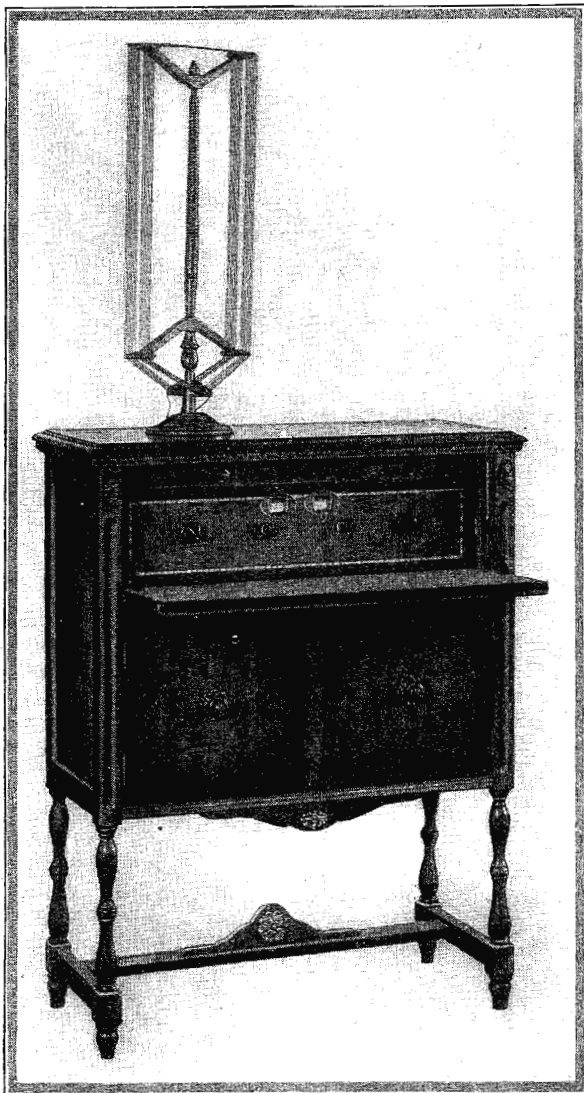
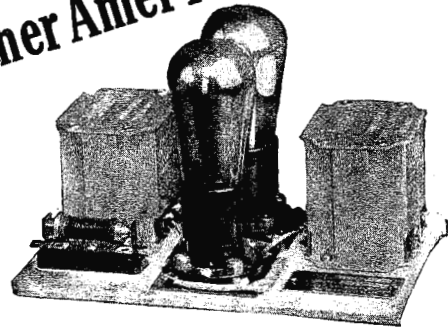

Figure 5. The receiver is illustrated in this photograph in a Fritts console and operated with a Qualitone DeLuxe loop

(Continued on page 136)

Another AmerTran Achievement



A Complete Push-Pull Power Stage Increases Clarity, Reality and Volume

HERE is an AmerTran wired unit that meets the demand for a power stage that may be easily assembled in the average receiver.

It contains an AmerTran type 151 input transformer* wired to two power tube sockets, a 50,000 ohm mounted resistance connected in series with the C — or grid bias lead, and an output transformer of the type required by the combination of power tubes and speaker desired. As in every case, AmerTran has considered all factors before offering a product to the public, and that is the reason for the fine results obtainable with this new power stage. It is designed for specific tubes and speakers, and when used as instructed will produce a very high standard of performance.

For best tone quality, this power stage should be preceded in the first stage by an AmerTran DeLuxe audio transformer, and the output connected to a high-grade speaker. The parts are firmly secured to a strong metal base, provided with mounting holes and the whole unit is compact and neatly finished. Complete information together with data on other products will be gladly sent free on request. Write to this company or see an authorized AmerTran dealer in your neighborhood.

* AmerTran Input and Output transformers have finest high permeability alloy core laminations and excellent frequency characteristics.

List price \$43, complete with two UX-171 tubes; \$54 with two UX-210 tubes. The unit is licensed under R. C. A. patents and must be sold complete with tubes as indicated.

AMERICAN TRANSFORMER CO.

177 EMMET STREET NEWARK, N. J.

"Transformer Builders for Over 28 Years"



RESISTORS POWEROHMS and GRID SUPPRESSORS for A-C Sets and Modern Circuits

NOW there is a DURHAM Resistor, Powerohm and Grid Suppressor for every type of radio receiver and every type of power supply unit—a full line of ranges—each using the famous Durham Metallized Filament principle, each supplied with standard or special tips to meet every modern radio requirement.

Durham Resistors are made in ranges from 500 ohms to 10 megohms.

Durham Powerohms (for "B" eliminators and Amplifier Circuits) are made in several power sizes, in ranges from 500 ohms and up.

Durham Grid Suppressors are made in ranges from 250 to 3,000 ohms in steps of 100. Absolutely NON-INDUCTIVE. Supplied with a variety of tips to simplify installation.

DURHAM

METALLIZED

RESISTORS and POWEROHMS

INTERNATIONAL RESISTANCE COMPANY
2½ South 20th Street, Dept. R Philadelphia, Pa.

(Continued from page 135)

Power Supply

- 1—668 Tobe filter condenser block
- 1—285-D General Radio audio frequency transformer
- 1—387-A General Radio speaker filter
- 1—463-101 Jefferson special power transformer
- 1—466-130 Jefferson special filter choke
- 2—507-24 Ward Leonard 1500 ohm resistances
- 1—507-26 Ward Leonard 2500 ohm resistance
- 1—507-20 Ward Leonard 225 ohm resistance
- 1—507-16 Ward Leonard 2250 ohm resistance
- 1—Formica 7x18x¼ inch sub-panel
- 1—Hagel 10 contact sub-panel mounting socket
- 1—Eby binding post
- 3—Eby four-prong sockets
- 3—Karas sub-panel brackets
- 20—Feet Belden No. 12 flexible rubber covered wire
- Miscellaneous lugs, nuts, screws, bolts
- 1—Hagel double plug cable
- 1—Chicago-Jefferson "Union" 2 ampere cartridge fuse

Victoreen 1928 A. C. Circuit Fully Electrified

(Continued from page 84)

Should the intermediate amplifiers oscillate when the r. f. rheostat is on full, the r. f. voltage is too high. If the volume of the set is found to change occasionally while tuning in on a station, this is likely caused by a fluctuation in the line voltage. Lack of control on the part of the 400 ohm potentiometer may be caused by its condenser being shorted. If this potentiometer should have an open circuit, the r. f. transformer will receive no plate voltage and the r. f. circuit will be dead. Test for this by momentarily shorting all three terminals of the 400 ohm potentiometer. Should it be found impossible to reduce the volume sufficiently by the r. f. rheostat, either the line voltage exceeds 117 volts or the rheostat value is incorrect.

Control of volume is accomplished by means of the r. f. rheostat. The potentiometer should be set at that point which produces greatest signal strength and selectivity. Very seldom, if ever, should the potentiometer be operated on either extreme end, as a hum may be found when so operated. In general practice, the set will operate most efficiently with the potentiometer arm near the center.

List of Parts

The following parts were used by the laboratory in the construction of the receiver described in this article:

(Receiver)

- 1—VU Victoreen .0005 mfd Master Control
- 2—Carter .0005 mfd grid condensers with clips
- 1—Carter .0005 mfd condenser
- 4—Dubilier 1 mfd bypass condensers
- 1—Dubilier 2 mfd bypass condenser
- 1—150 Victoreen coupling unit
- 1—160 Victoreen antenna coupler
- 4—170 Victoreen r. f. transformers
- 1—112 Victoreen audio transformer unit
- 1—326 Victoreen filament transformer
- 2—Durham 2 megohm grid leaks
- 2—Lynch grid leak mountings
- 1—Durham .05 megohm grid leak
- 1—Durham .25 megohm grid leak
- 1—Victoreen .5 ohm rheostat
- 1—Victoreen 30 ohm potentiometer
- 1—Victoreen 400 ohm potentiometer
- 1—Lignole 7x26x3/16 inch front panel
- 1—Formica 7¼x5½x3/16 inch terminal strip

(Continued on page 138)

Tell 'Em You Saw It in the Citizens Radio Call Book Magazine

Assemble My Latest and Greatest Success

HARKNESS

A. C. Counterfonic Six and Power-Pack

Since the earliest days of radio, Kenneth Harkness has been the one outstanding designer of highly successful receivers. His achievements include the HARKNESS REFLEX, HARKNESS COUNTERFLEX and KH-27.

The new A. C. Counterfonic Six is the finest receiver I have ever designed. I offer it with confidence that it is the best receiver of its type available to set builders.

KENNETH HARKNESS.



Complete Kit—
all parts to build
set, exclusive of
power-pack.....

LIST PRICE
\$72.60

Mail coupon
Below for
Complete Details

Every part tested before packing and fully guaranteed. Complete illustrated instructions enclosed.

BIG DISCOUNT from this price to
Set Builder Agents and Dealers.

Be My Local Sales Representative

Send your name right away to reserve exclusive protected sales territory for yourself. I will help you make **BIG MONEY** for every hour of your spare time, or increase your income if you're already in the radio business.

I want one alive, alert, energetic man in each community to demonstrate and take orders for the new HARKNESS A. C. Counterfonic Six. The set sells itself. You make a liberal profit on every sale; the buyer gets the finest set that money can buy for **LESS THAN HALF** the price of a good factory-built set. Mark the coupon N-O-W and be the first in your community to reserve the valuable rights to this wonderful receiver.

Operates from House Current

I have perfected operation from the light socket. The Harkness A. C. Counterfonic Six always operates at highest efficiency . . . no run-down batteries . . . no acids . . . no humming eliminators . . . no chargers . . . but a **REAL A. C. radio set with A. C. TUBES** . . . the finest tone quality you ever heard . . . so selective that you cannot believe it until you try it yourself . . . sensitivity so keen that distant stations are brought in with ease and with surprising loud-speaker volume.

Secret of Its Tone Quality

Harkness "Tuned Double Impedance" Audio Amplification used in the A. C. Counterfonic Six gives amazingly realistic reproduction . . . entire range of audible frequencies reproduced

uniformly by loudspeaker . . . distortionless . . . tremendous volume, when wanted, limited only by characteristics of the tubes . . . no tube-blocking . . . no motor-boating or other annoyances found in less efficient amplifiers.

Single Dial Control

One electric-lighted dial controls three sharply tuned circuits, shielded and neutralized by my own system, perfectly balanced at all broadcast frequencies . . . interstage coupling eliminated without appreciable increase of resistance of circuit.

Get Complete Details

Mail me the coupon today and I will send you complete details of this wonderful new set perfected in my laboratory and just released because I know it to be perfect.

I will reserve exclusive territory for you and show you how to make **REAL MONEY** out of radio.

SEND NO MONEY! Just print your name and address on the **COUPON** and mail **T-O-D-A-Y!**

KENNETH HARKNESS, Inc.

Suite 610

72 Cortlandt St. New York City

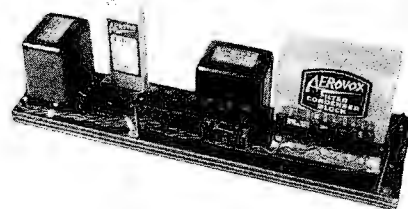

Complete Parts
for Power-Pack LIST PRICE
\$42.50

Big Discount from This Price to Set
Builder Agents and Dealers

\$ If you want to make money
in your spare time or increase
the profits of your business..... **\$**

Mail This Coupon N-O-W

KENNETH HARKNESS

Suite 610—72 Cortlandt St., New York City

Without obligation whatsoever on my part please mail me complete details of your new A. C. Counterfonic Six and show me how I can make money as your Authorized Representative.

I am a Set Builder Dealer

Print Name.....

Address.....

JOBBER: Write us today! Our sales plan works through you and to your profit. Your interests are protected and your profits increased with our co-operation.

Tell 'Em You Saw It in the Citizens Radio Call Book Magazine

KINGSTON



For Perfect Reception

KEEP your radio outfit in the pink of condition with a **KINGSTON!** The power source is positive, contains no acid or solution . . . no vibration . . . no noise . . . three voltage outlets arranged for 5 to 200 volts. Primary and main current supply is regulated by a rheostat, making possible perfect input control.

Handsome finished in satin black. Size: 9 inches long, 5 $\frac{1}{4}$ inches wide, 8 $\frac{1}{4}$ inches high. The Raytheon 125 milliamper tube BH tube is used as rectifier. Fully guaranteed.

PRICES

Type 2, for 110-120 Volt AC 50 or 60 Cycle Current, \$35.00.

For receiving sets having not more than eight tubes and not having type UX171 power tube or equivalent.

Type R, same as type 2, but equipped with automatic control to switch Unit on or off when switch on radio set panel is turned, \$37.50.

Type 2A, for 110-120 Volt AC 50 or 60 Cycle Current, \$42.50.

For all sets using type UX171 power tube or equivalent and for all large sets having nine or more tubes.

Type RA with automatic control switch, \$45.00.

Type 2C, for 110-120 Volt AC 25, 30 or 40 Cycle Current, \$47.50.

Type RC with automatic control switch, \$50.00.

Prices include
Type BH Raytheon Tube

Announcing the New Kingston Radiola A-C Kit!

KINGSTON engineers have perfected, after an extensive period of research and experimentation, a new KINGSTON A-C KIT, designed to convert with little or no alteration a regular Radiola Model 16 D. C. radio receiver into an efficient A. C. outfit, using regular A. C. tubes. No soldering is necessary . . . installation can be made in 15 minutes! The usual operating characteristics of the original set are unaffected . . . great improvement in volume and tone quality is noted. A. C. hum is entirely eliminated. The KINGSTON RADIOLA A-C KIT is small . . . simple to install . . . economical to operate!

KINGSTON PRODUCTS CORP.
KOKOMO INDIANA

(Continued from page 136)

- 1—Formica 4x $\frac{5}{8}$ x3/16 inch terminal strip
- 1—Wood baseboard, 9 $\frac{1}{2}$ x25x $\frac{1}{2}$ inches
- 13—Ensign Eby engraved binding posts marked SP—, SP plus, C-40, C plus, B plus 180, C—, B plus Amp, B plus Det, B—, loop, loop, antenna, ground
- 4—Benjamin UX base mounting sockets
- 4—Benjamin UY base mounting sockets
- 1—192 Marco 0-100 left to right vernier dial
- 1—760 Yaxley d.p. d.t. jack switch
- 4—Sonatron UY-227 type tubes
- 3—Sonatron UX-226 type tubes
- 1—Sonatron UX-112 type tube
- 40—Feet Acme Celatsite wire
- 1—Package Kester radio solder
- Miscellaneous lugs nuts, screws, bolts

(Power Supply)

- 1—116 Victoreen power transformer
- 1—216 Victoreen choke
- 2—316 Victoreen resistance units
- 1—115 Victoreen output unit
- 2—Tobe 2 mfd 1000 volt condensers
- 4—Tobe 4 mfd 1000 volt condensers
- 1—Tobe 2 mfd condenser
- 1—Porcelain miniature socket
- 1—6 volt flashlight bulb
- 3—Frost UX sockets
- 2—Sonatron type 281 rectifier tubes
- 1—Sonatron type 210 power tube
- 1—Wood baseboard, 9x18 inches
- 1—Celeron binding post strip
- 7—Eby engraved binding posts
- Miscellaneous lugs, nuts, bolts, screws

Ultradyn A. C. "Commander" and Power Supply

(Continued from page 108)

- 1—128 Birnbach 10 foot battery cable
- 10—Eby binding posts
- 8—9044 Benjamin sockets
- 5—Special matched fixed condensers
- 1—Tyrman drum dial
- 2—Hammarlund shields
- 25—Feet Acme Celatsite wire
- 2—Hammarlund extension shafts
- 1—Hammarlund flexible coupling
- 1—Wooden baseboard, 12x25 $\frac{1}{2}$ inches
- 1—Carter 110 switch
- 8—Sovereign a. c. tubes

Miscellaneous lugs, nuts, screws, bolts

(Continued on page 140)

Lowest Wholesale Prices!

Set Builders and Dealers!

Let the largest Radio Mail Order House in the East serve you!

You'll get better service and better merchandise at the lowest wholesale prices obtainable anywhere.

NEW 1928 BUYING GUIDE

Your copy is ready for you. It lists all the latest Radio Parts, Accessories, Sets and Kits. Catalog K also lists Electrical Supplies, Household Appliances, Golf and Tennis Equipment, Cameras, Traveling Bags, etc. Send for your copy now. It's free.

Allen-Rogers-Madison

35 WEST 31ST.

NEW YORK, N.Y.

Tell 'Em You Saw It in the Citizens Radio Call Book Magazine

MARATHON A-C KIT

Electrifies any set

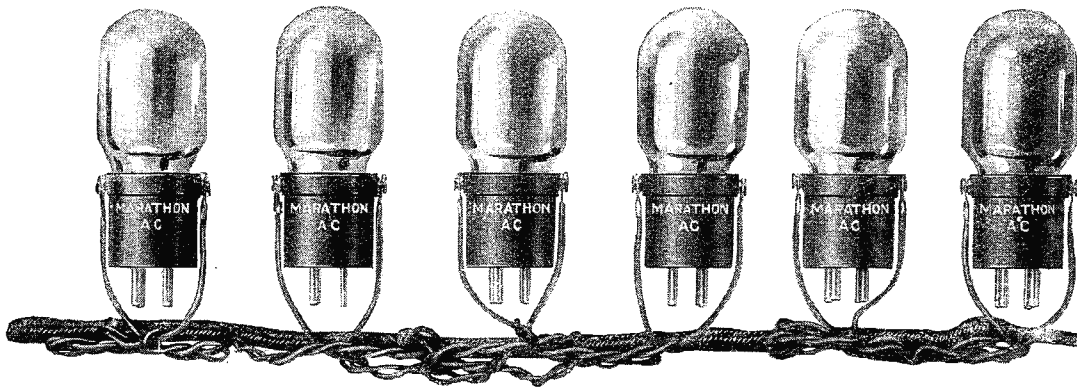

SIMPLE AS A-B-C

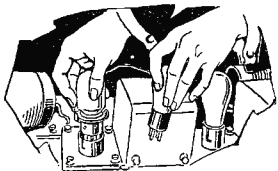

Replace your old Tubes with Marathon A-C Tubes

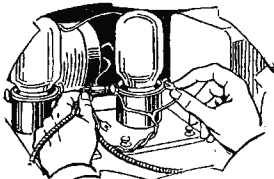

Connect the harness

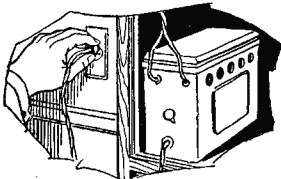

Plug in the light socket
-that's all there is to do

YOU CAN'T MAKE IT COMPLICATED

No re-wiring—no adapters—no by-pass condensers—no center-tap resistors—no additional "C" Batteries

AT last you can electrify your set within a few minutes—without changing a single wire, without using by-pass condensers, adapters, center-tap resistors or additional "C" batteries.

The change from DC to AC is as simple as the illustrations to the left show—you can not make it complicated. Anyone, no matter how ignorant of radio, can do it.

Marathon AC Tubes Guaranteed for a Year

The amazing, self-biasing Marathon AC Tube—an entirely new development in the radio art—automatically takes care of every condition. No other tube is like it. It is built on an entirely new principle and guaranteed for a year!

Guaranteed to Operate Satisfactorily on Your Set

No need to wonder if the Marathon AC Kit will work on your set. If you have a set now operating from an "A" battery (drycells or storage), employing UX sockets, and 5, 6, 7 or 8 tubes we guarantee perfect satisfaction. We will not tell you about the increased efficiency the Marathon AC Tubes will give your set, but you will be agreeably surprised.

Complete Kit—Nothing Else to Buy

The Marathon AC Kit is complete. The six tube Kit, for example, includes 6 Marathon AC Tubes, a universal harness which fits all six tube sets, a Transformer which steps down the voltage to 6 volts (on which all of the tubes operate), and a volume control. Nothing else to buy.

The five or six tube Kit is \$30.00; 7 tube, \$35.00; 8 tube, \$40.00. Send the coupon below for complete information, if you have any difficulty in finding the Marathon AC Kit at your dealer.

Jobbers and Dealers

Write or wire for our interesting sales proposition. The Marathon AC Kit is one that you can recommend with safety.

NORTHERN MANUFACTURING COMPANY
Newark, N. J.

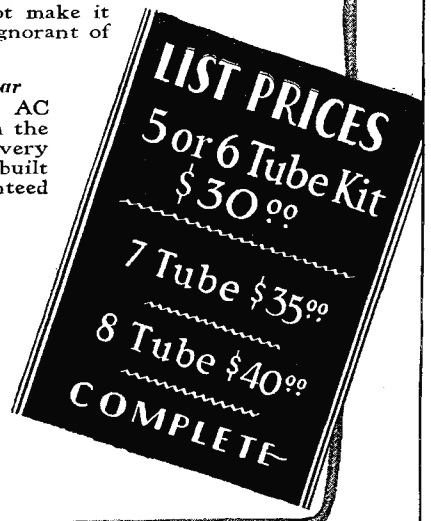

LIST PRICES
5 or 6 Tube Kit \$30.00
7 Tube \$35.00
8 Tube \$40.00
COMPLETE

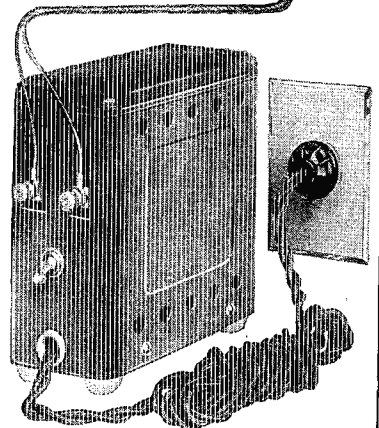

NORTHERN MANUFACTURING CO.,
370 Ogden Street, Newark, N. J.

Send me complete information on the Marathon AC Kit.

Jobber Dealer Professional Set Builder
 User (Please check your classification)

Name

Address

America's Leading Kit House

Official

Service Station for the Leading Kit Manufacturers

The confidence of the leading kit manufacturers is evidenced by our being appointed "Official Service Station." You will obtain here the same conscientious and courteous service the manufacturer would give you himself. Our corps of trained and experienced radio men will serve you efficiently.

All Parts Are Carefully Matched and Tested, Before Shipping, for the Following Popular Circuits

Laboratory Model Screened Grid Superheterodyne Custom Built Model Madison-Moore International "One-Spot"
Aero Short Wave Radio Telephone Transmitter
Citizens 115 K. C. Super
Citizens Birnbach A. C. Four
Complete Electric Phonograph and Amplifier
Line Voltage Regulator
Citizens Crystal Receiver
Victoreen 1928 A. C. Circuit
Melo-Heald Hot-Spot 14 with Shield Grid Tube
Citizens R. F. Amplifier
Samson PAB-3 Amplifier and Eliminator
Harkness A. C. Counterfonic Receiver
AmerTran ABC Supply Unit
Silver-Marshall Shield Grid Four Tube Receiver
Thordarson Shield Grid Amplifier
Knapp A Power Unit
Samson Public Address System
Citizens Short Wave Shield Grid Receiver

Set Builders and Dealers

Write or call on us for prices on any circuit appearing in any of the radio magazines. Our prices are lowest to professional set builders and dealers.

Mail Orders Filled Promptly Thirty Years Efficient Service Transmitting Equipment

We have complete line amateur transmitting and receiving equipment for short wave work. Write us for any amateur equipment.

M & H
SPORTING GOODS
COMPANY
512 MARKET STREET
PHILADELPHIA, PA.

(Continued from page 138)

(Power Supply)

- 4—A Acme Parvult 1 mfd bypass condensers
- 3—C Acme Parvult 2 mfd bypass 1,000 volt condensers
- 1—T2408 Thordarson push-pull transformer
- 1—T2420 Thordarson output choke
- 1—T2098 Thordarson high voltage transformer
- 1—Transformer Co. of America a. c. heater transformer
- 1—D70 Electrad Truvolt fixed resistor
- 1—B7.5 Electrad Truvolt fixed resistor
- 2—T50 Electrad Truvolt variable resistors
- 2—Carter 200 ohm potentiometers
- 1—Carter 50 ohm rheostat
- 12—Eby engraved binding posts
- 1—Panel, 7x12x3/16 inches
- 1—Wood baseboard, 12x15 inches
- 20—Feet Acme Celatsite wire
- 2—L10 Ceco tubes
- 2—R81 Ceco tubes
- 4—9040 Benjamin spring sockets
- 1—T2099 Thordarson double choke coil

Thordarson Shield Grid Amplifier

(Continued from page 113)

tone quality by replacing the original audio amplifier with this new unit.

When this shield-grid amplifier is built into the receiver it will be necessary to extend the front panel twelve inches beyond the space required by the radio frequency amplifier and detector. The old audio amplifier will, of course, then be discarded.

The new panel is drilled at its right-hand end for the power amplifier units, while its left-hand end is drilled to take the tuning controls for the radio frequency and detector tubes of the old set. The additional length required for the radio frequency portion of the remodeled receiver will seldom make the whole panel more than twenty-six inches long, so that the entire set will fit into any of a great variety of standard cabinets.

The connections ordinarily made to the push posts on the elevated strip are then made directly to the radio amplifier and a wire is brought from the plate terminal of the detector tube to the first Autoformer shown connected to the "input" push post. The only external wires then remaining are those for antenna and ground, the two to the A battery supply or battery and a cord to the lamp socket.

Parts used in the model described in this article are:

- 4 R-190 Thordarson Autoformers
- 1 R-76 Thordarson speaker coupling transformer.
- 1 R-171 Thordarson power compact.
- 1 R-171 Tobe B-block.

(Continued on page 142)

The Big Friendly Radio House Complete Line Jensen Dynamic Units and Speakers

WHEN you get our 1928 Catalog, you can have popular, nationally-advertised kits, parts, eliminators and accessories at prices that are real values.

Our dealer catalog, which lists everything in radio, means more real profit for you. Standard quality at the right price.

Write for our big Catalog

WESTERN RADIO MFG. CO.

128 West Lake St. Dept. OM Chicago, Ill.

Tell 'Em You Saw It in the Citizens Radio Call Book Magazine

HERE IS A REMARKABLY EASY WAY To Convert Your Battery Set TO AN A. C. SET

NA-ALD A. C. CONNECTOR-ALD KIT WITH ANY GOOD FILAMENT TRANSFORMER COMPLETELY DOES AWAY WITH STORAGE BATTERIES, TRICKLE CHARGERS—THEIR TROUBLES AND DANGERS



- No. 905 Kit for 5 Tube Set... \$ 9.00
- No. 906 Kit for 6 Tube Set... 10.00
- No. 907 Kit for 7 Tube Set... 11.00
- No. 601 Volume Control..... 3.00
- Oscillation Control Resistors
(See A. C. Booklet)..... .25



NOW—with the Na-ald A.C. CONNECTOR-ALD kits you can make an electric set out of your battery set. No rewiring is necessary—no changes in your set at all. Just plug into a light socket and know you will get constant power and better reception.

The Na-ald A.C. CONNECTOR-ALDS with a filament transformer completely do away with your storage battery—trickle charger—relays and their many troubles. There is nothing in the CONNECTOR-ALDS to wear out. What they really do is make it possible to put the new A.C. tubes in your battery type set, then bring out three pairs of wires to a filament transformer tapped for the correct voltages necessary to operate the new tubes.

It is remarkably simple and easy to hook up a Na-ald A.C. CONNECTOR-ALD kit. The picture above shows the kit which is universal and can be used in any standard set. In the lower corner the drawing shows how extremely simple the installation is and how compact. Compactness is an important feature. The Na-ald kit connected with twisted jumper wires can be used in closely shielded sets, and re-

gardless of the location of the tubes the installation will be neat.

While the characteristics of the new A.C. tubes are about the same as the battery type tubes, they have nearly 50% greater efficiency, giving them a tendency to oscillate. This can be completely overcome with the Na-ald automatic oscillation controls. These suppressors slip into little slots or jacks built into the CONNECTOR-ALDS and are an exclusive feature. Other features include the Y tap resistors which provide necessary C bias and ground or center tap connections.

Na-ald A.C. CONNECTOR-ALDS and a filament transformer take care of the filament or storage battery circuit. You can continue to use your B batteries, later getting a B eliminator, completing the electrification of your set. You will then have the same equipment as in a new A.C. set.

You will find it a real joy to sit and listen to radio without worrying about run down batteries and knowing when you ask friends in to listen to a concert your power will remain the same all evening. Why not get one from your dealer today or write us for further information?

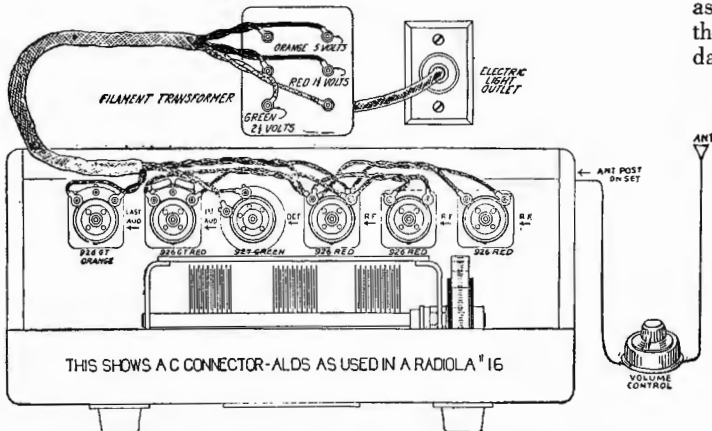

Alden Manufacturing Co.
Springfield, Mass.

Please send me complete story on Na-ald A.C. CONNECTOR-ALDS.

NA-ALD A.C. BOOKLET
 WHAT TO BUILD BOOK
 NA-ALD PARTS CATALOG

Name

Street

City

Alden Manufacturing Co., Dept. CCB, Springfield, Mass.

Tell 'Em You Saw It in the Citizens Radio Call Book Magazine

AEROVOX

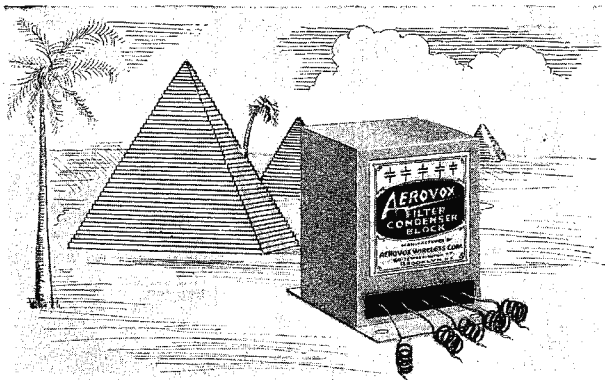

BUILT TO LAST FOREVER!



AEROVOX

Moulded Mica Condensers are the only ones with capacity definitely predetermined. You will find them most accurate.



AEROVOX

Pyrohm Vitreous Enamelled Resistors are made singly and in groups for every type of "A," "ABC," and "B" Eliminators.

TEST — TEST — TEST
 And still more tests. Raw material tests for conductivity, resistivity, dielectric strength. An assembly. A test. Further assemblies. Further tests. Ten tests during manufacture, for capacity, breakdown, resistance, power factor. Every test and method of construction that science can devise. More conservative ratings, because more insulation, both in quality and quantity, is used than in most other condensers of the same ratings.

That is why Testing Laboratories find Aerovox Condensers last longer than others under overloads, and never break down at their rated working voltage.

The Aerovox "Research Worker," edited by the engineering staff, is devoted to the diffusion of useful radio information of all kinds. A postcard puts you on the mailing list.

70 Washington Street
 Brooklyn, N. Y.

AEROVOX MEANS "BUILT BETTER"

(Continued from page 140)

- 1 Tobe 1 mfd filter condenser.
- 2 Tobe ¼ mfd bypass condensers.
- 1 T-50 Electrad Truvolt 5,000-ohm variable resistance.
- 1 E Electrad Royalty 500,000-ohm high resistance.
- 1 B-100 Electrad 10,000-ohm fixed resistance.
- 1 B-20 Electrad 2,000-ohm fixed resistance.
- 9 X-L bakelite push posts.
- 1 10 Yaxley battery switch.
- 3 9040 Benjamin spring sockets.
- 1 Carter 10-ohm filament resistor.
- 1 Carter 15-ohm filament resistor.
- 1 Celeron 9¾ x 12-inch base panel.
- 1 Celeron 7 x 12-inch front panel.
- 2 Base mounting brackets, 1 inch high.
- Miscellaneous lugs, nuts, screws, bolts.

Corwico A-C Adaptor Harness

(Continued from page 134)

The Corwico A-C Adaptor Harness enables anyone to convert a battery set into a house current receiver, without rewiring. The Corwico harness consists of a twisted cable of heavy Corwico flexible wire and the necessary number of adaptors to fit into the sockets of the battery set to be converted. The adaptors pick up the plate and grid connections of the original circuit while the harness supplies the required new filament circuit. Connect the harness to any standard step-down transformer, insert the A-C tubes into the adaptors and the old battery set is

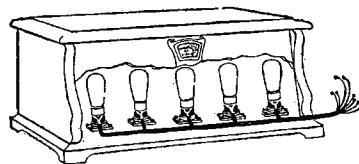

changed into an A-C receiver, eliminating all storage batteries or A eliminators.

Corwico A-C Harnesses are made in two types—one with adaptors attached for R.C.A. and other A-C type tubes, and one without adaptors for Arcturus A-C tubes. Arcturus A-C tubes are equipped for Corwico A-C Harness connections with the use of adaptors. This type Corwico A-C Harness should be used where there is not enough height left for the tubes if adaptors are used.

Made by the Cornish Wire Company, 30 Church St., New York City.

(Continued on page 144)

Lowest Wholesale Prices!

Set Builders and Dealers!

Let the largest Radio Mail Order House in the East serve you!

You'll get better service and better merchandise at the lowest wholesale prices obtainable anywhere.

NEW 1928 BUYING GUIDE

Your copy is ready for you. It lists all the latest Radio Parts, Accessories, Sets and Kits. Catalog K also lists Electrical Supplies, Household Appliances, Golf and Tennis Equipment, Cameras, Traveling Bags, etc. Send for your copy now. It's free.

Allen-Rogers-Madison
 35 WEST 31ST ST. NEW YORK, N. Y.



Figure 11. This photograph gives an idea as to the length of the tone column in the Newcombe-Hawley speaker

(Continued from page 127)

mers and the volume controls for best results. Do not use the rheostat or filament control constantly. The ideal setting for this will vary for different tubes, but once determined, should be fairly constant.

If the set has good volume, tunes fairly sharp and shows the customary response to superficial tuning, with a long screw driver or better yet, a pointed stick, screw the Variodensers all the way down.

Now, using the trimmers carefully, tune in a distant station. Adjust the Variodensers in the first stage so as to bring the station in with the greatest volume, and so on through the entire group. Do this with several stations and the best adjustment will be found.

The set can be logged on a kilocycle-dial reading graph. The example shown in Figure 2 was taken from a log on one of the laboratory models. The stations were selected merely to show the frequency curve. It represents what might reasonably be expected in a preliminary night of tuning. With a bit of experience it should be possible to log practically every station of importance on this continent.

The 0-100 voltmeter can be used as a very valuable adjunct to tuning. The setting of the volume control can be recorded as well as the dial setting, by jotting down the voltage reading at which the set was most sensitive to receive a certain station on a certain frequency. This is very valuable in logging new stations that you have never had before, because you know not only the dial readings on which they should be received, but also the proper voltage setting of the volume control.

It might be noted that this voltmeter is a standard type; not a high-resistance meter, even though it is used to measure the output of a "B" supply. Being constantly in the circuit, the small amount of

(Continued on page 144)

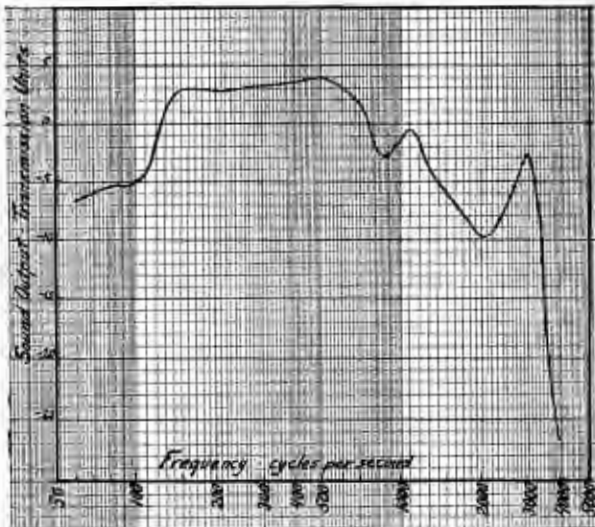

Figure 12. This graph represents the frequency response curve of the speaker used with the receiver

DeJUR
RESISTANCE SPECIALISTS
MANUFACTURERS OF ELECTRICAL AND RADIO
RHEOSTATS, CONTROLLERS AND REGULATORS SINCE 1912

CONDENSERS

Single - Double - Triple. In All Capacities
Including Low Capacities for Short Waves



Moulded Bakelite insulation outside electrostatic field suspends stator plates which bear only on one point. Condenser frame grounded to rotor, eliminates all hand capacity. End tie bar of rotor plates keeps spacing uniform.



End plates of brass, finished in highly polished nickel. Direct electrical connection made from rotor to frame by spring phosphor bronze pig-tail connector. Small phase angle difference; low minimum capacity.

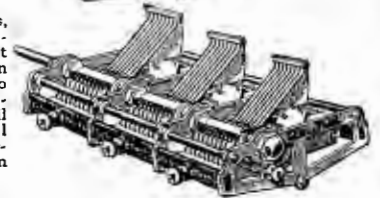

For Socket Power Devices

Realizing the ever increasing popularity of electric and electrified receivers the DeJur line for the coming season includes the highest quality and most efficient parts for all socket power units.

- Vitreous Enamelled Resistances
- "Synthetic" Resistors
- Metallized Grid Leaks and Resistors
- DeJur "Thermotrols"
- A New and Improved Filament Control
- Strip Resistances
- Power Rheostats

Write for new 1928-29 Catalog of all DeJur Guaranteed Radio Products and circular of valuable information for set builders and manufacturers

DeJUR PRODUCTS Co.
199 LAFAYETTE STREET, NEW YORK CITY

Tell 'Em You Saw It in the Citizens Radio Call Book Magazine

RADIO—a fast-growing money-making field

Get into it NOW!

WITH amazing rapidity, radio has developed from a scientific toy to a tremendous industry. Men still young hold responsible executive positions or head companies of their own. They have grown with the industry. They share its prosperity.

And radio, like the men who serve it, is still young. It is expanding, advancing always. Already, it has made television an actuality. It gives promise of almost unlimited future development.

Get into radio now, while opportunity offers. Learn to install sets—to service them. Build a business of your own and be independent. Or, if you prefer, enter the industry as a designer, engineer, operator, salesman.

All you need is training, and there is no better way for you to secure it than the Radio Course of the International Correspondence Schools. Endorsed by radio experts and manufacturers, this course is complete and thorough. Moreover, it is regularly revised to keep abreast of changing conditions.

Scores of I. C. S. radio graduates hold good positions in factories, laboratories and stores. J. B. McCune, of Donora, Penna., has established a flourishing business for himself. Quincy J. Workman, of Scranton, Penna., has "nearly doubled his salary" as manager of the Radio Department of a large store. I. C. S. training won for John M. Paynter of Charleston, S. C., a position as Radio Operator and Ship's Electrician. Men in many phases of the field report the same success.

If you are at all interested in things electrical and scientific, if you would like to enter a modern money-making industry, mail the coupon below for full information about the I. C. S. Radio Course. It will show you what you really can accomplish. There is no obligation, of course.

Mail the Coupon for Free Booklet

INTERNATIONAL CORRESPONDENCE SCHOOLS
Box 8319-C, Scranton, Penna.

Without cost or obligation, please tell me how I can qualify for the position or in the subject, before which I have marked an X:

RADIO

- | | |
|---|--|
| <input type="checkbox"/> Electrical Engineering | <input type="checkbox"/> Architect |
| <input type="checkbox"/> Electric Lighting | <input type="checkbox"/> Architects' Blueprints |
| <input type="checkbox"/> Mechanical Engineer | <input type="checkbox"/> Contractor and Builder |
| <input type="checkbox"/> Mechanical Draftsman | <input type="checkbox"/> Architectural Draftsman |
| <input type="checkbox"/> Machine Shop Practice | <input type="checkbox"/> Concrete Builder |
| <input type="checkbox"/> Railroad Positions | <input type="checkbox"/> Structural Engineer |
| <input type="checkbox"/> Gas Engine Operating | <input type="checkbox"/> Chemistry |
| <input type="checkbox"/> Civil Engineering | <input type="checkbox"/> Automobile Work |
| <input type="checkbox"/> Surveying and Mapping | <input type="checkbox"/> Airplane Engines |
| <input type="checkbox"/> Metallurgy <input type="checkbox"/> Mining | <input type="checkbox"/> Navigation |
| <input type="checkbox"/> Steam Engineering | <input type="checkbox"/> Agriculture and Poultry |
| <input type="checkbox"/> Pharmacy | <input type="checkbox"/> Mathematics |

BUSINESS TRAINING COURSES

- | | |
|--|---|
| <input type="checkbox"/> Industrial Management | <input type="checkbox"/> Advertising |
| <input type="checkbox"/> Personnel Management | <input type="checkbox"/> Business Correspondence |
| <input type="checkbox"/> Traffic Management | <input type="checkbox"/> Show Card Lettering |
| <input type="checkbox"/> Accountancy (including C.P.A.) | <input type="checkbox"/> Stenography and Typing |
| <input type="checkbox"/> Cost Accounting | <input type="checkbox"/> English |
| <input type="checkbox"/> Bookkeeping | <input type="checkbox"/> Civil Service |
| <input type="checkbox"/> Secretarial Work | <input type="checkbox"/> Railway Mail Clerk |
| <input type="checkbox"/> Spanish <input type="checkbox"/> French | <input type="checkbox"/> Common School Subjects |
| <input type="checkbox"/> Salesmanship | <input type="checkbox"/> High School Subjects |
| | <input type="checkbox"/> Illustrating <input type="checkbox"/> Cartooning |

Name.....

Address.....

(Continued from page 143)

energy that it consumes is of no consequence to the "B" supply which has an output quite in excess of that required, and the small drain means a drop of but about 2 per cent of the total output.

The success of this set or any other set can be traced directly to the efficiency of the parts employed. Those used in this set were selected after extensive experimentation as to their electrical and mechanical characteristics. They all work perfectly in the circuit and are of exactly the correct values and physical size, to conform to the base and panel layout, and theoretical circuit. It is not advisable to substitute. The parts are:

(Chassis)

- 4—Benjamin 2¼-inch r. f. transformers
- 6—Benjamin base mounting sockets
- 4—Karas .00037 SLF condensers, type 17
- 2—Karas audio transformers, type 28
- 1—Set Karas brackets
- 1—135 Jewell 0-8 d. c. voltmeter
- 1—135 Jewel 0-100 d. c. voltmeter
- 3—Carter .5 mfd bypass condensers
- 1—Muter .002 mfd fixed condenser
- 1—Muter .00025 mfd condenser and clips
- 1—Muter .0005 mfd fixed condenser
- 1—Muter 6 ohm rheostat
- 2—Muter ¼ amp. Tubestats
- 4—Aluminum Co. of America box shields 5x9x6-inch
- 1—Celoron 7x24x3/16-inch front panel
- 1—Celoron 10x23x3/16-inch sub-panel
- 4—Hammarlund 85 m. h. r. f. chokes
- 2—Hammarlund midget condensers
- 3—N-XL Variodensers
- 1—American Mechanical Laboratories Clarostat midget
- 2—National illuminated vernier dials
- 1—Belden 7-wire fused cable
- 1—Roll Belden Colorubber wire
- 1—Muter 3 megohm grid leak
- 2—Brass ¼-inch shafts 10-inch long
- 1—X-L binding post

(Power Supply)

- 1—Abox 6 volt A unit
- 2—Muter power condenser blocks No. 598
- 2—Muter 10,000 ohm resistors No. 2910
- 1—Muter 1000 ohm resistor No. 2901
- 1—Muter audio power choke No. 3130
- 1—Muter 2 mfd power condenser 600 volt
- 1—Benjamin base mounting socket
- 1—Thordarson power compact Type R210
- 1—American Mechanical Laboratories heavy duty high range Clarostat
- 9—X-L binding posts
- 1—Amsco 100 ohm resistor and mounting
- 1—Muter ½ mfd condenser No. 507
- 1—Celoron strip 1x9x¼-inch

(Speaker Circuit)

- 1—Newcombe-Hawley CG speaker
- 1—Baldwin unit, Rival type

(Antenna)

- 1—Belden indoor or outdoor antenna kit

Durham Grid Suppressors

(Continued from page 142)

The almost universal adoption by set constructors, and manufacturers, of grid suppressors to prevent oscillation in the high frequency stages of radio receivers, has led to a considerable amount of trouble in some cases due to the use of inductive and capacitive grid suppressing units.

A grid suppressor must, to accomplish its purpose, be as nearly free

(Continued on page 145)

Tell 'Em You Saw It in the Citizens Radio Call Book Magazine

(Continued from page 144)

from inherent inductance and capacity as possible. If a measurable amount of inductance is present it is almost certain to affect the circuit as well as to nullify the advantages of the use of a grid suppressing resistance.

In this connection, the International Resistance Company, manufacturers of Durham resistors, have developed low range resistance units of the values of from 250 ohms to 3000 ohms which are not of the wire wound type but of the metallized filament type, consequently en-



tirely free from any inductive or capacitive effects.

It is practically impossible to manufacture wire wound units, so that one-half of the inductance counteracts the other half of the natural inductance of the unit. These metallized filament grid suppressing units have, therefore, been adopted by many manufacturers, and are in increasing demand by experimenters and set builders who require non-inductive units.

High Voltage Storage Reservoir

A new "B" power device, remarkable not only in results but for its simplicity and positive action, consists of a high voltage storage reservoir in conjunction with built-in trickle "B" charger.

So enormous is its storing capacity that line voltage or power noises have absolutely no effect upon it. Not only this, but should the house

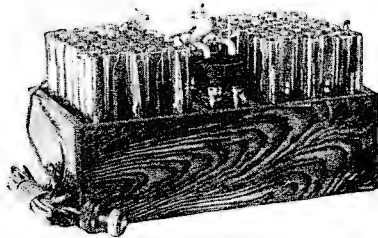

current go off completely it will run the average set four to six weeks. Is made for any a. c. voltage line of any cycle. Also for any d. c. line, including 32 volt home lighting plants. Uses no fixed or variable resistances to burn out. Has all tap voltages plainly marked for operation of any set from one to twelve tubes.

Made by The B. Hawley Smith Company, Danbury, Conn., who have manufactured radio products since 1920.

Marathon A. C. Kit

The Marathon a. c. kit, the transformer for which is illustrated below, consists of a harness, a volume control, the transformer and the same number of Marathon a. c. tubes which the receiver previously required. With such equipment it is possible to readily convert any

(Continued on page 146)

Lowest Wholesale Prices!

Set Builders and Dealers!

Let the largest Radio Mail Order House in the East serve you!

You'll get better service and better merchandise at the lowest wholesale prices obtainable anywhere.

NEW 1928 BUYING GUIDE

Your copy is ready for you. It lists all the latest Radio Parts, Accessories, Sets and Kits. Catalog K also lists Electrical Supplies, Household Appliances, Golf and Tennis Equipment, Cameras, Traveling Bags, etc. Send for your copy now. It's free.

Allen-Rogers-Madison

35 WEST 31ST ST. NEW YORK, N. Y.

"Super Ball" Antenna

for Permanent RADIO Satisfaction

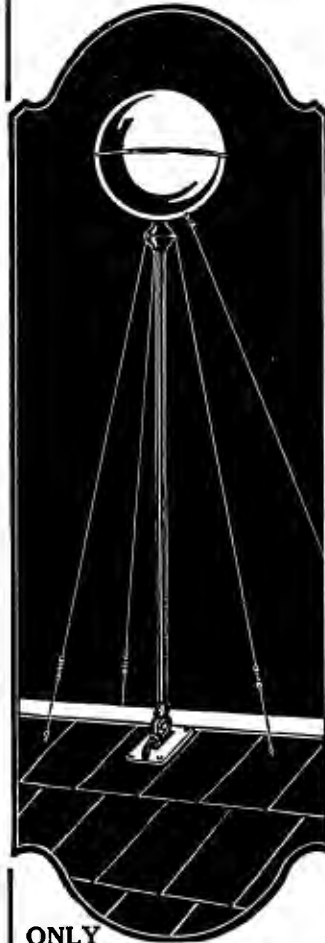

Permanent—because it is corrosion-proof. Sheds ice and snow and all directional because of its spherical surface—the Super Ball antenna is guaranteed to give greater radio selectivity. The concentrated conductive surface reduces interference and all wave lengths are received with equal efficiency.

Do you wish to enjoy your radio this summer? Super Ball Antenna minimizes static and the built in condenser which clarifies the tone will improve your summer reception.

The Super Ball can be placed within 10 feet of another aerial without interference. Count 'em on apartments and you know the owners who enjoy good reception.

Easy to install and inexpensive and guaranteed by manufacturer, the Super Ball is awaiting its opportunity to improve your reception.

Ask your dealer about the Super Ball Antenna—or write us for detailed information "Circulars."

DEALERS: Be prepared to cash in on the ready sale of this finest of antenna. Order from your jobber and write us for liberal selling helps.

ONLY
\$7.50

(50 Cents Higher West of the Rockies)

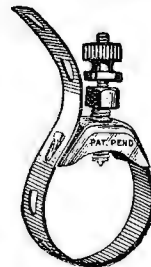

This improved Super-Ground Clamp gives perfect metal-to-metal contact—cuts through pipe scale, dirt, etc. Improves reception by providing perfect ground connection. Only 25c.



SUPER-BALL ANTENNA KIT
Contains all materials necessary for complete installation of Super Ball Antenna with complete directions for installation. **\$4**

YAHRLANGE

200 E. Water St. INCORPORATED MILWAUKEE, WIS.

Tell 'Em You Saw It in the Citizens Radio Call Book Magazine

Dubilier Socket Power Condensers



DUBILIER is proud of its part in the success of more than one manufacturer's power unit, and of the confidence shown by amateur experimenters everywhere.

The now complete line of Dubilier socket power condensers meets every requirement in the building of sturdy, compact eliminators for any purpose. Dubilier's recognized high factor of safety insures a life far longer than that of the average condenser and safeguards both receiver and power unit.

Ask your dealer to supply you with the correct Dubilier Block Condenser for your purpose.

Type PL 666—\$6.50
Type PL 667—\$11.00

Dubilier Light Socket Aerial



Don't fool around any longer with a troublesome, expensive outdoor aerial. Just connect the Dubilier Light Socket Aerial to your set and plug in. All the distance you need, all the volume you want, and clarity that an outdoor aerial can't touch. Less static, less interference and no lightning hazard. You risk nothing to prove it, for all good dealers sell the Dubilier Light Socket Aerial with a 5-day money-back guarantee.

Price \$1.50

Dubilier Condenser Corporation
4377 Bronx Blvd. New York, N. Y.

(Continued from page 145)

receiver from battery operated to alternating current operated.

There are two types of tubes available. The first is the detector tube No. 608, which operates with the plate voltage of from 45 to 90 and the usual grid leak and condenser for detection. Plate impedance is approximately 8000 ohms, mutual conductance about 1000 and voltage amplification of from seven to nine.

The radio frequency or audio frequency tubes are known as the 608-A. These tubes are of the self-biasing type and require no C batteries in the grid circuit, except in the output position where the usual 7½ volt C battery is used. Approximate bias applied to the grid of each tube is 1 volt for every 20 volts of B current and the voltages that may be applied range from 90 to 180 volts. The plate resistance is approximately 9000 ohms with an amplification constant of from seven to nine.

On the transformer shown here there is a center tap, which is used

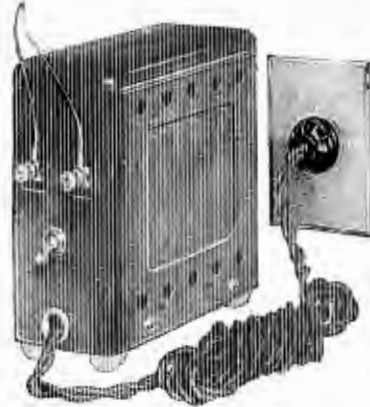

for stabilization. It is recommended that this tap be put either on 45 volts positive or ground. In some regenerative sets it may be necessary to use 90 volts.

The Marathon tubes are heated on a different principle than the regular a. c. type in that they are heated by radiation and the time lag is cut down to eight or ten seconds after the current is turned on.

Both the 608 and the 608-A are operated at one voltage, which ranges from five to six volts from the heater supply.

The harness is a universal one, which may be used in any set. Volume control should be used between the antenna and ground as a means of regulating the input to the first tube.

It will be noted that the Marathon tubes have two terminals on the side of the base for the alternating current supply, the balance of the tube being of the conventional type consisting of four prongs. The harness, which is supplied with the kit, is cabled and has short two-wire branches, which may be connected to the heater terminals on each of the tubes in the receiver.

The Trav-Ler Portable Set



Known as the original one-man portable, the Trav-Ler is a radio for home, for traveling, for vacations—all in one. It is so small and

(Continued on page 147)

Tell 'Em You Saw It in the Citizens Radio Call Book Magazine

(Continued from page 146)

compact it may be easily carried from room to room in the house or from place to place if you travel. There are no wires to disconnect or attachments with which to bother. Everything is self-contained in the one small Trav-Ler case, loud speaker, loop, aerial and batteries. All that is necessary to do is to lift the cover, turn on the switch and listen in.

In the event the user desires to use larger batteries or an eliminator, there is a socket on the case for a Jones plug and long cable. There is also an attachment that permits the use of the Trav-Ler with an antenna and ground.

Specifications of this unit are: single dial control, spring base sockets, built-in speaker and aerial, two stages radio frequency, one detector, two stages audio, phone jack, Jones plug and cable. The set may be operated with storage battery or eliminator. Also has binding posts for antenna and ground connection.

Manufactured by the Trav-Ler Mfg. Corp., 3401 N. Halsted Street, Chicago, Illinois.

Kingston Radiola A. C. Kit

A new a. c. kit, designed to convert with little or no alteration a regular Radiola model 16 direct current radio receiver into an efficient a. c. outfit, using regular a. c. tubes, has just been put on the market by the Kingston Products Company, Kokomo, Ind., nationally known manufacturers of radio power source accessories.

By means of special adaptors a. c. tubes replace the regular 5 volt direct current valves. The power supply, wiring changes, etc., are all previously taken care of in the kit itself, so that the actual installation is very simple. A service man can make the desired change in fifteen or twenty minutes with nothing more than a screwdriver. No soldering operation is necessary, and no changes are made in the actual wiring arrangement of the original set.

Especially designed for the Radiola model 16, the Kingston Radiola a. c. kit is not bulky and will not affect the usual operating characteristics of the set.

The a. c. kit comprises the following assembly, sold complete, ready to install: Kingston Type 2B current supply unit, a special a. c. transformer and C bias supply, adapters, volume control rheostat, and cable and approved a. c. switch.

Adapters are used in the present sockets which isolate the existing filament circuit of the set. Connection is made to the filament and heater terminals of the a. c. tubes through a cable which connects the adapters together.

The transformer is a well designed filament lighting type having four separate windings. There is a separate winding for the r. f. tubes, one for the 227 detector, one for the first audio tube and a 5 volt winding to light the 112 or 112-A power tube. All the amplifier tubes are supplied with negative grid bias which is necessary to give best operation, and greatly prolongs the life of the tubes.

The 227 tube is supplied with 2.2 volts at the heater terminals instead of the usual 2.5. This feature greatly lessens the amount of

(Continued on page 148)

MAGNAFORMER 9-8

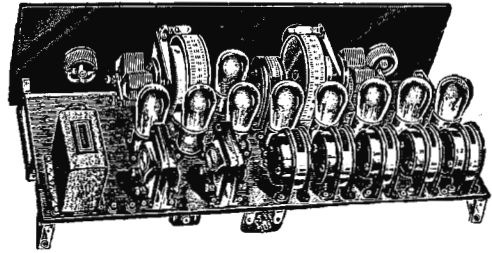

THE MAGNAFORMER 9-8 is without question the finest and most satisfactory custom-built receiver available today. Incorporating all the latest developments in radio set design, this receiver in its **PHENOMENAL PERFORMANCE** has earned for itself an enviable reputation among professional set-builders throughout the United States. The long-distance reception records made by the **MAGNAFORMER 9-8**, the exceptionally pure tone-quality, remarkable selectivity, quietness of operation and ease of tuning, are the direct result of the electrical and mechanical perfection of the **MAGNAFORMER INTERMEDIATE TRANSFORMERS**.

These entirely new and different transformers are precisely peaked to an exact frequency and permanently held to that frequency by unique methods of superior mechanical and electrical construction. Humidity, climatic conditions, changes in temperature and even jolts and jars have positively no effect on the **ABSOLUTE PRECISION** of these exceptional transformers. Only those parts are used in the receiver, which are recognized as being of the highest quality. This fact is strikingly demonstrated if an examination is made of the Official List of Parts. Drilled and engraved panels are furnished with each kit of parts, making it a comparatively easy matter to completely construct a receiver in a very short length of time. Complicated wiring has been entirely eliminated by the careful location of the various pieces of apparatus on the sub-panel. Short plate and grid leads are thus made a matter of fact. Due to its unusual stability and non-oscillating characteristics, the **MAGNAFORMER 9-8** is an exceptionally easy receiver to tune. Changes from 8 to 9 or 9 to 8 tubes instantly by means of a panel switch. The use of 9 tubes is necessary only on very distant stations. All instruments are carefully manufactured, subjected to the most rigid tests and fully guaranteed.

List of Parts Required to Build the Magnaformer 9-8 Receiver

1 Formica Front Panel 7x26x3/16", Drilled and Engraved	\$ 6.50
1 Formica Back Panel 7x26x3/16", Drilled	6.50
5 Magnaformer Intermediate Transformers, Unit R.F. No. G1	42.50
1 Uncoupler, Unit C.U. No. 71	6.50
2 Remler Universal Drum Type Dials with Controls, No. 110	9.00
2 Remler .0005 mfd. Variable Condensers No. 639	10.00
1 Benjamin Sockets No. 9044	4.00
2 Benjamin Panel Brackets 2" high, No. 8629	7.00
2 Ferranti Audio Transformers, A. F. No. 4	17.00
1 National Tone Filter	7.00
1 Samson Radio Frequency Choke Coil No. 125	2.25
2 Aerovox .00025 Grid Condensers, Type 1475, with Mountings	.80
1 Aerovox .001 Fixed Condenser, Type 1450	4.00
1 Aerovox 1 mfd. By-Pass Condenser, Type 200 Short	.90
2 Durham 2 megohm Grid Leaks	1.00
1 Frost DeLuxe 400 ohm Potentiometer, gold arrow knob, No. 1824	1.25
1 Frost DeLuxe 6 ohm Combination Rheostat and Battery Switch, gold arrow knob, No. 8-1806	1.35
1 Frost DeLuxe 10 ohm Rheostat, No. 1810	1.00
1 Frost DeLuxe 90 ohm Rheostat, No. 1830	1.00
4 Frost Tip Jacks, No. 253	.60
2 No. 112 Amperites, with Holders	2.20
1 Yaxley Cable Connector Plug No. 660	3.00
1 Yaxley Radio Jack Switch No. 60, Gold Plated	1.25
12 Feet Acme Bus Bar Wire No. 14 round tinned	.24
25 Feet Acme Flexible Celastite Wire	.40
2 " right angle supports for supporting rear of sub-panel	.10
Screws, Lugs, Nuts, Bolts, Solder	.50

\$128.94

Further details and information relative to the Magnaformer 9-8 Receiver will be furnished upon receipt of the coupon printed below

WE SPECIALIZE IN SUPER-HETERODYNE PARTS DISTRIBUTORS FOR

Melo-Heald "Hot Spot" 14
 Tyrman "70" Receiver Hagerman 210 A. C. Ensemble
 Tyrman "10" Receiver Browning-Drake Receiver
 Victoreen A. C. Super Bremer-Tully "Power Six"
 Silver-Marshall Screen Grid Electric
 Super Thordarson 210 Power Amplifiers
 Scott's World's Record Ten
 Melo-Meald Eleven Super 115 Kc. Remler Super

WE ARE WHOLESALE DISTRIBUTORS OF ALL STANDARD MAKES OF RADIO MERCHANDISE

Mail the handy coupon below and get our complete catalog and dealers' discount sheet

NELSON ELECTRIC COMPANY

Telephone Wabash 8719

508 South Dearborn Street Chicago, Illinois
 IMMEDIATE DELIVERIES—COMPLETE WITH NO SUBSTITUTIONS

Nelson Electric Company, 508 S. Dearborn St., Chicago, Ill.

Gentlemen: Please send me full particulars of

- Magnaformer 9-8 Receiver
 Complete Dealer's Catalog and Discounts
 User Professional Builder Builder for Own Use

Lowest Wholesale Prices!

Set Builders and Dealers!

Let the largest Radio Mail Order House in the East serve you!

You'll get better service and better merchandise at the lowest wholesale prices obtainable anywhere.

NEW 1928 BUYING GUIDE

Your copy is ready for you. It lists all the latest Radio Parts, Accessories, Sets and Kits. Catalog K also lists Electrical Supplies, Household Appliances, Golf and Tennis Equipment, Cameras, Traveling Bags, etc. Send for your copy now. It's free.

Allen-Rogers-Madison

35 WEST 31ST ST.

NEW YORK, N.Y.

Tell 'Em You Saw It in the Citizens Radio Call Book Magazine

LIGNOLE RADIO PANELS

Are

"THE PROFESSIONAL BUILDERS' CHOICE"

Now SPECIFIED for

VICTOREEN	MADISON-MOORE
CITIZENS 115 KC.	TYRMAN 70
WORLD'S RECORD SUPERS	HOT SPOT 14
NINE IN LINE	ST. JAMES TWIN FOUR
KARAS EQUAMATIC	KNICKERBOCKER 4

AND OTHERS

All Kit Panels furnished in two-tone effect with borders separated by a vein or a beautiful wood inlay.

Write for Complete Price List

If Your Jobber Does Not Carry Lignole Write for Name of One Near That Does

THE LIGNOLE CORPORATION

508 So. Dearborn St.

Chicago, Ill.

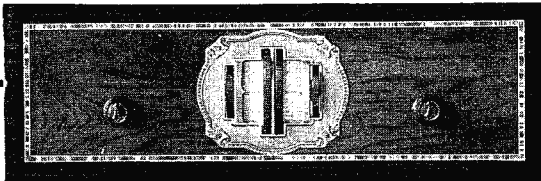

The Best in Radio Must Be CUSTOM BUILT!



No Adaptors Needed

The Arcturus A-C Cable and Arcturus A-C Tubes will transform your present set into a modern electric receiver without rewiring or adaptors.

ARCTURUS A-C TUBES

AMPLIFIER - DETECTOR
HIGH MU - POWER

Fit Present Sockets in Most
Popular Receivers

ARCTURUS RADIO CO.

255 Sherman Avenue, Newark, N. J.

ARCTURUS

(Continued from page 147)

trouble experienced with "heater burnouts." The 226 tubes are supplied with 1.4 volts (110 line voltage) and the grid bias used limits the plate current to approximately 2 milliamperes per tube, thereby getting away from "tube trouble" due to the usual overload placed on these tubes by permitting them to draw 5 to 7 milliamperes per tube.

Volume control is obtained by the use of a low-resistance rheostat (mounting in the same holes as the present volume control) placed in the filament circuit of the three r. f. tubes. Grid bias is secured through "drop resistors" in the plate return circuit. These resistors are by-passed with large condenser capacity so that no trouble is experienced with instability in either the r. f. or a. f. amplifier. The wires in the cable are twisted in pairs so a. c. hum is reduced to a minimum.

Aerovox Filter Condensers

Aerovox filter condensers, used in many of the most popular circuits, have a number of features which recommend them to the builder of an eliminator.

For example, although it is admitted that the working voltage of a condenser is the governing factor in the life of the unit, some people buy condensers by flash test rating. In the design of Aerovox condensers, the Aerovox engineers have built into the units a factor of safety which will ensure long life. As a matter of protection, the individual sections are tested in manufacture at four times the rated working voltage, which is far in excess of the Underwriters' requirements. Aerovox condensers are made for working voltages of 200, 300, 400, 600 and 1,000 volts d. c.

They are wound non-inductively, so that the d. c. resistance and the inductive impedance to alternating current are as low as

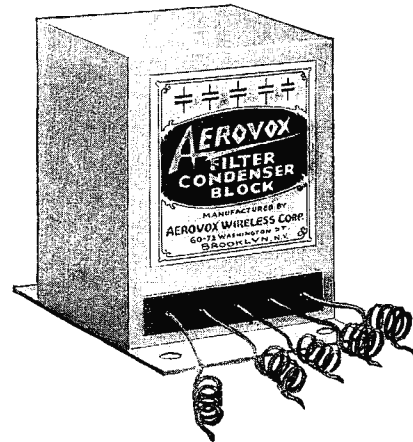

possible. Only the purest linen paper, the highest grade known to the art, and, incidentally, the most expensive, is used. The plates are made of a tin foil alloy which has been found through long laboratory research to be the softest and it will flatten out and conform to the surface of the paper much better than other alloys, thereby reducing the danger of breakdown due to moving foil. Special vacuum pumps connected with dryers and vacuum tanks create a vacuum within one-tenth of an inch.

For economy, compactness and easy assembly of battery eliminators, Aerovox furnishes complete assemblies for all the popular circuits as well as separate units of various capacities and with rated working voltages from 200 to 1,000. All of these are described in their catalog and some of the various processes are incorporated into the various issues of the Aerovox "Research Worker" which is issued monthly to experimenters who are sufficiently interested to write for a copy.

Made by Aerovox, 70 Washington Street, Brooklyn, N. Y.

(Continued on page 149)

Sterling Tri-Power Unit

For those who own a good battery-type receiving set, and who now regret they did not wait to buy one of the more recent models using a. c. tubes, an interesting unit has been developed by the Sterling Manufacturing Co., Cleveland.

This unit, called the Sterling "Tri-Power," supplies A, B and C voltages to six-volt d. c. sets, and converts them to use a. c. tubes.

The Tri-Power, with its general utility cable and adapters, is applicable to practically all popular makes of five-, six- and seven-tube sets. Special adapters are furnished to specification for sets which vary from the standard circuit layouts. A voltages supplied

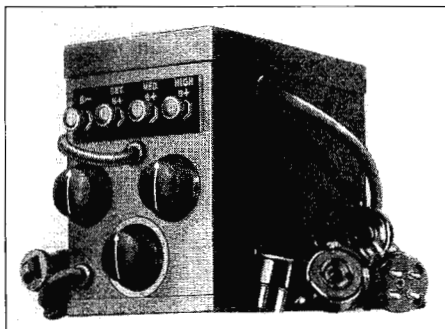

are for 171 or 112 power tubes, for 227 detector tubes, and 226 type tubes. The adapters contain proper removable grid resistors.

Single switch operation is made automatic by connection to the receiver filament switch, or by external switch depending upon the receiver design.

DeJur Illuminated Dial

An illuminated dial that is easy to mount, mechanically strong
(Continued on page 153)



Specified in

Samson Public Address System

and

Harkness A. C. Power Pack

Are Made of Finest Materials

Our Units Designed for Power Pack Use Have Withstood 5000 Volt D.C. Continuous Load in Samson Electric Co. Laboratories

Igrad Condensers Used in Finest Radio Apparatus by Peerless, Mohawk, Walbert, Philco, Hyatt, Eagle, Amplion, Etc., Also by Foremost Makers of High Frequency Devices

By-Pass, Filter, High Voltage, B, BH, 171, 210 Units in Stock—Others to Order at Reasonable Prices

Igrad condensers unexcelled for use in interference elimination

IGRAD CONDENSER & MFG. CO., Inc.

Condenser specialists

Rochester, N. Y.

Sales Agents: Aaron, Siedman & Co., 307 No. Michigan Ave., Chicago—State 6372

Stoner & Heath, Inc., 122 Greenwich St., New York—Technical Sales Co., 31 Bedford St., Boston—Marshank Sales Co., 224 E. 16th St., Los Angeles

FREE

We are offering a genuine CeCo tube as a premium for subscriptions to the Citizens Radio Call Book. Issued January, March, September and November.



The famous CeCo tubes are well known throughout the entire Radio field and have been endorsed by many leading Radio engineers and authorities. They give longer life and steadier performance than twenty-seven other makes of tubes on an unbiased test.

Select the type you need for your receiver from the chart below.

Type	No. of Consecutive Issues	Send Us
AX (201A)	4	\$1.75
BX (199)	5	2.25
N27 (AC)	13	6.25
M26 (AC)	8	3.50
F (112)	9	4.00
J (171)	9	4.00

If you desire additional tubes, simply send us your subscription for the proportionate number of issues.

Everybody that has a Radio receiver is constantly in the need of tubes, so clip the coupon and mail today.

COUPON

CITIZENS RADIO CALL BOOK

508 South Dearborn Street
Chicago, Ill.

Gentlemen:

Please find enclosed.....for which kindly enter my subscription for.....consecutive issues of the Citizens Radio Call Book, and send me..... type.....CeCo tube(s) as a premium. I enclose.....for full payment of same.

Please start my subscription with the January, March, September, November issue.

Name.....

Street.....

City.....State.....

Tell 'Em You Saw It in the Citizens Radio Call Book Magazine

Citizens Radio Call Book Magazine

\$99.50

For Your Old Radio!

Regardless of Size, Type, Age or Condition
(No Crystal Sets Accepted)

Think of It!

For only \$49.50—and your old radio set, it be a 1, 2, 3, 4, 5, 6, 7, 8, 9 or outfit. Whether it works or not, you can get one of the new models in a beautiful console cabinet

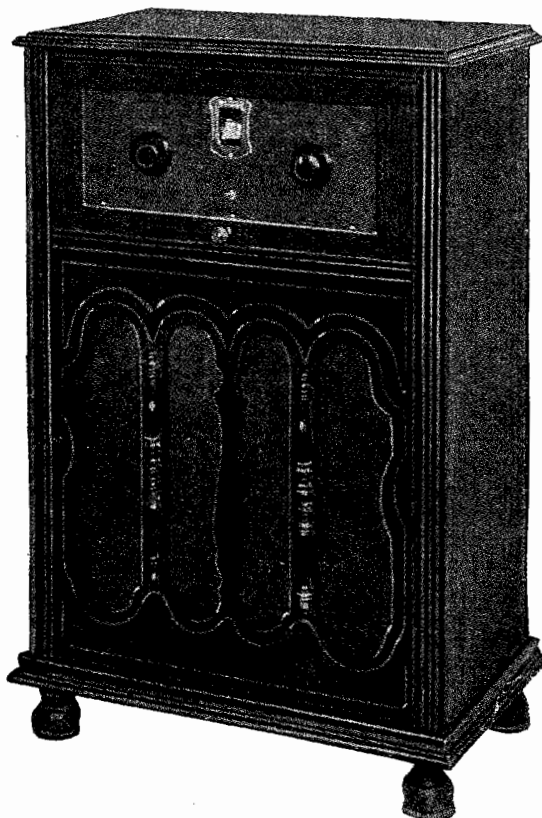

Act Now

This offer may be withdrawn at any time, and we urge you to send in your order immediately if you want to get in on the most sensational offer ever made by any radio concern in the history of radio. You take no chances. See our money back guarantee.

Cabinet alone is worth the price

MONEY BACK GUARANTEE

This receiver is fully guaranteed against all mechanical and electrical defects. Try it out for 10 days, and then if you are not satisfied with your bargain, ship it back in the original container and your money will be refunded.

Price \$99.50 Without Speaker or Accessories

THE NEW RADEX SHIELDED SIX CONSOLE

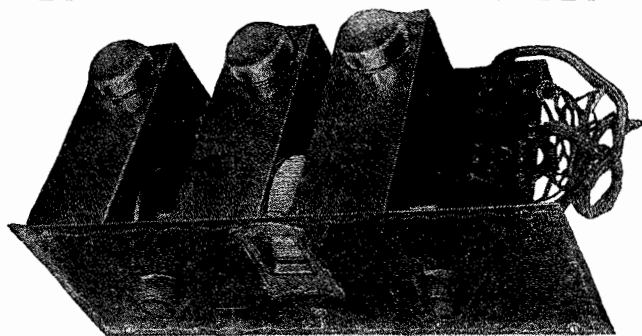

View Showing Interior of Radex Chassis

SPECIFICATIONS

Six tubes—3 R.F., Det., 2 A.F.; single dial control, illuminated; all metal construction throughout, including front and sub-panel. Tuned R.F. stages individually shielded. See illustration. Volume control and switch in one. Selectivity switch. Power tube operation as well as all electric operation.

Great volume; superior tone quality; extreme selectivity; distance getting ability. Simple and rugged construction throughout. Beautiful walnut finished cabinet with ample space for batteries, power units and any type of speaker desired. Outside dimensions 25 in. wide, 15 1/4 in. deep, 43 in. high.

Keep Your Batteries, Tubes, Speaker or Other Accessories—Just Ship Your Bare Set, PREPAID

The New RADEX ELECTRIC

FOR ONLY **\$77.50**

Another Sensational Offer—Write for Full Details

RADEX MFG. CO., SIOUX CITY, IOWA

USE THIS COUPON AT ONCE

RADEX MFG. CO., Dept. C, Plymouth Bldg.,
Sioux City, Iowa.

Enclosed find money order for \$49.50, for which please ship one of your new Radex Shielded Six Console Radio Sets. I will keep it ten days and if satisfactory will ship you my old radio, prepaid, but if I am not satisfied, I will return your set and you are to refund my money.

Name.....

Address.....

Town & State.....

Shipment is usually by express—if desired by freight advise

Tell 'Em You Saw It in the Citizens Radio Call Book Magazine

Radio Dealers and Professional Set Builders

can do away with the annoyance of buying from a large number of sources by keeping our catalogue handy. We have built up a national reputation on kits, accessories and special apparatus. By purchasing your kits and parts from Wholesale Radio Service Co. you not only assure yourself of the correct price, but save many dollars otherwise lost through delays in obtaining the parts from a dozen jobbers.

MAXIMUM DISCOUNT TO OUR DEALERS!

We give our dealers the maximum discount on all orders whether large or small. We feel sure that you will appreciate receiving a proper discount on your purchases without taking a larger quantity than you really need.

ALL THE LATEST KITS IN STOCK

We have ready for immediate shipment an array of the newest radio kits as specified by the Citizens Radio Call Book, Radio Broadcast, Radio News and other leading radio publications.

We always try to be first in the field with complete parts so that our dealers can supply their Customers promptly.

Parts for Every Circuit Published by This Magazine

IN STOCK—Remler Shielded Grid Receiver, Silver-Marshall Shielded Grid Six, The New Karas A. C. 2-Dial Equamatic, Knickerbocker "4," Tyrman 70 Shielded Grid Kit, Madison-Moore International One Spot, New World's Record Ten, Lynch Silver-Marshall "5," Samson Power Packs, Thordarson Power Pack, Magnaformer, New Browning-Drake, Hammarlund Hi-Q "6" Shielded Grid, and many others. Write for Catalogue.

WRITE FOR OUR CATALOG

Thousands of Dealers everywhere use WRS catalogue as a guide to all the newest and latest things in the radio field at the lowest wholesale prices. Dealers Everywhere look solely to Wholesale Radio Service Co. for their merchandise. They know they cannot beat WRS for Service and Prices.

We Are Exclusive Distributors for the RA-PAM Audio Unit

"As fine an audio unit as money can build" describes the RA-PAM perfectly. This unit is a completely self-contained, light-socket operated two-stage amplifier. The most radical difference between the RA-PAM and other similar devices, is that the RA-PAM does not supply the "B" current for the tubes in the set that remain in use after the RA-PAM is connected. This feature eliminates the cause of much trouble, such as motor-boating and audio distortion. The quality of reproduction from the RA-PAM is the finest obtainable from home-amplifying equipment.

WHOLESALE RADIO SERVICE CO.
6 CHURCH ST.,
'EVERYTHING FOR THE SET BUILDER!!'
NEW YORK CITY.

FREE

WHOLESALE RADIO CATALOG

KITS-SETS-ACCESSORIES

THE new Harco Catalog should be in the hands of every set builder and dealer in radio. It lists thousands of standard radio items at prices that will astound you. Complete sets—accessories—all the latest kits—a complete line of parts and an assortment of radio furniture that will satisfy the most discriminating—all at rock bottom wholesale prices.

Set Builders

All the latest and popular kits are listed in the Harco Catalog at genuine wholesale prices. Be sure to get a Harco catalog before you place the order for your kit.

Dealers

Our complete line of radio—plus a reputation for service—makes Harco a valuable connection for the live dealer. The Harco Catalog will tell you why!

Catalog on Request

THE HARCO COMPANY
1255 So. Wabash Ave. CHICAGO

WALES

"The Prince of Lighters"

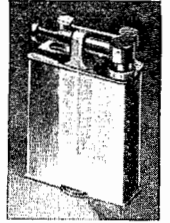

You must own a Wales pocket lighter to appreciate the beautiful finish and excellent mechanism. A slight pressure of your thumb on a clean wheel—sure fire. Small in size, handsome in appearance.

You have only to see this lighter and you'll be proud to own it. It's a JEWEL.

Silver plated, \$5.00—Leather covered genuine lizard 18 karat electro gold plated, \$7.50.

Lifetime Guarantee

WALES NOVELTIES CORPORATION

C-413 West Broadway

New York, N. Y.

QUALITY and POWER

5 times the power of resistance or impedance coupled amplification. Entire elimination of tube noise—tone separation that is proving a revelation to professional builders. Separation of tone so pronounced that you can actually feel the depth of the music, that's the tonal quality you'll get with

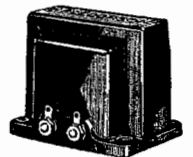

Haldorson Overtone Transformers

Ask your dealer to show you the Haldorson audio transformer and the output transformer. Try them in your own set. They are guaranteed to give you more power and a richness of tone than you have ever believed possible. At all dealer's. Price, each, \$6.00.

SET MANUFACTURERS: Let us quote on your requirements for Audio, output and A.B.C. power transformers.

THE HALLDORSON COMPANY

Sales Office: 607 Brooks Bldg.

Factory: 4745 N. Western Ave.

CHICAGO

CARTER PARTS

Specified in the following circuits:

- | | | |
|-----------------------------|---|--|
| S. M. Shielded Grid Super | Tyrman "70"
Shielded Grid Amplifier | Ultradyne A.C. Citizens Crystal Receiver |
| Victorine A.C. Super | | Line Voltage Regulator |
| Citizens Blirback A.C. 4 | | |
| Hagerman 210 A. C. Ensemble | Sansone Public Address System | Citizens R. F. Amplifier |

Harkness A. C. Counterphonic and Power Amplifier
Carter has kept pace with the industry in providing up-to-the-minute designs and original features for all the new developments in the industry.

See the new Carter line:

- | | |
|--|---|
| A. C. Adapter Harness for converting battery sets to A. C. tube operation. | A type of Adapter Harness for each standard filament transformer. |
| Fixed Condensers | Resistances for "B" |
| Resistors for A.C. Tubes | Eliminators |
| Virteous Enamel Resistors | A.C. Adapters for converting sets to A.C. Tubes |
| | Automatic Power Switches |
| | "Imp" Short-Jack Switches |
- Write for illustrated folder showing over 300 different parts. Any Dealer Can Supply

CARTER RADIO COMPANY, Chicago, Ill.

For B-Eliminator Hookups
filament control, variable grid leaks, and fixed resistors, use Bradleyohms, Bradleystats, Bradley-leaks and Bradleyunits.

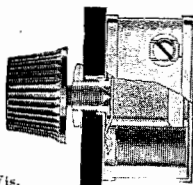

ALLEN-BRADLEY COMPANY

488 Clinton Street

Milwaukee, Wis.



Blackburn Ground Clamps

Telephone companies using MILLIONS. Adjustable—fits any size pipe. Requires no pipe cleaning—screw bores through rust and scale. Send 12 cents for sample and postage.

BLACKBURN SPECIALTY CO.
1968 E. 66th St. Cleveland, Ohio

FREE RADIO CATALOG

To Dealers: The new 136-page Colored and Illustrated 1928 Hamilton-Carr Wholesale Catalog is ready. Thousands of amazing values in kits, packs, nationally advertised accessories and parts. Features master-built, single-control six, seven and eight tube sets. Battery or all-electric operation. Beautiful consoles. Complete line of chassis. Full showing of "A" and "B" Eliminators, kits and parts. All merchandise guaranteed by pioneers in radio business. Immediate service. Write us today on your business letter-head for this wonderful catalog. The greatest assortment of merchandise ever shown at the lowest prices.

HAMILTON-CARR RADIO CORPORATION

711 West Lake St.

Dept. 406

Chicago, Illinois

NATIONAL WHOLESALE DISTRIBUTORS

SILVER MARSHALL
Kits & Parts
TYRMAN "70"
WORLD'S RECORD SUPER
REMLER, KARAS, ETC.
Send for New Catalog Just
Off the Press

SHURE RADIO

331B West Madison Street, Chicago

SILVER BEAUTY BATTERY CHARGERS



1/2 amp. and 2 amp.

5 amp. 15 and 30 battery size

Highest Quality Products

TRIPLE-A-SPECIALTY CO.

312 So. Hamilton Ave.

Chicago, Ill.

FREE!
30 DAY TRIAL

Retail \$36.75 to \$69.75

Radio's most amazing bargains, direct from big, reliable maker (8th successful year). All Electric or Battery sets. Consoles or table cabinets. Don't buy unless 30 days trial proves

Miraco unbeatable at 2 to 4 times the price for selectivity, distance, volume and rich, Cathedral tone. Turn one dial for all stations. Completely assembled, fully guaranteed sets!

FREE Literature, Users' Testimony and

BIG SPECIAL OFFER

MIDWEST RADIO CORPORATION

Pioneer Builders of Sets, 531-D Miraco Bldg., Cincinnati, O.



Big Discount to User Agents

Tell 'Em You Saw It in the Citizens Radio Call Book Magazine

RADIO AT NEW YORK'S LOWER PRICES

Unusual Values in Sets, Parts and Accessories

Our stock is one of the largest in the country. Our service is prompt and our prices low. Write us for what you want. We invite orders and inquiries from amateurs and professional set builders.

All parts in stock for the following and all other circuits described in the Citizens Radio Call Book:

Samson Push-Pull Amplifier	Silver-Marshall Shielded-Grid Super
Harkness A-C Counterfonic	Aero Radio Phone Transmitter
Madison-Moore International "One-Spot"	Citizen's-Birnback A-C "4"
Victoreen A-C Super	Citizen's Crystal Receiver
Line Voltage Regulator	Complete Electric Phonograph
Delco "A" Power Supply	Vacuum Tube Voltmeter
Citizen's R. F. Amplifier	

WE ARE NEW YORK
Distributors for the Following
Write for Our Rock Bottom Prices

Acme E-4 A-C "B" Eliminators 180 Volt Output With Raytheon Tube	Acme E-2 Direct Current "B" Eliminators
Farrand Output Transformers	Stromberg Carlson Audio Transformers
Elkon All Dry "A" Power Units	Genuine Western Electric VT-1 Tubes

Complete Line of Ward-Leonard Resistances in Stock

FREE Yorkville's two color catalog of unusual values in radio sets, accessories and parts. Write for copy today. Every amateur and professional set builder should be on our mailing list to receive our radio bargain bulletins.



YORKVILLE RADIO COMPANY

143 East 86th St., New York City

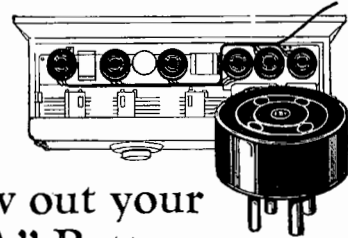

Throw out your wet "A" Battery
—but keep your radio set!

Without rewiring you can use AC tubes in your present set. Keep your B and C supplies and discard your A battery. Quick, simple and inexpensive with the Eby AC Adaptor Harness and a standard transformer.

Eby Adaptor Harness for five-tube sets.....\$ 9.00
Eby Adaptor Harness for six-tube sets..... 10.00



Our booklet tells the whole story. Write for it!

EBY

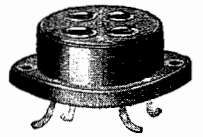

Sockets

Binding Posts

Specified in most of the popular circuits. Standard equipment on the majority of better known receivers. With non-removable tops. List price 15c.

Beautiful in appearance—Scientific in design—Efficient in operation.

One universal model—mounted either above or below metal, wood or Bakelite panel.

List Price 40c

THE H. H. EBY MFG. CO., Inc.
4710 Stenton Avenue Philadelphia, Pa.

Shanco

BETTER CONTACT

Grip-tite

Battery Clips

POWERFUL TENSION

SHANCO Griptite Battery Clips assure free and uninterrupted flow of electrical current.

There are no springs to heat up, burn or drop out. Made of powerful - tension, tempered spring steel, solidly riveted together, with all parts electro lead plated before assembly. This uniform lead coating is positive assurance against corrosion at the joints. Acid-resisting. Jaws open wide and are easily applied. The Griptite bulldog teeth are so arranged that the clip cannot fall over and "short" the battery. Terminals are wide and screws amply large for cable connections. No parts of Shanco Clips can be lost or displaced—everything is one compact, solidly built unit. Shanco Clips are approved by Radio News Laboratory and leading radio engineers; they will last longer and give greater satisfaction.

4 Sizes

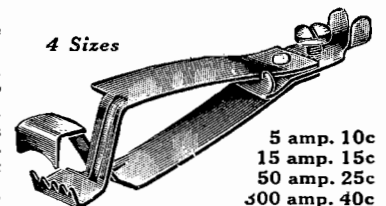

5 amp. 10c
15 amp. 15c
50 amp. 25c
300 amp. 40c

At all good radio stores and battery stations, or order direct from this advertisement, giving dealer's name. Dealers and jobbers write for discounts and special proposition.

Shanklin Manufacturing Company

Dept. 24, Springfield, Illinois

Tell 'Em You Saw It in the Citizens Radio Call Book Magazine



Can You Tell?

Look over some of the ads in this magazine. What's wrong with them—can you tell? There is something wrong with every ad—no advertisement is perfect. Sometimes it is the words used in the headline. Sometimes it's the illustration. Sometimes the ad is too crowded. Again the wrong publication may have been selected—these are a few of the fascinating problems confronting every advertiser. And the man or woman with ideas and opinions who can help solve these problems is being paid startling big money.

Millions upon millions of dollars are being spent every month in newspaper and magazine advertising—to say nothing of the many millions spent in mailing out catalogs, sales letters, circulars, house organs, and broadsides. And nearly every advertiser admits that his advertising and sales literature do not pull anywhere near the business they should—that there's tremendous room for improvement.

Get Into Advertising

ADVERTISING is easy to learn—especially under the right guidance. Can you imagine anything more fascinating than taking just an idea and developing it step by step into a finished advertisement, or a completed sales campaign? And that is the sort of practical work done by the students of this famous school.

The amazing growth of the Page-Davis School of Advertising (founded 1896) and the success of our graduates is undoubtedly due to our unique and practical method of instruction. No text books whatever are used. From the start you are given practical advertising work to do, just as though you were employed in an advertising department. Every step of this work is supervised and directed by experts.

Make Your Day Dreams Come True

If tomorrow you were offered the priceless opportunity of going into a prominent Chicago Advertising Agency for a year, to learn the business from beginning to end—and you knew that every day your every step would be guided by experts—and you knew that a sincere interest would be taken in your progress, and you also knew that you would be given real helpful coaching when and where you needed it—you would jump at the chance, wouldn't you? And that is substantially just what the Page-Davis School of Advertising is offering you!

Mail Coupon for FREE Book

Simply send the attached coupon and we will mail you a remarkable booklet called *How to Win Success in Advertising* which tells you how you may now quickly learn advertising during your spare time at home. It tells about the many opportunities open to you in this fascinating profession—how to develop your ideas and realize big money for them in advertising.

Remember that sending the coupon does not obligate you in any way. Then get it in the very first mail—it may be the means of putting you in the big money class almost over night.

Page-Davis School of Advertising
3601 Michigan Ave., Dept. 5083, Chicago



Page-Davis School of Advertising
Dept. 5083, 3601 Michigan Ave. Chicago

Please send me your free Booklet *How to Win Success in Advertising*—and full particulars regarding your Course in Modern Advertising. I am not obligated.

Name.....
Street.....
City..... State.....

(Continued from page 158)

With this test set the operator is enabled to check the voltage of B eliminators, ascertain in a moment the condition of tubes and circuits.

This test set consists of a milliammeter and a voltmeter mounted on a small stand containing the tube socket. In addition to this there is an adaptor, which plugs into the receiver socket and a

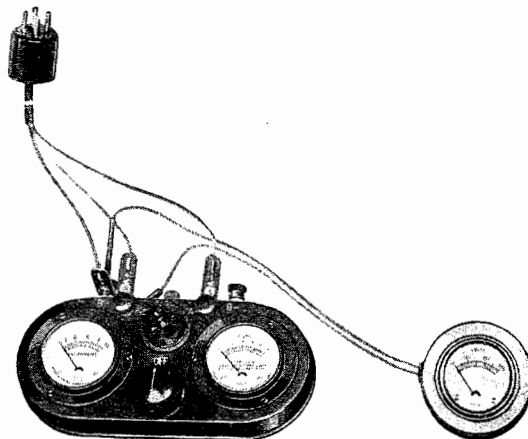

separate voltmeter with a reading of from 0-300 volts, which is designed for use in checking voltages from the eliminator. Suitable binding posts on the unit are connected to the adaptor cord and by means of this the user may readily determine the condition of filament, grid or plate circuits.

Arcturus A. C. Tubes for All Sets

Both factory and custom built battery operated receivers may now be converted without rewiring to alternating current operation by means of special a. c. tubes recently marketed by the Arcturus Radio Company, 255 Sherman Avenue, Newark, N. J.

These tubes are made in five special types for Freshman, Kolster, Stewart-Warner, Atwater-Kent and Crosley receivers, as well as a universal type tube.

These tubes may be obtained in the usual electrical designs of amplifier, detector, high-mu and power types. No adaptors are required for use with the Arcturus tubes. The a. c. cable used with these tubes consists of three twisted flexible wires in braid, with the leads for the heater connections brought out at spaces corresponding to the placing of the tubes in the particular receiver for which the cables are designed. The third wire is used as a cathode return.

The Arcturus a. c. type 6-K is for the Kolster, type 6-F for the Freshman, both of these being for six tube receivers.

A 15 volt transformer is used for the heaters of the Arcturus tubes. It takes about a half a minute for the cathode of these tubes to become properly heated. The taps on the transformers should be adjusted so the tubes reach normal operation in just thirty seconds. This will be the case if the potential applied across the heaters is exactly 15 volts. Whenever possible a voltmeter should be used to determine the correct voltage.

In addition to the factory built receivers, these tubes may be used in any custom built receiver and the transition from battery operation to a. c. operation requires practically no work and is quite simple. An article covering the operation of the Nine-in-Line with Arcturus tubes appeared in the January issue of this magazine, page 146.

BELDEN COLORUBBER A. C. WIRE KIT

Contains all wires necessary for
A. C. Receiver

Belden Manufacturing Company
2322-A S. Western Ave., Chicago, Ill.



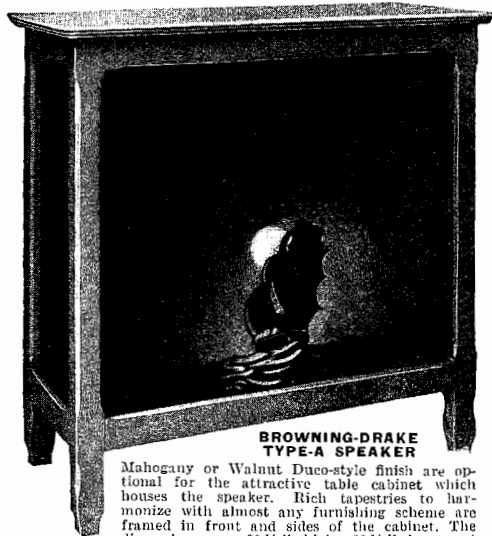

**BROWNING-DRAKE
TYPE-A SPEAKER**

Mahogany or Walnut Duco-style finish are optional for the attractive table cabinet which houses the speaker. Rich tapestries to harmonize with almost any furnishing scheme are framed in front and sides of the cabinet. The dimensions are 30 1/2" high, 30 1/4" long and 14 3/4" wide. A ten-foot silk cord is attached to each speaker.
Licensed under Whitmore (Air-Chrome) Patents pending.

Have you heard The BROWNING-DRAKE SPEAKER?

A new principle of loud speaker design and construction is incorporated in the Browning-Drake Speaker and a new interpretation of reproduction is found when this speaker is heard. There is no rasp or rattle and no distortion at any volume delivered by the best power amplifiers. Browning-Drake tradition for fine radio apparatus is sustained in this new speaker. The lowest frequencies of the musical scale, within range of the human ear, are brought out with astonishing volume.

DEALERS: A unique and interesting method of distribution has been arranged to handle sales of these speakers. Write today and get the details of this proposition.

See your nearest dealer or write direct

The Browning-Drake Speaker Sales Company

NEWARK
172 Emmet St.
Newark, N. J.

PITTSBURGH
910 Fulton Bldg.
Pittsburgh, Pa.

CHICAGO
53 W. Jackson Blvd.
Monadnock Block Chicago, Ill.

SAN FRANCISCO
905 Mission St.
San Francisco, Calif.

BOSTON
552 Massachusetts Ave.
Cambridge, Mass.

The Browning-Drake Corporation offers a complete line of A. C. and D. C. factory-built receivers as well as the most popular Kit parts on the market.

For present Browning-Drake users, the new shield grid single stage booster has just been announced, adapting your present set to the new 222 type tubes with their remarkable sensitivity.

The BROWNING-DRAKE CORPORATION 110 Brookline Street
CAMBRIDGE, MASS.

If—You've got a good radio receiver— Electrify! —and Keep It!

Don't be stampeded into trading in your present set on an AC receiver which may not prove up to expectations. You can now make your present set fully electric for a fraction of new set cost.

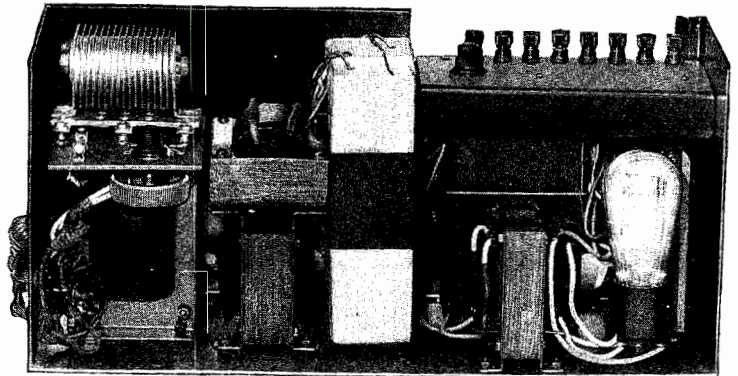

This Perfect "Bone-Dry" Power Pack is easily and quickly installed—

KNOW YOUR VOLTAGE

Jewel quality resistance volt meter, especially adapted for power requirements. Complete with 3 tap switch for instant reading of detector, intermediate and amplifying voltages. Built in handsome black metal case for convenient use or packed separately in standard Jewell boxes with wiring instructions.

Meter, boxed, \$7.55
Meter, plain, \$6.45

It fits in any console and forever ends your battery troubles. No liquids to spill—no acid fumes to irritate. If you have a dependable "B" eliminator our guaranteed "Bone-Dry" A Power Unit will completely electrify your receiver. Use the same tubes now in the set. No rewiring necessary.

Perfect ABC, Stripped Model, Complete, \$42.25;
Perfect Dry A, \$19.85

*Specify make and model set or "C"
voltage required*

UNITED SALES COMPANY
9713 Cottage Grove Ave. Chicago, U. S. A.



Tell 'Em You Saw It in the Citizens Radio Call Book Magazine

Successful Men Say-

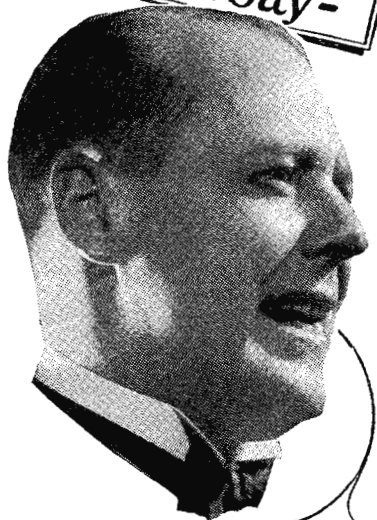

Be Law Trained
It Brings Greater Opportunities

A legal training equips you to rise quickly to the very top in the business world. You will see the proof in your own community! The leaders of big business are Law trained. That is why so many successful men say "Law training makes success more certain."

Now . . . Easy to Learn at Home!

Now under modern methods you can get this success training right at home, during spare time. The man in business who knows law, has facts at his finger tips that make him far more valuable than his associates. That is why a Law training often brings bigger opportunities, more money, and even social prominence. Incomes of \$5,000 to \$10,000 a year in business are only ordinary salaries for law trained men.

More Than 50,000 Have Enrolled

Our course and Service is endorsed by members of the bench and bar. Founded in 1886. More than 50,000 have enrolled for our training. Thousands of graduates are successfully practicing law, or filling positions of prominence in the business and political world.

Free Booklet

We shall be pleased to send you, free and without obligation, copy of an interesting booklet recently prepared for men who want to get ahead. Your name and address on the coupon below brings this booklet and full details of our method of law training. Low tuition Fee and easy terms now in effect. Mail the coupon now.

American Correspondence School of Law

Dept. 5083 3601 Michigan Ave. Chicago, Illinois



American Correspondence School of Law, Dept. 5083, 3601 Michigan Ave., Chicago, Ill.
Without obligation, mail me your Free booklet which tells all about your Law training, and how I can acquire a knowledge of Law, at home, in my spare time.
Name.....
Address.....
Town..... State.....

(Continued from page 156)

it is fairly obvious that we will have as a result a loudspeaker superior in tone and range and also in point of fidelity of reproduction.

Many efforts have been made to take advantage of this fact, but it is only within the last few months that research work has

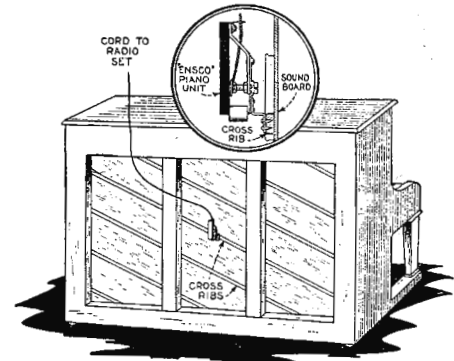

resulted in discovery of a practical means of using instruments already at hand in the average home.

The illustration shows the rear view of an upright type piano with this device attached. The absolute simplicity of the idea is readily apparent from the sketch. Made by Engineers Service Company, 25 Church Street, New York.

Readrite Radio Test Set

A new set of test instruments, filling a long felt need on the part of the professional set builder or the home experimenter, has recently been marketed by the Readrite Meter Works, Bluffton, Ohio.

(Continued on page 160)

WHY WASTE TIME AND MONEY experimenting with inferior apparatus when we can furnish you tested quality products at reasonable prices.

Since quality products are necessary for satisfactory results, Wireless Egert stocks complete lines of

Acme	AmerTran	Aero
Cardwell	Karas	Sangamo
General Radio	Hammarlund	Thordarson
Weston Meters		

Our experts are thoroughly experienced with new developments. We are known for our

WARD LEONARD RESISTANCES

SHORT WAVE Receiving and Transmitting Apparatus, Power Packs

Write Us for Our Special Prices—Mail Orders Promptly Filled

179 Greenwich Street New York N. Y. Tel. Cortlandt 5275-2085

THE OLDEST RADIO HOUSE
WIRELESS EGERT
DOWNTOWN

WIRELESS EGERT
179 Greenwich St., New York City
Gentlemen: Please send to the following address, your free "Short Wave and Transmitting Catalogue."
Name.....
Street.....
City..... State.....

Tell 'Em You Saw It in the Citizens Radio Call Book Magazine

A laboratory at your finger tips!

A new set of testing instruments. Fills a long felt need. Checks the voltage of B Eliminators. Tells in a jiffy the condition of tubes and circuits. The No. 346 Voltmeter and the No. 210 Tube Checker are separate units; but used in combination, simply by attaching the No. 21 Cord and plugging into the radio set. List prices are Voltmeter, \$5.00; Tube Checker, \$7.50; Cord, \$1.00; total only \$13.50.

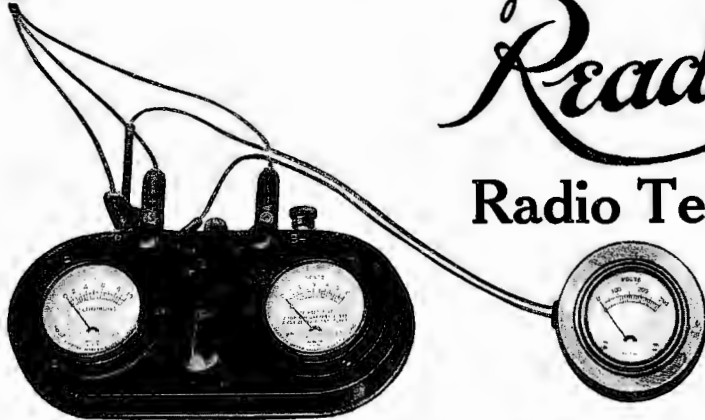

Readrite Radio Test Set

Also Supplied for
A. C. Tubes
Prices on Request

READRITE METER WORKS
10 College Ave. Est. 1904 Buffton, Ohio

D. C. and A. C. Panel Meters



Ammeters, Voltmeters
and Milliammeters
Also Portable Types

Type AA Home Tube Tester

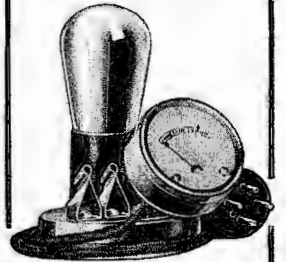

For testing 3 and 5 volt
tubes. Invaluable for
weeding out tubes that do
not function properly.
Price \$3.50

With Samson Units You do not Guess at Results

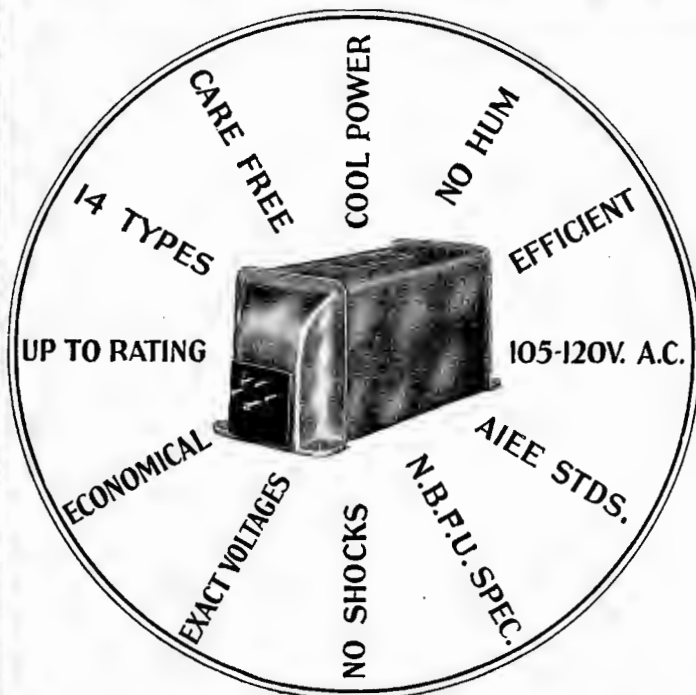

as each tube is operated under the exact conditions specified by its manufacturer. All terminals are covered to prevent shock. Underwriter and A.I.E.E. Standards are met by a less than 20 deg. C. temperature rise after 24 hours continuous operation under full load. Fourteen types of units meet the needs of all sets, from smallest to largest. Send 10c for Construction Bulletin on B Eliminators and Power Amplifiers.

Samson Electric Co.

MANUFACTURERS SINCE 1882

Manufacturers
Since 1882



Main Offices
at
Canton, Mass.

Tell 'Em You Saw It in the Citizens Radio Call Book Magazine

**Electrify
your set**
\$16⁰⁰



End All Battery Troubles

The above price includes all necessary change, A. C. switch installed on panel, A. C. filament transformer and necessary controls replaced and installed on set. There is absolutely no external control necessary.

The above price is for any type receiver including not more than six tube sockets.

**All Work
Fully Guaranteed**

Electrifying your old set will positively give more volume, better selectivity and improve the tone quality.

**Quick
Service**

Usually 24 to 36 Hours

**RADIO SERVICE
LABORATORIES, INC.**

*The Largest and Most Up-to-Date Radio
Service Station and Laboratory
in America*

508 So. Dearborn St.

CHICAGO, ILL.

Telephone Harrison 2870

(Continued from page 154)

Third, but by no means least, is the Sonatron X-201B, which has been hailed by many as the tube which the entire radio world has been waiting for. It is intended for use in battery operated sets and draws only one-eighth of an ampere.

Sonatron has made notable additions to radio tube history in offering these new tubes at this time. The company, which maintains offices at Chicago, New York, Detroit and Newark, N. J., is putting itself over in a very effective manner with dealers and jobbers as well as the radio public.

Stanley Aerial

What will, no doubt, be hailed by radio users as a distinct relief for antenna troubles is the Stanley Aerial, a compact, single-

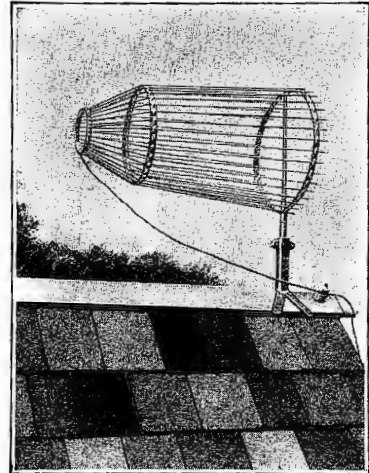

mounting unit of tin-dipped copper wire, manufactured by Stanley Engineering, Incorporated, of 161 Devonshire Street, Boston, Mass.

Where formerly it was necessary to clutter back yards and apartment-house roofs with innumerable entangling wires, the Stanley Aerial offers alleviation of all such conditions. It has been particularly effective for apartment-house use inasmuch as its superselectivity eliminates interference and all neighborhood noises that raise havoc with all good reception. In addition to this, its one-point mounting prevents the usual property damage that accompanies the installation of antennas. A few minutes only are required to erect the Stanley. It is thoroughly rigid and can be locked in any direction desired.

An interesting feature in connection with its origin is the fact that it was conceived and designed by a former General Electric engineer. Since its introduction two years ago, it has been in constant use by thousands of radio enthusiasts, and in every instance has given more than satisfactory service, obtaining greater clarity, volume and signals, with less static and electrical interference.

Piano as a Loudspeaker

With the latest development in loudspeakers whereby the remarkable acoustic properties of the piano sound-board are utilized for radio reproduction, the loudspeaker problem has been solved for the fan who has a piano or console phonograph. It has long been recognized that wood is the most perfect medium for reproduction of musical frequencies. The most important musical instruments and those capable of producing the most mellow and entrancing tones are made of wood. These include the piano, cello, violin and a number of other instruments essential to any orchestra and widely used for solo concerts. If this property of a seasoned wood sound-board can be utilized and adapted to radio

(Continued on page 158)

Tell 'Em You Saw It in the Citizens Radio Call Book Magazine

Improved 1928 Model of Trav-ler

The Original "ONE MAN" Portable Radio

Everybody loved the little Trav-ler as it was. Jobbers and dealers because it was a ready seller. Owners because of its easy portability and remarkable performance. *And now it's better than ever.*

Old Features in New Model. Weighs only 23½ pounds . . . All in one small case—loop aerial, 5 tubes, batteries, loud speaker . . . Standard parts . . . Sweet tone . . . Strong volume.

New Features. Improved appearance—beautiful black and gold color scheme . . . Jones plug—permitting use of Trav-ler with larger batteries or eliminator . . . Special attachment—permitting use of either the Trav-ler's loop aerial or antenna and ground . . . Rearranged construction eliminates service . . . Lower price. Write for complete information. Trav-ler Manufacturing Corporation, Dept. K, 3401 N. Halsted St., Chicago.



NOW only \$77.15 complete
 \$57.50 stripped (East of Rockies)
 \$60.00 stripped (West of Rockies)



Weights only 23½ pounds complete

Portable Radio

Trav-ler Manufacturing Corporation
 3401 North Halsted Street, Dept. K, Chicago, Illinois

Please send me complete information about the Trav-ler Portable Radio Receiver.

Name _____

Address _____



A-C Adaptor Harness

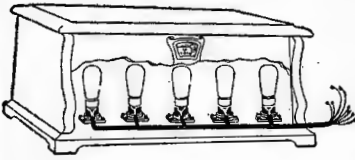

Enables YOU to convert your old battery set into a Modern House Current Receiver WITHOUT REWIRING.

The Corwico-A-C Adaptor Harness consists of a twisted cable of heavy Corwico Flexible wire and the necessary number of adaptors to fit into the sockets of the battery set to be converted. The adaptors pick up the plate and grid connections of the original circuit while the harness supplies the required new filament circuit. Connect the harness to any standard step-down transformer, insert the A-C tubes into the adaptors and the old battery set is changed into an A-C Receiver, eliminating all storage batteries or A eliminators.

Made in Two Types

Corwico A-C Harnesses are made in two types—one with adaptors attached for R.C.A. and other A-C type tubes and one without adaptors for Arcturus A-C tubes. Arcturus A-C tubes are equipped for Corwico A-C Harness connections without the use of adaptors. This type should be used where there is not enough height left for the tubes if adaptors are used.

Write for Particulars

CORNISH WIRE COMPANY

30 Church Street New York City

Renew OLD RADIO TUBES Instantly!

If your tubes are three months old, they need rejuvenating. And you'll be amazed at how much better they'll work. Particularly in Summer time when you need every bit of tube power you can get. One at a time, plug your tubes into the Master Craft Tube Renewer, then back into your set. They'll give you bigger volume, greater distance, finer tone. The Master Craft Tube Renewer makes most any old tube as good as new and keeps it new, indefinitely. Practically triples the useful life of all tubes.

Operates Off Your "B" Battery or Eliminator

Requires no electric light current. Simply connect to 22½ volt "B" battery tap, insert the tube and the job is done. Anyone can rejuvenate tubes with the Master Craft Tube Renewer. Small, compact, simple to use. Nothing to get out of order. Perfect results guaranteed. Thousands of satisfied users. Approved by Popular Radio, Popular Science Monthly, etc.



FREE TRIAL OFFER

Order a Master Craft Tube Renewer NOW! Test it on your old tubes. Decide, after you have seen it do its wonder work, whether you want to keep it. Clip the coupon right away. Pin it to a dollar bill and mail at once. Send the Master Craft back if you're not satisfied. We'll refund your dollar if you want it.

GUARANTEE COUPON
 Master Craft Products Co., Dept. C
 623 Briar Place, Chicago.

I enclose \$1. Send me one Master Craft Tube Renewer and full instructions. I understand that I can have my money back if not satisfied.

Name _____
 Street _____
 Town _____ State _____

Master Craft Products Co.
 623 Briar Place, Dept. C, Chicago

PRICE

\$12.50 Ready to Attach

The Pacent PHONOVOX

(THE Electric Pick-up)



Brings Wonderful New Tone Quality to Your Favorite Records

ATTACH the Pacent PHONOVOX to your radio and phonograph! Play one of your favorite records! The wonderful tone quality of reproduction; the greater volume will amaze and delight you—giving you at the small cost of \$12.50 the superb reproduction equivalent to the costly electric phonograph.

And the PHONOVOX is so easily and quickly attached to your radio and phonograph without tools or making any changes in wiring. There are no adjustments to make—nothing to wear out or get out of order—and it will last indefinitely. All good radio and phonograph dealers handle the PHONOVOX. Ask for it by name and accept no substitute.

Sold and demonstrated by dealers everywhere

PACENT ELECTRIC COMPANY, Inc. 91 Seventh Ave., New York

Makers of the famous Pacent Balanced Cone

Manufacturing Licensee for Great Britain and Ireland, Igranic Electric Co., Ltd., Bedford, England

Lewis Radio Jobbers

"The House of Service"

Philadelphia, Pa.

Guarantee 24 hour delivery on mail orders for all popular kits. Complete line of all nationally advertised Radio Parts carried in stock. Try us for any circuit described in this or other leading radio publications.

Tyrman "70"
Shielded Grid Amplimax



Approved—Endorsed

Editors, Engineers and Set Builders from all parts of the country claim the Tyrman "70" is the greatest receiver of all times. We have tested it in our own laboratory with remarkable results. We heartily endorse this circuit and guarantee complete satisfaction. All parts recommended by the designer now ready for shipment.

SAVE MONEY

OUR 1928 CATALOGUE is a "Money-Saver." It is very complete and contains our entire list of Radio Lines. WRITE FOR IT TODAY!

LEWIS RADIO JOBBERS

Distributors for Bosch Radio Products

45 No. Seventh St., Dept. A, Philadelphia, Pa.

LOOK!! IT'S FREE!!

DEALERS & PROFESSIONAL SET BUILDERS

Your BIG NEW 1928 Catalog Is NOW READY!

Contains nationally known Parts and Kits at **Maximum Discounts**

The following kits in stock:

Hammarlund-Roberts Hi-Q Six
Tyrman "70" Shielded Grid Amplimax
Improved Shielded Grid Laboratories Receiver
Samson Push-Pull Amplifier
Silver-Marshall Shielded Grid

Yaxley	Marco	Karas
Carter	Eby	Aero Coil
Acme	Amsco	Weston
Samson	Silver-Marshall	Benjamin
Tobe	Hammarlund	Precision Coil
Daven	Electrad	

IN STOCK ALL THE CIRCUITS described in the Citizens Radio Call Book

Send for Catalog Now—It's FREE!

New Address

S. HAMMER RADIO COMPANY
142 Liberty Street New York City

Tell 'Em You Saw It in the Citizens Radio Call Book Magazine

Set Builders

Register with our Technical Department. There is no charge. We are often requested to furnish names of professional set constructors to build sets described in this publication. We will be glad to have your name in our register.

Address

OSWALD PETERSON, Service Dept.

Citizens Radio Call Book

508 So. Dearborn Street, Chicago, Ill.

A Sensational Success!

Tested--Proved--

Over 35,000 Times

We defy anyone, anywhere, to match the quality and performance of the Townsend "B" Socket Power—performance that it is your privilege to obtain for only \$6.85. Thousands of reports show astounding results beyond the capabilities of many of the highest-priced "B" Eliminators. Convince yourself without delay at our risk.

A.C.--D.C.--any cycle

Delivers up to 100 volts on any set. Full tone, clarity, and volume. Sold on REAL GUARANTEE OF MONEY BACK IF NOT SATISFIED.

SEND ONLY \$1.00

Simply fill out the coupon and slip it into an envelope with only \$1.00, and mail at once. Your Townsend "B" Socket Power Unit will be sent promptly. Deposit only \$5.85 plus postage with the postman. Try out for 10 days—then if it does not do everything we say, return it to us and purchase price will be refunded.

TOWNSEND LABORATORIES

713 Townsend Street

Dept. 26

Chicago, Ill.

MONEY BACK GUARANTEE

Read These!

"About a year ago I purchased one of your Eliminators, and think it about time I told you of the excellent results I have had from it. I have two neighbors, one who paid \$38, and the other \$65 for their Eliminators, and out of a community of 14 radio owners, I am the only one that has logged Vancouver, B. C. I cannot speak too highly of your Eliminator as I have a leg of 230 stations, at the price of a couple of dry 'B' batteries"—J. Slator, Stony Mountain, Manitoba. Moran, Kans.

"Your Eliminator is giving excellent satisfaction on my Atwater Kent six tube set. It furnishes plenty of power and is as near noiseless as any eliminator I have ever seen"—R. E. Welborn, Supt. of Schools.



Townsend "B" Socket Power

Approved and passed by the rigid laboratory tests of Popular Radio and Radio News

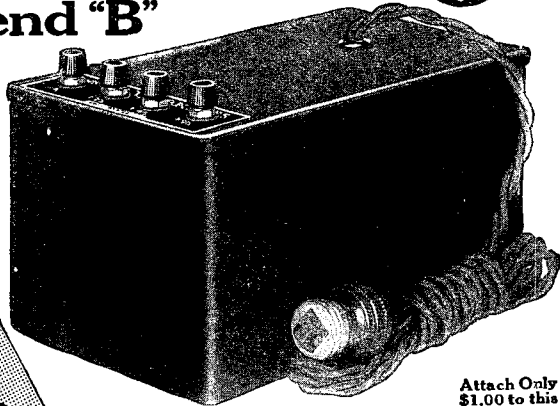

Attach Only \$1.00 to this Coupon



Send for Literature

TOWNSEND LABORATORIES
713 Townsend St., Dept. 26 Chicago, Ill.
Gentlemen: Attached find \$1.00. Kindly send at once Townsend "B" Socket Power Unit, C.O.D. for \$5.85, plus postage, on guaranteed 10-day free trial.

Name

Address

City..... State.....

The **BELLEVUE STRATFORD** PHILADELPHIA

The choice of discriminating Philadelphians and particular travelers.

Famous for its courteous service and homelike environment.

Centrally Located
BROAD & WALNUT

J. M. ROBINSON, Manager
Affiliated Hotels

WALDORF-ASTORIA New York NEW WILLARD Washington, D.C.



AT YOUR SERVICE

THE **WHITEHALL HOTEL**
100" ST. AND BROADWAY
NEW YORK

THE ideal hotel selection when you visit New York. All rooms have both bath and shower and at rates of \$5 per day for two! A perfect hotel. Ample parking space and near numerous garages.

Exceptional Restaurant
J. J. McAULIFFE—Res. Manager

WE NEED YOUR HELP

DUE to the rapid changes occurring in the radio industry and the varying tastes of readers, the Citizens Radio Call Book Magazine is desirous of giving its readers exactly the type of material they wish in each issue.

In order to know for a certainty what the readers wish it is necessary to have an accurate index of your desires. This information we can secure if our readers will carefully answer the questions shown below and mark their preferences on the answer blank printed on the bottom of this page.

In the interest of a bigger, better and more comprehensive magazine we ask your help in securing the information requested.

- | | |
|---|--|
| <ol style="list-style-type: none"> 1. Is our graphic diagram of a receiver the most helpful for your work? 2. Can you wire up a receiver by means of a simple schematic diagram? 3. Would you like more articles and shorter ones? 4. Do you like "Ampere Andy's Assistors"? 5. Do you like "With the Professional Set Builder"? 6. Is our present broadcast station list satisfactory? 7. Do you follow faithfully our specifications and lists of parts in building your sets? 8. Has the superheterodyne been your favorite circuit? 9. Has the tuned radio frequency set been your favorite? 10. Do you care for the regenerative circuit? 11. Have you built any of the power amplifiers recently illustrated in our magazine? 12. Would you like to see more radio wrinkles, shop hints, etc., in the book? | <ol style="list-style-type: none"> 13. With the present broadcast situation, do you prefer local programs? 14. How many receivers have you built? 15. Would you like to see this magazine add an electrical, mechanics and scientific section in each issue? 16. Do you prefer d. c. or a. c. circuits? 17. How much do you think a good custom built receiver should cost with tubes and power supply? 18. Do you want pictures of radio artists? 19. Do you own a factory built receiver? 20. Do you read magazines covering the electrical, mechanical and scientific fields? 21. Please give the names of magazines you read in the electrical and scientific fields. 22. Which circuits have you built with greatest success during the year? |
|---|--|
- Every letter answering this questionnaire will be acknowledged.

Please answer each by putting an X in the proper column. Tear answer blank off at this line and

Mail to Citizens Radio Call Book Magazine, 508 South Dearborn Street, Chicago, Ill.

Number	YES	NO	Number	YES	NO	Number	YES	NO	Number	YES	NO
1			6			11			16		
2			7			12			17		
3			8			13			18		
4			9			14			19		
5			10			15			20		

21 _____

22 _____

Name _____

Address _____

Age _____ Occupation _____

Tell 'Em You Saw It in the Citizens Radio Call Book Magazine

HAGERMAN ENSEMBLE

The Perfect
Custom-Built
Ensemble!

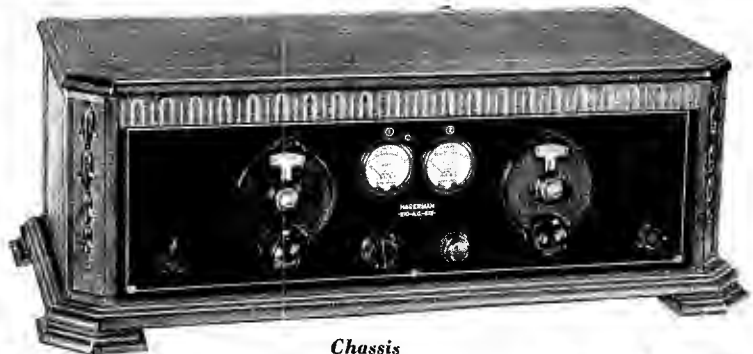

Chassis



Table model
Speaker with power
unit compartments.

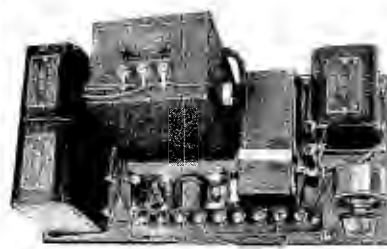

Super "B" Power Supply



"A" Supply

These Leading Manufacturers Make This

ABOX

"A" Battery Eliminator

Abox is a true alternating current converter that will light the filaments of all D. C. tubes direct from the light socket and impart added efficiency to a set. A standard for custom set builders. Makes any radio set an A. C. set, immediately. No additional parts or changes in wiring or tubes necessary. Also made in 4-volt model for Radiola sets.—The Abox Company, 215 N. Michigan, Chicago, Ill.

JEWELL

Voltmeters

In the Hagerman 210-A. C.-Six Ensemble, Jewell instruments were chosen because of the years of experience of the manufacturer and because of the special fitness of these instruments for adaption to this circuit; Jewell instruments are accurate, sturdy and good looking, and will give untold satisfaction in their use.—Jewell Electrical Instrument Co., 1650 Walnut St., Chicago.

THORDARSON

Power Compact

"Transformers" and "Thordarson" are almost synonymous. The reliability and efficiency of the radio set or power supply is directly in ratio to the theoretical and mechanical perfection of the voltage supply or amplifying transformers. The R-171 and R-210 Power Compacts are the heart of any power amplifier or "B" supply.—Thordarson Electric Mfg. Co., 500 W. Huron St., Chicago.

NEWCOMBE- HAWLEY

Speaker Console

The superb speaker, with a wider range of tonal reproduction and amplification than any other type. It imparts to a set, with or without power amplification, a beauty of tone and fullness, rivaled only by the original itself—Newcombe-Hawley, Inc., St. Charles, Ill.

Tell 'Em You Saw It in the Citizens Radio Call Book Magazine

210-AC-SIX M B L E

Every Desirable New Feature in One Set

A really new broadcast receiver ensemble for the custom set builder, incorporating super 210 tube power amplification *in the set itself*, complete A.C. operation with standard tubes, tone quality surpassing any but the highest priced manufactured receivers, and possessing every other feature to as great a degree as is possible to obtain with present-day laboratory precision in theoretical, technical and mechanical design.

The Hagerman 210-A. C.-Six Ensemble represents not the efforts or work of any individual, but the combined engineering and technical knowledge of the nationally known manufacturers associated in the promotion of this receiver *assuring success in its construction*.

In its design every factor has been considered. No one feature has been overdeveloped or sacrificed at the expense of another. It was not built to sell any one part or group of parts, but is offered to the set building public as a feasible and practical means of obtaining in *one* radio set, *all* the new developments of the past year, at a price approximately that of an ordinary, manufactured receiver.

Construction—Particular attention has been paid to the mechanical construction, as well as the theoretical and technical phase. When assembled, a Hagerman 210-A.C.-Six is as workmanlike and beautiful in appearance as the most expensive factory built receiver.

Performance—The Hagerman 210-A.C.-Six Ensemble actually has: 10 kilocycle selectivity . . . A power factor many times that of the ordinary set . . . Complete, perfected A. C. operation, with standard tubes . . . Super power amplification, using a 210 type tube *in the set itself* . . . Perfect tone quality, from a whisper to auditorium volume . . . Sensitivity, combined with great amplification that brings in distant stations with "local" volume . . . Perfect control of oscillation, both of the collective and individual stages of tuned radio frequency . . . An automatic, pre-determined tuning system. The station is known before hearing the announcement . . . These features speak for themselves more strongly than any superlative description. Complete parts sold the country over.

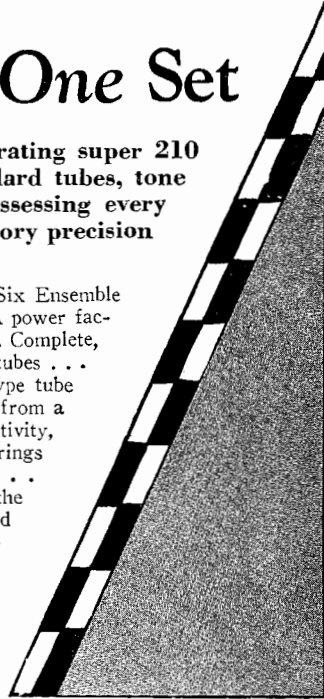

Set An Outstanding Radio Achievement

BENJAMIN

Sockets—R. F. Transformers

Benjamin Cle-ra-tone sockets are the acknowledged standard. Benjamin Tuned Radio Frequency Transformers will insure the success of any custom-built tuned radio frequency set, with their technical and mechanical perfection, exceptional efficiency and beauty of design—Benjamin Electric Mfg. Co., 120 S. Sangamon St., Chicago.

BELDEN

Wire—Cable—Antenna Kit

Wire is an essential factor in the mechanical perfection of any custom-built radio set or accessory. Belden Colorrubber Hookup Wire, because of its electrical efficiency and ease of working, is the natural preference. Other essential Belden radio products are power cords, indoor and outdoor antenna kits, and wire for every radio requirement.—Belden Mfg. Co., 2300 S. Western Ave., Chicago.

MUTER

Power Condensers—Resistances, Etc.

The filter condensers of a power circuit are its most critical constants. Muter precision manufacturing methods assure the custom set builder, when he uses Muter Power Condensers, as well as chokes, resistances, transformers, etc., that the set he builds will be perfect in every detail.—Leslie F. Muter Co., 76th and Greenwood Ave., Chicago.

W. C. BRAUN CO., Distributors

563-71 W. Randolph St., Chicago

Send me full information about the Hagerman 210-A. C.-Six Ensemble. *Please rush!*

MAIL COUPON NOW

NAME

ADDRESS

CITY

STATE

Tell 'Em You Saw It in the Citizens Radio Call Book Magazine



You really haven't heard radio in all its perfection until you use the

Madison-Moore INTERNATIONAL ONE·SPOT Batt'ry-less Transformer

TRULY, the "International One·Spot," because, in addition to reports of superb reception from all four borders of the country, we are receiving foreign countries.

These reports enthusiastically praise the MADISON-MOORE Transformer as the finest ever designed. Its tremendous, undistorted volume has been sought but never attained in any other instrument.

This "International One·Spot Transformer" operates on a frequency of 480 kilocycles and no transformer is really a "One·Spot" which operates at a lower frequency than this.

The MADISON-MOORE surpasses in ease of operation; does away with the bother of batteries. It has positively no hum. It is the **ONLY** true ONE·SPOT Transformer!

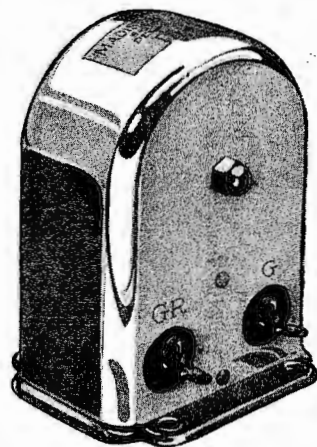

Type AC Madison-Moore International One·Spot Batt'ry-less Transformer

Your radio dealer should have them. If he can't supply you, send to us

MADISON-MOORE RADIO CORPORATION
2524 L. Federal Boulevard
Denver, Colorado · U. S. A.

MADISON~MOORE

The Finest RADIO APPARATUS in the World!

Tell 'Em You Saw It in the Citizens Radio Call Book Magazine

This JEFFERSON TRANSFORMER and CHOKE SPECIFIED EXCLUSIVELY

for Custom-Built International "One-Spot" A. C.
Receiver by MADISON-MOORE Radio Corporation



Jefferson Combination Filament and Plate Supply Transformer No. 463-101 for use with Madison-Moore A. C. International "One-Spot."

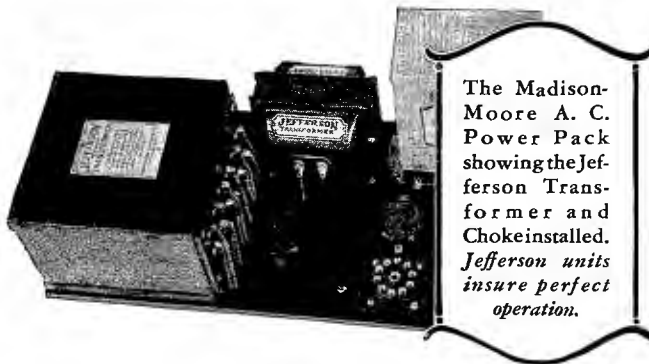

The Madison-Moore A. C. Power Pack showing the Jefferson Transformer and Choke installed. Jefferson units insure perfect operation.

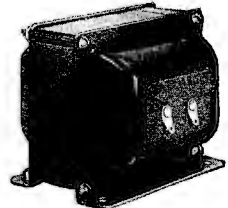

Jefferson Filter Choke No. 466-130 for use with Madison-Moore A. C. International "One-Spot."



Transformer for Heating Filament

For the set owner who has a "B" Eliminator and desires to convert his International "One-Spot" for use with A. C. tubes, we recommend No. 464-131 to heat the filament only. Price, \$7.50 list.

No. 464-131

To Improve Tone Quality



we recommend the Jefferson Concertone Sealed Audio Transformer. It is designed to amplify, evenly and uniformly, all notes within the musical scale in sets using A. C. or batteries. Heavily insulated throughout. Safe for use with power tubes. Assembled and sealed into a beautiful black enameled metal case that is moisture proof. Price, \$6.00.

No. 467-102

To Protect Loud Speaker Windings



we designed this output transformer for installation between the loud speaker and the power tube. It purifies and improves tone, allows more volume without distortion and prevents possible burn-outs by keeping the heavy plate current out of the speaker windings. In beautiful enameled upright case to match the Concertone Audio Transformer. Price, \$6.00.

No. 467-121

Limited space makes it impossible to list our complete line of radio transformers for Filament Heating, power amplifiers, "B" Supplies, A. B. C. {series} unit, and audio transformers. Write for Bulletin 564 and free circuit diagrams.

In designing the new International "One-Spot" for A. C. tube operation, Messrs. Madison and Moore wanted the best power unit obtainable—so they came to Jefferson Electric. Transformer No. 463-101 and Choke No. 466-130, both stock items, were found to meet the rigid requirements demanded by Madison-Moore.

In addition to their specification in the International "One-Spot," these two Jefferson units can be used to build a compact A. B. C. power unit for any set using 1.5—2.5 Volt A. C. tubes, one or two 171 power tubes, and a 280 type rectifier.

Whether you are building the Madison-Moore receiver or converting your present set to A. C. tube operation, benefit by the expert experience of Madison and Moore—use Jefferson Transformers.

CHICAGO-JEFFERSON FUSE & ELECTRIC CO.

General Offices

Lafin and 15th Streets, Chicago, Illinois

JEFFERSON TRANSFORMERS

Tell 'Em You Saw It in the Citizens Radio Call Book Magazine

ULTRADYNE A.C.

A Thoro-Bred "SUPER"

The *Ultradyn*e A. C. Commander uses the most modern engineering principles backed by the quality products bearing these trade marks:

ELECTRAD

CLAROSTAT

EC

SANGAMO

BENJAMIN

THORDARSON
ELECTRIC MFG. CO.

TYRMAN

Hammarlund

Sovereign

EBY

PARVOLT

LYNCH

CORBETT

BIRNBACH

Carter



**DISTANCE—SELECTIVITY
QUALITY AND VOLUME—
A RARE COMBINATION**

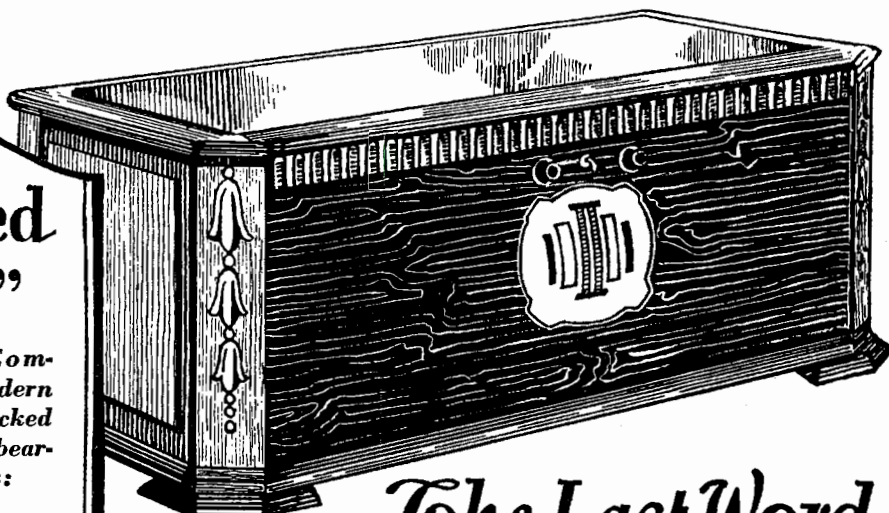

The Last Word in Radio Reception.

CLEARER tone, greater distance, unheard of sensitivity—these are the final achievements now available in the new *Ultradyn*e A. C. Commander, the latest improved "Super" Receiver, that has set the radio industry buzzing from coast to coast.

If only for its circuit, which employs the famous *Modulation System*, this set would hold its own in any competition. But it has more than that! It is a thoroughbred in every sense of the word.

It is *all-electric* (not electrified) in operation.

Its push-pull amplifier reproduces speech and music with perfect fidelity and with all the volume you may want.

It has no critical adjustments. It is easy to tune and smooth in operation.

The circuit was designed to use carefully selected parts made by reliable manufacturers. Each specified part is the best of its kind. Selected first on its own merits, and then because it will work most efficiently with the other units in this circuit.

Look at the names in the panel. *Headliners?*—every one of them.

And the *Ultradyn*e circuit has never been equaled! It has been endorsed by the technical editors of leading radio magazines. How can you go wrong?

COMMANDER

BEFORE you build or buy any receiver, investigate the ULTRADYNE A. C. COMMANDER and the ULTRADYNE POWER UNIT. The circuit is so advanced, the details worked out so thoroughly, and the parts specified are of such high quality that we invite your comparison with any set now being offered—regardless of price.

Here at last is a receiver which will work direct from the light socket without hum. It is receptive to the weakest signals and brings them in with quality and volume that is almost uncanny. Previous ULTRADYNES have established records which have been envied. The new ULTRADYNE A. C. COMMANDER will surpass even these records. Look at the record in the next column! 74 stations in one evening. One station 9600 miles away. Beat that!

The *Ultradyn*e A. C. Commander cuts through local stations and brings in distance without interference and without distortion. Side bands are preserved in full. Stations ten kilocycles apart are readily separated.

Build this new all-electric *Ultradyn*e and you will have a set of which you can be proud, because it is the last word in radio reception.

The *Ultradyn*e A. C. Commander may be operated with storage battery tubes, if desired, without any changes in the set.

Set Builders and Dealers: Write today for full details. We are the only source of supply for parts for this circuit. Our proposition will interest you.

The Modulation System

The original ULTRADYNE MODULATION SYSTEM, originated by R. E. LACAULT, is employed in this new circuit. It is recognized as the most sensitive method of signal reception. The technical editor of QST says—"The editor has become convinced that this circuit is distinctly more sensitive than the usual one when weak signals are being received." It will bring in the weakest signals and step them up to loud speaker volume.

Distance and selectivity are no longer problems when the modulation system is employed. Sensitivity is assured.

This new ULTRADYNE A. C. Commander again proves the supremacy of the modulation system, an original Ultradyn

74 STATIONS IN ONE EVENING

An Ultradyn

- KDKA—Pittsburgh, Pa.
- KFDM—Beaumont, Tex.
- KFI—Los Angeles, Cal.
- KFMO—Fayetteville, Ark.
- KFNF—Shenandoah, Ia.
- KFON—Long Beach, Cal.
- KFRU—Columbia, Mo.
- KFVE—St. Louis, Mo.
- KFVB—Denver, Colo.
- KFWB—Hollywood, Cal.
- KGO—Oakland, Cal.
- KGW—Portland, Ore.
- KHJ—Los Angeles, Cal.
- KMA—Shenandoah, Ia.
- KMMJ—Clay Center, Neb.
- KMOX—St. Louis, Mo.
- KNX—Los Angeles, Cal.
- KOA—Denver, Colo.
- KOIL—Council Bluffs, Ia.
- KPU—San Francisco, Cal.
- KPRC—Houston, Tex.
- KSO—Clarenda, Ia.
- KTBS—Hot Springs, Ark.
- KUT—Austin, Tex.
- KVOO—Bristow, Okla.
- KWKH—Shreveport, La.
- KYW—Chicago, Ill.
- WBAP—Fort Worth, Tex.
- WCAR—San Antonio, Tex.
- WDAF—Kansas City, Mo.
- WDOD—Chattanooga, Tenn.
- WGBH—Chicago, Ill.
- WENR—Chicago, Ill.
- WFAA—Dallas, Tex.
- WGBF—Evansville, Ind.
- WGBU—Tulford-by-sea, Fla.
- WGES—Chicago, Ill.
- WGHB—Clearwater, Fla.
- WGN—Chicago, Ill.
- WNO—Des Moines, Ia.
- WHT—Chicago, Ill.
- WIOD—Miami Beach, Fla.
- WJAD—Waco, Tex.
- WJAX—Jacksonville, Fla.
- WJAZ—Chicago, Ill.
- MJJD—Moose Heart, Ill.
- WLS—Chicago, Ill.
- WMAQ—Chicago, Ill.
- WMBB—Chicago, Ill.
- WMBF—Miami Beach, Fla.
- WMC—Memphis, Tenn.
- WOAI—San Antonio, Tex.
- WOAW—Omaha, Neb.
- WOC—Davenport, Ia.
- WOL—Ames, Ia.
- WOK—Chicago, Ill.
- WORD—Batavia, Ill.
- WOS—Jefferson City, Mo.
- WOJ—Chicago, Ill.
- WRR—Dallas, Tex.
- WSB—Atlanta, Ga.
- WSBC—Chicago, Ill.
- WSM—Nashville, Tenn.
- WSMB—New Orleans, La.
- WSWS—Chicago, Ill.
- WWAE—Plainfield, Ill.
- CNRV—Vancouver, B. C.
- KGU—Honolulu, Hawaii
- OAX—Lima, Peru
- XDA—Mexico City, Mex.
- 2BL—Sydney, Australia
- 7SR—Cauquey, Cuba

A record like this makes investigation worth while! Send the coupon to-day.

Full Constructional Folder on Request

MAIL COUPON!

ULTRADYNE SALES CO.,
508 S. Dearborn St.
Chicago, Ill.

Please send me, free, your eight-page folder giving constructional details of the new ULTRADYNE A. C. COMMANDER.

Name.....
Address.....

Tell 'Em You Saw It in the Citizens Radio Call Book Magazine

RADIO CORTLANDT PANELS

Panels for
 TYRMAN 70
 WORLD'S RECORD 10
 KNICKERBOCKER 4
 AERO A. C. 7
 REMLER A. C. SUPER
 MAGNAFORMER
 9-8 A. C.
 And Many Others

LATEST CIRCUIT PANELS IN STOCK

Drilled to Specification and Beautifully Decorated
 LOWEST PRICES

Cortlandt Panel Engraving Co.
 165 Greenwich St., New York City Cortlandt 1352

Panels for
 KARAS A. C.
 EQUAMATIC
 HARKNESS
 COUNTERFONIC SIX
 ST. JAMES TWIN
 FOUR
 THOMPSON
 SUPER 7
 And Many Others

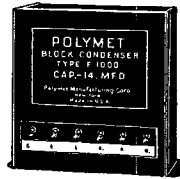

POWER

To meet the power requirements of Radio, Polymet Power is the first choice of leading engineers. Rigid, comparative tests prove Polymet's superiority in efficiency and value.

Polymet Condensers are rugged and strong. They are made under the most modern and scientific conditions.

Polymet Condensers are dependable. They stand up and deliver their full rated capacities throughout their long life.

Use Polymet Radio Essentials in the next set or power unit you build. A word to the wise—look for Polymet Parts in the next set you buy.

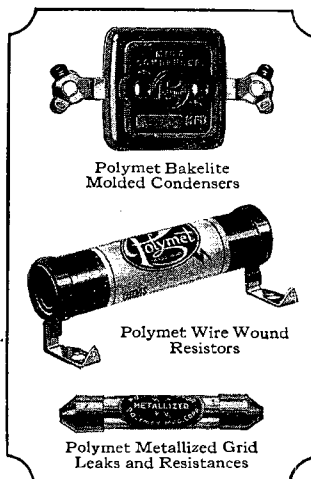

Write for complete information regarding Polymet Parts and catalog of all Polymet Radio Essentials.

POLYMET MANUFACTURING CORPORATION
 609 Broadway, New York City

POLYMET CONDENSERS

Sent to You



for Only \$1

A Sensational Offer!
 Only \$1.00 and you get the famous 21-Jewel Studebaker Watch direct from factory. Balance in easy monthly payments!
 Lowest prices ever named on similar quality. You save 30% to 50%.

DOWN

21 JEWEL-Extra Thin STUDEBAKER The Insured Watch

Ladies' Bracelet Watches, Men's Strap Watches. Diamonds and Jewelry also sold on easy payments. This company is directed by the Studebaker Family of South Bend, known throughout the world for three-quarters of a century of fair dealing. 100,000 satisfied customers. Send coupon at once for full particulars of our amazing offer. Studebaker 21-Jewel Watches have 8 adjustments—heat, cold, isochronism and 6 positions. An insurance policy is given free—insuring the watch for your lifetime!

WRITE FOR FREE CATALOG!
 A copy of our beautiful, new, six-color catalog will be sent free to anyone sending the coupon below. Shows 80 magnificent, new Art Beauty cases and dials. Latest designs in yellow gold, green gold and white gold effects. Exquisite thin models. Masterpieces of the watchmaker's craft.

Special Offer: Watch Chain FREE
 To those who write at once for free Catalog we will include particulars of our special offer of an exquisite Watch Chain free. This offer is for a limited time only. Send coupon at once—before it expires!

Studebaker Watch Co.
 Directed by the Studebaker Family—three-quarters of a century of fair dealing.
 WATCHES—DIAMONDS—JEWELRY
 DEPT. CR1036, South Bend, Ind.
 Canadian Address: Windsor, Ont.



SPECIAL OFFER COUPON

STUDEBAKER WATCH COMPANY
 Dept. CR1036, South Bend, Ind.
 Please send me your free Catalog of Advance Watch Styles and particulars of your \$1 down offer.
 Please send me Jewelry Catalog free.

Name.....

Street or R. F. D.

City or Post Office.....

State.....

SM

112 Kilocycle Amplifier Catacomb *for* Screen Grid Tubes

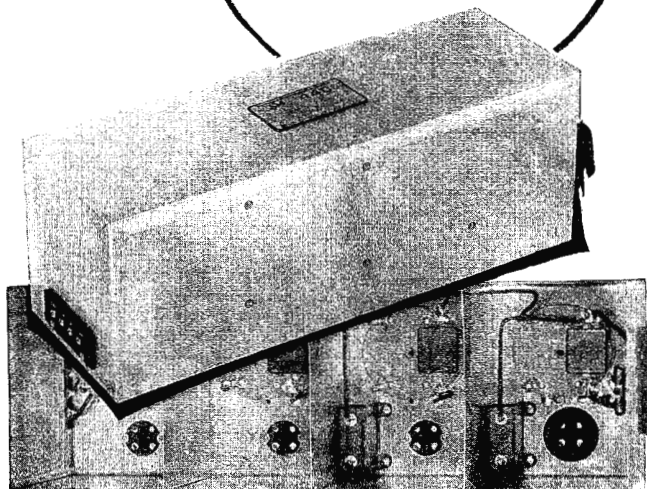

The new Silver-Marshall Time Signal Amplifier (440-SG), designed to take full advantage of the tremendous amplification possibilities of the new UX-222 and CX-322 screen grid R. F. amplifier tubes, is ready. Every experienced fan and professional set builder knows the remarkable efficiency of the famous S-M 440 amplifier, with its high amplification, absolutely accurate peaking, and perfect uni-

formity. This new 440-SG model is capable of providing *greater amplification than any other long-wave amplifier ever marketed.*

The new 222 type screen grid tubes are used in the three individually shielded low-loss R. F. amplifier stages, followed by a super-sensitive detector (UX-200A) in cushioned socket. The amplification is tremendous, the selectivity hair-splitting, yet tone well-nigh perfect.

The 440-SG Amplifier is laboratory tuned and calibrated to exactly 112 K. C. Either two or three R. F. stages may be used at will. It is 15 inches long, 5 inches wide, and 5½ inches high, with removable cover, finished in beautifully burnished copper. It requires three UX-222 (CX-322), and one UX-200A (CX-300A) type tubes, 6 volts at .65 amperes, 135 volts B at only 6 milliamperes, and 4½ volts of dry C battery for operation. Its current consumption is so low it may be operated on batteries, yet no finer amplifier can be had for use wherever a sharply tuned long-wave amplifier is needed. Unconditionally guaranteed against mechanical and electrical defects, the 440-SG Amplifier stands unequalled in the long-wave amplifier field. Price \$40.00, ready to use, less tubes.

Put a 210 or 250 Super Power Tube Right in Your Set!

The new S-M 675 Hivolt is a complete light socket A.B.C. power unit with a special adapter that lets you put a UX-210 or UX-250 super-power tube right into the last A. F. socket of your present receiver, without a single change to the set. And *what* an improvement in tone quality and power the Hivolt brings. Not only does it supply A, B and C power (at 425 volts) to the UX-210 or UX-250 power tube, but it also eliminates all receiver B batteries as well by supplying 45 and 90 or 135 volts B to any ordinary set. To an AC tube equipped set the Hivolt also furnishes 1.5 volts and 2.25 volts—enough for five 226 and two 227 type A.C. tubes. The Hivolt will completely electrify any 5 or 6 tube battery set by the addition of an A.C. harness and A.C. tubes.

You can sell a Hivolt to every one of your friends upon one demonstration, so wonderful is the tone it gives to *any set at all* with a UX-210 or UX-250 super-power amplifier tube. Price \$58.00 with adapter, less one UX-281 rectifier tube required for operation.

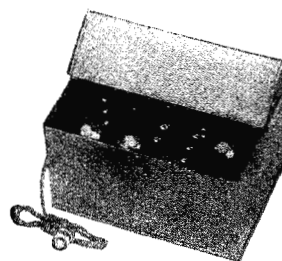

644-SG Screen Grid Universal All-Wave Tuner

The 644-SG Screen Grid Universal All-Wave Tuner is the justly popular one stage of R. F., regeneration detector and two stages of A. F. plus the tremendous amplification of the new 222 type tube. It has outperformed all standard five and six tube factory built receivers with which it has been compared. Its wavelength range is from 30 to 3000 meters—enabling you to bring in low and high wave broadcasts which are entirely out of the picture with the average set. The 644-SG receiver uses one stage of R. F. amplification with a UX-222 or CX-322 tube, a small tickler coil provides regeneration in the detector circuit which is followed by two high quality flat curve audio stages. The 644-SG Tuner has selectivity, amplification and tone quality. It will bring in stations over a range of 1500 miles even in New York and Chicago. It is indeed

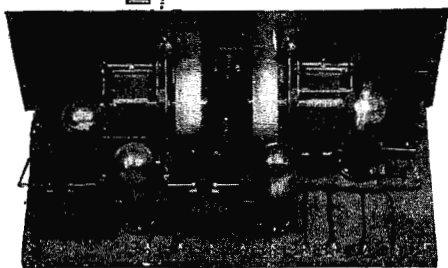

a receiver that will equal or outperform any six tube one dial factory set costing from fifty to one hundred dollars, yet it's priced below the cheapest factory competition!

You can get all parts for the Universal All Wave Screen Grid Tuner, ready to assemble, in the Silver-Marshall type 644-SG kit for just \$46.25, all neatly packed with complete blueprints and instructions. Get the kit from your dealer or if he can't supply you mail a check for prompt shipment from factory stock.

Universal All-Wave Tuners are made in many models. Let us send you full information.

SILVER-MARSHALL, Inc.
836 West Jackson Blvd. Chicago, U. S. A.

SILVER-MARSHALL, Inc.
836 W. Jackson Blvd., Chicago, U. S. A.

.....I enclose 10c for which please send me full information on the 440 Screen Grid Time Signal Amplifier, the 644 Screen Grid Universal Tuner and other new S-M developments.

.....I enclose 25c for complete instructions and blueprints for building the new Universal All-Wave Tuner.

Name.....

Address.....

City.....



Official Wholesale Distributors

QUICK

Get your Silver-Marshall Parts from W. C. Braun Company

We are wholesale distributors for all Silver-Marshall products. A complete stock of parts is on hand for immediate shipments to fill dealers' requirements anywhere.

Everything in Radio
We carry the largest and most carefully selected line of radio goods

W.C. BRAUN COMPANY

Pioneers in Radio

577B
W. Randolph St.





We're Ready to Ship
Silver-Marshall
Shielded Grid Sixes
—Universal All
Wave Tuners—

All Unipac Models

and all other outstanding S-M developments. Send your order to us—24 hour schedule on shipments. Every part tested and guaranteed against electrical and mechanical defects.

We Demonstrate Everything We Sell

If you are in Chicago, drop in to see us, or when you come to Chicago pay us a visit. We play from New York to Denver every evening through the entire Chicago barrage with an S-M Shielded Grid Six. We use a short indoor antenna in a steel building to do this. Write for complete literature.

Specials for Shipment SAME DAY Order is Received:

S-M 630-SG Shielded Grid Six Kit.....	\$97.00
S-M 630-LSG (loop) Kit.....	91.50
For either of above sets assembled and wired in beautiful Fritts walnut cabinet logged for 10 D.X. stations, add \$44 to kit prices.	
Screen Grid Laboratory Receiver parts, com.	92.65
S-M 644-SG Four Tube Screen Grid Receiver	46.25

Setbuilders—we offer a special service for you at most attractive discounts—get on our list.

Lincoln Radio Corporation
329 South Wood Street Chicago, U. S. A.



The Big Friendly Radio House
Complete Parts

Screen Grid Lab.
Model Super

WHEN you get our 1928 Catalog, you can have popular, nationally-advertised kits, parts, eliminators and accessories at prices that are real values.

Our dealer catalog, which lists everything in radio, means more real profit for you. Standard quality at the right price.

Write for our big Catalog

WESTERN RADIO MFG. CO.
128 West Lake St. Dept. OM Chicago, Ill.

DEALERS AND SET BUILDERS—
SEND FOR YOUR
FREE COPY—

Wholesale prices on

S-M Parts, including Improved A. C. Shielded Six Improved Laboratory Model Super S-M Unipacs Etc.



RADIO BUILDERS' GUIDE

Wholesale prices on

Tyrman "70" Victoreen Best Lincoln Hammarlund Bremer-Tully Etc., etc.

References: Dun's or Bradstreet's or your banker
Prompt Shipments—Lowest Prices

Serlin & Co., 1415 Broadway, Detroit, Mich.



CO-OP MONTHLY

For more than 15 years the **ELECTRICAL** and **RADIO DEALERS Handy Guide**. Net prices on All Standard Electrical and Radio Merchandise.

Co-Op Electric Supply Co.

33 N. Union Street
CHICAGO, ILL.

80 39th Street
BROOKLYN, N. Y.

HEADQUARTERS

For Set Builders and Dealers

We are the Wisconsin distributors for Silver-Marshall Tyrman Amplimax "70" Scott World's Record Super Madison-Moore AC Karas Equamatic and other popular merchandise. We can furnish you within ten hours the parts for the above circuits and others as specified in the CITIZENS RADIO CALL BOOK. Mail orders filled promptly.

Write today for special discount

RADIO PARTS COMPANY
311 State St.
Milwaukee, Wis.

Eby
Madison Moore
All American
Benjamin
Carter
Daven
Durham
Electrad
Hammarlund-Roberts
Sangamo
Silver-Marshall
Thordanson
Vaxley
Weston
Remler
Bodine
Aco
Central Lab.
Bremer-Tully
Jensen
Browning-Drake
National Radio
Tobe
Samson
General Radio
Ceco

Tell 'Em You Saw It in the Citizens Radio Call Book Magazine

SM

All Silver-Marshall Kits and Parts in Stock for Immediate Delivery

The New Screen Grid Laboratory Model Receiver

Silver-Marshall Four Tube Screen Grid Universal Receiver

Rush Delivery Service on the Following Kits and Parts

- | | |
|---------------------------|---------------------|
| Tyrman "70" | Karas Equamatic |
| Victoreen A. C. and D. C. | Thordarson Products |
| Remler 8 | National Products |
| Lincoln 9 | Samson Products |

Write us today on any of above kits and your new 1928 Radio Catalogue, free of charge

The M & M Co.

500 Prospect Ave. Cleveland, Ohio

SM

Fastest Mail Order Service West of the Rockies

WE carry a complete line of practically every known radio part and accessory. Whether it is a complete kit or an individual part you'll find it in our stock. And, we make immediate shipment—24-hour service. In other words, we combine quality products with a service that is not to be obtained anywhere else west of the Rockies.

SET BUILDERS:—Write for our discount sheets and catalog. We can save you money. Maximum discounts to dealers.

Send your order to us for the Shielded Grid Six, Silver-Marshall Unipacs, 4-Tube Screen Grid Universal or any S-M Products. We can supply complete or individual parts for any circuit described in this magazine, or parts for any standard hook-up.

Get acquainted with "The Radio Parts Jobbers" of the Northwest—your first order will make you our steady customer.

Mail Orders Solicited

WEDEL COMPANY

Established 1888

520 Second Avenue Seattle, Wash.

And Now **Radio's Greatest Discount Catalog**

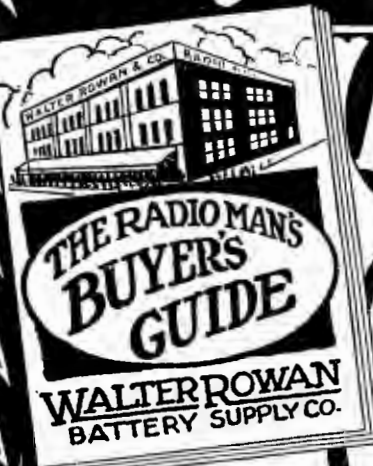

FREE
Write Today for **FREE COPY**

The Improved Laboratory Shielded Grid Receiver

By far the most advanced of the season's offerings. A combination of a proven and accepted design, with super selectivity and with the amplification and efficiency of the new Shielded Grid tubes. This is the set for your customers.



Build

the circuits recommended by Citizens Radio Call Book. We have in stock all kits as shown in this magazine and all other radio publications. Lowest prices to Professional Set Builders and Dealers.

Buy Direct

from the largest Radio Jobbing House in the middle west and save money on all radio equipment. Fill in the attached coupon and mail to us TODAY. You will be amazed at the many Radio Bargains displayed in our new 1928 catalog.

Professional Set Builders!

This catalog contains everything worth while in radio. Fill in the attached coupon and mail today.

WALTER ROWAN BATTERY SUPPLY CO.

225-231 N. Peoria St. Chicago, Ill.

Walter Rowan Battery Supply Co.
Dept. CB, 225 N. Peoria St.
Chicago, Illinois
Please send, without obligation to me, your 1928 Radio DISCOUNT Catalog.
Name.....
Address.....
City.....State.....

Tell 'Em You Saw It in the Citizens Radio Call Book Magazine



SM

Parts and Kits in Stock

Prompt Shipment—All New Items
We Also Carry All Nationally Known Kits and Parts—Tyrman "70"—Best's "115 KC. Shielded Grid"
Write for Catalog

WALTER ASHE RADIO COMPANY
 OZARK BUILDING ST. LOUIS, MO.

CARTER

Resistors, Rheostats, Switches
Fixed Condensers, Jacks

Specified—as usual—in
Screen Grid Laboratory Model Super
and in the
S. M. Shielded Grid Six

Further recognition of an established leadership.
Any Dealer Can Supply You



Build Your Own Exponential Horn



This marvelous 17x21" exponential horn with a 96" air column can be easily built by any amateur, of 1/4" soft wood which produces the most wonderful tone quality. We furnish you with a set of

FULL-SIZED PATTERNS

which have been accurately and scientifically worked out according to the exponential principle. Simply saw out the wood to the size and shape of the patterns and nail and glue together and you have the latest and

MOST EFFICIENT TONE PRODUCER

Send \$2.00 for a set of these full-sized patterns and complete instructions. Or we can furnish you the **Complete Kit**, which includes the wood cut to fit, the nails, the glue, our large sized **Concert Unit** and full instructions. All complete with postage prepaid for \$11.75.

Ask your dealer

RADIO PRODUCER COMPANY
1245CM Jefferson Bldg. Peoria, Ill.



SILVER MARSHALL
Kits & Parts
TYRMAN "70"
WORLD'S RECORD SUPER
REMNER, KARAS, ETC.
Send for New Catalog Just Off the Press

NATIONAL WHOLESALE DISTRIBUTORS



931A West Madison Street, Chicago

DISTRIBUTORS OF

SILVER-MARSHALL PRODUCTS

TYRMAN "70" H.F.L. NINE-IN-LINE

Remler
Frost
Aero

The Harry Alter Co.

18th and Michigan
CHICAGO

Carter
Thordarson
Yaxley



Call of the Palms

In the Balmy Land of
Ponce de Leon

On the choicest part on the finest Beach on the Southeast Coast, the superb Hollywood Beach Hotel, the brilliant, 500-room amazing structure, expresses the sparkling spirit of this delightful land.

It stands directly on the ocean front, only a broad, pearly beach separating it from the surf. Its capacious, airy, exquisitely furnished rooms provide every luxury and convenience. The broad dining hall is a symphony in green and brown. Furnishings, chairs, draperies neutralize, by their apt arrangement, the broad expanses of the lobby—the lounge—the dining hall.

The table of the Hollywood Beach Hotel, Hollywood-by-the-Sea, is famous for variety. The service is unsurpassed. Dancing, musical recitals, symphony concerts, golf, tennis, aquaplaning, motor boating, horseback riding, canoeing, fishing and surf-bathing provide a delightful round of pleasures.

Rates at *Hollywood Beach Hotel*, \$10 to \$15 a day for one in a room, \$20 to \$30 for two. American Plan. Rates of other Hollywood-by-the-Sea Hotels under the same management are: *Hollywood Hills Inn*, \$8.00, one in a room; \$12.50 for two. American Plan. *Park View Hotel*, \$8.00, one in a room; \$12.50 for two. American Plan. *Great Southern*, \$1.50 to \$3.00 for one in a room; \$4.50 to \$6.00 for two. European Plan.

HOLLYWOOD BEACH HOTEL

William Marsh Kimball, General Manager

"HOLLYWOOD BY THE SEA"
Hollywood, Florida



Make Your Radio a "MODERN" Shielded Set

No unshielded set complete without them, no reception as perfect as it could be with them. "MODERN" Shields give each tube a chance to function unhampered by interference from magnetic and static fields, prevalent in all unshielded sets regardless of make or hook-up as many interferences, some of which sound like static, are manufactured within the set itself and can only be remedied by metallic grounded shields. "MODERN" Shields protect the tubes from microphonic sound waves by insulating them from the surrounding ether and by three rubber tipped spring fingers inside of shield which press tightly against the tube, arresting any vibrations set up by jars, sound waves or telephonic vibrations in the cabinet; the rubber tips eliminate any possible conductive leakage from shield to tube. "MODERN" Shields confine the heat around the tube, causing quicker action, greater efficiency, less power, longer battery life and modified summer static. "MODERN" Shields are recommended for sets or tubes that squeal, whistle, howl, choke, snap or produce indistinct or mushy reproduction. Tone and volume are greatly improved by their use. "MODERN" Shields should be placed over each tube in the set to obtain maximum results, connect copper wire in series to binding post on each shield and to ground to assure against shorts or grounds in their application. Complete instructions come with each shield. "MODERN" Shields retail for \$1.00 each, none genuine without the "MODERN" trade mark. If you can not obtain "MODERN" Shields from your local dealer, send us your check or P. O. money order and Shields will be mailed to you P. P. prepaid.

"Modern" Laboratories
207 Washington St. Owosso, Mich.
Amateur Laboratory and Counselor Service at Nominal Fees.



Build Your Receiver With HAMMARLUND Parts

Approved by the World's Leading Radio Engineers



The
"MIDLINE"
CONDENSER

Still the standard variable condenser by which others are judged.

Here are some of the reasons: Soldered brass plates with tie-bars; warpless aluminum alloy frame; ball-bearings; bronze clock-spring pigtail; full-floating, removable rotor shaft permits direct tandem coupling to other condensers. Made in all standard capacities and accurately matched.

Backed by eighteen years of unequalled experience in the manufacture of precision instruments for radio, telephone and telegraph use.

Hammarlund Parts Are Officially Specified for Most of the Season's Popular Circuits Among Which Are the Following:

- HAMMARLUND-ROBERTS Hi Q SIX
- ULTRADYNE A. C. COMMANDER
- HARKNESS A. C. COUNTERPHONIC
- CITIZEN'S BIRNBACH A. C. FOUR
- SAMSON PUBLIC ADDRESS SYSTEM
- AND A SCORE OF OTHERS



The
AUTO-COUPLE
COIL

A justly popular innovation in radio coils because it automatically provides the most efficient coupling between primary and secondary circuits at all wave-lengths.

Space-wound on thin dielectric, its losses are extremely low.

A number of the most successful new circuits are built around the Hammarlund Auto-Couple Coil, including the famous Hammarlund - Roberts HiQ Six Receiver.

If Your Dealer Can't Supply You Write to Us
Write for Folders

HAMMARLUND MANUFACTURING CO.
424-438 W. 33rd St. New York

For Better Radio
Hammarlund
PRECISION
PRODUCTS



Dealers and Set Builders

You will be interested in our new 1928 catalog listing the products of more than EIGHTY-FIVE manufacturers.

We carry in stock complete kits and parts for

- New Remler-Best Screened Grid Super
- Silver-Marshall Shielded Six
- New Victoreen A C Kit
- B-T Power 6 Electric
- Tyrman "70"
- and others

WHOLESALE DISTRIBUTORS FOR

- | | | |
|-----------------|------------|----------------|
| Remler | Scott | Webster |
| Frost | Thordarson | Yaxley |
| Silver-Marshall | Jewell | Raytheon |
| Tyrman | Carter | Sylvania Tubes |
| Hammarlund | Aerovox | Victoreen |

And Other Nationally Known Radio Parts

Write today for your FREE copy of
our up-to-the-minute catalog—
JUST OFF THE PRESS

JAMES C. GORDON CO., Inc.
1213 Pine Street St. Louis, Missouri

Now - a New NATIONAL

VELVET
VERNIER

DRUM
DIAL
TYPE F
ILLUMINATED



New in design but with the familiar NATIONAL Qualities—famous Velvet Vernier Tuning, and made to USE and to last. 360 degree motion allows attachment to ALL types of variable condensers.

Smaller Drum, with automatic take-up, permits high position of sub-panel without cutting. Visible portion of dial inclined upward for easier reading.

Easily attached. List price, \$4. Type 28 Illuminator, 50¢

NATIONAL CO. INC., MALDEN, MASS.
W. A. READY, PRES.

Tell 'Em You Saw It in the Citizens Radio Call Book Magazine



Exclusively licensed by
Technidyne Corporation under
U. S. Patent Nos.
1593658, 1034103,
1034104.

Can You Control Volume Perfectly?

TONATROL

A True Tone and Volume Control

With the powerful new receivers now in use, controlling volume perfectly from the weaker and stronger stations alike, is often a difficult problem.

You can solve this problem and get the most delicate shading of volume by simply installing Tonatrol. A real improvement for any receiver that you can install yourself in a few minutes.

Tonatrol Standard Volume Control \$1.50. Tonatrol Type W.S. (with filament switch attached), \$2.00.

Write for free installation booklet for the proper way to control volume

Dept. 74-B, 175 Varick Street, New York, N. Y.

ELECTRAD

All Metal Chassis Shielded Ready to Wire

6 TUBE SUPERPHONIC

Radio ALL PARTS MOUNTED

Only \$16.95

FREE!
6 TUBES
UX 201-A TYPE
Tested and Matched

Can be wired in a few minutes



An amazing value that can't be beat! Latest 6-tube tuned radio frequency circuit. Extremely selective, marvelous sensitivity. Three stages of radio frequency, detector and two stages of low ratio audio frequency, for improved tone quality. Two-dial control. Straight line frequency condensers. All metal chassis. Shielded. Clear and realistic reception guaranteed. Beautiful black front panel (7"x18"); ornamental design, degree and kilocycle markings in gold. Metal panel and sub-panel. Complete chassis. No extra parts to buy. All parts mounted. Simply connect a few wires. No special tools needed. Kurz-Kash indicator knobs. New type UX sockets. All hook-up wire and colored battery cable included. Value \$60.00, our price \$16.95.

COAST to COAST RECEPTION

NO RADIO KNOWLEDGE NEEDED!

VERY EASY TO WIRE this set with the instructions we furnish! Just connect a few wires. All you have to do is to follow numbers. That is all. Can be wired in a few minutes by anyone. No radio knowledge needed. Make money by wiring these sets in your spare time and selling them to your friends.

SEND NO MONEY

Just write your name and address on a post card and ask us to send you this great outfit together with 6 tubes. We will ship them right away. When they arrive, pay only \$16.95 plus a small delivery charge. (Foreign countries send \$19.50 with order. We pay shipping charges.)

RADIO EQUIPMENT CO. 549 South Wells Street Dept. 30C, Chicago, Ill.

Tell 'Em You Saw It in the Citizens Radio Call Book Magazine



The SEASIDE HOTEL

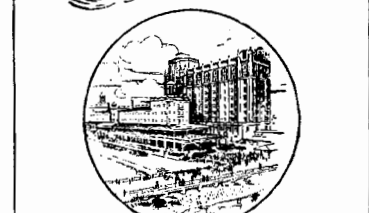

Atlantic City N.J.

To be free minded and cheerfully disposed at hours of meat and of sleep and of exercise is one of the best precepts for long lasting.

Francis Bacon 1625

WARD

ELECTRIC

SOLDERING IRONS

WE manufacture a complete line of soldering irons designed for any class of radio work and for any job whatever, where a soldering tool is required. When you purchase an iron from us, you have the satisfaction of knowing that you are getting a tool that will give you satisfactory service over a long period of time. Our irons maintain an even temperature when in use which is very essential to good soldering work. Remember that high grade soldering irons do high grade work, and when purchasing parts for your radio equipment, you of course buy the best you can, so why not buy the best soldering iron with which to construct your set. Well soldered joints are very essential in all radio construction.

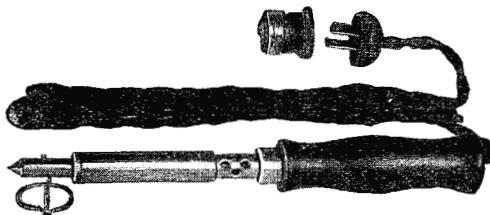

Ward Radio Junior

Repeat orders over a period of years from the leading jobbers throughout the country, and also from foreign countries, are real proof of the quality and workmanship of our irons. If your dealer cannot supply you, write us direct. Jobbers, dealers—write for special discount. Shipment made to any part of the world. Complete listings given below:

	List price	Tip	Wattage at 110 volts
Ward Radio Junior.....	\$1.70	3/8"	100 watts
No. 168.....	2.00	5/8"	100 watts
No. 169.....	2.50	3/8"	100 watts
No. 300.....	3.00	5/8"	100 watts
No. 600.....	6.00	3/8"	120 watts
No. 800.....	8.00	5/8"	150 watts
No. 900.....	9.00	5/8"	150 watts
No. 1000.....	10.00	7/8"	275 watts

The No. 900 and No. 1000 can be furnished in 220 volts, and the Radio Junior, No. 168, No. 169 and No. 300 are furnished in 32 volts. Diamond or screw-driver shaped tips furnished on all irons. All irons fully guaranteed.

Underwriters Laboratories approved and listed as standard

WARD MANUFACTURING COMPANY

941 Wellington Avenue

CHICAGO

ILLINOIS

SUCCESS!

Wouldn't take
\$5,000
for his RIA Diploma



"I have recently completed the most enjoyable and educating years of my life. I have reference to the time I have spent on shipboard as a radio operator, having just left to take up employment on shore, secured through contacts made while operating aboard passenger ships. "My 'Radio Institute' diploma is one of my most treasured possessions, and I would not take \$5,000 for it, for to me it is a daily reminder of the many pleasant times and adventures which came my way as a wireless operator and of my present success."

Claude Johnson

Golden opportunity and glorious adventures await you in radio.

You, too, can sail away as a radio operator. The Radio Institute of America, America's oldest radio school offering the world's finest radio instruction, qualifies you to pass your U. S. Government Radio License Examination and helps you to secure your first position. Advancement is rapid in radio, the field of golden opportunities.

Study at home

Complete instruction on every phase of radio—available for home study. You study when you please—as long as you please. The course has just been revised to include the very latest developments. Are you going to mark time when real opportunities await you in this billion-dollar industry? Send the coupon now for the booklet which shows how we help you to succeed.

RADIO INSTITUTE OF AMERICA
326 Broadway, New York City

RADIO INSTITUTE OF AMERICA Dept. BC-3
326 Broadway, New York City

Gentlemen:

Please send me your new catalog. I want to know more about your new radio course.

Name.....

Address.....

Tell 'Em You Saw It in the Citizens Radio Call Book Magazine

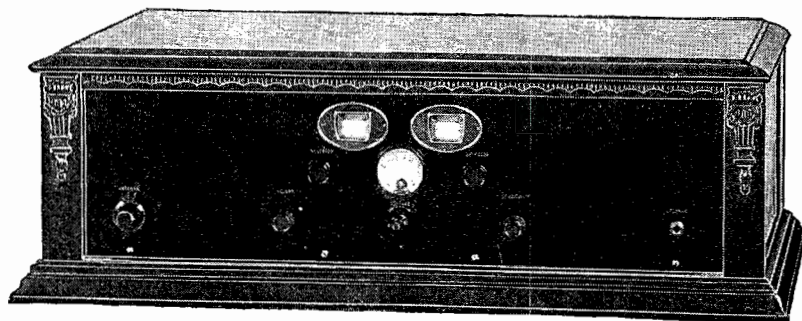

Full Size Working Prints for **Gerald M. Best's** *115 Kilocycle Shielded Grid Tube* **SUPER HETERODYNE**

NOTHING developed in radio for many months has enjoyed the popularity of Gerald Best's new 1928 Model 115 Superheterodyne, using the new shielded grid tubes. Positive clean cutting 10 kilocycle separation with the remarkable advantage of "death-like silence" in operation. It's a knockout—a powerful receiver which brings in distant stations with a bang. Not critical—not hard to build, and a sure-fire performer. Beautiful tonal qualities and unmatched in appearance. Massive copper shield cans house the individual stages, giving the set that much wanted "factory" appearance. Build it from Gerald Best's Official full size working plans and specifications, which we sell in package form for one dollar. Full size pictorial diagram, layout, drilling template and minute instructions for assembly and wiring. Get these prints today.

PRINTED ON EXCELLENT STOCK

These prints are 25x38 inches in size and printed on a very heavy grade of enamelled stock. White paper with blue sketches. Easy to follow and very clearly drawn. You will like them.

Special Offer

Add another dollar to your order and we will send you the next six issues of "RADIO," saving you 50c.

\$ 1 00
POST PAID

Jobbers and Dealers are invited to place their orders with us for these prints. Orders for any quantity filled immediately. Attractive prices on quantity orders. Write for particulars.

"RADIO" Magazine

Pacific Building
San Francisco, California

Here is \$1.00. Send me at once a complete set of full size working prints and instructions for building the 1928 Best shielded grid tube 115 kilocycle receiver as advertised in CITIZENS RADIO CALL BOOK.

Name.....

Street and No.....

City and State.....

Tell 'Em You Saw It in the Citizens Radio Call Book Magazine

A Smooth, Positive Volume Control for Circuits Using "AC" Tubes

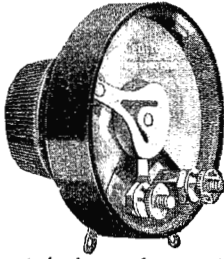

The delicate balance of "AC" circuits requires a different method of volume control than that commonly used with battery sets.

Centralab Radiohms RX-100 or RX-025 have been developed especially for smooth volume control with "AC" tubes. They have the same appearance as standard Radiohms, but the taper of resistance is entirely special. The RX-100 Radiohm in the secondary of an R.F. stage will control oscillation as well as volume. The RX-025 provides volume

control when used across the primary of an R.F. Transformer.

The same unit has the proper resistance for antenna circuit control, but no antenna circuit resistance will prove as uniformly satisfactory as when used across one of the R.F. stages.

A Centralab PR-050 Power Rheostat in series with the "AC" transformer will provide accurate voltage control and lengthen the life of the tubes.

Centralab wire wound Potentiometers and Fixed Resistors will prove trouble free in the power circuits.

Write for full information about these high quality controls. The new "AC" information sheet is now ready for you.

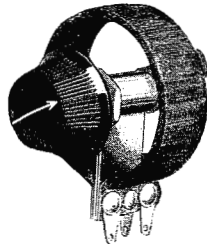

CENTRAL RADIO LABORATORIES

26 Keefe Ave. Milwaukee, Wis.



BENJAMIN Cle-Ra-Tone Sockets

Red Top
Green Top

For Standard UX Type Tubes. For quick and easy finding of the correct position of the tube and the prongs.

A new Five Prong Socket for A. C. Detector Tubes. Especially designed for heavy current-carrying capacity for these new tubes.

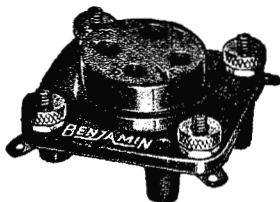

You can tell immediately into what socket each tube should go. No more mistakes, hesitation or confusion. Improves the appearance of the set. Cle-Ra-Tone Sockets are spring supported to absorb the shocks that distort tonal qualities. The tube "floats" on four finely tempered springs, which absorb shocks and jars from slamming doors, passing traffic and other disturbances caused by outside vibrations. One-piece terminal to tube connection. Positive contacts. Knurled nuts for binding post connections or handy lugs for soldering.

Cle-Ra-Tone Sockets have been chosen for practically every prominent circuit for several years.

At All Radio Jobbers and Dealers

Benjamin Electric Mfg. Co.

Chicago: 120-128 So. Sangamon St.
New York: 247 W. 17th St. San Francisco: 448 Bryant St.

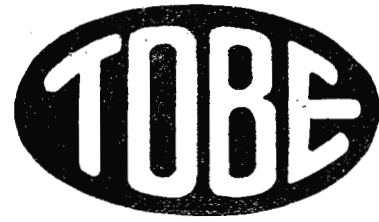

PUTTING RESISTANCE-COUPLED AUDIO ON THE MAP

RESISTANCE-AUDIO has long been known for its fine quality and faithfulness of reproduction. Held back in the past by poor resistors, it now can come into its own by the use of the TOBE VERITAS RESISTORS. No other resistors are quite like VERITAS. They don't change in values, and stand up day in and day out.

TOBE VERITAS RESISTORS

are used in resistance audio in

Martí Electric Radio Sets

Browning Drake Radio Sets

NATIONAL Power Amplifiers

Volney D. Hurd, Radio Editor, Christian Science Monitor says of Veritas Resistors:

« Resistance Coupling has been retarded due to the inability to stand up under high voltages over any useful period. The development of a new type of Resistor by Stratford Allen, electro-chemist of the Tobe Deutschmann Co., bring this type of Audio into a fixed place in Radio. »



ENGINEERING PAMPHLET ON B POWER AND AMPLIFIER DESIGN

HERE is a new 12-page book, 8½" by 11", containing blueprints of the circuits, photographs and full lists of parts for the construction of all of the newest and most modern Power Amplifiers and Power Supplies. The latest development of Samson, General Radio, Silver-Marshall, Thordarson, National Co., Acme, etc., for high quality, high power audio reproduction. Invaluable for all set builders and home constructors of Radio. Send for it today. Use the coupon below.

PRICE

25¢

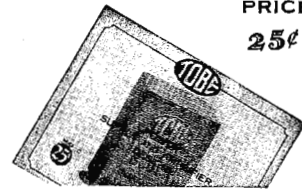

Tobe Deutschmann Co., Cambridge, Mass.

Gentlemen: Please send me your new book "TOBE B-POWER SUPPLY and AMPLIFIER DESIGN." Enclosed please find 25¢.

Name

Address

Tell 'Em You Saw It in the Citizens Radio Call Book Magazine



Radio dealers recommend and use the

ekko Ground Clamp

because it eliminates the high percentage of radio troubles due to faulty ground

Imperfect ground contacts are responsible for a high percentage of all radio troubles. The ekko Clamp eliminates these troubles by insuring perfect contact. Radio dealers know this. That is why they include an ekko Clamp with radio set installations and instruct their service crews to use it in replacing old faulty grounds.

The hardened steel points of the ekko Clamp bite through paint, rust, dirt, corrosion or any other insulation. Its positive contact insures full signal strength. Easy to use. Ground wire screws to Clamp. Clamp attaches to nearest pipe by a turn of the screw. Non-corrosive, permanent. Finished in white nickel. Fits 1/4 to 1 1/4 inch pipe. At your dealer's.

25¢



Radio Dealers:

The ekko Clamp is supplied in lots of ten in an attractive counter display that helps you sell this most popular of all ground clamps.

The Ekko Company

111 West Monroe Street, Chicago, Ill.

The Big Friendly Radio House Complete Parts

Hot Spot 14

WHEN you get our 1928 Catalog, you can have popular, nationally-advertised kits, parts, eliminators and accessories at prices that are real values.

Our dealer catalog, which lists everything in radio, means more real profit for you. Standard quality at the right price.

Write for our big Catalog

WESTERN RADIO MFG. CO.

128 West Lake St. Dept. OM Chicago, Ill.

Sovereign

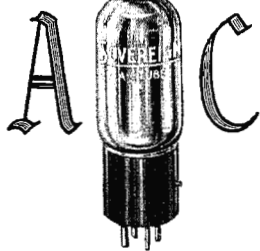

NO HUM

A-C reception with all its power and pep, with no hum—no microphonics—no noise—easily obtained with Sovereign A-C Standard Socket Tubes.

Don't be a back number. Enjoy the best today. Convert your old set to A-C. Anyone can do it. Booklet on A-C Tubes and Circuits free.

Sovereign Electric & Manufacturing Co.
123 N. Sangamon St. Chicago, Illinois

Jones MULTI-PLUG THE STANDARD SET CONNECTOR

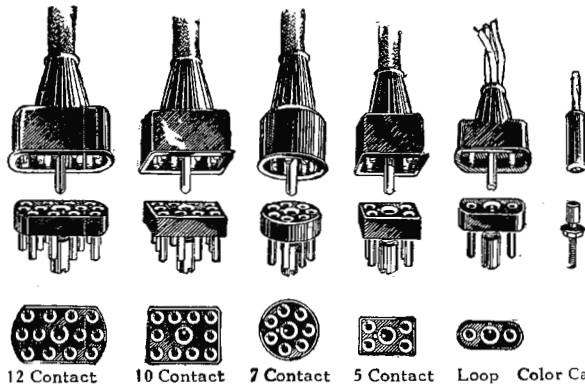

12 Contact 10 Contact 7 Contact 5 Contact Loop Color Cap

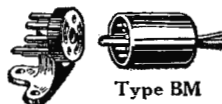

Type BM

With the present day sets having many power supply leads, Multi-Plugs are essential. The line this year embraces Multi-Plugs with as many as twelve contacts and five different types of socket mountings. Small illustration shows the bracket mounting (BM) most commonly used by set builders. Prices are materially reduced this year. See your dealer for price sheet or write direct to

HOWARD B. JONES
2300 Wabansia Ave.
CHICAGO



SAVE 50%

No better "A" Socket Power Unit can be obtained even at twice this amazingly low price. Combines all the efficiency of plate current with the undoubted convenience of socket power. No bothersome hauling around of batteries to be charged. No hum or noise. Highest quality. Westinghouse electric equipment. Operates on 50 or 60 cycles at 110 volts A. C. Thousands of satisfied users prove the worth of World Power Units. Approved by rigid tests of Radio News and other leading Laboratories.



Send No Money Just name and address and we will ship day order is received by express. C. O. D., subject to examination on arrival. 5% discount for cash in full with order. NOW is the time to do it.

WORLD BATTERY COMPANY
1219 So. Wabash Ave. Dept. 63 Chicago, Ill.

STATION W5EC
Owned and operated by World Battery Co.

\$5.50 buys this famous cabinet



The Iveyline
Sizes range from 7x18x10 to 7x30x12. Mahogany finish, \$5.50 to \$8.75. Solid Walnut, \$6.50 to \$10.50. I.o.b. Hickory. 12-hour service. Write for catalogue.

BUY direct from us and save money. Your choice in either gleaming mahogany finish or solid walnut. All orders shipped within 12 hours of receipt. You can't beat this Iveyline cabinet. Order today or write for catalogue.

SOUTHERN TOY CO., Manufacturers, HICKORY, N. C.

Raytheon LONG LIFE RECTIFYING TUBE

TYPE BH—Standard for "B" Power Units, 125 m.a., 300 volts, \$4.50.
TYPE BA—For complete A-B-C Power, 350 m.a., \$7.50.

Raytheon Manufacturing Company Cambridge, Mass.



50
%
Discount

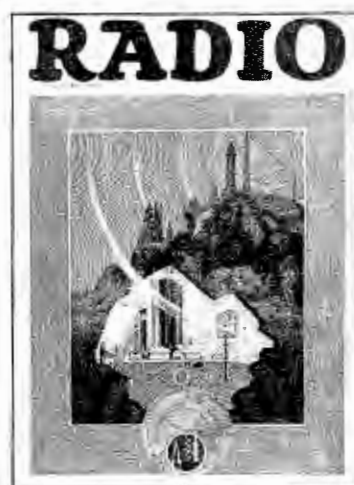

Two for The Price of One!
 "CITIZENS RADIO CALL BOOK" and "RADIO"
 a full year subscription to both for the price of one—if you act now!

Save \$2.50

LET us save \$2.50 for you . . . and make it well worth your while. We will send you CITIZENS RADIO CALL BOOK for a full year . . . four issues . . . and "RADIO" of San Francisco for a full year . . . twelve issues . . . all for the price of a one year subscription to "RADIO" alone, \$2.50. Copies of both of these great radio magazines, if bought from a news dealer, will cost you \$5.00 a year. By subscribing now you pay only \$2.50, a saving of exactly fifty per cent. And you are insured in advance of getting your copies several days before they appear on the news stands. "RADIO" and "CITIZENS RADIO CALL BOOK" mail out subscribers' copies at least three days before news stand shipments are made. To those who value the saving of 50% in cash—and earlier receipt of magazines—this offer should have more than ordinary appeal. Let us put you on the subscription list of both of these magazines right now—before the next issue is ready for mailing. Please remit by cash, money order or stamps.

Mail Coupon Now—Before You Turn This Page

CITIZENS RADIO SERVICE BUREAU
 508 South Dearborn St., Chicago, Ill.

Here is \$2.50 for which you will send me the next twelve issues of "RADIO" and the full year subscription to CITIZENS RADIO CALL BOOK (4 issues), as advertised in your MARCH issue.

Name.....Street & No.....
 City.....State.....

Tell 'Em You Saw It in the Citizens Radio Call Book Magazine

New AERO Circuits

For Either Battery or A. C. Operation

Proper constants for A. C. operation of the improved Aero-Dyne 6 and the Aero Seven have been studied out, and these excellent circuits are now adaptable to either A. C. or battery operation. A. C. blueprints are packed in foundation units. They may also be obtained by sending 25c for each direct to the factory.



Aero Universal Tuned Radio Frequency Kit

Especially designed for the Improved Aero-Dyne 6. Kit consists of 4 twice-matched units. Adaptable to 201-A, 199, 112, and the new 240 and A. C. tubes. Tuning range below 200 to above 550 meters. This kit will make any circuit better in selectivity, tone and range. Will eliminate losses and give the greatest receiving efficiency.

Code No. U-16 (for .0005 Cond.).....\$15.00
Code No. U-163 (for .00035 Cond.)..... 15.00



Aero Seven Tuned Radio Frequency Kit

Especially designed for the Aero 7. Kit consists of 3 twice-matched units. Coils are wound on Bakelite skeleton forms, assuring a 95 per cent air dielectric. Tuning range from below 200 to above 500 meters. Adaptable to 201-A, 199, 112, and the new 240 and A. C. tubes.

Code No. U-12 (for .0005 Cond.).....\$12.00
Code No. U-123 (for .00035 Cond.)..... 12.00

Note—All AERO Universal Kits for use in tuned radio frequency circuits have packed in each coil with a fixed primary a twice-matched calibration slip showing reading of each fixed primary AERO Universal Coil at 250 and 500 meters; all having an accurate and similar calibration. Be sure to keep these slips. They're valuable if you decide to add another R. F. Stage to your set.

A New Service

We have arranged to furnish the home set builder with complete Foundation Units for the above named Circuits, drilled and engraved on Westinghouse Micarta. Detailed blueprints for both battery and A. C. operation and wiring diagram for each circuit included with every foundation unit free. Write for information and prices.

You should be able to get any of the above Aero Coils and parts from your dealer. If he should be out of stock order direct from the factory.

AERO PRODUCTS, Inc.

1772 Wilson Ave. Dept. 113 Chicago, Illinois

The Big Friendly Radio House Complete Parts

MAGNAFORMER A. C. and D. C.

WHEN you get our 1928 Catalog, you can have popular, nationally-advertised kits, parts, eliminators and accessories at prices that are real values.

Our dealer catalog, which lists everything in radio, means more real profit for you. Standard quality at the right price.

Write for our big Catalog

WESTERN RADIO MFG. CO.

128 West Lake St. Dept. OM Chicago, Ill.

The "Power"



A B and C Unit

(NO BATTERIES)

Licensed by

RCA

—A, B, and C for sets **\$47⁵⁰**
using AC tubes.

—Super B for any set.

includes
RCA Tube

Write for Complete Facts!

Harold Power, Inc.

Manufacturers of Socket Power Devices
MEDFORD, MASS.

THE HOTEL
PRESIDENT
48th ST. WEST OF BROADWAY
NEW YORK CITY

This splendid new hotel, just around the corner from everything, offers you
A ROOM AND A BATH FOR \$2.50
ROOMS WITH BOTH BATH AND SHOWER \$3.00
ROOMS FOR TWO AT \$3.00 AND \$4.00
R. McCrimmon, Res. Mgr.

The President awaits your visit!

Tell 'Em You Saw It in the Citizens Radio Call Book Magazine



To Assure Satisfaction Use

TRUVOLT

All-Wire Resistances

If you would suit your eliminator to differences in circuits and receivers, if you would operate your set with utmost economy—be sure to build it with Truvolt Resistances.

All wire; permanently accurate; unique construction prevents overheating; potentiometer type, giving easy control and adjustment of voltage.

A Full Line of Variable, Fixed and Tapped Resistances for All Radio Purposes.

Write for Complete Free Truvolt Resistance Circular
Dept. 236-A, 175 Varick Street, New York, N. Y.

ELECTRAD

Finer Performance than you've ever enjoyed!

Light-Socket Power—Fidelity of Reproduction
Made Dependable by Complete

AMERTRAN Units



The AmerTran ABC Hi-Power Box. List price \$102.50, east of the Rockies. Complete with rectifying tube.

AN average receiver can be made one of the finest of modern instruments by the use of AmerTran products. For quality reproduction—limited only by the perfection of the speaker—for noiseless reliable power without the nuisance of batteries or chargers—these companion units set a new high standard of performance. Cased in compact cabinets, they may be installed in a console or where the batteries used to be.

The A B C Hi-Power Box requires no attention or adjustment after installation. It delivers uniform, dependable power from the house-current—supplying sufficient voltage and current for Push-Pull 210 tubes and all other A C tubes required in a modern receiver. The complete unit contains AmerTran designed equipment with a power transformer having separate windings to provide AC filament current for power tubes, the 281 rectifying tube, heater current for three or four UY-227 AC tubes, and current for four or five UX-226 raw AC tubes.

With either an AC power supply system or batteries, you'll find the fidelity of reproduction brought to your set by the AmerTran Push-Pull Power Amplifier actually limited *only* by the perfection of the speaker. It connects to the detector of any good receiver and may be entirely AC operated. The input to the speaker is free from distortion and objectionable AC hum—the energy output is increased especially at the lower musical frequencies bringing greater clarity at high or low volume. Furnished with cable and plug the amplifier connects directly with the ABC Hi-Power Box.

These two units are designed to work together, and when used with a good tuner and speaker will reproduce without exaggeration a philharmonic orchestra or pipe organ as though actually present.



The AmerTran Push-Pull Power Amplifier. List price \$60, east of the Rockies. Price of Amplifier complete with tubes depends on tubes specified.

See these new AmerTran products on demonstration at any store displaying the sign "Authorized AmerTran Dealer" or write direct to this Company. Both wired units are licensed under patents owners or controlled by R C A and must be sold complete with tubes.

AMERICAN TRANSFORMER CO.
177 Emmet Street : : Newark, N. J.
"Transformer Builders for Over 27 Years"

X-L Products

100% INCREASED RECEPTION ON LOW WAVE LENGTHS

Greater distance, volume, clarity, stability and easier, quicker tuning with X-L Vario-Densar in your circuit.

MODEL "N" Micrometer adjustment easily made, assures exact oscillation control. Capacity range 1.8 to 20 MFD. Price \$1.00



Model "N" Vario-Densar

Used in every high grade circuit or receiver today, including

Strobodyne
Loftin-White
Qualitone 6
Improved Aristocrat
Best's Super-Heterodyne
B-T Power Six
Hammarlund-Roberts
Daily News 4
Quadraformer 6
and many others

MODEL "G" gives positive grid bias on all sets. Capacity range. Model G-1, .00002 to .0001 Mfd.; Model G-5, .0001 to .0005 Mfd.; Model G-10, .0008 to .001 Mfd. Price each with grid clips, \$1.50.

X-L BAKELITE INSULATED PUSH POSTS. Convenient, simple, permanent connections which you do not have to remember to tighten. Just push down the X-L, insert wire, remove pressure, connection will stay tight; vibration will not loosen; releases instantly. All standard markings or boxed in complete sets for popular circuits. Price each 15 cents.



Bakelite Insulated



Model "G" Vario-Densar

FREE. New, big, up-to-date book of wiring diagrams of latest circuits including Loftin-White Constant Coupler. Send for your copy today. INVESTIGATE the Goodwin Aperiodic Detector Circuit.

X-L Products at your dealer. If he cannot supply you, write direct.

X-L RADIO LABORATORIES
2422 North Lincoln Ave. Chicago, Illinois

Tell 'Em You Saw It in the Citizens Radio Call Book Magazine

TRIMM

Quality Reproducers

Tune in on any program—Band Concert, Opera or Market Report—it's all the same to the new Trimm Cones. Volume, melody and distinctness, the three most desired features of radio reproduction, are there undeniably. And it's a beautiful cone, in forest brown with gold decoration.

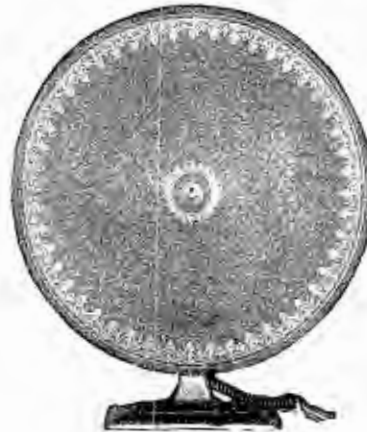

Trimm Cones are packed in special wire-bound wooden containers, assuring transportation and delivery in perfect condition.

CONCERTO GRANDE
 17" diameter
 West of Rockies, \$16⁰⁰
\$16.75
 Canada, \$22.00

CONCERTO
 14" diameter
 West of Rockies, \$10⁰⁰
\$10.75
 Canada, \$13.50

Free edge of cone fully protected. Unit, built on the balanced armature principle, will take maximum amplification of power and semi-power tubes without blasting or distortion. Ruggedly built; all parts rust-proofed.



Concerto Grande Cone Speaker Unit

Just the thing for the experimenter and mechanically inclined fan to make his own cone speaker. Identical in mechanical construction and in electrical and radio characteristics with the unit used in the Concerto Grande Trimm Cone Speaker.

\$9⁰⁰

- TRIMM Concert Speaker—a wonderful horn, 22 inches high with 15-inch bell, \$25.00.
- TRIMM Entertainer, horn 19½ inches high, with 12-inch bell, \$17.50.
- TRIMM Home Speaker, stands 18 inches high, with 12-inch bell; a tremendous value at \$10.00.
- TRIMM Professional Headsets. Used by Dr. Donald McMillan on three of his Arctic expeditions, \$5.50.



LYNCH

Write for this new Book



25 RADIO IDEAS PLUS
 for improving the tone quality and distance-getting ability of your set are explained in this valuable radio book. Charts, specifications, and wiring-diagrams show you how to make easy improvements at little cost. Send coupon with 25c or see your dealer for your copy.
ARTHUR H. LYNCH, Inc.
 General Motors Building
 1775 Broadway, at 57th Street
 New York City
 Sales offices in most large cities

Arthur H. Lynch, Inc.
 1775 Broadway
 New York City

Gentlemen:

I want to improve my radio. Please send me a copy of "Resistance the 'Control Valve' of Radio" for enclosed 25c.

Name _____
 Street _____
 City _____
 State _____

C. R. C. B. 3

The Big Friendly Radio House Complete Parts

"New" 1928 Single Control Browning-Drake—A. C. and D. C. Operation

WHEN you get our 1928 Catalog, you can have popular, nationally-advertised kits, parts, eliminators and accessories at prices that are real values.

Our dealer catalog, which lists everything in radio, means more real profit for you. Standard quality at the right price.

Write for our big Catalog

WESTERN RADIO MFG. CO.

128 West Lake St. Dept. OM Chicago, Ill.



"CHICAGO" HEAVY DUTY "B" is the only battery on the market carrying a six months' unconditional guarantee.

Dealers, Agents: Write today for discounts and details of our exclusive selling franchise. We make a complete line of Dry Cell Batteries for every radio requirement.

AUSTIN ACCESSORIES MFG. CO.
 12 S. Clinton St. Chicago, Ill.

SANGAMO

AUDIO APPARATUS
 Fixed Condensers
 SANGAMO ELECTRIC COMPANY
 SPRINGFIELD, ILL.

ELKAY

TRADE MARK REG.

SUPPRESSOR

Controls the Squeals

Fits into the grid circuit of any tuned R. F. set and stops the tendency to "boil" over. Just a few minor changes in the wiring; you can easily do it. Price, 75c each, unmounted; \$1.00, mounted. Satisfaction or money returned promptly. Can be used wherever grid resistances are specified, as in L. C. 28, Hi-Q 28 or Silver-Marshall T. R. F. When ordering, describe set: type of circuit, number of tubes before and after detector, etc.

Elkay Tube Equalizers—also in cartridge form, replace the old variable rheostats on all but first R. F. stage. Adjust themselves automatically to working voltage of any tube made. Unmounted, 50c; mounted, 75c.

The Langbein-Kaufman Radio Co.
Dept. C, 62 Franklin St.
New Haven, Conn.
Send for detailed literature on Elkay A. C. Receivers



FREE!!

with a year's subscription to the Citizens Radio Call Book Magazine

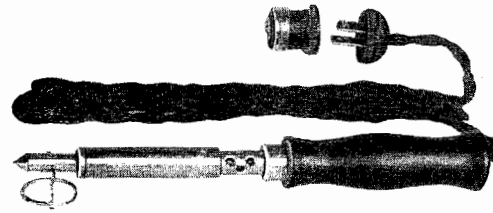

The Famous WARD needs no introduction. Heating Elements will not burn out; either A. C. or D. C., 110-115 volts draws 100 watts. Six feet of heater cord, standard 2-piece separable plug, ebony finish handle, brass plated barrel, 3/8-in. diamond-shaped tip, temperature 500 degrees maintained, handle remains cool. Handle insulated against possible short. A genuine high-grade electric iron. Lava rock core approved and listed as standard by Underwriters' Laboratories.

**A most useful household article.
Can be used to solder anything
that requires soldering**

Send in the coupon below and receive the iron absolutely free with a year's subscription to the Citizens Radio Call Book Magazine—for only \$1.75. Hurry—this offer is limited—mail coupon today.

***Iron Is Guaranteed by Manufacturer for
One Year—Hurry—This Offer
Is Limited***

Citizens Radio Call Book Magazine
508 So. Dearborn Street, Chicago, Ill.

Here's my \$1.75. Please send me a Ward Electric Soldering Iron free and enter my subscription for the Citizens Radio Call Book Magazine for one year starting with the

Jan. March Sept. Nov. issue.

Name.....

Address.....

City.....State.....



SET BUILDERS!

A complete line of the very latest
KITS and PARTS
STANDARD APPLIANCES
STANDARD PARTS
Get the Lowest Prices!

← FROM THIS BOOK *Write for it!*

Paramount

ELECTRICAL SUPPLY COMPANY
602 W. Adams St., Dept. 53, Chicago

WHOLESALE ONLY

The Big Friendly Radio House Complete Parts

New Gerald Best 115 KC Shielded Grid Receiver

WHEN you get our 1928 Catalog, you can have popular, nationally-advertised kits, parts, eliminators and accessories at prices that are real values.

Our dealer catalog, which lists everything in radio, means more real profit for you. Standard quality at the right price.

Write for our big Catalog

WESTERN RADIO MFG. CO.

128 West Lake St. Dept. OM Chicago, Ill.

Tell 'Em You Saw It in the Citizens Radio Call Book Magazine

OK
For Every Circuit

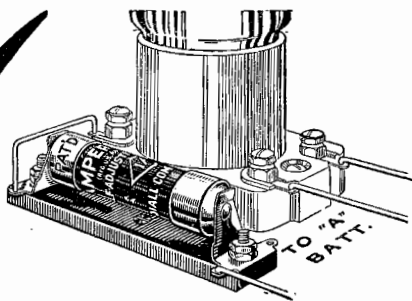

TUBE performance can be perfect—and tube life prolonged—only by keeping the tube filament voltage, or temperature, constant, despite variations in "A" battery voltage. AMPERITE alone does this—and it does it automatically. That is why AMPERITE is specified by every radio engineer—and is indispensable in every radio circuit. Takes the "guess", inconvenience and unsightliness out of panel rheostats. Simplifies wiring, panel design and tuning. Proved for 6 years. Entirely different from—and must not be confused with—fixed filament resistors. Particularly necessary with battery eliminators. Order AMPERITE by name. Accept nothing else. Price \$1.10 with mounting (in U.S.A.). For sale by all dealers.

FREE

Write for "Amperite Book" of season's best circuits and latest construction data. Address Dept. CCB2.

Radiall Company
 50 FRANKLIN ST., NEW YORK

AMPERITE
 REG. PAT. OFF.

The "SELF-ADJUSTING" Rheostat

**New Discovery
 in Radio**

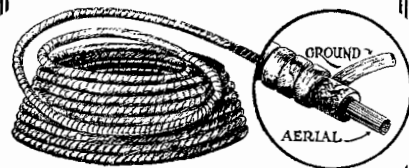

**THE COMPOSITE
 INSIDE AERIAL**

A copper flexible aerial wire with a flexible metal covering or armor. The copper wire is connected to your aerial binding post and the outside metal covering is connected to the ground, thus shielding the entire aerial from outside interference. All foreign noises are minimized or eliminated, and your reception is remarkably toned and softened. Just tuck up around the picture mold and you will be surprised at the results obtained.

Shipped in 100-ft. coils on receipt of \$3.00, plus postage. Weight 4 lbs. 21 cents takes it as far west as Kansas City, 50 cents to Pacific Coast. Shorter distances proportionate rates. Send your order at once to

**THE COMPOSITE
 AERIAL CO.**

121 Hudson Ave., Newark, Ohio

SET BUILDERS

Send name and address at once for NEW 28"x34" two-color, X-Ray, novel Wiring Diagram for the world-famous Magnaformer 9-8; also verifications of record-breaking, long-distance records—Europe, Australia, New Zealand, Japan and China. Also full and complete description of Magnaformer Coils that produce Exact Resonance in every stage, insuring greatest purity of tone—greatest sensitivity—greatest selectivity—double volume and utmost quietness; also 46 points of information including A.C. and Shielded Grid Tubes. ALL FREE. Address

RADIART LABORATORIES
 Department 23

19 South La Salle St. Chicago, Ill.

Sensational! Prices Reduced
 Continental Standard Meter Test RADIO TUBES

Formerly \$1.75
 Now Only **\$1.00**

The greatest and most sensational price reduction ever offered in high quality, standard, meter test guaranteed radio tubes. Genuine "firsts" of our very best grade. Increased production and large volume business enables us to offer tubes at the standard price of only \$1.00.

Never before has a standard quality radio tube been offered to the public at this low price. Take advantage of this opportunity now to get your radio tubes at a real saving.

X200A.....\$2.50	X281.....\$6.00
X112.....2.50	X210.....7.50
X171.....2.50	C226.....3.00
X280.....4.00	C227.....6.00

For sale by progressive dealers. If your dealer cannot supply, order direct, giving his name.

Dealers and Jobbers: Write for special offer
CONTINENTAL CORPORATION
 179 W. Washington St., Dept. CB3, Chicago, U. S. A.



Save 1/2

Satisfy your-self!

30 days FREE TRIAL

CONRAD 6
 SINGLE DIAL CONTROL
 COMPLETELY SHIELDED
 GENUINE LICENSED CIRCUITS

Manufactured under license grants of RADIO CORPORATION OF AMERICA and affiliated companies.

The set that's the talk of the radio trade. Manufacture under license grants insures highest quality; chassis incorporates all features found in finest sets. Latest thing in radio receivers. Illuminated dial. Very selective and sensitive. Gets long distance stations with wonderful tone and volume. Table and console models in newest styles and designs.

Prove It Yourself — 30 Day Free Trial. Con-Rad receivers will pass any test you demand. Try it in your home on our 30 day Free Trial Offer and be satisfied. If you are not, return the receiver to us and the money will be refunded. Write today for complete catalog and details of the Con-Rad Line of 1928 and our liberal 30 Day Free Trial Offer.

CONSUMERS RADIO CO.
 Dept. 102 4721 Lincoln Ave. CHICAGO

6 TUBE SETS Completely assembled \$34.75 \$66.66 UP Retail PRICE DISCOUNTS TO AGENTS

YAXLEY
 APPROVED RADIO PRODUCTS
 Specified for
Tyrman "70"
 Shielded Grid Amplimax

No. 915K—15 ohm Switching Rheostat.....	\$1.75
No. 125K—25 ohm Rheostat.....	1.35
No. 669—Cable Connector.....	3.25
No. 416—Pup Jack.....	.15
No. 815—15 ohm Resistance.....	.15
No. 4L—Resistance.....	.15

At Your Radio Dealer's
YAXLEY MFG. CO., 9 South Clinton St., Chicago

CHICAGO'S OLDEST RADIO HOUSE

Save! on Parts

For the New

Tyrman "70"

Shielded Grid Amplimax

Fully Described and Priced
in the
THE WORLD'S GREATEST

100
Page



100
Page

**It's Free! Send for Your
Copy Today**

All the Latest in Radio Is Shown

Established
1918



Established
1918

Telephone Maintenance Company
123 South Wells Street, Dept. 101
CHICAGO, ILLINOIS

WHOLESALE ONLY

The Big Friendly Radio House

Complete Parts New World's Record Super 10 with Power Supply

WHEN you get our 1928 Catalog, you can have popular, nationally-advertised kits, parts, eliminators and accessories at prices that are real values.

Our dealer catalog, which lists everything in radio, means more real profit for you. Standard quality at the right price. *Write for our big Catalog*

WESTERN RADIO MFG. CO.
128 West Lake St. Dept. OM Chicago, Ill.

\$75 to \$125 Weekly

Charging Batteries Starts You



Let me show you how to make big money right from the start. I've prepared a FREE book explaining all details. First week's profit pays for all equipment. You can get all the battery charging business in your community with my Service Station Charger—it's years ahead of ordinary chargers

—handles 50% to 70% more batteries. I explain everything—start you in a business of your own and put you on the way to big money. Write for FREE Book.

C. F. HOLMES, Chief Engineer, Dept. 15
Independent Electric Works, 5118 Ravenswood Ave., Chicago



Big Profits

FREE BOOK Just Out

The Celestial Stradivarius
The Advanced Hi-Q Six
-BOTH CUSTOM-BUILT!

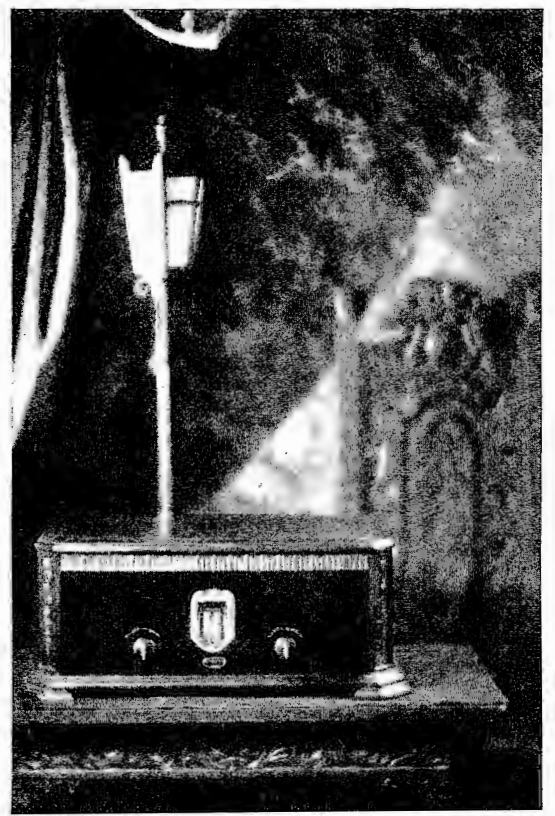

The Hi-Q Six—the newest advance in radio—four completely isolated tuned stages—Automatic Variable Coupling—symphonic amplification. This non-oscillating, super-sensitive receiver assures maximum, uniform amplification on all wave lengths and establishes a totally new standard of tonal quality.

Just as Antonio Stradivari gave the priceless CUSTOM-BUILT violin to musicians of his day, so does Hammarlund-Roberts offer music lovers of our day the CUSTOM-BUILT Radio—the advanced "Hi-Q Six" designed by ten of America's leading manufacturers—made with America's finest parts—incorporating every modern constructional feature—and built under your own eyes from plans so complete, so exacting and so clear-cut that the only outcome can be absolute radio perfection. The Hi-Q Six also offers equally unprecedented economy, for thus you save at least \$100.00 over the cost of fine factory-assembled sets. Complete parts including Foundation Unit chassis, panels and all wire and special hardware cost only \$98.50.

The Hi-Q Instruction Book tells the complete story with text, charts, diagrams and photos. Anyone can follow it and build this wonderful instrument. Get a copy from your dealer or write us direct. Price is 25 cents. Hammarlund-Roberts, Inc., 1182 Broadway, Dept. T, New York City.

Hammarlund
ROBERTS
Hi-Q SIX

Associate Manufacturers











H.F.L.

will continue to manufacture and distribute units for the Nine-In-Line Receiver. The same high standard of workmanship will be maintained. The same absolute guarantee will prevail. H. F. L. units, which operate with equal efficiency in the battery or A. C. operated receiver, represent the highest standard attainable at this time. In view of this fact no immediate change in our manufacturing policy is contemplated.

Concerning the Screened Grid Tube

This organization maintains a laboratory staff which is devoted to diligent and accurate research work. Any new development would necessarily have to show definite advantages over the present Nine-In-Line before its presentation would be justified. The receiver, in addition to being a good investment, would have to be thoroughly practical from the user's point of view. When such a design is realized then — but not until then — will H. F. L. make such an announcement.

HIGH FREQUENCY LABORATORIES
28C North Sheldon St., Chicago, Illinois

Gentlemen:

- Without obligation, please send complete information on the Nine-In-Line Receivers.
- Please place my name on your mailing list for advance information on H. F. L. Developments.

Name _____

Street _____

City _____

State _____

PLEASE PRINT PLAINLY



HIGH FREQUENCY LABORATORIES

28 North Sheldon Street, Chicago, Ill.

get!

Pure Direct Current



FOR YOUR ELIMINATOR

Bee Cee
Filter Condenser Compact

BROWN & CAINE



DEPENDABLE

THERE is a Bee Cee Filter Condenser Compact for use in every type of battery eliminator and power amplifier. Especially designed for its specific work, each Compact may be depended upon to render a pure, even, rectified current, with permanent capacity assured.

Because these units are the most delicate electrical devices used in radio, it is essential that you insist on Bee Cee quality.

Bee Cee Filter Condensers can be had in capacities from .1 MFD to 4. MFD for filter and by-pass work. Conservatively rated — and Halowax impregnated!

At your dealers, or write direct to
Dept. C B-3
2317 Calumet Avenue, Chicago

BEE CEE Filter Condenser COMPACTS

BROWN & CAINE INC.

BROWN & CAINE, Inc.
Chicago
Atlanta Cleveland Denver
Kansas City, Mo. Los Angeles Portland

ACME WIRE Makes Better Radio

Solid Celatsite Stranded Enamel Antenna Loop Antenna Battery Cable Spaghetti Tubing Parrot Condensers

FLEXIBLE CELATSITE

A cable of fine, tinned copper wires with non-inflammable Celatsite insulation. Ideal for sub-panel or point-to-point wiring. Strips easily, solders readily. Nine colors.

Sold only in 25-ft. coils in cartons colored to match contents.



Send for radio products folder... The Acme Wire Co., Dept. C, New Haven, Conn.

SPECIAL PRICES

World's Record Super Ten — Tyrman "70" — Nine in Line La Peer Nine — Arcturus Tubes

We can supply you with these parts at special prices. We BUILD any of the above sets or any circuits specified in the CITIZENS RADIO CALL BOOK.

Battery operated sets converted to AC operation.

NORTH SHORE RADIO LABORATORIES
6902 North Clark St. Assoc. I. R. E. Chicago, Ill.

I

n New York

stay at the

ABERDEEN HOTEL

17 West 32nd St., near 5th Ave.

Close to Pennsylvania Station—accessible to everything! Every modern hotel convenience and service.

Rooms with bath **\$2.50** ALWAYS available

JOHN F. DOWNEY, Managing Director

CARTER Adapter Harness

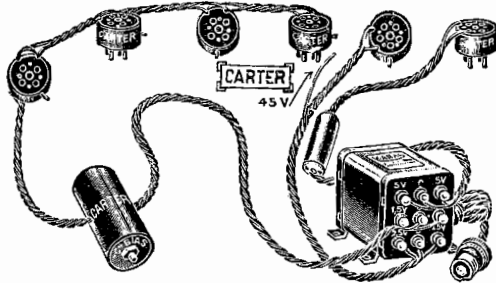

used with

KARAS "A-C-Former"

For converting your set to A.C. tube operation. No tools required; simply slip the adapters into present tube sockets, disconnect your A and C batteries; plug into light socket and you're ready to go.

No hum; no structural or wiring alterations; no C batteries. Can be done in 10 minutes. Send for illustrated folder.

Any dealer can supply

CARTER RADIO CO., CHICAGO

CONVERTS ANY SET TO AC!

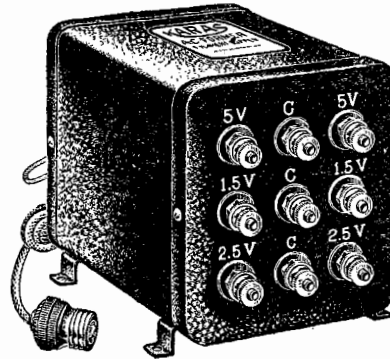

TYPE 12

Supplies filament potential for 12 tubes as follows: 8—1½ volt, type 226 or 326 tubes; 2—2½ volt, type 227 or 327 tubes, and 2—5 volt type 171

\$8.75

List Price

The Karas A-C-Former

END battery troubles and bring your set up-to-date with this new Karas achievement! Delivers correct voltage to the new AC tubes 226 and 227. Does not transmit excessive voltage fluctuations, insuring long life to your AC tubes. Needs no separate device for center tap. Has plug-in connection to "B" Eliminator and loop of wire for connection to panel switch. No re-wiring necessary. Operates with Carter, Eby, or other cable harness.

At Your Dealers or Write for Details to

KARAS ELECTRIC COMPANY

4026C North Rockwell St.

Chicago, Illinois

PROFESSIONAL SET BUILDERS

We heartily recommend the Tyrman "70" as described in our Radio DISCOUNT Catalog. We have tested this circuit in our own laboratories and find that its DX results are equal to the designer's claims. It has marvelous tone quality and selectivity.

Tyrman "70"

Shielded Grid Amplimax

Lowest Prices

We can ship this kit the same day your order is received. Write for our catalog which describes the Tyrman "70" and all other popular circuits and nationally advertised parts and accessories at surprisingly low prices.

WALTER ROWAN BATTERY SUPPLY CO.
225 North Peoria St. Dept. 208 Chicago, Illinois

The Big Friendly Radio House Complete Parts

Aero Radiophone Transmitter

WHEN you get our 1928 Catalog, you can have popular, nationally-advertised kits, parts, eliminators and accessories at prices that are real values.

Our dealer catalog, which lists everything in radio, means more real profit for you. Standard quality at the right price. Write for our big Catalog

WESTERN RADIO MFG. CO.

128 West Lake St. Dept. OM Chicago, Ill.

180 VOLT "B"

ONLY
\$12⁴⁵

For 110 Volt
50-60 Cy. A-C



Now—you can buy as good a "B" Eliminator as it is possible to build—at a price that won't cramp your purse. Now—you can enjoy the thrill of louder, clearer, better reception that a good "B" Eliminator affords. And you buy the PEERLESS without risk of any kind, for it is yours to try for 30 days and it is

GUARANTEED

2 YEARS This astounding offer is without precedent. Never before has such a value been offered. A "180" volt "B"—a "B" that will run your set and a type 171 power tube, too—and guaranteed for two long years—at the ridiculously low price of only \$12.45.

TUBE FREE

This is one of the first announcements of this new, super-powered, better quality guaranteed "B" Eliminator. The regular price is \$12.45 without the rectifying tube. But, as a special introductory offer to get thousands of these units out on sets, we will include, for a limited time only, a genuine \$4.50 Q. R. S. 35 Mill. Tube free with your order. Think of it! A 180 Volt "B"—a 2 year guarantee—the privilege of trying it 30 days at our risk—and a \$4.50 tube free—all for \$12.45. Mail coupon now.

PEERLESS MFG. CO.

3979 Cottage Grove Ave. Chicago, Ill.

1 DOWN TEST IT AT YOUR RISK
Send only \$1. A dollar bill will do. If it ships the price will be \$11.45 plus postage. Pay the express charges. Return small express charges. Return entirely at our risk. It is our risk if not satisfied. Your money back if not satisfied. —————
GUARANTEE COUPON
Peerless Mfg. Co., 3979 Cottage Grove Ave., Chicago, Ill. I enclose \$1. Send me one Peerless 180 volt "B" Eliminator and one \$4.50 Q. R. S. 35 Mill. Tube. I agree to pay express charges if refunded. I can have my money returned if not satisfied.
Name _____
Town _____
State _____

Tell 'Em You Saw It in the Citizens Radio Call Book Magazine

S Y D

**LIFE LONG
"B" BATTERY**

UNCONDITIONAL 2-YEAR GUARANTEE
It's Quality—Not Price—That Makes a Real Battery

Type B2
100 Volts
with a
Charger,
\$15.50



145 Volts
with a
Charger,
\$21.50

The SYD Battery pictured above is a storage "B" Battery made of Edison Elements, which have nickel and iron in their construction. The solution used is a preserver of nickel and iron, thereby giving the battery practically unlimited life.

SYD Batteries are built to give the user real value for every dollar he invests. Only the finest materials are used in their construction. Remember that the quality of the battery and not the price determines its worth. That's why SYD Batteries are preferred and used by thousands.

TESTED AND FOUND SATISFACTORY BY THE CHICAGO DAILY NEWS RADIO LABORATORY. ALSO BY POPULAR RADIO LABORATORIES, NEW YORK CITY

Manufactured and Sold Exclusively by
SYD STORAGE "B" BATTERY CO.
1464 South Wabash Ave., Chicago

MAIL ORDERS FILLED

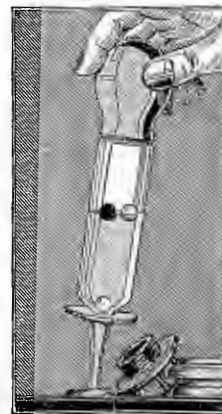

Follow the Lead of the Leaders

USE THE **SOS HYDROMETER**

The big battery manufacturers use the SOS (patented Chaslyn Balls) as standard equipment in Glass-Cased Batteries and Power Units.

Easier to Read

Nothing to Break

- Swim all three—charged fully.
- Sinks the white—charge still right.
- Sinks the green—charge is lean.
- Sinks the red—charge is dead.

Ask your dealer. If he can't supply, send 75c to us.

Chaslyn Corrosion Cure for Battery Terminals protects contacts. A large tube lists at 30c.

THE CHASLYN COMPANY
4607 Ravenswood Ave. Chicago, Ill.

ATTENTION—SET-BUILDERS AND DEALERS—

LET US FURNISH YOU FREE the most complete radio catalogue on the market today.

We can furnish parts specified in the **CITIZENS' RADIO CALL BOOK.**

We Carry the Following Lines—Also Many Others

Aero	Tyrman	Kingston	Hammarlund	Acusti-Cone	Kodel
Acro	Corbett	Victoreen	Perryman	Clarostat	Karas
Tobe	Bodine	Thordarson	Sterling	Benjamin	Marco
QRS	National	Centralab	Sangamo	Yaxley	Lynch
Eby	Jewell	Camfield	Silver Marshall	Samsom	Ramlar

EVERY SET BUILDER AND DEALER should have the NEW SIMPLEX RADIO CATALOGUE

THE SIMPLEX RADIO SUPPLY COMPANY
3319 Washington Blvd., St. Louis, Mo.
Wholesale Only

Free

100 PAGE CATALOG

FRITTS RADIO CABINETS

ARE MASTERPIECES IN SOLID WALNUT

Their leadership is maintained strictly on fine workmanship, character in design and lasting beauty.

STANDARD SUPER



SOLID WALNUT

The Standard Super model is the original Italian Chest Type in Motif—**SOLID WALNUT**, Four Post construction. Top and sides have raised panel effect. Decorations slightly Polychromed.

Our line includes also, Consolelets and Radio Tables. Descriptive leaflets and prices upon request.

D. H. FRITTS & COMPANY
604 Hearst Square, Dept. CB4 Chicago, Ill.



Rex Laboratories, Inc.

Announce

REX De Luxe 88—Shield Grid (Super)
REX De Luxe 66—Shield Grid (T.R.F.)
REX A. C. De Luxe—10 Tube Push-Pull (Super)

Write for Information—Diagrams—Discounts
341 THE ARCADE, CLEVELAND, OHIO



Pep up your set with a

WorkRite Cone Speaker

Greater volume—wider tone range—greater distance with this double magnet cone speaker, combine to give you greater pleasure from your radio set.

U. S. Electric Corporation
WorkRite Division
CLEVELAND OHIO

DEALERS—BIG DISCOUNTS

WHOLESALE RADIO SUPPLIES

SET BUILDERS

Make more money by getting into radio and electrical goods and do good business 12 months of the year. Our big catalog shows huge stocks of standard radio parts, sets, kits, and supplies at lowest rock-bottom wholesale prices. Includes A-C sets, parts for new A-C circuits, etc. Fast service. Guaranteed goods of leading makers. Thousands prefer our service. Wonderful special offers on sets, tubes, batteries. Get your free copy NOW before you buy another thing.

BARAWIK COMPANY
Dept. 813 Chicago, U.S.A.

\$2

Brings This

Amazing Discovery For Any Radio

SATISFACTION GUARANTEED

Get Distance

Why confine your radio programs to a few local stations when the expensive concerts, dance music and lectures of hundreds of big cities are ready for you? With every order for our treatise, "The Distance Getter," we include FREE our wonderful new Distance Transformer. Tune your set according to our special instructions and presto—note the distant stations roll in!

MAIL COUPON TODAY

Your money instantly refunded if you are not satisfied. The attachment furnished free with the "Distance Getter" alone is worth the price. "Results beyond all expectations. Cuts thru local stations like a knife." writes Galloway of Chicago, Ill. "Send three more for my friends. I get Denver and Calif. easily," says Homes, Palos, Ill.



HAZLETON LABORATORIES
4554 Malden St., Dept. X, Chicago, Ill.

Send me Distance Getter, postpaid. Enclosed find \$2.00 (M.O., stamps or check.)
Send C.O.D., plus small postage added.
Also send 100-page Radio Catalogue Free.

Name.....
Address.....
City..... State.....

OUR DRAFTING ROOM

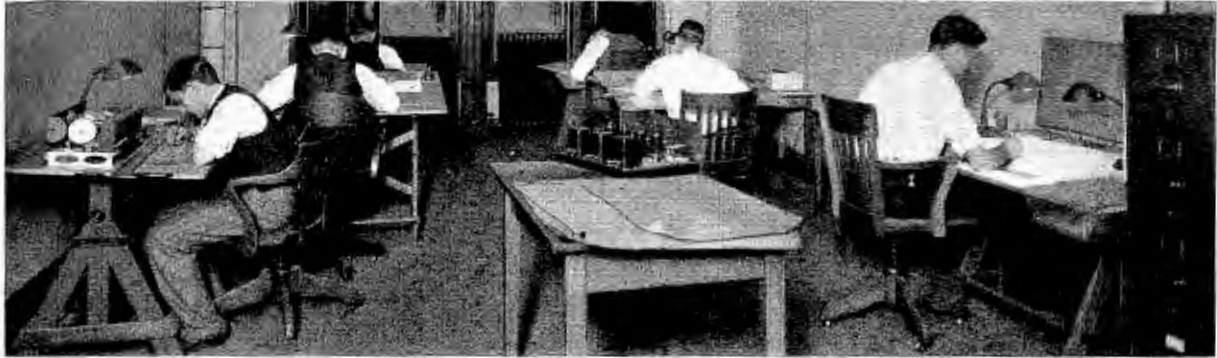

This staff of highly trained draftsmen is continually preparing the most accurate and complete full size blueprints of radio receivers and power packs obtainable.

Blue prints are available on all circuits described in the CALL BOOK. Each set of prints is composed of all the necessary drawings prepared in such complete detail and accuracy as to enable an inexperienced builder to duplicate in every respect the receivers built in our laboratory, thus assuring positive success and the greatest satisfaction.

Please Order Blue Prints by Number and Name

No. 4	Browning-Drake 5 Tube Receiver using National Impedaformers	1.40	No. 87	Improved Aero Dyne Six (5 drawings).....	1.50
No. 8	15 to 550 Meter Receiver	1.40	No. 89	The New Victoreen Universal Super-heterodyne.....	1.40
No. 12	Madison-Moore Super-heterodyne Receiver using 201-A Tubes	1.40	No. 91	Lincoln Quality Receiver (5 drawings).....	1.50
No. 13	Browning-Drake 5 Tube Receiver Using Acme Impedance Amplifier	1.40	No. 92	Improved Camfield Duoformer Seven (5 drawings).....	1.50
No. 14	Browning-Drake 4 Tube Receiver Using Audio Frequency Amplification	1.40	No. 93	Knickerbocker Four (5 drawings).....	1.50
No. 32	Scott "World's Record" Super Eight.....	1.40	No. 94	Silver-Marshall A. C. Shielded Six.....	1.25
No. 33	Bremer-Tully Power Six	1.40	No. 95	La Peer A. R. Nine (5 drawings).....	1.50
No. 37	Madison-Moore "One-Spot" Receiver	1.40	No. 97	Camfield Super Selective Ten (5 drawings).....	1.50
No. 44	Melo-Heald Super-heterodyne—11 Tube.....	1.40	No. 98	Madison Moore International One Spot and Power Pack Baseboard Job (6 drawings).....	1.50
No. 45	Shielded Localized Control Receiver.....	1.40	No. 99	Magnaformer 9-8 A. C. (5 drawings).....	1.50
No. 46	A 100 K. C. Super Using Air Core Transformers.....	1.40	No. 100	Tyrman Super Ten for "A" Elimination (5 drawings).....	1.50
No. 47	The "Phasatrol Five" (5 drawings).....	1.50	No. 105	Camfield Shielded Grid Seven (5 drawings).....	1.50
No. 48	The Citizens Super Eight.....	1.40	No. 106	R. G. S. Octa-Monic Receiver.....	1.15
No. 50	Camfield Super-Selective Nine "Revised" (5 drawings).....	1.50	No. 107	Bremer-Tully A. C. Power Six.....	1.40
No. 52	Improved Nine-in-Line Super Using 201-A Tubes (5 drawings).....	1.50	No. 109	Harkness Counterfonic 6-Tube Receiver.....	1.40
No. 53	Compact "B" Supply with Voltage Regulator Tube.....	1.40	No. 111	Tru-volt "B" Supply.....	1.40
No. 54	Self Modulated Oscillator.....	1.40	No. 112	Citizens Shielded 5 Receiver (5 drawings).....	1.50
No. 55	30 K. C. Super-heterodyne Receiver.....	1.40	No. 113	Unitone Symphonic 6-Tube Receiver (5 drawings).....	1.50
No. 56	Improved Browning-Drake	1.40	No. 115	Tyrman Amplimax "70" (Shielded Grid) 6 drawings.....	1.50
No. 58	"World's Record" Super Nine.....	1.40	No. 116	"New" Browning-Drake with Power Supply (8 drawings).....	1.80
No. 61	An Electrically Operated T. R. F. Receiver (Receiver only) (5 drawings).....	1.50	No. 117	Samson "B" Supply and Power Amplifier.....	1.30
No. 63	Portable "B" Eliminator Test Set (5 drawings).....	\$1.50	No. 118	Karas A. C. Equamatic (5 drawings).....	1.50
No. 64	Aero Seven Tube T. R. F. Receiver (5 drawings).....	1.50	No. 120	Early-Man Four	1.40
No. 66	QRS—ABC Unit used in conjunction with No. 61.....	1.40	No. 121	Bodine Electric Radio & Phonograph (8 drawings).....	1.80
No. 68	Improved Remler 45 K. C. Super-heterodyne Receiver (5 drawings).....	1.50	No. 122	Phasatrol DeLuxe 7-Tube T.R.F. Receiver (5 drawings).....	1.50
No. 70	Improved Nine-in-Line (5 drawings).....	1.50	No. 123	World's Record Super Ten & Power Pack (6 drawings).....	1.60
No. 71	"Hot Spot" Fourteen.....	1.40	No. 124	Hammarlund-Roberts Hi-Q Six.....	1.40
No. 72	Raytheon ABC Unit.....	1.40	No. 125	Silver-Marshall Universal & Power Pack (7 drawings).....	1.70
No. 73	Magnaformer Super-heterodyne Receiver (5 drawings).....	1.50	No. 126	St. James Twin Four.....	1.40
No. 74	Eight-in-Line Super-heterodyne Receiver.....	1.25	No. 129	Remler A. C. Super & Power Supply (9 drawings).....	1.90
No. 76	Tyrman Ten (5 drawings).....	1.50	*No. 133	Vacuum Tube Voltmeter.....	1.40
No. 79	Silver-Marshall High Amplification Super-heterodyne Receiver (5 drawings).....	1.50	*No. 137	Citizens-Birnback A. C. 4-Tube Receiver (5 drawings).....	1.50
No. 81	1928 Infradyne	1.25	*No. 138	Aero Radio-Phone Transmitter.....	1.40
No. 82	Thompson Super-heterodyne Receiver (5 drawings).....	1.50	*No. 145	Victoreen A. C. Super & Power Pack (5 drawings).....	1.50
No. 83	"Best Lincoln" Super-heterodyne Receiver.....	1.40	*No. 147	Custom-built Model Madison-Moore International One-Spot A. C.—Sub-panel Job (6 drawings).....	1.60
No. 84	Two Control Equamatic Receiver (5 drawings).....	1.50	*No. 151	Ultradyne A. C. Commander & Power Pack (5 drawings).....	1.50
No. 85	Citizens Super Nine (5 drawings).....	1.50	*No. 153	Citizens Shield Grid Short-Wave Receiver.....	1.50
No. 86	Thordarson Power Amplifier (5 drawings).....	1.40	*No. 159	Hagerman 210 A. C. Six Receiver (6 drawings).....	1.60

Full Size Graphic Wiring Diagrams

No. 20	Silver-Marshall Improved 7 Tube Super-heterodyne Receiver	\$0.60	No. 119	A-B-C Eliminator for D. C.....	\$0.60
No. 21	All American 5 Tube Toroid Receiver.....	.60	No. 127	Silver-Marshall Shield Grid Six.....	.60
No. 26	4 Tube Non-Radiating Receiver using Audio Frequency Amplification60	No. 134	Nine-in-Line A. C. Operated.....	.60
No. 38	Premier 6 Tube T. R. F. Receiver.....	.60	*No. 135	Electric Phonograph Power Pack.....	.60
No. 39	Unicontrol Nine-in-Line Super-heterodyne Receiver.....	.60	*No. 136	Citizens Crystal Receiver.....	.60
No. 40	Inexpensive 5 Tube T. R. F. Receiver.....	.60	*No. 139	Silver-Marshall Shield Grid Super.....	.60
No. 65	National Browning-Drake with Power Amplifier.....	.60	*No. 140	Citizens Radio Frequency Amplifier.....	.60
No. 77	St. James Semi-Portable Receiver.....	.60	*No. 144	AmerTran Power Pack.....	.60
No. 78	Silver-Marshall Unipac60	*No. 146	Citizens 115 K.C. Shield Grid Super.....	.60
No. 88	Two-Tube Browning Drake with Power Supply.....	.60	*No. 149	Harkness A. C. Counterfonic 6-Tube Receiver & Power Pack.....	.60
No. 101	World's Record Economy Super 8.....	.60	*No. 150	Samson Push-Pull Amplifier & Power Supply.....	.60
No. 108	Aero A. C. Seven T.R.F. Receiver.....	.60	*No. 154	Silver-Marshall 4-Tube Shield Grid Receiver.....	.60
No. 110	Lynch-Amsco 5-Tube Receiver.....	.60	*No. 155	Thordarson Shield Grid Power Amplifier.....	.60
No. 114	Lynch-Hammarlund 5-Tube Receiver.....	.60	*No. 156	Hot-Spot Fourteen Using a Shield Grid Tube.....	.60

*Circuits described in present issue.

Any of the above blue prints will be sent postpaid by return mail upon receipt of the proper amount or they can be obtained from any of the Radio jobbers advertising in this publication. C. O. D. orders not accepted.

CITIZENS RADIO SERVICE BUREAU

508 So. Dearborn Street

7th Floor

Chicago, Illinois



**Are You Hungry For...
Adventure...
Popularity...
Big Pay?**



**THEN CHOOSE
AVIATION!**

Think what Aviation offers you. Thrills such as you never had before! The praise and plaudits of the multitude. And a chance to get in on the ground floor where rewards will be unlimited!

Easy to Become An Aviation Expert!

ARE YOU a red-blooded, daring he-man? Are you eager for a life of constant thrills, constant excitement and fascinating events? Do you crave adventure, popularity, admiration, and the applause of great crowds? Then why not get into the Aviation Industry—the greatest adventure since time began—the greatest thrill ever offered to man?

Aviation is growing so swiftly that one can hardly keep track of all the astonishing new developments. Air-mail routes have just been extended to form a vast aerial network over the entire U. S. Airlines and airplane factories are springing up all over the country. Men like Henry Ford are investing millions in the future of commercial

Aeronautics in America! The possibilities are so tremendous that they stagger imagination!

Big Future For Young Men

Everything is set for the greatest boom in history. The fortunes that came out of the automobile industry and out of motion pictures will be nothing compared to the fortunes that will come out of aviation! There is just one thing holding it up—lack of trained men! Even in the beginning thousands will be needed—and generously paid. The opportunities open to them cannot be overestimated. Those who qualify quickly will find themselves on

the road to undreamed of money — success — popularity — and prominence!

Get into this thrilling profession at once while the field is new and uncrowded. Now—by a unique new plan—you can quickly secure the basic training for one of these wonderful high salaried jobs, at home, in spare time. Experts will teach you the secrets—give you all the inside facts that are essential to your success. And the study of Aviation

is almost as fascinating as the actual work itself. Every lesson is chock-full of interest—and so absorbing that you actually forget you are studying. But best of all are the ultimate rewards you are fitting yourself to gain!

Send for FREE Book

Send the coupon for our new, free book, just out—*Opportunities in the Airplane Industry*. It is vitally interesting, reads like a romance and tells you things about this astonishing profession you never even dreamed of. We offer a limited number of copies FREE. Write for yours today.

- PICK YOUR JOB!**
- Flying
 - Airplane Instructor
 - Airplane Engineer
 - Airplane Repairman
 - Airplane Assembler
 - Airplane Mechanician
 - Airplane Inspector
 - Airplane Builder
 - Airplane Salesman
 - Exhibition Manager
 - Airplane Contractor
 - Airplane Motor Expert
 - Airplane Designer



**AMERICAN
SCHOOL
OF AVIATION**
Dept. 5083
3601 Michigan Ave.
Chicago, Ill.

American School of Aviation
Dept. 5083, 3601 Michigan Ave.
Chicago, Ill.

Without obligation please send me FREE book, *Opportunities in the Airplane Industry*. Also information about your Home Study Course in Practical Aviation.

Name Age

Address

City State

Tell 'Em You Saw It in the Citizens Radio Call Book Magazine

Announcing the TABLE TYPE CLAROSTAT

And now you can have micro-metric resistance in the form of a convenient accessory. No need for extensive changes. No need for tools. No need spending time and effort. Just connect TABLE TYPE CLAROSTAT in circuit by means of handy connection cords and connection block, and you have micro-metric resistance at work improving your radio result.

Imagine controlling loud-speaker volume with knob at your finger tips. Instantly you can fit radio to the occasion, from soft incidental music for background of conversation, to full volume when the program changes to a speech or other feature of prime interest. And that is but one of many applications covered in booklet "Radio Etiquette," which is yours for the asking.

The TABLE TYPE CLAROSTAT is a handsome addition to any set. Finished in stately bronze and nickel, with attractive bakelite knob. Bottom provided with felt to protect surface of fine furniture. Two connection cords and tip connection block permit of insertion in any circuit, or through connection to loudspeaker. Ample resistance range. Sufficient current-handling capacity. Resistance range covered in several turns of knob. Noiseless. Holds resistance setting. Foolproof. Durable. In brief, a genuine Clarostat in a new dress.

There's a CLAROSTAT for every resistor purpose.

The Standard Clarostat for controlling voltage taps in the usual B-power unit, electrified receiver, and power amplifier. Also extreme resistance range in reception. (20 watt rating.)

Ask your dealer to show you the new Table Type Clarostat, as well as the Volume Control, Standard and Power Types. And don't hesitate to ask for descriptive and practical literature, either from him or from us.

You can make no better investment in radio than the \$2.50 you invest in the TABLE TYPE CLAROSTAT.

The Volume Control Clarostat for controlling volume, tone, plate voltage, oscillation, stabilization and other functions in radio receivers. (7 watt rating.)

The Power Clarostat, the giant variable resistor, for handling resistance problems usually considered the exclusive field of wire-wound units, particularly in the electrified receiver, A-B-C power unit, power amplifier, and for fine-voltage control. (40 watt rating.)

AMERICAN MECHANICAL LABORATORIES, Inc.

Specialists in Variable Resistors

285-7 North 6th St. Brooklyn, N. Y.



Beautiful, Durable CELORON PANELS for These Popular Kits

Citizens 115 K.C. Super:	
The Tyrman Ten:	
Front Panel.....each \$6.70	Sub-Panel.....each \$5.40
The Tyrman Seventy:	
Front Panel.....each \$6.00	Sub-Panel.....each \$5.40
Melo-Heald Super-heterodyne:	
Front Panel.....each \$6.00	Sub-Panel.....each \$3.36
The "Hot-Spot" Melo-Heald Fourteen:	
Front Panel.....each \$7.20	Sub-Panel.....each \$6.02
Aero Seven Tube T.R.F.:	
Front Panel.....each \$6.10	Sub-Panel.....each \$5.20
B-T Power Six:	
Front Panel.....each \$5.72	
St. James Upright Eight Super-heterodyne:	
Sub-Panels (2).....Per set of 2.....	\$6.00
Karas Equumatic—2 Dial:	
Front Panel.....each \$5.50	Sub-Panel.....each \$6.00
"World's Record" Super Ten:	
Front Panel.....each \$6.30	Sub-Panel.....each \$6.80
Magnaformer Super-heterodyne:	
Front Panel.....each \$6.40	Sub-Panel.....each \$6.50
Victoreen Super-heterodyne:	
Front Panel.....each \$5.64	
Victoreen Universal Super-heterodyne, Single Dial:	
Front Panel.....each \$5.80	
H.F.L. Nine-in-Line, Model 23:	
Front Panel.....each \$6.20	Sub-Panel.....each \$5.70
Knickerbocker 4:	
Front Panel.....each \$3.00	Sub-Panel.....each \$3.90
Thompson Super 7:	
Front Panel.....each \$5.24	Sub-Panel.....each \$4.58
Thordanson Power Amplifier:	
Front Panel.....each \$0.00	Sub-Panel.....each \$0.00
Camfield Super Selective 10:	
Front Panel.....each \$6.90	Sub-Panel.....each \$8.06
Camfield Seven:	
Front Panel.....each \$7.92	Sub-Panel.....each \$6.58
Citizens Super 11:	
Front Panel.....each \$5.80	Sub-Panel.....each \$6.28
Popular Mechanics:	
Front Panel.....each \$4.46	Sub-Panel.....each \$4.92
Sub-Panel with Am. Radio Hardware Sockets Mounted.....each	\$5.50

If Your Dealer Can't Supply You Order from THE CELORON CO., Bridgeport, Pa.

Beautiful—Efficient

The Console FIAT Type C Loop combines compactness of winding with the highest degree of sensitiveness and directional efficiency because of the FIAT exclusive Bank winding method. Constructed of a solid American black walnut frame with metal parts of rose gold, it is the perfectly efficient and graceful Loop desired by every set owner.

Specified for Nine-in-Line, Magnaformer 9-8, St. James and Many Other Famous Supers.

Patented Oct. 27, 1925—No. 1559193, March 1st, 1927—Design No. 72115. Others Pending

ARTISTIC WOOD TURNING WORKS
517 North Halsted St. Chicago, Ill.



BANK FIAT WOUND LOOP

.0005 Mfd.
.00035 Mfd.
Price \$12.50
Each

Greater Volume and Distance with any T. R. F. Set

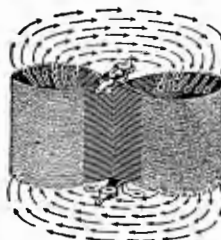

BODINE TWIN-EIGHT COILS give tremendous volume and distance to any T. R. F. set, because their unique design concentrates the magnetic field within the coil. This also prevents intercoupling between coils and eliminates undesirable feedbacks.

Radio fans and set builders everywhere are enthusiastic over the results obtained with these coils. Equip your T. R. F. set with Bodine Twin-Eight Coils for maximum selectivity. Mail the coupon for details and wiring diagrams using these coils.

Bodine Twin-Eight Coils, each...\$2.00

An Attractive and Efficient Loop

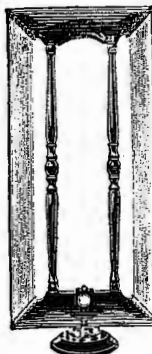

The Bodine DeLuxe Loop is a marvel of beauty, compactness, and efficiency. The beautiful, hand-rubbed solid walnut frame harmonizes with the finest furniture, and does not appear awkward when mounted on top of the set.

Its remarkable efficiency and directional characteristics add greatly to the selectivity of your set, and make tuning in congested areas easy.

The exclusive plug and jack-mounting eliminates trailing connecting wires. The jack may be mounted directly in the cabinet of the set if desired.

Model L-500, for .0005 condensers \$12.00
Model L-350, for .00035 condensers \$12.00

MAIL THIS COUPON
Bodine Electric Co., 2256 W. Ohio St., Chicago, Ill.
Please send complete information on Bodine Coils and DeLuxe Loop. Also latest wiring diagrams of Bodine Coils.
Name.....
Address.....
City.....
State.....

With the New SHIELD-GRID TUBES Use BRAXTON-KING Impedance Units

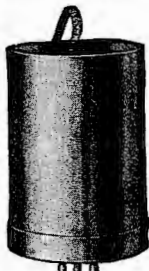

Plug-in Shielded R. F.

Impedance Units

Packed in sets of three, laboratory matched at 350 KC. Braxton-King Impedances and Shield-Grid tubes produce, in the new B-K Shielded Grid Seven, a remarkable combination of tremendous volume with undistorted tone.

Write for catalog sheets, circuit diagrams and prices

OTHER B-K PRODUCTS

King Coils for 1-dial Browning Drake, list.....	\$6.00
Braxton-King Plug-in Intermediate Tr.....	4.50
Braxton-King Plug-in Oscillator Coil.....	2.00
Braxton-King Shielded R. F. Coils.....	2.50

Fits any UX Socket
Price \$7.50 each

Mississippi Valley Radio Co.
914 Pine Street, St. Louis, Mo.

Tell 'Em You Saw It in the Citizens Radio Call Book Magazine

Delta Handi Shop

*Now do it Quicker, Easier, Better with
this New Sturdy and Powerful Unit*

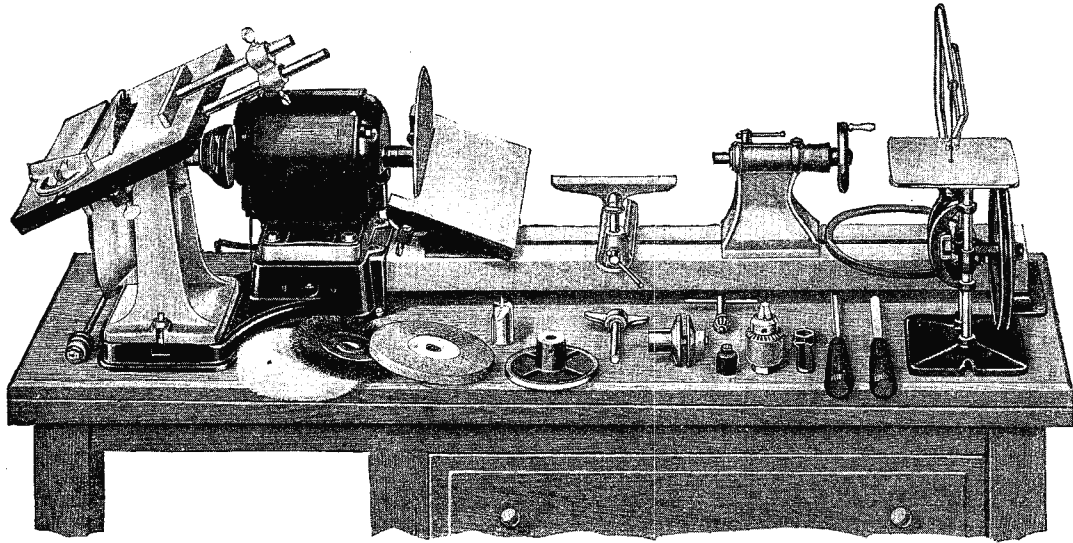

No Continuous Breaking up Operations

THERE are many superior points of design incorporated in the DELTA HANDI SHOP. Features that are very valuable and necessary to produce work on a really practical and efficient basis. For instance—there are always **TWO TOOLS** ready for work and driven by the powerful, quiet-running **TWO SHAFT MOTOR**. This enables you to cut your work on the Circular Saw, and then immediately sand it on the sanding attachment. Or you may have a turning job set up in the lathe, and want to sharpen a tool. Do you have to break up the operation? Certainly not, simply attach a small emery wheel to the Circular Saw arbor. $\frac{3}{8}$ " capacity JACOBS chuck fits on motor, tailstock or saw arbor without overhang. Note the novel arrangement of the circular saw which is practically used 80% of the time. There is no interference as length of work to be cut is limited only by ceiling, floor and walls. This saw is entirely different from any other on the market and is a distinct DELTA achievement. Table tilts 45 degrees without first removing Dado insert. Miter gauge and novel rip gauge, also four extension bars and support bar (not shown) enable you to do a wide range of difficult work. You may use 5" diameter Dado heads for grooving. Automatic oiling system is good for one hundred hours continuous running. There are many more superior features, but lack of space does not permit full description. Briefly, the DELTA HANDI SHOP consists of the following:

LATHE—Two models 9x24 and 9x36 between centers. Heavy lathe bed (U-section) will positively not chatter or spring. Ball bearing tailstock, wide and narrow tool rests and base, 4" face plate, spur center, cup center, thrust bearing, adapter flange, emery wheel, buffing wheel and wire brush all 6" dia. all oversize. $\frac{3}{8}$ " capacity JACOBS chuck with gear wrench, two turning tools and wrenches.

SANDER—8½" diameter Aluminum disc takes standard sheet of sand paper. Table of original DELTA design 5"x12" tilts 45 degrees down and 15 degrees up.

SCROLL SAW—The new AMERICAN GIANT heavy duty saw for production. Distance from blade to rear of frame 12". Cuts 1½" thick wood easily, quickly. Also metal fibre, Bakelite, Bone, Celluloid, etc. Large table tilts 45 degrees to left, 15 degrees to the right. Same patented design as our smaller model. Saw blade always guided right under table.

MOTOR—Special design two shaft construction. (A very important feature.) ¼ H.P. with 100% overload capacity. Quiet running, fully enclosed to keep out dust, with cord, plug and ground wire and clamp. You can easily see the immense size of this shop by noting that the unit is ready to operate and is mounted on a baseboard 14"x48", or 14"x60". Weight net 120 lb. or 135 lb.

CIRCULAR SAW—6" blade rips and cross cuts, runs about 4000 RPM. Does not slow down under load. Table tilts also raises or lowers without first removing Dado insert. 5" Dado heads can be used for grooving. No interference, no continuous breaking up of operations. Automatic oiling. Arbor extended to mount other attachments. Miter gauge and novel design, rip gauge with 4 extension rods and support bar (not shown), make difficult work possible. No other saw like it. No changing of pulleys and plenty of power to spare. Users enthusiastic in their praise.

LACK OF SPACE DOES NOT PERMIT FULL DESCRIPTION

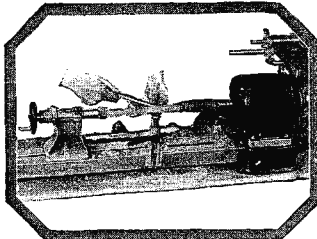
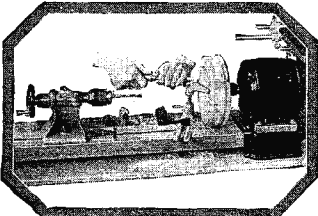
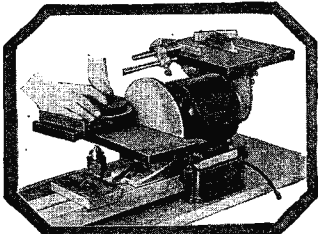
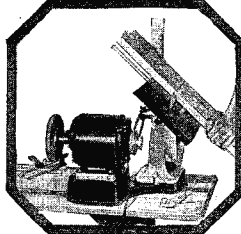
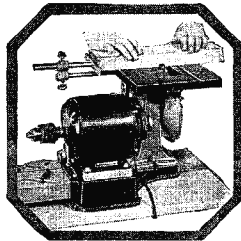

SEND COUPON NOW! IT WILL BRING YOU INTERESTING LITERATURE!

DELTA SPECIALTY CO. (Dept. R.C. 328)
858 3rd St., Milwaukee, Wis.

Send me your illustrated color folder describing Delta HandiShop. Tell me about your Free Trial Offer, Free blue prints and Easy Payment Plan.

Name.....

Street Address.....

City.....State.....

YAXLEY

APPROVED RADIO PRODUCTS

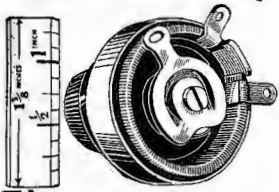

Junior Rheostat

A Junior Rheostat made to a standard. The most rugged and dependable design and material. Large radiating surface. Smooth operation. Furnished in all sizes in both rheostat and potentiometer.

Rheostats75c each
 Potentiometers to 400 ohms.....\$1.00 each
 Switches, furnished separately, fit all Yaxley Junior Rheostats or Potentiometers.....40c each

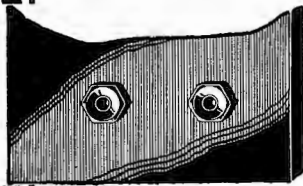

Phone Tip Jacks

These Phone Tip Jacks have Bakelite Heads—one in red and one in black to distinguish between plus and minus.

Phone tip sinks all the way in. Does away with danger of shocks.
 Per pair.....25c

At Your Dealer's

YAXLEY MFG. COMPANY
 Dept. C, 9 So. Clinton St.
 Chicago, Ill.

JENSEN DYNAMIC SPEAKER

The Finest in Radio



Cabinet Design of Models D-44, D-45 D-44 A.C.

A PERFECT POWER SPEAKER

The Jensen Dynamic Speaker responds with the same beautiful fidelity whether connected to the output of a 112 tube or the full undistorted output of a 210 push-pull amplifier.

A demonstration of the Jensen Dynamic Speaker will reveal to you a quality of reproduction heretofore considered unattainable.

CABINET MODELS		SPEAKER UNITS	
Model D-44.....	\$65.00	For Radio or Phonograph Consoles	
with 6-volt field, .4 amp.		Model D-4 (unit only).....	\$47.50
Model D-45.....	\$67.50	with 6-volt field, .4 amp.	
with 90-volt field, 40 millamp.		Model D-3 (unit only).....	\$50.00
Model D-44 A.C.....	\$75.00	with 90-volt field, 40 millamp.	
for 110-volt A.C. operation		Model D-4 A.C. (unit only) \$67.50	
		for 110-volt A.C. operation	

Literature on request

JENSEN RADIO MANUFACTURING COMPANY
 1136 Pure Oil Bldg., Chicago, Ill. 212 9th St., Oakland, Calif.
 Manufactured under Magnavox Patents

ANOTHER SPECIAL OFFER!

RCA Uni-Rectron Power Amplifiers Model AP-935

As the Uni-Rectron stands it is a super power amplifier, which can be used in connection with any radio set and loud speaker. Binding posts are provided for input to the Uni-Rectron and output to the speaker. Requires no batteries for its operation. It obtains its power from the 110 volt, 60 cycle alternating current lighting circuit of your house.

The UX-210 super power amplifying tube and the UX-216B or 281 rectifying tube are used with this amplifier, which cannot overload. From the faintest whisper to the loudest crash of sound—R.C.A. Uni-Rectron amplifies each note at its true value. High and low notes are all treated alike. The volume and quality delivered will be a revelation. Every one new and packed in original factory carton.

List Price \$88.50 (without tubes)

Special at \$19.75 ea.

AMERICAN SALES CO., 19-21 Warren St., N.Y.C.



Superior in Material and Design Insuring Durability and Dependability

Short circuits impossible—No pull strain on soldered connections

Plug and Socket-Molded Bakelite



This Plug Is Specified in the Custom Built Model Madison-Moore International One Spot Citizens' 115 K.C. Receiver Citizens' Short Wave Shielded Grid Receiver

PRICES	7 Contact	10 Contact
Plug and Cable Only.....	\$2.25 <input type="checkbox"/>	\$3.25 <input type="checkbox"/>
Double Plug Cable.....	3.25 <input type="checkbox"/>	4.75 <input type="checkbox"/>
Panel Socket (above).....	.50 <input type="checkbox"/>	1.00 <input type="checkbox"/>
Bracket Socket.....	.75 <input type="checkbox"/>	1.25 <input type="checkbox"/>

EUGENE A. HAGEL, 1035 E. 76th STREET, CHICAGO

Please send descriptive circular.

I enclose.....Amount.....

for which send, postpaid, items checked.

Name.....

Address.....

City.....State.....

The Big Friendly Radio House Complete Parts

Tyrman "70"

Shielded Grid Amplimax

WHEN you get our 1928 Catalog, you can have popular, nationally-advertised kits, parts, eliminators and accessories at prices that are real values.

Our dealer catalog, which lists everything in radio, means more real profit for you. Standard quality at the right price.

Write for our big Catalog

WESTERN RADIO MFG. CO.
 128 West Lake St. Dept. OM Chicago, Ill.

Tell 'Em You Saw It in the Citizens Radio Call Book Magazine

Do Unseen Hands Keep You Dumb.. *When You Ought to Talk?*



How often have you wanted to talk, but held back, silent, because you felt unequal to the other people present? How many times have you passed up, or avoided the chance to talk in public—before your business associates, your club or lodge, because of your fear of stage fright? Are you afraid of your own voice—instead of being able to use it as one of the greatest business and social assets in your possession? And yet you might be surprised to hear that many of the most brilliant public speakers we have today felt exactly this way—before they learned how to develop their "hidden knack" of powerful speech—a knack which authorities say seven men out of every ten actually possess. And the chances are that you, too, have in you the power of effective speech—which, if unloosed, would be almost priceless to you in a social or business way. Find out if you have this natural gift—read every word of the message below.

Discover These Easy Secrets of Effective Speech

PROBABLY you have never pictured yourself being able to sweep a giant audience off its feet—to win the applause of thousands. Yet the men who are doing such things know that it is all astonishingly easy once you are in possession of the simple rules of effective speech. Before you learn these secrets you may be appalled at the thought of even addressing a small audience. Still it all seems so ridiculously easy when you know how to banish stage fright, and exactly what to do and say to hold an audience of one or a thousand in the palm of your hand.

Yet what a change is brought about when a man learns to dominate others by the power of effective speech! Usually it means a quick increase in earnings. It means social popularity. You yourself know how the men who are interesting talkers seem to attract whomever they wish and name their own friends—men and women alike.

There is no magic, no trick, no mystery about becoming a powerful and convincing speaker—a brilliant, easy, fluent conversationalist. One of America's eminent specialists in effective speech has developed a method that has al-

ready raised thousands from mediocre, narrow ruts to positions of greater prestige and wider influence. This new method is so delightfully simple and easy that by spending 20 minutes a day in the privacy of your own home, you cannot fail to make rapid progress.

How you can use this method, how you can banish stage fright, self-consciousness and bashfulness, quickly shaping yourself into an outstanding influential speaker, is told in an interesting book, *How to Work Wonders With Words*. Not only men who have made millions, but thousands of others have sent for this book and highly praise it. You can

receive a copy absolutely free by simply mailing the coupon below. Act now to discover your priceless "hidden knack"—the natural gift within you. Fill out and mail the coupon at once.

What 20 Minutes a Day Will Show You

- How to address business meetings.
- How to propose and respond to toasts.
- How to make a political speech.
- How to tell entertaining stories.
- How to write better letters.
- How to enlarge your vocabulary.
- How to develop self-confidence.
- How to acquire a winning personality.
- How to strengthen your will-power.
- How to be the master of any situation.

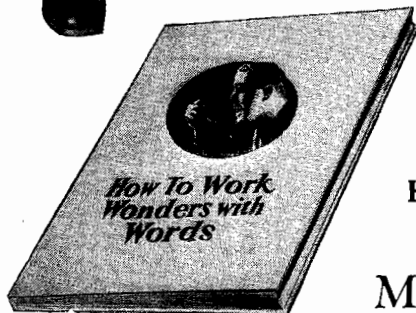

FREE

How to Work Wonders
With Words

Mail Coupon Today

NORTH AMERICAN INSTITUTE

Dept. 5083

3601 Michigan Ave., Chicago, Ill.

NORTH AMERICAN INSTITUTE
3601 Michigan Ave., Dept. 5083
Chicago, Illinois

Please send me free, without obligation, a copy of your inspiring book... *How to Work Wonders With Words*, and full information regarding your course in Effective Speaking.

Name.....

Address.....

City..... State.....

Tell 'Em You Saw It in the Citizens Radio Call Book Magazine

Samson "Pam" Amplifier

Type PAM 16 is for all ordinary types of loud speakers

Tubes required
 1—UX281
 1—UY227
 2—UX210

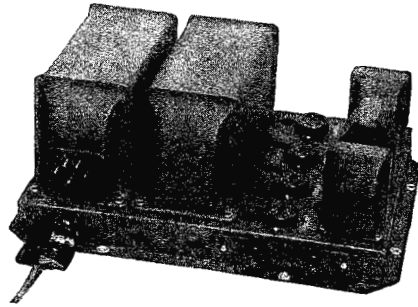

Type PAM 17 is for and supplies field current to dynamic type speakers

Type PAM 16 or 17, List Price \$125.00 for 110 Volt, 50-60 Cycle A. C.

A compact, self-contained, rugged, all electric, two stage audio amplifier for radio console or table. Designed to meet Underwriters' and A.I.E.E. standards. Compensation is made for line voltage variation. Approximate undistorted power output 7 watts.

Due to the high standard of parts used in its manufacture, the question of service ends with its installation. Jobbers and dealers should have them in stock.

With the use of superlatives in radio advertising all too prevalent the best guarantee of excellence in performance is the fact that Samson products have been standard in the quality field since 1882.



General Offices: Canton, Mass.

MANUFACTURERS SINCE 1882

Factories: Canton and Watertown, Mass.

The Big Friendly Radio House Complete Parts **Victoreen A. C. Super**

WHEN you get our 1938 Catalog, you can have popular, nationally-advertised kits, parts, eliminators and accessories at prices that are real values.

Our dealer catalog, which lists everything in radio, means more real profit for you. Standard quality at the right price.

Write for our big Catalog

WESTERN RADIO MFG. CO.

128 West Lake St. Dept. OM Chicago, Ill.

Ohmite VITREOUS ENAMELED RESISTANCES

ALL SIZES—ALL TYPES

OHMITE MFG. CO., 212 W. Ontario St., Chicago, Ill.

Build the LATEST Radio Creation. It has been tried and tested in our own laboratories with such startling results that we are glad to endorse the



Write for our catalog today for full details of this extraordinary receiver and all other popular kits.

CHICAGO RADIO APPARATUS CO.

415 South Dearborn Street Chicago, Illinois

Shielded Grid Tubes

Have provided astonishing results for numerous radio fans. Their superior quality has been demonstrated in the newly designed

Tyrman "70" Shielded Grid Amplimax

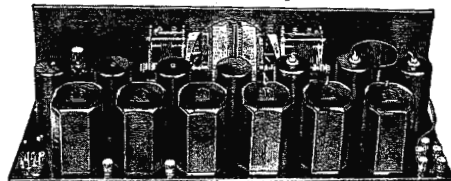

Hundreds

of Set Builders who purchased complete parts for the Tyrman "70" from us are astounded at the excellent tone quality and consistent DX programs this receiver brings in.

Send in your order today for parts, just as described in this issue. We GUARANTEE complete satisfaction or your money cheerfully refunded.

TRI-PAR RADIO COMPANY

110 North Wells Street

Chicago, Illinois

— MAIL TODAY —

TRI-PAR RADIO CO., 110 N. Wells St., Chicago, Ill. Enclosed please find \$....., for which send complete parts for the Tyrman "70."

Send literature and prices for Tyrman "70" (mention set you are most interested in).

Name.....

Address.....

City..... State.....

Tell 'Em You Saw It in the Citizens Radio Call Book Magazine

\$10.98 While They Last

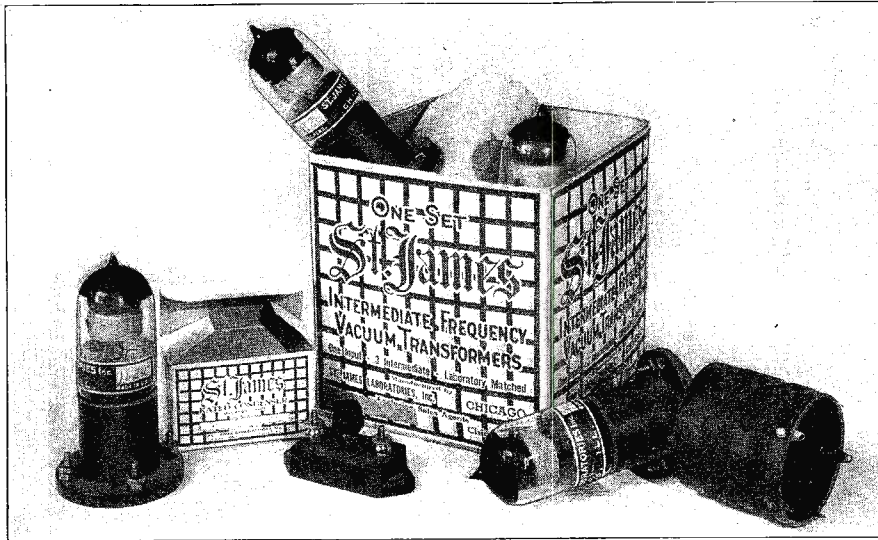

A REAL BARGAIN

THIS kit contains one complete set of St. James (*matched*) intermediate transformers (\$34.00 value); one oscillator coupler (\$2.50 value); one St. James rated variable condenser (\$1.75 value) and one complete set of blue prints (\$1.50 value). A total value of \$39.75 for only \$10.98.

The St. James intermediate frequency vacuum transformer needs no introduction to readers of this magazine. It will not change under any climatic conditions and each set is peaked on laboratory instruments at 280 kilocycles. Internal connections silver soldered. Coils mounted on glass rod. Windings use double silk covered wire. Evacuated to .001 m.m. Packed neatly in separate carton containing one input and three intermediate laboratory matched transformers.

The oscillator coupler is wound on bakelite tubing and is especially designed for this circuit.

One St. James adjustable type condenser is supplied having a range from 200 to 900

MACK-LABORATORIES

Superior and Cass Streets
CHICAGO ILLINOIS

M.M.F. This condenser is housed in a bakelite case easily mounted on the baseboard.

A complete set of blue prints is furnished, drawn to full scale, including panel layout, baseboard layout, schematic and pictorial wiring diagrams.

Thousands have built this famous circuit and have written in glowing testimonials as to its performance.

We have only a limited number of these kits on hand, so mail in the coupon below for this big offer

Cash—Money Order—Check. No stamps accepted

COUPON

MACK LABORATORIES

Superior and Cass Streets, Chicago, Ill.

Here is my \$10.98, for which send me postpaid one complete set of St. James transformers as described above. It is understood if all the kits are sold that my money will be refunded.

Name.....

Street.....

City..... State.....

Tell 'Em You Saw It in the Citizens Radio Call Book Magazine

QUALI-TONE



Price \$10.00

Specified Exclusively for the Madison Moore Receiver
(Described in this issue)

And for all leading circuits using .0005 condensers, including the Magnaformer, St. James, World's Record Super 9, Melo Heald, LaPeer and Lincoln.

Qualitone and DeLuxe loops are praised and endorsed by all leading radio engineers, designers and editors for their many superior features.



Holds World Records for DX Reception

DURO METAL PRODUCTS COMPANY
2649 North Kildare Avenue
Chicago, Illinois

DELUXE



Price \$12.50

Improve the selectivity, distance, tone and appearance of your receiver with a Qualitone or DeLuxe loop. On display at all reliable dealers.

Tyrman "70"

Shielded Grid Amplimax



The Tyrman "70," after many months of comparative tests, has proved itself to be far superior in Selectivity, Sensitivity, DX Reception and Volume.

It is in our opinion the finest radio receiver on the market today, embodying as it does, every up-to-date principle that can lend any improvement to radio reception. It is distinctly a Quality Receiver.

Rush Delivery Service on the Following Kits and Parts

- | | |
|-------------------------------|---------------------|
| Silver Marshall Shielded Grid | Karas Equamatic |
| Magnaformer 9-8 | Thordarson Products |
| Victoreen A. C. and D. C. | National Products |
| Remler 8 | Samson Products |
| Lincoln 9 | |

Write us today for further information on the Tyrman "70" and your new 1928 Radio catalogue free of charge.

The M. & M. Co.

500 Prospect Avenue Cleveland, Ohio
22 East Front St., Youngstown, Ohio; 131 East Market Street, Akron, Ohio

Dealers and Set Builders!

Let our new wholesale department serve you. Complete parts for all the latest circuits as described in this issue of the Call Book. Send for free catalog.

CHICAGO SALVAGE STOCK STORE

Wholesale Dept. CB
509 S. State St. Phone Harr. 9466 Chicago, Ill.



Master the Code

WIRELESS OR MORSE

—at home with the **TELEPLEX AUTOMATIC CODE INSTRUCTOR**. No better method for self-instruction exists. **Quick — Easy — Thorough.** Endorsed by U. S. Navy. The only instrument that **REPRODUCES** actual sending—messages, radiograms, etc. Any speed. Complete Course furnished. **THIRTY TIMES** as many words as any other instrument. Avail yourself of the **TELEPLEX** for a quick mastery of the code. Write for booklet **RC**.

Silent Phonograph Motor

TELEPLEX CO., 76 Cortlandt St., New York, N. Y.



The Perfected A-C Tube!

Adaptable to all circuits—from the Lynch Hammerlund to the 9-in-line Superheterodyne—requiring less circuit changes than any other A-C Tubes... Amplifier, detector, high mu and power types, of the humless heater design, operating from the same A-C voltage, and plugging into the standard UX four prong sockets without additional side or overhead wiring

Also made in cable type for use with the Arcturus Adaptorless A-C Cable

ARCTURUS RADIO CO.
255 Sherman Avenue, Newark, N.J.

ARCTURUS

DEALERS AND SET BUILDERS

Tyrman "70"

Shielded Grid Amplimax

KITS IN STOCK

GET OUR WHOLESALE PRICES FIRST

Distributors

For All Popular Kits and Parts

KEYSTONE RADIO COMPANY

111 N. 4th St. Philadelphia, Pa.

SEND FOR OUR FREE CATALOGUE

Amazing New Ground Antenna

Gets Everything But Static!

Brings in Faraway Stations Loud and Clear Regardless of Static Conditions

Fans everywhere are replacing their troublesome and static gathering up-in-the-air aerials with the marvelous new GROUND ANTENNA—Aer-O-Liminator. Radio engineers and hundreds of users testify that Aer-O-Liminator gets better long distance reception, almost unbelievable freedom from outside noises, far greater selectivity and marvelously true, clear, sweet tone quality.

John E. Christenson, RADIO ENGINEER, CHICAGO, writes: "I have tested and thoroughly approve the Aer-O-Liminator. I find it increases selectivity and volume without distortion, practically eliminates static, gives good clear tones, both on local and distant stations. I would recommend the use of the Aer-O-Liminator to every radio owner to get the best reception from his set."

FREE TRIAL

Make this thrilling test at our risk!

Install an Aer-O-Liminator (Ground Antenna). Leave your old overhead aerial up. Try out on a night when static is bad. If you do not get a wonderful improvement in freedom from static, greater selectivity and clear, sweet tone without interfering noises, if you can't get good reception on stations that are drowned out by static on your old aerial, you need not pay us a red cent for this test. Send coupon at once for scientific explanation of Aer-O-Liminator (Ground Antenna), proof of performance and our conclusive iron-bound guarantee, and remarkable Free Trial Offer—Mail Coupon TODAY!

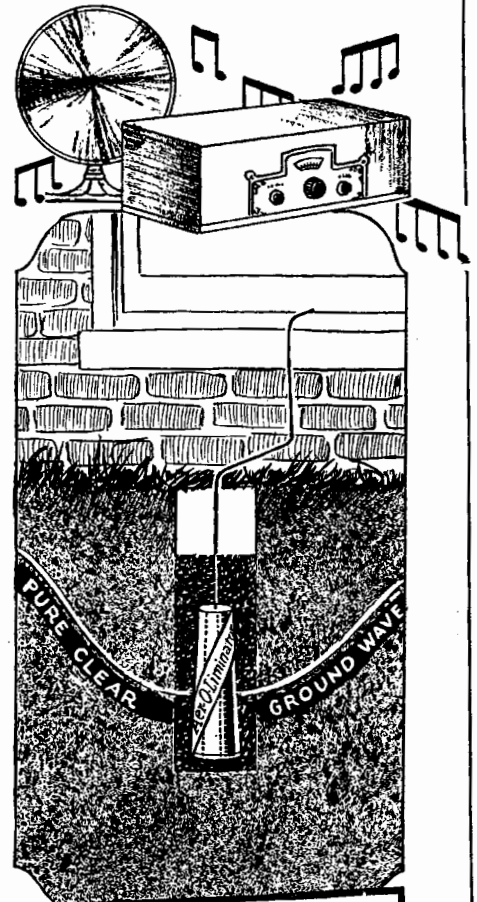

EASY TO INSTALL

Just dig a small hole about 6 inches in diameter and drop Aer-O-Liminator into it.

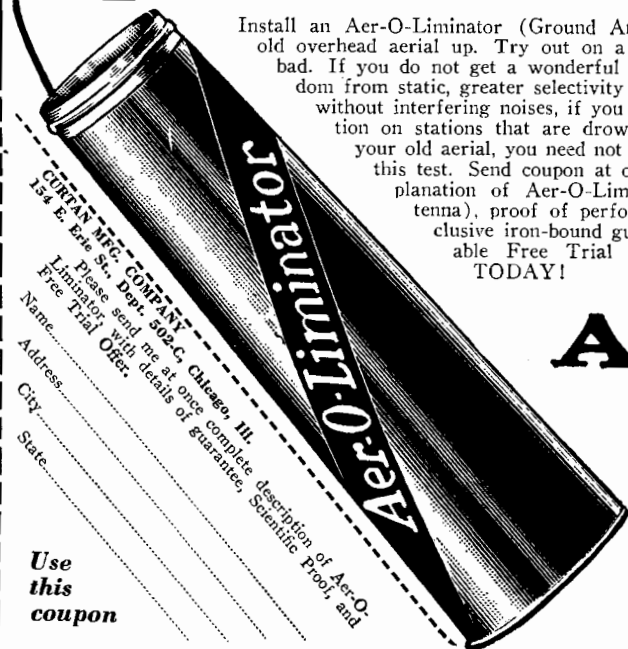

Aer-O-Liminator (Ground Antenna)

Endorsed by Foremost Engineers and Dealers

CURTAN MFG. COMPANY
Dept. 502-C, 154 East Erie Street, Chicago, Ill.

Use this coupon

Tell 'Em You Saw It in the Citizens Radio Call Book Magazine

90 Volt Power Unit :: \$12.75

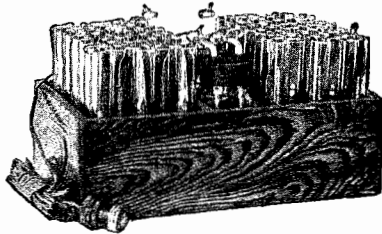

Hums, line noises, etc., positively impossible with this new advanced unit. Plug in and forget. Non-acid and noiseless. All detector and intermediate voltages plainly marked. Simpler to hook up than dry cells. Operates any type set, 1 to 12 tubes.

Greater volume and clearness guaranteed. If not thoroughly satisfied return after using 30 days for complete refund. Guaranteed further 2 years. For 110-120 volts A. C., 25 to 60 cycle current. 90 volts, \$12.75; 112½, \$15.25; 135, \$17.50; 157½, \$19.50; 180, \$24.00; 202½, \$26.00.

Also built for D. C. current 110 and 32 volts at only \$3.00 additional, any size above. Ample stock—same day shipments. Simply say—ship C. O. D. or write for my interesting literature, testimonials, etc.

B. HAWLEY SMITH

334 Washington Ave.

Danbury, Conn., U. S. A.

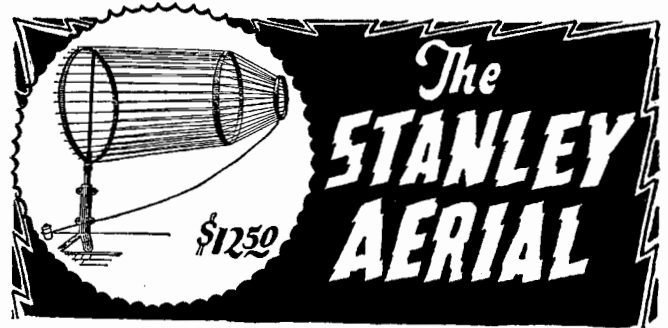

Assures Perfect Radio Reception

Now you can be sure of good reception *every night in the week!* Night after night, regardless of weather conditions, you get the same excellent performance with a Stanley Aerial. It eliminates the usual noises that spoil reception, it reduces static to a minimum and brings you broadcasts *clearly* and with *full volume*. The Stanley single-point mounting is quickly attached to your own roof. It has no wires to string up.

Don't delay—order yours now

Enjoy the radio performance you *should* be getting—equip your set with a Stanley cage-type Aerial! If your dealer cannot supply you, send check or money order for \$12.50 and we will ship one to you immediately. The Stanley is sold on a money-back guarantee—satisfaction or your money refunded.

Information and illustrated material sent on request

STANLEY ENGINEERING, Inc.

161 Devonshire St.

Boston, Mass.

Dealers—Our Special Proposition Will Interest You—Write for It Now!

KARAS PARTS

Are Specified for the

CITIZEN'S-BIRNBACH AC 4

Karas parts are consistently specified for the best and most popular circuits. Specifications for the Birnbach AC 4 include the sensational

Karas A-C-Former Filament Supply

which delivers correct voltage to AC tubes, and does not transmit excessive voltage fluctuations, thus insuring long tube life. Needs no separate device for center tap. Has plug-in connection for "B" Eliminator and loop of wire for panel switch.

Write for information to

KARAS ELECTRIC CO.

4026 C N. Rockwell St.
CHICAGO, ILLINOIS

DEALERS AND SET BUILDERS

Get Our Wholesale Prices on Parts for Popular Circuits
Silver-Marshall Sangamo Thordarson Remler Frost
Scott World's Record Hammarlund Yaxley Eby Electrad
and many others

PARTS FOR ALL CITIZENS CALL BOOK CIRCUITS

RELIABLE SUPPLY COMPANY

19 BROAD STREET

PROVIDENCE, R. I.

MUTER

Dependable Radio Products

The Complete Quality Popular Priced Line—
Send for Comprehensive Catalog

LESLIE F. MUTER CO., 76th and Greenwood, Dept. 502-C, Chicago

FROST-RADIO DE LUXE APPARATUS

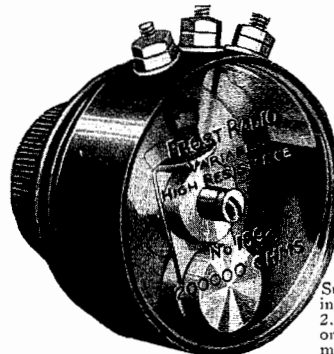

You will welcome a line of parts and accessories such as Frost Radio De Luxe because you can see with your own eyes how well it is made. We think you will agree with us when we say that no other parts on the market today are more carefully engineered and more serviceably built than those we are making for professional and amateur set builders.

Frost Variable High Resistances

Supplied in 2 or 3 terminal type, in wide range of resistances from 2,000 to 500,000 ohms, and with or without switch. 2 or 3 Terminal Type, less switch, \$1.75. 2 or 3 Terminal Type, with switch, \$2.10.

FROST-RADIO

Mail Coupon for Two Valuable Frost-Radio Booklets
If you will fill out and mail coupon below we will send you FREE our two new booklets: "What Set Shall I Build," and "For Better Reception." Write for these today.

HERBERT H. FROST, Inc.

Main Offices and Factory: ELKHART, IND.

HERBERT H. FROST, Inc.
160 No. La Salle Street, Chicago, Ill.

Send me your two free books, as advertised in Citizens Radio Call Book for March.

Name.....

Address.....

City.....State.....

Tell 'Em You Saw It in the Citizens Radio Call Book Magazine

Guaranteed

by the Largest and Most Up-to-date
Radio Service Station in America

THIS highly efficient organization with trained service men, together with a completely equipped laboratory, is at your disposal for repairing, testing and advice on all type radio receivers, battery eliminators and power units. Our experience in this field has helped all our clients to enjoy better and continuous radio reception. All laboratory instruments used in testing and repairing are modern and up-to-date, insuring rapid and accurate location of trouble involved in your receiver.

We are completely equipped to convert your present receiver for the AC tubes. It is not necessary to completely rewire any type receiver to make it all electric. Our economical process and the use of the proper tubes in the various types receivers will insure you continuous reception each time your radio is used. Let us give you an estimate and guarantee the results to be perfect reception without the use of batteries.



Because the largest staff of trained service repairmen and engineers are at your service, you can be assured at all times of the most careful and competent service. This is proven by the large numbers of sets shipped to us for service from every state in the U. S., Canada and Alaska.

Remember

the confidence of many leading manufacturers has been placed in this laboratory. The Radio Service Laboratories will give to you the same conscientious service that the manufacturer himself would give you.

Any receiver or power device repaired by this highly efficient organization is positively guaranteed to *perform* in the same manner claimed by the manufacturer.

RADIO SERVICE

508 South Dearborn Street

Telephone

RADIO SERVICE



The way it came in

WE will repair, test or design any type of receiver you may desire. Being specialists in this field we are in an excellent position to rebuild your present receiver and bring it up to date.

It is more practical and wise to bring your problems here than to some irresponsible radio man who is unfamiliar with the merchandise you wish serviced. This is an era of specialized effort and our charges are no more than you would pay for inferior workmanship.

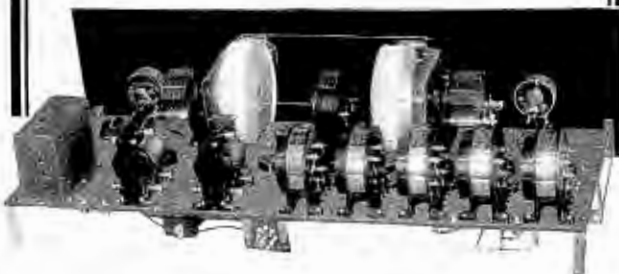

The way we returned it



(All receivers serviced in this laboratory are given a final test in a completely shielded room where the internal noises are absolutely eliminated.) This insures noise-free reception which is necessary for satisfactory performance. In addition, complete equipment is available for properly testing all types of power units.

If you are unable to personally deliver the receiver or unit you wish to have serviced, securely pack it in a strong box with plenty of cushioning material such as excelsior, and ship it to us via American Railway Express, prepaid. It is not necessary to ship the cabinet or accessories.

LABORATORIES, Inc.

Harrison 2870

Chicago, Illinois

Index to Advertisers

A

Aberdeen Hotel.....190
 Abox Co.....166
 Acme Wire Co.....9-190
 Aero Products Co.....3-184
 Aerovox Wireless Corp.....142
 Alden Mfg. Co.....141
 Allen-Bradley Co.....162
 Allen-Rogers-Madison Co.....138-142-145-147
 Alter Co., Harry.....176
 Aluminum Co. of America.....49
 American Correspondence School of Law.....158
 American Mechanical Laboratories.....195
 American Sales Co.....197
 American School of Aviation.....194
 American School of Photography.....194
 American Transformer Co.....135-185
 Arcturus Radio Co.....148-201
 Artistic Wood Turning Works.....195
 Ashe Radio Co., Walter.....176
 Austin Accessories Co.....186

B

Barawik Co.....192
 Belden Mfg. Co.....160-167
 Bellevue Stratford Hotel.....164
 Benjamin Electric Co.....167-181
 Birnbach Radio Co.....7
 Blackburn Specialty Co.....162
 Bodine Electric Co.....195
 Braun Co., W. C.....2-167-174
 Brown & Caine.....190
 Browning Drake Corp.....159

C

Carter Radio Co.....162-176-191
 C. E. Mfg. Co.....4th Cover
 Celoron Company.....195
 Central Radio Laboratories.....181
 Chaslyn Company.....192
 Chicago-Jefferson Fuse & El. Co.....169
 Chicago Radio Apparatus Co.....199
 Chicago Salvage Stock Co.....201
 Chicago Solder Co.....21
 Citizens Radio Service Bureau, Blue Prints.....193
 Citizens Radio Service Bureau, Questionnaire.....165
 Composite Aerial Co.....188
 Co-Operative El. Supply House.....174
 Consumers Radio Co.....188
 Continental Corp.....188
 Cornish Wire Co.....150-155
 Cortlandt Panel Engr. Co.....172
 Curtan Mfg. Co.....202

D

De Jur Products Co.....143
 Delta Specialty Co.....196
 Deutschmann Co., Tobe.....181
 Dubilier Condenser & Radio Corp.....146
 Duro Metal Products Co.....201

E

Eby Mfg. Co., H. H.....161
 Egert, R. W.....156
 Ehlerst Radio Furn. Co.....153
 Ekko Co.....182
 Electrad, Inc.....178-185
 Engineers Service Co.....207
 Excello Products Co.....27

F

Fansteel Products Co., Inc.....13
 Formica Insulation Co.....33
 Fritts & Co., W. H.....192
 Frost, Inc., Herbert H.....203

G

General Radio Co.....25
 Gordon, Inc., James C.....177
 Gray & Danielson.....35
 Great Northern Hotel.....154

H

Hazel, E. A.....197
 Halldorson Co.....162
 Hamilton-Carr Co.....162
 Hammarlund Mfg. Co.....177
 Hammarlund-Roberts Co.....189
 Hammer Radio Co., S.....163
 Harco Company.....162
 Harkness Co., Inc., Kenneth.....137
 Hazelton Laboratories.....192
 High Frequency Laboratories.....190
 Hollywood Beach Hotel.....176

I

Igrad Condenser & Mfg. Co., Inc.....149
 Illinois Transformer Co.....1
 Independent Electric Co.....189
 International Correspondence School.....144
 International Resistance Co.....156

J

Jensen Radio Mfg. Co.....197
 Jewell El. Inst. Co.....15-166
 J. M. P. Mfg. Co.....150
 Jones Co., Howard B.....182

K

Karas El. Co.....191-203
 Keystone Radio Co.....201
 Kingston Products Corp.....138
 Knapp Electric Corp.....11
 Kodel Radio Corp.....208

L

Langbein & Kaufman.....187
 Lewis Radio Jobbers.....163
 Lignole Corp.....148
 Lincoln Radio Corp.....174
 Lynch, Inc., Arthur H.....186

M

Mack Laboratories.....200
 Madison-Moore Radio Corp.....168
 Master Craft Products Co.....155
 Midwest Radio Corp.....162
 Mississippi Valley Radio Co.....195
 Modern Laboratories.....176
 M. & H. Sporting Goods Co.....140
 M. & M. Co.....175-201
 Muter Co., L. F.....167-203

N

National Company.....177
 National Radio Institute.....19
 Nelson Electric Co.....147
 Newcombe-Hawley, Inc.....166
 North American Institute.....198
 North Shore Radio Laboratories.....190
 Northern Manufacturing Co.....139

O

Ohmite Mfg. Co.....199

P

Pacent Electric Co., Inc.....163
 Page Davis School of Advertising.....160

Paramount El. Supply Co.....187
 Peerless Mfg. Co.....191
 Pierson Company.....37
 Polymet Mfg. Co.....172
 Power, Inc., Harold J.....184
 President Hotel.....184

R

Radex Mfg. Co.....151
 Radiall Company.....188
 Radiart Laboratories.....188
 Radio Association of America.....23
 Radio Equipment Co.....178
 Radio Institute of America.....39-179
 Radio Parts Co.....174
 Radio Producer Co.....176
 Radio Service Laboratories, Inc.....156-204-205
 Raytheon Mfg. Co.....182
 Readrite Meter Works.....157
 Reliable Supply Co.....203
 Rex Laboratories, Inc., The.....192
 Robertson-Davis Co.....45
 Rowan Battery Supply Co.....175-191

S

Samson Electric Co.....157-199
 Sangamo Electric Co.....186
 Scott Transformer Co.....5
 Seaside Hotel.....178
 Serlin & Co.....174
 Shanklin Mfg. Co.....161
 Shure Radio Co.....162-176
 Silver-Marshall, Inc.....173
 Simplex Radio Supply Co.....192
 Smith, B. Hawley.....203
 Sonatron Tube Co.....2nd Cover
 Southern Toy Co.....182
 Sovereign El. & Mfg. Co.....182
 Stanley Engineering Co.....203
 Sterling Mfg. Co.....31
 Straus & Schram.....17
 Studebaker Watch Co.....172
 Syd Battery Co.....192

T

Telephone Maintenance Co.....189
 Teleplex Co.....201
 Thordarson El. Mfg. Co.....29-166
 Townsend Radio Corp.....164
 Transformer Co. of America.....154
 Trav-Ler Mfg. Co.....155
 Tri-Par Radio Co.....199
 Trimm Radio Mfg. Co.....186
 Triple A Specialty Co.....162
 Tyrman El. Corp.....53

U

Ultradyn Sales Co.....170-171
 Underground Antenna Co., The.....3rd Cover
 United Sales Co.....159

W

Wales Novelties Corp.....162
 Walker Co., Geo. W.....43
 Ward Mfg. Co.....179
 Wedel Company.....175
 Western Radio Co.....140-174-182-184-186-187-189-191-197-199
 Weston Electrical Instrument Corp.....41
 Whitehall Hotel.....164
 Wholesale Radio Co.....152
 Workrite Mfg. Co.....192
 World Battery Co.....182

X

X. L. Radio Laboratories.....185

Y

Yahr-Lange, Inc.....145
 Yaxley Mfg. Co.....188-197
 Yorkville Radio Co.....161

\$ 10 "Try this on your piano" **\$ 10**
only Here it Is! **only**
 The Loudspeaker Sensation of 1928

If the success of any product is measured by what people say and think about it, then this newest radio product is a sensational success.

of course
 it's an **ENSCO** product

Simply attach the ENSCO piano unit to your piano and the cord to your radio set—it only takes a minute—and you have a marvelous, resonant loudspeaker.

This wonderful device makes use of the perfect sound-reproducing qualities of the piano sound-board. It took years to develop the piano to its present state of perfection, and you can now enjoy perfect radio reproduction by using this sound-board.

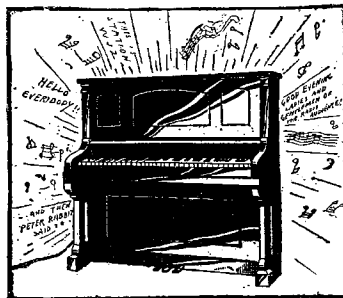

It doesn't show—it does not mar the piano in any way or interfere with its use as a piano. Fits any piano, grand or upright, and works on any radio set.

The reproduction is simply marvelous. The sonorous bass notes, the rolling notes of the middle register, and the thin, sharp tones of the upper treble—all perfect—and the voice sounds *natural*. The famous ENSCO drive mechanism—the rugged direct-drive, distortionless unit developed by Clyde J. Fitch, makes this possible. It is *new*, and the results will surely astound you.

MANY NOVEL APPLICATIONS

Musical furniture is now a reality. Imagine the dinner table, surrounded by guests, bursting forth into glorious song, a chair or bridge table telling a bedtime story, or a door or panel singing a baritone solo! All this is made possible by the ENSCO piano unit. It is made by the makers of the famous ENSCO cone speaker kits under U. S. Patent No. 1630199 and others pending.

The Best \$10 You Ever Spent!

If you do not have a piano, use it on the table or a panel, or door. It works!

Sold under money-back guarantee. You must be satisfied or your money will be refunded. Price only \$10.00. Complete with 20-foot cord. Ask your dealer or send order to our nearest office. Shipped prepaid on receipt of check or money order or C. O. D. with postage added. Price in Canada, \$11.50.



ENGINEERS' SERVICE COMPANY
 28 East Jackson Boulevard
 Chicago, Ill.
 25 Church Street, New York
 331 Bay Street, Toronto, Ont.

Engineers' Service Company
 Gentlemen: Please ship at once.....
 Ensco Piano Unit..... If it is not entirely satisfactory I will return it within ten days and you will refund the full amount paid. I enclose \$.....
 (or) Ship C. O. D.....
 Name.....
 Street.....
 City..... State.....

Tell 'Em You Saw It in the Citizens Radio Call Book Magazine

Any Tube is now an A.C. Tube

*Makes Any Set an A.C. Set
using ordinary 199 or 201A Tubes
without harnesses, adapters or changes in wiring!*

ANY radio receiver becomes an A.C. set when equipped with the new Kuprox Development—the Kuprox A.C. Power Pack. No necessity for buying new tubes—for this new Power Pack literally converts ordinary 201-A or 199 tubes into A.C. tubes.

The Kuprox A.C. Power Pack is the most revolutionary of all radio power developments. It eliminates all the necessity for makeshift harnesses and troublesome adapters—it converts any radio receiver into an A.C. set without changes in set wiring, or the purchase of expensive new tubes.

Contains No Battery of Any Kind!

The Kuprox A.C. Power Pack is not an ordinary battery eliminator. It contains no batteries or chargers of any kind. It contains none of the acids or liquids you find in battery eliminators. It never requires attention of any kind.

Performance of any set equipped with this new development is far superior to most sets equipped

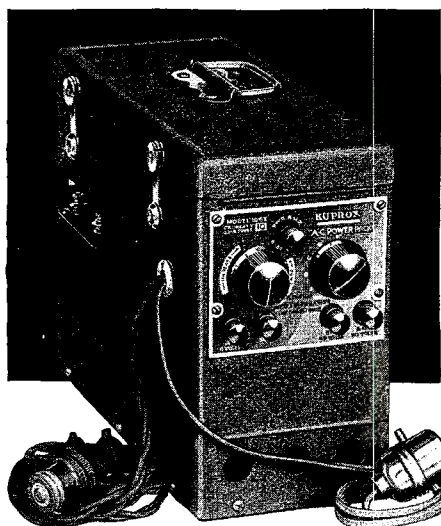

All A. C. Sets Use Built-in Power Supply

Contrary to the popular impression, all A.C. sets are fully equipped with a built-in power supply. A.C. current is not used direct from the house supply. A.C. sets use alternating current to the filament and direct current to the plates of the tubes. The new Kuprox A.C. Power Pack is very similar to these units used in A.C. sets. It has the added advantage however of operating any type of tube, thus making unnecessary the great expense of purchasing A.C. tubes.

*Write for illustrated folder giving
full particulars on all
models*

with A.C. tubes. There is absolutely no hum or noise—signals come into the receiver intensely amplified—the set can be tuned and controlled with much greater precision than where A.C. tubes are used.

Operates All Types of Sets and Circuits

Any type of set regardless of circuit can be converted into an A.C. set with the Kuprox A.C. Power Pack. No changes of any kind are necessary—the set remains just as it is. The Kuprox A.C. Power Pack is as simple to connect as a block of batteries. Each Power Pack is equipped with voltage control permitting the exact amount of filament and plate current necessary for best operation to flow through to the receiver.

Several models are offered. A separate filament current unit for those who now have a "B" eliminator. An efficient compact combination unit that supplies all filament and plate current to make any set completely A.C. Prices from \$32.50 to \$62.50. See your dealer, or write direct to us.

**No Acids
No Liquids
No Attention
of Any Kind**

KUPROX

A.C. POWER PACK

**Perfected
A. C.
Operation
for Any Set**

THE KODEL RADIO CORP., 510 East Pearl St., CINCINNATI, OHIO

Tell 'Em You Saw It in the Citizens Radio Call Book Magazine

**The Perfected
Invention of
Dr. J. Harris Rogers**

**Celebrated War Time
Naval Radio Consultant**

The eminent scientist, Dr. J. Harris Rogers is known the world over for his research work and successful accomplishments in the line of underground and underwater radio transmission and reception. His invention, the Rogers *Underground Antenna* for reception of waves within the B.C.L. band is, unquestionably, one of the most important radio advancements of the year.



This photo shows Dr. Rogers charting the country wide success of one of his numerous underground radio tests

**First news of the ROGERS
Underground
ANTENNA**

Made under exclusive license in accordance with patents of Dr. J. Harris Rogers Nos. 1303730, 1349103, 1349104 and pat. pend.

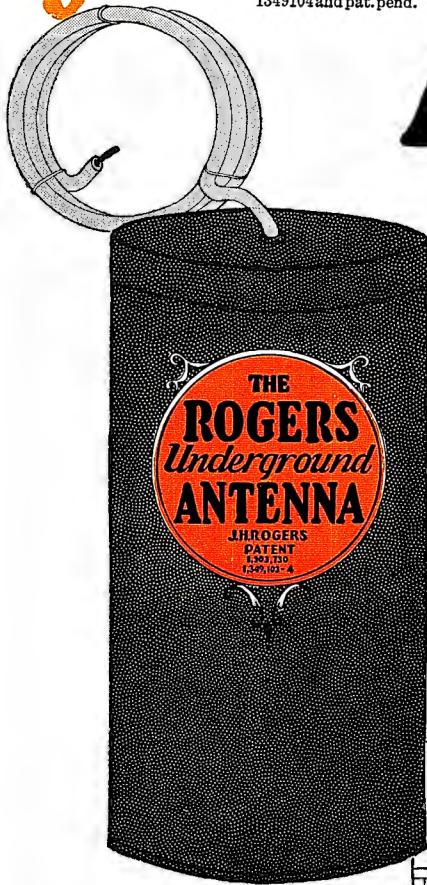

**Provides Clear, Loud Reception
Regardless of Weather Increases
Distance and Volume with Any Set**

That radio waves, unspoiled by static and less affected by weather conditions, travelled thru the ground was the belief of Dr. J. Harris Rogers. Test after test proved his contention. On nights when weather made reception from distant points impossible with an antenna suspended in the air, reception was clear, steady and loud when taken out of the ground. Static has little effect upon ground-wave reception, and it was found that ground waves usually exceeded the strength of air waves even when the latter were at their best. It then remained for someone to develop a device with which these clear, strong ground waves could be intercepted and brought to the receiving set. Followed more years of research, more experimenting, more practical tests—all resulting in the Rogers Underground Antenna—developed and perfected by Dr. Rogers, himself—the product of a lifetime of study—a proved device, successful wherever used and offered to you with a positive guaranty of money back if you are not satisfied.

**Yours to Test
FREE**

**EASILY INSTALLED
IN 5 MINUTES!**

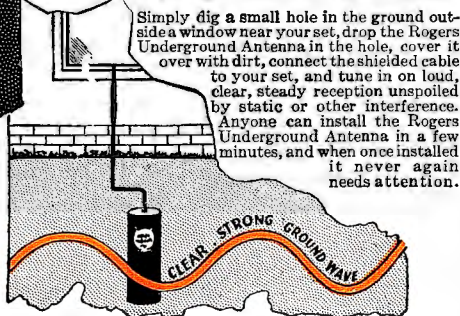

THE ILLUSTRATION at the right shows a typical installation of the Rogers Underground Antenna. As there is but little static in the ground, this Rogers unit delivers clear, strong, radio impulses to the receiver, thru the shielded connecting cable. And think! How much easier it is to install the Rogers Underground Antenna than it is to climb around on a slippery roof hanging up a wire which collects as much static as it does radio waves.

It costs you nothing to test the Rogers Underground Antenna. We will send it to you to try on your own set, and we don't ask you to pay a cent for this great radio improvement if you don't find it all that *Dr. Rogers claims* in his patents. Send the coupon now. Let us send you the startling facts of the Rogers Underground Antenna and full particulars of the FREE comparative test we want you to make. Clip the coupon. Send it today.

MAIL THIS NOW

**The Underground Antenna Co.
4207K Cottage Grove Ave.
Chicago, Ill.**

Send me all the facts on the Rogers Underground Antenna. Also full particulars of FREE Test Offer and GUARANTEE.

Name.....

Street.....

Town..... State.....

The Underground Antenna Co.
4207K COTTAGE GROVE AVENUE CHICAGO, ILL.

Scientifically Engineered

CeCo is the scientifically engineered tube, the laboratory tested tube, the tube endorsed by radio authorities including Browning, Lynch, Cockaday, Harkness, Hurd, Best, Bernard, Henney, Millen, and others.

Select the types of CeCo tubes best suited for your receiver.

There's a Type for Every Need:

General Purpose Tubes

Special Purpose Tubes

Filament Type Rectifiers

Power Tubes

and A. C. TUBES

Order from Your Dealer
This Special Combination
of CeCo Radio Tubes

for Maximum Efficiency in the New
"IMPROVED ARISTOCRAT"
Circuit, as specified by the designer,
Arthur H. Lynch.

- 1 Type "K"
Spec. R.F.
- 1 Type "H"
Spec. Det.
- 2 Type "G"
Hi-Mu 20
- 1 Type "F"
Power (112)

Complete

\$1300



C. E. MFG. CO., Inc., Providence, R. I., U. S. A.
Largest Exclusive Tube Manufacturers in the World



Write for Data Sheet giving
characteristics of all CeCo Tubes

*Chart showing
longer life and
steadier performance of
CeCo Tubes*

