

Citizens

# RADIO CALL BOOK MAGAZINE

*Not Indexed*

N.S.E.

## 50¢



### A COMPLETE RADIO CYCLOPEDIA

# A SONATRON in every SOCKET



*Means YOUR SET  
is at its BEST!*

For superior radio reception, see that every socket in your set contains a Sonatron tube! These quality tubes—*standard in every way*—are *carefully adapted* to their particular work. As a result, Sonatrons deliver pure, rich tone, and back up your distant reception with real volume. Sold everywhere—under a remarkable guarantee! Write for the latest tube news, our circular CB-12!

*A Tube for Every Purpose*

33 DISTINCT TYPES!



*This label identifies the genuine to  
hundreds of thousands of Sonatron  
enthusiasts!*

# SONATRON

SONATRON TUBE COMPANY

NEWARK, N. J.

108 West Lake St., CHICAGO

16 Hudson St., NEW YORK CITY

320 Lafayette Building, DETROIT

WINDSOR, ONT., CAN.



**\$17.50**



# Tower

## MODEL 28

**C**RUSADING always for highest quality radio reproduction at lowest cost, TOWER introduces Model 28—the new, perfected drum-type Cone. Of exceptional decorative value with its bronzed mesh front and ornamental wood grill embellished with the accoutrements of chivalry, this Speaker offers the utmost in modern radio enjoyment. It is equipped with the finest armature-type unit money and scientific experience can produce—a unit specially developed for power tubes—both A. C. and battery operation. No matter what you can afford to pay, you can buy no finer, all 'round reproducer.

*Ask Your Dealer or Write for Illustrated Folder*



**Adventurer**  
\$11.95  
SLIGHTLY HIGHER IN THE WEST



**Castle Cone**  
\$11.95  
SLIGHTLY HIGHER IN THE WEST

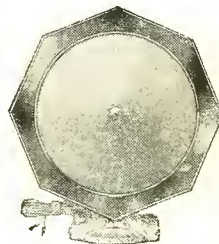

**NEW IMPROVED Meistersinger**  
\$15

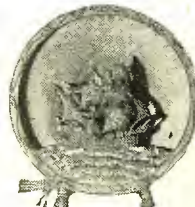

**Pirate Ship**  
\$8.95  
SLIGHTLY HIGHER IN THE WEST

**TOWER MFG. CORP.**

122 Brookline Ave., Boston

*Over Two Million Tower Products in Use*

*Tell 'Em You Saw It in the Citizens Radio Call Book Magazine*

# The Pioneer Distributors of Good Radio Are Now The Leaders!

**Complete Stocks, Speedy Service,  
Fair Treatment, Have Made This  
The Headquarters of Thousands  
of Retail Dealers the World Over.**

**F**OUNDED for the purpose of giving the retail dealer a single source of supply for all of his stock requirements in the sale of radio receivers and parts, the W. C. Braun Company has steadily advanced to its unquestioned leadership today. Thousands of retail dealers scattered all over the world look to us to carry the stock necessary to service their selling to the public. Thus the burden of space and investment is lifted from the shoulders of the retail dealer, allowing him to devote his entire resources and efforts to the proper handling of his customers.

This company has expanded until now it numbers an organization of more than one hundred trained service specialists, with its activities housed in a great building with thousands of square feet of space. From the patronage of a few dealers our customers now number into the thousands, many of them the most important radio dealers in their communities. We believe this tremendous expansion of our business, extending over only a few short years, has been entirely due to the extreme completeness of our showing, the right prices, fair treatment, and faster service than is obtainable anywhere else.



## Experienced Merchandising Counsel and 12-Hour Service Puts Braun Dealers at Advantage Over Their Competition

The Braun Dealer has come to rely on our listings as his guide in selling only the best items the market has to offer. Behind our selections lies the experience gained over the years from the very beginnings of radio. (Mr. Braun's first radio catalog was published in 1911!) The Braun Dealer knows at once what to push to insure the surest profits for himself and the greatest degree of satisfaction for his customers.

12-hour service on mail orders, 2-hour service on long distance telephone, telegraph and air mail orders, means a greater turn-over and more customer-friends for the retail dealer.

## Dealers Not on Our List Will Need This New Issue of the Confidential Wholesale Price Guide

If you are an established dealer, but not now on our list, we suggest you write us immediately on your letterhead, and if you are not rated, give us the names of three wholesale establishments from which you now purchase. If you are thus entitled to it, we will send you our enlarged new Radio Book of more than 200 pages.

# W. C. BRAUN COMPANY

*Pioneers in Radio*

**563-571 W. Randolph St. Dept. 116 Chicago**

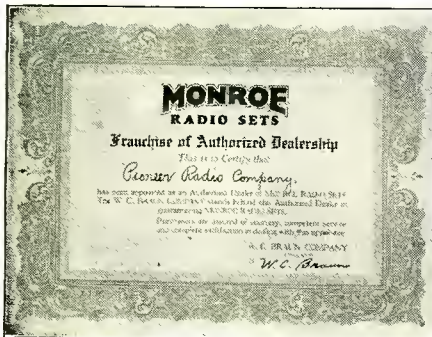

### The Monroe Franchise Has "Made" Many a Retail Radio Dealer

Our wonderful new line of Monroe Receivers has proven an instant and phenomenal success. Our Dealers are having tremendous success with them everywhere. Marvels of efficiency and beauty, they are easy to sell and stay sold. There are yet many territories open to live, industrious Dealers. Write us at once for this valuable franchise in your community. It has "made" many a retail radio dealer in the past!

*Tell 'Em You Saw It in the Citizens Radio Call Book Magazine*

# FROST RADIO DE LUXE

Built in Accordance with the BEST Engineering Standards



**FROST-RADIO**  
VARIABLE HIGH RESISTANCES  
A QUALITY PRODUCT

**FROST-RADIO** put precision into High Resistance Units and made the first wholly reliable, wear-proof unit ever manufactured. Bakelite shell and pointer knob. In resistances from 2,000 to 500,000 ohms, 2 or 3 terminals. Either type . . . \$1.75



A corner of the **FROST-RADIO** Engineering Department, where precision standards prevail.

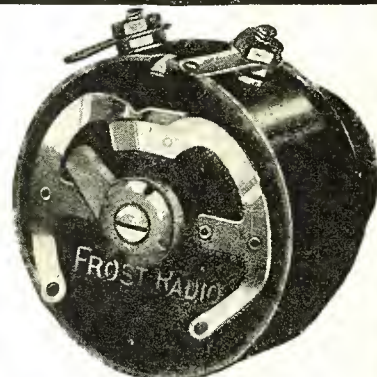

**FROST-RADIO**  
VARIABLE HIGH RESISTANCES  
WITH SWITCH

Combines the **FROST** Variable High Resistance Unit with durable filament switch. Bakelite cam locks positively in the off position. Nickel silver contact springs, with sterling silver contact points. 2 or 3 terminals, 2,000 to 500,000 ohms. Either type . . . \$2.10

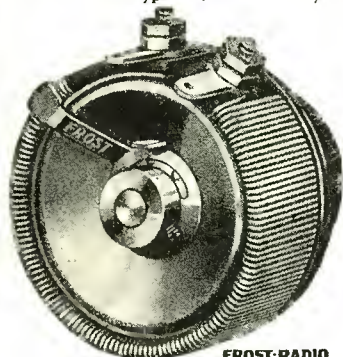

**FROST-RADIO**  
METAL FRAME RHEOSTATS AND  
POTENTIOMETERS

The pioneer small metal frame rheostat that was designed to carry 25% to 50% overload without reaching RMA temperature maximum. Has new flexible Bakelite strip on which resistance wire is wound. Supplied in variety of resistances from 2 to 75 ohms, and as 200 and 400 ohm potentiometers.

Rheostats, less switch . . . . \$ .75  
Rheostats, with switch . . . . \$1.10  
Potentiometers . . . . \$1.00

**FROST-RADIO GEM RHEOSTAT**

A good little rheostat, for which there was a great need. While small (it is but 1 1/2 in. in diameter), it is as finely built as our larger types. With or without switch, in 3 to 30 ohms and as 200 and 400 ohm potentiometers. Rheostat, plain . . . 75c

Rheostat, with switch, \$1.00  
Potentiometers, \$1.00



**FROST-RADIO**

## Where precision is paramount

**FROST-RADIO** has done pioneer work in placing the design and manufacture of radio parts and accessories upon a precision basis. We were first to realize the tremendous need for properly calibrated resistance windings on filament control apparatus, and the work of our engineering department was a vital factor in standardizing the industry with the advent of the new tubes. We introduced an entirely new standard of precision in rheostat, potentiometer and high resistance manufacture. We produced the first really practical metal frame rheostats, and the first high quality small rheostats. To realize the tremendous contribution of **FROST-RADIO** to set building ask for and secure **FROST** parts by name at your dealer's — compare them with other parts not so precisely engineered. By doing this you will find for yourself that **FROST** Quality, like **FROST** Precision, is paramount in every **FROST** Product.

**FROST**  
**ONES** \$3.00, \$3.50  
and \$6.00

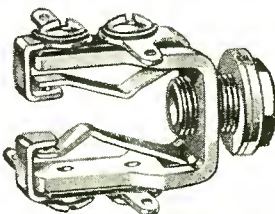

**FROST-RADIO GEM-JACS**

Have low capacity effect, positive inside contacts that are self-cleaning, sterling silver contacts, nickel silver springs and nickel plated brass frames, and occupy but 1 inch back of panel. Tinned terminals. Bakelite insulation. Priced from . . . 40c to 50c

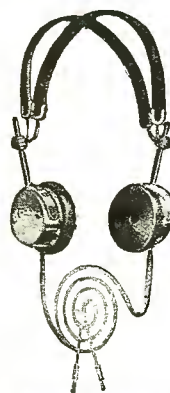

**FROST-RADIO**

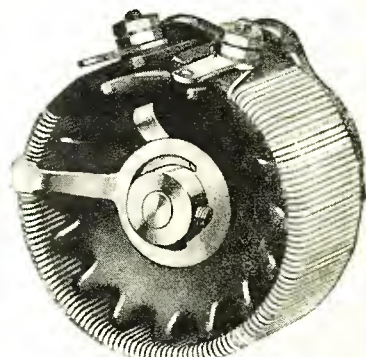

**FROST-RADIO**  
BAKELITE RHEOSTATS AND  
POTENTIOMETERS

Air cooled Bakelite frame keeps down any tendency to overheat. Highest grade resistance wire wound on new flexible resistance strip of Bakelite. Preferred by thousands of set builders. 2 to 75 ohms, and as 200 and 400 ohm potentiometers. The most efficient rheostats ever placed on the market.

Rheostats, less switch . . . . \$1.00  
Rheostats, with switch . . . . \$1.35  
Potentiometers . . . . \$1.25 to \$2.50

**FROST-RADIO**  
FIXED  
RESIST-  
ANCES



Precision quality in a fixed resistance unit. Bakelite frame, into which terminals are firmly staked. Tinned soldering lugs. Windings guaranteed correct resistances and supplied in a wide range from .4 to 1,000 ohms. .4 to 50 ohms, each . . . . 15c  
100 to 1,000 ohms, each . . . . 25c

# HERBERT H. FROST, Inc.

Main Offices and Factory: ELKHART, INDIANA



Chicago  
New York

Boston  
Philadelphia

Pittsburgh  
Washington

St. Paul  
New Orleans

Los Angeles  
Buenos Aires



Tell 'Em You Saw It in the Citizens Radio Call Book Magazine

# Citizens Radio Call Book Magazine

Established 1921

C. O. STIMPSON, President  
E. H. JAUDON, Vice-President  
D. H. BELL, Secretary-Treasurer  
E. M. GIBSON, Advertising Manager  
M. H. HARRIS, Circulation Manager

Executive Offices:  
508 So. Dearborn St., Chicago, Ill.

F. A. HILL, Managing Editor  
RICHARD K. PEW, Technical Editor

Member Audit Bureau of Circulations

NOVEMBER, 1927

Vol. 8, No. 3

## CONTENTS THIS ISSUE

Editorial .....	75
Silver-Marshall A. C. Shielded Six .....	76
Six-in-Line Using Audio Amplifiers .....	82
Improved Aero-dyne Six .....	87
Camfield Shielded Grid Seven .....	92
Citizens Super Nine .....	97
Madison-Moore International "One-Spot" .....	102
Lincoln Quality Super Nine .....	107
Thompson Super Seven .....	112
Walker Vari-Unit Receiver .....	117
Thordarson Power Amplification System .....	121
Victoreen Universal Receiver .....	124
Operating Hints on Karas Two-Dial Equamatic .....	128
Magnaformer 9-8 A. C. Super .....	129
Three Foot Cone Speaker Construction Article .....	132
LaPeer AR-9 Super .....	135
National Browning-Drake with Power Amplifier .....	140
Silver-Marshall Laboratory Model A.C. Shielded Super .....	144
Tyrman Super Ten with A Battery Elimination .....	147
R. G. S. Octamonic Super .....	150
World's Record Super Eight .....	154
Camfield Super-Selective Ten .....	157
The Knickerbocker Four Receiver .....	161
With the Accessory and Parts Manufacturer .....	166

## Our Cover Contest

SO generous was the response from artists all over the country to our recent art contest, that the judges and editors have been hard put to reach a decision within a limited space of time. Subjects were entered covering a wide range, from the most complex to the simplest of themes dealing with radio, which might be suitable for use on our front covers.

Some of the sketches submitted were beautiful from an artistic standpoint, but did not lend themselves for a color separation adaptable for cover purposes.

Now that the contest has been closed and the final decision given, the names of the winners are made public in the following paragraph.

- First Prize—\$150.00*  
Albert Kortner, Chicago, Ill.
- Second Prize—\$100.00*  
Dorothy Ray, Westfield, N. J.
- Third Prize—\$75.00*  
Silvio Beraldini, Paris, France.
- Fourth Prize—\$50.00*  
William G. Strohmer, Chicago, Ill.
- Five Prizes—\$25.00 each*  
A. A. Allen, Kansas City, Mo.  
Margaret Gardner, Chicago, Ill.  
F. C. Cutts, New York, N. Y.  
Marion Moore, Detroit, Mich.  
J. B. Brennan, St. Louis, Mo.

Copyright, 1927, by Citizens Radio Service Bureau, Incorporated, Publishers. Requests for permission to reprint any articles or other matter contained herein must be made in writing to the executive offices.

Citizens Radio Call Book Magazine is published four times a year and is on sale approximately the first of January, March, September and November. Subscription price \$1.75 per year in U. S. A. Canada and Foreign \$2.00 per year, payable in advance. Single copies 50 cents. Remit by check, draft or P. O. order. No foreign stamps or coins accepted. Mail subscriptions to 508 So. Dearborn Street, Chicago. We will not be responsible for cash sent for subscriptions unless registered.

Citizens Radio Call Book Magazine is for sale on all newsstands in the United States and Canada; also Department Stores and Book Stores; also can be purchased in most radio stores. Paris, France, Brentanos, Ave de L'Opera. England, R. A. Rothermel, Ltd., 24-26 Maddox St., Regent St., London, and W. H. Smith & Sons, London.

We also publish Citizens Radio Amateur Call Book, tri-annual, 75c per copy, listing all amateur transmitting stations in the world. Subscription price, \$2.00 yearly. Published September, December and March.

### Advertising Representatives:

Chicago—A. B. Mills, E. E. Hayes, 508 So. Dearborn St. Wabash 1901.  
New York—(Branch Office) 1674 Broadway, Columbus 4693. Cor. 52nd St.

Entered as second class matter March 17, 1927, at the Postoffice at Chicago, Illinois, under the act of March 3, 1879

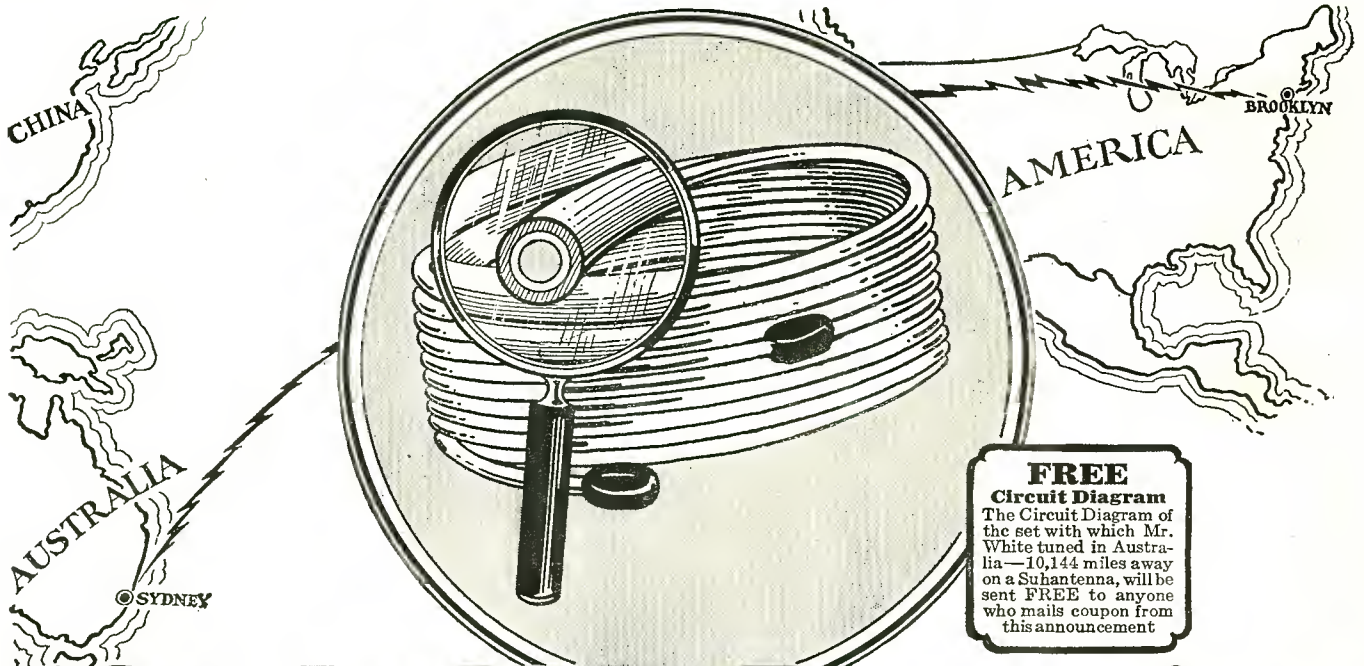

# 10,144 Mile Reception with a SUBANTENNA



Mr. JOHN WHITE of Brooklyn, N. Y.—who tuned in Australia with 6 tube set and a SUBANTENNA

10,144 miles—and the music came in loud and clear! Mr. J. O. White residing at 217 Wyckoff Ave., Brooklyn, New York, established the world's distance record for reception within the B.C.L. band of 200 to 550 meters by tuning in 2FC and 3AR Australia with a simple six tube tuned radio frequency set—and a Subantenna. Think of it!

10,144 miles, and reception that was not only audible—but loud, crystal clear, enjoyable music and song that Mr. White listened in on for some time before tuning it out and seeking other far away stations. The results obtained by Mr. White prove the distance getting capabilities of Subantenna beyond all doubt. For Mr. White writes that during his tests, neither 2FC nor 3AR could be heard on a two hundred foot up-in-the-air aerial, but the instant that he switched back to Subantenna, either station came in clearly.

Associated Radio Co. of Australia Limited  
 Mr. John White, 217 Wyckoff Avenue, Brooklyn, N.Y.  
 Dear Sirs: We are very pleased to get your letter dated March 15th and we are pleased to say that we can confirm your facts.  
 I may state that the power we were using at that time was only 100 watts destination and I think that your reception, considering our power, was excellent.  
 Yours faithfully,  
 ASSOCIATED RADIO CO. of Australia, Ltd.  
 J. C. (Manager) Chief Engineer

Confirmation letter from SAR, Melbourne, Australia

## GROUND WAVES are Practically STATIC-FREE—That's Why Subantenna Gives Greater Distance and Clarity

The same radio waves that you have always taken out of the air, also travel through the ground. The only difference between the air and ground components of the broadcast wave, is that the latter is practically static free, while the air component is always accompanied with static or noise of one kind or another. Scientists have long recognized this fact, and knew that if some device could be perfected for the reception of ground waves, clear, loud, long distance reception would be a reality for the owner of the oddest three or four tube set as well as for the possessor of the larger, more powerful set. Subantenna is the answer—tried, tested and proved by thousands of owners of all kinds of sets, and recommended to you by such leading radio laboratories as Radio News, Popular Radio, Radio Digest, and others.

## TRY IT ON FREE YOUR SET FREE

Install Subantenna. Leave your old aerial up. Select a had night when DX is almost impossible with the ordinary aerial. Make a comparison station for station, connecting first your aerial, then Subantenna. If, from stations that are just a mess of jumbled noise with the old aerial, you don't get reception that rivals local in sweetness and clarity the instant you switch to Subantenna, this test won't cost you even a single penny. Obtain a Subantenna from your dealer or send coupon at once for scientific explanation of Subantenna and for particulars of GUARANTEE and FREE TRIAL OFFER. SEND COUPON NOW!

### Other users get greatly increased distance

**Cuba—also South America**  
 "To show you that I received a program from Station PWX in Havana, Cuba, I enclose herewith a verification card from that station. On January 28th I received a program on my set broadcasted from Buenos Aires, South America, at 10:15 in the evening. Many other long-distance stations have been heard on my set after installing the Subantenna. I never could receive such distance on my outside antenna."—W. C. F. Chicago

**More Stations—No Static**  
 "I get plenty of stations with my Subantenna, on the loud speaker, that I have never been able to reach with my outside aerial. It absolutely cuts down interference to the minimum, cuts static out too—not just partly out—but ALL out."—H. S. M., North Carolina.

**Results—Almost Unbelievable!**  
 "After years of testing aerials I at last found the master in the Subantenna. The first night I used it was a very

hot summer night. Static was very had on my outdoor aerial. I connected my Subantenna and one could hardly believe the results. It was wonderful."—F. L. C., Massachusetts.

**Says "Static Is No More"**  
 "I have received the Subantenna. My grandson installed it. STATIC IS NO MORE. Am well satisfied. I can tune in stations I never could coax out of the air even though I had a long aerial."—A. E. F., Kansas

**CLOVERLEAF MANUFACTURING CO.**  
 2713-H Canal Street - - CHICAGO, ILLINOIS

**CLIP AND MAIL AT ONCE**

CLOVERLEAF MFG. CO.  
 2713-H Canal Street, Chicago, Illinois

Tell me about SUBANTENNA, your unconditional, unconditional guarantee and your Free Trial Offer.

Send me FREE Circuit Diagram of the set used by Mr. White in tuning in Australian Stations.  
 (Check here if you want Circuit Diagram)

Name .....

Address .....

Tell 'Em You Saw It in the Citizens Radio Call Book Magazine

# HELD JAPAN!

## Magnaformer 9-8 Spans the Seas!

"It was not long before we located three very interesting carrier waves . . . 352, 375 and 395 meters, and from experience we knew who they were long before any announcements were distinguishable, namely, Sydney, Tokyo and Melbourne. When 4 a.m. rolled around JOAK was way above the fading static level, and from 4 to 5 he steadily came through with volume to fill the house. In fact, it is probable that Mrs. Fischer since heard some caustic remarks from her neighbors, as the singing of a loud-voiced Japanese soprano in songs which seemed to be dozens of verses in length, is hardly compatible with restful slumber."  
—K. G. Ormiston in "Radio Doings," Sept. 17, 1927.

THE world's most powerful receiver has been developed in the Magnaformer 9-8. Imagine the thrill of receiving Tokyo, Japan, Sidney and Melbourne, Australia, of spanning 6000 to 9000 miles of space! Such loud-speaker performance is truly exceptional. Only the most highly perfected receiver could accomplish it.

Add to this thrill of extremely long distance loud-speaker reception, the keen enjoyment you experience from listening to the Magnaformer's sonorous, true-to-life tone, and you have an entertainment combination that cannot be equalled.



See editorial article in this issue

### ADVANCED ELECTRICAL DESIGN HERALDED BY EXPERTS

By its supreme performance in the five vital essentials—tone quality, distance, selectivity, ease of handling and volume—it has well earned and truly deserves its title—"Magnaformer—the Great Creator—Commander-in-Chief of the Air," the finest radio receiver ever designed.

When such radio experts as G. M. Best of "Radio,"

L. M. Cockaday of "Popular Radio," K. G. Ormiston of "Radio Doings," the technical editors of the *Citizens Radio Call Book* and other magazines come out month after month with enthusiastic articles in praise of the exceptional performance of the Magnaformer 9-8, you can bank on it that this receiver is remarkable and unusual.

### ABSOLUTE ELECTRICAL MECHANICAL PRECISION OF MAGNAFORMERS

The secret of the tremendous power and extraordinary performance of the Magnaformer 9-8 receiver lies in the Magnaformer Long Wave R. F. Transformers. These intermediates are strictly a laboratory product, each one being peaked in the laboratory to a wave length of EXACTLY 69.73 kilocycles (4300 meters), and permanently sealed. The full and complete wave-band, with 100% of its vital, quality-producing, harmonic-carrying side-bands, is positively and easily passed through all of the Radio Frequency amplifying stages, leaving no possibility for distortion. This accounts for the exclusive degree of True Tone Quality in the Magnaformer 9-8 and its wonderful non-critical selectivity.

### Easy Tuning—Powerful Reception

Stations are easily tuned in or out at will without having to be located by a micrometer adjustment of the dials. The amplification per stage is nearly double. Changes from 9 to 8 or 8 to 9 tubes instantly by means of panel switch. The use of 9 tubes is necessary only on very distant stations.

#### Send Now for Free Illustrated Literature

Send at once for FREE illustrated story of the Magnaformer 9-8. We will also send you testimonials such as have never before been written about any receiver. We will include the full story of K. G. Ormiston's unique experience with the Magnaformer 9-8; W. D. Scott's challenge and defeat. All this will be mailed to you the same day we receive the coupon. Don't build another set 'till you hear from us. Send right NOW while you have it in mind.

**Radiart Laboratories Co.** 19 S. La Salle St., Dept. 28  
CHICAGO, U. S. A.

### Everybody Who Hears It Wants One

The Magnaformer 9-8 is THE receiver everyone would insist upon having if they only knew how remarkably it performs. It is easy to build. It will give you the greatest satisfaction you have ever experienced from any radio receiver. Everyone who tunes or hears a Magnaformer 9-8 wants one immediately. Its praises are being sung by set builders everywhere. Read the construction articles in *Radio*, *Popular Radio*, *Radio Doings* and *Call Book*; or build it from the full-size official construction sheet 26"x34" printed both sides and full of illustrations.



#### COUPON

**RADIART LABORATORIES,**  
19 S. La Salle St., Dept. 28, Chicago

Dear Sirs: I am interested in the exceptional performance of the Magnaformer 9-8 Receiver, so please send me the Magnaformer story, details of Ormiston's unique experience and Scott's challenge and defeat.

Your Name.....

Address.....

City.....State.....

Tell 'Em You Saw It in the *Citizens Radio Call Book Magazine*





## FERRANTI A. F. 4 TRANSFORMERS

*exclusively specified  
for the Magnaformer  
9-8 Circuit*



# TRUE Musical Reception

... whether you build or buy your set!

That is your ideal, your goal in radio—true musical reception! Ferranti audio frequency transformers will give it to you, for they amplify every note faithfully, giving it the exact *tone* of the original. Even the elusive deep bass and quavering treble notes are caught and rendered exactly as they are—a transformer can do no more. Plenty of volume, too, and yet the amplified sound is always rich, mellow.

Whether you build your set from component parts or buy your set complete, make sure that Ferranti transformers are included in it. The part that they play in quality reception is so large, so important, that it is wise to use them if you want results.

### Audio Frequency Transformer TYPE AF-3 \$12.00

A new and better standard for 1928 in audio frequency amplification. Confidently recommended to all who wish the best in rich tone quality over the entire broadcast range.

Ratio . . . . 3½ to 1      Dimensions 2¼" x 3" x 3¼"  
Weight . . . 1 lb 14 oz.

### Audio Frequency Transformer TYPE AF-4 \$8.50

A Transformer giving exceptionally uniform amplification at a moderate price. All types tested to 1000 volts between windings and between windings and ground.

Ratio . . . . 3½ to 1      Dimensions 2¼" x 3" x 3¼"  
Weight . . . 1 lb. 8 oz.

### Output Transformer TYPE OP-1, \$10.00

The finishing touch of the modern radio set. Will purify and improve the tone of your speaker. Prevents possible accidents from shock and burnouts by eliminating D. C. and high plate voltage at speaker.

Ratio . . . . . 1 to 1      Dimensions 2¼" x 3" x 3¼"  
Weight . . . 2 lbs. 10 oz.

FERRANTI Ltd.  
Hollinwood, England

FERRANTI Incorporated  
130 West 42nd Street, New York, N. Y.

FERRANTI ELECTRIC Ltd.  
Toronto, Ontario, Canada

Tell 'Em You Saw It in the Citizens Radio Call Book Magazine

# SIXTEEN REMLER REASONS WHY!

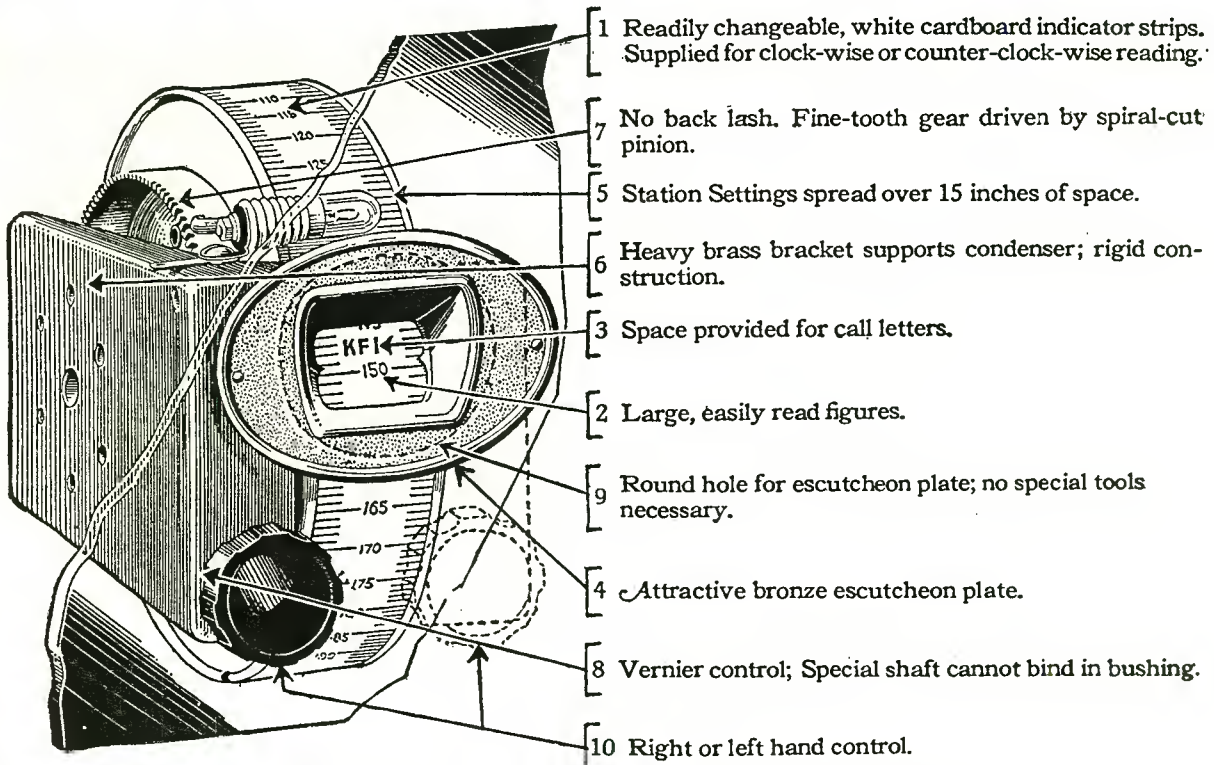

## REMLER *Drum* DIAL

Exclusively specified in the  
**Magnaformer 9.8 Circuit**  
—and many others—

- 1 360° rotation of shaft and reduction drive give vernier control.
- 2 Proper placing of insulating material minimizes resistance to radio frequency currents.
- 3 Complete insulation of plates from dial and dial shaft and provision for grounding dial and shaft give absolute freedom from body capacity effects.
- 4 Plates carefully aligned by hand and soldered rigidly in position at three points.
- 5 Balanced Twin-Rotor construction gives utmost smoothness of operation.
- 6 Shape of plates permits attainment of very low minimum capacity and wide tuning range.

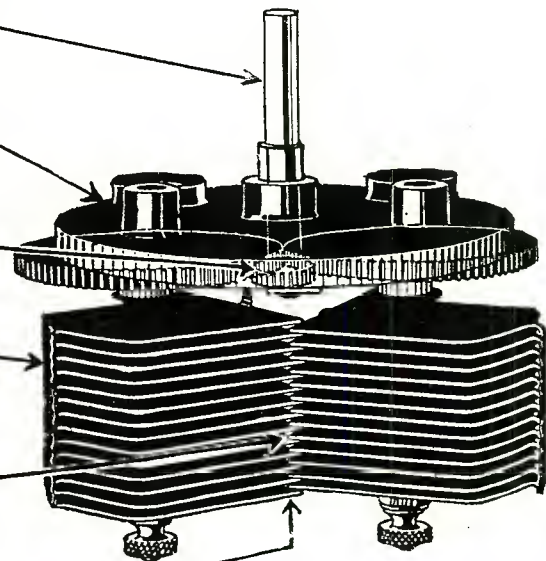

## REMLER *Twin-Rotor* CONDENSER

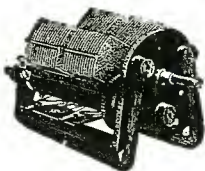

REMLER Gang CONDENSERS—both 2-in-line and 3-in-line—incorporate all the advantages of the Twin-Rotor Condenser. No common rotor. Balancing condensers provided.



**REMLER**  
DIVISION OF  
**GRAY & DANIELSON MANUFACTURING CO.**  
260 FIRST ST., SAN FRANCISCO  
CHICAGO NEW YORK  
EASTERN WAREHOUSE, ELKHART, INDIANA

# NINE YEARS OF RADIO EXPERIENCE

# MAKE THAT NEW SET THE ENVY OF ALL YOUR FRIENDS!

## Give It the Final PROFESSIONAL TOUCH of Perfection with Beautiful CELORON PANELS

THE same high quality radio panels that manufacturers are using in high grade popular sets—are now offered to you to beautify and improve the sets you build. You'll be amazed at their attractiveness—at the "professional" appearance they will give your set as they reflect each shining, neatly aligned part in their lustrous surface.

You will be amazed, too, at the greater dependability that the fine insulating properties of this famous material will contribute to your set's all-weather operation.

You will be amazed at the strength of these panels—at their durability that outlives all similar materials.

### Every Celoron Panel Is Guaranteed

Not to "cold flow" under screw pressure. Not to deteriorate with age. Not to fade, blister or lose its lustre. Not to be affected by moisture, oil, temperature or chemicals.

### No Matter What Kit You Buy—There Are Celoron Panels for It

How much easier it is to buy a true, accurately drilled factory finished and finely decorated Celoron Panel for any popular kit you select. And you can get Celoron Panels to harmonize with all fine cabinet woods. Standard Celoron Panels without decoration or drilling can also be supplied for experimental work on original hookups.

### \*Some of the Celoron Kit Panels Which Are Now Available Are Listed Below

- No. 84 Karas Equamatic—2 Dial:**  
Front Panel—7x24x3/16.....each \$5.50  
Sub-Panel—9x23x3/16.....each \$6.00
- No. 80 "World's Record" Super Ten:**  
Front Panel—7x26x3/16.....each \$6.30  
Sub-Panel—10x25x3/16.....each \$6.80
- No. 73 Magnaformer Super-heterodyne:**  
Front Panel—7x26x3/16.....each \$6.40  
Sub-Panel—9x25x3/16.....each \$6.50
- No. 7 Victoreen Super-heterodyne:**  
Front Panel—7x24x3/16.....each \$5.64
- No. 49 Victoreen Universal Super-heterodyne, Single Dial:**  
Front Panel—7x26x3/16.....each \$5.80
- No. 52 H. F. L. Nine-in-Line, Model 28:**  
Front Panel—7x26x3/16.....each \$6.20  
Sub-Panel—7x24x3/16.....each \$5.70

- No. 76 The Tyrman Ten:**  
Front Panel—7x26x3/16.....each \$6.70  
Sub-Panel—7x26x3/16.....each \$5.40
- No. 44 Melo-Heald Super-heterodyne:**  
Front Panel—7x28x3/16.....each \$6.00
- No. 71 The "Hot-Spot" Melo-Heald Fourteen:**  
Front Panel—7x30x3/16.....each \$7.20
- No. 64 Aero Seven Tube T.R.F.:**  
Front Panel—7x24x3/16.....each \$6.10  
Sub-Panel—7x23x3/16.....each \$5.20
- No. 33 B.-T. Power Six:**  
Front Panel—7x24x3/16.....each \$5.72
- St. James Upright Eight Super-heterodyne:**  
Sub-Panels (2).....Per set of 2 \$6.00

- Knickerbocker 4:**  
Front Panel—7x24x3/16  
Sub-Panel—9x17x3/16
- Lapeer A. R. 9:**  
Front Panel—7x24x3/16  
Sub-Panel—7x23x3/16
- Thompson Super 7:**  
Front Panel—7x21x3/16  
Sub-Panel—9x20x3/16
- Thordarson Power Amplifier:**  
Front Panel—7x16x3/16  
Sub-Panel—12x16x 1/4
- Camfield Super Selective 10:**  
Front Panel—7x30x3/16  
Sub-Panel—11x29x3/16
- National Browning-Drake:**  
Front Panel—7x21x3/16  
Sub-Panel—7x20x3/16

All front panels drilled and artistically decorated in gold. Supplied in polished block or beautiful wood grain finishes.  
Sub-Panels completely drilled. Supplied in polished block only.

\*Working Blue Prints for any of these kits can be procured from the Citizens Radio Call Book. Please use the numbers when ordering.

### If Your Dealer Can't Supply You—Use the Coupon

### JOBBERS—Hundreds of People Will Answer This Advertisement!

This means business for you. If you stock Celoron Panels we will refer all orders received from your territory to you. Write today.

THE CELORON COMPANY, Bridgeport, Pa.

**The Celoron Company**  
Bridgeport, Pa.

Gentlemen: Please send me (.....) sets of Celoron Panels in finish to best harmonize with a .....cabinet. I am enclosing my (check) (money order) for \$.....

Name & Number of Kit.....

Name.....

Street.....

City.....State.....

Tell 'Em You Saw It in the Citizens Radio Call Book Magazine

# ABOX

## "A" BATTERY ELIMINATOR



Licensed by The  
Andrews-Ham-  
mond Corpora-  
tion, under Pat-  
ent No. 1,637,  
795 and appli-  
cations

### True Electric "A" Power That Never Fails

WHEN you use an ABOX, all trouble with charging and charging equipment is done away with. The storage battery is made obsolete—and *your* radio set receives true "A" power from the light socket.

An ABOX "A" Eliminator consists of a rectifier and the famous ABOX Filter built into one compact unit. It takes alternating current from the light socket and delivers it to your set as perfect, 6 volt direct current "A" power. ABOX has no battery and operates only while the set is in use.

No more disappointments because of run-down storage battery—ABOX is always ready to deliver the correct amount of current for best results. Your set becomes as reliable and simple to operate as any electric appliance.

See the ABOX, hear it run ANY set, and learn how easily your set can be electrified with no change of tubes or wiring and without the services of a radio expert. Your radio store has ABOX.

[[ Send for interesting booklet,  
"ABOX and The Light Socket" ]]



**\$32.50**

*Slightly higher west of the Rockies*  
Input—110 volts, 50-60 cycles A. C. Output—6 volt direct current, 2 amperes. Shipping weight, 25 lbs. Unlimited shelf life.

4-volt model for Radiola sets or any receiver using small tubes **\$27.50**

The ABOX Filter is an entirely different unit from the Eliminator, being the filter circuit alone in a small, compact unit. If you have a suitable charger, it can easily be converted into an "A" Eliminator by substituting the ABOX Filter for the storage battery. Shipping weight, 11 lbs. Price, \$19.50. *Slightly higher west of the Rockies.* Send for Special Circular

## The ABOX Company

215 North Michigan Avenue

Chicago, Illinois

Tell 'Em You Saw It in the Citizens Radio Call Book Magazine

# 30 DAY FREE TRIAL

## Battery or A - Electric OPERATION

HERE is the great value offer of the day. Test and try this powerful seven-tube RANDOLPH RADIO for thirty days. After it brings in stations from coast to coast with amazing clearness—with easy one-dial tuning—after it easily equals any other radio regardless of cost—after you are more than satisfied then you can buy it direct at factory prices. Every RANDOLPH must make good before it is sold.

The RANDOLPH SEVEN-TUBE CONSOLE illustrated here can be had for use with batteries or connected direct to the electric light socket—absolutely batteryless—no batteries, chargers or acids—just plug in and tune in. 100% efficient either way. Its construction and performance have been tested and approved by leading radio engineers and authorities—by leading radio publications and laboratories.

### 7 Tubes—Single Control Illuminated Drum

One drum dial operated by one simple vernier control tunes in all stations with easy selectivity to tremendous volume. No overlapping of stations. Illuminated drum permits operation in the dark. Volume control for finer volume modulation. This is a seven-tube tuned radio frequency receiver with power transformers and power amplification. Space wound solenoid coils. Full and completely shielded. A real receiver of the highest quality. Tremendous distance, wonderful tone quality, simple to operate.

### Beautiful Walnut Console Built-in Cone Speaker

The Randolph Seven-tube Ampliphonic Console illustrated above is housed in a genuine burl-walnut cabinet with two-tone hand rubbed finish giving it unsurpassed beauty. The same expert cabinet work has gone into the making of these consoles as in the finest furniture. Has built-in cone loud speaker that compares with any on the market. Accurately reproduces complete range of musical notes from the highest to the lowest pitch.

### What Users Say

I have logged more than 50 stations from coast to coast.—Lloyd Davenport, Littlefield, Texas. I have logged 52 stations from Cuba to Seattle, the set is a world beater.—J. Tamplin, Detroit, Mich. Your set is a revelation, has all others tied to the post for distance and selectivity.—Waldo Powers, Vergennes, Vermont. On strength of its performance sold two more sets this week.—T. Scanlow, Orlando, Florida.

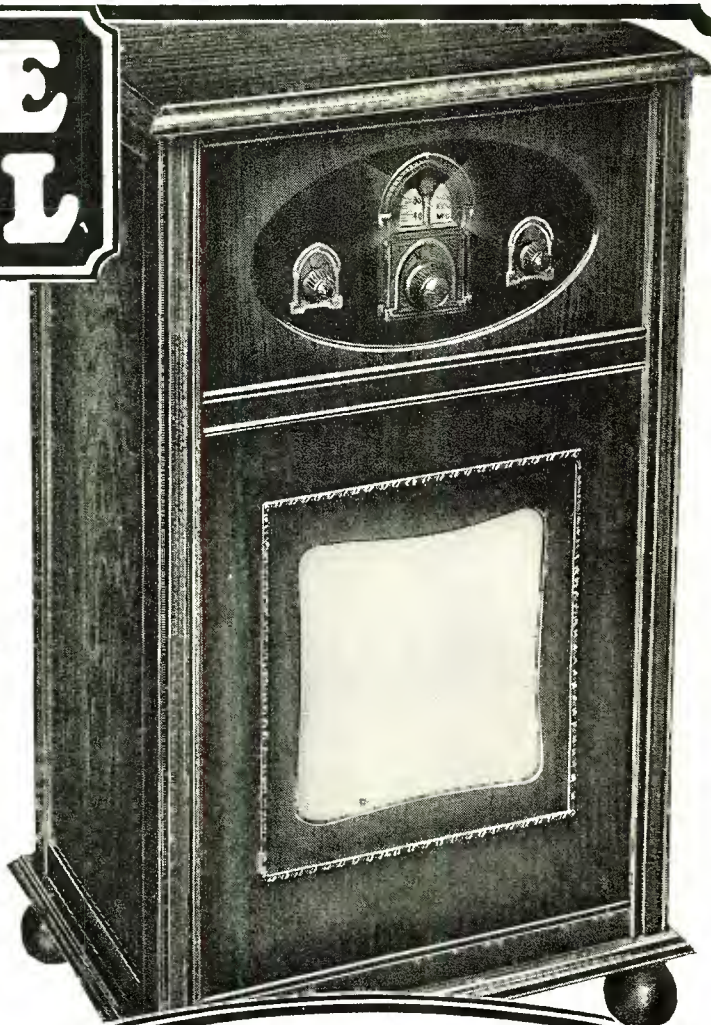

The Randolph \$  
7-Tube Console  
Single Control  
RETAIL PRICE  
Completely Assembled

# 99

MAIL  
COUPON  
NOW!

Sensationally Big  
Discounts to Agents

Work either full or part time and make big money. Tremendous advertising campaign helps you sell. Regardless of whether you have ever sold before, be sure to get our proposition. The Randolph sells on first demonstration. Men and women both can make money this easy way. Get your demonstration set for thirty day's FREE TRIAL.



### The Senior Six

Now you can have a new, modern, single-control, six-tube radio. Do not compare this set with old style 2-dial 6-tube sets selling for about the same price. The Randolph 1928 Senior Six has also been tested and approved by the leading radio engineers. Comes in a beautiful solid walnut cabinet of hand-rubbed finish. Single control. Illuminated Drum, with space for logging. Absolutely dependable and very selective. Sent for 30 Days' Free Trial. You test it before you buy.

6-Tube  
\$  
**55**  
Retail Price  
Single  
Control

The Randolph Radio Corporation are pioneers in the manufacture of radios. All of its vast and unlimited resources have been used in making and perfecting of the Randolph Receivers. Because of our long and successful experience in the radio business, we are perfectly confident in sending out a Randolph Radio on trial. We know what it will do. Mail us the coupon now for the greatest radio offer ever made.

Use This Coupon NOW!

Randolph Radio Corporation,  
711 West Lake Street, Dept. 197  
Chicago, Illinois.

Send me full particulars about the RANDOLPH Six and Seven-Tube All-Electric and Battery Table and Console Sets with details of your 30 Day FREE Trial Offer.

Name.....  
Address.....  
City..... State.....  
Mark here  if interested in Agent's proposition.

RANDOLPH RADIO CORPORATION  
711 West Lake Street Dept. 197, Chicago, Illinois

# American Broadcasting Stations

This list has been very carefully compiled from Federal Radio Commission bulletins and questionnaires sent to the broadcasting stations. If we have made any mistakes we want to know it. Address your corrections to the Citizens Radio Call Book, Caxton Building, Chicago, Ill., U. S. A.

**KDKA** Westinghouse Elec. & Mfg. Co., East Pittsburgh, Pa. 315.6 meters. 950 kilocycles, 30,000 watts. Week days, market and weather reports, 10 am, 12 noon, 4 & 5 pm. Time signals, 11:55 am; 6 pm, dinner concert. Evening program, 8 pm, Tues 7 pm. Mon, Wed, Fri, 7:15 pm, studio talks. Tues 11:35 pm, Fri 11:30 pm, concert. Sun, 10:45 am, church; 4 pm, organ; 4:45 pm, vespers; 6 pm, orchestra; 7 pm, church; 8:15, concert. Blue Chain Programs, Mon, 7:30-10 pm; Tues, Wed, Fri, 8-10 pm; Thurs, 8-10:30 pm; Sat, 9-10 pm; Sun, 8:15-10:15 pm. Eastern standard time.

**KDLR** Radio Elec. Co., Devils Lake, N. Dak. 230.6 meters, 1300 kilocycles, 15 watts. Daily ex Sun, 12:10 pm, weather; 6:15 pm, markets, sports, news, etc. Mon, 9:30-11 pm, studio program. Sun, 11 am, church; 4:30-6 pm, studio program. Central standard time.

**KDYL** Intermountain Broadcasting Corp., 1009-10-11 Ezra Thompson Building, Salt Lake City, Utah. 258.5 meters, 1160 kilocycles, 100 watts. Mon, Wed, Thurs, Sat, 10:30-11:30 am, 2-5 pm, 6-8 pm, studio program, etc.; 8-10:30 pm, studio; 10:30-11:30 pm, remote control dance music. Tues, 10:30-11:30 am, 2-10 pm, studio; 10-12 pm, midnight remote control dance music. Fri, 2-5 pm, 6-8 pm, studio program. Mountain time. Slogan: "On the Air—Goes Everywhere."

**KELW** Earl L. White, Broadcasting Station, Magnolia Park, Burbank, Calif. 228.9 meters, 1310 kilocycles, 250 watts. Daily ex Sun, 11:00 am, 1:00 pm, Press hour; 6-10 pm, Studio program. Western standard time. Slogan: "The White Spot of the San Fernando Valley."

**KEX** Western Broadcasting Co., Portland, Ore. 239.9 meters, 1250 kilocycles, 2500 watts. Sun, 8-10 pm, sacred music & organ concert. Daily ex Sun, 10 am, 12 noon, home economics; 6-10 pm, news, travelogues, music. Sat, 10-12 pm, midnight, dance music. Western standard time. Slogan: "A Public Service Necessity."

**KFAB** Nebraska Buick Auto Co., 13th and Que St., Lincoln, Nebr. 309.1 meters, 970 kilocycles, 5000 watts daytime, 2000 watts night time. Mon, Tues, Wed, Fri, Sat, 9:30-9:45 am, 10-10:30 am, 11:45 am-12:30 pm, 3:30-4 pm, 5:30-6:30 pm, 8-10:30 pm. Thurs, 9:30-9:45 am, 10-10:30 am, 11:45 am-12:30 pm, 3:30-4 pm. Sun, 9-10 pm. Central standard time. Slogan: "Home, Sweet Home."

**KFAF** Electrical Equipment Co., 312-16 N. Central av., Phoenix, Ariz. 272.6 meters, 1100 kilocycles, 500 watts. Daily, 12-15-1:15, 3-4, 6-7:30 pm. Tues, Fri & Sat, 8-9 pm. Wed & Thurs, 9-10 pm. Sun, 11 am to 12:30 pm, 8:30-9:30 pm. Mountain standard time. Slogan: "The Voice of Phoenix" and "The Gold Spot of America."

**KFAF** Alfred E. Fowler, 31st & San Antonio sts., San Jose, Calif. 217.3 meters, 1380 kilocycles, 50 watts. Pacific standard time.

**KFAU** High School, Boise, Idaho. 285.5 meters, 1050 kilocycles, 2000 watts. Sun, 3-5 pm, musical program; 7:30-8:30 or 9 pm, church services. Mon, Tues, Wed, Thurs, Fri, 12:30-1:15 pm, weather, market reports, U.S. Dept. of Agriculture features. Tues, 7:30-8 pm, Children's Half Hour; 8-9:30 or 10 pm, entertainment, news. Thurs, 7:30-8 pm; 8-9:30 or 10 pm, news, entertainment. Mountain standard time.

**KFBB** F. A. Buttrey Co., Havre, Mont. 275.1 meters, 1090 kilocycles, 50 watts. Daily ex Sun, 12 noon-1:45 pm, noonday program. Wed, 7:30-9 pm. Slogan: "Voice of the Treasure State."

**KFBC** Arthur W. Yale, M. D., and Union League Club of San Diego County, on roof of Balboa Theater Bldg., San Diego, Calif. 247.8 meters, 1210 kilocycles, 100 watts. Sun, 10-12 am. Daily ex Sun, 9:30-10:30 am, 12:45-1:45 pm, 5-10 pm. Pacific standard time.

**KFBK** Kimball Upson Co., 607 K st., Sacramento, Calif. 535.4 meters, 560 kilocycles, 100 watts. Mon, 7:30-9 pm, artist program & orchestra; 9-10 pm, dance program. Thur, 8-9 pm, artist program; 9-10:30 pm, dance program. Sat, 7:30-8 pm, dinner music; 8-9 pm, artist program; 9-10 pm, dance music. Pacific standard time. Slogan: "In the Heart of California."

**KFBL** Puget Sound Station, Leese Bros., 2814 Rucker ave., Everett, Wash. 223.7 meters, 1340 kilocycles, 50 watts. Daily, 7:30-8:30 pm. Sun, 11 am-12 noon. Mon, Wed, Fri, 6:30-8 pm. Tues, Thur, 7-8 pm, 9-10 pm. Sat, 9-11 pm. Pacific time. Slogan: "The Voice of Puget Sound."

**KFBU** St. Matthews Cathedral (Bishop N. S. Thomas), Laramie, Wyo. 428.3 meters, 700 kilocycles, 500 watts. Sun, 11 am, church. Daily ex Sun, 12 noon-1:30 pm, chapel services; 1:30 pm, studio programs. Mountain standard time. Slogan: "The Top of the World."

**KFCB** Nielsen Radio Supply Co., 311 N. Central av., Phoenix, Ariz. 243.8 meters, 1230 kilocycles, 125 watts. Sun, 9:30 to 10:30 am, Radio Community Bible Class. Mon, 7:30 to 8:30 pm, children's hour. Wed, 8 to 9 pm, musical. Thurs, 8 to 9 pm, educational program. Fri, 9 to 10 pm, dance music. Sat, 9 to 10 pm, dance music. Sun, 9:30-10:30 am, community Bible class. Mountain standard time. Slogan: "Kind Friends Come Back."

**KFCR** Santa Barbara Broadcasting Co., Daily News Bldg., Santa Barbara, Calif. 211.1 meters, 1420 kilocycles, 50 watts.

**KFDD** St. Michael's Episcopal Church (Paul Roberts), Boise, Idaho. 275.1 meters, 1090 kilocycles, 50 watts. Sun, 11:15 am-12:30 pm, 7:30-9:15 pm, church services. Mountain standard time. Slogan: "The Voice of the Saint and of Paul."

**KFDM** Magnolia Petroleum Co., Box 798, Beaumont, Tex. 374.8 meters, 800 kilocycles, 500 watts. Sun, 11-12 n, 8-9 pm, church services. Tues & Fri, 12:30 n, band concert; 8 pm, band concert. Central standard time. Slogan: "Kall for Dependable Magnolene."

**KFDX** First Baptist Church, Shreveport, La. 236.1 meters, 1270 kilocycles, 250 watts. Sun, 10:45 am, 7:45 pm, church services. Central standard time.

**GAIN** **TYRMAN**  
**SCORES**  
 Radios Newest Sensation  
**Tyrman A-C Ten**  
 ONE SPOT

Selectivity  
 Distance  
 Tone Quality  
 Elegance

See article in this issue.

Now duplicate the famous A-C Operated Tyrman Ten—the most powerful coast to coast receiver. Unequaled for its ultra fine tone quality—sensitivity—selectivity and DX reception. Far superior in appearance to any manufactured set. Convince yourself by comparing the Tyrman Ten with any existing receiver.

Front view of Tyrman Vernier Drum

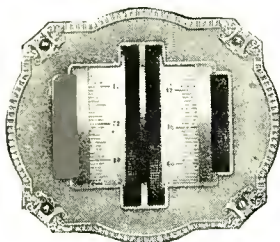

**FOR ALL POPULAR CONDENSERS**

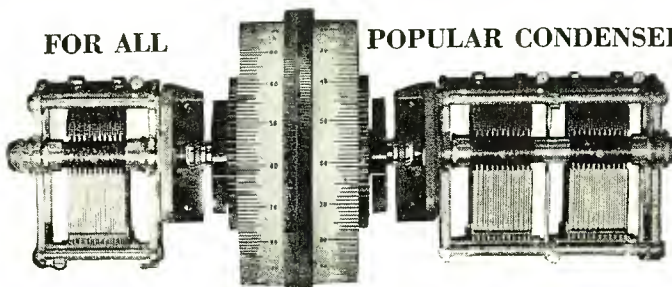

**TYRMAN VERNIER DRUM**

The Tyrman Vernier Drum is a precision tuning device assuring efficiency—accuracy and simplicity for all double and single control receivers.



**AUDIO TRANSFORMER**



**TYRMAN SHIELDED SOCKET**

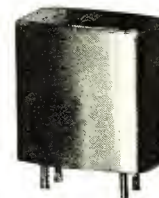

**TRF TRANSFORMER**

**Praised—Endorsed**

Radio Engineers and Technical Editors highly praise and endorse Tyrman products, now used in the better receivers of 1928.

ASK YOUR JOBBER

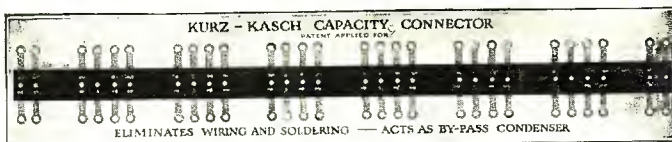

The Kurz-Kasch Capacity Connector is an exclusive Tyrman feature.

**2 Ounces of Interesting Radio Literature FREE TO SET BUILDERS**

**Mail This Coupon To-day**

**TYRMAN ELECTRIC CORP.**  
 141 W. Austin Avenue Chicago, Ill.

Tyrman Electric Corporation  
 141 W. Austin Avenue  
 Chicago, Illinois

Gentlemen:

Kindly send, gratis, your 2 ounces of radio literature.

Signed \_\_\_\_\_

Tell 'Em You Saw It in the Citizens Radio Call Book Magazine

**KFDY** South Dakota State College of Agriculture and Mechanical Arts, Brookings, So. Dak. 394.5 meters, 760 kilocycles, 500 watts. Daily, 12:30 pm, markets, weather, farm talks, news, music. Tues & Thurs, 7:30 pm, music and talks. Central standard time.

**KFDZ** Harry O. Iverson, 2510 Thomas av., South Minneapolis, Minn. 215.7 meters, 1390 kilocycles, 10 watts. Central standard time.

**KFEC** Meier & Frank Co., Portland, Ore. 214.2 meters, 1400 kilocycles, 450 watts. Daily ex Sun, 12 n, weather reports; 4-5 pm, music; 6-7 pm, weather, crop, market reports and music. Pacific time. Slogan: "Known for Every Courtesy." Divides time with KFIF.

**KFEL** Eugene P. O'Fallon (Inc.), Argonaut Hotel, Denver, Colo. 247.8 meters, 1210 kilocycles, 250 watts. Sun, 8:30 am, 9-10 am, church services. Daily ex Sun, 7:15 am, setting-up exercises; 10 am-12 noon, 2-6:45 pm, station programs. Mon & Sat, 11 pm, dance program. Tues, 8-10 pm, special program. Thurs, 8 pm-12 midnight, Sleepwalkers' program. Mountain standard time. Slogan: "The Argonaut Station."

**KFEQ** Scroggin & Co. Bank, Robidoux Hotel, St. Joseph, Mo. 230.6 meters, 1300 kilocycles, 1000 watts. Sun, 4:30-6 pm, 8:30-10 pm. Mon, Tues, Wed, Thurs, Fri, Sat, 2-3 pm, 8:30-10 pm. Central standard time.

**KFEY** Bunker Hill & Sullivan Mining & Concentrating Co., Y. M. C. A. & Union High School, Kellogg, Idaho. 232.4 meters, 1290 kilocycles, 10 watts. Sun, 11 am-7:30 pm, church services. Wed, 7:30-8:30 pm, musical. Thurs, 7:30, health talks. Sat, 9-10 pm, dance music. Pacific standard time. Slogan: "The Voice of the Coeur d'Alenes."

**KFGF** Full Gospel Church, "Old Glory" Station, Oklahoma City, Okla. 215.7 meters, 1390 kilocycles, 50 watts. Slogan: "The Whole Gospel to the Whole World."

**KFGL** N. L. Cotter, 219 W. Main St., Trinidad, Colo. 222.1 meters, 1350 kilocycles, 50 watts.

**KFGQ** Boone Biblical College, Boone, Iowa. 209.7 meters, 1430 kilocycles, 10 watts. Sun, 2:30 pm. Western standard time.

**KFH** Hotel Lassen (Rigby-Gray Hotel Co.), Wichita, Kan. 245.8 meters, 1220 kilocycles, 500 watts. Sun, 9:30-10:30 am, 7:30-9 pm, church services. Daily ex Sun, 8:30-9 am, 10-11 am, 1-2 pm, markets; 7:30-9 pm, studio program. Central standard time. Slogan: "Kansas' Finest Hotel—In the Very Heart of God's Country."

**KFHA** Western States College of Colorado, Gunnison, Colo. 254.1 meters, 1180 kilocycles, 50 watts. Tues, Fri, 7 pm, kiddies' hour; 7:30 pm, musical. Mountain time. Slogan: "Where the Sun Shines Every Day."

**KFHL** Penn College, Oskaloosa, Ia. 212.6 meters, 1410 kilocycles, 10 watts. Central standard time.

**KFI** Earle C. Anthony, Inc., 1000 S. Hope st., Los Angeles, Calif. 468.5 meters, 640 kilocycles, 5000 watts. Sun, 10 am, church; 5:30-10 pm, musical program. Wed, Fri, 10:45-11:05 am, household talk. Daily ex Sat, Sun, 5:30-10 pm, musical program. Sat, 5:30 pm-2 am, musical program. Pacific standard time. Slogan: "National Institution."

**KFIF** Benson Polytechnic School, Portland, Ore. 214.2 meters, 1400 kilocycles, 50 watts. Pacific standard time.

**KFIO** North Central High School, Spokane, Wash. 272.6 meters, 1100 kilocycles, 100 watts. Fri, 8-9:30 pm. Pacific standard time.

**KFIQ** Dr. I. M. Miller, 332 Miller Bldg., Yakima, Wash. 208.2 meters, 1440 kilocycles, 100 watts. Wed, Sat, 7:30 pm, musical programs. Sun, 11 am, 7:30 pm, church services. Pacific standard time.

**KFIU** Alaska Electric Light & Power Co., Juneau, Alaska. 225.4 meters, 1330 kilocycles, 10 watts. Mon, Wed & Fri, 6-7 pm, daily news items, steamer sailings, music, vocal and instrumental. Alaska time. (Note: 6-7 pm Alaska time is equivalent of 7-8 pm, Pacific standard time.) Slogan: "A Voice from the Far North."

**KFIZ** Fond du Lac Commonwealth Reporter, Fond du Lac, Wis. 267.7 meters, 1120 kilocycles, 100 watts. Daily, 5 to 5:30 pm, markets, weather and news. Occasional evening programs of music. Sun, 6-7 pm, dinner hour concert. Central standard time.

**KFJB** Marshall Electric Co., 1603 W. Main st., Marshalltown, Iowa. 247.8 meters, 1210 kilocycles, 15 watts. Daily ex Sun, 10 am, market reports. Tues & Fri, 7:30-11 pm, musical programs. Sun, 10 am-12 m; vespers, 3-6 pm. Central standard time. Slogan: "Marshalltown, the Heart of Iowa."

**KFJF** National Radio Mfg. Co., 406 N Hudson st., Oklahoma City, Okla. 272.6 meters, 1100 kilocycles, 1000 watts daytime, 750 watts night time. Daily ex Sun, 9 am, 10 am, 12:30 pm, 4:30 pm, market service; 9:15 am, music; 6-7, orchestra; 7 pm, dinner musical; 9 pm, musical program. Sun, 9 am, 10 am, 11 am, 7:30 pm, 9:30 pm, church. Central standard time. Slogan: "Radio Headquarters of Oklahoma, the Tired Hand Announcing."

**KFJI** E. E. Marsh, Astoria, Ore. 249.9 meters, 1200 kilocycles, 15 watts. Wed, 9-10 pm, organ music. Sun, 12:30-1:30 pm. Sat, 10:30-11 pm. Pacific standard time.

**KFJM** University of North Dakota, Grand Forks, N. Dak. 333.1 meters, 900 kilocycles, 100 watts. Limited com. Sun, 10:45-12, church service. Daily, 12 n-1 pm, music records; 6-7 pm, orchestra. Central standard time.

**KFJR** Ashley Dixon & Son, 1350 E. 36th st., Portland, Ore. 282.8 meters, 1060 kilocycles, 100 watts. Daily ex Sat & Sun, 5-8 pm. Tues, 10-11 pm, studio program. Thurs, 9:30 pm-12 midnight; Fri, 12 midnight-1 am. Pacific standard time.

**KFJY** Tunwall Radio Co., 1004 Central av., Ft. Dodge, Iowa. 440.9 meters, 680 kilocycles, 100 watts. Sun, 11 am, church services. Daily ex Sun, daily, 5:45 pm; market and weather reports. Mon, Wed, Fri, 10-11 am, musical. Mon, 11-12 pm, musical. Thurs, 8:30 pm, musical program. Central standard time.

**KFJZ** W. E. Branch, 3219 Avenue L, Fort Worth, Tex. 249.9 meters, 1200 kilocycles, 50 watts. Sun, 7-10 pm, 11-12:30 mornings. Daily ex Sun & Wed, 8:30-9:30 pm, 9 am to 6 pm. Central standard time.



**TRY IT 30 DAYS FREE BEFORE YOU BUY**

**FACTORY PRICES~SAVE 50%**  
Choice of beautiful cabinets offered

**3 Year Guarantee**

**ALL METAL SHIELDED CHASSIS**

**Only \$69<sup>75</sup>**

**Retail List Completely Assembled**

**6 Tube ~ one dial**

**MIRACO**  
TRADE MARK REGISTERED

**MAGNIFICENT TONE~SUPER SELECTIVE~POWERFUL DISTANCE GETTER**

**All Electric or Battery Set!**

**Big Discounts to User-Agents**

**MIRACO Users Say:**

Reports from users everywhere leave little for us to add. There are only a few of the many in our files and which we receive daily. Send coupon for plenty of additional proof and testimony of nearby users.

**CLEARER THAN A \$450.00 SET**  
Before I bought your set I tried out and heard quite a number of different makes sets and I believe I can truthfully say that I never yet have heard a set with such wonderful tone and clearness as the Miraco. I never thought that a set could be as clear and reproduce tones and voices as the Miraco. Saturday I listened to a \$450.00 set and it can't even compare your set for clearness and volume. I have looked some very distant stations on the Untinet and although people won't hardly believe me, the first week I had KFI Los Angeles on two nights in succession on a 30-ft. temporary inside aerial.—FRANK A. OLDENBURG, Milwaukee, Wis.

**SHARPLY SEPARATE STATIONS**  
The Untinet brings in stations very clearly and with a selectivity that is amazing when you take in consideration the mass of stations on the air at the same time. I have heard three and four stations that were on almost same wavelengths at the same time and was able to tune out one after the other without the least interference.—W. L. BROHACK, San Francisco, Calif.

**EXPERIENCED FAN PRAISES SET**  
Miraco is the most wonderful radio I have ever seen. I have had experience with many popular makes of radios, also have built a number of them myself but in tone quality it is far superior to all. For sensitiveness I can say it is more like a super-tetrodyne.—R. D. WHITE, Proctor, W. V.

**HAS POWER TO SPARE**  
"Well Pleased" with Miraco would be putting it mildly. Haven't heard anything to equal it regardless of price. With terms that are tuned in WEAF then WJOD Florida felt sure this must be WJZ the pet station of this locality. Stations all coming in clear with wonderful tone and tremendous volume. Set do m have more than half of volume turned on. A local agent insisted he could prove his set superior but to his surprise and astonishment my family and neighbors and the agent himself admitted his \$168 set had to step out of the way for Miraco.—H. W. HOEPFL, Parkersville, Pa.

America's big, old, reliable Radio Corporation\* (8th successful year) **guarantees** in its big, powerful, latest 6, 7 and 8 tube Miraco sets "the finest, most enjoyable performance obtainable in **high grade** radios." Unless 30 days' use in your home fully satisfies you a Miraco is unbeatable at any price for beautiful, clear cathedral tone, razor-edge selectivity, powerful distance reception, easy operation, etc.—**don't buy it! Your verdict final.** Save or make lots of money on sets and equipment—write for testimony of nearby users and **Amazing Special Factory Offer.**

**Miraco's work equally fine on "AC" electric house current or with batteries.** Take your choice. Many thousands of Miraco users—who bought after thorough comparisons—enjoy programs Coast

to Coast, Canada to Mexico, loud and clear—with the magnificent cathedral tone quality of costliest sets. Don't confuse Miraco's with cheap, "squawky" radios. Miraco's have finest parts, latest approved shielding, metal chassis, etc.—as used in many \$200 sets.

**Deal Direct with Big Factory**  
Your Miraco reaches you completely assembled, rigidly tested, fully guaranteed. Easy to connect and operate. **30 days' trial free.** 3 year guarantee if you buy. You take no risk, you insure satisfaction, you enjoy **rock-bottom money-saving prices** by dealing direct with one of radio's oldest, most successful builders of fine sets. 8th successful year in the radio manufacturing business.

**7 tube one dial METAL SHIELDED CHASSIS**

**\$49<sup>75</sup> RETAIL LIST**

MIRACO "Powerplus" sets—both in 8 and 7 tube models—have magnificent beauty, clear cathedral tone quality. Turn one dial for stations every where. Ultra-selective, Miraco multi-stage distance amplification gives "power-plus" on far-off stations. Latest all-metal shielded chassis. Illuminated dial. Fully guaranteed. Try one free for 30 days! Choice of beautiful cabinets.

**Dealers Write!**

USER-AGENTS! Make big profits showing Miraco to friends. Get Our Special Wholesale Prices!

**MIDWEST RADIO CORPORATION, Cincinnati, O.**

**BEAUTIFULLY ILLUSTRATED CATALOG AND AMAZING SPECIAL OFFER**

**Free!**

SEND NO MONEY—30 DAYS' TRIAL. Special Wholesale Price Offer to User-Agents, Bank References, testimony of nearby Miraco users—all the proof you want—sent with catalog.

**mail coupon right now!**

**Electrify Any Radio with MIDWEST NO-BATTERY "AC" Light Socket Power Units**

**BIG DISCOUNT TO User-Agent**

"A", "B" and "C" power, direct from light socket, without batteries! Write for Midwest prices and discounts. Midwest Units are highest grade—lastingly dependable, quiet in operation, fully guaranteed.

**6 tube Super 36<sup>75</sup> RETAIL LIST**

**Another Big Bargain!** Famous powerful big Miraco Super 6, 1928 model—ultra selective! Thousands find it outperforms sets of much higher price. **30 Days' Trial Free. Fully Guaranteed.**

**MIDWEST RADIO CORPORATION**  
Pioneer Builders of Sets  
531-E Miraco Building, Cincinnati, Ohio.

Without obligation, send free catalog, AMAZING SPECIAL OFFER, testimony of nearby Miraco users.  User  Agent  Dealer

**THIS COUPON IS NOT AN ORDER**

NAME \_\_\_\_\_

ADDRESS \_\_\_\_\_

**KFKA** Colorado State Teachers' College, Greeley, Colo. 399.8 meters, 750 kilocycles, 200 watts. Daily ex Sun, 12:05-12:15 pm, reports; 4-5 pm, studio programs; 8-10 pm, studio programs. Mountain time.

**KFMR** Morningside College, Sioux City, Iowa. 440.9 meters, 680 kilocycles, 100 watts. Commercial. Daily ex Sat & Sun, 11:40 am-12:30 noon. Tues, Wed, Thur, Fri, 7:30-8:30 pm. Central standard time.

**KFOY** Maurice Gordon Goldberg, St. Paul Minn. 285.5 meters, 1050 kilocycles, 250 watts. Sun, silent. Mon, 7 pm, popular hour. Mon, Tues, Fri, 9 pm, reports. Wed, Thurs, Sat, 9 pm, reports; 9:05 pm, dance music. Central standard time.

**KFKB** Dr. Brinkley's Hospital, Milford, Kan. 241.8 meters, 1240 kilocycles, 2500 watts. Sun, 8 am, 10 am, Bible lecture; 6 pm, 6:30 pm-12 midnight, concert. Daily ex Sat, 10:15 am, 12 noon, 6 pm, 10 pm, markets and weather reports; 1 pm, 6:30 pm, 10 pm, lectures; 3-4 pm, matinee program; 5:30-6:30 pm, 8-10 pm, Variety Program. Daily, 12 noon-1 pm, Tiffin Hour Program. Tues & Thurs, 11 pm-1 am. Central standard time. Slogan: "The Sunshine Station in the Heart of the Nation."

**KFMX** Carleton College, Northfield, Minn. 236.1 meters, 1270 kilocycles, 600 watts. Sun, 7 pm, college vesper service. Tues, 9:30 pm, lecture. Wed, 9 pm, concert. Fri, 10 pm, organ recital. Central standard time.

**KFPL** C. C. Baxter, 205 Grafton st., Dublin, Tex. 275.1 meters, 1090 kilocycles, 15 watts. Sun, 7:30 am, 1:30 pm. Mon & Thurs, 8-9 pm. Central standard time. Slogan: "Baxter's Place."

**KFKU** University of Kansas, Lawrence, Kan. 254.1 meters, 1180 kilocycles, 500 watts. Mon & Thurs, 7-8 pm. (Also special broadcasting.) Central standard time. Slogan: "Up at Lawrence on the Kaw."

**KFNF** Henry Field Seed Co., Shenandoah, Iowa. 461.3 meters, 650 kilocycles, 1000 watts. Sun, 8:30-9:30 am, 10:45-12:15 pm, 2-4 pm, 6-7 pm, 7:45-8:15 pm, church services, etc. Daily ex Sun, 6-8:30 am, 10-11 am, 12 noon-2 pm, 3-3:30 pm, 3:30-4 pm, 4:30-5 pm, 5-7 pm, varied programs. Slogan: "Known for Neighborly Folks."

**KFPM** The New Furniture Co., Box 628, Greenville, Tex. 230.6 meters, 1300 kilocycles, 15 watts, Sun, 11 am, services. Mon, & Fri, 8 pm, music; Wed, 8 pm, music; 7:15, sports in season; 1 pm daily ex Sun, musical program. Central standard time. Slogan: "Biggest Little Ten Watts on the Air."

**KFKZ** State Teachers College, 107 E. Harrison st., Kirksville, Mo. 225.4 meters, 1330 kilocycles, 15 watts. Sun, 3:30 to 4:30 pm. Mon, 8-9 pm, dance music; 9 pm, radio plays. Slogan: "Kirksville, the Home of Osteopathy."

**KFOA** Rhodes Dept. Store, 1321 2nd av., Seattle, Wash. 447.5 meters, 670 kilocycles, 1000 watts. Mon & Fri, 10 am-12 midnight. Tues, 12:30-11 pm. Wed, 10 am-10 pm. Thurs, 12:30 pm-10 pm. Sat, 4:30 pm-9 pm. Sun, 5:30-6:30 pm. Pacific standard time.

**KFPR** Los Angeles County Forestry, Los Angeles, Calif. 232.4 meters, 1290 kilocycles, 250 watts. Irregular schedule. Pacific standard time.

**KFLR** University of New Mexico, Albuquerque, N. Mex. 416.4 meters, 720 kilocycles, 100 watts. Fri, 8:10 pm. Mountain standard time. Slogan: "Sunshine Center of America."

**KFOB** KFOB, Inc., Burlingame, Calif. 225.4 meters, 1330 kilocycles, 50 watts. Tues & Thurs, 10-11:30 am, 1-2:30 pm, 5:30-7 pm, 8-11 pm. Sat, 1-3 pm, 5:30-7 pm, 9 pm-1 am. Pacific standard time.

**KFPW** Lannie W. Stewart, Cartersville, Mo. 263 meters, 1140 kilocycles, 50 watts. Sun, 1-2 pm, chapel service. Fri, 8-10 pm, popular and classical. Central standard time. Slogan: "Keeping Pace with Christ Means Progress."

**KFLU** San Benito Radio Club, San Benito, Tex. 236.1 meters, 1270 kilocycles, 15 watts. Wed & Sat, 8-9 pm. Central standard time.

**KFON** Nichols & Warinner (Inc.), 212 Jergins Trust Bldg., Long Beach, Calif. 241.8 meters, 1240 kilocycles, 500 watts. Daily including Sun, 9:30 am-12 midnight. Pacific standard time. Slogan: "Piggly Wiggly Station."

**KFPY** Symons Investment Co., Symons Block, Spokane, Wash. 245.8 meters, 1220 kilocycles, 250 watts. Sun, 7:45 pm-12 midnight. Mon, Tues, Wed, Thurs, Fri, 9:45-11 am, 3-5 pm, 6:15-10:30 pm. Pacific standard time.

**KFLV** Swedish Evang. Miss. Church, Rockford, Ill. 267.7 meters, 1120 kilocycles, 100 watts. Fri, 8:30 pm. Sun, 12:30 pm (Swedish), 9:30 pm (English). Central standard time.

**KFOO** Latter Day Saints University, Salt Lake City, Utah. 236.1 meters, 1270 kilocycles, 250 watts.

**KFQA** The Principia, 5539 Page av., St. Louis, Mo. 322.4 meters, 930 kilocycles, 50 watts. Sun, 8 pm, church services. Fourth Church of Christ, Scientist, St. Louis, Mo. Central standard time.

**KFLW** Earl L. White, 3702 Magnolia Ave., Burbank, Calif. 535.4 meters, 560 kilocycles, 250 watts.

**KFOR** Howard A. Shaman, Lincoln, Nebr. 217.3 meters, 1380 kilocycles, 100 watts. Daily ex Sun, 12:30-1:30 pm, 2-3:15 pm, 7-10 pm. Central standard time. Slogan: "The Poultry Station of the Middle West."

**KFQB** Lone Star Broadcast Co., Ft. Worth, Tex. 260.7 meters, 1150 kilocycles, 1000 watts. Daily ex Sun & Wed, 8-12 midnight, musical. Sun, 10 am-12 pm, 3-10 pm, church services. Central standard time. Slogan: "Keep Folks Quoting the Bible—KFQB."

**KFLX** George R. Clough, 3327 Avenue P, Houston, Tex. 270.1 meters, 1110 kilocycles, 100 watts. Central standard time.

**KFOX** Technical High School, Omaha, Nebr. 258.5 meters, 1160 kilocycles, 100 watts. Daily ex Sat & Sun, 12:30-2 pm. Tues, 7:30-9 pm. Central standard time.

# Balkite has pioneered— but not at public expense



Licensed under Andrews-Hammond patent

**Balkite "A"** Contains no battery. The same as Balkite "AB" but for the "A" circuit only. Not a battery and charger but a perfected light socket "A" power supply. One of the most remarkable developments in the entire radio field. Price \$35.00.



**Balkite "B"** One of the longest lived devices in radio. The accepted tried and proved light socket "B" power supply. The first Balkite "B," after 5 years, is still rendering satisfactory service. Over 300,000 in use. Three models: "B"-W, 67-90 volts, \$22.50; "B"-135, 135 volts, \$35.00; "B"-180, 180 volts, \$42.50. Balkite now costs no more than the ordinary "B" eliminator.

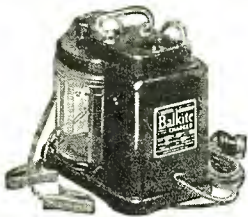

## Balkite Chargers

Standard for "A" batteries. Noiseless. Can be used during reception. Prices drastically reduced. Model "J,"\* rates 2.5 and .5 amperes, for both rapid and trickle charging, \$17.50. Model "N"\* Trickle Charger, rate .5 and .8 amperes, \$9.50. Model "K" Trickle Charger, \$7.50.

\*Special models for 25-40 cycles at slightly higher prices

Prices are higher West of the Rockies and in Canada

*The great improvements in radio power have been made by Balkite*

First noiseless battery charging. Then successful light socket "B" power. Then trickle charging. And today, most important of all, Balkite "AB," a complete unit containing no battery in any form, supplying both "A" and "B" power directly from the light socket, operating only while the set is in use.

This pioneering has been important. Yet alone it would never have made Balkite one of the best known names in radio. Balkite is today the established leader because of Balkite performance at the hands of its owners.

Because with 2,000,000 units in the field Balkite has a record of long life and freedom from trouble seldom equalled in any industry.

Because of the first 16 light socket "B" power supplies put on the market, Balkite "B"

alone remains in its original form; all others have either been radically revised in principle or completely withdrawn.

Because the first Balkite "B," purchased 5 years ago, is still in use and will be for years to come.

Because to your radio dealer Balkite is a synonym for quality.

Because the electrolytic rectification developed and used by Balkite is so reliable that today it is standard on the signal systems of most American as well as European and Oriental railroads.

Because Balkite is permanent equipment. Balkite has pioneered—but not at the expense of the public.

Today, whatever type of set you own, whatever type of power equipment you want (with batteries or without), whatever you want to pay for it, Balkite has it. And production is so enormous that prices are astonishingly low.

Your dealer will recommend the Balkite equipment you need for your set.

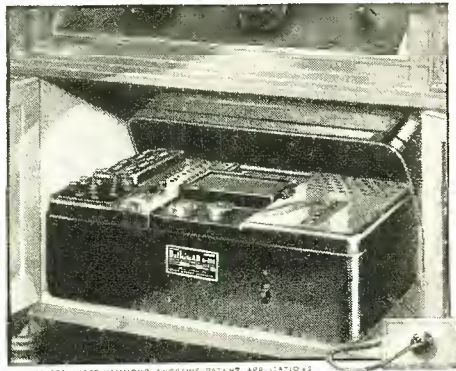

**Balkite "AB"** Contains no battery.

A complete unit, replacing both "A" and "B" batteries and supplying radio current directly from the light socket. Contains no battery in any form. Operates only while the set is in use. Two models: "AB" 6-135, 135 volts "B" current, \$64.50; "AB" 6-180, 180 volts, \$74.50.

FANSTEEL PRODUCTS COMPANY, INC., NORTH CHICAGO, ILLINOIS

Licenseses for Germany:  
Siemens & Halske, A. G. Wernerwerk M  
Siemensstadt, Berlin

Sole Licensees in the United Kingdom:  
Messrs. Radio Accessories Ltd., 9-13 Hythe Rd.  
Willesden, London, N. W. 10

FANSTEEL

# Balkite

## Radio Power Units

Tell 'Em You Saw It in the Citizens Radio Call Book Magazine

**KFQD** Anchorage Radio Club, Anchorage, Alaska. 244.6 meters, 870 kilocycles, 100 watts.

**KFQP** George S. Carson, Jr., 906 College st., Iowa City, Iowa. 223.7 meters, 1340 kilocycles, 10 watts. Central standard time. Irregular schedules as announced.

**KFQU** W. E. Riker, Holy City, Calif. 249.9 meters, 1200 kilocycles, 100 watts. Daily ex Sun, 6:30-7:30 pm, miscellaneous. Tues, 9:30-11:45 pm, musical. Wed, Thurs, Sat, 9-10 am, lecture. Fri, 9-11:30 pm, musical. Sun, 11 am-12 noon, 9-10 pm, lectures. Pacific standard time.

**KFQW** KFQW, Inc., Continental Hotel, Seattle, Wash. 217.3 meters, 1380 kilocycles, 100 watts. Sun, 10 pm-12 midnight, popular program. Daily ex Sun, 10-11 am, University District hour; 12 noon-1 pm, luncheon musicale; 4:30-5:30 pm, tea hour program; 5:30-6 pm, amusements; 6-11 pm, musical program. Pacific time. Slogan: "Gateway to Alaska and the Orient."

**KFQX** Alfred M. Hubbard, 609 Washington blvd., Seattle, Wash. 210 meters, 1428 kilocycles, 15 watts.

**KFQZ** L. E. Taft, 5653 De Longpre ave., Hollywood, Calif. 232.4 meters, 1290 kilocycles, 100 watts. Tues, Fri, 9-11 pm, musical program. Pacific standard time.

**KFRC** Don Lee (Inc.), San Francisco, Calif. 454.3 meters, 660 kilocycles, 1000 watts. Daily ex Sun, 7-9 am, musical program; 10-11 pm, studio program; 5:30-6:30 pm, children's program. Mon & Thurs, 6:30-10 pm. Tues & Fri, 6:30-11 pm, concert. Wed, 6:30-12 pm. Sat, 6:30 pm-1 am, dance music. Sun, 12-1 pm, church services; 5-6 pm, organ recital. Pacific standard time.

**KFRU** Stephen's College, a Junior College for Women, Columbia, Mo., "The Athens of the West." 249.9 meters, 1200 kilocycles, 500 watts. Sun, 7:30 am, sunrise service; 9:20 am, Burrall class; 7:30 pm, church services. Daily ex Sun & Sat, 8:30 am, public school convocation; 4:30 pm, popular program; 6 pm, dinner hour. Wed, 9 pm, musical program. Thurs, 10 pm, musical program. Sat, 4:30 pm, popular program; 6:15 pm, weather news. Central standard time. Slogan: "Where Friendliness is Broadcast Daily."

**KFSD** Airfan Radio Corporation, U. S. Grant Hotel, San Diego, Calif. 440.9 meters, 680 kilocycles, 500 watts. Sun, 3-4 pm, musical program; 6:15-10 pm, musical program. Daily ex Sun, 6:15-11 pm, musical program. Pacific time.

**KFSG** Angelus Temple, 1100 Glendale blvd., Los Angeles, Calif. 275.1 meters, 1090 kilocycles, 500 watts. Sun, 10:30 am-12:30 pm, 2:30-4:30 pm, 6:30-11 pm. Tues & Wed, 10:30 am-12:30 pm, 2:30-4:30 pm, 6:30-9:30. Thurs & Fri, 10:30 am-12:30 pm, 2:30-4:30 pm, 6:30-11 pm. Sat, 10:30 am-12:30 pm, 2:30-4:30 pm, 6:30-9:30 pm. Church services, organ recitals, band concerts, sacred and classical musicales. Slogan: "The Church of the Air."

**KFUL** Thos. Goggan & Bro. Music Co., 2126 Market, Galveston, Tex. 258.5 meters, 1160 kilocycles, 500 watts. Daily, 1-2 pm. Mon & Fri, 8 pm. Central standard time. Slogan: "The City of Perpetual Sunshine."

**KFUM** W. D. Corley, Mining Exchange Bldg., Colorado Springs, Colo. 236.1 meters, 1270 kilocycles, 100 watts. Sun, 11 am-12:30 pm, 6:30-8:30 pm. Mon, 6:30-7:30 pm, 8-9 pm. Tues, 8-9 pm. Thur, 6:30-9 pm. Fri, 4-5 pm, 6:30-7:30 pm. Slogan: "Known For Unsurpassed Mountain Scenery."

**KFUO** Concordia Seminary (Lutheran), St. Louis, Mo. 545.1 meters, 550 kilocycles, 500 watts. Sun, 9:15 pm. Mon & Thurs, 8 pm. Wed, 9:30 pm. Fri, 6:30-7:15 pm. Divides time with Station KSD. Central standard time. Slogan: "The Gospel Voice."

**KFUP** Fitzsimmons General Hospital, Educational & Recreational Dept., U. S. Army, Denver, Colo. 227.1 meters, 1320 kilocycles, 100 watts. Mountain time.

**KFUR** Perry Building Co., 420 Twenty-fifth st. (H. W. Peery, Mgr.), Ogden, Utah. 225.4 meters, 1330 kilocycles, 50 watts. Tues, Thurs, Sat, 9:50-11:50 pm, dance music. Mountain time.

**KFUS** Louis L. Sherman, 1444 Havenscourt blvd., Oakland, Calif. 256.3 meters, 1170 kilocycles, 50 watts. Tues, 2:30-3:30 pm, educational; 8-9 pm, 6:30-7:30 pm, sacred studio program. Wed & Fri, 8-9 pm, sacred program. Thurs, 4:30-5 pm, educational; 5-5:30 pm, children's program. Sun, 9-9:30 am, S.S. lesson; 3:30-4:30 pm, sacred program. Pacific standard time.

**KFUT** University of Utah, Salt Lake City, Utah. 499.7 meters, 600 kilocycles, 50 watts. Tues, Wed, Thur, Fri, 7-8 pm. Mountain time.

**KFVD** W. J. & C. I. McWhinnie, Venice Ballroom, Venice, Calif. 208.2 meters, 1440 kilocycles, 250 watts. Sun, 6-12 pm, dance program. Daily ex Sun, 9:30 am-12 noon, 4:30-6 pm, 9 pm-12 midnight. Pacific time. Slogan: "The Voice of the Sea." Divides time with Station KGFI.

**KFVE** Greater St. Louis Broadcasting Corp., International Life Insurance Company's Station, Hotel Chase, St. Louis, Mo. 234.2 meters, 1280 kilocycles, 1000 watts. Sun, 11:15 am-12 noon, 2:30-5 pm, 6:45-9 pm. Daily ex Sun, 10 am-12 noon, 2:30-5 pm, 6:45-10:45 pm. Central standard time.

**KFVG** First Methodist Episcopal Church, 204 S. Penn. ave., Independence, Kan. 225.4 meters, 1330 kilocycles, 50 watts. Sun, 10:55 am-12:30 pm & 7:30-9:15 pm, church services. Central standard time. Slogan: "Kansas Folks Very Good."

**KFVI** Headquarters Troop, 56th Cavalry Brigade, 305 Sabine st., Houston, Tex. 238 meters, 1260 kilocycles, 50 watts. Central standard time.

**KFVN** Carl E. Bagley, Fairmont, Minn. 228.9 meters, 1310 kilocycles, 100 watts. Mon, Tues, Wed, 9-10:30 pm, musical programs. Fri, 8:30-8:50 pm, children's religious hour; 9-10:30 pm, musical program. Sun, 2:30-3:30 pm, Sunday School. Central standard time.

**KFVR** Olinger Corporation, Denver, Colo. (near), 1075 Pennsylvania st. 475.9 meters, 630 kilocycles, 250 watts. Mon, Tues, Wed, Fri & Sat, 7-9:30 pm, 12-2 am. Thurs nite silent. Wed, Thurs, 12-1 am. Mountain time.

**KFVS** Hirsch Battery & Radio Co., 312 S. Frederick st., Cape Girardeau, Mo. 223.7 meters, 1340 kilocycles, 50 watts. Daily ex Sun, 12:15 noon, news and markets. Mon, Tues, 10:30 pm, musical. Wed, 7:30-10:30 pm, musical. Thurs, Fri, 7:30-9:30 pm, musical. Central standard time. Slogan: "The City of Opportunity."



# Covering the Radio Field

Jewell instruments fill all the needs of the radio industry for testing equipment.

Set builders, amateurs, radio dealers, service men, manufacturers—all use Jewell instruments, for they have found them more than satisfactory. Jewell instruments are sturdy and accurate, and will stand an unusual amount of abuse without becoming inaccurate. They are popular because there are so many styles and ranges from which to make a choice and because they are reliable.

You will want Jewell instruments also so write for a copy of our radio instrument catalog No. 15-C, which describes and lists all of our radio instruments.



Pattern No. 117

Radio Service Set for general servicing of radio apparatus. It tests tubes, batteries, "B" eliminators, transformers, condensers, resistance, circuits, charging rates, etc. Has a drawer for tools and a detachable battery compartment. It is the ideal instrument for doing a complete service job.



Pattern No. 116

High resistance voltmeter for checking the delivery voltages of "B" eliminators or power supplies. Special high resistance requires but one and one-fourth milliamperes to operate. It shows the true voltage, which cannot be obtained with the ordinary type voltmeter. Scale 0-50-250 volts.



Pattern No. 115

A small precision tube checker in genuine bakelite case suitable for checking all tubes up to and including the 210 power tube. The instrument comes equipped with a rheostat, socket, filament voltmeter 0-8 volts and plate milliammeter 0-8.40 milliamperes. Tubes can be rapidly checked with this instrument.



Pattern No. 133

Radio Set Analyzer provides a rapid and thorough means of shooting trouble in a radio set. Grid, plate and filament conditions of all tubes can be determined. Separate terminals provide for making continuity tests of circuits. The carrying case is covered with genuine morocco leather.



Pattern No. 57

A general testing voltmeter for radio circuit and battery checking. It has a plain dial with black characters and silver etched background. Movement is a high-grade D'Arsonval type with silvered parts and with a zero adjuster. It is furnished in combination ranges of which the 0-7.5-150 and 0-8-200 volts are most popular.



Pattern No. 98

Designed to make the testing of radio batteries easy, this instrument is recommended for use by set owners and radio dealers. It is supplied with three 18-inch colored leads corresponding with colored binding posts and specially colored scale. The double scale reads from 0 to 10 and from 0 to 50 volts.



Pattern No. 139

A small high resistance voltmeter of the D'Arsonval moving coil type, suitable for use by the individual in checking and adjusting B eliminator voltages. Scale range of 0-300 volts covers all ordinary requirements. It is a thoroughly high-grade instrument and can be depended upon.



Pattern No. 64

This instrument is a member of the famous Jewell Trio of transmitting instruments for amateurs. It is a thermo-couple type instrument and is guaranteed to stand an overload of 30%. The loss in the instrument is less than one-half of the minimum required by the Navy.

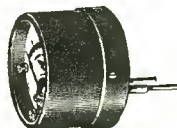

Pattern 135A

The Jewell tip-jack voltmeter is 2 inches in diameter and has two prongs that can be adjusted to fit varying spacings of the two phone jacks now found on the panels of several makes of radio sets. The movement is a high resistance type with a zero adjuster and a silver etched scale having black characters.



Pattern 135C

A beautiful Portable for the home, resembling a miniature mantel clock. The case is of genuine bakelite. Furnished with two leads equipped with phone tips which may be plugged into the phone jacks found on several of the popular sets. It can also be used for checking batteries.



Pattern 190

A flush type, 2-inch A. C. instrument of the same size and appearance as our Pattern 135. It will be found very valuable for filament control of the new alternating current tube. It is furnished in ranges of 0-1.5, 0-3, 0-5, 0-15 and 0-150 volts.

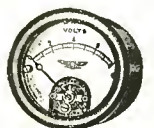

Pattern 135

This instrument is the type specified and used in most of the popular radio circuits being used this year. The case is two inches in diameter and mounts flush with the panel. It is a thoroughly high-grade instrument and is furnished in a number of ranges, of which the 0-5 and 0-8 are most popular.

"27 Years Making Good Instruments"

**Jewell Electrical Instrument Co.**  
1650 Walnut Street, Chicago

Tell 'Em You Saw It in the Citizens Radio Call Book Magazine

**KFVY** Radio Supply Co., 407 W. Central ave., Albuquerque, N. Mex. 249.9 meters, 1200 kilocycles, 10 watts. Daily ex Sun, 5:30-6:30 pm, news items & music. Tues & Fri, 8-9:30 pm, dance music. Mountain standard time.

**KFWB** Warner Bros. Motion Picture Studios, Inc., 5842 Sunset Blvd., Hollywood, Calif. 361.2 meters, 830 kilocycles, 500 watts. Sun, 8:30-11 pm. Mon, Thurs, Fri, 12 noon-3 pm, 5-11 pm. Tues, 11:30 am-2:30 pm, 5-11 pm. Wed, 12 noon-11 pm. Sat, 12 noon-11 pm. Pacific time.

**KFWC** L. E. Wall, San Bernardino, Calif. 222.1 meters, 1350 kilocycles, 100 watts. Sun, 9-12 am, church services; 9-12 pm, musical. Mon, 9 am-1 pm, 4-12 pm. Tues, 11:30 am-12:30 pm, 3-5 pm, 9-12 pm. Wed, 11:30 am-12:30 pm, 4-6 pm, 9-12 pm. Thurs, 12-1 pm, 4-6 pm, 9-12 pm. Fri, 11:30 am-12:30 pm, 3-5 pm, 9-3 pm. Pacific standard time. Slogan: "The Voice of the Orange Empire."

**KFWF** St. Louis Truth Center, 4030 Lindell st., St. Louis, Mo. 214.2 meters, 1400 kilocycles, 250 watts, non-commercial. Sun, 10:45 am, 7:45 pm, 9 pm, organ & chimes. Thurs, 10:45 am, sunshine hour; 7:45 pm, sermon; 9 pm, music. Central standard time. Slogan: "The Voice of Truth."

**KFWH** Times Publishing Co., Eureka, Calif. 254.1 meters, 1180 kilocycles, 100 watts. Daily ex Sun, 12 noon-1 pm, 5:30-6:30 pm, 8-10 pm. Pacific standard time. Slogan: "The Voice of the Redwoods."

**KFWI** Radio Entertainments, Inc., 205 Wiley B. Allen Bldg., San Francisco, Calif. 267.7 meters, 1120 kilocycles, 500 watts. Sun, 1-2 pm, 8-9 pm, 9-10 pm, 10-12 pm. Mon, 1-2 pm, 6:30-7 pm, 7-7:30 pm, 8-9 pm, 9-10 pm, 10-12 pm. Tues, 8-8:30 pm, 8:30-9 pm, 9-10 pm, 10-11 pm. Wed, 1-2 pm, 6:30-7:30 pm, 8-9 pm, 9:30-11 pm, 11 pm-1 am. Thurs, 10-12 pm. Fri, 1-2 pm, 6:30-7:30 pm, 8-10 pm, 10-12 pm. Sat, 10-12 pm, 12:30-3 pm.

**KFWM** Oakland Educational Society, 1126 Bella Vista av., Oakland, Calif. 236.1 meters, 1270 kilocycles, 500 watts. Sun, 9:30-11 am, 2-3 pm, 7:30-9 pm. Mon, Tues, Thur & Sat, 8-10 pm. Tues, Wed & Fri, 2-3 pm. Pacific standard time. Slogan: "Voice of Oakland."

**KFWO** Major Lawrence Mott, 346 Claressa av., Avalon, Catalina Island, Calif. 299.8 meters, 1000 kilocycles, 250 watts. Daily including Sun, 12:30-1:30 pm, 5-6 pm, 6-7:30 pm. Tues, 8 pm-midnight. Pacific standard time. Slogan: "Catalina for Wonderful Outings."

**KFWU** Louisiana College, Pineville, La. 238 meters, 1260 kilocycles, 100 watts. Central standard time.

**KFXB** Bertram O. Heller, Los Angeles, Calif. 252 meters, 1190 kilocycles, 500 watts. Daily ex Sun, 5:30 pm, news, road bulletins, lectures, music. Pacific standard time. Slogan: "The Rim of the World Station."

**KFXD** Service Radio Co., East Main St., Jerome, Utah. 204 meters, 1470 kilocycles, 15 watts. Daily at noon with news, markets, etc. Mountain time.

**KFXF** Colorado Radio Corporation, Republic Bldg., Denver, Colo. 282.8 meters, 1060 kilocycles, 500 watts. Mon, Tues, Wed, Fri, Sat, Sun, 6-12 pm. Slogan: "The Voice of Denver."

**KFXH** Bledsoe Radio Co., 115 S. El Paso st., El Paso, Tex. 241.8 meters, 1240 kilocycles, 100 watts. Mon, Wed, Fri, 8-10 pm, musical. Sat, 11-12 pm, frolic. Central standard time. Slogan: "The Voice of the Rio Grande."

**KFXJ** R. G. Howell, Olinger Gardens, Edgewater, Colo. 215.7 meters, 1390 kilocycles, 50 watts input. Daily, 2:30-4:30 pm, 6-8 pm, dinner concert; 8-10 pm, studio. Sun, 7 pm, sacred hour. Slogan: "America Scenic Center."

**KFXR** Exchange Avenue Baptist Church, Exchange Ave. and Pennsylvania. Oklahoma City, Okla. 223.7 meters, 1340 kilocycles, 50 watts. Central standard time.

**KFXV** Mary M. Costigan, Flagstaff, Ariz. 205.4 meters, 1460 kilocycles, 25 watts. Mountain time.

**KFYF** Carl's Radio Den (Carl Newcomb), Oxnard, Calif. 238 meters, 1260 kilocycles, 25 watts. Mon, Tues, Wed, 5-6 pm, crop reports, news, music; 8-11 pm, music. Fri & Sat, 5-6 pm, crop reports, news, music. Slogan: "The Baby Super Station."

**KFYJ** Houston Chronicle Pub. Co. (Portable Station), Houston, Tex. 238 meters, 1260 kilocycles, 10 watts. Central standard time.

**KFYO** Kirskey Bros., Breckenridge, Tex. 209.7 meters, 1430 kilocycles, 10 watts. Sun, 11 am, church services. Daily ex Sun & Sat, 12 noon-1 pm, musical program; 6-7 pm, dinner hour musical program. Sat, noonday program. Central standard time. Slogan: "Where Arkansas Ends and Texas Begins."

**KFYR** Hoskins-Meyer, Inc., 200 4th st., Bismarck, N. Dak. 239.9 meters, 1250 kilocycles, 250 watts night time, 500 watts daytime. Sun, 10:30 am-12 noon, church; 3-5 pm, music. Daily ex Sun, 6:30-8 pm, music, weather forecast, etc. Central standard time.

**KG A** Northwest Radio Service, Spokane, Wash. 260.7 meters, 1150 kilocycles, 2000 watts. Sun, 11 am-12:30 pm, 7:30-9 pm, church. Daily ex Sun, 11 am-12 noon, musical hour; 12 noon-12:25 pm, stocks, weather, etc.; 5:40-6 pm, news items, time; 6:15-7:15 pm, organ; 8-9 pm, music; 9-10 pm, orchestra. Pacific standard time.

**KGAR** The Tucson Citizen, 80 S. Stone av., Tucson, Ariz. 234.2 meters, 1280 kilocycles, 100 watts. Sun, 11 am-12:30 pm, 7:30-9 pm, church services. Daily ex Sat & Sun, 6-9 pm, musical program. Sat, midnight frolic every 2nd week from 12 midnight-3 am. Slogan: "Way Out on the Desert."

**KGBS** Arthur C. Daily, Moore Hotel, Seattle, Wash. 202.6 meters, 1480 kilocycles, 100 watts. Daily ex Sat & Sun, 6:30-10 pm. Pacific time.

**KGBU** Alaska Radio & Service Co., Ketchikan, Alaska. 228.9 meters, 1310 kilocycles, 500 watts.

**KGBX** Foster-Hall Tire Co., 1221 Fred av., St. Joseph, Mo. 288.3 meters, 1040 kilocycles, 100 watts.

**KGBY** Dunning & Taddiken, Shelby, Nebr. 202.6 meters, 1480 kilocycles, 50 watts. Sun, 3-5 pm, religious program. Tues, 8-10:30 pm, popular program. Fri, 6-7 pm, dinner program; 8-10:30 pm, popular program. Central standard time. Slogan: "The Voice of Shelby, in the Heart of the Corn Belt."

# Now Use This Shielded Grid Tube

## Radios' Greatest Last-Minute Achievement

[FOR RADIO FREQUENCY AMPLIFICATION]

Never before have so many outstanding features been incorporated into one tube. Radio Engineers throughout the country marvel at this newest and greatest discovery. Technical Editors proclaim it Radio's Greatest Achievement. (See article in this issue.)

### Note The 6 Points of Superiority

- 1. Amplification constant is 175 compared with constant of 8 in general purpose tubes.
- 2. Oscillation is entirely eliminated.
- 3. It is self-neutralized.
- 4. "A" Battery drain is only .131 amperes.
- 5. Operates on 3 volts.
- 6. Brings in DX stations like locals.

### GUARANTEED

The Shieldplate Tube Corporation guarantee these tubes to be just as represented, or your money cheerfully refunded.

## Don't Delay-

All Orders Filled in Rotation



Type SP 122

Price \$7.50

## BUY DIRECT FROM THE FACTORY

If your Jobber cannot supply you, order direct from the factory. Include money order with your request, or we will ship C.O.D.

Due to the limited stock on hand order immediately and avoid delay.

Jobbers are requested to telegraph their orders.

**SHIELDPLATE TUBE CORP.**  
 206 South LaSalle Street  
 Chicago, Illinois

**Mail-  
 Your  
 Order  
 To-day**

TEAR COUPON OFF HERE

Shieldplate Tube Corporation  
 206 South LaSalle Street  
 Chicago, Illinois

Gentlemen:

Enclosed find \$.....for which kindly send me.....Shielded Grid Tubes, type SP 122.

Name.....

Address.....

City.....State.....

Jobber.....

Tell 'Em You Saw It in the Citizens Radio Call Book Magazine

**KGBZ** Dr. George R. Miller, York, Nebr. 212.6 meters, 1410 kilocycles, 100 watts. Sun, 9 am, church services, 5 pm, alternately. Daily ex Sun. Tues, 12:30 pm, market, livestock; 2:30 pm, musical. Thurs, Sat, 9 pm, dance music. Central standard time. Slogan: "The Swine and Poultry Station."

**KGCA** Chas. W. Greeley, Decorah, Iowa. 247.8 meters, 1210 kilocycles, 10 watts. Sun, 2-4 pm. Daily ex Sun, 12:30-1:30 pm. Wed, 7:30-8:30 pm. Central standard time.

**KGCB** Wallace Radio Institute, 105 W. 13th st., Oklahoma City, Okla. 215.7 meters, 1390 kilocycles, 50 watts. On air daily, programs irregular. Divides times with Station KGFB.

**KGCH** Wayne Hospital, Wayne, Nebr. 293.9 meters, 1020 kilocycles, 250 watts. Sun, 2:30-4 pm, 6 pm, sacred service. Tues, Wed, Thurs, Fri, 6:30-8 pm, featuring college educational and entertaining programs. Central standard time. Slogan: "Remember Us When U R Ill."

**KGCI** Liberto Radio Sales, San Antonio, Tex. 204.6 meters, 1360 kilocycles, 15 watts. Sun, 1:30-2:30 pm. Daily ex Sun, 9:30-10:30 am, 11:30 am-12:15 pm, 3-4 pm, 5:30-6:30 pm. Mon & Thurs, 9:30-10:30 pm. Tues, 7:30-8:30 pm. Central standard time. Divides time with Station KGRC, the Gene Roth Co., San Antonio, Tex. Slogan: "Radio Sam at San Antonio."

**KGCL** Piper & Taft, Inc., Sporting Goods Store, 1107 2nd Ave., Seattle, Wash. 230.6 meters, 1300 kilocycles, 50 watts. Mon, Wed, Thurs, 9 am-11 pm. Tues, Fri, Sat, 9 am-7:30 pm. Sun, 12 noon-8 pm. Pacific standard time. Slogan: "Splitdorf Radio Center." Divides time with station KPCB, the Pacific Coast Biscuit Co.

**KGCN** Concordia Broadcasting Co., Concordia, Kan. 208.2 meters, 1440 kilocycles, 50 watts. Sun, 11 am-12 noon. Daily ex Sun, 12:30-1:30 pm, 7:30-9 pm. Central standard time. Slogan: "KGCN—The Shamrock Station."

**KGCR** Cutlers Radio Broadcasting Service, 415 Main st., Brookings, S. Dak. 208.2 meters, 1440 kilocycles, 15 watts.

**KGCU** Mandan Radio Association (H. L. Dahners), Mandan, N. Dak. 208.2 meters, 1440 kilocycles, 100 watts. Sun, 11 am-3 pm. Daily ex Sun, 12 noon-2 pm, 6:30-7:30 pm. Mountain standard time. Slogan: "Mandan, Where the West Begins."

**KGCX** First State Bank of Vida, Vida, Mont. 243.8 meters, 1230 kilocycles, 10 watts.

**KGDA** Home Auto Co., Dell Rapids, S. D. 254.1 meters, 1180 kilocycle, 15 watts.

**KGDE** Jaren Drug Co., Barrett, Minn. 205.4 meters, 1460 kilocycles, 50 watts. Daily ex Sun, 12:30 pm, 4 pm, 7 pm. Sun, 10:30 am, 3 pm, 6 pm, 8 pm. Central standard time.

**KGDJ** R. Rathert, 316 Fifth av., Cresco, Iowa. 202.6 meters, 1480 kilocycles, 10 watts.

**KGDM** Peffer Music Co., 42 S. California st., Stockton, Calif. 217.3 meters, 1380 kilocycles, 10 watts.

**KGDO** C. H. & Henry Garrett, 2012 Main st., Dallas, Tex. 285 meters, 1052 kilocycles, 100 watts.

**KGDP** Boy Scouts of America, Pueblo Council, Colorado (John D. Price). 261.7 meters, 1340 kilocycles, 10 watts.

**KGDR** Joe B. McShane, 206 Laurel Hgts. Place, San Antonio, Tex. 202.6 meters, 1480 kilocycles, 15 watts. Sun, 9-10 am, classical. Daily ex Sun, 4-5:30 pm, tea dancing program. Wed, 9:30-11:30 pm, frolic. Thur, 7:30-8:30 pm. Central standard time. Slogan: "The Little Station with the Big Programs."

**KGDW** Frank J. Rist, Humboldt, Nebr. 206.8 meters, 1450 kilocycles, 100 watts.

**KGDY** William E. Antony, 1513 Laurel st., Shreveport, La. 212.6 meters, 1410 kilocycles, 250 watts.

**KGDX** J. Albert Loesch, Oldham, S. Dak. 206.8 meters, 1450 kilocycles, 15 watts. Thur, 7:45 pm, 11:45 pm. Central standard time. Slogan: "The Little Brick Town on the Prairie."

**KGDZ** Norwegian Lutheran College, Decorah, Iowa. 431 meters, 695.6 kilocycles, 50 watts.

**KGEF** Trinity Methodist Church, Los Angeles, Calif. 263 meters, 1140 kilocycles, 500 watts.

**KGEH** Eugene Broadcast Station, W. E. Miner Bldg., Eugene, Ore. 201.2 meters, 1490 kilocycles, 50 watts.

**KGEK** Beehler Electric Equipment Co., Yuma, Colo. 263 meters, 1140 kilocycles, 50 watts. Daily, 12 noon-1 pm, stock markets, lectures, etc.

**KGEN** E. R., Irely & F. M. Bowles, El Centro, Calif. 225.4 meters, 1330 kilocycles, 15 watts.

**KGEO** Hotel Yancey, Grand Island, Nebr. 205.4 meters, 1460 kilocycles, 100 watts.

**KGEQ** Glenwood Radio Station, 920 5th av., No. Minneapolis, Minn. 202.6 meters, 1480 kilocycles, 50 watts. Mon, 7-8 pm, miscellaneous. Tues, Thur, 8:30-11 pm, miscellaneous. Wed, 6:30-8:30 pm, 10-11 pm. Fri, 6:15-9 pm, music, entertainment. Sat, 4:30 pm, Children's Story Hour. Central standard time. Slogan: "In the Land and Lakes and Rivers."



# NATIONAL



## AN ENTIRELY NEW AND UNIQUE HEAVY-DUTY BETTER-B

### Supplies

Detector voltages, 22 to 45, adjustable; R. F. voltages from 50 to 75; A. F. voltages from 90 to 135; Power tube voltage 180 fixed.

### An Exclusive Feature

Tubes and by-pass condensers are protected against excessive and harmful voltages.

Designed for lasting service with liberal factors of safety

### A Strictly Heavy-Duty Power Unit

Output rating is 70 mills at 180 volts. Uses R. C. A. UX-280 or Cunningham CX-380 Rectron.

Licensed under patents of Radio Corporation of America and Associated Companies. For 110-120 volts, 50-60 cycles A. C. List price with cord, switch and plug, \$40. Rectifier tube, \$5.

Write National Co., Inc., W. A. Ready, Pres., Malden, Mass., for new Bulletin C-124.

# NATIONAL B

Type 7180

## A "B" THAT'S BUILT FOR SERVICE

National Impedaformers, Tuning Units, Velvet Vernier Dials, Chargers, Tone Filters, Transformers, Filter Chokes, etc.

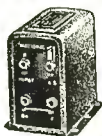

**TONE FILTER**  
FOR BETTER TONE AND  
SPEAKER PROTECTION



**FILAMENT TRANSFORMER**  
NO. 122 FOR THE  
NEW A. C. TUBES



**THE ORIGINAL  
VELVET VERNIER DIAL  
TYPE A**



**POWER TRANSFORMER**  
FOR PLATE  
SUPPLY UNITS

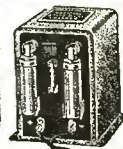
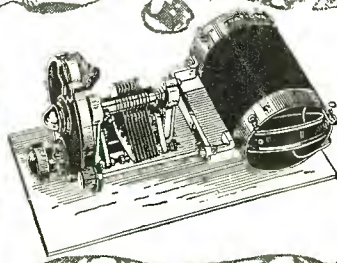
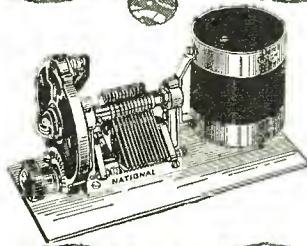

**R-26 BATTERY-CHARGER**  
2 1/2 TO 5 AMPERES



**IMPEDAFORMER**  
FOR QUALITY AUDIO



**ILLUMINATED VELVET VERNIER  
DIAL TYPE C**



**FILTER CHOKES  
TYPE 80**



**NATIONAL TUNING UNITS — THE HEAVENLY TWINS**  
More National Tuning Units have been used by set builders than all other similar components combined.  
Standard since 1923

Approved By **BROWNING & DRAKE** The OFFICIAL Design

Tell 'Em You Saw It in the Citizens Radio Call Book Magazine

**KGER** C. Merwin Bobyns, Long Beach, Calif. 215.7 meters, 1390 kilocycles, 100 watts. Slogan: "Service Club of the Air."

**KGES** Central Radio Electric Co., Central City, Nebr. 204 meters, 1470 kilocycles, 10 watts.

**KGEU** L. W. Clement, Lower Lake, Calif. 227.1 meters, 1320 kilocycles, 50 watts.

**KGEW** City of Fort Morgan, Fort Morgan, Colo. 218.8 meters, 1370 kilocycles, 10 watts. Sun, 11 am-12 noon, church; 2-4 pm, classical program. Tues, Thurs, Sat, 8-10 pm, varied programs. Sat, 12 noon-1 pm, talks. Mountain standard time. Slogan: "Fort Morgan, the City of Lights."

**KGEY** J. W. Dietz, Denver, Colo. 201.6 meters, 1490 kilocycles, 15 watts. Sun, 1-2 pm. Daily ex Sun, Thur, 7-8 pm. Western standard time.

**KGEZ** Flathead Broadcasting Association, Kalispell, Mont. 205.4 meters, 1460 kilocycles, 100 watts. Daily ex Sun, 12:30 pm-1:30 pm; 6:30-7:30 pm. Thurs, 9-10:30 pm. Sun, 11 am, church services. Mountain standard time. Slogan: "Located in the Switzerland of America—The Beautiful Flathead Valley."

**KGFB** Iowa City, Ia. 223.7 meters, 1340 kilocycles, 10 watts.

**KGFF** Earl E. Hampshire, 718 5th st., Alva, Okla. 205.4 meters, 1460 kilocycles, 25 watts. Programs irregular. Central standard time.

**KGFG** Oklahoma City, Oklahoma. 215.7 meters, 1390 kilocycles, 50 watts.

**KGFH** Crescenta, Calif. 223.7 meters, 1340 kilocycles, 100 watts.

**KGFI** Station KGFI, San Angelo, Tex. 220.4 meters, 1360 kilocycles, 15 watts. Sun, 11 am-8 pm. Daily ex Sun, 10 am-12 noon, 3:30 pm, markets & weather; 8-10 pm, music. Central standard time. Slogan: "The Voice of West Texas."

**KGfJ** Radio Station KGfJ, Los Angeles, Calif. 208.2 meters, 1440 kilocycles, 100 watts. Daily, 6:30-9:30 am, 12 noon, 4:30-6 pm, 9 pm. Silent Sundays. Pacific standard time. Slogan: "Keep Good Folks Joyful."

**KGFK** Hallock, Minn. 223.7 meters, 1340 kilocycles, 50 watts.

**KGFL** Raton, N. M. 222.1 meters, 1350 kilocycles, 50 watts.

**KGFM** Geo. W. Johnson, Yuba City, Calif. 211.1 meters, 1420 kilocycles, 15 watts. Daily ex Sun, 9:30-10:30 am, advertising; 2-2:30 pm, musical. Mon, Wed, Fri, 8-10 pm, entertainment. Pacific standard time.

**KGFN** Aneta, N. Dak. 199.9 meters, 1500 kilocycles, 15 watts.

**KGFO** Terre Haute, Ind. 204 meters, 1470 kilocycles, 100 watts.

**KGFP** Mitchell, S. Dak. 212.6 meters, 1410 kilocycles, 10 watts.

**KGQ** General Electric Co., Oakland, Calif. 384.4 meters, 780 kilocycles, 5000 watts. Sun, 11 am, 7:30 pm, church; 4 pm, 5:30-6:30 pm, concert; 9-10 pm. Daily ex Sun, 11:30 am; 4-5 pm, concert; 5:30 pm, Kiddies Klub; 6-6:55 pm, dinner concert; 9 pm, Book Review. Tues, Wed, Thurs, Fri, Sat, 9-10 pm, varied programs. Tues, Fri, Sat, 10-11 pm; Wed, 10 pm-12 midnight, dance music. Fri, 11 pm-12 midnight.

**KGRC** Gene Roth & Co., San Antonio, Tex. 220.4 meters, 1360 kilocycles, 50 watts.

**KGRS** Gish Radio Service, 108 E. 8th st., Amarillo, Tex. 243.8 meters, 1230 kilocycles, 150 watts. Daily ex Sun, 6:30 am-6:30 pm; 10 am, weather & markets. Mon, Wed, Fri, 9 pm. Sun, 11:30 am, 4:30 pm, 7:30 pm. Central standard time.

**KGTT** Glad Tidings Temple—Bible Institute, 1471 Ellis st., San Francisco, Calif. 206.8 meters, 1450 kilocycles, 30 watts. Sun, 2:30-5 pm, 8-10 pm. Mon, Tues, Thurs & Sat, 12:10-12:30, sacred. Wed, 12:10-12:30 pm, 2:30-3:33 pm, sacred. Fri, 12:10-12:30 pm, 3-4 pm, 8-10 pm, sacred. Pacific standard time. Slogan: "Knights of Glad Tidings."

**KGU** The Advertiser Publishing Co., 217 King st., Honolulu, Hawaii. 270.1 meters, 1110 kilocycles, 600 watts. 2½ hours later than Pacific time. Sun, 6-9:30 pm, music, lectures, church, news. Daily, 12 noon-1 pm, stock & weather reports. Daily ex Sat & Sun, 7:30-9:30 pm, Hawaiian program, news, sports, music, etc. Slogan: "In the Land of Sunshine, the Future Playground of America."

**KGW** Oregonian Publishing Co., Portland, Ore. 491.5 meters, 610 kilocycles, 1000 watts. Daily ex Sun, 10-11:30 am, Town Crier. Daily ex Sun & Thurs, 12:30-1:30 pm, concert. Sun, 8:30-9:15 am, Aunt Blossom and Winnie Winkle; 10 am-12 noon, church; 5:30-6:30 pm & 7-8 pm, concerts; 9-10 pm, symphony. Mon, Wed, Fri, Sat, 6-7 pm, concert. Mon, 7-12 pm, musical entertainment. Tues, 6-12 pm, music & educational program. Wed, 7:30-10 pm, diversified program. Thurs, 12:30-1:30 pm, dance music; 6-12 pm, concert. Fri, 7:30-9 pm, utility & musical entertainment; 9-10:30 pm, concert; 10:30-12 midnight, Hoot Owl Frolic. Sat, 8-9 pm, concert; 10-12 pm, dance music. Pacific standard time. Slogan: "Keep Growing Wiser."

**KGY** St. Martins College, Lacey, Wash. 243.8 meters, 1230 kilocycles, 50 watts. Tues, Thurs, Sun, 8:30-9:30, PST concert. Pacific standard time. Slogan: "Out Where the Cedars Meet the Sea."

**KHJ** Times-Mirror Co., Los Angeles, Calif. 405.2 meters, 740 kilocycles, 5000 watts. Sun, 10-12 am, 7-10 pm. Daily ex Sun, Mon, 6-10 pm. Pacific time. Slogan: "Kindness, Happiness, Joy."

**KHQ** Louis Wasmer, Inc., Peyton Building, Spokane, Wash. 370.2 meters, 810 kilocycles, 1000 watts. Sun, 11-12:30, 6-7:30, 7:30-10 pm, church services. Mon, Tues, Thurs, Fri, Sat, 2:30-4:30 pm, matinee; 5-6 pm, service hour. Thurs, Fri, Sat, 6-7 pm, concert. Mon, Tues, 7:30-12 pm, varied. Wed, 9-10 pm, dance music. Thurs, Fri, 8-10 pm, popular; 10:30-12 pm, KGW. Pacific time. Slogan: "In the Friendly City."

**KICK** Atlantic Automobile Co., Anita, Ia. 461.3 meters, 650 kilocycles, 100 watts.



Total Price Only  
**\$14<sup>95</sup>** *On Easy Payments*

# Radio Cabinet and Bench

**\$1<sup>00</sup> down**

Only \$1.00 with coupon below brings this handsome, massive, pure Period design console radio cabinet, with bench to match, to your home on 30 days

## Free Trial!

touch of elegance. Ample space inside of cabinet for all batteries, chargers and eliminators. Keep all unsightly accessories out of sight in this splendid piece of furniture. Made of well seasoned, selected hardwood in **Handsome Walnut Finish**. Two large, French style swinging doors at front with ornamental brass knobs. Front panels of doors in carved panel effects and legs of both cabinet and bench are neatly turned. Edge of top neatly bevelled. Cabinet has lower cross brace to insure rigidity. Top is 33<sup>1</sup>/<sub>4</sub> x 18 inches, height inside 11<sup>1</sup>/<sub>2</sub> inches. Full height 33 inches. Bench is 18 inches high.

**\$1<sup>50</sup> a Month**

After 30 days trial if not satisfied, send Cabinet and

**Send Coupon NOW!**

bench back at our expense and we'll refund your \$1.00 plus all transportation charges you paid. Or keep them and pay only \$1.50 a month till you've paid our smashed cut price for this sale—only \$14.95. Our credit price beats cash prices anywhere. Order by No. B182A. Shpg. wgt. about 70 lbs.

**Straus & Schram Dept. R1518 Chicago**

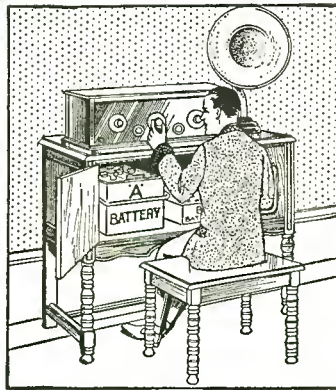

**FREE Catalog**  
 of home furnishings sent with or without order. See coupon.

**Straus & Schram, Dept. R1518 Chicago**

Enclosed find \$1. Ship Walnut Finish Radio Cabinet and Bench. I am to have 30 days free trial. If I keep the cabinet and bench I will pay you \$1.50 monthly. If not satisfied, I am to return them at your expense and you are to refund my money and any freight or express charges I paid.  
**Radio Cabinet and Bench No. B182A, \$14.95**

Name.....

Street, R.F.D. or Box No.....

Shipping Point.....

Post Office..... State.....

Married or Single..... Nationality or Color.....

If you want only our free catalog of home furnishings, mark X here

Tell 'Em You Saw It in the Citizens Radio Call Book Magazine

**KJBS** Julius Brunton & Sons Co., 1380 Bush st., San Francisco, Calif. 220.4 meters, 1360 kilocycles, 50 watts. Sun, (summer schedule—silent). Daily ex Sun, 9-11:30 am, 2-4 pm. Slogan: "San Francisco's Baby Station."

**KJR** Northwest Radio Service Co., 611 Terminal Sales Bldg., Seattle, Wash. 348.6 meters, 860 kilocycles, 2500 watts. Sun, 11 am-12:30 pm, church; 7:45-8 pm, organ; 8-9:15 pm, church; 9:15-10:45 pm, concert. Daily ex Sun, 10:30 am-7 pm. Mon, Tues, Wed, Thurs, 7 pm-12 midnight, varied programs. Mon, 3-3:15 pm, Book Chat. Fri, 7-9 pm.

**KKP** City of Seattle, Harbor Department, Seattle, Wash. 265.3 meters, 1130 kilocycles, 15 watts.

**KLDS** Reorganized Church of Jesus Christ of Latter Day Saints, Independence, Mo. 238 meters, 1260 kilocycles, 1500 watts. Sun, 8:30-11 am, 3-6:30 pm, 9 pm. Mon, silent. Tues, 6:30 am, 2:30 pm, 7 pm, 8 pm. Wed, silent. Thurs, 2:30 pm, 7 pm, 8 pm. Fri, 6:30 pm. Sat, 7 pm, 8 pm. Morning devotional, Tues & Fri, 6:30 am. Slogan: "The Station Dedicated to Knowledge, Liberty, Divinity and Service."

**KLIT** Portland, Ore. 206.8 meters, 1450 kilocycles, 10 watts.

**KLS** Warner Bros. Radio Supplies Co., 2201 Telegraph av., Oakland, Calif. 245.8 meters, 1220 kilocycles, 250 watts. Sun, 10-11 am, church services. Pacific standard time. Slogan: "The City of Golden Opportunity."

**KLX** The Oakland Tribune, Oakland, Calif. 508.2 meters, 590 kilocycles, 500 watts. Daily ex Sun, 5 pm, women's hour; 5:30 pm, children's hour; 6:30 pm, dinner concert; 7 pm, news; 8-9 pm, studio program; 9-10 pm, dance music, studio program. Pacific standard time. Slogan: "Where Rail and Water Meet."

**KLZ** Pioneer Station of the West, Shirley Savoy Hotel, Denver, Colo. 267.7 meters, 1120 kilocycles, 250 watts. Sun, 9:30-10:30 am, 11 am-12:30 pm, 3-4 pm, 7 pm-12 midnight. Daily ex Sun, 9-11 am, 3-4:30 pm, 6-10 pm. Sun, Tues, Fri & Sat, 10 pm-12 midnight, dance music. Mountain time. Slogan: "The Pioneer Station of the West."

**KMA** Earl E. May Seed & Nursery Co., Shenandoah, Ia. 394.5 meters, 760 kilocycles, 1000 watts. Sun, 8-9 am, sacred; 11 am, church service; 12:15-1:30 pm, music; 4-5 pm, sacred. Daily ex Sun, 5:30-7 am, 9-10 am, 11 am-12:30 pm, 2-4 pm, 6-7:30 pm, 9-10:30 pm. Daily, 12:15 pm and 6:30 pm, markets. Central standard time. Slogan: "Keeps Millions Advised."

**KMED** W. J. Virgin, Sparta Bldg., Medford, Ore. 267.7 meters, 1200 kilocycles, 50 watts. Sun, 11 am-12:15 pm, 3:30-4:30 pm, 8-9:15 pm. Daily ex Sat & Sun, 12:15-1:15 pm, 5:45-10 pm. Wed, 10-11 pm. Sat, 6:15-6:30 pm, 10-11:30 pm. Pacific standard time. Slogan: "See Crater Lake."

**KMIC** J. R. Fouch, Inglewood, Calif. 223.7 meters, 1340 kilocycles, 250 watts.

**KMJ** Fresno Bee, Fresno, Calif. 365.6 meters, 820 kilocycles, 50 watts. Mon, Wed, Fri, 7:15-9 pm. Pacific time.

**KMJP** Journal-Post, Kansas City, Mo. 440.9 meters, 680 kilocycles, 1000 watts.

**KMMJ** M. M. Johnson Co., Clay Centre, Nebr. 379.5 meters, 790 kilocycles, 500 watts. Sun, 9 pm. Daily ex Sun, 7-8 am, 8:30-9:30 am, 11 am, 12:30-1:30 pm, 8-10 pm. Tues, silent night. Central standard time. Slogan: "The Old Trusty Station."

**KMO** Hotel Winthrop, Tacoma, Wash. 254.1 meters, 1180 kilocycles, 250 watts. Sun, 11-12 am, 6:15-7 pm, 8-9 pm. Mon, 10-11 am, 2-4 pm, 7-8 pm. Tues, 10-11 am, 2-4 pm, 7:30-11 pm. Wed, 10-11 am, 2-4 pm, 8-9 pm. Thurs, 10-11 am, 2-4 pm, 8-10 pm. Fri, 10-11 am, 2-4 pm, 7-8 pm, 10-11 pm. Sat, 10-11 am, 2-4 pm, 6:15-7 pm, 10-11 pm. Pacific time.

**KMOX** KMOX, Voice of St. Louis (Inc.), St. Louis, Mo. 299.8 meters, 1000 kilocycles, 5000 watts. 9 pm, Skouras Brothers Sunday night club; 6:30 pm, Jaquinot Jules, organist; 7 pm, KMOX Radio orchestra; 8 pm, KMOX Radio orchestra; 9 pm, "By the Banks of Bonny Doon." KMOX Radio orchestra; 10 pm, KMOX Radio orchestra.

**KMTR** KMTR Radio Corp., 1025 N. Highland av., Hollywood, Calif. 526.0 meters, 570 kilocycles, 500 watts. Sun, 6:30-10 pm. Daily ex Sun, 7 am-11 pm. Programs vary. Pacific time. Slogan: "Your Friend in Hollywood."

**KNRC** Clarence B. Juneau, Municipal Auditorium Bldg., Santa Monica, Calif. 374.8 meters, 800 kilocycles, 500 watts. Sun, 10:45-11 pm. Daily ex Sat & Sun, 2-11 pm. Sat, 2 pm-2 am. Pacific standard time. Slogan: "The Station With a Smile."

**KNX** The Los Angeles Evening Express Broadcasting Station, 6116 Hollywood blvd., Los Angeles, Calif. 336.9 meters, 890 kilocycles, 500 watts. Sun, 10 am-10:30 pm, classical program. Mon, 7:30 am-12 midnight, semi and classical. Tues, 7:30 am-1 am, semi and classical. Wed, 7:30 am-12 midnight, semi and classical. Thurs, 7:30 am-12 midnight, semi and classical. Fri, 7:30 am-12 midnight, semi and popular. Sat, 7:30 am-2 am, semi, popular and classical. Slogan: "The Voice of Hollywood."

**KOA** Rocky Mountain Broadcasting Station, General Electric Co., 1370 Krameria st., Denver, Colo. 325.9 meters, 920 kilocycles, 5000 watts. Sun, 10:30 am; 6:30 pm, dinner concert; 7:30 pm, church. Daily ex Sun, 11:45 am, weather, news; 12 noon, time signals; 12:05 pm, organ. Daily ex Sat & Sun, stocks, markets, etc.; 6:30 pm, dinner concert; 8:15 pm, studio program. Tues, Thurs, Fri, 3:30 pm, matinee. Tues & Fri, 4 pm, culinary hints; 4:15 pm, fashion review. Mon, Tues, Wed, Fri, 7:30 pm, varied programs. Thurs, 4 pm. Mountain standard time.

**KOAC** Oregon Agricultural College, Corvallis, Ore. 270.1 meters, 1110 kilocycles, 500 watts. Mon, Tues, Wed, Thurs, Fri, 7-9 pm. Pacific standard time. Slogan: "Science for Service."

**KOB** New Mexico College of Agriculture & Mechanical Arts, State College, N. M. 394.5 meters, 760 kilocycles, 5000 watts. Daily ex Sun, 11:55 am & 9:55 pm, time signals; 12 noon & 10 pm, weather reports; 12:02 pm & 10:02 pm, road reports; 12:08 pm, financial reports. Mon, Wed, Fri, 7:30-8:30 pm. Mon, 12:20-12:30 pm, concert. Mountain standard time. Slogan: "The Sunshine State of America."

**KOCH** Central High School, Omaha, Neb. 258.5 meters, 1160 kilocycles, 250 watts. Sun, 3-5 pm, classical. Mon, Tues, Thurs, & Sat, 9-10:30 pm, musical. Central standard time. Slogan: "The Voice of 2,000 Students."

**KOCW** Oklahoma College for Women, Chickasha, Okla. 252 meters, 1190 kilocycles, 250 watts. Mon, Tues, Thur & Fri, 12-1 pm, educational talk and music. Tues, Fri & Sat, 8-9 pm, musical program. Wed, 10-10:40 am, chapel services; 12-1 pm, musical. Sun, 11 am-12 n, church services; 2:30-3:30 pm, musical. Central standard time.

**KOIL** Mona Motor Oil Co., Council Bluffs, Iowa. 277.6 meters, 1080 kilocycles, 4000 watts daytime, 2000 watts nighttime. Sun, 11 am-12 noon, church services, 1-2:30 pm, 6-9 pm, 11 pm-12 midnight. Daily ex Sun & Sat, 11:45 am-2:30 pm, 6-9 pm, 11 pm-12 midnight. Mon, 6-12 midnight. Central standard time. Slogan: "The Hilltop Studio."

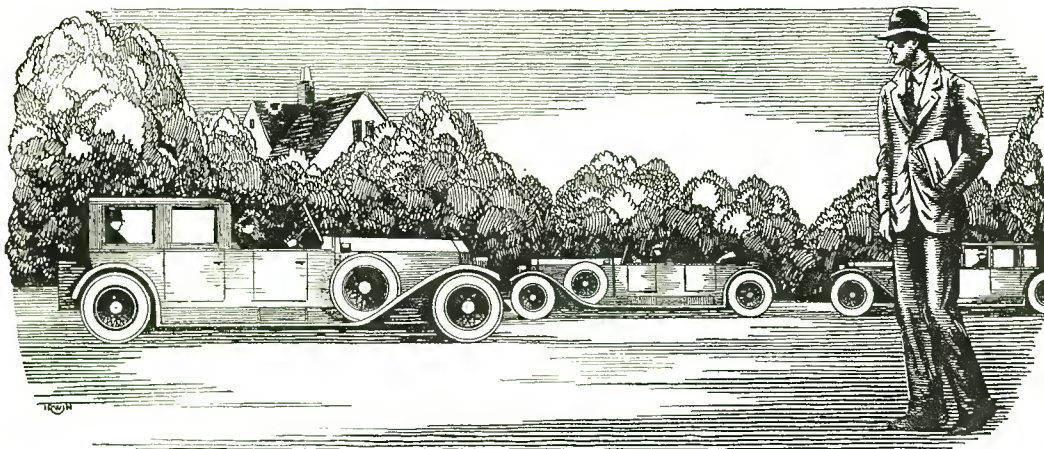

Many times in the old days, while I trudged home after work to save carfare, I used to gaze enviously at the shining cars gliding by me, the prosperous men and women within. Little did I think that inside of a year, I, too, should have my own car, a decent bank account, the good things of life that make it worth living.

# I Thought Success Was For Others

*Believe It Or Not, Just Twelve Months Ago I Was Next Thing To "Down-and-Out"*

**T**ODAY I'm sole owner of the fastest-growing Radio store in town. And I'm on good terms with my banker, too—not like the old days only a year ago, when often I didn't have one dollar to knock against another in my pocket. My wife and I live in the snuggest little home you ever saw, right in one of the best neighborhoods. And to think that a year ago I used to dodge the landlady when she came to collect the rent for the little bedroom I called "home"!

It all seems like a dream now, as I look back over the past twelve short months, and think how discouraged I was then, at the "end of a blind alley." I thought I never had had a good chance in my life, and I thought I never would have one. But it was waking up that I needed, and here's the story of how I got it.

**I** WAS a clerk, working at the usual miserable salary such jobs pay. Somehow I'd never found any way to get into a line where I could make good money.

Other fellows seemed to find opportunities. But—much as I wanted the good things that go with success and a decent income—all the really well-paid vacancies I ever heard of seemed to be out of my line, to call for some kind of knowledge I didn't have.

And I wanted to get married. A fine situation, wasn't it? Mary would have agreed to try it—but it wouldn't have been fair to her.

Mary had told me, "You can't get ahead where you are. Why don't you get into another line of work, somewhere that you can advance?"

"That's fine, Mary," I replied, "but what line? I've always got my eyes open for a better job, but I never seem to hear of a really good job that I can handle." Mary didn't seem to be satisfied with the answer but I didn't know what else to tell her.

*It was on the way home that night that I stopped off in the neighborhood drug store, where I overheard a scrap of conversation about myself. A few burning words that were the cause of the turning point in my life!*

With a hot flush of shame I turned and left the store, and walked rapidly home. So that was what my neighbors—the people who knew me best—really thought of me!

"Bargain counter sheik—look how that suit

fits," one fellow had said in a low voice. "Bet he hasn't got a dollar in those pockets." "Oh, it's just 'Useless' Anderson," said another. "He's got a wish-bone where his backbone ought to be."

As I thought over the words in deep humiliation, a sudden thought made me catch my breath. Why had Mary been so dissatisfied with my answer that "I hadn't a chance"? *Did Mary secretly think that too?* And after all, wasn't it true that I had a "wish-bone" where my backbone ought to be? Wasn't that why I never had a "chance" to get ahead? It was true, only too true—and it had taken this cruel blow to my self-esteem to make me see it.

With a new determination I thumbed the pages of a magazine on the table, searching for an advertisement that I'd seen many times but passed up without thinking, an advertisement telling of big opportunities for trained men to succeed in the great new Radio field. With the advertisement was a coupon offering a big free book full of information. I sent the coupon in, and in a few days received a handsome 64-page book, printed in two colors, telling all about the opportunities in the Radio field and how a man can prepare quickly and easily at home to take advantage of these opportunities. I read the book carefully, and when I finished it I made my decision.

**W**HAT'S happened in the twelve months since that day, as I've already told you, seems almost like a dream to me now. For ten of those twelve months, *I've had a Radio business of my own!* At first, of course, I started it as a little proposition on the side, under the guidance of the National Radio Institute, the outfit that gave me my Radio training. It wasn't long before I was getting so much to do in the Radio line that I quit my measly little clerical job, and devoted my full time to my Radio business.

Since that time I've gone right on up, always under the watchful guidance of my friends at the National Radio Institute. They would have given me just as much help, too, if I had wanted to follow some other line of Radio besides building my own retail business—such as broadcasting, manufacturing, experimenting, sea operating, or any one of the score of lines they prepare you for. And to think that until that day I sent for their

eye-opening book, I'd been wailing "I never had a chance!"

**N**OW I'm making real money. I drive a good-looking car of my own. Mary and I don't own the house in full yet, but I've made a substantial down payment, and I'm not straining myself any to meet the installments.

Here's a real tip. You may not be as bad off as I was. But, think it over—are you satisfied? Are you making enough money, at work that you like? Would you sign a contract to stay where you are now for the next ten years, making the same money? If not, you'd better be *doing* something about it instead of drifting.

This new Radio game is a live-wire field of golden rewards. The work, in any of the 20 different lines of Radio, is fascinating, absorbing, well-paid. The National Radio Institute—oldest and largest Radio home-study school in the world—will train you inexpensively in your own home to know Radio from A to Z and to increase your earnings in the Radio field.

Take another tip—No matter what your plans are, no matter how much or how little you know about Radio—clip the coupon below and look their free book over. It is filled with interesting facts, figures and photos, and the information it will give you is worth a few minutes of anybody's time. You will place yourself under no obligation—the book is free, and is gladly sent to anyone who wants to know about Radio. Just address J. E. Smith, President, National Radio Institute, Dept. O-27, Washington, D. C.

**J. E. Smith, President,  
National Radio Institute,  
Dept. O-27, Washington, D. C.**

Dear Mr. Smith:

Please send me your 64-page free book, printed in two colors, giving all information about the opportunities in Radio and how I can learn quickly and easily at home to take advantage of them. I understand this request places me under no obligation, and that no salesmen will call on me.

Name .....

Address .....

Town..... State.....

*Tell 'Em You Saw It in the Citizens Radio Call Book Magazine*

**KOIN** KOIN (Inc.), Portland, Ore. 319 meters, 940 kilocycles, 1000 watts. Daily ex Sun, 11 am-12 noon, Housewife's Hour; 12 noon-1 pm, organ concert; 3-4 pm, news; 5:15-6 pm; 6-7 pm, dinner organ concert; 7-7:15 pm, 7:15-8 pm, orchestra. Nightly ex Sat & Sun, 8-10 pm, diversified studio program. Sun, 6-7 pm, organ; 7-8 pm, orchestra; 8-9 pm, church services; 9-10 pm, orchestra. Silent Sat night. Pacific standard time. Slogan: "The Station of the Hour."

**KOLO** Durango, Colo. 199.9 meters, 1500 kilocycles, 5 watts.

**KOMO** Fisher's Blend Station (Inc.), Seattle, Wash. 305.9 meters, 980 kilocycles, 1000 watts. Mon, Tues, Wed, Thurs, Fri & Sat, 10 am-12:30 midnight. Tues, 7-8 pm, 8-9 pm, Sun, 10 am-9:30 pm, church service. Pacific time.

**KOW** The Associated Industries, Inc., 1429 Champa st., Denver, Colo. 475.9 meters, 250 watts. Sun, 11 am-12 noon, church program; 7:30-9 pm. Daily ex Sun, 11 am-12 noon, 1:30-3:30 pm, 6:30-10 pm. Mountain standard time. Slogan: "The KOW Station Away Out West."

**KOWW** Frank A. Moore (Inc.), Elks Bldg., Walla Walla, Wash. 299.8 meters, 1000 kilocycles, 500 watts. Daily ex Sat-Sun, 4:15 pm, news, markets & weather, 7-8 daily ex Sun; 8-12 pm, studio & orchestra. Sun, church service, 11-12 am.

**KPCB** Snowflake Station, Central Bldg., Seattle, Wash. 230.6 meters, 1300 kilocycles, 50 watts. Sun, 8-9 pm. Daily ex Sun, 9:30-10:30 am, household talks. Mon & Wed, 5:30-6 pm, children's program; 6-6:30 pm, sport news. Mon, Wed, Thurs, 7:30-8:30 pm. Tues, Fri, Sat, 7:30-11 pm. Evening programs, musical. Pacific standard time.

**KPNP** Muscatine, Iowa. 211.1 meters, 1420 kilocycles, 100 watts.

**KPO** Hale Brothers & The Chronicle, San Francisco, Calif. 422.3 meters, 710 kilocycles, 1000 watts. Sun, 9:45 am, church services; 5 pm, chamber music; 6-10 pm, concert, orchestra. Daily ex Sun, 6:45-7:45 am, health exercise; 8-9 am, happy hour; 10:30 am-1 pm, time signals, market reports, etc.; 1-5:30 pm, features, organ music, 6-11 pm, concerts, orchestra, studio programs. Pacific standard time. Slogan: "The City by the Golden Gate."

**KPPC** Pasadena Presbyterian Church, Colorado & Madison sts., Pasadena, Calif. 228.9 meters, 1310 kilocycles, 50 watts. Wed, 6:45-9 pm, mid-week service. Pacific standard time.

**KPRC** Houston Post-Dispatch, Houston, Texas. 293.9 meters, 1020 kilocycles, 500 watts. Sun am & pm, church services. Mon, Tues, Wed, Thurs, Fri, Sat, 11 am-12 noon; 3 pm, 7:30-10 pm. Wed, Sat & Sun, 11-12 midnight. Central standard time. Slogan: "Kotton Port Rail Center."

**KPSN** The Pasadena Star-News, 525 E. Colorado st., Pasadena, Calif. 315.6 meters, 950 kilocycles, 1000 watts. Tues, Thurs, Sat, 8-9 pm, studio concert. Sun, 10:30 am, church services. Daily ex Sun, 12:15 pm & 6-6:15 pm, news. Slogan: "Pasadena, California, Station KPSN."

**KQV** Doubleday Hill Elec. Co., 719 Liberty av., Pittsburgh, Pa. 270.1 meters 1110 kilocycles, 500 watts. Mon, Wed, Fri, 4-9 pm. Tues, Thurs, 4-7 pm. Sun, 1 pm, sacred music. Eastern standard time. Slogan: "The Smoky City Station." Divides time with Station WJAS.

**KQW** California Farm Bureau Station, San Jose, Calif. 296.9 meters, 1010 kilocycles, 500 watts. Daily ex Sun, 1-2:30 pm, music, news, etc.; 5-5:30 pm, Children's Hour; 5:30-6 pm, studio program; 6-8 pm, 8-9 pm, studio program. Sun, 10:15 am-12:30 pm, church; 7:30-9:30 pm, church. Pacific standard time. Slogan: "For God and Country."

**KRAC** Caddo Radio Club, State Fair Grounds, Shreveport, La. 220.4 meters, 1360 kilocycles, 50 watts.

**KRE** First Congregational Church and Pacific School of Religion, Berkeley, Calif. 256.3 meters, 1170 kilocycles, 100 watts. Sun, 7:30-9 pm. Mon, Tues, Wed, Thurs, 12:30 noon-1 pm. Fri, 8 pm, church. Pacific standard time.

**KRLD** The Daily Times Herald & The Adolphus Hotel, Dallas, Tex. 461.3 meters, 650 kilocycles, 500 watts. Sun, 9:30-10:30 am, Sunday School; 11 am, church; 6:45-7:30 pm, concert, sports; 8 pm, church; 9:30-10:30 pm, concert, musical. Daily ex Sun & Wed, 12:30-1:30 pm, music; 7:30-8:30 pm, music; 9:30-10:30 pm, concert hour. Daily ex Sun, 7 pm, sports, news. Central standard time. Slogan: "Down Where the Blue Bonnets Grow."

**KRLO** Los Angeles, California, 215.7 meters, 1390 kilocycles, 250 watts.

**KROW** Oregon Broadcast Co., Sovereign Hotel, Portland, Ore. 231 meters, 1298 kilocycles, 50 watts.

**KROX** N. D. Brown & W. J. Casamalia, 4728 Bennett St., Seattle, Washington. 211.1 meters, 1420 kilocycles, 50 watts.

**KRSC** Radio Sales Corp., 1202 Fifth av., Seattle Wash. 211.1 meters 1420 kilocycles, 50 watts.

**KSAC** Kansas State Agricultural College, Manhattan, Kan. 333.1 meters, 900 cycles, 500 watts. Daily ex Sat & Sun, 9-9:25 am, 9:55-10:25 am, 12:35 am-1:05 pm. Mon, Wed, Fri, 6:30-7 pm; 7-8 pm, College of the Air. Sat, 12:35-1:05 pm. Central standard time.

**KSBA** Shreveport Broadcasting Association, Shreveport, La. 267.7 meters, 1120 kilocycles, 1000 watts. Sun, 11 am-12 noon, church services; 5-6 pm, musical; 7:30-9 pm, church services. Mon, Wed, Thurs, Fri, 8-9, musical. Tues & Sat, 9-11 pm, Hotel Youree dance music. Mon, 11 pm-12 midnight, organ. Daily, 9:15 am, 12:15 pm and 2:15 pm, market and weather reports. Central standard time. Slogan: "Keep Shreveport Before America."

**KSCJ** The Sioux City Journal, Sioux City, Iowa. 243.8 meters, 1230 kilocycles, 500 watts. Sun, 11-12 am, 2-4 pm, 7-9 pm, Daily ex Sun, 9:45-10:45 am, markets; 11:30 am-12:30 pm, noon program; 6-7 pm, dinner program; 8:30-midnight, studio program; Central standard time. Divides time with Station "KWUC," 12:30-1:30 pm, 4-5 pm, 7-8 pm.

**KSD** St. Louis Post-Dispatch, 12th & Olive sts., St. Louis, Mo. 545.1 meters, 550 kilocycles, 500 watts. Sun, 4:30-5:30 pm, orchestra; 6:15 pm, 7:15 pm, 8:15 pm, Atwater-Kent Hour. Tues & Thurs, 7 pm, 7:30 pm. Tues, 8 pm, Eveready Program; 9 pm. Wed, 6:30 pm, opera; 7:30 pm, 8 pm, 8:30 pm. Thurs, 9 pm. Fri, 8 pm, music; 8:30, 9 pm, 9:30 pm, dance. Sat, 7 pm, concert; 8 pm, Philco Hour. Central standard time.

**KSEI** KSEI Broadcasting Association, Pocatello, Idaho. 333.1 meters, 900 kilocycles, 250 watts. Sun, 9-11 pm. Daily ex Sun, 3-4 pm, 6:30-7:30 pm, 9-11 pm. Mountain time. Slogan: "Kummunity Southeast Idaho."

# Important Radio Accessories That Make a Good Set Better

Specify  
Belden

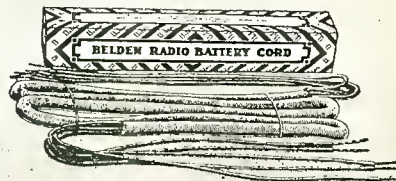

## Belden Aerial Kit

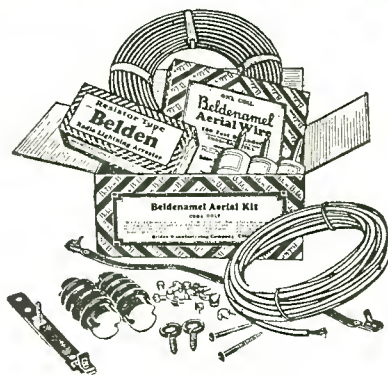

### Belden Aerial Wire

A good aerial is just as essential to efficient reception as good tubes. A poor aerial, one that is dirty and corroded, lowers the range and volume of the receiver. Such an aerial should be replaced with a Belden Aerial. A Belden Aerial is protected by a thick coating of Beldenamel baked on each strand. It cannot corrode. Even after years of service it is as good as new. A Belden Aerial solves the aerial problem *permanently*.

A good aerial properly erected is the first essential of effective reception. The Belden Aerial Kit provides every requirement for constructing an aerial which will remain permanently efficient. The Belden Aerial Wire supplied in this kit is the best. The Belden Resistor Type Lightning Arrester has no air gap. Insulators, ground wire, lead-in strip, ground strap, screws, staples, in fact everything that is needed for a first-class aerial, is supplied.

### Belden Radio Battery Cord

The safest and easiest way to connect your batteries to your radio set is by using a Belden Radio Battery Cord. This is the method used by leading radio set manufacturers. It eliminates the troublesome and messy confusion of connecting wires and improves the general appearance of the set. It also prevents the possibility of accidental short circuits between wires. This is because all conductors are thoroughly insulated and bound together with an overall protector. Short circuits are impossible. Belden Radio Battery Cords are coded for easy installation — another safety feature.



### Belden Inside Aerial and Loop Wire

Selectivity is a big problem in large cities where powerful broadcasting stations are congested. A short indoor aerial provides best selectivity. Belden Indoor Aerial and Loop Wire may be run around window or over molding, so that it is hardly noticeable. Its use results in an astounding improvement in selectivity.

### Belden Lightning Arrester

The Belden Resistor Type Lightning Arrester is all that the name implies. The design is of the latest, most approved type. It has no air gap and has been thoroughly tested and approved by underwriters. It can be used inside or outside. It is easy to install, and thoroughly reliable.



### Belden 25-Ft. Radio Extension Cord

Here is a cord that multiplies the usefulness of the radio receiver. It permits moving the loud speaker to any point desired without disturbing the set. Colorrubber insulation on both conductors assures faithful delivery of the signals with minimum waste. The handy bakelite Connector makes it easy to use the Belden Radio Extension Cord without tools.

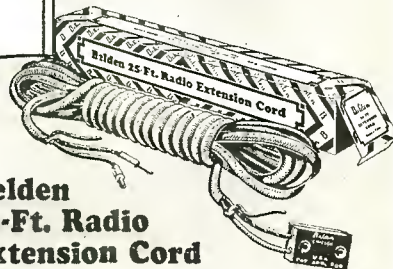

**Belden Manufacturing Company 2322-A S. Western Ave., Chicago**

Tell 'Em You Saw It in the Citizens Radio Call Book Magazine

**KSL** Utah Radio Service Corp., South Temple St., Salt Lake City, Utah. 302.8 meters. 990 kilocycles, 1000 watts. Sun, 10 am, 12 noon, 1:55 pm, 4-5 pm, 7:30-8:30 pm, 9-10 pm. Daily ex Sun, 10 am-12 noon, 4-5 pm, 6:30-8 pm, 9-10 pm, 11 pm, 12 midnight. Slogan: "The voice of the Inter-Mountain Empire."

**KSMR** Santa Maria Valley R. R., Santa Maria, Calif. 272.6 meters, 1100 kilocycles, 100 watts. Daily ex Sun, 6:30-10 pm, music, children's hour, home & farm, music. Sat, 7:30-8:15 pm, markets, reports, etc. Pacific time. Slogan: "Santa Maria, Calif., The Valley of Gardens."

**KSO** Berry Seed Co., Clarinda, Iowa. 227.1 meters, 1320 kilocycles, 500 watts, Sun, 11 am, church services; 5 pm. Mon, Tues, Wed, Thurs, Fri, 6 am, 12 noon, 6:30-8:30 pm, musical. Sat, 6 am, 12 noon, Sunday school. Sat, silent night. Central standard time. Slogan: "Keep Serving Others."

**KSOO** Sioux Falls Broadcast Association, 609 Minnehaha Bldg., Sioux Falls, S. D. 209.7 meters, 1430 kilocycles, 250 watts.

**KTAB** The Associated Broadcasters (Inc.), 1410 10th av., Oakland, Calif. 280.2 meters, 1070 kilocycles, 500 watts. Sun, 9:45-12:30 pm, 7:45-9:30 pm, church services. Daily ex Sun, 8:45-10 am, 5-6 pm, 7-7:30 pm. Daily ex Sat, Sun, 8-10 pm. Pacific standard time. Slogan: "Knowledge, Truth and Beauty."

**KTAP** Robert B. Bridge, 832 W. Mulberry st., San Antonio, Tex. 228.9 meters, 1310 kilocycles, 20 watts. Sun, 4-6 pm, varied musical program; 9:30-10:30 pm. Daily ex Sun, 6:30 am-2 pm. Tues, Thurs, Fri, 6:30-10:30 pm. Mon & Sat, 6:30-8:30 pm. Wed, 6:30-10:30 pm. Central standard time. Slogan: "The World's Biggest Little Station."

**KTBI** Bible Institute of Los Angeles, 536 S. Hope st., Los Angeles, Calif. 288.3 meters, 1040 kilocycles, 500 watts. Mon, Tues, Wed, Thurs, 8 pm, musical studio program. Fri, 7 pm, Sunday school lessons. Sun, 10:45 am, 7:15 pm, church services; 6 pm, vespers. Pacific standard time.

**KTBR** Brown's Radio Shop, 393½ Yamhill st., Portland, Ore. 282.8 meters, 1060 kilocycles, 50 watts. Mon & Wed, 11 am-12 noon, 1:30-2:30 pm, 6-7:30 pm, 8:30-9:30 pm. Tues, 11 am-12 noon, 1:30-2:30 pm, 7-7:30 pm. Thurs, 11 am-12 noon, 1:30-2:30 pm, 6-9 pm. Sat, 11 am-12 noon, 3-4 pm, 7-9:30 pm.

**KTCL** American Radio Telephone Co., Seattle, Wash., 277.6 meters, 1080 kilocycles, 500 watts. Sun, 7:15-8:15 pm. Mon, Wed, Fri, 5:45-11 pm. Tues, Thur, 6-8:30 pm. Pacific standard time. Slogan: "Know The Charmed Land."

**KTHS** The Arlington Hotel, Hot Springs National Park, Ark. 384.4 meters, 780 kilocycles, 1000 watts. Sun, 11 am-12:30 pm, 8-10:30 pm. Mon, Wed, Thurs, Fri, 12 noon-1 pm, 8-10:30 pm. Tues, 12 noon-1 pm, 6-8:30 pm. Sat, 12 noon-1 pm, 6-7 pm, 8-10 pm, music, entertainment. Central standard time. Slogan: "Kum to Hot Springs."

**KTNT** Norman Baker, Muscatine, Iowa. 256.3 meters, 1170 kilocycles, 3500 watts night, 5000 watts daytime. Sunday, 12 noon, sacred program; 2:30 pm, 8 pm, varied program. Mon, 6 am, 9 am, 11 am, 12 noon, 2-11 pm. Daily ex Sun & Mon, 6 am-8 pm; 8 pm, Homefolks' Hour; 11 pm. Sat, 6 am-8 pm. Slogan: "The Voice of the Iowa Farmers' Union."

**KTRL** Technical Radio Laboratory, (H. C. Hogencamp), 28 Sicomac av., Midland Park, New Jersey. 280.2 meters, 1070 kilocycles, 15 watts.

**KTSA** San Antonio, Tex. 265.3 meters, 1130 kilocycles, 2000 watts.

**KTUE** Uhalt Electric Co., 614 Fannin St., Houston, Tex. 212.6 meters, 1410 kilocycles, 5 watts. Daily, 5:30-6:30 pm. Tues & Sat, 8-9:30 pm. Central standard time.

**KTW** First Presbyterian Church 7th av. and Spring st., Seattle, Wash. 394.5 meters, 760 kilocycles, 1000 watts. Sun, 11 am to 1 pm, 3-4 pm, 7:30-9:30 pm. Pacific time.

**KUOA** University of Arkansas, Fayetteville, Ark. 296.9 meters, 1010 kilocycles, 500 watts. Sun, 7:30 pm. Mon & Thurs, 7:30 pm, Radio School; 8 pm, musical program. Central standard time.

**KUOM** State University of Montana, Missoula, Mont. 374.8 meters, 800 kilocycles, 500 watts. Mon & Thurs, 8 pm, music & popular educational talks. Sun, 9:15 pm, sacred concert & sermon. Mountain standard time.

**KUSD** University of South Dakota, Vermillion, S. D. 483.6 meters, 620 kilocycles, 250 watts. Mon and Fri, 6:30-7:30 pm. College events broadcast as they occur. Central standard time.

**KUT** University of Texas, Austin, Tex. 232.4 meters, 1290 kilocycles, 500 watts. Sun, 11 am, St. David's Episcopal Church. Mon & Wed, 8 pm, studio program. Slogan: "Come to University of Texas."

**KVI** Puget Sound Radio Broadcasting Co., 15 S. Tacoma av., Tacoma, Wash. 234.2 meters, 1280 kilocycles, 50 watts. Sun, 11:30-12:45 pm, 1:30-5:30 pm, 7:30-9:30 pm. Daily ex Sun, 8-10 am, 6:15-10 pm. Pacific standard time. Slogan: "Puget Sound Station."

**KVOO** South Western Sales Corp., Tulsa, Okla. 348.6 meters, 860 kilocycles, 1000 watts. Sun, 8 am-12 noon, church; 6-10 pm & 11 pm-12 midnight, musical entertainment. Daily ex Sun, 10 am, markets; 12 noon-1 pm, Farmer's Hour; 1:45 pm, markets; 3-4 pm, music; 6-10:30 pm, varied musical programs from Tulsa, Stillwater, Bristow or Oklahoma City, also Red and Blue network programs. Central standard time. Slogan: "The Voice of Oklahoma."

**KVOS** L. L. Jackson & L. Kessler, 1208 10th av., Seattle, Wash. 209.7 meters, 1430 kilocycles, 50 watts.

**KWBS** Schaeffer Radio Co., 226 E. 41st st., Portland, Ore. 199.9 meters, 1500 kilocycles, 15 watts.

**KWCR** H. F. Parr, 1444 2nd av. E., Cedar Rapids, Ia. 352.7 meters, 850 kilocycles, 250 watts. Daily, 6:30 am, chapel services; 11:30 am, music hour; 4 pm, music; 5:30 pm. Mon, Wed, Fri, 9:15 pm. Central standard time. Slogan: "Voice of Cedar Rapids."

**KWG** Portable Wireless Telephone Co., 530 E. Market st., Port Stockton, Calif. 344.6 meters, 870 kilocycles, 50 watts. Sun, 11-1 pm, 7:30-9:30 pm, church service; 4:30-5:30 pm, concert. Daily ex Sun, 4-5 pm, news; 5-6 pm, news; 6-7 pm, children's hour; 8-9 pm, studio; 9-10 pm, studio; 10-11 pm, studio.

**KWJJ** Wilbur Jerman Station, Route No. 1, Box 481, Portland, Ore. 228.9 meters, 1310 kilocycles, 50 watts. Studio at Broadway Theater, 220 Broadway st. Daily ex Sun, 10 am-12 noon, 3-4 pm. Mon & Wed, 5:30 pm-1 am. Tues & Thurs, 5:30 pm-12 midnight. Fri, 5:30 pm-12:30 am. Sat, 5:30-8 pm, 10 pm-12 midnight, dance music. Pacific standard time. Slogan: "The Voice from Broadway."



# There are many fluxes for soldering but only one— is safe for Radio!

**F**LUX for soldering is a general term; it embraces, as a class, all types of soldering fluxes. To designate a flux as safe for radio construction is specific; *it means rosin*. Chloride pastes, acids and fluid solutions are soldering fluxes, and are well adapted for certain work, but *conductive and corrosive properties forbade their use for radio assembly*. Their active elements, zinc and ammonium chlorides, display spreading, creeping tendencies that promote leakage and will eventually cause increased resistance in the wiring.

Rosin, an organic mixture, *is a non-conductor and non-corrosive*. The glass-like surface of this material does not readily lend itself to the collection of dust (carbon particles) as will the sticky organic greases of paste. Nor will rosin attract moisture from the atmosphere; the chlorides of pastes and fluids will. *Moisture plus carbon particles defeat the best insulations produced. Moisture plus chlo-*

*rides direct a slow but determined corrosive attack upon supporting metals*. Such slow corrosion in wiring causes a steadily increasing resistance to the flow of electrical energy.

Kester Rosin Core Radio Solder scientifically combines radio's premier flux, Rosin, with a solder alloy of unvarying quality. The use of Kester Radio Solder furnishes the user with a means of accomplishing *Safer, Faster, and Cleaner* set wiring. Constructors who solder-protect wiring with Kester Radio Solder enjoy increased receptive range, improved tonal quality and the satisfying assurance that their receivers will never be forced into the discard through the corrosive and conductive action of a chloride flux.



### A Kester Soldered Receiver Is a Better Set

*Manufacturers of Radio Sets and Equipment:* Tests conducted with the various types of commercial fluxes are under constant observation in our laboratory. Can we assist you in your soldering problems?

## KESTER Radio SOLDER

CHICAGO SOLDER COMPANY  
4226 Wrightwood Avenue, Chicago, U. S. A.

*Originators and World's Largest Manufacturers of Self-fluxing Solder — Convince Yourself Without Expense*

### USE THIS COUPON NOW!

CHICAGO SOLDER CO., 4226 Wrightwood Ave., Chicago, U. S. A.	C.R.—9-27
Gentlemen: Please send me a test sample of Kester Radio Solder, together with descriptive literature without any obligation whatsoever.	
Name.....	
Address.....	
City.....	State.....
Dealer.....	

*Tell 'Em You Saw It in the Citizens Radio Call Book Magazine*

**KWKC** Wilson Duncan Studios, 39th & Main sts., Kansas City, Mo. 222.1 meters, 1350 kilocycles, 100 watts. Tues, Wed, Thurs, Fri, 7-9:15 pm. Central standard time. Slogan: "Keep Watching Kansas City."

**KYA** Pacific Broadcasting Corp., Clift Hotel, San Francisco, Calif. 309.1 meters, 970 kilocycles, 500 watts. Sun, 11 am-12:30 pm, 7:30-9 pm, church. Daily ex Sun, 7-8 am, 11 am-12 noon, 12:30-2 pm, 5:30-7:30 pm, 8-10 pm. Pacific standard time. Slogan: "At the Golden Gate."

**WAAW** Omaha Grain Exchange, Grain Exchange Bldg., Omaha, Nebr. 348.6 meters, 800 kilocycles, 500 watts. Daily ex Sun, 6 am, Oma-Tan Program Harness Bill; 9:30 am-1:40 pm, market reports; 1:30-2:30 pm, program; 5-7 pm, Oma-Tan program. Central standard time. Slogan: "Pioneer Market Station of the West."

**KWKH** W. K. Henderson Iron Works & Supply Co., Spring & Fanning sts., Shreveport, La. 394.5 meters, 760 kilocycles, 1000 watts.

**KYW** Westinghouse Elec. & Mfg. Co., roof of Congress Hotel, Chicago, Illinois. 526.0 meters, 570 kilocycles, 5000 watts. Sun, 11 am-12:15 pm, church; 1-2, 7:15-8:15 pm, 10:55-11 pm, time signals & weather reports. Daily ex Sun, 10:55 am, time signals; 5:45 pm, markets; 6 pm, Uncle Bob's Bedtime Story; 6:30 pm, weather report. Daily ex Mon, 10:55-11:05, time signals. Mon & Thurs, 12 noon-1 pm, studio program. Tues & Fri, 4 pm, Women's Hour; 7-9 pm, program from New York; 9-10:55 pm, music. Wed, Thurs, Fri, 6:32-7 pm, dinner concert. Mon, 6:30-7 pm, Roxy and His Gang from WJZ, N.Y. Wed, 7-7:30 pm, program from WJZ, N.Y.; 7:30-8 pm, studio program; 8-9 pm, program from New York; 9-10:55, musical program, etc. Thurs, 7-8 pm, studio program; 8-9:30 pm, program from New York; 9:30-10:55 pm, musical program. Sat, 7-10:55 pm, music, etc.

**WABB** Harrisburg Radio Co., 424 Market st., Harrisburg, Pa. 204 meters, 1470 kilocycles, 10 watts.

**KWLC** Decorah, Iowa. 247.8 meters, 1210 kilocycles, 50 watts.

**WABC** Atlantic Broadcasting Corp., Richmond Hill, N. Y. 325.9 meters, 920 kilocycles, 2500 watts. Sun, 11 am-12:30 pm, 7:30-9 pm. Central standard time.

**KWSC** The State College of Washington, Pullman, Wash. 394.5 meters, 760 kilocycles, 500 watts. Mon, Wed, Fri, 7:30-9 pm. Pacific standard time. Slogan: "The Voice of the Cougars." Divides time with Stations KTW, KOB, and KFNF.

**KZM** Preston D. Allen, 13th & Harrison sts., Hotel Oakland, Oakland, Calif. 245.8 meters, 1220 kilocycles, 100 watts. Daily ex Sun, 6:30-8 pm, Hotel Oakland dinner orchestra. Sun, 8-10 pm, orchestra. Pacific standard time.

**WABF** Markle Broadcasting Corp., 292 Wyoming av., Kingston, Pa. 205.4 meters, 1460 kilocycles, 250 watts. Sun, 9:30-10:30 am; 10:30 am-12 noon, church; 7:30-9 pm. Daily ex Sun, 12 noon-1 pm, luncheon program. Mon, 7-9, music. Wed & Fri, 7:30-9 pm, music. Eastern standard time. Slogan: "The Voice of Wyoming Valley."

**KWTC** Dr. John Wesley Hancock, 1101 N. Ross st., Santa Ana, Calif. 352.7 meters, 850 kilocycles, 5 watts. Daily ex Sun, 6:30-7:30 pm, dinner hour; Tues & Thurs, 7:30-10 pm, studio program; Fri, 7:30-8 pm, Farm Bureau talk; Sat, 7:30-9 pm, program. Pacific standard time. Slogan: "The Garden of Eden Station."

**NAA** United States Navy, Arlington, Va. 434.5 meters, 690 kilocycles, 1000 watts. Daily 10:05 am, 3:45 pm, 10:05 pm. Tues, 7:30 pm. Eastern standard time. Slogan: "Where the Time Signals Originate."

**WABI** First Universalist Church, Park st., Bangor, Me. 389.4 meters, 770 kilocycles, 100 watts. Sun, 10:30 am-12 pm, morning services; 7:30-9 pm, evening services. Eastern standard time. Slogan: "The Pinetree Wave."

**KWUC** Western Union College, Le Mars, Iowa. 243.8 meters, 1230 kilocycles, 1500 watts. Sun, 4-5 pm, vesper service. Daily ex Sun, 9:30-11:15 am, markets, etc.; 12:30 pm, Who's Who from "Sioux City" studio; 7 pm, musical, organ. Sat, 10 pm, college frolic. Central standard time. Slogan: "Voice of Western Union College." Divides time with Station KSCJ.

**WAAD** Ohio Mechanics Institute, Cincinnati, Ohio. 267.7 meters, 1120 kilocycles, 25 watts. Central standard time.

**WABQ** Keystone Broadcasting Co., Philadelphia, Pa. 261 meters, 1150 kilocycles, 500 watts. Sun, 7-11:30 pm. Mon, Wed, Thurs, 5:45-11:30 pm. Tues & Fri, 5:45 pm-12:30 am. Sat, 6:30-11:30 pm, varied musical programs. Eastern standard time.

**KWWG** City of Brownsville, Board of City Development, Brownsville, Texas. 277.6 meters, 1080 kilocycles, 500 watts. Sun, church services at 11 am. Mon, weather and river reports, music 12-12:30; music, 6-6:30, 8:30-9:45, 12 midnight-1 am. Tues, weather & river reports, 12-12:30 pm; music, 6-6:30. Wed, Thurs, Fri, Sat, same as Tues. Slogan: "Kum to the World's Winter Garden."

**WAAF** Chicago Daily Drivers Journal, 836 Exchange av., Chicago, Ill. 389.4 meters, 770 kilocycles, 500 watts. Daily ex Sun, & holidays, 8:45 am, markets; 10:30 am, weather; 10:50 am, markets; 11 am, estimated receipts of following day; 12:30 pm, weather; 12:50 pm, markets; 3 pm, markets; 4:30 pm, eastern meat trade conditions. Sat, 12:30 pm, final weather & market reports. Central standard time.

**WABW** College of Wooster, Wooster, Ohio. 247.8 meters, 1210 kilocycles, 50 watts. No regular schedule. Eastern standard time.

**KXL** KXL Broadcasters, Inc., 7th floor Bedell Bldg., Portland, Ore. 220.4 meters, 1360 kilocycles, 50 watts. Slogan: "The Voice of Portland."

**WAAM** I. R. Nelson Co., 1 Bond st., Newark, N. J. 348.6 meters, 860 kilocycles, and 65.1 meters, 4600 kilocycles, 500 watts. Daily ex Sun, 7-8 am. Daily ex Sat & Sun, 11 am-1:30 pm, 4-6 pm. Mon, Wed, Fri, 7 pm-12:12 am. Tues, Thurs & Sat, 6:30-7:30 pm. Eastern standard time. Slogan: "Sunshine Station."

**WABX** Henry B. Joy, 1830 Pendbscot Bldg., Detroit, Mich., near Mt. Clemens, Mich. 245.8 meters, 1220 kilocycles, 500 watts. Central standard time.

**KXRO** Brott Laboratories, 609 Washington blvd., Seattle, Wash. 240 meters, 1249 kilocycles, 85 watts.

**WAAT** Bremer Broadcasting Corp., Hotel Plaza, Jersey City, N. J. 245.8 meters, 1220 kilocycles, 300 watts. Sun, 5:30 pm-12 midnight, mixed program. Daily ex Sun, 10 am-12 noon, 6-7 pm, 8-11 pm, mixed programs. Eastern standard time. Divides time with Stations WSOM and WGBB. Slogan: "The Voice At the Gate of the Garden State."

**WABY** John Magaldi, Jr., 930 S. 8th st., Philadelphia, Pa. 247.8 meters, 1210 kilocycles, 50 watts. Eastern standard time.

*When you have decided to use house current for your receiver-*

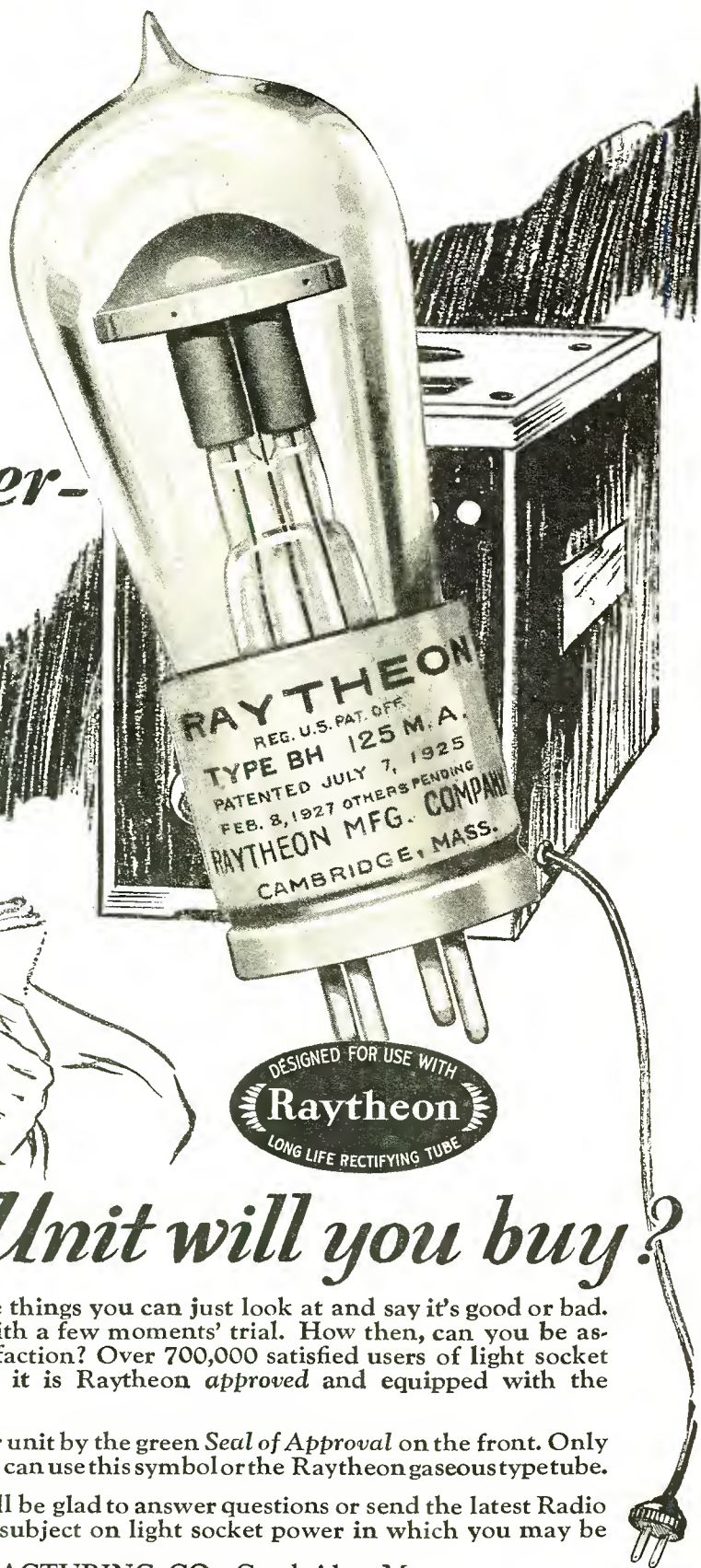

*..what Power Unit will you buy?*

A battery eliminator isn't one of those things you can just look at and say it's good or bad. Nor can you determine its qualities with a few moments' trial. How then, can you be assured of a reliable unit of lasting satisfaction? Over 700,000 satisfied users of light socket power units will tell you to be sure it is Raytheon *approved* and equipped with the Raytheon long life rectifying tube.

You can identify a Raytheon type power unit by the green *Seal of Approval* on the front. Only units that have been tested and approved can use this symbol or the Raytheon gaseous type tube.

Our Technical Service Department will be glad to answer questions or send the latest Radio Power Bulletin covering in detail any subject on light socket power in which you may be interested.

RAYTHEON MANUFACTURING CO., Cambridge, Mass.

Type BH  
125 m.a. 300  
volts

Type BA  
A-B-C power  
350 m.a.

**Raytheon**  
THE HEART OF RELIABLE RADIO POWER

Type A  
2½ Amps.

Type R  
90 V. 60 m.a.

*Tell 'Em You Saw It in the Citizens Radio Call Book Magazine*

**WABZ** Coliseum Pl. Baptist Church, 1376 Camp st., New Orleans, La. 247.8 meters, 1210 kilocycles, 50 watts. Sun, 10:30-11:45 am, 3-5 pm, 9-11 pm. Daily ex Sun, 5:30-6 pm. Saturday night, silent. Eastern standard time. Slogan: "The Station with a Message."

**WADC** Allen Theatre Broadcasting Station, Cadillac Bldg., Akron, Ohio. 296.9 meters, 1010 kilocycles, 500 watts. Sun, 10:30-11:45 am, 3-5 pm, 9-11 pm. Daily ex Sun, 5:30-6 pm. Saturday night, silent. Eastern standard time. Slogan: "Watch Akron Deliver Cars."

**WAFD** WAFD Broadcasting Co., Addison Hotel, Charlotte & Woodward Aves., Detroit, Mich. 230.6 meters, 1300 kilocycles, 100 watts. Menu service, 2 pm daily. Dinner music, 6:45 pm. Daily studio program, 7:30 pm daily ex Sat. Eastern standard time.

**WAGM** R. L. Miller, Royal Oak, Mich. 225.4 meters, 1330 kilocycles, 50 watts. Sun, Mon, Wed & Fri, 8-10:30 pm. Slogan: "The Little Station With the Big Reputation."

**WAGS** Willow Garages (Inc.), 131 Willow av., Somerville, Mass. 217.3 meters, 1390 kilocycles, 5 watts.

**WAIT** A. H. Waite & Co. (Inc.), 32 Weir st., Taunton, Mass. 214.2 meters, 1400 kilocycles, 10 watts. No regular schedule. Eastern standard time.

**WAIU** American Insurance Union, Columbus, Ohio. 282.8 meters, 1060 kilocycles, 5000 watts. Daily ex Sun, 10:30-11 am, 11:30 am-12:30 pm. Mon, Wed, Fri, 6 pm-12 midnight. Tues and Thurs, 6-7 pm. Sun, 3-5 pm, 9-11 pm. Eastern standard time. Slogan: "The Radio Voice of the American Insurance Union."

**WALK** Bethayres, Pa. 201.6 meters, 1490 kilocycles, 50 watts.

**WAMD** Radisson Radio Corp. & Stanley E. Hubbard, Minneapolis, Minn. 225.4 meters, 1330 kilocycles, 500 watts. Sun, 10:30 am, church; 12:30, funnies; 3 pm, popular program; 5:30 pm, concert; 9:30 pm, popular. Daily ex Sun, 10:30 am, musical; 11 am, Aunt Sammy; 12 noon & 5:30 pm, organ; 6:05 pm, farm feature; 7 pm, classical hour; 8-9 pm, popular program; 10 pm, dance music; 11:15 pm, organ. Central standard time. Slogan "The Call of the North."

**WAOK** A. H. Andreason, 10317-116 st., Richmond Hill, N. Y. 247.8 meters, 1210 kilocycles, 100 watts.

**WAPI** Alabama Polytechnic Institute, Auburn, Ala. 319 meters, 940 kilocycles, 1000 watts. Daily ex Sun, 12-1 pm, 9-10 pm Tues, Thurs, Fri. All programs include musical numbers, educational lectures and news. Central standard time.

**WARS** Amateur Radio Specialty Co., Hotel Shelburne, Brooklyn, N. Y. 227.1 meters, 1320 kilocycles, 500 watts. Sun, 7-9 am, 12:30-3 pm. Mon, Wed, Thurs, Fri, 7-8 am, 9-10 am. Mon & Fri, 8-10 pm. Wed & Fri, 3-6 pm. Tues & Thurs, 12 noon-2 pm. Mon, 3-7 pm. Wed, 7-10 pm. Thurs, 6-7 pm, 10 pm-12 midnight. Sat, 7-9 am, 1:30-3 pm, 9 pm-12 midnight. Eastern standard time. Slogan: "The Voice of the Atlantic."

**WASH** Baxter Launderers & Cleaners, 747 Fountain st., N. E., Grand Rapids, Mich. 256.3 meters, 1170 kilocycles, 250 watts. Sun, 11 am-12:15 pm. Daily ex Sun, 12:30-1:30, 5:30-6, 7-8 pm. Sat, 2:15 pm (football season only). Central standard time.

**WATT** Edison Elec. Illuminating Co., 39 Boylston, Boston, Mass. (portable). 201.6 meters, 1490 kilocycles, 100 watts.

**WBAA** Purdue University, West Lafayette, Ind. 272.6 meters, 1100 kilocycles, 500 watts. Daily, 9:50 am, markets, etc. Mon & Friday, 7 pm, music and talks. Athletic contests and special features as announced. Central standard time.

**WBAK** Pennsylvania State Police, 18th & Herr sts., Harrisburg, Pa. 299.8 meters, 1000 kilocycles, 500 watts. Daily ex Sun, 10:30 am, police reports; 1:30 pm, 4 pm. Mon & Thurs, 7 pm. Eastern standard time. Slogan: "The Voice of Pennsylvania."

**WBAL** Baltimore, Md. 285.5 meters, 1050 kilocycles, 3000 watts. Sun, 6:30-7:30 pm, concert orchestra; 7:30-8:15 pm. Daily ex Sun, Sat, 4-11 pm, varied programs, all musical. Eastern standard time. Slogan: "The Station of Good Music."

**WBAO** James Millikin University, Decatur, Ill. 267.7 meters, 1120 kilocycles, 100 watts. Mon, Wed, 7-8 pm, music & lectures. Thur, Fri, Sat, basketball & football games whenever scheduled. Central standard time. Slogan: "Millikin at Decatur."

**WBAP** Carter Publications (Inc.), 400 W. 7th st., Fort Worth, Tex. 499.7 meters, 600 kilocycles, 1500 watts. Sun, 11 am, church; 12:30 pm, kiddies' hour; 5 pm, sacred music, 9:30 pm, orchestra. Daily ex Sun, 6-7 pm. Daily ex Sun & Wed, 8-9 pm. Mon, Thurs, Fri, 10 pm-12 midnight. Central standard time. Divides time with Station WFAA, Dallas, Tex.

**WBAW** Waldrum Drug Co. & Braid Electric Co., 7th av., South & Broad sts., Nashville, Tenn. 247.8 meters, 1210 kilocycles, 100 watts.

**WBAX** John H. Stenger, Jr., 66 Gildersleeve, Box 104, Wilkes-Barre, Pa. 249.9 meters, 1200 kilocycles, 100 watts. 6:30 pm, studio. Mon, 7-8 dance music. Tues, 7-9 pm, main studio; 10:30 pm, classical. Thurs, 9-10:30 pm, recital; 3:15-5 pm, lectures; 11:15-2 am, witching hour. Sat, 10-12 pm, dance. Eastern standard time. Slogan: "In Wyoming Valley, Home of the Anthracite."

**WBBC** Peter J. Testan, 2123 Troy av., New York, N. Y. 227.1 meters, 1300 kilocycles, 500 watts. Tues, Thurs, Sat, 8-12 pm, musical. Eastern time.

**WBBL** Grace Covenant Presbyterian Church, Richmond, Va. 247.8 meters, 1210 kilocycles, 100 watts. Sun, 11 am-7:45 pm. Tues, 8 pm. Eastern standard time. Slogan: "Richmond, the Gateway North and South."

**WBBM** WBBM Air Theatre, 306 S. Wabash av., Chicago, Ill. 389.4 meters, 770 kilocycles, 1000 watts. Daily ex Sun & Mon, 12:45-2 pm, 7-11 pm. Mon, 12:30-2 pm, 6-7 pm. Sat, 12 midnight-2 am. Silent Sun. Central standard times. Divides time with Stations WJBT and WAAF, Chicago.

**WBBP** Petoskey High School, Petoskey, Mich. 239.9 meters, 1250 kilocycles, 100 watts. Program irregular. Central standard time. Slogan: "There's Only One Petoskey."

**NEW!**  
*The*  
**Two Tube**  
 OFFICIAL  
**BROWNING-DRAKE**  
 KIT SET

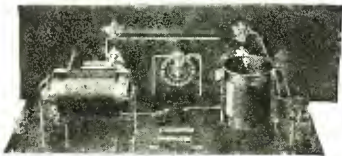

**T**HIS new assembly, the two tube Official Browning-Drake has been designed to be used with any good audio transformer system now on the market, such as Amertran, Thordarson, Silver-Marshall, etc. The combination gives remarkable tone quality and great volume. This two tube assembly uses only the detector and R. F. tubes. Special type T foundation unit makes construction easy. The Official Browning-Drake Kit is used. Other Browning-Drake Corporation products incorporated in the assembly are the Cartridge resistance and the neutralizer.

If your dealer does not carry all of the specified parts, send us his name and your requirements will be met immediately.

**Over  
 200,000  
 Have Been  
 Built!**



**B**ROWNING-DRAKE has been the outstanding kit set for over three years. Countless designs for home construction have come and gone but **ONLY** Browning-Drake remains as popular today as it was during the weeks following its presentation.

Over 200,000 Browning-Drakes have been built. Such popularity is explained by the fact that Browning-Drake is based on the sound, scientific research of Prof. Glenn H. Browning and Dr. Frederick H. Drake at Cruft Laboratory of Harvard University.

The Official Kit Set now standard on the market, was designed to take care of modern broadcasting conditions. It is unsurpassed for all around performance. Get the genuine parts **TODAY** and build this dependable receiver—the Official **BROWNING-DRAKE** Kit Set. Constructional booklet will be sent on receipt of twenty-five cents.

To those who wish to buy Browning-Drake Radio completely built, we offer two new models as well as the popular 5-R of last year. These receivers come in 5, 6 and 7 tube models and are unconditionally guaranteed to give satisfactory performance. If your dealer cannot supply you with the Browning-Drake Corporation Kit and other genuine parts or the factory-built receivers, send us his name and your requirements will be taken care of immediately.

*DEALERS: There is profit as well as satisfaction in handling dependable products that are popular. Write us about the Browning-Drake proposition TODAY.*

**BROWNING - DRAKE CORPORATION**  
 CAMBRIDGE MASS.

**BROWNING**  
 TRADE MARK  
**DRAKE**  
 CABINETS PARTS RECEIVERS KITS

*Tell 'Em You Saw It in the Citizens Radio Call Book Magazine*

**WBBR** People's Pulpit Association, 124 Columbia Heights, Brooklyn, Rossville, N. Y. 256.3 meters, 1170 kilocycles, 1000 watts. Sun, 10-12 am, orchestra, lectures, lessons; 2-4:30 pm, concert; 7-9 pm, Bible questions, music. Tues, Thurs, Fri, 7:30-9:30 pm, organ recital, health items, vocal & violin, Bible lecture. Eastern standard time. Slogan: "Watchtower."

**WBBW** Ruffner Junior High School, Norfolk, Va. 236.1 meters, 1270 kilocycles, 50 watts. Programs vary. Eastern standard time.

**WBBY** Washington Light Infantry, 240 King st., Charleston, S. C. 499.7 meters, 600 kilocycles, 75 watts. Irregular through week. Sat, 7-12 pm, orchestra, vocal, instrumental and talks. Eastern time. Slogan: "The Seaport of the Southeast."

**WBBZ** C. L. Carrell, 36 S. State st., Chicago, Ill. (Portable). 204.0 meters, 1470 kilocycles, 50 watts. Central standard time.

**WBCN** Great Lakes Broadcasting Co., Chicago, Ill. 288.3 meters, 1040 kilocycles, 250 watts. Sun, 10:30 am-12:15 pm, 5-6 pm, 7:30-9:30 pm, classical and religious. Daily ex Sun & Mon, 1-2 pm, 5-6 pm, classical; 7-8 pm, popular program. Central standard time. Slogan: "Voice of Service to the Public."

**WBES** Bliss Electrical School, Takoma Park, Md. 296.9 meters, 1010 kilocycles, 100 watts. Eastern standard time.

**WBET** Boston Transcript Co., 324 Washington st., Boston, Mass. 241.8 meters, 1240 kilocycles, 500 watts.

**WBIS** The Shepard Stores, Winter St., Boston, Mass. 302.8 meters, 990 kilocycles, 100 watts. Daily ex Sun, 8-10 am, music and talks; 2-4 pm. Eastern standard time.

**WBKN** Municipal Bank Bldg., 350 Stone av., Brooklyn, N. Y. 267.7 meters, 1120 kilocycles, 100 watts. Daily ex Sun, 12 noon-1 pm, 3-5 pm. Mon, Fri, 8-10 pm. Tues, 10 pm-12 midnight. Wed, 12 midnight-2 am. Thur, 6-8 pm. Sat, 6-8 pm. Eastern standard time. Slogan: "The Voice of Community Service." Divides time with Stations WWRL, WBMS, WIBI.

**WBMC** Malbrook Co., 4128 Betts av., Woodside, N. Y. 293.9 meters, 1020 kilocycles, 500 watts.

**WBMH** Braun's Music House, Detroit, Mich. 211.1 meters, 1420 kilocycles, 100 watts.

**WBMS** The Union City Municipal Broadcasting Station, State-Capital Theater Bldg., Union City, N. J. 267.7 meters, 1120 kilocycles, 100 watts. Sun, 10 am-1 pm. Popular program. Daily ex Sun, 10-11 am, dance program; 5-6 pm, dinner music. Mon & Fri, 12 midnight-2 am, nut club. Tues, Thur, 8-10 pm, popular program. Wed, 6-8 pm, popular program. Sat, 10 pm-12 midnight, popular program. Eastern standard time. Slogan: "The Voice of Union City, New Jersey." Divides time with Stations WWRL, WBKN, WIBI.

**WBNY** Baruchrome Corp., 145 W. 45 Tilmar Bldg., New York, N. Y. 218.8 meters, 1370 kilocycles, 500 watts. Daily ex Sun, 7-11 pm. Sun, 2:30-6 pm. Eastern standard time. Slogan: "The Voice of the Heart of New York."

**WBOQ** New York City, N. Y. 325.9 meters, 920 kilocycles, 500 watts.

**WBRC** Birmingham Broadcasting Corp., 1913 5th av. N., Birmingham, Ala. 243.8 meters, 1230 kilocycles, 250 watts. Sun, 10:45 am-12:30 pm, church; 6:30-7:30 pm, organ; 7:30-9:30 pm, church. Mon, Tues, Wed, Fri, 8-9 pm. Daily ex Sat & Sun, 1-2 pm. Central standard time. Slogan: "The Biggest Little Station in the World."

**WBRE** 16 N. Main St., Liberty State Bank & Trust Bldg., Wilkes-Barre, Pa. 249.9 meters, 1200 kilocycles, 100 watts. Sun, 9 pm-12 midnight. Mon & Fri, 6-11 pm. Wed, 6 pm-12 midnight. Eastern standard time.

**WBRL** Booth Radio Laboratories, 23 Summer st., Tilton, N. H. 461.3 meters, 650 kilocycles, 500 watts. Sun, 10:30-11:30 am, 7-8 pm, church services. Tues, Fri, 10-11:30 pm, dance program. Mon, Wed, Thurs, Sat, program varied. Eastern time. Slogan: "The Voice of the Granite State."

**WBRS** North American Broadcasting Corp., 1062 Broadway, Brooklyn, N. Y. 211.1 meters, 1420 kilocycles, 100 watts.

**WBSO** Babson's Statistical Organization, Wellesley Hills, Mass. 284.4 meters, 780 kilocycles, 100 watts. Sun, 12 midnight-1 am, religious service. Daily ex Sat, Sun, 6-6:20 pm, business talks. Daily including Sun, 12 midnight-1 am. Eastern standard time.

**WBT** C. C. Coddington, 500 W. Trade st., Charlotte, N. C. 258.5 meters, 1160 kilocycles, 500 watts. Sun, 10:55 am, church; 6:20 pm, Capitol Theatre program; 8 pm, church. Daily ex Sun & Tues, 12:30 pm, weather reports. Mon, 6:30, Roxy and Gang; 8 pm, Movie Club. Wed, 7:30 pm; 8 pm, Maxwell House Hour; 9 pm. Thurs, 8 pm, Bible students; 8:30 pm, Buick Hour. Fri, 8 pm, Philco Hour. Eastern standard time. Slogan: "The Queen City of the South."

**WBZ** Westinghouse Electric & Mfg. Co., 623 Page blvd., East Springfield, Mass. 333.1 meters, 900 kilocycles, 15,000 watts. Broadcasts on a 24-hour schedule daily. Eastern standard time. Slogan: "The Broadcasting Station of New England."

**WBZA** Westinghouse Electric & Mfg. Co., Hotel Statler, Boston, Mass. 333.1 meters, 900 kilocycles, 500 watts. Broadcasts on a 24-hour schedule daily. Eastern standard time.

**WCAC** Connecticut Agricultural College, Mansfield, Conn. 275.1 meters, 1090 kilocycles, 500 watts. Mon, Wed, Fri, 7:30-9 pm, farm lectures & music. Eastern standard time. Slogan: "Voice from the Nutmeg State."

**WCAD** St. Lawrence University, Canton, N. Y. 365.6 meters, 820 kilocycles, 500 watts pm, 1000 watts am. Sun, 4-5 pm, organ recital. Daily ex Sun, 12:30 pm-1 pm. Wed, 8-10 pm. Eastern standard time. Slogan: "The Voice of the North Country."

**WCAE** The Pittsburgh Press and Kaufman & Baer Co., Pittsburgh, Pa. 516.9 meters, 580 kilocycles, 500 watts. Sun, 9:30 am-10 pm. Daily ex Sun, 6:45 am-11 pm, inclusive. Programs include exercises, educational talks, musical programs, children's periods, news & recitals. Eastern standard time. Slogan: "Where Prosperity Begins."

**WCAH** C. A. Entreklin, 321 W. 10th av., Columbus, O. 535.4 meters, 560 kilocycles, 250 watts. Sun, 10:30-12, church services. Daily, 11:30 am-12:30 pm, 7:30-9:30 pm.

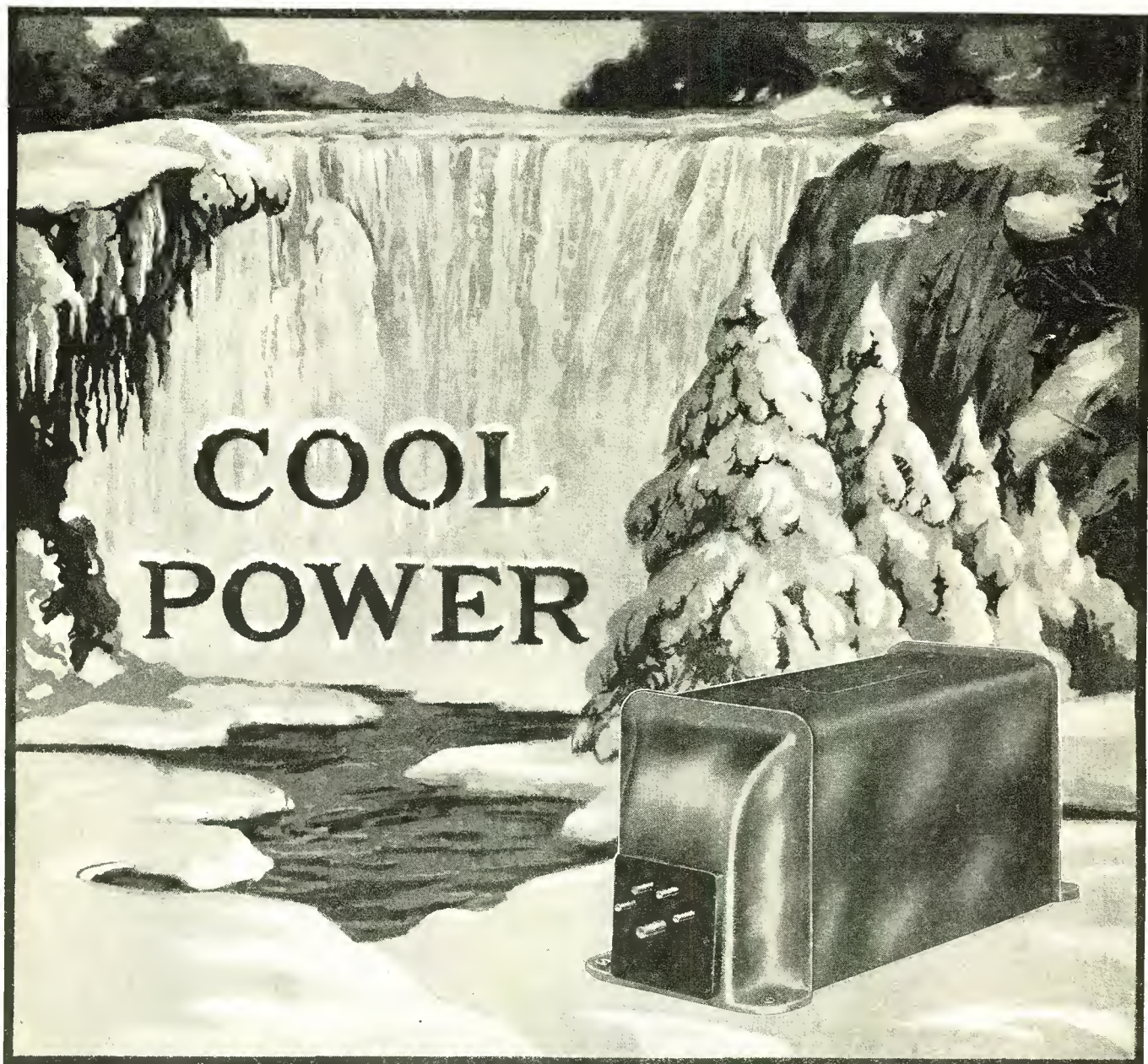

Samson Power Block No. 210. The only block which will supply 500 volts at 80 mils to two 210 tubes

## Powerize with Samson Units for Best Results

For new SAMSON Power Units insure the best there is in radio current supply by

1. Doing away with hum, motor boating and poor voltage regulation.
2. Remaining so cool after 24 hours continuous operation under full load that they will be well within the 20° rise of temperature specified by the A. I. E. E.
3. Being designed to more than meet the specifications adopted by the National Board of Fire Underwriters.

4. Insuring safety against shock because of protected input and output terminals.
5. Insuring for all tubes the correct filament voltages specified by their manufacturers.
6. Compensating for lighting circuit voltage variation by the use of a special input plug and terminal block to which is attached a 6 ft. flexible rubber-covered connecting cord and plug.
7. Being more economical in operation than other units of similar power rating.
8. Living up to the name plate rating.

*Limited space prevents us from listing the fourteen types that we make. Our Power Units bulletin, descriptive of these, is free for the asking. In addition, our construction bulletin on many different "B" Eliminators and Power Amplifiers will be sent upon receipt of 10c in stamps to cover the mailing cost.*

**Samson Electric Co.**

MANUFACTURERS SINCE 1882  
Canton, Mass.

*Tell 'Em You Saw It in the Citizens Radio Call Book Magazine*

**WCAJ** Nebraska Wesleyan University, University Place, Nebr. 379.5 meters, 790 kilocycles, 500 watts. Sun, 11 am, church services; 4 pm, vespers. Daily ex Sat & Sun, 10 am, convocation program; daily ex Sat & Sun, 4:30 pm, weather, news, features. Tues, Thurs, Fri, 12 noon, musical half hour. Tues, 7:30 pm, Bible study. Wed, 8 pm, Teachers' Training Course; 9 pm, musical program. Central standard time.

**WCAL** St. Olaf College, Northfield, Minn. 236.1 meters, 1270 kilocycles, 500 watts. Daily ex Sun & Thurs, 9:45 am, chapel service. Sunday, 8:30 am, Norwegian Church service. Central standard time. Slogan: "The College on the Hill."

**WCAM** City of Camden, Camden, N. J. 223.7 meters, 1340 kilocycles, 500 watts. Mon, Wed, Fri, 7:30-12 pm, mixed program. Eastern time.

**WCAO** Monumental Radio, Incorporated, 842 N. Howard st., Baltimore, Md. 384.4 meters, 780 kilocycles, 250 watts. Mon, Wed, Fri, 8-11 pm. Sun, 11 am-12 noon, church services; 3-4 & 4-5 pm, Columbia Chain Program; 8-9:30 pm, church services; 9:30 & 10 pm, Columbia Chain Program. Eastern standard time. Divides time with Station WCBM. Slogan: "The Gateway of the South."

**WCAR** Alamo Broadcasting Co., Plaza Hotel, San Antonio, Tex. 263 meters, 1140 kilocycles, 2000 watts. Daily ex Sun, 11 am, stock reports; 3 pm, late stock reports and news item; 8-10 pm, musical program. Central standard time. Slogan: "Down in Sunny Antonio."

**WCAT** South Dakota State School of Mines, Rapid City, S. Dak. 247.8 meters, 1210 kilocycles, 100 watts. Daily ex Sun, 9:30-9:45 am, weather; 12:30-1 pm, weather & agrigrams. Mountain time. Slogan: "WCAT, Station of the South Dakota State School of Mines at Rapid City."

**WCAU** Universal Broadcasting Co., Hotel Pennsylvania, 39th & Chestnut sts., Philadelphia, Pa. 336.9 meters, 390 kilocycles, 500 watts. Mon & Fri, 5:15 pm-12 midnight. Tues, Thurs, Sat, 5:30 pm-12 midnight. Wed, 5:15 pm-1 am. Sun, 2 pm-12 midnight. Eastern standard time. Slogan: "Where Cheer Awaits U."

**WCAX** University of Vermont, Burlington, Vt. 254.1 meters, 1180 kilocycles, 100 watts. Fri, 7:30-8:30 pm, education & entertainment. Eastern standard time. Slogan: "The Voice of the Green Mountains."

**WCAZ** Carthage College, Carthage, Ill. 340.7 meters, 880 kilocycles, 50 watts. Daily ex Sat & Sun, 11:40 am, church services. Mon, 7-8 pm, musical program. Athletic contests at various times. Central standard time.

**WCBA** Charles W. Heimbach (Queen City Radiophone Station WCBA), 1350 Allen st., Allentown, Pa. 222.1 meters, 1180 kilocycles, 100 watts. Wed & Fri, 8:15-11 pm, musical programs. Sat, 9:30-11 pm, dance program. Sun, 10 am, 5:30 pm, 7 pm, church services. Eastern standard time.

**WCBD** Wilbur Glenn Voliva, Temple Site, Zion, Ill. 344.6 meters, 870 kilocycles, 5000 watts. Sun, 9-10:45 am, 2:30-6 pm, 8-10:30 pm. Tues, 8-10:30 pm. Wed, 12:30-1 pm. Thur, 2:30-3:45 pm, 9-11:30 pm. Divides time with WLS, Sears Roebuck Station, Chicago.

**WCBE** Uhalt Bros. Radio Co., 1219 N. Rampart st., New Orleans, La. 227.1 meters, 1320 kilocycles, 5 watts. Daily ex Sun, 11:30-12:30 pm. Sun, 12:30-2:30 pm, 7:30-8:30 pm. Central standard time. Slogan: "Second Post, U. S. A."

**WCBM** Hotel Chateau, Baltimore, Md. 384.4 meters, 780 kilocycles, 100 watts. Sun, 9:45-11:30 pm, vocal & instrumental. Mon, midnight-1:15 am, dance program. Wed, 10-11:45 pm, dance selections. Sat, 9:30-10 pm, religious service; 10-11:30 pm, dance program. Eastern standard time. Slogan: "At Dixie's Door." Divides time with Station WCAO.

**WCBR** C. H. Messter (Portable), 42 Doyle av., Providence, R. I. 201.6 meters, 1490 kilocycles, 100 watts. Daily ex Sun, 6:30 pm, 7:30 pm, 9-10 pm. Eastern time.

**WCBS** St. Nicholas Hotel, Springfield, Ill. 209.7 meters, 1430 kilocycles, 250 watts. Sun, 10:45 am-12 noon, church services; 12:30-2 pm, 6-7 pm. Mon, Tues, Fri, 8:30-10:30 pm, 11-12 pm. Wed, Thur, 8-11 pm. Central standard time.

**WCCO** Cold Medal Station, Nicollet Hotel, Minneapolis, and Union Depot, St. Paul, Minn. 405.2 meters, 740 kilocycles, 3000 watts. Daily ex Sun, 9:30 am, 9:35 am, 9:45 am, 10:30 am, 11:30 am, 12 noon, 1:30 pm, news, markets, weather, noon concert, women's hour. Mon & Tues, 6-10 pm. Wed, 6-11:30 pm. Thurs, 6-10:05 pm. Fri & Sat, 6:15-10:05 pm. Sun, 9:45 am, 4:10-11 pm. Central standard time. Slogan: "Service to the Northwest."

**WCDA** New York City, N. Y. 211.1 meters, 1420 kilocycles, 250 watts.

**WCFL** Chicago Federation of Labor, 623 So. Wabash av., Chicago, Ill. 483.6 meters, 620 kilocycles, 1500 watts. Sun, 11-12:30 noon, church; 2-6:30 pm, popular program; 7:45-9:15 am, Baptist Church; 9:15, Utah Hour. Mon, 10 am-2 pm, 4-6 pm, musical. Daily ex Sun & Mon, 10 am-2 pm, 4 pm-12 midnight, music and speakers. Central standard time. Slogan: "The Voice of Labor." Divides time with Stations WLTS and WEMC.

**WCFT** Knights of Pythias Home (Knights of Pythias Orphanage), Tullahoma, Tenn. (Ovoca). 252 meters, 1190 kilocycles, 10 watts.

**WCGU** Chas. G. Unger, New Perl House, Coney Island, New York. 218.8 meters, 1370 kilocycles, 500 watts.

**WCLO** C. E. Whitmore, Camp Lake, Wis. 227.1 meters, 1320 kilocycles, 100 watts. Sun, 9-12 noon, church services; 2-5 pm, popular; 6-7 pm, supper bell program. Mon, Wed, Fri, Sat, 7 pm-midnight, Popular program. Central standard time. "The Playground of the Lake Region."

**WCLS** WCLS, Inc., 301 E. Jefferson st., Joliet, Ill. 215.7 meters, 1390 kilocycles, 150 watts. Sun, 9:30 am, services. 11 am, services; 8-11 pm, studio program. Tues, 8-11 pm, studio features. Wed, 7-8 pm, organ concert. Fri, 7-8 pm, organ & vocal; 8-11 pm, studio program. Sat, 8-11 pm, studio features, orchestra. Central standard time. Slogan: "Will County's Largest Store."

**WCMA** Culver Military Academy, Culver, Ind. 258.5 meters, 1160 kilocycles, 250 watts. Daily, 12:15 pm, public service hour, highway reports, etc. Sun, 11 am, chapel service. Mon, 8 pm, band concert & studio. Wed, 8 pm, dance music & studio. Slogan: "The Voice of Culver."

**WCOA** Municipal Broadcasting Station, City Hall, Pensacola, Fla. 249.9 meters, 1200 kilocycles, 500 watts. Sun, 11 am, 12:30-7:45 pm. Mon, Wed, Fri, 10:30 am, 12:30-8 pm. Tues, Thurs, Sat, 10 am-12 noon. Central standard time. Slogan: "Wonderful City of Advantages."

**WCOC** Crystal Oil Co., Columbus, Miss. 230.6 meters, 1300 kilocycles, 250 watts. Daily ex Sun, 5-6 pm, music. Tues, 8-10 pm, vocal & instrumental studio program. Fri, 8-10 pm, dance music. Central standard time.



# ACME CELATSITE Solid or Stranded Circuit Wire

*Recommended in the  
hook-ups of leading  
radio magazines*

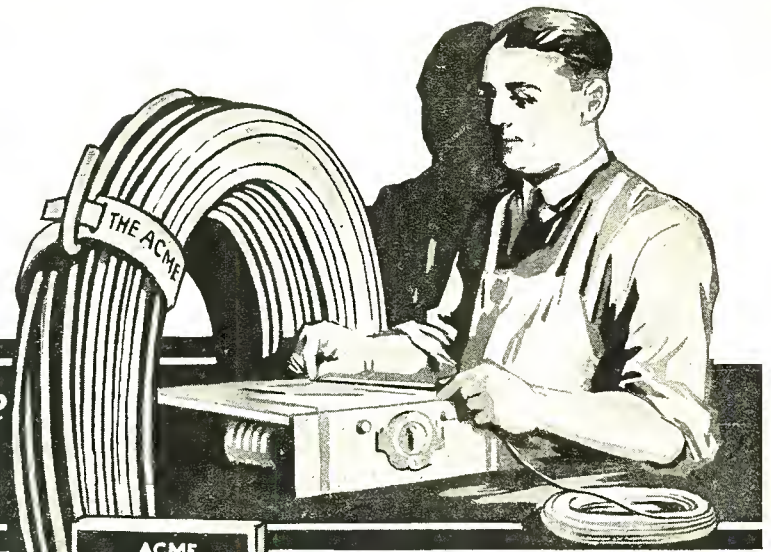

### Flexible Celatsite For Sub-Panel Wiring

**F**INE tinned copper wires twisted into a cable, then covered with improved, non-inflammable Celatsite compound. Soft and yielding, therefore, excellent for point-to-point and sub-panel wiring of radio sets. The insulation strips easily and the wires, being tinned, solder readily. Colors, red, yellow, green, maroon, brown, slate, blue, white and black. *Sold only in 25-foot coils, in cartons colored to match the contents.*

### Acme Solid Celatsite For Above-Panel Wiring



This is Nos. 14, 16, 18 and 19 tinned copper wire covered with improved, non-inflammable Celatsite compound. The insulation strips easily and will not crack at the bends. Acme Solid Celatsite in the small sizes is adaptable for sub-panel wiring; in the larger sizes it is ideal for visible wiring; the bright colors of varying shade make a splendid appearance. Made in red, yellow, green, maroon, brown, slate, blue, white and black; 30-inch lengths, single or assorted colors.

### Acme Spaghetti

Acme Spaghetti is oil, moisture and acid proof, and highly dielectric; the choice of manufacturers of the most delicate electrical instruments. In 30-inch lengths, for wire sizes from 12 to 18. Nine bright colors; red, yellow, green, maroon, brown, slate, blue, white and black. (We also make tinned bus bar, round and square, in 2 and 2½-ft. lengths.)



### Stranded, Enameled Antenna



Made of seven strands of copper wire thoroughly enameled, then twisted into a firm cable. This type of antenna resists corrosion and presents maximum surface to the incoming wave,

thus greatly improving the signals. Made in size to equal Nos. 14 and 16 solid enameled antenna wire. (We also make solid and stranded bare, and stranded tinned antenna.)

### Acme Loop Antenna

No wire but the best should be sold for loops. Acme Loop Antenna Wire is composed of sixty strands of No. 38 bare copper wire, to give it flexibility, and five strands of No. 36 phosphor bronze wire, to prevent stretching. Green or brown cotton next to the wire, and an outer covering of green or brown silk, result in splendid insulation and a very pleasing appearance. In convenient spools.

### Acme Celatsite Battery Cable

A thoroughly insulated cable composed of five, six, seven, eight or nine Flexible Celatsite wires all enclosed in brown Rayon braid. Each wire is of a different color. The workmanship and material are of the best. One to a box, with or without terminals.



Send for Folder

Dealers—Write Dept. C for catalog inserts showing the full line

**THE ACME WIRE CO.**

Main Office and Works, NEW HAVEN, CONN.

Branches at  
New York, 52 Vanderbilt Ave. Chicago, 427 West Erie St.  
Cleveland, Guardian Bldg.

# ACME WIRE

*For greater certainty in radio circuits*

*Tell 'Em You Saw It in the Citizens Radio Call Book Magazine*

**WCOM** New Hampshire National Guard, 172nd Field Artillery, Headquarters Battery, Manchester, N. H. 238.0 meters, 1260 kilocycles, 100 watts.

**WCOT** Jacob Conn, Olympia Theatre, Olneyville sq., Providence, R. I. 225.5 meters, 1330 kilocycles, 50 watts. Daily, 2-4 pm. Mon, Wed, Fri, 7:30-9 pm. Programs varied. Eastern standard time.

**WCRW** Clinton R. White, Embassy Hotel, Diversey parkway, at Pine Grove, Chicago, Ill. 223.7 meters, 1340 kilocycles, 500 watts. Daily ex Sun, 1130 am-1 pm. Daily ex Mon, 6:30-7:30 pm, 9:30-10:30 pm. Sun, 6:30-7:30 pm, 10-11 pm. Central standard time. Slogan: "For Your Entertainment."

**WCSH** Henry P. Rines, Congress Square Hotel, Portland, Maine. 361.2 meters, 830 kilocycles, 500 watts. Sun, 10:30-12 noon, 1:30-2:30 pm, 4-5:30 pm, 7:30-10 pm. Mon, 10-12 am, 12-1:30 pm, 3-4 pm, 6-11 pm. Daily ex Sun, same as Mon. Slogan: "The Voice from Sunrise Land."

**WCSS** Wittenberg College, Springfield, O. 256.3 meters, 1170 kilocycles, 500 watts. Mon, Wed, Fri, 8-10 pm. Tues, Thurs, 6-7 pm. Eastern standard time.

**WCWK** Chester W. Keen, Fort Wayne, Ind. 228.9 meters, 1310 kilocycles, 500 watts. Sun, 10:30 am, 6:30-7:30 pm, church services. Mon, Tues, Wed, Thurs, Fri, Sat, 11 am-12 noon, musical program. Mon, 4-5:30 pm, children's hour. Tues, Fri, 8-11 pm, musical program. Central standard time. Slogan: "The Hoosier Station."

**WCWS** The Connecticut Portable Broadcasting Station, Danbury, Conn. 214.2 meters, 1400 kilocycles, 100 watts.

**WCX & WJR.** Detroit Free Press & Jewett Radio & Phone Co., Pontiac, Mich. 517 meters, 580 kilocycles, 5000 watts. Sun, 3:30 pm, 7:15 pm, church services, Central Methodist Episcopal. Mon, Wed, Thurs, Fri, 4 pm, news bulletin; 6 pm, dinner concert, 8 pm, studio program. Mon, 8:15, code lesson. Wed, 8 pm, 9 pm. Fri, 8:30, Al and Pete; 9, classical program, dance music. Tues, 4 pm, news bulletin; 6 pm, dinner concert; 10 pm, Red Apple Club. Sat, 4 pm, news bulletin; 6 pm, dinner concert.

**WDAD** Dad's Auto Accessories, Inc., 171-173 8th av., North Nashville, Tenn. 225.4 meters, 1330 kilocycles, 1000 watts. Sun, 3-4 pm, 6:30-7:30 pm. Mon, Wed, Sat, 11:45 am-1 pm, 3-4 pm, 9 pm-12 midnight. Tues & Thurs, 11:45 am-1 pm, 3-4 pm, 7-9 pm. Central standard time. Slogan: "Where Dollars Are Doubled."

**WDAE** Tampa Daily Times, Tampa, Fla. 267.7 meters, 1120 kilocycles, 500 watts. On air every afternoon and evening. Eastern standard time. Slogan: "WDAE, the Voice of the Times at Tampa."

**WDAF** The Kansas City Star, Kansas City, Mo. 370.2 meters, 810 kilocycles, 1000 watts. Sun, 3-4:45 pm, church concert and services; 7:15-9:15 pm. Daily ex Sun, 8-8:15 am, Bible lesson; 12 noon-1 pm, 3-4 pm, 5:30-10 pm; 11:45 pm-1 am, musical. Central standard time. Slogan: "Enemies of Sleep."

**WDAG** J. L. Martin, 605 E. 4th st., Amarillo, Texas. 263 meters, 1140 kilocycles, 250 watts. Week days, 12:45 pm, chats, markets & weather; 9-10 pm, entertainment. Fri, 8-10 pm, entertainment. Sun, 9:45 am, Bible class; 7:30-9:30 pm, church services. Central standard time. Slogan: "Where Dollars Always Grow."

**WDAH** Trinity Methodist Church, El Paso, Tex. 234.2 meters, 1280 kilocycles, 100 watts. Sun, 9:30 am-12 noon; 7:30-9 pm. Wed, 7:30-8:30 pm, 8:30-10 pm, classical and semi-classical music. Standard mountain time.

**WDAY** Radio Equipment Corp., 119 Broadway, Fargo, N. Dak. 361.2 meters, 830 kilocycles, 250 watts. Sun, 10:30 am, church; 2 pm, lecture; 4-6 pm, entertainment. Daily ex Sun, 7-9 am, music, news; 10:15 am, Concordia Chapel; 12 noon-1 pm, Farmers' Musical Hour; 1:05 pm, Farm Flash; 3-4 pm, Women's Hour, music; 3:15 pm, Aunt Sammy Talk; 5:45 pm, news; 6-7:30 pm, entertainment. Daily ex Sun, 10 am, 11 am, 12 noon, 1 pm, 2 pm & 5:45 pm, markets. Mon, Wed, Thurs, 7:30-8:15 pm, College program. Central standard time.

**WDBE** Gilham Electric Co., Inc., 35 Cone st., Atlanta, Ga. 270.1 meters, 1100 kilocycles, 50 watts. Tues, 7-8 pm, 9C. S. T. Central standard time.

**WDBJ** Richardson Wayland Electric Corp., 106 Church st., S.W., Roanoke, Va. 230.6 meters, 1300 kilocycles, 250 watts. Sun, 7:30-8:30 pm, church services. Daily ex Sun, 12 noon-1 pm, 5:30-6 pm, 8-9 pm, musical. Wed, 9-11 pm. Fri, Sat, 9-10 pm, dance, sports, music. Eastern standard time. Slogan: "The Magic City."

**WDBK** The WDBK Broadcasting Station Co., Inc., 82 Carnegie av., Bolton Square Hotel, Cleveland, Ohio. 227.1 meters, 1320 kilocycles, 250 watts. Tues & Fri, 8-10 pm. Eastern standard time. Slogan: "Broadcasting from Cleveland."

**WDBO** Orlando Broadcasting Co., for Rollins College, Inc., Fort Gatlin Hotel, Orlando, Fla. 288.3 meters, 1040 kilocycles, 1000 watts daytime, 500 watts evening. Sun, 10:45 am, church; 4 pm, musicale; 7:30 pm, church. Mon & Tues, 8:40-10 pm. Thurs, 9:15-10:30 pm, studio program. Fri, 8:50-10:30 pm, studio program. Eastern standard time. Slogan: "The Voice of Central Florida."

**WDBZ** Kingston Radio Club, Kingston, N.Y. 215.7 meters, 1390 kilocycles, 50 watts.

**WDEL** Wilmington Electric Specialty Co., 405 Delaware av., Wilmington, Del. 265.3 meters, 1130 kilocycles, 100 watts. Sun, 8-10 pm. Tues, Thurs, 7:30-9:30 pm. Sat, 9:30-12 midnight. Eastern standard time. Slogan: "First City of the First State."

**WDGY** Dr. Geo. Young's Jewelry & Optical Station, Minneapolis, Minn. 263 meters, 1140 kilocycles, 500 watts. Mon, Wed, Fri, 7-8 pm, 10-12 pm. Tues, 7-12 pm. Thurs, 7-10 pm. Sat, 7-8 pm. Sun, 2-6 pm. Central standard time. Divides time with WRHM.

**WDOD** Chattanooga Radio Co., Inc., 615 Market st., Chattanooga, Tenn. 245.8 meters, 1220 kilocycles, 500 watts. Sun, 11 am, church; 7:30 pm, church. Daily ex Sun, 12 noon, WDOD Trio. Mon, Tues, Wed, Fri, Sat, 7 pm, Dinner Hour & studio program. Mon, 10 pm, Arrowhead Hosiery Hour. Thurs, silent night. Sat, 9 pm, dance program. Central standard time.

**WDRC** Doolittle Radio Corp., 70 College st., New Haven, Conn. 282.8 meters, 1060 kilocycles, 500 watts. Daily ex Sat, 11 am-12 noon. Daily ex Sat & Sun, 6:45-10 pm, classical and popular program. Eastern standard time.

**WDFW** Dutee Wilcox Flint, Inc., Cranston, R. I. 384.4 meters, 780 kilocycles, 500 watts. Eastern standard time.

# CASH IN ON RADIO Now



# EARN \$75<sup>00</sup> a Week in your spare time

**Follow the Example of Thousands—Join the Radio Association—Learn Radio—Take Advantage of Its Big-Pay Opportunities**

**THE RADIO ASSOCIATION OF AMERICA** will help you make money in Radio, full or part-time. It will teach you how to build and repair sets; start you in business, if you wish.

**Earned \$500 in Spare Hours**

Hundreds of members earn \$3 an hour serving their communities as "radio doctors." Member Lyle Follick, Lansing, Mich., has already made \$500 in his spare time. Member Werner Eichler, Rochester, N. Y., is earning \$50 a week. Member F. J. Buckley, Sedalia, Mo., is earning as much money in his spare time as he receives from his employer.

The Association will train you to be a "radio doctor" and to build sets "tailored" to your neighborhood needs, that you can sell for less than the "ready-made" sets offered by your local dealers.

**We Will Start You in Business**

If you prefer a business of your own to becoming a Radio Engineer, our co-operative plan will start you in a business of your own without capital.

This plan gives the ambitious man his opportunity to establish himself in his community.

Many have followed this plan and established radio stores.

**Doubled His Income in Two Months**  
Member W. E. Thon, Chicago, was a clerk in a hardware store when he joined the Association. The training we gave him enabled him to secure the management of the Radio Department of a large store at a 220% increased salary.

"I attribute my success entirely to the Radio Association," he writes. "Your method of instruction is wonderful."

Membership in the Association has increased the salaries of innumerable men. Some turned their extra hours into cash being "radio doctors" for their neighbors; others by accepting employment with neighborhood radio dealers. Scores of our members are now connected with big radio organizations in different capacities. Others are proprietors of prosperous stores.

**From Clerk to Owner**

"In 1922 I was a clerk," writes Member K. O. Benzing, McGregor, Ia., "when I enrolled. Since then I have built hundreds of sets—from 1-tube Regenerative to Superheterodynes.

"I am now operating my own store and my income is 400% greater than when I joined the Association. My entire success is due to the splendid help you have given me."

**Membership Privileges**

If interested in Radio as a profession or a profitable hobby, join the Association. You will receive a comprehensive and

practical training in Radio that will fit you for Radio's big-pay opportunities. You will have the benefit of proven business-building plans. Our Employment Service will be at your disposal. You will have the privilege of buying radio parts at wholesale. You will have the Association behind you in carrying out your ambitions.

**ACT NOW—If You Want the No-Cost Membership Plan**

Now is the time for you to join. The success of the Association was so tremendous during 1926 that we are still able to offer a limited number of Memberships that may not—need not—cost you a cent. To secure one of them, write today without fail. We will send you details and also our book, "Your Opportunity in the Radio Industry," that will open your eyes to the possibilities in Radio for you. Let us hear from you at once.

**RADIO ASSOCIATION OF AMERICA**  
4513 Ravenswood Avenue  
Chicago, Ill. Dept. RCB-11

Gentlemen:  
Please send me by return mail full details of your Special Membership Plan and also a copy of your book, "Your Opportunity in the Radio Industry."

Name.....  
Address.....  
City.....State.....

*Tell 'Em You Saw It in the Citizens Radio Call Book Magazine*

**WDWM** Radio Industries Broadcast Co., Chamber of Commerce, 625 Bangs av., Asbury Park, N. J. 236.1 meters, 1070 kilocycles, 500 watts. Eastern standard time.

**WDZ** James L. Bush, Star Store Bldg., Tuscola, Ill. 277.6 meters, 1080 kilocycles, 100 watts. Daily ex Sat & Sun, grain markets, 9 am-2:15 pm each half hour. Sat, 9 am-1:15 pm, each half hour. Slogan: "The Buckle of the Corn Belt." Central standard time.

**WEAF** National Broadcasting Company, Inc., Rm. 412, 195 Broadway, New York City. 491.5 meters, 610 kilocycles, 5000 watts. Sun, 2-11 pm. Daily ex Sun, 6:45-8 am, 4-6 pm, 6 pm-12 midnight. Daily ex Sun, Sat, 11 am-1:15 pm. Sat, 12:45-1:45 pm. Eastern time.

**WEAM** Borough of North Plainfield, North Plainfield, N. J. 239.9 meters, 1250 kilocycles, 250 watts. Eastern standard time.

**WEAN** The Shepard Co., Westminster st., Providence, R. I. 319.0 meters, 940 kilocycles, 500 watts. Sun, 10:45 am, 7-8:30 pm. Daily ex Sun, 11:55 am-1 pm, 4-5 pm, 6:30-10:30 pm. Eastern standard time. Slogan: "We Entertain a Nation."

**WEAO** Ohio State University, Columbus, Ohio. 282.8 meters, 1060 kilocycles, 750 watts. Daily ex Sun & holidays, 9:45 am, weather, market reports, agricultural bulletin; 11 am, market reports, music; 12:30 pm, market reports, music; 4 pm, markets. Mon, Wed, Fri, 10 am, Homemakers Half Hour. Tues, 7-11 pm, lectures, music (4 pm, Book Review). Wed, 7-9 pm, Farm Night program (4 pm, Story Hour). Thurs, 7-11 pm, lectures, music. Football and basketball games broadcast as per Ohio State schedule. Eastern standard time. Divides time with Station WAU.

**WEAR** The Willard Storage Battery Co., Union Trust Bldg., Cleveland, Ohio. 399.8 meters, 750 kilocycles, 1000 watts. Daily ex Sun, 11:30 am-12:05 pm, weather, markets. Daily ex Sat & Sun, 3:30-4:10 pm, weather, markets. Eastern standard time.

**WEAU** Davidson Bros. Co., Sioux City, Ia. 275.1 meters, 1090 kilocycles, 100 watts. Daily ex Mon, 8:35-9:35, 10:35-11:35 am, 12 noon-12:35 pm, 3:30-5 pm. Tues also, 6:30 pm. Sun, 2-4 pm, musical program. Central standard time.

**WEBC** Head of the Lakes, Walter C. Bridges, 1225 Tower st., Superior, Wis. 241.8 meters, 1240 kilocycles, 250 watts. Sun, 10:40 am, 7:45 pm, church services. Mon, 12:15 noon, musical; 5:30 pm, organ; 6 pm, musical; 6:45 pm, news & baseball, weather; 7:15 pm, childrens hour; 8 pm, feature music. Tues, Thur, Fri, Sat, 12:15 noon, musical; 6 pm, music; 6:45 pm, news; 7 pm, childrens hour; 7 pm, weather. Fri, Sat, 9 pm, organ, dance music. Wed, 10:30 am, cookery corner; 12:15 pm, music; 1:15 pm, weather; 6 pm, music; 6:45 pm, news; 8 pm, music. Slogan: "Where Sail Meets Rail."

**WEBE** Cambridge, Ohio, 247.8 meters, 1210 kilocycles, 10 watts.

**WEBH** Edgewater Beach Hotel, Chicago Herald & Examiner, 5349 Sheridan Rd., Chicago, Ill. 365.6 meters, 820 kilocycles, 2000 watts. Daily ex Sun, Mon, 7-8 pm, 9-10 pm, 11 pm-1 am (Sat, 11 pm-2 am). Sun, 10:40 am-12 noon, church service; 5-6 pm, 7-9 pm, musical program. Central standard time. Slogan: "Where Everybody's Happy."

**WEBJ** Third Avenue Railway, 2396 Third st., New York, N. Y. 370.2 meters, 810 kilocycles, 500 watts. Wed, 7-11 pm, & Fri, 9-11 pm, popular and educational. Eastern standard time.

**WEBQ** Raley's School of Beauty Culture, Harrisburg, Ill. 223.7 meters 1340 kilocycles, 15 watts. Daily ex Sun, 7:15-7:30 pm, local news, markets. Mon & Fri, 7:30-10 pm, musical programs. Sun, 7-8:30 pm, church services. Central standard time. Slogan: "The Voice from Egypt."

**WEBR** H. H. Howell, 54 Niagara st., Buffalo, N. Y. 241.8 meters, 1240 kilocycles, 200 watts. Mon, Wed, Fri, 8:30-11 pm. Sun, church services. Thur, 10:15 pm-12:15 am. Slogan: "We extend Buffalo's Regards."

**WEBW** Beloit College, Beloit, Wis. 258.5 meters, 1160 kilocycles, 500 watts. Sun, 4:25-5:40 pm, vesper services. Central standard time.

**WEDC** Emil Denmark Broadcasting Station, 3860 Ogden av., Chicago, Ill. 241.8 meters, 1240 kilocycles, 500 watts.

**WEEI** The Edison Electric Illuminating Co. of Boston, 39 Boylston st., Boston, Mass. 447.5 meters, 670 kilocycles, 500 watts. Sun, 10:50 am-12 noon. Daily ex Sat & Sun, 6:45 am, 9:30 am-12 noon, 2-5 pm, 5:45-11 pm. Sat, 2-5 pm, 6-10:30 pm. Eastern standard time. Slogan: "The Friendly Voice."

**WEHS** A. T. Becker, Evanston, Ill. 215.7 meters, 1390 kilocycles, 100 watts.

**WEMC** Emmanuel Missionary College, Berrien Springs, Mich. 483.6 meters, 620 kilocycles, 1000 watts. Daily ex Sat & Sun, 7:30-9 am. Sun, 9-10 am, 11 pm-12 midnight. Mon, 7 pm-12 midnight. Tues & Thurs, 3-4 pm. Central standard time. Slogan: "The Radio Light-house."

**WENR** Great Lakes Radio Broadcasting Co., Chicago. 288.3 meters, 1040 kilocycles, 500 watts. Sun, 2-4 pm, 6-7 pm, 9:30-12 midnight, classical music. Daily ex Sun & Mon, 11:30 am-12 noon, Home Service Feature; 12 noon-1 pm, classical program; 2-5 pm, popular request program; 6-7 pm, dinner concert; 8-9:30 pm, classical; 9:30 pm-12 midnight, popular program. Central standard time. Slogan: "Voice of Service to the Public."

**WEPS** Matheson Radio Co., Inc., Gloucester, Mass. 296.9 meters, 1010 kilocycles, 100 watts.

**WEW** St. Louis University, College Station, St. Louis, Mo. 352.7 meters, 850 kilocycles, 1000 watts. Daily ex Sun, 9-10 am, 2 pm, government reports. Tues, 7 pm, literary reading. Thurs, 7 pm, music, lectures. Sun, 9:35-11 am, religious services; 2 pm, difficulties in religion answered; 7:15 pm, lecture. Central standard time.

**WFAA** Dallas News & Journal, Dallas, Tex. 499.7 meters, 600 kilocycles, 500 watts. Sun, 1:45-6 pm, 6-7 pm, 11 pm-12 midnight. Daily ex Sun, each half hour from 6:30 am-6 pm, 7-8 pm, 9-10 pm. Tues & Sat, 11 pm-12 midnight. Central standard time. Slogan: "Working for All Alike."

**WFAM** St. Cloud Daily Times, St. Cloud, Minn. 252.0 meters, 1190 kilocycles, 10 watts. Daily, 5:30-6 pm, markets, news, weather. Standard time.

**WFBC** First Baptist Church, Knoxville, Tenn. 234.2 meters, 1280 kilocycles, 50 watts. Sun, 10:30 am, 7:30 pm, church services; 4 pm, concert sacred music. Central standard time.

# PUSH-PULL AMPLIFICATION

*Increases the Undistorted  
Output of Amplifier Tubes*

*Type 441  
Push-Pull  
Amplifier*

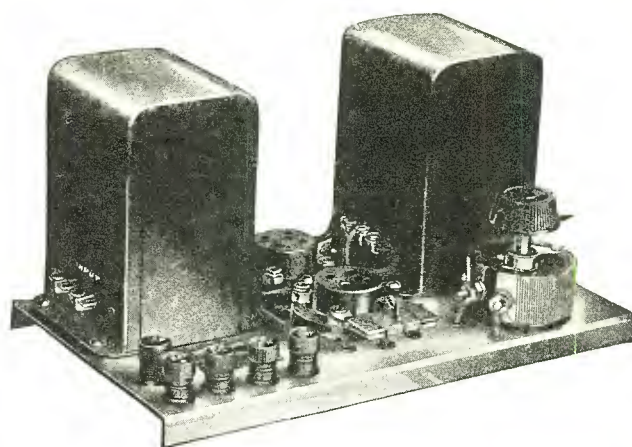

*Completely wired  
as shown*

**\$20<sup>00</sup>**

In a search for an amplifier combination which would give the maximum in quality and volume, the push-pull method has proved particularly satisfactory.

While push-pull transformer coupling does not increase the amplification per stage, the maximum undistorted power output is greatly increased. The reason for this is that distortion due to tube overloading cancels out, permitting a greater output from each tube than would be possible if the tubes were used as in other methods of coupling. A further advantage of push-pull amplification when using an A. C. filament supply is that hum voltages also cancel out, rendering the amplifier very quiet.

The type 441 unit with two type 171 power tubes having a plate voltage of 180 will give more volume and better quality than a single transformer coupled stage using the type 210 power tube with 400 volts on the plate.

The General Radio Type 441 unit is completely wired and mounted (as illustrated) on a brass base-board with conveniently located binding posts so that the unit may be built into a receiver or connected with an existing set as a separate unit.

The type 441 may be used with either the UX-226, UX-326, or UX-171, CX-371 tubes.

Type 441 Push-pull amplifier.....\$20.00

The Type 441 unit is licensed by the Radio Corporation of America for radio amateur, experimental, and broadcast reception only, and under the terms of the R. C. A. license the unit may be sold only with tubes.

Type UX-226 or CX-326 Amplifier Tube.....\$3.00

Type UX-171 or CX-371 Amplifier Tube..... 4.50

GENERAL RADIO CO.

::

CAMBRIDGE, MASS.

# GENERAL RADIO

LABORATORY EQUIPMENT

PARTS and ACCESSORIES

*Tell 'Em You Saw It in the Citizens Radio Call Book Magazine*

**WFBE** The Garfield Place Hotel Co., Cincinnati, Ohio. 245.8 meters, 1220 kilocycles, 250 watts.

**WFBG** Wm. F. Gable Co., Altoona, Pa. 280.2 meters, 1070 kilocycles, 100 watts. Sun, 10:45 am, 3:30 pm, 7:30 pm, church. Daily ex Sun & Mon, 3 pm, 6:30 pm, 8:30 pm. Tues, Wed, Thurs, 12:15 pm. Fri & Sat, 9:30 pm. Thurs & Sat, 7:30 pm. Wed, 6 pm. Thurs, 4 pm, 10 pm. Fri, 12 noon, 11:15 pm. Eastern standard time. Slogan: "The Original Gateway to the West and we wish you all the very best."

**WFBJ** St. Johns University, Collegeville, Minn. 272.6 meters, 1100 kilocycles, 100 watts. Wed, 8:30 pm. Fri, 4-5 pm. Central standard time. Slogan: "In the Heart of the Landscape Paradise."

**WFBL** The Onandaga Hotel, Syracuse, N. Y. 258.5 meters, 1160 kilocycles, 750 watts. Sat & Sun, 6:30-7:30 pm. Daily ex Sat & Sun, 6:30 pm-12 midnight. Eastern standard time. Slogan: "When Feeling Blue, Listen."

**WFBM** Indianapolis Power & Light Co., 48 Monument Circle, Indianapolis, Ind. 275.1 meters, 1090 kilocycles, 1000 watts. Sun, 9:30-10:45 am, 2 pm, 4:45 pm, 7:30 pm, church services. Daily ex Sat & Sun, 5:30 pm, sports, stock market reports; 10 pm, orchestra. Fri, 11 pm, request organ program. Central standard time. Slogan: "The Crossroads of America."

**WFBR** Fifth Infantry Maryland National Guards, Fifth Regiment Armory, Baltimore, Md. 225.4 meters, 1330 kilocycles, 100 watts. Daily ex Sun, 12 noon, dance music; 7-10 pm, sporting results and news. Tues, Thurs & Sat, 12 noon, 10 pm, 7 pm, general programs. Sun, 11 am. Central standard time. Slogan: "Home of the Star-Spangled Banner."

**WFBZ** Knox College, Galesburg, Ill. 247.8 meters, 1210 kilocycles, 50 watts.

**WFBI** Frank Crook, Inc., 103 Exchange st., Pawtucket, R. I. 241.8 meters, 1240 kilocycles, 50 watts. Mon, Wed, Fri, 8-10 pm, entertainment. Eastern standard time. Slogan: "The City of Diversified Industries."

**WFDF** Frank D. Fallain, Police Building, Flint, Mich. 374.8 meters, 800 kilocycles, 100 watts.

**WFHH** Clearwater, Florida. 365.6 meters, 820 kilocycles, 500 watts.

**WFI** Strawbridge & Clothier, Market, 8th & Filbert sts., Philadelphia, Pa. 405.2 meters, 740 kilocycles, 500 watts. Daily ex Sun, 10:45 am, markets; 1-2 pm, orchestra; 3-4 pm, concert; 6:30-7:15 pm, dinner music. Tues, Thurs, Sat, 8-11:30 pm, musical program. Sun morning and evening, alternating, church services; 9:15 pm, Atwater-Kent Hour. Eastern standard time.

**WFIW** Hopkinsville, Ky. 280.2 meters, 1070 kilocycles, 500 & 1000 watts.

**WFKB** Francis K. Bridgman, 4536 Woodlawn av., Chicago, Ill. 223.7 meters, 1340 kilocycles, 500 watts. Daily ex Sun, 2:30-4 pm. Mon, silent night. Tues, Wed, Thurs, Fri & Sat, 7-8 pm, classical; 9-11 pm, popular. Central standard time. Slogan: "Station of Vesta Battery Corporation."

**WFKD** Foulkrod Radio Engineering Co., 1510 Oxford av., Philadelphia, Pa. 247.8 meters, 1210 kilocycles, 50 watts.

**WFLA** The Clearwater Chamber of Commerce, Clearwater, Fla. 365.6 meters, 820 kilocycles, 500 watts. Daily ex Sun, 8:30 pm-12 midnight, studio programs, music, weather, markets, talks, etc. Eastern standard time. Slogan: "Inviting the World to the Springtime All the Time City."

**WGAL** Lancaster Elec. Sup. & Const. Co., 23 E. Orange st., Lancaster, Pa. 252.0 meters, 1190 kilocycles, 15 watts. On Wed, Fri, 5:45-6:15 pm, dinner concert. Wed, 11:15-1 am, organ concert. Eastern standard time. Slogan: "World's Gardens at Lancaster."

**WGBB** Harry H. Carman, 217 Bedell st., Freeport, N. Y. 245.8 meters, 1220 kilocycles, 400 watts. Sun, 10:40 am-12:30 pm, 4-5:30 pm. Mon, 7-8 pm. Wed, Fri, 7-11 pm. Slogan: "The Voice of the Sunrise Trail." Divides time with Station WAAAT—WSOM.

**WGBC** First Baptist Church, Memphis, Tenn. 277.6 meters, 1080 kilocycles, 15 watts. Sun, 9:55-10:55 am, 7:30-9 pm. Central standard time.

**WGBF** The Finke Furniture Co., 307 Upper Seventh st., Evansville, Ind. 236.1 meters, 1270 kilocycles, 250 watts. Daily ex Sun, 7:15 am, morning worship service; 12:10 pm, news, markets, weather, etc. Mon, 7-12 pm, musical program. Tues, 8-11 pm, music. Fri, 7-11 pm, musical program. Sun, 9 am, Bible class. Central standard time. Slogan: "Gateway to the South."

**WGBI** Adams av., Scranton, Pa. 230.6 meters, 1300 kilocycles, 250 watts.

**WGBR** Geo. S. Ives, 312 W. Third st., Marshfield, Wis., builders of Ives radio apparatus. 228.9 meters, 1310 kilocycles, 50 watts. Sun, 2-4 pm, musical. Central standard time. Slogan: "Wisconsin's Greatest and Best Radios."

**WGBS** Gimbel Bros., Inc., 33rd st. & Broadway, New York City, N. Y. 348.6 meters, 860 kilocycles, 500 watts. Sun, 8:30-10 pm, vocal & instrumental music. Daily ex Sun, 1:30-7 pm. Tues, Thurs, Sat, 1:30-6:30 pm, 7:30 pm-12:30 am. Programs consist of talks, vocal and instrumental selections. Divides time with Station WAAM—Mon, Wed, Fri. Eastern standard time.

**WGBU** Florida Cities Finance Co., Fullerton-by-the-Sea, Fla. 277.6 meters, 1080 kilocycles, 500 watts. Mon, Tues, Thurs, Fri, 12-1 pm, 6:30-7:30 pm, 11 pm-2 am. Wed. & Sat, 12-1 pm, 6:30-7:30 pm, 10 pm-1 am. Sun, 9:30-11 pm. Eastern standard time.

**WGCP** May Radio Broadcast Corp., 319 Central av., Newark, N. J. 280.2 meters, 1070 kilocycles, 500 watts. Daily ex Sun, 3-5:30 pm. Mon, Thurs & Sat, 6-12 pm. Tues, Wed, Fri, 7-8:30 pm. Sun, 7-9:30 pm. Eastern standard time. Slogan: "The Four Leaf Clover Station."

**WGES** Oak Leaves Broadcasting Corp., 128 N. Crawford av., Chicago, Ill. 241.8 meters, 1240 kilocycles, 500 watts. Mon, 5-7 pm, pipe organ, musical. Tues, Wed, Thurs, Fri & Sat, 5-7 pm, semi-classical; 8-9 pm, 11-1 am, musical. Sun, 10:15-12 am, 5-7:40 pm, 11-12 pm, religious pipe organ music. Central standard time. Slogan: "World's Greatest Electrical School."

**WGHB** Chamber of Commerce, St. Petersburg, Fla. 365.6 meters, 820 kilocycles, 500 watts. Daily ex Sun, 8:30 pm-12 midnight, studio and dance programs, markets, talks, etc. Eastern standard time. Slogan: "Sunshine City."

# EXCELLO RADIO CONSOLES

*in many models to  
suit every taste*

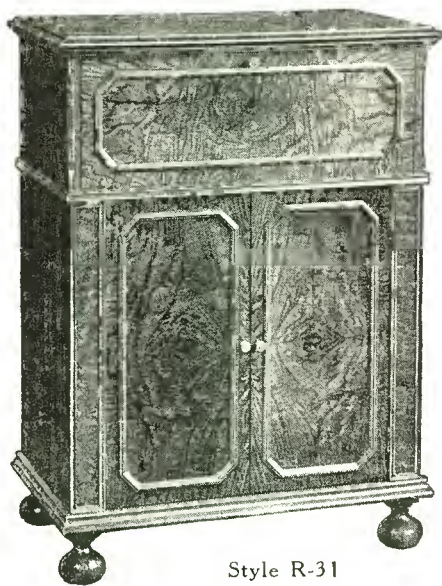

Style R-31



*Style R-31 opened to show location of long air travel type horn and accessories*

See the new Excello Consoles at your dealer, or write us for descriptive catalog.

Dealers and distributors, write for interesting proposition on open territory

In the Excello Line you will find every modern type of Radio Console all incorporating latest features of convenience and utility.

The creation of these smart designs so closely in keeping with the present trend is an achievement to delight all radio fans and to add a beautiful piece of furniture to the home.

The cabinet work is of true Excello quality. Doors of 5-ply butt walnut; rich piano finish.

The sound chambers are above or below the set compartment. In the latter type all confusing vibrations arising when a cone is enclosed are entirely eliminated. Consoles of this type come with or without horn speaker of long air travel type and will accommodate a 22-inch cone type speaker as well as batteries, charger or eliminator.

Excello Cabinets with sound chamber above as in Styles R-23 or R-32 are so designed that they develop the full tonal range from lowest base to highest treble.

Special filler panels are furnished without extra charge so that any Excello Console will accommodate Atwater-Kent, Fada, Freed-Eisemann, Kellogg, Stromberg-Carlson and all other standard receivers.



Style R-32

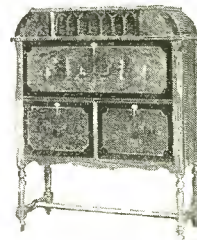

Style R-23



Style R-29

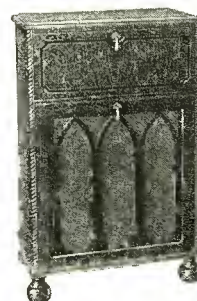

Style R-28

## EXCELLO Radio Consoles

### Excello Products Corporation

4820-28 West 16th Street, Cicero, Illinois  
(Suburb of Chicago)

*Tell 'Em You Saw It in the Citizens Radio Call Book Magazine*

**WGHP** George Harrison Phelps, Inc., Radio Division, Maccabee Bldg., Woodward and Putnam av., Detroit, Mich. 319 meters, 940 kilocycles, 750 watts. Sun, 10:45 am-12:15 pm, 2-4 pm, 8-10 pm. Daily ex Sat & Sun, 1:15-3 pm, 6-10 pm. Eastern standard time.

**WGL** International Broadcasting Corp., 16 E. 42nd st., New York, N. Y. 294 meters, 1020 kilocycles, 500 watts.

**WGM** Verne & Elton Spencer, 501 Cowan av., Jeannette, Pa. 208.2 meters, 1440 kilocycles, 50 watts, Sun, 1:30-3 pm, music. Daily ex Sun, Wed, Sat, 7:30-9 pm, dance music. Popular program. Eastern time. Slogan: "Voice from the Glass City, Voice from the Hilltop."

**WGMU** Atlantic Broadcasting Corp., New York City. 201.6 meters, 1490 kilocycles, 100 watts. Unlimited schedule. Eastern standard time.

**WGN** The Chicago Tribune Station on the Drake Hotel, Chicago, Ill. 305.9 meters, 980 kilocycles, 15,000 watts. Sun, 12 noon-5 pm, 6:10-11 pm. Daily ex Sun, 9-10:30 am, 11-11:30 am, 12:40-7 pm. Daily ex Sun & Mon, 8-11 pm. Central standard time. Divides time with Station WLIB, 10:30-11 am, 11:30-12:40 pm.

**WGR** Federal Radio Corp., Hotel Statler, Buffalo, N. Y. 302.8 meters, 990 kilocycles, 750 watts. Sun, 10:45 am, church; 7:45 pm, church; 9:15 pm, concert; 10:15-11:15, concert. Mon, 12 noon, reports; 1-1:30 pm, ensemble; 2:30 pm, program; 6:30, music; 7:30, reports; 1-1:30, ensemble; 2:30 pm, program; 6:30, music; 7:30, reports; 8-11 pm, program. Wed, 12 noon, reports; 1-1:30, ensemble; 2:30 pm, concert; 6:30 pm, music; 7:30, reports; 8-11 pm, program. Thurs, 12 noon, reports; 1-1:30, ensemble; 2:30 pm, music; 7:30 pm, reports; 8-11 pm, program. Fri, 12 noon, reports; 1-1:30, ensemble; 2:30, concert; 6:30, music; 8 pm-1 am, program. Eastern standard time. Slogan: "Key City of Industry."

**WGST** Georgia School of Technology, Atlanta, Ga. 270.1 meters, 1110 kilocycles, 500 watts. Mon, 9:30-10:30 pm, "Tech Nite" program. Thurs, 7-8 pm, "Artist Series" program. Central standard time. Slogan: "The Southern School with the National Reputation."

**WGWB** Radiocast Corp. of Wisconsin, 144 Broadway, Milwaukee, Wis. 218.8 meters, 1370 kilocycles, 500 watts. Daily ex Sun, 10:30 am-12:30 pm. Sun, 10-11 am, 6-7 pm. Silent Saturdays. Central standard time.

**WGY** General Electric Co., 1 River Road, Schenectady, N. Y. 379.5 meters, 790 kilocycles, 30,000 watts. Daily ex Sun, 11:55 pm, 12:30 pm, 12:45 pm, 6 pm, 6:10 pm. Mon, Tues, Thurs, Fri, 2-3 pm. Tues, Wed, Thurs, Fri, 6-11 pm. Mon, 6-7:30 pm. Sat, 6:30 pm-12 midnight. Sun, 10:30 am-12 noon, 4-5 pm, 5:30-6:30 pm, 7:20-10:15 pm. Eastern standard time.

**WHA** University of Wisconsin, Madison, Wis. 319.0 meters, 940 kilocycles, 750 watts. Mon, Wed & Fri, 7-9:30 pm. Programs on these evenings consist of educational talks, music, athletic events, etc. Central standard time.

**WHAD** Marquette University - Milwaukee Journal Bldg., 4th and State sts., Milwaukee, Wis., 293.9 meters, 1020 kilocycles, 500 watts. Sun, 3:15 pm, symphony concert. Mon, Tues, Wed, Thurs, Fri, Sat, 12 noon, news, musical program; 4 pm, studio program; 4:55 pm, stock quotations; 6 pm, market and financial news; 6:15 pm, dinner orchestra; 8:30 pm, popular program. Wed, 11:30 pm, midnight recital. Central standard time. Slogan: "The Voice of Wisconsin."

**WHAM** Stromberg Carlson Telephone Mfg. Co., Rochester, N. Y. 277.6 meters, 1080 kilocycles, 5000 watts. Daily ex Sun, 6:30 pm-12 midnight. Sun, 10:30 am-12 noon, 3:30-10 pm. Eastern standard time.

**WHAP** WHAP, Carlstadt, N. J. 236.1 meters, 1270 kilocycles, 1000 watts. Sun, 7:30-9:30 pm. Mon, Thurs, 6-9 pm. Wed, 9-12 pm. Sat, 7-11:30 pm. Eastern standard time. Divides time with stations WBNY, WMSG.

**WHAR** Pioneer Broadcasting Station of Atlantic City, the Hotel Seaside, Atlantic City, N. J. 272.6 meters, 1100 kilocycles, 750 watts. Sun, 10:45-1 pm, 2:15-3:10 pm, 7:30-9 pm. Daily ex Sun & Wed, 2:15-3:15 pm, 7:45-9 pm. Eastern standard time. Slogan: "Pioneer Broadcasting Station of Atlantic City."

**WHAS** The Courier-Journal Co. and The Louisville Times Co., Louisville, Ky. 461.3 meters, 650 kilocycles, 500 watts. Sun, 9:57-10:45 am, church services; 2-3 pm, 4:30-9:15 pm. Daily ex Sun, 2:15-2:30 pm, 3:30-5 pm, 7-9 pm. Central standard time. Slogan: "Old Kentucky Home."

**WHAZ** Rensselaer Polytechnic Institute, Troy, N. Y. 379.5 meters, 790 kilocycles, 500 watts. Mon, 8 pm. Eastern standard time. Slogan: "Transcontinental and International Radiophone Broadcasting from the Oldest College of Engineering and Science in America, Rensselaer Polytechnic Institute, Troy, N. Y."

**WHB** Sweeney Automotive and Electrical School, Kansas City, Mo. 336.9 meters, 890 kilocycles, 500 watts. Sun, 9:40-10:45 am, church services; 7-7:45 pm, church; 11:15 pm-12:15 am, organ. Daily ex Sun, 8:25-9:25 am, 10:25-11:20 am, 12 noon-1:25 pm, 2-3 pm. Ladies' Hour; 3 pm, markets. Mon, Tues, Thurs, Sat, 7-10 pm. Wed, Fri, 7-8 pm. Central standard time. Slogan: "Kansas City, Missouri, the Heart of America."

**WHBA** Shaffer Music House, Oil City, Pa. 260.7 meters, 1150 kilocycles, 10 watts. Limited commercial broadcast. Mon, 8 pm until 11 pm, musical. Fri, 9 pm until 12 pm, musical. Eastern standard time.

**WHBC** Rev. E. P. Graham, 627 McKinley av., Canton, Ohio. 236.1 meters, 1270 kilocycles, 10 watts. Mon, 8-8:30 pm, lecture, sermon. Eastern time. Slogan: "Dispel Ignorance."

**WHBD** Chamber of Commerce, 118½ N. Main st., Bellefontaine, Ohio. 222.1 meters, 1350 kilocycles, 100 watts. Sun, 10:45 am, 7:30 pm. Daily ex Sun & Sat, 7:30-9 pm. Eastern standard time. Slogan: "Ohio's Highest Point."

**WHBF** Beardsley Spec. Co., Inc., 217 18th st., Rock Island, Ill. 222.1 meters, 1350 kilocycles, 100 watts. Mon, Wed, 9-11 pm. Sat, 2-4, 7-9 pm. Central standard time. Slogan: "Where Historic Blackhawk Fought."

**WHBL** C. L. Carrell, 36 S. State st., Chicago, Ill. 204.0 meters, 1470 kilocycles, 100 watts. Central standard time.

**WHBM** C. L. Carrell (portable), 1506 No. American Bldg., 36 S. State st., Chicago, Ill. 201.6 meters, 1490 kilocycles, 100 watts. class A. Central standard time.

**WHBN** University of Florida, Gainesville, Fla. 296.9 meters, 1010 kilocycles, 10 watts. Eastern standard time.

**WHBP** The Johnstown Automobile Co., 101 Main st., Johnstown, Pa. 228.9 meters, 1310 kilocycles, 250 watts. Daily ex Sun, 1:15 pm. Tues & Sat, 10 pm. Eastern standard time. Slogan: "The Voice of the Friendly City."



# Build Your Own Power Amplifier



# Transform your Receiver into a Real Musical Instrument!

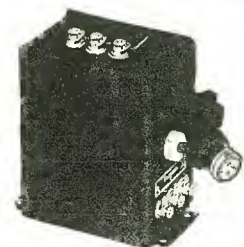
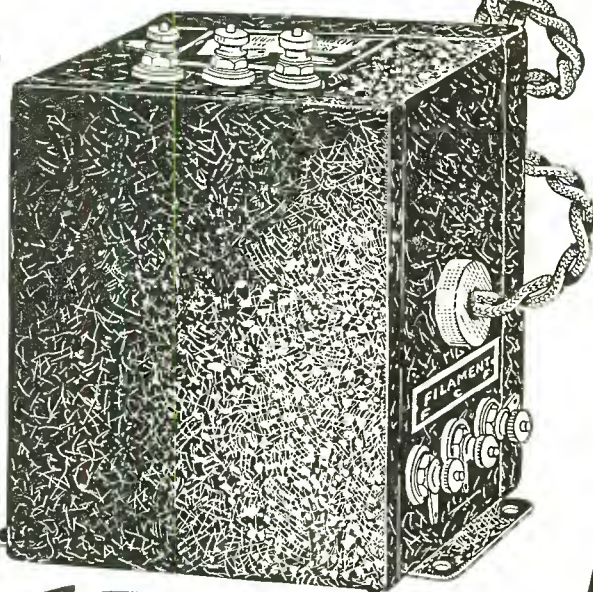

R-210 Power Compact . \$20

With a screw driver, a pair of pliers, and a soldering iron you can build a Thordarson Power Amplifier and B-supply in your own home that will equal the finest commercial amplifier on the market. Complete constructional booklet and simple diagram accompany every transformer.

## Thordarson R-210 Power Compact

The Thordarson R-210 Power Compact is scientifically designed to give maximum electrical efficiency and to make home assembly of power amplifiers as simple as possible. The R-210 Power Compact is the foundation unit and contains the following apparatus: (1) A power supply transformer designed for UX-216-B rectifier; (2) Two filter chokes of 30 henries inductance and 65 M. A. current carrying capacity; (3) A 7½ volt supply center tapped for the filament of one UX-210 power tube. Wiring of the complete amplifier is simple—20 leads complete the assembly.

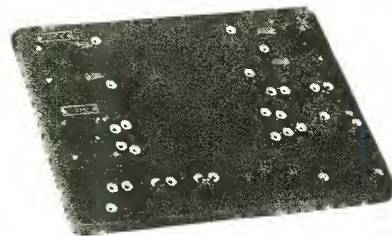

R-211 Metal Baseboard, including sockets, binding posts, mounting screws, and hook-up wire . . . . . \$5

## New Metal Baseboard for R-210 Compact Amplifier

To further simplify home construction of the R-210 type amplifier, you can now buy this new crackled finished metal baseboard. All spring sockets and binding posts are mounted and included in the list price. All mounting holes are drilled. All holes for sub-panel wiring are carefully insulated. Location of all sub-panel wiring is marked under baseboard.

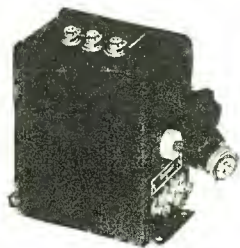

R-210 Power Compact . \$20

## R-171 Power Compact

This power compact is similar to the R-210 type, but is adapted for home construction of power amplifiers using the Raytheon BH rectifier and UX-171 power tube. Designed to meet the popular demand for a low priced yet highly efficient power amplifier. Delivers 320 volts either side of center to the Raytheon BH rectifier. The two choke coils are rated at 85 M. A. 30 henries. The filament winding of 5 volts center tapped is suited to one UX-171 power tube. Two 0.1 Buffer Condensers are also included in the case. Wiring the complete amplifier and B-supply is merely a matter of connecting 18 leads.



No. 2098 Power Supply Transformer . . \$20

## T-2098 Power Supply Transformer—T-2099 Double Choke Unit

Here is an extra heavy duty power amplifier supply that will satisfy the most exacting demands for excess power. An amplifier using this transformer and choke unit will deliver 425 volts at 130 M. A. drain, sufficient for the heaviest receiver using two UX-210 tubes in power push-pull. Transformer T-2098 delivers 550 volts each side of center tap and is designed to supply two UX-216-B rectifiers (full wave). The 7½ volt filament supply will easily handle two UX-210 power tubes. The double choke unit T-2099 consists of two 30 henries 130 M. A. choke coils mounted in a compound-filled case.



No. 2099 Double Choke Unit . . . . . \$14



THORDARSON ELECTRIC MFG. CO.  
500 West Huron St., Chicago, Ill.

Gentlemen:

Please send me a copy of your free booklet "Power Amplification Simplified."

Name .....

Address .....

City..... State.....

(3571)

← Get this **FREE Book!**

# THORDARSON POWER COMPACT

THORDARSON ELECTRIC MANUFACTURING CO.  
*Transformer Specialists Since 1895*  
WORLD'S OLDEST AND LARGEST EXCLUSIVE TRANSFORMER MAKERS  
Huron and Kingsbury Streets — Chicago, Ill. U.S.A.

Tell 'Em You Saw It in the Citizens Radio Call Book Magazine

**WHBQ** Broadcasting Station WHBQ, Inc., Dermon Bldg., Memphis, Tenn. 232.4 meters, 1290 kilocycles, 100 watts. Sun, church services. Daily ex Sun, 7-8 pm, orchestra. Central standard time.

**WHBU** Riviera Theater & Bing's Clothing, 1002 Meridian st., Anderson, Ind. 220.4 meters, 1360 kilocycles, 15 watts. Daily ex Sun, 9-9:30 am, 12-12:30 pm. Wed, Fri, Sun, 7-9 pm. Central standard time. Slogan: "The Home of Chief Anderson."

**WHBW** D. R. Kienzle, 4916 Chestnut st., Philadelphia, Pa. 220.4 meters, 1360 kilocycles, 100 watts. Tues., Thurs, Sun, pm. Eastern standard time.

**WHBY** St. Norbert's College, West De Pere, Wis. Green Bay-De Pere Broadcasting Station. 249.9 meters, 1200 kilocycles, 50 watts. Sun, 10-11 am. Daily ex Sun; 6:30 pm, weather & markets. Mon, 8-10 pm, musical entertainment. Wed & Fri, 5-6 pm, dinner hour. Central standard time. Slogan: "Prepared for All Good Works."

**WHDI** Dunwoody Industrial Institute, 818 Superior Blvd., Minneapolis, Minn. 245.8 meters, 1220 kilocycles, 500 watts. Daily ex Sun, 6:57-9:30 am. Mon, 8-9 pm. Wed, 8:30-10 pm. Fri, 9-10 pm. Divides time with Station WLB, Minneapolis, Minn.

**WHEC** Hickson Electric Co., Inc., 36 South av., Rochester, N. Y. 254.1 meters, 1180 kilocycles, 500 watts. Sun, 10:30-12 noon, 8-10 pm. Daily ex Sun, 12 noon-3 pm, 6:30-9 pm. Fri, Sat, 10-11 pm.

**WHFC** The Goodson & Wilson Station, 4145 Broadway, Chicago, Ill. 215.7 meters, 1390 kilocycles, 200 watts. Sun, Tues, Wed, Thurs, Fri, Sat, 8-12 pm. Slogan: "Where Happiness First Commences."

**WHK** The Radio Air Service Corporation, Inc., 1220 Huron road, Cleveland, Ohio. 265.3 meters, 1130 kilocycles, 1000 watts. Sun, 10 am, 5:15-9:30 pm. Daily ex Sun, 12 noon-1 pm. Mon, Tues, Thurs, Sat, 6 pm-12 midnight. Tues, Wed, Fri, 3:30-4:15 pm. Wed & Fri, 5:30-12 midnight. Eastern standard time. Slogan: "Cleveland's Pioneer Station."

**WHN** Marcus Loew Booking Agency, 1540 Broadway, New York, N. Y. 394.5 meters, 760 kilocycles, 500 watts. Sun, 12:30 noon-12 midnight. Daily ex Sun, 9 am-12 midnight. Eastern standard time. Slogan: "Voice of the Great White Way."

**WHO** Banker's Life Company, Des Moines, Iowa. 535.4 meters, 560 kilocycles, 5000 watts. Sun, 11 am, 2-5 pm, 6:30-9:30 pm. Daily ex Sun, 8-9 am, 10:30 am-12 noon, 12:15-1:15 pm, 2:15-4:30 pm, 6:30 pm-12 midnight. Daily ex Sun, 10 am, 12 pm; 2 pm, market, weather & road reports. Central standard time. Slogan: "W-H-O, Who? Banker's Life, Des Moines."

**WHOG** Huntington Broadcasters Assn., 409 N. Jefferson st., Huntington, Ind. 241.8 meters, 1240 kilocycles, 15 watts.

**WHPP** Bronx, New York. 206.8 meters, 1450 kilocycles, 10 watts.

**WHT** Radiophone Broadcasting Corp., Wrigley Bldg., 410 N. Michigan Blvd., Chicago, Ill. 416.4 meters, 720 kilocycles, 5000 watts. Sun, 10 am-2:30 pm, 7-10 pm. Daily ex Sun, 10 am-2:30 pm, 7-10 pm. Tues, Thur, 11 pm-1 am. Central standard time. Slogan: "Write Home Tonight."

**WIAD** Howard R. Miller, 1301-5 Filbert St., Philadelphia, Pa. 288.3 meters, 1040 kilocycles, 100 watts. Tues, Thurs, Fri, 2 pm-12 pm. Eastern standard time. Divides time with WNAT.

**WIAS** Home Elec. Co., 315 N. Third st., Burlington, Iowa. 475.9 meters, 630 kilocycles, 100 watts. Tues, 8-9 pm, Thurs, 7-8 pm. Sat, 10:30-11 pm. Sun, 10:30 am, church. Central standard time. Slogan: "Burlington on the Mississippi."

**WIBA** The Capital Times, Strand Theater, Madison, Wis. 239.9 meters, 1250 kilocycles, 100 watts. Mon, 7-11 pm. Wed, 8-10 pm. Fri, 6-7 pm. Sat, 7-8 pm. Sun, 12-1 pm. Central standard time. Slogan: "The Four Lakes City."

**WIBG** St. Paul's Protestant Episcopal Church, Elkins Park, Philadelphia, Pa. 440.9 meters, 680 kilocycles, 50 watts. Sun, 10:45 am, 3:45 pm. Eastern standard time.

**WIBI** Frederick B. Zittrell, Jr., 49 Boerum av., Flushing, L. I., N. Y. 267.7 meters, 1120 kilocycles, 100 watts. Eastern standard time.

**WIBJ** C. L. Carrell, 36 S. State st., Chicago, Ill. (portable). 201.6 meters, 1490 kilocycles, 100 watts. Central standard time.

**WIBM** C. L. Carrell, 36 S. State st., Chicago, Ill. 201.6 meters, 1490 kilocycles, 100 watts. Daily ex Sun, 8:45-9:45 pm. Central standard time. Slogan: "The Gypsy Station."

**WIBO** WIBO Broadcasters, Inc., 6310 Broadway, Chicago, Ill. 416.4 meters, 720 kilocycles, 5000 watts. Sun, 8:45-10 am, 2:30 pm-7 pm, 10 pm-1 am. Daily ex Sun, 2:30-4:30 pm, 5:30-7 pm. Tues & Thurs, 10-11 pm. Wed, Fri, Sat, 10 pm-1 am. Central standard time.

**WIBR** Tri-State Service Co. (Thurman A. Owings, Mgr.), Steubenville, Ohio. 249.9 meters, 1200 kilocycles, 50 watts. Daily, 6:30-7:30 pm. Mon & Fri, 8:30-9:30 pm. Wed, 11:15 pm-12:45 am. Eastern standard time. Slogan: "Where Investments Bring Results."

**WIBS** Lieut. Thomas F. Hunter (portable), 921 Edgewood road, Elizabeth, N. J. 204.0 meters, 1470 kilocycles, 150 watts, class A. Eastern standard time.

**WIBU** The Wisconsin State Journal, Electric Farm Station, Poynette, Wis. 217.3 meters, 1380 kilocycles, 20 watts. Sun, 2-3 pm, concert; 4-5:30 pm, vesper service. Mon, 9-12 pm., community program. Central standard time.

**WIBW** Topeka's Own Broadcasting Station, 901-2 National Reserve Life Bldg., Topeka, Kan. 204.0 meters, 1470 kilocycles, 100 watts. Sun, 12:15-1:45 pm, dinner music; 1:45-3 pm, studio program; 6:15-7:45 pm, string ensemble. Daily ex Sun, 12:15-1:15 pm, organ music; studio program, 5-7:30 pm, organ, weather, news, bedtime story, dinner music; 9:45-11:30 pm, studio program. Central standard time. Slogan: "Topeka—Where Investment Brings Wealth."

**WIBX** WIBX, Inc., Hotel Utica, Utica New York. 238.0 meters, 1260 kilocycles, 150 watts. Daily, 12 noon, music, stocks & markets, news, etc., 12-1 pm, 6-11 pm. Wed night, silent. Sun night, church services & musical program. Eastern standard time.

**WIBZ** A. D. Trum, 217 Catoma st., Montgomery, Ala. 230.6 meters, 1300 kilocycles, 15 watts. Fri, 9-10 pm. Sun, 12-1 pm. Central standard time. Slogan: "We Interest Business Zeal."

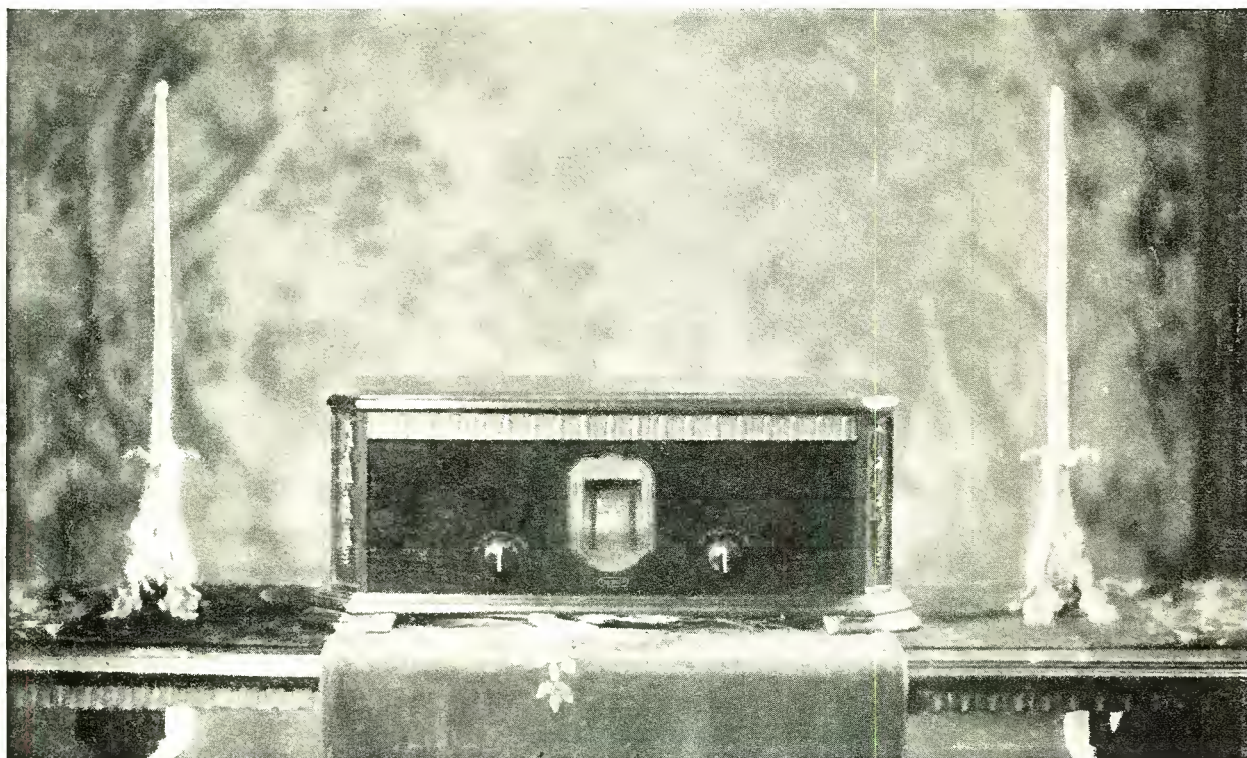

*The New Improved Hi-Q Six—the creation of ten foremost American Radio Engineers—a receiving instrument that is far in advance of its time.*

## Exclusively **CUSTOM-BUILT** By Yourself at Home . . . . from our Simple Instructions . . . . . and at Great Savings!

**N**O ordinary standards can be applied to this latest improved Hammarlund-Roberts Receiver, for it is the result of a determination to produce America's very finest instrument—absolutely regardless of cost!

Every modern constructional feature has been incorporated. Each part is the most efficient known to radio science, and the entire group has been purposely selected for perfect synchronization.

Complete isolation of four tuned circuits plus Automatic Variable Coupling effects maximum and uniform amplification over the entire wave band. Distortion is totally eliminated. Oscillation is utterly absent. Symphonic transform-

### Associate Manufacturers

*Acme Wire Company (Parvot)  
Benjamin Electric Mfg. Company  
Carter Radio Company  
H. H. Eby Mfg. Company  
Hammarlund Mfg. Company  
International Resistance Company  
(Durham Resistors)  
Radiall Company (Amperite)  
Samson Electric Company  
Sangamo Electric Company  
Yaxley Mfg. Company  
Westinghouse Micarta*

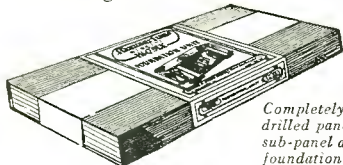

*Completely drilled panel and sub-panel are foundation for easy building.*

ers and a power tube faithfully reproduce the full musical scale. Selectivity, even in crowded areas is something to marvel at. And tonal quality simply **MUST** be heard to be appreciated!

Such a set, factory made, and sold through usual channels, would possibly cost around \$300.00, but through following our simple instructions you can purchase all parts for only \$95.80 and build this supreme receiver yourself—a **CUSTOM BUILT** set which gives you **CUSTOM BUILT** results at a saving of \$100 to \$150.

Get the complete Hi-Q Instruction Book from your dealer—or write us direct. Price 25 cents.



HAMMARLUND-ROBERTS, INC.

1182-T Broadway

New York City

*Tell 'Em You Saw It in the Citizens Radio Call Book Magazine*

**WICC** The Bridgeport Broadcast Station, Inc., 1044 Main St., Bridgeport, Conn. 214.2 meters, 1400 kilocycles, 500 watts. Sun, 10:50 am-2 pm, church services. Tues, Fri, 11 am, home management; 8 pm, studio program. Mon, 7-9 pm, studio program. Wed, 5:45-10:30 pm, concert, musical, etc. Thurs, 8 pm, Fri, 6:30-8:30 pm, orchestra, studio program. Eastern standard time. Slogan: "The Industrial Capital of Connecticut."

**WIL** Benson Broadcasting Corp., Missouri Hotel, 11th & Locust st., St. Louis, Mo. 258.5 meters, 1160 kilocycles, 250 watts. Sun, 5-7 pm. Daily ex Sun, 9:30-11:30 am, 2:45-5 pm, 8-11 pm. Central standard time. Slogan: "A Wave Length Ahead."

**WIOD** Carl G. Fisher, Miami Beach, Fla. 247.8 meters, 1210 kilocycles, 1000 watts. Slogan: "Wonderful Isle of Dreams."

**WIP** Gimbel Bros., Philadelphia, Pa. 508.2 meters, 590 kilocycles, 500 watts. Daily ex Sun, Mon & Fri, 6:45-7:30 am, 10-11 am, 1-2 pm, 3-4 pm, 6-7:30 pm. Tues, Thurs & Sat, 8 pm-12 midnight. Mon, Wed & Fri, 6:45-8 am, 10-11 am, 1-2 pm, 3-4:30 pm, 6-7:30 pm. Sun, 10:30 am-12:30 pm, 4-6 pm, 7-9:15 pm, 9:15 pm-12 midnight. Eastern standard time. Slogan: "Watch Its Progress."

**WJAD** Frank P. Jackson, 801 Austin av., Waco, Tex. 447.5 meters, 670 kilocycles, 500 watts. Mon, Tues, Thur, Fri, 8:30-10:30 pm, musical. Wed, 8:30-9:30 pm, musical. Central standard time. Slogan: "Waco, Texas, All Around It."

**WJAG** Norfolk Daily News, Norfolk, Nebr. 285.5 meters, 1050 kilocycles, 500 watts. Daily ex Sun, 12:15 pm, features, sports, word pictures, etc. Wed & Sat, 6:30 pm, dinner hour orchestra. Sun, 3 pm, musical program. Central standard time. Slogan: "Home of the Printers' Devil."

**WJAK** The Kokomo Tribune, Kokomo, Ind. 234.2 meters, 1280 kilocycles, 50 watts. Daily ex Sun, 11:45 am, radio chapel. Mon, 7:30 pm, musical program. Wed, Thurs, 6 pm, musical program. During basketball season, Fri & Sat, 7:30 pm. Central standard time.

**WJAM** D. M. Perham, 322 3rd av. W., Cedar Rapids, Iowa. 352.7 meters, 850 kilocycles, 250 watts. Daily, 9:15 am, 1:15 pm, Chicago grain & livestock markets. Daily ex Sun, 8:30 am-12:30 pm, music & talks. Mon, Wed, Fri, 7-9 pm, music. Tues, Thurs, 9-11 pm, music. Divides time with Station KWCR alternate evening hours.

**WJAR** The Outlet Company, 174 Weybosset st., Providence, R. I. 483.6 meters, 620 kilocycles, 500 watts. Daily ex Sun, 1:05 pm, musical; 1:30, weather reports. Mon, 8 pm, 9 pm & 10 pm, musical programs & grand opera. Tues, 7 pm, 8 pm, 9 pm, musical; 10 pm, bridge. Wed, 7:30 pm, music. Thurs, 8, 9 & 10 pm, music & entertainment. Fri, 8:20, 8:30, 9 & 11 pm, music & entertainment. Sun, 7:20 pm & 9:15 pm. Eastern standard time. Slogan: "The Southern Gateway of New England."

**WJAS** Pittsburgh Radio Supply House, Tenth st. & Penna. av. Pittsburgh, Pa. 270.1 meters, 1100 kilocycles, 500 watts. Daily ex Sun, 12 noon, church; 12:45 pm, Pathephonic Period. Mon, Wed, 9 pm, New York program. Tues, Thurs, Sat, 8-11, studio program. Sun, 11 am, church; 2 pm, studio program; 3 & 9 pm, New York program. Eastern standard time.

**WJAX** Jacksonville Municipal Radio Broadcasting Station, Waterworks Park, Jacksonville, Florida. 336.9 meters, 890 kilocycles, 1000 watts. Sun, 11 am, church; 6:30 pm, dinner hour concert; 7:30 pm, church. Daily ex Sun, 11:55 am, time signals; 12 noon, weather. Mon, 7:45 pm-12 midnight, musical. Tues, 8-10 pm, musical. Wed, 7:15-11 pm, musical. Fri, 7-10 pm, musical. Sat, 8-10 pm, musical. Eastern standard time. Slogan: "WJAX—W for Wonderful, JAX for Jacksonville."

**WJAY** Cleveland, Ohio. 227.1 meters, 1320 kilocycles, 500 watts.

**WJAZ** Zenith Radio Corp., 3620 Iron st., Chicago, Ill. Studio, Chez Pierre. 263.0 meters, 1140 kilocycles, 5000 watts. Sun, 7-9 pm. Tues, Wed, Fri, Sat, 7-8 pm, 9-11 pm. Thurs, 9-12 pm, Chez Pierre program. Divides time with Station WMBI, 8-9 pm, except Thurs, 7-9 pm. Sun, 3:30-7 pm. Central standard time.

**WJBA** D. H. Lentz, Jr., 301 Whitley av., Joliet, Ill. 322.4 meters, 930 kilocycles, 50 watts. Tues, 8-11 pm. Central standard time.

**WJBB** The Financial Journal, Inc., 126 13th st., N., St. Petersburg, Fla. 344.6 meters, 870 kilocycles, 250 watts. Eastern standard time. Slogan: "Land of Perpetual Sunshine."

**WJBC** Hummer Furniture Co., Second and Joliet, La Salle, Ill. 227.1 meters, 1320 kilocycles, 100 watts. Sun, 10-11 am, Catholic church services; 7:30-9:30 pm, Baptist church services. Mon, 8-10 pm, studio program. Tues, Thurs, Sat, 12:30-1 pm, organ concert. Sat, 1-2 pm, children's program. Central standard time. Slogan: "Better Homes Station."

**WJBI** Robert S. Johnson, 63 Broad st., Red Bank, N. J. 263 meters, 1140 kilocycles, 150 watts. Mon, 9-12 pm. Wed, 10-11 am, 4-6 pm, 10-12 pm. Fri, 9-10:30 am, 9-12 pm.

**WJBK** Ernest F. Goodwin, 803 Congress st., Ypsilanti, Mich. 220.4 meters, 1360 kilocycles, 15 watts. Central standard time.

**WJBL** Wm. Gushard Dry Goods Co., 301 N. Water st., Decatur, Ill. 212.6 meters, 1410 kilocycles, 250 watts. Mon, Wed & Sat, 9 pm. Sun, 3 pm. Central standard time.

**WJBO** Valdemar Jensen, 119 South st., New Orleans, La. 263.0 meters, 1140 kilocycles, 100 watts. Tues & Fri, 8 pm & 11 pm, dance programs. Sun, 3-4:30 pm, classical; 5-5:45 pm, church. Central standard time.

**WJBR** Gensch and Stearns, Omro, Wis. 227.1 meters, 1320 kilocycles, 100 watts.

**WJBU** Bucknell University, Lewisburg, Pa. 214.2 meters, 1400 kilocycles, 100 watts. Slogan: "In the Heart of the Keystone State."

**WJBW** Serve-U-Radio Co., 2743 Dumaine st., New Orleans, La. 238.0 meters, 1260 kilocycles, 30 watts. Tues, Fri, 7-8 pm, Central standard time. Slogan: "The Serve You Broadcasting Station at New Orleans."

**WJBY** Electric Construction Co., 517 Broad st., Gadsden, Ala. 234.2 meters, 1280 kilocycles, 50 watts.

**WJBZ** Roland G. Palmer and A. Coppotelli, 144 East 16th st., Chicago Heights, Ill. 208.2 meters, 1440 kilocycles, 100 watts. Mon & Tues, 7-10 pm. Slogan, "Crossroads of the Nation."

**WJJD** Loyal Order of Moose, Mooseheart, Ill. 365.6 meters, 820 kilocycles, 1000 watts. Children's programs from Mooseheart. Chicago programs from the Palmer House in cooperation with the Chicago Herald and Examiner. Sun, 3 hrs; Mon, 7 hrs; Tues, Wed, Thurs, 7 hrs 30 min; Fri, 5 hrs 30 min; Sat, 6 hrs 30 min. Central standard time. Slogan: "Every Child Is Entitled to a High School Education and a Trade."

# Be Sure To Build The Improved Aero-Dyne Six Receiver

*Described elsewhere in this magazine*

This excellent circuit combines many fine qualities that insure superlative receiving performance. Long range, extreme selectivity, and wonderful tone quality are only a few of the features offered.

Built around these Super-sensitive AERO UNIVERSAL COILS

**A  
wonderful  
kit**

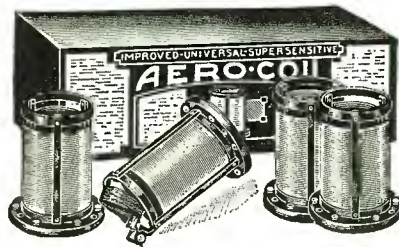

**Adaptable  
to all  
tubes**

The IMPROVED AERO-DYNE SIX owes much of its wonderful performance to this kit of AERO Universal Tuned Radio Frequency Coils around which it is constructed. These AERO Coils are undeniably the finest inductance units thus far produced.

This kit consists of 4 twice-matched units—adaptable to all standard tubes—201-A, 199, 112 and the new 240 and A. C. tubes. Has a tuning range below 200 to above 550 meters. So constructed that losses are practically eliminated, and receiving efficiency wonderfully increased. Each kit is carefully matched at both ends of the broadcast range. We unhesitatingly say that these coils will make any set better in selectivity, tone and range.

For .0005 Condensers (as described in this issue), Code No. U-16.....Price \$15.00  
For .00035 Condensers, Code No. U-163.....Price 15.00

**Other AERO KITS Employing the Improved AERO UNIVERSAL COIL**

**The AERO Universal Tuned Radio Frequency Kit—Kit of 3 Coils (for Aero-Seven)**

Consists of 3 twice matched units. Coils are wound on Bakelite skeleton forms, assuring a 95% air dielectric. Range from below 200 to 550 meters. Each kit carefully matched at both ends of the broadcast range. (This kit illustrated at the right.)

For .0005 Condenser, Code No. U-12.....Price \$12.00  
For .00035 Condenser, Code No. U-123.....Price 12.00



**AERO Universal 3-Circuit Tuner**



In the form of a 3 circuit tuner with a fixed tickler, this Aero Coil will improve any circuit. Adaptable only to 201-A, 199, 112, or the new A. C. Tubes. Has variable primary for governing selectivity.  
Code U-55 (for .0005 Condenser) or Code U-553 (for .00035 Condenser).....Price \$4.00

**AERO Radio Frequency Regenerative Kit**

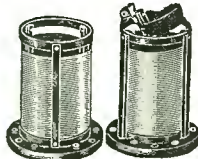

The supersensitive kit used in the new Aero 4 and The Chicago Daily News Receiver will improve the efficiency of any circuit. For use with 201-A, 112, 119, and the new A. C. Tubes. Used as .0005 variable condenser to tune fixed tickler. Code U-95 (for .0005 Condenser) or Code U-953 (for .00035 Condenser).....Price \$8.00

**AERO Universal Antenna Coupler**



A highly efficient low-loss antenna coupler with variable primary, adaptable to 201-A, 199, 112, 240 and the new A. C. Tubes.  
Code No. U-96 (for .0005 Condenser) or Code No. U-963 (for .00035 Condenser).....Price \$4.00

## IMPORTANT NOTICE!

We are able to furnish complete foundation units for the AERO-DYNE SIX, drilled and engraved by Westinghouse Micarta, complete with drilled bakelite sub-panel, 2 panel brackets, and blue print at \$12.50 each. This is a wonderful convenience and time saver for the home set builder. We can also supply foundation units for the Aero Short Wave, Aero 7, Aero 4, and Chicago Daily News 4 tube circuits, complete with full working blue prints. Prices on these units on application.

*Any of these AERO Kits and coils should be available at your dealers. If he cannot supply you, order direct from the factory. Be sure to specify code or key numbers when ordering.*

**AERO PRODUCTS, Inc., Dept. 113**  
**1172 Wilson Avenue** **Chicago, Ill.**

*Tell 'Em You Saw It in the Citizens Radio Call Book Magazine*

**WJPW** J. P. Wilson, Ashtabula, Ohio. 208.2 meters, 1440 kilocycles, 30 watts.

**WJR** Richards - Oakland Co., 2914 Book-Cadillac, Detroit, Mich. 440.9 meters, 680 kilocycles, 5000 watts. Daily ex Sun, 12 noon-2 pm, 6 am-12 midnight. Sun, 10 am, 1 pm, 2-4 pm. 6-10:30 pm. Eastern standard time. Slogan: "The Good Will Station."

**WJUG** Uda B. Ross, 30 Park pl., New York City, N. Y. 516.9 meters, 580 kilocycles, 500 watts. Daily on air. Unlimited time. Eastern standard time. Slogan: "The Jug."

**WJZ** Radio Corporation of America, 33 W. 42nd st., New York City, N. Y. 454.3 meters, 660 kilocycles, 30,000 watts. Sun, 9-10 am, 1-3 pm, 3:55-5:30 pm, 7-10:30 pm. Daily ex Sat & Sun, 1-2:40 pm, 4:30-6 pm. Mon, 7 pm-12 midnight. Tues, Wed, Thurs, 7-11:30 pm. Fri, 7 pm-12:15 am. Sat, 1-4 pm, 4:30-6 pm, 7-11:30 pm. Eastern standard time.

**WKAQ** Radio Corp. of Porto Rico, Telephone Bldg., San Juan, Porto Rico. 340.7 meters, 880 kilocycles, 500 watts. Sun, 7-9 pm, Municipal Band of San Juan. Wed, 7-9 pm, Municipal Band of San Juan. Fri, 7-10 pm, Studio Program. Slogan: "Porto Rico, The Island of Enchantment in the Caribbean Sea." Eastern standard time.

**WKAR** The Michigan State College, East Lansing, Mich. 285.5 meters, 1050 kilocycles, 1000 watts. Daily ex Sun, 12-12:30, markets, weather, educational program.

**WKAU** Laconia Radio Club, 480 Main st., Laconia, N. H. 223.7 meters, 1340 kilocycles, 50 watts. Sun, 10:30 am, 6:30 pm. Fri, 7:30 pm. Eastern standard time. Slogan: "The Voice of the Winnepesaukee Lake Region."

**WKBB** Sanders Bros., 607 Jefferson st., Joliet, Ill. 215.7 meters, 1390 kilocycles, 150 watts. Wed, 6-8:30 pm, dinner program. Thurs, 8:30-12 pm, good time program. Sun, 3-5 pm, classical; 8:20-12 pm, frolics. Central standard time.

**WKBC** H. L. Ansley, 1428 N. 12th av., Birmingham, Ala. 218.8 meters, 1370 kilocycles, 10 watts. Tues, Thurs, Sat, 7:30-8 pm, music. Sat, Sunday school talks on lessons for Sunday. Central standard time.

**WKBE** K. & B. Electric Co., 59 Emerald av., Webster, Mass. 228.9 meters, 1310 kilocycles, 100 watts. Mon, 8-11:30 pm. Thurs & Sat, 8-11 pm. Eastern standard time.

**WKBF** Hoosier Athletic Club, 902 N. Meridian st., Indianapolis, Ind. 275.1 meters, 1090 kilocycles, 500 watts. Slogan: "We Keep Building Friendships."

**WKBG** C. L. Carrell, 36 S. State st., Chicago, Ill. (Portable). 201.5 meters, 1490 kilocycles, 100 watts.

**WKBH** Callaway Music Co., 221 Main st., LaCrosse, Wis. 220.4 meters, 1360 kilocycles, 500 watts. Daily ex Sun, 10 am, 12 noon, weather report, farm service, music. Sun, 10:30 am, church service. Mon, 8:30 pm, studio program. Wed, 9 pm, studio program. Sat, 10 pm, dance program. Central standard time.

**WKBI** Fred L. Schoenwolf, 1917 Warner av., Chicago, Ill. 322.4 meters, 930 kilocycles, 50 watts.

**WKBJ** Gospel Tabernacle (Inc.), 5th av. & 10th st. S., St. Petersburg, Fla. 280 meters, 1071 kilocycles, 250 watts.

**WKBL** Monrona Radio Mfg. Co., 16 S. Monroe, st., Monroe, Mich. 205.4 meters, 1460 kilocycles, 15 watts. Mon, 8-9 pm. Wed, 9-10:30 pm. Thurs, 8-10 pm. Fri, 8-11 pm. Sat, 9-12 pm. Slogan: "The Most Powerful 15-Watt Station in the World."

**WKBN** Radio Electric Service, 17-21 N. Champion st., Youngstown, Ohio. 214.2 meters, 1400 kilocycles, 30 watts.

**WKBO** Camith Corp., Jersey Observer Bldg., Jersey City, N. J. 218.8 meters, 1370 kilocycles, 500 watts.

**WKBP** Battle Creek Enquirer & News, Battle Creek, Mich. 212.6 meters, 1410 kilocycles, 50 watts.

**WKBQ** Starlight Amusement Park, 1100 E. 177th st., New York City, N. Y. 218.8 meters, 1370 kilocycles, 500 watts. Daily ex Sun. Irregular hours. Eastern standard time.

**WKBR** Kenosha, Wis. 322.4 meters, 930 kilocycles, 15 watts output. Sun, 2-3 pm, religious services. Sat, 11-12:30 pm.

**WKBS** Weinberg Arcade, Galesburg, Ill. 217.3 meters, 1380 kilocycles, 100 watts. Daily ex Sat & Sun, 10-11 am, 12:30-1 pm, 2:30-3:30 pm. Sun, 1:30-3 pm, church. Mon, Wed, Fri, 7-11 pm. Tues, Thurs, Sat, 7-9 pm, 10-11 pm. Central standard time. Slogan: "The Mayflower Station in the Renowned City of Colleges."

**WKBT** First Baptist Church, 3436 St. Charles av., New Orleans, La. 252 meters, 1190 kilocycles, 50 watts. Sun, 11 am & 7:30 pm, church services & special music.

**WKBV** Knox Battery & Electric Co., 658 Main st., Brookville, Ind. 217.3 meters, 1380 kilocycles, 100 watts.

**WKBW** Churchill Tabernacle, 1420-28 Main, Buffalo, N. Y. 217.3 meters, 1380 kilocycles, 500 watts. Sun, 9:30 am, 10:30 am, 3 pm, 7 pm, 10:15 pm-12 midnight. Daily, 7:30 pm. Wed, 9 pm, civil service exams; 9:15 pm, prayer service; Thurs, 8 pm, YMCA. Fri, 7 pm, Sunday School Lesson. Eastern standard time. Slogan: "Well Known Bible Witness."

**WKBZ** Karl L. Ashbacher, First National Bank Bldg., Ludington, Mich. 199.9 meters, 1500 kilocycles, 15 watts.

**WKDR** Edward A. Dato, 936 N. Michigan av., Chicago, Ill. 491.5 meters, 670 kilocycles, 15 watts.

**WKEN** Radio Station WKEN, Kenmore, Buffalo, N. Y. 204 meters, 1470 kilocycles, 250 watts. Sun, 11 am-12 noon; 7:30-8:30 pm. Daily ex Sun, 6-6:45 pm. Mon, Tues, Thur, 8-11 pm. Eastern standard time. Divides time with Station WSVS, Wed, Fri evenings, 7:30-9:30 pm.

# Simplicity Supreme!

THE **EIGHT-IN-LINE** UNIT

*Simple to  
Construct*

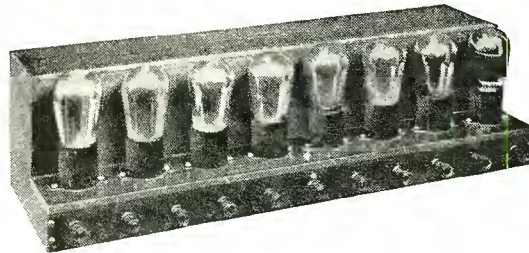

*Simple to  
Operate*

Only nine binding posts to connect to front panel instruments

— *~* —

## Announcing the New SIX TUBE UNIT OF THE FAMOUS EIGHT-IN-LINE



*Read the Article  
in This Issue*

The Eight-in-Line is the finest there is in radio today. No other receiver will compare with it for ease of construction, ease of operation, tone quality or selectivity.

There is now available for the set builder a six tube unit identical in every way with the regular Eight-in-Line unit except that the entire audio amplifier is omitted. This gives a perfectly balanced front end tested "on the air" which will not oscillate, and the constructor may use any type of audio amplification he may prefer.

The **GRADERGOOD** Co.

1435 Welton Street      NATIONAL SALES REPRESENTATIVES      Denver, Colorado

*Tell 'Em You Saw It in the Citizens Radio Call Book Magazine*

**WKJC** Kirk Johnson & Co., 16-18 W. King st., Lancaster, Pa. 252.0 meters, 50 watts, 1190 kilocycles. Sun, 9:30-12 noon, 7:30-9:30 pm. Mon, Wed, Fri, 7:30-9:30 pm. Sat, 2:30-4:30 pm. Eastern standard time.

**WKRC** The Kodel Radio Corp., 507 E. Pearl st., Cincinnati, Ohio 329.5, 333.1 meters, 900 kilocycles, 500 watts. Sun, 11 am, church; 10 pm, classical; 11:15 pm, popular. Mon, Wed, 6 pm, dinner music; 8 pm, instrumental. Mon, 12 midnight, dance music. Wed, 8:30 pm, classical. Tues, 10 pm, vocal, instrumental; 11 pm, popular. Sat, 10 pm, dance program. Eastern standard time. Slogan: "WKRC—K, Kodel—R, Radio—C, Corporation."

**WKY** WKY Radiophone Co., Huckins Hotel, Oklahoma City, Okla. 288.3 meters, 1040 kilocycles, 150 watts. Daily ex Sun, 9:45 am, Sunshine Hour; 12 noon-1 pm, organ; 6:30-7:30 pm, dinner hour; 7:30-8 pm, organ; 8 pm-12 midnight, Huckins Hotel Studio. Sun, 11 am, 7:30 pm, church; 3-4 pm, concert. Central standard time.

**WLAC** Life and Casualty Insurance Co., Nashville, Tenn. 225.4 meters, 1330 kilocycles, 1000 watts. Sun, 8:30-9:30 pm, band concert; 9:30-10 pm, studio. Mon, Sat, 7-9 pm. Tues, 9 pm-12 midnight. Wed, 1:30-2:30 pm, 7-9 pm. Thur, 6-7 pm, 9-12 midnight. Central standard time. Slogan: "The Thrift Station."

**WLAL** First Christian Church, 9th & Boulder sts., Tulsa, Okla. 249.9 meters, 1200 kilocycles, 100 watts, class A. Wed, 9:30 pm. Sat, 7:30 pm. Sun, 7:30 pm, church. Central standard time.

**WLAP** Virginia Av. Baptist Church, 2600 Virginia av., Louisville, Ky. 267.7 meters, 1120 kilocycles, 30 watts. Sun, 11 am-12 noon, 7:30-8:45 pm. Central standard time.

**WLB** University of Minnesota, Minneapolis, Minn. 245.8 meters, 1220 kilocycles, 500 watts.

**WLBC** D. A. Burton, 2224 S. Jefferson st., Muncie, Ind. 209.7 meters, 1430 kilocycles, 50 watts.

**WLBE** J. H. Fruitman, 2029-65th st., Brooklyn, N. Y. 230.6 meters, 1300 kilocycles, 15 watts.

**WLBF** Everett L. Dillard, 300-A E. 33rd st., Kansas City, Mo. 209.7 meters, 1430 kilocycles, 50 watts. Daily ex Sun, 10 am-11 pm, popular & classical; 7:30-10:30 pm, popular & classical. Central standard time. Slogan: "Where Listeners Become Friends."

**WLBG** R. A. Gamble, 126 N. Sycamore st., Petersburg, Va. 214.2 meters, 1400 kilocycles, 100 watts. Irregular programs daily.

**WLBH** Joseph J. Lombardi, Farmingdale, N. Y. 232.4 meters, 1290 kilocycles, 30 watts.

**WLB I** Wenona Legion Broadcasters, 107 Chestnut st., Wenona, Ill. 238.0 meters, 1260 kilocycles, 250 watts. Sun, 11 am, church. Mon, 7-11 pm, music. Wed, 7-8 pm, lecture, music, etc. Thurs, 2-3 pm, markets, etc. Fri, 7-9 pm, music. Sat, 2-3 pm, 7-9 pm. Central standard time. Slogan: "In the Heart of the Corn Belt."

**WLBL** Wisconsin Department of Markets, Stevens Point, Wis. 319.0 meters, 940 kilocycles, 1000 watts. Mon, Tues, Wed, Thurs, Fri, Sat, 8-11 am, 12 noon, 1 pm, markets. Thurs & Sat, 8 pm, musical program. Central standard time. Slogan: "Wisconsin, Land of Beautiful Lakes." Divides time with Station WHA, University of Wisconsin, Madison, Wis.

**WLB M** Boston, Mass. 230.6 meters, 1300 kilocycles, 50 watts.

**WLB N** William E. Hiler, 339 S. Homan av., Chicago, Ill. (Portable). 204.0 meters, 1470 kilocycles, 100 watts.

**WLB O** Frederick A. Trebbe, Jr., 526 Monmouth blvd., Galesburg, Ill. 217.3 meters, 1380 kilocycles, 100 watts.

**WLB Q** E. Dale Trout, Atwood, Ill. 202.6 meters, 1480 kilocycles, 25 watts.

**WLBR** Alford Radio Co., Belvidere, Ill. 312.4 meters, 930 kilocycles, 15 watts.

**WLBT** Harold Wendell, 317 E. North st., Crown Point, Ind. 322.4 meters, 930 kilocycles, 50 watts.

**WLB U** Kelsey Block, Canastota, N. Y. 220 N. Y. 220 meters, 1363 kilocycles, meters, 1363 kilocycles, 5 watts. Sun, 9:30 am, church services. Tues, Fri, 8 pm, musical program. Sat, 9 pm, musical program. Eastern standard time. Slogan: "The Heart of Canastota."

**WLB V** Mansfield Broadcasting Association, Chamber of Commerce Bldg., Mansfield, Ohio. 206.8 meters, 1450 kilocycles, 50 watts. Sun, 10:30-12 noon. Mon, Wed, 9 am-10 pm. Mon, 6-7 pm, dinner hour. Sat, 9:30-12 pm. Eastern standard time.

**WLB W** Northwestern Pennsylvania Broadcast Station, P. O. Box No. 163, Oil City, Pa. 293.9 meters, 1020 kilocycles, 500 watts. Sun, 3:30 pm, sacred. Mon, 9:30 pm, miscellaneous program; 10 pm, dance music. Wed, Fri, 10 pm, dance music. Thur, 10 pm, miscellaneous program. Eastern standard time.

**WLB X** John N. Brahy, 283 Crescent st., Long Island City, N. Y. 204.0 meters, 1470 kilocycles, 250 watts.

**WLB Y** Aimone Electric, 1236 Carpenter st., Iron Mountain, Mich. 209.7 meters, 1430 kilocycles, 50 watts.

**WLB Z** Thompson L. Guernsey, Dover-Foxcroft, Me. 208.2 meters, 1440 kilocycles, 250 watts.

**WLC I** Lutheran Association of Ithaca, Ithaca, N. Y. 247.8 meters, 1210 kilocycles, 50 watts.

**WLB I B** Liberty Magazine, Chicago, Ill. 305.9 meters, 980 kilocycles, 500 watts. Daily ex Sun & Mon, 10:30-11 am, 11:30 am-12:40 pm, 7-8 pm, 11-12:30 am. Sun, 5-6 pm, 11 pm-12:30 am. Central standard time. Slogan: "Liberty, a Weekly for Everybody."



# Enesco

## THE ORIGINAL AND WORLD'S FINEST 3 FOOT SPEAKER KIT

### And Now a Complete Line of "ENESCO" Models

The famous "Enesco" three foot cone has made radio history. Now we are introducing four new "Enesco" models:—two of them just like the old reliable 3 foot models but in the two foot size. And two with a beautiful polychrome pedestal, one three foot and one two foot. The new models round out the "Enesco" line and make it by far the most attractive on the market.

#### COMPLETE KITS

The "Enesco" Kits are complete. Every necessary part is included together with a twelve page illustrated instruction book which explains in detail just how to make six styles and three sizes of cone and roll speakers. The "Enesco" can be assembled in less than an hour.

#### ABSOLUTELY GUARANTEED

We guarantee the "Enesco" to be the equal of any manufactured speaker regardless of price. The "Enesco" produces the truest tones you have ever heard. After you hear your set with the "Enesco" Cone, you will wonder how you were ever satisfied with your former speaker.

#### AT YOUR DEALER OR DIRECT FROM US

Go to your dealer, ask him to demonstrate the "Enesco"—compare it with any speaker regardless of price. If your dealer has not been supplied send the coupon to our nearest office. Shipping charges paid. Our absolute money-back guarantee protects you.

#### Dealers and Jobbers

Write for the "Enesco" profit making proposition. The finest cone speaker at a price anyone can afford to pay.

### ENGINEERS' SERVICE COMPANY

25 Church Street, N. Y.      73 Cornhill, Boston

28 E. Jackson Boulevard, Chicago

331 Bay Street, Toronto, Ontario

ENSCO Ad. No. 240-G.V.-1927



As described in this issue

STANDARD KIT

\$10.00

WALL KIT

\$11.00

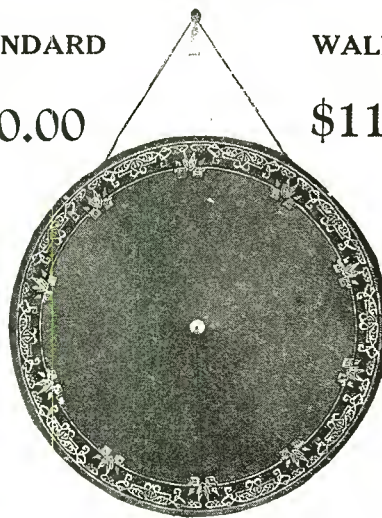

#### OTHER MODELS

- No. 10-24 Standard Kit in 24" size.....\$10.00
- No. 11-24 Wall Type Kit in 24" size..... 11.00
- No. F-135-24 24" Cone with special polychrome pedestal..... 13.50
- No. F-175-36 36" Cone with special polychrome pedestal..... 17.50

#### SEND THIS COUPON

Engineers' Service Company  
(Send to nearest office)

SEND ME	U. S. Prices	Canada Prices	I am enclosing
<input type="checkbox"/> Standard Kit	\$10.00	\$11.50	<input type="checkbox"/> Check
<input type="checkbox"/> Wall Kit	11.00	12.50	<input type="checkbox"/> Money order
<input type="checkbox"/> No. 10-24	10.00	12.50	<input type="checkbox"/> Cash (send registered)
<input type="checkbox"/> No. 11-24	11.00	17.50	<input type="checkbox"/> Send C.O.D.
<input type="checkbox"/> No. F-135-24	13.50		
<input type="checkbox"/> No. F-175-36	17.50		

Name.....  
Address.....  
City.....  
State.....  
C.R.C.B.

Tell 'Em You Saw It in the Citizens Radio Call Book Magazine

**WLIT** Lit Bros., Philadelphia, Pa. 405.2 meters, 740 kilocycles, 500 watts, class B. Daily ex Sun, 12-1 pm, 2-3 pm, 4:30-5 pm. Mon, 12 noon to 11 pm. Tues, 11 am to 8 pm. Wed, 12 noon to 11 pm. Thurs & Sat, 12 noon to 8 pm. Fri, 12 noon to 12 midnight. Eastern standard time. Slogan: "The Quaker City Siren."

**WLS** Sears, Roebuck & Co., Chicago, Ill. 344.6 meters, 870 kilocycles, 5000 watts. Sun, 10:45-12:20, U. of C. church; 12:20-1, organ; 1-1:30, trio concert; 6-8, Little Brown church. Mon, markets; 9-9:10-10-10:30-11-11:30-11:45, markets every day ex Sun; R. F. D. program & markets, 12-1 pm; closing markets every day, 1:25-1:35; home makers' hour, Mon, Tues, Wed, Fri, 2:30-3:30 pm; organ every day ex Sat & Sun, 5:30. Birthday time, ex Sat & Sun, 5:45 pm. Supper bell program ex Sun, 6 pm. Sports time ex Sun, 6:30 pm. Silent after 7 pm Mon, Tues, 5:30-8, 10:30-12:30 pm. Wed, 5:30-12 pm. Thurs, 5:30-8, 10:30-12:30 pm. Fri, 5:30-12 pm. Sat, 6-1 am. Central standard time. Slogans: "World's Largest Store," "Work Better, Live Better, Sell Better."

**WLSI** Lincoln Studios (Inc.), 335 Westminster st., Providence, R. I. 440.9 meters, 680 kilocycles, 500 watts.

**WLTH** Leverick Hotel Operating Co., Inc., Leverick Towers Hotel, Brooklyn Heights, New York. 218.8 meters, 1370 kilocycles, 250 watts. Eastern standard time.

**WLTS** Lane Technical High School, 1225 Sedgwick st., Chicago, Ill. 483.6 meters, 620 kilocycles, 100 watts. Daily ex Sat & Sun, 2-4 pm, musical & educational. Mon, 6-7 pm, musical. Central standard time. Slogan: "World's Largest Technical School." Divides time with WCFL, Chicago Federation of Labor Station.

**WLW** The Crosley Radio Corp., Harrison, Ohio. 428.3 meters, 700 kilocycles, 5000 watts. Daily ex Sat & Sun, 8-8:30 am; 10 am, Women's Hour; 11 am, markets; 12 noon, concert & time signals; 2:30-4:30 pm, musical program; 6 pm-midnight, diversified program (Fri night silent). Sun, 9:30 am, Sunday School; 11 am, church services. Eastern standard time.

**WMAC** Clive B. Meredith, Cazenovia, N. Y. 225.4 meters, 1330 kilocycles, 500 watts. Sun, 3:30 pm, choral singing; 9:30 pm, popular program. Mon, 8:30, semi-classical program; 7:30, Weekly Letter to Dad. Daily ex Sun & Mon, 7:30 pm. Tues, Autobiography of Infamous Bugs. Wed, Chats with Weatherman; 8:30, popular program. Thurs, Primer for Town Farmers. Fri, 7:30 pm, Agricultural Interview; 8:30 pm, classical program. Sat, Farm News Digest. Eastern time. Slogan: "Voice of Central New York."

**WMAF** Round Hills Radio Corp., South Dartmouth, Mass. 428.3 meters, 700 kilocycles, 500 watts. Eastern standard time.

**WMAK** WMAK Studios, Inc., Liberty Bank Bldg., Buffalo, N. Y. 545.1 meters, 500 kilocycles, 750 watts. Sun, 10 am-12 noon, 2-5 pm, 7-11 pm. Daily ex Sun, 11 am-12 noon, 1:30-6 pm, 6 pm-12 midnight. Eastern standard time.

**WMAL** Washington Radio Forum, owned & operated by the M. A. Leese Radio Co., 720 11th st., N. W., Washington, D. C. 302.8 meters, 990 kilocycles, 250 watts. Daily, 6:45-11 pm, varied programs. Eastern standard time.

**WMAN** W. E. Heskett Radio Station, First Baptist Church, Columbus, Ohio. 234.2 meters, 1280 kilocycles, 50 watts. Sun, 10:30 am-12 noon; 7:30-9 pm, church services. Eastern standard time.

**WMAQ** The Chicago Daily News, 15 N. Wells st., Hotel La Salle, Chicago, Ill. 447.5 meters, 670 kilocycles, 1000 watts. Daily ex Sun & Mon, 6:30-11 am, 12 noon-3 pm, 4-7 pm, 8-10 pm. Sun, 2-9:15 pm. Mon, 9-11 am, 12 noon-7 pm. Central standard time.

**WMAY** Kingshighway Presbyterian Church, St. Louis, Mo. 247.8 meters, 1210 kilocycles, 100 watts. Sun, 11 am-12 pm, 8-9 pm, church services. Central standard time.

**WMAZ** Mercer University, Macon, Ga. 270.1 meters, 1110 kilocycles, 500 watts. Mon, Thurs, 10-11 pm, musical. Tues & Fri, 8-9 pm, sacred music. Wed, 11-12 pm, musical program. Fri, 9-11 pm, musical. Central standard time. Slogan: "Watch Mercer Attain Zenith."

**WMBA** Leroy J. Beebe, 13 Robinson st., Newport, R. I. (Portable). 204.0 meters, 1470 kilocycles, 100 watts.

**WMBB** American Bond & Mortgage Co., 6201 Cottage Grove av., Chicago, Ill. 252.0 meters, 1190 kilocycles, 500 watts. Sun, 3-6 pm, popular concert program; 7:40-9 pm, Christian Science services; 9-11 pm, popular program. Daily ex Sun, Mon, 7-8:30 pm, semi-classical program; 9-10 pm, popular program. Tues & Fri, 7-10 pm, quartet. Central standard time. Slogan: "World's Most Beautiful Ballroom."

**WMBC** Michigan Broadcasting Co. (F. G. Siegel), Hotel Savoy, Detroit, Mich. 243.8 meters, 1230 kilocycles, 100 watts. Sun, 6:30-10 pm, dinner hour, studio program. Daily ex Sun & Sat, 6-6:30 pm, Children's Hour; 6:30-10 pm, dinner hour, studio program. Sat, 6-6:30 pm, Children's Hour; 6:30-8 pm, dinner hour. Eastern Standard time. Slogan: "Don L. Fox, The Singing Announcer."

**WMBD** Peoria Heights Radio Laboratory, Peoria Heights, Ill. 205.4 meters, 1460 kilocycles, 250 watts. Sun, 11 am-12 noon, church. Daily ex Sun, 6:55-7:30 pm, markets; 8-10 pm, studio program. Central standard time. Slogan: "World's Most Beautiful Drive."

**WMBE** Dr. C. S. Stevens, St. Paul, Minn. 208.2 meters, 1440 kilocycles, 10 watts. Slogan: "The Winter Garden Station."

**WMBF** Fleetwood Hotel Corp., Miami Beach, Fla. 384.4 meters, 780 kilocycles, 500 watts. Daily, 7-8 pm, concert orchestra; 8-9 pm, popular program; 10-1 am, dance music. Eastern time. Slogan: "Wonderful Miami Beach Fleetwood."

**WMBG** Havens & Martin, 914 W. Broad St., Richmond, Va. 220.4 meters, 1360 kilocycles, 15 watts. Daily ex Sun, 2-3 pm, 6-8 pm. Eastern standard time. Slogan: "The Daytime Station."

**WMBH** Edwin Dudley Aber, 1526 E. 53rd St. (Portable), Chicago, Ill. 204.0 meters, 1470 kilocycles, 100 watts.

**WMBI** The Moody Bible Institute of Chicago, 153 Institute pl., Chicago, Ill. 263.0 meters, 1140 kilocycles, 500 watts. Sun, 3:30-5 pm, 5-7 pm, Bible Exposition and sacred music. Daily ex Sun, 7-7:40 am, morning worship; 10:30-11:30 am, missionary hour, Bible study; 12:30-1:30 pm, organ program; 3:30-4:30 pm, reading & music; 8-9 pm, Bible study or sacred program. Central standard time. Slogan: "The West Point of Christian Service."

**WMBJ** Wm. Roy McShaffrey, Monessen, Pa. 232.4 meters, 1290 kilocycles, 50 watts.

**WMBK** John C. Slade, Hamilton, Ohio. 360 meters, 832.8 kilocycles, 10 watts. Sun, 2:30 pm, 8:30-10:30 pm, 12-2 am.

# Geo. W. Walker Sectional Radio Units—

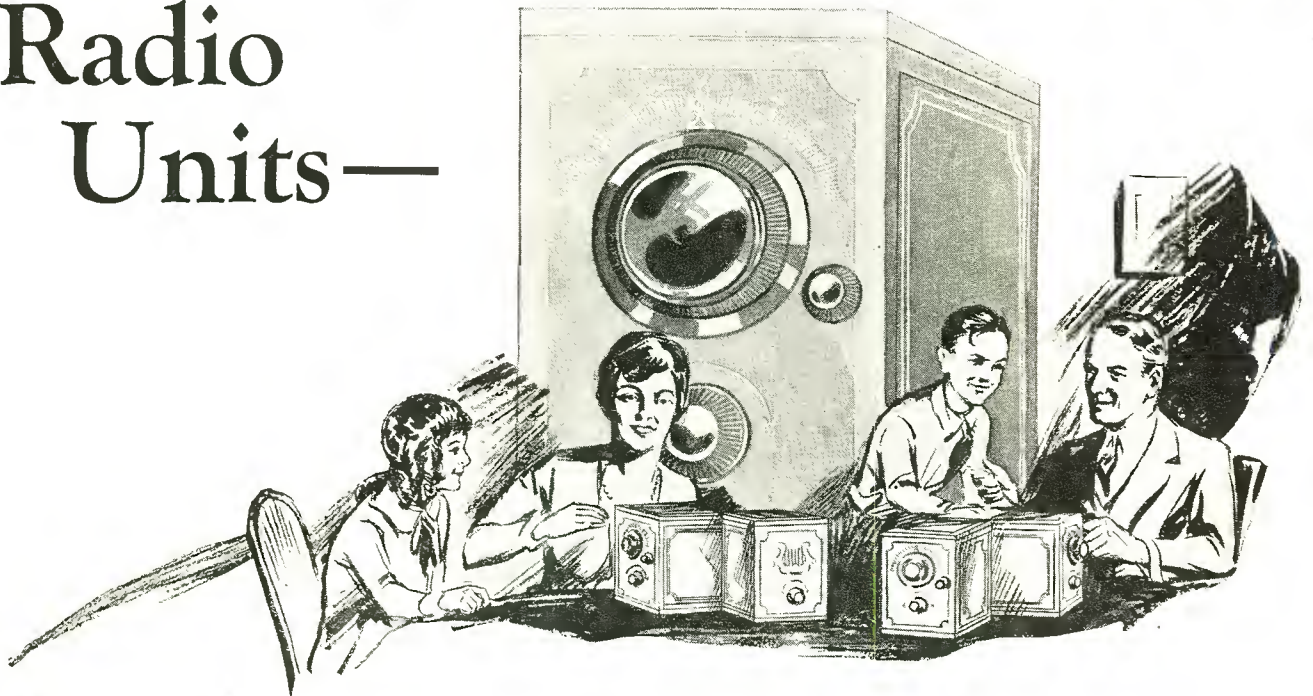

## The Center of Interest in Radio This Season!

### Audio-Unit

This unit is made in two styles

#### Audio-Unit No. 2

A 3-tube unit employing 2 transformer coupled stages with last two sockets wired in parallel. Either two or three tubes may be used.

Price .....\$20.00

#### Audio-Unit No. 3

A 3-tube unit—a combination circuit operated by standard make "B" eliminators or batteries resulting in volume and clarity equal to a power amplifier requiring special power of 400 volts—using ordinary tube and two power tubes, if desired.

Price .....\$35.00

### Vari Unit

This unit is completely wired and standard in design. The multi-point switch permits great flexibility in uses.

Price .....\$20.00

Should an additional cabinet or piece of furniture be desired, your dealer has a large assortment available to select from.

AND why shouldn't they be? New and sensational in design yet efficient and capable of marvelous results, these units are instructive, entertaining and thoroughly practical.

The many combinations which can be made with them hold the interest of amateur, novice and layman alike.

We can't begin to tell you about these wonderful units here. Write for descriptive literature if your dealer can't give you information.

## The Carter Mfg. Co.

Manufacturers of Geo. W. Walker  
Radio Products

6300 Euclid Ave. Cleveland, Ohio

**WMBL** Benford Radio Studios, Lakeland, Fla. 228.9 meters, 1310 kilocycles, 50 watts. Sun, church services, morning & evening. Daily ex Sun, 10:30 am-1:30 pm, varied program; 2:30-3:30 pm, varied; 8-9:30 pm, classical; 9:30-10:30 pm, popular; 10:30-11:30 pm, dance program. Eastern standard time. Slogan: "Lakeland—The City of Heart's Desire."

**WMBM** Memphis, Tenn. 209.7 meters, 1430 kilocycles, 10 watts.

**WMBO** Auburn, N. Y. 220.4 meters, 1360 kilocycles, 100 watts.

**WMBQ** 95 Leonard St., Brooklyn, N. Y. 204 meters, 1470 kilocycles, 100 watts. Slogan: "The Home Sweet Home Station of Williamsburgh."

**WMBR** F. J. Reynolds, 109 Franklin st., Tampa, Fla. 252.0 meters, 1190 kilocycles, 100 watts. Daily ex Sun, 1-2 pm, weather reports, organ; 7-8 pm, baseball returns, orchestra. Tues, 7-8 pm, orchestra. Wed, 9-10 pm, musical. Fri, 10 pm, fight returns. Sat, 8-10 pm, musical. Eastern standard time. Slogan: "WMBR, Everything for Radio at Tampa, Florida."

**WMBS** Macks Battery Service, 210 Locust st., Harrisburg, Pa. 234.2 meters, 1280 kilocycles, 250 watts. Sun, 9 am-9 pm. Daily ex Sat & Sun, 6-11:30 pm. Sat, 6 pm-2 am. Eastern standard time.

**WMBW** Youngstown, Ohio. 214.2 meters, 1400 kilocycles, 50 watts.

**WMBY** Bloomington, Ill. 199.9 meters, 1500 kilocycles, 15 watts.

**WMC** Commercial Publishing Co., The Commercial Appeal, 30 N. 2nd st., Memphis, Tenn. 516.9 meters, 580 kilocycles, 500 watts. Sun, 11 am, church services. Daily ex Sun, 9:45 am, markets. Mon, Wed, Fri, 12 noon, music. Tues, Thurs, 12 noon, markets. Mon, 8 pm, farm talks. Tues, 7:45 pm, bridge game. Thurs, 8 pm, music. Mon, Tues, Fri, Sat, 8:30-11 pm, music, frolic. Central standard time. Slogan: "WMC, Memphis, Down in Dixie."

**WMCA** Hotel McAlpin (Greely Square Hotel Co.), New York City. 370.2 meters, 810 kilocycles, 500 watts. Sun, 11 am-1 am. Daily ex Sun, 10:30 am-1 am. Eastern standard time. Slogan: "Where the White Way Begins."

**WMHA** Young Men's Hebrew Association of Washington Heights, 975 St. Nicholas av., New York, N. Y. 230 meters, 1304 kilocycles, 30 watts.

**WMPC** First Methodist Protestant Church, Lapeer, Mich. 234.2 meters, 1280 kilocycles, 30 watts. Sun, 10:30 am-1 pm, 4-5:30 pm, 7:30-10:00 pm. Daily ex Sat & Sun, 12 noon-1 pm. Mon, Tues, Wed, Fri, 7:30-10 pm. Programs include sermons, vocal, instrumental music, missionary, church & educational services. Eastern standard standard time. Slogan: "Where Many Preach Christ."

**WMRJ** Peter J. Prinz, 10-12 New York av., Jamaica, N. Y. 206.8 meters, 1450 kilocycles, 10 watts. Sun, 9:30 pm-12 midnight, dance music & popular program. Tues, 8:30 pm-11:30 pm, dance music, popular program. Thurs, 8:30 pm-11:30 pm, semi-classical, popular program. Eastern time. Slogan: "The Gateway to the Sunrise Trail."

**WMSG** Madison Square Garden, 319 W. 49th st., New York, N. Y. 236.1 meters, 1270 kilocycles, 500 watts.

**WMVM** Edward J. Malome, Jr., 126 1st st., Newark, N. J. 475.9 meters, 630 kilocycles, 500 watts.

**WNAB** The Shepard Stores, Winter st., Boston, Mass. 280.2 meters, 1070 kilocycles, 100 watts. Daily ex Sun, 3-4 pm, daily phonograph record hour. Eastern standard time.

**WNAC** The Shepard Store, Winter St., Boston, Mass. 352.7 meters, 850 kilocycles, 500 watts. Sun, 10:45 am, church services; 12:15-5 pm, concert; 7:30-9 pm, church services; 9-11 pm, concert. Daily ex Sun, 10:30-11:30 am, women's club, 12:15-1 pm, church; 1-2 pm, luncheon concert; 4-5 pm, Theatre Hour, music; 6-6:30 pm, children's club; 6:30-7:30 pm, dinner dance; 7:30-8 pm, news & talks; 8-11 pm, concert; 11 pm-12 midnight, dance program. Eastern standard time.

**WNAD** University of Oklahoma, Norman, Okla. 239.9 meters, 1250 kilocycles, 500 watts. Mon, 7:15-8 pm. Tues, 12:15-1 pm, 2:30-3:30 pm. Wed, 7:15-8 pm. Thurs, 7:15-8 pm. Fri, 12:15-1 pm, 2:30-3.3 pm. Sat, broadcast of athletic events. Central standard time. Slogan: "The Voice of Soonerland."

**WNAL** R. J. Rockwell, 5019 Capitol av., Omaha, Neb. 258.5 meters, 1160 kilocycles, 250 watts. Tues, Fri, 7:30-9 pm. Central standard time. Slogan: "Pioneer Station of Omaha."

**WNAT** Lennig Bros. Co., Spring Garden & 9th st., Philadelphia, Pa. 288.3 meters, 1040 kilocycles, 100 watts. Tues, Wed, Sat, 8:11 pm. Eastern standard time. Slogan: "We Never Are Tired." Divides time with WRAX and WIAD.

**WNAX** Gurney Seed & Nursery Co., Yankton, So. Dak. 302.8 meters, 990 kilocycles, 500 watts daytime, 250 watts nighttime. Daily ex Sun & Tues, 11 am-1:30 pm, 2:30-10 pm. Sun, 11 am-12 noon, 2.7 pm. Tues, 11 am-1:30 pm, 2:30-7 pm. Central standard time.

**WNBA** Forest Park, Ill. 208.2 meters, 1440 kilocycles, 200 watts.

**WNBF** Howitt-Wood Radio Co., Inc., Endicott, N. Y. 208.6 meters, 1450 kilocycles, 50 watts. Sun, 12:30-2 pm, 7:30-9:30 pm. Thur, 7:30-10 pm. Eastern standard time. Slogan: "The Voice of the Triple Cities."

**WNBH** New Bedford Hotel, Pleasant st., New Bedford, Mass. 260.7 meters, 1150 kilocycles, 250 watts. Mon, Wed, Fri, 6-10:30 pm, musical program. Tues, Thur, Sat, 7-7:30 pm, news reports, sports. Eastern standard time. Slogan: "The Gateway to Cape Cod."

**WNBL** Bloomington, Ill. 199.9 meters, 1500 kilocycles, 15 watts.

**WNBO** Symplex Electrical & Radio Research Laboratories, George Washington Hotel, Washington, Pa. 211.1 meters, 1420 kilocycles, 15 watts. Sun, 11-12 noon, 10-11 pm, church services. Mon, Tues, Thur, Fri, 3:30-4:30 pm, 9-11:30 pm, orchestra, baseball, weather. Sat, 3:30-4:30 pm, 9:30-12 pm, orchestra, studio programs. Eastern standard time. Slogan: "The Voice of Washington, Pa."

**WNBQ** Rochester, N. Y. 202.6 meters, 1480 kilocycles, 15 watts.

**WNBR** Memphis, Tenn. 228.9 meters, 1310 kilocycles, 20 watts. Sun, 2:30 pm, musical program of sacred numbers. Mon, Thurs, Fri, Sat, 6:30 pm, musical program. Tues, 6:30 pm, Old Time Melody Makers. Wed, 6:30 pm, Bible talk. Central standard time.

**WNBW** Lonsdale Baptist Church, 122 W. Connecticut av., Knoxville, Tenn. 206.8 meters, 1450 kilocycles, 50 watts.

**WNJ** Herman Lubinsky, 89 Lehigh av., Newark, N. J. 280.2 meters, 1070 kilocycles, 500 watts. Daily ex Mon & Thur, 6-6:30 pm, 8:30-12 pm, dance music. Eastern standard time. Slogan: "The Voice of Newark."

**WNOX** Peoples Tel. & Tel. Co., 313 Commerce st., Knoxville, Tenn. 263.3 meters, 1130 kilocycles, 1000 watts. Mon, Wed, Fri, 12 noon-9 pm. Central standard time. Slogan: "Smoky Mountain Station."

**WNRC** Wayne M. Nelson, 7 W. 4th St., Greensboro, N. C. 223.7 meters, 1340 kilocycles, 250 watts.

# Electrify Your Radio Set!

the  
Sterling  
Way—

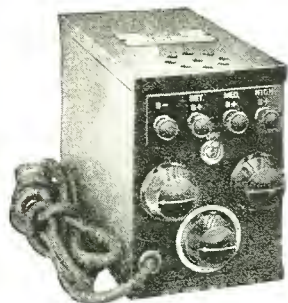
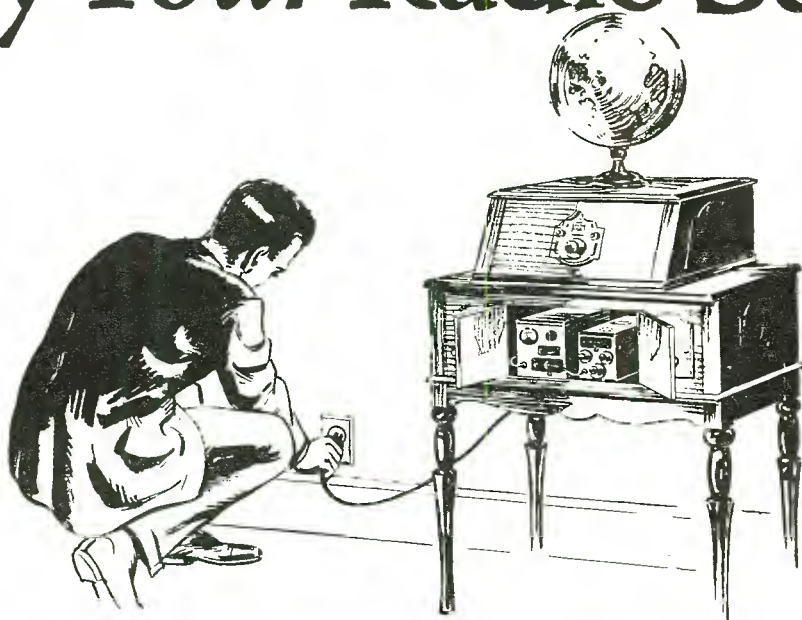

"B" Power R-81

For 3 to 8 tube sets including power tube. Output at 40 mls. is 160 volts. All three voltages, Detector, Medium and High, are adjustable within wide limits. On and Off switch. List Price, including Raytheon B-H tube,

\$28.50

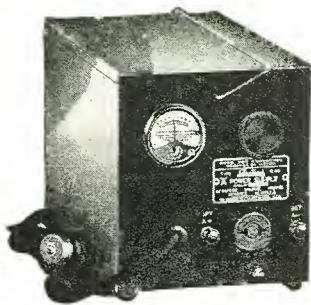

"A" Power R-96

Uses the famous Raytheon "A" unbreakable rectifier, silent, long-lived, non-heating. Has a steady output of 6 honest volts. Is meter equipped and fully automatic. Price complete,

\$47.00

—for *TONE* that will *AMAZE* you  
—for *POWER* that is *PERMANENT*

YOUR set may give you good results when batteries are fresh and strong, but its performance will reach new heights when it is operating by Sterling full-powered "A" and "B" units connected to your light socket. And, it will be *always* ready.

For as little as \$28.50, you can now equip your set with the improved Sterling "B" Socket Power Unit that not only does away with "B" batteries, but, because of its added feature of *exact current regulation*, brings out far finer tone quality than is obtained with the fixed units of "B" battery power.

Likewise, a Sterling "A" Socket Power Unit brings you steady, never failing "A" filament current. With these Sterling "A" and "B" Socket Power Units, complete control is reduced to one single switch.

Investigate Sterling Power Units. Hear the difference they make to reception, then think of the freedom from battery bother that will be yours when you install them. Remember, Sterling Power Units are backed by 21 years of electrical reliability and experience —your assurance of quality products throughout.

*A Sterling Demonstration will be a Revelation. Your Dealer will prove it.*

## Sterling

### Socket Power Units

THE STERLING MFG. COMPANY, 2831 PROSPECT AVE., CLEVELAND

Raytheon

Light-Socket Your Set the Sterling Way

Tell 'Em You Saw It in the Citizens Radio Call Book Magazine

**WNYC** City of New York, New York City, N. Y. 526 meters, 570 kilocycles, 500 watts, class B. Daily ex Sun, 6-11 pm. Mon, Wed, Fri, 11 am-12:30 pm. Sun, irregular. Eastern standard time. Slogan: "Municipal Broadcasting Station of the City of New York."

**WOAI** Southern Equip. Co., San Antonio, Tex. 302.8 meters, 990 kilocycles, 5000 watts. Sun, 11 am-7:45 pm, church services. Daily ex Sat, Sun, Mon, 8:30-9:30 pm, varied program. Central standard time. Slogan: "The Winter Playground of America."

**WOAN** The Vaughan School of Music, Lawrenceburg, Tenn. 285.5 meters, 1050 kilocycles, 250 watts. Daily ex Sun, 9-10 pm, musical. Central standard time. Slogan: "Watch Our Annual Normal."

**WOAX** Franklin J. Wolff, the Monument Pottery Co., Trenton, N. J. 239.9 meters, 1250 kilocycles, 500 watts. Daily ex Sun, 12:15-1 pm, music, weather forecast, etc. Wed, 7:30-9:30 pm, popular program. Fri, 7:30-9:30 pm, popular program. Fri, 7:30-8:30 pm. Sun, 7:30-8:30 pm, classical and dance orchestra. Eastern Standard time. Slogan: "Trenton Makes, the World Takes."

**WOBB** Longacre Engineering & Construction Co., 127 N. Dearborn st., Chicago, Ill. 555.2 meters, 540 kilocycles, 5 watts.

**WOC** The Palmer School of Chiropractic, 1002 Brady st., Davenport, Iowa. 374.8 meters, 800 kilocycles, 5000 watts. Sun, 11 am-12:15 pm, church; 12:15 pm-3 pm, WJZ & WEAJ programs; 4:30-5:30 pm, WEAJ program; 7-8 pm, church; 8:15-9:15 pm, Atwater-Kent Hour. Mon, Tues, Wed & Thurs 1:57 pm-6 pm. Mon, Tues, Wed, Thurs, Fri, 7:30-9:30 pm, WEAJ programs, etc. Sat, 12:27 pm, time signals; 12:30 pm, weather & markets; 5:45-6 pm, concert; 7:8 pm, musical; 8-9 pm, WJZ Philco Hour. Wed, 10 am-10:15 pm, WEAJ. Central Standard time.

**WOCL** A. E. Newton, Jamestown, N. Y. 223.7 meters, 1340 kilocycles, 25 watts. Sun, 10:30 am & 7:30 pm, church service. Mon, 9-9:15 pm, 9:15-12 midnight, educational feature popular program. Eastern standard time.

**WODA** The O'Dea Temple of Music, 115 Ellison st., Paterson, N. J. 293.9 meters, 1020 kilocycles, 1000 watts. Sun, 10:30 am, 7:30 am, church services. Daily ex Sun, 12-1 noon; 5-7 pm, studio; 8-11 pm, studio. Tues, 11:30-12:30 am, Nite Club. Thurs, 11-12 midnight, Nite Club. Fri, 10:30-11:30 pm, dance; 11:30-12:30 am, Nite Club. Eastern standard time. Slogan: "The Voice of the Silk City."

**WOI** Iowa State College, Ames, Iowa. 265.3 meters, 1130 kilocycles, 2500 watts night time, 5000 daytime. Daily ex Sun, 7 am, 7:45 am, 8:30 am, 9:30 am, 10:30 am, 1:30 pm, market reports, weather, etc. Daily ex Sun, 7:30 am, music; 10 am, educational program; 12:10 pm, chimes, educational program, etc. Mon & Thurs, 7:30 pm, 8 pm, entertainment. Sun, 10:45 am, chimes; 11 am, church. Central standard time.

**WOK** Neutrowound Radio Mfg. Co., Homewood, Ill. 252.0 meters, 1190 kilocycles, 5000 watts. Daily ex Sun, 6-7 pm, 8-9 pm, 11 pm-12:30 am. Sun, 6 pm-12 am, orchestra & popular program. Central standard time.

**WOKO** Harold E. Smith, Peekskill, N. Y. 215.7 meters, 1390 kilocycles, 250 watts. Mon, Thur, Sat, 7-12 pm. Tues & Fri, 7-12 pm, non-regular. Eastern standard time.

**WOKT** Titus-Ets Corp., 608 Terminal Bldg., Rochester, N. Y. 209.7 meters, 1430 kilocycles, 500 watts. Sun, 11 am-12:30 pm, religious. Daily ex Sun, 11:30 am-12 midnight, musical and educational programs. Eastern standard time. Slogan: "Where the Better Programs Are Broadcast From."

**WOMT** The Mikadow Theater, Manitowoc, Wis. 222.1 meters, 1350 kilocycles, 50 watts.

**WOO** John Wanamaker, Philadelphia, Pa. 508.2 meters, 590 kilocycles, 500 watts. Daily ex Sun, 11 am, music; 11:30, weather; 11:55 am, time signals; 12 noon, music; 4:40 pm, news reports; 4:45 pm, musical; 9:55 pm, time signals; 10:02 pm, weather report, Mon, Wed, Fri, 7:30-11 pm, concerts. Sun, 10:45 am or 7:45 pm, 2:15 pm, Sunday school musical program; 6 pm, organ recital. Eastern standard time.

**WOOD** Walter B. Stiles, Inc., Hotel Rowe, Grand Rapids, Mich. 260.7 meters, 1150 kilocycles, 500 watts. Sun, 9-10 pm. Daily ex Sun, 9-11 pm, popular request programs, vocal and dance programs. Central standard time. Slogan: "The Voice of the Whispering Pines."

**WOQ** Unity School of Christianity, 917 Tracy av., Kansas City, Mo. 336.9 meters, 890 kilocycles, 250 watts. Sun, 11 am-12:30 pm, 2:30-3 pm, 7:45-9 pm, church. Daily ex Sun & Thurs, 6-7 pm, concert; 11 pm, prayer service. Mon, 9-10 pm. Wed & Fri, 8-10 pm, concert. Sat, 10-11 pm, healing service. Central standard time.

**WOR** L. Bamberger & Co., 46 Bank st., Newark, N. J. 422.3 meters, 710 kilocycles, 500 watts. Mon, 3:45 pm, 5:15-12 pm. Tues & Thurs, 5:15-7:30 pm. Wed, 5:15-11 pm. Fri, 5:15-6:30 pm. Sat, 3 pm, 6:30-12 pm. Eastern standard time.

**WORD** Webster Hotel Studios, 2150 Lincoln Park West, Chicago, Ill. 275.1 meters, 1090 kilocycles, 5000 watts. Sun, 10-12 am, 2:30-5 pm, 7-10 pm. Daily ex Sun, Mon, 7-10 pm. Central standard time. Slogan: "The Watch Tower, Radio WORD." Divides time with Station WTAS.

**WOS** Missouri State Marketing Bureau, Board of Agriculture, Jefferson City, Mo. 468.5 meters, 640 kilocycles, 500 watts. Daily ex Sun, 9 am, markets, weather; 10 am, markets, stocks, weather; 11 am, markets, stocks & bonds, weather; 12 noon, grain market, stocks, weather; 1 pm, 2 pm, markets, weather; 3:30 pm, baseball scores; 4 pm, women's & children's hour; 5 pm, baseball scores; 7 pm, market review; 7:15 pm, news items. Central standard time. Slogan: "Watch Our State."

**WOW** The Voice of the Woodmen of the World Life Insurance Association, Headquarters Bldg., Omaha, Neb. 508.2 meters, 590 kilocycles, 10000 watts. Sun, 9-11 am, 2-3 pm, 4-5:30 pm, 6-11 pm, religious services. Daily ex Sun, 8-9 am & 10-11:30 am, stock reports and commercial instruction; 12:30-2 pm, stock reports & musical program; 3-5 pm, stock reports, news period & musical program; 6-7 pm, dinner concert; 7-11 pm, chain & other concert programs. Central standard time. Slogan: "The Omaha Station."

**WOWO** The Main Auto Supply Co., 215 W. Main st., Fort Wayne, Ind. 228.9 meters, 1310 kilocycles, 2500 watts night, 5000 watts daytime. Sun, 2-4 pm, 8-10 pm. Mon & Wed, 6 pm-12 midnight. Tues & Fri, 11 am-1 pm. Wed & Thurs, 12 noon-1 pm. Thurs, 6 pm-12 midnight. Fri, 4-5 pm, 8-10 pm. Sat, 12 noon-2 pm, 6-6:30 pm. Varied programs.

**WPAP** Palisade Amusement Park, Cliffside, N. J. 394.5 meters, 760 kilocycles, 500 watts.

**WPCC** North Shore Congregational Church, Chicago, Ill. 223.7 meters, 1340 kilocycles, 500 watts.

**WPCH** Concourse Radio Corp., Park Central Hotel, New York City, N. Y. 309.1 meters, 970 kilocycles, 500 watts. Mon, 7-9 pm, 10 pm-midnight. Tues, 4-7 pm. Wed, 6-10 pm. Thurs, 4-12 pm. Sat, 4-7 pm, 11 pm-2 am. Sun, 6:30 pm-midnight. Eastern standard time. Slogan: "Voice of Central Park."

**WPEP** Waukegan Pep Station; 140 Hazel Court, Waukegan, Ill. 215.7 meters, 1390 kilocycles, 250 watts. Sun, 3-5 pm, 7:30-9:30 pm, 10-12 pm. Daily ex Sun, Mon, 7:30-9:30 pm, 10-12 pm. All programs popular and semi-popular. Central standard time. Slogan: "Where Pep Entertains Public."

**WPG** Municipality of Atlantic City, Atlantic City, N. J. 272.6 meters, 1100 kilocycles, 2500 watts. Sun, 3:15 pm until 12 midnight. Mon, Tues, Thur, Fri & Sat, 1:30 pm-midnight. Eastern standard time.

**WPRC** Wilson Printing & Radio Co., 1740 5th st., Harrisburg, Pa. 209.7 meters, 1430 kilocycles, 100 watts. Sun, 9-11 pm, 1st & 3rd Mon, 9-11 pm. Eastern standard time. Slogan: "The Capital City of the Keystone State."

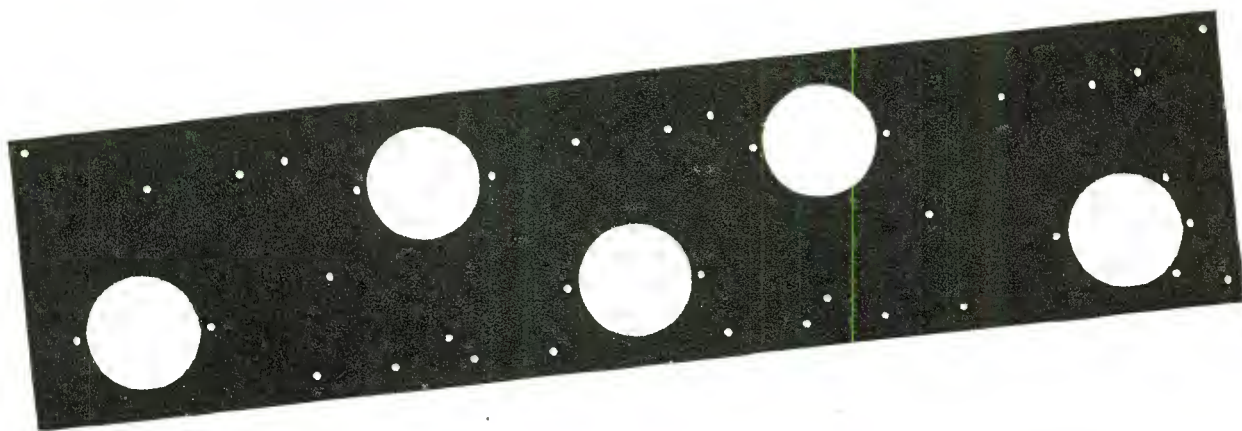

## Build Your Kit With Formica Front and Sub-Panels!

**F**ORMICA panels for well known kits are, in many cases accompanied by a drilled sub-panel made to the designers' layout. These sub-panels make assembly of the set very easy and make it certain that the placement of all the apparatus will be as the designer intended.

The Formica front panels, splendidly decorated by the Veri Chrome process, make it possible to build as fine a looking set as it is possible to build.

Well known kits of the new season for which both front and sub-panels are available, are:

*Magnaformer*

*Karas New Two Dial*

*World's Record Super Ten*

*Camfield Nine*

*Tyrman*

*H. F. L. New Superheterodyne*

There are also front panels for the new Madison-Moore International "One Spot" and E. T. Flewelling's Super Eight.

Victoreen, Bremer Tully Power Six, St. James, Melo-Heald, and many others may also be had.

These panels are carried in stock by most jobbers who handle the kits themselves. Any jobber can get them for you.

### THE FORMICA INSULATION COMPANY

4666 Spring Grove Avenue

Cincinnati, Ohio

**FORMICA**  
Made from Anhydrous Bakelite Resins  
**SHEETS TUBES RODS**

*Tell 'Em You Saw It in the Citizens Radio Call Book Magazine*

**WPSC** Pennsylvania State College Dept. of Elec. Engineering, State College, Pa. 299.8 meters, 1000 kilocycles, 500 watts. Mon, Wed & Fri, 7-11 pm. Eastern standard time. Slogan: "The Voice of the Titany Lion."

**WRAH** Stanley N. Read, 191 Alabama av., Providence, R. I. 199.9 meters, 1500 kilocycles, 250 watts.

**WRCO** Wynne Radio Co., 8 W. Hargett st., Raleigh, N. C. 217.3 meters, 1380 kilocycles, 250 watts. Sun, 10:45 am. Irregular programs at present. Eastern standard time.

**WPSW** Philadelphia School of Wireless Telegraph, Philadelphia, Pa. 202.6 meters, 1480 kilocycles, 50 watts. Wed, 7 pm, radio questions & answers. Fri, 7 pm, talks on radio, care & operation. Eastern standard time. Slogan: "First Wireless School in America."

**WRAK** Economy Light Co., 1105 Ludington st., Escanaba, Mich. 282.8 meters, 1060 kilocycles, 50 watts. Sun, 6:30-8 pm, classical. Mon and Fri, 10:30-11 am, household hints and weather forecast; 6:30-7:00 pm, late news and weather forecast followed by musical program. Tues & Thurs, same as Mon & Fri. Wed, 10:30-11:30 am, household hints & weather forecast. Sat, 10:30-11 am, household hints & weather forecast; 6-6:30 pm, late news & weather forecast, followed with dance program. Eastern standard time. Slogan: "The Gateway to Cloverland."

**WRCV** Radio Corp. of Virginia, Norfolk, Va. 209.7 meters, 1430 kilocycles, 100 watts. Wed, Fri, Sat, 2-5 pm, 7:30-9 pm. Sun, 10:30 am-12:15 pm, 7:15-8:45 pm, Eastern standard time. Slogan: "The Voice of the Business District."

**WQAA** Horace A. Beale, Jr., Parkersburg, Pa. 215.7 meters, 1390 kilocycles, 500 watts. Eastern standard time.

**WRAM** Lombard College, Galesburg, Ill. 247.8 meters, 1210 kilocycles, 50 watts. Mon, 7 pm, bedtime stories; 8 pm, educational; 9-11 pm, musical. Central standard time.

**WREC** Wooten's Radio & Elec. Co., Whitehaven, Tenn. 254.1 meters, 1180 kilocycles, 50 watts. Daily 8-9 pm. Sun, 4-5:30 pm. Central standard time. Slogan: "The Most Powerful 10-Watt Station in the World."

**WQAM** Electrical Equipment Co., 42 N. W. 4th st., Miami, Fla. 322.4 meters, 930 kilocycles, 750 watts. Sun, 10:45 am-12 noon, 8-9:15 pm, church. Daily ex Sun, 11:45 am-12:15 pm, organ, time signals, weather, stock reports: 7-8:15 pm, organ, dance orchestra, weather, baseball results & studio programs.

**WRAW** Antioch College, Yellow Springs, Ohio. 340.7 meters, 880 kilocycles, 100 watts. Thurs, 9-10 pm. Sun, 7 pm. Central standard time.

**WREN** Jenny Wren Co., Lawrence, Kan. 254.1 meters, 1180 kilocycles, 750 watts.

**WQAN** Scranton Times, 222 Spruce st., Scranton, Pa. 230.6 meters, 1300 kilocycles, 100 watts. Daily ex Sun, 12:30-1 pm, 4:30-5 pm. Tues & Fri, 8-10:30 pm. Sat, 10:30-12 pm. Eastern standard time. Slogan: "The Voice of the Anthracite." Divides time with WGBI, Scranton, Pa., Mon, Wed, Thur, nights, & Tues, Fri, 6:45-7:55 pm.

**WRAW** Avenue Radio & Electric Shop, 460 Schuylkill av., Reading, Pa. 238 meters, 1260 kilocycles, 100 watts. Sun, 11 am, 1:30-3 pm. Tues, 8 pm. Thur, 8-10 pm. Eastern standard time. Slogan: "The Schuylkill Valley Echo."

**WREO** The Reo Motor Car Co., Lansing, Mich. 230.6 meters, 1300 kilocycles, 500 watts. Daily ex Sun, 6-7 pm. Tues, Thurs, 8:15-10 pm. Sat, 10-12 midnight. Sun, 10 am, chimes; 10:30 am & 7:30 pm, church services. Eastern standard time. Slogan: "Home Port of the Flying Cloud."

**WQAO** Calvary Baptist Church, Cliffside, N. J. 394.5 meters, 760 kilocycles, 500 watts. Wed, 8-9 pm, mid-week evening services. Sun, 11 am-12:30 pm, church services; 3-4:30 pm, Bible study class; 7:45-9:30 pm, evening services. Eastern standard time. Slogan: "The Bible, the Whole Bible and Nothing but the Bible."

**WRAX** Berachan Church (Inc.), 1608 Alleghany av., Philadelphia, Pa. 288.3 meters, 1040 kilocycles, 250 watts. Eastern standard time.

**WRES** Harry Leonard Sawyer, Quincy, Mass. 217.3 meters, 1380 kilocycles, 50 watts. Mon & Thurs, 8 pm, entertainment.

**WQJ** Calumet Broadcasting Co., operated by Chicago Daily News, Hotel La Salle, Chicago, Ill. 447.5 meters, 670 kilocycles, 500 watts. Sun, 10:45 am-12:30 pm, 9:15-12 pm. Mon, 11 am-12 noon, 3-4 pm. Tues, 11-12 noon, 3-4 pm, 7-8 pm, 10-12 midnight. Wed, Thur, Fri, Sat, 11 am-12 noon, 3-4 pm, 7-8 pm, 10-12 pm, 12 midnight-2 am. Central standard time.

**WRBC** Immanuel Lutheran Church, Valparaiso, Ind. 238.0 meters, 1260 kilocycles, 250 watts. Sun, 7:30-9 pm, church service. Mon, 7:30-9 pm, diversified program. Central standard time. Slogan: "World Redeemed by Christ."

**WRHF** Washington Radio Hospital Fund, Colorado Bldg., Washington, D. C. 322.4 meters, 940 kilocycles, 150 watts. Daily ex Sun, 11 am-12 noon, news & current events. Eastern standard time.

**WRAF** The Radio Club (Inc.), 719 Michigan av., LaPorte, Ind. 208.2 meters, 1440 kilocycles, 100 watts. Sun, 10:45 am-12:15 pm, church services. Daily ex Sun, 12:15-7 pm. Central standard time. Slogan: "The Voice of the Maple City."

**WRBL** Farmington, N. Y. 201.6 meters, 1490 kilocycles, 30 watts.

**WRHM** Rosedale Hospital (Inc.), Nicollet & 44th st., Minneapolis, Minn. 260.7 meters, 1150 kilocycles, 1000 watts. Sun, 9:15 am, 10 am, Children's Bible stories; 11 am, church; 6:30 pm, dramatic hour; 7:45 pm, church; 9:30 pm, lecture. Mon, Wed, Fri, 9 am, Housewife's Hour. Daily ex Sun, 12 noon-2 pm, concert; 5-6 pm, Commercial Hour; 6 pm, dinner concert; 8 pm, popular; 9 pm, dance program. Central standard time. Slogan: "Welcome Rosedale Hospital, Minneapolis." Divides time with Station WDGy, Minneapolis.

**WRC** Radio Corporation of America, 3308 14th st., N. W., Washington, D. C. 468.5 meters, 640 kilocycles, 500 watts. Sun, 11 am-12:30 pm, church services; 4-5:30 pm, church; 6:20-10:15, musical. Mon, Tues, Wed, Thur, Fri & Sat, 6:45 am to 11 pm, varied. Eastern standard time. Slogan: "The Voice of the Capital."

**WRK** John C. Slade, R. R. No. 3, Hamilton, Ohio. 205.4 meters, 1460 kilocycles, 100 watts. Sun, 2:30-3:30 pm. Daily ex Sun, 1-2 pm. Mon, Wed, 8-10 pm. Tues, Thur, 7-9 pm. Fri, 6-12 pm. Sat, 6-7 pm, 8-11 pm. Eastern standard time. Slogan: "The Voice of the Miami Valley."



Every



# ALL-AMERICAN

TRADE MARK

## Audio Unit Guarantees / Natural Reproduction!

**F**INER radio reproduction than you have ever before experienced . . .

All those finer over-tones retained in their true and natural value, without muffle or distortion . . .

Smooth, flawless amplification . . . not a distorted note anywhere over the entire musical range . . . here is just what radio manufacturers and the public have been hoping to see developed!

All this is **GUARANTEED** by the makers of **ALL-AMERICAN** Audio Units.

These points of superiority have placed All-American in a position of leadership since 1919 . . . have made **ALL-AMERICAN'S** the largest selling transformers in the world.

**ALL-AMERICAN** Audio Units as shown here are the final refinement in radio manufacture. Any dealer, distributor or manufacturer will find it worthwhile to get the latest illustrated descriptive booklets—mailed free on request.

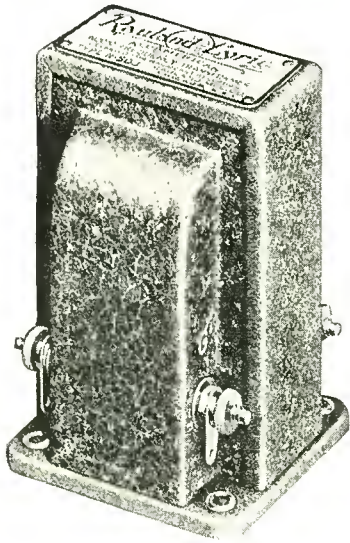

*Rauland-Lyric Audio Transformer. Type R-500. Price . . . \$9.00*

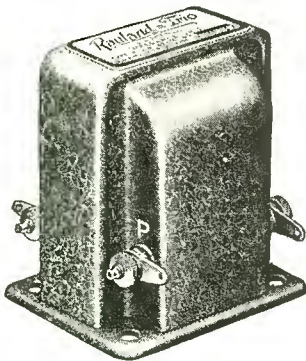

*Rauland-Trio Impedance Unit. Type R-300, for Intermediate Stage. Price . . . \$6.00 Type R-310, for Final Stage. Price . . . \$6.00*

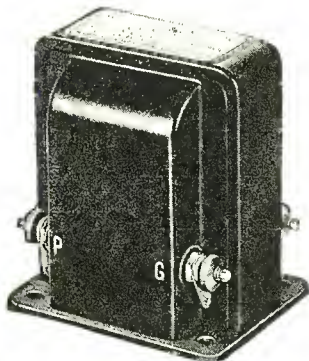

*Audio Transformer  
Type R-14, 3 to 1 Ratio, \$4.50  
Type R-15, 5 to 1 Ratio, \$4.50  
Type R-13, 10 to 1 Ratio, \$4.50*

**ALL-AMERICAN RADIO CORPORATION**

**4221 Belmont Avenue  
Chicago, Ill.**

**WRM** University of Illinois, Urbana, Ill. 272.6 meters, 1100 kilocycles, 500 watts. Sun, 3:45-4 pm, chimes; 4-5 pm, organ. Mon, Tues, Wed, Thurs, Fri, 5-6 pm, music & lectures. Tues, 7-8 pm, recital. Athletic events broadcast. Central standard time.

**WRMU** Atlantic Broadcasting Corp., New York City, N. Y. (Portable). 201.6 meters, 1490 kilocycles, 100 watts. Unlimited schedule. Eastern standard time.

**WRNY** Radio News, Hotel Roosevelt, 45th st. & Madison av., New York City, N. Y. 309.1 meters, 970 kilocycles, 500 watts. Sun, 10:30-1 pm, 1-7 pm. Mon, Wed, 10:30 am-7 pm. Wed, 9-12 midnight. Tues, 10:30-12. Thus, 10:30-1. Sat, 11 am-1, 7-9 pm. Eastern standard time. Divides time with Station WPCB.

**WRPI** Rose Polytechnic Institute, Hotel Deming, Terre Haute, Indiana. 208.2 meters, 1440 kilocycles, 100 watts. Sun, 9:30 am-12 noon, church. Daily ex Sun, 7 pm, markets. Mon, Wed, Fri, 8 pm, Popular programs. Central standard time. Slogan: "On the Banks of the Wabash."

**WRR** Municipal Station, Jefferson Hotel, Dallas, Tex. 352.7 meters, 850 kilocycles, 500 watts. Daily ex Sun and Wed, 12 noon-1 pm, 6-7 pm, 8-9 pm. Mon & Thurs, 11 pm-midnight. Mon, 9:30-10:30 pm. Fri, 8-10 pm. Sun, 10:45 am-12 noon, 7:30-9 pm, 9:30-10:30 pm. Thurs, 9-10 pm. Central standard time. Slogan: "City of Achievements."

**WRRS** Racine Broadcasting Corp., Hotel Racine, Racine, Wis. 322.4 meters, 930 kilocycles, 50 watts.

**WRSC** The Radio Shop (William S. Pote), 56 Washington av., Chelsea, Mass. 211.1 meters, 1420 kilocycles, 100 watts.

**WRST** Radiotel Mig. Co., Inc., 76 Main st., Bay Shore, N. Y. 211.1 meters, 1420 kilocycles, 250 watts. Daily ex Sun, 12 noon-1 pm. Mon, Wed & Fri, 7-11:30 pm, concerts. Tues & Thurs, 8-11:30 pm. Sat, 7-11:30 pm. Sun, 11 am-12:45 pm, church services; 7-11 pm, musical concert. Eastern standard time. Slogan: "Bay Shore, Garden Spot of Long Island."

**WRVA** Edgeworth Tobacco Station, Richmond, Va. 254.1 meters, 1180 kilocycles, 1000 watts. Mon, Wed, Fri, 12 noon-2 pm, 8 pm-12 midnight. Tues, Thurs, 12 noon-1 pm. Thurs, 8 pm-12 midnight. Sun, 11 am-1 pm, 8-10 pm. Eastern standard time. Slogan: "Carry Me Back to Old Virginnny."

**WSAI** United States Playing Card Co., Cincinnati, Ohio. 361.2 meters, 830 kilocycles, 5000 watts. Sun, 11 am, church services; 4 pm, Dr. Cadman; 7:45 pm, chimes; 8 pm, sermon; 9:15 pm, Atwater-Kent Hour. Mon, 7-10 pm, musical, grand opera. Daily ex Sun, Mon, Fri, Sat, 7-10:30 pm. Sat, 7:30-12 midnight. Eastern standard time. Slogan: "The Gateway to Dixie."

**WSAJ** Grove City College, Grove City, Pa. 223.7 meters, 1340 kilocycles, 250 watts. Irregular schedule. Eastern standard time.

**WSAN** Allentown Call Publishing Co., Inc., Allentown, Pa. 222.1 meters, 1350 kilocycles, 100 watts. Tues, Thurs & Sats, 8:15 pm, musical. Eastern standard time. Slogan: "We Serve Allentown Nationally."

**WSAR** Doughty & Welch, Elec. Co., 46 N. Main st., Fall River, Mass. 252.0 meters, 1190 kilocycles, 100 watts. Daily ex Sun, 12-1 pm. Sun, 10:30-12 m. Eastern standard time.

**WSAX** Zenith Radio Corp., 3620 Iron st., Chicago, Ill. 204.0 meters, 1470 kilocycles, 100 watts. (Portable.) Central standard time.

**WSAZ** McKellar Electric Co., 1143 4th av., Huntington, W. Va. 241.8 meters, 1240 kilocycles, 100 watts. Sun, 9 am-1 pm, 3-4 pm, 7:30-9 pm, 10-11 pm. Daily ex Sun, 12 noon-1 pm, 5:30-6:30 pm, 9:30-12: midnight. Eastern standard time.

**WSB** The Atlanta Journal, care Biltmore Hotel, Atlanta, Ga. 475.9 meters, 630 kilocycles, 1000 watts. Sun, 9:30 am-5 pm, church services. Daily ex Sun, 10 am, homemakers' half hour, market reports, etc.; 10:30 am, public school program; 12 noon, organ recital, songs, etc.; 1 pm, Radio Farm Service; 2:30 pm, market reports, etc.; 6 pm, public school program; 6:20 pm, garden message. Mon, 8 pm, Sears-Roebuck Agricultural Foundation program; 10:45 pm, concert, organ, skylark, etc. Tues, 8 pm, church choir. Thurs, Fri, Sat, 8 pm, club, orchestra, etc. Central standard time. Slogan: "The Voice of the South."

**WSBC** The World Battery Company Station, 1219 S. Wabash av., broadcasting from New Southern Hotel, Chicago, Ill. 232.4 meters, 1290 kilocycles, 500 watts. Sun, 5-7 pm, classical; 9:30 pm-1 am, popular. Mon, 5-7 popular program. Tues, Wed, Thur, Sat, 5-7 pm, 9:30 pm-1 am, popular program. Fri, 6-8 pm, 9 pm-1 am, popular program. Central standard time. "World Storage Battery Company."

**WSBF** Stix, Baer & Fuller, 6th & Washington av., St. Louis, Mo. 440.9 meters, 680 kilocycles, 250 watts. Sun, 9-10 pm, theater. Mon, 1 pm, 3-4 pm. Tues, 1 pm, 3-4 pm, popular. Wed & Fri, 12 noon-1 pm, 3-4 pm, music. Thurs, 12 noon-1 pm, 3-4 pm, popular. Sat, 12 noon-1 pm, 3-4 pm. Daily ex Sun, 7:30-11 pm, studio program. Central standard time.

**WSBT** South Bend Tribune, South Bend, Ind. 238 meters, 1260 kilocycles, 500 watts. Sun, 11 am-12 noon, church. Mon, 7:30-10:30 pm, 12 midnight-1:30 am, popular program. Wed, 8-10 pm, 12 midnight-1 am. Fri, 7:15-10 pm, classical, 12 midnight-1 am. Central standard time.

**WSEA** The Virginia Beach Broadcasting Co., Norfolk, Va. 263 meters, 1140 kilocycles, 500 watts. Daily ex Sun, 11 am-2 pm, music; 5 pm, stocks, talks, police & weather forecast; 6 pm, news flashes; 6:45 pm, dinner music; 7 pm-10 pm, studio; 10-11 pm, organ; 11 pm-12 midnight, dance music. Sun, 3-5 pm & 7-9 pm, concerts. Eastern standard time. Slogan: "The Voice of Tidewater Virginia."

**WSIX** Springfield, Tennessee. 212.6 meters, 1410 kilocycles, 150 watts.

**WSKC** World's Star Knitting Co., Bay City, Mich. 374.8 meters, 800 kilocycles, 500 watts. Daily ex Sun, 12 noon-1 pm, music. Tues, Thurs, Sat, 9-11 pm. Sat, 12 midnight-2 pm. Sun, 11 am. Eastern standard time. Slogan: "Where the Summer Trails Begin."

**WSM** The National Life and Accident Ins. Co., Inc., Seventh av. N. & Union st., Nashville, Tenn. 340.7 meters, 880 kilocycles, 5000 watts. Sun, 5:20-6:20 pm, 11-12 am, 7:45-9 pm. Daily ex Sat, Sun, 11:45-12:30 noon, 1-1:30 pm, 5:30-11 pm. Sat, 7-11 pm. Central standard time. Slogan: "We Shield Millions."

**WSMB** Saenger Theatres, Inc., & Maison Blanche Dept. Stores, 1401 Tulane av., New Orleans, La. 322.4 meters, 930 kilocycles, 500 watts. Daily ex Sun, 12:30-1:30 pm, 6-7 pm. Mon, Wed, Thurs & Sat, 8:30-10:30 pm, entertainment. Central standard time. Slogan: "America's Most Interesting City."

**WSMK** S. M. Krohn, Jr., 20th fl. U. B. Bldg., Dayton, Ohio. 296.9 meters, 1010 kilocycles, 200 watts. Daily ex Thurs & Sun. 9-11 am, shippers guide; 12-1 noon, dinner bell program, 6-10 pm, studio program. Sat, 11 pm-3 am Sun. Central standard time. Slogan: "The Home of Aviation."

**WSOE** School of Engineering of Milwaukee, Oneida & Jackson sts., Milwaukee, Wis. 270.1 meters, 1110 kilocycles, 500 watts. Sun, 3:30-4:30 pm, 7:30-8:30 pm. Daily ex Sun & Fri, 2:30-3:30 pm, music; 5:15-6 pm, 6:10-7 pm, organ; 8-11 pm, music, etc. Thurs, 8-9 pm, church. Fri, 11 am-12 noon; 2:30-3:30 pm; 5:15-5:50 pm; 5:10-6 pm, talk; 7:45 pm, book review; 8-11 pm, music.

# PERFECT RADIO PARTS

## *for Discriminating Set Builders*



### Bradleyunit-A

is a fixed resistor that is not affected by temperature, moisture, or age. It is a solid unit molded and heat-treated under high pressure and does not rely on glass or hermetic sealing for protection against moisture. The silver-plated end-caps can be soldered without affecting the accuracy of the Bradleyunit. The ideal fixed resistor for B-eliminator hookups, grid leaks, and for set hookups requiring a fixed resistance of a precise unvarying value. Inspect a Bradleyunit-A at your nearest radio dealer's.

When you build a set or a B-eliminator, demand Allen-Bradley Perfect Radio Resistors. Allen-Bradley parts have been perfected through many years of experience in service. The scientifically-treated discs in the variable resistor units do not deteriorate in service. They are not affected by temperature, moisture, or age. For perfect operating results, buy Allen-Bradley radio resistance units by name.

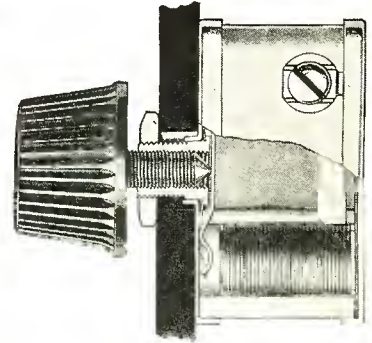

### Bradleyohm-E

provides accurate voltage control in a wide range of values. It is used as standard equipment for accurate plate voltage control by leading B-eliminator manufacturers. Scientifically-treated discs in the Bradleyohm-E provide stepless, noiseless plate voltage control. Resistance does not vary when the correct value is once selected.

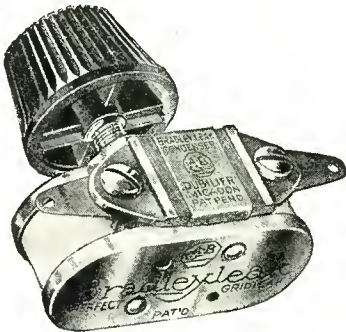

### Bradleyleak Bradleystat

A variable grid leak that provides perfect grid leak adjustment, thereby providing the best possible results with any tube you may use.

The ideal filament control. Gives noiseless, stepless control for all tubes. Can be easily installed in place of wire wound rheostats in service.



ALLEN-BRADLEY COMPANY, 488 CLINTON STREET  
MILWAUKEE, WISCONSIN

# Allen-Bradley

## PERFECT RADIO RESISTORS

*Tell 'Em You Saw It in the Citizens Radio Call Book Magazine*

**WSOM** Union Course Laboratories, 9024 78th st., Woodhaven, N. Y. 245.8 meters, 1220 kilocycles, 500 watts. Sun, 12:30-4 pm. Mon, Wed, Fri, 1-6 pm, 11-12 pm. Tues, 1-6 pm, 9-12 pm. Thur, 1-6 pm. Eastern standard time. Divides time with WAAT & WGBB.

**WSRO** Radio Company (Harry W. Fahrlander), Central & Canal sts., Midleton, Ohio. 384.4 meters, 780 kilocycles, 100 watts. Tues & Fri, 8-10 pm. Sun, 2-4 pm. Central standard time. Slogan: "We Sell Radio Only."

**WSSH** Tremont Temple Baptist Church, Boston, Mass. 288.3 meters, 1040 kilocycles, 100 watts. Sun, 10:15 am-12 noon, 6:30-9 pm. Fri, 7:30-9 pm. Eastern standard time. Slogan: "Stranger's Sunday Home."

**WSUI** State University of Iowa, Capitol & Washington sts., Iowa City, Iowa. 422.3 meters, 710 kilocycles, 500 watts. Sun, 9 pm, hymns. Daily ex Sun, 9 am, markets, weather forecast; 10:30 am & 12:25 pm, news, music; 5:30 pm, radio review. Wed, 9:10 am, high school program. Athletic contests broadcast. Central standard time. Slogan: "The Old Gold Studio."

**WSVS** Seneca Vocational School, 666 East Delavan av., Buffalo, N. Y. 205.4 meters, 1460 kilocycles, 50 watts. Wed, 7:40-8 pm, code lessons; 8-9:30 pm, musical program. Fri, 8-9:30 pm, musical program. Eastern standard time. Slogan: "Watch Seneca Vocational School."

**WSYR** Voice of Central New York, Hotel Syracuse, N. Y. 225.4 meters, 1330 kilocycles, 500 watts. Sun, 7:30 am, church services; 6:30-7:30 pm, dinner concert. Daily ex Sun, 6:20 pm-10:30 pm, varied programs. Eastern standard time.

**WTAD** Illinois Stock Medicine Broadcasting Corp., Quincy, Ill. 236.1 meters, 1270 kilocycles, 250 watts. Sun, 11-12 am, 2:30-3:30 pm, 10-12 pm. Daily ex Sun, 11:30 am-12:45 pm, 6:30-8:30 pm. Central standard time.

**WTAG** Worcester Telegram-Gazette Broadcasting Station, 18 Franklin st., Worcester, Mass. 516.9 meters, 580 kilocycles, 500 watts. Sun, 4-10:25 pm. Daily ex Sat & Sun, 10:30-11 am, 12:30-1:05 pm, 7:30-10:10 pm. Sat, 12:30-1:05 pm, 8-11:10 pm. Eastern standard time. Slogan: "The Voice from the Heart of the Commonwealth."

**WTAL** Toledo Broadcasting Co., Waldorf Hotel, Toledo, Ohio. 280.2 meters, 1070 kilocycles, 100 watts. Sun, 10:45 am-9:30 pm. Daily ex Sat & Sun, 6-11 pm. Sat, 8-12 pm. Divides time with Station WABR. Eastern standard time. Slogan: "The Gateway of the Sea."

**WTAM** Willard Storage Battery Co., 1100 Chester av., Cleveland, Ohio. 399.8 meters, 750 kilocycles, 3500 watts. Sun, 11 am-2 pm, 3-4:30 pm, 6-11:15 pm. Mon, Tues, Wed, Thurs, Fri, Sat, 10:45-11:30 am, 12:30-1:30 pm, 2:30-3:30 pm, 6 pm-12 midnight. Eastern standard time. Slogan: "The Voice from the Storage Battery."

**WTAQ** Gillette Rubber Co., Eau Claire, Wis. 254.1 meters, 1180 kilocycles, 500 watts. Sun, 11 am, church service. Mon, Wed, Thurs, Sat, 12:15 pm, weather, news, etc. Daily ex Sun & Sat, 6 pm, markets, news, etc. Mon & Wed, 6:30 pm, dinner hour. Tues & Fri, 12 noon, luncheon program. Mon, 7:30 pm, theater hour. Mon & Thurs, 10 pm. Tues & Thurs, 9 pm, concert. Fri, 8 pm, studio program.

**WTAR** Reliance Elec. Co., Inc., 519 W. 21st ave., Norfolk, Va. 275.1 meters, 1090 kilocycles, 500 watts. Daily ex Sun, 6 pm, weather, markets & news. Eastern standard time. Slogan: "Down in Old Virginia."

**WTAS** Illinois Broadcasting Corp., R.F.D., Elgin, Ill. 275.1 meters, 1090 kilocycles, 3500 watts. Sun, 10 am-1 pm. Daily ex Sun, 12 noon-2:30 pm, 6-7 pm, 10 pm-1 am. Central standard time. Slogan: "Willie, Tommy, Annie, and Sammy."

**WTAW** Agricultural & Mechanical College of Texas, College Station, Texas. 309.1 meters, 970 kilocycles, 500 watts. Sun, 11 am. Mon, Tues, Wed, Thurs & Fri, 12:15 pm. Central standard time.

**WTAX** Williams Hardware Co., 115 S. Vermillion st., Streator, Ill. 322.4 meters, 930 kilocycles, 50 watts. Mon, 8-10 pm, Studio program. Wed, Fri, 8-10:30 pm, studio program. Thur, 9-11 pm, dance program. Central standard time. Slogan: "Tappa Kugga Nails."

**WTAZ** Thomas J. McGuire, 48 N. Main st., Lambertville, N. J. 220.4 meters, 1360 kilocycles, 15 watts. Mon, 8-10 pm, musical. Eastern standard time.

**WTHO** W. J. Thomas Radio, Hotel Whittier, Burns Drive & East Jefferson st., Detroit, Mich. 218.8 meters, 1370 kilocycles, 250 watts. Mon, Wed, Fri, 6-7 pm, dinner music; 8-9 pm, studio; 10-12 pm, studio & dance music. Tues, Thurs, Sat, 7-8 pm, dinner music; 9-19 pm, dance music. Eastern standard time. Alternate hours not scheduled above used by WAFD, Hotel Addison, Detroit, Michigan.

**WTIC** The Travelers Insurance Co., 700 Main st., Hartford, Conn. 535.4 meters, 560 kilocycles, 500 watts. Daily, 11:45 am-12:15 pm, 6-11 pm. Mon, Tues, Thurs, Fri, 11:45 am-1 pm. Mon, 6-11:30 pm. Sun, 6-7 pm. Eastern time. Slogan: "The Insurance City."

**WTMJ** The Milwaukee Journal Station, Milwaukee, Wis. 293.9 meters, 1020 kilocycles, 1000 watts. Sun, 11 am-12 noon, studio trio; 12-12:30 pm, comics; 12:30-2:30 pm, organ, music, etc.; 2:30-5:15 pm, Little Symphony; 5:15-6:15 pm, trio; 6:15-7:15 pm, Chain from New York; 7:15-8:15 pm, Hour of Classics; 8:15-10 pm. Daily ex Sun, 10-11 am, 11-11:30 am, news, talks; 11:30 am-12:30 pm, organ; 12:30-1 pm, 2-5:15 pm; 6:15-7:30 pm, music; 8:15-9:45 pm, concert; 10:30-11:30 pm, dance music. Central standard time.

**WTRC** 20th Assembly District Regular Republican Club, 62 Woodbine st., Brooklyn, N. Y. 204.0 meters, 1470 kilocycles, 50 watts. Sun, 2-6 pm, general entertainment. Mon, 8-11 pm, musical program, sports, news items. Tues, Wed, Fri, 7-11 pm, general program. Eastern time.

**WTRL** Technical Radio Laboratory, 28 Sicomac av., Midland Park, N. J. 206.8 meters, 1450 kilocycles, 15 watts. Sun, 2-4 pm, religious program. Tues, Fri, 7-9 pm, Sports & dance music. Eastern standard time.

**WWAE** C. F. Courier, 2295 S. Wabash av., Chicago, Ill. 227.1 meters, 1320 kilocycles, 500 watts class A. Daily ex Sun, 12:30-1:30 pm, 9-12 midnight. Sun, 10:50-12:15 pm, church; 3:30-4:30 pm, musical. Central standard time.

**WWJ** Detroit News, Detroit, Mich. 374.8 meters, 800 kilocycles, 1000 watts. Sun, 7:20 pm, same as WEAJ. Daily ex Sat & Sun, 6 pm, dinner concert; 8 pm, entire program from WEAJ. Eastern standard time.

**WWL** Loyola University, New Orleans, La. 275.1 meters, 1090 kilocycles, 100 watts. Sat, 7:30-8:30 pm. Central standard time.

**WWNC** Chamber of Commerce, Asheville, N. C. 296.9 meters, 1010 kilocycles, 1000 watts. Sun, 11 am & 8 pm, church; 4-5 pm, musical program; 9-10 pm, organ. Daily, 1-2 pm. Mon, 7 pm-12 midnight. Thurs, 7-10:45 pm. Eastern standard time.

**WWRL** W. H. Reuman, 4130 58th st., Woodside, L. I., N. Y. 267.7 meters, 1120 kilocycles, 100 watts. Sun, 1-7:30 pm, 8:30-10 pm, popular program. Daily ex Sun, 11 am-12 noon. Mon, Tues, Thurs, Sat, 1-2 pm. Mon, Fri, 10-12 pm, mixed program. Tues, Sat, 12 midnight-2 am. Wed, Thurs, 8-10 pm, mixed program. Eastern standard time. Slogan: "Long Island Broadcast Laboratories." Divides time with Stations WMBS, WKBN, WIBI.

**WWVA** John C. Strobel, Jr., National Road, Wheeling, W. Va. 389.4 meters 770 kilocycles, 100 watts. Daily ex Sun, 6:45 am, 7:45 am, 2 pm, 6 pm, exercises. Sun, 3:30 pm. Y.M.C.A. Mon, 7-11 pm. Sat, 11 pm-1:30 am. Mountaineer Club. Eastern standard time.

**AMERTRAN AMERTRAN AMERTRAN AMERTRAN**

## New—AMERTRAN Push-Pull and Power Transformers

A STAGE of AmerTran Push-Pull with power tubes, following a first stage AmerTran De Luxe, provides even greater energy output to the speaker with less distortion than can be obtained with a single power tube. With push-pull amplification, tube distortion and harmonics are suppressed and the slight hum, caused by raw AC on the filaments of the power tubes, is eliminated.

The AmerTran Push-Pull Input and Output Transformers use high permeability alloy cores with multiple windings so arranged and balanced as to give high inductive coupling and low capacity coupling. The Input Transformer, which works out of the plate of one amplifying tube into the grids of two power tubes, has approximately the same primary impedance as the second stage AmerTran De Luxe. It is suitable for use ahead of any pair of standard power tubes.

The plate impedance of two tubes connected push-pull is double the impedance of a single tube. Since various types of power tubes have different values of plate impedance, this company provides output transformers of different types to correspond with the power tubes and the speakers which are in most general use. The impedance ratios are calculated for the greatest transfer of energy at frequencies from 60 to 100 cycles, because at these low frequencies more energy is required to drive the loud speaker mechanism.

AmerTran Push-Pull Transformers are now available in these types:

**Push-Pull Input Type 151—\$15.00 each.**

**Push-Pull Output Type 151 (Impedance ratio 4:1), for two UX-210's or similar power tubes—\$15.00 each.**

**Push-Pull Output Type 271 (Impedance ratio 2:1), for two UX-171 tubes connected push-pull—\$15.00 each.**

Type PF-281. AmerTran Power Transformer (\$25.00) becomes virtually an A-B-C eliminator when used with AC tubes and the proper filter circuit for DC voltages of from 425 to 650 volts, plate current 110 Ma. This unit is designed for use with the new UX-281 rectifying tube, and has a 750-volt plate winding which enables it to be used with a UX-281 or 216-B rectifying tube. In addition, there are filament heating windings for the new AC tubes. Used with types 709 and 854 AmerChokes in the filter circuit, a receiver may be constructed to operate entirely from the house lighting circuit.

Type H-67 Heater Transformer is a new unit recommended for use with the RCA UX-226 raw AC amplifier tubes and the UY-227 detector tube. It also has a third filament winding capable of handling two UX-171 tubes. In connection with the new AC tubes, type H-67 becomes the power source for the filament and is therefore a real "A" battery eliminator. This transformer sells for \$12.00.

*Write for complete, up-to-date information on these new units and their application*

**AMERICAN TRANSFORMER CO.**

178 Emmet Street

Newark, N. J.

*"Transformer Builders for over 26 years"*

**AMERTRAN AMERTRAN AMERTRAN AMERTRAN**

# U. S. Broadcasting Stations Listed by States

**ALABAMA**  
Auburn, WAPI  
Birmingham, WBRC, WKBC  
Gadsden, WBZY  
Montgomery, WIBZ

**ALASKA**  
Anchorage, KFQD  
Juneau, KFIU  
Ketchikan, KGUB

**ARIZONA**  
Flagstaff, KFXV  
Phoenix, KFAD, KFGB  
Tucson, KGAR

**ARKANSAS**  
Fayetteville, KUOA  
Hot Springs, KTFS

**CALIFORNIA**  
Avalon, KFWO  
Berkeley, KRE  
Berbank, KELW, KFLW  
Burlingame, KFOB  
Crescenta, KGEH  
El Centro, KGUN  
Eureka, KFVH  
Fresno, KMJ  
Hollywood, KFQZ, KFVW  
KMTB  
Holy City, KFOU  
Inglewood, KMPC  
Long Beach, KFON, KGCR  
Los Angeles, KFI, KFPR, KESG, KFNB, KGFB, KGET, KHH, KXN, KRLO, KTVB  
Lower Lake, KGEU  
Oakland, KFUS, KFWM, KGO, KLS, KLN, KTAB, KZM  
Ocean Park, KNRC  
Oxnard, KFYF  
Pasadena, KPCC, KPSN  
Sacramento, KPBC  
San Bernardino, KFVW  
San Diego, KFBC, KFSD  
San Francisco, KFRC, KFWI, KGTT, KJBS, KPO, KYA  
San Jose, KFAT, KQW  
Santa Ana, KWTC  
Santa Barbara, KFBR  
Santa Maria, KSMR  
Santa Monica, KNRC  
Stockton, KGDM, KWG  
Venice, KFVW  
Yuba City, KGFY

**COLORADO**  
Colorado Springs, KFUM  
Denver, KFEL, KFUP, KFVR, KFNE, KGEY, KIZ, KOA, KOW  
Durango, KOLO  
Edgewater, KFVJ  
Fort Morgan, KGEW  
Greeley, KFKA  
Gunnison, KFPA  
Pueblo, KGDP  
Trinidad, KFGL  
Yuma, KGEK

**CONNECTICUT**  
Bridgeport, WICC  
Danbury, WCWS  
Hartford, WFTG  
Mansfield, WCAC  
New Haven, WDRG

**DELAWARE**  
Wilmington, WDEL

**DISTRICT OF COLUMBIA**  
Washington, WMAL, WRC, WRHP

**FLORIDA**  
Clearwater, WEHH, WFLA  
Pulford-by-the-Sea, WGBU  
Gainesville, WHEN  
Jacksonville, WJAX  
Lakeland, WMLB  
Miami, WQAM  
Miami Beach, WIOD, WMBF  
Orlando, WRDZ, WOCB  
Pensacola, WCOA  
St. Petersburg, WGHB, WJBB, WKBJ  
Tampa, WDAE, WMBR

**GEORGIA**  
Atlanta, WDBE, WGST, WSB  
Macon, WLAZ

**HAWAII**  
Honolulu, KGU

**IDAHO**  
Boise, KFAU, KFDD  
Kellogg, KFEY  
Pocatello, KSEI

**ILLINOIS**  
Atwood, WLBO  
Belvidere, WLBR

Bloomington, WMBY, WNBL  
Carthage, WCZA  
Chicago, KYW, WAAF, WBBM, WBBZ, WBCN, WCFL, WCRW, WCBH, WEDC, WENR, WFKB, WGBS, WGN, WHL, WBBM, WHFC, WHT, WIR, WIBA, WIBO, WJAZ, WKBG, WKBI, WLSN, WLLB, WLS, WLTS, WMAQ, WMBB, WMBH, WJBI, WQBB, WPCG, WQJ, WSAX, WSBC, WVAE, WKDR, WVRD

Chicago Heights, WJZZ  
Decatur, WBAO  
Wenoua, WLBI  
Elgin, WTAS  
Evanston, WEHS  
Galesburg, WFBZ, WKBS, WLBO, WRAM  
Forest Park, WNBK, WBBN  
Harrisburg, WBEQ  
Honeoye, WOK  
Joliet, WCLS, WJBA, WKBB  
La Salle, WJCB  
Mooseheart, WJJD  
Peoria Heights, WMBD  
Quincy, WTAP  
Rockford, KFVY  
Rock Island, WHBF  
Springfield, WCBS  
Streator, WTAX  
Toscola, WDW  
Urbana, WRM  
Waukegan, WPEP  
Zion, WCBD

**INDIANA**  
Anderson, WBBU  
Brookville, WKBV  
Crown Point, WLBT  
Culver, WCMA  
Evansville, WGBF  
Fort Wayne, WCWK, WOWO  
Huntington, WHOG  
Indianapolis, WFBM, WKBF, Kokomo, WJAK  
La Porte, WRAF  
Muncie, WLBC  
South Bend, WSBT  
Terre Haute, KGFO, WRPL  
West Paris, WRBC  
Valparaiso, WBAW

**IOWA**  
Ames, WOI  
Anita, KICK  
Boone, KFGQ, KICK  
Burlington, WLAS  
Cedar Rapids, KWCR, WJAM  
Clarinda, KSO  
Council Bluffs, KOIL  
Cresco, KGDJ  
Davenport, WOC  
Decorah, KGCA, KGDZ, KWLK  
Des Moines, WHO  
Ft. Dodge, KFIJ  
Iowa City, KFQP, KGFB, WSTI  
Le Mars, KWUC  
Marshalltown, KFJF  
Muscatine, KPND, KNTT  
Oskaloosa, KFHL  
Shenandoah, KFNE, KMA  
Sioux City, KFMR, KSCJ, WEAU

**KANSAS**  
Concordia, KGCN  
Independence, KFVW  
Lawrence, KEKU, WREN  
Manhattan, KSAC  
Milford, KFBB  
Topeka, WIBV  
Wichita, KFH

**KENTUCKY**  
Hopkinsville, WFIW  
Louisville, WHAS, WLAP

**LOUISIANA**  
New Orleans, WABZ, WCEB, WJO, WJBW, WKBT, WSMR, WVL  
Pineville, KFVW  
Shreveport, KFDP, KGDZ, KRAC, KSBK, KWKH

**MAINE**  
Bangor, WABI  
Dover, WLRZ  
Portland, WSSH

**MARYLAND**  
Baltimore, WBAL, WCAO, WCMB, WFSB  
Tacoma Park, WBES

**MASSACHUSETTS**  
Boston, WATT, WBET, WBLS, WZLA, WEEL, WBLM, WNAB, WNAO, WSSH  
Chelsea, WRSC  
Dartmouth, WMAF  
East Springfield, WBZ  
Fall River, WSAR

**MAINE**  
Bangor, WABI  
Dover, WLRZ  
Portland, WSSH

**MARYLAND**  
Baltimore, WBAL, WCAO, WCMB, WFSB  
Tacoma Park, WBES

**MASSACHUSETTS**  
Boston, WATT, WBET, WBLS, WZLA, WEEL, WBLM, WNAB, WNAO, WSSH  
Chelsea, WRSC  
Dartmouth, WMAF  
East Springfield, WBZ  
Fall River, WSAR

Gloucester, WEPS  
New Bedford, WNBH  
Quincy, WRBS  
Sommerville, WAGS,  
Taunton, WAIT  
Webster, WKBE  
Wellesley Hills, WBOS  
Worcester, WTAG

**MICHIGAN**  
Battle Creek, WKBP  
Bay City, WSKC  
Berrien Springs, WEMC  
Detroit, WABN, WAED, WBMH, WGHP, WJR, WMCB, WTHO, WWJ  
Escanaba, WRAK  
Flint, WFDF  
Grand Rapids, WASH, WOOD  
Iron Mountain, WLBY  
Lapeer, WMPC  
Lansing, WKAR, WREO  
Ludington, WKBZ  
Monroe, WKBL  
Royal Oak, WAGM  
Petoskey, WBBP  
Pontiac, WCX  
Ypsilanti, WJBK

**MINNESOTA**  
Barrett, KGDE  
Collegeville, WFBJ  
Fairmont, KFVN  
Hallock, KGFK  
Minneapolis, KFDZ, KGEQ, WAJD, WCCO, WDCY, WHDI, WLB, WRHM  
Northfield, KFAX, WCAL  
St. Cloud, WFAM  
St. Paul, KFOY, WMBE

**MISSISSIPPI**  
Columbus, WCOO

**MISSOURI**  
Cape Girardeau, KFVS  
Carterville, KFPW  
Columbia, KFRR  
Independence, KLDS  
Jeffersonville City, WOS  
Kansas City, KMLP, KWKC, WDAF, WHB, WLBF, WQO  
Kirksville, KEKZ  
St. Joseph, KGBX, KFEQ  
St. Louis, KFQA, KFZO, KFVE, KFWF, KSD, KMOX, KWVW, WLV, WMAJ, WSBF

**MONTANA**  
Havre, KFBB  
Kalispell, KGEZ  
Missoula, KQOM  
Vida, KGCC

**NEBRASKA**  
Central City, KGES  
Clay Center, KMMJ  
Grand Island, KGEO  
Hastings, KFKA  
Humboldt, KGDV  
Lincoln, KFAB, KFBR  
Norfolk, WJAG  
Omaha, KFON, KOCH, WAAW, WNAL, WOW, Shelby, KGBY  
University Place, WCAJ  
Wayne, KGCH  
York, KGBZ

**NEW HAMPSHIRE**  
Laconia, WKAJ  
Manchester, WCOM  
Tilton, WBRL

**NEW JERSEY**  
Asbury Park, WDWB  
Atlantic City, WHAR, WPG  
Camden, WCAM  
Carlstadt, WHP  
Cliffside, WPAP, WQAO  
Elizabeth, WBS  
Jersey City, WAAT, WKBO  
Lambertville, WTAE  
Midland Park, KTRL, WTRL  
Newark, WAAM, WGPP, WMYM, WNJ, WOR  
North Plainfield, WEAM  
Paterson, WODA  
Red Bank, WJBI  
Union City, WBS  
Trenton, WOAX

**NEW MEXICO**  
Albuquerque, KFLL, KFVY  
Raton, KGPL  
State College, KOB

**NEW YORK**  
Auburn, WKBR, WMBO  
Bay Shore, WBS  
Bronx, WHPP  
Brooklyn, WARS, WBRR, WBKN, WBSB, WLBE, WLTH, WMBO, WHRC  
Buffalo, WEBR, WGR, WKBW, WKEN, WMAK, WSVS

Canastota, WLBU  
Canton, WCAD  
Cazenovia, WMAA  
Endicott, WNB  
Farmingdale, WLBH  
Farmington, WRBL  
Flushing, WBI  
Freeport, WGBB  
Ithaca, WLCI  
Jamaica, WMRJ  
Jamestown, WOCL  
Kingston, WDBZ  
Long Island City, WLB  
New York, WBBC, WBYN, WBOQ, WCDA, WCGU, WEAJ, WEBJ, WGBS, WGMU, WGL, WHN, WJUG, WJZ, WKBQ, WMCA, WMHA, WMSG, WNYC, WPCB, WRNY, WRMU

Peekskill, WOKO  
Richmond Hill, WABC, WAOK  
Rochester, WABO, WHAM, WHEC, WNBQ, WOKT  
Shenectady, WGY  
Syracuse, WBL, WSYR  
Troy, WHAZ  
Utica, WBYX  
Woodhaven, WSOM  
Woodside, WBM, WWR

**NORTH CAROLINA**  
Asheville, WWCN  
Charlotte, WBT  
Chapel Hill, WRNC  
Raleigh, WRCO

**NORTH DAKOTA**  
Aneta, KGFN  
Bismarck, KFYR  
Grand Forks, KDLR  
Grand Forks, KFJM  
Mandan, KGCU

**OHIO**  
Akron, WADC  
Ashtabula, WJPW  
Bellefontaine, WHBD  
Canton, WHBC  
Cambridge, WEBE  
Cincinnati, WAAD, WFBE, WABC, WSAZ  
Cleveland, WDBK, WEAR, WHK, WJAY, WTAM  
Columbus, WAJZ, WCAH, WEAQ, WMAN  
Dayton, WSMK  
Hamilton, WMBK, WRK  
Mansfield, WLB  
Middleton, WRSO  
Springfield, WCSO  
Steubenville, WBR  
Toledo, WTAL  
Wooster, WABW  
Yellow Springs, WRAY  
Youngstown, WKBN, WMBW

**OKLAHOMA**  
Alva, KGFJ  
Tulsa, KVOO  
Chickasha, KOCW  
Norman, WNAD  
Oklahoma City, KFGE, KFJE, KFNR, KGCB, KGFJ, WYK  
Tulsa, WLAL

**OREGON**  
Astoria, KFJJ  
Corvallis, KOAC  
Eugene, KGEH  
Medford, KMBD  
Portland, KREX, KFEC, KFIE, KFJR, KGW, KLIT, KROW, KTBK, KWBS, KXL, KOIN

**PENNSYLVANIA**  
Allentown, WCBA, WSAN  
Altoona, WFBG  
Bethayres, WALK  
East Pittsburgh, KDKA, KQV  
Grove City, WSAJ  
Harrisburg, WABB, WBAK, WBAZ, WPCB  
Jeannette, WGM  
Kingstown, WABF  
Lancaster, WGAL, WKJC  
Lewisburg, WJBU  
Monessen, WMBJ  
Oil City, WBEA, WLWB  
Parkersburg, WAAA  
Philadelphia, WABQ, WABY, WCAU, WFL, WFKD, WBBW, WIAD, WIBG, WIP, WLIT, WNAI, WOO, WRAX, WPSW  
Pittsburgh, WCAE, WJAS  
Reading, WRBW  
Scranton, WGOAN, WQAN  
State College, WFSC  
Wilkes-Barre, WRAX, WBRE  
Washington, WNBO

**PORTO RICO**  
San Juan, WKAQ

**RHOEE ISLAND**  
Cranston, WDWI  
Newport, WMBR  
Pawtucket, WFGI  
Providence, WCBR, WCOT, WEAN, WJAR, WLSI, WRAH

**SOUTH CAROLINA**  
Charleston, WBBY

**SOUTH DAKOTA**  
Brookings, KFDY, KGCR  
Dell Rapids, KGDA  
Mitchell, KGFY  
Oldham, KGDY  
Rapid City, WCAT  
Sioux Falls, KSOO  
Vermillion, KUSD  
Yankton, WNAX

**TENNESSEE**  
Chattanooga, WDDO  
Knoxville, WFPC, WNBU, WNOX  
Lawrenceburg, WOAN  
Memphis, WQBQ, WHBQ, WMBM, WMC, WNBR  
Nashville, WBAW, WQAD, WLAC, WSM  
Springfield, WSIX  
Tullahoma, WCFT  
White Haven, WREC

**TEXAS**  
Amarillo, KGRS, WDAG  
Austin, KUT  
Beaumont, KFDM  
Fort Worth, KFJZ, KFQB, WBAP  
Galveston, KEUL  
Greenville, KFPM  
Houston, KFVI, KFJJ, KPCC, KTVB, KFLX  
San Angelo, KGFI  
San Antonio, KGOL, KGDR, KRC, KRAP, KRTS, WCAR, WOAI  
San Benito, KFLU  
Waco, WJAD

**UTAH**  
Jerome, KFND  
Ogden, KFUR  
Salt Lake City, KDYL, KFOO, KFUT, KSL

**VERMONT**  
Burlington, WCAX

**VIRGINIA**  
Arlington, NAA  
Norfolk, WBWB, WRCV, WSEA, WPAR  
Petersburg, WLBG  
Richmond, WBLB, WMBG, WRVA  
Roanoke, WDBJ

**WASHINGTON**  
Everett, KFBL  
Lacey, KGY  
Pullman, KWSC  
Seattle, KFOA, KFQW, KFON, KGBS, KGCL, KJK, KKP, KOMO, KPCE, KROX, KRSC, KTCL, KTV, KWOS, KXRO  
Spokane, KFIO, KRFP, KGA, KHQ  
Tacoma, KMO, KVI  
Yalla, Walla, KOWW  
Yakima, KFTQ

**WEST VIRGINIA**  
Huntington, WSAZ  
Wheeling, WVVVA

**WISCONSIN**  
Beloit, WEBW  
Camp Lake, WCLO  
Eau Claire, WTAQ  
Fond du Lac, KFZ  
Kenosha, WFRB  
La Crosse, WKBH  
Madison, WHA, WIBA  
Manitowac, WQMT  
Marshfield, WGBR  
Milwaukee, WGWV, WHAD, WSOJ, WTMJ  
Ondaga, WJBR  
Poyntelle, WIBU  
Racine, WRRS  
Stevens Point, WLBL  
Superior, WBEBC  
West De Pere, WBHY

**WYOMING**  
Laramie, KFBU

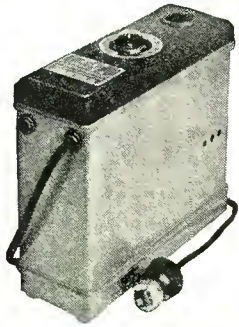

ACME E-4 B-Power Supply  
\$35.00

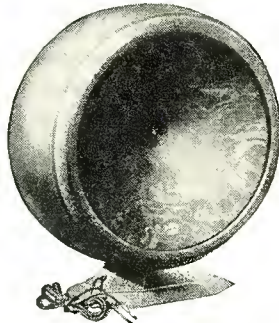

ACME K-1A SPEAKER  
\$25.00

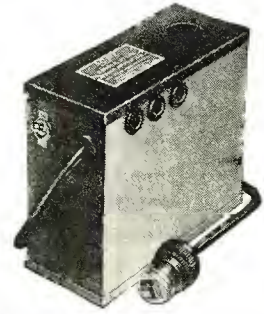

ACME PA-1 Power Amplifier  
\$14.50

# Give Your Present Set a Square Deal

Any Good Dealer Will Be Glad to Have You Try  
**ACME APPARATUS** on a Money-Back Guarantee

YOU can go to the nearest radio store and hear any one of a number of loud speakers that sound wonderful there. But perhaps your own old speaker at home sounds mighty good, too. Perhaps the actual reception in your old set is a great deal better than any previous speaker you've ever tried has been able to demonstrate. The conditions in your home and in the store are never the same. No two sets are exactly alike. The thing that counts is how the speaker sounds on your own particular set—in rooms the shape of yours—and how well it goes with the rest of your furniture.

But never until you hear the marvelous new Acme K-1-A double free-edge cone speaker—and hear it in your own home—can you possibly realize the tremendous strides that have been made in radio reproduction since your loud speaker left

its factory! It took five years and 320 experimental models to make this speaker.

This new K-1-A gives your old radio set a real square deal—shows how genuinely good your reception has been all along.

For the B Power Supply that has been proved absolutely sound—and

NEWSPAPERS in principal cities carry his newsy column telling of the biggest forthcoming radio programs each week.

As radio programs become better and better, the importance of supplementing your set with the farthest-advanced loud speaker becomes greater and greater.



AKMEE  
The Speaker of the House

proved by longer experience on the market than any other B Power Supply of this type... demand Acme B with Raytheon tube. It was the first on the market, three years ago. We said it would stand up and work—thousands of users now know we were right.

Acme now offers a single stage power amplifier to add to any set. All you have to do is connect your set, your B supply and your speaker to the amplifier, put in a power tube, plug into the lamp socket, and your radio enjoyment increases a hundred fold. No additional A battery current and no C battery to add, both of these supplies are included in the unit.

Acme has two booklets. (Amplification without Distortion) telling how to improve any radio set; and (Power Supply for Radio Sets) telling the story of Lamp Socket operation. Fill in the coupon below for the one you want.

**ACME**  
OF CAMBRIDGE  
*for amplification*

ACME APPARATUS CO.  
Dept. R.C.B.-2 Cambridge, Mass.

Gentlemen: Please send me a copy of the booklet checked below. I enclose 10 cents for each copy.

Amplification without Distortion   
Power Supply for Radio Sets

Name .....  
Street .....  
City ..... State .....

Tell 'Em You Saw It in the Citizens Radio Call Book Magazine

# Foreign Radio Broadcasting Stations

Call	Wave	Power	Call	Wave	Power
<b>ALASKA</b>			<b>New Brunswick</b>		
Anchorage: Chovin Supply Co. ....	KFQD	227.1 100	Fredericton .....	CFNB	247.8 25
Juneau: Alaska Electric Light & Power Co. ....	KFTU	225.4 10	Moncton: Canadian National Railways .....	CNRA	322.4 500
<b>ALGERIA</b>			<b>Quebec</b>		
Algiers: Colin & Fils .....	SDB	310 100	Montreal: Northern Electric Co., Ltd. ....	CHYC	410.7 750
<b>ARGENTINA</b>					
Buenos Aires: No data. Received at Pernambuco and Valparaiso .....	LOO	252 1000	E. Fontains .....	CHRC	347 5
No data .....	B2	275 100	La Presse Publishing Co. ....	CKAC	410.7 1200
No data .....	LOL	236 2000	Canadian Marconi Co. ....	CFCF	410.7 1650
No data .....	LOH	210 5000	Canadian National Railways. Uses equipment of other local stations. ....	CNRM	.....
Argentine Association of Broadcasters .....	LOR	314.8 1000	Quebec .....	CHRC	340.7 5
No data .....	LOT	400 1000	Le Soleil .....	CKCI	347 22 1/2
Francisco J. Brusa .....	LOY	261.5 1000	St. Hyacinthe .....	CKCV	340.7 50
Grand Splendid Theatre .....	LOW	303 1000	.....	CKSH	312.3 50
Radio Cultura Magazine .....	LOX	380 500	<b>Ontario</b>		
Radio Nacional .....	LOY	315.8 1000	Bowenville .....	CKCW	312.5 5000
University of La Plata .....	LOP	425 1000	Hamilton .....	CHCS	340.7 10
<b>AUSTRALIA</b>					
<b>New South Wales</b>					
Bathurst: Mockler Bros. ....	2MK	275 250	Jack V. Elliott, Ltd. ....	CFUC	340.7 500
New Castle: H. A. Douglas .....	2HD	288 20	Wentworth Radio Supply Co. ....	CKOC	340.7 50
Sydney: Burgin Electric Co. ....	2BE	326 20	Brantford: Brant Radio Supply Co., Ltd. ....	CFGC	297 50
Broadcasters, Ltd. ....	2BL	353 1000	Burketon Junction .....	CKGV	329.5 5000
Farmers Broadcasting Co., Ltd. ....	2FC	412 2000	Cobalt .....	CKMC	247.8 5
Otto Sandel .....	2UW	263 100	Huntsville: A. Staples .....	CHCO	247.8 5
Theosophical Broadcasting Service .....	2GB	326 1500	Iroquois Falls: Abitibi Power & Paper Co. ....	CFHC	499.7 250
Trades Hall Broadcasting Station .....	2KY	280 300	King: York Co. ....	CJCC	291.1 1000
Electrical Utilities Supply Co. ....	2UE	297 50	Kingston: Monarch Battery Co. ....	CFMC	267.7 20
Sydney .....	2WA	462 100	Queens University .....	CFRC	267.7 500
Wagga: Otto Sandel .....	2UX	200 500	Kitchener: O. Kumpel .....	CJCF	247.8 25
<b>Victoria</b>					
Brighton: Projected. No data .....	3BP	.....	London: London Area Press Printing Co., Ltd. ....	CJCC	329.5 500
Melbourne: Associated Radio Co. of A. Pty. Ltd. ....	3AR	484 320	Midland: E. O. Swan .....	CKPR	267.7 50
Broadcasting Co. of Australia Pty. Ltd. ....	3LO	371 1000	Ottawa: J. R. Booth, Jr. ....	CHXC	434.5 250
Druleigh Business & Tech. College .....	3DB	255 500	Canadian National Railways. ....	CNRO	434.5 500
O. J. Nilson & Co. ....	3UZ	319 20	Dr. G. M. Geldert. (For Ottawa Radio Assn.) ....	CKCO	434.5 100
L. J. Hellier, Wangaratta Sports Depot. ....	3WR	303 20	Prescott: Radio Association of Prescott .....	CFCL	296.9 50
Mildura: R. J. Egge .....	3EO	286 20	Preston: Wallace Russ .....	CKPC	247.8 7 1/2
<b>Queensland</b>					
Brisbane: Dr. V. McDowell .....	4CM	278 50	Scarboro Station .....	CJYC	291.1 500
Radio Manufacturers Ltd. ....	4MB	337 250	Toronto: Star Publishing & Printing Co. ....	CFCA	356.9 500
Queensland Government .....	4QG	385 1000	Toronto Radio Research Society .....	CHNC	356.9 500
Rockhampton: Ditto .....	4RN	323 100	E. Eaton Co. ....	CJED	356.9 50
Toowoomba: Gold Radio Elec. Service .....	4GR	294 20	Dominion Battery Co., Ltd. ....	CKCL	356.9 500
<b>South Australia</b>					
Adelaide: Central Broadcasting Co. ....	5CL	395 1000	Canadian Broadcasting Corp. Projected .....	CKCL	356.9 5000
E. J. Hume. Operated by 5DN Pty. Ltd. ....	5DN	313 100	Toronto .....	CJCI	291.1 500
Millswood Auto & Radio Co. ....	5MA	.....	Canada National Carbon Co. ....	CKNC	356.9 500
Marshall & Co. ....	5MC	273 500	Northern Electric Co. Uses equipment of other local stations. ....	CHIC	.....
Sport Radio Broadcasting Station .....	5KA	250 1000	Jarvis Street Baptist Church. Uses equipment of other stations. ....	CJRC	.....
<b>Western Australia</b>					
Perth: Westralian Farmers, Ltd. ....	6WF	1250 1000	Evening Telegram. Uses equipment of local stations. ....	CJSC	.....
<b>Tasmania</b>					
Hobart: Tasmanian Broadcasters, Ltd. ....	7ZL	525 3000	Canadian National Railways. Uses equipment of other local stations. ....	CNRT	291.1 1000
<b>AUSTRIA</b>			<b>Manitoba</b>		
Vienna: Oesterreichischer Radioverkehr A. G. broadcasts three 2-hour programs daily, including music (opera and popular), weather and market reports and news. Reception reported at Antwerp, Tcheran, Smyrna, Tunis. ....	ORV	577 1500	Winnipeg: Manitoba Telephone System .....	GKY	384.4 500
Oesterreichischer Radioverkehr A. G. Testing; to replace above station in the near future. ....	ORV	517.2 7000	Canadian National Railways. Uses equipment of CKY .....	CNRW	.....
Graz: Oesterreichischer Radioverkehr A. G. ....	365.8 500	.....	<b>Saskatchewan</b>		
Innsbruck .....	294.1 500	.....	Moose Jaw .....	CJRM	296.9 500
Klagenfurt: Relays Vienna .....	272.7 500	.....	Regina: R. H. Williams & Sons, Ltd. ....	CHWC	312.3 15
Liniz: (Projected) .....	254.2 500	.....	Leader Publishing Co., Ltd. ....	CKCK	312.3 500
Rosenlingel .....	517.2 5000	.....	Canadian National Railways. Uses Station CKCK equipment .....	CNRR	312.3 500
<b>BELGIUM</b>					
Antwerp: (General, 2 hours daily) .....	365.5 100	.....	Sask. Co-op. Wheat Prod. Ltd. ....	CJBR	312.3 500
Brussels: Radio Belgique .....	BAV	608.5 1500	Saskatoon: The Electric Shop .....	CFCC	329.5 500
Liège: Radio Wallonie Station .....	205 100	.....	International Bible Students' Association. ....	CHIC	329.5 500
Radio Central Station .....	294.1 100	.....	Wheaton Electric Co. ....	CJWC	320.5 250
<b>BOLIVIA</b>					
La Paz: (Irregular) .....	175.300	50	Canadian National Railways. Uses equipment of other local stations. ....	CNRS	329.5 500
<b>BRAZIL</b>			<b>Alberta</b>		
Bahia: Radio Sociedade do Bahia .....	465 50	.....	Calgary: W. W. Grant Radio, Ltd. ....	CFCA	434.5 1800
Bello Horizonte: National Telegraph Service .....	400 500	.....	Calgary Herald .....	CFAC	434.5 500
Fortaleza: Radio Club .....	30 30	.....	Canadian National Railways. Uses equipment of other local stations. ....	CNRC	434.5 500
Pana .....	80 30	.....	Radio Service & Repair Shop .....	CJCF	434.5 250
Pernambuco: Radio Club. One hour daily and two hours three days each week .....	310 300	.....	<b>Edmonton</b>		
Porto Alegre: Radio Society. Broadcasts one hour daily. To be replaced by 50-watt station .....	380 80	.....	Edmonton: International Bible Students' Assn. ....	CHGY	516.9 250
Rio de Janeiro: Radio Society. Daily programs by local artists National Telegraph Service, Praia Vermelha Station. Operated by Radio Club. Daily news and concerts. ....	400 1000	.....	Alberta Pacific Grain Co., Ltd. ....	CKLC	516.9 1000
Rio de Janeiro: No data. Phonograph records broadcast 2 to 4 pm daily; concerts from 7 to 9 pm three or four days each week. ....	312 500	.....	Christian & Miss. Alliance .....	CHMA	516.9 250
Santos: No data .....	..... 10	.....	University of Alberta .....	CKUA	516.9 500
Sao Paulo: Dias Carneiro & Co., operated by the Radio Club of Sao Paulo .....	380.420 100	.....	Radio Supply Co., Ltd. ....	CFCK	516.9 50
Radio Club of Sao Paulo Broadcasts Hotel Terminus orchestra and phonograph records daily. ....	350 10	.....	Edmonton Journal .....	CJCA	516.9 500
<b>CANADA</b>			<b>British Columbia</b>		
<b>Nova Scotia</b>					
Halifax: (Carlton Hotel station, Northern Electric Co., Ltd.) .....	CHNS	322.4 100	Burnaby: International Bible Students' Assn. ....	CFVC	410.7 500
<b>Prince Edward Island</b>					
Charlottetown: General during winter .....	CFCY	312.3 100	Kamloops: N. S. Dagleish & Sons and Weller & Weller .....	CFJC	267.7 15
Summerside: R. T. Holman, Ltd. ....	CHGS	267.7 25	Mission City: E. R. Streeter .....	CJCU	247.5 5
<b>CANARY ISLANDS</b>					
La Laguna: Servando Ortoll Delmotte .....	EAT5	280 50	New Westminster: Westminster Trust Co. ....	CFXC	291.1 20
Las Palmas: Canary Islands Radio Club .....	300 6	.....	Sea Island .....	CJOR	291.1 50
Club Radio Canarias .....	300 6	.....	Vancouver: A. Holmstead & William Hanlon .....	CFBC	410.7 15
Teneriffe: Servando Ortoll Delmotte .....	EAR5	250, 350 200	G. W. Desauville .....	CFCT	329.5 500
<b>CEYLON</b>					
Colombo .....	800 1500	.....	A. Halstead & Wm. Hanlon .....	CKWX	410.7 10



	Call	Wave	Power		Call	Wave	Power
<b>CHILE</b>							
Antofagasta: Senor J. Pedreny.....	CIAO			St. Etienne: Radio Club Forezien.....		220	50
Concepcion.....	CMAI	345	1500	Strasbourg: Military station.....		220	15,000
Santiago: El Mercurio, newspaper.....	CMAC	360	1200	Radio Club.....	SGF	222.2	1500
Fratelli Castagneto.....	CMAD	320	100	Toulonse: Radio du Midi.....		359.6	2000
Chilean Broadcasting Society.....	CMAE	280	100	Ministry of Posts, Telegraphs and Telephones. Aero-drome station.....	MIRD	260	1000
Commercial Radio Co.....	CRC	385	350	Radio Vitus.....		308	250
Tacna: Chilean Government.....	CRCT	550	200	Reziens.....		178	500
Valparaiso: Antonio Cornish.....		400	50	<b>GERMANY</b>			
<b>CHINA</b>				Berlin: Postal Authorities. Konigswusterhausen Station. Relays Vox Haus program. Reception reported at Rome, Constantiople, Beirut, Algiers.....			
Shanghai: Kellogg Switchboard & Supply Co. Operates four hours daily between 9:45 am and 11 pm. (Note: Stations have been reported in other Chinese cities, but the present operation is very doubtful. The above station is the only one mentioned in more recent reports.)		365	20	Postal Authorities. Vox Haus station.....	LP	1300	12,000
<b>CHOSEN</b>				Magdeburger Platz.....		566	400
Seoul: Under construction.....	JODK	345	1000	Konigswusterhausen Station.....	APT	1250	4000
<b>COSTA RICA</b>				Konigswusterhausen.....	AFP	4000	10,000
San Jose: Government. Under construction.....				Witzleben.....		483.9	4000
<b>CUBA</b>				Wolfs Bureau.....		252.5	5000
Central Elia: Elia Sugar Co.....		300	500	Freiburg.....		577	1000
Salvador Bionda.....	7SR	350	500	Bremen: Nordische Rundfunk A. G. Relays Hamburg program.....		400	140
Cienfuegos: Jose Gandux.....	6BY	260	200	Breslau: Schlesische Funkstunde. Received at Rome.....		315.8	750
Habana: Cuban Telephone Co.....	PWX	400	500	Cassel.....		272.7	750
Bernardo Barric.....	2BB	250	15	Dortmund: Mitteldeutscher Rundfunk A. G. Relays Leipzig program.....		283	300
Frederick W. Rorton.....	2BY	260	100	Dresden: Mitteldeutscher Rundfunk A. G. Relays Leipzig program.....		294.1	700
El Pais.....	2EP	355	400	Elberfeld.....		468.8	750
Credito y Construction Co.....	2HP	295	100	Frankfurt-on-the-Main: Sudwestdeutscher Rundfunkdienst.....		428.6	750
Jose Lara.....	2LR	235	50	Freiburg i. Br.....		577	750
Manuel y Guillermo Salas.....	2MG	254	20	Gleiwitz: Relays Breslau.....		250	750
Marjo Garcia Velez.....	2OK	350	100	Hanover: Nordischer Rundfunk A. G. Relays Hamburg program.....		394.7	4000
Columbia Radio & Cycle Co.....	2OL	257	100	Hannover: Nordischer Rundfunk A. G. Relays Hamburg program.....		297	750
Raoul Karmann.....	2RK	315	20	Kassel: Sudwestdeutscher Rundfunkdienst.....		272.7	750
Roberto E. Ramirez.....	2RW	270	20	Kiel: Relays Hamburg.....		254.2	750
Benito Vieta Ferro.....	2UF	275	10	Konigsberg: Ostmarken Rundfunk A. G.....		329.7	4000
Santiago: Alberto Ravelo.....	2SBY	250	100	Langenberg: Rheinland.....		468.8	2500
Tuinucu: Frank H. Jones.....	6JK	272	100	Leipzig: Mitteldeutscher Rundfunk A. G.....		365.8	750
Frank H. Jones.....	6KW	340	100	Muenster: Same.....		241.9	1500
<b>CZECHOSLOVAKIA</b>				Munich: Deutsche Stunde in Bayern.....		435.7	4000
Bratislava: Tues, Fri.....	OKR	300	500	Norddeich.....	KAV	1800	300
Brunn: Radio Journal.....	OKR	441.2	300	Nuremberg: Relays Berlin.....		303	750
	OKB	441.2	500	Stettin: Relays Berlin.....		252.1	750
Prague: Kbely.....	OKP	1110	1000	Stuttgart.....		379.7	4000
Radio Journal.....		384.9	5000	<b>GREAT BRITAIN</b>			
<b>DANZIG</b>				Aberdeen.....	2BD	500	1500
Danzig: Relays Koenigsburg.....		272.7	1500	Bradford.....	2LS	252.1	500
<b>DENMARK</b>				Birmingham: Received at Antwerp, Brussels, Rome.....	5IT	326.1	1500
Copenhagen: Radioadet.....		337	2000	Bournemouth: Received at Antwerp, Teneriffe, Jerusalem.....	6RM	491.8	1500
Hjerring: Relay station. Government.....		1225	250	Cardiff: Received at Antwerp and Rome.....	5WA	353	1500
Kallundborg (projected).....		1150	7500	Chelmsford.....	2RR		
Lyngby: Relay station. Government.....		2400		Daventry: Received throughout Europe, northern Africa and Asia Minor.....	5XX	1600	16,000
Odense: Relay station. Government.....		810	1000	Dundee.....	2DE	294.1	200
Ryvang: Relay station. Government.....		1150	500	Edinburgh.....	2EH	288.5	500
Soro: Ministry of War. News and weather.....		1153.8	1000	Glasgow.....	5SC	405.4	1500
Viborg.....		1110	1000	Hull.....	6KII	294	200
		214.3	750	Leeds-Bradford.....	2LS	277.8	500
<b>EGYPT</b>				Liverpool.....	6LV	297	200
Cairo.....	SRE	255		London: Received at Teneriffe, Strasbourg, Brussels, Rome, Barcelona, Tunis.....	2LO	361.4	3000
<b>ESTONIA</b>				Manchester: Received at Rome.....	2ZY	354.6	1500
Tallinn.....		1200	100	New Castle: Received at Brussels, Rome.....	5NG	312.5	1500
		408	500	Nottingham.....	5NG	275.2	200
<b>FINLAND</b>				Plymouth.....	5PY	400	200
Bjorenborg: Nuoren Voiman Liiton Radioyhdistys. Daily, general.....		311	200	Poldhu.....	2YT		
Hango: Same.....		260	200	Sheffield.....	6FL	272.7	200
Helsingfors: Civil Guard.....		500	1000	Stoke on Trent.....	6ST	294	200
Mon, Wed, Fri, General.....		375	2000	Swansea.....	5SX	294	200
Helsinki: Same as Helsingfors.....		275.2	200	<b>HAWAII</b>			
Jakobstad: Irregular.....		297	200	Honolulu: Marion A. Mulroy.....	KGU	270	500
Jyvaskyla: N. V. L. Radioyhdistys. Irregular.....		318	180	<b>HAITI</b>			
Laitis: Three programs weekly.....		566	250	Port au Prince.....	IHK	361.2	1000
Onlu.....		233	100	<b>HUNGARY</b>			
Pietarsalki: Same as Jakobstad.....		254.2	100	Budapest: Mensegyetemi Radio Magyar Tavislati Iroda. Broadcasts market reports and news.....	MTL	555.6	2000
Pori.....		561	500			1050	400
Tampere: Same as Tammerfors.....		400	250	<b>ICELAND</b>			
St. Michael: N. V. L. R.....		250	250	Reykjavik.....		333.3	100
Tammerfors: Relays Ifors.....				<b>INDIA</b>			
Uleaborg: Relays Ifors.....				Bombay: Bombay Presidency Radio Club.....	2FV	387	100
<b>FRANCE</b>				Walter Rogers & Co.....	2AX	320	50
Agen: Department of Lot et Garonne.....	2RD	297	250	Calcutta: Radio Club of Bengal.....	2BZ	800	500
Angers: Radio Anjou.....		275.2	500	Owner not reported.....	5AF	425	1500
Bezier.....		95	100	Karachi: Karachi Radio Club.....		425	40
Barritz: Cote d'arent.....		200	500	Madras.....	2GR	400	200
Bordeaux: Ministry of Posts, Telegraphs and Telephones.....		238.1	500	Rangoon: Radio Club of Burma and Wireless Club of Burma. Broadcasts musical programs every Sunday.....	2HZ	350	40
Lafayette.....		419	1500	<b>IRELAND—NORTH</b>			
Caen: Radio Club.....		277.8	1500	Belfast.....	2BE	306.1	1500
Dijon.....		207.5	1000	<b>IRISH FREE STATE</b>			
Greenoble: Ministry of Posts, Telegraphs and Telephones.....		588.2	1500	Cork.....	6CK	400	1000
Juan Les Pins.....		230	500	Dublin: Government.....	2RN	319.1	1500
Issy-les-Moulineaux: Ministry of War.....	QGA	1800	500	<b>ITALY</b>			
Lille.....		287	500	Genoa (projected).....		272.7	1500
Lyon: Dubanchet & Trollet, Station Radio Lyon.....		291	500	Milan.....	1MI	322.6	1500
Dubanchet & Trollet, Station Radio Lyon.....		291.3	1500	Unione Radiofonica Italiana.....	1RC	320	1500
Ministry of Posts, Telegraphs and Telephones, Station La Doua, named for suburb in which located.....	YN	480	1000	Naples: Unione Radiofonica Italiana. Broadcasts concerts and news, 8:30 to 11 o'clock pm daily. Reception reported at Antwerp, Jerusalem, Lille, Smyrna, Damascus, Barcelona, Tunis and Alexandria. This is at present the station best received throughout the Levant.....	1RO	449	3000
Marseilles: Ministry of Posts, Telegraph and Telephones.....		300	1000	Palero (projected).....	1CP	500	2000
Mout de Marsen.....		390	300	Venice (projected).....		254.2	1500
Montpellier: Radio Montpellier station.....		338	200	<b>JAVA</b>			
Nice.....		362	1000	Bandoeng: Vereeninging van Radio Amateurs voor Bandoeng en Omstreken.....	No call	310	6
Paris: Eiffel Tower station. Ministry of Posts, Telegraphs and Telephones.....	FL	2650	4000	Batavia: Ratavische Radio Vereeninging.....	JFC	220	40
Journal Petit Parisien.....	5NG	333	500	Soerabaja: Two concerts weekly.....		140	500
Lucien Levy.....		350	500				
Petit Parisien. Reception reported at Rome Societe Francaise Radioelectrique.....	FL	341	1000				
Societe Francaise de Radioelectrique.....	SAI	1780	100				
Cie. Francaise de Radiophonie. Reception reported at Teneriffe, Jerusalem, Brussels, Rome, Teheran, Smyrna, Barcelona.....		1750	4000				
Superior School of Ministry of Posts, Telegraphs and Telephones. Reception reported at Rome.....		447.8	5000				
Paris: Radio Paris.....		1750	3000				
Ecole Superieure.....	FPTT	458	1000				
Pic du Midi.....		350					

Call	Wave	Power	Call	Wave	Power
<b>JAPAN</b>			<b>SPAIN</b>		
Nagoya: Nagoya Radio Broadcasting Co. Broadcasts daily 9 am to 9 pm; Sundays and holidays, 12 m to 9 pm. Program consists of music, weather and market reports, etc. JOKK	360	1000	Barcelona: Radio Barcelona Station EAJ1	344	1000
Osaka: Osaka Radio Broadcasting Co. Programs in English and Japanese. 1500-watt station projected. JORL	385	1000	Radio Catalana Nacional Radiofusi6n. EAJ13	277.8	1000
Osaka Broadcasting station (Proj.) JIRK	385	1000	Bilabo: Radio Carlton Station. Radio Club Vizcaya. EAJ9	438	500
Tokyo: Tokyo Radio Broadcasting Co. Programs in English and Japanese. 155-watt. JOAK	375	1000	Radio Vizcaya Station. Don Armande de Otera. EAJ11	294.1	500
<b>JUGOSLAVIA</b>			Vizcaya Radio Broadcasting Station, broadcasts music, provided by local talent, and considerable advertising from 12 to 12 pm daily.	294.1	2000
Agram (Zagreb) JFF	275.2	100	Cadiz: Don Francisco de la Liesca. EAJ3	344	500
Belgrade HFF	225.6	2000	Radio Lehera. EAJ10	297	1000
<b>KWANTUNG</b>			Cartagena: Don Enrique de Orbe. EAJ16	294.1	500
Dairen: Government Bureau of Communications employs a commercial station. Daily programs broadcast, consisting of music, educational and entertainment numbers. JOAK	390	5000	Madrid: Don Antonio Castilla. EAJ4	400	500
<b>LATVIA</b>			Radio Iberica Station. EAJ6	275.2	3000
Riga KCX	526.3	2000	Union Radio. EAJ7	375	1000
<b>LITHUANIA</b>			Radio Madrilena. EAJ12	306	2000
Kovno	2000	2000	Association of Radio. EAJ15	490	1000
<b>LUXEMBURG</b>			Radio Espana. EAJ2	393	3000
Luxemburg JOAA	217.4	250	Malaga: Cia Iberia de Telecomunicacion. EAJ25	50-25	100
Luxemburg	1200	250	Oriado: Don Arbro Cima. EAJ20	254.2	100
<b>MEXICO</b>			Salamanca. EAJ19	201.3	100
Chihuahua: Federal Government State Capital station. CZF	310	250	Saragossa. EAJ22	495	500
Guadalajara: Federal Military Command. FAM	490	1000	San Sebastian: Don Sabino Ucelayeta. EAJ8	325	1500
Radio Club	280	10	Seville: Seville Radio Club. EAJ5	272.7	500
Mazatlan: Castulo Llamas. CYR	475	250	Don Manuel Garcia Ballesta. EAJ17	400	1000
Mexico City: Elfrin R. Gomez. CYA	300	500	Don Jorge la Riva, projected. EAJ21	344	500
Jose J. Reynosa, operated by El Ruen Tono, cigarette factory. CYB	275	500	Valencia: Radio Corporation. EAJ14	500	500
Miguel S. Castro, operated by Le High Life, newspaper. CYH	375	100	Under construction. EAJ24	360	500
Raoul Azcarraga, operated by Universal. CYL	400	2000	Zaragoza. EAJ23	566	500
Martinez y Zetina. CYO	425	100	<b>STRAITS SETTLEMENTS</b>		
El Excelsior-Parker. CYX	325	500	Amateur Wireless Society of Malaya: 2-hour program broadcast each Sunday evening, and children's concert on Wednesdays. Received at Colombo, Ceylon. ISE	330	100
Department of Education. CZE	350	500	<b>SWEDEN</b>		
Monterey: Roberto Reyes. CYM	275	190	Boras. SMRY	230	250
Constantino de Tarnava. CYS	311	250	Drebo. SMTI	237	250
Oaxaca: Frederico Zenilla. CYF	265	100	Roden: Radiojanst. SASE	454.5	1000
Puebla: Augustin del P. Zaenz. CYU	312	100	Eskestuna: Radio Club, Relays Stockholm programs 4 days each week, broadcasts local programs other days. SMUC	275.2	250
Tampico: El Mundo. Suspended. CYZ	322	100	Falnn: Radio Club, Relays Stockholm programs 4 days each week, broadcasts local programs other days. SMZK	400	750
Cipriano Sagon S en C. CYQ	322	100	Gavle: Radio Club, Relays programs 4 days each week, broadcasts local programs other days. SMNF	204.1	250
Local programs. CYZ	322	20	Goteburg: Radiojanst. SASB	416.7	1000
Vera Cruz. CYD	322	100	Halmstad. SMSB	215.8	250
Manuel Angel Fernandez, Recently inaugurated for broadcasting advertising of an American product. CYT	548	100	Heimberg. SMYE	235	250
Yucatan: Partida Socialista del Sureste. CYY	548	100	Hudiksval. SMSL	248	250
<b>MOROCCO</b>			Jonkopings: Jonkopings Rnnradiostation, Relays Stockholm programs 4 days each week, broadcasts local programs other days. SMZD	201.3	250
Casablanca: Radio Club of Morocco, Omega Station. CNO	305	2500	Kalmar. SMSW	253	250
<b>NETHERLANDS</b>			Kalmar. SMSN	254.2	25
Amsterdam	760	-----	Karlsborg: Radiojanst, Relays Stockholm programs 4 days each week, broadcasts local programs other days. SASF	1365	5000
Antwerp	508.5	-----	Karlskrona: Relays Stockholm programs 4 days each week, broadcasts local programs other days. SMSM	201.3	250
Bleemendall	566	-----	Karlstadt: Karlstadt Rnnradiostation, Relays Stockholm programs 4 days each week, broadcasts local programs other days. SMXG	220.6	250
DeRift. PCFF	1100	1250	Kristinehamn. SMTJ	202.7	100
Eindhoven: Philips Lamp Works. PCJJ	80.2	-----	Linkoping: Radio Club, Relays Stockholm 4 days each week, local programs other days. SMTV	588.2	250
Hilversum: Netherlandsche Seintoolen Fabrik and Hilversum Dreadloze Omroep. Reception reported at Teheran. HDO	1060	1000	Malmo: Radiojanst. SASC	229	1000
Scheveningen-Haven	1950	2500	Motala. SMVY	1304.5	40,000
<b>NEW ZEALAND</b>			Norrkopung. SMTI	372.7	250
Auckland: Radio Broadcasting Co. of New Zealand. General, two hours daily. IYA	420	500	Orebro. SMTI	566	250
Christchurch: R. R. Co. of N. Z. IYB	400	500	Osterlund. SMTS	720	1000
Dunedin: R. B. Co. of N. Z. IYC	380	110	Saffle. SMTS	252.1	500
Gisborne: Gisborne Radio Co. IYM	260	50	Stockholm: Radiojanst. SASA	416.7	1500
Wellington: R. B. Co. of N. Z. IYK	295	60	Sundsvall: Radiojanst. SASD	545.6	1000
<b>NORWAY</b>			Trollhattan. SMXQ	277.8	1000
Oslo: Broadcasting Company A. S. 461.5	1500	-----	Uddevalle. SMZP	294.1	100
Bergen: Bergen Broadcasters. 370.4	1500	-----	Umea: Relays Stockholm 4 days, local programs other days. SMSN	252.1	250
Fredrikstad: Relays Oslo. 434.8	750	-----	Uppsala. SMTU	500	250
Hamar. 566	750	-----	Varborg. SMSO	297	100
Porsgrund: Relays Oslo. 504	750	-----	<b>SWITZERLAND</b>		
Rjukan: Relays Oslo. 443	250	-----	Basel. HR3	1100	300
Tromsden: Relays Oslo. 243.9	-----	-----	Berne: Radio Berne Station, Radio Club of Berne. HBA	411	1500
Notodden: Relays Oslo. 447.8	-----	-----	General Post and Telegraph Office. 302	1500	-----
Stavanger. 277.8	250	-----	Geneva: Radio Broadcasting Society of Geneva. Broadcasts music and news. HR1	760	500
Tromso. 500	-----	-----	Lausanne: Champ de l'Air Station (Societe Romande de Radiotelephonie Lausanne). HB2	850	600
<b>PARAGUAY</b>			Zurich: Hoengg Station, Radio Genossenschaft Zurich University. Reception reported at Antwerp, Brussels, Rome, Vienna. HBZ	500	1000
Asuncion: General, Friday. 12	-----	-----	<b>TUNISIA</b>		
<b>PERU</b>			Carthage. 100	50	-----
Lima: Peruvian Broadcasting Co. (Ltd.). OAX	360	1500	Carthage. 1800	5000	-----
<b>PHILIPPINES</b>			Tunis: French Army. Two musical programs broadcast each week. TUA-OCTU	1450	100
Raguio. KZUY	359.9	500	French Army. Two musical programs broadcast each week. OCTU	45	-----
Manila: I. Beck Dept. Store. KZIB	249.9	20	<b>TURKEY</b>		
KZKZ	270.1	100	Osmaieh. 1200	6000	-----
KZRQ	222.1	500	<b>UNION OF SOUTH AFRICA</b>		
<b>POLAND</b>			Cape Town. 400	500	-----
Cracow. 422	1500	-----	Durban: Town Council. 400	1200	-----
Lemberg: Under construction. 247.9	1500	-----	Grahamstown. 400	-----	-----
Posen. 270.3	1500	-----	Johannesburg: Assn. Scientific and Tech. Societies. JB	438	900
Warsaw. AXO	1111.1	8000	Cape Town: Cape Peninsula Broadcasting Assn., Broadcasts 54 hours per week, programs by paid orchestra and local talent. 375	1200	-----
Vilna (projected). 234.4	2000	-----	<b>UNION OF SOVIET SOCIALIST REPUBLICS (formerly Russia)</b>		
<b>PORTUGAL</b>			Kiev. RA5	775	1000
Lisbon: Grandes Armazenes de Chiado. Irregular. IAA	267.8	500	Leningrad. RA42	1000	10,000
Monte Santo. CTV	2450	1500	Leningrad. RA6	940	2000
<b>PORTO RICO</b>			Moscow: Komitern. RDV	1450	40,000
San Juan: Radio Corp. of Porto Rico. WKQAQ	340.7	500	Radio Paredatcha. RA1	420	2000
<b>RUSSIA (Now U. S. S. R.)</b>			Popoff. 79	-----	-----
<b>SALVADOR</b>			Popoff. 25	-----	-----
San Salvador: Govt. National Broadcasting, Mon, Wed, Fri, 8:15 p. m., C. S. T. RUS	452	500	Popoff. 1010	2000	-----
<b>SENEGAL</b>			Trades Union. MSK	650	2000
St. Louis: Senegal Radio Club. Projected. 300	100	-----	Nijni Novgorod. RA13	1400	1500
<b>SIBERIA</b>			<b>URUGUAY</b>		
Tomsk. RA21	300	250	Montevideo. CWOR	350	500
<b>SPAIN</b>			CWOF	300	100
Barcelona: Radio Barcelona Station. EAJ1	344	1000	CWOG	280	10
Radio Catalana Nacional Radiofusi6n. EAJ13	277.8	1000	CWOS	380	500
Bilabo: Radio Carlton Station. Radio Club Vizcaya. EAJ9	438	500	<b>VENEZUELA</b>		
Radio Vizcaya Station. Don Armande de Otera. EAJ11	294.1	500	Caracas: Empress Venezolana de Radiotelefonla. AYRE	375	1000
Vizcaya Radio Broadcasting Station, broadcasts music, provided by local talent, and considerable advertising from 12 to 12 pm daily.	294.1	2000	<b>URUGUAY</b>		
Cadiz: Don Francisco de la Liesca. EAJ3	344	500	Montevideo. CWOR	350	500
Radio Lehera. EAJ10	297	1000	CWOF	300	100
Cartagena: Don Enrique de Orbe. EAJ16	294.1	500	CWOG	280	10
Madrid: Don Antonio Castilla. EAJ4	400	500	CWOS	380	500
Radio Iberica Station. EAJ6	275.2	3000	<b>VENEZUELA</b>		
Union Radio. EAJ7	375	1000	Caracas: Empress Venezolana de Radiotelefonla. AYRE	375	1000
Radio Madrilena. EAJ12	306	2000	<b>URUGUAY</b>		
Association of Radio. EAJ15	490	1000	Montevideo. CWOR	350	500
Radio Espana. EAJ2	393	3000	CWOF	300	100
Malaga: Cia Iberia de Telecomunicacion. EAJ25	50-25	100	CWOG	280	10
Oriado: Don Arbro Cima. EAJ20	254.2	100	CWOS	380	500
Salamanca. EAJ19	201.3	100	<b>VENEZUELA</b>		
Saragossa. EAJ22	495	500	Caracas: Empress Venezolana de Radiotelefonla. AYRE	375	1000
San Sebastian: Don Sabino Ucelayeta. EAJ8	325	1500	<b>URUGUAY</b>		
Seville: Seville Radio Club. EAJ5	272.7	500	Montevideo. CWOR	350	500
Don Manuel Garcia Ballesta. EAJ17	400	1000	CWOF	300	100
Don Jorge la Riva, projected. EAJ21	344	500	CWOG	280	10
Valencia: Radio Corporation. EAJ14	500	500	CWOS	380	500
Under construction. EAJ24	360	500	<b>VENEZUELA</b>		
Zaragoza. EAJ23	566	500	Caracas: Empress Venezolana de Radiotelefonla. AYRE	375	1000



**"I wanted to be sure of Quality so I built a VICTOREEN"**

T. W. GROGAN *President*  
 The T. W. GROGAN COMPANY  
 Union Mortgage Bldg. Cleveland, O

**F**RANK expressions of approval from the lips of men who know, are the best evidence of Victoreen superiority! Those who have spent much time and money in an effort to achieve the ultimate in radio, eventually find complete satisfaction in a Victoreen Super. Tone brilliancy, distance, knife-like selectivity and simplicity of assembly. These are the outstanding qualities which account for the great wave of Victoreen popularity in high places.

**The VICTOREEN 112**  
 Audio Transformer Unit

Presenting all of the intimate naturalness of the original program, this efficient unit is designed to handle up to 475 volts of B battery supply. It is especially adapted to the Western Electric cone speaker or similar types. The transformer consists of two stages of audio amplification in one case and is designed for use with two 112 power tubes.



*You can build a Victoreen "Super" and be assured of quality results. Send today for the 1928 blue print of the Victoreen circuit, there is no charge.*

**The GEORGE W. WALKER Co.**  
 MERCHANDISERS OF VICTOREEN RADIO PRODUCTS  
 2825 CHESTER AVENUE CLEVELAND OHIO

**Victoreen**

*Tell 'Em You Saw It in the Citizens Radio Call Book Magazine*

# Unexcelled—

# “The Aristocrat”

the finest looking—finest tuning

# Vernier-Port Dial



No. 702  
1-5/16" POINTER KNOB  
3/16", 1/4", One Piece  
(2 1/4" circle)



No. 792  
2 5/8" VERNIER POINTER  
1/4" E-Z-Toon movement  
(3 5/8" circle)

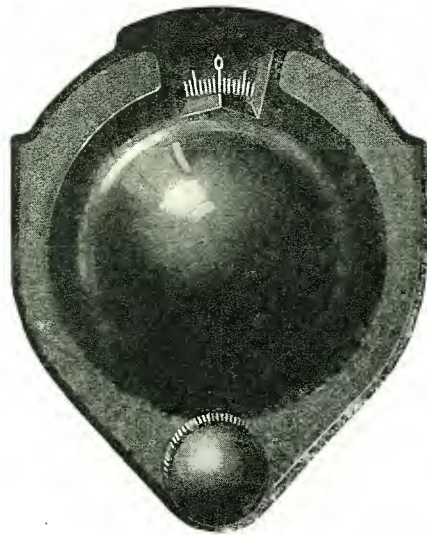

This Vernier is foolproof—troubleproof. One turn of the knob drives the dial 14 points on the scale. No gears, chains, or cogs to get out of order. The friction action is sure and simple—and cannot wear out or break down. Readings are visible thru a port in the casing. No back lash is possible. With this new Vernier Dial, you'll bring in stations you've never before been able to tune in.

FIRST in noteworthy improvements, the new “Aristocrat” Vernier-Port Dial is no exception to the excellence of Kurz-Kasch products. This new Vernier-Port, all bakelite dial affords you a real opportunity to bring your old set up-to-date and also improve its efficiency, all at a cost no more than ordinary vernier dials.

The Aristocrat is the only efficient Vernier-Port Dial on the market with all mechanism and condenser shaft-ends concealed. It cannot be surpassed for beauty—nor equalled in efficiency. You must install these dials to appreciate what a wonderful improvement they will make on your radio.

You may have this Vernier-Port Dial to match the panel of your radio. Furnished in black, mahogany or walnut finish. The graining of the colored dials is exquisite—obtained by an exclusive KURZ-KASCH process!

The Aristocrat Vernier-Port Dial is supplied in three finishes—black with white markings and mahogany or walnut with gold markings—at the same low price—\$2. It is sold at all the better dealers. If yours cannot supply you, tell us about it.

The KURZ-KASCH CO., Dayton, Ohio

# KURZ KASCH

*Aristocrat Dials and Knobs*

Tell 'Em You Saw It in the Citizens Radio Call Book Magazine

# Radio Enters The Custom Built Era

**R**ADIO has passed through many vicissitudes since the inception of its popularization about seven years ago. It has traversed successively the many weird stages between its first variometer and its present day high quality standard circuits, all the result of keener research by a multitude of minds on a single problem—that of giving the public the best possible value for the money, both in apparatus and performance.

But most interesting of all is the metamorphosis which the industry is now undergoing in response to a demand from the public. The era of the custom built set is at hand and the idea is meeting with genuine interest both with the public and parts manufacturers.

The custom built idea has no quarrel with the factory built receiver. Its adherents believe, and rightfully so, there is room for both kinds of business. Many who are well served with their manufactured receiver would not be interested in a custom built job, but on the other hand there are many who would prefer a radio built around their own local conditions and with perhaps a greater degree of flexibility than might be afforded with any other kind of set.

In the past it was quite natural the seed of the custom built idea did not take a strong hold because those who are now engaged in building these receivers were at that time serving their apprenticeship in this most fascinating of all arts. But with a background of four or five years experience in the construction and servicing of a host of circuits and sets, it is not to be wondered at that the professional setbuilder should find the time ripe for turning over a finished product in whose assembly he can well afford to take pride.

What proportions the custom built business will assume, it is not given for us to prophesy, but from indications given during the past six months we do not believe we would be amiss in stating before the end of another year the custom built set business will represent quite a considerable percentage of the sales of manufacturers of high quality parts who have been quick to see another promising outlet for their goods.

There will always be a demand for both the manufactured and the custom built receiver, the former going to those who have no desire to use their radio as anything other than a source of entertainment covering a more or less restricted area, and the latter type being built for those who are never satisfied unless they possess a set embodying the latest engineering ideas and constructed around their own operating conditions for use under either good or bad receiving conditions.

F. A. H.

# Silver Shielded Six Is Now Electrified

Complete Light Socket Operation Obtained Using A. C. Tubes, with Push-Pull Amplification and Seventh Tube Optional

**M**UCH of the work in radio design during the past six months has been centered on the problem of providing for the listener a set which requires no replacements, servicing or attention. In the past when using tubes which were supplied with direct current from a storage battery, the owner found it necessary to maintain the specific gravity of his battery at the proper point to insure the required voltage on the tubes. With the introduction of vacuum tubes which operate with raw alternating current, the battery may now be dropped from consideration. The plate supply of an electrical receiver must still be provided, of course, and for that purpose a standard B eliminator or power pack may be used. It is also possible to continue using dry batteries for plate supply if one desires.

## Six or Seven Tube Set

The receiver about to be described may be considered either a six or seven tube job, in view of the fact that with full push-pull amplification the receiver has seven tubes, whereas if a six tube receiver is desired one of the push-pull tubes may be removed and the set operated in that fashion. Both push-pull stages are type 171 tubes and when working in that form of connection, full advantage is taken of the tonal qualities of this system of amplification. As is customary in all transformers of this type, the output circuit of the 171 tubes is coupled through an audio frequency output transformer whose secondary leads to the

speaker and keeps direct current from its windings.

Those readers who may already have constructed a set similar to this one and who had provided for battery operation of the filament circuit may easily convert such a set into an electrically operated one. All that is involved in such a change would be the rearrangement of the filament leads, 2½ volts a.c. being supplied to all of the tubes containing the heater element. For the tubes using raw a.c., the filament voltage is 1½ volts, while the filaments of the 171 power tubes are supplied from a 5 volt a.c. source.

## It's Easy to Build

Considerable research work has been done on the preparation of the Silver-Marshall Shielded Six, both as regards the distance of the coils from the shields, the type of variable condensers used to cut down electrostatic effects and the general layout of all units inside of the cans to provide a minimum of wiring and make it possible for even the novice to readily hook up such a receiver and secure excellent results from it.

By examining Figure 2, which is a photographic view of this receiver, readers will note the antenna stage has not been shielded, since such a shield was not required. A special antenna switch is shown for either long or short antenna effects.

The second, third and fourth radio frequency transformers, each of which is located inside of a shield, are tuned by .00035

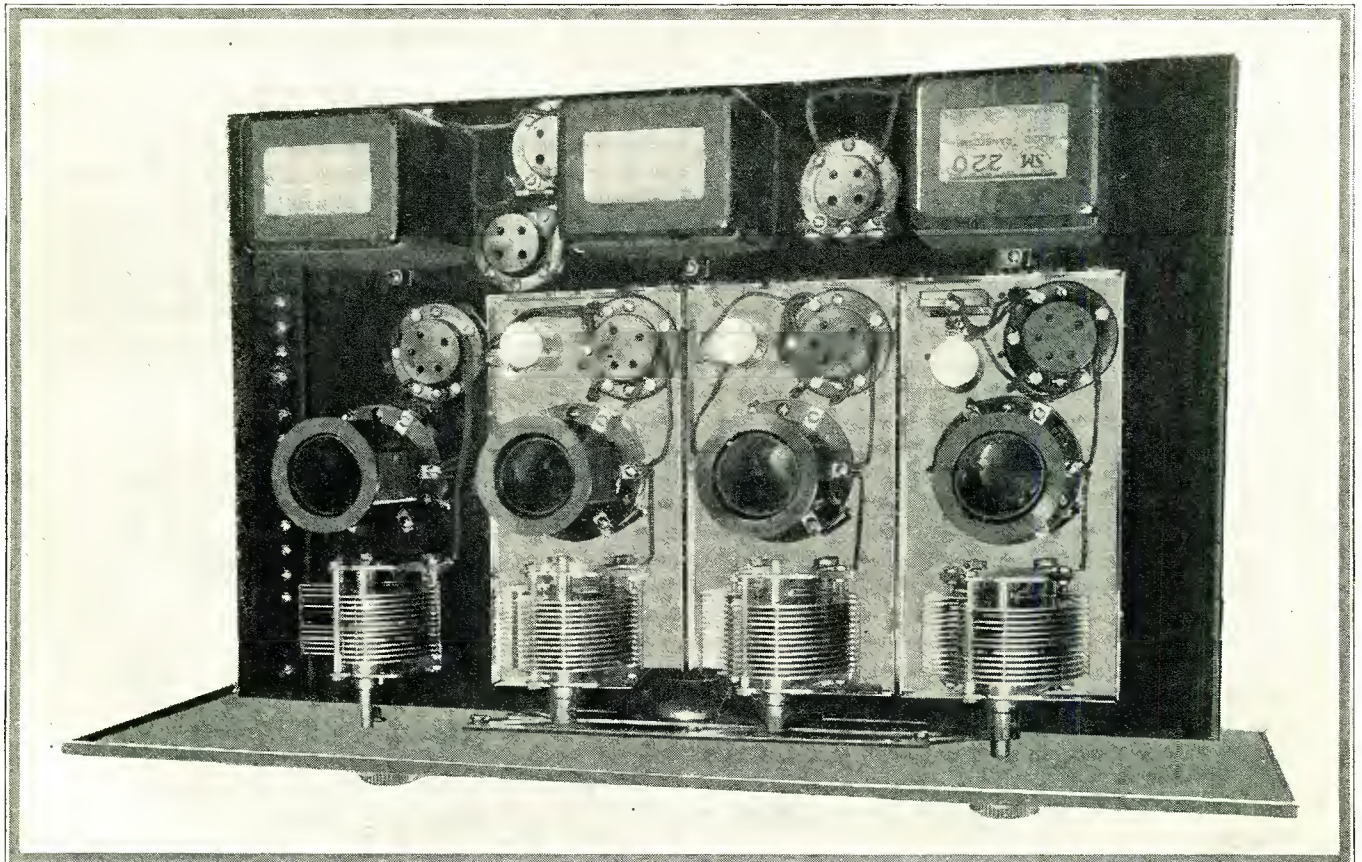

Figure 2. Shields removed, the reader may observe the inside of this compact receiver

(This receiver tested and illustrated in our laboratory)



Figure 1. Encased in a Corbett cabinet, the Silver-Marshall A. C. Shielded Six is shown on a Southern Toy console table

mfd. condensers arranged for gang tuning by means of a link motion, which may be seen between the three condensers in the shields and the front panel in Figure 2. This link motion is also shown in the sub-panel layout, Figure 4. The condenser at the extreme right of Figure 4 has a shaft that is sufficiently long to engage the Marco vernier dial used on the front panel. The second and third condenser shafts are shorter and do not project forward as far as the back of the panel, these shafts engaging the two collars of the link motion.

Referring to Figure 3, which is a schematic diagram, it will be seen that the first, second, third and fourth tubes in this receiver are of the heater type which give excellent amplification. The sockets for these tubes are arranged for five prongs, four of the prongs being the conventional grid, plate and two filament terminals, while the fifth prong is the cathode which is marked "C" in this particular diagram. A 600 ohm resistance is placed between the grid returns of the first, second and third r. f. stages and the cathode terminal bypassed by a .5 mfd. condenser. In

the detector stage the resistance between the grid return and the cathode is a 5000 ohm resistor, bypassed with a .5 mfd. condenser.

Volume Control Method

Plate voltage for the first, second and third r. f. stages is secured through a Carter 6000 ohm potentiometer, which is connected across the negative B and the positive 90 terminals, the arm of the potentiometer going to the B terminals of the second, third and fourth r.f. transformers. By means of this potentiometer any desired value of voltage between 0 and 90 may be applied to the plates of the r.f. stages. This serves as a volume control for the receiver.

The plate circuit of the detector is supplied with 45 volts, while the plate of the first audio is given a potential of 90 volts. The plate circuit of the two 171 power tube is supplied with 220 volts or more, if desired, this being possible on account of the use of an output transformer that prevents damage to the speaker windings, and because 40 volts are taken by the 1000 ohm resistance for a bias.

Use Large Conductors

Whereas the size of the conductor used in bringing filament current for the 171 tubes at 5 volts is not so important, it does become very important when carrying the 1½ and 2½ volt leads for the 226 and 227 type filaments respectively. In these cases, the conductor should not be smaller than a regular Kellogg hook-up wire and the leads from the transformer to the binding posts on the strip should be kept just as short as it is possible to do. It would be well for reader to remember that whereas in the storage battery operated tubes the filament current was only a quarter of an ampere, in most cases when the alternating current tubes are used in individual filaments are taking from 1 to 1¼ amperes per filament, and when a number of these tubes are used parallel, this gives a very high amperage at a relatively low voltage. Under these conditions it is but natural that even a small amount of resistance inserted in that circuit would immediately tend to reduce the voltage applied to the terminals of these tubes. Manufacturers, when designing transformers for heater filaments of alternating current tubes, have taken into consideration the fact that a generous sized conductor should be used, and if the constructor does not do so he is defeating the purpose of the transformer and giving rise to a difficulty which should not be charged against the maker of the filament supply transformer.

Referring to the diagram shown in Figure 3 will develop the fact that all sets of alternating current filament supply are made up of twisted pair and these are the returns which should have the most generous sized conductors. In addition to the large

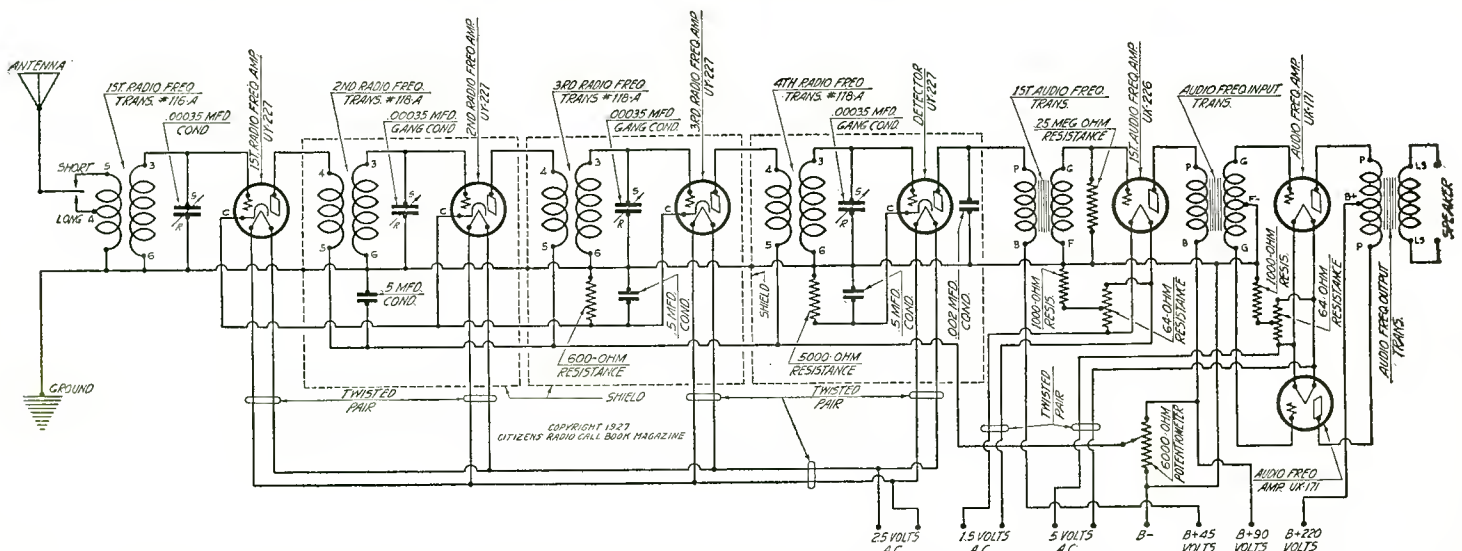

Figure 3. Complete schematic circuit of the receiver may be found in the drawing above. For experienced constructors this will serve for wiring purposes

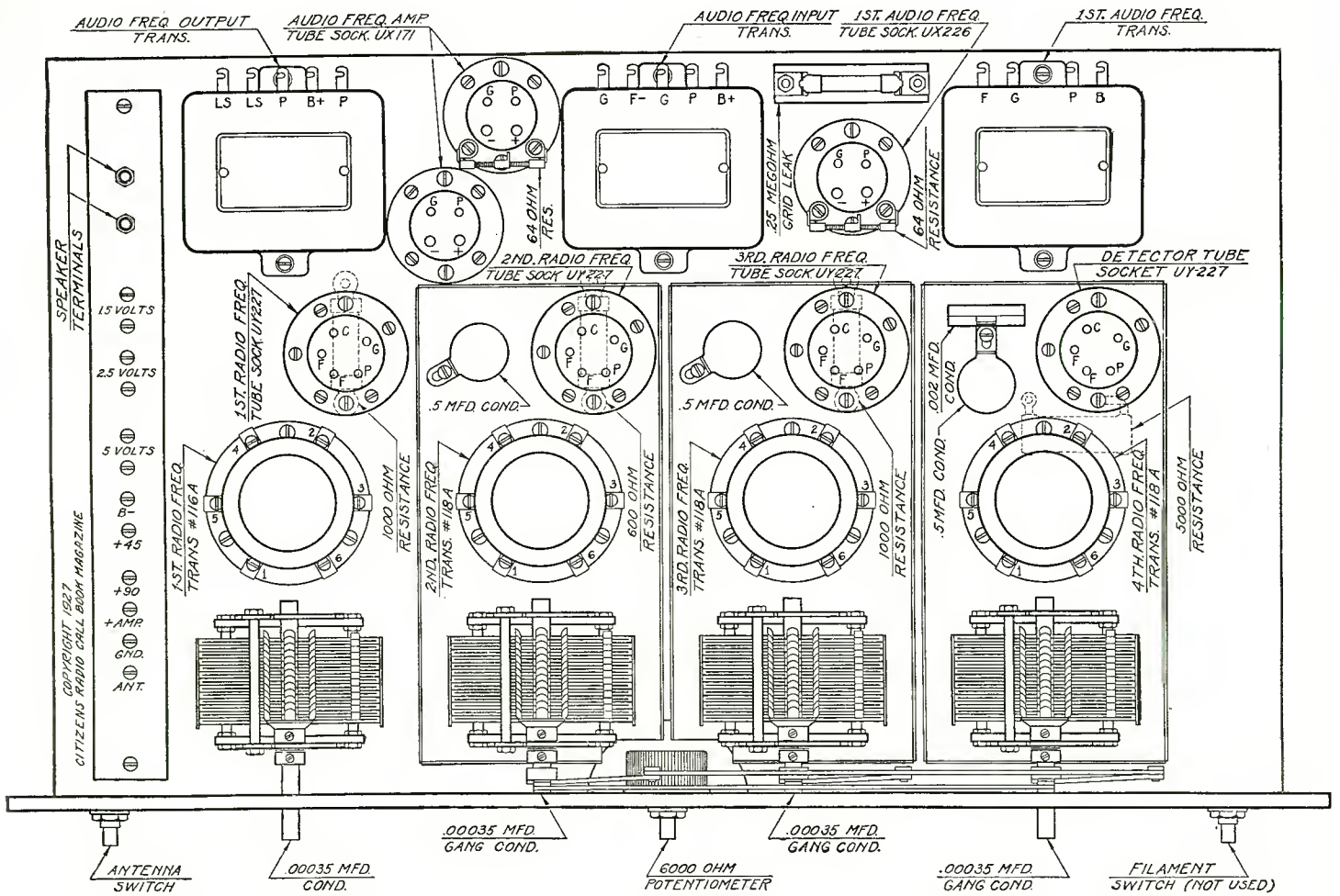
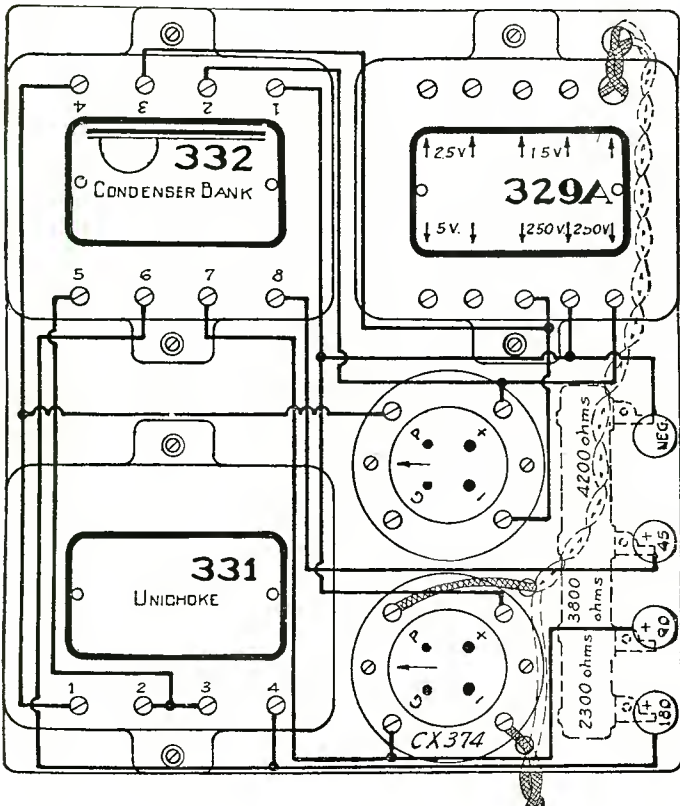

Fig. 4. Sub-panel layout of the A. C. Shielded Six is given above. All parts should be placed exactly as shown in this diagram

surface conductor used in these lines, the length should be kept down to a minimum.

Quite a number of interesting experiments may be performed

by the set owner with a shielded receiver of this type, especially if he is in a location where there are a number of broadcasting stations in operation at the same time. The Shielded Six, being designed for a very high ratio of radio frequency amplification, does not usually require more than a short length of wire for the antenna connection. Some users make use of a wire carried around the picture moulding when an outside antenna is not possible. Others, unable to put up an outside antenna, have found that a 10 or 15 foot piece of wire dropped out of the window will serve as an energy collector for the set. Still other experimenters have found that a loop when used as an open-ended loop may collect quite a quantity of energy for operating a receiver. When the loop is used as this kind of antenna, one terminal goes to the antenna position of the receiver, while the other terminal of the loop is left open. Still another means of feeding energy to the first stage would be through the use of a socket antenna, several types of which are on the market and which, under certain conditions, might work satisfactorily. It should be borne in mind, however, that all of these systems enumerated previously are more or less in the class of subterfuges, for after all there is no substitute for a good, high, well erected antenna and ground system.



Parts for Receiver

The following list of parts is used in the construction of the Silver A. C. Shielded Six, which has been tested and all illustrations of which were made in our laboratory. If any substitutions are made in this list, be very careful to see that parts are of high quality and the values specified.

- 3—631 Silver-Marshall stage shields.
- 2—316A Silver-Marshall condensers.



- 2—316B Silver-Marshall condensers.
- 4—515 Silver-Marshall inductance sockets.
- 3—118A Silver-Marshall r. f. transformers.
- 1—116A Silver-Marshall r. f. transformer.
- 3—511 Silver-Marshall sockets.
- 4—512 Silver-Marshall sockets.
- 1—220 Silver-Marshall audio transformer.
- 1—230 Silver-Marshall push-pull input transformer.
- 1—231 Silver-Marshall push-pull output transformer.
- 1—632 Silver-Marshall triple link motion.
- 1—636 Silver-Marshall a. c. terminal strip with terminals.
- 1—633 Silver-Marshall drilled and engraved metal panel 7x21 inch.
- 1—634 Silver-Marshall steel chassis 12x19¼x1¼ inch.
- 1—Carter .002 mfd. fixed condenser.
- 3—105 Carter .5 mfd. by-pass condensers.
- 1—MW6000 Carter potentiometer.
- 2—10 Carter tip jacks.
- 1—H600 Carter 600 ohm fixed resistance.
- 2—H1000 Carter 1000 ohm fixed resistances.
- 1—12 Carter antenna switch.
- 1—Carter imp battery switch.
- 2—FT64 Frost fixed resistances.
- 1—W Kroblak 5000 ohm resistor.

- 2—Marco vernier dials, walnut finish.
- 1—Coil Kellogg fabricated hook-up wire with screws, nuts, lugs, etc.
- 1—Polyeak 2/10 megohm resistor.
- 1—Package Kester radio solder.
- 1—Ekko ground clamp.

**For Power Supply**

A power supply device for this receiver may be secured by using the Silver-Marshall 652-A power unit kit, which consists of the following items:

- 1—329A Silver-Marshall ABC power transformer.
- 1—331 Silver-Marshall uni-choke.
- 1—332 SM-Tobe condenser block.
- 2—511 Silver-Marshall sockets.
- 1—659 Silver-Marshall (Ward-Leonard) resistance.
- 1—654 Silver-Marshall steel base.

Accompanying the type 654 base are:

- 4 Eby binding posts.
- 4 Soldering lugs.
- 4 Sets binding posts insulating washers.
- 12 Feet Kellogg hook-up wire.
- 4 Rubber bumper feet.
- 10 6/32x½ inch RHNP screws.

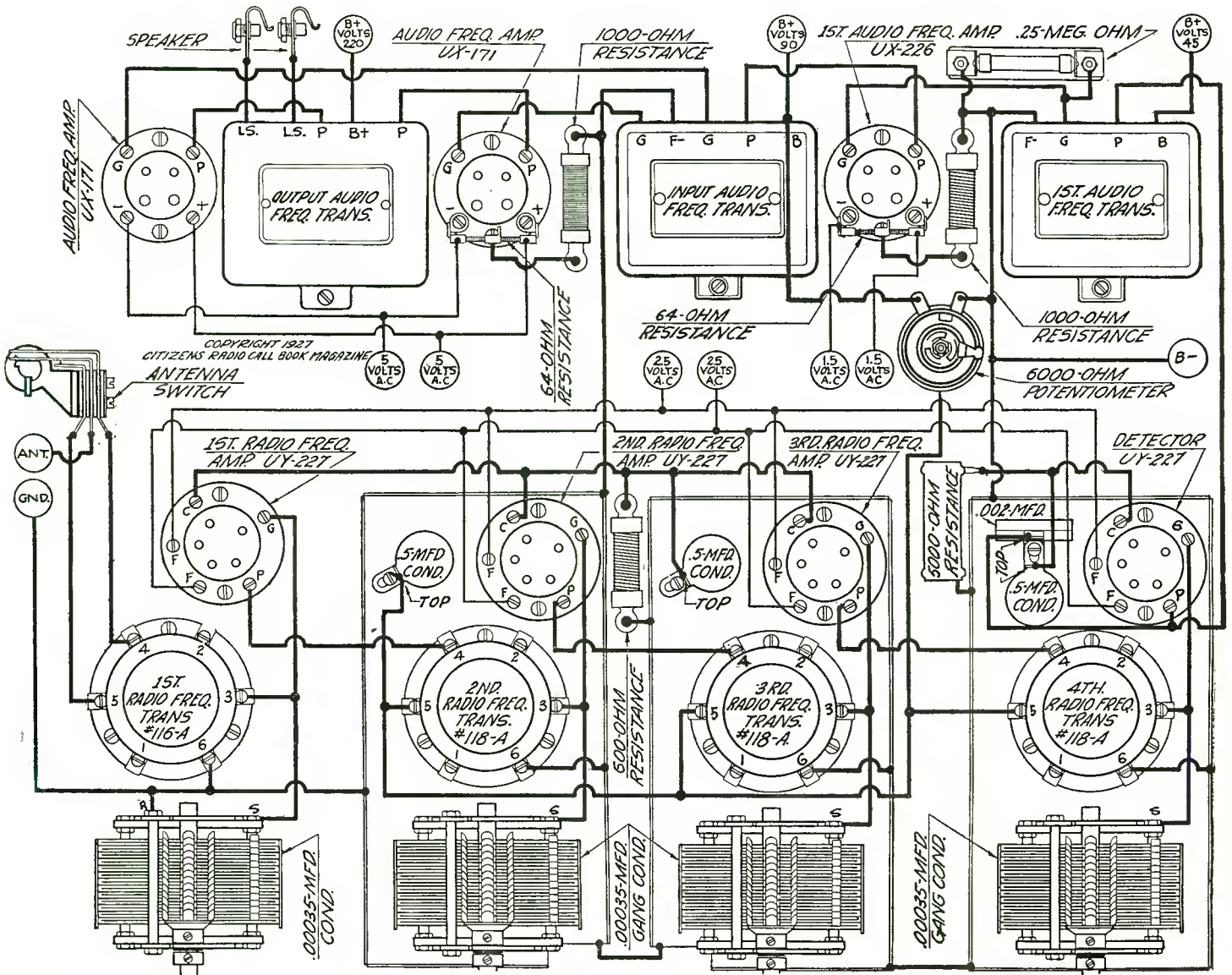

NOTE—THE VAR. CONDENSER ROTORS ARE GROUNDED THROUGH THE SHIELDS BY CONTACT MADE IN MOUNTING. ALL FILAMENT LEADS ARE TWISTED PAIRS.

Figure 5. Readers who are not confident enough to wire by a schematic diagram should make use of the graphic illustration prepared for this efficient receiver

# Tone reproduction

**that no one  
even thought  
was possible~**

New delights—beyond your fondest dreams—are realities in this new speaker—the sensation of the radio world. Now for the first time in your life hear radio as you never heard it before! No harsh notes—no grating—no slurring at the bottom of the scale. The marvelous tone quality of the *Temple Drum Speaker* is finer than anyone thought was possible.

Ask your dealer for a TEMPLE demonstration using the TEMPLE Comparator. This test will settle all speaker claims. You can close your eyes and pick the TEMPLE tone reproduction every time! Make this test for yourself today.

### Not a Cone

*Long compensated exponential air column design.*

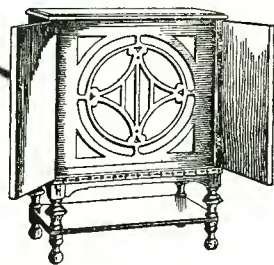

### No Radio Is Better Than Its Speaker

Regardless of the cost or make of your particular set, the TEMPLE SPEAKER will enhance its tone quality, will increase your pleasure in radio a thousand-fold over what you have been used to. Irrespective of the nature of the program—be it opera, an orchestra, ball game, etc., TEMPLE will bring it to you clearly, unfailling in its fullness.



**The  
TEMPLE  
DRUM SPEAKER  
has given the world a new  
appreciation of Radio**

No test is too severe to prove the wonderful merits of TEMPLE SPEAKERS. In Chicago recently a private yacht steamed out six miles on Lake Michigan and those on land heard the TEMPLE clearly.

Eddie and Fannie Cavanaugh, the Gaelic Twins of KYW, Chicago, say: "We have tried many speakers but none have the wonderful tone quality and volume of the TEMPLE, either in the open, in convention halls or at home."

TEMPLE SPEAKERS are selling like wild-fire all over the country. New enthusiasts by the thousands are hearing radio in a new way and marvel that such remarkable tone reproduction is possible.

Write for complete descriptive matter.

Console Cabinet Model No. 65—  
priced at \$65.00; west of Rockies, \$75.00  
Drum Type Model No. 13, 13 inch—  
priced at \$29.00; west of Rockies, \$32.00  
Drum Type Model No. 18, 18 inch—  
priced at \$48.50; west of Rockies, \$55.00

**TEMPLE, INC.**  
213 S. Peoria St., Chicago

On Sale By Leading Dealers

**L E A D E R S   I N   S P E A K E R   D E S I G N**

*Tell 'Em You Saw It in the Citizens Radio Call Book Magazine*



*Radio  
Celebrities*  
*People you hear  
but seldom see*

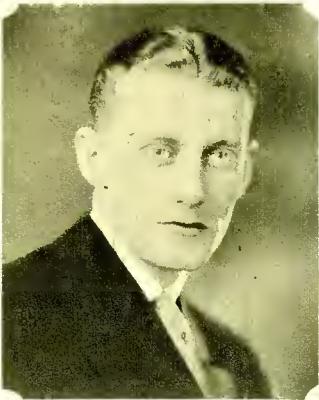

George L. Sutherland, Jr., Announcer and Manager of WSEA, Norfolk, Va.



Staff of the Totem Broadcasters, Station KOMO, Seattle, Wash.



Bernice Berwin, leading lady of the KGO Radio Players, Oakland, Calif.



Dailey Paskman, Director of WGBS, N. Y. City

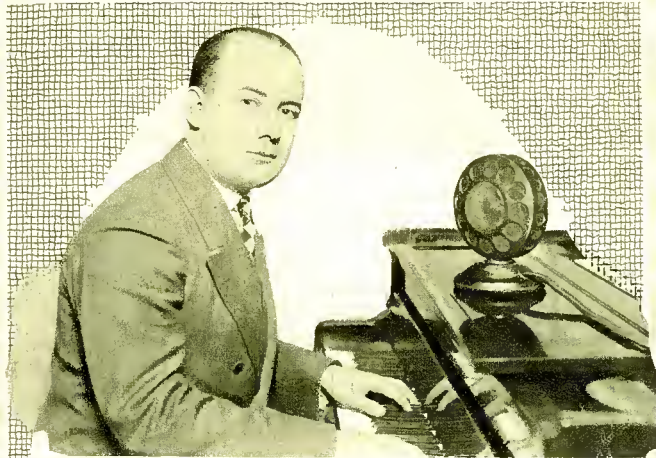

Charlie "Harmony" Garland, thousand fingered pianist of WBBM, Chicago, Ill.



Elfrieda Steindorff, soprano of KGO Light Opera Co., Oakland, Calif.



The "Thrift Twins," Reber Boulton, right, baritone, and Bob Carson, pianist and accompanist. Station WLAC, Nashville, Tenn.



Lillian Rehberg, cello-violinist heard over Station KYW, Chicago, Ill.



Ross W. Swift, chief announcer and program director of KJR, Seattle, Wash.



Tennessee Collegians, with Charles Riadon, Director. Feature artists for WLAC, Nashville, Tenn.



Guy Lombardo, director of the Royal Canadians, heard over WTAM, Cleveland, Ohio

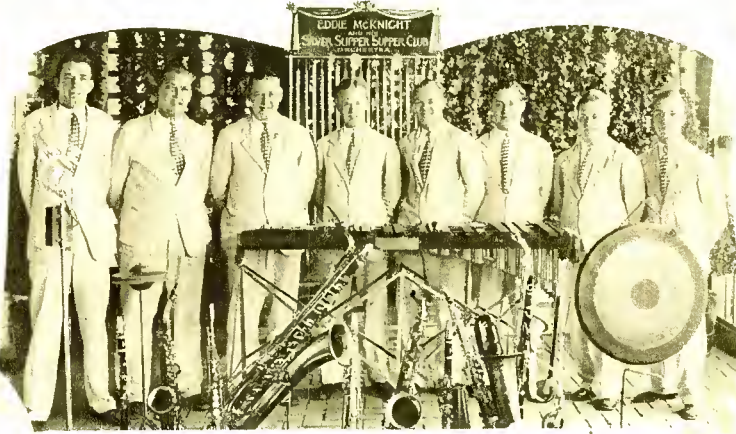

Eddie McKnight and his Silver Slipper Orchestra, broadcasting over WSEA, Norfolk, Va.



Douglas Stanbury, featured baritone soloist with "Roxy and His Gang," heard Monday night over the Blue Network Stations from WJZ, N. Y. C.

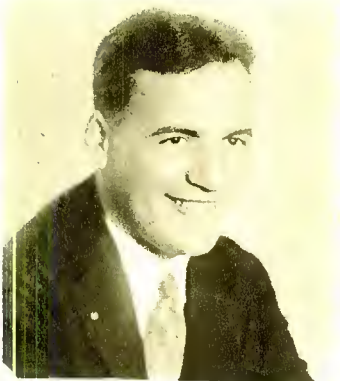

George H. Jaspert, director of Station WBZ, Boston, Mass.



Harold True, Announcer of WTAM, Cleveland, Ohio



Aidan Redmond, chief announcer of WBZ, Boston; also concert soloist with Bert Lowe and his Orchestra



W. Gordon Swan, Announcer of WBZ, Boston, Mass.



Rembrandt Trio, left to right, Dorothy Dukes Dim, cello; Eva Garcia, piano and Modesta Mortensen, violin, heard over KGO, Oakland, Calif.



Eddie Albright, Town Crier of the day at KNX, Hollywood, Calif.



Ted Guy and his Los Angeles Club Orchestra heard over WIL, St. Louis, Missouri



G. Allison Phelps, Manager and Announcer of KMTR, Hollywood, Calif.



Howard Neumiller, Musical Director and concert pianist on the staff of WIBO, Chicago, playing the celeste, the instrument with the sweet bell-like tones



Roscoe Grover, Announcer of KSL, Salt Lake City, Utah

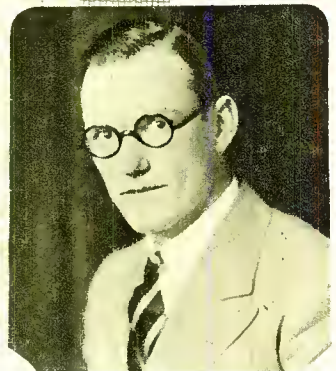

Clair E. Morrison, Manager of Station KYA, San Francisco, Calif.



Emilie W. Sturtevant, in charge of programs from Station WBZ, Boston, Mass.



Jennings Pierce, announcer and tenor soloist of KGO, Oakland, Calif.



Mrs. Billy Wright, contralto soloist of KFON, Long Beach, Calif.

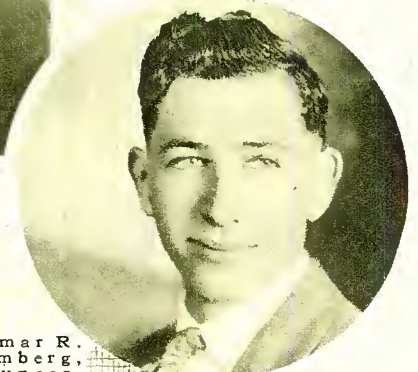

Hjalmar R. Stromberg, announcer, KGO, Oakland, Calif.



Wesley Booker's Orchestra heard every Wednesday from WRVA, Richmond, Va.



Mrs. Elva Stephens Cockrell, soprano, Station KFDM, Beaumont, Texas



The Harding Sisters, Betty and Laretta, Blues Singers, heard over KOMO, Seattle, Wash.



Max Rosenstein, violinist and a member of the Concert Orchestra of WBAL, Baltimore, Md.



Richard Kountz who has charge of the half hour with famous composers over KDKA, Pittsburgh, Pa.



J. Dale Stentz, Announcer and Director of Station WWNC, Asheville, N. Car.



Walter G. Haenschen, Director of the Philco Orchestra heard every Friday Night over the Blue Network Stations, through WJZ, N. Y. City



C. Merwin Dobyns, Owner and director of Station KGER, Long Beach, Calif.



Jessie Robinson, dramatic soprano and staff artist of WEHS, Evanston, Ill.



Mary D. Corbett, announcer of the Shopper's Radio Service, Station WIL, St. Louis, Mo.



Cavi's Elks Orchestra. WLBV, Iron Mountain, Mich.



Sidney Dixon, Announcer and Lyric Tenor of Station KOMO, Seattle, Wash.



John L. Dickinson, baritone, heard over Station WGHP, Detroit, Mich.



Quartette composed of Horace Easom, first tenor, George Hartrick, baritone, J. Dale Stentz, bass and Horace Seely, second tenor, heard over WWNC, Asheville, N. C.



Eva Garcia, concert pianist of KGO, Oakland, Calif.



Lois White, Staff artist of WEHS, Evanston, Ill.

Hal Totten, sports announcer of WM A Q, Chicago, Ill.



Whitney Trio, Robert Whitney, piano; Moreen Whitney, violin and Grace Whitney, cello. Heard over WMAQ, Chicago, Ill.



Bertha Brewster, program manager of KGER, Long Beach, Calif.

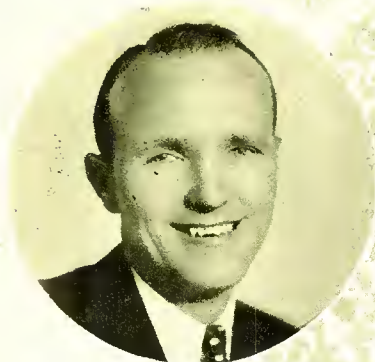

Walter Preston, announcer, director and manager of WIBO, Chicago, Ill.



Betty Jane Lamborn, hostess and accompanist of WGHP, Detroit, Mich.

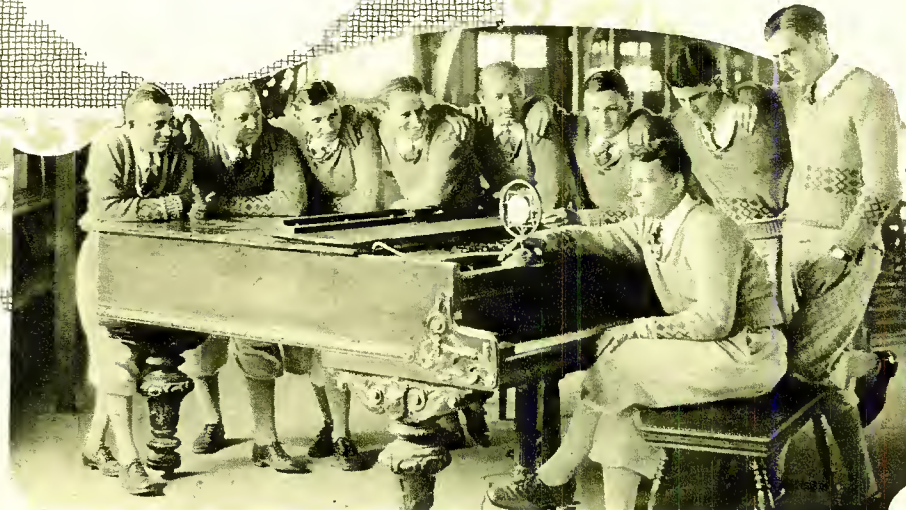

Pete Pretorius and his Coliseum Orchestra heard regularly over WLBV, Mansfield, Ohio





Emil Heerman, famous violinist and concert master of the Cincinnati Symphony Orchestra, featured every Wednesday night over WLW, Cincinnati, Ohio



Martha Rowland Brown, Musical Director and Bedtime Story Teller of WSM, Nashville, Tenn.



Babe Love, Blue Singer of Station KYW, Chicago, Ill.



Kay Ronayne, singer, heard over Stations WEBH, WBBM and KYW, Chicago, Ill.



Fireside Quartette, The Harmony Leaders of WRVA, Richmond, Va.



Stephen Leyshon, musical program announcer of KDKA, Pittsburgh, Pa.



Dorothy Paca, studio directress and soloist of WLBW, Oil City, Pa.



Frederick Rodgers, announcer and baritone singer heard over KDKA, Pittsburgh, Pa



Frank Bibb, pianist, heard once a month in a program entitled "An Hour With the Great Songs" over WBAL, Baltimore, Md.



Hotel Cleveland Orchestra, WTAM, Cleveland, Ohio



Irwin Abrams, director of Hotel Manger Orchestra heard Thursday and Saturday nights over WJZ, N. Y. C.



Anna Byrne and her La France Orchestra, heard over Station WEAF, New York City



Grace Corbin, Studio hostess of KJR, Seattle, Wash.



Bernice Ozmun, "Aunt Bernie" who broadcasts to the children every Wednesday from WIBO, Chicago



Larry Gallagher, 13 year old announcer who handles the Children's Hour of Station WTAM, Cleveland, Ohio



Alta Turney, soloist of WFLA, Clearwater, Fla.



Florence M. Jasper, program director, hostess and publicity director of WIBO, Chicago, Ill.



George Junkin, announcer and director of KM OX, St. Louis, Mo.



Tom, Joe and Jack (left to right, Jack Keefe, Joe Combs and Tom Mooney), known as the WSM Minstrels and heard every other Friday night from WSM Nashville, Tenn.

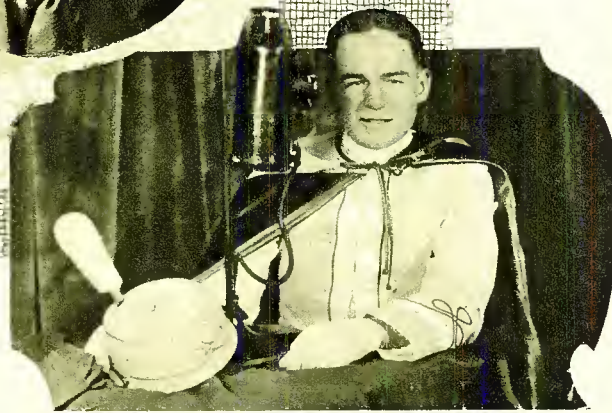

Ray L. Law, children's story teller, heard every Friday night from KGO, Oakland, Calif.



Joe Allabough, Director and Announcer of WEHS, Evanston, Ill.



Joe Rickards, announcer of WTAM, Cleveland, O.



Jack Goodwin, heard over WSBC, Chicago, Ill.



Marjory Garrigus Smith, pianist of WLW, Cincinnati, Ohio



Powel Crosley, Jr., owner and operator of Station WLW, Harrison, Ohio

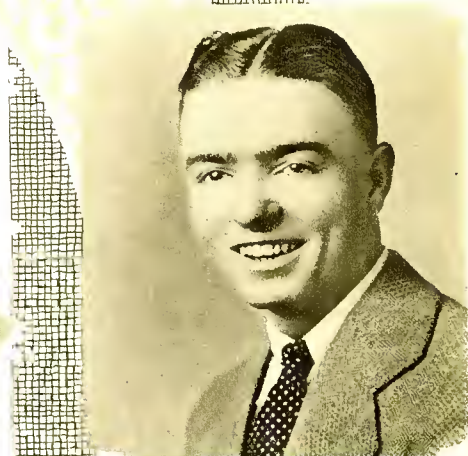

Ted Rogers, announcer of KSL, Salt Lake City, Utah



Erva Giles, soprano and leading lady of the Spotlight Hour every Thursday evening through the Blue Network Stations from WJZ, N. Y. City



Uncle John Daggett, Announcer, and his wife whose radio name is Pal O' Mine, heard over KHJ, Los Angeles, Calif.



Cesare Sodero, Director of the National Grand and Light Opera Companies heard over WEA, N. Y. City



Frances Sebel, Soprano, with the National Grand Opera Co., heard through WEA, N. Y. City

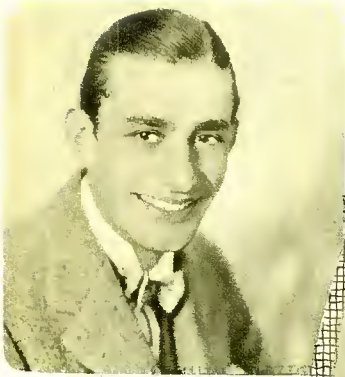

Albert Gillette, baritone and feature artist heard over KGO Oakland, Calif.



Kay Davidson, Blues Singer of WBBM, Chicago, Ill.



Lucille Hillers, staff pianist and organist of KFKX, Hastings, Neb.



John Lederer, conductor of the dance orchestra of WBAL, Baltimore, Md.



George Rogovoy, Cellist and member of the Totem Concert Orchestra, KOMO, Seattle, Wash.



Jerry Sullivan, announcer and director of WSBC, Chicago, Ill.



Lyn Bradshaw, operator of Station KYA, San Francisco, Calif.



Giuseppe di Benedetto, lyric tenor of the National Broadcasting Company's Grand Opera, heard over the Network Stations from WPAF, N. Y. City



Wendell P. Lovell, director of Radio Station WMBI, Chicago, Ill.

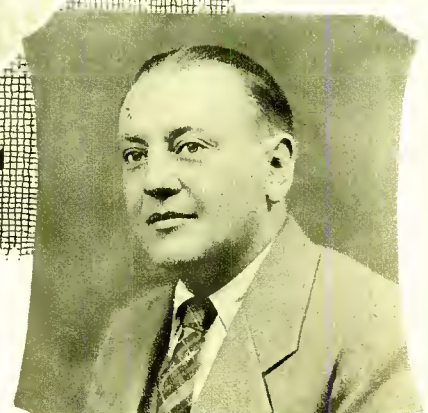

Thomas F. Burley, Jr., director of WDWM, Asbury Park, N. J.



Frank H. Ward, chaplain and director of Chapel Service KWCR, Cedar Rapids, Iowa



Milton G. Hall, Chief announcer and manager of Station WHEC, Rochester, N. Y.



Thomas Lejungh, violinist of WLBY, Iron Mountain, Mich.



June Pursell, song artist, heard over KNX, Los Angeles, Calif.



Walter N. Linthicum, baritone, heard over WBAL, Baltimore, Md.



Mrs. C. E. Dahlgren, soprano heard over WCSO, Springfield, Ohio



Mildred Hilliard, studio pianist of WHAR, Atlantic City, N. J.



Devora Nadworney, contralto soloist of the National Broadcasting Grand Opera Company, heard through WEA, N. Y. City



Teaberry Quartette, with Ollie Riehl, Director, KDKA, Pittsburgh, Pa.



Pauline Lombardo, violinist of KWCR, Cedar Rapids, Iowa

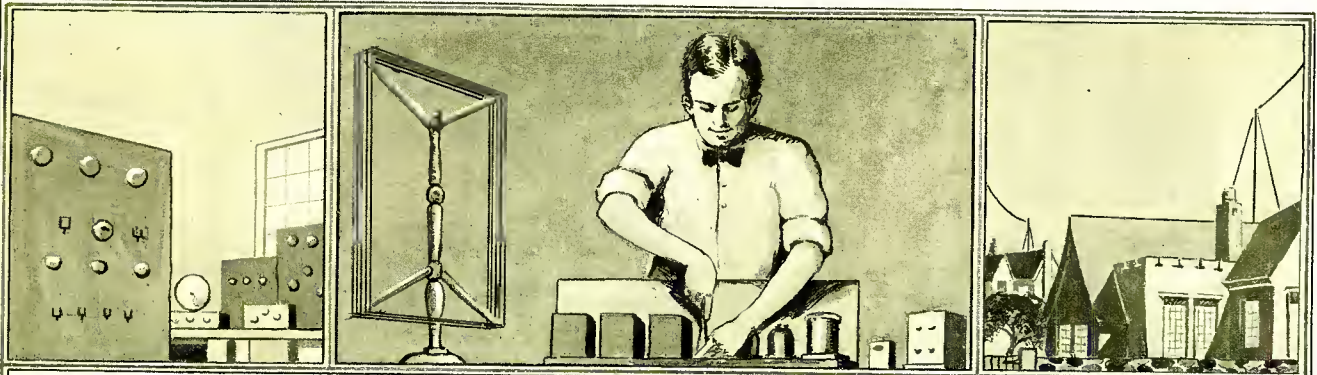

# AMPERE ANDY'S ASSISTORS



## Protecting the Polished Surface of a Panel

The polished surface of a bakelite panel should be protected at all times when the holes are laid out. A convenient method for protecting the surface of the panel, as well as furnishing a surface upon which pencil lines may be drawn, may be found in glueing a piece of paper to the panel surface before laying it out. Holes are located, centered and drilled before the paper is removed. After the panel is completely drilled, it should be soaked in water and the paper removed with a stiff brush. The water will dissolve the glue or paste used and a perfect finish will be preserved as far as the panel is concerned.

## Clean the Antenna

The antenna system should be inspected at regular intervals. Its efficiency depends entirely upon its insulation from supporting objects, as well as being in a condition of cleanliness at all times. The antenna proper and the insulators should be cleaned at frequent intervals with denatured alcohol. This will leave the antenna system in such a condition that maximum efficiency will be realized. While cleaning the insulators, it is best to examine them and note whether or not they are cracked or chipped. A perfect glazed surface must cover the entire insulator or it will absorb moisture and short-circuit when damp weather occurs.



## An Easy Method for Testing Head Phones

Head phones may be easily tested by wetting the two cord tips and bringing them forcibly together, while the head phones are over the ears. If a good click is heard, the head phones are in excellent shape and suitable for the purpose for which they are designed. If but a mediocre click is heard, their sensitivity has been greatly destroyed and it is advisable that a new pair be purchased. This test is more sensitive than the common practice of connecting a battery across the terminals of the head phones, since the magnets may have their permeability destroyed by the large voltage which passes through them.

## Using Old Tubes in UX Sockets

Many home constructors have in their possession old models of 201-A tubes equipped with a brass shell around the base. The use of these tubes in the UX type of socket is entirely practical, but the mechanical design of some of these sockets is such that the brass base short circuits the terminals, when an old type of tube is inserted. This often has disastrous results in so far as the tubes' life is concerned, as well as burnt-out rheostats caused by a short circuited "A" battery. If a piece of celluloid, slightly larger in diameter than the base, is pierced with four holes to correspond with the location of the prongs on the tube, it may be easily inserted over the prongs and will act as an insulator, effectually preventing any short circuit between terminals through the brass shell.

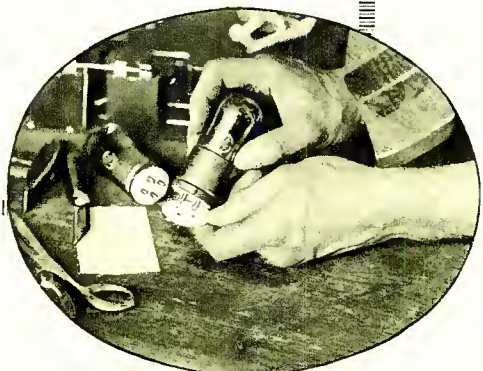



### A Handy Checking Method for Wiring Diagrams

Considerable confusion often results in wiring a receiver from a blue print, due to the fact that difficulty is experienced in remembering just what circuits have been completed. If the constructor will obtain a blue crayon and cross out those wires and connections which he has made, from the blue print, he will have an accurate check as to which wires and connections have been made. This method has its advantages and after having once been used, will be resorted to at all times.

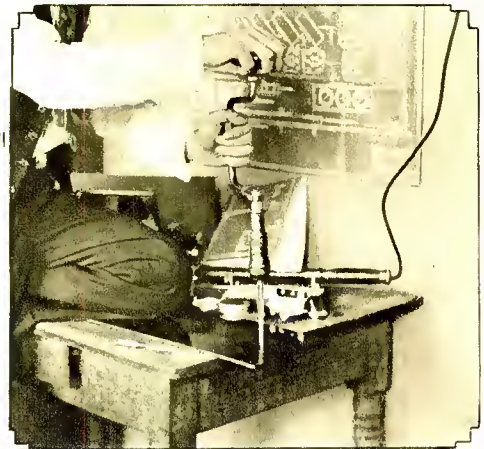

### An Easy Way to Drill Large Holes in Panels

The proper mounting of certain instruments on a panel often requires a number of large holes. To drill these holes with the ordinary twist drill of large diameter is well-nigh impractical, due to the tendency of the material to chip out around the hole. This often disfigures the panel, if not seriously detracting from its value. The difficulty can sometimes be obviated by the use of a "butterfly" drill, such as is used for drilling the large meter holes. The holes too small for a "butterfly" drill can be easily made by the use of any ordinary taper reamer. This very handy tool makes holes up to  $1\frac{1}{2}$  in. in diameter and can be purchased at any hardware store. Various sizes of reamers are available, the smallest size making a maximum hole of approximately  $\frac{3}{4}$  in. in diameter. Larger sizes may be had, which run up to  $1\frac{1}{4}$  in. and  $1\frac{1}{2}$  in. These reamers fit into the ordinary carpenter's brace and will quickly shape a hole to the required size and make a perfectly clean job of it.

### Protect Clothing While Carrying a Storage Battery

It is good insurance to protect the clothing while carrying a storage battery by wrapping a sheet of heavy paper around the battery and tying it in place. It is almost impossible to carry a battery for any distance without having it come in contact with the clothes. Due to the action of sulphuric acid when combined with water and going through a charging and discharging process, there is bound to be an accumulation of acid on the tops and terminals of storage cells. Any fabric may be ruined by coming in contact with the storage battery. If possible, it is advisable to use a piece of paper which has been oiled, since the acid does not soak through the paper impregnated with oil.



### Keeping a Soldering Iron Tinned

A very convenient help for keeping a soldering iron tinned at all times is found in the use of a hock of sal-ammoniac, which may be procured at any drug store. The sal-ammoniac has the ability of removing the oxidation forming on the soldering tip. In fact a soldering iron rubbed on the sal-ammoniac block will tin much easier. Since the sal-ammoniac does not deteriorate with heat, a small piece will ordinarily last for a considerable length of time.

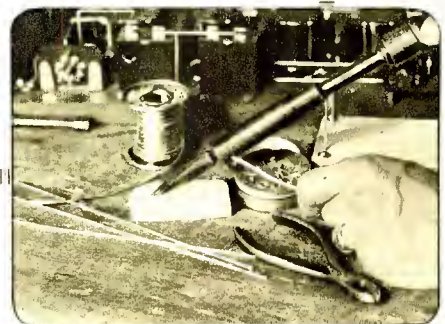

### A Compact Radio Set Tester

This compact portable radio set tester is exceptionally useful to the radio service man for measuring the various voltages of either a battery or a battery eliminator operated set, both at the battery terminals and in the tube sockets, for testing the tubes under the same condition as exists when in their sockets, and for testing the continuity and condition of circuits. It will make all these tests with the regular batteries or battery eliminator used in the radio set, with no change in connections so that no auxiliary batteries are required. A multiplicity of connections may be arranged by means of this compact tester through manipulation of the multi-pointed switch illustrated at the center of the accompanying photograph. Such a device is especially helpful to a builder while making tests of a receiver on the bench, since one may immediately ascertain which circuit is at fault or incomplete. It is especially designed to reduce the over-head incurred in such servicing, and is by far the most comprehensive set tester for its size upon the market today.



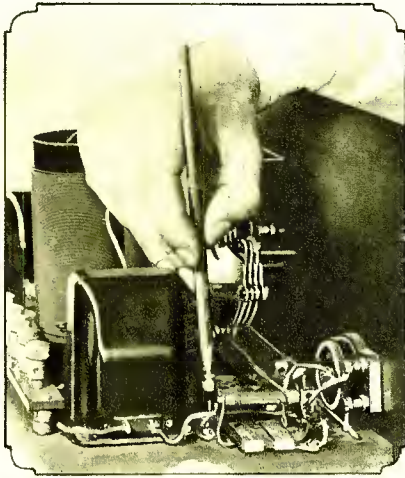

### An Easy Method of Replacing Nuts in Tight Corners

Very often a nut is removed from some terminal in a radio receiver for the insertion of an extra soldering lug or wire. The experimenter, suddenly possessed with all thumbs, is often aggravated by his inability to get the nut back on the screw. An extremely simple method of replacing the nut is to take a wooden pencil, which has the lead point broken, and forcing its pointed end into the nut so that it is securely held in place. By then placing the nut over the threaded portion of the terminal, it is a comparatively simple matter to revolve it a few turns, so that the threads will mesh. The use of a pair of pliers or a "spin tite" wrench will then tighten the nut so that a good contact is provided.



### Solving a Soldering Difficulty

Considerable difficulty is often experienced by the experimenter in soldering connections in tight corners in a receiver. This difficulty may be completely overcome by wrapping a piece of No. 8 or No. 10 gauge copper wire around the soldering tip about five times and allowing 1½-inch of the wire to project in front of it. The projection of wire should then be sharpened in the same manner as a regular soldering tip and tinned. The wire will conduct sufficient heat to properly melt the solder and make a good joint. It is advisable to also make one or two extra extensions with various lengths of projections, say from 2 inches to 2½ inches long. This will allow access to extremely cramped portions of the receiver, which are normally inaccessible with the shorter extensions.

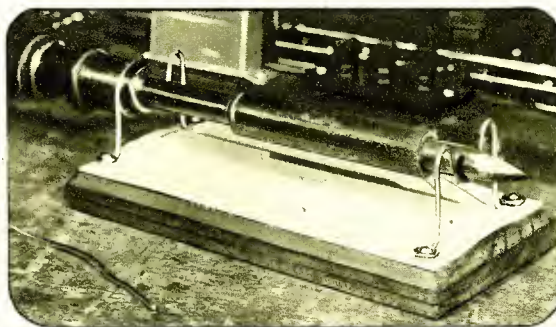

### A Convenient Series Connector

A very convenient connector for hooking up apparatus in series may be easily made by soldering two cord tip jacks together. This connector may be put to various uses, especially in respect to connecting speakers in series for better tone quality from a receiver, or the use of more than one pair of head phones in conjunction with the same radio set. Its use is comparatively simple, as may be observed from the photograph. The wire with the red tracer from one speaker or pair of head phones is connected to one end of the series connector and the black wire from the other speaker or head phones is connected to the other end of the connector. The remaining wires from each of the speakers or head phones are connected to the normal output terminals of the receiver.

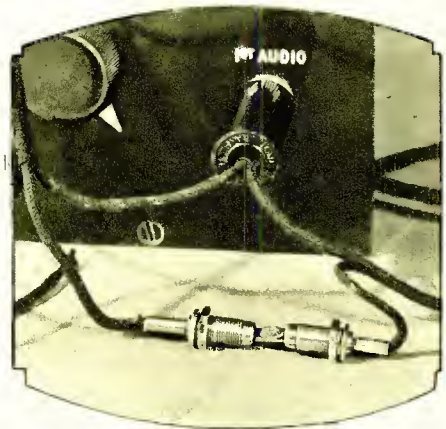

### Correct Polarity in Loud Speakers

The majority of speaker cords have one of the wires equipped with a red tracer. The wire, thus marked, should at all times be connected to the "B" positive of the loud speaker output of the receiver unless an output transformer is used. Damage may result to the speaker if the "B" battery voltage is applied to the wrong terminal. A convenient method for testing whether or not the polarity is correct, is to connect the speaker to the output of the receiver and observe the quality and volume of reproduction. Then reverse the terminals and repeat. If the volume and reproduction is of a better order, it is safe to allow the connections to remain. If, on the other hand, a decided decrease in quality and volume is observed, reverse the terminals to their original polarity.



### A Homemade Plug-In Battery Cable

A convenient method for connecting batteries to a receiver is in the use of a tube base from a burnt out tube and a standard tube socket. The glass portion of the tube is removed by heating the sealing compound and breaking the glass away. Four colored wires are then soldered to the tube base prongs, sealing wax poured into the opening, and flushed off at the top of the base. The four wires are then cabled and connected to the "A" positive, "A" negative, "B" detector and "B" amplifier terminals of the batteries. A socket is then wired into the receiver, using the same polarity on the terminals as has been observed in the tube base and battery cable. This makes an extremely simple battery cable and in the event that more than four wires are necessary, it is possible to double the arrangement by using another tube base and socket for any extra connections. The jumper between the "A" and "B" batteries may be either connected internally or externally from the receiver.

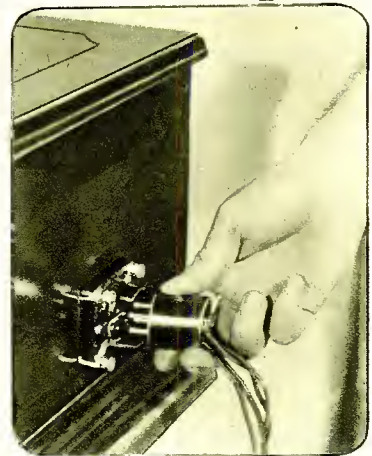

### A Soldering Iron Stand

The average electric solder iron of today does not come equipped with a stand for holding the heated iron while it is not in use. A very excellent device for supporting an iron can be easily constructed by the use of a small block of wood approximately 3 in. x 6 in. in size, upon which is mounted two supporting members fabricated from common bus-bar wire. The two brackets are securely fastened to the board by wood screws and washers. To prevent charring of the wood block, it is advisable to cover it with a thin sheet of asbestos.



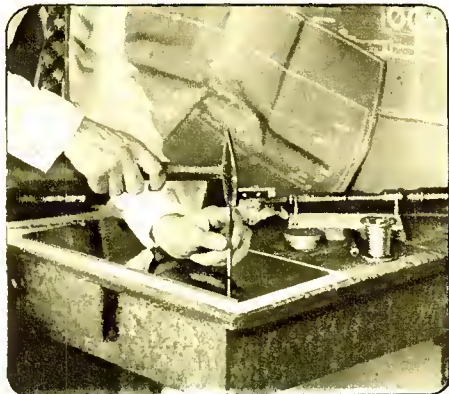

### The Proper Method for Locating Centers When Drilling a Panel

Accuracy in the location of holes when drilling a panel can be considerably increased by the use of a center punch in locating the holes. Use a very light tack hammer and a sharp center punch. Only a slight tap is needed to form an impression at the exact center of the location of a hole. This serves as a starting point for the twist drill, which is used later. Best results will be found if the center punch is held in a vertical rather than a slanting position, since in the latter position there is a possibility of the point skidding and marring the surface of the panel. It is best to place the panel on a sheet of paper when laying out the location of holes, since there is a possibility of the panel becoming scratched if it is placed on a table top without any protective covering.

### An Old Tube Base as a Handy Tester

An excellent use for an old tube base is its use in connection with the testing of various circuits in a receiver by its substitution for the tube normally using a particular socket. Four leads are soldered to the prongs of the tube base and brought out to a proper voltmeter, by which "A", "B" and "C" working voltages may be tested in comparison to their proper values. The use of this type of handy tester will disclose many abnormal conditions, which are otherwise not apparent.

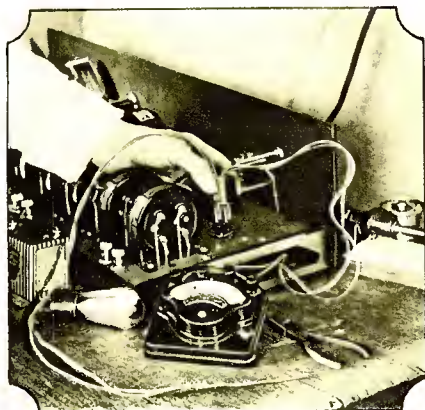

### Connecting Fixed Condensers in Parallel

It is sometimes necessary to have a particular capacity in a fixed condenser which is not available at the time. If two condensers are connected in parallel, each having the proper value, the desired capacity may be obtained. The resultant capacity of two condensers connected in parallel is the sum of their individual capacities. In this respect, it is possible to get a .0003 mfd. condenser by connecting two .00015 mfd. condensers in parallel.

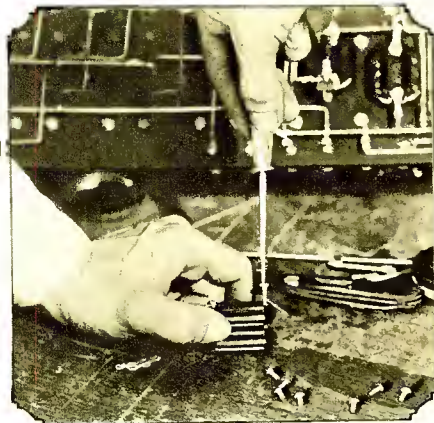

### Removing Scratches From Radio Furniture

In tinkering around a receiver, the highly finished cabinet or console may become scratched. To totally obliterate such a defacement is almost impossible, unless one has had long experience in wood finishing, or unless the owner desires to refinish the article of furniture, which, of course, is a very tedious and painstaking task. If the furniture is not gouged too heavily, a simple and convenient means for darkening the scratches so that they will be less apparent is to rub over the scratch with the kernel of a Brazil nut, commonly known as a "nigger-toe." The large amount of oil in the kernel will darken the scratch to such an extent that it is almost imperceptible.

### Testing a Variable Condenser

A variable condenser may be easily tested for short circuits by "hooking up" a pair of head phones and a small "C" battery in series with it. The accompanying photograph shows the exact method of connecting the various pieces of apparatus which are included in the circuit. As the condenser shaft is slowly turned through its entire range of rotation, carefully listen on the head phones. If a click or grating noise is heard at any point during the rotation of the condenser shaft, a short circuit between the movable and stationary plates has occurred. It is then best to examine the condenser and note where the plates touch. With proper care, the plates may either be bent to clear or an end adjustment made to move the entire series of plates. Attention should be called to the fact that this method of testing is only suitable when the variable condenser is not associated with other apparatus. For example, if the condenser is tested in a set by this method, a short would show, which in reality would not exist in the condenser because the inductance windings would be bridged by the plates of the condenser. If such a test is to be made on a condenser already wired up in the set, one end of the inductance should be disconnected from the condenser before going ahead with the test.

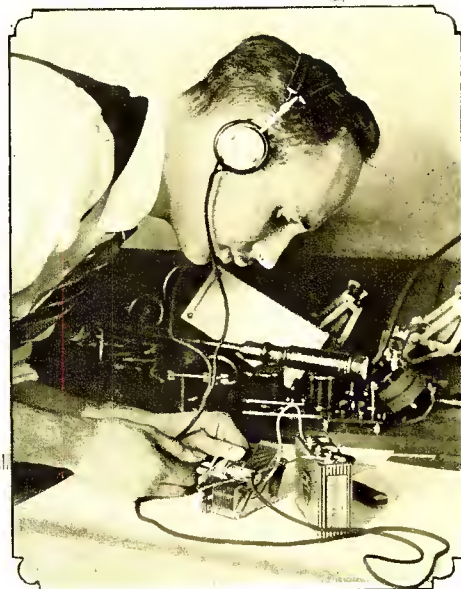



### Driving Screws in Hardwood Baseboards

The use of a hardwood, such as cherry or maple, as a baseboard in a radio receiver, or other device of similar nature, is the proper procedure. This type of wood is extremely close-grained and non-porous to a high degree. If a coat of shellac is given the wood, it will make it practically impervious to moisture. This, of course, will obviate any low resistance paths through the moisture laden wood, which would interfere with the operation of the receiver. When mounting apparatus on a hardwood baseboard, difficulty is often experienced in turning the mounting screws home, due to the extreme hardness of the wood, as well as the possibility of cracking it. If a hole is first drilled in the usual manner with a push drill, and the wood screw waxed with a piece of paraffine, it may be turned in very easily. Care should be exercised that just enough of the wax is applied to the screw; or it will appear under the piece of apparatus or around the screw head, which is more or less unsightly.

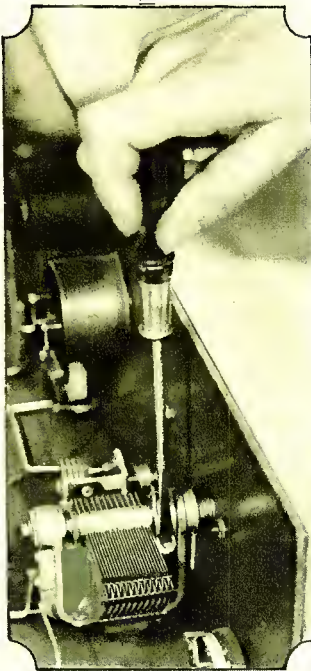

### Proper Adjustment of Vernier Dials

Many vernier dials are operated on a friction principle and their use in a receiver is often interfered with by the mechanical construction of the variable condenser which they actuate. A great number of condensers are equipped with a braking mechanism to provide various tensions in respect to the ease with which the shaft may be revolved. Many condensers are adjusted at the factory so that a considerable amount of tension is present. A friction driven vernier dial will slip when used in conjunction with such a condenser and is subject to considerable "back lash." The use of a screw-driver or pliers, as the case may be, will allow the braking mechanism to be loosened so that operation of the vernier dial will be most satisfactory. A careful examination of the condenser will usually disclose just what part acts as the brake.

### Removing Kinks From Short Pieces of Bus-Wire

The home constructor is often confronted with the difficulty of straightening a number of short pieces of bus-wire which have a slight twist or bend along their length. A valuable adjunct to the experimenter's kit of tools is two blocks of hardwood, such as cherry or maple, cut to about 4 in. by 6 in. in size. The one block is placed upon a flat surface and the wire to be straightened out laid upon its upper face. The second block is then placed on top of the wire and considerable pressure is brought to bear, while a reciprocating motion, to roll the wire between the two blocks, is applied at the same time. A few strokes will usually suffice. It is even possible to remove right angle bends from bus-wire if the bend is first partially removed with a pair of pliers.



### Better Tone Quality From a Receiver

The tone quality of the average receiver may be improved to a very noticeable degree by the addition of an extra speaker connected in series with the one being used. If only a cone speaker is used, the addition of a good type of horn speaker, connected in series with it, is advisable, and vice versa. The cone is usually an excellent reproducer of the lower frequency or bass notes. The use of a cone speaker alone, except in rare cases, does not permit a full register of both high and low notes. With the addition of a horn type of speaker, which has the ability of reproducing the higher frequency notes to an excellent degree, a quality of music will be added which is usually lacking in the use of a cone type of speaker alone. To hook up the speakers in series, connect the black cord of one to the red cord of the other, and attach the remaining terminals to the normal loud speaker terminals of the receiver.

# World's International Championship

## ROBERTSON-DAVIS **HOT SPOT** FOURTEEN RECEIVER

**TAKES SEASON'S CAPITAL PRIZE AT RADIO WORLD'S FAIR IN NEW MADISON SQUARE GARDEN**

When the busy week of the Radio World's Fair at New York had ended, and it once more was time to award the Cup and Title for the World's International Championship in Set Building, the *HOT SPOT Fourteen* again made good the reputation of Robertson-Davis Receivers. Mr. John H. Hartley, of Brooklyn, won Radio's Highest Honors in fair contest to retain this title he won last year. The wisdom of his choice and confidence in the famous *HOT SPOT Fourteen* is proven by the decision of the judges in his favor.

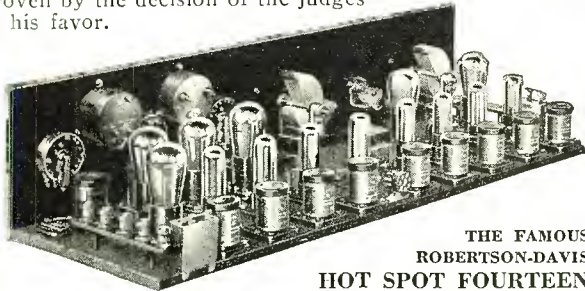

THE FAMOUS ROBERTSON-DAVIS **HOT SPOT FOURTEEN**

### BUILD THIS CHAMPIONSHIP RECEIVER!

The *Robertson-Davis Hot Spot Fourteen Circuit* comes to you with a reputation of performance that agrees with what you are looking for. 14 Tubes No Oscillator Repeats. 2 Tuning Controls. 8 Stages of Intermediates. 3 Stages of Audio. Easily Tuned as Single Stage. "A" Battery, 2 amps. "B" Battery, 35 mils. No Receiver Harmonics. Razor Edge Selectivity. Real Single Point Reception. A Beautiful Panel and Chassis. Brings in DX clear and loud through local interference. Everything you are looking for. The 1927 Fall issue of the Call Book contains full plans and construction details. Or, use the coupon below.



Certified *Meloformers* and *Melocouplers*, the audio frequency and radio frequency transformers that make such excellent reception possible, are the secret of the success of the *Hot Spot Fourteen* and *Melo-Heald Eleven* Circuits.



The same mixing system is used in the *HOT SPOT Fourteen* that made the *Melo-Heald Eleven* famous. Each Intermediate Transformer is designed specifically for its position. Easy to build and easy to operate.

The 1927 Spring issue of the Call Book contains full plans and construction details for the famous *Melo-Heald Eleven*. For the radio fan who desires power, clearness, beauty of tone, and maximum efficiency, and prefers less tubes but doesn't mind an occasional harmonic, the *Melo-Heald Eleven* answers his radio reception problem.

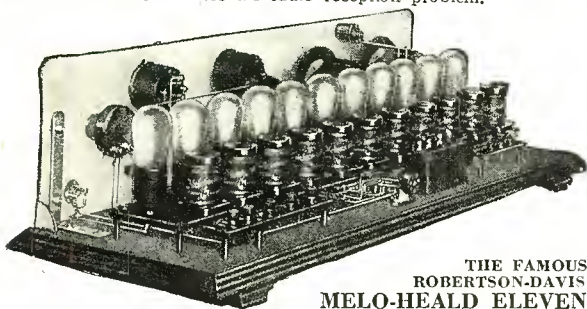

THE FAMOUS ROBERTSON-DAVIS **MELO-HEALD ELEVEN**

SEE YOUR DEALER—OR MAIL COUPON!

**ROBERTSON-DAVIS COMPANY, Inc.**  
 (Engineers and Manufacturers of Electrical Windings)  
 412 ORLEANS STREET CHICAGO, U. S. A.



PHOTO FROM: WORLD WIDE PHOTOS

### JOHN H. HARTLEY AND WORLD'S PRIZE RECEIVER

The photograph above shows Mr. Hartley with his prize winning *Robertson-Davis HOT SPOT Fourteen Receiver*, his 1927-28 World's International Championship Cup, and some of his other trophies. Presentation of this year's trophy was made in the Crystal Studio of Madison Square Garden by the famous flyer, Clarence D. Chamberlin, on Sept. 24th.

### 2 BLOCKS OF LOCAL—NO HARMONICS

Sept. 19, 1927—HENRY J. STORMS, Asst. Chief, Western Union Telegraph Co., Spokane, Wash., writes: "Gentlemen, I sure must admit that the 14 Tube Hot Spot is the best yet. I tuned it for two hours one night two blocks from our worst local and never picked up a harmonic. Sure wonderful. From my experience with the Eleven and this new one, you can always count on me to be pushing the *Melo-Heald* and the *Hot Spot Fourteen*."



**FILL IN AND MAIL TODAY FOR FREE PLANS TO CONSTRUCT RECEIVER**  
**ROBERTSON-DAVIS COMPANY, Inc., 412 Orleans St., Chicago, U.S.A.**

Gentlemen: Without charge or obligation, please send me Plans and Specifications for construction of receiver checked below and described in the Citizens Radio Call Book. Also, send further particulars regarding Certified *Meloformers* and *Melocouplers* manufactured by you and used in construction of the set. (Check Receiver you are interested in.)

I am interested in The Famous **HOT SPOT Fourteen**.....   
 I am interested in The Famous **Melo-Heald Eleven**.....

Name.....  
 Address.....  
 City..... (Write or print clearly)

Tell 'Em You Saw It in the Citizens Radio Call Book Magazine

# Six-in-Line Super Is Hooked Up with Various Audio Units

Acme, Modern and General Radio Audio Systems May Be Used in Any Combination the Builder Desires

**M**ANY who have been experimenting with the Eight-in-Line receiver which was described in our September issue have been wondering if it would be possible to use this receiver in combination with various separate audio amplifying systems. In order to be in possession of full data on this subject, our laboratory secured one of the six tube units belonging to the Eight-in-Line family and has recently made up in the laboratory three different types of audio frequency amplifying systems, any one of which may be operated with perfect satisfaction in conjunction with the six tube unit.

Whereas in our preceding issue we concerned ourselves principally with the description of the Eight-in-Line, which is a complete superheterodyne, in this article we will deal with the six unit as connected and operated with these audio systems. In the photograph shown in Figure 1, the six unit is connected up with the Bodine loop, the necessary front panel containing the condensers, rheostats and other fittings, and the separate General Radio amplifier using two stages of double impedance coupled amplification.

## What the Circuit Shows

To refresh the mind of the reader, we are showing again the schematic circuit of the Eight-in-Line, which is a complete superheterodyne equipped with two stages of audio frequency amplification and which formed the basis of the article in our last issue. For our purpose at this time we need be interested only in that portion of the diagram from the second detector towards the left, as the audio frequency end is represented in the various audio systems which will be described separately.

The Six-in-Line unit, parts for which are all contained inside of a single housing, consists of an oscillator coupler, a first detector, four stages of intermediate frequency transformer amplification, the secondary of the last intermediate stage feeding the second detector, whose output should be led to the input of any of the audio amplifying systems. Grid leak and condenser rectification is utilized in both the first and second detector circuits. The pick-up winding of the oscillator coupler is shown in series with the center tap of the loop, which is the low potential side

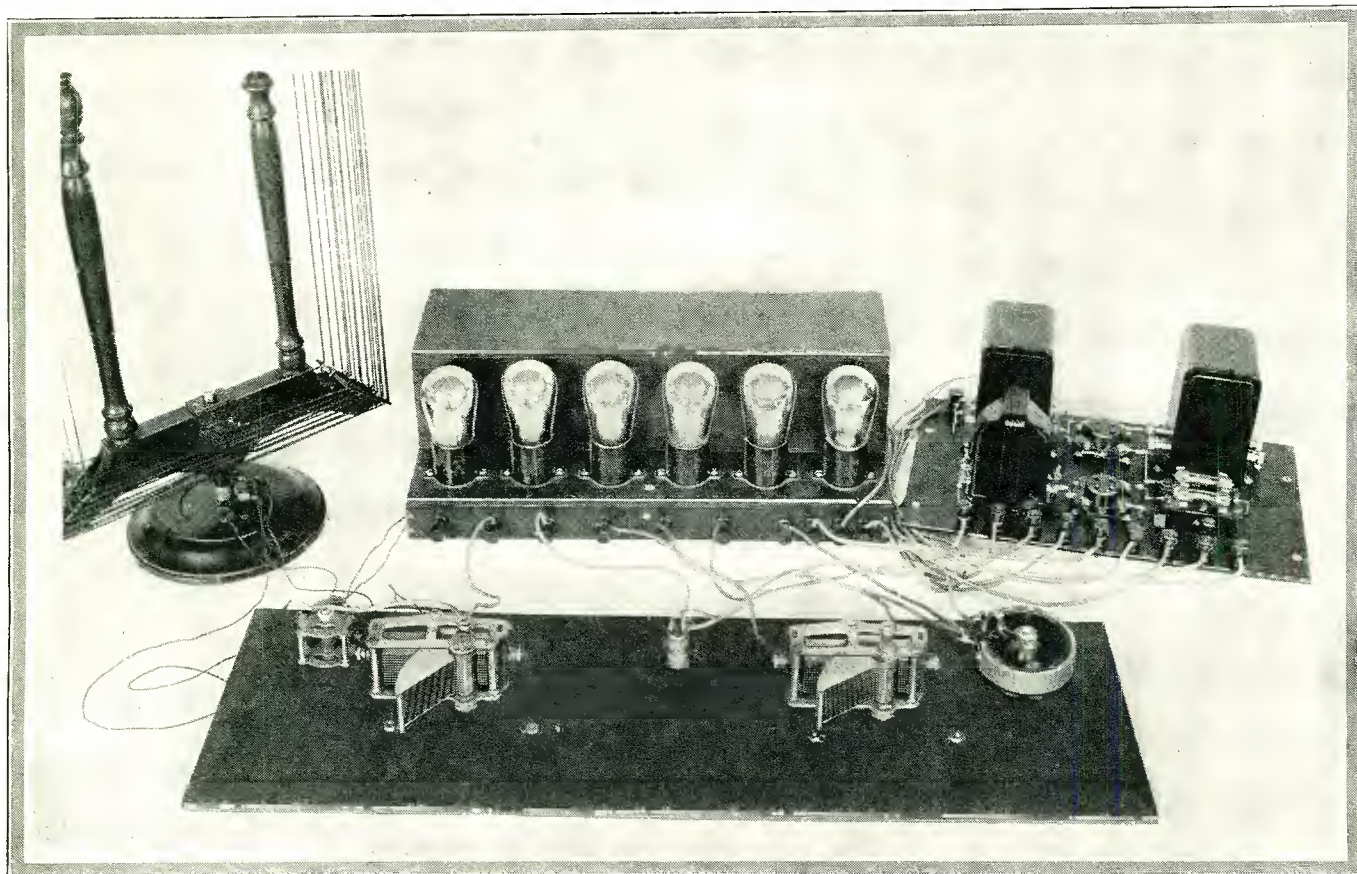

*Figure 1. At the left of this photograph is shown the Bodine loop; the Six-in-Line unit is located at the center rear, with its associated panel shown in the foreground. The General Radio amplifier, which is hooked up with the superheterodyne, is photographed at the right*

(This receiver tested and all illustrations made in our laboratory)

of that circuit and is connected to the negative terminal of the oscillator tube on the tube side of a resistance which takes care of the filaments of the oscillator and the first detector.

Energy, after leaving the plate circuit of the first detector, is successively passed through the first, second and third intermediate frequency transformers and thence into the second detector. These intermediate transformers are tuned to a frequency of 85 kilocycles and all units in the case are matched together for that value. This balancing is performed at the factory with two small plate condensers controlled by a lock nut, which is set and locked as soon as the correct position is found. This obviates variance between the peak of one intermediate and that of another. Inasmuch as the intermediates are all located inside of the housing and their frequency value is set at the factory, the operator is assured of uniform operation on that frequency.

**Many Combinations Possible**

This particular model presents several interesting factors for the home builder or professional set builder, because the Six-in-line unit may be adapted to any form of construction and may have its audio amplifying system separate from the main receiver. The builder having in his possession one of the Six-in-line units needs only to rig up a front panel on which he locates the two variable condensers, one for tuning the loop and the other for tuning the oscillator; a filament switch, a balancing condenser for regenerative properties of the loop, and a 10 ohm rheostat for controlling the filaments of the first, second and third intermediate stages. On account of the compactness of the Six-in-line unit, it may be placed inside of a cabinet, fastened down firmly and the necessary leads run to the parts located on the front panel. This form of construction is also very pleasing to the experimenter who wishes to have his material located on the top of a work bench or table. Where the Six-in-line unit is to be located inside of a cabinet, the connections may be made between the units on the front panel and their respective binding posts, with bus bar wire, for the appearance of the job. However, for experimental work where all units are laid out on the table, flexible wire will serve just as well for the connections. Another point in connection with this set is the fact the super unit itself need not necessarily be directly behind the panel, but may be located above, below or over to one side, as long as the length of the leads is not carried to an unreasonable extent. Standard quarter ampere tubes may be used throughout in the Six-in-line unit, although different type tubes are used in the audio systems, which will be noted as a description is given of that section of the receiver combination.

This audio amplifying system, the transformers and impedances for which General Radio is well known, contains two stages of

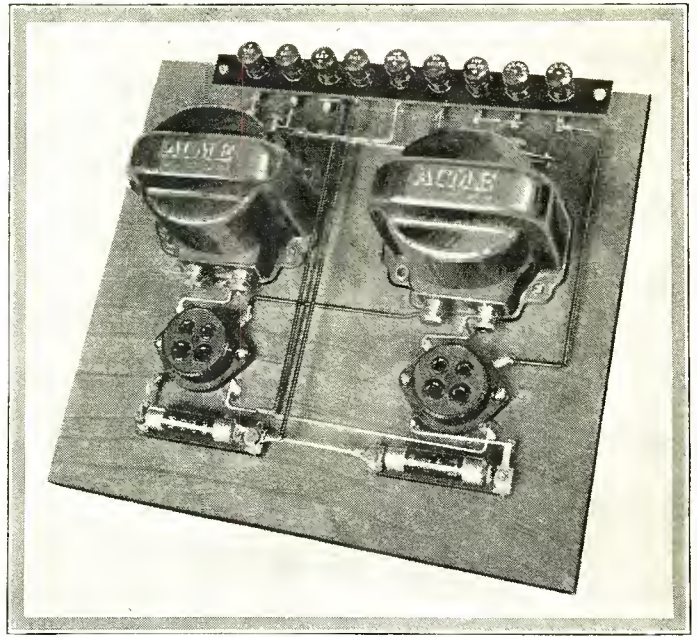

**Figure 2.** This picture shows the simplicity of arrangement in the construction of the Acme audio amplifier, the schematic of which is shown in Figure 9 and whose graphic illustration is shown in Figure 10

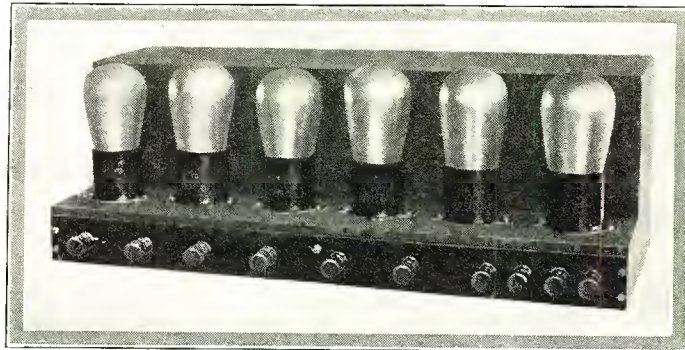

**Figure 3.** The Six-in-Line unit is photographed above with the necessary tubes. Note that all binding posts are on the front, where they may be easily reached when wiring this unit up either in a cabinet or on a work bench. The schematic circuit in Figure 11 gives the reader an idea of what is contained inside the housing

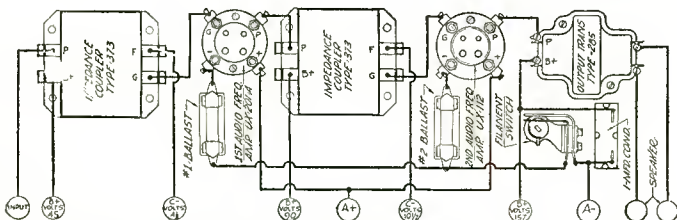

**Figure 4.** Above is shown graphically the manner in which all connections may be made for the General Radio amplifier, shown connected to the Six-in-Line unit in the photograph on the first page of this article

impedance coupled amplification utilizing the General Radio type 373 impedance coupler for the electric story of which is shown in Figure 5. Its output stage is handled by means of a type 285 output transformer, so the speaker windings may be isolated from the plate circuit of the 112 power tube. As will be noted in the schematic circuit in Figure 5, the impedance units are tuned and are designed to give a uniform response over the band of frequencies most used in broadcast transmission and reception. Each impedance coupler is placed in a suitable metallic container and is represented in the schematic diagram by the dotter lines shown around the two windings. A 4½ volt negative potential is applied to the grid of the first impedance stage, which uses a 201-A tube, while a 10½ volt negative potential is applied to the grid of

the 112 tube located in the last audio stage. Plate voltages are three in number, 45 being supplied to the impedance coupler primary, 90 to the primary of the second impedance amplifier and 157 to the plate of the 112 tube through the primary winding of the output transformer. The last named voltage terminal is bypassed with a ½ mfd. condenser to negative. Although a filament switch is located on the front panel used in conjunction with the Six-in-line unit, another filament switch has been provided in the audio amplifier, so if it is desired to operate the superheterodyne unit with only a pair of headphones in the second detector circuit, the audio amplifier may be turned off so it will not be consuming battery current when not desired.

Due to the fact that not a great deal of information has been made public on the subject of double impedance amplification, we believe a little of its history may be welcomed by the serious experimenter and those who wish to learn as much as possible of each system of amplification that is in favor with the public.

Experimentation has apparently developed the fact that a great deal can be accomplished in the reduction of audio distortion by the tuning or adjusting of each stage of amplification to obtain a

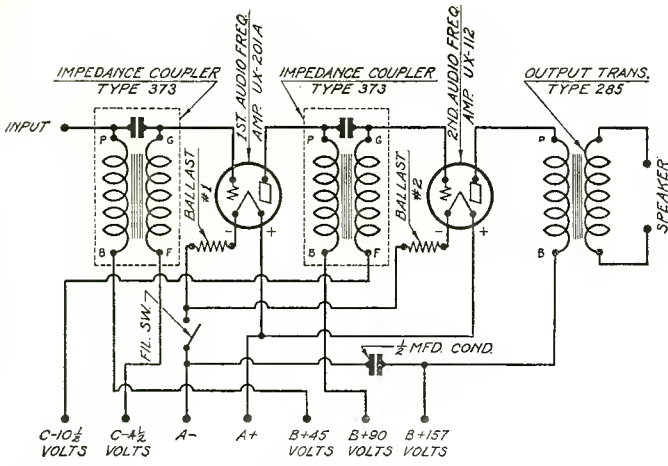

Figure 5. Type numbers of the impedance coupler and output transformer, together with other constants of this circuit, are shown in the schematic covering the construction of the General Radio impedance coupled power amplifier

more energy shall be available at the lower portion of the register than has been customary in the past. This method of amplifying proportionately to the energy requirements of the loud speaker contributes to the presence of other interesting facts, one being that a steady average grid potential is maintained. "Motor-boating," which in many systems has been present, is now eliminated without the necessity of any auxiliary apparatus. A further virtue of this arrangement is that a complete magnetic shielding is provided, which does away with the presence of radio frequency currents in the audio circuits.

Reference to the schematic diagram Figure 5 will disclose the internal connections of the impedance coupler type 373. This unit consists of a laminated core carrying one coil on each outer leg. A fixed condenser is also contained in the case which houses the coils. The coupling condensers, which are shown in the diagram but on which no values are specified are the condensers which serve to tune the units for production of maximum energy on the lower frequencies, where it is required. The voltage step-up in one stage is determined by the relation between the positive and negative reactances in the grid circuit. The value of coupling condenser placed inside of these units is that value which the

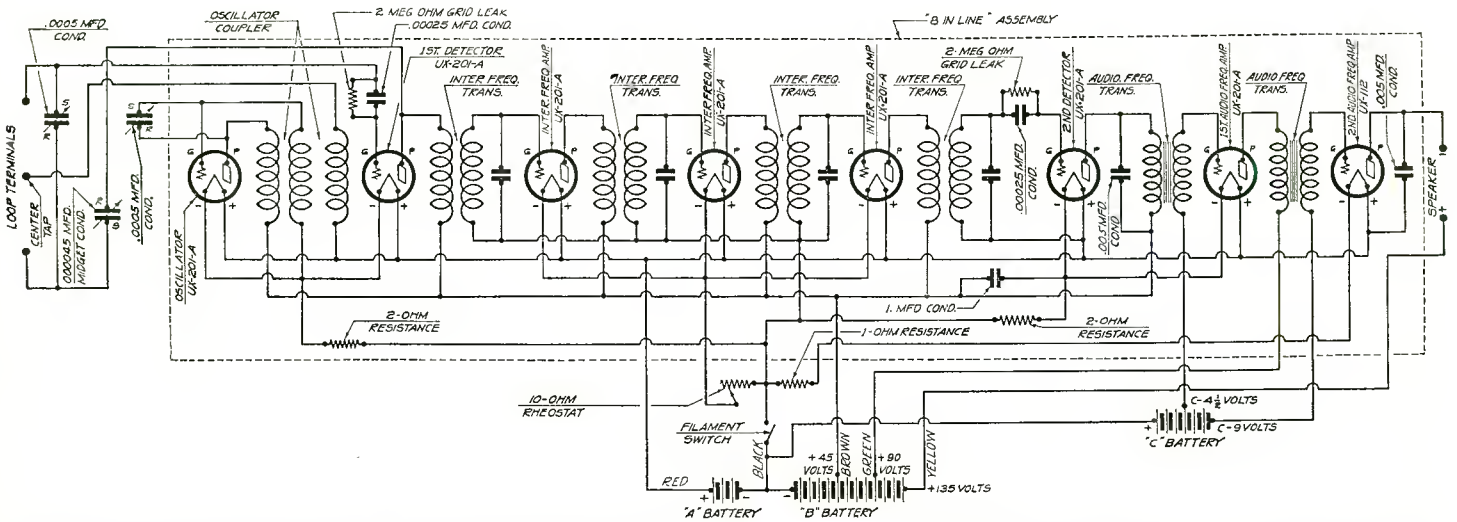

Figure 11. This schematic diagram is reproduced to give the reader an idea of what is contained in the Six-in-Line housing. It should be observed that although eight tubes are shown in this sketch, only the first six are actually contained in the unit under discussion, which is a six tube combination for operation in conjunction with separate audio amplifier systems

resultant frequency characteristic which would conform more or less with that of an average loud speaker, of which there are perhaps hundreds on the market. This change or adjustment might be considered the tuning of an audio stage and is possible in amplifying systems having both a plate and grid impedance coil. It is most satisfactory, of course, when applied to the double impedance unit where the plate winding is wound around one section of the iron in the transformer and the secondary impedance is wound around the other section. It is quite possible with a system embodying two impedances located in a single unit to shift the frequency characteristic suit almost any desired condition. The tuning of an impedance coupled amplifier has been desirable in view of the fact that certain straight audio frequency amplifiers are deficient at the low frequencies, that is, the low notes are brought out in proportion to those higher in frequency. This has not been such a drawback when the loud speaker development was not very greatly advanced, but with more research expended on reproducing apparatus it has been necessary for the audio system to be brought right up-to-date, so that both the amplifying system and the reproducing system shall complement each other in the production of music that is true to the type transmitted from the broadcasting stations.

More Energy on Low Notes

If sufficient energy is available, a loud speaker may be operated at low frequencies as well as at the upper end of the scale. The tuning of the tuned impedance amplifier is desirable so that

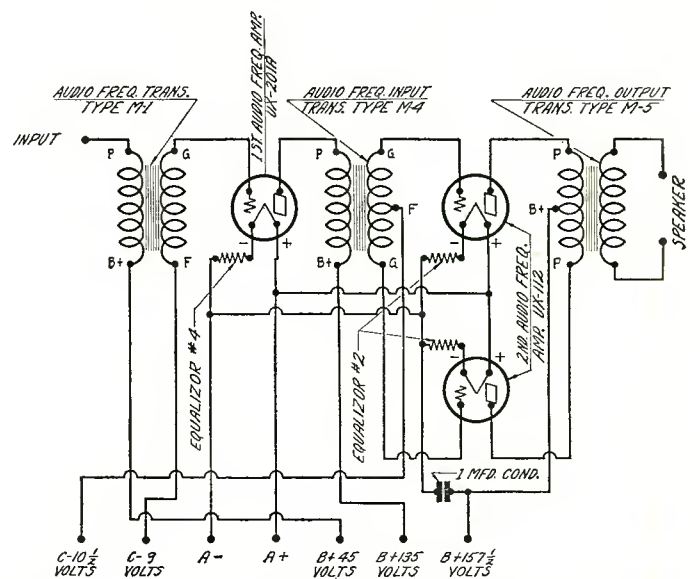

Figure 6. Push-pull amplification is exemplified in the schematic wiring diagram shown above, which should suffice for those experienced in set construction. For those who are not thoroughly acquainted with this form of drawing and still desire to make up the Modern push-pull amplifier, attention should be directed to the graphic illustration shown in Figure 8

manufacturer has found most satisfactory for operation with the units under discussion.

**Acme Two Stage Amplifier**

The photograph shown in Figure 2 represents a view of the Acme two stage amplifier, which was built up for use with the Six-in-line unit. The schematic circuit for this unit is shown in Figure 9. The graphic illustration showing how the audio section may be wired up is shown in Figure 10. This unit uses two of the Acme audio transformers known as type MA-2. This transformer is enclosed in a metal case and has a winding ratio of five to one. The input of this audio amplifier is connected to the output terminal of the Six-in-line unit ahead. Plate voltage of 45 volts is given the input primary of the first audio transformer, 90 volts is supplied the plate of the second audio transformer, while 135 volts is given the plate circuit of the last audio tube, which is a 112 type. On account of this fairly low plate voltage, the speaker windings may be placed directly in the plate circuit of the 112 tube without the necessity of an output transformer. The filament circuit regulation in the amplifier is automatic and is accomplished by means of a 1-A in the first stage and a 112 Amperite in the second stage. The bias values for this amplifier are  $4\frac{1}{2}$  volts negative on the grid of the first audio frequency amplifier and 90 volts on the grid of the 112 tube in the last stage. As will be observed in Figure 10, which is the graphic illustration of this amplifier, the parts are located for a symmetry

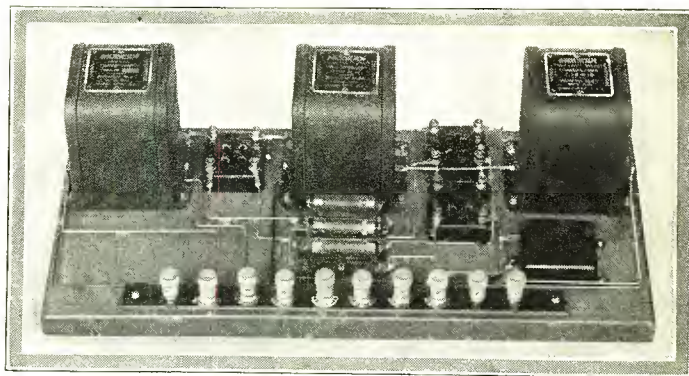

Figure 7. Above is shown a photograph of the Modern push-pull amplifier, whose electrical connections are shown in Figure 6 and whose graphic illustration is represented in Figure 8

M-4 and an output transformer type M-5. In this form of amplification the first stage is a straight transformer coupling, while the second stage is arranged for push-pull operation. The input and output transformers are, therefore, different from the type M-1 transformer shown in the first stage.

In the case of the input audio transformer, its primary is a

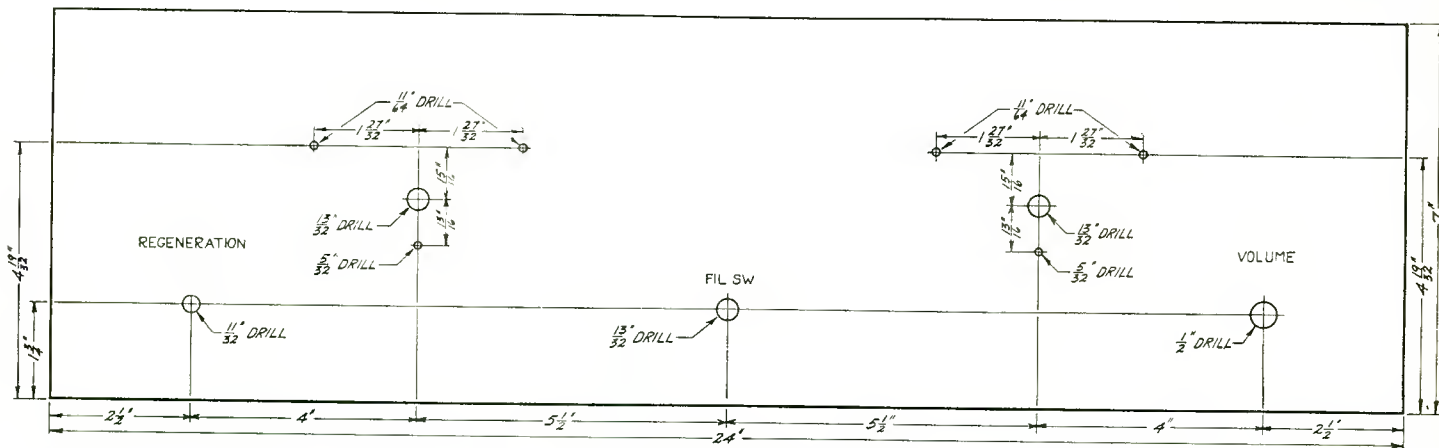

Figure 12. The sketch above gives the proper distances between units and informs the reader of the drill sizes to be used in drilling the panel

of appearance and their wiring may be accomplished without the slightest trouble.

**Modern Push-Pull Audio**

For those desiring the push-pull method of amplification attention should be directed to the schematic circuit shown in Figure 6, where the electrical wiring data are given, and to Figure 8, which is a graphic illustration showing the layout of the amplifier and the proper method of wiring it for those who are unable to use a schematic circuit to work by. This amplifier unit consists of a modern type M-1 audio transformer, an input transformer type

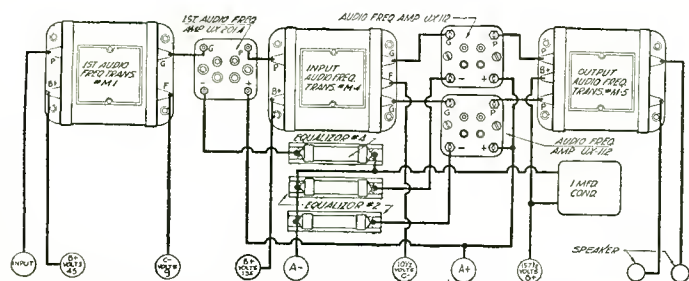

Figure 8. Newcomers in radio will be able to rapidly wire up the Modern push-pull amplifier by means of the graphic illustration which is shown above

single winding, while the secondary is center tapped and the grid of each 112 tube used goes to an end of that center tapped secondary, with the actual center tap itself going to the  $10\frac{1}{2}$  volt negative volt bias which is applied simultaneously to the grids of the 112 power tubes. In the output transformer the form of winding is opposite to that in the input, and has a center tapped primary with each extremity going to the plate of a 112 tube and the center tap going to the positive high potential, which in this particular unit is 157 volts. The secondary of the output audio transformer then becomes the speaker winding, by means of which the direct current may be kept away from the speaker so that no damage will result from the use of high voltages on this last stage.

Filament control in this amplifier is also fixed and consists of two Lynch No. 2 equalizers, one located in each negative lead to the 112 tubes, and a No. 4 equalizer of the same make placed in the negative filament of the first audio amplifier tube.

**Audio Connected to Any Set**

It will be observed by the reader by referring to the various schematic circuits which are shown in this article, that no provision has been made in any of them for the negative return of the B battery or plate supply. This is not an omission but is rather omitted on purpose, so that when the amplifier system is added to the superheterodyne circuit ahead and the filament con-

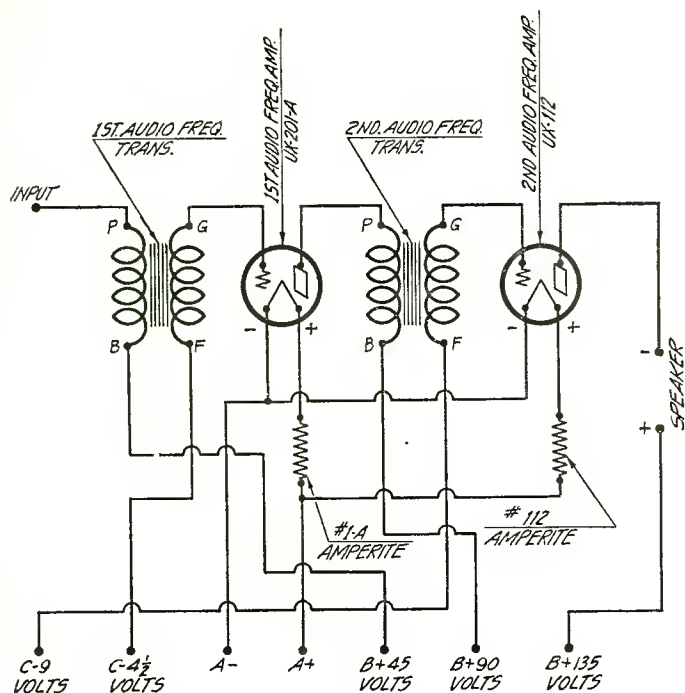

Figure 9. In this diagram, and the other one shown on the same page, readers may see the connections necessary for the construction of the Acme audio amplifier. This schematic circuit may be followed by those who have had experience in set construction

nections shown in the amplifier carried over to the main supply, there will not be any difficulty from short circuits. The return of the positive potential is, of course, made in the superheterodyne circuit ahead and suffices for the amplifier unit. In connecting up the amplifier and the Six-in-line, the 45 volt terminal of an audio amplifier and the terminal bearing the same marking on the six tube unit should be connected together, and the return to the 45 volt terminal on the plate power supply, regardless of whether such supply is a battery or an eliminator. The same thing holds true with the 135 volt tap on the amplifier and the same tap on the superheterodyne. In the case of the Modern push-pull amplifier and the impedance coupled amplifier made by General Radio, the maximum voltage is 157 volts, whereas in the Acme the maximum is 135. These voltages are not especially critical and for that reason any value lying between the two extremes outlined above may be utilized. It should also be remembered that in applying the plate voltages shown, the correct C bias value should be adhered to. The proper bias values can always be ascertained by the builder from the literature accompanying the power tubes which are used. If the bias voltage is too low for a given plate current, the set will draw an inordinate amount of plate current, which is not desirable. On the other hand, if the bias is too high, the milliamperes drain in the plate circuit will be materially reduced and possibly the amplification may fall off to a certain extent. It is, therefore, advisable to follow the manufacturer's recommendations as to the amount of negative potential to be used with the various plate voltages applied.

For the man who is never content to have a fully built-up receiver, the combination of the Six-in-line and one of the audio systems described in this article should be quite acceptable. The assembly of this receiver does not involve any amount of labor and naturally the wiring is kept down to a minimum, because of the fact the superheterodyne units are all located inside of the wooden housing. This arrangement should also appeal to the experimenter who wishes to discover for himself the virtues of each form of audio frequency amplification, for this individual may very easily adapt either the straight transformer coupled amplifier, the tuned impedance amplifier or the push-pull system to his basic receiver; and if he is desirous of doing so, he may make a study of the comparative merits of each system.

### Six-in-Line with Audio Units

- 1—Six-in-Line unit.
- 1—Lignole 7x24x3/16 inch grilled and engraved panel
- 1—De Jure 10 ohm rheostat
- 2—De Jure .0005 mfd variable condensers
- 1—Muter filament switch
- 1—Marco .000045 mfd variable midget condenser
- 2—Kurz-Kasch Aristocrat vernier dials, walnut finish

### Modern Push-Pull Amplifier

- 1—M-1 Modern audio transformer
- 1—M-4 Modern input transformer
- 1—M-5 Modern output transformer
- 3—530 Frost sockets
- 1—4 Lynch ballast
- 2—2 Lynch ballasts
- 1—John E. Fast 1 mfd bypass condenser
- 10—X-L binding posts
- 10—Feet Belden No. 14 tinned copper hook-up wire
- 1—7x16x1/2 inch baseboard

### General Radio Tuned Impedance Amplifier

- 2—373 General Radio double impedance couplers
- 1—285 General Radio audio transformer
- 2—439 General Radio sockets
- 1—1 Daven tube ballast resistor with mounting
- 1—2 Daven tube ballast resistor with mounting
- 1—10 Yaxley filament switch
- 10—Engraved Eby binding posts
- 1—Acme Parvolt .5 mfd bypass condenser
- 5—Feet No. 14 tinned Belden copper hook-up wire
- 2—Karas sub-panel brackets
- 1—7x12x3/16 inch Cortlandt panel

### Acme Audio Amplifier

- 2—Acme MA-2 audio transformers
- 10—Feet Acme Celatsite wire
- 2—Eby sockets
- 9—Eby engraved binding posts
- 1—1-A Amperite
- 1—112 Amperite
- 1—9x10x1/2 inch wood baseboard
- 1—5/8x8x3/16 inch binding post strip

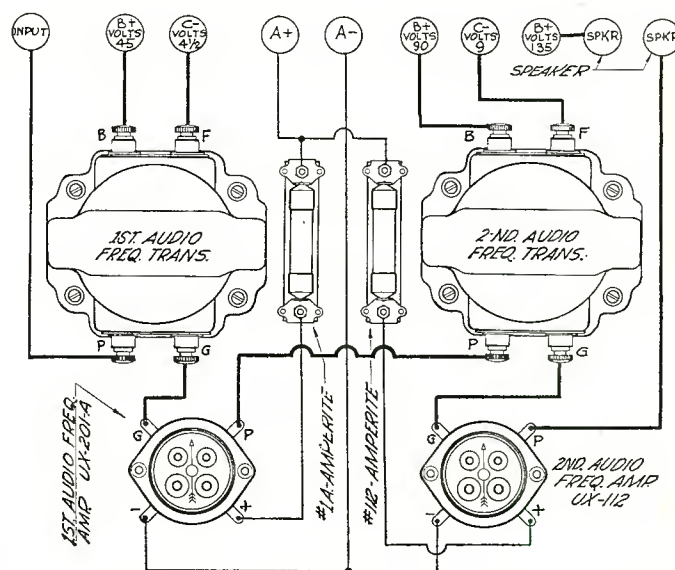
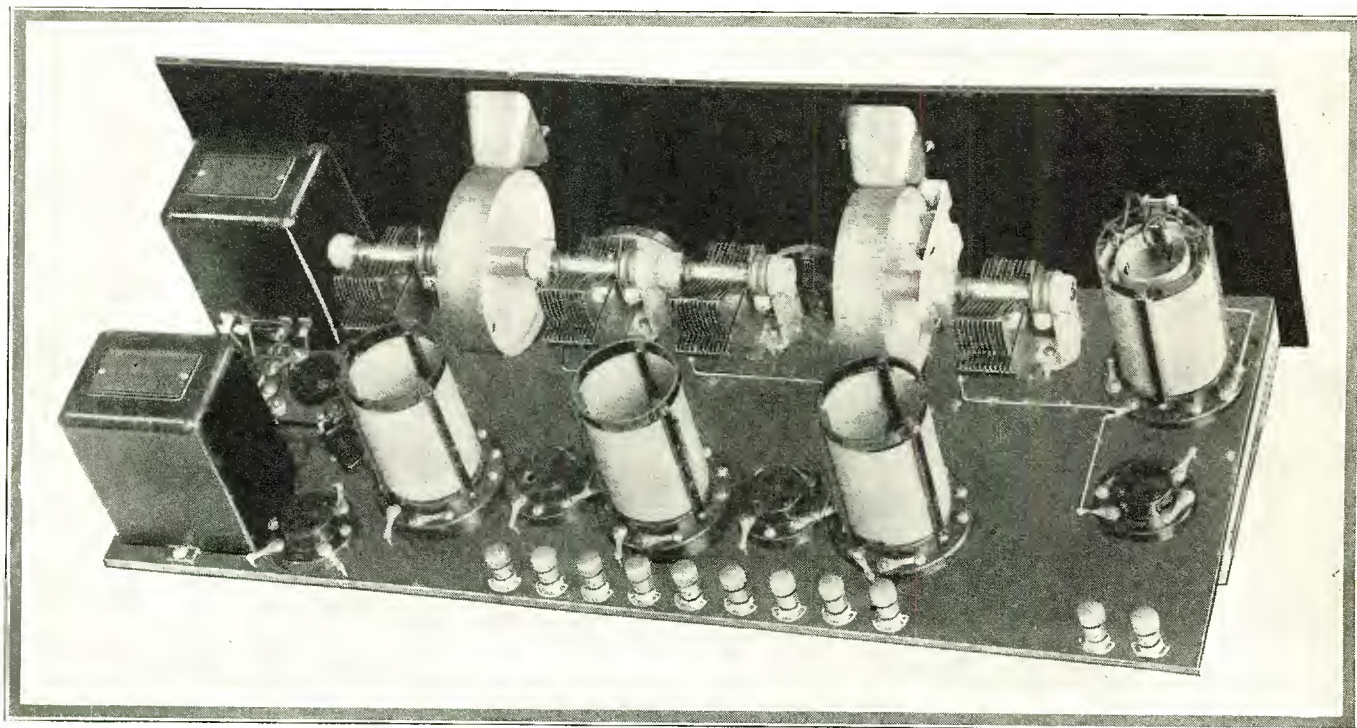

Fig. 10. In this graphic illustration the reader may see how all connections should be made after the apparatus involved in the Acme amplifier is assembled on the baseboard



# The Improved Aero-Dyne Six



*Fig. 2. Photographic view of the Improved Aero-dyne Six with all parts in place and wired*

## Reduction of Inductance Losses Important Factor in This Popular Tuned R. F. Receiver

**C**ONSTRUCTION of the Improved Aero-dyne Six brings to mind an outstanding point in present day radio engineering, which is the attention being paid to the loss characteristics of inductances and other essential apparatus. It has been found, after considerable experimentation, that inherent characteristics of coils are dependent upon several factors. With the bulk of public attention centered on the tuned radio frequency circuits, it is only natural manufacturers have expended a great deal of time and money on research work to produce inductances with the least possible losses.

The effect these losses have on volume, range and selectivity can be more simply explained by observing briefly the action of vacuum tubes used, such as radio frequency amplifiers, detectors and audio frequency amplifiers. A very slight change in the potential applied to the grid of the first radio frequency tube causes a corresponding fluctuation of enormously increased magnitude in the space current of the plate circuit. If energy is lost in the inductance preceding the tube, a decrease in the potential applied to the grid will result. The resulting space current is but a small portion of what it would be if the losses were not present. In a two stage amplifier this change occurs twice.

### Guard Against Losses

It is well known the sensitivity of a vacuum tube detector is approximately proportional to the square of the voltage applied to it. Hence, the losses in the three coils preceding the detector cause enormous reduction of energy in the plate circuit of the detector and audio frequency amplifying tubes. This naturally brings about a marked decrease in the sensitivity of the receiver, together with broadened tubing and inferior tone quality. Furthermore, energy below a certain signal strength will not operate the detector tube.

It can thus be readily seen a small loss in the tuning inductance or radio frequency transformers may entirely prevent the reception of a distant station, whereas if the loss were not present, the signal could be clearly heard.

With new types of tubes appearing with startling rapidity, the design of inductances which will fit each type of tube has been somewhat of a problem. In the improved Aero coils, which furnish the basis for the receiver about to be described, a happy solution is reached in making the plate windings of the r. f. coils capable of change for accommodation to the plate circuit of the various new tubes. Thus it will be noted while the Aero coils are provided with six terminals, only four are used. As shown in the schematic and graphic diagrams, which accompany this article, terminal 6 is the grid, terminal 5 the filament and terminal 1 the plate connection. Where receiving conditions are rather congested, requiring the utmost selectivity, terminal 2 is used for the other primary connection, as shown in the schematic. Using the receiver away from broadcast congestion, one may choose to use terminal 3 instead of 2, which will result in a considerable gain in sensitivity of the receiver and some decrease in selectivity. Terminal 3 may also be used by experimenters for the plate circuit of the dry cell or other tubes for higher impedance than that of the usual 201-A. The use of terminal 4 for the plate circuit is of little avail except with high-Mu impedance tubes. This point may be of interest to those who are desirous of playing with the type 240 tube.

The name "Aero-dyne" has been used on a receiver that for two seasons has enjoyed unusual prestige among set builders and experimenters. To say the new Aero-dyne of the 1927-1928 season is a better receiver seems to be all that is necessary in commenting on the merits of the design. It still remains the leader in the Aero line of kits.

(This receiver constructed, tested and all illustrations made in our laboratory)

Quality Comes First

While extravagance was guarded against in the selection of parts, wherever a division appeared necessary between quality and price, the deciding factor was quality. By way of some detail the outstanding points of this receiver are: the use of the new Aero universal coil, giving the utmost in sensitivity and selectivity per stage; the use of three stages of radio frequency amplification, one more than the previous model; two controls of the modern drum type, facilitating simple operation of the set; separate tuning condenser for the first stage of radio frequency, allowing perfect tuning regardless of the length of antenna used; and modern transformer amplification with power tube equipment in the last stage.

One of the greatest charms of the tuned radio frequency receiver lies in the fact that with closely matched inductances, and capacities which are accurate, the tuning may be gang controlled for utmost simplicity. This gang control might be carried all the way to the antenna circuit were it not for the fact that antenna conditions vary with each individual constructor, and where one individual might secure close tuning at all points in the broadcast band, the next one might fail because of a different antenna and ground condition.

Coil manufacturers have been ever on the alert to produce inductances of identical size, shape and turns so radio enthusiasts might have no difficulty in making all gang condenser connections work out perfectly as far as tuning is concerned. Then again, in the past considerable difficulty has been encountered in the tendency of coils to feed back upon each other and require either excessively wide spacing between units or else their location at an arbitrary angle to reduce this undesirable coupling. However, in the new coils used in this receiver, the shape ratio, that is, the ratio of length to diameter is such that magnetic coupling between coils is at a minimum and mounting becomes a very simple matter and shielding may be dispensed with, if desired.

The Hammarlund condensers used are of great accuracy and are constructed in such a way they may be assembled in the receiver and a long control shaft substituted for the regular shafts without disturbing the accuracy of the units. These accurate parts together form a combination of accurate tuned stages over the entire broadcast band and with the efficient Aero coils produce a remarkably sensitive receiver.

It will be noted these tuning condensers are of the .0005 mfd. type, which value of capacity has been found most satisfactory for the present set of coils, which are known as U-16. It is also possible to use .00035 mfd. condensers, but in that event it is necessary to specify the Aero U-163. For the present receiver



Fig. 1. Console view showing the completed set in an attractive housing

the .0005 condenser is admirably suited.

Has Variable Primary

Inspection of the antenna coupler will reveal the fact the primary winding is made variable. This type of inductance permits a wide range of flexibility in comparison to a winding of a fixed nature. Were the receiver to be used only in one location, the fixed winding might suffice, but with the vast difference in locations, absorption factors and desire on the part of the operator to have complete control over the receiver, it is natural that a variable primary is supplied. To properly use this primary, the antenna coil should be set at a point where the signal is strongest and selectivity is still retained. By moving the coil up or

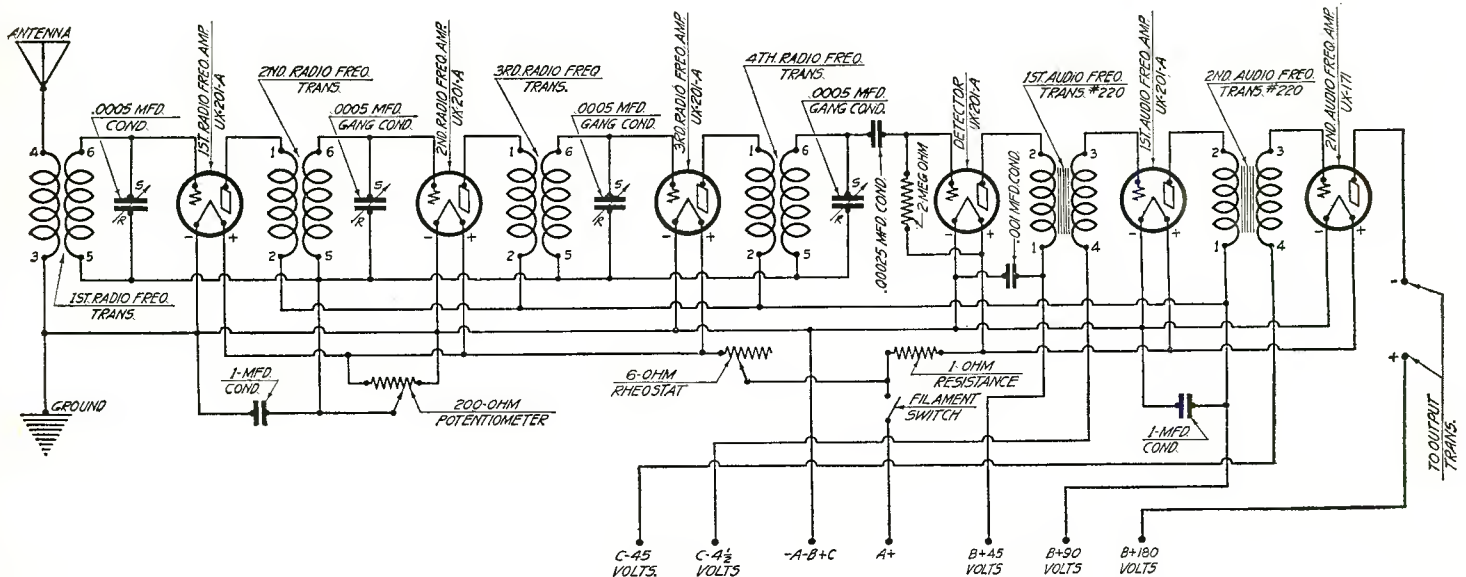

Fig. 3. Electrically accurate, this schematic will suffice for the experienced constructor

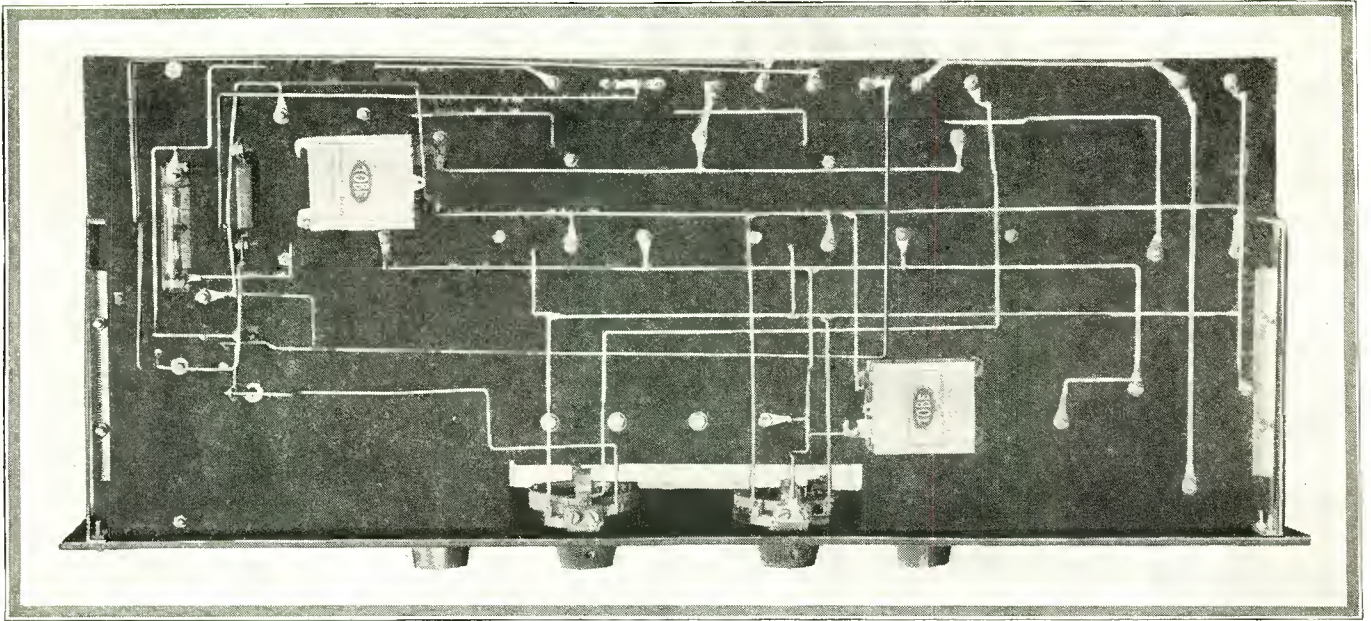

Fig. 4. Here is shown photographically the bottom view of the set, with its simple wiring

down it will compensate for a long or short antenna.

Quarter ampere tubes are used in all positions of the set, with the exception of the last socket, where a 171 tube is placed.

In beginning the construction of the set, the builder should first consult carefully all photographs and drawings in this article so as to absorb as much as possible of the general layout. With the Micarta drilled and engraved panel specified, no particular work is involved on the part of the builder. However, if an undrilled panel is used, the panel layout in figure 5 should be consulted. The location of all parts may be traced from the sub-panel layout shown in figure 7. These parts may be first tentatively placed in the position shown in this layout and then affixed to the sub-panel. Figure 6 shows the graphic illustration by means of which the wiring may be accomplished, in case the builder is not quite certain as to his ability to interpret a schematic diagram.

For those who are accustomed to putting together sets and wiring them up, the schematic diagram in figure 3 will suffice. The rear view of the completed set is shown photographically in figure 2, while figure 4 is a picture of the bottom of the sub-panel showing all parts located and wired. Figure 1 is the completed receiver shown in its console.

Binding posts are provided for the antenna and ground connections, together with the A, B and C supplies.

A glance at the schematic circuit shown herewith will readily disclose the electrical connections involved in the construction of the receiver. For those to whom radio is an open book, the schematic should suffice for the construction of the set. How-

ever, each year there is an ever increasing army of experimenters and set builders, who must rely upon either the manufacturer or radio magazines like ours for a simple method of construction which does not involve a thorough knowledge of the art. It is for that reason we print the graphic diagrams, which have been in the past the most popular with the newcomer in radio.

Accurate Illustrations

The graphic diagram has been carefully checked against the schematic, which is the criterion of electrical accuracy. Because of this, no one need hesitate to construct this set from the graphic illustration, shown in figure 6. Taking up the receiver section by section, we find there are three stages of radio frequency amplification, a tuned detector and two stages of high class audio amplification, using a UX-171 power tube in the last stage for maximum undistorted output. The first r. f. stage which is adjacent to the antenna and ground is controlled by a single .0005 Hammarlund variable condenser. The succeeding two stages of r. f. and the detector are tuned by three condensers of the same capacity, but ganged together so as to be operative from a Silver-Marshall single drum dial. Any slight inequalities of tuning that might exist in varying antenna conditions may be readily ironed out by means of the single antenna stage condenser, because this stage may be put in absolute resonance with the remaining stages for highest r. f. amplification; or where interference appears, this same stage may be thrown out of resonance for aiding in selectivity. There are possibly a dozen ways in which the oscillatory tendency of a coil and tube may be curbed, but in the present

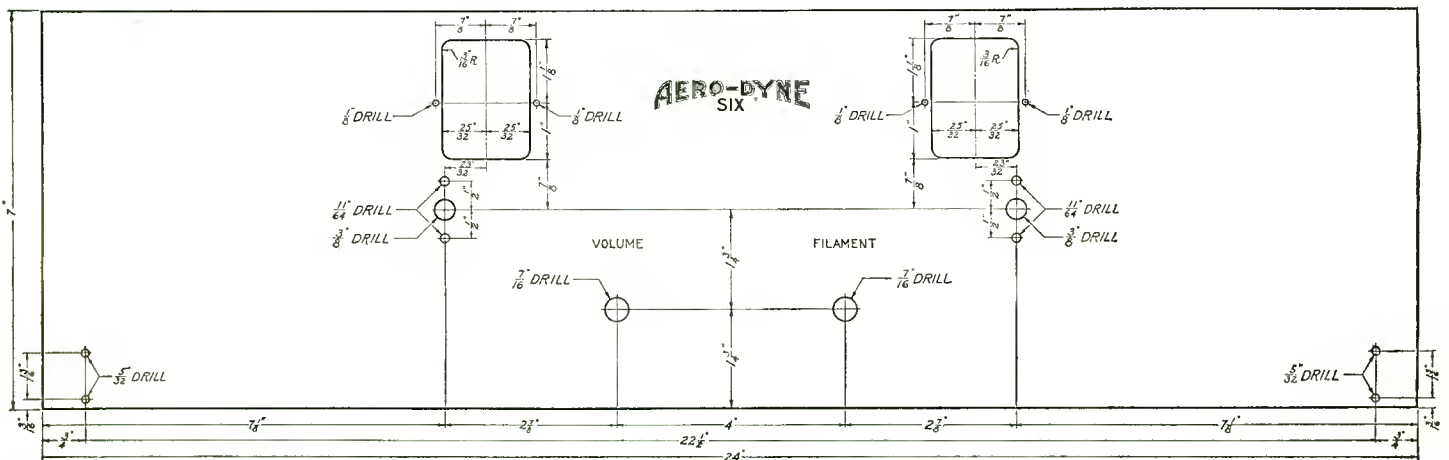

Fig. 5. Front panel layout for the receiver described in this article, dimensions being given for those using an undrilled panel

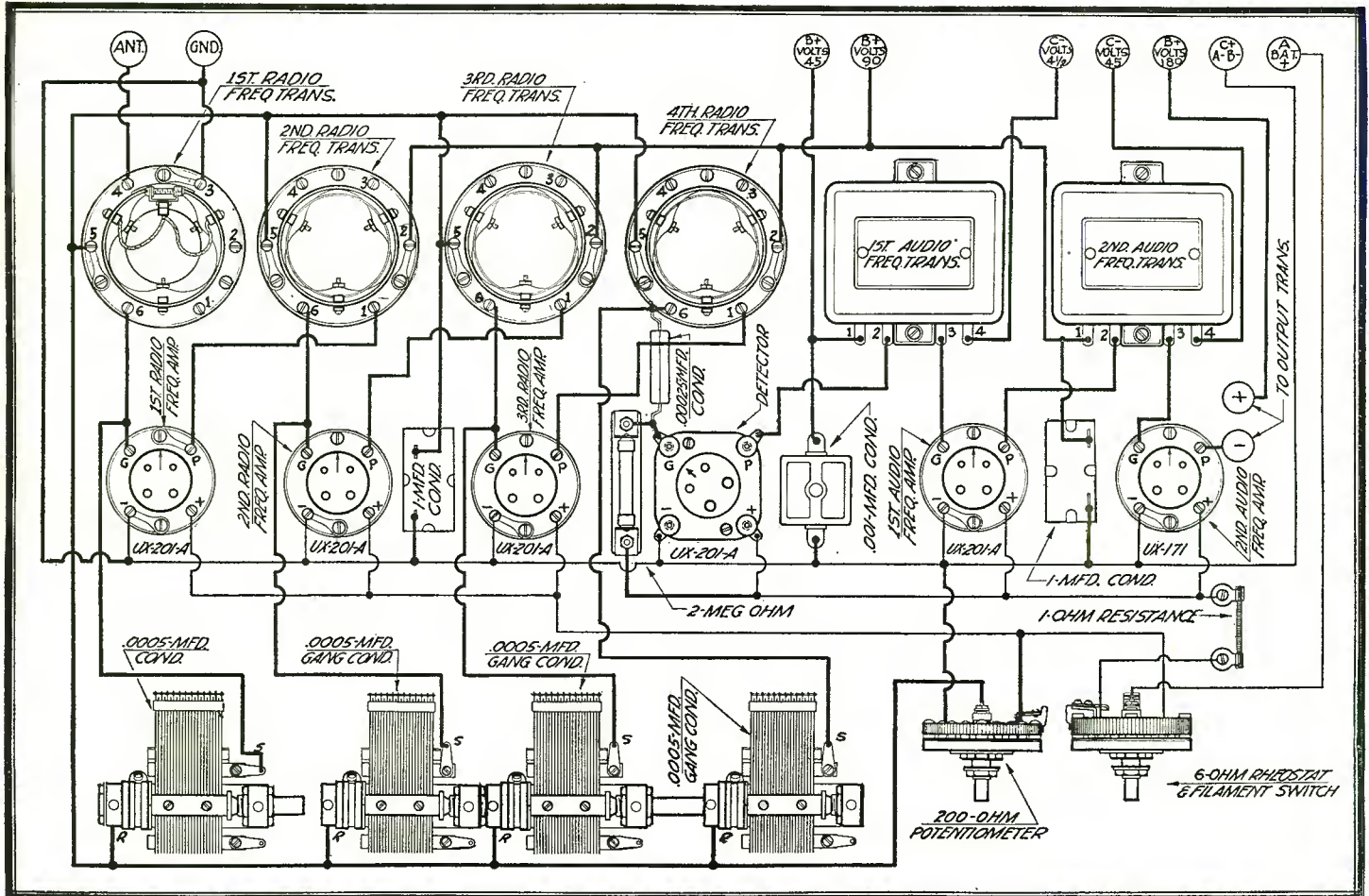

Fig. 6. Double checked for accuracy, this graphic illustration will permit even a novice to properly build this set

instance readers will observe that all grid returns are made to the center arm of a Yaxley 200 ohm potentiometer. This allows the bringing of each grid circuit to a point which is below oscillation and one which is the most likely to produce high r. f. amplification. It is obvious, of course, if the tubes were allowed to oscillate no amplification would ensue and the listener would soon discover this fact. The grid potentiometer method of control likewise permits the operator to alter the volume of the receiver signal at will.

Rectification in the detector circuit is accomplished by means of the .00025 mfd. grid condenser with a two megohm leak from the grid to the positive filament terminal of the tube. In the first audio stage 45 volts is applied to the detector plate, while the second audio takes 90 volts, which value is also applied to the plates of all r. f. amplifiers. The Silver-Marshall type 220 audio transformers give exceptionally colorful tone quality and excellent amplification. While these transformers might be considered as somewhat bulky, nevertheless in practice it has been found the added weight is justified in view of the resulting tone quality. In using a UX-171 tube in the last stage, the bias voltage on that grid circuit should be approximately 45 volts. Instead of placing the speaker windings directly in series with the plate and the high voltage terminal, it is recommended an output transformer be used to isolate the direct current component and save the speaker windings from possible injury through excessive current values.

#### Simple Filament Control

Filament control in the Improved Aero-dyne Six has been simplified to the point where a one ohm Yaxley fixed resistance carries the detector, first audio and second audio filaments. This particular portion of the circuit requires no attention. The remainder of the set (first, second and third r. f. tubes), is controlled by a Yaxley six ohm rheostat with switch. To shut off the set, this rheostat should be turned all the way to the left, when the circuit will be automatically opened. To turn on the

receiver, merely turn the rheostat knob to the right and the circuit is made. Thus one may save the use of a separate switch for the filaments by the use of this combination.

Bypassing is done on the 90 volt terminal to negative, this value being 1 mfd. The bypass value in the plate circuit in the detector tube is .001 mfd. Another Tobe 1 mfd. bypass condenser is placed across the negative filament and the center arm of the potentiometer to prevent any inductive effect in that particular unit.

Photographically we are showing three views of the receiver, figure 1 being the set placed in a Corbett D-20 console, figure 2 showing the rear view of the completed receiver and figure 4 giving an idea of the bottom of the sub-panel showing all wires in position.

Tuning the Improved Aero-dyne Six is very simple, being confined to the operation of the left hand drum dial for placing the antenna stage in resonance with the incoming signal and the right hand dial for bringing the two r. f. stages and the detector to their point of maximum amplification, which would, of course, be at the frequency for which the left drum is set. Volume may be controlled by means of the potentiometer, to whose center arm all grid returns of the r. f. stages are connected. On the lower wavelengths, where the tendency of any tube circuit to oscillate is strongest, it will be found necessary to retard the potentiometer towards the positive side. In the case of the longer waves, the potentiometer may be advanced further towards the negative to secure maximum amplification. Another refining control, by means of which the sensitivity of the set may be governed, is found in the six ohm rheostat which allows the tubes to be operated either at a lower brilliancy for local stations or higher brilliancy for distant signals.

For general all-around work the 201-A type tube, used as a detector, has been found uniformly satisfactory. However, some experimenters are desirous of using the 200-A type, since that particular tube seems to give a slightly better response to weak

signals, although it is somewhat noisier in operation than the conventional quarter ampere tubes. Readers will observe that the grid leak on the detector stage, when using the 201-A, goes from the grid to the positive filament. If the 200-A tube is to be used, it is suggested the leak termination be made the negative filament, which is in accordance with the recommendation made by the manufacturers of the tube. In the operation of the 171 power tube some little experimentation may be done with the C bias value for that grid circuit. The safest way, however, is to consult the printed slip which accompanies all power tubes and which gives their characteristics. Knowing the total voltage for the plate circuit which one has available, it is merely a matter of consulting the manufacturer's chart to determine the bias value which will give best results. This point is well worth stressing in view of the tendency on the part of some set builders to ignore instructions regarding C bias values, and who seem to labor under the apprehension that a 9 volt bias on a 171 power tube is sufficient. It should be understood the higher the bias potential applied to a power tube, the less current will be consumed in the plate circuit of that tube. This is especially important when using dry B batteries for the plate circuit, because here an improper C bias will cause an excessive drain on the batteries. In the case of an eliminator, it is also important because an excessive drain in the plate of the 171 might cause a considerable lowering of the output voltages on the eliminator.

Builders of sets should remember a thorough checking of the completed receiver against the schematic or the graphic is advisable in the interest of preventing burned out tubes or shorted condensers. Even experts who have built hundreds of sets have been known to make errors in connections. This double checking, while it might require a little more time, will repay the builder in the satisfaction of knowing there are no wrong connections which might cause trouble.

Some mention should be made on the subject of antennas for operation of tuned r. f. receivers. The effectiveness of any receiver making use of an antenna or ground is largely dependent upon the voltage which can be impressed upon the grid of the first tube. In previous paragraphs of this article attention has been called to the fact that inductance losses have been reduced to a minimum in the coils to permit a high degree of r. f. amplification. That is about as far as a manufacturer can go in the design of a set. Next it devolves upon the builder or operator to see that he is supplying the first stage with as much energy as is possible to secure from the advancing wave front of a signal. Height of an antenna is usually more important than length, although in many cases there is a compromise between these

two factors. Insulation of the antenna is, of course, a prime requisite. Lead-in wires from the antenna should be kept away from all absorbing surfaces, such as gutter-spouts and walls. Ground connections should preferably be made to cold water pipes, either soldered thereto or affixed by means of connectors. Gas jets or radiators are at best poor substitutes for a ground. While it is not possible to lay down any hard and fast rules about the length of an antenna, it may be stated that an average would be in the neighborhood of 75 feet of antenna and about 25 feet of lead-in, making an overall length of 100 feet. In especially congested districts it will be found a shorter antenna will give much greater selectivity than an exceedingly long one. However, when located in outlying districts, greater length may be used to afford a stronger pick up. With the type of antenna coupling coil used on this receiver, the length of the antenna does not cut such a figure, because the coupling between primary and secondary may be opened or closed at will to compensate for differences in antenna length.

**List of Parts**

These parts, or their equivalent, may be used in the construction of the Improved Aero-dyne Six:

- 1—U-16 Aero kit consisting of 4 r. f. transformers
- 2—805 Silver-Marshall drum dials
- 2—220 Silver-Marshall audio frequency transformers
- 5—511 Silver-Marshall sockets
- 4—ML-23 Hammarlund .0005 mfd. variable condensers
- 1—9040 Benjamin socket
- 2—Tobe 1.0 mfd. bypass condensers
- 1—Tobe 2 megohm Tipon grid leak
- 1—Carter .00025 mfd. grid condenser
- 1—Carter .001 mfd. fixed condenser
- 1—906K Yaxley 6-ohm rheostat with switch
- 1—200 Yaxley 200-ohm potentiometer
- 1—801 Yaxley 1-ohm fixed resistance
- 1—Polymet EZ grid leak mounting
- 11—X-L binding posts
- 1—Aero foundation kit consisting of:
  - 1—Micarta drilled and engraved panel 7x24x1/8 inch
  - 1—Micarta drilled sub-panel 9x23x3/16 inch
  - 2—Aero sub-panel brackets
- 1—Package Kester radio solder
- 1—Ekko ground clamp
- 30 Feet Acme Celesite wire
- Miscellaneous lugs, nuts, screws, etc.
- 5—Ceco type A tubes
- 1—Ceco type J71 tube

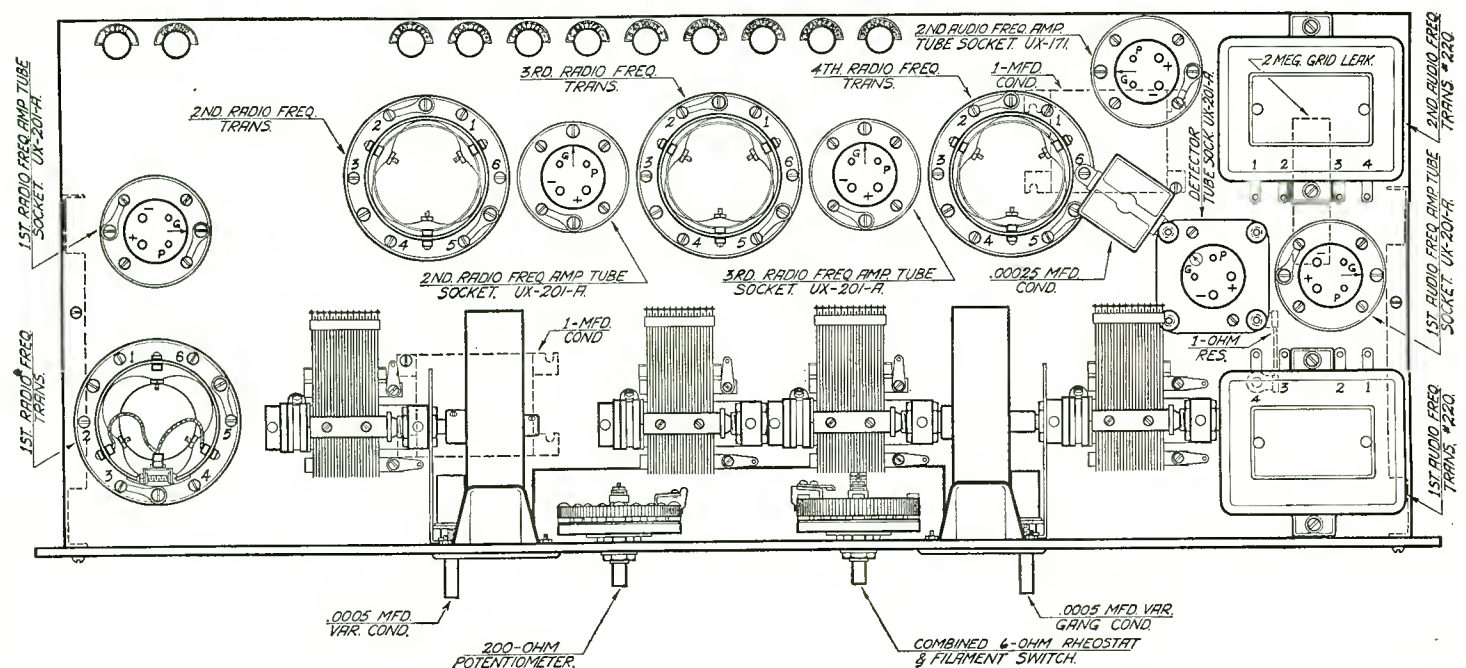

Fig. 7. Parts for this receiver should be placed in accordance with this layout, and then wired either by the schematic or graphic illustrations

# New Shielded Grid Tube Is Employed in Camfield Seven

Great Possibilities Seen in Latest Tube Development; Neutralization  
Is No Longer Necessary

**W**HAT is considered as one of the most far reaching developments in the radio business since the beginning of broadcasting is now made available to radio manufacturers, experimenters and set builders in the form of a tube capable of an astounding degree of amplification which has heretofore not been possible. The full details of this tube, its charac-

ters stand out as possibilities which may be of interest to all kinds of readers. From the experimental standpoint the new tube should be the key that will unlock the door through which hosts of new circuit arrangements may be devised. From the manufacturing standpoint it should be possible for receivers containing fewer tubes to be produced at a lower cost and this saving in turn should accrue to the benefit of the radio public. From the standpoint of receiver efficiency the employment of the new tube should bring about the shielded unit system whereby one or more stages of amplification may be used on the set, without the necessity of neutralization and with a very high radio frequency amplification factor. Further advantages of this tube will probably be seen on reading the article on these pages.

For the past five years, since the radio first came into use as a means of entertainment, the development of circuits for broadcast receivers has been limited by the vacuum tubes available.

All developments in circuits have been made around the so-called general purpose tube such as the UX 201-A, the CX 301-A and tubes of similar characteristics, and a careful analysis shows that there has been no radical change or departure in the general characteristics from the receiving circuits that were in use five years ago.

Radio is one of the leading industries of the United States, and the engineers of thousands of companies engaged in the manufacturing and selling of radio equipment have been working towards the betterment of the art for the past five years. In their laboratory work on receiving circuits these engineers have made many minor improvements and refinements, but when it came to making really new developments they have all met with the same limitation, namely, the vacuum tubes available for use in receiving circuits.

Now for the first time the radio industry has been startled by a really new and revolutionary development in vacuum tubes, which opens up an entirely new field in the design of better and more efficient receiving circuits.

## Shielded Grid Tube

This development was recently made public by the announcement of the Shield Plate Tube Corporation of their new shielded grid tube type SP 122 and by a practically simultaneous announcement of the Radio Corporation of America of a similar tube known as their screened grid radio frequency amplifier type UX 222.

These new tubes are specially designed as voltage amplifiers for use in specially designed radio frequency circuits, and also as space charge grid tube for use in impedance and resistance coupled audio frequency amplifier circuits.

As will be seen from an examination of Figure 6, the new tube is a radical departure from the former general purpose 201-A type, in appearance and construction as well as electrical characteristics. The new tubes have a filament, a grid and a plate, and a second grid placed between the control grid and the plate and also extending around the outside of the plate so as to completely shield the control grid from the plate.

When used in the proper circuit this second grid acts as an electrostatic shield between the control grid and plate, and



*Fig. 6. General outline of the new tube is shown in the above photograph, while its characteristics may be ascertained by a careful reading of the accompanying article*

teristics and its application in a receiver containing an especially designed circuit arrangement for this newcomer in the field will be disclosed by a further reading of the article on these pages.

## What It Means

The extent to which this new tube development will effect the industry cannot be imagined at this writing, although several

(This receiver constructed, tested and all illustrations made in our laboratory)

thereby reduces the capacity between those elements to a negligible quantity. This eliminates one of the principal causes of disturbing oscillation in tuned radio frequency circuits, and with it the necessity of any form of neutralizing.

### Characteristics of Tube

The new SP 122 tube has a filament similar to that used in the well known type 120 tube which draws  $\frac{1}{8}$  ampere at 3 volts. The tube may be operated, however, with a filament terminal voltage as high as 3.3 volts without danger to the life of the filament. In general use of the SP 122 as a radio frequency amplifier its manufacturers recommended a plate voltage of 135, a filament terminal voltage of 3.3, a control or inner grid voltage of minus 1 to minus 2, and an outer or shield grid voltage of 45. Tests made with a number of SP 122 tubes at the above voltages show them to have an amplification constant of 170 to 180, a plate impedance of approximately 500,000 ohms and a mutual conductance of between 350 and 450.

The SP 122 is mounted on a standard X type of base. The terminal arrangement for the filament, the plate and the shield

becomes a complicated one and requires the use of specially built units containing proper bypass condensers, choke coils, etc.

### Camfield Designs Set

The Camfield Radio Mfg. Company, a well known and aggressive parts manufacturer, has been working on this problem for many months and is now producing a specially designed amplifier unit that is suitable for use with the SP 122, the UX and CX 222 and tubes of a similar type. This new unit, known as the Camfield shielded grid amplifier unit type 122, has been especially designed for use by those who desire to experiment with the new shielded grid tubes. The units are so arranged that a number of them may be placed side by side to form a cascade amplifier. The units are so constructed that several of them may be operated by a single tuning control or with individual tuning controls at the choice of the user. The units are mounted in a heavy aluminum can and a very convenient terminal arrangement is provided on the back of each unit. The input and output terminals are so located that when several units are used in a cascade amplifier the grid leads will be extremely short. When

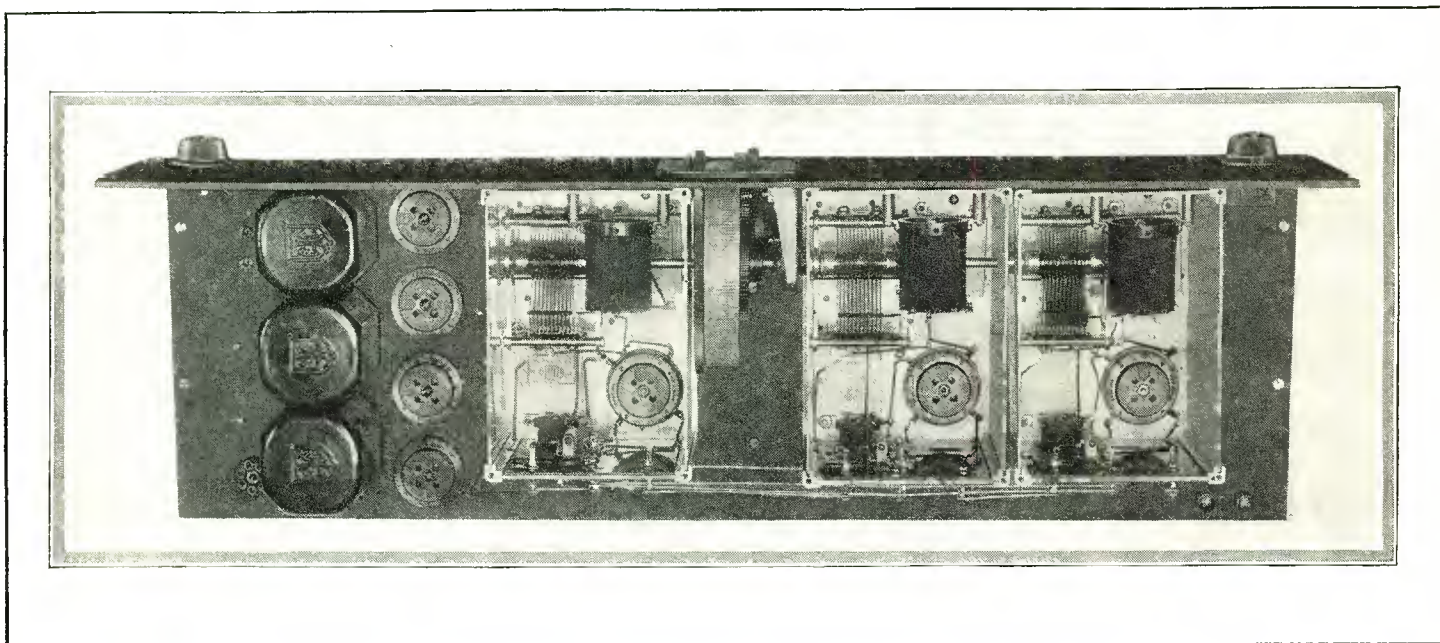

**Fig. 2. Practically everything in the receiver in the radio frequency end is located inside of the shields, which are shown in the above photograph**

grid are the same as in the standard 201-A type. The connection to the inner or control grid is made through a metal cap on the top of the bulb. This connection is brought out of the top of the bulb to prevent any capacity between the grid lead and that of plate and other elements.

In order to obtain the maximum efficiency from the SP 122 and tubes of similar construction in a radio frequency amplifier circuit it is necessary to carefully shield each individual stage. When this is done an actual amplification of 30 to 40 per stage may be obtained without any disturbing oscillation. When this amplification is compared with the usual gain of 6 to 8 per stage obtained from the general purpose type 201-A tube when used as a radio frequency amplifier the reader will clearly see the advantage of this new type of vacuum tube.

While an actual amplification of 30 to 40 per stage is obtained at the broadcast wave lengths, amplification of over 150 per stage is obtained at lower frequencies, and it is safe to assume that interesting developments in connection with the use of this tube in circuits of the superheterodyne type will be made in the near future.

If maximum efficiency is to be obtained from the tube and oscillation entirely prevented, the problem of complete shielding

used in this manner parallel wires can be run down the backs of the cans to connect the battery terminals, and when this is done a complete radio frequency amplifier circuit is formed. One unit is required for each stage of radio frequency amplification and any number of units from one to three may be successfully used. The use of more than three units is not necessary, due to the tremendous amplification obtained.

The first application of the new shielded grid tubes in a commercial receiving circuit is in the Camfield Shielded Grid Seven. This is a seven tube radio frequency amplifier using three stages of radio frequency amplification with the new SP 122 tubes, a detector and a push-pull audio frequency amplifier.

### For Experimenters

This circuit should be of great interest to the home constructor and the professional set builder, inasmuch as it makes use of the completely wired Camfield shield grid r.f. amplifier units type 122, and is, therefore, extremely simple to construct. The tone quality is excellent, due to the use of Tyrman audio frequency transformers with a 112 power tube in the first stage of the audio amplifier and two 171 power tubes in the push-pull stage.

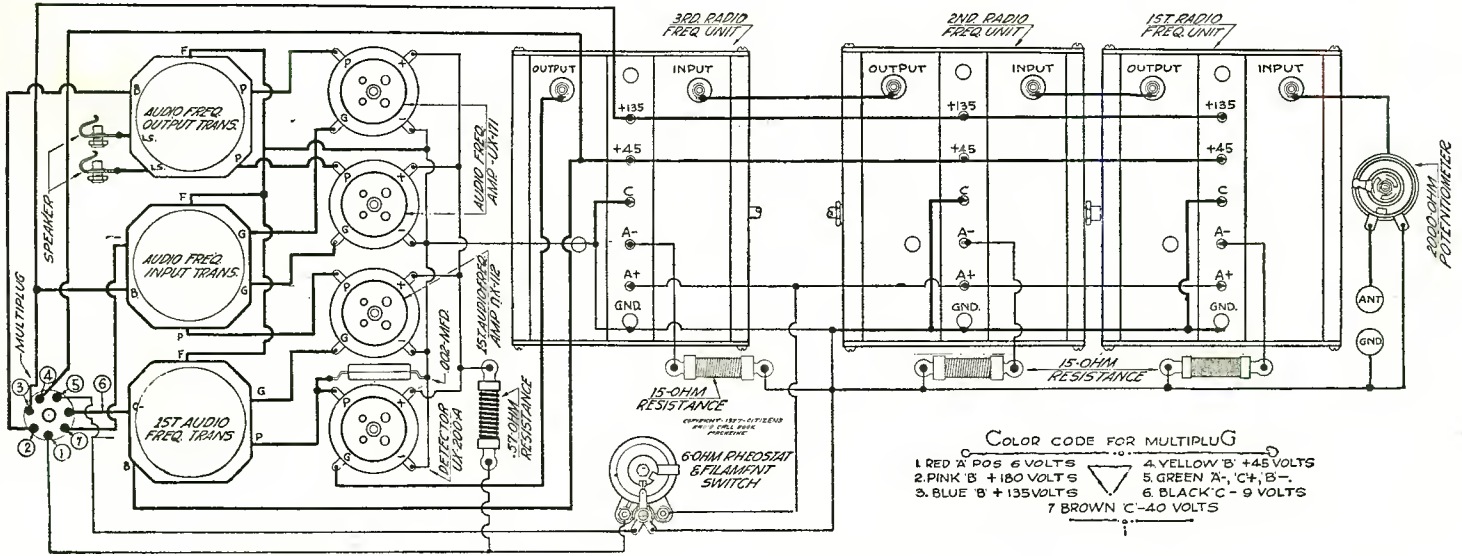

Fig. 7. Be sure to study the graphic illustration shown above so you may be familiar with all connections

This set has been designed with a single tuning control and is extremely simple to operate. The volume control consists of a 2000 ohm variable resistance in the antenna circuit as illustrated in the schematic wiring diagram of Figure 3. With this system a smooth and noiseless volume control is obtained, and the tuning circuit is not affected by the characteristics of the antenna used. When the volume control is turned clear to the left the grid of the first tube is grounded. However, the amplifier system is so sensitive that even when the volume control is in this position local stations will be heard. It is, therefore, sometimes necessary to use the rheostat in the circuit of the radio frequency tubes as an additional means of volume control.

This receiver may be used on a short inside antenna with entire satisfaction. When an outside aerial is used it should never exceed fifty feet in length and with the average outside aerial the series condenser of .0001 mfd capacity or smaller should be used.

**What the Schematic Shows**

Reference to the schematic diagram shown in Figure 3 will give the reader an idea of the special circuit used in conjunction with these tubes. It will be noticed that each of the sections containing a tube is located inside of a shield, where it is possible to have control over the action of the tube, the bypassing of plate and grid control elements, the tuning of each individual

plate circuit and the shielding of the tube, condenser and inductance. The receiver, when using the special form of circuit shown in the schematic diagram, is an impedance coupled tuned radio frequency set, each stage having its proper capacity coupling and leak for inputting to the succeeding amplifier. On account of the high voltage used on these tubes and the amount of resistance in the grid circuit bias, it is not anticipated that any difficulty will be encountered with premature detection. Each rotor of the .0005 variable condenser, which tunes the plate inductance, is common with the ground terminal and eliminates any possibility of body capacity. No coupling can exist between the plate coil of one stage and that of another, on account of the individually shielded units. The only possible point where trouble might be encountered would be in the lead from the output of one stage to the input of another, although in the model which was tested in our laboratory the length of this connection was kept so short that no ill effects were experienced. It might be possible that a form of conduit or shield, placed around the lead from the output of one stage to the input of another, would be a good means of shielding this lead so that it could not act against any other leads on the next unit.

Examination of the sub-panel layout shown at the bottom of page 94 will give the builder a good idea of the location of all the units employed in the construction of this receiver. A sixteen inch length of quarter inch steel shafting is used as a means of linking together the three variable condensers and the drum dial which actuates them in tuning for signals. In placing the

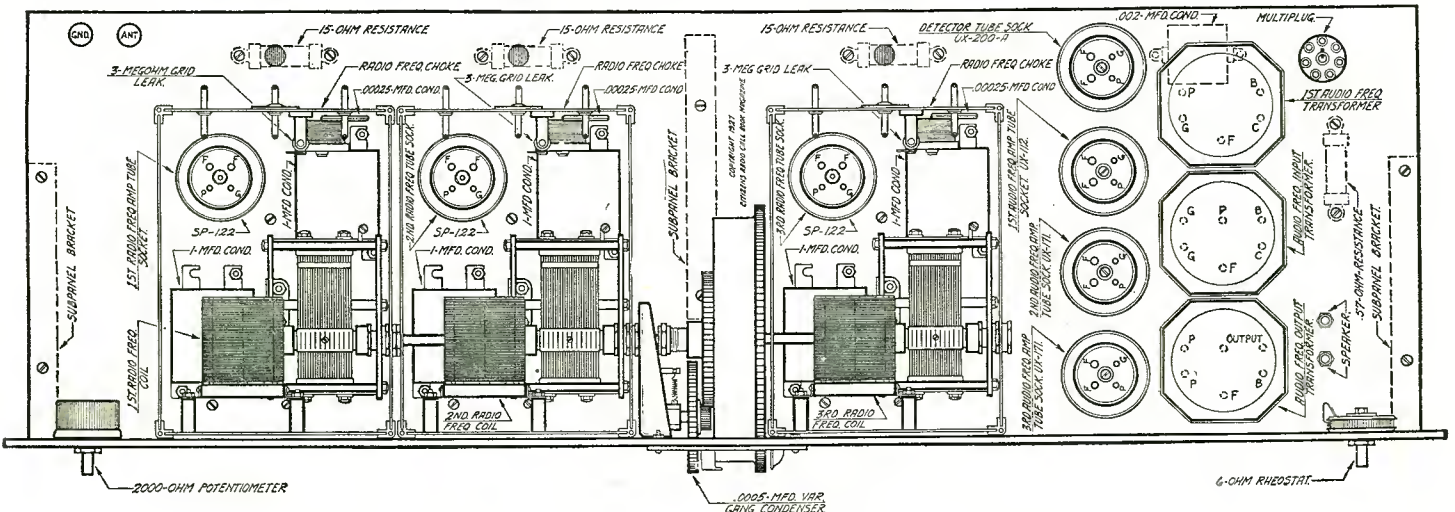

Fig. 4. Very little work is required on the part of the set builder in assembling one of these receivers, because of the fact only a few connections have to be made from shield to shield, as shown in the graphic illustration



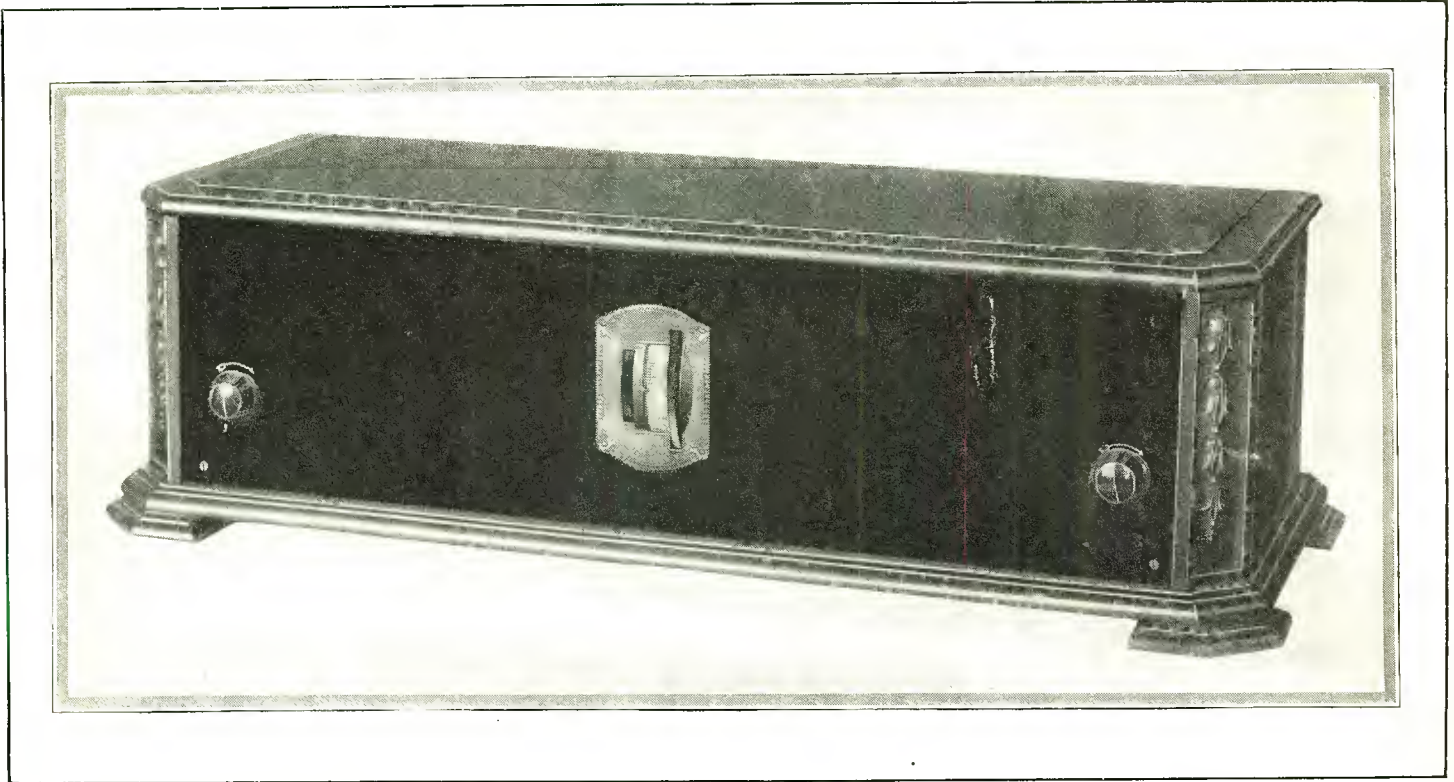

Fig. 1. This photographic view shows the Camfield Shielded Grid Seven Tube receiver, as constructed and tested in our laboratory

units (the shielded r.f. stage ones) on the sub-panel it would be well to carefully line them up so there will be no friction on the various condenser collars when the length of shaft is slipped through them. If there is any irregularity in the assembly of these units there is a likelihood of the units binding on the extension shaft and causing it to turn hard. A little attention paid to this particular detail will assure the set builder of a smooth running drum dial.

On account of the weight of the audio amplifying transformers the extra sub-panel bracket is provided down the center of the

sub-panel. These transformers are all connected in the circuit through binding posts or lugs at the bottom which go through the proper holes in the sub-panel. A template is provided so the builder may locate the holes properly. In the case of the drum dial another template is supplied so the constructor will not go wrong on this end of the assembly work.

Under operating conditions the Camfield Shielded Grid Seven receiver should have all of the top shields fixed tightly in place with the screws provided for that purpose. Those experimentally inclined will observe that whereas with the covers on tightly

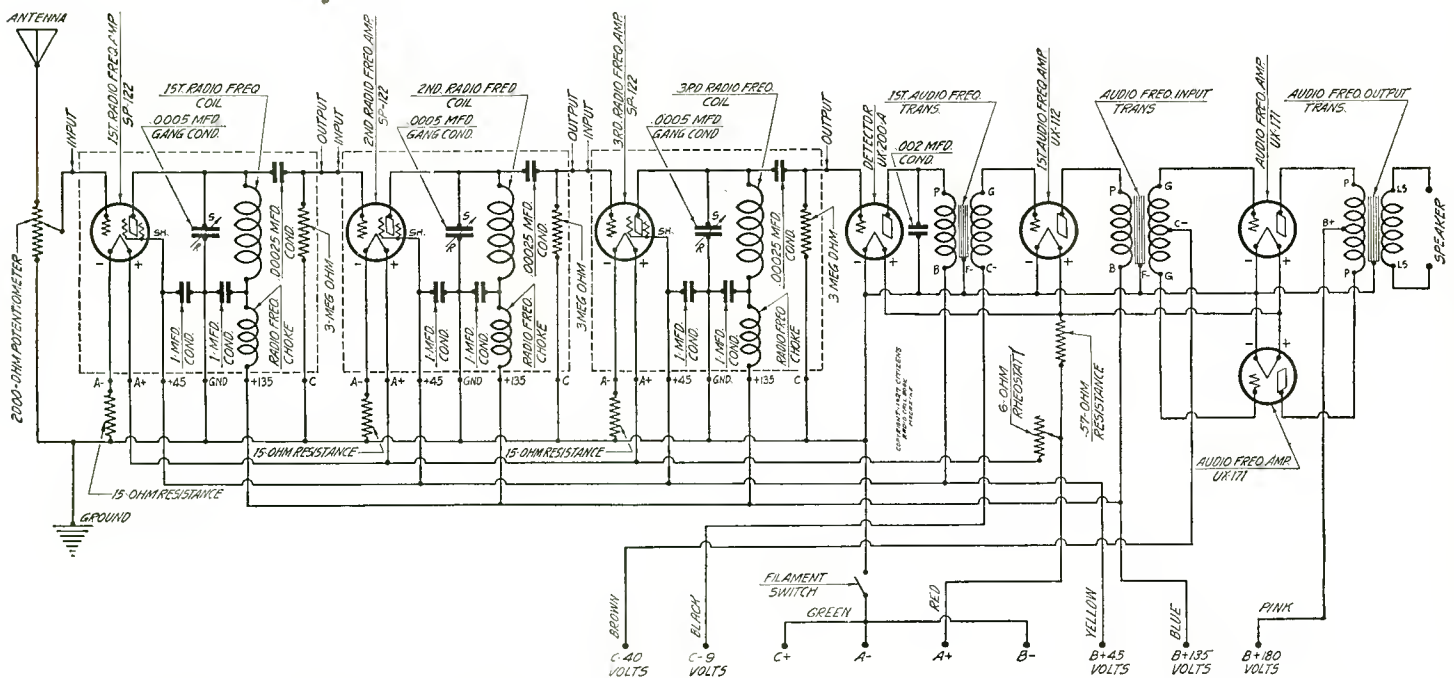

Fig. 3. Schematically the circuit which is necessary for use with the shielded grid tubes may be seen above

there will be no difficulty with oscillation, yet if one of the covers is left open a trifle the set will at once exhibit tendencies towards oscillation and instability. It is also interesting to observe that when the receiver is tried out with only a ground connection a fairly good signal is secured on local stations, although when the ground signal is dropped there is no signal to be heard. Considerable work may be done by the operator, if he chooses, in determining the length of antenna which he is to use on the receiver.

In laboratory tests while the receiver was being designed it was found that even as short a length of wire as a twelve inch piece would give a very good response on local signals, all of which serves as an indication of the amplification that may be expected from the radio frequency end of the receiver when using the shielded grid tubes. The antenna length may be tried out by the builder at several different values to see which one gives the best results for the particular location in which the receiver is installed and being operated. Possibly in some instances an open-ended loop may serve as an energy collector, while in others a short length of insulated wire carried around the picture moulding in the room may suffice for all the volume that is considered necessary. Of course for maximum distance in reception it would be well to have an antenna that is as high as possible and in the clear from absorbing structures.

Control of the first tube stage is very simple and smooth and has a degree of flexibility that should be welcomed by any fan. The only other control is that involved in the operation of the six ohm rheostat on the front panel at the right of the operator and which governs the brilliancy of the radio frequency stages.

It will be observed that on account of the method of coupling from one stage to the other that the grid leak and condenser which is normally required in any set, in the case of this last radio frequency stage, is located inside of the shielding with the connection from it going directly to the grid of the 200-A detector tube. This is a welcome innovation that eliminates the grid condenser and leak from the exposed portion of the sub-panel where it might be affected by stray fields when apparatus is placed close together for compactness of assembly.

On account of the haste involved in the preparation and design of such a set within the limited time available it has not been possible to touch upon all the ramifications of the new tube with such a welcome high ratio of radio frequency amplification. It is anticipated that future issues of this magazine will carry many interesting articles touching upon all of the uses to which the interesting newcomer in the tube field may be put. Certainly it will not be difficult to conceive of numerous combinations that will be quite efficient now that the remaining obstacle in development work—the tube—has been successfully overcome.

To old-timers in the radio field the introduction of the new shielded grid will come as a divine relief after ten years or more spent in the problem of wrestling with undesired oscillation in vacuum tube circuits. And now that the tube is announced and

its operation is beginning to be understood, there will be a host of experimenters and engineers who are due to wonder why, with all of its simplicity, the thing was not put into practice before. While abroad the four element tube has been used in a more or less spasmodic manner, it has remained for the commercial exigencies of this country to push to the front development work on this newest performer, and present to the radio industry a means of greatly improving all receivers to a point heretofore considered impracticable. With the oscillation bugaboo vanquished there will be countless set builders who will now be able to turn out a surprisingly good receiver for a relatively small cost. Alternating current operation and the report of the new shielded grid tubes are two of the announcements which the set building fraternity and the radio public in general have been awaiting eagerly. With these two facts established there should be no reason why the industry should not forge rapidly ahead at a greater speed than ever known in the history of broadcasting reception.

Parts used in the construction of the Camfield Shielded Grid Seven are:

- 3—222 Camfield shielded grid amplifier units
- 1—Camfield 16 inch length of  $\frac{1}{4}$  inch condenser shaft
- 1—Tyrman single drum dial
- 1—3-30 Tyrman audio transformer
- 1—3-50 Tyrman power input transformer
- 1—3-51 Tyrman power output transformer
- 4—Tyrman shielded sockets
- 1—Carter 2000 ohm potentiometer
- 1—Carter 6 ohm rheostat with switch
- 3—Carter 15 ohm resistance units
- 1—Carter .57 ohm fixed resistance
- 2—Carter tip jacks
- 1—Carter .002 mfd fixed condenser
- 1—PM Jones multiplug
- 3—Karas sub-panel brackets
- 2—Engraved Eby binding posts
- 1—Celeron 8x30x3/16 inch drilled and engraved panel
- 1—Celeron 9x29x3/16 drilled sub-panel
- 3—Shield grid tubes type SP 122
- 1—Diatron 200A detector tube
- 1—Diatron 112 power tube
- 2—Diatron 171 power tubes
- 30—Feet Acme Celatsite wire
- 1—Package Kester radio solder
- 1—Ekko ground clamp
- Miscellaneous lugs, nuts, screws, etc.

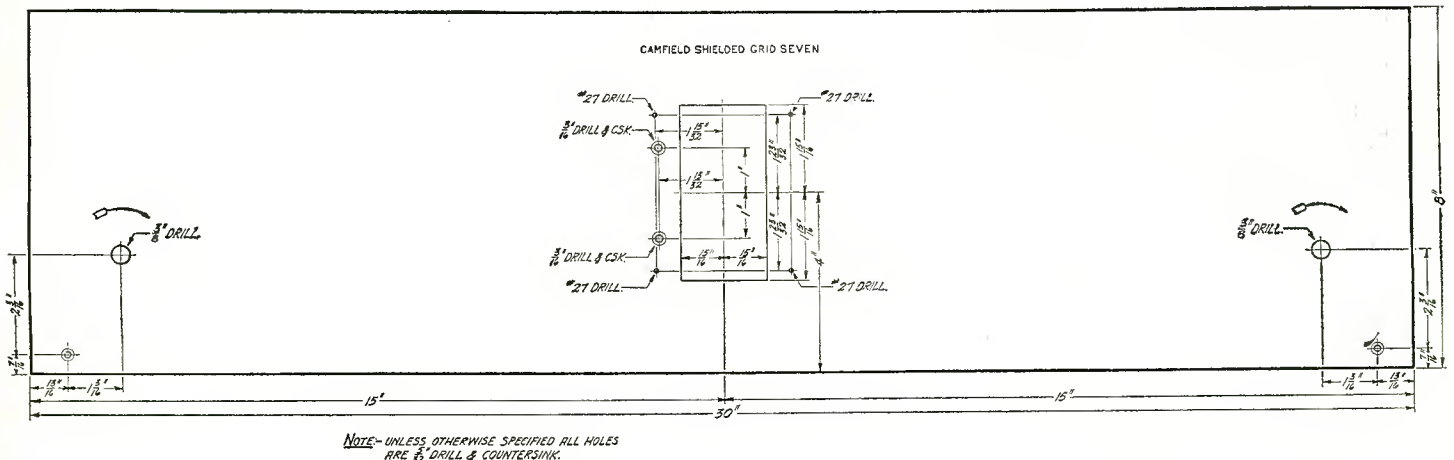
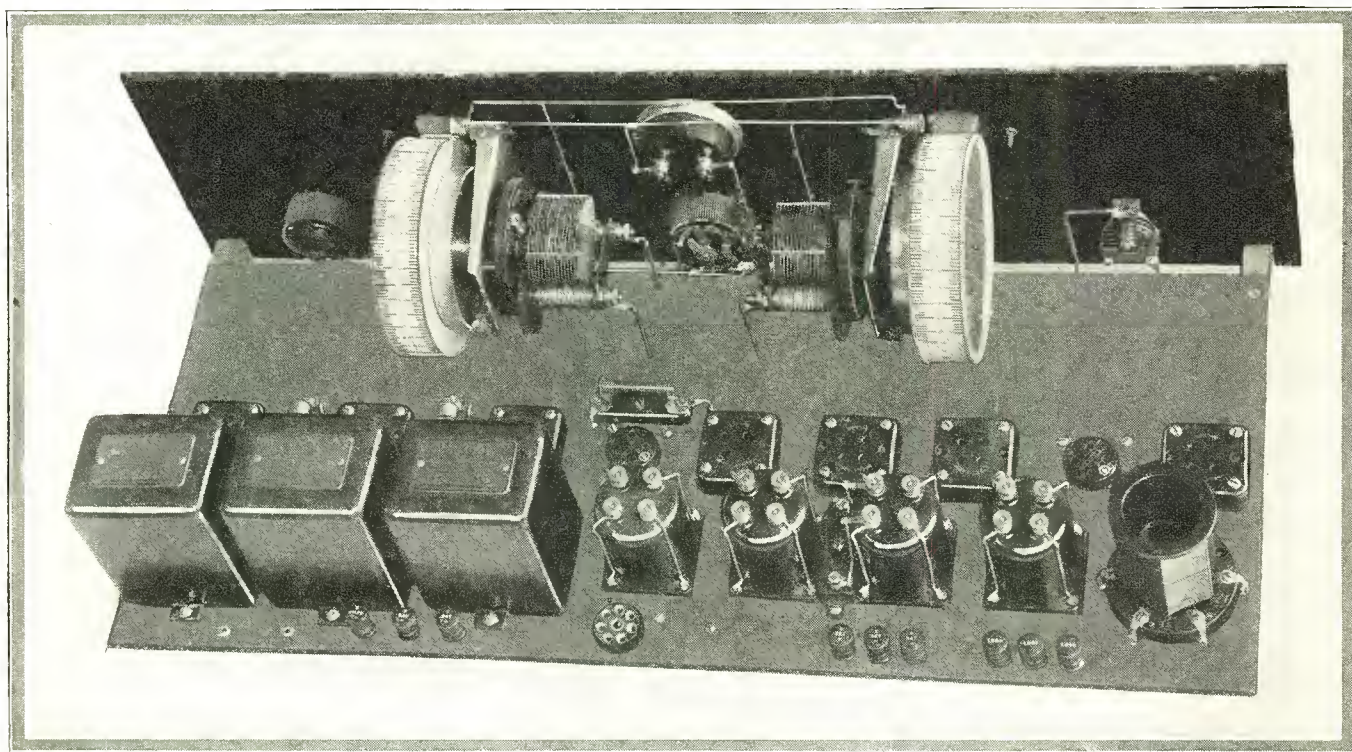

Fig. 5. Dimensions for all holes and drill sizes are shown in the front panel illustration

# The Citizens Super Nine Easy Receiver to Build



*Fig. 2. Neatness is a predominating feature in this receiver illustrated photographically herewith*

## Pleasing and Effective Combination Designed from This Versatile Circuit

**S**UPERHETERODYNE combinations are legion, which fact to a marked degree indicates the vast amount of interest which the public displays towards this advanced type of receiver. The public taste has so many ramifications that, even with the large number of super arrangements already exploited, there is always a large number of radio fans who will be interested in such combinations, this interest resulting from the experimenters desire to always have a receiver embodying the latest engineering practices or utilizing time saving methods of construction.

Apparently the superheterodyne circuit will never go out of date if we are to take into consideration all of its interesting possibilities. As each forward step is made in the industry towards betterment of component parts or higher quality products, the superheterodyne manages to keep a pace or two ahead of the crowd.

While this type of circuit is not essentially a simple one, nevertheless it may be approached without trepidation on the part of the set builder. For the professional the super has always been an outlet for his mechanical and electrical ingenuity. For the novice at times the super has presented many problems which, considered in the light of unmatched intermediates, tubes with decidedly non-uniform characteristics and improperly designed circuit arrangements made it almost impossible to build such a set with any degree of success.

### Constantly Improved Products

That condition, of course, no longer obtains. In the highly competitive business of producing parts for the consumer to use

in such important circuits, some manufacturers fell by the way-side, while the majority spent more time on research and more money to secure a standard product of unvarying excellence. This fact is responsible for the long wave transformers which have been available in the past season or two. The industry having been presented with a tube whose operating characteristics could be depended upon for the life of the tube, makers of intermediate frequency transformers were able to base their transformer designs upon those tubes, secure in the knowledge that when a construction job was undertaken by the set builder, the results would be the same as those secured in the laboratory. A large share of the credit for the success of the superheterodyne at this time must undoubtedly be reserved for those manufacturers who were quick to sense the wide gulf that intervenes between apparatus tested by itself and apparatus tested under operating conditions.

Everything considered, the individual set builder is better off today than ever before. All of the engineering problems with which he might have been confronted in the past have been swept aside by the manufacturer. All of the details of assembly or initial design of a set have been shouldered by publications such as the CITIZENS RADIO CALL BOOK MAGAZINE. Therefore, even those who are not well versed in super construction may feel certain that most of the trouble heretofore attending their efforts has now been dissipated. With our magazine designing, constructing, testing and illustrating such receivers, we feel confident our readers will be assured of success in their work.

### Possibilities of Circuit

In this article covering the Citizens Super Nine we are show-

(This receiver constructed, tested and all illustrations made in our laboratory)

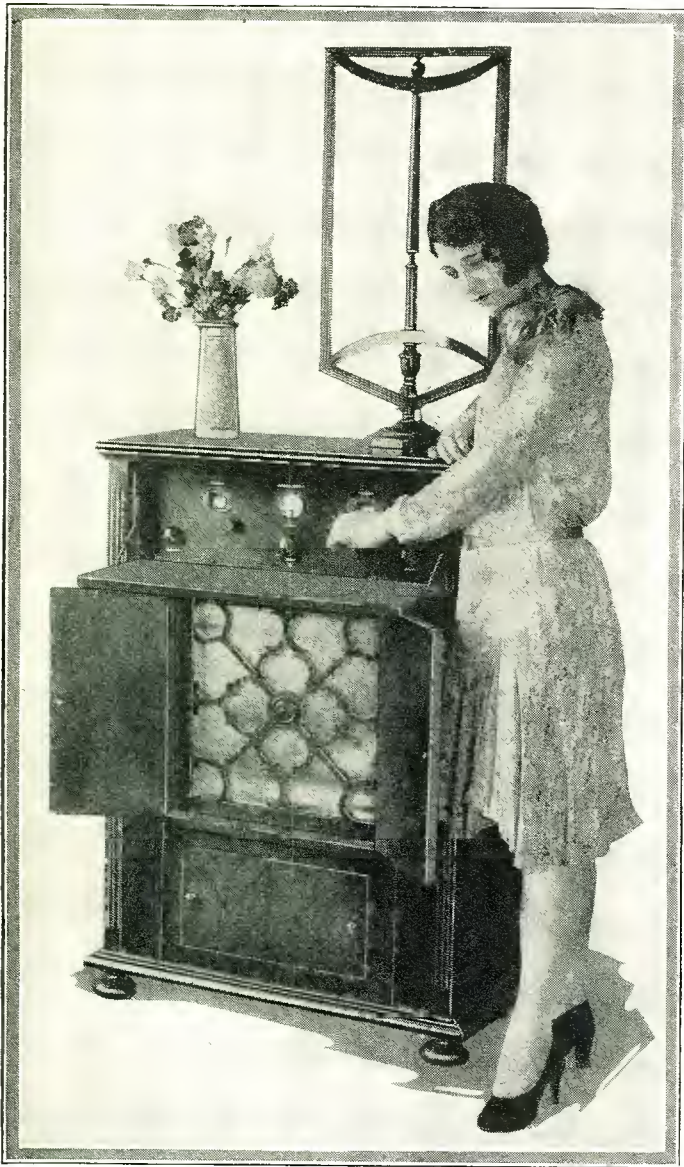

**Fig. 1. Even the ladies might be expected to become fans when sets of this character are made**

ing further possibilities of this circuit and its constituent parts. Economy of filament operation in this receiver was one of the factors which dictated the use of 199 tubes in all the stages preceding the first audio. With this type of tube it has been possible to secure good amplification at a considerable saving in filament current, as well as to reduce the oscillatory tendency of

the intermediate stages. The same measure of economy which is observed in the method of filament supply may be expected as far as the plate potential source is concerned.

In the first audio stage where it is desired to handle more volume than an intermediate stage is called upon to deliver, it is necessary to have a 201-A type tube. This makes certain the first audio channel will not be overloaded by the output from the preceding train. To gain an improved tone quality without recourse to excessively high plate voltage and to materially reduce audio distortion which might be present with but a single tube, it was deemed expedient to take advantage of push-pull amplification, using Silver-Marshall transformers. This method of audio amplification requires the use of two tubes of the same type, connected to the extremities of an input and output audio frequency transformer system. Transformers of this type, when on the input side, consist of a primary winding and a center tapped secondary; when used in the output stage, the primary is center tapped and the secondary winding is used to feed the speaker. By this means, without the necessity of a separate output transformer, the direct current component of the plate circuits is kept from the speaker windings. Thus the speaker is actuated only at such times as alternating current is set up by the primary in the secondary winding.

In designing the Citizens Super Nine our laboratory made use of Remler intermediate frequency transformers which have been known to the public for their excellence since the early days of superheterodyne construction. Two of the transformers are of the iron core type, No. 600, while two are of the air core type, No. 610. The secondaries of both 610 transformers are tuned, the fourth intermediate frequency transformer having a fixed .00025 mfd. condenser across its secondary. The second intermediate frequency transformer has a small G-5 XL variocoupler across its secondary winding, in order to permit the operator a certain amount of latitude in peaking the intermediate train. The first and third intermediate frequency transformers being iron core are not tuned by any condensers, their response curve centering around 45 kilocycles. Thus in this particular model of the superheterodyne circuit the first intermediate transformer peak has a fairly broad top, which is materially sharpened by the succeeding air core intermediate. In the third intermediate stage we again find an iron core whose output is likewise sharpened by the tuned air core in the fourth intermediate stage. It must follow that the second detector is supplied with energy covering a comparatively narrow band of frequencies.

**May Alter Selectivity**

Width of this band may be altered somewhat by the operator who desires to take advantage of a flexibility not afforded in previous models. While the X-L condenser previously referred to is variable, nevertheless it does not constitute a control which is used all of the time by the operator. As a general rule it will be found most satisfactory to set this condenser for the required selectivity and then leave it alone.

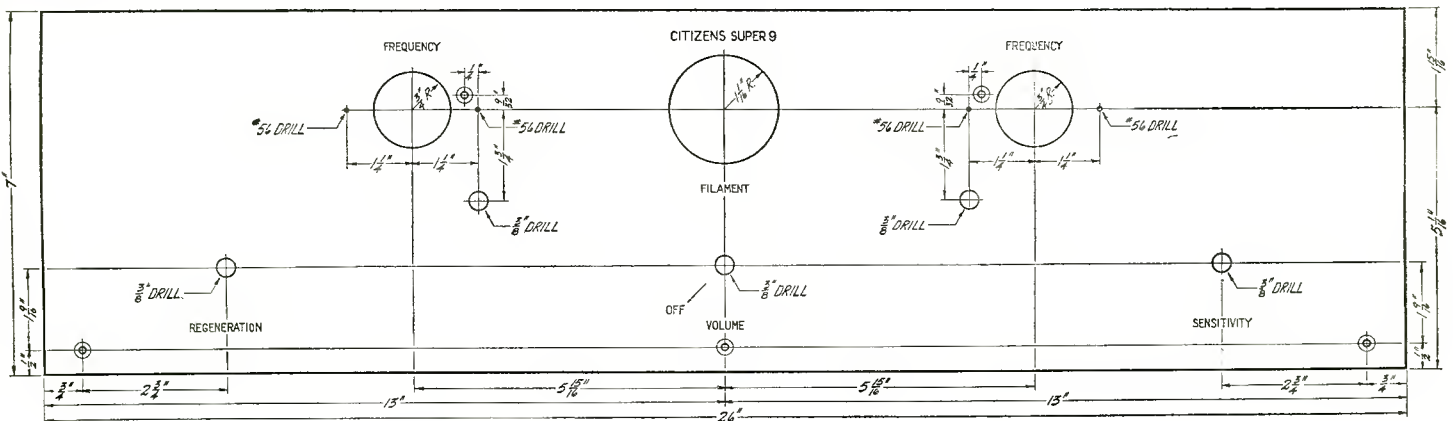

*NOTE— UNLESS OTHERWISE SPECIFIED ALL HOLES ARE  $\frac{3}{32}$ " DRILL & COUNTERSINK.*

**Fig. 6. This illustration gives front panel dimensions which should be followed by the builder**



mounted on the front panel, but if that capacity is set at a definite value by the operator no further trouble may be expected. The grid circuit of the oscillator makes it return to a common 1½ volt negative bias for the first, second and third intermediate frequency transformers. This method of oscillator grid return to some extent conserves plate current in that circuit, where after all a great deal of oscillatory current is not required. The volt and one-half negative applied to the grid returns of the first, second and third intermediate transformers performs an identical function here as it does in the oscillator namely: conservation of plate current. The plate winding of the oscillator coupler is arranged for series feed, is common with the B terminal of all intermediate transformers and the first audio transformer, being supplied from the 45 volt positive terminal and bypassed from the oscillator by a .006 mfd. fixed condenser to negative filament. Another bypass condenser is provided with a value of .0025 mfd. and is located across the positive C and 1½ volt negative of the C battery used for the intermediate stages. Other bypass condensers may be found by referring to the schematic circuit, figure 5, a .5 mfd. bypass being used across the 45 volt terminal and a 1 mfd. condenser between the positive 157 terminal and negative A. To prevent radio frequency current passing through the windings of the first audio transformer, another bypass, which is a .0025 mfd. condenser, is placed between the plate and negative filament.

Filament control is automatic in the audio stages, the first audio amplifier being served by a No. 1-A Amperite, while the two paralleled filaments of the 112 tubes are served from a No. 1 Amperite. The filament current of the oscillator, third intermediate amplifier and first detector may be changed by means of a Frost 10 ohm rheostat in series with a Frost 3 ohm fixed resistance. Filament control in the first and second intermediate tubes is changed through a Frost 30 ohm rheostat. A Weston 0-5 d. c. voltmeter is connected across from positive A to negative A on the tube side of the 10 ohm rheostat and 3 ohm resistance, thereby allowing the determination of voltages applied to the oscillator, first detector and third intermediate amplifier. As a rule this voltage should be set at the value prescribed by the manufacturer of the tubes. It might be worth while to remark at this juncture that one of the causes of superheterodyne failure has been the absence of a voltmeter to acquaint the listener with the voltage placed on those filaments. One should not expect good performance from tubes when the manufacturer's rating is ignored and

the filaments operated at higher current values than are considered safe.

**Reduced Microphonic Tendency**

First and second detector tubes are placed in Benjamin cushion sockets to prevent any microphonic tendency on their part, while the remaining seven sockets are made by Frost for sub-panel mounting. The output winding of the Silver-Marshall 231 transformer is carried to a pair of Frost tip jacks on the sub-panel, so the speaker wires need not be brought to the front of the set.

In building the set it is recommended that to reduce labor involved the Formica drilled and engraved front and sub-panels be secured. This will greatly facilitate the placing of the two Remler drum dials, the rheostats, midget condenser and the voltmeter. However, if undrilled panels are used, the dimensions may be found by referring to the front panel layout shown in figure 6. On account of the weight of the audio transformers used in this set, it would be advisable to provide an extra sub-panel leg or support to prevent possible damage to the sub-panel. Thus three sub-panel supports might be used, one at each rear end and one in the center, which would be ample for any weight that might be placed on the base.

In the event that novices desire life-size work diagrams and blue prints, it is possible to secure these on application to this magazine. A list of such blue prints available may be found on page 193.

**Short Oscillator Leads**

On account of the oscillator coupler being placed at the left of the sub-panel, it was considered necessary in the interest of short leads for that circuit to place the oscillator condenser on the drum shown at the left of the operator, or the right in photograph shown in Figure 2 at the head of this article. The loop circuit is placed at the right of the operator and three connections from this condenser are carried beneath the sub-panel to the three binding posts shown next to the oscillator coil.

In tuning for a desired station, the oscillator condenser may be set at a given value and the loop condenser rotated back and forth until resonance between these two circuits is established. This point of resonance will be indicated when the volume control is thrown towards maximum by a slight rushing or hissing sound. On sensitive supers, even when there is no station transmitting, it is even possible to find the resonant point of the loop against the oscillator by listening for static or extraneous

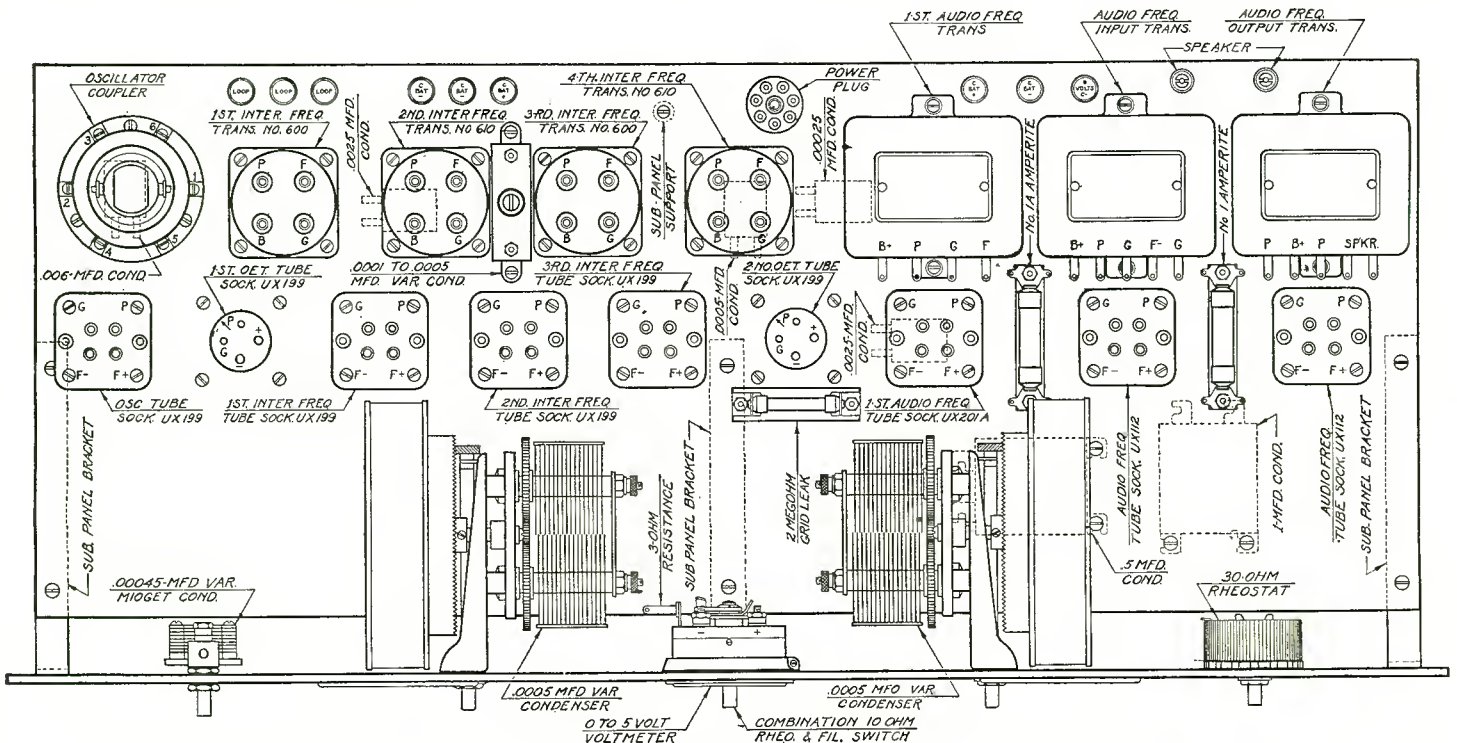

Fig. 4. When constructing the set all parts should be arranged as shown in the above graphic illustration

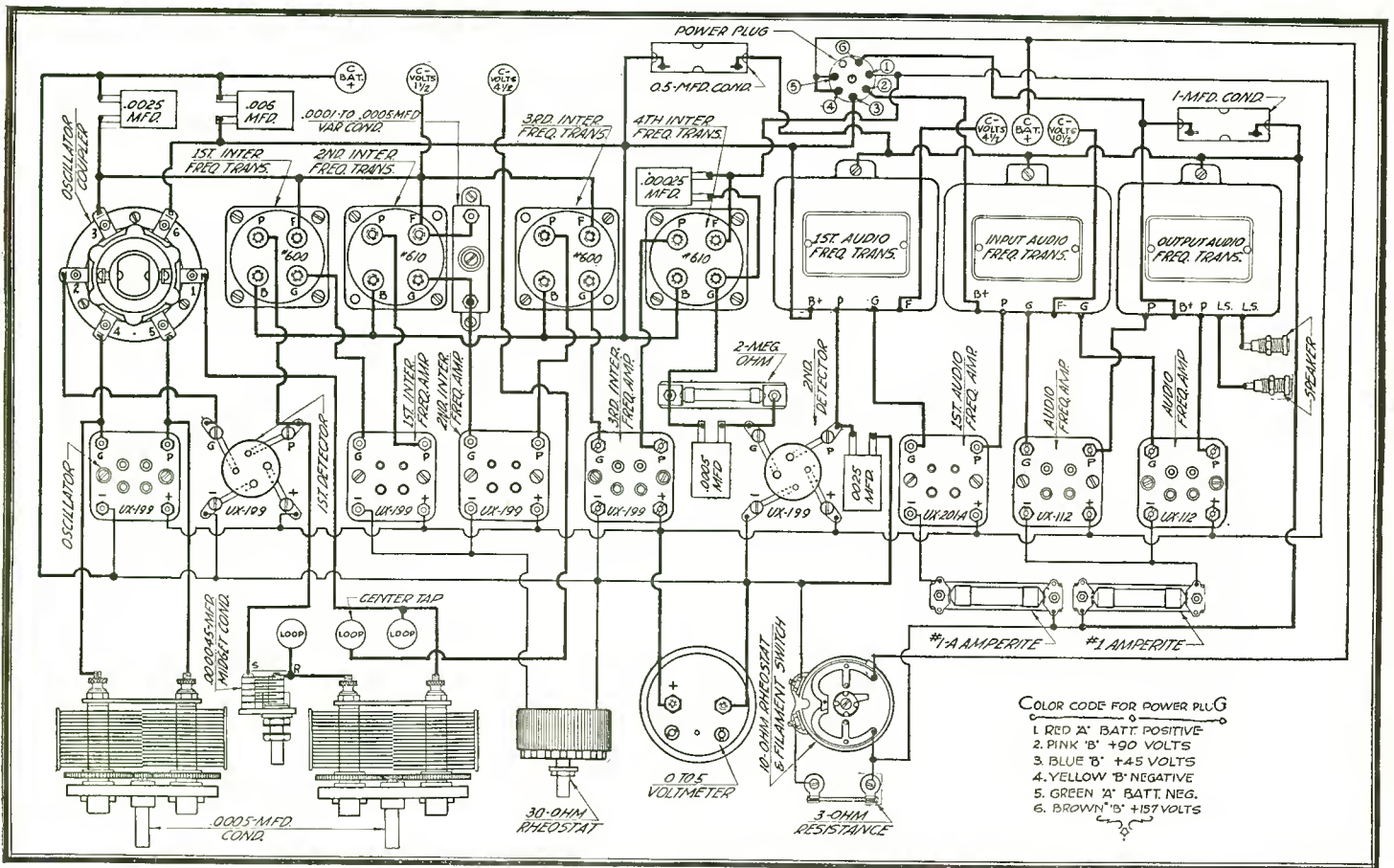

Fig. 7. A clear idea of all the parts and their wiring relationship is disclosed in the graphic shown above

noises, which will be noticeable at the time the loop condenser is exactly in step with the oscillator. The sensitivity of the loop circuit may be appreciably sharpened by use of the midget condenser at the operator's extreme right, which may be set for greatest pick-up in the first detector. In the event this control is turned too far, a squeal will be noticed, which is an indication that the first detector is oscillating, a condition not desired in superheterodyne operation. Under certain conditions it might be possible to secure oscillation in the intermediate stages, if the 30-ohm rheostat governing the first and second intermediate stages is advanced too far. When this is done, there is also a possibility of a squeal being heard, the set giving forth a choked sound. Best operation of the intermediates will be at the point where greatest intermediate amplification is secured without blocking or distortion.

In the type of oscillator coupler used in this circuit, the pick-up winding is placed on a tube and may be changed by the operator to either increase or decrease the amount of energy which the oscillator feeds into the grid circuit of the first detector. If possible, the operator should tune in a fairly distant station and then make pick-up coupling adjustment for best value of signal, consistent with freedom from interference on the part of local stations on adjacent channels. As previously mentioned, a further degree of selectivity may be chosen by use of the XL variodenser, which tunes the secondary of the second intermediate frequency transformer.

Under certain conditions the regenerative tendency of the loop circuit may be slightly improved by transposing outside terminals, although this may not work in each case. At least it is worth the trial on the part of the listener who desires to get the most from his set.

**List of Parts**

The following parts were used in the construction of the Citizens Super Nine. If substitution is resorted to care should be taken to see that their equivalents are secured:

- 2—110 Remler universal drum dials
- 2—600 Remler intermediate frequency transformers

- 2—610 Remler intermediate frequency transformers
- 2—649 Remler .0005 mfd. variable condensers
- 1—Tobe Tinytobe .006 mfd. fixed condenser
- 1—Tobe Tinytobe .0005 mfd. fixed condenser
- 1—Tobe Tinytobe .00025 mfd. fixed condenser
- 2—Tobe Tinytobe .0025 mfd. fixed condensers
- 1—Tobe 1.0 mfd. bypass condenser
- 1—Tobe 0.5 mfd. bypass condenser
- 1—340 Silver-Marshall midget condenser
- 1—110-A Silver-Marshall oscillator coupler
- 1—220 Silver Marshall audio frequency transformer
- 1—230 Silver-Marshall input audio frequency transformer
- 1—231 Silver-Marshall output audio frequency transformer
- 1—515 Silver-Marshall inductance socket
- 1—1810 Frost 10-ohm de luxe rheostat
- 1—1830-S Frost 30-ohm de luxe rheostat with switch
- 2—253 Frost tip jacks
- 7—531 Frost sub-panel mounting sockets
- 1—Frost 3-ohm fixed resistance
- 2—9044 Benjamin sockets
- 1—506 Weston 0-5 voltmeter
- 1—112 Amperite
- 1—1 Amperite
- 9—Eby engraved ensign binding posts
- 1—Daven 2 meg ohm grid leak
- 1—50 Daven mounting
- 1—Hagel power plug
- 1—G-5 X-L variodenser
- 1—Formica drilled and engraved 7x26x3/16 inch panel
- 1—Formica drilled 10x25x3/16 inch sub-panel
- 3—Karas sub-panel brackets
- 50—Feet Aeme Celesite wire
- 60—Kellogg solder lugs
- 1—Package Kester radio solder
- 6—Sonatron 199 type tubes
- 1—Sonatron 201 type tube
- 1—Sonatron 112 type tube

# Madison-Moore International One Spot Designed for A. C. Tubes

Set May Be Plugged into Light Socket; All Batteries Eliminated  
in New Model

HAVING for some time past been accustomed to producing superheterodyne circuit arrangements with a high degree of response from the set building and experimenting radio public, the Madison-Moore interests, whose previous work along this line has been detailed in other issues of this magazine, have now turned their attention to the production of an alternating current superheterodyne operated directly from the alternating current mains and using a power amplifier for the plate potential supply.

Still adhering to the original form of transformers which have made this series of circuits a very popular one with the fans, the new Madison-Moore International One-Spot transformer has been redesigned only in enough detail to make it operable from vacuum tubes using raw alternating current on the filaments.

It will be quite well worth the reader's time to closely study the electrical connections outlined in the schematic circuit shown in Figure 3 which will form the basis of our discussion on this present receiver.

## Cannot Use Potentiometer

As contrasted to other forms of the superheterodyne where a potentiometer is used for controlling the grid potential applied to the intermediate tubes, this model transformer is so designed that its grid return is common with the negative bias and the ground. One side of the loop and the rotor of the first .0005 mfd condenser are also attached to this common connection. It will, therefore, not be possible to make use of a potentiometer in a circuit of this kind because its use would defeat the purpose of closely matching a set of transformers. It will be observed from the schematic that no C batteries are employed in any portion of the circuit, the requisite biasing potential for all tubes being

furnished from the power supply and the fact that all filaments are operated from alternating current. It will also be noticed there are neither A batteries nor B batteries to look after and as a result the mere turning of a switch throws the set either in operation or off as desired.

Examining the front portion of the receiver as disclosed in the schematic circuit, Figure 3, the reader will find that two 199 tubes are used, the first located in position as the first stage of radio frequency amplification and tuned by a .0005 mfd variable condenser. Between the first 199 tube and the second may be seen the first radio frequency transformer which feeds into a second 199 tube whose output is led through the second radio frequency transformer to the grid circuit of the first detector which is a type 226 alternating current tube. It should be noticed that the filaments of the 199 tubes are in series and current for their operation is obtained through the drop between the common ground connection and the B negative terminal of the power amplifier which also goes to the center tap of the 20 ohm resistance located across the filament of the second intermediate frequency amplifier and therefore is parallel to all filament circuits using  $1\frac{1}{2}$  volts of alternating current. Thus the 199 tubes are functioning in a dual role, the first being that of acting as radio frequency amplifiers and the second that of by their filament resistance becoming a portion of the C bias circuit and supplied directly from the power amplifier. On account of the small grid plate capacity of these tubes and the design of the first and second radio frequency transformers no trouble should be experienced from oscillation and extreme sensitivity coupled with selectivity should be available for the operator.

The second tuned circuit in this receiver is the secondary of the oscillator coupler AC-1 across which is placed a .00035 mfd

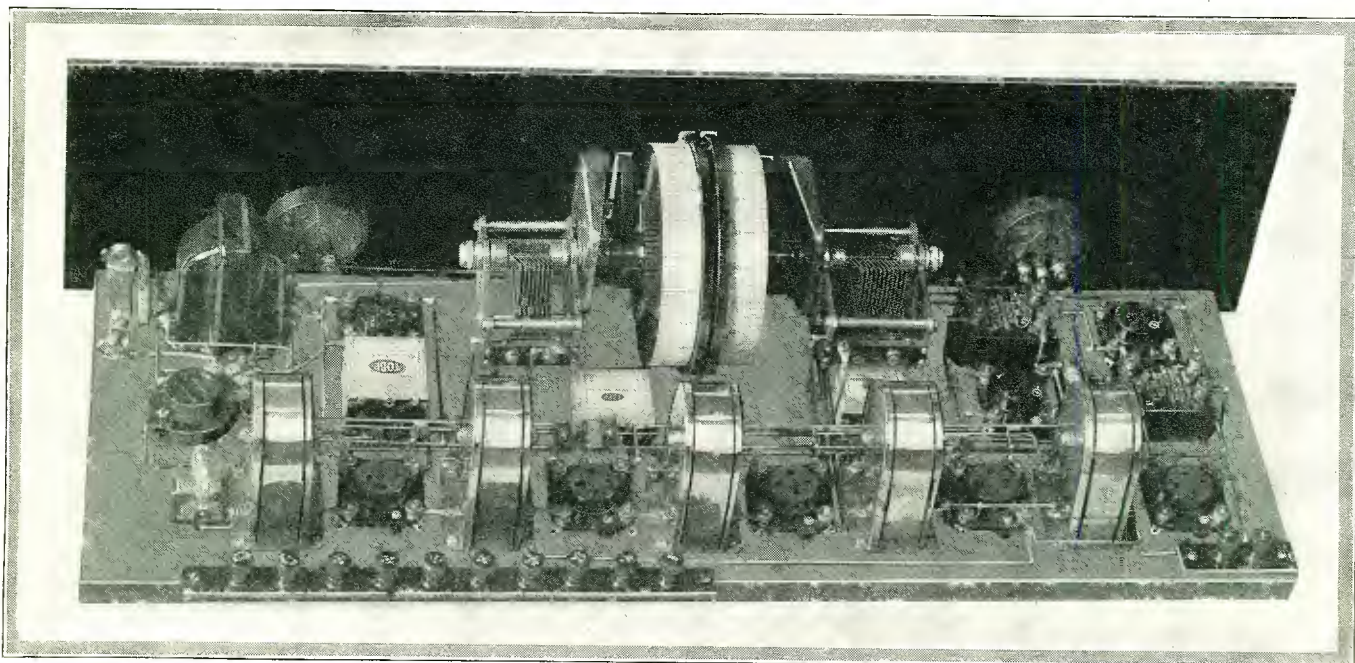

Fig. 2. Rear view of the Madison-Moore International One Spot Receiver is shown in the accompanying photograph

(This receiver constructed, tested and all illustrations made in our laboratory)



variable condenser. The primary circuit of the oscillator coupler is center-tapped and a connection is carried from the center tap shown in the diagram as X, to the X terminal of the first intermediate frequency transformer AC-2, from which coil a lead is carried to the plate of the first detector. Plate supply for both of these tubes is obtained through the plus 90 volt terminal on the set to the B connection on the oscillator coupler. This method of plate supply for the oscillator and the first detector furnishes a magnetic coupling means whereby energy from the oscillator may also be fed into the plate circuit of the first detector where it mixes with the incoming signal brought in through the tuning of the Qualitone loop.

Control of the input to the first intermediate frequency amplifier is through a 500,000 ohm potentiometer located across the secondary of the AC-2 with a movable arm leading directly to the grid terminal of the first intermediate. The second and third intermediate frequency transformers are the conventional ones designed by Madison-Moore, while the fourth intermediate transformer shown in the diagram as AC-5 is arranged for grid leak and condenser rectification in the second detector. Whereas in the previous intermediate stages the filaments are operated on raw AC, in the second detector stage the heater type of tube is used where the filaments are operated from 2½ volts alternating current and electronic omission is supplied by the cathode in that tube which secures its heat by conduction from the heater element. In both research and experimental work, it has been found that the heater type of tube is so far the only one which may be used with perfect stability in the detector circuit of a set, although the raw AC tubes will function satisfactorily in other portions of the circuit as is exemplified in this particular model of receiver.

**Separate Power Amplifier**

By having a separate power amplifier the actual receiver may



**Fig. 1. The receiver has been built and is now placed in an Excello 22 console**

be constructed with only one stage of audio amplification, the second stage being located within the power amplifier and the output of the receiver being carried to the input binding posts of the power amplifier. The power amplifier is shown schematically in Figure 6 and graphically in Figure 7.

When using the resistances of the values specified in the schematic and graphic illustrations the voltage available for the plates of the 199 tubes will be 50 volts, although the illustrations show the standard 45 volts. It is recommended that the exact values of resistance shown in this diagram be followed to make sure that the 50 volts is furnished for the 199 stages. This 50 volt value is the one which gives the best results not only on the 199 tubes but the second detector of the heater type. Another point of interest may be brought up regarding the 1000 ohm resistance which is

shown in the grid circuit of the first detector. If possible this should be a non-inductive resistor and its resistance may be any value between 200 and 1000 ohms. If the tube seems inclined to oscillate, the higher resistance value should be used, although a smaller value may be tried and if the circuit is perfectly stable, it may be left there.

**Use Resistor in Mounting**

This resistor should preferably be of the solid slug type and mounted in one of the customary cartridge mountings so its value may be changed at will by the operator in keeping with the best operation of that particular tube.

Before taking up the operation of the receiver, the power amplifier diagram should be examined so that the reader may be thoroughly familiar with all of the parts and their functions. As will be observed, the output of the receiver is carried through two wires to the input of the audio frequency input transformer, the secondary of which goes to the grid of the 171 power tube stage. The plate of the power tube has in series with it an output choke, with the speaker terminals to be connected across

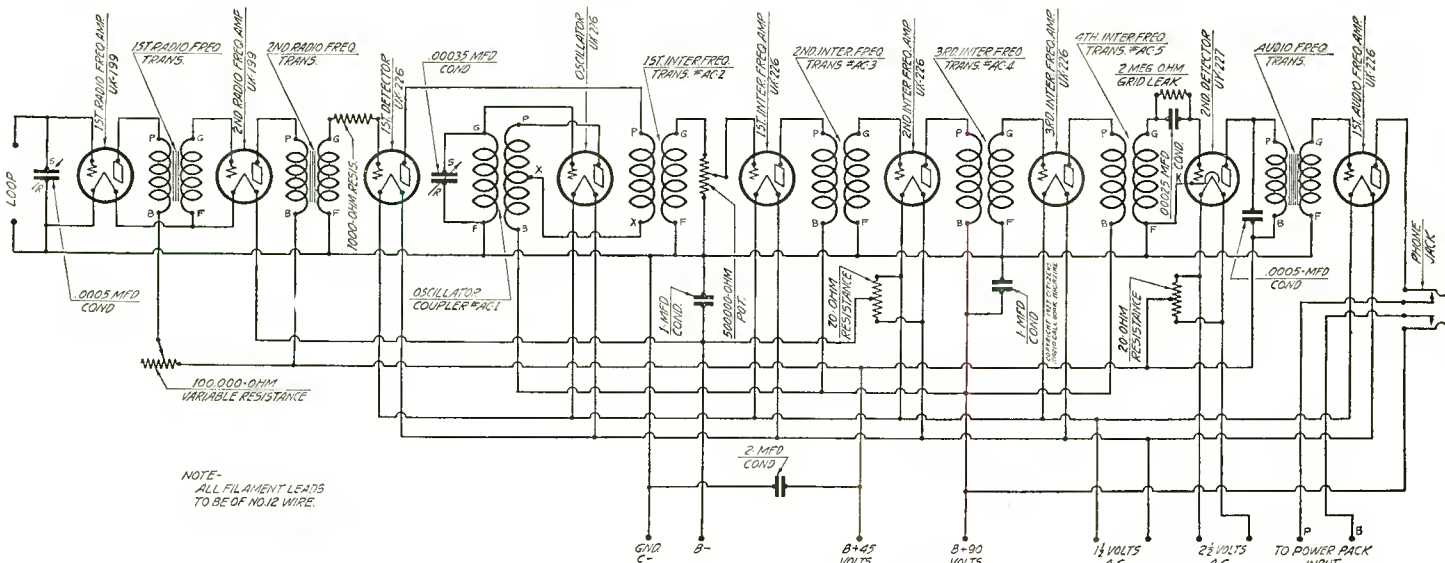

**Fig. 3. Novel electrical ideas are expressed in the schematic shown above especially in reference to the use of 199 tubes in series operated from a C bias furnished by the power amplifier**

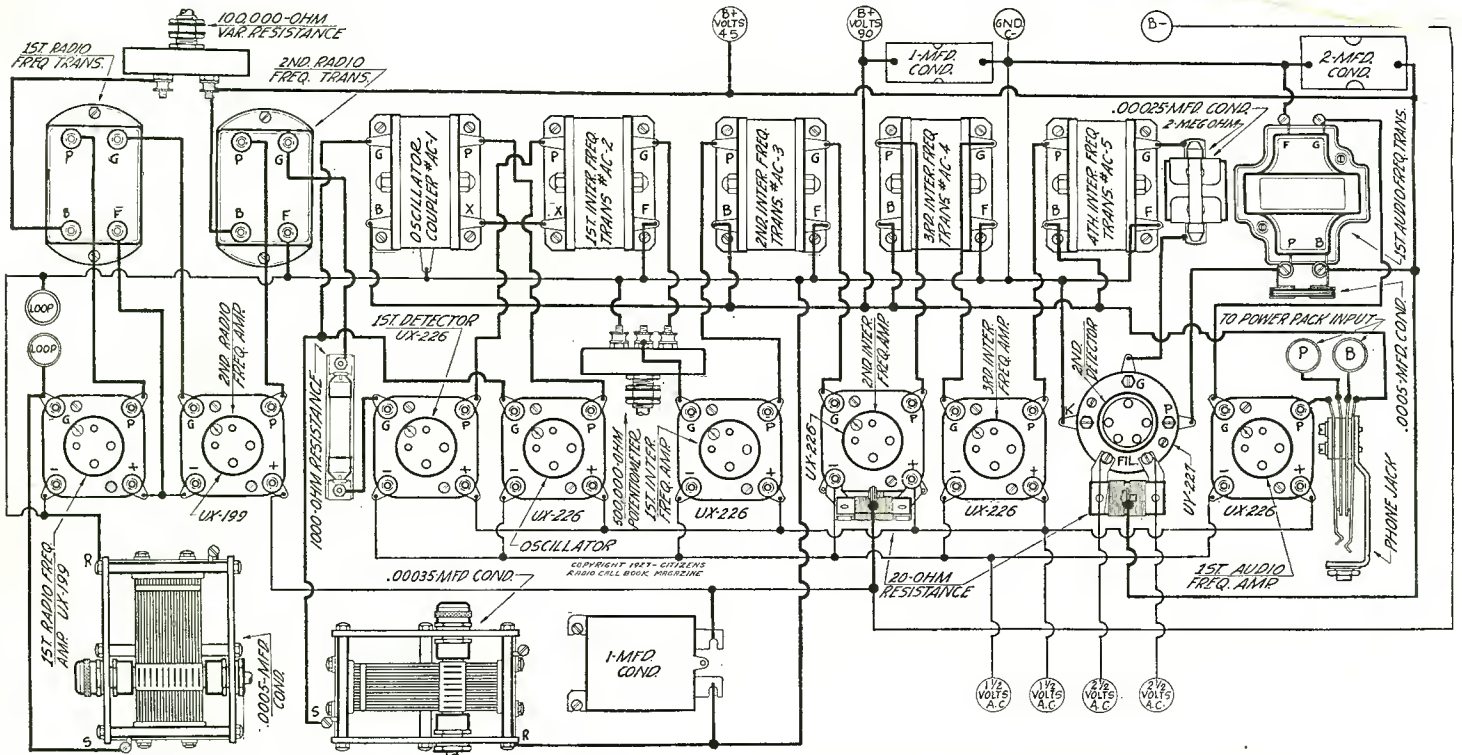

Fig. 5. Those who are not confident enough to wire up a receiver by means of the schematic shown in Fig. 3 may use this graphic illustration for that purpose

the lower end of the output choke and one side of a 4 microfarad condenser, the other side of which is connected to the junction of the plate and the output choke. This will serve to isolate the direct current from speaker windings and save them from any possible damage during operation.

Rectification in this particular unit is performed by the full wave rectifier of the 280 type, whose plates are located across the extremities of the high voltage secondary of the power transformer No. 330, the center tap of which is the ground connection and is connected to the zero position on the condenser block No. 660. Filament supply for the 280 tube is secured from a 5 volt a.e. secondary on the filament transformer No. 325. The low voltage winding on the 330 power transformer has a 5 ohm resistance in series with it and supplies the filament of the 171 power tube. Filament potential of 1½ volts alternating current

for use in all of the 226 type alternating current tubes and the 2½ volts a.c. potential used on the 227 heater type of tube is obtained from the separate low voltage windings on filament transformer 325. The No. 331 choke is connected in the circuit as shown at the left of the schematic diagram and has the proper number of filter condensers placed across it, these condensers being contained in the 660 block. All of the resistors, which are of a fixed type, may be seen both as to values in the schematic and as to position in the graphic illustration. In order to keep the voltage on the positive 90 and positive 50 volt terminals as constant as is possible regardless of the current used in operating the set, a voltage regulator tube of the 874 type is utilized, being connected as shown in the graphic illustration, where the G terminal of the socket is common with the 90 volt terminal of the set and the plus filament terminal of the socket is attached to

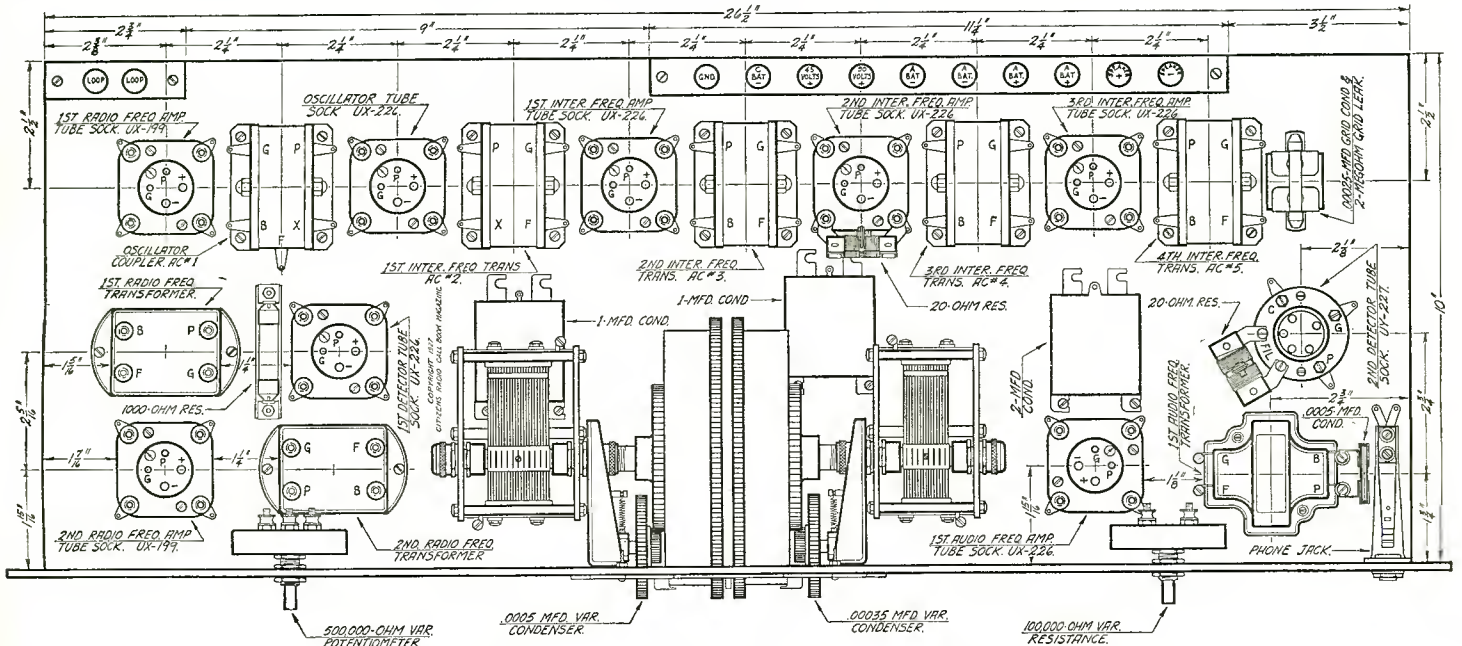

Fig. 4. In construction of this receiver the builder would do well to lay out all parts in strict accordance with the baseboard layout shown in this illustration

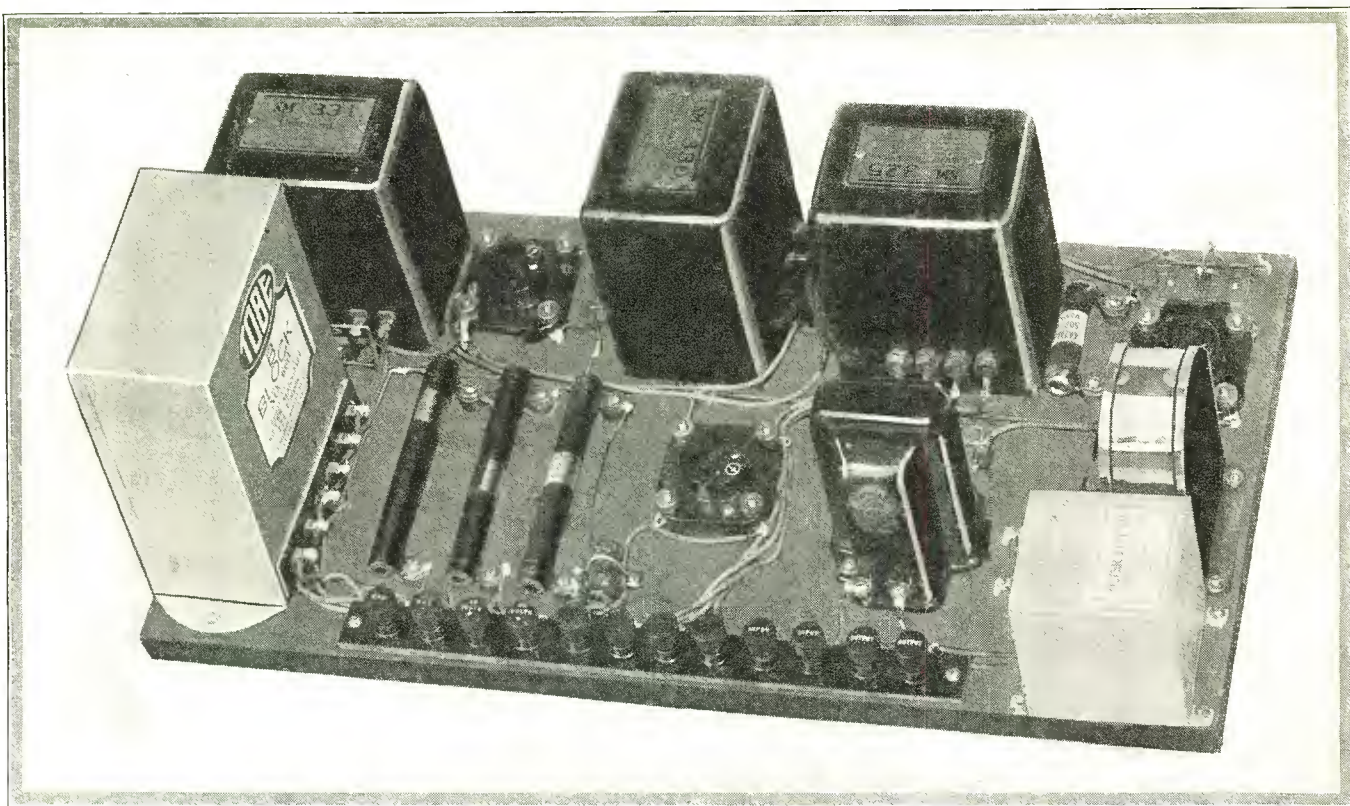

Fig. 8. The finished power amplifier is shown in the accompanying photograph, the graphic representation of which is shown in Fig. 7

the line which is common with ground. It is recommended that all filament leads be of a wire size not smaller than No. 12, so as to minimize the resistance in that circuit and permit full voltage being furnished on both the 1½ volt and 2½ volt a.c. lines.

Has Two Untuned Stages

Returning now to the receiver, we find in the first and second stages of radio frequency amplification two Dubilier Duratrans which have a period from approximately 200 to 550 meters and which in this particular design of the Madison-Moore are not

tuned. It has been ascertained by experiment that a considerable degree of amplification may be secured in the preliminary r.f. stages, so that the first detector is given a very strong signal. These transformers are located at the left of the set, as shown in the baseboard layout, Figure 4.

In operating this set, the operator should find the tuning quite simple, and observe an absence of repeat points on account of the high frequency peak of the intermediate frequency transformers. This "one-spot" operation is perhaps not a novelty with many of our readers, since they have constructed Madison-

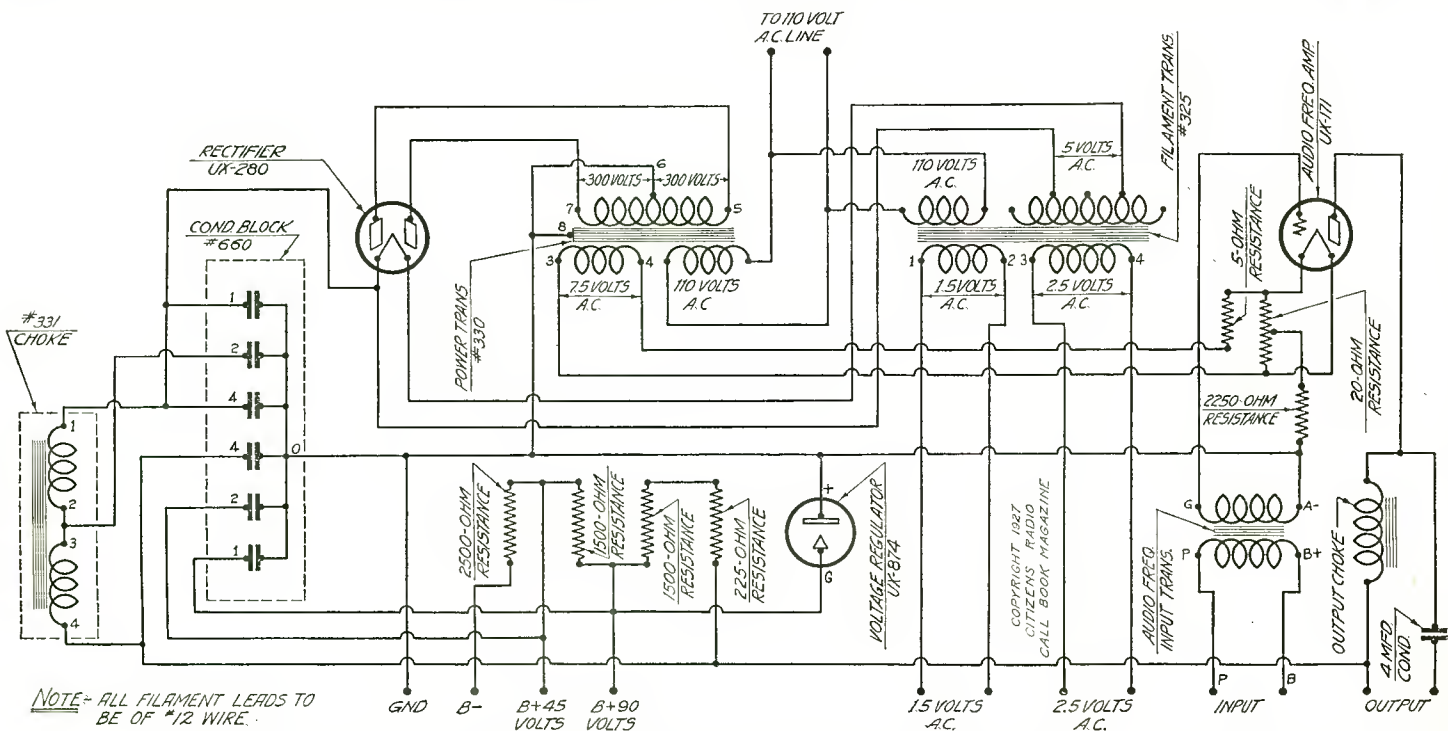

Fig. 6. The power supply unit for operation of the receiver is detailed in the above schematic which will serve as a wiring diagram for those accustomed to building sets

Moore "one-spot" receivers from our previous issues and they will be able to fully appreciate the appearance of a station on the oscillator dial in only one position. The two controls used for altering the sensitivity of the receiver are shown at the left and right of the front panel illustrated in Figure 1. The 100,000 ohm variable resistance located at the right of the center drums is in series with the plate circuit of the first radio frequency amplifying tube and serves to raise or lower the sensitivity of that particular portion of the circuit. The 500,000 ohm potentiometer located at the left of the set governs the input to the grid circuit of the first intermediate frequency amplifier and by means of it volume may be controlled.

**I. F. Transformers Shielded**

As will be remembered by readers who have experimented with this kind of a superheterodyne design, the intermediate stage transformers of the oscillator coupler are completely shielded, the metal being made common with the F terminal on all units so that this shield may be grounded when desired. With the shielding used, the local pick-up is eliminated as far as the intermediates are concerned, while in the r.f. stages the inductances are of such a small size that they present no appreciable surface to the field of a local broadcasting station's energy.

This receiver may be assembled from the parts shown in the following list, our laboratory having used the ones specified below:

**Receiver**

- 5—Madison-Moore transformers
- 1—285-D General radio (audio) transformer
- 1—438 General radio socket
- 2—439 General radio center tap resistances
- 8—9040 Benjamin sockets
- 1—Camfield .00035 mfd variable condenser
- 1—Camfield .0005 mfd variable condenser
- 1—Pair Tyrman drum dials
- 1—4 Yaxley jack
- 1—Centralab 500,000 ohm variable resistance

- 1—Centralab 100,000 ohm variable resistance
- 2—Dubilier Duratrans 200 to 550 meters
- 1—Dubilier .00025 mfd grid condenser with mounting
- 1—Dubilier 2 megohm grid leak
- 1—Tobe Veritas 1000 ohm resistor with mounting
- 2—301 Tobe 1 mfd bypass condensers
- 1—302 Tobe 2 mfd bypass condensers
- 1—Lignole 7x28x3/16 inch panel
- 1—27x10x1/2 inch wood baseboard
- 2—Ceco 199 tubes
- 6—Ceco 226 tubes
- 1—Ceco 227 tube
- 2—Eby binding posts
- 1—870 Jones 12 point multi-plug
- 1—Package Kester radio solder
- 30—Feet Belden No. 12 tinned copper hook-up wire
- Miscellaneous lugs, nuts, screws, etc.

**Power Supply**

- 1—331 Silver-Marshall Uni-choke
- 1—330 Silver-Marshall power transformer
- 1—325 Silver-Marshall filament transformer
- 1—660 Tobe "B" block
- 1—304 Tobe 4 mfd filter condenser
- 1—285-D General radio audio transformer
- 1—439 General Radio center tapped resistance
- 1—Madison-Moore 200 henry choke
- 1—805 Yaxley 5 ohm fixed resistance
- 12—Eby binding posts
- 3—9040 Benjamin sockets
- 2—507-24 Ward-Leonard 1500 ohm resistances
- 1—507-26 Ward-Leonard 2500 ohm resistance
- 1—507-20 Ward-Leonard 225 ohm resistance
- 1—507-16 Ward-Leonard 2250 ohm resistance
- 1—Raytheon R tube
- 1—Magnatron 280 type tube
- 20—Feet Belden No. 12 flexible rubber covered wire
- 1—9x17x1/2 inch wood baseboard

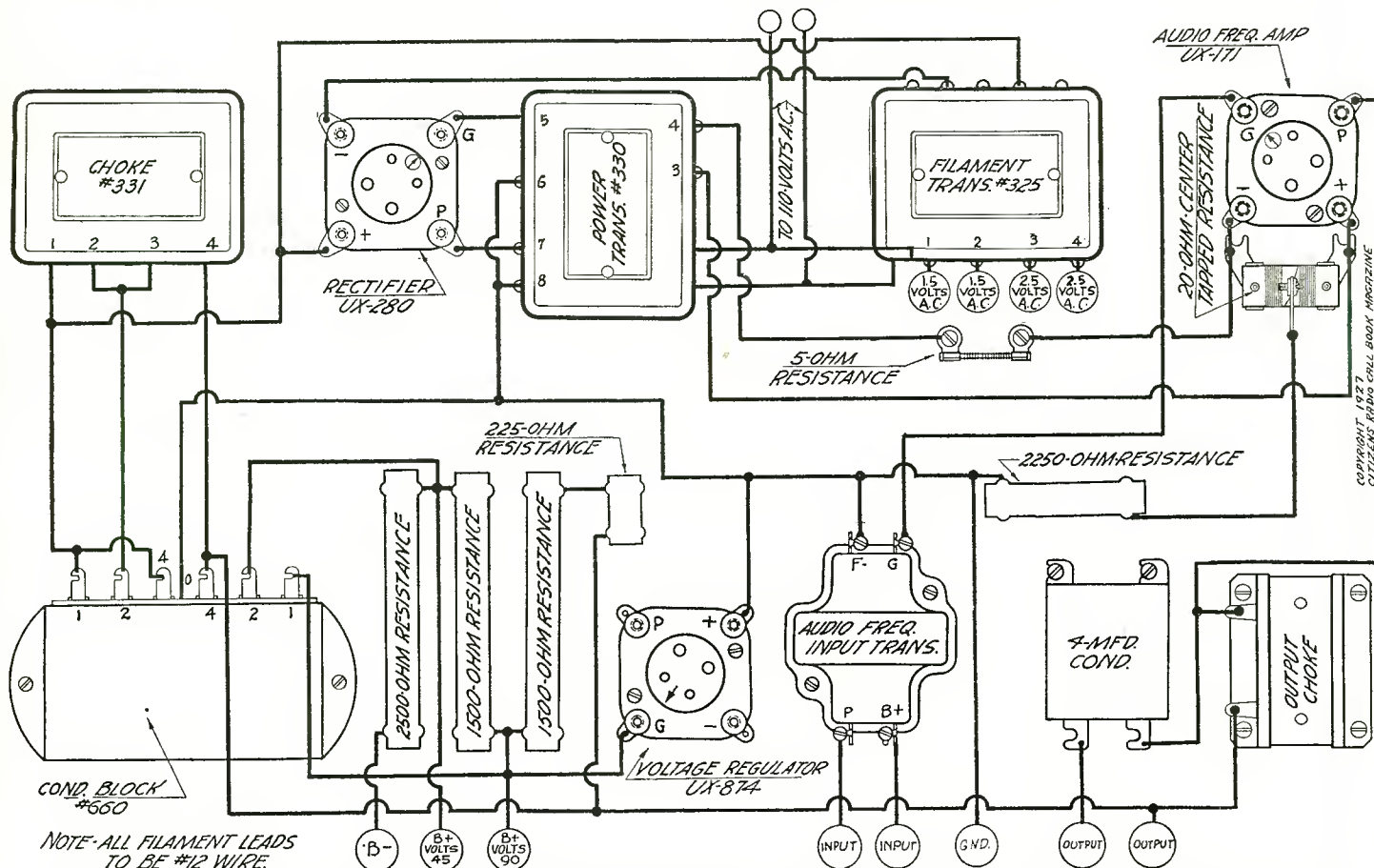

Fig. 7. This is the graphic representation of the circuit which appears in Fig. 6 and should be used by those who are not sufficiently experienced in building receivers

# Lincoln Quality Super Nine

## Adequate Radio and Audio Chokes Assure Distortionless Reproduction

**P**ROBABLY no circuit in the history of radio has presented the opportunity for engineers and circuit experimenters to give full reign to their ingenuity, and as a result readers will find there are sufficient super designs to please even the most fastidious. The same axiom that operates in allowing one individual to have a decided preference for oysters while the other does not care for seafood, finds its parallel in the design of a superheterodyne for a set building public that is growing daily.

In the Lincoln Quality super readers will find a pleasing variant of the famous superheterodyne circuit, embodying apparatus of quality laid out for maximum efficiency and workmanlike appearance.

### Uses Air Core Units

Essentially the Lincoln Quality super consists of five stages of intermediate frequency amplification, all units of which are of the well known air core type of construction. Added to the inherent amplification obtained from this number of intermediate stages, there has been incorporated a regenerative first detector which serves to add materially to the overall amplification and assures the operator of a little more flexibility than might be expected were the first detector to be of a fixed nature regeneratively.

In order to keep the number of component parts down to a minimum, no grid leaks or grid condensers are used in either the first or second detector. The rectifying properties of these tubes when properly biased by negative potential from a C battery are utilized, this bias voltage on the first detector being 7 volts and on the second detector 6 volts.

In the case of the intermediate transformers a negative potential of 3 volts is applied to the grid returns of the first, second, third and fourth intermediate transformers to reduce the plate drain in those tubes and stabilize the operation of the intermediate train. The schematic diagram shown in Figure 6 will also be found to contain a negative bias of 3 volts on the grid return of the oscillator, whose plate is supplied with  $67\frac{1}{2}$  volts. The bias potential on the grid of the oscillator is also a means of decreasing the amount of plate current consumed by this tube.

Samson radio frequency chokes are utilized in two positions in the Lincoln Quality receiver, the first one being a 125 millihenry radio frequency choke placed in series with the  $67\frac{1}{2}$  volt terminal of the battery or eliminator and supplying the plate circuit of the first detector, first intermediate, second intermediate, third intermediate and fourth intermediate tubes. The second Samson choke is of the same inductance as the one previously described and is located in series with the plate of the second detector and bypassed by a .001 mfd. fixed condenser. In this position the radio frequency choke serves to keep out of the audio system any radio frequency which may have passed through the second detector stage. To further stabilize the audio circuit, a Samson No. 3 audio frequency choke is placed in series with the B positive terminal of the first audio transformer and the  $67\frac{1}{2}$  volt terminal. Another audio frequency choke of the same size and design is located between the B positive terminal of the second audio transformer and the positive of the 135 volts. The presence of these two radio frequency chokes and the two audio frequency chokes gives the constructor the assurance of freedom from distortion in the input of his receiver.

### Controlling the Filaments

Part of the filament circuit in the Lincoln Quality is taken care of by Amperites and in other parts by Yaxley rheostats. The second audio frequency amplifier, which is a 171 type tube, has a No. 112 Amperite in series with its positive terminal, while the first audio amplifier, which uses a 112 tube, has an Amperite of the same size and type. For controlling the filament of the second intermediate amplifier, the third intermediate amplifier and the fourth intermediate frequency amplifier a 3-A Amperite is used. In the second detector a 20 ohm rheostat is placed in series with the positive side of the filament and serves to give flexibility in that stage. A 15 ohm rheostat

controls the filament voltage on the first detector and the first intermediate frequency amplifier, while a second 20 ohm rheostat is used for controlling the filament of the 201-A tube used as an oscillator. In this latter circuit the variable filament control

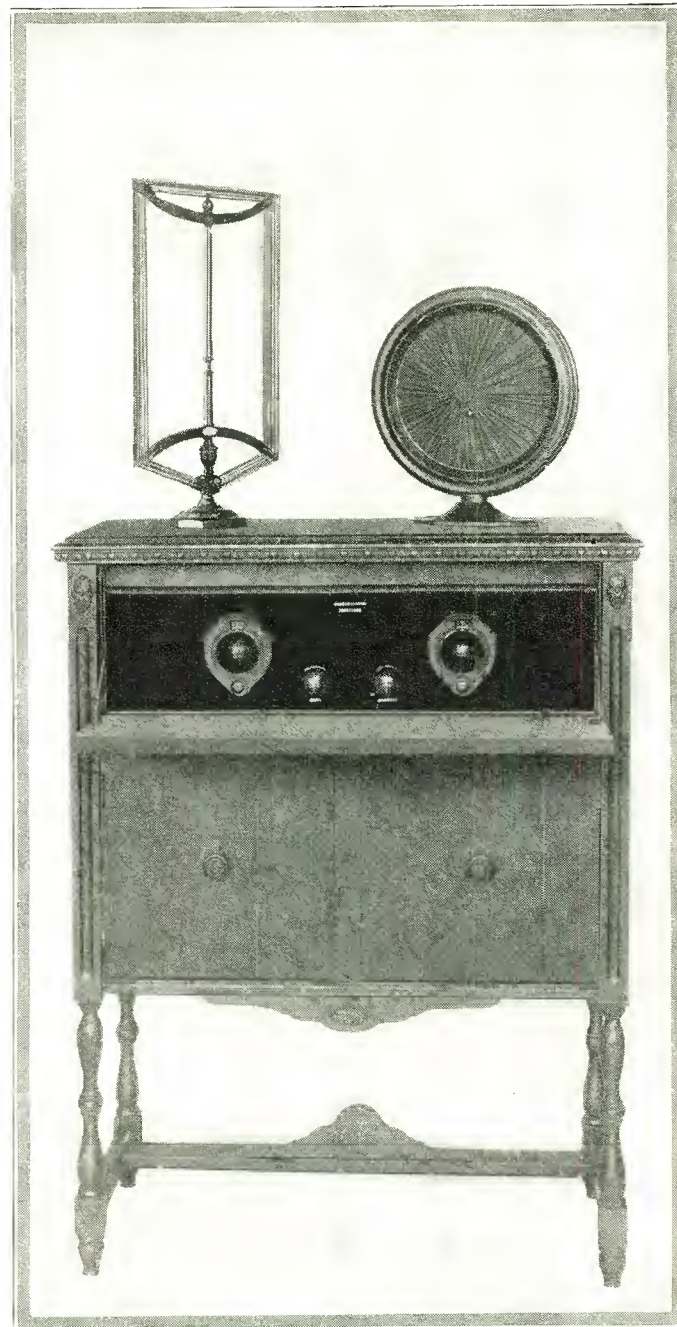

*Figure 1. Equipped with a Fiat loop and Sonochorde speaker, the Lincoln Quality Super is illustrated above in a console made by Corbett*

(This receiver constructed, tested and all illustrations made in our laboratory)

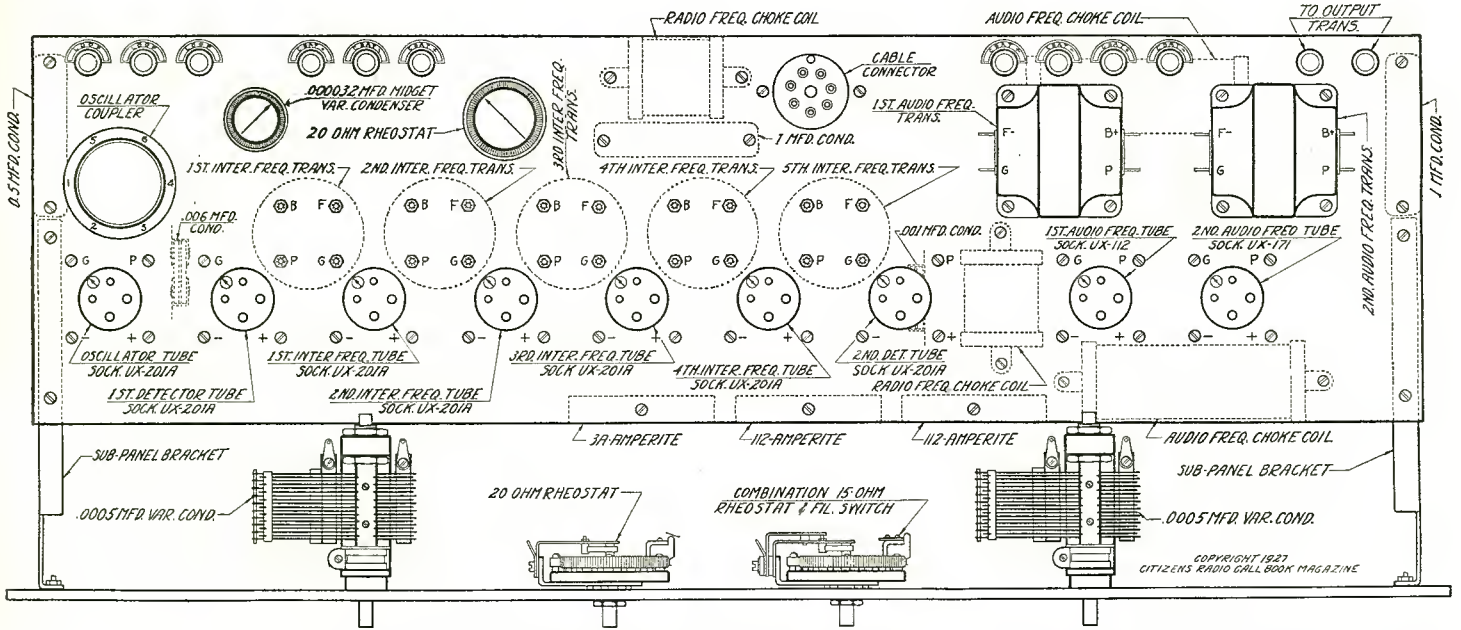

Figure 5. From this illustration the constructor may learn the location of all parts in this receiver. These parts should be laid out exactly in accordance with this sketch so as to permit simplest of wiring

sometimes is of advantage in that the operator may use it as a means of reducing the power of the oscillator, as well as shifting to a slight degree the position of a given station on the dial. Thus, if a certain station makes its appearance at, say, 50 degrees on the oscillator dial, and the loop dial is only one or two degrees away from that reading, a slight readjustment of the oscillator filament might in certain cases permit the matching of the loop and oscillator loggings. Of course, if there is a great difference between the readings of these two dials it will not be possible for this matching to be accomplished by means of the filament rheostat in the oscillator circuit.

A protective measure for the .0005 Hammarlund variable condenser shown in the oscillator circuit is provided through the use of a .006 mfd. fixed condenser, one side of which is attached to the plate of the oscillator and the other side made common with the rotor of the variable, whose stator goes to the grid of the oscillator. This would seem to be a wise precaution in view of the fact that quite frequently the builder might accidentally short circuit the plates of the oscillator condenser and, if this safety condenser were not provided, burn out an oscillator tube. To some extent this method of connection also serves to lessen the amount of body capacity present in grid to plate tuning of an oscillator.

**Uses Samson Audios**

Audio transformers used in the superheterodyne illustrated in this article are made by Samson and give pleasingly distortion-

less amplification. The form of winding employed by that company in the manufacture of audio transformers is one on which they have been specializing for a number of years and is known as helical winding. This form of winding permits securing the proper value of inductance and impedance in a given transformer without having a high value of capacity across the windings. This same type of winding is likewise employed in the radio frequency chokes, where the matter of capacity between turns is of vital importance. It is possible to make the choke action of a radio frequency choke much more effective by reducing the capacity across the winding than with any other form of transformer winding.

For the oscillator used in this super, the grid, plate and pick-up windings are of the fixed type. This fact gives further justification for the use of a 20 ohm rheostat in series with the positive filament of the oscillator tube in order to govern the amount of energy which that circuit must create. If the pick-up winding were made variable, this filament control might not become necessary, because the pick-up rotor could be turned so as to increase or diminish the amount of energy fed into the first detector. It is perhaps a good thing, especially for the novice, that the pick-up circuit in this oscillator is of a fixed nature, since it does not add to the complexity of tuning. After all, the novice is principally interested in having a high quality receiver involving the least trouble in operation.

Another factor which is highly desirable from the standpoint

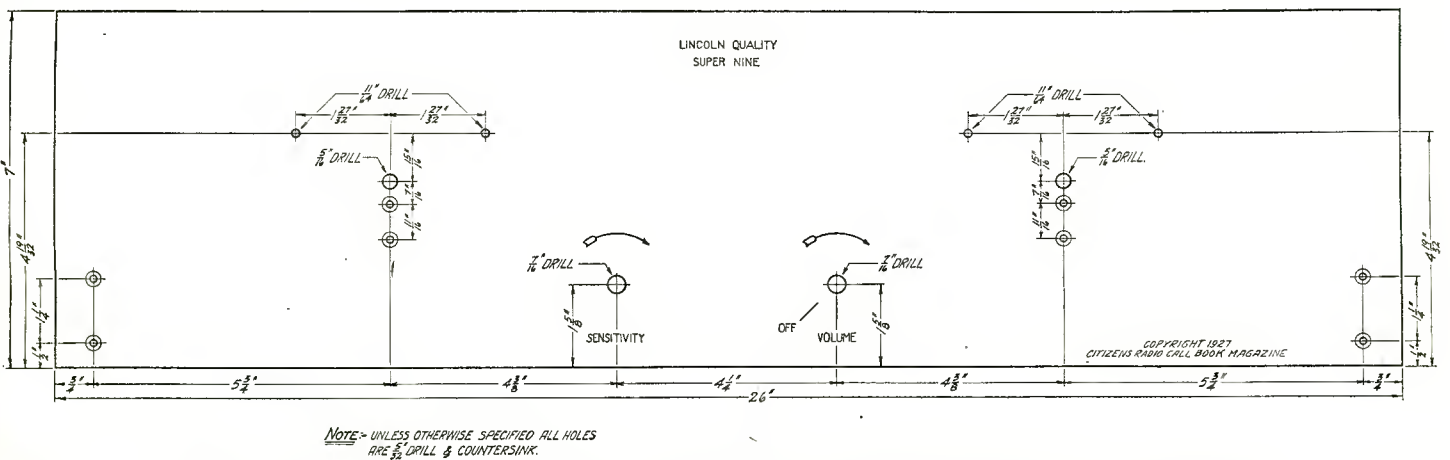

Figure 4. The above front panel layout will give all of the required dimensions and drill sizes

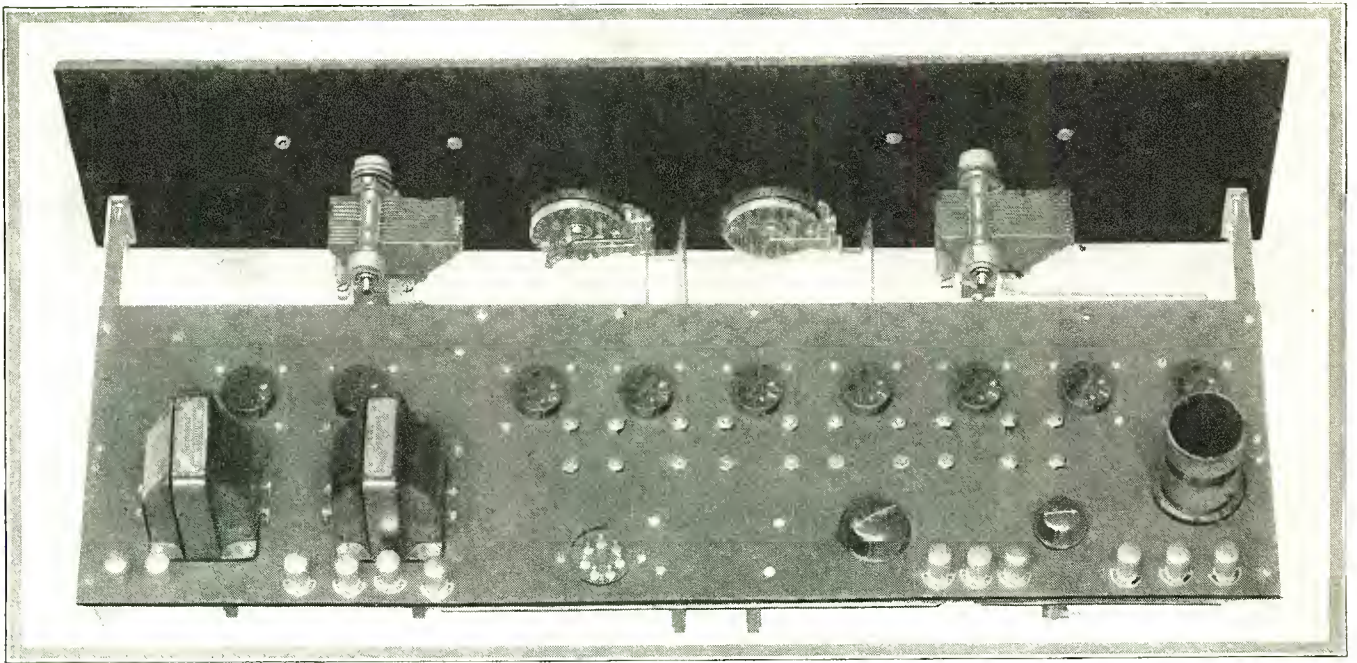

Figure 2. Photographed from the rear, the Lincoln Quality Super presents a clean-cut appearance. Most of the units necessary for its operation are located beneath the sub-panel and out of view in this photograph

not only of the man who builds the set but that of the one who will operate it, is the fact with the exception of the oscillator coil and the audio transformer everything is placed below the sub-panel, where it is out of the way. This leaves only the tubes showing on the top of the sub-panel and adds materially to the orderliness of the set's appearance. The intermediate frequency transformers are made on a relatively small form, meaning their fields will not be very large and consequently they may be placed quite close together without affecting one another. Close examination of the photograph shown in Figure 2 will disclose the fact each transformer is so disposed that the grid and plate connections on each transformer protrude through the sub-panel and at the same time gripping and making firm electrical connection with the grid and plate springs of the Benjamin sub-panel mounting sockets used for the first detector, first intermediate, second intermediate, third intermediate, fourth intermediate

and the grid circuit of the second detector. This eliminates at one stroke the necessity for putting in ten connections from the sockets to the intermediate frequency transformers.

### Only Two Main Controls

Only two minor controls are provided on the front panel of the receiver, both of these being rheostats, the 20 ohm rheostat on the left of the front panel being used for the filament control of the oscillator and the other being the combination 15 ohm rheostat for filament switch, the former part of which is used to control the filament voltage of the first detector and the first intermediate frequency amplifier. The second 20 ohm rheostat which is used for controlling the filament current of the second detector is not placed on the front panel but is located near the left center of the sub-panel and is not considered as a control

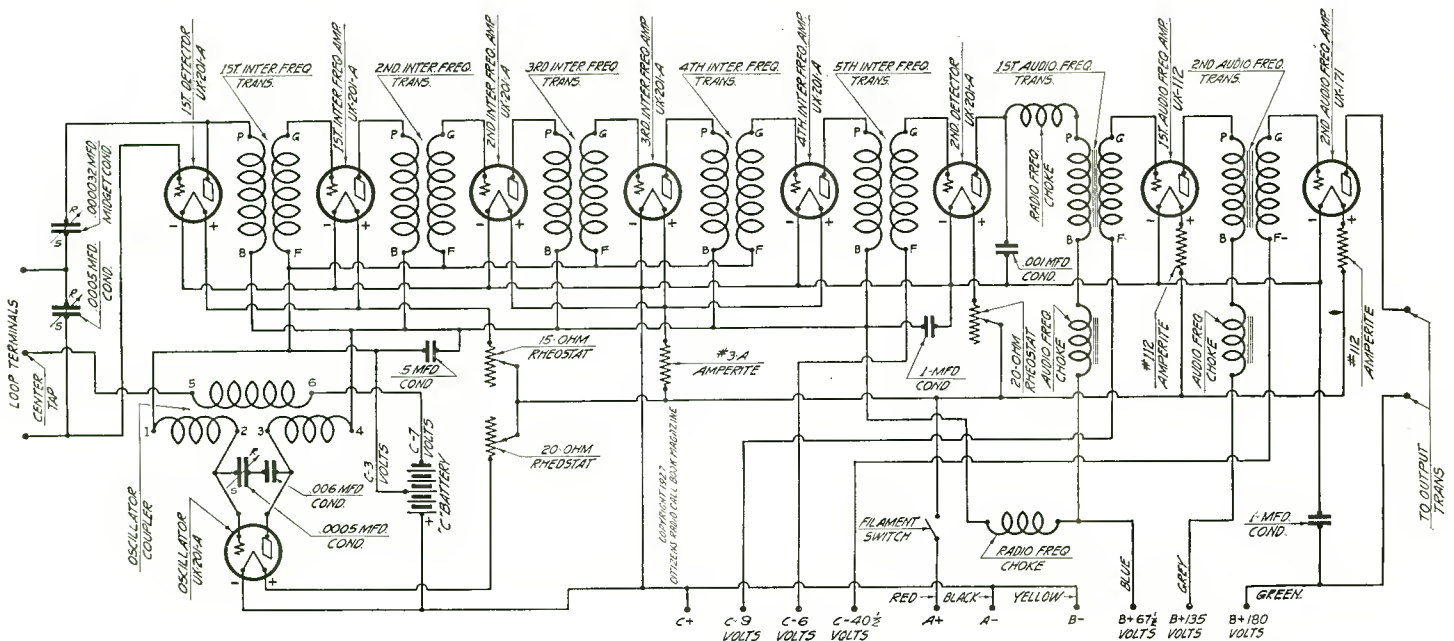

Figure 6. A sequence of all circuits is shown in the schematic diagram by means of which an experienced constructor may build the receiver. Novices are advised to make use of the graphic illustration shown in Figure 7

after it is once set for a given tube in use at that particular time. The knob showing on the sub-panel in Figure 2 just to the left of the oscillator coil is the .000032 mfd. midget condenser made by Hammarlund and is used for regenerative peaking of the center-tapped Fiat loop, which is used with this model of the Lincoln Quality Super. The setting of this midget condenser will depend to a great extent upon the inductance value of the loop, the type of tube used as a first detector, and the filament or plate voltage applied to it. Since this is a regenerative control there will be found that changing either the filament or plate voltage of the first detector will cause a slight difference in the position at which the condenser causes the tube to be highly regenerative.

**Fixed Plate Voltage**

Since the plate voltage is fixed and cannot be changed in the set, there remains only the filament voltage which is governed by the 15 ohm rheostat previously described. It will be found that on the lower wavelength stations a small amount of capacity in the regenerative condenser will be needed to bring the loop to its most sensitive point, whereas on the higher wavelengths more and more capacity will be required until the condenser plates are fully meshed. In the event regeneration in the first detector tube is not subject to control at the time the operator puts the receiver into service, it might be advisable to try a very small fixed capacity between the P terminal of the first intermediate frequency transformer and the negative filament terminal on the socket of the first detector. This value of capacity should be somewhere around .0005 mfd. With this small capacity present, it will probably be ascertained that the regenerative condenser will throw that tube in and out of regeneration, whereas without the fixed capacity across the plate to filament

no control might be available. In the laboratory model which was built and tested for the benefit of our readers, this condition did not obtain, but trusting upon our fund of previous experience with all classes of superheterodynes, we remember that quite frequently, through a variation in wiring or other constants associated with the first detector tube, an uncontrollable condition might arise which may be corrected by the method we have just described.

All intermediate transformers used in this receiver are of the air core type and have no arrangement for external tuning. For that reason they should not deviate from the frequency for which they are originally peaked at the factory, unless they are damaged in some manner. Intermediate frequency amplification of these units should, therefore, be uniform and no difficulty should be encountered with the tendency of the intermediate tubes to oscillate unless voltages far above the recommended values are applied to those plate circuits.

**Check All Parts**

In constructing a receiver of this size, regardless of the manufacturer, it is always advisable for the builder to carefully test transformers of all types for continuity of winding, this suggestion also applying to the oscillator coupler. It has been known that occasions arise when a particular unit will pass a satisfactory test at the factory and yet through a slight damage windings may go open. To make sure that all units are in first class condition, the continuity test should be applied to all of the transformers and chokes, while all variable and fixed condensers should be subjected to a test to determine whether or not they are short circuited. This is no reflection on any manufacturer's goods, but is merely a precautionary measure which all set builders take

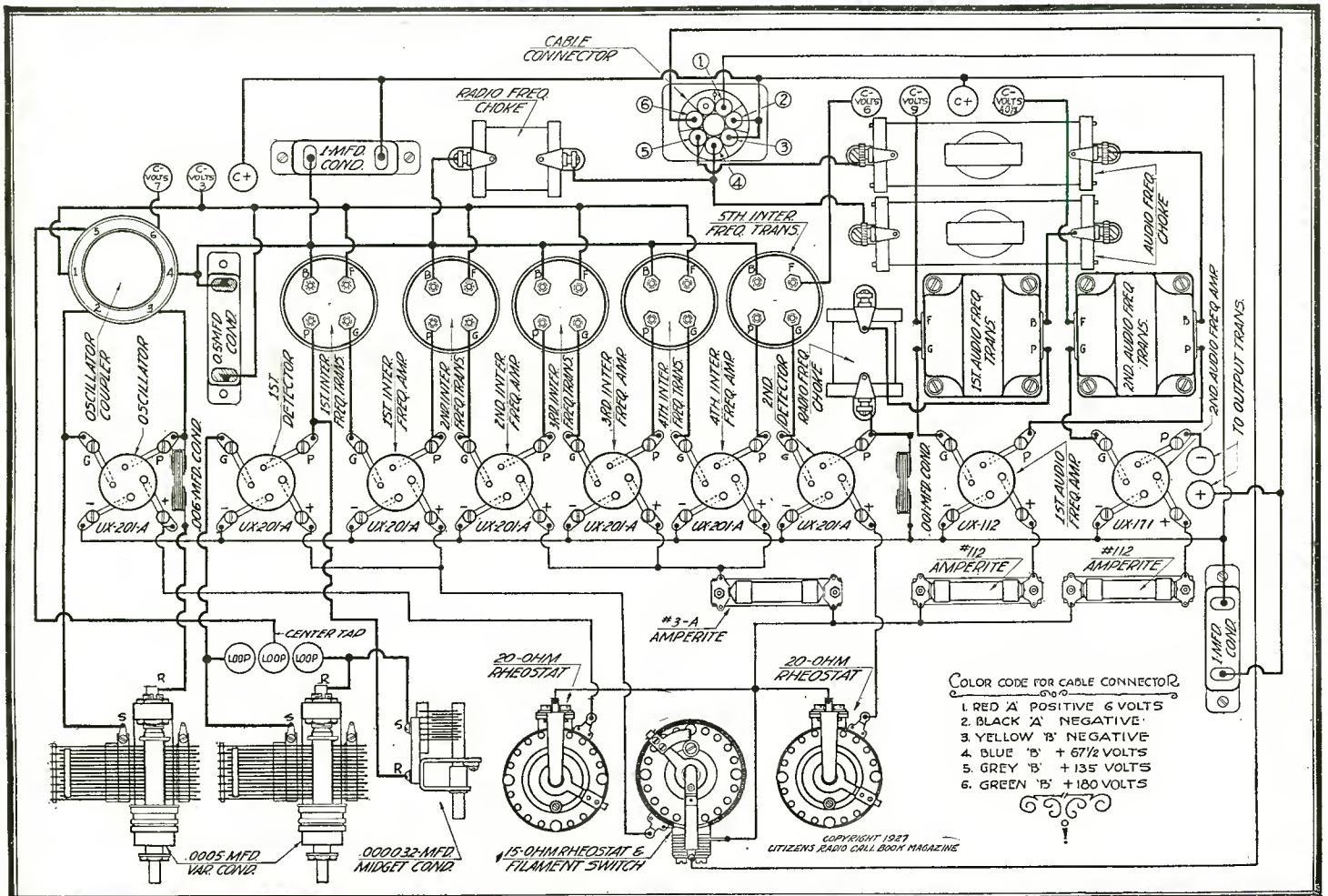
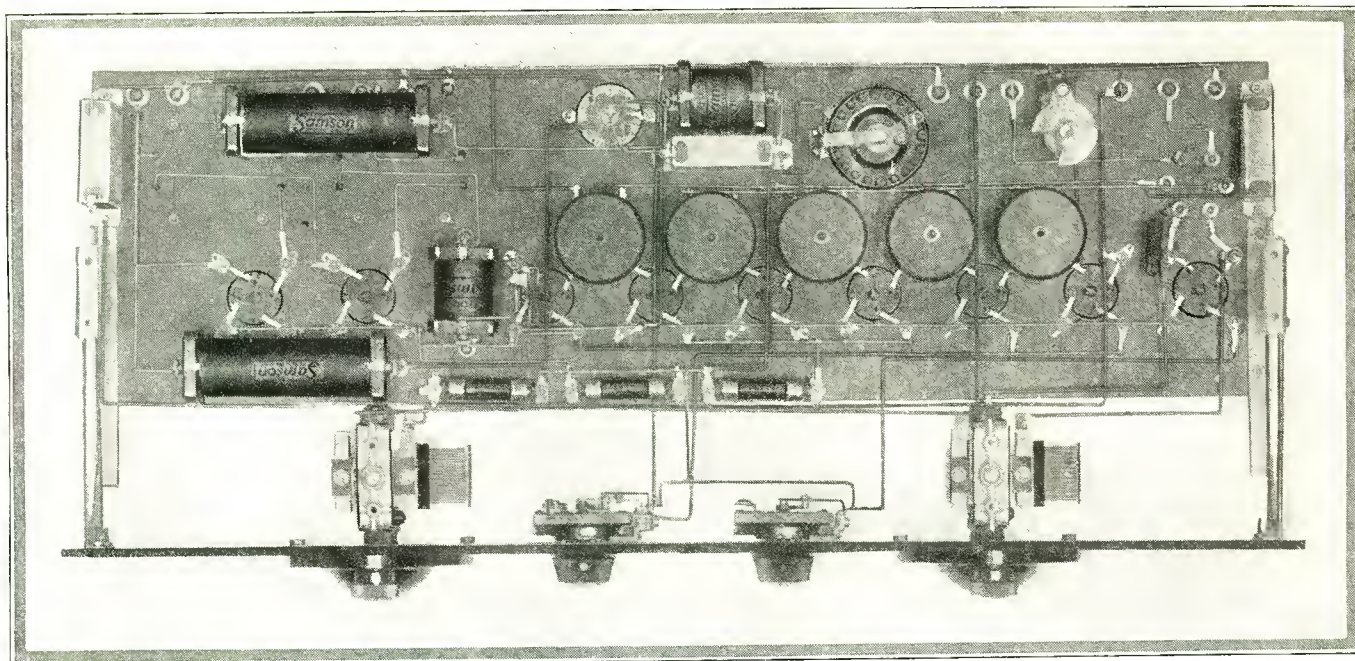

Figure 7. Illustrated above in a graphic form is the counterpart of the schematic circuit on the preceding page. Do not use this diagram for placement of parts, since it is only designed for wiring purposes. See Figure 5 for the correct location of all units





**Figure 3.** Much of the material not apparent in the photograph shown in Figure 2 will be found in the above photographic view. All of the intermediate frequency transformers and chokes are located on the under side of the sub-panel as shown above

before fastening parts to a front or sub-panel. In the case of rheostats and resistances it is rather difficult to imagine how they could be damaged, but as long as a certain amount of care is used in testing inductances and condensers the continuity test should also be applied to resistors. The simplest manner in which these tests may be made is by taking a d.c. voltmeter of the low voltage reading type and placing it in series with a  $4\frac{1}{2}$  volt C battery. Two flexible wires with clips will serve to complete a circuit through a transformer and show continuity of winding. When applied to a variable or fixed condenser, these test clips will not cause a reading to be shown unless the condenser is short circuited. Condenser tests should not be made on a variable which is connected across the extremities of an inductance, because in that event the builder would find a reading which would give him the wrong impression, since the condenser would actually be in good condition but the inductance across it would give a closed circuit reading.

Looking at the receiver in its console, the dial on the left which is turned by a Kurz-Kasch vernier operates the oscillator condenser, while the dial on the right controls the inductance of the loop circuit. Arrangement of the oscillator at the left in this particular model is provided to shorten up the length of grid and plate wires from the oscillator tube to the variable condenser. Longer leads in the loop circuit are not as undesirable as long leads in the oscillator circuit.

For operation with the receiver, make sure that the loop is of a type designed for use with a .0005 mfd. tuning condenser, as it will probably be found the oscillator readings and those of the loop will be more nearly alike when that kind of a loop is used than if a larger size is employed. It is also well to remember in the operation of a superheterodyne from a loop that occasionally considerable advantage in the matter of further increase in selectivity may be gained by using the directional properties of such a loop as much as possible. Remember loops should not be placed too close to the walls of the room, especially if the set is being operated in some of the new types of dwellings where either metal lath or other metallic substances are used in the construction of the building. In the event that more volume is desired in the loop circuit, a simple way of bringing about this increase would be to wind a single turn of wire around the perimeter of the loop, one end of the wire going through the window and up to the antenna, the other end being left open. This method of supplementing the energy furnished to the first detector is quite

helpful in some cases where the receiver is being operated in a location that is pretty well shielded by buildings and other absorbing structures. The use of a single turn of wire for a coupling to the loop circuit need not broaden the tuning of the loop dial out of proportion, unless the antenna is quite long. A little experimenting on the part of the set builder may develop interesting experiences.

Parts used in our laboratory model are shown below. Do not substitute unless you are certain of getting parts of equal merit:

- 5—Lincoln intermediate frequency transformers
- 1—Lincoln fixed inductance
- 9—9044 Benjamin sockets
- 2—Kurz-Kasch 100-0-100 vernier dials
- 2—120K Yaxley 20 ohm rheostats
- 1—Yaxley 15 ohm rheostat with switch
- 1—660 Yaxley cable connector
- 1—Hammarlund .000032 mfd. midget variable condenser
- 2—Hammarlund .0005 mfd. variable condensers
- 1—3-A Amperite
- 2—112 Amperites
- 1—Formica drilled and engraved 7x26x3/16 inch panel
- 1—Formica drilled 7x25x3/16 inch sub-panel
- 1—601 Dubilier .006 mfd. fixed condenser
- 1—601 Dubilier .001 mfd. fixed condenser
- 1—907 Dubilier .5 mfd. by-pass condenser
- 2—907 Dubilier 1.0 mfd. by-pass condensers
- 2—125 Samson radio frequency chokes
- 2—3 Samson audio frequency chokes
- 2—HW-A3 Samson audio frequency transformers
- 11—X-L binding posts
- 2—9029 Benjamin brackets
- 7—Ceco type A tubes
- 1—Ceco type F tube
- 11—Ceco J71 tube
- 30—Feet Corwico solid wire
- 1—Package Kester radio solder
- Miscellaneous lugs, screws, nuts, etc.

# Thompson Super Seven Is a Fine Performer at Low Cost

Balanced Parts Contribute Much to Success of Receiver

**T**ONAL quality and selectivity are always important features sought in the design and construction of a receiver, more especially if the set is to be a superheterodyne. There are many ways of obtaining both of these features and doubtless our readers have noted with interest in the past all the interesting combinations which are possible with this kind of a circuit. In seeking the two objectives mentioned in the first line of this article, experimenters and builders are often called upon to choose between one line leading to a large number of parts with critical control and complex circuit arrangements, and another line where the same control is reached through the employment of a limited number of constituent parts, ease of control and constructional simplicity. The first mentioned line leads to a considerable expense on the part of the builder, whereas the second involves less expenditure of money. Those who can afford the first choice secure the same relative satisfaction of those who pick the second. Since the majority of people are desirous of obtaining excellent operation at a small cost, we are presenting in this article the Thompson Super Seven, where the aim was to produce a reasonably priced super that could be built with quality products.

## Minimum Number of Parts

One of the first things which will be apparent when the reader studies the schematic diagram shown in Figure 5 is the fact that relatively few parts are shown in this sketch, which bears out the statement made before that one of the aims was to produce a good performing receiver at a reasonable figure. Tracing the course of the signal energy which the loop serves to gather, we find a potential will be impressed on the grid of the first detector tube, which is of the conventional quarter-ampere type. Across the extremities of the loop will be found a Camfield .0005 mfd variable condenser, whose stator goes to the grid of the first detector and the rotor

to the other outside terminal of the loop. This circuit is used for obtaining resonance between it and the frequency of the incoming wave. To secure detection in this tube, a bias voltage of three volts negative is applied through the pick-up winding of the oscillator coil, into the center tap of the loop and to the grid of the first detector. In the Ellis oscillator coupler selected for use in the Thompson Super Seven, the pick-up winding is fixed, as are the grid and plate sections. Another .0005 condenser is placed across from the grid to the plate terminals of the oscillator coupler and varies this capacity, which governs the frequency of the locally generated current which is merged with that of the incoming signal through the pick-up winding. As is always customary, the stator of the tuning condenser goes to the grid side of the tube and the rotor to the plate. Both of these variable condensers are operated by two Silver drum dials. The drum on the left of the set, as shown in Figure 2, controls the oscillator wave length, while the one on the right tunes the Bodine loop to the desired wave length. The midget condenser, which is the one at the left of the oscillator condenser, is the one governing sensitivity of the receiver and is represented in the schematic circuit as being a .00005 mfd located between the rotor side of the loop condenser and the plate of the first detector, where it serves to throw that tube in and out of regeneration as the operator may elect.

## High I.F. Amplification

In order to gain a large amount of intermediate amplification in a set with only seven tubes, it was necessary to use long wave transformers with a high amplification factor and for this purpose two Halldorson Precision I.F. transformers were chosen, these being the type 540 iron core. These two iron core stages are followed by a Hall-dorson No. 541 air core transformer, which serves as the tuned filter which determines the width of the frequency band over which

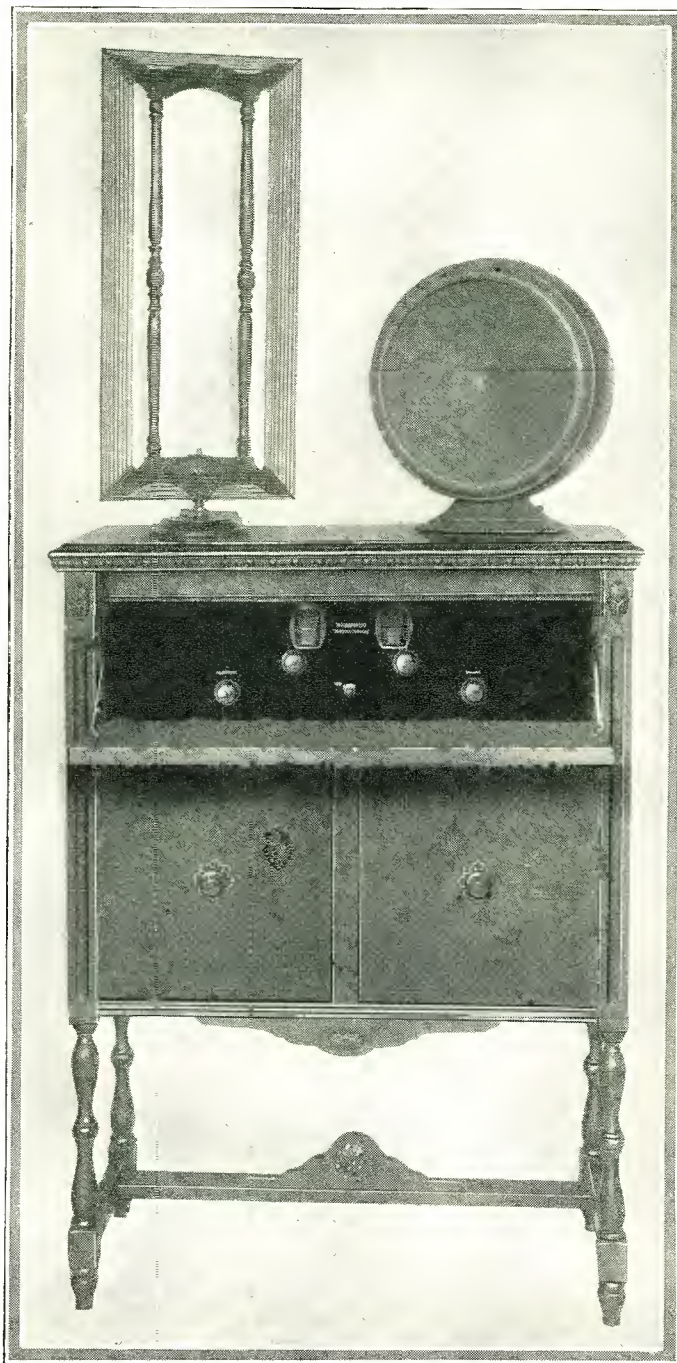

Figure 1. The Thompson Super Seven receiver is here shown in a Corbett cabinet. It is operated from a Bodine loop with an Acme speaker

(This receiver constructed, tested and all illustrations made in our laboratory)

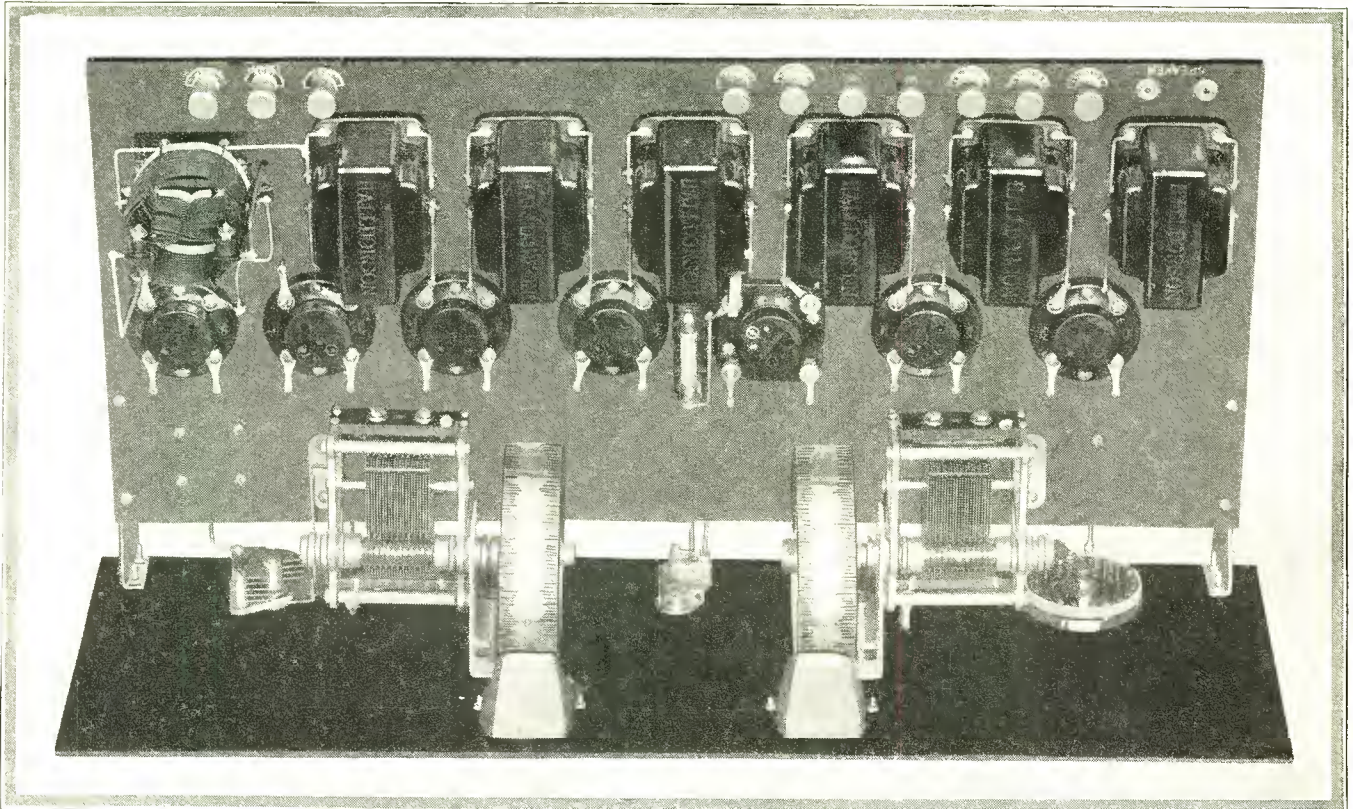

Figure 2. Pleasing appearance of the sub-panel of this worthy receiver is reflected in photographic view shown above

the signals would be heard. The problem of selectivity in a super alone is not so difficult to overcome, but to gain a combination of selectivity, tonal quality and distance presents a much more difficult task. To obtain selectivity and still pass a wide enough frequency band requires an extremely careful balancing of the component parts of the receiver. If it is desired to retain amplification over the entire audible range, it then becomes necessary to have a band of at least 10 kilocycles in which to work, some authorities arguing for even a wider band. If the selectivity is increased beyond the 10 kilocycle width, the field of reproduction is entered and the cutting of side bands with its attendant distortion will inevitably follow. The problem, therefore, is to come as close as possible to a point where no side bands are deleted. When this point has been reached, the peak of selectivity is at hand. This point can only be obtained by precision peaking of

the filter transformer to cut off on either side of the 10 kilocycle band. As is the case in most of the intermediate frequency transformers now available to the radio public, the manufacturer takes upon himself the peaking of the filters to be used in the intermediate amplifier, so that its operation will not be left to chance when the set is built up by the constructor. The necessity for this step has been made apparent by the desire on the part of the manufacturer to know positively that his apparatus will be given a fair chance to operate when turned over to enthusiasts who may not have a full enough understanding of the construction of a super to secure the results to which they are rightfully entitled.

Conserving Plate Current

Liberal use has been made of the C battery bias, a three volt

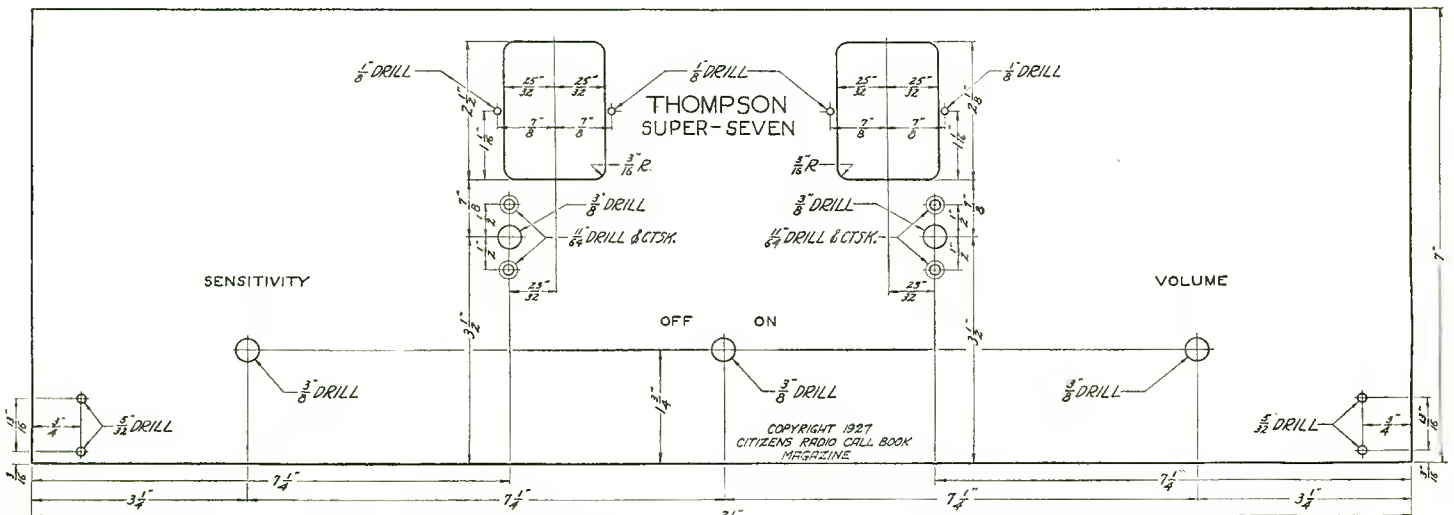

Figure 4. With processed front and sub-panels obtainable from any up-to-date radio store much time may be saved in laying out and drilling. For the benefit of those who wish to use an undrilled panel, the dimensions and drill sizes are shown in the sketch above

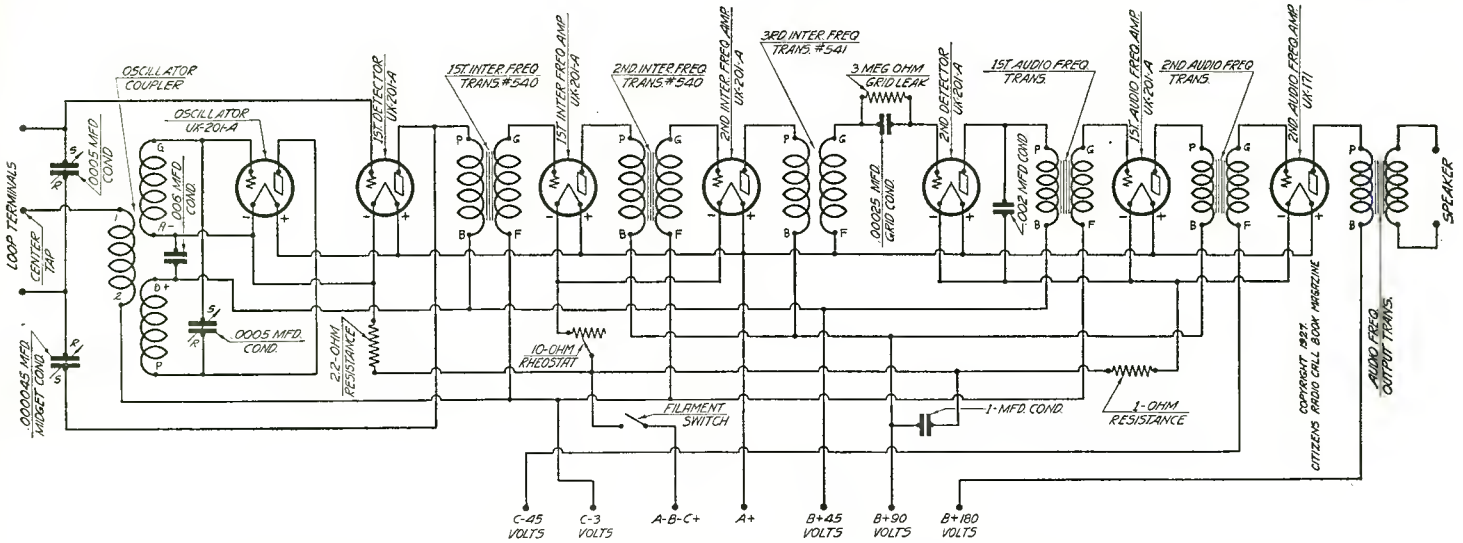

Figure 5. Functions of the Thompson Super Seven are seen by consulting the schematic diagram, which gives all necessary details

negative, being applied to the grids of the first and second intermediate stages in preference to employing the conventional potentiometer method of control, in the belief that this method is more efficient inasmuch as it reduces the B battery consumption of the set. Where detection in the first detector is by means of the bias supplied to its grid by the three volts negative, rectification in the second detector is by means of grid leak and condenser, with the filament return of that grid circuit going to the positive of the A battery when using 201-A tubes. The control of volume and the sensitiveness of the receiver is handled through one Yaxley 10 ohm rheostat in the filament circuit of the first and second intermediate tubes. The balance of the filament control is automatic and involves a 2.2 ohm fixed resistance, which carries the oscillator and first detector, while a 1 ohm fixed resistance handles the filament of the second detector, first and second audio

stages. The filament switch is placed in the negative A line between the binding post and the resistance. All binding posts are of the X-L type and are located at the rear of the sub-panel.

Audio amplification is secured through the use of two Hall-dorson Overtone audio frequency transformers, with an output transformer of the same make, amplification being over a range that takes in frequencies up to around 7000 or 8000 cycles, which will still allow the passage of many of the high notes which are necessary for the shadings and overtones of the voice or music.

The first step in the construction of the receiver by an experimenter or novice should be a careful study of the circuit for the electrical connections and baseboard layout for the location of the various parts. It will be noted that arrangement of all parts is such that leads have been cut to a minimum. Bypass condensers have been judiciously used in order to obtain maxi-

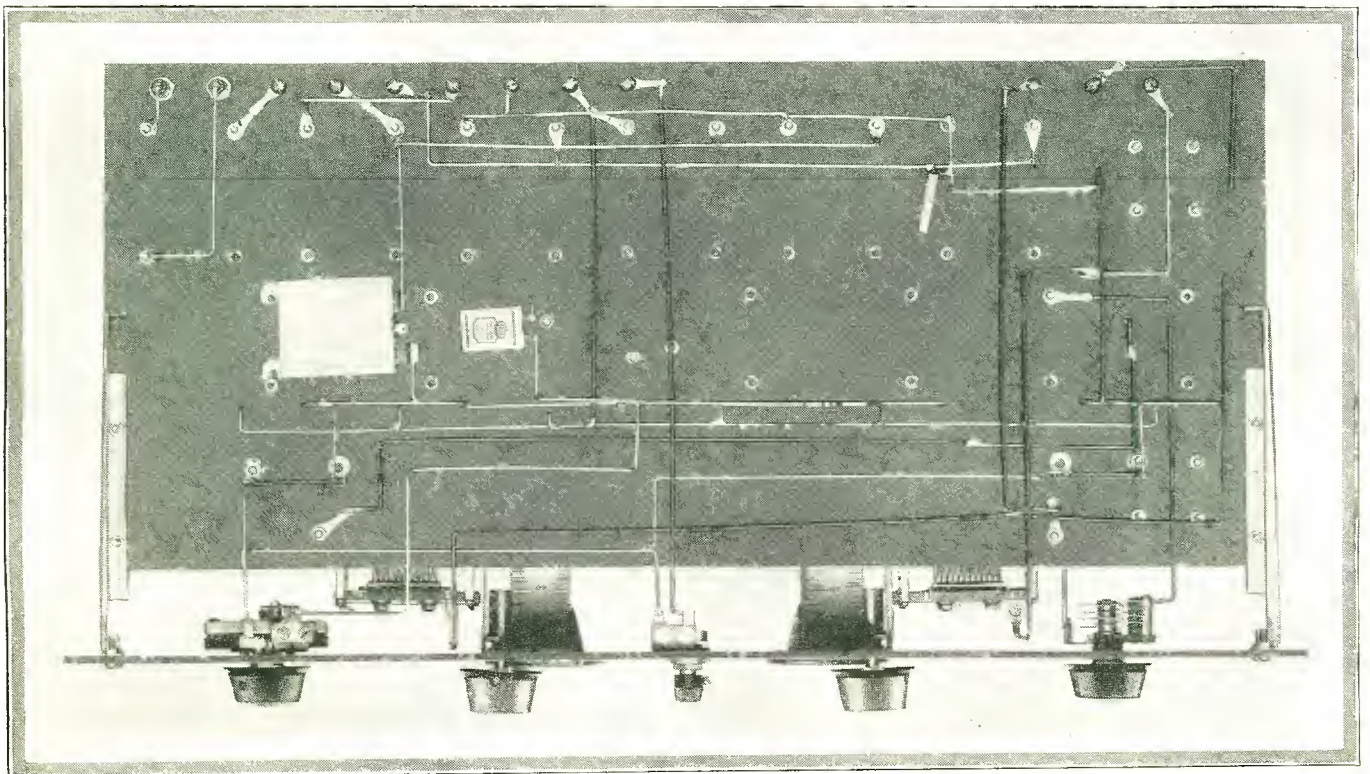

Figure 3. Since most of the apparatus used in this receiver is mounted on the top of the sub-panel, there remains little to do on the bottom other than to run the wires to their respective terminals

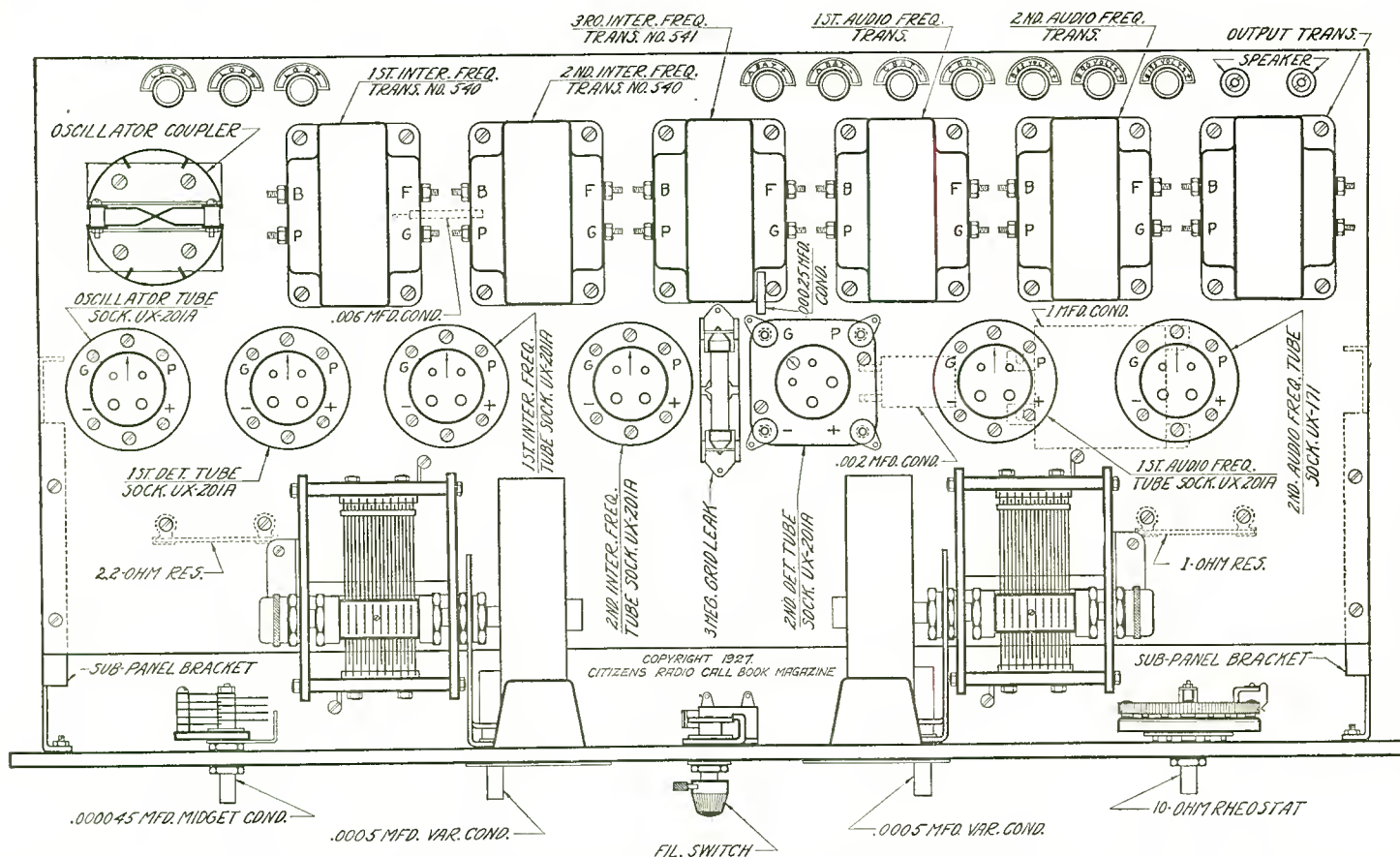

Figure 6. When laying out the parts which are to be used in a receiver, this drawing should always be followed closely, since it represents the actual position of each unit in the set

num efficiency. The oscillator circuit is designed so it will not unbalance the first detector tube on weak signals. Care should be taken to see that the rotor plates of the oscillator condenser are connected to the plate of the oscillator tube and the stator to the grid. If the reader will pay strict attention to the foregoing injunction, he will not be troubled with body capacity, although experience in servicing superheterodyne receivers convinces us of the fact that out of ten who build any receiver, at least one individual will make the wrong connection to the stator and then wonder why the station he is seeking disappears from hearing every time his hand approaches the dial.

Though the receiver has been designed primarily for loop operation, an antenna coil might be used. Obviously the distance getting ability of a set is somewhat better when antenna and ground connections are used, but this is partly offset by the fact there is considerably less static disturbance with a loop and in a number of cases the same signal strength may be obtained with loop operation as with an outside aerial, most especially on distant stations, for after all the chief virtue of the superheterodyne lies in its ability to amplify a relatively weak signal in greater proportion than it would a strong signal. In addition to this, the loop being directional eliminates a great many squeals, howls and heterodyning, which accompany the reception of distant stations and which an antenna might bring in above the signal strength of the station being received. This is particularly true on silent nights in the various sections of the country.

Quarter-ampere tubes should be used in all stages of the receiver, with the exception of the last stage, where a power tube of the 171 type may be utilized. If the wiring has been carefully done, there is no reason why the set should not operate perfectly from the moment it is connected up. It may be necessary to alter slightly the C battery voltage, but it will be found in most cases that, assuming the tubes are in good condition, the three volt C bias for the radio frequency stages, as shown in the schematic diagram, will be correct. Should a B eliminator be employed, one of sufficient output should be obtained, capable of delivering at

least 180 volts at about 40 milliamperes, since this is approximately what the receiver being described will take when a 171 power tube is used in the last stage. The fact that almost all of the tubes used in the circuit are biased with a negative potential to reduce the plate current consumption, practically reduces the possibility of the set "motor-boating" with certain types of B eliminators. Should this difficulty arise, it may be eliminated by using bypass capacities on the order of two to ten microfarads across the output of the eliminator.

### Always Test Your Tubes

Although the warning seems unnecessary, yet we have found it advisable to repeatedly call the attention of our readers to the fact that when preparing to put a superheterodyne in operation, it is imperative that all tubes be tested to determine their condition. There is no part of a radio receiver that is like a tube as far as failing to give any intimation of its disinclination to work. When a battery is dead, it refuses to function and the set likewise. When a transformer goes open, the set immediately gives an indication through either silence or howling, but when a tube has become dethoriated it does not show on the surface, and the resulting trouble in the receiver is usually blamed on every other item until in desperation the operator finally concludes the tube is at fault and proves it by pulling one from a certain socket and replacing it with a spare. It would, therefore, save the constructor considerable time and trouble if all tubes were to be tested, either by a dealer or by the builder, using standard tube testers which have been on the market for some time. One poor tube in a vital position of a superheterodyne will cause more trouble than can be imagined. Do not be misled by the fact a tube's filament lights—make sure its emission is good and excellent results may be expected.

On account of the small number of parts with which the Thompson Super Seven has been constructed, builders should find no cause for complaint on the score of complexity of the set. Barring a poor tube or tubes, there are practically no positions

where any difficulty might be experienced. However, as a precautionary measure, before wiring the set it would seem advisable to test all inductances, transformers, resistors and condensers. If dry batteries are used for plate operation, be sure to measure their voltage so that values as specified in the schematic diagram, Figure 5, are supplied. Also test the storage battery with a hydrometer to make sure it is fully charged. The resistances which are placed in the filament circuit of the set are designed to handle all tubes when a 6 volt source is obtainable, but maximum results should not be expected if the builder has been careless in maintaining his storage battery and has let its specific gravity drop. Naturally if the battery voltage is down, the potential applied to the tubes will be lower than the amount required for best operation.

**Follow the Specifications**

In the construction of the receiver outlined in the foregoing article, parts shown below were used. Beginners in the art should follow specifications very carefully in order to make sure of satisfactory operation of the set. Those with wider experience in the construction of radio sets may substitute other parts, but in so doing care must be taken that equal merit and identical constants are obtained.

- 2—540 Halldorson Precision intermediate frequency transformers
- 1—541 Halldorson Precision intermediate frequency transformer
- 2—Halldorson Overtone audio frequency transformers
- 1—Halldorson Overtone output transformer
- 1—340 Silver-Marshall midjet condenser

- 6—511 Silver-Marshall sockets
- 2—805 Silver-Marshall drum dials
- 2—540 Silver-Marshall sub-panel brackets
- 1—10 Yaxley filament switch
- 2—Yaxley tip jacks
- 1—2L Yaxley 2.2 ohm fixed resistance
- 1—3L Yaxley 1 ohm fixed resistance
- 1—Yaxley 10 ohm rheostat
- 1—Tobe .006 mfd fixed condenser
- 1—Tobe 1.0 mfd bypass condenser
- 1—Tobe .002 mfd fixed condenser
- 1—Tobe .00025 mfd fixed condenser
- 1—Tobe .001 mfd fixed condenser
- 1—Celeron 7x21x3/16 inch drilled and engraved panel
- 1—Celeron 9x20x3/16 inch drilled sub-panel
- 1—Lynch 3 megohm grid leak
- 1—Lynch resistor mounting
- 2—Camfield .0005 mfd variable condensers
- 10—X-L binding posts
- 1—Ellis oscillator coupler
- 6—Ceco type A tubes
- 1—Ceco type 171 tube
- 1—9040 Benjamin socket
- 30—Feet Acme Corwico solid Braidite wire
- 1—Package Kester radio solder
- Miscellaneous lugs, nuts, screws, etc.

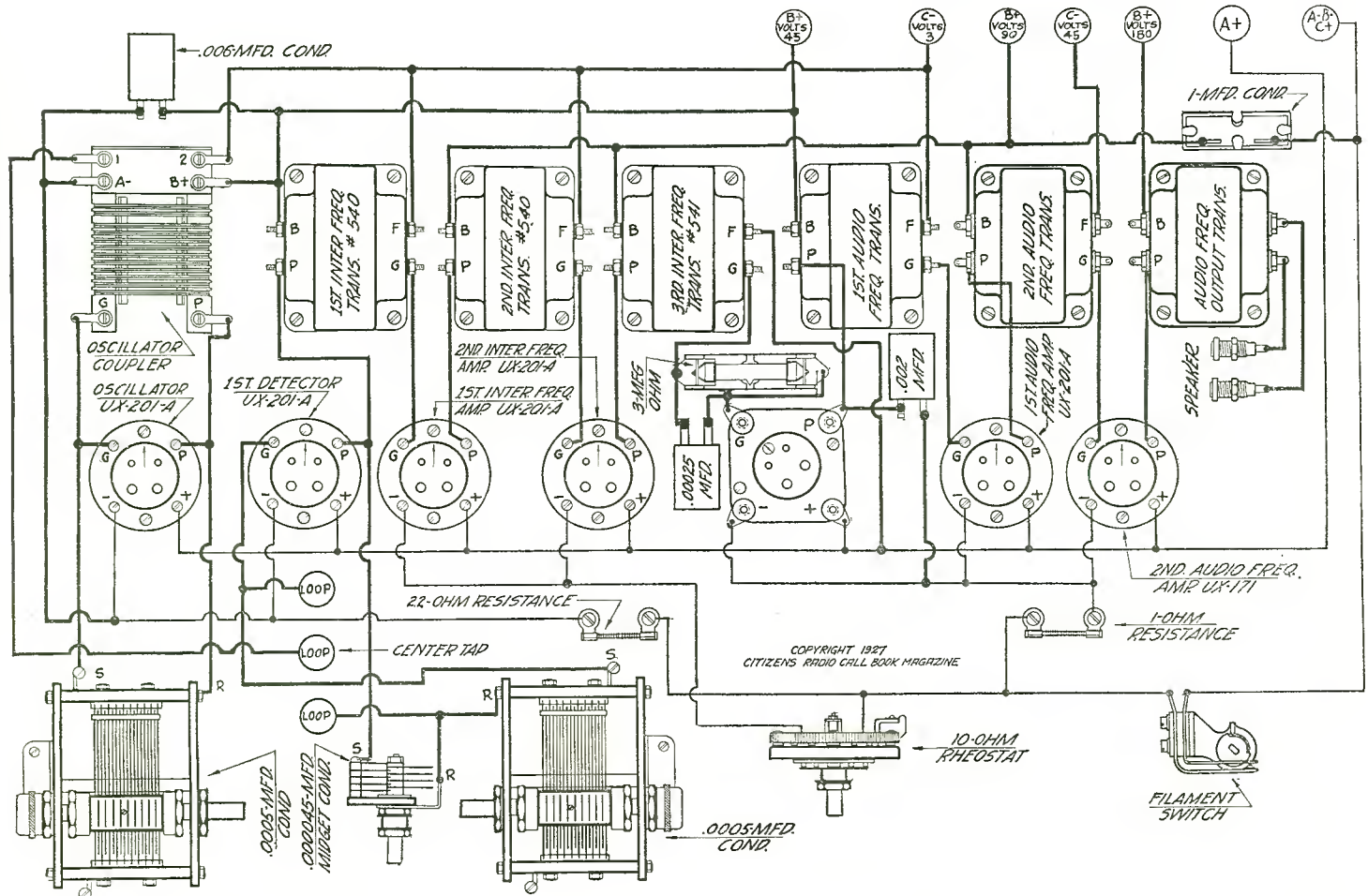

Figure 7. Wiring of the seven tube super may be greatly facilitated by following the lines representing connections shown in this graphic illustration. Advanced experimenters may do their wiring from the sketch shown in Figure 5, but beginners are cautioned to follow this graphic diagram exactly

# Sectional Idea Applied in Walker Vari-Unit Receiver

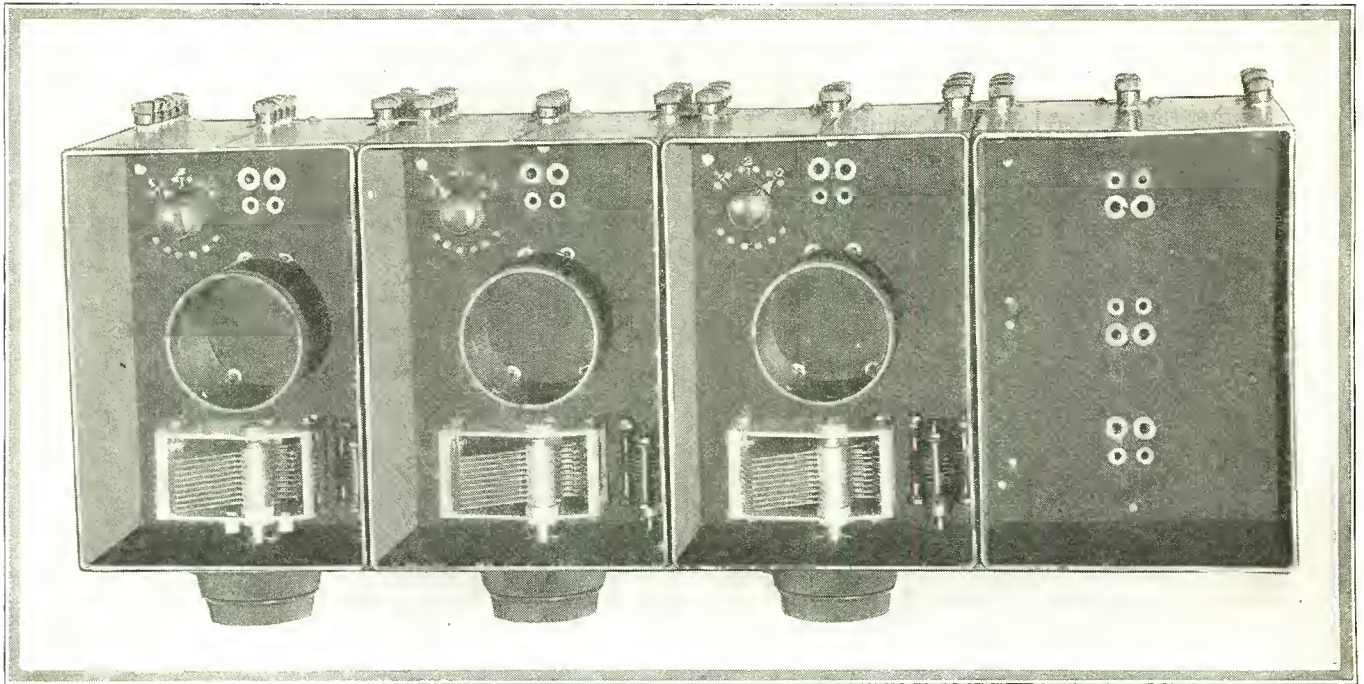

Figure 2. Above is illustrated a train of Vari-units. All connections are made between units through binding posts at rear

## Antenna Impulses Carried to Speaker by Shortest and Most Efficient Route

“BUY AS YOU GO” has long been a slogan associated with sectional bookcases and other mercantile products, but it has remained for George W. Walker to adapt the idea to radio in such a convenient and economical form that those whose purchasing power is temporarily limited may start from a simple and inexpensive beginning, gradually working up to the highest type of receiver that is desired.

### Radio's High Standard

Today, radio attains a high standard of efficiency. This is made possible through ceaseless development and research as well as modern machine shop practice in producing apparatus true to characteristic. Radio is no longer a hobby, but is, on the contrary, an essential that brings to our very homes the concerts rendered by our highest paid musicians and artists, words of wisdom and learning from our wisest speakers, news reports of the day, and other educational features.

And, as radio advances, we become all the more critical. Perfection in the reproduction of the violin, the rumble of the low organ notes, the spoken voice, all must resemble the original as picked up by the delicate mechanism of the microphone. This, therefore, is an era of improvement—in radio.

How often we hear the set owner bemoan his fate in commenting on the fact that he'd be happy—"if his set only had a wee bit more power"—"was a tiny bit more selective"—or—"if he could only get a little more distance." Still, there was the original investment to be considered, and as the set cost so much in the beginning, it wouldn't be quite right to discard it. With

### CIRCUIT NO. 1

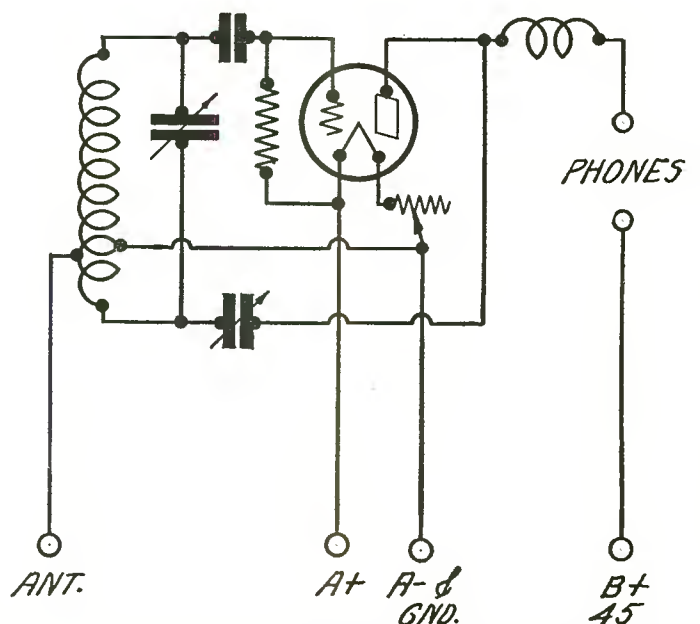

Figure 3. Simple electrical circuit governing operation of first Vari-unit, shown in graphic form in Fig. 4

(This receiver tested and all illustrations made in our laboratory)

CIRCUIT NO. 1

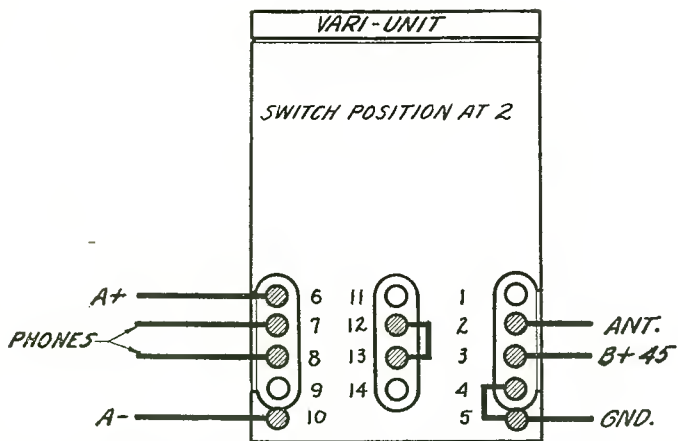

Figure 4. Rear sketch of Vari-unit showing connections outlined in figure 3 on page 117

the unit plan even an old receiver may be improved, as will be shown further in this article.

Purpose of Shielding

Listeners living within the shadow of a number of high powered broadcasting stations will doubtless remember that one of the greatest problems encountered is the amount of pickup from local stations. Unless the set is completely shielded, energy from the local station will creep in and cause the receiver to be broad in its tuning. Without antenna and ground connections it is quite often possible to secure good volume from a nearby station. Most of this trouble occurs through the amount of wiring in the set and the fact that coils are not shielded from the field of the transmitter. By shielding the units, as is the case with the Vari-units, the majority of this type of pickup is eliminated. There remains only the associated wiring and this is kept down to a minimum by means of the rear connections on the backs of the various units. For those who are at some distance from a broadcasting center the matter of shielding does not make a great deal of difference, although if there is local interference in the form of power line leaks the shielding will be found beneficial.

In attempting to do experimental work the radio fan is often desirous of making a certain combination of tubes and inductances, but the work involved in putting together all the parts is generally enough to make him consider seriously the tearing up of the old receiver or circuit. Having the desire to add to or change circuits, the experimenter may now do so without having to demolish an existing set. He merely takes the particular unit he desires and places it ahead of his set (if r. f. amplification is desired) or after the set if audio amplification is desired.

Another use for one of these units would be as an oscillator which could be calibrated with a fair degree of accuracy and which might serve as a miniature transmitter for the fan who wants to test the wavelength range of any particular set. The single tube regenerative combination is chosen for this purpose, and will serve quite nicely in that capacity. This same unit,

CIRCUIT NO. 2

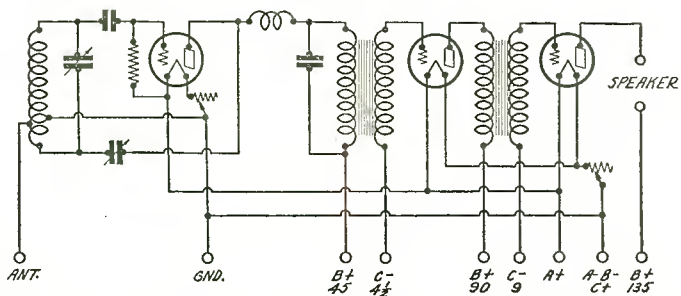

Figure 5. Three tube receiver with regenerative detector. Unit combination is shown in figure 6 on this page

when used with an inductance of the smallest type, will likewise serve as an oscillator, or regenerator when the set owner wishes to go down on the lower wavelength and pick up programs broadcast by some of the larger stations for European entertainment. Using one of the short wave coils in the single Vari-unit, it is possible to hear stations at a much greater distance than when listening on the standard broadcast band.

Many other uses will occur to the serious experimenter who wishes to study circuit combinations with the least expense of energy and money.

Coincident with the sectional idea of placing one unit beside another, there appears the simplicity and directness of all battery connections. In such an arrangement it is quite possible to develop circuits along a progressive line. For instance, in circuit No. 2, which is shown by the sketch in figure 6, readers may observe how easily the connections may be made for a regenerative detector and two stage audio receiver. In figure 6 energy enters via the antenna on terminal two, while the ground is placed on terminal five with a jumper to terminal four. Terminals twelve and thirteen are tied together, while the output of the first Vari-unit is led directly to the input of the second Vari-unit by the connections shown in figure 6.

Small Starting Cost

For those who wish to start in the reception of programs at a very small cost, circuit No. 1 shown in figure 3 will give them an opportunity of doing so. The first Vari-unit consists essentially of an inductance, a tuning condenser, a rheostat capable of

CIRCUIT NO. 2

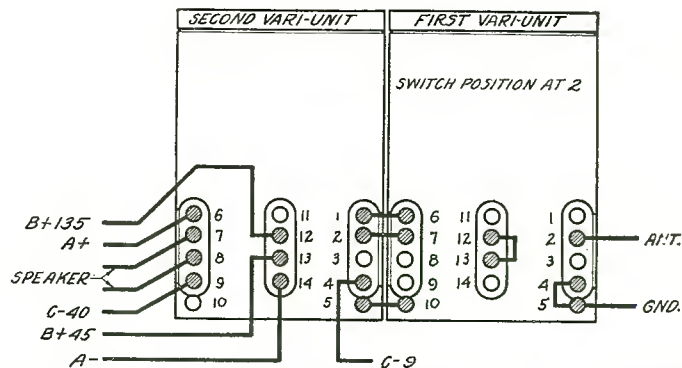

Figure 6. Joining the first Vari-unit and the second Vari-unit will give a receiver similar to the one illustrated schematically in figure 5

taking all types of tubes, an r. f. choke, grid leak and condenser, regenerative condenser and a switch, by means of which larger and more interesting combinations than the single tube set may be secured when associated with other Vari-units. A sketch of the rear of the first Vari-unit illustrated in figure 3 is shown in figure 4.

A more pretentious arrangement is shown in figures 7 and 8, the former being the schematic of a four tube set comprising one stage of tuned r. f., regenerative detector and two stages of audio, actual connections for these units being shown in the latter figure. Here again it is possible to see the continuity of the circuits by observing the connections shown on the rear of the units in figure 8.

A non-regenerative combination is shown in figure 9, where the schematic is given, and in figure 10, where connections for the two stage tuned r. f. detector and tuned audio receiver are illustrated.

If the listener prefers push-pull amplification to the usual two stage transformer coupled amplifier, he may secure this type of amplification through the audio system shown in figure 11, with proper connections for same being shown in figure 12.

When it is desired to use a single unit ahead of an existing set as a means of boosting the r. f. amplification of the old set, a single unit may be hooked into the antenna and ground circuits and the output terminals of this single unit carried to the old antenna and ground connections, A and B battery lines. This



arrangement will give the equivalent of an added stage of tuned r. f. and will serve to considerably increase the volume of distant signals. It is also possible with certain combinations to use a loop on the receiver instead of an antenna connection. It is also possible to use two of these units coupled to serve as an antenna coupler and oscillator to replace present similar stages in a superheterodyne.

**Plate Power Supplies**

Standard plate supply devices will perform satisfactorily on the type of receiver herein described, although for best results at high voltages the power supply may be made in the form of a half wave or full wave compact, using the well known 216-B type of tube. This form of plate supply system will allow a much greater amount of amplification without distortion where it is desired to entertain more than a room full of people. For ordinary purposes in the home, either dry batteries or an eliminator of a standard make may be used with complete satisfaction.

After the phase shifting switches have once been set, they are left untouched unless the owner desires to change the form of receiver. On account of the compactness of the units, it would probably be best, when desiring to make a change in the switch positions, to remove the tube and the plug-in coil, which can be readily replaced when the proper position has been found on the switch.

**Universal Wave Range**

Conspicuous in the Vari-unit is the interchangeable coil. This is of plug-in type and a series of these coils permit the owner to

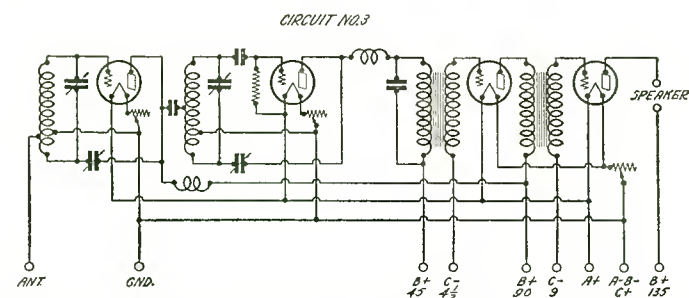

Figure 7. In this schematic we find a four tube receiver with regenerative detector

tune in stations all the way from 30 to 2,600 meters, a tremendous feature for the advanced student of radio.

All characters on the front of the units are clearly and plainly shown in gold, adding marked refinement to appearance. The dial is of vernier type and permits close tuning. Each unit has, as front panel controls, a major vernier dial and tuning condenser, the handy knob on the compensating condenser and the rheostat control, which, when once adjusted, requires no further attention.

Workable, in conjunction with the controls, is a three-phase switch within the container, and on the back of each unit and out of view except when the container is reversed, are a series of binding posts. These are numerically designated. Each binding post serves a purpose. Charts show how these may be coupled together or treated with respect to outgoing wires to accomplish the various hook-ups.

The aluminum container for each Vari-unit contains a newest type .00035 variable condenser, of approved manufacture, a .000045 compensating or midget condenser, a variable rheostat capable of controlling any type of tube, a helical wound radio frequency choke coil, grid leak, fixed condensers, plug-in type of coil covering 200 to 550 meters, and a novel three phase switch. This switch is the heart of the Vari-unit. Through its use each phase is changed over to conform to the particular circuit one desires.

Circuit students will recognize in figure 3 a simple Hartley receiver with the tuning condenser across the extremities of the coil, and the balancing, or regenerative condenser, from the lower end of the inductance to the plate of the tube. The filament connection and the antenna tap are located at the low potential portion of the inductance and as a result the amount of energy



Figure 1. Front view of Vari-units shown on console table. Quite a number of combinations may be made by merely adding sections to the basic receiver

picked up from the antenna does not materially alter the tuning of the circuit as it would were the antenna lead brought in closer to the grid connection. This results in a sharper signal delivery and aids considerably in holding down interference between two stations on adjacent channels. The choke coil shown in the plate circuit of figure 3 is to prevent the passage of r. f. into the headphones or the primary of the first audio transformer. The balancing condenser acts as a by-pass as well as a balancing capacity.

Figure 5 discloses a conventional regenerative detector with two stages of audio. In this circuit the coupling to the audio stage is by transformer. In figure 7 we note the schematic of a receiver employing one stage of tuned r. f., regenerative detector (if desired) and two stages of audio amplification. In the radio frequency end of the circuit the coupling from the plate of the first r. f. tube to the grid of the detector is by means of a capacity. This system of coupling is known as an impedance coupling with tuned input as compared with other impedance systems where the output circuit of the first tube is tuned. Of course if regeneration is desired it would not be possible to tune the plate circuit of the first tube, and for that reason this particular mode of tuned grid input is employed.

**Method of Coupling**

This same impedance coupling method is also seen again in the schematic circuit illustrated in figure 9. Here both the first and second stages of radio frequency may be placed in a regenerative condition by manipulation of the balancing condensers. If this regeneration is carried too far, oscillation will ensue and spoil

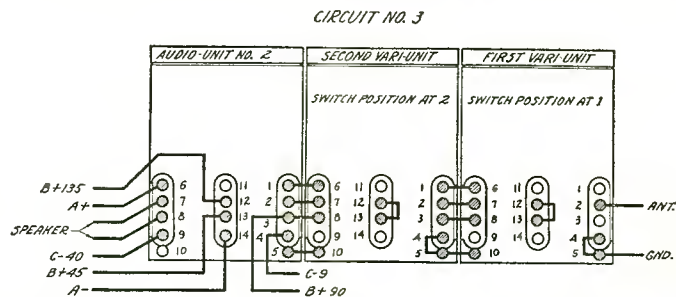

Figure 8. Connections for a four tube receiver with regenerative detector should be made in accordance with sketch above

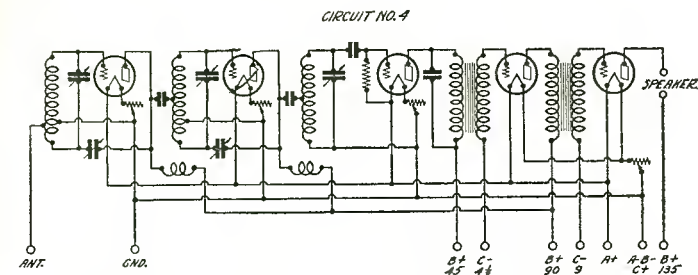

Figure 9. Above is shown a non-regenerative tuned r. f. receiver, which may be changed from a five to a six tube set by the use of different audio units

the results, but this will not be long tolerated by anyone listening to the receiver when it is in that condition. The amount of balancing will depend to a considerable extent upon the wave band on which the receiver is tuned at the time. For the lower wavelengths around 200 meters very little capacity will be required for balancing, whereas on the higher wavelengths around the top of the present broadcast band the condenser will be used more and more. These capacities afford a high degree of flexibility which is quite welcome to the fan who wishes to gain as much energy from each stage as can be secured.

Attention should also be directed to the schematic circuit shown in figure 11, which is a push-pull amplifier system. The input transformer has a single primary but a center tapped secondary, with a grid of one tube going to one extremity and the grid of a second tube going to the other. The center tap carries the C bias lead and furnishes a biasing potential for both grids. The output circuit of the two tubes arranged for push-pull

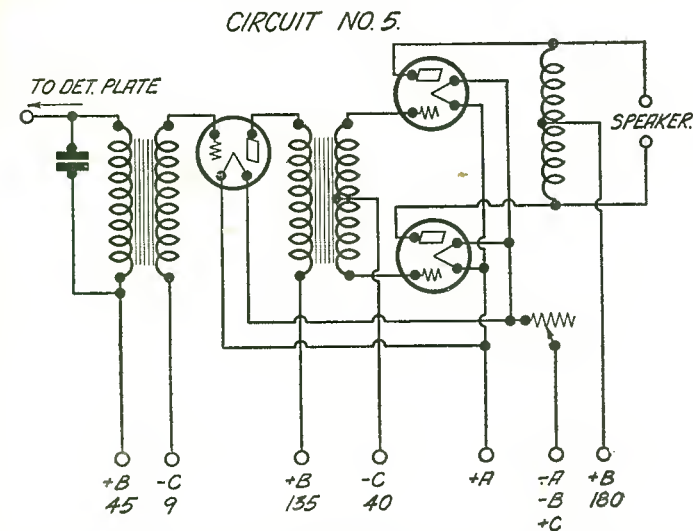

Figure 11. Push-pull amplification is illustrated in the accompanying schematic and is known as audio unit No. 3 illustrated in figure 12

goes to a center tapped coil, with a plate at each extremity and the B battery potential of 180 volts attached to the center tap. With the speaker shown as in the schematic, the current flowing through the windings is only that value which one tube takes and the losses usually encountered in output systems eliminated, or reduced quite materially. Therefore this system seems to give promise as a means of using a speaker with a relatively high voltage without much danger of damage to the windings.

Hints on Tuning

Walker units have been created to give owners the utmost in reception. They are not difficult to operate, in fact, the mode of tuning is indeed simple. After you have selected the hook-up which offers its appeal to you and all wires have been connected, before the batteries are turned on, check over your wiring and make sure that all connections are snug, and correct as in the diagram, and that no wire comes in contact with the metal con-

tainer or stage shield. This takes but a moment.

You now rotate the dials, keeping their readings about the same. When a station is heard the midget condensers, small right hand knobs, are adjusted to maximum volume. On the low wave stations, adjustments will be found critical, but all such adjustments, through this type of feed-back or regeneration, add greatly to volume and distance.

Should you fail to hear a signal and you are sure there is broadcasting at the particular hour, there is a possibility that the midget condensers require readjustment. Move each until a slight hissing sound is heard and proceed with the dial tuning.

Remember, you are becoming acquainted with a new receiver and patience is required in tuning a set with which you are not familiar. A little time spent in learning the set will permit greater efficiency. While the set is quite simple in operation, the multi-dials permit accomplishments in range and selectivity seldom possible with other types of receivers. The single dial re-

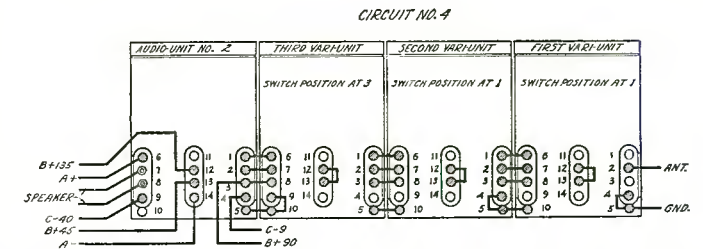

Figure 10. Audio unit No. 2 together with a first, second and third Vari-unit will give a five tube combination, while a six tube may be secured by using an audio unit No. 3 instead of No. 2

ceiver which has made its appearance on the market today is one of convenience only and is usually selected by the novice first. It is not long before greater flexibility is desired, and the second set of the enthusiast will be one of multi-dial operation, one which actually performs in keeping with much wanted results.

When the units are in operation and one desires to cut regeneration in or out of the detector circuit—the coil and the tube should be removed so that the switch may be easily reached. Make sure that the moving arm of the switch is in exact line with the numeral which denotes the phase of the switch. This is important. It is not necessary to disconnect the batteries when this switch is moved to a new position.

Never permit the set to oscillate. It is unnecessary and destroys efficiency. The circuit you select may permit oscillation, and if so, care should be exercised in tuning. While it is an accepted fact that the closer you tune to the "breaking point" or point of oscillation, the greater the efficiency, you must realize and remember that to go beyond this point is to destroy efficiency and the great advantages of regeneration.

CIRCUIT NO. 5.

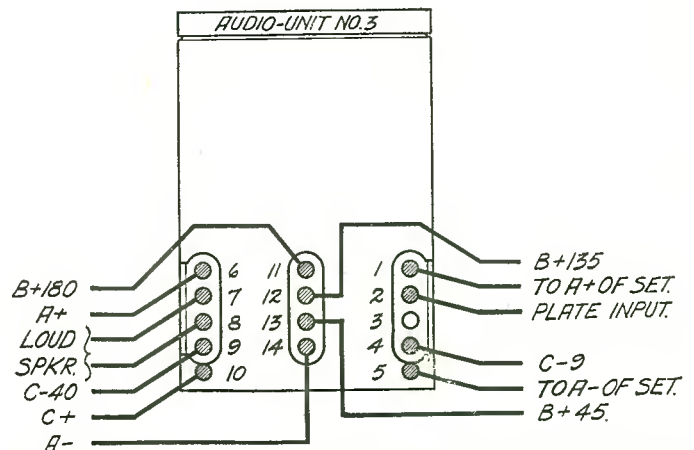

Figure 12. Those desiring push-pull amplification should use audio unit No. 3, whose schematic is shown in figure 11

# Full Wave Thordarson Power Amplifier for Use on Any Set

Standard Arrangement May Be Made Using Output Choke and Input Transformer So the Amplifier Can Be Adapted to Use With Any Circuit

ON many occasions there has been a demand on the part of the set builders and experimenters for a standard audio frequency amplifying system which may be plugged into the output of a preceding receiver, regardless of whether it is of the superheterodyne type or of the conventional tuned radio frequency. Some of the necessity for this type of an amplifier may be recognized from the fact that quite frequently a builder desires to construct only the front end of a circuit and if he has a standard power amplifying system there is no necessity for building an audio amplifying system into each of the receivers which he may construct.

Many cases also will arise where the listener may desire to plug in a power amplifying unit in place of an existing one in a set which he may be operating, and the procedure is likewise feasible and convenient for the listener.

Desiring to have such a combination made up so that the detail of its construction and operation might be made known to our readers, our laboratory has recently constructed such an amplifying system, which is giving excellent service when hooked up to any form of receiver. The photographs and diagrams which accompany this article will give a great deal of information to the builder, and in the text we will attempt to make its construction as simple as possible.

### Made for Maximum Current

In order to assure ourselves of an ample current available for almost every conceivable purpose, the amplifier was designed to

high voltage transformer known as type 2098. Referring to the schematic diagram shown in Figure 3, the reader will notice that the center tap of the high voltage winding is common with the center tap of the low voltage winding which operates the filaments of the two 210 power tubes arranged for push-pull audio amplification. This line is also common through a 2000 ohm variable resistance to the negative of the B supply. The biasing potential secured for the grid return of the first audio frequency transformer is taken from the drop across the 2000 ohm resist-

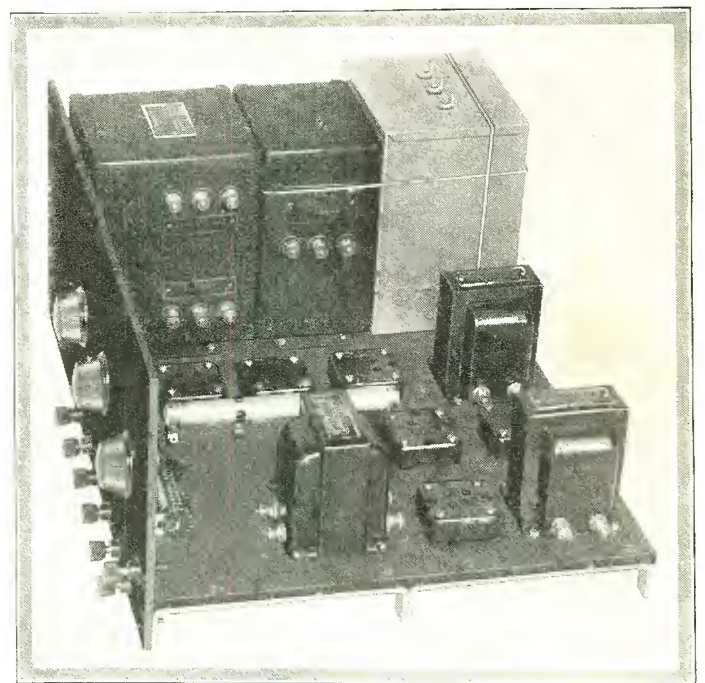

Figure 1. In the above photograph the Thordarson power amplifier is shown just after all parts had been placed on the front panel and the sub-panel but before the wiring had been done

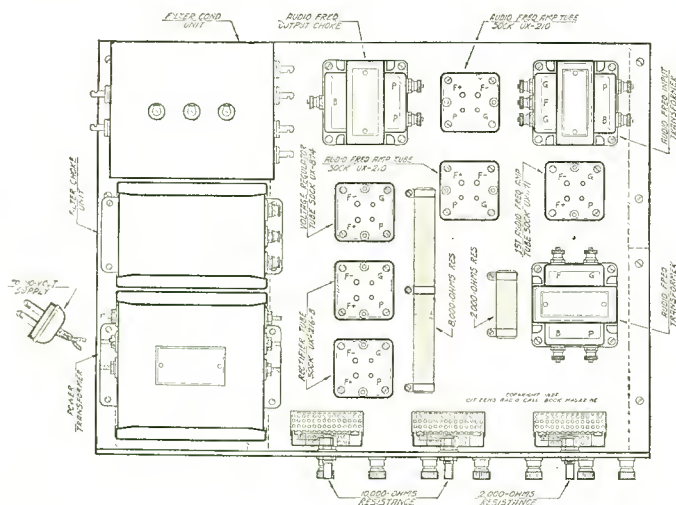

Figure 4. This illustration gives the builder the correct location of all units before they are to be wired

accommodate the 216-B type of tube or its latest successor, the 281. These tubes are arranged for full wave rectification with their plates located at the outside extremities of a Thordarson

ance, this being the resistance section at the bottom of the resistance line shown at the right of the diagram. For biasing the two grids of the 210 power tubes, a fixed 2000 ohm resistance is placed between the center tap of the low voltage filament winding and the center tap of the audio frequency input transformer.

A second low voltage winding serves to energize the filaments of the 216-B tubes, while its center tap becomes the positive terminal of the rectifier and is led through a Thordarson filter choke unit, type 2099, and thence to the common junction of an 8000 ohm resistance and the center tap of the Thordarson audio frequency output choke. As is shown in the schematic, a filter condenser unit is used containing six separate capacities disposed as shown in the diagram just mentioned. The neutral or common terminal of this American Electric condenser block

(This Amplifier Designed, Tested and All Illustrations Made in Our Laboratory)

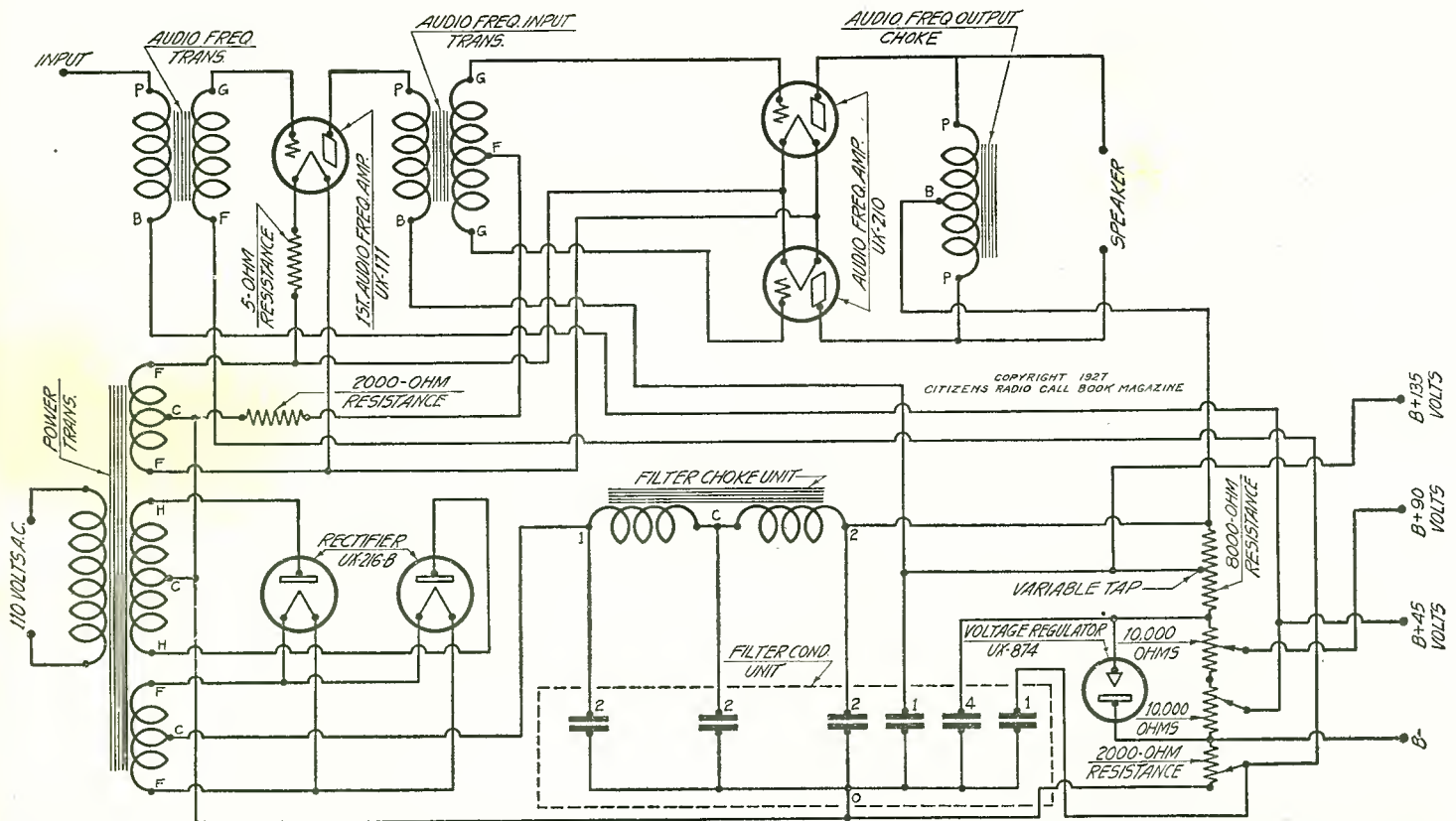

Figure 3. Above are shown the electrical connections which must be made in order to operate this set. It would be worth the builder's study so as to thoroughly acquaint himself with the functions of all of the various sections

is connected to the line from the cent tap of the high voltage winding.

#### Uses Voltage Regulator

To insure stable operation of the power amplifier unit, regardless of the load which may be placed upon it by the preceding receiver, it has been considered advisable to employ a voltage regulator tube so that voltages at the 90 and 45 volt terminals shall be as constant as it is possible to obtain. The 45 volt positive terminal supplies the plate circuit of the first audio frequency transformer and a slider arm on the 10,000 ohm resistor permits this voltage to be shifted within limits to any value desired. Another slider arm is provided on the 10,000 ohm resistance for securing 90 or more volts, while a variable tap on the 8000 ohm resistance is supplied so that 135 volts may be secured for use if desired. The regulator tube is placed across the negative B terminal and the junction of the 8000 ohm and 10,000 ohm resistors, so that it holds relatively steady the 90 volt output and the 45 volt output.

#### Filaments on A.C.

All filaments in the amplifier are operated from alternating current, the filament of the 171 power tube in the first audio stage being supplied through a 5 ohm fixed resistance located in series with the filaments, this serving to drop the voltage to the proper value for that particular tube. In the case of the filaments of the 210 tubes arranged for push-pull amplification, their supply is from the low voltage winding on the power transformer and does not require a resistance, since the winding is designed for  $7\frac{1}{2}$  volts, which is the proper value for these tubes. The same holds true with regard to the filaments of the rectifying tubes, which are also provided with  $7\frac{1}{2}$  volts.

Instead of using an output transformer in the last stage, the designers considered the matter a little simpler if an output choke were used and the speaker connected across the outside terminals of this choke. This form of connection allows the operation of the speaker with a considerably reduced current passing through its windings and should be of interest to those

who wish to experiment with this and other forms of speaker coupling.

Upon inspection of the graphic illustration shown in Figure 2, the builder will notice that the 800,000 ohm resistor is sufficiently large to carry the maximum current which this amplifier may be called upon to use, and a sliding tap is provided on the resistor so voltage may be shifted either up or down to take care of any special value which the operator cares to use. The two 10,000 ohm variable resistances and the 2000 ohm variable resistance are of the Truvolt type and are variable so that different voltages than those specified on the terminals in this diagram may be secured if one wishes. It will be observed that only two of the connections on the socket in which the voltage regulator tube is to be placed are utilized, these being the positive filament and the grid terminals. The other two are left plain and if desired may be clipped off.

#### Makes a Neat Appearance

As is shown in the photograph in Figure 1, all of this material may be mounted for extreme simplicity and neatness of wiring. The wiring may be done either with flexible rubber covered or may be accomplished by using buss bar wire and short lengths of spaghetti wherever there is a possibility of wires crossing close to each other.

This particular unit has been tested out with several of the Infradyne receivers which have been described in previous issues of this magazine and has performed satisfactorily. It may be adapted to almost any of the receivers which we have described in the past and should give considerable volume without distortion, due to the fact that the tubes utilized in the push-pull stage are capable of taking care of any amount of energy which the ordinary receiver is capable of supplying them.

#### Be Careful of High Voltage

After the power unit is assembled and wired and is ready for test, care should be exercised that in working with the unit the operator does not come in contact with any of the high potential

wiring. A warning of this nature was not quite so necessary during the time that batteries were used for operating receivers, but in this day and generation when voltages on the order of 400 to 500 are being utilized, the builder should exercise considerable caution in playing around with an amplifier of this kind. It is also a good policy to thoroughly insulate the connection from the high voltage taps on the transformer, the leads to the filter condenser unit and the leads going to the various resistances. If the wiring is made with flexible covered conductor, there will probably be less chance of trouble, although if it is desired to do the job with buss bar, complete safety may be secured if spaghetti is used to insulate any lengths where possibility of trouble might arise.

The input terminal on the amplifier may lead to the plate terminal of any detector circuit. On those receivers using less than 45 volts on the plate of a detector, it may be necessary to reduce that voltage by means of the variable resistances shown in the sketch. The voltage regulator tube, if working properly, should have a purplish haze inside of it, which indicates that it is performing its function of being a drag on the circuit and thereby stabilizing the lower output voltages.

Construction of a power amplifier along the lines laid out in the article above should be quite interesting for the professional set builder, who has occasion to test a large number of receivers and who may use this amplifier to plug in on any receiving set which he may be testing at the time. A piece of flexible rubber covered wire may be attached to the input terminal on the power amplifier with a clip at the other end, which may be connected to the plate circuit of any detector stage and which will serve to tie in the two amplifiers. Under certain conditions it might be possible to connect up the power amplifier with a preceding stage of audio amplification, although unless the work is done very carefully too many stages of amplification might cause audio howling.

Power amplification needs but little introduction to the radio public, for no single feature in the field of radio has earned so much publicity as this recent development along the lines of better reproduction.

Bass notes require a considerable expenditure of energy. When we reason back and realize how much more mechanical energy it takes to sound the pedal diapason or the organ than the note of the violin, it is not difficult to appreciate that a correspondingly greater amount of electrical energy is required in the reproduction of these deeper tones. Consequently a radio tube with the capacity just sufficient to amplify comfortably the music of the violin cannot be expected to do justice to the tones of the heavier bass instruments. Hence the reason for a power amplifier that will give ample volume and no distortion.

#### List of Parts

The following parts were used by our laboratory in making up this power amplifier:

- 1—2098 Thordarson power transformer
- 1—2099 Thordarson choke unit
- 1—R200 Thordarson audio transformer
- 1—2408 Thordarson power input transformer
- 1—2420 Thordarson power output choke
- 1—703 American Electric condenser block
- 6—531 Frost sockets
- 2—Electrad 10,000 ohm truvolts
- 1—Electrad 2,000 ohm truvolts
- 1—Electrad 8,000 ohm fixed resistor 75 watts
- 1—Electrad 2,000 ohm fixed resistor 25 watts
- 7—Engraved Eby binding posts
- 6—Karas sub-panel brackets
- 1—12x16x $\frac{1}{4}$  inch sub-panel
- 1—7x16x $\frac{3}{16}$  inch engraved panel
- 1—Type UX171 tube
- 2—Type UX216B tube
- 2—Type UX210 tube
- 1—Type UX874 tube
- 30—Feet Corwico Braidite hook-up wire
- 1—Package Kester radio solder
- Miscellaneous screws, nuts, lugs, etc.

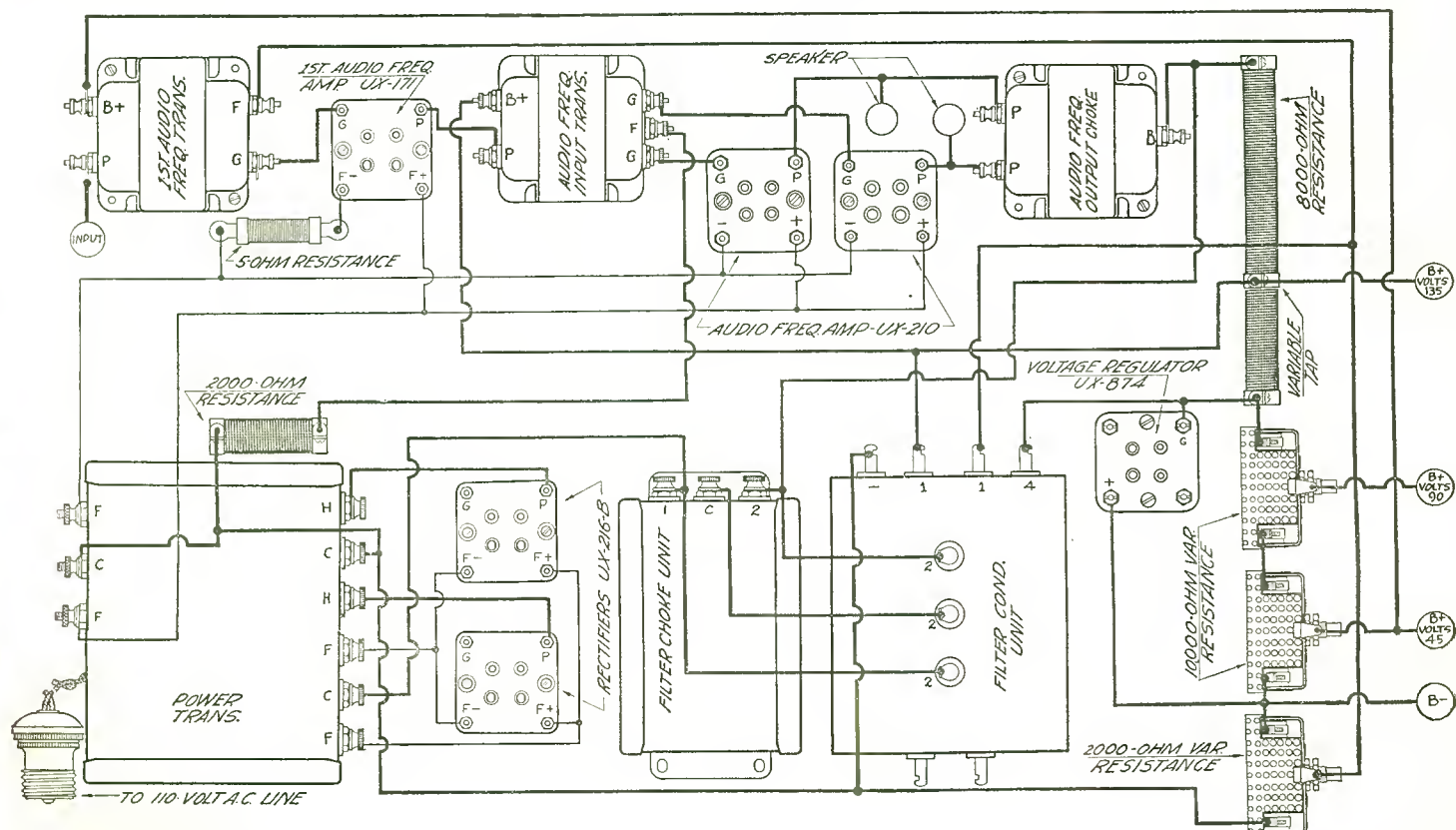

Figure 2. This graphic illustration will show the builder how each of the parts required for the construction of this power amplifier may be wired up. However, this diagram should not be consulted for the actual placement of the parts, since it is only arranged in the fashion shown above for simplicity for carrying the connections from one point to another

# Victoreen Universal Receiver

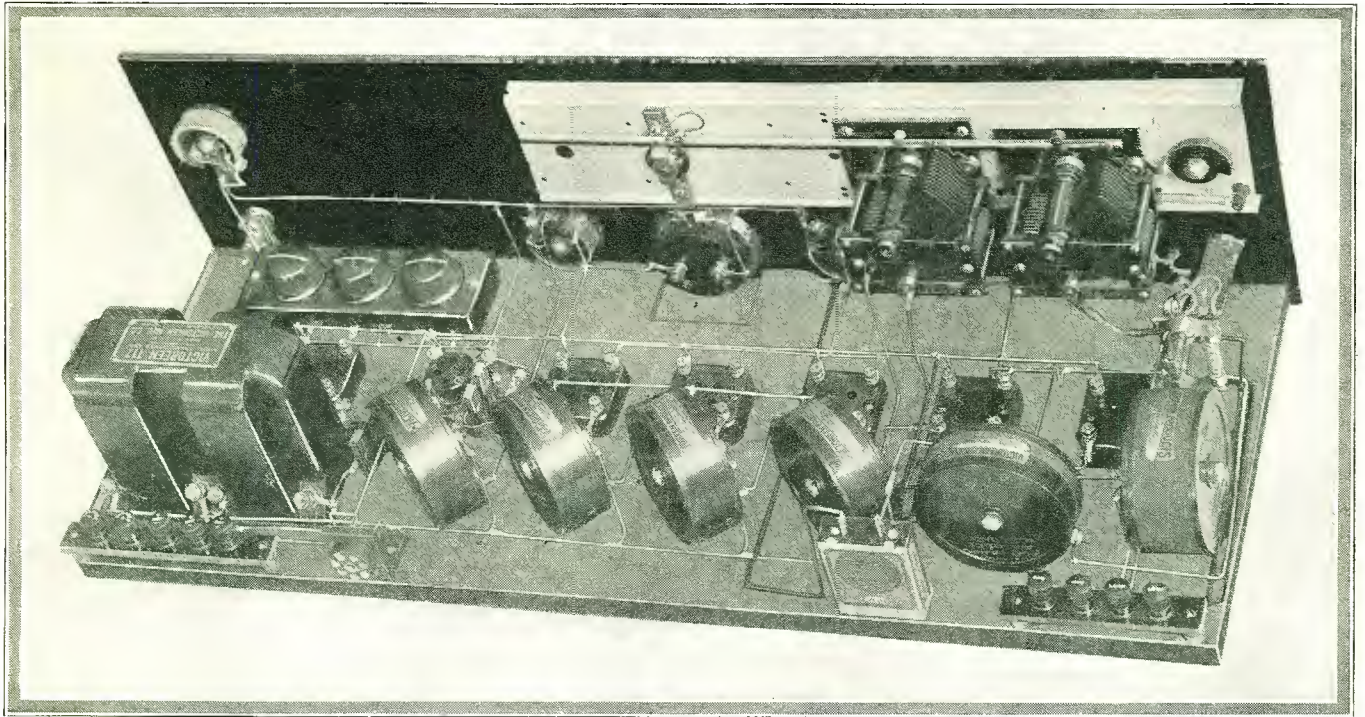

Figure 2. Simplicity of construction and symmetry of design are disclosed in the photographic rear view shown above

## New Audio Unit Especially Designed for Use of 112 Tubes

READERS of this publication on seeing the 1928 Victoreen Universal will feel as if they were greeting an old friend. It is easily recognized through its individual characteristics, with standardized layout and its simplified and harmonious panel arrangement.

Designed for single hand tuning, the number of controls has been reduced so as to make the finished receiver as simple as possible, consistent with a certain amount of flexibility without which the enthusiasts would be lost. Working either from a loop or from antenna and ground connections, the super about

to be described will readily fit in with almost any condition of operation.

In preparing the 1928 circuit diagram, considerable experimenting was done with various hook-ups of eight and nine tube combinations. However, the final experimental model has been based on Victoreen's already established hook-up, with the addition of new units which have been prepared for the coming season. Principal attention in this respect is directed to the audio frequency amplifier unit designed for use with 112 tubes. By standardizing on the well known Victoreen circuit arrangement,

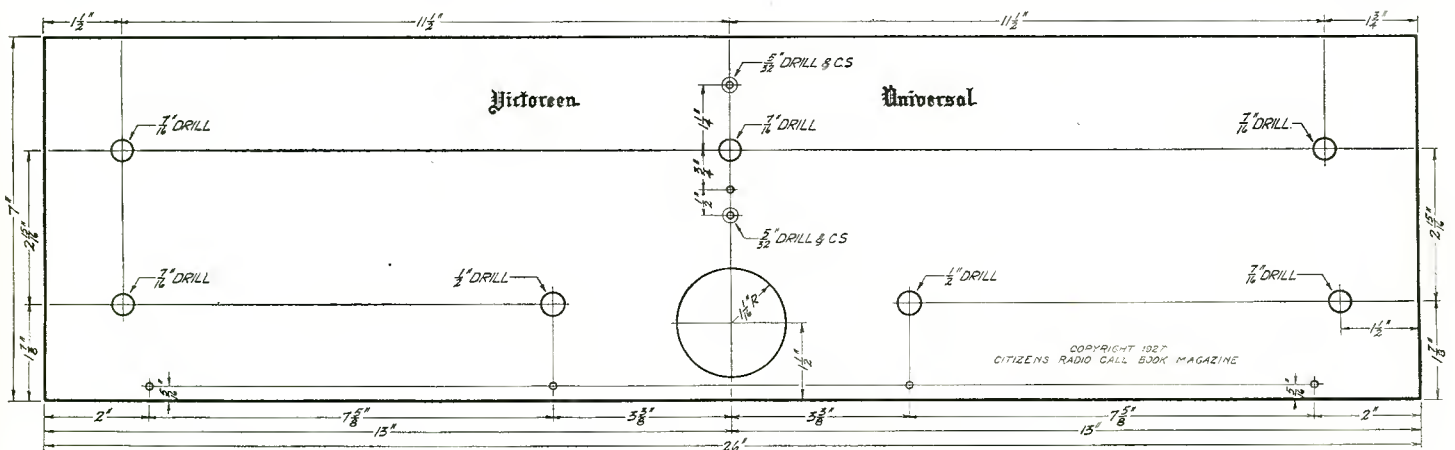

NOTE-UNLESS OTHERWISE SPECIFIED ALL HOLES ARE  $\frac{5}{32}$ \"/>

Figure 7. Front panel layout for this receiver is shown here and gives all dimensions and drilled instructions

(This receiver constructed, tested and all illustrations made in our laboratory)

many old fans are enabled to bring their receiver up-to-date by merely adding the new developments described.

**An Established Circuit**

Analyzing the circuit around which the present receiver has been constructed, readers will find it consists of an oscillator, first and second detector, three stages of intermediate frequency amplification and two of audio amplification. The layout of the set is clearly expressed in diagram figure 5, and all parts should be mounted thereby. As will be noted in the photographic view of the receiver shown in figure 2, all parts are readily accessible with connections being as short and direct as possible.

Consulting figure 3, which is the schematic diagram, we find a Yaxley No. 60 jack switch serving to transfer the input of the first detector on to antenna connection shown in the sketch, or else on the two terminals of a loop, depending upon the desires of the operator. The pick-up winding is located in the grid circuit of the first detector and is designated in the diagram referred to by the letters Z and Y. On account of using grid leak and condenser rectification in the first detector, the return for the pick-up coil is made common with the positive terminal of the socket, which is proper for a 201-A type of tube.

The output of the first detector, after having been mixed with energy supplied by the oscillator, is led through the first, second, third and fourth intermediate frequency transformers, all of these transformers being type No. 170 when used with storage battery tubes. When used with dry battery tubes, the No. 171 transformer is to be used:

**Use Proper Intermediates**

The basic factor in the success of any receiver is found in the selection and use of the proper intermediate transformers. The Victoreen r. f. transformers used in this model (which was built, tested and illustrated in our laboratory) make use of air core construction, being built over a 2-inch air core, permitting a minimum of wire to be used for obtaining the proper inductance value. The intermediate wavelength curve of these transformers is peaked at 3,400 meters or 88 kilocycles, which point was selected as it offers the least trouble with harmonics between stations. By a special adjustment at the factory interstage oscillation is overcome, the transformers are all sealed and no adjustments or matching of tubes is required.

Output energy from the intermediate train is fed to the second detector by the secondary of the fourth intermediate frequency transformer, where this energy is rectified by grid leak and condenser method. The grid return on this stage is also made to the positive terminal of the socket when using a 201-A tube. The audio output of the second detector goes into the special audio frequency amplifier unit No. 112 to the first audio and



Figure 1. When placed in a console the set takes on added attractiveness

thence through the second audio winding to the last tube, which is also a 112 power tube. The Victoreen 112 audio transformer unit consists of two stages of audio amplification in one case, and is designed to operate with two 112 power tubes or a 112 in the first stage and 210 in the second stage. This unit is the latest in modern audio amplification and is so designed that it enables a pair of unusually large core transformers to be placed conveniently in a set, and requires no more space than most two stage audios would use. The first and second stage transformers have been placed in a single case not only to conserve space, but also to insure the proper location and combination of these transformers. Their design is such that the tendency to set up a sustained howl through mechanical vibration has been almost entirely overcome. The unit meets the main requirements of an audio amplifier, inasmuch as its peculiar construction offers wide tonal limits with freedom from distortion. For correct operation of the audio unit, high plate voltages up to 500 volts may be employed. Such voltages, of course, would come only from the

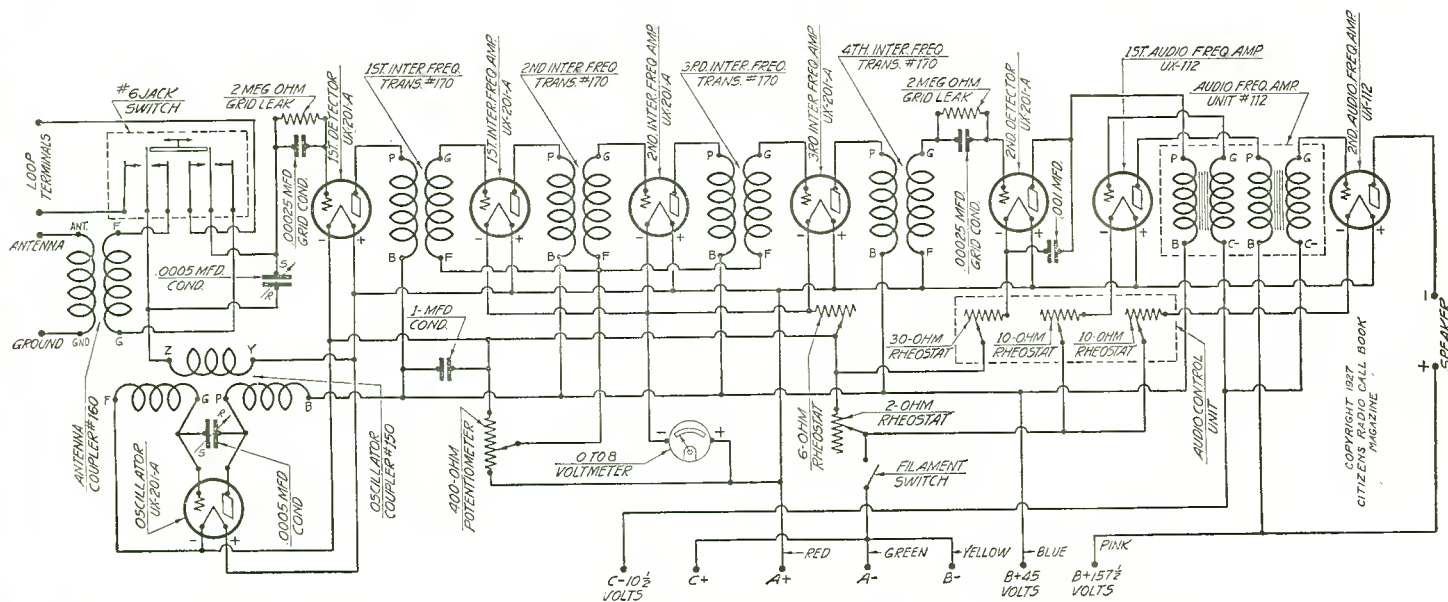

Figure 3. Electrical sequence is shown in this schematic which will serve as a guide for the experienced constructor

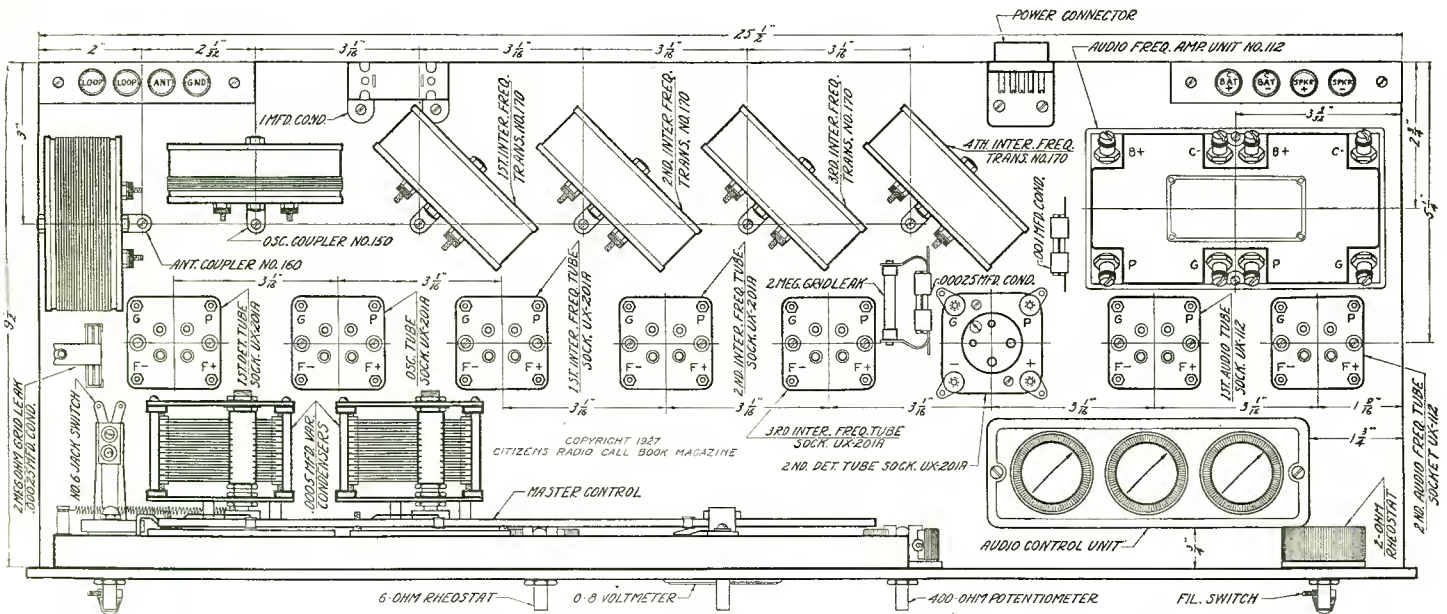

Figure 5. The above is a baseboard layout of the super and should be followed for position of all units. It is suggested intermediate frequency transformers be placed in the angle shown on this drawing

use of 210 power systems. However, this does not mean the unit will not operate with low voltages, for tests made in our laboratory showed very satisfactory results at 135 volts. The question of a 210 power system need not be alarming, for perusal of our columns will show a variety of forms that may be constructed and which will give undoubted satisfaction.

#### No Body Capacity

In the oscillator circuit two windings are shown, one being the grid filament inductance and the other the plate and plus B winding. Tuning of the oscillator is accomplished by a .0005 mfd. condenser with stator to the grid and rotor to the plate. Inasmuch as a master control is used, no body capacity results. Another condenser of the same size is used for tuning the grid circuit of the first detector, and this condenser is likewise made a portion of the master control unit, which consists essentially of two .0005 mfd. variable condensers mounted on an aluminum back plate controlled by a bakelite rack and operating on gears which control both condensers. By means of a compensator attached at one end of the panel on the antenna and loop condenser, an adjustment is provided which will allow for any variance in capacities between the lower and higher wavelengths. The master control unit does away with odd dial settings and allows one to log in accordance with a definite dial reading. In addition to this fact, of course, it must be remembered that since the two condensers are controlled by a bakelite rack, no body capacity will be possible when operating the set from the single control dial on the front of the panel. Filament control for the audio stages is through a Victoreen audio control unit, which requires no adjustment after once having been set for a given arrangement of tubes. The second detector may be controlled through a 30-ohm rheostat shown in the diagram as a portion of the audio control unit. This unit is located on the sub-panel and for that reason it is not considered as a control. A 6-ohm rheostat placed in the negative filament of the first, second and third intermediate stages allows a method of increasing or decreasing the amount of intermediate amplification. The first detector and oscillator are placed on a 2-ohm rheostat, which also supplies the audio control unit. Here again no adjustments are necessary after having once set the rheostats for the proper amount of filament voltage.

When using not to exceed 157 volts on the plate of the last tube, it is possible to use a speaker whose windings are directly in that circuit. However, if voltages in excess of 157 are used, in the interest of safety it is suggested an output transformer be used. Or if that system of coupling is not desired, at least use an output choke and condenser coupling so as to isolate the

battery current from the speaker windings.

Filament voltage on the intermediate train may be ascertained with a Jewell O-8 voltmeter, which is placed across the positive filament line, and the tube side of the 6-ohm rheostat for controlling the intermediate filaments. Be sure to run these tubes at the values specified by the manufacturer for that particular type of tube.

Regeneration can be incorporated into the Victoreen, but the receiver is so sensitive and selective without regeneration that it has not been deemed advisable to incorporate it in this case.

Regardless of the care that may be taken in the manufacture of the individual parts, there is always a chance of damage in transit. Before you assemble any of the transformers or condensers in your receiver test them out with a battery and voltmeter to be sure there are no open circuits in the transformers or any short circuits in the condensers.

#### Check All Connections

Success and satisfaction are assured if you have followed directions, but it will help to give a few final words of caution as to possible troubles which may develop.

One poor connection is enough to spoil an otherwise good set. Check each connection carefully to be sure they are all good.

Check up on your batteries occasionally to be sure they are in good condition.

Have your tubes tested in a standard tube tester. The fact that they light up is not always an indication that they are up to the mark. It is important that all connections be made as described in this article. Shifting the rotary and stationary plate terminals on the oscillator condenser, for instance, might cause body capacity effects.

A ringing noise which gradually builds up in volume may be due to a defective tube in the second detector tube socket. Change the tube to another position. In many cases a tube that will not function well as a detector will be all right in another position.

Due to the congested condition of the wave bands below 300 meters, reception of such stations is sometimes very difficult because when one or more of them are slightly off their wavelength interference results in distortion.

Maximum selectivity and volume can be obtained by setting the potentiometer arm at a point about one-quarter of the way from the negative potentiometer terminal and obtain further volume control with the r. f. rheostat.

#### To Tune the Receiver

Tuning of the receiver is a simple operation, much easier than the tuning of the conventional five tube receiver.

Either the loop or an outside aerial may be used. The only



adjustment necessary to shift from loop to outside aerial is a simple twist of the knob of switch jack. The switch jack marker has two positions, one reading "On" and the other "Off."

Turn on the "A" battery by turning the battery switch to the "On" position; adjust rheostat until the voltmeter reads 5 volts for storage battery tube or 3 volts for dry cell tubes. Set the potentiometer at the middle position and the intermediate frequency tubes rheostat as far as it will go in a clockwise direction. Also set the audio rheostats as far as they will go in a clockwise direction. Then start tuning with the main tuning condenser dial until you hear a station to best advantage. A slight adjustment of the compensating knob will clear up the station.

A loop's inductance may be of such value that it cannot be properly tuned with a .0005 condenser. This can be determined by the position of the compensator knob when tuning in a station of medium wavelength. If this knob must be turned a considerable distance to the left of the center position to bring in the signal to best advantage, the need for additional turns on the loop is indicated; if to the right, turns should be decreased. The same result can be accomplished by shifting the rotor of the loop condenser one tooth on the gear rack in the direction in which the arrow on the compensator knob varies from the center position.

**Volume Control**

Increase in volume is accomplished by varying the r. f. rheostat with potentiometer arm toward the negative terminal of the potentiometer. The knack of tuning will come to you after a little experimenting with the control. Slight readjustment of the rheostats and potentiometer will bring in the signals to best advantage, but always remember to keep the voltmeter at the rated voltage of the tubes or slightly less by use of the master control rheostat.

The use of the outside aerial is not recommended in very congested districts where a large number of stations are broadcasting. It is for use in such districts only in going after distance when the locals have shut down. You will find that the loop will give you all the distance reception you want with plenty of volume.

and greater freedom from interference.

If you use an outside aerial be sure to make it no longer than about fifty feet, including length of lead-in. A larger aerial will prove to be a collector of undesirable interference.

**List of Parts**

Parts used below were used in our experimental model. If other parts are used be sure their equivalent is secured.

- 1—Lignole 7x26x3/16-inch drilled and engraved panel.
- 1—Wood baseboard, 9½x25½x5/8-inch.
- 1—Formica 5/8x5x3/16-inch terminal strip.
- 1—Formica 5/8x4x3/16-inch terminal strip.
- 1—Victoreen 2.2-ohm rheostat.
- 1—Victoreen 6.6-ohm rheostat.
- 1—Victoreen 400-ohm potentiometer.
- 1—Victoreen master control unit.
- 1—Victoreen audio control unit.
- 1—112 Victoreen audio frequency transformer.
- 4—170 Victoreen intermediate frequency transformers.
- 1—150 Victoreen oscillator coupler.
- 1—160 Victoreen antenna coupler.
- 1—10 Yaxley battery switch.
- 1—60 Yaxley jack switch.
- 7—530 Frost sockets.
- 1—9040 Benjamin socket.
- 2—Electrad .00025 mfd. grid condensers with clips.
- 1—Electrad .001 mfd. fixed condenser.
- 1—Electrad 1.0 mfd. by-pass condenser.
- 2—Electrad 2-megohm grid leaks.
- 9—Eby engraved binding posts.
- 1—192 Marco O-100 vernier dial.
- 1—135 Jewell O-8 voltmeter.
- 6—Ceco type A tubes.
- 2—Ceco type F tubes.
- 30—Feet Belden No. 14 tinned copper hook-up wire.
- 1—Package Kester radio solder.
- 1—Ekko ground clamp.
- Miscellaneous lugs, nuts, screws, etc.

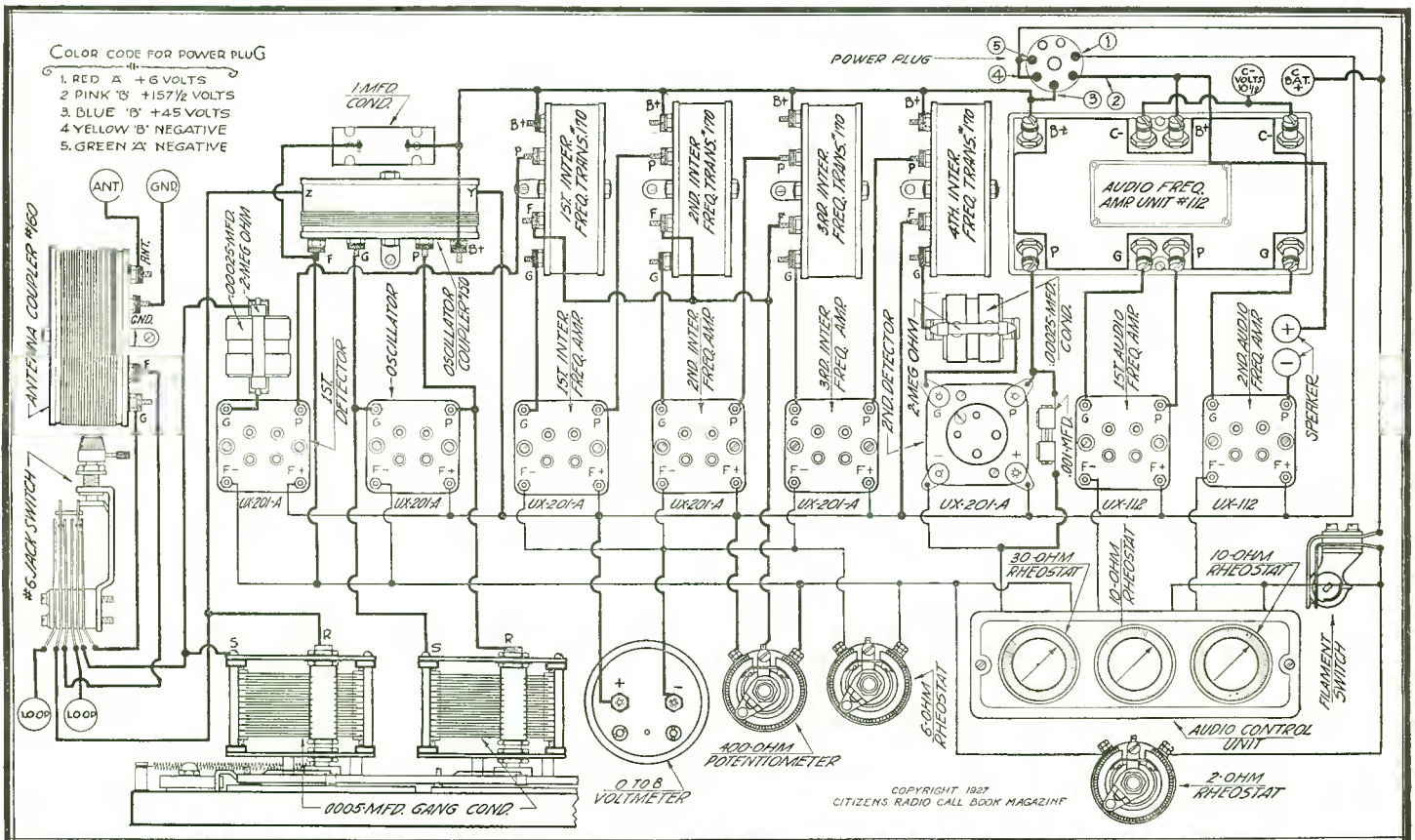

Figure 4. Graphically this illustration shows how each connection is made in the Victoreen receiver. Do not use this diagram as a means of laying out the set. It is intended only for wiring purposes

# Operating Hints on Karas 2-Dial Equamatic

This Receiver, Described in Our September Issue, Is Unusually Efficient Because of Automatically Variable Coupling

**I**N the constructional article which appeared in the September issue, no detailed instructions were given regarding adjustment of the variable coupling system to produce maximum results. Experiment has shown that in general excellent average efficiency could be obtained by mounting the primary and secondary coils at one particular angle. This angle was marked directly on the assembly sub-panel of the Equamatic receiver.

It is a recognized fact, however, that all receivers constructed from the same description will not necessarily be alike. Unusual local conditions, different tubes, etc., all tend to account for differences in operation and in the requirements. It therefore follows that the preliminary adjustment of the coupling coils indicated by the engraved mounting line on the sub-panel will not give maximum efficiency in every case, but it will provide extremely high efficiency—far higher than would fixed coupling for instance.

## Getting Best Results

In making the adjustment of the coils there are two factors to bear in mind. If provision is made for too close coupling the selectivity of the receiver will suffer. On the other hand if the coupling is too loose there will be a falling off of sensitivity. With the automatic variable coupling provided by the Equamatic coupling units a degree of coupling can be obtained which will provide plenty of selectivity and at the same time permit a sufficiently large transfer of energy between stages to make the receiver highly sensitive to weak signals.

The Equamatic coil adjustment can be made in three different ways. First, the secondary coil of the coupler may be moved toward or away from the primary coil (which is mounted on the extension shaft of the tuning condenser); second, the secondary coil may be swung around to any angle; and third the primary coil may be turned on its pivoted mounting.

If the secondary winding is swung around to a position where it is parallel with the front panel of the receiver then there can be no change of coupling as the primary coil is rotated no matter at what angle the primary is set because the primary winding always maintains the same angle in its relation with the secondary winding. If the primary is adjusted to a position where its winding is parallel with the front panel, then the coupling between it and the secondary coil will remain fixed, regardless of the angle at which the secondary coil is set. To obtain a variation in coupling with the tuning of the receiver therefore requires that both secondary and primary coils be so adjusted that neither will be parallel with the front panel.

## When to Adjust

The second rule is that the primary coil should always be adjusted so when the tuning condenser to which this coil is attached is set at 100 on its dial, that is, with its plates entirely meshed, the primary winding will parallel that of the secondary. To carry out this rule it is advisable to make all coil adjustments with the condenser plates entirely meshed, and to adjust both coils at the same time, keeping them always parallel with one another.

Actually the only purpose of making the primary coil adjustable is so it can be adjusted to parallel the secondary coil winding. Adjustments for different degrees of coupling are always made with the secondary coil. The mounting used to attach the primary to the extended shaft of the variable tuning condenser is not an adjustment. The mounting bushing should be slipped over the condenser shaft with the set screw uppermost, and with the condenser plates entirely meshed, and the set screw should be tightened when in that position.

The logic of this second rule will be clear when it is realized maximum coupling is obtained when the two windings are parallel, and that at the high wavelengths the maximum coupling is necessary. If because of severe local interference for instance, it is desired to provide slightly looser coupling on the higher wavelengths, it is accomplished by sliding the secondary coil away from the primary coil. The secondary coil brackets are mounted under spring washers and can be slid away from the primaries without changing the mounting screw which projects through the sub-panel. Usually it will not be necessary to make this change except in the case of the first coupling unit, that is, the transformer between the antenna and the first tube, and then only where a very long antenna is used.

The difference in coupling obtained by tuning from the high to the low waves will depend upon the angle at which the secondary coil is placed. If the secondary is placed so that its winding is parallel with the front panel then there will be no variation of coupling, as explained above. On the other hand, if the secondary is placed at an angle of 45 degrees to the front panel, and the primary is set at this same angle with the condenser plates fully meshed in accordance with rule two above, then the coupling will vary from maximum when the receiver is tuned to the highest wavelengths, to zero when the receiver is tuned to the lowest wavelengths.

## Coupling Always Right

From this discussion it is evident that if just the right angle is found for the secondary coil the coupling will be just right at all wavelengths. At the highest wavelengths there will be the required maximum coupling while at the low waves, where less coupling is required, there will be proportionately less. This ideal angle is the one indicated by the line on the sub-panel.

In some cases this ideal coupling variation may not be the best, however. Where there is a powerful local broadcasting station that causes unusually severe interference on the lower wavelengths for instance it may be advisable to increase the secondary angle slightly, thus providing greater selectivity through the looser coupling obtained at the low waves. Or perhaps the tubes used in the radio frequency amplifier stages are not standard and show a greater tendency toward oscillation than standard tubes. This oscillation will take place only on the low waves and can be eliminated by slightly decreasing the low wave coupling as above.

## Fits Local Conditions

In any case the flexibility of the preliminary adjustment of the coupling system is such that it can be adapted to any unusual conditions that may exist in any particular receiver or installation. This 2-dial Equamatic receiver is therefore not only capable of providing unusually high efficiency in reception, but can be fitted exactly to local conditions or requirements.

There is just one more word to be said about the adjustment of the coupling. The second and third coupling transformer in this receiver should be adjusted alike. Inasmuch as these two coupling circuits are tuned by a single control, the values and characteristics of the circuits must remain exactly alike. A change in the coupling adjustment of one circuit but not in the other would throw the two out of balance, but if any change in the angle or location of the secondary coils is made in both stages alike, the circuit values will also change alike and the proper balance will be maintained.

The first coupling circuit may be adjusted individually inasmuch as it is tuned by its own individual condenser.

# Magnaformer 9-8 Receiver Now Operated From Alternating Mains

Tonal Fidelity, Selectivity and Ample Volume Available in Popular Set Recently Converted to New Filament System

**M**ANY of our readers who have built the Magnaformer 9-8 receiver described in the September issue of the Citizens Radio Call Book Magazine, and are now interested in taking advantage of the possibility of electrifying their set in accordance with the latest practice made possible by the introduction of the alternating current tubes, will doubtless be gratified to know such a thing is not only possible but eminently practical, as will be shown further in this article.

Recent tests conducted by our laboratory staff have demonstrated that with the proper type of alternating current tube just as good, if not better, operation of a receiver may be expected from the employment of the new a.c. tubes as was secured with the storage battery type. The main reason for the conversion of the receiver to complete electric operation may be seen when one considers the amount of interest which the radio public is manifesting in the more advanced forms of electrification as have been demonstrated within the last few months.

## Heater Type Used

When the electric tubes were first announced there appeared to be some doubt as to the extent to which they could be utilized, but since more extensive research has been made on the subject it has been ascertained that certain of the tubes, notably the a.c. heater type, may be adopted to any form of circuit arrangement with excellent results. Being satisfied that these new tubes will perform properly, the conversion of the Magnaformer 9-8 to

alternating current operation has been relatively simple. Aside from a few physical changes involved in drilling holes for the five-terminal sockets carrying the Magnatron heater type tubes no alterations have been required. The result is a receiver which is entirely independent of batteries for filament operation and which may be used with either B eliminators, plate power units, or dry B batteries, though in the latter case the current drain might be considered rather heavy.

Assuming the constructor, who already has built the Magnaformer described in our September issue, desires to make the change from d.c. to a.c. operation, we will describe the steps involved in drilling sub-panel holes for the new Benjamin 9037 sockets for the five prong tubes. Take the template which accompanies each 9037 socket and, before the socket is removed from the template, mark the reverse side of the template exactly in accordance with the socket terminal markings. These terminals are: K, H, H, P, and G, the K connection being the additional terminal and representing the cathode terminal of the type 227 heater tube. Then remove socket from the template. Place template on the under side of the sub-panel in normal wiring position over the one inch socket hole, with the markings K and G to the left. Line up the center of the hole on the template marked G with a point 3/16 inch from the G terminal hole in the standard sub-panel. Now mark with a prick punch the centers of the five holes to be drilled. Use a No. 20 drill. This will place the K terminal and one H terminal of the template in line across the

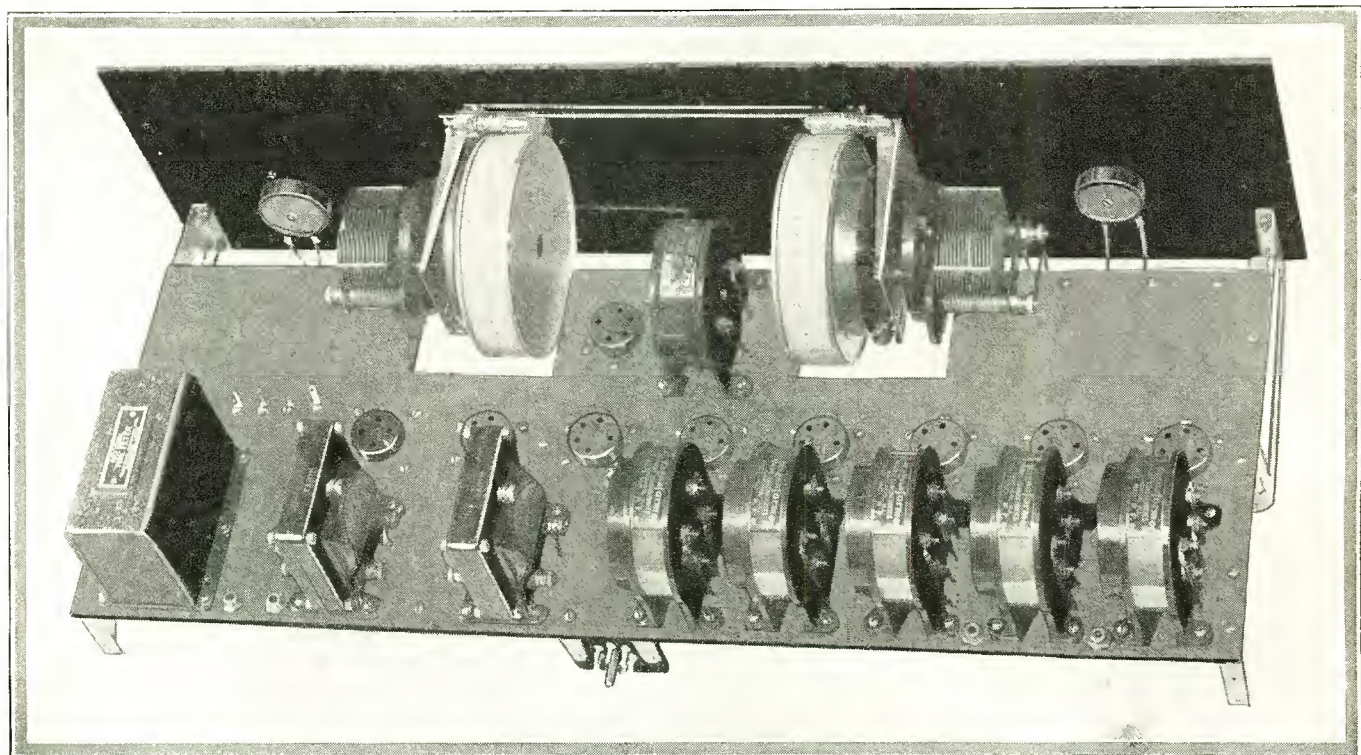

Figure 2. Set builders duplicating this receiver may well feel proud of their work, since it is a worthy model

(This receiver constructed, tested and all illustrations made in our laboratory)

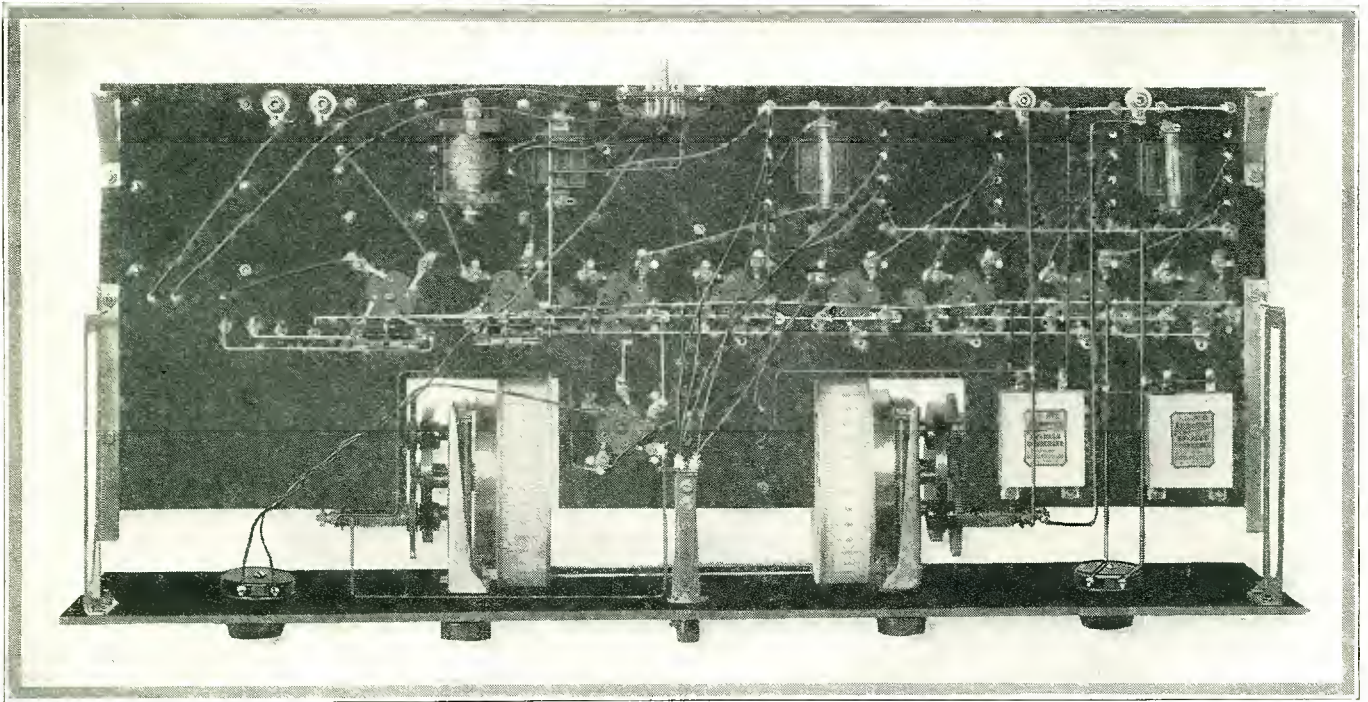

Fig. 5. This photograph shows the bottomview of the set described in this article

panel for all eight sockets. Drill the holes for mounting each of the remaining 9037 sockets in the same manner.

This work finished, the constructor may rewire the heater and cathode connections as shown either in the schematic diagram which accompanies this article, or in the event he is not able to read a schematic the wiring may be done by means of

the graphic illustration. The schematic is shown in Figure 3 and the graphic in Figure 4.

Features of Set

For the benefit of new readers who are constantly being added to our ranks it might be interesting to describe some of the

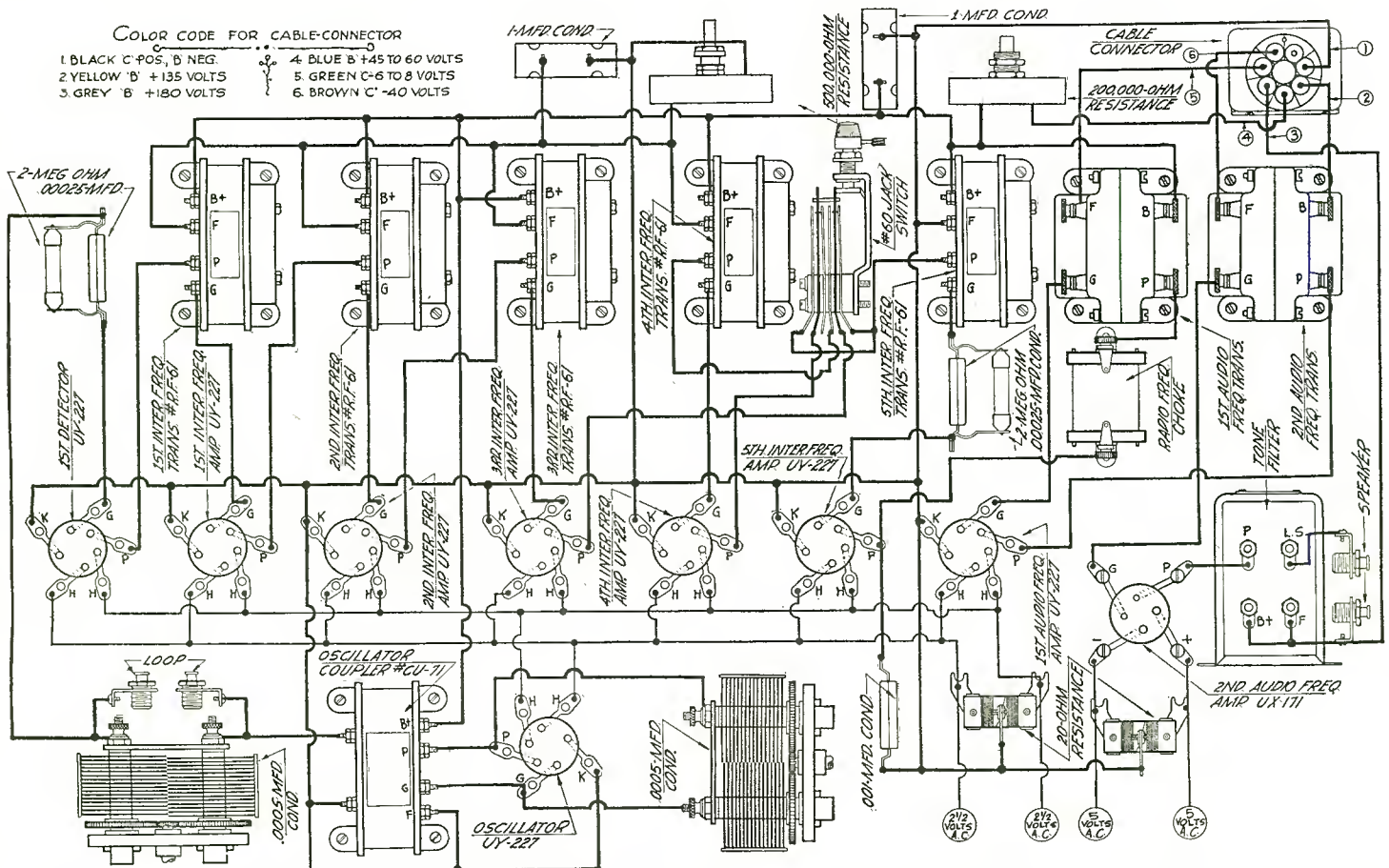

Figure 4. Graphically the above illustration shows the builder exactly how all connections should be made, either to duplicate this set or to convert the one described in the September issue to A.C. operation

features of the Magnaformer 9-8 A.C. The schematic circuit which is the index of any receiver, shows the conventional super-heterodyne circuit with such changes as are necessary to allow its operation from the alternating current mains. One of the features which should prove valuable to the operator is the use of a jack switch by means of which it is possible to cut in or out the third intermediate frequency stage, thus permitting the operator to use the Magnaformer either as an eight tube set or as a nine. The graphic diagram shows the correct connections to make for wiring up the switch. This flexibility may be of advantage when the highest amplification is not desired so as to reduce the volume, of which there should be ample even on the eight tube combination.

Five stages of intermediate frequency amplification are used, all of which are of the air core type. At this point we believe it would be a good place to describe these particular intermediates, since they are constructed in a different manner from the conventional long wave coils. In the first place the secondary and primary windings are on a Bakelite spool, the wire being thoroughly impregnated with wax so it may not be affected by moisture or humidity or other climatic changes. Across the secondary is placed a metal plate. Another metal plate goes around both the secondary and primary coils, the two metal plates being connected to each other. On the outside of the first metal plate, the one which goes across the secondary coil, is placed a Bakelite insulator which contains a small variable condenser. This condenser is used to tune the secondary coil to exactly 69.73 kilocycles, which frequency value represents a wavelength of about 4300 meters. After coils are peaked at the wave length they are aged, retested for wave length, aged again and given a final check for accuracy of their response peak. The effect of peak construction, shielding and placing of the tuning condenser outside the field of the coil, results in preventing oscillation of the tube with which the intermediate is associated, thereby gaining considerable in intermediate amplification. With all coils peaked at the same value, it follows the response for the entire train should be the desired width as far as the frequency band is concerned, and should deliver to the second detector all of the required sidebands for producing tone fidelity which is a characteristic of the receiver under discussion. Two stages of audio frequency amplification in conjunction with a tone filter serve to complete the amplifying system.

**A.C. Filament Operation**

Whereas in the storage battery operated type of tubes it has always been possible to use the filament circuits as an oscillation or regeneration control, this method of governing the electronic emission of a tube is not considered wholly satisfactory when

(Continued on page 200)

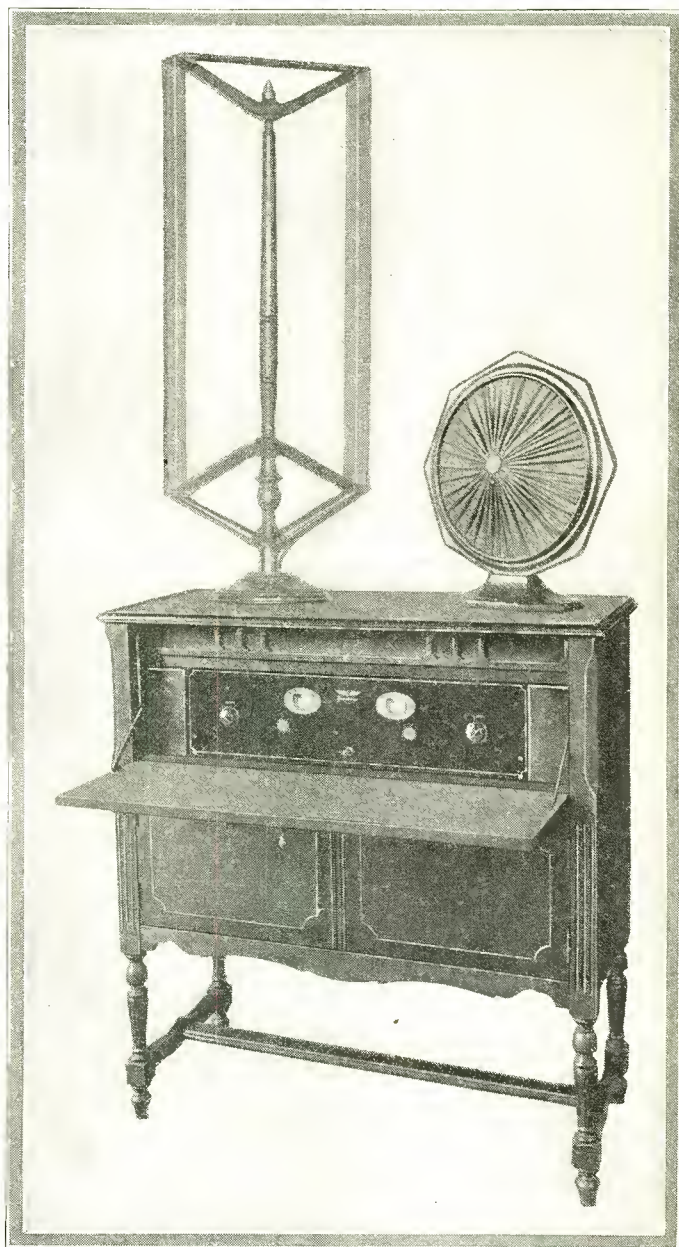

Figure 1. Placed in an attractive console, the Magnaformer 9-8 A.C. is described for operation with a Qualitone loop

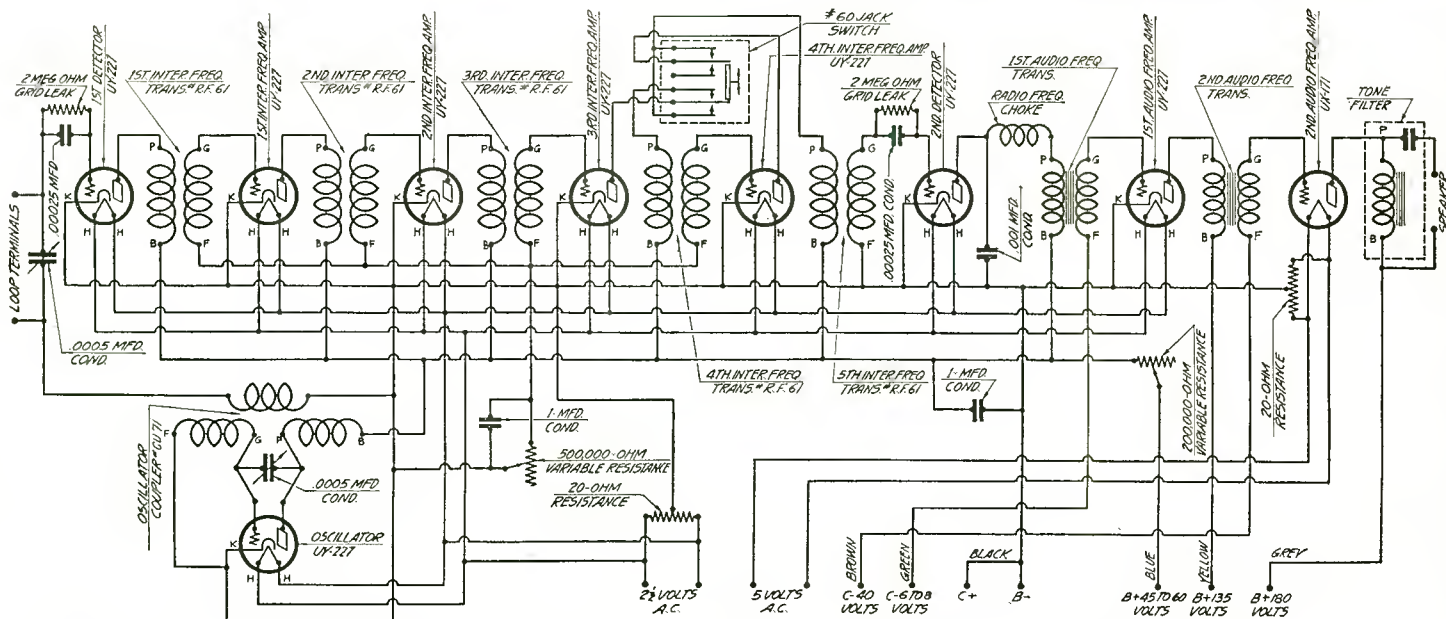

Figure 3. Study the schematic circuit carefully, paying attention to the filament lines which are now arranged for the use of alternating current

# Building Three-Foot Cone Speakers Surprisingly Easy

Two Outstanding Products Are Assembled and the Various Steps Described

**R**EADERS of this magazine have quite frequently called upon our editorial department for an article on the construction of a cone speaker. In response to these demands it was decided to take the products of two well known manufacturers, build up the units, and detail, for the benefit of our readers, the necessary steps in such construction work.

Frankly we do not know of any more pleasant way of spending a part of an evening than to build up a cone speaker from a kit. The time involved in doing this work is short, the task is not in any manner tedious, and the finished product should make any builder proud of his prowess as a maker of cones. Not more than forty minutes time is expended by the builder in the actual making of the speaker, although for best results the cement used in fastening the edges should be given ample time to set and dry.

Aside from the parts which are contained in the kits, nothing but a pair of scissors is required. To give the reader an idea of the parts which are contained in the two kits, we are listing them herewith.

## G.R.P. No. 3 Kit

This kit contains decorated genuine Phonotex 38x38 inch for front cone, marked genuine Phonotex 38x38 inch for back cone, G.R.P. cone speaker unit, G.R.P. back ring, latch, nuts, bolts, washers, edging braid, cone apex assembly complete, G.R.P. Ambroid cement, G.R.P. No. 3 unit mounting, rubber bumpers and adhesive fabric.

## The Ensco Kit

This kit contains an Ensco unit completely assembled, a sheet of decorated and marked Alhambra Phonotex paper, metal apexes, wall plate, adjustment wrench and extension pin.

It will be observed that two different types of speakers are illustrated and described in this article, the G.R.P. cone being of the double type, that is, using a front and back cone, whereas the Ensco is a single cone using only the front section. Thus these products take into consideration the desires of constructors for building either type. Some individuals have a preference for the double cone, while others choose the single cone. Possibly

a few minutes longer is taken in constructing the double cone because of the fact the front and back cones must be cemented together. As far as the operating conditions are concerned, both cones will prove very interesting to the builder, since the quality of the music is considerably improved by cone speaker operation.

## How It Is Done

In constructing the Ensco Three Foot Cone, after laying the Phonotex sheet down flat and reading the instructions which are marked on the paper itself, cut out the circle on the marked outer line. Then cut the segment as shown. This leaves a flap for pasting the cone in shape. When the cone is ready to paste, take a blunt instrument, such as the back of a knife, and score the line marked "bend on this line." This allows the edge to be turned back when the cone is completed. Now, pull the cone partly into place so that the edge fits over the space marked "glue here," spreading a thin coat of cement. Be sure to pull the cone into shape with due regard to the style to be used. If the wall or pedestal type is to be made, the design should be on the outer or convex side of the cone. Turn the sheet with the design downward and proceed to paste by spreading glue on the back cone. Now press the edges together by pressing gently at the seam; start at the inner apex and work outward. Allow cone to dry for a few minutes and then paste in the small cone, which is cut from a corner of sheet and which is also plainly marked. This small cone goes on the inner apex when a pedestal or wall cone is made and on the outer apex when the console type is built.

The small cone makes the large cone rigid. When the cone is completed lay it face down and bend back the edge on the scored line.

## Attaching the Unit

Figure 2 shows the rear view of a completed wall type speaker. The Ensco contains a metal frame consisting of three or four dowels matched to a block. The four dowels are inserted in the block and glued in place so that each leg is the same length. By inserting the opposite sticks first and sighting through the other



*Figure 1. This photograph represents the G. R. P. completed cone speaker and gives the reader an idea of its pleasing appearance. Even the young lady who is holding it seems to be quite proud of the results*

two holes, the two can be brought to the exact center and glued. The other two should then match perfectly. The unit is then mounted and fastened by two screws through the mounting plate. For wall mounting a cord is attached to two dowels about half way to the center. When mounting the unit, be sure that the drive pin is in line with the center of the cross stick. Next attach the drive pin extension and mounted cone. The cone is clamped to the drive pin extension with the two metal apexes and two nuts. A detail of this may be seen by consulting the upper part of Figure 5. One apex is placed on each side of the main cone apex. The center should be mounted in such a way that the bent-up flange rests lightly on the arms of the frame without putting any strain or tension on the pin. The flange of the cone is now attached to the arms of the frame with four thumb tacks.

Figure 5 shows the Ensco unit, whose single magnet is made of high grade tungsten steel, marked as NS in the sketch. The air gap, G of the unit, is located at the center of the coil C, magnetic leakage thereby being reduced. The only adjustment necessary is to regulate the air gap. If the cone chatters, the gap is too small. A slight turn of the nut A in a clockwise direction facing the back of the speaker will open it. If the cap is too wide, the volume will be low. Nut A is then turned about one-eighth of a turn in the opposite direction.

The speaker will operate on any sets using 90 to 180 volts, may be used in conjunction with all types of tubes, including the 171 and 210. However, on voltages in excess of 180, an output filter or transformer should be used.

**Making the G.R.P. Cone**

Having built one cone of the type described just above, the reader is now ready to construct another one, this time the G.R.P. being selected for construction.

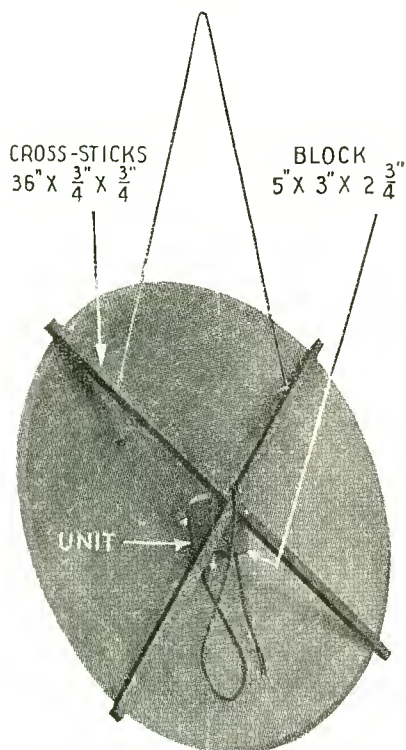

Figure 2. In this photograph is shown a rear view of the Ensco wall speaker. The dimensions of the frame are shown in this illustration

While it is a simple matter to assemble the G.R.P. three foot double cone speaker, it is still necessary to use a little care for which you will be amply repaid by a better looking and more workmanlike job than if you tried to hurry the speaker to com-

pletion. One of the first things is to read the directions accompanying the kit, so that they are thoroughly understood before starting the work. If you are not quite certain in your own mind as to the exact method of doing this work, read the instructions over a second time.

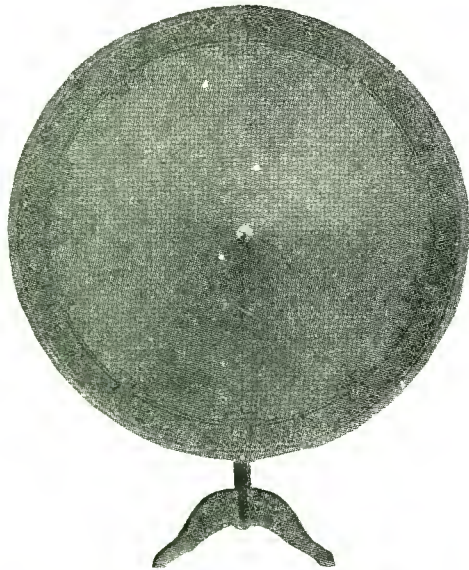

Figure 3. In making the G. R. P. speaker the back cone is weighted. With one finger preventing the cement from seeping between the cones, apply the Ambroid cement around the circumference of the back cone

Then remove the Phonotex from the tube in which it is packed, doing this carefully so as not to tear the edges or crack the sheet. Flatten out both sheets by rolling them the opposite way from which they were rolled. If the roll is made too tightly, the sheet may crack. Take the sheet marked "back cone" and with a pair of shears cut out the cone along the solid lines marked on the sheet. Do so carefully so as not to tear the edges. Next lay the Phonotex for the front cone with the decorated rough side down. With a sharp knife or pair of scissors, carefully cut out the wedge-shaped piece. Do not at this stage of the assembly cut away anything else from the front cone. A newspaper or sheet of wrapping paper may be placed under the wedge-shaped opening and between the two cones before going ahead with the work. Place the cut out back cone on the front cone, the smooth side of the back cone against the smooth side of the front cone along the dotted line of the front cone which is so marked. You will observe three arrowheads printed on each of the cones and marked X, Y and Z. The arrowheads on the back cone should exactly meet those on the front cone and the back cone should fit exactly into the circle made by the dotted line. When you have placed the back cone, properly hold it in position by putting weights on it, books, flatirons, or other heavy objects with smooth surfaces.

The reader is now ready to join the two cones with Ambroid cement. Place the spout top on the Ambroid can and start cementing the back cone to the front cone at one tip end of the back cone. This is illustrated in Figure 3, where the cementing

work has just been started. With the fore finger of the left hand holding the back cone tightly against the front cone, so the Ambroid cannot seep in between the two edges, slowly place a thin stream of cement directly around the circumference of the back cone. Work slowly so as to give the cement an opportunity



**Figure 4.** This photograph shows an Enesco speaker mounted on a pedestal. The same speaker may also be used for wall mounting if desired

to set before removing your finger. Fanning or blowing on the cement will add in hastening its setting.

When you have gone completely around the back cone the first time, start it over again, this time placing the tip of the spout about one-eighth inch in from the edge of the back cone. Make sure that the Ambroid flows over the edge of the back cone on to the front cone, so as to join the two solidly all the way around. Also be sure to allow ample time for the cement to dry thoroughly. With the cement thoroughly dry, it is then possible to cut away the remainder of the front cone carefully along the solid line.

#### Reinforcing the Cone

In one corner of the cutaway sheet you will find a diagram showing a small cone marked "reinforcing cone." Cut this out along the solid lines, spreading a little cement on the flap, bringing line one over to line two, smoothing it down and holding

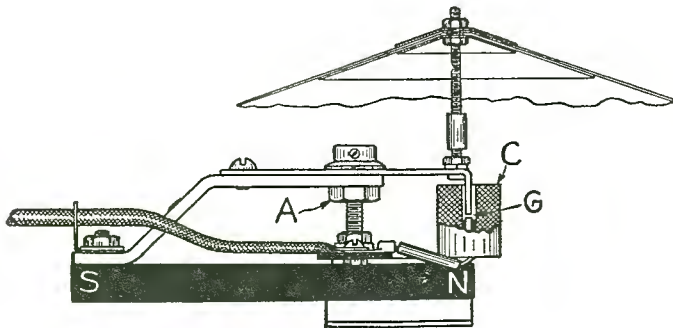

**Figure 5.** In this sketch are shown the details of the Enesco unit and the driving rod

until the Ambroid dries. Your next step is to put the back ring on to the back cone. This can be done immediately after you have cut away the excess from the front cone. Removing the

spout from the cement can, pour some of its contents on one side of the back ring, spreading evenly and thinly over the outer line of the back ring. Do not let any cement get on the cross arm. Then press the back ring into position indicated for it on the back cone, laying heavy weights thereon and allowing sufficient time for the cement to dry thoroughly. By consulting Figure 6 in this article, you will find how the back ring latch is fastened to the back ring. With a nail or other pointed instrument, punch holes in the Phonotex through the holes in the back ring. The back ring latch goes on the back ring on each side of the slit. There are holes in the back ring so the constructor can not go wrong. Over each of the five brass bolts to fasten the back ring latch slip a brass washer. Bring these brass bolts through from the inside of the back ring. Run the nuts down, secure tightly and clip off the excess portion from each bolt. The edging braid should now be applied before the cone is shaped and may be done in the following manner: Secure about a dozen spring clothes pins for use in holding the braid on the circumference of the cone. Half of the braid should be on the front and the other half on the back of the cone. Spread a little cement on about a foot of the braid and then start at the seam, using a clothes pin to hold the braid at the seam, and right next



**Figure 6.** To close the back ring and shape the G. R. P. cones, hold as shown in the illustration, then slip the ring over the hump and close the latch

to it place another clothes pin, and so on until the clothes pins have been used. Allow about five minutes for the cement to dry and then remove the first eleven of the pins, allowing the other to remain in place. Repeat this process until the braid has been cemented around the entire cone.

Your cone is now nearly finished. Only a few more minutes of work and it will be ready for operation. After the cones have been shaped, the latch closed, and the cross arm fastened to the back ring, you are ready to mount the unit into the cone, instructions for which accompany the unit. Next the G.R.P. cone speaker unit should be inserted in the speaker, being sure to follow the instructions given in the circular which comes with the kit.

When the cone speaker is completed, it should be plugged into the set. The G.R.P. cone speaker has an adjusting screw, which should be turned slowly to the right or left until the speaker operates at maximum efficiency, when the set screw in the side of the chuck should be turned up until it engages securely the driving rod. After this is done, no further change is required.



# Lapeer A R 9 Super Uses Double Detection System

Intermediates Made in Form of "D" to Reduce Coupling Effect on Each Other

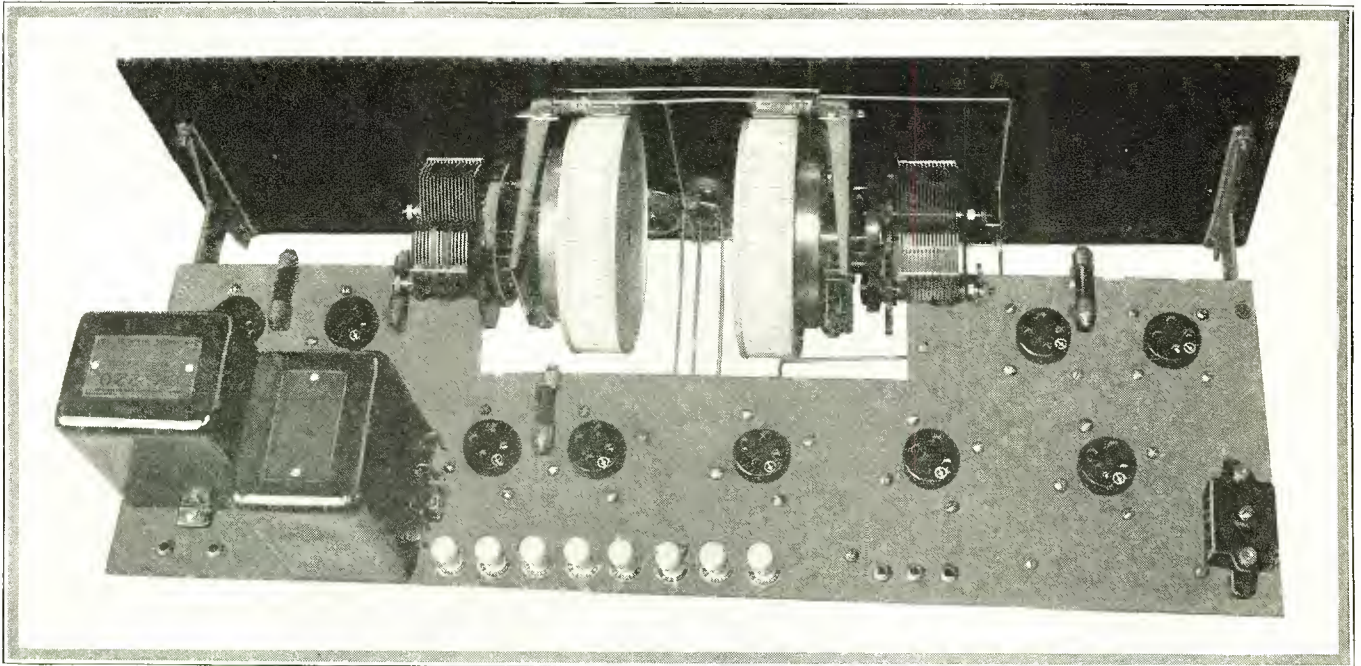

Figure 2. Photographic view of the rear panel shows the variable condensers, drum dials and audio transformers used in the LaPeer A R 9

**B**UILT in response to the demands of our readers for a multiplicity of superheterodyne circuits with which they may experiment to their heart's content, our laboratory has tested and illustrated the LaPeer A R 9 Super, using an efficient combination of a number of parts made by well known manufacturers. As is almost universally the custom now, the reader will find that this receiver is arranged for sub-panel assembly and wiring. Not so many years ago the prospect of having to locate parts on a baseboard and then wire them up was of such a complex nature that only those intrepid young souls who are the energetic set builders of today would tackle the task. With the introduction of the insulated sub-panel sometime ago, the work of putting together a receiver has been decreased to such an extent that almost anyone is capable of completing a receiver in a very workmanlike manner and with full credit to themselves for their craftsmanship. With all of the holes in the sub-panel drilled, it is only a few minutes work to line the necessary parts and get them properly fastened in their positions. It will be noted that more and more of the wiring in receivers is being carried beneath the sub-panel, which fact is attributable to the desire on the part of builders to economize on the amount of personal energy involved in assembling any type of radio set. This same principal of conservation of human energy is also represented in the drilled and engraved front panels which are available for almost every circuit of any importance in the radio world.

### Making It Simple

Assuming that a newcomer in the fascinating art of set building is interested in producing a receiver from which he may secure

untold entertainment, to say nothing of a liberal education in the principles involved in superheterodyne operation, we are going to relate the various steps necessary for the construction of such a set. Professional set builders who have already served their apprenticeship will perhaps bear with us while we extend the helping hand to the man who wants a good set and still does not know exactly how to go about getting one.

Probably the first step in the assembly of the LaPeer A R 9 (assuming you have already secured your drilled and engraved panel) would be to test all transformers and condensers to make sure transformers are continuous in their windings and that all condensers are open (that is, not short circuited). A simple method for doing this test is to use a pair of head phones and a small C battery hooked together, so that when one of the tips of the head phone is placed on one terminal of a transformer winding and a flexible lead from the battery is placed on the other terminal, a click will be heard in the head phones. This will signify the fact the current has been able to pass through the windings of the transformers under test and is an absolute indication of the fact that the transformer is O. K. This test on the primary of an audio transformer will give a fairly loud click in the head phones, but when the same test is performed on the secondary of the audio the chances are the response in the head phones will not be as pronounced as that obtained from the primary. Nothing should be thought of this occurrence because of the fact that secondaries have a much greater number of turns of wire than for the primaries, and, after all, students of electricity realize the resistance of any coil increases with the number of turns which are used in the winding. Care should be

(This receiver tested and all illustrations made in our laboratory)

taken, however, in learning the difference in intensity between primary and secondary clicks, because sometimes in testing a secondary which is open the experimenter may secure a very slight click which would be represented, not by the continuity of the windings, but by the fact that the secondary is acting as a condenser, and when the test outfit was placed across its two terminals this condenser discharged itself. If a secondary is open and still gives a slight click at the first contact of the test wires, repeat the test two or three times and in all probability you will find that the clicks disappear, and this silence will indicate the end winding is open. If you wish to further assure yourself, you may substitute a low reading voltmeter for the head phone, and then when no reading is shown on the voltmeter you may be positive in your belief that the secondary is open.

**Difference Between Tests**

When making the head phone and battery test on a condenser, a slight click might be heard on by-pass condensers when they are first discharged, but on touching their terminals the second time no click will ensue. Do not test variable condensers when these variables are connected to an inductance unless you first disconnect one end of the inductance which is attached to the variable. The reason for this statement is the fact that if you try to test a variable condenser around an inductance, you secure a click which is caused by the windings of the inductance placed across the plates of the condenser. What is desired in a condenser test is an open test, which can only be secured when no connection is made through an inductance or resistance across the plates of the condenser. Therefore, these two tests are made in the same manner, but their effects are diametrically opposed. The transformer test is for a closed circuit, which is the required condition for a transformer that is perfect. In the condenser test what is required is an open test, which signifies the condenser is

good. If a test on a condenser shows a click or a reading on a voltmeter, it can safely be stated that the condenser is short circuited and should not be used.

**Next Comes Assembly**

Having assembled all of the parts after they have been tested, the beginner may use the graphic illustration shown in Figure 6 to make sure he has located all units in their proper position. When he is certain of that fact, the wiring may be done following the lines which are shown in the graphic illustration, Figure 7. It will probably be noticed that the parts shown in Figure 7 do not appear to be arranged in the same position as they are in Figure 6. This is not an error, but is due to the fact that for easy understanding by the set builder it is necessary to show the units in the fashion outlined in Figure 7 so that he may readily see which terminals are to be connected together. This is merely a detail of illustrating and should cause no misunderstanding on the part of the reader. It will be a safe rule to state that parts should always be laid out according to the sub-panel assembly illustration, but they should be wired by the graphic illustration. Of course, after you have made a number of sets and have gained proficiency in the art, you will find that it is possible to do all your wiring by the electrical circuit which is known as the schematic and is illustrated in Figure 5.

Having definitely located all of the parts which are to be used in the receiver, the constructor may now go about wiring up the set. In view of the fact that all sockets used in this model are the Benjamin sub-panel mounting type, the filament leads may be first placed in position and soldered to the lugs. If the reader will glance again at the photograph shown in Figure 3, he will see that it is possible to make a very neat and workmanlike wiring job on the bottom of the sub-panel. It would be a good idea to remember that in soldering a hot iron should be used, which will easily melt the solder. Be very careful not to allow

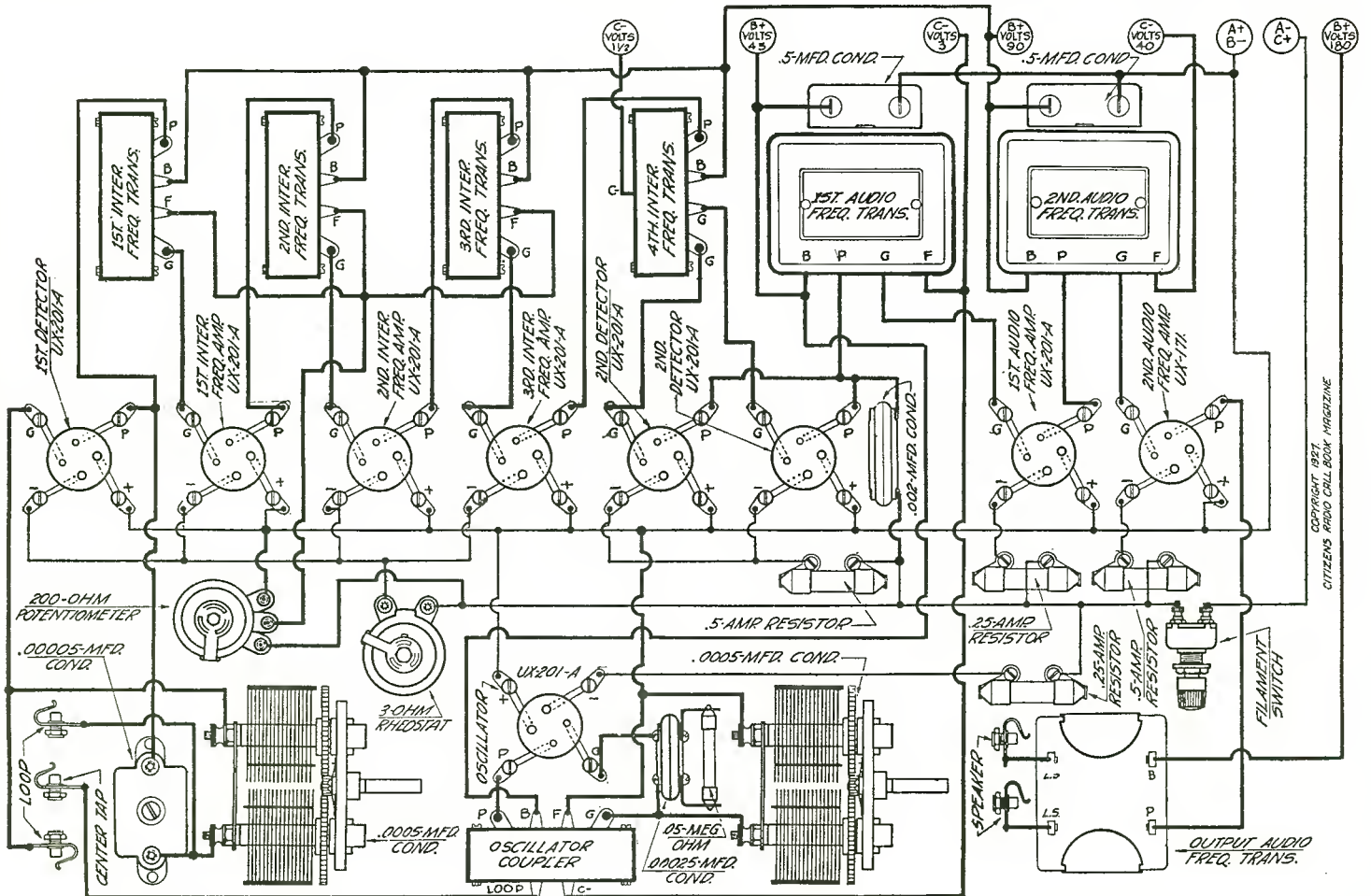

Figure 7. Graphic illustration shown above gives all necessary details for completely wiring this receiver. Be sure to check your work against this for any possible errors on your part

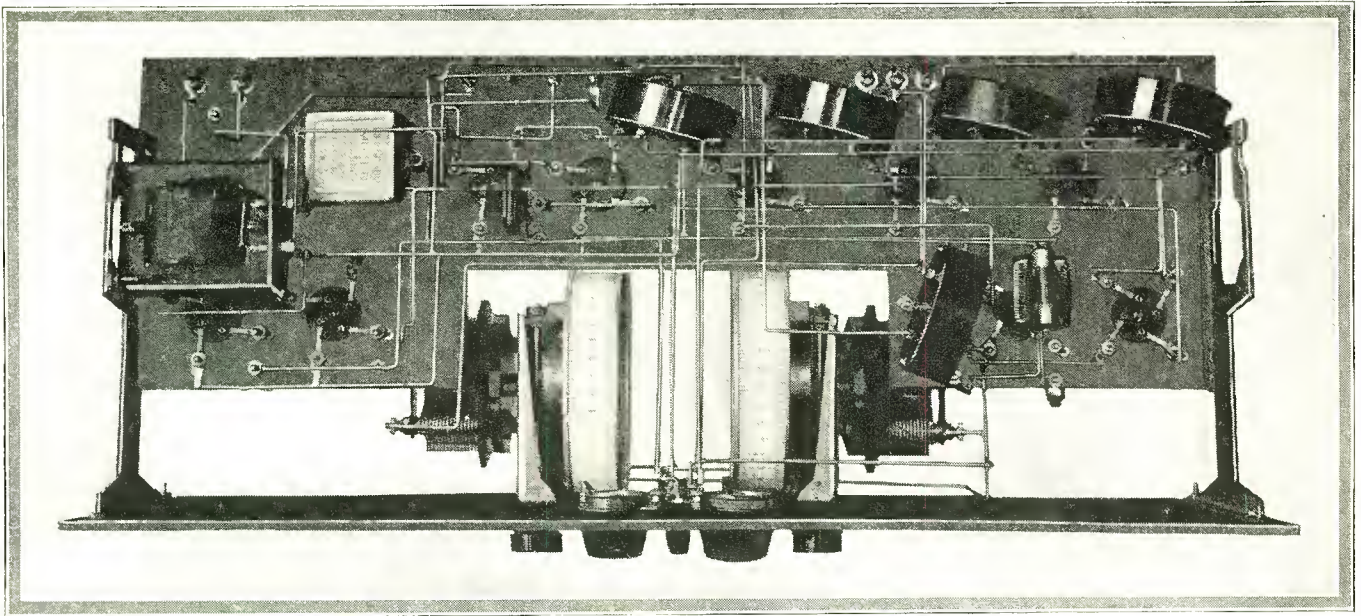

Figure 3. Lower view of the sub-panel showing all intermediate transformers and oscillator coupler

any rosin joints, since this will give a high resistance connection and if it is a complete rosin joint will leave an open circuit. Grid and plate wires of the intermediate stage and second detector sockets may be brought to their respective terminals as indicated in the graphic diagram shown in Figure 7. It is always a good idea for the embryo set builder to consider one or more ways of running a set of wires and picking the way which gives the shortest length consistent with a good looking appearance.

#### Full Wave Detector

The LaPeer Receiver described, which has been tested in our laboratory, consists of a first detector, four stages of intermediate frequency amplification and two detector tubes arranged for push-pull (full wave) rectification. In addition there is the customary first and second audio stages, with an output transformer and an oscillator which departs from the conventional in that a .00025 mfd. grid condenser and a .05 megohm grid leak are used to reduce B battery consumption in the plate of that tube and to insure oscillation at all frequencies within the band which the oscillator tuning condenser is called upon to cover. Since the LaPeer A R 9 is the only receiver we know of which is using a double second detector, a few words of explanation covering its operation might be of interest to our readers.

In the ordinary detector using only a single tube, rectification may be accomplished by either grid leak and condenser in the grid circuit of the tube, or no grid leak and condenser but with a negative bias on the grid of a sufficient value to cause the tube's operating characteristic to be shifted down to a point where it becomes a rectifier. This value of bias may differ with various tubes and may run from any value between  $1\frac{1}{2}$  and  $4\frac{1}{2}$  volts. Therefore the detector under either condition may become a half wave rectifier. When it is desired to make a rectifier a full wave rectifier, two tubes are utilized, the grids of which go to the

outside extremities of a center tapped secondary, the center connection going to the negative terminal of a  $1\frac{1}{2}$  volt C bias. Energy entering the center tapped secondary from the fourth intermediate frequency transformer primary divides equally between the grid of one tube and the grid of the other tube, one tube working on one half of the cycle and the other tube on the opposite half. The two plates being tied together take fully rectified energy and the rectification process is complete. From that point onward the audio components are carried through the first and second audio stages and then made known to the listener through the speaker, whose windings are placed on the secondary of an output transformer. It will be observed that this double second detector is only made possible by virtue of the fact that a special fourth intermediate frequency transformer is used, which has a center tap at the middle of the especially designed secondary winding. It is, therefore, not possible to secure the full wave rectification effect with a transformer which is not designed for that purpose.

#### Conserves Plate Current

Conservation of plate energy in the oscillator is explained in a previous paragraph, is secured through the utilization of a .00025 mfd grid condenser spanned by a .05 megohm grid leak. The grid return of the oscillator winding is made to the positive terminal of the socket, which connection is common with the positive terminal of all tubes in the receiver and with the positive A and negative B battery binding posts. The pick-up winding of the oscillator coupler, which is of a fixed nature, is located in series with the center tap of a Bodine loop and thence to the C minus biasing terminal, which is also common with the filament return of the first audio frequency transformer. The grid winding of the oscillator is tuned by means of a .00035 mfd Remler condenser operated by a Remler drum dial. The plate winding of the oscillator is series feed and goes directly to the



Figure 1. This photograph gives the reader an idea of how the set looks when placed in an attractive console

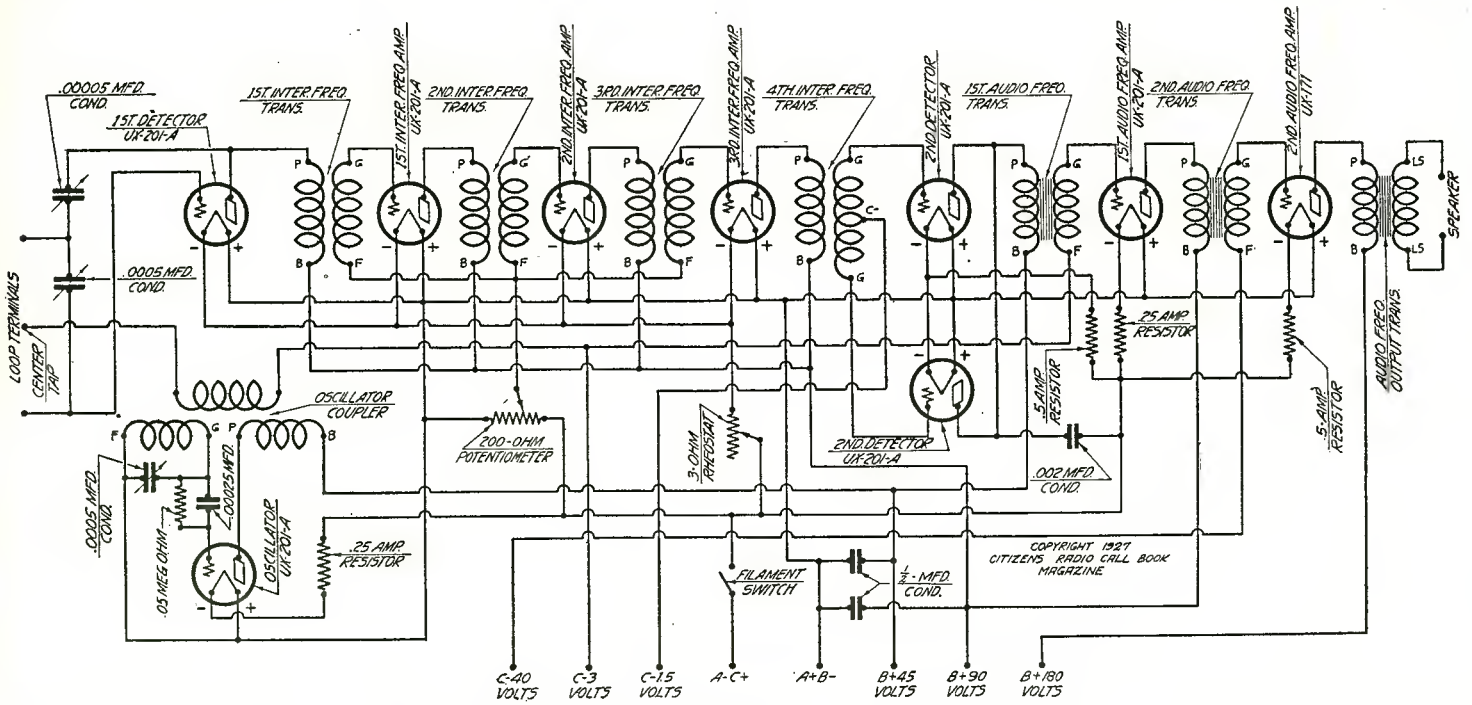

Figure 5. This type of diagram tells the electrical story of what will happen in a receiver. Familiarity with radio is required for reading a schematic circuit, whereas no such experience is required for following connections shown in Figure 7

positive 45 volt terminal, which is also common with the B terminal of the first audio frequency transformer. Tuning of the loop is accomplished by another Remler .00035 mfd condenser actuated by the second Remler drum dial. Regenerative effects in the first detector may be secured through use of a .00005 mfd Muter Variall, located between one outside terminal of the loop and the plate of the first detector tube. In the photograph shown in Figure 2, this balancing condenser is shown at the extreme right of the rear sub-panel and is used only when it is desired to make a critical balancing in the loop circuit. As a rule this capacity may be set for a given tube and loop and then not changed further.

Grid returns of the first, second and third intermediate transformers, which are made by LaPeer and known as their type D transformers, are made to the center arm of a 200 ohm potentiometer located across the positive and negative filament lines. This control is brought out to the front panel and is the left hand lower knob shown in Figure 1. The right hand lower knob visible in Figure 1 is a 3 ohm rheostat for governing the filaments of the first detector, first, second and third intermediate tubes. Thus, only two minor controls are found on the front of the set and these are located for convenience near the two

drum dials, which are naturally used the most in tuning. While the particular model which was tested in our laboratory is designed for operation with a loop, if the builder should desire to make use of an outside antenna, it will be necessary to insert an antenna coil in the loop jacks and the set is ready for operation. The antenna coil is known as the LaPeer type AC. The audio system in the LaPeer consists of two of the well known Silver-Marshall No. 220 audio transformers with an output transformer, this latter unit being located underneath the sub-panel.

Operating The Set

Reference to the sub-panel layout, which is shown in Figure 6, will disclose the fact that the oscillator tube is located at the left and quite close to the oscillator coupler and the variable condenser which tunes that particular circuit. This allows the use of extremely short leads from grid to filament of this circuit, which is a desirable method of wiring. This particular circuit is of course a resonant one and for best operation all leads included in the tuning portion should be kept down to a minimum. The length of the leads which go from the loop condenser to the loop terminals does not become so important as in the case of the oscillator. However, it is a good plan to always try to

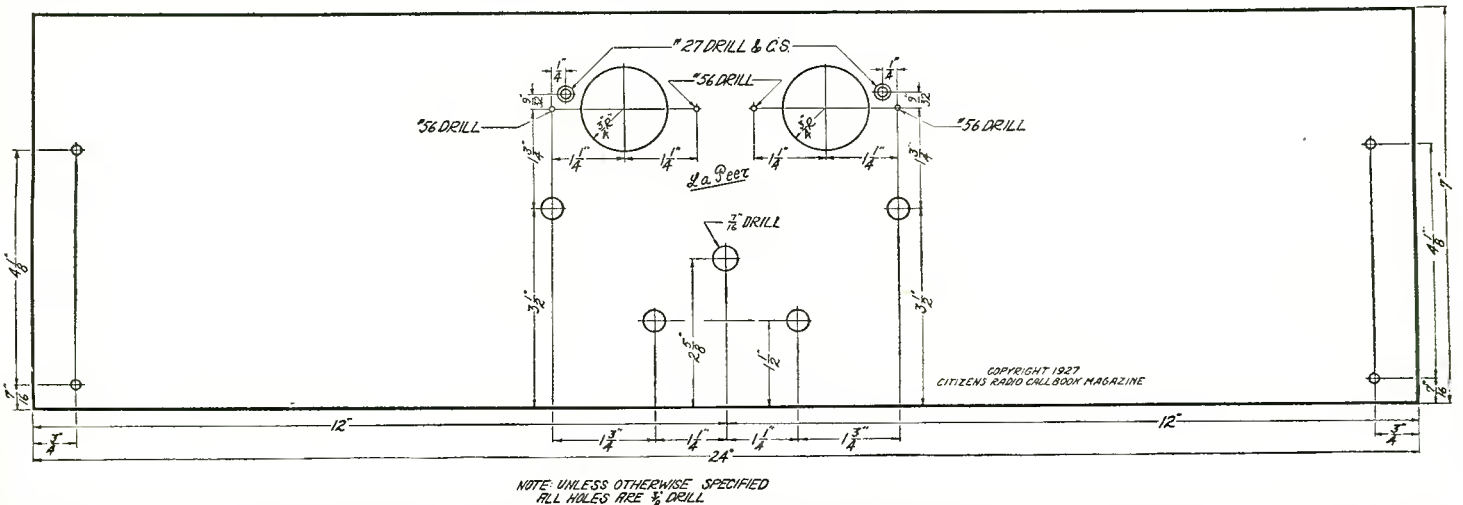

Figure 4. On account of the amount of drilling necessary for using the Remler drum dials, it is recommended that builders secure panels already drilled and engraved, which will greatly simplify their work

keep every lead as short as can be done consistently with a shapely appearance of the wiring. Since the left hand dial controls the oscillator, it is the one most used in tuning in a station. This circuit is usually the sharpest one in any superheterodyne, the loop not being nearly a critical as the oscillator unless regeneration is advanced to a very critical point. However, excessive regeneration is not desirable because it contributes materially to the instability of the receiver. The operator as a rule in tuning will rotate the oscillator condenser first and then bring the loop condenser to resonance with the frequency of the incoming signal, at which time this condition of resonance will be manifest in the speaker by a gentle hissing sound. This hiss may either be due to the high degree of intermediate amplification or it may represent a fairly large amount of extraneous noise which the loop is picking up on that particular frequency. This hissing noise is most noticeable, of course, when the arm of the 200 ohm potentiometer is thrown towards the negative of the A battery which this control spans. It is in this position that the intermediate stages are at their most critical point and consequently yield the highest degree of amplification. If the potentiometer arm is thrown too far towards the negative of the filament, the intermediates, instead of being highly regenerative, will be oscillating, and this state will be recognized by a squeal or whistle through which no station may be received without distortion. Use of the potentiometer control on a superheterodyne is quite handy because it permits the listener to get the most amplification from the intermediate train, whereas if the potentiometer is not used and a bias is applied, the control is not quite so smooth or gradual. This form of biasing the grids of the intermediate stages is also useful when desiring to reduce volume on local stations, although when the arm of the potentiometer is thrown towards the positive terminal of the A battery, each one of the intermediate tubes consumes more plate current than when the negative bias is applied. If dry B batteries are used, this might result in increasing the drain on them to a considerable extent, but where eliminators are employed it does not make a great deal of difference.

Even at the risk of the subject becoming monotonous, we would again call the attention of readers to the necessity of testing all tubes before they are placed in the receiver when putting it into operation. Tubes whose electronic emission is low, due to deterioration, will not function properly in any circuit, more especially a superheterodyne where each individual tube is called

upon to perform a great deal of work. There are possibly three critical positions in which poor tubes will effect the operation of the set, first detector, oscillator and second detector. In this particular model which uses a double arrangement of detection in the second detector, it would be especially fitting that both tubes be thoroughly tested so that their efficiency will be about equal.

**Parts as Used**

The laboratory model built by our staff used the following list of parts, which should be followed closely by the novice, since the set is designed to give excellent results with the apparatus and values shown therein:

- 4—D LaPeer transformers
- 1—D LaPeer oscillator coupler
- 2—AR9 LaPeer sub-panel brackets
- 2—110 Remler drum dials
- 2—649 Remler .0005 mfd variable condensers
- 2—220 Silver-Marshall audio transformers
- 1—241 Silver-Marshall output transformer
- 1—IR3 Carter 3 ohm Imp rheostat
- 1—IR200 Carter 200 ohm potentiometer
- 1—Carter Imp battery switch
- 5—10<sup>1</sup> Carter tip jacks
- 2—507 Muter .5 mfd by-pass condensers
- 1—306 Muter .00025 mfd grid condenser
- 1—325 Muter .002 fixed condenser
- 1—1900 Muter Variall condenser
- 2—1700 Muter .25 ampere Tubstats
- 2—1702 .5 ampere Tubstats
- 1—781 Muter 1/20 megohm grid leak
- 9—9044 Benjamin sockets
- 9—X-L binding posts
- 1—Celeron 7x24x3/16 inch drilled and engraved panel
- 1—Celeron 7x23x3/16 inch drilled sub-panel
- 8—Sonatron type 201 A tubes
- 1—Sonatron type 171 tube
- 50—Feet No. 16 Corwico solid Braidite wire
- 1—Package Kester radio solder
- Miscellaneous lugs, nuts, screws, etc.

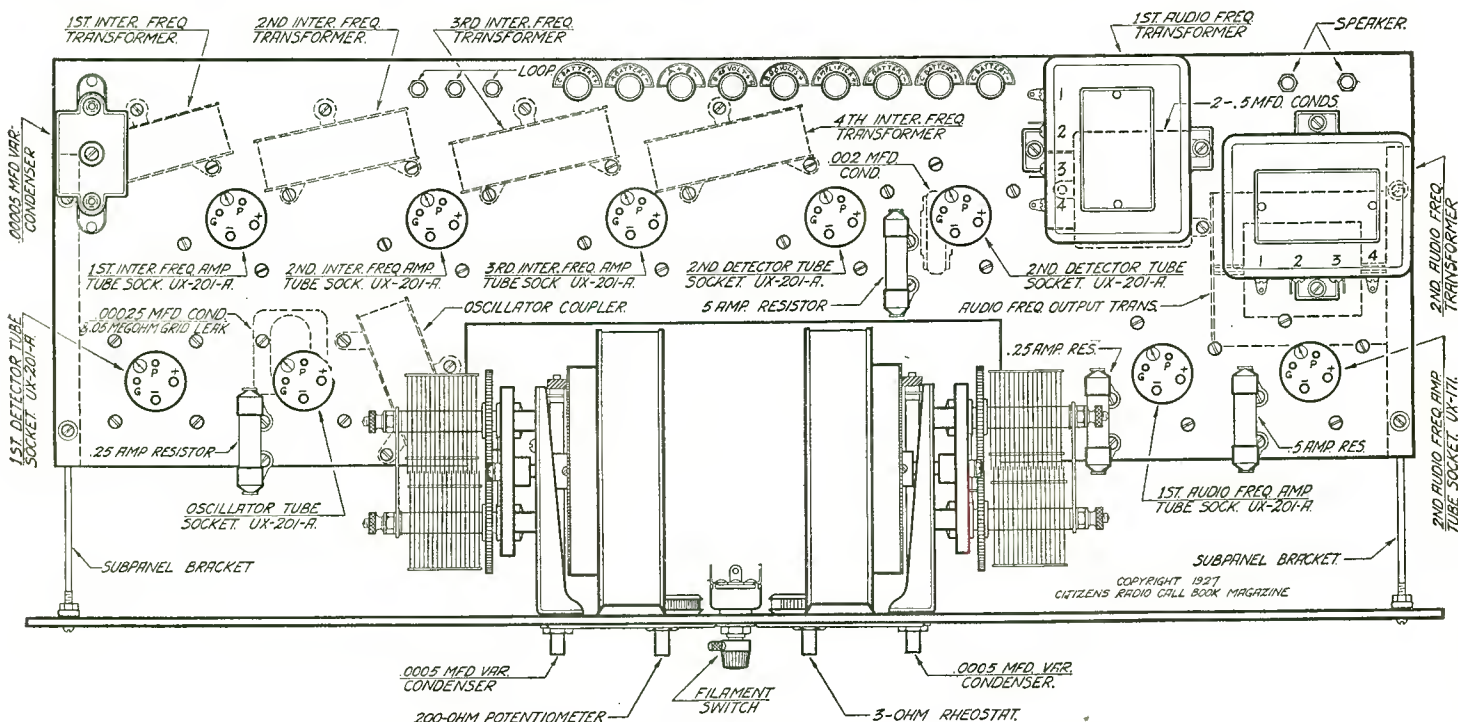

Figure 6. All necessary parts constituting this popular receiver may be found placed in accordance with the illustration shown above. Be sure to follow it for the location of the parts but not for their wiring up

# National Browning Drake Used With Power Amplifier

Low Cost of Operation, Large Undistorted Output and Facility of Control Found in This Novel Receiver

**O**PERATING any receiver with a power amplifier has become the rule in latter day radio rather than the exception, as was the case two and three years ago. It is not very difficult to see the reason for this change in design practice. One of the chief causes in the past of distortion in audio amplifier circuits has been the overloading of the amplifier tubes to a point where their output was considerably distorted. At that time, in order to have secured a higher undistorted output, it would have been necessary to place two of the smaller tubes in parallel and even that was not an especially efficient arrangement. Then came the introduction of the power tubes, three different types having been provided for the experimenter and enthusiast, each one handling a good deal more current than its predecessor. While the 112 tube at first sufficed for most operating practices, nevertheless such operation was generally rather heavy for dry battery plate supply. Coincident with the perfection and wider distribution of B eliminator, the 171 came into greater prominence. For the last season considerable work has been done on the power amplifier supplying plate voltages up to 500 or 600 volts, and for this kind of power supply the largest of the power tubes has been requisitioned, that is, the 210.

## Simple and Inexpensive

Taking cognizance of the amount of interest which the set builders and experimenters have exhibited in the medium voltage range power supplies, we are describing at this time the use of the National power amplifier which employs a standard Raytheon BH tube, this plate supply unit being connected with the two stage National Browning-Drake set.

This particular type of receiver, embodying one stage of r.f. amplification and a regenerative detector, has made its appeal to a large number of fans who desired a set which would give good performance, can be easily constructed, is capable of receiving distant stations with good volume, with very satisfactory tone quality, and above all original cost of the necessary parts not too expensive. These factors have all culminated in the National Browning-Drake receiver about to be described, which we feel will prove very interesting to our readers. Referring to the schematic circuit shown in Figure 3, the reader will observe the electrical connections for both the receiver and the power amplifier. Energy enters through the

antenna in series with which is a .0001 mfd midget condenser, which is attached to the A-1 terminal of the antenna coil and leads to the grid of the first radio frequency amplifier, in which stage a 199 tube is employed. The grid return of this stage is through the coil, is common with the negative filament and the ground. A National .0005 mfd variable condenser is used to the antenna stage to tune to resonance with the incoming signal. In order to use the 199 r.f. tube from a 6 volt source, an Amperite of the 6 volt-199 type is used in series with a 30 ohm rheostat and connects to the negative of the A battery. This rheostat will allow sufficient control for the filament of the radio frequency tube and may be used to increase or decrease the sensitivity of any particular stage, especially when being operated against local stations.

## Neutralization of Tube

Stabilization of this first radio frequency stage is secured through utilizing a .00002 mfd variodenser located between the grid connection of the first tube and the tap of the second Regenaformer. This balancing condenser is used to maintain the stability of the 199 tube, and if it is once adjusted during the operation of the receiver, it may be left alone. Its adjustment will be described later under notes on operating the set.

## Uses Sensitive Detector

In the detector circuit we find a National Regenaformer having primary, secondary and a regenerative winding. The secondary is tuned by a .00035 mfd condenser, with the grid return being made to the negative filament of a 200-A type tube, which has been utilized in order to gain as much signal as possible from distant stations. As is commonly known, this type of

tube is much more sensitive to weak signals than it is to strong ones, so it is only natural that advantage should be taken of that fact to bring up the receiver's efficiency to the highest possible point.

The filament control in this detector tube is by means of a 1-A Amperite located in the negative side of the line. The regenerative coil, which is variable, is bypassed from its lower end to the negative to provide a suitable path for radio frequency current through the .001 mfd fixed condenser. Output of the plate circuit of the detector is carried through the input of the National first stage Impedaformer and thence to the plus detector terminal



*Figure 1. This photographic view shows the National Browning-Drake amplifier placed in a cabinet and located on top of an artistic table. If desired, the power amplifier which goes with the set may be placed inside of the table, since room is not provided on top*

(This receiver constructed, tested and all illustrations made in our laboratory)

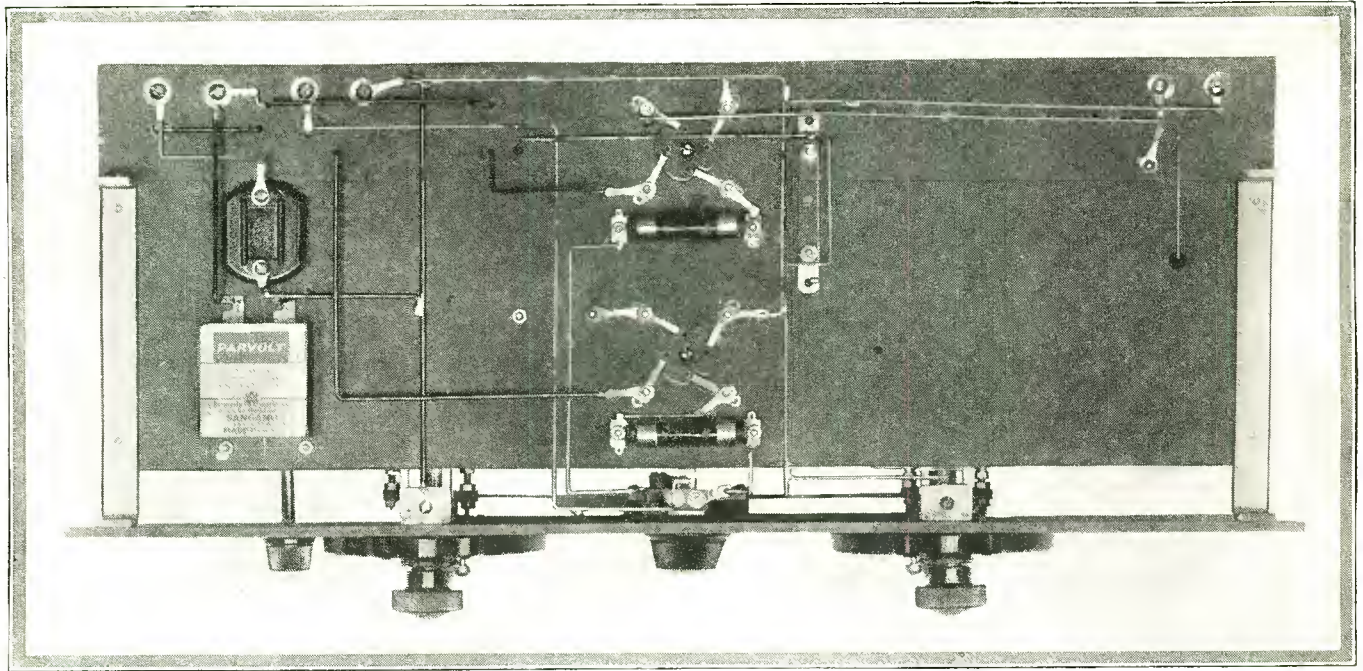

Figure 6. Bottom view of the receiver is shown in the photograph above and indicates the relatively small number of parts required in its construction

on the amplifier, which is supplied with any voltage desired through the Clarostat variable resistance. This flexibility of plate voltage control in the detector circuit is very satisfactory, principally because of the fact the 200-A type of tubes are more or less critical to plate voltages and the variable resistor allows the operator to put the most satisfactory operating voltage on the plate of the detector tube. The audio signal, having passed through the primary of the first Impedaformer, goes through a fixed capacity inside of this unit, to the grid of the first audio frequency amplifier, where a Ceco type G high-mu tube is used. A grid leak value of one-tenth megohm is placed between the G terminal of the first Impedaformer and the negative A, which serves to produce the necessary bias for the high-mu amplifier. The output of the first audio frequency amplifier is then led through a one-tenth mfd fixed condenser into the grid of the second Ceco G high-mu tube. The plate resistor in the first audio amplifier is a .01 megohm, while the grid biasing resistor in the second audio frequency stage is a .05 megohm. From the plate of the second audio frequency the energy goes to the input circuit of the National three stage Impedaformer and thence through a capacity, to the grid of the third audio fre-

quency amplifier, which is a 171 type tube. Energy is taken from that tube's plate through a tone filter, to which are connected the terminals of the speaker. The plate resistance in the plate of the second audio tube is another .1 megohm, while the biasing resistance of the last tube is a .1 megohm in series with the output winding of the three stage Impedaformer.

#### Amplifier Plate Supply

Whereas the filaments of the first and second high-mu tubes are operated from the same battery that serves for the first radio frequency and regenerative detector, the filament of the last power stage, where a 171 is employed, is supplied with raw alternating current secured from a 5.5 volt winding of the National power transformer used in the amplifier. The connections from the low voltage secondary of this power transformer to the socket terminals of the power tube should be made with twisted pair in order to cut down the possibility of a hum induced into the balance of the set from the alternating current circuit.

A 7.5 volt winding on the power transformer is not connected unless another type of power tube is used, such as a 210. The high voltage winding on this transformer is a center tapped one,

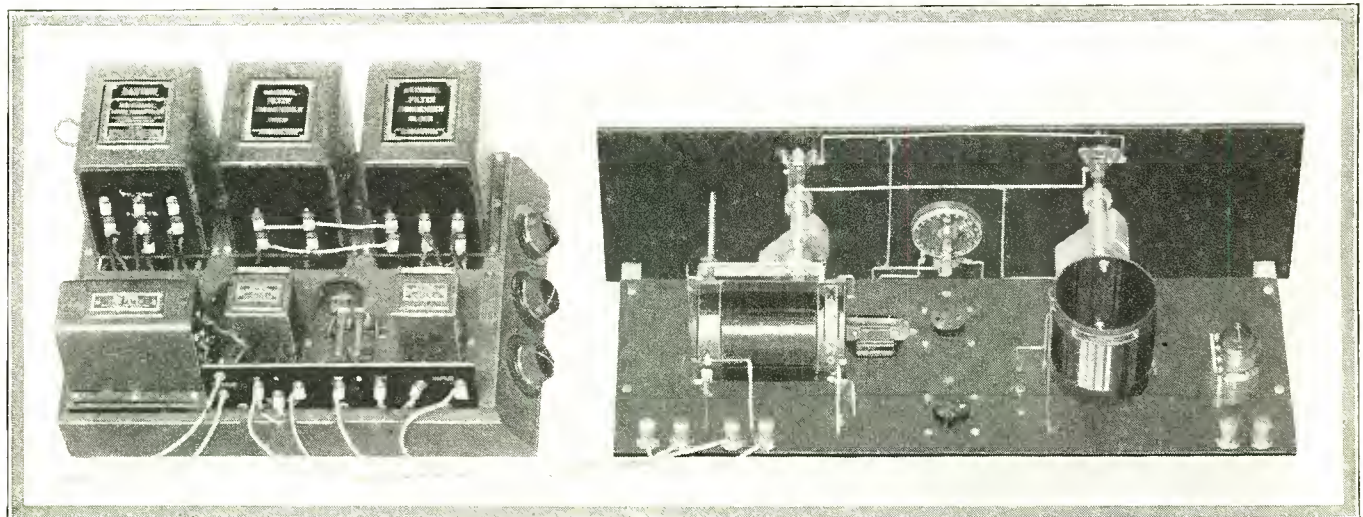

Figure 2. In this photograph may be seen the rear views of both the receiver and the power amplifier. If sufficient space is provided, the two may be placed together or in the event that there is not enough room on a table, the power amplifier may be placed a little distance away

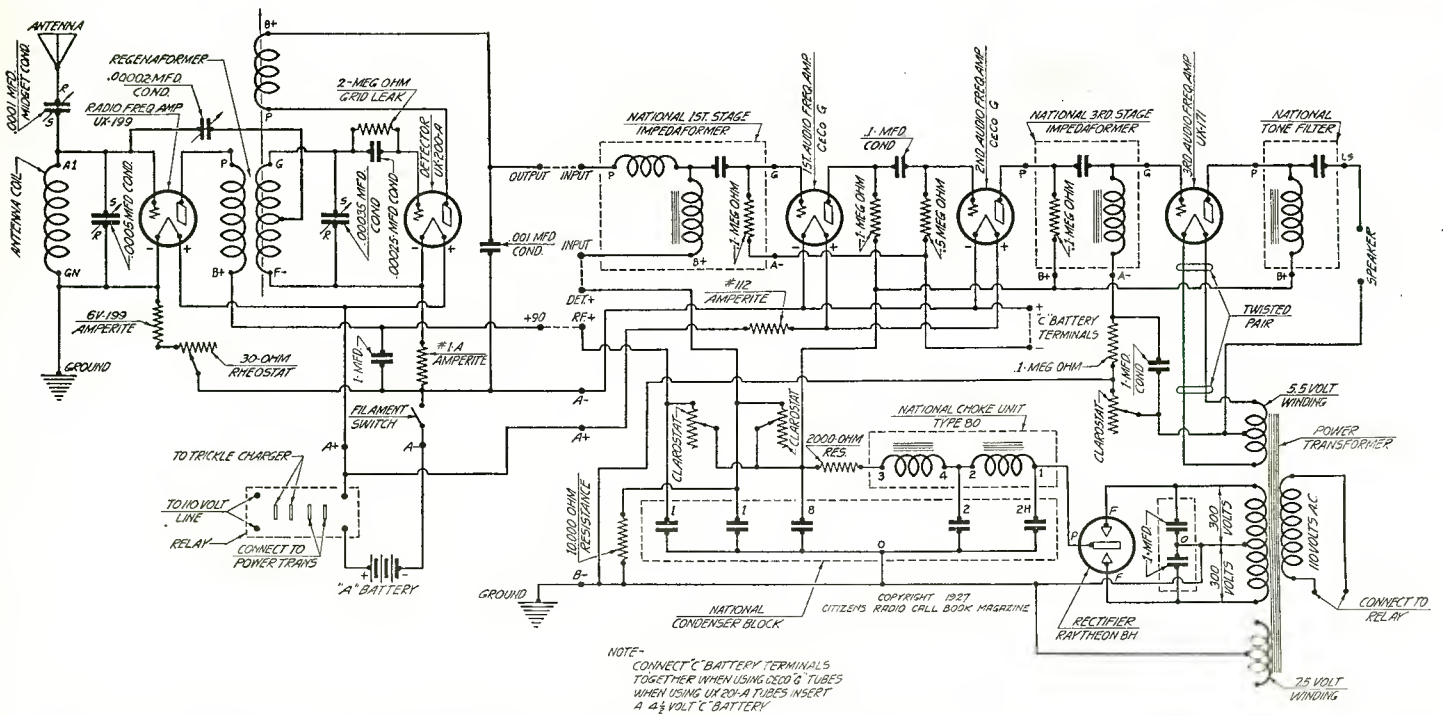

Figure 3. In this schematic circuit the reader will find the electrical connections for the receiving set as well as the power amplifier

giving 300 volts each side of a center point. This voltage is fed to the Raytheon BH rectifier. The P connection shown on the full wave rectifier in the diagram in Figure 3 leads through the type 80 choke unit, through a 2000 ohm fixed resistance and thence into the two Clarostats, one governing the voltage applied to the detector stage and the other controlling the voltage available on the plus 90 terminal of the first r.f. amplifier. Full voltage of the rectifying system after it has passed through the 2000 ohm resistance is carried to the plates of the first, second and third audio frequency tubes. A third variable resistance, which is located between the center tap of the 5.5 volt winding and the negative of the B circuit which is common with ground, is placed in that position to enable the operator to shift the bias on the grid of the 171 tube in the last power stage. After a proper value of biasing potential has been secured, this control need not be further considered, since the bias will then be automatic and proper for that grid, regardless of the plate current consumed.

This set is shown in the schematic circuit as being operated from a storage battery connected to a trickle charger, to a relay, so when the set is not in operation the trickle charger may be functioning. The plate supply end of the set is cut off when the filament switch is turned to the "off" position.

**Condensers Inside Block**

Proper filter condensers are provided across the high voltage outputs and are to be found inside of the National condenser block.

When using the Ceco tubes (type G) the positive and negative terminals of the C battery shown in the schematic should be connected together, whereas if the regular 201-A type of tubes is to be used a 4 1/2 volt C battery should be inserted in the circuit with connections as indicated in the schematic.

**Use a Short Antenna**

As will be noticed by referring again to the schematic circuit in Figure 3, the antenna connection is from the aerial to the grid

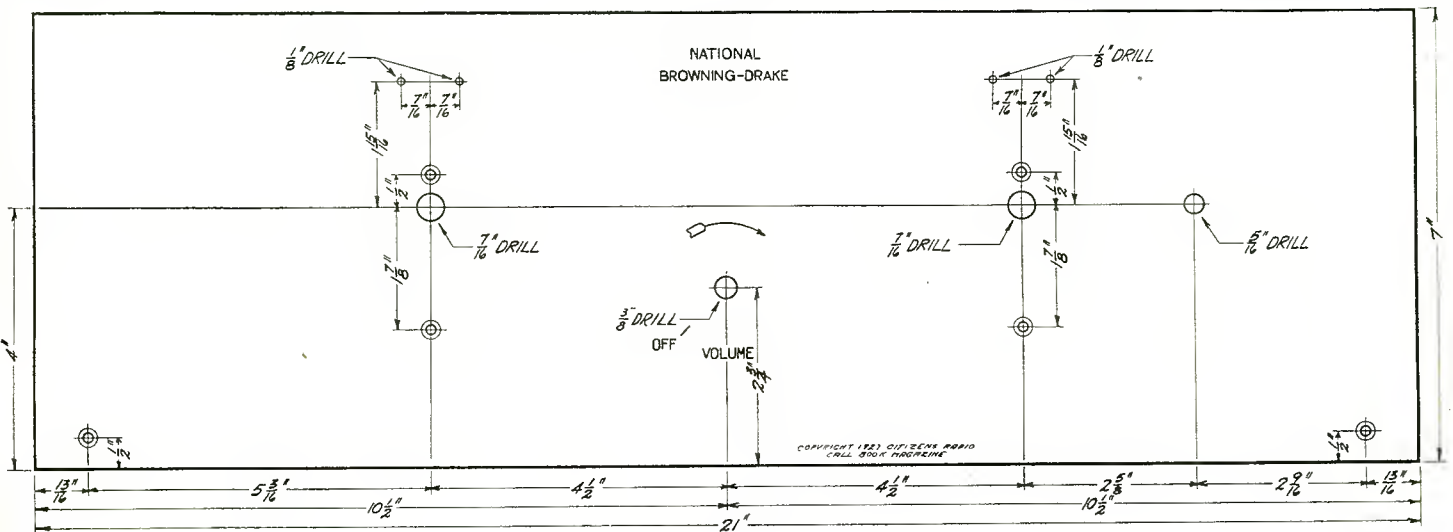

NOTE - UNLESS OTHERWISE SPECIFIED ALL HOLES ARE 3/32 DRILL & COUNTERSINK

Figure 5. For those who contemplate using undrilled panels, the dimensions shown in the sketch above will give the required information as to the location of all holes and drill sizes



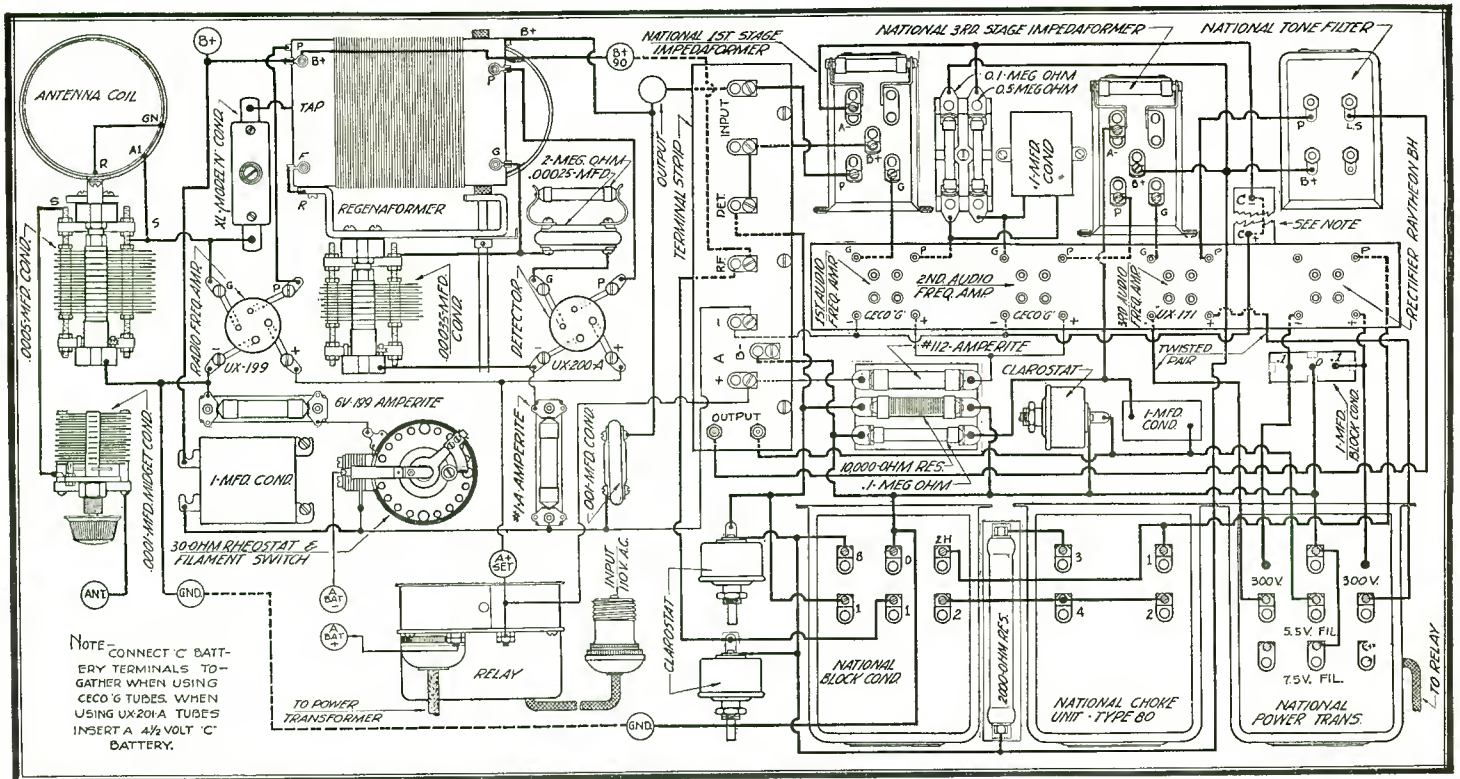

Figure 4. The graphic illustration shown above is a condensed one and represents the correct connections to be made for both the receiver and the power amplifier

of the tube but intercepted by a .0001 mfd midget condenser. This design was adopted because of the great difference which may be encountered in antenna lengths. In some cases a long one is used and in others a short one. As a general rule the length of the aerial to be used with this receiver should run between thirty and sixty feet. Antennas of greater length than this will be likely to interfere with the selectivity of the receiver. With the .0001 mfd midget in series with the aerial lead the capacity may frequently be shifted to such a point that both the first and second dials may be made to read alike. This method of antenna coupling has also been found very satisfactory on the shorter waves because it allows a considerable degree of flexibility in antenna systems that would not be possible with the fixed antenna winding. The coils and condensers used in the receiver are of the latest National design and their electrical characteristics are good. They have a very low minimum capacity and sufficient insulation so that their high frequency resistance is quite low. This contributes a great deal to the sharp tuning of the receiver.

When the set has been constructed in accordance with the various diagrams shown in this article, it may be balanced. The thirty ohm rheostat may be turned full on and the antenna coupling condenser set at about half way in. Turn the left condenser, the one across the r.f. secondary, back and forth over the entire range and observe whether whistles are heard at any position of its travel. If none are heard, a further check may determine whether or not the first r.f. stage is oscillating, this being the tapping of the stator of the first variable condenser (the one on the left) with your finger. If a "plop" is heard when the stator is touched it may be assumed the first tube is oscillating. If such is the case start turning the set screw on the X-L Variodenser, making this change with a sharpened wooden stick until an adjustment has been reached that will permit your turning the first condenser dial from zero to its maximum without hearing any squeals or whistles. While this is being done the regenerative coil on the Regenaformer should be in such a position that no regeneration or oscillation is present in the detector tube. After finding the point where the first condenser may be turned from minimum to maximum without oscillation, bring the right hand dial which controls the secondary of the detector into resonance with the first circuit (the readings may be approximately the same if the receiver has been carefully con-

structed). Then bring up the regenerative coil and tune for a station, either a local one or one fairly distant. While doing this see whether it is possible to run up and down the first dial without oscillation in the first stage. If it is not possible, it may be necessary for you to make a slight readjustment of the Variodenser to finally balance the 199 tube which is serving as a radio frequency amplifier. It may also be necessary to make a further shift in the position of the midget condenser in series with the antenna before the set is brought into perfect balance at last.

Parts shown in the list below were used in the construction of the model described above. Other parts of equal merit may be used if desired, although the builder should assure himself that identical constants are secured.

- 1—National Browning-Drake kit consisting of:
  - 1—National .0005 mfd variable condenser
  - 1—National .00035 mfd variable condenser
  - 2—National Browning-Drake coils
  - 2—National illuminated dials
- 1—Yaxley 30 ohm rheostat with switch
- 2—9044 Benjamin sockets
- 2—Karas sub-panel brackets
- 1—Sangamo .00025 mfd grid condenser with clips
- 1—Sangamo .001 mfd fixed condenser
- 1—Acme Parvolt 1.0 mfd bypass condenser
- 6—X-L binding posts
- 1—"N" X-L Variodenser
- 1—Precise .0001 mfd midget condenser
- 1—1-A Amperite
- 1—6V-199 Amperite
- 1—Daven 2 megohm grid leak
- 1—Celeron 7x21x3/16 inch drilled and engraved front panel
- 1—Celeron 7x20x3/16 inch drilled sub-panel
- 1—L-3 National power amplifier, completely assembled and wired
- 1—Ceco type 199 tube
- 1—Ceco type A tube
- 2—Ceco type G tubes
- 1—Ceco type J71 tube
- 1—Ekko ground clamp
- 1—Package Kester radio solder
- Miscellaneous lugs, screws, nuts, etc.

# Operating the Improved S-M Super From the Light Socket

Set Is Ready at a Snap of the Switch—Uses Sovereign A.C. Heater Tubes

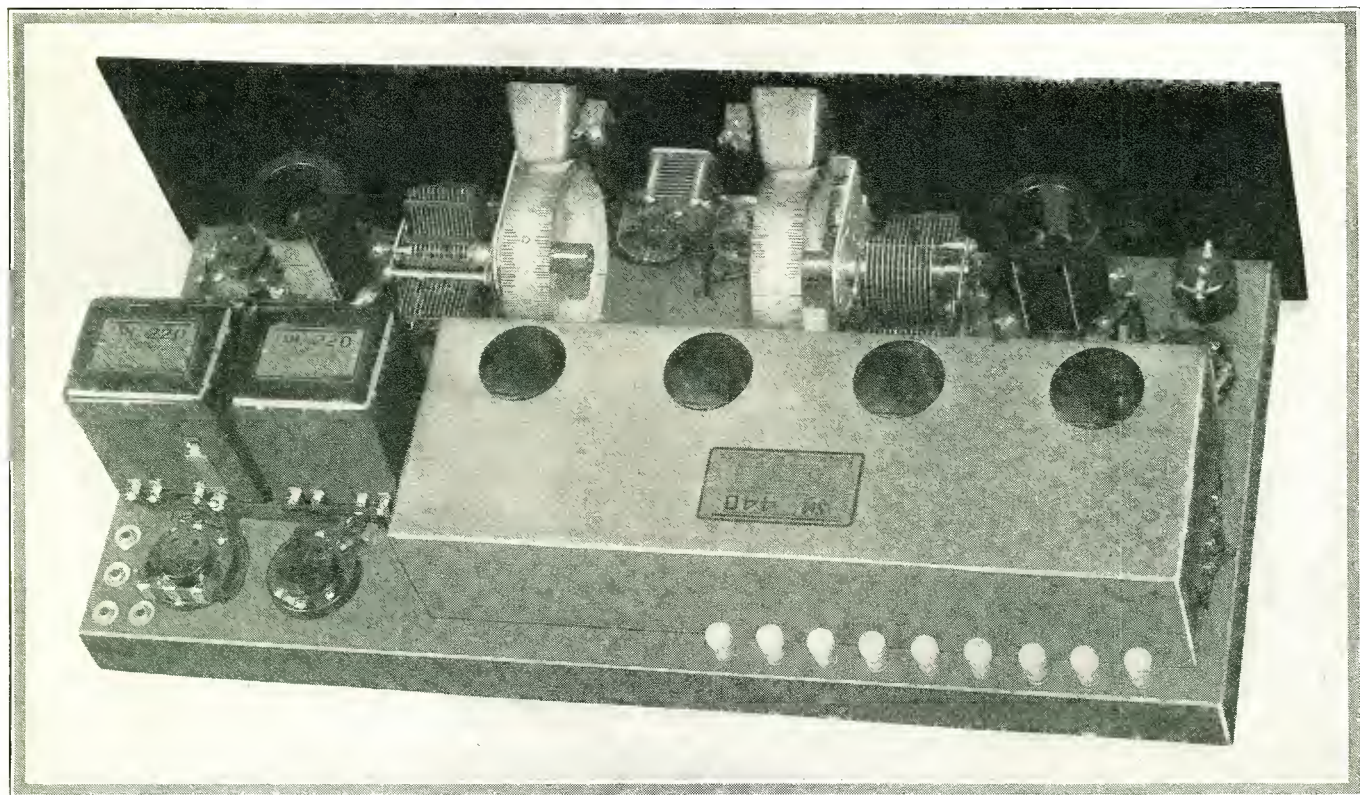

*Fig. 2. It does not take much of an imagination to appreciate the simplicity of construction on this laboratory model of the electric light socket operated superheterodyne*

**E**XPERIENCED set builders as well as those who are just entering the radio field will probably exhibit more than ordinary interest in a superheterodyne that has been recently tested and operated in our laboratory and which is described and illustrated in these columns. One of the chief reasons for anticipating the readers' interest lies in the fact the set is so simple that it immediately appeals to the novice, while its operation is so efficient that the seasoned veteran will probably wonder what has prevented the design being advanced prior to this time. Another contributing factor in the set's appeal can readily be seen when it is discovered it is an electrically operated superheterodyne involving the use of the Silver-Marshall plate supply kit and the Sovereign a.c. tubes of the heater type. Thus the snap of a switch throws on the set; another snap and it is off. While lying idle there is nothing to deteriorate; when in action its cost is trifling as far as electric current is concerned.

#### Amplifier Is Main Unit

In the September issue of this magazine a description was given of the Silver-Marshall type 440, 112 kilocycle three stage long wave amplifier and detector which forms the basis around which this novel electrically operated superheterodyne is built. Each of the individual r.f. stages are shielded in separate compartments so the whole unit might be likened to a copper-brass catacomb. Amplification jumps tremendously when such a long

wave unit is shielded because all detrimental feedbacks are eliminated. Wiring pickup in a receiver of this type may be neglected since so much of the cabling is carried quite close to the metal chassis. The initial frequency at which the long wave stages are measured and peaked is 112 kilocycles and from this value one need not expect any deviation as far as the separate transformers are concerned. The unit is designed to function with any of the standard tubes, either of the a.c. or d.c. type without variation in frequency of the individual transformers. It has been demonstrated by Silver that a logical manner of building an intermediate frequency amplifier is to follow along the lines of r.f. amplifier design practice, using low resistance, air core transformers in all stages, tuning these with fixed capacities so variation in tube capacities will not affect the operation of the whole. The long wave units are housed in a copper can 15 inches long, 5 inches wide and 3 inches high as is illustrated in Figure 2 at the beginning of this article. The tubes are inserted in the long wave amplifier through the four holes shown in the top of the catacomb, while oscillator, first detector and the audio tubes are placed in the sockets noted in the baseboard layout in Figure 4.

For the benefit of those who have not yet become acquainted with this novel contribution to the art a few words of description may not be amiss. Examination of the schematic circuit in Figure 3 will disclose the fact the improved laboratory model consists

(This receiver constructed, tested and all illustrations made in our laboratory)

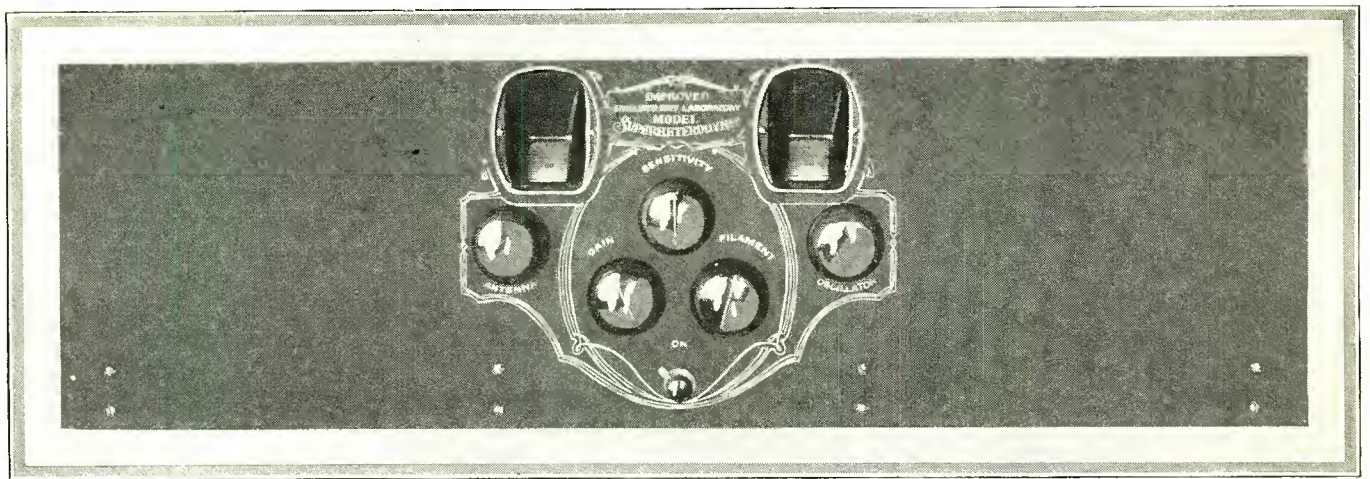

Fig. 1. All controls are brought to a central location for greater ease in tuning as shown in this photograph

of a regenerative first detector, an oscillator, three stages of calibrated intermediate frequency amplification and a second detector (this much of the receiver being separately located in the catacomb to which previous reference has been made) and two stages of audio frequency amplification, giving faithful reproduction to all notes delivered to the set.

**How Energy Enters**

For picking up energy from the antenna the conventional Silver-Marshall 111-A coil is used. Its primary winding, shown as 1 and 2 in the schematic diagram, is placed in series with the antenna. The secondary of this coupler represents the tuned input circuit of the first detector in series with whose grid is placed the pickup winding of the second 111-A inductance which acts as an oscillator. The third winding of the antenna coupler is one shown as 5 and 6 in the schematic and by means of this winding and the .000075 mfd. midget condenser the first detector can be brought to a regenerative condition if that is desired for sensitizing this particular stage of the receiver. Output from the first detector is led to the P terminal on the 440 amplifier unit through a radio frequency choke. The first, second and third intermediate frequency stages amplify the heterodyned signal and deliver it to the second detector, which is the last tube inside of the catacomb at the right end. Terminal P of the catacomb (right end) then leads to the primary circuit of the first stage audio and thence into the second audio from whose plate, through an output transformer winding, the amplified audio signal is fed

to the speaker. The output transformer is not shown in these drawings since it has been found more satisfactory to have this isolating transformer located in the power supply unit. In looking at the schematic circuit we would recommend that readers who desire to construct only the receiver portion of the set should not place their speaker directly in the plate circuit of the 171 tube shown if 220 volts are used on the 171's plate. Voltages up to about 135 might be satisfactory for use direct on speaker windings, but values in excess of that voltage should not be used unless an output transformer is employed.

**Alternating Current Data**

The remainder of the circuit has mostly to do with alternating current and since this subject is one that is destined to be an absorbing topic of discussion with the radio public for some time to come, it might be worth while to devote some attention to it in an article of this nature. Special tubes have been introduced which operate on alternating current. To eliminate the audio frequency hum caused by the sixty cycle pulsations in the line, the filaments are made in a ribbonlike form so they may be operated at a relatively low voltage but a decidedly high amperage (high compared to what we have been accustomed to for the past few years). Due to the high thermal inertia (large mass filaments do not cool down between alternations in the current), this method of a.c. tube operation has been fairly satisfactory only in an amplifier, while for detector stages it is decidedly unsatisfactory. In addition the raw a.c. filament tubes are also

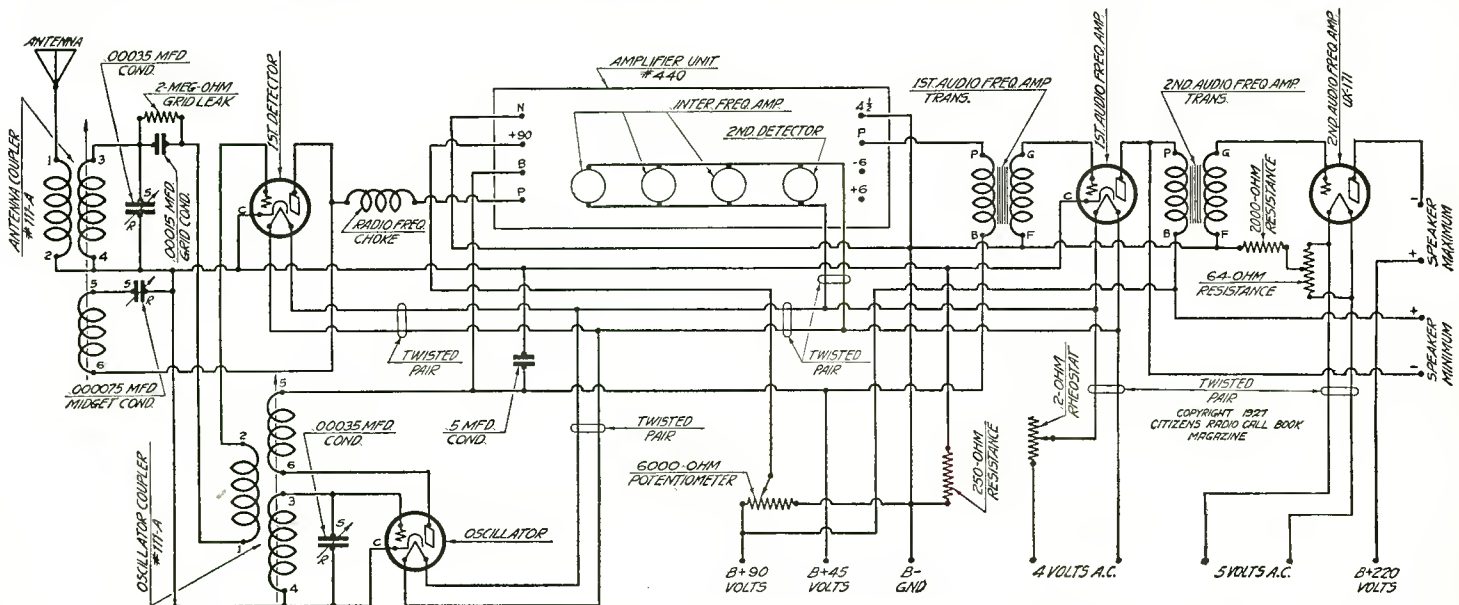

Fig. 3. The same marked simplicity shown in the two preceding photographs is again represented in the schematic diagram by means of which the improved laboratory model may be wired in a very short time

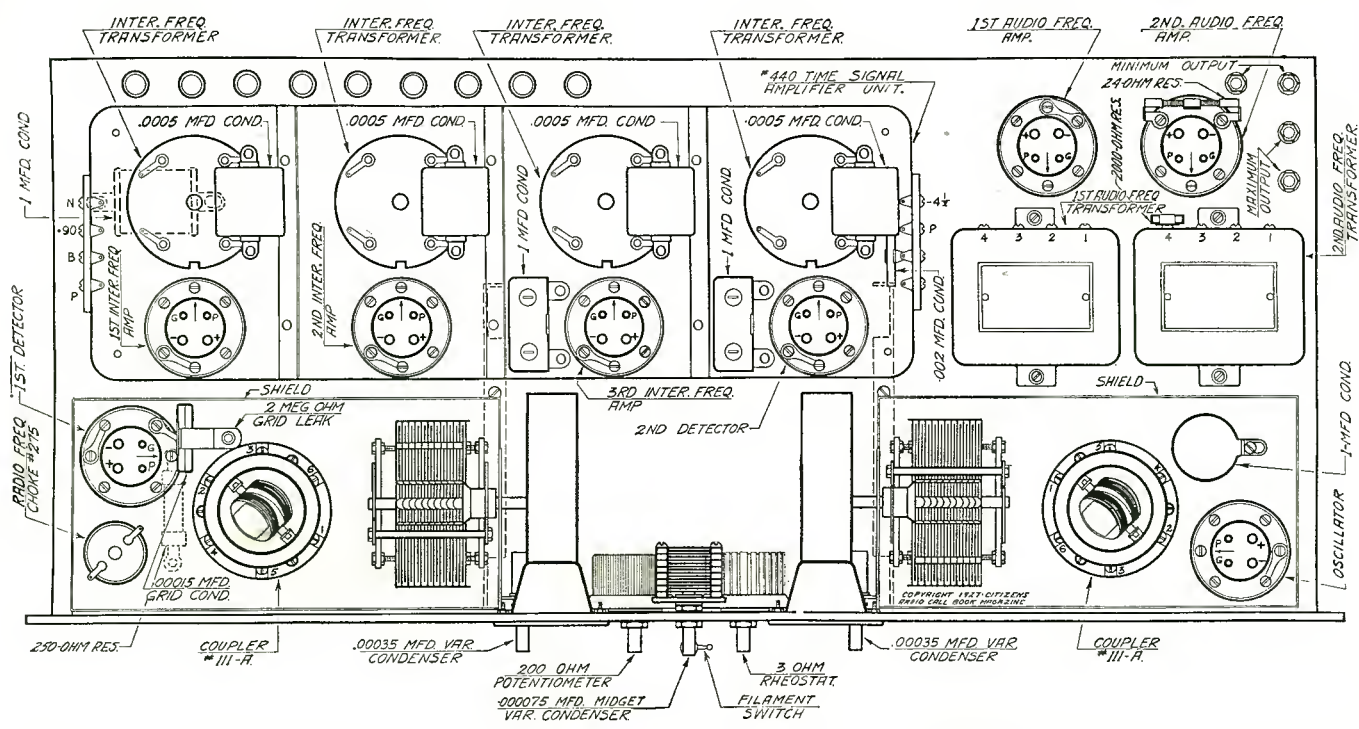

Fig. 4. Baseboard layout of the super described in the accompanying article is shown in the sketch above. Wiring should be done by reference to the schematic diagram, Fig. 3

susceptible to line noises in the supply circuit. Therefore to get away from such disadvantages the industry has turned to the heater type of a.c. operated tubes, in which a heater coil directly in series with the raw a.c. merely supplies heat by conduction to a cathode which actually furnishes the electronic emission for the tube. Therefore the cathode forms no part of the alternating current circuit and is free from the disadvantages previously related. Sovereign tubes of the heater type have been utilized in this model and have been found to perform satisfactorily. It will be observed that the heater tubes are used in all stages of the receiver except the 171 stage where raw a.c. is given the filaments. In this position no difficulty is experienced.

Bias for the cathodes of the heater tubes (shown as "C" in the schematic diagram) is provided through a 250 ohm fixed resistance placed between the negative of the B battery and the common cathode connection. Bias for the first audio and the 440 amplifier unit is secured through the  $4\frac{1}{2}$  volt C battery terminal on the unit, while bias for the 171 tube is through the drop across a 2000 ohm resistance between center tap of a 64 ohm resistor spanning the 5 volt filaments and the grid return of the second audio transformer. Twister pair, not smaller than No. 12 in current carrying capacity, should be used for all filament leads and their length kept down to the very shortest possible.

#### Antenna Is Used

Antenna tuning is by means of the condenser carried by the left hand drum dial while the right hand dial operates the condenser which tunes the oscillator. A small antenna, 30 to 60 feet long, may be used on the set for best results. Weak stations may be intensified by turning up the regeneration condenser on the front panel. Adjustment of the midget condenser (shown as "gain" on the front panel) will alter slightly the settings of stations on the antenna dial. The sharpness of the antenna tuning condenser will depend upon the position of the antenna rotor and the capacity used in the midget. The oscillator rotor should be set on a weak signal around 300 meters to get the right amount of feed from the oscillator to the first detector and after this adjustment is made, it may be left alone.

It will be found by the owner or builder of such a set the harmonic question is practically settled in a model of this kind,

due to the frequency value at which the main amplifier is tuned. In intermediates peaked at frequency values lower than that mentioned above repeat points quite frequently appear when the frequency difference between two local stations, or one local and one out-of-town station, is exactly twice the fundamental frequency of the intermediates. Doubling 112 kilocycles would give 224, which value is not represented by the difference between any two stations unless one of these stations is badly off its prescribed wavelength.

#### List of Parts

Below are the parts used in the laboratory model. We would not recommend substitutions on account of the balanced nature of this special receiver:

- 1—Van Doorn panel and chassis unit
- 1—Carter .00015 grid condenser with clips
- 1—MW6000 Carter potentiometer
- 1—105 Carter .5 mfd. by-pass condenser
- 1—MW  $\frac{1}{2}$  Carter rheostat
- 1—110 Carter power switch
- 4—10 Carter tip jacks
- 1—H2000 Carter 2000 ohm resistance
- 1—H250 Carter 250 ohm resistance
- 1—FT64 Carter resistor
- 1—Polymet 2 megohm grid leak
- 2—220 Silver-Marshall audio transformers
- 4—511 Silver-Marshall sockets
- 2—805 Silver-Marshall drum dials
- 1—275 Silver-Marshall radio frequency choke
- 1—342 Silver-Marshall midget condenser
- 1—440 Silver-Marshall time signal amplifier
- 2—515 Silver-Marshall inductance sockets
- 2—111A Silver-Marshall inductances
- 9—X-L binding posts
- 2—320 Silver-Marshall .00035 mfd. variable condensers
- 7—Sovereign a.c. heater tubes
- 1—Sonatron type 171 tube
- 40 Feet flexible Acme celatsite wire
- 1 Package Kester radio solder
- Miscellaneous lugs, nuts, screws, etc.

# Tyrman Super Ten Operated from Line By "A" Eliminator

Powerful Combination Using Receiver, Abox Eliminator and Thordarson Power Amplifier

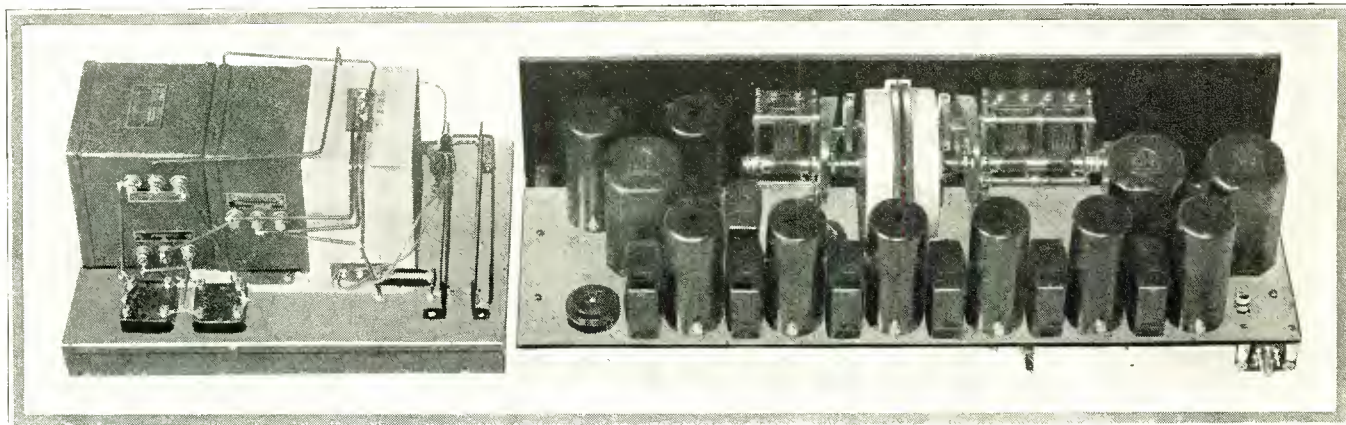

Figure 1. This photograph shows the rear view of the Tyrman Super Ten at the right and the Thordarson power amplifier at the left. Elsewhere in this magazine will be found another form of Thordarson amplifier which may be of interest to the set constructor

**R**EARRANGED so that it may be operated from a standard A eliminator, the Tyrman Super Ten Receiver has been furnished with a special power amplifier to insure ample voltage and current for its operation and thereby gain the most quality possible in reproduction. On account of the voltages necessary to operate the 210 tubes arranged in push-pull form at their peak efficiency, it was decided that a power compact would be the only suitable means, and this unit together with an Abox filter supplies plate and filament current for operation of the receiver from an electric light circuit and without the use of batteries other than the C battery used in the second detector and oscillator grid returns.

## Receiver Well Known

Since the receiver is quite well known to our readers, having appeared in another form in the September issue of this magazine, not much description will be given to the set itself but will be spent on informing our readers of the manner in which it works from the electric light socket. The schematic diagram, of course, will disclose all of the electrical connections involved in this receiver and will serve for builders who are desirous of making up the present set. Those who have already made the previous model and desire to change may readily do so by consulting both the schematic shown in Figure 3 and the graphic shown in Figure 4. The receiver uses one stage of tuned radio frequency ahead of the first detector and has four stages of intermediate frequency amplification, a second detector, an oscillator,

first audio and two stages of audio arranged for push-pull amplification. Standard quarter-ampere tubes are used in all positions, with the exception of the first audio, which is a 171, and the push-pull stages, where a pair of 210 tubes are utilized. Tyrman r. f. transformer, input and output audio transformers, drum dial and shielded tube sockets are employed in this model, together with Camfield .00035 variable condensers, one of them being a single unit used for tuning the oscillator and the other a double unit which spans the first stage of tuned radio frequency and the first detector.

Since it was the desire of the designers to completely eliminate storage batteries or B batteries in the operation of the receiver, the Abox filter, which is illustrated in this article, was chosen as a means of supplying the filament current. This unit consists of a transformer, a rectifier and the Abox filter all combined in one unit, taking power direct from the light socket and delivering hum-free filament current in a sufficient quantity to operate up to and including eight quarter-ampere type tubes. A further description of this interesting filter, which gives many more details than might be possible in an article of this kind, may be found in the Accessory Section of this issue.

## Full Wave Rectifier

The Thordarson power amplifier, which was built up for operating the plates of the two power tubes, consists of a pair of 216-B tubes arranged for full wave rectification and filtered through the conventional

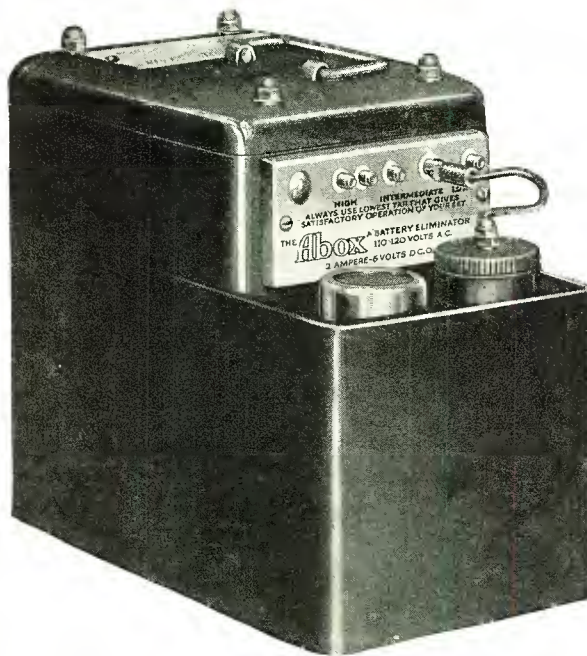

Figure 5. In the above photograph may be seen the Abox A eliminator, which consists of a rectifier and a filter, which is used in operating the Tyrman Super Ten from the electric light mains

(This receiver tested and all illustrations made in our laboratory)

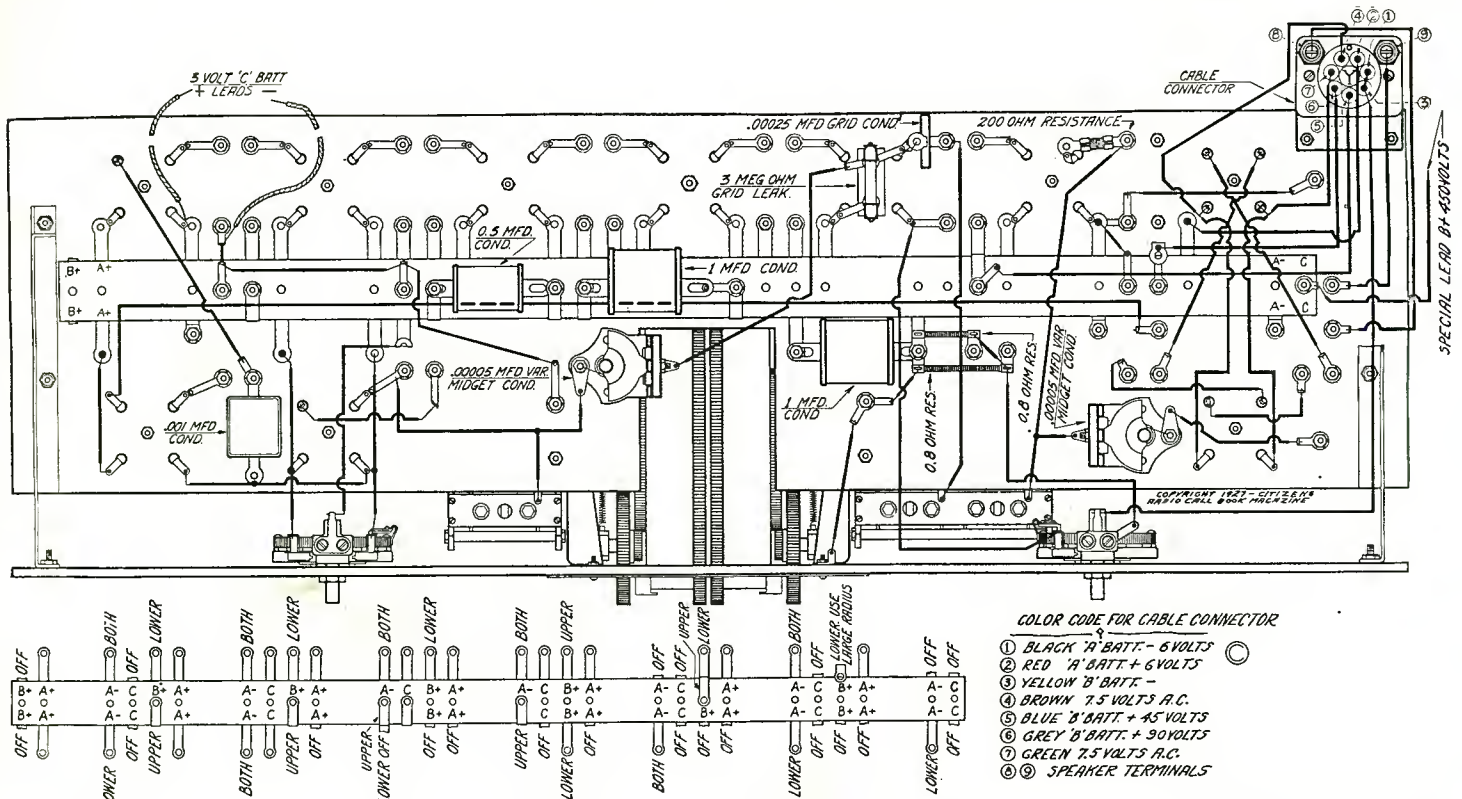

Figure 4. This graphic illustration shows the connections necessary on the bottom of the sub-panel, together with a detail of the capacity strip used for tying in all of the tubes, transformers and inductances

Thordarson choke and Tobe filter block. The maximum voltage of the power amplifier, which runs around 400 volts, is carried to the B connection on the audio frequency power output transformer, where it supplies the plates of the 210 tubes arranged for push-pull operation.

**Feeding the Detector**

Inspection of the schematic circuit shown in Figure 3 will reveal a novel method of feeding oscillator energy to the input circuit of the first detector, a method which does not seem to have been used by other circuit designers. A .00005 mfd midget condenser is connected between the grid of the oscillator tube and the tube side of the first detector grid. This small condenser is used to furnish a variable capacitive coupling between the grid of the oscillator and the first detector, and its value may be shifted at will by the operator for either increasing or decreasing

the amount of mixing current for use in the first detector. Using this system of pick-up energy, it is possible to utilize a double winding oscillator coupler, whereas if the pick-up winding method of connection were used it would be necessary to have an oscillator coupler with three separate windings.

Another small variable capacity is used between the antenna and the grid connection of the radio frequency transformer used in the first stage and known as type 8-70. This capacity allows a fairly wide range of signal intensity for use on the grid of the first tube. This grid circuit is further stabilized for operation over the present broadcasting range by means of a 200 ohm fixed resistance located between the stator of the .00035 mfd condenser and the grid terminal of the tube. Being outside of the tuned circuit, the presence of the resistor in this position merely acts as a means of cutting down the instability of the radio frequency stage.

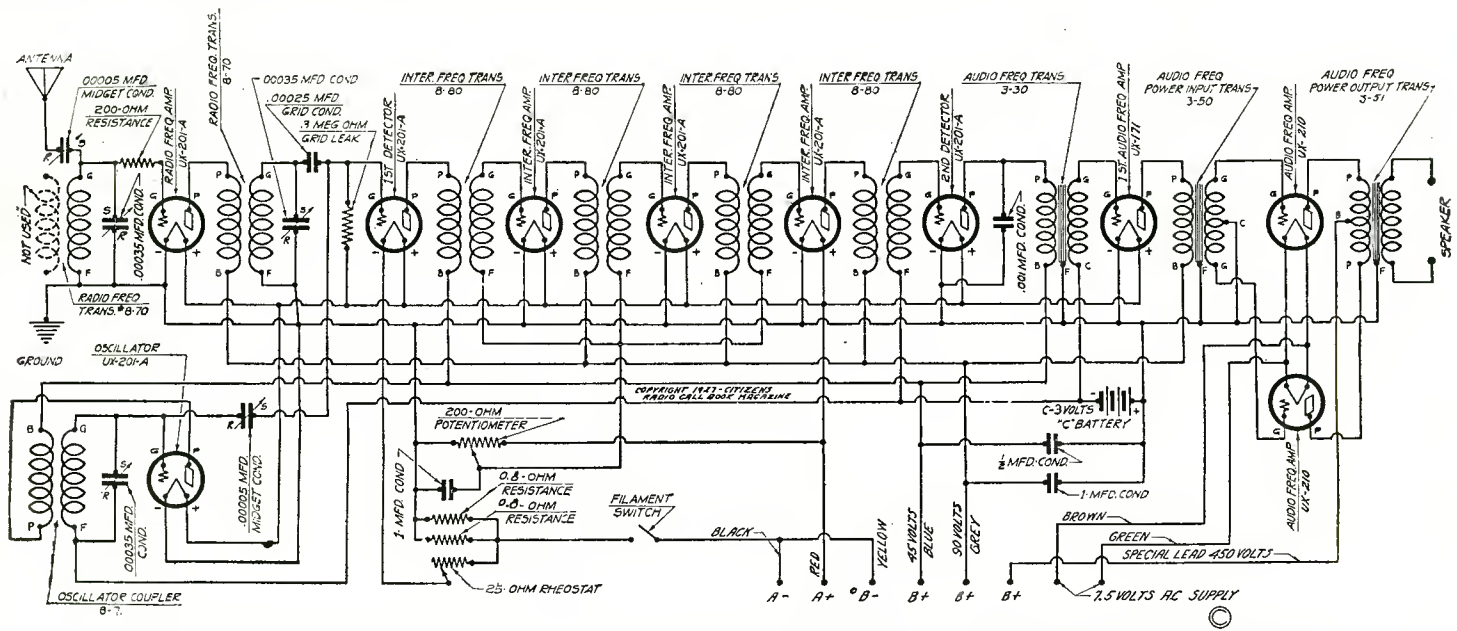

Figure 3. The story of the Super Ten may be learned from inspection of the schematic diagram shown above

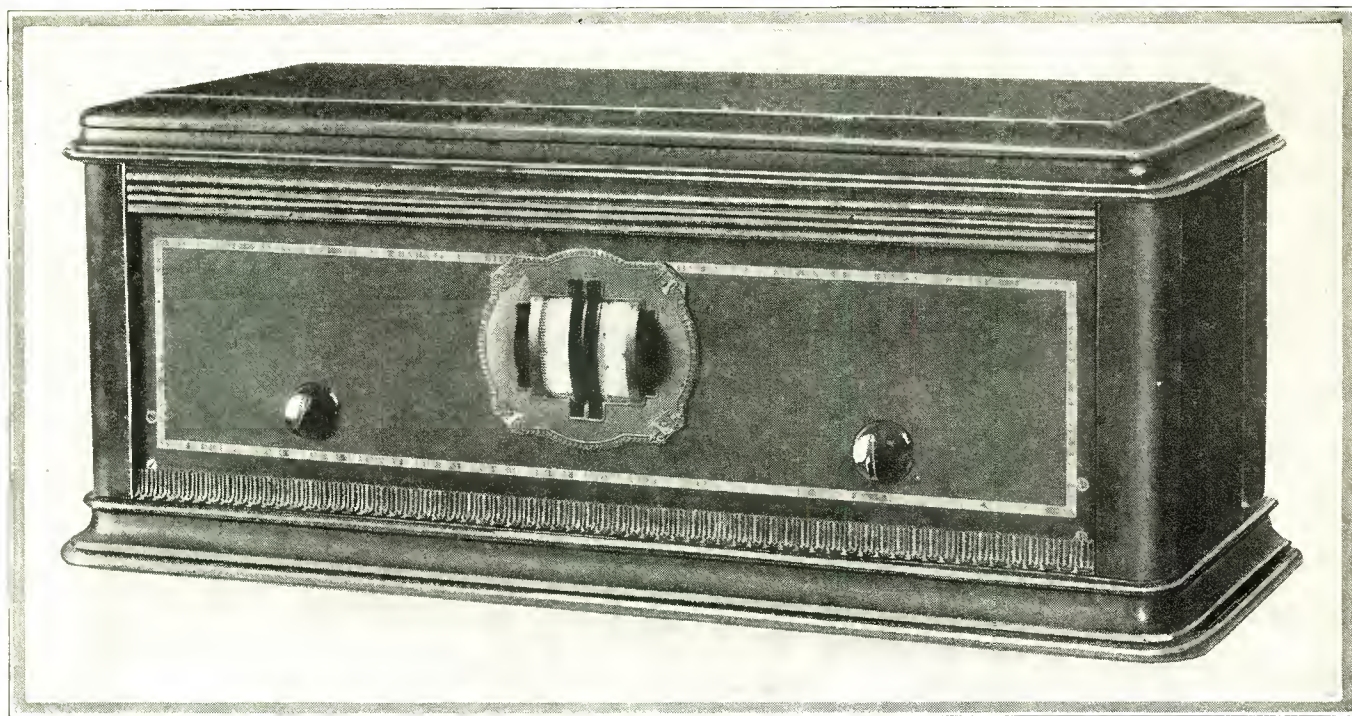

Figure 2. Front view of the Tyrman Super Ten is shown together with an Ehlert cabinet

Grid returns of the first, second and third intermediate frequency transformers go to the center arm of a 200 ohm potentiometer, bypassed with a 1 mfd condenser to negative. And this potentiometer allows the operator control of the r. f. tendencies of the intermediate stages, so that if desired it may be used for cutting down volume on local stations. A further control is also seen in the use of the 25 ohm rheostat.

The left hand section of the Tyrman drum dial governs the first stage of tuned r. f. and the first detector, while the right hand one controls the frequency of the oscillator. In the photograph shown in Figure 1, it will be observed that tube shields have been placed over all of the sockets except the one shown on the extreme left, which has been left off and which indicates the position into which a phonograph may be plugged if it is so desired.

#### Panel Work Simple

About ninety-five per cent of the work in the assembly of this receiver has been eliminated by virtue of the drilled sub-panel, which may be secured, and the capacity connector which is used. All units required for the operation of this set fit into their respective holes, as shown in the graphic illustration, Figure 4, so practically all that the builder has to do is to tighten up the nuts and run a few short leads of wire, which are indicated in the graphic diagram.

Those who have constructed this receiver from the description appearing in our previous issue will observe a difference in the connections on the metal tabs of the capacity connector, as well as some of the leads shown in darker lines on the graphic drawing. This is due to the fact that in the previous issue the largest size tube used was a 171 type, whereas in this receiver the largest sizes are 210's. Only two controls, aside from the oscillator and antenna tuning, are used, these being a 25 ohm rheostat in the negative filament circuit for controlling the brilliancy of the first detector and which is the left hand control on the front panel; and the 200 ohm potentiometer which biases the grids of the intermediate stages, which is located on the right hand side of the front panel. These are refining controls and serve to increase or decrease the volume of the received signal.

The following parts were used in the construction of the model described here:

#### Receiver

- 2—8-70 Tyrman r. f. transformers
- 1—8-71 Tyrman r. f. transformer

- 4—8-80 Tyrman r. f. transformers
- 1—3-30 Tyrman a. f. transformer
- 1—3-50 Tyrman power input transformer
- 1—3-51 Tyrman power output transformer
- 1—Tyrman double drum dial
- 10—Tyrman shielded tube sockets
- 1—Kurz-Kasch capacity connector
- 1—351 Camfield .00035 mfd variable condenser
- 1—352 Camfield .00035 mfd variable condenser
- 1—Lignole 7x26x3/16 inch drilled and engraved panel
- 1—Formica 7x26x3/16 inch drilled sub-panel
- 1—8629 Pair Benjamin sub-panel brackets
- 2—110 Carter 1 mfd bypass condensers
- 1—105 Carter .5 mfd bypass condenser
- 1—Carter .00025 mfd grid condenser
- 1—Carter .001 mfd fixed condenser
- 1—660 Yaxley cable connector
- 1—4L Yaxley 1 ampere fixed resistance
- 1—3L Yaxley  $\frac{3}{4}$  ampere fixed resistance
- 1—200 Yaxley 200 ohm potentiometer
- 1—7200 Yaxley 200 ohm grid resistance
- 1—125K Yaxley 25 ohm rheostat with switch
- 7—Sonatron type A tubes
- 1—Sonatron type 171 tube
- 2—Sonatron type 210 tubes
- 1—Muter 3 megohm grid leak and mounting
- 2—X-L binding posts
- 2—Hammarlund mmf midget variable condensers
- 1—Package Kester radio solder.
- 1—Ekko ground clamp
- 10—Feet Acme Celatsite wire
- Miscellaneous lugs, nuts, screws, etc.

#### Power Supply

- 1—2098 Thordarson power transformer
- 1—2099 Thordarson choke unit
- 1—210 Tobe condenser block
- 1—Carter 7400 ohm resistor with two slides
- 1—Carter 7400 ohm resistor without slides
- 1—Carter 400 ohm resistor
- 1—Carter 750 ohm resistor
- 2—530 Frost sockets
- 4—X-L binding posts
- 15—Feet flexible Acme Celatsite wire

# Grimes Octa-Monic

New Principle Involved in Use of Harmonic Generator Tube for Increasing Selectivity in Receiver

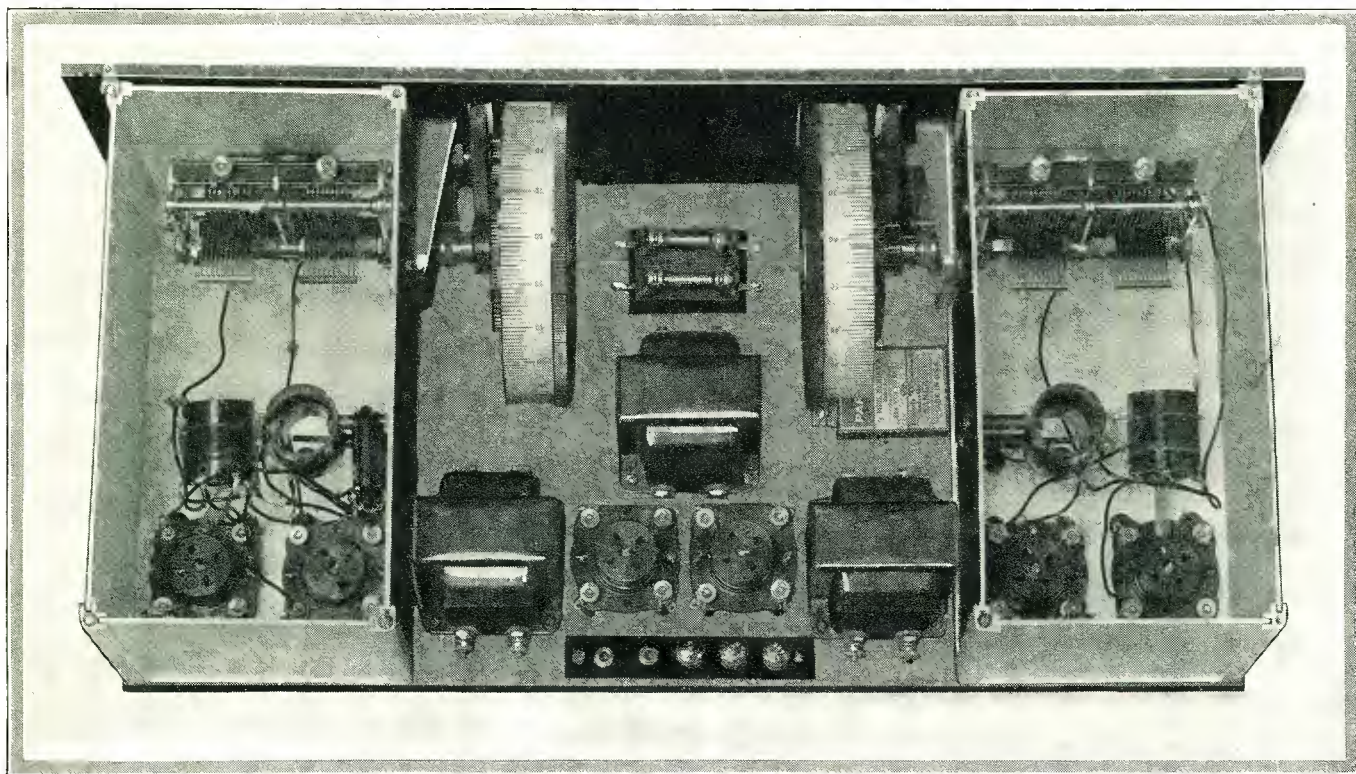

Figure 2. Important and critical sections of the receiver are enclosed in metallic housings as shown by this photograph

THE primary object which every radio designer has had in mind during the past few years of radio broadcasting is the building of a radio receiver which has super-selectivity and good tone quality. Of course, some efforts have come closer to the ultimate than others, but one thing has become apparent. The problems of super-selectivity and good tone quality do not seem to be co-related. In fact, the greater the selectivity of the receiver the more noticeable is the distortion of sound reproduced therefrom. This tendency has been called, in engineering parlance, "the cutting of side bands."

There have been only three fundamental circuits developed to date, and all three of these have been subject to a greater or less degree to the same difficulty. The regenerative principle of obtaining increased signal strength by feed-back is notorious for the nasal tone produced when the regeneration is boosted up to efficiency. Tuned radio frequency was not quite so noticeable in this regard, but if the tuned r. f. circuits are made extra-selective the effect on tone quality is quite apparent. The super-heterodyne has real limitations on its tone quality when the selectivity of the receiver is increased so as to satisfactorily operate on anything but a small loop.

But this fourth fundamental circuit recently developed by David Grimes has been worked out to solve just this problem. This circuit Grimes has chosen to call the "Octa-Monic." It functions in an entirely different manner than that experienced in the other three well known principles mentioned above. Every broadcast station that is received is automatically shifted to the half-wave length, which is equivalent to saying that the frequency of every carrier wave is doubled by means of a harmonic

generation. The interesting part of this harmonic principle is that super-selectivity results without detrimental side-band reduction. This increase in selectivity results not from any particular arrangement of circuits but from a shift in wavelength itself which occurs in one of the tubes of the receiver specially arranged for the generation of second harmonics. The "Octa-Monic" principle thus radically departs from all previous radio design where selectivity was obtained by circuits. The selectivity in this latest Grimes development is obtained from the vacuum tube itself.

## Considerable Research Done

So far the theory is all very simple. Even second harmonics themselves are not particularly complicated and have long been known and often used for various purposes. The idea of employing them for gaining selectivity to meet modern broadcast conditions is new. The only particularly complicated part of the arrangement has occurred in the determination of design detail. No great amount of information on this design was obtainable in the prior art; so a vast amount of research work was necessary to determine the empirical equations necessary for calculating the electrical constants of the circuit. This applies particularly to those sections of the layout dealing with the generation of harmonics, their detection, and tuning.

Schematically are shown the over-all circuit arrangements covering the radio frequency and tuning ends of the circuit as well as the audio arrangement. The radio energy comes in the antenna in the conventional manner where it is tuned rather broadly and is then impressed upon an r. f. coupling tube. The

(This receiver tested and all illustrations made in our laboratory)



main purpose of this tube is purely amplification and the increased r. f. energy resulting is then tuned and placed on the input to the harmonic generating tube. Second harmonics which occur in the plate circuit of this tube and which inherently exhibit unusual properties of selectivity and sharpness of tuning, are taken off the plate circuit of the harmonic generator tube to a special tuned transformer. This transformer is resonated at the second harmonic frequency and the r. f. voltages arising from this tuned circuit are placed on the grid of a standard grid leak detector tube.

The antenna circuit is most unusual because of the incorporated harmonic wave-trap. The purpose of this trap is to eliminate heterodyning which has been found to occur on various broadcast stations above 400 meters, resulting from the simultaneous operation of nearby local stations whose wavelengths are just half of that station being heterodyned above 400 meters. As an illustration, heterodyning has often been heard on the carrier wave of WEAf operating on 492 meters. It was thought at first that this heterodyning was of the ordinary type caused by some other station operating on the same wavelength, but extensive tests show that this was not the case. The heterodyning was arising from the fact that WAAT was operating simultaneously on 246 meters—the half-wavelength of WEAf! A wave-trap inserted in the antenna tuned to reject the 246 meter station reduced the heterodyning to almost nothing! The theory is that the 492 meter station incidentally generates a second harmonic current in the plate circuit of the radio frequency tube and this second harmonic current heterodynes with the low wavelength station. This is not a peculiarity of the Octa-Monic, but is occurring on many tuned radio frequency sets today. The harmonic wave-trap is the real answer and at the same time has no detrimental effect on the station which is being picked up and received.

The primary of the fundamental tuned transformer connecting the r. f. coupling tube to the harmonic generator is the next unusual arrangement. This primary is tapped almost at its center point and a .00025 fixed condenser is connected between the tap and the filament of the coupling tube. The low end of the primary passes on to 90 volts through a variable non-inductive stabilizing resistance. This method of coupling to the tuned secondary permits more equal amplification of all of the wavelengths in the broadcast band than a straight untapped primary. The low wavelengths pass through the first half of the primary, where they are diverted to the filament by means of the bypass

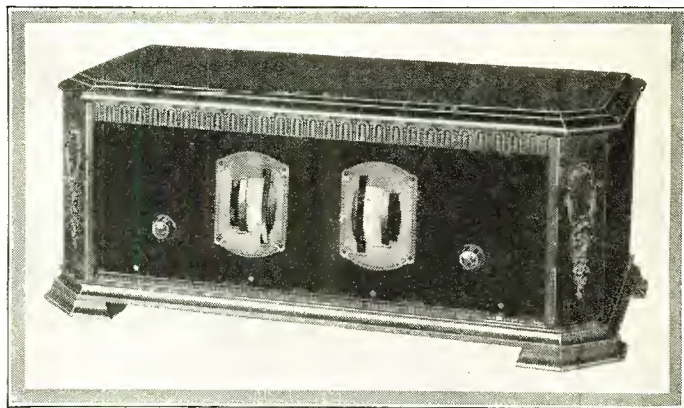

Figure 1. Simplicity of tuning control is discerned in the front panel of the receiver illustrated above

condenser. The long wavelengths which use lower frequencies have difficulty passing through this condenser and therefore travel through the entire primary. This arrangement gives fairly equal coupling over the frequencies used in broadcasting.

**Works on Straight Part of Curve**

It will be noted that the r. f. coupling tube employs 90 volts on the plate and 4½ volts minus C on the grid. This is absolutely essential in order to eliminate any tendency toward cross-talk between a nearby local station and a distant station. These values of voltages enable the tube to be operated on the straightest part of its grid voltage-plate current characteristic curve. This gives maximum amplification with a minimum rectification or detection action. Any appreciable tendency toward the rectification of the radio frequency wave in the coupling tube will create audio currents in the plate of this tube corresponding to the modulation on the particular carrier wave that is being rectified. Hence, if a nearby local station is being rectified in the coupling the audio currents resulting therefrom will impress themselves upon the carrier wave of the weak distant station which is coming in close to the same setting as the local station. The distant station will be found to have on its carrier wave the local program, even though there may be several degrees of silence between the tuning positions of the two stations. This action is called cross-talk or cross-modulation. Its remedy is the operation of this coupling tube on the straight part of its charac-

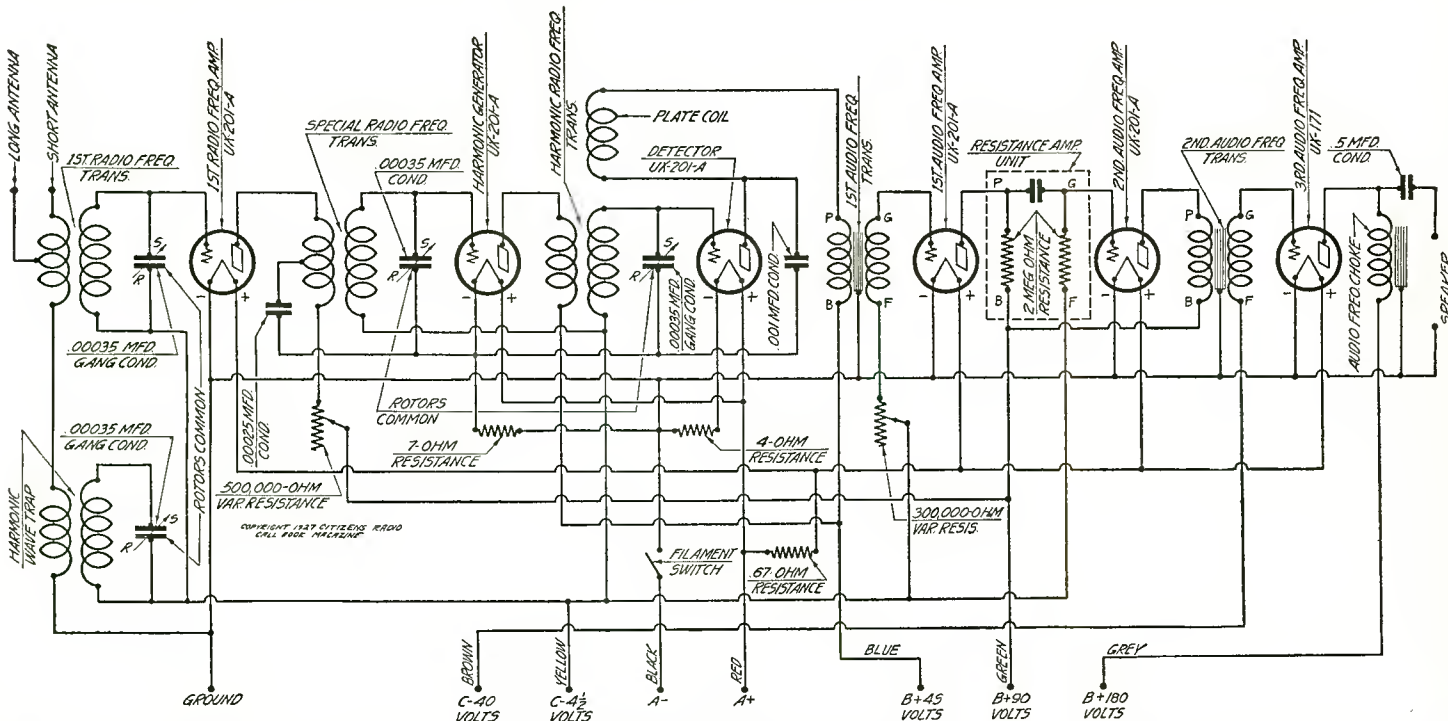

Figure 3. Experimenters and set builders should study this schematic diagram very carefully, as it will give them a clue as to the operation of the Octa-Monic

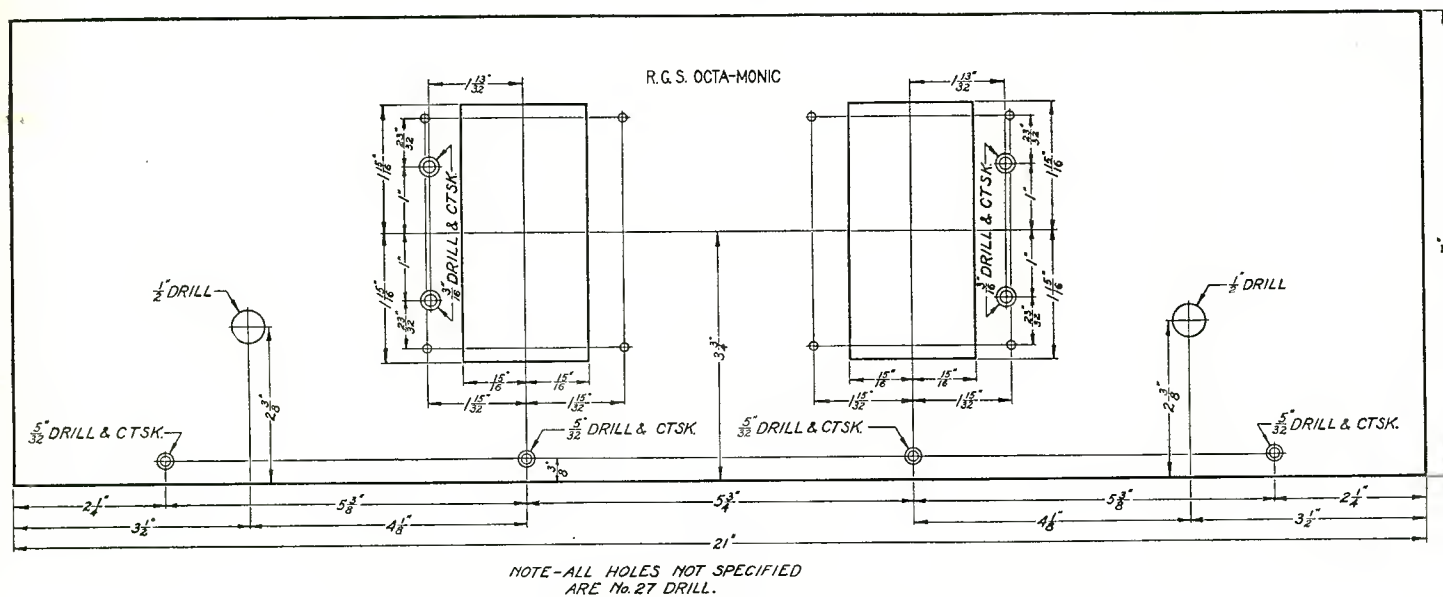

Fig. 5. Front panel layout is shown here for proper location of all holes

teristic curve, which is obtained by 90 volts B and  $4\frac{1}{2}$  volts C.

The harmonic generator tube is so arranged that the carrier wave is deliberately unbalanced—the positive halves of the wave being amplified greater than the negative halves. This very unbalanced condition creates the second harmonic currents. In order to obtain this unbalanced condition, the tube must be operated about the lower knee of the curve. This condition is obtained by means of 45 volts on the plate circuit and about 2 volts minus potential on the grid circuit. The 45 volts value is standard and can be obtained on either batteries or power sources. The 2 volts bias on the grid presents a harder problem commercially, as the ordinary C battery does not give this voltage. Other means have to be employed for this, the best being an IR drop in the negative side of the filament of the harmonic generator tube. This drop is obtained by means of a 7 ohm resistance. This 2 volt drop, of course, allows only 4 volts on the filament of the harmonic generating tube, but, unfortunately, the filament voltage on the harmonic tube is not at all critical, as the lower knee of the curve is not affected within wide limits of the filament voltage.

It is quite true that the condition shown in the harmonic generator will result not only in the generation of second harmonics but in audio currents as well. These audio currents in the plate circuit of the harmonic tube are not utilized, but unless they are considered, considerable trouble will arise therefrom. All of which involves the question of the proper type of detector tube. And right here now is a good time to distinguish between detection and harmonic generation, even though both may occur simultaneously under certain conditions in the same tube. A tube operating according to the arrangement shown in the harmonic generator will create both harmonic currents and audio detection. A grid leak detector operating in the standard detector manner will function very well as the detector of audio currents, but is a very poor harmonic generator. Hence, we cannot use a grid leak system for harmonic generation. It appears at first sight that we might use either a C battery system or a grid leak system for the conventional detector.

#### Both Detector Types Tried

Both types of detectors were subjected to tests and it was found that the quality with the grid leak system was far superior. This seems somewhat contrary to theory, but it was substantiated time and again. The explanation seems to lie in an interesting condition. The audio currents set up in the plate circuit of the harmonic generator always increase upon an increase in the carrier wave applied to the grid. When using a grid leak detector the audio currents set up in its plate circuit always decreases upon an increase in the carrier wave applied to

its grid. This reversal of detection in the two tubes places these two audio currents out of phase with each other in the common 45 volt source of potential. This avoids any excessive battery drop through the inherent resistance which always exists in every battery or even in power sources. If a C battery detector were employed, the audio currents resulting therefrom would increase upon an increase in the carrier wave and would therefore be in phase with the audio currents resulting in the plate circuit of the harmonic generator. An excessive IR drop would thereby occur in the 45 volts potential source, resulting in a rather disagreeable tone quality. So even the choice of detector systems is the result of much thought and study.

The design of tuning condensers and coils for the RGS Octa-Monic presents a very interesting problem, especially when an attempt is made to operate the tuning condensers from a common shaft. It is quite obvious that the frequencies in the tuned secondary of the detector tube are very different from the frequencies occurring simultaneously in the tuned grid circuit of the harmonic generator. They are actually just one octave apart. Whenever 400 meters is being tuned on the grid of the harmonic generator, 200 meters must be tuned on the grid of the detector tube, and so on. The stunt is to so design these two tuning circuits that a standard double gang condenser on a common shaft will simultaneously correctly tune each of these circuits to its proper value—one at exactly an octave higher than the other. At first sight this seems an impossible task, but if the proper precautions are taken it works out very simply.

A little calculation will show that the two circuits can be correctly tuned simultaneously by similar condensers if the inductance of the second harmonic circuit is exactly one-fourth of the inductance of the fundamental circuit. This makes the size of the tuned secondary in the grid of the detector tube very, very small. If the fundamental coil is wound on a bakelite tubing of one and one-quarter inches with No. 30 wire, it will be found that the secondary will require 105 turns of wire for properly covering the broadcast band with a .00035 variable condenser. Under these conditions the secondary of the second harmonic transformer will only have 41 turns of the same size wire on the same size tubing.

Another very interesting thing that arises between the harmonic generator and the detector tube is the condition of absolute non-oscillation, irrespective of the closeness of the coupling or other things with which we are familiar which affect or increase oscillation. The primary of the second harmonic transformer consists of 18 turns of No. 30 wire very closely coupled to the 41 turns secondary. This makes this transformer almost a 2-1 affair. The reason for the total absence of any oscillatory tendencies is the fact that the tuned circuit associated with the

plate circuit of the harmonic generator is resonated at an entirely different frequency from the tuned circuit in the grid of the harmonic generator. Oscillation obviously cannot possibly occur under these conditions.

The question of audio stability is becoming more and more important with the ever-increasing use of B battery eliminators. In the old days when B batteries were exclusively employed for a source of B potential, the audio stability margin was less important. If a peanut whistle developed the batteries were thrown away and new ones installed without any questions asked. Now many B eliminators have fairly high resistance values which would cause peanut whistling or motor-boating with the audio circuit as employed in the average receiver. The relative freedom from such trouble is called the audio stability margin and can be easily determined by a resistance inserted in the common B return to the A battery. In many receivers, less than 30 ohms can be inserted at this point before whistling occurs. By very careful design in the Octa-Monic the stability margin has been increased to over 800 ohms, which insures satisfactory operation on every type of B eliminator designed to give the voltages specified.

The abnormally high stability margin is obtained by means of the reversed primary winding in the first audio transformer and the choke coil output in the plate circuit of the power tube. The phases of the various audio currents are so arranged that they tend to oppose or neutralize themselves in the B potential source. This prohibits any excessive IR voltage drops which would otherwise occur—these excessive drops being the cause of peanut whistling. It will be noted that the return from the loud speaker is brought directly back to the filament of the power tube. This keeps all of the audio currents in the last tube completely out of the B battery circuit.

The equipment layout in the RGS Octa-Monic is extremely simple. The harmonic wave-trap and antenna tuning coils and condensers are placed in a shielded can at the left of the receiver. The harmonic generating and detector tuning coils and condensers are placed in a completely shielded can at the extreme right of the receiver. The audio circuit is arranged on the baseboard in the space between the two shielding cans. The drum dials are also in this space. The complete arrangement is shown in the accompanying photographs.

The entire tuning of the receiver is accomplished by means of

two drum dials and two small auxiliary knobs. The knob on the extreme left turns off and on the receiver and in addition regulates the amount of audio volume without affecting the tone quality nor the distance-getting ability of the set. This control is a combined filament switch and a 300,000 ohm shunting resistance across the secondary of the first audio transformer. The small right hand control is the stabilizer which is used to offset any variation in B battery potential that may occur in various B eliminators. By proper adjustment of this the receiver may be kept at its most efficient point at any wavelength. This stabilizing knob controls the 400 ohm non-inductive variable resistance in the plate circuit of the r. f. coupling tube.

Parts used in the construction of this receiver follow:

- 6—9040 Benjamin sockets
- 2—R200 Thordarson audio transformers
- 1—R196 Thordarson output choke
- 1—Acme Parvolt .5 mfd bypass condenser
- 1—Electrad 500,000 ohm variable resistance
- 1—Carter 300,000 ohm volume control with filament switch
- 2—De Jure .00035 mfd two gang variable condensers
- 1—Sangamo .001 mfd fixed condenser
- 2—Sangamo .00025 mfd fixed condensers
- 1—RGS harmonic wave-trap
- 1—RGS antenna tuner coil
- 1—RGS broadcast tuner coil
- 1—RGS harmonic tuner coil
- 1—Carter 7 ohm fixed resistance
- 1—Carter .67 ohm fixed resistance
- 1—Carter 4 ohm fixed resistance
- 1—De Jure resistance coupling unit with 2 megohm resistors
- 2—Alco aluminum shield boxes
- 2—Tyrman single vernier drum dials
- 1—RGS 9x20x3/8 inch drilled wood baseboard
- 1—Lignole 7x21x3/16 inch drilled and engraved front panel
- 1—Belden 7 wire battery cable
- 1—RGS binding post strip
- 3—Engraved Eby binding posts
- 2—Carter tip jacks
- 30—Feet flexible Belden rubber covered wire
- 1—Package Kester radio solder
- 1—Ekko ground clamp
- Miscellaneous, lugs, nuts, screws, etc.

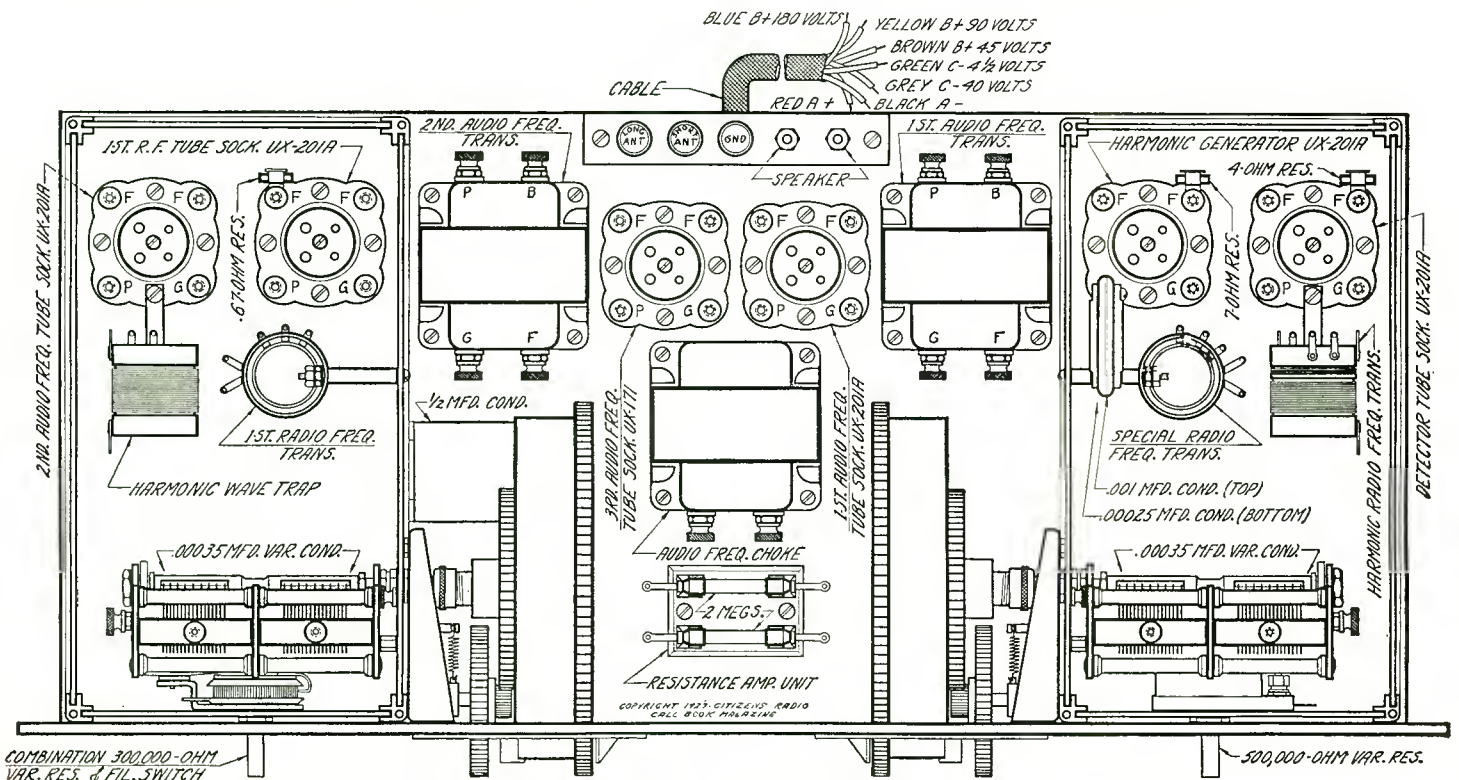

Figure 4. All parts for this set should be laid out in accordance with the illustration above

# World's Record Super Eight Is Economy Model for 1928

Latest Improvements and Recent Laboratory Practices  
Seen in New Design

**E**CONOMY seems to be the watchword in radio just as well as all other circles except in the case of the radio business the fans and experimenters are combining economy with consistent performance and high quality. With this in view we are presenting the electrical and mechanical details of the economy model of the 1928 World's Record super. It seems hardly necessary to remind our readers that past issues of our magazine have contained articles on construction, description and operation from which a large number of these receivers have been successfully assembled and operated, both by the experimenters and the novices.

At the outset it should be borne in mind this eight tube super has been designed with the idea of retaining the highest possible efficiency consistent with another very desirable attribute—that of low cost. It might also be well to state while the net figure is low, the efficiency of the receiver is believed to be as great as sets which may be obtained at a higher figure. It is the belief of the designer that the economy model to be described will give enthusiasts of moderate means a set that is low in cost yet as efficient as eight tubes can be made to perform.

## Two Major, Two Minor Controls

The front panel view of the receiver as illustrated in Figure 1 shows the arrangement of the controls, of which there are four. Two tuning dials, adjusting the loop and oscillator condensers respectively, form the major tuning controls. Two refining controls, the right one the detector-oscillator rheostat for sensitivity

and selectivity adjustment, and to the extreme left the stabilizer, which is the efficiency adjustment of the intermediate stages. The filament switch is automatic with the setting of the rheostat to zero, being built on the frame of the rheostat. A semi-fixed regeneration control using an X-L variodens is located at the back panel on the baseboard, but requires no adjustment or attention, once the proper value is effected. This latter adjustment is very useful in sharpening up the tuning of the loop dial by introducing a small amount of regeneration into the input circuit, and contributes materially to the sensitivity of the first detector and the receiver as a whole.

Two Kurz-Kasch Port dials impart to the front panel appearance a simple elegance, eliminating any suggestion of economy in the receiver. These dials also make the operating of the receiver more pleasureable and simple.

Diverting our attention to the back panel view shown in Figure 2 we find baseboard type of construction is used. The tubes are arranged in "T" fashion on the baseboard, and can be recognized from right to left as the oscillator, the first detector, then three intermediate frequency amplifiers, a second detector (to the rear of the baseboard), the first audio stage, and finally the last power audio stage which uses a 171 tube.

The connections to the Qualitone loop are made through three tip jacks mounted on a small bakelite support. The battery connections are conveniently brought up through a Jones 4 foot multiplug cord, with the exception of the C biases for the second detector, first audi and power tubes.

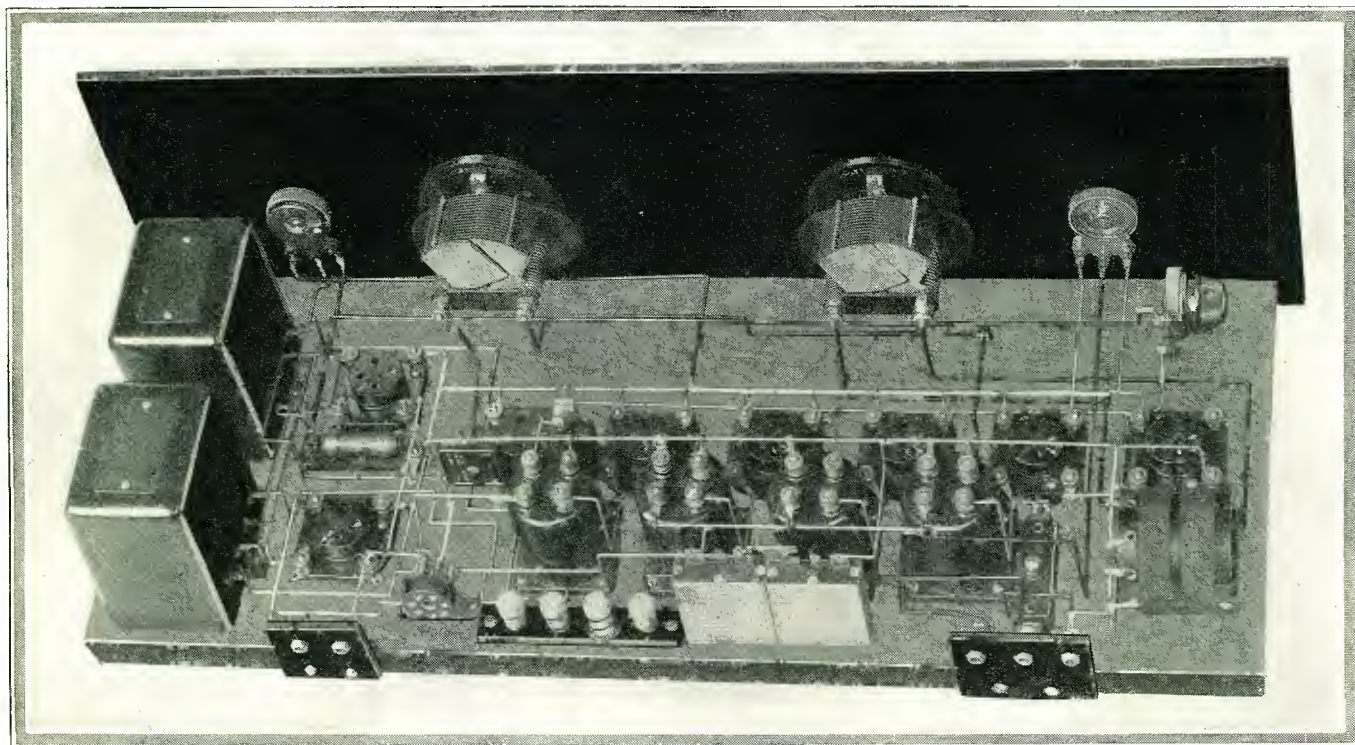

Figure 2. One of the first things the reader will observe in this photograph is the few parts involved—hence the economy model should be attractive to those of modest resources

(This receiver tested and all illustrations made in our laboratory)

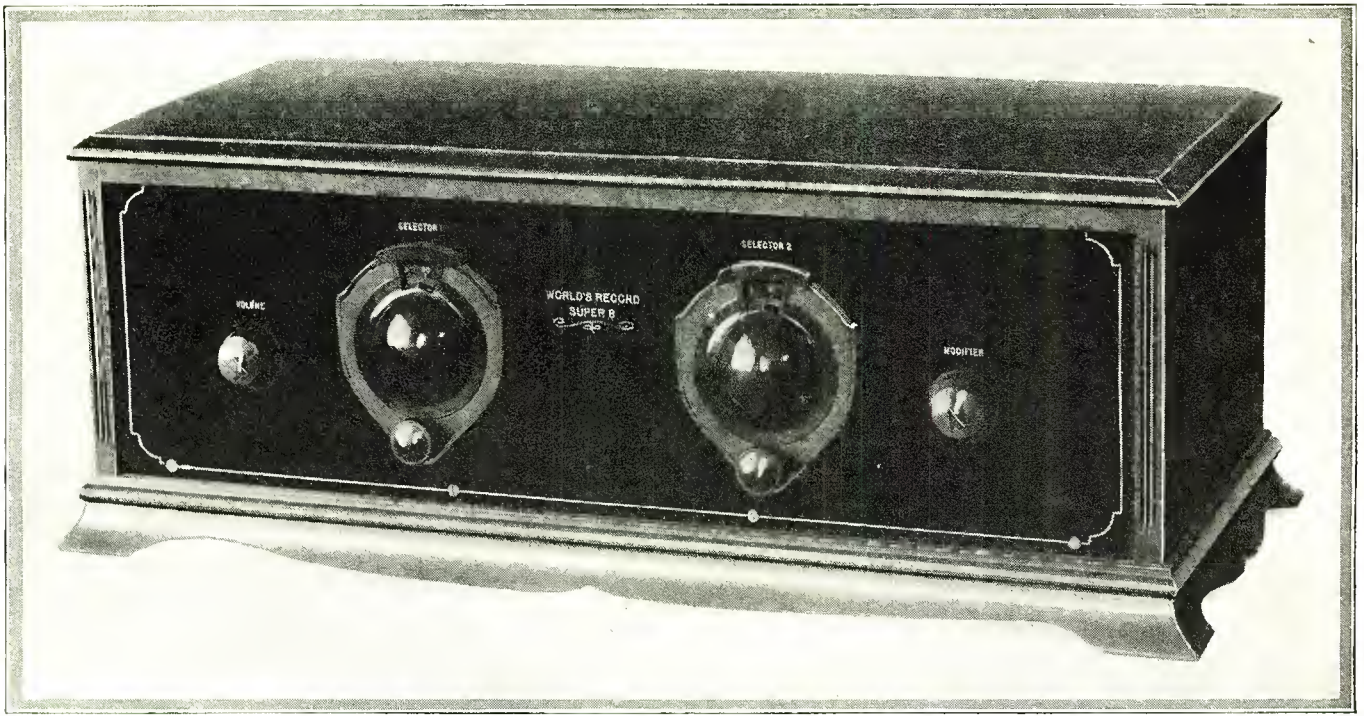

Figure 1. Extreme simplicity is represented in the appearance of this version of the World's Record super which is photographed in an Ehler cabinet

Remler .0005 mfd condensers and Silver audio transformers need no introduction or description excepting that the type 631 Remler is used and the Silver 220 is specified for this receiver.

The electrical details of the circuit are shown in Figure 3 and reveal an interesting series of improvements over previous models, including many recent findings of the designer. This new 1928 model of the World's Record super 8 combines to great advantage all the merits and fine points of previous models, and offers at the same time recent improvements all of which serve to make the receiver one of the most efficient supers now in popular demand.

Loop or Antenna Operation

The receiver can be operated either with loop or straight antenna, though loop operation is preferred when high selectivity

is demanded. Antenna operation requires the use of an antenna coupler of the three tap type, connected outside of the set. Any radio frequency coupler or antenna coupler having a primary and secondary of sufficient dimensions electrically will serve. Those not having a center tap may be easily converted by the builder by counting turns till the center is reached and the center tap made by soldering a suitable connection thereto. The antenna and ground should be connected to the primary of the coupler (either P or B, as it is not critical) and the three secondary taps may be connected in substitution for the loop, making sure that the center tap is properly connected. The two outer ends of the coupling coil are not critical, though the grid connection should be furthest away from the primary or antenna coil.

The rheostat located in the first detector and oscillator circuits enables fine adjustment of the oscillator output over the entire

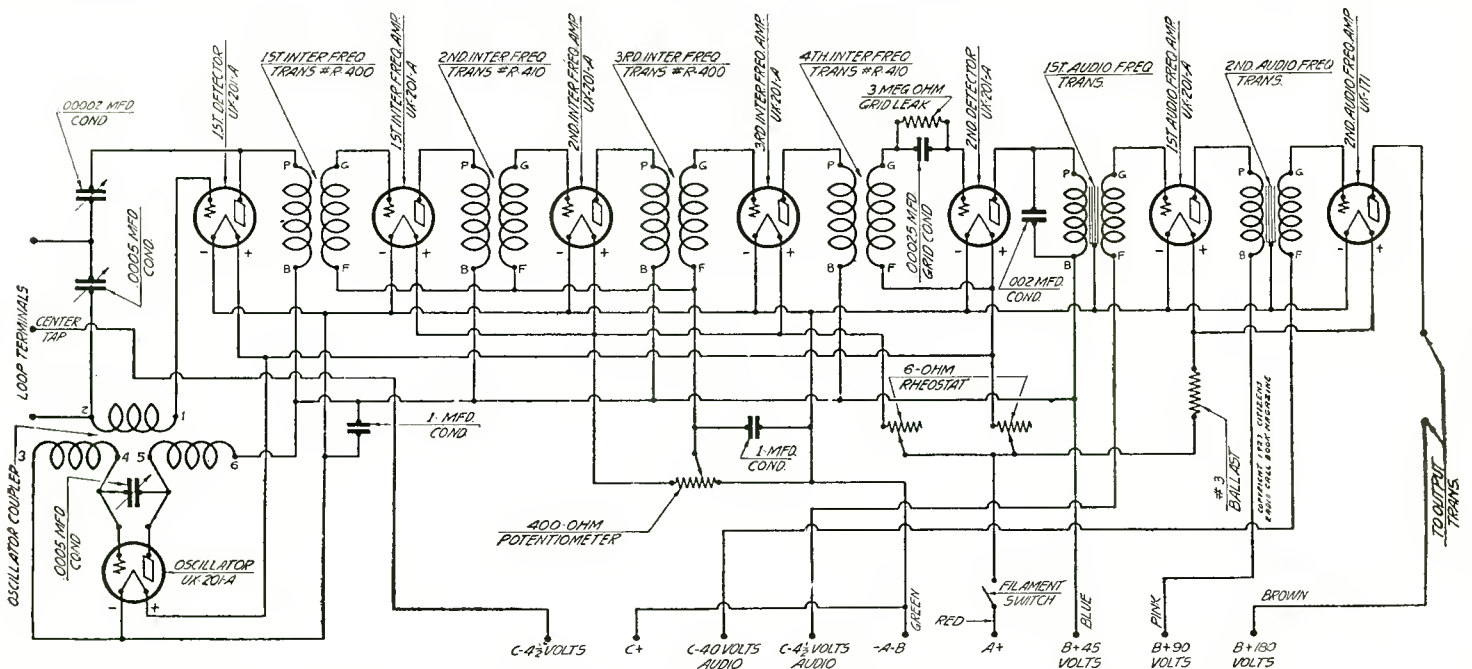

Figure 3. All electrical connections may be followed from the diagram shown above. Although not shown schematically the first intermediate is iron core, the second air, the third iron and the fourth air core

range of the oscillator, and effects simultaneously the correct filament potential for the first detector, essential in attaining the maximum sensitivity, selectivity and tone, especially on long distance reception. This control is frequently used by the operator in working through heavy interference.

The first detector is followed by the first Sectone R-400 intermediate transformer, which is considered one of the most efficient iron core intermediate transformers on the market. The beat frequency produced by the oscillator and first detector is greatly amplified by this high gain long wave transformer before being relayed to the first air core filter which immediately follows. This filter drains undesirable frequencies before passing them to the second intermediate stage where once again the amplitude of the beat frequency is increased, this time by a second iron core stage, after which the highly amplified signal is filtered once more by a second air core Selectone R-410. This second filter is laboratory matched with the preceding one, and governs the sharpness of tuning which the economy model of the World's Record super 8 possesses. The matching process of these units is very interesting and involves a great deal of painstaking work on the part of the manufacturer.

Due to the exceptionally high gain of the intermediate amplifier, the potentiometer stabilization can be used to excellent advantage. The use of the Frost 400 ohm potentiometer makes possible very accurate adjustment of the grid bias on the intermediate tubes, and enables operation of the amplifier at the point of high gain, best tone and keenest selectivity. This new arrangement is a decided advantage over previous models.

The audio amplifier is not radical in design, and is necessary to call attention to the use of a filament ballast in the A negative line for filament control of these two last tubes. A three-quarter Daven does the work efficiently and thoroughly. The Silver 220 audio transformers are well known for their tonal fidelity in amplification. It is advisable to use a good cone speaker at the output for the best tone.

One of the sterling features of this economy model of the receiver is the ease of disposing of the power supply problem. The set works equally well with B eliminator or B batteries, and will operate on any of the standard models now on the market.

The plate current load of the entire receiver with a 171 tube in the last stage (properly biased) is less than 20 milliamperes, which can be obtained from nearly every B lightsocket power device. This reasonable load makes it possible to use B batteries and obtain a fair operating period with each block if B batteries are preferred.

**Assembly Simplified**

The assembly of this model is considerably simplified by the new layout of parts shown in the graphic illustration, Figure 4.

Following parts were used in the construction of the receiver described in this article. If other parts are used they should be of equal merit and of the same constants specified:

- 2—R410 Selectone transformers
- 2—R400 Selectone transformers
- 1—R340 Selectone oscillator coupler
- 1—N X-L variodenser
- 2—631 Remler .0005 mfd variable condensers
- 2—220 Silver-Marshall audio transformers
- 8—9040 Benjamin sockets
- 2—Tobe 1.0 mfd bypass condensers
- 1—Carter .00025 mfd grid condenser with clips
- 1—Carter .002 mfd fixed condenser
- 1—1906 Frost 6 ohm rheostat
- 1—S1906 Frost 6 ohm rheostat with switch
- 1—1924 Frost 400 ohm potentiometer
- 4—X-L binding posts
- 2—253 Frost tip jacks
- 2—Kurz-Kasch vernier dials
- 1—Courtland drilled and engraved 7x24x3/16 inch panel
- 1—Wood baseboard 9x23x1/2 inch
- 1—Jones BM multiplug
- 1—3 Daven 3/4 ampere ballast
- 7—Ceco type A tubes
- 1—Ceco type 171 tube
- 30—Feet Corwico Braidite solid wire
- 1—Package Kester radio solder
- Miscellaneous lugs, nuts, screws, etc.

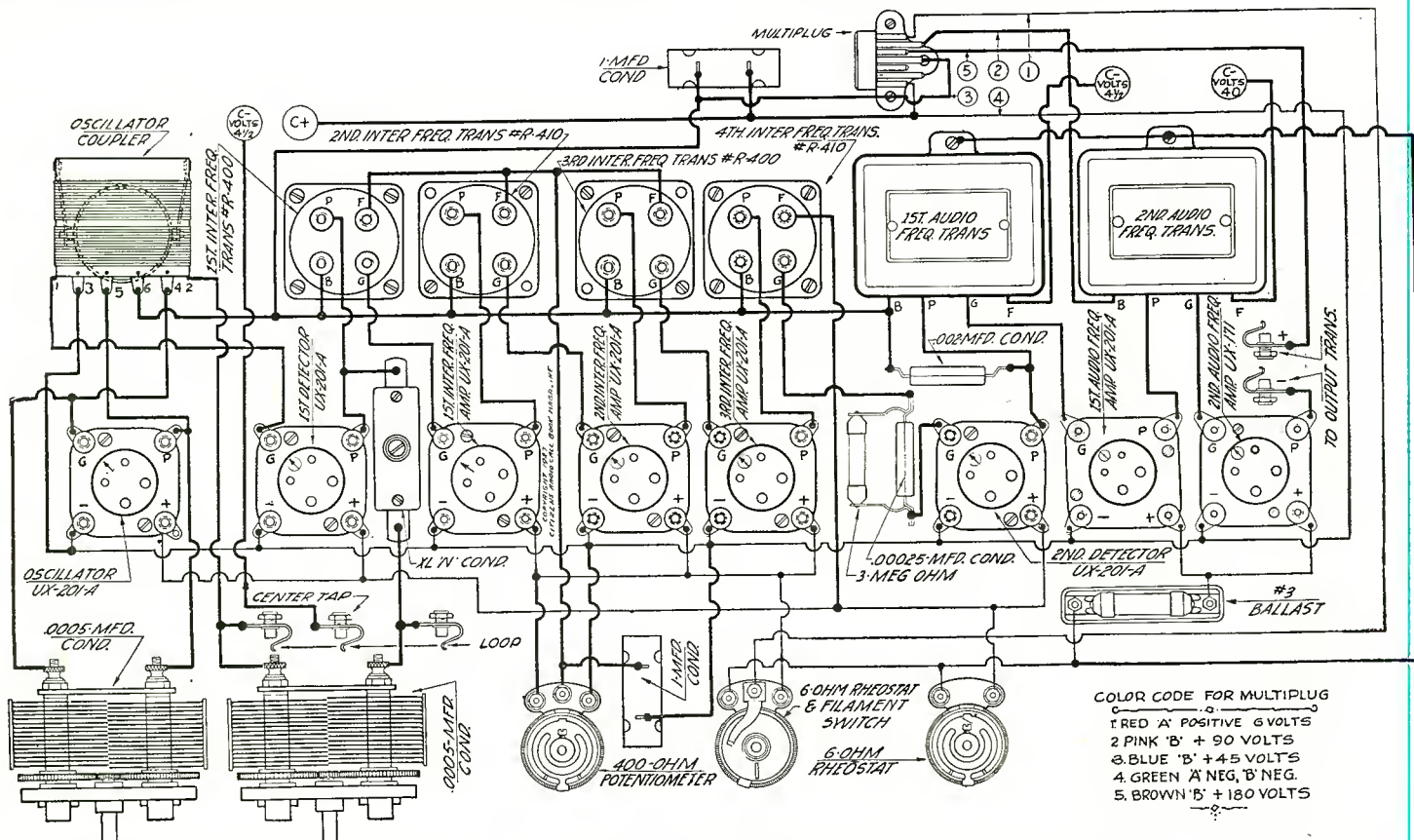

Figure 4. Duplication of this economy model receiver is simple and all wiring should be done in accordance with this graphic illustration

# Camfield Super Selective Ten Either 6 or 10 Tube Set

Band Pass Filter Is Used; Jack Switch Enables Owner to Change at Will

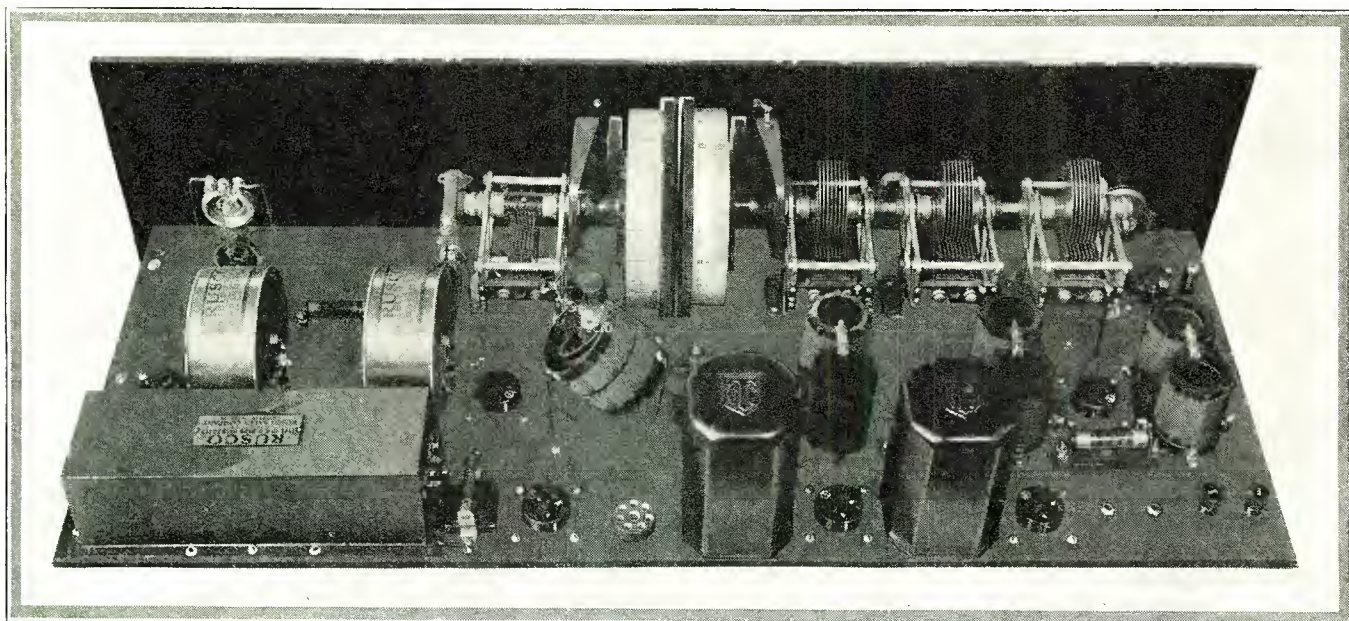

Fig. 2. Photographic view taken from the rear showing the receiver all wired and ready to slip into a console or cabinet

NOT every one is desirous of having to maintain two separate radio receivers to secure both local and long distance reception. Such a combination possible in one set would appear to be welcome news to the radio constructors and experimenters. This transition from a small to a large set is accomplished in the Camfield Super Selective Ten by the simple ex-

pedient of a jack switch that in one position makes the set a six tubular for use on local stations, and in the other position a ten tube super capable of bringing joy to the heart of any listener who has a flair for distance.

Under one form of connection (by means of the jack switch) the set is operated as a tuned r.f. receiver with three tuned r.f. stages, and two stages of audio amplification, the first r.f. tube not being tuned and serving as a coupling tube to the antenna. When the switch is thrown in the 10 position (shown on the front panel drawing Fig. 4) the intermediate frequency stages and a band pass filter are switched into position for operation as a full-fledged ten tube super.

Tuning of the radio frequency stages is achieved in the use of three Camfield .00035 mfd. variable condensers ganged together and operating from a Tyrman dial, this gang condenser and dial arrangement being shown at the right of the photograph in Fig. 2. The single Camfield .00025 mfd. condenser shown at the left of the same photograph is operated by the second section of the Tyrman dial and it is used for tuning the oscillator.

### Novel Volume Control

Taking a look at the schematic circuit shown in Fig. 5, the reader will find the first radio frequency tube has its grid connected to one side of a 2000 ohm potentiometer whose other end is common with the ground and the negative filament of all tubes. The arm of the potentiometer is connected directly to the antenna and serves as a means of controlling the input voltage to the grid of the first radio frequency tube. Inasmuch the grid circuit with this type of connection is aperiodic and responds fairly well over the entire broadcast band, it is not necessary to tune this grid circuit. The arm of the potentiometer when at the grid end of the potentiometer will feed that tube the greatest amount of radio frequency energy from the antenna. When the arm is thrown towards the filament connection the amount of energy dwindles off until at the bottom of the potentiometer no energy should



Fig. 1. Another view of the receiver, this time photographed in its Exello console

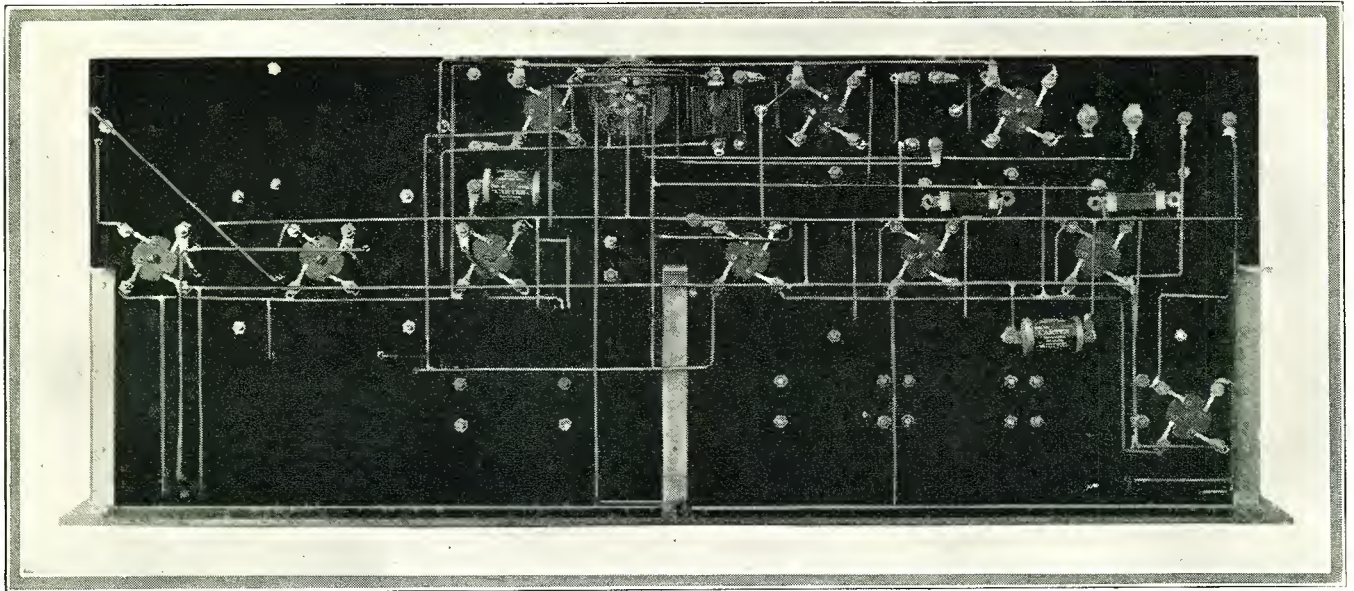

Fig. 3. Ninety-five per cent of the wiring in this set is placed beneath the subpanel as is shown in the accompanying photograph

reach the grid. This device may therefore be used either as a volume control or as a sensitivity governor for the set, greatest sensitivity being secured when the arm is towards the grid and least when it is away from it.

**Uses Duoformer Coils**

First, second and third radio frequency transformers are of the well known Duoformer type which have been previously described and illustrated in earlier articles on this type of a superheterodyne. With the .00035 mfd. variable condensers shunted across their secondaries, these coils cover the existing broadcasting band and serve to greatly augment the r.f. energy fed to the grid of the first detector of the set when used as a super, or the detector when used as a tuned r.f. receiver. That portion of the receiver which is not in the circuit when the switch is thrown in position 6 is shown in the schematic diagram in dotted lines.

Energy from the oscillator of the set is supplied to the grid of the first detector through the pickup winding of the oscillator coupler. The degree of oscillatory energy required for proper mixing is determined by the inductive relationship of the pickup winding and the grid-plate sections of the oscillator. This energy will be at a maximum when the pickup winding is turned so its plane is the same as that of the grid-plate windings. Least energy of course is withdrawn from that circuit when the pickup coil is at right angles to the grid-plate section. This variation permits the operator quite a bit of latitude in measuring the proper amount

of energy to be used for mixing with the incoming signal in the grid circuit of the first detector.

**Band Pass Filter**

In previous issues of this magazine we have touched upon the principles underlying the use of a band pass filter as a means of securing a desired degree of selectivity for the superheterodyne. For the benefit of new readers we might say the band pass filter, which is a network of capacities and inductances arranged in a series of parallel resonant circuits, has for its main objective a filtering action where certain frequencies are allowed to pass through the network and others are prevented from so doing. In the Rusco filter used in this particular circuit the width of the frequency band which is permitted to pass is 10 kilocycles and lies between 90 and 100 kilocycles. Frequencies within the 10 kilocycle band are presumed to be amplified equally, whereas those frequencies above and below that value are cut off sharply, which process of filtering brings into play a greater degree of selectivity without distortion than might be encountered in another form of intermediate frequency filtration.

As contrasted with other forms of i.f. selection, the use of a band pass filter has no adjustments with which the builder must concern himself. The unit is adjusted at the factory and placed in its container with proper inductances and capacities for the filtering action which the unit is called upon to perform. Suitable binding posts or connections are provided on the filter unit so

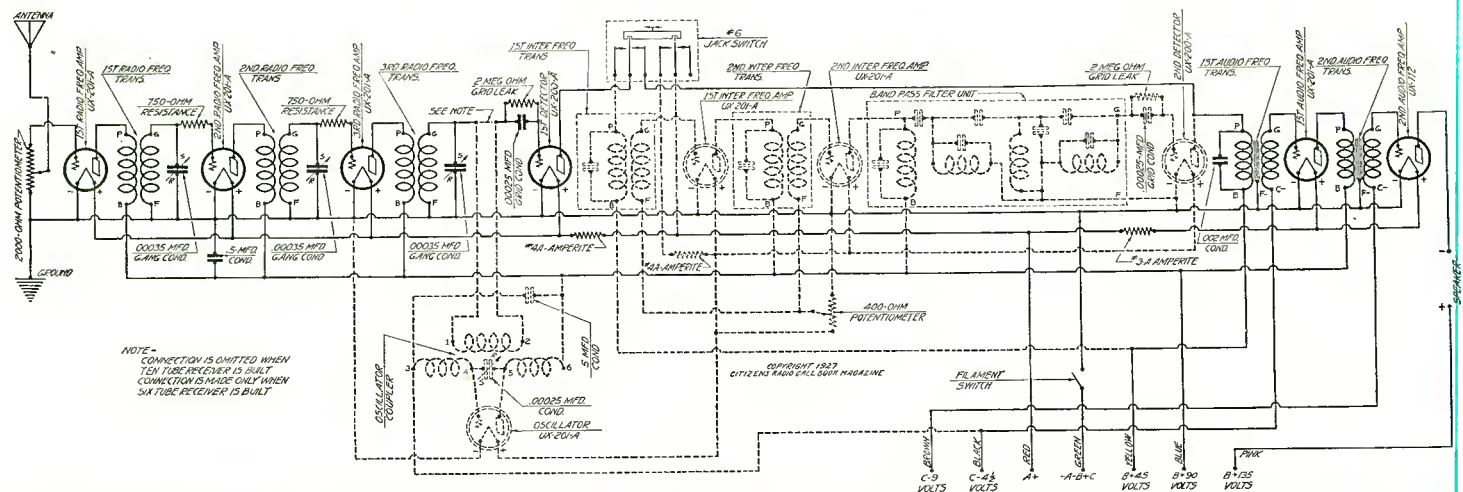

Fig. 5. By means of the above schematic it should be possible for any set builder to trace out all connections and duplicate the receiver described in this article



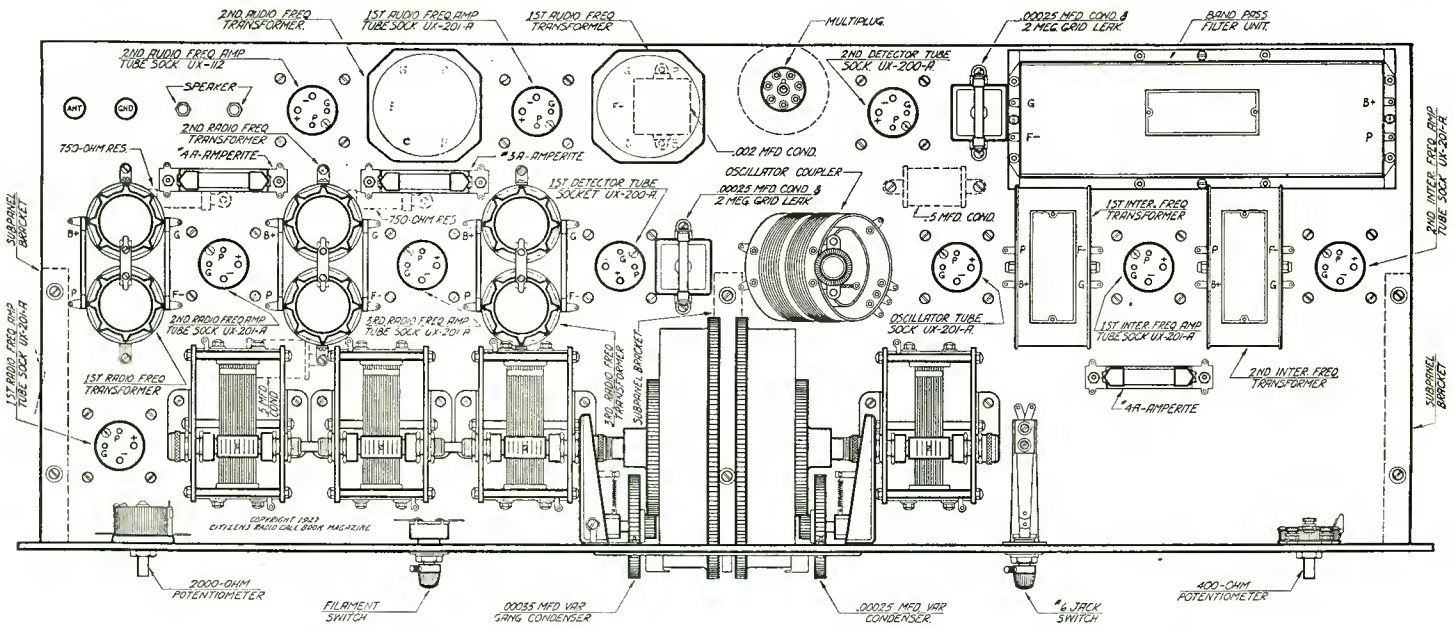

Fig. 6. There should be no doubt in the constructor's mind as regards placement of all parts if the above illustration is followed

it may be easily hooked into the receiver. Granting the unit is not mistreated or damaged there should be no reason for any internal change and it should always remain at the value for which it was originally designed.

Both the first and second detectors in this receiver make use of grid condenser and leak rectification, with grid returns both made to the negative filament terminals for the 200-A type of tubes which are recommended for use in this model. Grid capacities are identical, being .00025 mfd., while the grid leak values are also the same, 2 megohms.

**Transformer Coupling**

Audio frequency amplification in this set which was built, tested and illustrated in our laboratory, is the familiar transformer coupling involving the use of two Tyrman audio transformers giving full play to all the used frequencies in the audio range. These transformers are arranged for subpanel mounting with the proper terminals coming out on the under side of the subpanel, where all connections may be made with a minimum of wire and time. The cores are shown grounded to the negative filament which is common with the ground connection on the set.

Filament control is by means of Amperites and does away with the necessity of altering the filament voltage on the tubes during operation of the receiver. The first, second, third r.f. tubes and the first detector are supplied from a 4-A Amperite, while another resistor of the same type supplies energy for the filaments of the oscillator, first and second intermediate frequency tubes and the

second detector. Using a 112 tube in the last stage and a 201-A in the first audio the filament resistor used is a 3-A Amperite. These resistors are all located on top of the subpanel, although their respective connections are made underneath. This materially reduces the amount of wiring in a set.

In the oscillator circuit there are no departures from the conventional method used in circuits of this kind. The tuning is from grid to plate of the oscillator tube, the rotor of the .00025 mfd. variable condenser being placed on the plate and the stator on the grid for reduction of body capacity. The grid return of the grid coil is made to the negative 4½ volt C battery terminal in order to provide a bias on that tube and conserve the plate current, since a great deal of energy is neither necessary nor desirable. Plate voltage of 90 is used on the oscillator, which is bypassed with a .5 mfd. fixed condenser.

**Potentiometer Control**

Grid returns of the first and second intermediate transformers are to the center arm of a 400 ohm potentiometer, which permits changing the amount of amplification in this train when the receiver is set up for operation as a ten tube set. Greatest volume will be secured when the potentiometer arm is towards the negative side and least when it is nearest the positive terminal. This potentiometer does not function when the receiver is cut down by means of the switch to a six tube tuned r.f. set, because the intermediate stages are cut out by the switch.

Bias voltages on this receiver are only two, the first audio bias

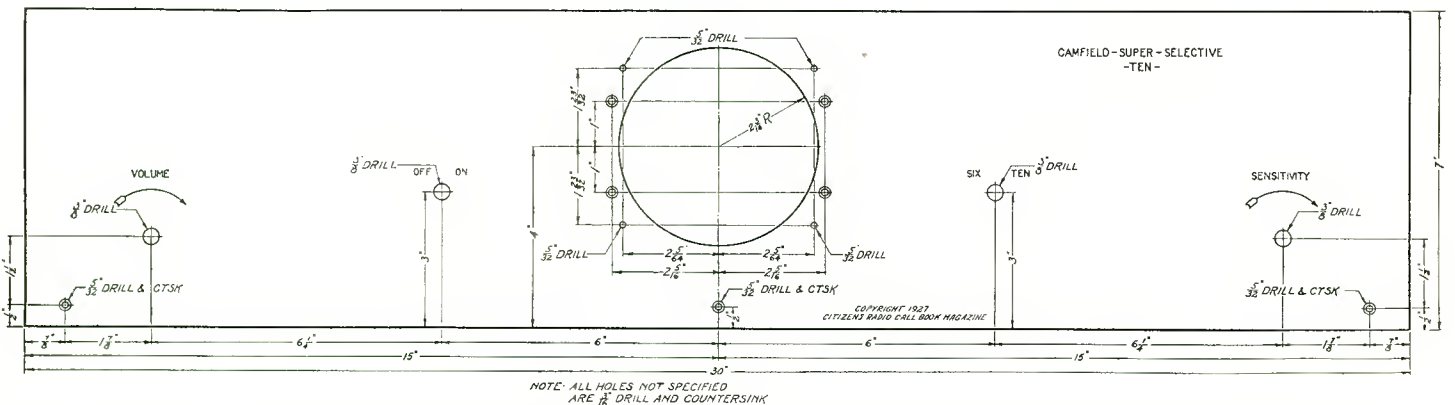

Fig. 4. Dimensions of the front panel and location of required holes are shown in the above sketch. Full sized blue prints of this receiver may be secured if desired. See page 193 for list of prints available

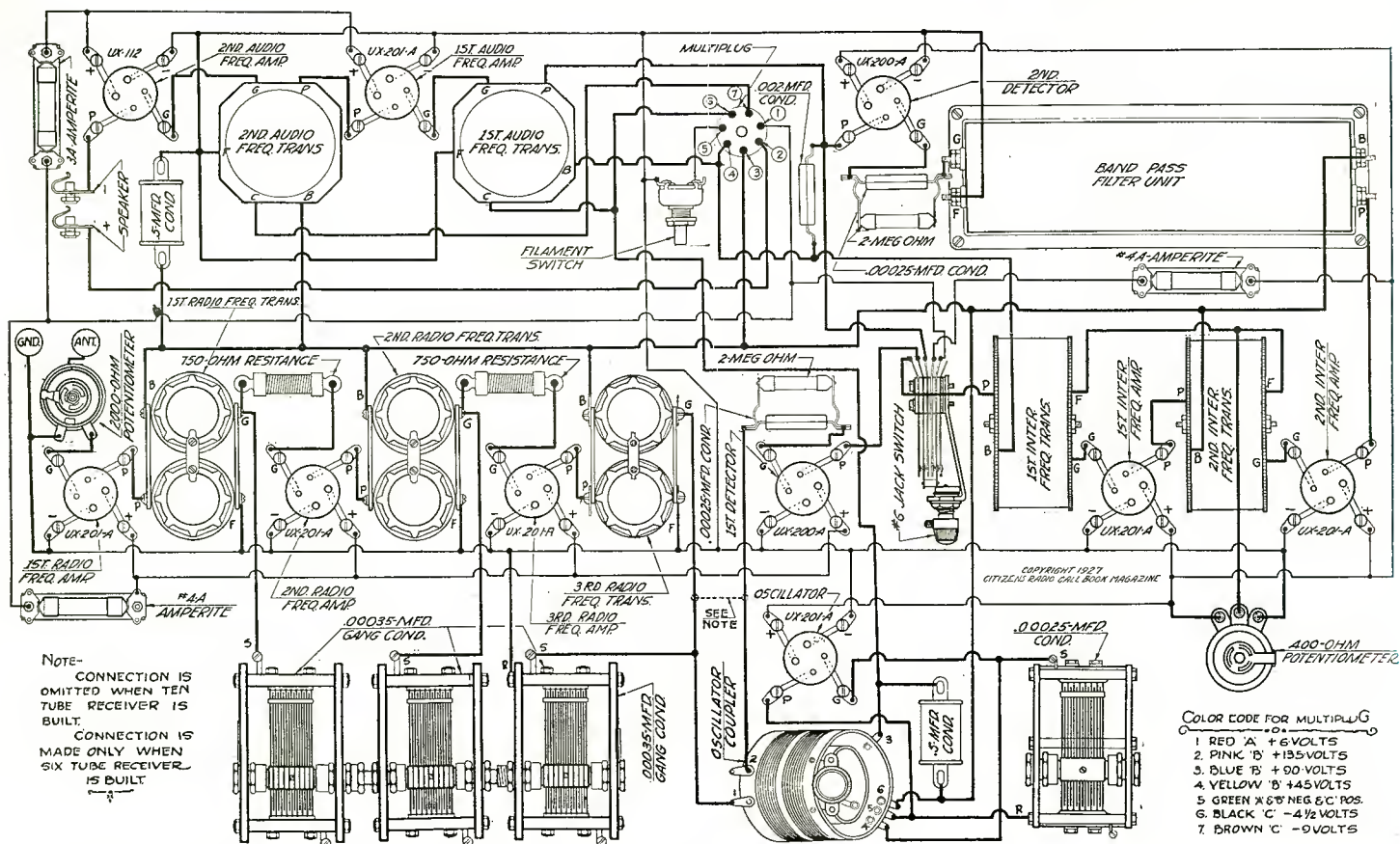

Fig. 7. Depicted above are the proper electrical connections to make for wiring of this powerful receiver. Always check your work against the diagram to make certain no errors have been made

and that of the oscillator grid return being 4½ volts negative, while the grid, of the last tube, which is a 112, is served with 9 volts when its plate is given 135 volts.

First and second detectors receive a plate voltage of 45, while the balance of the receiver, excepting the last stage, is given 90 volts. These voltages may be secured from either of three sources: B batteries, standard B eliminators or B power supplies. The current consumption on the set is small and should not prove a burden for batteries or eliminators.

Tuning Very Easy

Tuning of the receiver need cause no one any concern, for it is as simple as possible. When used as a six tube r.f. receiver the left section of the Tyrman drum dial (when looking at the front of the panel) controls the r.f. stages and affords single control for wavelength. The volume control on this form of receiver is at the extreme left of the panel and is the 2000 ohm potentiometer previously referred to as altering the input to the first r.f. tube. When the set is arranged for the ten tube combination, the right section of the drum dial governs the oscillator tuning, and an additional control for sensitivity is afforded through the use of the 400 ohm potentiometer which biases the grids of the first and second intermediate stage tubes. Harmonics should be greatly minimized with this kind of a superheterodyne circuit on account of the presence of the tuned radio frequency stages ahead, and the fact the intermediate stages are peaked at 95 kilocycles.

Parts Used in Set

In the construction of the Camfield Super-Selective Ten in our laboratory the list of parts given below was used. We believe it would be policy for the newcomer in radio to adhere faithfully to this list. Experienced constructors will doubtless be able to make substitutions as they see fit, although it should be borne in mind that equal merit and identical constants should be demanded in such substitution.

- 1—Camfield .00025 No. 251 variable condenser.
- 3—Camfield .00035 No. 352 variable condensers.
- 1—Camfield steel shaft for above.
- 8—Camfield condenser support brackets.
- 3—Camfield new type 44 Duoformers.
- 1—Camfield No. 620 oscillator coupler.
- 1—Rusco No. 10 K.C. band pass filter.
- 2—Rusco No. 95 K.C. I.C. transformers.
- 1—Carter .001 mfd. fixed condenser.
- 1—Carter 400 ohm potentiometer IR-400.
- 1—Carter 2000 ohm potentiometer MW-2000.
- 2—Carter .5 mfd. condensers No. 105.
- 2—Carter .00025 mfd. grid condensers with clips.
- 2—Lynch 2 megohm grid leaks.
- 2—Tyrman type No. 330 audio transformers.
- 1—Tyrman vernier double drum dial.
- 1—Carter battery switch No. 10.
- 1—Carter No. 6 jack switch.
- 2—Carter 750 ohm resistance.
- 2—Carter tip jacks.
- 10—Benjamin No. 9044 sockets.
- 3—Karas subpanel brackets.
- 2—Eby engraved binding posts.
- 1—Jones type PM multi-plug.
- 2—Amperites 4A.
- 1—Amperite 3-A.
- 1—Celeron 7x30x3/16 inch drilled and engraved panel.
- 1—Celeron 10x29x3/16 inch drilled subpanel.
- 7—Sonatron type 201A tubes.
- 2—Sonatron type 200A tubes.
- 1—Sonatron type 112 tube.
- 40 Feet Acme Celatsite wire.
- 1 Package Kester radio solder.
- 1—Ekko ground clamp.
- Miscellaneous lugs, wire, screws, etc.

# Automatic Coupling Feature of the Knickerbocker Four

Progressively Regenerative Detector Is Equivalent of an Added Tube

ON many occasions this magazine has had numerous requests from its readers for a small, inexpensive and efficient receiver with which they might secure a great deal of entertainment without involving a large monetary outlay. It is in response to these numerous appeals that our laboratory has designed, built, tested and illustrated the Knickerbocker Four Receiver, utilizing many of the parts made by Karas Electric Company.

For a set having but four vacuum tubes we do not know of any combination which would be more satisfactory from all standpoints than that of one stage of radio, a regenerative detector and two stages of quality audio amplification, the final stage using the 112 type of power tube. This circuit arrangement alone would be quite satisfactory to almost any listener or enthusiast. But when there is added to the scheme an automatic means of maintaining antenna coupling at a maximum and a progressive regenerative coupling the Knickerbocker Four takes on a much more interesting aspect, which should appeal quite strongly to our readers.

## Progressive Regeneration

This automatic coupling method is somewhat in line with the principles involved in the Equamatic tuning system with which

Karas has led the field, with the slight difference that in the Knickerbocker Four progressive regeneration is secured, whereas in the Equamatic receiver described in our September issue the regenerative condition was not desired. It is needless for us to repeat the fact that judicious regeneration is equivalent to two tubes of the non-regenerative type, and for that reason the Knickerbocker Four could legitimately be classified as a five-tube receiver as far as results are concerned. A much stronger signal is delivered to the grid of the first radio frequency tube, because the antenna coupling is automatically varied at the time the tuning range of that grid circuit is traversed by the variable condenser. Therefore, at the lower wavelengths where loose coupling is desired for selectivity, the coupling coil is furthest away from the secondary, whereas at the higher wavelengths the coupling coil is closest inductively to the secondary. This results in a progressive and uniform amount of energy delivered to the first tube and is a system which has not made its appearance in other receivers. The regenerative function of the detector is not hard to understand if it is considered in the same light as the preceding description of the antenna stage, where the plate coil in the detector has its inductive relationship continuously varied at the same time the detector secondary condenser is being turned from minimum to maximum. In order to make the first stage of

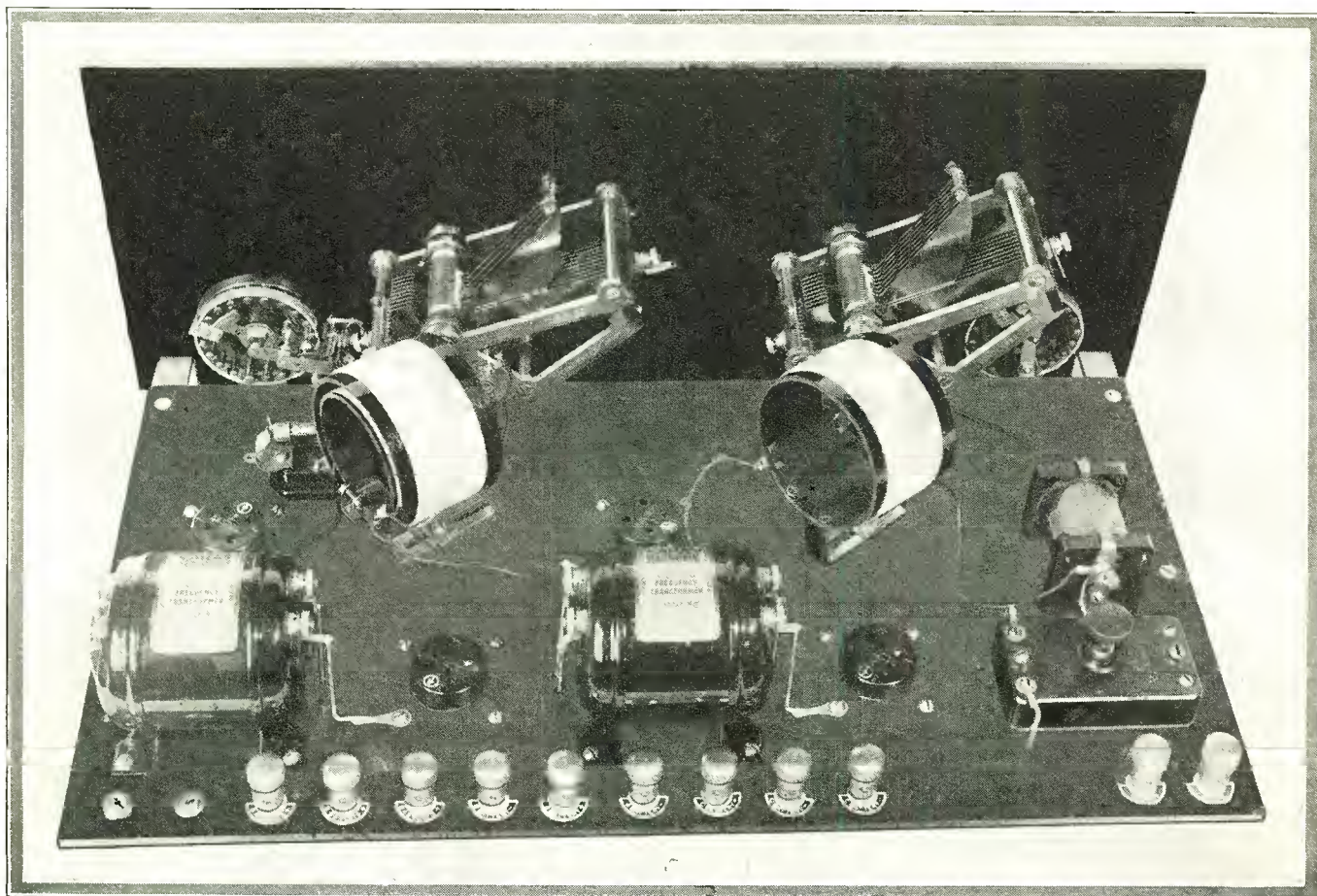

*Figure 2. This photographic view shows all parts of the Knickerbocker Four in place and properly wired*

(This receiver constructed, tested and all illustrations made in our laboratory)

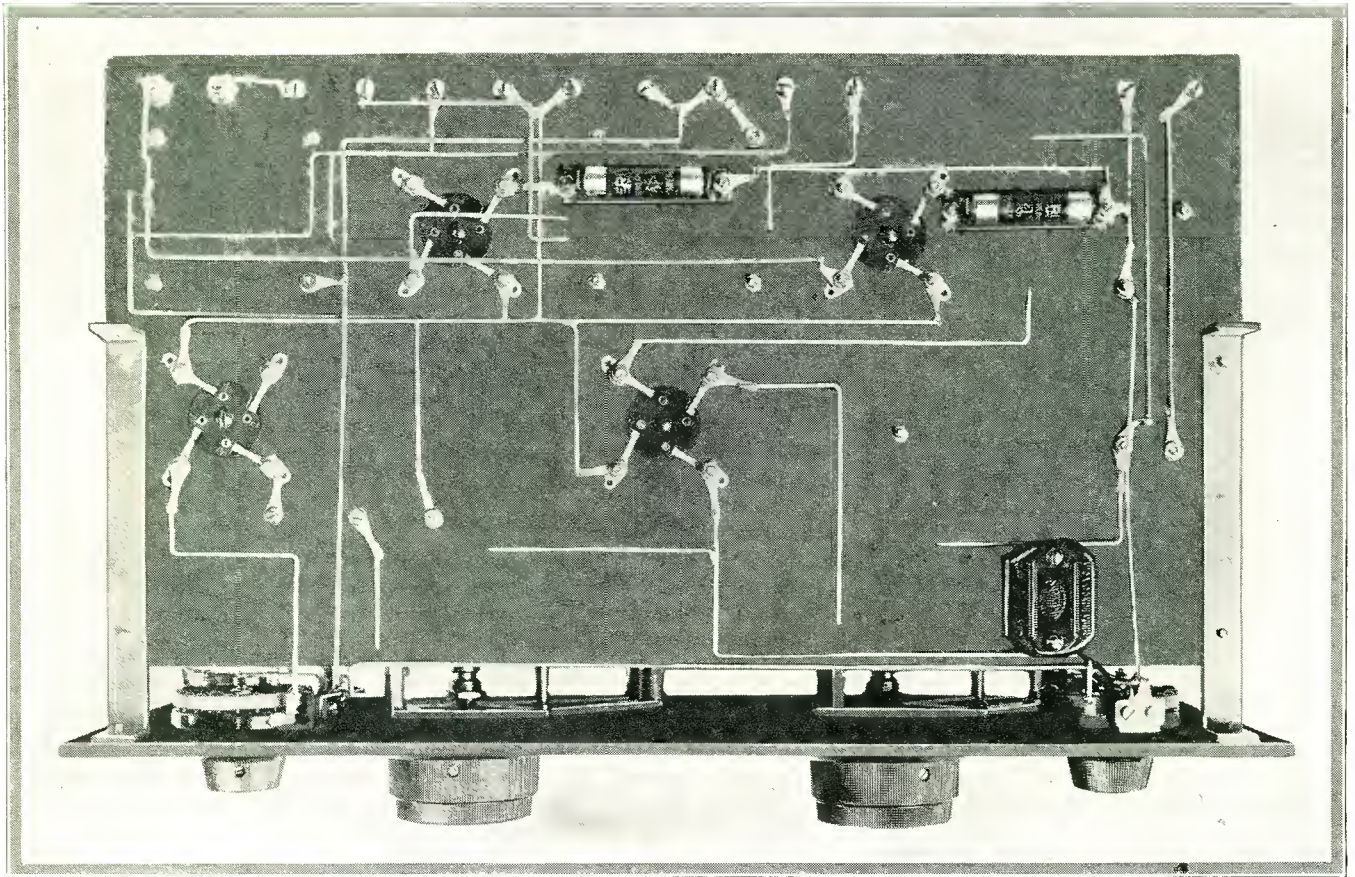

Figure 3. Much time and personal energy is saved the constructor by using the sub-panel form of assembly, which is illustrated in the photograph above

radio frequency as stable as possible, the Knickerbocker Four uses a Samson .00003 to .0003 mfd. neutralizing condenser in conjunction with an 85 millihenry radio frequency choke, the latter being located between the rotor of the first variable and the ground connection which is common with the negative filament. This neutralizing condenser is adjusted during the operation of the set to such a point, that when the condenser across the first secondary is turned from minimum to maximum, no squeals will follow. This particular adjustment will require a

few minutes time on the part of the listener to locate accurately. When this is done the changing of the filament rheostat in the first tube will not materially effect the balancing of the set.

**A Refining Control**

Another refining control on the receiver is the second 20-ohm rheostat, which is located in the negative filament of the detector and may be used to increase or decrease the volume secured from the particular circuit. Audio filaments are handled auto-

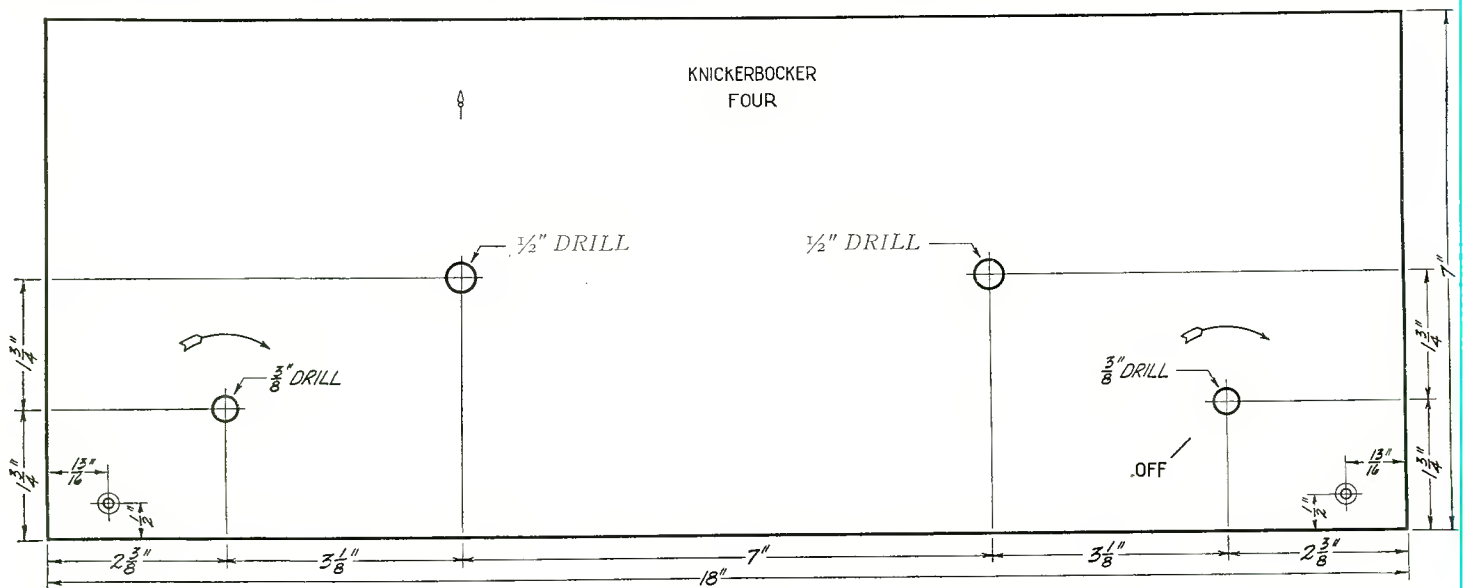

NOTE-UNLESS OTHERWISE SPECIFIED ALL HOLES ARE 5/32" DRILL & COUNTERSINK.

Figure 4. All necessary data for marking and drilling the front panel of the receiver may be secured from this sketch. Drilled front and sub-panels are available and reduce the amount of labor involved in marking and drilling these two items

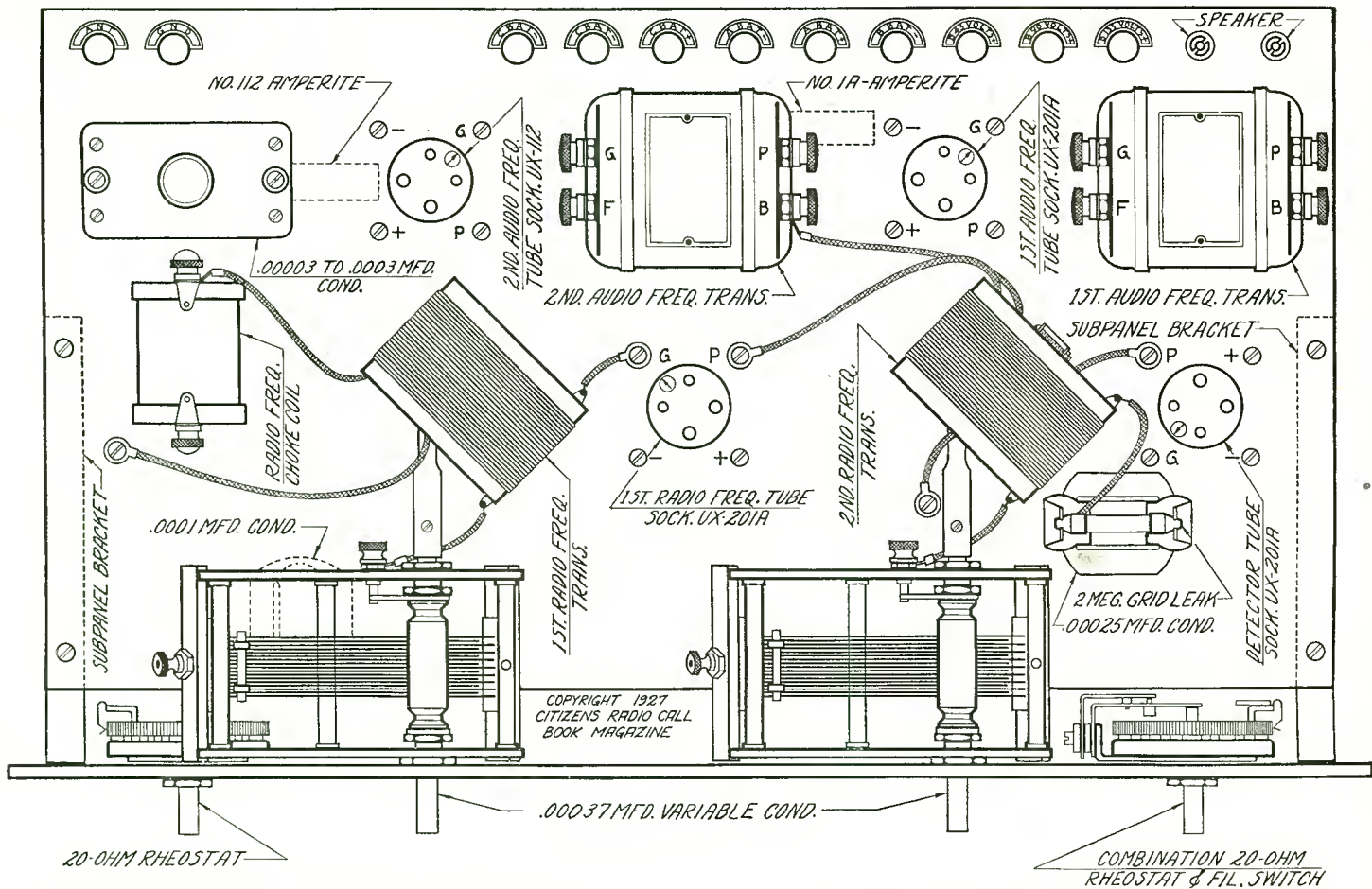

Figure 6. All parts should be laid out in strict accordance with the sub-panel assembly sketch shown above, especially with regard to the placing of the two variable condensers

matically by means of a 1-A Amperite in the negative of the first audio and a 112 Amperite in the negative of the second audio, which is a power tube.

**Only Two Controls**

Little need be said about the tuning of this receiver, which is

so simple that almost anyone could begin picking up stations with it, even in the dark. The left dial, which is a Karas micrometric, governs the wavelength of the first radio frequency circuit, while the right dial of the same type controls the wavelength of the detector circuit. Dial readings should be approximately the same, assuming there have been no great variations in the amount of wire used in hooking up the Knickerbocker Four. The Orthometric variable condensers were designed for use with the particular type of inductances shown in our laboratory model and as a result the stations are quite well distributed over the 100 degrees of the dial. The Knickerbocker Four is especially desirable as a personal receiver for those who like to spend the late hours of the night busily engaged in chasing down the elusive long distance signals and for that purpose a pair of headphones may be used at reduced volume in order not to disturb others in the home.

**Follow All Constants**

In the construction of the laboratory model illustrated in this article, the parts given below were used. If the builder should desire to use other parts than those specified, we would recommend that he be extremely careful and see that all parts of equal merit are used and that all constants shown in this story be religiously followed.

- 2—Karas Harmonik audio transformers
- 2—Karas .00037 mfd. Orthometric variable condensers, extended shaft
- 1—Karas Equamatic inductance coil
- 1—Karas three-circuit inductance.
- 2—Karas micrometric dials—0-100
- 3—Karas sub-panel brackets
- 1—Samson 85 millihenry choke
- 1—Samson .00003-.0003 mfd. neutralizing condenser
- 1—Yaxley 20 ohm rheostat
- 1—Yaxley 20 ohm rheostat with switch
- 2—Yaxley pin jacks



Figure 1. Placed in a Corbett cabinet, the Knickerbocker Four is shown atop of a Southern Toy table

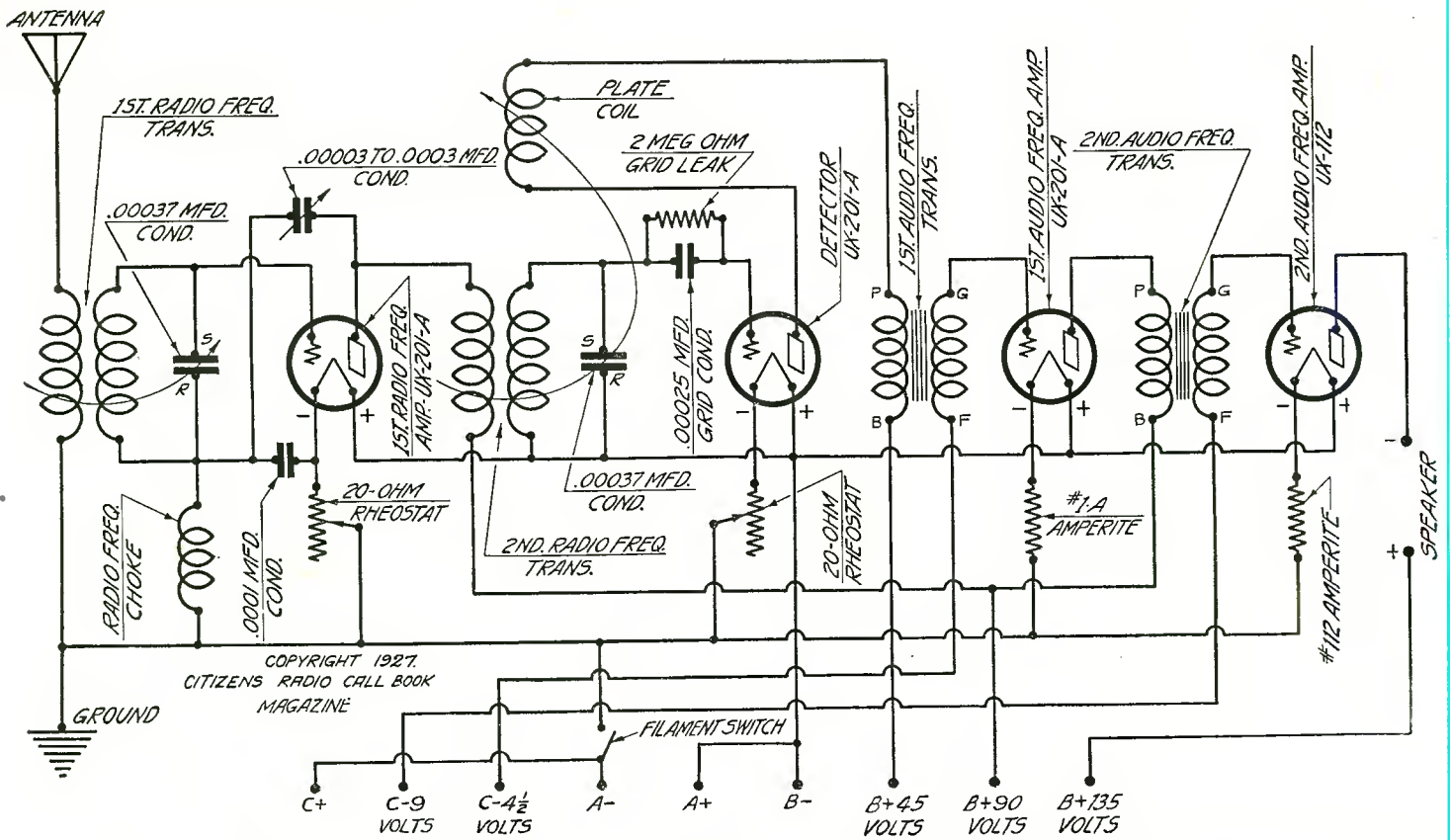

Figure 5. Professional set builders and others who are thoroughly acquainted with construction work may wire the receiver from the schematic above

- 4—9044 Benjamin sockets
- 1—Sangamo .0001 mfd. fixed condenser
- 1—Sangamo .00025 mfd. grid condenser with clips
- 1—1-A Amperite
- 1—112 Amperite
- 1—Durham 2 megohm grid leak
- 1—Celeron 7x18x3/16 inches drilled and engraved panel

- 1—Celeron 9x17x3/16 inches drilled sub-panel
- 3—Sonatron type A tubes
- 1—Sonatron type 112 tube
- 20—Feet Belden No. 14 tinned copper hook-up wire
- 1—Package Kester radio solder
- 1—Ekko ground clamp
- 11—X-L binding posts

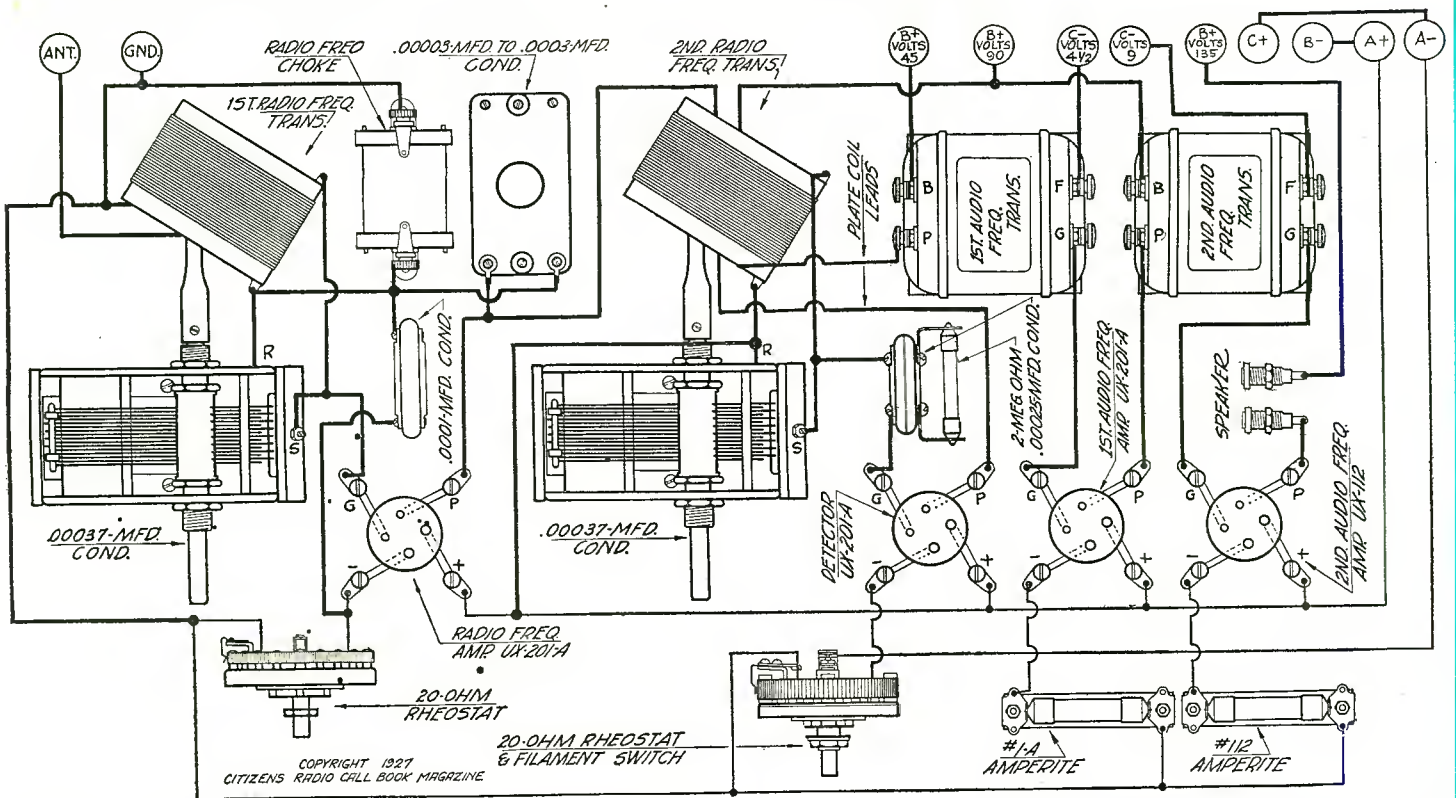
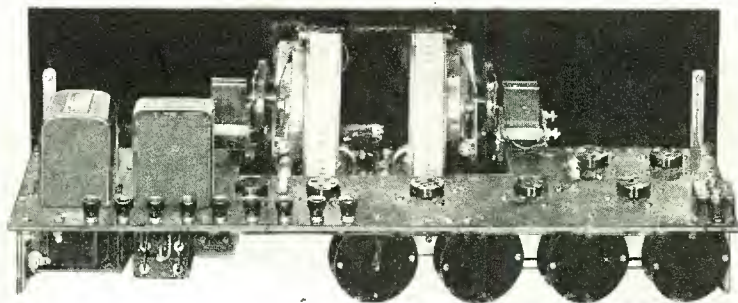

Figure 7. This graphic illustration should be followed by the newcomers in radio and all connections should be made in strict accordance with this diagram

# LaPeer AR-9



## New Construction Design Main Parts Under Sub-Panel

THE newest radio creation, the La Peer AR-9, is designed along new, scientific lines from parts of leading manufacturers, and embodying highly refined principles found in no other receiver. It has the appearance of a high class factory-built set and the performance of a radio engineering masterpiece.

The illustration above clearly shows why the La Peer AR-9 is different. Note that practically all the apparatus is mounted *underneath* the sub-panel, wiring thus being reduced to a minimum and leaving only the dials, condensers, tubes and audio transformers in view and keeping the R. F. transformers, wiring and minor apparatus hidden entirely, protecting these essential parts from handling, possible breakage and tinkering. Thus you have a complete set that looks and is clean cut, efficient and attractive.

## Easiest Wiring Job on the Market

One of the really big surprises furnished by the La Peer AR-9 is the small amount of wiring required. This is due to the workmanlike sub-panel mounting. Most builders of multi-tube sets have a confusing maze of wiring to handle, whereas in the La Peer 9 about one-half usual wire is used. Think of the greater stability this gives a set—and how much easier it is to build when direct connections can be made quickly and conveniently. There is a big saving in time and trouble.

Both coupler and transformers have extended grid and plate terminals which are connected *directly* to the terminals of the tube socket, thus assuring a direct, positive connection.

The very heart of the La Peer AR-9 lies in the "D" shaped construction of the La Peer R. F. air core transformers. The windings are "D" shaped, the two "D's" facing each other and forming a closed magnetic circuit, assuring perfect selectivity and greatest amplification.

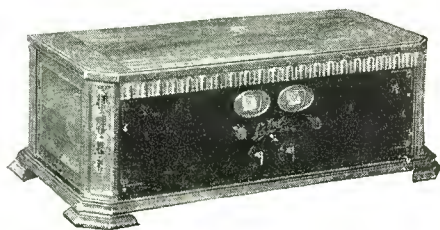

Showing built-up set in Fritts cabinet

## What "D" Coil Construction Means

"D" SHAPED construction means a completely confined field within the transformer itself, thus there is no effect on adjoining coils or circuit windings. These coils cannot be affected by outside influences or broadcast interference. The inherent shielding is so complete that you can place the La Peer AR-9 directly under the antenna of a high-powered broadcasting station and still not hear that station unless it is actually tuned in.



## 10 KC Separation

Another feature is that their low resistance and condenser tuned secondaries act as a 10 kilocycle band pass filter as well as an intermediate frequency amplifier. This produces hairline selectivity and perfect quality reception, powerful nearby stations being tuned out easily with one or two divisions of the oscillator dial.

## Double Second Detector

Another interesting feature of the La Peer AR-9, found in no other receiver, is that the La Peer "D" transformers furnish a double second detector, because with their especially developed windings the exact center of the secondary coil is located and tapped. This tap goes to a grid bias of about 1½ to 3 volts. The "G" side of the transformer goes to the grid of the 1st tube of the 2nd detector and the "F" side to the grid of the 2nd tube. Thus the plates of both detector tubes are hooked in parallel and returned to the "P" of the 1st audio transformers.

There are no better parts and accessories to be had than those specified. The names speak for themselves: La Peer, Remler, Silver-Marshall, Carter, Muter, Benjamin, X-L, Westinghouse-Micarta and Fritts.

Read the article in this issue. Then build the La Peer AR-9 and enjoy reception of the highest order. Build now and you will forever be proud of this exceptional receiver. Your friends will wonder at its performance as much as you yourself.

## Be the First to Possess Radio's Best

Your dealer or jobber has the parts. Get them now and get in on the ground floor of a real opportunity to possess radio's best.

Write for full details. Jobbers and dealers, get our proposition at once.

## LA PEER ELECTRICAL MFG. CO.

336 W. Madison St., Suite 604  
Chicago, Ill.

Remler Condensers and Dials

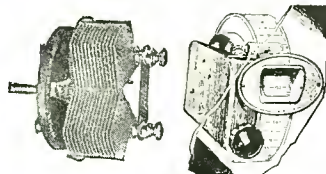

Silver-Marshall Transformers

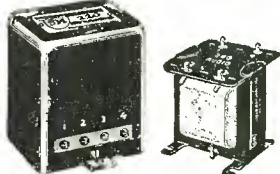

Carter Parts



Muter Condensers



Benjamin Sockets

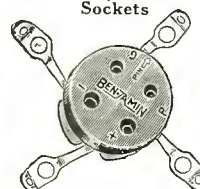

X-L Binding Posts



REMEMBER: "YOU CAN BUILD BETTER THAN YOU CAN BUY"

Tell 'Em You Saw It in the Citizens Radio Call Book Magazine

## WITH THE ACCESSORY & PARTS MANUFACTURERS

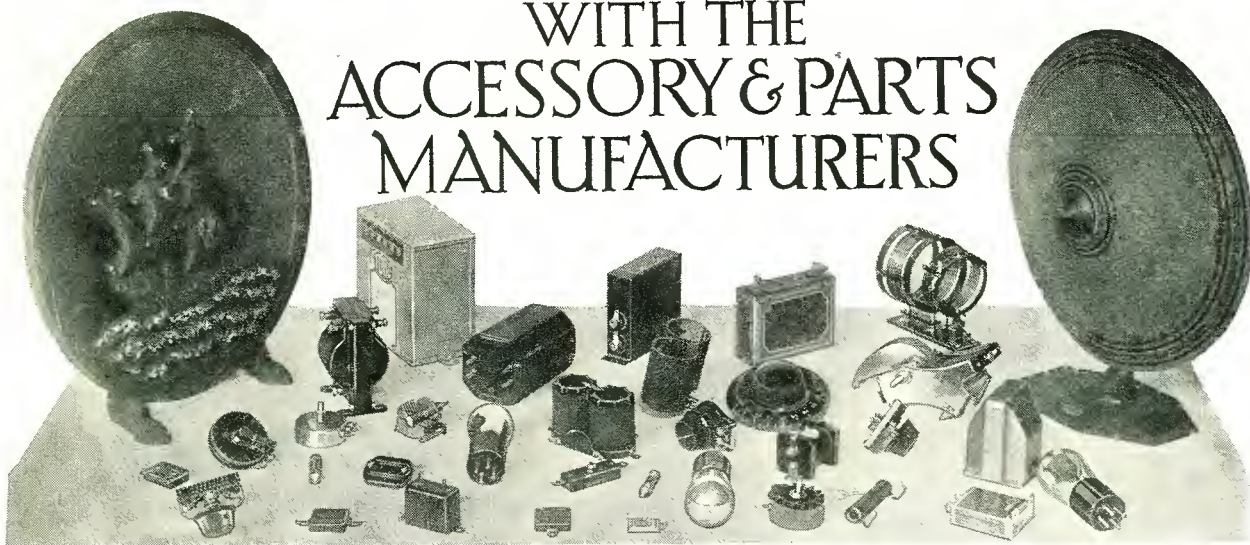

Readers desiring any further information on products shown in these columns, may secure full data on writing to the Accessory and Parts Department, care of this magazine. Be sure to specify name of product on which information is desired

### Abox Is Battery Eliminator

THE Abox Company of Chicago, manufacturers of the Abox Filter, a device that has been eliminating storage batteries in conjunction with battery chargers for the last year or so, announce a complete A battery eliminator in a small, compact form and at a surprisingly low price.

The new Abox A battery Eliminator consists of a transformer, a rectifier and the Abox Filter all combined in one unit. It takes power straight from the light socket and delivers it to any set, as pure, hum-free radio A current of sufficient quantity to operate eight or less  $\frac{1}{2}$  ampere standard tubes.

The problem of true A battery elimination is one that has puzzled radio engineers for several years. Theoretically it is no more difficult than B elimination. The difficulty has been that the current required for A power is very different in value from that of B power, which necessitates a great variation in the values of the constants incorporated in constructing a proper rectifier and filter.

Taking the B eliminator as a basis of comparison, an A eliminator must deliver a full two amperes, which is approximately one hundred times the output in amperes of a B eliminator. As the power to be handled increases the capacity of the filter, condensers must also increase in direct proportion.

Then we have the voltage factor; a condenser stores increasing power with increasing voltage; therefore, at one hundred and fifty volts, which we will take as a B eliminator average, it will store more energy than at six volts for A elimination. To compensate for this the capacity of the filter condenser must again be increased in proportion to the difference in voltage, or another twenty-five times. And last, the A eliminator delivers current to the filament circuit. Any imperfections

will be automatically introduced into the grid circuit where it is amplified according to the factor of the tube, which, on an average, is about seven. The capacity must be again increased another seven times to offset this.

It is found as a conclusion that the filter condenser of an A battery eliminator must be one hundred times twenty-five times seven, or 17,500 times as great as that used for B elimination. The capacity of a B filter condenser must be at least 4 microfarads; therefore, the capacity required is the tremendous amount of 50,000 microfarads.

To obtain this The Abox Company developed a condenser consisting of a number of nickel and iron plates immersed in a caustic potassium solution, which is not an acid. This causes thin films of oxygen and hydrogen to form on the surface of the plates and this film is used as the dielectric of the condensers. The solution is one side of the condenser—the plates are the other. This should not be confused in any way with a storage battery.

Since the capacity of a condenser increases as the thickness and amount of dielectric decreases, this infinitesimally thin gas film is no doubt responsible in part for the tremendous capacity obtained.

This film as dielectric has other advantageous features. Should an excess voltage be pressed on the condenser, the film immediately breaks down and bypasses the excess through the unit. When the input returns to normal, the film reforms and the condenser is good as new. The bugaboo of burnt out condensers that make life so interesting for dry condenser manufacturers is thereby done away with.

The resistance of this film can be controlled. In the Abox it will pass just exactly six volts. The moment this is exceeded it breaks down and bypasses the excess. This automatically controls the output so

(Continued on Page 168)

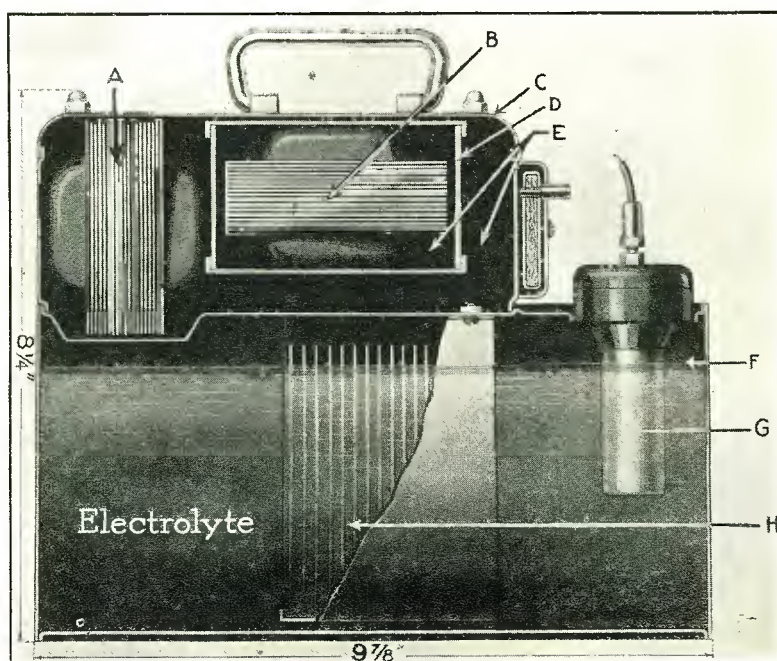

Figure 1. This photograph shows a cut away view of the Abox A battery eliminator. Note that both rectifier and condenser work in the same solution



Having had a musical education, I had definitely high ideals about tone quality in a reproducer. To say that the G.R.P. 3-ft. Cone Speaker meets my ideal is the highest compliment that I can pay it. That my clumsy, inexpert hands could assemble it perfectly is a tribute to its simplicity of construction.

Never have heard its equal; never expect to hear its superior.

No one seeing my G.R.P. 3-ft. Cone Speaker will believe that I built it myself. And they cannot believe that a speaker having such wonderful tone quality costs so little.

*Expressions such as these are to be heard everywhere. G.R.P. 3-ft. Cone Speakers arouse enthusiasm because they create a new standard of tone quality. Bring complete, enjoyable reproduction within everyone's reach.*

Such wonderful tone quality as comes from the G.R.P. 3-ft. Cone Speaker is a challenge to perfection. I cannot imagine anything better, more natural or complete in range from low to high.

With your new Back Ring and Back Cone Design you have created a speaker which the most inexperienced person can build with confidence that the result will be delightful.

Your G.R.P. 3-ft. Cone Speaker is as near perfection as I imagine a radio reproducer can be. You have contributed a wonderful instrument to radio and your simple method of assembly makes it a pleasure to build.

My ideas of how good a speaker can be and of how enjoyable radio reception can be made have been entirely changed by the G.R.P. 3-ft. Cone Speaker.

And as for Tone Quality, after having heard nearly all the new speakers, I am more enthusiastic than ever about G.R.P.

Your G.R.P. 3-ft. Cone Speaker needs to be heard to be appreciated. Comparison with high priced speakers, supposed to be the best, serves but to emphasize the quality of yours... The most astonishing thing about it is that such wonderful tone quality can be enjoyed for such a small outlay of money. I wouldn't have believed it if I didn't know it to be so.

Now I know how fine reproduction can be. G.R.P. 3-ft Cone Speaker has shown me.

## G.R.P. BACK RING

(PAT. PENDING)



## and exclusive G.R.P. BACK CONE Design

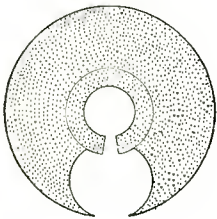

simplify cone speaker building wonderfully; no cones to form—they shape themselves; the complete speaker is assembled FLAT!

### Simple, complete, illustrated Directions for Assembling

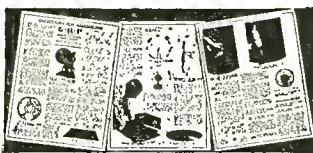

and clearly, accurately marked  
sheets of genuine FONOTEX



for Front and Back Cones enable ANY-ONE to assemble a perfect G.R.P. 3-ft. Cone Speaker, even if you never have made anything before. G.R.P. Simplified Method of Assembling is your assurance of success and satisfaction.



## One Hour from KIT to Reception



## G·R·P 3 FOOT CONE SPEAKER *Build It Yourself*

# Easiest to Build of any 3ft. Double Cone Speaker

The finest radio reproducer that you can own is now the easiest to assemble.

G.R.P. Back Ring and G.R.P. Back Cone Design have completely revolutionized home construction of 3-ft. DOUBLE Cone Speakers. G.R.P. simplified method of assembling makes experts of novices—enable anyone without experience to assemble a perfect 3-ft. DOUBLE Cone Speaker quickly.

### Never Before So Wonderful A Speaker

Radio experts, musicians and laymen who have heard the G.R.P. 3-ft. DOUBLE Cone Speaker were amazed at its wonderfully rich, sweet and accurate reproduction. Never, they said, had they heard anything that sounded so natural that it was not radio but a true duplicate of the original itself.

If that is what YOU want in radio reproduction you can have it with a G.R.P. 3-ft. DOUBLE Cone Speaker. Improves repro-

duction from any set because it gives you the best that is in the receiver.

### Build Yours Now!

If you've hesitated about assembling your 3-ft. cone speaker remember that the G.R.P. simplified method of assembling makes an expert of you.

You CAN do the job perfectly. Anyone can. Assembling a G.R.P. 3-ft. DOUBLE Cone Speaker is simplicity itself. And this really fine loud speaker cost no more than a low-priced speaker.

### Ask Your Dealer

Reliable radio dealers everywhere have or can get genuine G.R.P. 3-ft. Cone Speaker Kits. If your dealer hasn't them and will not get them for you, we will ship direct, f.o.b. N. Y. C., on receipt of price. You need not be content with less than G.R.P. Quality and G.R.P. ease of assembly.

Write for "How to Build Seven Practical 3-ft. Cone Speakers," by C. Denton. Regular price 50c; for limited time sent for only 10c, coin or stamps.

**No. 3 G.R.P. Kit for 3-ft. DOUBLE Cone**  
Absolutely complete in every particular including G.R.P. Unit. **\$13.50**  
*Nothing else to buy*  
Slightly more in Far West and Canada

**No. 4 G.R.P. Kit for 3-ft. SINGLE Cone**  
Most complete, lowest priced wall type Single Cone Kit; finest tone quality... **\$10.50**

PENN RADIO SALES COMPANY, Exclusive Selling Agents for  
G. R. P. PRODUCTS CO., Inc.

104 Fifth Avenue

Suite 2736

New York City

Tell 'Em You Saw It in the Citizens Radio Call Book Magazine



# SCANLAN SPEAKER CHEST

CHICAGO U. S. A.

Transforms the S-c-r-a-t-c-h  
in Your Speaker  
To a Beautiful Mellow Tone

An output transformer that will instantly eliminate all rasping and distortion caused by paralysis from high "B" voltage and allow your speaker to perform as it should—with a soft and mellow tone quality.

SCANLAN SPEAKER CHEST combines beauty with performance. It protects speaker coils from the shattering "B" voltage

which will materially decrease the life of your loud speaker! The design and finishes of the SCANLAN SPEAKER CHEST eliminate the trouble of having to install it inside your set. It needs no mechanic to install it. Just hook your speaker into the chest and the chest wires into the speaker-jack on set. The beauty of tone and volume is instantly apparent.

**If Your Dealer**

does not have one in stock he can obtain one from his jobber. If you want it at once fill in the coupon and we will send it direct on receipt of price or C. O. D. from the factory. Our guarantee is your protection and our reputation.

**SCANLAN ELECTRIC MANUFACTURING CO.**

1113 N. Franklin Street Chicago, Ill.  
Write for complete information on audio frequency transformers and power compacts

SCANLAN ELECTRIC MFG. COMPANY  
1113 N. Franklin St., Chicago, Ill.

Gentlemen:

Send \_\_\_\_\_ Speaker Chest, at once, postage prepaid,  
\$10.00 enclosed. C. O. D.

Antique Brass Finish      Name \_\_\_\_\_  
 Antique Bronze Finish      Address \_\_\_\_\_  
 Antique Silver Finish      City \_\_\_\_\_ State \_\_\_\_\_  
 Walnut

Tell 'Em You Saw It in the Citizens Radio Call Book Magazine

that at no time can more than six volts be impressed on the filaments of the tubes regardless of line voltage fluctuation.

The capacity of the Abox Filter is far in excess of that required. It can be conservatively estimated at more than one hundred thousand microfarads. When used with the Abox rectifier it reduces the alternating component of the input pulsating direct current to less than 1/3000 of its original value. This is far below audibility in any radio set.

Figure 1 shows the cut away view of the Abox A battery eliminator. The rectifier, electrode, the condenser plates, the transformer and choke are clearly shown. Note that both the rectifier and condenser work in the same solution. This never requires replacement, and the addition of distilled water every six months or so is the only care or maintenance needed. The condenser plates are never affected by use or disuse. The rectifier electrode has a life of several years and can be replaced in a few seconds at a very low cost.

The tapped resistance which compensates for the number of

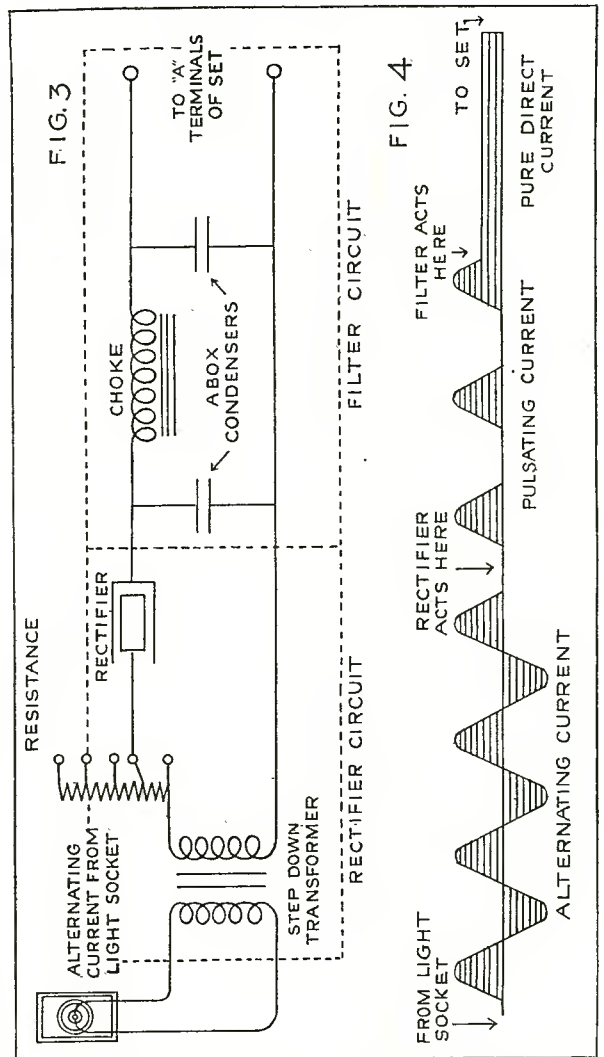

Figure 3. In the above sketch is shown the theoretical circuit of the complete eliminator. Figure 4 in this sketch shows the effect of the rectifier and filter on the alternating current and illustrates the theory of the Abox very comprehensively

tubes used is shown in the front of the unit. Once adjusted, it is never changed.

Figure 3 shows the theoretical circuit of the complete eliminator. The alternating current from the houselighting circuit is stepped-down from 110 volts to the proper low voltage by the transformer. This is then passed through the rectifying valve which will pass current in one direction only, thereby eliminating

(Continued on Page 170)

# 30 Days FREE TRIAL

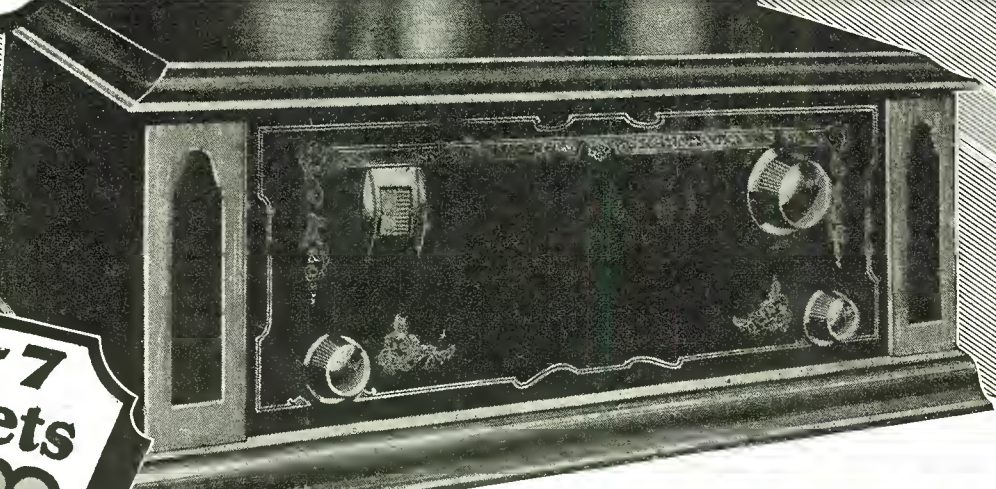

**5-6-7  
Tube Sets  
\$47.00  
to  
\$72.00  
RETAIL PRICES**

## Westgale Radio Sets

NOW, you can get the finest quality Radio, DIRECT FROM FACTORY on 30 Days' Trial and save almost half. Now you can put any of the new 1928 WESTGALE models in your home and use them to your heart's content for 30 Days at our risk. Listen to the music, concerts, news, sports, market reports from all over the country. Test the Westgale Radio for distance, selectivity and REAL Tone value. Compare it for quality and price with any other Radio. Then if not convinced that Westgale gives you the biggest value for the money—YOU DON'T HAVE TO KEEP IT.

*The Last Word in Guaranteed Radio Sets and the Biggest Values Ever Offered*

### Why Not Be Our Agent?

Buy at cost. We want Agents and Dealers in every locality to demonstrate and take orders for these amazing new 1928 Westgale Models. This is your chance to get a Westgale Radio at a big discount and make it pay you big money. Millions of radios will be sold this season. Get a Westgale set on 30 Days' Trial—demonstrate to your neighbors and friends and get your share of these big radio profits.

### Your Own Radio Free

Our new Catalog also explains a plan whereby you can put a Westgale Radio in your home on 30 Days' Trial—demonstrate it to your neighbors and friends in your spare time and get your own set without cost before the trial period is up.

### Westgale Sets Are Licensed Under R. C. A. and Associated Companies Patents

For the 4th consecutive year Westgale offers you the newest and latest in Radio at lowest prices. Our 1928 models are licensed under the basic patents of the Radio Corporation of America and Associated Companies. That assures dependable service. Beware of an unlicensed Radio. Why not have the best? Why pay high prices? Why take chances when you can test out any Westgale model in your own home on 30 Days' Trial? Our retail prices are low factory prices. Our Agent's prices are lower. Send for our new 1928 catalog and see for yourself.

### 24 Styles to Choose From—Table Styles—Consoles—De Luxe Cabinets

This season Westgale offers you 5 tube—6 tube and 7 tube models in your choice of a beautiful array of table styles, consoles and period type Walnut cabinets.

Don't buy any radio until you send the coupon for our new catalog which pictures and describes our complete line in almost any size or style you could wish for. Don't wait—a special introductory discount from retail prices for those who write quick. Mail the coupon today—get posted before you buy.

### Special Discount to Agents

To quickly introduce these wonderful new 1928 models we are offering for a limited time a big reduction, way below retail prices on the FIRST Westgale set placed in each community. So get busy now. Be first in your locality to mail the coupon for our FREE catalog and get full particulars of this special discount offer.



Only **\$87.00**  
Retail Price Including Speaker

## WESTGALE ELECTRIC COMPANY

Dept. 1411  
1751 Belmont Ave. Chicago, Ill.

### Mail Today—Don't Delay

Westgale Electric Co.,  
Dept. 1411, 1751 Belmont Ave.,  
Chicago, Ill.

Please send me your FREE catalog on the new 1928 Westgale Radio Sets. Also full particulars of your Special Discount Offer on the first outfit placed in each community.

Name.....

Address.....

# There's a BIRNBACH COLORED RUBBER BATTERY CABLE For every Circuit and Purpose

These Battery Cables are composed of Stranded Wires insulated with Colored Rubber and enclosed in an attractive Braid over all wires. For use in connecting A, B and C Batteries or Eliminators to Set. Furnished with brass soldered lug terminals on all ends for neat and quick attaching of cable to batteries or eliminator. Each wire of separate Solid Color. Made in 5, 6, 7, 8, 9 or 10 Wires. Packed in individual cartons.



No. 110- 5-Wires 54 inches.....	\$0.50	No. 114- 5-Wires 10 foot.....	\$1.25
111- 6-Wires 54 inches.....	.60	116- 6-Wires 10 foot.....	1.55
112- 7-Wires 54 inches.....	.70	117- 7-Wires 10 foot.....	1.85
113- 8-Wires 54 inches.....	.85	118- 8-Wires 10 foot.....	2.15
126- 9-Wires 54 inches.....	1.00	127- 9-Wires 10 foot.....	2.45
119-10-Wires 54 inches.....	1.15	128-10-Wires 10 foot.....	2.75

## Birnbach Radio Battery Connectors

Made of Stranded Wires, insulated with rubber and covered with a distinctive braid. All ends assembled with brass soldered lug terminals to fit the binding post or clips on all batteries. A handy accessory for use in connecting Dry Cell "A" Batteries, B and C Batteries. Carton contains 25 of each size.

No. RC 3...3-in. Connectors.....	each.....	\$0.04
RC 6...6-in. Connectors.....	each.....	.05
RC 8...8-in. Connectors.....	each.....	.06
RC12...12-in. Connectors.....	each.....	.07



## Birnbach Loud Speaker Extension Cord Units

You can move your Loud Speaker into any room desired—Bedroom, Kitchen, Dining Room, Baby's Room, Living Room. A BIRNBACH EXTENSION CORD UNIT improves the tone quality when power tubes are used, by placing the Speaker away from the Set. Made in six sizes and furnished complete with Connector. Packed in individual cartons.

No. 166...10 foot, complete.....	\$0.75
120...20 foot, complete.....	1.00
121...30 foot, complete.....	1.40
122...40 foot, complete.....	1.80
123...50 foot, complete.....	2.20
124...100 foot, complete.....	4.20



## Birnbach Replacement Cords

These Five Foot Cords are to be used for replacement of worn Loud Speaker or Head Set Cords. Packed in individual cartons.

102—Loud Speaker Cord Pin Tips.....	each \$0.35
103—Loud Speaker Cord Pin and Spade Tips.....	.35
106—Loud Speaker Cord Pin and Eye Tips.....	.35
104—Head Set Cord Pin Tips.....	.50
105—Head Set Cord Pin and Spade Tips.....	.50
107—Head Set Cord Pin and Eye Tips.....	.50



## Birnbach Bakelite Tuners in Duco Colors

Decidedly new and attractive. Make your set not only look better and different, but perform better. This 3-Circuit Tuner is wound on colored Bakelite and will improve any Circuit. A marvel for performance. Use BIRNBACH TUNERS for best tone quality, long range distance, and volume. For use with .0005 Mfd. Condenser. Tuning range 200 to over 550 meters.

No. 60...Colored Bakelite 3-Circuit Tuner.....	\$2.00
No. 60...Colored Bakelite Radio Frequency Coil.....	1.25



## Birnbach "180" Bakelite 3-Circuit Tuner in Duco Colors

This Tuner is larger in size than our No. 60 and in this form it is the most efficient TUNER ever designed. Distant stations can be tuned in with greater volume and the very best tone quality. For use with .0005 Mfd. Condenser. Tuning range 200 to over 570 meters.

No. 180...BIRNBACH Colored Bakelite 3-Circuit Tuner.....	\$3.50
No. 180...BIRNBACH Colored Bakelite Radio Frequency Coil.....	1.50



## Birnbach "400" Bakelite Post Strip

A new and convenient strip for sub-panel mounting, moulded in Bakelite with 9 characters engraved. Packed in individual cartons.

No. 400...Birnbach Bakelite Post Strip.....	each \$0.65
---	-------------



**BIRNBACH RADIO CO.**  
254 West 31st Street, New York City



one phase of the alternating current and creating a pulsating direct current.

This is then passed through the filter circuit which it is smoothed and all variations in current removed, producing a pure, hum-free direct current ideal for radio A supply and at full power all the time.

Figure 4 shows the effect of the rectifier and filter on the alternating current and illustrates the theory of the A box very comprehensively.

## National Full Wave Charger

A unique feature of the full wave Duo Range 2.5-5 ampere battery charger manufactured by the National Company, Inc., of Malden, Mass., is the pilot lamp which serves the double purpose of indicating when this silent charger is in operation and the rate at which the battery is being charged. As the battery becomes charged, the rate of charge gradually tapers off and the brilliancy of the pilot lamp decreases.

This charger employs two of the new Raytheon A rectifier

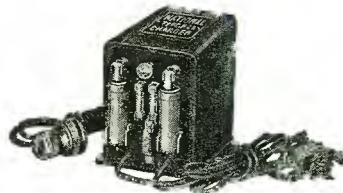

cartridges, and has a specially designed transformer which insures a maximum life from the rectifiers.

Because of the high electrical efficiency of the National Duo Chargers, the cost of recharging a battery is quite low, in fact, a saving of as much as from \$6 to \$10 a year in the amount of electrical power consumed from the house lighting system may be effected by the use of one of the new chargers in place of one of the old bulb or chemical varieties.

Another new National charger is the midget R-13, which also employs a Raytheon collodial rectifier cartridge. This inexpensive 2.5 ampere charger is particularly well suited for use as a "booster" by owners of trickle chargers. When the A battery



gets down too low for the trickle charger to bring it up again, instead of having to send the battery to a service station for charging, it is only necessary to clip on the R-13 for a few hours.

Most trickle charger users will find that the use of the little 2/5 amp. charger will soon pay for itself in both convenience and elimination of service station charges.

Like all other National radio power apparatus, the Duo-Range Charger is mounted in a pressed steel case attractively finished with black crystalline lacquer. Charging leads with clips as well as a 5 ft. 110 volt cord and plug are provided.

## H. F. L. Has New Audio

In the last issue of the Citizens Radio Call Book was given a write-up of the new improved Nine-in-Line receiver and from all reports this circuit has been gaining in popularity ever since. It is evident that this receiver has been improved gradually and brought up to its present day perfection just like the automobile,

(Continued on Page 172)

# SELECTONE TRANSFORMERS

used in THE WORLD'S RECORD SUPER

Which Holds Four Verified World's Records For Reception of Stations 6,000 to 8,000 Miles Distant



TYPE B for Sub-Base Mounting

TYPE B-500. THE NEW SELECTONE HIGH GAIN INTERMEDIATE TRANSFORMER, designed for use with Selectone Twin Filters. Accurately tuned and laboratory matched to a precision of less than one-tenth of one per cent in frequency. Tested for High Gain and voltage amplification which guarantees your reception of DX stations. Price \$6.00.

TYPE B-510. THE SELECTONE B-510 FILTER is designed for use with High Gain Intermediate Transformer B-500. It is an accurately tested and matched unit, designed to impart to the receiver the keen tuning and sensitivity necessary in receiving over long distances. Price \$6.00.

TYPE B-520. THESE RADIO FREQUENCY COUPLERS, listed as the Selectone RF Couplers, Type E-520, are an innovation in radio frequency design, each matched to within one-third of a turn of uniformity, enabling their use in gang or individually controlled tuning circuits without trouble in balancing. Price \$5.00.

TYPE B-530. A SPECIAL SELECTONE ANTENNA COUPLING UNIT designed for use with a Twin set of Selectone B-520 RF Couplers. Has a slightly lower inductance value than the B-520 to permit the use of a small variable trimmer across the secondary in addition to the main tuning capacity, for long distance tuning. Price \$5.00.

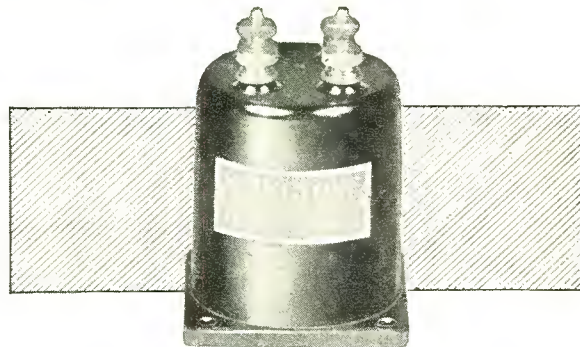

TYPE R for Baseboard Mounting

TYPE B-540. SELECTONE OSCILLATOR COUPLER. Typifies the same precision construction as all other Selectone products. Price \$5.00.

TYPE R-400. THE BASE MOUNTING HIGH GAIN SELECTONE R-400 is famous among radio enthusiasts for its exceptionally high voltage amplification with gratifying stability. Special closed core construction limits stray fields and coupling. Price \$6.00.

TYPE R-410. THE SELECTONE BASE MOUNTING FILTER, designed for use with the High Gain R-400 Intermediate Transformer. These filters are precision matched with laboratory equipment and enable 10 kc. separation on local stations with great sensitivity. Price \$6.00.

TYPE R-340. THE SELECTONE OSCILLATOR COUPLER, designed especially for use with the R series transformers. Price \$3.50.

## Free Book

WE will gladly mail you our booklet "The Story of Selectone Transformers," also complete building instructions on the World's Record Super—the receiver that brings in DX stations like locals.

## Guaranteed Performance

Every Selectone transformer is fully covered by our money back guarantee. You must be satisfied or we return your money. Every set of transformers is given an actual operating test for tone, selectivity and sensitivity (see the photograph below) insuring perfect performance when you build them into your receiver.

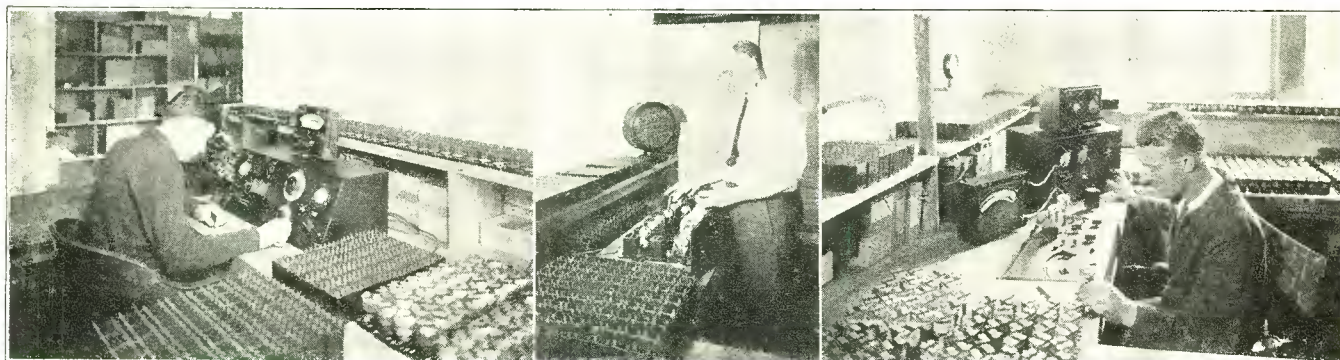

Testing Selectone Radio Frequency Units

Mr. E. H. Scott testing Selectones in special test receiver

Peaking Intermediate Transformers

**Set Builders:** The World's Record Super is not only a great DX receiver but also has truly marvelous tone quality. It's easy to build and will out-demonstrate anything you can put against it. Write at once for full information.

The SCOTT TRANSFORMER CO., Dept. A, 7620 Eastlake Terrace, Chicago, Ill.

Tell 'Em You Saw It in the Citizens Radio Call Book Magazine

# Orchestrion

LINE OF  
RADIO LOUD SPEAKERS

## The Last Word in TONAL FIDELITY



Console Type  
Orchestrion  
Speaker  
\$35.00

You'll be happy with an ORCHESTRION. You'll hear every least modulation of tone just as it enters the microphone. Gone is every metallic sound that marred speakers. True music with all its soft modulations and its swelling volume.

The renowned ORCHESTRION tone arm and unit is built into the Console Type illustrated above.

The simple dignity and beauty of this Console blend with every style of home furnishing. Front, top and sides built of five-ply, sliced mahogany of lustrous finish. Rigidly constructed, it stands 30 inches high, 36 inches long and 15 $\frac{3}{4}$  inches wide. Ample cabinet space for batteries, socket power devices or charger.

Hear an ORCHESTRION before you decide. Ask your dealer, or write for folder describing Console; The Orchestrion DeLuxe Horn Type Speaker; The Orchestrion Junior Speaker and the Orchestrion Power Unit.

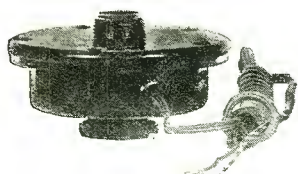

Orchestrion  
Power Unit  
\$7.00

New reproducing unit—the finest of its type. Extraordinary volume without necessity of power amplifier. Has adjustment for adaption to any type radio receiver. Ideal for phonograph installation.

**The RADIO CABINET CO.**  
2118 North Gale St.  
INDIANAPOLIS, INDIANA

rather than being heralded as a radical revolution in radio. This receiver incorporating the utmost in design and performance has in the course of time been tried and tested and is now accepted as a standard for comparison.

In our last issue attention was called to many improvements over last years Nine-in-Line which the new true tone large type audio transformers were the outstanding features. Since the introduction of the new audio transformers another transformer,

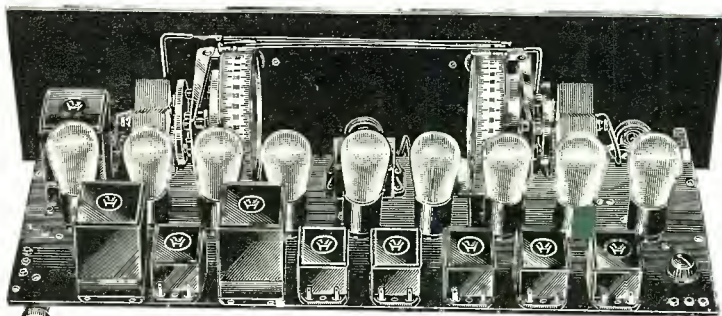

type C-26, has been developed by the High Frequency Laboratories which is ideally suited in the second stage of audio frequency in the Nine-in-Line and other receivers as well.

For ideal audio reproduction rather than maximum amplification the use of one H. F. L. C-16 in the first audio stage and one C-26 in the second audio stage using a C-25 output transformer are recommended.

### Triple Mershon Condenser

The Triple Mershon condenser is ideal for use in an A, B and C power unit for the new A C tube. It is recommended to use the so-called raw A C tubes (UX 226) in all but the detector socket. The detector requires the use of the heater type tube UX 227 with either a UX 171 or UX 210 in the last audio stage for the power amplifier. In that the new tubes have practically the same constants as the battery tubes (UX 201 A) it is not



necessary to change the design of the radio or audio frequency circuits. The filament wiring must be changed to accommodate the extra current required, and potentiometer and bypass condensers supplied to eliminate the A C hum.

For the 'B' power the conventional 'B' circuit may be used. It is, however, necessary that the circuit of the unit has as low internal resistance as possible. This can best be accomplished by the use of a Mershon Condenser directly across each positive output terminal of the eliminator.

(Continued on Page 174)

Tell 'Em You Saw It in the Citizens Radio Call Book Magazine

Employing the New  "Octa-Monic" Principle

The Radically and Fundamentally New

# R·G·S "OCTA-MONIC"

## Battery or "B" Eliminator Models

### R. G. S. "Octa-Monic" Kit

of parts including all required apparatus, complete instructions and blueprints, ready to build, \$84.60.

### R. G. S. "Octa-Monic" Chassis

completely assembled according to latest laboratory methods, ready to operate, \$89.60.

### R. G. S. "Octa-Monic" Receiver

housed in an attractive, well-designed, walnut table cabinet, \$104.60.

### R. G. S. "Octa-Monic" Tuning Kit

including all necessary apparatus, blueprints and instructions, \$63.60.

### R. G. S. "Octa-Monic" Tuning Chassis

completely assembled according to latest laboratory methods with complete instructions and ready to wire to your favorite amplifier, \$66.60.

### Price Notice

The actual apparatus required to build the R. G. S. Octa-Monic lists at over \$100.00.

## A. C. Tube Models

### R. G. S. "Octa-Monic" A-C Tube Kit

including instructions and blueprints, all necessary apparatus, ready to build, \$119.60.

### R. G. S. "Octa-Monic" A-C Tube Chassis

Completely assembled according to latest laboratory methods, with instructions and blueprints for installation, ready to plug-in your lamp socket and operate, \$129.60.

### R. G. S. "Octa-Monic" A-C Tube Receiver

housed in an attractive, partitioned, walnut table cabinet, \$149.60.

### Price Notice

All models of the R. G. S. "Octa-Monic" have been adapted to the Cunningham A C and Power Tubes (Four (4) CX 326, one (1) C 327, and one (1) CX 371). The "B" Battery Eliminator and the Cunningham Tubes are not included in the following prices. This eliminates an unnecessary expenditure on your part because the A-C Tube models of the R. G. S. "Octa-Monic" have been designed to operate satisfactorily with any good "B" Eliminator. It is recommended if your "B" Eliminator has no "C" battery tap, that you use the regular 45 volts of C battery.

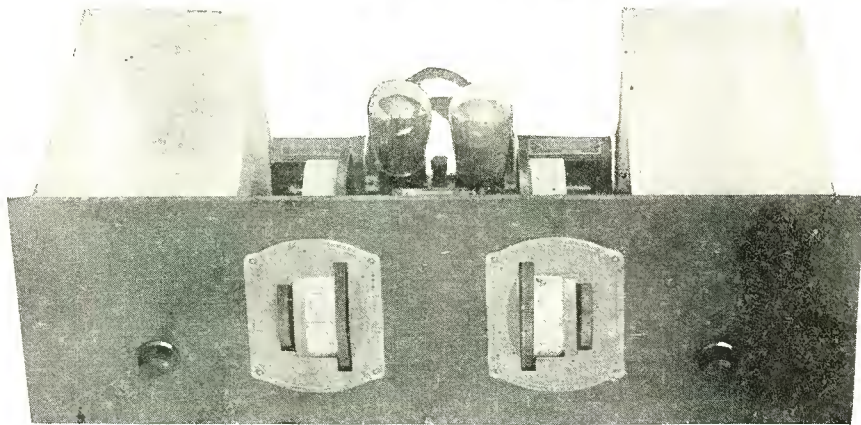

developed by David Grimes, is one of the great outstanding radio developments of the past ten years. The RGS "Octa-Monic" principles are fully as basic a contribution to the art as were any of the discoveries of DeForest, Armstrong, Alexanderson, etc., etc. The RGS "Octa-Monic" is suited ideally for congested broadcast conditions because it was designed to meet the radio conditions that obtain in metropolitan areas. This receiver was not designed and built by guess work, but it was developed and designed by one of the most brilliant engineers the industry has produced, David Grimes. The RGS "Octa-Monic" welcomes a comparative test with any receiver on the market regardless of cost, a comparative test run under similar conditions. These claims are made for the RGS "Octa-Monic" and these claims can be proved:

1. **SELECTIVITY** superior to the Super-Heterodyne without the cutting of side-bands or loss of tonal values. Selectivity sufficient to separate with ease the local jumble of metropolitan stations; selectivity positive enough to make use of vernier control unnecessary; selectivity that is equal over the whole drum without being at all critical at any point; selectivity enough to give five (5) degrees of absolute silence between stations WEAJ and WNYC in a location 200 yards away from WNYC.
2. **AUTOMATIC WAVE-TRAP.** In a thorough survey of the apparatus displayed at the Radio World's Fair, New Madison Square Garden, the RGS "Octa-Monic" was the only Receiver displayed that had an Automatic Wave-Trap for the elimination of the annoying heterodyne squeal on WEAJ, WJZ, etc., etc., when the half wave-length or first octave beat stations are also on the air.
3. **TONAL QUALITY.** The RGS "Octa-Monic" delivers as fine Tonal Quality as present developments in the Radio Art will permit. It is impossible, regardless of cost, to buy finer reproduction.
4. **VOLUME,** sufficient to fill a hall that will seat 3,500. Yet the volume control is so efficient that this tremendous volume can be reduced to a mere whisper without the sacrificing of a single note.
5. **SENSITIVITY.** It is not unusual to hear through the local barrage of metropolitan stations WEBH, WGN, WTAM, WJAX, KDKA, etc., etc.
6. **APPEARANCE.** The consensus of opinion at the Radio World's Fair, New Madison Square Garden, New York City, seemed to be that the RGS "Octa-Monic" was one of the best-looking receivers at the show. It is quite certain, in any event, that it would grace the most exquisite quarters, not only from the standpoint of appearance but in performance as well.
7. **OPERATION.** The RGS "Octa-Monic" is one of the simplest receivers to operate. There are but two knobs, one of which is an ordinary volume control and switch combined, and two drum controls with vernier adjustments, the most efficient system of tuning POSSIBLE. This Receiver employs five (5) CX301-A's and one (1) CX371.
8. **SERVICE.** The RGS "Octa-Monic" is free from ordinary service, tuning condensers being the only movable parts. There are, as a consequence, no fussy mechanisms, either mechanical or electrical, to get out of order. Any good "B" eliminator will operate satisfactorily without motor-boating. "B" Batteries will not howl. As a matter of fact, due to the high stability margin, the RGS "Octa-Monic" will deliver a clear tone on batteries registering as low as 10 volts.
9. **FURNITURE.** The RGS "Octa-Monic" is easily adapted to the elaborate console, the handy bookcase, or the modest table cabinet, all, equally well.

Go to your favorite dealer today and insist on a demonstration. If he hasn't stocked the RGS "Octa-Monic" yet, send us his name and address and every effort will be made to arrange a demonstration at the first possible moment.

Arrange for that demonstration now because you have a real radio thrill waiting for you. In the RGS "Octa-Monic" you will hear radio at its best. And when you hear it and operate it yourself you will know why New York City is buying it.

All models of the RGS "Octa-Monic" and the RGS "Four" are fully protected by Grimes Patents issued and pending.

Trade mark registered U. S. Patent Office.

**R. G. S. MANUFACTURING CO., West Brighton, Staten Island, New York**  
Dealers—Write for Complete Merchandising Plans

BUILT FOR MODERN  BROADCAST CONDITIONS

Tell 'Em You Saw It in the Citizens Radio Call Book Magazine

# KUPROX



The REVOLUTIONARY, new dry metallic-disc rectifier obsoletes at a single stroke all present types of rectifiers, including electrolytic, tube and vibrating. It gives to RADIO, at last, a system of rectification that is absolutely dependable, noiseless and efficient; one that is as substantial as a piece of solid metal. It does not use glass, chemicals or liquids of any kind and is truly a rectifier that requires absolutely no attention. It is unlimited in its length of life.

**TYPE "A" KUPROX REPLACEMENT UNIT**.....each \$4.50  
Replaces electrolyte and jars of all Trickle Chargers, "A" Powers, Power Units, etc., of the electrolytic type. Changes ½ ampere Trickle Charger to 1 ampere.

**Model "A" KUPROX TRICKLE CHARGER**.....each \$10.50  
A silent, dry 1 ampere Trickle Charger, can be installed and forgotten.

**Model "D" KUPROX HOMECHARGER**.....each \$18.50  
Noiseless, efficient, no renewals of any kind necessary. Two charging rates, 1 ampere Trickle rate and 3 ampere Booster rate.

OUR CATALOGUE GIVES FULL INFORMATION ON THE NEW KODEL DRY "A," "B" and "C" Power supplies.

## We Specialize in Super-Heterodyne Parts

### Distributors for

<b>Victoreen</b>	<b>Tyrman Ten</b>
<b>Magnaformer</b>	<b>Melo-Heald Eleven</b>
<b>Eight-in-Line</b>	<b>Melo-Heald Hot Spot Fourteen</b>
<b>Scott's World's Record Ten</b>	<b>Karas Equamatic</b>
<b>Hanmarlund-Roberts Hi-Q Six</b>	
<b>H. F. L. Nine-in-Line</b>	

We are also wholesale distributors for the following manufacturers of HIGH-GRADE Radio parts and accessories.

<b>Klear-tone Dry Batteries</b>	<b>Ferranti</b>
<b>Universal Storage Batteries</b>	<b>Scott Transformer Co.</b>
<b>Kodel Radio Corporation</b>	<b>Fiat &amp; Qualitone Loops</b>
<b>The Abox Co.</b>	<b>Lignole Corporation</b>
<b>Benjamin Electric Mfg. Co.</b>	<b>Carter Radio Mfg. Co.</b>
<b>Fritts Super Cabinets</b>	<b>Herbert H. Frost Co.</b>
<b>Sterling Mfg. Co.</b>	<b>Clarostats</b>
<b>Remler</b>	<b>Amperites</b>
<b>Hanmarlund Mfg. Co.</b>	<b>Baldwin Speakers &amp; Units</b>
<b>Yaxley Mfg. Co.</b>	<b>Quam Radio Corporation</b>
<b>Sangamo Condensers</b>	<b>ENSCO Cone Kits</b>
<b>Tobe Condensers</b>	<b>Temple Speakers</b>
<b>Camfield Radio Mfg. Co.</b>	<b>Aero Coils</b>
<b>Karas Electric Co.</b>	<b>Melo-Heald</b>
<b>Victoreen Products</b>	<b>Thordarson Electric Mfg. Co.</b>
<b>X. L. Radio Laboratories</b>	<b>Sonatron Tubes</b>
<b>Kurz Kasch Co.</b>	<b>Sovereign Tubes</b>
<b>Tyrman Electric Co.</b>	<b>Acme Wire Co.</b>
<b>Daven Radio Corp.</b>	<b>Magnaformer</b>
<b>Pacent Radio Corp.</b>	<b>Jewell Meters</b>
<b>Hood Rubber Co.</b>	<b>Sunlight Crusader Tubes</b>

## Dealers Wanted Everywhere

Write for Catalogue and Discounts

# NELSON ELECTRIC CO.

Tel. Wabash 8719

508 S. Dearborn St., Chicago, Ill.

Liberal Discounts

Immediate Deliveries

## Temple Makes Comparator

Within recent years many milestones of progress have been past in the onward rush of the radio manufacturer and layman in search of an idea. This tremendous growth of the radio industry has caused the most intensive development of practically every device pertaining to the improvement of radio, and more particularly to the equipment which is responsible for the improvement of quality of reproduction. Prospects of improved air conditions along with the outstanding achievements of loud-speaker and audio frequency amplifiers gives the manufacturer the feeling that the public will appreciate the efforts he is making for better radio.

Because of the great improvements which have been made in quality of reproduction, it is apparent that this improved radio



will enjoy a well earned popularity this coming season.

With the rapid improvement of speakers there comes the demand for some method of quickly demonstrating the merits of one speaker or amplifier over another to the public and in this way settling any controversy or doubt as to the relative performance in the observer's mind. It often happens that a dealer in making a demonstration to a prospective customer has been asked to switch the set from one speaker to another so that the customer might compare the volume and quality of response on a particular piece of music, but before the change could be made the selection was either finished or it changed in its tempo so that the customer received an erroneous impression of the speaker.

Many types of switches with jacks have been assembled by ingenious dealers to facilitate making comparative demonstrations of speakers. Most of these devices have been more or less crude.



but nevertheless they answered the problem. In laboratories where it is imperative that an unbiased opinion of the merits and faults of the speaker be known, switches have been made from the early days, which will allow a rapid change over from one circuit to the next.

As shown in the figure, a compact and new design of such a switch has been developed which incorporates every desirable feature in such a simple apparatus and which is available to the dealer and layman as well as to the laboratory. It consists of a bakelite turret, moulded in the form of a hollow truncated cone. Around the base of this cone five pin jacks are mounted, all of which are electrically connected together on the inside of the cone form, and form the common lead to five speaker circuits. Directly above each of these pin jacks five more jacks are mounted in such a way so as to allow the switch arm to make

(Continued on Page 176)



# VITROHM RESISTORS and RHEOSTATS

## Vitrohm Radio Resistors

**WARD LEONARD**  
Resistors and Rheostats are now available to the experimenter and home constructor in 93 types and styles covering the resistance demands of *every* current supply circuit.

A few of these products are listed on this page. A full description is contained in Radio Bulletin 507 which will be sent you without charge.

"Vitrohm News," a monthly Bulletin covering circuits and items of interest to the radio fan, was first published in September. This copy and subsequent issues will be sent you upon request.

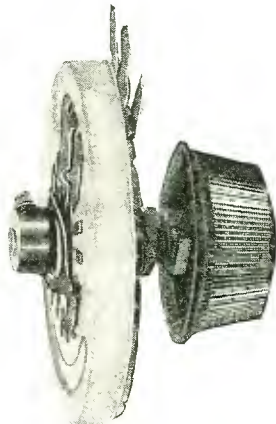

THE ADJUSTAT

### The Adjustat

The Vitrohm Adjustat is a 15-step potentiometer connected rheostat adopted for use in all current supply circuits. Like all Vitrohm Products, the resistive element, wire, is embedded in and protected by fused-on vitreous enamel.

The Adjustat is priced at \$3.00.

#### Types

507-79	1 ohm	4000 m. a.	507-81	600 ohms	180 m. a.
507-71	2 ohms	3000 m. a.	507-75	1000 ohms	125 m. a.
507-72	6 ohms	1500 m. a.	507-76	2250 ohms	90 m. a.
507-73	20 ohms	1000 m. a.	507-84	7500 ohms	50 m. a.
507-74	30 ohms	800 m. a.	507-77	10,000 ohms	40 m. a.
507-80	50 ohms	650 m. a.	507-78	25,000 ohms	20 m. a.

### Resistor 507-66

Vitrohm Resistor 507-66 is a transmitting grid leak for circuits up to and including 1000 watts input. It is particularly recommended for circuits employing the R. C. A. UX852 Tube.

Total Resistance 15,000 ohms, tapped at 5000 and 10,000 ohms. \$6.00.



RESISTOR 507-66



RESISTOR 507-9

### Resistor 507-9

This resistor is for use in B & C Supply Circuits having an output under load of 180 volts. At this voltage, intermediate voltages of 22, 45, 67, 90 and 135 are available. Priced at \$6.75.

### Vitrohm HEAVY DUTY Rheostat

The Vitrohm *heavy duty* Rheostat has 11 steps of adjustable resistance. It is particularly adaptable to use in series with transformer primaries to compensate for line voltage changes. These Rheostats are 4 inches in diameter and are arranged for either base or panel mounting. \$5.50.

#### Types

507-83	12.5 ohms	2200 m. a.
507-39	20 ohms	2000 m. a.
507-63	50 ohms	100 m. a.

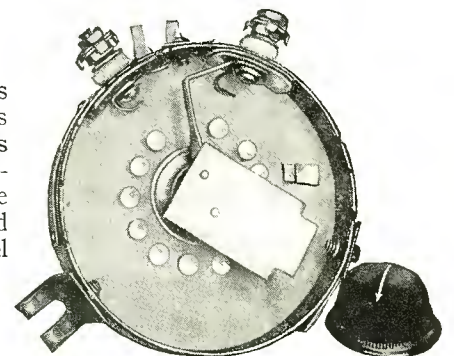

VITROHM HEAVY DUTY RHEOSTAT

# Ward Leonard Electric Company

31-41 South Street

Mount Vernon, N. Y.

resistor specialists for more than 35 years

Tell 'Em You Saw It in the Citizens Radio Call Book Magazine

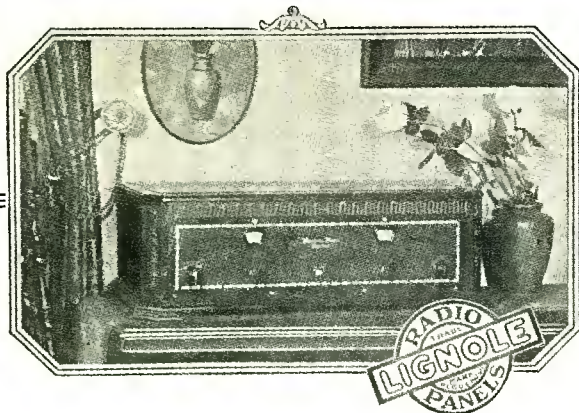

## Lignole Users are Lignole Boosters

**L**IGNOLE is a specially treated wood panel that meets all panel requirements. Lignole panels are standard specification in many of the world's leading kits. Their use is approved and recommended by leading radio engineers and designers. As a di-electric, there is no better panel material obtainable. It is extremely rigid and will not warp.

Lignole panels are made of genuine woods, 5 ply laminated construction and finished either plain or in two-tone. The two-tone panels have a darker border separated from the body of the panel by a small vein or by a beautiful inlaid Marqueterie. This finish produces a panel that will blend and harmonize with any style or make of cabinet in which it is placed.

Lignole can easily be drilled with a wood or metal twist drill. If through accident Lignole is marred or scratched, it can be repolished the same as you do your cabinets.

Completely drilled and decorated panels can now be obtained for all of the more prominent kits and circuits.

Lignole Panels Are Approved and Obtainable for Circuits Designed by Citizens Radio Call Book

*Sold by Jobbers and Dealers  
Everywhere*

Write for Latest Price Circular

**The LIGNOLE Corporation**  
508 South Dearborn Street  
Chicago, Ill.

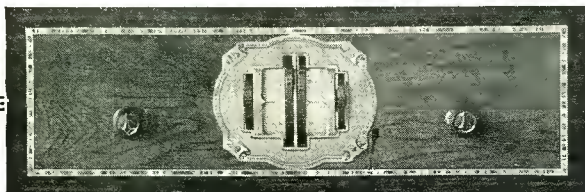

individual contact with the terminal of each one of them.

The switch arm is mounted on a shaft which extends through the flat top of the truncated cone. A ball bearing is placed in the cap nut which holds the switch arm on the shaft and the bakelite turret is notched so that when the switch is turned from one jack to the next it drops into position with a snap and in such a way so as to make definite and positive electrical contact. The switch arm is insulated from the metal name plate. It passes from one to another one of five speakers almost instantaneously, which allows the same tones to be heard in each of the speakers. From this a critical comparison can be made and definite conclusions as to respective merits of each speaker can be obtained very easily.

A number of the present radio set owners are using more than the loudspeaker. In fact, many radio fans are having their homes wired with speaker outlets in each room of the house. With this comparator it is a simple matter to so arrange the circuits so that it is possible to project the output from a set to any one of five speakers located in different rooms.

The radio dealer and jobber finds such a simple device as this of great value in conveying to his customer convincing proof as to the merits of one speaker over another when tested on a common radio set.

## Braidite New Hookup Wire

Braidite is a new hook-up wire that is fast winning favor among set builders and manufacturers.

In making a connection it is not necessary with Braidite to



strip back the insulation. The insulation is easily pulled back and after soldering it slides right back into place, leaving no exposed sections of bare wire. Braidite holds its shape permanently after bending, thus enabling the builder to make a neat workmanlike job. Another strong feature about Braidite is that you cannot scorch or burn it with a soldering iron.

Braidite is made from either solid or stranded tinned copper wire covered first with a cotton wrap and then with a cotton braid. The product is then impregnated with a damp proof compound making it impervious to moisture and adding to its insulating qualities.

Corwico radio wires were used by Mr. John Harrison Hartley, winner of the World's International Set Building Championship and also by the second and third prize winners in the set building contest held at the Radio World's Fair in New York in September.

## Amperite Adaptor Modernizes Old Set

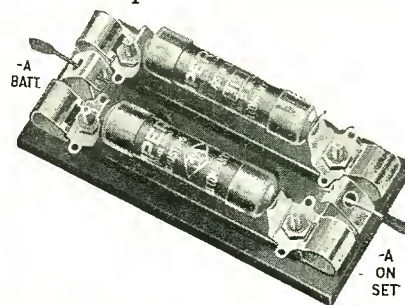

By means of a new device just introduced, it becomes possible to modernize the old set without the use of tools or the per-

*(Continued on Page 178)*

*Tell 'Em You Saw It in the Citizens Radio Call Book Magazine*

# RESULTS COUNT

## 3,000 MILES WITH THE THOMPSON SUPER SEVEN

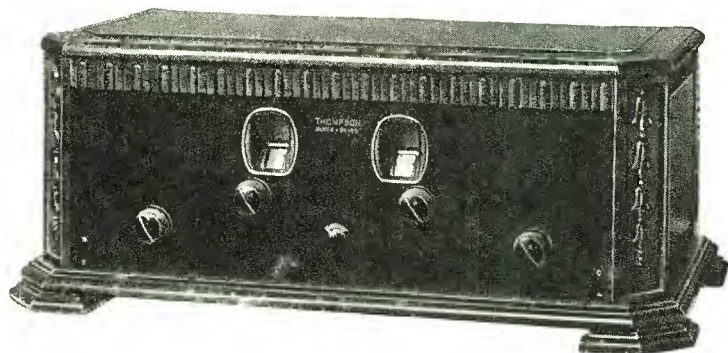

### Power—Selectivity—Distance—Volume—Overtone Amplification

You'll be amazed at the results that this receiver will give you. Halldorson Precision long wave transformers and Overtone audio transformers are the heart of the Thompson Super Seven. Because they are built like the finest watches they will give you results that you never dreamed possible.

The ability to detect and reproduce weak signals

is so acute that the set has unlimited range. Overtones that give depth and life to all music are brought to the foreground with a richness that is astonishing. The selectivity is so marked that powerful local stations can be tuned out and distance brought through with ease.

Get your parts today, a few hours work and your set is ready to be initiated in the realms of distant stations, and you'll be surprised at the low cost of the complete parts for so efficient a receiver.

*Louis Buck of Winnipeg, Canada, writes:*

Have had the Thompson Super Seven working now for about three weeks and have had several stations over three thousand miles regular. Can set the dials at ten o'clock (eight o'clock Pacific Time) and KFI comes through with enough volume to dance to. Can always pick up PWX, Havana, Cuba, when they are on the air and have also had CYX, Mexico City, two or three times. Even up here where reception is fairly good I have never heard a receiver perform the way this one will.

### Write for circulars covering all Halldorson products

	Each
Halldorson Overtone Audio Transformers .....	\$6.00
Halldorson Overtone Output Transformers .....	6.00
Halldorson Precision Long Wave Transformers—	
Type 540 I. C. ....	6.00
Type 541 Filter .....	6.00
Full size blue prints covering construction of THOMPSON SUPER SEVEN.....	1.00

## Rich Tones, Beauty and Compactness

### Halldorson Overtone Audio Transformer

The new Halldorson Overtone Audio Transformer is the result of several years research work to develop a transformer that would faithfully reproduce broadcasting with present day loud speakers. With new ideas in design, its ability to amplify the overtones of both music and speech is a revelation.

The Halldorson Overtone Transformer delivers greater power on the low frequencies and falls off rapidly in amplification on the higher frequencies. The effect of this is readily apparent to the musical ear, for the bass notes are brought to the foreground with a richness that is astonishing. Over-tones that give depth and life to all music are amplified with a deep, rich power that can only be found in this new and remarkable unit. Being incased in a beautiful brown polished bakelite case, it fairly radiates a rich beauty that lends distinction to any radio set. It may be mounted on wood, bakelite, or a metal sub-base, and has soldering lugs situated low upon the casing for convenience in wiring.

Every part of the unit is made of the finest materials and assembled with the technical skill of master craftsmen. Each transformer is rigidly tested before leaving the factory and is guaranteed to give perfect satisfaction. Made in one type for all circuits and all tubes.

### Halldorson Precision Long Wave Transformers

Halldorson Precision Long Wave transformers are the result of precision methods and extremely careful and accurate calibrating. Assembled, calibrated, tested and re-tested by skilled craftsmen, they are built to meet the most rigid inspection that a long wave transformer can be subjected to, its ability to give maximum amplification over a ten kilocycle band and to exclude any energy on either side of this narrow band.

The success of any super-heterodyne receiver depends primarily upon the intermediate transformers. Halldorson precision transformers are matched so exactly that all oscillation is eliminated, and the full power of the transformer is available on very weak signals.

Selectivity with this new transformer is so marked that even the most powerful local stations can be tuned out and a DX station brought through ten meters away without interference.

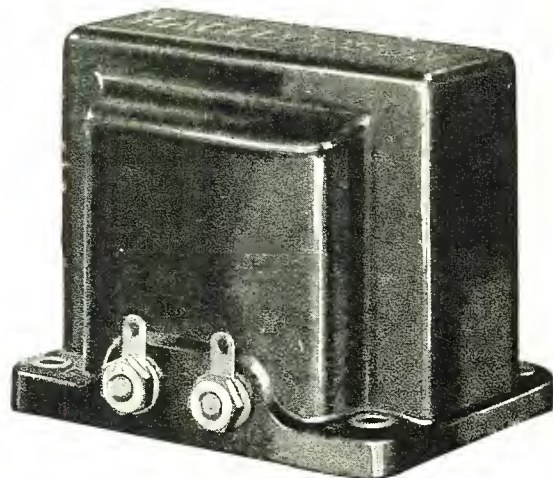

## Halldorson Overtone *Audio Transformer*

PRICE EACH \$6.00

### WRITE TODAY

### Set Builders!

Let us tell you why Halldorson Overtone Transformers will increase your profits and how you can make big money building the Thompson Super Seven, its equal to kits selling at twice the price. List price, complete parts, only \$78.55.

*Replace your present transformers with Halldorson Overtones. If you use them once you'll use them always*

### A. C. TUBE OPERATION

The Thompson Super may be operated with either the new R. C. A.-Cunningham or independent A. C. Tubes. Build the D. C. set first, then send 10c in stamps for the simple wiring changes for A. C. Tubes.

THE HALLDORSON COMPANY  
Sales Office—607 Brooks Bldg., Chicago, Ill. Dept. C.

Please send data telling how I can improve the tonal quality of my receiver and obtain Overtone Amplification with the new Overtone Transformers.

I enclose 2c in stamps for full information on the new Thompson Super Seven using Halldorson Precision Long Wave Transformers.

Name.....

Address.....

# THE HALLDORSON COMPANY

SALES OFFICE  
223 W. Jackson Boulevard, Chicago

FACTORY  
4745 N. Western Avenue, Chicago

*Tell 'Em You Saw It in the Citizens Radio Call Book Magazine*

# The final improvement to be made in your set, install—



## MODERN Type M Transformers

Regardless of how perfectly your set may be working, there is still finer reception in store for you. The performance of Modern Type M Transformers represents such an advance in audio amplification that they represent a new standard by which transformers may be judged. They combine high inductance, large core and wire sizes and perfectly proportioned windings. Impedances have been carefully matched to the units with which they must work.

This result is an almost flat performance curve with full response at 30 cycles and all harmonics and over amplified high notes full eliminated.

Satisfactory performance of Type M Transformers is guaranteed. Prices 1st and 2nd stage, \$8.50 each; Output, \$8.00; Push-Pull, \$10.00 each.

**MODERN  
"B" Compact**

A Raytheon "B" power unit that has been proven dependable and is guaranteed. Price \$26.50 without tube. Sent by mail, postpaid, if your dealer cannot supply you.

Mail coupon below for blueprint folder showing Type M audio amplifying circuits.

**THE MODERN ELECTRIC MFG. CO.**  
Toledo, Ohio

Modern Elec. Mfg. Co., Toledo, Ohio. CB-11  
Please send prints of Type M audio circuits. I enclose 2c stamp.

Name.....

Address.....

City.....

formance of a major operation. In fact, not a single wire within the set is altered; not a thing is changed; not a single practical fact need be known about radio; yet the old set is instantly transferred into a modern set so far as efficient and simplified operation is concerned.

Briefly, the new device is the Amperite Adapter, comprising a base with clips to take two standard Amperite units complete, which are thereby connected in parallel so as to obtain their combined current-carrying capacity. The Amperite units are selected in order that the combination may provide the desired amperage for the group of tubes in the receiver thus controlled. Combinations are available for the precise control of any set from the simple three-tube layout without power tube, to the six-tube layout with power tube.

The Amperite Adapter may be mounted within the cabinet or at the rear or again near the external storage battery, according to preference. It is connected in the minus A lead, between storage battery and receiver. No tools are required. The wire ends clip into place. The only remaining step is to turn the rheostats of the set full on. If there are individual resistances or so-called ballasts, these are short-circuited.

The set is now ready to operate with group control of the tube filaments, removing all guesswork as well as the extra manipulation of antiquated rheostats. The receiver is started or stopped by means of a single switch. The longest life is assured from the tubes, since they are operated at the correct filament temperature at all times.

## Muter Tuned Double Impedance

The Leslie F. Muter Co., 76th and Greenwood Ave., has developed a new B-Power Supply Unit that operates on all sets

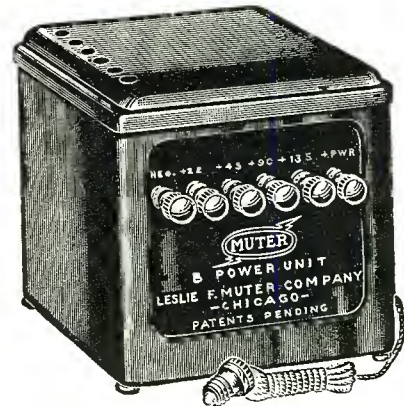

up to ten tubes or seven with a power tube. Fixed controls are used with separate fixed voltage taps, allowing ample range and definite knowledge of voltage received. Rating is 40 mils. at

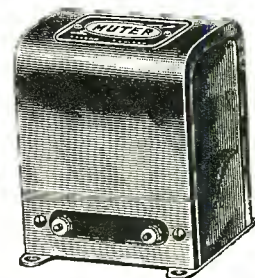

150 volts; will deliver 180 volts for new type 171 power tube. Contains Muter filter condensers of ample capacity. Rectifying Tube is used because of long life and stability. The Unit is for 110 to 120 volt, 60 cycle A. C. Current. The Muter Co., by producing every part of this unit in their own factory under the most modern methods is in a position to extend a truly popular price. One type operates with 213 or 280 tube, the other is for

(Continued on Page 180)

Tell 'Em You Saw It in the Citizens Radio Call Book Magazine

# BENJAMIN

## Red Top Cle-Ra-Tone Sockets

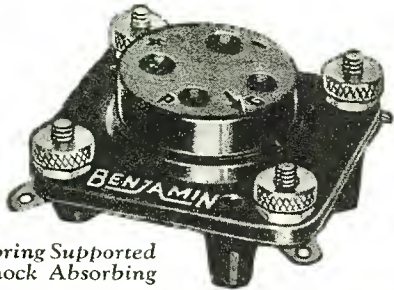

Spring Supported  
Shock Absorbing

Makes the socket stand out from the dead black of the base and panel.  
Easier to establish correct position of tube and prongs.  
Improves the appearance of the set.

Have all of the spring supported and shock absorbing features of the famous Cle-Ra-Tone Sockets. Non-microphonic. Unaffected by stiff bus wiring. Tube holding element "floats" on 4 finely tempered springs. **Used in most of the leading circuits.** Among the most recent for which Cle-Ra-Tone Sockets have been specified are:

- Strobodine 8 • Magnaformer 9-8
- Camfield Super-Selective 9 • H. F. L. Nine in Line
- Lynch Suppressor Circuit
- World's Record Super 10
- Melo-Heald Fourteen • St. James Super
- Karas Two-Dial Equamatic • Knickerbocker 4
- Hilograd Receiver • International One-Spot
- Thompson Super 7 • Hot Spot Fourteen

**PRICES**

**Push Type, on Mounting Base**

- Benjamin Cle-Ra-Tone Sockets .....75c each
- Without Mounting Base .....50c each

**Green Top Socket for A. C. Tubes**

- Specially designed for use with 5-pronged A. C. Radio Detector Tubes:
- For direct attachment to panel.....90c each
- For mounting on top of panel.....\$1.20 each

**Insist on the socket used by those who know and want the best. ASK for BENJAMIN "RED TOP" or "GREEN TOP"**

At all Radio Jobbers and Dealers

Made by

### Benjamin Electric Mfg. Co.

120-128 So. Sangamon St., Chicago  
New York San Francisco  
247 W. 17th St. 448 Bryant St.  
Manufactured in Canada by the Benjamin Electric Mfg. Co., Canada, Ltd., Toronto, Ontario

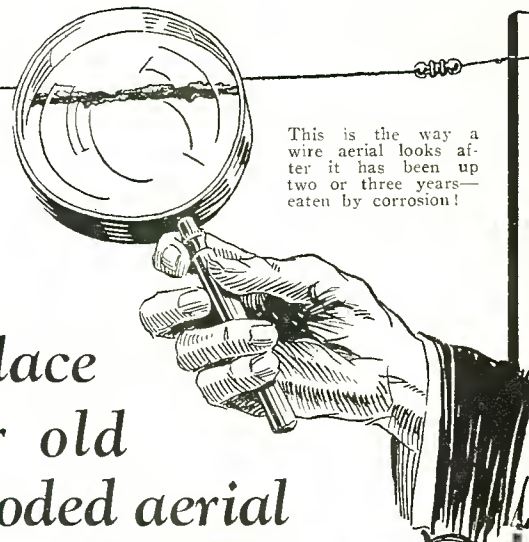

This is the way a wire aerial looks after it has been up two or three years—eaten by corrosion!

Replace your old corroded aerial with a

## Super Ball ANTENNA



If your radio doesn't seem to work as good this year as it did last year or the year before, don't blame your radio until you have investigated the aerial and ground connections!

Replace your old wire aerial with a corrosion-proof Super-Ball Antenna. Enjoy better reception than ever before—the same excellent reception from all directions—greater selectivity, better volume, increased clarity, less static! Built-in patented condenser at base of ball adds greatly to volume.

Order a Super-Ball Antenna from your radio dealer. You can install this aerial within 10 feet of another aerial without interference!

### YAR TRUE-TONE FLOOR SPEAKER



An aluminum floor-type speaker that employs a scientific air column with reproducing unit in base—will handle 200 volts without oscillation or "blasting." May be used with any set having 3 tubes or more. Reproduces highest pitched treble and deepest bass notes by unique tone separation. Provided with 20 feet of power cord—may be placed wherever desired. Ask your dealer for a demonstration.



This improved Super-Ground Clamp gives perfect metal-to-metal contact—cuts through pipe scale, dirt, etc. Improves reception by providing perfect ground connection. Price, 25c.

If your local dealer cannot supply you with any of these radio products, write us for name of the nearest dealer and descriptive literature.

## YAHRLANGE

MILWAUKEE INCORPORATED WISCONSIN

# Silver **A** Beauty POWER

For Your Present Set or the Set you eventually buy



Our 4-volt "A" Eliminator Fits Into All Radiola Consoles

## The Perfect "A" Eliminator

Perfect, because its principle is simple and correct!

THE 110 volts Alternating Current is scientifically reduced with the famous "Silver Beauty" transformer coil to deliver the proper voltage to an especially developed dry, noiseless rectifier, which transforms the electricity to direct current. This current of exact voltage is then transmitted through a patented special filter which clarifies the current, eliminating all foreign noises caused by rectifier or generator.

The result! A smooth, noiseless, constant "A" current supply that makes radio reception the pleasure it is intended to be.

Silver Beauty is the outstanding "A" eliminator today. Nothing equals it. Endorsed by prominent radio engineers—adopted by leading distributors and dealers—approved by thousands of users.

These are sufficient reasons for making Silver Beauty your final choice.

### Silver Beauty "B-C" Unit

Does away with "B" and "C" batteries

Embodies every up-to-date refinement and principle, insuring smooth, un-failing reception. As beautiful as it is efficient.

No. 450  
180 Volts—  
40 Milli-  
amperes  
**\$45**

No. 460  
135 Volts—  
35 Milli-  
amperes  
**\$35**

Individual adjustment adapted to all sets

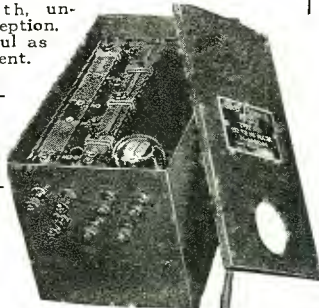

PRICES	
<b>\$39<sup>50</sup></b>	6-volt—2 amp.
<b>\$43<sup>50</sup></b>	6-volt—3 amp.
<b>\$39<sup>50</sup></b>	4-volt—½ amp.
<i>\$2 Higher West of Rockies</i>	

### Silver **A** Beauty POWER

Replaces "A" storage battery and charger. Has full wave "dry" rectification.

Maintains required voltage in uniform, constant flow. Operates automatically by moving a switch.

Economical—uses minimum amount of current [about 1-10 cost of using electric iron].

Has rheostat control for additional refinement in voltage and reception.

Gives maximum power to radio tubes and lengthens their life.

No acids to test or spill.

Satisfactory Results Guaranteed

### SILVER BEAUTY CHARGERS

Employing an entirely new method of rectification. Two models—with or without bulbs.

See Your Dealer or Jobber

### Triple-A-Specialty Company

Manufacturers of the famous Silver Beauty Chargers

312-316 South Hamilton Ave.  
CHICAGO, ILLINOIS



Raytheon B. H. Tube. See your dealer or write the Muter Co. for full particulars.

The tuned double impedance illustrated, manufactured by the Leslie F. Muter Co., 76th and Greenwood Ave., Chicago, is an Audio-Amplifier coupling unit consisting of two tuned impedances, which are tuned to a very low frequency by means of a fixed condenser, which is in the same container. By tuning or adjusting each stage, an ideal resultant characteristic curve is obtained, which overcomes the deficiencies noted on average audio frequency amplifiers at low frequencies, which are usually charged to the speaker. Speakers are deficient only to the extent that it requires greater energy to operate them at lower frequencies than the average amplifier is capable of delivering. The tuned double impedance amplifier corrects this condition by favoring the low frequencies, thus proportioning the energy required by the speaker, giving quality, volume, and a depth of tone which is the last word in present day audio frequency amplification. Motorboating is eliminated by a steady average grid potential and radio frequency currents are prevented from disturbing the audio circuits by the complete magnetic shielding of the unit.

### Holmes Service Station Battery Charger

Capacity: 17 batteries, 6 amp. rate. Cat. No. 309. Dimensions, 12x12x12 inch. Dealers price, \$79.50.

Easy to make money charging batteries when you receive 50 cents to \$1 for charging a single battery. Radio stores opening up a charging service have made the cost of their chargers in a week's earnings. Garages can make unused corners pay profits by installing chargers.

This charge is years ahead in design. Is constructed so as to

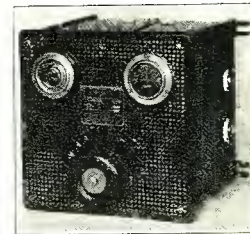

pass underwriters' specifications wherever installed. Charges all makes of auto, radio or lighting batteries. Easy to install. Comes complete with bulb. Most economical on current consumption, effecting 40 to 60 per cent saving in current bills. Easy to operate. Just connect batteries in series to the charging circuit. The better service and lower operating cost insure bigger profits. Size, 12 inches square. Mounts on wall. Operates on 110-volt, 60 cycle A. C. Fitted with switch, meter and regulator. Price includes 5 amp. tube.

### Sentinel A Unit

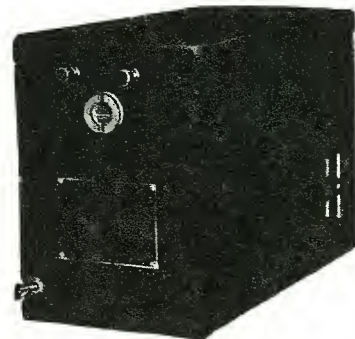

This device, the first of its kind, consists of high grade 7-plate storage battery, 60 ampere hour capacity, together with a 3 ampere Dry Elkon Rectifier and the famous Sentinel completely

(Continued on Page 182)

Tell 'Em You Saw It in the Citizens Radio Call Book Magazine

# ELKAY

TRADE MARK REG.

## EQUALIZORS

Take the place of the old variable rheostat on all but the first R. F. stage. Space-saving, quiet, efficient. Adjust themselves automatically to working voltage of the tube. With Elkay Equalizers you can

**Change Instantly to Any Combination of Tubes in the Same Set**

Simply insert the correct Equalizer for each tube. There is one for every tube made. No rewiring. Simple as slipping a shell into a gun. Mounted, 75c; unmounted, 50c.

**Elkay Suppressors**, in cartridge form, suppress regeneration noises and squeals. Best little stabilizers you ever used. Mounted, \$1.00; unmounted, 75c. Order from us if not at your dealers.

**The Langbein-Kaufman Radio Co. Dept. C**  
62 Franklin St.  
New Haven, Conn.  
Makers of  
**ELKAY RECEIVERS**

## Do You Know How to Stop That Rasping Cackle In Your Loud Speaker



**Protect It From Paralyzing "B" Current with The New Muter Clarifier**

[Output Transformer]

Haven't you often wondered just why it's so difficult to get clear, natural, enjoyable reception? Haven't you many times felt like throttling that scratching, squawking, inhuman voice? Thousands of set owners are surprised to learn that their speakers are being throttled—constantly—by paralyzing high "B" voltage current. That's exactly what ails them.

The Muter Clarifier is especially designed to prevent this; it diligently protects the speaker and coils, assuring vast improvement in tone, quality and volume. **Nothing else** serves the same purpose. This compact, attractive little instrument is easily attached in a few moments without disturbing set. Try out to your own pleasure on our liberal guarantee—you won't recognize your set.

**See Your Dealer—or Send Direct**

Dealers can quickly secure Muter Products for you from leading jobbers. However, should you have any difficulty obtaining them from your dealer, mail coupon direct to us. Prompt shipment of Clarifier, complete with phone cords attached, will be made upon receipt of price, or C.O.D. if you wish. Give your speaker a chance to show what good reception means. **MAIL COUPON TODAY!**

**LESLIE F. MUTER COMPANY**  
76th and Greenwood Ave.  
Dept. 502-P Chicago, Illinois

*Complete Quality Popular Priced Line  
Send for Comprehensive Catalog*

**Use This Coupon!**

**LESLIE F. MUTER CO.,**  
76th and Greenwood Avenue,  
Dept. 502-P, Chicago, Ill.



**Dependable Products**



- Send Muter Clarifier at once, postage prepaid. \$5.00 is enclosed.
  - Send C.O.D.
  - Send complete Muter Catalog.
- Name \_\_\_\_\_  
Address \_\_\_\_\_  
City \_\_\_\_\_ State \_\_\_\_\_





## Check Your Condensers

Compactness, simplicity and dependability are the new quality standards for better set construction. Sprague Midgets, small, compact and dependable meet every set building requirement.

Order the new .1 M.F.D. from your dealer or send one dollar for sample complete with mounting bushings. It is the outstanding condenser revelation of the season.

**SPRAGUE SPECIALTIES CO.**  
Dept. C  
Quincy, Mass.



*Tell 'Em You Saw It in the Citizens Radio Call Book Magazine*

D. C., A. C.  
and Thermo-  
Couple Types

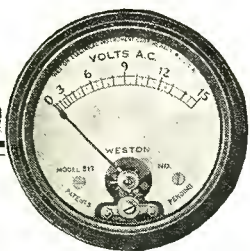

Models 506,  
507 and 517

**Flush Type 2" Panel Instruments**

**A matched line of  
A. C. and D. C. Instruments**

WESTON now offers the amateur transmitter and set owner a complete line of A. C. and D. C. high grade panel instruments, uniform in size and appearance—and priced attractively low. They are made as D. C. Filament or Plate Voltmeters, Filament Ammeters, Plate Milliammeters and as A. C. Voltmeters, Ammeters and Milliammeters. Also furnished in thermo-couple types. Both sizes—2" and 3 1/4" diam.—have a guaranteed accuracy of 2% on any commercial frequency, and may be left in circuit continuously. These new models are without parallel in modern small instrument design, and they are deservedly the sensation of the radio industry. Set makers should fully investigate their superior characteristics and compare them with other makes before final selection. Made in both metal and Bakelite cases.

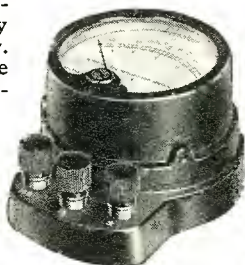

**The A. C. and D. C.  
Portable Models**

will also meet your fullest expectancy for accurate and comprehensive tests. Model 489—125 ohms per volt, for general testing work on battery operated sets; and 1,000 ohms per volt for checking the output of B-Eliminators. Similar in size and appearance is the portable A. C. Model 528 for A. C. voltage and current measurements on the new A. C. sets. Write for Circulars V and T, containing full information, and let us assist you with your radio problems.

Model 489 D. C.  
and 528 A. C.

**WESTON ELECTRICAL INSTRUMENT  
CORPORATION**

1 Weston Avenue

Newark, N. J.

**Flush Type 3-1/4" Panel Instruments**

Models 301,  
425 & 476

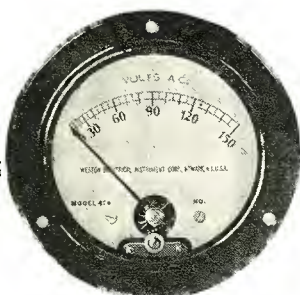

D. C., A. C.  
and Thermo-  
Couple  
Types



automatic control. This unit supplies ample pure d.c. current for all radio receivers regardless of number of tubes, and is controlled by radio set switch.

A flush receptacle is provided on the face of the completely automatic A Unit for the plugging in of any "B" Power Unit. The multiple control makes the "B" Power Unit also complete automatic. When the user turns on his radio set the Sentinel Unit turns on the "B" Power Unit. When the radio set switch is turned off the "B" Power Unit is automatically turned off and the 3 ampere charging unit is automatically turned on. As soon as battery is fully recharged the charging unit is automatically turned off. Both sides of the 110 volt charging line are cut and the unit is entirely disconnected from any source of current until the radio set is again turned on.

**Sentinel A, B, C Unit**

The perfection of Sentinel's "DRY-A" makes possible two A-B-C Combinations, one a completely dry unit, or one using Sentinel's famous relay and charged with battery, and B-C unit. In either combination the set user has a complete power supply for all radio needs in one compact package. Either Sentinel



A-B-C Combination will supply any quantity of "A," "B" and "C" power to run any radio receiver irrespective of the number of tubes. Sentinel DRY A-B-C has no limit as to hours of service and the Sentinel Completely Automatic A-B-C will, under all normal usages, operate for considerably more than the average number of hours. When receiver is turned off, "A" battery is automatically recharged, making it fully ready for use when set is again turned on.

**Qualitone Loop Antennae**

The woodwork used in Qualitone Loops is selected solid walnut, hand rubbed, natural finish. Qualitone Deluxe woodwork is turned wood, of pleasing period design and harmonious with

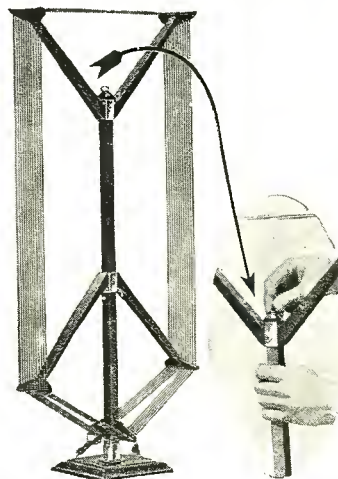

surroundings to suit the most exacting taste. The wire spacers are made of best grade insulating material, reducing losses to a minimum. Well insulated, flexible stranded wire, covered with brown silk braiding is used on all Qualitone Loops. Three long

(Continued on Page 184)

Tell 'Em You Saw It in the Citizens Radio Call Book Magazine



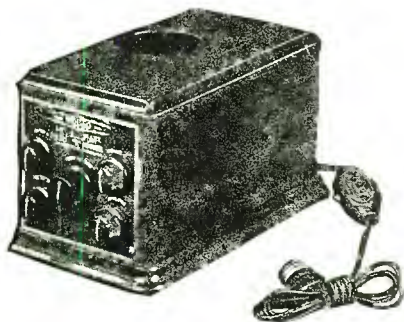

**Little Giant B-C**  
with tube, \$48.50

Silent "B" and "C" current for any standard set. All taps minutely controllable.

**"Bonedri" Charger, \$7.50**

Raytheon "A" rectifier, \$4.50 extra; 1 for 2½ amp., or 2 for 5 amp.

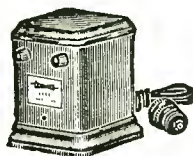

**WEBSTER**  
PAT. PEND.  
TRADE **BONE-DRI** MARK

**Light Socket Power**  
*Raytheon Equipped*

Be sure to get the Webster "Bone-Dri" Unit when you eliminate your batteries—to operate your radio from the light socket.

"Bone-Dri" units completely electrify any radio receiver to operate from the light socket *without any revolutionary* rebuilding of sets. Users need only throw away the batteries—the trouble and expense—and put in a "Bone-Dri" unit. New receivers perform better with "Bone-Dri" socket-power.

If your dealer will not supply you the Webster "Bone-Dri," don't take a substitute, but write or wire us for name of nearest distributor and free booklet "How to Eliminate the Batteries."

**THE WEBSTER COMPANY**  
860 Blackhawk Chicago, Ill.



**Webster Super B**  
with tube \$37.50

**Economy B**  
with tube \$33.50

No acid to spill.  
No filament to burn out.

**Popular B**  
with tube \$31.00

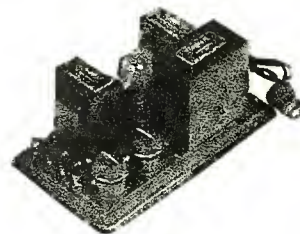

At \$~~6.00~~ this famous  
**Cabinet**  
has no equal!

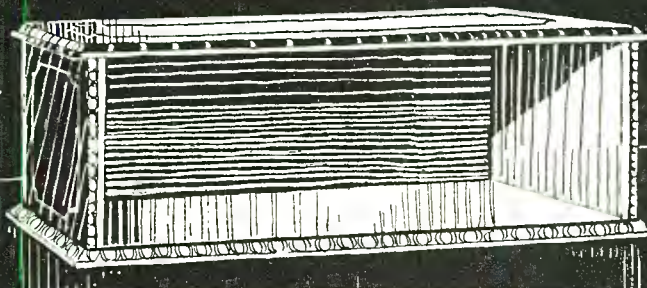

**THE BLUE RIDGE**  
Dimensions—7x18x10. Mahogany or Walnut Finish

The Blue Ridge is also made in various sizes at various prices ranging up to 7x30x12 at \$9.75. Or we are glad to make a cabinet specially to your order. Just write for catalog and full information. All prices are f.o.b. Hickory, or c.o.d. half price with order.

The Blue Ridge Cabinet is made from best grade birch, noted for the quality

and the beautiful finish it takes. Specializing for years in woodworking craftsmanship we are especially equipped to produce cabinets famous for quality or construction and lustrous finish. The Blue Ridge, finished either in gleaming Mahogany or rich Walnut has full length nicked piano hinge and nicked lid support, rubber anti-vibration feet and free, non-warping baseboard. Send us your order today. It will be on its way within 12 hours of receipt.

12 Hour Service—Factory to You

**Southern Toy Co., Inc. Manufacturers Hickory, N. C.**

Tell 'Em You Saw It in the Citizens Radio Call Book Magazine



*millions may now enjoy the thrill of improved reception with MUTER B POWER*

Outstanding Characteristics of the

**MUTER B Power Unit**

FIXED CONTROLS used with separate fixed voltage taps, giving ample range and definite knowledge of voltage received.

CAPACITY ten tubes or seven with a power tube.

RATING 40 mills at 150 volts. Will deliver 180 volts for new type 171 power tube.

CONDENSERS. Muter filter condensers of ample capacity and acknowledged quality ensure long life and uniform output.

Uses Standard Cunningham or Radio Corp. Full Wave Vacuum Rectifying Tube because of long life and stability. Used on 110 to 120 volt, 60 cycle A. C. current only.

No noise—no vibration

**\$24.50**

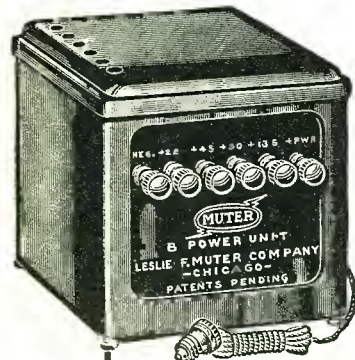

When your favorite radio hour is at hand! That's the time to settle back at ease and appreciate the real joy of clear, true, uninterrupted reception with the new Muter B Power Unit. The Muter Policy of "Dependable quality at a popular price" has brought this enjoyment within the means of every set owner. Convince yourself of the pleasure that can now be yours by an early try-out on our liberal guarantee of satisfaction. Model 3000 for 280 or 213 Tube, \$24.50; model 3050 for Raytheon B. H. Tube, \$26.00.

**Ask Your Dealer or Send Coupon**

Prompt shipment, postpaid, will be made upon receipt of price—or C.O.D. plus postage, if you prefer. Make this moderate investment with perfect assurance that of all the enjoyment Radio offers you will find none greater than the difference in reception with Muter "B" Power.

**Leslie F. Muter Co.**  
76th and Greenwood Avenue  
Dept. 502-PX Chicago, Ill.



**DEPENDABLE PRODUCTS**

*The Complete Quality, Popular Priced Line*  
**Send for Comprehensive Catalog**

**LESLIE F. MUTER CO.**  
76th and Greenwood Ave.,  
Dept. 502-PX, Chicago, Ill.

- Send \$24.50 model for 280 or 213 Tube.
- Send \$26.00 model for Raytheon B. H. Tube.
- Payment is enclosed. You pay postage.
- Send C. O. D. plus postage.
- Send me complete Muter Catalog.

Name.....

Address.....

City..... State.....



leads for readily connecting loop to receiver are furnished. All Qualitone Loops are provided with a removable center tap and either two or three leads may be used as desired. Qualitone Loops are provided with an adjustment feature which assures tight wires at all times—no sagging wires on Qualitone Loops.

The Deluxe turns within a radius of 5½ inches. The Qualitone within a radius of 7½ inches. All Qualitone Loops are designed for use with .0005 condensers.

Qualitone Loops are specified with the most popular circuits, including the Magnaformer and World's Record Super Eight in this issue.

The Deluxe: Dimensions erected, 29x11x3¾ inch; dimensions packed, 5x8x19 inch; shipping weight, 4 lbs.

**W-E-B-B Socket Aerial**

The W-E-B-B ball and socket full adjustable aerial is shown in the accompanying photograph and may be secured in either firewall mounting, or face board mounting, which may be ad-

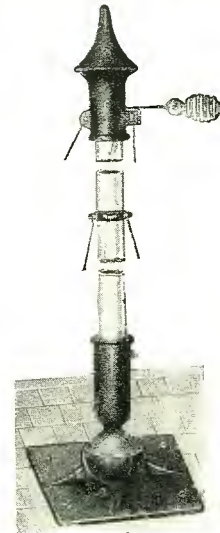

justed to any angle or combination of angles desired. It is made of semi-steel and practically everlasting, no strength being lost at any angle, as the socket engages more than half of the ball. This product is made by the Timing Gears Corp. of Chicago, Ill.

**France Automatic Trickle**

France Dry Trickle Chargers are of the dry disc type—employ neither bulbs, liquids nor moving parts. Made in two models. For trickle charging a 6 volt battery. When trickle charging a 4 volt battery only the ½ amp. post should be used with resistance to cut down charging rate. When intermittently charging a 4 volt battery only either the ½ or ¾ amp. post should be used.

The France Dry Automatic Trickler is equipped with relay



switch and receptacle for "B" Eliminator plug. Automatically, when switch on set is thrown "ON," "B" Eliminator is cut "In" and trickler cut "Out" and vice versa.

Three Charging Speeds—½, ¾, 1¼ amperes. These tricklers are designed to meet conditions on all sets regardless of the number of tubes, long hours of reception or capacity of battery.

(Continued on Page 186)

Tell 'Em You Saw It in the Citizens Radio Call Book Magazine

**TOBE**



**SAMSON**

Chooses **TOBE CONDENSERS**  
for the Samson Power Amplifiers

The unflinching, true and powerful quality of this fine Radio instrument matches the unflinching strength of TOBE Condensers and we have not been able to find any kind of a Delilah that will break down TOBE strength.

Just the same, when the orchestra plays Samson and Delilah, the haunting reality of it will ring truly and clearly on the Samson Power Amplifier, and the TOBE'S will insure its being just as good next year as now. Used also in the Samson Block for the official Hammarlund-Roberts Hi-Q.

Write for **TOBE Power Pamphlet with descriptions of Power Circuits and prices of TOBE BLOCKS**

TOBE B BLOCKS are recommended for use in the "International One-Spot". Story in this issue of Call Book

**TOBE-SAMSON  
B BLOCK No. 713**  
using one 171  
Power Tube

**TOBE-SAMSON  
B BLOCK No. 718**  
using two 171 Power  
Tubes in Push Pull

**TOBE-SAMSON  
B BLOCK No. 210**  
using two 210 Power  
Tubes in Push Pull

**TOBE-HAMMARLUND-  
ROBERTS OFFICIAL  
B-BLOCK**  
for Hi-Q Set

Tobe Deutschmann Company : : Cambridge, Mass.

*The* **ROWAN BATTERY**  
*Always Ready*

**Call Book Specifies It!**

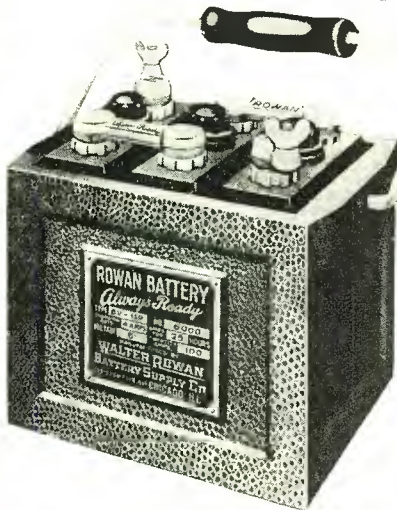

Citizens Radio Call Book heartily endorses the ROWAN "Always Ready" BATTERY and recommends its use to all readers.

Known for unexcelled quality, guaranteed long-lived service and unvarying dependability, ROWAN "Always Ready" Batteries offer the radio fan an "A" power that is backed by years of experience and master workmanship with the finest materials available. ROWAN "Always Ready" Batteries in their Goodrich solid rubber cases represent an amazing value. Ask your dealer. Literature sent upon request.

Each ROWAN "Always Ready" BATTERY carries a

**24 MONTH GUARANTEE**

Professional Set Builders and Dealers

Send for This  
**FREE Catalogue**

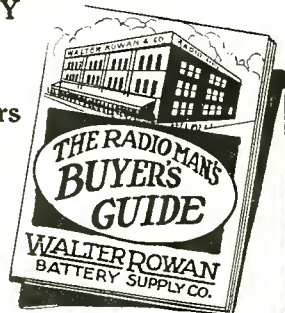

**WALTER ROWAN BATTERY SUPPLY CO.**

221-231 N. PEORIA ST.  
CHICAGO ILL.

TELEPHONE  
HAYMARKET 5895-5896

*Tell 'Em You Saw It in the Citizens Radio Call Book Magazine*

# CORBETT CABINETS

*That Add to the Coziness of Any Home*

**T**HE SUPER-CRAFTSMANSHIP that goes into the making of every CORBETT Cabinet is the precise reason why the most exacting women are demanding CORBETT Radio Furniture.



Model D-20 Walnut  
Model D-25 Mahogany

MODEL D-20, Walnut.....\$70.00  
MODEL D-25, Mahogany.... 70.00

### D-20-25 Models

are beautifully decorated with vari-colored polychrome pulls and carvings, and the embossed moldings complete the decorative scheme. AN ILLUSTRATION OF THIS CABINET CAN NEVER DO FULL JUSTICE TO THE DISTINCTIVE BEAUTY BROUGHT OUT BY THE HAND PAINTED POLYCHROME DECORATIONS.

### Specifications for Model D-20-25

Top 16x34", height 43", Battery Compartment 14" high, 14" deep and 30" long, clearance for dials 1 3/4", depth back of panel 12". The cabinets are in stock with removable fillers to take 7x21" panel size. These fillers may be adjusted to take any panel size up to 7x28". Larger panel sizes up to 9x28", either straight or sloping front, may be had at no extra charge.

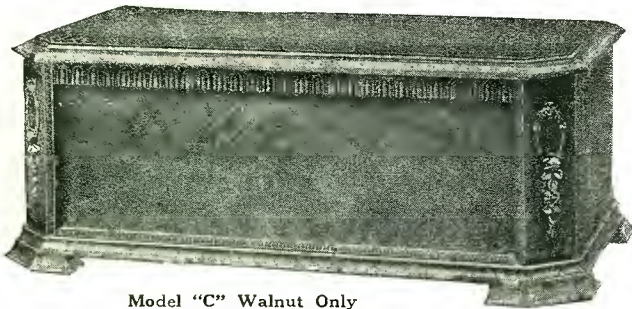

Model "C" Walnut Only  
Model "C"

The ultimate in elaborate and attractive radio furniture is offered in our model "C". It is an adaptation of the old Italian Chests, being designed and decorated in the spirit of the Renaissance period.

The back is grooved into place, and no nails or screws are used on any exposed surface. The front is grooved for 3/16" panel, the top rail being removable. Fancy folding top stay and piano hinge are applied.

### PRICE LIST MODEL "C" CABINETS Walnut only

Panel Size	10 in. deep	12 in. deep	Weight	Mounting Boards
7x18	15.50	17.00	26	.90
7x21	17.00	18.50	28	1.00
7x24	19.00	20.50	31	1.10
7x26	20.50	22.00	34	1.20
7x28	.....	23.00	37	1.30
7x30	.....	24.00	40	1.40

**Corbett Cabinet Manufacturing Company**  
ST. MARY'S, PENN.

A single speed will meet some conditions; two, most conditions but three, especially with the 1 1/4 ampere booster rate, will meet all. The set owner with these three speeds can "tap off" the proper input terminal that will maintain his "A" Battery at full charge. Flexible!

Not An Experiment. These tricklers are not an experiment in dry rectification. They are not a sensationally new discovery. Just new to the trade. We are releasing them only after more than two years exhaustive research. Laboratory tests are more than satisfactory. Several thousand in actual service on sets have demonstrated long and satisfactory service. Set owners say they are right. A common report is, "Five thousand hours and still going strong"—continuous operation. Thus far tests in both laboratory and actual service seem to indicate almost an unlimited life.

Size 7x5x5 1/2 inches. Shipping weight, 8 pounds each.

## Quam Loud Speaker

New "Stretched Reed Principle" Gives "New Voice to Radio." Just as there is a difference in the tone qualities of the human voice, so are their great differences in the speaking voices of Radio. That speaker approaches nearest to perfection which has



the widest range in accurate tone reproduction. It must pick up and reproduce the highest tones of the violin and the deepest tones of the pipe organ. The outstanding feature of the Quam Loud Speaker is its unmatched range—its ability to give you all. This is accomplished by bringing to the Radio Speaker a new principle of construction—the "Stretched Reed" Unit. Instead of a floating reed secured at only one end, the Quam Speaker has a stretched reed—like the human vocal chords, and the result is amazingly superior to any you have heard before. Listen to your favorite program as brought to you through a Quam Loud Speaker and you will say "Here Is a New Voice for Radio."

## Balkite "AB" Power Unit

Balkite "AB" (batteryless) supplies "A" and "B" current from the light socket.

Balkite "AB." A complete, batteryless, electric radio power unit replacing both "A" and "B" batteries entirely, and supplying both plate and filament current directly from the light socket.



It employs no battery in any form. It is complete in itself and requires no accessories of any kind. Occupies little more space than ordinarily occupied by "B" batteries alone.

Balkite "AB" consists of Balkite "A" and Balkite "B" in one housing. The "A" side is a complete rectifier and electrolytic filter-condenser combined in one cell. The "B" side is the new improved Balkite "B." Like all other Balkite radio power units, it is noiseless in operation. It has no hum. It has no tubes to burn out or replace. Its current output is constant and uniform, and it delivers to the set at all times the same current delivered by batteries when these are fresh and fully charged. It does

*(Continued on Page 188)*

Tell 'Em You Saw It in the Citizens Radio Call Book Magazine

## Jones MULTI-PLUG

THE STANDARD SET CONNECTOR

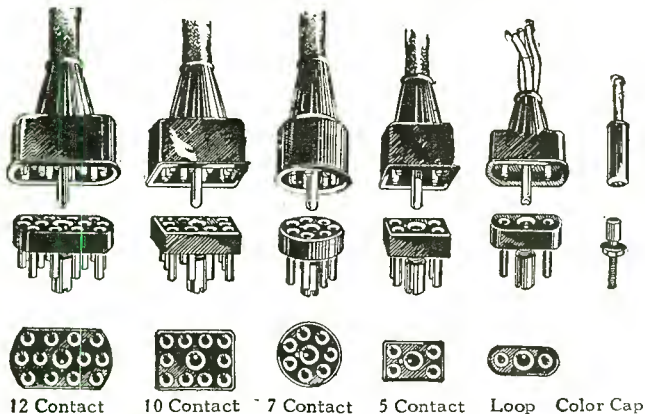

12 Contact    10 Contact    7 Contact    5 Contact    Loop    Color Cap

With the present day sets having many power supply leads, Multi-Plugs are essential. The line this year embraces Multi-Plugs with as many as twelve contacts and five different types of socket mountings. Small illustration shows the bracket mounting (BM) most commonly used by set builders. Prices are materially reduced this year. See your dealer for price sheet or write direct to

**HOWARD B. JONES**  
2300 Wabansia Ave.  
CHICAGO



# PARVOLT

## WOUND CONDENSERS

It is not "horse sense" to jeopardize the success of a circuit or the investment made in the parts by the use of inefficient by-pass or filter condensers.

Parvolt Wound Condensers are made in three service voltage ratings and in a wide variety of capacities and styles. Use them wherever the circuit calls for capacity. Their use is assurance of

Continued accuracy within 10 per cent of rating.

Continuous duty at full rated voltage.

Available in capacity and voltage ratings suitable for all radio and audio frequency by-pass and filter work.

Series A 400 Volt Duty	Mfds.	Series B 800 Volt Duty
\$0.85	0.1	\$1.25
.95	0.25	1.50
1.00	0.5	2.00
1.25	1.0	2.50
2.25	2.0	3.50
4.00	4.0	6.00

Series C—1,000 Volt Duty

1 Mfd.—\$5.00; 2 Mfds.—\$7.00; 4 Mfds.—\$12.00. Buffer Condensers 0.1 Zero—0.1 Mfd.—\$1.75.

CONDENSER GROUPS

	List
For R171.....	\$12.00
For R210.....	15.00
Raytheon ABC.....	17.50
Q. R. S. (400 mil. tube).....	19.00
Special 4-4-2-2-1-1.....	13.00

Exclusively licensed by the Technidyne Corporation under U. S. Patent No. 1593638. July 27, 1926.

### Recognized Superior!

## ELECTRAD Royalty

### Variable High Resistances

Specified by radio engineers and technicians where accurate and dependable resistances for all circuit work are desired. Note these superior features:

- 1—Same resistance always obtained at same point.
- 2—Resistance element not exposed to mechanical wear.
- 3—Entire range of resistance covered with one turn of knob.

A range for every purpose—11 in all. Type E, \$2.00. All other types, \$1.50.

Write for hook-up circular  
Dept. 73A    175 Varick Street, New York, N. Y.

# ELECTRAD



**THE ACME WIRE COMPANY**  
New Haven, Connecticut

# DAVEN AMPLIFICATION



## Still the Superior Audio for any Circuit

**A**FTER three years, Daven Amplification is still the most faithful audio amplifier. No matter what your favorite circuit, Daven Amplification will improve it, for only with Daven can you get absolutely straight line amplification over the entire audible range. **No Motorboating on "B" Eliminators.**

Daven Amplification is now engineered for either AC or DC Tubes—for use with "B" Eliminators or batteries. With AC operation the new Daven AC-15 tubes are used in the first two stages and an AC-10 or Mu-6 in the last stage.

**ELECTRIFY** your set with the new Daven AC Tubes. Laboratory tested and built to Daven standards. Four prong, Platinum Coated Filament. Five types to meet every condition. Demand Daven AC Tubes—the round tube with the Platinum Filament.

*a complete line of*  
**A-C TUBES**



- AC-1 Radio and Audio Amplifier
- AC-15 Special High-Mu Audio Amplifier
- AC-D1 Special Detector

AC-10 400 Volt Power  
AC-R1 Half Wave Rectifier  
**GLASTOR**—the standard Resistor—cannot change in value or resistance unless glass is broken.

**BALLAST**—the most rugged Filament Control.

**FREE CATALOG** giving complete information of these and other new products on request.

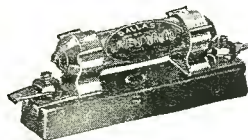

*"The Sine of Merit"*

**DAVEN RADIO CORPORATION**

TRADE MARK "Resistor Specialists" REGISTERED

130 Summit St.

Newark, N. J.

away with batteries, chargers, relays and switches. It puts an end to run-down "A" current. It requires no adjustments. Turn it on and your set operates. Turn it off and you're through. It is the most economical of all sources of radio current. Used only during reception, its life will be even longer than the long life of any Balkite radio power unit. It requires no other attention than the addition of water once every three or four months. In case the liquid evaporates no harm results, the unit merely ceasing to operate until water is added. Shipped so that water only need be added to the unit when it is received. All connections to the set made inside the set.

Model 6-135. Output: 6 volts 2 amperes "A" current, 40 milliamperes at 135 volts "B" current. Will serve practically any standard set now using 6-volt "A" batteries of any type, and using either standard 201-A or 112 tubes. Weight: (Approximately only) Net 42 pounds. Shipped 50 pounds. Dimensions: 10¼x18½x7¾ inches high overall. Operates from 110-120 AC.

Model 6-180. Output: 6 volts 2 amperes "A" current, 55 milliamperes at 180 volts "B" current. Will serve practically any standard set now using 6-volt "A" batteries and using any type of tubes, including both 112 and 171. Weight: (Approximately only) Net 44 pounds. Shipped 56 pounds. Dimensions: 10¼x18½x¾ inches high overall. Operates from 110-112 AC.

## Bodine Motor Generator Set

With the advent of alternating current operated radio sets has come an insistent demand for a source of 60 cycle alternating current for the operation and demonstration of these sets in localities where only direct current is available.

Ordinary D. C. to A. C. conversion equipment on the market will not satisfactorily operate A. C. radio sets due to the fact

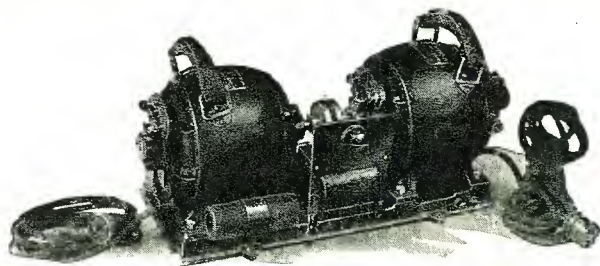

that many disturbances are set up in the machine which come through in the speaker as hum and other objectionable noises.

The new Bodine Radio Motor-Generator Set as pictured above has a very efficient filter system built into the machine itself which entirely eliminates the disagreeable noises and furnishes a pure 60 cycle alternating current which will operate any A. C. radio set.

The Bodine set consists of a direct current motor coupled directly to a 60 cycle alternating current generator. The output of the generator is 250 watts, which is ample to operate any radio set or radio and phonograph combination. The whole machine is nicely finished in black baked enamel and is equipped with carrying handles and rubber padded feet. A small rheostat is provided to take care of variations in D. C. line voltage and insure exactly the right A. C. voltage at the set.

No complicated wiring is necessary. Extension cords are provided and all that is necessary to do is to plug the motor cord into the D. C. socket and the A. C. output cord into the radio set. It is also desirable to run a wire from ground to a binding post provided on the frame of the motor generator set.

Radio dealers located in D. C. districts can use the Bodine Radio Motor Generator Set to demonstrate A. C. radio sets and test A. C. sets and accessories. The installation of a Bodine set will do away with the necessity of keeping a special D. C. set for demonstration purposes only and will make it possible to test and demonstrate any set.

The new and improved Bodine DeLuxe Loop is a remarkable  
*(Continued on Page 190)*

Tell 'Em You Saw It in the Citizens Radio Call Book Magazine

# FOUR YEARS THE STANDARD

## Loop on Super-Heterodyne Receivers

Expert set builders the world over choose the Fiat Bank Wound Loop because of its remarkable efficiency and beauty.

Thousands now in use on Madison-Moore, Victoreen, Melo-Heald, St. James, Nine-in-Line and many other popular Super-Heterodynes.

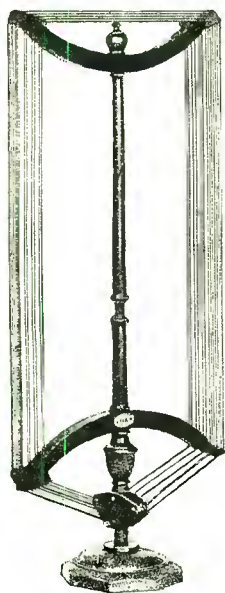

**TYPE "C"**  
Price \$12.50  
\$13.50 West of Rocky Mountains



Stocked by leading jobbers in principal cities of U. S. A., designed and manufactured under exclusive patents by

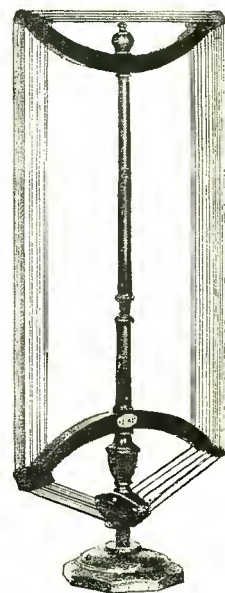

**TYPE "C"**  
Dimensions—Erected 13 1/2" wide by 30" high  
Tuned with 0005 M. F. Condenser 180 to 600 Meters.

## RADIO APPLIANCE CORPORATION

4884 North Clark Street

Chicago, Illinois, U. S. A.



I will save you money on the kit you buy!

*Our many years in the radio business is our guarantee to you—that we offer you more—give you better service—and better merchandise. Proof of this is in the Harco Catalog. Write for a copy.*

**Sumner B. Harris**  
Pres., The Harco Company

## FREE CATALOG

THE new Harco Catalog should be in the hands of every set builder and dealer in radio. It lists thousands of standard radio items at prices that will astound you. Complete sets—accessories—all the latest kits—a complete line of parts and an assortment of radio furniture that will satisfy the most discriminating—all at rock bottom wholesale prices.

### Set Builders

All the latest and popular kits are listed in the Harco Catalog at genuine wholesale prices. Be sure to get a Harco catalog before you place the order for your kit.

### Dealers

Our complete line of radio—plus a reputation for service—makes Harco a valuable connection for the live dealer. The Harco Catalog will tell you why!

Catalog on Request



## THE HARCO COMPANY

Wholesale Distributors

1259 South Wabash Avenue

Chicago, Illinois

# KINGSTON

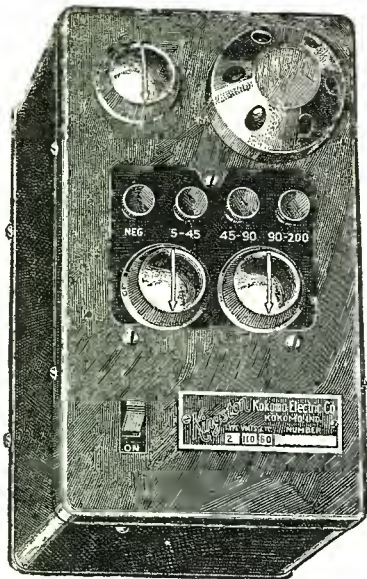

## For Perfect Reception

THE KINGSTON will maintain the radio set always at its perfection peak. It contains no acid or solution, operates without vibration or noise and will not heat. There are provided three different voltage terminals, each adjustable over a wide range, making possible any desired voltage from 5 to 200. A fourth variable voltage may be easily had, if desired, by connecting a separate variable resistor to one of the terminals. The primary or main current supply is controlled by a rheostat, making it possible to reduce the current entering the unit to the amount actually required for any individual set, thus protecting the set against overload.

Handsomely finished in satin black. Size: 9 inches long, 5 1/4 inches wide, 8 1/4 inches high. The Raytheon 125 milliamper type BH tube is used as rectifier. Fully guaranteed.

### PRICES

Type 2, for 110-120 Volt AC 50 or 60 Cycle Current, \$35.00.

For receiving sets having not more than eight tubes and not having type UX171 power tube or equivalent.

Type R, same as type 2, but equipped with automatic control to switch Unit or on off when switch on radio set panel is turned, \$37.50.

Type 2A, for 110-120 Volt AC 50 or 60 Cycle Current, \$42.50.

For all sets using type UX171 power tube or equivalent and for all large sets having nine or more tubes.

Type RA with automatic control switch, \$45.00.

Type 2C, for 110-120 Volt AC 25, 30 or 40 Cycle Current, \$47.50.

Type RC with automatic control switch, \$50.00.

Prices include Type BH Raytheon Tube

**KOKOMO ELECTRIC COMPANY**  
KOKOMO INDIANA

Tell 'Em You Saw It in the Citizens Radio Call Book Magazine

handsome piece of high grade walnut furniture combined with an unusually efficient and well insulated loop winding and an ingenious and convenient method of mounting.

The grace and beauty of the DeLuxe Loop makes it particularly desirable for use on high grade radio cabinets. There is nothing about it suggestive of the laboratory or workshop and it will harmonize with the most artistically decorated interior. The frame is made of selected American walnut, hand-rubbed to a smooth glossy finish. The winding of stranded copper wire is covered with lustrous brown silk braid and mounted on black bakelite spreaders.

The signal pick-up ability of the DeLuxe Loop compares favorably with loops of great size and awkwardness. Its directional characteristics are very pronounced, aiding greatly in selective tuning in congested broadcasting districts.

The small size of the Bodine DeLuxe Loop makes it easy to use the mounted on the average radio cabinet. The outside dimensions of the winding are 12x26 inches. When mounted on its base it stand 28 inches high and has turning radius of 6 inches.

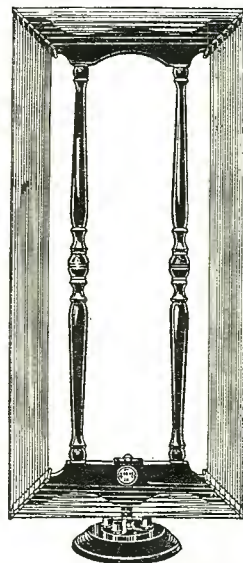

A very desirable feature of the DeLuxe Loop is the method of mounting the loop in a jack as illustrated in the accompanying cuts. This mounting eliminates entirely all trailing and entangling connecting wires. The loop may be rotated continuously in either direction without disturbing the connections to the set. All models are equipped with a center tap for use on those sets which require it. Strong springs make contact with collector rings on the mounting plug. This contact is positive and we guarantee no noise from contacts even while the loop is being rotated.

Bodine Electric Company, 2254 W. Ohio St., Chicago, U. S. A.

## Birnbach Extension Cord

The Birnbach Extension Cord Unit makes your radio loud speaker as portable as your vacuum cleaner, and with even less trouble. Move your loud speaker anywhere, any room, and as often as you like, without disturbing your set. Reception is actually improved, especially where power tubes are used.

You have spent considerable money on your radio; you undoubtedly take keen enjoyment in "listening in." But too often



you are busy in other rooms of your house where the radio cannot be heard satisfactorily. Now, with a Birnbach Extension Cord Unit, you can listen to the many splendid programs any

(Continued on Page 192)



# The Magnaformer 9-8 Receiver

## COMMANDER-IN-CHIEF OF THE AIR

*The Great Creator of True Tone Quality*

We carry in stock a full and complete line of parts specified by the CITIZENS RADIO CALL BOOK for this super powerful circuit fully described in this issue.

- |   |   |
|---|---|
| <ul style="list-style-type: none"> <li>1—Formica 7"x26"x3/16" Drilled and Engraved Panel.</li> <li>1—Formica 9"x25"x3/16" Drilled Sub-Panel.</li> <li>5—Magnaformer Intermediate Frequency Transformers.</li> <li>1—Unicoupler.</li> <li>2—110 Remler Universal Drum Dials.</li> <li>2—Remler .0005 mfd. Variable Condensers.</li> <li>8—9037 Benjamin Sockets.</li> <li>1—9044 Benjamin Socket.</li> <li>2—8629 Benjamin Sub-Panel Brackets.</li> <li>2—AF-4 Ferranti Audio Transformers.</li> <li>1—National Tone Filter.</li> <li>1—125 Samson Radio Frequency Choke.</li> <li>2—Aerovox .00025 mfd. Grid Condensers with Prongs.</li> </ul> | <ul style="list-style-type: none"> <li>1—Aerovox .001 mfd. Fixed Condenser.</li> <li>2—Aerovox 1.0 mfd. By-Pass Condensers.</li> <li>2—Durham 2 meg-ohm Grid Leaks.</li> <li>1—660 Yaxley Cable Connector.</li> <li>1—60 Yaxley Jack Switch.</li> <li>1—1882 Frost 200,000 Ohm Variable Resistance.</li> <li>1—1885 Frost 500,000 Ohm Variable Resistance.</li> <li>2—FT64 Frost Center Tap Resistances.</li> <li>4—Frost Tip Jacks.</li> <li>30—Feet Acme Celatsite Wire.</li> <li>15—Feet No. 14 Tinned Acme Hook-up Wire.</li> <li>1—Package Kester Radio Solder.</li> <li>Miscellaneous—Lugs, Nuts, Screws, etc.</li> </ul> |
|---|---|

We also carry in stock the parts specified for all other circuits featured in the CITIZENS RADIO CALL BOOK.

*Write today for new catalog just off the press*

### NORTH AMERICAN AUTO SUPPLY COMPANY

4608 Prospect Avenue

Cleveland, Ohio

*just out!*

**GET YOURS QUICK**



Don't wait! Send today for this wonderful book. See how 14,000 live radio dealers make bigger profits by buying from The Harry Alter Company, America's foremost wholesalers of receiving sets, kits, parts and accessories—the largest stock of standard, nationally advertised radio goods carried anywhere.

**RADIO'S GREATEST CATALOG**

Compare its low prices with those of any other catalog. You will be amazed. Note: We sell only to radio retailers. Write for your copy NOW.

**The Harry Alter Co.**

1742 Michigan Ave. CHICAGO, ILL.

**Quali-Tone**

**Now Demanded by Experts**

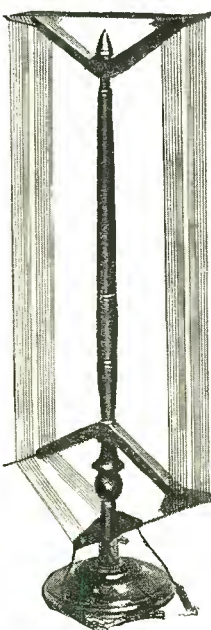

Radio Engineers and Technical Editors accept Quali-Tone Loops as the ultimate in effecting highest efficiency in radio reception.

**UNEXCELLED FOR Distance-Selectivity-Tone**

The electrical characteristics of Quali-Tone Loops meet the demand of the present day successful loop antenna receivers—resulting in Quali-Tone Loops being highly endorsed and specified as standard equipment with the better circuits.

Convince yourself of Quali-Tone's superiority by comparing it with any other loop made.

Allow your set to do full justice to itself by using a Quali-Tone loop.

**Holds Two World Records for DX Reception**

The DeLuxe.....\$12.50  
The Quali-Tone.... 10.00

Jobbers Send for circulars Write for discounts Dealers

**DURO METAL PRODUCTS CO.**  
2649 North Kildare Avenue Chicago, Illinois

*Tell 'Em You Saw It in the Citizens Radio Call Book Magazine*

# DeJUR

**RESISTANCE SPECIALISTS**  
MANUFACTURERS OF ELECTRICAL AND RADIO  
RHEOSTATS, CONTROLLERS AND REGULATORS SINCE 1912

## CONDENSERS

Single - Double - Triple. In All Capacities

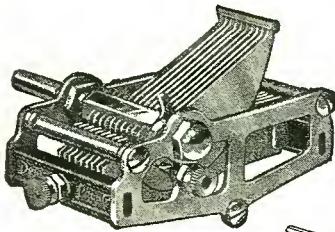

Moulded Bakelite insulation outside electrostatic field suspends stator plates which bear only on one point. Condenser frame grounded to rotor, eliminates all hand capacity. End tie bar of rotor plates keeps spacing uniform.

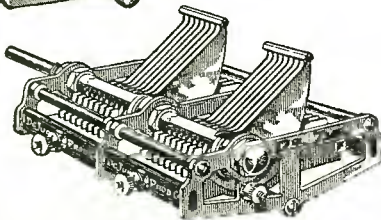

End plates of brass, finished in highly polished nickel. Direct electrical connection made from rotor to frame by spring phosphor bronze pig-tail connector. Small phase angle difference; low minimum capacity.

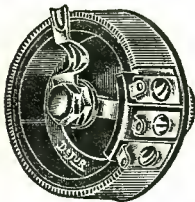
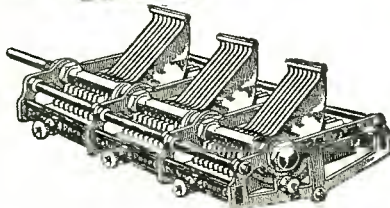

### Power Rheostat for Socket Power Sets

Designed for a large current carrying capacity. It has a large Bakelite base  $2\frac{3}{4}$  inches in diameter, and is a single-hole mount. Made in 2, 3, 4, 6, 10, 50, 100, 200, 400, 1000, 2000 OHMS. This rheostat has been adopted by all leading manufacturers of socket power sets.



### All-Metal Air-Cooled Rheostat

Bakelite arrow pointer knob, one-hole mount. No noticeable temperature rise at constant co-efficient of conductivity. Filament voltage can be built up slowly and uniformly, and held at right point for most efficient operation.



### Combination Switch and Air Cooled Metal Rheostat

Simplifies the panel by eliminating switch. This new DeJur Rheostat acts as switch and volume control. It is sturdy and efficient and the metal frame will not bend or warp. Shaft alignment is permanent and contact perfect. One hole mount.

Write for new 1927-28 Catalog  
of all DeJur Guaranteed  
Radio Products

## DeJUR PRODUCTS Co.

199 LAFAYETTE STREET, NEW YORK CITY

time you want, by simply moving the load speaker to the room where you happen to be.

Complete with cord connector; fits all speakers and radio sets; no tools required; just plug in and listen. Made in six convenient lengths.

### Birnbach Radio Cable

Made of flexible stranded colored rubber conductors for A, B and C Batteries, assembled with soldered lug terminals which



prevent loose connections. Each conductor of separate solid color in accordance with Radio Manufacturers Association, Inc., standards. Packed in individual cartons.

### Silver Beauty A Power

Does away with "A" storage batteries. The principle is so simple.

The 110 volts Alternating Current is scientifically reduced with the famous "Silver Beauty" transformer coil to deliver the proper voltage to an especially developed dry, noiseless rectifier, which

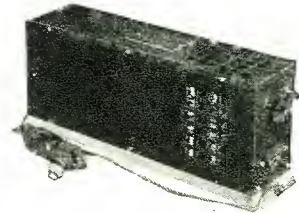

transforms the electricity to direct current. This current, of exact voltage, is then transmitted through a patented special filter which clarifies the current, eliminating all foreign noises caused by rectifier or generator.

The filtered output is a perfect, silent Direct Current 6 volt or 4 volt capacity with proper ampere strength.

Has receptacle for attaching the Silver Beauty "B" eliminators described below—all controlled by one switch.

The Silver Beauty "A" power unit is considered by experts to be the supreme achievement in "A" eliminators. Made for all sizes radio sets.

### Rowan A Battery

Contains the highest grade of materials in their construction.

Specifications: Sure-Seal Screw Post. A—Lock nut, screws down through the uniseal cover on the screw post, which prevents leakage. B—Rubber gasket washers, prevent any possible

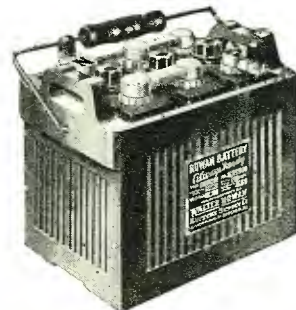

leakage up through the post. C—Screw cover, lock nut and washer fitted into cover, which gives you 100 per cent perfect contact to prevent leakage.

Goodrich Rubber Container, Goodrich Rubber Gasket Covers, Goodrich Vent Caps with Inserts, Resawed Fir Separators,

(Continued on Page 194)

Tell 'Em You Saw It in the Citizens Radio Call Book Magazine

# FULL SIZE BLUE PRINTS

Actual size blue prints are now available for the construction of any circuit described in the Citizens Radio Call Book. Each set of four or more prints consists of a schematic wiring diagram, a graphic wiring diagram, a baseboard layout, a front panel layout, and where a sub-panel is used, a sub-panel layout.

The schematic wiring diagram shows in a symbolic manner each piece of apparatus and all connections between component parts. It is of exceptional value to the experienced builder in that it allows an instant visualization of the circuit. The graphic wiring diagram is helpful to the less experienced builder, since it illustrates in a pictorial way all connections made between the various parts. Each instrument is carefully drawn to scale, with all terminals plainly marked so that the receiver may be completely assembled and wired with no chance of error even though the person has no knowledge of radio symbols.

The baseboard layout accurately shows the location of each piece of apparatus mounted on the baseboard or sub-panel. The front panel layout indicates the size and location of all holes and appropriate engraving. Either the baseboard or front panel layout can be used as a template, since they are drawn with such accuracy so as to insure the proper placing of parts on the baseboard and obviate the possibility of ruining the panel through any inaccuracy in scaling or faulty calculation.

Receivers built from Citizens Radio Blue Prints will be exact duplicates of those built in our Laboratory, assuring positive success and the greatest satisfaction.

## Please Order Blue Prints by Number and Name

No. 3	Qualitone 5 Tube T. R. F. Receiver (5 drawings).....	\$1.50	No. 63	Portable "B" Eliminator Test Set (5 drawings).....	\$1.50
No. 4	Browning-Drake 5 Tube Receiver using National Impedaformers .....	1.40	No. 64	Aero Seven Tube T. R. F. Receiver (5 drawings).....	1.50
No. 5	General Radio Universal Receiver (5 drawings).....	1.50	No. 66	QRS—ABC Unit used in conjunction with No. 61.....	1.40
No. 8	15 to 550 Meter Receiver.....	1.40	No. 68	Improved Remler 45 K. C. Super-heterodyne Receiver (5 drawings) .....	1.50
No. 9	Improved St. James Super-heterodyne Receiver.....	1.40	No. 70	Improved Nine-in-Line (5 drawings).....	1.50
No. 10	De Luxe 5 Tube T. R. F. Receiver.....	1.40	No. 71	"Hot Spot" Fourteen.....	1.40
No. 11	9 Tube 45 K. C. Super-heterodyne Receiver.....	1.40	No. 72	Raytheon ABC Unit.....	1.40
No. 12	Madison-Moore Super-heterodyne Receiver using 201-A Tubes .....	1.40	No. 73	Magnaformer Super-heterodyne Receiver (5 drawings).....	1.50
No. 13	Browning-Drake 5 Tube Receiver Using Acme Impedance Amplifier .....	1.40	No. 74	Eight-in-Line Super-heterodyne Receiver.....	1.25
No. 14	Browning-Drake 4 Tube Receiver Using Audio Frequency Amplification .....	1.40	No. 76	Tyrman Ten (5 drawings).....	1.50
No. 18	An Efficient 5 Tube Receiver Using Space Wound Coils .....	1.40	No. 79	Silver-Marshall High Amplification Super-heterodyne Receiver (5 drawings).....	1.50
No. 32	Scott "World's Record" Super Eight.....	1.40	No. 80	"World's Record" Super Ten (5 drawings).....	1.50
No. 33	Bremer-Tully Power Six.....	1.40	No. 81	1928 Infradyne .....	1.25
No. 36	Monotone Receiver.....	1.40	*No. 82	Thompson Super-heterodyne Receiver (5 drawings)....	1.50
No. 37	Madison-Moore "One-Spot" Receiver.....	1.40	No. 83	"Best Lincoln" Super-heterodyne Receiver.....	1.40
No. 44	Melo-Heald Super-heterodyne—11 Tube.....	1.40	No. 84	Two Control Equamatic Receiver (5 drawings).....	1.50
No. 45	Shielded Localized Control Receiver.....	1.40	*No. 85	Citizens Super Nine (5 drawings).....	1.50
No. 46	A 100 K. C. Super Using Air Core Transformers.....	1.40	*No. 86	Thordarson Power Amplifier (5 drawings).....	1.40
No. 47	The "Phasatrol Five" (5 drawings).....	1.50	*No. 87	Improved Aero Dyne Six (5 drawings).....	1.50
No. 48	The Citizens Super Eight.....	1.40	*No. 89	The New Victoreen Universal Super-heterodyne.....	1.40
No. 50	Camfield Super-Selective Nine "Revised" (5 drawings).....	1.50	*No. 91	Lincoln Quality Receiver (5 drawings).....	1.50
No. 51	Lodge "N" Receiver.....	1.40	No. 92	Improved Camfield Duoformer Seven (5 drawings).....	1.50
No. 52	Improved Nine-in-Line Super Using 201-A Tubes (5 drawings).....	1.50	*No. 93	Knickerbocker Four (5 drawings).....	1.50
No. 53	Compact "B" Supply with Voltage Regulator Tube.....	1.40	*No. 94	Silver-Marshall A. C. Shielded Six.....	1.25
No. 54	Self Modulated Oscillator.....	1.40	*No. 95	La Peer A. R. Nine (5 drawings).....	1.50
No. 55	30 K. C. Super-heterodyne Receiver.....	1.40	*No. 97	Camfield Super Selective Ten (5 drawings).....	1.50
No. 56	Improved Browning-Drake.....	1.40	*No. 98	Madison Moore International One Spot and Power Pack (6 drawings).....	1.50
No. 58	"World's Record" Super Nine.....	1.40	*No. 99	Magnaformer 9.8 A. C. (5 drawings).....	1.50
No. 61	An Electrically Operated T. R. F. Receiver (Receiver only) (5 drawings).....	1.50	*No. 100	Tyrman Super Ten for "A" Elimination (5 drawings).....	1.50
			*No. 105	Camfield Shielded Grid Seven (5 drawings).....	1.50
			*No. 106	R. G. S. Octa-Monic Receiver.....	1.15

## Full Size Graphic Wiring Diagrams

No. 20	Silver-Marshall Improved 7 Tube Super-heterodyne Receiver.....	\$0.60	No. 40	Inexpensive 5 Tube T. R. F. Receiver.....	\$0.60
No. 21	All American 5 Tube Toroid Receiver.....	.60	No. 41	Samson Special T. C. Receiver.....	.60
No. 22	Premier 5 Tube T. R. F. Receiver.....	.60	No. 43	Six Tube T. R. F. Receiver using Alden Localized Control .....	.60
No. 26	4 Tube Non-Radiating Receiver using Audio Frequency Amplification .....	.60	No. 59	Impedance Coupled Super-heterodyne Receiver.....	.60
No. 27	5 Tube Non-Radiating Receiver using Resistance Coupled Amplifier .....	.60	*No. 65	National Browning-Drake with Power Amplifier.....	.60
No. 38	Premier 6 Tube T. R. F. Receiver.....	.60	No. 77	St. James Semi-Portable Receiver.....	.60
No. 39	Unicontrol Nine-in-Line Super-heterodyne Receiver..	.60	No. 78	Silver-Marshall Unipac.....	.60
			No. 88	Two-Tube Browning Drake with Power Supply.....	.60
			*No. 101	World's Record Economy Super 8.....	.60

\*Circuits described in present issue.

Any of the above blue prints will be sent postpaid by return mail upon receipt of the proper amount or they can be obtained from any of the Radio jobbers advertising in this publication

# CITIZENS RADIO SERVICE BUREAU

508 So. Dearborn Street

7th Floor

Chicago, Illinois

Tell 'Em You Saw It in the Citizens Radio Call Book Magazine

# The SONOCHORDE Junior

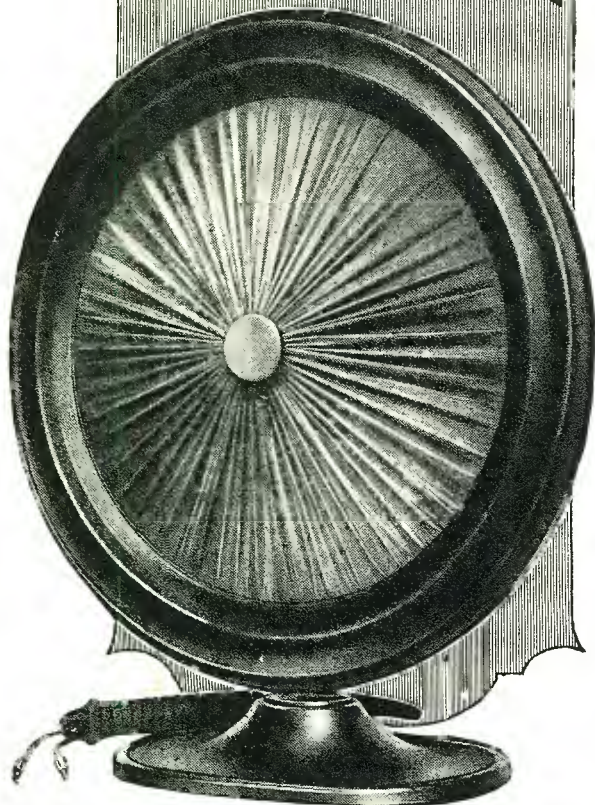

**\$15**

The secret of its acknowledged success is the UNIT—produced by one of the greatest masters of acoustics, employing eighteen features of design exclusively SONOCHORDE. Both cones have a deep wine-colored silk front of finest texture. The frames, though different in shape, have a rich semi-gloss mahogany finish and are practically unbreakable.

Learn more of these wonderful Cone Speakers today. Ask your dealer.

Write for details, circulars, etc.

**BOUDETTE MFG. CO.**  
Chelsea, Mass.  
Dept. F

Senior Model—larger, more decorative, with fuller volume, operates successfully on all receivers, including power sets.

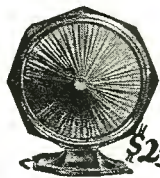

**\$25**

Rowan Increased Absorbent Plates, heavy Lead Plate Connectors, pure Grasselli Sulphuric Acid, Sure-Seal Threaded Screw Post Straps, Lead Nuts have Rubber Washers.

A perfect product, sure-seal, screw-post, A-1-Grade, made with Goodrich Solid Rubber Container. The highest grade and finest made battery that has ever been offered to the trade at such low and attractive prices. Twenty-four months' guarantee.

Sure-Seal Screw Post Batteries, non-leakable, contain the highest grade of materials in their construction.

Longer life—Perfect Reception—HOLDS-A-CHARGE. Non-breakable, non-leakable, non-deteriorating, non-conductive, heat and acid resisting.

Staggered Grid Plates Hold a Charge. We do not manufacture surface grid plates because the active material of red lead and litharge will fall out of grid, causing short life in a battery.

Four million plates per year in the capacity of our new factory. This enables us to make prompt shipments and also places us in a position to maintain the lowest possible prices for our customers.

## Super Ball Antenna

The remarkable results you can obtain from the Super-Ball Antenna—with your present radio—are due to its perfected design, and the way in which Super-Ball engineers have anticipated every problem of radio reception.

Complies with the standard of the National Electric Code and the rulings of the National Board of Fire Underwriters.

An outstanding feature of the Super-Ball Antenna is the non-

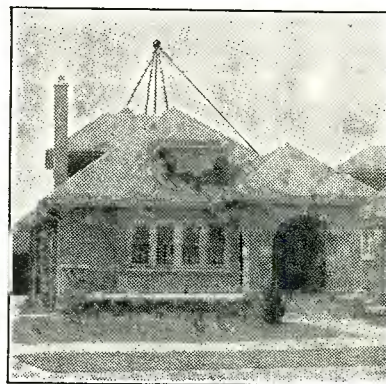

directional smooth surface, with no welded, brazed or soldered joints to impair its efficiency.

By reason of its condenser, full volume is assured at all times. You get perfect clarity of tone.

Super-Ball Antennas may be placed as close as 10 feet apart and still give perfect satisfaction. This means, for instance, that a considerable number of Super-Ball Antennas can be put on an apartment building without interfering with each other, or on your own premises without reaching out to your neighbors.

Super-Ball Antenna gives increased selectivity, improves summer reception, and a minimum of static. It is impervious to ice or snow and unaffected by heat. Therefore, gives unqualified reception in all climates. Easy to install and less costly than others to erect.

Made of non-corroding aluminum alloy, the Super-Ball Antenna will last a lifetime. Its durability and absolute reliability at all times and under all conditions have been proved. The Super-Ball Antenna has achieved an international reputation and has given complete satisfaction in the service of every user.

The Super-Ball Antenna receives all wave lengths—and serves with any make of receiver. It accepts radio frequency signals and rejects a large part of the interference which long aerial wires collect. Furthermore, it is much more responsive to distance than wire aeri-als.

Its perfected performance is further assured by the 30 day unqualified guarantee of the manufacturer, the Yahr-Lange Co., Milwaukee, Wis.

Tell 'Em You Saw It in the Citizens Radio Call Book Magazine

## Amrad Mershon Electric Condenser



The Triple Mershon Condenser is ideal for use in an AB and C Power Unit for the new AC tube. It is recommended to use the so-called raw AC tubes (UX 226) in all but the detector socket. The detector requires the use of the heater type tube UX 227 with either a UX 171 or UX 210 in the last audio stage for the power amplifier. In that the new tubes have practically the same constants as the battery tubes (UX 201A) it is not necessary to change the design of the radio or audio frequency circuits. The filament wiring must be changed to accommodate the extra current required, and potentiometers and bypass condensers supplied to eliminate the AC hum.

For the "B" power the conventional "B" circuit may be used. It is, however, necessary that the circuit of the unit has as low internal resistance as possible. This can best be accomplished by the use of a Mershon Condenser directly across each positive output terminal of the eliminator.

Send for Instruction Bulletin ME2

**THE AMRAD CORPORATION**  
Medford Hillside - - - Massachusetts

## ALL D-X RECORDS BROKEN

With

### St. James Upright "8" and "U" Circuit

The results obtained are a revelation. Selectivity, tone and freedom of noise level are all achieved to a degree never before experienced. Simplicity of design contributes to a variety of uses. The set proper is but 15 inches high, 19 inches long, **THREE INCHES** deep and weighs but **13 lbs.** It is compact enough to use for a portable, may be mounted in your car without taking up valuable space, installed in the Victrola, in fact many uses will suggest themselves.

### Now Available—Regular 7x18 Panel

We also have this same "U" circuit mounted on a regular 7"x18" panel, interchangeable with the "Upright 8," and using the same parts, so that it can be used as a portable whenever desired. The essential parts, including bakelite socket strips with sockets mounted thereon, 4 St. James Intermediate Transformers, Oscillator and choke coil, will be sent prepaid direct, where no local dealer or jobber handles it, together with full-size working plans complete in every respect, for \$42.10; upright wood frame for portable, extra, \$1.50.

Ten feet of wire makes all connections in the set. No adjustments to be made. Instant reception comes in like a rifle shot, and as quickly cleaning itself out with the slightest turn of the tuning dial. Volume enough for a convention hall, which may be shaded to a whisper without a change in its remarkable quality.

### Breaks All Records

Naval Hospital, San Diego, Calif., 9 Oct., 1927  
Dear Mr. St. James: Last nite, 8 Oct., was my best reception this season—fifty-six stations played on St. James Super-Loud Speaker, one audio stage. Most distant stations among them being KDKA (Pittsburgh), PWX (Cuba), 4YA (New Zealand), 2BL (Sidney, Australia), JOAK (Japan). Not bad for the season, eh? When old winter comes we'll have some real reception Lt. C. H. Forth, U.S.N.

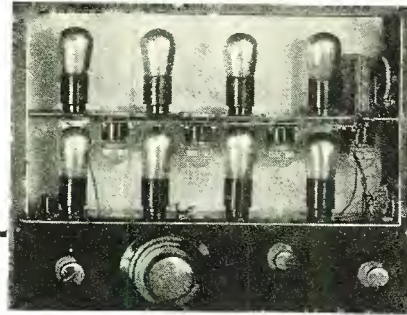

Write for free descriptive literature and astounding testimony from fans the world over.

**St. James Laboratories**  
845 Washington Blvd.  
Dept. AA,  
Chicago, U.S.A.



## SENSATIONAL!

Prices Reduced  
Continental  
Standard Meter Test  
RADIO TUBES

Formerly \$1.75  
Now Only **\$1.00**

The greatest and most sensational price reduction ever offered in high quality standard meter test guaranteed radio tubes. No job lot or old style base tubes but genuine CONTINENTAL tubes, "firsts" of our very best grade. Increased production and large volume business enables us to offer CONTINENTAL quality tubes at the now established standard price of only \$1.00.

Never before has a standard quality radio tube been offered to the public at this low price. Take advantage of this opportunity now to get your radio tubes at a real saving. Each tube packed in individual box, carefully tested and marked perfect. Unconditionally guaranteed in the 201A type to show an emission reading of 55-60 at 45 volts or 65-70 at 90 volts and in the 199 type a reading of 20-25. That's real quality!

### LOOK AT THESE NEW LOW PRICES

Types UX 201A, \$1.00; 199 (UV, UX and standard base), \$1.25; Types X-120 Power, X-112 Power with adapter base, Type X-112 Power, X-171 Power and 200A Power Detector, \$2.50; Rectifier tubes, X-213, \$4.00; X-216, \$6.00; X-210, \$7.50; X-280, \$4.00; X-281, \$7.75.

For sale by progressive dealers. If your dealer cannot supply, order direct, giving his name.

Dealers and Jobbers: Write for special offer  
CONTINENTAL CORP., 179 W. Washington St., Dept. CB, Chicago, U.S.A.

## FREE!!

### Genuine Ward Electric Soldering Iron



Lists for \$1.40

### Everyone Needs a Good Electric Soldering Iron

The Famous WARD needs no introduction. Heating Elements will not burn out; either A.C. or D.C., 105-115 watts draws 100 watts. Six feet of heater cord, standard 2-piece separable plug, mahogany finish handle, brass plated barrel, 3/8" diamond-shaped tip, temperature 500 degrees maintained, handle remains cool. Handles insulated against possible short. A genuine high-grade electric iron. Sold regularly for \$1.40.

Send in the coupon below and receive the iron absolutely free with a year's subscription to the Citizens Radio Call Book Magazine—total value \$3.15, for only \$1.75. Hurry—this offer is limited—mail coupon today.

Citizens Radio Call Book Magazine  
508 So. Dearborn Street, Chicago, Ill.

Here's my \$1.75. Please send me a Ward Electric Soldering Iron free and enter my subscription for the Citizens Radio Call Book Magazine for one year starting with the ( ) Nov. ( ) Jan. ( ) March ( ) Sept. issue.

Name.....  
Address.....  
City.....State.....

Tell 'Em You Saw It in the Citizens Radio Call Book Magazine

# LYNCH

*Improved Aristocrat*

# tube de luxe Deck

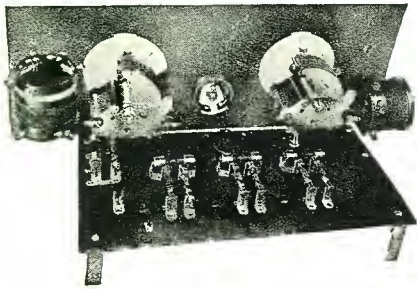

Here is an example of a real receiver made with the Lynch 5-tube De Luxe Deck. This is one model of the Improved Aristocrat. The list price for all the parts necessary is less than \$30.00.

**For Use in Building  
any 5-Tube Receiver**

The Deck includes, all mounted ready for wiring

- 1 Westinghouse 6"x12" Micarta Panel
- 5 Eby De Luxe Sockets
- 4 Lynch Cartridge Condensers
- 7 Lynch Metallized Resistors
- 4 Lynch Special Mounts

The Deck is a Lynch innovation which greatly reduces the cost; improves the appearance and performance and simplifies home construction beyond belief.

**THE LYNCH 5-TUBE  
DECK \$12.50**

**and now:**

The LYNCH BOOK, Just Off the Press  
"Resistance the Control Valves of Radio"

A very thorough treatise on the proper use of resistors of every type for every radio purpose. Many pages—many illustrations—many dollars worth of sound information for a quarter.

Send for booklet today

**ARTHUR H. LYNCH, Inc.**

General Motors Building  
NEW YORK CITY

Sales Offices in Most Large Cities

# WARD Electric Soldering Irons

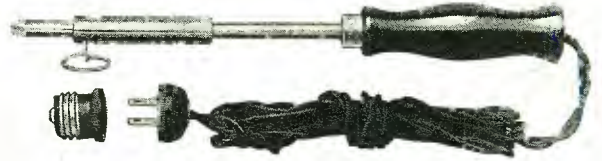

No. 212—\$1.40

A complete line of soldering irons designed for radio work—or wherever a soldering tool is required.

Repeat orders, over a period of years, from the leading jobbers throughout the country prove beyond anything we could ever tell you that the workmanship and quality of these irons is of the best. If your local dealer cannot supply you, write us direct.

Heavy Irons for Manufacturers

Jobbers, Dealers—Write for  
Special Discount

**WARD MFG. COMPANY**

941 Wellington Avenue

Chicago, Illinois

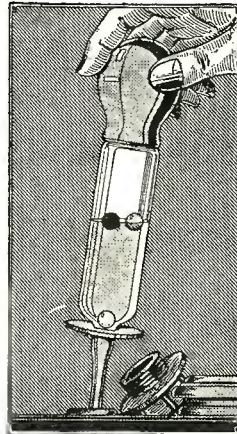

# FREE A High Grade HYDROMETER

Lists for 75 Cents

Send in coupon below and receive this Hydrometer free with a one year's subscription to the Citizens Radio Call Book Magazine.

Every radio set needs a Hydrometer. It tells you instantly the condition of your battery. This is the famous Chaslyn Hydrometer, sold regularly for seventy-five cents.

Regular subscription price is \$1.75, Hydrometer 75c—\$2.50 value—for only \$1.75. Hurry, this offer is limited.

----- COUPON -----

CITIZENS RADIO CALL BOOK MAGAZINE  
508 So. Dearborn Street, Chicago, Ill.

Here's my \$1.75. Please send me the Chaslyn Hydrometer free and enter my subscription for one year to the Citizens Radio Call Book Magazine. Start subscription with  January  March  September  November issue.

Name.....

Address.....

City.....State.....

Tell 'Em You Saw It in the Citizens Radio Call Book Magazine

# Six New Precision Radio Products

By the Makers of the Famous



(1)

## Illuminated DRUM DIAL

Makes single-control of multiple circuits practicable. Two circuits tuned as one, or individually. Translucent wave length scales illuminated from back. Beautifully embossed, oxidized bronze escutcheon plate gives distinction to panel.



(2)

## Flexible COUPLING

Permits coupling condensers in tandem without exact alignment. Bakelite insulation makes the two sides electrically independent of each other. Tough spring phosphor-bronze with brass bushings and hardened steel set screws.



(3)

## EQUALIZER

For neutralizing R. F. circuits or equalizing multiple tuning units. Small size fits limited space. Bakelite base, mica dielectric, phosphor-bronze spring plate.

## HAMMARLUND "Midline" CONDENSER

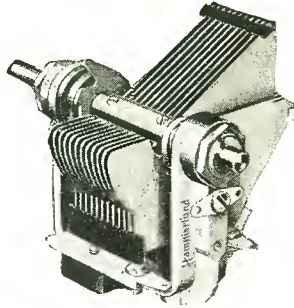

Write for Folders

## Radio-Frequency CHOKE COIL

Special winding and impregnating gives minimum distributed capacity for a given inductance and provides extremely high impedance to all broadcast frequencies. Distinctive Bakelite case. Two sizes: 85 and 250 millihenries.



(4)

## The Improved "HAMMARLUND, JR"

A new, high-ratio midget condenser with all the distinctive Hammarlund features—plus sturdier, simplified construction. Has new locking device for fixing rotor plates in any position. Knob included.

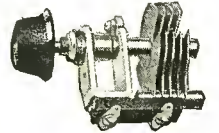

(5)

HAMMARLUND MANUFACTURING CO.  
424-438 W. 33rd St. New York

For Better Radio  
**Hammarlund**  
PRECISION PRODUCTS

## New AUTO-COUPLE

Specified for Hammarlund-Roberts HiQ Six Receiver. Essentially the same as previous model, but designed for use with the new Hammarlund Drum Dial.

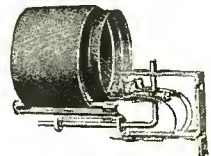

(6)





Pat'd 5-2-'16, 7-27-'26  
Licensed by Rider  
Radio Corporation  
Pats. Pending

## A Favorite With Fans!

# "PHASATROL"

Reg. U. S. Pat. Off.  
A True Balancing Device for  
Radio Frequency Amplifiers  
Price \$2.75

MODERNIZE your set and get better reception with Phasatrols. Can be installed in a few minutes—no technical knowledge or skill is necessary.

PHASATROLS simplify tuning, stop radio frequency oscillations and distortion, enable your tubes to work at maximum efficiency and prevent them from radiating interference to your neighbors.

*At your dealer's or write direct. Write for hook-up circular for any set or circuit*

Dept. 72-A 175 Varick Street, New York, N. Y.

# ELECTRAD Inc.

# EIGHT-IN-LINE



## THE FINEST PIECE OF RADIO APPARATUS MANUFACTURED

Why worry with the average kit trying to *make it work*? This one is working when you buy it. Each unit laboratory tested "on the air" and fully guaranteed.

**Largest Stock of Parts and Kits in the West**

All Call Book Circuits Carried in Stock  
NO SUBSTITUTIONS      QUICK SERVICE  
**WE SAVE TIME AND MONEY**

Free Catalogue      Our Laboratory at Your Service

# RADIO STORES INC.

1433 WELTON ST.      DENVER, COLO.

Tell 'Em You Saw It in the Citizens Radio Call Book Magazine



Why all this stuff  
for an aerial ~

when all  
you need  
is this ~?

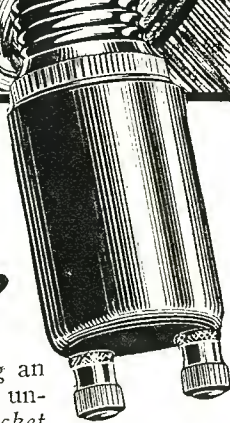

The trouble and expense of erecting an outdoor antenna are now absolutely unnecessary. The Dubilier Light Socket Aerial has taken the place of loose wires, crazy poles, lightning arresters and all the other accessories of an old-fashioned antenna. Full volume is guaranteed. So is clarity and distance. You'll find, too, that this remarkable device greatly reduces both static and interference. Convince yourself without risk—all dealers sell the Dubilier Light Socket Aerial on a 5-day money-back basis.

Price \$1.50



Dubilier Approved Blocks  
for Power Units

If you're building an A-B-C eliminator, insist on the high factor of safety found only in the approved Dubilier condenser blocks. Raytheon and all standard circuits provided for.

THE ACCURATE DUBILIER METALEAK



Don't underestimate the importance of accurate and quiet tubular leaks in the performance of your receiver. Metaleak is smaller than most, but interchangeable on any standard mounting. All resistances—40c to 65c.

DUBILIER CONDENSER CORPORATION

4377 Bronx Blvd. New York

**Dub'lier Condensers**

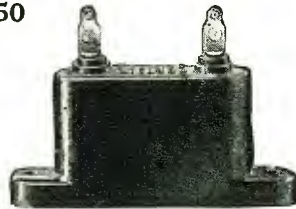

You'll like the new  
Dubilier Micadon

A new shape and moulded Bakelite case have made the "Standard Fixed Condenser of Radio" a better and better-looking Micadon. Fully protected from injury and outside capacity. Terminals adapted to screwed or soldered connections.

Prices 45c to \$1.50

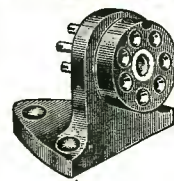

A  
A-B-C & D  
GENUINE  
BAKELITE

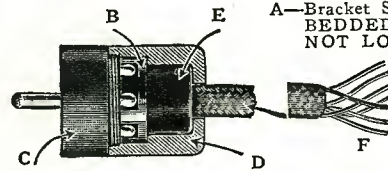

## No More Short Circuits!

Read these specifications! They tell you why the HAGEL POWER PLUG AND CABLE is attracting country-wide attention—and show you how it has made short circuits impossible!

A—Bracket Socket. PINS FIRMLY EMBEDDED IN BAKELITE—WILL NOT LOOSEN IN SOLDERING.

B—Insulator (Leak-Proof) PROJECTIONS SEPARATE CONTACTS—IMPOSSIBLE FOR STRAY WIRES TO SHORT CIRCUIT.

This Insulator cannot rotate on soldered heads, consequently NO CIRCULAR FILM OF SOLDER CAN FORM ON IT CONNECTING CONTACT HEADS.

C—Contact Mounting, Pilot and Key.

D—Cap.

E—Soft Rubber Bushing compressed around Braid of Cable. PREVENTS TWISTING OF CONDUCTORS AND RELIEVES SOLDERED CONNECTIONS OF ALL PULL STRAIN.

F—Seven Conductor Cable. Wires in colored rubber RMA Standard Colors. BROWN BRAID.

## HAGEL POWER PLUG & CABLE

Plug and Cable Only.....	\$2.25
Sockets: Bracket Mounting.....	.75
Flush Mounting.....	.50
Binding Post.....	1.25
Wall Outlet.....	.75

—and these important features are not combined in any other plug

**EUGENE A. HAGEL**

1035 East 76th Street

Chicago, Illinois

## STOPS Radio Interference

on your set. Simple and easy to operate. No tools required to install, simply attach your aerial lead-in to one of the leads on the Liminator and run the remaining lead to your antenna post on your set.

This is a new interference eliminator that limits the interfering stations from spreading all over your tuning dials. It keeps them separated from interfering with each other, helps to bring out some stations stronger. Built with the new type low-loss cyclone coil, neatly and substantially constructed, nothing frail, everything encased. Don't confuse with anything you have ever tried. Wonderful for broad tuning sets. Works on any aerial except a loop. Try the



To Ant. Post on Set

## "King Liminator"

Best Ever Offered for Only One Dollar. Money Back if Not Satisfied with Results

Pin Your Dollar to This Ad  
**\$1** Postpaid  
Order at Once

ARLINGTON RADIO MFG. CO.

Box 42, Firestone Park Sta., Akron, O.

Print Your Name and Address

Name.....  
Address.....  
Make of Set?.....

Tell 'Em You Saw It in the Citizens Radio Call Book Magazine



**Total Shielding**

*for Leading Kits*

**The Vee Dee NO. 250 Cabinet**

B-T POWER SIX  
 B-T POWER SIX CODY REPAIR  
 SILVER COCKADEY 2  
 ROUND RAY SET  
 BEST LINCOLN SUPER  
 S-M SHIELDED SIX  
 S-M LABORATORY MODEL  
 WORLDS RECORD SUPER EIGHT  
 KARAS TWO DIAL EQUAMATIC  
 EIGHT TUBE STROBODINE  
 BODINE TWIN EIGHT  
 THOMPSON SUPER  
 HAMMARLUND ROBERTS HQ  
 BROWNING-DRAKE  
 AERO SIX  
 ETC.

List Price, Including Panel, F. O. B. Factory **\$18.00**

Inside Dimensions, 23"x12"x7" or 8"  
Packed in Strong Carton

Special Chassis, Size 11x20x½  
List Price, \$2.10

## 100% Shielding!

Do away with "man-made" interference by housing your radio in this all metal—all shielded cabinet—possessing the beauty of natural wood grain finishes combined with the efficiency of all metal construction, at low prices made possible through large scale production.

Manufacturers of leading kits have recommended Vee Dee 100% shielded metal cabinets for better service and better reception.

The cabinet illustrated here is "made-to-order" for the fifteen famous, popular kits mentioned. The spacious interior dimensions make this cabinet readily adaptable for practically any kit on the market.

*Manufacturers, Jobbers—Write for Further Particulars*

**THE VAN DOORN COMPANY**  
 160 North LaSalle Street  
 Chicago, Ill.  
 FACTORY: QUINCY, ILL.

**6 TUBE SUPERPHONIC**

All Metal Chassis Shielded Ready to Wire +

Radio ALL PARTS MOUNTED

**Only \$16.95**

**FREE! 6 TUBES UX 201-A TYPE Tested and Matched**

*Can be wired in a few minutes*

An amazing value that can't be beat! Latest 6 tube tuned radio frequency circuit. Extremely selective, marvelous sensitivity. Two stages of radio frequency, detector and three audio amplifiers for improved tone quality. Two dial control. All metal chassis. Shielded. Clear and realistic reception guaranteed. Beautiful front panel, crystalline finish. Metal panel and sub-panel; all parts mounted. Simply connect a few wires. No special tools needed. Vernier dials for fine tuning. New type UX sockets. All hook-up wire and colored battery cable included. Value \$60.00; our price **\$16.95**.



### SIMPLE WIRING DIRECTIONS

Very easy to wire this set with the instructions we furnish. Just connect a few wires. That is all. Can be wired in a few minutes by anyone. No radio knowledge needed. Make money by wiring these sets in your spare time and selling them to your friends.

**NO RADIO KNOWLEDGE NEEDED!**

**SEND NO MONEY**

Just write your name and address on a post card and ask us to send you this great outfit, together with six tubes. We will ship them right away. When they arrive, pay only **\$16.95** plus a small delivery charge.

**RADIO EQUIPMENT CO.** Dept. CA, 549 S. Wells St. CHICAGO, ILLINOIS

ALL-ELECTRIC A-C OPERATED

**AERO-SEVEN RECEIVER**

# 10-Kilocycle Selectivity

Thousands have already built the famous Aero-7 Receiver for battery operation and are receiving exceptional service from this high-grade receiver.

Experts pronounce the Aero-7 A. C. circuit the best electrical circuit for true tone quality.

*Send today for descriptive literature on the new A. C. model*

**AERO PRODUCTS, Inc., 1768 Wilson Avenue, Dept. 311 Chicago, U. S. A.**

*Associated Manufacturers*

- AMSCO
- AERO
- CARTER
- WESTINGHOUSE-MICARTA
- SILVER-MARSHALL
- X-L RADIO LAB.

**MAIL TODAY**

**AERO PRODUCTS, Inc.**  
 Dept. 311, 1768 Wilson Ave., Chicago.

Dear Sirs: Please send me construction data and all the facts in building the new Aero-Seven Receiver; also for A. C. operation.

Name.....  
 Address.....

## FRITTS CABINETS and CONSOLES are Masterpieces in Solid Walnut

They are all made with the one thought of adding dignity to any setting and are worthy of housing the finest radio receiver made.

That's the reason our best radio engineers show them with their receivers.

The beautiful combination of design and fine finish has placed FRITTS a leader in the field. Their originality of design and superior craftsmanship warrant the attention of those who understand the best.

### STANDARD SUPER

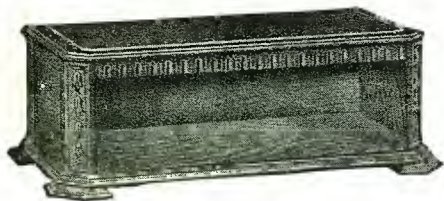

The Standard Super model is the original Italian Chest Type in Motif—SOLID WALNUT. Four Post construction. Top and sides have raised panel effect. Decorations slightly Polychromed.

### SOLID WALNUT

The Super Vesta is identical in outer design and finish to the Standard Super. Has Instrument Panel Door with Diamond Insert of genuine Burled Walnut—Handle, Antique Brass. Top Panel strip (back of door) has inverted Panel Lighting, an exclusive feature on Fritts Cabinets only.

### SUPER VESTA

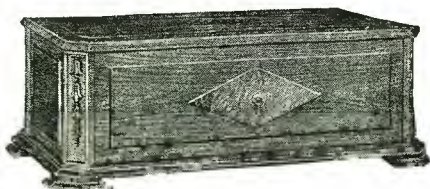

### SOLID WALNUT

Our cabinets are made in all standard panel sizes, from 18 in. to 30 in. inside depth from panel to back 12 in. inside height 8 in.

## Vanity Super Console Table

An Exclusive Fritts' Design of Exquisite Beauty



### SOLID WALNUT

compartments each 7¼ in. wide x 13½ in. high x 13 in. deep

This Console Table is a Speaker model, equipped with the Newcombe-Hawley 40 in. Air Column Speaker and Baldwin Rival Unit. The tone reproduction of the Speaker, as well as the distinctive design and fine finish of the Vanity Console Table, will satisfy the most fastidious. When the Speaker is used, the center panel is dropped and placed under the Speaker shelf. When the Speaker is not used, this Table is a decided Console design.

The art work is all hand painted. Fritts quality throughout, viz: Dark American Walnut, varnished and oiled rubbed. All grill work packed with finest quality gauze.

Overall dimensions—  
Top 38 in. x 16 in.—  
33 in. high—two side

Our line of cabinets, tables and consolettes are all finished the very best known to the trade, viz.: Dark walnut, varnished, hand water and oil rubbed.

*Descriptive Leaflets and Prices Upon Request*

**D. H. FRITTS & COMPANY**

604 Hearst Square, Dept. C

Chicago, Ill.

## Magnaformer 9-8 Receiver Now Operated from Alternating Current

(Continued from page 131)

using the new series of tubes designed for the use of alternating current on the filament. This is due to the fact that on account of the heavy amperage which each filament carries and the thickness of the ribbon filament, an interval of approximately 20 to 30 seconds is required from the time the filaments are first turned on until the heater has reached a sufficient temperature to cause the cathode to emit electrons by virtue of the heat furnished to the cathode by conduction. It is, therefore, quite easy to see that if this condition obtains at the moment the filaments are turned on, the use of the filament circuit as a means of regulating the amplification or sensitivity of a set is not to be considered. Therefore, another means must be used of controlling the receiver, and in glancing at the schematic circuit shown in this article, the reader will find that the method of control employed is a 500,000 ohm variable resistance located between the common grid return of the first, second, third and fourth intermediate transformers and the common connection of the cathode on all of the heater type 227 tubes. This resistance is bypassed by a suitable fixed condenser, which allows r. f. currents to go through it instead of the resistor. In the case of the fifth intermediate transformer, which is located in the second detector circuit, no control is used at this point, the grid return of that intermediate being made direct to the cathode which is common with the negative B. The 500,000 variable resistance previously mentioned is used as a volume control. The other resistance involved in the operation of the Magnaformer 9-8 A.C. is a 200,000 ohm variable resistor located across the 45 to 60 volt terminal and the negative of the B, where it serves to control the plate voltage applied to the plates of the first, second, third, fourth and fifth intermediate stages. This resistance should be one that is capable of safety handling at least 25 milliamperes, whereas the currents involved in the 500,000 ohm resistor are of a very much lower order.

### Source of Filament Supply

For control of the filament circuits it has been found expedient to locate the rheostat in the primary of the 110 volt a.c. line, where the current value is much lower, although at a higher voltage, than in the secondary circuit. Therefore, in the model under test, the General Radio 214-B type table mounting rheostat was used with a resistance of 50 ohms and calling for the passage of a half ampere of current. The filament transformer itself was a Silver-Marshall type 325 using the 2.5 volt tap of the secondary windings. This transformer should be located just as close to the set as is possible and the wiring between it and the terminals of the filament lines on the receiver should be of a conductor not smaller than No. 12. It should be borne in mind that with the introduction of alternating current tubes, the reader must deal with currents of a much higher order than he has been accustomed to doing before. Instead of a single tube taking a quarter ampere at 5 volts, to which the reader has been accustomed, the new tubes use about 1¾ amperes per filament at voltages ranging from 1½ to 2½ volts. It is only logical that when eight of the heater type filaments are placed in parallel, the amperage will be eight times as great and will be of sufficient value that resistances in conductors, which were ignored on battery operated filaments, become a very important factor. It can readily be seen that if a small amount of resistance lowers the potential on the battery operated tube filaments at 5 volts and a quarter of an ampere, this resistance would make a decided inroad upon the voltage of the a.c. heater tubes, as their original value is only 2½ volts. Therefore, do not make the mistake of imagining that a No. 14 or 16 wire will be sufficient to carry the current involved, because it has been pretty thoroughly demonstrated that nothing smaller than a 12 conductor, either solid or stranded, must be used. Even the length of this conductor, if the length is made too great, will have a detrimental effect upon

(Continued on page 202)

# Diamond-Weave Sickles Coils

(TRADE-MARK REGISTERED Aug. 4, 1925)

(Patented Aug. 21, 1923)

Our No. 30 Shielded Tuned Radio Frequency Transformer is designed on an entirely new scientific principle. It will tune sharply to wave lengths from 200 to 550 meters with a .00035 variable condenser. The shielding prevents intercoupling between coils, and local interference. Dimension of shield 3 in. diameter, 1 1/8 in. high.

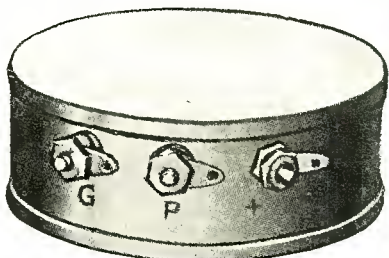

No. 30 Shielded Tuned Radio Frequency Transformer.....\$2.00

OTHER COIL PRICES	Set
No. 20 Craig Circuit.....	\$4.50
No. 9 Acme Reflex.....	4.50
No. 8 Knockout Reflex.....	4.00
No. 21 Hoyt Circuit.....	10.00
No. 25 "Aristocrat" Circuit.....	8.00
No. 18A Roberts Circuit.....	8.00
No. 24 Browning-Drake.....	7.50

Special Coils will be made for other circuits if desired.

Send for descriptive catalog

**THE F. W. SICKLES CO.**

144 Union Street

Springfield, Mass.

# RADIO CATALOG free

**2000**  
Exceptional  
Radio  
Values

**1928**  
WHOLESALE  
CATALOG

RADIO  
Sets, Kits  
and  
Everything  
in Radio

LOWEST  
PRICES  
to  
DEALERS

Send Today for  
This Great Book

Compiled exclusively for dealers in radio sets, radio parts and for set builders. An amazing catalog containing the newest things in the world of radio.

Unbeatable values in radio parts, kits and supplies of National fame. A complete array of cabinets and consoles, in all the latest styles, finishes and popular sizes, and at unmatched prices.

SILVER MARSHALL AC PARTS IN STOCK. 630A Kit, retail price, \$99.00; 652A Kit, retail price, \$36.50. Liberal discounts to the trade. Immediate delivery.

SHORT WAVE SECTION—Our catalog contains a section devoted to a showing of the highest grade short wave receiving and transmitting apparatus. Also the finest electrical appliances for use in the home.

WRITE TODAY—Whatever your radio needs may be, you will find them in our 1928 catalog. Write for a copy today.

**SHURE RADIO COMPANY**

339-F. WEST MADISON STREET, CHICAGO, ILLINOIS

Shure service means sure profits. You can take orders direct from our illustrated list price catalog. The high quality of our products eliminates loss. Large stocks offer you a large selection. Our speedy shipments insure your customers' good will and bigger profits for you.



## Accepted as Standard

Throughout the radio world from amateurs to experts and among the leading radio set manufacturers

## Polymet Products

are accepted as the standard of measurement for quality, dependability and all-around efficiency. Why use inferior parts when at no additional cost you can get the best—Polymet. No matter whether you build a Power-Pack, a Battery Eliminator, an Electric Set, or a Battery Operated Receiver, you can insure better results by using Polymet Radio Essentials.

Polymet radio essentials are stocked by all reliable dealers.

- Mica Condensers
- Filter Condensers
- Condenser Blocks
- Wire Wound Resistors
- Potentiometers
- Extension Connectors



- Grid Leaks
- Phone Plugs
- Claro Plugs
- Polytrois
- Metal Resistors
- Rheostats

Resistance Coupled Kits

Send today for Polymet's new 1928 booklet of popular circuits and full particulars regarding all Polymet products.

**POLYMET MANUFACTURING CORP.**  
599-601 Broadway New York City

**POLYMET PRODUCTS**



Radio dealers recommend and use the

## ekko Ground Clamp

because it eliminates the high percentage of radio troubles due to faulty ground

Imperfect ground contacts are responsible for a high percentage of all radio troubles. The ekko Clamp eliminates these troubles by insuring perfect contact. Radio dealers know this. That is why they include an ekko Clamp with radio set installations and instruct their service crews to use it in replacing old faulty grounds.

The hardened steel points of the ekko Clamp bite through paint, rust, dirt, corrosion or any other insulation. Its positive contact insures full signal strength. Easy to use. Ground wire screws to Clamp. Clamp attaches to nearest pipe by a turn of the screw. Non-corrosive, permanent. Finished in white nickel. Fits 1/4 to 1 1/4 inch pipe. At your dealer's.

25¢



Radio Dealers:

The ekko Clamp is supplied in lots of ten in an attractive counter display that helps you sell this most popular of all ground clamps.

**The Ekko Company**

111 West Monroe Street, Chicago, Ill.

## Magnaformer 9-8 Receiver Now Operated from Alternating Current

(Continued from page 200)

the current, and for that reason the filament transformer should be located very close to the set itself. In testing the receiver, we found it possible to place the transformer at the right rear of the receiver and used a twisted pair for making this connection. While considering the subject of resistance in these circuits, attention should be called to the fact that here, more than any other place, great care must be exercised to see that all connections are electrically and mechanically tight. A loose connection should not be allowed to exist in any circuit, of course, but in these filament circuits such a connection will probably cause trouble.

### Operation Same as Usual

As far as operation of the receiver under alternating current is concerned, there is no difference in the actual tuning, since the two drum dials control the same circuit they would control in any other superheterodyne, that is, the loop circuit on one drum and the oscillator circuit on the other. The two minor refining controls which are normally found in any superheterodyne are likewise present in the Magnaformer 9-8 A.C. in the form of the 500,000 ohm variable resistance and the 200,000 ohm variable resistance, whose functions have been explained previously in this article. Therefore, there is no reason why the operator should have any difficulty in tuning the receiver when it is operated by alternating current.

Detection is accomplished in this model by use of the grid leak and condenser method in both the first and second detectors. The loop has not been made regenerative, because ample volume has been secured without this method of connection. One of the first things which a reader might notice in glancing at the rear view of the set shown in Figure 2 is the excellent appearance of the receiver due to the symmetrical layout employed. The same pleasure as is given the builder in making a well made set will, no doubt, be obtained when actually operating the receiver. In undergoing tests at our laboratory, the tonal fidelity was remarked on by more than one of the listeners.

Below are given the parts used in the construction of the receiver described. If any substitution is practiced make sure parts of equal merit are secured:

- 1—Formica 7x26x3/16 inch drilled and engraved panel
- 1—Formica 9x25x3/16 inch drilled sub-panel
- 5—Magnaformer intermediate frequency transformers
- 1—Unicoupler No. CU71
- 2—110 Remler universal drum dials
- 2—Remler .0005 mfd variable condensers
- 8—9037 Benjamin sockets
- 1—9044 Benjamin socket
- 2—8629 Benjamin sub-panel brackets
- 2—AF-4 Ferranti audio transformers
- 1—National tone filter
- 1—125 Samson radio frequency choke
- 2—Aerovox .00025 mfd grid condensers with prongs
- 1—Aerovox .001 mfd fixed condenser
- 2—Aerovox 1.0 mfd bypass condensers
- 2—Durham 2 megohm grid leaks
- 1—660 Yaxley cable connector
- 1—60 Yaxley jack switch
- 1—1882 Frost 200,000 ohm variable resistance
- 1—1885 Frost 500,000 ohm variable resistance
- 2—FT64 Frost center tap resistances
- 8—Magnatron or Ceco type 227 tubes
- 1—Ceco type J71 tube
- 1—Package Kester radio solder
- Miscellaneous lugs, nuts, screws, etc.
- 4—Frost tip jacks
- 15—Feet No. 14 tinned Acme hook-up wire
- 30—Feet Flexible Acme Celatsite wire

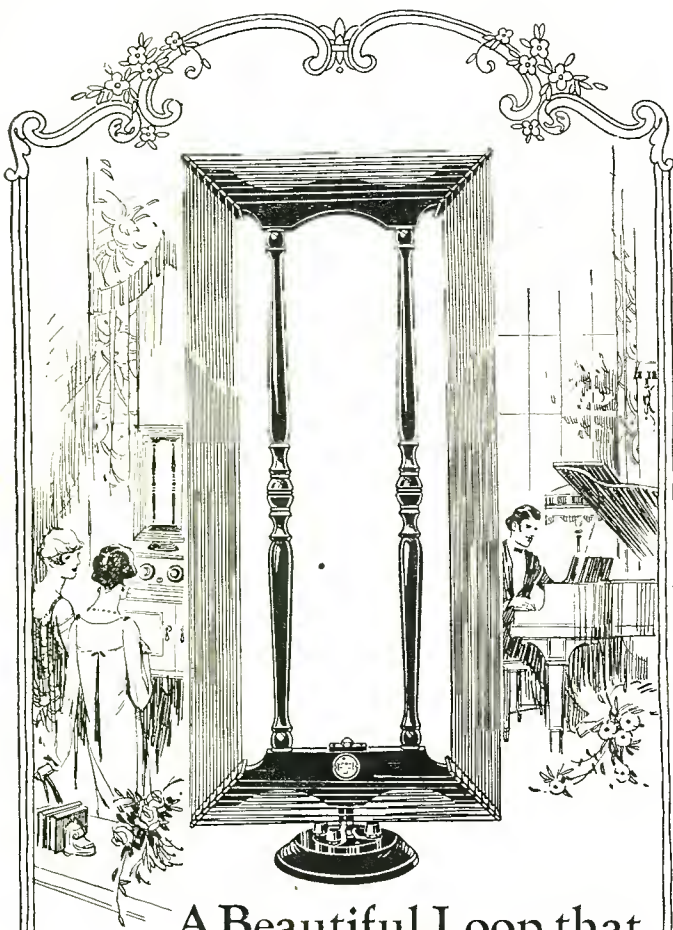

## A Beautiful Loop that is Remarkably Efficient

THE Bodine DeLuxe Loop combines harmonious beauty with remarkable efficiency and selectivity. The unit enhances the most artistically furnished room. The pickup of this loop is remarkable. It brings in long distance stations on the loud speaker with great volume. It is an aid to tuning and thus improves tone quality. A plug and jack permits mounting the loop on the set, and eliminates trailing connecting wires. Merely turning the posts tightens the winding. Order a Bodine DeLuxe Loop today. Prices, all models, \$12.00.

## Bodine Twin-Eight Coils

Because of their unique winding, these remarkable coils provide amazing selectivity with undreamed-of amplification per stage. The self-contained magnetic field eliminates losses due to interference from adjacent coils. Control of oscillation is simple, even with three stages of T. R. F.

Use Twin-Eights in new circuits, and to rejuvenate old T. R. F. sets. Price \$2.00 per coil, 3 matched coils \$6.00.

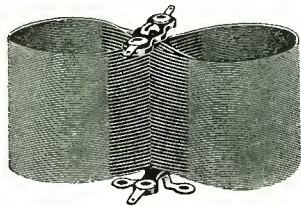

### MAIL THIS COUPON

for free constructional articles showing how to use Bodine Twin-Eight Coils, and also how to use the Bodine DeLuxe Loop with T. R. F. receivers.  
Bodine Electric Company,  
2256 West Ohio Street,  
Chicago, Illinois

Name.....

Address.....

Tell 'Em You Saw It in the Citizens Radio Call Book Magazine

*Attention!!*

## Dealers and Set Builders

Why pay high prices when you can order direct from us and SAVE!! We are distributors for the foremost radio manufacturers in the country. Our great volume of business means DOLLARS and DOLLARS to you. Write today for our

### Wholesale Prices On

SILVER MARSHALL NINE-IN-LINE BEST LINCOLN	VICTOREAN WORLDS RECORD And Many Others
---	---

*We carry complete parts for circuits described in this and the other reliable Radio Magazines. Try the Michigan Radio Supply Company FIRST!*

#### Set Builders

If your name is on our register we will turn over orders for Custom Built sets to you. Our policy is: Our Customers First!

#### Send for

our wholesale prices on kits and parts on the NEWEST circuits. We have them!!

#### Newest Equipment

We pride ourselves in being the FIRST to supply new equipment for new hook-ups. By special arrangement we can supply you with your needs the moment any new circuit is announced. Don't waste time with concerns of lesser importance. Let the Michigan Radio Supply Co. serve you. Our service BEST by TEST!

## Michigan Radio Supply Company

206 E. Grand River Ave.  
Detroit, Mich.

## Without Equal

Do you still fuss with "A" Batteries and Chargers? Is your set noisy? Do you get microphonics? How about the tone? Is the music clear, clean, full overtone?

Why not put Sovereign A-C Tubes into your set? Throw away your "A" Batteries, "A" Eliminators and Chargers. Be free from all battery noises and bother, and get the kind of reception you've dreamed of. Clear, clean, true music with full overtone and without hum or crackling.

Sovereigns use standard sockets. They are easy to install. Anybody can do it in a few minutes. From then on it's simply a matter of throwing a switch, for your power is unfailing and plenty.

Have your set up-to-date. Write for treatise on A-C Tubes and Receivers with typical wiring diagrams included, if your dealer cannot supply you.



Sovereign  
A C  
Tube

STANDARD SOCKET

### Sovereign Electric & Mfg. Company

123 North Sangamon Street  
Chicago, Illinois

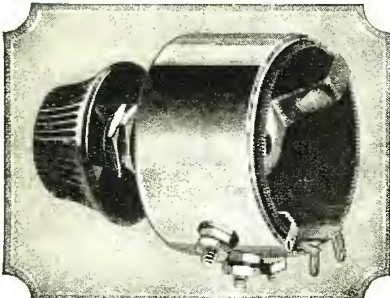

## Improved Positive Voltage Control for "B" Eliminators

The new Centralab Heavy Duty Potentiometer is all wire wound and will carry the entire output of any "B" power device with an unusually high margin of safety. Resistance remains constant at any knob setting so that panel or knob can be marked in volts. A single turn of the knob will give full variation.

Has sufficient current carrying capacity to permit shunting a low resistance value across the "B" power unit to obtain constant voltage regulation. A sufficient current load is maintained through the resistances to reduce the rectifier voltage to workable pressure even though set is not connected,—an insurance against filter condenser break down.

*Write for folder giving details of this circuit*  
Resistances 2,000, 3,000, 5,000, 8,000, 10,000, 15,000, 20,000, 50,000, price \$2.00; at your dealer's, or C. O. D.

### CENTRAL RADIO LABORATORIES

26 Keefe Avenue                      Milwaukee, Wisconsin



# S Y D

LIFE LONG  
"B" BATTERY

**UNCONDITIONAL 2-YEAR GUARANTEE**  
It's Quality—Not Price—That Makes a Real Battery

Type B2  
100 Volts  
with a  
Charger,  
**\$15.50**



145 Volts  
with a  
Charger,  
**\$21.50**

The SYD Battery pictured above is a storage "B" Battery made of Edison Elements, which have nickel and iron in their construction. The solution used is a preserver of nickel and iron, thereby giving the battery practically unlimited life.

SYD Batteries are built to give the user real value for every dollar he invests. Only the finest materials are used in their construction. Remember that the quality of the battery and not the price determines its worth. That's why SYD Batteries are preferred and used by thousands.

**TESTED AND FOUND SATISFACTORY BY THE CHICAGO DAILY NEWS RADIO LABORATORY. ALSO BY POPULAR RADIO LABORATORIES, NEW YORK CITY**

Manufactured and Sold Exclusively by  
**SYD STORAGE "B" BATTERY CO.**  
1464 South Wabash Ave., Chicago

MAIL ORDERS FILLED

Tell 'Em You Saw It in the Citizens Radio Call Book Magazine

# KNOW THE LINCOLN

It is today's Stand

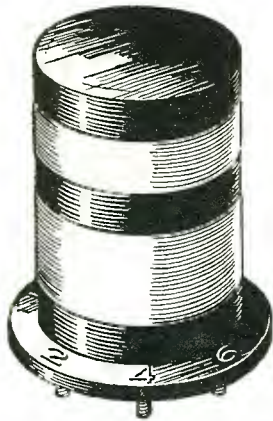

The Lincoln Fixt Inductance



Amperite Filament Control

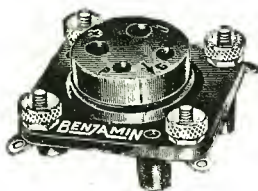

Benjamin Sockets

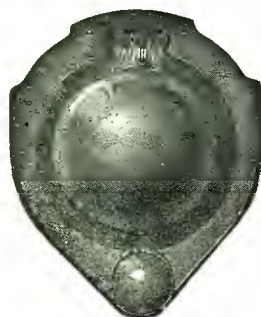

Kurz-Kasch Dials

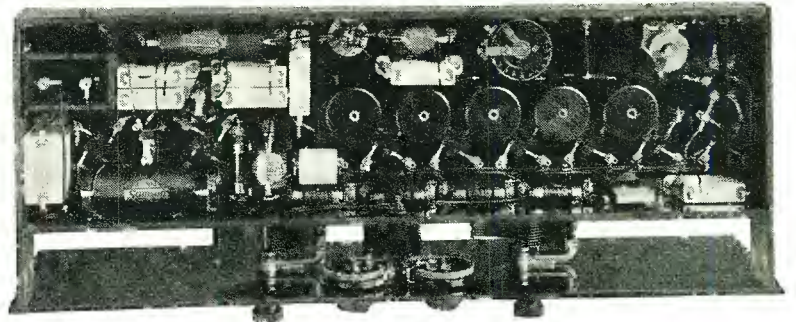

## The GENUINE

—designed for super-efficiency—represent the development and properly connected and used in conjunction with other complemen are shown herewith) the result is a truly remarkable set—a revela

*They are acutely selective and have tremendous amplification.*

*They eliminate 40 to 60% of extraneous noises.*

*They are the most stable long-wave transformers manufactured.*

We furnish accurate drilling templates, com other parts recommended after severe tests, tion, all so clear that the veriest tyro can

The LINCOLN QUALITY RECEIV  
disappointments you  
other experimentation



Sold by the best retailers and with builders, amateurs and

**REX LABORATORIES, Inc.**  
341 THE ARCADE,

Tell 'Em You Saw It in the Citizens Radio Call Book Magazine

# QUALITY RECEIVER

## Standard of Comparison

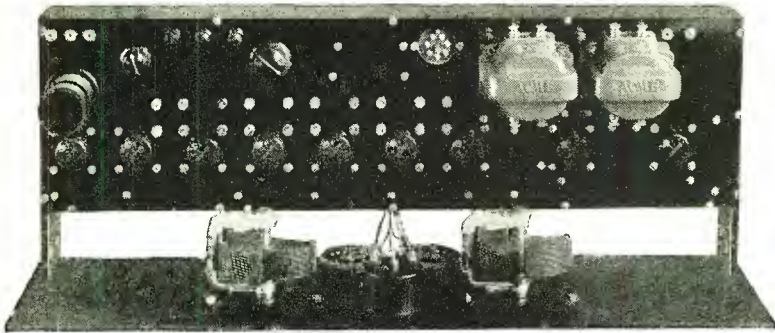

## Lincoln Units

application of entirely new principles in radio engineering. When  
tary parts that have passed our laboratory tests (some of which  
tion to novice and expert alike.

*They make fidelity of tone an enjoyable actuality.*

*They have only one harmonic on local stations.*

*They bring in distant stations with the volume and  
quality of locals.*

plete schematic and pictorial diagrams, list of  
and also minutely detailed building informa-  
follow with surety.

**ER abundantly compensates you for all  
may have suffered with  
to date.**

jobbers everywhere. Correspondence  
dealers given prompt attention.



## Lincoln Quality Products

CLEVELAND, OHIO

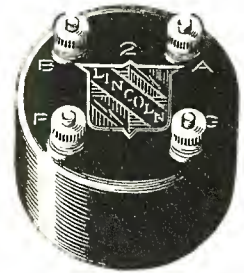

The Lincoln Transformer

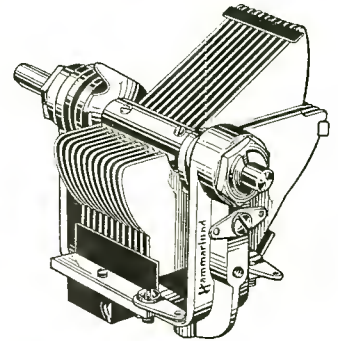

Hammarlund Midline Condenser



Yaxley Rheostats

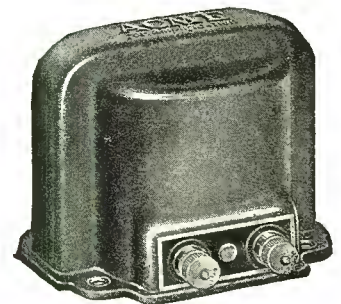

Acme Transformers Type MA2

Tell 'Em You Saw It in the Citizens Radio Call Book Magazine

# SM

## "The Finest Tone I've Ever Heard" //

and complete A. C. operation

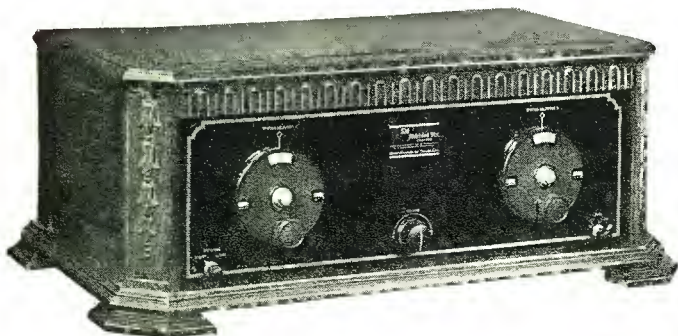

### 87% at 30 Cycles

At 30 cycles, an S-M 220 audio transformer in a standard amplifier circuit gives 87% of the amplification obtained at 1000 cycles, while its curve is substantially flat from 100 to 1000 cycles. Above 2000 cycles, the curve for a single stage falls off gradually, while in a standard two stage amplifier circuit, the curve is substantially flat up to 5000 cycles above which frequency it falls off rapidly to keep static, heterodyne squeals and "set noise" at a minimum.

The above paragraph sums up at once the desirable characteristics of an audio amplifier and the actual performance of S-M audio transformers. It is just this fact that has made 220's the choice of over half of the designers of the new 1927-1928 circuits, for engineers know that the short cut to the finest of quality is to use S-M audios. 220's have outsold every other transformer in their class for over a year. And S-M audios are being used in more broadcasting stations than any other type. WCAE, WBBM, KFCR, WTAQ, KGDJ, WLBF, and many others. WCFL, the "Voice of Labor," checks quality of all programs with them. Nathaniel Baldwin, Inc., famous speaker experts, test with 220's and 221's.

Your guarantee of quality is to use S-M 220's and 221's in every circuit you build, and you'll find that over half the popular 1927 and 1928 circuits will give you just this same guarantee.

The 220 audio is the biggest value on the market, and its performance measures up to its 4-pound size. It contains more steel and copper than any other transformer—the measure of transformer merit. Price \$8.00.

221 output transformer not only protects loud speakers against power tube plate circuits, but compensates low frequencies for all loud speakers. Price \$7.50, or with cord and tip jacks, No. 222, \$8.00.

230 push-pull input and 231 push-pull output transformers are priced at \$10.00 each.



THAT'S THE STORY of the famous Silver Shielded Six in a nut-shell. Every one of the thousands who built last year's Shielded Six said the same thing—"The Six has the finest tone I ever heard." And now the new and improved 1928 Model of this famous receiver is ready, with the same fine tone as the original and tremendously increased selectivity and distance getting ability.

And just as last year S-M engineering led the field with the first individual stage shielding, dual control, all metal assembly features that definitely established the Six as the finest of kits, so S-M again leads. With the new A. C. tubes just out S-M offers for immediate delivery, A. C. Shielded Six Kits—before other A. C. tube circuits have even been announced, S-M engineering has been completed.

The Shielded Six may be built for operation with standard tubes, using batteries or eliminators, or it may be built with new A. C. tubes using the compact S-M 652A, ABC power plant. Or the man who wants the finest possible tone can build self-contained super-power push-pull amplification, for 171 or 210 tubes right into his Six. And with its three stages of tuned R. F. amplification, plug-in coil covering all waves from 200 to 3000 meters, its all-metal assembly, individual stage shields, light socket operation, and other features, the Six can't be duplicated for less than \$250 to \$500. Above all, the Six is *guaranteed* to have finer tone than any other set you can buy.

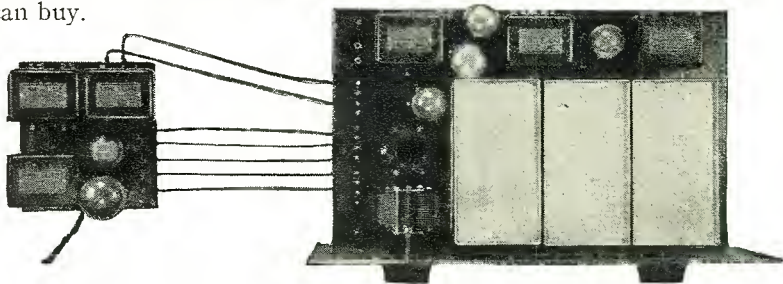

The astonishing simplicity of the light socket operated Improved Shielded Six is here illustrated. This Six (a special model with push-pull 171 power amplifier) is complete, ready for operation with all power supplied by the small unit at the left. Only a short antenna, a ground connection, and loud speaker need be added for operation.

Type 630 kit contains all parts for standard Improved Shielded Six for 5 volt tubes, for battery or eliminator operation. Price \$95.00.

Type 630 AC kit contains all parts for the light socket operated model using 4-C327, 1CX326 and 1-CX371 A. C. tubes. Price \$99.00.

Type 652A, ABC power plant kit contains all parts for an ABC power supply for 630 AC kit or any standard receiver using A. C. tubes. Price \$36.50, or assembled, ready to use, No. 656A, price \$40.50.

Send 10c to cover postage and we'll mail you enough new dope on A. C. operation, super-quality amplification and how to bring last year's Six up-to-date to fill your reading evenings for a week

**SILVER-MARSHALL, Inc.**

836-A West Jackson Blvd.

Chicago, U. S. A.





# Power Amplification With Tone--

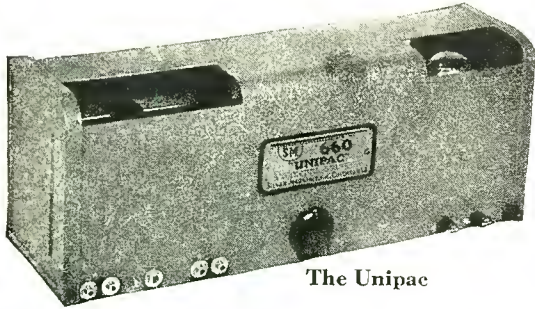

The Unipac

Do you know that no matter what kind of a set you have, by adding an S-M Unipac you can eliminate all B batteries and add power amplification that will give you tone quality obtainable by no other method—not even with the most expensive of the new sets?

The 660-210 push-pull Unipac is a light socket push-pull 210 power amplifier stage (and receiver B supply) far superior to any other power pack you can buy. It will give from five to fifteen or more times the power you can get from any other 210 power pack—in fact, it is the finest amplifier ever offered. It is priced at \$83.25 for the kit.

Then there's the new 660-171A Unipac, a similar model for 112 or 171 tubes that will far out-perform ordinary 210 packs, and it also supplies ABC power for any receiver at all using A. C. tubes. It is priced at \$66.00, or for the same kit, slightly lower powered, with receiver B supply as well, \$64.00.

The 660-240 Unipac, a two stage amplifier and B supply for any set at all is the choice of L. M. Cockaday for his LC-28 set, and of Glen Browning for the new two tube Browning Drake. It is priced at \$81.25 for the kit, and uses one 210 amplifier, one 226 A. C. amplifier, two 216B or 281 rectifiers and one 874 ballast tube.

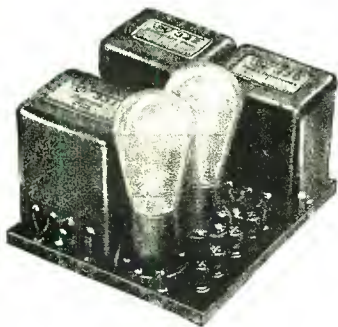

652A "Reservoir B"

### Light Socket ABC Power

S-M power supplies are available in two types, 625A is an ABC power plant delivering up to 180 volts B, 40 volts for C, for any receiver, and 1.5, 2.5 and 5 volts for A power for A.C. tube sets. It is \$36.50, ready to assemble. Type 652 unit, a B supply only of 180 volts output, is \$34.50. Both use the ballast or glow tube voltage regulator tube, insuring no "motor-boating," "putting" or "humming."

### The New Transformers

Three new S-M transformers are ready. One is the new super-power 328 unit, with two 550 volt secondaries, two 7.5 volt secondaries and one 1.5 volt primary, in addition to a 105-120 volt, 60 cycle primary. For single or full-wave power supplies, it costs but \$18.00 (331 Unichoke at \$8.00 is a single unit selective brute-force filter choke for all powers up to 125 M.A. and for use with 328 transformer). The new small type audios (selected by Hugo Gernsback for the Peridyne, by L. M. Cockaday for the LC-28 amplifier and approved by Glen Browning for the two tube Browning Drake amplifier) contain more steel and copper than any other transformers you can buy except S-M 220's, and perform on a par with the 220's from 100 to 5000 cycles. The new compact 240 audio is but \$6.00—241 output \$5.00—the best values ever offered by any manufacturer.

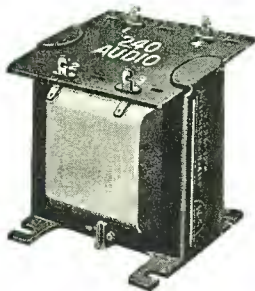

240 Audio and 241 Output Transformer

### 440 Jewelers' Time Amplifier

The 440 Time Signal Amplifier is tremendously popular already. The Waltham Watch Company uses one for controlling their master clock, as do many jewelers and observers. Thousands have been sold, for it's the best long wave amplifier ever developed. Three stages and a detector, shielded and tuned exactly to 112 K. C., provide tremendous sensitivity and selectivity. Price, laboratory calibrated, sealed in a copper and brass catacomb, \$35.00.

### An Illuminated Drum Control for Your Set

The new S-M illuminated drum dial adds beauty and distinction to any set, and is one of the few drums that is a real true vernier, controlled by a panel knob. It's almost universal, and will fit any single-hole mount—and most multiple mounting screw condensers, right or left types.

Furnished with oxidized brass panel window, black and gold universal drum and lamp bracket, price \$3.00.

*We can't tell you here all about the new S-M developments, but if you'll send us 10c for postage we'll send you more information on complete light socket operation super audio amplification and other pertinent subjects than you can read in a week.*

## SILVER-MARSHALL, Inc.

836A West Jackson Blvd.

Chicago, Ill.

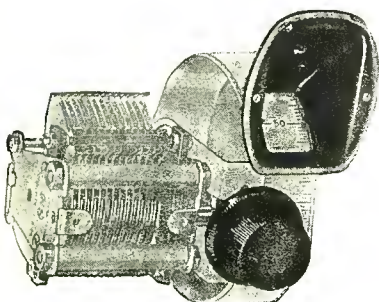

805 Vernier Drum Dial

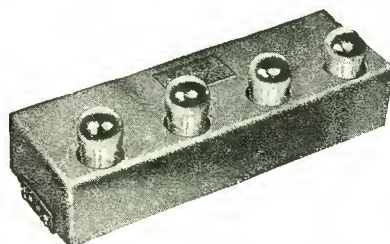

440 Jewelers' Time Amplifier

SILVER-MARSHALL, Inc.  
836A W. Jackson Blvd., Chicago

Please send me full information on the new S-M developments for which I enclose 10c.

Name.....

Address.....

Read About the Latest "A. C." Electrically Operated Kits, Together With the Newest Things in Radio in This 96-Page Catalog



*This Big Beautiful Catalog*

We carry a complete line of parts for all kits featured in Citizens Radio Call Book.

Chicago's Oldest Radio House



**Telephone Maintenance Co.**

Dept. 44

123 South Wells Street

Wholesale Only

Chicago, Illinois

Wholesale Only



# FREE SERVICE for the PARTS BUYER

A SERVICE MANY FANS NEED. To enable more people to get the better Custom Built Set without the trouble of wiring, we have arranged to have constructed any of the Sets listed in this issue of the "CITIZENS CALL BOOK" absolutely FREE OF CHARGE, providing the Kit is purchased from us. Wiring is done with Celasite, and is guaranteed to be correct, as shown in Citizens Call Book Hookups. All Sets tested on distance.

Improved Silver Laboratory Model Super.....	\$ 89.45	The "Best Lincoln" Nine Super Heterodyne Receiver.....	\$116.75
Tyrman Ten.....	141.90	Melo-Heald Hot Spot Fourteen.....	153.00
Camfield Super Selective Nine.....	124.70	Karas 2 Dial Equamatic.....	94.25
Victoreen Standard I Dial.....	88.05	Hammerlund Hi-Q (1928).....	98.90
Victoreen Single Dial with Victoreen New Audio.....	114.00	Loftin White (1928).....	86.60
World's Record Super Ten.....	123.58	Remler Infradyne (1928).....	172.50
Improved Remler 45 K.C. Super.....	109.00	Madison-Moore "One Spot".....	116.90
H. F. L. Nine-in-Line Receiver.....	125.00	Madison-Moore "AC" One Spot.....	120.00
Magnaformer 9-8 Receiver.....	121.00	B. T. Counterphase Power Six.....	82.10

The above represents a saving of at least \$5.00 per tube.

*If You Build Your Own We Guarantee to Save You Money on Your Parts and Accessories*

## WRITE FOR OUR CATALOG

*A book of real bargains*

We distribute and carry full line of Silver-Marshall Parts and Kits

211 North Tenth

**WALTER ASHE RADIO CO**

St. Louis, Mo.

*Tell 'Em You Saw It in the Citizens Radio Call Book Magazine*

**SM**

**24-Hour Mail Order Service on Silver-Marshall Products**

WHEN you send to M & M for Silver-Marshall Kits, parts, and accessories, you are sure to get not only the highest quality radio products made, but you will get from us prompt delivery and helpful service. We carry a complete stock of all leading lines: S-M Improved Shielded Six Kits, S-M Unipacs, "Reservoir B" power supplies, S-M Transformers, and all parts specified for any Call Book circuit.

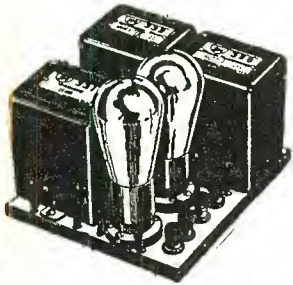

**Reservoir "B" Power Supply**

For complete ABC supply to operate any receiver using AC tubes. S-M Kit, No. 652A, list price, \$36.50. S-M Wired Model No. 656A, list price, \$40.50.

**Improved Laboratory Model Super**

The outstanding super-heterodyne of the year. Guaranteed to out-perform any other 8-tube receiver. Possesses knife-like selectivity. No other super so easy to build. All parts as specified in the last September issue of the Call Book, \$93.45 list (without shields \$89.45). All parts as specified in this issue, for AC tube operation, \$0000, with Reservoir B power supply included.

**Improved AC Shielded Six**

The finest type of tuned radio frequency receiver kit on the market. Unsurpassed for tone quality. Famous the country over for its marvelous performance. Standard factory No. 630 kit, for battery operation, \$95 list. All parts as specified in this issue of the Call Book, for complete AC tube operation, \$99.50. (With S-M "Reservoir B" power supply kit No. 652A, \$136.00.)

**Dealers and Set Builders: Write for Our FREE 1927-28 Catalog**

Listing all of the leading parts and kits on the market. We carry the most complete stock of radio parts in the state of Ohio, and on all standard equipment can make shipment within 24 hours after your order is received. In addition to the above popular kits, we also specialize in

Magnaformer 9-8  
Victoreen Super 8  
Camfield Super 9

Tyrman Ten  
Remler 8  
Lincoln 9

Camfield Five  
Camfield Seven  
Karas Equamatic

Thordarson Products  
National Products  
Samson Products

*Distributors for SPARTON, AC DAYTON, ALL-AMERICAN and STEINITE Sets*

131 East Market Street  
Akron, Ohio

**The M. & M. Co.**  
508 Prospect Avenue  
Cleveland, Ohio

22 East Front St.  
Youngstown, Ohio

**LEWIS RADIO JOBBERS**

"The House of Service" Philadelphia, Pa.

DISTRIBUTORS FOR THE FOLLOWING POPULAR CIRCUITS:

- |   |   |
|---|---|
| HAMMARLUND HI-Q SIX                                 | VICTOREEN SUPER-HETERODYNE                |
| HARKNESS COUNTERFONIC SIX                           | KARAS KNICKERBOCKER FOUR                  |
| STROBODYNE  | SILVER A. C. SHIELDED SIX AND A. C. SUPER |
| NATIONAL BROWNING-DRAKE WITH POWER AMPLIFIER        | CAMFIELD SUPER SELECTIVE TEN              |
| CITIZENS SUPER NINE                                 | NEW MADISON MOORE A. C. SUPER HETERODYNE  |
| THORDARSON POWER AMPLIFIER WITH PHONOGRAPHIC PICKUP | MAGNAFORMER 9-8 A. C. SUPER-HETERODYNE    |
| IMPROVED AERO-DYNE SIX                              | TYRMAN A. C. SUPER TEN                    |

We carry the largest and most complete stock of QUALITY RADIO PARTS in the East. Check the above list of Kits and you will agree it is a complete one. And we can make 24-Hour Delivery on all lines we distribute—"Making the best better"—that's LEWIS SERVICE.

OUR 1928 CATALOGUE is a "Money-Saver." It is very complete and contains our entire list of Radio Lines. WRITE FOR IT TODAY!

SERVICE—Our sales extend to 48 states—and then some. National Distribution and Service

REMLER—RAY-O-VAC—WEBSTER—EAGLE  
TOBE—BOSCH—ACME—THORDARSON

**LEWIS RADIO JOBBERS**

Send for our catalogue today

DISTRIBUTORS FOR BOSCH RADIO PRODUCTS  
45 North Seventh Street, Dept. A  
PHILADELPHIA, PA.

**LOOK!! IT'S FREE!!**

**DEALERS & PROFESSIONAL SET BUILDERS**

Your BIG NEW 1928 Catalog Is NOW READY!

Contains nationally known Parts and Kits at Maximum Discounts

- |        |                     |
|--------|---------------------|
| Yaxley | Hammarlund          |
| Carter | Eletrad             |
| Acme   | Karas               |
| Samson | Aero Coil           |
| Tobe   | Weston              |
| Daveu  | Benjamin            |
| Marco  | Precision Coil      |
| Eby    | Silver-Marshall     |
| Amsco  | General Instruments |

IN STOCK ALL THE CIRCUITS described in this issue

Send for Catalog Now—It's FREE!

S. HAMMER RADIO COMPANY  
305 Atkins Avenue, Brooklyn, New York

SM

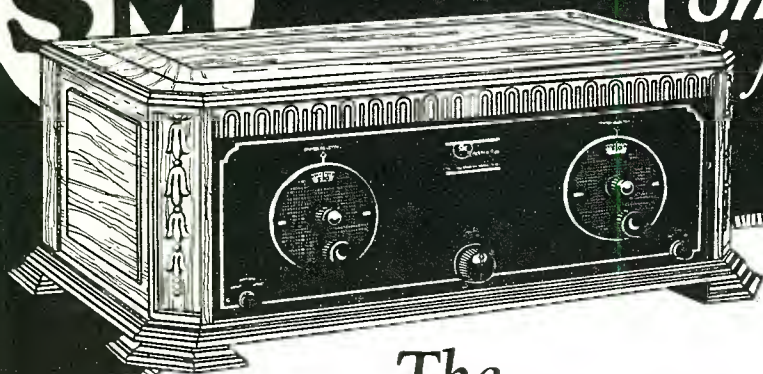

# Complete Parts for the New SILVER-MARSHALL Shielded Six in Stock

The large and attractive catalogue of the Wholesale Radio Service Co. is designed to help either our customers or our non-customers in the selection of profit-building lines. Within its covers will be found, in a comprehensive and instructive way, information on all the latest and most constructive improvements in radio,—50 pages of it. This catalogue is part of the Wholesale Radio Service Co.'s "Service of Excellence," maintained at all times. It is sent free upon application to any point on the globe.

**SEND FOR YOUR COPY TO-DAY.  
IT WILL BE WORTH YOUR WHILE.**

Also S-M Uni-Pack  
and all other S-M  
parts and kits  
in stock

### KITS WE STOCK

New Remler Infradyne  
New Karas Equamatic  
New Hammarlund Hi-Q  
L. C. 28  
Thordarson Power Pack  
We carry in stock complete parts for all latest circuits.

**WHOLESALE RADIO SERVICE CO.**  
6 CHURCH STREET ESTABLISHED 5 YEARS NEW YORK CITY, U.S.A.

SM

## Fastest Mail Order Service West of the Rockies

WE carry a complete line of practically every known radio part and accessory. Whether it is a complete kit or an individual part you'll find it in our stock. And, we make immediate shipment—24-hour service. In other words, we combine quality products with a service that is not to be obtained anywhere else west of the Rockies.

**SET BUILDERS:**—Write for our discount sheets and catalog. We can save you money. Maximum discounts to dealers.

Send your order to us for the Improved Shielded Six, Silver-Marshall Unipacs, or any S-M products. We can supply complete or individual parts for any circuit described in this magazine, or parts for any standard hook-up.

Get acquainted with "The Radio Parts Jobbers" of the Northwest—your first order will make you our steady customer.

Mail Orders Solicited  
**WEDEL COMPANY**

Established 1888

1625 Fourth Avenue

Seattle, Wash.

OUR experience in repairing and testing radio receivers has helped all our clients to obtain better reception.

We are equipped to repair and test all types of radio receivers and power units.

All work is given a test for actual performance before being returned, together with a final test in a completely shielded room, thereby eliminating all internal noises. Each receiver is also given special mechanical test for quality, thus assuring perfect reception.

Send us your receiver today and we will give you an estimate for repairing and remodeling it with all the latest developments.

**Radio Service Laboratories, Inc.**

508 South Dearborn Street

Chicago, Illinois

7th Floor

Harrison 2870

Tell 'Em You Saw It in the Citizens Radio Call Book Magazine

## The Big Friendly Radio House

Write  
for  
this **Up to**  
  
**Date!**

# BIG RADIO CATALOG

**G**ET this up-to-the-minute, 1928 Book of Bargains! Popular, nationally advertised sets, parts, eliminators and accessories at prices that mean real values. Parts for Tyrman Ten, Silver-Marshall Unipacs, Melo-Heald Super's, Camfield Super Selective Nine, Victoreen Super, Remler Infradyne, World's Record Super, and many other popular circuits.

**DEALERS**  
YOU will want this dealer catalog. It lists everything in radio—standard quality at the right price!  
*It means more profit for you!*

Send for this Great Book Today!

# WESTERN RADIO MFG. CO.

128 W. Lake St. Dept. 22  
Chicago, Ill.

# Lowest Wholesale Prices!

## Send for Our 1928 Buying Guide

Your copy of the *free* 1928 Buying Guide is ready for you—one hundred pages chock-full of bargains on all latest Radio Parts, Accessories and Sets. Read our price policy below. Lowest prices are *assured*.

### For Set Builders

#### Our Price Policy

We endeavor to sell day by day for less than the prices of our legitimate competitors.

Remember, when comparing prices, that we allow a cash discount of 3%.

Compare our prices with others. If they quote lower than we do, furnish name of concern and catalog page number and we will meet their price.

Set builders will find this 1928 Buying Guide chock-full of information about new sets, circuits and parts. A veritable encyclopedia about the newest in radio. Professional set builders cannot afford to be without this new catalog. Write for it.

### Electrical Goods—Sporting Goods

Catalog C also lists electrical supplies, household appliances, golf and tennis accessories, bags, trucks, etc.—at the same low prices.

## Allen-Rogers-Madison

INCORPORATED

35 WEST 31<sup>ST</sup> ST.

NEW YORK, N.Y.

Tell 'Em You Saw It in the Citizens Radio Call Book Magazine



# Dealers' Headquarters For S-M Parts

**Official Wholesale Distributors**

We are wholesale distributors for all Silver-Marshall products, including S-M Unipacs, Improved Silver Super and others that are being featured in the Citizens Radio Call Book and other radio magazines. A complete stock of parts is on hand for immediate shipments to fill dealers' requirements anywhere.

## Everything in Radio

Quality products and dependable service to dealers have built up the reputation of the W. C. Braun Co. We carry the largest and most carefully selected line of radio goods in the country—the lines of the leading manufacturers of sets, parts, kits and accessories.

Mail orders given special attention. We are fully equipped to serve dealers on mail orders promptly and efficiently. Our new 214-page dealers' catalog lists over 4000 items in radio, electrical goods, sporting goods and allied lines that keep the dealers' business humming twelve months of the year.

Write for free copy of this catalog on your letterhead and learn about our successful dealer plan.

**W. C. BRAUN COMPANY**  
563-571 W. Randolph St., Dept. 92A  
CHICAGO, ILL.



# Dealers' and Set Builders' Headquarters

We are the *oldest* New York Silver-Marshall distributors and can make *immediate* shipment of Shielded Six Kits, Unipacs, Reservoir B power supplies, and parts for all Call Book circuits, or receivers featured in any magazine. Send for our complete catalog and discounts to dealers and set-builders. *We ship your order the day received.*

**Official Distributors for Silver-Marshall and Hammarlund**

Specializing in these lines, as well as other *nationally advertised* lines, we can render helpful co-operation to dealers and set-builders. Established in 1921, we know radio, and can give you valuable assistance. Compare our *specialized and personal service* with the ordinary kind and you will be glad to have made our acquaintance. Mail your inquiry to us today.

Abox  
All American  
Amperites  
Benjamin  
Cardwell  
Carter  
Daven  
Durham  
Electrad  
Hammarlund  
Hammarlund-Roberts  
Igrad  
Marco  
Pacent  
Raytheon  
Sangamo  
Silver-Marshall  
Thordarson



**CLARK & TILSON, INC.**  
122 Chambers Street  
New York City



## The Catalog every Set Builder should have

**Everything for the Set Builder**

The Harco Catalog is chock full of unusual bargains in all the latest kits, standard parts, complete sets, furniture and accessories. Don't place your order until you get a copy of this money-saving book.

**Prices That Save You Money**

Harco merchandise and service form the ideal combination for the set builder and experimenter. Don't delay. Write now for your copy and see for yourself the wonderful values we offer. **THE HARCO COMPANY**  
1259 So. Wabash Ave. Chicago, Ill.



**The HARCO COMPANY**  
1257 SO WABASH AV. CHICAGO



## RADIO WHOLESALE

We Are Headquarters for All Silver Marshall Parts and Kits

Lowest wholesale prices on all that is newest in radios and equipment listed in any big 1928 Catalog. Contains thousands of astonishing bargains in nationally advertised goods. Get this regular encyclopedia on radio. It's free! Send postcard now for your copy.

**AMERICAN AUTO & RADIO MFG. CO.**  
Harry Schwartzburg, Pres.  
Dept. 163-A, American Radio Bldg., Kansas City, Mo.





## "CHICAGO" HEAVY DUTY "B"

is the only battery on the market carrying a six months' unconditional guarantee.

Dealers, Agents: Write today for discounts and details of our exclusive selling franchise. We make a complete line of Dry Cell Batteries for every radio requirement.

**AUSTIN ACCESSORIES MFG. CO.**  
12 S. Clinton St. Chicago, Ill.

# FREE To Set Builders and Dealers

Write today for this big new Catalog. Its yours for the asking without obligation. Contains everything worth while in Radio, including all popular kits described in this and other leading Radio publications. We carry in stock a complete line of parts, accessories, consoles and cabinets.

**Buy Direct**

from the largest jobbing house in the middle west and save money on all radio equipment. Try us for quick, accurate service.

*No Delays—No Substitutions*

**Walter Rowan Battery Supply Company**  
223 N. Peoria St. Chicago, Ill.



**SM**

Silver-Marshall Headquarters  
A. C. Shielded Six  
A. C. Laboratory Super Unipacs

## A REAL BARGAIN!!

# FILTER CONDENSERS

Manufactured by Dubilier Condenser & Radio Corp.

1 1/4 mfd. 1000 volts rated D. C. Working Voltage, SPECIAL AT.....	<b>\$1.35 ea.</b>
7 mfd. 600 volts, rated D. C. Working Voltage, SPECIAL AT.....	<b>3.50 ea.</b>
3.9 mfd. 900 volts rated D. C. Working Voltage, SPECIAL AT.....	<b>\$2.70 ea.</b>

Manufactured by Stromberg-Carlson Tel. Mfg. Co.

3 1/2 mfd. 600 volts rated D. C. Working Voltage, SPECIAL AT.....	<b>\$1.75 ea.</b>
---	-------------------

All of these High Quality Filter Condensers, are brand new, and guaranteed as rated. They are excellent for use in your Eliminator or Experimental Work.

**AMERICAN SALES CO., 21 Warren St., N.Y.C.**



Tell 'Em You Saw It in the Citizens Radio Call Book Magazine



"Marvelous!" "Unbelievable!" "What a Bargain!" Every day we receive scores of letters from users of the amazing new Roll-O "B" Battery Eliminator praising this invention to the skies. It does all that any higher priced "B" Eliminator can do—and more!

### Read This Proof!

I have received the Roll-O "B" Battery Eliminator and I am greatly pleased with it. We did not know we had a good radio till we hooked up your Eliminator. To me it is a 100% perfect Eliminator.  
Detroit, Mich.

I received the Eliminator and will say that its performance is all I could ask.  
Waterman, Cal.

I have your "B" Eliminator and like it very much.

So far it has given me very good service.

Perth Amboy, N. J.  
Recently received a "B" Eliminator. Works fine.  
Akron, Ohio.

The eliminator is working perfectly.  
Louisville, Ky.

Your "B" Eliminator received and worked satisfactory. Please send me another one at once. Do you give agencies for local counties? I can sell several of these here.  
Zanesville, O.

Names on request.

### Forget Battery Troubles Forever

All you do is hook up this Roll-O Eliminator to your set and sit back to the greatest radio pleasure of your life. No more batteries to worry about. Enjoy better reception, sharper tuning. Don't worry because "B" batteries run down and spoil the reception of your set.

### Operates on All Sets

Works perfectly on any direct or alternating current, giving up to 90 volts and using full wave of the power supply. Hooks up in a moment to any set up to six tubes. Constant voltage assures more power.

### Completely Equipped—No Extras to Buy

Five minutes after you receive this Eliminator you can be enjoying its advantages. Comes to you completely equipped, together with simple,

easy instructions. Made to last years. Solidly built in beautifully finished metal case with genuine Bakelite top.

### Order Today—10 Days Trial

Now, for no more than the cost of good "B" batteries you can own a Roll-O Eliminator that will make batteries unnecessary forever. Pin a dollar bill to coupon and mail today. Postman will deliver Eliminator to you. Deposit \$6.95 (plus few cents postage) with him. Use Eliminator 10 days. If not delighted with results, return it within ten days and receive your money. Don't delay. Act quick to become one of the thousands of enthusiastic users.

### Trickle Charger, \$3.95

Charges "A" or "B" batteries using ordinary house current. Hooked to your "A" battery gives complete "A" power unit. Send \$1.00 with order. Pay \$2.95, plus few cents postage, to postman when he delivers your charger (C. O. D.). Use for ten days. If not more than satisfied, return it and get your money back.

**Send \$1 with this Coupon**  
**only!**

The Roll-O Radio Co.,  
Dept. B-203,  
3rd and Sycamore Sts.,  
Cincinnati, Ohio.

Gentlemen: I attach \$1.00. Please send Roll-O Eliminator to me C. O. D. for \$6.95 (plus a few cents postage) on special 10-day Trial Guarantee.

Name.....

Address.....

Town.....State.....

## THE ROLL-O RADIO CO.

Dept. B-203, 3rd & Sycamore St., Cincinnati, Ohio

Tell 'Em You Saw It in the Citizens Radio Call Book Magazine

## The Madison-Moore International One Spot Specifies Camfield Equaltune Condensers

Camfield Condensers are again specified! Equalizing adjustment device makes them unequalled for accuracy, mechanical design, electrical efficiency, workmanship and general utility. They look the part, too—as handsome a job as you ever saw.

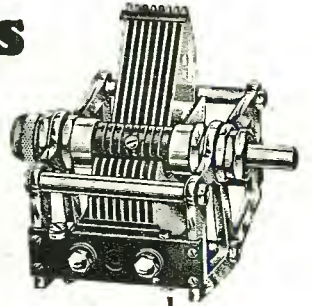

### A TRIBUTE TO A LEADER

That's the reason why Camfield condensers are so popular. They are the selection of leading circuit designers and are officially specified for the Camfield Super-Selective-9 and 10, Tyrman Ten, Madison Moore, Citizens Super-8, Duoformer-7, Duoformer-5, Thompson Super-7, and many other circuits.

Leading jobbers and dealers supply Camfield's. No other condenser will give such remarkable service.

Write for Free Booklet, "Wherever You Require Quality"

### Camfield Radio Manufacturing Company

35 E. Wacker Drive

Dept. CBI

Chicago, Illinois

Type No. 501  
Price \$6.00 each

# 1928 Wholesale RADIO Catalogue

## FREE

**136 Pages of Illustrated Wholesale Bargains**

Just off the press—our new **wholesale catalog** of everything in Radio. The most complete illustrated catalog of quality Radio merchandise ever found in one book. It comprises the entire line of all the popular **Nationally advertised** radio sets, accessories, parts and kits—particularly all the latest features shown in this and previous issues of this magazine. Rock-bottom prices on each item. **Electric Sets—6, 7 and 8 tubes, also non-electric sets.** Astonishing values in "A" Eliminators, "B" Eliminators, loud speakers, chargers, cabinets, consoles, kits and parts. For immediate shipment.

**Values That Will Astonish You—The Latest Kits, Power Packs, Parts and Accessories**

Also how to make your old sets electrically operated at very low cost. Here's quality radio merchandise at extraordinary low prices. No dealer can afford to be without this book—a veritable clearing house for radio needs. Be sure and get your copy! **We are pioneers in radio and deal in radio exclusively.** Only our tremendous purchasing power makes these extraordinary values possible. Write for this **FREE** catalog **NOW.**

**HAMILTON-CARR CORPORATION**  
711 West Lake St., Dept. 249 • Chicago, Ill.

## A RADIO technician will invariably obtain his apparatus at Wireless Egert. There's a reason! We employ only commercial and amateur licensed operators as our salesmen.

Purchase a good piece of apparatus the first time and save buying twice.

We carry complete lines of

Acme	Amertran	Cardwell	Daven
General Radio	Hammarlund	Karas	
Samson	Silver-Marshall	Thordarson	
Ward-Leonard		Yaxley	

# Q. S. T.

## Short Wave and Transmitting

Let us furnish you, FREE, a complete short wave and transmitting catalogue. This catalogue embodies all standard merchandise used in short wave and transmitting work of the present day. Discount quoted upon request. Mail Orders Promptly Filled.

179 Greenwich Street  
New York  
N. Y.

Tel. Cortlandt  
5275-2085

Write us for our special prices—mail orders promptly filled

## Send for this New Book free

Every new radio development is shown in this big catalog, including such hook-ups as the Tyrman Ten, 9 In Line, Camfield, Silver-Marshall, Karas, Carter, Aero Seven, and numerous others. All nationally advertised radio parts and accessories are listed and described. Everything worth while in Radio now in stock and ready for shipment. Orders filled and shipped same day they are received. Lowest prices given to Set Builders and Dealers. Write today for this catalog.

**MILLER-WELLES CO.**  
20-C West Kinzie Street Chicago

## SEND FOR FREE CATALOG

From Chicago's Oldest Radio Jobbers  
The Most Valuable Radio Catalog

**GREATER** — **BETTER** — **VALUES**

WRITE FOR YOUR COPY TODAY  
SEE WHAT YOU SAVE

**New Kits Featured Include:**  
Aero—Bodine  
Camfield—Citizens  
H-F-L—Infradyne  
Karas—Melo  
Heald—Scott's  
Silver Marshall  
St. James—Tyrman  
Etc.

Everything new and desired—all under one roof. You don't need to look elsewhere. Complete stock carried.

Est. 1918

**Prompt Efficient Dependable Service**

**TELEPHONE MAINTENANCE CO.**  
123 S. Wells St., Dept. 45 Chicago, Illinois

## CHICAGO'S OLDEST RADIO HOUSE

WHOLESALE ONLY

Tell 'Em You Saw It in the Citizens Radio Call Book Magazine



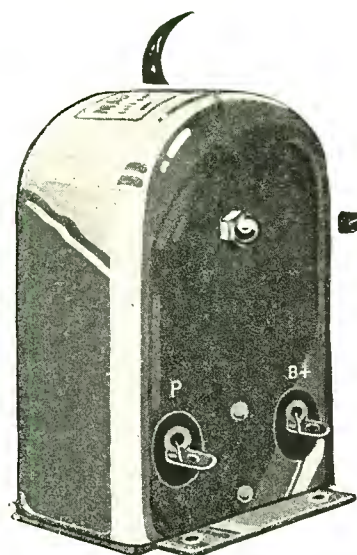

Type AC Madison-Moore International  
One • Spot Batt'ry-less Transformer

# Marvelous!

—describes the new conception you  
get of radio reception with the

## Madison-Moore INTERNATIONAL ONE • SPOT Batt'ry-less Transformer

For Use with the New Alternating Current Tubes

WITH this remarkable new Madison-Moore Transformer, you may successfully build a receiving set to operate on alternating current. It eliminates all A, B and C batteries, because connection is made with the light socket.

Reception is truly marvelous in the delicate shading of tones in the extreme sensitivity to weak signals and the utmost selectivity without sacrifice of tone quality.

Should an improvement in circuit necessitate a change in this type A. C. transformer, such change will be made free of charge in our laboratory. The only cost to you will be postage for transportation.

[ Just as the previous Madison-Moore One • Spot Transformer set a new high standard of perfection for battery-operated sets, so this New Batt'ry-less Instrument has created, for the first time, supreme results for its type. ]

If you would KNOW superior radio efficiency, build a set with these new Units. Your radio dealer should have them ready for delivery. If he can't supply you, send to us.

MADISON-MOORE RADIO CORPORATION  
2524 K. Federal Boulevard  
Denver, Colorado - U. S. A.

# MADISON~MOORE

*The Finest RADIO APPARATUS in the World!*

Tell 'Em You Saw It in the Citizens Radio Call Book Magazine

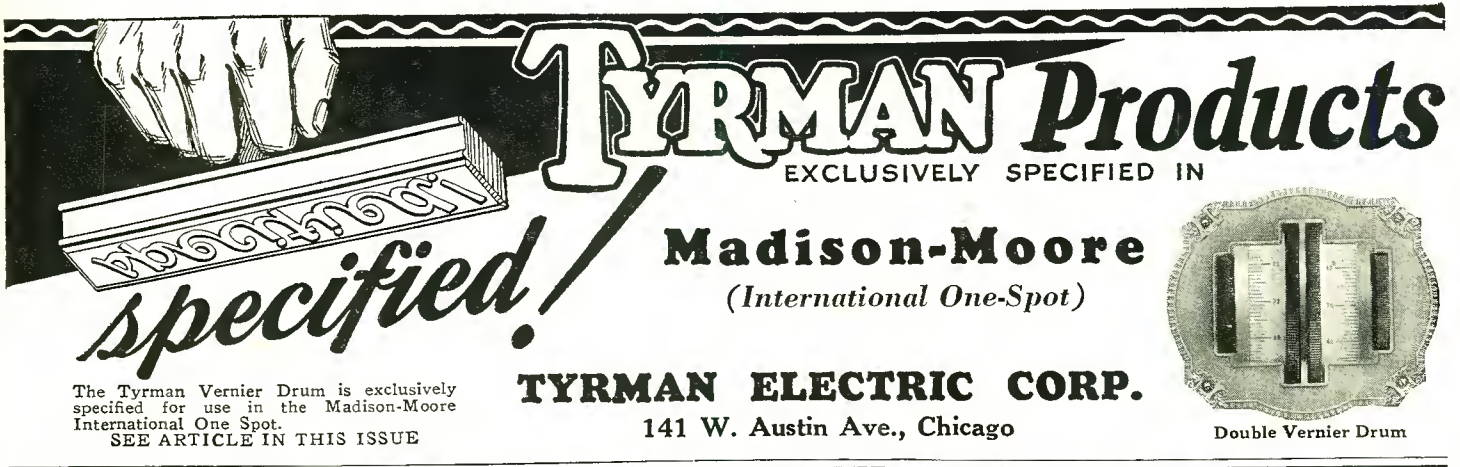

# TYRMAN Products

EXCLUSIVELY SPECIFIED IN

## Madison-Moore

(International One-Spot)

### TYRMAN ELECTRIC CORP.

141 W. Austin Ave., Chicago

Double Vernier Drum

specified!

The Tyrman Vernier Drum is exclusively specified for use in the Madison-Moore International One Spot.  
SEE ARTICLE IN THIS ISSUE

# CARTER

## PARTS

Standard Since 1922

Specified—as usual—in these circuits as described in this issue

Camfield 10	La Peer AR-9
Tyrman Ten	Silver AC Shielded Six
Improved Aero-dyne 6	
Camfield Shielded Grid 7	
AC Laboratory Model Super	

Carter originality and latest up-to-the-minute design has long been recognized by the leading manufacturers in the industry.

*Carter reputation is your strongest guarantee*

See the new Carter line of

Fixed Condensers	110 Volt Power Switches
Resistors for AC Tubes	Automatic Power Switches
"IMP" Short Jack Switches	Resistances for "B" Eliminators
Vitreous Enamel Resistors	

Write for illustrated folder showing over 300 different parts.

The most complete line of up-to-date radio parts in the field.

In Canada: Carter Radio Co., Ltd., Toronto  
Offices in Principal Cities of the World

**Carter Radio Co.**  
CHICAGO, ILL.

MEMBER  
RMA

# FREE!



**BIG Discounts**

## Before You Buy Any Radio

Receivers, kits, power units, antenna equipment, electrical supplies, consult this catalog. In it you will find all the latest material, nationally advertised in the Citizens Call Book and other radio magazines—all at the Lowest Dealers Wholesale Prices.

### Big Stocks on Hand Ready to Ship

All the popular kits, Tyrman, 9 in Line, Karas, Browning-Drake, Hammarlund, Victoreen, St. James, etc.

All the leading power units, Sentinel, Majestic, Balkite, Raytheon, Sterling, Modern, Tungal, Philco, etc.

Leading nationally advertised Radio Receivers.

*Send for This BIG Dealers' Catalog—  
It Is Yours FREE—Write for It*

**Midland Wholesale Company, Dept. CB**  
5116 Ravenswood Ave., Chicago, Ill.

Confidential  
Dealers  
Wholesale  
Catalog

## A BARREL of RADIO SURPRISES

### EVERY MONTH

Dealers Write for

CO-OP MONTHLY

Net price catalog of radio and electrical devices and appliances.

### Co-Op Electric Supply Co.

33 N. Union Street CHICAGO, ILL.	80 39th Street BROOKLYN, N. Y.
-------------------------------------	-----------------------------------



## RADIO

Parts Dealers,  
Professional  
Set Builders  
and  
Schools and Colleges

Should first get our free 400 page Radio Catalog, illustrating the products of over 100 radio manufacturers. Parts and accessories for all the latest circuits.

"Distributing Radio Since 1919."

### F. D. Pitts Company

219-223 Columbus Ave.  
Boston, Mass., U. S. A.

"The Oldest and Largest Radio Distributor in the  
New England States"



*Tell 'Em You Saw It in the Citizens Radio Call Book Magazine*

**Amateurs  
in  
More Than  
75  
Countries  
!**

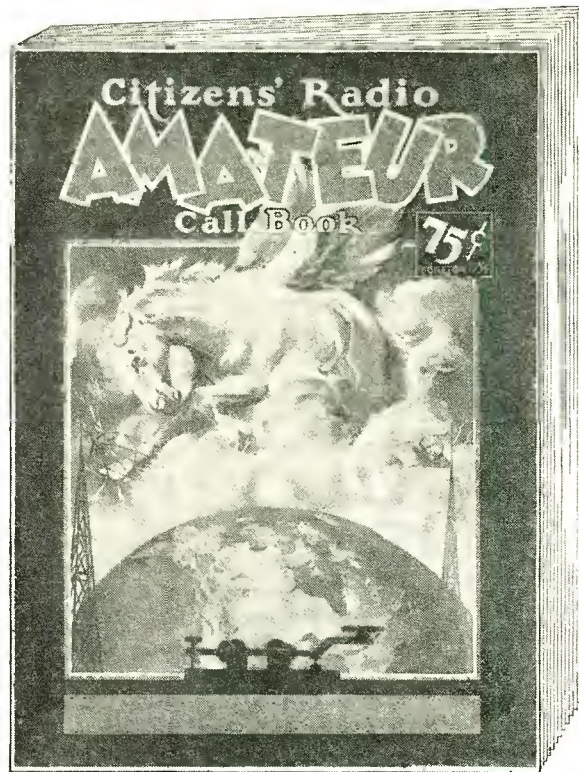

**September  
1927  
Book  
Just Out  
!**

Did you like the MARCH number? Well, you "ain't seen nothin' yet." The new SEPTEMBER edition has all the new stations licensed since the previous book, over 75 countries listed, with 9FO QRA Service now covering the whole world.

The Commercial Land and Ship section is back again, bigger and better than ever, with all calls listed alphabetically AAA to ZZZ.

Other new features include a table of postage rates to foreign countries, and many new operating helps that are of value to operators the world over.

Use the blank below, and start off with this big new number.

**Citizens Radio AMATEUR Call Book**  
508 So. Dearborn Street, Chicago

Date.....192.....

Please enter my subscription to the CITIZENS RADIO AMATEUR CALL BOOK. Enclosed please find \$2.00 in full payment (U. S. and Canada \$2.00, Foreign \$2.25).

Published March first, September first and December first—three times yearly.

Name.....

Address.....

State.....

Do not send currency unregistered. Will accept U. S. stamps of small denominations.  
Start subscription with issue checked:  September  December  March

*Tell 'Em You Saw It in the Citizens Radio Call Book Magazine*



# Build the KN CKERBOCKER "4"

## The Wonder Set of Radio

### AND ENJOY MARVELOUS RESULTS



2 Karas Harmonik Audio Transformers, used in the KNICKERBOCKER "4", insure its tremendous volume. Price, each, \$5.

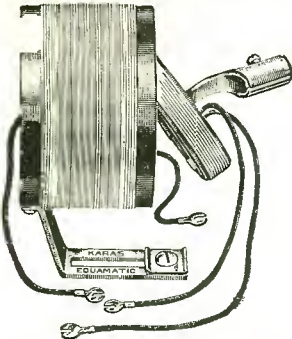

The Karas 3-Circuit Inductance is the heart of the KNICKERBOCKER "4". Price, \$5.50. This circuit also utilizes 1 Karas Equamatic Inductance Coil, price \$4.00.

TO get a new thrill out of a radio receiver build the KNICKERBOCKER "4", The Wonder Set! Here is a four tube Karas circuit that does things we have never before seen a 4-tube accomplish. It has tremendous volume. It pulls in the distant stations every time. It has a rich, pure, beautiful tone. And it is one of the simplest receivers to operate that was ever designed. In the KNICKERBOCKER "4" all of the adjustments of the detector circuit are automatically handled by simply turning the dial of the tuning condenser. Both the Karas 3-Circuit Inductance and the Karas Condenser are automatically, accurately and instantly adjusted by this simple operation.

KNICKERBOCKER "4" volume is due to Karas Harmonik Audio Transformers. Two of these are used. The marvelously sharp tuning of this great circuit lies in the use of Karas Orthometric Straight Frequency Line Variable Condensers, controlled by Karas Micrometric Vernier Dials. But the heart of the KNICKERBOCKER "4" is the Karas 3-Circuit Inductance, used in the detector circuit in conjunction with the Karas Extended Shaft Orthometric Condenser.

Build this great receiver today. To do so you will require the following Karas Parts, plus certain standard parts easily obtainable anywhere:

- 2 Karas Orthometric .00037 Extended Shaft Condensers.
- 2 Karas Harmonik Audio Transformers.
- 1 Karas Equamatic Inductance Coil.
- 1 Karas 3-Circuit Inductance.
- 2 Karas Micrometric Vernier Dials.

You can easily and quickly build the KNICKERBOCKER "4". The first step is to mail the coupon below for detailed instructions, blue prints, etc. Do this NOW. Then see your dealer about the necessary Karas and other parts for this receiver.

#### Mail Coupon for Complete Information

Sign, tear out and mail the attached coupon and we will send you complete information about the KNICKERBOCKER "4", full size blue prints, all necessary wiring instructions, etc. All sent FREE on request. Write us for these today.

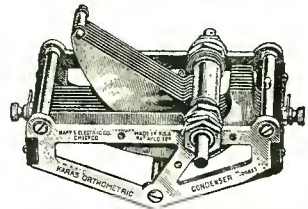

2 .00037 mfd. Karas Orthometric Extended Shaft Variable Condensers are used in the KNICKERBOCKER "4". Price, each, \$7.00.



2 Karas Micrometric Vernier Dials are used in the KNICKERBOCKER "4". They are marvels of precision control apparatus. Price, each, \$3.50.

KARAS ELECTRIC CO.  
4026-K North Rockwell St., Chicago

Send me complete information about the KNICKERBOCKER "4", together with blue prints, wiring instructions, etc.

Name.....  
Street Address.....  
City..... State.....

**KARAS ELECTRIC CO.**  
4026-K North Rockwell St. Chicago, Ill.

## IT'S HERE!

### You Will Like It—and Profit!

# THE WORLD'S GREATEST

## RADIO CATALOG

Now Free—Send for your copy today!

The best in Radio—at a big saving—all under one roof. You don't need to look elsewhere. Contains all the information you need.

Complete stock carried. Prompt, efficient, dependable service, always.

Established 1918

TELEPHONE MAINTENANCE CO.  
123 S. Wells St., Dept. 46 Chicago, Illinois

### CHICAGO'S OLDEST RADIO HOUSE

WHOLESALE ONLY

### BIG NEW CATALOG FOR RADIO BUILDERS

FREE My big 1928 Radio Catalog, Call Book and Trouble Finder. 132 pages about Radio. Chock full of newest circuits—kits, transmitter parts, short wave outfits, eliminators and speakers. Thousands of bargains at lowest wholesale prices. A regular Radio Encyclopedia—Free. Write today.

American Auto & Radio Mfg. Co.  
HARRY SCHWARTZBERG, PRES.  
Dept. 165 American Radio Bldg., Kansas City, Mo.

We Handle All Parts for KNICKERBOCKER FOUR and the 2-Dial Karas Equamatic

LATEST RADIO CIRCUITS

### Blackburn Ground Clamps

Telephone companies using MILLIONS. Adjustable—fits any size pipe. Requires no pipe cleaning—screw bores through rust and scale. Send 12 cents for sample and postage.

BLACKBURN SPECIALTY CO.  
1968 E. 66th St. Cleveland, Ohio

ATTENTION~ SET-BUILDERS AND DEALERS~

LET US FURNISH YOU FREE the most complete radio catalogue on the market today.

We can furnish parts specified in the CITIZENS RADIO CALL BOOK.

We Carry the Following Lines—Also Many Others

Acme	Tyrman	Kingston	Hammarlund	Accusti-Cone	Kodel
Aero	Corbett	Victoreen	Perryman	Clarostat	Karas
Tobe	Bodine	Thordarson	Sterling	Benjamin	Marco
QRS	National	Centralab	Sangamo	Yaxley	Lynch
Eby	Jewell	Camfield	Silver Marshall	Samson	Reimler

EVERY SET BUILDER AND DEALER should have the NEW SIMPLEX RADIO CATALOGUE

THE SIMPLEX RADIO SUPPLY COMPANY  
3319 Washington Blvd., St. Louis, Mo.  
Wholesale Only

# Free

100 PAGE CATALOG

## SET BUILDERS!

### A Complete Line of

The Very Latest KITS and PARTS  
STANDARD APPLIANCES  
STANDARD PARTS  
Get the Lowest Prices

← FROM THIS BOOK Write for it!

WHOLESALE ONLY

# Paramount

ELECTRICAL SUPPLY COMPANY  
602 W. Adams St., Dept. 58, Chicago

Tell 'Em You Saw It in the Citizens Radio Call Book Magazine

# 2-DIAL KARAS EQUAMATIC



*The Perfectly Balanced and Completely Neutralized 5-Tube Receiver De Luxe*



2 Karas Type 28 Audio Transformers are used in the 2-Dial Equamatic. Price, each \$8.00.

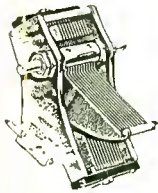

3 Karas S. F. L. Variable Condensers, with removable shafts, are used in the 2-Dial Equamatic. Price, each, \$5.25.



The new Karas Output Filter, price \$8.00, is used in the 2-Dial Equamatic.

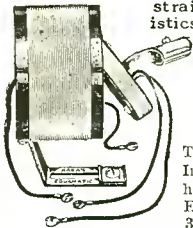

The Karas Equamatic Inductance Coil is the heart of the 2-Dial Equamatic. Per set of 3 coils, \$12.00.

Output Filter, responsible for its clear, sweet, pure tone. And Karas Inductance Coils and Micrometric Dials combine to give perfect, hair-line precision tuning at all broadcast wave lengths.

2 Karas Micrometric Vernier Dials give 1/1000th of an inch regulation to the 2-Dial Equamatic. Price, each, \$3.50.

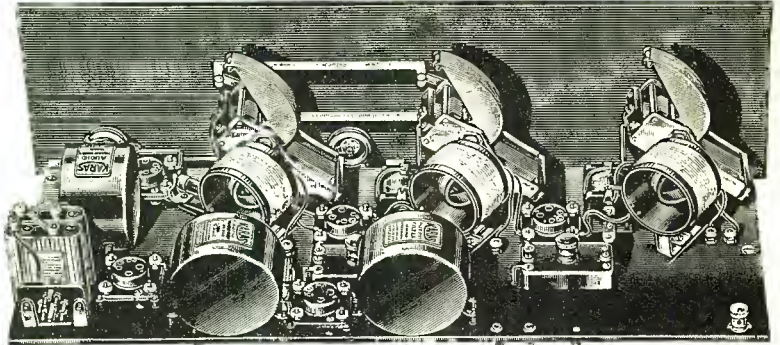

### Build This Marvelous Receiver Today!

See your dealer today about the necessary Karas and other parts you will require in building the 2-Dial Karas Equamatic. Plan to build this receiver at once, so that you may enjoy the perfect reception it gives, plus its marvelous simplicity of operation. To secure full-size blue prints and all necessary wiring instructions you have only to fill out and mail the coupon below. Do this today. All of this material will be mailed you FREE on request.

**KARAS ELECTRIC CO., 4026-K N. Rockwell Street, CHICAGO**

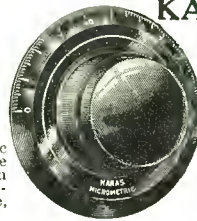

**KARAS ELECTRIC CO.,**  
4026-K N. Rockwell St., Chicago

I'm interested in building your new 2-Dial Equamatic Receiver. Send me complete information, blue prints, and all instructions.

Name.....  
Street Address.....  
City..... State.....

*Selected for the Season's Best Bets in All Kinds of Sets*

## YAXLEY APPROVED RADIO PRODUCTS

*Assure Enduring Reliability in Set Operation*



### Automatic Power Control

Switches on the B eliminator and cuts out the trickle charger when you turn on the set. The B eliminator is cut out automatically and the trickle charger cut in when the set is turned off. Controls both B eliminator and trickle charger in combination or switches either eliminator or charger separately when either is installed alone.

No. 444—Series Type.....\$5.00



### Cable Connector Plug

Just take this article in your hands but once and you will be completely sold on its many merits. It will enable you to turn a messy maze of battery connections into one neat, compact, good looking job. Has polished Bakelite plug with phosphor bronze contact springs that assure positive contact at all times.

No. 660—Cable Connector Plug, complete.....\$3.00

No. 670—For Binding Post Connections, complete.. 3.50

### Air-Cooled Rheostat

This Rheostat possesses a smooth, quiet action, with an extremely close adjustment that permits building up of filament voltage to just the right point and keeps it there throughout reception. Base is of Bakelite, as is also the knob furnished with every Rheostat.

Air-Cooled Rheostat—2 to 100 Ohms.....\$1.35



### Midget Battery Switch

An efficient filament control switch. Quick make and break. Furnished complete with "Off" and "On" Plate as illustrated. This switch is standard equipment in over a million of the best sets in use today.

No. 10—Midget Battery Switch.....50c



### Radio Convenience Outlets

These Convenience Outlets make it easy to have the radio set in one room and the batteries in the basement or closet, and one or more loud speakers in any distant room of the house. Plug for battery connections cannot be inserted incorrectly.

No. 135—For Loud Speaker.....\$1.00  
No. 137—For Battery Connections..... 2.50  
No. 136—For Aerial and Ground..... 1.00

*Featured in Many of the Most Prominent and Popular Hookups*

### INCLUDED IN THIS ISSUE

Browning-Drake  
Improved Aerodyne 6  
Lincoln

Thompson Super 7  
Knickerbocker 4  
Magnaformer

Tyrman 10  
Six-In-Line

Madison-Moore International One Spot  
Victoreen

at Your Radio Dealer

**YAXLEY MANUFACTURING COMPANY, Dept. C, 9 So. Clinton St., Chicago, Ill.**

*Tell 'Em You Saw It in the Citizens Radio Call Book Magazine*

*famous "Perfect"* **ONLY**  
**"B" BELIMINATOR** \$ **4.75**  
*Complete*

**Operates Splendidly**  
**On Any Type of Set**

This wonderful new invention, using a special filter circuit, developed after months of experimenting, gives a uniform and constant flow of power that you cannot get from batteries. Special counterpoise effect minimizes "fading" and static. Can be plugged in to any kind of set up to seven tubes.

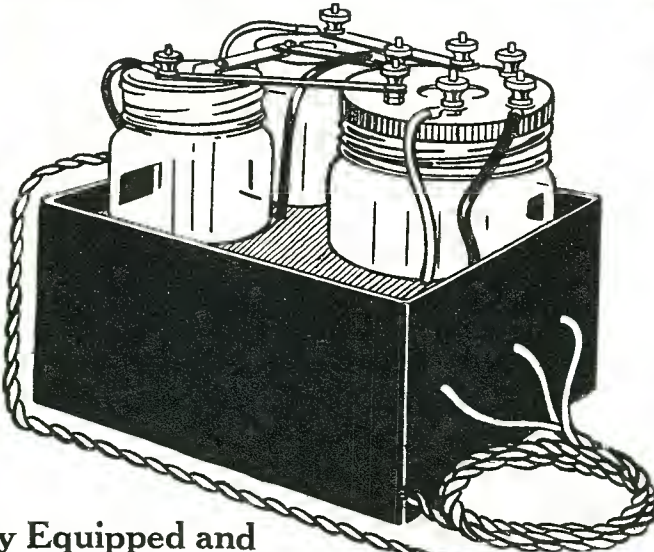

**Must Delight You—or Your Money Back**

Here's the announcement you have been waiting for. The amazing new "Perfect" "B" Battery Eliminator makes "B" Batteries obsolete. Costs much less than a set of cells (it's by far the lowest priced Eliminator ever offered) and it ends plate current troubles forever.

**Completely Equipped and Assembled—Nothing Else to Buy**

No "extras" of any kind to buy. The amazingly low price—\$4.75—covers everything. No "bulbs" to break or wear out. No moving parts. A solidly built, permanent addition to your set, all ready to plug in. Works perfectly on ordinary house current, either alternating or direct. Gives power up to 90 volts, using the full wave of the power supply. Operates any set up to seven tubes.

**Hooked Up in 60 Seconds**

No mechanical knowledge necessary to connect the "Perfect" Eliminator. Hook it up just as your old batteries were connected. And then sit back and get the greatest radio thrill you've had in years. Nothing to do but enjoy the music. No "frying" noises caused by run-down cells. Sharper tuning—more power because of the steady, powerful flow of current through the tubes.

**Needs No Attention**

Once hooked up it works automatically. Just attach it and forget it. Milliampere supply twice as great as any other Eliminator. Only our direct sale method, cutting out the retailers' and jobbers' profits, makes this amazingly low price possible.

**You Take No Chances**

Thousands of enthusiastic users all over the country testify to the quality of "Perfect" Eliminators. And our absolute Money-Back Guarantee makes you the sole judge. If, for any reason, you are not satisfied, simply return your Eliminator in good condition within ten days after you receive it and we will refund your money.

Reference:  
 Pearl Market Bank, Cincinnati

**RUSH ORDER TODAY—TEN DAYS' TRIAL**

Pin a dollar to the coupon and mail it to us today. The postman will deliver you "Perfect" Eliminator within a few days. Pay him the balance due (\$3.75 plus a few cents postage). Plug in the Eliminator and use it for ten days. If not more than satisfied with results, return it and get your money back. Act NOW and become one of our thousands of enthusiastic users.

**PROOF!\***

"We did not know what a good set we had until we hooked up your Eliminator. It is indeed a 'Perfect' instrument."  
 \_\_\_\_\_, Louisville, Ky.

"All my friends are asking about my 'Perfect.' It makes my set work better than batteries ever did."  
 \_\_\_\_\_, St. Louis, Mo.

"I was doubtful about an Eliminator at your astonishingly low price. But you certainly do deliver the goods. I congratulate you on the quality of the device and wish you success."  
 \_\_\_\_\_, New York, N. Y.

\*Names of writers on request.

PERFECT ELIMINATOR CO.,  
 CM-1 National Theatre Bldg.,  
 Cincinnati, Ohio.

I attach \$1.00. Please send "Perfect" Eliminator to me C. O. D. for balance (\$3.75 plus a few cents postage) on your Guarantee as stated above.

Name.....  
 Address.....  
 Town.....State.....

**Perfect Eliminator Co.**  
 CM-1 National Theatre Building Cincinnati, Ohio

Tell 'Em You Saw It in the Citizens Radio Call Book Magazine

# LOOK!

Everybody uses Tubes—now's the chance to pep up your set with new Tubes.



For a limited time the publishers of the Citizens Radio Call Book Magazine will give one genuine CeCo Tube with each one year's subscription.

List price of tube is \$1.75, therefore your subscription costs you nothing, as the subscription price is only \$1.75 per year. This offer is for a limited time only—so rush your subscription in at once. No limit to number of tubes—one for each one year's subscription—two tubes for a two year subscription or two single subscriptions; three tubes for three year subscription or three single yearly subscriptions, etc. These tubes are genuine first quality and guaranteed.

Use the coupon below. Send check, money order or currency (register currency). Regular subscription price, one year, \$1.75. On this offer one A type CeCo Tube with each yearly subscription.

### COUPON

Citizens Radio Call Book Magazine  
508 S. Dearborn St., Chicago, Ill.

Please enter my subscription for.....

year(s) and send me.....genuine A Type CeCo Tube(s) as premium. I

inclose \$..... full payment for same.

Start subscription with:  January,  March,  September,  November

Name.....

Address.....

City.....State.....



*I want every set-builder and dealer to have a copy of this 116 page wholesale radio catalog*  
Sumner Harris

President  
The Harco Co.

SETS—KITS—PARTS  
ACCESSORIES AND  
FURNITURE—

Everything for the  
Radio Dealer and  
Set Builder

FREE  
CATALOG



### COUPON

Date.....

THE HARCO COMPANY  
1259 So. Wabash Ave., Chicago, Ill.  
Gentlemen: Please send me your free catalog.

Name.....

Address.....

City..... State.....

DEALER  SET BUILDER  AMATEUR

Tell 'Em You Saw It in the Citizens Radio Call Book Magazine

Dependable Blueprints in Each Issue  
 Monthly Corrected Broadcast Station List  
 Timely Construction Articles, Clearly Illustrated  
 And Two New Departments:  
*Everyday Mechanics and Current Science*

# RADIO AGE

(Established 1922)

THE ORIGINAL BLUEPRINT MAGAZINE

Radio experimenters, always keen on the trail of new developments in the theory and practice of radio transmission and reception, are naturally interested, too, in the mysteries of modern mechanics and science generally. For this reason the pages on these two subjects, culled from the best sources in the country, give the magazine a vastly increased appeal.

These two departments have not resulted in any reduction in the departments devoted to radio and, as for years past, Radio Age continues to give thousands of home-radio constructors the latest and best in hook-ups, with full constructional data.

Radio Age made a country-wide impression with its fine series on the World's Record Super Eight and the same circuit with nine tubes. Ask your friend who has built a set from Radio Age data. Always up-to-date and always clear and interesting.

Twelve issues a year for \$2.50. **Special rate on two years' subscription, \$4.00, and three years' subscription, \$5.00.**

-----SEND IN YOUR SUBSCRIPTION TODAY-----

Radio Age, Inc.,  
 500 North Dearborn St.,  
 Chicago, Ill.

**\$2.50 a Year**

Gentlemen:

Please enter my subscription for RADIO AGE, the Magazine of the Hour, for <sup>One</sup>Two year(s) beginning with the  
 .....issue, for which I enclose <sup>\$2.50</sup>4.00. (Please underline subscription term desired.)  
 .....5.00

Name.....

Street Address.....

City..... State.....

(Send cash, money order, or draft.)

CRCB

Tell 'Em You Saw It in the Citizens Radio Call Book Magazine



# Shanco

Grip-tite

## Battery Clips

4 Sizes

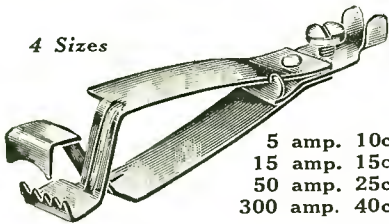

- 5 amp. 10c
- 15 amp. 15c
- 50 amp. 25c
- 300 amp. 40c

**S**HANCO Griptite Battery Clips assure free and uninterrupted flow of electrical current. There are no springs to heat up, burn or drop out. Made of powerful-tension, tempered spring steel, solidly riveted together, with all parts electro lead plated before assembly. This uniform lead coating is positive assurance against corrosion at the joints. Acid-resisting. Jaws open wide and are easily applied. The Griptite bulldog teeth are so arranged that the clip cannot fall over and "short" the battery. Terminals are wide and screws amply large for cable connections. No parts of Shanco Clips can be lost or displaced—everything is one compact, solidly built unit. Shanco Clips will last longer and give greater satisfaction.

At all good radio stores and battery stations, or order direct from this advertisement, giving dealer's name. Dealers and jobbers write for discounts and special proposition.

**Shanklin Manufacturing Company**  
Dept. 22-A, Springfield, Illinois

# A Complete to your Radio Set

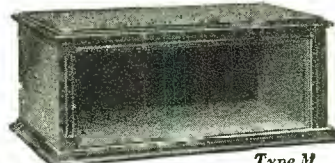

Type M

Any radio owner may well be proud of his set installed in a Signal Cabinet. In either Walnut or Mahogany finish, Signal Cabinets are attractive and add beauty to the set. And, these cabinets are as carefully built as the set itself. All wood is properly matched to secure the fine grain so well known and distinctive in Signal Cabinets. All Signal Cabinets have the same high gloss lacquer finish.

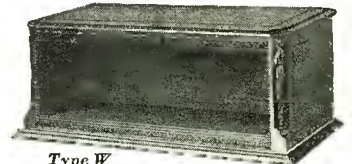

Type W

### Wireless Sets and Keys



The Signal Wireless Practice Sets are just the instrument for beginners. The code is printed on a little brass plate fastened to the base. Set is complete in detail, high grade key, true tone adjustable high pitch buzzer.



The Signal Buzzer has standard resistance of 2 ohms. Same buzzer as on practice set. Black crystallized lacquer finish.

Signal Wireless Keys are strongly made with coin silver contacts. Brass parts polished and lacquered. Very reliable units.

Call for Signal Radio products from your dealer—and get real satisfaction.

**SIGNAL ELECTRIC MFG. CO.**  
MENOMINEE, MICHIGAN  
"Electrical Manufacturers Since 1890"

### DEALERS

Signal Radio products are proving profitable items for hundreds of dealers. It is a real dealer's line that makes good in every way with the customer. Signal Cabinets are especially attractive for dealers. Write for our sales co-operation plan and discounts.

# FREE Wholesale Radio Catalog

SEND FOR THIS GREAT BOOK

Compiled exclusively for dealers in radio sets, radio parts, and for set builders. An Amazing Catalog containing the newest things in the world of radio.

Unbeatable values in Radio Parts, Kits and Supplies of National Fame. A complete array of cabinets and consoles, in all latest styles, finishes and popular sizes, at Unmatched Prices.

The high quality of our products eliminates loss. Large stocks offer you large selection. Our speedy shipments insure your customers' good will and bigger profits for you.

Silver Marshall A. C. Parts in Stock. 630A Kit, retail price, \$99.00; 652A Kit, retail price, \$36.50. Liberal discounts to the trade. Immediate delivery.

### SHORT WAVE SECTION

Our catalog contains a section devoted to a showing of the highest grade short wave receiving and transmitting apparatus. Also the finest electrical appliances for use in the home.

Shure Service means sure profits. You can take orders direct from our illustrated list price catalog. Whatever your radio needs may be, you will find them in our 1928 catalog. Write for a copy TODAY.

**SHURE RADIO COMPANY** 339T West Madison St. CHICAGO, ILLINOIS

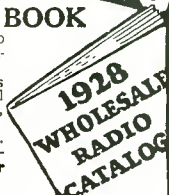

# The Famous De Land One Spot R. F. Transformer



Today we are making a transformer that has a higher gain per stage, more uniform frequency and amplification characteristics than any other One Spot Transformer on the market.

There is no oscillation when using these perfectly matched units in an approved circuit.

At your local dealer or write us

**DeLand Radio Manufacturing Company**  
780—29th Street Milwaukee, Wisconsin

# Workrite Cone Speaker

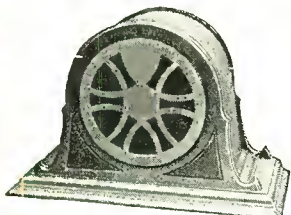

The new WORKRITE SPEAKER is built from start to finish on the latest scientific principles. It has TWO standard sized magnets which gives greater undistorted volume with the same input that can be obtained with the ordinary speaker. Has complete built-in filter. The outer edge of cone is supported by soft leather to eliminate rattles. The baffle pan eliminates echos. The volume and pure tone quality is absolutely unsurpassed. Just TEST A WORKRITE against others and see.

- WORKRITE TYPE A (as illustrated) .....\$32.00
- WORKRITE TYPE B (in plain box) ..... 20.00

Manufactured by  
**United States Electric Corp.**  
Workrite Division  
1812 E. 30th St., Cleveland, O.

Sales Dept.  
**The Zinke Company**  
1323 S. Michigan Ave.  
Chicago, Ill.

# \$2

brings this

**Amazing Discovery For Any Radio**

**SATISFACTION GUARANTEED**

# Get Distance

Why confine your radio programs to a few local stations when the expensive concerts, dance music and lectures of hundreds of big cities are ready for you? With every order for our treatise, "The Distance Getter," we include FREE our wonderful new Distance Transformer. Tune your set according to our special instructions and presto—more the distant stations call!

**MAIL COUPON TODAY**

Your money instantly refunded if you are not satisfied. The attachment furnished free with the "Distance Getter" alone is worth the price. "Results beyond all expectations. Cuts thru local stations like a knife," writes Galloway of Chicago, Ill. "Send three more for my friends. I get Denver and Calif. easily," says Homes, Palos, Ill.

**HAZLETON LABORATORIES**  
4554 Malden St., Dept. X, Chicago, Ill.

Send me Distance Getter, postpaid. Enclosed find \$2.00 (M.O., stamps or check.) Send C.O.D., plus small postage added. Also send 100-page Radio Catalogue Free.

Name.....  
Address.....  
City..... State.....

# Here, Mister Radio Fan, is a "Surprise Package" for You!



**Mail this today!**

Hampton-Wright  
148 Darmody Bldg.  
Indianapolis, Ind.

Dear Sirs: I'm interested in your surprising bargains in radio parts and accessories. Send me one of your catalogs today.

Name \_\_\_\_\_  
Street \_\_\_\_\_  
City \_\_\_\_\_  
State \_\_\_\_\_

**R**ADIO DEALERS, set-builders and fans are saying it with orders. That's why we know that you have a surprise in store for you when you see this

*New 1927-28*

## Hampton-Wright Free Catalog of Radio Parts and Accessories

This "Book of a Thousand Radio Bargains" shows 80 pages of surprising values in radio parts and accessories, made by the world's best-known manufacturers. Radio fans in all parts of the country are pleased with our service and prices. This is Hampton-Wright's biggest year—take advantage of it.

"Keeping Pace with Radio"

**HAMPTON-WRIGHT**  
RADIO PARTS AND ACCESSORIES  
DARMODY BUILDING ✦ ✦ ✦ INDIANAPOLIS

Mail the Coupon TODAY!

## In New York stay at the ABERDEEN HOTEL

17 West 32nd St., near 5th Ave.

Close to Pennsylvania Station—accessible to everything! Every modern hotel convenience and service.

Rooms with bath **\$2.50** ALWAYS available

JOHN F. DOWNEY, Managing Director

## Blueprints of Inexpensive DX Circuits

### The Five-Tube Diamond of the Air

a very selective circuit of thrilling tone quality, that brings in distant stations to the great delight of the fans, is easily built, in fact can be constructed in a couple of hours. The authorized blueprints that make this speed and efficiency possible are just off the press and will be shipped at once, together with a booklet of full textual exposition of construction, including winding of coils, how to connect coil terminals, what values of condensers and resistors to use, etc. If you want a tone quality set that will give you great enjoyment, be sure to build this five-tube Diamond of the Air. The receiver consists of a stage of tuned radio frequency amplification, a specially sensitized detector, first stage of transformer audio and next two stages of resistance audio. It is easily adapted to playing phonograph records on your speaker. Get acquainted with this NEW delight.

### The Four-Tube Diamond

represents the most that is obtainable from four tubes. A stage of tuned radio frequency amplification, a specially sensitized detector, and two stages of transformer coupled audio. Follow the diagrams as shown in the blueprint and you can't go wrong. You will be amazed at the results. Build the set from parts that you have. Full instructions cover utilization of such apparatus. Thousands are eager to build an economical set and this one is the most economical in cost of construction and upkeep, where one considers the surpassing results. Works splendidly from batteries, with either type 99 or type 01A tubes, and can be used with A and B eliminators, power packs, etc., with great success.

### Look Over Both of These

blueprints and read the text in both cases before choosing the receiver you are to build.

### Send No Money!

Just fill out the coupon below, and note what you get FREE!

Guaranty Radio Goods Co., Dept. CB  
141 West 45th Street, New York City

Please send me one newly-printed official blueprint of the 5-tube Diamond of the Air, one newly printed official blueprint of the 4-tube Diamond, and the textual data giving full directions for constructing these sets. I agree to pay the postman 75 cents on delivery. Also, you are to send me, without extra cost, one Auto Strop Safety Razor, one blade and one automatic razor stop.

Name.....  
Address.....  
City.....State.....

## SAVE 50%

No better "A" Socket Power Unit can be obtained even at twice this amazingly low price. Combines all the efficiency of plate current with the undoubted convenience of socket power. No bothersome hauling around of batteries to be charged. No hum or noise. Highest quality Westinghouse electrical equipment. Operates on 50 or 60 cycles at 110 volts A. C. Thousands of satisfied users prove the worth of World Power Units. Approved by rigid tests of Radio News and other leading Laboratories.

**Send No Money** Just name and address, and we will ship day order is received by express, C. O. D., subject to examination on arrival. 5% discount for cash in full with order. NOW is the time to do it.

**WORLD BATTERY COMPANY**  
1219 So. Wabash Ave. Dept. 63 Chicago, Ill.



Station **WSBC**  
Owned and operated by World Battery Co.

Tell 'Em You Saw It in the Citizens Radio Call Book Magazine

# Startling---New---Beautiful Decorative Indoor Aerial

Now You May Have a  
Highly Efficient Aerial  
That Will Ornament Your Home

COMPLETE  
\$950

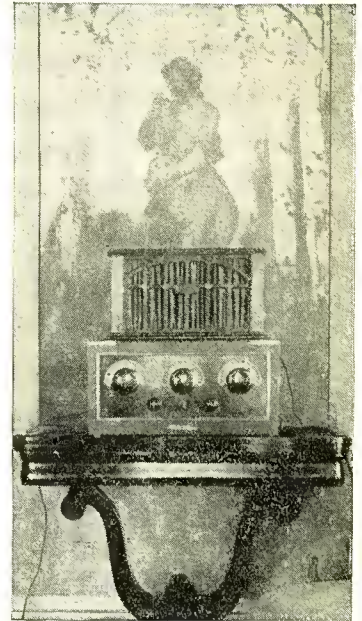

The day of costly and dangerous outdoor aerials and bulky, inefficient loops is over. Here is an aerial so simple that a child may install it, yet it is scientifically constructed to bring in marvelously clear, sweet reception. And in addition it is finished with an artistic tapestry effect that makes it a welcome adornment in the finest home. All wires are perfectly concealed and no one would ever guess that he is looking at anything but a beautiful tapestry.

### EASILY INSTALLED

Simply hang it on the wall as you would a picture or mirror and attach it to your set. Other Effarsee models, non-decorative, are handled the same way. Just hang them where they are out of the way—in attics, closets, behind doors, mirrors or furniture or under rugs. No extra attachments needed. No interference from proximity to neighbors' aerials.

**Effarsee**  
ANTENNAE  
REG. U. S. TRADE MARK  
PATENT PENDING

work without interference from metal structural work, phone or light wires and without lightning risk. They are made with special parchment covering that keeps wires properly spaced and insulated from moisture and electrical losses. Fixed condensers at each end provide the sharp tuning of a short aerial and the range and volume of a long one.

### CUT DOWN STATIC

Effarsee antennae catch both sides of the radio wave and give you greater selectivity and a better tone, practically free of static. Get an Effarsee at once for real radio enjoyment with a minimum of expense and trouble. If you have an old type receiver that is not selective it is not necessary to buy a new set to get selectivity as the Effarsee will make your set selective. Because the Effarsee is a tuned aerial it cannot help but be selective.

### USE THIS COUPON

If your local dealer does not sell Effarsee Antennae, send your order direct to us. Send no money. Just fill in and mail the coupon below and we will send your antennae at once, C.O.D. We absolutely guarantee every Effarsee Antennae to be mechanically perfect. Each one is tested thoroughly before shipment and is fully guaranteed to do all we claim, providing set is in good working order and properly tuned.

**FISHWICK RADIO COMPANY**  
Dept. 300, 133 West Central Parkway,  
Cincinnati, Ohio

Please send me the Effarsee Antennae checked below. I will pay the postman price quoted plus postage.

- Effarsee Tapestry Finish Art Panel.....\$9.50
- Effarsee IXL, non-decorative, large..... 4.00
- Effarsee BXL, non-decorative, small..... 2.50

Prices slightly higher West of the Rockies

Name.....

Address.....

City..... State.....

**FISHWICK RADIO CO.**  
Dept. 300, 133 West Central Parkway  
CINCINNATI, OHIO

Tell 'Em You Saw It in the Citizens Radio Call Book Magazine

# The "Power"



## A B and C Unit

(NO BATTERIES)

Licensed by

**RCA**

—A, B, and C for sets using AC tubes.  
—Super B for any set.

**\$47<sup>50</sup>**

includes RCA Tube

Write for Complete Facts!

*Harold Power, Inc.*

Manufacturers of Socket Power Devices  
MEDFORD, MASS.

## Changes Your Set Into a Short Wave Receiver

Sent postpaid anywhere in U. S. upon receipt of \$15.00 M. O. or C. O. D. plus postage upon receipt of \$1.00 to guarantee carrying charges.

When ordering state kind of set so that detailed directions for use may be given if necessary. Also state type of tubes, such as UX 199, UV 199, WD11 or 201A.

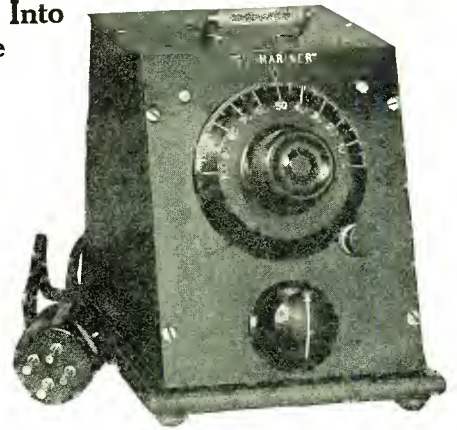

## The SUBMARINER

Regardless of the kind of set you have, this device will permit you to listen to short wave stations between 30 and 75 meters. Operates with sets such as T R F, Neutrodyne, Super-Heterodyne, regenerative sets and all other types. No additional tubes or batteries required. No changes to the wiring of the set. A short aerial and ground is connected to the "Submariner," and a cable and plug attaches it to the set. Requires less than a minute to attach or detach. Operates as a wave changer with Super-Heterodynes, and as a detector unit with others.

### SHORT WAVE RECEPTION

is practical because they penetrate better, and there is less static. There are several powerful stations using the wave band covered by the "Submariner" for broadcasting programs. You may also learn code by listening to amateurs from all parts of the world. Get a thrill by tuning in a station your friends cannot get. You will have a highly efficient short wave receiver when the "Submariner" is attached to your set. Nothing else like it on the market. Take a trip in the low waves on board the "Submariner."

### ORDER TODAY

*We guarantee to refund if the "Submariner" fails to operate*

ADDRESS

J-M-P Manufacturing Co., Dept. 111X, Milwaukee, Wis.



## Make Your Radio a "MODERN" Shielded Set

No unshielded set complete without them, no reception as perfect as it could be with them. "MODERN" Shields give each tube a chance to function unhampered by interference from magnetic and static fields, prevalent in all unshielded sets regardless of make or hook-up as many interferences, some of which sound like static, are manufactured within the set itself and can only be remedied by metallic grounded shields. "MODERN" Shields protect the tubes from microphonic sound waves by insulating them from the surrounding ether and by three rubber tipped spring fingers inside of shield which press tightly against the tube, arresting any vibrations set up by jars, sound waves or telephonic vibrations in the cabinet; the rubber tips eliminate any possible conductive leakage from shield to tube. "MODERN" Shields confine the heat around the tube, causing quicker

action, greater efficiency, less power, longer battery life and modified summer static. "MODERN" Shields are recommended for sets or tubes that squeal, whistle, howl, choke, snap or produce indistinct or mushy reproduction. Tone and volume are greatly improved by their use. "MODERN" Shields should be placed over each tube in the set to obtain maximum results, connect copper wire in series to binding post on each shield and to ground post on set. "MODERN" Shields are pressed from special alloy metal fitted with rubber cushion base which eliminates transmission of telephonic vibrations to the tubes, each shield is adjustable to any tube, height or spring tension desired. The base of each shield is dipped in a special insulation to assure against shorts or grounds in their application. Complete instructions come with each shield. "MODERN" Shields retail for \$1.00 each, none genuine without the "MODERN" trade mark. If you can not obtain "MODERN" Shields from your local dealer, send us your check or P. O. money order and Shields will be mailed to you P. P. prepaid.



**"Modern" Laboratories**  
207 Washington St. Owosso, Mich.  
Amateur Laboratory and Counselor Service  
at Nominal Fees.

## HOTEL FORT SHELBY

Lafayette and First, Detroit

### New 22-Story Addition

equipped with every advanced feature of accommodation, including SERVIDORS

WHETHER your choice be one of the very comfortable rooms at \$2.50, \$3 or \$4, or one of the especially large rooms or fireplace suites in the new addition, with an entrancing view of city, river and Canadian shore, you will enjoy a special sense of value in Hotel Fort Shelby.

Convenient to all downtown and to all transportation. Shopping, theatrical, financial and wholesale districts within five minutes' walk. Garage in connection.

Cars delivered without service charge.

Brochure on request

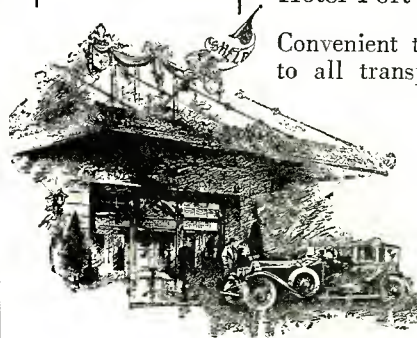

Tell 'Em You Saw It in the Citizens Radio Call Book Magazine

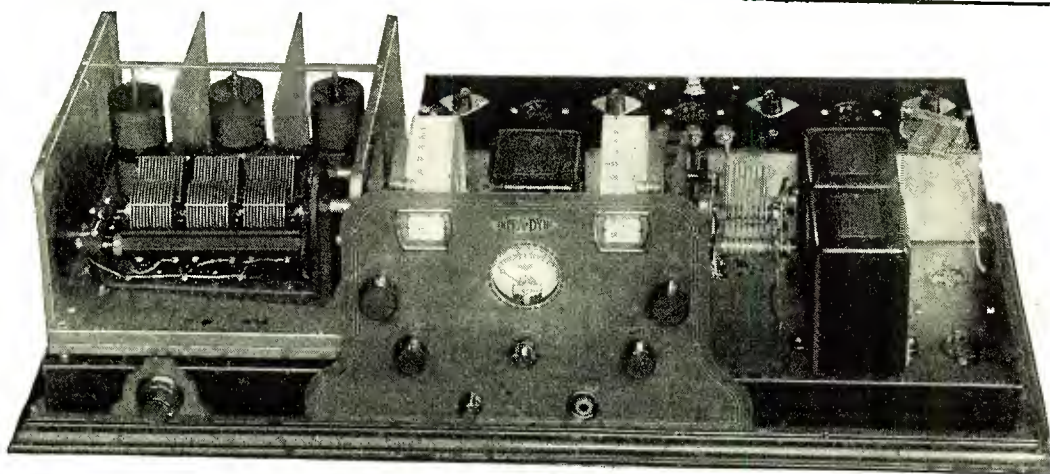

# REMLER UNITS

## Make the 1928 Infradyne

the outstanding leader among all the circuits that are being offered today. With four Remler Units, factory tested, plus transformers and voltmeter, you can build the Infradyne in a few hours.

Write for special descriptive folder

# REMLER

Division of

GRAY & DANIELSON MANUFACTURING CO., 260 First Street, SAN FRANCISCO  
 CHICAGO EASTERN WAREHOUSE, ELKHART, INDIANA NEW YORK

# X-L Products

Used in Every High Grade Receiver or Circuit Today

Model "N"



100% increased reception on low wave lengths. Greater distance, volume, clarity, stability, easier, quicker tuning with an X-L VARIO DENSER in your circuit.

Model "N" Micrometer adjustment easily made, assures exact oscillation control in all tuned radio frequency circuits, Neutrodyne, Roberts 2-tube, Browning-Drake, Daily News 4, Qualitone Six, Strobodyne, etc. Capacity range 1.8 to 20 Mfd. Price \$1.00.

Model "G"—For Cockaday, Oliver Lodge N, Loftin-White, Nankin Ultra-5 circuits, filter and intermediate tuning in superheterodyne and positive grid bias in all sets. Capacity range, Model G-1, .00002 to .0001 Mfd.; Model G-5, .0001 to .0005 Mfd.; Model G-10, .0003 to .001, Mfd. Price each with grid clips, \$1.50.

Model "G"

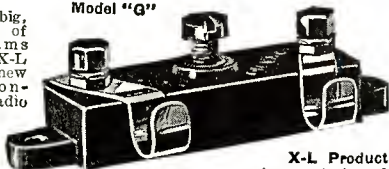

X-L Products at your dealer, if he cannot supply you, write direct.



Bakelite Insulated

### New Bakelite Insulated Push Post

At last a perfect Push Post. Convenient, simple, permanent connections. You don't have to remember to tighten X-L Push Posts. Just push down, insert wire, remove pressure. Connection is tight and will stay tight. Vibration will not loosen, releases instantly. All standard markings or boxed in complete sets for all popular circuits. Price each, 15 cents.



All-Metal Push Post

FREE—New, big, up-to-date Book of wiring diagrams showing use of X-L units in the new Loftin-White constant coupled radio frequency circuit, Strobodyne and in other popular hook-ups. Send for yours today.

## X-L RADIO LABORATORIES

2422 North Lincoln Ave. Chicago, Illinois

Write quick FOR HARRY ALTER'S

New Wholesale RADIO BOOK

"Minute-Man" shipping service means quicker turnover for radio dealers

—bigger business and more profits without increasing your capital investment.

## Everything in RADIO at BED-ROCK PRICES

made possible by cash buying and cash selling. If it is used in radio and is a reputable product, we have it. Send now for catalog.

Note: We sell radio retailers only

# The Harry Alter Co.

1744 Michigan Avenue

CHICAGO

Tell 'Em You Saw It in the Citizens Radio Call Book Magazine

# There's money for you in RADIO

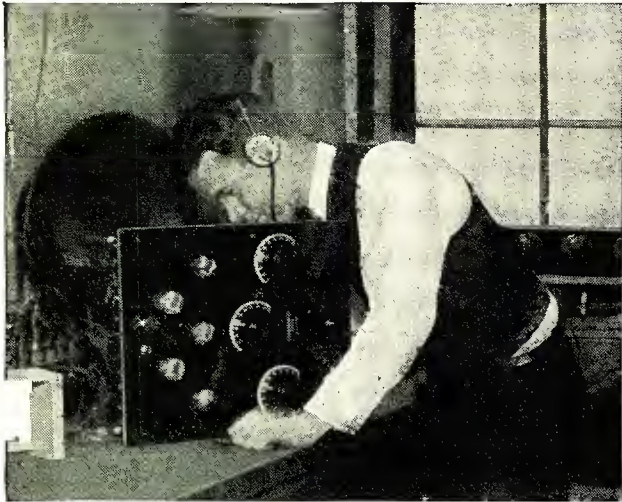

*Wonderful opportunity for ambitious men to win success in this fast-growing profession*

The Radio industry is expanding so rapidly that trained men are at a premium. There is a constant, urgent demand for operators—factory superintendents—engineers—service men—designers—salesmen.

There is no better way for you to succeed in this fascinating business than to study the Radio Course of the International Correspondence Schools. This course is new and complete. It was written by practical authorities in this field. It is endorsed by leading radio experts and radio manufacturers.

Quincy J. Workman, of Scranton, Penna., writes that he has "nearly doubled his salary" since he took up the I. C. S. Radio Course. He is now manager of the Radio Department of a large store.

J. B. McCune, of Donora, Penna., writes that the I. C. S. Radio Course enabled him to start a radio business of his own. This same course enabled John M. Paynter, of the U. S. Lighthouse Service, Charleston, S. C., to get a position as Radio Operator and Ship's Electrician. Scores of other men in radio factories, laboratories and stores report similar progress.

You, too, can get in on the ground floor if you act quickly. But don't delay too long. Mark and mail the coupon today and let us tell you all about the I. C. S. Radio Course and what it can do for you.

**Mail the Coupon for Free Booklet**

**INTERNATIONAL CORRESPONDENCE SCHOOLS**  
Box 8317-C, Scranton, Penna.

Without cost or obligation, please tell me how I can qualify for the position or in the subject, before which I have marked an X:

**RADIO**

- |   |  |
|---|--|
| <input type="checkbox"/> Electrical Engineering | <input type="checkbox"/> Architect               |
| <input type="checkbox"/> Electric Lighting      | <input type="checkbox"/> Architects' Blueprints  |
| <input type="checkbox"/> Mechanical Engineer    | <input type="checkbox"/> Contractor and Builder  |
| <input type="checkbox"/> Mechanical Draftsman   | <input type="checkbox"/> Architectural Draftsman |
| <input type="checkbox"/> Machine Shop Practice  | <input type="checkbox"/> Concrete Builder        |
| <input type="checkbox"/> Railroad Positions     | <input type="checkbox"/> Structural Engineer     |
| <input type="checkbox"/> Gas Engine Operating   | <input type="checkbox"/> Chemistry               |
| <input type="checkbox"/> Civil Engineering      | <input type="checkbox"/> Automobile Work         |
| <input type="checkbox"/> Surveying and Mapping  | <input type="checkbox"/> Airplane Engines        |
| <input type="checkbox"/> Metallurgy             | <input type="checkbox"/> Navigation              |
| <input type="checkbox"/> Steam Engineering      | <input type="checkbox"/> Agriculture and Poultry |
| <input type="checkbox"/> Pharmacy               | <input type="checkbox"/> Mathematics             |
- BUSINESS TRAINING COURSES**
- |  |   |
|--|---|
| <input type="checkbox"/> Business Management                     | <input type="checkbox"/> Salesmanship                                     |
| <input type="checkbox"/> Industrial Management                   | <input type="checkbox"/> Advertising                                      |
| <input type="checkbox"/> Personnel Organization                  | <input type="checkbox"/> Better Letters                                   |
| <input type="checkbox"/> Traffic Management                      | <input type="checkbox"/> Show Card Lettering                              |
| <input type="checkbox"/> Business Law                            | <input type="checkbox"/> Stenography and Typing                           |
| <input type="checkbox"/> Banking and Banking Law                 | <input type="checkbox"/> Business English                                 |
| <input type="checkbox"/> Accountancy (including C.P.A.)          | <input type="checkbox"/> Civil Service                                    |
| <input type="checkbox"/> Nicholson Cost Accounting               | <input type="checkbox"/> Railway Mail Clerk                               |
| <input type="checkbox"/> Bookkeeping                             | <input type="checkbox"/> Common School Subjects                           |
| <input type="checkbox"/> Private Secretary                       | <input type="checkbox"/> High School Subjects                             |
| <input type="checkbox"/> Spanish <input type="checkbox"/> French | <input type="checkbox"/> Illustrating <input type="checkbox"/> Cartooning |

Name \_\_\_\_\_  
Address \_\_\_\_\_

**get!** **FOR YOUR ELIMINATOR**

**Pure Direct Current**



**Bee Cee Filter Condenser Compact**  
BROWN & CAINE

**DEPENDABLE**

THERE is a Bee Cee Filter Condenser Compact for use in every type of battery eliminator and power amplifier. Especially designed for its specific work, each Compact may be depended upon to render a pure, even, rectified current, with permanent capacity assured.

*Because these units are the most delicate electrical devices used in radio, it is essential that you insist on Bee Cee quality.*

Bee Cee Filter Condensers can be had in capacities from .1 MFD to 4. MFD for filter and by-pass work. Conservatively rated — and Halowax impregnated!

At your dealers, or write direct to Dept. C B-9 2317 Calumet Avenue, Chicago

**BEE CEE Filter Condenser COMPACTS**

**BROWN & CAINE INC.**

BROWN & CAINE, Inc. Chicago  
Kansas City, Mo. Atlanta Los Angeles Cleveland Denver Portland

**STATEMENT OF THE OWNERSHIP, MANAGEMENT, CIRCULATION, ETC., REQUIRED BY THE ACT OF CONGRESS OF AUGUST 24, 1912**

Of CITIZENS RADIO CALL BOOK MAGAZINE, published four times yearly at Chicago, Illinois, for October 1, 1927. State of Illinois, County of Cook, ss.

Before me, a notary public in and for the State and county aforesaid, personally appeared Chas. O. Stimpson, who, having been duly sworn according to law, deposes and says that he is the Editor of the CITIZENS RADIO CALL BOOK MAGAZINE, and that the following is, to the best of his knowledge and belief, a true statement of the ownership, management (and if a daily paper, the circulation), etc., of the aforesaid publication for the date shown in the above caption, required by the Act of August 24, 1912, embodied in section 411, Postal Laws and Regulations, printed on the reverse of this form, to wit:

- That the names and addresses of the publisher, editor, managing editor, and business managers are: Publisher, Citizens Radio Service Bureau, Chicago, Ill.; Editor, Chas. O. Stimpson, Chicago, Ill.; Managing Editor, Fred A. Hill, Chicago, Ill.; Business Manager, D. H. Bell, Chicago, Ill.
- That the owner is (if owned by a corporation, its name and address must be stated and also immediately thereunder the names and addresses of stockholders owning or holding one per cent or more of total amount of stock. If not owned by a corporation, the names and addresses of the individual owners must be given. If owned by a firm, company, or other unincorporated concern, its name and address, as well as those of each individual member, must be given): Citizens Radio Service Bureau, Chicago, Ill.; Chas. O. Stimpson, Chicago, Ill.; D. H. Bell, Chicago, Ill.; H. Anheiser, Chicago, Ill.
- That the known bondholders, mortgagees and other security holders owning or holding 1 per cent or more of total amount of bonds, mortgages, or other securities are (if there are none, so state): There are none.
- That the two paragraphs next above, giving the names of the owners, stockholders, and security holders, if any, contain not only the list of stockholders and security holders as they appear upon the books of the company but also, in cases where the stockholder or security holder appears upon the books of the company as trustee or in any other fiduciary relation, the name of the person or corporation for whom such trustee is acting, is given; also that the said two paragraphs contain statements embracing affiant's full knowledge and belief as to the circumstances and conditions under which stockholders and security holders who do not appear upon the books of the company as trustees, hold stock and securities in a capacity other than that of a bona fide owner; and this affiant has no reason to believe that any other person, association, or corporation has any interest direct or indirect in the said stock, bonds, or other securities than as so stated by him.
- That the average number of copies of each issue of this publication sold or distributed, through the mails or otherwise, to paid subscribers during the six months preceding the date shown above is (this information is required from daily publications only).

CHAS. O. STIMPSON,  
(Signature of editor)  
Sworn to and subscribed before me this 13th day of October, 1927.  
(SEAL) NELLIE E. RYAN.

(My commission expires July 26, 1928.)

Tell 'Em You Saw It in the Citizens Radio Call Book Magazine

# EBY SOCKETS

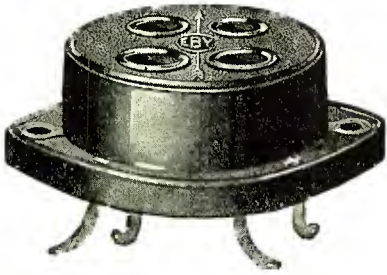

## Are Right in Step With New Ideas

Not more than two, and in many cases not any, cushion type sockets are used in most of the better factory built receivers. You can check this up yourself.

Improvements in tube design and manufacture enable the rigid type socket to give performance equal to any other socket—at a considerably lower cost.

The NEW EBY Socket has a 3 point wiping spring contact—the most scientifically perfect type of contact known. On all counts the EBY Socket is the most efficient rigid socket made. Easy to mount above or below bakelite, metal or wood.

LIST PRICE 40c



## BINDING POSTS

EBY Binding Posts are specified in most of the popular circuits and are standard equipment on the majority of the leading receivers. The special circuit packages give you a complete set of EBY Posts for any circuit you want.

Inbuilt quality and *non-removable* tops.  
List price 15c

**THE H. H. EBY MFG. CO., Inc.**  
4710 Stenton Ave. Philadelphia, Pa.

# Townsend "B" Socket Power "Best in World!"

Says A. W. GALE  
of Gloversville,  
New York

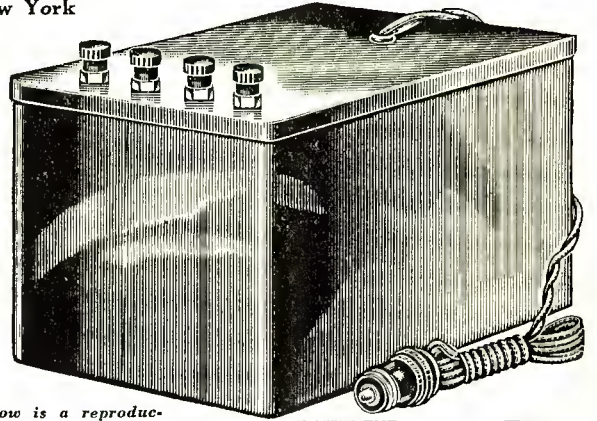

Below is a reproduction of Mr. Gale's letter of May 8th, 1927.

COMPLETE

48 W. Fulton St.,  
Gloversville, N. Y.

"Received the Townsend all O. K. It is the best in the World and that is saying some. I have a Radiola 4 tube. Get more stations than ever before. Some of them are CFCF, CKNC, WGY, KDKA, WGZ, WIP, WWJ, KTHS, KOP, KOA, WHAS, WTAM and KSD—besides four in Chicago, all in the East and then some."

A. W. Gale.



## Replaces "B" Batteries

The letter above speaks for itself—proves beyond doubt that the Townsend "B" Socket Power is the most remarkable value in Radio today. Sam E. Fry, of 1415 Holmes St., Kansas City, Mo., writes: "Eliminator works fine. Showed it to a friend and he wants one also. I will say it sure beats batteries. I get stations I never got before on a 6 tube set." Charles Ellis, 88 Jones Ave., Columbus, Ohio, says, "Your Eliminator is working fine. Have had station WJAX and others over 1,000 miles distant. Picked up 22 different stations one evening and around 30 another time. My neighbor has a \$27.50 Eliminator and I don't see that it works any better than yours."

Delivers up to 100 volts on any set, on D. C. or A. C.—any cycle. Full tone, clarity and volume.

Tested and approved by America's leading Radio authorities—Radio News and Popular Radio Laboratories

## ORDER TODAY!

Simply fill out the coupon and slip it into an envelope with only \$1.00 and mail at once. Your Townsend "B" Socket Power Unit will be sent promptly. Deposit only \$5.85 plus postage with the postman. Try out for 10 days—then if not delighted with improvement in reception, return it to us and purchase price will be refunded.

TOWNSEND LABORATORIES  
713 Townsend St. Dept. 26, Chicago, Ill.  
Attach Only \$1.00 to this Coupon!  
SEND TODAY



TOWNSEND LABORATORIES  
713 Townsend St., Dept. 26, Chicago, Ill.

Gentlemen: Attached find \$1.00. Kindly send at once Townsend Socket Power Unit, C. O. D., for \$5.85, plus postage, on guaranteed 10-day free trial.

Name \_\_\_\_\_  
Address \_\_\_\_\_  
City \_\_\_\_\_ State \_\_\_\_\_



# 1928 -

## Wholesale RADIO Catalogue

**FREE**

**136 Pages of Illustrated Wholesale Bargains**

Just off the press—our new **wholesale catalog** of everything in Radio. The most complete illustrated catalog of quality Radio merchandise ever found in one book. It comprises the entire line of all the popular **Nationally advertised** radio sets, accessories, parts and kits—particularly all the latest features shown in this and previous issues of this magazine. Rock-bottom prices on each item. **Electric Sets—6, 7 and 8 tubes; also non-electric sets.** Astonishing values in **"A" Eliminators, "B" Eliminators,** loud speakers, chargers, cabinets, consoles, kits and parts. For immediate shipment.

**Values That Will Astonish You—The Latest Kits, Power Packs, Parts and Accessories**

**Also how to make your old sets electrically operated at very low cost.** Here's quality radio merchandise at extraordinary low prices. No dealer can afford to be without this book—a veritable clearing house for radio needs. Be sure and get your copy! **We are pioneers in radio and deal in radio exclusively.** Only our tremendous purchasing power makes these extraordinary values possible. Write for this **FREE catalog NOW.**

**HAMILTON-CARR CORPORATION**  
711 West Lake St., Dept. 250 • Chicago, Ill.



# BRAIDITE

**"The Braid Snaps Back"**  
**A New and Better Hook-Up Wire**



Braidite is the neatest, fastest and easiest working hook-up wire ever made. In making a connection, it is not necessary to strip back the insulation. Simply push it back and after soldering the insulation snaps right back into place, leaving no exposed sections of bare wire. Braidite holds its shape permanently after bending and you cannot scorch or burn it with a soldering iron.

Braidite is now being used by all the leading set manufacturers and professional set builders. For better results use Braidite in the next set you build. Made in red, green, yellow, brown and black. 25 feet with solid copper wire core—per carton 30c; with stranded copper core, 35c. If your dealer cannot supply you, write us direct.

**"Corwico" Products**

- Antenna Wire (Solid, Stranded and Braided)
- Complete Aerial Kits
- Magnet Wire
- Battery Cable
- Bus Bar Wire
- Hook-up Wire
- Lead-in Wire
- Annunciator Wire
- Loop Aerial Wire
- Litz Wire
- Flexible Wire

*"Corwico" Radio Wires are sold by leading dealers everywhere. Write for interesting FREE booklet on radio wires and their uses.*

**CORNISH WIRE COMPANY**

30 Church St., New York City

**A HOMEY HOTEL IN THE HEART OF NEW YORK**

## THE *New Flanders*

47th to 48th STREET — EAST OF BROADWAY

*One of the finest Hotels in* **TIMES SQUARE**

- Single Rooms with Running Water, \$2.00
- Double Rooms with Running Water, \$3.00
- Single Rooms with Bath . . . . . \$2.50
- Double Rooms with Bath . . \$3.50

*Special Weekly Rates*

F. W. BIZEL, Resident Manager



Tell 'Em You Saw It in the Citizens Radio Call Book Magazine



Aerovox Condensers  
are exclusively specified  
for the

## Magnaformer

9-8 Circuit



### Eternal Life

We cannot guarantee eternal life, but we do guarantee the AEROVOX FILTER CONDENSER when properly used to outlast all the other equipment used in conjunction with it.

**WHY???**

*Because —*

each section of a block is individually sealed and impregnated against moisture absorption.

the safety factor used in manufacture, testing and rating will permit indefinite continuous operation at the rated working voltage without injury.

For all eliminators

# AEROVOX

*"Built Better"*  
70 Washington St., Brooklyn, N. Y.

# THOUSANDS of our graduates have made good— in RADIO

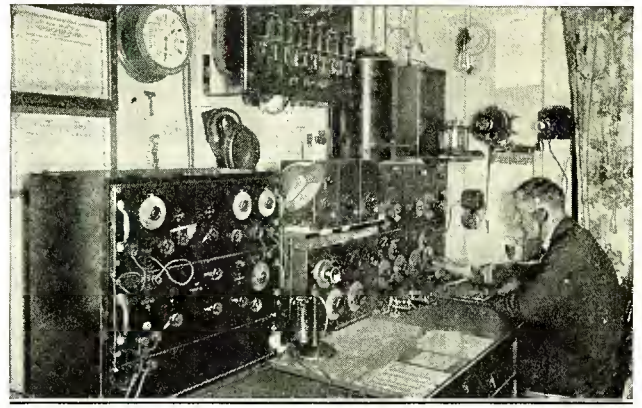

**Y**ou, too, can make rapid strides of advancement in this field of fascinating work and attractive salaries. Trained radio men are always in high demand—as ship operators, sailing to foreign lands, and as mechanics, assemblers, salesmen and installers on shore.

## Study at Home

Radio Institute of America offers the finest radio instruction obtainable—qualifies you to pass the U. S. Government Commercial or Amateur License Examination. The cost of the course is low. Time payments are allowed. And you can study at home without sacrificing your present position! Mail the coupon now for full information.

**RADIO INSTITUTE OF AMERICA**  
326 Broadway, New York City

Send this in



**RADIO INSTITUTE OF AMERICA**  
326 Broadway, New York City

Please send me full information about your Home Study Course of code and technical radio instruction which qualifies for the U. S. Government Commercial or Amateur Radio License.

Please send me full information on your technical course for radio dealers, jobbers and salesmen.

Name \_\_\_\_\_

Address \_\_\_\_\_

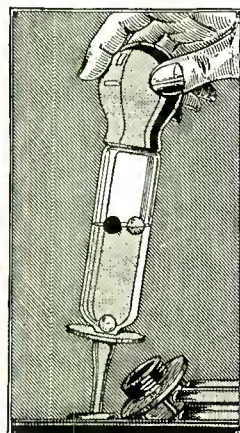

## Follow the Lead of the Leaders

### USE THE **SOS HYDROMETER**

The big battery manufacturers use the SOS (patented Chaslyn Balls) as standard equipment in Glass-Cased Batteries and Power Units.

#### Easier to Read

#### Nothing to Break

*Swim all three—charged fully.  
Sinks the white—charge still right.  
Sinks the green—charge is lean.  
Sinks the red—charge is dead.*

Ask your dealer. If he can't supply, send 75c to us.  
Chaslyn Corrosion Cure for Battery Terminals protects contacts. A large tube lists at 30c.

**THE CHASLYN COMPANY**  
4607 Ravenswood Ave. Chicago, Ill.

*Tell 'Em You Saw It in the Citizens Radio Call Book Magazine*



BODINE TWIN-8

AERO-7



# A truly fine product

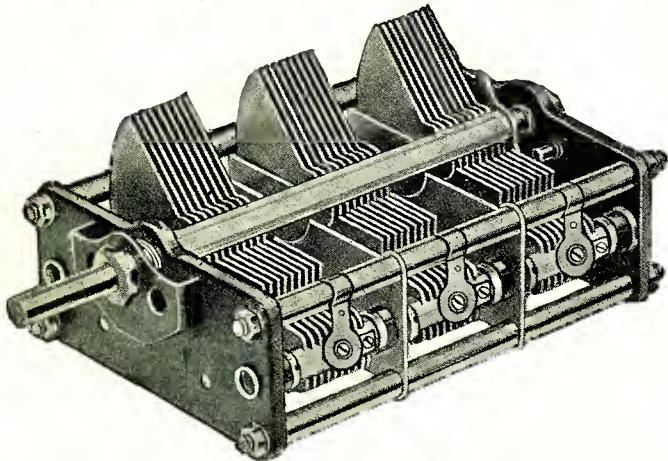

## THE AMSCO COMPENSATED TRIPLET CONDENSER

Engineering precision, from the formula for the curve of the tuning line to the final adjustment of the equalizing condensers, justifies the quiet commendation of engineers.

The two outstanding receiver developments of 1927, the Bodine Twin-8 and the Aero-7, use this condenser. We shall be pleased to send literature on these circuits.

The inclusion of Amsco Products—rheostats, sockets, resistors and condensers,—adds to any receiver a touch of real beauty and the assurance of electrical efficiency.

Amsco Products, Inc., Broome & Lafayette Sts., N. Y. C.



# POWER!

WHETHER you are talking short-wave transmission or just good broadcast reception, you are today talking in terms of POWER. That's the keynote of radio progress in all direction.

No longer are we content with mere microwatts or microamperes in our circuits. And not every

variable resistor in sight will do the bigger job now called for when it comes to handling honest-to-goodness energy. As usual, however, your old friend CLAROSTAT has kept in step with developments.

Five years of persistent, concentrated and specialized effort to develop a satisfactory device that would provide the convenience of the variable resistor and the reliability of the fixed resistor, have gone into the development of the Clarostat design. The well-known Standard type has found wide application in radio B-eliminators, receiving sets, and in the smaller radio transmitters. And the same sound design, on a necessarily large scale, has made the Power Clarostat possible.

So much for today. But when larger variable resistors are required, CLAROSTAT will be the first to build them.

*The fact that others have seen fit to copy the CLAROSTAT and to offer something "just as good as the Clarostat" speaks for itself.*

Write for literature on the use of the Power and Standard Clarostats. Ask your dealer to show you these improved variable resistors.



American Mechanical Labs., Inc.  
285 N. 6th St. Brooklyn, N. Y.



Exclusively Licensed by  
Technidyne Corporation  
under U. S. Patent No.  
1593658, July 27, 1926.

## And Now!

# "TONATROL"

### A True Tone and Volume Control

At last, you can have the exact volume you want—to meet your mood and fancy. "Tonatrol" makes this possible—regulates volume from low, soothing music to the deepest inspiring tones—instantly!

Reception will be much more satisfactory with "Tonatrol." Made with genuine Bakelite. Can be installed in a jiffy. Get "Tonatrol" from your dealer today.

Tonatrol—Standard Volume Control.....	\$1.50
Tonatrol—Type W. S. (with filament switch attached).....	2.00

*Hook-up circular for the correct way to control volume free on request*

Dept. 74-A 175 Varick Street, New York, N. Y.

# ELECTRAD

Inc.

## A New Hotel Without "UPS"!

**IT'S NEVER BEEN DONE BEFORE**  
*One Price for All the Rooms*



THE 12-story fireproof Cornish Arms Hotel, just opened, has eliminated all the hokum of "up" prices. This convenient and comfortable new hotel has only one price for a single room and bath, \$3.00 per day. Single room for two, with bath, \$4.50. Remember, there are no "ups." There's a bath with every room: 340 rooms to select from. Excellent restaurant service at moderate prices.

5 minutes to Times Square, 5 minutes to Pennsylvania Station, 8 minutes to Grand Central, and near all Steamship Lines.

Come and Compare

# Cornish Arms Hotel

West 23d Street, at Eighth Avenue, New York

Tell 'Em You Saw It in the Citizens Radio Call Book Magazine

# First choice

*Metallized*

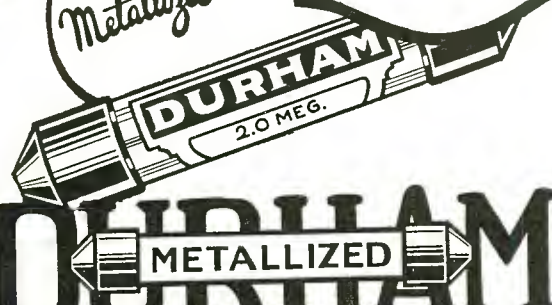

**DURHAM**  
RESISTORS & POWEROHMS

First choice for uniform high quality — unvarying, consistently fine results—absolute dependability!

First choice of leading set manufacturers—professional builders—eminent engineers—and radio fans!

First choice during past years—first choice for years to come!

INTERNATIONAL RESISTANCE CO., Dept. R, 2 1/2 So. 20th St., Philadelphia

## Make this Amazing FREE TEST!



**GOLD WAVE AERIAL**

Will you prove at our risk the famous GOLD WAVE AERIAL actually does the amazing things we claim? Will you test this triple gold-plated aerial 10 days to prove it will GIVE STATIONS YOU HAVEN'T BEFORE RECEIVED?—BRING IN FAR GREATER DISTANCE!—IMPROVE TONE AND QUALITY MARVELOUSLY! Filled with conductivity—it draws and is GUARANTEED to produce these remarkable results on any make radio set. Seven strands—gold triple plated—Aerial 100 feet long. Installed in or outdoors like any other aerial.

**SEND NO MONEY**

If your dealer can't supply, send name and address. Pay postman only \$4 plus few pennies postage. Use 10 days. If not delighted money refunded. All radio engineers recommend it. Now sold in all European countries.

**LUXEM & DAVIS Mfg. Co.**  
Dept. D-11, 6229 Broadway, Chicago  
Distributors

JOBBERS—DEALERS—AGENTS—Write for liberal discounts and generous proposition.

No More "Leaking"  
Tuf-glass All-Weather Antenna Insulator positively resists temperature changes. Cut out grind and squeal! Stops leaks. 91,000 volts high frequency resistance. Only 35 cents!

## \$75 to \$125 Weekly

### Charging Batteries Starts You



Let me show you how to make big money right from the start. I've prepared a FREE book explaining all details. First week's profit pays for all equipment. You can get all the battery charging business in your community with my Service Station Charger—it's years ahead of ordinary chargers —handles 50% to 70% more batteries. I explain everything—start you in a business of your own and put you on the way to big money. Write for FREE Book.

C. F. HOLMES, Chief Engineer, Dept. 15  
Independent Electric Works, 5116 Ravenswood Ave., Chicago

**FREE BOOK - Just Out**

Big Profits

## 27 MODELS



Consoles  
Desks  
Tables  
Speaker-  
Consoles  
Cabinets

8", 10" or 12" Deep

Cabinets, Desks, Consoles to fit all advertised circuits or Atwater Kent, Radiola, Crosley or other well-known models. We have in stock for immediate delivery 27 models that will take any set with panel as large as 8x30.

### Amazingly Beautiful Radio Furniture

Judge our Cabinets, Consoles or Desks on any point. Charming grace of design, refinement, smart appointments, graceful shapings, beautifully grained and matched burl walnut finish or construction. "Surprisingly beautiful" is what our customers say, and we can assure you that our Cabinets surpass anything that you have seen.

Send for Complete Illustrated Catalogue

# Ehlert

Radio Furniture Co.  
2468 Lincoln Ave.  
Chicago

## Much More Power Better Reception

### No More Ground Troubles



Doubles the enjoyment from your radio set. Clearer reception. More volume. Greater distance. Eliminates faults of water pipes and radiators. Rusted joints, insulating gaskets, lime deposits cannot affect it.

### Rose Silver Streak Ground

No need for spades, shovels and post hole diggers. Pointed. Drives like a nail. Galvanized to prevent rust. Improved solderless connection. Highly sensitive. No. 2, 6 ft., 90c; No. 1, 4 ft., 60c. From dealers or sent postpaid. Guaranteed.

Frank Rose Mfg. Co., Dept. R-3, Hastings, Neb.

6 ft. 90¢

Dealers Write for attractive dealer offer. Big season now here. Sells on sight. Write for details TODAY!

### Fast Electrical Condensers



The life of a condenser depends upon its dielectric strength. Since 1919 millions of Fast condensers in daily use in leading makes of radio sets have become famous for their extraordinarily high insulation resistance. Fast by-pass short-path type condensers afford zero resistance to radio frequency curve. They are absolutely non-inductive.

An exclusive feature—Fast by-pass condensers are enclosed in a one-piece die-press steel housing, making them positively impervious to all climatic conditions or abuse. Before being encased they undergo a special laboratory treatment whereby the moisture content is effectually removed; and once removed, they stay that way, for the housing seals them permanently thereafter. That's why Fast Hi-Test condensers give such long, dependable service.

Being one of the largest condenser manufacturers in the country, Fast condensers can be depended upon to satisfy you completely.

Manufacturers, send us your specifications. Jobbers, dealers: Write for price list and catalog.

Radio fans: Insist upon Fast condensers from your dealer.

# JOHN E. FAST & CO

3982 Barry Avenue  
Dept. RCB  
Chicago, U. S. A.

Tell 'Em You Saw It in the Citizens Radio Call Book Magazine

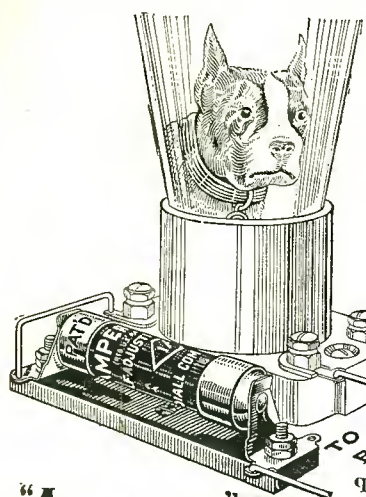

# If TUBES! Could Talk!

They would tell you—that only at the precise and definitely prescribed filament current, or temperature, can their tonal qualities, clarity and sensitiveness be brought out to the full. That "A" hattery current constantly varies according to the age of the hattery and state of charge—and operation with too little or too great current is certain death to efficient tube performance—and too quickly, of the tube itself. That only AMPERITE can automatically supply and control this exact current despite hattery variation—as long as sufficient current is to be had. That you should never confuse AMPERITE with fixed filament resistors which do not do the Amperite's job. AMPERITE is sold by dealers everywhere. Price \$1.10 mounted (in U. S. A.).

**"AMPERITE"**  
Watch Dog  
of your  
Tubes

Write for FREE "Amperite Book" of the season's best circuits and latest construction data. Address Dept. CCB3

*Radiall Company*  
50 Franklin St., New York

# AMPERITE

REG. U. S. PAT. OFF.

The "SELF-ADJUSTING" Rheostat

## Professional Set Builders

Send Your Name  
and Address to Us

Information of interest  
to you will be sent  
from time to time.

Address Us Attention  
**F. A. HILL**

**Citizens Radio  
Call Book**  
508 So. Dearborn St.  
Chicago, Ill.

Tune In Those Distant Stations  
BY ELIMINATING THE LOCALS WITH A

## WEB Wave Trap

NEW TYPE IMPROVED GREATLY

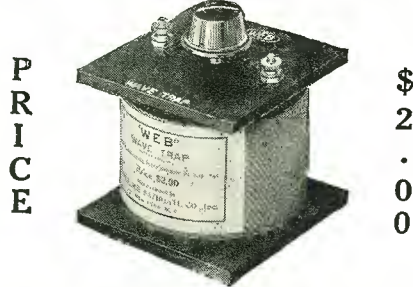

Do you know that when a WEB WAVE TRAP is used in the GROUND WIRE of your set the distant stations come in like locals. NO set is complete without a WEB WAVE TRAP. Many uses for it. DON'T ACCEPT ANY OTHER MAKE TRAPS. THE WEB is the only genuine one of its type. Thousands sold. Ask your dealer or shipped prepaid by manufacturer on receipt of price.

Walter E. Bathgate Company, Inc.  
65 WEST BROADWAY, NEW YORK, N. Y.

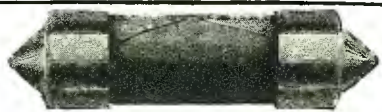

**IMPROVED TURN-IT**  
Variable Grid Leak (Non-Evaporating)  
.5 to 12.6 megohms.....\$1.00  
If your dealer can't supply you write direct  
**GARDINER & HEPBURN, INC.**  
611 Widener Building Philadelphia, Pa.

## Don't Buy Your New Speaker Until You Hear the New WEB Giant 36" Cone-Speaker Kit

\$12.00 List, Including Stand

V  
O  
L  
U  
M  
E



M  
E  
L  
L  
O  
W

The WEB Kit includes the famous new WEB Unit—guaranteed to stand 600 volts; two sheets Fon-O-Tex Paper (front sheet designed); reinforcement cone; Apex fittings; wooden baffle rings; brass brackets with handle; 6-ft. extension-cord; cement; screws; nuts and everything needed for assembling, which can be done by anyone in a half hour.

SEND CHECK OR MONEY-ORDER NOW AND WE'LL SHIP PREPAID—

Manufactured by  
**Walter E. Bathgate Co., Inc.**  
65 West Broadway, New York, N. Y.

## RADIO AT WHOLESALE

Write for my Big 1928 Radio Catalog—just off the press. Thousands of marvelous bargains in nationally advertised goods. All the LATEST IN RADIOS and equipment. Lowest wholesale sale prices. Agents Wanted.

It's a regular encyclopedia on Radio. All about trouble finding. **FREE Log and Call Book and Catalog.** Get your copy today. Send postcard now!

**American Auto & Radio Mfg. Co.**  
HARRY SCHWARTZBERG, PRES.  
Dept. 163 American Radio Bldg., Kansas City, Mo. 3



We carry complete parts for Magnaformer Circuit.

## Nathaniel BALDWIN LOUD SPEAKERS

## A Famous Speaker



Benj. Franklin once said: "My performance devotes itself entirely to thy service & will serve thee faithfully and if it has the good fortune to please its master, tis gratification enough for the labor of 'Poor Richard.'"

## The New "99" Baldwin 99

is without comparison. Baldwin is the standard by which others are judged, and there is pride and satisfaction in owning one. CAN BE USED ON ANY SET.

On demonstration at all good dealers **\$28.50**

Write for booklet  
**J. W. & W. L. WOOLF**  
Distributors & Importers for  
**NATHANIEL BALDWIN, Inc.**  
227-229 Fulton St., N. Y.



In Canada: BALDWIN INTERNATIONAL LTD., Toronto

# ENGINEERING SERVICE

The engineering laboratories of the Citizens Radio Call Book are equipped with the finest precision instruments that are available -- no expense has been spared in equipment or staff personnel. These laboratories are now open to the public, at prices which are within the purse of those needing laboratory service.

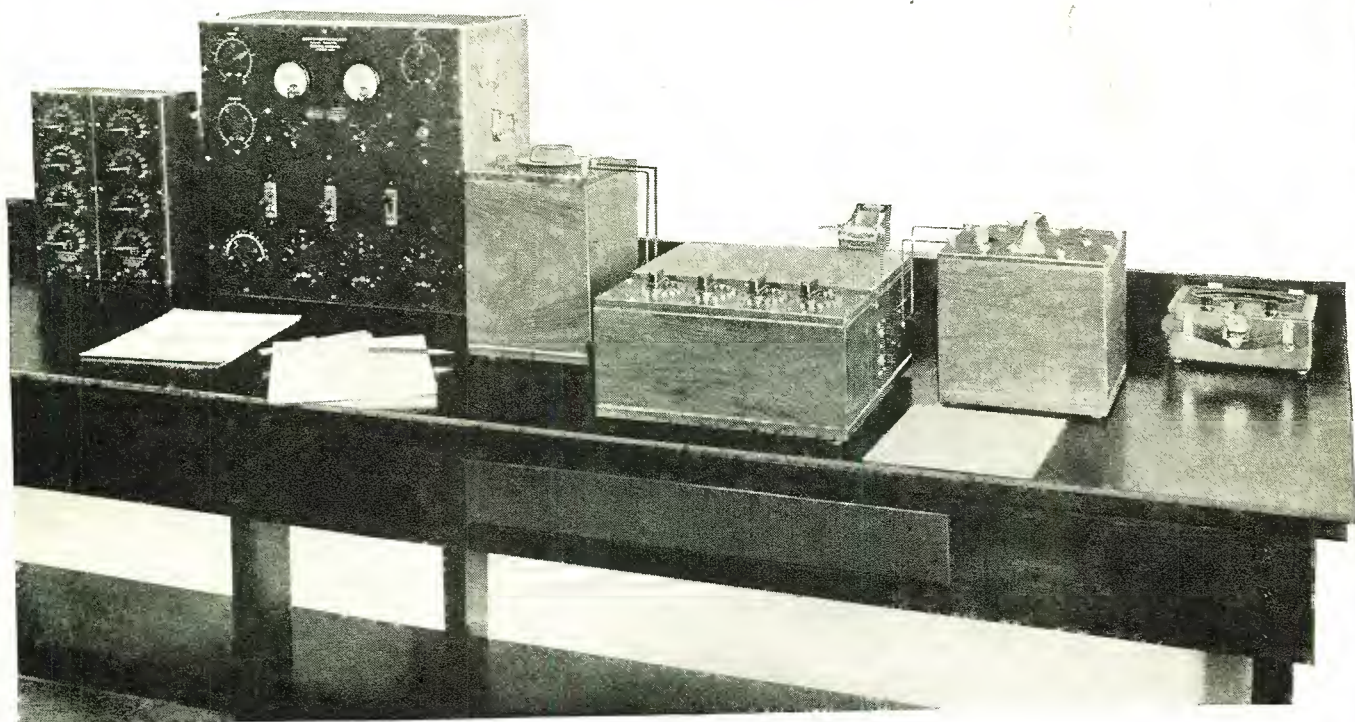

*The apparatus pictured above is a set-up used in the Engineering Laboratories for the measurement of capacity, power factor, dielectric constant and phase angle of condensers. This equipment is some of General Radio's latest creations in precision equipment.*

We do any type of measurement or design work. Our specialties are design of special test equipment, laboratory equipment and calibration of wave meters, condensers, inductors, etc.

## THE CITIZENS RADIO CALL BOOK ENGINEERING LABORATORIES

Dept. C-1, 508 South Dearborn Street

Chicago, Ill.

*Tell 'Em You Saw It in the Citizens Radio Call Book Magazine*

# SENSATIONAL NEWS!

**—for YOU—Mr. Dealer—  
in our Big—New 1928 Catalog**

THIS is the Greatest **MONEY SAVING** Radio Catalog. It describes the best in radio—shows how you can **SAVE MONEY**. Contains all the latest radio information. Write for your copy today. It's free.

**NEW KITS FEATURED include:** Aero—Bodine—Garnfield—Citizens—H-F-L—Infradyne—Karan—Melo—Heald—Scott's—Silver Marshall—St. James—Tyman—etc.

**WHOLESALE ONLY**



Established 1918

**TELEPHONE MAINTENANCE CO.**  
123 S. Wells St., Dept. 47 Chicago, Illinois



**CHICAGO'S OLDEST RADIO HOUSE**

# FREE Wholesale Radio Catalog

Every set builder needs this book. Every live dealer in radio sets, parts, accessories, supplies, etc., should have a copy of this bargain catalog. You will be amazed at the thousands of money saving radio items illustrated and listed in this storehouse of everything you could possibly need in radio. The book contains all the latest and most popular kits—all the famous, nationally known radio parts, accessories and supplies—the very newest types and designs of table cabinets and consoles—everything at prices that mean bigger profits for you.

**Silver Marshall AC Parts In Stock.** 630A Kit, retail price, \$99.00; 652A Kit, retail price, \$36.50. Liberal discounts to the trade. Immediate delivery.

**SHORT WAVE SECTION**

Our catalog contains a section devoted to a showing of the highest grade short wave receiving and transmitting apparatus. Also the finest electrical appliances for use in the home.

**DEALERS! MAKE MORE MONEY**

Tie up with a house that carries large, complete stocks—that gives you the highest quality radio parts—that insures speedy shipments and 100% satisfactory service. Tie up with Shure. Our wholesale vest pocket price list and discount sheet, together with the 1928 bargain catalog will be sent to you on request.

**SHURE RADIO COMPANY**  
341F West Madison St. CHICAGO, ILLINOIS

# FREE

**WHOLESALE RADIO CATALOGUE**

*The Book they are all talking about*

**Get Yours Now**

**Special Prices to Set Builders**

Every set builder who plans to build a set from the Call Book should have a copy of the Harco Catalog. All the latest popular kits are listed at prices that save you money.

**Every Set Builder Should Have a Copy**

All that is new in radio is in the Harco Catalog. Harco service gets the parts to you when you want them. Get the catalog and send your next order to Harco.

**THE HARCO COMPANY, 1259 So. Wabash Ave., Chicago, Ill.**

*The HARCO CO. 1257 So. Wabash Ave., Chicago*

## THE FAMOUS ELLIS "D" COIL

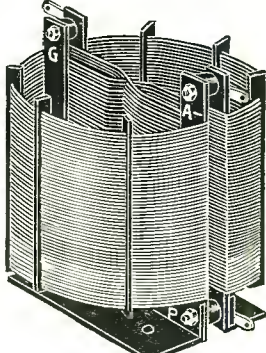

Oscillator has been chosen for use in the Thompson Super Seven because of its exceptional efficiency—Ellis "D" Coils will improve the performance of any T. R. F. Set, giving astonishing Distance, Volume, Selectivity, and Tonal Quality.

**WRITE FOR DETAILS**

Enclosed find 2c stamp for Data telling how Ellis "D" Coils will improve my T. R. F. Set.

Name.....

Address.....

**ELLIS ELECTRICAL LABORATORY**  
607 Brooks Bldg. Chicago, Ill.

**R. F. Coils Matched Sets.  
Per Coil, \$2.50  
ELLIS "D" Coils**



## THE G-R CIRCLE CUTTER

Cuts holes in Radio Panels from 3/8 to 3 in. Fits into an ordinary carpenter brace.

**Price 65 cents**

SENT POSTPAID ON RECEIPT OF MONEY ORDER

**Garrison-Rumely** 3020 Sheridan Rd. Chicago, Ill.

## "In the Heart of Cleveland"

# AUDITORIUM HOTEL



EAST 6TH AND ST. CLAIR AVE.

**TO THE PUBLIC:**

Are you wondering why we have built "Another" Hotel in Cleveland. One must have a good reason for spending nearly two million dollars. We have a reason worth far more than that.

Every hotel operator gives "His best efforts for his comfort." We have centered our efforts around one ideal desire. "To make you happy."

There must be something back of that desire. You can easily prove it by coming here just once.

Sincerely yours,  
*James L. Smith*  
Manager

# It's Impossible to Fail

WITH the Roberts Short Cut to the code, anybody can learn the code in one evening. Designed by a naval officer to teach operators for war purposes, when speed was paramount.

**Fifty Cents, U. S. Stamps or Coin**

Used in schools and by thousands of students, the world over. No phonograph records or mechanical devices needed. Just send 50c in stamps and you will get a thrill from receiving messages from every country in the world.

**FAILURE IMPOSSIBLE**

*Remember—No Tedious Weeks and Months—One Night and the Code Is Mastered*

**ROBERTS RADIO SERVICE**  
780 CAXTON BUILDING CHICAGO, ILL.

Tell 'Em You Saw It in the Citizens Radio Call Book Magazine

# Guaranteed Radio Service

All receivers or power devices repaired by this highly efficient organization are positively guaranteed to perform in the same manner as claimed by the manufacturer.

Let us solve your radio difficulties. Our completely equipped service laboratory, with its corps of carefully trained and experienced service men, is at your disposal for repair and test work on all types of receivers, battery eliminators and power units. All laboratory instruments used in test and repair work are modern and up-to-date, insuring rapid and accurate location of troubles involved in your receiver.

All receivers serviced in this laboratory are given a final test in a completely shielded room where all internal electrical noises are absolutely eliminated;—thus insuring noise-free reception which is vital to satisfactory performance.

Being specialists in the radio field we are in an excellent position to rebuild your present receiver and return it to you with all latest developments incorporated in it. We will also repair, test or design any type of receiver which you may desire.

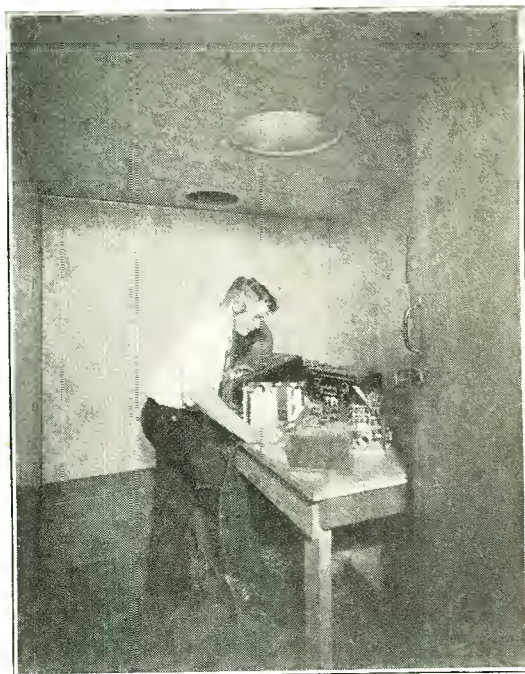

Shielded Testing Room

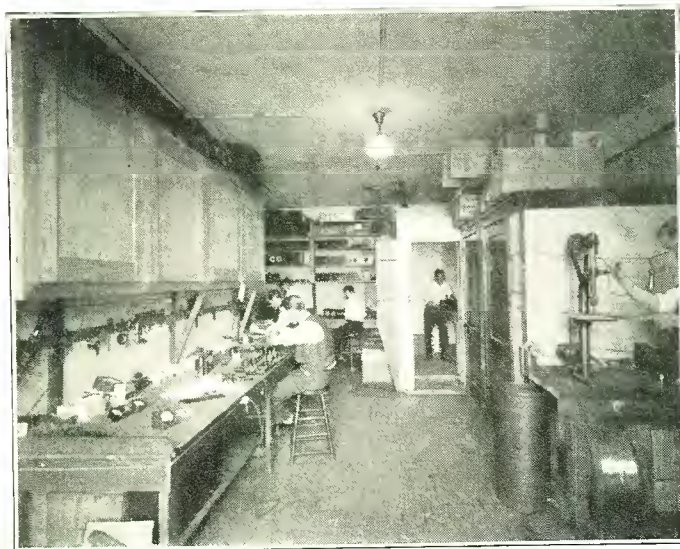

Repair Department

Remember—the confidence of many leading manufacturers has been placed in this laboratory. The Radio Service Laboratories will give to you the same conscientious service that the manufacturer, himself, would give you. It is more practical and wise to bring your problems here than to some irresponsible radio man who is unfamiliar with the merchandise you wish serviced. This is an era of specialized effort and our charges are no more than you would pay for inferior workmanship.

*If you are unable to personally deliver the receiver or unit you wish to have serviced, securely pack it in a strong box with plenty of cushioning material such as excelsior, and ship it to us via American Railway Express, prepaid. It is not necessary to ship the cabinet or accessories.*

## RADIO SERVICE LABORATORIES, Inc.,

508 So. Dearborn Street

Telephone: Harrison 2870

CHICAGO, ILL.

*Tell 'Em You Saw It in the Citizens Radio Call Book Magazine*

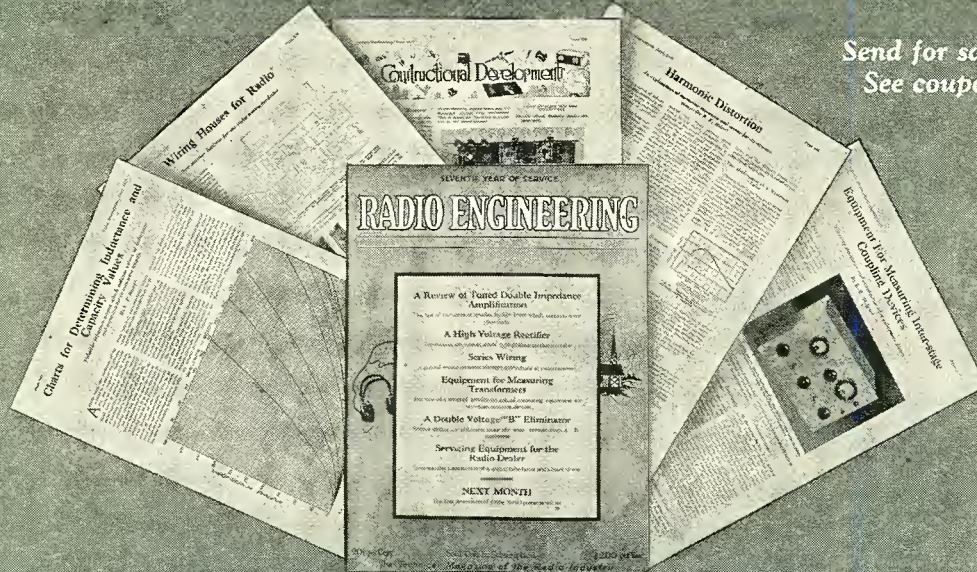

Send for sample copy.  
See coupon below.

## FOR THE PROFESSIONAL RADIO MAN

Custom Set Builders, Advanced Experimenters, Engineers,  
Manufacturers, Service Men and Technicians

# RADIO ENGINEERING

has been published for seven years exclusively for the professional men of the radio industry and trade—for custom set builders—for experimenters who “know what it’s all about.” It includes each month a complete review of important construction developments together with carefully selected articles on technical and semi-technical subjects prepared by leading engineers of the industry exclusively for Radio Engineering.

NOTE—An information service covering technical, engineering and construction problems is available without charge to subscribers.

THE EDITORIAL STAFF IS HEADED BY MR. M. L. MUHLEMAN, FORMERLY TECHNICAL EDITOR OF RADIO NEWS. ASSOCIATE EDITOR, MR. JOHN S. RIDER, FORMERLY ASSOCIATE EDITOR OF RADIO DEALER

*A non-biased, impartial source of accurate technical information*

**RADIO ENGINEERING IS NOT SOLD ON NEWS-STANDS**

RADIO ENGINEERING, Inc.,  
52 Vanderbilt Avenue, New York, N. Y.

Enclosed find { \$2.00 for 1 year } subscription to Radio Engineering.  
                                  { \$3.00 for 2 years }

Enclosed find twenty cents (20c) for which send sample copy of Radio Engineering.

PLEASE CHECK YOUR CLASSIFICATION

- Dealer  Professional Set Builder
- Engineer  Service Man
- Manufacturer  Distributor
- Anything Else \_\_\_\_\_

Name \_\_\_\_\_

Address \_\_\_\_\_

Town and State \_\_\_\_\_

*Tell 'Em You Saw It in the Citizens Radio Call Book Magazine*



The Big Friendly Radio House

**TYRMAN  
TEN**

THE PERFECT RECEIVER

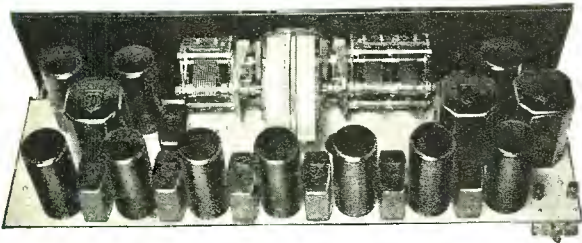

Blue Prints and Parts in Stock

Big Radio Catalog

GET this up-to-the-minute, 1928 Book of Bargains! Popular, nationally advertised sets, parts, eliminators and accessories at prices that mean real values. Parts for Tyrman Ten, Silver-Marshall Unipacs, Melo-Heald Super's, Camfield Super Selective Nine, Victoreen Super, Remler Infradyne, World's Record Super, and many other popular circuits.

**DEALERS**  
YOU will want this dealer catalog. It lists everything in radio—standard quality at the right price!  
It means more profit for you!

Send for this Great Book Today!

**WESTERN  
RADIO MFG. CO.**

128 W. Lake St. Dept. 22  
Chicago, Ill.

**A Quality Catalog**  
from a  
**Quality House**

**DEALERS** should have this book, issued by Chicago's quality radio house. It lists the newest in radio—at prices that enable you to meet competition. Everything in it conforms to our famous slogan—"GOOD APPARATUS PAYS." Cash in on the experience of the engineers who own and direct this Recognized Radio House.

**DEALERS—WRITE FOR IT TODAY!**

*Browning-Drake  
Bremer Tully  
Nine-in-Line  
Tyrman Ten  
World's Record  
Balkite  
Burgess  
—and others.*

**National Radio Co.**

227 W. Madison St. Dept. 29 Chicago, Ill.

**LATEST CIRCUIT  
PANELS  
IN STOCK**



EIGHT IN LINE SUPER  
HOT SPOT FOURTEEN  
BEST REMLER 45 K.C.  
SUPER  
IMPROVED NINE IN LINE  
IMPROVED INFRADYNE TEN  
KARAS EQUAMATIC (Two Control)  
WORLD'S RECORD SUPER TEN  
BODINE PHASATROL A.C. 6  
B. T. POWER SIX  
BROWNING-DRAKE  
AERO SHORT WAVE  
AERO FOUR  
AERO SEVEN  
AMBASSADOR LINK  
L. C. COCKADAY 28

CAMFIELD SUPER SELECTIVE NINE  
MADISON-MOORE ONE SPOT SUPER  
LODGE "N" RECEIVER—2 TUBES  
LINCOLN SUPER  
STROBODYNE  
TYRMAN TEN  
UNICONTROL 9 IN LINE  
VICTOREEN UNIVERSAL  
MELO-HEALD SUPER HET 11  
MAGNAFORMER SUPER  
IMPROVED BROWNING-DRAKE  
QUADRAFORMER SIX  
RAYTHEON A. B. C.

AND MANY OTHERS

**All Fully Drilled and Beautifully Decorated**

Manufacturers of Bakelite and Hard Rubber Panels  
Factory Representatives:

AARON SIEDMAN & CO.  
32 W. Randolph Street  
Chicago, Ill.

LYONS RADIO SALES CO.  
150 N. 8th Street  
Philadelphia, Pa.

**Cortlandt Panel Engraving Co.**  
79 CORTLANDT ST., NEW YORK

## The TYRMAN TEN specifies Camfield Equaltune Condensers

The following features of the Camfield Equaltune Condensers are not to be found in any other one Condenser on the market:

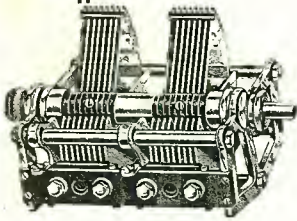

Type 352 (Two Gang)  
Capacity .00035—Price \$10.50

Member  
RMA

1. To facilitate sharp tuning and perfect balancing in sets of the unit control type, the Camfield Equaltune Condensers are provided with a special adjustment feature which makes possible the perfect equalization of all circuits after the receiver has been completely wired. This eliminates the necessity for using Vernier or trimmer condensers of any kind. Complete instructions and a special tool for making this adjustment are packed with each double and three-gang condenser.
2. The shaft may be shortened or lengthened or entirely removed without affecting the adjustment of the rotor plates. This provides a simple means for connecting several units together with a single shaft and anywhere from one to six condenser units may be operated with one dial.
3. The Condenser is so designed that it may be mounted from either end. This is accomplished by reversing the shaft cap nut and the panel mounting nut. After the shaft cap nut has been removed the shaft may be extended from the opposite end of the condenser by loosening the set screws on the rotor hub.
4. A variable spring tension is provided and the rotor is mounted on ball bearings which insure extremely smooth running over a long period of operation.
5. Camfield Equaltune Condensers are beautifully finished. The rotor and stator plates are of bright dipped brass. All other parts are hand buffed and nickel plated.
6. A pair of special brackets for mounting the condensers on a baseboard or sub-panel can be obtained at a slight additional cost. With the use of these brackets several single condensers may be mounted in a row on a baseboard or sub-panel and all operated with a single shaft.

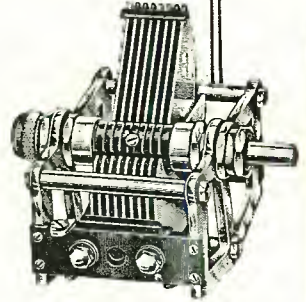

Type 351 (Single)  
Capacity .00035—Price \$5.75

Send for Free Booklet, "Wherever You Require Quality"

**Camfield Radio Manufacturing Company**

35 EAST WACKER DRIVE  
DEPT. CB CHICAGO, U. S. A.

## A 1y kit—any part— —get them from VAN-ASHE!

The home set-builder is a big factor in radio today. He wants and deserves service. Van-Ashe is prepared to furnish this service on 12 hours notice.

Try any of the newest, most popular circuits. We stock all parts and accessories, ready for 12-hour shipment. Come to Van-Ashe for the new



**Tyrman Super, S-M Super, World Record Super  
Camfield Super Infradyne  
Victoreen Raytheon ABC Power Unit**

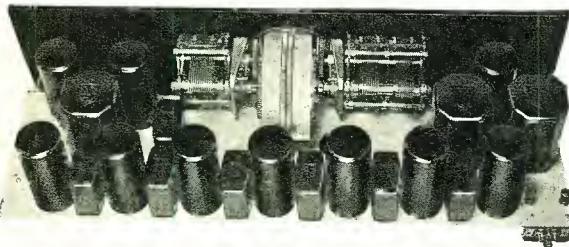

Write today for our big 1927-28 catalog and discount sheet. Our prices make set-building profitable!

### Any Trouble?

Our Repair and Experimental Department runs 24 hours a day if need be—to find and correct troubles, solve problems, and generally help the set builder. Advice and suggestions are freely given. Write us about it!

### Set Builders! Dealers!

**FREE**  
—this catalogue

Standard parts and equipment at money-saving prices. New AC tubes and transformers—parts for any circuit—power audio equipment—short wave supplies—they are all in our big new 1928 catalogue. Write for it today, with discount sheet. 12-hour shipment guaranteed. Send name and address on a postcard.

# VAN-ASHE RADIO COMPANY

208 North 10th Street

St. Louis, Mo.

OUR STOCK OF RADIO PARTS AND SUPPLIES IS COMPLETE. WE SHIP IN 12 HOURS OR LESS.

## Greater—Better Radio Values IN THE WORLD'S GREATEST RADIO CATALOG

ALL under one roof. You don't need to look elsewhere. Complete stock carried. Prompt, efficient, dependable service. All orders, small or large, filled promptly.

You must have this catalog if you want everything—the best in radio, at a big saving. Contains all the information that you need. Answers all radio questions that you ought to know. It won't cost you a cent. Just drop us a card today.

Established 1918

**IT'S FREE!**

Complete sets—Cabinets—Speakers—Tubes—Batteries—Accessories—New Devices—Complete Parts for Every Known Circuit.

**WHOLESALE ONLY**

**TELEPHONE MAINTENANCE COMPANY**  
123 S. Wells St., Dept. 48 • CHICAGO, ILL.

**CHICAGO'S OLDEST RADIO HOUSE**

## RADIO ENJOYMENT INCREASED

**W-E-B-B  
CHI-CAGO  
BALL AND SOCKET  
FULL ADJUSTABLE  
AERIAL**

You will get better reception on your radio when you install W-E-B-B Chi-Ca-Go Aerial Supports. Gives firm, steady, permanent support, and neater appearance on roof than makeshift poles. Reception is faulty even with costly sets unless aerial is right—and W-E-B-B makes it right.

Two styles and sizes—fit any roof. Ball-and-socket base adjusts tension. Style here fits gable roof; other fits sloping, flat roof or side wall. Either style, 1/2-in. pipe size, \$1.50; 1-in. pipe size, \$3.00. See it at radio shops, or write us.

**TIMING GEARS CORP.** 2801 FULTON ST. CHICAGO, ILLINOIS

# All Electric Radio



*The Randolph*

## 7 Tubes-Single Control

JUST plug this Randolph Radio into the electric light socket—and tune in. A powerful, selective radio that gives dependable coast to coast reception. **No batteries, chargers, eliminators, acids or fluids.** Here is complete radio satisfaction whenever you want it. The easy tuning with one control brings on all stations. Illuminated drum allows you to operate the radio in the dark and has space for logging stations. Every detail of the Randolph is modern and perfected—it is the utmost in radio—unsurpassed regardless of price. It is this wonderful radio that you test and try for 30 days FREE before you buy. Listen to it in your own home. When it convinces you by actual performance it is the ideal radio—the one you have always hoped for—you can buy it direct at factory prices. Be sure you write for free descriptive literature today.

### Beautiful Ampliphonic Console



Illustrated here is one of the beautiful Randolph Seven Console Models—made of the finest carefully selected heavy solid walnut, hand-rubbed and with burl finish. Has built-in genuine large cone speaker that compares with any on the market. Assures unlimited reception of high notes and low notes clear as a bell. Completely electric—uses no batteries of any kind. Be sure you send for fully illustrated, full color folder giving complete details.

**Genuine Walnut Cabinets**  
The finest of heavy, genuine, solid burl finish walnut is used in the making of all Randolph cabinets. No picture can do them justice. You must see them to appreciate them.

### 6-Tube Radio

New, modern, single-control, six-tube radio. Do not compare this set with old-style, 2-dial, 6-tube sets selling for about the same price. The Randolph 1928 Senior Six has also been tested and approved by the leading radio engineers. Comes in beautiful solid walnut cabinet of hand-rubbed finish. Single control. Illuminated drum with space for logging. Absolutely dependable and very selective. **Send for 30 days free trial. You test it before you buy.**

**All Sets Guaranteed**

**30 DAYS FREE TRIAL**

**6 Tube \$55 Retail Price**

**Biggest Discounts To Agents**

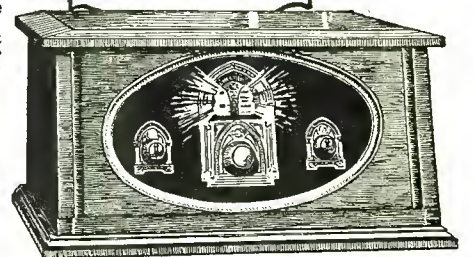

**Biggest Discounts to Agents**  
Work either full or part time and make big money. Sensationally big discounts to agents. No experience required. Randolph All-Electric Sets sell on first demonstration. Tremendous advertising campaign helps you. Men and women both make big money this way. Demonstrating set sent on 30 Days TRIAL. WRITE NOW for proposition.

### USE THIS COUPON TODAY!

**Randolph Radio Corporation**  
711 West Lake Street, Dept. 248  
Chicago, Illinois

Send me full particulars about the RANDOLPH Six and Seven-Tube Electric and Battery Table and Console Sets with details of your **30 Day FREE Trial Offer.**

Name.....

Address.....

City..... State.....

Mark here  if interested in Agent's proposition.

**RANDOLPH RADIO CORPORATION**  
711 West Lake Street Dept. 248 Chicago, Ill.

# TYRMAN Products

EXCLUSIVELY SPECIFIED IN  
**Camfield Super-Selective "10"**

*specified!*

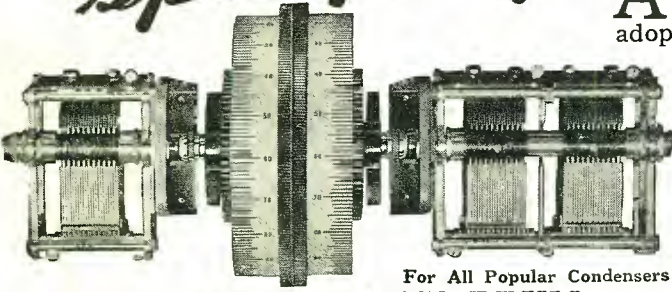

For All Popular Condensers

## TYRMAN VERNIER DRUM

is a precision tuning device assuring efficiency—accuracy and simplicity for all double and single control receivers.

A high grade bronze ornamental escutcheon encloses the drums and vernier—a Tyrman unit of unequalled beauty. The center knurl enables fast tuning while the vernier provides hair line adjustment.

Single Control Unit.....\$ 5.00  
Double Control Unit..... 10.00

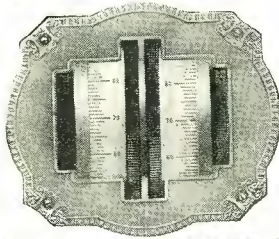

**A**FTER exhaustive tests, the engineers and designers of the Camfield Super Selective "10" have adopted Tyrman products and have specified the Tyrman Vernier Drum and Audio Transformers to maintain the high quality of their receiver.

See article in this issue

## Tyrman Audio Transformer

*A New Achievement in Tone and Volume*

Whether it is the deep low notes of the bass viol or the delicate high notes of the oboe—whether the low rumbling roll of kettle drums or the wide range of the human voice, you get life-like reproduction of tone values, regardless of amplification.

Never has the full value of orchestra reproduction been more appreciated than in receivers which have adopted Tyrman Audio Transformers.

Bear in mind that receiver reproduction is no better than its audio.

Tyrman Audio Transformers are your assurance of faithful reproduction.

Ask Your Jobber



Type 3-30.....\$ 8.00  
Type 3-50..... 10.00  
Type 3-51..... 10.00

**TYRMAN ELECTRIC CORP. 141 W. Austin Ave. Chicago**

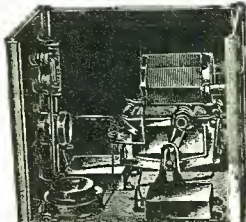

# Camfield

**Amazing! Shielded Grid powerful!**

*With the NEW "7" Shielded Grid Tubes*

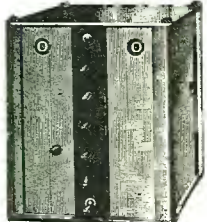

**Read the Complete Description in this Issue Then Avail Yourself of Our 24-Hour Mail Order Service**

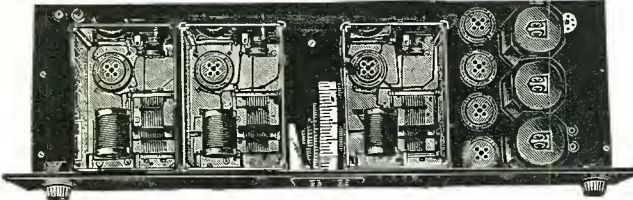

**Use This Coupon!**  
**Send Your Order and Write for Information Today!**

*The M & M Co.*

480-500 PROSPECT AVE.  
CLEVELAND

**THE M & M COMPANY**  
500 Prospect Avenue, Cleveland, Ohio

Gentlemen: Find inclosed \$..... for which please send me the following:

( ) Camfield type 222 Shielded Grid Amplifier Units

( ) Camfield type 222K, (Knocked-down) Shielded Grid Amplifier Units

( ) Shielded Grid Tubes type SP 122

( ) Complete set of parts for Camfield Shielded Grid 7

You may also send me free of charge:

( ) Complete information on Camfield Shielded Grid Seven

( ) Your latest catalog of radio parts, sets and accessories

THE new shielded grid tubes specially designed for radio frequency amplification are astounding the radio world with their amazing performance. These new tubes have an amplification factor of 175 and when used in specially designed circuits such as the Camfield Shielded Grid Seven they give an actual gain of 30 to 40 per stage.

As described elsewhere in this magazine these new tubes require completely shielded radio frequency amplifier units. The Camfield Shielded Grid Amplifier Units type 222 have been designed to meet the requirements of this new tube after months of experimental work. They are specified for use in the Camfield Shielded Grid Seven described in this magazine, and are also ideal for use as radio frequency stages in any circuit using the new shielded grid tubes and for general experimental work.

From now on general purpose tubes are obsolete as radio frequency amplifiers. In all future circuits the new shielded grid tubes will be used for that purpose. Buy your units for these tubes now and be first with the latest and the most important development since the beginning of radio.

These Camfield units may be had either completely assembled and wired or in knocked-down kit form.

Use the coupon on this ad to order any of the following material from us. We are Ohio's largest radio house, and we guarantee the merchandise we ship you to be exactly as represented and first class in every respect.

Camfield type 222 Shielded Grid Amplifier Unit, completely assembled and wired.....\$25.00  
Camfield type 222K Shielded Grid Amplifier Unit knocked-down kit..... 20.00  
Complete set of parts for Camfield Shielded Grid Seven Receiver, including drilled sub-panel and drilled and engraved front panel.....123.15  
Shielded Grid Amplifier Tube, type SP 122.. 7.50

**DOWN** **Brings You Guaranteed** **Electrifies**  
**“A” or “B” Eliminator** **Any**  
**Radio**

**Completely Replaces Batteries**

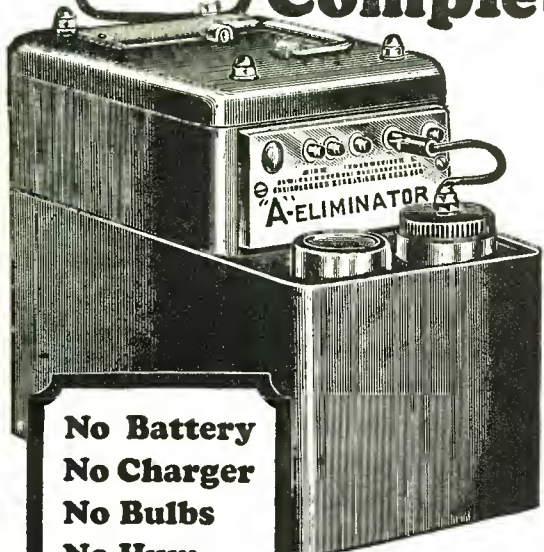

**Super-Power “A” Eliminator**

UNCERTAIN storage batteries with their changing power, chargers and other bothers and expenses are done away with. This eliminator is not a battery charger combination but completely and permanently replaces “A” Batteries. It consists of a large capacity rectifier which changes the alternating house lighting current into direct current. Then a highly efficient heavy duty filter system of extremely high capacity changes the pulsating direct current from the rectifier into smooth, even current for lighting the filament in the radio tubes. Smooth, constant, unvarying, humless current for your radio. Anyone can install this eliminator in a few minutes. Simply connect between electric light socket and the radio and your set is instantly supplied with current used only when it is in use. Works perfectly whether used daily or only at long intervals. No moving parts to wear out. Operates from light socket 110-120 volts, 50-60 cycle A. C., output 6 volts for all sets up to 12 tubes with or without power tubes. Fool-proof in operation. Now sold direct at astonishingly low price.

No Battery  
 No Charger  
 No Bulbs  
 No Hum  
 Nothing to  
 Wear Out  
 Or Replace

COMPLETE  
**\$32<sup>50</sup>**

**Completely Replaces “B” Batteries**  
**Easy to Attach Plug Into Electric Light Socket**  
 COMPLETE  
**\$29<sup>50</sup>**

**Super-Power “B” Eliminator**

Used with any good “A” Eliminator, this “B” Eliminator completely electrifies any radio. Battery troubles are forever ended. You operate your radio as easily as you turn on a light.

**Complete with Raytheon Tube** — This Super-power “B” Eliminator can be used with any set up to 12 tubes. It comes complete with full wave rectifying 85 mil. Raytheon tube, making possible the delivery of great current at a high voltage. This Raytheon tube has indefinite life as it has no filament to burn out. Delivers up to 180 volts.

The case is beautifully finished in olive green Duco, with black panel etched in gold. Equipped with rubber-covered cord and socket plug. High voltage taps and variable adjustments enable the use of new power tubes. Operates from 110-120 A. C., 50-60 cycle current. Has tap for intermediate voltage on which 67½ to 90 volts may be obtained. The detector tap will supply 22½ to 67½ volts. Variable adjuster will deliver any desired detector voltage. On and off switch and high and low voltage switch are integral parts of the eliminator. No additional switches or cords are necessary.

**Only \$1.00 Down—Then Test Before You Buy**

Indicate on the coupon below which eliminator you wish. Pin a dollar bill to the coupon and mail it to us. We will send you the Eliminator you want to test. If you want both eliminators send two dollars and mark coupon accordingly. You test them for 30 days before you pay another cent. Balance on easy installments when you are satisfied.

**New Low Prices**

Our great buying power and direct sales method enables us to offer both eliminators at tremendous savings. The “A” Eliminator now selling most places for \$40.00 and more can be had here for \$32.50—only \$1.00 and balance on easy payments. The “B” Eliminator sells for the cash price of \$37.50 and more but by buying direct on easy payments you can have it for only \$29.50.

**Elliott Radio Corporation**

709 West Lake St. Dept. 247. Chicago, Illinois

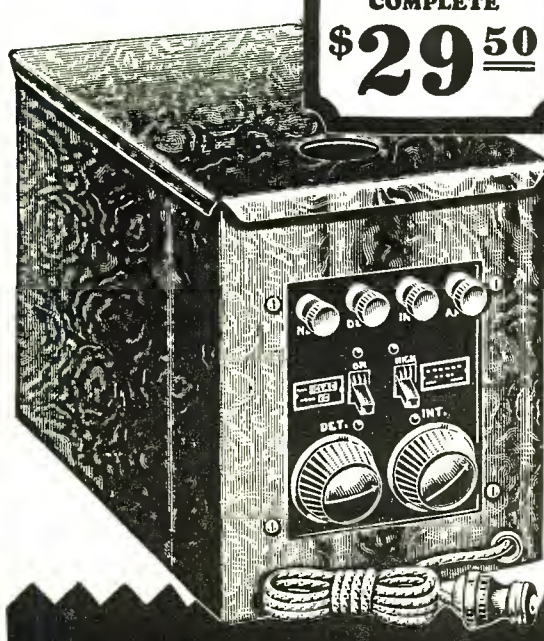

**Mail Coupon NOW!**

**Mail This Coupon NOW!**

Elliott Radio Corporation, Dept. 247  
 709 West Lake Street, Chicago, Ill.

Attached find \$1.00 for which you agree to send me ( ) “A” Eliminator at \$32.50 ( ) “B” Eliminator at \$29.50 (send \$2.00 if both are desired) as described in your ad. Full particulars will be sent me by return mail and my money refunded if I do not accept your offer.

Name.....  
 Address.....  
 City..... State.....

# Index to Advertisers

## A

Aberdeen Hotel .....224  
 Abox Co., The..... 10  
 Acme Apparatus Co..... 69  
 Acme Wire Co.....39-187  
 Aero Products Co.....51-199  
 Aerovox Wireless Corp.....231  
 All-American Radio Corp..... 63  
 Allen-Bradley Co..... 65  
 Allen-Rogers-Madison, Inc.....211  
 Alter Co., The Harry.....191-227  
 American Auto & Radio Mfg. Co.....  
 .....212-218-234  
 American Mechanical Laboratories.....232  
 American Sales Co.....212  
 American Transformer Co.....67  
 Amrad Corp.....195  
 Amsco Products Co.....232  
 Arlington Radio Mfg. Co.....198  
 Ashe Radio Co., Walter.....208  
 Austin Accessories Mfg. Co.....212

## B

Bathgate Co., Inc., Walter E.....234  
 Belden Mfg. Co..... 29  
 Benjamin Electric Co.....179  
 Birnbach Radio Co.....170  
 Blackburn Specialty Co.....218  
 Bodine Electric Co.....202  
 Boudette Mfg. Co.....194  
 Braun Co., W. C.....2-212  
 Brown & Caine.....228  
 Browning Drake Corp..... 35

## C

Camfield Radio Mfg. Co.....214-240-245  
 Carter Mfg. Co..... 57  
 Carter Radio Co.....216  
 Celoron Co., The..... 9  
 Central Radio Laboratories.....203  
 C. E. Mfg. Co..... Back cover  
 Chaslyn Co..... 231  
 Chicago Salvage Stock Co.....246  
 Chicago Solder Co..... 31  
 Citizens Radio Amateur Call Book.....217  
 Citizens Radio Engineering Labora-  
 tory .....235  
 Citizens Radio Service Bureau, Blue  
 Prints .....193  
 Clark & Tilson, Inc.....212  
 Cloverleaf Mfg. Co..... Third cover & 5  
 Continental Corp.....195  
 Co-Operative El. Supply House.....216  
 Corbett Mfg. Co.....186  
 Cornish Arms Hotel.....232  
 Cornish Wire Co.....230  
 Cortlandt Panel Engr. Co.....239

## D

Daven Radio Corp.....188  
 De Jur Products Co.....192  
 De Land Mfg. Co.....223  
 Deutschmann Co., Tobe.....185  
 Dubilier Condenser & Radio Corp.....198  
 Duro Metal Products Co.....191

## E

Eby Mfg. Co., H. H.....229  
 Egert, R. W.....214  
 Ehlert Radio Furniture Co.....233  
 Ekko Co.....201  
 Electrad, Inc.....187-197-232  
 Ellis Electrical Laboratory.....236  
 Engineers Service Co..... 55  
 Excello Products Co..... 45

## F

Fansteel Products Co..... 17  
 Fast & Co., John E.....233  
 Ferranti, Inc..... 7  
 Fishwick Radio Co.....225  
 Flanders Hotel.....230  
 Formica Insulation Co..... 61  
 Fort Shelby Hotel.....226  
 Fritts & Co., W. H.....200  
 Frost, Inc., Herbert H..... 3

## G

Gardiner & Hepburn, Inc.....234  
 Garrison-Rumely Co.....236  
 General Radio Co..... 43  
 Gradergood Co., The..... 53  
 Gray & Danielson.....8-227  
 Guaranty Radio Goods Co.....224

## H

Hagel, E. A.....198  
 Hallderson Co.....177  
 Hamilton Carr Co.....214-230  
 Hammarlund Mfg. Co.....197  
 Hammarlund-Roberts Co..... 49  
 Hammer Radio Co., S.....209  
 Hampton-Wright Co.....224  
 Harco Co., The.....189-212-221-236  
 Hazelton Laboratories .....223  
 High Frequency Laboratories.....248

## I

Independent Electric Co.....233  
 International Correspondence Schools.....228  
 International Resistance Co.....233

## J

Jewell Electrical Instrument Co..... 19  
 J. M. P. Mfg. Co.....226  
 Jones Co., Howard B.....187

## K

Karas Electric Co.....218-219  
 Kokomo Electric Co.....190  
 Kurz-Kasch Co..... 74

## L

Langbein & Kaufman.....181  
 La Peer Electrical Mfg. Co.....165  
 Lewis Radio Jobbers.....209  
 Lignole Corp.....176  
 Luxem & Davis Mfg. Co.....233  
 Lynch, Inc., Arthur H.....196

## M

Madison-Moore Radio Corp.....215  
 Marwood Radio Corp.....247  
 Michigan Radio Supply Co.....203  
 Midland Wholesale Co.....216  
 Midwest Radio Corp..... 15  
 Miller-Welles Co.....214  
 Modern Electric Mfg. Co.....178  
 Modern Laboratories .....226  
 M & M Co.....209-242  
 Muter Co., L. F.....181-184

## N

National Co..... 23  
 National Radio Co.....239  
 National Radio Institute..... 27  
 Nelson Electric Co.....174  
 New Auditorium Hotel.....236  
 North American Auto Supply Co.....191

## P

Paramount Electrical Supply Co.....218  
 Penn Radio Sales Co.....167  
 Perfect Eliminator Co.....220  
 Pitts Co., F. D.....216  
 Polymet Mfg. Co.....201  
 Power Co., Harold J.....226

## R

Radiall Co.....234  
 Radiart Laboratories Co..... 6  
 Radio Age .....222  
 Radio Appliance Corp.....189  
 Radio Association of America..... 41  
 Radio Cabinet Co.....172  
 Radio Engineering .....238  
 Radio Equipment Co.....199  
 Radio Institute of America.....231  
 Radio Service Laboratories, Inc.....237  
 Radio Stores, Inc.....197  
 Randolph Radio Co.....11-241-243  
 Raytheon Mfg. Co..... 33  
 Rex Laboratories .....204-205  
 R. G. S. Mfg. Co.....173  
 Robertson-Davis Co..... 81  
 Roberts Radio Co.....236  
 Roll-O-Radio Co.....213  
 Rose Mfg. Co., Frank.....233  
 Rowan Battery Supply Co.....185-212

## S

Samson Electric Co..... 37  
 Scanlan Electric Mfg. Co.....168  
 Scott Transformer Co.....171  
 Shanklin Mfg. Co.....223  
 Shieldplate Tube Corp..... 21  
 Shure Radio Co.....201-223-236  
 Sickles Co., F. W.....201  
 Signal Electric Mfg. Co.....223  
 Silver-Marshall, Inc.....206-207  
 Simplex Radio Supply Co.....218  
 Sonatron Tube Co..... Second cover  
 Southern Toy Co.....183  
 Sovereign Electric & Mfg. Co.....203  
 Sprague Specialties Co.....181  
 Sterling Mfg. Co..... 59  
 St. James Laboratories.....195  
 Straus & Schramm ..... 25  
 Syd Battery Co.....203

## T

Telephone Maintenance Co.....  
 .....208-214-218-236-240  
 Temple, Inc..... 80  
 Thordarson El. Mfg. Co..... 47  
 Timing Gears Corp.....240  
 Tower Mfg. Co..... 1  
 Townsend Radio Corp.....229  
 Triple A Specialty Co.....180  
 Tyrman Electric Corp.....13-216-242

## V

Van Ashe Radio Co.....240  
 Van Doorn Co., The.....199

## W

Walker Co., The George W..... 73  
 Ward Leonard El. Co.....175  
 Ward Mfg. Co.....196  
 Webster Co., The.....183  
 Wedel Co.....210  
 Western Radio Co.....211-239  
 Westgale Electric Co.....169  
 Weston Electrical Instrument Co.....182  
 Wholesale Radio Service Co.....210  
 Woolf, J. W. & W. L.....234  
 WorkRite Mfg. Co.....223  
 World Battery Co.....224

## X

X. L. Radio Laboratories.....227

## Y

Yahr-Lange, Inc.....179  
 Yaxley Mfg. Co.....219

# Camfield

## Amazing! Shielded Grid powerfu

### With the NEW "7" Shielded Grid Tubes

**CAMFIELD SHIELDED GRID R.F. AMPLIFIER UNITS TYPE 222 INSURE SIMPLICITY OF CONSTRUCTION**

Here, for the first time in radio history, is a really revolutionary development—the perfection of a new design of radio circuit—using the new shielded grid tubes type SP 122, UX 222 or CX 322, and doing away entirely with the 201A type vacuum tube as a radio frequency amplifier.

So powerful is the amplification of this new tube that it will show a gain of 30 to 40 per stage at broadcast wave lengths and of over 150 per stage at lower frequencies.

The Camfield Shielded Grid Seven receiver utilizes for the first time this new and remarkable tube, in a 7-tube R. F. amplifier, using three stages of R. F. amplification with the new SP 122 tubes, a detector and a push-pull audio frequency amplifier using 112 and 171 power tubes.

The home constructor and the professional set builder will find this new receiver extremely simple to construct by making use of the completely wired Camfield Shielded Grid R. F. Amplifier Units, type 222.

Never before has the radio fan been able to tinker with such a really marvelous combination as this. By all means, do not miss this opportunity to secure the very latest in radio and thus experience the really new thrill of bringing in DX stations like locals.

The Camfield Shielded Grid Amplifier Unit type 222 has been designed by our engineers after months of work on the new shielded grid tube and circuits for its use, and it represents a unit that will insure maximum efficiency from the shielded grid tubes. The highest quality of parts are used throughout and the complete wiring of the unit greatly simplifies the construction of the Camfield Shielded Grid Seven receiver. We are offering this unit completely wired and ready for use at \$25.00 each. For those who prefer to build their own complete we will supply this unit in knocked-down form with blueprints for wiring at \$20.00 each.

It must be remembered that this new tube employs an absolutely new circuit that is entirely different from anything that has ever been used in radio frequency amplification in the past and to insure the obtaining of maximum efficiency we urgently recommend that professional set builders and home constructors make use of our completely wired unit.

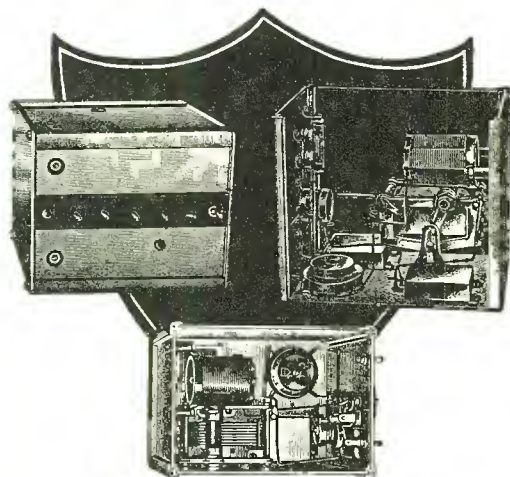
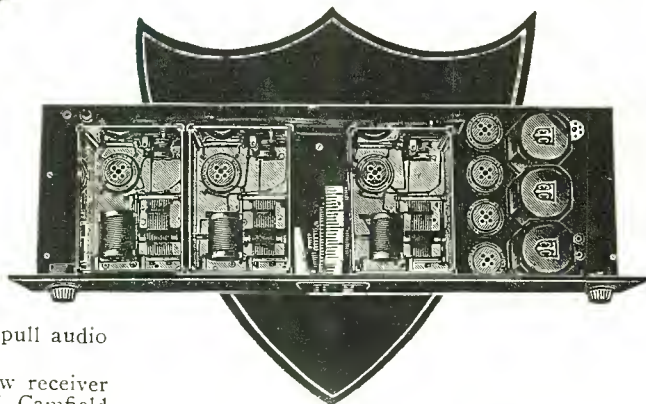

### CAMFIELD SUPER-SELECTIVE 10 (Completely described in this issue)

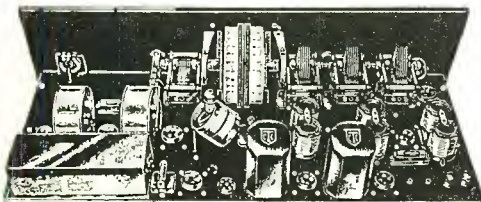

A new and remarkable 10-tube receiver. Combines both a radio frequency and a super-sensitive circuit, in principle like the Camfield-9, but having an added untuned stage of R. F. amplification. All R. F. stages operate on a single control, thus making this a modern 2-control drum dial job with increased amplification and greatly simplified operation.

A turn of a switch converts the receiver from a 6-tube R. F. circuit for use on local stations, to a 10-tube super-selective circuit for D-X stations. It can be built as a complete 6-tube job and 4 tubes added later as desired without changing any parts or wiring.

#### Ten Outstanding Features

- 1 **Extreme selectivity**, due to use of Rusco Band Pass Filter, giving 10 K. G. separation of all stations. Will tune through powerful local stations and receive D-X stations without interference.
- 2 **Perfect tone quality**, due to the Band Pass Filter, which will not cut off side bands, and the well-designed audio frequency transformers.
- 3 **Stability of operation**. Squealing and howling is entirely eliminated while set is being tuned.
- 4 **Extreme Sensitivity**. The use of three stages of R. F. amplification and two stages of intermediate frequency amplification makes it the most sensitive circuit ever developed.
- 5 **Simplicity**. Two tuning controls make it simple to operate—no vernier or trimmer condensers necessary. One dial logs the R. F. receiver and locates the stations.
- 6 **Economy of construction and operation**. Can be built up as a complete 6-tube job and 4 tubes added later. Reduces battery drain for local stations, as switch on front panel changes it instantly from 10 to 6 tubes or 6 to 10 tubes as desired.
- 7 **Especially suited for congested areas** like New York, Philadelphia, Chicago, coast stations, etc., as well as being sensitive and powerful enough for distant stations anywhere in U. S. and Canada.
- 8 **Antenna operated**—no loop required.
- 9 **No squeals and whistles** because oscillator-harmonics have been eliminated.
- 10 **Gives uniform amplification** under all conditions due to correct design and use of band pass filter.

If your jobber or dealer cannot supply you, ask him to order it—or order the complete amplifier units direct from factory—cash or C. O. D. Be sure to enclose your jobber's or dealer's name and address with your order.

### CAMFIELD RADIO MFG. CO.

35 East Wacker Drive  
Dept. CBS Chicago, Illinois  
COUPON—TEAR OFF HERE

Mail-today

Camfield Radio Mfg. Company  
35 E. Wacker Drive, Dept. CBS, Chicago.

Dear Sirs:

( ) Send me full details of your new Shielded Grid-7.

( ) Send me complete data on new Camfield Super-Selective-10.

( ) Send me.....completely wired 122 amplifier units .....\$25.00

Knocked-down Kits ..... 20.00

Your Name.....

Address.....

City.....State.....

Jobber's or Dealer's Name.....

# RADIO CONFIDENCE

**F**ROM the very earliest days of radio --- while others shouted wild claims of performance and impossible exaggerations of selectivity --- we have been noted for sticking closely to the facts ---for offering sound advice and intelligent service---and have thereby gained the confidence of thousands of radio fans from all over the country.

## Our New Free Service Laboratory

In order to continue rendering the very best radio service consistent with our reputation as the world's largest radio store we have completely reorganized and enlarged our service laboratory.

This completely equipped laboratory is at your service. Our experts are in attendance to help you with your radio sets. If your set is not working properly, bring it to our service laboratory and we'll soon find out what's wrong.

Absolutely no charge is made for this service --- and all are welcome.

## Blue Prints and Kits A Complete Service

We carry a complete stock of blue prints and parts to build all of the new sets illustrated and described in this issue of the "Citizens Radio Call Book." All parts offered to you are guaranteed exactly as specified. A few of the sets are as follows:

World's Record Super Ten  
New Two Control Equamatic  
Improved Nine-in-Line  
Camfield Super-Selective Nine  
Improved Remler  
The "Best Lincoln" Nine  
Silver Super  
Eight-in-Line Super  
Aero Seven  
1928 Infradyne  
Magnaformer 9-8 Receiver  
And Others

### Free Catalog

Come to our store or write us for a copy of our new 1927-1928 Radio Catalog. Parts for all the latest circuits including those described in this issue of the "Citizens Radio Call Book" are included.

### Save Money

We guarantee to save you money on parts and accessories made by leading manufacturers. Get our catalog before you buy.

**Set Builders and Dealers  
Write for Our Wholesale Catalog**

**CHICAGO SALVAGE STOCK STORE**

*"The Largest Radio Store in the World"*

**509 South State St. Dept. CB**

**CHICAGO, ILL.**



**30 Days  
FREE  
TRIAL  
5 Year  
Guarantee**

**MARWOOD**

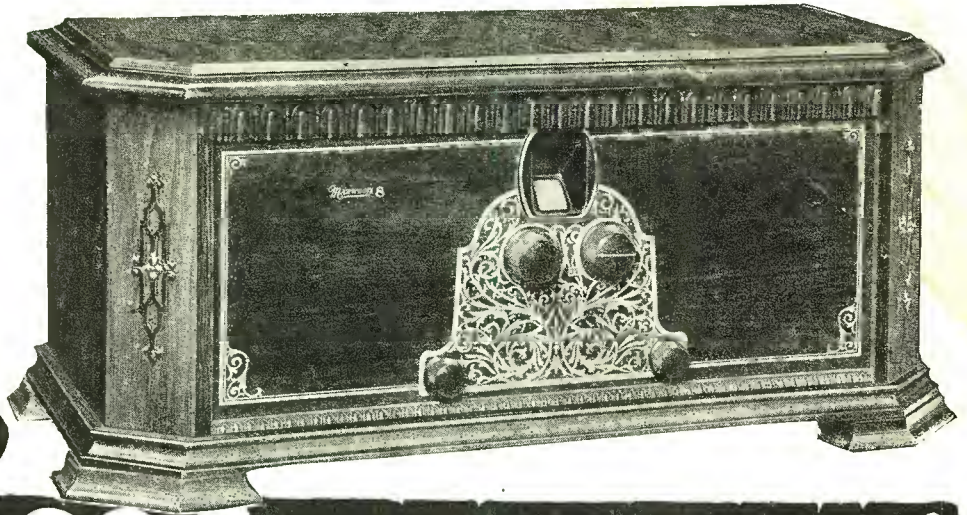

# The 1928 Sensations! 8 Tube-1 Control

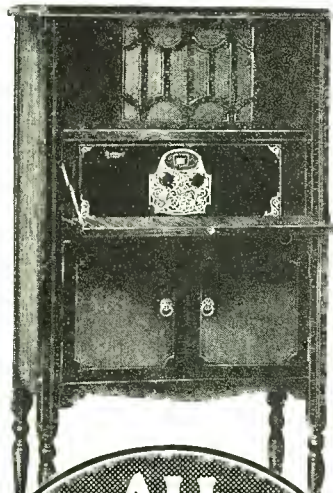

## All Electric or Battery Operation

AGAIN Marwood is a year ahead—with the Radio sensation of 1928—at a low price that smashes Radio profiteering. Here's the sensation they're all talking about—the marvelous 8 Tube Single Control Marwood for BATTERY or ALL ELECTRIC operation. Direct from the factory for only \$69.00 retail price—a price far below that of smaller, less powerful Radios. Big discount to Agents from this price. You can't beat this wonderful new Marwood and you can't touch this low price. Why pay more for less quality? To prove that Marwood can't be beat we let you use it on 30 Days Free Trial in your own home. Test it in every way. Compare it with any Radio for tone, quality, volume, distance, selectivity, beauty. If you don't say that it is a wonder, return it to us. We take the risk.

## New Exclusive Features

Do you want coast to coast with volume enough to fill a theatre? Do you want amazing distance that only super-power Radios like the Marwood 8 can get? Do you want ultra-selectivity to cut out interference? Then you must test this Marwood on 30 Days Free Trial. An amazing surprise awaits you. A flip of your finger makes it ultra-selective—or broad—just as you want it. Every Marwood is perfectly BALANCED—a real laboratory set. Its simple one dial control gets ALL the stations on the wave band with ease. A beautiful, guaranteed, super-efficient Radio in handsome walnut cabinets and consoles. A Radio really worth double our low price.

## Buy from Factory—Save One-Half

Why pay profits to several middlemen? A Marwood in any retail store would cost practically three times our low direct-from-the-factory price. Our policy is highest quality plus small profit and enormous sales. You get the benefit. Marwood is a pioneer, responsible Radio, with a good reputation to guard. We insist on the best—and we charge the least. If you want next year's improvements NOW—you must get a Marwood—the Radio that's a year ahead.

Only  
**\$69** RETAIL PRICE  
Big Discount  
to Agents  
From This  
Price

## Get Our Discounts Before You Buy a Radio

Don't buy any Radio 'till you get our big discounts and catalog. Save half and get a Radio that IS a Radio. Try any Marwood on 30 Days Free Trial at our risk. Tune in coast to coast on loud speaker with enormous volume, clear as a bell. Let your wife and children operate it. Compare it with any Radio regardless of price. If you don't get the surprise of your life, return it. We take the risk. Don't let Marwood low prices lead you to believe Marwood is not the highest quality. We have smashed Radio prices. You save half.

## Six Tube—One Control

This is the Marwood 6 Tube, 1 Control for BATTERY or ALL ELECTRIC operation. Gets coast to coast on loud speaker with great volume. Only \$47.00 retail. Big discounts to Agents. Comes in handsome walnut cabinets and consoles. This low price cannot be equalled by any other high grade 6 tube Radio. Has the volume of any 7 tube set. If you want a 6 tube Radio you can't beat a Marwood and you can't touch our low price.

**\$47**  
Retail price  
Big  
Discount  
to Agents  
from This  
Price

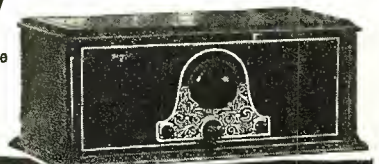

**ALL  
ELECTRIC  
8 Tube  
1 Control  
\$98** RETAIL PRICE

## Big Discount to Agents From this Price

### Has Complete A-B Power Unit

A REAL ALL ELECTRIC Radio with one of the best A-B power units on the market—no batteries needed—at the world's lowest price. This Marwood can't be excelled at ANY price. If you have electricity in your home, just plug into the light socket and forget batteries. No more battery trouble and expense. Costs less than 2c a day to operate. Always have 100 per cent volume. ALL ELECTRIC Radios are high priced because they are new. We cut profit to the bone and offer a \$250.00 outfit for \$98.00 retail price. Big discount to Agents. Don't buy any Radio 'till you get details of this sensational new ALL ELECTRIC Marwood.

## AGENTS

### MAKE BIG SPARE-TIME MONEY

Get your own Radio at wholesale price. It's easy to get orders for the Marwood from your friends and neighbors. Folks buy quick when they compare Marwood quality and low prices. We want local agents and dealers in each territory to handle the enormous business created by our national advertising. Make \$100 a week or more in spare time demonstrating at home. No experience or capital needed. We show you how. This is the biggest season in Radio history. Everybody wants a Radio. Get in now. Rush coupon for 30 Days Free Trial, beautiful catalog, Agents' Confidential Prices and Agents' New Plan.

MARWOOD RADIO CORPORATION  
5315 Ravenswood Avenue  
Department A-8 Chicago, Illinois

## Rush for Free Trial

MARWOOD RADIO CORPORATION,  
5315 Ravenswood Ave., Dept. A-8, Chicago, Ill.

Send Agents' Confidential Prices, 30 Days Free Trial, New Catalog and Agents' New Money Making Plan. No obligations on my part.

Name.....

St. or R.F.D.....

City.....State.....



# TRANSFORMERS



For Set Builders Who Demand

**EFFICIENCY  
SENSITIVITY  
PRECISION  
HIGH QUALITY  
BEAUTY**



**H. F. L. C-16  
Audio Trans-  
formers and  
C-25 Output  
Transformer**  
—new com-  
panions to the  
famous H. F.  
L. Products.

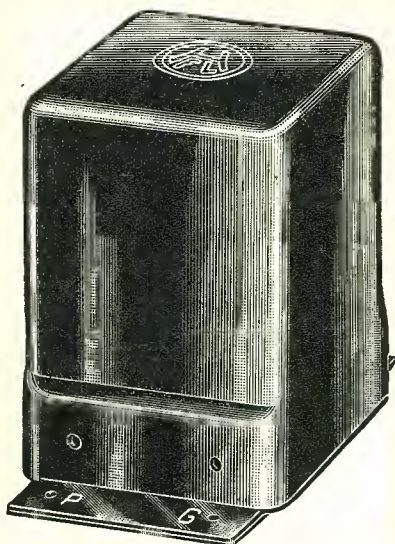

The new C16  
and C25 Trans-  
formers will  
improve any  
circuit and will  
work in any  
Radio Set.

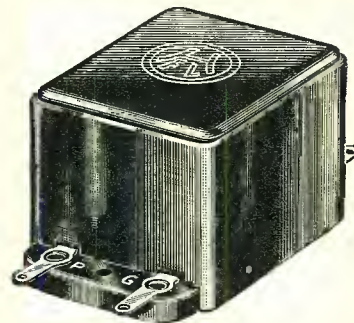

## LAST SEASON'S RADIO SENSATION!

Now Greatly Improved By These Marvelous Additions—The  
Supreme Achievement In Audio Amplification

Technically and practically the H. F. L. C-16 is the most efficient Audio Frequency Transformer built. It is constructed to match perfectly the two circuits between which it is placed and carries signals at highest volume without blasting or developing harmonics, and will amplify signals of low amplitude as well.

Even with the most up-to-date broadcasting stations there is a noticeable loss in amplification at frequencies of 100 cycles or less, and again on the high registers of 5,000 cycles or over. Remote control operation takes an other toll, only that the high register starts to drop off even sooner. In most cases at 3,500 cycles per second. Furthermore, it is a known fact that the amplification curves of the present day loud speaker shows over and under amplification of certain notes.

The H. F. L. C-16 Audio Transformer is so designed as to bridge over and under amplification. Therefore the amplification of all frequencies throughout the entire musical scale is accomplished with amazing, life-like truthfulness. A specially treated silicon steel alloy, combined with proper gapping and right proportion in density, make saturation of core practically impossible.

### A Guarantee That Counts

We positively guarantee each and every H. F. L. Transformer against any mechanical or electrical defect.

Furthermore, we will exchange—free of charge—any H. F. L. Transformer that fails to give complete satisfaction, providing that the shells and terminals are not damaged.

**JOBBERS—WRITE  
FOR FURTHER DETAILS**

In conjunction with this core the correct size of wire and the correct balance of primary turns has been determined and is being used to insure the proper impedance and to make possible distinct amplification of low notes and frequencies of low amplitude with a marked absence of harmonics. The H. F. L. C-16 Audio Transformer is especially designed to operate with all power tubes as well as the standard type of tubes.

An important feature in connection with our C-16 audio is our H. F. L. C-25 Output Transformer. Its ability to handle the voltage output of the power amplifying tubes and at the same time match the impedance of the average speaker to the tubes, makes it a very desirable addition to audio amplification. It is especially recommended because of the protection it renders to the loud speaker unit without reducing the plate voltage.

The mechanical features of the H. F. L. C-16 and C-25 Transformers are: A coil designed and treated so as to exclude moisture and withstand heavy electrical surges without breaking down, complete magnetic shielding to avoid interstage coupling, with terminals brought out so as to insure short leads.

### PRICES

No. H-210 Transformers.....	\$8.00
No. H-215 Transformer.....	8.00
No. C-16 Transformer.....	8.00
No. L-425 R. F. Choke.....	5.50
No. L-430 R. F. Trans- former.....	5.50
No. C-25 Output Trans- former.....	8.00

**Dealers—Set Builders**  
If your jobber cannot supply you with H. F. L. Transformers, write us direct for name of your nearest jobber.

### Endorsed by Leading Radio Engineers

H. F. L. Units have been used, approved and most highly endorsed by Radio News, Citizens Radio Call Book, Radio Review, Radio Age, Radio Engineering, Radio Mechanics, Chicago Evening Post, the Daily News and thousands of radio engineers.

**JOBBERS—WRITE  
FOR FURTHER DETAILS**

# HIGH FREQUENCY LABORATORIES

133B NORTH WELLS STREET

CHICAGO, ILLINOIS

Uses Q. R. S. or  
Raytheon  
85 Mil. Tube

**new**  
advanced  
TYPE  
**180 volt**  
**"B"**  
Eliminator



For  
110 Volt  
60 Cycle A.C.

Brand new—radically different in design—obviously better—and guaranteed for years! The first "B" Eliminator ever offered at a reasonable price which combines high power output with real long life. Delivers every voltage required by the modern multi-tube set, 5-8-10 tubes—it makes no difference. Plenty of pure, smooth, hum-free power for any set. And we let you try it free before you buy.

**A Real High Quality Lifetime "B"—at a Price that Staggers Comparison**

Do not confuse this new, advanced type "B" unit, with chemical rectifier types or with cheap eliminators having only a single filter choke or employing short lived single paper filter condensers. The Cloverleaf Lifetime "B" is all that its name implies. It is the true lifetime unit; good for long years of dependable service, even under heavy load. Only the very finest quality materials go into the Cloverleaf Lifetime "B"—two oversize filter chokes—the very finest grade high voltage heavy duty filter condensers that money can buy—the best, longest lived, newest type of thoroughly dependable wire-wound voltage control resistances that experts could design. Every part, every bit of workmanship is the best. Yet, the Cloverleaf Lifetime, high voltage "B" costs only half what others of equal capability cost you.

**Operates "171" and "210" Power Tubes**

Many "B" eliminators costing more than the Cloverleaf will test at 180 volts on a meter. But what YOU must have is high voltage under load. The Cloverleaf Lifetime "B" provides plenty of voltage and plenty of current for all the ordinary demands of the set—then it supplies ample voltage for the proper operation of either a "171" or a "210" power tube.

Heretofore you have had to pay a really exorbitant price for an eliminator that would do what the Cloverleaf does. Read our FREE TRIAL OFFER. Then send the coupon.

Made by the makers of Subantenna the underground antenna whose remarkable performance has placed the Cloverleaf Mfg. Company in the enviable position of being known as makers of reliable radio apparatus

*lifetime*  
**Cloverleaf**  
**"B" ELIMINATOR**

**Cloverleaf Manufacturing Company**  
2712-K Canal Street Chicago, Ill.

**TRY IT FREE**

**ONLY 1/2 THE PRICE OF OTHERS**

We want you to try the Cloverleaf; to put it to any test you can. Hook it on to 8 or 10 tubes. Make it drive a power tube. Compare it with any "B" eliminator at any price. Compare its performance—compare its many detailed advantages such as the absence of exposed binding posts and many other important refinements. Make this test at our risk under our **FREE TRIAL GUARANTEE OFFER**. Then decide why, if at all, you should pay more for a "B" eliminator than the ridiculously low price at which the Cloverleaf Lifetime "B" is sold. Mail coupon at once for full particulars of this great new "B" and for details of our **FREE TRIAL GUARANTEE OFFER and 2 YEAR GUARANTEE**

**Users Anxious to Spread Praise for this Great, New, Better Eliminator**

"I purchased a Cloverleaf "B" eliminator from you on the strength of the wonderful performance of your other product—Subantenna. The Cloverleaf "B" is, in every sense of the word, all you claim for it. I have it hooked up to an eight tube set. It not only operates the set in beautiful style but also operates my power amplifier which has two Western Electric power tubes in it. No "B" eliminator ever made my set perform like the Cloverleaf does."—L. M. P., Chicago.

"I have tried several "B" battery eliminators on my superhetrodyne but they all caused 'motor-boating.' The Cloverleaf works perfectly. No 'bubbling' sounds, and no hum. I am well satisfied."—W. J. S., Cadott, Wisc.

"The Cloverleaf "B" received and it works fine. Other eliminators all failed when the A. C. line voltage fluctuated. The knob on the front of the Cloverleaf certainly takes care of that condition nicely.

"Several of my friends have seen the Cloverleaf at my house and said they were going to order eliminators for their sets. I gave them your name and address."

F. E.,  
Watervliet, Mich.

**Get Ready for WINTER**

**CLIP AND MAIL AT ONCE!**

**CLOVERLEAF MFG. CO.**  
2712-K Canal St., Chicago, Ill.  
Tell me more about the Cloverleaf "B" Eliminator and particulars of your FREE TRIAL OFFER.

Name.....  
Town.....  
State.....



**Amplifier  
Type M-26**

**Amplifier  
Type M-26**

(226)

Fil. Volts 1.5  
 Fil. Amp. 1.05  
 Plate Volts 90—135  
 Not to Exceed 180

List Price, \$3.00



**Detector  
Type N-27**

**Detector  
Type N-27**

(227)

Heater Volts 2.5  
 Heater Amps. 1.75

PLATE VOLTS

As Detector 90—135  
 As Amplifier 45  
 Not to Exceed 180

List Price, \$6.00

Announcing

**A. C. Tubes**

Alternating Current

**T**HE new M-26 and N-27 tubes are tubes using raw A. C. on the Filament or Heater and can be used in any set specifying these types. The M-26 is used in the radio and audio frequency stages and has a standard base. The N-27, of the separate heater type is used as a detector or amplifier and has a five-prong base. These tubes will give superior results and maximum useful life in any set designed to use A. C. tubes of this type.

Write for particulars.

**C. E. MFG. CO., Inc.**

Providence, R. I., U. S. A.

*Largest Plant in the World Making Radio Tubes Exclusively*

**CEC**

**RADIO  
TUBES**



**CEC**  
**A Tube for  
Every Radio Need**

General Purpose Tubes  
 Special Purpose Tubes  
 Power Tubes

Filament Type Rectifiers  
 Gas Filled Rectifiers  
 A. C. Tubes

Make a  
 Good Receiver  
 Better