

Notes on
Amateur Radio
Transmitter
Design

Compiled by

JAMES MILLEN

Price 50¢

Notes on
Amateur Radio
Transmitter
Design

Compiled by
JAMES MILLEN

PUBLISHED BY JAMES MILLEN, INC., MALDEN, MASS.

Copyright 1937

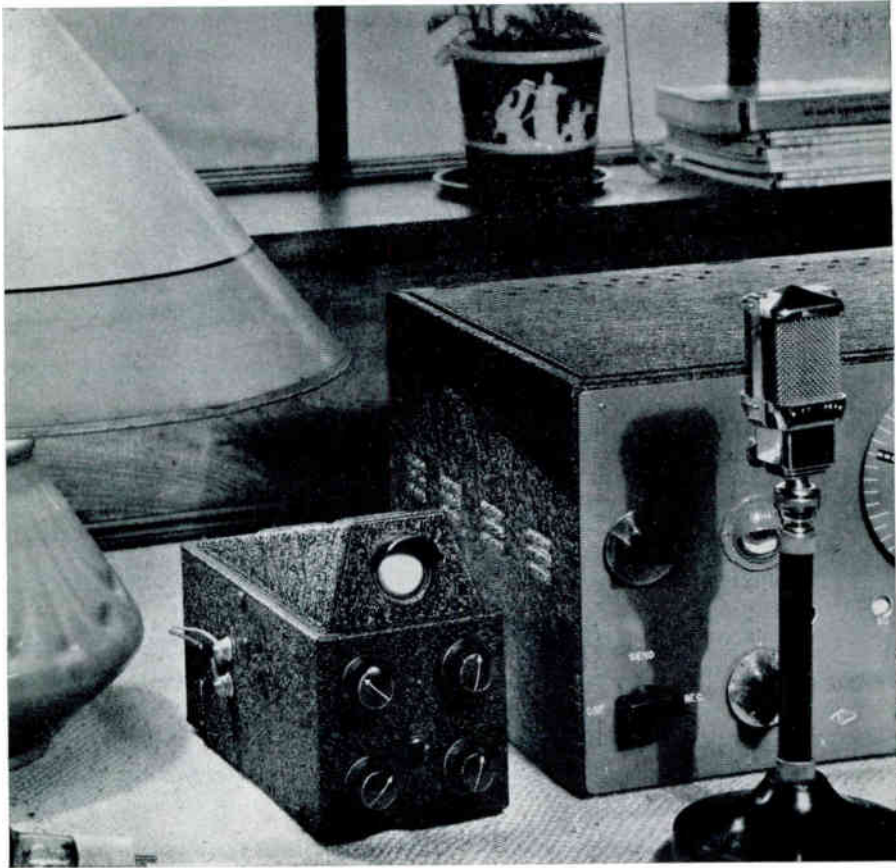

The Oscilloscope is just as an essential part of an amateur 'phone transmitter as the microphone. Shown here is the new, inexpensive, National Type CRM unit, using the midget 913 tube.

INTRODUCTION

THIS BOOKLET is not offered as a handbook on amateur transmitter design, but as a miscellaneous collection of ideas, suggestions, and handy data that it is hoped will prove helpful to the amateur, whether he is new or old, planning a revision of his station equipment. For a complete and somewhat more academic treatment of the subject, Amateur Transmitter Design, no book is likely to surpass the A.R.R.L. official *Radio Amateur's Handbook*.

Most of the apparatus described and illustrated herein was originally designed for use at W1HRX. In addition, we are indebted to Herb. Becker, W6QD; Martin Brown, W6ABF; George Grammer, W1DF; and Ed. Ruth, W2GYL, and Dana Bacon, W1BZR for the privilege of including illustrations and descriptions of transmitters built by them for use in their own stations.

In order to secure at least some semblance of order in the presentation of the subject, the contents of the booklet have been divided into sections on Exciters, Final Stages, Complete Transmitters, Modulators, Power Supplies, and Antennae. Naturally, some transmitters are so physically designed that it is rather hard to arbitrarily divide them under such headings for editorial presentation; consequently, in the chapter on Complete Transmitters will be found some material pertaining theoretically at least to some of the other divisions.

In treating Final Stages, all references to linear amplifiers have been purposely avoided, as their use up to the present in amateur communication work has been quite limited. Primarily, this is because until a little over a year ago, when W. A. Doherty of the Bell Telephone Laboratories presented his paper on High Efficiency Linears, it was generally considered that their efficiency was limited to about 25 per cent. Sufficient time has not yet elapsed for the amateur fraternity to put into extensive application the

principles of the Doherty high efficiency linear amplifier. Perhaps another year may see a trend in that direction.

All material on ultra-high frequency equipment has also been purposely avoided, as it is felt that such material is rightfully the subject of another booklet.

In addition to the individuals mentioned above, we are also indebted to the editors of *QST* for permission to re-use many of the illustrations which appeared originally in *QST*. We are also indebted to M. L. Muhleman of *All-Wave Radio* for the illustrations on pages 54 and 56, and to the Radio-Television Supply Co., the Radio Supply Company and the magazine, *Radio*, all of Los Angeles, for the illustrations of the W6QD and W6ABF transmitters.

JAMES MILLEN

May 1, 1937

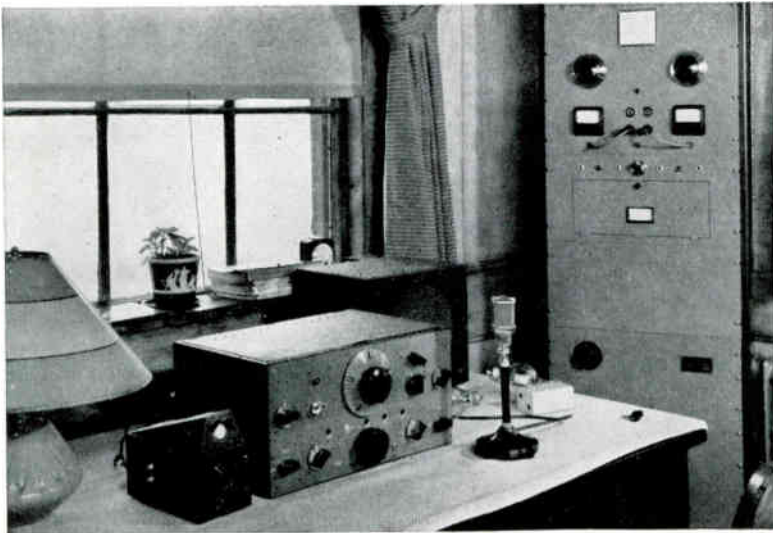

C O N T E N T S

| | |
|---------------------------------|----------------|
| Exciters | <i>Page 7</i> |
| Final Stages | <i>Page 17</i> |
| Complete Transmitters | <i>Page 21</i> |
| Modulators | <i>Page 45</i> |
| Power Supplies | <i>Page 51</i> |
| Antennae | <i>Page 55</i> |

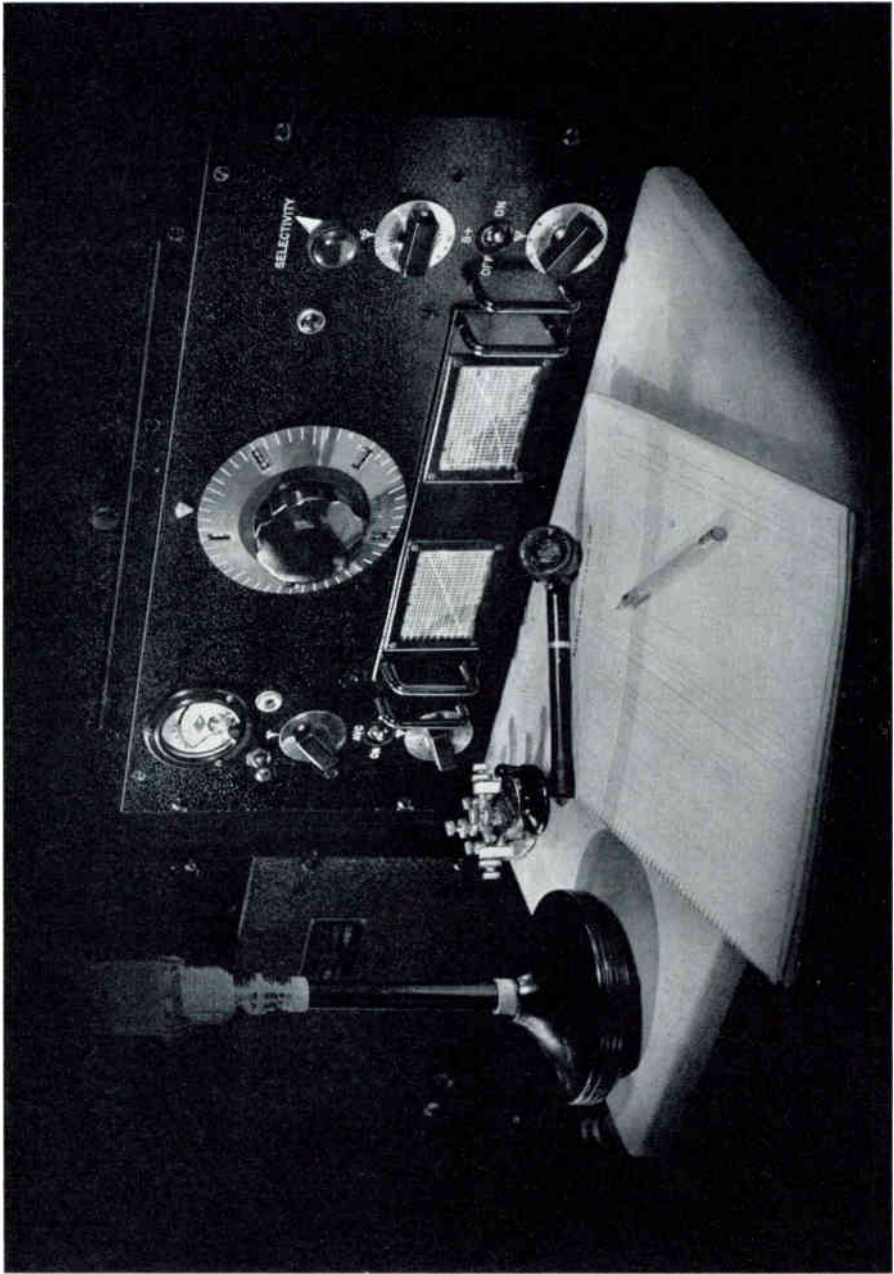

The EXCITER

IN RECENT YEARS the trend in both amateur and commercial transmitter design practice seems to be toward the treatment of the exciter as a separate unit. During the past year or so, much progress has been made in the design details of exciter units with a view toward increasing their reliability, compactness, universal applicability, ease of hand-shift, and vernier control of frequency adjustment.

The advent of the 53 tube, and its counterpart the 6A6, has made possible a very practical and compact circuit which is the basis of most of the exciters described and illustrated herewith. In using the double-triode type of tube, such as the 53-6A6, one of the sections is used as a triode

sides harmonic output, two other advantages over simple triode or pentode oscillators. It is a very persistent oscillator — crystals rarely fail to “start” when plate voltage is applied. “Crankiness” with regard to oscillation is a common failing with the simpler circuits, especially if the crystal is not as active, piezo-electrically, as it might be. The second advantage is the buffering action attributable to electron-coupling between crystal and output circuits. This makes the crystal less susceptible to changes in loading (such as might be caused by tuning a following stage) and hence enhances the frequency stability.

But so much for circuits: we will confine our space to the description of practical compact lay-

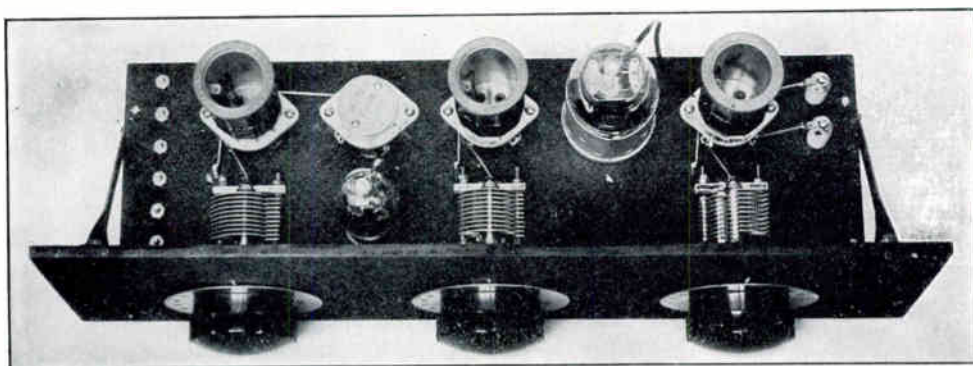

FIG. 1 — A TWO-TUBE FIVE-BAND EXCITER UNIT OR LOW-POWER TRANSMITTER

Using an 89 and 802 or RK-25, with plug-in coils. In this view the shield about the oscillator plate coil (center) has been removed to show parts and wiring. The shield about the lower part of the amplifier tube is a regular large-size tube shield cut to fit around the shield ring inside the tube.

crystal oscillator and the other as a triode doubler. In most of the accompanying layouts, the triode sections are used in normal sequence; in the case of the transmitter shown on page 23, however, very material simplification of the circuit wiring was secured by “crisscrossing.” Thus, one triode section of the first tube is used as a crystal oscillator while one triode of the second tube is used as a doubler; then the remaining section of the first tube is used as the second doubler, and, finally, the remaining section of the second tube as the final doubler.

While our preference for exciter circuits leans strongly to the use of the 53 type tubes, nevertheless the Tritet circuit developed by Jim Lamb, Technical Editor of *QST*, has also found considerable favor. In the Tritet exciter illustrated in Figs. 1 and 2, is shown all the details on a compact unit using an 89 tube as the crystal oscillator-frequency-multiplier, and an RK-25 pentode buffer.

According to Lamb, the Tritet circuit has, be-

outs readily adaptable to either type circuit and permitting flexible operation on any band. The Tritet arrangement just referred to uses conventional plug-in coils and panel-controlled variable tuning condensers. In Fig. 3 is a similar arrangement using the double-53 circuit.

Figs. 6 and 15 are typical of the “53” type of exciter circuits. Additional circuits will be found on pages 23 and 43; the one on page 23 being of the criss-cross variety.

Most of the plug-in type of coils used in the exciters such as the ones in Figs. 1, 3, 4, etc., are wound on forms $1\frac{1}{2}$ inches in diameter, such as were originally designed for receiver use. Of particular interest are the forms of this type which instead of being molded of ordinary bakelite are molded of the low-loss dielectric material known as R-39. R-39 is made of ground mica held together with a minimum of pure bakelite resin. It does not contain wood-flour, clay, or other such fillers generally used with ordinary molded plastics, and which contributes so much to the high

R. F. losses of such materials. The table on the lower right-hand corner of page 8 will be found particularly helpful in designing exciter coils on 1½ inch forms. The following is the data for use with these curves:

Curve A — winding length, one inch; Curve B — winding length, 1½ inches; Curve C — winding length, 2 inches. After determining the number of turns for the capacity and frequency band to be used, consult the wire table below to find the wire size which will fit in the space available. No. 18 wire is about the largest size that need be used; larger sizes are difficult to handle on this type of form. Keep in mind that the capacity indicated is the actual shunt capacity. This includes tube and stray circuit capacity; an allowance of at least 15 μμfd. should be made for this stray capacity.

It is handy to remember that when soldering the ends of the coil to the prongs in the coil form base, about the only practical method to use is to dip the prong in a small pool of solder, and withdraw it slowly.

| Gauge No. B. & S. | Turns per Linear Inch | |
|-------------------|-----------------------|------------------|
| | Enamel | D.S.C. or S.C.C. |
| 18 | 23.6 | 22.0 |
| 19 | 26.4 | 24.4 |
| 20 | 29.4 | 27.0 |
| 21 | 33.1 | 29.8 |
| 22 | 37.0 | 34.1 |
| 23 | 41.3 | 37.6 |
| 24 | 46.3 | 41.5 |
| 25 | 51.7 | 45.6 |
| 26 | 58.0 | 50.2 |
| 27 | 64.9 | 55.0 |
| 28 | 72.7 | 60.2 |
| 29 | 81.6 | 65.4 |
| 30 | 90.5 | 71.5 |
| 31 | 101. | 77.5 |
| 32 | 113. | 83.6 |

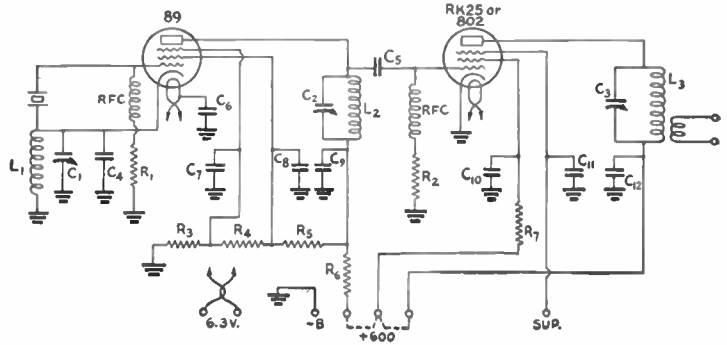

FIG. 2 — CIRCUIT DIAGRAM OF THE TWO-STAGE TRI-TET EXCITER UNIT

The three connections marked "600 volts" can be tied together. Oscillator plate and screen leads are brought out separately to facilitate metering.

- C₁, C₂, C₃ — 100-μμfd. (National ST-100).
- C₄ — 100-μμfd. mica.
- C₅ — 50-μμfd. mica.
- C₆ to C₉, inc. — 0.01-μfd. paper, non-inductive, 400-volts (Aerovox).
- C₁₀, C₁₂ — .002-μfd. paper, non-inductive, 1500-volt (Sprague).
- C₁₁ — .001-μfd. mica.
- R₁ — 50,000 ohms, 1 watt.
- R₂ — 50,000 ohms, 2 watt.
- R₃ — 10,000 ohms, 1 watt.
- R₄, R₅ — 10,000 ohms, 1 watt.
- R₆ — 10,000 ohms, 25 watt.
- R₇ — 25,000 ohms, 25 watt.

- L₁ — Oscillator cathode coil:
 For 1.75-mc. crystal: 28 turns, No. 20, close-wound.
 " 3.5 " " 14 " " 18, winding length 1 inch.
 " 7 " " 7 " " 18, " " 1 "

- L₂ — Oscillator plate coil:
 1.75 mc.: 65 turns No. 22, close-wound.
 3.5 " 32 " " 18, winding length 1½ inches.
 7 " 16 " " 18, " " 1 "
 14 " 8 " " 18, " " 1 "

- L₃ — Buffer plate coil:
 1.75 mc.: 65 turns No. 22, close-wound.
 3.5 " 32 " " 18, winding length 1½ inches.
 7 " 18 " " 18, " " 1 "
 14 " 10 " " 18, " " 1 "
 28 " 5 " " 18, " " 1 "

All coils wound on 1½-inch diameter forms such as National R39 with enamelled wire. Link coils on L₃ consist of one or more turns, closely coupled to L₃ at the bottom (cold) end; exact number must be found by experiment to give optimum loading of buffer tube.

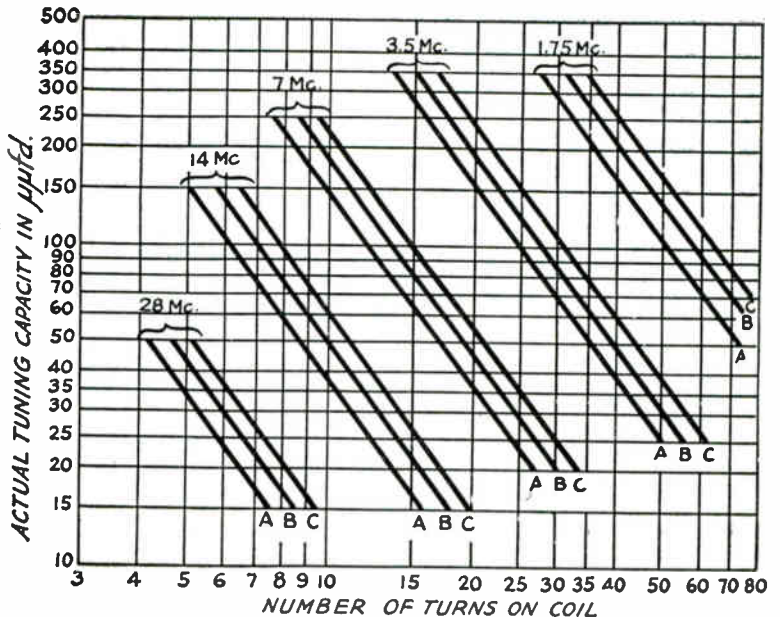

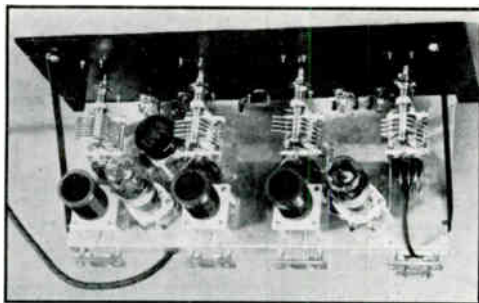

FIG. 3—PLAN VIEW OF THE EXCITER UNIT SHOWING IN DETAIL THE ARRANGEMENT OF THE COMPONENTS

Two 53 tubes do the work of four triodes in the crystal oscillator (left) and three doubler stages. The coils in place are for 56-mc. output from a 7-mc. crystal.

Shortly after this unit was originally built, Herb Hollister, W9DRD, developed the idea of pre-tuned tank circuits, as illustrated in Figs. 4, 5, 6, and 7.

Referring to the rear view of the exciter, shown in Fig. 4, we start at the right with six crystal holders lined up on the edge of the chassis. The mounting was made from a strip of Victron, using wafer socket clips for contacting the holder prongs. Next, along the rear of the chassis we have the 3.5-Mc. oscillator coil, the first 53, the 7-Mc. coil, the 14-Mc. coil, the second 53, and the 28-Mc. coil. The condensers for all four coils are mounted beneath the chassis on the bakelite strip which forms the back edge of the chassis. In the center, directly behind the meter, is the RK23 buffer with its quartette of tank circuits clustered round.

Now, taking a quick glance at the schematic circuit (Fig. 6), the plot unfolds in all its simplicity. The grid of the first triode section of our first 53 is driven by any of the six crystals which may be selected by the six-point switch. These A-cut crystals are ground to frequencies in 3.5-Mc. band—which will permit the widest possible selection of harmonics for such interference-free spots as may appear in the four bands, 10, 20, 40, and 80 meters. The second triode section of the same 53 is tuned to 7 Mc. The first section of the second 53 is tuned to 14 Mc. and the second section of the same tube to 28 Mc. These four

tanks once peaked will require no retuning with crystals whose fundamental frequencies fall between 3500 kc. and 3575 kc. It will, of course, be necessary to retune for a crystal in the 3.9-Mc. 'phone band, but in this case it is only the oscillator tank condenser; and, after all, it should be worth that extra effort to get to work on the 75-meter 'phone band.

The four sections of the two 53's are permitted to run constantly, and therefore we have excitation voltage in each of the four bands on tap at all times with which to drive the grid of the RK-23 buffer. Capacity feed is used, with the tap coming directly off the plates of the 53's, through a four-point switch the arm of which is hooked to the RK-23 grid.

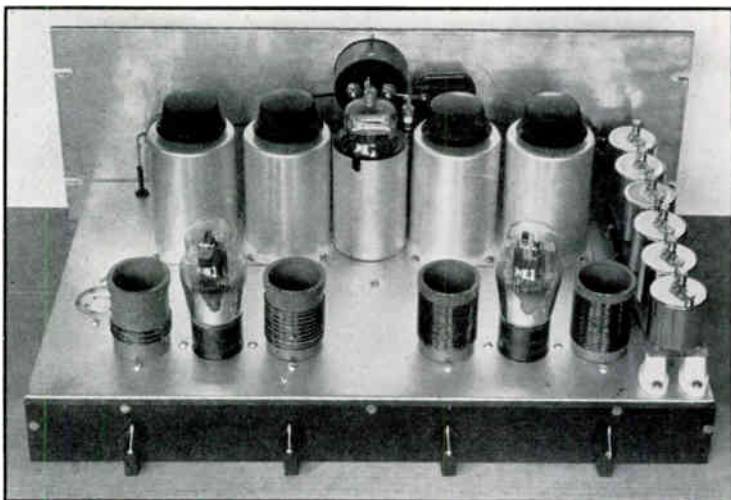

FIG. 4—SEEN FROM THE REAR, THE EXCITER LOOKS A GOOD DEAL LIKE A NEATLY-BUILT SUPERHET

But don't be deceived by its appearance; the output on any of the four bands is sufficient for driving a pair of 800's as modulated Class-C amplifiers. Although the oscillator and doubler coils are wound on plug-in receiving coil forms for convenience, actually they are permanent fixtures. The socket which can be glimpsed behind and to the left of the ten-meter doubler coil is for the power-supply plug.

FIG. 5—AN "X-RAY" VIEW OF ONE OF THE BUFFER TANK CIRCUITS

The tank coils are mounted below and suspended from the tuning condenser. The individual circuits are peaked at about the center of the band for which they are designed. No fine adjustment has been found necessary in working over the higher-frequency bands with different crystals, as is explained in the text.



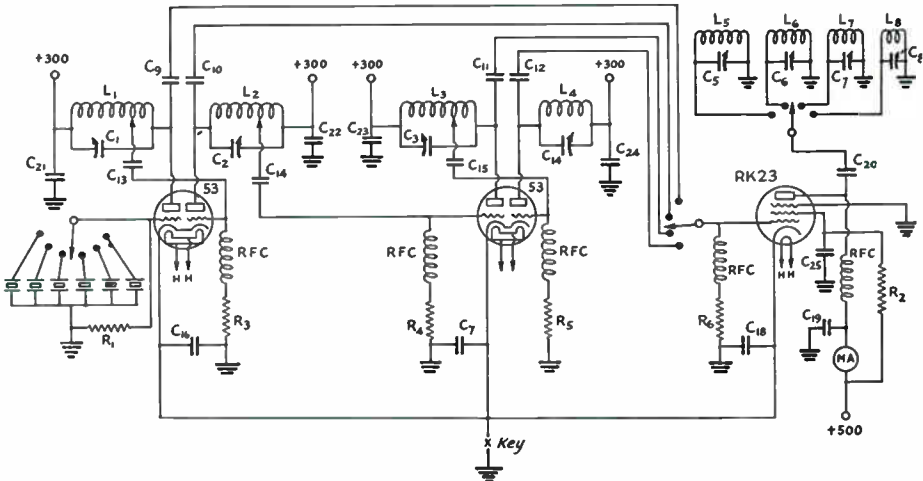

FIG. 6 — CIRCUIT DIAGRAM OF THE BAND-SWITCHING EXCITER

- C₁ — 100- μ fd. midget air condenser
- C₂, C₃, C₄ — 50- μ fd. midget
- C₅ — 100- μ fd. midget
- C₆ — 50- μ fd. midget
- C₇, C₈ — 35- μ fd. midget
- C₉ — C₂₀, inc. — .001- μ fd. mica condensers
- C₂₁ — C₂₅, inc. — .01- μ fd. mica condensers
- R₁ — 5000 ohms, 2-watt
- R₂ — 10,000 ohms, 2-watt
- R₃ — 20,000 ohms, 2-watt
- R₄, R₅, R₆ — 10,000 ohms, 2-watt
- L₁ — 3.5-mc. oscillator coil; 35 turns No. 22, diameter 1 1/2 inches, winding length 1 1/2 inches
- L₂ — 7-mc. doubler coil; 20 turns No. 16, diameter 1 1/2 inches, winding length 1 1/2 inches

- L₃ — 14-mc. doubler coil; 10 turns No. 16, diameter 1 1/2 inches, winding length 1 1/4 inches
 - L₄ — 28 mc. doubler coil; 3 1/2 turns No. 14, diameter 1 1/2 inches, winding length 3/4 inch
 - L₅ — 3.5-mc. buffer coil; 30 turns No. 16 diameter 1 1/2 inches, winding length 1 1/2 inches
 - L₆ — 7-mc. buffer coil; 16 turns No. 14, diameter 1 1/2 inches, winding length 1 1/4 inches
 - L₇ — 14-mc. buffer coil; 9 turns No. 10, diameter 1 1/4 inches, winding length 1 1/4 inches
 - L₈ — 28-mc. buffer coil; 3 1/4 turns No. 10, diameter 1 1/4 inches, winding length 3/4 inch
 - RFC — Sectional-wound chokes, high-frequency type
- The tuning condensers, C₁-C₈, inclusive, are National Ultra-Midgets

In order to facilitate construction, several forms of commercially available fixed-tuned tank units have been developed. The first of these, shown at the right in Fig. 12, is for direct mounting to the chassis, in the Hollister manner. An effective application of this unit is shown in Fig. 11.

It is built up in a modified form of the newer Western Electric practice of vertical chassis arrangement for "dish" relay rack mounting. The variations from standard Western Electric practice that have been made can hardly be called an improvement, but are resorted to solely for the sake of adapting this type of construction to the

amateur's workshop. The vertical chassis for the exciter (and buffer) offers worth-while advantages. Construction and wiring is simplified, tanks and crystals are readily accessible, and an uncluttered compactness is achieved.

This particular exciter also possesses other unique features. In the first place, it is designed for use in a two-band transmitter and actually comprises two complete separate exciters in one unit. By means of the key switch on the front panel, the B-supply is thrown from one unit to the other, and thus R.F. output made instantly available on either the 20-meter or the 75-meter bands. The 20-meter section uses a single 53 tube with a group of 40-meter crystals, whereas the 75-meter side uses but one-half of a single 53 tube with 75-meter crystals.



FIG. 7 — BAND-CHANGING BECOMES A PLEASURE WITH AN EXCITER LIKE THIS ONE

No tuning adjustments to be gone through — simply flip the "buffer" and "exciter" switches to the band desired and select any one of six crystals on the "crystal" switch. The 53's handle the oscillator and doubler functions; the buffer, always used as a straight amplifier, is an RK-23.

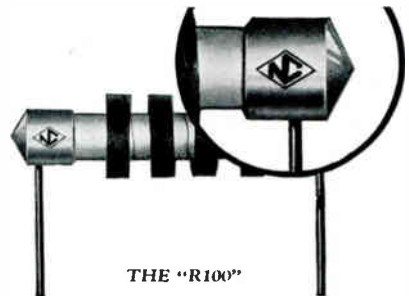

THE "R100"

Experience has shown that a more preferable arrangement would have been to use 160-meter crystals and both sides of the 53 for the final output in the 75-meter 'phone band. Of particular interest in this unit is the switch for selecting various crystals; this switch is illustrated in Fig. 9, and is, in actuality, a combination single-pole multi-point switch and variable trimmer condenser. The condenser is so adjusted as to retune the crystal circuit as crystals of different frequencies within a given band are selected. Its range is readily adjusted by varying the spacing between the rotor and stator plates.

The actual adjustment is extremely simple. With the crystals plugged in their proper sockets and the switch turned to the highest frequency, the rotor plate should be all the way out. Now tune the tank circuit in the usual way, using the main condenser. Next, turn the switch to the lowest frequency. This puts the lowest-frequency crystal in circuit and turns the rotor all in. Now retune by moving the stator plates of the vernier condenser by means of the nuts on the stator studs. Do not touch the main tank tuning condensers. The adjustment is now complete. For the two intermediate frequencies it is unlikely that the tank will be exactly in tune, but it is even more unlikely that they will be more than a fraction of a per cent out of tune, which is more than good enough.

From the above, it might seem that the range of the condenser must be adjusted for a group of crystals operating in one band only. This objection is easily overcome, however, if the crystals to be used in another band are chosen so that the ratios of the upper and lower frequencies are

the same. For instance, 75-meter crystals having frequencies between 3920 and 3980 KC would require exactly the same range of vernier condenser capacity as a group of 160-meter crystals operating at frequencies between 1960 and 1990 KC.

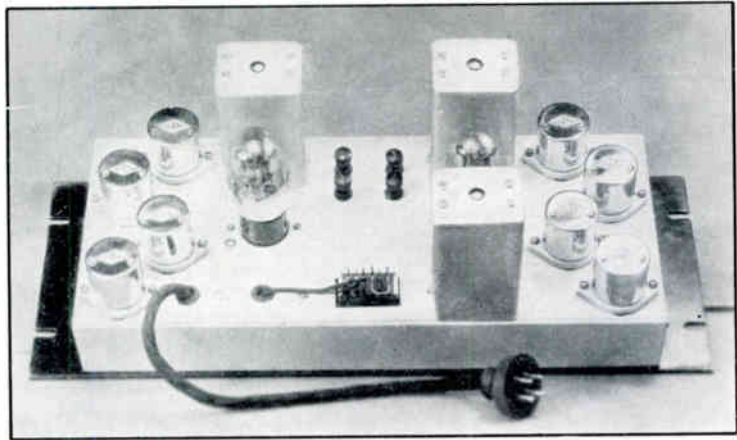

FIG. 8 — THE EXCITER UNIT, FACE DOWN, WITH THE 75-METER SECTION AT THE LEFT AND THE 20-METER SECTION AT THE RIGHT

The tank circuits are contained in the shield cans, the tuning condensers being adjusted with a socket wrench.



FIG. 9 — CLOSE-UP OF COMBINED CRYSTAL SELECTOR SWITCH AND OSCILLATOR TANK TRIMMER CONDENSER



FIG. 10 — PANEL VIEW OF THE EXCITER UNIT, SHOWING THE TWO CRYSTAL SELECTOR CONTROLS (RIGHT AND LEFT), WITH THE BANDSWITCH BELOW THE PLATE MILLIAMMETER

FOR CIRCUIT
DIAGRAM AND
PARTS LIST, SEE
PAGE 43

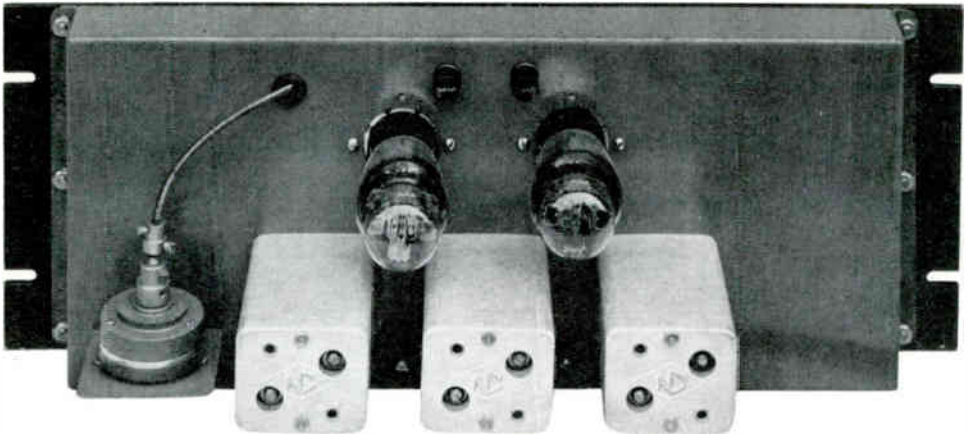

FIG. 11

In Fig. 11 is still another example of the use of fixed-tuned tank units to form an efficient and compact exciter. This particular unit is for operation in the 20-meter 'phone band, using an adjustable air-gap type of variable frequency crystal control, in which the crystal is mounted behind the panel and controlled from the knob on the front by means of a length of flexible shafting, furnished with the crystal holders for just that purpose.

It was designed for driving the pair of RK-20 buffers shown in Fig. 60 on page 40 which were in turn used to drive the twenty meter one kilowatt final amplifier at W1HRX using a pair of W.E.251s. The crystal is an 80 meter Hollister in the National CHV variable holder, giving a 25 KC range in the 20 meter 'phone band. The cir-

cuit uses a pair of 53s. Simplicity of construction is secured by using a pair of FXT fixed tank units mounted on a shallow vertical chassis in which is concealed all of the wiring. Control of the crystal frequency is brought out to the front panel by means of the flexible drive shaft furnished as standard equipment with the CHV holder. Where the drive shaft passes through the hole in the chassis, a standard soft rubber grommet, such as used on A.C. cords, is employed to secure smooth turning.

By using 6-prong plug-in bases for the pre-tuned tank circuits it is possible to have an independent link-coupling winding on each output tank and to connect all of the corresponding socket terminals in parallel across the output terminals. In practice it will be found advisable,



FIG. 12

In addition to the exciter tank units of the style shown at the right, similar type units can be made up to fit particular requirements by mounting standard National ultra-midget condensers and XR-2 coil forms in the same size shield cans shown at the left. In addition, plug-in style bases are available which may be added to either of these units in order to form a plug-in type of tank circuit, which makes possible the design of an exciter which can be shifted from band to band by changing the removable pre-tuned tank units. An exciter employing such an arrangement is shown in the illustrations on pages 13 and 14.



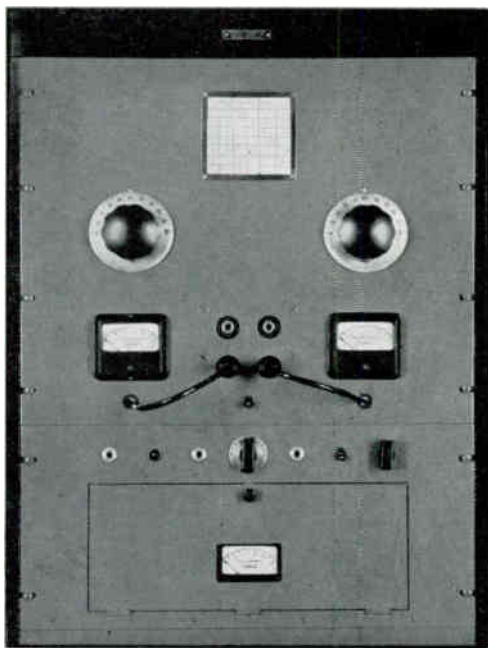

FIG. 13— MODERNISTIC APPEARANCE CHARACTERIZES THE TRANSMITTER ASSEMBLY IN WHICH THE EXCITER IS MOUNTED BELOW THE BUFFER-FINAL UNIT

A hinged panel opening gives quick access for changing the shielded plug-in coil units.

for quick band shift, to have additional tank circuits fitted with the output coils for those bands upon which the exciter is to be operated, inasmuch as the loading of the link circuit appreciably changes the tuning of the tank coil being used in the output stage, as against the tuning of the same tank coil when the output winding is open and the stage is being used as a doubler. If, however, the slight additional time required to re-tune the tank is of less importance than economy, then, of course, the one unit can be made to serve double duty by means of a slight retuning operation.

Another circuit detail which, while neither new nor original is yet seldom seen in amateur equipment, is the method of using a dummy plug for switching the d.c. meter from one circuit to another, rather than the more general practice of conventional jacks with a plug-and-cord connected to the meter.

Another commercial trick for securing neat wiring is the use of dummy lugs, such as those between the r.f. chokes and the resistors. These handy little gadgets can be obtained from any radio dealer.

While commenting on wiring, it might be well to suggest that whenever a switch is mounted on the panel of the unit, such as the B-supply switch in this instance, a pair of terminals be located at some handy place in the rear and connected across the switch terminals so that should it be desirable at any time to control the switching by either an extension lead or a relay, it will not be necessary to remove the complete unit from the rack and half-disassemble it in order to delve into the interior to get at the switch contacts. This point is particularly applicable to power supplies, which, sooner or later, you will want to control either directly or by relays from a master switch on the operating table. After all, in our anxiety to get a new transmitter on the air, most of us at first have at least six switches to throw, in various parts of the room, before being able to shift from "send" to "receive." Sooner or later, however, we settle down to at least a brief spell of just plain operating, during which time we all take a little pride in seeing just how quickly we can shift.

In the rear view most of the wiring can be seen. There is a handy trick used by commercial companies for wiring jacks that is not generally understood by the average amateur; it is to prepare the leads and solder them to the jack contacts before mounting the jack in place. By so doing, the necessity for soldering in an awkward position is eliminated. It is also possible to skin and tin the wires so that the insulation comes right up to the contact and does so without being frayed or sloppy looking. The jack is then mounted in place, the leads run through the necessary bushings to their proper terminals and, if necessary, re-cut and skinned for soldering to the other pieces of apparatus which are invariably more conveniently located for neat soldering; as are, in this case, the socket terminals.



FIG. 14— FRONT VIEW OF THE EXCITER UNIT WITH THE COILS REMOVED

The dial in the center is the crystal gap control for varying frequency. A dummy plug is fitted into the four jacks for meter switching. Between the jacks at the left is the pilot light and between those at the right is the on-off toggle switch.

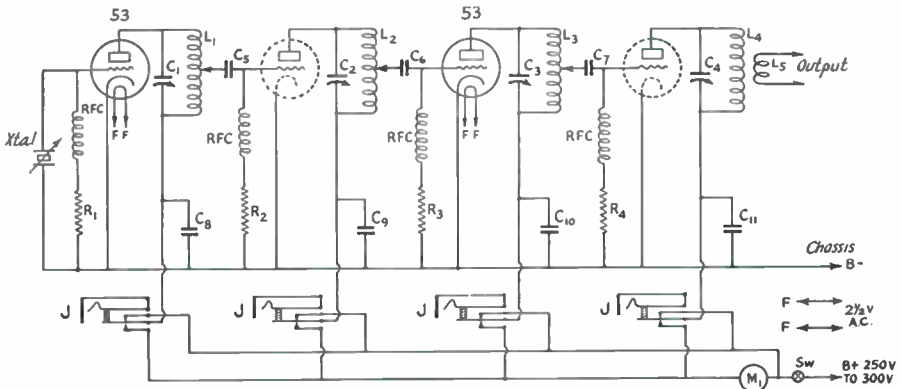

FIG. 15 — FOUR TUNED CIRCUITS WITH TWO DOUBLE-TRIODE TUBES ARE USED IN THE EXCITER CIRCUIT. THE TRIODE ELEMENTS ARE DIAGRAMMED SEPARATELY FOR CLARITY
*L*₁, *L*₂, *L*₃, *L*₄ — Plate coils in shielded units (see coil table).
*L*₅ — Output link coil (see table).
*C*₁, *C*₂, *C*₃, *C*₄ — Two 35- μ fd. ultramidget tuning condensers in parallel except for 28-Mc. (Included in National FXTB coil units — see text).
*C*₅, *C*₆, *C*₇ — 100- μ fd. mica condensers.
*C*₈, *C*₉, *C*₁₀, *C*₁₁ — p.01- μ fd. mica condensers.
*R*₁, *R*₂, *R*₃, *R*₄ — 10,000-ohm 2-watt grid-leak resistors.
 RFC — 2.5-millihenry r.f. chokes (National Type R-100).
*M*₁ — 0-50 d.c. milliammeter (Triplet).
 The crystal is a special Hollister type in a National Type CHV Vari-Gap crystal holder.

FEATURES:

- An effective, dependable circuit
- Variable frequency control
- Pre-tuned band shifting
- Compactness
- Universal application
- Ease of construction
- Relative low cost of component parts

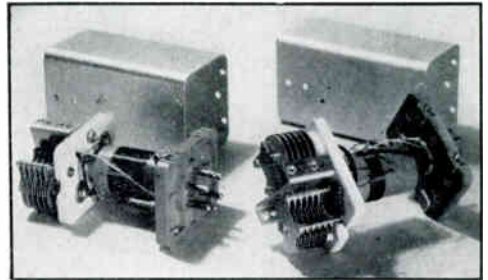

FIG. 16 — TWO OF THE COIL UNITS WITH THEIR SHIELDS REMOVED TO SHOW THE CONSTRUCTION

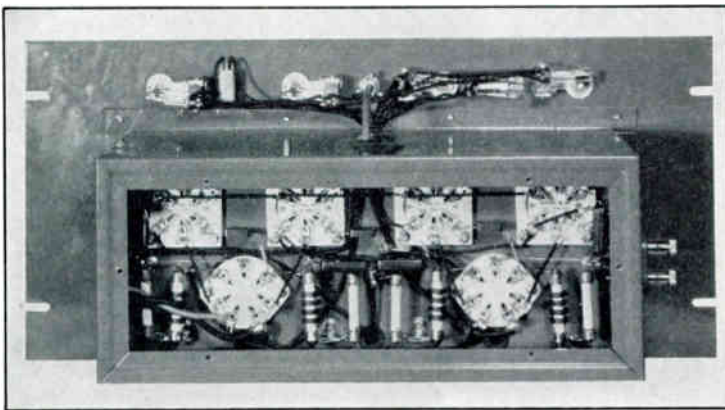

FIG. 17 — REAR VIEW OF THE UNIT WITH THE BACK AND THE DUST COVER OF THE CONTROLS REMOVED TO SHOW THE WIRING

COIL TABLE

| Coil | <i>L</i> ₁ | <i>L</i> ₂ | <i>L</i> ₃ | <i>L</i> ₄ | <i>L</i> ₅ |
|------------------------|-----------------------|-----------------------|-----------------------|-----------------------|-----------------------|
| Band (Mc.) | 3.5 | 7 | 14 | 28 | |
| Coil form dia. | 1" | 1" | 1" | 1" | 1" |
| Wire size | 28 enam. | 24 enam. | 24 enam. | 24 enam. | 20 d.s.c. |
| Turns per inch | 60 | 24 | 24 | 24 | |
| Turns | 38 | 20 | 9 | 5 | 2-turn link |
| Tap (turns from plate) | 13 | 4 | 4 | | |

CRYSTAL HOLDERS

THERE are many different types and styles of crystal holders. Most used in amateur transmitters in the past has been the flat plate pressure type. The National holder of this style, the CHT, has as one of its unusual features, the



FIG. 18—THE NATIONAL TYPE CHT CRYSTAL HOLDER MAY ALSO BE USED WITH SPACER BARS AS HERE SHOWN TO PROVIDE AN AIR-GAP TYPE OF MOUNTING

In this instance, the crystal is one of the thick low-frequency resonator types used in the intermediate frequency amplifier of the single signal type of super-heterodyne. The spacer bars are made of glass ground to size, and provide, in this case, an air gap of .002".

arrangement for quick and easy changing of crystals which is quite an advantage to the station operator having a limited number of holders at his disposal. When the number of available crystals and holders are not limited, it is convenient to incorporate several in each exciter unit as already shown in several of the exciter illustrations on the preceding pages.

A more compact and less expensive arrangement is the new type multiple holder in which four holders with selector switch have been combined into a single unit. While provided with a plug-in base for mounting in a standard five prong tube socket, the unit may also be single hole panel mounted. In many ways this latter is the most preferable arrangement in that the selection switch is easily accessible. When so mounted, connections are made directly to the ends of the plug prongs.

In the photograph below will be discerned the thermal bar against which all four of the crystals are mounted, as well as the low-capacity switch which makes the action of any one crystal completely independent of the others.

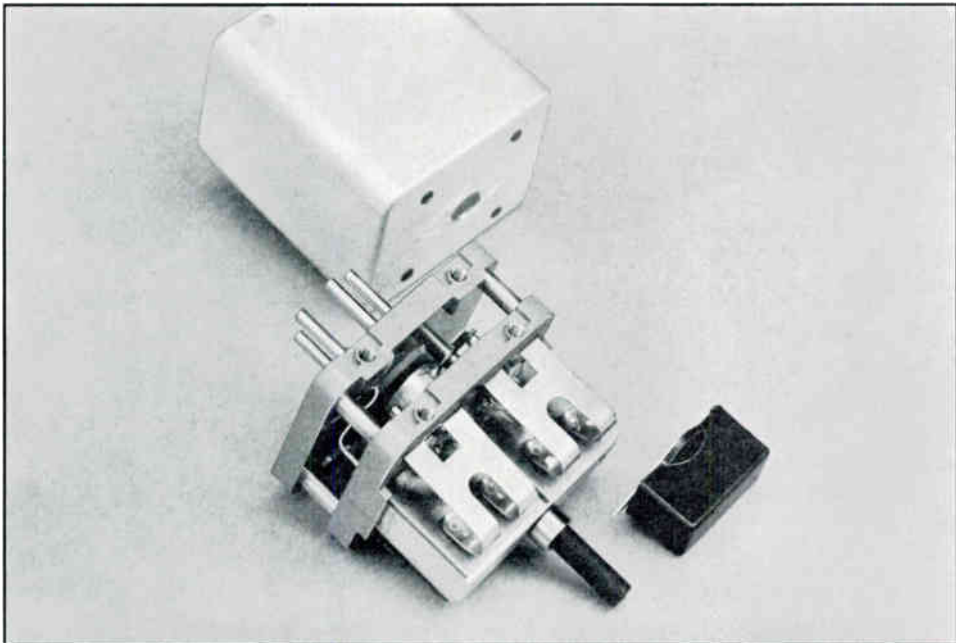

FIG. 19—THE SAME GENERAL TYPE CONSTRUCTION IS EMPLOYED IN THE NATIONAL FOUR-CRYSTAL MULTIPLE HOLDER AS IN THE TYPE CHT SINGLE UNIT

Variable Frequency CRYSTALS

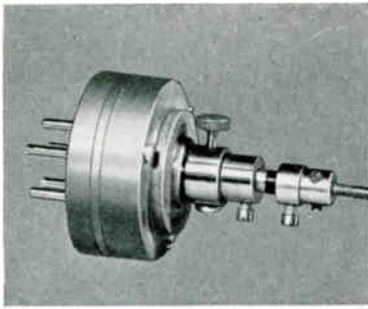

FIG. 20—THE NATIONAL VARI-GAP HOLDER

ONE of the characteristics of a properly finished A-cut crystal is its ability to oscillate with uniform output as the air gap of the holder is varied through a reasonable range. By taking advantage of this principle, it has been possible to develop the type holder illustrated in Fig. 20. Fig. 21 shows an average performance curve. In the commercial model, the air gap is varied by means of a special shaped cam, resulting in practically a straight line frequency tuning curve. The outstanding advantage of a "variable frequency" crystal-control arrangement is, of course, the ease with which minor frequency shifts can be readily made without the danger of going outside of the band limits. Not only is this valuable in avoiding heterodynes, but also in calling a station with which a definite schedule has not been previously made.

The Hollister crystals furnished with the National vari-gap holders are normally ground for a fundamental frequency in the 3900-4000-kc. band. As the frequency range is one part in 600, the range of any one unit at the fundamental frequency is approximately 6 kc. In the 20-meter 'phone band this means a range of 24 kc. and in the 28-Mc. band, a range of approximately 48 kc.!! In actual operation this range is wide enough to permit evasion of heterodyne interference, and still not so wide that out-of-band operation becomes a hazard.

It is important that a carefully ground low-drift type crystal of proper design be used with the mounting described. Many crystals have been found to oscillate smoothly with an air-gap of more than three times the crystal thickness, while some crystals apparently good enough for use in contact-type holders have flatly refused to cooperate in the air-gap mounting.

The standard 5-prong type base is furnished with the vari-gap holder so that it may be readily plugged into any conventional exciter unit in place of a standard crystal holder. When so used, it may frequently be desirable to remove the flexible drift shaft and fasten the dial directly to the control shaft at the top of the holder.

In the transmitter shown in Figure 28 on page 23 will be seen such an application.

A locking screw is also provided so that the frequency adjustment may be locked at any given setting whenever it is desired to use the unit for fixed frequency operation.

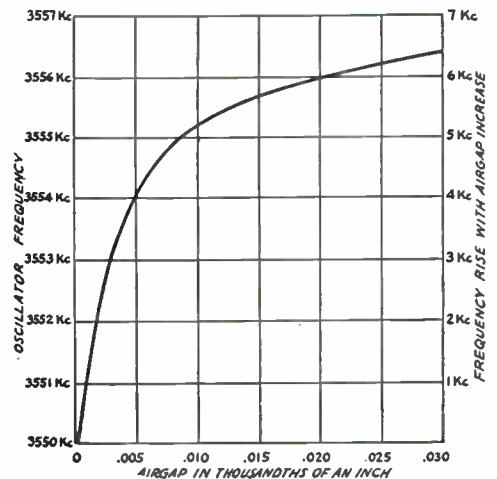

FIG. 21—OSCILLATOR OUTPUT POWER REMAINS PRACTICALLY CONSTANT OVER A FREQUENCY RANGE OF 6 KC. WITH A 3550-KC. CRYSTAL

FINAL STAGES

UNDER just what classification belong the "buffer" stage or stages is, generally rather a moot point. In some cases the buffer is physically, at least, built right into the exciter, as in the case of the W9DRD unit on page 10. Then again it is built into the final stage assembly as in the transmitter on page 25. Of course, there are many instances also, such as in the transmitter on page 41 when the buffer rates a separate panel of its own.

Having already been partially treated in some of the exciters just described and about to be treated more fully in connection with the complete transmitter descriptions soon to follow we will drop further mention of buffer stages herewith and pass on to a few notes and comments on Final Output Stages.

Aside from symmetry of layout, which is desirable from the standpoint of ease of neutralization, and of proper placing of the grid and plate tank circuits from an interaction angle, the one most generally neglected, and yet most important part of a final power amplifier design is the output tank circuit.

Unfortunately, an oscillatory circuit is quite complicated mathematically. Radio textbooks explain such calculations in detail, but amateurs can hardly be blamed for resorting to "rule-of-thumb." After all, amateur radio is a hobby, not a course of mathematics.

As a matter of fact, "rule-of-thumb" does very well when it is guided by experience and followed by skilful adjustment. Judging from the letters we receive, however, there is no general agreement as to the best type of circuit or the proper $\frac{L}{C}$ ratio. We do not wish to become involved in highly technical discussions or mathematics on this page, but we are going to try to clear up some of the confusion regarding the proper $\frac{L}{C}$ ratio in final amplifier plate tank circuits.

We are on safe ground in saying that the impedance of the plate circuit should be high, since this permits the tube to operate at highest efficiency.

This impedance equals $\frac{L}{RC}$ approximately. Therefore, for any given coil efficiency ("Q"), we may conclude that the impedance increases as L increases, and that the tank circuit having the lowest capacity has the highest efficiency.

The above statements apply particularly to unloaded circuits. When the circuit is loaded, another consideration enters, namely storage capacity (or flywheel effect, if you prefer). To make this clear, suppose a single tube, Class C, is driving a loaded parallel resonant circuit. Once each cycle, the tube will supply a short pulse of power to the oscillating circuit. The circuit, however, must supply power steadily to the load, throughout the entire cycle. Obviously then, the storage capacity must be large compared to the peak input per cycle, or poor waveform and unsatisfactory operation will result. As the tube bias is decreased, the driving impulses will become

of longer duration and less storage is needed. When grid bias is decreased to Class B conditions, the input power will be supplied over an entire half cycle,

and the $\frac{L}{C}$ ratio may be safely doubled as compared to Class C. Going one step further, push-pull Class A or B gives power over the entire cycle, and the $\frac{L}{C}$ ratio may be increased to perhaps eight times the Class C value.

Other things being equal, the power output is proportional to the plate current. Therefore if the plate current is doubled, the energy storage should be doubled, which means that the $\frac{L}{C}$ ratio should be $\frac{1}{4}$ as high. (Double capacity, one half induc-

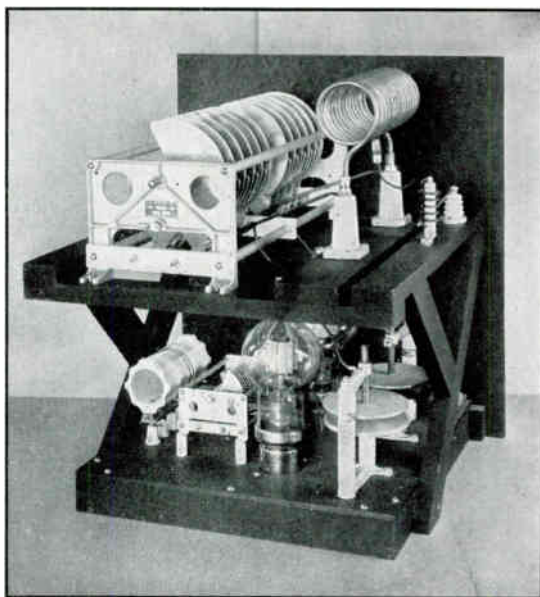

FIG. 22 — A REAR VIEW OF THE HIGH-POWER PUSH-PULL AMPLIFIER

This view shows the arrangement of the tubes and circuit elements. Filament bypass condensers and power wiring are underneath the base.

tance.) Similarly, double plate voltage also requires double the energy storage. But since doubling the plate voltage doubles the oscillatory voltage, the storage capacity is automatically increased four times. Therefore doubling plate voltage permits using an $\frac{L}{C}$ ratio four times as high. (Double inductance, one half capacity.)

It is a simple matter to summarize the foregoing principles, combining them in a formula which is based upon past experience

$$\frac{I}{E} \times \frac{ma}{\text{volts} \times \text{Freq.}} \times K = \text{Tank Condenser Capacity (mmf.)}$$

for any reason, the excitation fail, considerable damage to the tubes and associated equipment will undoubtedly result. To use a complete battery bias supply is frequently awkward and expensive. A practical compromise is to use a combination of both, employing just sufficient battery voltage to reduce the plate current to the final stage to a sufficiently low value, should excitation fail, to prevent damage for the few moments that this plate current will be flowing before the operator can cut off the high voltage supply. In the case of the large transmitter at W1HRX, we use the DC exciter voltage to the high voltage generator for this purpose, inasmuch as the output of the exciter generator is approximately 250 volts.

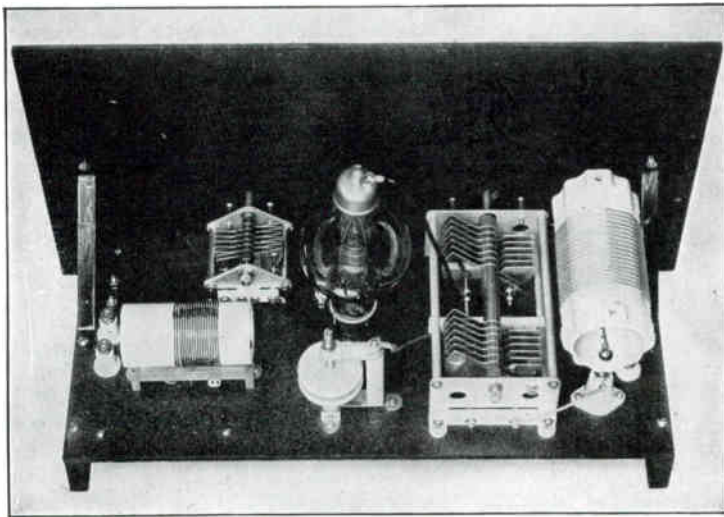

FIG. 23—A SINGLE-TUBE HIGH-FREQUENCY AMPLIFIER OF MEDIUM POWER

For use on 7, 14 and 28 mc. This unit can be used with either a 50T or RK36. Plug-in coils, wound on manufactured forms, are used for changing bands. Condensers are mounted to bring the shafts out symmetrically on the front panel.

“K” will depend upon the type of transmitter, as follows:

| | |
|--------------------|--------|
| Single ended c.w. | K=2600 |
| Single ended Phone | K=5200 |
| Push-Pull c.w. | K=650 |
| Push-Pull Phone | K=1300 |

But now let us get back again to this business of L C ratios.

While we do not claim any great accuracy for this formula, we believe the information it gives will help the amateur in building a new transmitter, or in obtaining better performance from his present rig.

Perhaps at this point it might be well to digress for just a moment, and comment on bias supplies. The normal practice in the average low-power amateur transmitter is to use grid-leak bias. It is convenient and inexpensive. In larger transmitters, however, such practice is hazardous. Should,

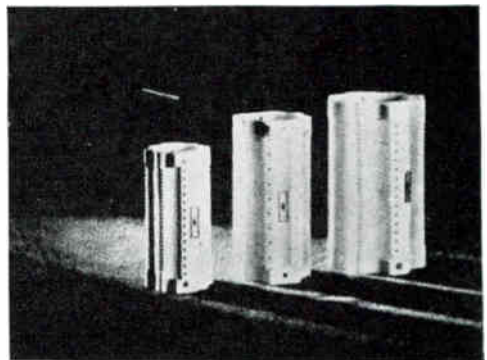

CAPACITY versus TURNS

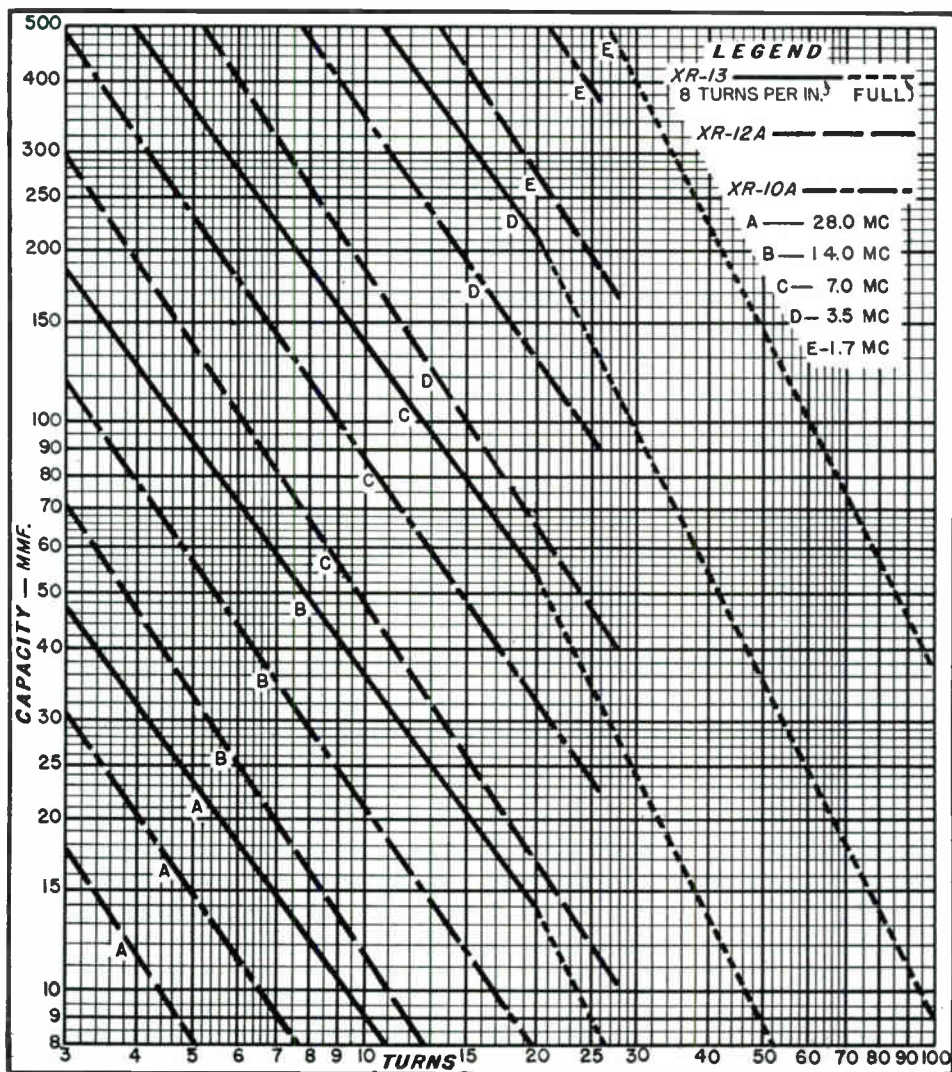

The chart above will prove a convenient means for determining the correct coil form and number of turns of wire to use with the calculated capacity. There are five groups of curves (one for each ham band) plotted for three of our coil forms. The XR-13 is our 1 3/4" dia. Buffer Coil Form, the XR-12A (4" dia.) and the XR-10A (2 1/2" dia.) are our Transmitter Coil Forms. As an example of the use of the chart, suppose the calculated capacity is 60 mmf. and the operating frequency of the rig is to be 7 megacycles. Then for this frequency we refer to group "C" of the curves and at this capacity we find that the XR-12A requires 8 turns, the XR-10A requires

13 turns and the XR-13 requires 18 turns (wound 8 turns to the inch). If the transmitter is to be operated only on one band, the type of coil form will be determined by individual requirements. However if plug-in coils are to be used then it will be convenient to use only one type of form throughout. The best type can be determined by calculating the capacity required for each frequency and by referring to the chart to see which coil form can be used in all cases.

There is one thing to remember when selecting the tank condenser; the chart capacities are the sum of the tube, wiring and the tank condenser capacities.

Having arrived at the design of the output tank circuit, the next question is the mounting. Few indeed are the variable condensers designed with a view toward simplifying the work of the transmitter constructor with limited shop facilities. Just recently, however, a complete line of mounting lugs, brackets, and jack strips have been designed by National for use with their line of transmitting inductance forms and transmitting condensers so that these two units which have been designed to work together electrically may also be easily used together mechanically. An ideal application of one of these combination coil-condenser units is shown in the transmitter on page 25. In addition to their use in forming tank circuits, they may also be used in combination, as shown at the centre top of the illustration, to form a compact Everett type of antenna filter network.

In the accompanying illustration, it will be noted that the smaller UR-13 Isolantite coil form is not threaded as are the larger sizes. The surface of this coil form is quite rough, and as normally it is wound with smaller sized wires, it was found

generally more convenient to have an unthreaded surface so that coils with different pitch of winding can be readily constructed. Whether the wire be silk-covered or just plain enamel, it can be rigidly held in place if the finished coil is given a good coat of National Coil Dope. ("National liquid Victron" is made by dissolving the scrap Victron accumulated from production of One-Ten receivers, etc., in Victron solvent. As this cement contains no other impurities, it has an extremely low loss factor.)

When mounting any type of ceramics whether they be transmitter coil forms, stand-off insulators, ceramic mounting strips, etc., it is well to use a small cardboard, fiber, or cork washer under the head of each screw. By so doing, it is possible to tighten up on the screw just as if it were being used on metal without danger of damaging the ceramic. The ceramic in itself is generally of ample strength provided the pressure exerted by the screw head is uniformly distributed. The washer serves this purpose and prevents excess pressure on a single point.

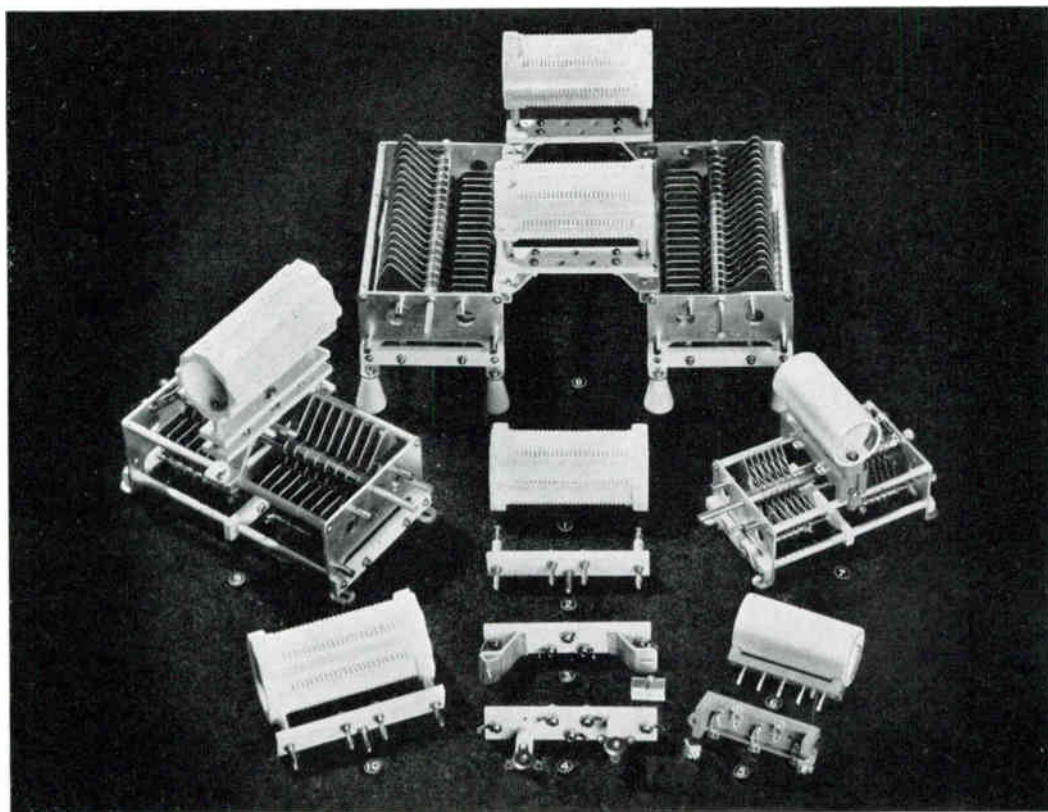

FIG. 24. — AT THE LEFT IS THE XR-10A FORM MOUNTED ON THE FRAME OF A TYPE TMA NATIONAL CONDENSER, WHILE AT THE RIGHT IS THE XR-13 COIL FORM AND TYPE TMC CONDENSER. Plug-in mounting strips are shown in both of these applications.

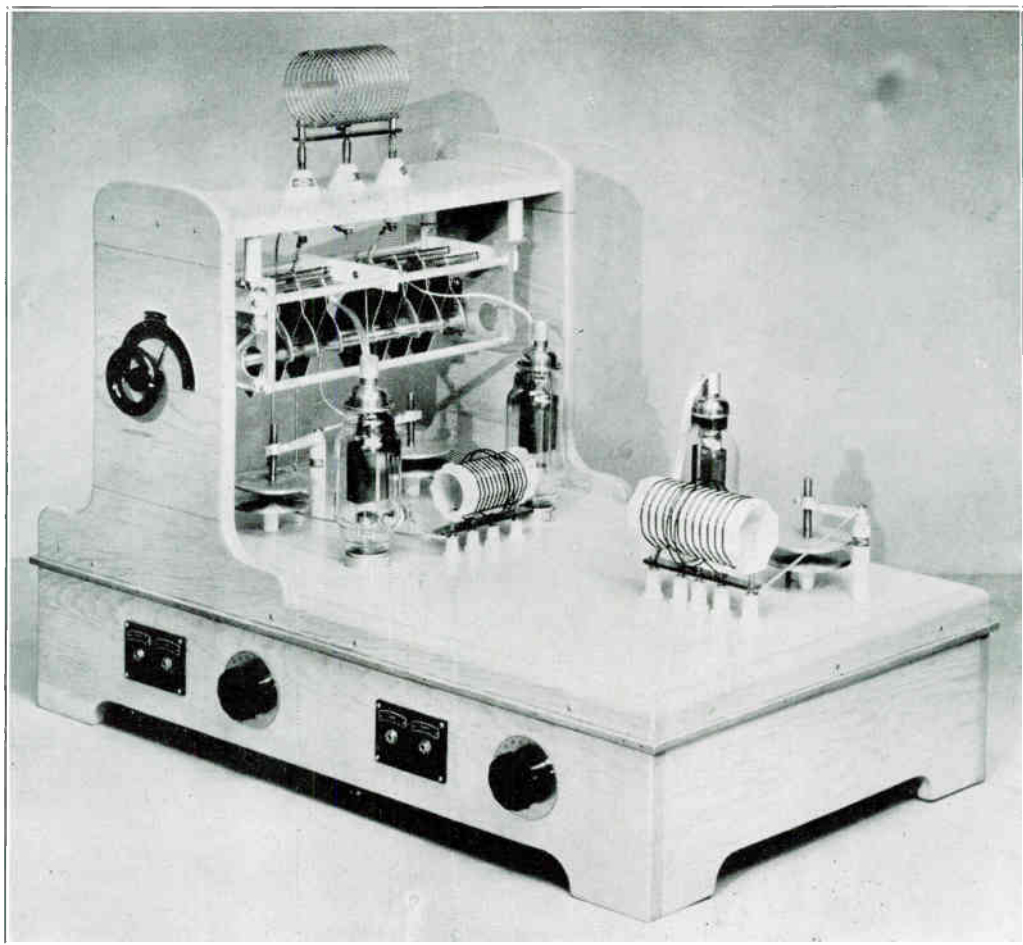

FIG. 25

Some Complete TRANSMITTERS

FREQUENTLY it is desirable to build a complete transmitter as a single unit, rather than as an assembly of such individual units as exciters, buffers, and final amplifiers. An interesting example of such construction is the outfit at W6QD, illustrated herewith. The construction used differs from the conventional breadboard layouts of the past, in that many of the component parts are mounted on different levels so as to shorten the leads and thus provide a more compact, symmetrical, and efficient layout.

By means of plug-in coils this one kilowatt outfit is easily shifted between the 20- and 40-meter c.w. bands, upon which W6QD confines its operation. The addition of suitable coils and modulation equipment will make the transmitter

equally effective upon the 10- and 20-meter 'phone bands.

A pair of Amperex 6X4's are used in push-pull in the final stage and normally operated at a plate voltage of 2800 to secure an input of exactly one kilowatt. The final tank circuit comprises an air-wound inductance, mounted with plugs and jacks supported with National XS-2 high-frequency bushings. The capacitor is the large National type TML-30DE, having a breakdown voltage rating of 20,000 and a capacity of 30 mmf. per section. Type NC-150 neutralizing condensers are used in both the buffer and final stages. Link coupling is used between the buffer and the final stage, and the link-coupling coils are so constructed, as will be seen from the photo, as to

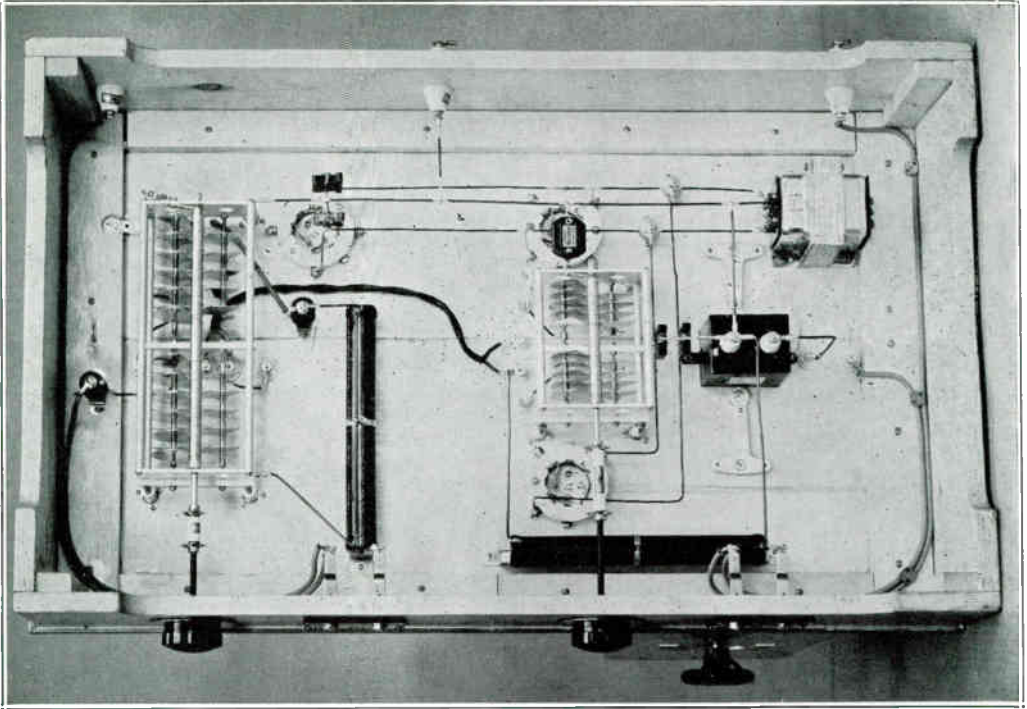

remain in position when the plug-in inductors are changed.

An amplifier in which such care has been used to secure symmetrical mechanical layout in the final stage, even to the smallest details, as in the case of the W6QD transmitter, will be found to work well at the higher frequencies, particularly on the 10-meter band, when others which have been indifferently designed in this connection give trouble. Symmetry of design of the output stage, in particular, has been given extremely careful consideration in all of the transmitters described and illustrated in this booklet.

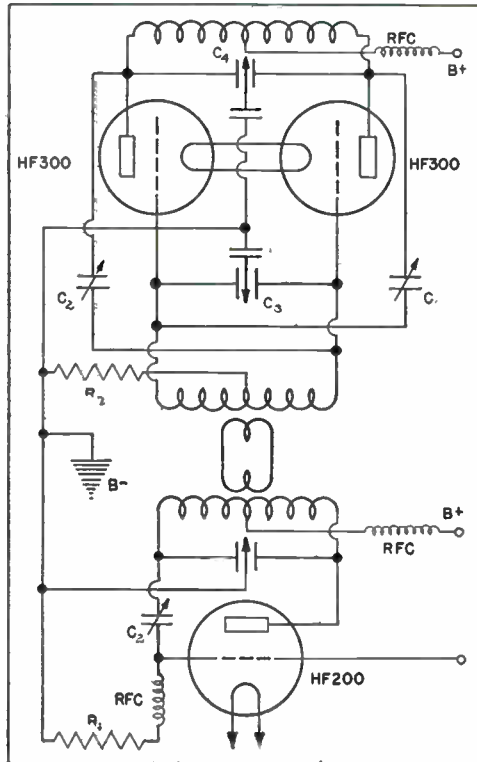

FIGS. 26 AND 27

In the under-view of the W6QD transmitter shown above, will be noted how the two type TMA transmitting condensers, which are operated "above ground," are insulated from the base by small GS-1 stand-offs. They are also insulated from the dial drives by means of the National TX-1 and TX-2 Isolantite insulated couplings. By being so insulated, as well as so located beneath the sub-base, there is little danger of anyone coming into contact with them.

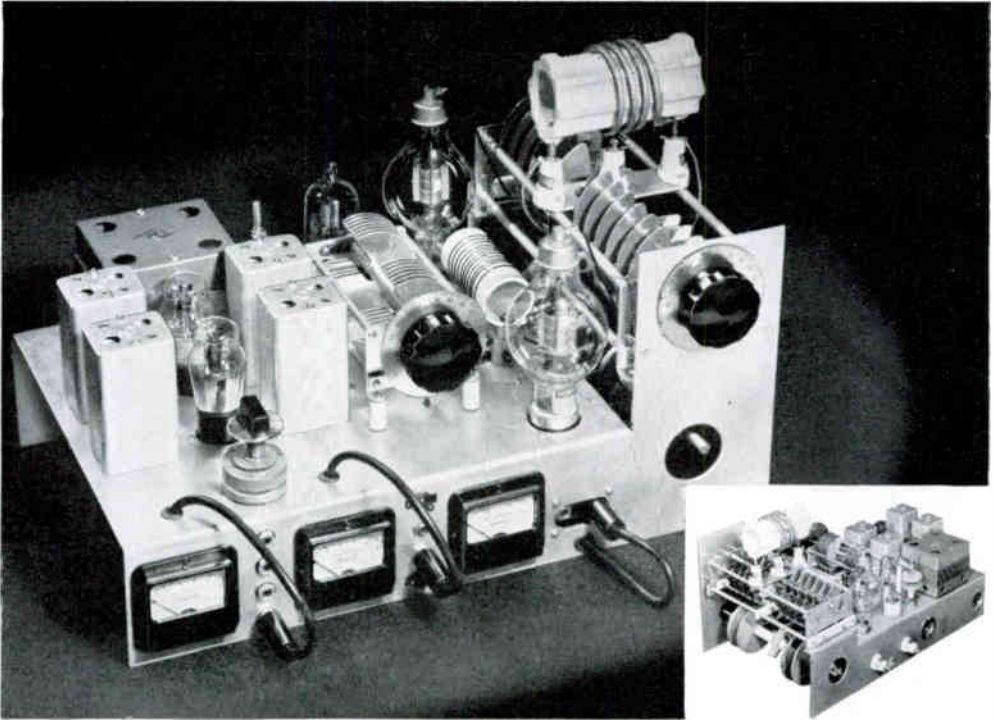

FIGS. 28, 29, 30

Following the thought originated in connection with the W6QD transmitter of the preceding pages, we have, in designing the one shown herewith, gone a step further and incorporated not only the entire exciter, including the variable frequency crystal holder, but also the filament feeding transformer in a single compact one-half kilowatt outfit. Meter economy is secured by providing jacks and plugs for switching the meters between different plate and grid circuits. The exciter uses two 53 tubes in the "crisscross" circuit arrangement, to which we have previously referred. Using a 75-meter crystal, the output from the last section of the second 53 is ample to drive the 35T Eimac high- μ triode used as a buffer. This tube, in turn, can fully drive a pair of RK-36's, even with 600-watt input.

This particular transmitter has been operated a great deal on the 10-meter 'phone band and found to be particularly well adapted to such high-frequency operation. In this design, as in the case of the previous one, great care has been exercised to secure symmetry of mechanical arrangement in the final stage.

The scheme of mounting the filament transformer directly on the chassis of a transmitter of this type has been found to be extremely worth while in eliminating long leads carrying heavy

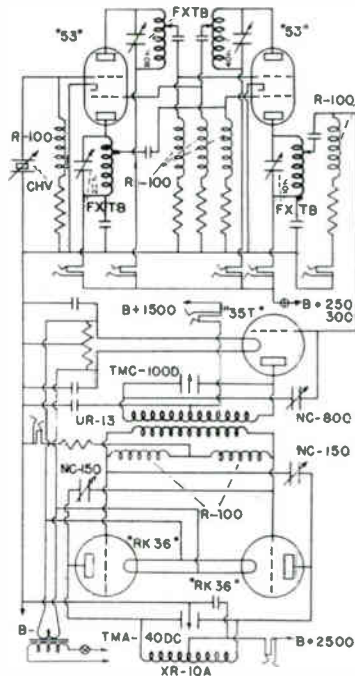

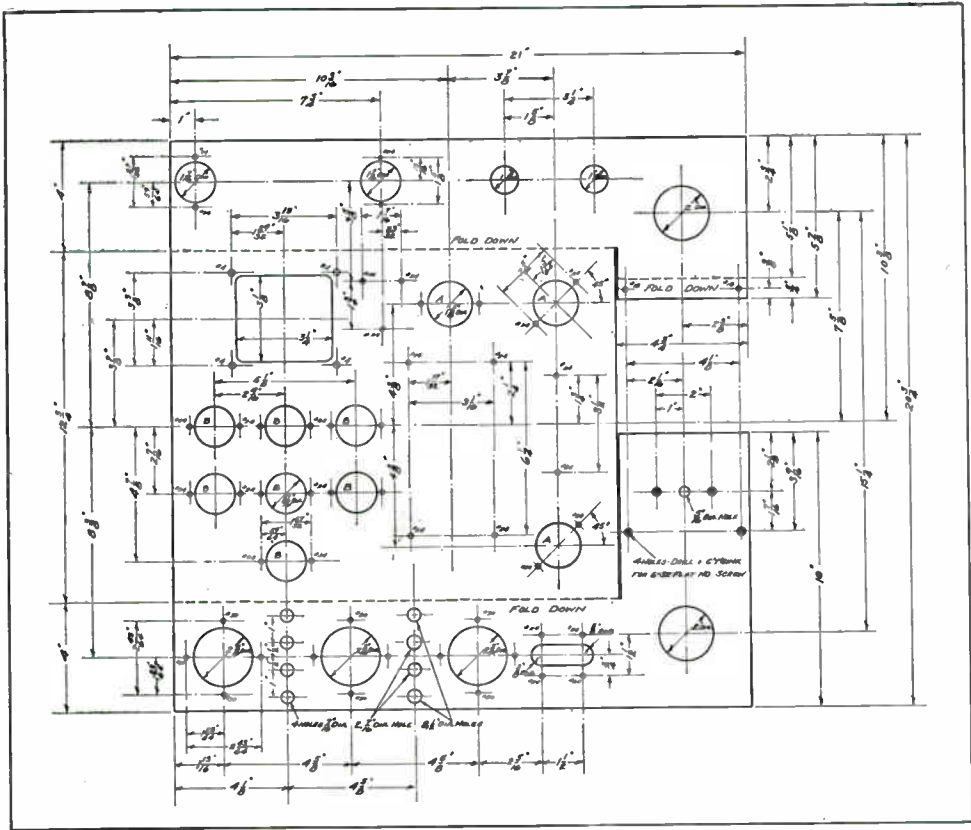

FIG. 31

currents. The chassis itself is cut and formed from a single sheet of one-sixteenth inch half-hard aluminum. Fig. 31 gives the essential construction details. By forming the chassis in the manner indicated, mounting brackets for the final stage tank condenser are eliminated. A bracket made from sheet aluminum is, however, required for suspending the NC-150 neutralizing condensers of the final stage.

Parts List

- | | |
|---|--|
| 4 National Isolantite 5-prong sockets | 4 National FXTB 5-prong fixed tuned exciter tanks |
| 2 " Isolantite 7-prong (large) sockets | 7 " R-100 chokes |
| 1 " Isolantite 4-prong socket | 4 " GS-1 Stand-off insulators |
| 3 " Isolantite XM-10 sockets | 4 " No. 12 Grid-grip clips |
| 2 " NC-150 neutralizing condensers | 1 " Type 38 filament transformer |
| 1 " NC-800 neutralizing condenser | 8 Three-way phone jacks |
| 1 " TMA-40DC condenser | 2 S.P.S.T. Toggle switches |
| 1 " TMC-100D condenser | 2 triplitt meters — Type No. 326 — 0-50 mils. |
| 2 " Type 0 No. 2 dials | 1 " " — Type No. 326 — 0-300 mils. |
| 1 " UR-10A coil form assembly | 1 Aerovox Type 1883 condenser — .001 mfd. — 7000 volts |
| 1 " UR-13 coil form assembly | 1 " " 1882 condenser — .001 mfd. — 3500 volts |
| 1 " CH-V Vari-gap crystal holder — with Hollister crystal | 2 " " 1450 condenser — .01 mfd. |
| | 4 " " 1465 " — .0001 mfd. |
| | 1 60-ohm center-tapped resistor |
| | 5 20,000-ohm resistors — 2-watt |
| | 2 Tubular condensers — .1 mfd. — 400 volts |

Feeling that it really takes no more time to do a good mechanical job in the first place than the more usual rag-time one, it is the particular intent herewith to illustrate and comment upon the mechanical rather than the electrical design features of a moderate-power r.f. final amplifier recently designed for use with a companion exciter unit (see pages 13 and 14) to form a complete one-half kilowatt 'phone transmitter. Consequently, we will use more than the customary number of photographic illustrations and devote less space to circuit comments and description. Particularly interesting should be the views taken prior to wiring and panel mounting.

Structurally, the transmitter is built around the central steel chassis of U-frame, under which is mounted the filament transformer and the RK-38 sockets, and to the sides of which are attached the aluminum brackets carrying the relatively lightweight r.f. components, such as the two variable condensers, the neutralizing condensers, input tank circuit, and the buffer tube socket. This chassis unit is illustrated in Figs. 33, 35 and 38, without wiring and without mounting of the front panel, in order to illustrate the simplicity and neatness of this type of construction.

Perhaps at this time it may be well to point out some of the constructional details that contribute much to the neat final appearance of the complete unit. Most prominent in this connection are, of course, the aluminum brackets carrying the variable condensers; actually, it takes very little, if any, more labor on the part of the constructor to form-up the type of brackets shown from sheet aluminum in an ordinary vise, than it does to bend up strip stock in the more normal manner. The round holes cut in the two rear brackets add much to the appearance and little to the labor, as

holes of this size are very easily cut in aluminum with an ordinary trepanning tool or fly-cutter.

By mounting the filament transformer in the manner shown, not only is its relatively heavy weight supported by the strongest part of the chassis, but extremely short leads also result.

Coupling between the exciter and this amplifier is by means of a low-impedance link with a pre-tuned plug-in tank, mounted adjacent to the buffer tube on the amplifier chassis.

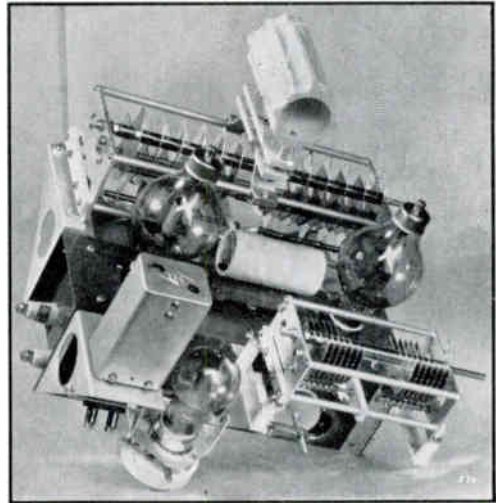
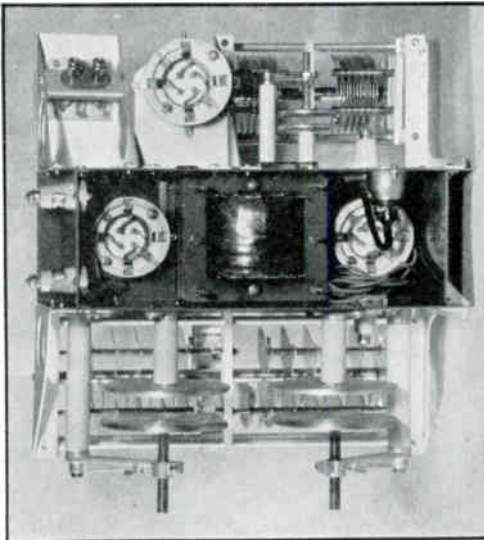
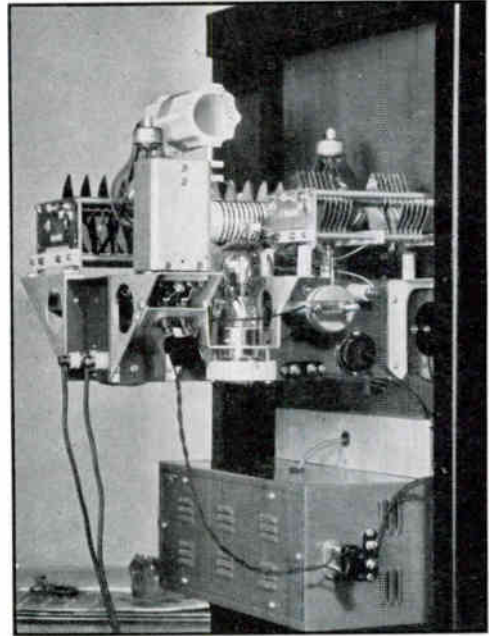

FIGS. 33, 34, AND 35

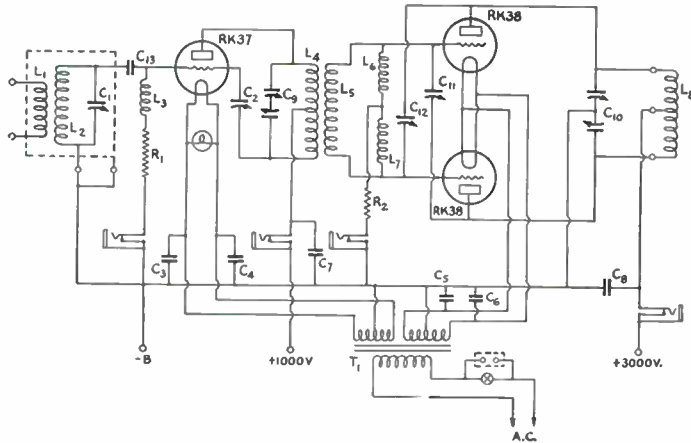
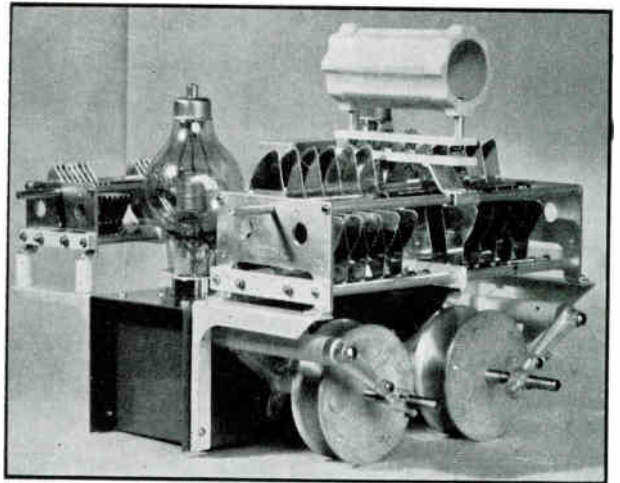
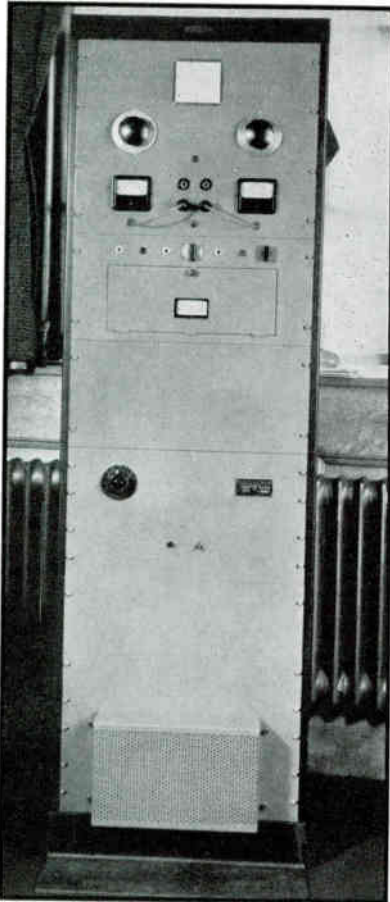

FIG. 36—CIRCUIT DIAGRAM OF THE 20-10-METER DRIVER-AMPLIFIER

- C₁ — 50- μ fd. variable (National FXTB, units connected in parallel).
- C₂ — Neutralizing condenser (National NC-800).
- C₃, C₄, C₅, C₆, C₇, C₈ — 0.01- μ fd. mica (Aerovox).
- C₉ — Split-stator, 100 μ fd. per section, 0.077-inch airgap (National TMC-100D).
- C₁₀ — Split-stator, 40 μ fd. per section, 0.359-inch airgap (National TMA-40DC).
- C₁₁, C₁₂ — Neutralizing condensers (National NC-150).
- R₁ — 20,000 ohms, 2 watts.
- R₂ — 12,000 ohms, 10 watts.
- T₁ — Filament transformer, 5 volts, 16 amps., and 7.5 volts, 3.25 amps.
- L₃, L₆, L₇ — Short-wave chokes (National R-100).



FIGS. 37 AND 38
COIL DATA

- L₁ — 28 Mc., 2 turns; 14 Mc., 3 turns; both No. 24 d.s.c. wire.
- L₂ — 28 Mc., 5 turns; 14 Mc., 10 turns; No. 20 enameled, spaced 20 turns per inch.
- L₄ — 28 Mc., 6 turns No. 16, 2 turns per inch, c.t. 14 Mc., 16 turns No. 14 enameled, 6 turns per inch, c.t.
- L₅ — 28 Mc., 5 turns No. 16, interwound with L₄. 14 Mc., 13 turns No. 14, 5 turns per inch.
- L₈ — 28 Mc., 4 turns No. 10 enameled, 4 turns per inch. 14 Mc., 12 turns No. 10 enameled, 7 turns per inch.
- Note: L₁ and L₂ wound on 1-inch diameter forms (in FXTB unit).
- L₄ and L₅ — wound on 13/4-inch diameter Isolantite forms (National UR-13 unit).
- L₈ wound on ceramic form 2 1/2 inches in diameter (National UR-10A unit).

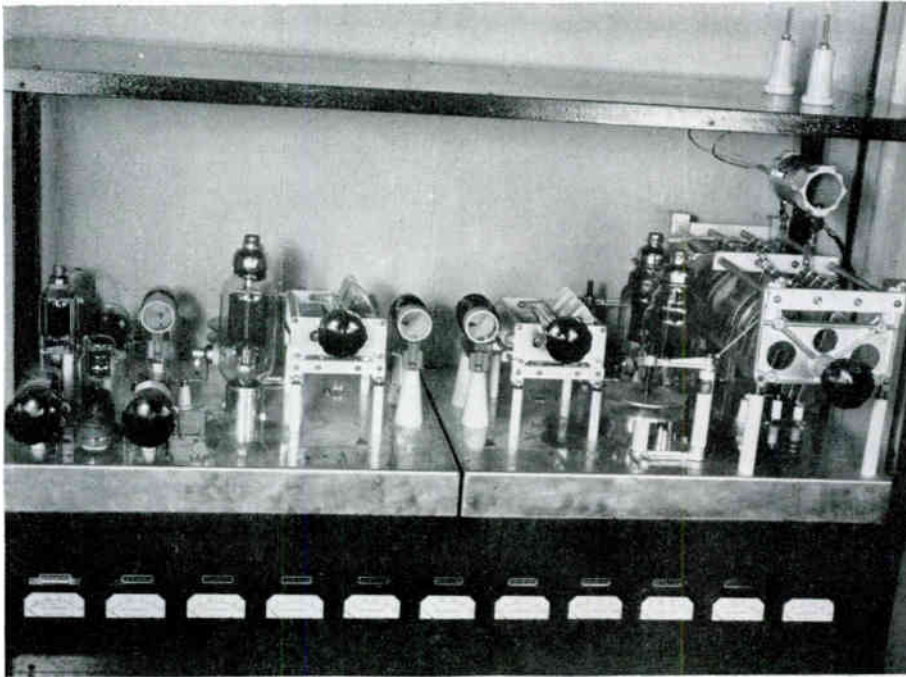

FIG. 39—THE COMPLETE R.F. SECTION OF THE ONE-KILOWATT TRANSMITTER AT W6ABF

The illustrations on this page show the semi-breadboard style of construction used by W6ABF in a newly completed one-kilowatt 20-meter 'phone transmitter. The layout is quite straightforward. The exciter-buffer unit at the left is link-coupled to the final amplifier at the right. A National vari-gap crystal holder can be seen in the left-hand front corner. All of the meters for the transmitter are located on the panel, directly below the shelf containing the R.F. section. Modulator and power supply are below the meters. The diagram below shows the tube line-up.

Principal Parts

- 1 National TML-501DB+ condenser
 - 2 " TMA-501DA condensers
 - 2 " TMS condensers
 - 1 " NC-800 neutralizing condensers
 - 3 " NC-150 neutralizing condensers
 - 1 " Vari-gap crystal holder with Hollister crystal
 - 3 " UR-13 coil form assemblies
 - 1 " XR-10A coil form assembly
 - 4 " R-100 chokes
 - 1 " R-154 choke
- Miscellaneous national isolantite sockets, stand-off insulators, etc., etc.

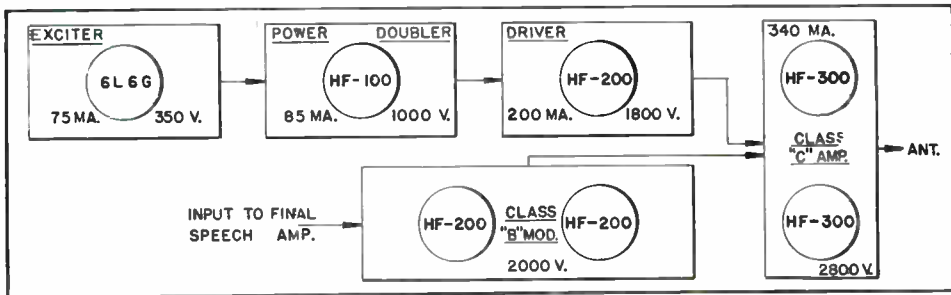

FIG. 40

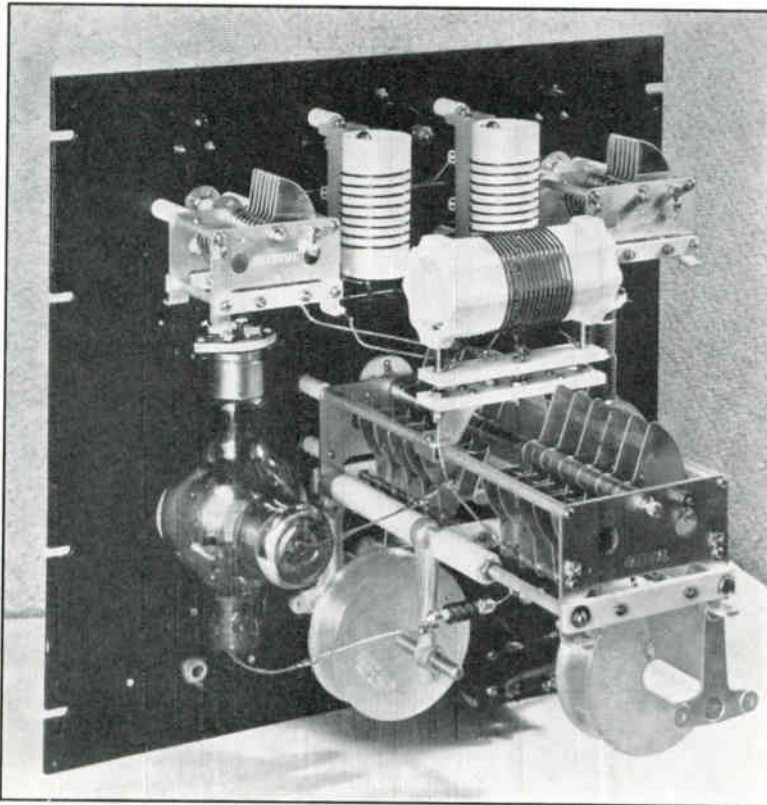

FIG. 42 — A VERY UNUSUAL LAYOUT FOR AN 852 POWER AMPLIFIER

Note the symmetrical parts arrangement, compactness, and short leads.

One of the most generally used tubes in medium-powered amateur phone transmitters is the 852. Here is shown a rather unusual, but most effective layout for a 600-watt Class C amplifier and antenna tuning network designed to use a pair of 852s. A careful study of the illustration will show how two standard National NC-150 Neutralizing Condensers have been combined with a National Type TMA-40DC split stator transmitting condenser and an UR-10A tank form into a single unit. By mounting a tube upside down at each side of this single RF unit, the entire amplifier practically completes itself. The filament transformer is mounted on the back of the front panel, just below the plate tuning condenser. In the illustration it can be seen between the two neutralizing condensers.

The antenna tuning network comprises a pair of TMC-100 Condensers and a pair of UR-13 Inductance forms. RF Chokes (R-100s) are used in the grid circuit as this amplifier was designed for capacity coupling of the grids directly to the output circuit of an RK-28 buffer, mounted on the "panel below" in the relay rack. An RK-28 was selected for this purpose rather than an RK-20 (which would have furnished sufficient

driving power) as it may be operated directly from the same high-voltage power supply (3000 V) as the 852s without power loss in dropping resistors. The suppressor of the RK-28 is then operated slightly negative rather than heavily positive, so as to reduce the output to the required level and thus reduce the plate current and consequently the load on the power supply unit.

Also note how all of the variable condensers are insulated from the front panel with National GS-1 stand-off insulators. In using the GS-1 stand-offs in this manner it is more convenient to remove the standard hardware and just employ the Isolantite pieces. TX-1 Isolantite Insulated Couplings are used on the drive shafts.

The panel is a standard 19" x 3/16" x 17 1/4" aluminum relay rack style. On the front, in addition to the three type O dials, for the three variable condensers, are three meters for indicating plate, grid, and antenna currents.

In the illustration, it is rather difficult to see what holds the sockets in place. Actually they are suspended from small brackets mounted directly on the back of the front panel. They are painted black, however, and consequently are not readily discernible in the illustration.

The main transmitter in use at W1HRX at present is a 1-KW. 20-meter 'phone unit with a pair of W.E. 251As in the final, modulated with a pair of RCA 851s in Class A-B. This final amplifier, illustrated herewith, is driven by the lower-power RK-20 transmitter, described on page 40. When so used, the suppressor bias of this smaller transmitter is changed, of course, from negative to positive and the suppressor-modulating amplifier shifted to the input of the 851 Class AB audio stage. Link-coupling is used between the plate coil of the RK-20 push-pull stage and the grid coil of the 251A push-pull final stage. The RK-20s supply ample RF power to properly drive the 251As in this type of application.

As the mechanical construction features are a little unusual, we are showing several views.

The relay rack front panels carry all of the "behind the panel" structures. The RF and the modulator panels are separate units. The supporting framework of the RF section is made of $\frac{3}{4}$ " duralium angle. The "sockets" for the 251As are homemade from standard fuse clips, National Grid Grips and some of the Isolantite insulating bars made for the Type TMI condensers, but also sold separately. The filament transformers are located close to the filament contacts of the tubes to provide leads as short as possible for the heavy AC filament heating current. Quarter-inch copper tubing is used for filament leads and the volt meters are connected directly to the socket terminals. Both the plate and grid coils are "plug-in," as this same amplifier is used at times on the 10- and 75-meter 'phone bands in addition to 20.

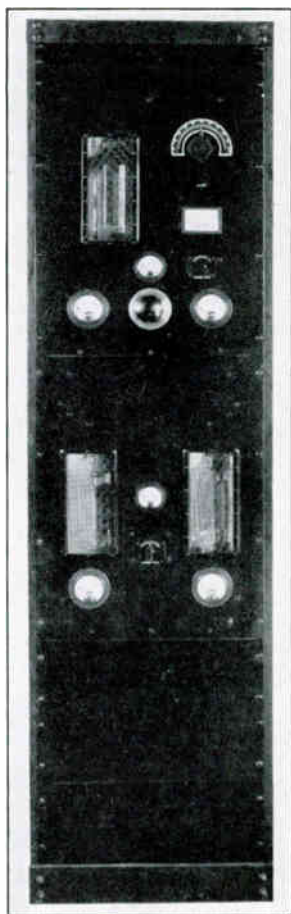

FIG. 43—FRONT VIEW OF THE 1-KW. AMPLIFIER-MODULATOR

The two small indicators are the controls for the filament transformer primary tap switches.

The two NC-500 neutralizing condensers are suspended on a strip of aluminum formed in channel fashion for rigidity and suspended on brackets directly beneath the TMI-40DC final tank condenser. The final tank coil is self-supporting, and constructed from $\frac{1}{4}$ " copper tubing. It is fitted with the large size General Radio banana plugs for plugging directly into jacks on a strip of Micalex mounted on top of the condenser. This location of the final tank coil, in addition to being close to its associated condenser, also places it free and clear of any surrounding objects that might introduce dielectric losses. It is also out in the open where it may quickly and easily be changed in band shifting.

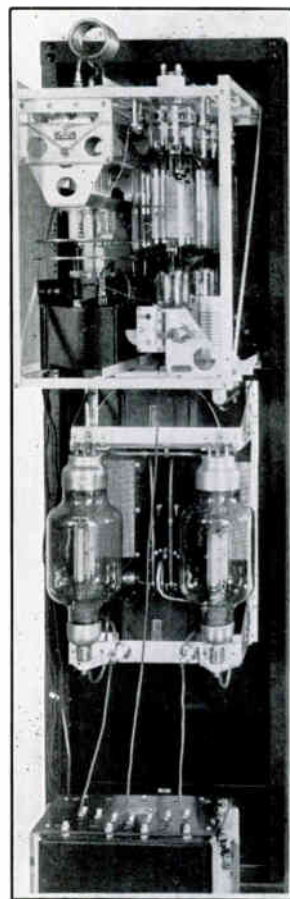

FIG. 44—A REAR VIEW OF THE 1-KW. AMPLIFIER-MODULATOR

The transformer at the bottom is not a pole pig but the audio coupling transformer!

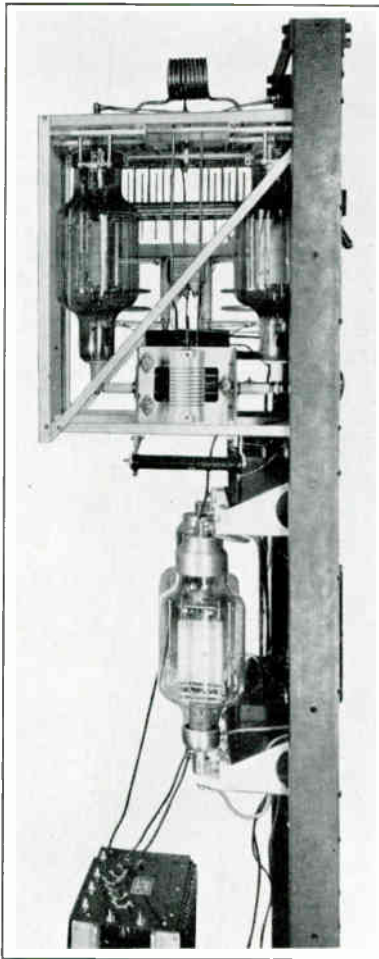

FIG. 45

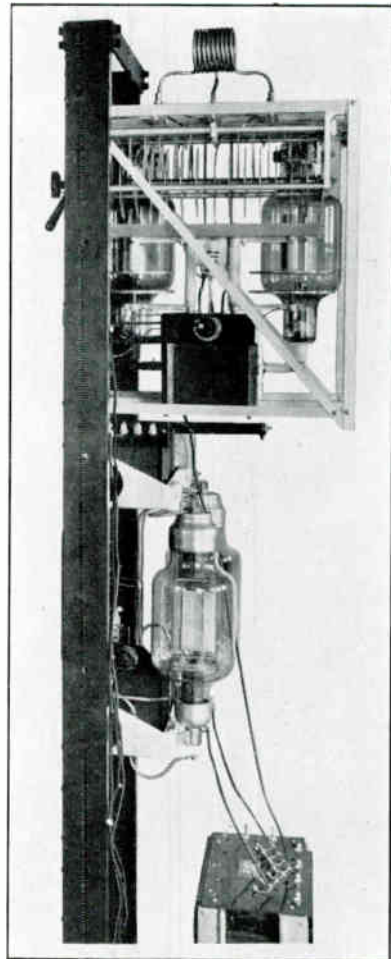

FIG. 46

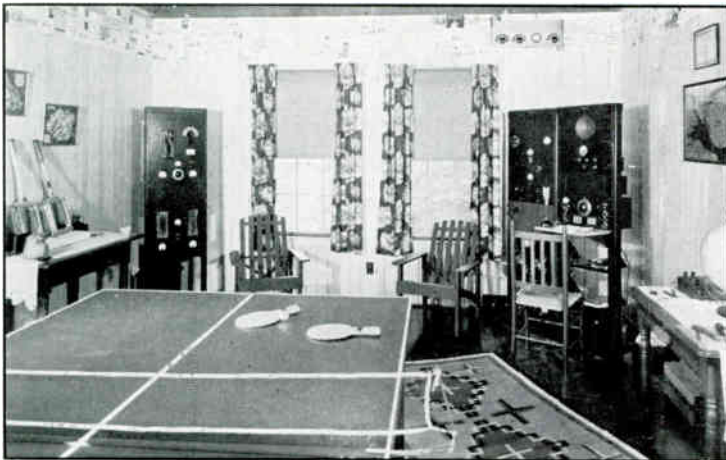

FIG. 47, at the left, shows the 1-KW. Amplifier and also the operating position with HRO Receiver, speech amplifier, exciter, and RK-20 buffer amplifier.

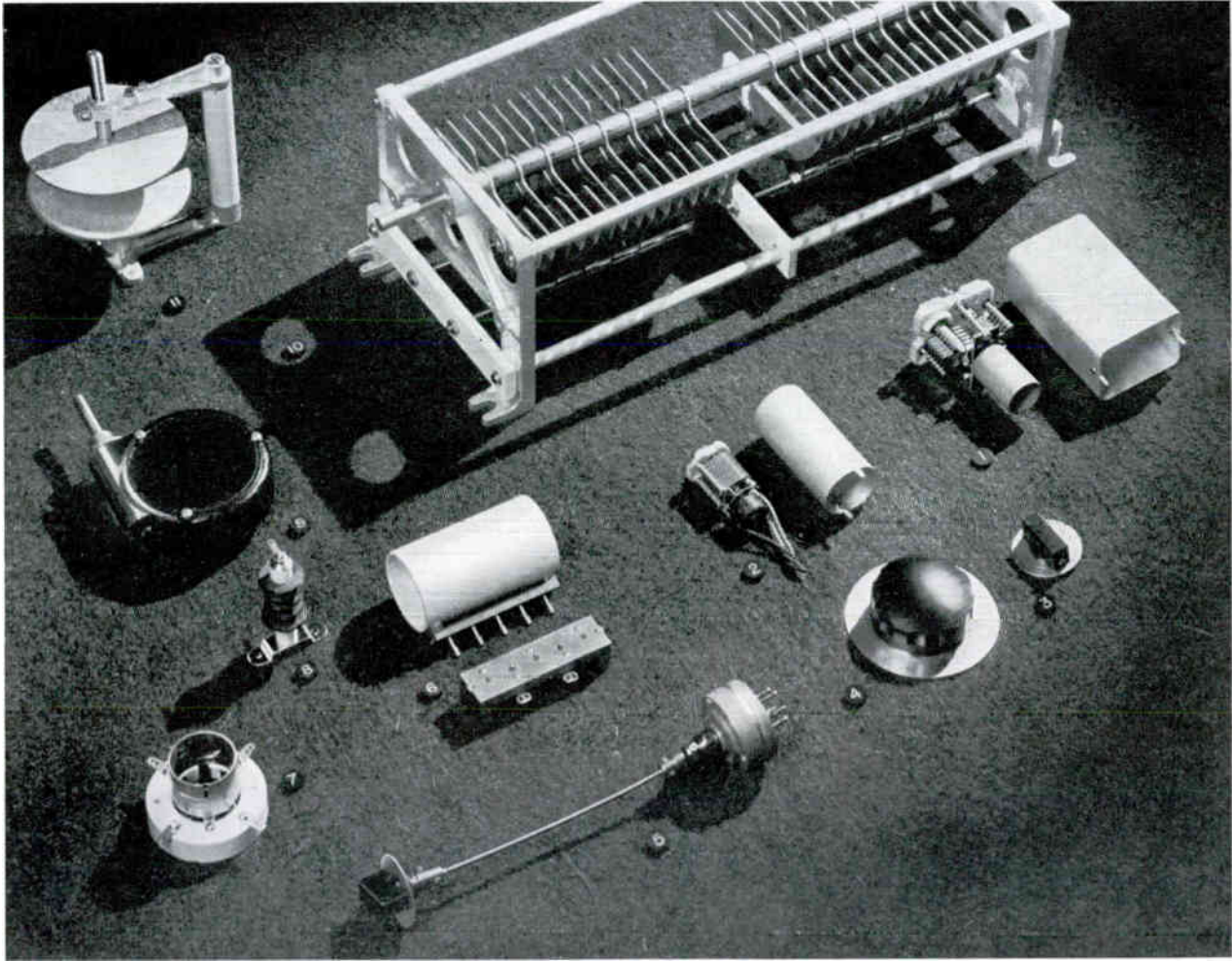

FIG. 48—A GROUP OF SOME OF THE NEWER NATIONAL COMPONENT PARTS

A slightly different style of construction than that used in any of the other transmitters shown in this booklet, is that of Figs. 49 and 50, designed and built by W2GYL. All of the units are constructed on standard relay rack panels in the more conventional manner, but, instead of being mounted on a standard rack, are mounted in a light gauge steel cabinet with hinged rear door. Such cabinets are now being stocked by many of the larger parts dealers and are finding considerable favor among those amateurs especially, who have small children in their family¹ from whose wanderings the wiring of any transmitter must be protected.

The complete transmitter, including exciter, buffer, final stage, modulator, and power supplies, is housed in the one rack-cabinet. The top panel carries the antenna tuning system comprising an inductance link coupled to the final plate tank

coil, the tuning condenser, and the thermal-couple ammeter.

Reference to the rear view shows that the usual stepladder construction has been avoided. There are two important reasons for this change. One is that the assembly results in the elimination of long filament leads. No filament lead in this transmitter is longer than three inches. The filaments for the RK-30's are supplied by two individual filament transformers located directly above their sockets. The second important result of avoiding stepladder construction is to provide a "chimney effect" for the whole transmitter so that the heat generated by the tubes rises toward the top of the case and draws in cool air through the louvres down near the floor. A distinct departure from usual construction is the inversion of the modulator tubes, which has the effect of putting the tubes themselves in plenty of free space along with a material shortening of the leads.

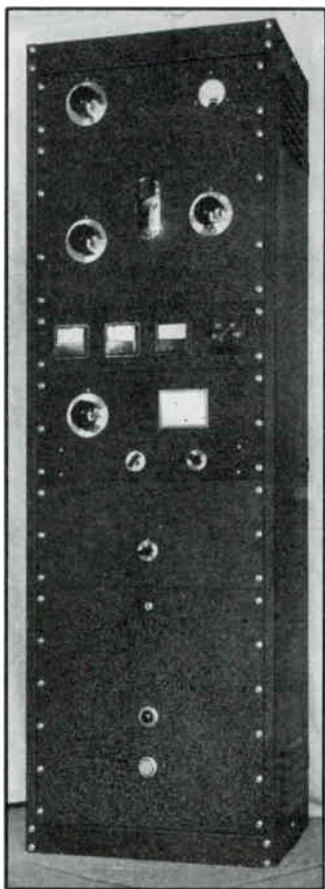

FIG. 49 — FRONT VIEW OF THE TRANSMITTER

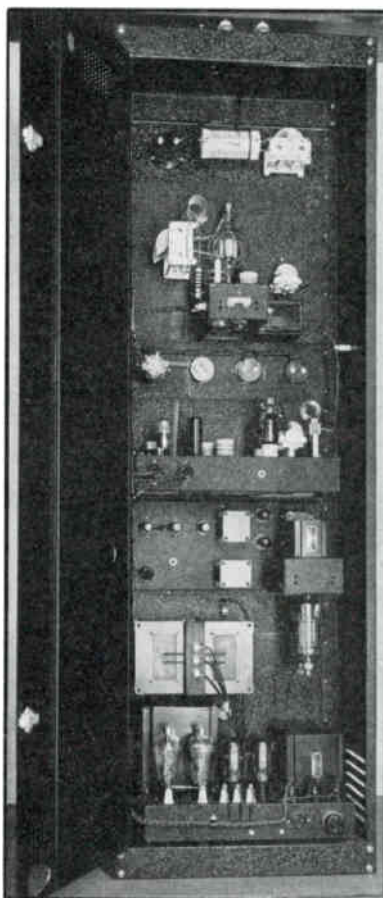

FIG. 50 — REAR VIEW OF THE TRANSMITTER

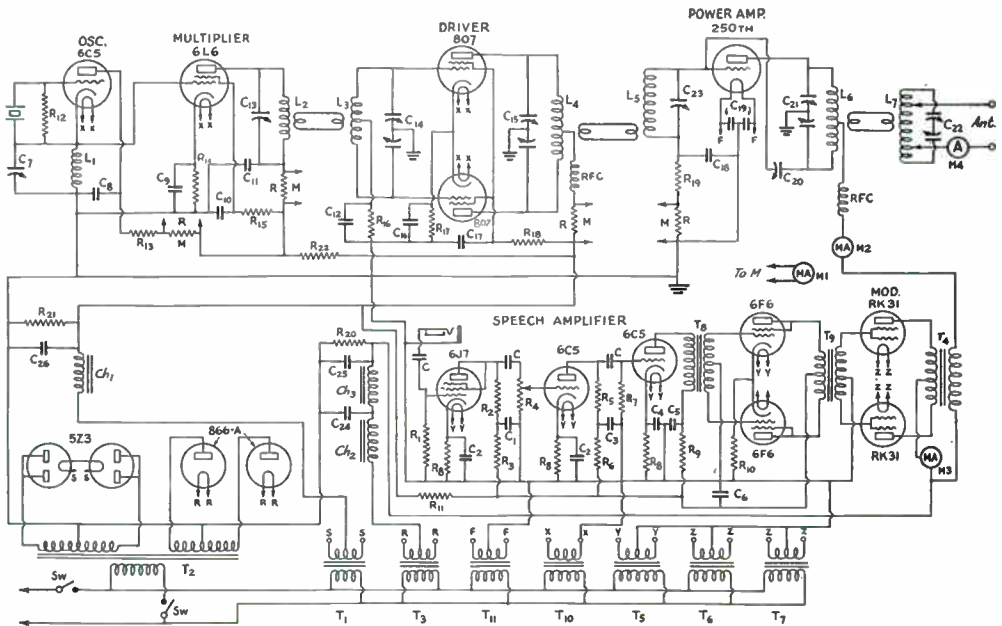

FIG. 51 — THE COMPLETE TRANSMITTER CIRCUIT

- L₁ to L₇ — See coil table
- C — 0.1- μ fd. 400-volt tubular
- C₁, C₃ — 0.1- μ fd. 400-volt tubular
- C₂, C₄ — 5- μ fd; 25-volt electrolytic
- C₅ — 0.25- μ fd. 400-volt tubular
- C₆ — 8- μ fd. 400-volt electrolytic
- C₇, C₁₃ — 100- μ fd. midget variable (National UM-100)
- C₈ — 0.004- μ fd. mica
- C₉, C₁₀, C₁₁, C₁₂, C₁₆ — 0.01- μ fd. 500-volt tubular
- C₁₄ — Double-section variable, 0.018-inch air gap, 100- μ fd. per section (National STHD-100)
- C₁₅ — Double-section variable, 0.026-inch air gap, 100- μ fd. per section (National TMS-100D)
- C₁₇, C₁₉ — 0.004- μ fd. 1000-volt mica

- C₁₈ — 0.002- μ fd. 1000-volt mica
- C₂₀ — 10- μ fd. neutralizing condenser (National NC 800)
- C₂₁, C₂₂ — Double-section variable, 0.077-inch air gap, 100- μ fd. per section (National TMC-100D)
- C₂₃ — 50- μ fd. variable, 0.065-inch air gap (National TMSA-50)
- C₂₄ — 2- μ fd. 1500-volt filter condenser
- C₂₅ — 4- μ fd. 1500-volt filter condenser
- C₂₆ — 8- μ fd. 600-volt filter condenser
- RFC — 1-mh. 600-ma. r.f. choke (National R-154U)
- M₁ — 0-200 d.c. milliammeter
- M₂ — 0-500 d.c. milliammeter
- M₃ — 0-250 d.c. milliammeter
- M₄ — 0-2 ampere r.f. meter
- R₁ — 5-meg. 1/2-watt resistor
- R₂ — 0.25-meg. 1/2-watt

- R₃, R₆ — 25,000-ohm 1/2-watt
- R₄ — 250,000-ohm volume control
- R₅ — 50,000-ohm 1/2-watt
- R₇ — 100,000-ohm 1/2-watt
- R₈ — 2500-ohm 1/2-watt
- R₉ — 10,000-ohm 1-watt
- R₁₀ — 750-ohm 10-watt
- R₁₁ — 5000-ohm 50-watt
- R₁₂ — 75,000-ohm 1-watt
- R₁₃ — 20,000-ohm 1-watt
- R₁₄ — 5000-ohm 10-watt
- R₁₅, R₁₆ — 20,000-ohm 10-watt
- R₁₇ — 200-ohm 10-watt
- R₁₈ — 10,000-ohm 10-watt
- R₁₉ — 5000-ohm 25-watt
- R₂₀, R₂₁ — 50,000-ohm 100-watt
- R₂₂ — 2500-ohm 10-watt
- R — 20-ohm 10-watt (milliammeter shunts)
- T₁ — 10-volt 4-amp. filament transformer (Kenyon T-365)
- T₂ — Double secondary plate transformer, 1460-volt 500-ma. and 630-volt

- 200-ma. (Kenyon T-660)
- T₃ — 2.5-volt 10-amp. filament transformer (Kenyon T-360)
- T₄ — Class-B output transformer (Kenyon T-460)
- T₅, T₁₀ — 6.3-volt 3-amp. filament transformer (Kenyon T-351)
- T₆, T₇ — 7.5-volt 4-amp. filament transformers (Kenyon T-353)
- T₈ — Push-pull input transformer, ratio 1:2 (Kenyon T-58)
- T₉ — Class-B input transformer (Kenyon T-258)
- T₁₁ — 5.25-volt 12-amp. filament transformer (Kenyon T-357)
- Ch₁ — 14-henry 250-ma. filter choke (Kenyon T-164)
- Ch₂ — 6-21-henry 500-600-ma. swinging choke (Kenyon T-521)
- Ch₃ — 12-henry 500-ma. filter choke (Kenyon T-177)

COIL DATA

| | L ₁ | L ₂ | L ₃ | L ₄ | L ₅ | L ₆ | L ₇ |
|---------------------------------|--------------------------|--|--|--|---|--|--|
| 28 Mc. | 10 t. No. 18 close wound | 4 t. No. 18 Length 1/8". Link 1 turn at cold end | Split winding 2 t. ea. side c.t. 2 t. link wound in center. Total length winding and link 1" | 8 t. No. 14 1 1/4" dia. link 2 t. in center. Winding length 2" | 4 t. No. 18 Link 2 t. at cold end winding length 1/2" | 8 t. No. 12 1 1/2" dia., length 2 1/2" | 11 t. No. 12 on National XR10A form, full length of form |
| 14 Mc. | Same as above | 7 t. No. 18 length 1/8". Link 1 t., cold end | Same as above except 4 t. each side center tap | 10 t. No. 18 on National XR13 form. Length 2 1/2". Link 2 t. inside center coil form | 7 t. No. 18 length 1/8" link 2 t., cold end | 10 t. No. 12 on National XR10A form, full length of form | Same as above |
| All wire used is enamel covered | | | | | | | |

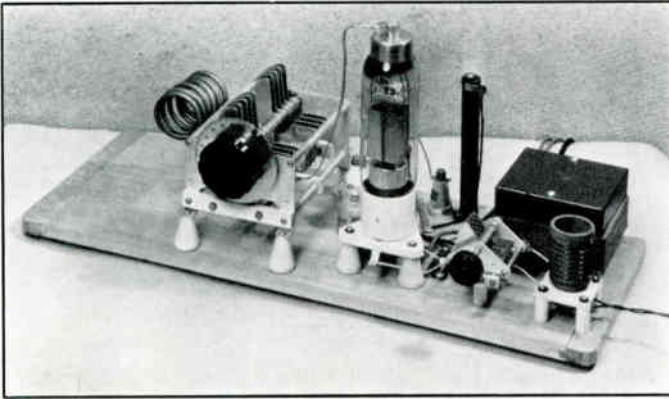

FIG. 53—THE 803 IN AN EXPERIMENTAL SET UP

The extremely low R.F. driving power, the small amount of audio-modulating power, and the freedom from neutralization difficulties, has made the R.F. pentode a much used final stage tube in moderate-power 'phone transmitters. While the initial cost of the tube itself is slightly higher than that of a triode of equivalent rating, the saving in associated equipment generally considerably more than offsets this difference.

When suppressor modulated, the maximum carrier power is approximately 25 per cent of the DC power input to the plate circuit. Inasmuch as the legal limitations on power used by amateur transmitters is determined by the DC input to the plate circuit, rather than the actual carrier magnitude, the pentode would have no field of application in the final stages of transmitters designed for maximum legal output. In the case of 100 per cent modulated carriers of the order of 100 watts, or less, they are, however, quite ideal. Of course, for use for c.w. purposes, in which case the efficiency approaches that of the triode, there is no legal handicap and they have the definite advantage over triodes of low R.F. driving power and the elimination of neutralizing condensers and associated circuits.

R.F. pentodes may be divided into three general groups: Those of the 802-

poses, a carrier of approximately one-quarter kilowatt. The table on page 35 tabulates all of the essential characteristics of these three groups of tubes for ready comparison.

Fig. 52 on this page illustrates an experimental transmitter made up with a single RK-28 in the final stage and a single 802 (removed from the socket in the illustration) as the Tritet crystal oscillator-exciter. While the complete internal shielding of the tube itself makes possible the elimination of neutralization, this condition is only arrived at when the input and output circuits are sufficiently isolated. An excellent example as to just how this can be efficiently done is shown in this particular transmitter, where the output tank circuit is located at the very top of the transmitter and the grid input circuit at the very bottom, as far removed as possible from each other and yet so located as to provide short leads between the two tanks and their associated tube elements.

Fig. 53 shows another experimental breadboard layout of the more conventional style, in which a single 803 is experimentally tried out. This transmitter is essentially the same as that in Fig. 52.

Excitation is secured from a separate exciter link-coupled to the tuned grid circuit of the 803 by means of plug-in grid coils.

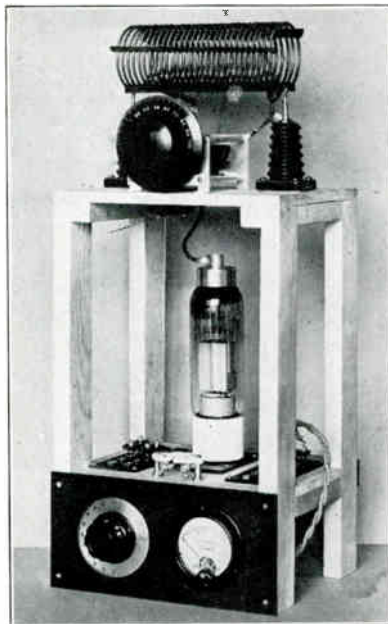
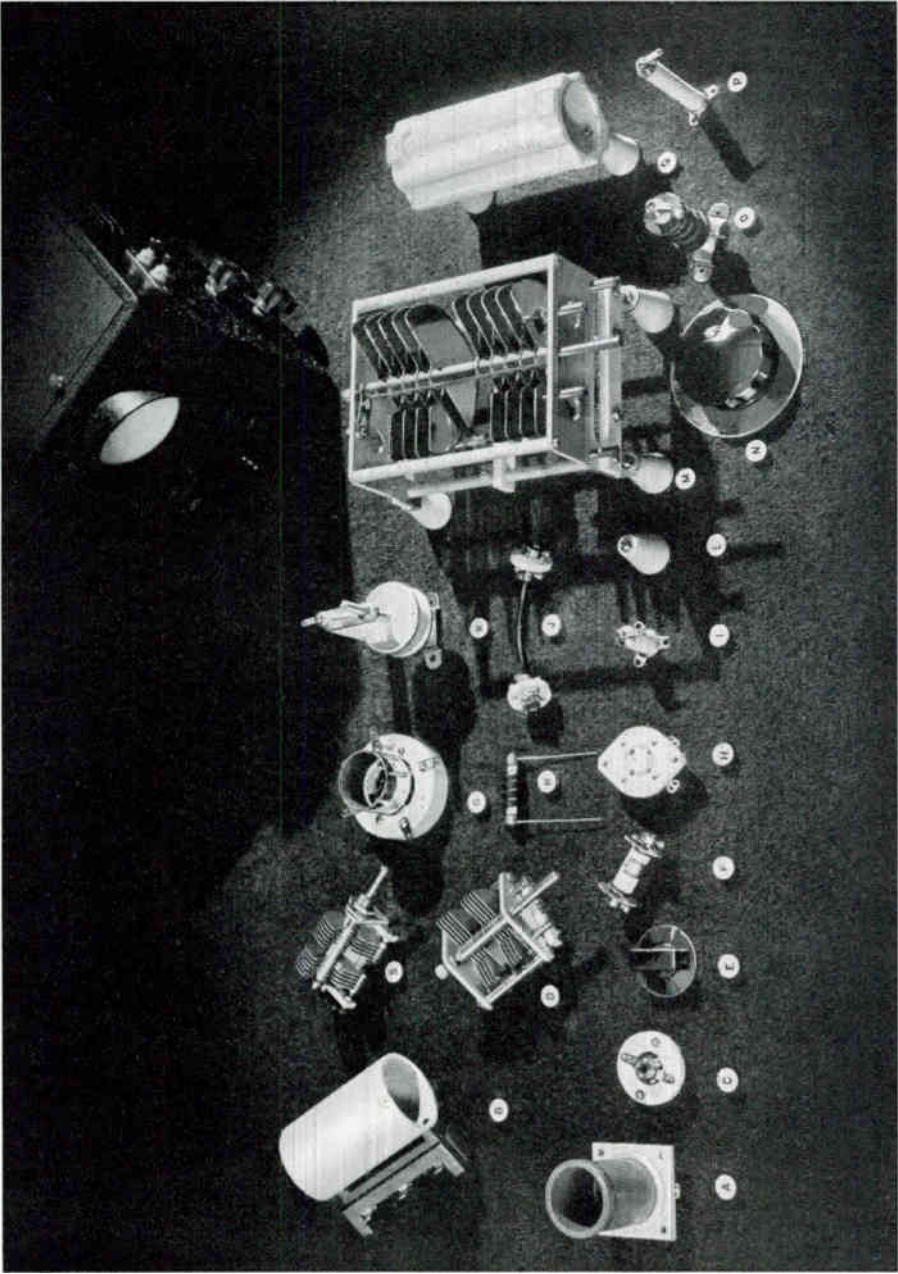

FIG. 52—THE NEW RK-28 PENTODE IN AN EXPERIMENTAL TEST SET-UP

A quarter kilowatt output with only a few watts driving power is only one of the things we like about this tube. With suppressor modulation a carrier output of 65 watts or more is readily obtainable, the audio power required being less than one-half watt.



A GROUP OF PARTS THAT SHOULD SUGGEST MANY INTERESTING TRANSMITTER DESIGN POSSIBILITIES

In addition to the many other advantages of the R.F. pentode when used in a low-power transmitter, is the convenience with which band-shifting can be accomplished. W1AF designed and built the transmitter illustrated in Figures 54 and 55, which is practical proof of this feature. This transmitter also serves to emphasize the low cost of the associated equipment required in pentode transmitters. The aluminum chassis

on stand-offs from the aluminum base and the leads to them carried through suitable insulating bushings, such as the National XS-6. The cathode coil is shorted when operating on the 3.5- and 7.0-Mc. bands, in which case the oscillator is operated as a straight pentode. This is done automatically by bending over a corner of one rotor plate of C_1 so that it will touch the stator when set at full capacity.

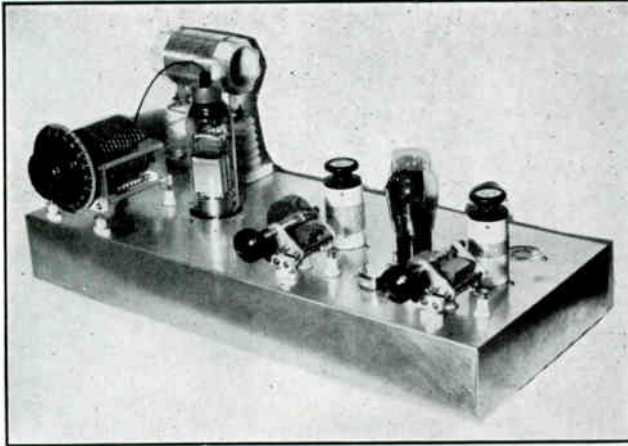
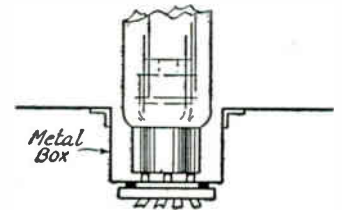

FIG. 54 — SIMPLE — BUT IT'S THE COMPLETE R.F. END OF A THREE-BAND TRANSMITTER RATED AT 100 WATTS C.W. AND 20 WATTS ON 'PHONE

A 59, pentode or Tri-tet, drives an RK-20 amplifier, using 3.5- and 7-mc. crystals. No buffer stages are needed.



THE SHIELD-BOX MOUNTING FOR THE RK-20

This is a cross-section; the box actually has four sides and a bottom, with the tube socket mounted on the latter.

measures 17" x 10" x 3" and is thus short enough to be mounted on a relay rack panel, as was subsequently done at W1AF, so that the complete transmitter, including speech equipment, modulator, and power supply, could be carried in a single relay rack. Note in particular the way in which the grid and plate circuits of the RK-20 have been carefully isolated. By mounting the socket of the RK-20 under the aluminum sub-base, the grid-circuit leads are shielded from the plate-circuit leads.

It will be noted from the circuit diagram that provision for using the oscillator for electron-coupled output on 7.0 and 14 Mc. has also been built into this compact transmitter, so that frequency changes within a band can be made quickly and easily. Inasmuch as none of the variable condensers in this transmitter are operating at ground potential, they must be carefully insulated

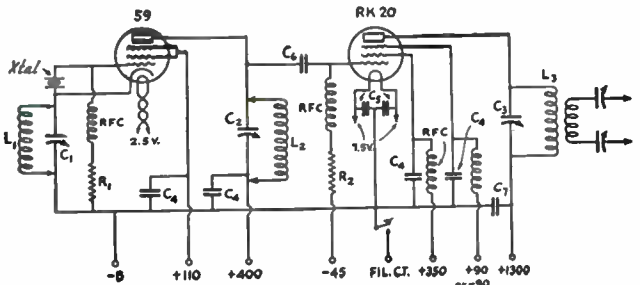

FIG. 55 — CIRCUIT DIAGRAM OF THE TWO-STAGE PENTODE TRANSMITTER

- C_1 — 250- μ fd. cathode tuning condenser (National TMS-250)
- C_2 — 100- μ fd. oscillator plate condenser (National TMS-100)
- C_3 — 150- μ fd. amplifier plate condenser (National TMC-150)
- C_4 — .002- μ fd. mica condenser, receiving type (Sangamo)
- C_5 — .004- μ fd. mica condenser, receiving type (Sangamo)
- C_6 — 100- μ fd. mica condenser, receiving type (Sangamo)
- C_7 — .002- μ fd. mica condenser, 5000-volt (Sangamo)
- R_1 — 50,000 ohms, 2-watt rating (I. R. C.)
- R_2 — 15,000 ohms, 2-watt rating (I. R. C.)
- RFC — S.w. chokes (National Type 100)

See separate table for coil data.

Antenna tuning equipment will depend upon the type of antenna system used. With series tuning of Zepp feeders, tuning condensers of 250- μ fd. each will be satisfactory.

Another application of the RK-20's to a compact transmitter is shown herewith. Two of the RK-20's are used in push-pull in the output stage and the entire transmitter, built of units on standard relay rack panels, is mounted in one of the standard National table-type racks.

This particular transmitter was originally built for semi-portable use, inasmuch as it could be quickly disassembled and each unit dropped into a special carrying case for shipment as regular baggage. The RK-20's in the final stage are mounted horizontally, with a baffle arranged to electrostatically shield the input and output circuits. The antenna tuning network is also combined into the same unit as the final amplifier. Three separate power supplies are used: one for the exciter; one for the audio system, and one is the high-voltage unit for the plate and screen circuits of the RK-20's.

The exciter unit has already been described on page 9. Originally it was intended to use this transmitter on all bands, including 56 megacycles,

but it was later found impractical to secure satisfactory performance on this latter band. The transmitter was, however, operated for many months on all of the other bands, including 28 megacycles. The coils for these bands, namely, 28, 14, 7 and 3.5 Mc., are shown in Fig. 57. On page 39 is given complete data on the construction of these coils, as well as a close-up view of the final stage with the 3.5-Mc. coils in place. Band-changing is quickly accomplished by shifting the link-coupling circuit to the proper output terminal block on the exciter unit and changing the coils in the final stage and antenna-tuning filter network.

In mounting RK-28's horizontally, it is important to so arrange each socket that the plane of the filament is always vertical. Thus if the filament should sag slightly, as is quite possible under normal operating temperature, a material change in tube characteristics will not take place. Fuse clips mounted on National type GS-1 standoffs make ideal plate terminals for tubes so mounted.

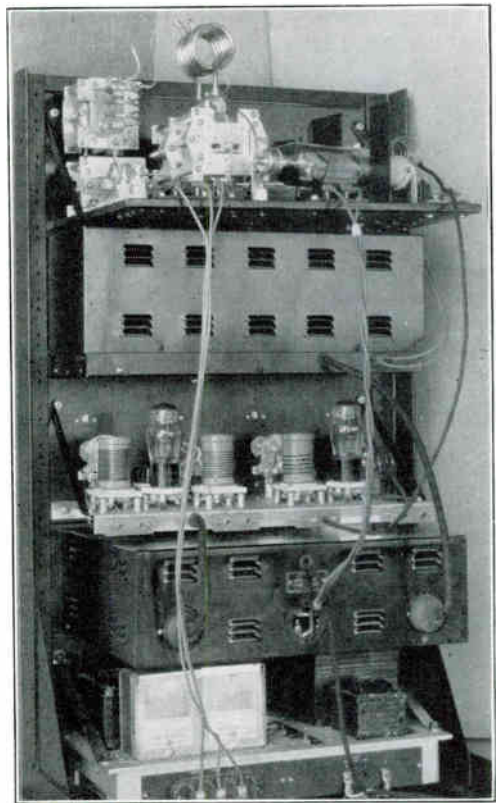
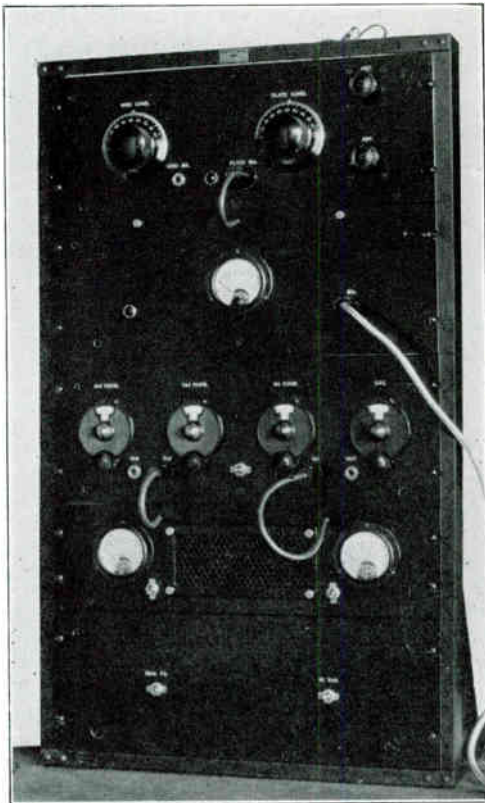

FIG. 56 — FRONT AND REAR VIEWS OF THE COMPLETE TRANSMITTER IN ITS RACK MOUNTING

From top to bottom the panel units are: final pentode amplifier and antenna coupling filter, speech amplifier and modulator, crystal-controlled exciter, modulator and exciter power supply, and 1000-volt power supply for the final stage. Note the individual jack strips (rear) for each stage of the exciter from which r.f. output of the desired frequency is tapped by the plug-and-cord link to the final stage.

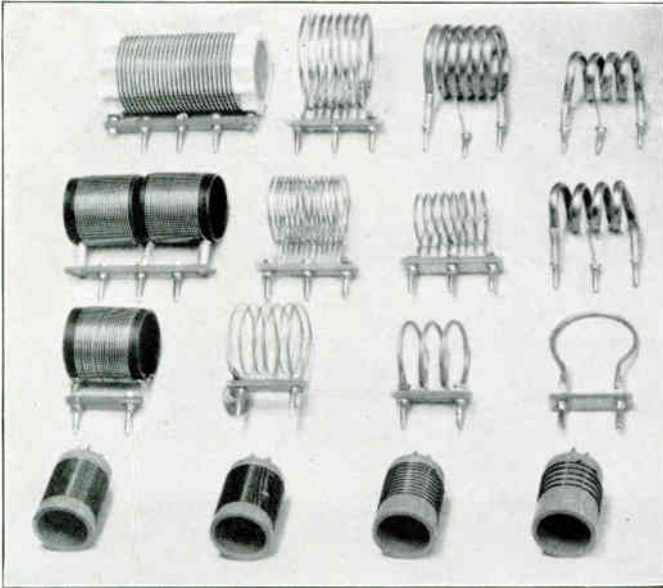

FIG. 57—ILLUSTRATING THE FIVE TYPES OF COIL CONSTRUCTION USED

Winding data are given in the tables.

that we recommend, as the meter is very apt to be "sticky" afterward. Apparently, the principal reason for this "stickiness" is almost invisible dust which drags against the moving system. It is very difficult to guard against this as magnetic particles are attracted to the air gap and non-magnetic dust is attracted to the scale and coil by the electro-static charge which is often present. If you must take your meters apart, do it only in a place where the air is clean, and lay a clean sheet of paper over the table surface that you are working on.

Many transmitters are designed to use a single meter for all measurements, by the use of jacks with a plug on the meter leads. This single instrument is usually a milliammeter of high enough range to carry the maximum current anywhere in the transmitter, probably 200 MA or

To most amateurs, electric meters or instruments present only one problem, that of balancing the budget. Toward the solution of this problem we can offer little help, unfortunately, but we do think some of the suggestions below may be helpful in making the most of available meters.

more. However, this range is much too high for many purposes. For instance, a low range of perhaps 20 MA is highly desirable as an indicator of grid current when neutralizing or checking excitation. A multi-range instrument could be used, but

(Cont. 2nd col., p. 39.)

We shall start with two warnings. The first is this: beware of steel meter panels. Iron, being magnetic, will shunt the permanent magnet in D.C., Thermo, and Rectifier A.C. instruments, causing the meter to read low. This error is larger than one might imagine. Before writing this page, we tested a number of instruments of different makes in a standard steel relay rack panel. With the meter in the worst position, the error was from 10 per cent to 20 per cent, depending upon make. In the position where they are normally used, the error is, fortunately, about one-half as much.

Sometimes it is expedient to remove a meter from its case, to repair resistors, change scales, and so forth. This is not an operation

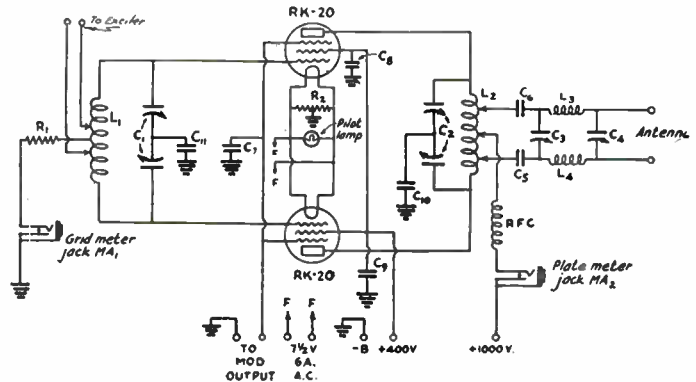

FIG. 58—THE RK-20 FINAL AMPLIFIER CIRCUIT

- L1 and L2 — Grid and plate coils. See coil table.
- L3 and L4 — Antenna coupler coils. See coil table.
- C1 — Split-stator midget variable, 50- μ fd. per section (National Type STD 50 or equivalent).
- C2 — Split-stator transmitting condenser 100- μ fd. per section, 3000-volt (National TMP-100 or equivalent).
- C3 and C4 — Receiving type variable condenser, 150- μ fd. (National EMA-150 or equivalent).
- C5, C6 and C7 — 0.001- μ fd. mica bypass condensers.
- C8, C9, C10 and C11 — 0.01- μ fd. mica bypass condensers.
- R1 — 12,000-ohm 25-watt grid leak.
- R2 — 50-ohm filament center-tap resistor.
- RFC — Receiver-type r.f. choke (National Type 100 or equivalent).
- MA1, MA2 — Single-circuit closing jacks for 0-200 milliammeters.

POWER AMPLIFIER COIL DATA

| Frequency Mc. | L ₁ (Grid) | L ₂ (Plate) | L ₃ and L ₄ (Awt.) |
|--------------------------|------------------------------------|------------------------------------|--|
| 1.75 (160-meter band) | 81 T. 3" D. 5" L. No. 18 | 51 T. 4" D. 6" L. No. 14 | 34 T. 3½" D. 1½" L. No. 16 |
| 3.5 (80-meter band) | 54 T. 2" D. 3¾" L. No. 16 | 34 T. 3" D. 4½" L. No. 14 | 34 T. 1¾" D. 1½" L. No. 16 |
| 7.0 (40-meter band) | 28 T. 2" D. 1½" L. No. 16 | 22 T. 2½" D. 3" L. No. 14 | 12 T. 2" D. 1½" L. No. 16 |
| 14.0 (20-meter band) | 14 T. 2" D. 2½" L. No. 14 | 8 T. 3" D. 2½" L. No. 10 | 6 T. 2" D. 1½" L. No. 14 |
| 28.0 (10-meter band) | 8 T. 1½" D. 2" L. No. 14 | 6 T. 2" D. 2" L. ¼" tub. | 3 T. 1¾" D. 1½" L. No. 10 |

T. = No. of turns. D. = diameter of coil. L. = Length of coil. No. = Wire gage (B & S). Tub. = Copper tubing of specified diameter. Total turns are given for push-pull plate and grid coils; put tap at center.

Plate coils for 1.75, 3.5 and 7 mc. are wound on standard National Steatite transmitting coil forms. Plate coils for 14, 28 and 56 mc. are self-supporting. (See coil photo.)

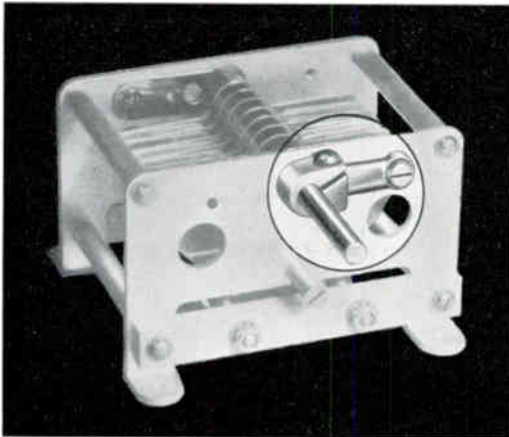

Above is illustrated a handy gadget for locking the rotor shaft of a variable transmitting condenser. This simple device clamps the rotor sufficiently rigid to make adjustments proof to vibration and unauthorized tampering. Thus, once a transmitter is properly tuned, the settings for the condenser equipped with such a locking device can be definitely secured. The rotor lock is designed primarily to fit National condensers having ¼" shafts, but may, of course, be fitted to many condensers of other manufacture.

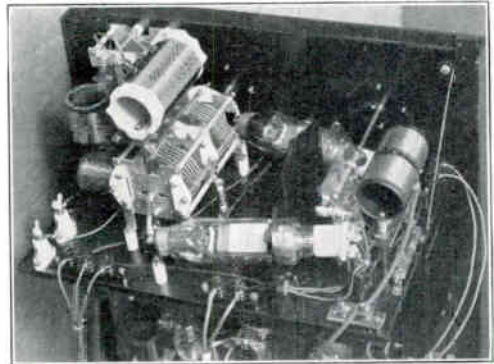
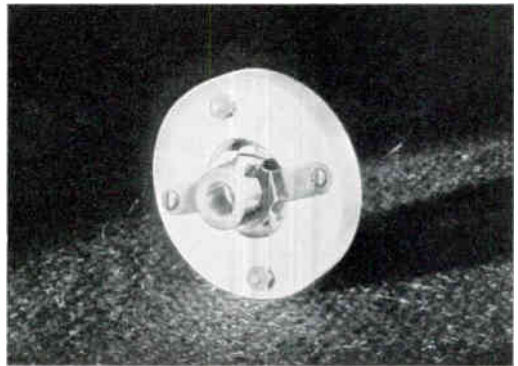

FIG. 59 — LOOKING DOWN ON THE PUSH-PULL FINAL STAGE

Link-coupled grid input circuit at the right, plate tank and antenna coupler at the left.

(Continued from page 38)

it is expensive and can easily be damaged if the wrong range is inadvertently used. We have a suggestion. For the meter, use a 50-millivolt one-mil instrument. In each circuit where it is desired to measure current, wire in a shunt of the proper range connected to an open circuit jack suitably marked to show instrument range and circuit position. These shunts are quite inexpensive and are easily obtainable. In use, it is thus merely necessary to plug in the meter and the proper range is automatically cut in. Best of all, the meter is also available for voltage measurements, in which case multiplier resistors are used instead of shunts, of course. If a "universal" rectifier instrument is used, even A.C. filament voltages can be measured. It is obvious that the system is flexible, but it also happens to be quite inexpensive. One precaution should be observed when using shunts in this way. The leads and contacts between the meter and its shunt must be of low resistance, as this affects the accuracy of the meter. One-fourth of an ohm, or less, is satisfactory and not difficult to obtain.



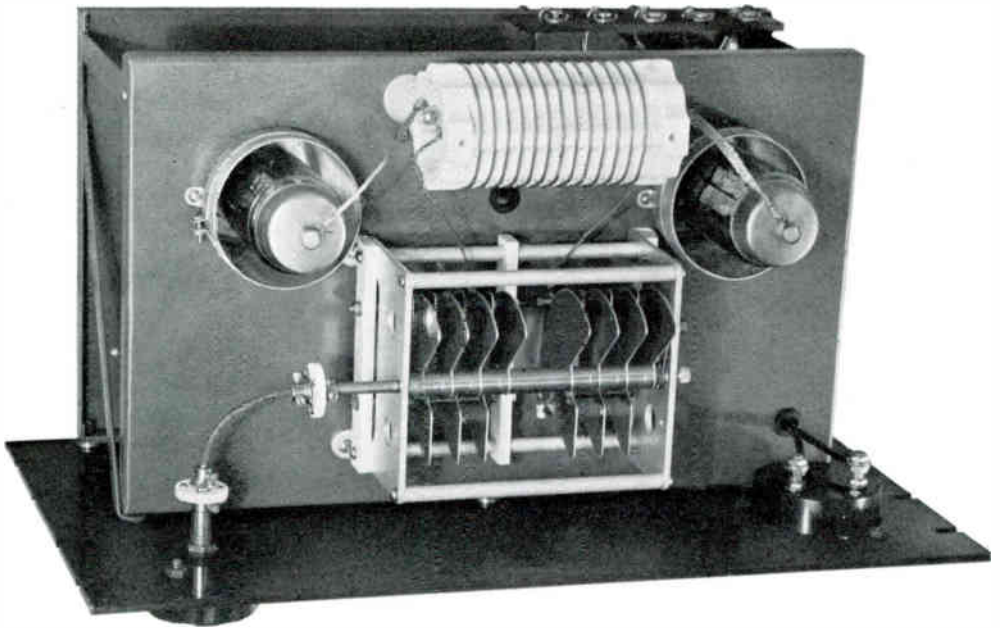

FIG. 60

The two views of the RK-20 amplifier shown on this page clearly illustrate its unusual layout and construction features. While originally designed as the final stage of a suppressor modulated 'phone transmitter, the unit is now being used to drive the Class C one-kilowatt amplifier shown on pages 29 and 30. In both services it has proven most satisfactory, the unusual layout not only

providing short leads and symmetry of the push-pull circuit, but also extremely effective shielding between the input and output circuits. The shield cans around the tubes are held in place by means of the clamps normally furnished as standard equipment with the large electrolytic receiving condensers. They are quite ideal for this use as they permit ready adjustment of the shield height.

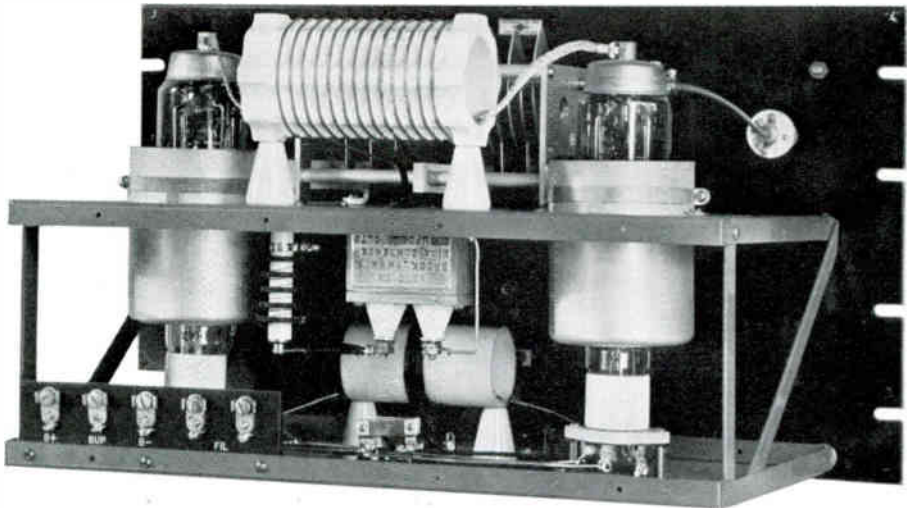

FIG. 61

There are obvious advantages in having a choice of transmitting frequencies quickly available in each amateur band. Many times one would like to use a transmitter on another band if the labor of band-switching was not too great. Then again, a slight change in frequency during a QSO will often take care of immediate interference difficulties.

Such universal transmitters have been built, of course, but the natural complexity of such gear puts it beyond the facilities of most amateurs. In an attempt to make a successful compromise between convenience and necessity, the transmitter described here was recently built.

The most important compromise in simplifying the band switching was to limit operation to two bands. This step was taken with misgivings, but it has not been regretted. Two bands, quickly

available, are in practice much more useful than four bands in a transmitter which requires laborious handling of plug-in coils and retuning to make frequency changes. For example, a 'phone man does quite nicely with just the 20- and 75-meter bands, which between them will take care of varying conditions of skip, etc. Similarly, c.w. fellows will in most instances want either the 20- and 40-, or the 40- and 80-meter bands.

With this concession made, the transmitter design took shape rapidly. The system used calls for the switching of complete pre-tuned tank circuits right down from the final stage to the crystal oscillator. Such a method of band switching minimizes troubles due to variation on contact resistance in the switches, eliminates breaking high R.F. currents, and makes unnecessary any retuning whatsoever when shifting bands. Due to the

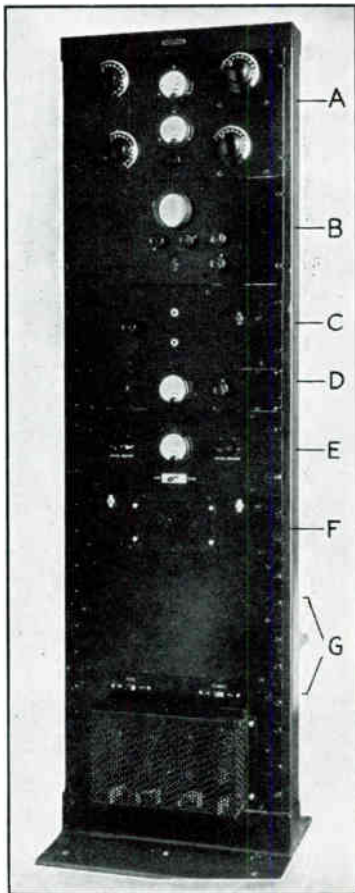

FIG. 62— THE COMPLETE TRANSMITTER IS MOUNTED IN ONE RACK WITH INDIVIDUAL PANELS FOR THE COMPONENT UNITS

The letter designations for the panels are identified with the rear view.

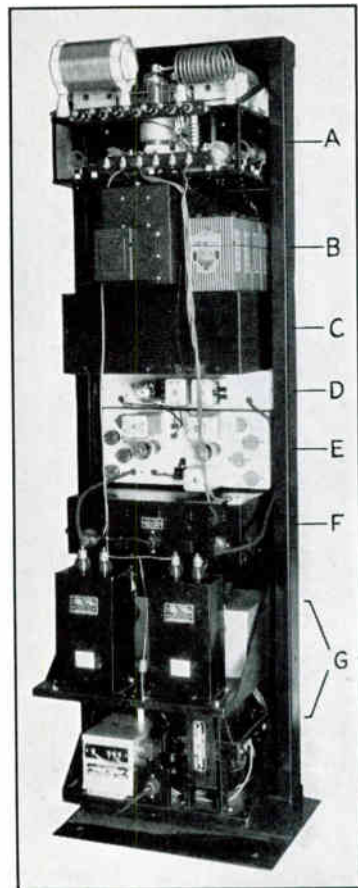

FIG. 63— REAR VIEW OF THE TRANSMITTER ASSEMBLY

The panels are identified as follows: A, final power amplifier; B, oscillator with p.a. bias batteries; C, speech input and modulator; D, buffer; E, exciter; F, dual low-voltage power supply; and G, high-voltage power supply.

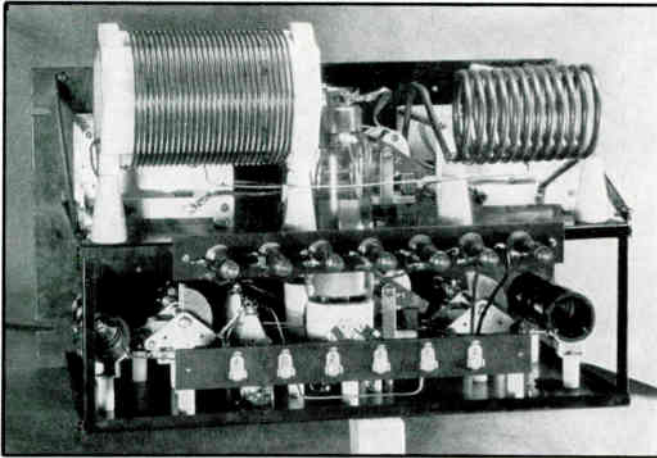

FIG. 64 — SHOWING THE DETAILS OF THE FINAL POWER-AMPLIFIER UNIT AS VIEWED FROM THE REAR

characteristics of medium-power pentodes, such as the 803 and the RK-28, no difficulty with neutralization is encountered in a quick change transmitter of this type.

The exciter unit has already been described in detail on page 11. The buffer, employing a single RK-23, uses pre-tuned series tanks which eliminate any necessity for switching. The final stage uses a pair of separate tanks for each band, switched by a single knob.

The exciter was originally intended to drive a pair of RK-20's in the final stage. For this purpose its output is entirely adequate. When it was decided to use the larger 803 or RK-28 pentodes, however, it was found that the R.F. output was not sufficient except when running with relatively low plate voltage on the final, and consequently the RK-23 buffer was added. The output of this buffer is more than ample, even when using 803's with slightly over 3000 volts on the plate.

The buffer is visible in the rear view, just above the exciter unit. It is built up on the same kind of depressed panel unit that was used for the exciter. The gear on this chassis is quite simple, and the illustration shows the layout of the RK-23, the two tanks, and the plate milliammeter.

The series plate tank circuit will probably be new to some amateurs. The two tanks for 20 meters and 75 meters are of themselves quite conventional, but it will be noted that they are connected in series and are always in the circuit. This is possible because the impedance of a parallel-resonant circuit drops rapidly as it is detuned from the driver. Consequently the unused tank causes only a negligible loss by being left in circuit, and virtually the entire output voltage is built up across the used tank. This scheme also eliminates switching in the output circuit of the buffer, and permits the buffer tanks to be permanently coupled to the grid tanks of the final.

There is a further refinement in the buffer circuit which we believe is quite unique. This is the excitation control R_8 , which varies the suppressor voltage from zero to about -90 volts. At zero voltage the RK-23 is doing its best, while at the other extreme the full negative bias is sufficient to cause almost complete cut-off. The control is exceptionally smooth at all positions, and is very satisfactory in every way. The negative voltage is obtained from the voltage drop across the bias resistor R_7 . These resistors are connected in parallel, and could be a single resistor. The reason for the arrangement shown is that it puts the burden of the load on the fixed resistor R_7 ,

and makes it possible to use a receiver-type potentiometer for the control R_8 .

A double-deck type of construction is used in the final stage in order to shield the input and output circuits of the pentodes when mounted vertically, as recommended by the tube manufacturers. This shielding also provides a very handy shelf on which to mount the plate tank-tuning condensers, coils and band-shifting switch. Similar equipment for the grid circuit is mounted on the lower shelf. The grid coils are standard National R-39 receiving coil forms with the pins knocked out of the base and then mounted back to back. The grid and plate switches are ganged together with ordinary link-and-lever construction. These switches may be purchased complete or, as in the case of this transmitter, made from odds and ends to be found in most every amateur workshop. The Steatite discs are from National flexible couplings and the Isolantite strips are from midget receiving condensers. The switch jaws are taken from an old double-pole double-throw knife switch. The shaft is a piece of $\frac{1}{4}$ -inch rod, and the frame and bearings are bent up from a piece of brass strip.

The circuit in general is exactly that recommended by the tube manufacturers. Care should be used, however, in running the high-voltage plate supply lead to see that it is so placed and by-passed that R.F. is prevented from getting into the power supply. The condenser and R.F. choke shown in the illustration and diagram were found essential for this purpose, even though the circuit is of the push-pull variety. Likewise, an R.F. by-pass condenser should be connected across the plate-circuit milliammeter. The screen voltage is obtained from the dropping resistors mounted on the back edge of the upper deck. The suppressor-grid and control-grid biasing voltages are obtained from B-batteries.

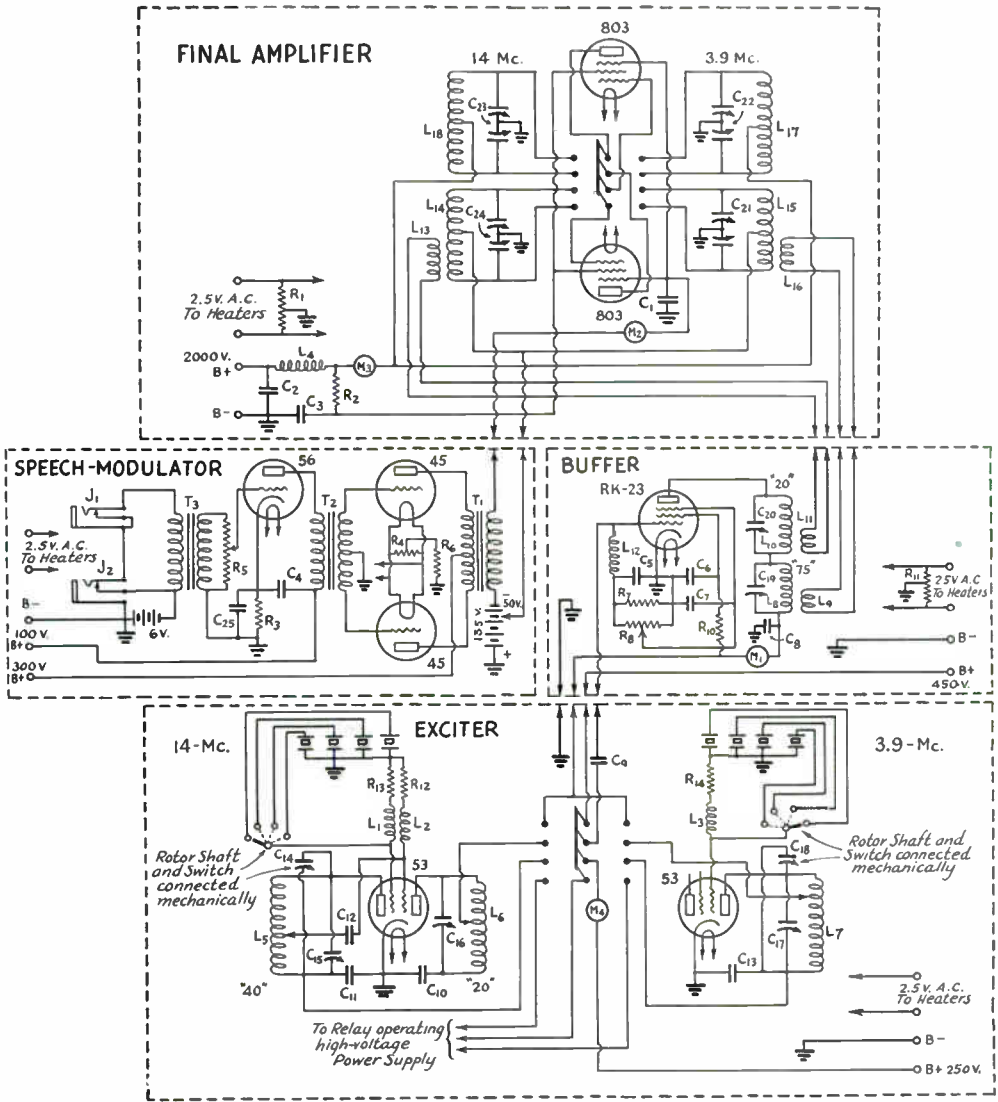
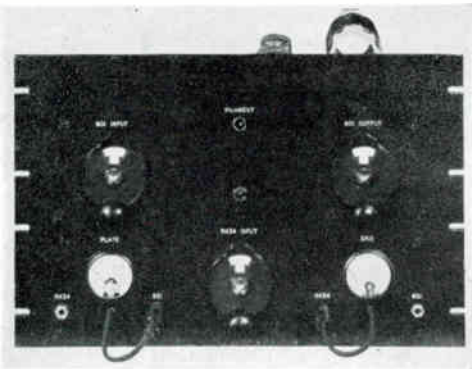
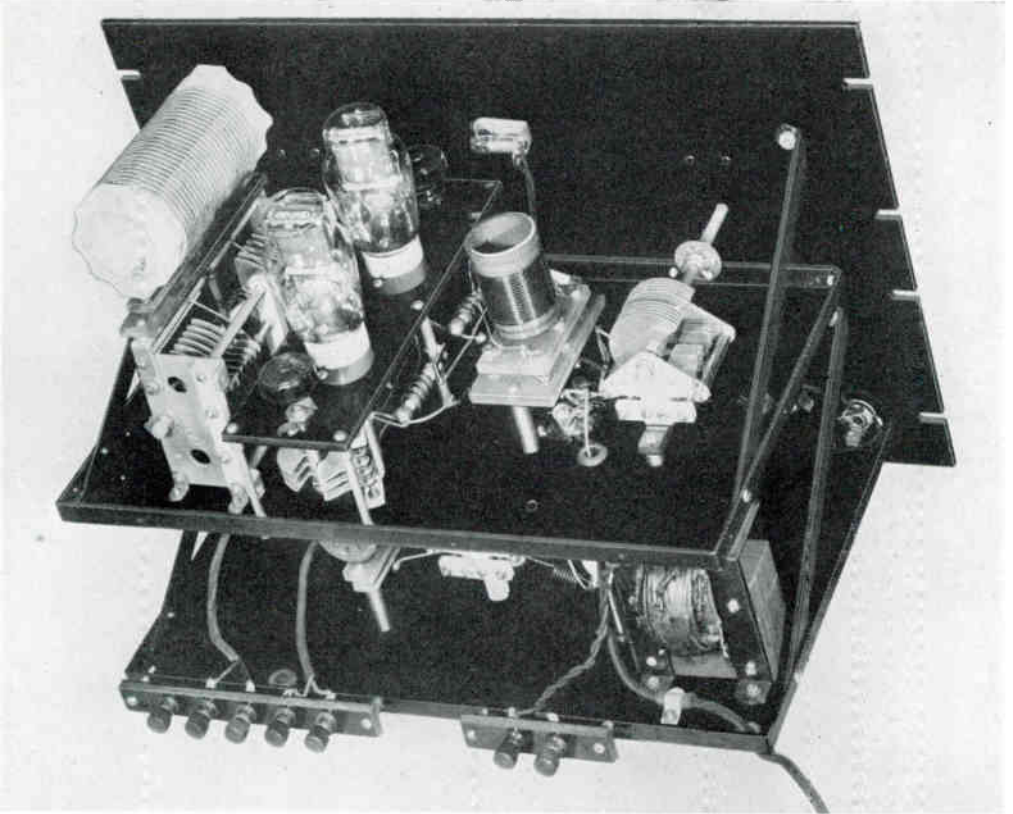

FIG. 65 — CIRCUIT OF THE TWO-BAND TRANSMITTER

- L1, L2, L3, L12 — 2.5-mh. r.f. chokes (National R-100).
- L4 — 4-mh. transmitting r.f. choke (National R-154).
- L5 — 22 turns, center tapped, No. 24 enameled wire on 1" dia.
- L6 — 11 turns, center tapped, No. 24 enameled wire on 1" dia.
- L7 — 40 turns, center tapped, No. 28 enameled wire on 1" dia.
- L8 — 48 turns, No. 28 enameled wire on 1" dia.
- L9, L11 — 3 coupling turns on 1" dia.
- L10 — 13 turns No. 24 enameled wire on 1" dia.
- L13, L16 — 3 coupling turns on 1½" dia.
- L14 — 16 turns No. 12 wire, 8 turns per inch on 1½" dia. Center tapped.
- L15 — 60 turns No. 22 wire, 30 turns per inch on 1½" dia. Center tapped.
- L17 — 27 turns No. 10 wire center tapped wound on 4" dia., 6 turns per inch (National XR-12A coil form).
- L18 — 10 turns ¼" copper tubing self-supporting on 3" dia., 2 turns per inch.
- C1, C2, C3 — 0.001-µfd. fixed.
- C4, C5, C6, C7, C8, C10, C11, C13 — 0.01-µfd. fixed.
- C9, C12 — 100-µµfd. fixed.
- C25 — 0.01 µfd. fixed.
- C14, C18 — Vernier condenser on crystal switch. (See text.)
- C15, C16, C17, C19, C20 — 25-µµfd. receiving type variable condensers (National UMA-25).
- C21, C24 — Split stator transmitting condenser, 70 µµfd. per section, 1000-volt (National TMS-70D).
- C22, C23 — Split stator transmitting condenser, 50 µµfd. per section, 6000-volt (National TMA-50DA).
- R1 — 120-ohm fil. c.t.
- R2 — 10,000-ohm 200-watt.
- R3 — 3000-ohm 1-watt.
- R4, R11 — 20-ohm fil. c.t.
- R5, R8 — 50,000-ohm potentiometer (vol. control type).
- R6 — 750-ohm 1-watt.
- R7, R9 — 10,000-ohm 1-watt.
- R10 — 12,000-ohm 10-watt.
- R12 — 20,000-ohm 1-watt.
- R13, R14 — 5000-ohm 1-watt.
- M1, M4 — 0-50 d.c. milliammeter.
- M2 — 0-30 d.c. milliammeter.
- M3 — 0-300 d.c. milliammeter.
- T1 — Audio output transformer (National S11).
- T2 — Audio input transformer (National S51).
- T3 — Microphone transformer, 200-ohm input.
- J1 — 200-ohm input or microphone current jack. (See text.)
- J2 — Single button carbon microphone jack. (See text.)



THE BUFFER AND DRIVER AT WIBZR.

Designed to operate as the connecting link between a low-power universal exciter and the final amplifier shown on page 28, the assembly shown above has several features of interest. The buffer tube, an RK-34, may be seen near the center of

the upper view, where a section of the top shelf has been cut out, allowing the tube itself to make connection between the two chassis levels. The input circuit, link-coupled from the exciter, is connected to the grids of the RK-34 through two small chokes which effectively prevent high-frequency parasitic oscillations. One of these chokes is shown clearly, just at the left of the tube socket.

The input circuit of the driver (push-pull 801's) can, by means of the 5-prong plug-in arrangement, be tapped off the RK-34 plate coil at any desired points. This plug-in system, and that of the 801 tank, are the forerunners of the UR-13 and UR-10A, illustrated in the catalog section of the booklet.

In common with other such equipment, the driver will give excellent performance when used as a final amplifier, with inputs up to 80 watts. Good efficiency is maintained at frequencies as high as 60 Mc., and due to the symmetry of the circuit, the settings of the neutralizing condensers, when once determined, never need be changed.

MODULATORS

THERE ARE a number of possible ways to modulate a transmitter, and occasionally some very curious circuits are developed. The prize for work along this line probably goes to a system we saw a few years ago, in which the usual arrangement was reversed and the final RF amplifier modulated the audio. Very curious effects were obtained in this manner, none of them desirable.

Among the more orthodox modulation systems are grid bias modulation, suppressor modulation, and plate modulation. Grid bias modulation has the virtue of requiring relatively little audio power, but it has definite disadvantages. The carrier plate efficiency of the modulated stage is low, being of the order of 30 per cent or somewhat less in usual practice. At 100 per cent modulation it rises to 60 per cent efficiency. Furthermore, adjustment for proper operation is a little troublesome, for both excitation and modulation are introduced into the same control grid circuit, and adjustments are not independent. This latter objection is avoided in suppressor grid modulation, where excitation and modulation are not combined in one circuit. In other respects, the two systems are very similar, and plate efficiencies are about the same.

Plate modulation is the most widely used arrangement. It permits the highest plate efficiency of any modulation system (about 65 per cent) and will readily modulate up to 100 per cent and with negligible distortion. Unfortunately it requires quite large amounts of power. For 100 per cent modulation, the modulator must supply an audio signal whose peak voltage is equal to the plate supply voltage. This peak voltage determines the maximum peak instantaneous power required from the modulator, and is the deciding factor when a Class A modulator is used, since the average plate dissipation of a given Class A amplifier remains constant for any waveform or output up to its peak capacity. This is not true of Class B amplifiers, for in Class B the average plate current and plate dissipation vary with the average power output. Thus, although the Class

B stage must be able to handle the peak power without distortion, its capacity is more likely to be determined by the average power required in actual practice. If the signal is a sine wave, calculations show that the average audio power required for 100 per cent modulation is equal to 50 per cent of the carrier power. However, George Grammer has pointed out that the wave form of speech bears little resemblance to the sine form, and that in general the average audio power required with speech is only about 25 per cent of the carrier. An economical modulator designed by George Grammer to take advantage of this fact is shown in Figure 66, Figure 67, and Figure 68.

This unit is sufficiently noteworthy to warrant a rather complete description. It was intended for a transmitter using a pair of 801 tubes at their normal input of 84 watts. It employs a pair of 46's in Class B and has an output of about 20 watts. On normal speech this has proved to be sufficient to modulate the Class C input of 84 watts quite satisfactorily. However, in order to supply the required peak power, it was found necessary to increase the plate voltage from the rated maximum of 400 v. to 500 v. This voltage overload is not a serious one, as the ratings are quite conservative. The rated peak plate current of 200 ma. is not exceeded.

The constructional details of the unit are rather obvious from the illustrations, circuit diagram, and list of parts. A few notes are in order, however. The speech amplifier in the unit uses a 57 pentode first stage having a rated gain of 100, and a 57 triode-connected second stage having a gain of about 14, giving a total gain of approximately 1400. The driver stage requires a peak grid swing of 50 volts. An input of about .03 volts peak is therefore necessary for full output, and this can be supplied quite nicely by a crystal microphone when it is held near the lips.

The chassis is a stock item available in most radio stores, and measures 7 by 11 by 2 inches. The arrangement of the parts was the result of experiment to find the positions for minimum



FIG. 66 — THE UNIT CONTAINS A CRYSTAL-MICROPHONE SPEECH AMPLIFIER, DRIVER AND CLASS-B MODULATOR, AS WELL AS A POWER SUPPLY FOR THE LOW-POWER STAGES

While the 46's in the Class-B stage normally would be considered to have an audio output in the vicinity of 20 watts, for speech work they can readily be made to modulate a Class-C input of 80 watts, as explained in the text.

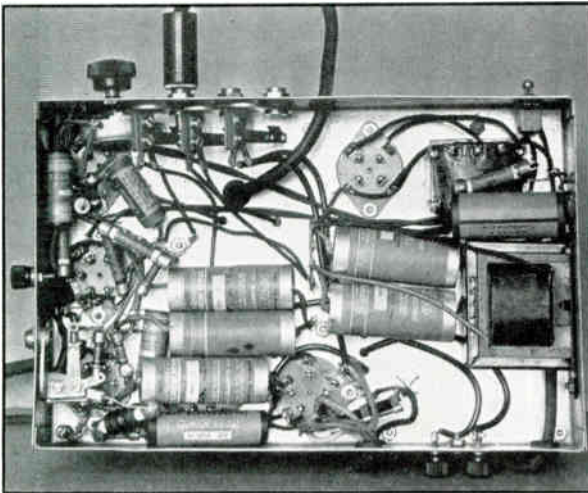

FIG. 67 — UNDER THE MODULATOR UNIT CHASSIS

The binding post on the left wall of the chassis is the ground post; below it is the microphone jack. The binding posts at the bottom right are the output terminals from the secondary of the modulation transformer. The filter choke is on the right wall. The top (front) wall contains the gain control, jacks for reading driver plate current, Class-B amplifier grid and plate currents, and the on-off switch for the power supply.

hum pickup, and the positions shown were found to be very satisfactory in this respect. Due to the small size of the chassis, care will have to be

taken if this arrangement is changed.

While on the subject of speech amplifiers, one further point should be mentioned. When handling speech, a limited frequency range is not only permissible but in most cases desirable. It has been found that a frequency range of 250 to 2500 cycles transmits speech almost as intelligibly as an unlimited range. Some of the naturalness is lost, but it can be understood just as accurately. Approximately this frequency range is used by the telephone companies, and experience has shown it to be quite adequate.

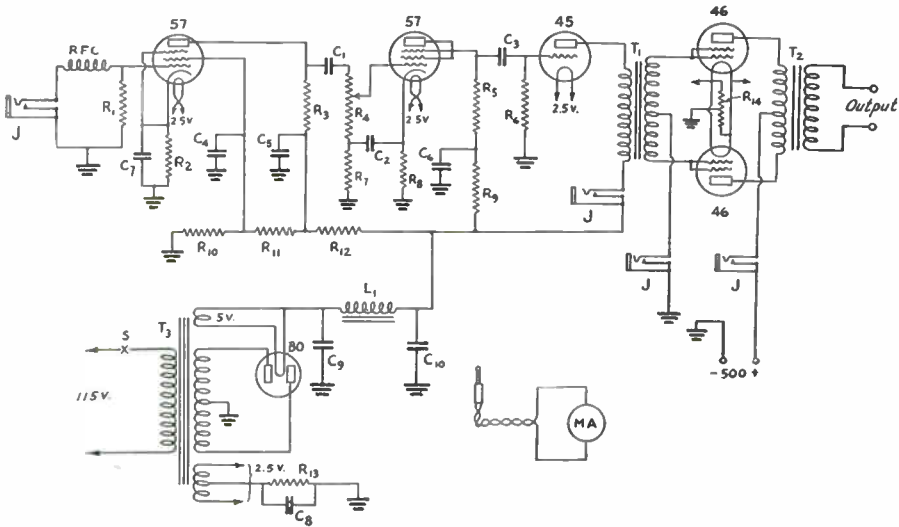

FIG. 68 — CIRCUIT DIAGRAM OF THE SPEECH AMPLIFIER AND ECONOMY CLASS-B MODULATOR

The power supply furnishes plate and filament power for the first three tubes only; the Class-B stage must be supplied from a separate source. If a power transformer having an additional 2.5-volt winding is used, filaments of the 46's may be heated from the second winding.

- R₁ — 5 megohms, 1/2 watt.
- R₂ — 3500 ohms, 1/2 watt.
- R₃ — 250,000 ohms, 1/2 watt.
- R₄ — 500,000-ohm volume control.
- R₅ — 50,000 ohms, 1 watt.
- R₆ — 0.5 megohm, 1/2 watt.
- R₇ — 0.1 megohm, 1/2 watt.
- R₈ — 2250 ohms, 1 watt.
- R₉ — 10,000 ohms, 1 watt.
- R₁₀ — 50,000 ohms, 1/2 watt.
- R₁₁ — 250,000 ohms, 1/2 watt.
- R₁₂ — 50,000 ohms, 1/2 watt.
- R₁₃ — 1500 ohms, 2 watt.
- R₁₄ — 20-ohm center-tap resistor.

- C₁ — 0.1μfd., 400-volt.
- C₂ — 0.1 μfd.
- C₃ — 0.1 μfd., 400-volt.
- C₄, C₅, C₆ — 2-μfd. electrolytic, 400-volt.
- C₇, C₈ — 10-μfd. electrolytic, 25-volt.
- C₉, C₁₀ — 8-μfd., electrolytic, 400-volt.
- T₁, T₂ — Class-B input and output transformers; (National Type B1 and B0 respectively). The input transformer should have a turns ratio, total primary to one-half secondary, of 2:1. Output transformer turns ratio

- should be between 1.05:1 and 1.3:1, total primary to total secondary.
- T₃ — Midget power transformer, 275 volts each side center-tap with 5-volt and 2.5-volt windings. (Thordarson type T-5002.)
- L — 22-henry, 35-ma. filter choke (Thordarson type T-1892).
- J — Single closed-circuit jacks.
- MA — 0.200 d.c. milliammeter.
- RFC — Short-wave choke (National type 100).

Such a range permits economies in the design of the amplifier for many reasons. Speech microphones have higher output than high-fidelity ones, and usually are less expensive also. The same is true of audio transformers, in general. Also, the lower limit of 250 cycles is enough higher than the hum frequencies to practically eliminate all difficulties from this source in the input stages. Furthermore, the distribution of energy in speech is such that rejection of the frequencies below 250 will usually cause a marked reduction in the average power required for modulation, while the elimination of frequencies above 2500 will reduce interference by narrowing sidebands.

All of these advantages are so definite that it seems well worth while to give the frequency range careful consideration. It is a point that should be definitely decided before the design is begun, for if advantage is to be taken of the restricted range it is necessary to reject the undesired frequencies. Some sort of filter must be used, and this filter should preferably be placed as near the output stage as possible because only

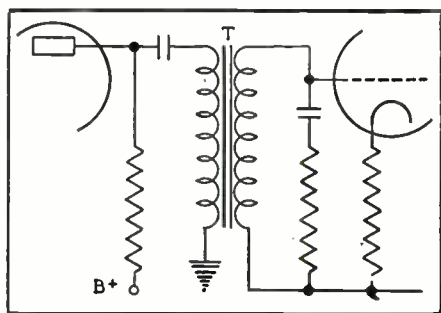

FIG. 69 — THE SPEECH-TRANSFORMER CIRCUIT

the hum and background noise originating in stages ahead of the filter will be eliminated. If the filter is actually placed in the output, it must be able to handle power, and the same is true of the driver stage. However, there is little voltage amplification and no high impedance circuits in these stages, so that little would be gained by filtering them. Probably the most practical place is in the input to the driver stage.

The filter does not have to be a complicated affair, for a sharp cut-off is not at all necessary. The circuit shown in Figure 69 is suggested. In this, T is an audio transformer from which some of the laminations have been removed. C_1 is a condenser of the proper value to be in series resonance with the primary of the transformer at about 250 cycles, while C_2 is in parallel resonance with the secondary at 2500 cycles. To avoid a sharp resonance peak at the latter frequency it

may be necessary to add the damping resistance R_2 . Resistance may possibly be required in the series resonant (primary) circuit also, but if the proper number of laminations are removed the resonance peak should be just about compensated. The exact circuit constants cannot be given here, for they will depend entirely on the transformer.

There is no question, however, that an audio system of greater range is more fun, and many amateurs prefer to have the frequency range as wide as feasible. We confess that most of our own speech equipment does not take advantage of the economies described in preceding paragraphs.

As these pages have doubtless made evident, we have always preferred to build as much equipment as possible in the form of separate units. This seems to work out particularly well in the case of audio equipment. The basic unit is the speech amplifier. This should have an output of five or ten watts class A, and enough gain to deliver full output with not more than .05 volts input. Such a unit is extremely useful, because it has ample power to serve either as a modulator when suppressor grid modulation is used, or as the driver when large amounts of Class B power are required for plate modulation. The use of the unit as a driver for Class B will be described in following paragraphs.

This primary unit can often consist of the amplifier from a broadcast set with one stage of extra amplification. For several years we used such a unit with a pair of 45's in the output, and except for the fact that it did not have quite enough power, it proved to be very satisfactory. Unfortunately, nearly all of the larger and more modern broadcast sets have either Class B or pentode output, neither of which are desirable in a driver stage. As it happens, it is usually quite easy to revamp the older broadcast amplifiers of the variety that used PP 45's and 80 rectifier. These can very easily be changed to use PP 2A3's, which are practically interchangeable with the 45's except for plate current and load resistance, and yet have more than twice the output. These old amplifiers were usually designed to supply plate current for the tuner, and when relieved of this load they are quite able to supply the extra plate current required to make the 2A3's deliver their maximum rated output of 7 watts. The heater winding intended for the tuner can usually be drafted to supply the heavier filament current of the 2A3's. A new output transformer will be required, and this should match the tubes to a 500-ohm line. The use of a low impedance line permits the amplifier to be located remotely if desired, and, being a standard impedance value, it makes the unit more universal.

Another very good way to solve the speech amplifier problem is to go out and buy one. At present we use a Collins 7C amplifier, mounted on a relay rack panel.

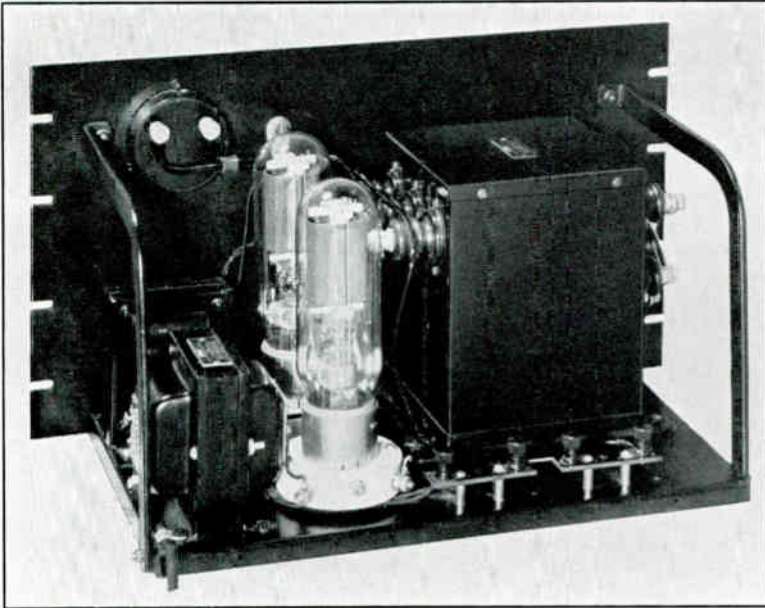

FIGS. 70 AND 71
A 1/4-k.w. Class B
Modulator using the
838 zero bias tubes.

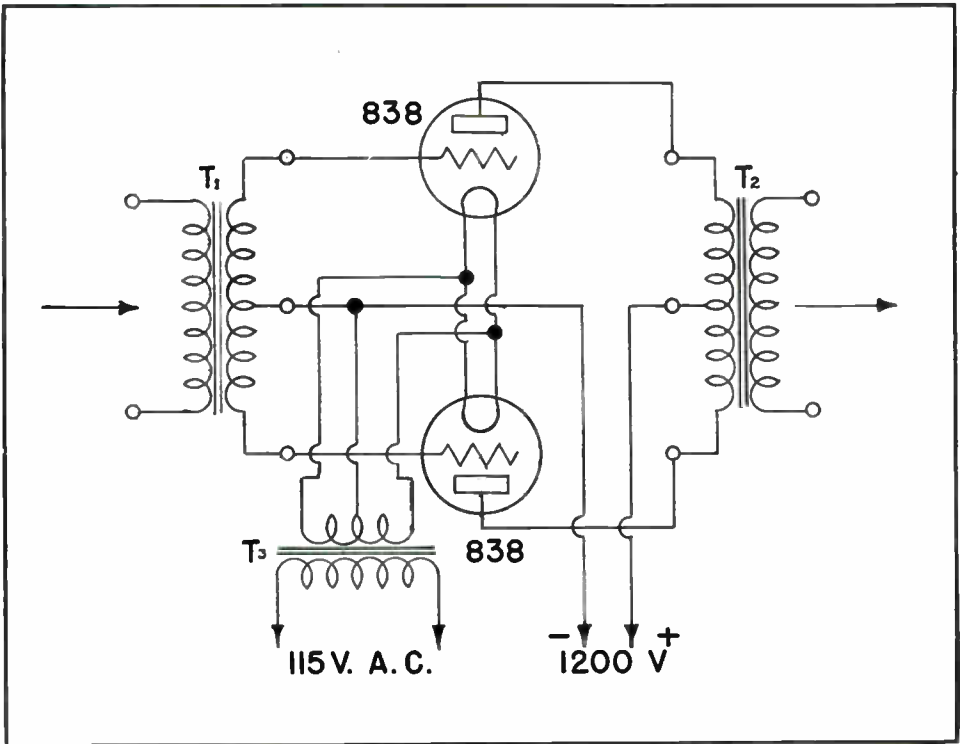

THE CIRCUIT DIAGRAM OF THE CLASS B MODULATOR

- T₁ — Input Transformer (500-ohm line to 838 grids).
- T₂ — Output Transformer (838 plates to R.F. load).
- T₃ — Filament Transformer (6.5 amps. at 10 volts).

As we have remarked, a ten-watt amplifier does very nicely for grid or suppressor modulation, but it does not go very far with plate modulation. Where larger amounts of power are required we use the rig illustrated in Figure 70 and shown in diagram in Figure 71. This unit employs a pair of 838's in Class B and has a rated output of approximately 260 watts. These tubes were picked in preference to the many others of the same approximate output because they operate with zero grid bias. Quite aside from convenience and simplicity, low levels of distortion in Class B operation require that the grid voltage remain constant, and this is easy only when this voltage is zero. The input transformer is designed to match the grids to a 500-ohm line, so that this unit operates very nicely using the speech amplifier described above as driver. It requires a little more power than 2A3's are rated to produce in straight Class A (half a watt more), but this slight additional power is easily obtained either by exceeding the ratings by a small amount, or by inclining toward AB operation.

The output circuit employs a matching transformer of the universal type, taps being provided so that any output impedance likely to be needed can be readily obtained. The proper tap is very easy to determine. When modulating a Class C amplifier, the plate circuit input resistance of the latter, as viewed from the modulator output, will be equal to the plate voltage divided by the plate current. The correct load resistance for the modu-

lator is obtained by looking it up in a table of tube characteristics. The ratio of these two resistances is equal to the square of the turns ratio of the transformer when the match is correct. To determine whether it is step-up or step-down, the simplest rule is that the winding having the highest voltage also has the highest impedance.

There is one still larger modulator at W1HRX that is quite interesting, though it is doubtful whether any amateur would choose to copy it. It employs a pair of 851 tubes, which are capable of developing about 2.4 KW Class B. Though we never operate them Class B, it is interesting to note that only 6 watts of signal driving power are required, which is well within the capabilities of our speech amplifier. In actual practice they are never called on to deliver more than 500 watts, and as they are rated at 320 watts Class A, it is evident that the most conservative of AB operation gives ample output. The reason for choosing such excessively large tubes requires some explanation. One reason is that W1HRX is located in the country, and power is supplied by a gas engine generator. Although the voltage regulation of our present generating system is much better than that of our earlier attempts, our experience has made us disinclined to run a high-powered Class B stage with home-made power. Another reason (and a good one) is that we had the 851's already. They are a legacy from the pre-Class-B days of W1HRX, when if you wanted power you had to use big bottles to get it.



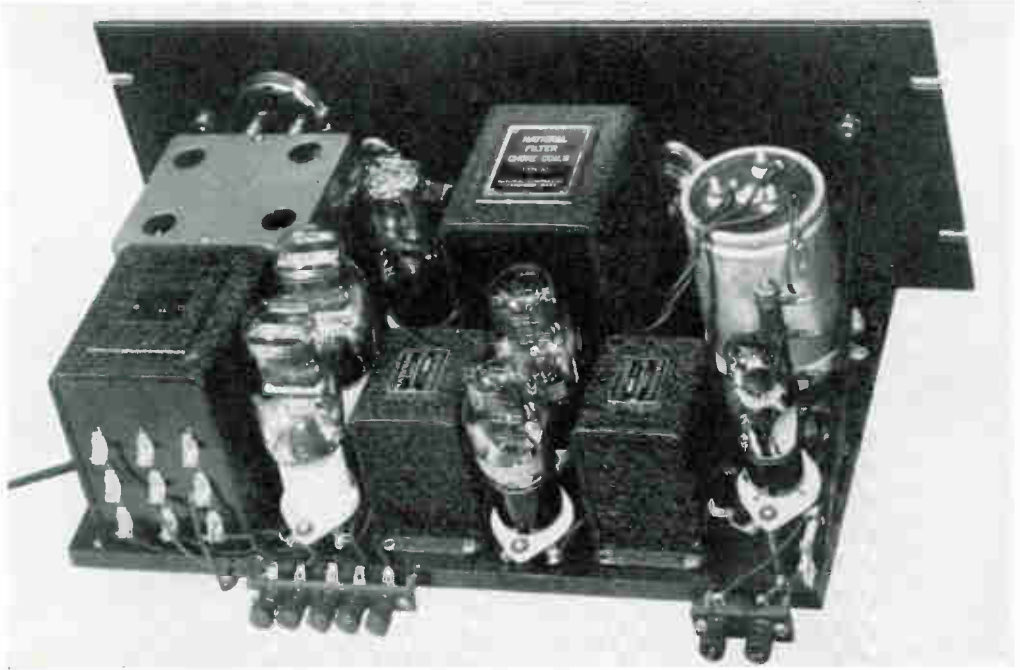

A combination unit, developed for use in conjunction with the buffer-driver assembly shown on page 14. The power supply for the 45 and 56 tubes is built along the back of the panel and will furnish well-filtered voltage for an external pre-amplifier. Two 801's in push-pull may be ap-

erated either in Class B, or in Class A when it is desired to drive a pair of 838's. The schematic diagram, below, shows the circuit to be entirely conventional. The input leads to the 56 must be shielded and may, in some cases, require filtering to overcome R.F. pick-up.

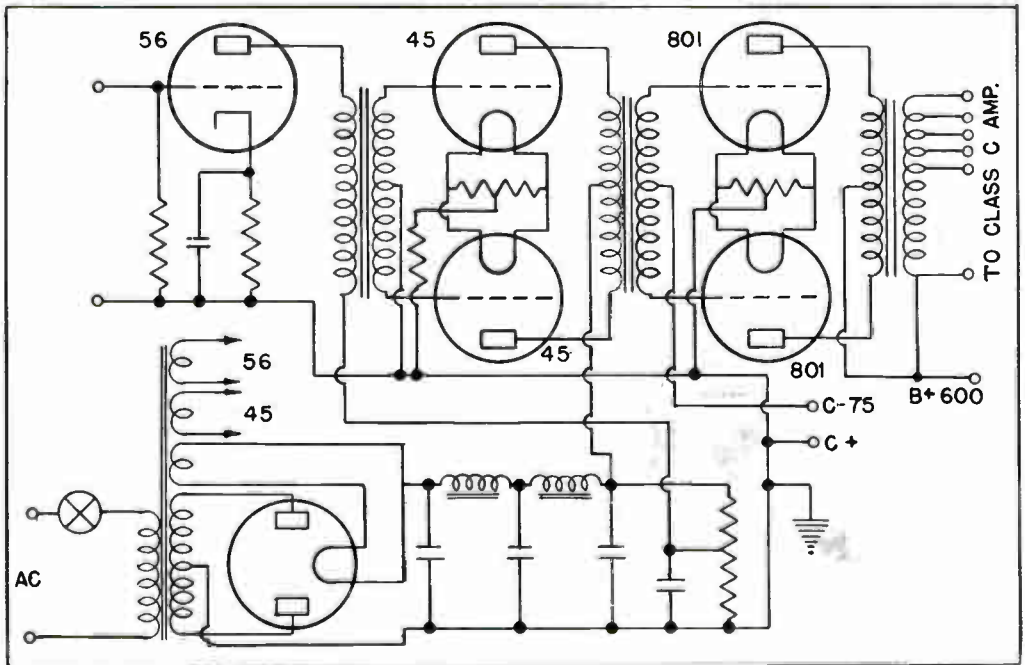

POWER SUPPLIES

BECAUSE ALL POWER supplies tend to be pretty much standardized, without allowing much play for new and novel ideas, they are apt to be treated as a necessary chore. They deserve more attention than they usually get, for they are inherently one of the most expensive items in the transmitter as well as one of the most important.

There is a lot to be said in favor of condenser-input filters. To be sure, it is a characteristic of such filters that high peak currents flow through the rectifier tube. This certainly is not very good for the tube, but judging from experience it is not very bad for it either. The load regulation of condenser-input filters is also poor, so that on fluctuating loads their output voltage varies considerably, making them unsuitable for such uses as serving Class B stages. However, they will give more watts of filtered DC per dollar of cost than a choke-input filter and for such purposes as C biasing voltages and Class A amplifier plate current, the condenser-input filter is just as satisfactory and more economical. The first condenser in a condenser-input filter provides a very convenient means of adjusting the output voltage without power loss. Even a small condenser at this point will increase the output voltage as compared to choke-input by 35 to 50 per cent, depending on the load.

Very often resistors can be used instead of chokes for filtering out hum. Chokes are normally used in power supply filters because they present a high impedance to the unwanted ripple and a low impedance to the desired DC. If a resistor, having an impedance similar to that of a choke on AC, is used, it will have essentially the same filtering action as the choke. It will also have a large DC voltage drop. In some cases such a drop is quite permissible. For instance, in early audio amplifier stages only about 200 volts is required although the power supply necessarily supplies 300 to 400 volts in order to take care of the output tubes. Resistors are very often used in this way for RF filtering, particularly in receivers.



FIG. 72

Condensers for transmitter power supplies are preferably either of the oil-impregnated-paper type or the electrolytic type. For voltages of about 450 or higher, it has been our experience that oil-impregnated units are by far the most satisfactory. It is possible to operate electrolytic condensers in series for use on high voltages, and our original 2000-volt power supply at W1HRX used a large bank of electrolytics in this way. They gave quite a bit of trouble. Every now and then one condenser in a group would blow, probably because of the difference in leakage resistances of the different units, which caused the voltage to divide unevenly. As soon as one unit blew, the others would go also, of course. It is characteristic of electrolytic condensers for the insulating film to deteriorate when lying idle, so that when a power supply employing them is unused for a time it is necessary to run it at reduced voltage for a short period to reform the film. This precaution was not always taken at W1HRX, and possibly the condenser troubles can be attributed to this in part. On the other hand, we have never had any trouble at all with the oil-impregnated-paper condensers we have used, and are inclined to think that over a period of years they have been less expensive than cheaper units. They certainly can take it.

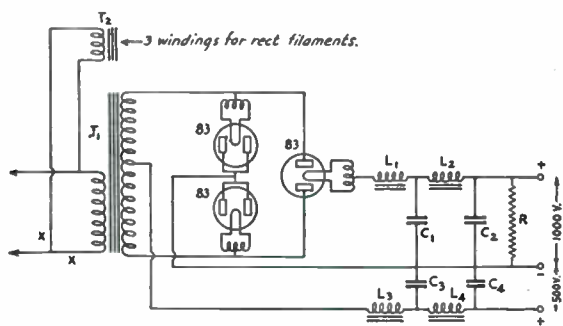

FIG. 73 — A DUPLEX PLATE SUPPLY CIRCUIT

This plate supply will deliver 500 and 1000 volts at a total of 250 milliamperes (sum of currents from both taps).

- T₁ — Power transformer, 600 volts each side center tap; 350 VA.
- T₂ — Rectifier filament transformer, three 5-volt 3-amp. windings.
- C₁ — 2μfd., 1250-volt rating.
- C₂ — 4μfd., 1250-volt rating.
- C₃, C₄ — 2μfd., 800-volt rating.
- L₁ — Swinging choke, 8/40 henrys, 275 ma.
- L₂ — Smoothing choke, 12 henrys, 275 ma.
- L₃, L₄ — 10 henrys, 200 ma.
- R — 40,000 ohms, 25-watt rating.

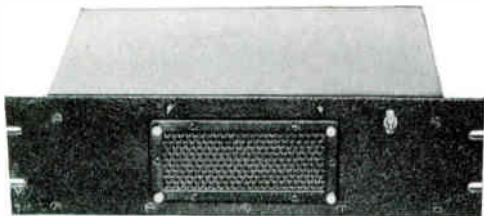

FIG. 74 — A COMPACT RELAY RACK TYPE OF POWER SUPPLY FOR EXCITERS, SPEECH AMPLIFIERS, ETC., IS THE NATIONAL TYPES LRDP (DUPLX) AND GRSPU (SYMPLEX) FURNISHING 250 VOLTS DC AND EITHER 6.3 OR 2.5 VOLTS AC

primary of the transformer in case of a short circuit in the load circuit. If there is no fuse to blow, the damage is sometimes appalling. Fuses must be used with care, however, because in certain cases shutting off the power may do more damage than a short circuit. For example, excitation must not fail when final amplifiers with grid-leak bias have power on. As far as fuses go, the answer lies in proper grouping. Circuits which are mutually dependent should have a common fuse, so both will go dead together if the fuse goes.

Of course, the nicest solution to this problem is to use a system of interlocking relays such as have been described from time to time in *QST* and elsewhere. Such arrangements not only protect the equipment from overloads or failures, but also energize circuits in the proper sequence when power is turned on.

With mercury-vapor rectifiers such as the 866, filaments should be allowed to come up to operating temperature before the plate voltage is applied. This usually takes about 30 seconds. There are various time-delay relays on the market designed to provide this interval automatically, but there are several simple and satisfactory "homemade" arrangements. One of the best employs a slow-heating tube such as the 27 with a voltage-dropping resistor in the heater circuit to still further increase the warming-up period. By choosing a suitable value for the resistor, it is

quite easy to cause a delay of 30 seconds or more before the 27 draws plate current. A relay is used in the plate circuit to turn on the plate voltage of the high-voltage rectifiers. One virtue of this device is that it compensates for line voltage, etc. If for any reason the rectifiers heat unusually slowly, the 27 will probably do likewise. Another point worth mentioning is that the grid of the 27 may be used also as a safety device. For example, in line with the case already cited, it might be tied in to the exciter circuit so that the 27 would be biased beyond cut-off unless the exciter was working. Thus plate voltage would not be applied to the final amplifier unless there was proper excitation.

Once the component parts that are to be used have been collected, the actual assembly and wiring presents little difficulty. It is hard to go wrong, provided condensers are not placed where



FIG. 75 — THE NATIONAL 5897 PACK IS THE SAME AS THE GRDPU UNIT OF FIG. 74 ABOVE, EXCEPT IN MORE COMPACT AND INEXPENSIVE FORM

they will get too hot, and chokes are not placed where they will have too much coupling with the transformer. The practice of using bus wire and spaghetti for wiring high-voltage power supplies is greatly to be condemned, if for no other reason than danger to the operator.

Rubber covered wire of the kind used for house wiring is cheap and much better. The common variety is rated at 600 volts working, but it is also made with insulation for higher voltages. Where a very flexible conductor is required spark-plug cable is satisfactory, though somewhat expensive.

The unit shown in Figure 72 is representative of what a well-planned power supply should look

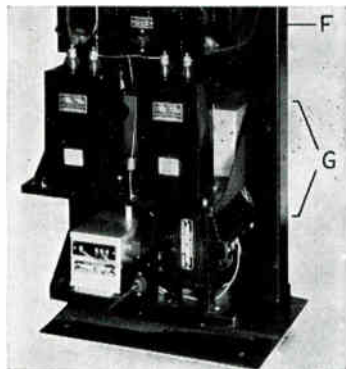
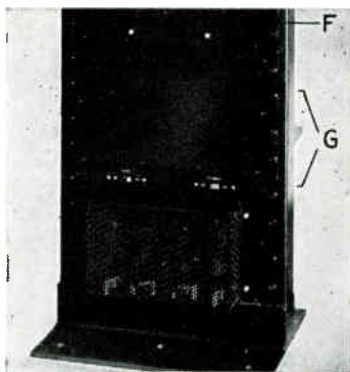

FIG. 76 — TWO VIEWS OF A BRIDGE TYPE 866 RECTIFIER POWER UNIT FURNISHING 2200 VOLTS FOR THE 1-KW FINAL AMPLIFIERS

like. It is a commercially manufactured unit (made by Acme Delta) and was not intended for relay-rack mounting. The circuit is given in Figure 73, and it will be seen that a straight bridge rectifier circuit is used. In this particular unit, three type 83 full-wave rectifiers were used instead of four half-wave rectifiers. As only four plates are required for the bridge circuit, there are two plates left over. By bringing out a lead from the center-tap of the transformer it is possible to utilize these two plates in a conventional full-wave rectifier circuit giving half the output voltage of the bridge. Thus two separate outputs are available.

For supplying the 851's mentioned in the preceding chapter, we originally designed the high-voltage unit shown in Figure 76, using four 866 rectifiers. It is built relay-rack style and in two units, the filament and plate transformers being located in the lower unit and the filter in the upper unit. All of the high-voltage wiring was done with H.T. spark plug cable, supported on GS-1 standoffs. This supply provided 2200 volts at one ampere, and served both the 851 Class A modulators and the Class C modulated amplifier. Later on this equipment was moved to a farm in Middleton where power had to be obtained from a small engine-driven AC generator. This generating plant was rated at 3 KW, which was thought to be ample. However, it was very quickly discovered that the regulation was not very good, and that it was not suitable for operating large Class B modulators. Even a Class B stage of a hundred watts was enough to blink

the lights when talking into the microphone. This generating plant was, therefore, demoted to such duties as running receivers, lighting filaments and providing illumination, for which service it has proven quite ideal.

One of the Boston broadcasting stations was being revamped at about this time, and from them we obtained a large motor-generator set. The AC motor on this unit was removed, and in its place an old automobile engine was mounted. This plant, which easily supplies 1 ampere at 2000 volts, has effectively disposed of the problem of where high-voltage power is coming from at the farm. The complete unit is shown in Figure 77. It is mounted close to the radio shack to avoid long and dangerous high-voltage leads. However, it is somewhat noisy, and being close by the operating desk it has been found necessary to shut it off when receiving. This is somewhat of a nuisance, but otherwise the unit has proved very satisfactory.

At the time this booklet is being written, we are in the midst of a slight change in the engine generator set-up. Instead of directly coupling the engine to the generator, as at present, we are adding a jack-shaft and Vee belts so as to provide a three-to-one speed reduction. After all, it is rather ridiculous to have a 40 or 50 horsepower engine turning over at 1800 r.p.m. to drive a 2 or 3 horsepower load.

For small transmitters with Class A modulation such as the one on Page 37, we have had extremely satisfactory results with the standard Kato 1KW gas engine driven 110 V. AC unit.

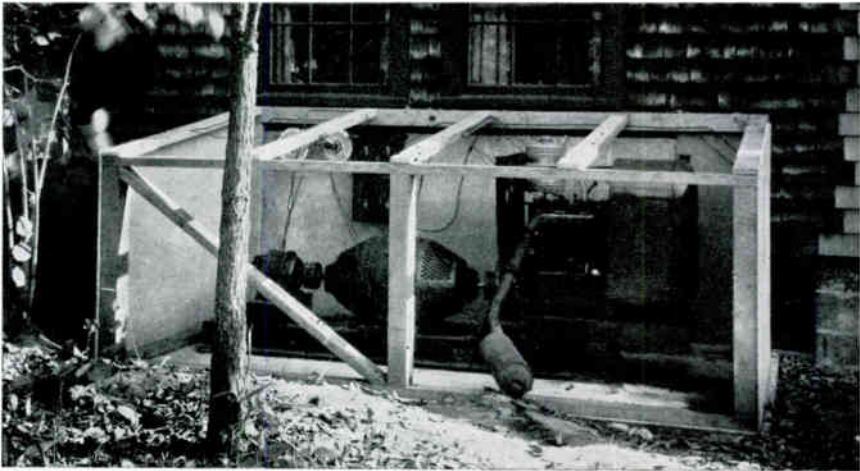

FIG. 77 — THE HIGH-VOLTAGE GAS-ENGINE-DRIVEN GENERATOR WITH COVER REMOVED FROM THE HOUSING

This machine is started and stopped from inside the station, going "on" only during transmission.



FIG. 78 — THE "SHACK" AT W1HRX

ANTENNAE

THIS CHAPTER will be well started if we admit right at the beginning that it is not intended to be a treatise on the subject. Such treatment will be found in any one of a number of excellent books, — such as the A.R.R.L. Handbook. This chapter is merely a collection of random notes on our experiences.

For general purpose work on 20 and 10 meters we have had very good luck with the vertical doublet with Q-bar center feed. This system has a lot to recommend it, at the higher frequencies at least. It is easy to adjust, and (unlike twisted pair) is easy to insulate well. Radiation is at a favorably low angle. The system works out particularly well for the fellow who lives in the city where space is at a premium, for room can always be found for a vertical wire and it can usually be placed so that the Q-bar feeders come directly in the second story window.

We favor "homemade" Q-bars, on the ground that they can then be designed throughout to fit the particular job. This, of course, is not true of universal kits. It is possible to buy seamless duralumin tubing in a variety of diameters and in 14-foot lengths which are straight to one part in 1200. As a matter of fact, straight lengths up to 52 feet long are obtainable from the mill, but 14 feet is the usual length stocked. Because of the extra expense and long delay in getting long pieces, it is better to buy in whatever length is most available, and then splice as necessary. It is not difficult to make a good splice, and a suggested method is shown in Figure 81. The plug should be a light drive fit into the open ends of the tubing. The knurl is to insure cutting through the oxide film to get good contact. The plug should preferably be made of the same material as the tubing to avoid corrosion.

The insulators were specially made to the dimensions shown in Figure 82. As is evident from the drawing, they are not intended to be adjustable, thus eliminating troubles from oval slots, clamps, lead washers, etc. They are simply slipped over the duralumin rod to the position desired and held in place with a wrap of tape. The insulators and tubing shown are designed to match 72 ohms to 600 ohms, or in other words they will match a center-fed half-wave antenna to a feeder using No. 12 B&S wire and 6-inch spreaders (such as National AA-3 spreaders). The convenience and rigidity of the non-adjustable assembly have proved so marked that an extra quantity of the insulators have been made. These are obtainable from National Company for the time being, but are not a regularly listed item with them.

The vertical doublet described was quite effective, but the next step was obvious, — adding a half-wave reflector to get directional effect. One of our more pretentious developments along this line is shown in Figure 78 and Figure 80. Two reflectors and two radiators are used in this array, all suspended from four bamboo poles which fan out like the ribs of an umbrella. The whole is mounted on the top of the mast shown in Figure 79, and is capable of being rotated at will. This array worked very well indeed — while it lasted. Unfortunately, such an array not only looks like an umbrella frame, but in a strong wind it acts like one also. However, Mims of 5BDB has been using a somewhat similar arrangement for some time, and apparently it is immune to any ordinary wind. It employs a single horizontal half-wave reflector and a single radiator, which is structurally much better than the four dangling conductors at W1HRX. Fellows who

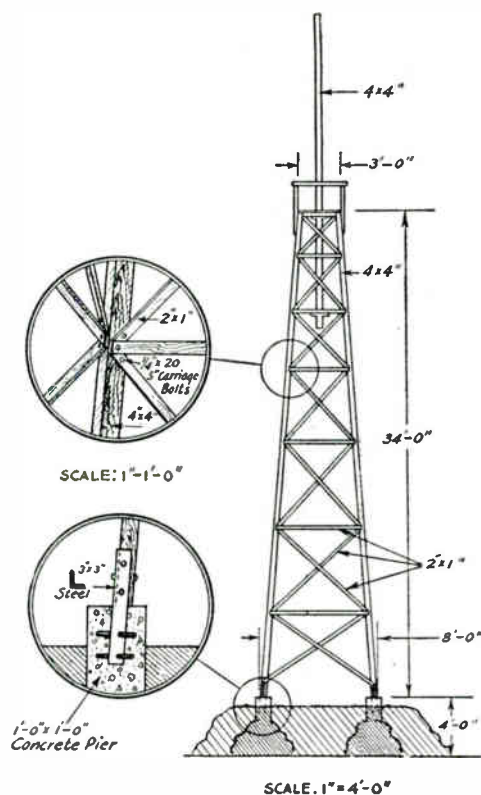

FIG. 79 — DETAILS OF THE SELF-SUPPORTING WOODEN TOWER

A tapering tower of square cross-section, made with 4 by 4 corner posts and 1 by 2 cross pieces.

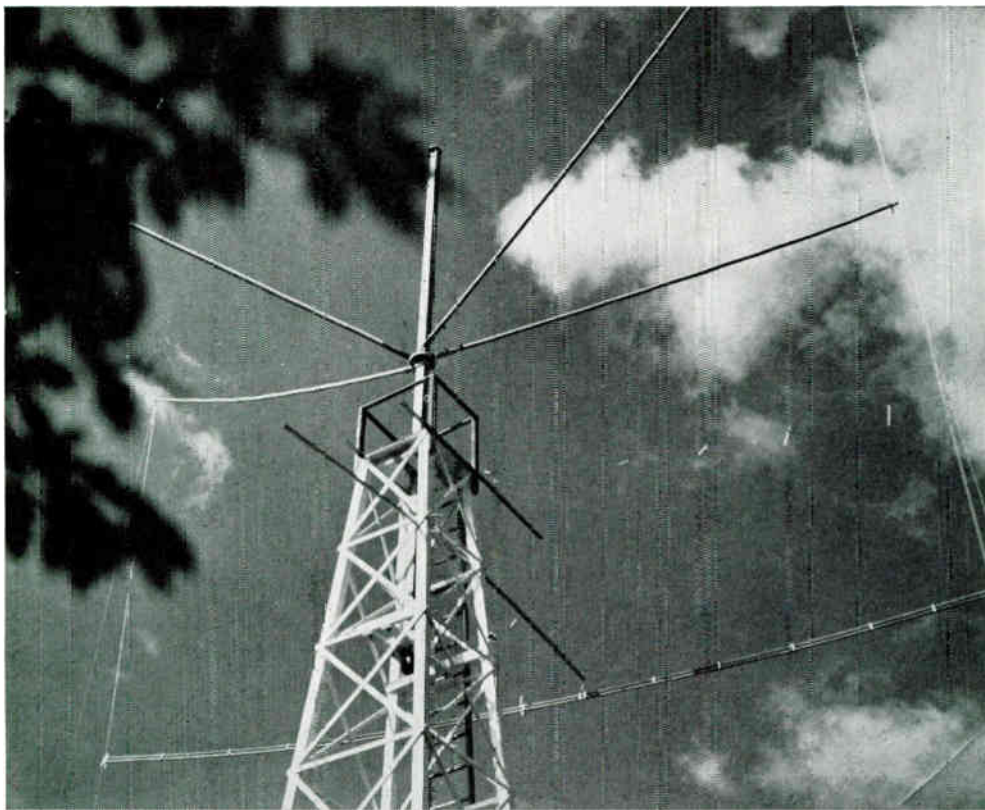

FIG. 80 — THE ISOLANTITE BLOCKS SHOWN IN FIG. 82 CAN BE SEEN PLAINLY IN THIS VIEW OF THE COMPLETED FOUR-ELEMENT ARRAY

have heard Mims demonstrate the directional qualities of his array know how very effective it is.

We should perhaps point out that the failure of the antenna lay in the mechanical weakness of the array, and not in the tower which supports it. This tower was put up by local carpenters to our design, and is very much of an asset. This business of being a human fly is all right the first dozen times or so, but after a while the virtues of having a solid railed platform 34 feet up begin to grow on you. Also the ladder bolted rigidly to the side of the tower is a big help when going up with one end of the sky-wire spliced to your belt, your hands full of tools and your pockets full of insulators. This particular tower is, in short, fine from a convenience point of view. However, it is stronger than necessary for most purposes, and its expense is usually not justified.

At the present time a large V antenna is being constructed at W1HRX. The tower described, being already available, is doing service at the apex of the V, but at the farther ends lighter and cheaper towers are planned. These are built of ladders bolted together in the manner shown in Figure 84, and although they are comparatively

cheap, they are self-supporting and easy to climb. The ladders used for this purpose should be sound and very strong. A preferred type is shown in the drawing. This sells for about twenty-five cents a foot "over-the-counter," but when six ladders or so are bought at a time the price is somewhat less. The actual construction of the tower requires very little comment. The three ladders are bolted together, using stove bolts and steel angles. These are available at any hardware store. The splices where the ladders are joined end to end are bolted in similar fashion, using fish plates. The first tier of ladders should be of different lengths (such as 8, 12, and 14 feet). This will not only stagger the joints, but will also make the tower much easier to erect. The top tier will also have the ladders of different lengths, of course, to make it come out even. Intermediate tiers will have ladders of the same length. If the tower so constructed is bolted down to a concrete foundation, no guy wires will be required for heights up to about 35 feet, for the structure is quite rigid.

Incidentally, if four ladders are used to make a square tower, it will be about 41 per cent stronger in its weakest direction than the tri-

angular tower. In its strongest direction (parallel to the faces of the square) it is twice as strong, so that the tension of the antenna, etc., should be in this direction. The square tower will require some diagonal bracing.

As has been mentioned above, we are in process of constructing a large V (four wavelengths long) at W1HRX. There seems to be a definite trend in the direction of V's and Diamonds for high-frequency work. They were in disfavor at first because they radiate horizontally polarized signals which was thought to make them unsuitable for use at the high frequencies. Apparently this is true only because most high-frequency receiving antennae have been vertical and therefore unsuitable for the reception of such signals. When proper receiving antennae are used the

the antenna is the same for both transmission and reception, the same array can be, and usually is, used for both purposes. A changeover switch of some sort is necessary of course. It is a good idea to have this switch interlocked with the power supplies of the transmitter and receiver, so that plate voltages are shut off automatically when the switch is thrown.

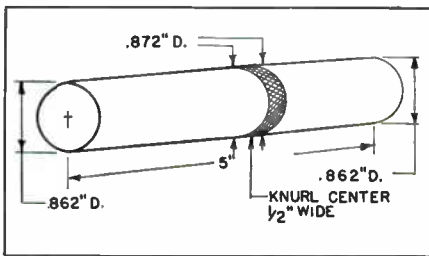

FIG. 81 — THE DETAILS OF THE TAPERED PLUGS, USED FOR JOINING THE DURAL TUBES OF THE Q-BAR TRANSFORMER

results have been excellent because of the large power gains obtainable, and interest in these types has been growing.

As between the V and the Diamond, the former seems to be the more popular. Both take up a lot of room, and usually there are not enough acres of cleared and level land available. As a result, the antenna usually has to be strung up hill and down, through trees and between obstacles. Under such unfavorable circumstances the V seems to work out better, as it seems to be less affected by departures from the theoretically correct layout. Also, it usually is easier to build. The principal advantage of the Diamond, or rhombic, antenna is that it can be made unidirectional by closing the far end with a resistor. We personally have found that matching this resistance to the antenna is a nuisance, and we usually leave it out in practice, in which case the system radiates in two directions like a V. The choice between the two types must depend, of course, on individual circumstances.

With either type it is necessary to use some sort of horizontal antenna for reception. As has been pointed out many times, a directional antenna offers advantages in reception that are at least equal to the benefits in transmission, for it not only increases the strength of the signal but also reduces background noise. As the design of

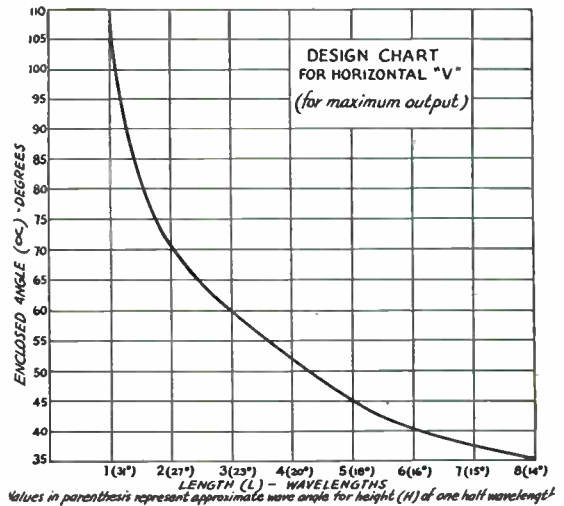
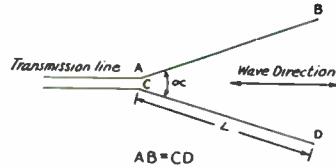

FIG. 83 — DESIGN CHART FOR HORIZONTAL "V" ANTENNAS

Enclosed angle between wires versus length of sides.

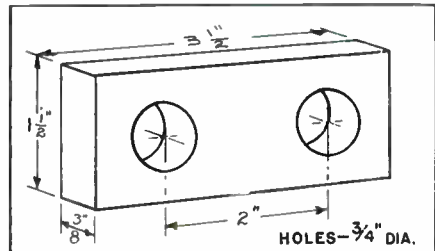

FIG. 82 — THE DETAILS OF THE SPECIAL NATIONAL ISOLANTITE Q-BAR SPACERS

The accompanying illustrations rather succinctly tell the story of our ladder mast, originally designed and erected to support one end of a "V" antenna. The tower shown on the preceding pages served as the support for the apex of the "V" and a convenient tree supported the remaining end.



FIGS. 84, 85, & 86

TOP—THE FIRST REQUISITE IS A HOLE ABOUT THE SIZE OF THE ONE SHOWN IN THIS PHOTOGRAPH

The ladders will later be spliced together to make the mast.

CENTER—THE FOUNDATION, READY TO BE FILLED WITH CEMENT

The anchor strips are spiked to a triangular frame to keep them in position during pouring.

BOTTOM—READY TO TAKE THE MAST

The bottoms of the ladders later will be bolted to the anchoring strips.

SOME USEFUL POINTERS

The first step in the erection of the mast is the construction of a suitable base. The hole for the base should be at least three feet deep and three feet square, preferably larger at the bottom than at the top.

Cement economy can be achieved by using quite a few rocks in with the cement. Before pouring the cement and placing the rocks, the steel inserts for attaching the ladder to the base should be put in place. A triangular frame of 2 X 4's was found quite practical for this use. The steel inserts were attached to the ends of each of the 2 X 4's with a spike. The entire assembly was then placed in the hole and carefully leveled. Care must be used in shoveling the concrete into the hole and in throwing in rocks to see that the alignment of the inserts is not disturbed.

For inserts we used standard building irons as stocked by most building supply companies for tying masonry walls to timber frames. They are iron straps approximately $\frac{1}{4}$ inch thick, $1\frac{1}{2}$ inches wide and 2 feet long, with a crow-foot end for anchoring in the concrete. While these supports were quite ample for our particular mast, we feel that on a higher mast it would be well to use much wider strips for this purpose and to have them extend quite a distance farther up each ladder leg than in our case. In an unguied mast of any appreciable height, there is considerable strain on the corner posts at the position of attachment to the base, and a large overlap between the corner posts and the steel inserts is very advisable.

The cement base should be given ample time to harden before starting the erection of the tower; three or four days is not at all too much. If any old iron wire, steel re-enforcing rods or other such material is handy, it is wise to throw a few pieces into the hole while pouring the concrete.

In some sections of the country it is difficult to obtain the shorter length ladder with parallel sides; that is, one in which the top rung is not shorter than the bottom rung. Also, it is sometimes hard, we find upon inquiring at different Boston hardware stores to get 10- or 15-foot ladders that are exactly the same width as the 20-foot ones. We solved the problem by buying only 20-foot lengths and cutting them into the required sections for staggering the joints. If the mast is to stay in service a long time, it is strongly recommended that heavy plates and bolts be used in the assembly, so that if neglected and allowed to rust, it will be many years in reaching a dangerously weak state.

The tower is first completely assembled on the ground, painted, and all parts carefully numbered; then all but the bottom section disassembled. (A convenient time for painting is when the tower has been pre-assembled; then, before dismantling it for erection, the different sections can be numbered on top of the paint. We made the mistake of numbering first, disassembling, paint-



SPLICING AND PAINTING

Twenty- and ten-foot ladder sections are bolted together with angle-iron strips (the bend in the strips is 120 degrees).



THE BOTTOM SECTION IN PLACE ON THE FOUNDATION

The plumb bob is an essential to keep the mast exactly vertical as its construction goes up.

ing, and then trying to fit the pieces together when the tower was half in the air!) The bottom section is easily up-ended by two people and bolted in place to the base inserts. If necessary, thin shims can be driven under some of the corner posts to bring the entire unit truly vertical. A plumb bob dropped through the center is the most practical way to determine when the mast is properly lined up. When the lower part is properly lined up and rigidly fastened, then proceed to add one ladder at a time, as you climb spirally up the assembly. Always advance the suspension point of the plumb bob as you add another unit, and carefully adjust its alignment. Incidentally, be sure to use a belt, rope with the right kind of knot, or other means of securing yourself to the tower during this process, so that both hands are free for fastening bolts and hauling up additional ladder sections. Don't, however, indulge in the trick attributed to W6ZH. As his friends know only too well, Herb is a most meticulous sort of fellow, and when, not so long ago, he wanted to try out some large vertical V's for 60-megacycle work,

he found he needed another 8-foot or so extension on one of his California telegraph poles (California used in the same sense as in "California kilowatt"). Not having a linesman's belt, he took some sash cord and carefully fastened himself at the top of his pole, then proceeded to spike in place an overlapping piece of 2 by 4 to give the required additional extension. Just about that time, he was suddenly faced with the problem of how to get the several turns of sash cord out from under the 2 by 4. We have heard that someone finally came to his rescue with a knife!

Just how high a ladder mast can safely be carried without guys is a matter on which we hesitate to express a definite opinion. Maximum local wind velocity will, of course, have much to do with the matter. In our case, the original unguied mast was limited to thirty feet, plus a three-foot extension to make it suitable for use also as the support for a half-wave vertical radiator at twenty. By the addition of three guys, however, the height may safely be extended a great deal further. Of course if we want to work on the same narrow factor of safety by which some of our friends seem to have been getting by for quite a few years now, we might suggest much greater heights.

UP WITH ANOTHER SECTION!

The author recommends a linesman's belt for this job, although he doesn't seem to be wearing one.

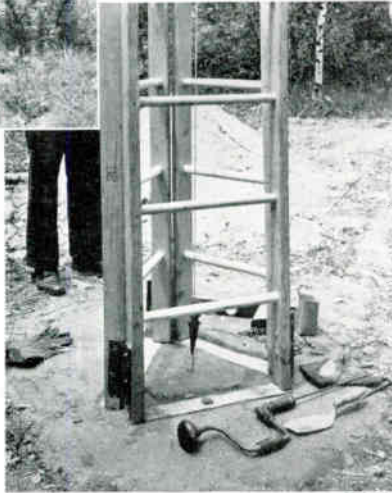

READY FOR THE ANTENNA

With reasonable loads, this type of mast does not require guying until heights of forty or fifty feet are reached. It's a snap to climb it.

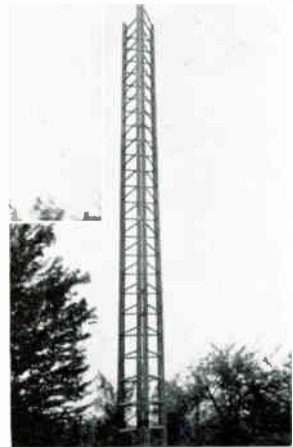

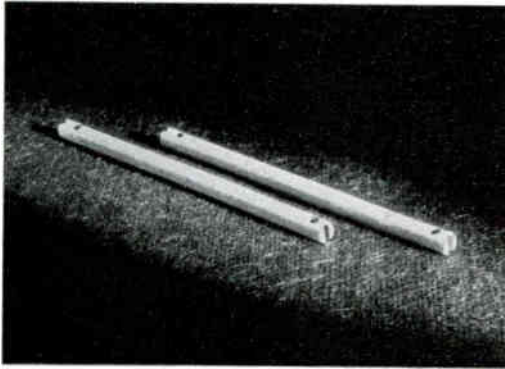

FIG. 90.—THE THIN STRONGLIGHTWEIGHT NATIONAL STEATITE-ISOLANTITE TRANSMISSION LINE SPREADERS PROVIDE FOR A 6-INCH SPACED LINE

As will be seen from Fig. 92, these spreaders when used with No. 12 wire form a line having a surge impedance of 600 ohms.

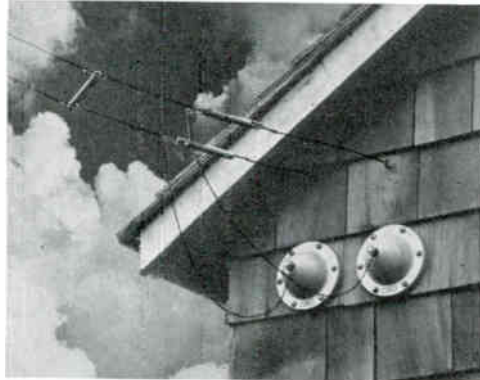

FIG. 91.—GOOD CONSTRUCTION FOR A LONG TRANSMISSION LINE IS TO USE ANTENNA INSULATORS NEAR EACH END, AS SHOWN HERE, TO TAKE THE STRAIN

The illustrations on this page may prove helpful in connection with the construction of open-type transmission lines. In addition to the general high efficiency of such lines they have also the advantages of low cost and easy construction to recommend them. Where multiple Vs, diamonds or other types of directional antennae are employed either some means of remote switching or else several sets of transmission lines must be used.

As previously mentioned, a directive antenna system is just as advantageous for reception as for transmission and, consequently, some means should be employed in the shack for quickly, or better yet automatically, shifting the feeders from the transmitter to the receiver and vice-versa at the proper time. A double pole-double throw switch with good insulation and reasonable low intercontact capacity may be used. A more handy arrangement, however, consists in the employment of a relay for this purpose. At W1HRX we have made the functioning of this relay entirely automatic by having it derive its operating voltage from the 6-volt battery charging generator on the gas engine that drives the high-voltage plate supply generator. Thus, as soon as the engine is started up for a period of transmission the relay is energized automatically and shifts the antenna feeders from the receiver input to the transmitter output. For this purpose

we use one of the 6-volt Ward Leonard double pole-double throw Nos. 507-523.

The ends of our feeders are attached to the shack just under the eaves with two antenna insulators as shown in Fig. 91. This construction takes away any strain from the lead-in bowls and thus prevents possibility of rain leaks due to the opening of the joint between the bowl and the building wall. Incidentally, before fastening lead-in bowls in place, gaskets should be made of builder's felt well saturated with roofing cement. Also, at this point, it might be well to comment that the difference in price between some of the cheaper lead-in bowls on the market and those offered by the more reputable manufacturers is represented

not only in a difference in grade of the ceramic material from which the bowls themselves are fabricated, but also in the hardware. It is rather disheartening to look over a lead-in some weeks after an installation to discover that the supposedly brass hardware is, after all, only nickel-plated steel!

A V, or other such antenna system can accumulate quite an appreciable static charge during a local thunderstorm and should be grounded when not in use.

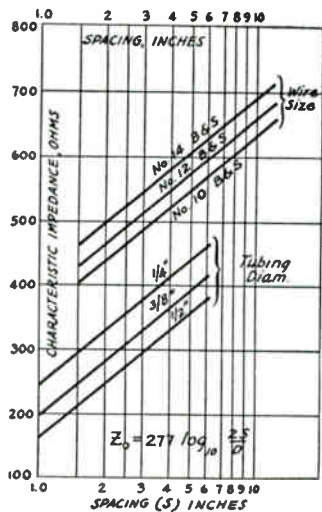
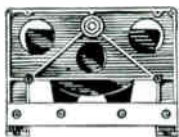
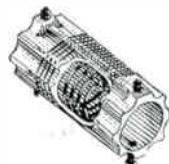

FIG. 92.—GRAPHICAL TABLE OF CHARACTERISTIC IMPEDANCES OF TYPICAL SPACED-CONDUCTOR TRANSMISSION LINES

Miscellany:



ABOUT CONDENSER INSULATION: High grade ceramic insulators (such as the best quality of Isolantite) are properly regarded as second only to fused quartz for high frequency insulation. Quartz is so very expensive that it is out of the question for most uses. Fortunately it makes but little difference, because the best ceramics give results almost equally good, when properly used. "When properly used" is a big phrase however, and covers a multitude of things. As far as the user is concerned, the main thing is to keep the insulator clean. Dust (and particularly the sooty dust of industrial districts) causes a marked reduction in the breakdown voltage as well as an increase in losses. The best cure is to inclose the rig in a dust cover, but where this is not practical all insulators should be cleaned periodically. Carbon tetrachloride is usually used for this purpose, but it leads to unfortunate results unless proper precautions are taken. Unglazed ceramic insulating materials of the highest grade are quite porous and consequently absorb moisture readily. To prevent this absorption it is usual to impregnate the material with a low-loss wax. As carbon tetrachloride dissolves the wax, cleaning by this method leaves the insulator at the mercy of atmospheric conditions unless reimpregnated or otherwise protected. Probably the best treatment that the amateur can use is simply to paint the surface, after cleaning, with National Vietron Coil Dope. This gives excellent results in every way.



ABOUT PICK-UP COILS: Pick-up coils for antenna or link coupling are often constructed by winding ordinary rubber covered wire around the outside of the coil. Although convenient, this method has serious objections. It is definitely not safe, since the low breakdown strength of the rubber often allows lethal voltages to appear in unexpected places. Further, losses at high frequencies are unreasonably great. A better scheme is to wind the pick-up coil of heavy bus wire, and mount it *inside* the coil form. To do this, wind the pick-up coil with a diameter slightly greater than the inside of the form. Then, holding one end of the coil in each hand, twist it as if you were winding up a spring. As you twist the turns of wire will grow smaller in diameter. When small enough, insert the pick-up coil in place, and release the ends. As it unwinds it will expand again until it fits snugly in the form. The ends of the coil are brought out to terminals on the coil form. The result is a neat, efficient, and well-insulated job.



ON SOLDERING COIL PRONGS: Many plug-in coil forms have hollow terminals similar to tube prongs. We are sometimes asked how to solder wires in these terminals without leaving lumps on the side of the prong. Answer: Dip the prong in a small pool of solder, and withdraw it slowly. This is the only practical method. It is handy to have a small cup drilled in the tip of your soldering iron for this purpose. It should be about $\frac{1}{4}$ " diameter and $\frac{1}{4}$ " deep. Though less convenient, the same results can be secured by melting a lump of solder in an iron spoon.

ON LEAD-THROUGH BUSHINGS: Occasionally also we are asked why we do not make a small lead-through bushing. We do. A GS-8 Stand-off, mounted through the panel, leaves nothing to be desired either for efficiency or neatness.

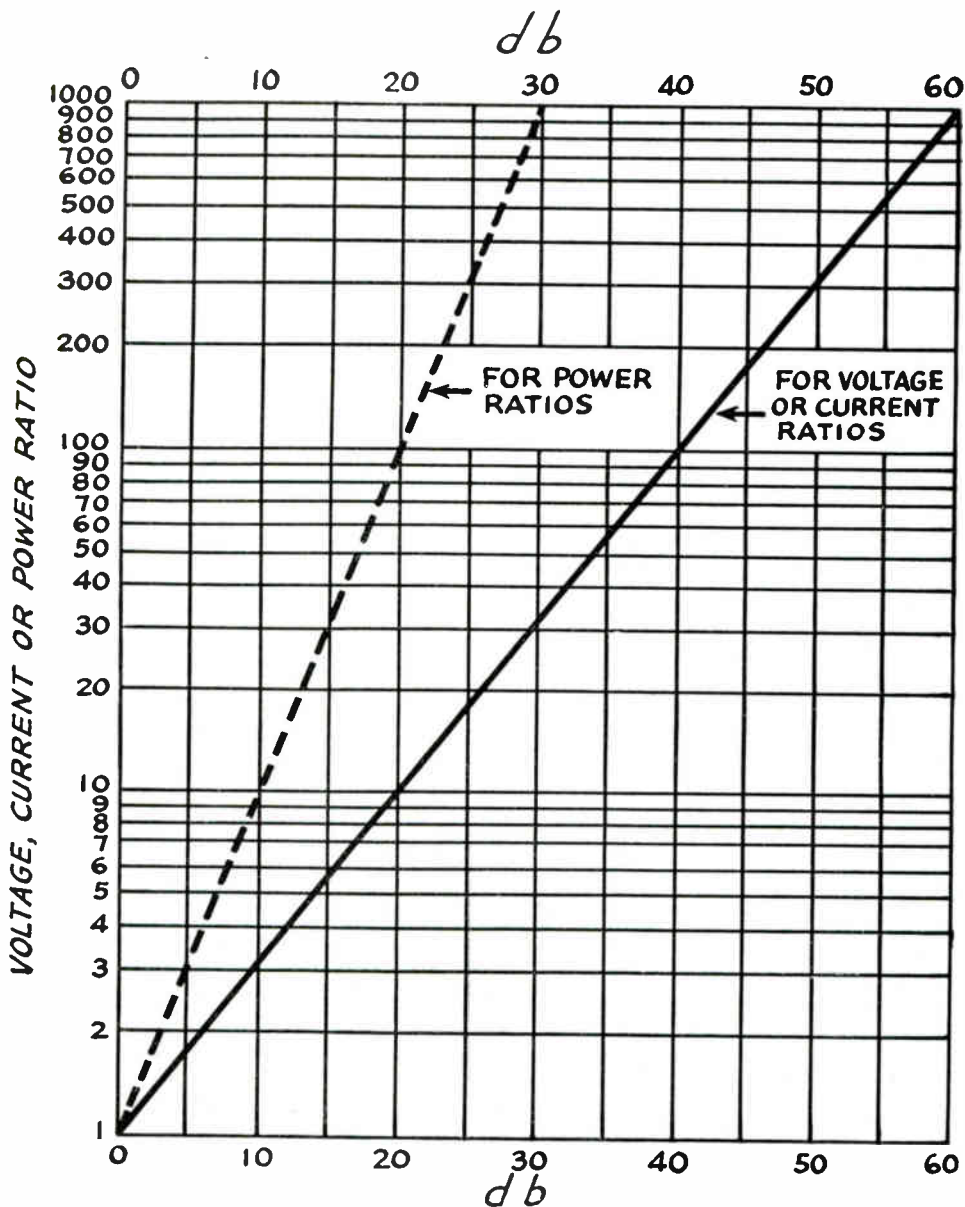

DECIBEL CHART FOR POWER, VOLTAGE OR CURRENT CALCULATIONS

To find db gain, divide output power, voltage or current by corresponding input value and read db value for this ratio. To find db loss, as where output is less than input, divide input value by output value. Power, voltage or current values must be in same units (watts, millivolts, microamperes, etc.). The chart also can be used for ratios greater than 1000. For power ratios between 1000 and 10,000, divide given ratio by 10 and add 10 db to value read from the chart. For voltage and current ratios between 1000 and 10,000, divide given ratio by 10 and add 20 db to value read from the chart. For example, to find db gain for a power ratio of 8000, read db value for power ratio of 800 (29 db) and add 10 db, the answer being 39 db; or to find db gain for a voltage ratio of 8000, read db value for voltage ratio of 800 (58 db) and add 20 db, the answer being 78 db.

This chart is reprinted herewith for your convenience through the kindness of the publishers of the A.R.R.L. Handbook.

In the section to follow will be found several National Company Engineering Bulletins describing in detail such essentials of the amateur station as receivers and oscilloscopes. Also for the convenience of the transmitter constructor, is included a copy of the latest National Company catalog of component parts.

The HRO Receiver
The NC100 Receiver
The CRM Cathode Ray Oscilloscope
The NATIONAL Company Catalog

Instruction Manual
for

The New HRO
COMMUNICATION
RECEIVER

Designed to meet the most ex-
acting demands of the more
advanced communication service

By JAMES MILLEN
and DANA BACON

Price 10c



While intended primarily as an operating instruction manual, it is hoped that this booklet will also serve to better acquaint the owner of a National HRO high-frequency communication receiver with the engineering details of its design. Only by a proper appreciation of some of the many unusual design features of this new receiver is it possible for the operator to secure the unusually high degree of performance that we have built into the HRO.

Copyright 1937



The HRO

Amateur Communication Receiver

THE HRO receiver is a high-frequency super-heterodyne employing nine tubes, as follows:

| | | |
|--|-----|--------|
| First R.F. | 58 | or 6D6 |
| Second R.F. | 58 | or 6D6 |
| First Detector. | 57 | or 6C6 |
| High Frequency Oscillator. | 57 | or 6C6 |
| First I.F. | 58 | or 6D6 |
| Second I.F. | 58 | or 6D6 |
| Diode Detector, AVC, First Audio. | 2B7 | or 6B7 |
| Second Audio. | 2A5 | or 42 |
| Beat Frequency Oscillator. | 57 | or 6C6 |

All voltage dividers, etc., are built into the receiver. The six-volt type of tubes, that is, 6D6's, etc. listed above are interchangeable with the 2½-volt types as far as alignment and performance are concerned, but should not be used in this receiver with an A.C. filament supply. The receiver is designed to operate from a National Type No. 5897 AB power unit employing a 280 rectifier tube. This power unit will deliver approximately 230 volts at 65 milliamperes and about 2½ volts at 9½ amperes for the heaters. Other power units may be used provided they will fulfill these specifications closely, but it is important that an adequate heater supply be furnished, since there is a voltage drop in the heater leads of the power supply cable of about .2 volt.

The HRO receiver has been designed around and tested with RCA tubes; consequently we can vouch for its performance only when these tubes are used.

Antenna

The input circuit of the HRO is arranged for operation with either the doublet type or the single-wire type of antenna. There are two input binding posts, marked "ANT" and "GND." When using a single-wire antenna, the lead-in should be connected to the antenna post and the short flexible lead, which is connected to the chassis near the ground post, should be clamped under the "GND" terminal. An external ground connection may or may not be necessary, depending upon the installation. The ground is usually desirable when receiving wavelengths above 100 meters, but for wavelengths below 50 meters, the use of a ground may actually weaken signals. Doublet antenna feeders should be connected directly to the input terminals and the flexible ground connection, mentioned above, is not used at all.

The input impedance of the receiver varies over the total frequency range but averages about 500 ohms.

Output Circuit

The plate circuit of the output tube is brought to the output tip jacks located at the rear left-hand side. There is no output transformer in the receiver.

The speaker requirements are not at all critical, but tone quality will, of course, depend almost entirely upon speaker characteristics. A good magnetic speaker will be satisfactory, provided it is capable of carrying the plate current of the output tube (about 30 ma.). Many magnetic speakers will require a filter system, however, and such a filter may consist of a 1-to-1 transformer, or a 30-henry choke and a 1-mfd. condenser.

Dynamic speakers are, in general, superior to the magnetic types, but if these are used some provision must be made for field excitation, since this power cannot be obtained either from the receiver or No. 5897 power unit. For this reason, the permanent magnet type of dynamic speaker is recommended, no field excitation being required. The output impedance of the HRO is 7000 ohms, and a dynamic speaker must, of course, have a suitable built-in coupling transformer of 7000-ohm input impedance.

A headphone jack is located on the front panel, just below and to the right of the "S"-meter. This jack is wired into the output of the pentode section of the 2B7. When the phones are plugged in, the signal input to the last tube is completely disconnected. *It is important, however, that the plate circuit of the output tube be complete at all times.* If the speaker is to be disconnected, a jumper must be inserted in the tip jacks to connect them together. If this precaution is neglected, the output tube may be seriously injured.

Controls

The main tuning dial is located near the center of the front panel and operates the 4-gang tuning condenser. Full details of the tuning arrangement will be found in the last section of this booklet, which is reprinted from an article originally appearing in *QST*.

Starting at the top right-hand side of the front panel, the uppermost knob is the Variable Se-

SCHEMATIC DIAGRAM — TYPE H.R.O. RECEIVER.

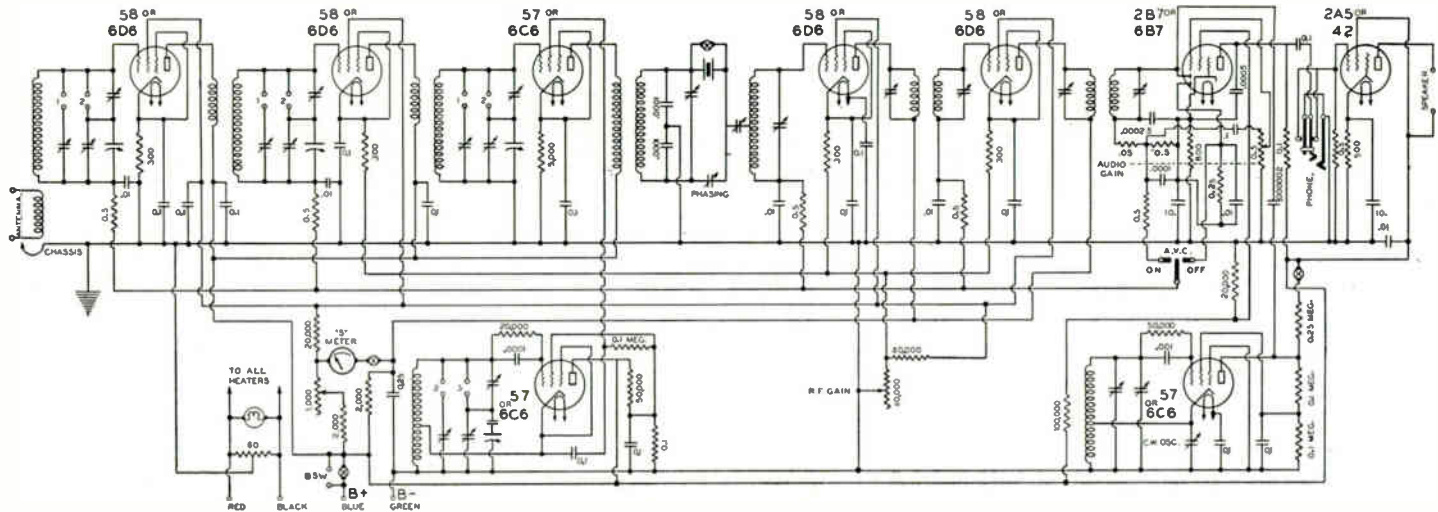

lectivity Control of the Single-Signal Crystal Filter. With the crystal filter in use, minimum selectivity will be found with the pointer nearly vertical. Rotating the knob in either direction from this point will increase the selectivity. When the filter is not in use, the knob should be set at the point giving maximum volume and sensitivity.

Immediately below the Selectivity Control is the Phasing Control and the Crystal Filter Switch. When this control is rotated to 0, the crystal filter is disconnected. When the control is at any other setting between 1 and 10, it acts as a phasing condenser for balancing the crystal bridge circuit, eliminating heterodynes, etc. The action of these two controls is explained in detail in Part 2 of the Alignment Section.

The switch below the phasing control is connected in the B+ lead of the receiver and its purpose is to shut off the receiver during periods of transmission OR WHEN CHANGING COILS. This last function is important.

The bottom control on the right-hand side is an R.F. Gain Control, connected to the second R.F. tube and to the two I.F. tubes.

At the bottom left-hand side of the front panel is located the C.W. Oscillator Switch and Vernier Tuning Control. The c.w. oscillator is used to obtain an audible beat note when receiving c.w. signals or to locate the carrier of weak phone and broadcast stations. After the phone carrier has been found, the c.w. oscillator is, of course, turned off.

The switch just above the c.w. beat oscillator dial is for turning the AVC on or off. AVC is disconnected with the toggle thrown to the right.

Above this switch is the Audio Gain Control, which is wired into the output of the diode detector and serves, therefore, to control audio volume when using either headphones or speaker.

The S-Meter for indicating carrier intensity or signal strength is in the upper left-hand corner. Just below it, and to the left, is a push-switch which connects the meter in the circuit.

Operating Instructions

Phone or Broadcast Reception

In receiving phone signals, the AVC may or may not be used, as desired. If it is not used, we suggest operating the audio gain control about halfway on and controlling the sensitivity with the R.F. gain control. If the operator prefers a "quiet" receiver, the audio control may be operated at 1 or 2. If AVC is used (left-hand toggle thrown to the left), the R.F. gain control may be turned all the way on; i.e., to 10; and the volume controlled by the audio gain control only. The setting of the two gain controls is largely a matter to be determined by the preference of the operator and by receiving conditions. If, for instance, local noise or atmospheric static is high

it will be desirable to retard the R.F. gain control when using AVC so that the sensitivity of the receiver will be held to a definite maximum. If the c.w. oscillator is to be used for locating carriers, as mentioned above, the AVC switch must be in the off position (to the right). Turning on the c.w. oscillator with the AVC on will block the receiver, making reception of anything but extremely strong signals impossible.

C.W. Reception

When receiving c.w. signals, the c.w. oscillator must be turned on and the AVC switch turned off. Best signal-to-noise ratio will usually be obtained by retarding the audio gain control considerably and controlling sensitivity with the R.F. gain control. Turning on the c.w. oscillator switch will, of course, result in a considerable increase in circuit noise. When the control is turned back and forth, the characteristic pitch of this noise will change. When the characteristic pitch is fairly high, the semi-"single signal" properties of the receiver are very pronounced, one side of the audio beat note being several times as loud as the other.

Phone Reception Using the Crystal Filter

The use of the crystal filter in phone reception is recommended particularly when the operator must contend with heavy interference, static, heterodynes, etc. Since such conditions prevail at most times in the amateur phone bands, the filter will be found particularly useful to amateur phone operators. To receive a phone signal when using the crystal filter, the filter is switched in by means of the phasing control and the phasing dial set at approximately mid-scale. The selectivity control is then adjusted for minimum selectivity, as indicated by maximum noise as the control is rotated back and forth. All phone signals will be greatly reduced in volume, making it necessary to advance both audio and R.F. gain controls. The signals may then be tuned in in the usual manner, but it will be found that the selectivity is very high, with the result that all audio frequency side bands above a few hundred cycles are comparatively weak. Normally, this would result in low intelligibility of the received signal, but since the background noise, static, etc., have been correspondingly reduced, the net result is usually an improvement.

The principal advantage of the crystal filter, however, is its ability to eliminate heterodynes. Suppose, for instance, a signal has been carefully tuned in with reasonably good intelligibility and during the transmission an interfering station comes on, causing a bad heterodyne, inverted speech, etc. Ordinarily the desired signal would be "smeared," but careful adjustment of the phasing condenser will eliminate the heterodyne and the interfering station, in most cases, completely. Intelligibility will remain practically as good as before the interfering station came on.

From a practical standpoint it is important that the crystal filter be used most of the time where such interference is apt to be encountered, as it is almost impossible to switch on the crystal filter and re-tune the desired signal through the heterodyne. The phasing adjustment will remove one signal only. If another interfering station comes on, however, only one heterodyne will be present, instead of the several resulting from three station carriers beating together.

C.W. Reception with the Crystal Filter

To use the crystal filter for c.w. reception, the filter is switched in by means of the phasing control and the phasing condenser set about mid-scale. The AVC switch must be off and the c.w. oscillator turned on. Advancing the R.F. and audio gain controls will result in a hollow, ringing sound the pitch of which will depend upon the setting of the c.w. oscillator dial. The actual pitch is not important as long as it is near the middle of the audio range, where the loudspeaker or phones have good sensitivity.

When a signal is picked up, it will be found that as the receiver is tuned *slowly* across the carrier the beat note will be very sharply peaked at the same pitch as that of the ringing noise, previously mentioned. All other parts of the beat note will be extremely weak and, furthermore, this peak will be found to occur on only one side of the audio beat note. The sharpness of the peak is determined by the selectivity control (upper right-hand knob). At maximum selectivity, the peak is so sharp that it may be hard to find, whereas at minimum selectivity the peak will be very broad. If a signal is being received, after having been properly tuned in, and an interfering station comes on, the resulting heterodyne and interference may be eliminated by adjustment of the phasing condenser. This phasing adjustment is effective in eliminating interference regardless of the setting of the selectivity control.

S-Meter

The S-meter serves to indicate the strength of a received signal. It is calibrated from 1 to 9 in arbitrary units which correspond, roughly, to the definition of the nine points of the "S" scale of the R-S-T system of amateur signal reports.

Probably no two operators will agree on just how strong a signal must be to warrant an S-9 report. After making measurements on a large number of amateur signals, the present meter scale was chosen and we believe it will provide a good practical means of giving accurate reports. The accompanying curve shows the relation between the meter reading and the actual signal input to receiver in microvolts.

Before making a measurement on a signal, certain receiver adjustments must be made. Since the meter is actuated by the amount of signal reaching the second detector, it is obviously

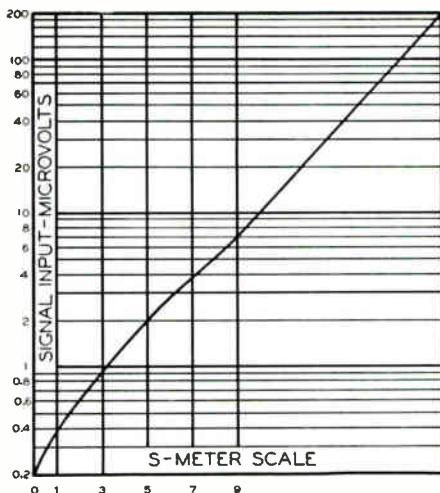

necessary that the receiver be adjusted to have a predetermined amount of amplification between the antenna and second detector. To adjust the amplification to the proper value, the AVC switch must be off, the c.w. oscillator off, the crystal filter off, and the selectivity control set for maximum sensitivity. Now press the meter switch and advance the R.F. gain control until the meter comes to 0. The R.F. gain dial will read about $9\frac{1}{2}$. The receiver is now adjusted and the strength of any signal may be measured by throwing the AVC switch on and tuning for maximum meter deflection. The audio gain control does not have any effect on the R.F. adjustments or upon the meter reading, so that it may be retarded as much as necessary to prevent audio overload when making the preliminary adjustments.

If the signal being measured is extremely strong, however, or if local noise is exceptionally high, it may be impossible to bring the meter to 0. In this case, it is necessary to detune the receiver from the signal or to disconnect the antenna. The above procedure will hold true when checking either phone or c.w. stations. It is, however, impossible to obtain a continuous check on c.w. signals, as the beat oscillator must be off. The principle upon which the S-meter operates is described in the last paragraphs of this booklet.

Coil Ranges

Four plug-in coil assemblies are supplied as standard equipment for the HRO receiver, each assembly consisting of three R.F. coils and one oscillator coil, all individually shielded and provided with built-in trimmer condensers. Calibration curves are mounted on the front of each assembly.

The four assemblies cover all frequencies between 1.7 and 30 megacycles, the division being as follows:

1.7 to 4.0 mc.
3.5 to 7.3 mc.
7.0 to 14.4 mc.
14.0 to 30.0 mc.

Inspection of the coil terminal panels will show several small rectangular metal pieces. There are two of these pieces or terminal blocks on each of the coil panels. A small flat-head machine screw will be found in the left-hand terminal block of each coil, looking at the assembly from the front. With the screws in the left-hand positions, the coil range will be that shown in the left-hand, or

general coverage, chart. If it is desired to change the calibration to amateur band-spread, as shown on the right-hand chart, it is only necessary to move the four screws to the right-hand terminal block of each coil.

A complete description of the coils, tuning condensers, and the range changing system, is given in the last section of this booklet.

In addition to the coils furnished as standard equipment, three other assemblies are available, covering the frequencies as follows: 2-to-9 mc., 500-1000 k.c. and 175-400 k.c.

Alignment and Service Data

THE four high-frequency coil assemblies are aligned in the laboratory to the individual receiver with which they are to be used. No coil adjustments of any kind should be necessary after the receiver is put into operation, but if coils are purchased separately the alignment should be checked in accordance with the following procedure.

The coil panel screws must be in the left-hand terminal blocks to give the full coverage range, as described in the preceding section. The tuning dial is turned to approximately 490 and a frequency meter, or accurate test oscillator, is set to the frequency indicated by the general coverage calibration chart. This will, incidentally, always be near the high-frequency edge of some amateur band. The oscillator coil trimmer, shown on the layout diagram of the receiver as No. 8, is then adjusted so that the dial reading checks the calibration curve. Trimmers Nos. 2, 4 and 6 are then adjusted for maximum sensitivity. In adjusting these three trimmers, no signal is necessary, as the correct adjustment is that which will give maximum background or tube noise. This background noise should be fairly loud when the R.F. and audio gain controls are fully advanced, the crystal filter being switched off. The tuning dial should then be rotated to the low-frequency end of the range. The background noise should not vary greatly as the dial is being turned. If it does, however, poor ganging is indicated.

The ganging is checked by pressing the outside rotor plate of the oscillator condenser sideways toward the stator, but not far enough to short the condenser. If sensitivity is increased, more inductance is needed in the oscillator coil. On the three low-frequency coil assemblies oscillator inductance is increased by loosening the nut which holds the inductance trimmer disc, inside the oscillator coil, so that the disc may move toward the back of the coil shield. If, however, sensitivity decreases when the oscillator rotor plate is bent toward the stator, the other condensers, particularly the first detector tuning condenser,

should be tested the same way. If sensitivity decreases when the rotor plate is moved in, ganging is perfect and the general coverage range is completely adjusted. However, if sensitivity increases, the oscillator coil inductive trimmer must be adjusted to decrease inductance. In the case of the 14 to 30 megacycle coils, inductive trimming is accomplished by moving a loop of wire around the end of the oscillator coil. Bending this loop from right to left across the end of the coil form will increase inductance. After any change in the oscillator coil inductance has been made, it will be necessary to tune back to the high-frequency end of the range in order to readjust the No. 8 trimmer condenser. The procedure as outlined above is then repeated until the ganging is correct.

It will be found that the setting of the various trimmers, particularly the No. 8, is quite critical, but that the setting of the inductive trimmer is not at all sharp and, when making the inductance adjustment, the nut may be rotated a full turn for each trial.

In the case of the 14 to 30 megacycle coils, special care must be exercised to see that the oscillator is operating on the high-frequency side of the signal. Two points will be found when adjusting the No. 8 trimmer and of these, the correct one is on the counter-clockwise side. Furthermore, in adjusting the No. 6 trimmer of this coil assembly, there will be some interaction or interlocking between the first detector and oscillator circuits. In adjusting the No. 2 trimmer, it will be necessary to have the antenna connected with some signal or noise input.

The band-spread range may now be adjusted. It should be pointed out here that adjustments for the general coverage range will affect the band-spread range, but the separate band-spread adjustments may be made without changing the general coverage alignment.

The four screws must be shifted to the right-hand terminal blocks, as outlined under "Coil Ranges" in the preceding section. The tuning dial

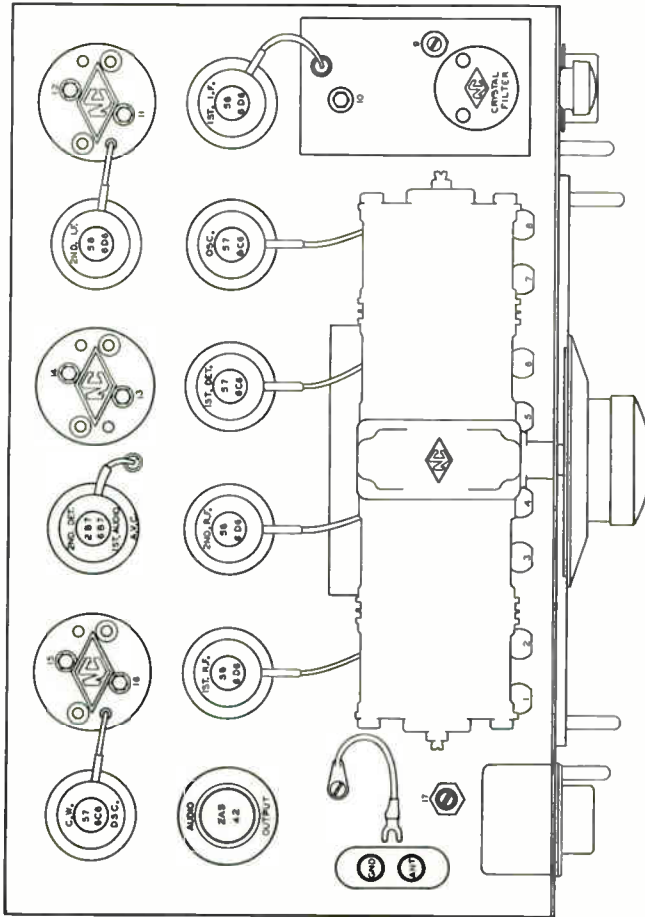

The Layout Diagram

is set at 450 and a test oscillator adjusted to the exact high-frequency edge of the proper amateur band. Trimmer No. 7 (of the layout diagram) is adjusted until the signal is picked up. Trimmers Nos. 1, 3 and 5 are then adjusted for maximum sensitivity. The dial is then rotated to the low-frequency end of the band; that is, to 50; and the left-hand calibration curve should be checked. If found incorrect, it will be necessary to adjust the band-spread series padding condenser, mounted inside the oscillator coil and adjustable from the rear by means of a socket wrench. If the low-frequency end of the band is tuned in at any dial reading above 50, the capacity of this series padding condenser must be decreased. If the low-frequency edge of the band is found between 0 and 50, the capacity must be increased. The setting is critical. After making a trial adjustment, the dial is returned to 450 and trimmer No. 7 readjusted. The above procedure is repeated until the dial checks the calibration curve.

Tracking of the two R. F. and first detector circuits may then be checked by tuning to the low-frequency end of the band and checking the adjustment of the Nos. 1, 3 and 5 trimmers. If more capacity is needed for best sensitivity (as indicated by improved signal strength when the trimmer is rotated clockwise), the series padding condenser of the coil being adjusted must have more capacity. If any of the Nos. 1, 3 or 5 trimmers require less capacity, a corresponding decrease must be made in the capacity of the series padding condenser. After the series padding condenser has been adjusted for trial, the dial is returned to 450 and the procedure repeated.

The above instructions may seem complicated, but they cover complete alignment under the worst possible conditions, where everything is out of adjustment. The chances are that the only adjustments that will need to be made are the conventional trimmer adjustments of the trimmers Nos. 1 to 8.

Simple antenna compensation for the general coverage range is made by adjusting trimmer No. 2, and for the bandspread range by adjusting trimmer No. 1.

The instructions will probably be simplified after reading the general description of the tuning system given in the last section of this booklet.

With regard to the two coil groups covering the frequencies between 2 megacycles and 500 kilocycles, there are only five trimmer adjustments. These are Nos. 2, 4, 6, 7 and 8. The No. 8 adjustment is used here as in the other coils for adjusting the oscillator circuits to correspond with the calibration. The No. 7 trimmer is the conventional series padding adjustment. Nos. 2, 4 and 6 are the usual trimmers.

I.F. and Crystal Alignment Instructions

Before attempting to check the alignment or adjust a single signal receiver it is essential that

the operator be familiar with the principles involved and the type of performance to be expected.

A receiver of this type is simply a superheterodyne which may be adjusted to have extremely high selectivity on all signals. The effective width of the selectivity curve is only a few cycles, usually between 20 and 100. This means that when tuning in a given c.w. signal, tuning is going to be very sharp and the dial must be turned slowly in order to avoid missing the signal entirely. As compared to the straight superheterodyne, the single signal receiver is about 100 times as selective. The straight super will pick up a signal and will reproduce both sides of the audio beat note at about the same strength; that is, the carrier whistle may be varied from either side of zero beat up to about 3000 cycles when the receiver is tuned and the whistle will remain about the same strength at any pitch. The s.s. receiver, however, being 100 times as sharp, will not perform in this manner, but as the receiver is tuned across the carrier the audio response will be very sharply peaked at one certain pitch of the carrier whistle. Detuning the receiver a small fraction of a degree, while it changes the pitch only slightly, will make the signal much weaker, since it has been detuned from the sharp selectivity peak.

It is evident, therefore, that the great selectivity available shows up as a peak in the audio response and when the receiver is in operation all signals, after being correctly tuned, will peak at the same audio frequency.

General Superheterodyne Theory and the Explanation of Single Signal Operation

(It is extremely important that these paragraphs be very carefully studied, if a full understanding is to be had of the detailed data on adjusting Single Signal receivers)

To those who are not entirely familiar with the operating principles of a superheterodyne, the following explanation may be of interest:

It is the function of the first detector and high frequency oscillator of a super to convert a high frequency signal to the frequency of the intermediate amplifier. If, for instance, a 7000-k.c. signal is being received, the high frequency oscillator, in the case of the HRO receivers, will be tuned to 7456 k.c. producing a beat with the signal equal to the difference between these two frequencies; that is, 456 k.c., the frequency of the I.F. amplifier. The 456-k.c. beat is amplified in the I.F. amplifier and is detected or de-modulated in the case of phone signals at the second detector. When receiving c.w. signals a beat note is obtained by the use of a separate beat oscillator coupled to the second detector and operating at, or close to, the intermediate frequency. If the beat oscillator is tuned exactly to 456 k.c. and if the signal mentioned above is tuned to give an I.F. beat of exactly 456 k.c., it is evident that

the receiver as a whole will be tuned to zero beat.

An audible beat note may be obtained by doing either one of two different things. The first is to change the tuning of the high frequency oscillator (by means of the tuning dial) slightly, so that it will produce a different I.F. beat with the signal. For example, suppose the dial is changed so that the high frequency oscillator oscillates at 7457 k.c.; the I.F. beat will now be 457 k.c., which will be amplified as before by the intermediate amplifier, but when reaching the second detector will produce a 1 k.c. (thousand cycle) audio beat with the beat oscillator, which is operating at 456 k.c. as before. Similarly, the tuning dial could be moved in the other direction, so that the high frequency oscillator is tuned to 7455 k.c., in which event the I.F. beat would be 455 k.c. and the audio beat note would be a thousand cycles but on the other side of the carrier.

The selectivity of the I.F. amplifier is such that a signal detuned from it by only one kilocycle (.2 of 1%) will still be amplified almost as much as a 456-k.c. signal, although there will, of course, be some loss in gain.

The other method of getting an audible beat note is to leave the signal tuned exactly, as in the original case, with the 456-k.c. I.F. signal but to detune the beat oscillator so that it operates at say 457 k.c. The I.F. amplifier is now exactly in tune with the I.F. signal and will amplify it at full efficiency. The beat note will be 1000 cycles, as before. This method, wherein the signal is tuned exactly and the beat obtained by detuning of the beat oscillator, is fundamentally that used in any single signal or semi-single signal receiver. It is evident that changing the tuning dial slightly will detune the I.F. signal from the I.F. amplifier so that it will not be amplified as much, causing a corresponding decrease in the strength of the audio beat note: thus, if tuning is changed in such a way as to raise the pitch of the beat note, the signal will be weaker. Similarly, if the tuning is changed to lower the pitch down toward the zero beat region, the signal will be weaker. If the tuning is still further changed, so that the audio note passes through the zero beat region, and "up the other side of the carrier," the signal will become weaker still. The falling off in signal strength, as the receiver tuning is changed, is due entirely to the selectivity of the I.F. amplifier. Suppose now that the I.F. amplifier has very high selectivity, as is the case when a crystal filter is employed in single signal reception; the crystal will pass only a very narrow band of frequencies, say from 455.9 k.c. to 456.1 k.c. It will be necessary, therefore, to tune the signal so that the I.F. beat is exactly 456 k.c., and in order to obtain an audible beat note, the beat oscillator **MUST** be detuned. If the beat oscillator is set as before at 457 k.c., the beat note will be 1000 cycles. Detuning, as in the above case, will make the signal practically inaudible, except at this one pitch, and "the other

side of the carrier," or audio image, will be almost entirely suppressed.

With the receiver tuned exactly so that the crystal will pass the I.F. beat, the beat oscillator may be adjusted to give any desired audible beat note. In the above case, the beat oscillator being set at 457 k.c. produced a 1000-cycle beat at which all signals would be peaked. If the beat oscillator were set at 458 k.c., all signals would be peaked at 2000 cycles.

If the receiver tuning is left alone, then, the beat oscillator may be adjusted to give any desired pitch without changing the signal strength. Any change in tuning which changes the pitch of the audio signal will greatly weaken the signal.

The main point to remember when considering single signal receivers is that they are simply ultra selective superheterodynes, which must be tuned exactly to the signal and that the beat oscillator must be detuned from the crystal frequency in order to obtain an audible beat note.

Preliminary Adjustments—The I.F.

From the above explanation, the reader will see that it is absolutely essential that the I.F. transformers be aligned to the crystal, since the two must work together. This alignment may be accomplished in a number of ways. If the I.F. transformers are far out of adjustment, it is necessary to connect an external crystal oscillator which uses the crystal from the receiver. This oscillator is put in operation and is coupled to the first detector of the receiver. In most cases no actual connection will be required since the field from the oscillator will be sufficiently strong to be picked up, even with the I.F. far out of adjustment. If coupling is required, a lead twisted around the grid cap of the detector tube and run near the oscillator tank coil, will be suitable. The beat oscillator is turned on and adjusted until the crystal signal is picked up. The pitch of the beat note is not important as long as it is well inside the audible range.

All the I.F. transformers are now adjusted for maximum signal. This adjustment need not be made with any great degree of precision, since the crystal will not oscillate at exactly the same frequency to which it will be resonant in the receiver. The phasing control should be set at "0".

The five I.F. adjustments are indicated on the layout diagram, Nos. 10 to 14 (inclusive).

The crystal filter output coupling condenser, adjustment No. 9, serves as a fixed I.F. gain control and, in general, **should not be touched.**

The crystal may now be removed from the oscillator and installed in the receiver. Throw the switch to connect the crystal for single signal reception. Set the selectivity control for maximum selectivity; that is, with the pointer rotated all the way to the right. Now, tune in a steady signal

from a local oscillator or monitor. Tuning very slowly across the carrier, there should be one point at which the signal will peak very sharply. The audio pitch of this peak will be nearly the same as the pitch of the beat used when the crystal oscillator was being picked up.

The Beat Oscillator

Once the peak has been found, it would be well for the operator to familiarize himself with the action of the beat oscillator control by changing its tuning in order to obtain an audio note which is most pleasing to copy, or which coincides with any peaks in the loudspeaker or headphones. It makes little difference to which side of the audio beat, the beat oscillator is tuned. After a satisfactory pitch has been found, tune the signal by means of the tuning dial so that the signal goes down through zero beat and up to approximately the same pitch on the other side. This response is, of course, much weaker than that of the peak and it may be necessary to turn up the volume control in order to obtain fair volume. The phasing, or balancing, condenser is now adjusted until the signal is WEAKEST.

The Selectivity Control

The action of the selectivity control may now be checked. With the receiver tuned exactly as it was when adjusting the phasing condenser, the selectivity control should be rotated and it will be found that the signal will be loudest at a certain setting. This setting is usually found with the pointer nearly vertical. The setting giving this maximum response is that at which the selectivity of the crystal filter is minimum. Since even at this minimum selectivity the crystal filter is much more selective than the straight super, the signal will be weaker than that obtainable when the crystal is cut out.

When a pure steady signal is carefully tuned to a single signal peak, the selectivity control should have practically no effect upon signal strength. If there is any form of modulation, however, the signal will be loudest when the selectivity control is set for minimum selectivity, since this adjustment allows a greater width of signal or modulation to be passed.

Final I.F. Adjustment

The final adjustment of the I.F. transformers may now be made. Set the control for maximum selectivity, carefully tune in a steady signal until it is exactly on the crystal peak, and adjust each of the I.F. transformer tuning condensers for maximum signal strength. In almost all cases where the I.F. amplifier has once been aligned to the crystal, this check is all that would

be required, and it is not necessary to put the crystal in an external oscillator. Even if the I.F. amplifier is considerably out of alignment, the crystal frequency may be found by employing a strong local signal from a monitor or frequency meter, slowly tuning across it while listening for a peak in the audio beat note. If the peak is found at a very high audio pitch it will be necessary to change the tuning of the beat oscillator so that the audio peak will be well inside the limits of audibility. It is probable that if the peak signal is found at all, the I.F. amplifier will not be far out of tune and the readjustments required will be small.

Where the I.F. transformers are tuned with air dielectric condensers, the adjustments when once made are permanent and need only be checked when new tubes are substituted, provided of course the receiver is not subjected to severe mechanical shocks or vibration. I.F. transformers tuned by compression type mica dielectric condensers, on the other hand, should be checked frequently, since the capacity of such condensers is changed by temperature and humidity fluctuations. These statements are equally applicable to the beat oscillator circuits.

Checking Crystal Action

The crystal response, or crystal activity, may be easily checked as follows: With the signal tuned in exactly as mentioned in the previous paragraph and the selectivity control set at maximum selectivity, disconnecting the filter (by turning the phasing knob to "0"), should weaken the signal slightly. There will, of course, be a great increase in tube hiss, background noise and interfering signal, but the actual strength of the desired signal should be weaker. It is possible, of course, to obtain a louder signal in the straight super connection by resetting the selectivity control and this is quite normal. The fact that a signal is weakened when using the crystal filter is relatively unimportant, inasmuch as the filter is only used when interference or static is present, and such interference will be made about 100 times weaker, thereby greatly improving the readability of the signal.

A crystal which is found to be a poor resonator should be carefully removed from the holder and both crystal and plates cleaned with alcohol, gasoline, carbona, ether, or some similar fluid. In reassembling the holder care must be taken to see that the crystal is free between the plates; that is, that there is a suitable air gap (usually two or three thousandths) between the plates and the crystal and that the crystal is free to move sideways in any direction. The fibre pieces may be removed if desired as they serve only to protect the crystal in shipment.



The improved model National Air Dielectric condenser-tuned I.F. transformer as used in the National FB7A, AGSX and HRO receivers

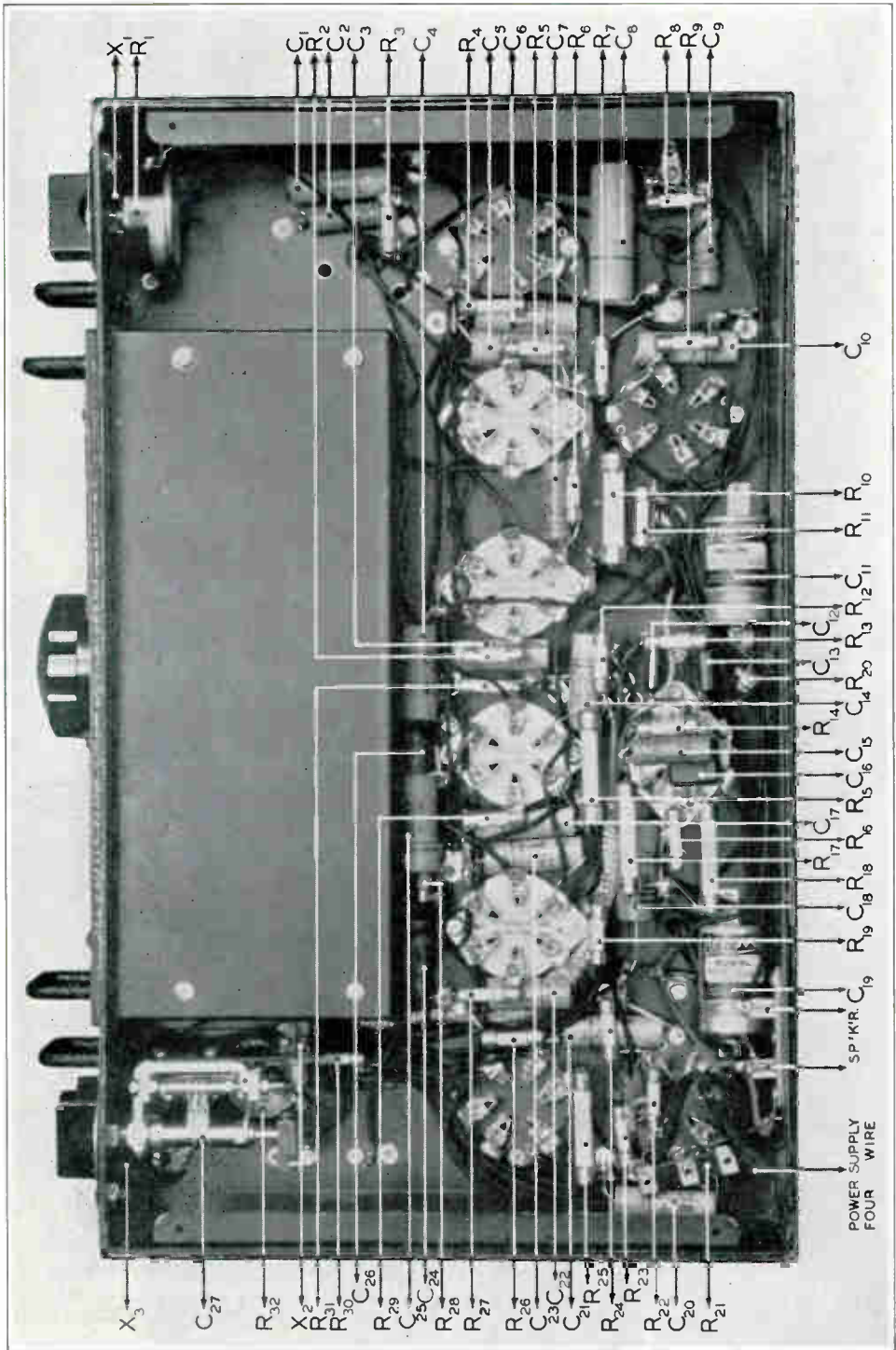

Resistor & Condenser List

| | | | |
|-----------------|--|-------------|----------|
| R ₁ | R.F. Gain Control | 10,000 ohms | Variable |
| R ₂ | 2nd Detector Bias Resistor | 5,000 " | 1/2 Watt |
| R ₃ | 1st I.F. Grid Filter Resistor | 500,000 " | 1/2 Watt |
| R ₄ | 1st I.F. Bias Resistor | 300 " | 1/2 Watt |
| R ₅ | H.F. Osc. Screen Resistor | 50,000 " | 1/2 Watt |
| R ₆ | 1st Det. Screen Resistor | 100,000 " | 1/2 Watt |
| R ₇ | H.F. Osc. Bleeder Resistor | 100,000 " | 1/2 Watt |
| R ₈ | 2nd I.F. Grid Filter Resistor | 500,000 " | 1/2 Watt |
| R ₉ | 2nd I.F. Bias Resistor | 300 " | 1/2 Watt |
| R ₁₀ | R.F. and I.F. Screen Resistor | 20,000 " | 2 Watt |
| R ₁₁ | S-Meter Bridge Resistor | 2,000 " | 1/2 Watt |
| R ₁₂ | 2B7 Pentode Grid Resistor | 500,000 " | 1/2 Watt |
| R ₁₃ | Diode Filter Resistor | 50,000 " | 1/2 Watt |
| R ₁₄ | Diode Equalizing Resistor | 250,000 " | 1/2 Watt |
| R ₁₅ | Screen Bleeder Resistor | 30,000 " | 1 Watt |
| R ₁₆ | Pentode Screen Bleeder Resistor | 20,000 " | 1/2 Watt |
| R ₁₇ | Pentode Screen Resistor | 100,000 " | 1 Watt |
| R ₁₈ | Pentode Plate Resistor | 100,000 " | 1 Watt |
| R ₁₉ | AVC Filter Resistor | 500,000 " | 1/2 Watt |
| R ₂₀ | 2B7 Bias Resistor | 800 " | 1/2 Watt |
| R ₂₁ | Heater — Center-Tapped Resistor | 60 " | |
| R ₂₂ | CW Osc. Screen Resistor | 250,000 " | 1/2 Watt |
| R ₂₃ | CW Osc. Plate Resistor | 100,000 " | 1/2 Watt |
| R ₂₄ | CW Osc. Screen Bleeder Resistor | 100,000 " | 1/2 Watt |
| R ₂₅ | Output Pentode Bias Resistor | 500 " | 1 Watt |
| R ₂₆ | Output Pentode Grid Resistor | 500,000 " | 1/2 Watt |
| R ₂₇ | 1st R.F. Bias Resistor | 300 " | 1/2 Watt |
| R ₂₈ | 1st R.F. Grid Filter Resistor | 500,000 " | 1/2 Watt |
| R ₂₉ | 2nd R.F. Bias Resistor | 300 " | 1/2 Watt |
| R ₃₀ | S-Meter Bridge Resistor | 2,000 " | 1/2 Watt |
| R ₃₁ | 2nd R.F. Grid Filter Resistor | 500,000 " | 1/2 Watt |
| R ₃₂ | S-Meter Balancing Resistor | 1,000 " | Variable |
| C ₁ | Heater By-pass Condenser | .1 mfd. | 200 Volt |
| C ₂ | 1st I.F. Grid Filter By-pass Condenser | .01 " | 400 Volt |
| C ₃ | 1st Det. Cathode By-pass Condenser | .1 " | 200 Volt |
| C ₄ | 2nd R.F. B+ By-pass Condenser | .1 " | 400 Volt |
| C ₅ | H.F. Osc. Screen By-pass Condenser | .1 " | 200 Volt |
| C ₆ | 1st I.F. Cathode By-pass Condenser | .1 " | 200 Volt |
| C ₇ | 1st Det. Screen Coupling Condenser | .1 " | 200 Volt |
| C ₈ | I.F. B+ By-pass Condenser | .25 " | 400 Volt |
| C ₉ | 2nd I.F. Grid Filter By-pass Condenser | .01 " | 400 Volt |
| C ₁₀ | 2nd I.F. Cathode By-pass Condenser | .1 " | 200 Volt |
| C ₁₁ | 2B7 Cathode By-pass Condenser | 10. " | 50 Volt |
| C ₁₂ | Diode Filter Condenser | .0001 " | Mica |
| C ₁₃ | Diode Filter Condenser | .00025 " | Mica |
| C ₁₄ | 2B7 Grid Coupling Condenser | .1 " | 200 Volt |
| C ₁₅ | Diode By-pass Condenser | .01 " | 400 Volt |
| C ₁₆ | 2B7 Plate By-pass Condenser | .0005 " | Mica |
| C ₁₇ | 2nd R.F. Cathode By-pass Condenser | .1 " | 200 Volt |
| C ₁₈ | Output Pentode Grid Condenser | .1 " | 400 Volt |
| C ₁₉ | Output Pentode Cathode By-pass Condenser | 10. " | 50 Volt |
| C ₂₀ | Heater By-pass Condenser | .1 " | 200 Volt |
| C ₂₁ | CW Osc. Screen By-pass Condenser | .1 " | 200 Volt |
| C ₂₂ | 1st R.F. Cathode By-pass Condenser | .1 " | 200 Volt |
| C ₂₃ | R.F. and I.F. Screen By-pass Condenser | .1 " | 200 Volt |
| C ₂₄ | 1st R.F. Grid Filter By-pass Condenser | .01 " | 400 Volt |
| C ₂₅ | 1st R.F. B+ By-pass Condenser | .1 " | 400 Volt |
| C ₂₆ | 2nd R.F. Grid Filter By-pass Condenser | .01 " | 400 Volt |
| C ₂₇ | CW Osc. Receiver Tuning Condenser | 30. mmf. | Variable |
| X ₁ | B+ (stand-by) Switch | | |
| X ₂ | CW Oscillator Switch | | |
| X ₃ | AVC On-Off Switch | | |

Modern Design of High-Frequency Stages for the Amateur Superhet

Matching, Tracking and Stabilizing Multi-Tuned Circuits

By James Millen, W1HRX;* and Dana Bacon, W1BZR**

This article is reprinted from the January 1935 issue of the magazine QST. We are indebted to the editors for permission to reprint herewith.

THE advantages of a multi-stage r.f. amplifier between the antenna and first detector of a superheterodyne receiver are well known to most amateurs. As repeatedly shown in *QST*, such an amplifier is essential to obtaining high effective sensitivity and a high signal-to-image ratio. Simple regenerative input circuits, while offering some aid, have definite limitations, as well as being difficult to tune and erratic in performance.

Offhand, it might be wondered that receivers employing one or two r.f. stages have not been more generally available to the amateur; but in the construction of such a receiver there have been many difficult design problems to overcome. It is unfortunate that the unquestioned advantages of a multi-stage r.f. amplifier between the antenna and first detector of a superheterodyne receiver cannot be realized in simple fashion.

Amateur-band superhets with pre-amplifiers have become standard, however; and since the receiver is of such primary importance in the amateur station, the design problems of this type of equipment are of no little interest. The principal problems relate to tracking of tuning, uniform gain, h.f. oscillator stability and adequately calibrated band-spreading.

Circuit Tracking and Uniform Gain

At the lower frequencies the circuit matching problem is relatively simple and requires only the usual precautions with regard to careful matching of coils and gang condenser sections. Above 10,000 kc., however, ordinary production methods cannot be used. Much greater precision is required. Not only are precisely adjustable trimmer condensers required in all circuits, but also some means must be employed for obtaining inductance trimming. For instance, it was found that the total length of wire in a 28-mc. tuned circuit (including condenser leads, etc.) must be held within one-quarter inch. One satisfactory method of inductance trimming is illustrated in Fig. 1A.

The last half-turn of wire is brought out in a loop, normally at right angles to the rest of the coil. Bending the loop one way or the other gives an inductance variation equivalent to adding or subtracting a half-turn from the coil. The lower frequency coils can conveniently employ a

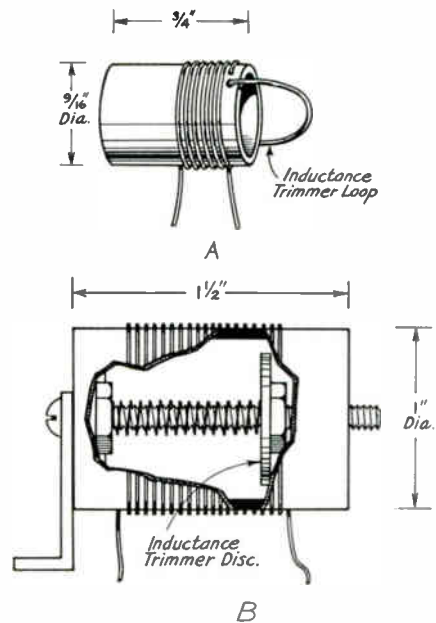

FIG. 1—INDUCTANCE TRIMMING METHODS
A—High-frequency coils.
B—Low-frequency coils.

different type of inductance trimmer, shown in Fig. 1B. As the disk is moved toward the center of the coil, the inductance is decreased.

Understanding of the electrical matching and tracking will be clarified by an explanation of the exact function of each of the somewhat imposing

*Middleton, Mass.

**41 Bellington St., Arlington, Mass.

array of condensers associated with each stage in the diagram of Fig. 3. To begin with, the ganged main tuning condensers C_1 (those at the lower right-hand side of each group) have a capacity range determined by the widest frequency span required, namely, 4000 to 1700 kc. All the other variable condensers shown are built into the plug-in coil assemblies and are, therefore, adjusted individually in one range only. The condensers C_3 connected directly across the tuning condensers are the main trimmers, the purpose of which is to bring the minimum capacity of all circuits to the correct value. As far as the general coverage ranges are concerned, these trimmers, together with the oscillator series tracking condenser C_4 (shown just above the stator of the oscillator tuning condenser) and coils of the proper inductance, are all required for exact ganging.

When changing to amateur band-spread, two additional condensers are necessary in each circuit. The "A" contacts, being open, connect con-

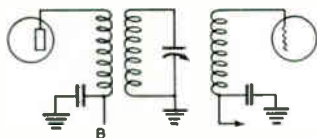
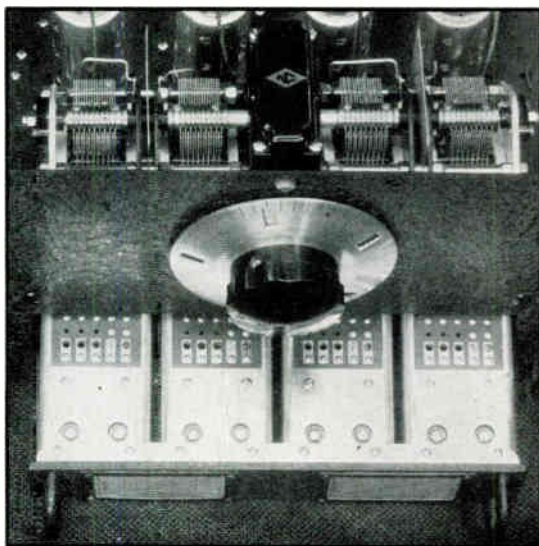

FIG. 2—TUNING ARRANGEMENT USED TO GIVE UNIFORM GAIN IN THE 14- TO 30-MC. RANGE

denser C_5 in series with each tuning condenser, thus lowering the maximum capacity effective and limiting the tuning range so that the desired band is spread over the major portion of the dial. These condensers, now being in series with both the tuning condensers and the main trimmers, also cause the minimum capacity across the coils to be lowered considerably. With the "B" contacts closed, however, another condenser C_2 is connected in parallel with each of the coils, bringing the minimum capacity to the value required for properly centering the band on the dial.

The problem of obtaining uniform gain over

ranges below 14 mc. is comparatively simple since it is only necessary to use high inductance primaries with the correct amount of capacity coupling. To those who are not familiar with this



ESSENTIAL ELEMENTS OF THE MULTI-TUNED INPUT CIRCUITS DISCUSSED IN THIS ARTICLE

The shielded coil assembly (shown in front of the panel) plugs in beneath the condenser gang, four such assemblies being used for full frequency coverage.

system of coupling, a brief explanation will be of interest. The primary winding has a large number of turns of fine wire, so that it will be broadly resonant just below the low-frequency end of the tuning range. The point of resonance is determined by the circuit and plate capacity of the r.f. tube in parallel with the coil. The signal transfer from the tube to the primary will, therefore, increase as the resonant point is approached; in other words, as the tuning condenser is varied from minimum to maximum capacity. On the other hand, the impedance of the tuned circuit will decrease as the capacity

is increased and at the low-frequency end will, therefore, require the additional signal which the primary is supplying.

It often happens, however, that the effect of the primary is predominant, resulting in higher gain at the low-frequency end. Additional compensation is obtained by a small amount of capacity coupling directly between the plate and the grid of the following tube. This coupling, being small, will have less effect at the low frequencies but will have a large effect at the high-frequency end, since the impedance of the coupling condenser decreases as the frequency is raised. This system of r.f. coupling is entirely satisfactory below 14 megacycles, but between 14 and 30 megacycles it is not effective. In this range the gain falls off rapidly and the resonance of the primary is inadequate in its levelling action.

The system finally devised to overcome this difficulty is illustrated in Fig. 2. The primary plate winding is coupled as closely as possible to the tuned circuit, being interwound with it, and having the same number of turns. The grid winding is also closely coupled to the tuned circuit and consists of a large number of turns of fine wire, the coil itself being resonant just outside the low frequency end of the range. This grid winding gives considerable voltage step-up and at the same time compensates for the varying impedance of

the tuned circuit in such a way that the gain is uniform. It should be pointed out, however, that the grid coil itself is resonant and not the coil plus the circuit and the tube capacity.

Frequency drift in the oscillator becomes an increasingly difficult problem to solve as the range of the receiver is extended toward 10 meters. While variations in the room temperature are

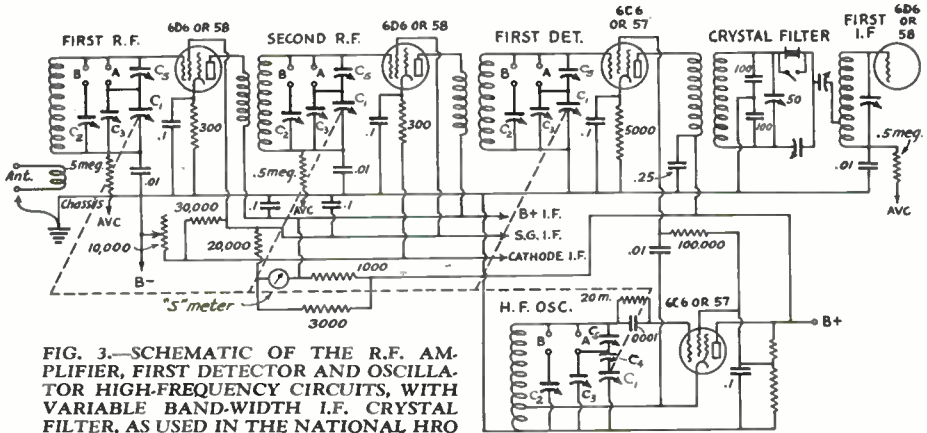

FIG. 3.—SCHEMATIC OF THE R.F. AMPLIFIER, FIRST DETECTOR AND OSCILLATOR HIGH-FREQUENCY CIRCUITS, WITH VARIABLE BAND-WIDTH I.F. CRYSTAL FILTER, AS USED IN THE NATIONAL HRO RECEIVER

The main tuning condensers C_1 are ganged. Other condensers of the high-frequency circuits are identified in the text. Resistance values indicated are ohms, capacitance values μfd . (fractions) and μfd . (This is a preliminary diagram and is superseded by the one on page 4.)

The H.F. Oscillator

The third problem encountered in the design of wide range Single-Signal receivers is the high-frequency oscillator. The requisite degree of stability can be obtained through the use of a screen-grid tetrode or pentode in the oscillator. When used in the conventional electron-coupled circuit, however, the tetrode has one particularly objectionable characteristic; namely, it delivers to the first detector not only the desired fundamental frequency but also strong harmonics, the 2nd, 3rd, and 4th often being responsible for the reception of phantom signals, whistles, and for the aggravation of general noise. These harmonics are much stronger (as compared to the fundamental) in the non-selective oscillator plate circuit than they are in the tuned grid-cathode circuit. Hence it is more desirable that the first detector should be coupled to some portion of the latter circuit, rather than to the plate circuit. The electron-coupling feature, necessary to isolate the oscillator tuned circuit from the detector tuned circuit, can be obtained in the detector tube.

The circuit diagram of Fig. 3 shows the screen grid of the first detector capacity-coupled to the cathode of the oscillator. Coupling in this manner has the advantages of electron-coupling, inasmuch as the first detector screen is not directly associated with the tuned signal circuits. In addition to eliminating trouble from harmonics, this system has another important advantage; by correct placement of the cathode tap, the oscillator input to the detector may be held constant over the entire range. Incidentally, this coupling condenser serves a double purpose in that it also acts as an i.f. by-pass condenser.

usually so gradual that drift resulting from this source is not objectionable, it is minimized through the use of padding and tuning condensers which are compensated against temperature change and through the use of material for coils which has a small temperature coefficient.

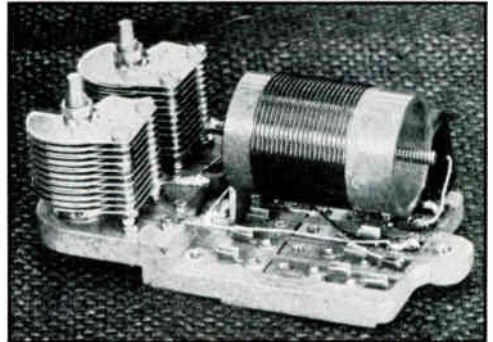

A MEDIUM-FREQUENCY R.F. COIL UNIT REMOVED FROM ITS SHIELD

The cause of the most objectionable frequency drift is the change of inductance of the coil as the interior of the receiver is heated by the tubes and power supply. The chief offender, the power supply, fortunately can be a separate unit; but the tubes must remain in the receiver. To minimize heating the coils are placed at the very bottom of the receiver, underneath the chassis, in a separate shielded compartment. The heat from the tubes will, of course, rise toward the top of the receiver and the coils will remain nearly at room

temperature. The coil shielding must be complete, of course, to prevent convection air currents from coming in contact with the coils, as well as for good magnetic and electro-static shielding.

The oscillator must be of the Hartley type if the full advantages of the tetrode type of oscillator are to be utilized.¹ The system described fulfills this requirement, in that all the tuning devices are connected across the whole coil. This is important. If, for instance, the tuning condenser is connected across only a portion of the coil, the circuit tends to become unstable and the frequency will change with variations in the line voltage. In receivers employing separate coil units for the general coverage and band-spread ranges, however, it is permissible to use extremely high "C" circuits to obtain stability.

Probably as the result of broadcast receiver practice, many short-wave receivers have been designed with the idea of covering the greatest possible range with the fewest coils, with the individual coil ranges determined entirely by the size of the tuning condenser. This is hardly satisfactory for amateur work since unfavorable L/C ratios and non-uniform band spread result, and the operator must refer to calibration charts in order to locate, even approximately, any amateur band. In the tuning system under consideration, the coil ranges are chosen so that each just covers two amateur bands, one at either extremity of the range. For instance, the highest frequency range starts just above 30 megacycles and extends to just below 14 megacycles; the next range starts just above 14.4 megacycles and extends to just below 7 megacycles; and so on. For general coverage it is thus possible to tune through any two adjacent bands without change of coils.

Furthermore, any coil unit may be used alternatively for either general coverage or calibrated amateur band spread. As indicated in the circuit diagram of Fig. 3, there are two pairs of contacts in each tuning circuit. When the "A" contacts are connected, the general coverage ranges will be as described above. When the "A" contacts are open and the "B" contacts closed, two circuit changes are made: a small condenser is connected in series with the main tuning condenser thus reducing its capacitance range; and an additional trimmer condenser is connected across the coil, thus increasing the minimum circuit capacitance. These condensers are of such size that, when in use, full band spread will be obtained on any amateur band. For instance, changing the contacts from "A" to "B" on the 30- to 14-megacycle coils will give full band spread on the 30- to 28-mc. amateur band. The 14-mc. band can still be received without change of connections by using the next lower frequency set of coils.

There are several advantages to this system,

¹ This circuit is derived from the Hartley arrangement described by J. J. Lamb in the article, "Stabilizing Superheterodyne Performance," *QST*, April, 1932.

the first and most obvious being a positive, unchanging and uniform calibration for each of the band-spread ranges. The condensers are, of course, adjusted so that each band has the same spread on the dials. There is still another advantage which is not readily apparent from an inspection of the diagram; namely, that it is possible to obtain straight-frequency-line tuning on both band-spread and general coverage ranges. It will be noted that one trimmer condenser is connected directly across the tuning condenser while the other is connected across the coil terminals with the "B" contacts in series. With the "A" contacts connected ("B" open) the first mentioned trimmer is directly across the coil and serves as a conventional padding condenser. The plates of the main tuning condenser are shaped so as to give straight-frequency-line tuning on the full coverage ranges. With the "A" contacts open and "B" closed, this trimmer is effective only in increasing the minimum capacity of the tuning condenser and by so doing gives practically straight-frequency-line tuning on the band-spread ranges also.

Mechanical Considerations

So far we have discussed principally the electrical considerations involved. The mechanics of the tuning arrangement, together with the condenser and coil construction, are fully as important.

A good tuning system should be convenient to operate and this requirement necessitates the use of a positive vernier drive in order that band-spread tuning may be obtained at any point in the frequency range. A little thought will show that band-spread tuning is always obtained through a combination of mechanical and electrical devices. While continuous band spread might seem possible mechanically with a condenser drive having a sufficiently large reduction, in practice a very large reduction is not easy to obtain without introducing backlash, or without sacrificing accuracy of calibration.

In the mechanical section of the tuning system under consideration the tuning condensers are driven through a worm gearing, spring-loaded to take up backlash and wear. The main dial is mounted directly on the worm shaft and is rotated ten times for 180° rotation of the condensers. The auxiliary dial numbers appear through windows in the main dial shell and are changed automatically every revolution of the dial by means of an epicyclic gearing so that the calibration is numbered consecutively from 0 to 500. Through this mechanism, it is thus possible to obtain a continuous dial reading of from 0 to 500, the actual useful length of the equivalent scale being twelve feet. The result is that signals are well spread out on the scale, even on the general coverage ranges, making tuning and logging both convenient and precise. With the coil connections shifted to give full spread on any amateur band the character of the system is

especially striking. The 14-mc. band, for instance, is given 400 dial divisions, which, since the band is 400-ke. wide, means that the tuning rate is 1000 *cycles* per dial division. This feature will be especially appreciated by anyone who is accustomed to tuning the Single-Signal type receiver with the crystal filter circuit adjusted for maximum selectivity.

Gain Control and Strength Meter

We come now to the matter of r.f. gain control. While no unusual difficulties are presented, the multi-stage r.f. amplifier offers the designer an opportunity to overcome problems which are bothersome in simpler receivers. In order to obtain the best signal-to-noise ratio the first tube should be operated at maximum gain. This is especially important for weak signal reception. When two tubes precede the first detector, the manual r.f. gain control may be connected only to the second r.f. tube (and to the i.f. tubes) with a decided gain in weak-signal performance. The a.g.c. circuits are, however, connected to both r.f. stages, so that strong signals will be held more closely to the same output level.

Such a combination of a.g.c. and manual con-

trol makes possible accurate "S-meter" measurement of the carrier strength of any received signal. Fig. 3 shows the "S-meter" network connected in the B-supply circuit to the r.f. and i.f. stages. Actually the meter is the indicator of a bridge circuit, three legs of which are fixed resistors, and the fourth (variable) leg the plate circuits of the a.g.c. controlled tubes. The bridge is balanced by means of the manual r.f. gain control, which, through its action of indirectly changing the plate resistance of the tubes, automatically adjusts the r.f. and i.f. gain to a predetermined level at the same time that the meter is brought to zero. The strength of the incoming signal is, therefore, accurately indicated by the action of the a.v.c. circuits in controlling high frequency gain.

If it should happen that the S-meter network gets out of balance, the alignment procedure is as follows. Disconnect the antenna and turn off the AVC, set the R.F. gain control at $9\frac{1}{2}$, then, by means of a screw driver, adjust the control No. 17 (as shown in the layout diagram) until the meter reads 0. This control is located in the chassis in back of the meter near the antenna binding post.

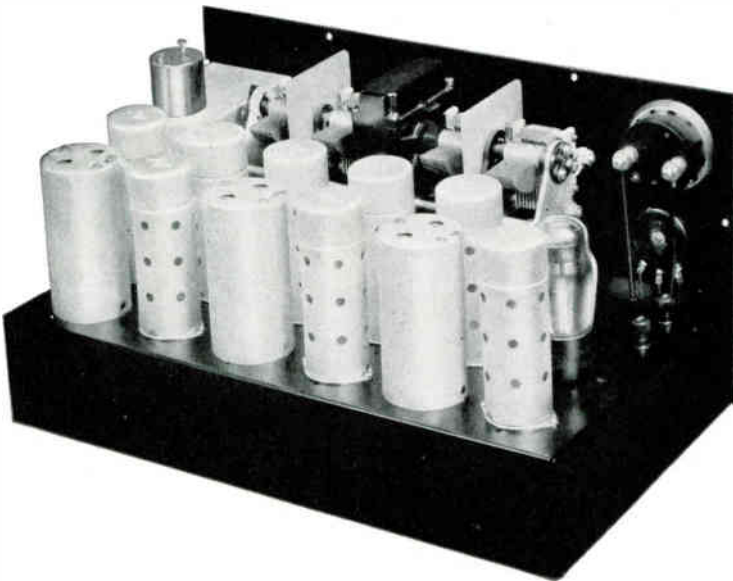

TYPE HRO RECEIVER

HRO Receiver, 2½ volt A.C. or 6 volt model, complete with coils and tubes as described, but without speaker, or power supply. *List Price, \$299.50*

HRO Receiver, 2½ volt A.C. or 6 volt model, same as above but supplied with leatherette finished panel for relay rack mounting. *List Price, \$320.00*

Tubes required for 2½ volt operation: Four 58, Three 57, One 2B7, One 2A5.

Power supply requires 1 Type 280.

Tubes required for 6 volt operation: Four 6D6, Three 6C6, One 6B7, One 42.

ACCESSORIES

A complete set of coils for the range from 1.7 M.C. to 30 M.C. is supplied as standard equipment with each receiver.

Two additional sets of coils covering the broadcast band (500–1000 K.C. and 900–2000 K.C. respectively) are available at extra cost.

List Price, each, \$20.00

Low frequency coils are also available for range 175–400 K.C.

List Price, each, \$27.50

RFSH Speaker and Panel, employs a dynamic speaker of the permanent magnet type, requiring no power supply. The speaker is mounted on a standard panel (8¾ x 19") and is provided with an impedance matching transformer and connecting cord.

List Price, \$30.00

MCS Speaker and Cabinet, employs a dynamic speaker of the permanent magnet type, requiring no power supply. The speaker is mounted in a table model metal cabinet with a crinkle finish to match receiver, and is provided with an impedance matching transformer and connecting cord.

List Price, \$23.50

RR Relay Rack, floor mounting, built to Government Specifications and drilled and tapped to receive standard panels of all sizes, is of steel, finished in black gloss Duco. 5¾ ft. high.

List Price, \$65.00

LRR, a knockdown, lightweight rack designed especially for amateur station use is now available. This rack can be "cut down" for bench mounting if desired.

List Price, \$22.50

POWER SUPPLIES

Power Supply Unit, Type 5897, for 2½ Volt HRO receiver, 115v. 60 cycle, less tubes.

List Price, \$26.50

The above power supply is for table or floor use and is of the standard compact National type. A power supply unit is also available in the Relay Rack mounting style as follows: Power Supply Unit, Type GRSPU, special 2½ volt HRO style.

List Price, \$49.50

The above prices are "list." A 40% discount applies when purchase is made through an authorized distributor.

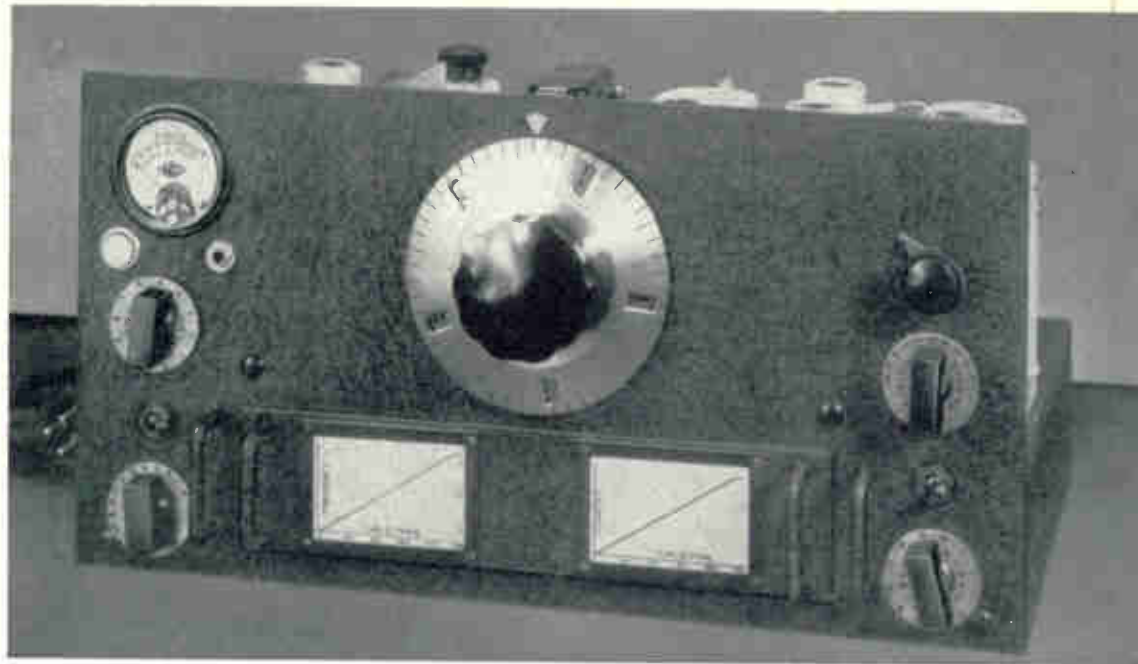

SINGLE SIGNAL

The completely shielded single signal unit has a front-panel selectivity control with sufficient range for phone reception, as well as a front panel phasing control for heterodyne elimination. The crystal is of a new type, virtually eliminating side peaks. The holder, also new, mounts the crystal vertically, permitting free oscillation. And when turned "off," the unit becomes a conventional I.F. coupling unit which contributes its full share to the remarkable overall selectivity of the HRO.



WORM DRIVE TUNING

The HRO employs the new PW precision condenser with worm-drive tuning. Smoother and more sensitive than a friction drive, it permits swift, accurate tuning and precise calibration. The micrometer dial has an effective scale length of twelve feet, direct-reading to one part in 500. The electrical characteristics are of the same high order, each of the four sections having low-loss Steatite stator insulation, insulated rotors and individual non-inductive rotor contacts.

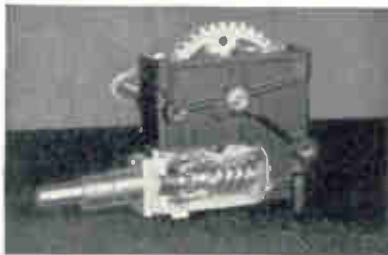

GANGED PLUG-IN COILS CALIBRATED BAND-SPREAD

The plug-in coils of the HRO are ganged for easy handling, and individually shielded for stability. Used as general coverage coils, each range includes two amateur bands and the spectrum between. By a simple switching device, the same coils are changed to band spread the respective amateur bands, spreading them over a uniform span of 400 divisions. All ranges are accurately calibrated at the factory.



HIGH PERFORMANCE CIRCUIT

The nine-tube circuit employed in the HRO is remarkable for level gain from 1.7 to 30 mc. Two stages of tuned R.F. amplification preceding the tuned detector provide the notable signal-to-image ratio of 1000 to 1 at 14 mc., as well as exceptional usable sensitivity. The HRO is designed for either double or single wire antenna. Other features include separate audio and R.F. gain control, AVC, Beat Frequency Oscillator, Signal Strength Meter, Phone Jack and B-voltage switch.



World Radio History

THE H R O

SINGLE SIGNAL SUPERHET

**NATIONAL COMPANY
MALDEN, MASS.**

Instruction Manual
for the

NATIONAL

NC-100
RECEIVER

Tuning Range:
30 Megacycles to 540 Kilocycles

By JAMES MILLEN
and DANA BACON

Price 10c



FOR many years we have used only "plug-in" inductors in National high frequency receivers, because only by so doing could we build into these receivers the outstanding performance for which they are so well known. We have, of course, realized that a switching arrangement would be more convenient to the operator. Inasmuch, however, as the use of any switching arrangement that we know of would have resulted in a definite decrease in performance, we have steadfastly continued to use plug-in inductors. In the NC-100 receiver, we have now reached a design of plug-in inductor that is in every way equal to the switch in convenience, and at the same time retains all of the superior electrical and mechanical advantages of the original plug-in inductors.

THE NATIONAL COMPANY



MALDEN, MASS., U. S. A.

Copyright 1937

THE NC-100 RECEIVER

General Description

THE NC-100 receiver is a twelve tube super-heterodyne covering all frequencies from 540 to 30,000 kc., in five ranges. The circuit employed on all ranges consists of one stage of R.F., separate first detector and high frequency oscillator, two I.F. stages, a bias type power detector and a transformer coupled push-pull pentode output stage. Maximum undistorted audio output is 10 watts. A separate tube is employed to provide amplified and delayed AVC action and a separate beat frequency oscillator is coupled to the second detector for c.w. reception. A built-in power supply provides all voltages required, including excitation for a dynamic speaker field having a resistance of 500 ohms.

Aside from the unusually high sensitivity and selectivity of this receiver, the outstanding feature is the unique system of automatic coil changing. The simplicity and efficiency of the arrangement combines all the desirable features of plug-in coils and coil switching. It is described in some detail later.

Tubes

The NC-100 is supplied complete with tubes which are tested in the receiver at the time of alignment.

The tubes employed are as follows:

| | |
|---------------------------|-----|
| R.F. Preselector | 6K7 |
| First Detector | 6J7 |
| High Frequency Oscillator | 6K7 |
| First I.F. | 6K7 |
| Second I.F. | 6K7 |
| Second Detector | 6C5 |
| AVC | 6J7 |
| Beat Frequency Oscillator | 6J7 |
| Push Pull Output (2) | 6F6 |
| Tuning Indicator | 6E5 |
| Rectifier | 80 |

Antenna

The input circuit of the NC-100 is arranged for operation with either the doublet type or the single-wire type of antenna. There are two input binding posts, marked "ANT" and "GND". When using a single-wire antenna, the lead-in should be connected to the antenna post and the short flexible lead, which is connected to the chassis near the ground post, should be clamped under the "GND" terminal. An external ground connection may or may not be necessary, depending upon the installation. The ground is usually desirable when receiving wavelengths above 100 meters, but for wavelengths below 50 meters, the

use of a ground may actually weaken signals. Doublet antenna feeders should be connected directly to the input terminals and the flexible ground connection, mentioned above, is not used at all. The input impedance of the receiver varies over the total frequency range but averages about 500 ohms.

Output Circuit

As shown in the schematic diagram, Page 14, the output leads of the receiver are brought to a 4-prong socket, which is mounted at the rear of the chassis. The speaker furnished with the receiver is supplied with a cable and plug, which is simply plugged into this socket.

A headphone jack is mounted on the front panel and is wired in such a manner that the speaker is quiet when the phones are in use. The impedance of the headphones should be approximately 20,000 ohms, this being the usual impedance of phones having a total DC resistance of between 2000 and 3000 ohms. The receiver cannot be operated unless the speaker plug is inserted in its socket, even though the speaker itself is not being used.

Speaker Mounting

The speaker is supplied either in chassis form, unmounted, or mounted in a small cabinet finished to match the receiver. To obtain best tone quality the speaker should be mounted on a large baffle isolated mechanically from the receiver. The baffle should be of non-resonant material, so that it will not vibrate. A baffle three or four feet square will generally prove satisfactory. More uniform bass response will be obtained by increasing the baffle size up to about 9 feet square.

Mounting the speaker and receiver in the same cabinet, or console, is not recommended, since vibration from the speaker is apt to be transferred to the tubes, producing microphonic noises.

Controls

The main tuning dial is located near the center of the front panel and operates the 3-gang tuning condenser. This dial is of the multi-revolution type operating through a spring-loaded gear train having a step-down ratio of 20 to 1. In tuning across any one coil range, the dial makes ten complete revolutions and since its diameter is four inches, the equivalent scale length is approximately twelve feet. There are fifty divisions about $\frac{1}{4}$ " apart around the circumference of the dial and the index numbers are changed auto-

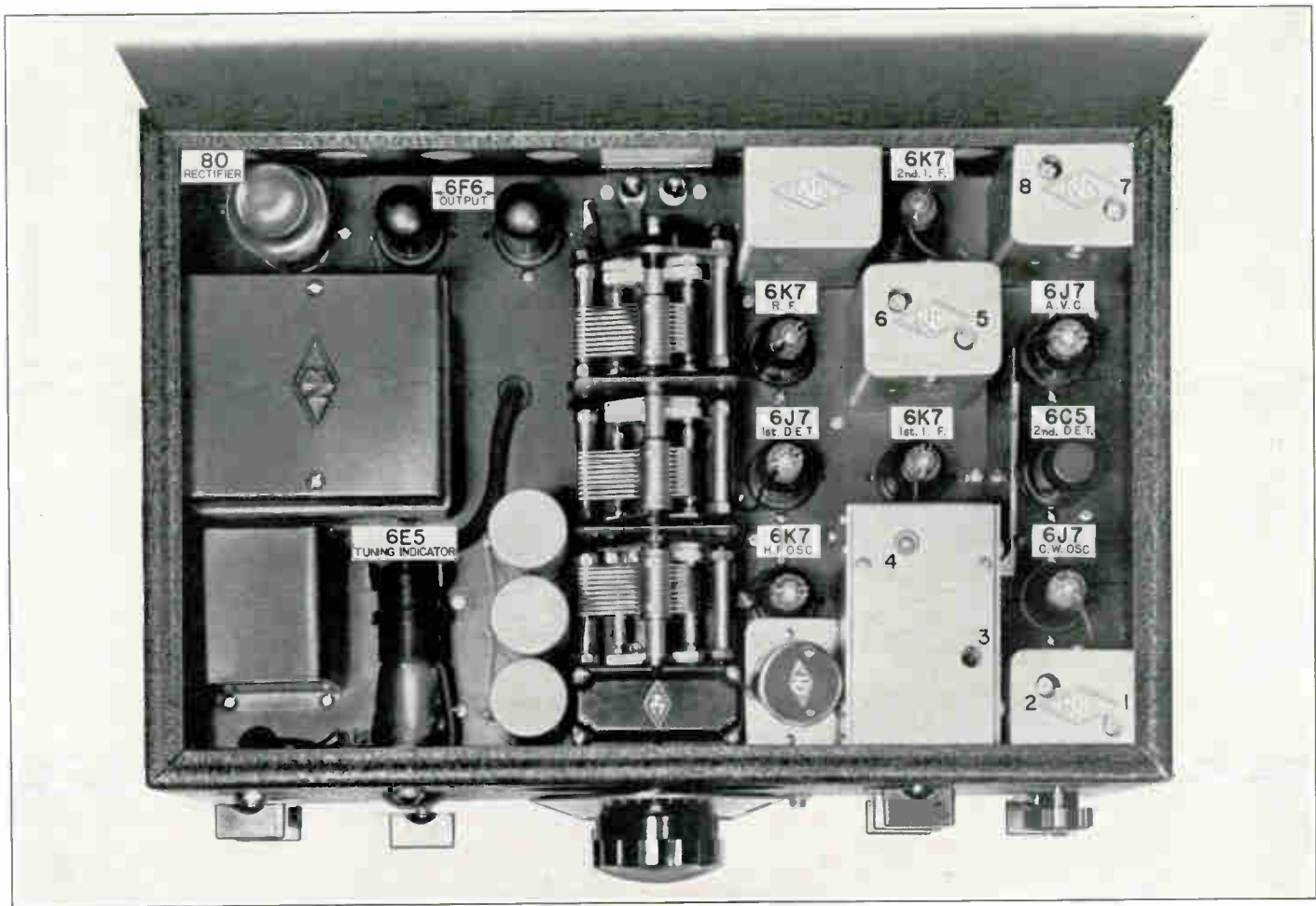

TOP VIEW OF NC- 100X RECEIVER

matically as the dial is rotated by means of an epicyclic gearing, so that the calibration is numbered consecutively from 0 to 500. The index numbers are actually changing continuously, the shift occurring at the bottom of the dial where it is not ordinarily visible.

Through this mechanism it is thus possible to obtain a continuous dial reading from 0 to 500, with the result that all signals are well spread out on the scale, making tuning and logging both convenient and precise.

The tuning system is so arranged that the dial reading increases with frequency, as shown by the calibration curves on Page 15.

Immediately below the dial is the range selector knob which actuates the coil changing mechanism. This knob must be rotated approximately one turn to change from one range to another. The arrangement is unique in that each individual coil is completely shielded from all others and that only the coils actually in use are in any way connected in the circuit. This automatic "plug-in coil" system is extremely efficient. Dead spots, often occurring when using unshielded coils in conjunction with a switch are, of course, completely absent and the particular coils in use are in the best position both mechanically and electrically. The relatively large movement of the coils, when changing from one range to another, makes possible the use of rugged contactors of such construction that trouble-free performance is assured.

The five coil ranges are marked on the front panel in a horizontal line directly over the range selector knob. Each of the range markings has a small "window" in back of which an indicator appears when that particular coil assembly is plugged into the circuit.

Starting at the lefthand side of the front panel the uppermost knob is a tone control for varying the frequency characteristic of the audio amplifier. When the control is rotated to the extreme counter-clockwise position, high frequency cut-off occurs at about 1500 cycles. In the mid-position (zero) the characteristic is flat from 50 to 10,000 cycles. At the extreme clockwise position, low frequency cut-off starts at 300 cycles, and the characteristic rises (about 6 db.) between 1000 and 5000 cycles. When receiving strong signals free from interference, best audio quality will be obtained with the tone control set at 0. When receiving fairly weak signals through considerable interference, it is often helpful to retard the tone control so that the noise will be reduced in relation to the signal.

Below the tone control is a combination switch. In the extreme counterclockwise position the receiver is turned off; in the mid-position all heater circuits and the rectifier are turned on but no B-voltage is applied; in the clockwise position the B+ is turned on to place the receiver in operating condition. In other words, the righthand

switch position is used for temporarily rendering the receiver inoperative as required during periods of transmission.

There are two insulated terminals mounted at the back of the receiver chassis, which are connected in parallel with the B+ switch. They are intended to serve as a convenient means for connecting a relay for automatically turning the receiver on and off.

To the right of this switch is the manual R.F. gain control. This control is ordinarily used only for receiving c.w. signals but may, of course, be used as a conventional volume control if the operator does not wish to use the AVC system. With the automatic volume control circuits in operation, as explained later, the R.F. gain control is limited in its action and is useful principally in adjusting the maximum sensitivity of the receiver. For instance, if local noise and static level is high, the R.F. gain control need only be advanced to the point where the disturbance is just plainly audible. Signals may then be tuned in with the AVC on but inter-channel noise will not be objectionably high. It will be found that after a signal is tuned in, further advancing the control has no effect on output, inasmuch as the AVC characteristic is practically flat.

To the right of the range selector knob is the audio gain control, the primary purpose of which is to control volume (on either head phones or speaker) when using AVC. When using the manual R.F. control, the audio gain should not be retarded too far. If, for instance, it is set below three or four on the scale, audio output will be limited to the point where I.F. overload may occur before maximum output is reached.

The knob at the lower righthand corner of the front panel is a combination switch having three positions. In the counterclockwise position the AVC circuits are in operation; in mid-position the AVC is turned off; in the clockwise position the c.w. oscillator is turned on, the AVC still being off.

Above this switch is the c.w. oscillator vernier tuning control which varies the frequency of the oscillator over about 10 kc. The exact function of this control is explained fully in the Operating Instructions.

Near the tuning dial is mounted a pilot light, or bullseye, and an electron ray tuning indicator. The pilot is lighted at all times when the AC switch is turned on, but the tuning indicator is lighted only when the B+ switch is on. The purpose of the tuning indicator is to provide a visual means of accurately tuning phone signals. The shaded portion of the tuning indicator normally covers a sector of about 90 degrees. When tuning in a signal, the shaded area will become smaller, correct tuning being indicated by the smallest angle. Certain individual electron ray tubes may be of such construction that the shaded area dis-

appears entirely when receiving a strong signal and the bright green edges of the pattern may actually overlap. In this case, tuning is correct when the overlap is the greatest. As a general rule, the R.F. gain control should be retarded to a point where the edges of the pattern are still separated, the angle being about 15 degrees. Turning on the c.w. oscillator will make the tuning indicator inoperative, the pattern being the same as that resulting from an extremely strong signal.

On models of the NC-100 having the crystal filter (NC-100X) two additional controls are provided, and these are mounted at the righthand side of the tuning dial. The uppermost knob is the selectivity control of the crystal filter. With the filter in use, minimum selectivity will be found with the pointer nearly vertical. Rotating the knob in either direction from this position will increase selectivity. When the filter is not in use, the knob should be set at the point giving maximum volume and sensitivity.

Immediately below the selectivity control is the phasing control and crystal filter switch. Turning this control to zero disconnects the filter; at any other setting between 1 and 10, it acts as a phasing condenser for balancing the crystal bridge circuit, eliminating heterodynes, etc. The action of these two controls is explained in detail in the following section.

Operating Instructions

Phone or Broadcast Reception

In receiving phone signals, the AVC may or may not be used, as desired. If it is not used, we suggest operating the audio gain control about halfway on and controlling the sensitivity with the R.F. gain control. If the operator prefers a "quiet" receiver, the audio control may be operated at 1 or 2. If AVC is used, the R.F. gain control should be well advanced and output is adjusted by the audio gain control only. The setting of the two gain controls is largely a matter to be determined by the preference of the operator and by receiving conditions. If, for instance, local noise or atmospheric static is high, it will be desirable to retard the R.F. gain control so that the sensitivity of the receiver will be held to a definite maximum. The c.w. oscillator may be used for locating carriers, in which case it is advisable to retard the audio gain control in order to avoid excessive volume when switching over to AVC. When tuning over any band, or when hunting for signals, the background noise between stations when using AVC may be objectionable. In this case, again, the audio control should be retarded and may even be turned to the off position, signals being shown by the tuning indicator.

C.W. Reception

When receiving c.w. signals, the c.w. oscillator must be turned on. Best signal-to-noise ratio will

usually be obtained by retarding the audio gain and tone controls considerably and adjusting sensitivity with the R.F. gain control. Turning on the c.w. oscillator switch will, of course, result in a considerable increase in circuit noise, due to the increased sensitivity. As the oscillator vernier tuning control is turned back and forth, the characteristic pitch of this noise will change. When the characteristic pitch is fairly high, the "semi-single signal" properties of the receiver are very pronounced, one side of the audio beat note being several times louder than the other.

Phone Reception Using the Crystal Filter

The use of the crystal filter in phone reception is recommended particularly when the operator must contend with heavy interference, static, heterodynes, etc. Since such conditions prevail at most times in the amateur phone bands, the filter will be found particularly useful to amateur phone operators. To receive a phone signal when using the crystal filter, the filter is switched in by means of the phasing control and the phasing dial set at approximately mid-scale. The selectivity control is then adjusted for minimum selectivity, as indicated by maximum noise as the control is rotated back and forth. All phone signals will be greatly reduced in volume, making it necessary to advance both audio and R.F. gain controls. On the majority of signals, the maximum audio output of 10 watts will not be available when using AVC with the filter, since the carrier level is held constant at the second detector and side band power is reduced by the filter. The signals may then be tuned in the usual manner, but it will be found that the selectivity is very high, with the result that all audio frequency side bands above a few hundred cycles are comparatively weak. Normally, this would result in low intelligibility of the received signal, but since the background noise, static, etc., have been correspondingly reduced, the net result is usually an improvement. The tone control should always be fully advanced.

The principal advantage of the crystal filter, however, is its ability to eliminate heterodynes. Suppose, for instance, a signal has been carefully tuned in with reasonably good intelligibility and during the transmission an interfering station comes on, causing a bad heterodyne, inverted speech, etc. Ordinarily the desired signal would be "smeared," but careful adjustment of the phasing condenser will eliminate the heterodyne and the interfering station, in most cases, completely. Intelligibility will remain practically as good as before the interfering station came on.

From a practical standpoint, it is important that the crystal filter be used most of the time where such interference is apt to be encountered, as it is almost impossible to switch on the crystal filter and re-tune the desired signal through the heterodyne. The phasing adjustment will remove one signal only. If another interfering station

comes on, however, only one heterodyne will be present, instead of the several resulting from three station carriers beating together.

C.W. Reception with the Crystal Filter

To use the crystal filter for c.w. reception, the filter is switched in by means of the phasing control and the phasing condenser set about mid-scale. The c.w. oscillator must be turned on. Advancing the R.F. and audio gain controls will result in a hollow, ringing sound, the pitch of which will depend upon the setting of the c.w. oscillator control. The actual pitch is not important as long as it is near the middle of the audio range, where the loudspeaker or phones have good sensitivity.

When a signal is picked up, it will be found that as the receiver is tuned *slowly* across the carrier the beat note will be very sharply peaked at the same pitch as that of the ringing noise, previously mentioned. All other parts of the beat note will be extremely weak and, furthermore, this peak will be found to occur on only one side of the audio beat note. The sharpness of the peak is determined by the selectivity control. At maximum selectivity, the peak is so sharp that it may be hard to find, whereas at minimum selectivity the peak will be very broad. If a signal is being received, after having been properly tuned in, and an interfering station comes on, the resulting heterodyne and interference may be eliminated by adjustment of the phasing condenser. This phasing adjustment is effective in eliminating interference regardless of the setting of the selectivity control.

Measurement of Signal Strength

The combination of the R.F. gain control and tuning indicator make possible the accurate measurement of signal strength. With AVC either on or off, the R.F. gain control is advanced to the point where the electron ray tuning indicator just begins to show some change in pattern. The accompanying calibration curve shows the relation between signal input and this setting of the R.F. gain control.

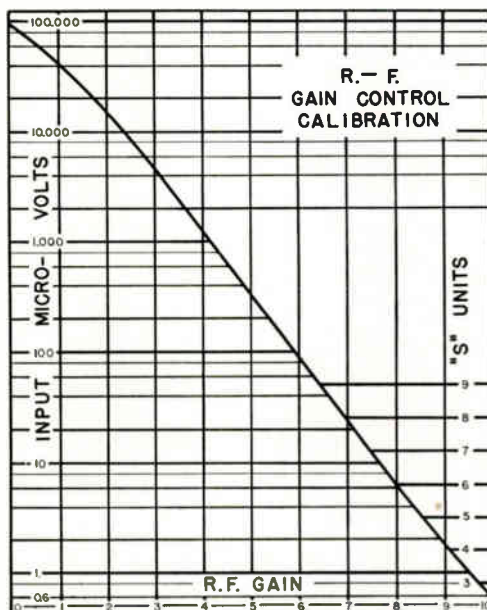

The size of the shaded area will vary with the modulation of the signal when the AVC is off. This variation does not indicate over-modulation, or carrier shift, but is the normal result to be expected when using an amplified-delayed system of AVC.

For the amateur station operator who prefers to give reports in R or S units, rather than microvolts input, we suggest the use of the righthand scale of the chart. Adjacent points are 6 db. apart, this spacing giving a total range, between the weakest signal and an S-9 signal, of 48 db. Most operators seem to agree that the S-steps should be separated by a 4 to 1 power ratio (6 db.), and since the characteristics of the receiver determine the level of the weakest signals which may be received intelligibly, an "extremely strong" signal (S-9) is, on the NC-100, defined as one resulting in an input of 51 microvolts.

Alignment and Service Data

Tubes

Individual tubes of the same type will vary slightly in their characteristics and it is well to remember this fact when replacements become necessary. Even though the circuit is designed to reduce the effect of such variations to a minimum, the high frequency oscillator and I.F. tubes should be selected with some care. A replacement high frequency oscillator should be checked in the receiver to make sure that the inter-electrode capacities are the same as those of the tube originally employed. This is easily determined by noting any change in calibration at the high frequency end of any coil range. The change should not exceed two or three dial divisions. Compensation for small variations in tube capacity may be made by changing the position of the oscillator grid lead with relation to the body of the tube.

Substitution of new tubes in the I.F. amplifier may possibly alter overall gain and selectivity characteristics. Instructions for realignment are given in detail in the following pages.

Two other points should be checked when trying the new high frequency oscillator; a fairly strong steady signal should be tuned in, preferably on some frequency above 10 mc.; the c.w. oscillator should be turned off; jarring the receiver or lightly tapping the tube, should not show any evidence of noise in the output. Next turn on the c.w. oscillator to make sure that the tube does not introduce "modulation hum" on the carrier. The tube should again be lightly tapped to see whether or not its characteristics change.

R.F. and H.F. Oscillator Alignment

All circuits are carefully and accurately aligned before shipment, using precision crystal oscillators which insure close conformation to the calibration curves. No readjustments will be required, therefore, unless the receiver is subjected to extremely rough handling. Do not attempt to make any adjustments without first determining the exact function of each trimmer condenser and the effect that it will have upon performance.

The coil group which is plugged into the circuit at any time is the one directly underneath the 3-gang tuning condenser at the center of the chassis. The coil nearest the front of the receiver is the high frequency oscillator, the middle coil is the first detector, and the coil nearest the antenna-ground binding post strip is the R.F.

As shown in the photographs, there are two holes in each coil compartment; of each pair, the one nearest the front of the receiver is directly over the trimmer condenser.

Complete alignment of any one coil range is

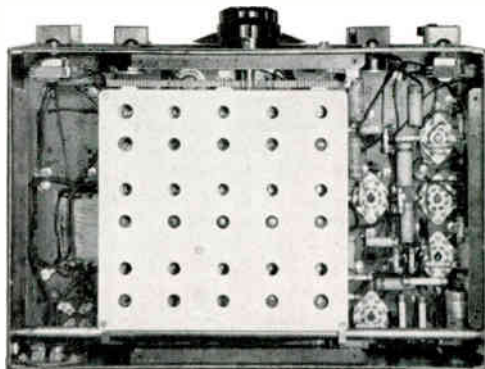

BOTTOM VIEW

The coil assembly is shown mid-way between the 1.3-2.8 mc. and 2.7-5.4 mc. ranges.

made as follows: Set the tuning dial near the high frequency end of the range between 470 and 490, check the dial reading against the calibration curve by means of an accurate test oscillator or a signal of known frequency; readjustment should be made if the dial reading is in error by more than five or six divisions. In checking the error, disregard the numbers between 495 and 500.

Correction for calibration is made by adjustment of the high frequency oscillator trimmer (nearest the front of the receiver). A screw driver with a metal shaft may be used, but the shaft should not touch the aluminum casting while the trimmer is being turned. If the dial reading is found to be too low, more trimmer capacity is needed and vice versa. In adjusting the R.F. and first detector trimmers, no signal is necessary, correct alignment being indicated by maximum background noise. This background noise should be fairly loud when the R.F. and audio gain controls are fully advanced, the crystal filter being switched off. Furthermore, the background noise will be approximately the same on all ranges. The first detector trimmer will have much greater effect upon the amplitude of this noise than the R.F. trimmer, but actually the setting of each is equally important.

With calibration correct at the high frequency end of the range, the dial should be rotated toward the lower numbers. The background noise may vary slightly over the range but should not get appreciably weaker except in the case of the .54 to 1.3 mc. coils. Ganging is checked by pressing one of the outside rotor plates of the oscillator condenser sideways toward the stator, but not enough to make the plates touch. The same check may be applied to the first detector and R.F. tuning condensers. Any bending of the rotor plates should make the background noise defi-

nately weaker. A similar check can, of course, be made by bending the rotor plates out, away from the stator, care being taken not to bend the plates so far that they will not return to their original position.

On the two highest frequency ranges, it may be possible to make the initial oscillator adjustment incorrectly. There are two settings of the oscillator trimmer condenser which will tune in the desired signal at the proper point on the dial; of these, the higher frequency setting (least trimmer capacity) is correct. In checking the ganging of the 13.5 to 30. mc. range, the R.F. condenser has little effect upon the background noise at the low frequency end of the scale and at this one point it is better to use a test signal. Should any error in tracking be found on one range, it is probable that the same error will be present on all ranges and correction may be made by permanently bending the rotor plates of the tuning condenser section in question.

I.F. and Crystal Alignment Instructions

Before attempting to check the alignment or adjust a single signal receiver it is essential that the operator be familiar with the principles involved and the type of performance to be expected.

A receiver of this type is simply a superheterodyne which may be adjusted to have extremely high selectivity on all signals. The effective width of the selectivity curve is only a few cycles, usually between 20 and 100. This means that when tuning in a given c.w. signal, tuning is going

to be very sharp and the dial must be turned slowly in order to avoid missing the signal entirely. As compared to the straight superheterodyne, the single signal receiver is about 100 times as selective. The straight super will pick up a signal and will reproduce both sides of the audio beat note at about the same strength; that is, the carrier whistle may be varied from either side of zero beat up to about 3000 cycles when the receiver is tuned and the whistle will remain about the same strength at any pitch. The s.s. receiver, however, being 100 times as sharp, will not perform in this manner, but as the receiver is tuned across the carrier the audio response will be very sharply peaked at one certain pitch of the carrier whistle. Detuning the receiver a small fraction of a degree, while it changes the pitch only slightly, will make the signal much weaker, since it has been detuned from the sharp selectivity peak.

It is evident, therefore, that the great selectivity available shows up as a peak in the audio response and when the receiver is in operation all signals, after being correctly tuned, will peak at the same audio frequency.

General Superheterodyne Theory and the Explanation of Single Signal Operation

(It is extremely important that these paragraphs be very carefully studied, if a full understanding is to be had of the detailed data on adjusting Single Signal receivers.)

To those who are not entirely familiar with the operating principles of a superheterodyne, the following explanation may be of interest:

It is the function of the first detector and high frequency oscillator of a super to convert a high frequency signal to the frequency of the intermediate amplifier. If, for instance, a 7000 kc. signal is being received, the high frequency oscillator, in the case of the NC-100 receivers, will be tuned to 7456 kc., producing a beat with the signal equal to the difference between these two frequencies; that is, 456 kc., the frequency of the I.F. amplifier. The 456 kc. beat is amplified in the I.F. amplifier and is detected or de-modulated in the case of phone signals at the second detector. When receiving c.w. signals a beat note is obtained by the use of a separate beat oscillator coupled to the second detector and operating at, or close to, the intermediate frequency. If the beat oscillator is tuned exactly to 456 kc. and if the signal mentioned above is tuned to give an I.F. beat of exactly 456 kc., it is evident that the receiver as a whole will be tuned to zero beat.

An audible beat note may be obtained by doing either one of two different things. The first is to change the tuning of the high frequency oscillator (by means of the tuning dial) slightly, so that it will produce a different I.F. beat with the signal. For example, suppose the dial is changed so that the high frequency oscillator oscillates at 7457

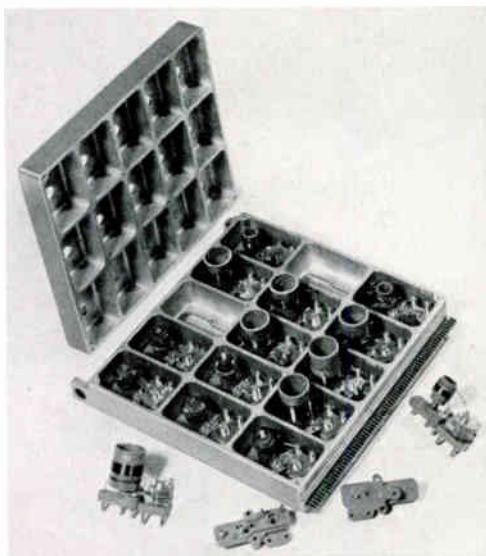

THE COMPLETE COIL ASSEMBLY

Permanence of circuit characteristics is assured by the rigid cast aluminum shield and by air dielectric trimmer condensers with R-39 insulation.

kc.; the I.F. beat will now be 457 kc., which will be amplified as before by the intermediate amplifier, but when reaching the second detector will produce a 1 kc. (thousand cycle) audio beat with the beat oscillator, which is operating at 456 kc., as before. Similarly, the tuning dial could be moved in the other direction, so that the high frequency oscillator is tuned to 7455 kc., in which event the I.F. beat would be 455 kc. and the audio beat note would be a thousand cycles but on the other side of the carrier.

The selectivity of the I.F. amplifier is such that a signal detuned from it by only one kilocycle (.2 of 1%) will still be amplified almost as much as a 456 kc. signal, although there will, of course, be some loss in gain.

The other method of getting an audible beat note is to leave the signal tuned exactly, as in the original case, with the 456 kc. I.F. signal but to detune the beat oscillator so that it operates at say 457 kc. The I.F. amplifier is now exactly in tune with the I.F. signal and will amplify it at full efficiency. The beat note will be 1000 cycles, as before. This method, wherein the signal is tuned exactly and the beat obtained by detuning of the beat oscillator, is fundamentally that used in any single signal or semi-single signal receiver. It is evident that changing the tuning dial slightly will detune the I.F. signal from the I.F. amplifier so that it will not be amplified as much, causing a corresponding decrease in the strength of the audio beat note: thus, if tuning is changed in such a way as to raise the pitch of the beat note, the signal will be weaker. Similarly, if the tuning is changed to lower the pitch down toward the zero beat region, the signal will be weaker. If the tuning is still further changed, so that the audio note passes through the zero beat region, and "up the other side of the carrier," the signal will become weaker still. The falling off in signal strength, as the receiver tuning is changed, is due entirely to the selectivity of the I.F. amplifier. Suppose now that the I.F. amplifier has very high selectivity, as is the case when a crystal filter is employed in single signal reception; the crystal will pass only a very narrow band of frequencies, say from 455.9 kc. to 456.1 kc. It will be necessary, therefore, to tune the signal so that the I.F. beat is exactly 456 kc., and in order to obtain an audible beat note, the beat oscillator MUST be detuned. If the beat oscillator is set as before at 457 kc., the beat note will be 1000 cycles. Detuning, as in the above case, will make the signal practically inaudible, except at this one pitch and "the other side of the carrier" or audio image, will be almost entirely suppressed.

With the receiver tuned exactly so that the crystal will pass the I.F. beat, the beat oscillator may be adjusted to give any desired audible beat note. In the above case, the beat oscillator being set at 457 kc. produced a 1000 cycle beat at which all signals would be peaked. If the beat

oscillator were set at 458 kc., all signals would be peaked at 2000 cycles.

If the receiver tuning is left alone, then the beat oscillator may be adjusted to give any desired pitch without changing the signal strength.

The main point to remember when considering single signal receivers is that they are simply ultra selective superheterodynes, which must be tuned exactly to the signal and that the beat oscillator must be detuned from the crystal frequency in order to obtain an audible beat note.

Preliminary Adjustments — The I.F.

From the above explanation, the reader will see that it is absolutely essential that the I.F. transformers be aligned to the crystal, since the two must work together. This alignment may be accomplished in a number of ways. If the I.F. transformers are far out of adjustment, it is necessary to connect an external crystal oscillator which uses the crystal from the receiver. This oscillator is put in operation and is coupled to the first detector of the receiver. In most cases no actual connection will be required since the field from the oscillator will be sufficiently strong to be picked up, even with the I.F. far out of adjustment. If coupling is required, a lead twisted around the grid cap of the detector tube and run near the oscillator tank coil, will be suitable. The beat oscillator is turned on and adjusted until the crystal signal is picked up. The pitch of the beat note is not important as long as it is well inside the audible range.

All the I.F. transformers are now adjusted for maximum signal. This adjustment need not be made with any great degree of precision, since the crystal will not oscillate at exactly the same frequency to which it will be resonant in the receiver. The Phasing control should be set at "0".

The I.F. adjustments are indicated on the layout diagram, page 4, Nos. 4 to 8 (inclusive).

The crystal filter output coupling condenser, adjustment No. 3, serves as a fixed I.F. gain control and, in general, **should not** be touched.

The crystal may now be removed from the oscillator and installed in the receiver. Throw the switch to connect the crystal for single signal reception. Set the selectivity control for maximum selectivity; that is, with the pointer rotated all the way to the right. Now, tune in a steady signal from a local oscillator or monitor. Tuning very slowly across the carrier, there should be one point at which the signal will peak very sharply. The audio pitch of this peak will be nearly the same as the pitch of the beat used when the crystal oscillator was being picked up.

The Beat Oscillator

Once the peak has been found, it would be well for the operator to familiarize himself with the

action of the beat oscillator control by changing its tuning in order to obtain an audio note which is most pleasing to copy, or which coincides with any peaks in the loudspeaker or headphones. It makes little difference to which side of the audio beat the beat oscillator is tuned. After a satisfactory pitch has been found, tune the signal by means of the tuning dial so that the signal goes down through zero beat and up to approximately the same pitch on the other side. This response is, of course, much weaker than that of the peak and it may be necessary to turn up the volume control in order to obtain fair volume. The phasing, or balancing, condenser is now adjusted until the signal is WEAKEST. Normally, this setting is near mid-scale.

The Selectivity Control

The action of the selectivity control may now be checked. With the receiver tuned exactly as it was before adjusting the phasing condenser, the selectivity control should be rotated and it will be found that the signal will be loudest at a certain setting. This setting is usually found with the pointer nearly vertical. The setting giving this maximum response is that at which the selectivity of the crystal filter is minimum. Since even at this minimum selectivity the crystal filter is much more selective than the straight super, the signal will be weaker than that obtainable when the crystal is cut out.

When a pure steady signal is carefully tuned to a single signal peak, the selectivity control should have practically no effect upon signal strength. If there is any form of modulation, however, the signal will be loudest when the selectivity control is set for minimum selectivity, since this adjustment allows a greater width of signal or modulation to be passed.

Final I.F. Adjustment

The final adjustment of the I.F. transformers may now be made. Set the control for maximum selectivity, carefully tune in a steady signal until it is exactly on the crystal peak, and adjust each of the I.F. transformer tuning condensers for maximum signal strength. (*In almost all cases where the I.F. amplifier has once been aligned to the crystal, this check is all that would be required, and it is not necessary to put the crystal in an external oscillator.*) Even if the I.F. amplifier is considerably out of alignment, the crystal frequency may be found by employing a strong local signal from a monitor or frequency meter, slowly tuning across it while listening for a peak in the audio beat note. If the peak is found at a very high audio pitch it will be necessary to

change the tuning of the beat oscillator so that the audio peak will be well inside the limits of audibility. It is probable that if the peak signal is found at all, the I.F. amplifier will not be far out of tune and the readjustments required will be small.

Since the I.F. transformers are tuned with air dielectric condensers, the adjustments when once made are permanent and need only be checked when new tubes are substituted, provided of course the receiver is not subjected to severe mechanical shocks or vibration.

Checking Crystal Action

The crystal response, or crystal activity, may be easily checked as follows: With the signal tuned in exactly as mentioned in the previous paragraph and the selectivity control set at maximum selectivity, disconnecting the filter (by turning the phasing knob to "0"), should weaken the signal slightly. There will, of course, be a great increase in tube hiss, background noise, and interfering signal, but the actual strength of the desired signal should be weaker. It is possible, of course, to obtain a louder signal in the straight super connection by resetting the selectivity control and this is quite normal. The fact that a signal is weakened when using the crystal filter is relatively unimportant, inasmuch as the filter is only used when interference or static is present, and such interference will be made about 100 times weaker, thereby greatly improving the readability of the signal.



THE CRYSTAL HOLDER

A crystal which is found to be a poor resonator should be carefully removed from the holder and both crystal and plates cleaned with alcohol, gasoline, carbona, ether, or some similar fluid. In reassembling the holder care must be taken to see that the crystal is free between the plates; that is, that there is a suitable air gap (usually two or three thousandths) between the plates and the crystal and that the crystal is free to move sideways in any direction. The fibre pieces may be removed if desired as they serve only to protect the crystal in shipment.

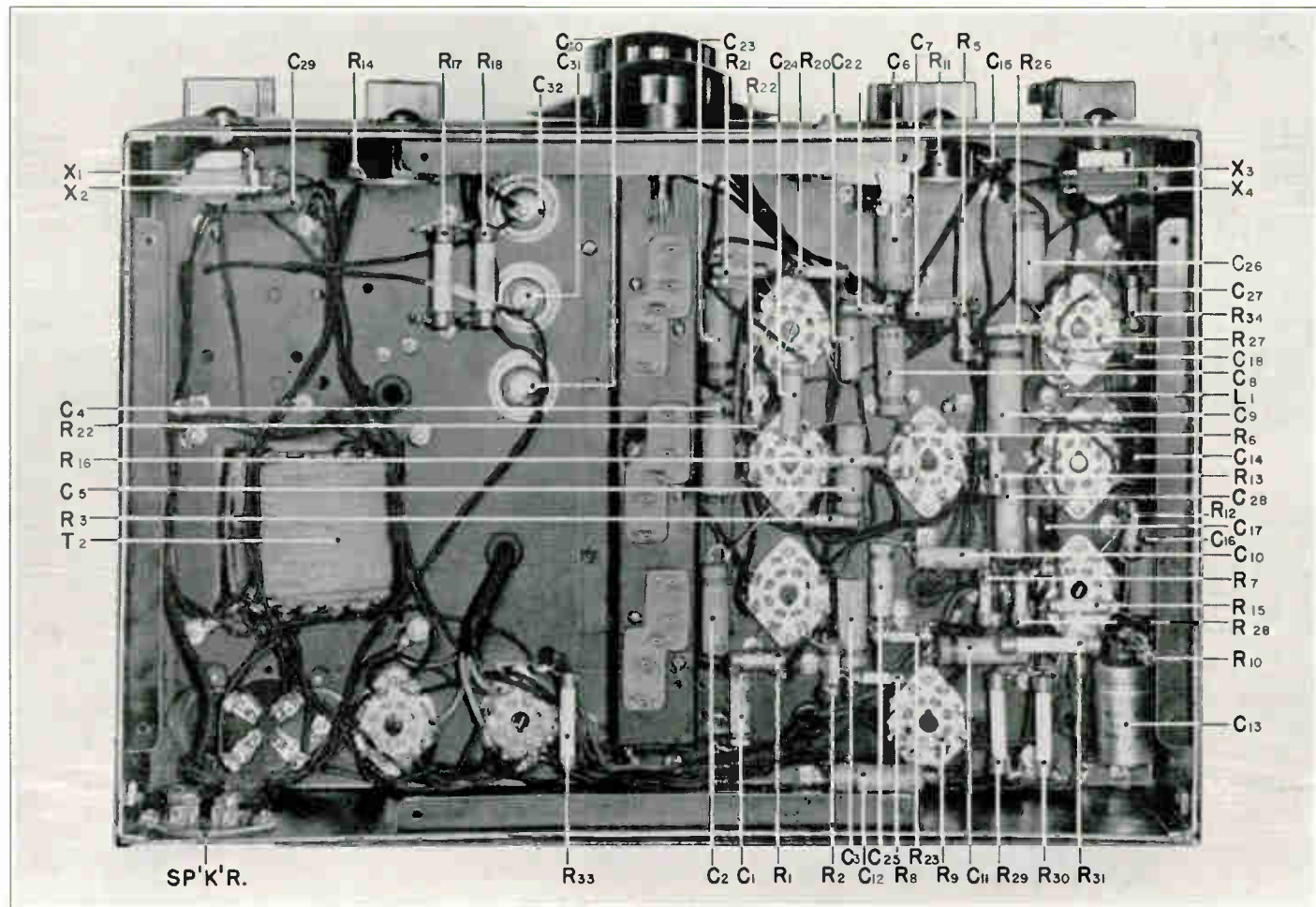

Resistor and Condenser List

| | | | | | | | |
|-----|---------------------------------|---------------------------|----------|-----|--|------------|--------------------|
| R1 | R.F. Grid filter | .5 megohm | ½ watt | C6 | 1st Det. Plate Filter | .1 mfd. | 400 volt |
| R2 | R.F. Cathode Bias | 350 ohms | ½ watt | C7 | 1st I.F. Grid Filter | .01 mfd. | 400 volt |
| R3 | 1st Det. Cathode Bias | 5000 ohms | ½ watt | C8 | 1st I.F. Cathode Bypass | .1 mfd. | 200 volt |
| R4 | H.F. Circuit B+ Filter | 2000 ohms | ½ watt | C9 | 1st and 2nd I.F. Plate Filter | .1 mfd. | 400 volt |
| R5 | 1st I.F. Grid Filter | .5 megohm | ½ watt | C10 | 2nd I.F. Grid Filter | .01 mfd. | 400 volt |
| R6 | 1st I.F. Cathode Bias | 350 ohms | ½ watt | C11 | 2nd I.F. Cathode Bypass | .1 mfd. | 200 volt |
| R7 | 2nd I.F. Grid Filter | .5 megohm | ½ watt | C12 | 2nd I.F. Screen Filter | .1 mfd. | 200 volt |
| R8 | 2nd I.F. Cathode Bias | 500 ohms | ½ watt | C13 | 2nd Det. Cathode Bypass | 10. mfd. | 50 volt |
| R9 | 2nd I.F. Screen Filter | 2000 ohms | ½ watt | C14 | 2nd Det. Plate Bypass | .001 mfd. | Mica |
| R10 | 2nd Det. Cathode Bias | 20,000 ohms | ½ watt | C15 | Phone Coupling | .1 mfd. | 400 volt |
| R11 | Audio Volume Control | 50,000 ohm potentiometer | | C16 | AVC Plate Bypass | .1 mfd. | 200 volt |
| R12 | AVC Plate | .5 megohm | ½ watt | C17 | AVC Grid Coupling | .0001 mfd. | Mica |
| R13 | I.F. B+ Filter | 2000 ohms | ½ watt | C18 | C.W. Oscillator Coupling | 2 mmf. | Special |
| R14 | R.F. Gain Control | 10,000 ohm variable | | C19 | C.W. Oscillator Grid | .001 mfd. | Mica |
| R15 | Common Grid Filter | .5 megohm | ½ watt | C20 | H.F. Oscillator Grid | .0001 mfd. | Mica |
| R16 | Gain Control Bleeder | 50,000 ohms | ½ watt | C21 | H.F. Oscillator Series Padding — Different range | | for each |
| R17 | Voltage Divider | 20,000 ohms | 2 watt | C22 | H.F. Oscillator Heater Bypass | .01 mfd. | 400 volt |
| R18 | Voltage Divider | 20,000 ohms | 2 watt | C23 | H.F. Oscillator Screen Bypass | .1 mfd. | 200 volt |
| R19 | H.F. Oscillator Grid Leak | 20,000 ohms | ½ watt | C24 | H.F. Oscillator Coupling | .01 mfd. | 400 volt |
| R20 | H.F. Oscillator Voltage Divider | 50,000 ohms | ½ watt | C25 | Tuning Indicator Grid Filter | .01 mfd. | 400 volt |
| R21 | H.F. Oscillator Voltage Divider | 100,000 ohms | ½ watt | C26 | C.W. Oscillator Heater Bypass | .1 mfd. | 200 volt |
| R22 | 1st Det. Screen Filter | 100,000 ohms | ½ watt | C27 | C.W. Oscillator Screen Bypass | .1 mfd. | 200 volt |
| R23 | Tuning Indicator Grid Filter | .5 megohm | ½ watt | C28 | AVC Cathode Bypass | .1 mfd. | 200 volt |
| R24 | Tuning Indicator Target | .1 megohm | ½ watt | C29 | Tone Control | .01 mfd. | 400 volt |
| R25 | C.W. Oscillator Grid Leak | 50,000 ohms | ½ watt | C30 | B-Supply Filter | 8 mfd. | 450 volt |
| R26 | C.W. Oscillator Voltage Divider | 100,000 ohms | ½ watt | C31 | B-Supply Filter | 8 mfd. | 450 volt |
| R27 | C.W. Oscillator Voltage Divider | 100,000 ohms | ½ watt | C32 | B-Supply Filter | 8 mfd. | 450 volt |
| R28 | AVC Grid Return | .5 megohm | ½ watt | C33 | Crystal Filter Bridge | .0001 mfd. | Mica |
| R29 | AVC Voltage Divider | 350 ohms | 1 watt | C34 | Crystal Filter Bridge | .0001 mfd. | Mica |
| R30 | AVC Voltage Divider | 1000 ohms | 2 watt | C35 | Crystal Filter Coupling | 35 mmf. | Variable |
| R31 | AVC Voltage Divider | 1000 ohms | 2 watt | X1 | B+ (stand-by) Switch | | |
| R32 | Tone Control | 500,000 ohm potentiometer | | X2 | AC On-Off Switch | | |
| R33 | Output Cathode Bias | 250 ohms | 2 watt | X3 | C.W. Oscillator Switch | | |
| R34 | C.W. Oscillator Plate Filter | .25 megohm | ½ watt | X4 | AVC On-Off Switch | | |
| C1 | R.F. Grid Filter | .01 mfd. | 400 volt | L1 | 2nd Det. I.F. Choke | 7. mh. | |
| C2 | R.F. Cathode Bypass | .1 mfd. | 200 volt | L2 | Tone Filter Choke | 18. Henry | |
| C3 | R.F. and 1st I.F. Screen Bypass | .1 mfd. | 200 volt | L3 | B-Supply Filter Choke | 20. Henry | |
| C4 | R.F. and H.F. Osc. Plate Bypass | .1 mfd. | 400 volt | T1 | Push-Pull Input Audio Transformer | 4:1 Ratio | |
| C5 | 1st Det. Cathode Bypass | .1 mfd. | 200 volt | T2 | Power Transformer | | Mounted on Speaker |
| | | | | T3 | Output Transformer | | |



THE NC-100X RECEIVER

The standard table model is converted to rack mounting by simply attaching the type RRA brackets.

SCHEMATIC DIAGRAM — TYPE NC-100 RECEIVER

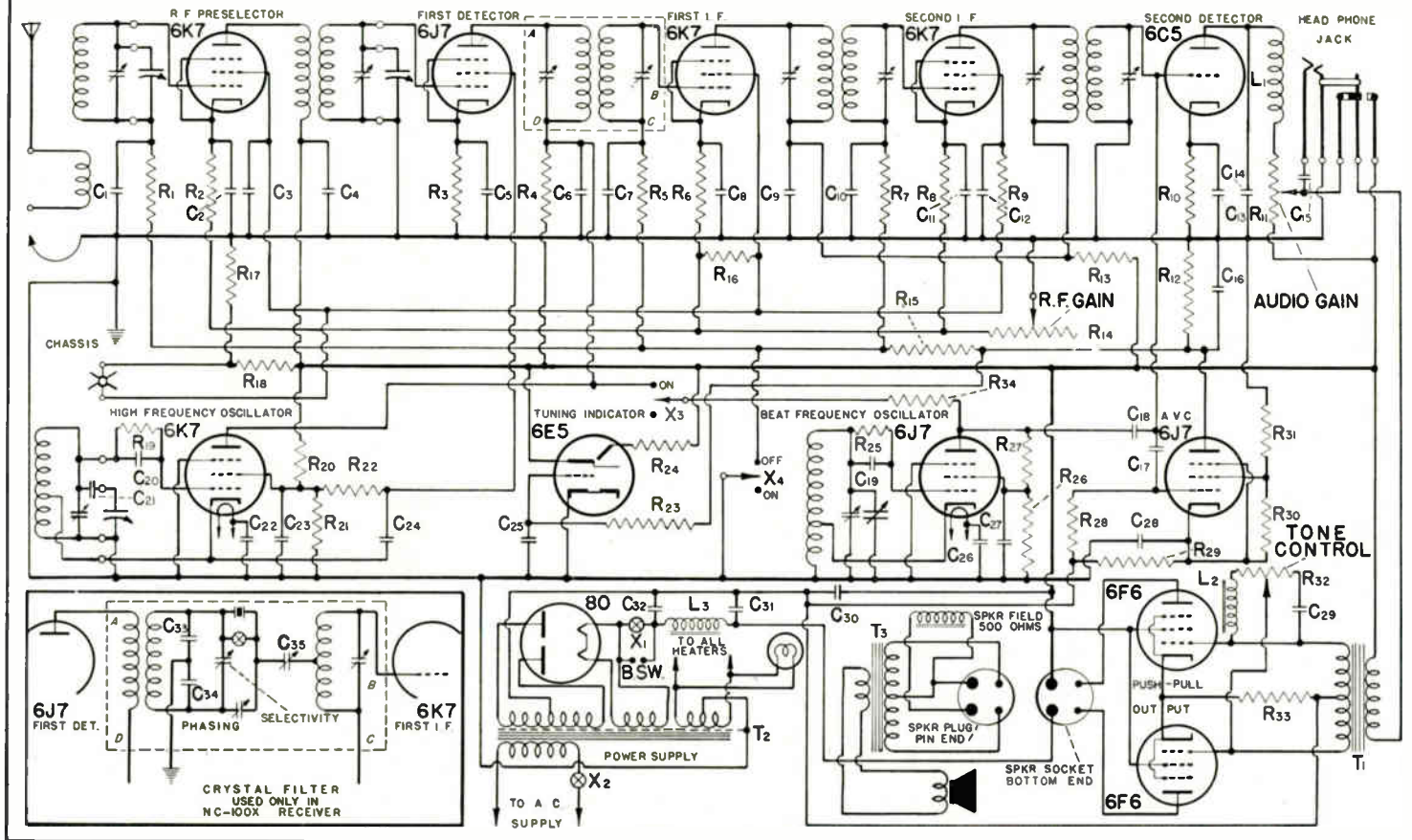

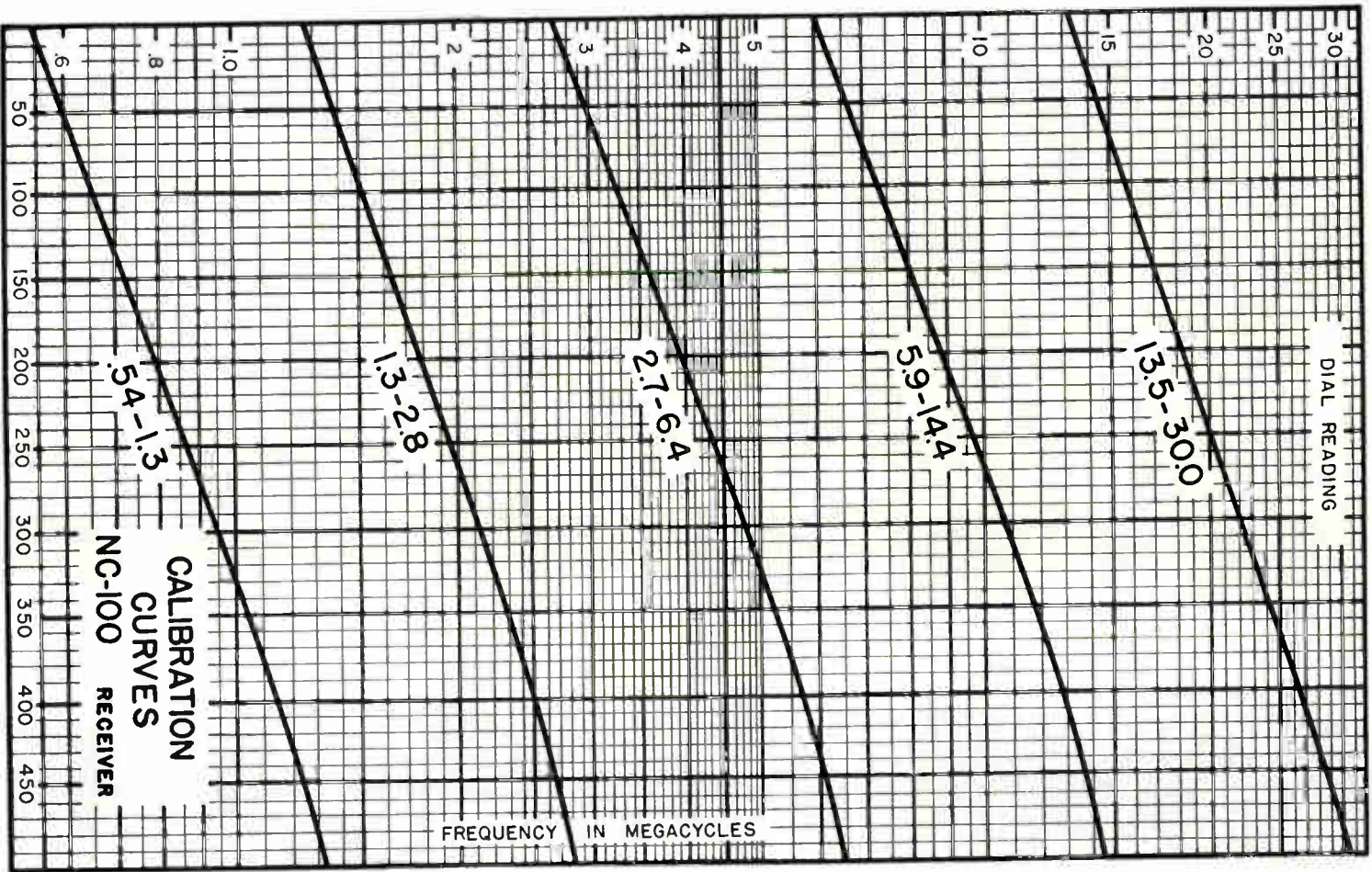

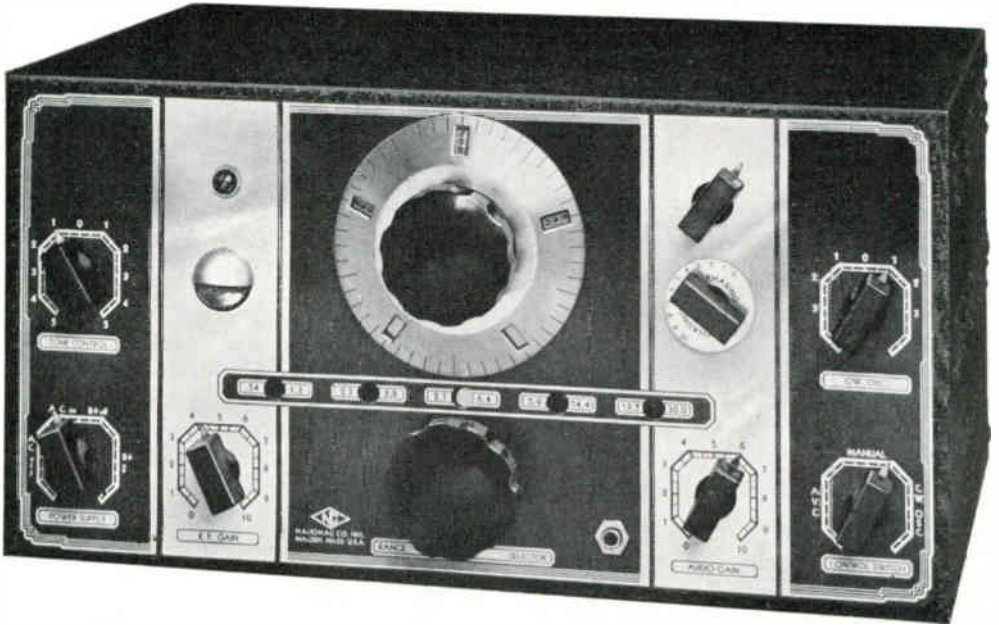

NC-100 Receiver, complete with tubes and built-in power supply and 10-inch dynamic speaker. **List Price \$175.00**

NC-100S Receiver, as above but with 12" Rola G-12 High Fidelity Speaker **List Price \$197.50**

NC-100X Receiver, complete with 10" speaker, etc., as above and having crystal filter with both variable selectivity and phasing controls. **List Price \$212.50**

NC-100XS Receiver, same as NC-100X but with 12" Rola G-12 High Fidelity Speaker. **List Price \$235.00**

DCS Metal Table Model Cabinet for 10" dynamic speaker, finished to match receiver cabinet and lined with wood for best acoustic properties. **List Price, Cabinet Only \$8.50**

RRA Steel angle pieces designed for mounting the NC-100 receivers in a standard relay rack. These angles may be conveniently fitted to the standard receiver cabinet, making a finished rack mounting unit $8\frac{3}{4}'' \times 19''$. **List Price, per pair \$2.50**

Above prices subject to change without notice

NATIONAL COMPANY, INC., MALDEN, MASS.



RP 12.000—7-37
Printed in U.S.A.

NATIONAL

Cathode-Ray Oscilloscope

TYPE CRM

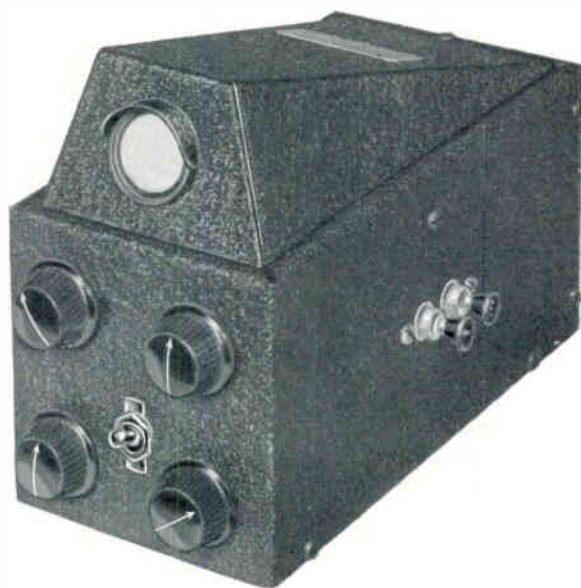

In the past the Cathode-Ray Oscilloscope has generally been considered beyond the financial reach of the average amateur. Without such a device, however, it is most difficult to properly adjust a phone transmitter, as is evidenced by the present day performance of many amateur transmitters, even in the more exclusive 20 and 75 meter bands. Perhaps some amateurs may question the accuracy of this statement. If so, it is because they have not examined the performance of their own transmitter with an oscilloscope. Should they do so, they would find the results rather startling!

With the advent of the RCA No. 913 tube and the National CRM Oscilloscope, there is no longer any prohibitive financial barrier to keep every amateur station owner from having one of these modern indicating devices for his own station. The Cathode-Ray Oscilloscope is just as essential as is the monitor to the amateur 'phone station.

Copyright 1937

NATIONAL CATHODE-RAY OSCILLOSCOPE

MOST amateurs, and particularly those interested in 'phone transmission, recognize the cathode-ray oscilloscope as an extremely useful piece of apparatus which makes it possible to get the utmost out of a short-wave transmitter. Until just recently, however, such equipment has been both complicated and expensive, the latter item particularly preventing the amateur from enjoying its advantages. Recently, however, cathode-ray type tubes have appeared on the market at cost no higher than a low power transmitting tube, and with this tube as a basis, simple oscilloscope apparatus which will answer almost any question arising in the adjustment or operation of an amateur transmitter has been made possible.

It is the purpose of this booklet to describe and show how to use such a unit, the outstanding features of which are its simplicity, compactness and low cost, and which will do practically everything that the more complicated oscilloscope will do. The circuit is shown in Fig. 1.

Tubes

The rectifier tube employed is the type 6X5 operated as a half-wave rectifier, only one plate being used. The cathode ray tube is the RCA-913. The life of the 913 is the same as any of the common receiving tubes; that is, approximately 1000 hours. The life of the tube will, of course, be shortened if it is subjected to overloads or if it is operated at improper setting of the focusing and brilliancy controls.

Controls

The oscilloscope is put into operation by turning on the A.C. switch, located near the center of the front panel. This switch controls the primary circuit of the power transformer.

The two knobs at the bottom of the oscilloscope unit are used to adjust the size and brilliancy of the spot; or, properly speaking, the clarity and brilliancy of the pattern. Of the two knobs at the top, the right is a switch and the left is a potentiometer. These controls are shown at the upper righthand corner of the schematic diagram. The switch controls the horizontal sweep circuit and has two positions. When the switch pointer is to the right the horizontal deflection plates are connected to the two right hand binding posts. When the pointer is turned toward the left the 60

cycle A.C. sweep is connected to the horizontal deflection plates, the external sweep being disconnected.

The two binding posts on the left hand side are connected directly to the vertical deflection plates. One of each pair of binding posts is marked "GND" and is permanently connected to the cabinet.

Operation

After the tubes are properly installed and the cover plate fastened in place, the oscilloscope may be turned on. The focusing and brilliancy controls should be turned as far as they will go counter-clockwise. The switch should be turned so that the 60 cycle sweep circuit is connected, and the potentiometer turned about one-third of the way on. The tubes should be allowed to warm up for 15 or 20 seconds.

The focusing and brilliancy controls are now advanced slowly until a horizontal line appears on the screen. The length of the line may be controlled by the potentiometer. The width of the line is determined primarily by the focusing control at the left of the front panel and its brilliancy by the right hand control. When properly adjusted, the line will be about one-thirty-second inch wide. The apparent brilliancy will depend largely upon the amount of light that falls upon the screen, the clearest and brightest patterns being obtained when the screen is in shadow.

The operator is cautioned not to operate the oscilloscope unless some voltage is being applied

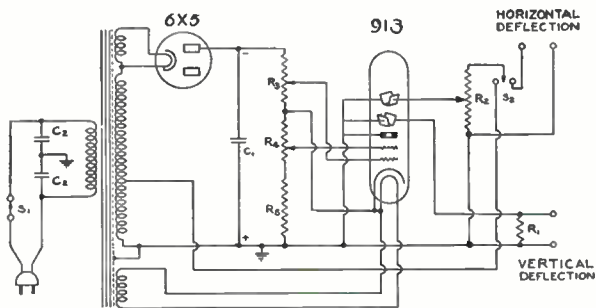

FIG. 1. CIRCUIT OF THE TYPE CRM OSCILLOSCOPE

- C₁—0.01 mfd. r.f. filter condensers
- C₂—2. mfd. 600 volt (working) condenser
- C₃—Small r.f. bypass, if necessary
- R₁—5 megohm— $\frac{1}{2}$ watt fixed resistor
- R₂—500,000-ohm potentiometer (sweep voltage control)
- R₃—50,000-ohm potentiometer (brilliancy control)
- R₄—100,000-ohm potentiometer (focusing control)
- R₅—250,000-ohm $\frac{1}{2}$ watt fixed resistor
- S₁—Line switch
- S₂—Horizontal sweep switch, s.p.d.t.

to one of the sweep circuits. If the beam is allowed to become stationary (in other words, to produce a spot on the screen) the screen itself may be damaged or, in extreme cases, the glass may be punctured. If the nature of the work requires that the beam be adjusted to a spot, the room illumination should be kept low.

The spot will normally be near the center of the screen or, in the case of the horizontal line, the screen will be divided by the line into two equal parts. The actual position of the figure on the screen is, of course, unimportant.

When installing a new 913 tube, the socket may be adjusted so that the horizontal sweep is actually horizontal by simply loosening the mounting screws and rotating the tube as may be required. The position of the tube is adjustable from front to back by moving the socket mounting as a whole.

APPLICATIONS

Checking the Phone Transmitter

One of the main items of expense in the construction of an oscilloscope is the sweep circuit having a linear time base, usually employing a type 34 and a type 885 with the associated batteries, relaxation circuit, etc.¹ For amateur use, however, such a sweep circuit is generally unnecessary. In fact, a clearer and more readily interpreted indication of the performance of the r.f. portion of the 'phone transmitter is obtainable with the a.c. horizontal sweep-voltage obtained directly from the modulator. Using this system, the pattern appearing on the screen will be in the form of a trapezoid or triangle, depending upon the percentage of modulation. This pattern is obtained in the following way:

Audio output voltage of the modulator tube is coupled to the horizontal deflection plates, moving the electron beam back and forth across the screen. Since the same audio voltage is modulating the r.f. output of the transmitter, at the negative peak of the audio cycle the r.f. output will be at minimum, while at the positive peak it will be maximum. Assuming the transmitter to be modulated exactly 100%, the r.f. voltage will fall to zero on the negative peak and rise to double its normal value on the positive peak. With the modulated r.f. voltage coupled to the vertical deflection plates, the electron beam will move up and down on the screen, the movement being proportional to the r.f. voltage. Hence the pattern for 100% modulation will be a triangle, on the negative audio peak (as applied to the hori-

¹L. C. Waller, "A Cathode-Ray Oscillograph for the Amateur Station," *QST*, March, 1933.

Caution

The operator is cautioned not to touch any of the exposed terminals or socket connections inside the oscilloscope cabinet when the unit is in operation, since the 913 is supplied with 500 volts D.C.

One precaution, especially important where the oscilloscope is to be used for checking a powerful transmitter, is to prevent stray r.f. voltages from getting into the supply circuits via the a.c. line. Usually two 0.01- μ f. condensers (C_1), connected in series across the line with the midpoint grounded to the cabinet, will be completely effective. In some cases, however, it may be necessary to increase the size to 0.1 μ f. The condensers must be mounted inside the cabinet where they, themselves, will not be in the field from the transmitter.

zontal deflection plates), the r.f. voltage will be zero. At the other side of the screen, where the audio voltage is positive, the r.f. voltage will be maximum, producing a large vertical deflection.

Since the r.f. voltage increases in proportion to

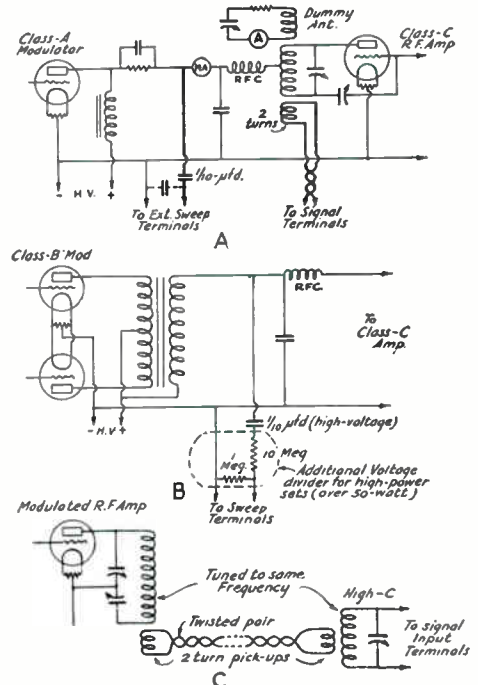

FIG. 2—METHODS OF COUPLING THE OSCILLOSCOPE TO 'PHONE TRANSMITTER CIRCUITS

the change in the modulator output as the audio cycle goes from negative to positive, it does not matter what audio frequency is used, or what the wave form is—the picture will be the same. This is a great advantage in checking a Class-C or a linear Class-B r.f. amplifier, as there is no possibility of a distorted audio signal from the modulator giving a picture which seems to indicate such troubles in the r.f. circuits as improper excitation, overmodulation, etc. Although the envelope pattern obtained with a linear sweep circuit is much prettier to look at the operator is likely to misinterpret irregularities which may be present in it. For instance, if the positive r.f. peaks are too flat, the trouble may be caused either by insufficient r.f. excitation to the modulated stage, overload in the modulator circuit, or both. Such confusion does not arise when observing the trapezoidal pattern.

Using the Oscilloscope

The diagrams of Fig. 2 show how the oscilloscope is connected to different types of modulators. Note that in all cases the voltage for horizontal deflection is taken from the final audio circuit; that is, the point where the Class-C amplifier supply lead is connected. *This is very important.* Do not attempt to supply the horizontal deflection plates from some other part of the speech circuits, for the audio voltage at any intermediate point may be out of phase with the actual modulating voltage, resulting in a weird pattern which has little meaning.

With a dummy antenna substituted at the transmitter output, r.f. voltage is coupled to the vertical deflection plates by means of a 3-inch diameter pick-up coil, consisting of a few turns of

than it is at the bottom, or vice versa. The bright portion will probably be longer than the dim portion. This phenomenon *may* be entirely normal; in fact, it is to be expected with a single-ended r.f. amplifier working into a heavily loaded low-C tank circuit, where the "excited" side of the r.f. cycle is apt to be much stronger than the other side. In order to obtain a symmetrical r.f. voltage for the vertical deflection plates, the leads of the pick-up coil should be coupled loosely, link-circuit fashion, to an additional tank circuit, which is tuned to the transmitter frequency and is placed near the oscillograph. The deflection plates are then connected to the tank circuit terminals.

If there is r.f. present in the modulator output circuit, it will be impressed upon the horizontal deflection plates and the vertical line will have the appearance of a cylinder. The same effect might possibly be obtained by incorrect adjustment of the focusing controls, but if their readjustment does not clear up the line, r.f. is present. It can usually be filtered out by the addition of a small by-pass condenser, shown by the dotted lines in Fig. 2. The leads connecting the oscillograph with the modulator may pick up a small amount of r.f. but this seldom causes trouble, provided they are not more than a few feet long.

After a suitable vertical (r.f.) line has been obtained, speaking or whistling in the microphone should cause the trapezoidal pattern to appear. If the vertical line stretches out into a band, the audio voltage on the horizontal sweep is too great, and should be reduced by means of the control, R_1 , or by an external voltage divider.

When the modulator is functioning properly, the pattern will spread out an equal distance on

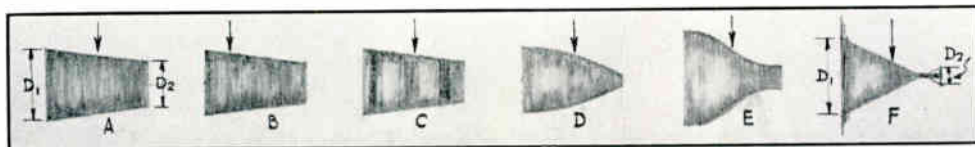

FIG. 3—SKETCHES OF TYPICAL TRAPEZOIDAL FIGURES REPRESENTING VARIOUS OPERATING CONDITIONS

The normal trapezoidal figure obtained with a medium degree of modulation is shown by "a". The modulation percentage is obtained by measurement of the dimensions D_1 and D_2 , and substituting in this simple equation:

$$\text{Per cent modulation} = \frac{D_1 - D_2}{D_1 + D_2} \times 100$$

Output containing even harmonics is represented in B; and C is typical of odd-harmonic content. Flat-topped positive peaks of the modulation envelope, as would occur with insufficient Class-C amplifier excitation, are represented in D, while E shows this condition combined with distortion of the negative peaks. In F we have that old bear, overmodulation, with the negative peaks cut off and with "whiskers" on the positive peaks. Arrows indicate carrier position without modulation. Further explanation of these figures is given in the text.

wire. This coil is placed near the Class-C tank circuit and the coupling adjusted so that the vertical deflection on the screen of the tube will, in the absence of modulating voltage, be a line about $\frac{1}{2}$ inch long. The line should have the same intensity and length above and below the center. Even with the transmitter circuits in perfect adjustment, the r.f. line may be brighter at the top

each side of the original r.f. line (Fig. 3A). If it doesn't, there is distortion from even harmonics (2d, 4th, 6th, etc.) in the modulator circuits. Such distortion might be caused by passing excessive Class-C amplifier plate current through the secondary of a Class-B modulator output transformer, or from an overloaded modulation choke having a saturated core. There are, of course, many other

possible causes of even harmonic distortion; for instance, unbalanced tubes in a Class-B modulator; all of which will make the trapezoid shorter on one side of the vertical center line than on the other.

Third (and higher odd-) audio harmonics are, unfortunately, not so apparent. They show up as one or more vertical bands having greater brilliance than other nearby parts of the pattern, and are clearest close to the wide end of the figure (Fig. 3C). This type of wave cannot be detected when second harmonics are also present, as the latter may cause similar vertical bands.

Regardless of the fact that various harmonics may be present in the audio output of the modulator, *the upper and lower edges of the trapezoid should be straight lines*. If they show any curvature whatever, the characteristic of the Class-C amplifier is not linear.

Before progressing further, it might be well to consider the source of the audio signal. As mentioned above, whistling or talking in the microphone will produce the pattern, but unless the operator has good lungs and an exceptionally steady whistle, the dimensions of the trapezoid will be constantly varying, making accurate measurements difficult. It is much better to apply a steady, controllable, audio signal to the speech amplifier, preferably from an audio oscillator having good wave form and variable frequency. This would be ideal, as the operator would then be able to determine the overall frequency characteristic of his equipment, excepting the microphone. The next best arrangement is to take a.c. from the line, step it down to a few volts, and connect it, through a potentiometer, to the speech amplifier. By varying the a.c. input (or speech amplifier gain) the operation of the transmitter may be studied in detail at different percentages of modulation.

Interpreting the Patterns

When the oscilloscope is set up with both audio and r.f. sweeps working properly, the modulation should be increased slowly until the triangular pattern is obtained indicating 100% modulation. If everything is working perfectly, the Class-C plate current will not change, the antenna current (in the dummy antenna!) will increase 22% and the modulator tubes will not be overloaded. In all probability, however, the picture will look more like Fig. 3D. This shows a flat-topped r.f. wave caused by an incorrectly adjusted Class-C amplifier. The operator should remember that a flat-topped audio wave cannot possibly cause the upper and lower sides of the triangle to be curved; so, for the present, forget about the audio signal.

The most common cause of this type of curvature is insufficient excitation to the Class-C stage. This may be checked by detuning the preceding stage slightly and watching to see if the curvature increases. If it does, more excitation must be

supplied to the Class-C amplifier, although occasionally decreasing its bias will straighten things out. Possibly the buffer has insufficient excitation. Flat-topped positive peaks also are sometimes present when a Class-B modulator and the Class-C amplifier are operated from a common power supply of poor regulation, although usually in this case the negative peaks are distorted also (Fig. 3E). Flat positive peaks will appear in a Class-B linear r.f. amplifier if the preceding Class-C stage is not properly loaded, or if the average excitation to the linear is too high. This is the result of the grid load of the linear being greatest on the positive peaks. Oftentimes an increase in the Class-B linear's bias will reduce the load enough to straighten the characteristic; but when doing this, watch out for distortion on the negative side.

The oscillograph shows up overmodulation very definitely, as indicated in Fig. 3F. When the modulation exceeds 100%, the r.f. voltage falls to zero and remains there over an appreciable portion of the negative cycle, producing a line on the screen which extends beyond the tip of the triangle horizontally. There are also high amplitude r.f. transients on the positive peaks and although these are hard to see, because they do not remain stationary long enough, they are the cause of the "burps" and "gurgles" which cover so many kilocycles on each side of the offending 'phone carrier. The transients are not so noticeable on the negative peaks, because the Class-C plate voltage is zero during this part of the cycle, although they sometimes appear as a slight fuzziness on the extending horizontal line.

The percentage of modulation may be easily and accurately determined from the formula given with Fig. 3A. It should be calculated only, however, when the upper and lower sides of the pattern are straight, and when the modulation is less than 100%. To determine the degree of overmodulation, the upper and lower sides of the triangular pattern must be extended, as shown by the dotted lines in Fig. 3F. D_2 will then have a negative value.

It is suggested that the operator adjust the transmitter so that the test signal is modulating it just under 100%, carefully noting meter readings which may serve indirectly as operating checks on the percentage. The plate current of a Class-B modulator gives a good indication, while the antenna current change is a poor last choice.

Now disconnect the test signal, connect the microphone, and start talking, at the same time trying to watch both the oscillograph and the meter. It will be found that the peaks of the speech wave will cause overmodulation, clearly visible on the oscillograph, while the meters which measure only the r.m.s. and average values indicate considerably less than 100%. Draw your own conclusions—but believe the oscilloscope, not the meters.

MEASURING MODULATION AT THE RECEIVER

Such measurements are by no means as difficult as is generally supposed. The connections are made as shown in the illustration at the right. The common terminal of the horizontal and vertical deflection plates is tied to the receiver chassis. The free terminal of the horizontal deflection plates is tied to the plate of the last I.F. tube in the receiver through a .5 mfd. blocking condenser, and also connected through a fifty thousand ohm resistor to the free terminal of the vertical deflection plates.

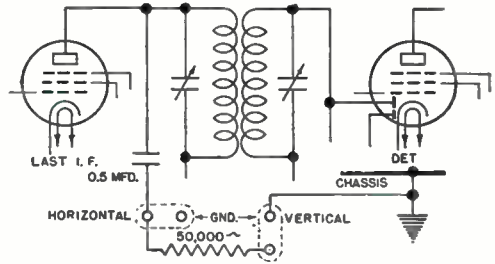

These simple connections are all that are required, but in making them certain precautions must be observed. Since this system is tied to the plate of the last I.F. tube, the wiring should be carefully made to have minimum capacity to ground, and the last I.F. transformer should be retuned after the connections are made.

The principle of operation is not complicated either. The signal is impressed directly on the horizontal deflection plates, causing a horizontal trace. At the same time, the signal is also impressed on the vertical deflection plates, but because of the 50,000 ohm resistor, the vertical trace is out of phase with the horizontal and an elliptical pattern results.

Three typical patterns are illustrated at the left, all reproduced from unretouched photographs. The top picture represents an unmodulated signal. It is a single, sharp oval line.

If the signal is now modulated, the trace will be seen to widen to a ribbon, as shown in the second picture. It should be noted that this widening occurs in "both directions"; that is, the outside length of the oval increases, while the length of the inside dark area decreases. If these two dimensions are called D_1 and D_2 , respectively, the percentage modulation can be calculated from the well-known formula:

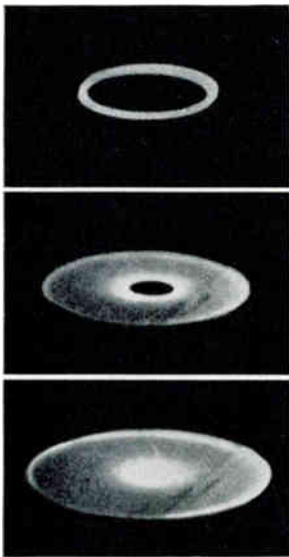

$$\text{Modulation} = \frac{D_1 - D_2}{D_1 + D_2} \times 100 \text{ (per cent)}$$

As might be expected, for 100% modulation, the dark area in the center of the pattern decreases to zero. This point can be determined quite accurately. If the signal be over-modulated, the illuminated area increases still further, and a bright spot appears in the middle of the figure. Such a pattern is shown in the lowest illustration. This last pattern is quite unmistakable, and looks for all the world like the revolving turntable of a phonograph with a record in place. The exact amount of over-modulation cannot be calculated, but this is not particularly important since all percentages of over-modulation are equally illegal under the regulations.

One or two precautions must be observed in interpreting the signals. The most important thing to remember is that the device measures modulation at the second detector of the receiver, not necessarily at the transmitter. Errors can be due to two sources. Defects in the receiver, such as cross-modulation, poor frequency characteristic and improper coupling of the H.F. oscillator, can all affect the apparent

modulation. In a well-designed receiver the resulting error is quite small, and in any case, results can be readily checked by tuning in a transmitter whose modulation is known. Such a test can usually be arranged without any difficulty, since a large number of transmitters are equipped with oscilloscopes these days.

The second source of error is more of a variable. Static, heterodynes and similar disturbances appear at the second detector as a modulation of the carrier (since otherwise they could not ride through the receiver). Since these extraneous signals are superimposed on the regular modulation, they will make the signal appear to have a higher percentage modulation than is really the case. Therefore, in order to make measurements it will be necessary to have the signal out in the clear. Even when conditions are very bad, it will usually be found that there are moments when the signal is clear and a moment is enough when one is watchful.

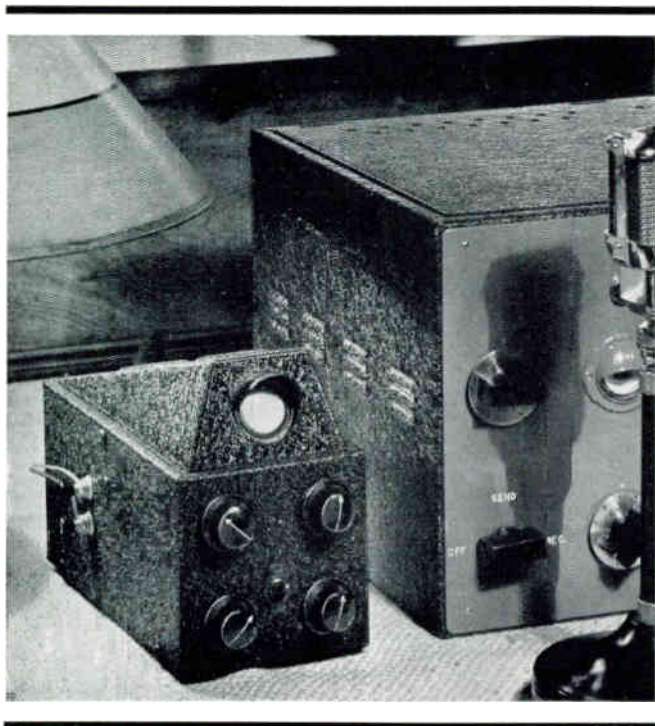

THE Type CRM Oscilloscope employs the little RCA-913 tube having a one-inch screen. In spite of its small size, this new equipment is thoroughly

A MINIATURE OSCILLOSCOPE at a LOW PRICE

practical and is quite satisfactory for routine measurements in the amateur station. The circuit includes a power supply with controls for brilliancy and focus, a potentiometer for controlling the amplitude of the horizontal deflection, and a built-in 60-cycle sweep. The latter is particularly convenient as it permits checking transmitter operation with no connection other than a pick-up coil.

NET PRICE \$11.10

Without Tubes

NATIONAL COMPANY, INC.
Malden, Massachusetts

RP-737-12M
Printed in U.S.A.



NATIONAL *Ganged* CONDENSER

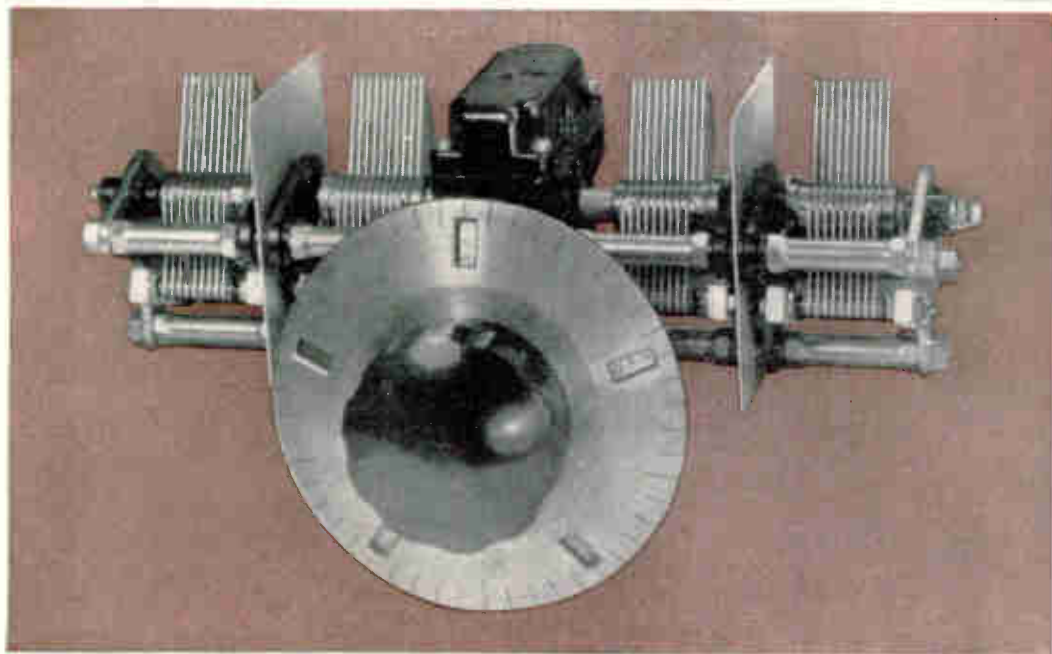

PRECISION GANGED CONDENSER

The PW Precision Condenser has been particularly designed for use in H.F. circuits. It is available with 2, 3 or 4 ganged sections for use in receivers, and in a new single section model for use in laboratory equipment. The sizes available are listed at the right.

The condenser is of extremely rigid construction, with four bearings on the rotor shaft. The drive, at the midpoint of the rotor, is through an enclosed pre-loaded worm gear with 20 to 1 ratio. Each rotor is individually insulated from the frame, and each has its own individual rotor contact, of the multi-fingered brush type. Stator insulation is Steatite.

The Micrometer dial is of a new type and reads direct to one part in 500. Division lines are approximately $\frac{1}{4}$ " apart. As is evident from the illustration above, the dial is read in the usual way. However, the dial revolves ten times in covering the tuning range, and the numbers visible through the small windows change every revolution to give consecutive numbering by tens from 0 to 500. As the illustration shows, the numbers rotate with the division lines at the top of the dial, and change rapidly at bottom where they are out of the operator's line of sight. As the dial has only two moving parts, both rotating, the dial is very smooth in operation and does not interfere with delicate tuning adjustment.

The dial and enclosed worm drive is listed separately, for use in driving transmitting condensers and similar equipment.

SPECIFICATIONS

PW Ganged Condensers are available in 2, 3 or 4 sections, in either 160 or 225 mmf per section. Larger capacities cannot be supplied. The single-section PW condenser is supplied in capacities of 150, 200, 350 and 500 mmf, single spaced. Capacities up to 125 mmf can be supplied double spaced. The rotor is not insulated on the single section model.

Plate shape is straight-line-frequency when the frequency range is 2:1.

| | |
|-------------------------------|--------------------|
| Single Section | |
| PW-1 | List Price \$15.00 |
| Two Section | |
| PW-2 | List Price \$20.00 |
| Three Section | |
| PW-3 | List Price \$24.00 |
| Four Section | |
| PW-4 | List Price \$27.50 |
| Drive Unit with TX-9 Coupling | |
| PW-0 | List Price \$13.50 |

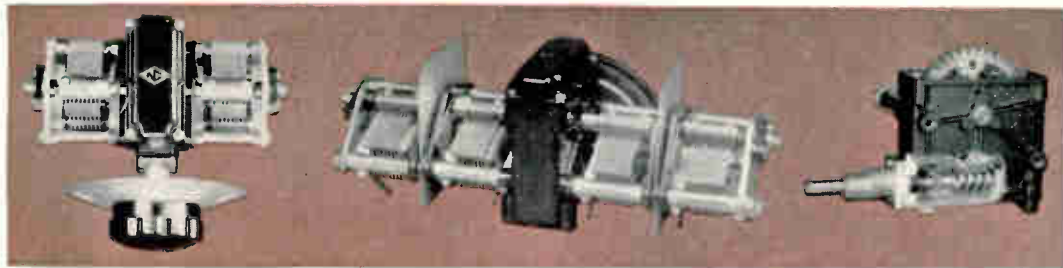

2 . . . NATIONAL COMPANY, INC., MALDEN, MASS.

World Radio History

"HRO" & "O" DIALS

FIGS. 1a & 1b

The 1 $\frac{5}{8}$ " dia. HRO dial (Fig. 1a) is etched nickel silver and fits $\frac{1}{4}$ " shafts. Reads from 0 to 10 over 180°, numbers increasing with clockwise rotation.

List Price, each \$.75

The insulated 3 $\frac{1}{2}$ " dia. O dial (Fig. 1b) is circular-grained German Silver and fits $\frac{1}{4}$ " shafts. Available with 2 scale.

List Price, each \$1.50

The type HRK Knob used on the O dial is also available alone. Fits $\frac{1}{4}$ " shafts.

List Price, \$.85

The type ODL locking device with thumbscrew control is available for use with the type "O" dial. Ideal for transmitter applications.

List price, each \$.50

"N" & "NW" DIALS

FIGS. 2 & 3

Precision Dials, Type N, have engine divided scales and verniers of solid German Silver. The Verniers are flush, eliminating errors from parallax.

The four-inch Type N dial (Fig. 3) employs a smooth and powerful planetary mechanism with a 5 to 1 ratio. It is available with either 2, 3, 4 or 5 scale.

List Price, each \$6.75

The six-inch Type NW dial (Fig. 2) has a variable ratio drive that is unusually powerful at all settings. It is recommended for use on large transmitters and precision instruments. Available with either 2, 3, 4 or 5 scale.

List Price, each \$15.00

"A" DIAL

FIG. 4

The original "Velvet Vernier" Dial, Type A, is still an unchallenged favorite for general purpose use. It is exceptionally smooth and entirely free from backlash. The mechanism is contained within the bakelite knob and shell. Ratio 5 to 1. Available with either 2, 4 or 5 scale in 4" diameter. Available with 2 scale in 3 $\frac{3}{8}$ " diameter.

List Price, each \$3.00

"B" & "BM" DIALS

FIGS. 5, 6

"Velvet Vernier" Dial, Type B (Fig. 6) provides a compact variable-ratio drive that is smooth and trouble free. The mechanism is inclosed in a black bakelite case, the dial being read through a window. Available with 1 or 5 scales.

List Price, each \$2.75

If illuminator is desired, add \$.50 to List Price.

The Type BM Dial (Fig. 5) is a smaller version of the Type B Dial for use where space is limited. It is similar to the Type B Dial in appearance and mechanism, but does not have the variable-ratio device. Available with 1 or 5 scales.

List Price, each \$2.50

"H" DIAL

FIG. 7

Projection Drum Dial, Type H, employs the proved and popular non-conducting cord drive with spring take-up. The dial scale is optically projected in illuminated figures on a ground-glass screen, considerably enlarged. Parallax is entirely absent. Condenser shaft must be parallel to panel. Available with either 2, 3 or 4 scale.

List Price, each \$5.50

DIAL SCALES

| Scale Type | Divisions | Degrees Rotation | Direction of Condenser Rotation for increase of dial reading |
|------------|-----------|------------------|--|
| 1 | 0-100-0 | 180° | Either |
| 2 | 0-100 | 180° | Counter Clockwise |
| 3 | 100-0 | 180° | Clockwise |
| 4 | 150-0 | 270° | Clockwise |
| 5 | 200-0 | 360° | Clockwise |
| 6 | 0-150 | 270° | Counter Clockwise |

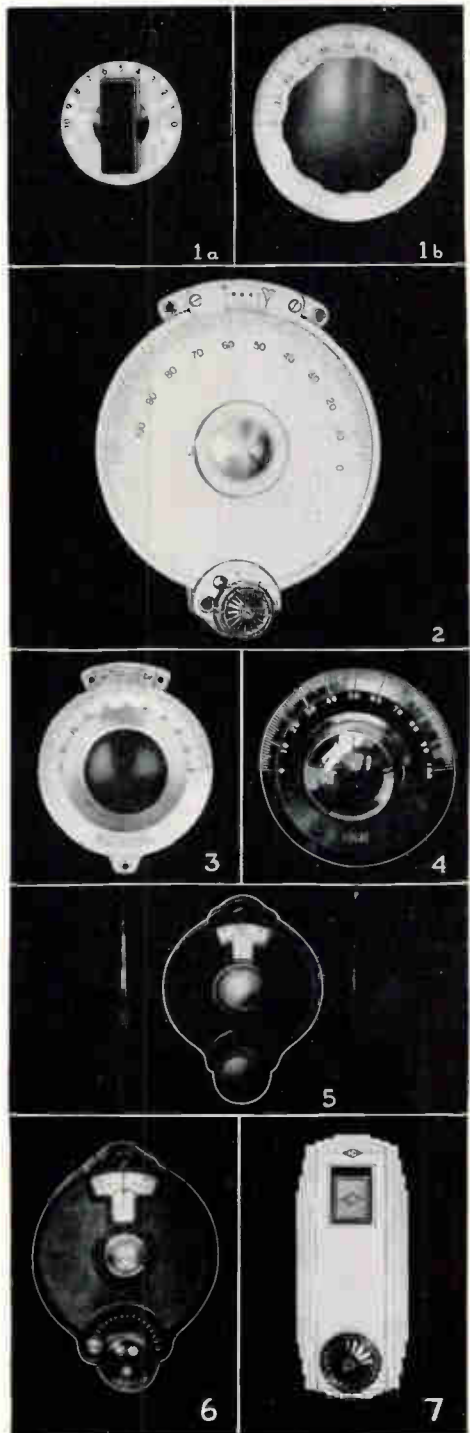

NATIONAL *Transmitting* CONDENSERS

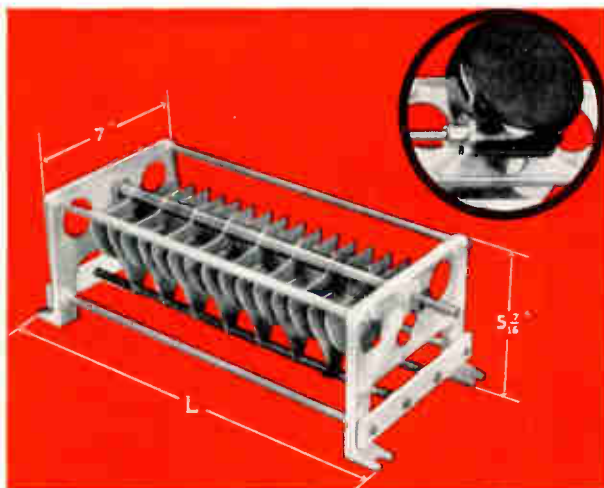

TML {Heavy Duty, Inexpensive}

The TML condenser is a 1 KW job through-out. Isolantite insulators, specially treated against moisture absorption, prevent flash-overs. A large self-cleaning rotor contact provides high current capacity. Thick capacitor plates, with accurately rounded and polished edges, provide high voltage ratings. Sturdy cast aluminum end frames and dural tie bars permit an unusually rigid structure. Precision end bearings insure smooth turning and permanent alignment of the rotor. End frames are arranged for panel, chassis or standoff mounting. And a PW-type self-locking right-angle drive unit can be easily added to provide precision tuning and convenient parallel-panel mounting.

Type PWL Drive Unit. List Price, \$9.50 extra

| Capacity | Peak V. | Airgap | Length | Plates | Cat. Symbol | List Price |
|----------|---------|--------|----------|--------|-------------|------------|
| 75 Mmf. | 20,000 | .719" | 18 1/8" | 17 | TML-75E | \$26.00 |
| 150 | 15,000 | .469" | 18 1/2" | 27 | TML-150D | 26.50 |
| 100 | 15,000 | .469" | 14 1/16" | 19 | TML-100D | 23.50 |
| 50 | 15,000 | .469" | 8 3/4" | 9 | TML-50D | 16.50 |
| 245 | 10,000 | .344" | 18 1/8" | 35 | TML-245B+ | 28.50 |
| 150 | 10,000 | .344" | 14 1/16" | 21 | TML-150B+ | 26.00 |
| 100 | 10,000 | .344" | 11 3/8" | 15 | TML-100B+ | 25.00 |
| 75 | 10,000 | .344" | 8 3/4" | 11 | TML-75B+ | 18.00 |
| 500 | 7,500 | .219" | 18 1/2" | 49 | TML-500A+ | 35.00 |
| 350 | 7,500 | .219" | 14 1/16" | 33 | TML-350A+ | 28.00 |
| 250 | 7,500 | .219" | 11 3/8" | 25 | TML-250A+ | 26.00 |
| 30-30 | 20,000 | .719" | 18 1/2" | 7-7 | TML-30DE | 26.50 |
| 60-60 | 15,000 | .469" | 18 1/2" | 11-11 | TML-60DD | 28.50 |
| 100-100 | 10,000 | .344" | 18 1/2" | 15-15 | TML-100DB+ | 31.50 |
| 60-60 | 10,000 | .344" | 14 1/16" | 9-9 | TML-60DB+ | 27.50 |
| 200-200 | 7,500 | .219" | 18 1/2" | 21-21 | TML-200DA+ | 35.00 |
| 100-100 | 7,500 | .219" | 11 3/8" | 11-11 | TML-100DA+ | 28.50 |

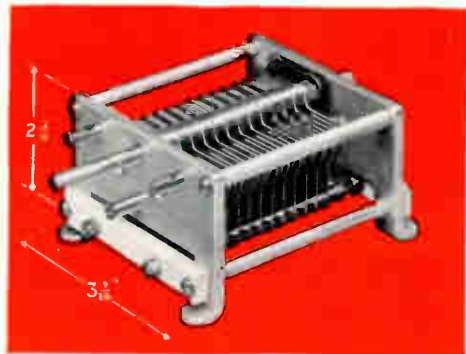

TMC {Moderate Power, Compact}

The TMC is designed for use in the power stages of transmitters, where peak voltages do not exceed 3000. The frame is extremely rigid and arranged for mounting on panel, chassis or stand-off insulators. The plates are aluminum, with buffed edges. Insulation is Isolantite, located outside of the concentrated electrostatic field. The stator in the split stator model is supported at both ends.

| Capacity | Peak V. | Airgap | Length | Plates | Cat. Symbol | List Price |
|----------|---------|--------|--------|--------|-------------|------------|
| 50 Mmf. | 3000 | .077" | 3" | 7 | TMC-50 | \$4.00 |
| 100 | 3000 | .077" | 3 1/2" | 13 | TMC-100 | 4.50 |
| 150 | 3000 | .077" | 4 1/2" | 21 | TMC-150 | 5.25 |
| 300 | 3000 | .077" | 6 3/4" | 39 | TMC-300 | 6.50 |
| 100-100 | 3000 | .077" | 6 3/4" | 13-13 | TMC-100D | 7.50 |



Only the most popular sizes of condensers, as carried in stock by our dealers, are listed above. Other sizes can be promptly supplied from standard parts on special order at the same price as the next largest size in the tables above.

A rotor shaft lock can be supplied for either the TMC or the TMA condensers. See page eleven for details.

4 . . . NATIONAL COMPANY, INC., MALDEN, MASS.

NATIONAL *Transmitting* CONDENSERS

TMA {Heavy Duty}

The TMA is a larger model of the popular TMC. The frame is extremely rigid and arranged for mounting on panel, chassis or stand-off insulators. The plates are of heavy aluminum with rounded and buffed edges. Insulation is Isolantite, located outside of the concentrated field.



| Capacity | Peak V. | Airgap | Length | Plates | Cat. Symbol | List Price |
|----------|---------|--------|---------|--------|-------------|------------|
| 300 Mmf. | 3000 | .077" | 4 9/16" | 23 | TMA-300 | \$12.00 |
| 200-200 | 3000 | .077" | 6 7/8" | 16-16 | TMA-200D | 15.00 |
| 50 | 6000 | .171" | 4 9/16" | 8 | TMA-50A | 6.50 |
| 100 | 6000 | .171" | 6 7/8" | 17 | TMA-100A | 10.00 |
| 150 | 6000 | .171" | 6 7/8" | 23 | TMA-150A | 12.00 |
| 230 | 6000 | .171" | 9 5/16" | 35 | TMA-230A | 16.00 |
| 50-50 | 6000 | .171" | 6 7/8" | 9-9 | TMA-50DA | 11.00 |
| 100-100 | 6000 | .171" | 9 5/16" | 15-15 | TMA-100DA | 17.50 |
| 100 | 9000 | .265" | 9 1/4" | 23 | TMA-100B | 13.50 |
| 150 | 9000 | .265" | 12 1/2" | 35 | TMA-150B | 17.00 |
| 60-60 | 9000 | .265" | 12 1/2" | 15-15 | TMA-60DB | 18.50 |
| 50 | 12000 | .359" | 7 1/8" | 13 | TMA-50C | 8.00 |
| 100 | 12000 | .359" | 12 7/8" | 27 | TMA-100C | 14.50 |
| 40-40 | 12000 | .359" | 12 7/8" | 11-11 | TMA-40DC | 13.50 |

TMS {Low Power, Compact, Inexpensive}

Type TMS is a condenser designed for transmitter use in low power stages. It is compact, rigid, and dependable. Provision has been made for mounting either on the panel, on the chassis, or on two stand-off insulators.

Insulation is Isolantite. Voltage ratings listed are conservative.



| Capacity | Peak V. | Airgap | Length | Plates | Cat. Symbol | List Price |
|----------|---------|--------|--------|--------|-------------|------------|
| 100 Mmf. | 1000 | .026" | 2 3/4" | 10 | TMS-100 | \$2.50 |
| 150 | 1000 | .026" | 2 3/4" | 14 | TMS-150 | 2.75 |
| 250 | 1000 | .026" | 2 3/4" | 23 | TMS-250 | 3.00 |
| 300 | 1000 | .026" | 2 3/4" | 27 | TMS-300 | 3.60 |
| 50-50 | 1000 | .026" | 2 3/4" | 5-5 | TMS-50D | 3.75 |
| 100-100 | 1000 | .026" | 2 3/4" | 9-9 | TMS-100D | 4.50 |
| 35 | 2000 | .065" | 2 3/4" | 8 | TMSA-35 | 3.00 |
| 50 | 2000 | .065" | 2 3/4" | 11 | TMSA-50 | 3.25 |

Only the most popular sizes of condensers, as carried in stock by our dealers, are listed above. Other sizes can be promptly supplied from standard parts on special order at the same price as the next largest size in the tables above. A rotor shaft lock can be supplied for either the TMC or the TMA condensers. See page eleven for details.



NATIONAL COMPANY, INC., MALDEN, MASS. . . .

World Radio History

5

NATIONAL *Receiving* CONDENSERS

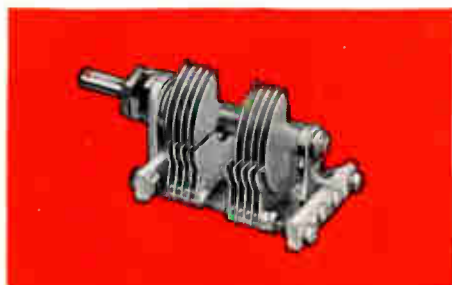

ST 180° Straight-Line-Wavelength

The ST Condenser has 180° Straight-Line-Wavelength plates. General construction is the same as the SE condenser although its overall height is less. For minimum overall length, a single bearing model—the STHS—is offered. All other models are double bearing. Two split-stator models are available.

| Capacity | Air Gap | Plates | Length | Cat. Symbol | List Price |
|----------|---------|--------|--------------------|-------------|------------|
| 15 | .018" | 3 | 1 $\frac{3}{16}$ " | STHS 15 | \$1.40 |
| 25 | .018" | 4 | 1 $\frac{3}{16}$ " | STHS 25 | 1.50 |
| 50 | .018" | 7 | 1 $\frac{3}{16}$ " | STHS 50 | 1.60 |
| 35 | .026" | 8 | 2 $\frac{1}{4}$ " | ST 35 | 1.50 |
| 50 | .026" | 11 | 2 $\frac{1}{4}$ " | ST 50 | 1.80 |
| 75 | .026" | 15 | 2 $\frac{1}{4}$ " | ST 75 | 2.00 |
| 100 | .026" | 20 | 2 $\frac{1}{4}$ " | ST 100 | 2.25 |
| 140 | .026" | 28 | 2 $\frac{3}{4}$ " | ST 140 | 2.50 |
| 150 | .026" | 29 | 2 $\frac{3}{4}$ " | ST 150 | 2.50 |
| 200 | .018" | 27 | 2 $\frac{1}{4}$ " | STH 200 | 2.75 |
| 250 | .018" | 32 | 2 $\frac{3}{4}$ " | STH 250 | 3.00 |
| 300 | .018" | 39 | 2 $\frac{3}{4}$ " | STH 300 | 3.25 |
| 335 | .018" | 43 | 2 $\frac{3}{4}$ " | STH 335 | 3.50 |
| 50-50 | .026" | 11-11 | 2 $\frac{3}{4}$ " | STD 50 | 3.50 |
| 100-100 | .018" | 14-14 | 2 $\frac{3}{4}$ " | STHD 100 | 4.50 |

SS 180° Straight-Line Capacity

The SS Condenser has 180° Straight-Line-Capacity plates and except for this detail is the same in all other respects as the ST condenser. When ordering, substitute SS for ST under the catalog symbol column in the listing at the right.

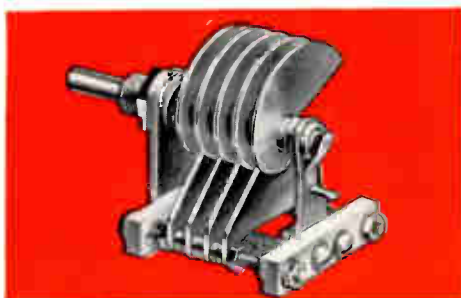

| Capacity | Air Gap | Plates | Length | Cat. Symbol | List Price |
|----------|---------|--------|-------------------|-------------|------------|
| 15 | .055" | 6 | 2 $\frac{1}{4}$ " | SEU 15 | \$2.50 |
| 20 | .055" | 7 | 2 $\frac{1}{4}$ " | SEU 20 | 2.75 |
| 25 | .055" | 9 | 2 $\frac{1}{4}$ " | SEU 25 | 2.75 |
| 50 | .026" | 11 | 2 $\frac{1}{4}$ " | SE 50 | 3.00 |
| 75 | .026" | 15 | 2 $\frac{1}{4}$ " | SE 75 | 3.25 |
| 100 | .026" | 20 | 2 $\frac{1}{4}$ " | SE 100 | 3.50 |
| 150 | .026" | 29 | 2 $\frac{3}{4}$ " | SE 150 | 3.75 |
| 200 | .018" | 27 | 2 $\frac{1}{4}$ " | SEH 200 | 3.75 |
| 250 | .018" | 32 | 2 $\frac{3}{4}$ " | SEH 250 | 4.00 |
| 300 | .018" | 39 | 2 $\frac{3}{4}$ " | SEH 300 | 4.00 |
| 335 | .018" | 43 | 2 $\frac{3}{4}$ " | SEH 335 | 4.25 |

SE 270° Straight-Line-Frequency

The SE Condenser has 270° Straight-Line-Frequency plates. Insulation is Isolantite. All models have two rotor bearings, the front bearing being insulated to prevent noise. The rotor contact is through a constant impedance pigtail. The SEU models are suitable for high voltages as their plates are thick polished aluminum with rounded edges. The other SE models do not have this feature.



UM (Ultra Midget)

The UM Condenser is designed for ultra high frequency use and is small enough for convenient mounting in our square shield cans. They are particularly useful for tuning receivers, transmitters and exciters. Shaft extensions at each end of the rotor permit easy ganging when used with one of our flexible couplings. The UMB-25 Condenser is a balanced stator model, two stators act on a single rotor. The UM can be mounted by the angle foot supplied or by bolts and spacers, as illustrated.

| Capacity | Air Gap | Plates | Cat. Symbol | List Price |
|----------|---------|--------|-------------|------------|
| 15 Mmf. | .017" | 6 | UM- 15 | \$1.25 |
| 35 | .017" | 12 | UM- 35 | 1.50 |
| 50 | .017" | 16 | UM- 50 | 1.60 |
| 75 | .017" | 22 | UM- 75 | 1.70 |
| 100 | .017" | 28 | UM-100 | 1.90 |
| 25 | .050" | 14 | UMA- 25 | 1.85 |
| 25 | .017" | 4-4-4 | UMB- 25 | 1.85 |



If an extended shaft is wanted for ganging on either the ST or the SS Series of Condensers listed above, add the letter E to the standard catalog symbol. Prices are the same.

NATIONAL *Special Purpose* CONDENSERS



NEUTRALIZING CONDENSERS

STN (Fig. 1) A compact, rigid, and efficient condenser particularly suitable for neutralizing 245, 247, 210 and similar tubes in amplifier, buffer or doubler stages. Very low minimum capacity. Isolantite insulation. Maximum capacity 18 mmf. Peak voltage breakdown — 3000v. **List Price, \$2.00**

TCN (Fig. 2) A heavy duty neutralizing condenser having a peak voltage rating of 6000 volts. Suitable for use with 203A, 852, 204A and similar tubes. Maximum capacity 25 mmf. **List Price, \$4.00**

NC 800 (Fig. 3) A high voltage neutralizing condenser, suitable for use with the RCA-800. Insulation is Isolantite. For capacity-air gap relation see Figure 8. **List Price, \$3.00**

NC-150 (Fig. 6) A heavy duty condenser designed to neutralize such tubes as the HK 345, RK 36, 300 T and 852. The NC-500, a still larger condenser, is available for neutralizing the W.E. 251A and similar tubes. See Figure 8 for capacity-air gap relation.

Type NC-150
Type NC-500

List Price, \$6.50
List Price, \$12.50

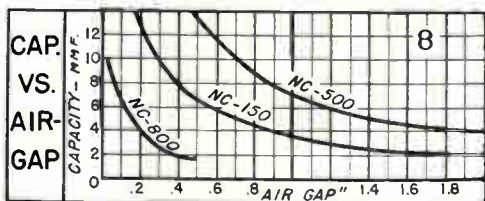

GENERAL PURPOSE

EMC (Fig. 5) National EMC Condensers have high electrical efficiency, and calibrations may be relied on. Insulation is Isolantite, and Peak Voltage Rating is 1000 volts. Plate Shape is SLW.

| Capacity | No. of Plates | Cat. Symbol | List Price |
|----------|---------------|-------------|---------------|
| 150 | 9 | EMC 150 | \$3.25 |
| 250 | 14 | EMC 250 | 3.75 |
| 350 | 18 | EMC 350 | 4.25 |
| 500 | 26 | EMC 500 | 4.75 |
| 1000 | 56 | EMC 1000 | 7.25 |

Split-Stator Models

| | | | |
|---------|-------|----------|-------------|
| 350-350 | 18-18 | EMCD-350 | 7.50 |
|---------|-------|----------|-------------|

PADDING CONDENSERS

National Air-Dielectric Padding Condensers (Fig. 4) are extremely compact and have a very low temperature coefficient. The aluminum shield is 1 1/4" diameter by 1 1/4"-1 1/2" high.



A very small mica Padding Condenser (Fig. 7) is also available, mounted on an Isolantite base and designed to be supported by the circuit wiring. The maximum capacity is 30 mmf., and the overall dimensions are 13/16" long x 9/16" wide x 1/2" high.

| | |
|----------------------|---------------------------|
| W 75 (75 Mmf. Air) | List Price, \$2.25 |
| W 100 (100 Mmf. Air) | List Price, 2.50 |
| M 30 (30 Mmf. Mica) | List Price, .30 |



PARTS

R.F. CHOKES

R-100. Isolantite mounting, continuous universal winding in four sections. For pigtail connections or standard resistor mountings. Inductance $2\frac{1}{2}$ m.h.; distributed capacity, 1 mmf.; D.C. resistance 50 ohms; Current rating, 125 M.A. For low powered transmitters and high frequency receivers.



List Price, \$6.60



R-152, R-154, R-154U. These transmitter chokes have honeycomb coils (0.6 amps. rating) wound on Isolantite cores. The R-152 is designed for the 80 and 160 meter bands; inductance 4 m.h., D.C. resistance 10 ohms. The R-154 and R-154U give maximum impedance on the 20, 40 and 80 meter bands; inductance 1 m.h., D.C. resistance 6 ohms. The R-152 and R-154 are as illustrated. The R-154U does not have the small insulating pillar and the third mounting foot.

R-152 or R-154
R-154U

List Price, \$2.25
List Price, 1.75

R-201. A two-section honeycomb-wound choke in R-39 case, suitable for output circuit of second detector in H.F. receivers (475 KC Intermediate Frequency). Inductance, approximately 12 m.h., D.C. resistance approximately 120 ohms.



List Price, \$1.25

TWIN DIODE TRANSFORMER



I.F.D. This transformer is designed for use in the new noise silencing circuits, and in detector and a.v.c. circuits where the secondary will be working into a diode detector tube. The primary is tuned by an air dielectric condenser with aluminum plates. The secondary is untuned, closely coupled, for push-pull output. The condenser and coils are mounted on an Isolantite base treated against moisture absorption.

I.F.D., 450-550 KC.

List Price, \$3.50

I.F. TRANSFORMER

This new I.F. Transformer has dielectric condensers (isolated from each other by an aluminum shield) and Litz wound coils mounted on an Isolantite base which is treated against moisture absorption. The aluminum shield can, housing the assembly, measures $4\frac{1}{8}$ " x $2\frac{3}{8}$ " x 2". These transformers are available with or without Iron Cores in the 450-550 KC model; the 175 KC model is air core only. For iron core add \$.50 to list price.

Type IFC Transformer (air core)

List Price, \$5.00

Type IFCO Oscillator (air core only)

List Price, \$5.00

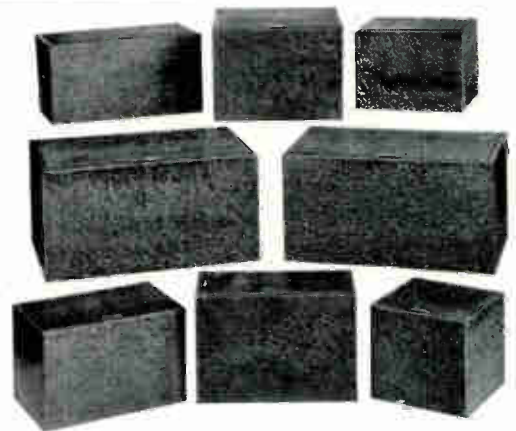

STANDARD CABINETS

The National Receiver Cabinets illustrated above, are for use in constructing special equipment. List Prices include sub-bases and bottom covers. Reading left to right:

| Top Row | Width | Height | Depth | List Price |
|----------------|--------------------|-------------------|--------------------|------------|
| Type C-HWR | 13 $\frac{1}{2}$ " | 7" | 7 $\frac{1}{4}$ " | \$5.00 |
| Type C-FB7 | 11 $\frac{1}{2}$ " | 8" | 12" | 7.00 |
| Type C-SW3 | 9 $\frac{3}{4}$ " | 7" | 9" | 5.50 |
| Middle Row | | | | |
| Type C-NC100 | 17 $\frac{1}{4}$ " | 8 $\frac{3}{4}$ " | 11 $\frac{1}{4}$ " | 8.50 |
| Type C-HRO | 16 $\frac{3}{4}$ " | 8 $\frac{3}{4}$ " | 10" | 8.50 |
| Bottom Row | | | | |
| Type C-One-Ten | 11" | 7" | 7 $\frac{1}{4}$ " | 4.50 |
| Type C-PSK | 6" | 8" | 12" | 6.00 |
| Type C-SRR | 7 $\frac{1}{2}$ " | 7" | 7 $\frac{1}{2}$ " | 3.50 |

TUBE AND COIL SHIELDS

The Aluminum Shields shown are from left to right:

| Type | List Price |
|--|------------|
| HRO coil shield, 2" x 2 $\frac{3}{8}$ " x 4 $\frac{1}{8}$ " high | \$.35 |
| J30 coil shield, 2 $\frac{1}{2}$ " dia. x 3 $\frac{3}{4}$ " high | .35 |
| B30 coil shield, 3" dia. x 3 $\frac{3}{4}$ " high | .35 |
| B30 coil shield, with mounting base | .50 |
| TS Tube Shield, with cap and mounting base | .40 |
| T58 Tube Shield, with cap and mounting base | .40 |
| T78 Tube Shield, with cap and mounting base | .40 |

The T58 and T78 fit such tubes as the 57, 58, 77, 78, etc.



CODE PRACTICE OSCILLATOR

This small audio oscillator is suitable for either code practice, or as an audio signal source for ICW on the Ultra High Frequency Bands.

A type 30 tube is used, and four flashlight cells in the case provide filament and plate current.

Type CPO, without batteries or tube. List Price, \$6.00



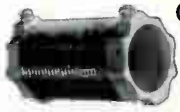

COIL FORMS. These transmitter coil forms of low-loss ceramic are designed for high efficiency and should not be confused with ordinary porcelain forms. A data sheet supplied with each form shows the correct wire turns to use.

- XR-10A, 20 or 40 meter **List Price, \$1.50**
- XR-12A, 160 meter **List Price, 2.50**
- XR-13, (1 3/4" dia. x 3 1/2" long.) **List Price, 1.10**

SCREEN GRID DETECTOR COUPLING UNIT. This impedance coupling unit, when employed to couple the output of a screen grid detector to an audio amplifier tube, will give from two to three times as much amplification as resistance coupling. Plate choke, 700 henries. Coupling condenser, .01 mfd. Grid leak, 250,000 ohms.
Type S-101 **List Price, \$6.00**

RECEIVER COIL FORM. These well-known R-39 forms are machinable, permitting the experimenter to groove and drill them to suit individual requirements. They are available in 4-, 5- and 6-prong types. Length, 2 1/4". Dia. 1 1/2".
XR-4, XR-5, or XR-6. **List Price, \$.75**



RECEIVER COIL FORM. Smaller in size than the R-39 forms listed above and made of Steatite, these forms are drilled for leads and left unglazed to provide a tooth for coil dope. They have 6 prongs.
Type XR-20. **List Price, \$.35**

MIDGET COIL FORM. Made of low-loss R-39, these small coil forms are designed with excellent form factor, contributing to high efficiency in H. F. circuits. Diameter, 1"; Length, 1 1/2"; Wall thickness, 1/16". Type XR-1 has four prongs, others are plain.
Type XR-1, four prongs. **List Price, \$.50**
Type XR-2, without prongs. **List Price, .35**
Type XR-3, 9/16" dia. x 3/4" long. **List Price, .30**



PLUG-IN COIL FORMS. These R-39 coil forms, originally used in the FB-7, are designed for plugging-in through the front panel of a receiver, monitor, etc. A padding condenser mounts inside the coil, and a special bakelite sleeve protects the winding. The coil shield listed is bolted to the back of the panel, and supports the Isolantite socket.
XR-39A Coil Form, Air Tuned. **List Price, \$4.75**
XR-39M Coil Form, Mica Tuned. **List Price, 3.65**
XCS Coil Shield and Socket. **List Price, 1.75**



COIL FORM. This Steatite Choke Coil Form is ideally suited for small choke coils and precision resistors. The winding is divided in four sections by partitions. A slot is provided for leading the wire from section, and to the terminals.
Type XT-8. **List Price, \$.50**

FIXED TUNED EXCITER TANK



Mounted on the Isolantite base are two 25 mmf. condensers (2000 volts — isolated from each other by an aluminum shield) and an R-39 coil form (1 1/2" x 1" diameter). The assembly is enclosed in an aluminum can, 4" x 2 3/8" x 2". This unit is also available with the Plug-In Base shown below which makes it ideal for conveniently and rapidly changing transmitting frequencies.
Type FXT without plug-in base.

List Price, \$4.50
Type FXTB with plug-in base (either 5 or 6 prong). **List Price, \$4.90**



PLUG-IN BASE AND SHIELD

The low-loss R-39 base has prongs moulded in for easy plug-in mounting. This unit is ideal for mounting condensers and coils when it is desirable to have them shielded and easily removable from a circuit. Four mounting holes that match our UM condenser

are provided. The Aluminum Shield can is 2" x 2 3/8" x 4 1/8". Two models are available; 5 or 6 prong.
Type PB-10, (Base and Shield). **List Price, \$.75**
Type PB-10A, (Base only). **List Price, .40**

VICTRON SHEET AND COIL DOPE

The Loss Factor (0.2) of this non-hydroscopic material is 1/8 of "Low-Loss" rubber and 1/90 of the usual R.F. insulators. Its Power Factor is .06%-.08%. Ideal for mounting high frequency gear and it is readily drilled or sawed. In color it is a transparent amber. National Coil Dope, a special R.F. lacquer using this same Victron as a base, is ideal as a cement for holding windings in place as it will not spoil the properties of the best coil form.

- 12" x 6" x 3/16" thick sheet. **List Price, \$6.00**
- 12" x 6" x 1/8" thick sheet. **List Price, 5.00**
- 6" x 3" x 3/16" thick sheet. **List Price, 1.50**
- 6" x 3" x 1/8" thick sheet. **List Price, 1.25**
- Coil Dope, per can. **List Price, 1.50**

LOW FREQUENCY OSCILLATOR COIL.

Two separate inductances, closely coupled, in an aluminum shield. It is used in the SRR and other super-regenerative receivers for the interruption-frequency oscillator. Sec. Inductance 6.25 m.h. Tunes to 100 K.C. with .00041 Mfd.
Type OSR. **List Price, \$1.50**



PARTS

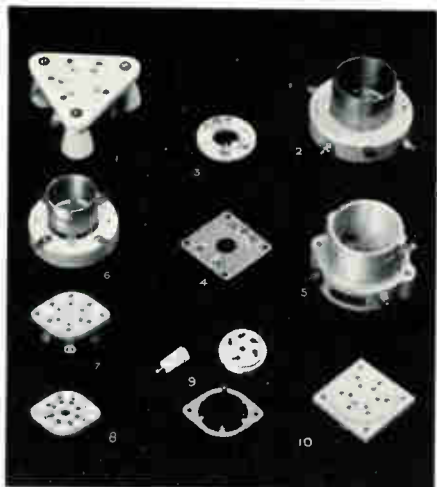

LOW-LOSS SOCKETS

The sockets illustrated above will meet every amateur need.

1 is a wafer type Isolantite socket for power Pentodes such as the RK-28 and the RCA-803.

Type JX-100S, as illustrated. **List Price, \$3.60**
 Type JX-100, as above but without stand-off insulators. **List Price, \$3.00**

2 is a fifty watt socket with sturdy side wipe contacts and employs the conventional bayonet-lock metal shell.

Type XM-50. **List Price, \$1.75**

3 is an Isolantite socket for the Triode Acorn tube. The socket contacts are of a new design providing very short leads and have a current path nearly independent of tube position.

Type XCA. **List Price, \$1.50**

4 is for the Pentode Acorn tube and is assembled, with the same type of contacts as the XCA, on a square copper base with built-in by-pass condensers for stable high frequency operation.

Type XMA **List Price, \$2.00**

5 is another 50 watt socket made entirely of low-loss Steatite and is for higher frequencies and voltages than the XM-50.

Type XC-50. **List Price, \$3.50**

6 is a socket, similar in construction to the XM-50, designed for those tubes using the type UX base.

Type XM-10. **List Price, \$1.25**

7 is one of the complete line of National Isolantite Receiving Sockets that fit all standard receiving tubes. Types 4 prong, 5 prong, 6 prong, 7 prong—small, 7 prong—large. **List Price, \$.60 each**

8 is an Isolantite wafer socket for the Octal (metal) tubes.

Type 8 prong. **List Price, \$.60**

9 is a new socket of Isolantite, modern in every detail, from the contact that grips the tube prong for its full length to the metal ring for six-position mounting. The sockets for the glass type tubes are supplied with a stand-off insulator that allows center mounting for bread board layouts. This line also includes an 8 prong socket (for metal tubes) which is supplied with two metal stand-offs.

Type 4 prong, 5 prong, 6 prong, 7 prong—small, 7 prong—large, 8 prong (octal), CIR Series.

List Price, \$.40

10 is a square Isolantite coil socket designed to fit National 6 pin coils. A wafer type socket, similar to figure 6, is also available to fit these same coil forms.

Type 6 prong Square Coil Socket **List Price, \$.75**

Type 6 prong Wafer Coil Socket **List Price, \$.60**

SHAFT COUPLINGS

The shaft couplings illustrated below will solve every problem usually experienced in coupling 1/4" Dia. shafts in receivers or transmitters.

1 is a small coupling of Steatite, providing high electrical efficiency when used to isolate circuits.

Type TX-9. **List Price, \$1.10**

2 is another small coupling that is well known and liked for its small size and freedom from backlash. Insulation is canvas bakelite.

Type TX-10. **List Price, \$.55**

3 is a coupling providing high insulation with compact size. Insulation is glazed Isolantite.

Type TX-1 (leakage path 1"). **List Price, \$1.00**

Type TX-2 (leakage path 2 1/2"). **List Price, 1.10**

4 is a flexible shaft, providing a driving means between offset shafts, or shafts at angles up to 90 degrees, virtually eliminates mis-alignment problems. Isolantite hubs are provided at each end.

Type TX-12. **List Price, \$1.25**

5 is a flexible shaft without the insulation of the TX-12, but otherwise the same.

Type TX-11. **List Price, \$.60**

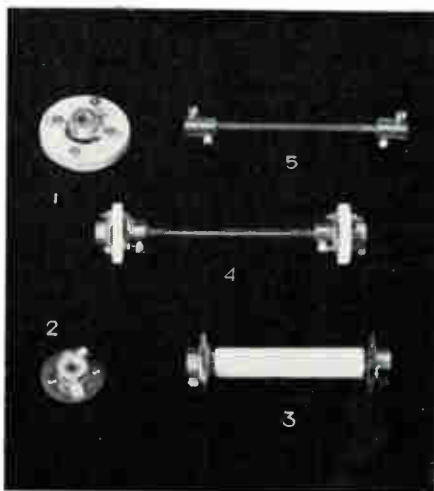

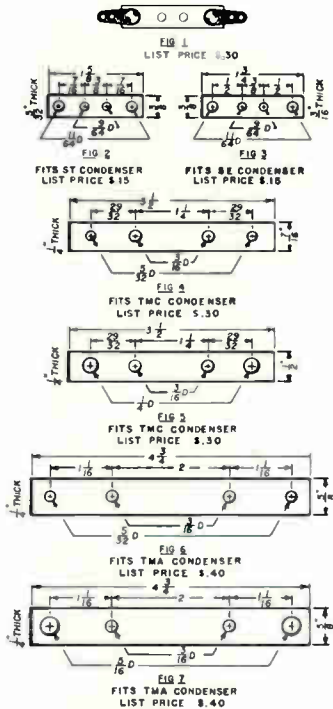

INSULATORS: A number of our standard condenser insulators are shown above. In addition to their obvious use as repair parts they may be used for a variety of other purposes such as supports for coils, spreaders, etc. The insulator shown in Fig. 1 is the same as Fig. 3, but has a metal solder lug riveted to each end. It is useful as a 5-meter lead-in spreader, or as a mounting for 5-meter inductances.

GRID GRIPS

This Grip provides the best means for attaching a wire to the top-cap of tubes. Made in three sizes.

- Type 24 — for standard glass tubes List Price, \$.05
- Type 12 — for transmitting tubes List Price, .10
- Type 8 — for metal tubes List Price, .05



**SHAFT EXTENSION.
SCREW LUG.**

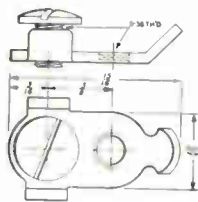

List Price, \$.25
List Price, \$.15

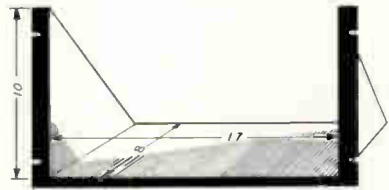

FIG 10

RELAY RACK SHELF: This recessed shelf will fit any standard relay rack, and is particularly useful for supporting portable equipment, instruments, test equipment, etc., Type RRS. List Price, \$4.00

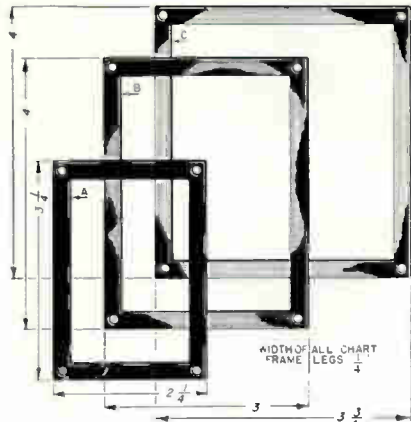
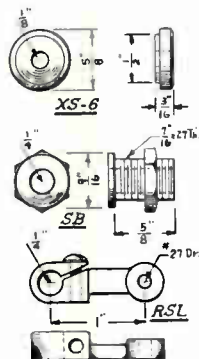

FIG 11

COIL CHART FRAMES: Nickel Silver Chart Frames are available in the sizes shown above. The largest frame is the same as that used on the AGS, the medium frame is the same size as that on the FB-7, and the smallest is the same as the HRO frame. Prices include celluloid sheet to protect the chart.

- Size A. List Price, \$.50
- Size B. List Price, .60
- Size C. List Price, .70



H.F. BUSHING: This small Steatite bushing has many uses in Amateur equipment. Type XS-6 List Price, \$1.15

SHAFT BUSHING: A bushing that gives a professional touch to equipment where 1/4" shafts have to be brought through panels.

Type SB List Price, \$.25

ROTOR SHAFT LOCK: This lock is designed to clamp securely either the TMA or the TMC rotor shafts.

Type RSL List Price, \$.85



NATIONAL *High Frequency* RECEIVERS



STANDARD HRO RECEIVER

National has built into this receiver every feature the most advanced amateur requires.

The two preselector stages give remarkable image frequency suppression, weak signal response and high Signal-to-Noise Ratio. The two high gain I.F. stages employ Litz-wound coils and are tuned with air condensers. The useable sensitivity and selectivity are exceptional. Other circuit details are automatic and manual volume control, a vacuum tube voltmeter calibrated in "S" units for carrier intensities, a phone jack, a Send-Receive switch and a Lamb Single Signal crystal filter. This filter makes selectivity adjustable over a wide range and the circuits are so precisely balanced that heterodyning signals may be completely phased out.

Most notable among the mechanical details is the PW precision four-gang condenser, described in detail on page 2.

For best performance, a reliable speaker should be chosen with an input impedance of 7000 ohms. The Monitor speaker listed on page 17 is recommended or a similar speaker can be furnished in a cabinet to match the HRO.

OUTSTANDING FEATURES

- Nine Tubes, not including rectifier
- Single Signal (Crystal Filter)
- Ganged Plug-in-Coils, each coil shielded
- Strictly single control tuning
- Four gang PW condenser
- Micrometer Dial, tuning over 500 divisions
- "S" meter
- Two I.F. stages — Litz-wound coils, air condenser tuned
- Beat Frequency Oscillator for "Offset" C.W. Tuning
- Two Preselector Stages

STANDARD HRO Receiver, table model, complete with tubes and four sets of coils covering range 1.7 MC to 30 MC, but no speaker or power supply — 2½ volt A.C. or 6 volt battery model.

List Price, \$299.50

STANDARD HRO Receiver, relay rack model — 2½ volt A.C. or 6 volt battery model. **List Price, \$320.00**
Specify Grey or Black finish.

5897 AB Power Supply — less tube — for above receiver. **List Price, \$26.50**

Shipping weights: Receiver 62 pounds, power supply 15 pounds.

MCS Table-model Metal Cabinet and 8" Dynamic Speaker (P.M. type — requires no power supply) with impedance matching transformer for a single Class A Pentode (7000 ohms). **List Price, \$23.50**



Other accessories suitable for use with the HRO are described on page 17.

12 ... NATIONAL COMPANY, INC., MALDEN, MASS.

NATIONAL *High Frequency* RECEIVERS

GANGED PLUG-IN COILS

CALIBRATED BAND-SPREAD

The plug-in coils of the HRO are ganged for easy handling and individually shielded for stability. When these coils are used for general coverage, each of the 4 coils includes two amateur bands and the spectrum between. A simple switching device is provided which makes these same coils band-spread their respective amateur bands (except 160) over a span of 400 divisions on the dial. Each set of coils is accurately calibrated at the factory and the complete set of four coils, as supplied with each standard HRO, covers the range from 1.7 MC to 30 MC.

Additional sets of coils are available only as listed below.

50-100 KC
100-200 KC
175-400 KC
500-1000 KC
900-2000 KC

List Price, \$37.50
List Price, 30.00
List Price, 27.50
List Price, 20.00
List Price, 20.00



JUNIOR HRO RECEIVER

For those who require the high performance of the Standard HRO but do not need its extreme versatility, the HRO Junior is offered. The circuit and mechanical details of both receivers are identical in every respect, but the lower priced model has been greatly simplified by omitting the Lamb Single-Signal crystal filter, the "S" meter, and by designing coils for continuous band spread only.

Although these omissions do not greatly restrict its usefulness, they make it possible to price the HRO Junior at a very attractive figure.

HRO JUNIOR RECEIVER table model, complete with tubes and one set of coils, 10 to 20 meters (2 amateur bands) but no speaker or power supply — 2½ volt A.C. or 6 volt battery model.

List Price, \$180.00

List Price, 16.50

Additional HRO Junior Coils (2 amateur bands per coil).

List Price, 26.50

5897 AB Power Supply — less tube — for above receiver.

THE STANDARD HRO

THE HRO JUNIOR

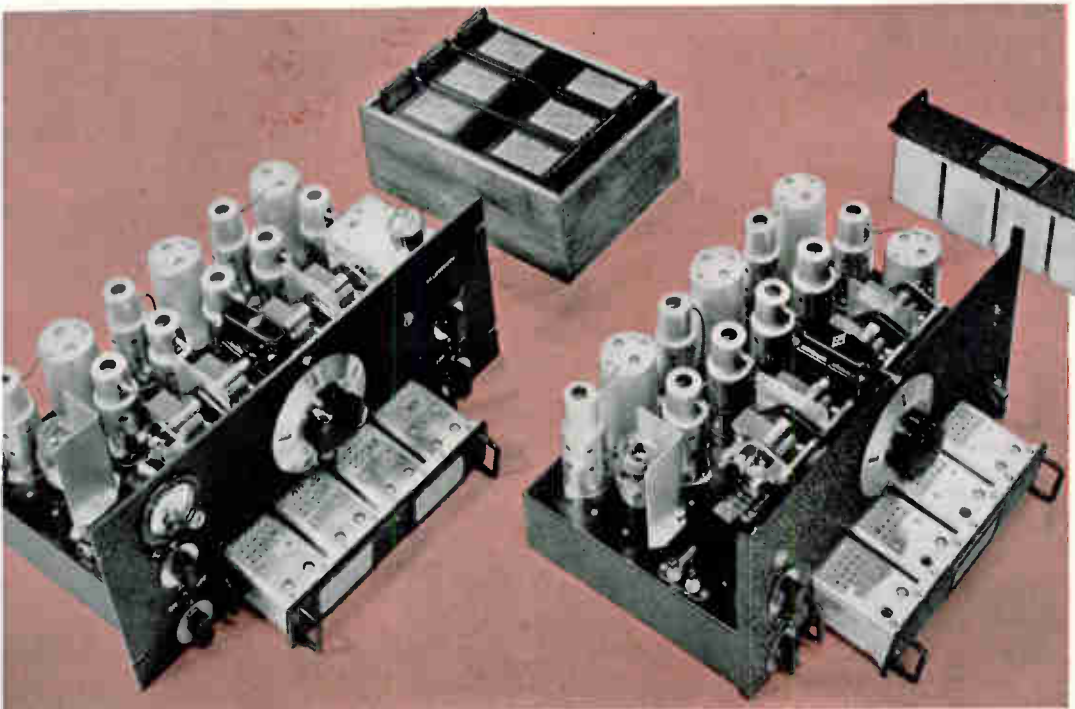

An engineering bulletin describing the above receivers in detail will be mailed on request.



NATIONAL COMPANY, INC., MALDEN, MASS....

13

NATIONAL *High Frequency* RECEIVERS



THE NC-100

These receivers are 12 tube super-heterodynes and except for the speaker are self-contained in a table model cabinet which is readily adaptable to relay rack mounting by brackets listed below.

One stage of R.F. and two stages of I.F. are used. Low-loss insulation and high-Q coils give ample sensitivity and selectivity. Separate R.F. and Audio Gain Controls permit complete control of the receiver. A 6E5 tuning indicator tube, with provision for signal strength measurement, provides an added convenience. Other controls are Tone, C.W. Oscillator, AVC with amplified and delayed action, a B+ switch, and a phone jack. A self-contained power supply provides all necessary voltages including speaker field excitation.

The range changing system is unique in that it combines the mechanical convenience of a coil switch with the electrical efficiency of plug-in coils. The coils are, in effect, automatically plugged in. A twist of the Range Selector Knob brings the desired set of coils into position and plugs them in. This mechanism is well supported by the PW Dial and Drive, direct reading to one part in 500. Station logging is consistent and calibration permanent.

The NC-100 covers the range of 540 KC to 30 MC and is available with or without a crystal filter. The NC-101X is built and designed strictly for the amateur bands and covers the ranges: 1.7-2.0 MC, 3.5-4.0 MC, 7.0-7.3 MC, 14.0-14.4 MC, and 28.0-30.0 MC. The Lamb Single Signal Crystal Filter, with separate controls for phasing and selectivity, is standard equipment on the NC-101X.

The battery models, of the above receivers, differ from the A.C. in that 10 tubes are used; the power supply being eliminated and one output tube is used and also that an 8" permanent magnet type of dynamic speaker is used instead of the 10" dynamic speaker supplied with the A.C. model. Power output of A.C. model — 10 watts; Battery model — 2 watts.

THE NC-101X

- NC-100 — complete with tubes.
AC model — 10" speaker chassis. **List Price, \$200.00**
Battery model — 8" speaker chassis. **List Price, \$184.17**
- NC-100X — complete with tubes and crystal filter.
AC model — 10" speaker chassis. **List Price, \$237.50**
Battery model — 8" speaker chassis. **List Price, \$221.67**
- NC-100S — complete with tubes.
AC model — 12" Rola G-12 Speaker. **List Price, \$222.50**
- NC-100XS — complete with tubes and crystal filter.
AC model — 12" Rola G-12 Speaker. **List Price, \$260.00**
- NC-101X — complete with tubes.
AC model — 10" speaker chassis. **List Price, \$215.00**
Battery model — 8" speaker chassis. **List Price, \$200.00**
- DCS-10 — Metal Cabinet for 10" speaker, same finish as receiver. **List Price, \$8.50**
- DCS-8 — Metal Cabinet for 8" speaker, same finish as receiver. **List Price, \$8.00**
- Note: Cabinets for 12" speaker chassis cannot be supplied.
- RRA Relay Rack Adapters, designed for mounting any of the above receivers in a standard relay rack. **List Price, per pair, \$2.50**
- Note: 230 volt 50 cycle and 115 volt 25 cycle models of above receivers available at slightly higher price.



NATIONAL *Ultra High Frequency* RECEIVERS



ONE-TEN RECEIVER

The One-Ten Receiver fulfills the need of the experimenter for an adequate receiver to cover the immense and ever more valuable field between one and ten meters. Designed chiefly for the experimenter, this receiver has been engineered for maximum sensitivity, high signal-to-noise ratio, a wide frequency range, ease of operation and with particular consideration for the characteristics of experimental high frequency transmitters.

A four tube circuit is used, composed of one tuned R.F. stage, a self-quenching super-regenerative detector, transformer coupled to a first stage of audio which is a resistance coupled to a power output stage. Six sets of plug-in coils are used. The popular PW-0 drive and dial are employed as the main tuning control. Three small dials control detector regeneration, audio gain and alignment of the R.F. circuit. A "B+" switch and

a head-phone jack are mounted on the front panel. Voltage dividers are built in, necessitating only one B voltage lead. The receiver is designed for operation from the National 5886 A B power unit. Batteries may be used if desired (Heater 6 volts, B supply 180 volts). Tubes required: 954-R.F.; 955-Detector; 6C5-1st Audio; 6F6-2nd Audio.

Tubes can be supplied at standard prices

Type 110 Receiver and 6 sets of coils, without tubes, speaker or power supply.

List Price, \$85.00

Type 5886 Power Supply for above receiver, less tube.

List Price, \$29.50

Shipping Weights: Receiver 16 lbs., Power Supply 17 lbs.

SW-3 High Frequency RECEIVER

The SW-3 Receivers employ a circuit consisting of one R.F. stage transformer coupled to a regenerative detector and one stage of impedance coupled audio. This circuit, as incorporated in the SW-3, with thorough shielding, grooved R-39 coil forms, Isolantite insulated condensers and tube sockets, etc., provides maximum sensitivity and flexibility with the smallest number of tubes and the least auxiliary equipment. The single tuning dial operates a precisely adjusted two gang condenser; the regeneration control is smooth and noiseless, with no backlash or fringe howl; the volume control is calibrated from one to nine in steps corresponding to the R scale, and is connected in the R.F. amplifier circuit; — the features all contribute to the efficiency and ease of operation so essential to equipment of this type.

The receiver especially suitable for installations where space is limited as in semi-portable or mobile stations, on yachts, etc.

Available in three models — ACSW-3 for AC operation — 6DCSW3 for 6 volt DC operation — 2DCSW3 for 2 volt DC operation. AC Models use "60" Series Coils. DC Models use "10" Series Coils.

Tubes required — 2 Volt AC Model, two 58, one 27 — 6 Volt DC Model, two 36, one 37 — 2 Volt DC, two 32, one 30.

SW-3, any model, without coils, phones, tubes or power supply.

List Price, \$35.00

Shipping weight 17 pounds

5880-AB Power Supply, 115 V, 60 cycle, without 80 Rectifier.

List Price, \$29.50

Shipping weight 18 pounds



General Coverage Coils

| Catalog Number | Range | List Price Per Pair |
|----------------|---------------------|---------------------|
| 10 or 60 | 9. to 15. meters | \$5.00 |
| 11 or 61 | 13.5 to 25. meters | 5.00 |
| 12 or 62 | 23. to 41. meters | 5.00 |
| 13 or 63 | 40. to 70. meters | 5.00 |
| 14 or 64 | 65. to 115. meters | 5.00 |
| 15 or 65 | 115. to 200. meters | 5.00 |
| 16 or 66 | 200. to 360. meters | 5.50 |
| 17 or 67 | 350. to 550. meters | 5.50 |

Five additional sets of coils are available to cover up to 3000 meters

Band Spread Coils

| | | |
|------------|------------------|--------|
| 10A or 60A | — 10 meter band | \$5.00 |
| 11A or 61A | — 20 meter band | 5.00 |
| 13A or 63A | — 40 meter band | 5.00 |
| 14A or 64A | — 80 meter band | 5.00 |
| 15A or 65A | — 160 meter band | 5.00 |



NATIONAL COMPANY, INC., MALDEN, MASS. . . .

15

NATIONAL *High Frequency* RECEIVERS



THE NC80X and NC81X

This is an inexpensive receiver having exceptional operating characteristics. Ten tubes are used in a high gain superheterodyne circuit as follows: 1st detector 6L7; HF osc. electron coupled, 6J7; three IF stages, 6K7's; linear 2nd detector, 6C5; amplified and delayed AVC, 6B8; panel controlled beat frequency oscillator, 6J7; beam power output, 25L6G; and rectifier, 25Z5. The IF amplifier is of entirely new design, operating at a frequency of 1560 KC, and providing a high order of image suppression, better, in fact, than that obtainable in many receivers having elaborate preselectors. The crystal filter (2nd IF stage) is truly remarkable in its performance, since selectivity is *continuously variable* between 400 cycles for single signal CW, and 5 KC for high quality broadcast. The range of the phasing circuit (heterodyne elimination) has been similarly extended. With such unusual characteristics, the crystal filter remains in the circuit at all times, simplifying tuning considerably. With the development of the 25L6G beam power tube having an undistorted output of 9 watts, it has become possible to design a high performance communication receiver operating with full efficiency on either AC or DC, 115 volts.

The tuning system, likewise entirely new, employs a multiple scale dial of the full-vision type,

accurately calibrated in megacycles. Several unusual features are incorporated, such as the mirror for overcoming parallax, the auxiliary linear scale (at the bottom), and the adjustable frequency markers, by means of which any particular stations, or frequencies, such as band limits, may be "logged" on the dial itself. Two vernier reduction ratios are available, 16 and 80 to 1, with a separate knob for each.

Automatic plug-in coils are used, controlled by a knob on the front panel, as in the NC-100. This arrangement has proven itself to be thoroughly reliable and efficient. The frequency coverage is continuous, except for a small gap at 1560 kc., from 550 kc. to 30 mc., in four ranges.

The NC-81X is a special amateur model covering the following bands only: 1.7-2.0 mc., 3.5-4.0 mc., 7.0-7.3 mc., 14.0-14.4 mc. and 28-30 mc. The dial is calibrated in megacycles.

NC-80X — complete with tubes, crystal filter, 8" PM speaker chassis, etc. for 115v. AC or DC. **List Price, \$146.65**

NC-81X — Amateur Model, complete with tubes, crystal filter, 8" PM speaker chassis, etc. for 115v. AC or DC. **List Price, \$146.65**

Note: Either of the above receivers can be supplied modified for Battery Operation by heater, 135v. B supply. To order, add "B" to symbol number. List prices are the same as the corresponding AC-DC model.

Type DCS-8 Metal Cabinet for 8" speaker, same finish as receiver. **List Price, \$8.00**

Larger speakers or cabinets cannot be supplied for these receivers.



An engineering bulletin describing the above receivers in detail will be mailed on request.

16

... NATIONAL COMPANY, INC., MALDEN, MASS.

World Radio History

RELAY RACKS, OSCILLOSCOPES, POWER UNITS

RELAY RACK UNITS

At the right is a Relay Rack assembly featuring the HRO (see pages 12 & 13). Above the receiver and mounted on one panel is the Combination Unit consisting of: 1, a coil rack for storing five HRO plug-in coils; 2, an 8" dynamic speaker of the permanent magnet type with an impedance matching transformer; 3, a power supply providing all necessary voltages for the HRO.

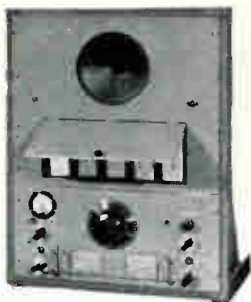

Type SPC Combination Unit — grey or black finish — less tube. **List Price, \$90.00**

These three units may be obtained mounted on separate panels. For Power Supply — see Power Units below.

Type HCRP Coil Rack and 7" Panel. **List Price, \$27.50**
Type RFS 8" Monitor Speaker and 8 3/4" Panel. **List Price, \$30.00**

Blank 3/16" Aluminum Relay Rack Panels, finished in black leatherette or grey enamel are available in the following sizes:

| | |
|---------------|---------------------------|
| 1 3/4" x 19" | List Price, \$3.25 |
| 3 1/2" x 19" | List Price, 4.50 |
| 5 1/4" x 19" | List Price, 5.75 |
| 7" x 19" | List Price, 7.00 |
| 8 3/4" x 19" | List Price, 8.25 |
| 10 1/2" x 19" | List Price, 9.50 |

RELAY RACKS

These steel racks are drilled and tapped to accommodate, up to their capacities, standard relay rack panels of all sizes.

Type RR Relay Rack built to Government specifications — panel capacity 70 1/8", black finish. **List Price, \$65.00**

Type MRR Table-model Relay Rack — panel capacity 24 1/2", grey or black finish. **List Price, \$22.50**

POWER PACKS



These units are equipped with a receptacle for plugging in the power cable from the set and special filament windings compensate for power cable voltage drop. At the left is shown a rack-mount pack; at the right is a table-model pack.

These Power Units have exceedingly low inherent hum as a double section filter, using high quality chokes and condensers, is employed. The transformer primary is shielded from other windings and "tunable hums" are eliminated by a built-in R.F. filter.



Type GRSPU Single Pack for rack mount can be supplied with same characteristics as 5897, 5886 or 5880.

List Price, less tube, \$49.50

Type GRDPU Double Pack for rack mount, same characteristics as GRSPU but with two complete and separate power supplies built in. **List Price, less tubes, \$79.50**

Type 5897 Table Pack — for 2 1/2 volt tubes, 220 volts, 60 mils.

List Price, less tube, \$26.50

Type 5886 Table Pack — for 6 volt tubes, 180 volts, 35 mils.

List Price, less tube, \$29.50

Type 5880 Table Pack — for 2 1/2 volt tubes, 180 volts, 35 mils.

List Price, less tube, \$29.50

Type 3580 General Purpose B Supply Pack provides three adjustable voltages (22 to 45, 45 to 90, 90 to 135) and 180 volts fixed (35 M.A.). **List Price, less tube, \$22.50**

CATHODE RAY OSCILLOSCOPE

These Oscilloscopes give a graphic picture of operating conditions in your transmitter; such as percentage modulation, signal distortion and peak voltage. The units are self-contained, power supply and controls are built in. An audio signal from the transmitter is used as a linear sweep, as the trapezoid pattern thus obtained is more easily interpreted. The conventional linear sweep may be added at any time. A self contained 60 cycle sweep is provided. Two models are available. The larger type CRO is the preferred equipment for the amateur station, but the smaller type CRM will give excellent results where size and cost are important.



Type CRO Oscilloscope 3" Screen — shown at left measures 6" x 8" x 18".

List Price, less tubes, \$32.50

Tubes required: One RCA-906, one 80.

Type CRM Oscilloscope 1" Screen — shown at right measures 4 1/8" x 6 1/8" x 8".

List Price, less tubes, \$18.50

Tubes required: One RCA-913, One 6X5.



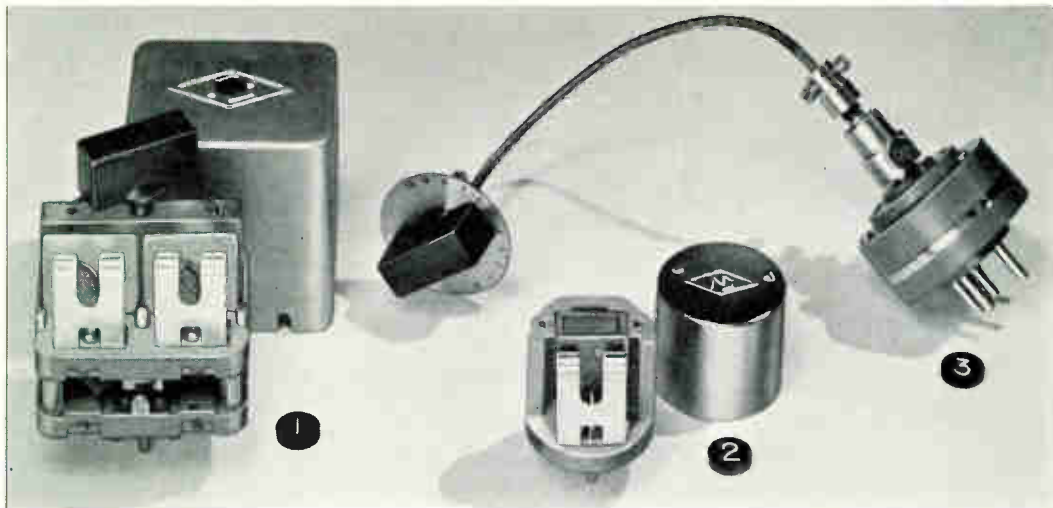

CRYSTAL HOLDERS

These crystal holders are moulded of low-loss R-39 and have prongs moulded in for easy plug-in mounting.

1 is a new type holder that will accommodate 4 crystals and has a built-in low-capacity switch for selecting frequencies. It accommodates crystals up to 1" square and is very convenient when an immediate choice of frequencies is desirable.

Type 4 in 1 — pressure type **List Price, \$7.50**

2 is a holder for a single crystal in which crystals may be changed readily. The metal cover is used for protection and shielding, as is also true of the 4 in 1 holder. Three models are available:

Type CHR — for use in receivers, resonator type.

Type CHS — for use in transmitters, Pressure, Constant Air-Gap, type.

Type CHT — for use in transmitters, Pressure type, no air gap.

List Price, less crystal, of \$2.50 each

3 is a novel holder permitting front-of-panel tuning of the crystal over a range of one part in 600 without loss in output. Only specially selected zero temperature coefficient crystals should be used as X and Y cut crystals will not oscillate satisfactorily under the conditions imposed.

Type CHV (less crystal)

List Price, \$9.50

Type CHV (with 80 meter Hollister crystal that will double into the 20 meter phone band)

List Price, \$32.50

PLUG-IN COIL FORM AND SOCKET

The new UR-10A Assembly consists of the XR-10A coil form (figure 3) for 20 and 40 meters and the new Isolantite Plug-in Base and Socket (figures 2 and 1 respectively). The Plug has five prongs and is easily attached by two screws to the Coil Form or may be used alone as a base for air wound coils. The socket, with five matching jacks, is supplied with special attachments for mounting directly on the tie bars of our TMA Transmitting Condenser.

Type UR-10A Coil Form Assembly

List Price, \$4.60

Type XR-10A Coil Form only

List Price, 1.50

Type PB-15 Plug-in Base only

List Price, 1.35

Type XB-15 Socket only

List Price, 1.75

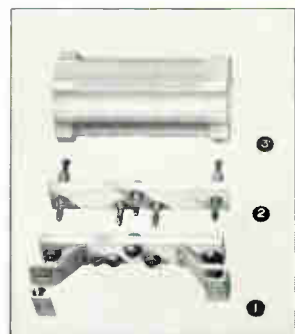

BUFFER COIL FORM AND SOCKET

At the left is the Buffer Coil Form Assembly. The Isolantite Coil Form (drilled for leads) is 1 3/4" diameter x 3 1/2" long and may be used as shown or mounted on stand-offs. The upper right figure is the molded R-39 coil plug with five tube prongs for easy wiring and plug-in mounting, designed to be easily attached by two screws to the Coil Form. The Coil Plug may also be used as a base for air-wound plug-in coils, the tube prongs serving as coil anchoring points. The lower right figure is the molded R-39 Socket employing five sturdy side-wipe contacts, three on one side and two on the other for symmetrical wiring of the buffer circuit.

Type UR 13 Buffer Coil Form Assembly

List Price, \$2.50

Type XR 13 Coil Form only

List Price, 1.10

Type PB 5 Plug only

List Price, .75

Type XB 5 Socket only

List Price, .75



H. F. DIELECTRICS

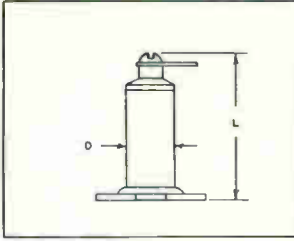

STAND-OFF INSULATORS: These well known Isolantite insulators combine electrical efficiency with strength and convenience. They are metal mounted.

- Type GS-1 (L=1 $\frac{3}{8}$ " , D=1 $\frac{1}{2}$ ")
List Price, \$.25
- Type GS-2 (L=2 $\frac{7}{8}$ " , D=1 $\frac{1}{2}$ ")
List Price, \$.35
- Type GS-3 (L=2 $\frac{7}{8}$ " , D=3 $\frac{1}{4}$ ")
List Price, \$.90
- Type GS-4 (L=4 $\frac{7}{8}$ " , D=3 $\frac{1}{4}$ ")
List Price, \$ 1.10

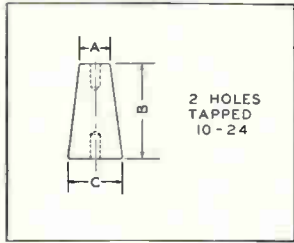

STAND-OFF INSULATOR: This popular style of insulator is offered in three sizes, all of low-loss Steatite. The smallest model is tapped 8-32 each end, the larger 10-24.

- Type GS-5 (A=1 $\frac{1}{2}$ " , B=1 $\frac{1}{4}$ " , C=1")..... List Price, \$.25
- Type GS-6 (A=5 $\frac{1}{8}$ " , B=2" , C=1 $\frac{1}{8}$ ")..... List Price, \$.45
- Type GS-7 (A=3 $\frac{3}{4}$ " , B=3" , C=1 $\frac{1}{2}$ ")..... List Price, \$.75

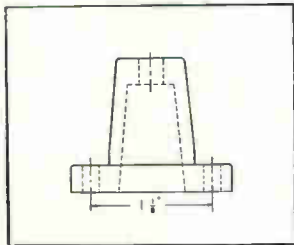

STAND-OFF INSULATOR: Another small insulator suitable for a variety of applications. Being made of Steatite, it is eminently suited for Low Loss H.F. circuits. It is available in a special model with a jack for mounting plug-in inductances.

- GS-8 List Price, \$.35
- GS-9 (with jack)..... List Price, \$.50

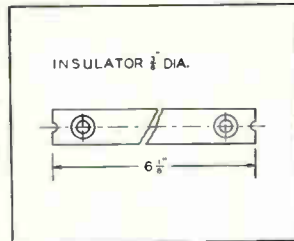

SPREADER: The unusual efficiency of these Steatite spreaders will more than justify their slight extra cost. The six inch line spacing when used with No. 12 wire will give feeders having a surge impedance of 600 ohms.

- Type AA-3 List Price, \$.30

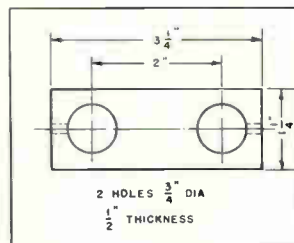

Q-BAR: These Isolantite Insulators when used to space 3/4" tubes 2" apart will give a transformer of the correct impedance for matching a 72 ohm center-fed half-wave doublet antenna to a 600 ohm line.

- Type QB List Price, \$.35



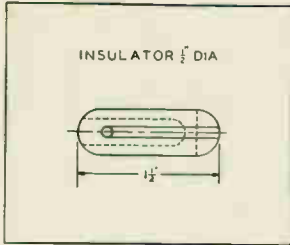

STRAIN INSULATOR. This aircraft-type insulator, in spite of its short leakage path, has a variety of uses in small portable, mobile and police installations. Being loaded in compression, the insulator provides great mechanical strength.

Type AA-5..... List Price, \$.30

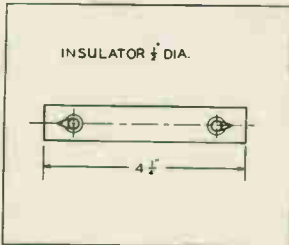
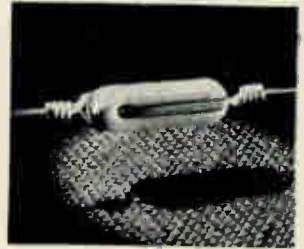

ANTENNA INSULATOR. This insulator is particularly suited for general use by the amateur. Its length provides ample leakage path, while its cross-section provides ample strength for all but the heaviest loads. The use of Steatite assures excellent electrical performance.

Type AA-6..... List Price, \$.35

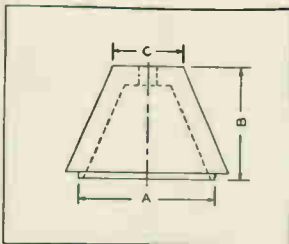
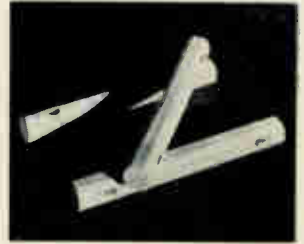

H.F. BUSHING. This small Steatite bushing has a variety of uses in transmitter construction, not only as a neat and efficient means of bringing H.F. leads through partitions, but as a support for coils, etc. Each pair of cones includes suitable metal fittings.

Type XS-1 (A = 1", B = 1 1/16")
per pair..... List Price, \$.75

Type XS-2 (A = 1 1/2", B = 1 3/16")
per pair..... List Price, \$.90

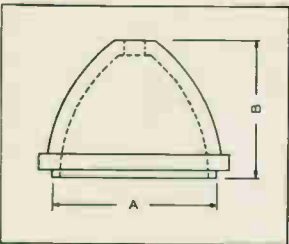

H.F. BUSHING. Larger in size than the bushings described above, and shaped to conform to the lines of electrical stress, these Steatite insulators are suitable for higher H.F. voltages. Prices are per pair, with metal fittings.

Type XS-3 (A = 2 3/4", B = 2 5/16")
List Price, \$ 5.00

Type XS-4 (A = 3 3/4", B = 2 25/32")
List Price, \$ 6.50

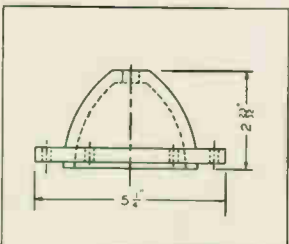
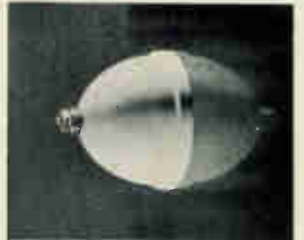

H.F. BUSHING. A heavy bowl-type lead-in, suitable for large transmitters, this Steatite insulator provides a weatherproof joint for antenna lead-in purposes. Leakage Path 3 1/4".

Type XS-5 each..... List Price, \$ 7.50

Type XS-5, with fittings, per pair
List Price, \$15.50



All Prices in this catalog subject to change without notice.

RP25M—7-37

CATALOG



NO. 270

20

NATIONAL COMPANY, INC., MALDEN, MASS.

World Radio History