

HAMMARLUND

Short Wave Manual

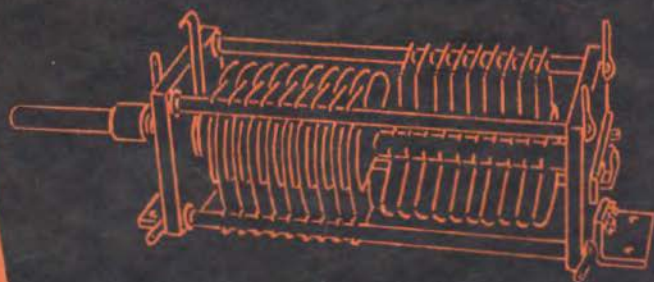

For the AMATEUR
and EXPERIMENTER

SIXTH EDITION

THE
HAMMARLUND
SHORT WAVE MANUAL

SIXTH EDITION

C O N T E N T S

Introduction.....	2-3
Two Tube Receiver.....	4-5
QST-Two Tube Superhet.....	6-7
Two Tube Preselector.....	8-9
Three Tube Regenerator.....	10-11
Receiver Power Supply.....	12-13
One Tube Transmitter.....	14-15
Short Wave Components.....	16-17
815-Dual Beam Transmitter.....	18-19
Two Tube Transmitter (812 tube).....	20-21
ECO Transmitter of Modern Design.....	22-23-24-25
Medium Power Modulator.....	26-27
Antennas (receiving and transmitting).....	28-29
Transmitting Power Supplies.....	30-31

P U B L I S H E D

B Y

THE HAMMARLUND MFG. CO. Inc.

424 W. 33rd STREET, NEW YORK CITY

INTRODUCTION

AMATEUR RADIO is truly an American hobby, and has proved time after time to be of great public value. In times of emergency, amateur stations have carried on communication long after general public and private facilities had failed. Floods, hurricanes, etc. have all provided occasions for amateur radio to perform great public services.

This book contains constructional arti-

prospective commercial or government operator can have.

Amateur radio of course holds other attractions; e.g., amateurs communicate with expeditions and provide regular schedules for members to communicate with folks at home. Also various groups of amateurs have established relay chains and receive and transmit hundreds of messages each week. Others belong to the



A typical Army Amateur Net station, W4LMC-WANG. This station was also used to receive messages from members of the Byrd Expedition.

cles of simple equipment with which to get started in this fascinating hobby. Before transmitting equipment is used it is necessary to obtain a government license. The penalty for illegal operation is heavy and since a license is relatively easy to obtain, there is no excuse for "boot leggers" as they are called by amateurs. The beginner will need to study other books. Those to be recommended are published by the A.R.R.L. (American Radio Relay League), an organization composed entirely of amateurs.

Now more than ever before a great many operators are in demand. While there are some 50,000 "ham" operators all are not able to serve, and new ones are continually needed to keep pace with our defense program. Training in amateur radio is perhaps the greatest asset a

Army-Amateur organization which is affiliated with the United States Signal Corps. There are hundreds of other interesting angles to amateur radio and first among these, is building and experimenting with your own transmitters and receivers. While many "hams" use factory made transmitters and receivers, the majority build and develop their own equipment from parts available through authorized amateur supply dealers. The budding amateur usually starts off with building a simple receiver.

These simple receiving sets are really fine performers and it is not too many years ago when they were used in nearly every "ham" station. Their performance of course, cannot be compared with that of modern communications receivers, but never-the-less they do get signals from all parts of the world under favorable con-

Famous "Super-Pro" receiver well known to amateurs and commercial operators. Receivers such as this one are used exclusively in commercial services. Several were employed on the Byrd Expedition to the Antarctic.



ditions. Interference is the great bug-a-boo, with the simple regenerators. Super-heterodyne receivers on the other hand, operate on the principle where selectivity is independent of the operating frequency to which the receiver is tuned. Small regenerative receivers must have all circuits tuned to the signal frequency and consequently the selectivity varies considerably. An ideal receiver would be one having variable selectivity characteristics of quite a wide range. The Hammarlund "Super-Pro" is an excellent example of such a receiver. It has a band width from nearly 16 kc. to better than 100 cycles. This permits reception of high quality music under suitable conditions and also makes

available any other degree of selectivity which might be required. For general short wave reception in crowded amateur and broadcast bands, a high degree of selectivity is more to be preferred, than the wide band type of selectivity. Here to, there is great advantage in having the variable feature. The Hammarlund "HQ-120-X" has a variable range of selectivity from 100 cycles to over 3 kc. This takes in practically all short wave broadcast and amateur requirements.

To get the most out of any receiver, regardless of whether it is a simple regenerator or a complicated communications type receiver, the operator must spend a great many hours at the controls.

Mrs. Clay Bailey, wife of the chief radio officer of the Byrd Expedition, listening to broadcasts emanating from the South Pole. The receiver is an "HQ-120-X".



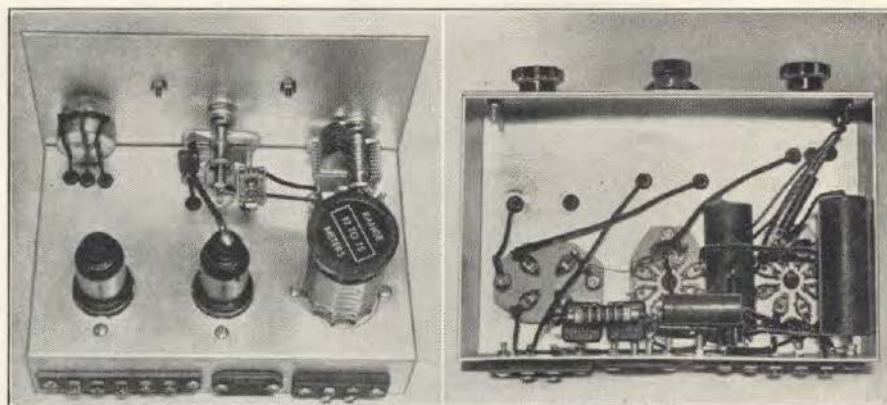

Rear and bottom views showing placement of parts and wiring.

The "Metal Tube Two"

THE "Metal Tube-Two" receiver is for the more advanced short wave experimenter. Two of the newer metal tubes are employed. One is a 6J7 regenerative detector and the other, a 6C5 triode, is a resistance coupled audio amplifier. This combination provides about the ultimate in simple short wave receivers. It is especially sensitive and will produce extremely loud signals. Loud enough, in fact, to operate a small speaker.

This receiver is designed to operate from the power supply described in another part of this book. Two-hundred-fifty volts are required for the B-supply and 6.3 volts A.C. for the heaters.

As in other receivers previously described, we also employ standard Hammarlund SWK plug-in coils in this one. In simple receivers the plug-in coil method is unquestionably the most satisfactory, because there is no danger of dead spots due to absorption caused by unused windings. Here too, we have also employed the band-spread system shown in the other receivers.

The tickler is connected in the plate circuit for obtaining regeneration. In the diagram, the tickler is shown at the top of the grid coil while actually it is wound at the bottom of the coil form. However, the connections remain identical. It is drawn at the top merely as a convenience.

In order to eliminate feed back in the audio stage, and to keep all traces of R.F. out of the grid circuit of the audio amplifier, a filter consisting of a 2.1 mh. R.F. choke and two .0005 mf. condensers, is employed in the B-plus side of the tickler circuit.

Regeneration is controlled by varying the voltage applied to the screen grid of the 6J7 regenerative pentode detector. The 50,000 ohm potentiometer and the 100,000 ohm resistor, are connected in series across the B-supply, that is, between the B-plus and B-negative, in order to obtain the correct voltage for the screen grid. The adjustment of this regeneration control is covered in other parts of this Manual and need not be discussed here.

The 30 mmf. trimmer, connected in series with the antenna, serves for varying the antenna coupling. Once set for the highest frequency coil, this condenser will need no further adjustment unless an extremely weak signal is encountered. Closing the condenser plates (increasing capacity), will increase the sensitivity and thus bring up the strength of the weak signal. However, as the capacity of this condenser is increased, the set automatically tunes broader. There is an optimum adjustment; one which provides sufficient signal strength without interference from stations transmitting on adjacent channels.

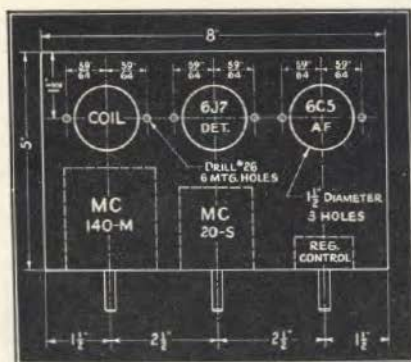

Drilling dimensions for chassis.

The diagram contains the circuit for an additional pentode power amplifier. This amplifier, when added to the main receiver will provide full speaker volume on all popular short wave stations. The .006 mf. condenser connected between the plate of the 6C5 and the B-minus should be connected between the plate of the 6F6 and B-minus when the additional audio stage is employed. The parts list does not contain the items employed in the additional amplifier. Also, the chassis on which the original receiver is built is not large enough for the second amplifier. We suggest a 10" chassis—one extending 2" farther to the right. The drilling of the 8" portion will, of course, remain the same. The panel should also be correspondingly larger.

This receiver has been found to operate best on an antenna from 40 to 75 feet long. Consisting of a single wire, the antenna should be mounted in the clear

and away from all trees, metal roofs, etc. A receiver is only as good as the antenna with which it is used. Use a good antenna system and you will be well repaid.

The beginner will find this the ideal set with which to start. Even today thousands are in use by Hams.

PARTS LIST

HAMMARLUND

- 1—MC-140-M Band setting cond.
- 1—MC-20-S Band-spread cond.
- 1—MEX antenna trimmer (30 mmf.)
- 1—CH-X r.f. choke
- 1—S-4 socket
- 2—S-8 sockets
- 1—SWK-4, 17 to 270 meter plug-in coil set

CORNELL DUBILIER

- 1—100 mmf. mica condenser
- 2—500 mmf. mica condensers
- 1—.006 mf. mica condenser
- 1—.1 mf. paper condenser
- 2—1 mf. paper condensers

I. R. C.

- 1—2 meg. 1/2 watt Resistors
- 2—1/4 meg. 1/2 watt Resistors
- 1—2,000 ohm 1 watt Resistor
- 1—100,000 ohm 1 watt Resistor
- 1—50,000 ohm potentiometer

MISC.

- 1—8 x 5 x 2" Chassis
- 1—8 x 6 x 1/16" Panel (aluminum/ Terminal strips, screws, etc.)
- 2—Knobs
- 1—Dial

R. C. A.

- 1—6J7 metal tube
- 1—6C5 metal tube

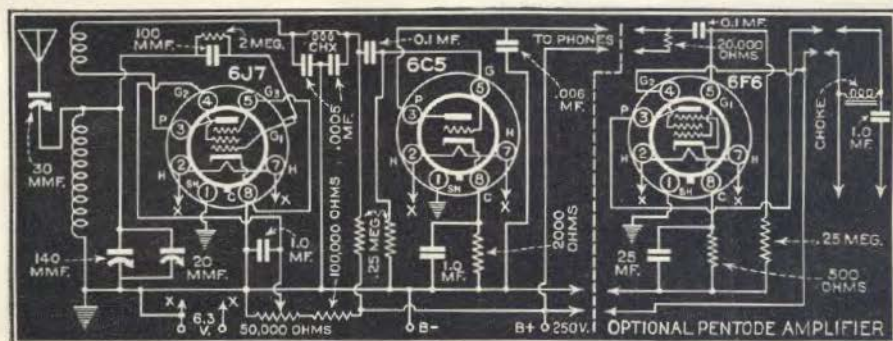

Wiring diagram for "Metal Tube Two"

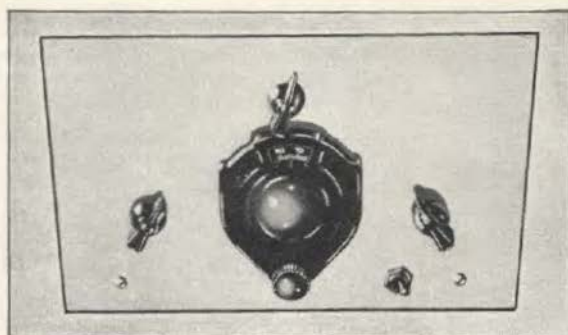

This two-tube Superhet is modeled after one previously described in "QST" magazine. Many budding amateurs will do well to start out with this type of receiver.

QST 2-Tube Superhet



WHILE this receiver operates on the superheterodyne principle, the beginner will probably get a clearer picture of the circuit by considering it a modified regenerative type receiver. In a regenerative receiver the detector is tuned to the incoming signal. The disadvantage lies in the fact that the frequency of the detector must be changed to coincide with the frequency of the desired signal. If we could have all signals operating on one frequency without interference, the detector could then be adjusted for maximum stability and sensitivity. The obvious solution seems to be to convert the frequency of the desired signal to that of the regenerative detector which is fixed tuned; that is exactly what is done in this receiver. A converter stage operates ahead of the regenerative detector. The regenerative detector operates exactly the same as in other receivers, except that its frequency remains fixed after it has been adjusted for maximum performance. The same thing happens in a superhet, except that an IF amplifier usually exists between the convert system of the second detector.

By selecting a rather high frequency at which to operate the regenerative detector in this receiver, it is possible to reduce the shortcomings of the usual simple Super-

heterodyne not having preselection. Some interference from images will be present but it is obvious that this receiver should outperform a usual 2-tube regenerator. The intermediate frequency in this particular case is approximately 1600 kc. The converter system consists of a 6K8 in the usual pentagrid circuit. The second detector and audio amplifier are combined in a twin triode 6C8G. The chassis on which the receiver is mounted is $5\frac{1}{2} \times 9\frac{1}{2} \times 1\frac{1}{2}$ " and provides ample space for all parts. The photographs clearly illustrate the position of the tubes, coils and condensers. Use of

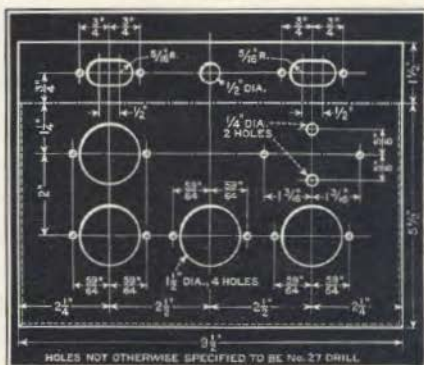

Chassis lay-out for two tube superhet.

Front and rear views of the "Two Stage Pre-Selector." Ideal unit for reducing noise and images.

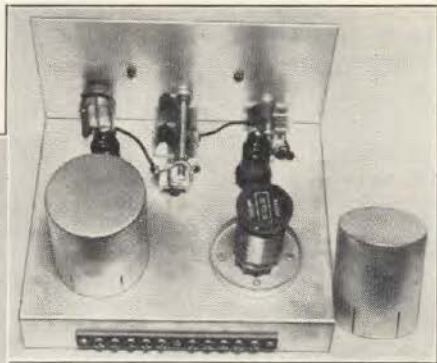
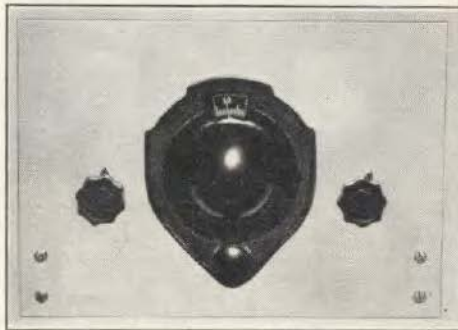

This unit will improve any superheterodyne

Two Stage Pre-Selector

THE pre-selector is a worthwhile addition to any superheterodyne, particularly those not having too much sensitivity. This one, in particular, will work well with present superheterodynes having no R.F. ahead of the first detector. Even those already having one stage of R.F. can be improved by the use of this unit. Not only does it increase the sensitivity of your present superheterodyne, but it also goes a long way toward eliminating images—that is, two-spot tuning. Noise is also reduced somewhat due to the overall increase in sensitivity and selectivity of the receiver.

A power supply for operating this pre-amplifier is not included in the unit. Inasmuch as it is to be used with some sort of receiver, the power can be taken directly from the receiver power supply. From 180 to 250 volts are required for the plate supply and 6.3 volts for the heaters. If your present receiver employs 2.5 volt tubes, such as the 58's and 56's, then it will be necessary to employ two type 58 pentodes in place of the 6K7 metal tubes shown in the diagram. If the glass tubes are used, it is necessary to shield them in order to prevent feedback. In this regard, the metal tubes are superior because of their thorough shielding.

It will be noticed that the two plug-in coils, which are SWK-6, 3-winding Hammarlund coils, are shielded with Hammarlund "CS" coil shields. Do not

attempt to operate the amplifier without these shields because it just won't work. Also it will be noticed that the dual 140 mmf. condenser has a shield plate between the two stators. This must also be grounded in order to eliminate feedback.

Band spread is not employed for the simple reason that it is not necessary. R. F. stages tune rather broad as compared to the tuning control of the receiver. In the first R. F. stage—that is, the one nearest the antenna circuit, the interwound winding is employed for trimming. Here we have a 100 mmf. condenser connected across the winding with one side grounded. The grounded side is that nearest the grounded side of the

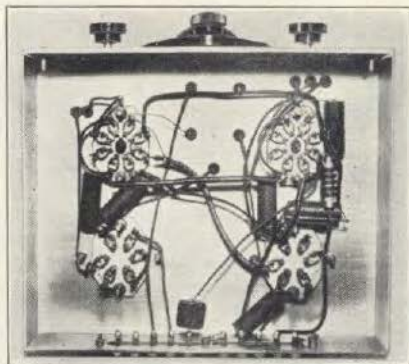

Bottom view showing the wiring.

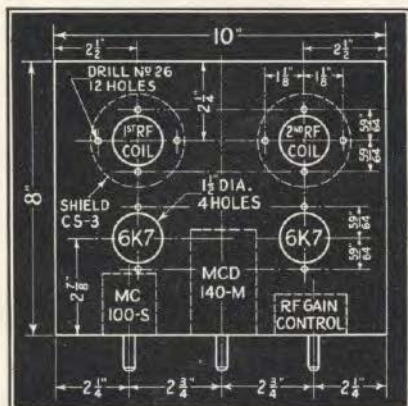

Drilling dimensions for the chassis.

larger winding. The small coil at the bottom of the form, usually termed the tickler, is used as the antenna coupling coil. This coil remains unused in the second stage. The interwound winding serves as the plate coupling coil and the large winding as the grid coil for the second amplifier tube. This also is tuned with a 140 mmf. condenser. With proper adjustment, of the 100 mmf. padding condenser, the two circuits will track very nicely.

There are many arrangements which can be used for coupling the pre-selector to the receiver proper. However, the arrangement shown is the simplest and is entirely satisfactory. Merely connect the output terminal of the converter to the antenna post of your receiver. The negative side of the converter need not be connected to the receiver because this connection is already made through the power supply. In wiring up the converter, all leads should be short and direct.

Long leads in a high gain amplifier of this type will cause no end of trouble. The longest lead is the one going from the second coil to the plate of the first 6K7. It will be noticed that this lead is shielded in order to reduce feedback. Do not employ ordinary shielded wire. This lead should be made with hook-up wire having heavy insulation, and a short length of braided shielding material should be placed over the wire. If the capacity between the shielded wire is too great, considerable sensitivity will be lost. The converter has a volume control of its own which should be operated independent of the receiver. The correct setting for the volume control can only be learned by experience.

PARTS LIST

HAMMARLUND

- 1—MCD-140-M two gang condenser
- 1—MC-100-M trimmer condenser
- 1—CHX R.F. choke
- 2—S-8 sockets
- 2—S-6 sockets
- 2—CS coil shields
- 2—SWK-6 6-prong coil sets 17-270 M.

CORNELL DUBILIER

(Condensers)

- 6—.1 mf. paper
- 1—500 mmf. mica

I. R. C.

(Resistors)

- 2—300 ohm 1/2 watt
- 2—100,000 ohm 1/2 watt
- 1—50,000 ohm 1 watt
- 1—10,000 ohm potentiometer

MISC.

- 1—8 x 10 x 2" chassis
- 1—7 x 10" panel (aluminum)
- 1—Dial
- 2—Knobs
- Binding post strips, screws, etc.

R. C. A.

- 2—6K7 Metal tubes

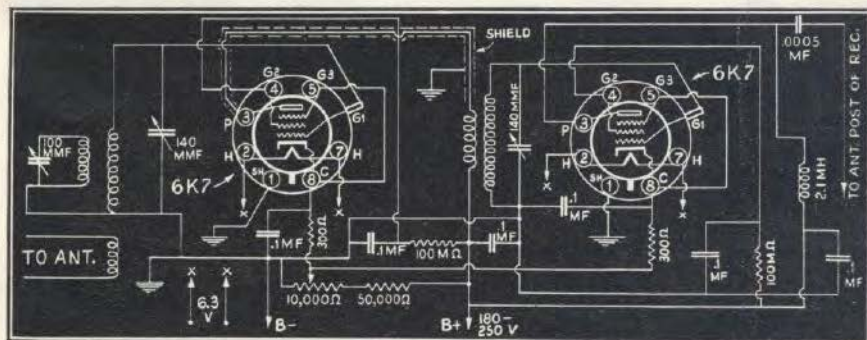

Wiring diagram and values of "Two Stage Pre-selector."

Three Tube Regenerator

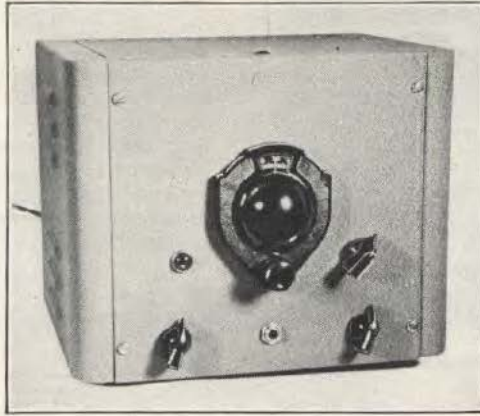

Three tube receiver for the beginner.

THIS simple three tube receiver employs an untuned RF stage. The purpose of this RF stage is to reduce detuning effects, usually caused when the antenna is directly coupled to a regenerative detector grid circuit. The RF tube operating with relatively fixed characteristics provides a uniform load for the detector circuit and also isolates it from the antenna.

Radiation from the oscillating detector is also reduced. An oscillating detector coupled directly to an antenna works much the same as a transmitter and will interfere with other receivers tuned to the same signal. The addition of the RF stage however, prevents such radiation. Regeneration is also less difficult to control when the antenna is not coupled directly to the detector. This is due to the relatively constant load, as pointed out previously, which exists with the additional coupling stage.

Dead spots usually caused by resonant characteristics of the antenna also do not appear in this receiver. The regeneration control is not at all critical and a single adjustment will suffice over a relatively wide band of frequencies.

Standard 3-winding Hammarlund coils are used in the tune circuit. The primary or plate coil for the RF tube is interwound with the detector grid coil. The usual plate tickler, or feedback coil, is connected in the cathode circuit. The normal tickler winding with which these coils are wound

is too large for use in a cathode feedback oscillator and therefore, requires pruning. We have found that approximately $\frac{1}{2}$ the original number of turns works out satisfactorily. Additional experimenting may be required in individual receivers.

Single-ended tubes are employed because they definitely make the wiring job easier, although if the experimenter has other tubes available, there is no reason why they should not be used. The audio



Inside view

PARTS LIST**HAMMARLUND**

- 2—CHX chokes
- 1—set 17-270 meter coils, SWK-6
- 1—50 mmf. var. cond. HFA-50-B
- 1—100 mmf. var. cond. HFA-100-A
- 1—6 prong socket, S-6
- 3—8 prong socket, S-8

CORNELL DUBILIER

- 6—.05 mf. paper cond. 500 V
- 3—.0005 mf. mica cond.
- 1—.0001 mf. mica cond.

I. R. C.

- 1—300 ohm 1/2 resistor
- 1—100,000 1/2 resistor
- 1—2 meg. 1/2 resistor
- 3—1/4 meg. 1/2 resistor
- 1—2000 1/2 resistor
- 1—7000 1/2 10W resistor
- 1—20,000 ohm pot.
- 1—50,000 ohm resistor

PARMETAL

- 1—7" x 7" x 2" chassis
- 1—cabinet to match

R. C. A.

- 1—6C5 tube
- 1—6SK7 tube
- 1—6SJ7 tube

MISC.

- 1—pilot light assembly

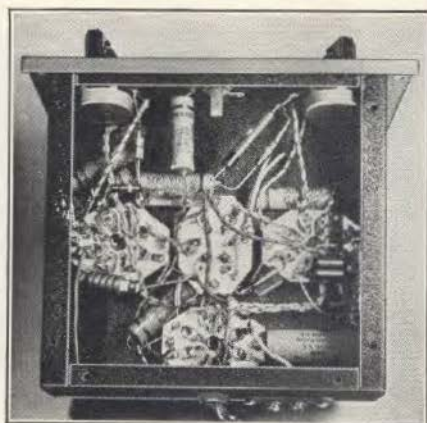

Bottom view showing resistors and condensers.

stage is a triode and provides sufficient volume for earphones. A pentode might have been used but the increase in volume would not have been sufficient to operate a speaker and for earphone operation there would have been no particular advantage.

Power for this receiver may be obtained from the supply described on pages 12 and 13. Any good power supply however, delivering in the neighborhood of 200 to 250 volts, will serve nicely.

Operation of the receiver is much like other regenerative receivers. In addition to the regeneration control there is also an RF gain control. Actually this should be termed an attenuator for there is no gain

in the untuned RF stage used in this receiver. This control reduces the strength of strong signals which would overload the regenerative detector. Since a regenerative detector works best with relatively weak signals, this control is definitely worthwhile. Some very strong signals such as local broadcasting stations will cause interference in this type of receiver and it is advisable to use a short antenna to limit this interference.

In addition to controls already mentioned, there are two tuning condensers. One is termed "main tuning" and the other "band spread". The main tuning control adjusts the receiver to the approximate frequency or band of frequencies where reception is desired. Fine tuning is then done with the band spread control.

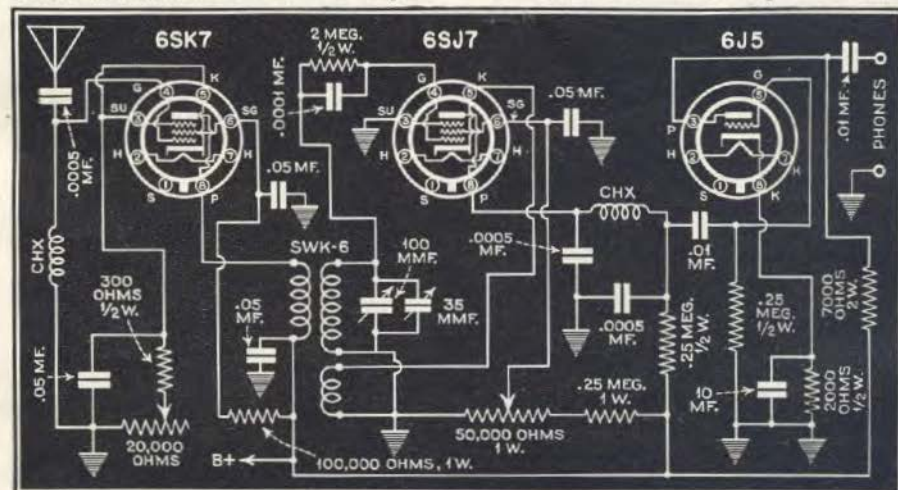

Wiring diagram for 3-tube set



Two views showing the construction of the receiver power-supply.

Receiver Power- Supply

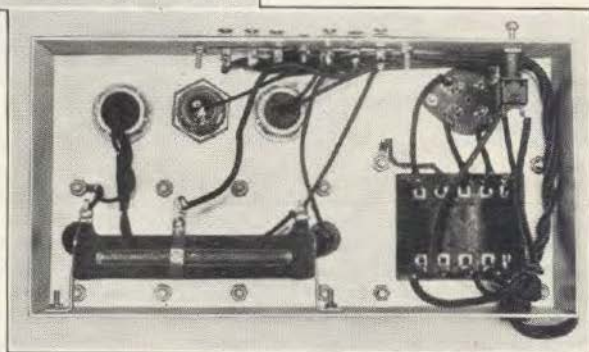

THE several short wave receivers previously described require a separate power-supply. While the power-supply and the receiver may be incorporated in one unit, it is to the advantage of the experimenter to have the power-supply separate. This permits its use with other apparatus. This power-supply is constructed of good parts with ratings sufficient to work with the receivers in this book and still maintain a wide range of safety. If the experimenter desires to build larger receivers, that is, receivers having considerably more tubes than those illustrated in this book, it is advisable to use components of higher ratings. For instance, the power transformer in this particular power-supply, while delivering sufficient voltage at 70 milliamperes, will handle up to three or four tubes. In case larger receivers are to be used with it, we recommend that the transformer have a rating of at least 100 milliamperes. The filter choke coils of this power-supply are rated at 80 ma. These also should be increased to approximately 100 ma., if the larger sets are contemplated. No other values in the power supply need be changed in order to increase its current capacity. Another point

which should be considered is the type tubes which may at some time or other be used during experimenting. Our diagram shows a single 6.3 volt filament winding. If at any time you expect to employ $2\frac{1}{2}$ volt tubes in your receiver for some other experimental set-up, we suggest that the power-supply be equipped with a $2\frac{1}{2}$ volt winding as well as the 6.3 volt winding. Such transformers are readily available. For convenience, we have used a 5x8x2 inch chassis constructed of $\frac{1}{16}$ " aluminum. All four sides are bent down in order to make it rigid. On one of these sides is mounted the terminal strip containing the plate and filament connections. On the other side we have the on-off toggle switch. The placement of these items can be learned from the photograph.

The output voltage of the power-supply is very important. In this particular one, the output voltage is 300 under normal load. Choke input is employed. If condenser input were used, the voltage would be entirely too high. If condenser input is desired, for any particular reason, the high voltage rating of the secondary should be around 250 volts. The bleeder or voltage

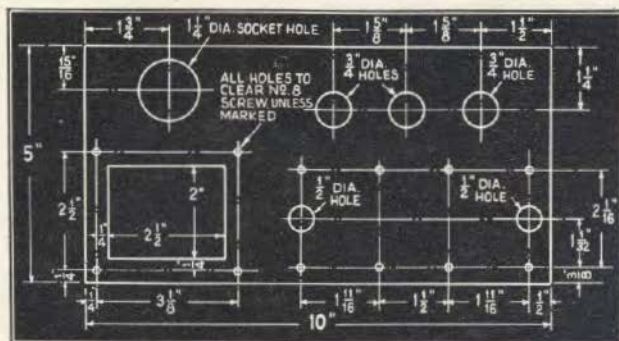

Drilling specifications for power-supply chassis.

divider connected across the output terminals of the filter consists of a 20,000 ohm 50 watt resistor. As can be seen in the diagram, one tap is provided in case lower voltages are required. This tap should be adjusted under load with the aid of a voltmeter in order to obtain proper voltage. If more than one intermediate voltage is required, additional taps may be placed on the voltage divider. However, bear in mind that the resistor shown is only rated at 50 watts and that there is an idle current of approximately 15 milliamperes already flowing through it with no load. This means that the total additional load which the resistor will stand is 35 ma. If greater current requirements are necessary a resistor with a higher rating should be employed. One of approximately 75 to 100 watts would serve, depending upon the current drawn. During tests, this power-supply in conjunction with the receivers previously illustrated, was what might be considered hum-free. If trouble is experienced due to tunable hums, that is, hums appearing in some places on the dial in the receiver and not in others, they may be eliminated by connecting .001 mf. condensers be-

tween each plate of the rectifier and one side of the filament. Juggling these connections may be necessary in order to completely eliminate tunable hums. Also, outside line noises can be reduced considerably by connecting a .1 mf. condenser between one side of the 110 volt primary and B-minus. Use a high grade 400 V. paper condenser.

PARTS LIST

STANCOR

- 1—Power transformer—P 948
- 2—Filter chokes—C-1420

AEROVOX

- 3—8 mf. electrolytic condensers (500 V).

I. R. C.

- 1—20,000 ohm voltage divider with one slider

R. C. A.

- 1—Type 80 rectifier

MISC.

- 1—5" x 8" x 2" chassis (1/16" aluminum)
- 1—Toggle switch

Wiring diagram and parts values for power-supply.

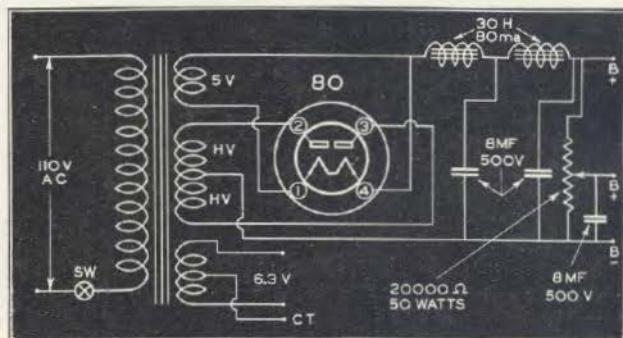



This one tube transmitter is ideal for the beginner. It is effective and amateurs have worked stations all over the world with this type transmitter.

1-TUBE BEGINNER'S TRANSMITTER

ONE need not have a lot of money to get started in amateur radio. All that is necessary is a conscientious desire to be a Ham and the ability to use one's hands.

We assume the reader already has some kind of receiver suitable for operation in the amateur bands. Many simple receivers are described in this, and other magazines. We also assume the reader (if he contemplates building this transmitter) already has a license or will obtain one before he attempts to use a transmitter. The simplest form of transmitter is the one tube tri-tet which is crystal controlled and operates on two bands with a single crystal. There is nothing home-made about this transmitter. Every part is available through your favorite Ham parts dealer. A few of the parts could be made at home but if you are a newcomer, it's safe to bet you don't have a lot of junk or paraphernalia from which you would be able to make the parts if we were to provide sufficient information.

Besides, standard parts are available at fairly low prices and, needless to say, they are superior to any even the most experienced Ham might build.

The chassis is a 7" x 7" x 2" steel unit with black crackle finish. A wood base could be used here, but the few cents saved would be of little importance. The tube is a 6L6 metal type, not the glass variety. In the cathode, we find a standard single circuit tuning unit which is intended to tune to 40 meters. We have connected an additional fixed condenser across it, so that it will tune slightly lower in frequency and enable the crystal to oscillate. In the plate circuit, we have standard plug-in coils and tuning condensers. This circuit may be tuned to either the crystal frequency which is between 3500 kc. and 3650 kc.; or to the second harmonic which falls between 7000 and 7300 kc. (the 40 meter band). When the plate, or output circuit is tuned to the crystal frequency, the cathode coil should be shortcircuited by the switch marked "SX". Under some

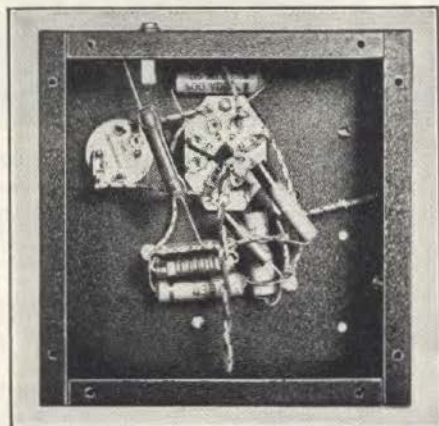

Bottom view showing the placements of parts.

conditions, using a tube with better internal shielding, the cathode circuit could be left operating. We mention this so that the reader will not be confused by information in other articles where this circuit is left in operation. With the 6L6, however, this circuit should be shorted to protect the crystal when the output circuit is tuned to the fundamental. Tuning and adjusting should be done at a reduced voltage. Use 250 volts or less, or connect a large resistor, 10,000 ohms 25 watts, in series with the B-plus to the plate and screen. Set the plate condenser at mid-scale and adjust the cathode tuning condenser for maximum plate current. Then, adjust the plate condenser for minimum current. This indicates resonance. You can now apply the full plate and screen voltage and connect the antenna. For

best all-around results, use a doublet with twisted pair feeders. If a good grade of twisted pair is used, this antenna performs excellently and is very simple. It will, however, only work on one band. The single wire fed Hertz will work on 80 and 40 meters with fair success, but is slightly more complicated. In either case, after the antenna is connected, the plate circuit should be retuned for the lowest plate current. If this value is found to be too low, increase the antenna coupling. This can be accomplished by winding the antenna coil on top of the plate coil near the B-plus end. In this case, use wire with good insulation. In the case of the Hertz antenna, increased coupling is accomplished by moving the tap nearer the plate end of the output coil.

PARTS LIST

HAMMARLUND

- 1—40 meter coil, No. 42
- 1—80 meter coil, No. 43
- 1—MC-100-S variable condenser
- 1—ETU-40 tuning unit
- 1—XS-2 crystal socket
- 1—S-8 tube socket
- 1—S-4 coil socket
- 1—CHX R. F. choke

I. R. C.

- 1—400 ohm 20 watt resistor
- 1—20,000 ohm 1 watt resistor
- 1—20,000 ohm 2 watt resistor

BLILEY

- 1—3.5 mc. crystal

R. C. A.

- 1—6L6 tube

PARMETAL

- 1—7" x 2" black chassis

CORNELL DUBILIER

- 1—.0001 mf. mica condenser
- 3—.05 mf. 500 V. paper condensers
- 1—.005" 500 V. mica condensers

There are few parts in this simple transmitter and the beginner should have little difficulty in getting it working.

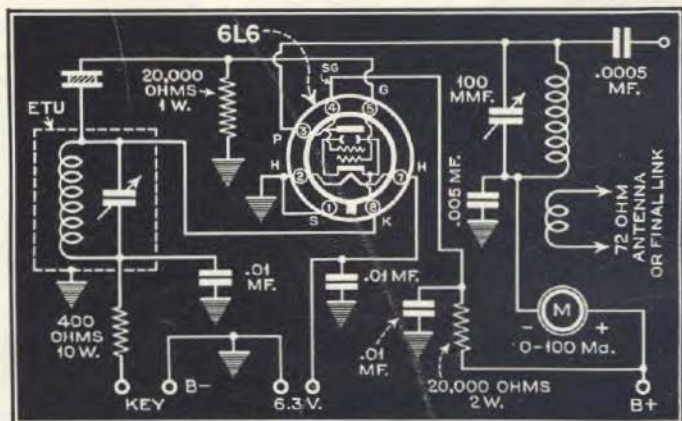

Parts for building receivers and transmitters in this book, are here listed.



HAMMARLUND



All prices shown are list prices, and subject to change without notice.



"MC" MIDGET CONDENSERS

Ideal variables for ultra-short and short wave tuning. Isolantite insulation. All contacts riveted or soldered. Vibration proof. New improved Hammarlund split type rear bearing, and noiseless wiping contact. Cadmium plated soldered brass plates. Shaft— $\frac{1}{4}$ ".

CODE	CAPACITY	LIST
MC-20-S	20 mmf.	\$1.40
MC-35-S	35 mmf.	1.50
MC-50-S	50 mmf.	1.60
MC-50-M	50 mmf.	1.60
MC-75-S	80 mmf.	2.00
MC-75-M	80 mmf.	2.00
MC-100-S	100 mmf.	2.25
MC-100-M	100 mmf.	2.25
MC-140-S	140 mmf.	2.50
MC-140-M	140 mmf.	2.50
MC-200-M	200 mmf.	2.75
MC-250-M	260 mmf.	3.00
MC-325-M	320 mmf.	3.50

"M"—Midline Plates "S"—Straight Line Cap. Plates

"MCD" SPLIT-STATOR CONDENSERS

Like single midgets, these incorporate every requirement imperative to highest quality. Specifications identical to single types except that shield plate is located between stator sections. Overall length behind panel— $3\frac{3}{8}$ ". Strong Isolantite base. Single hole panel mount.

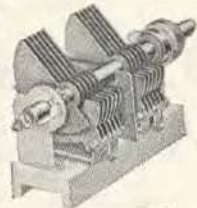

CODE	CAPACITY	LIST
MCD-50-M	50 mmf. per sect.	\$3.00
MCD-50-S	50 mmf. per sect.	3.00
MCD-100-S	100 mmf. per sect.	3.50
MCD-100-M	100 mmf. per sect.	3.50
MCD-140-M	140 mmf. per sect.	4.00
MCD-140-S	140 mmf. per sect.	4.00

"M"—Midline Plates "S"—Straight Line Cap. Plates

"MCDs" DOUBLE SPACED CONDENSERS

CODE	CAPACITY	LIST
MCD-35-SX	31 mmf. per sect.	\$3.50
MCD-35-MX	31 mmf. per sect.	3.50

"MX"—Midline Plates "SX"—Straight Line Cap. Plates

"HF" MICRO CONDENSERS

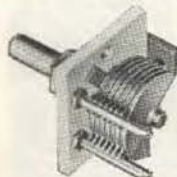

For tuning or trimming on high frequencies. Cadmium plated soldered brass plates. Isolantite. Base mounting, single hole panel mount, or panel mounting with bushings. 140 mmf. size $1\frac{9}{32}$ " high x $1\frac{7}{32}$ " behind panel.

HF-15	17.5 mmf.	\$1.25
HF-35	35 mmf.	1.50
HF-50	50 mmf.	1.60
HF-100	100 mmf.	1.90
HF-140	140 mmf.	2.25
*HF-30-X	30 mmf.	1.85

*Double-Spaced

HAMMARLUND MANUFACTURING CO., Inc., 424-438 West 33rd Street, New York

"HFD" MICRO DUAL CONDENSERS



A compact dual—ideal as a high frequency tuning condenser, for tuning low-powered short wave and ultra-short wave transmitters, etc. Heavy Isolantite base equipped with new Hammarlund split rear bearing

and individual noiseless wiping contact for each section. Rotor contacts variable to several positions for shortest leads. Shield between sections. The 140 mmf. size is $1\frac{1}{2}$ " high x $3\frac{3}{8}$ " long behind panel, $\frac{1}{4}$ " shaft. Cadmium plated soldered brass plates.

CODE	CAPACITY	LIST
*HFD-50	50 mmf. per sect.	\$2.75
HFD-100	100 mmf. per sect.	3.25
HFD-140	140 mmf. per sect.	3.75
*HFD-30-X	28.5 mmf. per sect.	3.25

*Double-Spaced

"SM" STAR MIDGET CONDENSERS

For receiving and transmitting, for short wave tuning, regeneration, antenna coupling, etc. Low loss, natural bakelite insulation. Non-corrosive aluminum plates. Phosphor bronze spring plate affords proper tension and smooth control and provides perfect contact. Single hole mounting, $\frac{1}{8}$ " shaft. $5/16$ " mounting bushing. $1\frac{9}{16}$ " wide x $1\frac{1}{2}$ " high. Depth behind panel from $11/16$ " to $1\frac{1}{2}$ " depending on capacity. Light in weight, strong and compact in construction. Tinned soldered lugs on the front end are supplied to simplify wiring. Plates of straight line capacity types.

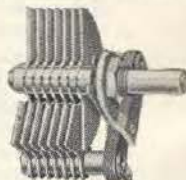

CODE	CAPACITY	LIST
SM-15	15 mmf.	\$0.85
SM-25	25 mmf.	.85
SM-50	50 mmf.	.90
SM-100	100 mmf.	1.00
SM-140	140 mmf.	1.25
*SM-35-X	35 mmf.	1.00
*SM-50-X	50 mmf.	1.25

*Double Spaced Transmitting Types

"XP-53" COIL FORMS AND KITS



Outstanding forms using new low loss insulation material—XP-53, Natural coloring eliminating losses. Groove-ribbed for air spaced windings. Flange grips, meter indexes. Moulded threaded shell in form. $1\frac{1}{2}$ " diameter and $2\frac{1}{2}$ " long exclusive of prongs. Kits with wound coils for MC-140-M condenser also available.

CODE	LIST
SWF-4 (4 prongs, coil form only)	\$0.35
SWF-5 (5 prongs, coil form only)	.35
SWF-6 (6 prongs, coil form only)	.40
No. 40 coil (wound coil, 4 prongs, 10-20 meters)	1.00
No. 41 coil (wound coil, 4 prongs, 17-41 meters)	1.00
No. 42 coil (wound coil, 4 prongs, 33-75 meters)	1.00
No. 43 coil (wound coil, 4 prongs, 66-150 meters)	.75
No. 44 coil (wound coil, 4 prongs, 135-270 meters)	.75
BCC-4 (wound coil, 4 prongs, 250-560 meters)	1.25
No. 60 coil (wound coil, 6 prongs, 10-20 meters)	1.35
No. 61 coil (wound coil, 6 prongs, 17-41 meters)	1.25
No. 62 coil (wound coil, 6 prongs, 33-75 meters)	1.25

No. 63 coil (wound coil, six-prongs, 66-150 meter)	\$1.00
No. 64 coil (wound coil, six-prongs, 135-270 meters)	1.00
BCC-6 (wound coil, 6-prongs, 250-560 meters)	1.50
SWK-4 (kit—4, four-prong coils, 17-270 meters)	3.00
SWK-6 (kit—4, six-prong coil, 17-270 meters)	3.75

"S" ISOLANTITE SOCKETS



Standard socket at left. Lowest losses. Constant resistivity. Gripped prongs—cannot shift. Guide groove. Rust-proof side gripping contacts. Glazed top and sides. Sub-panel or base mounting. $2\frac{1}{4}$ " x $1\frac{1}{2}$ ".

CODE	LIST
S-4 (4 prongs)	\$0.60
S-5 (5 prongs)	.60
S-6 (6 prongs)	.60
S-7 (lge. base, 7 prongs)	.60
S-7-B (sm. base, 7 prongs)	.60
S-8 (8 prongs)	.75



UHS-900

Acorn socket at right. Isolantite. For new high frequency acorn tubes—954 or 955. 1" diameter. Five double grip silver plated phosphor bronze prongs. Top, sides, and plug glazed.

CODE	LIST
UHS-900	\$1.10

NEUTRALIZING CONDENSERS



Improved neutralizing condensers with heavy aluminum polished plates and rounded edges. Isolantite. Fine adjusting screw. Positive locking nut. Designed for horizontal adjustment. $2\frac{1}{2}$ " high x $1\frac{1}{16}$ " deep.

CODE	LIST
N-10 (2 to 10 mmf.)	\$3.00

EXCITER TUNING UNITS



These exciter tuning units are available for 80, 40, 20 and 10 meters. They are adjusted so that they will cover the entire band when used with the usual 6L6 or similar type tube. The ECO-160 is used in the electron coupled oscillator described elsewhere in this book. It is designed for maximum stability and should be used in conjunction with the ETU-80. When a 140 mmf. tuning condenser is used, the entire 80 meter band can be covered.

The permeability tune coil PTC-40 covers only the 40 meter band and is designed particularly for the type of transmitter described on page 22.

CODE	LIST PRICE
ETU-80	\$ 5.50
ETU-40	5.50
ETU-20	5.50
ETU-10	5.50
ECO-160	2.00
PTC-40	2.00

"CH-X" R.F. MIDGET CHOKES



Invaluable item where space is at a premium. It is so small in size and light in weight that it can be supported by own leads. Five impregnated universal wound pies $\frac{3}{4}$ ". Impregnated Isolantite core insuring ruggedness and stability. Ind.—2.1 mh. D.C. res.—35 ohms. Dist. cap.—1 mmf. Current carrying cap.—125 ma. Length across caps $1\frac{1}{4}$ ". Diameter $\frac{1}{2}$ ".

CODE	LIST
CH-X	\$.50
CH-250	(250MA.) .50

"HFB" INSULATED ROTOR CONDENSERS

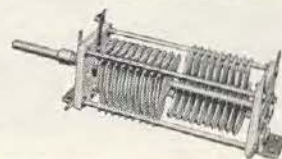

This new line of transmitting condensers departs considerably from the usual design. The end plates are isolantite and the rotor is 100% insulated from the mounting brackets. Also, the control shaft is completely insulated from the rotor permitting high voltage to be applied directly to the rotor without danger of electrical shock. The length of the condenser varies with capacity. The $\frac{1}{4}$ " shaft is $1\frac{1}{2}$ " long and the end plates are $1\frac{1}{16}$ " square.

CODE	CAPACITY PER SECTION	AIR GAP	LIST PRICE
HFBD-50-C	50	.950"	\$4.15
HFBD-100-C	100	.950"	5.15
HFBD-35-E	35	.070"	5.50
HFBD-65-E	65	.070"	7.00
HFBD-100-E	100	.070"	9.00
HFB-50-C	50	.950"	3.20
HFB-100-C	100	.950"	3.70
HFB-150-C	150	.950"	4.10
HFB-100-E	100	.070"	5.80

"HFA" VARIABLE CONDENSERS



The HFA condenser is available in both the single and dual types. The type "A" has .020" plate spacing and type "B" has .030" plate spacing. These are ruggedly built with a $1\frac{13}{32}$ " x $1\frac{1}{32}$ " isolantite end panel. Both singles and duals have single hole panel mounting and can also be base mounted with brackets. The HFAD has $1\frac{3}{8}$ " square front and rear isolantite panels with a $9/16$ " shaft extension. Construction is the same as the HFB type condensers. Heavy brass plates are securely soldered and the entire assembly is cadmium plated to preserve the finish.

CODE	CAPACITY PER SECTION	TYPE	LIST PRICE
HFA-75-A	75 mmf.	single	\$1.80
HFA-200-A	100 mmf.	single	1.95
HFA-140-A	140 mmf.	single	2.30
HFA-25-B	25 mmf.	single	1.45
HFAD-75-A	75 mmf.	dual	3.15
HFAD-100-A	100 mmf.	dual	3.40
HFAD-140-A	140 mmf.	dual	3.90
HFAD-35-B	25 mmf.	dual	2.80
HFAD-100-B	100 mmf.	dual	4.00

For complete catalog of Hammarlund parts, write Dept. SWM-3 at address given above.

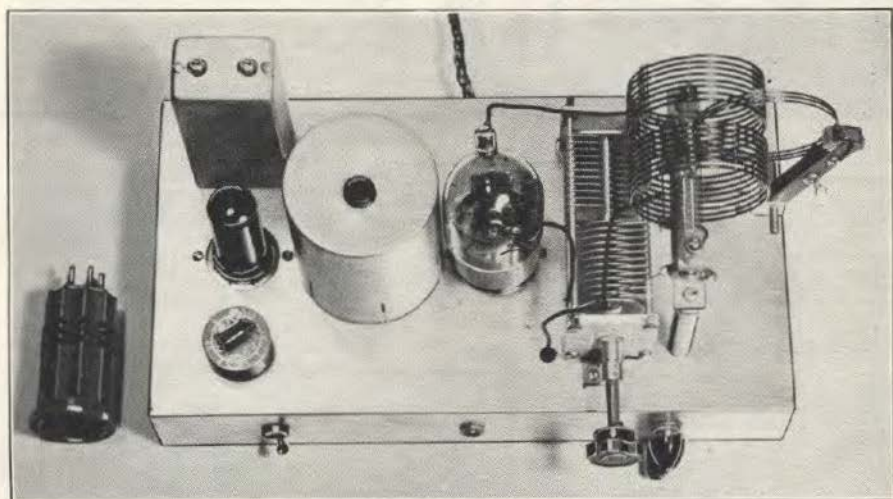

2-Tube 815 Transmitter

AFTER passing through the beginner stage, the new "ham" usually requires greater flexibility and increased power not found in the first transmitter. Operation on several of the amateur bands is desired after the "newness" has worn off and this means the second transmitter must be of more elaborate design. Some of the recently developed tubes permit great flexibility in simple designs. The 815, for example, is a push pull beam power tube which will provide 50 watts output and can be driven with any small receiving tube. The oscillator in

this transmitter is a 6F6 connected in a "tritet" circuit to allow frequency multiplying independent of the amplifier. The oscillator will furnish excitation on 3 amateur bands with one crystal.

The cathode circuit consists of an ETU-40 tuning unit, in addition a 100mmf fixed condenser is externally connected across the coil. Adjustment of the variable condenser in the tuning unit is not at all critical.

Plug-in coils are used for coupling the two stages. The untuned primary is located between the grid coils and the tuning condenser for the grid coil is mounted inside the coil form. As a safety measure, this coil is shielded to prevent coupling.

The 815 amplifier tube being easy to drive requires adjustment of the spacing between the coils in order to obtain proper grid current. Approximately 4ma. provides efficient excitation. With the fully insulated plate condenser, the plate voltage can be applied directly to the rotor without danger of the operator being shocked when making adjustments. This assumes, of course, that the operator only touches adjusting knob. Keying can be done in either the oscillator or amplifier cathode circuits. When the oscillation is keyed, adjustments should be made while listening to the signal

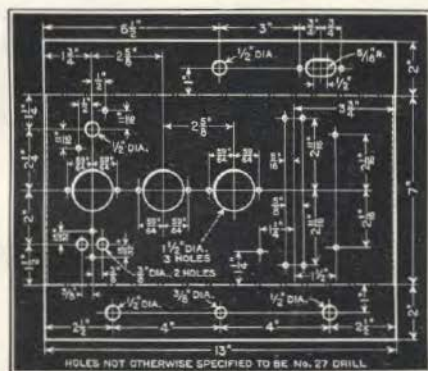

Drilling dimensions.

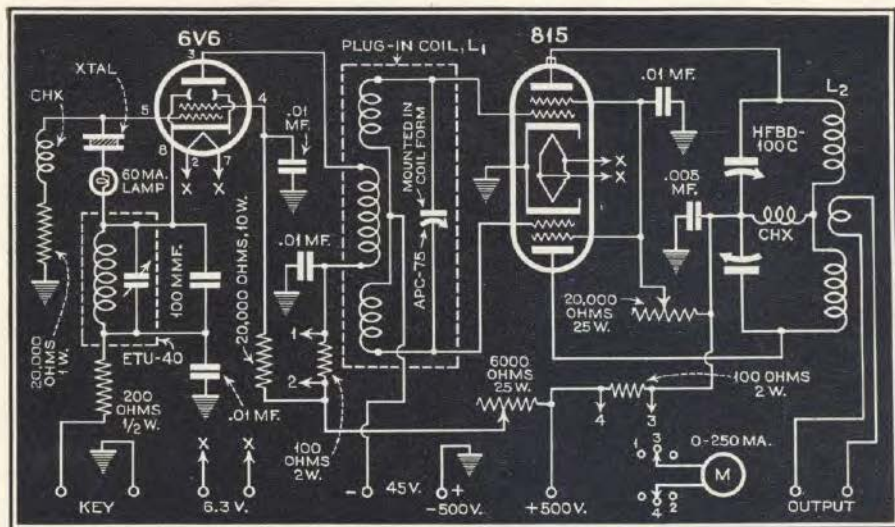

in a monitor so that the keying will be clean. Meters can be connected in all circuits, however, a simple and more economical method is shown in the diagram. Here we find a 100 ohm resistor connected in each circuit to be metered and a rotary switch connects the meter to the desired circuit. A suitable power supply and modulating unit will be found on pages 26 and 30.

Coil Data, L 1

Band	Plate	Total grid
20 m.	6	8
40 m.	7	14
80 m.	11	36

Coil Data, L 2

14 mc. 14 T. No. 16
 7 mc. 24 T. No. 16
 3.5 mc. 40 T. No. 18
 all 2 3/4" long, 1 3/4" dia.

PARTS LIST

HAMMARLUND

- 1—ETU-40 tuning unit
- 1—HFBD-100-C Var. Cond.
- 1—APC-75 midget cond.
- 2—8-prong Sockets, S-8
- 1—XS-2 Crystal socket
- 1—CHX RF Choke
- 2—SWF-5-Coil forms
- 1—CH-250 RF choke
- 1—CS-3 Coil Shield

I. R. C.

- 1— 200 ohms 1/2 w.
- 1—20,000 ohms 1 w.
- 1—20,000 ohms 10 w.
- 1— 6,000 ohms 25 w.
- 2— 100 ohms 2 w.
- 1—20,000 ohms 25 w.

CORNELL DUBILIER

- 4—.01 mf. paper cond. 600 V.
- 1—.0001 mf. mica Rec. type
- 1—.005 mf. mica, 1000 V.

CENTRALAB

- 1—Rotary switch No. 2505

PARMETAL

- 1—7" x 13" x 2" chassis

BARKER AND WILLIAMSON

- 1—80-BVL coil
- 1—40-BVL coil
- 1—20-BLV coil
- 1—BV-base assembly

R. C. A.

- 1—815 tube
- 1—6V6 tube

BLILEY

- 1—Variable crystal

Bottom view showing placement of parts. This transmitter is easy to build and operate.

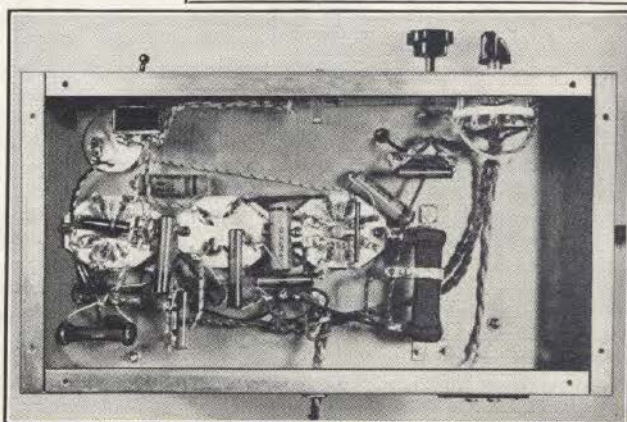

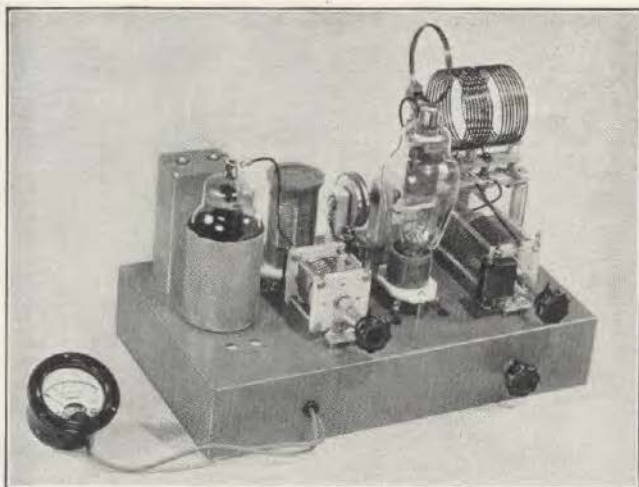

Efficient 2-Tube Transmitter

THE newcomer to ham radio who chooses to build his own transmitter rather than purchase a ready-made one, usually starts off with something simple. Though, all too often the beginner, in his haste to get on the air, puts together a haywire transmitter with rather disappointing results. Assuming the beginner is going to operate on two bands (80-40 meters) and the desired power output is in the neighborhood of 100 watts, we believe this outfit is just about ideal. Such a rig can be built cheaply and need not be complicated.

Looking over our manufacturer's tube list, the 812 variety seems to be the best buy from the standpoint of economy. Since this tube only requires some 5 or 6 watts driving power for around 100 watts output, a single 807 crystal oscillator should do the trick nicely. Using the 807 in a tritret oscillator-doubler circuit permits full output on two bands with one crystal. This transmitter works on 80 and 40 meters with no provision for adding other bands. Although 20-meter operation can be had with some sacrifice in output, if the final is used as a doubler. In this case, the tube should not be loaded as heavily as when operated as a straight amplifier.

The entire R.F. portion of this transmitter is mounted on $7\frac{1}{2}$ " x 13" x $2\frac{1}{2}$ " steel chassis which was given a coat of gray lacquer after all drilling was completed. This treatment provides a much neater appearance and eliminates finger stains

which would appear on the unpainted chassis.

The cathode circuit of the 807 employs a 40-meter shielded coil and condenser assembly. This unit does not have sufficient range to tune to a suitable frequency in order to provide proper crystal operation. Therefore, it is necessary to add a small fixed capacitor of 100 mmf. In the plate circuit of the oscillator, we have a plug-in coil because here we change from 80 to 40 meters when doubling.

The 812 amplifier is extremely simple and uses the split coil and condenser arrangement in order to obtain neutralizing voltage. Both stages use a new type of variable condenser having an insulated rotor allowing much more compact construction and results in a considerable saving in cost.

In wiring the transmitter, ordinary #16 push-back wire is used and enough terminal strips are employed to make a neat and simplified wiring job. The wiring diagram and coil data, should complete the constructional information. Getting the rig on the air is just about as simple as building it. Apply voltages to the oscillator and adjust the cathode condenser for maximum plate current of the 807. Then, adjust the plate condenser of this same stage for the minimum plate current. Neutralizing is next. With filament voltages applied to the 812 but with *no plate voltage*, open the neutralizing con-

denser all the way. Then, with the meter switched to the amplifier grid circuit, rotate the plate condenser and a decided change in grid current will be noticed. Swing the plate condenser back and forth, at the same time close the spacing of the neutralizing condenser. The fluctuation in grid current will gradually become smaller and smaller until it disappears. As the neutralizing condenser plates become closer, the fluctuation of grid current will then reappear. Correct neutralization is that point at which no fluctuation in grid current is noticed as the amplifier plate circuit is tuned through resonance. While doing this job, it is well to note the point of resonance, or rather the point where the change in grid current occurs, and before the plate voltage is applied to the 812, the plate condenser should be set as near as possible to this point. Then, when the plate current is applied, readjust the plate condenser for minimum current.

The last and final operation is connecting the antenna to the link coil and in-

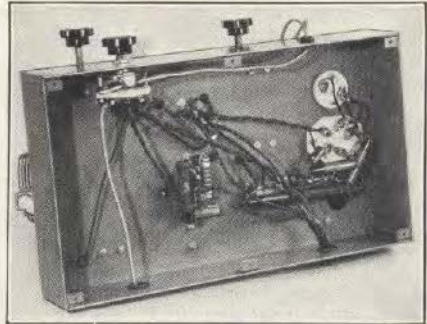

Bottom view of two-tube transmitter.

crease the coupling until the tube draws proper plate current. With 1,000 volts applied to the tube, the plate current should be between 100 and 125 milliamperes. For highest efficiency, the grid current should be in the neighborhood of 25 milliamperes.

COIL DATA

80-meter osc. plate: 37 turns No. 26 bare wire.
40-meter osc. plate: 17 turns No. 22 bare wire.
Both coils wound on 4-prong Hammarlund forms 1 1/2" dia. and spaced to a length of 1 1/2".

PARTS LIST

HAMMARLUND

- 1—ETU-40 tuning unit
- 1—HFB-50-C (single) condenser
- 1—HFB-100-C (split stator) condenser
- 1—S-5 Isolantite socket, 5 prong
- 2—S-4 Isolantite socket, 4 prong
- 1—XS-2 crystal socket
- 1—CH-250 R.F. choke
- 2—CHX RF choke
- 1—N-10 neutralizing condenser
- 2—2-1/2" stand-off insulators SOS-250
- 1—PTS power tube shield
- 1—No. 43 plug-in-coil for 80 meters
- 1—No. 42 plug-in-coil for 40 meters

BLILEY

- 1—LD-2 crystal (80 meter band)
- I. R. C.
- 1—400 ohm wire wound resistor (type AB)
- 1—2,500 ohm wire wound resistor (type AB)
- 1—20,000 ohm wire wound resistor (type AB)
- 1—30,000 ohm metallized resistor (2 watt)
- 3—100 ohm metallized resistors (2 watt)

TRIPLETT

- 1—0-150 milliammeter
- CORNELL DUBILIER
- 1—75 mmf. mica cond. (rec. type)
- 1—0.001 mmf. mica cond. (1,000 V)
- 1—0.005 mmf. mica cond. (5,000 V)
- 6—.01 mmf. paper cond. (600 V. Dwar tiger)

CENTRALAB

- 1—No. 2505 5-pole 5-position Isol. switch
- GENERAL ELECTRIC
- 1—GL-807 tube 1—GL-812 tube

BARKER-WILLIAMSON

- 1—BVL Coil base assembly
- 1—80 BVL 80-meter coil
- 1—40 BVL 40-meter coil

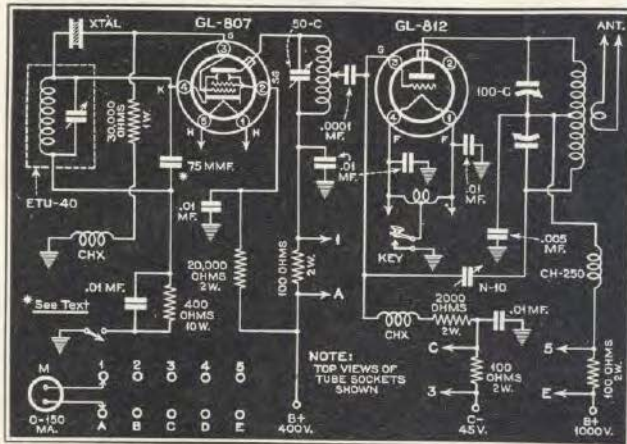

Complete wiring diagram less power supply. Note the simple method employed to switch the meter to various circuits.

The performance of an e.c.o. is at least as much in the construction as in the circuit. Here's a frequency-control unit which combines a circuit novelty or two with interesting constructional features. It has had a thorough "air test" and came through with flying colors.

A compact and businesslike instrument having output on 80, 40, and 20 meters. Complete, including power supply, it measures only 8 by 16 by 8 inches.

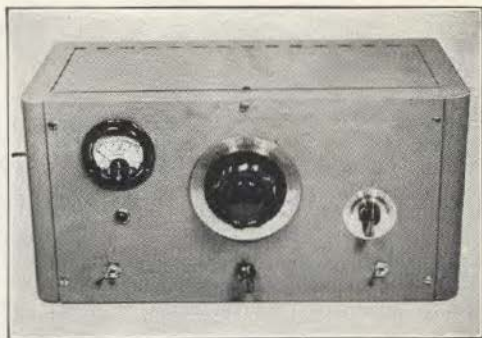

A Transmitter Frequency Control Unit with Three-Band Output

A Self-Contained Cabinet-Type Exciter or Low-Power Transmitter

BY G. W. SHUART,* W2AMN

THE variable-frequency oscillator, while not new by any means, has really only begun to come into its own within the last year or two. We shudder to think of the amateur bands eventually cluttered up with thousands of e.c.o.'s or v.f.o.'s darting back and forth like a bunch of sizzlers in an aerial fireworks display; while the v.f.o. is a swell piece of apparatus, it requires some careful and prudent use. Undoubtedly, before the evil of these instruments manifests itself, plenty will be written to overcome the problem. In the meantime we have found in the v.f.o. something that can never be replaced by any other instrument. The particular

* c/o Hammarlund Mfg. Co., New York City.

v.f.o. to be described is an e.c.o. It seems that the type of circuit used is not so important as the physical arrangement and general mechanical design. Before we get into the details of construction, let's see what makes this v.f.o. different from others.

In its design, a definite effort was made to keep it simple to build and operate. Only one control is operated during normal use and output is available on three bands—80, 40 and 20—by changing only the output coil. Although plug-in coils are used, band-switching could be employed without difficulty. Also, the tuned circuit could be arranged to cover two bands with one coil so that only two coils would be necessary for complete coverage. The entire design of this unit is simplified by the use of only a single tuning condenser. Usually three-gang condensers are employed in this type of instrument.

The Oscillator

The electron-coupled oscillator operates in the 160-meter band and covers 1750 to 2000 kc. The tuned circuit is a self-contained unit and includes everything but the main frequency-changing condenser. The mechanical arrangement of this unit provides excellent stability and free-

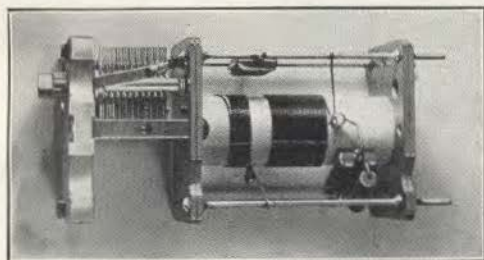

Inside the oscillator tuned circuit assembly. The stiff wires at the corners serve both as supports and terminals.

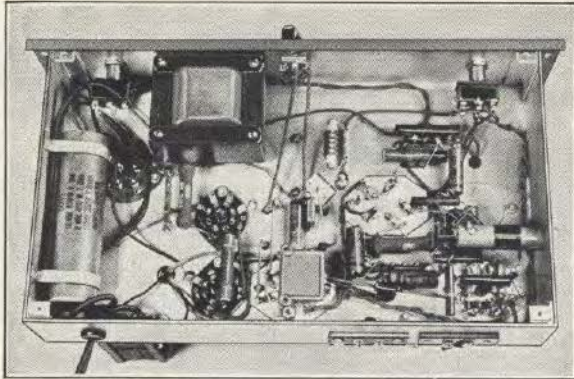

On the extreme right can be seen the permeability tuned coil which provides excitation for the output stage on 80, 40 and 20 meters. This coil is mounted under the chassis so there will be no coupling between it and the output circuit.

dom from frequency changes caused by vibration or shock. This e.c.o. doesn't have to be operated on sponge rubber pads. As a matter of actual fact, there is only slight modulation, and that from tube element vibration, when the instrument is subjected to mechanical shock. As shown in the photograph four vertical bars hold the entire oscillator assembly together, and these also serve as terminals for external connections. One goes directly to the grid of the 6SJ7 tube, a second to the cathode, one to the B-negative and the last to the tuning condenser.

Keying in the oscillator circuit is accomplished by breaking the negative lead. A simple filter consisting of a small r.f. choke and a 0.005- μ fd. silvered mica con-

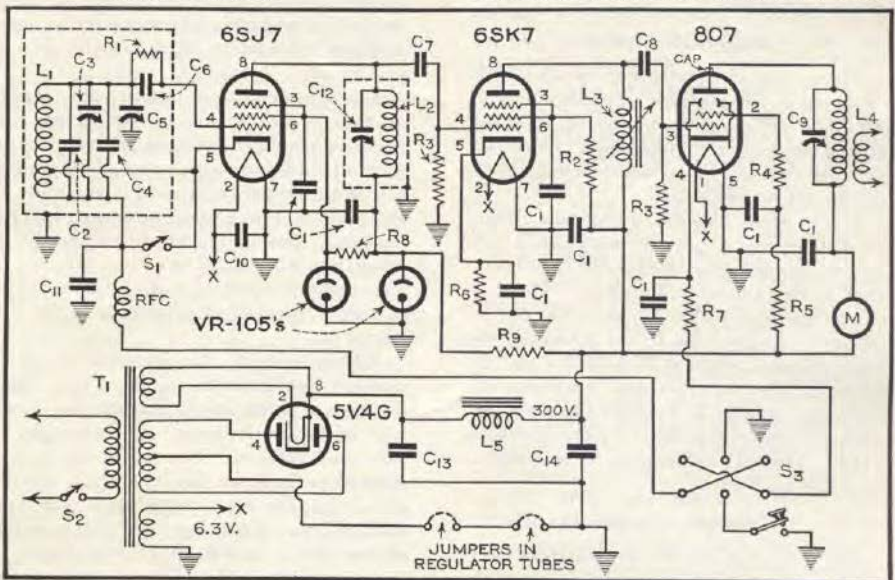

- C₁ — 0.01- μ fd. paper.
- C₂ — 35- μ fd. compensator (Erie Ceramicon N680).
- C₃ — 50- μ fd. air trimmer.
- C₄ — 300- μ fd. silvered mica.
- C₅ — 140- μ fd. variable (Hammarlund MC-140-S).
- C₆ — 100- μ fd. silvered mica.
- C_{7, C₈} — 500- μ fd. silvered mica.
- C₉ — 100- μ fd. variable (Hammarlund MC-100-S).
- C₁₀ — 0.001- μ fd. mica.
- C₁₁ — 0.005- μ fd. silvered mica.
- C₁₂ — 50- μ fd. air trimmer.
- C₁₃ — 8- μ fd. electrolytic, 450-volt.
- C₁₄ — 32- μ fd. electrolytic, 450-volt.
- R₁ — 20,000 ohms, 1/2-watt.

- R₂ — 50,000 ohms, 1-watt.
- R₃ — 20,000 ohms, 1-watt.
- R₄ — 20 ohms, 1-watt.
- R₅ — 20,000 ohms, 2-watt.
- R₆ — 400 ohms, 1/2-watt.
- R₇ — 400 ohms, 10-watt.
- R_{8, R₉} — 3000 ohms, 20-watt.
- L₁ — 30 turns No. 24 enamelled, close-wound, on 3/8-inch diameter form. Cathode tap 10 turns from bottom. (In Hammarlund ECO-160 unit.)
- L₂ — 60 turns No. 24 enam., close-wound, on 3/8-inch diameter form. (L₂ and C₁₂ in Hammarlund ETU 80 unit.)
- L₃ — 17- μ h., 36 turns No. 28, close-wound, on 3/8-inch

- form, with tuning plug (Hammarlund No. 6014).
- L₄ — 3.5 Mc.—38 turns No. 24, length 1 1/2 in., diam. 1 1/2 in.; link 11 turns.
- 7 Mc.—18 turns No. 20, length 1 1/2 in., diam. 1 1/2 in.; link 6 turns.
- 14 Mc.—9 turns No. 16, length 1 1/2 in., diam. 1 1/2 in.; link 4 turns.
- L₅ — 15 henrys, 150-ma.
- T₁ — 300 volts d.c. at 100 ma., with rectifier and 6.3-volt filament windings.
- S₁ — S.p.s.t., low-capacity type.
- S₂ — S.p.s.t. toggle.
- S₃ — D.p.d.t. toggle.

denser removes all traces of r.f. and permits clean keying.

The voltages to the plate and screen grid of the 6SJ7 are regulated, the screen by a VR-105 and the plate by a VR-150. The screen voltage, being more critical, has compound regulation and consequently a high degree of voltage stability is obtained. The 6SJ7 proved to be the best tube for the purpose since very little output was required. In this particular case connecting the screen and suppressor together proved beneficial.

The output of the oscillator is tuned to 3550 kc. with a fixed tank circuit. Unless the entire unit is to be operated on the high-frequency portion of the 80-meter c.w. band, or the 75-meter 'phone band, this circuit will require no adjustment. Tuning it to 3550 kc. permits operation over a very wide portion of the c.w. band and all of the 40- and 20-meter bands.

Buffer Multiplier

The second tube in the line-up is a 6SK7, operated as a fixed-tune amplifier-doubler. Its plate circuit is resonated to 7050 kc. with a permeability-tuned coil. Once set, this coil requires no adjustment regardless of the output frequency.

It may seem unusual to tune this circuit to 7050 kc. and expect the amplifier which follows to operate in the 3.5-Mc. band, but that is exactly what happens. The 807 can be operated on the 80-meter band with efficiency as great as, if not greater than, that obtained when it is operated on the 20-meter band as a doubler. Sufficient r.f. excitation gets by L_3 to make the amplifier work efficiently over the complete 80-meter band. The 807, of course, is a straight amplifier on 7 Mc.

Output Stage

The output of the 807 is relatively constant over any one band and is approximately the same on all three. A careful check of the 807 grid current showed that ample excitation was present at any fre-



quency in the 40- or 20-meter bands and over two-thirds of the 80-meter c.w. band. For maximum output in the high-frequency portion of the 80-meter c.w. band, or the 'phone band, it is necessary to make a slight adjustment of the oscillator output circuit.

The amplifier plate circuit when loaded to the normal 60 ma. by an antenna or another amplifier requires no adjustment over an extremely wide range of frequency, although a separate control is available on the panel to touch up this circuit when necessary. The plate current of the 807 is a fairly good indication of how the rest of the outfit is working. A 0-100 milliammeter is connected permanently in this circuit.

Returning to L_3 , the permeability-tuned coil, we would like to point out that slight changes in value might disrupt the operation of the entire unit. For example, in one unit built up experimentally it was desired to increase the excitation for the 807. On the assumption that the grid leak, R_3 , was absorbing some of the output of the 6SK7, an r.f. choke was placed in series with the leak. The excitation went up on 40 and 20 meters, but the circuit no longer passed sufficient r.f. at 3.5 Mc. to give satisfactory operation. Removing

Fig. 2 — Drift characteristic of the oscillator unit, measured from a cold start. Frequency 3.5 Mc.

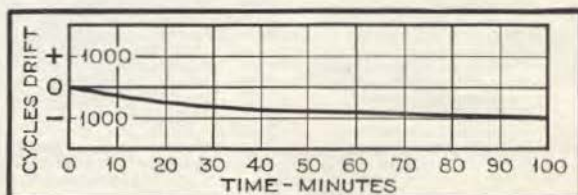

the choke permitted normal operation.

On 7 Mc. a tendency of the 807 to oscillate with the key open in oscillator keying was overcome by connecting a 20-ohm resistor in series with the screen.

Although not shown in the photograph, additional terminal strips have been made available to provide external grid bias—we believe this is a worthwhile addition, as it prevents oscillation in the amplifier when the oscillator is keyed—and to connect an external 600-volt plate supply for the 807 in cases where higher output is required.

While there may be no particular advantage in the key change-over arrangement, it was installed in this unit for test purposes so that the key could be switched from oscillator to amplifier under any particular set of conditions to determine whether or not keying of the oscillator was satisfactory at all times.

Frequency Drift

In an effort to make this unit compact, the power supply and all other equipment was built on the one chassis. Naturally, some particular conditions existed that may not exist in some other arrangement. For example, every experimental unit built up proved to have ample stability and low frequency drift, although there was occasionally hum modulation in the carrier and in some cases the keying was not clean. In all cases, it was found necessary to by-pass the oscillator heater right at the tube to clear up hum modulation and coupling between the input and output circuits. With the addition of this condenser, complete isolation was achieved. The output circuit can be tuned through resonance, loaded or unloaded, and there is absolutely no change in the oscillator frequency.

The frequency drift encountered in this particular unit was mostly caused by the heat radiated by the power transformer and rectifier tube. If the power supply were not contained in the cabinet, no drift compensation would be required, although the addition of drift compensation can be an asset in any case. We found that with a 35 μ fd. compensator the overall drift of the complete unit shown in the photograph was quite low. The accompanying curve gives the result of a careful laboratory check. It would be possible to use more compensation, but it was not deemed desirable because of the danger of overcompensation and a reversal of drift some time during operation. We are of the opinion that to have a known drift in a known direction is about the safest bet.

General

It is surprising how much more effective low power becomes when the frequency can be varied at will. We have used this outfit just as shown with no additional amplification for a period of about four months at W2AMN. During that time practically the entire U. S. was worked and the performance was really remarkable. Of course it doesn't pay to call CQ with this sort of rig; our practice was to wait for a CQ, adjust the frequency of the oscillator to coincide with that of the other station, and then call when the CQ was finished. Contacts were numerous and operation appeared to be just as satisfactory as with any 200- or 300-watt rig we ever operated. All this took place in the 40-meter band, which is pretty crowded.

Normally, the amplifier is keyed. This permits the "quiet" switch, S₁, to be used for frequency setting. The oscillator can be turned on and the signal checked in the receiver without radiation from the transmitting antenna. Thus a lot of unnecessary disturbance is prevented. Every v.f.o. should have some arrangement by which the oscillator can be turned on and operated independently of the output amplifier so it will not cause interference during adjustments. Finding a place for the "quiet" switch seemed, at first, to be quite a problem. However, a low-capacity switch connected between the cathode and the negative return of the tuned circuit killed the oscillator and permitted everything else to remain the same in the circuit insofar as current and tube temperature were concerned. One word of warning—the leads to this switch should be very short because if there is appreciable inductance in the switch circuit the oscillator will operate even though the switch is closed. If the mechanical layout demands that the oscillator tuning unit be mounted a considerable distance from the panel the switch should be operated by an extension shaft.

No effort was made to calibrate the oscillator since it was operated in conjunction with a calibrated receiver. However, we would suggest calibrating it and providing some means of checking it periodically. Our tests have shown that a unit of this type, if carefully designed and constructed, will remain in calibration indefinitely, but as a matter of precaution, even though its calibration can be relied upon the oscillator frequency should be checked in the receiver before transmission is attempted. *This article is reprinted in part from June 1941 QST.*

Medium Power Modulator

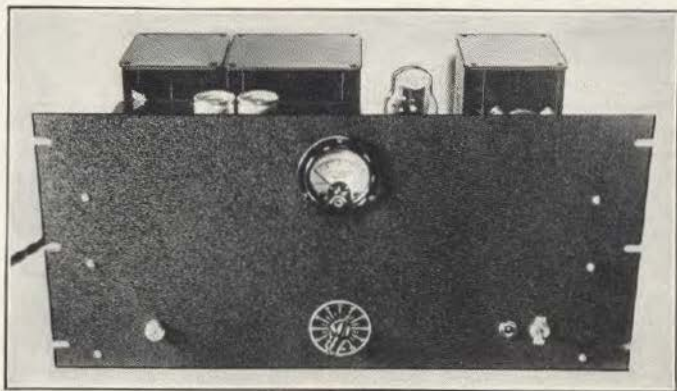

AMATEURS interested in phone operation will find this an ideal compact modulator unit. Although it has medium power output, when used together with an efficient transmitter, its range should be almost unlimited. It will work with either the 812 transmitter or the 815 transmitter already described. The maximum available output of this modulator unit is in the neighborhood of 65 watts. Naturally at this level, some distortion will be experienced, although the quality will be satisfactory for amateur use. We mention distortion, and we trust that the reader will not be horrified to learn that this amplifier has distortion: all amplifiers have distortion at certain levels and those that sound excellent over the air, probably have more distortion than exists in this amplifier. Distortionless output can be obtained at levels up to 30 watts.

Fundamentally, the audio power required to modulate an RF amplifier, should be equal to half the DC input of the RF amplifier. Twenty five watts of audio power will completely modulate 50 watts input. On the other hand, very satisfactory radio-phone performance can be obtained with as little as 25 or 30% audio power. Therefore, it is reasonable to assume that this amplifier can be used with inputs of 150 watts.

The 815 dual beam power tube, was selected for this amplifier because of its economy and relatively high output at low voltage. The output transformer, T494 is adjusted for a 4500 ohm output load, however, this can be changed to meet

almost any load conditions, providing the total power in the load circuit is in line with our previous comments on ratio of audio to DC power input. The speech amplifier and driver is about the simplest form available and is designed to work with a crystal or other high impedance low level microphone. In the speech amplifier circuit, we have a 6SJ7 driving a dual triode connected in a phase inverting circuit, this in turn drives a pair of 6C5's which are used to drive the 815 output tube.

Extreme care has been taken to maintain complete isolation in the various high gain circuits. The builder should be prepared to adhere closely to the values specified in order to avoid trouble. A departure from some of these values of condensers or resistors in some of the filters, might result in feed-back and instability.

The power supply section of this amplifier employs a transformer with a bias tap on the high voltage winding; this supplies negative grid voltage for the output tube. Another method for obtaining this voltage would be to use separate dry batteries, however, the method used in this amplifier is more economical in the long run. Two rectifiers and two filter systems are required. The 33 mercury vapor rectifier tube is used in the high voltage supply and 82 is used for the "C" supply. It should be noted that load resistor in the C supply is extremely low. A 1000 ohm load resistor is employed to permit good regulation and reduce voltage drop appear-

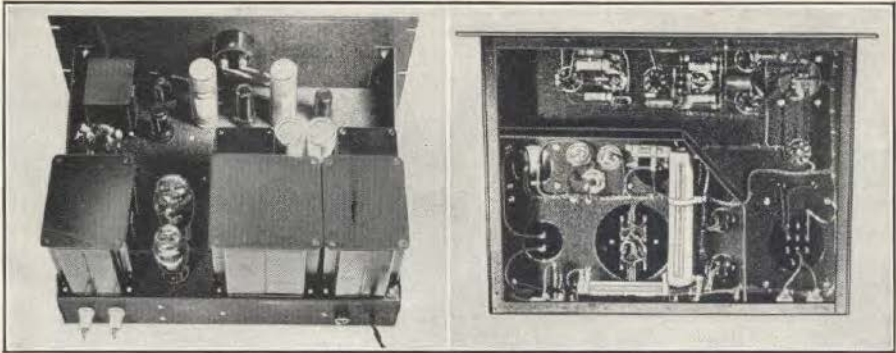

These views show the general mechanical lay-out of the modulator unit.

ing across the resistor during periods when grid current flows.

This entire unit is built on a 17" x 13" x 2" chassis with an 8 3/4" x 19" panel. It can be rack mounted or enclosed in a standard cabinet. The panel contains the microphone jack, gain control, plate current meter and primary switch with its associated pilot light. The output terminals are brought out at the rear of the chassis.

PARTS LIST

PARMETAL

- 1—Parmetal Chassis, 17 x 13 x 3"
- 1—Black Parmetal Panel, 19 x 8 and 3/4"
- 1—Pair Side Brackets (Parmetal)

KENYON TRANSFORMERS

- 1—T-494 Output trans.
- 1—T-507 Choke
- 1—T-154 Choke
- 1—T-153 Choke
- 1—T-255 Input trans.
- 1—T-216 Power trans.

TUBES

- 1—RCA 6SJ7
- 1—RCA 6N7
- 2—RCA 6CS
- 1—RCA 815
- 1—RCA 83
- 1—RCA 82

RESISTORS

- 1—IRC 3 meg. 1/2 watt metalized
- 1—IRC 1 meg. 1/2 watt metalized

- 2—IRC 1000 ohm 1/2 watt metalized
- 3—IRC 250,000 ohms 1/2 watt metalized
- 2—IRC 50,000 ohms 1/2 watt metalized
- 1—IRC 3000 ohms 1/2 watt metalized
- 1—IRC 20,000 ohm 1/2 watt metalized
- 2—IRC 500,000 ohms 1/2 watt metalized
- 1—Ward Leonard 507-249 1000 ohm 25 watt VAR.
- 1—Ward Leonard 507-749 25,000 ohm 100 watt VAR.
- 1—Ward Leonard 507-139 10,000 ohm 50 watt VAR.
- 1—Mallory-Y 500,000 MP Carbon Control

CONDENSERS

- 2—Cornell-Dub TLA 6040 4 mfd 600 V
- 1—Cornell-Dub KR-288 8-8 mfd 250 V
- 2—Cornell-Dub EP 9081 8 mfd 450 V
- 2—Cornell-Dub BR 252 25 mfd 25 V
- 1—Cornell-Dub BR 102 10 mfd 25 V
- 3—Cornell-Dub DT 6S1 .01 mfd 600 V
- 1—Cornell-Dub DT 4P1 .1 mfd 400 V

MISCELLANEOUS

- 5—Amphenol sockets 8 prong
- 2—Amphenol sockets 4 prong
- 1—Pilot assembly for 6 watt-110 V bulbs
- 1—Amphenol CL-PCM closed ckt. input recep.
- 1—Amphenol MC 1 F Mic. connector
- 1—6 watt 110 V bulb
- 1—S. P. T. Toggle switch (3 amps)
- 3—5 point dummy lugs
- 1—Panel mount fuse holder (3 AG)
- 1—Small feathur insulators (Birnbach)
- 1—"Gain" Dial plate
- 1—Bar Knob
- 1—2 amp. fuse (3 AG)
- 2—Medium grid caps
- 1—A C. Line cord with plug

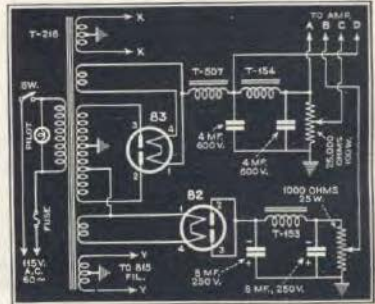
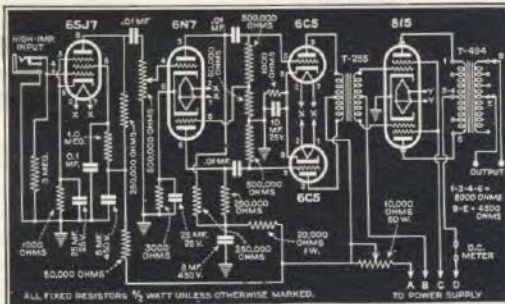

Diagrams of the complete modulator and its power supply.

Antenna tuning unit which can be used to make up for a great many antenna deficiencies. Wiring diagrams show how it can be used with various antennas.

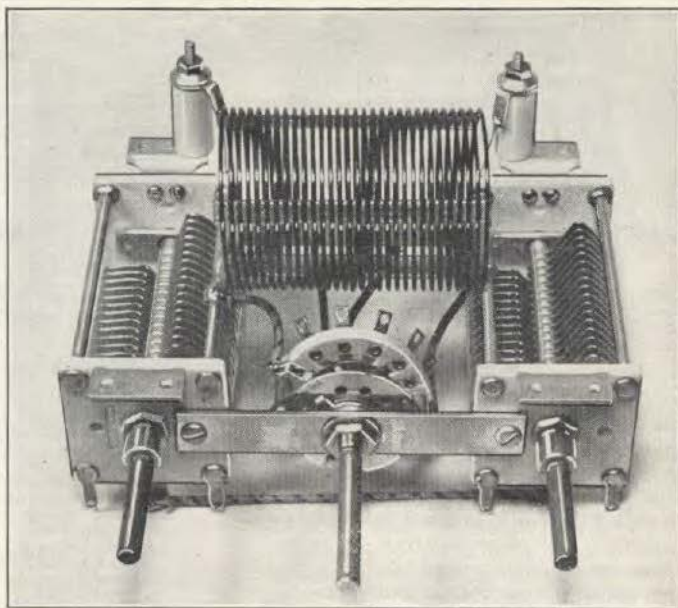

RECEIVING and TRANSMITTING ANTENNAS

WHILE radio signals can be received on almost any piece of wire, care exercised in building a good antenna system will pay dividends. For general broadcast and short wave reception, a single wire about 75 feet long seems to give best results. For reception on any particular short wave band, the doublet is perhaps the simplest and most generally used; and it is very effective. This latter type is restricted to use over very narrow ranges of frequency. The flat top or main wire of the doublet should be $\frac{1}{2}$ wave length long. A convenient formula for calculating this length is:

$$468/\text{freq. (mc)}$$

For example, a 20 meter antenna (14 mc.) should be 33.42 feet long. This is then cut in the center and fitted with a special twisted pair transmission line. In attaching this type of lead-in, the two terminals at the antenna should be separated from 12 to 16 inches, and the lead-in wires should be spread to form a triangle having all sides approximately 16 inches. Make sure the better grade material is used for the lead

in. Poor quality here will result in inferior performance particularly during damp weather.

"Transmitting Antennas"

More complicated antennas are usually employed for transmitting, but here too, the simplest perform consistently well and it is advisable for the beginner to avoid the complicated antennas, until he is well up on his theory. The doublet described above is best suited where break-in or duplex operation is desired. There is less interference due to the feeders not radiating in or near the operating room. When a similar type antenna is used for receiving and they are separated several wave lengths, fine results will be experienced.

Another simple transmitting antenna is one with a single wire feeder. This feeder is connected to the antenna at a point removed slightly from the center of the flat top. Care should be taken not to create sharp bends in the lead-in and it should be kept well away from all trees, metal roofs, etc. The distance from the center of the flat top to the point where the feeder is

14 per cent of the total length of the flat top and is the same for each of the important amateur bands. A single wire feeder can be tapped on the plate coil of the transmitter through a blocking condenser or it can be coupled through a tuning unit.

Time was when nearly every amateur used the Zepp antenna. This is also shown in the drawing. In cases where the feeders are an odd number of quarter waves long, the tuning condensers should be connected in series. An even number of quarter wave lengths in the feeding system requires parallel tuning.

There are many other types of impedance matched antennas, but these require technical knowledge and equipment to get them operating properly and the beginner will do well to use the simple forms of antennas, at least until his experience fits him for the more complicated systems. The drawings show a number of methods for connecting antennas and many methods for tuning them. Most of the diagrams are self-explanatory or are covered in the caption.

In many locations, circumstances will dictate the type of antenna to use. However, there are a few simple rules which can be followed for all locations: First,

the antenna should be well in the clear and away from all surrounding objects. Second, it should be as high as possible and third, all connections should be thoroughly soldered. Many amateurs prefer #12 solid enameled copper wire. Usually this type of wire is difficult to handle and many kinks will remain in the wire, particularly in cases where masts are not strong enough to permit the antenna to be pulled sufficiently tight to remove kinks. Stranded wire consisting of 7 strands of #22 will overcome the trouble with kinks and it is much easier to handle. Each strand should be thoroughly cleaned and soldered where a joint is made. The stranded wire works out particularly well in spaced feeder systems where it is difficult to maintain tautness.

PARTS LIST

HAMMARLUND

- 2—150 mmf. conds. HFB-150-C
- 2—Standoff Insulators

CENTRALAB

- 1—Rotary Switch, No. 2505

COIL DATA

- 30 turns No. 14 enameled wire
- 2 inch diameter, spaced to a length of 3 inches.

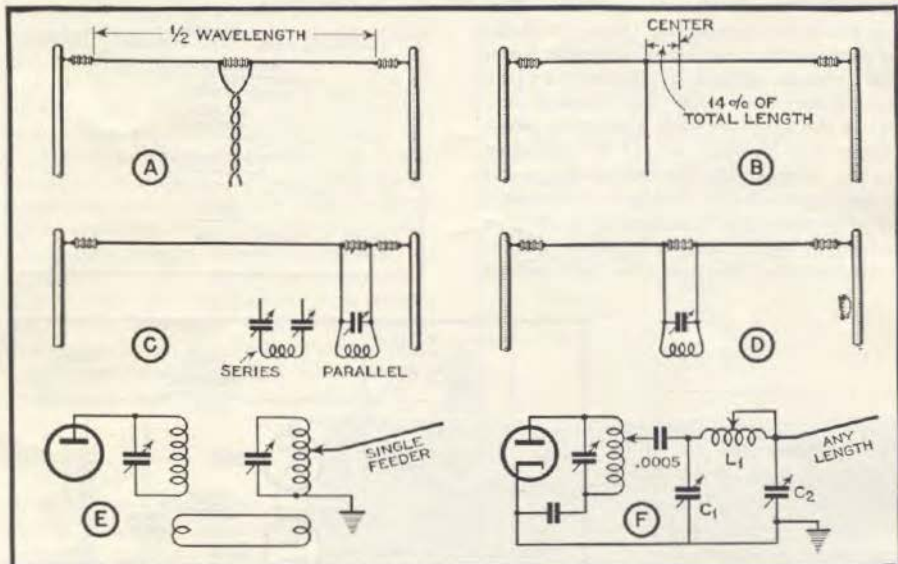

Diagrams of various simple antennas with which the beginner may obtain excellent results. A & B do not require a tuning unit, while the others make use of the unit shown on the opposite page. In figure F, the antenna can be any convenient length, preferably a $\frac{1}{4}$ wave-length or more, but it does not have to be any exact length; the tuning unit will bring about a match.

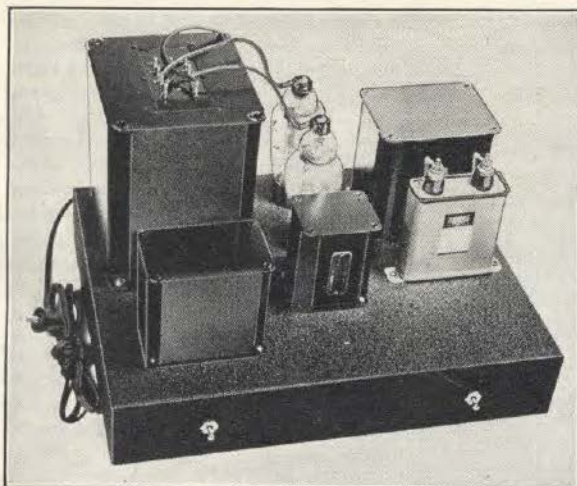

TRANS- MITTER POWER SUPPLIES

*High voltage power
supply.*

ALTHOUGH there is nothing complicated about this high voltage power supply, it is important that good materials should be employed and care should be exercised in wiring. The high voltage transformer has three out-put voltages ranging from 1000 to 1500 volts, which are sufficient to cover the requirements of the high voltage amplifiers described in this book. Since this power supply feeds the last amplifier in the transmitter, filtering is not too important. A single choke of good quality with a 2 mf. filter condenser will provide sufficient smoothing to produce a very clear note. The filament supply in the amplifier with which this power supply will be used, should be contained on the chassis with the rest of the power supply equipment. The switch arrangement permits the filaments to be heated before the high voltage is applied. This is quite important because if the high voltage

were to appear across the tubes before the filaments were heated, it is more than likely they would be completely ruined.

PARTS LIST

KENYON

- 1—Rect. filament transformer
- 1—High voltage plate transformer
- 1—Amp. filament transformer
- 1—Filter choke.

I. R. C.

- 1—50,000 ohm, 75 wt. resistor

CORNELL DUBILIER

- 1—2mf. dykanol, 2000 v.

R. C. A.

- 2—866 rect. tubes

PARMETAL

- 1—17" x 13" x 3" chassis

MISC.

- 2—sp. st. toggle switch
- 2—Plate clips for 866 tubes.

*Wiring diagram for a
high voltage power supply
to be used in trans-
mitters requiring a
thousand or more volts.*

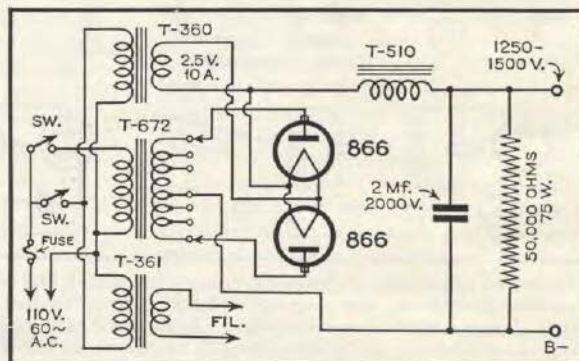



Top view of low voltage power supply. This will work with all transmitters requiring around 400 volts.

Low Voltage Supply

THIS power supply can be used with any of the low power transmitters, described in this booklet, or the low power stages of any high power transmitter. The chassis used is the standard 7" x 13" x 2" steel unit and provides plenty of space for the various parts. Since most of the parts of a power supply become quite hot during operation, it is important to provide ample ventilation. Do not crowd the parts or mount them in an unventilated container or cabinet.

While filtering is more important in low power stages, this supply with its single section filter provides sufficient smoothing to produce a clean, crystal clear note from any good transmitter. Remember! it isn't always the fault of the power supply when the note sounds bad. Spurious oscillation due to poor design of the transmitter can do more to spoil a signal than even the poorest filter. The single choke with input and output condensers will produce excellent results if not abused by overloading.

The transformer contains all windings for filament and high voltage. With con-

denser input to the filter, a full load voltage is just about equal to the 400 voltage rating of the secondary of the transformer. With condenser input it is advisable not to use a mercury vapor rectifier. The 5Z3 gives the best results. One very important part of this power supply is the fuse, by all means include a fuse in every power supply you build, it costs very little and will pay big dividends. Even if it only saves a tube in case of overload due to a short circuit, you will be way ahead in dollars and cents.

PARTS LIST

HAMMARLUND

- 1—S-4, 4-prong socket
I. R. C.
- 1—20,000 ohm, 50 watt resistor
AEOROVX
- 2—8 mf. 500 V. electrolytic conds.
STANCOR
- 1—Plate-fil. transformer No. P-4081 (see text for rating)
- 1—Filter choke 20 H. 175 ma. No. C-1410
R. C. A.
- 1—5Z3 tube
MISC.
- 1—Toggle switch
PARMETAL
- 1—7" x 13" 2" chassis

Drilling dimensions for the low voltage power supply. Sufficient filtering is obtained with one choke and two condensers.

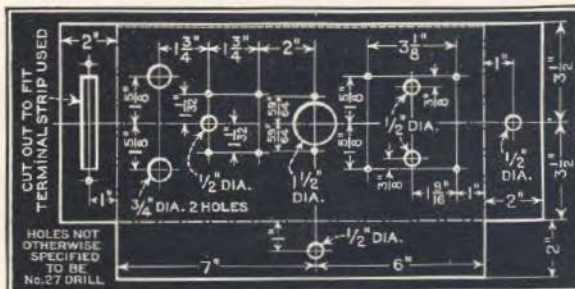

Notes

Clip Earphones before X-former for testing
Build GFL amp & Mod.

2.00 miss you
main course, J. N. out, true plug, phones

Better compare my rec. with this one & old Hadlock
Navy P in + any one for Tandy
lay in some condensers, tubes, coils, resistors
Try some diff. earphones.

See about getting back (B, Mrs Byrd, Mrs A)

walk 12.50
mirror
foul weather gear

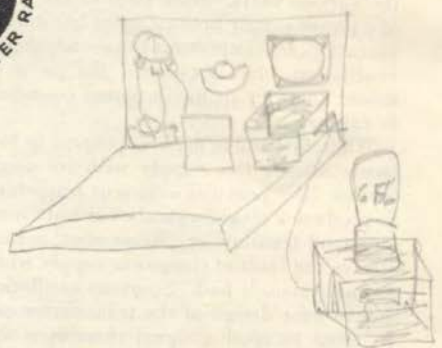

4" x 4"
amp belt

Speaker
E10
also GFL in
can

Dixie Radio Supply Co.
423 South Church St.
Charlotte, North Carolina