

GILBERT

REG. U.S. PAT. OFF.

RADIO TELEPHONE AND BROADCASTING

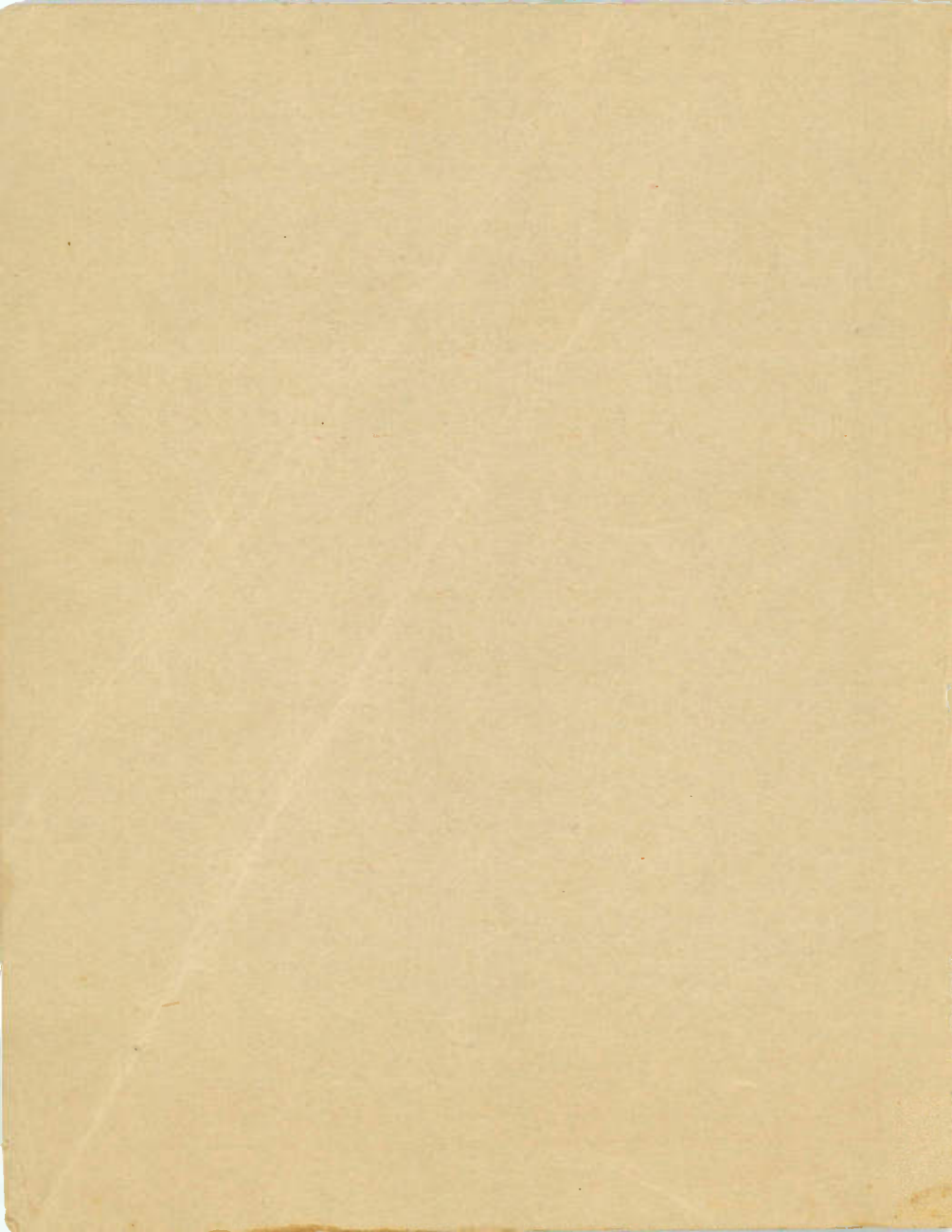



GILBERT
Radio Telephone
and
Broadcasting

BY
CLARENCE D. TUSKA
Assoc. I. R. E.

Prepared under the direction of
ALFRED C. GILBERT
YALE UNIVERSITY, 1909

Printed in U. S. A.

PUBLISHED BY
THE A. C. GILBERT COMPANY
NEW HAVEN, CONN.

NEW YORK CHICAGO SAN FRANCISCO TORONTO LONDON

M911

Copyright, 1922, by A. C. Gilbert, New Haven, Conn.

TABLE OF CONTENTS

- Chapter .I. History and Elementary Theory**
How Electric Currents are Generated
What a Condenser Is
How Electric Oscillations are Produced
The Discovery of Radio Waves
What Electric Resonance Is
Invention of the Wireless Telegraph
- II. The Ether and Electric Waves**
What the Ether Is
How Radio Waves Travel
The Water Wave Analogue
Length and Speed of Radio Waves
Effect of Various Mediums on Radio Waves
Variations in Strength of Radio Waves
Variations Due to Static
Variations Due to Fading
Variations Due to Blind Spots
- III. Simple Transmitting Apparatus**
How the Spark Coil Is Made
The Action of the Spark Coil
Connections of a Simple Transmitter
About Closed Circuits
The Primary or Open Oscillation Circuit
The Secondary or Closed Oscillation Circuit
Spring Analogue of a Closed Oscillation Circuit
Spark Gaps
The Fixed Gap
The Rotary Gap
The Quenched Gap
The Open or Antenna Circuit
- IV. Simple Receiving Apparatus**
Action of a Simple Detector
Action of a Tuning Coil
Action of a Receiving Circuit
How the Detector Is Adjusted
About the Telephone Receivers
- V. Coupled Circuits**
Magnetic Effect of the Electric Current
How a Current Is Induced
Electric Resonance
Resonance of Electric Circuits
- VI. Antennae and Grounds**
Types of Antennae
Directive Properties of Antennae
Length of Antennae
Capacity of Antennae
Resistance of Antennae
Kinds of Grounds
The Loop Antenna
The Use of the Loop as a Radio Compass
Lightning Protective Devices
- VII. Amateur Transmitting Sets**
A Simple Transmitting Outfit
A Helix Transmitting Outfit
Analogue Illustrating Variable Coupling
Apparatus Operated by Commercial Power
The Power Transformer
The Condenser

Chapter VII.—Continued

- The Fixed Spark Gap
- The Rotary Spark Gap
- The Quenched Spark Gap
- About Oscillation Frequencies
- The Oscillation Transformer
- Continuous Wave Transmitters

VIII.. The Operation of Amateur Transmitting Sets

- How Tuning Is Done
- The Importance of a Good Ground
- The Importance of Good Insulation
- Kinds of Transmitter Connections
- Connections for Continuous Wave Sets

IX. Amateur Receiving Sets

- Single-Slide Tuner Sets
- Loose-Coupler Tuner Sets
- Rotating Coil Loose Coupler
- Connections of Loose Couplers
- The Use of Condensers
- Vacuum Tube Receiving Circuits
- Straight Vacuum Tube Detector Circuit
- Amplification by Vacuum Tubes
- The Inductive Feed-Back
- The Capacity Feed-Back
- Variometers for Tuning
- A Short Wave-Length Receiver
- The Third or Loading Coil
- Other Kinds of Connections
- Damped versus Undamped Waves

X. Vacuum Tubes

- How a Simple Vacuum Tube Works
- How the Grid Affects the Plate Current
- Plotting Grid Plate Curves
- How the Vacuum Tube Acts as a Detector
- The Action of Soft and Hard Vacuum Tubes
- The Vacuum Tube as an Amplifier
- Connecting Up Vacuum Tubes for Amplifiers
- The Armstrong Regenerative Amplifier and How it Works
- The Vacuum Tube as an Oscillator
- Microphone Analogue of Current Variations
- Kinds of Oscillation Circuits
- The Vacuum Tube as a Receiving Oscillator

XI. The Operation of Amateur Receiving Sets

- Simple Types of Receiving Sets
- The Antenna
- The Ground
- The Use of Crystal Detectors
- How to adjust a Crystal Detector
- Tuning the Receiving Set
- The Use of Variable Condensers
- Loose Coupler with Vacuum Tube
- Adjusting the Audion
- How to Prevent Burn-Outs
- Amplifying Audions
- Use of the Loop Antenna

XII. The Radio Telephone

- The Invention of the Radio Telephone
- Amateur Radio Telephony
- The Radio Telephone Transmitter
- Limitations of the Microphone
- Amplifications of the Microphone Current
- Kinds of Radio Telephone Circuits
- The Oscillation Arc
- The High-Frequency Alternator
- The Vacuum Tube Oscillator
- A Vacuum Tube Radio Transmitter
- Sources of High-Voltage Currents

Chapter I

ELEMENTARY HISTORY AND THEORY

AMATEUR radiotelegraphy is rapidly becoming an important element in the every-day affairs of the United States. Amateur wireless experimenters already number in the hundreds of thousands. From the ranks of the amateurs have come some of the brilliant radio engineers who are rapidly advancing the wireless art.

The experimental work, the education, the interest and pleasure which go along with amateur wireless work can hardly be equaled in any other science, hobby, or sport. The purpose of this book is to point out not only the elementary theory which has been established for wireless work, but to tell of the apparatus that is used and the work of the amateur in general.

The theory of wireless telegraphy may be easily understood if the reader can start from certain definite assumptions which are very elementary. In describing the theory, it is logical to proceed from the sending to the receiving station. For a beginning we shall follow the electromagnetic waves without attempting to describe in detail all of the apparatus which is used in their generation.

HOW ELECTRIC CURRENTS ARE GENERATED. Electric currents may be generated in several ways: first, by means of chemical action such as takes place in a dry-cell, wet-cell, or storage battery; second, in a dynamo, which is a machine for generating current; and third, by friction methods, as the static machine. An electric current has "potential," which is often called voltage. The voltage is the pressure which overcomes the resistance (that which opposes the current) of a circuit and forces the current through the circuit. To illustrate this: a dry cell has a potential of 1.5 volts. This voltage will overcome a resistance of 1 ohm and force a current of one ampere through the circuit. (See notes at the bottom of page for definitions of these terms.)

The understanding of these definitions will enable you to grasp the general theory of the electric current. A dynamo generates a direct current,

NOTES: A volt is the electrical pressure which, when steadily applied to a conductor the resistance of which is one ohm, will produce a current of one ampere.

An ampere is the unvarying electric current which, when passed through a solution of silver nitrate and water, deposits silver at the rate of .001118 gram per second.

The ohm is the resistance offered to an unvarying electric current by a column of mercury at the temperature of melting ice, 14.4521 grams in mass, of a constant cross-sectional area and a length of 103.3 centimeters.

but there are machines which generate alternating currents, hence these machines are called "alternators." An alternator sends the current through the circuit, first in one direction and then in another, or "it alternates."

Most cities have electric supply systems for light, heat, and power of 110 volts alternating current. This alternating current may be easily changed by means of a transformer from a voltage of 110 to any voltage, either higher or lower. For wireless telegraph purposes, let us assume that we have available an alternating current of 5000 volts.

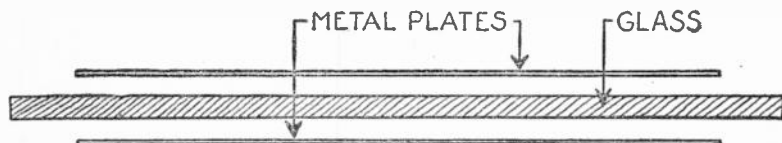

Fig. 1

WHAT A CONDENSER IS. We will use this potential of 5000 volts to charge a condenser. Just as a water reservoir holds a supply of water, so we may store electric energy in a condenser. The condenser consists of two metallic conductors separated by a non-conductor as shown in Fig. 1. A familiar form of condenser consists of a glass plate, which is the insulator or non-conductor, coated on the opposite sides with tinfoil which form the conductors.

Our potential of 5000 volts is connected to the plates of the condenser which accumulates a charge of 5000 volts and will hold that charge until some discharging device connects the opposite sides together. In order that we may discharge the condenser, it becomes necessary to connect two wires, one on each of the tinfoil sheets, or on each of the metal plates, as shown in the picture, to a spark gap. If the ends are brought together, the charge that has been stored in the condenser will be changed into an oscillating electric current, and we find that it is not necessary to touch the ends of the wires, but merely to bring them close together, when the charge will set up a spark and discharge the condenser. (See Fig. 2.)

If the wires are brought within about $\frac{1}{16}$ of an inch of each other, a bright blue electric spark will snap between them. This spark is of the same kind as the electric spark which occurs in the plug of an automobile engine. Another illustration of the spark discharge is the lightning which accompanies an electrical storm.

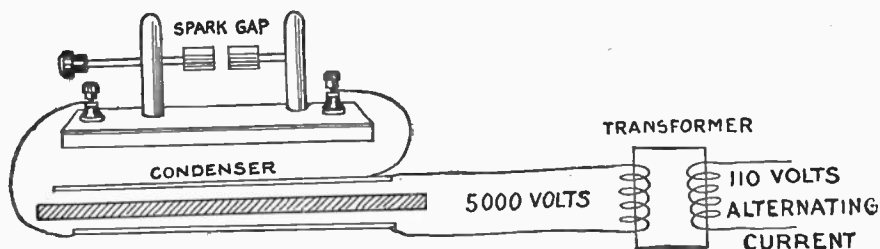

Fig. 2

HOW ELECTRIC OSCILLATIONS ARE PRODUCED. All of the readers have seen these sparks, and if they were to describe them they would probably say they appeared as a single bright discharge. As a matter of fact, when a condenser discharges, provided there is not too much resistance in the circuit, the discharge is a whole series of small sparks. These sparks jump first in one direction and then in the reverse direction and so produce a series of alternate sparks. By means of mathematics, one of England's foremost scientists, James Clerk Maxwell, proved that the sparks oscillate at an extremely rapid rate, depending upon the size of the condenser, the length of the wire in the spark gap circuit. We may say that a single condenser discharge is made up of electric oscillations at the rate of 15,000 to 6,000,000 per second, depending upon the size of the condenser and the circuit.

Maxwell was not working on radio. He was interested in other matters, but in a footnote to one of his extremely brilliant lectures, he predicted that a condenser discharging at the rate of several hundred thousands of oscillations per second would set up electric waves which would travel with the velocity of light; namely, 186,500 miles per second. These are the radio waves of to-day, and to Maxwell really belongs the credit of having been the first to point out the way to set up electric waves.

THE DISCOVERY OF RADIO WAVES. A German by the name of Hertz read Maxwell's statement and he reasoned that the theory seemed probable. If it were true, he thought he ought to be able to produce electric waves which would travel with the speed of light. He went to work in his laboratory, and after many attempts and many fail-

tures, he succeeded in setting up electric oscillations which radiated their energy as electric waves, and in detecting the latter. This he did by charging a condenser and discharging it when it sent out electric waves which he was able to detect at some distance away.

Hertz continued his laboratory experiments and showed that the electric waves could be reflected, refracted, and made to act exactly like light waves. All of the experiments which he conducted were of a scientific nature and it probably never occurred to him that there might be a commercial use for the waves which were afterwards named Hertzian waves.

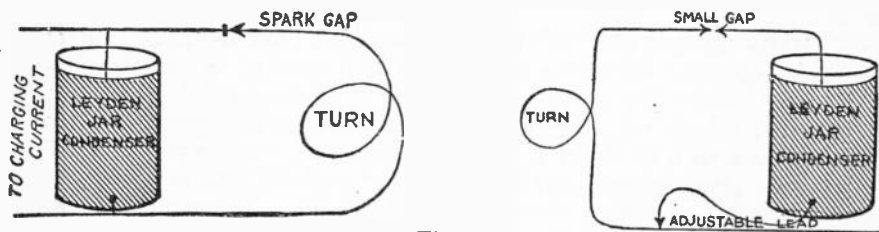

Fig. 3

The early experiments of Hertz required only the simplest of apparatus. To-day the apparatus which he used looks crude indeed when compared to our modern equipment. A demonstration which is often given in high schools and colleges is to repeat one of the historic experiments of Hertz, as devised by Sir Oliver Lodge and shown in Fig. 3.

WHAT ELECTRIC RESONANCE IS. The experiment is performed as follows: A condenser is connected through a single turn of wire and a spark gap in order to provide a means of charging it until it has enough potential to discharge across the gap. Near to this outfit is set up a condenser and a similar loop, which may be adjusted for length and in which there is a very minute spark gap. It is found that if the charge of the first condenser discharges across the gap, the receiving condenser will absorb some of the energy which is sent out from the transmitting condenser, without there being any electrical connection between them.

There will be enough energy received to cause a spark to jump in the receiving circuit spark gap. It is found that the length of wire in the receiving circuit, as well as the capacity of the condenser, must equal in size the wire and condenser of the sending set. The phenomenon thus produced is called "resonance."

An every-day example of resonance may be had by singing a note near the sounding board of a piano. A note corresponding to the one sung will be set up in the piano and will respond every time the note is sung. This resonance is an indication that the two notes are in tune. It has been found that each condenser circuit will send out electric waves of a certain definite length. To detect these waves, it is necessary to have a system which will respond to the wave length of the transmitter, or is "in tune."

This resonance adjustment to wave length can be shown very nicely in the Hertz experimental apparatus by varying the length of the wire on the receiving loop. If the wire is a little too long or a little too short, no response is had in the receiving system. A response is obtained only when the two systems have the same wave length.

INVENTION OF THE WIRELESS TELEGRAPH. Not a few scientists of that time read of the work of Hertz, but it remained for a brilliant young Italian inventor, Marconi, to devise the first successful apparatus which would transmit messages from place to place without the aid of wires. His apparatus at that time was very elementary and crude, but it operated with enough success to establish radiotelegraphy as a means of communication.

From Marconi's early experiments in the late 1890's, radiotelegraphy developed with great rapidity, and in 1901 Marconi succeeded in transmitting radio signals across the Atlantic from Poldhu, Cornwall, England, to St. John's, Newfoundland. This was only the beginning of rapid developments, and along with these developments there sprang up a class of experimenters who were not interested in commercializing radio, but in enjoying the pleasure of being able to communicate among themselves without the aid of wires.

It was in this way that the development of radio came about, and you have seen that wireless hinges upon the electric discharge of a condenser which sets up electric oscillations and that those in turn send out electric waves. We are now in a position to consider with greater detail and care the action and theory of radiotelegraphy.

Chapter II

THE ETHER AND ELECTRIC WAVES

ALL matter is made up of minute particles which are called "molecules." A molecule is a very minute particle indeed. Many thousands of them added together would not be as large as the finest grain of chalk or sand. Molecules are not visible, even by the aid of the most powerful microscope. The very smallest thing you can imagine would contain hundreds of thousands of molecules.

The difference between wood and iron, or between air and water, is, to a large extent, the difference in the kind of molecules and the number of them that are crowded into a given space. If there are a great many molecules and they are tightly bound together, the material is a dense one, such as iron, while a material made up of molecules not so closely bound together is generally a less dense one, such as air or water.

WHAT THE ETHER IS. Regardless of the number of molecules existing in a certain volume, there still remains a space between the molecules. A certain substance occupies this space. This substance is called the "ether." We have just said that all matter is made up of molecules. We have also shown that in addition to the molecules, matter has space which is filled with this attenuated substance—the ether. The phrase "all prevailing" well describes the ether. It exists everywhere—in the air, in buildings, and in hills. Radio waves are transmitted by, in, and through the ether, and since the ether exists everywhere, it is possible to send a radio wave in every direction as well as through buildings and even mountains.

HOW ELECTRIC WAVES TRAVEL. The manner in which a radio wave is sent from the transmitting antenna is very interesting. The current from the transmitting apparatus surges, or flows up and down the antenna. This flow or current causes a magnetic strain to be set up in the ether which surrounds the antenna. This strain might be likened to the strain which is set up in a certain volume of air when it is compressed by means of a bicycle pump. As long as the current is charging the antenna, the strain continues to exist in the ether. Fig. 4 illustrates an imaginary electric strain in the ether about a single vertical

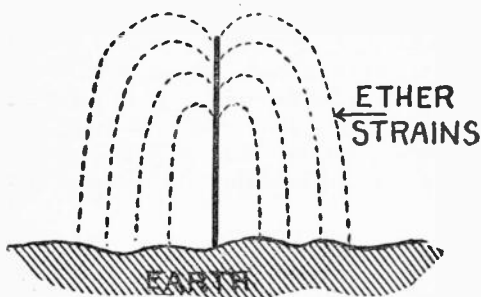

Fig. 4

kind of strain. That is to say, if we have an electric strain surrounding an antenna and this strain starts to die out, a magnetic strain will be set up. Now let us consider the magnetic strain which we have just established. In turn the magnetic strain sets up an electric strain. This electric strain again changes into a magnetic strain, and so on. It is very easy to see that this process will continue until every bit of energy which was used in the original electric strain has disappeared. Not only do these changes in strains take place in the ether, but as they occur, the strain moves out from the antenna at a very rapid rate and in all directions. This electromagnetic energy continues through the ether in all directions until finally it dies out completely, due to absorption, etc. Fig. 5 shows in greater detail the electromagnetic strains or electric waves, as they are called, as they are created about an antenna and travel away from it. The dotted lines are the elec-

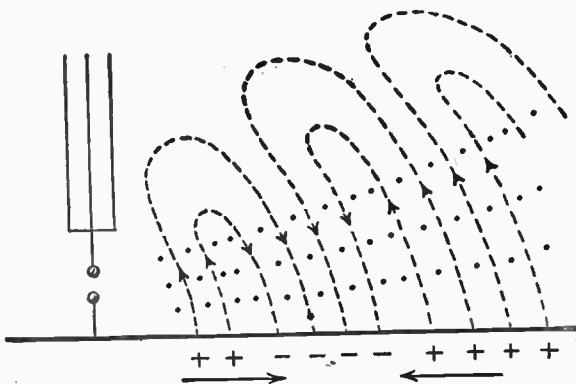

Fig. 5

wire. This strain is accompanied by another strain which is an electric one. The magnetic lines or strains are always at right angles to the electric ones. A magnetic line of force will surround an electric line of force in a circular manner. Any change in either an electric strain or a magnetic strain causes a change to the opposite

trical strains. The dots represent magnetic strains which are perpendicular to the page and, of course, cannot be shown completely. However, they may be visualized as small circular strains around each electrical strain. In the illustration, we have shown only a few lines. This is to make the drawing as clear as possible. Actually, the lines would be very, very dense and there would be a great many of them. We have considered the strains as real material lines, to aid our understanding of the theory, but they are really invisible.

THE WATER WAVE ANALOGUE. The foregoing explanation may seem more or less complicated and theoretical. As we wish the reader to understand, in his own mind, just how a wireless wave travels,

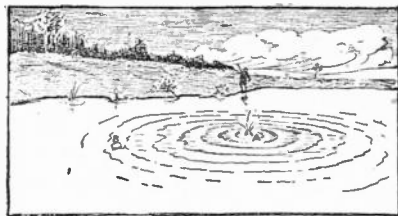

Fig. 6

we shall describe an experiment which every boy knows and which is illustrated in Fig. 6. If you throw a stone into a pond of water at "A" it will create a wave which will extend out from "A" in all directions, and may be detected by the rocking of a block of wood at "B." The waves will become smaller and smaller as they extend out from "A" until finally they die out entirely or reach the shore and are stopped.

The stone at "A" corresponds to the transmitting antenna. The waves created correspond to wireless waves. The water is equivalent to the ether. The block of wood floating at "B" is the same as our radio receiving station. These waves are limited to the surface of the water and probably do not go deeper than a few inches. In the case of radio, the disturbance extends throughout the ether from the surface of it to many miles above it and to a considerable distance in it. If there were an island in the pond, the water waves would travel around it. If they were radio waves, instead of going around the island, they would probably go through it.

The island which we have just mentioned would probably be equivalent to a mountain, as far as regular wireless waves are concerned, and whether the waves went through it, over it, or around it, would depend to a large extent upon the shape of the mountain and the material it is made up of. In all probability, a radio wave meeting a mountain does all three of these things. Part of the wave will go through it, a certain part over it, and still another portion around it. Some of the energy of the wave will be lost as it travels through the mountain. In the case of a slowly rising hill, the radio waves will probably curve over it. The

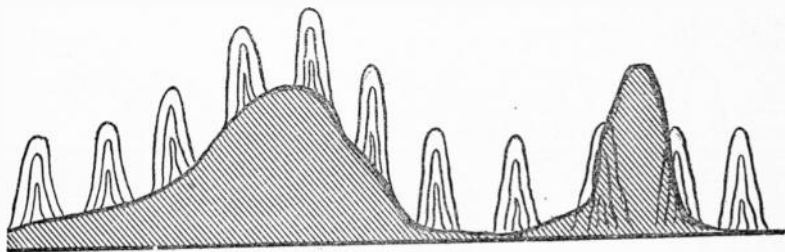

Fig. 7

waves are more apt to go through, rather than over a very sharply pointed mountain. Fig. 7 shows two different types of obstacles and the probable path of a radio wave when it meets them.

LENGTH AND SPEED OF RADIO WAVES. A radio wave travels at the rate of 186,500 miles per second. This is the speed of light and, in fact, the only difference between light waves and radio waves is the difference in their lengths. Light waves are extremely short, being of the order of ten-millionths of an inch. Wireless waves in general use are not shorter than 50 meters or longer than 20,000 meters. The longer waves are generally more suited for transmitting over long distances, while the short waves are efficient for short-distance transmitting.

This, of course, does not mean that short waves cannot be used for long-distance work. There are numerous cases on record where amateur radio stations have transmitted over 2000 miles, using a wave length of 200 meters. The reader should understand that there is no connection, except as stated above, between the wave length and the distance transmitted. When we speak of a wave which has a length of 200 meters, we

mean that it is 200 meters or about 660 feet from the peak of one wave to the peak of the next wave.

EFFECT OF VARIOUS MEDIUMS ON RADIO WAVES. As a radio wave extends outward from the transmitting antenna, a certain portion of it is above the ground and the remaining part is through the earth. Generally, the part through the earth will travel a path of varying resistance due to the different kinds of conducting soil it meets, and this resistance will hold back the foot of the wave while the peak will slant forward. As the distance becomes greater and greater, this slanting becomes more marked, and it results in a decrease of the intensity at the receiving station.

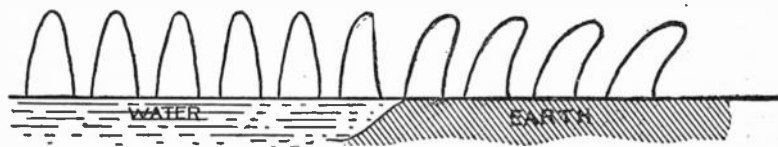

Fig. 8

Fig. 8 illustrates the slanting of a radio wave. In transmitting over salt water, the wave has a good conducting material for its base, while the ether above it is of approximately uniform density as there are no houses or mountains, trees or other obstructions in the ocean. This makes a radio wave much more efficient over water than over land. A certain transmitting set will often have twice the range over salt water as it shows over land.

One reason for the greater transmitting range and the louder signals which radio operators observe in the winter, is the fact that the trees have lost their foliage and the waves are absorbed less than in the summer time when all the leaves are on the trees and the sap is running through the limbs. Trees absorb a great deal of the energy of radio waves and oftentimes a dense grove of trees will even cause a radio shadow to take place close to them. Of course, off at a distance the effect of this shadow is very slight.

VARIATIONS IN STRENGTH OF RADIO WAVES. There are variations in the strength of signals during the night and day. This is

due probably to a condition of the ether. During the daytime, the sun has a certain effect upon the ether which results in decreased strength of signals. An hour or two after sundown, the ether becomes much better for radio transmitting with the result that the receiving range of a station under certain conditions may be twice as great at night as it is during the daytime.

VARIATIONS DUE TO STATIC. There are a number of things that take place in the ether, or the air, which are familiar to all radio operators. One is "static." Static seems to be stray charges of electricity which are created in the atmosphere. These charges collect on an antenna and cause a series of crashes and growlings in the telephone receivers. Static interferes with receiving and is very troublesome, especially in the tropics.

Static is more marked in the summer than in the winter, and is worse at night than in the morning. One of the struggles of the radio experimenter has been in attempting to eliminate his worst enemy, static. During the latter part of 1919, numerous claims have been made by different radio engineers that they have succeeded in devising circuits and apparatus which will eliminate static. Roy Wegeant of the Marconi Company described a rather complicated invention which is reported to eliminate static.

VARIATIONS DUE TO FADING. There is a second phenomenon of the ether which applies directly to radio amateurs, and that is "fading." When an amateur transmitting station works over a fairly long distance in certain parts of the United States and Canada, the signals from the transmitter fade in and out at the receiving station. This fading is not a constant thing. Some evenings it will occur very rapidly, while on other evenings it will be slower and not as pronounced.

It also seems to vary in different sections of the country. It has been extremely bad throughout New England, while less pronounced on the Pacific Coast. Amateur radio organizations are making attempts to solve the problem. The American Radio Relay League, which is probably the largest amateur organization in the United States, is directing a series of tests among the amateurs of the whole country so that extensive data will be collected by them which may lead to a comprehensive theory about fading. Next to static, fading is one of the biggest handicaps in long-distance amateur radio work.

VARIATIONS DUE TO BLIND SPOTS. A third phenomenon of the ether — that is, the writer says it is of ether, although it is probably a combination of things — is that of “blind spots” along the coasts of the country. As a ship travels up the Long Island Sound from New York to Boston, there will be certain positions from which the operator finds it almost impossible to communicate with New York, while from the same location he can easily communicate with New London or Newport or some other station.

The Newport and New London stations are also able to communicate directly over the ship operator's position with New York. These so-called blind spots also exist on land. An example may be given by the writer which he has personally witnessed. Bristol, Connecticut, is about sixteen miles southwest of Hartford. At this town much better receiving is done than in Hartford.

There have been many times when a station would be transmitting and equally distant from both Hartford and Bristol, yet the transmitting station could barely be heard in Hartford, while it was easily readable in Bristol. The reverse of this particular case has never been noticed. This problem may be met by superior antennae and superior apparatus, in places where the receiving range is poor.

Chapter III

SIMPLE TRANSMITTING APPARATUS

THIS chapter will deal with the elementary apparatus which is required to transmit messages. Later chapters will cover more fully the latest and more complex types of transmitting apparatus.

Our first requirement is a primary source of power. For the sake of simplicity, we shall consider this primary power to consist of four dry cells. This forms a battery of approximately six volts. We will connect this through a key to a spark coil. One of the Ford automobile coil units answers the purpose nicely. In order that the reader may clearly understand each step, we shall describe the action of the spark coil first.

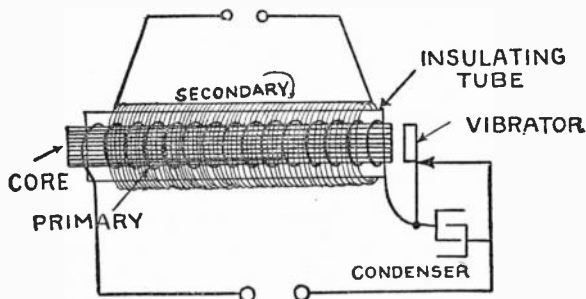

Fig. 9

HOW THE SPARK COIL IS MADE. The spark coil consists of two windings (primary and secondary), an iron core, a vibrator, and a condenser. The primary consists of a few turns of coarse insulated wire wound around an iron core which is made up of iron wire. The primary winding is covered with a heavy insulating tube and over this is placed the secondary winding which consists of many thousands of turns of fine insulated wire. The vibrator is connected in series with the primary winding. Fig. 9 shows a diagram of the connections of a spark coil.

THE ACTION OF THE SPARK COIL. The action of the spark coil (see Fig. 10) is this: when the key is closed, thus establishing a circuit,

the current flows through the vibrator, then through the primary winding, and back to the battery. The current flowing through the primary magnetizes the iron core and this draws the vibrator toward the core, thus breaking the contact. The vibrator springs back to its normal posi-

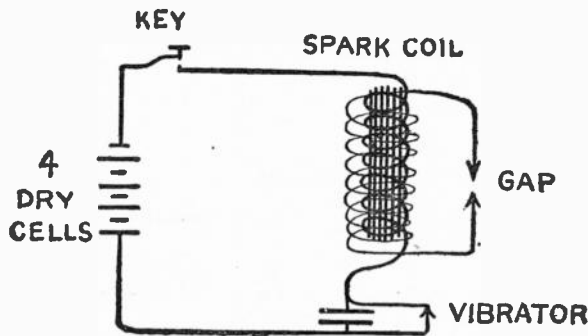

Fig. 10

tion, which again closes the circuit when the vibrator armature is drawn to the core. This action is repeated just as long as the key is held down.

With each making of the circuit, a current is induced or set up, in the secondary windings of the spark coil. At each break, a current is set up in the spark-coil winding. The voltage of this current depends mainly upon the quickness or sharpness of the vibrator break and the number of turns of wire on the secondary. The greater the number of turns of wire and the quicker the break, the higher the potential will be that is set up in the secondary.

An ordinary spark coil has a secondary potential which will often exceed 20,000 volts. This voltage is sufficient to jump a needle-point air gap of nearly one inch. The purpose of the primary condenser is to prevent an arc from forming between the vibrator contacts.

CONNECTIONS OF A SIMPLE SENDING SET. Now we have described the operation of a spark coil and the reader can see how it is possible to develop a potential of many thousands of volts. Let us connect the spark coil so as to make use of this high potential current. First, we shall put a spark gap across the secondary.

To one end of the spark gap we shall connect a ground wire, that is, a wire which leads to the earth through the water-pipe system in a house, or any other means of earth connection. To the other end of the spark gap, we shall connect an antenna. This antenna for amateur purposes may consist of from one to six or eight wires, 50 to 100 feet long, and must be carefully insulated at each end. The antenna may be 20 to 100 feet high. (See Fig. 11.)

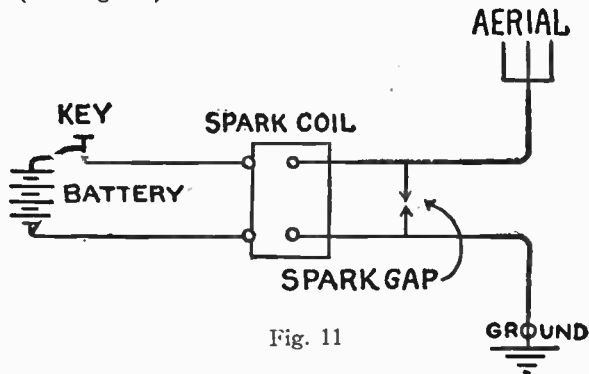

Fig. 11

We press the key which closes the circuit and what happens? The spark which would jump one inch before being connected to the antenna, will not jump a scant eighth of an inch. We discover another thing, too. The longer spark which we obtained before connecting in the aerial was a thin, colorless discharge, or, perhaps, a reddish-colored spark, and it lacked volume. Now, however, the spark is a bright blue, snappy, crashing discharge. It will fill a gap about one-quarter inch in diameter and one-eighth inch long.

What has caused this change in spark characteristic? It is the connecting in of the antenna and ground. The antenna acts like a condenser. The antenna has absorbed the energy from the spark coil and stores it up in itself until it reached a potential which is great enough to jump the spark gap. The spark discharge of the gap sets up "oscillations." By this we mean that the antenna allows its charge to rapidly surge back and forth between the spark gap and electrodes. This rapid surging, or oscillating, is accompanied by an electric wave which extends outward from the antenna, as described in the preceding chapter.

This constitutes the briefest and simplest apparatus with which it is possible to transmit radio waves. The particular type of apparatus described above is called a plain antenna circuit, and is not encouraged by the Government. In fact, its use is prohibited. The reason for this is that a plain antenna sends out a very broad and interfering wave.

ABOUT CLOSED CIRCUITS. Actual radio transmitting is done to-day by means of "coupled circuits." We propose to describe what is meant by the term "coupled circuits" and how they are used. Just as a spark coil consists of a primary and secondary, so radiotelegraph circuits may be made to consist of a primary and secondary. The primary circuit is connected to the spark coil. The secondary circuit is connected to the antenna.

THE PRIMARY OSCILLATION CIRCUIT. The following paragraphs will deal with the primary oscillation circuit. The primary oscillation circuit used by amateurs to-day consists of a condenser, spark gap, and coil of wire. The condenser is often called by the name which applies to one of its properties, that is "capacity." The "capacitance" of a condenser is measured by a unit called the "farad" and in radio work this unit is too large, so a unit called the "micro-farad," which is the $1/1,000,000$ of a farad, is used instead.

The coil of wire is often called an "inductance." The unit of inductance is the "henry," and as this unit is also too large for radio work, we have the "milli-henry" and "micro-henry," that is, the $1/1000$ and $1/1,000,000$ part of a henry, respectively.

Just as the current in the antenna circuit was shown to oscillate, so will a current in any circuit that has capacitance and inductance,—provided the "resistance" of the circuit does not exceed a certain value.

HOW A CLOSED CIRCUIT ACTS. Let us consider a closed circuit which consists of a condenser, a coil of wire, and a spark gap. If the condenser is charged and allowed to discharge through the spark gap, it will set up oscillations in the closed circuit. The question as to whether these oscillations are extremely rapid or exceedingly slow might be asked.

NOTES: The capacitance of a condenser is the relation between the quantity of current which it will hold to the voltage across it. That is, the capacity of a condenser is the quantity divided by the voltage.

Inductance is that property of a circuit by virtue of which any change in the current flowing through that circuit sets up a counter E. M. F. (voltage) which opposes the change.

The answer to this question is one of the fundamental facts in radio, and it should be studied with care.

A current in a circuit made up of capacitance and an inductance oscillates at a rate which is inversely proportional to the size of the capacitance and the size of the inductance. This may be expressed in another way by saying that the larger the capacitance and the larger the inductance of a circuit, the slower will be the oscillations. If the current in a closed circuit is likened to a pendulum, oscillating back and forth, we know that the longer the pendulum, the slower it will oscillate; the shorter the pendulum, the more rapid will be its oscillation. In radio circuits the same thing is true. The more capacitance and inductance we use, the slower the current will oscillate.

Connected with the rate of oscillation is a feature which is extremely important in radio work, and that is the length of the wave it sets up. Just as light waves and sound waves, as well as water waves, have a certain length, which is the distance from peak to peak, so radio waves have a given length, which is generally measured in meters.* The wave length is inversely proportional to the rate of oscillation. If an oscillation occurs at an extremely rapid rate, the wave length is short.

If the oscillations are occurring slowly, the wave length is much longer. In amateur radio work the closed circuit is generally made of a capacitance and inductance which produce oscillations at the rate of 1,500,000 times per second and has a wave length of 200 meters. Commercial radio stations at the present time operate on a wave length of 600 meters. This is equivalent to 500,000 oscillations per second.

Some of the navy stations use a wave length which is approximately 1000 meters long, and these wave lengths are set up by oscillations that have a "frequency" of 300,000 per second. All the statements which have been made in the last two paragraphs may be expressed by mathematical formulas. We shall give these, as probably some of our readers are mathematicians and may be interested in them.

Rate of oscillation in a closed circuit: $f = 2 \pi \sqrt{LC}$

Where: f = Rate of oscillation in frequency in cycles, per second.

π = 3.1416

L = Inductance in henries

C = Capacity in farads

*NOTE: One meter equals 39.37 inches.

For actual use in a radio circuit, this formula is expressed in terms of wave length. To show the relation between wave length and "frequency," we are giving an additional formula:

$$\text{Wave length in meters} = \frac{300,000,000 \text{ meters}}{\text{Frequency}}$$

The formula to express the wave length of a closed or primary circuit is as follows:

$$\text{Wave length} = 1885 \sqrt{LC}$$

Where: C is in micro-farads

L is in milli-henries

Wave length is in meters

SPRING ANALOGUE OF A CLOSED OSCILLATION CIRCUIT.

The closed oscillation circuit may be likened to a spiral spring on which is hung a weight. (See Fig. 12.) If the weight is pulled a little, thus stretching the spring, a certain stress or potential will be raised in the spring. This is equivalent to the charging of the condenser. If the weight is then released the spring will rebound to its former position and will still have energy enough left to shoot past the former zero position and it will again overshoot the mark so that the spring is stretched again. This condition will be repeated again and again, each time with decreasing amplitude, until all of the energy is used and the weight will return to the zero position.

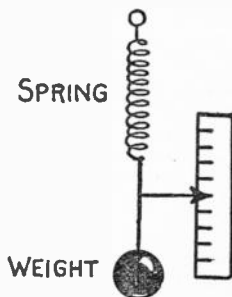

Fig. 12

In the closed oscillation circuit the same changes take place. The condenser allows the charge to surge through the spark gap and then back to the condenser, then through the spark gap again. The energy in this case is held in the condenser, due to capacitance, which is equivalent to the weight on the spring. The wire in the closed circuit stores up the overshoot energy due to its inductance, just as the spring for an instant stores up the energy of the weight in motion.

The changes which take place in the closed circuit are changes of electric strain and magnetic strain. It might be said here that a collapse

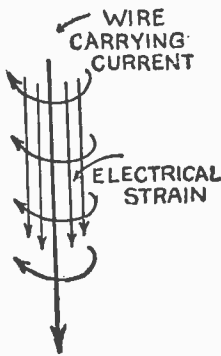

Fig. 13

or change of any electric strain sets up a magnetic strain. The collapse of this magnetic strain in its turn sets up an electric strain. This is shown in Fig. 13. The straight line represents the electric strain and the curved line the magnetic strain. The collapsing of one kind of strain is always followed by setting up the other kind. We almost have perpetual motion.

Once the thing is started, it keeps repeating and repeating, and the only thing which stops it is the resistance of the circuit. The resistance of the closed oscillation circuit is that which causes the oscillations to gradually die out. This gradual dying out is called "damping." The rate of damping is called the "decrement." Decrement is the relation of the amplitude of one oscillation to the next oscillation following. This is illustrated in Fig. 14.

The higher the resistance of a closed circuit the greater is the damping. The resistance may be extremely high, and if it reaches a certain critical value, no oscillations will take place. Although the term "decrement" may seem high-sounding and theoretical to many of the readers, it is not at all so, and to understand it is important. The Government in regulating radiotelegraphy has placed a limit on the decrement which will be permitted. This is because a train of oscillations which has a high decrement, that is, one which is damped out in a few swings, sends out a broad wave and one that generally causes much interference.

SPARK GAPS. The closed circuits which amateurs are using at the present time have a spark gap which may be one of several varieties. The fixed, rotary, and quenched spark gaps are all being used.

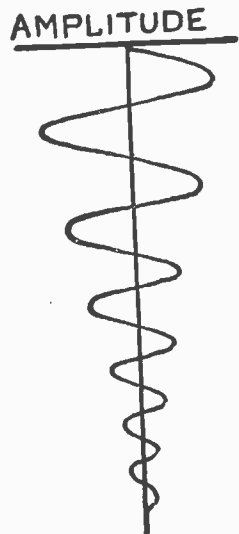

Fig. 14

THE FIXED SPARK GAP. The fixed gap merely consists of two electrodes which are generally made of zinc, and are quite large, perhaps half an inch in diameter. This type of gap is generally used with a spark coil. (See Fig. 15.)

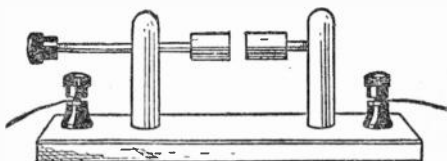

Fig. 15

THE ROTARY GAP.

The rotary gap is employed in amateur stations, and it consists of a disk with a number of zinc points on its circumference. These points are all connected and the spark occurs from the disk which is driven by a motor to fixed points which are set opposite the moving points, as shown in Fig. 16. This gap causes a spark to jump each time the moving and fixed points coincide.

The rate at which these sparks occur depends, of course, upon the speed at which the disk is rotated. If the rotating disk has eight electrodes and is turning over 60 times per second, the spark note will be 480 per second. The rotary gap has many advantages over the fixed type, in that it not only gives a clear-cut musical note, but also causes the condenser in the closed circuit to give up its charge quickly. The system may be operated at a lower decrement and a sharper and a more definite wave length results.



Fig. 16

THE QUENCHED GAP. The quenched gap consists of a number of disks of copper which are separated by air-tight washers. The large number of disks causes the spark to be divided up into many smaller sparks, and the heating effect is less pronounced

than with a fixed gap. The quenched gap radiates the heat quickly and, as the name indicates, quenches the spark rapidly. The rapid quenching of the spark again leans toward a better decrement in the open circuit.

There are other varieties of spark gaps, but generally they are only

modifications or combinations of the three types just described. The design of a spark gap is extremely important in that much of the efficiency of the amateur set depends upon the spark gap. What we try to

get in a spark gap is a good musical note and high quenching so that the energy may be easily and efficiently transferred to the antenna circuit.

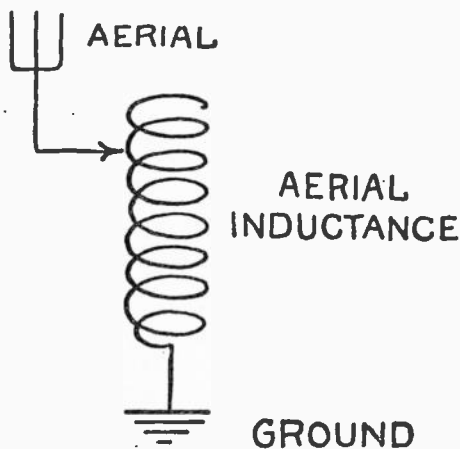

Fig. 17

THE OPEN CIRCUIT.

This consists of an inductance or coil of wire, which is placed close to the inductance, or wire, of the primary circuit. One end of this coil is connected to the earth. The other connection is generally arranged so that the number of turns in the coil may be varied and this connection goes to the antenna. The diagram of the connections is shown in Fig. 17.

The open circuit is really a duplication of the closed circuit, except that the spark gap is omitted. In the case of the open circuit, the induct-

ance consists of the coil of wire. The antenna in this case is equivalent to the condenser of the closed circuit. Fig. 18 represents the manner in which the antenna is equivalent to a condenser. The wires of the antenna correspond to one plate of the condenser and the

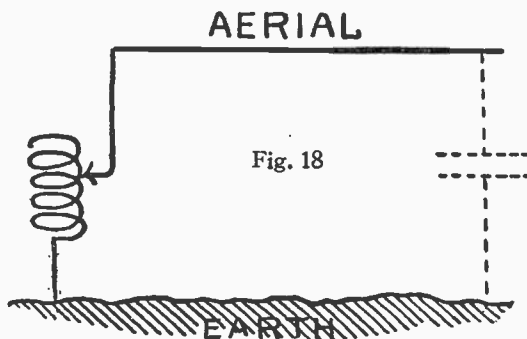

Fig. 18

ground to the other plate. The space between is the insulator, or dielectric.

THE ANTENNA OR AERIAL. The antenna may be charged in just the same manner as any other condenser. In the case of the open circuit, the energy or power to charge the antenna comes from the closed circuit. This transfer of power takes place between the primary inductance and antenna inductance. The method of transferring the energy is not unlike the transformation of voltage in a spark coil. For the present we will not attempt to explain just how this transfer is accomplished.

The energy which is delivered to the open circuit surges up into the antenna, then back to the ground, and then to the antenna again. This surging continues, and if it were not for the resistance of the antenna, the surging would continue indefinitely and we would have electrical perpetual motion. However, the antenna system does have a resistance and this resistance absorbs a small portion of the energy of each surge or oscillation, so that the next oscillation has a little less amplitude and, finally, the oscillations die out completely. The rate of the dying out or damping of the oscillations is the decrement of the open circuit and this decrement has been limited by the Government.

HOW THE OSCILLATIONS ARE TRANSMITTED. Now let us consider what happens to the energy as it surges up and down the antenna. The rapid oscillations of the current in the antenna system cause a disturbance to be set up in the ether surrounding the antenna. This disturbance in the ether is an electromagnetic wave which extends out through it at the rate of 186,500 miles per second.

As the wave moves out, some of its energy is absorbed by trees, mountains, houses, and other bodies so that gradually the wave dies out. Any antenna within the field of the waves has set up in it oscillations which correspond to the oscillations in the transmitting antenna. This electric current may be detected in a variety of ways. The next chapter will deal with the receiving apparatus.

Chapter IV

SIMPLE RECEIVING APPARATUS

THE most elementary radio receiving apparatus used by amateurs consists of an antenna, an inductance coil, a ground, a detector, and a pair of head phones. The antenna may be the same one that is used for transmitting and this is connected with an inductance, or coil of wire. The coil of wire is generally called a "tuning coil" and, as its name indicates, it is used for "tuning"; that is, "to tune or bring in," or adjust it to the various wave lengths which are sent out by the transmitting antenna of the complementary sending station.

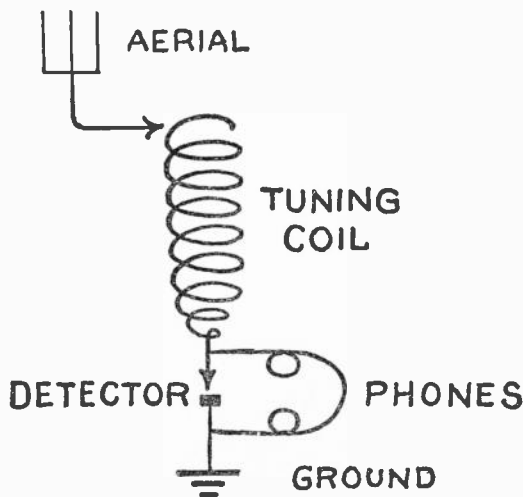

Fig. 19

The tuning coil has connected to it, as shown in Fig. 19, a detector and a pair of head phones. A ground connection is also used. The energy of the electric wave surges through the tuning coil, but it oscillates at such high frequencies as to be inaudible in the telephone receivers. The purpose of the detector is to make these signals audible in the telephone receivers.

ACTION OF A SIMPLE DETECTOR. It will be well to pause here to describe the action of an elementary type of detector. Many amateur stations use a mineral called "galena." Many other minerals, such as silicon and iron pyrite, may be used, but the action is similar for all of them. The incoming electric energy oscillates rapidly from positive values to negative and back again. This is shown in Fig. 20.

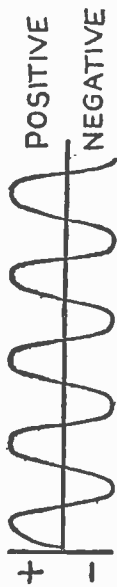

Fig. 20



Fig. 21



Fig. 22

Now galena has the marvelous property of passing all of the current which comes in one direction and holding back the current flowing in the opposite direction. This is an inherent quality of many minerals, and we find all of these minerals act as detectors in the same manner as galena. The current passes through in one direction and not at all, or very little, in the opposite direction. This gives us the equivalent of a direct current which pulsates, as shown in Fig. 21. This intermittent current is smoothed out and becomes a single direct current as illustrated in Fig. 22, and produces an audible signal in the telephone receivers.

THE TUNING COIL. This, of course, is the most elementary type of receiving apparatus. It is possible to greatly increase the efficiency in range by using a system which is not unlike the two circuits of the transmitting apparatus. We have a primary and secondary circuit to our receiving tuner as shown in Fig. 23.

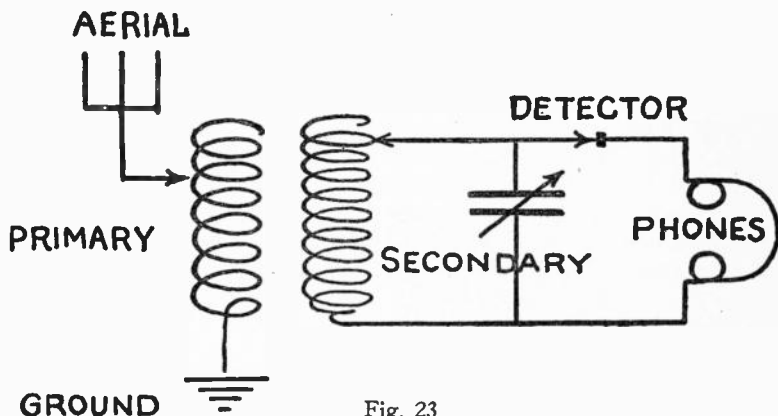

Fig. 23

The primary circuit connects to the antenna and a variable contact is made with the tuning coil. This enables us to tune to various wave lengths which depend upon the amount of wire used. The secondary circuit corresponds to the closed circuit of the transmitting apparatus. In this case the inductance is a coil of wire which is so constructed that it will slide in and out of the primary winding.

A switch is connected in so that all or any part of the secondary may be used. Across the terminals of the secondary a variable condenser is generally used.

By varying the number of turns of wire and the amount of capacity in the secondary circuit, we can vary the electrical size of it so that it will respond to waves of different lengths. A detector and pair of head phones are connected either across the secondary or in series with it.

HOW THE RECEIVING CIRCUIT WORKS. Referring again to the diagram of the receiving circuit, we shall describe its operation in

detail. First, the radio waves which strike the antenna cause a series of alternately positive and negative currents to be set up in it. These currents surge from the antenna through the primary inductance and from the primary, which may be tuned to varying wave lengths, the currents are transferred to the secondary winding. The capacitance of secondary circuit is varied until it is tuned to the wave length which the antenna, or primary circuit, is receiving.

The detector takes the oscillating current which has been set up in the circuit and "rectifies" it, that is, the detector allows all of the oscillations in one direction to pass through the telephone receivers while the oscillations in the opposite direction are not permitted to pass.

Various detectors may be used. Of the minerals in use, the most common are galena, silicon, iron pyrite, and a combination called "perikon," which consists of a piece of zincite and chalcopyrite in contact with each other. These detectors vary in sensitiveness, and in many stations galena is considered the most suitable. Galena, however, is more difficult to adjust, but once adjusted, it is more sensitive, and also more easily knocked out of adjustment than silicon or iron pyrite.

HOW THE DETECTOR IS ADJUSTED. We have spoken of the adjustment of the detector. This is accomplished by what is known as a "buzzer test." An ordinary electric buzzer is connected as shown in Fig. 24. The buzzer sets up very feeble oscillations and, hence, emits waves, and while it is in operation, it is possible to adjust the detector until the note of the buzzer may be heard loudest in the telephone receivers. This generally indicates a sensitive adjustment of the detector and shows that the receiving station is in working order.

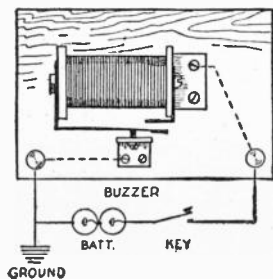

Fig. 24

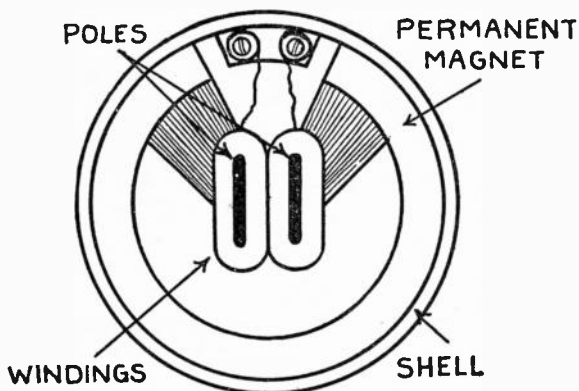

Fig. 25

thin and the coils consist of many hundreds of turns of extremely fine copper wire.

Radio receivers are generally of the two-pole type. That is, there are two magnets as shown in Fig. 25. A small, direct current flowing around the coils energizes the magnets and a variation of this magnetic energy causes the diaphragm to be attracted or repelled so that an audible note is made.

Modern amateur stations are making use of the "vacuum tube" detector or, as it is sometimes called, the "audion" detector. This device is extremely sensitive and many times more sensitive than galena, or any of the crystals. Fig. 26 shows one of the types of vacuum tube detectors which are used in amateur stations. The vacuum tube really constitutes a separate piece of equipment and Chapter VI will be devoted to it. For the present we can say that a vacuum tube not only acts as a detector, but an amplifier of the signals as well.

THE TELEPHONE RECEIVERS. The telephone receivers used in radio work are generally much more sensitive to feeble currents than the ordinary telephone receiver which is used on line telephones. The diaphragms in radiotelephone receivers are very

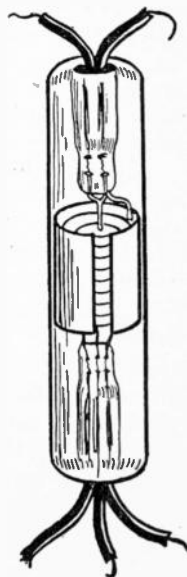

Fig. 26

Chapter V

COUPLED CIRCUITS

THROUGHOUT the description of the apparatus, we have made use of primary and secondary inductance coils and open and closed circuits. We have spoken of the transfer of electric energy from one to the other, without making any effort to describe in detail just how this transfer of energy was effected. The purpose of the present chapter is to cover this point.

MAGNETIC EFFECT OF AN ELECTRIC CURRENT.

If iron filings are scattered on a piece of cardboard and a wire passed through the cardboard and connected as shown in Fig. 27, it can be demonstrated that an electric current through the wire will cause the filings to take up their position in definite circles around the wire, as shown in the picture, Fig. 27.

If, now, a magnetic compass needle is brought close to the wire, it will also assume a definite position when the current flows through the wire. This position is at right angles to the flow of current and in a plane perpendicular to the wire. From this we may draw

a conclusion that an electric current flowing through a wire causes a magnetic field to be established in concentric circles about the wire.

HOW A CURRENT IS INDUCED. Now let us take the reverse case. A permanent magnet has a magnetic field about its poles. This may be shown by scattering iron filings over a paper laid on the poles

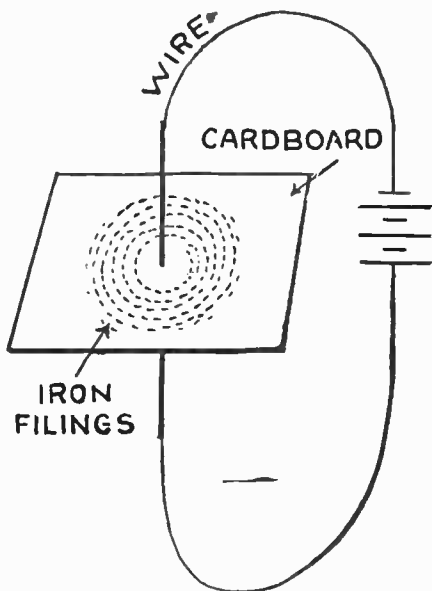

Fig. 27

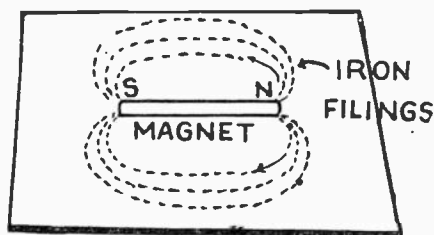

Fig. 28

of a permanent magnet, as shown in Fig. 28. If the magnet is brought close to a circuit, such as shown in Fig. 29, a current will be set up in the circuit as the magnet is rapidly moved back and forth near the wire so that the magnetic lines of force of the permanent magnet are made to pass through

the wire. From this we may draw the conclusion that a magnetic field cutting an electric conductor induces or sets up an electric current in that conductor.

Now then we have two elementary experiments from which we may study coupled circuits and show how the energy is transferred from one circuit to the other. Let us take first the two coils of wire shown in

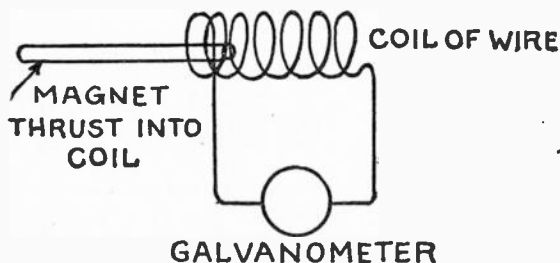

Fig. 29

Fig. 30. One of these we shall call the primary, the other the secondary. If a current is made to flow through the primary, it will set up magnetic lines of force about this primary. The secondary coil is close enough so that these lines of force intersect or cut the turns of the secondary. From our experiments above, it will be seen that the cutting of these magnetic lines will induce electric currents in the secondary. This is the way in which electric energy is transferred from one circuit to the other.

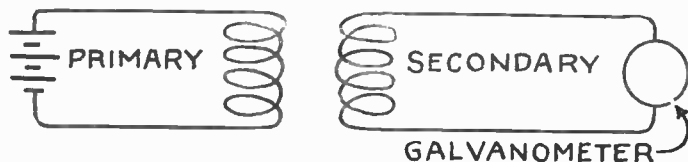

Fig. 30

ELECTRIC RESONANCE. Under certain conditions more electric energy may be transferred from one circuit to the other, and this condition is known as "resonance." There are many physical examples of resonance. You have already seen that resonance takes place when a person sings a note into a piano and the piano responds to that note. The corresponding note is automatically set in vibration by the piano and gives out the same note which the singer started with.

There are many other examples of resonance. The reader may perform a simple experiment which will demonstrate resonance. Two small weights which are equal are tied to a piece of string about two feet long. These two strings are in turn connected to a horizontal string which is placed between two supports. The scheme is shown in Fig. 31. Consider either one of the weights as a primary circuit and the other weight as a secondary. Start weight No. 1 swinging, but do not touch weight No. 2. Observe what takes place and you will find that weight No. 2 will begin to swing and keep on until it has reached an amplitude that is nearly as great as the original swing of weight No. 1.

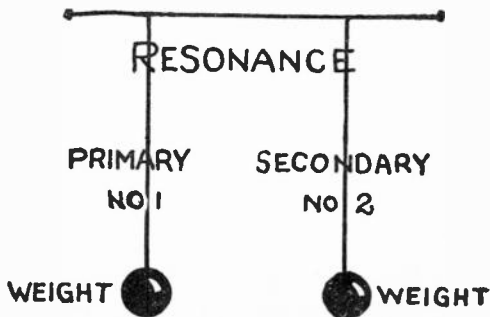

Fig. 31

The energy will be transferred back and forth between the two strings. This is a case where the strings are in resonance, that is, in tune. Now

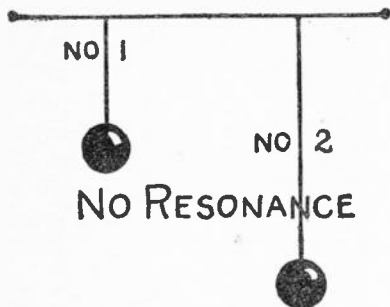

Fig. 32

throw them out of resonance by making one of them considerably shorter than the other, as shown in Fig. 32. Energy will be transferred from string No. 1 to string No. 2, but not as completely as was done when the strings were in resonance.

RESONANCE OF ELECTRIC CIRCUITS. The same effect is obtained electrically in two circuits. If they are of the same electrical length, a great

deal of energy may be transferred from one circuit to the other; but if they are of greatly different lengths, only a little energy is transferred.

In the case of a primary and secondary circuit, either for transmitting or receiving, the two circuits are made of the same electrical lengths. The amount of energy transferred from one circuit to the other is controlled by varying the "coupling," that is, the space between the coils of the two circuits. If the space between the two is very great, the amount of electric energy which passes from one to the other will be small; but if the two coils are close together, a correspondingly large amount of energy will be transferred.

Chapter VI

TYPES OF ANTENNAE

WE have already spoken of the antenna and of the part it plays, but we have not explained in detail the construction of a simple antenna or the various types. While the same antenna is used for both transmitting and receiving, for the purposes of this discussion we might well divide the antenna into two classes; namely, those used for receiving and those used for sending. Almost any type of antenna will prove successful for receiving, but when it comes to transmitting long distances the amateur must erect a suitable type of aerial.

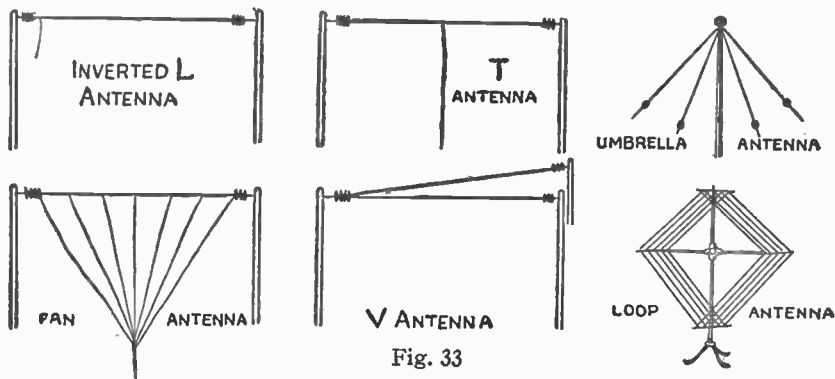

Fig. 33

TYPES OF ANTENNAE. There are various types of antennae, which have been named as follows: the inverted L, T, umbrella, fan, V, and closed antennae or loops. The various types represent a form which is equivalent to their names. There are many modifications, but in general the antenna will correspond closely to one of the above types. Perhaps the most frequent among amateurs are the inverted L and the T antennae. Fig. 33 illustrates the different types which we have listed above.

The advantages and disadvantages of one type over another depend to a certain extent upon the kind of work which is to be done by the antenna. The different types, excepting perhaps the umbrella, have cer-

tain directional characteristics; that is, if the antenna is located where the surrounding objects have little or no effect upon it, signals will be transmitted and received from one direction better than in the opposite.

The inverted L antenna transmits and receives signals best in a line which points through the length of the antenna and away from the lead-in. (The lead-in is that part of the antenna which leads into the station and connects it with the apparatus. The free end of the antenna is the end opposite the lead-in.) The T antenna receives and transmits best in a line through the antenna and parallel to the horizontal part. The umbrella antenna is supposedly non-directional. This holds true just so long as we are concerned with messages which are received from the ground. However, in the case of receiving signals from aircraft, the umbrella antenna has been found to have certain "dead spots" directly overhead, that is, it receives poorly in a direction which is directly above it.

DIRECTIVE PROPERTIES OF ANTENNAE. The various directional properties of the different types of antennae may be shown graphically. The antenna with its lead-in will be shown and about the antenna will be drawn a line which indicates that equal signal strengths are

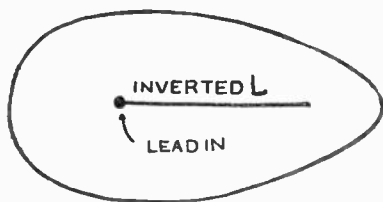

Fig. 34

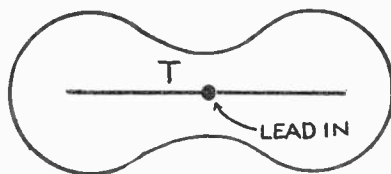

Fig. 35

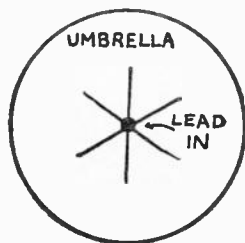

Fig. 36

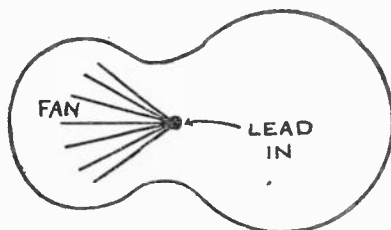

Fig. 37

received on that line. In other words, the line may be twice as far from the antenna at one point as it is from another, and this indicates that the signals are just as loud at twice the distance as they are at the poorer direction and only one-half as far away. Figs. 34, 35, 36, 37, 38, 39 illustrate the various directional properties of different types of antennae.

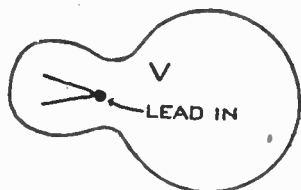

Fig. 38

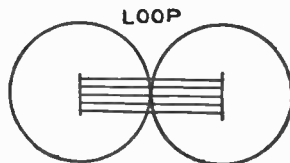

Fig. 39

LENGTH OF ANTENNAE. The transmitting antenna for amateur station is limited in length, as the Government permits the use of only 200 meter wave lengths as the maximum which amateurs may use. This length is approximately 120 feet including the length of the ground connection; that is, the length of the antenna plus the length of the ground lead ought not to be more than 120 feet in order that the transmitter may operate efficiently on a wave length of 200 meters.

In mentioning this length of 120 feet, we might say that it applies to the inverted L, the umbrella, fan, and V, but it does not apply to the T. The T antenna may be of slightly greater length. It is not possible to give exact figures for this type, as the length of the lead-in affects the wave length which it will transmit.

Roughly, the natural period of an antenna—that is, the wave length which it will radiate when connected directly with the ground—is equal to the length in meters from the ground connection to the farthest end of the antenna times the constant 4.2. This constant varies slightly with the different types of antennae, but 4.2 is approximately correct for the types in amateur use. When we speak of the length of the antenna, we mean the actual length and not the length multiplied by the number of wires used.

CAPACITY OF ANTENNAE. An antenna might be said to be a condenser or a large capacity; one plate of the condenser being the aerial, the other plate being the ground underneath. For transmitting purposes,

it is desirable to have the largest capacity which may be had with the greatest possible height. To get a large capacity, it is necessary to have the plates just as large as possible. This means, a large number of wires spaced as far apart as possible.

If we were to put several wires in the aerial but only space them one inch, it would be but little better than one wire. It is easily understood that there is a limit under which the wires should not be spaced. This limit is about $\frac{1}{25}$ of the length; that is, if the antenna is 100 feet long, the wires should be spaced about four feet apart.

RESISTANCE OF ANTENNAE. Next to a large capacity, an antenna should have a low resistance. In order that we may have low resistance, we use heavy conductors of stranded wire. One of the sizes of wire which is being used extensively by the best amateur stations is stranded copper or phosphor-bronze, which is made up of seven No. 22 wires twisted together, and in some stations the wire is made up of seven No. 18's.

For ordinary purposes the seven No. 22 conductors make an excellent antenna. It is almost needless to say that the antenna must be thoroughly insulated. Each wire should have the best possible insulation. The free end of the antenna is subjected to the greatest voltage strains, and for this reason it must be given special consideration with regard to insulation. The moulded type of insulator is widely used and gives satisfaction. Several types of moulded insulators are built and are illustrated below (Figs. 40, 41, 42). The largest insulator is suitable for the average one-kilowatt transmitter, while the smaller size is sufficient insulation for a spark-coil set.

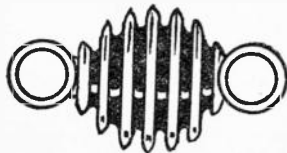

Fig. 40



Fig. 41

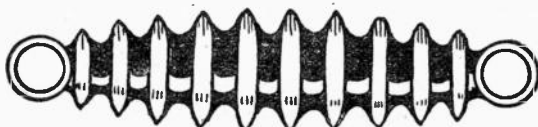

Fig. 42

KINDS OF GROUNDS. Of equal importance to the antenna construction is a successful ground system. The ordinary water-pipe connection will do for low-power local transmitters and receivers, but a water pipe does not offer a ground of sufficiently low resistance for high-powered transmitting purposes. The ground system might be said to be even more important than the aerial.

There are two types of grounds which are used. One is the "counterpoise." This consists of a large number of wires spread underneath the antenna and insulated from the ground. The other ground system consists of a large number of conductors or sheets of metal buried in the ground beneath the antenna. To this are added all of the water pipes, gas pipes, and metal conductors which are located near the transmitting station.

The majority of long-distance amateur transmitting stations in this country use the buried ground. This may be due to the fact that a counterpoise is more difficult to secure and is a decided inconvenience if any one tries to walk under the antenna. Fig. 43 illustrates a fan antenna which has been used by radio station IAW, which is the most successful long-distance amateur station in New England. We have also shown in Fig. 44 a successful type of inverted L antenna.



Fig. 43

Perhaps the two foremost things to bear in mind in erecting an antenna for transmitting are a good ground connection made by means of a great many wires buried underneath the antenna and a large number of wires in the antenna proper well spaced. It is always good practice to bring into the station just as many wires as are in the antenna proper.

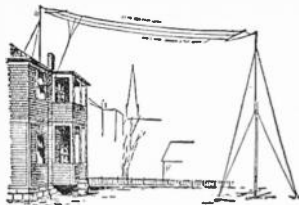

Fig. 44

The same holds true in making the earth connection. It is said that a chain is no stronger than its weakest link; the same thing may be said for radio. An antenna has no lower resistance than the point of poorest conduction. Every joint in the antenna should be well made and soldered.

When it comes to receiving, the question of an antenna and ground connection seems to be much less serious. A single wire at least 20 feet from the ground and 100 feet long will give excellent results for receiving with no other connection than a carefully made contact on the water-pipe system. Of course, the higher the antenna and the greater its capacity, the greater the amount of energy will be received and the better receiving antenna it becomes. For receiving purposes there is not the marked difference between one wire and several wires as we find in the case of high-powered transmitting stations. Fig. 45 shows the tickler loop antenna.

THE LOOP ANTENNA. One of the developments of the war was the use of the so-called "loop" or closed antenna. Fig. 45 shows the

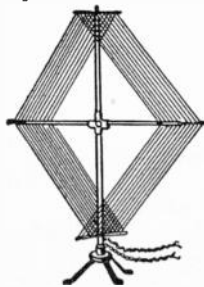

Fig. 45

Gilbert loop antenna. This type of antenna is in reality nothing more than a large coil of wire. The loop antenna is generally wound on a

square frame which is placed perpendicular to the earth. Fig. 46 shows a loop antenna and its approximate dimensions are ten turns of wire spaced half an inch on a frame four feet square.

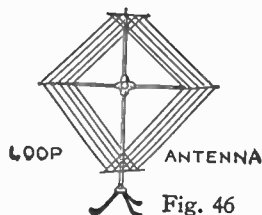

Fig. 46

Various sizes of loop antenna are used according to the wave lengths and distances which are to be covered. It is said that a loop only twenty centimeters in diameter has been used successfully to receive the high-power, long-wave, undamped stations which are used in this country to transmit to France and England. This type of the loop will receive these signals in England with sufficient intensity so that they are readable. In using the loop antenna, extremely sensitive detecting systems are required and many stages of amplification are used.

One of the remarkable features of the loop antenna is its extremely critical and also valuable directional characteristics. The loop antenna receives signals of maximum intensity from a direction through the plane of the loop. This is shown in Fig. 47. Of course, it is not possible to tell

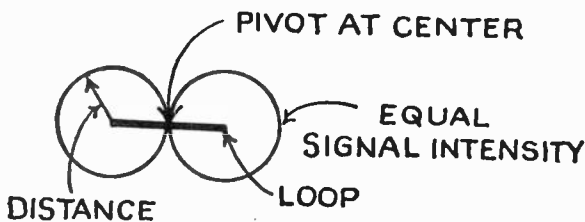

Fig. 47

from which end of the loop the signals are being transmitted. However, the operator generally has some previous knowledge about the transmitting station which would enable him to determine from which side of the loop the signals originated. This critical directional characteristic has

proved to be very beneficial. The loop is used as a direction finder or radio compass.

THE USE OF THE LOOP AS A RADIO COMPASS. The use of loops for radio compass work may be most easily explained by considering the several radio compass stations which are located about the entrance of New York harbor. These stations are established around the harbor and are several miles apart. They are all connected to a central station located at New York.

A vessel approaching the harbor calls one of the navy stations and asks for its (the vessel's) position. A certain signal (— — — —) is sent at frequent intervals. Two of the compass stations adjust their loop antennae until the line of the vessel is found. That is to say, the loops

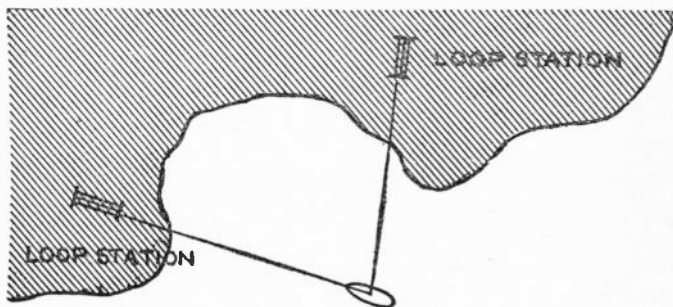

Fig. 48

are rotated until the transmitting signals indicate a maximum which gives the direction of the vessel from the compass station.

The readings of the two compass stations are quickly transmitted to the central station. These readings are given in degrees on the compass. Lines may be drawn from the two compass stations which will intersect. The intersection of these lines is the exact position of the ship which asks for its location. We have shown a map and the intersection of two lines in Fig. 48.

Loop antennae were frequently used during the war to locate an enemy radio station. They were also used in the direction of aircraft. During the war the Germans established radio compass sets which were used in

directing the flight of the big Zeppelins which bombed England. The English soon discovered that the Germans were using this method of directing their bombing airships and accordingly a decoy station was set up in the lower part of France. After a German airship had reached England and started to return to Germany, the decoy radio compass was put in operation. The operator on board the airship naturally became confused and followed the path indicated by the decoy radio compass station. The German dirigible soon found itself well in the interior of France and there it was captured.

The wonderful flight of the American Navy's Seaplane N-C4 was directed by means of radio compasses. The success of the N-C4 in its flight was largely due to the radio work. It might be also mentioned that the N-C4 not only had a radio compass, but a very successful long-distance radio transmitter, radiotelephone, and radio receiving equipment to aid it in its flight.

Some amateur stations have succeeded in doing successful receiving with indoor antennae. A few wires stretched in the attic will often prove to be an excellent receiving antenna. Transmitting may also be accomplished with the indoor antenna, although the losses become more pronounced.

LIGHTNING PROTECTIVE APPARATUS. An outdoor antenna should have some kind of protection against lightning. The National Board of Fire Underwriters have adopted certain regulations to insure lightning protection. The antenna is connected to a 100-ampere, 250-volt, single-pole, double-throw knife switch. One terminal is connected to the apparatus while the other terminal is connected to the street side of the water meter, or other satisfactory earth connection with a No. 6 Brown and Sharpe gage copper wire. We have shown in Fig. 49 the method of connecting the lightning switch and grounding it.

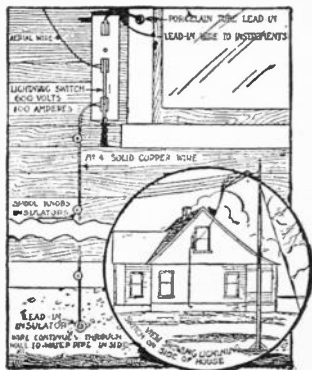

Fig. 49

Chapter VII

AMATEUR TRANSMITTING OUTFITS

TRANSMITTING sets are like the receiving apparatus in that they may be either elementary or far advanced. For example, we have the spark coil transmitter on one hand and at the other end of the scale the most up-to-date type of vacuum tube transmitter.

A SIMPLE TRANSMITTING OUTFIT. The simplest type of transmitter consists of a spark coil, spark gap with the antenna and

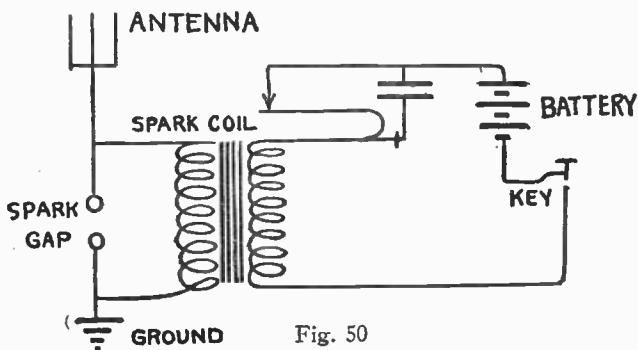

ground connected to the opposite ends of the gap. This type of transmitter is shown in Fig. 50. It is called the plain antenna transmitter. It is so called because it is not tuned, does not make use of any condensers except the condenser effect of the antenna.

This type of transmitter sends out a wave length which is approximately equal to the natural period of the antenna it is used on. While it is the most elementary type, it is not the type which will be found in the amateur stations of to-day. This is because the use of such a transmitter has been prohibited by the regulations governing amateur radio.

The reason for this can easily be seen when one realizes that the antenna with a plain spark gap, as shown in Fig. 50, will send out an extremely broad and interfering wave, that is, the wave length sent out by

this transmitter could probably be received over an extremely wide range of wave lengths. This can be shown graphically by drawing a curve which represents the signal strength against the wave length, as in Fig. 51. The curve should be similar to the dotted-line portion for a transmitter which is sending out a wave sharp enough to conform to the regulations.

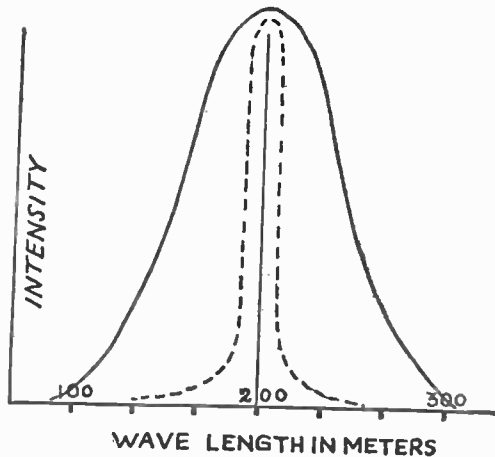

Fig. 51

A HELIX TRANSMITTING OUTFIT.

The next type of sending equipment consists of the spark coil with a spark gap, condenser, and helix, that is, a single coil of wire. This type of transmitter can be connected up so that it will consist of an open circuit and a closed circuit.

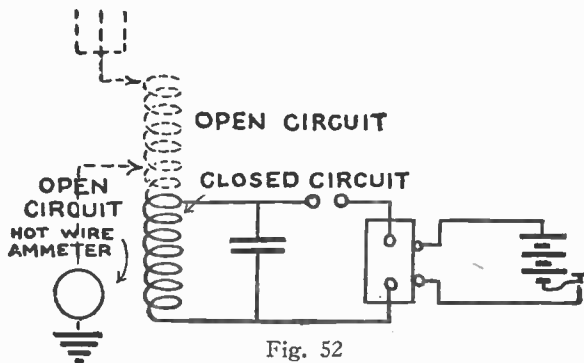

Fig. 52

The diagram for this apparatus is shown in Fig. 52. The closed circuit is illustrated by the heavy full line. The open circuit is represented by a heavy broken line. The spark coil, batteries, and key are shown in

light lines. The open circuit, which consists of the spark gap, condenser, and part of the turns of the helix, is tuned to the wave length which is to be used. For example, this may be 200 meters.

The open circuit is now connected in and the turns of the helix in this circuit are varied until the greatest amount of current is put in the antenna. This current may be read by means of a hot-wire ammeter, which is shown in the illustration. With this construction, the station may be made to emit a wave which will be sharp and will comply with the law in every detail.

A slight improvement can be made by using an "oscillation transformer" instead of a helix. The advantage in the oscillation transformer lies in the ease with which the coupling may be adjusted.

ANALOGUE ILLUSTRATING VARIABLE COUPLING. To describe the action of varying a coupling between the open and closed circuit, we shall use a mechanical device which can be made by the reader in a few minutes. Two pieces of string should be cut to the same length, and a small weight tied to one end of each of these pieces of string, a third piece of string should be tied horizontally between two chairs or similar supports. The strings with the weights are now tied to the horizontal string as shown in Fig. 53. One of these strings will represent the primary circuit, the other the secondary. The distance between the two strings corresponds to the coupling.

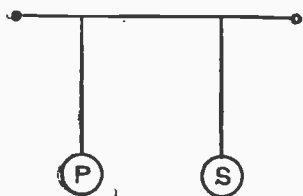

Fig. 53

The primary string should be given a short swing which will set it in motion. It will then oscillate back and forth just as the primary circuit of a transmitter oscillates. In a short time the oscillation of the primary string will begin to die out, and as it dies out the secondary string will commence to oscillate or swing back and forth and have the same period as the primary. As the oscillations of the secondary string are brought to a close, the primary again begins to act. The rate of this interaction between the primary and the secondary depends upon how close the strings have been placed together. If they are widely separated, the interaction will occur at a slower rate.

In a radio transmitter of the spark type, the object is to give the

primary circuit a powerful impact and then quickly shut it off so that the secondary or antenna circuit will take up the oscillations. If the coupling is too close, the antenna will interact on the primary instead of radiating its energy. Thus we see that the aerial inductance should be separated from the closed circuit inductance. If this separation is too slight, interaction will occur. If it is too great, not enough energy will be transferred to the antenna circuit. In the case of the average amateur transmitter, the coupling between the primary and the secondary is usually too close rather than too loose.

STATIONS OPERATED BY COMMERCIAL POWER. The more up-to-date amateur radio stations use transformers and commercial electric power rather than spark coils and batteries. One reason for this is that much more power may be obtained, and it also can be had with

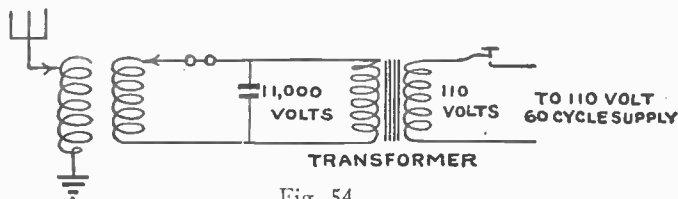

Fig. 54

far less trouble. In the case of the helix circuit or the oscillation transformer circuit which we have just described, a transformer may be substituted for the spark coil and battery. This is shown in the pictures in Fig. 54.

If a transformer is used, the helix and oscillation transformer must be of heavier design to take care of the current which will be used. The condenser must also be of greater electrical strength to stand the strain of the higher voltage. The spark gap requires heavier electrodes, and even special types of gaps are necessary if the outfit is to be at all efficient.

THE TRANSFORMER. As far as the transformer itself is concerned, there are a great many types on the market as well as a large number of home-made ones in use. Little need be said about transformers, except that they are generally of the closed core type; a closed iron core

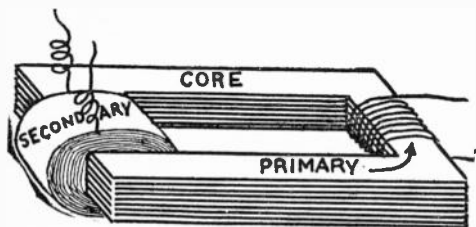

Fig. 55

is made of soft iron sheets as shown in Fig. 55. On one end of this core is wound the primary which generally consists of a few hundred turns of coarse insulated wire. The secondary is wound on the opposite end of the core and consists of several thousands of turns of fine insulated wire.

The primary is connected to either a 110-volt alternating current lighting supply or else a special transformer is used for 220 volts. The secondary steps up the voltage in the exact ratio to the number of turns that are used. For example, if there are 200 turns on the primary and 20,000 turns on the secondary, and the primary voltage is 110, the secondary voltage will be just 100 times as great—or 11,000 volts. Some types of transformers employ what is known as a "magnetic leak." This is a magnetic circuit which is added to the core for purposes of controlling the current.

These transformers are generally rated in terms of the power which they draw from the line under average conditions. For example, a quarter, half, or one kilowatt means that the transformer when connected to the power line will draw approximately one-quarter or one-half or one kilowatt of power. A quarter kilowatt means approximately two and one-half amperes on a 110-volt line. The efficiency of the transformer is the ratio of what may be taken out of the secondary compared to what power is put into the primary. Thus, if a quarter kilowatt is put into the primary and a fifth of a kilowatt is taken out, the efficiency is 80%.

THE CONDENSER. The secondary of the transformer is now connected to a condenser. If the transformer is of extremely high voltage, the type of condenser used must have sufficient electrical strength to withstand this voltage. For the average transformer, a condenser may be built up from photographic plates and tinfoil.

The tinfoil should be carefully fixed to each plate by means of hot paraffin. The alternate sheets of tinfoil are connected together. A con-

denser made up of ten 8 x 10-inch photographic plates, coated with 6 x 8-inch tinfoil will give approximately the capacity which is required to operate on 200 meters. The construction of such a condenser is shown in Fig. 56.

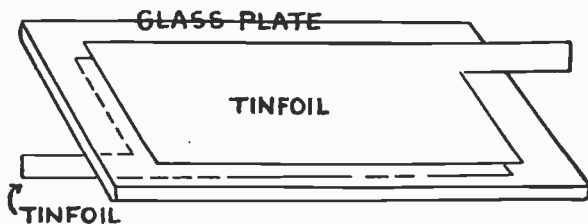

Fig. 56

THE FIXED SPARK GAP. The next thing to take into consideration is the spark gap. If a fixed gap is used, the electrodes should be of heavy zinc. Cooling flanges on the electrodes will assist in the efficiency of a gap. For a quarter kilowatt the spark gap should have zinc electrodes at least one-half inch in diameter. The larger the electrodes the greater will be the cooling effect and the more quickly will it quench out the spark in the primary circuit.

It is desired, above all else, that the primary circuit should quickly and efficiently give up all of its energy so that the secondary will be free to radiate this energy without turning any of it back into the primary circuit. The quenching action on the part of the primary circuit depends mostly upon the gap. The fixed gap is not efficient, nor does it give a clear musical note on a sixty-cycle current supply. The note with a sixty-cycle current and a fixed gap is apt to be mushy and irregular.

THE ROTARY GAP. To get a clear note, better quenching, and greater efficiency, the up-to-date amateur uses a "rotary gap." The rotary gap gives not only a clear, musical note, but due to its rotating electrodes, stays cool and mechanically shuts off the spark quickly, or, in other words, quenches it rapidly. One type of rotary gap is shown in Fig. 57. This gap has twelve rotating electrodes and two that are fixed.

The spark takes place between the two fixed electrodes and the twelve rotating ones. The number of times which the spark occurs per second

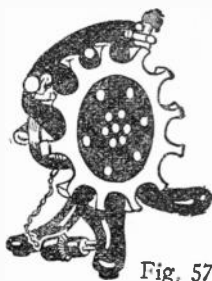

Fig. 57

depends upon the speed of the wheel and the number of electrodes. For the one in question, the speed is approximately 60 revolutions per second. There are twelve electrodes, so we get 12 times 60, or 720 sparks per second. This is a fairly high musical note and is much more pleasant for the receiving operator than the mushy tone of a fixed gap.

The greater the speed of the electrodes, the better will be the quenching effect. The same is true of the width of the electrodes. The more narrow we make the electrodes, the more quickly they pass each other and the less time is given for the spark to oscillate between them. The ideal gap would permit four or five oscillations of the primary circuit and would then shut off the primary until the antenna had taken up the oscillations and radiated all of the energy before another train of oscillations was set up by the gap.

ABOUT OSCILLATION FREQUENCIES. It is a little confusing to the beginner to understand that we are concerned with two frequencies. One is the frequency of the spark, the other is the frequency of the oscillations. This can be demonstrated to better advantage by means of graphs. We are showing spark frequency and oscillation frequency in Fig. 58.

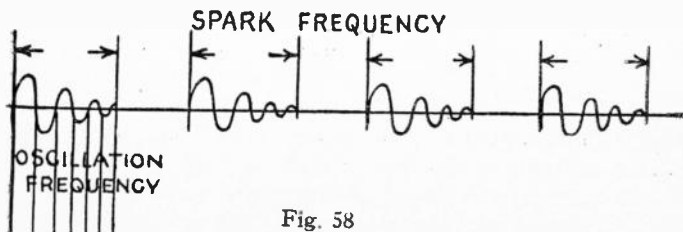

Fig. 58

Each spark of the spark frequency is made up of a series of oscillations. These oscillations are cut off quickly if the quenching in the primary circuit is good. The secondary circuit receives its impulse from the primary and then continues to oscillate until all of the energy has been used up. This is shown in Fig. 59.

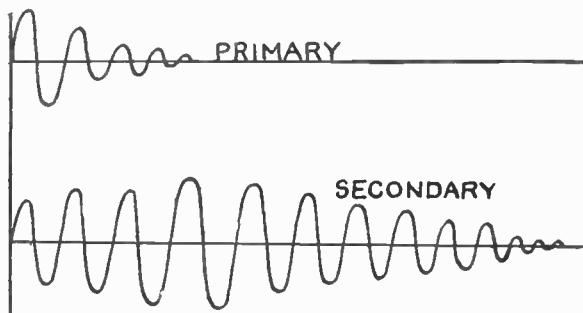

Fig. 59

THE OSCILLATION TRANSFORMER. The oscillation transformer which is used in conjunction with the apparatus we have been describing may consist of five turns of copper ribbon wound in a helix, one foot in diameter; the secondary may be formed of a helix of copper ribbon, having sixteen turns and wound one foot in diameter. The primary ribbon should be about one inch broad and a thirty-second or a sixteenth of an inch thick. The secondary ribbon may be slightly smaller, or, say, half an inch broad and a thirty-second of an inch thick.

The amount of coupling between the two helices will depend upon a number of factors; for example, the kind of gap used, the efficiency of the gap, and the antenna. The oscillation transformer should be constructed so that the primary and secondary can be separated at least ten inches. The average coupling employed would probably be in the neighborhood of five inches between the two coils.

CONTINUOUS WAVE TRANSMITTERS. The transmitting systems just described are the spark, or damped type, that is, the waves radiated are not persistent or continuous, but die out with each impulse. Against this type of transmitting systems is the undamped or continuous

wave system. The undamped wave travels much farther for the same amount of power than the damped, that is, given two waves created by the same amount of power in the transmitting antennae, the undamped wave will travel much farther and more persistently than the damped wave which quickly dies out.

Until recently, the amateur operator has devoted all of his attention to the transmission of damped waves. This was probably due to the difficulty of setting up continuous waves. The vacuum tube is a comparatively recent radio development and is still quite new as far as its use for transmitting purposes is concerned. However, the indications are that the vacuum tube will be widely used by amateurs for transmitting. In fact, not a few stations in the amateur field have already begun to use continuous waves. All of these stations are using vacuum tubes as the source of these oscillations. The vacuum tube can easily be connected so that it will generate continuous waves of 200 meters length.

At the present time there are several types of vacuum tubes which are being used by the amateurs. There is a small tube which is rated at about two watts output. Then there is a larger tube rated at five watts output. Of the five-watt tubes there are two types. One is made by the Western Electric Company and has an oxide-coated filament which draws one and four-tenths amperes. The other is a Tungsten filament tube, and is called a "Pliotron." This tube is made by the General Electric Company. The same company manufactures a 50-watt Pliotron and also a 250.

The writer will deal with the five-watt tubes since it is with these that the average beginner will first experiment. This type of tube requires seven and one-half volts on the filament. This means an eight-volt storage battery. The plate of the tube will use anywhere from 250 to 500 volts direct current. To obtain this voltage, one of three methods can be used and these are: batteries, a direct-current motor generator, or a high-voltage rectifier for alternating current.

Perhaps the cheapest of these three methods is the rectifier. The batteries are satisfactory, but are correspondingly expensive. A motor generator can be made without much difficulty by converting a direct-current motor into a generator. Any direct-current motor will generate, and the only change is to get sufficient voltage from the motor. There are two ways of taking care of this; one is, to purchase a shunt-wound motor which was designed to run on a high voltage. This machine can

then be made to generate approximately the voltage which was required to run it as a motor.

For example, a 550-volt motor which runs at 1700 R.P.M. will generate approximately 550 volts when it is driven at 1700 R.P.M. by another motor. If the experimenter cannot obtain a motor designed to run on high voltage, he may easily rewind the armature of a lower-voltage motor so that it will develop the required voltage. The question of a motor generator set is foreign to the purpose of this book, and for this reason we will not attempt to describe the details of how a motor generator may be constructed. Several such articles have appeared in the current radio publications.

Different styles of rectifiers which will give 500 volts have also been described in detail so that the average experimenter might easily construct one. It is sufficient to say that some steady source of high voltage must be secured.

Chapter VIII

THE OPERATION OF AMATEUR TRANSMITTING STATIONS

WHEN using a transmitting set of the damped type as described in the last chapter, the tuning is done in the following manner:

HOW TUNING IS DONE. The aerial lead is disconnected. A wave meter is brought near the primary circuit. The key is depressed and the wave length measured. If it is more than the required length, some of the turns of the primary circuit should be taken out. This may be quickly and easily done by means of clips. If the wave length is less than the required amount, more turns of the primary coil are added.

When the wave length has finally been secured, the antenna circuit is loosely connected to it. The number of turns in this circuit varies until the greatest amount of current is shown by a hot-wire ammeter in the ground lead. When the maximum current reading is obtained, the set is in tune and the coupling should be brought closer until another maximum reading is obtained in the ammeter.

If the coupling is brought too close, two wave lengths will be sent out instead of one or one broad wave length. This may be corrected by again loosening or separating the coupling until a single sharp wave is sent out from the transmitting station.

THE IMPORTANCE OF A GOOD GROUND. Too much care cannot be taken in the matter of securing a satisfactory earth connection. With a poor connection to ground, much of the efficiency of a transmitting station is lost, due to the high resistance between the earth and the connection. This may be corrected by burying a number of copper wires under the antenna and connecting all of these wires into one big cable which is fixed directly to the oscillation transformer. It is not necessary to bury these wires more than six or eight inches in the ground. They should be spaced three or four feet apart, and the more wires there are connected together the better will be the earth terminal and the more energy will be put into the antenna.

THE IMPORTANCE OF GOOD INSULATION. Of equal importance with a good ground comes careful insulation of the antenna. The free or far end of the antenna is subjected to the greatest strains in

voltage and, hence, danger from the leakage of energy. This end of the antenna should be insulated most thoroughly. Be careful that none of the wires come near trees or gutter pipes, or any other kind of conductors. The voltage at the free end of an antenna is so high that it will often jump eight or nine inches to a ground. Two or more insulators may be connected in series to improve the insulation.

KINDS OF TRANSMITTER CONNECTIONS. The connections for a vacuum tube transmitter are entirely different from that of the spark type. The circuits are different and we will not attempt to analyze all of the different kinds and the theory of their operation. Instead, we shall show what is known as a capacity circuit and shall give briefly the sizes of the various units so that the average amateur will be able to duplicate the outfit.

The inductance, or oscillating coil, is wound on a form about four inches in diameter and six inches long. It should consist of forty turns of No. 14 D. C. C. magnet wire. A tap should be brought out from each turn and clips made so that a lead may be fastened on any one of the taps. A coil of this size with an antenna of the usual amateur characteristics can be made to work efficiently on a wave length of 200 to 325 meters.

The variable condenser shown in the ground lead should be one which has a capacity of approximately .001 micro-farad. It should be placed in an oil container filled with transformer oil so that it will withstand the high voltages of the generator. The fixed condenser should be approximately .0015 micro-farad.

The various other units, meters, etc., will vary for different conditions. The following set of meters is approximately the requirement for one or two five-watt tubes. Voltmeter 0—500, ammeter 0—5 amperes, milli-ammeter 0—100, the hot wire ammeter 0—1. (See Fig. 60.)

CONNECTIONS FOR CONTINUOUS WAVE SETS. If the outfit is to be

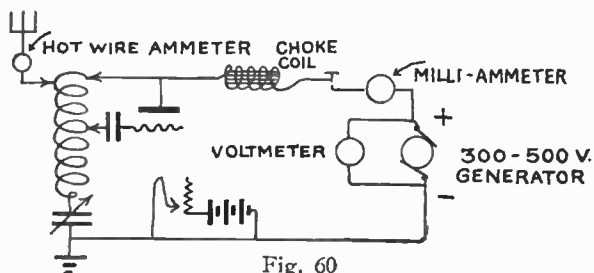

Fig. 60

used for continuous waves, the key may be placed in the plate circuit of the tube. However, if it is desired to modulate the continuous waves, a buzzer should be installed in the grid lead. To tune such an outfit, the best way is to experiment with it. For every different antenna, new tuning positions are required on the inductance coil. The antenna and plate lead should be adjusted, accompanied by adjustments of the variable condenser, to bring the set to maximum efficiency where it will radiate the greatest current.

If the set is tuned properly, the plate in the vacuum tube will remain comparatively cool. However, if the outfit is not oscillating correctly, the plate will get red hot. Retuning will generally find a place where the plate will remain cool. With a single tube correctly adjusted, the current in the antenna should be about one-half or one ampere.

In the case of a continuous wave transmitter, the receiving apparatus will have to be of the oscillation type; that is, it must have a period of oscillation slightly more or slightly less than the transmitting set, when it will heterodyne, which means that it will form beats at a frequency of 1,500,000 per second, the incoming oscillations to give a musical pitch. At the present time it seems to be rather difficult to heterodyne.

The slightest change on the part of either the transmitting or receiving equipment will throw the receiving apparatus out of tune and it will be impossible to maintain a steady note at the receiving station unless a very careful adjustment is made. If the continuous waves are interrupted or modulated 500 times per second by means of a buzzer, it is not necessary to use an oscillating set at the receiving station. The modulated continuous wave, while very sharp, is much easier tuned and will not be as apt to vary from the tuning. The modulated continuous wave, of course, has the musical pitch of a buzzer or interrupter at the transmitting end. This pitch may be made anything from a low to a very high frequency note.

The undamped wave transmitting apparatus is still in a state of development, and it will probably be quite some time before the equipment becomes standardized. At the present time, the vacuum tube seems to be established as the chief source of oscillations. However, the amateur is not necessarily limited to this one source. It seems possible that an arc lamp might be developed which would maintain a constant frequency. Whether it is an arc or a vacuum tube, seems to be a question of development. Notwithstanding the difficulties that now stand in the way, it can be safely said that the continuous waves are many more times efficient in their carrying qualities than the damped waves.

Chapter IX

AMATEUR RECEIVING SETS

THROUGHOUT the earlier chapters of the book, receiving sets have been discussed in a very elementary manner. We have mentioned the essentials and described the theory. This chapter will deal with receiving sets in a more complete and practical manner.

SINGLE-SLIDE TUNER SETS. The first type of receiving apparatus to which the amateur usually gives consideration is the so-called single-slide tuner. The tuner is connected to the antenna and ground and also to a detector and pair of telephone receivers, as shown in Fig. 61. This type of receiving set tunes the antenna to the wave length of the transmitting station and is not very selective, neither will it tune accurately. Consequently, it is very little used by amateurs at the present time.

One of the drawbacks of this type of receiver is the reception of the inductive hum of alternating-current lines in the vicinity of the antenna. With the single-slide type of tuner it becomes very difficult to eliminate this hum. Since the single-slide type of tuner is so rarely used, we will pass over it quickly and consider the more important types of receiving sets.

LOOSE-COUPLER TUNER SETS. The next tuning coil which is being widely used is the so-called loose coupler. Fig. 62 illustrates one type of loose coupler and this has coils which pull in and out of each other. In this type the primary winding is generally the larger one and the secondary

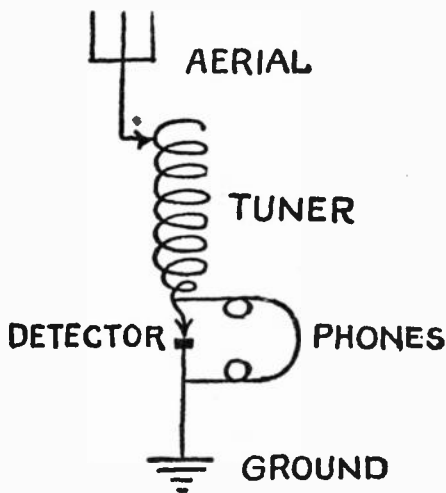

Fig. 61

slips inside the primary. The primary is generally wound with a larger size of wire and fewer turns than the secondary. The secondary has many more turns than the primary and is wound with finer wire. Many

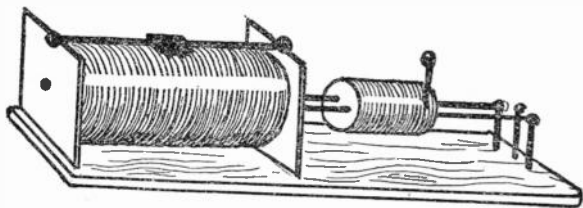

Fig. 62

manufacturers tap the coils and connect the different taps to switch points and switches.

Sometimes the primary has two switches; one which tunes a large number of turns per tap, the other being one which tunes perhaps one or two turns for each switch point. This insures accurate tuning of the aerial system without the aid of variable condensers. Other manufacturers use sliders either on the primary, the secondary, or both. The slider is generally recognized as being a poorer method due to the uncertain contact with the wires and the probability of touching more than one turn at a time.

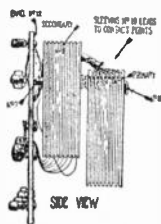

Fig. 63

THE ROTATING COIL LOOSE COUPLER. Another type of loose coupler is shown in Fig. 63. This particular model is constructed in a slightly different form from the one just described. The primary and secondary coils are wound on forms, the turns being made up in

sections, as shown in Fig. 64. With this type of coupler, the primary is rotated past the secondary as a means of varying the magnetic effect between the two. The coils are wound in slots which are well spaced and of such dimensions as to eliminate losses and undesirable effects from distributive capacity.

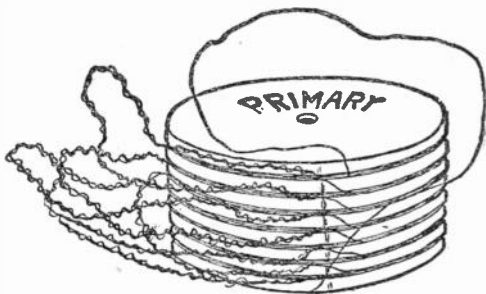

Fig. 64

CONNECTIONS OF LOOSE COUPLERS. The loose coupler is connected as shown in Fig. 65. In this connection the telephone receivers and detector are in "series," that is, the current flows through one and then the other element. This is not absolutely necessary since the telephone receivers and crystal may be connected in "parallel." However, the series connection seems to be the easier in operation. This type of connection may be modified in a great many ways.

For example, the addition of variable condensers is a decided improvement in selective tuning, because the signals can be more accurately received and wave lengths which do not differ greatly from the one being

received can be eliminated. Two variable condensers may be added, one of which is placed across the secondary circuit. The other may be put in series with the antenna or in parallel with the primary coil.

Whether the series or parallel connection is used depends upon the antenna and the wave lengths desired. If the

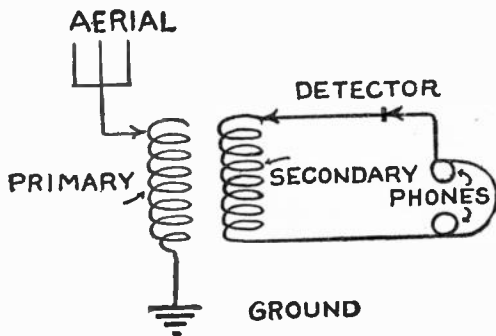

Fig. 65

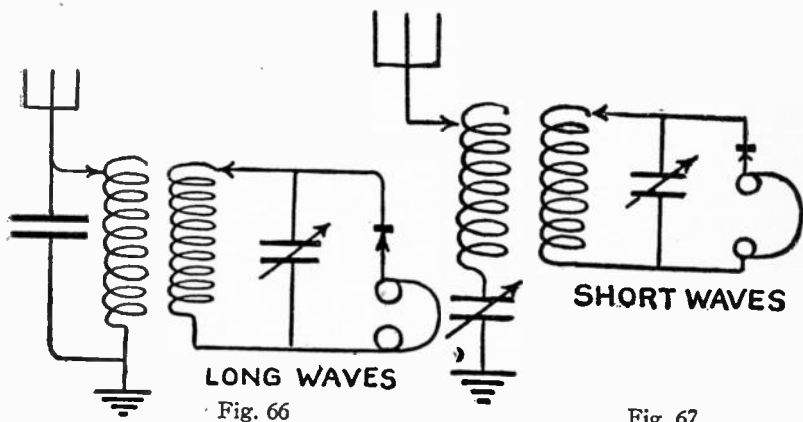

Fig. 66

Fig. 67

antenna is short and long wave lengths are to be received, the variable condenser is put in parallel with the antenna coil. If the antenna is long, short wave lengths can be received by placing a variable condenser in series with it. These two methods of connection are shown in Figs. 66 and 67.

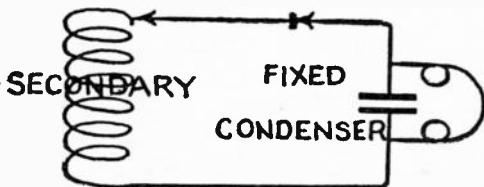

Fig. 68

signals received. Several ways of connecting in the fixed condensers are shown in Figs. 68, 69, and 70. These fixed condensers are generally of small capacity and may be made up of several alternate sheets of paper and tinfoil.

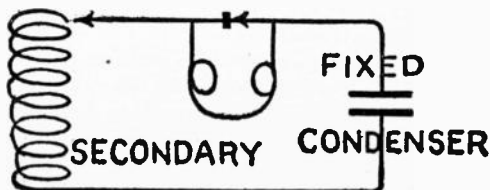

Fig. 69

Fixed condensers may be used in a circuit, sometimes in series with the secondary and crystal detector, and sometimes across the telephone receivers. A condenser across the telephone receivers will often add to the strength of the

VACUUM TUBE RECEIVING CIRCUITS.

The greatest variety of radio receiving circuits can be had with the use of a vacuum tube detector. The reason for this is that the vacuum tube not only detects, but also amplifies the received signals. It is possible to increase this amplification by the use of certain types of circuits which are often called "regenerative" or "feedback" circuits. The explanation of these functions of the audion or vacuum tube will be described in the next chapter. However, the circuits used for receiving will be described here.

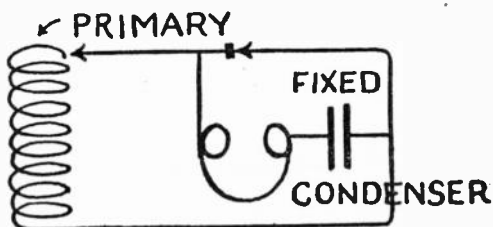

Fig. 70

It is possible to increase this amplification by the use of certain types of circuits which are often called "regenerative" or "feedback" circuits. The explanation of these functions of the audion or vacuum tube will be described in the next chapter. However, the circuits used for receiving will be described here.

STRAIGHT VACUUM TUBE DETECTOR CIRCUIT. The first type of vacuum tube circuit is the one where the vacuum tube is used as

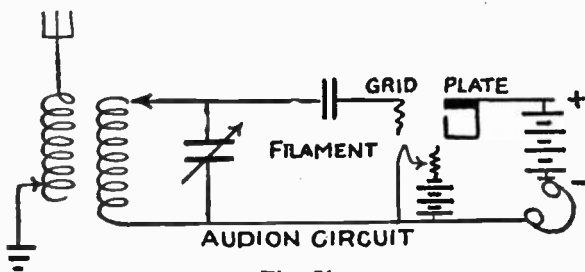

Fig. 71

a straight detector. The only amplification occurs from the tube itself without the assistance of specially constructed circuits. This type of receiving circuit is shown in Fig. 71. The vacuum tube is merely the detecting means and does not in any way vary the receiving system which has already been shown in Fig. 54.

AMPLIFICATION BY VACUUM TUBES. Enormous amplification may be had in the receiving sets which use the vacuum tube if some

type of feed-back or regenerative connection is used. Of the latter, there are two general types. One is the "inductive feed-back," the other is the "capacity feed-back." By inductive feed-back we mean that two coils of wire are brought into inductive relation so that the current set up in one induces currents in the other. In the case of the capacity feed-back, two variable condensers, or one variable and one fixed condenser, are so connected that a charge induced in one is made to act upon the other so that it produces amplified signals in connection with the vacuum tube.

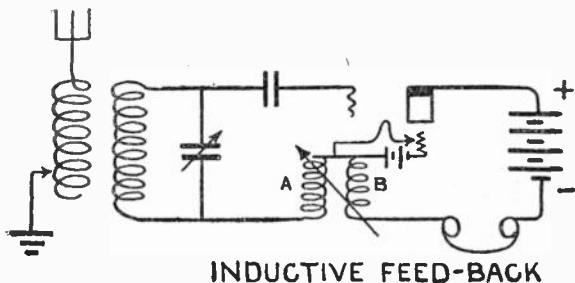

Fig. 72

THE INDUCTIVE FEED-BACK. Fig. 72 illustrates the inductive feed-back. The audion or vacuum tube takes the original strength of the signal and amplifies it in the telephone receivers. This amplified signal is fed back to the intake of the audion and it again becomes amplified. This action is repeated again and again until the limit of amplification is reached. In the circuit shown, the two coils "A" and "B" are the feed-back coils; "A" is in the intake circle of the tube and "B" is in the telephone circuit or outlet circuit.

The current set up in the outlet circuit acts from "B" to "A" and once given to the intake circuit it reappears in the outlet circuit and is amplified in the action. This feeding back, or amplification, may be repeated again and again until the signals sometimes reach a strength as great as fifty times that of the original, or unamplified, signals. The feeding-back action may be continued until the vacuum tube begins to "oscillate," that is, to set up oscillations. When this point is reached the signals become extremely loud, lose their characteristic note, and make a hissing sound.

THE CAPACITY FEED-BACK. The capacity type of feed-back circuit is shown in Fig. 73. In the circuit the two variable condensers

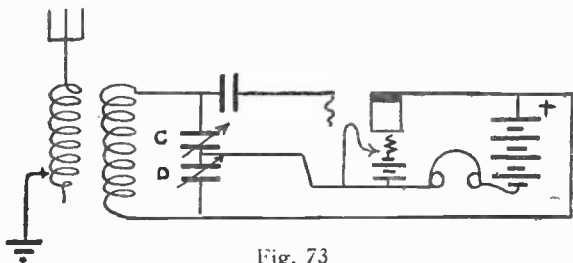

Fig. 73

“C” and “D” are the feed-back apparatus. Condenser “D” may be set at some maximum value. The current in the phone circuit induces a charge in the condenser “D” which in turn creates a charge in condenser “C.” The smaller capacity of “C,” the greater potential is set up in it. This potential acts on the intake circuit and is amplified in the same manner as the inductive feed-back.

The rapid development of amateur radio stations has brought about certain improvements in the apparatus used by these stations. Amateurs transmit on a wave length of 200 meters. Receiving apparatus can be designed so that most efficient results may be secured with this wave length. A certain type of receiver known as the Paragon has been one of the most efficient for receiving wave lengths from 200 meters up to 600 meters. This type of receiver employs “variometers” for tuning instead of variable condensers.

VARIOMETERS FOR TUNING. A variometer consists of two coils of wire which have about the same electrical dimensions. They are connected in series and one rotates inside of the other. In one position the inductive effects of the two coils add to each other, and in another position the coils “buck” each other. Thus there is a maximum and minimum effect and between these two positions of the coils there are other values of inductance, so that the inductance may be steadily increased from a minimum to a maximum by rotating one coil within the

other. The Paragon type of connection is shown in Fig. 74. The variometer in the phone circuit acts as the regenerative, or feed-back, coil and produces very large amplifications in the strength of the signals.

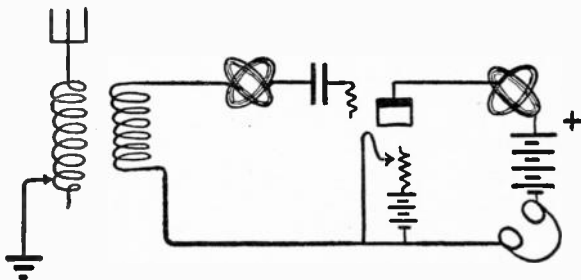

Fig. 74

A SHORT-WAVE-LENGTH RECEIVER. The receivers, such as the Paragon, are generally limited to wave lengths of not more than 600 meters. One of these types of short-wave receiver may be easily made by any amateur who has had a little experience with tools. It is intended to describe the construction of a short-wave receiver which amplifies by means of the capacity feed-back method. Of course, it must be understood that with the vacuum tube detector only can this set be used efficiently for amplifying purposes.

The primary coil should be formed of a piece of cardboard or wooden tubing and have an inside diameter of $3\frac{1}{2}$ inches. The outside diameter should not be greater than $3\frac{3}{4}$ inches. This cylinder should be 2 inches long and wound with 50 turns of No. 26 double-cotton-covered wire. Leads should be brought out from every 10 turns.

The secondary coil is a piece of tubing with an outside diameter of approximately $2\frac{3}{8}$ inches.

The inside diameter may be of any size. The length of this coil should be two inches. It is wound with 30 turns of No. 26 double-cotton-covered wire. No taps are taken off this coil. In the case of both the primary and secondary coils, a space of about $\frac{3}{16}$ of an inch should be left in the middle of the coil so that a rod may be passed through the two and fastened to the secondary coil in such a manner as

will permit it to rotate within the primary. Both the primary and secondary coils, with the method of winding, are shown in Figs. 75 and 76. Fig. 77 shows how the two coils are connected together so that the secondary may be rotated. This rotation gives the coupling effect.

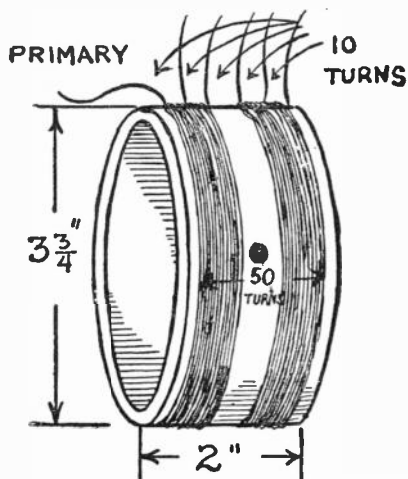

Fig. 75

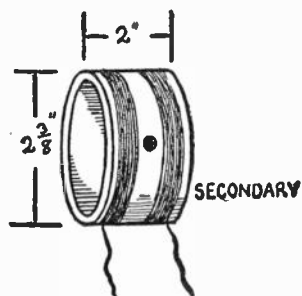

Fig. 76

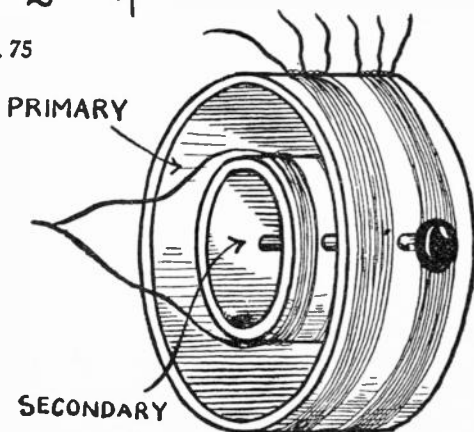

Fig. 77

THE THIRD OR LOADING COIL. It will be seen that the secondary coil is not tapped. It is necessary to add a third coil, which is really a "loading coil" for the secondary. This third coil is $2\frac{1}{2}$ inches long and $2\frac{3}{8}$ inches outside diameter, and is wound with 40 turns of No. 26 D. C. C. wire. Taps are taken out at every tenth turn. This method of tapping is shown in Fig. 78, which illustrates the primary, secondary, and secondary loading coil all connected.

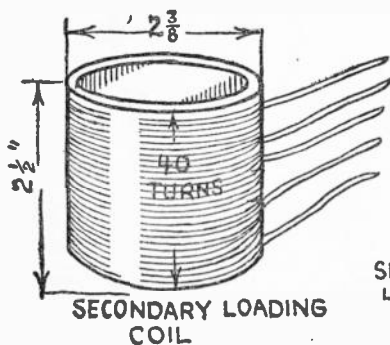

Fig. 78

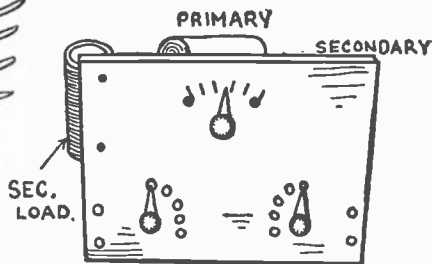

Fig. 79

The three coils may be mounted behind a panel as shown in Fig. 79. In describing this tuning system, the writer has purposely omitted detailed dimensions as well as description. If the figures given are followed approximately, the coil will have the proper characteristics for short-wave reception. By not requiring a detailed description to be followed, the experimenter is given a certain amount of leeway which, in the majority of cases, will enable him to produce a finished product which is better from the constructional standpoint.

The apparatus just described requires three variable condensers and two fixed condensers. The fixed condenser may consist of our 5 x 7 photographic plates, coated with 4 x 6 tinfoil. Every other lead may be extended so that connections are easily made. One of the variable condensers is connected in series with the antenna circuit. Another is connected in parallel with the secondary. The third variable condenser

acts as a feed-back. The detailed connection, together with the vacuum tube hook-up, is shown in Fig. 80.

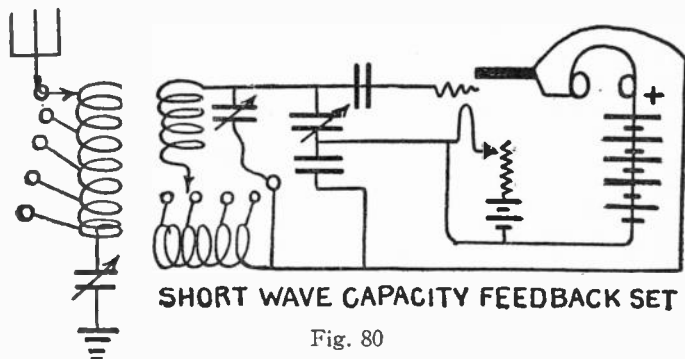

Fig. 80

OTHER KINDS OF CONNECTIONS. A great many other types of connections may be used. Instead of having separate coils to produce the feed-back action, a third coil may be added in such a manner as will enable it to be brought close to the secondary coil. This third type of coil is generally known as a "tickler" coil. It usually has the same dimen-

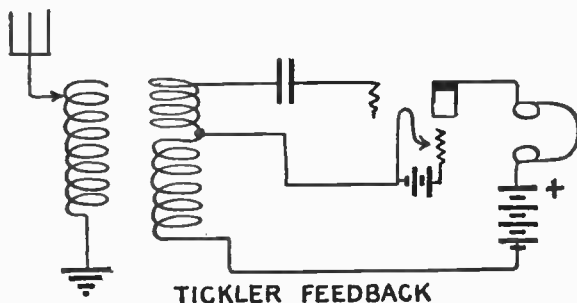

Fig. 81

sions as the secondary, or may be slightly smaller so as to revolve within it, and has, in general, fewer turns than the secondary. Fig. 81 illustrates the tickler coil connection.

Some amateurs will find it difficult to construct a tickler coil. In this case, they may experiment with the primary so that it not only acts as a primary, but at the same time becomes the feed-back coil. This may

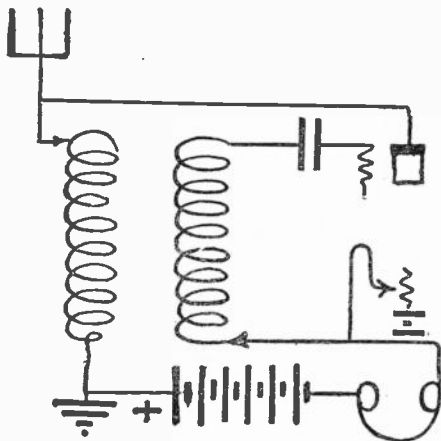

Fig. 82

be connected as shown in Fig. 82. A great many other varieties of connections will give amplified signals. It is quite evident that the various types of receivers are all based upon either the inductive or capacity methods.

The inventor and originator of the feed-back connection is Major Edward H. Armstrong, who is one of the foremost amateurs in America. He was commissioned by the Signal Corps at the beginning of the war, and had charge of the Research Division of the Signal Corps in the American Expeditionary Forces in France.

DAMPED VERSUS UNDAMPED WAVES. All of the receivers which we have described in this chapter have been primarily intended for the reception of "damped" waves. Another type of signal which is being used extensively and is coming into greater prominence every day, is the "undamped" wave. This type of radio wave differs from the damped wave in that it is persistent; that is, it does not die out and is of constant amplitude. While these signals can be heard with the crystal type of detector, a vacuum tube is generally employed.

This tube is used in what is known as an oscillation circuit; that is, the detector tube sets up a slight oscillating current in the receiver. This oscillating current in the receiving set is made to act at a slightly greater or lesser rate than the oscillating wave which is being received. The difference in the two rates of oscillations makes an audible signal which can be heard in the telephone receivers.

It may be a little difficult to understand just how this audible note is made, but it is clearly shown in the diagrams. If A, Fig. 83, illustrates a continuous wave which is oscillating at the rate of 100,000 per second, and if B, Fig. 83, shows the detector circuit oscillating at the rate of

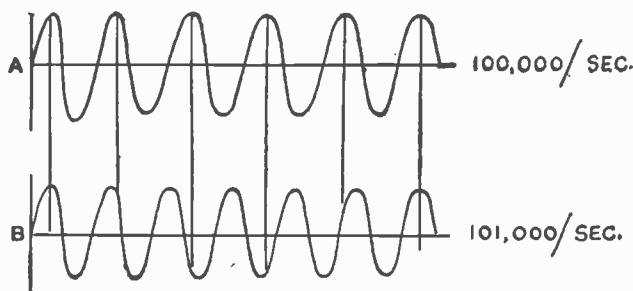

Fig. 83

101,000 per second, the two curves may be added just as we add figures in arithmetic. It can be seen at a glance that the two oscillations generally go together, but every so often they get out of step; that is, one gets slightly ahead of the other and when this occurs they neutralize each other. This occurs 1000 times per second, which is the difference in the two rates, and is the audible note which we can hear in the telephone receivers.

The vacuum tube detector can be made to oscillate by means of several different types of circuits which are all similar to the regenerative circuits just described. In fact, all of the regenerative or feed-back circuits shown can be made to oscillate and receive continuous waves. Most of the continuous, or undamped, wave work in this country is done with wave lengths that are above 5000 meters. This wave length is much greater than the average loose coupler will receive. This means that an exceptionally large loose coupler or else special coils must be made to receive the continuous waves. Some of the wave lengths in use are as great as 17,000 meters.

Any of the receiving circuits shown may employ still another, or even two additional vacuum tubes which can be connected in such a manner that they will amplify the signals received as many as 25 to 100 times the intensity with which they were received with a single tube. The method of connecting in, as well as the theory of, the vacuum tube amplifier has been described in Chapter VI.

Chapter X

ABOUT VACUUM TUBES AND CIRCUITS

IT might be said that most of the recent radio developments have been based upon the vacuum tube. It is certain that this piece of radio apparatus has a most important bearing on improvements in general. Quite a number of years ago, Edison discovered that if a cold plate is put inside of an electric-light bulb, and if the plate is connected to a battery in such a way that is slightly positive, an electric current will flow from the heated filament to the cold plate. This was known as the "Edison effect."

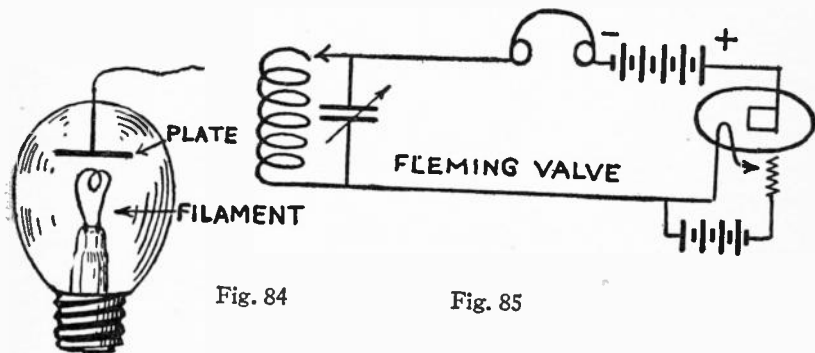

Fig. 84

Fig. 85

Several years later, Fleming, a British scientist, made use of the so-called "Edison effect" and constructed what is known as the Fleming oscillation valve. In reality this valve was nothing more than Edison's electric-light bulb and plate, but Fleming found that this device was a reliable detector of radio waves. Its advent in the radio field filled a long-felt want. Up to that time numerous detectors were made, but none of them equaled the reliability and sensitiveness, as well as the uniformity, of the Fleming oscillation valve, or vacuum tube, as it is now called.

The method of connecting the valve (Fig. 84) to a tuned circuit is pictured in Fig. 85. This is shown partly for its historical value and also to demonstrate to the reader the connection between the old-style Fleming valve and the modern vacuum tube.

HOW A SIMPLE VACUUM TUBE WORKS. Lee DeForest, an American radio experimenter, found that the vacuum tube comprising two elements might be greatly improved by the introduction of a third member between the filament and the plate. This third member is a zig-zag wire called "the grid." Fig. 86 shows an elementary vacuum tube or "audion," as he named it.

It is the purpose of the writer to describe the theory of the audion in an elementary manner. There are slight modifications of this theory, but for ordinary purposes the explanation which follows covers its operation.

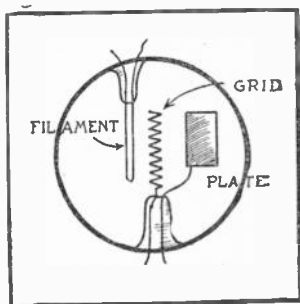

Fig. 86

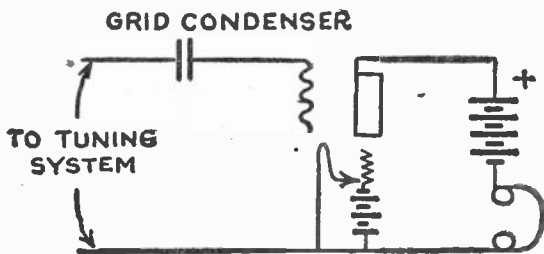

Fig. 87

If a filament is heated in a vacuum and the plate near the filament is made positive, "electrons," that is, negative charges of electricity, will be liberated from the filament. Unlike charges of electricity attract each other. The negative electrons and the positive plate carry unlike charges. Therefore, the electrons are drawn over to the plate. (See Fig. 87.) The more positive the plate is made, and the higher the filament temperature, the more electrons will flow from the filament to the plate. For any given

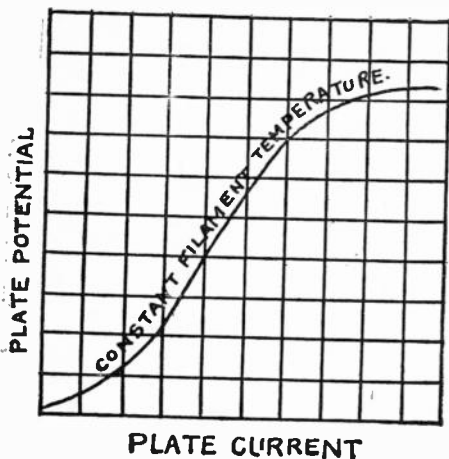

Fig. 88

rent in a two-element vacuum tube.

HOW THE GRID AFFECTS THE PLATE CURRENT. The introduction of a third element in the tube affects the characteristic curves of plate current. To state, in simple terms, the effect of the grid, we shall ask the reader to consider a vacuum tube as a resistance. We shall speak of the space between the heated filament and the plate in terms of resistance. This space offers a certain resistance to the flow of current and the grid simply varies this flow.

filament temperature the electrons will flow in increasing numbers for increasing plate potentials. There is, however, a limiting value to the increased flow, that is, there is a point when increased positive potential on the plate does not increase the flow of the electrons. In a similar manner for any fixed positive value on the plate, the electron flow becomes more dense with increasing filament temperatures. These two actions are shown in a graphic manner in Figs. 88 and 89, which are two curves that indicate the flow of cur-

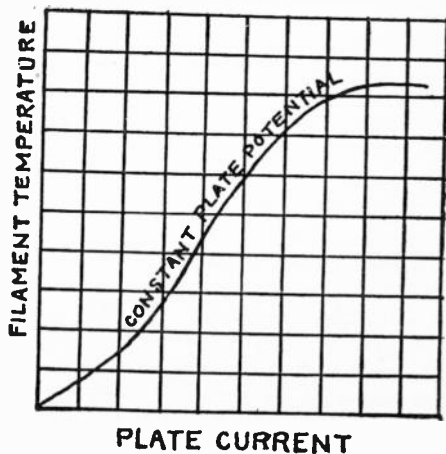

Fig. 89

If the grid is charged positively, it will decrease the resistance and more current will flow. If the grid is made negative the resistance is increased and less current flows. The connection is made as shown in Fig. 90. A certain value of plate potential is chosen, for instance, let us say, 45 volts.

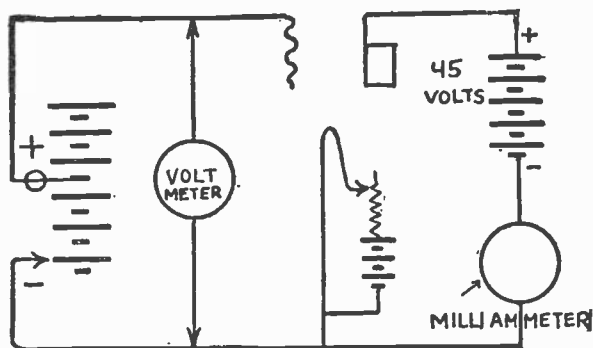

Fig. 90

The filament is heated by means of a battery. This can be made a constant value, and a steady current will flow from the filament to the plate. A sensitive ammeter may be inserted in the plate circuit, as shown in the illustration, and this will record the plate values. The battery can be varied over a certain range of voltage. Let us say that the grid is varied from four volts negative to four volts positive. We find that four volts of negative potential on the grid will almost shut off the current flowing in the plate circuit, but the four volts positive charge has very little effect upon the plate current, though it does increase it slightly.

PLOTTING GRID PLATE CURVES. This variation from four volts negative to four volts positive on the grid may be carried out for all the ranges of voltage between the two values. The results may be graphically shown, a curve showing them can be plotted. This has been done and is shown in Fig. 91. This type of curve is known as the "characteristic grid-plate curve." The characteristic curve is, of course, taken for a given filament temperature, or filament current, and the plate is given a certain constant positive potential.

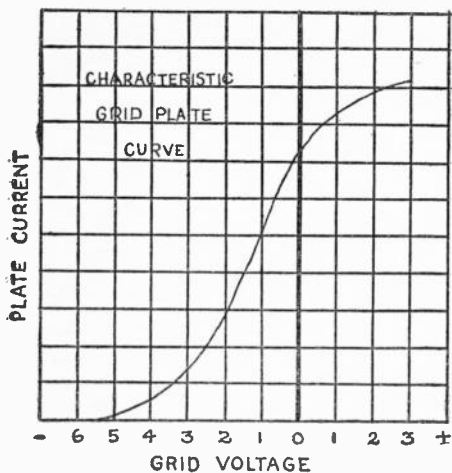

Fig. 91

Another curve may be taken with a different positive value on the plate. The filament is generally left a constant and is kept at the value of current which is usually indicated by the maker of the tube. The majority of receiving tubes operate with a filament current between .5 and 1.1 amperes. When a whole series of curves are taken with different plate potentials, this series of curves are often called a family of curves.

The reason for emphasizing the characteristic curves of a vacuum tube is because of their extreme importance,

as well as the help which they give in understanding the subject, especially the more complicated forms of vacuum tube action which will be described later.

HOW THE VACUUM TUBE ACTS AS A DETECTOR. The action of a vacuum tube in receiving radio signals may be easily explained by reference to the characteristic curve. First consider the diagram

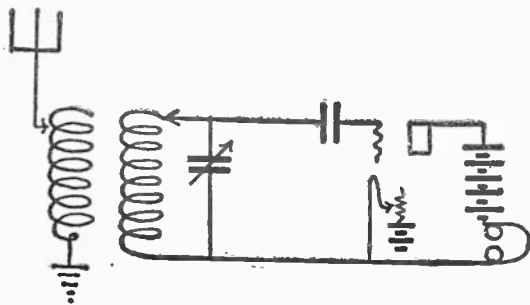

Fig. 92

shown in Fig. 92. An oscillating current is induced in the antenna which flows up and down and through the primary inductance. A similar oscillating current is set up in the secondary coil. This oscillating current, of course, varies from negative values to positive values.

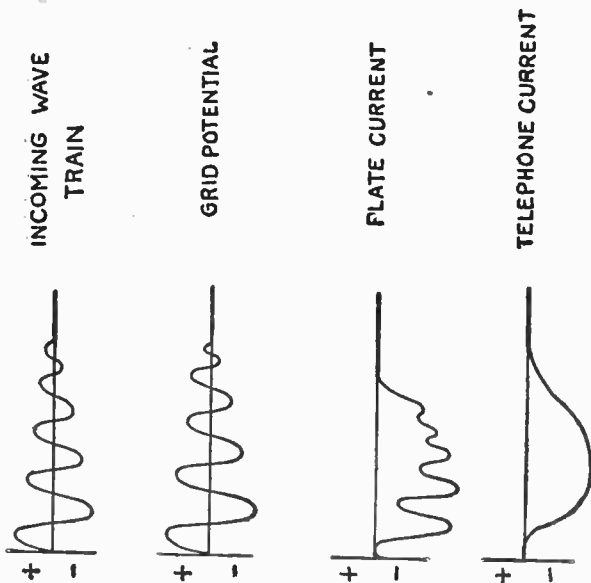

Fig. 94

This gas causes sharp critical points in the characteristic curve. For receiving purposes, a soft or gas tube may be adjusted to one of these critical points at which it will show remarkable sensitiveness. The gas tube is a great deal more difficult to operate, but once adjusted will often show marked superiority over the so-called hard tube; that is, the tube which has a more nearly perfect vacuum.

The "hard" vacuum tubes can be made with a marked degree of similarity; that is, the characteristic curve and the detector action of several tubes will be quite alike. However, the exact reverse is generally true of the soft or gas tubes. The majority of gas tubes differ greatly among themselves. No two of them are alike. Their characteristic curves are different. In a gas tube certain values of plate current will often produce a bluish haze or "blue glow," as it is sometimes called. This glow is caused by the impact of the electrons with gas molecules in the tube.

In general, for practical operation, the gas tubes are the more sensi-

tive as detectors. However, when the tube is used, either as an amplifier or an oscillator, the hard tube is the more practical. One reason for this is the ease with which a hard tube can be adjusted. It takes a certain definite plate voltage and a fixed value of filament current. When these two values are reached, the tube is ready for operating. On the other hand, the gas tube requires careful adjustment of the filament current and correspondingly critical plate voltages.

So far we have considered the vacuum tube only as a detector. There are other uses to which these tubes may be put, since they not only detect, but amplify and also generate oscillations of their own. We shall next consider the vacuum tube as an amplifier.

THE VACUUM TUBE AS AN AMPLIFIER. It again is desirable to refer to the characteristic curve. A certain portion of the characteristic is almost a straight line, and if a point is chosen in the center of this line, it will be seen that equal changes in grid voltage will produce correspondingly equal changes in the plate current. Not only are these changes equal, but they are of much greater amplitude than the current required to make the change.

When a small effect can be made to produce a greater effect, we have "amplification," and this is what can be made to take place in a vacuum tube. Small changes on the grid can be made to produce large changes in the plate current. This can be illustrated graphically, and Fig. 95 shows a small oscillating current on the grid and the resultant current in the plate circuit.

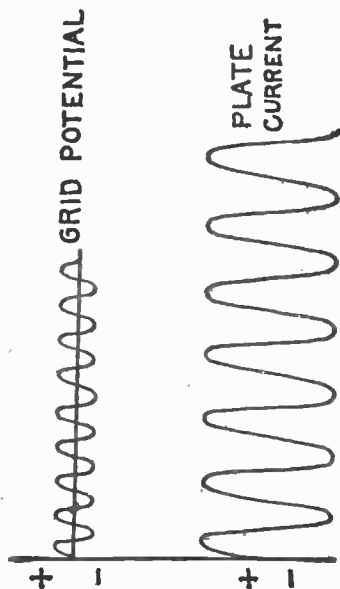

Fig. 95

The amplifying possibilities in a vacuum tube can readily be made use of. Each circuit is shown in Fig. 96. In this circuit the impedance X is used to equal the impedance which ordinarily would be

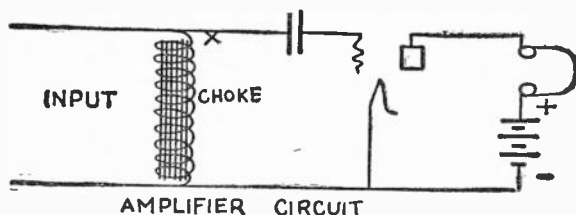

Fig. 96

represented by the telephone receivers in the detector circuit. The amplifier is connected to the detector in place of the telephone receivers. The incoming signals are detected in the usual manner by the first vacuum tube.

In this tube the signals receive their first amplification, due to the battery in the plate circuit, and the particular trigger action of the vacuum tube. These amplified signals are put into the impedance instead of the telephone receivers in the amplifier circuit. Now the signals are again amplified so that the final strength is many times that of the original signal.

CONNECTING UP VACUUM TUBES FOR AMPLIFICATION.

It is possible to use another amplifier and again amplify the signals which are coming from the first amplifier. It is not considered practical to amplify more than two or three steps by this particular method which is called "audio frequency amplification." This name is given to it since the amplification takes place at audible rates.

There are several different methods of coupling amplifiers together as well as amplifiers to the detectors. We have already described the impedance method. Instead of connecting an impedance in the circuit to take the place of the resistance of the telephone receivers, we may connect a straight ohmic resistance as shown in Fig. 97. This resistance should be in the neighborhood of $\frac{1}{2}$ to 3 megohms. It is connected in place of the telephone receivers and for the best results equals the

resistance, or impedance, which exists from the filament to the plate of the tube used.

In place of impedances or resistances, we may use a small transformer. This method of connection is shown in Fig. 98. The transformer method offers certain advantages. For example, the transformer

can be made to step up the voltage, thus causing greater amplification. It may also be used so that the input side equals the impedance of the filament to the plate path of the first tube, while the secondary has an

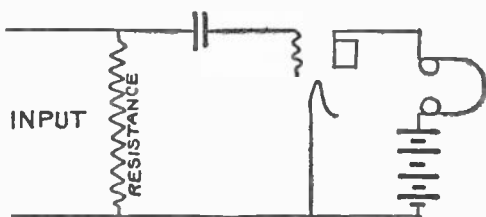

AMPLIFIER CIRCUIT
USING RESISTANCE

Fig. 97

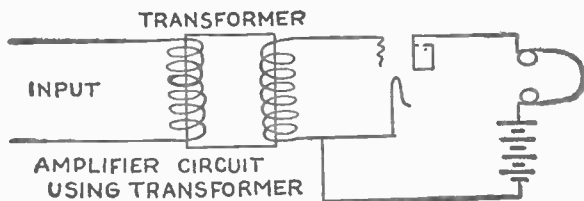

Fig. 98

impedance which is equal to the impedance from the filament to the grid of the amplifying tube. Under these circumstances, we receive the maximum amplification with a given tube without distortion.

A steady direct current in a circuit is opposed only by the resistance of that circuit. However, if the current is oscillatory and the circuit has inductance and capacity, or both, the opposition to the current is no longer its resistance alone, but it must also overcome the effects of the capacity and inductance. The opposition is termed "impedance," and it corresponds in every way to oscillating currents as resistance does to direct currents.

THE ARMSTRONG AMPLIFIER AND HOW IT WORKS. In describing the use of a vacuum tube as a detector and an amplifier in the preceding paragraphs, we referred to its use as a separate tube. Major Armstrong developed a circuit which requires only a single tube not only to detect, but also to amplify. The method is obvious enough after some

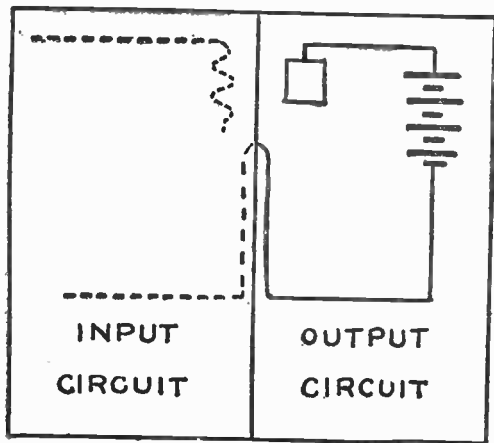

Fig. 99

one else has pointed out the way. Armstrong's method was to take the amplified signals which we would ordinarily put into the telephone receivers and to feed these signals back to the input of the vacuum, when they will reappear at the outlet and will be amplified. These amplified signals can again be returned to the input and again they will appear at the output considerably more amplified. Fig. 99 shows the input and output circuits of a vacuum

tube. The method which was used by Armstrong will be understood from Fig. 100. The telephone circuit is connected back to the input circuit by means of coil T. The current flowing through the telephone receivers also flows through the coil T which is placed near the secondary inductance.

Variations in current in coil T cause variations of current to be induced in the secondary and these variations reappear in the telephone receiver greatly amplified. A sin-

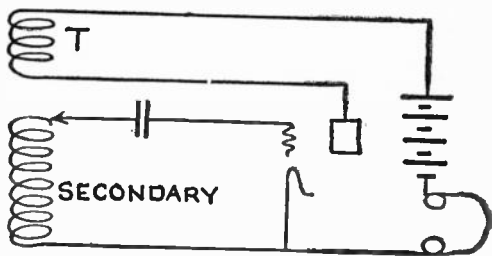

Fig. 100

gle tube may be made to produce amplifications as great as 100 times the original signal strength.

After amplification has been had by the Armstrong method, these signals may be put into audio frequency amplifiers and the intensity of the signals increased many more times. Radio signals, by means of vacuum tubes, can be amplified again and again. Instead of telephone receivers, loud speaking horns may be put into operation so that the sound of the signals can be heard over a large room.

The vacuum tube amplifiers may be used for all kinds of amplification. As an illustration, we might point out the amplification which is done over the long-distance trans-continental lines. Vacuum tube amplifiers are used on the long-distance telephone lines and they make telephony between New York and San Francisco possible. The wonderful advantage of the vacuum tube over all other methods of amplifying is due to the fact that it is a perfect amplifier and can be made to amplify without the slightest distortion.

THE VACUUM TUBE AS AN OSCILLATOR. So far, we have shown how the vacuum tube detects, amplifies within itself, and amplifies as an amplifying tube. These same tubes can be made to generate electric oscillations. These oscillations may be used for radio telegraphy or telephony. To understand the action of a vacuum tube as a generator need not be any more difficult than understanding its action as a detector. We shall not consider yet the detailed circuits which are required, but just the elementary facts.

A steady current is flowing in the plate circuit of a vacuum tube. Variations of potential on the grid will cause variations in the plate current. If we can vary the grid circuit a million times per second, the plate current will likewise vary a million times per second. These million variations per second correspond to a wave length of 300 meters, and if the plate circuit of the tube is connected to an antenna, a wave length of 300 meters will be emitted.

MICROPHONE ANALOGY OF CURRENT VARIATIONS. It need not be a difficult matter to cause a million variations of potential to take place on the grid of a vacuum tube provided we are not forced to use mechanical means. An automatic method is extremely easy and here again we make use of Armstrong's "regenerative" or "feed-back" principle. To understand this principle as it applies to transmitting tubes, let us consider an analogue.

If a telephone receiver is connected in series with a microphone and battery as shown in Fig. 101, a disturbance in the microphone causes a

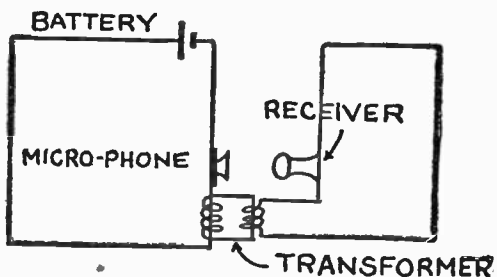

Fig. 101

sound to be emitted by the telephone receiver. Supposing, now that a sound is started, we take the telephone receiver and bring it near the microphone; the sound in the telephone receiver will act on the microphone. The microphone, in turn, will set up a noise in the telephone receiver. This action will be repeated again and again and faster and faster, once it is started. The only thing which limits the frequency is the type of the circuit and its inertia of the diaphragms of the microphone and telephone receiver.

The microphone and telephone receiver may be likened to the inlet and output circuits of a vacuum tube. If the two circuits are coupled together and a disturbance is created which will cause a slight change in the grid potential, the tube will start to oscillate and it will continue to oscillate for some time, the only limit to the rate of oscillation is the value of inductance and capacitance in the circuits. We can choose the inductance and capacitance so that the rates can be anything from one or two oscillations per second up to several hundred millions of oscillations per second.

Not only does the tube set up oscillations and furnish the necessary current to transmit radio signals, but it also furnishes undamped oscillations, that is, oscillations of constant amplitude. There is no dying-out action, and the waves travel a much greater distance without losing their energy. An additional advantage is present; that is, the undamped waves traveling from the transmitting to the receiving station are good carriers of the voice. Thus we have a radiotelephone made practical by the use of the vacuum tube at the transmitting end.

KINDS OF OSCILLATION CIRCUITS. An elementary circuit for setting up oscillations by means of the vacuum tube is shown in Fig. 102.

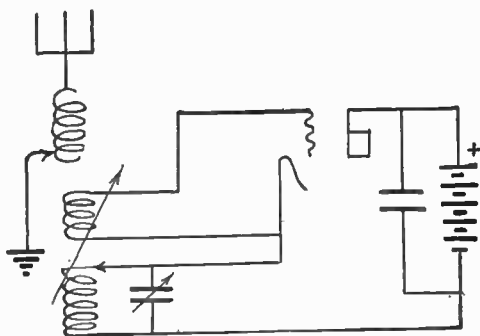

Fig. 102

There are many modifications possible, but all of these modifications are based either upon an inductive feed-back or capacity method. The elementary circuit for a capacity feed-back is shown in Fig. 103.

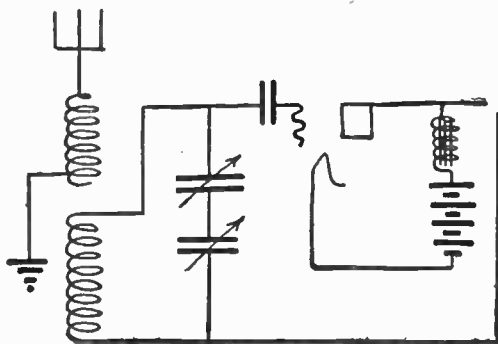

Fig. 103

A complete hook-up of an oscillating tube for either transmitting telegraph signals or speech is shown in Fig. 104. This is the capacity

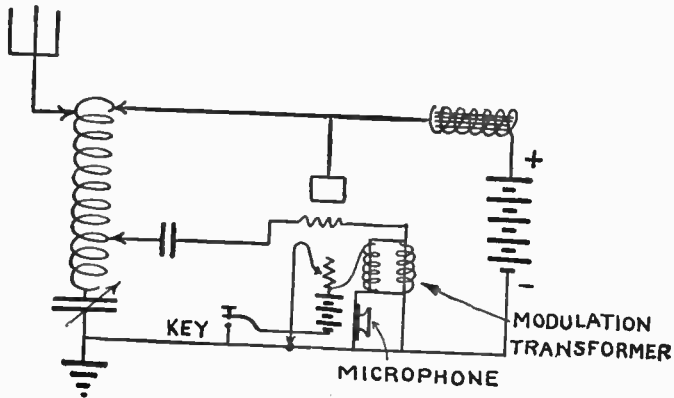

Fig. 104

method. The inductive type of circuit for telegraph or telephone is shown in Fig. 105. The latter part of this chapter will be devoted to various circuits for receiving and transmitting which require the use of vacuum tubes.

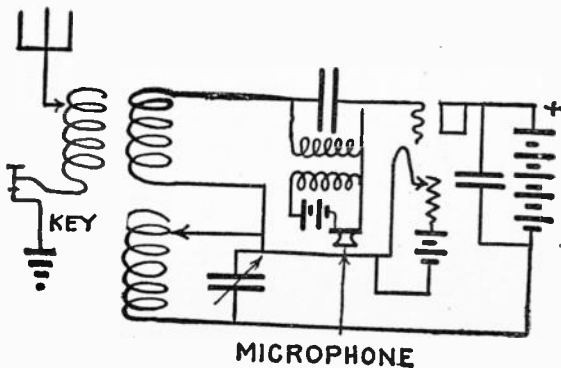

Fig. 105

THE VACUUM TUBE AS A RECEIVING OSCILLATOR. There is still another use for the vacuum tube and that is as an oscillator for receiving. If the transmitting station is sending out undamped waves at the rate of 1,000,000 oscillations per second, this cannot be heard at the receiving station since the rate is not only beyond that of the human ear, but is also too fast for the diaphragm of the telephone receivers.

If, however, the receiving vacuum tube is made to oscillate at the rate of 1,001,000, the two rates will interfere with each other and 1000 times per second the oscillations will add to each other, instead of interfering. This 1000 times per second becomes an audible note to which the telephone receiver responds and which is within the range of the human ear.

To receive continuous waves, we make use of the Armstrong feed-back circuit, and instead of feeding back the oscillations at an audible rate, we feed them back at a rate which is slightly greater or slightly less than the transmitting rate, thereby making it possible to hear the continuous wave signals. One form of continuous wave receiving circuit is shown in Fig. 106.

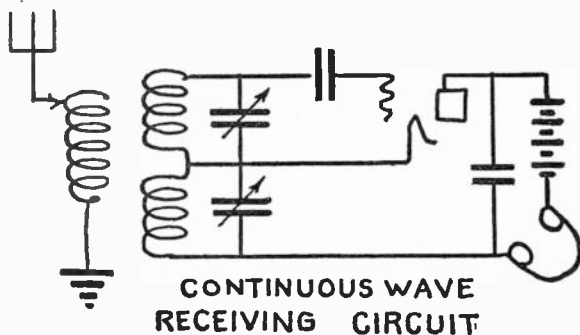

Fig. 106

Chapter XI

THE OPERATION OF AMATEUR RECEIVING SETS

In this chapter several types of receiving apparatus will be described so that the reader will have some information as to their operation. We will begin with the elementary receiving apparatus and then consider the more complex types.

Simple Types of Receiving Sets

THE ANTENNA. The most elementary type of radio receiving set which is in general use consists of an antenna, loose coupler, crystal detector, and telephone receivers. For receiving purposes, the antenna need only be of the simplest kind. The higher the receiving antenna is erected, the better will be the results obtained. If the antenna consists of a single wire 100 feet long and 40 feet high, it will be very satisfactory.

An insulator should be placed at each end of the wire and the lead-in soldered and carefully insulated from all objects which might conduct current, such as the leaves and limbs of trees. The method of installing the receiving antenna is illustrated in Fig. 107.

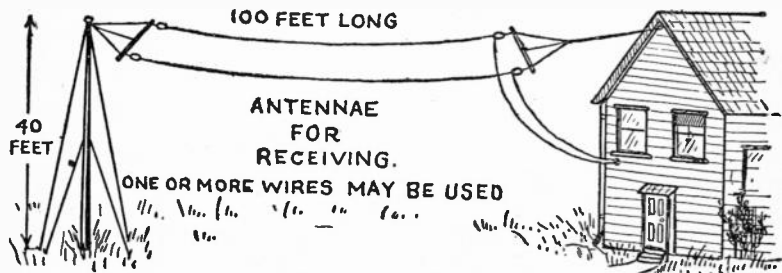
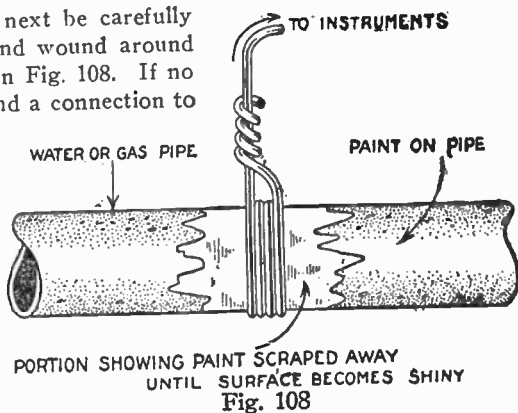

Fig. 107

THE GROUND. A ground connection must next be made. This may be done by making a careful electrical connection to the water pipe or gas pipe. To make sure that the electrical connection is good it is necessary to carefully scrape the pipe so that it is free from paint, dirt, or rust.

A copper wire should next be carefully cleaned of its insulation and wound around the water pipe as shown in Fig. 108. If no water or gas pipe is at hand a connection to a water pump or a well will prove satisfactory. If neither of these are available, the "ground" may be made by burying a copper wire directly under the antenna and extending the whole length of the aerial. This wire need not be more than three or four inches under the soil. With regard to the size of wire, the antenna wire should be of sufficient mechanical strength.



Number 14 or 16 B & S gage copper wire is recommended. It is not desirable to use much finer than No. 20 B & S gage. The same size will do for the ground connection. Larger sizes of antenna wires will give slightly better results, but the main difference is the mechanical strength.

The antenna and the ground should now be carefully connected to the primary of the loose coupler. This is shown in Fig. 109. A crystal

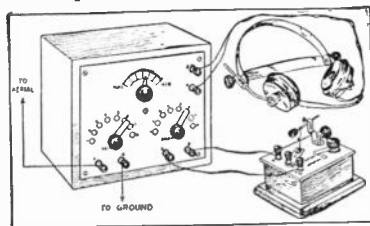

Fig. 109

detector and a pair of telephone receivers are connected in series with the secondary of the loose coupler. In the illustration shown, the loose coupler has already been provided with binding posts to make this connection. When the connections are completed the next step is to adjust the crystal detector.

THE USE OF CRYSTAL DETECTORS. Various types of crystals may be used. Silicon, galena, and iron pyrites are all found among the amateur radio stations. Probably galena is considered the most sensitive of the crystal detectors. It is generally hard to adjust. Silicon is much easier to adjust and is fairly sensitive.

The next step is to find the sensitive point on the detector, for not all points of the crystal are sensitive. If the station is being operated in the neighborhood of many amateur and commercial transmitters, this adjustment may be done by trial, that is, the adjusting wire may be moved over the surface of the mineral until a spot is found where the signals become audible in the telephone receivers. This method is not always satisfactory since sometimes there are no stations sending and a great deal of time is lost in attempting to adjust the detector.

HOW TO ADJUST A CRYSTAL DETECTOR. The adjustment of a crystal detector may be greatly facilitated by the use of what is known as a "test buzzer." A test buzzer is nothing more than an ordinary electric buzzer which is grounded and controlled by the operator. The buzzer may be connected as shown in Fig. 110. Either a switch or a push button may start the buzzer in operation.

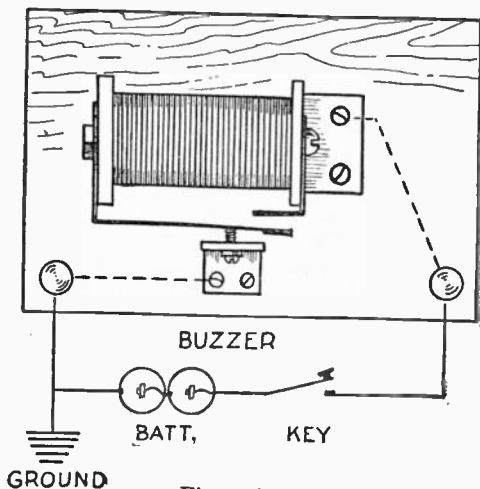

Fig. 110

The writer has found it very handy to rig up a switch which may be controlled by the operator's foot. This leaves both hands free to adjust the detector and tune the receiving apparatus. A foot contact may easily be made from two strips of brass as shown in Fig. 111.



Fig. 111

The operator places his foot upon the contact, thus starting the buzzer. The little spark at the buzzer points sends out a feeble radio wave. The operator simply adjusts the detector until a point is found where the buzzer sound comes in loud and clear. When this point has been found it is generally a sensitive point and will detect the regular radio messages which are continually being sent by commercial stations.

TUNING THE RECEIVING SET. The next step in operating the receiving station is to tune to the various wave lengths which are used in transmitting. In the case of the loose coupler shown, there are eight switch points on the primary and eight switch points on the secondary. Each of these points will respond to a certain wave length. The lower numbers opposite the points indicate the short wave lengths, while the higher numbers indicate the longer wave lengths.

As far as the primary circuit is concerned, the wave lengths to which it will respond depend upon the length and capacity of the receiving antenna. In the case of an antenna about 100 feet long, switch point No. 8 on the primary indicates that the primary circuit is tuned to a wave length of 2500 meters. Switch point No. 1 on the primary indicates about 200 meters. The points between these two values of 200 and 2500 meters are wave lengths which lie between these limits. Point No. 3 on the primary with the antenna mentioned will respond to about 600 meters.

Once the primary has been tuned to a certain wave length, it becomes necessary to adjust the secondary to respond to this same length. As in the case of the primary, the lower numbered switch points indicate the lower wave lengths while the higher numbers indicate the higher wave lengths. Switch point No. 8 on the secondary responds to a wave length of 2500 meters. If the primary circuit has been tuned to 2500 meters, the secondary must be tuned to the same wave length in order that the signals may be a maximum.

The coupling is a device which separates or brings closer the primary and secondary coils. The purpose of the coupling is to assist in tuning

and by means of it the tuning becomes much sharper and interference from several stations on approximately the same wave length may be reduced by putting the coupling to a minimum value. For general receiving work, the coupling may be left in the maximum position.

The actual tuning of radio signals is not a very difficult matter to learn. In fact, it is much more difficult to describe in writing. The amateur radio experimenter can only learn how to tune by actual operating. It requires a little patience but the operator is soon rewarded and acquires considerable skill in tuning in the various wave lengths.

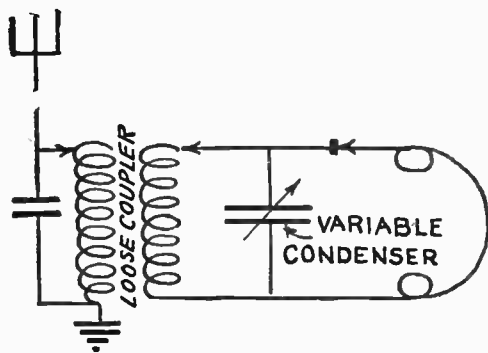

Fig. 112

and increase the strength of signals, but they also eliminate to a large extent the interference caused by several stations on approximately the same wave length.

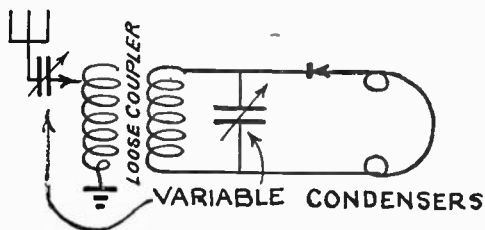

Fig. 113

THE USE OF VARIABLE CONDENSERS.

The tuning of signals may be very much improved by the use of variable condensers. The variable condenser enables the operator to tune his receiver to a much more accurate degree for the wave length which he is attempting to receive. Not only will the variables greatly aid tuning

The method of connecting in a variable condenser in shown in Fig. 112 or two variable condensers may be used as in Fig. 113. In this case the primary condenser is the one which should be omitted. Where the operator is attempting to receive short wave

lengths, that is, lengths of less than 600 meters, the primary condenser should be connected in series with the antenna, rather than across the antenna and ground. This method of connection is also shown in Fig. 113. The addition of a small fixed condenser across the telephone receivers will often aid in improving the strength of the signals.

LOOSE COUPLER WITH VACUUM TUBE. The next type of receiving set of general interest is the loose coupler with a vacuum tube for the detector.

The aerial, ground, and primary of the loose coupler are connected in the same manner as we have already described for the crystal detector. The vacuum tube control panel has on it eight binding posts. Two of these are connected to the secondary of the loose coupler. The particular loose coupler which we have described has two additional binding posts for the telephone receivers.

These are not required when using an audion. They are, therefore, short-circuited by a short piece of wire. The two remaining posts are connected to the input of the audion as shown in Fig. 114. This leaves

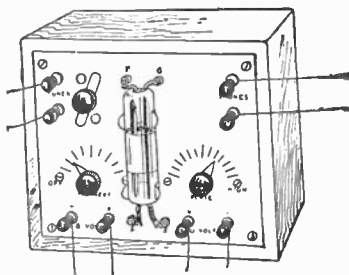

Fig. 114

four more posts to be accounted for. Two of these posts are marked "six volts." One is positive and has a plus mark near it, while the other is negative.

The positive post is connected to the positive terminal of a six-volt storage battery or five dry cells which have been connected in series. The negative post of the battery is connected to the negative terminal.

This connects six volts across the two terminals as called for and is the battery which heats the filament.

Two more posts on the lower right-hand side of the detector cabinet are marked "40 volts." These posts have near them a plus mark and also a negative mark. One post is positive, while the other is negative. A 45-volt battery which is made up of 30 small dry cells is connected so that the positive terminal of the battery connects to the binding post marked plus, while the negative terminal of the 45-volt battery connects to the negative binding post. The telephone receivers connect to the two binding posts in the upper right-hand corner marked "Phones."

The audion tube is connected on the panel to the small binding posts which are marked "G, F, P, F." These letters stand for grid, filament, plate, filament. The audion bulb furnished with this particular cabinet has these terminals in different colors. The scheme is as follows: Grid, Green; Filament, Brown; Plate, Red. There are three filament leads. These are all brown, and where there are two at one end of the tube, it simply indicates there are two filaments and either one may be used. It is not necessary to use both at once. The terminals of the bulb are connected to the posts marked "G, F, P, F," so that the green terminal is on G—the brown terminal on F—the red terminal on P—and either of the two brown terminals on the remaining F binding post. This completes the connection of the audion.

ADJUSTING THE AUDION. The next step in operating this particular type of receiving set is to adjust the audion. This adjustment is accomplished with two knobs. One of these knobs is marked "filament" and it controls the filament current. Moving the knob from the off to the on position increases the current flowing through the filament. The filament should be adjusted until it shows a fairly bright red color.

The next step is to adjust the plate voltage. To accomplish this, the knob marked "plate" is turned from left to right, which increases the plate voltage from zero to 45 volts. With the filament constant, the plate voltage is varied until a hissing noise can be heard in the telephone receivers. Either the plate or the filament is decreased slightly so that the hissing noise almost disappears. This means the tube is in operating condition and will detect signals.

After a little experience has been gained in adjusting the vacuum tube type-of detector, the operator will be able to quickly make the necessary

adjustment to bring the tube into its most satisfactory operating condition. Once this adjustment has been made, it is not necessary to change it. The detector will operate at approximately the same value throughout the life of the tube. However, some of the gas tubes are found to change somewhat with age. This means that slight corrections in the plate voltage are required in order that the tube may be kept in its most sensitive condition.

HOW TO PREVENT BURN-OUTS. A word of caution may serve to prevent the burning out of a valuable tube. When the batteries operating the filament get weak, the operator turns the rheostat to make up for the drop in voltage of the battery. When the set is left and the audion turned off, the filament battery will recuperate, that is, its voltage will come back to nearly its original value. If the rheostat on the filament has been left at its final adjustment and the current turned on, the voltage will often be so high that enough current will flow to burn out the tube. This may be avoided by always decreasing the filament rheostat to a minimum when turning off the detector.

The operator will not always use the same type of vacuum tube cabinet which we have described to illustrate the operating points. In order that the operator may be fully familiar with the type of connections,

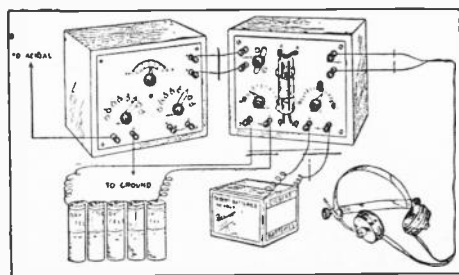

Fig. 115

we are showing in Fig. 115 the connections which are used in this cabinet. These same connections will, of course, apply to any vacuum tube detector.

The loose coupler audion set which we have just described may be greatly improved by the addition of variable condensers across or in series with the primary and also in parallel with the secondary. In Fig. 116 we have shown how variable condensers may be connected to improve the operation of this set.

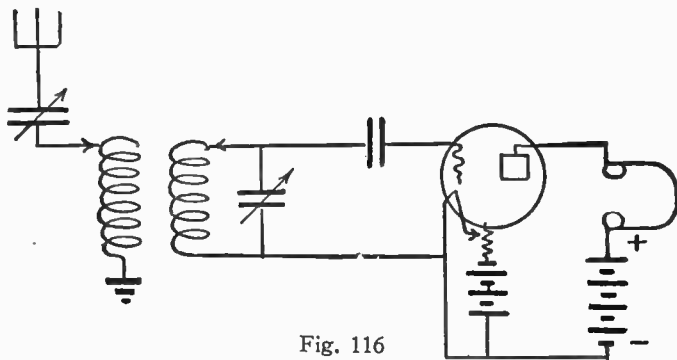

Fig. 116

AMPLIFYING AUDIONS. The next receiving set that will interest the amateur is the outfit which makes use of the regenerative or amplifying audion. The same loose coupler and audion cabinet may be used with a slight modification in the form of connection, as well as the addition of feed-back coils. Two small coils may be connected as shown in Fig. 117.

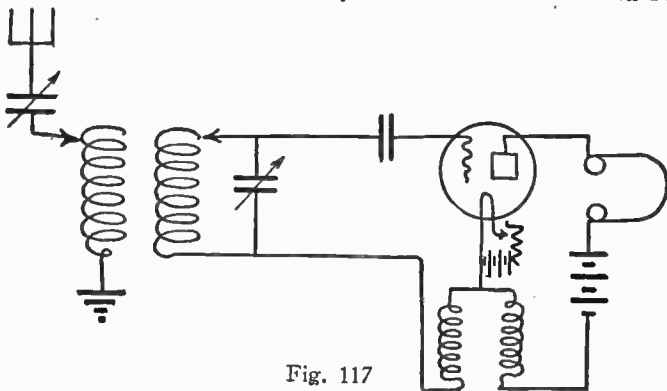

Fig. 117

One of these coils is connected between the secondary of the loose coupler and the audion. The other coil is connected in series with the plate or telephone receivers. An arrangement is made by means of which the coupling between the two coils is varied.

When the coupling is made as close as possible, the maximum amount of energy is delivered to the audion input so that the greatest amplification takes place. When the coupling is the loosest, a minimum amount of energy is returned to the audion and minimum amplification occurs. The coupling of the feed-back coils may be made so close that the tube will set up oscillations and then the damped wave signals will become distorted.

The operator will soon gain the necessary amount of experience in handling the regenerative vacuum tubes and will learn just what adjustment gives the most satisfactory results. It probably will be necessary to adjust the two coils for every signal which is received. If the coils do not increase the strength of the signals, it is because they are opposing each other instead of aiding. To correct this, try reversing the leads to the plate or telephone receiver terminals.

With any of the receiving circuits described, audio-frequency amplifiers may be added to greatly increase the signal strength. The amplifying vacuum tubes are adjusted in the same manner as the detector tube. The method of connecting amplifying tubes is shown in Fig. 118. It will be

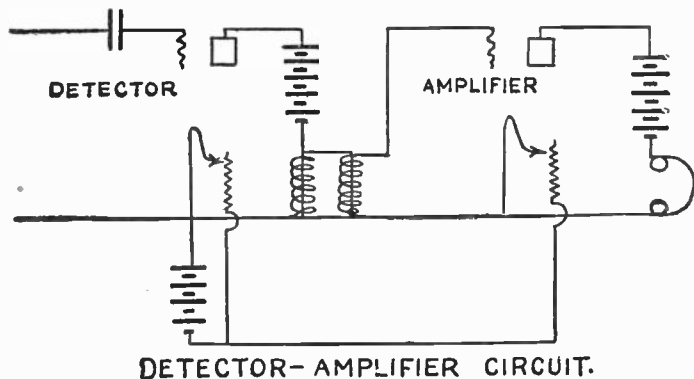

Fig. 118

noted that all of the tubes use the same filament battery, while they require a separate plate battery for each tube.

USE OF THE LOOP ANTENNA. By the use of a vacuum tube as a detector and at least one as an audio-frequency amplifier, the loop antenna may be used to receive signals. The loop is connected to a variable condenser, loading inductance and feed-back coil as shown in Fig. 119. The detector and amplifier are connected to this in the usual manner and are shown in the same illustration.

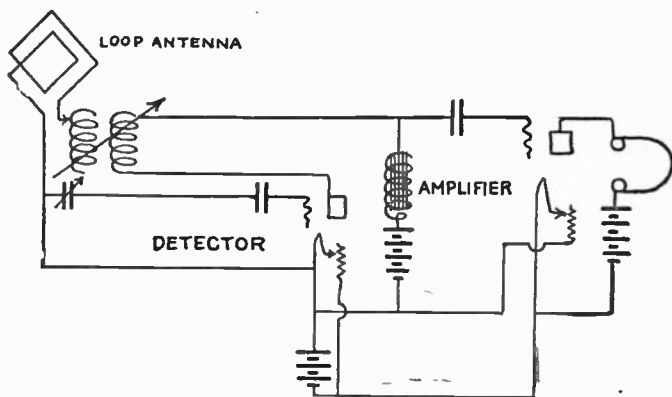

Fig. 119

The adjustment of the loop tuning system is very much more critical than the ordinary loose coupler and variable condenser sets. The inductance and capacity are adjusted for wave length, while the feed-back coil is placed at the maximum amplification for that particular wave length. The loop itself must also be rotated so that its plane will lie in the plane of the transmitting station. The adjustment for wave length and also amplification is exceedingly critical.

Once signals are received, the loop may be rotated and the signals will decrease in intensity until a minimum is reached. The minimum, or zero position of the loop is at right angles to the plane of the transmitting station. The position of a loop for maximum and minimum signals is shown in Fig. 120. The loop shows a somewhat greater freedom from static and interference than the ordinary type of receiving antenna. One reason for this is that the loop may be revolved so as to receive maximum signals from one station and less intense signals from another station which is not in the same plane.

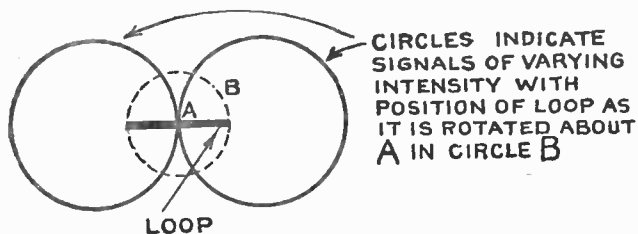

Fig. 120

In general, the loop antenna does not bring as loud signals as the regular type of antenna and its range is not nearly as great. However, it does offer certain advantages. How great these advantages are will be shown after the amateur operators have made use of the loop antenna to a greater extent than it is being used now.

Chapter XII

THE RADIOTELEPHONE

NOT a few amateur radio experimenters are investigating the possibility of the radiotelephone. Telephoning by radio is no longer an experiment. With certain apparatus, one may expect certain results, and it is no longer a question as to just what equipment is required to telephone a given distance.

THE INVENTION OF THE RADIOTELEPHONE. The first radiotelephone, which has led up to the present development, used an arc lamp as a means of generating sustained oscillations. That a direct-current arc light transforms a part of its energy into oscillations was demonstrated by Firth and Rogers in 1893, and it was graphically shown by a series of curves plotted in 1900 by Marchant and Duddell.

The apparatus employed by these physicists consisted of a source of direct current, a choke coil, the arc lamp, and a resistance, while around the arc lamp was shunted an inductive coil and a condenser. When the inductance, capacitance, and resistance of the shunt circuit were properly balanced the arc light emitted a musical note and at the same time it transformed a portion of the direct current into continuous high-frequency currents whose amplitudes were sustained.

Duddell ascertained, however, that the arc light will generate sustained oscillations only when there is a small change in the potential difference between the electrodes of the arc and when the corresponding change in the current through the arc is numerically greater than the resistance of the direct-current circuit in series with the arc.

The first radiotelephone to use a direct-current arc was made by A. Frederick Collins in 1902, when he connected one side of the oscillation circuit with an antenna, the other side to a ground and a microphone in the direct-current circuit. Collins ascertained that a greater percentage of direct current is converted into high-frequency oscillations when the electrodes are kept at a low temperature.

In order to get this result he employed a pair of graphite disks for the electrodes; these disks were mounted on parallel spindles so that they are in the same plane and were geared or belted together so that they could be rotated at a high speed. The rotating oscillation arc keeps the electrodes cool, which prevents untoward variations in the frequency of the oscillations and enabled the optimum length of the arc,

that is, the length when the strength of the oscillations is greatest, to be maintained for long periods of time, which was quite impossible when stationary carbons were used.

LONG-DISTANCE RADIOTELEPHONY. Experimental work conducted at Arlington, Virginia, several years ago, demonstrated that a telephone conversation was possible not only across the American Continent, but also from America to France. In one of the tests a telephone message was received in Paris and also in Honolulu. This is probably the longest distance on record. Since that time, the increasing development of the vacuum tube has made the radiotelephone a still simpler problem.

During the war, the radiotelephone was developed largely through necessity. It became apparent that a radiotelephone was almost a necessity from aircraft to the ground, not to mention its use from airplane to airplane. The radiotelephone is used in directing the movements of an air squadron from the ground and also in the air by the director of the flight.

AMATEUR RADIOTELEPHONY. All of these developments have come within the reach of the amateur experimenter and not a few amateur stations are already equipped with radiophones which will transmit several miles. The receiving apparatus for radiotelephone work may be the identical apparatus which is used for telegraph operations. The telephone conversation may be picked up with crystal detectors.

Of course, a more sensitive and better detector for the work is the vacuum tube. To secure the most efficient radiotelephone receiving apparatus, it is really necessary to use some form of regenerative set in

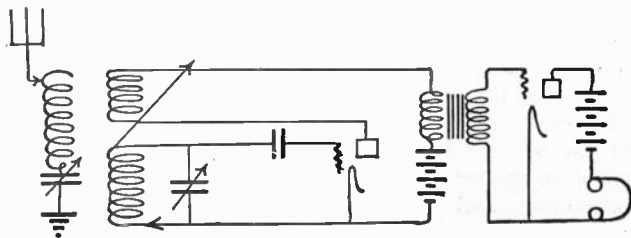

Fig. 121

connection with the vacuum tube. Amplifiers may be used provided they are designed so as to be free from distortion. A conventional diagram of receiving equipment with a regenerative connection and one stage of audio-frequency amplification is shown in Fig. 121. This equipment will bring satisfactory results as a radiotelephone receiving station.

The tuning of the telephone does not differ materially from the tuning of telegraph signals. In order that there be no distortion of speech at the receiving end, it becomes necessary to do the tuning carefully and many times it is not advisable to attempt the maximum amplification, because at this point distortion is apt to occur.

THE RADIOTELEPHONE TRANSMITTER. The most interesting part of the radiotelephone is the transmitter. The vacuum tube can again be the basis of the set. Vacuum tubes may be used for transmitters; that is, the source of oscillation. They may also be used to modulate this source with the human voice and also for the amplification of speech before it is transmitted.

Perhaps the simplest form of telephone is that which makes use of a single vacuum tube as an oscillator; this is connected with the antenna and a microphone is placed in the aerial circuit to modulate the waves which are sent out. Fig. 122 represents the continuous oscillations which

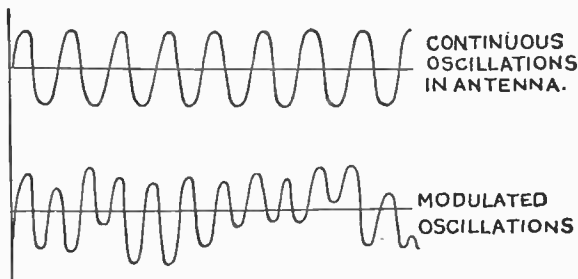

Fig. 122

are sent out from the antenna. The microphone is in series with the antenna lead and consequently any change in the resistance of the microphone will change the resistance of the antenna, and thereby affect the current going into the antenna. (See Fig. 123.)

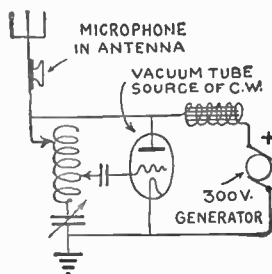

Fig. 123

The microphone itself generally consists of a diaphragm to which is attached a small container with carbon granules loosely packed in it. A voice wave striking the diaphragm tends to compress the carbon granules, that is, it packs them more closely together and the tighter the

granules are packed, the less is the resistance. Fig. 124 shows a drawing of a microphone. By tracing the action of a sound wave striking the diaphragm, the reader will have no trouble in understanding its action.

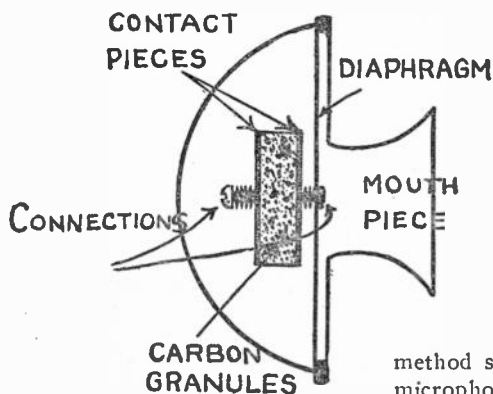

Fig. 124

LIMITATIONS OF THE MICROPHONE.

The trouble with the method shown in Fig. 124 is that the microphone will handle only a certain amount of current. This amount is very limited and naturally tends to limit the range of the transmitter. Various types of microphones have been constructed which will handle a larger amount of current. One inventor used a stream of water in place of the carbon grains. He arranged

his diaphragm so as to vary the amount of water flowing. This, in turn, varied the resistance, and since the water was continually flowing, it was possible to keep the microphone cool, thus making it possible to use comparatively large currents.

The use of vacuum tubes seems to have eliminated the necessity for a transmitter microphone which would take care of large current. Instead of placing the microphone in the antenna lead, it is possible to connect it to the grid of the vacuum tube in such a way that it will modulate perfectly the output of the tube and at the same time handle only a small amount of current. If larger powers are required, a vacuum tube can be

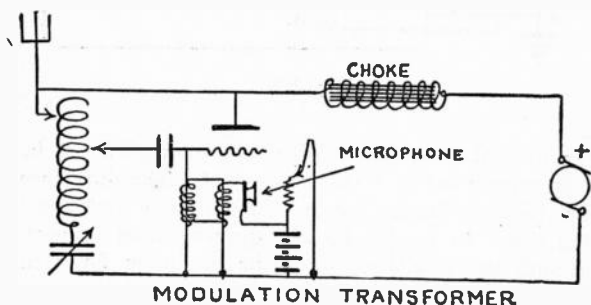

Fig. 125

connected so as to amplify the microphone current. Fig. 125 shows a conventional method of connecting up a single tube and of modulating the grid.

AMPLIFICATION OF THE MICROPHONE CURRENT. In Fig. 126 we have shown the single-tube transmitter with an additional tube connected so as to amplify the microphone current. One of the recent circuits which has been received with a great deal of favor is the so-called Heising system, which was developed by the Western Electric Company. Two tubes are used. One is an oscillator and the other a modulator. The two tubes are connected in parallel across the high-voltage leads.

By means of an impedance coil, the source of high voltage is made constant in its current value, that is, it is not easy to change the total amount of current. The two tubes connected in parallel take the same amount of

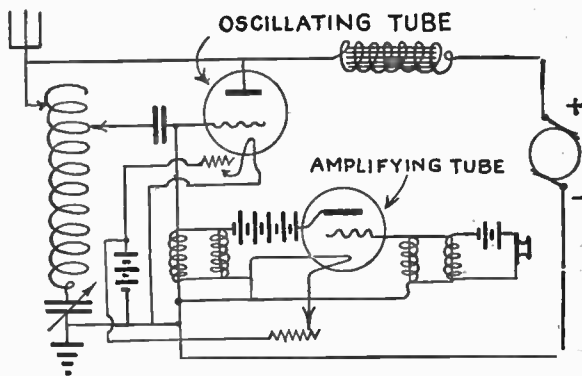

Fig. 126

current under normal conditions. When the microphone is in operation, the amount of current taken is still a constant. The difference is that it will first flow heavily through the modulating tube and lightly through the oscillating tube. At another instant, the maximum amount of current will flow through the oscillator, while the minimum flows through the modulator.

This system of using two tubes gives very great, as well as perfect, modulation. Two small tubes can be connected as shown in Fig. 127.

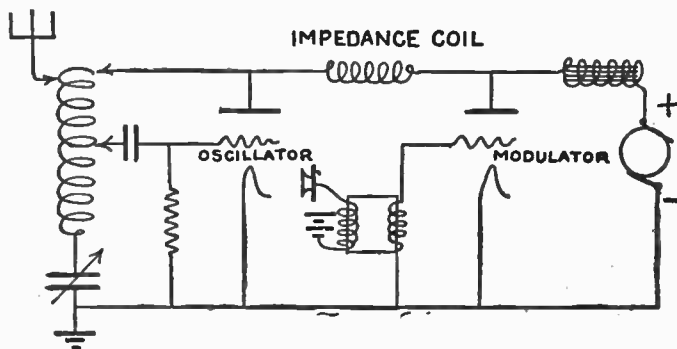

Fig. 127

lengths. This is due to the difficulty of maintaining steady oscillations at the rapid rate which is required for wave lengths of 200 meters. However, the arc transmitter has been used for telephone work and the microphone may be placed in the antenna lead as shown in Fig. 129. This method of

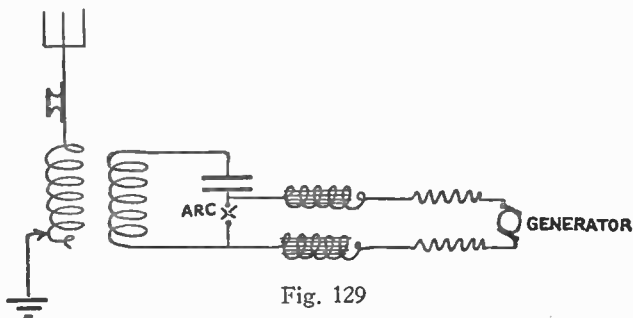

Fig. 129

modulating is limited to the amount of current which the microphone can handle without heating. It is possible to make use of the vacuum tube as a means of modulating the output from an arc transmitter.

We have pointed out that the vacuum tube is a detector, amplifier, oscillator, and modulator. It can be made to perform still one other

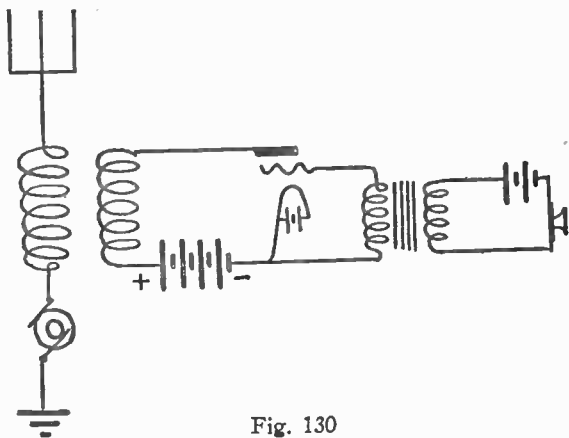

Fig. 130

function, that is, the reverse of amplifying, or an absorber of energy. The vacuum tube may be connected, as shown in Fig. 130, to absorb the energy transmitted to the antenna and in this way modulate the output of an arc station so that it may be used for telephone work.

THE HIGH-FREQUENCY ALTERNATOR. We shall mention one other source of continuous waves which may be used for radiotelephone, and this is the high-frequency alternator. An alternator has been constructed which delivers its current directly to the antenna at a frequency which corresponds to the frequency which is to be used in transmitting. That is, if a wave length of 3000 meters is to be used, the wave length of the generator is also 3000 meters, or its frequency is 100,000 per second. In the case of such a high-frequency generator, the modulation may be done in three ways. The first is the microphone in the antenna. The second is to modulate the field current of the alternator. The third is to use the vacuum tube to absorb the antenna energy. These three methods are shown diagrammatically in Fig. 131.

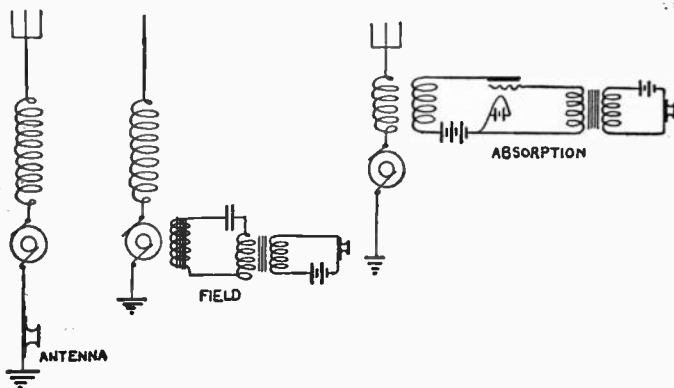

Fig. 131

THE VACUUM TUBE OSCILLATOR. The method of radiotelephony which is within the reach of the amateur seems to be the use of a vacuum tube as a source of the continuous waves. A single five-watt tube will give excellent results and can transmit understandable speech

will have a range of approximately .001 micro-farad is needed, and this should be one which can be immersed in transformer oil so that it will withstand the potential of the generator. The small fixed condenser can be made up of four 5 x 7 glass photograph plates coated with 6 x 4 tinfoil. The modulation transformer can be purchased or made. It is more advisable to purchase this, or else secure a telephone induction coil which will serve the same purpose.

The vacuum tube itself will, of course, be too difficult for the majority of experimenters to make. The next need is a rheostat to control the filament current. Here, again, it is better to buy rather than to attempt to build one. Several meters are really required to secure the most careful and efficient adjustments. However, all of these, with the exception of the hot-wire ammeter in the antenna lead, might be dispensed with.

If the meters can be procured, the results will make their use well worth while. The following ranges are needed. Hot-wire ammeter 0—1 ampere, voltmeter 0—500 volts, milli-ammeter 0—100 milli-amperes, filament ammeter 0—3 amperes.

SOURCES OF HIGH-VOLTAGE CURRENTS. The source of high voltage is a rather difficult problem and may be solved in a variety of ways. At least 300 volts of direct current are required. This may be supplied from batteries or alternating currents and can be rectified by means of a transformer and rectifying tubes. The last method is to use a high-voltage motor generator. Regardless of the method, from three to five hundred volts of direct current must be secured.

Motor generators are supplied by several manufacturers as well as rectifying transformers and tubes. If the motor generator or rectifier is used, a filter is required to eliminate the hum or ripple which accompanies the rectifier or commutation in the case of a generator. A satisfactory form of filter seems to be the use of a one micro-farad and half micro-

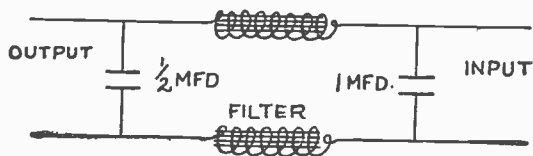

Fig. 134

farad telephone condenser with two small inductances which correspond to the magnet windings in an electric bell. The connection of the filter is shown in Fig. 134. This eliminates the noise which would otherwise accompany the generator or rectifier.

To keep the oscillations from flowing back into the generator, a "choke coil" of some type is required. The core may be a bundle of soft iron wires, four inches long and one-half inch in diameter. This may be wound with about 300 turns of No. 24 double-cotton-covered wire. The microphone can be any ordinary telephone transmitter. An eight-volt storage battery is required for illuminating the vacuum tube filament.

The adjustments of the inductance and capacity are rather critical. Only by experience can the experimenter become familiar with the various adjustments. Slight variations of the filament current and plate voltage will oftentimes greatly affect the output and oscillations. Distortions in speech can generally be corrected by varying the voltage across the microphone. If the modulation transformer has not the correct ratio turns, there is apt to be some distortion. If the milli-ammeter shows increases in current when the microphone is in operation, this means distortion, and adjustments of the various elements will generally correct this.

SYMBOLS USED IN RADIO CIRCUIT DIAGRAMS



FIXED
CONDENSER



VARIABLE
CONDENSER

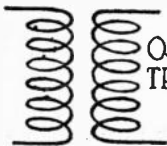

OSCILLATION
TRANSFORMER



GROUND

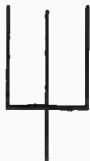

ANTENNA



PHONES



VARIABLE
CONTACT



SPARK GAP



KEY



BATTERIES



DETECTOR

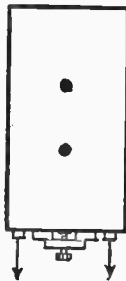

SPARK COIL

SYMBOLS USED IN RADIO CIRCUIT DIAGRAMS



VARIABLE
RESISTANCE
OR
RHEOSTAT

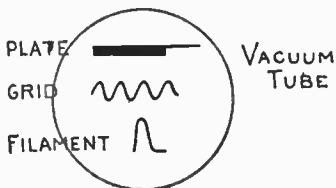
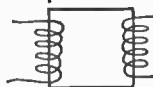

PLATE
GRID
FILAMENT

VACUUM
TUBE



METERS



CLOSED
CORE

OR

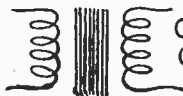

IRON CORE
TRANSFORMER

OPEN
CORE



MICROPHONE

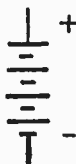

+
BATTERIES
-



CHOKE COIL



D.C. GENERATOR



A.C. GENERATOR

Keeping Up With Father

with the

Gilbert Master Hand Library



Hello Boys!
REG. U.S. PAT. OFF.

I am going to ask your indulgence while I tell you something of my own story.

My reason for this is that I want my boy friends to know what I have been through myself, and why I feel that every boy should be trained for skill, adeptness, knowledge, popularity

I am not very far past boyhood myself and have always been interested in three outside things: athletics, sleight-of-hand, and scientific experiments.

In the Northwest I got beaten in wrestling the first year, and the second year won the Pacific Coast championship. I broke the Northwest pole vaulting record, besides winning the track championship of that section.

Then I went to Yale, won the "Y" in three different branches, the wrestling championship of the United States, first honors as all-round gymnast and twice broke the world's pole-vaulting record.

This is a lot for a man to talk about himself, you will admit. But I want you to know these things to see therein where I got the inspiration to build the Master Hand Library for Boys which my publishers are now offering.

A.C. Gilbert
President

Do You Want to Know —

How to understand the wonders of the Radio Telephone and Broadcasting and how to build your own wireless outfit?

How to train to become a champion athlete, to be a champion pole vaulter, high jumper or broad jumper?

How to do the strange rope tricks of the Davenport Brothers, who, as you know made everybody think they had spiritualistic powers until their secrets were exposed?

How to master the secrets of Hydraulic and Pneumatic Engineering, Coin Tricks and Chemistry, how to do some of the amazing tricks that made such magicians as Herrmann and Kellar famous?

How to build all kinds of wonderful and useful things at home with a few tools and a carpenter's bench?

How to be able to talk about big inventions intelligently and explain them to others?

If You Do, Get This Set of 10 Wonderful Volumes

Gilbert Radio Telephone and Broadcasting, Boy Athletics, 68 Stunts with the Electric Motor, 75 Electrical Toys and Tricks, Chemistry, Hydraulic and Pneumatic Engineering, Signal Engineering, Carpentry, Knots and Splices, Coin Tricks.

GET THEM FROM YOUR DEALER
IF HE DOES NOT HAVE THEM,
WRITE TO

THE A. C. GILBERT CO.,
New Haven, Conn.



