

# *Baby Radio Transmitter* "D" of 9XH-91EK



March 20, 1928

Engineering  
Circular No. 8

**BURGESS BATTERY COMPANY**

Report No. N-1361  
C. F. BURGESS LABORATORIES, INC.

for

## **BURGESS BATTERY COMPANY**

ENGINEERS DRY BATTERIES MANUFACTURERS  
FLASHLIGHT - RADIO - IGNITION - TELEPHONE  
GENERAL SALES OFFICE: HARRIS TRUST BLDG., CHICAGO  
LABORATORIES AND WORKS:  
MADISON, WISCONSIN FREEPORT, ILLINOIS  
IN CANADA  
PLANTS: NIAGARA FALLS AND WINNIPEG

*The description of the apparatus in this Engineering Circular is presented as a contribution to the art and for the benefit of those interested in investigation or experimentation or merchandising. Such apparatus is constructed, experimentally, in the Burgess Radio Laboratory as laboratory equipment, and parts are not manufactured for re-sale by this company.*

Copyright, 1926, BURGESS BATTERY COMPANY. Printed in U. S. A.  
Released for publication by acknowledgment of source.

## Dry Cell Power Source:

A transmitter operated from dry cells in the high frequency region has a pure D. C. note which is very difficult to obtain from any source of power other than batteries. This pure note characteristic is obtained without the use of a filter system of any kind and makes it possible to use a set of this type for radio telephony with a minimum of additional apparatus and a very simple arrangement. The circuit diagram, Fig. VI, shows how a Heising Modulation System was added to the "Baby Transmitter" for the transmission of voice.

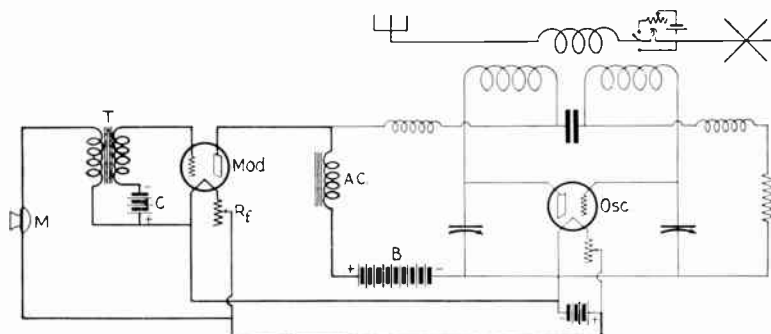

FIG. VI. SCHEMATIC DIAGRAM SHOWING THE ADDITION OF MODULATING APPARATUS FOR THE TRANSMISSION OF VOICE

- T = Microphone transformer, such as Radio Corp. of America, Acme, or General Radio. A Ford spark coil may be used.  
M = Microphone. Any good hand microphone or ordinary telephone microphone.  
C = "C" battery, 4- $\frac{1}{2}$  volts.  
Mod = Modulator tube, UV199 or C299.  
Rs = Filament rheostat, 30 ohms.  
AC = Audio Choke Coil, 1 henry or larger. The primary of an audio transformer may be used.

## OPERATING ADJUSTMENTS

For convenient operation, it is best to connect a switch somewhere in the lead to the "A" battery for cutting off the current to the tube filament.

An equal number of turns are connected in each of the inductance coils and the two variable condensers should be adjusted to approximately equal settings.

When the tube filament is lighted and the key, which is connected in the negative "B" battery lead, is closed the transmitter will oscillate persistently. The condenser settings are varied until resonance with the antenna circuit is obtained.

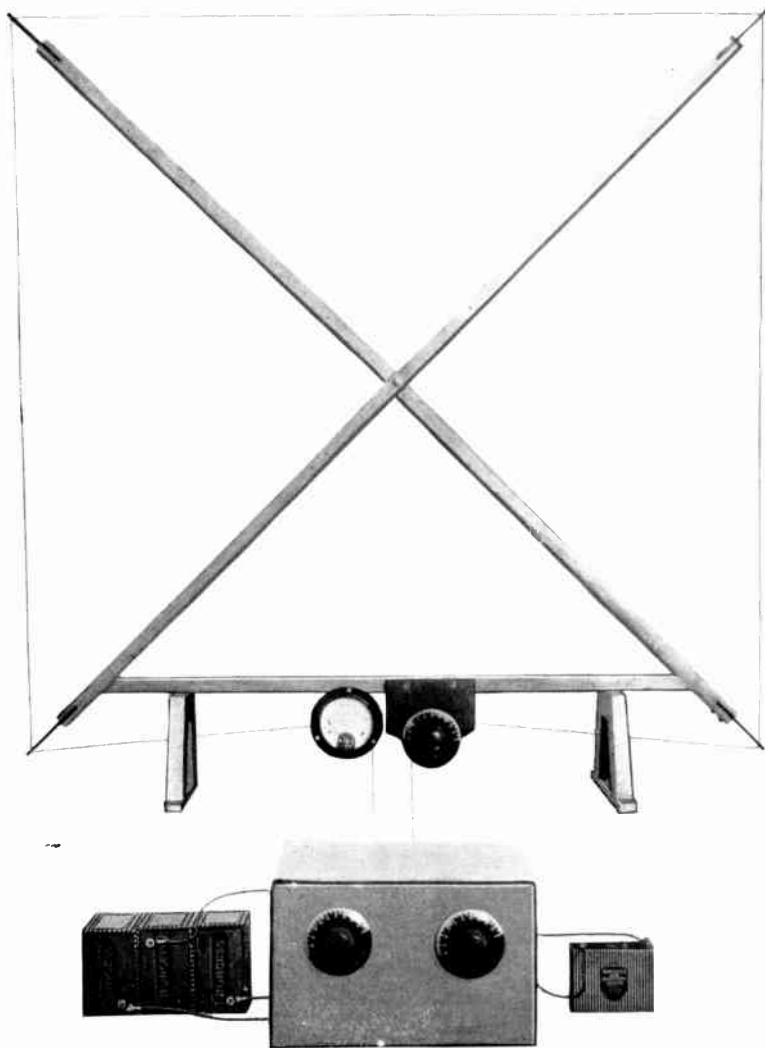

FIG. V. VIEW SHOWING THE TRANSMITTER COUPLED TO A 40 METER LOOP. SHIELDING IS PLACED AROUND THE TRANSMITTER WHEN USED ON A LOOP TO PREVENT DIRECT COUPLING BETWEEN THE TRANSMITTER INDUCTANCE AND THE LOOP

feet on a side, in series with a three plate (two stationary and one rotary) variable condenser and a single turn, three inch diameter, coupling coil will tune to the 40 meter band. The loop shown in Fig. V has been used for effecting transmission of both C W signals and voice over distances of from 1 to 3 miles.

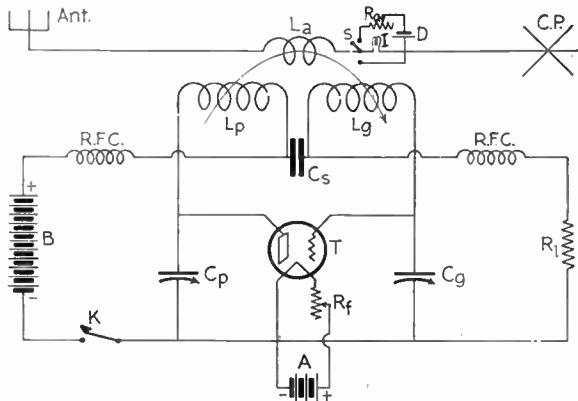

FIG. IV. SCHEMATIC DIAGRAM OF "SPLIT COLPITTS" SHORT WAVE OSCILLATING CIRCUIT USED IN THE "BABY TRANSMITTER"

*Constants for 40 Meter Wave Band*

- A = 4-1/2 volt, dry cell battery.
- B = 90 to 140 volt "B" battery.
- Cg and Cp = Variable air receiving condensers, 0.00025 mfd.
- Cs = Fixed mica condenser, receiving type 0.0005 or 0.001 mfd.
- Lg and Lp = Inductance coils, 7 turns each, 3 inch dia.
- La = Antenna coupling coil, 1 to 6 turns depending on type antenna.
- T = UV199 or C299 dry cell type receiving tube.
- Rl = Grid leak, Bradley or Daven resistor 0.005 meg. (5000 ohms).
- Rf = Filament rheostat, 30 ohms.
- RFC = Radio frequency choke coils, 40 turns, basket weave type, wound on 8 pins set 1-3/4 in. dia., No. 22 SCE wire.
- K = Telegraph hand key.
- S = Single pole, double throw switch.
- Ra = Bradleystat.
- D = Uni-cel, 1-1/2 volts.
- I = Flashlight bulb, 2-1/2 volt.

One satisfactory method is to use a small antenna having a natural frequency approximately the same as that at which it is desired to transmit. For 7500 kilocycle transmission (40 meters) a single wire about 33 feet long erected as nearly vertical as practical should prove effective. If a counterpoise is used instead of ground it should be of approximately the same dimensions as the antenna. A series antenna condenser of about 0.00025 mfd. capacity may be connected between the counterpoise and the coupling coil.

Another method is to use a larger antenna and tune it to exactly 3 or 5 times the wavelength of the transmitter. This has sometimes been termed transmitting on a harmonic, and has been used very effectively in connection with the "Baby Transmitter."

A coil antenna or loop may be used for transmitting over distances of at least a few miles. A single turn loop, three

inductance coil, placed between the other two, couples energy into the antenna circuit. A baseboard and upright panel mount the apparatus as shown in Fig. III.

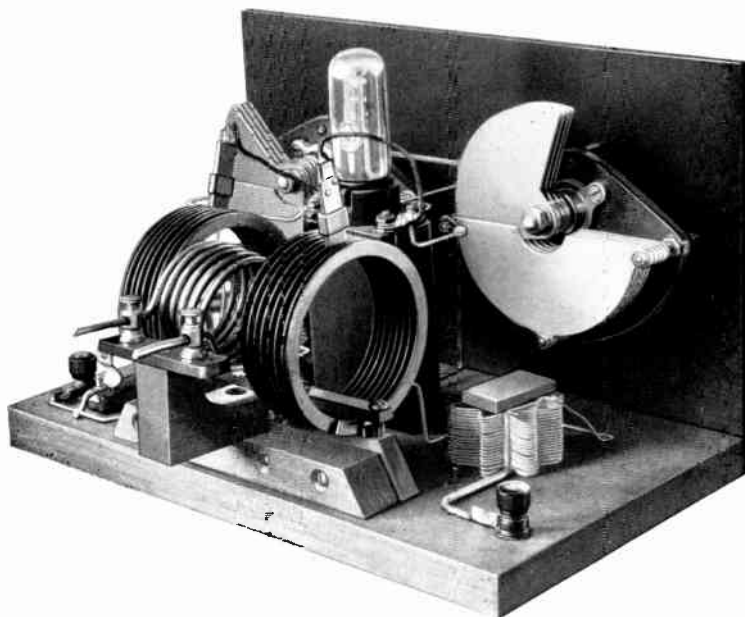

FIG. III. VIEW FROM REAR SHOWING ARRANGEMENT OF COILS AND TUBE MOUNTING

### **Radio Frequency Oscillating Circuit:**

The oscillating circuit arrangement shown in Fig. IV is a modification of the Colpitts oscillator developed at this Laboratory where it has been used for larger power transmitters at frequencies from 1000 to 150,000 kilocycles. (300 to 2 meters) with high efficiency and splendid stability. The efficiencies and stability obtained by the use of this circuit are due to the fact, in part at least, that the two series inductances and the two series capacities form a high frequency bridge circuit. The "B" battery circuit as well as the grid leak circuit are connected to points of little or no difference in radio frequency potential, thus reducing to a minimum radio frequency losses through them.

### **Antenna Circuit Arrangement:**

Effective transmission at high frequencies may be accomplished by a number of methods.

feeble radio currents only and are very loosely coupled to antenna systems.

If the circuits associated with the small receiver tubes were made highly efficient and properly coupled to an antenna system it would be reasonable to expect that the whistling would be heard in receivers at much greater distances and become useful for communication purposes. This has been shown to be the case in the work accomplished with the "Baby Transmitter."

## GENERAL DESCRIPTION

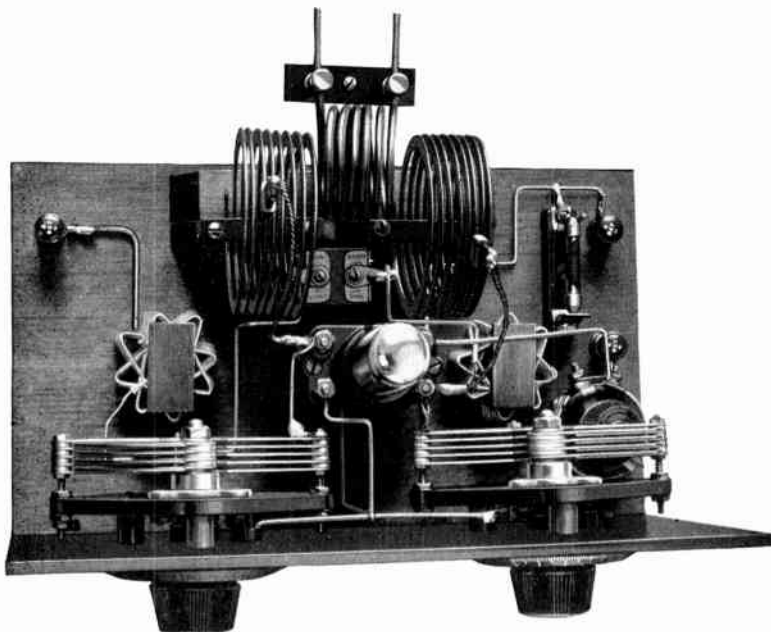

FIG. II. TOP VIEW OF TRANSMITTER SHOWING RELATIVE POSITIONS OF APPARATUS. THE BASE BOARD MEASURES 7 BY 12 INCHES

### General Arrangement:

Around a UV 199 or a C 299 tube, there are assembled in as compact a form as practicable, two receiving type variable air condensers, two small inductance coils and a small fixed condenser, Fig. II. These form a radio frequency generating circuit to which "A" and "B" battery energy is fed from dry cells. Radio frequency choke coils in series with the "B" battery feed and with the grid leak resistor, prevent losses of the high frequency energy in these circuits. A third small



When a receiver is sending out a signal in this manner it is functioning as a radio transmitter and deriving its power from the "A" and "B" batteries which are connected to it. The circuits and arrangements of a receiver, however, are not usually such as to make an efficient transmitter. For best receiver action the receiving tubes are arranged to generate

## THE WONDERS OF RADIO



*It won't be long before they perfect a small sending machine—*



*—and then the marooned mariners can send in a report of their exact whereabouts—*



*—and the miners imprisoned by a cave-in can direct the work of rescue—*

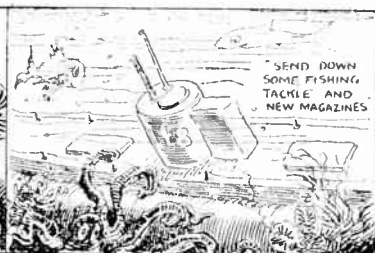

*—and the submarine victims can send out valuable information to the rescuers—*

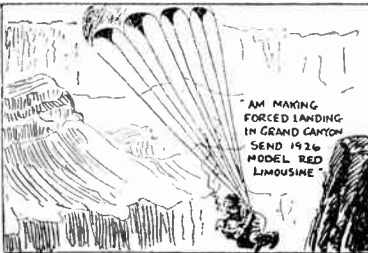

*—and the airplane survivor can tell where the car is to call for him—*

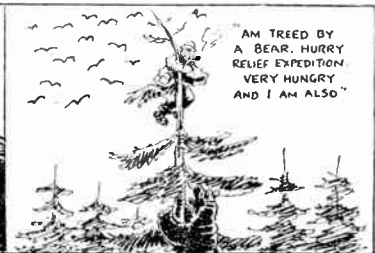

*—and the tired Nimrod can tell his folks what has delayed him for dinner.*

Cartoon by McCutcheon. Reprinted through courtesy of Chicago Tribune

The many and varied uses to which equipment similar to that described in this circular may be put are too numerous to attempt to enumerate, but Mr. McCutcheon in a cartoon of November 18, 1925, in the "Chicago Tribune", pictures in a happy manner, some possibilities of uses for portable baby transmitters.



ment of dry cell batteries suitable for reliably supplying the energy drawn by these and larger tubes.

The C. F. Burgess Laboratories Radio Station, 9EK-9XH at Madison, Wisconsin, is being operated with the idea of keeping contact with radio amateurs, experimenters and other stations and to aid in the development of the radio art. One of the interesting problems of the station has been high frequency (short wave) communication, especially with low power, and a study of the possibilities of the use of dry cells for transmission.

The "Burgess Baby Transmitter" which is the subject of this paper was built at these Laboratories and makes use of circuits which were developed here. It is of especial interest because of its small power input and the use of the dry cell type receiving tube.

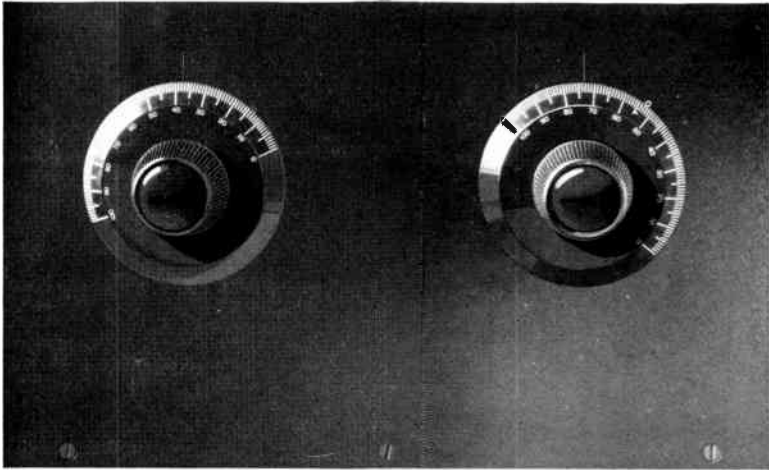

FIG. I. FRONT VIEW OF TRANSMITTER SHOWING THE TWO TUNING CONTROLS

### **Receivers May Act as Transmitters:**

Every radio fan who operates a radio receiver, except at some isolated point, is well familiar with the interference caused by other receivers which radiate. The energy from these interfering receivers, generally called "Bloopers," is great enough to carry for many city squares and cause whistling and squealing noises in the receivers of others. Ship operators after leaving port and reaching distances from land as great as 30 miles have reported that the "Bloopers" could still be heard.

**BABY RADIO TRANSMITTER "D"  
OF 9XII-9EK**

By W. H. HOFFMAN

FOR

**BURGESS BATTERY COMPANY**

**ABSTRACT**

*A simple, small and efficient radio transmitter using dry cell tubes and operating with dry cells is described in detail. In operation on an aerial, efficiencies of 2000 miles per watt have been obtained. Loop antenna operations are described. The cost, weight, and estimated battery service-hours are given.*

---

**INTRODUCTION**

Demand for low power radio transmitting apparatus dates back into the early history of radio communication itself. The purposes for which such equipment may be placed into operation are many and varied. It may perform the important and serious service of saving life and property, such as aid for small boats at Sea or saving of forests from fire. Or it may furnish a hobby for those who are experimentally inclined and who seek diversion from the routine of ordinary toil and amusement.

The possibilities of the low power transmitter have increased in recent months at an enormous rate. The effectiveness of such equipment has been contributed to by a number of factors. Possibly the greatest of these is the development of the dry cell type radio receiving tube (three element vacuum tube). This tube operating normally consumes less than half a watt. Another factor is the recent discovery of the effectiveness of small powers in establishing communication over comparatively great distances, when high frequency radio currents are used, such as can be generated by the vacuum tube. A third factor is contributed by the develop-

### Antenna Resonance Indication:

Resonance with the antenna circuit may be obtained in a number of ways.

A thermo galvanometer, such as that ordinarily used in wavemeters, may be inserted in series with the antenna and used as an antenna ammeter the maximum deflection denotes resonance.

A D. C. milliammeter having a scale of 0 to 20 or 50, connected in series with the "B" batteries will show resonance by rising sharply as the resonant point is passed over when tuning.

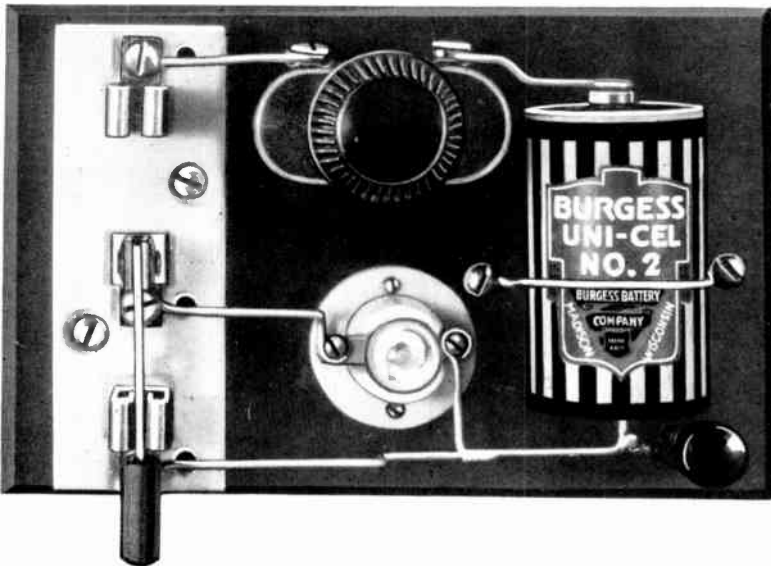

FIG. VII. FLASHLIGHT BULB AND ASSOCIATED APPARATUS FOR INDICATING WHEN THE TRANSMITTER IS TUNED TO RESONANCE WITH THE ANTENNA CIRCUIT

Where no meters are available, a 2.5 volt flashlight bulb may be connected in the antenna circuit, as shown in the schematic diagrams and the photograph Fig. VII. To find resonance the switch is thrown to connect the battery to the lamp. The rheostat is adjusted until the lamp filament just begins to glow. When the transmitter is carefully tuned to resonance with the antenna circuit the slight amount of additional energy will noticeably brighten the lamp filament.

To prevent unstable action that may occur between coupled tuned circuits it is best to adjust the transmitter to a

point slightly one side of the point where maximum radiation is obtained.

After the adjustments are completed by means of the lamp, the switch should be thrown to the side where the lamp is disconnected from the battery and shorted out, thus removing its resistance from the antenna circuit.

#### OPERATING CHARACTERISTICS

##### Points Communicated with from Madison, Wis.:

The table below shows some of the stations worked and the strength of received signals reported from them. There is also shown the total watt input to the transmitter for each transmission. This watt input is the sum of the filament and plate wattage. By measuring the distance from Madison to these various points it may be seen that communication has been carried on from 1000 to 2000 miles per watt.

Date, 1925	Time, C. S. T.	Station	Location	Signal Strength	Total "A" and "B" Battery watts
Sept. 21	8:00 P. M.	1BYX	Auburndale, Mass.	R3	0.98 watts
Sept. 21	9:00 P. M.	5NJ	New Orleans, La.	R3	2.00 watts
Sept. 22	5:30 A. M.	M-1AA	Mexico City, Mex.	R6	2.00 watts
Sept. 22	6:00 A. M.	2AUY	New York City	R2	0.41 watts
Sept. 23	3:30 P. M.	9CDV	Minneapolis, Minn.	R4	0.84 watts
Oct. 1	4:30 P. M.	9EJI	Indianapolis, Ind.	R5	1.4 watts
Oct. 1	8:45 P. M.	9CVN	Wichita, Kans.	R4	1.4 watts
Oct. 2	2:00 P. M.	9ADO	Savannah, Mo.	R4 on detector	1.4 watts
Oct. 3	3:18 P. M.	9DPJ	Ft. Wayne, Ind.	R3	1.4 watts
Oct. 3	11:50 A. M.	9DAU	Nichols, Ia.	Phone	2.7 watts
Oct. 5	3:15 P. M.	9ATT	Jacksonville, Ill.	Phone CW	2.7 watts
Nov. 2	7:22 P. M.	4CU	Memphis, Tenn.	R1	0.28 watts .76 watts
Nov. 2	7:58 P. M.	5ATX	Waco, Tex.	R3	1.7 watts
Nov. 2	8:30 P. M.	2BRB	New York City	R4	.76 watts
Nov. 18	4:23 P. M.	8XAU	Rogers, Mich.	R6	0.90 watts
Nov. 19	9:45 P. M.	9BQY	St. Paul, Minn.	R3	0.90 watts

It will be noted that the average received signal strengths are R3 and R4. R3 denotes that the signals are weak and R4 that the strength is "fair."



FIG. VIII. A 2- $\frac{1}{2}$  VOLT FLASHLIGHT BULB HAVING A 3 INCH DIAMETER LOOP OF INSULATED WIRE CONNECTED TO ITS TERMINALS WILL INDICATE IF THE TRANSMITTER IS OSCILLATING PROPERLY WHEN THE LOOP IS BROUGHT NEAR THE COILS OF THE TRANSMITTER THE LAMP FILAMENT WILL GLOW

It should not be expected that communication over the extreme distances shown in the table can be carried on under other than favorable conditions. Any considerable amount of interfering noise from atmospherics or other signals would greatly reduce the distances covered.

It is a difficult and complicated matter to obtain definite data on the reliable range of a high frequency transmitter due to the changes of transmission efficiency from day to day and at different seasons of the year. Sufficient time has not been available for the collection of conclusive data with the Baby Transmitter. However, if the successes already achieved with the extremely low powers will act as a stimulus to further efforts along the same lines, definite data should soon become available.

#### **Hours of Battery Service:**

Of interest in connection with the working of this set is the question of how long batteries will last.

The filament current may be supplied by three six inch dry cell "A" batteries or a 4.5 volt tubular flashlight or "C" battery.

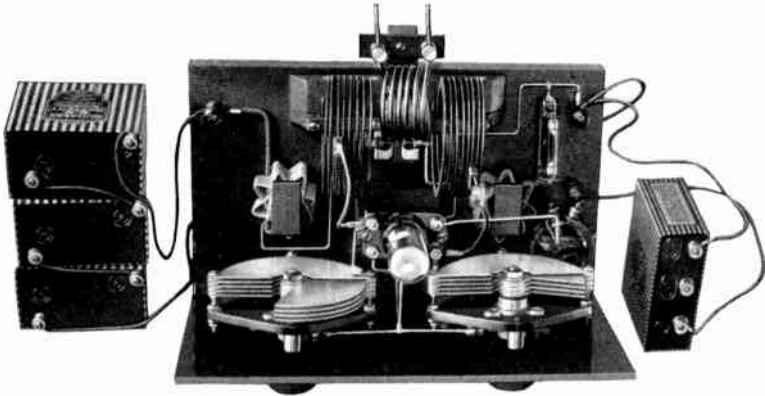

FIG. IX. VIEW FROM TOP SHOWING BATTERIES CONNECTED FOR TRANSMITTING

battery. With three dry cell batteries about 700 service-hours will be obtained on one tube and 300 service-hours on two tubes. If flashlight or "C" batteries, like those shown in the cut, Fig. IX are used, one must be provided for each tube and about 100 service-hours will be obtained. The retail price of the "A" cells is about \$0.50 each and for the "C" battery \$0.60 each.

The plate current from the "B" batteries varies with the number of tubes and the voltage. Various sizes of batteries may be used and experience shows that they can be run down to a lower end voltage than when they are used on receiving sets. On transmitting sets drawing currents up to 10 milliamperes the capacities of three suitable sizes of "B" batteries are as follows:

**22½ Volt "B" Batteries:**

Catalogue No.	4156	5156	2156
Retail Price.....	\$1.50	\$1.75	\$2.00
Weight.....	1 lb.	1 lb. 9 oz	5 lb.
Length.....	3¾ in.	4½ in.	6⅝ in.
Width.....	2 in.	2⅞ in.	4 in.
Height.....	2½ in.	2¾ in.	3 in.
Mil. Amp. Hrs.....	500	1400	4600

### **Power Consumption Compared with that of other Devices:**

In showing the small powers required by the set, Fig. X should be of interest. The two cell flashlight case, when lighted consumes about 0.7 watts from the battery. The hand generator will deliver about 1.5 watts. Both of these powers are greater than that taken by the transmitter when working from Madison to New York City—a distance of 800 miles.



FIG. X. THE FLASHLIGHT AND HANDGENERATOR SHOWN HERE EACH DELIVER MORE POWER IN NORMAL OPERATION THAN THAT TAKEN BY THE TRANSMITTER WHEN WORKING SEVERAL HUNDRED MILES

### **Government License Requirements:**

It is pointed out that the laws of the United States require that all radio transmitting stations be licensed. Such station licenses are issued by the Department of Commerce and copies of the laws may be obtained from the Superintendent of Documents, Government Printing Office, Washington, D. C.



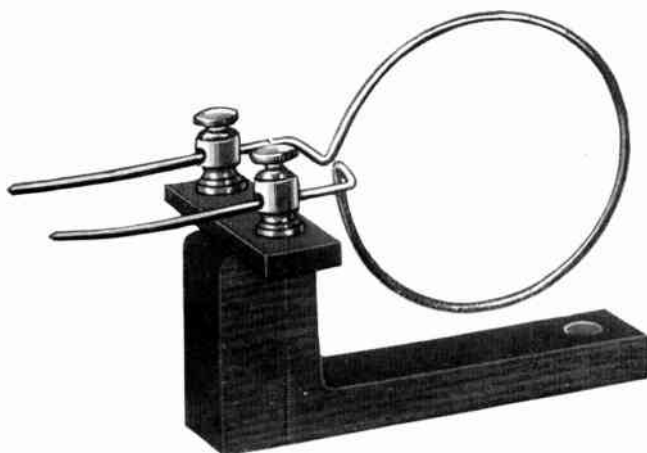

FIG. XI. THE COUPLING COIL AND ITS SUPPORT REMOVED FROM THE SET. THE SINGLE TURN IS USED WHEN COUPLING TO THE LOOP.

Amateur stations are allowed to transmit on a number of wave bands, one of which is from 37.5 to 42.8 meters using telegraph signals.

Voice transmission on this 40 meter band is not allowed except by those stations which hold "Experimental Station" licenses and are operated by personnel holding commercial operators' certificates.

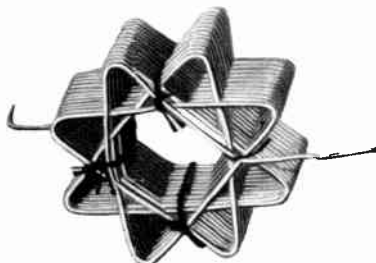

FIG. XII. AN RF CHOKE COIL REMOVED FROM THE SET. 40 TURNS OF ABOUT NO. 22 WIRE BASKET WOUND, OVER 8 PINS SET 1- $\frac{3}{4}$  IN. DIA. CIRCLE. WIND OVER ONE AND SKIP TWO, ETC.

Amateur voice transmission is allowed on a wavelength band from 170 to 180 meters only.<sup>1</sup> This band is above the tuning range of the Baby Transmitter as described in this paper. (For those who are experienced in experimental development of such apparatus it may be stated that by increasing the values of inductance and capacity in the tuned circuit to a little more than 4 times the values given for the 40 meter band, transmission in the amateur telephone band may be effected.)

<sup>1</sup> Since the writing of this circular the Dept. of Commerce has granted permission for Amateur telephone transmission at wavelengths from 83.28 to 85.66 meters as well as the 170 to 180 meter band.

## SUMMARY

Among other low power communication records that have been reported recently is that of New Zealand station 3AL which worked English station 2LZ with a power of  $2\frac{1}{2}$  watts,<sup>1</sup> and Canadian station 9CK which exchanged messages with Australian station 3YX using a receiving tube and dry cell batteries.<sup>2</sup> These instances serve to illustrate that distances covered with the Baby Transmitter are not merely the result of freak conditions.

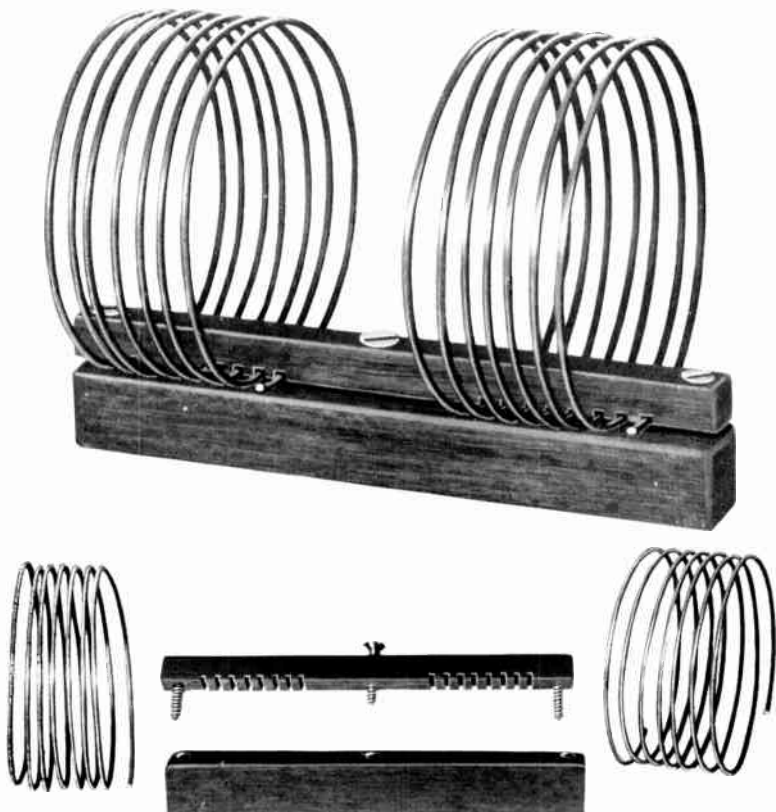

FIG. XIII. THIS COIL SYSTEM MADE FROM NO. 11 COPPER WIRE MAY BE USED IN THE PLACE OF THE EDGewise WOUND STRIP SHOWN IN THE TRANSMITTER. THE SUPPORTS ARE MADE FROM DRY HARD WOOD

The retail cost of the parts for the Baby Transmitter is about \$18.00. Its dimensions are 7 inches by 7 inches by 12 inches, or 588 cu. in., and its weight is 4 pounds.

<sup>1</sup>"Radio", November 1925.

<sup>2</sup>"Radio News of Canada", November 1925.

The batteries shown in Fig. IX retail for \$3.60 and they occupy a space of 7 in. by 3½ in. by 4¼ in. or 111 cu. in.

No special effort was made to construct and assemble the apparatus in extremely compact form. Undoubtedly there are many possibilities along this line.

---

Since this Circular was first issued some interesting reports have been received giving results secured with the Baby Transmitter. Below are some comments that have very kindly been sent in by Mr. Raymond Combs, Honorable Organizing Secretary of the South African Radio Relay League:

#### **Johannesburg, South Africa**

November 2—I am very pleased indeed to be in touch with you and to be able to tell you that your little Radio Burgess Transmitter in British South Africa is just the thing we have been wanting here badly. Members of the Radio League have gone in for them good and strong and no difficulty has been experienced in holding communication with fellow members all over the country. Several of the Gang are now experimenting with telephony on the same set and we are expecting just as fine results in this direction as we have obtained with Morse. I can tell you, Sir, the Burgess Baby Transmitter is now practically standard in all divisions for field stations and it is on this line of experimental work that we are pushing ahead with.

November 24—Mr. A. S. Innes O-A3Y and O-A42, has received confirmation of transmission on his Baby Burgess Transmitter from OM J. Harding, 38 Victoria Road, Victoria, Australia. The power used by OM Innes was 5 watts.

November 30—You will be pleased to know that the Burgess Radio Baby Transmitter seems to be becoming standard for all our experimenters who have difficulty with obtaining power and the results obtained are remarkable.

Just as this goes to press for the fourth reprinting, the following radiogram was forwarded to us by 9BPL, Fredonia, Kansas:

From: FO-A6U Johannesburg, South Africa  
March 16, 1928.

To: Mr. Schulte, Secretary of Burgess Battery Co.,  
Chicago, Illinois.

Our station FO-A6U qualified last night for W. A. C. (worked all continents). All continents worked on Burgess Baby Transmitter. Greetings from South Africa.

Signed: Raymond Coombs.

Received March 15, 1928 at 11:00 P. M., C. S. T.

## BURGESS BATTERY COMPANY ENGINEERING CIRCULARS

---

- No. 1—How Long Will My "B" Batteries Last—1924. (Out of print.)
- No. 2—Small Dry Cell "B" Batteries for Portable Receiving Sets—1924.  
(Out of print.)
- No. 3—Burgess Dry Cell Batteries with the MacMillan Expedition—1924.  
(Out of print.)
- No. 4—"B" Battery Service Hours—April 20, 1925. (Revision of No. 1—  
Out of print.)
- No. 5—Test Capacity of Unused "B" Batteries of the MacMillan Expedi-  
tion—May 1, 1925. (Out of print.)
- No. 6—Dry Cell Batteries for Plate Voltage of Radio Transmitting Sets—  
June 26, 1925. (Out of print.)
- No. 7—Short Wave Radio Receiver No. III of 9XH—9EK—July 8, 1925.—  
Reprinted Sept. 15, 1926—May 10, 1927—Nov. 15, 1927.
- No. 8—Baby Radio Transmitter "D" of 9XH—9EK—November 25, 1925.—  
Reprinted Feb. 15, 1927—May 10, 1927—March 20, 1928.
- No. 9—Dry-Cell Battery Capacities for Radio Transmitting—January 20,  
1926.—Reprinted Oct. 27, 1926—April 20, 1927—March 6, 1928.
- No. 10—Arctic Radio Equipment with Battery Supply.—May 10, 1926—  
Reprinted Oct. 27, 1926—Feb. 14, 1927—Nov. 15, 1927.
- No. 11—Estimating "B" Battery Service Life.—(Revision of No. 4.) Sept.  
2, 1926.—Reprinted May 1, 1927—Oct. 29, 1927.
- No. 12—A High Frequency Driver—Short Wave Wavemeters—September 2,  
1926.—Reprinted Feb. 15, 1927.
- No. 13—High Frequency Radio Receiver No. VI, of 9XH—9EK.—April  
12, 1927.
- No. 14—A Resonance Indicator—October 5, 1927.
- No. 15—Experimental High Frequency Radio for Aircraft—February 10,  
1928.

---

Burgess Battery Company Engineering Circulars that are still in print may be obtained by sending ten cents for each one to E. C. Department, Burgess Battery Company, Madison, Wisconsin.